

Electronic Design 13

VOL. 21 NO.

FOR ENGINEERS AND ENGINEERING MANAGERS

JUNE 21, 1973

Electronic calculators appear in bewildering numbers and types. Variations in size, in displays, in keyboards and functions—as well as a new jargon—make a

comparison difficult. There are many models but only a few calculator chips. Evaluating chip designs and functions helps in making a choice. See page 28.

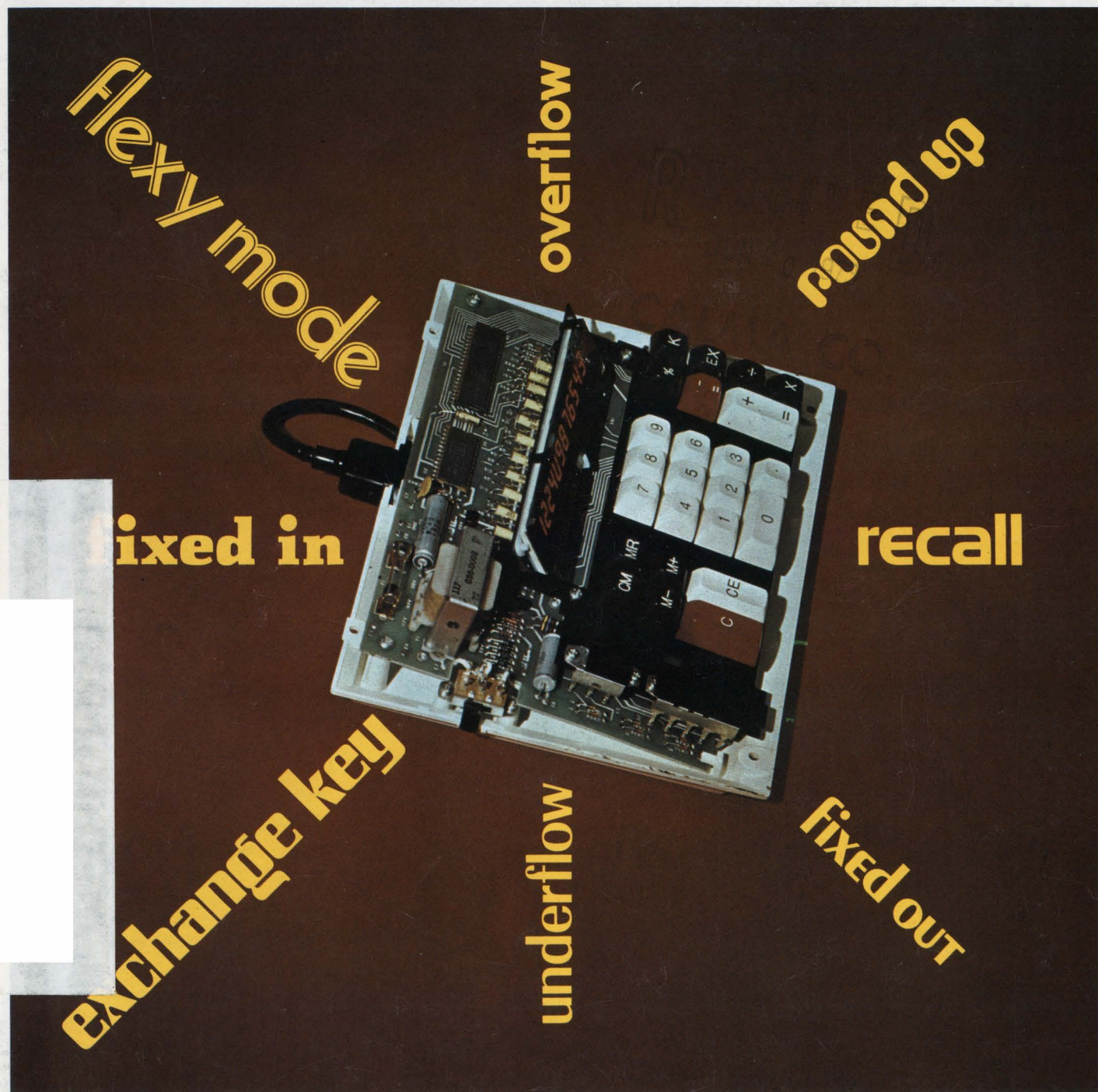

Odd Jobs Wanted

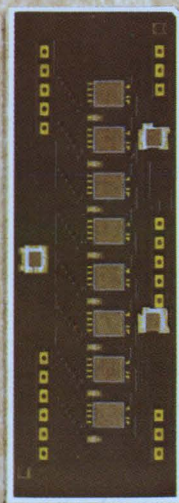

Highly respected company with reputation for fast handling of special resistance projects seeks challenging assignments in thick film. Completely equipped to design and/or produce special circuitry inside DIP and SIP packages. Laser trimming facilities for high volume needs. Also special capabilities for non-standard configurations, hybrids and high power requirements. Custom substrate preparation, including LED metallization, a specialty. References furnished. Contact your Dale Representative or call 402-564-3131.

Dale Electronics, Inc., Box 609,
Columbus, Nebraska 68601.
In Canada: Dale Electronics
Canada, Ltd. A subsidiary of
The Lionel Corporation.

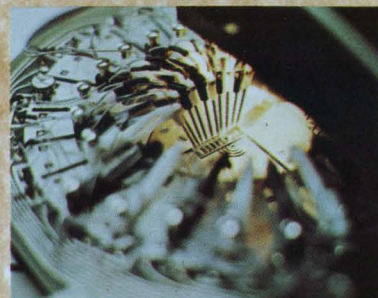
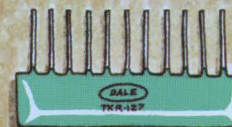
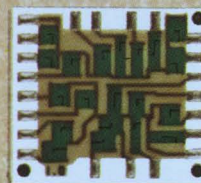
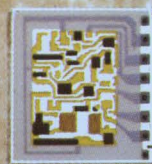



HP offers OEMs more. Like a thoroughly modern mini with Writeable Control Store.

WCS is a powerful new tool for the OEM. By microprogramming the HP 2100, you can tailor it to your customer's specific application. In manufacturing, process control, medicine, you name it. And you can add WCS anytime. Now — or in the future. Even add it to your present installations.

If you have time-critical or often-used routines, WCS lets you run them 10 times faster. And a powerful microprogramming assembler simplifies the

development of special purpose functions such as I/O handlers.

Using WCS and our new programmable ROM writer, you can also put together applications with unique instructions usable only on your equipment. This gives you real hardware security. After developing microprograms, you can write them into inexpensive programmable ROMs for your OEM production systems.

But the nicest thing about our WCS
INFORMATION RETRIEVAL NUMBER 2

is that it's part of our thoroughly modern mini. Why not get the full story? For our free 80-page microprogramming guide and 2100 brochure write Hewlett-Packard, Palo Alto, California 94304.

22216

HEWLETT  PACKARD

The best of both worlds

10 AMP SOLID STATE RELAY FEATURING: OPTICAL ISOLATION AND ADAPTIVE PACKAGE DESIGN

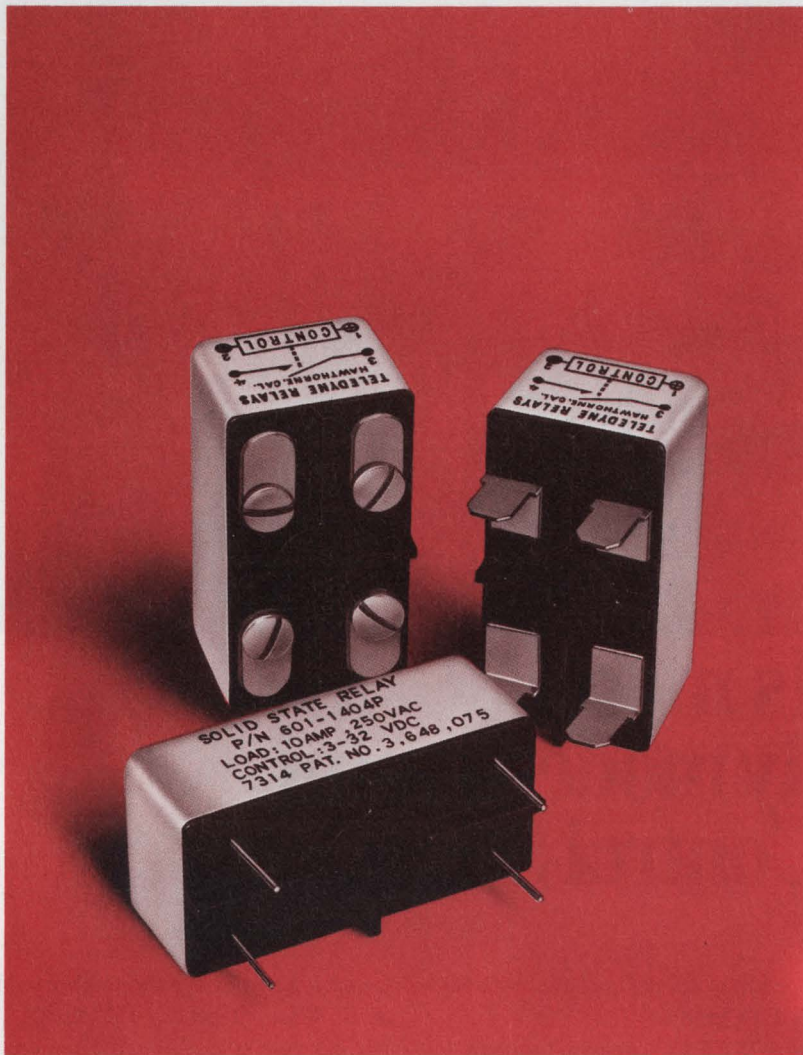

The new 601-1400 series features LED optical isolation and synchronous/zero voltage switching to virtually eliminate RFI for any resistive or reactive load, up to 10 amps steady state. 1000% surge current capability assures maximum reliability without derating for the toughest loads — lamps, solenoids, motors, transformers, etc. High dv/dt rating assures maximum output transient immunity. The sensitive control input is TTL compatible, accepting drives from 3 to 32 VDC.

Teledyne offers designers the most versatile package in the industry — the “adaptive” configuration with either screw or quick disconnect terminals for chassis or panel mounting, or solder pins for PC boards. And the 1” x 2” x .9” size makes it the smallest 10 amp AC solid state relay available.

Build total solid state reliability into your equipment with this latest addition to the Teledyne line of application engineered relays. Our engineers are ready to back this product with complete applications assistance. Write or phone.

 **TELEDYNE RELAYS**

3155 West El Segundo Boulevard Hawthorne, California 90250
Telephone (213) 679-2205

INFORMATION RETRIEVAL NUMBER 3

NEWS

- 25 **News Scope**
- 28 **Increasingly sophisticated custom chips** are turning that lowly calculator into a vest-pocket computer.
- 52 **Tape-automated bonding technique** is pushed as a replacement for chip-and-wire methods.
- 54 **Japanese planar interconnection technology** for multilevel ICs is hailed as a reliability 'breakthrough.'
- 56 **Digital and analog printout given simultaneously** by single device.
- 58 **U.S. developing a super-efficient laser.**
- 85 **Technology Abroad**
- 77 **Washington Report**

TECHNOLOGY

- 90 **BCD: Logic of many uses.** Calculators rely on it, and future applications appear unlimited. Start with addition and subtraction and learn how you can use it.
- 98 **Analog switches replace reed relays** for higher speed, bounceless contact and TTL compatibility. Available types include versatile CMOS switches.
- 104 **Breadboard active filters at a computer:** A single run of this program lets you evaluate the effects of finite op-amp gain and passive-component variations.
- 114 **Measure random-pulse frequencies** the analog way. It offers better accuracy than capacitor averaging circuits and lower costs than digital techniques.
- 120 **'Fashion' the company's growth** from the ranks of engineering, corporate chief advises. Training, he says, yields both good design and good management.
- 124 **Ideas for Design:** Voltage-to-frequency converter constructed with few components is accurate to 0.2% . . . Two very-low-power CMOS ICs detect tone-signaling frequency shifts . . . Toroid and photo-SCR prevent ground loops in high-isolation biological pulser . . . Electronic controller resolution improved with an equilibrium sustaining mode . . . Need an inverter? Use a spare J-K flip flop.

PRODUCTS

- 135 **ICs & Semiconductors:** 14-pin ceramic DIP holds matched op-amp pair.
- 136 **ICs & Semiconductors:** Chopper stabilized op amp now fits in a 14-pin DIP.
- 142 **Microwaves & Lasers:** Bidirectional coupler comes in 14-pin DIP at low cost.
- 150 **Packaging & Materials:** Heat pipes carry heat from component to sink.
- 156 Modules & Subassemblies
- 170 Instrumentation
- 162 Data Processing
- 176 Components

Departments

- 87 **Editorial:** Let's go beyond taking in each other's laundry
- 7 Across the Desk
- 187 Vendors Report
- 181 Application Notes
- 190 Advertisers' Index
- 182 New Literature
- 192 Product Index
- 186 Bulletin Board
- 194 Information Retrieval Card

Cover: Photo of Summit Model 1224 Electronic Calculator, courtesy of Cherry Electrical Products Corp., Waukegan, Illinois

surround it
with something special



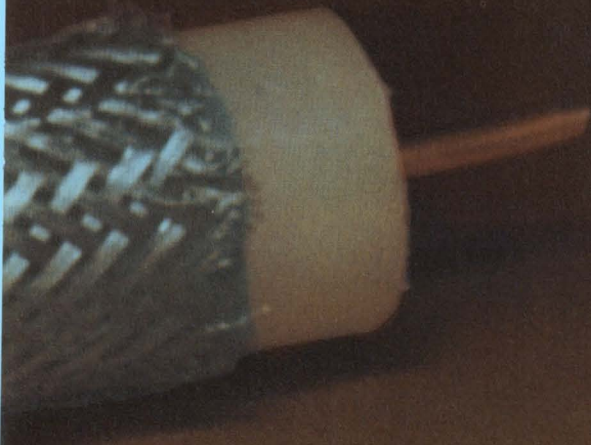

Safety. Reliability. Long-haul performance. Cost. They all have an effect on your product's design parameters and capabilities.

Belden has a custom design capability in wire, cable, and cord that can help you meet the most demanding performance for your products. We've helped solve some extraordinary problems. Can provide definitive data and answers on flex life, oil resistance, electrical characteristics, aging that can cope with practically any environment your specific job criteria calls for.

Talk to your Belden specialist about it. He understands design requirements. Can give you straight answers on cable or cord design feasibility. What modifications are possible. What the trade-offs are. The costs involved. We haven't perfected that "fancy" jacketing yet, but can improve the wire, cable, or cord package you need to meet the most challenging electrical, physical and thermal applications you might be faced with.

If you need answers right now, phone:
(312) 887-1800, Transportation Division
(312) 681-8920, Electrical Division
(317) 966-6681, Electronic Division
Or write Belden Corporation, P. O. Box 386, Geneva, Illinois 60134.

H-2-3

BELDEN 

INFORMATION RETRIEVAL NUMBER 234



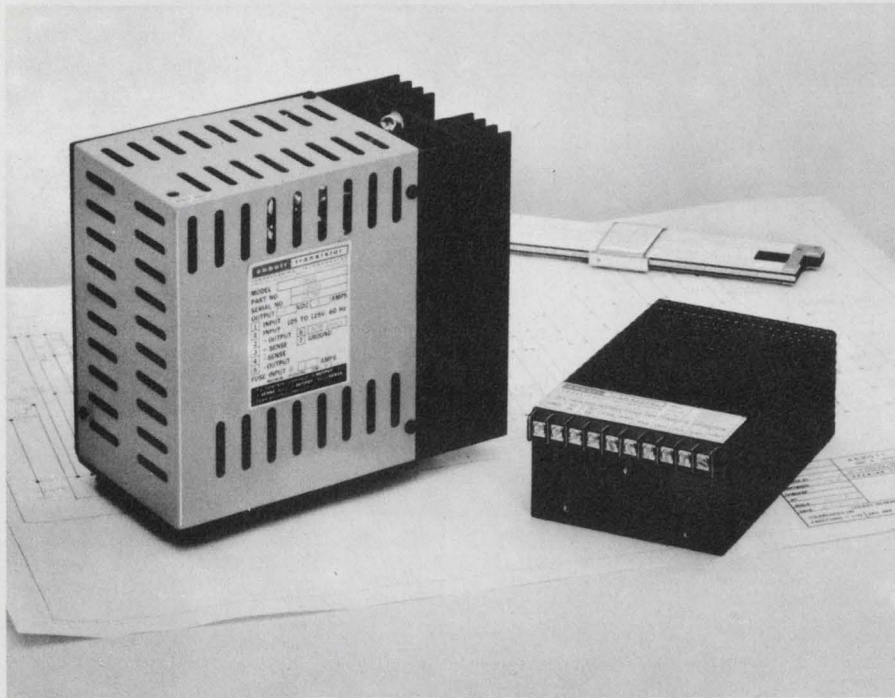

Reduce Your Power Supply Size and Weight By 70% for \$49

A new way has been found to substantially reduce power supply size and weight. Consider the large power supply shown at left in the above photo — it uses an input transformer, into a bridge rectifier, to convert 60 Hz to 5 volts DC at 5 amperes. This unit measures 6½"x4"x7½" and weighs 13 pounds. It sells for \$170 in small quantities. For just \$49.00 more, Abbott's new model Z5T10, shown at right, provides the same performance with 70% less weight and volume. It measures only 2¼"x4"x6" and weighs just 3 pounds.

This size reduction in the Model Z5T10 is primarily accomplished by eliminating the large input transformer and instead using high voltage, high efficiency, DC to DC conversion circuits. Abbott engineers have been able to control the output ripple to less than 0.02% RMS or 50 millivolts peak-to-peak

maximum. This design approach also allows the unit to operate from 100 to 132 Volts RMS and 47 to 440 Hertz. Close regulation of 0.15% and a typical temperature coefficient of 0.01% per degree Centigrade are some of its many outstanding features. This new Model "Z" series is available in output voltages of 2.7 to 31 VDC in 9 days from receipt of order.

Abbott also manufactures 3,000 other models of power supplies with output voltages from 5 to 740 VDC and with output currents from 2 milliamps to 20 amps. They are all listed with prices in the new Abbott catalog with various inputs:

- 60 Δ to DC, Regulated
- 400 Δ to DC, Regulated
- 28 VDC to DC, Regulated
- 28 VDC to 400 Δ , 1 ϕ
- 24 VDC to 60 Δ , 1 ϕ

Please see pages 618 to 632 of your 1971-72 EEM (ELECTRONIC ENGINEERS MASTER Catalog) for complete information on Abbott modules.

Send for our new 56 page FREE catalog.

abbott transistor

LABORATORIES, INCORPORATED
 general offices eastern office

5200 W. Jefferson Blvd./Los Angeles 90016
 (213) 936-8185 Telex: 69-1398

1224 Anderson Ave./Fort Lee, N.J. 07024
 (201) 224-6900 Telex: 13-5332

INFORMATION RETRIEVAL NUMBER 4

Vice President, Publisher

Peter Coley

Editors

Editorial Offices
 50 Essex St.
 Rochelle Park, N.J. 07662
 (201) 843-0550
 TWX: 710-990 5071
 Cable: Haydenpubs Rochellepark

Editor-in-Chief: George Rostky

Managing Editors:

Ralph Dobriner
 Michael Elphick

Associate Editors:

Dave Bursky
 Jules H. Gilder
 Morris Grossman
 Seymour T. Levine
 John F. Mason
 Stanley Runyon
 Edward A. Torrero
 Richard L. Turmail

Contributing Editor:

Peter N. Budzilovich

Editorial Field Offices

East

Jim McDermott, Eastern Editor
 P.O. Box 272
 Easthampton, Mass. 01027
 (413) 527-3632

West

David N. Kaye, Senior Western Editor
 2930 West Imperial Highway
 Inglewood, Calif. 90303
 (213) 757-0183
 Northe K. Osbrink, Western Editor
 112 Coloma St.
 Santa Cruz, Calif. 95060
 (408) 426-3211

Washington

Heather M. David, Bureau Chief
 2506 Eye St., N.W.
 Washington, D.C. 20037
 (202) 338-3470

Editorial Production

Marjorie A. Duffy

Art

Art Director, William Kelly
 Richard Luce
 Anthony J. Fischetto

Production

Manager, Dollie S. Viebig
 Helen De Polo
 Maxine Correal
 Anne Molfetas

Circulation

Manager, Nancy L. Merritt
 Ron Deramo

Information Retrieval

Peggy Long

Promotion

Manager, Jeffrey A. Weiner
 Karen Kerrigan

across the desk

Satisfy that passion

If you've always yearned to have your engineering thoughts immortalized in the pages of *ELECTRONIC DESIGN*, take heart. Your golden opportunity may have arrived. For you and you alone, the editors have prepared a handy-dandy little booklet, modestly and poignantly entitled, "How to write for *ELECTRONIC DESIGN*—An Author's Guide."

Written in the language of William Shakespeare, George Bernard Shaw, Ernest Hemingway and Richard Nixon, this great little opus should prove a boon to those who would like to convert engineering ideas into English prose. It should prove especially helpful

writing
for
Electronic Design

An
Author's
Guide

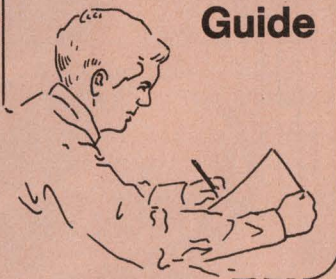

to those who suffer from frequent petrification of the typewriting muscles.

Despite its title the pocket-sized 12-pager can prove valuable to anybody taking pen to paper—even if he never writes for *ELECTRONIC DESIGN*. Most of the information is of general—if not everlasting—value, but there are a few paragraphs devoted to *ELECTRONIC DESIGN*'s preferences in technical articles. Avid readers and would-be authors who would like a copy would do well to . . .

CHECK NO. 319

EJC official charges 'misstatements' in letter

There are a number of misstatements of fact in the long letter by Joel B. Snyder that you reprinted in the April 12 issue ("Scarcity of Engineers? Not So, Asserts IEEE," *ED* No. 8, p. 10). I would like to answer his erroneous statements about my organization, the Engineers Joint Council.

EJC did not conduct "a huge publicity campaign" for the aerospace companies during the late 50s. EJC is a nonprofit federation of engineering societies and does not work for companies in aerospace or any other industry.

EJC did not predict in 1968 that there would be a shortage of 100,000 engineers by 1971. We did find in that year that employers fell 25% short in their hiring goals because engineering graduates were not available. The companies hired less qualified people to fill the gap, which is one of the real problems of the engineer.

According to the Bureau of Labor Statistics, there were 39,000
(continued on page 10)

low cost ceramic trimmer capacitors

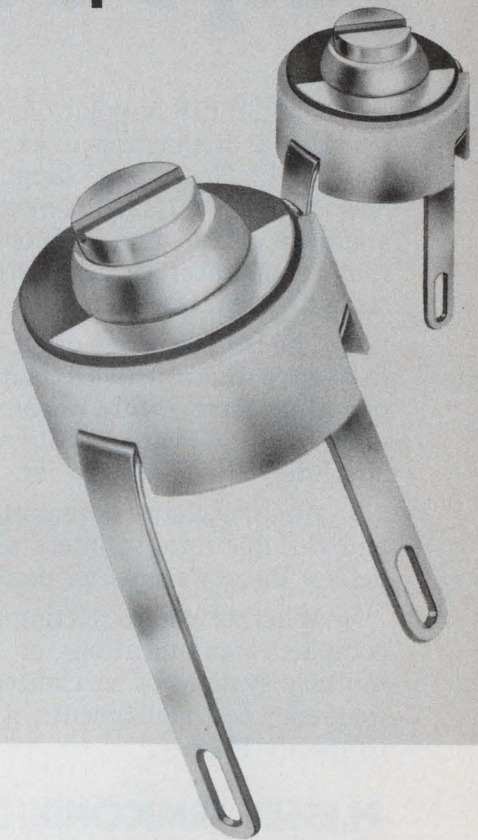

These ceramic trimmer capacitors are designed for broadband application, from audio to 500 MHz and afford an ideal *low cost* means of "trimming" circuitry such as crystal oscillators, CATV amplifiers and all varieties of communication and test equipment.

FEATURES

- Capacitance values from 1-3 to 5-25 pf
- Low profile - .208 above board height
- Low cost - 75c in 1000 quantities
- Delivery from stock

Johanson

MANUFACTURING CORPORATION

BOONTON, NEW JERSEY 07005

201 / 334-2676

TWX 710-987-8367

Electronic Design welcomes the opinions of its readers on the issues raised in the magazine's editorial columns. Address letters to Managing Editor, *Electronic Design*, 50 Essex St. Rochelle Park, N. J. 07662. Try to keep letters under 200 words. Letters must be signed. Names will be withheld on request.

INFORMATION RETRIEVAL NUMBER 5 ►

PLESSEY BEATS THE MHZ'S OUT OF EVERYONE ELSE.

The SP 616 bi-polar digital divider operates at frequencies in excess of 1000 MHz. One top IC supplier declares a 500 MHz; the next best only guarantees 220 — and both only at room temperature. And so it goes — straight down the line.

The SP 600 series of DC to 1GHz frequency dividers (with guaranteed operating temperature ranges of —55 to +125 degrees centigrade) is absolutely the fastest by far.

And it includes dozens of prescalers and variable ratio counters which deliver Plessey's superior performance.

Whether you're putting together complex communications, or military systems or specialized high frequency test instruments, it pays to specify Plessey.

PLESSEY SEMICONDUCTORS

1674 McGaw Avenue, Santa Ana
California 92705 (714) 540-9945

Please send me a complete literature packet.
Now.

I would like information only at this time.

I would like to talk to your representative personally.

Name _____

Title _____

Firm _____

Address _____

City _____ State _____ Zip _____

Phone No. _____

Minneapolis, Minnesota
(612) 835-2717

Framingham, Massachusetts
(617) 879-7920

San Diego, California
(714) 295-2500

Farmingdale, New York
(516) 694-7377

Los Altos, California
(415) 941-4080

Houston, Texas
(713) 462-4077

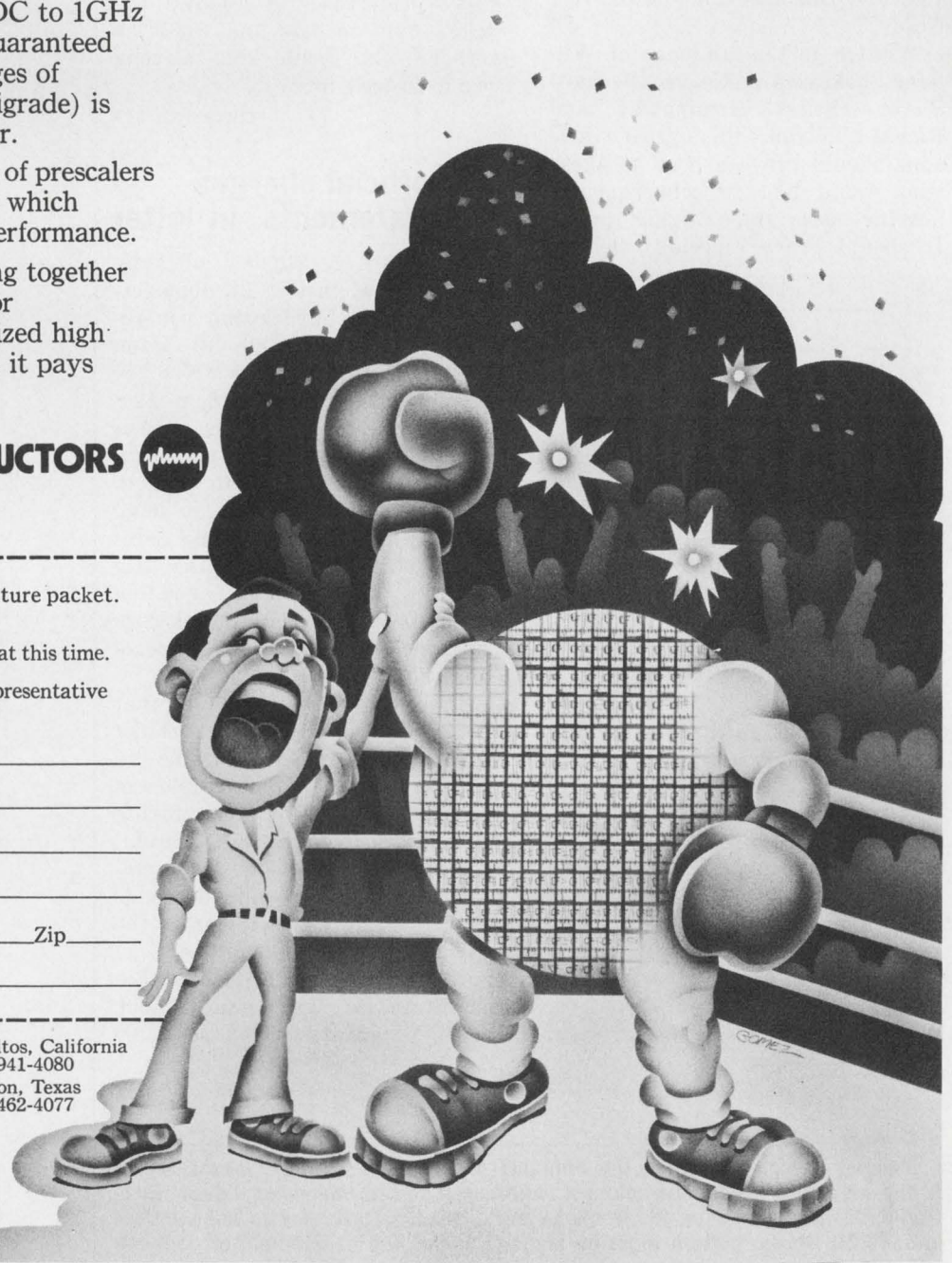



***Announcing
the winner in
the race for a 4-digit
multimeter that performs
like a 5-digit machine.***

Cimron DMM-40

With 140% overrange capability, the Cimron DMM-40 resolves 1 millivolt from a 22 volt power supply. So you get 5-digit performance in a quality, \$695 instrument.

You also get full autoranging in all functions and ranges, including 5 dc and ac ranges, 6 resistance ranges, 2 ac and dc current ranges. In a DMM with such typical Cimron quality features as a rugged, all-metal case and time-saving, built-in calibration instructions.

You can put the portable, systems compatible DMM-40 to work in everything from bench

testing to process control. And you can choose options like an internal battery pack or isolated data output, now or in the future. For more facts on the DMM-40, write today. Or call 714/774-1010 for a demonstration. You'll know a winner when you see one. Cimron Instruments, Lear Siegler, Inc., 714 N. Brookhurst, Anaheim, California 92803.



LEAR SIEGLER, INC.

ELECTRONIC INSTRUMENTATION DIVISION
CIMRON INSTRUMENTS

CIMRON

When we win you win.



Cut package count . . . Simplify board layout . . .
Reduce equipment size . . . with

DIP MULTI-COMP[®] RESISTOR-CAPACITOR NETWORKS



(Metanet[®] Film Resistors, Monolythic[®] Ceramic Capacitors)

STANDARDIZED DESIGNS* FOR BETTER AVAILABILITY, BETTER PRICES

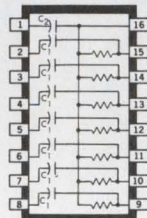
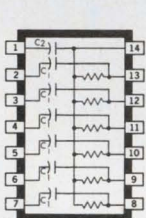

R (Ω)			C ₁
100	470	2000	100pF
150	500	2200	330pF
200	680	3300	0.01μF
220	1000	4700	C ₂
330	1500	6800	

BYPASSED PULL-UP AND R-C COUPLING NETWORKS

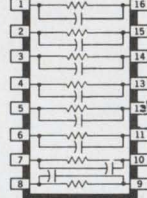
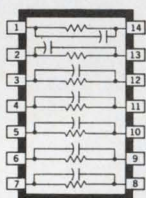

R (Ω)			C
100	470	2000	1000pF
150	500	2200	3300pF
200	680	3300	0.01μF
220	1000	4700	
330	1500	6800	

SPEED-UP NETWORKS

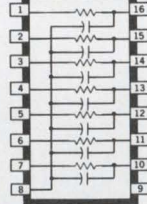
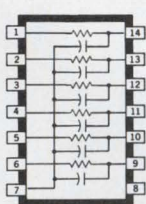

R (Ω)			C (pF)
100	470	2000	100
150	500	2200	
200	680	3300	330
220	1000	4700	
330	1500	6800	

ACTIVE TERMINATOR NETWORKS

* OTHER PACKAGES, CIRCUIT CONFIGURATIONS, AND RATINGS AVAILABLE ON SPECIAL ORDER

Sprague puts more passive component families into dual in-line packages than any other manufacturer:

- TANTALUM CAPACITORS
- CERAMIC CAPACITORS
- TANTALUM-CERAMIC NETWORKS
- RESISTOR-CAPACITOR NETWORKS
- PULSE TRANSFORMERS
- TOROIDAL INDUCTORS
- HYBRID CIRCUITS
- TAPPED DELAY LINES
- SPECIAL COMPONENT COMBINATIONS
- THICK-FILM RESISTOR NETWORKS
- THIN-FILM RESISTOR NETWORKS
- ION-IMPLANTED RESISTOR NETWORKS

For more information on Sprague DIP components, write or call Ed Geissler, Manager, Specialty Components Marketing, Sprague Electric Co., 347 Marshall St., North Adams, Mass. 01247. Tel. 413/664-4411.



THE BROAD-LINE PRODUCER OF ELECTRONIC PARTS

INFORMATION RETRIEVAL NUMBER 8

ACROSS THE DESK
(continued from page 7)

unemployed engineers at peak unemployment during the first quarter of 1971. Mr. Snyder's assertions of huge numbers of unemployed are not supported by any reliable statistical studies conducted to date. Also, the statement that "in 1971 industry was able to absorb only about 50% of all engineering graduates into engineering jobs" is grossly misleading. A total of 36% of the new graduates were not even looking for employment, because of graduate school, military service and other plans. Actually 91% of the 1971 BS graduates in engineering had jobs or other commitments before they left school, and most of the rest were employed by the end of that summer.

ELECTRONIC DESIGN does a disservice to its readers when it publishes inflammatory statements that could have been checked out as either without factual foundation or false. You might note that the headline on the letter, attributing the statement to IEEE, is also erroneous. There are over 150,000 members of IEEE, and Mr. Snyder is only one of them. IEEE has made and published several excellent studies of electrical engineering employment, none of which supports Mr. Snyder's allegations. Mr. Snyder is entitled to his opinions, but let's not get them too confused with facts.

John D. Alden
Engineering Manpower
Commission

Engineers Joint Council
345 E. 47th St.
New York, N.Y. 10017

Ed. Note: Mr. Snyder is chairman of the Long Island (N.Y.) Section of IEEE.

And yet another view

I was pleasantly surprised at your reprinting of comments of Joel B. Snyder. The April 12 publication was like fresh air displacing stagnated, if not now fouled, rhetoric about engineering being a profession.

Unfortunately there are still many engineers—not educated, but programmed like so many self-

(continued on page 14)

INFORMATION RETRIEVAL NUMBER 9 ►

New Era in film capacitors!

**POLYESTER MICROMATIC®
CAPACITOR***

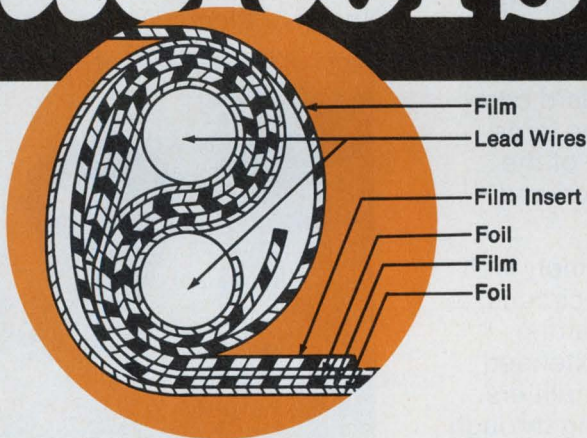

ITW Paktron does it again. Following closely the introduction of the unique design breakthrough of its Micromatic Polypropylene Capacitor; Paktron now offers another new era in film capacitors—the Polyester Micromatic. Once again, here is a completely self-encased capacitor. Outside wrapping is eliminated. Nor are there any separate lead attachments because the new Polyester Micromatic is wound on

its own leads. Best of all, this all new film capacitor is smaller in size than comparable wrap and fill polyester capacitors. And they're competitive with shrink tube and/or conformal coated axial lead products presently marketed. Capacitance tolerances are a low $\pm 5\%$. Capacitance value range .001 to 0.15mfd. Up to 600 volts. You'll find the Polyester Micromatic ideal for automatic PC board insertion due to its lead

concentricity. In addition to polyester, Micromatic Capacitors are also available in Polypropylene dielectrics. See and test the new era of film capacitors for yourself, write to the innovator in capacitors: **Paktron, Division Illinois Tool Works Inc., 1321 Leslie Avenue, Alexandria, Va. 22301. Phone (703) 548-4400. TWX 710-832-9811.**



* Patent No. 3638086
Other Patents Pending

ITW PAKTRON

The Electronic Group of ITW...PAKTRON ■ LICON ■ ELECTRO MATERIALS ■ CHRONOMATIC

What national semiconductor firm would you turn to to fill the op amp price/performance gap?

Wrong! We got it first, the LM 141/142. And we're going to second source it even if the first source isn't ready. Why? Because there's a crying need for an op amp like this from any source.

Here's why: When you're all set to design with op amps and the 741 type simply runs out of gas or the 108 type offers too much performance for the price, the LM 141/142 fills that gap.

The fully compensated 141 offers five times better input bias and offset current than the 741 and faster slew rate. The 142, with standard compensation equals the large signal performance of the 101A without feedforward compensation.

Both perform extremely well in sample and hold circuits, long interval integrators, active filters, and extended frequency range amplifiers with full output swing through the audio range.

We also have an LM 341/342 relaxed specification version priced at 99¢ in 100-999.

Compare:

Specification	141	142	741	101A	108	
Input offset current (max.)	5	5	200	10	.2	nA @ 25°C
Input bias current (max.)	30	30	500	75	2.0	nA @ 25°C
Slew rate (min.)	1.0	1.0	.3	.3	.1	V/μs @ 25°C
Distributor list price of popular brands (100-999)	\$4.25	\$3.95	\$3.95	\$7.95*	\$12.95*	

Then Sample Order. We'll give you a *free* sample of the LM 141/142 or 341/342, if you tell us a little about yourself and intended use. Write on your company letterhead. Or call National and give them a nudge, we need that first source.

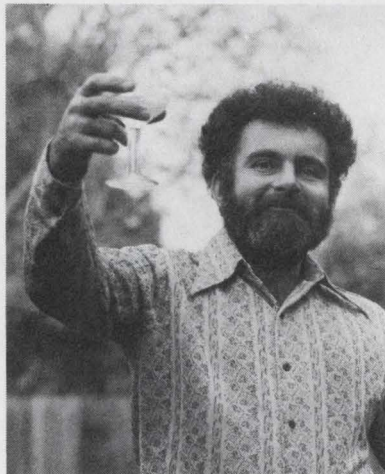

I'll Drink to That. (I'll Drink to Anything.)

the challenger

TELEDYNE SEMICONDUCTOR

1300 Terra Bella Avenue Mountain View, California 94040 (415) 968-9241 TWX: 910-379-6494 Telex: 34-8416

*Teledyne's prices on these IC's are lower.

INFORMATION RETRIEVAL NUMBER 10

INFORMATION RETRIEVAL NUMBER 11 ►



New Licon® LPB switch has a secret!

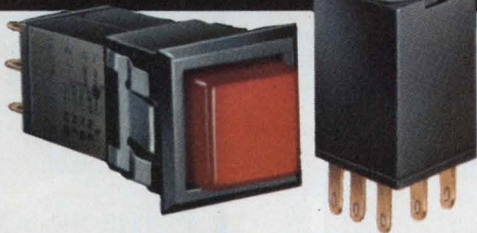

Licon's new C-III LPB Switch... it's either alternate or momentary action. Just slide the concealed selector to the mode you want. Either action in same compact size.*

Quick-change artist: that's the new low-cost Licon® C-III Lighted Push-Button Switch. You or your distributor can change it from alternate to momentary action and back again. Just by sliding the concealed selector. Only $2\frac{1}{8}$ " x $\frac{5}{8}$ " square, this crisp-operating snap-action lighted switch comes in a selection of lens cap styles, colors, shapes and sizes. Lists as low as \$2.25 each. Features simplicity throughout. For example,

to replace lamp, just pull out cap assembly, insert new lamp, snap back together. Licon's C-III LPB Switch is immediately available in SPDT and DPDT circuitry, and various mounting configurations—including rear or front panel mounting, time-saving snap-in mounting with bezel or bezel barrier configurations. Look into Licon's secret. Call your local Licon rep or distributor for a demo

of the new C-III LPB in your office. Or call or write for a Licon Switch Catalog. **Licon, Division Illinois Tool Works Inc., 6615 W. Irving Park Road, Chicago, Illinois 60634. Phone (312) 282-4040. TWX 910-221-0275.**



*Patent Applied for

i t
L W LICON

The Electronic Group of ITW...LICON ■ ELECTRO MATERIALS ■ PAKTRON ■ CHRONOMATIC

© ILLINOIS TOOL WORKS INC. 1972

DO THESE PRODUCTION PESTS "UP" YOUR DOWN TIME?

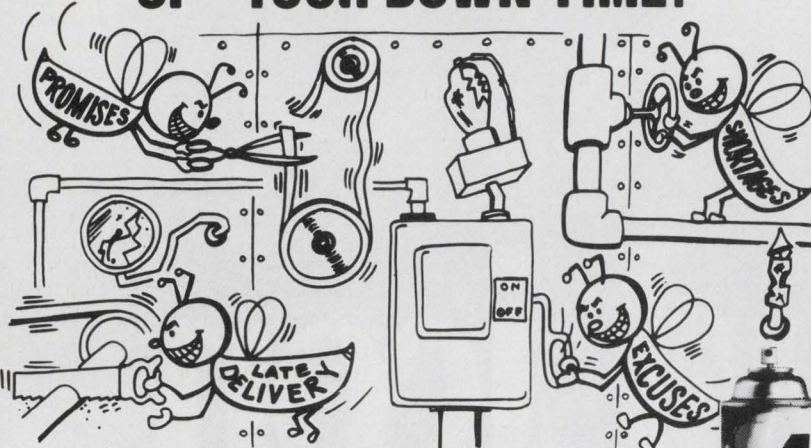

ALLIED HAS A GUARANTEED CURE!

Immediate Shipment of Thousands of Items—Partial List Below

Here's the sure cure for production line ills - Allied Electronic's Guaranteed Shipment Program. It covers thousands of popular and often hard-to-get items. Check your open order files, then check the list below. It's just a sample of our IN-DEPTH inventory parts that are ready to be shipped to you today!

And, we back this new program with this statement: you get the parts you order from our published list, or we give you a Credit Voucher for 10% of your total order (good for 90 days) to be applied to your next order. See the next issue of this publication for more Guaranteed Shipment items. Call us now for total service!



AMPHENOL	AMPHENOL	AMPHENOL	AMPHENOL	ALPHA	ALPHA	BUD	BUD
284-1	26-190-24	77MIP20	146-817	FIT-221 1/4"/6"	PVC-105 AWG	C-1585 HG	PA-1105 HG
1309	26-4100-16P	77-115	160-2N	Bik.	10/100 Bik.	C-1609	PA-1106 HG
1350	26-4100-24P	78-PC63		FIT-221 3/8"/6"	PVC-105 AWG	C-1883 HG	PA-1107 HG
1370	26-4200-16S	78S58	160-5N	Bik.	12/100 Bik.	PA-1112 HG	RC-1756
2201B-1K	26-4200-24S	78-PF8	160-8N	FIT-221 1/2"/6"	PVC-105 AWG	CB-1371	RC-7758
4101B-1K	26-4301-8S	78-PF11	160-9N	Whl.	16/100 Bik.	CB-1372	RR-1248 HG
4101B-5K	26-4301-16P	78S51	160-10N	FIT-221 3/4"/6"	PVC-105 AWG		RR-1249 HG
4101B-10K	26-4301-16S			Bik.	18/100 Bik.		SB-2140
4101B-50K	26-4401-8P		165-14	FIT-221 1/2"/6"	PVC-105 AWG	CMA-1930	SB-2142
4101B-100K	26-4401-16P			Red	18/100 Chr.	CMA-1936	SC-2130
MS3102A-10SL-4P	26-4401-24P	80-MC2M	168-015	Whl.	TFT-200 AWG	CU-124	SC-2131
MS3102A-14S-2P	26-4401-32P	80-MC2F1	220-P01	FIT-221 1/4"/4"	16/100	CU-234	SC-2132
	26-4401-32S	80-PC2M	220-P02	Bik.	TFT-200 AWG	225-247	SFA-1832
MS3102A-14S-5P	UG-88/U 31-002	UG-218/U 82-61	220-S01	FIT-221 3/4"/6"	18/100	CU-341	SFA-1833
	31-002-1050	UG-578/U 82-100	220-S02	Bik.	TFT-200 AWG	CU-347	SFA-1834
	UG-290/U 31-003	PL-258-49191	221-535	FIT-221 1/2"/6"	20/100	CU-482	SFA-1836
	UG-274/U 31-008	83-1-J	221-1660	Red	TFT-200 AWG	CU-585	TV-2156
	31-008-1050	83-1-J-1050	221-2553	Whl.	TFT-200 AWG	CU-592	
MS3106A-10SL-3S	UG-306/U 31-009	50-239-49194	225-22221-401	FIT-221 3/4"/4"	26/100	CU-622	
	31-009-1050	83-1R	(117)	Bik.	TFT-250 AWG		
	UG-260/U 31-012	PL-259-49190	261-15622-2	FIT-221 1/2"/6"	22/100	CU-728 BR	
	UG-261/U 31-015	83-1SP	356-200	Bik.		CU-728 HG	
MS3106A-14S-5P	UG-888/U 31-018	83-1SP-1050	UG-215/U 2900	FIT-221 3/4"/6"		CU-829 HG	
MS3106A-14S	UG-273/U 31-028	UG-176/U 83-188	UG-185-4500	Whl.		CU-883 BR	
MS3106A-14S-6P	UG-657/U 31-102	UG-175/U 83-185	UG-625/U 5575	FIT-221 1/2"/4"		CU-1898 HG	
	31-102-1050	UG-111/U 83-750	5375-1050	Bik.		CU-1899 BR	
	UG-806/U 31-202	86-PM1	36900	FIT-221 3/4"/6"		CU-2100-A	
	31-202-1050	86-CP5	UG-932/U 27000	Whl.		CU-2101-A	
	UG-274A/U 31-208	86-PM8	UG-932/U 28000	FIT-221 1/2"/6"		CU-2102-A	
	31-208-1050	86-PM11	36775	Bik.		CU-2104-A	
MS-3057-3	UG-760B/U 31-212	86-CP6	36900	FIT-300 1/2"/6"		CU-2105-A	
MS-3057-4	UG-348A/U 31-217	91-MC3F1	91-PC3M	Dir.		CU-2016-A	
	UG-491A/U 31-218	91-MC3M	91-MC4M	FIT-300 3/4"/6"		CU-2108-A	
	31-218-1050	91-MC4M	91-PC3F	Whl.		CU-2109-A	
	UG-574/U 31-219	91-PC4F	UG-492A/U 31-220	FIT-350 1/2"/6"		CU-2110-A	
	31-219-1050	91-MPM3S	31-220-1050	Dir.		CU-3000-A	
MS-3057-12A	UG-1094U 31-221	91-854	UG-1094U 31-221	FIT-350 3/4"/6"		CU-3001-A	
MS-3057-12B	31-221-1050	91-854	31-221-1050	Whl.		CU-3002-A	
MS-3057-18A	UG-629B/U 31-236	126-011	UG-629B/U 31-236	FIT-350 1/2"/6"		CU-3003-A	
MS-3057-24	31-236-1050	126-195	57-10580-7	Dir.		CU-3004-A	
97-3057-12-6	57-10580-7	126-196	57-30580-7	FIT-105 1/2"/25"		CU-3005-A	
97-3057-14	57-30580-7	126-197	57-30590	FIT-105 3/4"/100"		CU-3006-A	
9779-513-3	57-30141	126-198	57-40140	FIT-105 1/2"/25"		CU-3007-A	
	57-30360	126-216	57-40240	FIT-105 3/4"/100"		CU-3008-A	
9779-513-8	57-30360	126-217	57-40360	FIT-105 1/2"/25"		CU-3009-A	
9779-513-10	57-40140	126-218	57-40500	FIT-105 3/4"/100"		H-9111	
9779-513-12	57-40240	126-219	61-F1	FIT-105 1/2"/25"		H-9168	
9779-513-16	57-40500	126-220	143-010-01	FIT-105 3/4"/100"		MB-1266	
	61-F1	126-223	143-012-01	FIT-105 1/2"/25"		PA-1102 HG	
	61-F1	143-010-01	143-015-01	FIT-105 3/4"/100"		PA-1103 BY	
17-10250	61-M10	143-012-01	61-MIP-51F	FIT-105 1/2"/25"		PA-1103 GY	
17-20090	61-MIP-51F	143-015-01	75MC1F	FIT-105 3/4"/100"		PA-1103 HG	
26-159-16	75MC1F	143-012-01	77MIP8	FIT-105 1/2"/25"		PA-1104 BY	
26-159-24	77MIP8	143-022-03	77MIP11	FIT-221-MS1		PA-1104 HG	
26-190-16	77MIP11	146-104	77MIP11T	FIT-221 3/4"/6"			
	77MIP11T	146-103		Bik.			

PERFORMANCE SPEAKS FOR ITSELF!
ALLIED'S RECORD TO DATE ON OUR GUARANTEED SHIPMENT PROGRAM

As of March 23, 1973, 98.8% of all orders containing Merchandise covered by the Guaranteed Shipment Program were filled.
Does Your Present Supplier Guarantee Shipment or Give a 10% Credit Voucher if He Defaults? Call Your Nearest Allied Facility Today for the Parts You Were Looking for Yesterday.

Call Your Nearest Allied Facility Today!

- Garden Grove, Calif. (213) 598-6605
- Washington, D.C. (301) 345-4600
- Chicago, Ill. (312) 421-2400
- Boston, Mass. (617) 848-4150
- Fort Lauderdale, Fla. (305) 772-6464
- Fort Worth, Texas (817) 336-5401

NEW CATALOG
1973 Edition. Write or phone for your copy today.

ALLIED ELECTRONICS DIVISION OF TANDY CORP.

2400 WEST WASHINGTON BLVD., CHICAGO, ILL. 60612

INFORMATION RETRIEVAL NUMBER 12

ACROSS THE DESK
(continued from page 10)

renting computers—who cannot recognize nor relate nonscientific truths. Lacking in social consciousness, they cannot effect change in their own conditions, no matter how large their numbers.

Malcolm Kasparian Jr.
113 Warwick Ave.
Waltham, Mass. 02154

A brickbat for a brickbat

With reference to the editorial "Guidelines Drawn in Invisible Ink" (ED No. 8, April 12, 1973, p. 71):

Granted the recently published guidelines for engineers/scientists and their employers may not be perfect. But let's give the societies credit—at least a start has been made. Previously there were no such formally published, mutually agreed upon guidelines.

Let us hope that engineers and their employers will follow the guidelines because they want to do so. Cooperation is far better than enforcement. While you may feel unsatisfied, there is, in fact, some meat there. Let's endorse the guidelines at least as a starting point, a baseline. Then we can all work to improve them and encourage adherence.

IEEE and the rest are now trying to become more relevant. They need your encouragement, not brickbats.

Robert S. Duggan Jr.
1112 Mason Woods Dr., N.E.
Atlanta, Ga. 30329

And gratitude for same

Thank you for your refreshing editorial of April 12, which, for me, identified your magazine as one for engineers and engineering managers. . . . Your magazine is No. 1 in our library.

Wallace C. Collins
Director of Engineering
McGraw-Edison Co.
Edison Electronics Div.
Granier Field Municipal Airport
Manchester, N.H. 03103



LCR Testing - now HP gives you 0.2% accuracy for only \$585*

It gives you five times better accuracy - at a new low price.

With the 4265A you can measure:

C from 0.1pF to 1111 μ F.

L from 0.1 μ H to 1111H

R from 0.1m Ω to 1.111M Ω

The built-in oscillator and selective detector operate at 1kHz (or use the 4265A from 50Hz to 10kHz with an external oscillator). Front panel conveniences include both in-line digital readout and schematics of the circuits under test.

Our new Model 4265A Universal Bridge frees you from the old 1% limitations.

Like the other "Useables", the new universal bridge is backed by HP's long-time reputation for reliability and service. That's another advantage you get when you let HP fill your testing needs.

*Domestic U.S.A. Prices Only.

**For new standards
in component testing,
think HP**

HEWLETT  PACKARD

Sales, Service and support in 172 centers in 65 countries.
Palo Alto, California 94303. Offices in principal cities throughout the U.S.

The Useables:

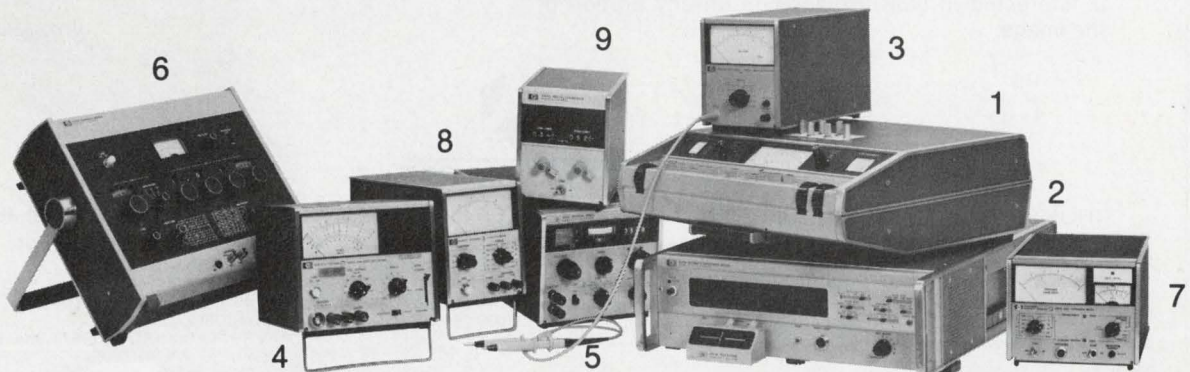

No. 1: 4342A Q Meter, No. 2: 4270A Automatic Capacitance Bridge, No. 3: 4328A Milliohmmeter, No. 4: 4329A High Resistance Meter, No. 5: 4260A Universal Bridge, No. 6: 4265A Universal Bridge, No. 7: 4350A High-Capacitance Meter, No. 8: 4332A LCR Meter, No. 9: 4050A Analog Comparator.

INFORMATION RETRIEVAL NUMBER 13

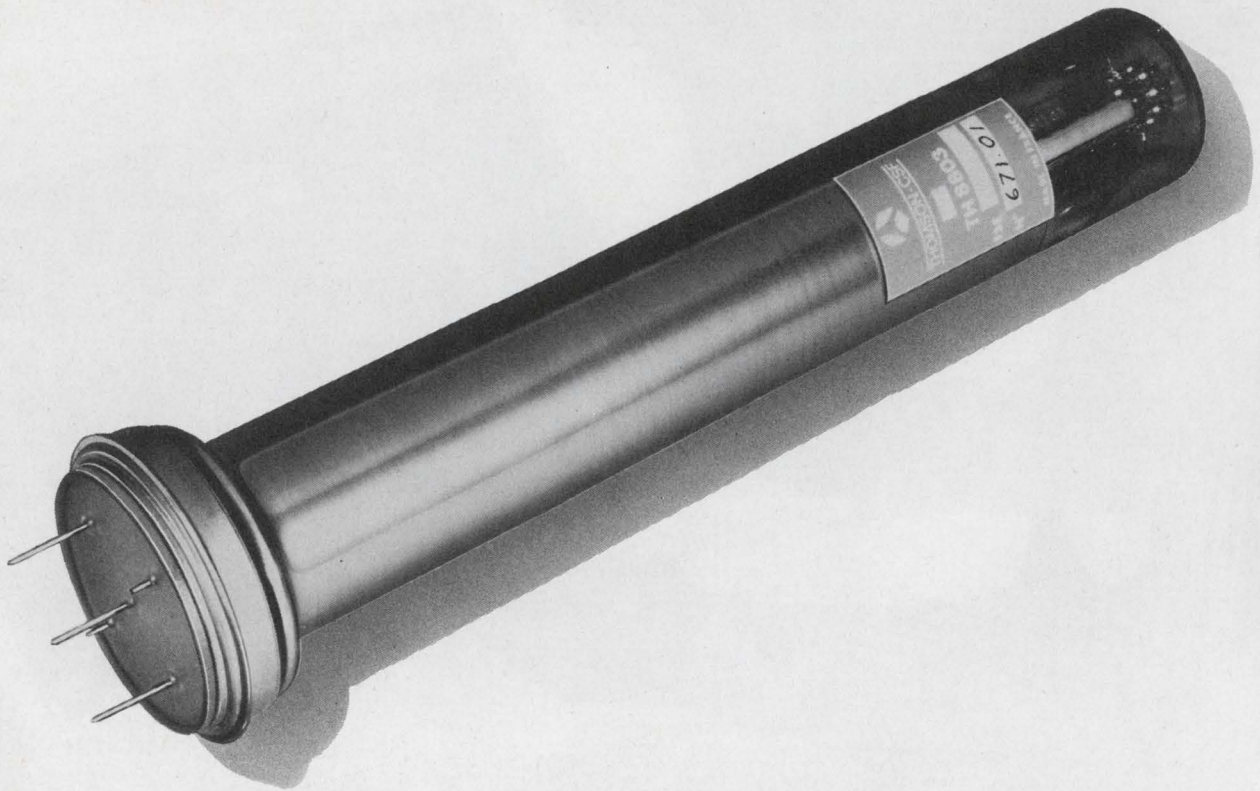

We proudly present our new high resolution storage tube...

Over 4000 lines resolution, with the same long storage and fast erase features of our mini tubes.

Our TH 8803 storage tube is a single ended design in a two inch diameter Vidicon configuration that provides a limiting resolution performance of 4300 TV lines per diameter. It can store 16 millions of bits, in the digital form or the equivalent in the full TV gray-scale image form, for more than 20 minutes under continuous readout scanning operation.

A unique feature of the TH 8803 is its fast erasing capability by means of a special gun design*. Two TV frames are sufficient to erase the whole surface down to the noise level of a good amplifier. Because the display function is separated from the storage system, the user can selectively edit the stored image or, if he is interested in blow-up, zoom-in on any portion of the image.

The two-inch diameter structured silicon target of the TH 8803 permits a resolution of 2700 TV lines at 50 % modulation level. It also permits operation with standard Vidicon hardware, and low voltage levels.

The high performance level reached makes the TH 8803 ideal for a number of applications such as buffer memory, high density data storage and retrieval, bandwidth compression or expansion, scan conversion, etc.

For more information about this tube and our entire line of storage and display tubes, please circle the appropriate number on the Reader Service Card, or contact us directly.

* Thomson-CSF patent.



THOMSON-CSF

THOMSON-CSF ELECTRON TUBES, INC. / 50 ROCKEFELLER PLAZA / NEW YORK, N.Y. 10020 / TEL. (212) 489.0400

France - THOMSON-CSF Groupement Tubes Electroniques / 8, rue Chasseloup-Laubat / 75737 PARIS CEDEX 15 / Tél. 566 70.04

Germany - THOMSON-CSF Elektronenröhren GmbH / Am Leonhardsbrunn 10 / 6 FRANKFURT/MAN / Tél. 70 20.99

Italy - THOMSON-CSF Tubi Elettronici SRL / Viale degli Ammiragli 71 / ROMA / Tél. 638 14.58

Japan - THOMSON-CSF Japan K.K. / Kyosho Building / 1-9-3 Hirakawa-cho / Chiyoda-ku / TOKYO / 〒102 / Tel. (03) 264.6341

Sweden - THOMSON-CSF Elektronrör AB / Box 27080 / S10251 STOCKHOLM 27 / Tél. (08) 22 58.15

United Kingdom - THOMSON-CSF Electronic Tubes Ltd / Bilton House, Uxbridge Road, Ealing / LONDON W 5 2TT / Tel. (01) 579.1857 / Telex : 25 659

1720



READ THIS PAGE FROM 10 FEET AWAY.

It'll tell you what to do when you want a state-of-the-art green LED indicator that's human-engineered to be seen from a considerably greater distance than possible with present industry offerings.

It'll give you a name to remember when you want the lowest-cost green LED in the industry: the MLED750 that costs just 99¢, 100-up . . . more than a nickel less than dimmer devices.

It'll indicate what green device goes on like this: 0.5 millicandellas brightness at 25 mA, 2 volts V_F and a 90° viewing angle. And stays on — evergreen.

It'll reveal who's got the technical competence to offer a brighter-packaged LED.

It'll show you you should specify green. . .



From Motorola, the LED Producer.

LOW NOISE LOW DRIFT OP AMPS... *made easy!*

0.5 $\mu\text{V}/^\circ\text{C}$

0.6 μV pk-to-pk

8.0 $\mu\text{V}/\text{Month}$

Max!

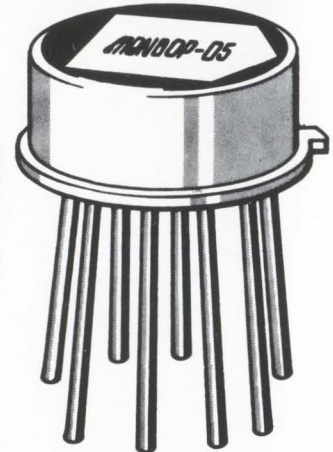

YOUR TOUGHEST OP AMP SOCKET JUST GOT FILLED!

The new monoOP-05 series guarantees the most accurate input specs in the industry . . . and no additional components are required for frequency compensation or protection! Best of all . . . the parameters are rock-stable, month after month! With offset voltages as low as 150 μV (Max), bias currents as low as 2.0 nA (Max), and CMRR as high as 114dB (Min), the monoOP-05 is the "ideal" op amp for all precision aerospace and industrial transducer and computation circuitry!

Try one! Discover just how easy low noise, low drift op amp designs can be! (The monoOP-05 is a direct replacement in 725, 108 and unullted 741 sockets . . . upgrade your system now!)

Units processed to MIL-STD-38510 and/or with long-term stabilities 100% tested and guaranteed to better than 5.0 $\mu\text{V}/\text{Month}$ are available . . . contact the factory or your local PMI representative. Matched dual versions in 14-pin DIP packages are also available . . . inquire about the amazing monoOP-10 series!

GUARANTEED MIN/MAX SPECIFICATIONS

	monoOP-05A	monoOP-05	monoOP-05E	monoOP-05C	
Operating Temp. Range	-55/+125	-55/+125	0/+70	0/+70	$^\circ\text{C}$
Vos @ 25 $^\circ\text{C}$	0.15	0.5	0.5	1.3	mV
Vos vs. Temp.	0.5	1.0	0.6	1.5	$\mu\text{V}/^\circ\text{C}$
Vos vs. Time	8.0	9.0	9.0	—	$\mu\text{V}/\text{Month}$
Noise (0.1 Hz to 10 Hz)	0.6	0.6	0.6	0.65	μV , pk-to-pk
Input Bias Current	2.0	3.0	4.0	7.0	nA
CMRR	114	114	110	100	dB
Open Loop Gain	300	200	200	120	V/mV
Price @ 100 pcs. (TO-99)	\$44.95	\$19.95	\$14.95	\$7.95	



1500 SPACE PARK DRIVE, SANTA CLARA, CALIFORNIA 95050
TEL. (408) 246-9225 • TWX 910-338-0528 • CABLE MONO

AUTHORIZED DISTRIBUTORS

NEW YORK METROPOLITAN AREA Harvey Radio, Woodbury, N.Y.: (516) 921-8700 • NEW ENGLAND AREA Gerber Electronics, Dedham, Mass.: (617) 329-2400 • UPSTATE NEW YORK Harvey/Federal Electronics, Binghamton, N.Y.: (607) 748-8211 • NORTHEAST Newark Electronics, Malden, Mass.: (617) 321-3930 • BALTIMORE-WASHINGTON Whitney Distributors, Baltimore, Md.: (301) 944-8080 • MICHIGAN RS Electronics, Detroit, Mich.: (313) 491-1000 • SOUTHEAST Kirkman Electronics, Winston-Salem, N.C.: (919) 724-0541 • CENTRAL Hallmark Electronics, Elk Grove Village, Ill.: (312) 437-8800 • Minneapolis, Minn.: (612) 925-2944 • St. Louis, Mo.: (314) 521-3800 • TEXAS-OKLAHOMA Sterling Electronics, Houston, Texas: (713) 623-6600 • Dallas, Texas: (214) 357-9131 • SOUTHWEST Sterling Electronics, Albuquerque, N.M.: (505) 247-2496 • Phoenix, Ariz.: (602) 258-4531 • WEST Westates Electronics Corp., Chatsworth, Calif.: (213) 341-4411 • Sterling Electronics, San Carlos, Calif.: (415) 592-2353 • Intermark Electronics, San Carlos, Calif.: (415) 592-1641 • Denver, Colo.: (303) 936-8284 • Seattle, Wash.: (206) 767-3160 • Salt Lake City, Utah: (801) 359-0531 • San Diego, Calif.: (714) 279-5200 • Santa Ana, Calif.: (714) 540-1322 • WESTERN CANADA Intek Electronics Ltd., Vancouver, B.C.: (604) 873-2477.

INFORMATION RETRIEVAL NUMBER 15

A reliable way to come in under budget.

Our commercial Series 8 miniature manual switches provide quality construction and reliable performance at a low cost.

The positive detent action is a good example of our quality construction. It assures you of excellent tactile feedback.

For safer operation, there's maximum separation between the terminals and the metal mounting and operating elements. And our case, using superior arc-resistant materials, has excellent compartmentation to isolate individual internal circuits.

There's a choice of toggles (select from lever styles and colored, slip-on caps), paddles and rockers (snap-in mounting and choice of colored buttons), and lighted rockers. Also select from pushbuttons with colored buttons in two sizes.

All this makes the Series 8 perfect for jobs where money and space are limited, but performance standards aren't. Communications equipment, test and measuring devices, computer peripheral and business equipment are examples. Series 8 switches are rated 6 amps, 125 VAC.

For additional information, see your MICRO SWITCH Branch Office or Authorized Distributor (Yellow Pages, "Switches, Electric"). Or write for our Series 8 Product Brochure.

MICRO SWITCH makes your ideas work.

MICRO SWITCH

FREEPORT, ILLINOIS 61032
A DIVISION OF HONEYWELL



Shown 20% oversize

For \$495.⁰⁰

Screen out your bad IC's before they hide out.

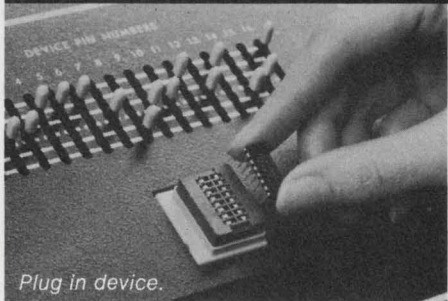

Plug in device.

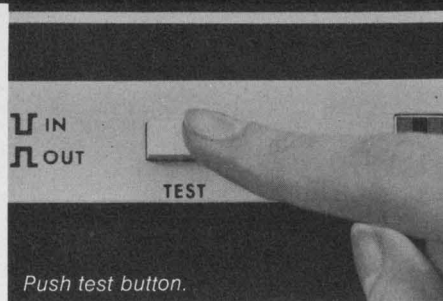

Push test button.

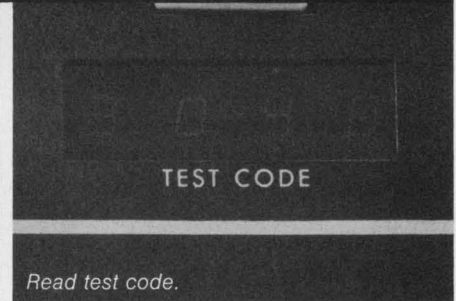

Read test code.

Easy as one...two...three

The Model 1248 IC Functional Tester will start paying for itself on the first day of use, even low volume use. Incoming digital ICs—TTL, DTL, and CMOS—can be tested for functional failure at the rate of 10 per minute or better by a non-technical person. Plug in, push the button, and eliminate *all* your DOAs before they go into your circuit and require expensive trouble-shooting to track down.

Operation is simplicity itself.

After the switches are set to apply the proper function to each pin of the 14 or 16 pin DIP, testing is a matter of seconds—one second for TTL/DTL and five seconds for CMOS. The test result, displayed as a



highly visible four-digit test code, is absolute. No comparison with a "good" IC is necessary. Switch settings and test codes for most devices on the market come with the instrument, along with complete instructions including how to test unlisted devices.

Self-contained, rugged, and compact, this tester goes anywhere. You are invited to try it—free. No obligation if returned within 10 days. Call or write the factory for our full-color booklet on this unique IC functional tester.

Electro Scientific Industries,
13900 N. W. Science Park Dr.
Portland, Oregon 97229.
Telephone 503/646-4141.
Telex 36-0273.

esi

CHANGEOVER TO TEST ANOTHER IC IS FAST.

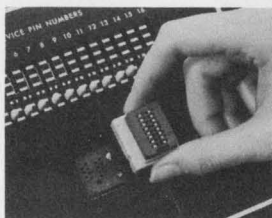

insert different device socket if necessary.



push proper mode button.

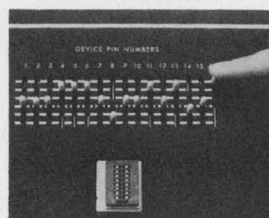

set switches to new positions.

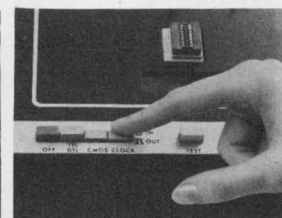

check clock button for polarity. Now test as above, one, two, three!

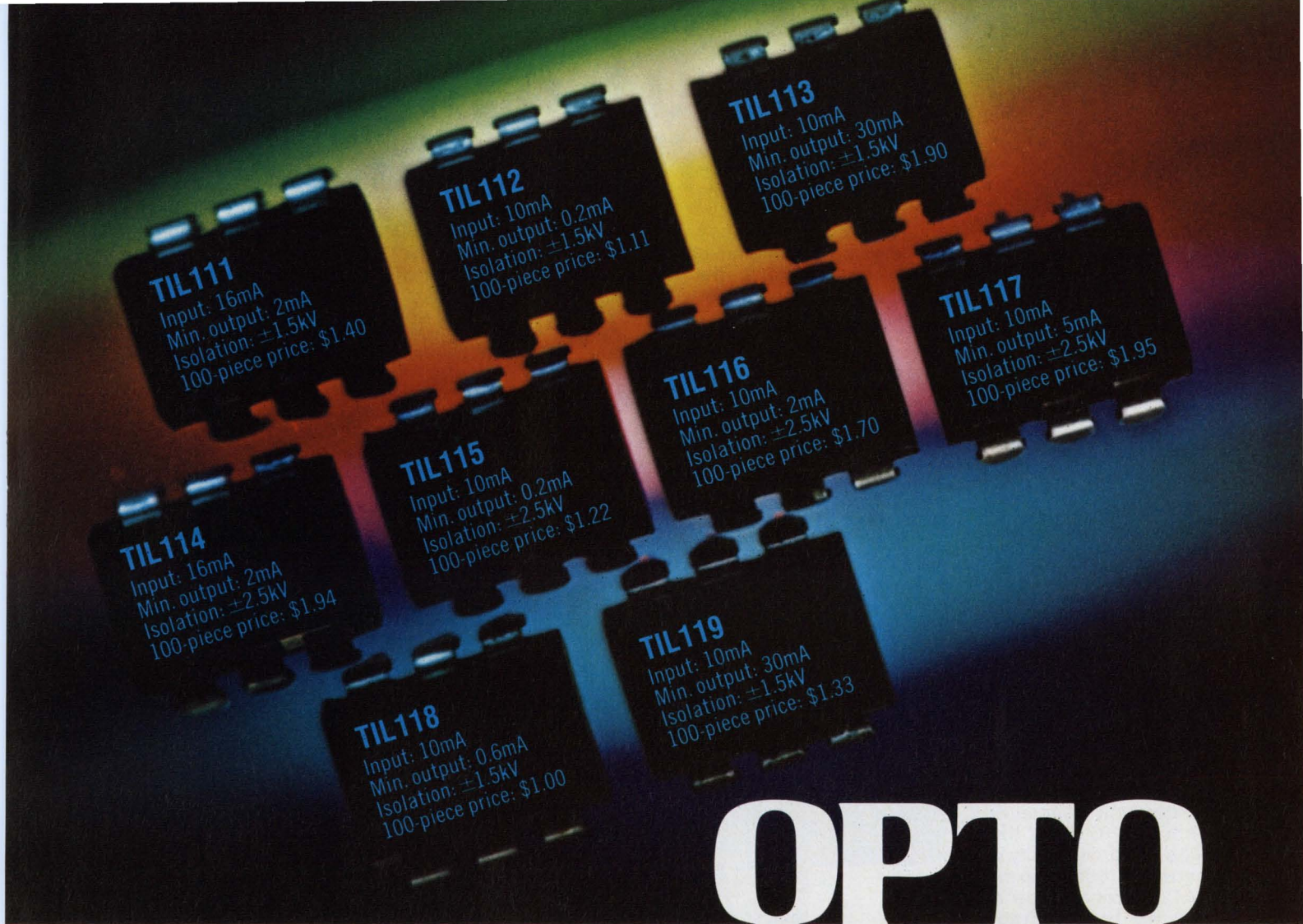

OPTO

The right coupler at the right (very low) price.

You'll find it in TI's big new opto isolator line.

TI's newly expanded optically coupled isolator line now gives you two ways to lower system costs.

First, TI's broad selection (including six new units) allows you to more closely match device performance and circuit requirements. You won't have to pay for more coupler than you need.

Second, they're all available in economical six-pin plastic dual-in-line packages — at prices up to 50% lower than you'd expect to pay. For example, TI's TIL118 is \$.88 in 1000-piece quantities.

Also available: Metal can couplers.
If you need hermetically sealed units, TI also has these metal can JEDEC-registered optically coupled isolators:

Device type	Current transfer ratio		Electrical isolation rating
	Minimum	@ I _F	
4N22	25%	10mA	± 1 kV
4N23	60%	10mA	± 1 kV
4N24	100%	10mA	± 1 kV

A call to your local TI distributor (he's already well stocked) can get you quick quotes on the devices you need. Or call your local TI sales office.

But broad choice at low cost isn't the whole story.

TI introduced the industry's first optically coupled isolator back in 1965 — and since then has amassed more design and volume production experience than any other supplier. The result: Excellent availability, unsurpassed quality, proven reliability.



TEXAS INSTRUMENTS
INCORPORATED

When you look inside, you won't see much-

Advanced LSI design, only \$299. For the money, no multimeter digital or otherwise gives you higher accuracy, more protection, greater sensitivity or better reliability. And no one matches Fluke's no-nonsense year long guarantee or 48-hour turnabout service in the U.S., Canada, Europe or the Far East.

In the short time since introduction, our new 8000A LSI multimeter with 26 ranges and five functions has become the standard of excellence in the low cost field. Thousands of satisfied users all over the world are using the 8000A daily to diagnose service problems and analyze design of electrical and electronic circuits.

Some like using the 8000A on the bench to make in-circuit checks on fets, diodes, and other active circuit elements. Others like the extra capability of our big 600 ampere AC current probe or 30 KV high voltage probe. Perhaps even more go for the calculated 20,000 hour reliability factor, wide choice of options or simplicity of Fluke's LSI design—our two LSI circuits are equivalent to more than 3,000 electronic com-

ponents! And the 8000A has a unique self-zero capability to eliminate offset uncertainty in your readings.

But make up your own mind about this fine new low cost multimeter from Fluke. Here's what you get: 26 ranges to measure voltage from 100 μ V to 1200 V, AC and DC, current from 0.1 μ A to 2A AC and DC and resistance from 0.1 ohm to 20 megohms. Basic DC accuracy is $\pm 0.1\%$ of reading. Specifications carry a year's guarantee. Fluke gives you 48-hour turn-around on repairs. Wide range of low cost options include an internal rechargeable battery pack, digital printer output, high voltage probe, high AC current probe, carrying case, deluxe test leads, and rack mount adapters.

Try one for fifteen days, with our no obligation return privilege. We invite you to participate in our special trial offer and "ask the man who owns one" deal. For details call your local Fluke sales engineer. In the continental U.S., dial our toll free number, 800-426-0361 for his name and address. Abroad and in Canada, call or write the office nearest you listed below.

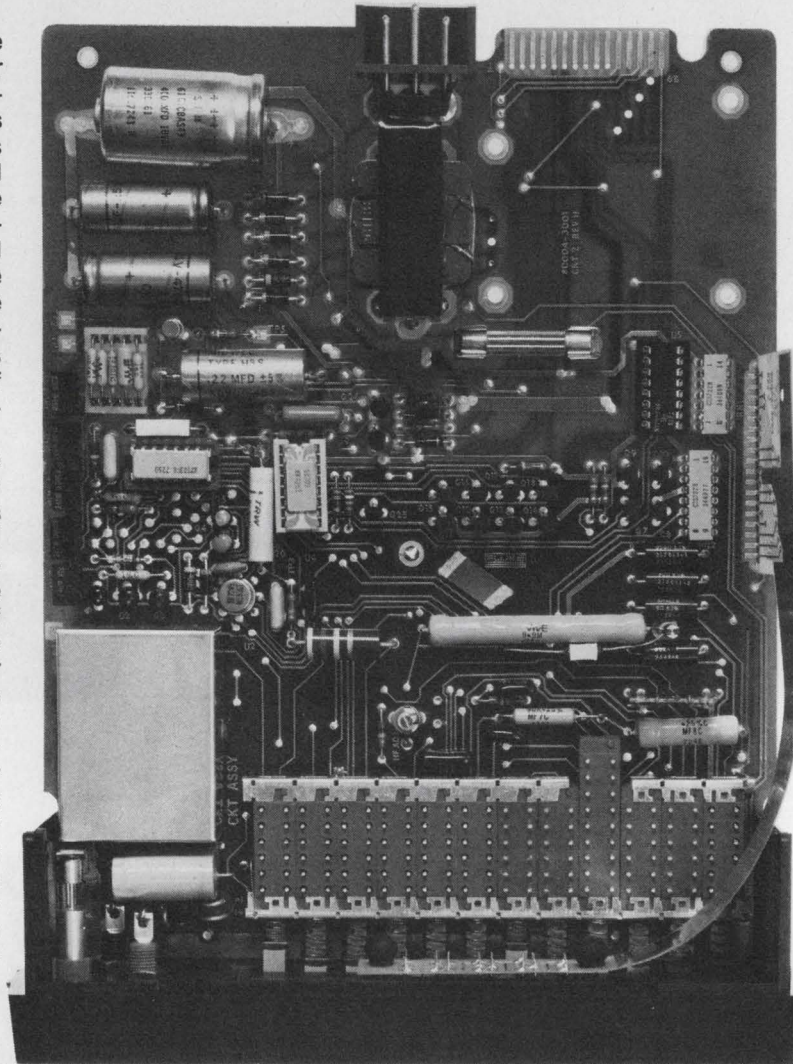

but quality.

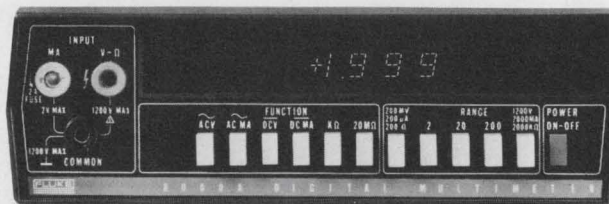

Buy it with your American Express, BankAmericard or Master Charge Card.



For details call your local Fluke sales engineer. In the continental U.S., dial our toll free number, 800-426-0361 for his name and address. Abroad and in Canada, call or write the office nearest you listed below. John Fluke Mfg. Co., Inc., P.O. Box 7428, Seattle, Washington 98133. Phone (206) 774-2211. TWX: 910-449-2850. In Europe, address Fluke Nederland (B.V.), P.O. Box 5053, Tilburg, Holland. Phone 13-673973. Telex: 844-52237. In the U.K. address Fluke International Corp., Garnett Close, Watford, WD2 4TT. Phone, Watford, 33066. Telex: 934583. In Canada, address ACA, Ltd., 6427 Northam Drive, Mississauga, Ontario. Phone 416-678-1500. TWX: 610-492-2119

INFORMATION RETRIEVAL NUMBER 19

INFORMATION RETRIEVAL NUMBER 20 ►

OPEN WIDE AND SAY "Ahhh... Now that's what I call a **SNAP SWITCH CATALOG!"**



Send for this new Cherry Handbook and Guide

Just what the doctor ordered: "instant access" and "tell-all data" on scores of basic Cherry Snap-Action Switches and tens of thousands of variations. Complete with the unique Switch Selector-Locator that lets you choose—in seconds!—the right snap switch for any application. Plus engineering drawings, specifications, operating characteristics and technical data. Plus, never-before-published "inside" information on Cherry's plant facilities, equipment, in-house manufacturing capabilities and worldwide sales offices. All in a handsome new, easy-to-use 72-page format. **And it's yours for the asking: Just TWX 910-235-1572 . . . or PHONE 312-689-7702 . . . and ask for Frank.**



CHERRY

CHERRY ELECTRICAL PRODUCTS CORP.
3609 Sunset Avenue, Waukegan, Illinois 60085



Cherry affiliates worldwide • Hirose Cherry Precision Co., Ltd., Tokyo • G. W. Engineering Pty. Ltd., Sydney
Cherry Electrical Products (U.K.) Ltd., St. Albans, Herts • Cherry Mikroschalter GmbH, Bayreuth, Germany

This is all the voltage you need for a 100-watt solid state SSB mobile transceiver

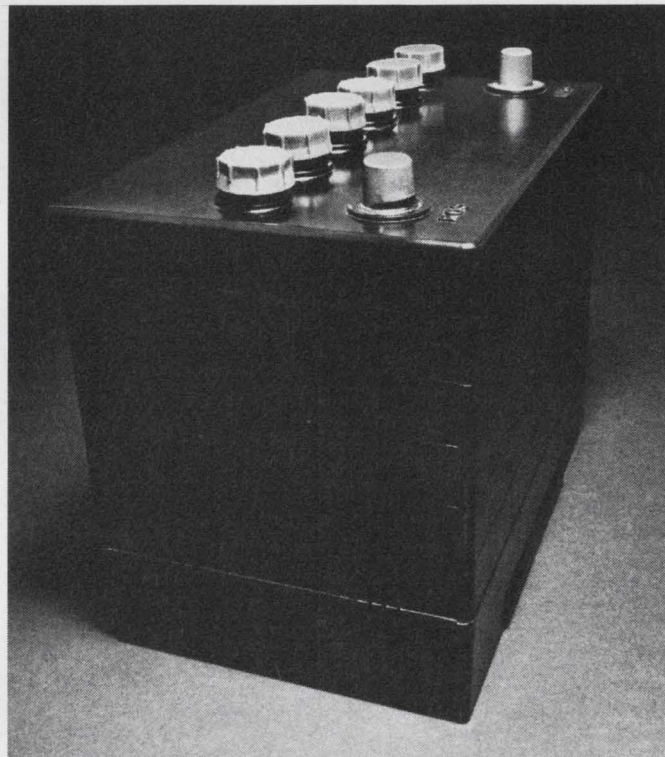

TRW's family of 12-volt linear RF power transistors makes it possible. And the total equipment cost is comparable to tube designs.

Since they operate directly from a 12-volt DC source, these new transistors immediately eliminate the need for DC conversion in mobile designs. And they'll withstand open and short circuit VSWR at 16V in a broad-band circuit at full power output. Intermodulation distortion is better than 30dB.

To make these benefits more immediately available to you, we have designed a solid state 100-watt broad-

band linear power amplifier using our transistors! It operates on 12 volts DC, covers the 1.5 to 30MHz band, and provides superior performance and reliability in SSB applications.

Our Application Note CT-113-71 describes this design in detail, including performance characteristics, parts lists, P.C. board and component layout.

For a copy, call or write Sales Manager, TRW Semiconductors, an Electronic Components Division of TRW, Inc., 14520 Aviation Blvd., Lawndale, Calif. 90260. (213) 679-4561.

TRW SEMICONDUCTORS

INFORMATION RETRIEVAL NUMBER 21

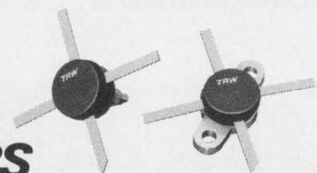

II developments spur laser communications

Since the laser was first discovered, researchers have predicted that it would be used in communication systems to provide greater channel capacity. That day has been brought a bit closer to reality with the announcement of two developments by Bell Laboratories, Murray Hill, N.J. They are:

1. An improved solid-state laser that has an expected lifetime of 10,000 hours.
2. High-efficiency light fibers that can be fabricated from a single material.

Although the early laser work was carried out with gas devices, emphasis soon shifted to solid-state lasers after they were announced in 1970. But the first solid-state devices were able to operate continuously at room temperature for only a few hours—impractical for use in optical communication systems.

After studying the problems, Bell scientists have now come up with a way of greatly extending the lifetime of the laser. According to Dr. Bernard C. DeLoach, head of the Gallium Arsenide Laser Dept. at Bell, the early devices had flaws in the material. These consisted of holes, into which foreign particles, such as dust, could enter and block the light source. By paying closer attention to the processing and handling of the device, Bell has stretched the lifetime. "The laser has been operating for more than three months continuously," De Loach reports. Measurements and calculations indicate that it will probably last for about nine months more.

While this increase is impressive, it still is not satisfactory. To use it in communication systems, says DeLoach, the laser should have a lifetime of about 10 years.

In addition to a reliable, low-cost source of laser light, optical

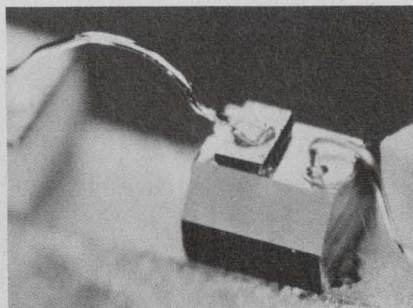
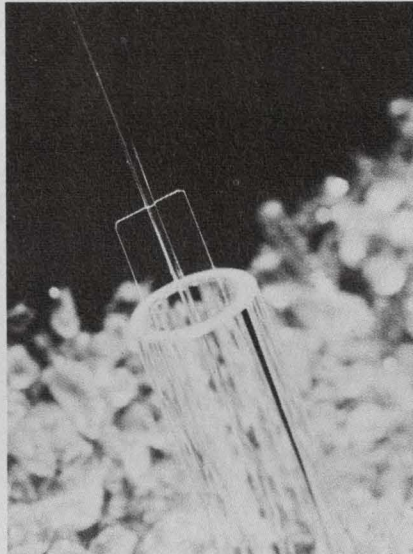

New optical fiber (top) and an improved solid-state laser (bottom) bring laser communication systems a step closer.

communication systems require an efficient transmission medium. To fill this need, Bell Laboratories has developed low-loss optical fibers. In contrast with earlier clad fibers that used two different types of material, the new fiber is unclad and made from a single material—a pure, commercially available type of glass.

By using an unusual type of fiber construction consisting of a tube, a solid inner rod and a supporting plate for the rod, Bell eliminated the need for two different types of glasses without sacri-

ficing the light-carrying efficiency of the fiber. In operation, the solid glass rod becomes the light-carrying central core of the fiber, while the plate provides support for the rod without allowing light to escape. The outer tube provides overall support and protection for the fiber.

The low loss of the new fibers—only 5 dB every 3300 feet—means that repeaters can be placed farther apart in an electrical one. For a twisted pair repeaters are currently placed five miles apart. In the optical system this could be increased to every eight miles.

Consumer electronics adding sophistication

Greater sophistication in the design of entertainment products were in evidence at the Consumer Electronics Show in Chicago last week. The advances displayed included these:

- The incorporation of automatic control features in black-and-white TV for easier tuning, as with color sets.
- Small, three-way portable TVs for use in cars, boats at home or in the field. Considerable effort is being extended to make these sets more compact.
- The use of solid-state devices, such as bucket brigades and assemblies of green and red LEDs, in products like tape recorders and radio tuners.

In one automatic-control circuit in Motorola's black-and-white TV line, the combined brightness and contrast can be preadjusted. Both functions are then operated simultaneously. In another arrangement called the "quick-set," a single control adjusts the horizontal frequency while also balancing brightness and contrast to preset levels.

Several portable solid-state black-and-white TVs capable of operating on ac, dc or even dry cells were on display at the show. Motorola featured a nine-inch set and Panasonic a Superslim five-inch set in which the picture tube has been redesigned to reduce its over-all length from seven inches to 4-3/4. At the same time Panasonic engineers have developed a 120-degree deflection system together with new driving circuits to reduce the high-

current usually required for this large angle.

Television sets that operate from standard dry cells were shown, Hitachi with a seven-inch model and Panasonic with a five-inch set. For the Panasonic set, nine D cells last three hours, and alkaline cells are good for eight hours.

Advanced solid-state bucket-brigade devices were demonstrated by Panasonic in a prototype of a voice-operated tape recorder. The bucket brigade delays the input audio signal long enough for the tape to reach operating speed. The brigade stores initial syllables, and with this arrangement no syllables are lost.

Zenith privately demonstrated a new tuning system in which red and green LEDs replace a tuning meter. The diodes were mounted on a radio tuning dial pointer with a green in the center and red on each side. If the station is not tuned properly, either of the red devices glows. When exactly in tune, the green LED lights up.

A new small calculator and new chip available

A new scientific calculator by Hewlett-Packard and a new calculator-chip line by Cal-Tex Semiconductor, Inc., have been announced.

Hewlett-Packard's battery-powered, hand-held calculator—the HP-45—is identical in size and keyboard format with the HP-35, but with several added functions, is a substantially more powerful machine.

The HP-45, which sells for \$395, can perform several types of calculations not available in the HP-35 (now selling for \$295), according to Peter Nelson, sales promotion manager for Hewlett-Packard's Advanced Products Div. in Cupertino, Calif. These calculations include operation with trigonometric functions that can be performed in any of three selectable angular modes—degrees, radians or grads (European system)—with instant conversion to or from degrees, minutes and seconds.

Polar coordinates in any of the four quadrants can be converted

with the HP-45 to rectangular coordinates or vice versa, Nelson points out. Also, vector components may be directly added or subtracted.

The increased power of the HP-45 is due in large part to inclusion of nine addressable memory registers, as contrasted with one in the HP-35. A 10th register is also built into the HP-45 for automatic storing of the last input of a calculator. This register is used for error correction or for multiple operations on the same number.

The unique four-register operational stack of the HP-35 is retained in the HP-45.

The user can change the display of the new calculator by depressing a key from medical scientific notation or the reverse.

Cal-Tex Semiconductor of Santa Clara, Calif., is offering prototypes of a new line of adding-machine-type calculator chips, the CP5030/31. Significant features, according to William Micheletti, VP of Engineering, include the following:

- Production of the MOS chips in the depletion mode—a two-step, ion-implant process.

- Inclusion of self-test logic that is sequenced by a test key closure.

- A self-contained clock on the chip.

- Calculating provisions for automatic squares, reciprocals and discounts, as well as averaging.

Use of the two-step, ion-implant process, Micheletti says, gives a wider voltage-supply range, smaller current drain and faster operation.

Shortcomings noted in solid-state surgery

"Going solid-state" is not always the ideal solution—specifically not for electrosurgical equipment—according to a recent report by the Emergency Care Research Institute, Philadelphia. The report states that while the new solid-state machines are smaller, lighter and often safer than the older spark-gap units, they generally don't perform as well and often have a lower output power.

The machines provide high-frequency, high-energy signals that surgeons use to cut into a patient. Dr. Joel J. Nobel, director of the institute, which advises hospitals and health professionals, says that the poorer performance of the new machines can be attributed to the output waveform. The waveform of the older units is generated by a spark-gap signal that contains considerable "hash" and can cause radio-frequency interference, Dr. Nobel asserts. The "hash" is necessary for blood coagulation, he says.

The report is available from Health Devices, ECRI, 913 Walnut St., Philadelphia, 19107.

Les Brenner, marketing manager for Liebel Flarsheim of Cincinnati, Ohio—which manufactures both types of devices—agrees that there is a problem with the coagulation mode of the new machines. "The solid-state units still cut a little when they're in the coagulation mode," he notes.

About the only way to overcome this problem, Dr. Nobel speculates, is to simulate the waveform of the spark-gap machine.

News Briefs

An optical character-recognition system for high-speed computer data entry that sells for \$30,000—or less than one-half the cost of its nearest competitor, the IBM 3886, Model 2—has been announced by Decision, Inc., of Oakland, Calif. The OCR 7600 is said to be capable of interfacing with all major computer systems in use today. It can read up to 600 characters per second, numeric or alphanumeric, in a va-

riety of fonts; data from typewriters; preprinted forms; computer printouts and numeric hand printing.

A monolithic chopper stabilized operational amplifier with a FET input will be introduced by Harris Semiconductor, Melbourne, Fla., in the beginning of July. If no one beats them to the punch, it will be the first all-monolithic device of its type.

ASSURE
PRECISE
OUTPUT
CONTROL
for
EVERY
APPLICATION



**SPECIFY
BOURNS®
PRECISION
POTENTIOMETERS**

10, 5, 3, and Single Turns

Less than 0.5% Return Rate

Exclusive SILVERWELD®
Termination

1 1/16" · 1 1/16" · 1/8" · 3/4" · 1/2" Diameters

Wirewound and Nonwirewound Types

Competitive Pricing

Bourns matchless precision potentiometers are stocked in-depth at your local Bourns Distributor. Contact the one nearest you for price and fast delivery.



That lowly calculator is turning into a vest-pocket computer

With over 400 different electronic calculators now being produced by more than 50 manufacturers—a bewildering array of sizes, types and capabilities, reminiscent of the introduction of the transistor radio—one thing is clear: The calculator is no mere electronic Comptometer. It is growing in sophistication and is emerging a miniature computer.

Among the major trends apparent today are these:

- Calculator-chip manufacturers have developed generic chips that, with relatively inexpensive change of a mask, can produce a line of calculators with individual differences in function and in calculating capacity. This is allowing low-cost, mass production of custom calculator circuits.

- More of the discrete components formerly off the chip are being placed on it. These include gas and fluorescent-tube display drivers, LED segment drivers and clock oscillators. This is cutting the cost of manufacturing and assembling calculators.

- The number of pins in the chip package is being reduced by matrixing the keyboard inputs and multiplexing them with the display digit and segment drivers. This is simplifying calculator design.

- Features are being incorporated to prevent the erroneous entry of digital data into the calculator through bouncing of key contacts, noise or accidental depression of more than one key.

- Techniques are being spurred to triple or quadruple the life of batteries in portable calculators.

Ranging from small, hand-held units to simple desk models and on to more complex printer models

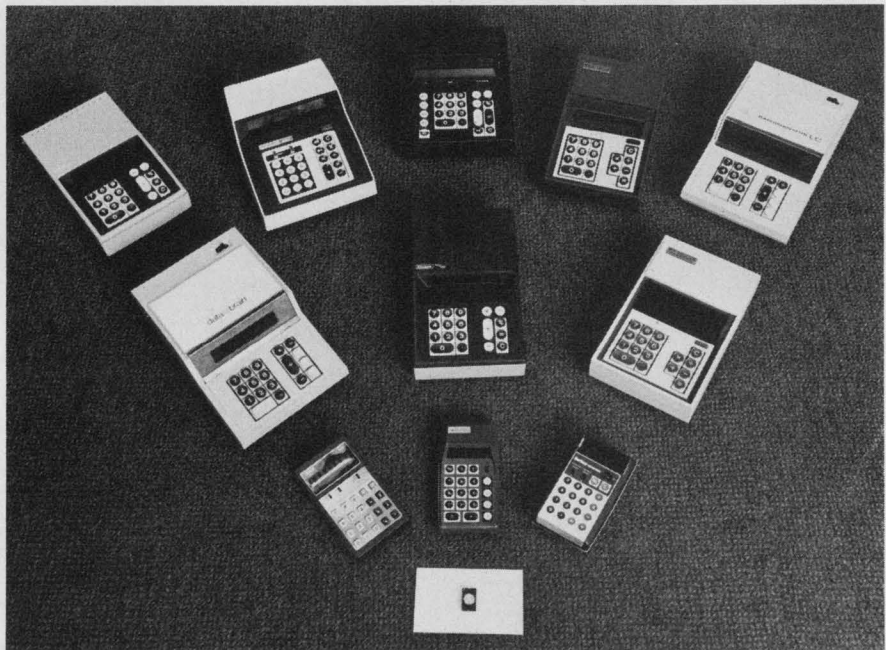

These 11 versions of same basic electronic calculator are produced at Rockwell International by changes in the microprogram in the generic chip.

and programmable machines, today's calculators are still an electronic enigma to many engineers. How does the circuitry operate? Which is the best calculator to buy? The situation is compounded by a new jargon that has arisen in connection with the design specifications of these miniature computers.

Basic calculator is simple

The basic calculator—particularly the mass-produced hand-held and desk units—is simple. It consists of six elements:

1. An IC calculator chip (or chips).
2. A keyboard.
3. A display.
4. A display interface circuit or component.
5. A power supply (battery or ac).

6. A case.

In early calculator designs, chips were fabricated to provide a specific machine. To revise, add to or change functions meant a costly redesign of the chip. Today chip manufacturers have developed generic, microprogrammed calculator chips that can be modified in function by changes in the information in memories on the chip. A simple mask change is all that is necessary.

As a result, lines of calculators have been developed from each of the generic chips. For example, at least 11 different calculators have been produced from the same basic chip by Rockwell International Microelectronics Div. of Anaheim, Calif. (see photo).

According to Jerry Moffitt, MOS marketing manager at Texas Instruments, Dallas, that company's basic TMS 0100 one-chip

calculator (Fig. 1) has given rise to 30 different calculators.

While most four-function calculator chips can, with proper programming, duplicate the functions of competitive chips, they differ in details. For example, TI uses an external clock while Rockwell International puts its clock on the chip.

The trend, however, is to put more and more of the interfacing

cent displays, because the LED is a high-current device. Although individual LED segment drivers are now appearing on chips, the full seven-segment digit current is too high for standard MOS on-chip transistors. As a result, either discrete digit-driving transistors alone or digit and segment drivers together may be used.

A way to eliminate the discrete LED driving elements is beginning

matrix. Four lines return the keyboard entries into the chip.

Prominent in calculator specifications is key-bounce protection or "key debounce" circuitry. This feature prevents an added digit from being entered into the calculator by bouncing of the key contact elements when the key is depressed.

One method used to provide this protection is the connection of ex-

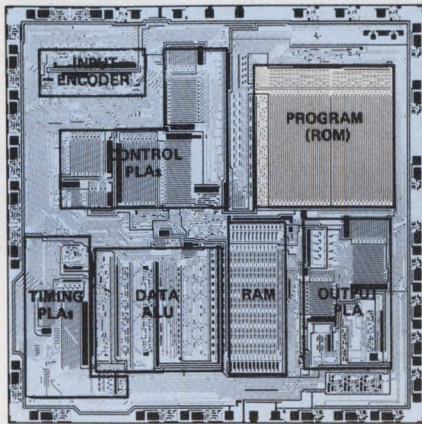

1. The heart of today's electronic calculators is a small microprogrammable MOS-LSI microcomputer dedicated to calculating functions. The compartmentation of functions on Texas Instruments' TMS 0100 calculator chip, used in 30 versions, is shown above. The microprogram is contained in the program ROM. A functional diagram of TI's calculator chip is shown at right.

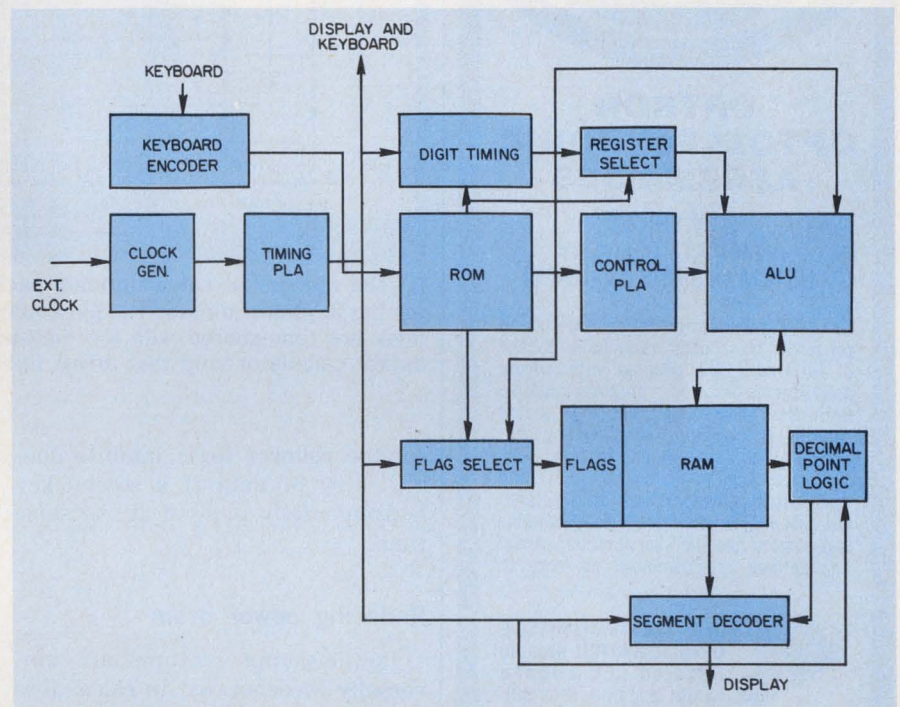

circuitry and components on the chip to reduce the calculator manufacturer's costs. For example, Richard Eiler, product marketing manager of Electronic Arrays, Inc., Mountain View, Calif., points out that in his company's S129—a 12-digit, two-chip set designed for the Burroughs Panaplex display—high-voltage MOS buffers that can withstand the 50 to 60 V for the display have been put on the chip.

Calculator chips, he continues, are generally tailored to drive a specific display. While Nixie tubes are used in some of the more expensive desk-top business machines and programmable calculators, the displays for the smaller machines are of three principal types: gas-discharge, fluorescent tubes and LEDs.

More interfacing driver circuitry is needed for LEDs than for the gas-discharge or fluores-

cent displays, however, IC packages have been developed with the driver elements on a separate chip.

A way to minimize costs

To minimize costs, calculator chip manufacturers use a matrix for the keyboard inputs or a binary-coded decimal input scheme. In some chips they reduce the pin count further by putting the keyboard input lines on the display output lines and time-sharing them.

"Most of the inexpensive machines use a matrix input," says Eiler, "because the keyboard is cheaper. The matrix provides an X-Y grid, and every time a key is closed an X is connected to a Y line."

In National's arrangement (Fig. 2) the eight digit-select lines also scan, or strobe, the keyboard, which is arranged as an 8-by-4

ternal RC circuits to the input lines. The RC time constant prevents excessively fast changes of voltage across either the closing or opening keyboard contacts, thus smoothing transient contact disturbances.

Another method of bounce protection—one currently in vogue—is to combine the debounce circuitry with the keyboard matrix decoding timing. In this case the closure or opening is scanned two or more times, and protection is provided by a series of latches and interlocks operated from the internal clock timing (Fig. 3).

"Rollover"—or, more accurately, rollover protection—is another term specified by chip manufacturers. When incorporated in the keyboard logic system, this feature prevents more than one key from entering data at a time. For example, when one key is depress-

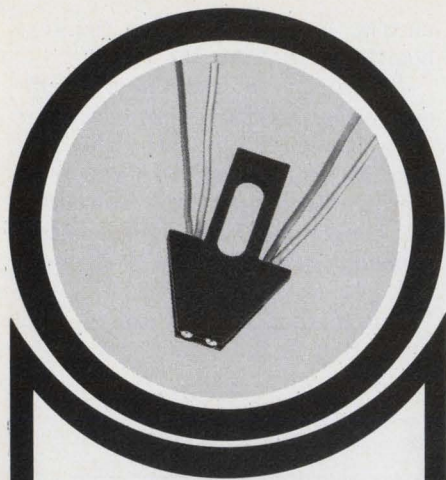

OPTRON OPTOELECTRONIC ASSEMBLIES

LOW PRICED
IMMEDIATE DELIVERY
CUSTOM DESIGNS AVAILABLE

OPTRON transmissive optical switch and reflective transducer assemblies consist of infrared LED's coupled with silicon phototransistors or photodarlington. Both use discrete hermetically sealed devices for maximum reliability and sensitivity. The assemblies feature non-contact switching, TTL compatibility and fast switching speeds. Low priced standard assemblies are immediately available and custom designed versions for special applications are available on request.



OPB 120 TRANSMISSIVE OPTICAL SWITCH uses an infrared LED aligned across a gap with a silicon phototransistor. The

OPB 120 replaces mechanical switching elements with solid state dependability. Typical applications include rotary encoders, tachometers and motion sensors. Standard gap widths are 0.125 and 0.200 inches.



OPB 125 OPTOELECTRONIC REFLECTIVE TRANSDUCER consists of a gallium arsenide infrared LED coupled with a silicon phototransistor in compact low-cost molded plastic housing. It has

extremely high sensitivity and is ideal for such applications as EOT/BOT sensing, line finding, and edge and flaw detection.

Detailed technical information on these and other OPTRON optoelectronic products . . . chips, components and PC board arrays . . . is available from your nearest OPTRON sales representative or the factory direct.



OPTRON, INC.

1201 Tappan Circle
Carrollton, Texas 75006
214/242-6571

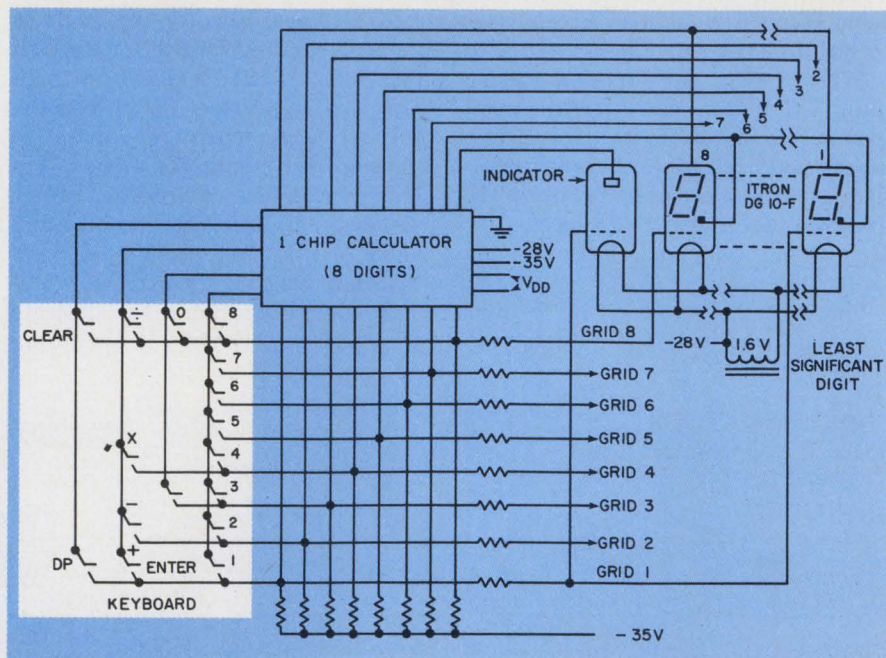

2. The number of calculator-chip package pins is reduced by use of a matrix for the keyboard inputs. The pin count is further lowered if the keyboard input lines are time-shared with the digit-select lines, as in this National Semiconductor calculator chip that drives fluorescent display tubes.

ed, the rollover logic inhibits double entry of data if a second key is accidentally pressed at the same time.

Reducing power drain

Power-saving features are universally incorporated in calculators designed for battery operation. A typical feature is a display blanking. With this circuit on the chip, the depressing of any key initiates a blanking signal that turns off the display after 10 or 20 seconds of keyboard inactivity. A decimal point or single segment remains lighted to indicate the machine status. While this circuit is usually on the chip, its timing is controlled by an external capacitor or an RC network.

Another trick to save power drain is to reduce the clock frequency when the machine is idle. Because the MOS circuits draw power only on transitions, the operating power thus saved is proportional to the reduction in clock frequency. This can be as much as 2:1.

For the majority of four-function electronic calculators—exceptions include the specialized, complex scientific and business machines—there are two basic calculation methods and two types of

calculator keyboards.

One is the adding-machine calculator, while the other is the algebraic. Both are available frequently from the same manufacturer in different models. The clue to identifying each can, almost without exception, be found in the layout and design of the keyboard (Fig. 4).

For the adding-machine version—also called a “business machine” by some manufacturers—look for two keys, one containing a (\pm), and the other with a (\equiv). The algebraic version has separate (+), (-) and (\equiv) keys.

The algebraic machine is easier to use, because it operates the way one naturally thinks. For example, to subtract 3 from 5, the keys are pushed in the following order: (5) (-) (3) (\equiv), and the answer 2 appears.

In an adding-machine version, for the same problem these four keys are pushed in this sequence: (5) (\pm) (3) (\equiv) and the answer 2 appears. In this machine each time a number is entered for addition, the user adds it to or subtracts it from the running total.

However, multiplication and division are performed sequentially, as in the algebraic machines.

The following major factors should be considered in selecting

Heinemann Type J. Outside, something for your customers.

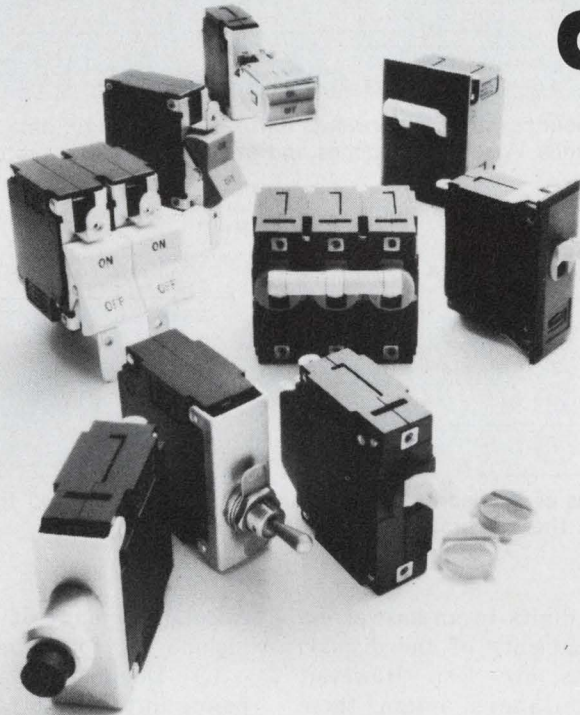

A word to those of you who've been considering our hydraulic-magnetic breakers only in terms of reduced component and service costs—your customers may like the way they look on your equipment.

Heinemann Type J, for instance. This uncommonly versatile design is based not only on the tasteful use of form and color, but on some down-to-earth human engineering criteria as well.

We offer a choice of packaging that includes two types of toggle actuator, a rocker handle, and both lighted and unlighted pushbuttons. There's also a snap-in model that installs without hardware to reduce your assembly costs.

Inside, something for you.

Inside, our handsome, economical, and inherently reliable Type J breakers offer some intriguing possibilities in switching, protection, and control. (By applying one of our eight special-function internal circuits to a knotty design problem, you could become a hero in your company.)

Consider what you could do with a breaker that trips on current or voltage changes *in another circuit*... a breaker whose trip point is adjustable... another that controls not one, but two loads per pole... a single-pole breaker with two coils: one for overload protection, one for a separate control circuit. New this year is trip-alarm—built-in SPDT or DPDT contacts that actuate when the breaker trips electrically, but not when it's manually switched.

Our new Bulletin J-3333 gives a thorough airing to many such ideas based on actual applications of these internal circuits. You can obtain a copy by writing to Heinemann Electric Co., 2626 Brunswick Pike, Trenton, N.J. 08602.

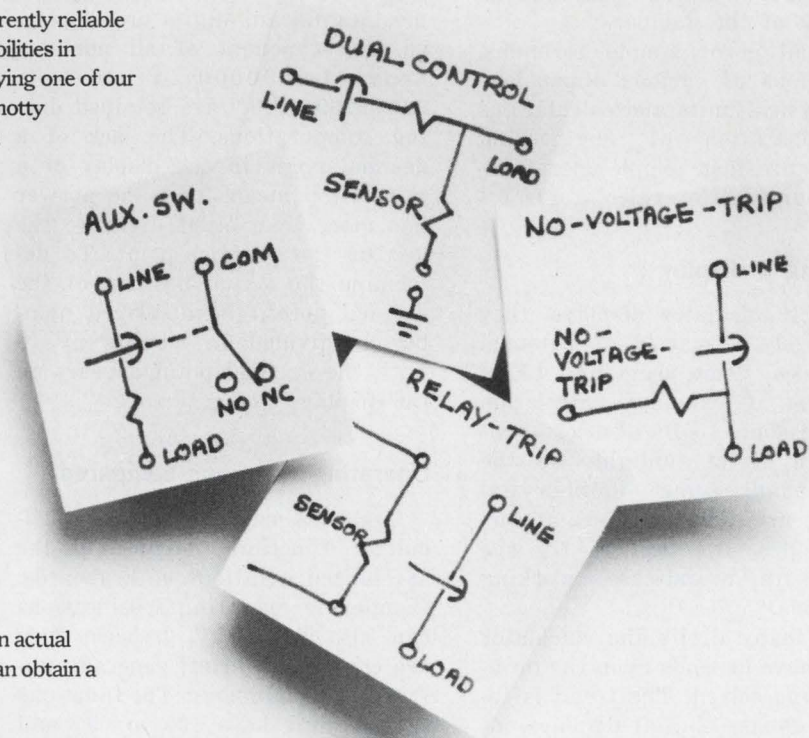

HEINEMANN

INFORMATION RETRIEVAL NUMBER 24

an electronic calculator:

- Calculating requirements.
- Display considerations.
- Power-supply considerations.
- Keyboard-function capabilities.
- Automatic-function (internally programmed) capabilities.

Where complex, scientific calculations involving trigonometric, logarithmic, angular and nonlinear functions are a part of the day's work, specialized calculators—either hand-held, desk-type or large programmable machines—are the logical choice. Examples of recently developed hand-held types are Hewlett-Packard's HP 35, Compu-corp's 324G, Texas Instrument's SR-10 and Rockwell International's new ESR. Dietzgen has a small desk-top equivalent of these, the ESR-1.

However, with a simple four-function calculator—having an automatic or insertable constant and at least one memory—both chain and mixed calculations can be readily performed.

Experience has shown that users of calculators—like slide-rule users—are continually finding shortcuts to solve fairly complex computations. Types of problems that can be solved with little difficulty include raising a number to the *n*th power, finding the power to which the number is raised or finding the *n*th root of the number.

Evaluation of simple formulas, conversions of various dimensions and physical units and calculations in preparation of engineering budgets are fast, simple operations with four-function calculators.

Choosing a display

As for calculator displays, they are largely a matter of personal preference. Some users find LEDs fatiguing if extended calculation must be done. LEDs also lose visibility in direct sunlight. On the other hand, some liquid-crystal displays are difficult to see at certain angles. It's best to try the display in worst-case working conditions.

How many digits the calculator should have depends upon the problems to be solved. The trend is toward eight or 12-digit displays, although as few as six digits and as many as 16 are available.

With most calculators, if the

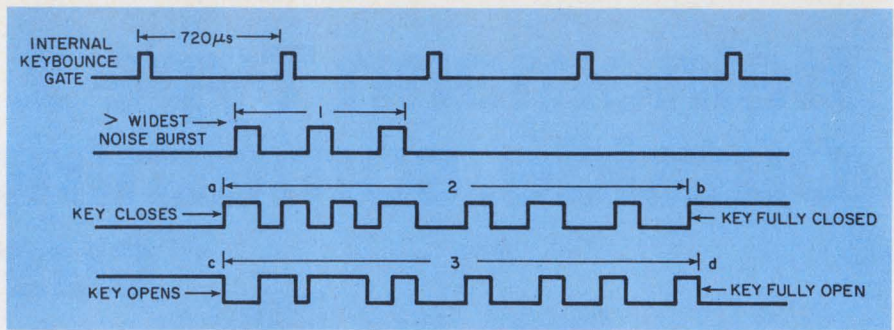

3. Key debounce circuitry prevents false entry of digit data resulting from contact bounce. A series of latches and interlocks provide protective intervals.

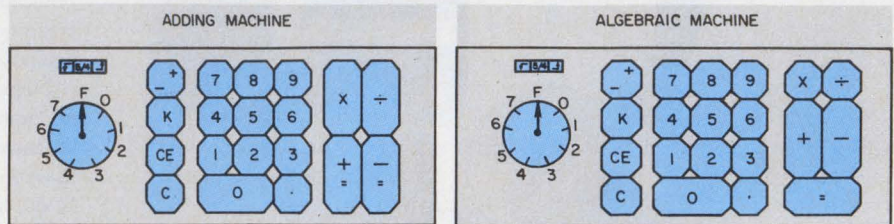

4. Two types of keyboards—adding and algebraic—are used for four-function calculators. The algebraic operates the way a person thinks.

number of digits in an answer exceeds the capacity of the display, these digits are lost. However, some calculators retain these digits. They can be displayed, usually by dividing or multiplying by powers of 10.

For example, in some of General Instrument's eight-digit, single-chip ICs, although only the eight most-significant digits are displayed, the exponent of all numbers from $1.0000000 \times 10^{-20}$ to 9.9999999×10^{19} are retained during computations. The lack of a decimal point in the display of a calculation means that the answer has more than eight digits to the left of the decimal point. To determine the actual position of the decimal point, the displayed number is divided by powers of 10 until the decimal point appears on the display.

Operating functions compared

Problems arise in comparing calculator functions, because of the specialized notations on keyboards. Comparing operating specifications can also be tricky, because they are couched in brief, generally unfamiliar terminology. The functions of the digit keys (0) to (9) and the five principal arithmetic keys of (+), (-), (×), (÷) and (=) are obvious. Other keys found on

calculators, many of them optional, include the following:

(.) **Decimal:** Enters decimal point, initially at far right.

(CE) **Clear Entry:** Clears most recently entered figure without disturbing results of the previous calculation.

(C) **Clear:** Clears entire calculator in most machines. In others, clears all registers except memory storage.

(CA) **Clear All:** Clears all registers. In some cases individual keys are combined. For example,

(CE/C) clears entry with the first stroke and the second stroke clears all.

(K) **Constant:** Permits a constant factor to be saved for further use in multiplication or division.

(EX) **Exchange:** Interchanges multiplier and multiplicand in multiplication or dividend and divisor in division. Or exchanges the contents of two registers.

(M +) **Memory Add:** Adds the number in the display register to the memory register. The display remains the same.

(M -) **Memory Subtract:** Subtracts the number in the display from the memory register. The display remains the same.

(M ±) **Memory Plus/Equals:** Performs any preceding operation and adds this result to the memo-



Powerful, specialized machines, like the \$295 HP-35 (top) and the \$1095 CompuCorp 344 statistical machine (bottom), are available for complex computations.

ry register and to the display.

(M \equiv) Memory Minus/Equals: Performs any preceding operation and subtracts this result from the memory register and the display.

(MR) or (MS) Memory Recall: Displays contents of the memory register without clearing it.

(CM) or (MC) Clear Memory: Clears contents and sign of the memory register only.

(MT) Memory Transfer: Moves the contents of the memory register into the display and clears the memory.

(5/4) Round Off Switch: Rounds off calculation when set. If digit to the right of least-significant digit is 5 or more, increases the answer 1; if 4 or less, truncates the number by dropping off the 4.

(%) Percentage. Divides the number entered by 100.

INFORMATION RETRIEVAL NUMBER 25 ►

monoform

out of the West!

A whole family of switchlights that don't cost much

It used to be you touched a spur to a horse and something happened right away. Nowadays, you lay a finger to a switch that better be even more reliable. And because you may need hundreds of them, they should be low cost and arrive in a hurry. That's the way it is with our Monoform family of switchlights.

Monoform I (the single lamp, momentary & alternate, rated 2 amp 120 Vac).

Monoform II (two independent lamps for horizontal split legends, mom. & alt., 2 amp 120 Vac).

Monoform III (10 amp, ¼ H.P. power switch).

There's a whole family designed by Clare-Pendar to give you more value, more flexibility than any other switchlight that costs just about two silver dollars.



CLARE-PENDAR
Phone 208-773-4541

P.O. Box 785 Post Falls, Idaho 83854 Telex 32-6448



Electronic calculators with printout, like this Unicom 500P, use buffers between the calculator chip and printer.

In all but the lowest-cost calculators certain features are pre-programmed into the chip's calculating routine. These may simplify or speed certain calculations, or they may give indications of what is happening inside the machine that is not reflected in the digits displayed. These features include the following:

Overflow Protection: If a large number that is entered—or if the solution to a calculation—exceeds the capacity of the working register, the excess digits are said to overflow the register. In this case an audible or visual warning is provided, and the calculation is halted in many machines. In others there is additional protection. For example, in machines made from Western Digital's LC-1662B chip, overflow occurs when the calculated result exceeds $10^8 - 1$. An overflow indication appears in the ninth-digit position, and the machine divides the eight most-significant digits by 10^8 , thus moving the decimal point eight positions to the left. The overflow condition is cleared by depression of a clear key, and the calculation can be continued, with the user noting that the results should be multiplied by 10^8 .

Underflow Protection: With this, the machine accepts the full digit capacity of the display for multiplicand and multiplier when using whole-number digits. The left-hand digits of the answer are displayed. For example, in an eight-digit machine, eight whole numbers can be multiplied by eight other numbers, and the display will show the eight left-hand digits of the answer. The eight least-significant digits will not

appear. With Western Digital's LC1662B chip, underflow occurs when the result is less than 10^{-7} , which causes the eight most-significant nonzero digits to be displayed. In this case the digits are multiplied by 10^8 . The user can perform continued calculations by clearing and noting that the results should be multiplied by 10^{-8} .

Automatic-Add Mode: Numbers may be entered to two decimal places without need to enter the decimal point.

Flexy Mode: Numbers may be entered to any setting of the decimal switch or wheel without entering the decimal point.

Floating In: The decimal point need not be preset. The numbers are entered as they would be written.

Floating Out: The decimal point is automatically correct in the answer.

Fixed In: The decimal point is preset and numbers are entered. But digits to the right of the decimal are dropped.

Fixed Out: The machine is preset for the required number of decimal places in the answer.

Automatic Constant: No constant (K) switch is used. For addition, subtraction and division, the number entered following the depression of the (+), (−) or (÷) key is automatically the constant. For multiplication, the number preceding the depression of the (×) key is the constant.

Round Up: The last digit displayed is increased by one if the following digit would have been 1 or greater.

Microprogrammed control: The internal program of the chip generates all the algorithms used in the key-stroke sequence and in the computation. Computation time display is controlled by the ROM. ■■

Electronic Design wishes to thank the calculator chip manufacturers who supplied information for this article. In addition to those already mentioned, the following also contributed: Mostek Corp., Carrollton, Tex., and American Micro Systems, Inc., Cal-Tex Semiconductor, Inc., Nortec Electronics, Inc., and Intel Corp., all in Santa Clara, Calif.

Is Your Copy Gone?

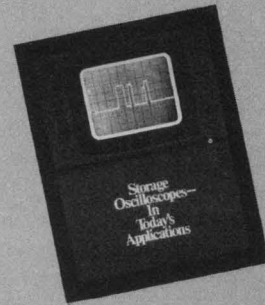

If our informative 16-page brochure "Storage Oscilloscopes In Today's Applications" has been removed from your issue, we'll be happy to send you a copy—FREE.

We're sure that you'll want your own personal copy because it shows how companies use storage and variable persistence to solve their fast, very slow, or momentary signal measurement problems. They're capturing, for easy viewing, those elusive signals that just a short time ago required expensive and time-consuming photography.

And there's a good chance that by reading how other companies solve their measurement problems with today's better-than-average storage and variable persistence scopes, you'll find immediate solutions for your own problems.

If your copy is gone, simply circle the reader service number listed below.

**For New Standards
In Oscilloscopes,
Think HP.**

083/4

HEWLETT  PACKARD

Sales, service and support in 172 centers in 65 countries. Palo Alto, California 94303. Offices in principal cities throughout the U.S.

INFORMATION RETRIEVAL NUMBER 246
ELECTRONIC DESIGN 13, June 21, 1973

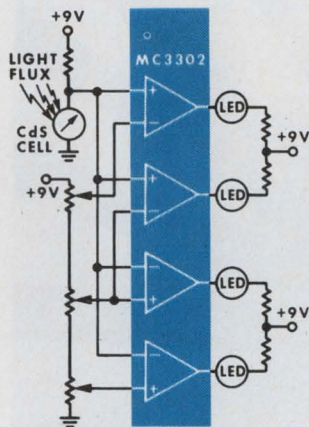

Quad Comparator simplifies light level indicator system.

Quad Comparator sees the light.

Showing Motorola's MC3302P in a handy light level detector system* only hints at the broad range of applications where

this *new* comparator development can conserve space and reduce costs.

We're not talking about situations where one of the excellent single or dual comparators formerly available is still adequate or even required. We're talking about system applications where the use of multiple comparators makes maximum cost reduction and high density design significant.

There are certainly other recommendations for the MC3302P, as well. For example, it is specifically designed for positive single supply operation over a wide +2 to +28 V range. The differential

inputs can handle a broad range of voltage levels, from a full V_{CC} down to ground potential. The output of each comparator is TTL compatible, and can be connected to the other outputs to give the Implied AND function. It has a wider than usual operating temperature range for plastic packaged units, from -40° to $+85^{\circ}$ C.

If you buy from 100 to 999 of these quads, the price is only \$1.50 each — less than 38¢ per comparator. And the MC3302P is the first quad comparator readily available. Just ask your franchised Motorola Distributor or Motorola Sales Office. *By the way, in this specific type of application, one of Motorola's panel mount LEDs would be ideal: either the MLED650 or the MLED655. For additional information on the Quad, write to Motorola Semiconductor Products Inc., P.O. Box 20912, Phoenix, AZ 85036 or circle the reader service number.



Practical innovations for systems design.

INFORMATION RETRIEVAL NUMBER 27

Tape-automated bonding pushed as replacement for chip-and-wire

A new automated chip-interconnection technique described at the recent Electronic Components Conference in Washington, D.C., has stirred wide interest in the semiconductor industry. Semiconductor manufacturers since the middle 1960s have been trying to speed the chip-handling process by automating chip transfer from the wafer to the dual-inline lead frame. Many techniques have been tried, but none has been widely accepted.

The new process—known as TAB, for tape-automated bonding—has been developed by Société Honeywell Bull in St. Ouen, France, as a replacement for the chip-and-wire bonding technique now being used. Honeywell Bull is so confident of its general acceptance that Michel Leclercq, manager of Honeywell's Advanced Processes Laboratory in St. Ouen, predicts that by 1976 about 95% of all the chips used by Honeywell will be made with this technique.

Improvement on Minimod

TAB is an improvement on General Electric's Minimod process, Leclercq told a technical session at the Components Conference. Integrated circuits are first picked up from a sawed wafer and bonded to tin-plated copper lead frames that have been etched from a copper laminated plastic tape. To do this, Leclercq explained, the IC chips must have either gold or solder bumps instead of the conventional aluminum pads.

"Gold-bumped wafers are now available from almost any integrated circuit manufacturer," the Honeywell manager noted.

Once the chips have been bonded

Jules H. Gilder
Associate Editor

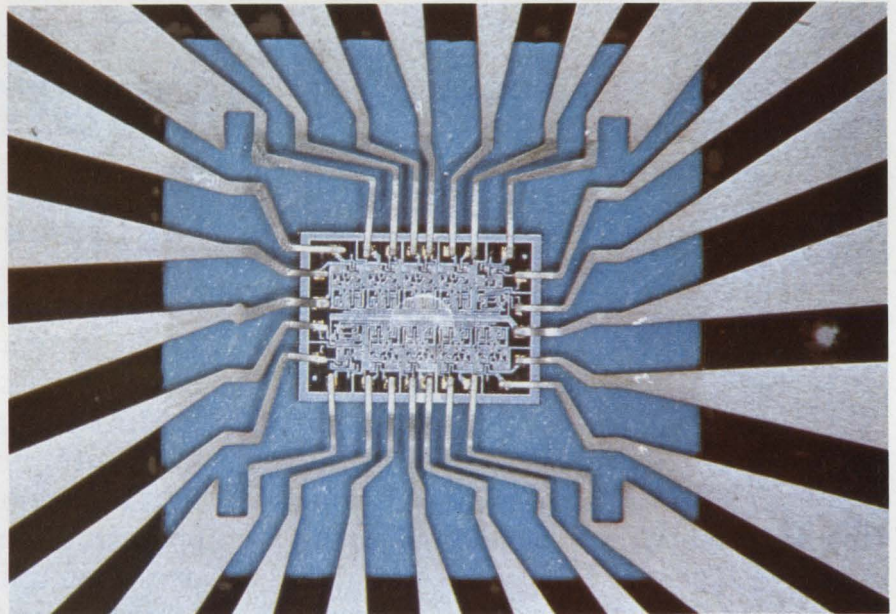

Lead frames used in the TAB process are etched from a metallized plastic film. Devices with up to 72 pins have been fabricated.

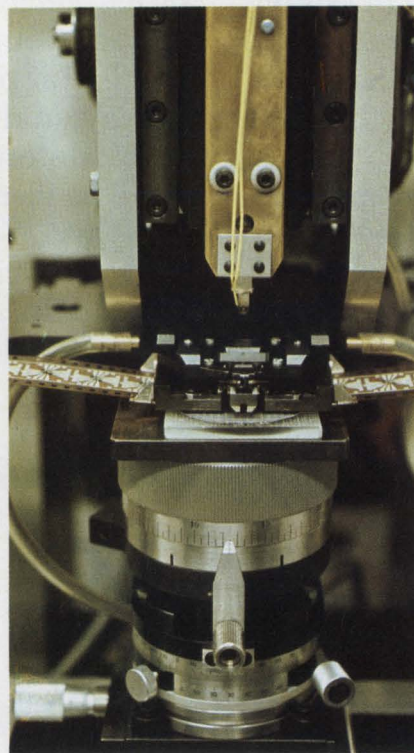

to the tape, they are ready for fast dynamic testing. The ease of testing, Leclercq emphasized, is due to standardization of the location of the outer ends of the leads at the tape level. Even though the pad location on the chips being tested may vary, the test pads on the lead frame will always be in the same position. Thus the same test-probe head can be used for any chip whose pin count does not exceed that of the probe.

Representatives of leading components manufacturers and users in this country crowded around Leclercq, seeking further details, after he had presented his paper. He told *ELECTRONIC DESIGN* that licensing agreements were now being explored with several American companies. ■■

(continued on page 54)

Chips are bonded to lead frames on a metallized plastic tape.

**This member
of our family
is still the
thriftiest ASR
terminal
around.**

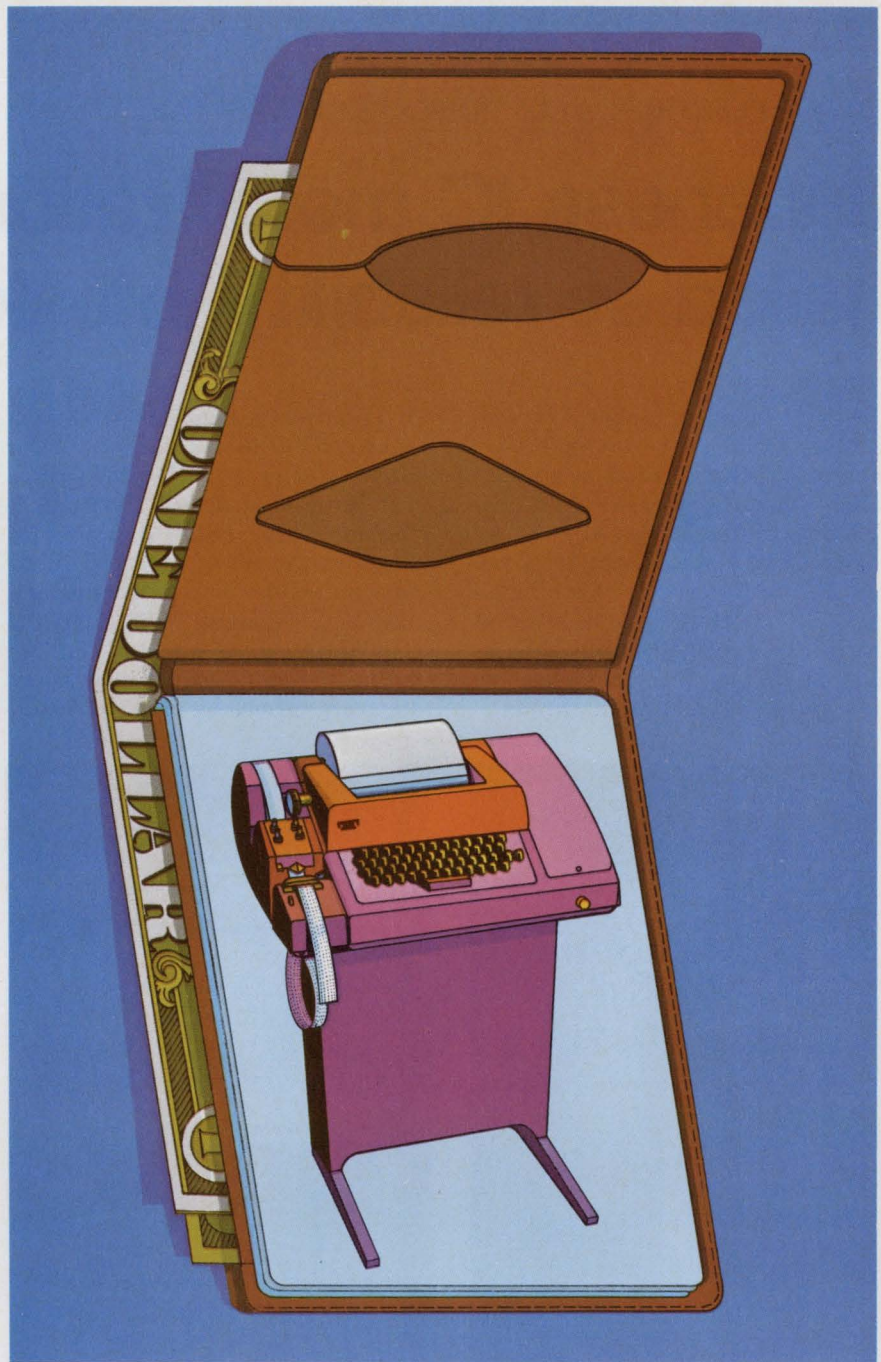

Teletype is a trademark registered in the United States Patent Office.

Dollar for dollar, the Teletype® model 33 is the least expensive, most reliable data terminal in its class. Because once you see how well it performs, you won't believe its price.

That's one reason why the model 33 is the most popular terminal in the industry. But it's hardly the only reason.

The model 33 is designed and built for extremely reliable operation at 100 wpm. And since

it operates on the eight-level ASCII code, it speaks the language most computers understand. Both mini-computers and maxi-computers. Which makes compatibility another reason behind its popularity.

Then there are some reasons you can't see. But they're there just the same. Like complete technical sales and service back-up to help you with installation and maintenance.

Available in three basic configurations, the model 33 is a lot of machine. At a very small price.

It takes more than manufacturing facilities to build the machines Teletype Corporation offers. It also takes commitment. From people who think service is as important as sales. In terminals for message communications and computers.

That's why we invented a new name for who we are and what we make. The computercations people.



The computercations people.

For more information about any Teletype product, write or call: TERMINAL CENTRAL: Teletype Corporation, Dept. 89P, 5555 Touhy Avenue, Skokie, Illinois 60076. Phone 312/982-2500.

INFORMATION RETRIEVAL NUMBER 28

Japanese IC metallization method hailed as reliability 'breakthrough'

A new Japanese planar interconnection technology for multilevel integrated circuits promises higher reliability and increased yield over techniques presently used.

Described at the Electronic Components Conference in Washington by Dr. Seiki Harada, a scientist at Hitachi's Central Research Laboratory in Tokyo, the technique was viewed as a "real breakthrough"

by engineers attending the session.

According to Harada, the technique—known as PMP, for planar metallization with polymer—uses a polyimide film as an insulator instead of silicon dioxide. Since polyimide is a polymer, it has a fluid property that always gives an ideal flatness to the wafer, no matter how many steps are formed by previous metal-

lizations (Fig. a). This contrasts, with silicon dioxide, which follows the contours of the metallization and results in a nonplanar surface (Fig. b).

Multilevel failures prevented

The PMP structure, Harada notes, eliminates failures of multilevel devices from circuit openings of metal layers at crossovers and via-holes. Short-circuiting between metal layers, caused by pinholes in the oxide insulating layers, is also minimized.

In conventional semiconductor processing, Harada notes, electrical continuity between layers is obtained through the window of a silicon-dioxide film used as an insulator. The problem, however, is that the metallization cannot be uniformly maintained at the steps of the oxide window; thus there is a good chance of bond failure. The use of bumps to interconnect metal layers and the inherent planarity of the PMP process can eliminate this problem.

As far as short-circuits are concerned, Harada says, the electrical insulation between metal layers in any semiconductor process depends partly on the pinholes in the insulating layer. The pinhole density with the PMP process can be greatly decreased, he says, simply by making the polyimide film thicker. This is not possible with silicon dioxide, he explains, since thick silicon-dioxide films tend to crack.

Because of the planarity of the PMP process, the scientist says, as many as five levels of metal can be applied. The good planarity also means that a fine pattern of metal layers can be formed in each metal level. This, Harada points out, is very important for higher-density, large-scale integrated circuits. ■■

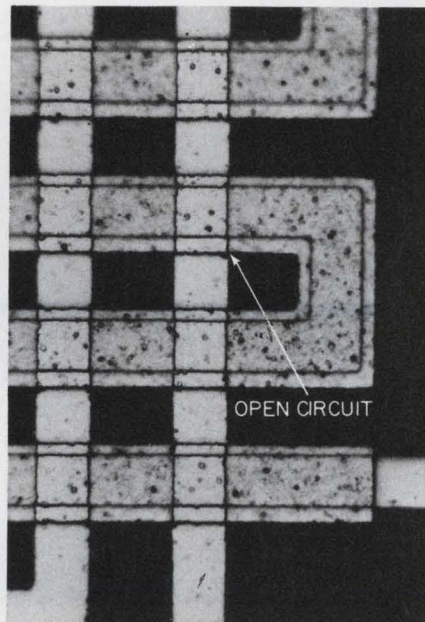
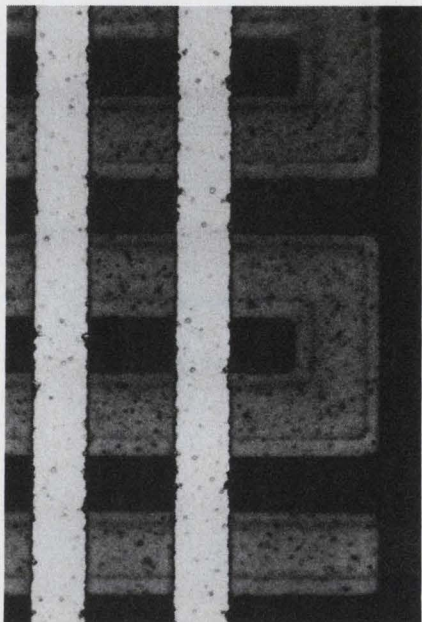

Planarity of the PMP process can be seen in the three-layer device at left. In the same device fabricated by conventional means (right), bond failure caused by an open circuit at an oxide step can be seen.

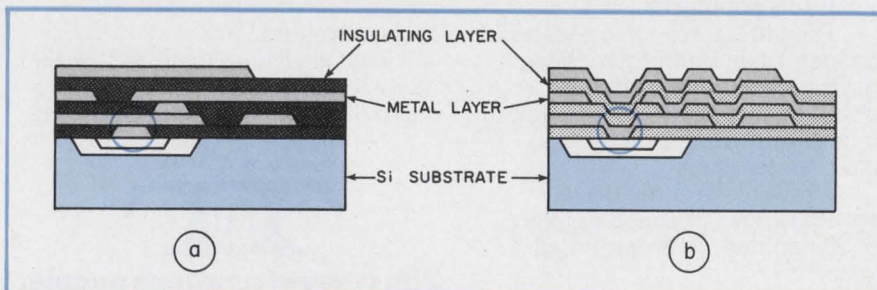

A comparison of the circled areas of the PMP device (left) and a conventional device (right) shows how the metal step is eliminated.

**We can solve
your IC Packaging
problems...**

**We
do it
better**

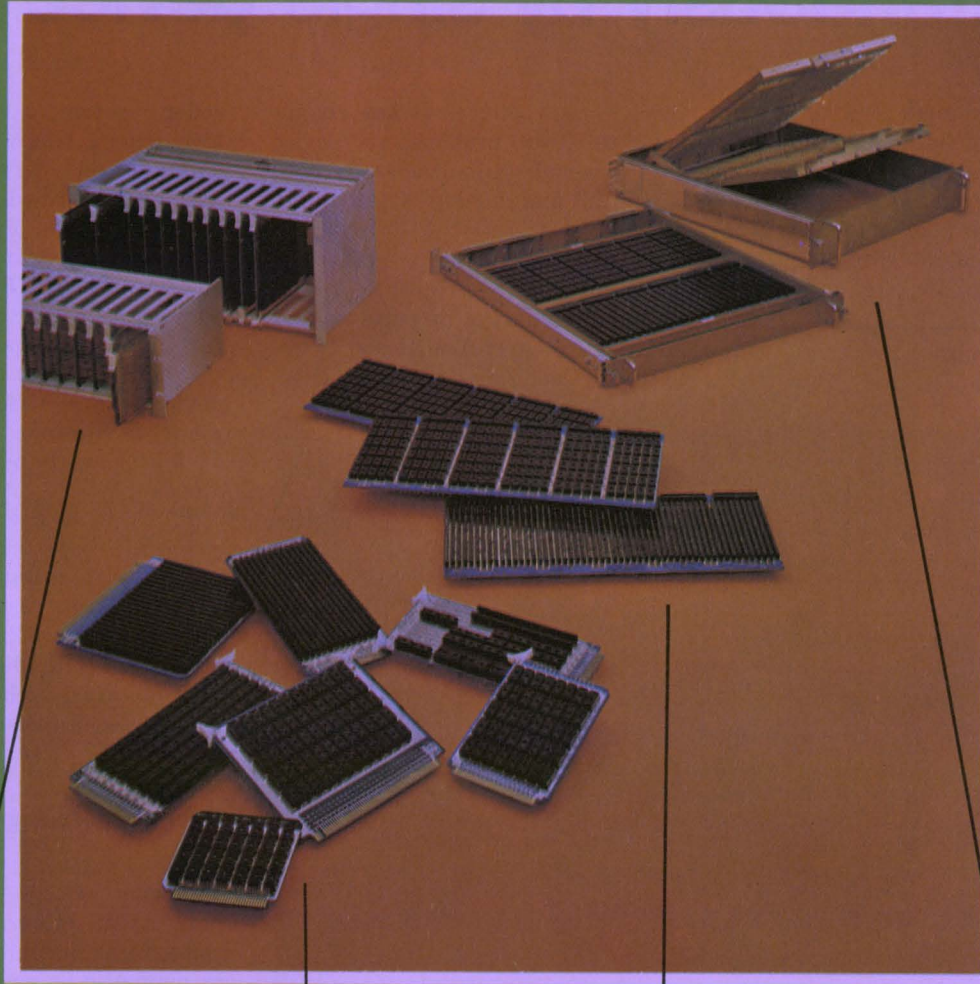

Socket Card Files

Ruggedly constructed, precise card/connector fit, holds up to 14 socket cards in standard EIA racks. Standard sizes for all socket cards—customs also available. Standard I/O systems include connectors, optional mother board and I/O panel.

Socket Cards

40 and 60 position cards that mount 14 and 16 pin devices, universal cards that mount any device 6 to 40 pins, Kit cards for those special customs. Cards have 72 or 122 I/O connections. All have decoupling capacitor provisions. Prices about \$1.00/position.

Socket Panels

14 and 16 pin models with sockets and zones of 30 to 180; Universal model for 6 to 40 pin devices with 9 to 54 pin rows in 9 row zones. All have decoupling capacitor provisions and female or feed-thru pin I/O systems. Prices about \$35.00 per zone.

Socket Panel Drawers

Single and Double page drawers with 14, 16 and universal patterns. Singles from 30 to 510 positions. Doubles up to 1120 positions. I/O connection from 120 to 1200—customs readily available.

We really know how to solve your I.C. packaging problems. We do it with cards, panels, drawers and complete systems. We do it with decoupling capacitor provisions on all cards and panels. We do it with high reliability contacts which insures positive I.C. connections. So give Scanbe a call or send us your requirements and we'll prove that when it comes to solving I.C. packaging problems we can help you do it better.



"The Packaging People"

Scanbe Manufacturing Corporation
3445 Fletcher Avenue
El Monte, California 91731
(213) 579-2300/686-1202
• TWX: 910-587-3437

Digital and analog printout given simultaneously by single device

It's estimated that 90% or more of all numerical data generated by digital instruments and data processors is never used, simply because it would take the user too long to read and interpret the figures. Digicom, Inc., of Chelms-

ford, Mass., believes it has an answer to this problem: a device that generates simultaneously both a digital and analog printed display.

This permits both a quick visual scan of the record for immediate evaluation of patterns and later, more careful analysis, if required. Used on-line, the Digi-

coder system can monitor real-time events where the quantity of data would defy interpretation without intermediate steps, such as charting or plotting.

Patterns appear and trends are shown clearly. Even semiskilled persons can be trained to watch for important patterns. Off-line, the data can be run through the device several times with enhancement techniques to improve the visibility of important events or trends.

"This is a new concept to engineers," says Digicom's president, Joseph Patenaude, "I feel that when its usefulness is realized, it will replace minicomputers in many applications and find use in areas where no suitable display techniques exist."

Northe K. Osbrink
Western Editor

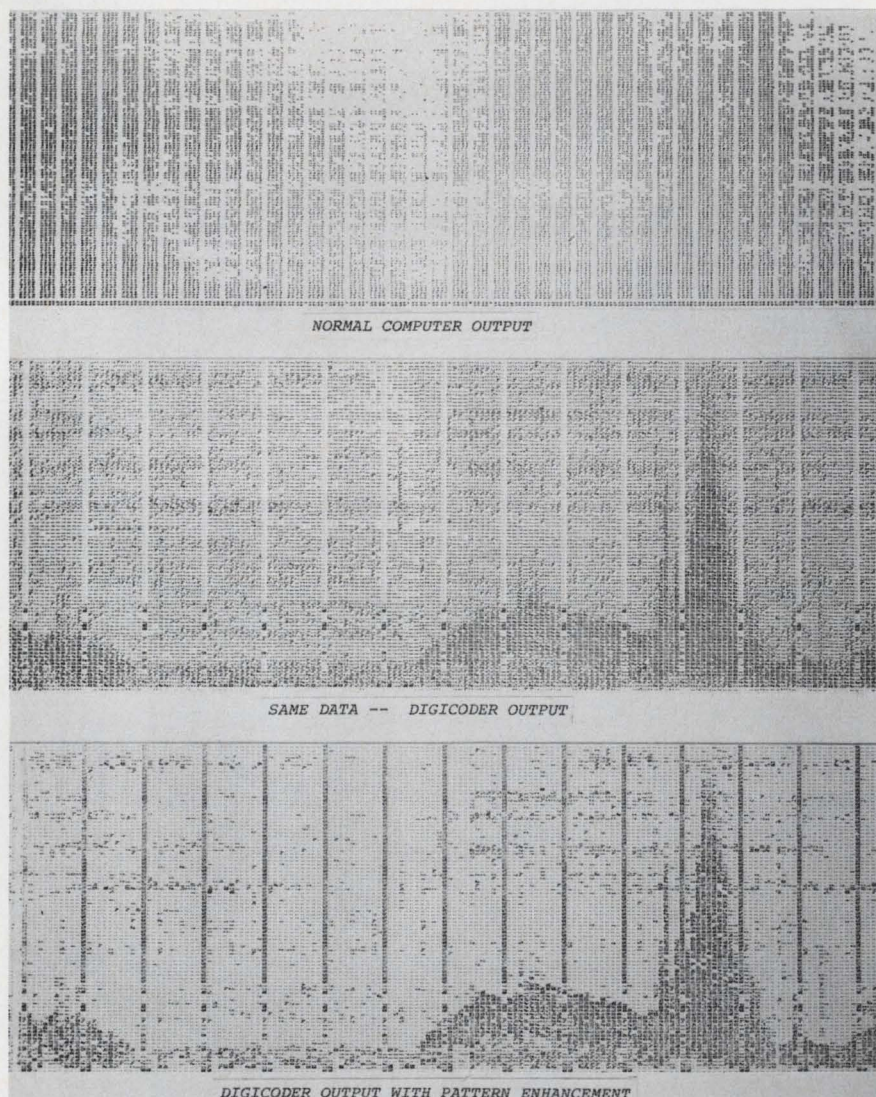

The Digicoder pattern in the bottom photo is enhanced, but at the expense of digital information.

Direct processing of data

With certain restrictions, the Digicoder accepts numerical outputs from either mini or large computers, digital instrumentation or magnetic or paper tape. It processes the data directly, without need for a computer or processor, and generates characters that are printed on either an electrostatic or facsimile printer.

The key to the system is an optically weighted font of the numerical characters 0 to 15 (see illustration). Each character consists of a 4 by 5 dot matrix, and the numbers appear darker with increasing value. This means that besides seeing the individual characters on a page, the user also sees a pattern of gray shades that vary with the values being printed. The pattern may have 16 levels of intensity. In addition the darkness of each character can be controlled through four levels from

No-hitch Schottky Comparators



**Compatible multi-function plug-ins:
more speed—more output—more profits in the end.**

Really bugs you, doesn't it? Make your move into ultra high speed comparators—and the penalty whistle goes off. Currently available parts just can't get along with TTL levels, and input characteristics are much too stringent.

Start counting your blessings: 521, 522. Signetics' exclusive linear breakthrough in extremely fast trouble-free dual comparators. There's nothing else on the market today that can touch 521/522 for cost-conscious ease of use, over a unique range of applications. You work *with* the remarkably high speed that Schottky technology delivers, instead of against it.

The 521 typically operates at 6ns, with 10ns guaranteed; 522, from 10-15ns. But you can't take advantage of these major increments in comparator speed if penalties keep cutting you down to size.

Use the 521/522 any place you'd snap your old 710/711/760 and you clear the board for maximized action. Pin-for-pin replacements for 75107/108: but Signetics' no-forfeit performance can't be matched, while requiring fewer auxiliary parts.

Absolutely TTL compatible in both strobes and output structure. Rock-bottom input characteristics for industrial applications. 20 μ A max input bias current guaranteed—so low you won't load down your input transducers. And you no longer add a preamplifier to detect more minute variations of input voltage.

We built in function flexibility too. You not only reduce parts count, you save on stock variety needs as well. These versatile Schottky-fast dual

comparators are smooth design-in's as zero crossing detectors, Schottky line receivers, and for A/D and D/A conversions. Plus the most popular alternate application to date—as MOS RAM sense amplifiers.

**NE522 COMPARATOR
USED AS MOS RAM SENSE AMPLIFIER**

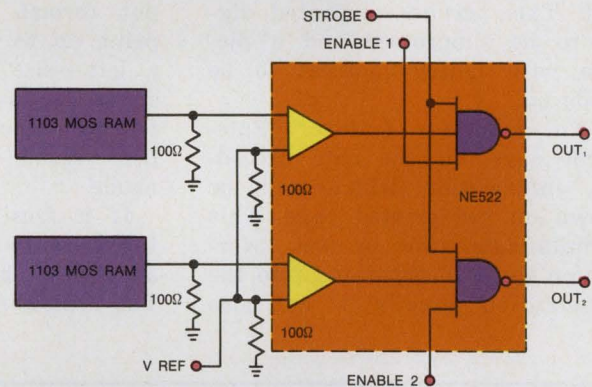

Optimized system performance, with lower costs coming in and going out. That's our commitment to you, the user. From one end of our linear line to the other: from phase locked loops and the IC timer, to these innovative 521/522 high speed Schottky-clamped comparators.

And they're all on the shelf at your distributor. Now.



CLIP THIS COUPON TO YOUR LETTERHEAD FOR IMMEDIATE ATTENTION

- Please send us a free sample of 521/522.
- Include complete specs, data sheets and application literature for ultra high speed 521/522 comparators.

Name _____

Title _____

Attach this box to company letterhead, and mail to:
Signetics-Linear
811 East Arques Avenue
Sunnyvale, California 94086
(408) 739-7700

Signetics Corporation. A subsidiary of Corning Glass Works.

signetics

INFORMATION RETRIEVAL NUMBER 30

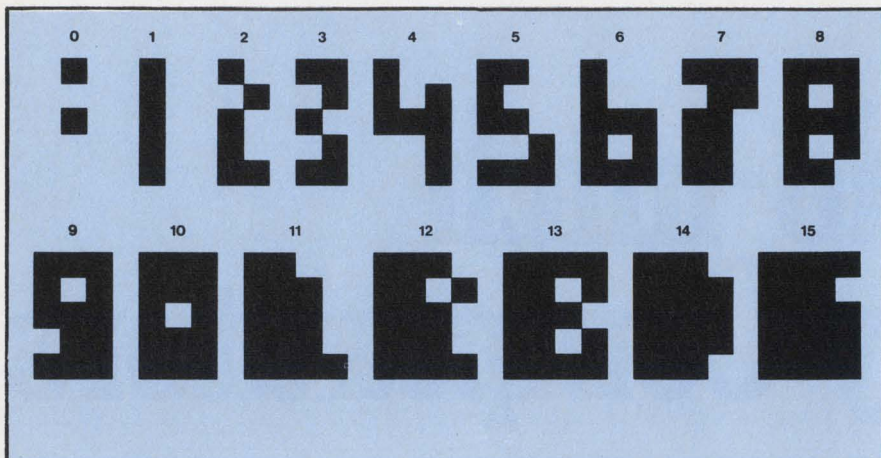

Optically weighted font that is used to produce digital graphics.

light gray to full black. Thus the Digicoder can produce 64 levels of recognizable intensity, allowing six-bit data to be plotted.

Pattern enhancement is provided when visual clarity is more important than the digital content. This permits unwanted digits to be suppressed and a picture with better contrast to be produced.

"An important feature," Patenaude says, "is the data precoding information which can be shown on the printed page. This permits date, time or test information to be incorporated into the presentation directly. It can also

be used to generate grid lines to ease reading."

The device accepts an asynchronous input at up to a 1.2-MHz rate. It has a buffer to permit the assembly of an entire data record before printing. The output format is flexible and will print up to 30,000 characters on a letter-size page. With a high-speed electrostatic printer the output rate goes to 2300 characters per second, according to Patenaude.

If a facsimile printer is used for the output, the speed drops to about 64 characters per second. The printer may, however, be con-

nected to the Digicoder via telephone line for remote monitoring.

The system was developed during the testing of a sophisticated digital instrumentation system. The pattern generated by data fed into a particular stage of the system was compared to that of data leaving the stage. Distortions and errors in the stage showed up clearly and graphically.

Technique was used elsewhere

A similar technique has been used at the Lowell (Mass.) Technological Institute Research Foundation for three years to display ionospheric data. They are offering the Air Force a system that would employ the technique for vortex studies.

"We have used the Digicoder to make pictures directly from the output of a microdensitometer and a proton radiograph," Patenaude says. "We have a new concept here, and the design community is having a little trouble believing in it. It has been used to present a variety of digital data already and can do more—much more."

The Digicoder sells in stripped down form for \$2000, in a fully flexible version for \$5000 and in complete systems for \$7000 to \$30,000, depending on the input and output equipment needed. ■■

U.S. developing a super-efficient laser

Transmitting kilowatts of energy to space satellites, providing illumination for undersea mining and mapping shallow coastal areas of the earth from satellites are only a few of the potential applications for a highly efficient copper vapor laser being developed by NASA, the Air Force and the Office of Naval Research.

Although such a laser was first built in 1966 by William Walters, a research scientist at the Farmingdale, N.Y., campus of the Polytechnic Institute of Brooklyn, it has only recently become of interest to the Government. The reason, Walters explains, is that it is a visible laser with very high energy-conversion efficiency.

Other visible lasers, such as the helium-neon and the argon-ion, have an efficiency of about 0.01% at best, he says. The copper vapor laser has 1% efficiency at present and could probably go to 10%, he reports, adding that the maximum potential is 23%.

Work to date has yielded a copper vapor laser with an average power output of 1 W and a peak of 20 kW. The laser has been operated at 2 kHz with pulses 20 ns wide, Walters says. It emits light at two wavelengths: 5106 Å, which is green, and 5782 Å, which is yellow.

A spokesman for the Office of Naval Research in Arlington, Va., notes that the Navy's interest stems from the laser's high trans-

missivity in water. The green light can easily penetrate ocean water and can be used for illumination and imaging.

NASA's interest is in the laser's ability to supply power to satellites. Present solar cells use the energy of the sun, and they have an efficiency of about 10%, a NASA spokesman notes. The energy-conversion efficiency can be increased by a factor of 4, however, if a copper vapor laser is used to illuminate photocells that are sensitive to only one wavelength of light.

Although the Air Force is also sponsoring work on this device, no application information is yet available. ■■

The Uncomputers.

An unabashed attempt to uncomplicate mathematics.



Until today, everybody who needed a computer to help with his job was faced with a far greater decision than a simple choice of hardware. He literally had to go back to school to learn a whole new language. Indeed a science. Just to be able to translate his job (which he knew well in the first place) into something computers and programmers could understand.

This is utter nonsense. So we decided to bring out a kind of computer that works from the job up instead of from computerese down. What follows is a glossary of the terms that guided us and can help you understand what the Uncomputers are all about.

Unlearn.

This is what you do with Fortran and Cobol and all the other ungainly languages you need for ordinary computers.

Uncomputerese.

This is the language we use. It's made up of algebra, trigonometry, basic arithmetic and common sense.

Unbudgeted.

When you bring out a computer everybody can use, you have to be sure everybody can afford it. Uncomputers are for sale for around \$3,000 and lease rates start at under \$20 a week.

Unlimited.

We didn't forget anything. With the Uncomputers over 4,000 steps of programming

and up to 522 complete arithmetic registers, symbolic logic, sub-routines, and capability for up to 22 simultaneous equations fit into a space no bigger than the corner of a desktop.

Unessential.

With the Uncomputers you don't need a lot of extra-cost extras either. The basic unit creates, debugs, and updates its own magnetic program cards. You will however be able to get a lot of pretty advanced peripherals if you really need them.

Uninformed.

If you have a computer everybody can use and everybody can afford, the next thing is to be sure everybody can get to see it at least. And try it at most. We went for most. Just call your local man from Monroe, and we'll let you try one in your office for a week free of charge and obligation.

Monroe.
The Calculator
Company.

Times...the most coaxial cable



When it comes to coaxial cable nobody offers the selection we do. Flexibles, semiflexibles, high temperature, low temperature, miniatures as well as standard sizes... we've got them all. Hundreds of items from RG5 to RG404 including our own improved versions of RG cables.

Most of these cables are in stock now at our plant or our distributors throughout the country.

You'll find the whole selection in our latest "RF Transmission Line Catalog & Handbook"... the book that's become the bible of the industry. This 40-page reference is packed with all the necessary information you need to design or select cable for your application.

If you have a requirement that goes beyond what's currently available Times can still take care of you. We have the best special cable group in the business. If anybody can come up with a "prescription" for your problem, we can. We'll even make the entire assemblies for you... and probably save you money doing it.

Call us the kings of coax... or anything else you want. Just be sure to call us first when you're looking for coaxial cable, multiconductor cables or cable assemblies. We have what you want.

complete line of in the business.



It's all in here...

Please send me a copy of your "RF Transmission Line Catalog & Handbook" with its special guide to selecting coaxial cable.

INFORMATION RETRIEVAL NUMBER 33



NAME _____ TITLE _____

COMPANY _____

ADDRESS _____

CITY _____

STATE _____ ZIP _____

PHONE _____



SUBSIDIARY OF

Insitec

TIMES

Wire & Cable Co.

358 Hall Avenue
Wallingford, Connecticut 06492
(203) 269-3381 TWX 710-476-0763

“We wanted to go right from keyboard to disc, right? But space was critical. GP relay specs were OK, but I didn't have any

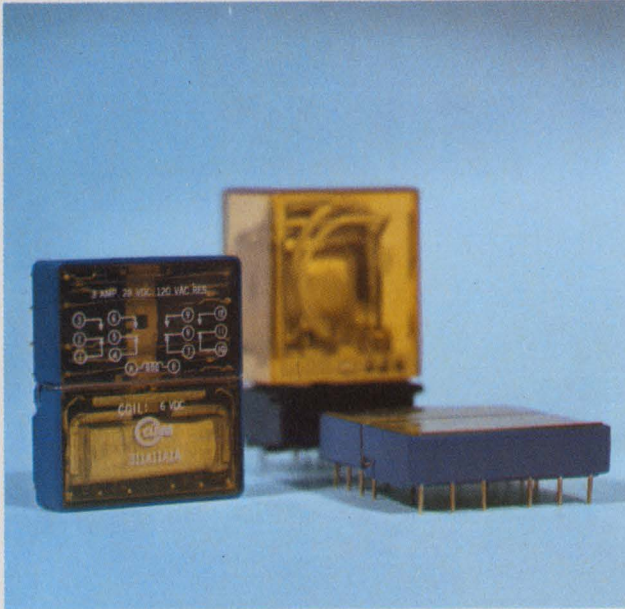

room. Besides, we had to flow solder and dip clean the assemblies to get volume up and cost down.

What I needed was a new kind of relay--

and some help-- right now...”

PROBLEM: The market for computer periphery is wide open. And equipment that takes you directly from keyboard to disc is a fantastic idea—if you can make it small enough and cheap enough to sell. And that's tough. Relays are one problem. They've got to be dependable (nothing radical, something available) yet small enough to fit your P.C. design. And they've got to maintain reliability under the effect of high speed production. You can't afford any weak links in your final package, but you have to make your decision fast because of competition.

SOLUTION: Clare's new 311 Series General Purpose Relays saved the day.

They offer 3 amp switching in an extremely low-profile package with .5" mounting centers. They sit a mere 0.350" above the board and take up less than 0.7 cubic inch space. The Lexan® dust cover and pins molded in the base fully protect the relay during wave soldering and partial dip cleaning. And the pins are mounted on a .1" center grid, to add flexibility and save you money. The new 311 also has excellent voltage breakdown ratings and shock resistance, gold plated steel terminals, and fine silver contacts.

Clare's expertise lies in the design and manufacture of relays. That's why we can give you so

much in a single low-profile relay. Right now.

But our energy lies in the application of relays to help you solve specific problems. We specialize in getting down to work.

If you need help—or just some specific information about our new low-profile 311 series relay—get in touch with us. The “right now bunch” is ready to go to work for you.

Contact your local Clare Distributor or Sales Engineer. C. P. Clare & Co., 3101 Pratt Avenue, Chicago, Ill. 60645. 312/262-7700.

QUALITY/SERVICE/RELIABILITY

we help. get in touch with us. CLARE the “right now” bunch.

a GENERAL INSTRUMENT company

GENERAL PURPOSE RELAYS MERCURY-WETTED RELAYS REED RELAYS SOLID STATE RELAYS TELEPHONE RELAYS STEPPING SWITCHES

INFORMATION RETRIEVAL NUMBER 34

The 5 fastest ways to make better inverters.

1 The new 81RM — fastest 125 Amp inverter SCR around.

It has $20\mu\text{S}$ turn-off, through 1000V, with efficiency that cuts filtering, commutating and snubbing costs up to 30% in new designs. Plugged into existing circuits, it can increase overload capability or power rating by 50%. Its 30% lower switching losses let you operate efficiently at 10KHz. And for today's circuits, a guaranteed turn-off time of $25\mu\text{S}$ with an antiparallel diode gives unequalled speed. The best "soft recovery" in the business assures the lowest RFI generation, minimizes false triggering and improves reliability. Voltage ratings from 100-1000V. dv/dt is $200\text{V}/\mu\text{S}$, and di/dt is $800\text{A}/\mu\text{S}$.

2 New 35 Amp IR140/141's. None faster. Lowest switching losses.

At $15\mu\text{S}$ and $10\mu\text{S}$ turn-off, there are no faster SCRs in their range. But what really sets them apart is the 30% lower switching loss for unequalled efficiency at high frequencies. No derating to 4KHz, and 50% of the rated current at 20KHz. Excellent as commutating SCRs. Conforms to JEDEC 2N3649-58. Reapplied dv/dt is $200\text{V}/\mu\text{S}$, and di/dt is $400\text{A}/\mu\text{S}$. Voltage ratings: 50-400V.

To get our Inverter SCR "Data pack" fast, write Dept. ED

International Rectifier
233 Kansas Street
El Segundo, CA 90245

New — The fastest Turn-Off ($10\mu\text{S}$) high-current inverter SCRs available!

These low-frequency inverter SCRs turn off four times faster than others at their power level. You can reduce commutating component size and cost $\frac{1}{3}$ and still increase inverter ratings with greater reliability. Higher surge ratings give you bigger safety margins, easier fuse selection. To top it off, you can choose from three package types in 50-600V ratings to optimize your design.

3 New 430 Amp (RMS), 275RF Series. The only stud-mounted 430 Amp (RMS) inverter SCR available. 7000 Amp surge rating. $200,000\text{A}^2\text{Sec}$. I^2t rating.

4 New 710 Amp (RMS), 450PF Series. Rated 710 Amp (RMS), this ceramic "Hockey Puk" has a surge rating of 9000 Amps and I^2t of $340,000\text{A}^2\text{Sec}$.

5 New 710 Amp (RMS), 451PF Series. For maximum economy, the first and only plastic encapsulated 710 Amp (RMS) "Hockey Puk" SCR. Surge rating: 9000 Amps. I^2t is $340,000\text{A}^2\text{Sec}$.



International Rectifier

...the innovative power people 

New and recent Spartan Books . . .

Introduction to Defense Radar Systems Engineering

JAMES N. CONSTANT, *President, RCS Associates, Inc.*

Just Published! The first book to bring together all aspects of radar systems and integrate them in a systematic and logical pattern offers all the background needed to specify a system for a given application. Each chapter presents analyses and equations in engineering terms. Among this comprehensive volume's many unique features are: the most extensive treatment of the effects of Electronic Counter Measures (ECM); coverage of the theory of trajectory predictions and array theory; and an in-depth treatment of data processing in radar systems. 260 pp., 6 x 9, illus., #9194, cloth, \$20.00

Checklists for Management, Engineering, Manufacturing, and Product Assurance

W. B. ROSSNAGEL, *Rossnagel and Associates*

Technically accurate and ready to be applied, these checklists are an excellent means to ensure that a given specification, contract, design, etc., is complete in every respect.

Volume I, Management Checklists

22 checklists cover computers, engineering, finance, labor relations, manufacturing, marketing, personnel, product assurance, proposals, publications, small business, and other subjects. 192 pp., 6 x 9, illus., #9178, cloth, \$14.00

Volume II, Electrical and Electronic Checklists

22 detailed lists encompass cables and connectors, communication radios, multi-coders, lasers, microelectronics, integrated circuits, and much more. 192 pp., 6 x 9, illus., #9181, cloth, \$14.00

Vibration and Acoustic Measurement Handbook

MICHAEL P. BLAKE, *Development Engineer, and*
WILLIAM S. MITCHELL, *Vibration and Acoustical Consultant, both of Lovejoy, Inc.*

This original 700-page illustrated guide closes the great technological gap between theory and operations in the field. Developed through years of practical testing, it demonstrates the value of vibration and acoustic measurement in terms of actual situations and machine problems. It clearly shows how these measurements can give warning months in advance of 90 percent of equipment problems, allowing time to take corrective action before trouble starts. The net-result: less production stoppage, fewer lost man-hours, better quality control, and lower maintenance costs. 656 pp., 6 x 9, illus., #9195, cloth, \$30.00

Analysis of Plates

D. E. McFARLAND, B. L. SMITH, and
W. D. BERNHART, *Wichita State University*

This comprehensive text presents both classical and computer-oriented solutions for the analysis of thin plates for stresses, strains, and lateral deflections. The coverage includes orthotropic plates, continuous plates, various shapes, plates on elastic foundations, large deflections, and laminated plates. The authors add new insight to the variational approach to plate theory, including many illustrative examples. Although intended as a text in mechanical engineering, the book should be of great interest to engineers in industry. 296 pp., 6 x 9, illus., #9191, cloth, \$18.50

Control Theory, Volume 1

Elements of Modern Control Theory

ARTHUR L. GREENSITE, *Convair Division of General Dynamics*

The first of these two volumes on flight control provides the practicing engineer and advanced student with a comprehensive, modern, and up-to-date exposition of all facets of modern control theory. Based on a series of monographs written for NASA, it is recommended as a primary or supplementary reference text. Extensive sample problems and exercises included. 896 pp., 6 x 9, illus., #9154, \$29.95

Control Theory, Volume 2

Analysis and Design of Space Flight

Vehicle Control Systems

The companion volume treats applications to aerospace vehicles in detail. It examines techniques and methods for the design of launch vehicle control systems, and presents an analytical framework for the study of the performance of satellite attitude control systems. 752 pp., 6 x 9, illus., #9163, cloth, \$29.95

Modeling of Thinking and the Mind

N. M. AMOSOV, *Academy of Medical Science, U.S.S.R.*

An exciting work on the theory and techniques of simulating the functions of the human intellect by one of the Soviet Union's leading cyberneticists and Lenin Prize winner. Presenting his original hypothesis concerning programs of man's psychic functions, the author outlines methods for modeling these on the computer. 208 pp., 6 x 9, illus., #9147, cloth, \$12.00

SPARTAN BOOKS / HAYDEN BOOK COMPANY, Inc., New York

... now available from Hayden

Pattern Recognition

M. BONGARD, *Translated from the Russian by T. Cheron;*
Edited by J. K. Hawkins, Robot Research

Although primarily directed toward specialists in computers and artificial intelligence, this volume is of importance to engineers and others attempting to understand such brain functions as the ability to "find similarity," "create abstract ideas," and "act by intuition." The Soviet scientist clarifies the meaning of pattern recognition and problem solving. 256 pp., 6 x 9, illus., #9195, cloth, \$12.95

The Future of Science

MORRIS GORAN, *Roosevelt University*

A provocative, well documented investigation of the scientists' relationships with society, government, and money. It examines three current problems of the scientists: communication, education, and financing. Throughout, discussions are supported by facts rather than moralistic statements. 168 pp., 6 x 9, #9190, cloth, \$8.50

Technology Gap in Perspective

Strategy of International Technology Transfer

DANIEL LLOYD SPENCER, *Morgan State College*

An original strategy for visualizing and coping with the technological variants of the modern world. Presenting a novel systems vision, the author deals with the problems of incessant waves of technological impact, and holds that we must view them as a world technology system. 192 pp., 6 x 9, illus., #9180, cloth, \$10.00

Character Readers and Pattern Recognition

Edited by V. A. KOVALEVSKY, *Institute of Cybernetics, Kiev, U.S.S.R.*

This collection of articles focuses on problems of pattern recognition and computer simulation of various algorithms

and recognition systems. All methods discussed and all work examined are based on procedures used in the development of actual equipment at the Institute of Cybernetics. 280 pp., 6 x 9, illus., #9150, cloth, \$12.00

Durability and Reliability in Engineering Design

GILBERT KIVENSON

This thought-provoking work places at your disposal highly relevant findings from a variety of technical areas. It examines materials properties, breakdown mechanisms and phenomena, and failure modes along with steps to counter them; provides a capsule course in reliability theory; relates design considerations to the user's needs. 200 pp., 6 x 9, illus., #5851-9, cloth, \$9.95

Materials Science and Technology for Design Engineers

Edited by ALEX E. JAVITZ

The fundamentals of materials integrated with the hard facts of day-to-day engineering practice. The coverage offered you ranges from basic structure and behavior through new materials and applications, to environmental effects, reliability concepts, and cost effectiveness. 560 pp., 6 x 9, illus., #5640-0, cloth, \$23.95

The Successful Engineer-Manager

A Practical Guide to Management Skills for Engineers and Scientists

Edited by ROBERT C. HAAVIND and RICHARD L. TURMAIL

A well-organized, realistic guide to the critical areas of technical management — career, decisions, people, projects, finances, and communications. Articles carefully chosen from *Electronic Design* offer you valuable pointers on financial analysis, person-to-person dealings, project scheduling, promoting new ideas, and much more. 176 pp., 7 $\frac{1}{8}$ x 9 $\frac{3}{4}$, illus., #5879-9, cloth, \$8.95

15-DAY FREE EXAMINATION

Please send the book(s) circled on 15-day free examination. At the end of that time, I will remit payment, plus postage, or return the book(s) with no further obligation.

9194	9195	9163	9150	5851-9
9178	9191	9147	9190	5640-0
9181	9154	9195	9180	5879-9

Save Money!

Payment Enclosed. Publisher will pay all shipping and handling charges — same 15-day guarantee.

Name _____

Firm _____

Address _____

City/State _____ Zip _____

\$10.00 minimum for free exam orders. Because of higher billing and collection costs, we must ask for payment in full with any order for less than \$10.00. Same 15-day guarantee.



HAYDEN BOOK COMPANY, INC., 50 ESSEX STREET, ROCHELLE PARK, N.J. 07662

ISBN Prefix 0-8104

72-87

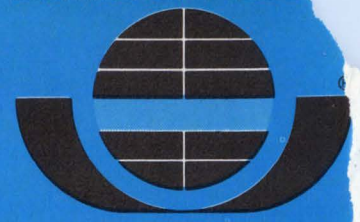

CENTRALAB

Electronics Division
GLOBE-UNION INC.5757 NORTH GREEN BAY AVENUE
MILWAUKEE, WISCONSIN 53201

Centralab perspectives

FOR USERS OF ELECTRONIC COMPONENTS

New Selectashaft Rotary Switch program corrects industry shortcoming.

Users of custom rotary switches can now get delivery within days, thanks to this new field assembly program offered by participating Centralab Distributors.

If it's taking you several weeks or even months to get delivery of custom rotary switches, you'll want to look into a new field assembly program pioneered by Centralab and available from their Selectashaft™ Distributors.

The thrust of the program is to ship orders of custom rotary switches within hours of their receipt. Eliminated are lengthy factory delays and special factory set-up charges.

Customers are finding the scope of Selectashaft switches indeed awesome. More than 100,000 combinations of miniature and subminiature

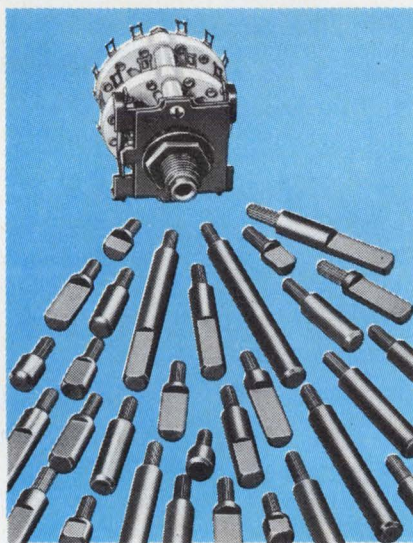

Custom switch assemblies with more than 100,000 combinations are available in days from Centralab Selectashaft Distributors.

switches are available, filling 95% of user needs.

The program enables you to select the exact length front shaft,

INFORMATION RETRIEVAL NUMBER 131

exact shaft end details, and the exact shaft flat angles required. You can choose from 92 types of rotary switches for field assembly by the Distributor to your choice of three .250 inch diameter shaft styles: plain round, .218 inch flat, or .156 flat configurations. The shafts themselves are offered in 24 sizes from .687 inch to 2.375 inches long from the mounting surface. Shaft flat angles can be specified in increments of 15°.

The Selectashaft Distributor program has been underway barely a year, and both Distributors and customers agree it meets a definite shortcoming that previously existed. In that short span, the number of participating distributors has grown to make the benefits of Selectashaft rotary switches available nationwide — on a local basis.

For complete product and price information, contact the Centralab Selectashaft Distributor nearest you. Or write Centralab Distributor Products, Dept. SAS-1.

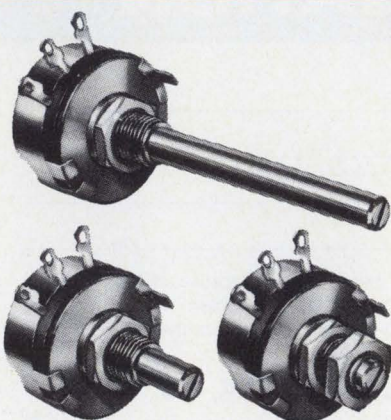

MIL spec pots. A few words about a big bargain. What more can be said about a line of hot molded potentiometers that meets MIL-R-94C requirements—and can be purchased for as little as 92¢ each, in quantities of 251-500? How about the fact that the pots are shelf items and available immediately. And that they're made by Centralab, whose quality control sets the standard for the industry. Why not write for the catalog which gives a few more reasons to try them before buying them. Ask for Catalog 34-I supplement.

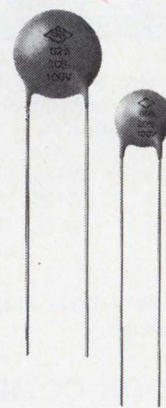

New 100 VDC transistor circuit caps. Low voltage rating of 100 VDC is combined with high capacitance of .005 mf to .1 mf in these new ceramic disc capacitors from Centralab. Their miniature size is specially designed for transistor circuits, where tighter tolerances are essential. Write for Bulletin 42D562.



BECOME FAMOUS IMMEDIATELY.

But, whether or not you become our winner has nothing to do with your receiving some really terrific FREE prizes. Just for sending in your entry, you'll receive our basic, THERE'S-NOTHING-LIKE-A-WARM-WOM KIT. (We don't have too many, so you'd better snap to it.)

THERE'S-NOTHING-LIKE-A-WOM KIT.

Included in the kit is a pair of hilarious glasses with a not-so-hilarious nose.



1. Mr. R. C. Abalone without funny disguise.

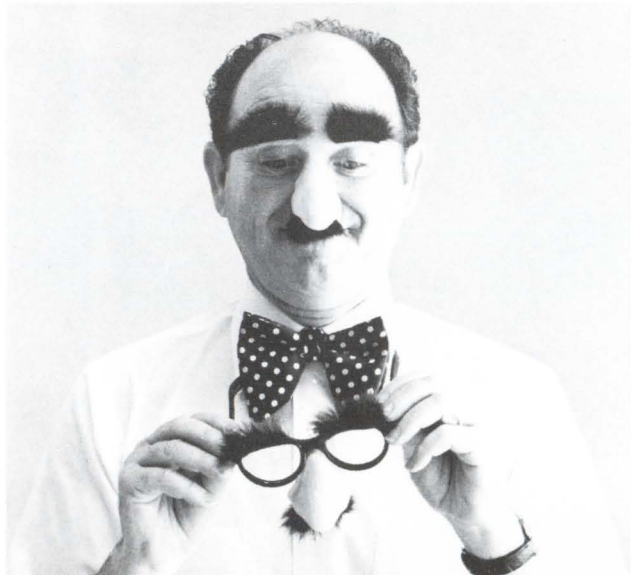

2. Mr. R. C. Abalone putting on funny disguise.

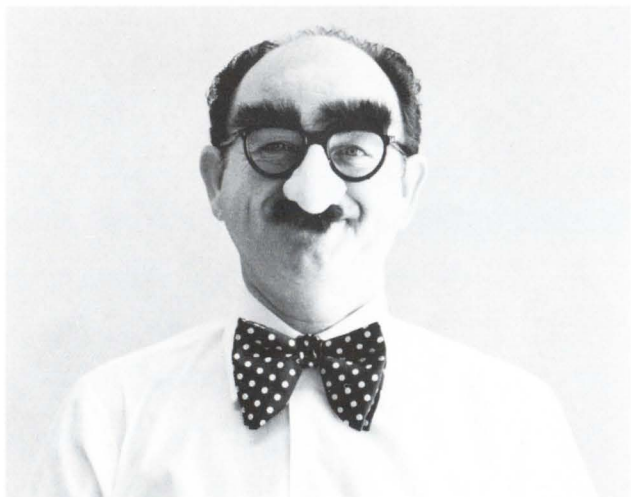

3. Mr. R. C. Abalone disguised.



A bumper sticker that says: HONK YOUR HORN, I'M WOMSOME. A button that says: BETTER LIVING THROUGH ELECTRICAL STUFF. The MOS Cross Reference guide and device selector. And just for good luck (you may need it) one real fortune cookie with one real fortune.

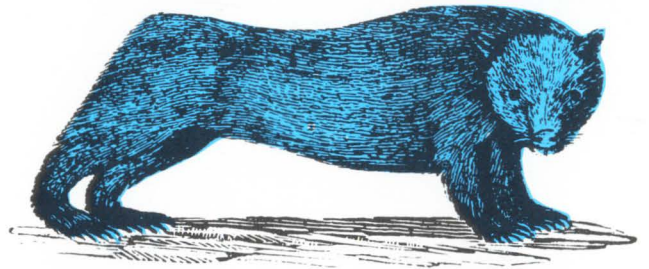

wom•bat 'wäm-,bat *n* [native name in New So. Wales]: any of several stocky Australian marsupials (family Vombatidae) resembling small bears.

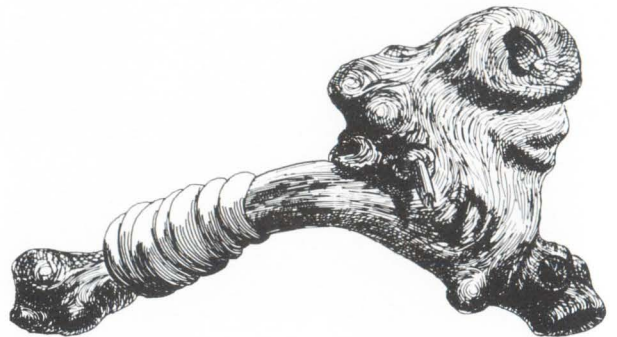

Wom•bat wom'bat *n.* heavy, wooden stick. A member of the club family. Used to beat WOM into semi-conscious state.

So what are you waiting for? Do you think something like this happens everyday? Of course not. Get with it. Send in your entry, and dream the dream that few men have dared to dream—the chance to have a WOM named after you!

HAVE A



NAMED AFTER YOU.

Here it is. Finally.
 The opportunity of a lifetime.
 Your chance to have a real complex,
 super gimmicky, super dynamic,
 space age, ambidextrous module
 named after you.



That's right. We're offering you the chance to have your name immortalized, eternally-linked with our latest bombastic breakthrough in better living through electrical stuff—our 25120 WOM!



better living
 through electrical stuff
 25120 WOM.

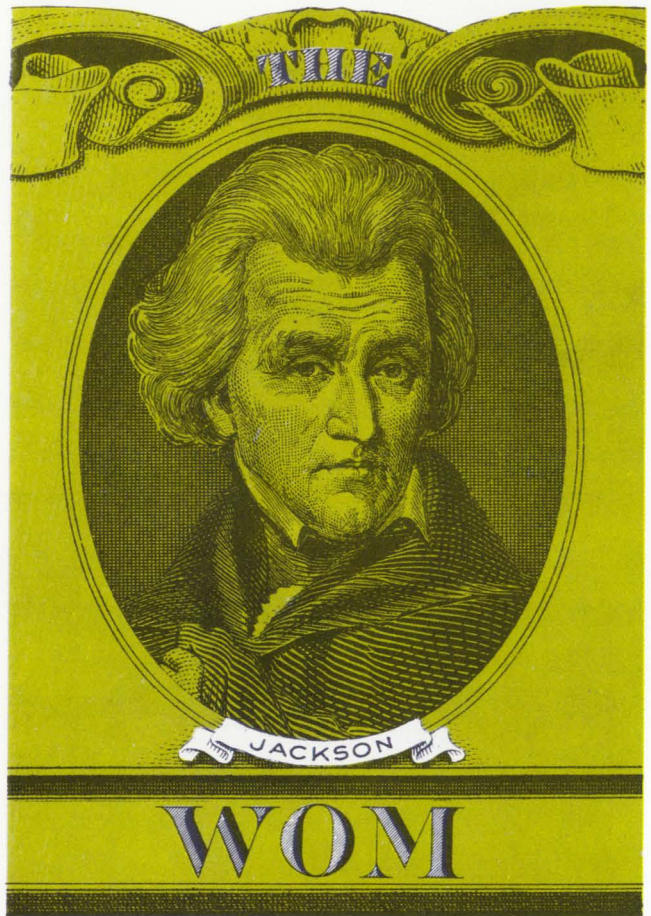

Just think, if your name was Jackson, and you came up with a use for our WOM that's better than everybody else's, from then on it would be referred to as The Jackson WOM.

Here's all you have to do: Read our spec sheet. (Not as easy as it sounds.) Figure out the best use for the 25120 WOM, and send it to us. And that's it. (Eventually, we plan to publish all the entries with appropriate credits in the First Annual WOM Report.)



We'll pick the winner, and his picture along with his spectacular idea will appear in our next promotion. Think of it. If you're our winner, you'll be able to run all the way home waving a picture of your immortalized face spread all over a real magazine. Great, huh!

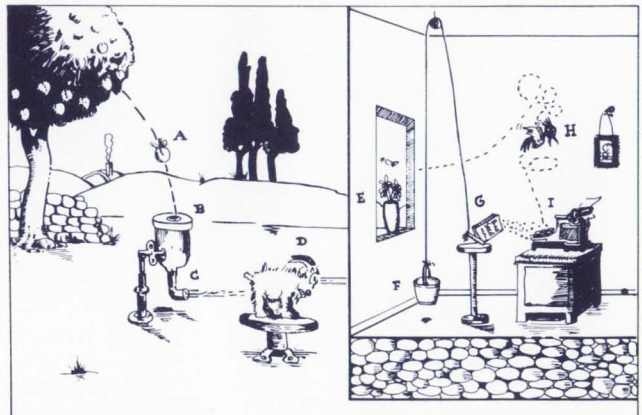

Just one fantastic use submitted for the 25120 WOM.



Signetics Corporation
811 E. Arques Avenue
Sunnyvale, California 94086



WOM CONTEST RULES

1. Contest entrants must provide, in 200 Anglo-Saxon words or less, a clear and complete description of their unusual, unique, and original use for the Signetics 25120 Write-Only-Memory. The suggested use should solve a real or imagined problem, or non-problem if so indicated. The entry must be typed or written by hand. Use one-sided plain 8½" x 11" company letterhead. Lithographs, spirit prints, and Mobius loops are not acceptable. Nor are tombstones, pampers, oilcloth, and isinglass. Schematics or drawings are OK. Plagiarism should be covert.
2. Information contained in the entry must not be confidential in nature nor involve proprietary thought processes. If in doubt, consult your company shrink. Winning entries will be judged on ingenuity, imagination, practicability, saleability, aptness of thought, and adaptability to the work-a-day world. Neatness is nice, but won't help a lousy idea. Saneness of entries will be judged according to the McNaughton guidelines. No purchase is necessary, but remember this promotion to make YOU famous is costing us plenty and money doesn't grow on trees.
3. Judging will be performed by a panel of experts skilled in the art and science of go, no-go electronics. Their decision will be final.
4. There is no limit on the number of entries provided they don't exceed one (1). Entries must be postmarked no later than midnight, July 31, 1973. Mail entries to "I Want to Be Famous", C/O Signetics Corporation, 811 East Arques Avenue, Sunnyvale, California 94086. Do not send entries to 810 or 812 East Arques as they will end up in a fire station or tomato patch. Anonymous entries will be returned to the sender. All other entries become the property of the U.S. Department of Abnormal Psychology.
5. The winning entrant and runners-up will be notified by August 31 and their entry will be published soon after for all the world to see and marvel at.
6. Contest is void where prohibited by state or federal law or company policy which denies fame to employees. Employees of Signetics Corporation, its sales affiliates, representatives, advertising agency, and members of their families up to 2nd cousins by marriage are not *excluded* from sending entries, but will never win.
7. Warning: Participation in this contest may be harmful to your mental health, especially if you lose.



DESCRIPTION

The Signetics 25000 Series 9046XN Random Access Write-Only-Memory employs both enhancement and depletion mode P-Channel, N-Channel, and neu⁽¹⁾ channel MOS devices. Although a static device, a single TTL level clock phase is required to drive the on-board multi-port clock generator. Data refresh is accomplished during CB and LH periods⁽¹¹⁾. Quadri-state outputs (when applicable) allow expansion in many directions, depending on organization.

The static memory cells are operated dynamically to yield extremely low power dissipation. All inputs and outputs are directly TTL compatible when proper interfacing circuitry is employed.

Device construction is more or less S.O.S.⁽²⁾.

FEATURES

- FULLY ENCODED MULTI-PORT ADDRESSING
- WRITE CYCLE TIME 80nS (MAX. TYPICAL)
- WRITE ACCESS TIME ⁽³⁾
- POWER DISSIPATION 10uW/BIT TYPICAL
- CELL REFRESH TIME 2mS (MIN. TYPICAL)
- TTL/DTL COMPATIBLE INPUTS⁽⁴⁾
- AVAILABLE OUTPUTS "n"
- CLOCK LINE CAPACITANCE 2pF MAX.⁽⁵⁾
- V_{CC} = +10V
- V_{DD} = 0V ± 2%
- V_{FF} = 6.3V_{ac}⁽⁶⁾

APPLICATIONS

- DON'T CARE BUFFER STORES
- LEAST SIGNIFICANT CONTROL MEMORIES
- POST MORTEM MEMORIES (WEAPON SYSTEMS)
- ARTIFICIAL MEMORY SYSTEMS
- NON-INTELLIGENT MICRO CONTROLLERS
- FIRST-IN NEVER-OUT (FINO) ASYNCHRONOUS BUFFERS
- OVERFLOW REGISTER (BIT BUCKET)

PROCESS TECHNOLOGY

The use of Signetics unique SEX⁽⁷⁾ process yields V_{th} (var.) and allows the design⁽⁸⁾ and production⁽⁹⁾ of higher performance MOS circuits than can be obtained by competitor's techniques.

BIPOLAR COMPATIBILITY

All data and clock inputs plus applicable outputs will interface directly or nearly directly with bipolar circuits of suitable characteristics. In any event use 1 amp fuses in all power supply and data lines.

INPUT PROTECTION

All terminals are provided with slip-on latex protectors for the prevention of Voltage Destruction. (PILL packaged devices do not require protection.)

SILICON PACKAGING

Low cost silicon DIP packaging is implemented and reliability is assured by the use of a non-hermetic sealing technique which prevents the entrapment of harmful ions, but which allows the free exchange of friendly ions.

SPECIAL FEATURES

Because of the employment of the Signetics' proprietary Sanderson-Rabbit Channel the 25120 will provide 50% higher speed than you will obtain.

COOLING

The 25120 is easily cooled by employment of a six-foot fan, 1/2" from the package. If the device fails, you have exceeded the ratings. In such cases, more air is recommended.

BLOCK DIAGRAM

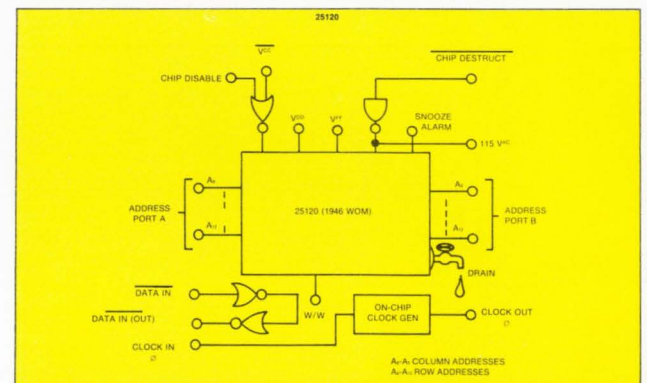

PART IDENTIFICATION

TYPE	"n"	TEMP. RANGE	PACKAGE
25120	0	0 to -70°C	Whatever's Right

1. "Neu" channel devices enhance or deplete regardless of gate polarity, either simultaneously or randomly. Sometimes not at all.
2. "S.O.S." copyrighted U.S. Army Commissary, 1940.
3. Not applicable.
4. You can somehow drive these inputs from TTL, the method is obvious.
5. Measure at 1MHz, 25mVac, 1.9pF in series.
6. For the filaments, what else!

7. You have a dirty mind. S.E.X. is Signetics EXtra Secret process. "One Shovel Full to One Shovel Full", patented by Yagura, Kashkooli, Converse and Al. Circa 1921.
8. J. Kane calls it design (we humor him).
9. See "Modern Production Techniques" by T. Arrieta (not yet written).
10. Final until we got a look at some actual parts.
11. Coffee breaks and lunch hours.
12. Due credit to EIMAC for inspiration.

TYPICAL CHARACTERISTIC CURVES

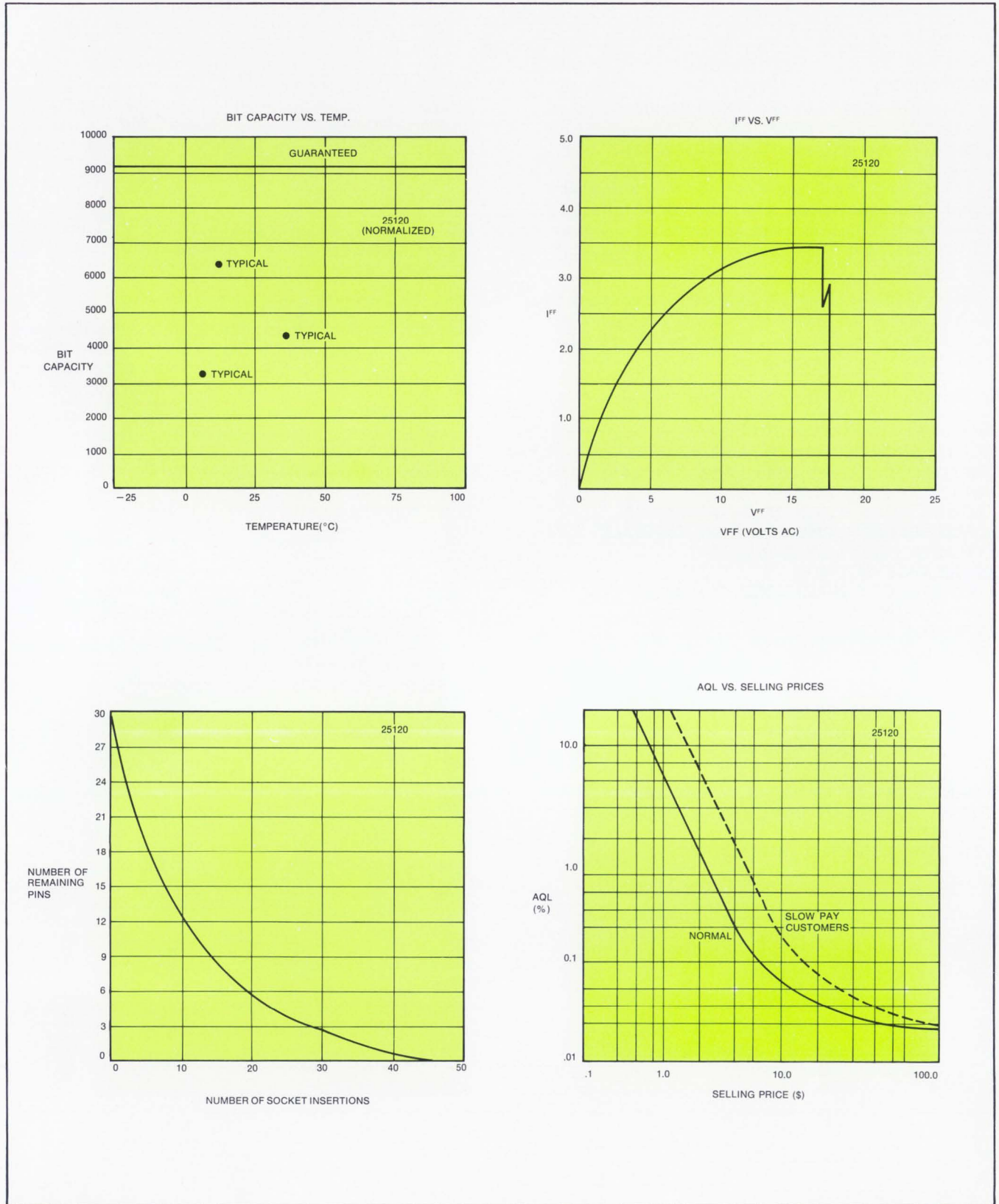

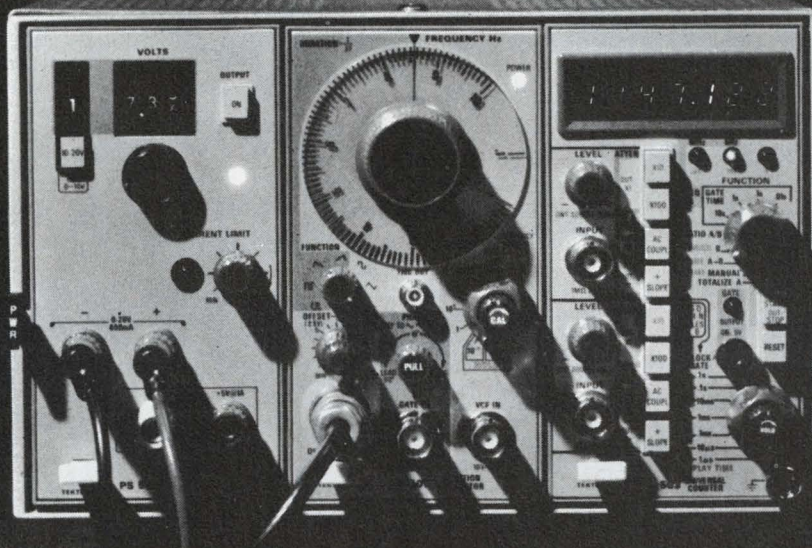

Take a close look at this new approach in test instruments . . .

The Tektronix counter, signal generator, and power supply plug ins shown in the versatile TM 503 power unit represents a new approach in test and measurement instrumentation. Additional Tektronix digital counters, multimeters, signal generators, oscillators, and power supplies cover a wide range of measurements.

They're modular

Each module is interchangeable. They plug in the three compartment TM 503 power unit or a single compartment TM 501 power unit. Cabinet-to-rackmount conversion kits enable either one or two TM 503's to become a standard 5¼" installation.

They're compatible

An intra-compartment interface permits multi-function applications. The modules "talk to each other". This results in a synergistic effect: modules working together perform more functions than the same modules working independently.

They're expandable

As new modules are introduced, you simply plug them into your existing power unit. So your equipment never becomes obsolete.

They're compact

That saves you valuable space on your work bench. And imagine a light weight portable test system with flexibility to suit your special needs.

They're by Tektronix

That means latest circuitry, finest packaging, quality and service you can rely on. And the TM 500 series gives you more performance per dollar than any other test and measurement system.

. . . now take a closer look.

Call your Tektronix Field Engineer for a demo or write us for detailed specifications:

Tektronix, Inc., P.O. Box 500,
Beaverton, Oregon 97005.



TEKTRONIX

VACTEC PHOTODETECTORS

VACTEC adds one lobster and two new detectors
(NPN phototransistors & silicon cells)
to make the broadest line of
photodetectors in the World.

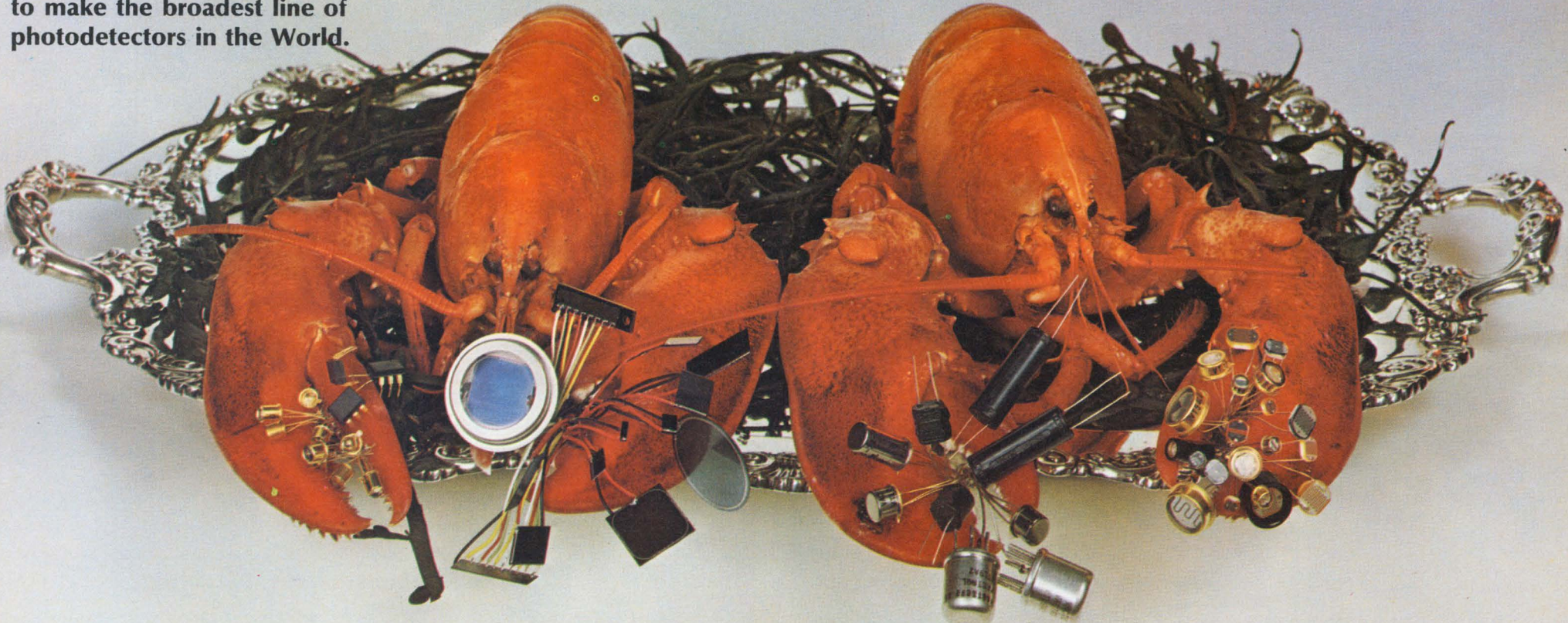

New NPN silicon phototransistors and
DIP package opto-isolators.

New complete line silicon P on N
photovoltaic (solar) cells. N on P Blue
sensitive also available.

Vactrols (opto-isolators) incandescent
or LED drivers with photoconductors
in new low cost packages.

Photoconductive Cells. Six different
materials and nine packages.

Selenium photovoltaic cells, custom detector or array designs and a portable photometer complete the line.
Contact VACTEC for any photodetector application.

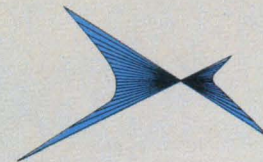

VACTEC, INC.

2423 Northline Industrial Blvd.
Maryland Heights, Mo. 63043
Phone (314) 872-8300

washington report



Heather M. David
Washington Bureau

AEC developing high-energy lasers

The Atomic Energy Commission is pushing high-energy laser research both for use in fusion reactors for electric power and for potential weapons applications. At present the commission's Los Alamos, N.M., laboratory, is looking for a TEM₀₀ laser to operate at pressures of approximately greater than 1800 torr. The Livermore laboratory in California is planning to build a high-energy laser facility to test a heavily weighted, short-pulsed laser for bombarding fusible material, such as deuterium or tritium, to see if the facility can produce at least as much yield as the energy of the laser light. AEC scientists think it may take a laser some 100 times more efficient than today's glass lasers, with energies 1000 times higher, to produce more energy from the fusion reaction than there is in the laser. If it can be developed, the commission says, serious reactor work could begin around 1980, with reactor development taking another 10 to 20 years.

Safeguard leftovers going into new radars

Remnants of the Safeguard antiballistic missile system's Perimeter Acquisition Radar (PAR) system, which had been scheduled for installation at Malmstrom Air Force Base in Montana but was canceled because of the strategic arms-limitation talks with the Soviet Union, are being bought from General Electric by the Air Force for incorporation into two new long-range, phased-array radars. The two new radars, expected to cost a total of at least \$60-million, will be placed on the East and West Coasts to detect any sub-launched ballistic missiles aimed at the continental U.S. The Air Force also is modifying the 10-story high AN/FPS-85 Space Track phased-array radar at Elgin Air Base in Florida so that it, too, will have some capability for detecting submarine-launched missiles.

Space program gets boost in Congress

Congressmen in favor of accelerating the space-shuttle program are using the energy crisis to gain support. They point out that Rockwell International, prime contractor for the NASA shuttle, is studying a satellite orbiter system designed to relay electrical energy from one section of the country to another by converting it to microwave frequencies and beaming it back and forth from space via a synchronous-orbit satellite. Remote energy sources, such as solar power generators in the

desert or an isolated nuclear plant using the highly toxic Plutonium 239, could then be made economically feasible.

Thus far NASA's budget is faring well in Congress, having been boosted 1% by the Senate Space Committee and 1.9% by the House Space Committee over the Administration's \$3.016-billion request. The House committee had some unkind words for the Administration's actions in cutting NASA out of the communications R&D business. Rep. James Symington (D-Mo.) called the decision "incredible" and said that much remains to be done in the fields of direct-broadcast satellites, laser communications, higher-gain antennas and higher-power transmitters—the kind of "far-out" work industry probably will not support.

Trade bill arguments heat up

The schism between business and labor interests testifying before the House Ways and Means Committee on the proposed trade-reform act (H.R. 6767) seems likely to broaden as hearings go on. Hewlett-Packard's board chairman, David Packard—representing WEMA, the West Coast trade association, told the committee that WEMA supports the Administration bill, but he asked for provisions to give more aid to companies that have been hurt by imports. He also opposed Treasury Dept. proposals for additional taxes on U.S. corporations engaged in manufacturing abroad, arguing that the foreign activity helped electronics companies penetrate markets abroad, increased U.S. exports and thus provided more employment in the U.S. Dr. C. Lester Hogan, President, Fairchild Camera and Instrument Corp., Mountain View, Calif., told the committee that semiconductors simply "cannot be totally produced in the U.S. and sold competitively."

I. W. Abel, chairman of the AFL-CIO Economic Policy Committee, termed such arguments "statistical quackery" and accused multinational companies of trying to "brainwash the public."

Capital Capsules: NASA is looking at the possibility of using power from a solar array for a propulsion stage for some future space vehicle. Ten companies are bidding on a contract to identify and work on the technological problems associated with propulsion. . . . **Fairchild Industries and TRW, Inc., are teaming up** for the design, development and manufacture of communications satellites. They are planning a proposal to RCA Global Communications and RCA Alaska for a three-axis, body-stabilized spacecraft rather than the usual spin-stabilized type. . . . **The Air Force is developing a sun-powered laser**, using lenses and mirrors to collect solar energy to power a neodymium laser, for use in satellite optical communications. GTE Sylvania is working on the project. . . . The White House Office of Telecommunications has given its blessing to **AT&T's proposed digital data-transmission system** for five major cities. . . . The Naval Ship Research and Development Center in Bethesda, Md., is planning an **eight-year program to formulate computer programs for the design and construction of entire ships**. Current efforts are aimed at developing computer programs for the design of ship piping. . . . The Federal Aviation Administration has told the airlines and military to **prepare to switch from 50 kHz-spaced communications channels to 25 kHz between channels beginning January, 1977**, at altitudes over 18,000 feet. Channel splitting will not be adopted for aircraft operating below this altitude until heavy communications traffic makes this absolutely necessary, the FAA said.

storage does more...

... like letting you view changes in characteristics while you vary operating conditions. As pictured here, the zero temperature coefficient of a junction F.E.T. is easily found by observing the curve that changes least with changing temperature.

Storage also extends your measurement capability at low currents where device capacity normally limits a curve tracer to DC operation and a set of dots on the display. With storage you can trace and retain complete characteristics by slowly varying the DC conditions.

Plug-in test fixtures provide the flexibility required to keep your testing capability in stride with the ever-advancing semiconductor industry.

When equipped with the 177 Standard Test Fixture, the 577 displays the characteristic curves of transistors, FET's, tunnel diodes, SCR's, Zeners, or any device which current-versus-voltage plots are desired.

Measuring parameters of linear IC's such as op-amps, diff-amps, comparators and regulators becomes an inexpensive, simple task with the plug-in 178 Linear IC Test Fixture.

The 577 system prices range from \$1850 to \$3200.

Let us assist you in solving your measurement needs. Call your local Tektronix Field Engineer for added information and a demo, or if you prefer, write Tektronix, Inc., P.O. Box 500, Beaverton, Oregon 97005. In Europe, write Tektronix Ltd., P.O. Box 36, St. Peter Port, Guernsey, C.I., U.K.

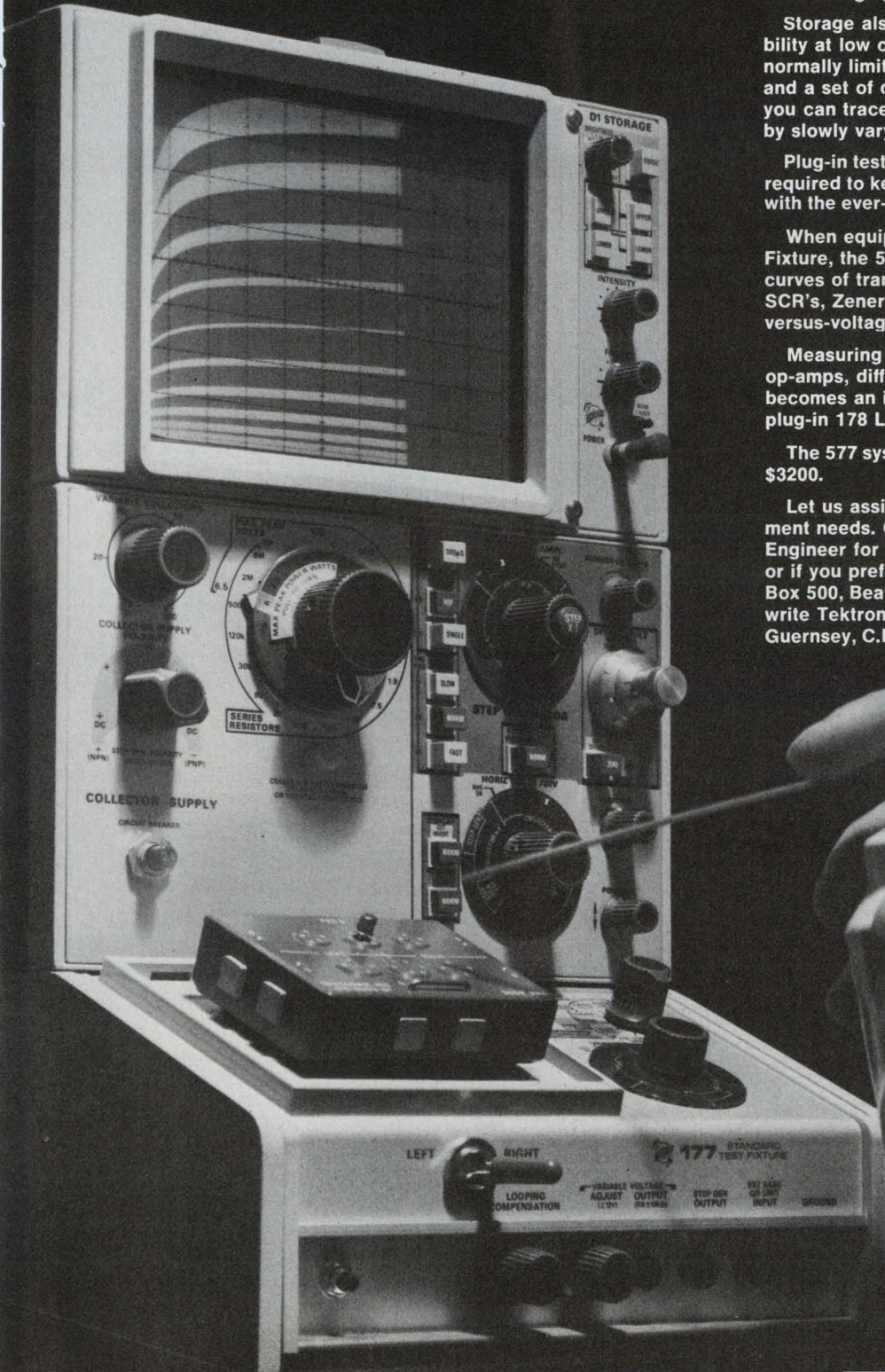

TEKTRONIX®

committed to
technical excellence

NEW FAST ANSWER FOR ELECTRONIC NOISE PROBLEMS...



Ceramag® Ferrite Beads on Lead Tape

Stackpole Ceramag® ferrite beads provide a simple, inexpensive means of obtaining RF decoupling, shielding and parasitic suppression without sacrificing low frequency power or signal level.

Now beads are available with leads, cut and formed or on lead tape. Most equipment that is capable of automatic insertion of lead tape components can be modified to accept this special Stackpole bead.

No other filtering method is as inexpensive . . . and now as fast to insert in your circuit. Starting with a simple ferrite bead (a frequency-sensitive impedance element) which slips over the appropriate conductor, Stackpole has available a variety of materials and shapes providing impedances from 1 MHz to over 200 MHz. The higher the permeability, the lower the frequency at which the bead becomes effective.

CERAMAG® FERRITE BEAD CHARACTERISTICS

GRADE NUMBER	24	7D	5N	11
Initial Permeability	2500	850	500	125
Volume Resistivity @ 25°C	1.0x10 ²	1.4x10 ⁵	1.0x10 ³	2.0x10 ⁷
*Effective Suppression At:	1 MHz	20 MHz	50 MHz	100 MHz
Curie Temperature	205	140	200	385

*A tutorial guide on how these passive components behave with frequency and geometry is available from the Electronic Components Div.

Impedance varies directly with the bead length and log [O.D./I.D.]. Beads are available in sleeve form in a range of sizes starting at .020" I.D., .038" O.D., and .050" long. The bead on lead tape is .138" O.D. and .175" long. Where quantities warrant, other beads on leads and/or lead tape are a design possibility. Tight mechanical tolerances are held in sizes and shapes as varied as the pair of giant, mating channels shown on the left which are used to eliminate the effect of transient noise in computers.

Sample quantities of beads are available for testing. Consult Stackpole Carbon Company, Electronic Components Div., St. Marys, Pa. 15857. Phone: 814-781-8521. TWX: 510-693-4511.



a DC to 1 GHz sampling oscilloscope for only \$2290!

**sound
impossible?**

Not for Tektronix. We designed a complete dual-channel sampler into a double-width plug-in package. Using engineering know-how and modern economical manufacturing techniques we built a lower priced unit. The 5S14N includes new operating conveniences and entirely new capabilities. Installed in a 5103N/D10 oscilloscope mainframe this package is the lowest priced sampling oscilloscope offered today.

The 5S14N has a dual-channel vertical with risetimes of 350 ps and sensitivities ranging from 0.5 V/div down to 2 mV/div. The time base section includes two time bases which allow calibrated delayed sweep operation, a *first for low priced sampling*. Our new trigger circuit permits "hands off" triggering for pulses from 10 Hz to 100-MHz.

Simplified controls minimize the difficulties of operation. Most users familiar with the operation of conventional scopes can learn to operate the instrument in a short time. *Another first* is a "two-dot" feature which makes time measurements easier and more accurate than ever before.

The 5S14N sells for only \$1750. The package of the 5S14N and 5103N/D10 mainframe is priced at \$2290. Installing the 5S14N into a 5103N/D11 mainframe gives a *storage* sampling oscilloscope for \$2770.

Features of the 5S14N are available for 7000-series oscilloscopes too. The 7S14 Sampling Unit with CRT READOUT sells for \$1850.

For more information write Tektronix, Inc., P. O. Box 500, Beaverton, Oregon 97005. In Europe, write Tektronix Ltd., P. O. Box 36, St. Peter Port, Guernsey, C.I., U.K.

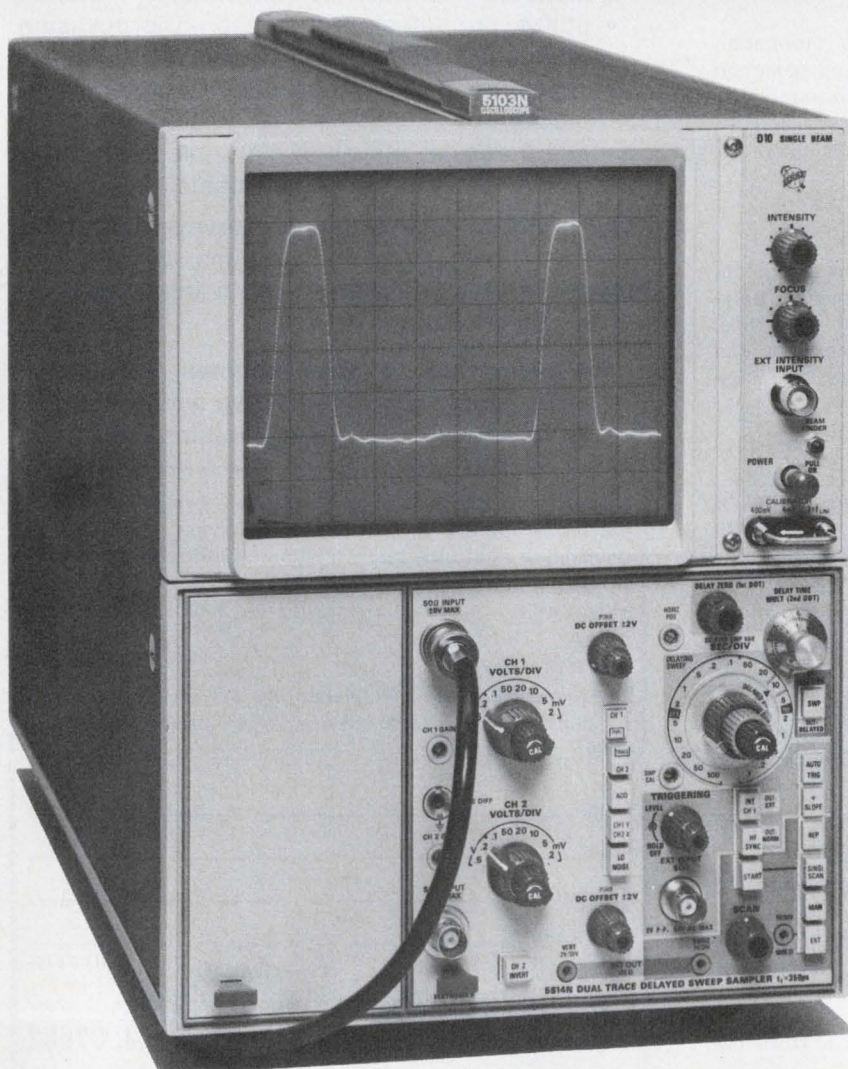

INFORMATION RETRIEVAL NUMBER 43

Always select the best materials... assure your product's performance, reliability and profitability

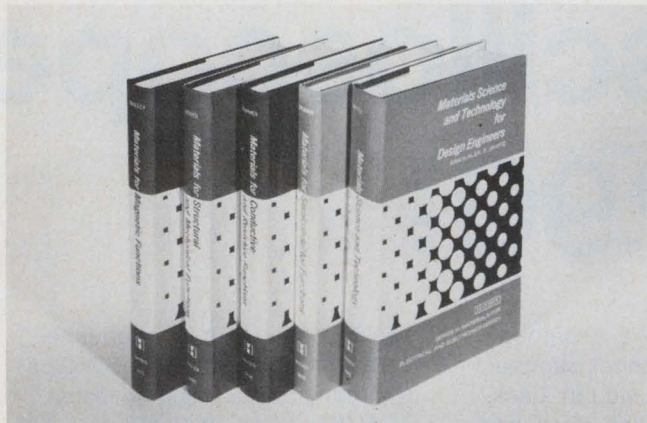

Materials Science and Technology for Design Engineers

Edited by Alex. E. Javitz

This comprehensive reference integrates the fundamentals of materials with the hard facts of day-to-day engineering practice. Covers basic structure and behavior, new materials and applications, environmental effects, reliability concepts, and cost effectiveness. 560 pages, 6x9, illustrated, #5640-0, cloth, \$23.95.

Materials for Semiconductor Functions

E. G. Bylander, Texas Instruments, Inc.

Vital information for all levels of semiconductor fabrication and application. Provides materials processing and selection criteria—based on intended function for diodes and transistors, solar cells, thermo-electric and electro-optical devices, passive circuit components and transducers. 220 pages, 6x9, illustrated, #5638-9, cloth \$13.50.

Composite Materials for Combined Functions

E. Scala, Cornell University and technical consultant

Provides the latest information and techniques in designing, forming and applying composite materials—ceramics, polymers, alloys. Details the latest materials and their properties, processing techniques, and practical design methods and guidelines vital to optimum performance. 392 pp., 6x9, illustrated, #5639-7, cloth, \$19.95.

Materials for Magnetic Functions

Fennimore N. Bradley, Michigan Technological University

Isolates physical concepts such as superexchange, sublattice magnetization, and anisotropy. Covers key parameters of ferrite (ceramic) materials, and the magnetic metals. 360 pages, 6x9, illustrated, #5635-4, cloth, \$14.95.

Materials for Structural and Mechanical Functions

Gabor Kovacs, IBM General Systems Division

Clarifies the relation between device malfunction and failure and conditions such as shock, vibration, wear, fatigue, static and dynamic load. Deals with *all* classes of materials and treats specific application problems in detail. 360 pages, 6x9, illustrated, #5637-0, cloth, \$13.95.

Materials for Conductive and Resistive Functions

G. W. A. Dummer, formerly British Ministry of Technology

Broad and detailed coverage of conductive, contacting, and resistive functions, as well as of the new field of superconductive functions and devices. 366 pages, 6x9, illustrated, #5636-2, cloth, \$13.95.

Forthcoming

Materials for Electrical Insulating and Dielectric Functions, by H. L. Saums and W. W. Pendleton

HAYDEN SERIES IN MATERIALS FOR ELECTRICAL AND ELECTRONICS DESIGN

ALEX. E. JAVITZ, *Editor-in-Chief, Technical Consultant;*
Senior Member, IEEE, ACS, SPE.

This series of practical design references has been specifically planned to help you and your colleagues meet the challenge of proper materials selection on all fronts. These volumes place at your disposal—in engineering terms—the concepts, data, and techniques you need in order to

- understand how fundamental properties of materials affect their ultimate performance
- exploit the potential of advanced materials
- make optimum use of conventional materials
- utilize the latest techniques in processing, fabrication, test and measurement
- specify materials that resist environmental damage
- guard against misuse of materials that may be hazardous or produce pollutants

One interdisciplinary volume surveys the entire spectrum of design considerations. Each of the others provides you with in-depth information on a major functional area.

Examine any of these volumes *without risk!* Simply check those you would like to review on 15-day free examination.

Please send the book(s) checked on 15-day free examination. At the end of that time, I will remit payment plus postage, or return the book(s) with no further obligation.

5640-0 5635-4 5638-9
 5636-2 5637-0 5639-7

Save Money!

Payment Enclosed. Publisher will pay all shipping and handling charges. Same 15-day return privilege and full return if not satisfied.

Name _____

Firm _____

Address _____

City/State _____ Zip _____

73-50 ISBN Prefix 0-8104

 **HAYDEN BOOK COMPANY, INC.**
50 Essex Street, Rochelle Park, N.J. 07662

a handful of measurement solutions...

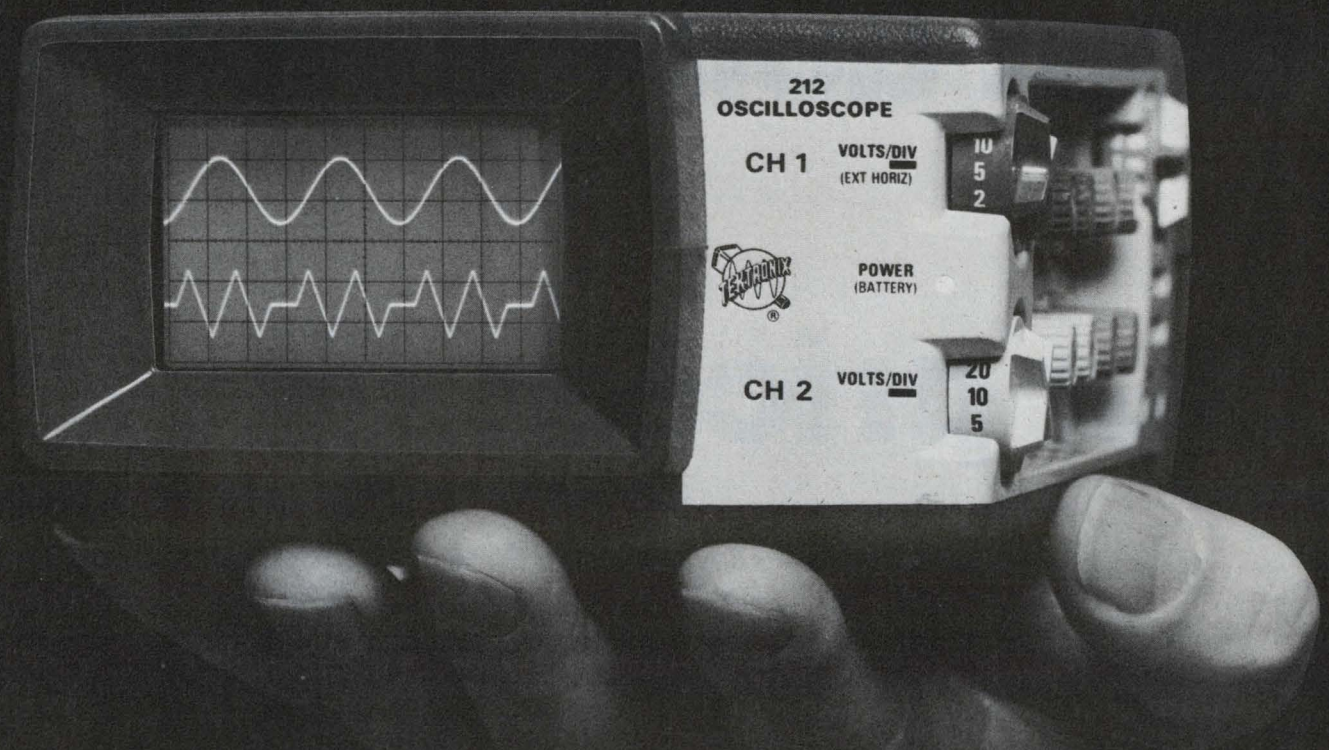

With the 212. A completely new DUAL-TRACE, 500-kHz, 3 x 5 1/4 x 9-inch scope that weighs only 3.4 pounds and costs just \$725. The high-impact plastic case withstands severe environments — double-insulated construction helps protect you while making high-voltage measurements.

Many other benefits are available in our first dual-trace mini: (1) 500 kHz and 1 mV/div; (2) Designed, developed and manufactured within the

United States; (3) For clarity, probe bodies and vertical deflection controls are color-matched; (4) When not in use, the permanently connected probes and power cord store in an easy-to-use compartment; (5) There are only two trigger controls, one for level and slope, the other for source selection; (6) Controls are recessed to prevent accidental damage; (7) Up to 5 hours operation are provided from rechargeable internal batteries; (8) Vinyl carrying case . . .

For complete information or to arrange a demonstration, contact your local Tektronix, Inc. Field Office. Or, write Tektronix, Inc., P.O. Box 500, Beaverton, Oregon 97005. In Europe, write Tektronix, Ltd., P.O. Box 36, St. Peter Port, Guernsey, C.I., U.K.

212 Oscilloscope \$725

U.S. Sales Price FOB Beaverton, Oregon



TEKTRONIX®

committed to
technical excellence

Lighted pushbutton switches this good should cost dollars more.

Our prices:

\$125*

\$160†

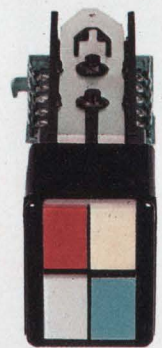

OAK SERIES 300.

Get premium performance—at much less than a premium price. Oak Series 300 lighted pushbutton switches give you tested-for-reliability operation and long life. The economical solution to pushbutton applications for bank terminals, calculators, copiers, and more.

Modular design simplifies panel design. Oak Series 300 switches are relampable from the front, with

replaceable lenses, legend plates, and button assemblies. The snap-on lamp holders withstand physical shock, help prolong lamp life.

Choose from single, dual, or four-lamp display, as well as indicators and non-lighted types. Specify one to twelve station banks, with momentary, interlock, alternate action, or any switching combination available on the same bank.

Colors? Your choice of any one of the following for single-leg switches (or any combination for split-leg switches): lunar white, white, red, green, amber, yellow, orange, blue.

Get the complete details. Write for our Series 300 brochure.

* Single-leg, single-lamp, normal latch, 2P2T, glass alkyd insulation, no engraving, less lamps. OEM quantities.

† Split-leg, four-lamp, normal latch, 2P2T, glass alkyd insulation, no engraving, less lamps. OEM quantities.

OAK Industries Inc.
SWITCH DIVISION/CRYSTAL LAKE, ILLINOIS 60014
 TELEPHONE: 815 • 459 • 5000 ■ TWX: 910 • 634 • 3353 ■ TELEX: 72 • 2447

INFORMATION RETRIEVAL NUMBER 46

Who to call for fast delivery on Oak Series 300 Switches.

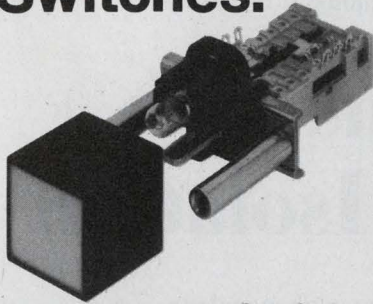

Now you can order Oak Series 300 Lighted Pushbutton Switches and assemblies (single-legend/single-lamp or non-illuminated) in quantities up to 149 from your regional Oak distributor. These distributors are equipped to assemble custom units and ship within 3 days.

DRW

MASSACHUSETTS, Watertown. (617) 923-1900
NEW YORK, Farmingdale. (516) 249-2660*

G. S. MARSHALL

CALIFORNIA, El Monte. (213) 686-1500*
CALIFORNIA, San Diego. (714) 278-6350
CALIFORNIA, Sunnyvale. (408) 732-1100
COLORADO, Arvada. (303) 427-5858
OHIO, Dayton. (513) 278-9496

HALL-MARK

ALABAMA, Huntsville. (205) 539-0691
FLORIDA, Orlando. (305) 855-4020*
GEORGIA, Atlanta. (404) 963-9728
ILLINOIS, Chicago. (312) 437-8800
KANSAS, Kansas City. (913) 888-4747
KANSAS, Wichita. (316) 682-2073
MARYLAND, Baltimore. (301) 265-8500
MINNESOTA, Minneapolis. (612) 925-2944
MISSOURI, St. Louis. (314) 521-3800
NORTH CAROLINA, Raleigh. (919) 832-4465
NEW YORK, New York. (516) 293-7500
OHIO, Dayton. (513) 278-6963
OKLAHOMA, Okla. City. Enterprise 50094
OKLAHOMA, Tulsa. (918) 835-8458
PENNSYLVANIA, Philadelphia. (215) 355-7300
TEXAS, Austin. (512) 454-4839
TEXAS, Dallas. (214) 231-6111*
TEXAS, Houston. (713) 781-6100
WISCONSIN, Milwaukee. (414) 476-1270

INTERFACE ELECTRONICS

WASHINGTON, Seattle. (206) 285-3500*

* Assembly Locations

OAK Industries Inc.
Crystal Lake, Illinois 60014

technology abroad

Trapatt diodes that produce current pulses with a half-pulse width of 150 ps at a repetition rate of 1 GHz have been used to modulate a double-heterostructure gallium-arsenide laser. The Trapatt oscillator, developed by researchers at the University of Cambridge in England, is capable of driving these short current pulses into the low laser-diode impedance. The laser and the diode were mounted in the same

coaxial cavity, with the current pulses being reflected from the laser instead of from the usual low-pass filter. The Trapatt was run in a pulsed mode with a duty cycle of about 0.05%. The laser operated at room temperature and was biased very close to the lasing threshold. The research effort is believed to have potential use in the study of photon-electron interactions.

CHECK NO. 447

A range of electrically alterable nonvolatile memory devices has been developed by Plessey with metal-nitride-oxide semiconductors. Information, says Plessey, can be stored for more than 100 years. Readout is nondestructive. Applications include microprogramming, numerical control, data logging and airborne systems. The devices are available as single transistors, as pairs or quads or as an 8-by-8 array. Write times

extend from less than 1 μ s to 10 ms. Plessey has also developed equipment to measure the mobility of carriers in memory devices of this type. The effective field-effect mobility over a range of gate potentials is measured by superimposing a small ac signal on the dc gate supply and measuring the transconductance. The mobility gate-potential curve is displayed directly on an X/Y recorder.

CHECK NO. 448

An acoustoelectric voltage in photoconductive cadmium sulphide has been detected by researchers at the University of Helsinki. The Finnish researchers used a novel configuration employing horizontal-plate shear waves. For certain classes of piezoelectric crystal, these waves were found to propagate along a particular direction with only one component of particle motion. The particle motion was parallel to the surface and

perpendicular to the sagittal plane, and the fundamental symmetric mode corresponded to a shear wave along the crystal. These horizontal-shear waves were easily excited in thin cadmium-sulphide plates. Typical insertion loss of the plates at 20 MHz was about 70 dB. Single, silver-painted stripes acted as input and output transducers for the fundamental shear mode.

CHECK NO. 449

L-alanine doped triglycine sulphate—a new pyroelectric material developed at the Royal Radar Establishment, Malvern, England, in conjunction with Mullard Research Laboratories—has been used in infrared detectors with performance described as greatly improved over that of previous pyroelectric materials. The new devices appear to be at least as good as the best uncooled thermal detectors available. The detector spectral response is practically

constant from the visible throughout the infrared, falling off at millimeter wavelengths. The detectors also have better frequency response and are more rugged than other types of IR room-temperature detectors. Devices produced with this material include spectrometers, horizon sensors, radiometric detectors for satellites and detectors for thermal sensors. Microwave applications are also being investigated.

CHECK NO. 450



P-channel
J FET



N-channel
J FET

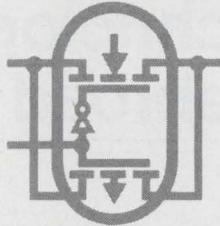

CMOS
FETs



P-channel
MOS FET

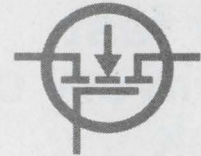

N-channel
MOS FET

Since 1962, Siliconix has evolved FET technology and applied it to a complete line of singles, duals, arrays, and ICs. So what's new?

Switch 10 MHz Signals with better than 60 dB OFF Isolation

The Siliconix DG181-DG191 family of FET switch/IC drivers is well-suited for processing high-frequency signals, and is directly compatible with most computer logic. FET switch/monolithic driver combinations are available in SPST, SPDT, or DPST functions.

Features include:

- Constant ON resistance with signals to ± 10 V and 100 MHz
- 60 dB OFF isolation at 10 MHz with 75 Ω load
- t_{on} and t_{off} = 150 ns typical
- 1 nA max (100 pA typical) leakage from signal channel in either ON or OFF state.

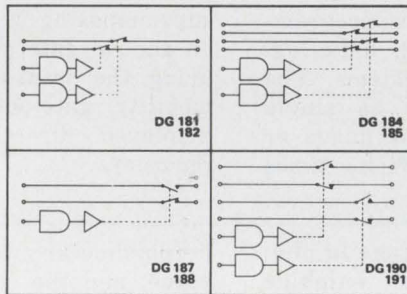

DG181-DG191 Functional Diagrams

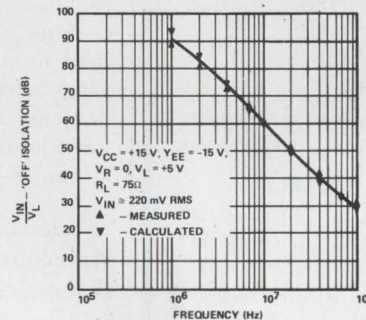

Switch OFF Isolation vs Frequency—DG181

The key to this exceptional performance is the Siliconix concept of monolithic driver design, with careful attention to critical details such as low driver output impedance. DG181-DG191 driver (switch OFF) resistance

to ground is only 200 Ω , providing good a-c by-pass on the FET switch gate. Contrast this with other driver circuits with impedances as high as 26 M Ω , which adversely affect isolation characteristics.

The DG181-DG191 series of FET analog switches is an ideal solution to most switching problems. If your case is unique—and whose isn't—our applications people are eager to help. For complete information

write for data

Applications Engineering (408) 246-8000, Ext. 501



Siliconix incorporated

2201 Laurelwood Road, Santa Clara, California 95054

INFORMATION RETRIEVAL NUMBER 48

Let's go beyond taking in each other's laundry

We're still living in an incestuous industry. With just a few exceptions, we live for and design for our brothers in the electronics industry. Sure, we've always designed military products, which are used outside the electronics industry. We design computers that go into almost any field you can name. And we design consumer gear that's bought by our wives and cousins. But for the most part, we're still like the community whose economy was based on the citizens' taking in one another's laundry.

The pulse-generator manufacturer still designs better pulsers, which he can sell to the transistor designer, who can then develop better transistors for use in better pulse generators. The IC designer makes better integrated circuits for computers that are used in IC testers. The instrument designer makes better gear for testing the circuits that go into instruments. Exaggerated? Yes.

But if this approach is not always our way of life, it's almost our way of thinking. We think in terms of what we can design for the computer market, or the instrumentation market or the communications market. We too seldom think in terms of what we can design for the world outside the electronics industry.

And yet, despite our myopia, we're making some progress. The recent, explosive growth of calculators is a powerful example. These units, unlike earlier ones that served only the professional and business markets, have created an entirely new customer—the man in the street. Low-cost electronic calculators have become an impulse buy.

Will we find more calculators in our future? Will we finally crack machine and process-control equipment? Will we get into people's homes in a big way? Will we learn to design for the doctor, the hospital, the steel mill and the city? Will our products move into a thousand avenues we've never walked before? They can if we think and plan outward. The days of our growing by selling to one another are numbered.



A handwritten signature in cursive script that reads "George Rostky".

GEORGE ROSTKY
Editor-in-Chief

The Same HP That Instruments Now Makes Them

Take signal sources for example...

You can't see the automated testing and the other manufacturing advances that help lower the price of HP's quality signal sources. But you sure can see the versatility and extra performance you get for your money. From the simplest function generator to the most capable synthesizer, HP technology has brought the price of quality way down.

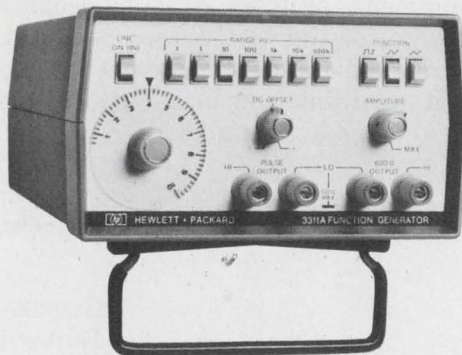

Brand New Function Generator 3311A shows what a performance plus you get from this technology in action. Priced at only \$249, it adds sweep capability and a separate high-power pulse output to the usual sine, square and triangular wave outputs. Sweep it over any 10 to 1 span within its 0.1 Hz to 1 MHz range. The pulse output drives up to

20 TTL loads. Note that price again. It's 15% lower than its nearest major competition.

Wide Range Function Generators 3310A/B deliver general-purpose waveforms with extended low-frequency response. These 0.0005 Hz to 5 MHz instruments equip you with a linear very-low-frequency ramp, in addition to sine, square, triangle and pulse waveforms. Prices are a modest \$595 for the 3310A, and \$735 for the 3310B that also provides free-run, single-cycle and multiple-cycle operating modes.



Technology Makes Better... Cost Less



Lowest Cost Frequency Synthesizers 3320A/B bring you synthesizer quality for as little as \$1,900. You get 1 part in 10^6 frequency resolution over the entire 0.01 Hz to 13 MHz range. Also, on the 3320B, HP's thermopile control of amplitude level gives 0.01 dB level resolution. If precise amplitude setting and calibration aren't required, get the 3320A for \$1,900. Or, get *both* frequency and amplitude precision in the 3320B for \$2,550 (add \$595 for full ASCII programmability). How's that for a blend of quality, performance and low price!

Top-of-the-line Automatic Synthesizers 3330A/B have a built-in "brain" that lets you avoid tying up a computer. They're like the 3320A/B, only these can be programmed to automatically sweep their frequency spectrum (and, on the 3330B, its precision amplitude level). With the 3330B you're getting a synthesizer, a sweeper, a marker generator, a counter, a programmable attenuator, a built-in controller and a precision level generator—in other words a lab-in-a-box—for just \$6,000. Or, cut that to \$5,100 for the manual-amplitude-control 3330A.

Whatever your needs in signal sources, satisfy them with one of HP's technology-leader instruments. They're packed with more capability than ever before—and priced lower, too. For more information on the entire family of HP signal sources, contact your local HP field engineer. Or, write



Hewlett-Packard, Palo Alto, California 94304. In Europe: HPSA, P.O. Box 85, CH-1217 Meyrin 2, Geneva, Switzerland. In Japan: Yokogawa—Hewlett-Packard, 1-59-1, Yoyogi, Shibuya-Ku, Tokyo, 151.

093/43A

HEWLETT  PACKARD
SIGNAL SOURCES

INFORMATION RETRIEVAL NUMBER 49

BCD logic-Part 1

BCD: Logic of many uses. Calculators rely on it, and future applications appear unlimited. Start with addition and subtraction and learn how you can use it.

This article discusses the fundamentals of binary-coded-decimal logic, and shows how addition and subtraction are performed.

Binary-coded-decimal (BCD) logic is a good compromise, if you want to operate with decimal numbers while using hardware that works in binary fashion. The BCD system needs only a minimum of conversion hardware to do this.

Each decimal digit in the system is expressed by a four-bit binary number. But there are at least 88 different weighted BCD codes. Of these only 17—those employing all positive weights—are used in practical designs. In a weighted code, a ONE bit is assigned a specific value; if the bit is a ZERO, the value is zero. The sum of all the weights corresponds to the value of the decimal digit represented.

The popular 8-4-2-1 code

The most popular BCD code uses weightings that are in the ratios of 8, 4, 2 and 1. Thus the number 529 becomes:

0101	0010	1001
5	2	9

Hermann Schmid, General Electric Co., Box 5000, Binghamton, N.Y. 13902

in an 8-4-2-1 code, with the least-significant-bit at the right.

BCD codes, however, are less efficient than the straight binary code; they generally need more bits to represent a number, and thus more hardware. For example, a six-decimal number requires 24 bits in BCD but only 20 in pure binary. However, in calculators this lower efficiency is offset by easy BCD-to-decimal and decimal-to-BCD conversions.

The X3 code: Easy to use

Another frequently used BCD code is the excess-three (X3). When the sum of the weights of the bits of a BCD code exceeds the value of the decimal digit that it represents, the code is called excess-weighted. In the X3 code, the excess weight is three. Though X3 is conceptually more difficult than the 8-4-2-1 code, X3 computation circuits are simpler. One reason for this simplicity is that the decimal number pairs that are nines complements are also complements in the X3 code. And the complement method of doing subtraction or handling negative numbers is very efficient. Thus in Table 1, decimal number pairs—such as 0 and 9, 1 and 8, 2 and 7—are nine complements, and the X3 representations of these pairs are binary complements—0011 and 1100, 0100 and 1011, 0101 and 1010, and so on.

BCD calculations will be everywhere—

When only a few calculations must be performed and there are frequent manual input and manual output operations, binary-coded-decimal (BCD) logic is the most economical. Its major use today is in the booming calculator field. But it has many potential applications elsewhere. In stores, BCD calculations can sum totals at the point of sale. In banks, automatic tellers can enter deposits, issue withdrawals and make small loans by using BCD. In the home, BCD may emerge as the key help in food preparation and environmental control. And in schools, BCD logic

appears in terminals for programmed teaching.

This is the first in a series of articles on the basics of BCD logic and its use in design.

As one ELECTRONIC DESIGN reader said recently: "Calculators have burst upon the market like a raging flood. But their innards are a mystery to most engineers, since most of the work on these devices was conducted under industrial secrecy. Now that the development is completed and marketing is under way, how about explaining the innards?"

Herewith the beginning of an explanation.

In an electronic calculator, data are entered and displayed in sign-and-magnitude form. It would thus appear logical to perform computations by use of this same form. However, it is often more efficient to handle negative numbers inside the calculator in complement form. Thus, if an attempt is made to subtract $A = 5437$ from $B = 4921$ directly, the result is:

$$\begin{array}{r} 4921 \\ -5437 \\ \hline (9 \dots 999484) \end{array}$$

The nines continue to the machine's limit, and a borrow remains after the last nine. The resulting number is the nines complement of the more conventional sign-and-magnitude form. The conventional, or desired result, however, would be

$$\begin{array}{r} -5437 \\ +4921 \\ \hline -516 \end{array}$$

With the X3 code, you merely take the binary complement of the code for 9484 and add a one to it. This one is automatically derived from the borrow that remains after the most-significant nine's digit. It is treated as a carry to the least significant digit. The nines complement of 9484 is 0515, and $0515 + 1$ (carry) = 0516. This carry-addition operation is called an end-around-carry. The presence of this carry also signals that the number associated with it is a nines complement of a negative number.

Digits are binary, but numbers are decimal

A number represented in a BCD code, though it is modulo-10 at the word level, is modulo-2 at the bit level. Thus, on a bit-by-bit basis and within the word length of four bits, the rules for addition are identical to straight binary addition, as shown in Table 2.

In straight binary addition, the carry bit is simply added to the next higher bit. Thus, by successive application of these basic rules two binary numbers of any length can be added.

Table 1. Decimal and X3 complements

Decimal Number	BCD Numbers	
	8-4-2-1	X3
0	0 0 0 0	0 0 1 1
1	0 0 0 1	0 1 0 0
2	0 0 1 0	0 1 0 1
3	0 0 1 1	0 1 1 0
4	0 1 0 0	0 1 1 1
5	0 1 0 1	1 0 0 0
6	0 1 1 0	1 0 0 1
7	0 1 1 1	1 0 1 0
8	1 0 0 0	1 0 1 1
9	1 0 0 1	1 1 0 0

For example:

Decimal		Binary
63	Augend	1 1 1 1 1 1
+38	Addend	1 0 0 1 1 0
11	Carries	1 1 1 1 1 0
101	Sum	1 1 0 0 1 0 1

But, in BCD the carry from one word to the next

Table 2. Binary addition

Augend		Addend		Sum		Carry
0	+	0	=	0	and	0
0	+	1	=	1	and	0
1	+	0	=	1	and	0
1	+	1	=	0	and	1

Table 3. Correction for addition 8-4-2-1 code

Decimal Sum (N+M)	Uncorrected		Corrected		Correction
	carry	sum	carry	sum	
0	0	0 0 0 0	0	0 0 0 0	0
.
5	0	0 1 0 1	0	0 1 0 1	0
.
9	0	1 0 0 1	0	1 0 0 1	0
10	0	1 0 1 0	1	0 0 0 0	+6
11	0	1 0 1 1	1	0 0 0 1	+6
12	0	1 1 0 0	1	0 0 1 0	+6
13	0	1 1 0 1	1	0 0 1 1	+6
14	0	1 1 1 0	1	0 1 0 0	+6
15	0	1 1 1 1	1	0 1 0 1	+6
16	1	0 0 0 0	1	0 1 1 0	+6
17	1	0 0 0 1	1	0 1 1 1	+6
18	1	0 0 1 0	1	1 0 0 0	+6
19	1	0 0 1 1	1	1 0 0 1	+6

Table 4. Corrections for addition X3 code

Decimal Sum (N+M)	Uncorrected (N+M+6)		Corrected (N+M+6±3)		Correction
	carry	sum	carry	sum	
0	0	0 1 1 0	0	0 0 1 1	-3
.
5	0	1 0 1 1	0	1 0 0 0	-3
.
9	0	1 1 1 1	0	1 1 0 0	-3
10	1	0 0 0 0	1	0 0 1 1	+3
.
15	1	0 1 0 1	1	1 0 0 0	+3
.
19	1	1 0 0 1	1	1 1 0 0	+3

needs special handling. The sum of the digits in the 8-4-2-1 code must never exceed nine. However, when adding two decimal digits, the resulting four bits can add to a maximum of 15. To take care of those cases when the value of the sum does exceed nine, six (0110) must be added to convert the sum to a corrected code (see Table 3).

Uncorrected sums must be tested to determine whether they are greater than nine. This requires not only additional hardware but also valuable computation time. Note that when the correction is made, the sum and the carry are both modified.

Again the X3 code allows a simpler approach, because it automatically provides an indication when the sum of two digits exceeds nine, without any extra circuitry. When two X3-coded digits, N and M, are added, you get:

$$(N + 3) + (M + 3) = (N + M + 6).$$

When $N + M = 9$, the value $N + M + 6 = 15$. And since this is 1111 in binary notation—the maximum possible with four bits—uncorrected X3 codes over 15 automatically produce a carry. Therefore, to correct a sum to correspond to the X3 code, the quantity 0011 = 3 is added when a carry is generated; the same quantity is subtracted, when no carry is generated. This property of the X3 code not only simplifies hardware but also reduces computation time. Thus for the X3 code, Table 4 shows the required corrections.

Other, more detailed examples of BCD addition are shown in Table 5.

Direct subtraction with BCD

BCD subtraction can be achieved either directly or by a method of complements, as previously described. Both methods are used in electronic calculators. There is, in general, little difference in the amount of hardware required for the two methods. Having looked at the method of complements, let's look now at direct subtraction (Table 6).

In direct subtraction with the 8-4-2-1 code, a correction is needed when the difference between two digits, designated M and N, is a negative quantity. The correction is made by subtracting the quantity 6 = 0110 from the uncorrected result. However, instead of writing a negative number, the familiar borrow operation is performed. For example:

XXX4 minus XXX5 is XXX9, since a unit quantity is borrowed from the next higher column and added to the four (LSB of the minuend). The answer for this operation is equivalent to a -1. Therefore the corrections for the 8-4-2-1 BCD code are as shown in Table 7.

Similarly, to obtain the corrected difference in the X3 code, the quantity 3 = 0011 must be sub-

Table 5. BCD addition

	Decimal Code	8-4-2-1 Code		X3 Code	
Augend	59	0101	1001	1000	1100
Addend	25	0010	0101	0101	1000
S* = Uncorrected sum	7(14)	0111	1110	1101	0100
Correction	—		+0110	-0011	+0011
Carry	10	+0001		+0001	
S = Corrected Sum	84	1000	0100	1011	0111

Addition algorithms		
8-4-2-1 Code	$\left\{ \begin{array}{l} \text{No correction when } S^* \leq 1001 \\ S = S^* + 0110 \text{ when } S^* > 1001 \end{array} \right.$	
X3 Code	$\left\{ \begin{array}{l} S = S^* + 0011 \text{ when } S^* \leq 1001 \\ S = S^* + 0011 \text{ when } S^* > 1001 \end{array} \right.$	

Table 6. BCD direct subtraction

	Decimal code	8-4-2-1 Code		X3 Code	
Minuend	87	1000	0111	1011	1010
Subtrahend	-59	-0101	-1001	-1000	-1100
D* = Uncorrected Difference	3(-2)	0011	1110	0011	1100
Correction	(+10)		-0110	+0011	-0011
Borrow	-1	-0001		-0001	
D = Difference	28	0010	1000	0101	1001

Subtraction algorithms		
8-4-2-1 Code	$\left\{ \begin{array}{l} \text{No Correction} \text{ when } D^* \geq 0 \\ D = D^* - 0110 \text{ when } D^* < 0 \end{array} \right.$	
X-3 Code	$\left\{ \begin{array}{l} D = D^* + 0011 \text{ when } D^* \geq 0 \\ D = D^* - 0011 \text{ when } D^* < 0 \end{array} \right.$	

Table 7. Corrections for subtraction—8-4-2-1 code

Decimal Difference	Uncorrected difference		Corrected difference D =		Correction G
	D* = (M - N)		(M - N - G)		
(M - N)	Borrow	Difference	Borrow	Difference	G
+9	0	1001	0	1001	—
+8	0	1000	0	1000	—
.
+1	0	0001	0	0001	—
0	0	0000	0	0000	—
-1, or 9 and a borrow		1111	1	1001	-0110
-2, or 8 and a borrow		1110	1	1000	-0110
.
-9, or 1 and a borrow		0111	1	0001	-0110

Table 8. Corrections for subtraction-X3 code

Decimal difference (M-N)	Uncorrected difference $D^* = (M+3) - (N+3)$		Corrected difference $D = (M-N \pm 3)$		Correction
	Borrow	Difference	Borrow	Difference	
+9	0	1001	0	1100	+0011
+8	0	1000	0	1011	+0011
.
+1	0	0001	0	0100	+0011
0	0	0000	0	0010	+0011
-1	1	1111	1	1100	-0011
-2	1	1110	1	1011	-0011
.
-8	1	1000	1	0101	-0011
-9	1	0111	1	0100	-0011

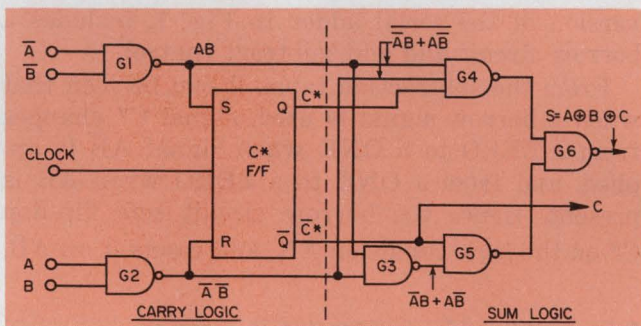

1. A serial binary adder is the most economical circuit upon which to base a BCD calculation system. This makes the all-serial approach a candidate for use in low-speed, low-cost calculator circuits.

tracted from or added to the uncorrected difference, as shown in Table 8.

Implementing BCD adder/subtractors

Pure binary numbers, when added or subtracted serially, require only one circuit—no matter how many bits each number has. BCD adders/subtractors (A/S), however, are more complex than their pure-binary counterparts. As previously shown, the BCD process of addition or subtraction requires several successive operations. The first results in an uncorrected sum. This sum must then be tested to establish the proper correction signal and its polarity. Then the correction signal is applied to the uncorrected sum. Thus BCD adders/subtractors usually require at least two binary A/S circuits plus additional control circuits, and the pure binary A/S then becomes a building block circuit in BCD systems.

But before we tackle BCD adder/subtractors, let's examine the logic details of the binary add/subtract process. The truth table for simple bi-

nary addition is as shown in Table 9.

From the truth table, we obtain the logic equations for the sum and carry outputs, and each equation contains four terms.

$$\begin{aligned} \text{SUM} &= \overline{A} \overline{B} C + \overline{A} B \overline{C} + A \overline{B} \overline{C} + A B C \\ &= \overline{C} (\overline{A} B + A \overline{B}) + C (\overline{A} B + A \overline{B}) \\ &= A \oplus B \oplus C, \end{aligned}$$

$$\begin{aligned} \text{CARRY} &= \overline{A} B C + A \overline{B} C + A B \overline{C} + A B C \\ &= C (\overline{A} B + A \overline{B}) + A B (\overline{C} + C) \\ &= C (A \oplus B) + A B \\ &= AC + BC + AB, \end{aligned}$$

where \oplus denotes the Exclusive-OR function.

There are several ways to implement these equations. Some approaches optimize speed, others aim to minimize the number of gates. In a high-speed version, the sum and carry equations are implemented in their unreduced form simply by ORing all the basic terms, such as $(\overline{A} \overline{B} C + \overline{A} B \overline{C} + A \overline{B} \overline{C} + A B C)$ for the sum. But the serial adder in Fig. 1 is a good compromise. It minimizes hardware without sacrificing too much speed, by taking advantage of the simple logic dependence of the carry signal on the two input words A and B.

Examine the binary-addition truth table, and you will note that the output carry bit changes, under any condition of C*, from a ONE to a ZERO only when both A and B are ZERO. Similarly it changes from a ZERO to a ONE only when both A and B are ONE. Under all other conditions of A and B, the state of the output carry bit corresponds to the state of C* and does not change. Thus the flip-flop is set by a clock pulse when $A = B = 1$, and reset when $A = B = 0$ to provide the carry signal for the next most-significant-bit pair. Of course, the C* flip-flop is reset before a summing operation is started.

In Fig. 2 we see that the first two NAND gates, G₁ and G₂, generate the terms AB and $\overline{A} \overline{B}$. These are then used to control the flip-flop states. The third gate, G₃, generates the Exclusive-OR term $\overline{A} B + A \overline{B}$, and the last three gates G₄, G₅ and G₆ perform the Exclusive-OR function on C and the $\overline{A} B + A \overline{B}$ term.

Though other configurations are possible, circuits like Fig. 1 are good candidates for use in most low-cost calculators. Further, with only a small change you can convert this circuit to perform BCD subtraction, too.

Addition and subtraction in the same circuit

Subtraction is often considered to be the reverse of addition. This is not exactly true. Subtraction is not commutative; the two numbers cannot be interchanged. And subtraction introduces the idea of borrowing, which has a logic that is different than that for the carry.

The logic rules for subtracting two binary bits

Table 9. Binary addition with carry

Inputs			Outputs	
A	B	C*	Sum	Carry
0	0	0	0	0
0	1	0	1	0
1	0	0	1	0
1	1	0	0	1
0	0	1	1	0
0	1	1	0	1
1	0	1	0	1
1	1	1	1	1

*Carry from summation of preceding bit pair

Table 10. Binary subtraction with borrow

Inputs			Outputs	
A	B	C*	A-B Difference	Borrow
0	0	0	0	0
0	1	0	1	1
1	0	0	1	0
1	1	0	0	0
0	0	1	1	1
0	1	1	0	1
1	0	1	0	0
1	1	1	1	1

*Borrow from difference of preceding bit pair

are as shown in Table 10. Note that the difference column of this table is identical to the sum column of the addition table. Thus:

$$\begin{aligned} \text{DIFF} &= \overline{A} \overline{B} C + \overline{A} B \overline{C} + A \overline{B} \overline{C} + A B C \\ &= A \oplus B \oplus C. \end{aligned}$$

But the equation for the borrow signal differs from that for the carry signal:

$$\begin{aligned} \text{BORROW} &= \overline{A} \overline{B} C + \overline{A} B \overline{C} + \overline{A} B C + A B C \\ &= (\overline{A} \overline{B} + A B) C + \overline{A} B (\overline{C} + C) \\ &= (\overline{A} \oplus \overline{B}) C + A B. \end{aligned}$$

We see, therefore, that the sum and difference are identical and thus can be performed by the same circuit, but the carry and borrow operations need two separate circuits. During addition the C* signal can be made to represent the carry, and during subtraction the C* can serve as the borrow signal. And, of course, the flip-flop is set and reset by the different functions. The serial adder/subtractor in Fig. 2, which is a modified version of the serial adder in Fig. 1, includes a borrow circuit and add/subtract control.

From the subtraction table, it can be seen that when a borrow signal is used, signal C* changes from a ZERO to a ONE when signal $\overline{A} \overline{B}$ is applied, and from a ONE to a ZERO when $A \overline{B}$ is present. Hence the borrow circuit sets flip-flop C* on the logic condition $\overline{A} \overline{B}$, and resets it on $A \overline{B}$.

A serial X3 adder/subtractor is simpler

Addition and subtraction with X3-coded numbers is simpler than with 8-4-2-1 numbers. This is because the required corrections are self-determined. Therefore let's concentrate on the X3 type of circuit. The serial X3 adder/subtractor (Fig. 3) can accept two X3-coded words, M and N, and it can generate the sum or difference, R, also in X3. The circuit can be built with two serial-binary adder/subtractors (as in Fig. 2), two four-bit shift registers and additional control logic.

The first A/S performs conventional serial-binary addition or subtraction, as commanded by the A/S control signal. Since both M and N are in the X3 code, and the sum output is therefore an uncorrected result, $R^* = (M + 3) \pm (N + 3)$. For each digit, only the carry output that is generated during clock time t_4 is of interest, and the carry determines whether the correction is added or subtracted. Thus the carry output of the first A/S circuit is gated with t_4 to set or reset flip-flop CB on the trailing edge of t_4 . The output of CB then controls the operation of the second A/S. The correction signal, 0011, is generated simply by ORing the clock pulses t_1 and t_2 . Since the correction for addition has the opposite sense of that for subtraction, the output of the flip-flop CB must be reversed when changing from add to subtract.

The sum output of the first adder is delayed

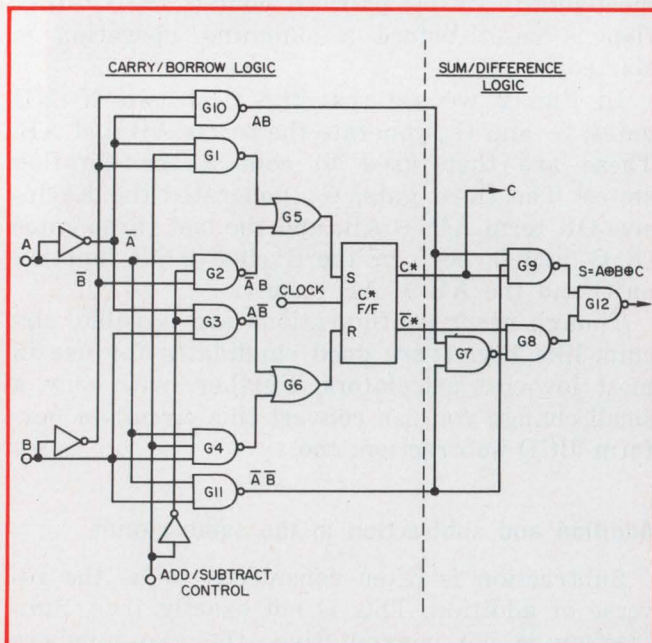

2. The binary add and subtract functions are combined into a single serial circuit that uses a selection control signal to choose the carry or borrow logic circuit. While the carry and borrow circuits are different, the sum and difference logic is identical.

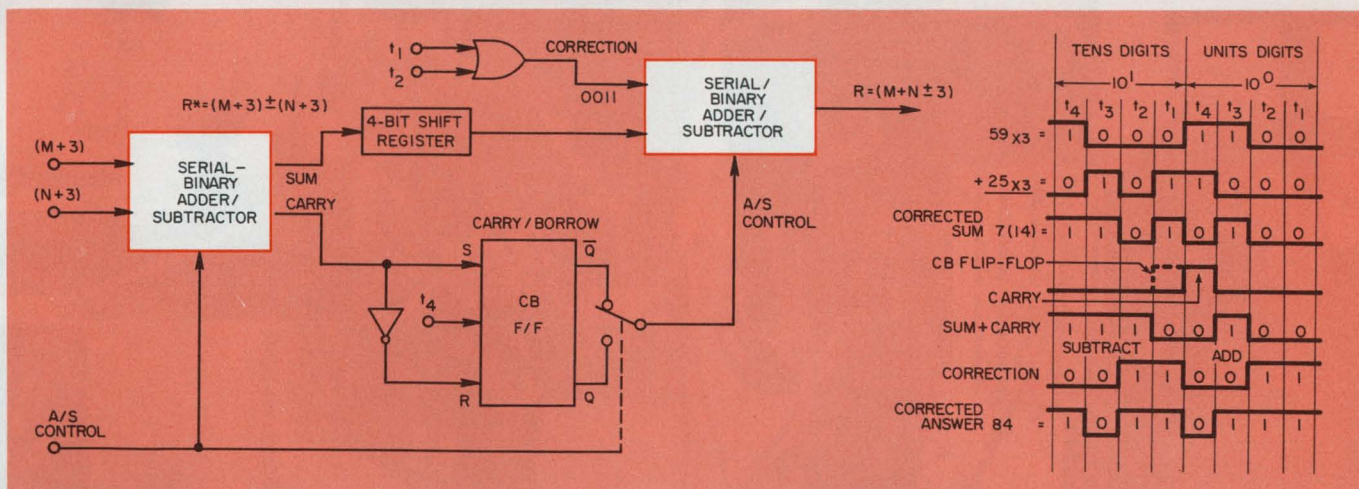

3. Two serial binary adders, a four-bit shift register and a carry/borrow flip-flop provide the complete add/

subtract function for the X3-BCD code. Note that the timing runs from right to left.

four clock periods by a four-bit register before it is connected to the second A/S. The second A/S adds or subtracts the correction (0011) to or from this delayed output of the first A/S to produce the corrected result, R.

Parallel X3 adder/subtractor is fast

In most calculators speed is of secondary importance. However, in the more advanced units, such as those with programmable features, faster computations are desirable. Parallel A/S systems can provide this improvement.

A relatively simple bit-parallel, but digit-serial A/S unit, can speed calculation at least fourfold. Again, the X3 code is used. The circuit (Fig. 4) consists of only two four-bit parallel A/S units, and it has a minimum of control logic. Each four-bit parallel A/S can be one of the standard TTL-IC packages now available, such as the F9340/1 or SN74181.

The first A/S unit adds or subtracts the two four-bit X3-coded numbers in conventional binary fashion. Its outputs are available almost immediately, since TTL logic creates only a 30-to-40-ns delay. The outputs, however, are uncorrected and designated R*. The carry output of the first A/S unit, in combination with the A/S control signal, determines the correction to be performed in the second A/S.

The second four-bit A/S performs the correction by adding or subtracting the quantity 0011 to or from R*. The 0011 correction is generated simply by connecting the two least significant inputs to a ONE (+5 V). The output of the second A/S is therefore in the X3 code.

The carry output from the first A/S must, in addition, be stored for one clock period to make it available as an input for operating on the next higher digit.

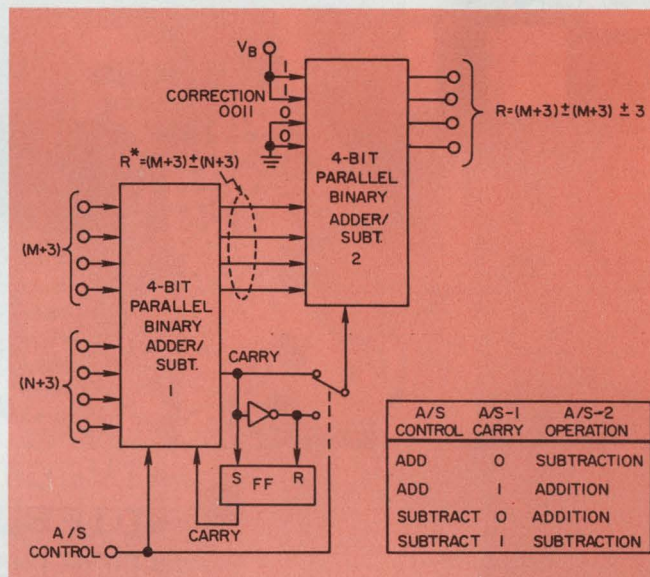

4. A bit-parallel adder/subtractor is sometimes used in high-speed calculators.

With TTL circuits, two one-digit numbers can be added in as little as 100 ns.

Table lookup can add or subtract

Semiconductor read-only-memories (ROMs), which contain a table of sums or differences for two digits, can also provide the A/S functions. The two four-bit BCD digits to be added or subtracted can provide an eight-bit ROM address. A five-bit output can then be obtained for each of the possible 200 combinations (100 sums and 100 differences). Of the five-bit output, four bits are the sum and one bit is the carry or borrow to the next digit. The output and input codes can be in any BCD code desired. ■■

The second article will discuss BCD multiplication.

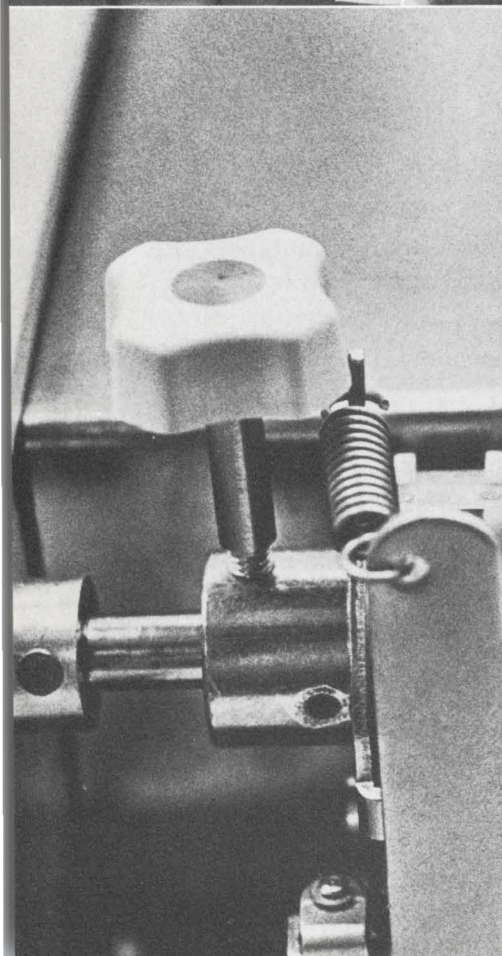
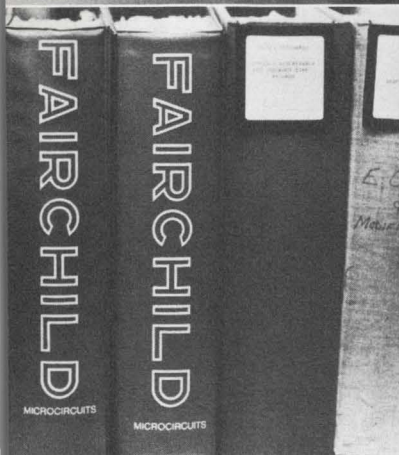
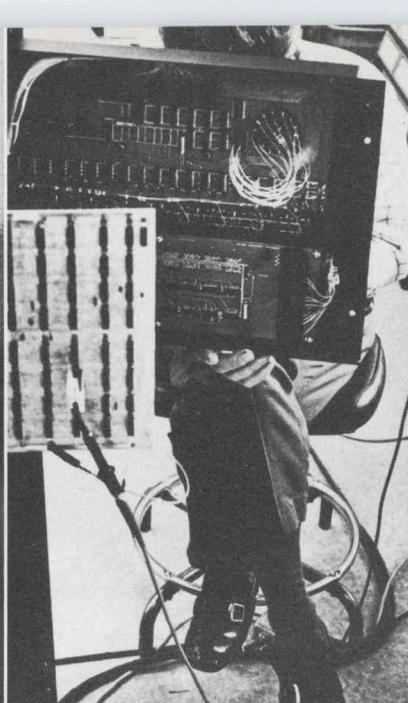
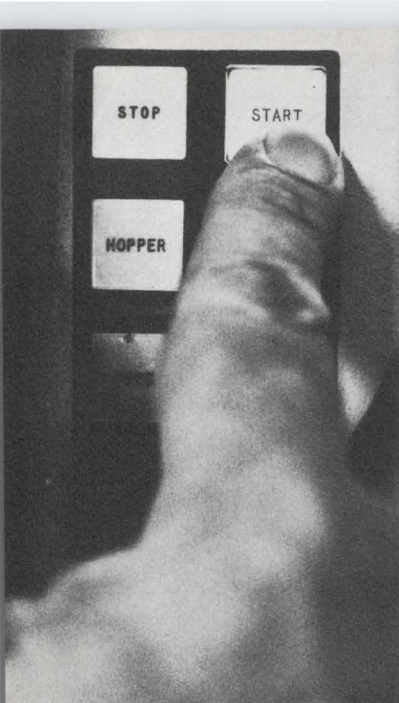

●	*TVECT	S	000384	000343
●	*DIFBU	S	000096	000049
	*DOFBU	S	000096	000049
	*FCOM1	S	001248	001214
●	*DBUP	S	001392	001390
	*CRDTA	S	001008	000997
	*TAPLP	S	001152	001150
●	*LISTC	S	000336	000292
	*FDTT	S	003408	003362
	VT	S	000288	000271
	1	S	013680	013658
	DE	S	015552	015512
	VE	S	012624	012596
	DC	S	015216	015208
	AK	S	000000	000000
	EC	S	000240	000205
		S	011088	011056
		S	006000	005985
		S	001008	000971
		S	001536	001490
		S	002112	002069
		S	001296	001268

Too many testers are installed and left to their own devices.

We can help.

You turn the key, the current flashes on. And everyone disappears. But just try to conjure up field service when the tester's feeling low, and you discover the cord's been cut.

What we have here, gentlemen, is a failure to communicate. By the system's manufacturer. And that leaves you with a large-scale circuit tester on your hands, and no one to give you a lift.

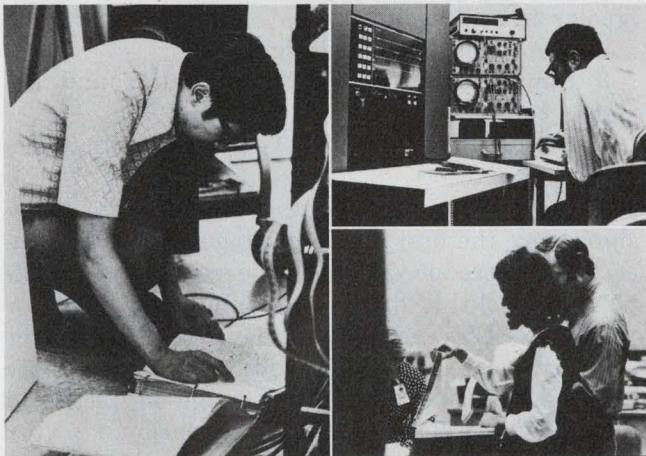

When Fairchild Systems sets up one of our Sentry semiconductor testers in your plant, you never get us out of your system. If we couldn't back up every piece of equipment we produce, we'd back right out of the business. We consider our job is still only half-done even when you're up and running.

With the largest service task force ever fielded by a test system producer, Fairchild's primed to keep in close touch. You don't always have to call us...we'll call on you. Small problems can grow into big ones, and if our experts can catch them while they're still nothing much, we can often save a lot of grief later on.

Of course there may be times when you just can't prevent a real crisis in the system. Count on Fairchild for a fast turnaround. Because our service network extends around the world, we can turn on a dime, providing next-door repairs, maintenance, and systems support.

Field service reps are not the only Fairchild forces you can tap. Just as our engineering/applications/software groups play a major role in targeting your Sentry equipment levels and software packs, you can go to them anytime to solve unusual testing problems, and to help you get the most out of existing software.

The Sentry concept—one family of six interrelated circuit testing systems with total compatibility between each function-optimized component—may require these teams to pitch in with appropriate programs to meet your upgrade or downgrade into a sister system. You can also dip into their expertise when specialized programs are needed. They can devise custom programs for virtually any test requirement.

When we tie you into a Sentry, we tie you onto the lowest cost, highest throughput, most advanced test/measurement technologies available anywhere in the field—for every device type, configuration, and sophisticated component you could use today. From MOS to bipolar, from ICs to discretes, MSI/LSI, from transistors to ECL (with software/hardware compatible to all), Sentry offers you total semiconductor testing capability for both production and engineering, with enormous expansion and adaptability options. And with all that going for you, you'll never get us out of your system.

FAIRCHILD Fairchild Systems Technology
3500 Deer Creek Road
Palo Alto, California 94302

Send me information on the Sentry Test Systems.
Our monthly test requirement is approximately _____
of transistors, I.C.s MSI.

Name _____

Title _____

Company _____

Street _____ City _____

State _____ Zip _____

Phone () _____ Ext. _____

ED

Fairchild Systems

Fairchild Systems Technology, a division of Fairchild Camera & Instrument Corporation.

Analog switches replace reed relays

for higher speed, bounceless contact and TTL compatibility.
Available types include versatile CMOS switches.

Reed relays have some good points to offer in analog switching applications: They have low ON resistance, can handle signals as high as several hundred volts and are easy to apply—a current through a coil opens or closes isolated contacts. But there's a bad side, too: The switching speeds in reed relays are limited to hundreds of microseconds, and contact bouncing can lead to troublesome transient problems.

A semiconductor device that overcomes these limitations is the analog switch—the closest semiconductor switch to the reed relay in terms of cost and packaging. The analog switch can't match the reed relay in ON resistance and signal voltage capability, but it does offer switching speeds of less than a microsecond, while avoiding contact-bounce problems. Moreover analog switches can be obtained with more switches per package than are available with reed relays, and the analog switches can interface directly with TTL circuits without need for back-emf diode protection. The salient features of the two switch types are summarized in Table 1.

David Fullagar, Manager of Analog Engineering, Intersil, 10900 N. Tantau Ave., Cupertino, Calif 95014.

Like their electromechanical counterparts, analog switches can be thought of as form A, B and C relays. For example, devices covering several basic forms are shown in Table 2. The switch states shown assume a logic ONE input.

Many different types available

Four basic analog switch types are available commercially:

1. Combination FET (MOS or junction) and bipolar hybrid designs.
2. Monolithic CMOS designs.
3. Simple, low-cost JFET virtual-ground designs.
4. Simple low-cost JFET positive-signal designs.

The combination FET and bipolar hybrid designs were the first single-package analog switches to be introduced. This type consists of a bipolar, monolithic driver chip and MOSFETs or junction FETs as output devices. The driver stage translates the TTL voltage levels to those suitable to drive the output stage—typically a 3-to-15-V or a 0.8 to -15 V translation.

A typical commercially available series, DG111 through DG125 has a bipolar driver and a

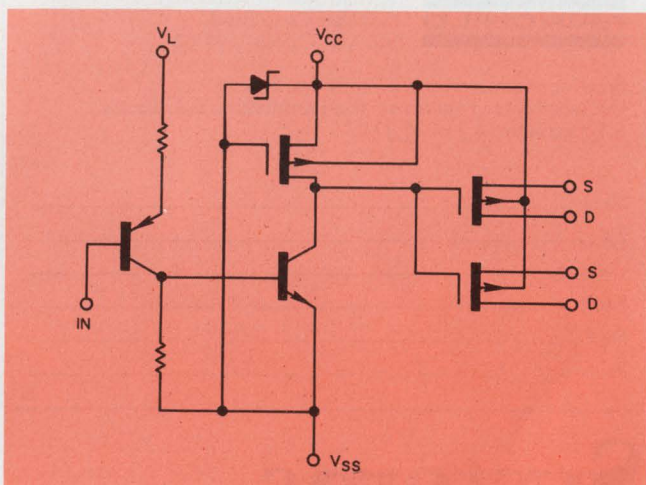

1. FET and bipolar hybrid switches include the DG120 (one channel section shown) that uses a bipolar driver and up to six independent output MOSFETs.

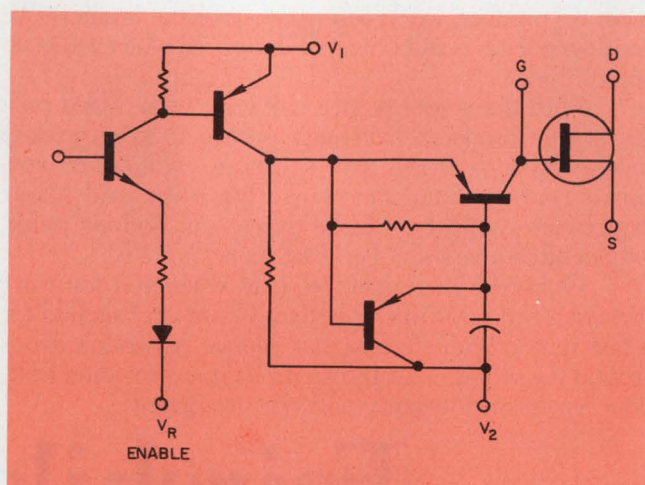

2. Another hybrid design uses discrete FET chips as output stages. This includes the IH 5001 (shown here) through 5007 and the DG126-through-164 types.

PMOS monolithic output stage, with up to six independent MOSFETs on each chip (Fig. 1). The MOSFETs are enhancement-mode devices that are turned off with no application of power. They handle analog signals of up to ± 10 V with $+20$ -V and -10 -V power supplies. Typical R_{DS} (ON) is 70Ω for $+10$ -V signals, 150Ω for low-level signals and about 300Ω for -10 -V signals.

Note that these simple MOSFET switches do not have a constant impedance as the signal level is varied. To minimize this modulation effect, the MOSFET switches should work into relatively high load resistances— $R_L \geq 10 \text{ k}\Omega$.

Newer hybrid switches, the DG126-through-DG164 and the IH5001-through-IH5007 families, also have a bipolar driver chip for voltage translation, but discrete JFET chips are used as output stages (Fig. 2). Typical R_{DS} (ON) values are in the 5-to-50- Ω range, depending on part number, and all are characterized by a constant switch resistance. Typical analog switching levels are ± 8 V with ± 15 -V supplies.

For both the MOSFET and JFET families, switching speeds are typically $0.3 \mu\text{s}$ and $1 \mu\text{s}$ (t_{on} and t_{off}), and leakages are in the 1-nA range. Moreover both types share common weaknesses in some applications. They have similar undesirable make-before-break switching and relatively high power-dissipation characteristics. These weaknesses have been circumvented in newer designs.

CMOS switches better than hybrids

Newer monolithic CMOS analog switches outperform the earlier hybrids in almost every parameter. Commercial versions include types

IH5040 through IH5052. Each monolithic part contains a complete driver and output-stage combination (Fig. 3), and has the following salient features:

- TTL compatibility.
- Switch capability up to ± 14 V with ± 15 -V supplies.
- Overvoltage protection capability to ± 25 -V

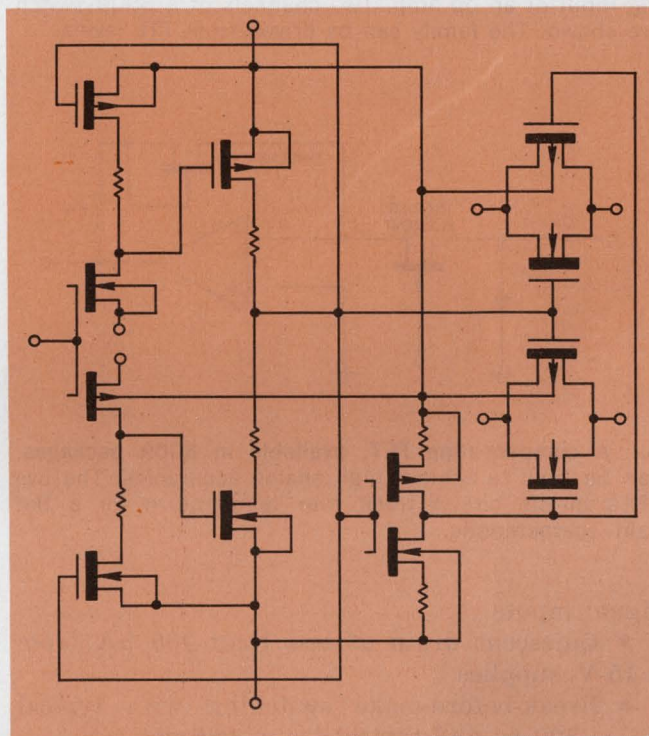

3. CMOS switches feature microwatt dissipation, switching capability up to 1 V of the power supply voltage and low ON resistances over wide signal voltages. Shown here, the monolithic IH 5042.

Table 1. Compare switch families

Family Parameter	Typical Reed Relay	Hybrid FET-and-Bipolar Switch	CMOS Switch	Virtual-Ground Switch	Positive-Signal Switch
Signal Handling—V ($V_s = \pm 15$ V for analog switches)	± 300	± 8	± 15	± 15	0 to +10
ON Resistance— Ω	0.1	30	75	100	100
Speed, t_{on}/t_{off} — μs	1000/500	0.5/1.0	1.0/0.5	0.5/0.5	0.2/0.2
Logic Compatibility	No	Yes	Yes	Yes	Yes
Steady State Quiescent Current when on—mA	10 (At 15 V)	3.5	0.1	0	0
Cost per Channel at 1000 pieces—\$	3.00	4.00	2.50	<1.00	<1.00

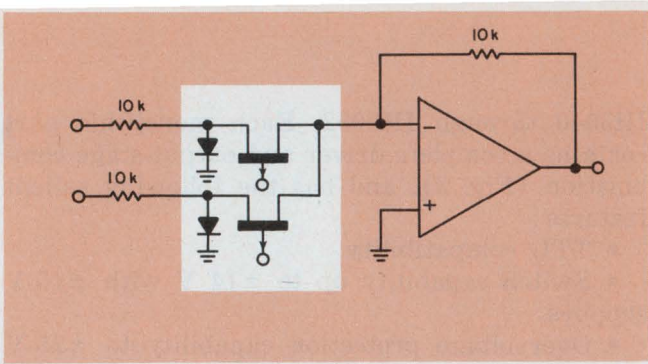

4. Virtual-ground switches provide an economical alternative for switching low-level signals, such as the inverting input of an op amp. Two channels of a 5009 series are shown. The family can be driven from TTL levels.

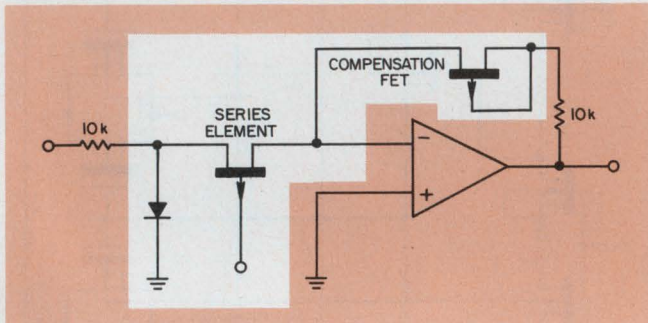

5. A compensating FET, available in 5009 packages, can be used to achieve high analog accuracies. The two FETs in the circuit track over temperature for a flat gain characteristic.

signal inputs.

- Quiescent drain of less than 100 μ A from ± 15 -V supplies.
- Break-before-make switching with typical $t_{on} \cong 500$ ns and typical $t_{off} \cong 200$ ns.
- $R_{DS(ON)} < 75 \Omega$.

The CMOS devices can switch signals of peak amplitudes to within 1 V of the power-supply values, while earlier hybrid types could switch only ± 8 V with ± 15 -V. Also in the quiescent state, CMOS devices usually draw microamperes instead of milliamperes; thus they are suitable for portable equipment. And the CMOS switches are compatible with all logic while earlier types were designed for the 5-V logic level of TTL.

The CMOS switches are offered in a variety of configurations, including SPST, dual-SPST, DPST, dual-DPST, DPDT and 4PST. Each part is generally a metal-mask option of the basic CMOS device.

Virtual-ground switches for low levels

Either the FET-and-bipolar hybrid designs or the CMOS designs provide the flexibility to switch ac signals into any load with up to ± 10 -V signal amplitudes. On the other hand, if you are switching into the inverting input of an op amp

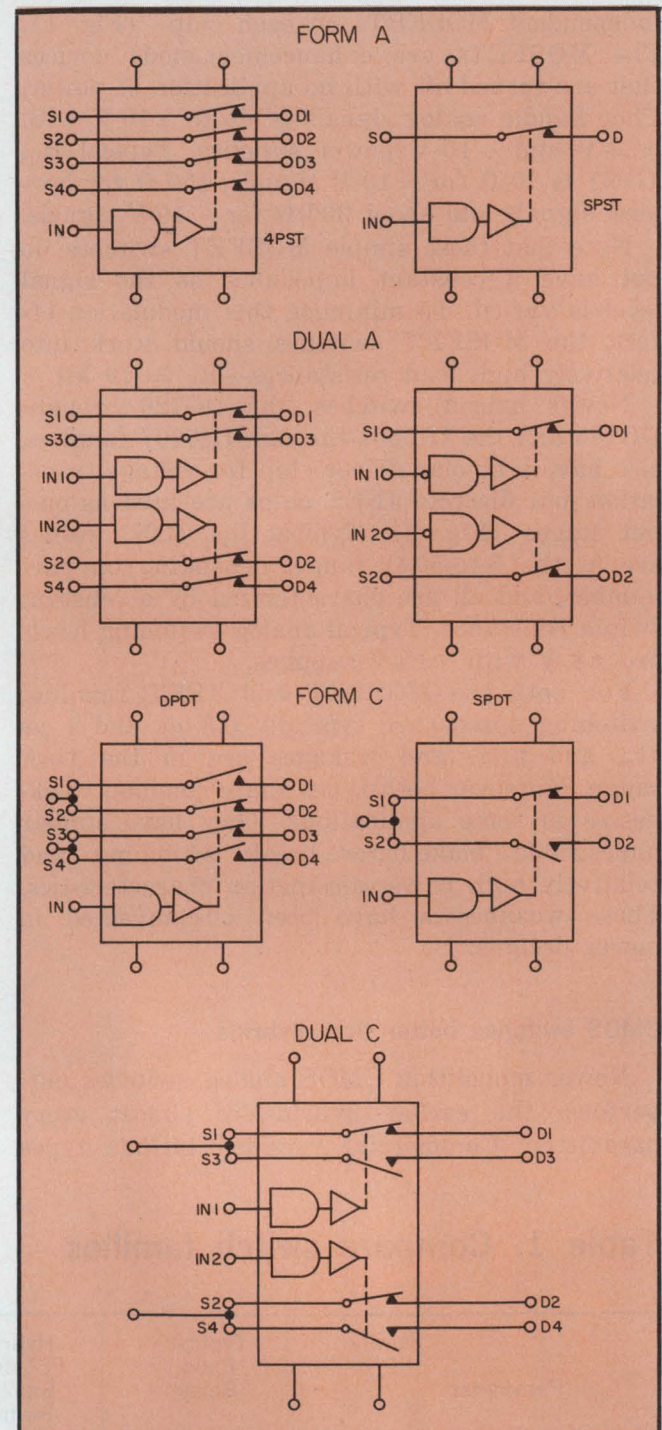

or are switching low-level signals, the virtual-ground switches, such as the 5009 series (Fig. 4), can offer a more economical alternative.

The family uses a p-channel gating element that can be driven directly from TTL, or positive-going logic. The TTL driver eliminates the need for the separate driver that was required in previous designs.

The phrase "low-level switching" is something of a misnomer as applied to the 5009 family of virtual-ground switches (the latter so called be-

cause the negative feedback point of an op amp is a virtual ground). Actually the low-level switch could handle ± 100 V if the op amp were capable of ± 100 -V output swings. The switch-amplifier combination is capable of handling such amplitudes because the signal appearing at the virtual ground is attenuated by the open-loop gain.

When the switch is off, the diodes from the source to ground limit the swings at the JFET to ± 0.7 V, typical, which is compatible with the logic used. As a result, the circuit is not erroneously switched by large amplitude input signals.

An advantage of the 5009 family is high speed, which results from the use of the bipolar gate as the driver. The driver is normally the major speed-limiting element. Typical turn-on times are 50 ns, and typical turn-off times are 150 ns. At present no monolithic op amps can swing even 10 V and settle to 0.01% in less than 500 ns, although the 5009 is easily capable of such performance.

The 5009 family also has a compensating FET to correct for $I_{in} \times R_{DS}$ (ON) errors (Fig. 5). The use of this FET in the feedback loop permits accuracies of 0.1 to 0.01%. The compensating FET and the series FET track over temperature for a relatively flat gain characteristic, and system accuracy can be maintained.

The 5009 series consists of two groups: (1) Odd-numbered parts, for use with ± 15 -V supplies, have JFET pinch-off voltages of 4 to 10 V and a maximum R_{DS} (ON) of 100 Ω —65 Ω , typical. (2) Even-numbered parts operate with 5-V supplies and have a pinch-off range of 2 to 3.9 V and a maximum R_{DS} (ON) of 100 Ω —65 Ω , typical. For both types, the nominal match between any two channels is less than 50 Ω .

Positive signal switches go to 25 V

For positive-signal switching, a new series of switches (IH5025 to IH5038) have been introduced for use with high voltages. These circuits can switch any signal from 0 to +10 V with +15-V supplies. Signals up to +25 V can be switched with a +30-V supply at an open-collector terminal point. There is no restriction on the load, as with the 5009 family, and any load resistance from 50 Ω can be handled.

A typical switching circuit is shown in Fig. 6. Note that, unlike the 5009 family, no op amp is required. A disadvantage of the positive-signal types is that they can't switch negative signals unless external parts are added, as in Fig. 7. But with the addition of a pnp transistor—2N3638 or 2N2907, for example—and two resistors, the 5025 family becomes just as versatile as any other analog switch. Of course, open-collector logic must still be used.

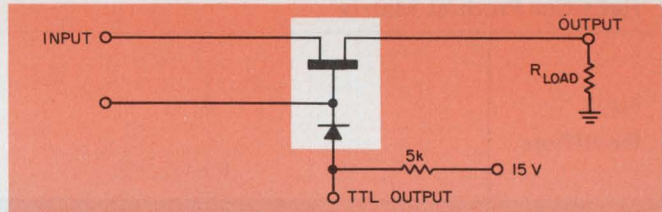

6. A positive-signal switch does not require an op amp, as with virtual-ground switches. One channel of an IH 5025 is shown. This switch family can handle signal levels as high as 30 V.

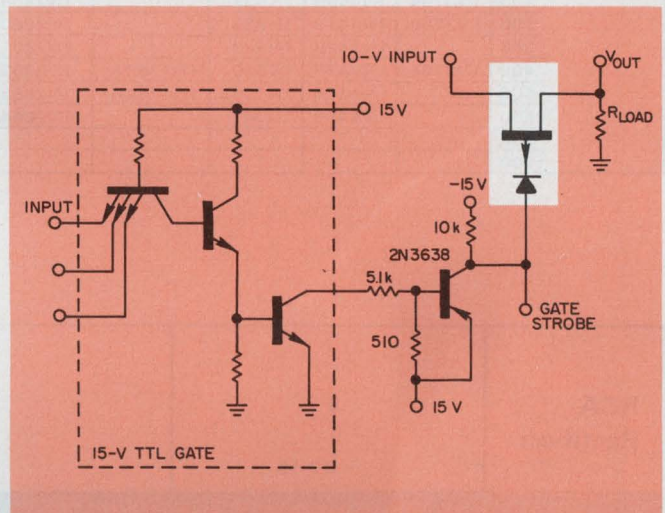



7. Positive-signal switches and additional components handle negative signals. However, switching speeds are now reduced to 300 ns (t_{on}) and 1 μ s (t_{off}).



When switching positive signals only, so that the circuit is driven directly from the logic levels, the speed is very fast: $t_{on} \approx 50$ ns and $t_{off} \approx 200$ ns up to $R_L = 1$ -k Ω loads ($C_L \leq 10$ pF). However, when driving through a pnp stage, as in Fig. 7, the speed is considerably reduced—to 300 ns and 1 μ s for t_{on} and t_{off} , respectively.

The 5025 family has pinch-off voltages ranging from 2 to 3.9 V, and it consists of two groups: Odd-numbered parts have a maximum R_{DS} (ON) of 100 Ω and even-numbered devices have a maximum of 150 Ω . The difference between the two groups is that a larger geometry FET is used for odd-numbered parts. This larger geometry, while producing a lower ON resistance, also inherently has about twice the charge injection when compared with the even-numbered parts. This is spec'd at 20 mV maximum into a 10,000-pF capacitance for all parts. Typical charge injections are 7 mV for even-numbered parts and 14 mV for odd-numbered parts. As with the 5009 family, the 5025 series has a channel-to-channel R_{DS} (ON) match of 50 Ω or less, with typical values about 25 Ω .





The new family can also be used with 5-V logic so long as a maximum signal of 1 V is switched. ■■

Rectifier Product Matrix

RCA Rectifiers	 DO-1						 DO-26					
	I_o	0.125A	0.75A	0.75A	1A	1A	2A	0.5A Ava- lanche	0.75A	0.75A Insulated	1A	1A Insulated
I_{FSM}	30A	15A	15A	35A	35A	35A	35A					
$V_{RRM}(V)$	50			1N536		1N2858A						
	100	1N3754	1N440B	1N537		1N2859A	40266					
	200	1N3755	1N441B	1N538		1N2860A	40267		1N3193	1N3253	1N5211	1N5215
	300		1N442B	1N539		1N2861A						
	400	1N3756	1N443B	1N540	1N1763A	1N2862A			1N3194	1N3254	1N5212	1N5216
	500		1N444B	1N1095	1N1764A	1N2863A						
	600		1N445B	1N547		1N2864A		40808	1N3195	1N3255	1N5213	1N5217
	800							40809	1N3196	1N3256	1N5214	1N5218
	1000									1N3563		

RCA Rectifiers	 DO-15			 DO-4			 DO-5		
	I_o	1A	1.5A	5A	6A	10A	12A	20A	40A
I_{FSM}	30A	50A			160A	140A	240A	350A	800A
$V_{RRM}(V)$	50	44001	1N5391	1N1612	1N1341B	40108	1N1199A	1N248C	1N1183A
	100	44002	1N5392	1N1613	1N1342B	40109	1N1200A	1N249C	1N1184A
	200	44003	1N5393	1N1614	1N1344B	40110	1N1202A	1N250C	1N1186A
	300		1N5394		1N1345B	40111	1N1203A	1N1195A	1N1187A
	400	44004	1N5395	1N1615	1N1346B	40112	1N1204A	1N1196A	1N1188A
	500		1N5396		1N1347B	40113	1N1205A	1N1197A	1N1189A
	600	44005	1N5397	1N1616	1N1348B	40114	1N1206A	1N1198A	1N1190A
	800	44006	1N5398			40115			
	1000	44007	1N5399						

Fast Recovery Types

RCA Rectifiers	 DO-26		 DO-15		 DO-4		 DO-5	
	I_o	1A			6A	12A	20A	40A
I_{FSM}		35A			125A	250A	300A	700A
$V_{RRM}(V)$	50			44933	43879	43889	43899	40956
	100			44934	43880	43890	43900	40957
	200	TA7892		44935	43881	43891	43901	40958
	300				43982	43892	43902	
	400	TA7893		44936	43983	43893	43903	40959
	500							
	600	TA7894		44937	43984	43894 [†]	43904	40960
	800	TA7895						
1000								
Reverse Recovery	Time t_{rr}							
	Typ.	200 ns		200 ns	200 ns	200 ns	200 ns	200 ns
	Max.	500 ns		250 ns	350 ns	350 ns	350 ns	350 ns

RCA SOLID STATE OFFERS YOU A BROAD LINE OF RECTIFIERS WITH THE BEST CHARACTERISTIC YOU CAN ASK FOR RIGHT NOW...

AVAILABILITY

RCA's broad line of standard and fast recovery rectifiers is only a phone call away. Go ahead . . . try us out. Pick out a type and order it. You'll be delighted at the speed with which you can get the finest rectifiers available. Just call your local RCA solid state distributor or RCA directly.

Want more information? Write RCA Solid State, Sec. 57F-21, Box 3200, Somerville, N.J. 08876. Or phone: (201) 722-3200.

RCA Solid State

INTERNATIONAL: RCA, Sunbury-on-Thames, U.K., or Fuji Building, 7-4 Kasumigaseki, 3-Chome, Chiyoda-Ku, Tokyo, Japan. In Canada: RCA Limited, Ste. Anne de Bellevue 810, Canada.

INFORMATION RETRIEVAL NUMBER 51

Breadboard active filters at a computer.

A single run of this program lets you evaluate the effects of finite op-amp gain and passive-component variations.

Component costs for high-performance, active multipole filters have been lowered by the availability of low-to-moderate-priced IC op amps. And design costs can be slashed by use of a computer to calculate component values for these filters. But for a complete design, you need additional information, such as the effects of finite op-amp gain, the effect of using actual, instead of calculated, component values, and the variation of phase and time delay with frequency.

To provide comprehensive design information along with user interaction, a conversational program written in BASIC has been developed that does the following:

- Designs Butterworth, Chebyshev and Bessel filters of order 2 to 10.
- Designs filters to meet a gain specification at some arbitrary frequency.
- Computes phase-amplitude and group-delay errors caused by op-amp gain variation with frequency.
- Computes phase amplitude and group-delay vs frequency for components chosen by the user or the computer.
- Designs other low-pass filters, using singularities supplied by the user.

The program computes solutions of quadratic and cubic equations, trial-and-error solutions by sweep techniques of k^{th} -order equations and solutions of two k^{th} -order simultaneous equations. These features allow the user to design and calculate the performance characteristics of two-pole and three-pole active-filter stages—both inverting and noninverting types. The program provides stage-by-stage component values plus the over-all response for the number of poles chosen.

Four basic filter circuits

The response of any of the four active stages (Fig. 1) analyzed by the program can be written as the product of a desired response multiplied by an error term. The ideal term is completely

William A. Geckle, Senior Engineer, Westinghouse Electric Corp., Friendship International Airport, Box 746, Baltimore, Md. 21203.

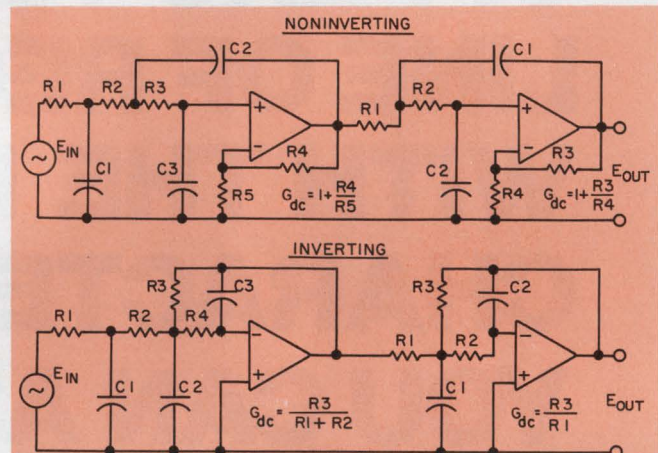

1. Multipole low-pass filters are designed and analyzed by the program. The user can choose noninverting or inverting gain stages. Filters containing up to 10 poles are designed from these four basic stages. Each op amp forms a two or three-pole section whose input is at R_1 .

independent of the op-amp characteristics, and the second term is unity only if the op amp has infinite gain (see box).

The user initially specifies if inverting or noninverting stages are desired, but the program selects type 1 or type 2 stages (three poles or two poles) so as to equal the total number of poles specified in the design.

In the evaluation of the error term

$$\frac{L_G}{1 + L_G},$$

the op-amp input resistance and gain at dc are assumed infinite, while the output resistance is taken as zero. But the gain of the op amp is made to roll off with a single slope. The user specifies the roll-off by giving the computer the value of open-loop gain at the cutoff frequency F_c of the filter.

Sequence of operation

The operating sequence (Fig. 2) begins with the running of the design phase, in which the user selects one of the four types of filter and the inverting or noninverting amplifier configuration. Root locations for Chebyshev and Butterworth filters are calculated; Bessel-filter locations

Filter error analysis

The ideal transfer function is defined as one obtained with infinite amplifier gain. The transfer function can be written as the product of the ideal transfer function and an error term. The general model is shown in "a," and its transfer function given by:

$$\frac{E_{OUT}}{E_{IN}} = \left[\frac{D}{H} \right] \cdot \left[\frac{G \cdot H}{1 + G \cdot H} \right] \quad (1)$$

Quantity D/H represents the ideal transfer function (infinite gain). The second, or error, term depicts the effect of finite amplifier gain. Transfer functions for all four filter types described in the article can be written as the product of two such terms. To use the method, break the loop at X and compute D and H, defined as follows:

- D is the insertion loss from input to summing point with the loop broken at X.
- H is the insertion loss from the output to the summing point with the loop broken at X and the input grounded.
- G is the amplifier gain between the summing point and the output. L_G is the loop gain, which is the product of $G \cdot H$.

As an example (b), identify point C as the

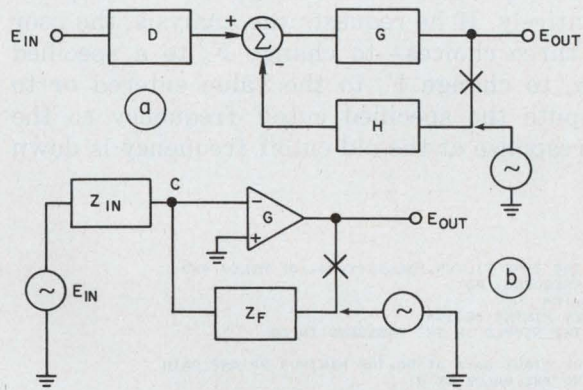

summing point and compute the insertion losses:

$$D = \frac{Z_F}{Z_{IN} + Z_F} \quad (2)$$

$$H = \frac{Z_{IN}}{Z_{IN} + Z_F} \quad (3)$$

$$L_G = G \cdot H = \frac{G Z_{IN}}{Z_{IN} + Z_F} \quad (4)$$

Then compute the transfer function

$$\frac{E_{OUT}}{E_{IN}} = \frac{Z_F}{Z_{IN}} \cdot \frac{G \cdot Z_{IN} / (Z_{IN} + Z_F)}{1 + G \cdot Z_{IN} / (Z_{IN} + Z_F)} \quad (5)$$

based on Eq. 1.

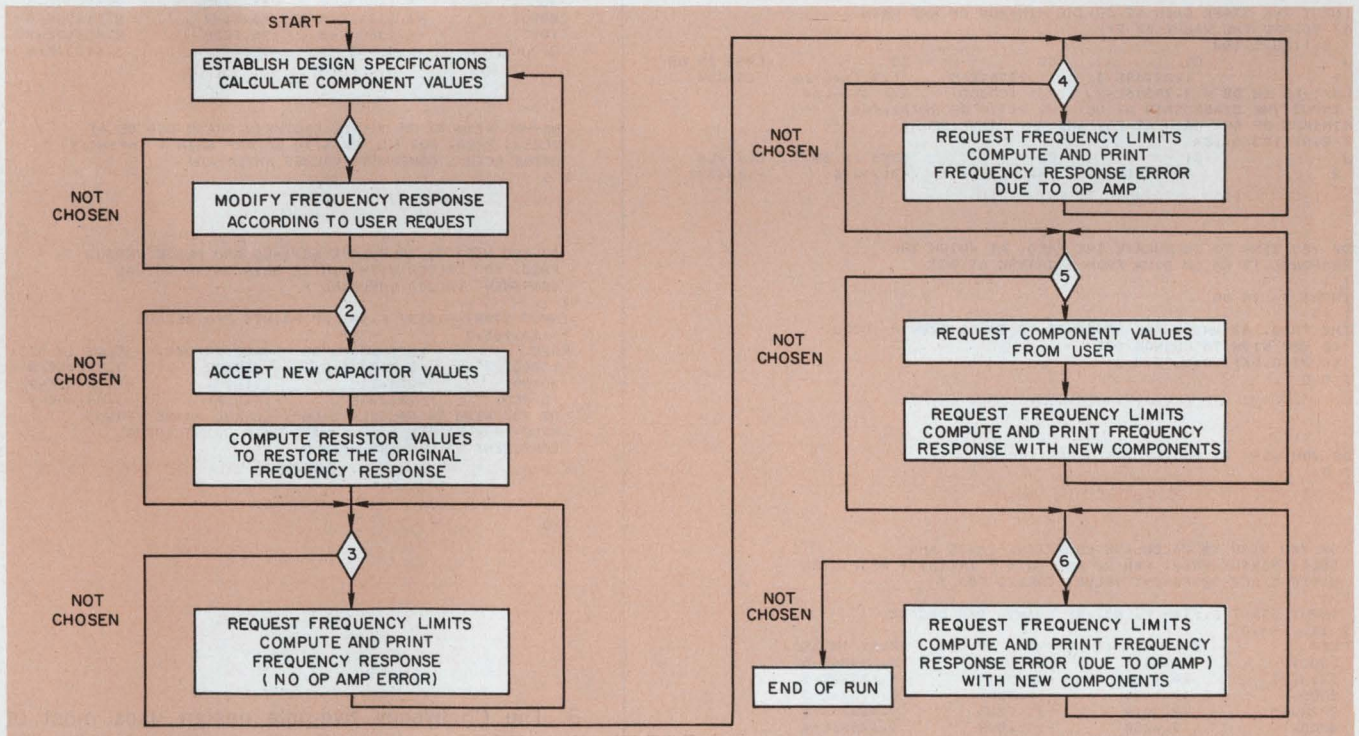

2. Filter design proceeds in an orderly manner, starting with the initial design phase. Requests for frequency-response modification cause a return to a portion of the initial phase. Other phases permit component

changes without modification of the response, or insertion of actual component values. The numbered boxes represent points where the user may elect to move on to the next phase.

are prestore. The user supplies root locations for special filters in the data statements between lines 05680 and 05740. The normalizations are shown in Table 1.

During cutoff frequency analysis the user can request the frequency at which the response is down by "S4" dB, or he can bypass the computation entirely. If he requests the analysis, the user faces three choices—to change F_0 to a specified $W_0/2\pi$, to change F_0 to the value entered or to recompute the specified cutoff frequency so the filter response at the old cutoff frequency is down

"S4" dB. The required input responses are:

- 0,0 (proceeds to next section)
- 1, W_0 } (performs cutoff frequency change)
- 2, F_0 }
- 3,3 }

After completing or bypassing the frequency operations, the user can elect to alter the capacitor values. The program then recomputes all the remaining component values to yield the original filter response.

The program provides separate frequency-response data for the over-all error term and the

```

INPUT THE TYPE FILTER,POLARITY,NØ. OF POLES AND
CUTØFF FREQUENCY FØ
? 2,1,5,1E4
CHEBYSHEV FILTER DESIGN
INPUT THE RIPPLE IN THE PASSBAND IN DB
? 1
INPUT THE STAGE GAIN AT DC,THE MINIMUM ØP AMP GAIN
AT FØ,AND THE VALUE ØF R1
? 5,1000,1E4
J          C1          C2          C3          LØSS IN DB
1          1.15504E-8   1.15504E-8   1.16728E-10  -35.604
LG/1+LG IN DB = .109768   R3= 100000   R4= 4166.04
INPUT THE STAGE GAIN AT DC, THE RATIO ØF R2/R1,THE
MINIMUM ØP AMP GAIN AT FØ, AND THE VALUE ØF R1
? 2,2,1000,1E4
J          C1          C2          LØSS IN DB   LG/1+LG
2          1.77909E-8   3.60152E-11  -41.9376     -1.60031
  
```

Chooses five-pole Chebyshev filter with inverting stages

```

DØ YOU WISH TØ CALCULATE THE FREQ. AT WHICH THE
RESPONSE IS S4 DB DØWN FRØM RESPONSE AT DC?
? 1
INPUT S4 IN DB
? 10
THE FREQ. AT WHICH THE RESPONSE IS S4 DB DØWN = 11235.
DØ YOU WISH TØ CHANGE FØ?
INPUT 0,0;1,WØ;2,FØ;3,3
? 3,3
AT FØ= 8900.76
ØP AMP GAIN FØR J= 1   IS 1123.5
ØP AMP GAIN FØR J= 2   IS 1123.5
  
```

Performs cutoff frequency analysis

```

INPUT THE STAGE GAIN AT DC,THE MINIMUM ØP AMP GAIN
AT FØ,AND THE VALUE ØF R1
? 5,1123.5,1E4
J          C1          C2          C3          LØSS IN DB
1          1.29769E-8   1.29769E-8   1.31144E-10  -35.604
LG/1+LG IN DB = 9.79586E-2   R3= 100000   R4= 4166.04
INPUT THE STAGE GAIN AT DC, THE RATIO ØF R2/R1,THE
MINIMUM ØP AMP GAIN AT FØ, AND THE VALUE ØF R1
? 2,2,1123.5,1E4
J          C1          C2          LØSS IN DB   LG/1+LG
2          1.99881E-8   4.04631E-11  -41.9376     -.136372
  
```

Part of design analysis is repeated

```

DØ YOU WISH TØ CALCULATE THE FREQ. AT WHICH THE
RESPONSE IS S4 DB DØWN FRØM RESPONSE AT DC?
? 1
INPUT S4 IN DB
? 10
THE FREQ. AT WHICH THE RESPONSE IS S4 DB DØWN = 10000.
DØ YOU WISH TØ CHANGE FØ?
INPUT 0,0;1,WØ;2,FØ;3,3
? 0,0
  
```

No change in cutoff frequency this time

```

DØ YOU WISH TØ MØDIFY THE CAPACITØR VALUES?
? 0
  
```

Does not modify capacitor value

```

DØ YOU WISH TØ CALCULATE EQUT/EIN, PHASE AND
DELAY VERSUS FREQ. FØR ØP AMP GAIN = INFINITY ØF FILTER
USING EXACT CØMPØNENT VALUES CALLED FØR ?
? 1
INPUT START F,STØP F, NØ. ØF PØINTS PER DECADE
? 1E3,1E4,8
FREQ.      EQUT/EIN IN DB  PHASE IN DEG.  DELAY IN SEC.
1000.      19.691          -29.5894       8.53434E-5
1414.21    19.4589          -40.8873       8.62930E-5
2000.      19.1635          -55.8006       8.85674E-5
2828.43    19.0019          -75.7205       9.46879E-5
4000.      19.4458          -105.848       1.12561E-4
5656.85    19.9016          -161.649       1.34740E-4
8000.      19.5587          -245.809       1.64836E-4
10000.     10.0002          -366.995       1.04264E-4
  
```

```

DØ YOU WISH TØ CALCULATE EQUT/EIN, PHASE AND
DELAY VERSUS FREQ. FØR ØP AMP GAIN = INFINITY ØF FILTER
USING EXACT CØMPØNENT VALUES CALLED FØR ?
  
```

Obtains frequency sweep for calculated components

```

? 0
DØ YOU WISH TØ CALCULATE AMPLITUDE AND PHASE VERSUS
FREQ. ØF LG/1+LG TERM FØR EXACT CØMPØNENT VALUE FILTER ?
? 1
INPUT START F,STØP F,NØ. ØF PØINTS PER DECADE
? 1E3,1E5,2
FREQ.      LG/1+LG IN DB  PHASE IN DEG.  DELAY IN SEC.
1000.      1.04178E-2       -6.32278E-2    3.80827E-8
4000.      -1.43419         -1.11687       3.80031E-7
10000.     -.823689         -3.11767       -1.04143E-6
40000.     -.430731         -6.02087       3.03765E-9
100000.    -.421346         -1.17755       4.67970E-9
  
```

Obtains frequency sweep of error term

```

DØ YOU WISH TØ CALCULATE EQUT/EIN,PHASE AND DELAY
VERSUS FREQ. FØR FILTER WITH ØP AMP GAIN = INFINITY
USING ACTUAL CØMPØNENT VALUES EMPLOYED?
? 1
INPUT R1,R2,R3,R4,C1 AND C3
? 1E4,1E4,2E4,2701.9,2.188842E-9,3.8929E-10
INPUT R1,R2,R3,C1,C2 FØR J= 2
? 1E4,1E4,1E4,3.86277E-9,1.63939E-10
  
```

Chooses to insert component values that form a five-pole Butterworth filter

```

INPUT START F,STØP F, NØ. ØF PØINTS PER DECADE
? 1E3,4E4,4
FREQ.      EQUT/EIN IN DB  PHASE IN DEG.  DELAY IN SEC.
1000.      2.63635E-8     -9.27361       2.56971E-5
2000.      1.06740E-7     -18.565        2.55473E-5
4000.      8.14923E-9     -37.2753       2.51277E-5
8000.      -4.53367E-4     -75.8147       2.51253E-5
10000.     -4.23604E-3     -96.1258       2.60857E-5
20000.     -3.01032        -225.          3.69037E-5
  
```

Computes the new filter's response

```

DØ YOU WISH TØ CALCULATE EQUT/EIN,PHASE AND DELAY
VERSUS FREQ. FØR FILTER WITH ØP AMP GAIN = INFINITY
USING ACTUAL CØMPØNENT VALUES EMPLOYED?
? 0
  
```

Elects to leave this loop

```

DØ YOU WISH TØ CALCULATE LG/1+LG AND PHASE VERSUS
FREQ. FØR FILTER WITH FINITE GAIN USING ACTUAL
CØMPØNENT VALUED EMPLOYED ?
? 1
INPUT START F,STØP F,NØ. ØF PØINTS PER DECADE
? 1E4,1E5,2
FREQ.      LG/1+LG IN DB  PHASE IN DEG.  DELAY IN SEC.
10000.     3.40324E-2     -.418403       3.51040E-8
40000.     -.18487        -1.18701       -2.78442E-9
100000.    -.210458       -1.43588       3.68146E-9
  
```

Computes frequency response for the error term

```

? 0
Ends the run
  
```

3. The Chebyshev five-pole design uses most of the program options. Typing 0 after the "Do you wish—" phrase advances the program to the next phase. Note how the program normally returns to the most recent decision point after it completes a computation.

```

INPUT THE TYPE FILTER,POLARITY,NØ. ØF PØLES AND
CUTOFF FREQUENCY FØ
? 4,2,5,8E3
SPECIAL FILTER DESIGN
INPUT THE STAGE GAIN AT DC,THE RATIO ØF R2/R1,THE RATIO
ØF R3/R1,THE MINIMUM ØP AMP GAIN AT FØ, AND THE VALUE ØF R1
? 1,1,1,8,4375,1E4
J      C1      C2      C3      LØSS IN DB
1      2.69374E-9  3.48705E-9  8.38255E-10  -9.06135
LG/1+LG IN DB =-777664
INPUT THE STAGE GAIN AT DC, THE RATIO ØF R2/R1,THE
MINIMUM ØP AMP GAIN AT FØ, AND THE VALUE ØF R1
? 1,1,1,8,4375,1E4
J      C1      C2      LØSS IN DB      LG/1+LG
2      6.43795E-9  6.14770E-10  -15.8982      -1.89281

```

Chooses special five-pole filter with noninverting stages

```

DØ YØU WISH TØ CALCULATE THE FREQ. AT WHICH THE
RESPONSE IS S4 DB DØWN FRØM RESPONSE AT DC?
? 0

```

Bypasses cutoff frequency analysis

```

DØ YØU WISH TØ MØDIFY THE CAPACITØR VALUES?
? 1
INPUT C1,C2,C3 AND INITIAL R2/R1 AND R3/R1
? 2,7E-9,3,6E-9,8,2E-10,1,1
R1      R2      R3
10212.  9541.14  10139.1
INPUT C1(J) AND C2(J) FØR J= 2
? 6,8E-9,6,2E-10
R1= 7807.84  R2= 12023.4

```

But elects to alter the capacitors

```

DØ YØU WISH TØ CALCULATE EØUT/EIN, PHASE AND
DELAY VERSUS FREQ. FØR ØP AMP GAIN = INFINITY ØF FILTER
USING EXACT CØMPONENT VALUES CALLED FØR ?
? 1
INPUT START F,STØP F, NØ. ØF PØINTS PER DECADE
? 1E3,1E5,4
FREQ.      EØUT/EIN IN DB  PHASE IN DEG.  DELAY IN SEC.
1000.      -1.66488E-8      -23.2231      6.47687E-5
2000.      -4.19205E-6      -46.734      6.60011E-5
4000.      -4.23928E-3      -96.1257      7.23357E-5
8000.      -3.0103      -225.      9.89175E-5
10000.     -10.1339      -282.941      6.09810E-5
20000.     -39.7945      -374.185      1.10334E-5
40000.     -69.897      -412.725      2.61587E-6
80000.     -100.      -431.435      6.46274E-7
100000.    -109.691      -435.155      4.13041E-7
DØ YØU WISH TØ CALCULATE EØUT/EIN, PHASE AND
DELAY VERSUS FREQ. FØR ØP AMP GAIN = INFINITY ØF FILTER
USING EXACT CØMPONENT VALUES CALLED FØR ?
? 0

```

Computes frequency responses of filters

```

DØ YØU WISH TØ CALCULATE AMPLITUDE AND PHASE VERSUS
FREQ. ØF LG/1+LG TERM FØR EXACT CØMPONENT VALUE FILTER ?
? 1
INPUT START F,STØP F,NØ. ØF PØINTS PER DECADE
? 1E3,1E5,4
FREQ.      LG/1+LG IN DB  PHASE IN DEG.  DELAY IN SEC.
1000.      9.67183E-2      -1.82093      9.13434E-7
2000.      .365484      -4.36481      1.38337E-6
4000.      1.14713      -14.0687      3.06731E-6
8000.      -2.252      -50.1281      -5.54831E-7
10000.     -4.48389      -42.1273      -1.72646E-6
20000.     -5.40752      -35.5899      2.46265E-7
40000.     -6.49329      -52.8434      4.17374E-7
80000.     -9.98919      -85.9366      3.02264E-7
100000.    -11.9265      -98.2469      2.43801E-7
DØ YØU WISH TØ CALCULATE AMPLITUDE AND PHASE VERSUS
FREQ. ØF LG/1+LG TERM FØR EXACT CØMPONENT VALUE FILTER ?
? 0

```

Elects to compute error response

```

DØ YØU WISH TØ CALCULATE EØUT/EIN,PHASE AND DELAY
VERSUS FREQ. FØR FILTER WITH ØP AMP GAIN = INFINITY
USING ACTUAL CØMPONENT VALUES EMPLOYED?
? 1
INPUT R1,R2,R3,C1,C2,C3 AND GDC FØR J=1
? 1,02E4,9,531E3,1E4,2,7E-9,3,6E-9,8,2E-10,1
INPUT R1,R2,C1,C2 AND GDC FØR J= 2
? 7,87E3,1,21E4,6,8E-9,6,2E-10,1
INPUT START F,STØP F, NØ. ØF PØINTS PER DECADE
? 1E3,1E4,4
FREQ.      EØUT/EIN IN DB  PHASE IN DEG.  DELAY IN SEC.
1000.      2.98946E-4      -23.1925      6.46850E-5
2000.      2.47851E-3      -46.6624      6.59178E-5
4000.      2.10621E-2      -95.9799      7.24757E-5
8000.      -3.00826      -225.617      9.90886E-5
10000.     -10.1957      -283.156      6.05649E-5

```

Inserts 1% components

```

DØ YØU WISH TØ CALCULATE EØUT/EIN,PHASE AND DELAY
VERSUS FREQ. FØR FILTER WITH ØP AMP GAIN = INFINITY
USING ACTUAL CØMPONENT VALUES EMPLOYED?
? 0

```

Leaves component insertion loop

```

DØ YØU WISH TØ CALCULATE LG/1+LG AND PHASE VERSUS
FREQ. FØR FILTER WITH FINITE GAIN USING ACTUAL
CØMPONENT VALUED EMPLOYED ?

```

Does not want error characteristic

? 0

Ends the run

filter transfer function. One of the major loops (decision point 5) lets the user substitute his own component values for the ones calculated previously.

Some typical design sessions

Since the program begins with the design phase, use Table 2 as a guide to the types of input. The rest of the session is self-explanatory.

The computer printouts for two five-pole filter designs are shown. The first run (Fig. 3) shows the design of a five-pole Chebyshev filter with

Table 1. Normalization of stored filter designs

Filter type	Normalized Performance at W_0
Butterworth	-3 dB gain loss
Chebyshev—N odd	-X dB gain loss
Chebyshev—N even	0 dB gain loss
Bessel	One-second group delay
Special	As selected by the user

X—User specified ripple factor

Table 2. Input specifications for design phase

Type of stages	Odd no. of poles (3)	Even no. of poles (2)
Noninverting	<ul style="list-style-type: none"> stage gain at dc ratio of $R2/R1$ ratio of $R3/R1$ minimum op-amp gain at F_0 value of $R1$ 	<ul style="list-style-type: none"> stage gain at dc ratio of $R2/R1$ minimum op-amp gain at F_0 value of $R1$
Inverting	<ul style="list-style-type: none"> stage gain at dc Minimum op-amp gain at F_0 value of $R1$ 	<ul style="list-style-type: none"> stage gain at dc ratio of $R2/R1$ minimum op-amp gain at F_0 value of $R1$
<p>These inputs are for the first stage, which has three poles for odd-order filters and two for even-order filters. Subsequent stages all have two poles, so additional data inputs correspond to the even column.</p>		

4. Singularities for a Butterworth filter are stored by the user in this example. Results are calculated for 1% components.

inverting stages. It has 1-dB peak-to-peak ripple, and the response is 10 dB down at 10 kHz. The gain of the triple-pole stage has been set at five; the gain of the double-pole stage has been set to two. The operational amplifiers are assumed to have a gain of 100 at 10 kHz—indicating a unity-gain crossover near 10 MHz.

To show an application of the special filter section of the program (Fig. 4), the pole locations of a five-pole Butterworth response have been stored between lines 05680 and 05740. Non-inverting stages are used. When inputting pole information in this section, the pole pattern should be set to yield the desired filter shape. Also, the amplitude scaling of the pole values is obtained at the radian frequency $\omega = \omega_0$. Fig. 5 illustrates the program's accuracy. ■■

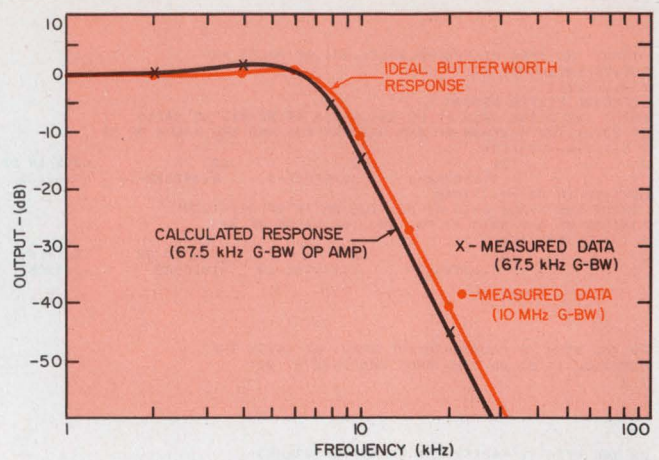

5. Effect of finite op-amp gain, as well as over-all accuracy of the computational model, are seen in this comparison between actual and computed data for a five-pole 8-kHz Butterworth filter.

BASIC program for low-pass filter design and analysis

```

00100 REM PROGRAM WAGA2
00110 PO=3.1415926535
00120 REM FNR TYPE FILTER INPUT 1=BUTTERWORTH,2=CHEBYSHEV
00130 REM 3=BESSEL,4=SPECIAL
00140 REM FNR POLARITY INPUT 1=INVERTING STAGES,2=NON INVERTING
00150 PRINT " INPUT THE TYPE FILTER,POLARITY,NB. OF POLES AND "
00160 PRINT "CUTOFF FREQUENCY FO "
00170 INPUT L,N,F0
00180 DEF FNB(N)=20/2.3025851*L0G(N)
00190 W0=2*PO*F0
00200 DEF FNA(N)=EXP(2.302581/20*N)
00210 QN L G0 T0 00260, 00220, 00500, 00620
00220 PRINT "CHEBYSHEV FILTER DESIGN"
00230 PRINT " INPUT THE RIPPLE IN THE PASSBAND IN DB"
00240 INPUT X6
00250 G0 T0 00290
00260 PRINT "BUTTERWORTH FILTER DESIGN"
00270 U=1
00280 T=1
00290 FNR I=2 T0 10
00300 IF L=1 THEN 00340
00310 A=1/I*L0G(1/SQR(FNA(X6)+2-1)+SQR(1+(1/(SQR(FNA(X6)+2-1)))^2))
00320 T=(EXP(A)-EXP(-A))/2
00330 U=(EXP(A)+EXP(-A))/2
00340 FNR J=0 T0 I STEP 2
00350 IF J=0 THEN 00430
00360 NEXT J
00370 FNR J=1 T0 I/2+.5
00380 Q=(J-1)*PO/I
00390 W(I,J)=U*SIN(Q)
00400 S(I,J)=T*COS(Q)
00410 NEXT J
00420 G0 T0 00480
00430 FNR J=1 T0 I/2
00440 Q=P0/I*(J-.5)
00450 W(I,J)=U*SIN(Q)
00460 S(I,J)=T*COS(Q)
00470 NEXT J
00480 NEXT I
00490 G0 T0 00670
00500 PRINT " BESSEL FILTER DESIGN"
00510 FNR I=2 T0 10
00520 FNR J=1 T0 I/2+.5
00530 READ S(I,J)
00540 NEXT J
00550 NEXT I
00560 FNR I=2 T0 10
00570 FNR J=1 T0 I/2
00580 READ W(I,J)
00590 NEXT J
00600 NEXT I
00610 G0 T0 00670
00620 PRINT " SPECIAL FILTER DESIGN"
00630 REM READ FROM SUB 05680 S(N,J) VALUES
00640 G0 SUB 05680
00650 REM READ FROM SUB 05720 W(N,J) VALUES
00660 G0 SUB 05720
00670 QN N G0 T0 00690, 00680, 00690, 00680, 00690, 00680, 00690, 00680, 00690
00680 S=1
00690 J=1
00700 IF S=0 THEN 01000
00710 G0 SUB 00770
00720 IF N=3 THEN 01730
00730 FNR J=2 T0 N/2
00740 G0 SUB 00770
00750 NEXT J
00760 G0 T0 01730
00770 PRINT " INPUT THE STAGE GAIN AT DC, THE RATIO OF R2/R1,THE"
00780 PRINT "MINIMUM OP AMP GAIN AT FO, AND THE VALUE OF R1"
00790 INPUT G(J),K(J),L(J),R
00800 B(J)=2/SQR(1+(W(N,J)/S(N,J+1-S))^2)
00810 IF L9=1 THEN 00900
00820 V1=B(J)+2*K(J)/(1+K(J))^2
00830 V2=(G(J)-1)/(1+K(J))
00840 A(J)=V1/2+V2+.5*SQR((V1+2*V2)^2-4*V2^2)
00850 C1=B(J)/(R+SQR(A(J)*K(J))^2+S(N,J+1-S)*W0)
00860 D3=B(J)/(B(J)+G(J)/SQR(A(J)*K(J)))
00870 Q4=G(J)*2*S(N,J+1-S)/(B(J)*L(J))
00880 L6=1/SQR(1+(Q4/D3)^2)
00890 G0 T0 00960
00900 C1=(K(J)+G(J)+K(J)*G(J))/(2*K(J)*G(J)*S(N,J+1-S)*W0*R)
00910 A(J)=G(J)*B(J)+2*K(J)/(G(J)+G(J)*K(J)+K(J))^2
00920 V1=B(J)+SQR(G(J)/(A(J)*K(J)))
00930 D3=B(J)/SQR(G(J)+V1^2)
00940 Q4=2*S(N,J+1-S)/(B(J)*L(J))
00950 L6=B(J)/SQR((Q4*V1)^2+(B(J)+Q4*G(J))^2)
00960 PRINT "J","C1","C2","L6SS IN DB","LG/1+LG"
00970 PRINT J,C1,A(J)*C1,FNB(D3),FNB(L6)
00980 RETURN
00990 IF N=2 THEN 01730
01000 D=(S(N,2)/S(N,1))^2*(1+(W(N,1)/S(N,2))^2)
01010 B(1)=2/SQR(1+(W(N,1)/S(N,2))^2)
01020 G9=EXP(1/3*L0G(D))
01030 B1=(2*S(N,2)/S(N,1)+D)/(EXP(1/3*L0G(D))^2)
01040 B2=(2*S(N,2)/S(N,1)+1)/EXP(1/3*L0G(D))
01050 D1=SQR((1-B2)^2+(B1-1)^2)
01060 IF L9=1 THEN 01330
01070 PRINT "INPUT THE STAGE GAIN AT DC,THE RATIO OF R2/R1,THE RATIO"
01080 PRINT "OF R3/R1,THE MINIMUM OP AMP GAIN AT FO, AND THE VALUE OF R1"
01090 INPUT G(J),K2,K3,L(J),R
01100 G=G(1)
01110 IF G=1 THEN 01130
01120 G0 T0 01140
01130 G=1.000001
01140 F=10
01150 G0 SUB 05820
01160 IF D6-A3>0 THEN 01180
01170 K9=1
01180 D8=1
01190 G0 T0 02210
01200 A2=(B2-F+2*(K2*A3+K3*A3))/(F+2*(K3*A3*(1+K2)-K2*(G-1)))
01210 D8=0
01220 G5=EXP(1/3*L0G(A2*A3*K2*K3))
01230 C1=1/(W0*R*G5*G9*S(N,1))
01240 D4=1-(K2*(A2+A3)+K3*(A2*A3*(1+K2)+A3))/G5+2
01250 D5=((1+K2)*(A2+A3)+1+A3*K3)/G5-1
01260 Q8=G(1)*S(N,1)*G9/L(1)
01270 L5=D1/SQR((1-B2-Q8*D5)^2+(B1-1+Q8*D4)^2)
01280 D2=SQR(D4+D5+2)
01290 PRINT "J","C1","C2","C3","L6SS IN DB"
01300 PRINT J,C1,A2*C1,A3*C1,FNB(D1/D2)
01310 PRINT "LG/1+LG IN DB ="FNB(L5)
01320 G0 T0 00720
01330 PRINT "INPUT THE STAGE GAIN AT DC,THE MINIMUM OP AMP GAIN "
01340 PRINT "AT FO,AND THE VALUE OF R1"
01350 INPUT G(1),L(1),R
01360 P8=-2*B1
01370 Q8=4*B2
01380 R8=-10
01390 A8=1/3*(3*Q8=P8+2)
01400 B8=1/27*(2*P8+3*Q8+27*R8)
01410 IF A8>0 THEN 01530
01420 H8=SQR(B8+2/4+A8+3/27)
01430 J8=-B8/2+H8
01440 J9=-B8/2+H8
01450 F8=EXP(1/3*L0G(-B8/2+H8))
01460 IF J9=0 THEN 01490
01470 F9=EXP(1/3*L0G(J9))
01480 G0 T0 01500
01490 F9=0
01500 X8=F8+F9
01510 T1=X8-P8/3
01520 G0 T0 01580
01530 J8=1/2*ATN(SQR((A8+3/27)/(B8+2/4)))

```



```

01540 U8=ATN(EXP(1/3*L0G(TAN(J8))))
01550 T1=2*SQR(A8/3)/TAN(2*U8)-P/3
01560 IF B8<0 THEN 01580
01570 T1=2*SQR(A8/3)/TAN(-2*U8)-P/3
01580 IF H3=1 THEN 05270
01590 K4=1/(2*G(J)*B2*T1-6*G(J)-1)
01600 A2=G(J)*2*2*K4*T1+3
01610 C1=T1/(W0*R*S(N,1)*G9)
01620 Q8=S(N,1)*G9/L(1)
01630 K1=1/(2*G(J))
01640 K2=K1
01650 D4=G(1)*(1+2*K1-(K1+K1*K4+3*K4+A2*K1)*T1/2)/(A2*K1)
01660 D6=-G(1)*T1+3*K4/(A2*K1)
01670 D5=D6+G(1)*(3*A2*K1+A2*K1+2*K4+2*K1+2*K1*K4)*T1/(A2*K2)
01680 L5=D1/SQR((1-B2-Q8*D5)^2+(B1-1-Q8*D4)^2)
01690 PRINT "J","C1","C2","C3","L5","LOSS IN DB"
01700 PRINT J,C1,C1,A2,FNB(D1/(SQR(D4^2+D5^2)))
01710 PRINT "LG/1+LG IN DB ="FNB(L5),"R3="R/K1,"R4="K4/R/K1
01720 G0 T0 00720
01730 PRINT "D0 Y0U WISH T0 CALCULATE THE FREQ. AT WHICH THE "
01740 PRINT "RESP0NSE IS S4 DB D0WN FR0M RESP0NSE AT DC?"
01750 INPUT H6
01760 IF H6=0 THEN 02880
01770 PRINT "INPUT S4 IN DB"
01780 INPUT S4
01790 Q=(FNA(S4))^2
01800 G0 T0 02210
01810 I=J+1-S
01820 E(J)=F*B(J)/(2*S(N,1))
01830 G4=B(J)^2/W0*(1+E(J)^2)/((1-E(J)^2)^2+(B(J)*E(J))^2)*2*S(N,1)
01840 N6=(1-E(J)^2)^2+(B(J)*E(J))^2/(G(J)^2)
01850 IF L9=1 THEN Q1930
01860 T1=1/SQR(A(J)*K(J))
01870 Q4=G(J)/L(J)
01880 T2=1-(1+2*S(N,1)*Q4*(1+G(J)/(SQR(A(J)*K(J))*B(J))))*E(J)^2
01890 T3=(B(J)+2*S(N,1)*Q4/B(J)-(2*S(N,1)*Q4/B(J))*E(J)^2)*E(J)
01900 T4=T2+T3+T2
01910 T5=T4/(N6*G(J)^2)
01920 G0 T0 01990
01930 V1=(B(J)^2*K(J)+K(J)*G(J)+1+G(J))/(K(J)*B(J))
01940 Q4=2*S(N,1)/(B(J)*L(J))
01950 T2=1-(1-Q4*V1)*E(J)^2
01960 T3=(B(J)+Q4*G(J)+Q4-Q4*E(J)^2)*E(J)
01970 T4=T2+T3+T2
01980 T5=T4/(N6*G(J)^2)
01990 IF 1-E(J)^2<0 THEN 02010
02000 G0 T0 02030
02010 Q2=-P/2
02020 G0 T0 02050
02030 Q2=-ATN(B(J)*E(J)/(1-E(J)^2))
02040 IF 1-E(J)^2<0 THEN 02060
02050 G0 T0 02070
02060 Q2=-P+Q2
02070 IF T2=0 THEN 02090
02080 G0 T0 02110
02090 Q5=-P/2
02100 G0 T0 02120
02110 Q5=-ATN(T3/T2)-Q2
02120 IF T2<0 THEN 02140
02130 G0 T0 02150
02140 Q5=-P+Q5
02150 M=N6*M
02160 Q1=Q2+Q1
02170 G3=G3+G4
02180 T6=T6+T5
02190 Q6=Q6+Q5
02200 RETURN
02210 H=0
02220 F0R X=0 T0 H STEP H/10
02230 F0R Y=0 T0 H/10 STEP H/100
02240 F=H-X-Y
02250 G0 SUB 02540
02260 IF P>0 THEN 02290
02270 NEXT Y
02280 NEXT X
02290 F0R X1=0 T0 H/10 STEP H/100
02300 F0R Y1=0 T0 H/100 STEP H/1000
02310 F=H-X-X1-Y1
02320 G0 SUB 02540
02330 IF P>0 THEN 02360
02340 NEXT Y1
02350 NEXT X1
02360 F0R X2=0 T0 H/100 STEP H*1E-3
02370 F0R Y2=0 T0 H*1E-3 STEP H*1E-4
02380 F=H-X-X1-X2-Y2
02390 G0 SUB 02540
02400 IF P>0 THEN 02430
02410 NEXT Y2
02420 NEXT X2
02430 F0R X3=0 T0 H*1E-3 STEP H*1E-4
02440 F0R Y3=0 T0 H*1E-4 STEP H*1E-5
02450 F=H-X-X1-X2-X3-Y3
02460 G0 SUB 02540
02470 IF P>0 THEN 02500
02480 NEXT Y3
02490 NEXT X3
02500 W9=W0*F
02510 IF D8=1 THEN 01200
02520 PRINT "THE FREQ. AT WHICH THE RESP0NSE IS S4 DB D0WN ="W9/(2*P0)
02530 G0 T0 02700
02540 M=1
02550 IF D8=1 THEN 02640
02560 F0R J=1 T0 N/2
02570 E(J)=F*B(J)/(2*S(N,1+S))
02580 M=M*((1-E(J)^2)^2+(B(J)*E(J))^2)
02590 NEXT J
02600 IF S=1 THEN 02620
02610 M=M*(1+(F/S(N,1))^2)
02620 P=Q-M
02630 RETURN
02640 G0 SUB 05820
02650 IF K9=1 THEN 02680
02660 P=A3-D6
02670 RETURN
02680 P=D6-A3
02690 RETURN
02700 PRINT " D0 Y0U WISH T0 CHANGE F0?"
02710 REM INPUTING 0,0 MOVES THE PROGRAM ON T0 THE NEXT MAJ0R SECTI0N

```

```

02720 REM INPUTING 3,3 CAUSES F0 T0 BE REN0RMALIZED SUCH THAT
02730 REM AT 0RIGINAL F0 0UTPUT WILL BE S4 DB D0WN.
02740 PRINT " INPUT 0,0;1,W0;2,F0;3,S"
02750 INPUT H7,H8
02760 IF H7=0 THEN 02880
02770 ON H7 G0 T0 02780, 02800, 02820
02780 W0=H8
02790 G0 T0 00690
02800 W0=2*P0*H8
02810 G0 T0 00690
02820 W0=W0/F
02830 PRINT " AT F0="W0/(2*P0)
02840 F0R J=1 T0 N/2
02850 PRINT "0P AMP GAIN F0R J=" J" IS " L(J)*F
02860 NEXT J
02870 G0 T0 00690
02880 PRINT"D0 Y0U WISH T0 M0DIFY THE CAPACIT0R VALU0S?"
02890 INPUT H8
02900 IF H8=0 THEN 03630
02910 F0R J=1 T0 N/2
02920 IF L9=1 THEN 03290
02930 IF J>1 THEN 03200
02940 IF S=1 THEN 03200
02950 PRINT "INPUT C1,C2,C3 AND INITIAL R2/R1 AND R3/R1"
02960 INPUT C1,C2,C3,K2,K3
02970 A2=C2/C1
02980 A3=C3/C1
02990 G=G(1)
03000 B=(1+K2)*(A3-(G-1)*A2)+1+A3*K3
03010 X1=B+3*A2*A3*K2*K3-B*F
03020 X2=3*B+2*(A3-(G-1)*A2)-B+3*A2*A3*K3
03030 X3=3*B+2*A3-K2*B+3*A2*A3
03040 X4=B+2*B+2-B+2*(K2*(A3-(G-1)*A2)+K3*(A2*A3*(1+K2)+A3))
03050 X5=2*B+2*B*(A3-(G-1)*A2)-B+2*(A3-(G-1)*A2+K3*A3*A3)
03060 X6=B+2*(A2*A3*(1+K2)+A3)-2*B*A3*B2
03070 X=(X1*X6-X3*X4)/(X5*X3+X2*X6)
03080 Y=(X4-X5*X)/X6
03090 K2=K2+X
03100 K3=K3+Y
03110 M=X+Y+2
03120 IF M>1E-10 THEN 03000
03130 R1=1/(S(N,1)*G9*W0*C1*EXP(1/3*L0G(A2*A3*K2*K3)))
03140 G5=EXP(1/3*L0G(A2*A3*K2*K3))
03150 D4=1-(K2*(A2+A3)+K3*(A2*A3*(1+K2)+A3))/G5+2
03160 D5=((1+K2)*(A2+A3)+1+A3*K3)/G5-1
03170 PRINT "R1","R2","R3"
03180 PRINT R1,K2*R1,K3*R1
03190 G0 T0 03270
03200 PRINT "INPUT C1(J) AND C2(J) F0R J="J
03210 INPUT C1,C2
03220 A(J)=C2/C1
03230 V4=(2*(1+A(J)-G(J))*A(J)-B(J)^2*A(J))/A(J)^2
03240 K(J)=-V4/2+.5*SQR(V4^2-4*(1+A(J)-G(J))/A(J))^2)
03250 R1=B(J)/(SQR(A(J)*K(J))*2*C1*W0*S(N,1+S))
03260 PPRINT "R1="R1,"R2="K(J)*R1
03270 NEXT J
03280 G0 T0 03630
03290 IF J>1 THEN 03550
03300 IF S=1 THEN 03550
03310 PRINT "INPUT C1 AND C3"
03320 INPUT C1,C3
03330 A2=C1/C3
03340 K1=1/(2*G(1))
03350 G=EXP(1/3*L0G(A2^2*(K1*K4-K1^2*K4*G(1))))
03360 A=B1*G/(3*K4)-G(1)-1
03370 B=A2*K1-K1^2*A2*G(1)+K4*G(1)+1+K4-B1*G
03380 C=A2-2*K1*A2*G(1)-B1*G*(1-2*G(1)*K1)/(3*K1*(1-K1*G(1)))
03390 D=EXP(1/3*L0G(A2*(K1*K4*(1-G(1)*K1))^2)
03400 E=2*B2*D/(3*K4)+G(1)*K1^2-K1-1-K1*G(1)
03410 F=K1+K1*K4-G(1)*K1^2-G(1)*K1^2*K4+K4*K4*K1*G(1)-B2*D
03420 H=1+K4-2*G(1)*K1*K4+K4*G(1)
03430 J5=-2*B2*D*(1/K1+G(1)/(G(1)*K1-1))/3
03440 X=(F/E-B/A)/(C/A-(H+J5)/E)
03450 Y=F/E+(H+J5)*X/E
03460 K1=K1+X
03470 K4=K4+Y
03480 M=X+Y+2
03490 IF M>1E-10 THEN 03550
03500 K2=1/G(1)-K1
03510 R3=1/(W0*C3*G9*S(N,1)*EXP(1/3*L0G(G(1)*A2^2*K1*K2*K4)))
03520 PRINT "R1","R2","R3","R4"
03530 PRINT K1*R3,K2*R3,R3,K4*R3
03540 G0 T0 03270
03550 PRINT "INPUT C1(J) AND C2(J) F0R J="J
03560 INPUT C1,C2
03570 A(J)=C2/C1
03580 V4=(G(J)*B(J)^2-2*G(J)*(1+G(J))*A(J))/A(J)^2+(1+G(J))^2)
03590 K(J)=-V4/2+.5*SQR(V4^2-4*(G(J)/(1+G(J))^2)
03600 R1=(K(J)+K(J)*G(J)+G(J))/(2*K(J)*G(J)*S(N,1+S)*W0*C1)
03610 PRINT "R1="R1,"R2="K(J)*R1,"R3="G(J)*R1
03620 G0 T0 03270
03630 PRINT " D0 Y0U WISH T0 CALCULATE E0UT/EIN, PHASE AND "
03640 PRINT " DELAY VERSUS FREQ. F0R 0P AMP GAIN = INFINITY 0F FILTER"
03650 PRINT " USING EXACT C0MP0NENT VALU0S CALLED F0R ?"
03660 INPUT D9
03670 IF D9=0 THEN 03960
03680 G0 SUB 03710
03690 G0 T0 03630
03700 RETURN
03710 PRINT " INPUT START F,ST0P F, N0. 0F P0INTS PER DECADE "
03720 INPUT Z1,Z2,N7
03730 PRINT"FREQ.," "E0UT/EIN IN DB","PHASE IN DEG.,""DELAY IN SEC."
03740 F1=Z1*2*P0/W0
03750 F=F1
03760 G0 SUB 05750
03770 IF F>10*F1 THEN 03940
03780 IF S=0 THEN 03830
03790 F0R J=1 T0 N/2
03800 G0 SUB 01810
03810 NEXT J
03820 G0 T0 03870
03830 F0R J=2 T0 N/2
03840 G0 SUB 01810
03850 NEXT J
03860 G0 SUB 04330
03870 IF F>22*2*P0/W0 THEN 03700
03880 IF L9=2 THEN 03910
03890 0N (N-1+S)/2 G0 T0 03900, 03910, 03900, 03910, 03900

```

(continued on next page)

```

03900 Ø1=Ø1+P0
03910 PRINT W0*F/(2*P0),-FNB(SQR(M)),Ø1*180/P0,G3
03920 F=F*10*(.30103*4/W7)
03930 Ø0 TØ 03760
03940 F1=10*F1
03950 Ø0 TØ 03750
03960 PRINT "DØ YØU WISH TØ CALCULATE AMPLITUDE AND PHASE VERSUS"
03970 PRINT" FREQ. ØF LG/1+LG TERM FØR EXACT CØMPØNENT VALUE FILTER ?"
03980 INPUT D9
03990 IF D9=0 THEN 04830
04000 Ø0 SUB 04040
04010 Ø0 TØ 03960
04020 IF H3=1 THEN 05670
04030 RETURN
04040 PRINT "INPUT START F,STØP F,NØ. ØF PØINTS PER DECADE "
04050 INPUT Z1,Z2,W7
04060 PRINT "FREQ.", "LG/1+LG IN DB", "PHASE IN DEG.", "DELAY IN SEC."
04070 F1=Z1*2*P0/W0
04080 F=F1
04090 S8=F1*IE-5
04100 FØR T7=-1 TØ +1 STEP 2
04110 IF F>10*F1 THEN 04260
04120 Ø0 SUB 05750
04130 F=F*17*S8
04140 IF S=0 THEN 04280
04150 FØR J=1 TØ N/2
04160 Ø0 SUB 01810
04170 NEXT J
04180 T8=T7+1
04190 Ø(T8)=Ø6
04200 IF F>22*2*P0/W0 THEN 04020
04210 S9=(Ø(0)-Ø(2))/(2*P0*S8*W0)
04220 NEXT T7
04230 PRINT W0*F/(2*P0),-FNB(SQR(T6)),Ø6*180/P0,S9
04240 F=F*10*(.30103*4/W7)
04250 Ø0 TØ 04090
04260 F1=10*F1
04270 Ø0 TØ 04080
04280 Ø0 SUB 04300
04290 Ø0 TØ 04180
04300 FØR J=2 TØ N/2
04310 Ø0 SUB 01810
04320 NEXT J
04330 N1=(F/(S(N,1)*G9))#2
04340 N2=((1-B2*N1)#2+N1*(B1-N1)#2)/G(1)#2
04350 IF 1-B2*N1=0 THEN 04380
04360 N7=-ATN(SQR(N1))*(B1-N1)/(1-B2*N1)
04370 Ø0 TØ 04390
04380 N7=-P0/2
04390 IF 1-B2*N1<0 THEN 04410
04400 Ø0 TØ 04420
04410 N7=-P0+N7
04420 Ø1=Ø1+N7
04430 IF L9=2 THEN 04520
04440 M3=A2*K1*(1+K2)+A2*K2*(1+K1/K2)+K4+(K1+K2)*(1+K4)
04450 M4=A2*K1*(K2+K2*K4+K4)+A2*K2*(1+K1/K2)*K4+A2#2*K1*K2
04460 T3=1/EXP(1/3*LØG(A2#2*K1*K2*K4*G(1)))
04470 N3=1-(B2+Ø8*M3*G(1)*T3)*N1+Ø8*N1#2
04480 N4=B1+G(1)*Ø8*(K1+K2+1)-(1+T3#2*M4*G(1)*Ø8)*N1
04490 N5=(N3#2+N1*N4#2)/G(1)#2
04500 T6=T6*N5/N2
04510 Ø0 TØ 04550
04520 N3=1-(B2+Ø8*(1+D5))*N1+Ø8*N1#2
04530 N4=B1+Ø8-(1+Ø8*(1-D4))*N1
04540 T6=T6*(N3#2+N1*N4#2)/(N2*G(1)#2)
04550 IF N3=0 THEN 04570
04560 Ø0 TØ 04590
04570 N8=-P0/2
04580 Ø0 TØ 04600
04590 N8=-ATN(SQR(N1)*N4/N3)
04600 IF N3<0 THEN 04650
04610 IF N4<0 THEN 04630
04620 Ø0 TØ 04660
04630 N8=-P0+2*N8
04640 Ø0 TØ 04660
04650 N8=-P0+N8
04660 M=M*N2
04670 G2=1/((S(N,1)+F#2*S(N,1))*W0)
04680 E(1)=F*B(1)/(2*S(N,2))
04690 G4=B(1)#2/W0*(1+E(1)#2)/(((1-E(1)#2)#2+(B(1)*E(1))#2)*2*S(N,2))
04700 G3=G2+G3+G4
04710 Ø6=-N7+Ø6+N8
04720 RETURN
04730 DATA 1.5,2.32218,1.838907,2.89621,2.103789,3.64674
04740 DATA 3.351956,2.324674,4.248359,3.73571,2.51593
04750 DATA 4.971787,4.75829,4.070139,2.68568,5.58789,5.204841
04760 DATA 4.36829,2.83898,6.29702,6.129368,5.604422,4.63844
04770 DATA 2.97926,6.92204,6.61529,5.967528,4.88622,3.1089162
04780 DATA .8660254,1.754381, .867234,2.657418,1.742661
04790 DATA 3.571023, .86751,2.626272,4.49267,1.739286,3.51717
04800 DATA 5.42069, .8676144,2.6161751,4.41444,6.3539113
04810 DATA 1.737848,3.498157,5.317272,7.291464, .8676652
04820 DATA 2.611568,4.384947,6.224986,8.2327
04830 PRINT " DØ YØU WISH TØ CALCULATE EØUT/EIN,PHASE AND DELAY"
04840 PRINT " VERSUS FREQ. FØR FILTER WITH ØP AMP GAIN = INFINITY "
04850 PRINT " USING ACTUAL CØMPØNENT VALUES EMPLOYED?"
04860 INPUT D9
04870 IF D9=0 THEN 05610
04880 IF S=0 THEN 05110
04890 FØR J=1 TØ N/2
04900 IF L9=1 THEN 05000

```

```

04910 PRINT "INPUT R1,R2,C1,C2 AND GDC FØR J="J
04920 INPUT R1,R2,C1,C2,G(J)
04930 K(J)=R2/R1
04940 A(J)=C2/C1
04950 B(J)=(A(J)+A(J)*K(J)+1-G(J))/SQR(A(J)*K(J))
04960 T8=1/(R1*C1*W0*SQR(A(J)*K(J)))
04970 S(N,J+1-S)=T8*B(J)/2
04980 IF H3=1 THEN 05580
04990 Ø0 TØ 05090
05000 PRINT "INPUT R1,R2,R3,C1,C2 FØR J="J
05010 INPUT R1,R2,R3,C1,C2
05020 G(J)=R3/R1
05030 K(J)=R2/R1
05040 A(J)=C2/C1
05050 B(J)=(K(J)+G(J)+K(J)*G(J))*SQR(A(J)*K(J)/G(J))/K(J)
05060 T8=1/(R1*C1*W0*SQR(A(J)*K(J)*G(J)))
05070 S(N,J+1-S)=T8*B(J)/2
05080 IF H3=1 THEN 05580
05090 NEXT J
05100 Ø0 TØ 05590
05110 H3=1
05120 IF L9=1 THEN 05340
05130 PRINT "INPUT R1,R2,R3,C1,C2,C3 AND GDC FØR J="J
05140 INPUT R1,R2,R3,C1,C2,C3,G
05150 G(1)=G
05160 A2=C2/C1
05170 A3=C3/C1
05180 K2=R2/R1
05190 K3=R3/R1
05200 H1=1/EXP(1/3*LØG(A2*A3*K2*K3))
05210 B1=H1*(1+K2)*(A3-(G-1)*A2)+1+A3*K3
05220 B2=H1#2*(K2*(A3-(G-1)*A2)+K3*(A2*A3*(1+K2)+A3))
05230 P8=-B1
05240 Q8=B2
05250 R8=-1
05260 Ø0 TØ 01390
05270 IF L9=1 THEN 05480
05280 S(N,1)=H1/(W0*R1*C1*T1)
05290 S(N,2)=S(N,1)*.5*(B2*T1-1)
05300 W(N,1)=S(N,2)*SQR(T1#3/(S(N,2)/S(N,1))#2-1)
05310 D4=1-((K2*(A2+A3)+K3*(A2*A3*(1+K2)+A3))*H1#2)
05320 D5=((1+K2)*(A2+A3)+1+A3*K3)*H1-1
05330 Ø0 TØ 05520
05340 PRINT " INPUT R1,R2,R3,R4,C1 AND C3"
05350 INPUT R1,R2,R3,R4,C1,C3
05360 A2=C1/C3
05370 K1=R1/R3
05380 K2=R2/R3
05390 K4=R4/R3
05400 G(1)=R3/(R1+R2)
05410 H1=1/EXP(1/3*LØG(G(1)*A2#2*K1*K2*K4))
05420 B1=G(1)*H1*(K1*K2*A2+K4*(K1+K2)*(1+K4))
05430 B2=G(1)*H1#2*(A2*K1*(K2*(1+K4)+K4)+K2*A2*K4*(1+K1/K2))
05440 P8=-B2
05450 Q8=B1
05460 R8=-1
05470 Ø0 TØ 01390
05480 T9=W0*R1*C1/(H1*K1*A2)
05490 S(N,1)=T1/T9
05500 S(N,2)=(B2-T1)/(2*T9)
05510 W(N,1)=1/T9*SQR(1/T1-(B2-T1)#2/4)
05520 D=(S(N,2)/S(N,1))#2*(1+(W(N,1)/S(N,2))#2)
05530 G9=EXP(1/3*LØG(D))
05540 Ø8=S(N,1)*G9/L(1)
05550 B(1)=2/SQR(1+(W(N,1)/S(N,2))#2)
05560 FØR J=2 TØ N/2
05570 Ø0 TØ 04900
05580 NEXT J
05590 Ø0 SUB 03710
05600 Ø0 TØ 04830
05610 PRINT " DØ YØU WISH TØ CALCULATE LG/1+LG AND PHASE VERSUS "
05620 PRINT " FREQ. FØR FILTER WITH FINITE GAIN USING ACTUAL "
05630 PRINT " CØMPØNENT VALUED EMPLOYED ? "
05640 INPUT D9
05650 IF D9=0 THEN 05910
05660 Ø0 SUB 04040
05670 Ø0 TØ 05610
05680 S(5,1)=1.0
05690 S(5,2)=.809017
05700 S(5,3)=.309017
05710 RETURN
05720 W(5,1)=.5877852
05730 W(5,2)=.9510565
05740 RETURN
05750 T6=1
05760 M=1
05770 Ø1=0
05780 G3=0
05790 Ø6=0
05800 J=1
05810 RETURN
05820 D=F#3*(K2+K3)*(1+K2)*(G-1)-B1*F#2*K3*(1+K2)
05830 D7=F#3*(K3*(1+K2)-(1+K2+K3)*K2*(G-1))
05840 D2=K3*(1+K2)*(1+K2+K3)*F#3
05850 D3=-B2*F*(1+K2)*(G-1)+B1*F#2*K2*(G-1)-F#3*K2*(G-1)
05860 A3=(D+D7)/(2*D2)+.5*SQR(((D+D7)/D2)#2-4*D3/D2)
05870 U4=(F-B1)/(F*(1+K2+K3))
05880 U5=-(1+K2)*(G-1)/(F#3*K2*K3*(1+K2+K3))
05890 D6=-U4/2+.5*SQR(U4#2-4*U5)
05900 RETURN
05910 END

```

MADE IN

FAIRCHILD

**A CIRCUIT
FOR EVERY
RADIO/AUDIO
FUNCTION**

A circuit for every socket: All the building blocks for any Radio/Audio System. Ask for a desk top demonstration.

AM	FM	HIGH GAIN FM	FM STEREO	HIGH GAIN FM STEREO
μA720 AM RADIO SUBSYSTEM	3075 FM DETECTOR AMPLIFIER	μA753 FM GAIN BLOCK	3075 FM DETECTOR AMPLIFIER	μA753 FM GAIN BLOCK
μA706 AUDIO AMPLIFIER	μA706 AUDIO AMPLIFIER	3075 FM DETECTOR AMPLIFIER	μA758 PLL STEREO	3075 FM DETECTOR AMPLIFIER
		μA706 AUDIO AMPLIFIER	μA706 AUDIO AMPLIFIER	μA758 PLL STEREO
			μA706 AUDIO AMPLIFIER	
				μA706 AUDIO AMPLIFIER
				μA706 AUDIO AMPLIFIER

Each working module (above) contains a Fairchild radio/audio circuit in combination with several passive components. Using these Fairchild LIC Demonstration Blocks, you can have an actual working demonstration of how to build similar systems. We'll plug them together instantly at your desk. Just call any of these Fairchild sales offices (at the right) and one of our applications engineers will arrive, pronto, demonstration kit in hand.

Boston 617-237-3400	Cleveland 216-461-8288
Chicago 312-671-4660	Dallas 214-234-3391

**AM/FM STEREO
WITH PHONO/TAPE**

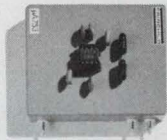

μA753 FM
GAIN BLOCK

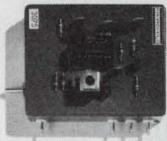

3075 FM DETECTOR
AMPLIFIER



μA758
PLL STEREO



μA720 AM RADIO
AMPLIFIER

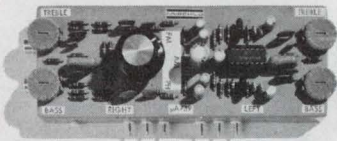

μA739 DUAL
PRE-AMPLIFIER

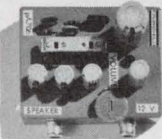

μA706 AUDIO
AMPLIFIER

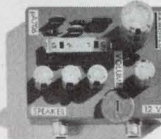

μA706 AUDIO
AMPLIFIER

Indianapolis 317-542-0641	New York 516-293-2900	Philadelphia 215-886-6623
Los Angeles 214-558-1881	Orlando 305-834-7000	San Francisco 415-941-3150

Ours is the most complete line of consumer analog circuits available anywhere.

μA720	AM Radio Subsystem	DIP
μA703	Gain Block	CAN
μA757	Gain Block	DIP
μA753	FM Gain Block	MINI-DIP
3076	FM Gain Block	CAN
3075	FM Detector Amplifier	DIP
2136	FM Detector Amplifier	DIP
μA758	PLL Stereo Decoder	DIP
μA767	Stereo Decoder	DIP
μA732	Stereo Decoder	DIP
μA768	Stereo Decoder	DIP
μA769	Stereo Decoder	DIP
μA739	Dual Pre-Amplifier	DIP
μA749	Dual Pre-Amplifier	CAN
μA706	5W Audio Amplifier	DIPP

We have a comprehensive family of the most used, and the most useful, radio/audio IC's for AM and FM radio, tape and phono-graph applications. High in performance and low in cost, they answer all the LIC needs of any radio/audio system designer. A circuit for every socket. In many cases, even, a choice of circuits for a given socket.

We invented the first consumer industry LIC standard, the μA703, today one of the largest selling IC's in the world. We added 7 more. Then, in the last year, an additional 7, including these new industry standards:

μA758 Phase Locked Loop Stereo Decoder. A complex subsystem that consists of pilot subcarrier regenerator, multiplex decoder circuit, audio output stage, and stereo function switch, all on one chip. Designed to satisfy performance and reliability

requirements of premium high fidelity stereo components. Plus the tough economic requirements of low-cost FM receivers. Features minimization of parts count (no coils required), 40dB power supply rejection, 45dB channel separation, and alignments eliminated.

μA720 AM Radio Subsystem. Combines RF amplifier, IF amplifier, RF oscillator-converter, voltage regulator and AGC detector. Features overvoltage protection, regulated power supply, separately accessible amplifiers.

μA706 5 Watt Audio Amplifier. Up to 5.5 watts continuous output into a 4 Ohm speaker, using single 14V power supply. Operates over a 6-18V range. Features high peak output current, self-centering bias, direct coupling input, low quiescent current, low distortion. Few external components and high ability to withstand AC shorts make it ideal for automotive applications.

μA753 Gain Block. Input and output designed for use with ceramic filters, minimizing external parts count (filter equalization components are on the chip). Full temperature compensation provides excellent gain/temperature stability. Built-in short circuit protection. Low-level output pin for AGC. Excellent noise performance and power supply ripple rejection.

FOR MORE INFORMATION write for our new IC Radio/Audio Design Kit (including application notes and product data).

**MADE IN
FAIRCHILD**

Measure random-pulse frequencies the analog way.

It offers better accuracy than capacitor averaging circuits and lower cost than digital techniques.

Measuring the time interval between periodic pulses is easy enough: The designer has a choice of capacitor-averaging schemes, active analog circuitry or digital-counting techniques, depending on his accuracy and cost goals. But when there are varying intervals between pulses—such as the changing intervals between heart beats—measurement poses a problem: Capacitor averaging is not accurate enough, and digital counting is difficult to implement. This leaves analog circuitry as an obvious choice. And with recent drops in the price of active analog circuits, it is also attractive.

A technique that uses analog circuitry to measure varying pulse intervals is shown in Fig. 1. The generalized block diagram can be used to develop a circuit that offers a tremendous im-

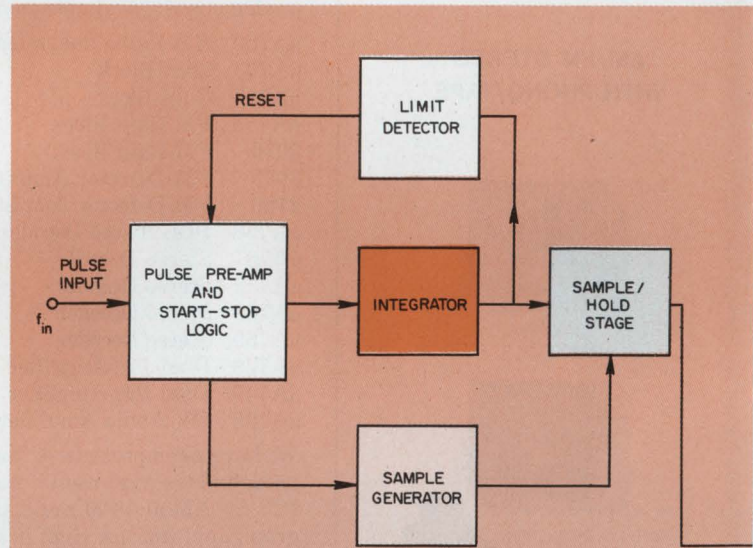

1. Pulse-per-unit-time converter uses analog signal processing to determine the scaled output rate.

Vincent Caggiano, 8302 Post Oak Rd., Rockville, Md. 20854

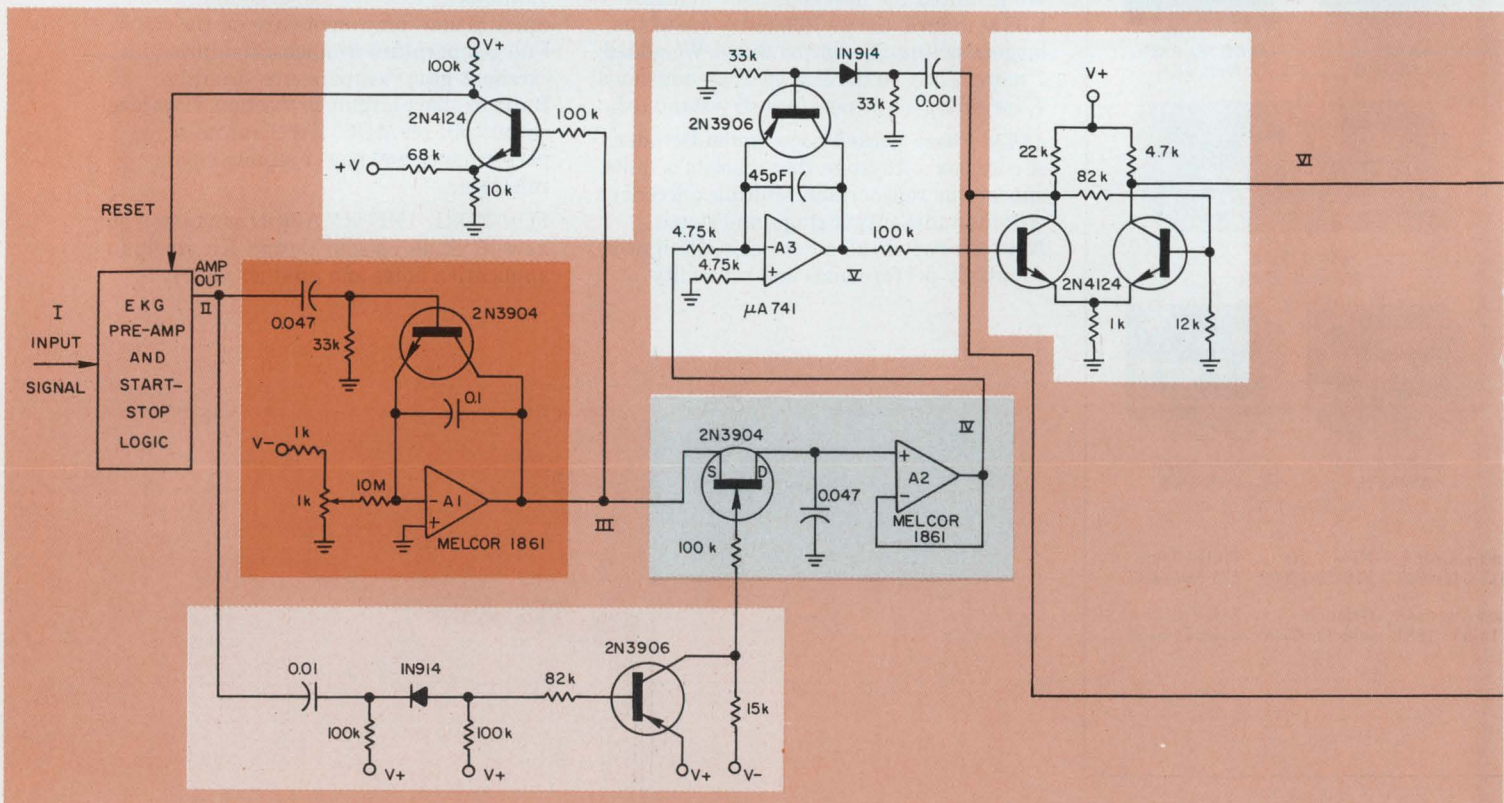

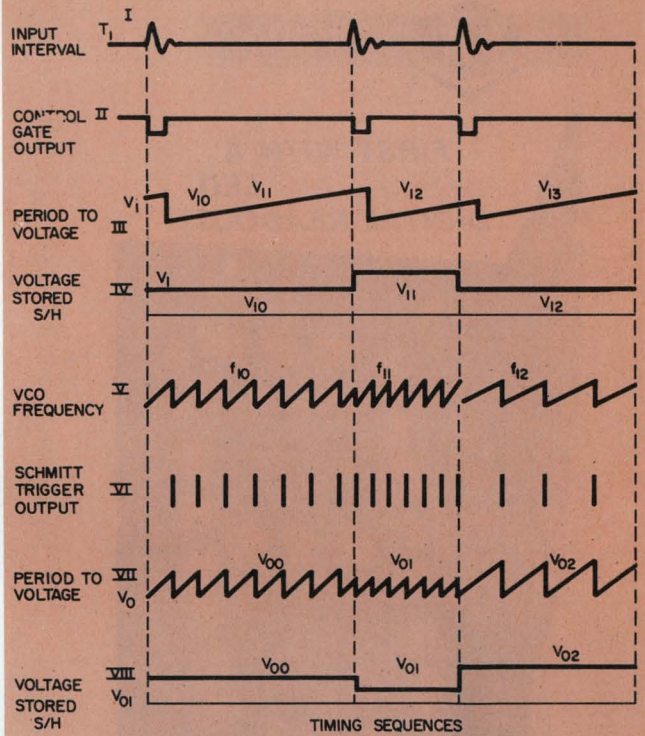
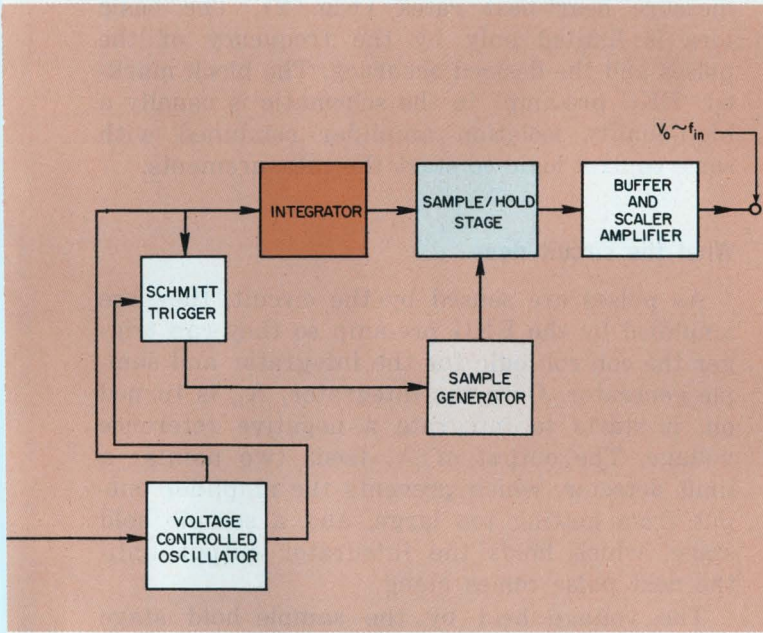

3. **Input pulses generate** all the controlling waveforms needed by the analog circuits to perform the conversion. The input pulses (I) trigger a one shot (II), which controls the integrator (III) and the sample/hold (IV). Voltage levels held by the sample/hold (IV) cause the VCO (V) to produce different frequencies, which are then converted into pulses (VII) by the Schmitt trigger. The trigger output is processed similarly to waveforms I to IV, then the output (IX) is fed into an output buffer amplifier for scaling and impedance matching.

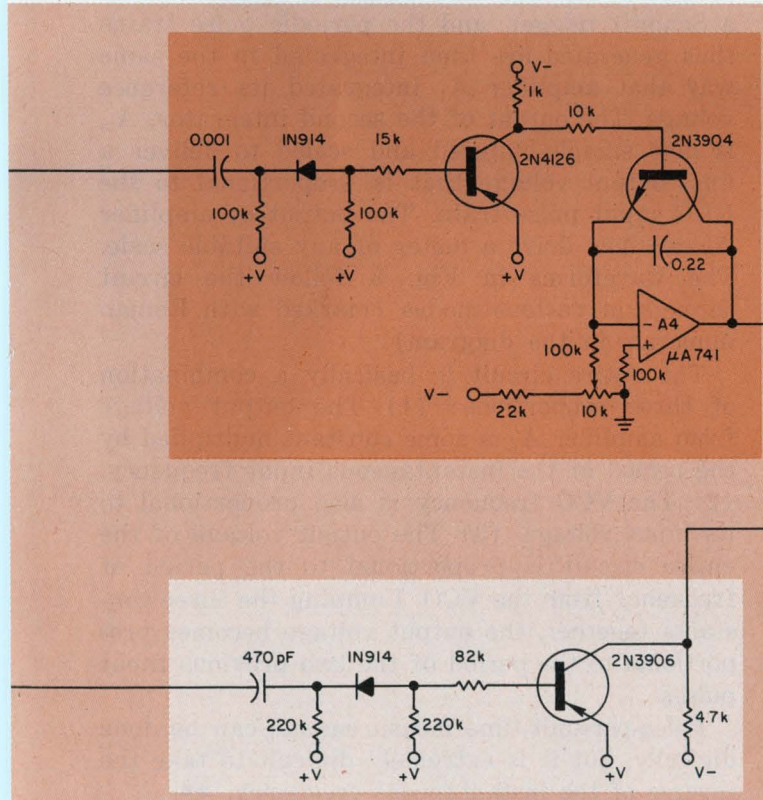

2. **Analog circuitry converts** nonrepetitive pulses into pulses-per-unit-time measurements by, from left to right, first converting them into a voltage level, converting the voltage into a frequency, converting the frequency back into a voltage, and then scaling the output voltage to a convenient level.

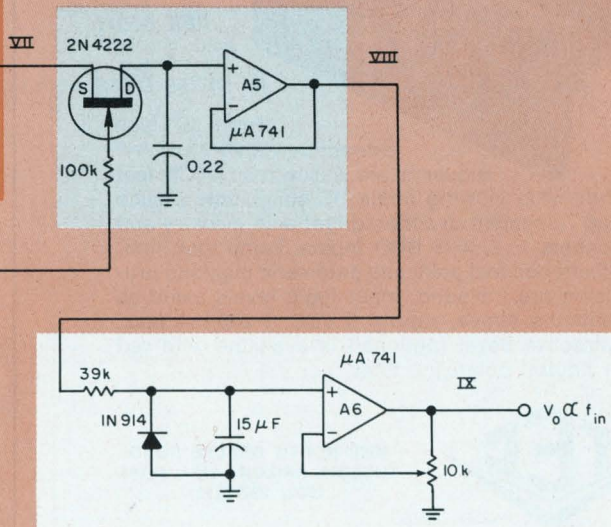

**FIRST WITH A
REALLY BIG LED
DIGITAL READOUT!**

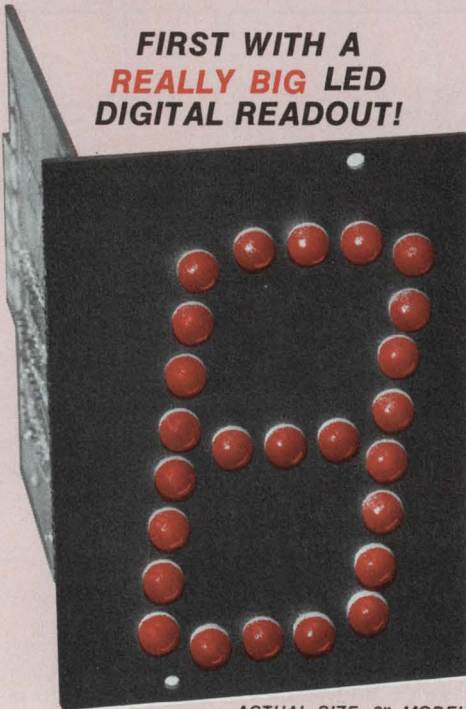

ACTUAL SIZE, 2" MODEL

New 1", 2" and 3" readouts are clearly visible at over 60 feet... and we can build them up to 1 foot high! All have solid state, 7-segment decoder/driver with memory option and accept 1, 2, 4, 8 BCD inputs. Includes lamp test and non-driven decimal point. Input logic levels are 2.5 to 5 VDC for logic "1" and 0 to 0.8 VDC for logic "0." Supply is 5 VDC @ 550 to 750 mA (max), depending on model. Optional bezel available to enhance panel appearance. Low as \$25 per digit in 50-199 quantities.

**ANOTHER FIRST: LOW-COST
HEXADECIMAL LED READOUT**

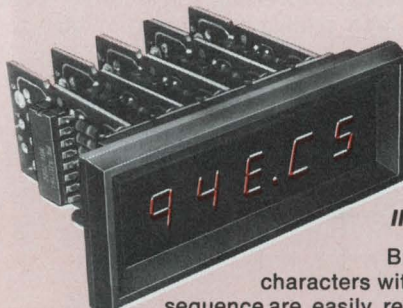

**ONLY
\$ 8.35
PER DIGIT**

IN 50-199 QTYS.

Bright .27" high characters with 0-9 and A-F sequence are easily read at 10 feet over wide viewing angle. IC-compatible device has 7-segment decoder/driver with memory and accepts 1, 2, 4, 8 BCD inputs. Lamp test, non-driven decimal point and automatic blanking provision are included. Input logic levels same as readouts above; supply, 5 VDC @ 200 mA max. Attractive bezel (optional) is available with red or neutral polarizing filter.



9800 NORTH ORACLE ROAD
TUCSON, ARIZONA USA 85704
(602) 297-1111

provement over the capacitive-averaging technique. It can deliver 1% accuracy with a dynamic range of almost 100 to 1. Capacitive averaging, by contrast, is nonlinear, has limited dynamic range and requires a repetitive input.

Basically the analog-circuit system detects the pulses that represent the beginning and end of an interval and then takes the inverse of the duration between the two pulses to give the instantaneous frequency. The instantaneous frequency is then converted back to a voltage that is scaled to provide the desired range.

Let's see how this method can be used to measure heart-beat rates (Fig. 2). The basic idea is limited only by the frequency of the pulses and the desired accuracy. The block marked "EKG pre-amp" in the schematic is usually a high-quality isolation amplifier combined with some control logic to start the measurements.

What the circuit does

As pulses are sensed by the circuit, they are amplified by the EKG pre-amp so they can trigger the control logic for the integrator and sample generator. Once the integrator, A_1 , is turned on, it starts to integrate a negative reference voltage. The output of A_1 feeds two points: a limit detector, which prevents the amplifier output from getting too large, and a sample/hold stage, which holds the integrator output until the next pulse comes along.

The voltage held by the sample/hold stage controls a voltage-controlled oscillator (VCO) formed by A_3 . The VCO output is squared off by a Schmitt trigger, and the periodic pulse trains thus generated are then integrated in the same way that amplifier A_1 integrated its reference voltage. The output of the second integrator, A_3 , is now sample-buffered and scaled to deliver a final output voltage that is proportional to the EKG input pulse train. The output of amplifier A_6 can now drive a meter of any suitable scale. The waveforms in Fig. 3 follow the circuit through at various modes (marked with Roman numerals in the diagram).

The entire circuit is basically a combination of three proportions: (1) The output voltage from amplifier A_2 is some constant multiplied by the period of the instantaneous input frequency. (2) The VCO frequency is also proportional to its input voltage. (3) The output voltage of the entire circuit is proportional to the period of frequency from the VCO. Lumping the three constants together, the output voltage becomes proportional to the period of the two previous input pulses.

Pulse-per-unit-time measurements can be done digitally, but it is extremely difficult to take the inverse of the instantaneous frequency. ■■

You'd probably expect a portable oscilloscope as rugged and reliable as this one to cost a lot.

You'd be wrong.

Introducing the B & K Model 1403 3" Solid-state oscilloscope. It's so compact, reliable, and inexpensive that it's the perfect scope for most on-the-line monitoring applications. Look at its specs: DC to 2MHz bandwidth at 20mV/cm. Recurrent sweep speeds from 10Hz to 100KHz. New wide-angle CRT to reduce case depth to a minimum. Direct-deflection terminals for waveforms up to 150 MHz. Weighs only 8½ pounds. And has a smoked acrylic graticule for trace sharpness and easy reading. All the reliability and accuracy you need in a monitor scope—at a surprisingly low price.

Contact your distributor, or write Dynascan Corporation.

\$179⁹⁵

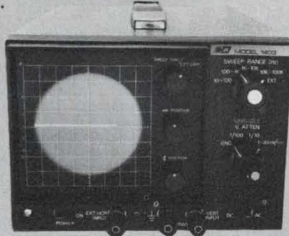

B&K Very good equipment at a very good price.

Dynascan Corporation.
1801 West Belle Plaine Avenue, Chicago, Illinois 60613

INFORMATION RETRIEVAL NUMBER 72

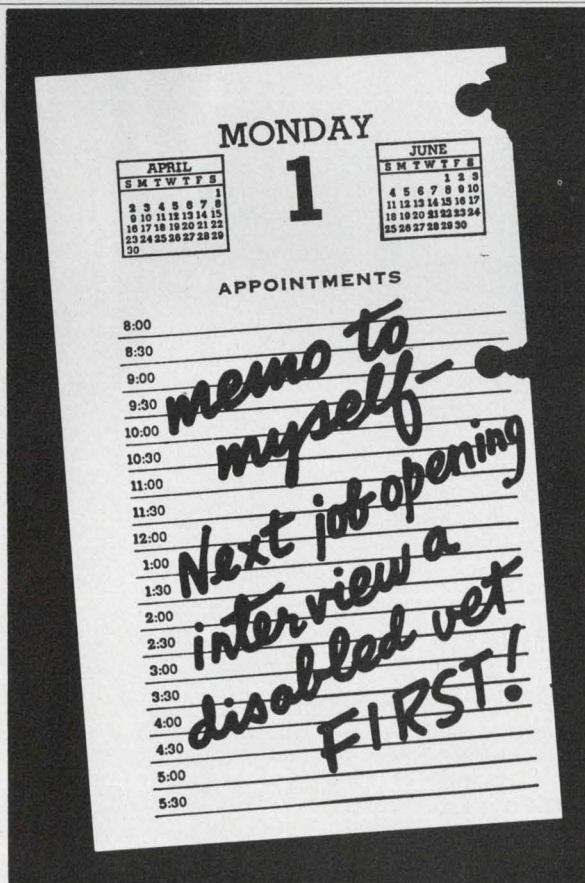

The President's Committee on Employment of the Handicapped
Washington, D.C. 20210

10 MHz TO 2500 MHz, 65 W MIN.

How do you find an r-f power oscillator with high output power, exceptional stability and longer life?

We finally had to build one.

It's a familiar power source problem. Do you sacrifice power for life or vice versa?

We were faced with a situation that specified a power oscillator with higher output power plus longer life, plus minimum r-f leakage. And it had to cover a range of 10 MHz to 2.5 GHz.

End result: We designed the MCL Model 15022, 65 watt CW Signal Generator. It has a frequency stability of $\pm 0.003\%$ /10 minutes and power stability of ± 0.2 db/hour after warmup. Its 6 plug-in heads cover the frequency range of 10 to 2500MHz. Internal 100% square wave modulation, external pulse modulation and optional external 100% AM modulation from 100Hz to 10KHz. And it has enough r-f output to satisfy any prescribed EMI tests.

Meets MIL-STD 462 RFI and MIL-STD 810B Environmental specs.

If you want to end your search for a high-performance power source write today for detailed specifications.

MCL, Inc.,
10 North Beach
Ave., La Grange,
Illinois 60525.



INFORMATION RETRIEVAL NUMBER 73

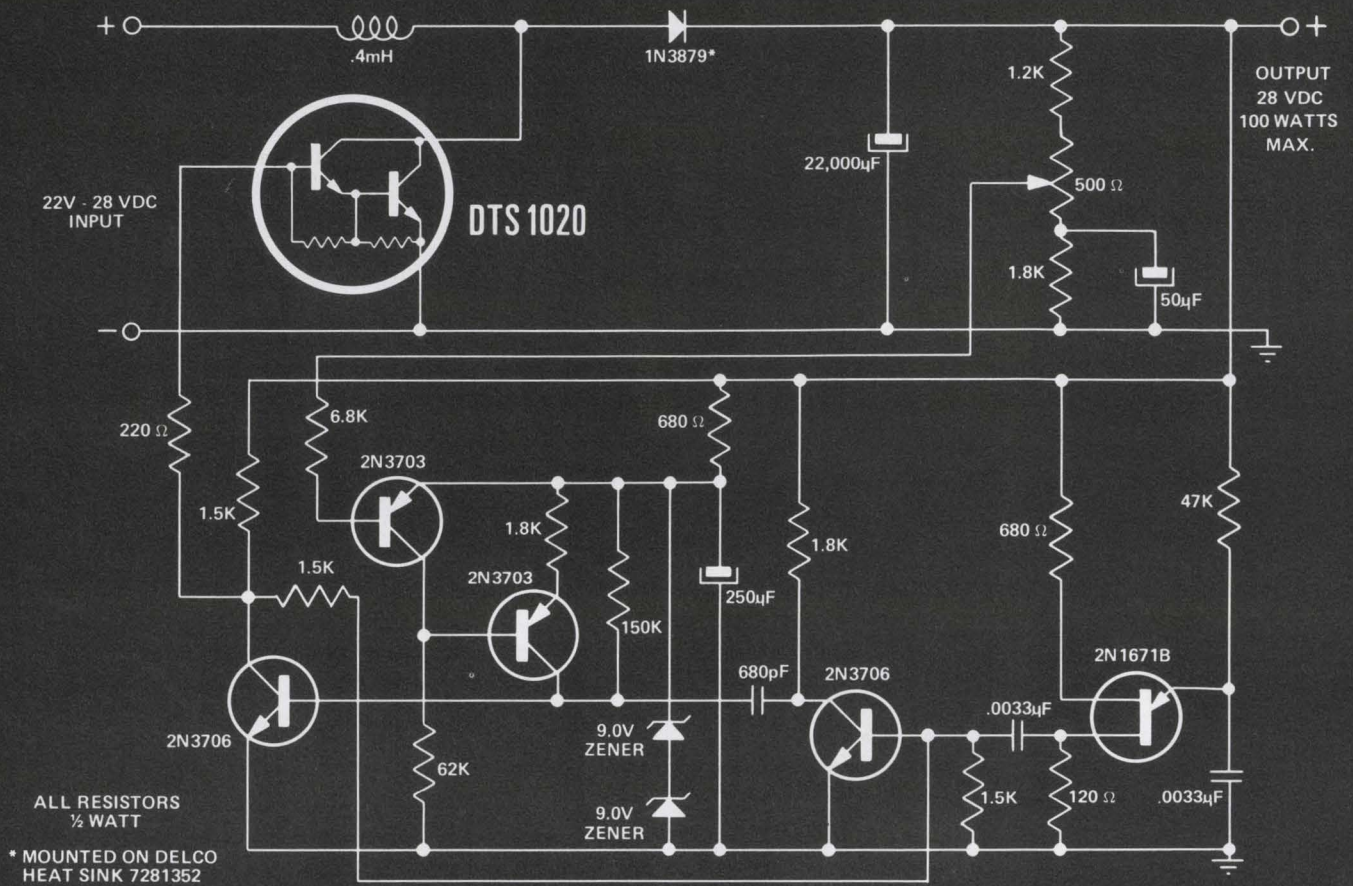

SWITCHING REGULATOR

	V_{CEO} @ 0.1 mA	V_{EBO} @ 50 mA	$V_{CE(SUS)}$ @ 500 mA	h_{fe} @ 1 MHz ($V_{CE}=10V,$ $I_C=200 mA$)	h_{FE} ($V_{CE}=5V,$ $I_C=10A$)	$V_{CE(SAT)}$ @ 5.0 A	I_C	P_T @ 75°C
DTS-1010	120V	7V	80V	12	200	1.8V	10A	100W*
DTS-1020	120V	7V	80V	12	500	1.5V	10A	100W*

*100 percent tested at 2.5A, 40V.

The Kokomoans now give you Darlington Switching Power.

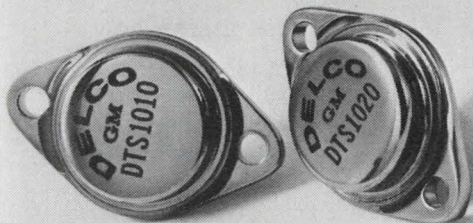

Use a Darlington in place of an ordinary transistor, and you'll realize an additional magnitude of gain plus increased switching power. Use a Delco silicon power Darlington (DTS-1010 or DTS-1020) and you'll also realize a gain in dependability.

Delco's Darlington's are triple diffused mesa units housed in copper TO204MA cases and built for ruggedness. The design gives them high energy capability—the ability to handle surges of current and voltage simultaneously. They are ideal for switching inductive loads in circuits subject to transients or fault conditions.

Design a switching regulator circuit around a Delco Darlington or use it in any 60-100 volt

application to reduce circuit size, weight, and cost. In addition, the Darlington space saving feature allows you more design flexibility. Unlike an ordinary transistor, it's only energy-limited, not beta-limited. You can exploit its full energy capability in your circuit.

Call your nearest Delco distributor. He has them in stock and he's got the data on high energy switching for small spaces.

For details on the switching regulator circuit, ask for Application Note 49.



Delco Electronics

DIVISION OF GENERAL MOTORS CORPORATION.
KOKOMO, INDIANA

Now available from these distributors in production quantities.

ALA., BIRMINGHAM • Forbes Distributing Co., Inc. (205)-251-4104
ARIZ., PHOENIX • Sterling Electronics (602)-258-4531
CAL., LOS ANGELES • Kierulff Electronics, Inc. (213)-685-5511 • Radio Products Sales, Inc. (213)-748-1271
CAL., PALO ALTO • Kierulff Electronics, Inc. (415)-968-6292
CAL., SAN DIEGO • Radio Products Sales, Inc. (714)-292-5611
CAL., SAN DIEGO • Kierulff Electronics, Inc. (714)-278-2112
CAL., SUNNYVALE • Cramer/San Francisco (408)-739-3011
COLO., DENVER • Cramer/Denver (303)-758-2100
CONN., NORWALK • Harvey/Connecticut (203)-853-1515
FLA., MIAMI SPRINGS • Powell/Gulf Electronics (305)-885-8761
FLA., ORLANDO • Powell/Gulf Electronics (305)-859-1450
ILL., ROSEMONT (Chicago) • Kierulff Electronics (312)-678-8560
ILL., SKOKIE (Chicago) • Bell Industries (312)-282-5400
IND., INDIANAPOLIS • Graham Electronics Supply, Inc. (317)-634-8202
MD., BALTIMORE • Radio Electric Service Co. (301)-823-0070
MASS., NEEDHAM HEIGHTS • Kierulff Electronics, Inc. (617)-449-3600

MASS., NEWTON • The Greene-Shaw Co. Inc. (617)-969-8900
MICH., FARMINGTON • Harvey-Michigan (313)-477-1650
MINN., MINNEAPOLIS • Stark Electronics Supply Co. (612)-332-1325
MO., NO. KANSAS CITY • LCOMP-Kansas City, Inc. (816)-221-2400
MO., ST. LOUIS • LCOMP-St. Louis, Inc. (314)-647-5505
N.J., CLIFTON • Eastern Radio Corporation (201)-365-2600, (212)-244-8930
N.Y., BINGHAMTON • Harvey/Federal (607)-748-8211
N.Y., EAST SYRACUSE • Cramer/Syracuse (315)-437-6671
N.Y., ROCHESTER • Cramer/Rochester (716)-275-0300
N.Y., WOODBURY • Harvey/New York (516)-921-8700, (212)-582-2590
OHIO, CINCINNATI • United Radio, Inc. (513)-761-4030
OHIO, CLEVELAND • Pattison Supply (216)-441-3000
OHIO, DAYTON • Kierulff Electronics (513)-278-9411
PENN., PHILADELPHIA • Almo Electronics (215)-676-6000
PENN., PITTSBURGH • RPC Electronics (412)-782-3770
S.C., COLUMBIA • Dixie Radio Supply Co., Inc. (803)-253-5333

TEXAS, DALLAS • Adleta Electronics Co. (214)-741-3151
TEXAS, FORT WORTH • Adleta Electronics Co. (817)-336-7446
TEXAS, GARLAND • Kierulff Electronics, Inc. (214)-271-2471
TEXAS, HOUSTON • Harrison Equipment Co., Inc. (713)-224-9131
UTAH, SALT LAKE CITY • Cramer/Utah (801)-487-3681
VA., RICHMOND • Meridian Electronics, Inc., a Sterling Electronics Company (703)-353-6648
WASH., SEATTLE • Kierulff Electronics, Inc. (206)-763-1550
CANADA, ONT., SCARBOROUGH • Lake Engineering Co., Ltd. (416)-751-5980
ALL OVERSEAS INQUIRIES:
General Motors Overseas Operations Power and Industrial Products Dept. 767 Fifth Avenue, New York, N.Y. 10022. Phone: (212)-486-3723.
Kokomoans' Regional Headquarters.
Union, New Jersey 07083, Box 1018, Chestnut Station, (201) 687-3770.
El Segundo, Calif. 90245, 354 Coral Circle, (213) 640-0443.
Kokomo, Ind. 46901, 700 E. Firmin, (317) 459-2175 (Home Office).



MARK OF EXCELLENCE

'Fashion' the company's growth from the ranks of engineering, corporate chief advises. Training, he says, yields both good design and good management.

Ten or 15 years ago, when the going was tough for my former company, I wanted to believe that there was some magic solution in the form of "professional managers." I thought perhaps a superman would appear who would know more than the men who had built the company. What I believe now is that when you're building a technically-based company, what you need to do is *fashion* more of the same kind of man you started with.

I've been in the instrumentation field for 20 years, and I can tell you that many of the companies in it are constantly getting into trouble. Many that existed 15 years ago—the Consolidated Systems Co., the Beckman Systems Div., Redcor and Astrodata—are no longer around. Why? They all started with a few talented, highly motivated and creative people who solved customer's problems, but when the business grew, they couldn't find engineers in their own image to help them expand.

When you can't find them, you have to train them, and that means training good managers. The point of growth that causes the most difficulty for managers of instrumentation companies has been at the \$5-million to \$7-million level, or 150 to 200 employees. When our company was going through that phase, I told my people that no one could be a manager unless he could do, or know how to do, the jobs of all the people reporting to him.

Teaching the tools of the trade

Many people think that this is the wrong management approach. Most business schools say that a good administrator should be able to hire the people who are qualified for the jobs, and if they can't do the job, replace them.

But in a business where you're always trying to relate your capabilities to new designs, applications and quick reactions on the production line to solve the customer's problem, I ask myself: How can a manager who doesn't know how to do a job or know what's required even inter-

view a man for that job, much less assess how the work is going on?

If I hire a kid out of school, I can't expect him to know much beyond what he learned there. If I hire a man who's 10 years out of school, then I look for him to be expert at something, and able to express it, too.

I like to tell job applicants about all the problems we're having in the company. I have a few technical tests that I give them, but I'm not really interested if they pass them or not. I'm interested in whether or not they give up, whether they insist they can solve the problem. I'm interested, too, in seeing how they react when they lose.

I also tell them that I'm not going to make them an offer until they tell me that they want to work here. I don't want them to work for me because I'm offering them \$500 more than someone else will pay them.

When I find people who can be taught and motivated, my managers know that their job is to teach them what they don't know. No matter how bright the new ones are, they still don't know what they don't know, and the managers must prevent them from making too many mistakes. That means that the managers must know their subject. I've never seen an engineer quit a company unless he felt that he was failing. Part of the job of our managers is to prevent a newcomer from failing. They can't do that unless they can teach.

The most important things our engineering managers teach engineers are the economics of our business, self-development and the problems to expect in their work.

In the instrumentation business we produce a multiplicity of products, many tailored to a customer's requirements. This calls for a high ratio of engineers to shipment. Each senior development engineer develops about \$1-million worth of products in a year. In the hand-calculator business, they're probably running about \$5-million to \$10-million per engineer. Two or three engineers can do all the development because all the products are essentially the same. They've turned on the faucet of the production

Bernard M. Gordon, Chairman of the Board, Analogic Corp., Wakefield, Mass. 01880.

line and have given and taken all the aggravation from suppliers and Murphy's Law, and now they're producing the same product over and over again.

Many engineers don't understand the economic requirement of our business, particularly those who come from a military background. The new engineer must also understand that his boss will give him the maximum opportunity to develop himself professionally. But he must remember that he is still an apprentice; he must understand that there are many things that are beyond

his comprehension. He has to be taught to ask for help when he needs it.

From the manager's point of view, it's just as important for the engineer's success that the manager know what he can't do as what he can do. Very often a guy who's limited can be extremely valuable to the company, provided everyone knows what his transfer function is. One engineer who has worked for me for eight years now had 10 jobs in seven years before he joined us. He had always been hired as the engineering designer, but he never succeeded because he's

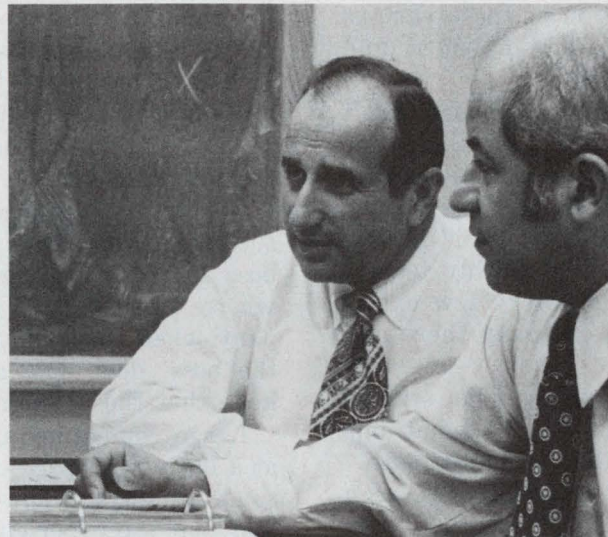

Bernard M. Gordon

Education: B.S.E.E. and M.S.E.E., Massachusetts Institute of Technology.

Responsibility: Chairman of the Board of Analogic Corp.; general partner and technical director of Gordon Engineering Co., the parent company of Analogic Co.

Experience: Internationally known for his contributions and leadership in the fields of high-speed data handling, computations, digital communications, automatic control and PCM telemetry. His experience with information systems may be traced back from the earliest days of the development of high-speed electronic computers. His previous positions include President and Technical Director-Epsco, Inc.; Technical Section Head, Laboratory For Electronics; Project Supervisor, Eckert Mauchly Computer Corp.; Development Engineer, Philco Research Div.

Patents: Nearly 200 patents issued or pending on binary counters; timed signal generators; balanced modulators; frequency meters; low-inductance precision resistors; function generators; amplitude comparators; frequency-conversion systems; rate multipliers; operational digital techniques; hybrid computation; Doppler navigation; and perhaps most

important, high-speed a/d conversion.

Societies: (Honorary Engineering and Professional Groups). Tau Beta Pi. Eta Kappa Nu. Sigma Xi. Hex Alpha (MIT). IRE (Institute of Radio Engineers). Founder of the Professional Group of Electronic Computers, IRE. Former Member, Executive Committee, Professional Group of Electronic Computers, IRE. Chairman, Professional Group on Space Electronics and Telemetry, IEEE.

Company: Analogic designs, develops, manufactures, and sells modules, instruments, and subsystems used for signal translation measurement, communications, computation, and control. These products play important roles in rapidly developing markets: precision electrical measurement; analytical and bio-medical instrumentation; process and machine-tool control; data computation and display; and commercial weighing and batching. The company does not manufacture single components or basic materials. To be successful in its field Analogic must combine a high degree of technological expertise with advanced production methods and apply both with precision and self-discipline. Sales and net earnings for 1972 were about \$4 million and \$250,000 respectively.

not a designer. But he is hellishly responsible, knows how to schedule, understands economics, works well with other people and understands customer requirement and production techniques. So we gave him a managerial post.

Conducting the engineering orchestra

I used to believe that if I hired someone for a job, he could do it completely. I got very upset when a man couldn't be a hotshot project engineer, because that was my image of myself. Then I began to realize that hotshots don't need to have hotshots working for them. The hotshot's job is to assess the cross-section of these various men, decide what has to be accomplished and conduct the engineering orchestra.

Most excellent development engineers don't make particularly good managers because they don't understand other people's motivations. Yet here's a paradox: You'll find that nearly all the successful companies on Route 128 around Boston were started and are still run by highly technically competent guys. There are very few examples of generalists starting a company there and making it succeed.

Yet the development engineers who started those successful ventures do not see what one man who works for us calls the "revealed truth." They can't face reality. For example, I've seen engineers read magazines like *ELECTRONIC DESIGN* with interest and suddenly come to an ad from a competitor and quickly turn the page, because they don't want to admit to themselves that the competitor might have out-engineered them.

That requires a subordination of ego, and it's another important lesson our managers try to teach our new men. I don't think engineers can become good managers until they've learned to subordinate their egos and learned to give the credit where due, regardless of whose idea it was. At the same time they've got to be willing to accept blame for a job that didn't turn out so well—and learn how to correct it.

Another point to impress on the potential engineering manager is that the only reason he is working for us is because there are problems, and usually there are two kinds:

One is the problem the potential manager is assigned, like anticipating the design of a device, or a sales approach to a major customer, or the design of test equipment for production. He knows what the problem is, and he's working on it.

Learning what's reasonable

The other problem is the unexpected: A vendor doesn't ship, or his righthand man gets the

measles, or his chief engineer's wife runs away from him and the chief engineer leaves the area. The potential manager has to cope with these problems, and many people who are not prepared to be managers end up documenting the reasons why they cannot do the job. Those guys are going to fail. Our managers try to make people understand that they get points by facing the problem and saying: "This is how I'm going to solve it."

Also, in fashioning a new man, the manager must tell him what's reasonable to expect. For example, a guy who's never had a secretary might find that he has to hire one, but he doesn't know how much help a secretary can be and he doesn't know how fast she should take dictation. Unless an older guy tells him what's reasonable, he may never find out.

And, finally, the manager has to build faith in the management.

For a small-to-medium-sized company to be successful the people have to have faith in their boss and the feeling that they're going somewhere. When I was young, I worked in a company where most of the employees made fun of the boss' decisions, and all they could do was hope that the company was going to fail.

Large companies are managed by veto. Once, at a large aerospace company, I asked how thousands of guys would design an airplane. I was told that the experienced guys let the other guys start the tasks, and after the newer ones had got to a certain point, the experienced men would review it, veto it, correct it, veto it again, and eventually—by a process of elimination and successive approximation—arrive at the desired result.

We can't afford the luxury of that in a smaller company. We've got to be right the first time most of the time. So the role of the manager is to think out how he would do if he had to do it himself. He has a frame of reference, and he gets his people believing that they are doing the job themselves. By subliminal suggestion, he's got to bring them into doing what he wants them to do, because they're not going to be motivated properly to do it otherwise. They'll integrate their own good ideas with his, but they'll end up doing it the way he thought it should be done if he'd done it himself.

In the instrumentation business there has to be an advocate. There has to be a man who wants to see the program succeed. Without that attitude, we couldn't build a larger company, because we can't administrate motivation or intellectual capability or the capacity for work. In our industry, management is not a "best effort" activity. It isn't good enough simply to say, "Well, we did our best, and it wasn't good enough." You go out of business that way. ■■

Drive your SCR and Triac with an RCA Zero-Voltage Switch.

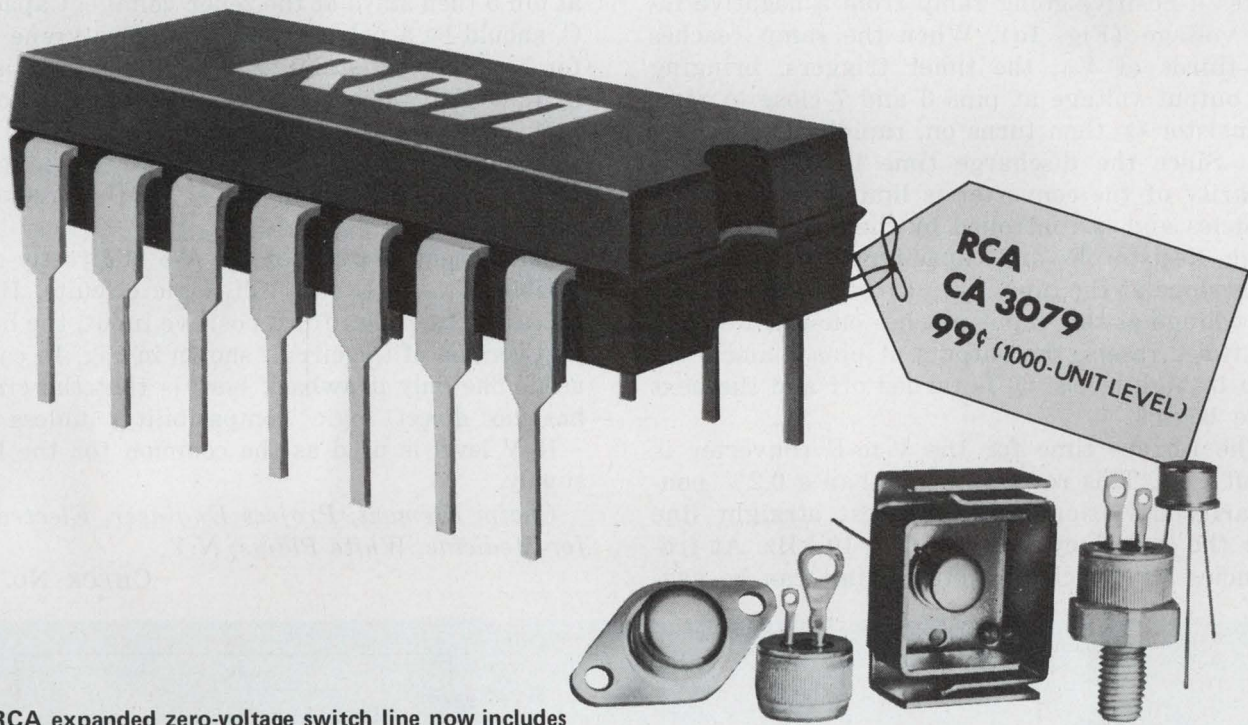

RCA expanded zero-voltage switch line now includes three types with the outstanding features shown below.

	CA3058	CA3059	CA3079
■ 24V, 120V, 208/230, 277V at 50, 60, or 400 Hz operation	✓	✓	✓
■ Differential input	✓	✓	✓
■ Low Balance input current (max) μ A	1	1	2
■ Built-in protection circuit (fail-safe) for open or shorted sensor (term. 14)	✓	✓	
■ Sensor range (RX) — $k\Omega$	2 to 100	2 to 100	2 to 50
■ DC mode (term. 12)	✓	✓	
■ External trigger (term. 6)	✓	✓	
■ External inhibit (term. 1)	✓	✓	
■ DC supply volts (max.)	14	41	10
■ Operating temperature range, $^{\circ}$ C	-55 to 125	-40 to 85	-40 to 85

RCA-CA3079 Zero-Voltage Switch brings you an economical answer to Triac (and SCR) triggering — without radio frequency interference. This economy IC — and an RCA matching series of Triacs (40693-40734) — offer you a combination of economy and design freedom. RCA Triac series 40693-40734 has been designed for 2.4-40 amp, 100-600 volt operation with RCA Zero-Voltage Switches.

For Data Bulletin File No. 490 and Technical Application Note ICAN 6182 write: RCA Solid State, Section 57F-21, Box 3200, Somerville, N.J. 08876.

RCA Solid State
products that make products pay off

Voltage-to-frequency converter constructed with few components is accurate to 0.2%

A simple and accurate voltage-to-frequency converter can be built with a 555 timer, an LM 301A op amp and a few additional parts. Applications for a V-to-F circuit are numerous: in analog-to-digital conversion, analog-data transmission and voltage-controlled ramp generators, to list a few.

The op amp, connected as an integrator, generates a positive-going ramp from a negative input voltage (Fig. 1a). When the ramp reaches two-thirds of V_{cc} , the timer triggers, bringing the output voltage at pins 3 and 7 close to zero. Transistor Q_1 then turns on, rapidly discharging C_1 . Since the discharge time is constant, the linearity of the converter is limited at high frequencies and is controlled by the R_5C_3 time constant. Resistor R_5 and capacitor C_3 slow the retrace slope at the input (pin 2) of the 555. When the voltage at this input reaches one-third of V_{cc} , the timer resets, the outputs at pins 3 and 7 return to high levels, Q_1 is turned off and the next cycle begins.

The retrace time for the V-to-F converter is about $1 \mu s$. This results in less than a 0.2% non-linearity deviation from the best straight line over the frequency range of 0 to 10 kHz. At frequencies for which the retrace time can be neg-

lected, the conversion constant is given by

$$f = 3[V_{in}/2(V_{cc}R_1C_1)]$$

In the circuit shown, $f = (10^3)(V_{in})$.

If the V_{cc} supply is not sufficiently regulated, the timer's reference voltage at pin 5 can be stabilized if a zener diode is connected to ground and a resistor to V_{cc} and if the resistor is adjusted for the nominal zener current. The voltage at pin 5 then stays at the zener voltage. Capacitor C_1 should be a polycarbonate or polystyrene type for best thermal stability. The zero adjust is set by R_3 so that the output frequency with a shorted input is about 0.1 Hz. Worst-case shift of this adjustment with a 20-C temperature change is 1.2 mV, corresponding to a 1.2-Hz frequency shift.

The output at pin 7 of the 555 is directly compatible with DTL and TTL logic circuits. If it's necessary to design for a positive input, the modified version of the circuit shown in Fig. 1b can be used. The only drawback here is that the circuit has no direct logic compatibility, unless the -15-V level is used as the common for the logic supply.

Chaim Klement, Project Engineer, Electronics for Medicine, White Plains, N.Y.

CHECK NO. 311

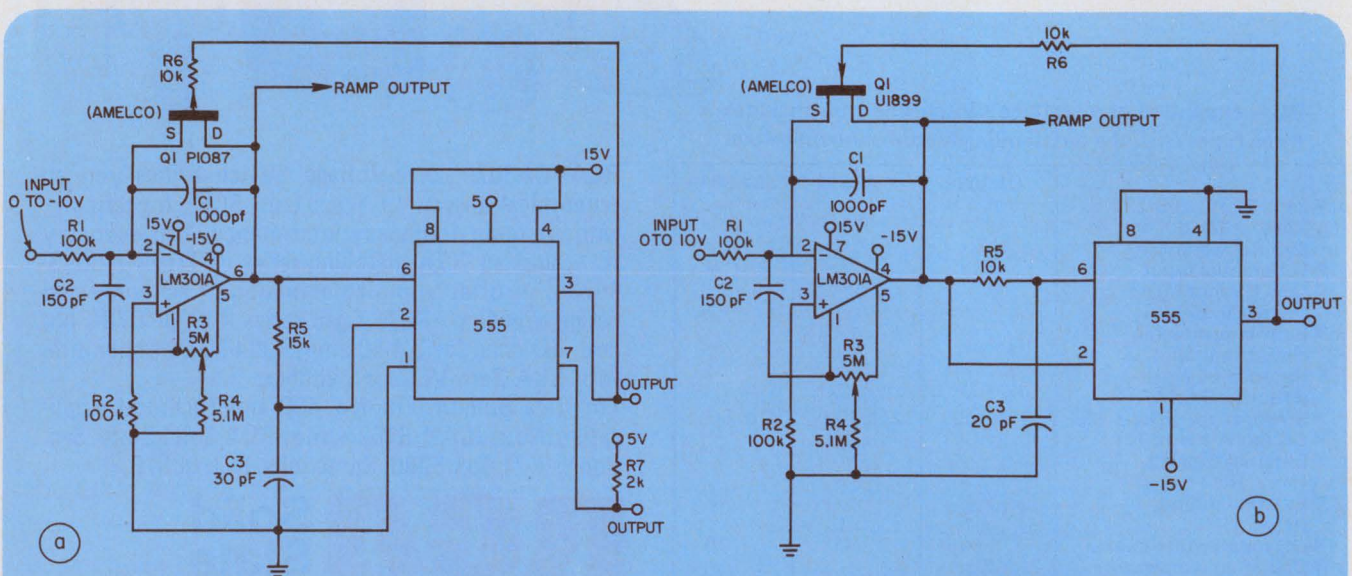

1. Linear voltage-to-frequency converter (a) achieves good linearity over 0 to -10 V . Its mir-

ror image (b) provides the same linearity over the 0-to- $+10\text{-V}$ range but is not DTL/TTL compatible.

ecl

Testing Is Very Special- So Is HP's 8007B Pulser

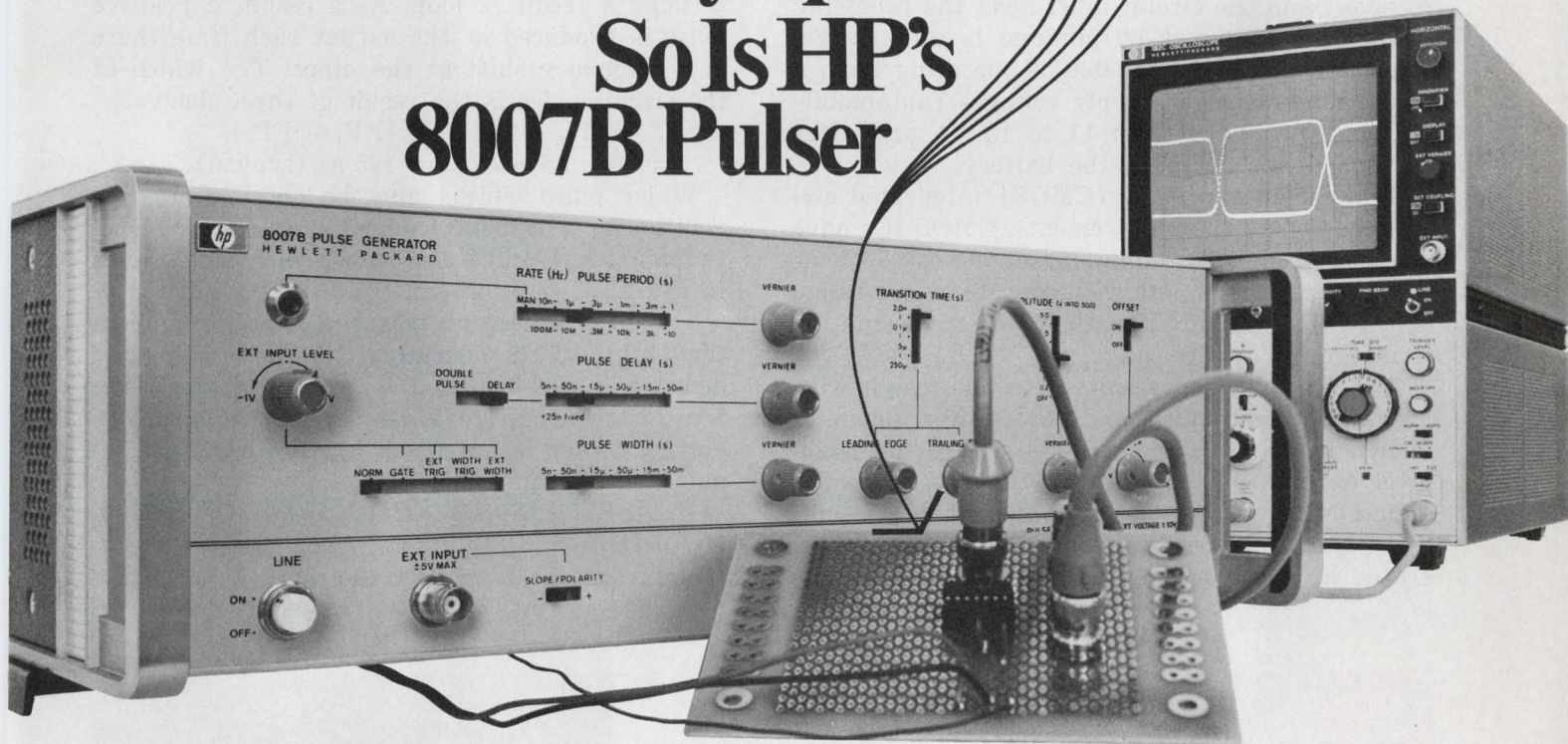

Leading IC manufacturers use it — and they can't afford to take chances in testing. They know that the 8007B delivers the pulses they need. And they know that the \$1,750* price is below competitive models.

Look at the specs of this fast pulse generator: rep rates from 10Hz to 100MHz, variable transition times from 2.0ns to 250 μ s, \pm 5V amplitude and \pm 4V dc offset. It's this kind of capability that you'll need for testing ECL II, ECL 10,000, and other comparable families.

Also note the generator's 50 ohm source impedance — mighty important for minimizing reflections when you're working with fast

ECL. Today's testing also calls for a wide span of linear transition times, like the 2.0ns to 250 μ s of the 8007B. You can really use this when you're measuring propagation delay to a manufacturer's specs (even test linear devices).

In addition to ECL, the 8007B equips you to test most other IC families. You can, for example, measure the sensitivity of a flip-flop; or determine the noise immunity of TTL circuits by adding pulses onto as much as a 4V dc level. These types of tests are made possible because of the continuously variable \pm 4V offset.

If your test needs call for even higher repetition rates (to 200

MHz) or faster transition time (to 1.2ns), you may also want to look into its companion generator, the 8008A.

For more information on either the 8007B or the 8008A fast pulse generators, contact your HP field engineer.

*Domestic USA Prices Only

**For new standards
in pulse generators,
think H-P.**

083 / 3A

HEWLETT  PACKARD

Sales, Service and support in 172 centers in 65 countries. Palo Alto, California 94303. Offices in principal cities throughout the U.S.

Two very-low power CMOS ICs detect tone-signaling frequency shifts

In mobile telephone systems, subscriber identification data are frequently transmitted by frequency-shift keying, sometimes called "dual tone signaling." In this mode the dual tones, or frequencies, are carriers for data; each shift in frequency (f), as shown in Fig. 1 (f_1 to f_2 or f_2 to f_1), represents one bit of data. Some means of detecting this frequency shift is required in the receiver, and the circuit must meet the following constraints: It must be immune to automotive-generated noises, be capable of operating from a wide range of power-supply voltages (automobile batteries can vary from 11 to 15 V) and offer extremely low drain on the battery.

Complementary MOS (CMOS) integrated circuits easily fill the requirements. CMOS ICs have a guaranteed noise immunity of almost 50% of the supply voltage, and they operate over a range of 6 to 15 V. In addition their power dissipation is in the microwatt range.

A simple frequency-shift detector design with high noise immunity and low power drain is shown in Fig. 2. Inputs f_1 and f_2 are the logic-level outputs of tone filters; the presence of a logic ONE at either f_1 or f_2 (but not both) indicates the presence of a tone. The detector generates a positive-going output pulse each time

there is a frequency shift—that is, $f_1 = \text{ONE}$, $f_2 = \text{ZERO}$ changes to $f_1 = \text{ZERO}$, $f_2 = \text{ONE}$ or vice versa. The logic ONE at f_1 or f_2 triggers the flip-flop made of gates G_1 and G_2 . The positive edge at A or B triggers the D latches, FF_1 or FF_2 , ($f_1 = \text{ONE}$ triggers FF_2 , or $f_2 = \text{ONE}$ triggers FF_1). The output of FF_1 or FF_2 is delayed through gates G_3 and G_4 , and thus resets FF_1 or FF_2 through a feedback loop. As a result, a positive pulse is produced at the output each time there is a frequency shift at the input. The width of the output pulse is the result of three delays:

$$T_w = T_{G3} + T_{G4} + T_R (FF_1 \text{ or } FF_2) \\ = 25 + 25 + 75 \text{ ns} = 125 \text{ ns (typical).}$$

Wider pulse widths may be obtained by the addition of a resistor, capacitor and a diode between gates G_3 and G_4 , as shown with dotted lines in Fig. 2.

The total quiescent power dissipation is less than 3.1 mW. In operation, the frequency-shift detector is not required to operate faster than 8 to 12 frequency shifts per second; thus the operating power is not much higher than that required in the quiescent state.

W. A. Wilke, *Systems Engineering, Dept. 2120, Microsystems International, Ltd., Box 3529, Station C, Ottawa, Canada K1Y, 4J1.*

CHECK NO. 312

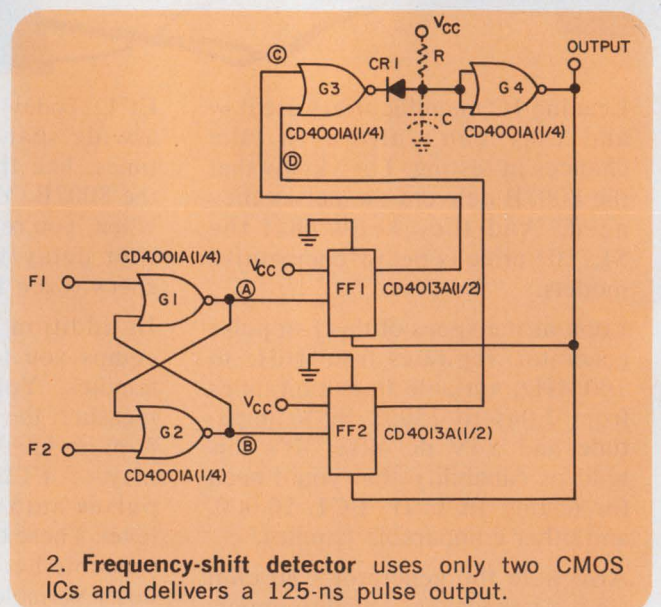
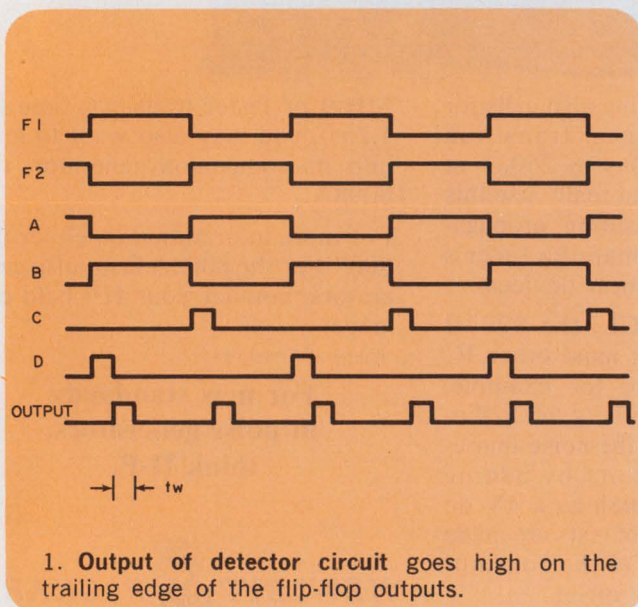

gen'er-ate *v.* - to originate — to produce —

Announcing the Function Generator that grows.

June—

Model 505 with sweep. \$645



The very versatile 500 Series Function Generators — they already do things no other test instruments can do. Now we've designed them to grow. For June we've added an independent yet integrated sawtooth sweep generator to our already trigger-gated Models 501 (5 MHz), 511 (10 MHz) and 521 (20 MHz).

All models are capable of sweeping continuously at any rate from 0.001 Hz (1000 sec.) to 100 KHz, anywhere within the 8 decade range of the basic generator, for a total sweep rate range of 8 decades. The sweep generator can be either continuous, triggered or held at the highest rate. The sawtooth can be used for a trigger-gate input to create tone bursts, low duty cycle pulses (5×10^{-9} !), and a wide variety of special waveforms. The

sawtooth signal can also be amplified by the function generator and summed with the other signals available. Used as a pulse generator it is possible to generate 100-nanosecond pulses approximately once every 17 minutes. As a tone burst generator you can generate such forms as sine, triangle, sawtooth, pulse, square-wave, or haversine.

We said versatile — we meant it. The reason? Our sweep function wasn't tacked on; it was designed in. The simple-to-understand controls are grouped together for complete ease of operation.

If we've started you thinking, don't stop now. Write for more information, or better still, call for a free demonstration. Let's all grow together when we grow.

PART OF THE GROWING GOLD LINE SERIES FROM:

AILTECH 
A CUTLER-HAMMER COMPANY CONTROL

EAST COAST OPERATION • 815 BROADHOLLOW ROAD • FARMINGDALE, NEW YORK 11735 • TELEPHONE: (516) 595-6471 • TWX: 510-224-6558
WEST COAST OPERATION • 19535 EAST WALNUT DRIVE • CITY OF INDUSTRY, CA. 91748 • TELEPHONE: (213) 965-4911 • TWX: 910-584-1811

OTHER SOLID GOLD PRODUCTS FROM AILTECH INCLUDE SPECTRUM ANALYZERS, NOISE MEASUREMENT EQUIPMENT, RF POWER SOURCES, OSCILLATORS AND TRANSDUCERS.

Toroid and photo-SCR prevent ground loops in high-isolation biological pulser

In electrophysiological measurements with high-impedance microelectrodes, it's important to eliminate ground loops. This helps to reduce the signal-to-noise ratio of the measurement and to ensure safety.

Batteries can be used to power active elements in a transformer-coupled circuit. The approach is adequate for delivering 5 to 15 V pulses, but the batteries become quite cumbersome if the circuit must deliver large pulses—say of 200 V.

In the circuit shown, pulses with periods from 100 μ s to indefinite duration (dc) are generated with rise and fall times of approximately 20 μ s. The output voltage can be varied from 0 to 200 V regardless of the input levels. The maximum current output is 200 μ A.

The secondary circuit contains no active elements. Hence it can be isolated entirely from ground in terms of both conductance and capacitance. The factors limiting isolation are the leakage resistance and capacitance of the photo-SCR ($10^{11} \Omega$, 1.3 pF) and the stray capacitance of the secondary winding of the transformer (20 pF). In the main circuit a 555 timer is connected as a pulse generator. It is adjusted to give 30- μ s pulses with approximately a 50% duty cycle. Incoming signal pulses gate the timer. When the signal pulse is high, a train of current pulses is

applied to the primary of the isolation transformer (wound on a 1-in. toroid core). The steep leading edges of the primary current pulses cause a fast rise time for the secondary voltage. To obtain a high-voltage output, the secondary voltage is then rectified with a full-wave doubler and the ripple removed with a zener diode.

The normally slow turn off time of the output voltage is due to the discharge of the doubler capacitors through the load. This can be accelerated by the photo-SCR. The logic to drive the photodiode is derived directly from the signal pulse. When this pulse is high, the diode is off and the SCR is in the forward blocking mode; therefore it is almost an open circuit. When the signal pulse starts turning off, the photodiode is saturated, and the SCR nearly short-circuits the doubler capacitors. This results in very fast discharge of the capacitors and consequent rapid turn off time of the output voltage. Also, during the low state of the output, the voltage is at true zero level and not at the saturation voltage of a transistor.

Joseph Sonsino, Electrical Engineer, University of Pennsylvania, Dept. of Physiology, A407 Richards Bldg., Philadelphia, Pa. 19104.

CHECK NO. 313

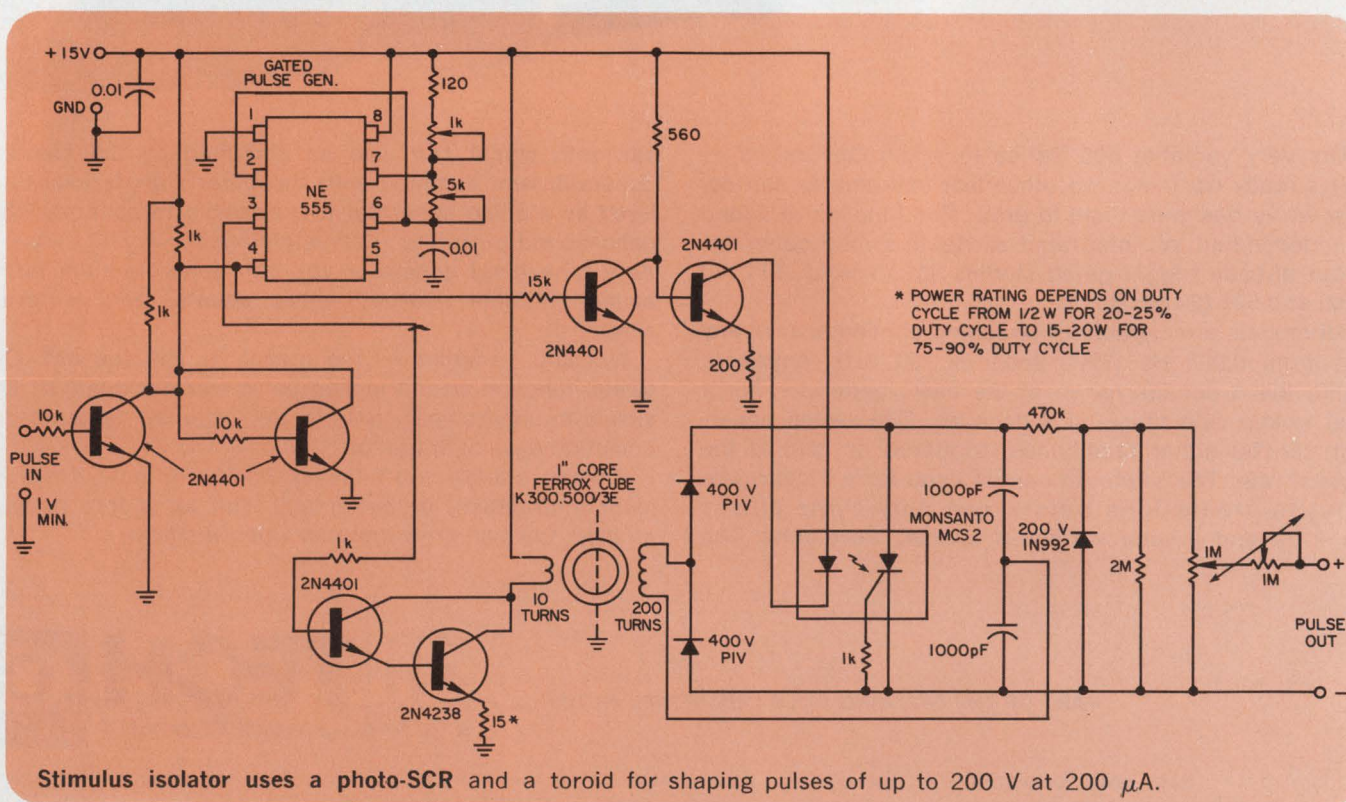

mighty mods...



Now . . . High Efficiency, Switching Regulated Power Supplies

The new Switching Regulated Series is the most recent addition to the expanding line of Hewlett-Packard Modular Power Supplies. The MIGHTY MODS started with the 62000 Series — a complete line of modular power supplies with coverage from 3 to 48 volts, up to 192 watts.

The new Switching Regulated Supplies, Series 62600, feature advanced transistor switching design with up to 80% efficiency. You get more power in a smaller, cooler operating package . . . with 4 to 28 volts, up to 300 watts, 0.2% combined line and load regulation, 20mV rms/30mV p-p ripple and noise. And, HP thinks ahead to give you all the protection you need: overvoltage, overcurrent, over-temperature, reverse voltage and protected remote sensing. What it all adds up to is: selection, performance, reliability plus competitive pricing (with quantity and OEM discounts). Whether it's a modular, laboratory, or digitally programmable power supply — be confident when you specify . . . specify HP.

For detailed information, contact your local HP field engineer. Or write: Hewlett-Packard, Palo Alto, California 94304. In Europe, Post Office Box 85, Meyrin-Geneva, Switzerland.

HEWLETT  PACKARD

21303

Electronic controller resolution improved with an equilibrium sustaining mode

Most simple electronic controllers switch an actuator full on or full off as a sensor output varies about a reference level. Resolution is limited by system overshoot, resulting from the great output change, hysteresis and slow system response to the on-off change. To overcome these resolution limitations, use a proportional controller.

An actuating signal developed by the controller is proportional to the error signal between the sensor output and the reference level. Overcorrection is then greatly reduced, and hysteresis is not needed to limit overshoot.

A sustaining, proportional-heater controller formed with two op amps is shown in Fig. 1. It is basically a pulse-width modulation circuit with feedback from a heater to sensing diodes in the medium being heated. If the sensor diodes change in temperature, their voltage-drops also change. Thus, the temperature change produces a voltage difference from the reference level. This differential voltage is integrated by A₁, and the resulting voltage change on R₅ alters the charging current to C₂. The charge and discharge rates of C₂ determine the output pulse width from A₂, which is connected as a square-wave

oscillator. Pulse width is then changed by the variation in the charging current supplied through R₅. As a result, the duty cycle of the heater current is altered, correcting the sensor temperature and returning the sensor voltage to that of the reference.

At equilibrium, the pulse width of A₂ settles to a width that sustains the zero error as shown in Fig. 2. When the integrator's input error signal goes to zero, the integrator output holds at the existing voltage level. This in turn holds the controller's output pulse width at that equilibrium level until a change in heat loss occurs.

Depending primarily upon sensing accuracy, the circuit can provide a resolution of ±0.1 to ±0.5 C for control temperatures of 35 to 125 C. Similar resolution can be achieved in cooling control. Sensor/reference comparison accuracy is limited by the input offset voltage, V_{os}, input offset current, I_{os}, and dc gain of the integrator amplifier. Offset voltage and current effects are removed during normal calibration, but their thermal drifts produce a calibration drift along with the reference drift. This is expressed by

$$\text{Error } (^{\circ}\text{C}) = -\frac{1}{2 \text{ mV}} \left(\frac{dV_{os}}{dT} + \frac{dI_{os}}{dT} R_9 + \frac{dE_R}{dT} \right).$$

The error due to finite dc gain in the integrator represents a linearity error in output holding voltage due to the associated summing junction voltage. However, a general-purpose op amp that

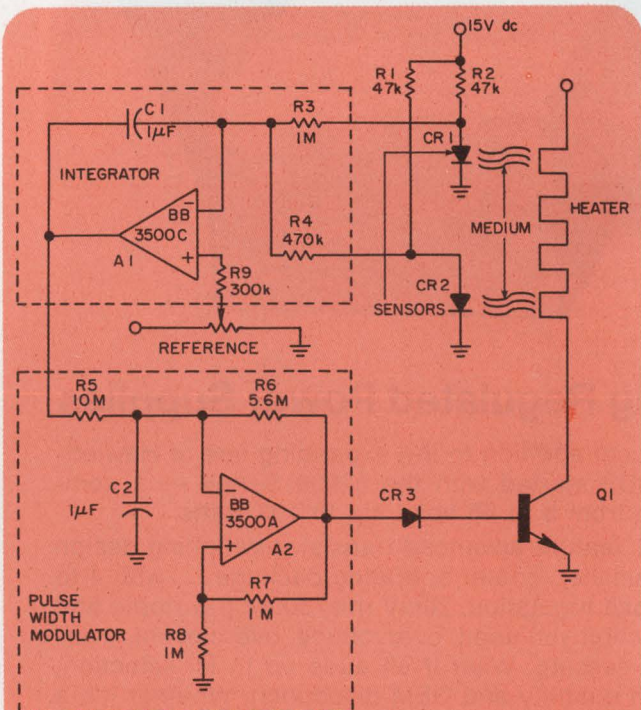

1. Proportional controller varies the heater-current pulse width to maintain equilibrium.

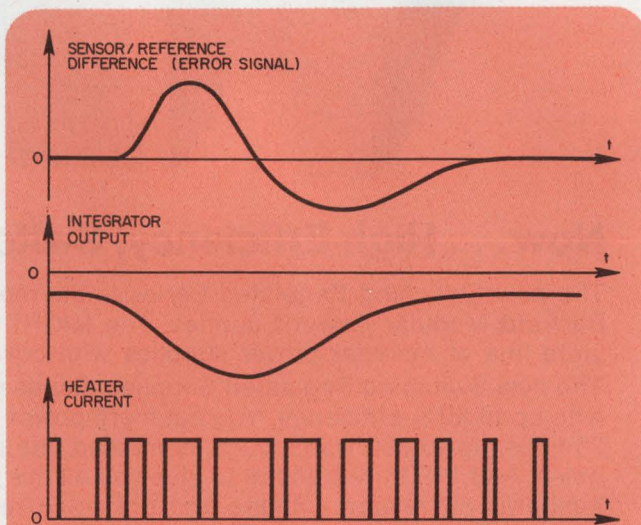

2. Heater current settles to a sustaining level as the error signal returns to zero after a change in temperature.

New 42R motors/gearmotors

**From the people at Bodine:
More power. Smaller package.**
The 42R! A new line
of totally enclosed fan cooled
AC motors and gearmotors.
With new cool. New quiet.
Power capabilities you'll find
hard to believe in a NEMA
42 frame configuration. Ratings
of higher hp Bodine 42R motors
are comparable to many NEMA
48 frame motors.

The Bodine 42R runs cool to
the touch, even after hours of
continuous use. Because die cast
aluminum frame, rotor fan and
extruded aluminum center ring
dissipate heat fast. Ball bearings
are used throughout. And the
42R delivers Bodine's traditional
long-life service and dependability.
Another plus: Bodine application
engineers are ready to help you
apply the 42R. We'd like to

be of service. Bodine Electric
Company, 2500 W. Bradley
Place, Chicago, Illinois 60618.

*... the people
with the drive
to solve your
fhp problems*

BODINE

ELECTRIC

COMPANY

**BODINE MOTORS
GEARMOTORS
SPEED CONTROLS**



42R Motor line: Standard continuous
ratings from 1/20 through 1/4 hp.
Available in all AC winding types
including special arrangements. Options
include capacitor mountings, overload
protectors, etc.

**42R-E Parallel-Shaft
Gearmotor line:** Gear
ratios up to 300:1 available.
Helical steel gearing. High output-
to-size loading ratio. Output shaft
rotates in large needle bearings provid-
ing high overhung load capabilities.

has a 100-dB gain makes this change negligible.

Since the controller described is a null-seeking feedback system, nonlinearities in the controller are diminished by the loop gain. This permits use of a rather crude pulse-width modulator when the latter is preceded by a high-gain op-amp integrator. Resolution is then determined by the

sensing and comparison accuracies. Sensing accuracy is primarily limited by sensor placement and thermal transfer delays. Placement affects the thermal resistance and thermal loss between the object controlled and the sensors.

Jerry Graeme, Manager, Monolithic Engineering, Burr-Brown Research Corp., International Airport Industrial Park, Tucson, Ariz. 85706.

CHECK No. 314

Need an inverter? Use a spare J-K flip-flop

An unused J-K flip-flop can be made into an inverter, provided each flip-flop has a separate clock-line input. Fan-in and fan-out specs of the dual J-K flip-flop then apply to the resulting inverter.

The schematic of a typical J-K flip-flop is shown in Fig. 1. To convert it into an inverter, first connect its unused clock input to a 5-V line via, say, a 1-k Ω resistor (Fig. 2). Now, if either the clear or preset input is tied to a LOW, an inverter results.

The example shown in Fig. 2—with the preset input LOW and the clock input HIGH, produces an inverter input at clear, with its output at \bar{Q} . The spare Q output, which is always HIGH, provides a useful node for tying unused inputs.

Mike Middleton, Honeywell Computer Div., P.O. Box 6000, Phoenix, Ariz. 85029.

CHECK No. 315

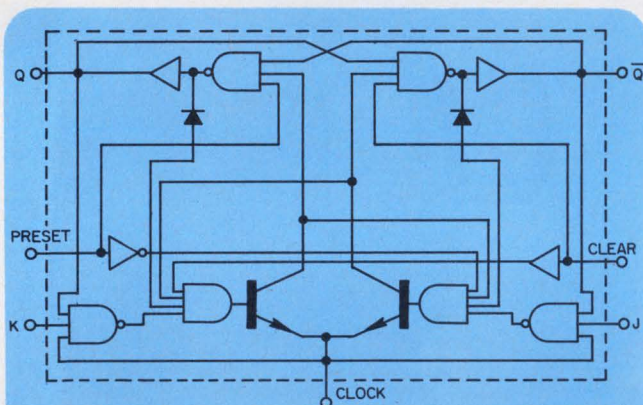

1. Schematic of a typical J-K flip-flop suggests possibilities for separating a single inverter.

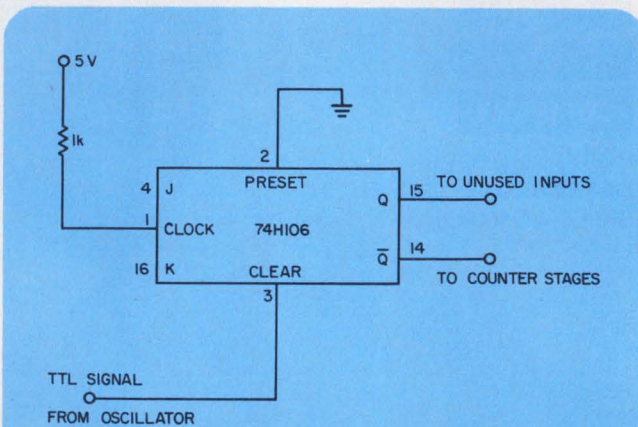

2. An inverter results when the flip-flop's clock input is ONE, and its preset input ZERO.

IFD Winner of February 15, 1973
Christopher B. Schwerdt, Design Engineer, Westinghouse Electric Corp., Defense Development Div., Station 482, Box 746, Baltimore, Md. 21203. His idea "Adjustable sinewave audio oscillator employs improved agc for wide frequency range" has been voted the Most Valuable of Issue Award.

Vote for the Best Idea in this issue by checking the number for your selection on the Information Retrieval Card at the back of this issue.

SEND US YOUR IDEAS FOR DESIGN. You may win a grand total of \$1050 (cash)! Here's how. Submit your IFD describing a new or important circuit or design technique, the clever use of a new component or test equipment, packaging tips, cost-saving ideas to our Ideas for Design editor. Ideas can only be considered for publication if they are submitted exclusively to ELECTRONIC DESIGN. You will receive \$20 for each published idea, \$30 more if it is voted best of issue by our readers. The best-of-issue winners become eligible for the Idea of the Year award of \$1000.

STRIP BUS

by Rogers

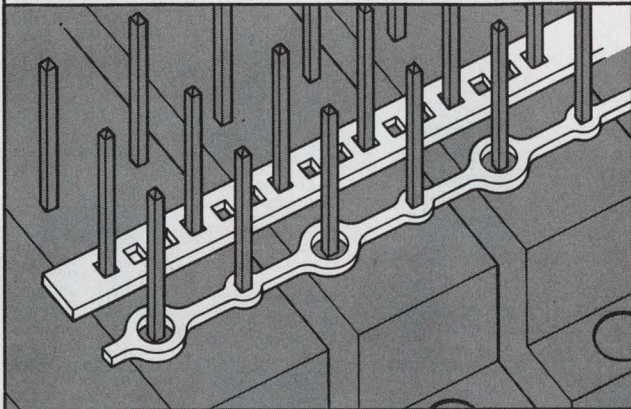

Low Cost Bussing Systems
Easy Installation
Reliable Solder Joints
Greater Pin Exposure



Write or call for details

Rogers Corporation / Rogers, Conn. 06263 (203) 774-9605

INFORMATION RETRIEVAL NUMBER 61



SENSITROL, INC.

Timing period begins when input voltage is applied and internal control relay energizes. Control relay de-energizes at the end of time delay period. Time delay resets when input voltage is removed. If the input voltage is removed before timing period is completed, control relay de-energizes and time delay resets.

The delay time can be set with the knob or by adjusting the external resistor to any period of .1 through 10 seconds, or 2.0 through 200 seconds. Delay time can also be pre-determined by customer and set at the factory from .1 through 200 seconds. **\$28.50-35.50**

200 S. 4th Street
P. O. Box 150
Albion, Illinois 62806

A Subsidiary of Champion Laboratories

INFORMATION RETRIEVAL NUMBER 62

ELECTRONIC DESIGN 13, June 21, 1973

Eight



**Marco-Oak
Presslites
qualify under
MIL-S-22885**

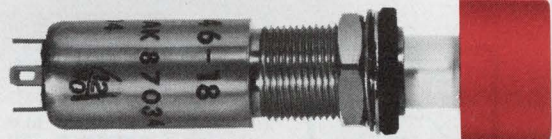

**Who says a
tough switch
can't be bright
and beautiful?**



- Listed on QPL 22885
- 3 to 15 amps, alternate and momentary
- Variety of pushbutton sizes, shapes and colors
- Complete specification catalog now available

*Lighten your decisions
contact . . .*

MARCO-OAK

A Subsidiary of OAK Industries Inc.

P. O. Box 4011
207 S. Helena Street, Anaheim, Calif. 92803
Tel. (714) 535-6037 • TWX — 910-591-1185

INFORMATION RETRIEVAL NUMBER 63

14-pin ceramic DIP holds matched op-amp pair

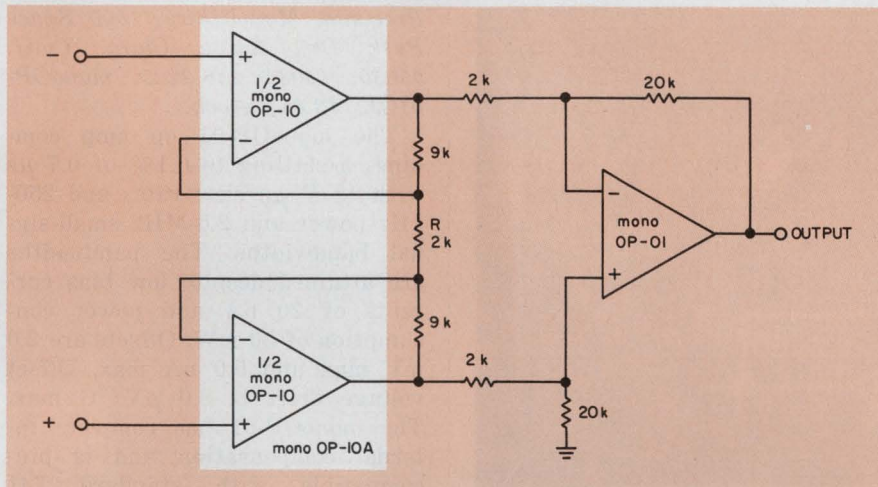

Precision Monolithics, Inc., 1500 Space Park Dr., Santa Clara, Calif. 95050. (408) 246-9222. P&A: see text.

The industry's first line of matched, dual operational amplifiers in single packages is now available. The Precision Monolithics units can be used as building blocks for instrumentation amplifiers with performance tailored to specific requirements.

Each unit in the new monoOP-10 series contains two op-amp chips mounted on a substrate and packaged in a single 14-pin ceramic DIP. The individual chips are internally compensated and have full input and output protection. During the wafer sorting process a special automated test program matches the chips for six critical parameters: offset voltage (ΔV_{os}), offset voltage tracking ($TC\Delta V_{os}$), current offset for inverting (I_{os+}) and noninverting (I_{os-}) inputs, common-mode rejection matching ratio ($\Delta CMRR$), and power-supply matching ratio ($\Delta PSRR$).

The monoOP-10EY, which has the highest performance of the two commercial versions, operates over a 0-to-70 C range. Over the entire range (not just at 25 C, as op amps are commonly specified) the ΔV_{os} between amplifiers is 0.18 mV and (with external trim) $TC\Delta V_{osm}$ is

0.3 $\mu V/^{\circ}C$. The I_{os+} and I_{os-} are each 6 nA. The channel separation is 140 dB.

A listed specification that may be unfamiliar to some users is common-mode-rejection matching ratio ($\Delta CMRR$). This is defined as the equivalent input-referenced error ratio in dB that results from the difference between the common-mode-error ratios of amplifiers used in a balanced configuration. If the error polarities match, the $\Delta CMRR$ of the amplifier pair will be better than the CMRR for either of the individual amplifiers. The power-supply-rejection ratio (PSRR) can be similarly analyzed. The typical $\Delta CMRR$ for the mono-OP-10EY is 117 dB and the $\Delta PSRR$ 105 dB over the entire operating-temperature range.

The chips in the monoOP-10 are the same as those in the company's earlier monoOP-05 single op amps (see "Internally compensated, fully protected op amp beats key specs of 725 family," ED No. 15, July 20, 1972, p. 92).

Several companies offer monolithic dual amps—for example, Fairchild's $\mu A747$. But these do not have the accurate matching of the monoOP-10 series. The masks from which they are made are not laid out to produce matched units. In addition such difficulties as

substrate current feedback and capacitances limit the channel isolation of junction-isolated dual amplifiers.

An interim step in the production of matched-pair op amps was provided by Burr-Brown with its 3500MP matched pairs. Because op-amp matching is tricky and costly, Burr-Brown chose to match only the V_{os} ($\Delta V_{os} = 200 \mu V$ at 25 C and TCV_{os} ($TCV_{os} = 1 \mu V/^{\circ}C$). Burr-Brown's op-amps are packaged in TO-99 cans that can be strapped together with a metal clip. This approach, however, has the weakness that the two cans may be heated differentially by adjacent hot components. For a temperature offset of 1 C between chips (not packages), the V_{os} will be 5 μV .

The primary use for the monoOP-10S is expected to be as an input stage for high-performance instrumentation amplifiers. A composite amplifier using matched op amps for the input and a single op-amp output can provide extremely high input impedances and excellent common-mode rejection.

The circuit shown uses a high-speed output op amp and the monoOP-10AV (the top of the line) to produce a slew rate of 4 V/ μsec , small-signal bandwidth of 85 kHz and a full-power bandwidth of 43 kHz. If the resistors are ratio-matched to 0.005%, the circuit can provide common-mode rejection of 112 dB and gain nonlinearity of .002%. Over-all gain is controlled by adjustment of R.

The monoOp-10 line consists of two commercial-temperature-range units—monoOP-10CY and monoOP-10EY—and two military units—monoOP-10Y and monoOP-10AY. The military versions operate from -55 to +125 C.

Prices in lots of 100 are \$16, \$25, \$40 and \$60, respectively. Units are available from stock.

CHECK NO. 254

Chopper stabilized op amp now fits in a 14-pin DIP

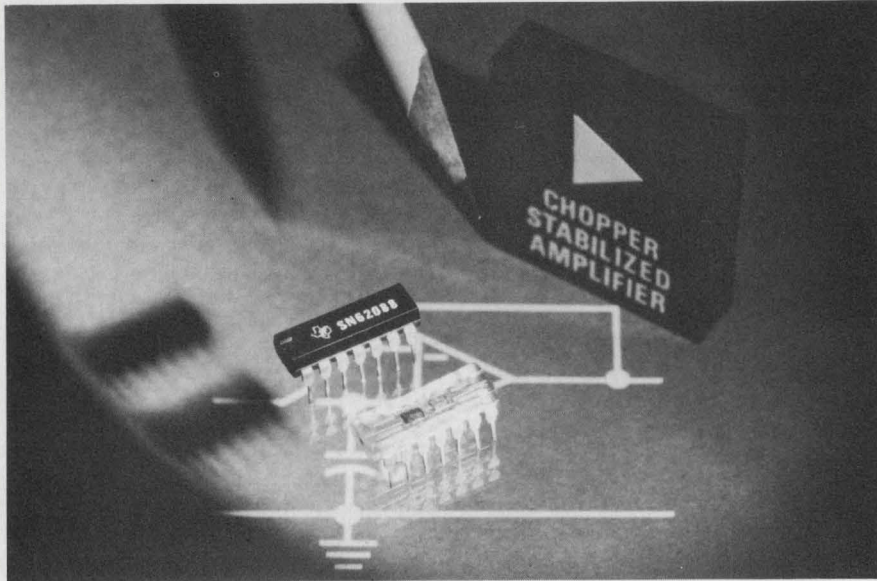

Texas Instruments, Box 5012, MS/84, Dallas, Tex. 75222. (214) 238-3741. For 25 to 99 pieces: \$69.80 (72088), \$120.75 (62088); stock to 8 wk.

Chopper stabilized op amps have long been the ultimate for stable measurement systems and Texas Instruments has just introduced what it claims is the smallest chopper stabilized op amp available—the SN62088/72088. The circuit size has been reduced to fit a standard 14-pin DIP.

Along with the reduction in size, some rather outstanding features include a slew rate of 25 V/ μ s, a 3-MHz bandwidth at unity gain, voltage drift of 0.6 μ V/ $^{\circ}$ C and full differential inputs, with a common-mode input voltage range of -5 to $+12$ V.

The SN62088 is specified for operation over a temperature range of -25 to $+85$ C, and the 72 version over a 0-to-70-C range. Some other electrical specifications are a voltage gain of 130 dB (open loop), a small-signal rise time of 65 ns, an input bias current of 0.4 nA, a maximum closed-loop bandwidth of 400 kHz and a pk-pk output swing of 20 V min.

These units are not intended as replacements for discrete component chopper modules but to replace premium IC op amps where low voltage drift and thermal stability are required.

The 088 is actually two separate chips mounted in a single package. One chip is an all-MOS circuit that contains three p-channel linear amplifiers, a clock generator, a chain of count-down flip-flops, the necessary logic and decoding circuitry and the analog switches. This chip performs the chopper control, synchronous demodulation control and some sample/hold functions.

The second chip combines bipolar op amps and JFET input transistors to provide two FET-input differential amplifiers. One amplifier is an internally compensated, high-frequency, wideband type. The other is used as an active low-pass filter and provides nulling of the offset voltage of the first amplifier.

Only six external components are needed for amplifier operation—the two feedback resistors, three capacitors and one other resistor.

CHECK NO. 255

High-speed op amp has 0.1% settling of 0.7 μ s

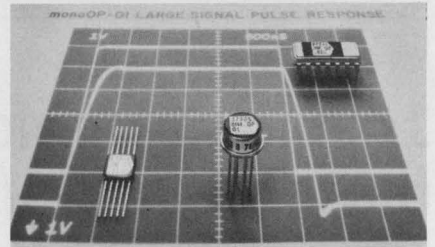

Precision Monolithics, 1500 Space Park Dr., Santa Clara, Calif. 95050. (408) 246-9225. monoOP-01CJ: \$3.65; stock.

The monoOP-01 op amp combines a settling to 0.1% of 0.7 μ s with 18 V/ μ s slew rates and 250-kHz power and 2.5-MHz small-signal bandwidths. The bandwidths are attained despite low bias currents of 20 nA and power consumption of 50 mW. Offsets are 2.0 mV max and 5.0 nA max. Offset voltage drift is 8.0 μ V/ $^{\circ}$ C max. The monoOP-01 has complete internal compensation and is pin-compatible with standard 741 sockets.

CHECK NO. 256

LED hexadecimal display has dual decimal points

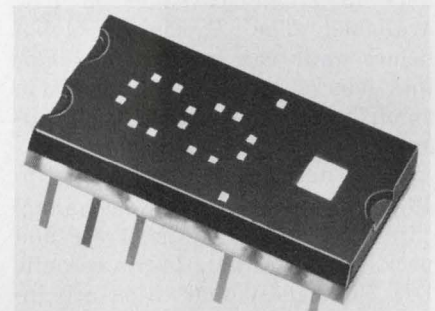

IEE Inc., 7720 Lemona Ave., Van Nuys, Calif. 91405. (213) 787-0311. \$12.50 (100 up); stock.

The series 1707 is a solid-state hexadecimal display with integral TTL circuitry to accept, store and display four-bit binary data. It contains a four-bit latch, decoder-driver and a 4 \times 7 LED matrix with two externally-driven decimal points (left or right) in a 14-pin DIP package. The TTL/MSI chip is designed for a wider supply-voltage range than standard series 54/74 circuits. It will operate from either a 5 or 6-V power supply. Character height is 0.27 in., and supply current is 60 mA for the logic and 45 mA for the display.

CHECK NO. 257

New High Voltage Rectifiers

Are you working with 10,000 volts, 100,000 volts, 1,000,000 volts or even more?

Do you need a special high voltage rectifier package?

Do you have a high frequency application?

Is a more economical high voltage rectifier desirable?

Would higher voltages in smaller rectifier packages help?

If your answer to any of these questions is yes, you'll find an off-the-shelf or custom solution at Semtech — the leader in "power electronics."

KV-PAC *We cooked up a good one for Microwave ovens!*

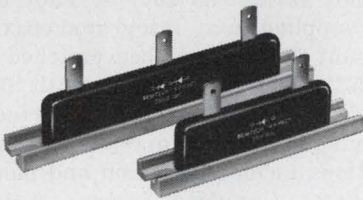

With P.I.V. from 5000 to 15000 volts, new corona free KV-PAC is designed to operate at 0.6 amp when utilized as a half-wave rectifier and 1.2 amps in center-tap, doubler or bridge applications.

KV-PAC offers insulated aluminum mounting slots and universal 3-way electrical connections for easy assembly.

KV-PAC is an economical rectifier for many commercial and Industrial applications, including microwave oven power supplies.

SLIMPAC® *Their all in the family!*



SEMTECH
SCH5 5000

The entire SLIMPAC family consists of high density axial lead silicon assemblies, molded into rugged compact rectangular configurations. Internally, SLIMPAC has double heat sink junctions welded together for mechanical strength.

SLIMPAC offers PIV of 2,500 or 45,000 volts and average rectified current ratings between .050 amp and 2 amps (at 55°C free air) depending on PIV.

The entire SLIMPAC family has corona free construction and meets the most stringent life and environmental requirements.

STACPAC *They stack up for the BIG jobs!*

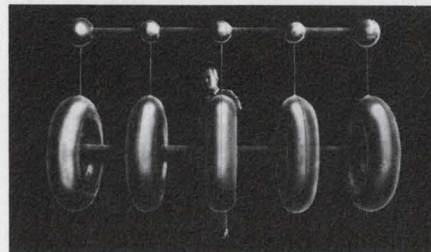

820,000 volt fast recovery device.

STACPAC completely eliminates all external component parts and solder joints — all components are encapsulated and connected to aluminum discs. These discs serve as compensation, cooling fins and corona protection.

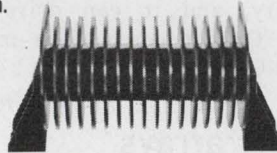

By utilizing silicon rectifiers only, the number of temperature sensitive components have been reduced and the overall configuration simplified.

STACPAC is available in 4kV, 5kV, 25kV and 32kV as well as larger devices.

STICPAC "X"-rayed!



Faced with the problem of selecting high voltage rectifiers for X-ray generators or other stringent applications? Solve these problems with STICPAC silicon rectifiers.

Measuring .695 inches in diameter by 3.38 to 8.50 inches in length, STICPAC is ideal for replacement of vacuum tube type rectifiers.

STICPAC is available in a range of voltages: 50, 75, 100, 125, 150, 175 and 200 kV. Average output is 100mA @ 55°C in an oil environment.

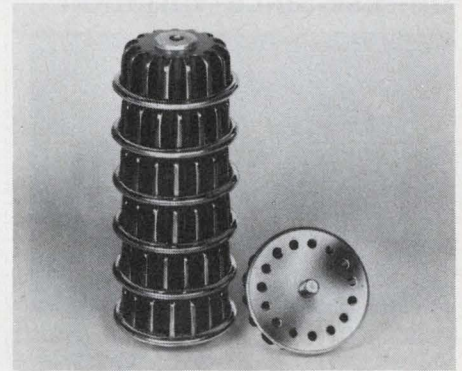

H.V.M. *Building blocks to high voltage assemblies!*

Semtech's High Voltage Modules (H.V.M.) allows the designer to construct either high voltage assemblies or other circuit configurations such as doublers, center taps and bridges. To assemble, simply screw appropriate modules together to form desired device.

Metal discs serve as compensation, cooling fins and corona protection.

Modules are offered in P.I.V. from 2.5 to 15kV. Average rectified current from 0.5 to 7.5 amps.

Fast recovery H.V.M. available — (Trr) 250ns.

MINISTIC® "MAXI" voltage in a "MINI" package!



MINISTIC rectifiers are multipurpose assemblies, ideally suited for low current high voltage applications and multiplier circuits.

MINISTIC has a molded cylindrical case with axial leads. The case is insulated for easy handling.

Offering PIV from 10kV to 40kV, MINISTIC has low reverse leakage and is corona free.

"We're number 1 because we try harder"



652 Mitchell Road, Newbury Park, California 91320
(805) 498-2111, (213) 628-5392 / TWX: 910-336-1264

CHICAGO: (312) 352-3227
DALLAS: (214) 253-7644
FLORIDA: (305) 644-5404
NEW JERSEY: (201) 654-4884
SAN FRANCISCO: (415) 328-8025
EUROPEAN SALES: (Switzerland) (042) 323-242

®SLIMPAC AND MINISTIC ARE REGISTERED TRADEMARKS OF THE SEMTECH CORPORATION.

CMOS ICs offer low on-resistance variation

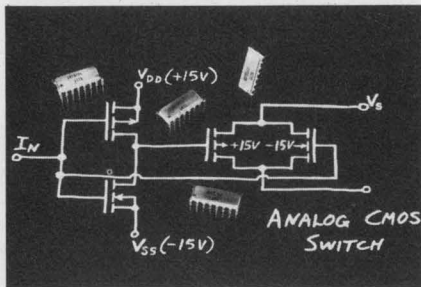

Analog Devices, Route 1 Industrial Park, P.O. Box 280, Norwood, Mass. 02062. (617) 329-4700. AD-7501J and AD7502J: \$28; AD-7510J: \$13 (1-49 pieces); stock to 4 wk.

A single eight-channel analog multiplexer, AD7501; a differential four-channel multiplexer, AD-7502; and an uncommitted quad analog switch, AD7510, are all compatible with TTL, DTL or CMOS logic. The K and S versions provide true TTL, DTL compatibility without pull-up resistors. All devices are available in 16-pin DIPs for operation over the 0 to 75 C and -55 to +125 C temperature ranges. The multiplexers exhibit "on" resistances of 200 Ω and leakage currents of 100 pA, while the quad switch shows a 70 Ω resistance and 200 pA leakage. The standby power dissipation, with all switches open, is only 30 μ W, while the variation of the "on" resistance over the analog signal range of ± 10 V is only 20%.

CHECK NO. 258

100-millisecond arith unit for serial BCD

Texas Instruments, P.O. Box 5012, M/S 308, Dallas, Tex. 75222. (214) 238-3741. \$32.11 (100 up); stock.

The TMS0117, a BCD arithmetic processor that handles numerical data in the serial format, can process numbers up to 10 digits in less than 100-milliseconds main operation time. The four basic operations—add, subtract, multiply and divide—are provided. In addition, add-to-overflow and subtract-to-zero, other operations provided, may be used to set up variable delays, with digital accuracy from a few microseconds to 200 days.

CHECK NO. 259

Bus transceivers handle up to 200 devices

Advanced Micro Devices, 901 Thompson Pl., Sunnyvale, Calif. 94086. (408) 732-2400. Am26S12-PC: \$1.95 (100 up).

The Am26S12 series of combination bus line drivers and receivers, built with Schottky-clamped transistors, offer a drive-current sinking capability of 100 mA at a maximum of 0.8 V. The high-current sink capability of the drivers coupled with the high input impedance of the receivers enables as many as 200 devices to be connected onto a 100- Ω double-terminated bus line. The receivers' built-in hysteresis insures noise margins of a minimum of one volt. Delay through the receiver from bus to data output is 26 ns maximum, and 15 ns maximum through the driver from data input to bus.

CHECK NO. 260

64-bit ECL RAM accesses in 14-ns

Fairchild, 464 Ellis St., Mountain View, Calif. 94040. (415) 962-3816. \$20 (100-999).

A 64-bit ECL RAM, the 95400, features a typical access time of only 14 ns. The device, organized as 16 four-bit words, has built-in temperature compensation and fully decoded four-bit address capability, and it can drive 50- Ω lines. Output connections may be wired-ORed.

CHECK NO. 261

Linear arrays offered

RCA Solid State, Route 202, Somerville, N.J. 08876. (201) 722-3200. CA3095E: \$3.75; CA3096E: \$1.50 (100-999).

A super-beta array, the CA-3095E, and two npn/pnp arrays, the CA3096E/AE, are now available. The CA3095E consists of a super-beta ($h_{FE} > 1000$) differential cascode amplifier and three independent 45-V, 50-mA npn transistors. Input bias current is less than 1 nA. The CA3096E/AE ICs are general-purpose, 35-to-45-V transistor arrays consisting of five independent transistors—two pnp and three npn types. The CA3096-AE has a matched npn transistor pair.

CHECK NO. 262

Vacuum photodiodes have sub-ns response

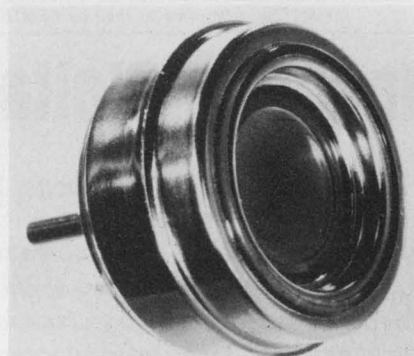

Instrument Technology Ltd., c/o EG&G Electro-Optics Div., 35 Congress St., Salem, Mass. 01970. (617) 745-3200. \$735 (small qty.).

The FD-125 series of vacuum photodiodes are capable of sub-nanosecond response time with rise times as fast as 200 ps. They can be supplied in an integrated coaxial mount with impedance matched to 125 Ω . They are available with S-20 and S-1 photocathode surfaces having a 20 mm diameter. Applications include detection and monitoring of pulsed lasers, optical heterodyning up to 4 GHz, nuclear explosion monitoring, scintillation detection, transit time measurements and high speed switching.

CHECK NO. 263

Power Darlington spec'd at 50 A

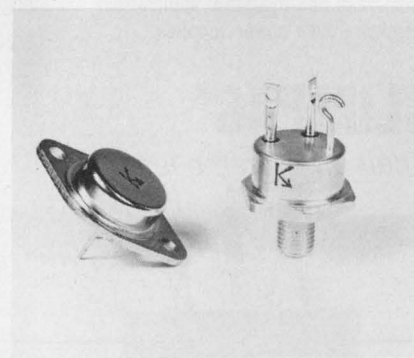

Kertron, 7516 Central Industrial Dr., Riviera Beach, Fla. 33404. (305) 848-9606. \$17 to \$45 (1-99); 10 days.

A new line of power-Darlington transistors, called the KDA5001 to KDA5016, feature a 50-A collector current and have a current gain of 1000 at 30 A. Collector voltage ratings are available from 60 to 200 V. The line includes six transistors available in TO-3 packages and six in TO-63 packages.

CHECK NO. 264

Analog gates priced at \$1 per switch point

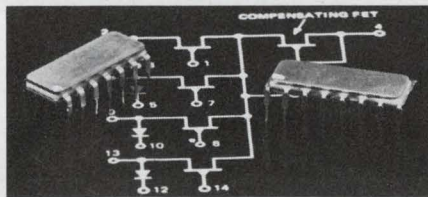

Teledyne Crystalonics, 147 Sherman St., Cambridge, Mass. 02140. (617) 491-1670. P: see below; stock to 3 wk. (Sample qty.).

A series of low-cost FET analog gates featuring on-resistances of less than 150 Ω , are available for about \$1 per switch point in 100-piece quantities. The on-resistances are matched within as close as 5 Ω for critical applications, and the units include an extra FET for temperature compensation of the feedback resistance. Called the IH-5009 series, the new gates are intended for shunt or summing-point switching of signals up to ± 15 V, or series switching of signals under 200 mV. These gates can be driven directly from TTL or HNIL logic.

CHECK NO. 151

Quad line driver and receiver offered

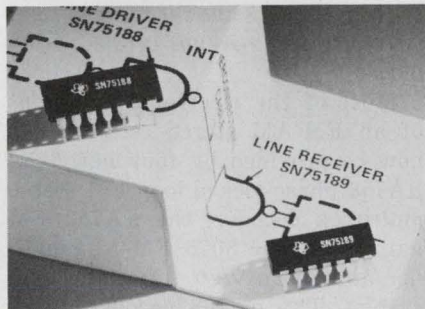

Texas Instruments, P.O. Box 5012, M/S 308, Dallas, Tex. 75222. (214) 238-3741. SN75188N: \$4.43; SN-75189N: \$3.74 (100 up).

The quad line driver, the SN-75188, and a quad receiver, the SN75189, can replace the MC1488 and MC1489 ICs, respectively, in EIA RS-232-C applications. The 188 driver features a power-off source impedance of 300 Ω minimum. The 189 receiver has an input signal range of 30 V as well as built-in input threshold hysteresis. Input resistance for the receiver ranges from 3 to 7 k Ω .

CHECK NO. 152

Quad comparator uses a single or dual supply

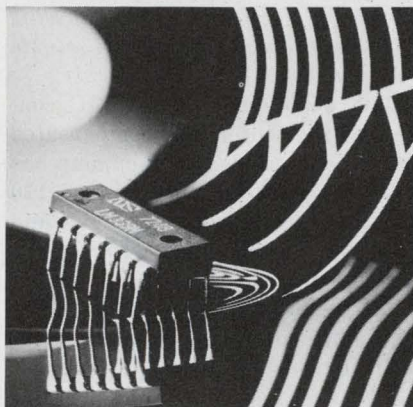

National Semiconductor, 2900 Semiconductor Dr., Santa Clara, Calif. 95051. (408) 732-5000. From \$3.80 (100 up); stock.

The LM339 quad comparator is designed for use with both CMOS and bipolar logic. It can operate over a wide range of power supply voltages—from 2 to 36 V on a single supply, or ± 1 to ± 18 V on dual supplies. Input offset voltage on all four comparators is typically 2 mV and is guaranteed to 5 mV max at 25 C. Total current requirement for all four comparators is only 0.8 mA. Thus, with a 5-V supply, the LM339 draws only 1 mW per comparator. Its output saturation voltage is 0.3 V when sinking about 5 mA, and it can swing from 0.3 to 36 V, sinking a maximum of 20 mA. Other specs for the LM339 include an input bias current of 25 nA and an input offset current of 5 nA, typical.

INQUIRE DIRECT

First CCD image sensor introduced

Fairchild, 464 Ellis St., Mountain View, Calif. 94040. (415) 962-3816.

The first commercially available charge-coupled device (CCD), a 1 \times 500-element image sensor, combines a typical dynamic range of 1000:1 with a sensitivity of 15 microfootcandle-seconds. The n-channel CCD registers use three-phase clocking. Photosensor elements are spaced on 1.2-mil centers, and the shift register elements are on 2.4-mil spacing (0.8-mil per phase). Over-all dimensions of the chip are 60 \times 635 mils, and the device is packaged in a 24-pin DIP.

CHECK NO. 153

Up/down counter covers four decades on a chip

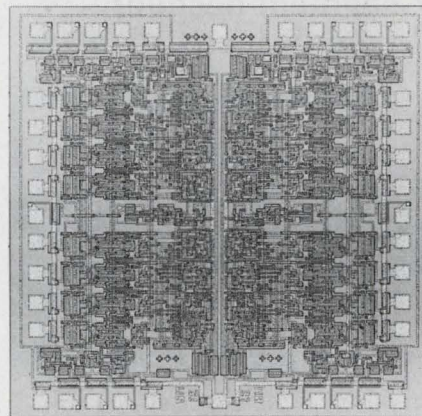

SGS-ATES Semiconductor, 435 Newtonville Ave., Newtonville, Mass. 02160. (617) 969-1610. 100-up prices: \$10 (003), \$8 (004); stock.

The M003 is a four-decade, synchronous up/down counter arranged as two subsystems, each comprising two decades. Each subsystem has inputs for a single phase clock and for resetting to 0 and 9. The M004 is a four-digit multiplexer/decoder. It accepts outputs from the counter and continuously decodes them to ten decimal outputs. Blanking signals provide synchronous output turnoff. The M003 and M004 are available in 40-lead dual inline ceramic packages.

CHECK NO. 154

8-bit multiplying DAC lists $\pm 1/2$ -LSB linearity

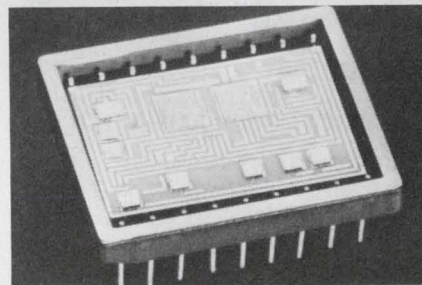

Micro Networks, 5 Barbara Lane, Worcester, Mass. 01604. (617) 753-4756. \$175 (1-24); 2-3 wk.

The MN380 eight-bit plus sign multiplying d/a converter features a linearity of $\pm 1/2$ LSB over the full operating range of 0 to 70 C. Other specifications include low power of 600 mW, settling time to $\pm 1/2$ LSB of 20 μ s maximum and a 5- Ω output impedance. Power-supply voltages can range from 5 to 18 V. The MN380 requires no zero or gain adjustments.

CHECK NO. 155

7-segment decoder drives gaseous displays

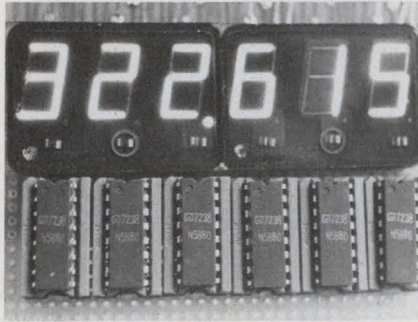

Signetics, 811 E. Arques Ave., Sunnyvale, Calif. 94086. (408) 739-7700. \$2.70 (100 up); stock.

A high-voltage seven-segment decoder IC drives gas-filled display tubes. Called the N5880, the IC is a pin-for-pin replacement for National Semiconductor's DM8880 decoder. The output of an on-chip 16-word \times 7-bit decoding ROM drives sink generators that withstand up to 110 V. With external controls, output current can be varied from 0.2 to 1.5 mA.

INQUIRE DIRECT

FET op amp features $\pm 50 \mu\text{V}/^\circ\text{C}$ drift

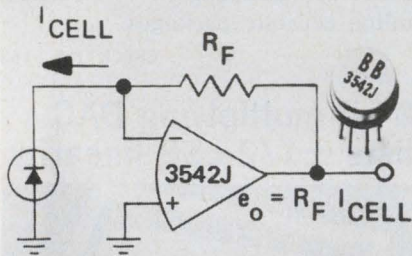

PHOTOCELL AMPLIFIER

Burr-Brown Research, International Airport Industrial Park, Tucson, Ariz. 85706. (602) 294-1431. P: see below; stock (small qty.).

The Model 3542J FET op amp offers a maximum voltage drift of $\pm 50 \mu\text{V}/^\circ\text{C}$ and a guaranteed input bias current of -25 pA for a 100-quantity price of \$4.50. Hermetically sealed in a TO-99 package, the unit is pin compatible with 741 type op amps. Initial voltage offset at 25 C is a low 20 mV and the minimum dc voltage gain is 88 dB. Full power frequency response reaches 8 kHz, while slew rates of $0.5 \text{ V}/\mu\text{s}$ can be achieved. The op amp delivers $\pm 10 \text{ V}$ at $\pm 10 \text{ mA}$.

CHECK NO. 265

Four 741-type op amps on a chip

Raytheon Semiconductor, 350 Ellis St., Mountain View, Calif. 94040. (415) 968-9211.

The 4136 quad op amp IC consists of four internally compensated 741-type op amps. Each op amp has a large-signal voltage gain of 110 dB, input resistance of $5 \text{ M}\Omega$ and slew rate of $1.2 \text{ V}/\mu\text{s}$. Input bias current is only 40 nA, while unity-gain bandwidth reaches 3 MHz. The 4136 comes in a standard 14-pin DIP.

CHECK NO. 266

Passivated diode chips for high-temp assembly

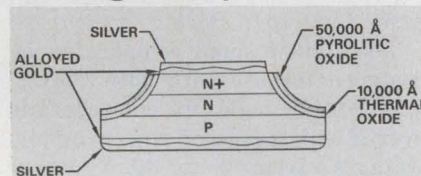

Microsemiconductor Corp., 2830 S. Fairview St., Santa Ana, Calif. 92704. (714) 979-8220. 1000-qty prices: from \$0.25 (rect), from \$0.20 (sig. diodes), from \$0.40 (zeners); stock.

Mesa diode chips are passivated with thermal oxide and pyrolytic glass to withstand high-temperature assembly operations. Rectifier diodes handle 0.5, 1 and 3-A and have PIVs from 100 to 1050 V. Computer and general-purpose diodes range to 3 A, have B_V 's from 50 to 250 V and a T_{rr} of 3 ns. Zener chips have breakdown voltages from 6 to 200 V, in 0.5, 1.5 and 5-W sizes.

CHECK NO. 267

Linear ICs for consumer circuits

RCA Solid State, Route 202, Somerville, N.J. 08876. (201) 722-3200. CA2111AE: \$1.05; CA3120E: \$1.35 (1000).

An FM/i-f amplifier-limiter detector and a TV signal processor are offered. The CA2111AE and the CA2111AQ consist of an FM/i-f amplifier-limiter driving a quadrature-type FM detector. Sensitivity is $400 \mu\text{V}$ typical at 10.7 MHz and $2.5 \mu\text{V}$ typical at 4.5 and 5.5 MHz. The CA3120E TV signal processor consists of a sync separator, noise inverter, agc comparator and rf agc delay amplifier.

CHECK NO. 268

Three-pin voltage regulators supply 1 A

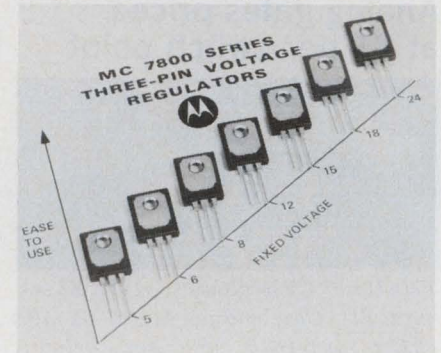

Motorola Semiconductor Products, P.O. Box 20912, Phoenix, Ariz. 85036. (602) 244-3466. \$1.75 (100 up); stock.

A family of seven fixed-voltage regulators housed in plastic power-transistor packages, the MC7805/24 series, has only three terminals—input, output and ground—and can supply in excess of 1 A at nominal voltages of 5, 6, 8, 12, 15, 18 or 24 V. They require no external components and can accept a maximum input voltage of 35 V except for the MC7824 which is spec'd at 40 V.

CHECK NO. 269

Four ICs form most of stereo receiver

Fairchild, 464 Ellis St., Mountain View, Calif. 94040. (415) 962-3816. $\mu\text{A}758$: \$3.95; $\mu\text{A}753$: \$1.27; 3075: \$1.18; $\mu\text{A}720$: \$1.35. (100-999).

Most of the electronic functions of an FM-AM stereo receiver can now be provided by four new ICs: $\mu\text{A}758$ phase-locked loop FM stereo multiplex decoder, the $\mu\text{A}753$ FM gain block, the 3075 FM i-f amplifier and the $\mu\text{A}720$ AM radio subsystem. The $\mu\text{A}758$ decoder eliminates the coils normally required and features 45-dB channel separation and power-supply rejection. The $\mu\text{A}753$ gain block provides 50 dB of gain at 10.7 MHz, and is insensitive to power supply and ambient temperature variations. The 3075 is a pin-for-pin replacement for the RCA CA3075, an industry standard FM i-f amplifier. The circuit also performs the functions of limiter, detector and audio preamplifier. The $\mu\text{A}720$ functions as an rf amplifier, rf oscillator/ converter, i-f amplifier, voltage regulator and agc detector.

CHECK NO. 270

Dramatic new product opportunities ... yours with new 3C8 ferrites

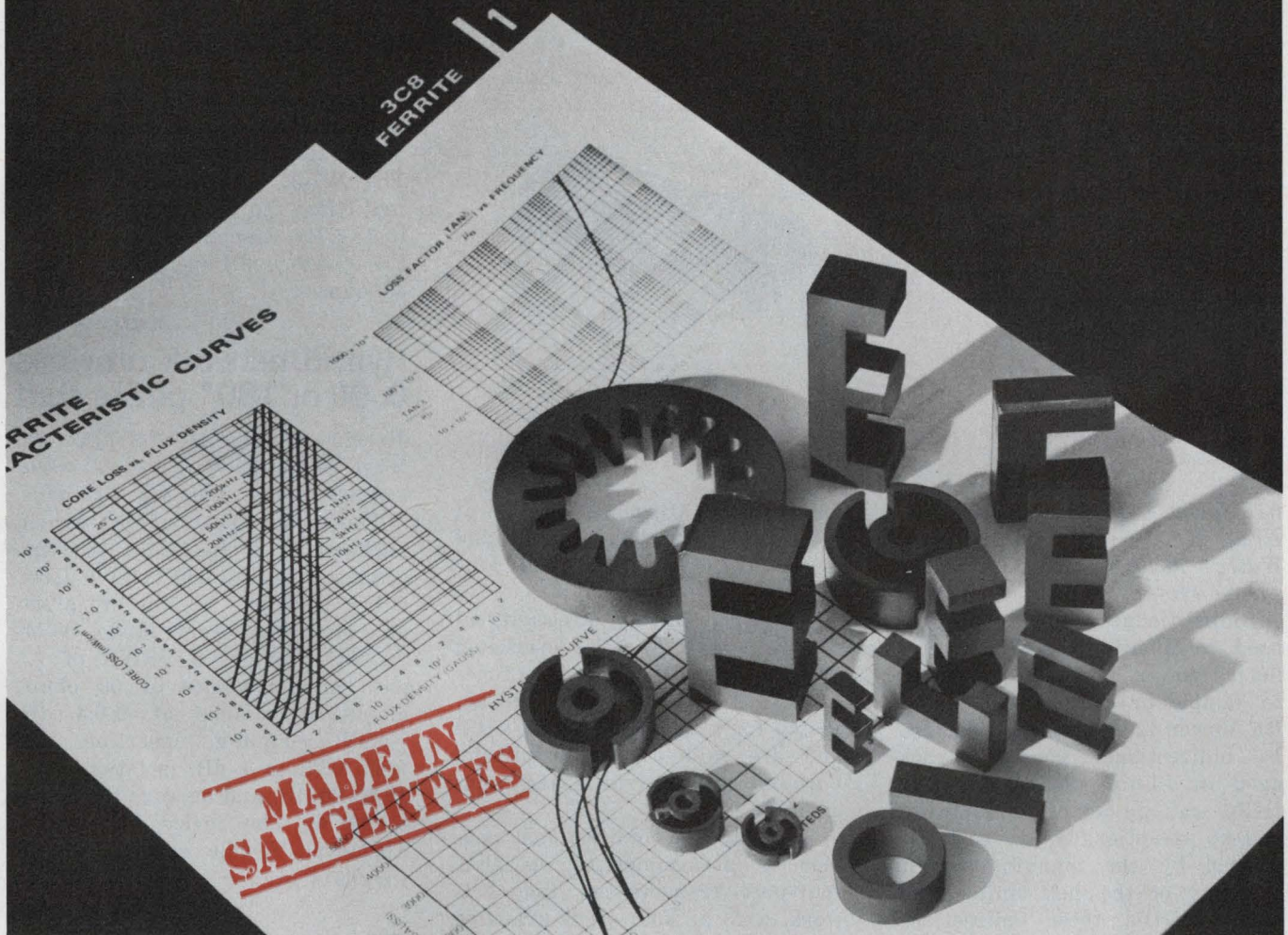

The market is ripe for product breakthroughs. Just look, for example, at the growth of such items as the hand-held calculator, small camera flashguns, ultra-mini portable radios and recorders. The key to these tremendous sales successes is high frequency power conversion circuits.

And the key to still *more* efficient, high-frequency power conversion is Ferroxcube's new 3C8!

This important new ferrite material gives significantly higher flux densities at higher temperatures, and lower losses at high excitation levels than any other magnetic core material. It is available in practical size cores for use up to kilowatt power levels.

3C8 is already being used with great success in: inverters, battery chargers, fluorescent lamp ballasts,

strobe light devices for highway markers and harbor buoys, power oscillators, power amplifiers, ultrasonic generators.

In all of these circuits Ferroxcube's 3C8 material has led to greater efficiency, lower cost, less weight, and smaller sized units. In one power supply, for example, the size of the core was reduced from 13 lbs. at 60Hz to 4 lbs. at 20,000 Hz and the volume from 35 to 9 cu. inches—savings of 70 to 75%!

Can 3C8 improve your present products or suggest new products and markets for your company? If you've got the imagination, we've got the core! Call 914•246-2811, TWX 510-247-5410 or write today.

Ferroxcube linear ferrites—made in Saugerties, N.Y. and stocked in seven U. S. locations.



FERROXCUBE CORPORATION, SAUGERTIES, N.Y. 12477
A NORTH AMERICAN PHILIPS COMPANY

Distributed through North American Philips Electronic Components Corporation with warehouses in Boston, 617•449-1406; New York, 516•538-2300; Saugerties, 914•246-5861; Philadelphia 215•927-6262; Chicago, 312•593-8220; Santa Clara, 408•249-1134; San Diego, 714•453-9250

INFORMATION RETRIEVAL NUMBER 67

Bidirectional coupler comes in 14-pin DIP at low cost

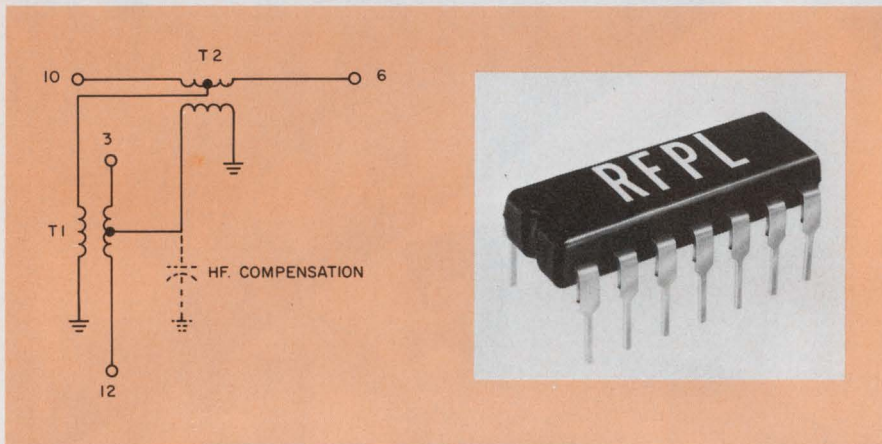

RF Power Laboratories, 924-104th Ave., N.E. Suite 103, Bellevue, Wash. 98004. (206) 454-3886. \$13.20 (10-24); stock.

Bidirectional couplers can be used to monitor load-VSWR, reflected power, rf signals or simply to sample or couple signals. The RF Power Laboratories series DC-14—bidirectional couplers packaged in 14-pin, glass-filled epoxy DIPs—can do all of these things and at exceptionally low cost. Described by the manufacturer as the only off-the-shelf units available in DIPs, these bidirectional couplers can replace units that cost three to 10 times more in most designs.

Four versions are designated 14A, C, D and E. Each weighs 0.1 oz. There are also two versions in a modified flat-pack case, the 14 and 14B. They are electrically identical to the A and C versions but are only half as high as the usual DIP.

The frequency ranges covered by the units are 2 to 300 MHz for the 14A, 1 to 300 MHz for the 14C, 0.5 to 100 MHz for the 14D and 0.05 to 100 MHz for the 14E.

The A and D models have an insertion loss of 0.7 dB, a power rating of 2 W, a coupling factor of 13 dB and a gain that is flat to within -0.5 and $+0$ dB. The C and E models have insertion

losses of 0.3 dB, power ratings of 3 W, coupling factors of 20 dB and a gain flatness of -0.3 and $+0.4$ dB.

All models have a directivity of 25 dB, VSWR of 1.2:1 maximum and operating temperature ranges of -54 to $+100$ C. They are adjusted for load impedances of 50 Ω and are said to be "practically burn-out proof" (static and transient).

Basically the bidirectional coupler is a symmetrical, passive, four-port transmission line network, with all four ports available for external connection. Because of its symmetry, it doesn't require the input and output ports to be reversed for VSWR forward and reverse measurements.

Manufacturers like Lorch, Merrimack and Adams-Russel have metal flat-pack bidirectional couplers, but their prices start at about \$50 and range to \$180. These units typically have a frequency range of 1 to 500 MHz and a power rating of about 5 W. Other operating specifications are similar to the units made by RF Power Laboratories.

RF Power	CHECK NO. 250
Lorch	CHECK NO. 251
Merrimack	CHECK NO. 252
Adams-Russel	CHECK NO. 253

GaAs oscillators cover 8-to-18 GHz range

Watkins-Johnson, 3333 Hillview Ave., Stanford Industrial Park, Palo Alto, Calif. 94304. (415) 493-4141.

The WJ-5127/8 series YIG-tuned GaAs oscillators cover the 8-to-18-GHz frequency range with a nominal output power of +10 dBm. Combined nonlinearity and drift is ± 15 MHz, while operating temperatures extend from -55 to $+75$ C. The units meet the environmental requirements of MIL-E-5400. The WJ-5127 series covers 8 to 12.4 GHz; the WJ-5128 series, 12.4 to 18 GHz. Standard units measure $2.5 \times 4.0 \times 3.1$ inches and weigh 48 ounces.

CHECK NO. 271

Hybrid network provides 0, 90 or 180° phase shift

Merrimack Ind., 41 Fairfield Pl., West Caldwell, N.J. 07006. (201) 228-3890. \$140 (unit qty); 30 days.

The model QTM-3-.750G hybrid network is a four-port stripline coupler, covering 500 to 1000 MHz. Other frequency ranges are available on special order. Model QTM-3-.750G provides a VSWR of 1.3 with an impedance of 50 ohms, amplitude balance of ± 0.4 dB, -3 -dB coupling, insertion loss from 0.75 to 1 dB, isolation from 15 to 20 dB, and average power up to 50 W. The device comes with SMA-type female connectors and weighs 4 oz.

CHECK NO. 272

C-band radar transponder draws 1 A

American Electronic Laboratories, MS/1123, P.O. Box 552, Lansdale, Pa. 19446. (215) 822-2929. \$1500 (large qty.); 10-12 wks.

The RT-5200 C-band radar transponder has a minimal power drain of typically 1 A at the maximum interrogation rate. The unit has a 5.4-to-5.9-GHz frequency range and incorporates a superheterodyne receiver and pulsed magnetron within a volume of 44 cubic inches. The receiver has a sensitivity of -70 ± 2 dBm and a maximum bandwidth of 12 MHz. The transmitter delivers a minimum of 200 W with a maximum stability of ± 3 MHz.

CHECK NO. 273

A New Selection for the Electronics Designer

1. Low-Noise Electronic Design

By **C. D. Motchenbacher**, *Honeywell Corporate Research Center*, and **F. C. Fitchen**, *University of Bridgeport, Connecticut*

Low-Noise Electronic Design offers the electrical engineer and technician a practical, yet comprehensive guide to the problems of low-noise design. Among the materials presented are a computer program for the calculation and integration of noise, new information on noise in passive components, and many practical design examples.

1973 358 pages \$19.95

2. A User's Handbook of Integrated Circuits

By **Eugene R. Hnatek**, *Signetics Corporation*

This handbook will enable the electronics designer to take full advantage of the wide selection of circuitry available to him. It provides a thorough, practical review of fabrication and presents comprehensive discussions of the advantages and disadvantages of the various approaches as they relate to particular applications.

1973 464 pages \$24.95

3. Vibration Analysis for Electronic Equipment

By **Dave S. Steinberg**, *Consultant*

Written to provide a better understanding of the fundamentals of vibration for engineers in the electronics industry, this book explains proven analytical methods for the design, evaluation, and testing of sophisticated systems that must operate reliably in a vibration environment.

1973 528 pages \$24.95

4. Advances in Electrochemistry and Electrochemical Engineering

Edited by **Paul Delahay** and **Charles W. Tobias**

Volume 9: Optical Techniques in Electrochemistry, edited by **Rolf H. Muller**, *University of California, Berkeley*

This book provides critical reviews of principles and applications of a number of rapidly developing optical techniques. These include: reflection spectroscopy, ellipsometry, interferometry, holography, microscopy.

1973 560 pages \$29.95

Available at your bookstore or from Dept. 520

Wiley-Interscience

a division of JOHN WILEY & SONS, Inc., 605 Third Avenue, New York, N.Y. 10016
In Canada: 22 Worcester Road, Rexdale, Ontario

5. Electrostatics and Its Applications

Edited by **A. D. Moore**, *University of Michigan*

Written by 18 recognized experts in the field, *Electrostatics and Its Applications* is the first unified and complete survey of modern electrostatics. The entire state of electrostatic art is described in discussions ranging from the charging of macroscopic particles to the status of electrostatics abroad.

1973 496 pages \$24.95

6. Ion Beams

With Applications to Ion Implantation

By **Robert G. Wilson** and **George R. Brewer**, *Hughes Research Laboratories*

The first book of its kind, *Ion Beams* goes beyond the physics of ion implantation to treat the principles and design criteria of equipment needed in the fabricating and processing of microelectronic devices.

1973 500 pages \$19.95

7. Deep Impurities in Semiconductors

By **Arthur George Milnes**, *Carnegie-Mellon University*

Carefully avoiding extensive mathematical developments, *Deep Impurities in Semiconductors* provides the first cogent, comprehensive treatment of impurity semiconductors.

1973 528 pages \$24.95

8. Thick Film Hybrid Microcircuit Technology

By **Donald W. Hamer**, *State of the Art, Inc.*, and **James V. Biggers**, *Pennsylvania State University*

Written to give the reader a feel for thick film materials and processes, this book provides an ample introduction to thick film microelectronics, and goes on to deal with topics ranging from thick film materials to layout and design.

1972 424 pages \$19.95

Prices subject to change without notice.



WILEY-INTERSCIENCE, Dept. 520, 605 Third Avenue, New York, N.Y. 10016

Please send me the book(s) whose number(s) I have circled: 1 2 3 4 5 6 7 8

My check (money order) for \$_____ is enclosed. Please bill me.*

Name _____ Company _____

Address _____

City/State/Zip _____

Please add state and local taxes where applicable. Prices subject to change without notice. *Restricted to the continental United States.

093-A-1289-WI

Double-balanced mixers attain 1-10 GHz range



RHG Electronics Laboratory, 161 E. Industry Ct., Deer Park, N.Y. 11729. (516) 242-1100. \$145 to \$240; stock to 30 days.

The DML series of non-MIL-spec double-balanced mixers features a frequency range of up to 1 to 10 GHz, noise figure of 9 to 11.5 dB and LO-to-rf isolation of 15 dB minimum. The i-f range extends from dc to 250 MHz, and VSWR is 3:1. The DML units measure 1 × 1 × 3/4 inches.

CHECK NO. 274

Mm band receivers have palm-sized packages

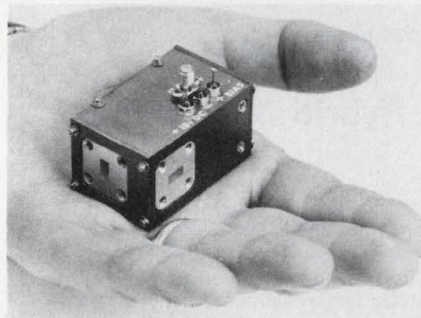

Control Data Corp., 400 Border St., East Boston, Mass. 02128. (617) 569-2110. 60 to 90 days.

The TRG series 9125 of millimeter receivers cover the A, V and W microwave bands. The A-band model spans a range of 26.5 to 40 GHz with an instantaneous bandwidth of 1 GHz. It has a double-sideband noise figure of 5 dB and an i-f amplifier in the 10 to 110 MHz range. The rf to i-f gain is 25 dB min., i-f impedance is 50 Ω, and VSWR is 1.4:1 max. The size is only 2 × 1-1/4 × 1-1/8 in. Units for the V and W bands have similar design and size specifications.

CHECK NO. 275

Gunn oscillators for radars, detectors

N. V. Philips, P.O. Box 523, Eindhoven, The Netherlands.

Present X-band frequency bands for intruder detectors and Doppler radars can be covered using only two Gunn oscillators. The CL8630 Gunn oscillator covers frequencies from 10.5 to 10.7 GHz, while the CL8632 operates over the 9.3-to-9.5-GHz range—the two bands for detectors and radars. The manufacturer reports a stability of frequency over the temperature range of 0 to 40 C.

CHECK NO. 276

Ferrite modulator handles 220 kW

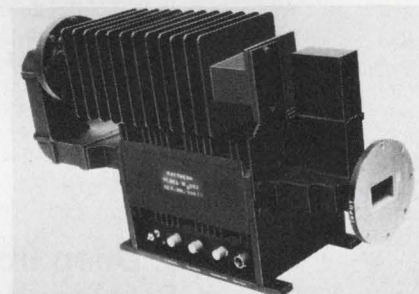

Raytheon, 190 Willow St., Waltham, Mass. 02154. (617) 899-8400.

A ferrite modulator operating over the frequency range of 5.4 to 5.9 GHz has a power rating of 220 kW peak and 330 W average, with switching speeds of only 25 μs. Called the MaCH2, the modulator has an attenuation range of 0 to 20 dB, with 0.8 dB maximum insertion loss and maximum VSWR of 1.25.

CHECK NO. 277

Transistor offers 10 W at 1.8 to 2.1 GHz

Power Hybrids, 1742 Crenshaw Blvd., Torrance, Calif. 90501. (213) 320-6160. \$165 (1-24); stock to 2 wks.

The PH2010C, the first device in the company's MAC-PAC series, delivers 10-W over the 1.8-to-2.1-GHz frequency range. The transistor dissipates up to 2.7 W and operates from a 28-V supply. Typical narrowband performance at 1.5 GHz is 17 W. The MAC-PAC series features multicell, gold-metallized emitter-ballasted transistor chips and MOS capacitor matching. Devices in this series can be operated in both class-C and class-A.

CHECK NO. 278

Electron-bombarded devices emerge from lab

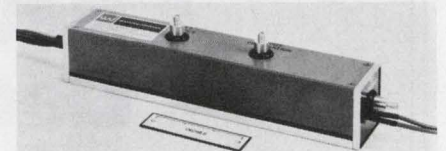

Watkins-Johnson, 3333 Hillview Ave., Stanford Industrial Park, Palo Alto, Calif. 94304. (415) 493-4141.

Three devices are now available, for the first time, that use a modulated energetic electron beam to control the current in a semiconductor. The WJ-3650 video pulse amplifier can produce ±125-V pulsed output with 27-dB gain into a 50-Ω load; pulse rise times are less than 1.5 ns. The WJ-3653 high-voltage switch produces 400-V output with a 3-ns rise time into a 100-Ω load, and a 10-ns rise time into 100 Ω in shunt with a 30-pF capacitance. Total delay (10% points) is 3 ns and it can be operated up to 4% duty factor. The WJ-3660, a pulsed linear rf amplifier, provides 150 W peak power from dc to 160 MHz with 25-dB gain, in one version, and 50 W peak power from dc to 320 MHz with 20-dB gain, in another. Maximum duty cycle is 2%.

CHECK NO. 279

TWT amp guarantees low spectral noise



Varian, 611 Hansen Way, Palo Alto, Calif. 94303. (415) 493-4000. Under \$5000; 90 days.

The VZX-6988 P3 TWT amplifier—a typical unit in a new series of amplifiers—features guaranteed low spectral noise. The unit provides 2 W cw over the 9.5-to-10.3-GHz frequency band with a maximum noise figure of 30 dB. Gain is 39 dB at the 2-W output level. At frequencies ranging from 1.7 to 200 kHz from the carrier frequency, AM noise ranges from 110 to 120 dB below the carrier; FM single-sideband noise, 80 to 110 dB below the carrier.

CHECK NO. 280

**Switchers* are
cooler, smaller, more efficient.
(everyone knows that)**

**ACDC makes 10 switchers.
(maybe you didn't know that)**

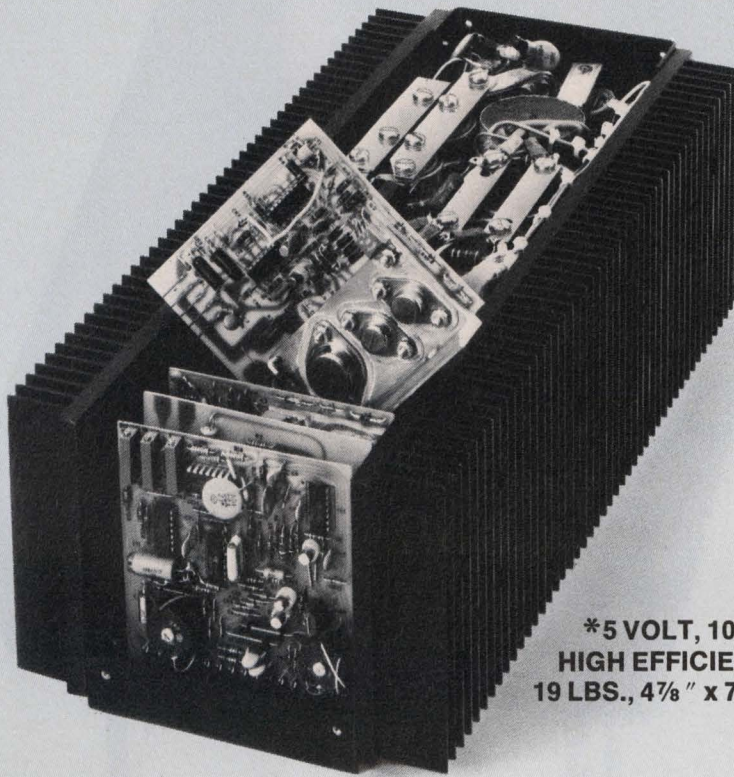

***5 VOLT, 100 AMP
HIGH EFFICIENCY POWER SUPPLY
19 LBS., 4 7/8" x 7 1/8" x 15": \$550**

Nominal Output Voltage (±5% Adj)	Maximum Rating (amps) 40°C	Case Size (inches)	Weight	Model Number	Price
5	60	4 7/8 x 7 1/8 x 10 1/4	15 lbs.	JP5N60	\$425
5	100	4 7/8 x 7 1/8 x 15	19 lbs.	JP5N100	\$550
12	26	4 7/8 x 7 1/8 x 10 1/4	15 lbs.	JP12N26	\$425
12	43	4 7/8 x 7 1/8 x 15	19 lbs.	JP12N43	\$550
15	21	4 7/8 x 7 1/8 x 10 1/4	15 lbs.	JP15N21	\$425
15	35	4 7/8 x 7 1/8 x 15	19 lbs.	JP15N35	\$550
24	14	4 7/8 x 7 1/8 x 10 1/4	15 lbs.	JP24N14	\$425
24	23	4 7/8 x 7 1/8 x 15	19 lbs.	JP24N23	\$550
28	12	4 7/8 x 7 1/8 x 10 1/4	15 lbs.	JP28N12	\$425
28	20	4 7/8 x 7 1/8 x 15	19 lbs.	JP28N20	\$550

Besides being cooler, smaller and more efficient, there are a lot of other reasons to switch to switchers . . . especially ours. These 20KHz inaudible switching power supplies operate from a universal input of 115/230VAC, 47-440Hz or from 150VDC, with 70% to 80% efficiency and 0.1% regulation. Overvoltage and overload protection is standard and radiated and conducted EMI is minimized by shielding and filtering. (We even offer an optional built-in input filter for compliance with Mil-Std 461, CE03.) You get low inrush on turn-on for soft start and can parallel up to three switchers in master-slave configuration. So if you're thinking about switching, switch to ACDC. No one knows more about switching than we do.

acdc electronics inc.

Oceanside Industrial Center, Oceanside, California 92054, (714) 757-1880

SURPRISE!



HP's new \$2.95* displays!

Now a great looking solid-state display for only \$2.95.* HP's new low-cost digit is really something to see. Wide viewing angle and bright, evenly-lighted segments offer excellent readability.

Designed for commercial applications, the 5082-7730 Series is a pin-for-pin replacement for other displays such as the MAN 1, MAN 7, DL 10 and DL 707 and offers a large 7-segment 0.3 inch character with right or left hand decimal points. Quality? Still the best around. Contact your nearby HP distributor for immediate delivery. Or write us for more details.

This display is worth a closer look.

01326

*1K quantity; Domestic USA Price Only.

HEWLETT  PACKARD

Sales, service and support in 172 centers in 65 countries.
Palo Alto, California 94304. Offices in principal cities throughout the U.S.

INFORMATION RETRIEVAL NUMBER 70

SURPRISE! SURPRISE! SURPRISE!

Our new \$2.95 displays
are in stock now!

Distributor Stocking Locations:

SCHWEBER ELECTRONICS

Hollywood, Florida
(305) 927-0511
Elk Grove Village, Illinois
(312) 593-2740
Troy, Michigan
(313) 583-9242
Rockville, Maryland
(301) 881-2970
Waltham, Massachusetts
(617) 890-8484
Rochester, New York
(716) 328-4180
Westbury, New York
(516) 334-7474
Somerset, New Jersey
(201) 469-6008
Beachwood, Ohio
(216) 464-2970

WYLE DISTRIBUTION GROUP

Liberty Electronics/Arizona
Phoenix, Arizona (602) 264-4438
Liberty Electronics
El Segundo, California (213) 322-8100
Elmar Electronics
Mt. View, California (415) 961-3611
Western Radio
San Diego, California (714) 235-6571
Elmar Electronics
Commerce City, Colorado (303) 287-9611
Liberty Electronics/Northwest
Seattle, Washington (206) 763-8200

HALL-MARK ELECTRONICS

Huntsville, Alabama
(205) 539-0691
Lenexa, Kansas
(913) 888-4747
St. Louis, Missouri
(314) 521-3800
Raleigh, North Carolina
(919) 832-4465
Oklahoma City, Oklahoma
ENterprise 50094
Tulsa, Oklahoma
(918) 835-8458
Austin, Texas
(512) 454-4839
Dallas, Texas
(214) 231-6111
Houston, Texas
(713) 781-6100

EUROPE

Celdis Ltd.
37-39 Loverock Road, READING, Berks, England
Tel.: READING 58 22 11
I.S.C. France
20, rue Gambetta, 92-Boulogne, France
Tel.: 604.52.75
Ingenieurbüro Dreyer
238 Schleswig, Flensburger Strasse 3, Germany
Tel.: (04621) 2 31 21
EBV Elektronik
8 Munich 2, Gabriel-Max-Strasse 90
Tel.: (0811) 644055-8
6 Frankfurt/Main 1, Myliusstrasse 54
Tel.: (0611) 720416-18

HEWLETT  PACKARD

MICROWAVES & LASERS

Vhf amps deliver 80 to 120 W

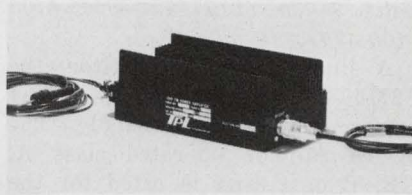

TPL Communications, 13125 Yukon
Ave., Hawthorne, Calif. 90250.
(213) 679-0131.

A series of vhf amplifiers—the PA3-IEE, 1AE and 1ED—provide 80 to 120 W of output power in the 136-to-175-MHz frequency range for land-mobile applications. Input power for the 1EE version is 50 to 250 mW; it's 0.75 to 3 W for 1AE version and 5 to 15 W in the 1ED. All models can be operated from 12 or 24-V-dc supplies.

CHECK NO. 281

Spdt switches come with TTL compatible drivers

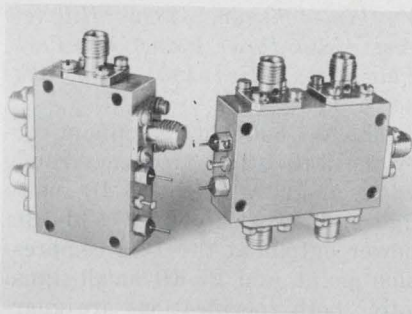

GHZ Devices, 16 Maple Rd.,
Chelmsford, Mass. 01824. (617)
256-8101.

The GC-77000 series of switches provide high power handling (up to 7.5 W cw) and fast switching speeds (as fast as 30 ns). They also have low insertion loss and high isolation. For example, Model GC-77034 operates from 0.5 to 4 GHz, provides a minimum of 60 dB isolation and exhibits 1.1-dB maximum insertion loss. The GC-77000 series, with TTL compatible drivers, comes in six basic package styles. The spdt switches provide a minimum of 50-dB rf rejection at the driver input. The integral drivers operate with either a 5 or 12-V power supply. In addition to 18 standard spdt microwave switches in the series, custom designs are available.

CHECK NO. 282

Low-noise transistor amp covers S-band range

Varian, 611 Hansen Way, Palo
Alto, Calif. 94303. (415) 493-4000.

An S-band thin-film microwave IC amplifier, the VSS-7450A, has a 6.5-dB noise figure in a package size reportedly 25% smaller than most competitive units. The device operates over the frequency range of 2 to 4 GHz, delivering a typical gain of 30 dB and power output of +10 dBm at the 1-dB gain-compression point. Power requirements are 160 mA at +15.0 V dc.

CHECK NO. 283

P-i-n diode introduced

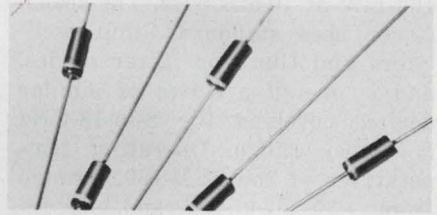

Hewlett-Packard, 1501 Page Mill
Rd., Palo Alto, Calif. 94304. (415)
493-1501. \$2.20 (100 up); stock.

A low-capacitance, planar-passivated silicon p-i-n diode, the 5082-3077, features an effective minority carrier lifetime in excess of 100 ns for low harmonic distortion in the frequency range of 100 to 1000 MHz. Dynamic range is from 1 to 10,000 Ω and reverse bias capacitance is less than 0.3 pF. The diode has a cw power switching capability of 2.5 W.

CHECK NO. 284

Rf power transistor can deliver 80 W at 220 MHz

Communications Transistor Corp.,
301 Industrial Way, San Carlos,
Calif. 94070. (415) 591-8921. \$70
(100 up); stock.

A 28-V rf power transistor, the 2N6369, with internal matching, provides 80 W of rf power output. It is specifically designed for broadband high-power vhf operation over the frequency range of 70 to 220 MHz. The unit has internal matching to eliminate problems caused by low input impedance and high input Q. It is guaranteed to withstand a 5:1 VSWR at all phase angles when operated at rated power and supply voltage.

CHECK NO. 285

Doppler transceivers use Gunn diodes

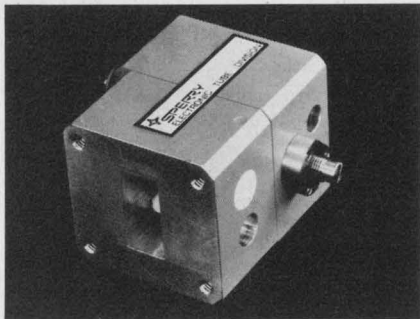

Sperry Rand, Dept. 9002, Waldo Rd., Gainesville, Fla. 32601. (904) 372-0411. 4 wk. (small qty.).

The SSX-16010 doppler transceiver provides an output power of 100 mW at 10.525 GHz. The transceiver uses standard Gunn oscillators and Gunn or mixer diodes, and is one of a series of similar devices covering the 8-to-18-GHz frequency range. Operating temperatures of the SSX-16010 range from -30 to +54 C, and bias requirements are 10 V and 600 mA.

CHECK NO. 286

Relay has pre-formed cables for PC mounting

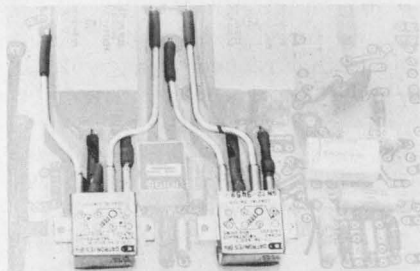

Datron Systems, 18900 N.E. Sandy Blvd., Portland, Ore. 97220. (503) 665-0121.

The F and H series (full and half-size crystal can) of relays can switch rf signals of up to 500 MHz. Units require a pickup power of 250 mW. Available contact arrangements include dpdt rf, spdt rf or spdt aux. The rigid cables are custom designed for the user's particular PC board requirements. The relays also are available with flexible cables for standard installation. The coaxial relays employ resilient bifurcated contacts and meet or exceed MIL-R-5757F specifications. Standard mounting arrangements include two-hole flange and side bracket.

CHECK NO. 287

225-400 MHz transistor delivers 60 W

Communications Transistor Corp., 301 Industrial Way, San Carlos, Calif. 94070. (415) 591-8921. \$103 (100-499); 10 days.

A linear power transistor, the C2M60-28, provides 60 W of rf power from a 28-V supply. The device can be operated class A, AB, B or C and is rated for the 225-to-400-GHz range. The C2M60-28 is guaranteed to withstand infinite VSWR at all phase angles when operated at 400 MHz, 28 V and 60-W rf power output.

CHECK NO. 288

2-to-4-GHz amps provide 4.5-dB NF



Watkins-Johnson, 3333 Hillview Ave., Stanford Industrial Park, Palo Alto, Calif. 94304. (415) 493-4141. 60-90 days.

The WJ-5004-200 amplifiers cover the 2-to-4-GHz frequency range with a guaranteed 4.5-dB noise figure. They also deliver +10-dBm power output at the 1-dB compression point and 25-dB small-signal gain; both specifications are guaranteed. The units measure 1.3 x 2.3 x 2.9 inches with 115 V ac integral power supply.

CHECK NO. 289

1 to 2 GHz amp delivers 10 W

Microwave Power Devices, Adams Ct., Plainview, L.I., N.Y. 11803. (516) 433-1400. 30-60 days.

The Model LWA1020-5, a solid-state high-power amplifier, instantaneously covers the 1-to-2-GHz frequency range delivering a minimum of 5 W output at the 1-dB compression point and a saturated power output of 10 W. The linear amplifier has 47-dBm intercept point, minimum gain of 32 dB (± 1 -dB variation) and harmonics at least 20 dB below the fundamental frequency.

CHECK NO. 290

Receiver does spectral analysis in GHz region

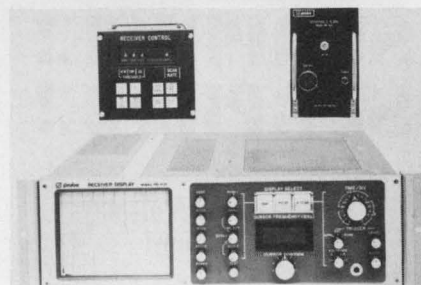

Probe Systems, 665 N. Pastoria, Sunnyvale, Calif. 94086. (408) 732-6550.

The system, called the 3100, covers octave bands in the 0.5 to 18 GHz range with parallel IFM (instantaneous frequency measurement) and sweeping TRF (tuned radio frequency) subsystems. It can detect simultaneous emissions—thereby eliminating spurious IFM responses. The display handles IFM, TRF or mixed receiver outputs. A low data-rate digital command, adaptable to audio-bandwidth communications systems, provides receiver control. Receiver outputs include digital readings of signal amplitude and frequency for TRF and IFM—plus stretched video from IFM and TRF channels for audio monitoring.

CHECK NO. 291

Impatt diodes cover 6-to-22-GHz range

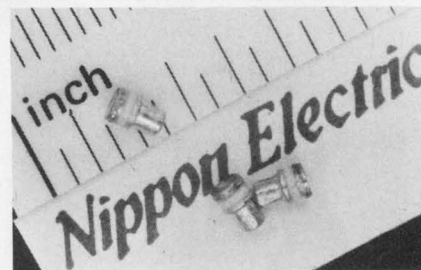

Nippon Electric, One Edwards Ct., Burlingame, Calif. 94010. (415) 342-7744.

A series of Impatt diodes, the 1ST11 through 1ST14, cover a frequency band of 6 to 22 GHz, with minimum power output ranging from 1 W for the 1ST11 to 0.3 W for the 1ST14. Efficiencies are 7.6% at the lower frequencies and 5% at 22 GHz. For higher power over the same frequency band, the 1ST19 through 1ST22 offer a power range of 2 W for the 1ST19 to 0.7 W for the 1ST22.

CHECK NO. 292

The new Wang 2200. Some people call it a mini; others call it a calculator.

Plug in the new Wang 2200 and you're in business. If your data handling has been constantly delayed or reshuffled by crowded, expensive time-sharing . . . here's a cost/efficient alternative. If you are thinking of time-sharing to meet growing needs; here's a way to beat high terminal costs and programming time. If you run a smaller engineering or technical/scientific group; the Wang 2200 may be all the computing power you will ever need.

BASIC Programming With Hard-Wired R/O Memory: You get 4K (field expandable to 32K) of unimpaired memory. And BASIC programming; the easiest to work with language yet developed. And it's *pure* BASIC, not some manufacturer's version that really requires learning a new language.

Programming Doesn't Byte Off Much Storage: In the Wang 2200, program statements are a single keystroke and single byte. Example: The statement "Print Using" takes only one byte of memory; not ten! This almost doubles capacity compared to the usual system.

Big 16 Lines (of 64 Characters) CRT Display: It's hard to crowd this tube. You'll get ample space for monitoring programs and data . . . it "rolls" forward or backward on command . . . remaining storage is automatically displayed as the last line on every program. It tells you where you've been, where you

are and how far you can go. You can go a long way on the 2200.

Read/Write/Modify Programs On Cassette Tape. This could put big tape consoles to shame. With our optional cassette drive, you can search programs and data files by name and read, write and up-date in place. This usually requires two tape drives to carry off. Additional Tape Drives may be added to increase the file handling capability.

Two Keyboards, Two Printers and Other Goodies: Our 2200 lets you tailor a system to your needs; not vice versa. Take either an Alpha keyboard or a traditional calculator (with alpha) arrangement. Your choice. We have two fast printers and both handle carbon forms. There's even a plotter typewriter and a graph plotter that prints letters too.

For under \$7,000, Try To Match The Wang 2200 For Price/Performance and Flexibility. Even if you call the 2200 a small system, you've got to admit it's a big idea. For the price, you can't match the storage or its power in handling tough problems. Compared with anything on the market today, it's cheap, fast, powerful and flexible.

For under \$7,000, call it a miracle!

A Low Cost Alternative To Time-Sharing: Since the 2200 can tackle big problems, many users are installing them to replace more expensive time-sharing terminals. And, they are eliminating the waiting, scheduling and priority problems of time-sharing. They're getting more done at lower cost.

Faster Problem Solving: "Basic" programming on the 2200 is almost literal. You get to the heart of problems and examine alternatives faster. And, the Wang *special function* feature gives you 32 additional keys that allow you to "tailor" the system to facts, figures and constants that are particular to your business or your company . . . or your department.

Drives Wide Range of Peripherals: Our new 2200 gives you more ways to solve problems. We have 15 (more soon) peripheral devices like flat bed plotters, additional mag tape cassette drives, a typewriter that makes graphs and a 3 million byte high speed disc.

It's Got The Price, Performance and Delivery: If you need more calculating and computing power now or if you want to examine cost/efficient alternatives to time-sharing, the new Wang 2200 system could be your answer.

For More Information

- Please send me full details on the Model 2200.
 Please ask my representative to call.

Name _____

Title _____

Company _____

Street _____

City _____ State _____ Zip _____

Wang Laboratories, Inc.

836 North Street

Tewksbury, Mass. 01876

ED-6

Tel: (617) 851-4111 Twx 710-343-6769

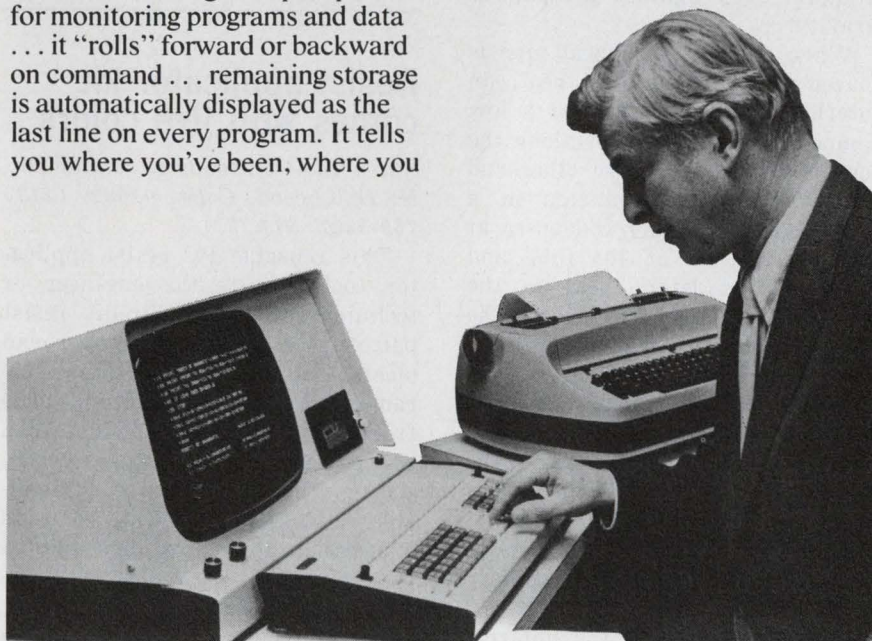

INFORMATION RETRIEVAL NUMBER 71

Heat pipes carry heat from component to sink

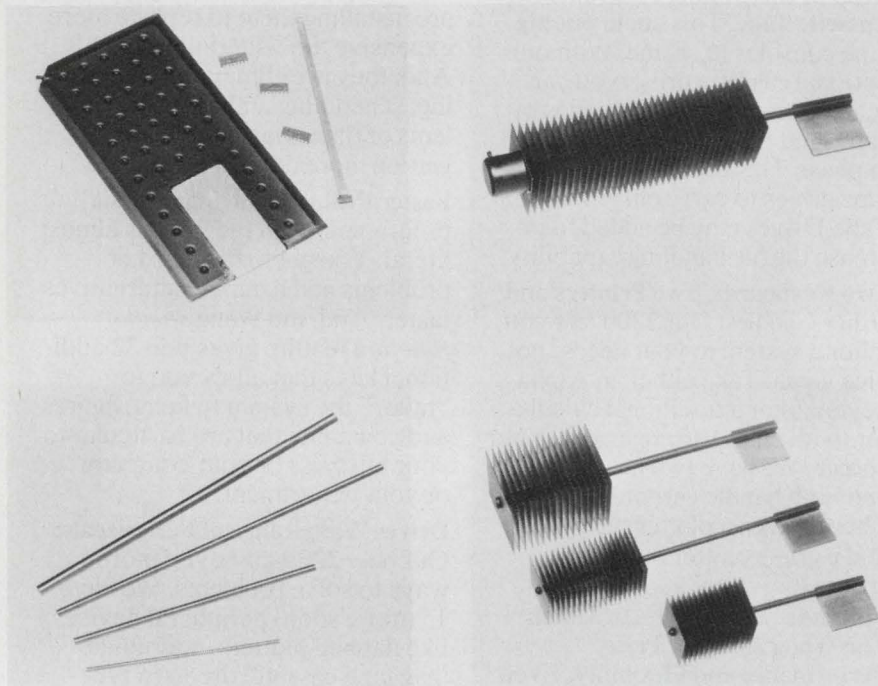

Jermyn, 712 Montgomery St., San Francisco, Calif. 94111. (415) 362-7431.

The conventional method of removing excess heat from electronic packages is to mount the device directly on a heat sink, which has a low thermal resistance to the ambient. But heat sinks are bulky, and space and access to the ambient may not be available in the area where the device should be placed for optimum electrical performance. A heat pipe built by Jermyn can overcome such problems by transporting the heat to a sink at some more convenient remote point.

What is a heat pipe? Simply put, it is a sealed copper tube that contains a stainless-steel mesh and a working fluid. This transports heat over 100 times better than any solid metal, Jermyn says. Hot spots can be eliminated, several components can operate at the same temperature, and heat can be transferred great distances with almost no thermal drop.

A heat pipe acts like a heat pump. Its operation makes use of

the following principles:

- A liquid boils at a lower temperature in a partial vacuum than at atmospheric pressure.
- Heat that converts a liquid to a vapor is given back when the vapor condenses.
- Capillary action can transport a liquid even against the pull of gravity.

When one end of a heat pipe is placed at the source of heat, an internal liquid vaporizes at a low temperature and expands along the length of the tube. The other end of the tube is terminated in a heat sink. The vapor condenses at this cooled end of the tube and gives up its latent heat to the ambient via the heat sink. The cooled tube end thus stays near ambient temperature.

Since the condensate occupies less volume than the vapor, there is a pressure difference along the length of the tube. This causes more vapor to travel from the hot to the cool end. The condensate is transported back, by capillary action, through a stainless-steel mesh fitted around the internal

surface of the tube. At the heat source the liquid again vaporizes. The process is continuous.

A typical figure for the temperature difference between evaporator and condenser ends of a pipe is 3 C for a pipe handling 100 W at 100 C.

Four standard styles of heat pipes are available:

- Tubular pipes in four sizes, all rated at 100 C. When they are used in a horizontal position, the heat transfer rates are 30, 110, 100 and 180 W.

- Finned pipes in three sizes, with input mounting pads and output fins. Their input pads may be drilled to hold the heated devices.

- Flat pipes in two types. The first, for devices like high-power TO3 and TO66 semiconductors, has a solid-copper pad for mounting the part. The second mounts between DIPs and a PC board.

- Variable conductance pipes (JVC-12), which maintain a constant input pad temperature (+55°C) when the input power remains between 10 and 50 W.

Since the capillary action must work against gravity, the horizontal/vertical orientation of the pipe affects the unit's heat capacity. With the pipe vertical and the evaporator end down, the heat capacity of a unit is twice as large as when it is horizontal. Placing the evaporator vertically at the top reduces the cooling action to near zero.

CHECK NO. 293

Resist applicator kit comes with five colors

Starnetics Co., 10639 Riverside Dr., N. Hollywood, Calif. 91602. (213) 769-8437. \$11.75.

This reusable PC resist applicator tool permits the engineer or technician to make circuit resist patterns directly on copper-clad plastic boards or metallized-ceramic substrates. Lines and pads from 0.030 to 0.060-in. widths can be constructed. To help circuitry coding, the liquid resist is available in five colors. A kit contains one resist applicator pen, plus a 2-oz container of resist in a reusable plastic case.

CHECK NO. 294

Mounting pads aid breadboarding of LSI

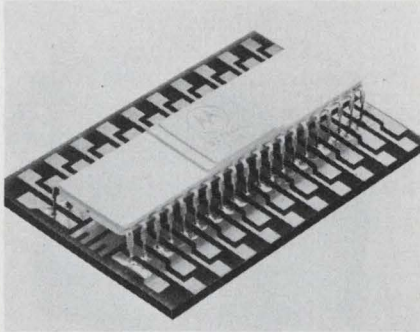

Christiansen Radio, 3034 Nestall, Laguna Beach, Calif. 92651. (714) 497-1506.

Without drilling holes, you can assemble circuit prototypes on any flat surface with this component mounting pad. A pressure-sensitive adhesive on the back of the LSI-42 Mini-Mount holds it in place in the finished assembly while connecting wires are installed. Mini-Mounts also fit 14 and 16-pin DIPs, 6 to 12 pin TO-5 cans, transistors, inductors, resistors and other components.

CHECK NO. 295

Fluorescent inks ease marking problems

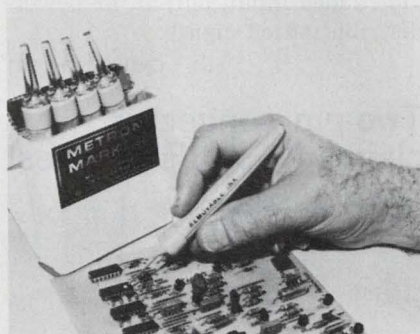

Metron Optics, P.O. Box 690, Solana Beach, Calif. 92075. (714) 755-4477. \$2.95 (unit qty).

Two kinds of ink—removable and permanent—are available in five fluorescent colors. These inks adhere to any surface, including Teflon and oily films. The removable type will not harm most surfaces and is electrically nonconductive. The permanent type is waterproof and flexible when dry. A marker applicator supplied by Metron can reach difficult spots. The inks do not bleed, thus one color can be laid on top of another. Colors available are red, green, blue, orange and yellow.

CHECK NO. 296

Compact package... dual speed capabilities and 5.5 oz-in. synchronous torque at 600 rpm.

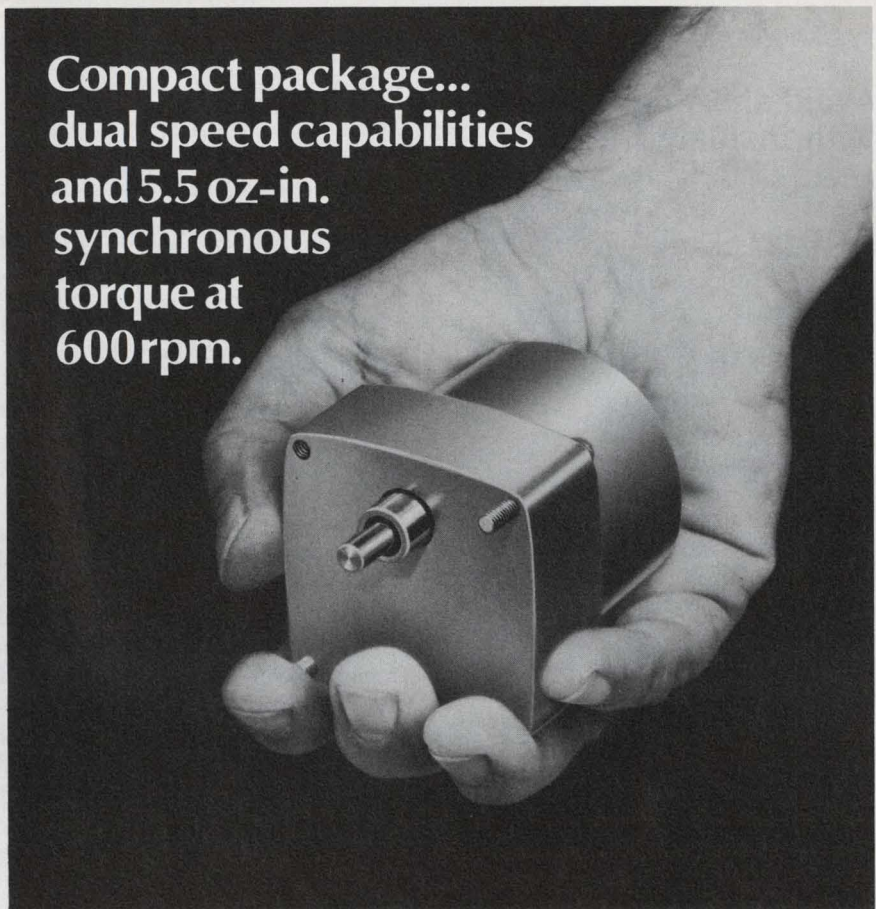

Meet the 86600...workhorse of our economy-priced synchronous motor family.

Designing medical or scientific instruments, computer peripherals, environmental control units or other devices needing a better synchronous drive? Take a look at our new, compact 86600 economy-priced synchronous motor. Its increased power can open up whole new design possibilities for you.

Greater Torque

A UL recognized component and built to NEMA type 2-11 configuration, the 86600 gives you 5.5 oz-in at 600 rpm rotorspeed. You have a selection of 10 gear trains to handle torque loads up to 200 oz-in.

Dual Speed Capabilities

High torque isn't the only advantage you'll gain. You can use the

86600 either as a single speed electrically reversible motor, or you can specify it in a variety of unidirectional dual speed combinations. Either way, the 86600 is reliable, efficient and compact. A real space saver! Models are available for 120 VAC, 24 VAC, or 230 VAC.

All in the Family

If your requirements call for something else, remember that NAPCC offers a full range of synchronous motors—starting at .75 oz-in at 300 rpm rotor speed. Chances are we can fill your needs off the shelf. If not, we have the capabilities to design and build a motor to your specifications. Try us.

Write for details today!

A. W. HAYDON CO. PRODUCTS

NORTH AMERICAN PHILIPS CONTROLS CORP.

A NORTH AMERICAN PHILIPS COMPANY
Cheshire, Conn. 06410 • (203) 272-0301

INFORMATION RETRIEVAL NUMBER 74

Avoid shorting wrap pins with insulated loop

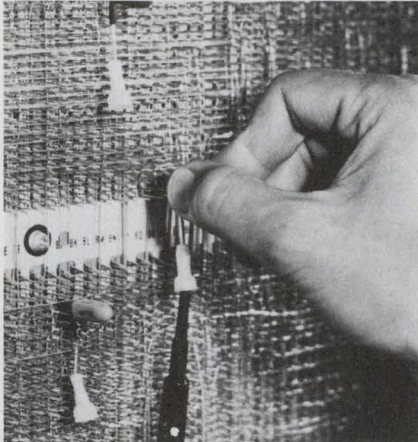

Megasales, P.O. Box 548, Dayton, Ohio 45401. (513) 294-8144. \$1.55 (unit qty).

Saf-T-Leeds fit 0.025 in.² wrap pins. A protected loop at the other end provides hook-on access for test probes, providing a single, fully insulated electrical connection from the wrap pin to the test unit. Special configurations are also available. There are six available colors, which can be used to identify different circuits.

CHECK NO. 297

Compact indicator has Fresnel lens

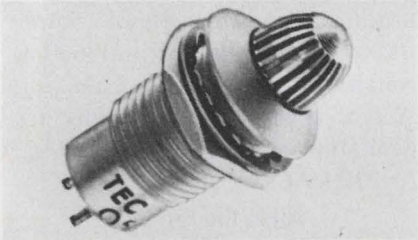

TEC, Inc., 9800 N. Oracle Rd., Tucson, Ariz. 85704. (602) 297-1111. \$1.70 (100 up); stock.

Tec-Lite L-1021 series indicators can replace incandescent and neon lamps in low-current, solid-state applications. The device is only 1.08-in. long, including its silver-finished brass terminals, and mounts through a 3/8-in. hole. Internal current-limiting resistors can adapt the units over the range of 2 to 28 V dc at 15 to 40 mA. The indicators have flat or spherical lenses both with Fresnel diffusing rings for increased side-angle viewing. Lenses come in clear, red or green colors.

CHECK NO. 298

Repair PC boards with brush plating system



Selectrons, Ltd., 116 E. 16th St., New York, N.Y. 10003. (212) 228-6800.

Two new PC repair and plating installations, Model 200PC and junior repair kit 205PC, include: power packs with built-in digital ampere-hour meters for precision thickness control, an assortment of stylii anodes, other necessary accessories, and Selectron plating solutions. The kits use a method of high-speed brush plating that requires no plating bath. Metals such as gold, rhodium, nickel, copper and many others can be deposited on any conductive surface without the necessity of extensive masking or disassembly.

CHECK NO. 299

Glass photomask blanks etch like an emulsion

Micro Mask, Inc., 676 N. Pastoria Ave., Sunnyvale, Calif. 94086. (408) 245-7342. Stock.

Micro Mask's TXT photomask blanks are hard-surfaced and combine the durability of chrome with the etch-handling of an emulsion. The new blanks are squares of ultra-flat borosilicate or soda-lime glass that are coated with a 100-Å film of a proprietary metallic compound. Unlike chrome, TXT blanks are free of pinholes that are larger than 1 micron, and the film coating is flatter than on most chrome blanks. Coatings vary less than 10%. Also TXT film is about 25% less reflective than chrome, thus exposure control is improved and operator eyestrain is reduced. Ultraviolet light absorption is better than 99.9%. TXT plates are etched in dilute nitric acid. The blanks are stocked in three sizes (2-1/2, 3-1/2 and 4 in.) and three flatness grades (master, submaster and working plate).

CHECK NO. 300

Logic card will mount any size module

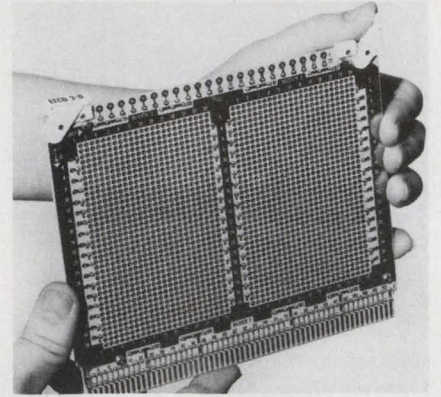

EECO, 1601 E. Chestnut Ave., Santa Ana, Calif. 92701. (714) 547-5651. \$45 (unit qty); stock to 4 wk.

Plated-thru holes, on 100-mil centers on the EECO 3-D card, provide for the mounting of DIP sockets, DIP plug-in strips, discrete components and modular packages. Each card has 1872 uncommitted thru-holes, and 36 thru-holes for components directly relating to power input. 214 pins on the board provide interconnection with 120 gold-plated connector contact fingers, 22 test points and 72 power-distribution points. 24 additional pins are grouped to provide added input, output, or power-distribution efficiency.

CHECK NO. 301

Two-pin connector claimed world's smallest

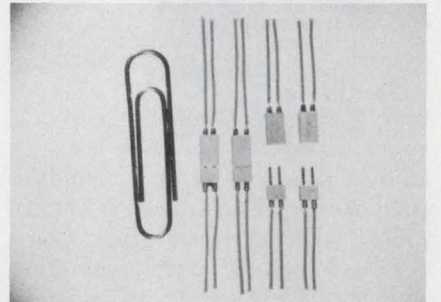

Microtech, 777 Henderson Blvd., Folcroft, Pa. 19032. (215) 532-3388. \$0.65 (1000 up); stock.

Microtech claims that its two-contact G-Series connectors are the world's smallest. The male plug is less than 1/16 × 1/8 × 1/8 in. and the female receptacle is 1/16 × 1/8 × 1/4 in. The pins and sockets are made of gold-plated brass and the bodies are molded from a high-dielectric vulcanized material.

CHECK NO. 302

inverter rated™

Ferramic® components
guarantee circuit
performance

cool
power!

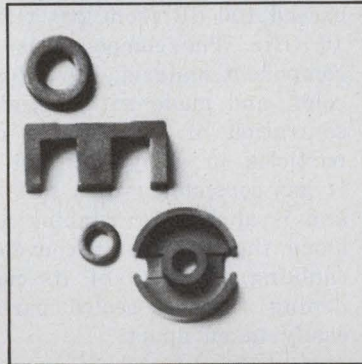

Ferrites for inverters

Inverter-Rated components were developed specifically for inverter circuits. This advanced ferrite technology gives you components optimized for low power loss. They keep their cool to 150°C.

Specs that make sense

The improved characteristics of *Inverter-Rated* components are spelled out in terms of their circuit performance under both maximum and recommended conditions. You get design flexibility and data you can use directly—not just routine magnetic parameters.

You can design precisely with guaranteed component characteristics. And you can select optimum components without using trial-and-error approximations in meeting your power conditioning re-

quirements in computers, motor controls, lighting, telephone systems, ignition systems, displays, watches, appliances, etc.

Circuit performance

We test *Inverter-Rated* components as *inverters* to assure performance in your circuit. These new components meet specified electrical characteristics in addition to closer magnetic tolerances.

The performance you design in—stays in. And the production version of your design meets *your* circuit conditions.

Expanded line

You get design flexibility with the full range of Cross Cores, Pot Cores, Toroids, U Cores, and E Cores. *Inverter-Rated* components are available now in production quantities. All with factory-ready hardware.

New design guide

Our new design guide speaks your language and gives you complete component specifications, temperature characteristics, application data. Key information you need in applying the latest ferrite technology to your inverter designs.

The reader service card will get you a copy of our design guide and (201) 826-5100 will put you in touch with the men who wrote it. Either way, if you're talking inverters, talk to the ferrite experts.

That's us.

Indiana General,
Electronic Products,
Keasbey, N.J. 08832.

*National distribution
through eight Permag
locations.*

indiana general 

a division of Electronic Memories & Magnetics Corp.
INFORMATION RETRIEVAL NUMBER 75

Tool eases removal of subminiature lamps



Switchcraft, Inc., 5555 N. Elston Ave., Chicago, Ill. 60630. (312) 792-2700. \$1.50 (unit qty).

Part No. P-2460 is a tool for the removal of subminiature lamps in switches, pilot lights and other components using T-1 3/4 lamps where front-panel access is possible. The tool removes lamps in a three-step operation: slip tool over lamp, slide sleeve forward to engage lamp and pull or slide lamp free. An orange plastic cap on the tool provides a positive fingertip grip.

CHECK NO. 303

DIP heat sinks provide choice of fin directions

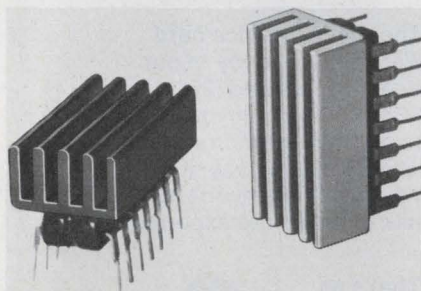

Wakefield Engineering, Audubon Rd., Wakefield, Mass. 01880. (617) 245-5900. 650/651-B: \$0.22 (1-2500).

Heat sinks can protect plastic and ceramic DIPs by improving their cooling. Type 650 (fins across length of DIP) or 651 (fins along length of DIP) provide a choice of fin direction to conform to the air flow. The heat sinks are bonded to the top side of the 14 or 16-pin DIPs with epoxy. Wakefield recommends its own Delta Bond 152 epoxy. The units are made of extruded aluminum. Suffix B is for a black-anodize and suffix G for a gold-irridite finish.

CHECK NO. 304

Conductive putty seals seams in rf enclosures

Emerson & Cuming, Inc., Canton, Mass. 02021. (617) 828-3300. \$10 per lb; stock.

Eccoshield VX is a nonhardening, easily applied, caulking and sealing compound for use in assuring the rf shielding integrity of metal seams and pipe threads. When properly applied, the rf shielding effect can be helped to exceed 100 dB from 200 kHz thru 10 GHz. The compound is a one component material, silver-black in color, and made with a high concentration of silver-plated copper particles in a hydrocarbon resin. It has consistency of a soft butter and is applied by running a bead along the seam as in conventional caulking. Because of its nonhardening feature, sealed parts are easily taken apart.

CHECK NO. 305

Gold plating solution is 99.999% pure

Technic, P.O. Box 1965, Providence, R.I. 02901. (401) 781-6100.

The Orotemp-20 solution is 99.999% pure neutral gold designed for ultra-high-speed plating. You can plate 50 to 60-millionths of an inch in 1-1/2 to 2-1/2 s. The solution is stable with current densities to 1800 A/ft². Plating deposits can be die-bond resistance-welded and then soldered with no discoloration. Orotemp contains no brighteners or free cyanide.

CHECK NO. 306

Glass in paste form melts at 370 C

Electro Materials Corp. of America, 605 Center Ave., Mamaroneck, N.Y. 10543. (916) 698-8434. Stock.

Glass 101 is low melting-temperature sealing glass in paste form that is suitable for screen printing. It has the low firing temperature of 370 ± 10 C, which is about 70 C lower than comparable products, according to EMCA. This temperature will not dissolve tin-oxide coating on glass. Particle size is in the range of 2 to 5 μm with a solid mixture content of 80 ± 4%. Recommended mesh is 200 with a stainless steel screen. Coarser screens of 100 and 140 may also be used for thicker deposits.

CHECK NO. 307

Microelectrodes come in 21 sizes, 0.0005 in. up

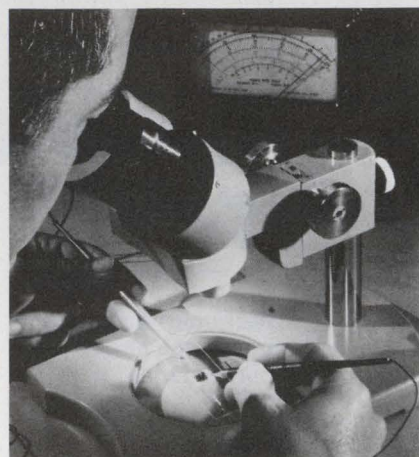

Circon Corp., 749 Ward Dr., Santa Barbara, Calif. 93111. (805) 967-0404. \$10 to \$15 (single probe); stock.

Hand-held microelectrodes for testing miniature electronic equipment have screw-based, interchangeable probes. They are ideal for use under a microscope and come with 21 interchangeable tips. The balanced handles are made of anodized aluminum and they are fully insulated. The smallest tip has radius of 0.0005 in. Each MicroProbe can be supplied straight, or with a 45 or 90 degree bend in the region of the tip, for maximum accessibility. Six different sets are available.

CHECK NO. 308

Adhesive bonds metals, handles 3000 F

Aremco Products, P.O. Box 145, Briarcliff Manor, N.Y. 10510. (914) 762-0685. \$40 per quart; stock.

Ultra-Bond 552 is a single-component, high-purity, alumina-base adhesive with ability to bond to ceramics and metals such as stainless steel, aluminum and copper. It has a modulus of rupture of 5000 lb/in². The material comes in a pre-mixed paste form. The bond can be put to use after only drying at room temperature and it can then withstand 3000 F. It works well in almost any atmosphere, including hydrogen, because of its high-purity alumina content. Ultra-Bond 552 is also a good electrical insulator with a dielectric strength of 250 V/mil.

CHECK NO. 309

Connector easily joins flat cable to PC boards

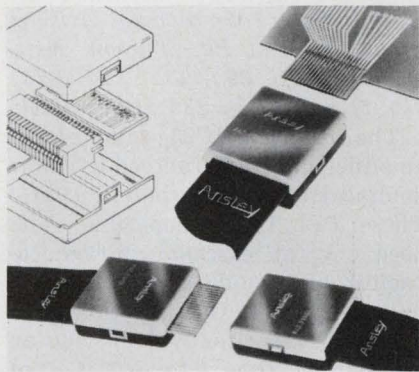

Ansley Electronics, Old Easton Rd., Doylestown, Pa. 18901. (215) 345-1800. \$6.00 (unit qty); 2 wk.

Series 607 connectors for flat-cable applications can be used as edge-card connectors or as male/female connectors. The connector will mate with boards 0.035 in. to 0.065 in. thick. There are 41 contacts (20 × 21 on 0.05 in. centers—0.025 in. offset) and the connector is only 1.265 × 1.5 × 0.48 in. (w l, t). The two-colored cover eases recognition of polarity. Bifurcated contacts are gold-plated beryllium copper. Contact rating is 0.5 A with a 6 C rise. Max voltage drop at rated current (0.5 A) is 5 mV.

CHECK NO. 310

Stripper takes on all wire shapes and sizes

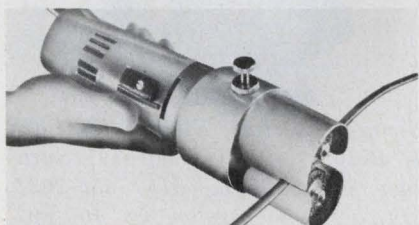

The Eraser Co., P.O. Box 1342, Syracuse, N.Y. 13201. (315) 454-3237.

The Rush Model PD-2 wire stripper is a heavy-duty, hand-held, portable wire stripper that removes insulation from round square or rectangular wire up to 2 AWG with only one knob adjustment. The unit requires no special tools to operate. It simply plugs into a 110 V ac outlet to strip most types of wire. You can use either soft, self-flaring fiberglass wheels for delicate work, or extra-firm, wire-brush wheels for the tough jobs.

CHECK NO. 320

A sure cure for your control headaches!

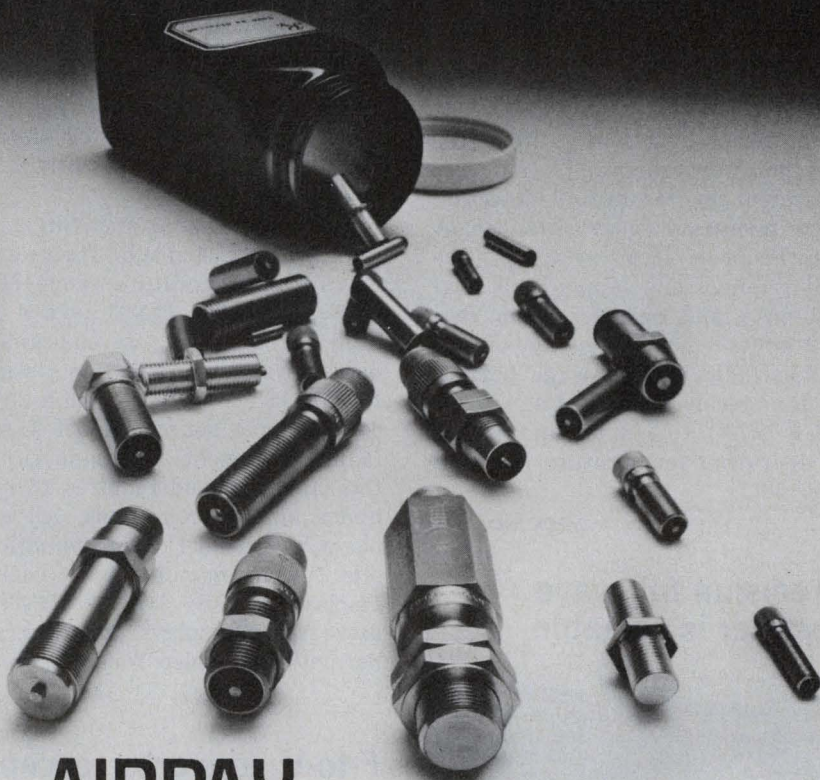

AIRPAX MAGNETIC PICKUPS for every need

Control mechanical motions with ac voltage signals produced through the use of Airpax magnetic transducers (pickups).

Select from over 50 "passive" analog, or "active" digital models that operate by accurately detecting moving ferrous metal discontinuities.

Cure your headache with one of our *standard types:

- High-sensitivity
- High-temperature
- Miniature
- Long-reach
- UL approved
- Low-cost

Included are some that produce digital TTL outputs and also work at zero-speed.

For complete specifications call (305) 587-1100.

AIRPAX™ ELECTRONICS

Controls Division
6801 W. Sunrise Blvd.
Ft. Lauderdale, Fla. 33313



*If your application is of a special nature, our experienced engineers will design to your specifications.

Secure data transmitted with a crypto generator

Crypto Industries, P.O. Box 23163, San Diego, Calif. 92123. (714) 224-0224. \$525.

The model 213 cryptogram generator provides both transmitting (encryption) and receiving (decryption) modes of operation. Sequence length of the code generator is in excess of 66×10^9 bits with more than 25×10^9 programmable code combinations available. The generator has 35 input lines for external programming. Internal preamble generators and detectors allow operation in synchronous or asynchronous data systems. The unit requires one supply (+5 V at 760 mA) and operates from zero to 2 Mbits/s with a message-output enable indicating message periods in the receive mode. Its size is $4\frac{5}{8} \times 3 \times 7\frac{7}{8}$ in. and it has an operating temperature range of 0 to 50 C.

CHECK NO. 321

Precision full-wave rectifier is portable



Fogg System Co., 1380 S. Dahlia St., Box 22226, Denver, Colo. 80222. (303) 758-2979. \$285; 30 days.

Model 85, a precision full-wave rectifier, can convert a bipolar signal to a unipolar signal. Features include internal batteries that supply power for over 800 hours of continuous operation, and a digital-dial input-offset control that simplifies the recording of small signal variations around a dc voltage level. Inexpensive VOMs and panel meters can be used on high sensitivity dc ranges for recording the average rectified value of bipolar signals from dc to 1 kHz. The unit has an operating temp range of 10 to 50 C.

CHECK NO. 322

Large area LCDs have a 4-by-5 in. viewing size

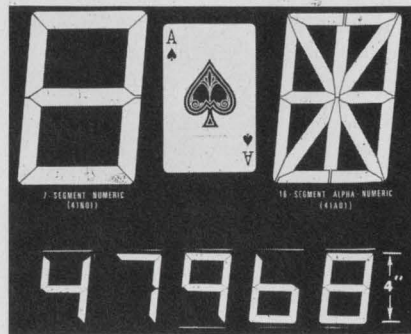

Transparent Conductors Inc., 26 Coromar Dr., P.O. Box 549, Goleta, Calif. 93017. (805) 968-3010. \$100 (sample qty).

Seven different 3 and 4-in. high liquid-crystal displays feature an operating temperature range of 0 to 50 C. Model 41N01 is a 4 in. high single-digit seven-segment numeric and has a power dissipation of 15 mW typical with a 24-V, 60-Hz, drive source. Model 41A01 is a 16-segment alphanumeric of the same size and requires 18 mW under similar conditions. All displays have solderable terminations and can be mounted with backlit displays. Readily available ICs can drive these displays and they are hermetically sealed for long life.

CHECK NO. 323

F-to-V converter accepts frequencies to 300 kHz

Solid State Electronics, 15321 Ragen St., Sepulveda, Calif. 91343. (213) 894-2271. \$279 (100 up); 4 wk.

The series 486E expanded scale Freqmeters deliver dc outputs linearly proportional to the input frequency. The input center frequency can be specified anywhere from 10 Hz to 200 kHz and the frequency deviation from $\pm 1\%$ to $\pm 50\%$ of the center frequency. This gives a total range of 5 Hz to 300 kHz. Any of the standard IRIG proportional and constant bandwidth channels are also available. Output voltage varies from -5 to 5 V—depending upon frequency. Linearity is to within $\pm 0.5\%$ of bandwidth. Input waveforms can be sinewave, triangular, square, pulse, etc.—but their duration should be at least 1 μ s to ensure conversion. The units have an operating temperature range of 0 to 70 C.

CHECK NO. 324

Nonlinearity of $\pm 0.01\%$ guaranteed by s/h unit

Burr-Brown, International Airport Industrial Pk., Tucson, Ariz. 85706. (602) 294-1431. (SHC-23) \$45, (SHC-23ET) \$85 (1-9); stock.

The model SHC23 sample/hold amplifier has a guaranteed dynamic nonlinearity of less than $\pm 0.01\%$. These TTL/DTL compatible units need only an external storage capacitor to provide a complete s/h unit. Typically, the selection of a 0.005 μ F capacitor will provide an acquisition time (to 0.01%) of about 25 μ s. Hold time can be selected in the same way. Model SHC23 is available with an operating temperature range of 0 to +70 C and has a maximum droop rate of 0.1 mV/ms over the entire range. A companion unit, the SHC23ET, has an operating temperature range of -55 to +125 C and a maximum droop rate of 2 mV/ms over the entire range.

CHECK NO. 325

Solid-state relay uses zero-voltage switching



General Electric, Electronics Park 1, Bldg. 7, Mail Drop 49, Syracuse, N.Y. 13201. (315) 456-2021. \$11.70 (5-A version in 100-up), \$13 (10-A in 100-up); stock.

Solid-state relays feature zero-voltage switching, optical isolation and an input of 4 to 30 V, while providing an output of up to 10 A and 140 V. Besides having 1500 V rms optoelectronic isolation, both models also feature TTL and 30 V dc compatible inputs. Model GSR-10AU5 is rated at 5 A, 120 V, and model GSR10AU10 is rated at 10 A, 120 V. Both units are in high-impact plastic cases. Screw terminals are provided at both input and output for connections. All models provide 5-V peak zero-voltage switching.

CHECK NO. 326

SURPRISE!

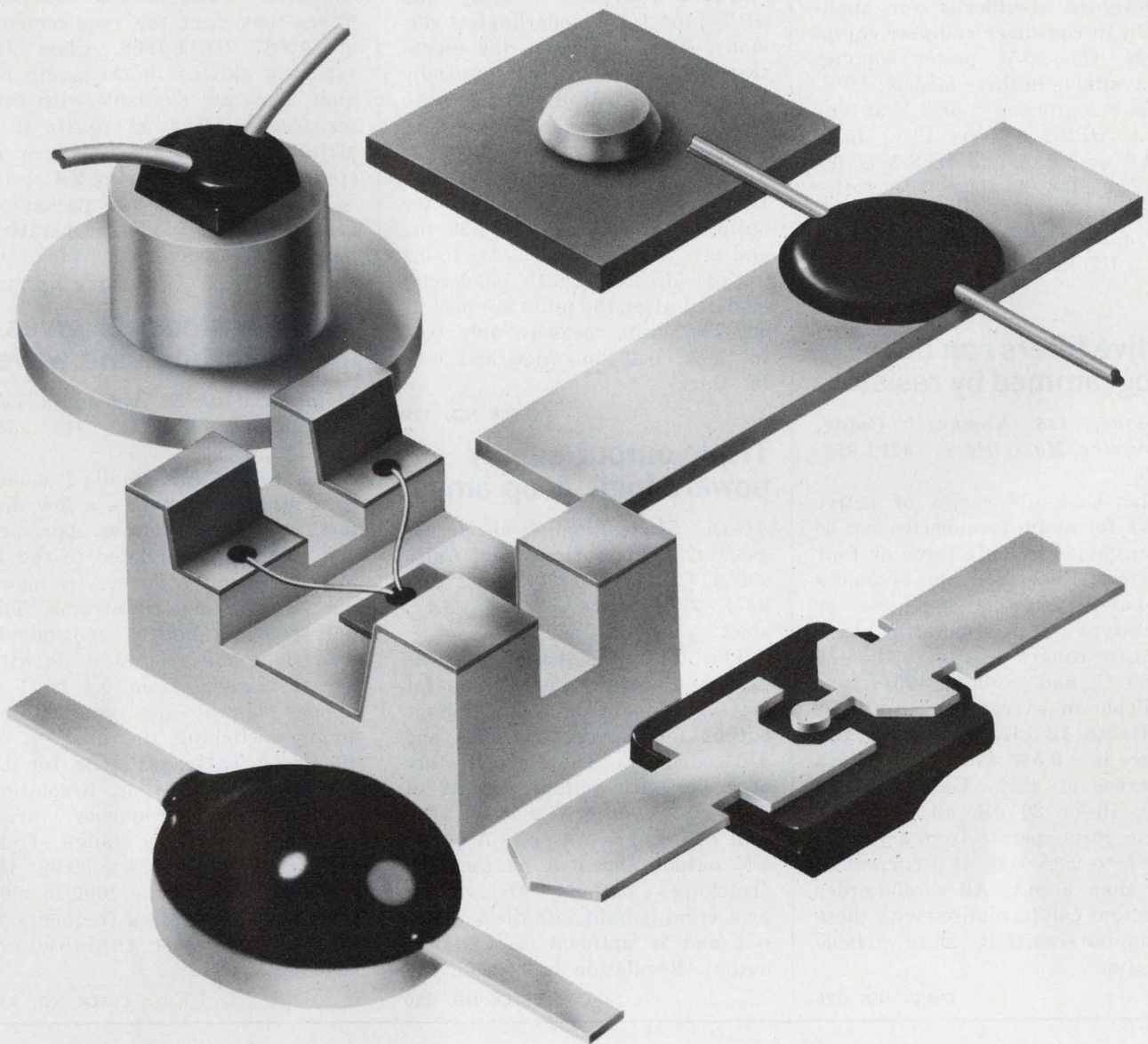

Diode chips and carriers for hybrid circuits.

Need high performance diodes in your hybrid circuit? We can deliver Schottkys, PIN and Step Recovery diodes as chips, E-2's, LIDs or mini-strips—plus a beam lead Schottky. Just select the configuration you need for your RF, microwave and switching semiconductor devices.

All are built to the high standards you associate with Hewlett-Packard. All are available in large quantities and at low prices for commercial production. Call us today for applications assistance. Or write for Application Note 940 and our hybrid circuit data sheet.

01318

HEWLETT  PACKARD

Sales, service and support in 172 centers in 65 countries.
Palo Alto, California 94304. Offices in principal cities throughout the U. S.

INFORMATION RETRIEVAL NUMBER 77

UL listing given three power-supply models

Tele-Dynamics/Wanlass, 525 Virginia Dr., Fort Washington, Pa. 19034. (215) 643-6161. \$21.75 (50 up); stock.

Designed specifically for application in consumer end-user equipments, the 20-W power supplies are available in three models: DPS-1 has dc output of 5 or 6 V at 3 or 2.5 A, DPS-2 delivers 12 or 15 V at 1.5 or 1.2 A and DPS-3 is for 24 V at 0.8 A. The DPS series features $\pm 1\%$ regulation, 0.3% rms filtering, overload protection and a UL listing.

CHECK NO. 327

Active filters can be programmed by resistors

Sprague, 115 Northeast Cutoff, Worcester, Mass. 01606. (617) 853-5000.

The UAF-100 series of active filters for audio frequencies can be programmed by only three or four resistors. Each filter can become a low-pass, high-pass, bandpass, or notch-type filter. Operating temperature ranges of 0 to 70 C, -25 to 85 C, and -30 to 125 C are available in a frequency range of 25 Hz to 12 kHz. Frequency tolerance is $\pm 0.5\%$ with a bandwidth tolerance of $\pm 2\%$. Gain available is 0, 10 or 20 dB, all ± 0.2 dB. These units operate from a voltage of ± 5 to ± 15 V dc at a current of less than 6 mA. All second-order functions can be realized with these minimum sensitivity state-variable circuits.

CHECK NO. 328

LED and phototransistor form reflective sensor

Spectronics, 830 E. Arapaho Rd., Richardson, Tex. 75080. (214) 234-4271. \$5.90 (1000 up); stock.

Spectronics reflective sensing devices are designated SPX 1404-2 (phototransistor version) and SPX 1404-3 (photodarlington version). When activated, the phototransistor version will typically generate a signal of 600 μ A, with 30-mA current in the LED. Under the same conditions, the photodarlington version generates 8 mA. Both versions are designed for optimum performance at 0.25 in., and are TTL compatible. Up to 0.2 in. of adjustment can be accommodated after the units are mounted. The units measure only 0.64 in. long, 0.49 in. wide and 0.17 in. thick.

CHECK NO. 329

Triple-output supply powers logic & op amps

AC-DC Electronics, Oceanside Industrial Center, Oceanside, Calif. 92054. (714) 757-1880. Prices (10-24): \$129 (10A), \$109 (5A); stock.

The TR-series power supplies provide a single voltage output for driving IC logic and a dual voltage output for driving op amps and a/d converters. These supplies are available with voltage outputs of 5 V/ ± 12 V or 5 V/ ± 15 V. Current ratings are 5 A or 10 A on the 5-V output and 1 A on the dual (tracking) outputs. Overvoltage protection is built into the 5-V output and is optional on the dual output. Regulation is 0.1%.

CHECK NO. 330

Span five decades with series of active filters

Testronic Development Lab., P.O. Drawer H., Las Cruces, N.M. 88001. (505) 382-5574. From \$49 unit qty; stock to 4 wk.

Models AF 3B1-020-XXX are one-third octave active bandpass filters that meet the requirements of ANSI S1.11-1966, Class III (steepest skirts) in the audio region. They are available with center frequencies from 10 Hz to 1 MHz. The units are packaged in epoxy modules measuring $2.4 \times 1.5 \times 0.62$ in., but custom packaging is available on request. Operating temperature range is 0 to 70 C.

CHECK NO. 331

Audio synthesizer gives low distortion sine wave

Motorola, 1301 E. Algonquin Rd., Schaumburg, Ill. 60172. (312) 358-7900. \$1285.

The SLN-6381A, audio-frequency synthesizer provides a low distortion sine-wave output. Accuracy and stability are related to the 1-MHz oscillator in the service monitor (S 1327 A) mainframe. The unit provides both a continuous-tone mode and a burst mode with period variable from 0.1 to 1 s. Longer bursts are obtained by simply switching the unit on or off, in the continuous mode, for the desired length of time. Resolution of the output frequency varies with the frequency range—from 0.01 Hz in the 10-to-99.99 Hz range to 1 Hz in the 1000-to-9999 Hz range. The desired frequency is selected by four thumbwheel switches.

CHECK NO. 332



ANALOGY

THE A-733 IS A MULTIPLE FUNCTION MODULE PROGRAMMED TO MULTIPLY DIVIDE SQUARE ROOT, SQUARE, SQUARE OF A RATIO, AND RAISE YOUR RATIOS TO AN ARBITRARY POWER. INPUTS FROM 100 mV TO 10V CAN BE PROCESSED WITH MAXIMUM OUTPUT ERROR OF LESS THAN 0.5% OF FULL SCALE. TAKE IT HOME TO MOTHER.

intech INCORPORATED
(408) 244-0500
1220 COLEMAN, SANTA CLARA CA 95050

Modular s/d converters act as building blocks

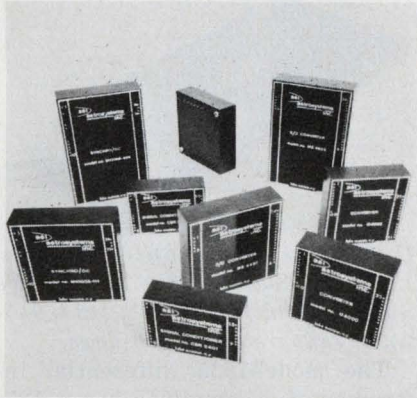

Astrosystems Inc., 6 Nevada Dr., Lake Success, N.Y. 11040. (516) 328-1600.

A series of modular synchro-to-digital converters makes it possible to assemble s/d converters as well as multichannel and dual-speed systems. All of the converters are DTL/TTL compatible. Their inputs and outputs are transformer isolated and all have an integral output-register to simplify interfacing. Accuracy of all versions is ± 1 LSB. Synchro or resolver inputs can be accommodated at standard signal levels of 11.8 V, 400 Hz; 90 V, 400 Hz; or 90 V, 60 Hz.

CHECK NO. 333

Wide-bandwidth servo controller has high gain

Torque Systems, P.O. Box 167, 225 Crescent St., Waltham, Mass. 02154. (617) 891-0230. \$273; 4 wk.

Units in the Snapper series of wideband, direct-drive, servo systems consist of a low-inertia permanent-magnet dc motor/tachometer and a transistorized servo controller. They feature a choice of output power from 0.01 to 0.5 hp, a wide speed range (2000 to 1, bidirectional), precise speed regulation (1 rev/min from no load to full load), a low flutter (1% instantaneous speed variation), excellent linearity (1% of set speed or 1 rev/min.) and a fast dynamic response (over 200 Hz of servo bandwidth). Available options include power supply, dc reference, and panel mount. The motor/tachometer can be furnished with an integral optical encoder and a brake.

CHECK NO. 334

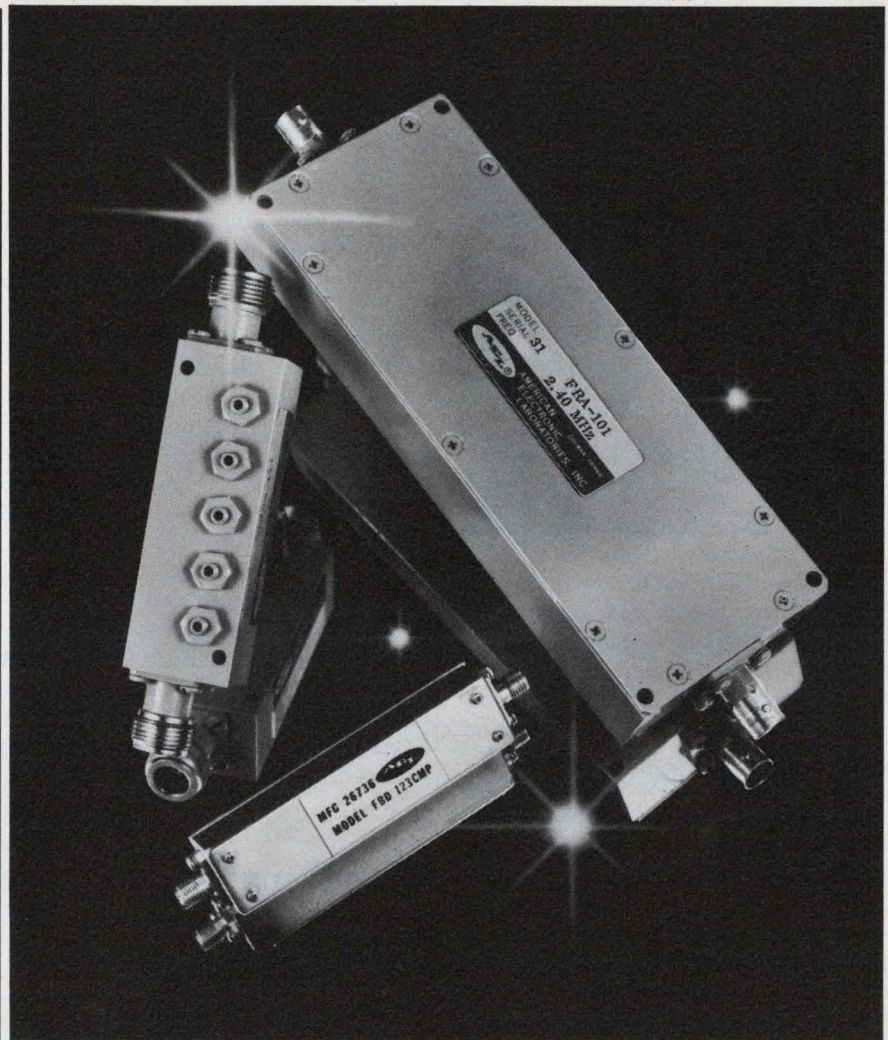

For most filter needs—
AEL provides
off-the-shelf,
quick delivery.



For customized filter needs—AEL's computer banks have the answers. This, combined with AEL's ENGINEERING EXCELLENCE, provides filters such as:

Lumped-Constant Filters • Tubular Filters • Combine Filters • Inter-digital Filters • Low Pass Filters • High Pass Filters • Bandpass Filters • Band-reject Filters

Call or write today for more information about our filter line. Our product, as well as our ideas, are off-the-shelf.



WASHINGTON DIVISION

American **E**lectronic **L**aboratories, Inc.

6629 Iron Place, Springfield, Va. 22151 • (703) 354-5700, ext. 275

INFORMATION RETRIEVAL NUMBER 79

TO-100 case houses a 27-MHz, 1/4-W Xmitter

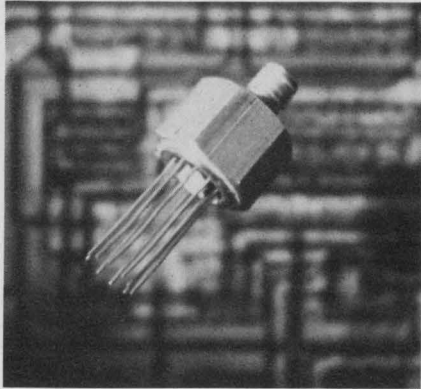

Lithic Systems, P.O. Box 478, Saratoga, Calif. 95070. (408) 867-5600. \$18.75 (100 up); stock.

The LP2001 IC, packaged in a stud-mounted version of the 10-pin hermetic TO-100 package, retains the pin configuration and functions of the company's earlier LP2000 microtransmitter, with two-and-a-half times the output power—1/4 W at 27 MHz. It also includes a transformerless modulator, buffer stages, and a self-biased output stage which drives an external LC antenna-matching network. A pre-amplifier is provided for low-level modulation inputs, as well as internal power-supply regulation. A latching power supply switch permits zero-standby alarm applications. The circuit operates from a single +3 to +15-V power supply.

CHECK NO. 335

Three-phase relay can handle 25 A at 230 V rms

Flight Systems, P.O. Box 25, Mechanicsburg, Pa. 17055. (717) 697-0333. \$145 (1-10).

Model 31A250-1 is a solid-state relay with three-pole single-throw normally-open "contacts" whose ratings are 25 A at 230 V rms. Fully-potted in an aluminum housing, the unit can be actuated directly from TTL circuitry, or by 12 V dc at 150 mA. False turn-on is eliminated by proprietary circuitry. The mounting flange is 3-1/4 x 3-3/4 in. and the unit is 3 in. high. Connection is by standard screw terminals. Models are also available for 440 V rms and/or 400-Hz operations, and full zero switching.

CHECK NO. 336

No trimmers needed for accurate a/d converter

Phoenix Data, 3384 W. Osborn Rd., Phoenix, Ariz. (602) 278-8528. From \$175 (8 bits) to \$345 (14 bits); stock to 4 wk.

Accuracy and temperature coefficient specifications in the 400 series are fully listed. Included are errors due to the analog switches, internal reference voltage generator, comparator offset, gain error, nonlinearity, calibration resolution, resistor-network tracking, quantizing error, and power-supply variations within $\pm 5\%$ tolerance. Conversion times run from 80 μ s for 14 bits to 8 μ s for eight bits, for the successive approximation a/d converters, with accuracy to 0.01% of full-scale range, and an over-all temperature coefficient of 12 PPM over 0 to 70 C. No external reference voltage sources, amplifiers, or trimming potentiometers are required.

CHECK NO. 337

Power supplies are made on rack pluggable cards

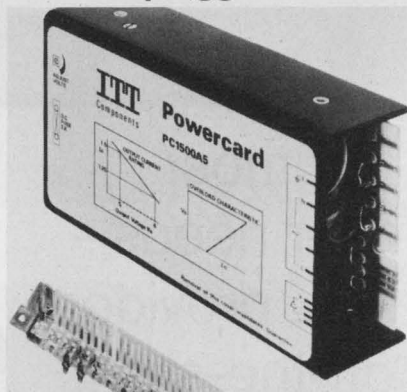

ITT Jennings, 970 McLaughlin Ave., San Jose, Calif. 95116. (408) 292-4025.

Five Powercard dc supply models are available. Two have single outputs of 5-to-6 V at 1.5 A or 12-to-15 V at 500 mA. Three dual-output units provide 250-mA outputs with voltage options of 12-to-15 V tracking, 12-to-15 V independent, or asymmetric outputs of 12-to-15 V/5-to-6 V. All units are suitable for inputs of 100-to-132 V and 200-to-264 V, at 48 to 65 Hz. All units have three safety features—reverse polarity protection, parallel protection and current-limiting protection. Additionally, the 5-V unit has "crowbar" overvoltage protection.

CHECK NO. 338

Differential dc amp has 125 kHz bandwidth

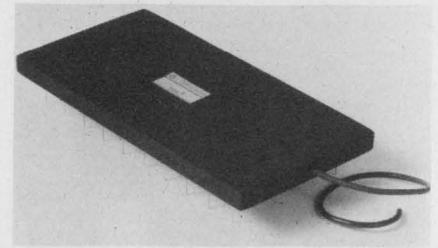

Dynamics Electronic Products, 12117 E. Slauson Ave., Santa Fe Springs, Calif. 90670. (213) 945-2493. \$225; stock to 30 days.

The model-7535 differential instrumentation amplifier has a 125-kHz bandwidth at a gain of 1000. It also has a 3.8 V/ μ s slew rate, a CMRR of 120 dB at a 1-k Ω unbalance, a common-mode level of ± 50 V and an output swing of ± 10 V at 100 mA. The gain can be adjusted over a range of 1 to 1000 using just one external resistor. Drift is only $\pm 0.8 \mu$ V/ $^{\circ}$ C.

CHECK NO. 339

Image intensifier comes in very small package

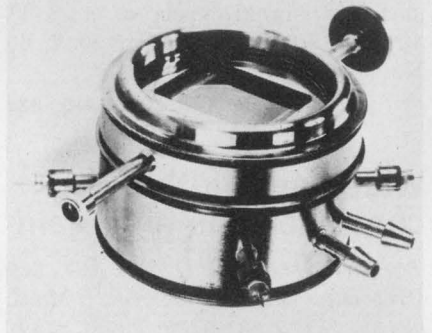

Phillips Research Labs, Eindhoven, Netherlands.

The Phototitus intensifier performs the following functions: real-time, high-velocity processing of optical information; printed-character recognition by optical scanning (objective: 20,000 char/s); analog or digital recording of holograms; two-dimensional modulation of light in phase or in amplitude; large-screen display of television pictures. Characteristics of the system are as follows: target temperature, -50 C; sensitivity (minimum contrast 10/1), 100 ergs/cm 2 ($\lambda = 4200 \text{ \AA}$); maximum contrast, $> 40/1$; resolution in reflection, is 20 pairs of lines/mm; and storage time of information, 10 to 20 min.

CHECK NO. 340

The RCA line of RF devices is expanding in all directions. New types, higher frequencies, broader bandwidths and new packages . . . all aimed at improving your system performance. That's why we call them the RF performance expanders.

Here are ten of the new types now available up to 3.5 GHz. They include such features as emitter ballasting; multi-cell structure for low thermal resistance

and a microstrip package with partial input and output impedance matching.

Type	Freq. (MHz)	Output Power (W)	Gain (db)	Supply (Volts)
TA7992/TA8778	3500	4.5/1.5	5	28
TA8807/8/9	3000	1/3/5	5	28
2N6390/1/2	2000	3/5/10	7	28
RCA2003/05/10	2000	3/5/10	7	28
TA8340	1700	0.5	Oscillator	20
TA8695	1300	30	8	28
R44M 10/13/15	390-440	10/13/15	20	12.5

So if you want to design reliability and high performance into your system, de-

sign in RCA's RF performance expanders.

Want more information? Write RCA Solid State, Section 57F-21 Box 3200, Somerville, N.J. 08876. Or phone: (201) 722-3200.

RCA Solid State

RF performance expanders.

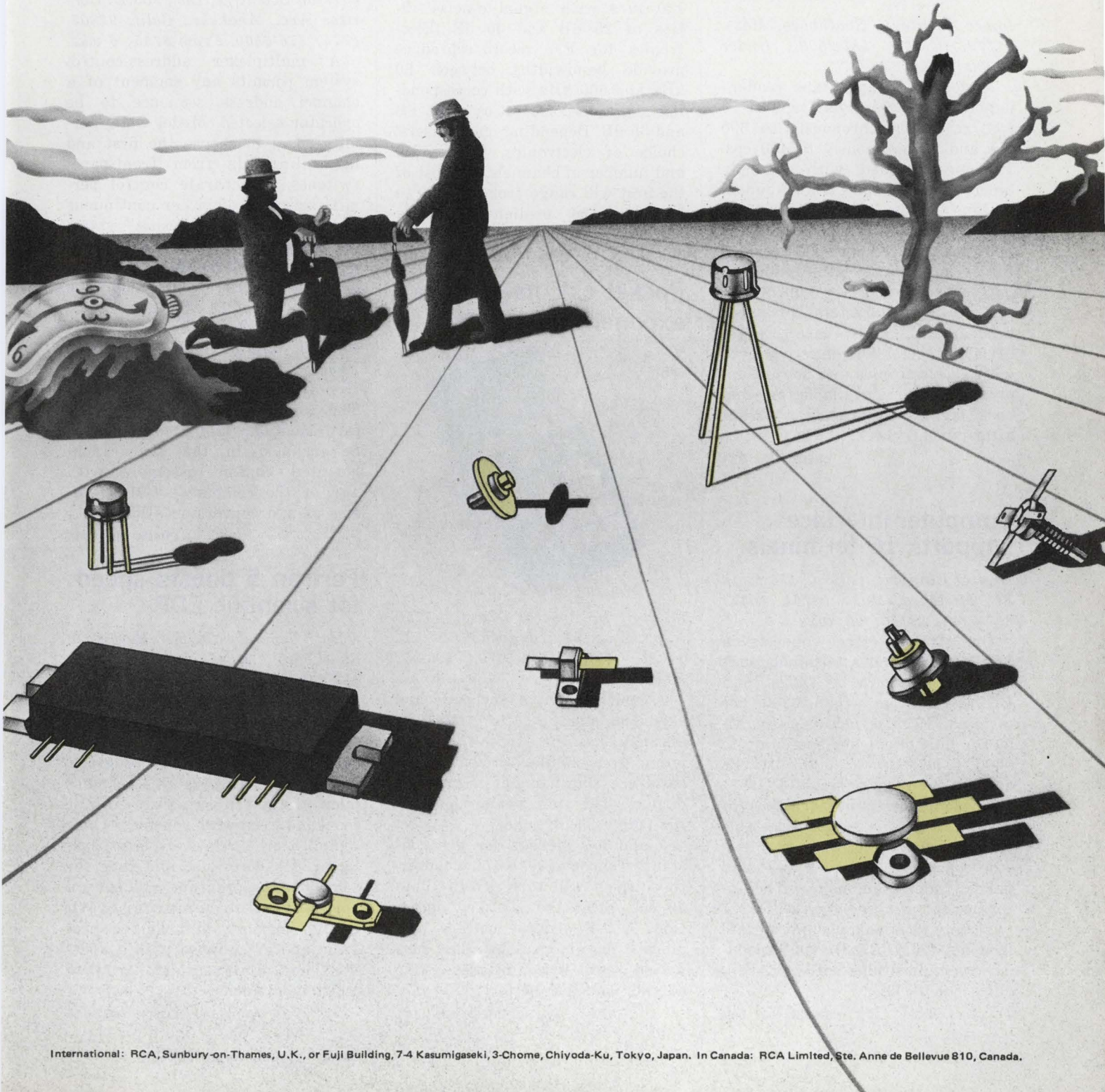

Punch-reader unit offers long service life

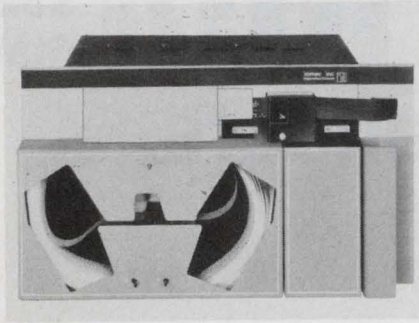

Iomec, Route 9, Southboro, Mass. 01772. (617) 481-2500. Under \$2000 (quan).

Model 7470 paper tape reader/punch perforates Mylar tape at 70 cps, reads asynchronously to 300 cps and synchronously to 400 cps. It comes complete with a supply bin for holding 1000 feet of punched tape. Reader and punch sections can operate independently. The photo-electric reader will read 5 to 8 level tape bi-directionally. Life expectancy of the punch head is 2×10^8 characters for paper tape and 6×10^7 characters for Mylar. Model 7470 comes equipped with all electronics and power supply. An option is available for echo-back signals to provide a "read-after-punch" check.

CHECK NO. 341

Computer interface supports 16 terminals

Digital Equipment Corp., 146 Main St., Maynard, Mass. 01754. (617) 897-5111. \$3100; 90 days.

One DJ11 interface connects up to 16 asynchronous terminals such as teletypewriters or CRTs to a PDP-11 for less than \$200 per terminal. Each asynchronous multiplexer unit offers line speeds up to 9600 baud. Up to eight DJ11's can be used on a single PDP-11 type computer. Other features of the DJ11 include switch selectable code lengths (5, 6, 7, or 8 bits), stop codes (1, 1-1/2 or 2 bits) and parity (odd, even, none). The interface can also interface a PDP-11 to remote terminals via appropriate modems. COMTEX Digital's modular communications software, supports the DJ11.

CHECK NO. 342

Laboratory recorder offers wide speed range

Honeywell Test Instruments Div., 4800 E. Dry Creek Rd., Box 5227, Denver, Colo. 80217. (303) 771-4700. See text; June.

A vacuum-buffered tape drive system provides reduced skew and flutter for the model 96 instrumentation recorder. The unit features 28 channels, nine selectable speeds (15/16 to 240 in/s) and up to 16-in. reel capacity. Direct record electronics are available for bandwidths of 600 kHz or 2 MHz at 120 in/s with signal-to-noise ratios of 25 dB and 40 dB. Electronics for FM record/reproduce provide bandwidths between 80 kHz and 500 kHz with corresponding signal-to-noise ratios of 55 dB and 35 dB. Depending on the users' choice of electronics, tape width and number of channels, the cost of the unit will range from \$15,000 to \$40,000; the median figure is \$20,000 to \$25,000.

CHECK NO. 343

Pocket calculator uses exponent notation



Melcor Electronics Corp., 1750 New Hwy., Farmingdale, N. Y. 11735. (516) 694-5570. \$99.95; stock.

A touch-sensitive keyboard and exponent storage (10^{-20} to 10^{79}) distinguishes the Model-370 calculator from similar products. Results are shown on an eight-digit display. The unit performs floating-point calculations (+, -, \times , \div) and has storage for one constant. To conserve battery power, the display will turn off in 10 to 30 sec. after the last key operation; a 9-V alkaline battery provides 7 hr. of operation. The suggested retail price includes an ac adaptor and 9-V battery.

CHECK NO. 344

Unit allows off-line data-acquisition control

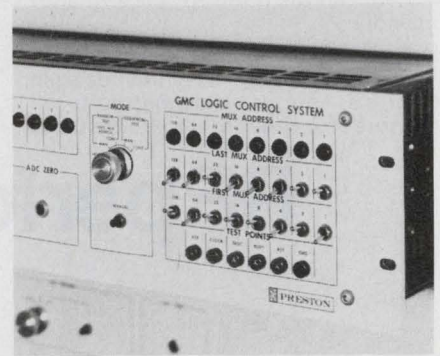

Preston Scientific, Inc., 805 E. Ceritos Ave., Anaheim, Calif. 92805. (714) 776-6400. From \$755; 6 wks.

A multiplexer address-control system permits any segment of a channel address sequence to be operator selected. Model GMC permits users to choose the first and last channels from front-panel switches. A separate control permits selection of either continuous re-cycling, or "single-shot" starts of each scan sequence. Single channel "stepping" can also be accomplished from the front panel. The unit can interface with data-acquisition systems that use the most common digital logic codes and levels, including TTL (both positive true and inverted positive). The control system is completely card mounted, and is designed to be included in the same rack-mounted chassis assembly with any of the company's GMAD series of a/d conversion systems.

CHECK NO. 345

Fortran 5 boosts speed for scientific EDP

Data General Corp., Route 9, Southboro, Mass. 01772. (617) 485-9100. See text.

Fortran 5, a superset of Fortran IV, is said to increase the computation rate because the compiler optimizes the entire user program. Among the features of the compiler are multitasking, re-entrant code and recursive routines. Once compiled on a relatively large system (28 k core, disc and tape for \$48,000), the program will run on any Nova-line computer with enough memory to hold the program and is equipped with a floating point processor and hardware multiply/divide.

CHECK NO. 346

THE MINIATURE
PC ROTARY SWITCH.

Very big in communications circuits.

The screwdriver operated PC mount rotary is 0.6 inches in length. It's half that in diameter. (A shaft-actuated bushing-mounted version also available.)

Both provide a 36° angle of throw with one or two pole circuitry. Rated make or break 200 milliamps at 115 VAC resistive load for 5,000 cycles. (Or 50 milliamps at 25,000 cycles.)

For more information on all Grayhill products, write today for our newest Engineering Catalog. Grayhill, Inc., 565 Hillgrove Avenue, La Grange, Illinois 60525. (312) 354-1040.



INFORMATION RETRIEVAL NUMBER 81

integrated circuits

NEED INFORMATION ON
integrated circuits?

Who makes them?

Where to get them?

PICK UP YOUR PHONE
AND DIAL TOLL FREE
800-645-9200

(or, in New York State, call collect (516) 294-0990)

**this service is
FREE**

use it whenever you're about to specify
any electronic product

eem

645 Stewart Ave., Garden City, N. Y. 11530

INFORMATION RETRIEVAL NUMBER 82

ELECTRONIC DESIGN 13, June 21, 1973

The First Thing You Put On Your CRT Should Be A Celco Yoke.

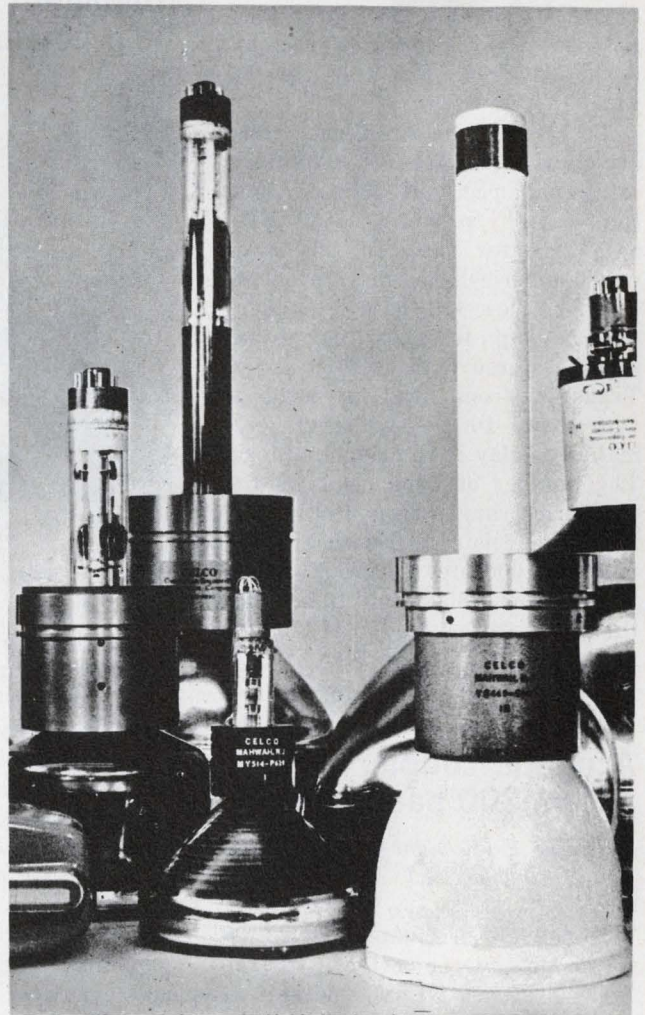

Go Ahead And Call CELCO.
All You've Got To Lose Are Your Yoke Problems.

Celco

MAHWAH, N. J. 07430 TEL. 714-982-0215
UPLAND, CAL. 91786 TEL. 201-327-1123

CONSTANTINE ENGINEERING LABORATORIES COMPANY
INFORMATION RETRIEVAL NUMBER 83

Fixed-head disc drives boost computer power

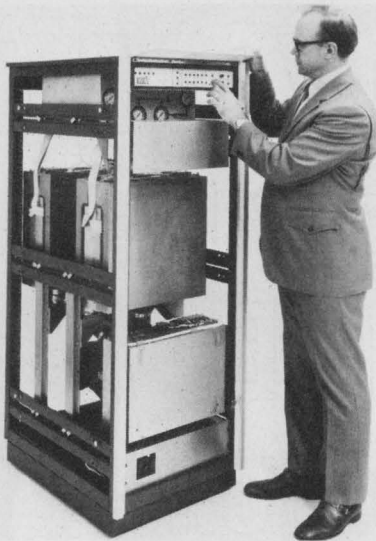

Pacific Micronetics, Inc., 5037 Rufner St., San Diego, Calif. 92111. (714) 279-7500. See text; 90-120 days.

A family of fixed-head disc drives, the FASTRACK 3 features rotational speeds of 3600 to 6000 rpm, thereby providing a 12 MHz data transfer rate. In the lower cost 010 series, each drive provides storage for 1.875 megabytes, whereas up to 11.25 megabytes may be stored with the 100 series. Transfer from head to head is very fast—10 μ s—while the remaining delay is rotational latency. The number of fixed heads in the 100 series ranges from 192 to 768, but all models record with a density of 120,000 bits per track. Prices range from \$8600 to \$10,800 for the 010 series and \$19,300 to \$59,940 for the 100 series.

CHECK NO. 347

Acoustic coupler allows 300 baud speed

Terminal Equipment Corp., 26 Just Rd., Fairfield, N.J. 07006. (201) 227-4141.

Model-920 originate-only acoustic coupler is compatible with the Bell 103-A modem and operates at rates from zero to 300 baud. The unit can be used with any terminal having an EIA RS-232 connector and can switch from full to half-duplex. It can also switch automatically between data and acoustic operations.

CHECK NO. 348

Two-wire modem affords full-duplex service

Vadic Corp., 505 E. Middlefield Rd., Mountain View, Calif. 94040. (213) 888-9912. \$750; 60 days.

Named the VA 3400, this modem provides simultaneous 1200-bit/s transmission in both directions over a two-wire telephone line. The unit provides the speed of the Bell 202 modem (half-duplex) without turnaround delay. According to the manufacturer, no terminal or software modifications are required. Dynamic range and channel separation are sufficient to enable simultaneous 0-dBm transmission with -50 dBm reception. Terminal interface can be synchronous or asynchronous.

CHECK NO. 349

Intelligent terminals help edit user data



Olivetti Corp. of America, 500 Park Ave., New York, N. Y. 10022. (212) 371-5500. From \$6700.

Series DE 520 intelligent terminals permit preprocessing of entered data prior to transmission. User data may be entered against format control programs, processed internally and then stored on internal tape cassettes. The series of terminals consist of desk top units containing ROMs and RAMs for data and program storage, a 310 character display screen, alphanumeric and numeric keyboard and cassette storage. Optional equipment includes serial printers (40 to 160 char/s), paper tape reader/punch, card reader, and 600-2400 baud telephone line modem. With the latter, transmission may take place in an attended or unattended mode.

CHECK NO. 350

Relay interface extends computer control

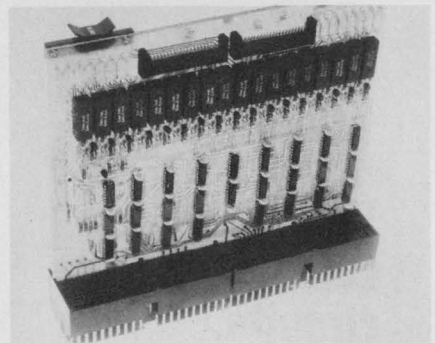

Digital Equipment Corp., 146 Main St., Maynard, Mass. 01754. (617) 897-5111. \$350; stock.

The M1801 16-bit relay output interface is designed for use with the PDP-11. It controls programmable instruments, display lamps, and power relays in applications which require electrical isolation between the TTL-compatible computer signals and the external power signals. Each bit of the PDP-11 data word controls one of 16 reed relays mounted on the M1801 module. The relays can be operated at rates up to 80 actuations per second. Equipment can be remotely located and connected to the module by standard 40-conductor cables that plug into two connectors on the module board.

CHECK NO. 351

Dedicated CPU furnishes FFT in real-time

Spectra Data, 187586 Bryant St., Northridge, Calif. 91324. (213) 993-1622. See text; 60-90 days.

A stand-alone unit, Model 1040 FET analyzer, processes 4096 complex data points in 68 ms—which is 10 times faster than most minis. The unit operates asynchronously and supplies 16-bit output words to the host processor. Use of the basic frame requires that data be supplied on demand from the host computer. With optional buffer memory, almost any mini or large-scale computer can load the analyzer just once per computation. The basic frame costs \$11,250; buffer storage plus interface costs about \$5000. Optional equipment includes cartesian to polar converters, additional memory blocks (to 32 k) and floating-point FFT which will be available at a later date.

CHECK NO. 352

Digital analyzer offers high spectral resolution

Sanders Associates, Daniel Webster Hwy. S., Nashua, N. H. 03060. (603) 885-2816. \$20,000; 60 days.

Providing high resolution with real time operation, model DSA-2004 digital spectrum analyzer covers a frequency range from 10 Hz to 40 kHz. Analysis bandwidth is selectable from 0.01 Hz to 40 Hz. A 1024 line spectrum is computed. The basic unit provides linear and logarithmic outputs for external CRTs or recorders on a single channel. Two optional cards provide for the simultaneous display of four to eight signal channels. The number of display points per spectrum is then 1024 divided by the number of plots.

CHECK NO. 353

Badge reader operates via remote control

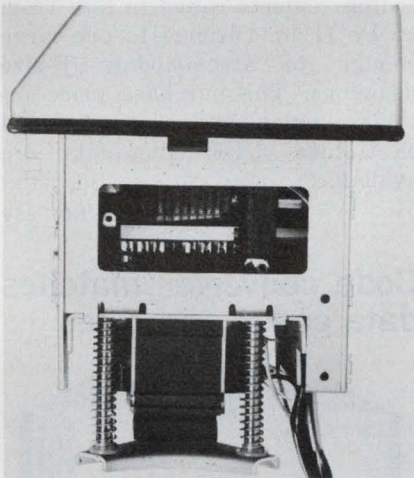

Sealectro Corp., 225 Hoyt St., Mamaroneck, N. Y. 10543. (914) 698-5600. From \$80; stock.

The SCR 1010-B reader accepts standard plastic ID badges and will not read a misoriented or wrong-type badge. Its wiping contacts are remote from the read area and protected from card-carried dirt or grease. The cover plate is designed to accept badges with clips. Proper card orientation and position, and presence of a hole in the Hollerith pattern actuate the units "read" sensor solenoid. All activated contacts remain closed as long as a badge is in the "read" position. Once information acquisition is complete, a feedback signal from the system breaks the solenoid hold circuit, and the card is ejected.

CHECK NO. 354



to step, turn, push or pull

actuating & positioningsimplified!

incremental action

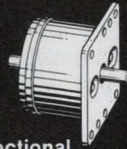

unidirectional

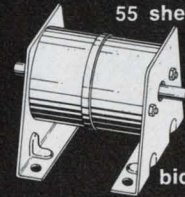

bidirectional

stepping motors

55 shelf models

Drive high inertial loads in increments of 10, 15, 20, 30 or 36 degrees. Positive drive clutch doubles as a brake to stop overdrive. Ledex stepping motors follow simple square wave pulses, so you don't need complex logic circuitry. Self-pulsing models also available.

rotary & linear action



life: 100,000,000 cycles

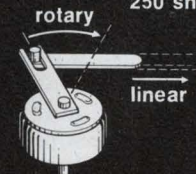

rotary solenoids

250 shelf models

Get direct rotary action, without complicated motion converters, linkages, and the like. Keeps design simple, compact, easy to install and maintain. The uniform output of a Ledex rotary solenoid also makes it a practical solution for many linear actuating applications.

linear action

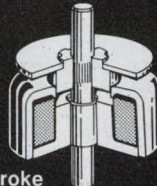

short stroke

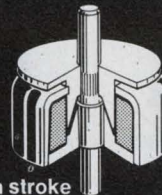

medium stroke

push-pull solenoids

72 shelf models

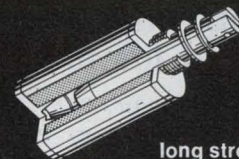

long stroke

Response in less than 5 milliseconds, force to 350 pounds, or strokes to .750" and more . . . At Ledex we vary the shape, the pole face contour, the size, or whatever it takes to give you the exact performance you need. Wide choice of variations make it easy to pick the solution best for you.

Altogether, at Ledex you'll find some 375 simplified actuating and positioning solutions on the shelf. But that's just a starting point. Should your application fall beyond the range of these shelf models, we're the people to see about a simplified custom solution.



Over 375 ways to step, turn, push or pull, plus interface circuits to control acceleration and deceleration, program pulses and work from logic level sources.

LEDEX INC.

123 Webster Street
Dayton, Ohio 45401/513-224-9891

Positioning • Switching • Interface Circuits

Toll free number for name of your nearest representative: 800-645-9200; New York firms call 316-245-0990.



Instrumentation recorder handles 35 kHz range



Nagra Magnetic Recorders, 19 W. 44 St., New York, N. Y. 10036. (212) 661-8066. \$2625; stock.

Designed for use in instrumentation recording on 1/4-in. tape, model SJ handles signal frequencies between zero and 35 kHz. Data are recorded in one of two bands 0 to 3.5 kHz or 25 Hz to 35 kHz. Frequency response is flat to within ± 2 dB over this range. In addition, the portable unit provides two AM sound tracks plus an FM cue track. Additional features include A-B-C-D weighting filters, peak/average modulation meter and a 90-dB step attenuator. The recorder has four speeds 15, 1.5, 3.75 and 1.5 in/s.

CHECK NO. 355

Floppy-disc storage system fits most minis

Standard Logic, 2215 S. Standard Ave., Santa Ana, Calif. 92707. (714) 979-4770. From \$2500; 30 days.

Floppy-disc storage systems FD-8S and FD-8H provide complete random-access facilities for the PDP-8, PDP-11, HP 2100, TEMPO II and NOVA 1200. Both systems incorporate an interface, formatter and disc drive. The FD-8S, costing \$2500, offers 131,072 bytes of storage per drive, 6-ms track-to-track access (64 tracks), 333-ms latency and a 4200 byte/s transfer rate. The FD-8H which costs \$3300 stores 262,142 bytes/drive and offers 10-ms track-to-track access, 80-ms latency and a 31,200 byte/s transfer rate. Optional plug-in modules allow use of the systems with most minicomputers. Each interface handles one to four drives.

CHECK NO. 356

Microcomputer gets alterable program

Intel Corp., 855 Sansome St., San Francisco, Calif. 94111. (415) 434-2244. See text; stock.

Microcomputers built with the 4004 CPU chip can now execute programs stored in alterable RAMs or reprogrammable pROMs. Two interface ICs, Model-4008 address latch and 4009 I/O device, couple the CPU directly to 1024-bit RAMs or 2048-bit pROMs. The RAMs are programmed by the CPU under software control. The PROMs are programmed electrically. The interface ICs also increase the number of I/O ports to 16 four-bit input ports and 16 four-bit output ports. The devices cost \$100 each in quantities of 100.

CHECK NO. 357

CRT terminal mounts on relay rack

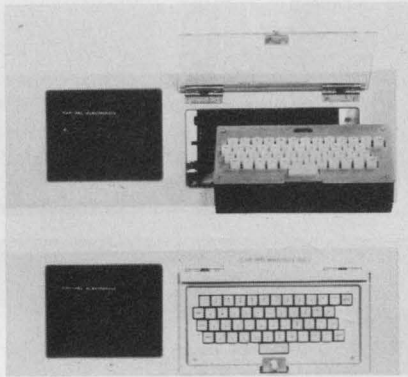

Car-Mel Electronics, 5794 Venice Blvd., Los Angeles, Calif. 90019. (213) 934-1866. \$1200 (100); stock.

Designated the Executive Informer, this 20 lb. input/output terminal has an RS-232 interface which permits plug-in interchangeability with most computer peripherals. It can be plugged directly into an acoustic coupler or a Bell-System Data-Phone. The rack-mounted terminal operates at any speed from 110 to 9600 baud. The 6-in. CRT display contains 16 lines, with 32 characters per line, and uses the 64-character ASCII upper-case set. The 5×7 dot-matrix characters are exceptionally sharp and bright. The keyboard may be mounted in the rack or removed for desktop use. Unit price is \$2050, dropping to \$1200 in hundred lots.

CHECK NO. 358

Digitizer tablets handle E-size drawings

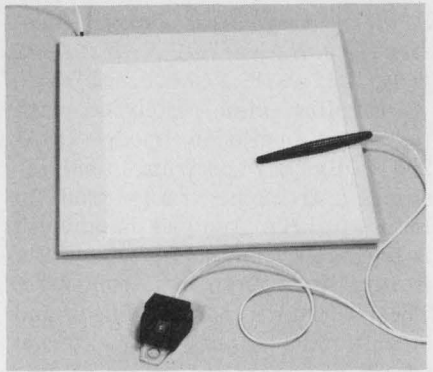

Scriptographics Corp., 398 Kings Highway, Fairfield, Conn. 06430. (203) 384-1344. From \$2000; 3 wks.

The free-cursor digitizers offer resolution of ± 0.005 in. (100 lines/in.) plus accuracy exceeding one-half of the least-significant bit. The unit generates absolute coordinates at rates up to 200 pairs/s with either binary or BCD coding. Tablets range in size from 11 by 11 in. (\$2000) to one large enough to accommodate E-size drawings. The purchase price includes tablet, stylus, cursor and electronics. OEM discounts are available.

CHECK NO. 359

Code converter matches data codes and rates

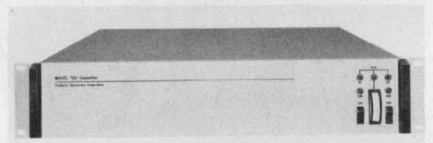

Plantronics, 385 Reed St., Santa Clara, Calif. 95050. (408) 249-1160. \$1545; 30 days.

Data communications systems with different code formats, levels or bit-rates can operate compatibly through use of the Model 702 code converter. The unit converts ASCII, Baudot or other 5, 6, 7 or 8-level data signal to another corresponding code. Conversion is accomplished by means of a MOS ROM programmed to customer requirements. Data rates range from 37.5 to 4800 bit/s. Available interface levels meet industry standards. Optional storage, to 10,000 characters, can be added to compensate for speed differentials or code character expansion.

CHECK NO. 360

Facsimile system gives pictures on demand

Alden Electronics, Alden Research Center, Westboro, Mass. 01581. (617) 366-8851. \$5000-\$7500; 60-90 days.

A system consisting of three units, an Alden-4 facsimile camera, and Alden-4 graphic recorder and the Model-9403 automatic answer/disconnect unit provides hard-copy records of remotely scanned images such as panel meters and pressure gauges. Operation of the system consists of interrogating the remote camera via a phone line through a data coupler (provided by the telephone company). The camera starts the recorder and commences panning a pre-selected sector of up to 360 degrees in 18-degree increments. At the completion of scanning, the camera stops the recorder, rotates to zero degrees and switches to the standby mode. At the same time the auto-answer device clears the phone line at the remote location. Copy for a single 18-degree panned frame (4 by 4 in.) prints out in one minute, a 360° panned format (4 by 75 in.) requires 20 minutes.

CHECK NO. 361

PDP-11 peripherals perform rapid FFT

Time/Data, 1050 E. Meadow Circle, Palo Alto, Calif. 94303. (415) 327-8322. See text.

Two PDP-11 computer peripherals are said to improve FFT computation time by approximately 10:1 over software Fast-Fourier-Transform computations. The processors interface directly to the I/O bus and perform direct or inverse Fourier transforms, power spectra and cross spectra with averaging and frequency windowing. Both processors are microprogrammed and use the host computer's core memory. Model F2 processes a 1024-point FFT in 146 ms and Model F4 in 100 ms. They cost \$5750 and \$6450 respectively. Each occupies two system-unit mounting spaces in standard BA-11-ES extension mounting boxes. Driving software is provided for performing operations with simple calls from FORTRAN or assembly-language programs.

CHECK NO. 362

Multipoint recorder scans low-level signals

Doric Scientific Corp., 7601 Convoy Ct., San Diego, Calif. 92111. (714) 277-8421. \$2195; 90 days.

The Digitrend 210 scans, conditions, displays and records multiple low level signals from thermocouples, current transmitters and millivolt transducers. A solid state multiplexer with overload protection to 130 V permits continuous

scanning (to 2 points/s), single scan on remote command, or internally timed periodic scan. The Digitrend includes a thermocouple reference junction, digital linearization, display and printout for up to 100 inputs. Price for 10 channels is \$2195. The optional BCD output allows interface to magnetic tape, punched tape or computer. Other options include dual set-point alarms and time-of-day digital clock.

CHECK NO. 363

We didn't go open frame until we could go one better

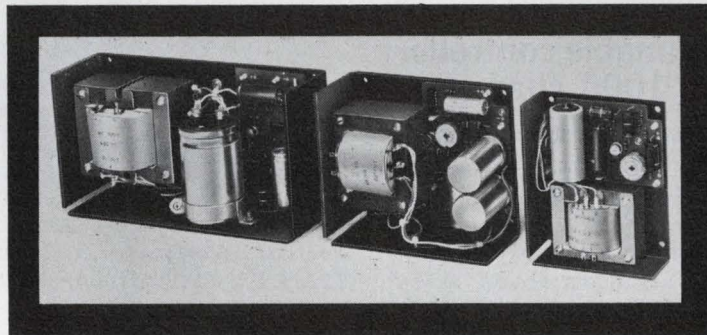

Here's the open frame power supply you've been waiting for. Built with Dynage quality to improve system reliability. Designed to give you maximum power for your dollar and simplify your design problems. Bulletin

273 tells the whole story. Write for your free copy and see how we go one better. Dynage, Inc., 1331 Blue Hills Avenue, Bloomfield, Connecticut 06002. Telephone (203) 243-0315.

DYNAGE

PC board microcomputer has expandable I/O bus

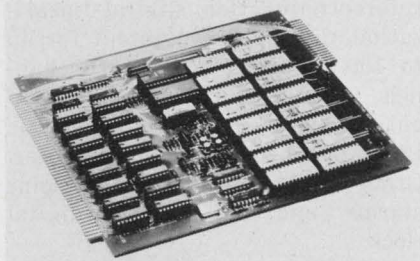

Applied Computing Technology, 17815 G Sky Park Circle, Irvine, Calif. 92707. (714) 549-3123. \$695 (1-9); 45 days.

A single PC board contains this parallel four-bit general purpose microcomputer. The computer consists of five basic elements: a CPU, a ROM for assembled program storage, a RAM for data storage and expandable I/O bus and a clock. The CPU includes subroutine stack nesting to three levels, four program stack registers, 16 index registers, and four-bit adder. Options include RAM data storage expandable in 80-word increments to 1280 words and ROM program storage expandable to 8192 words in 512-word increments. The microcomputer has an 11.8 μ s cycle time.

CHECK NO. 364

Programmable controller handles 1000 channels

FX Systems Corp., Mount Marion Rd., Saugerties, N.Y. 12477. (914) 246-9571. From \$5000; 90-120 days.

The basic Mark I controller unit consists of a random access, 4k by 18-bit core memory, with digit, word, and instruction registers and an arithmetic logic unit. A 5.25-in. high rack-mounting chassis houses the system and provides space for nine interface-card modules. I/O interface modules include controls for readers, printers, a/d and d/a converters, as well as timers and drivers. Memory expansion is available in 4k increments, up to 32k by 18-bit words. Power-level I/O capacity is 512 channels, input or output, in any combination. Maximum low-level I/O capacity is 1000 inputs and outputs. The standard instruction set is said to be short.

CHECK NO. 365

Quiet printer accepts DTL/TTL inputs

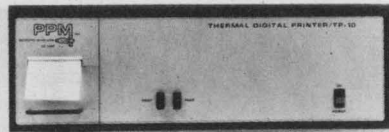

PPM, Inc., 32 W. Monroe St., Bedford, Ohio 44146. (216) 232-1880. See text; 6 wk.

According to the manufacturer use of a motor drive helps make this a quiet instrumentation printer. The unit accepts parallel BCD data (DTL or TTL) and prints at a rate of 5 lines/s continuously or 10 lines/s in bursts of 1000 prints. All models are available with four, eight or 12-column capacity and print a floating decimal point. The basic print mechanism (TP-10 M) uses a thermal print head which prints on thermally sensitive paper. The complete unit (TP-10) with all electronics costs \$650 in quantity. The basic mechanism costs \$190 in quantity.

CHECK NO. 366

Palm-sized computer has long predicted life



Teledyne Systems Co., 19601 Nordhoff St., Northridge, Calif. 91324. (213) 886-2211. \$1000; stock.

A 2.5-in. diameter, 0.1-in. high, hermetically sealed package now contains a minicomputer with a 47-instruction repertoire (16-bit words) and 2048 words of memory. This particular member of the TDY family, designated the TDY-52A, executes an add instruction in 50 μ s. The predicted mean time between failures (MTBF) is about 25 years. Other CPUs are available with add times as low as 10 μ s. In addition to offering a broad line of packaged CPUs, I/O modules and memory units, the manufacturer can provide programming software support or complete operational programs.

CHECK NO. 367

Modular data-acquisition system fits most minis

Data Technology, 2700 S. Fairview Ave., Santa Ana, Calif. 92704. (714) 546-7160. See text; stock.

Intended for data-acquisition applications, the Milliverter II accommodates up to 64 low-level signals (5-500 mV) at a cost of \$125/channel, or 256 high-level channels (1-10 V) for less than \$35/channel. Any channel mix can be accommodated and the unit can be expanded to 1024 channels. Other features of the Milliverter II include fixed or programmable gain track-and-hold amplifiers and 15-bit a/d conversions that occur in under 15 μ s. The unit is available with interfaces to most minicomputers. Conversion timing can be controlled by a CPU, by an internal timer or an external signal source. The basic system price is \$3250 plus amplifier cards.

CHECK NO. 368

Cassette system mimics disc peripheral



Computer Automation, 895 W. 16th St., Newport Beach, Calif. 92660. (714) 642-9630. \$2850; 30 days.

Users of the company's 8 and 16-bit Naked Mini or Alpha Computers can add a cassette system that features high speed search and a direct-access mode of operation. In the direct-access mode, one of the two cassette tracks contains prewritten address marks so that the entire length of tape can be treated as a sectored disc. The entire tape can be searched at 120 in/s, but read and write operations occur at 12 in/s. Data are recorded at a density of 800 bit/in., using 11 bits per data byte. A complete single-cassette system, with one transport, interface controller, cabling and software, costs \$2580. Each controller permits use of one to four cassettes.

CHECK NO. 369

Card reader accepts punched or penciled data

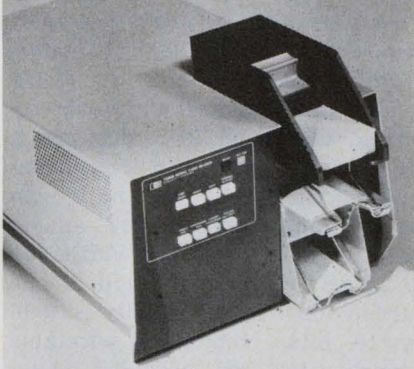

Hewlett Packard, 1501 Page Mill Rd., Palo Alto, Calif. 94304. (415) 493-1501. \$2975; May.

Model 7260A card reader accepts most marked or punched cards at rates up to 300/min. Data read from the cards are stored in buffers for serial transmission at switch-selectable rates from 110 to 2400 baud. Single cards with appropriate clock marks can be both punched and marked. The desk-top reader transmits the 128-character Hollerith set in 7-level ASCII code and will retransmit, on command, data already read by the computer.

CHECK NO. 370

Uninterruptable power sources span wide range



Topaz Electronics, 3855 Ruffin Rd., San Diego, Calif. 92123. (714) 279-0111. From \$1825.

A series of uninterruptable power systems is available in sizes from 500 VA to 10 kVA. Systems include battery charger, inverter, and a choice of a relay or solid-state switch with actuation times as low as 4 ms. The systems operate from power lines of 95 to 130 V ac and are said to provide excellent attenuation of power-line noise spikes. Systems up to 2000 VA contain sealed, maintenance-free batteries and are completely self-contained for full-load back-up operation up to 20 minutes.

CHECK NO. 318

ENM
COMPAC®

time
counts
and we
count
time

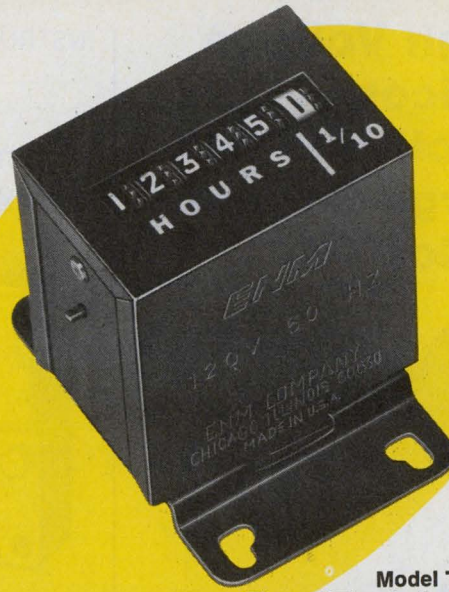

Model T12
Elapsed Time Indicator
6 Digit, Base Mount

ENM's CompaC® Model T12 elapsed time indicator counts/records up to 100,000 hours with tenths of hours in relief.

So what? So think of a better way to schedule maintenance, time processes or establish rental fees. And what about the way you warrant your product? Hours of use are a lot more meaningful and protective than mere length of ownership. One user's month may be another owner's year. A calendar warranty can't fairly cover both.

Thanks to its space saving epicyclic step-down gearing, the American made compact Model T12 will fit on almost anything—and with its five mounting styles—anyway you'd like.



Back of Panel



Flange Mount



NEMA Bezel Panel Mount



Round Panel Mount

Model T12 6-digit time scale to 99,999.9 hours. Figures .140" high, hours white on black, tenths black on white. Universal base mount and other mountings illustrated above. Synchronous motor requires no lubrication. 115 V. AC. Case width 1.72". Priced from \$5.40 in 1000 lot quantities.

CompaC Digital Counter Buyers Guide
Write for it today, so you won't be wrong tomorrow.

ENM COMPANY

5340 Northwest Highway, Chicago, Ill. 60630 • Telephone: (312) 775-8400

INFORMATION RETRIEVAL NUMBER 86

High Voltage Silicon Rectifiers for Large Screen Color TV

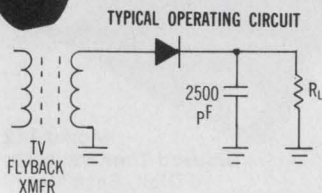

These silicon rectifiers are designed to replace the high voltage rectifier tubes in either hybrid or solid state large screen color TV.

The configuration shown, series H-431 & H-484, is designed for maximum performance. It features: a corona ring, PRV rating of 45 kV, high humidity resistance, 250 and 300 nsec. t_{rr} , and 85°C, T_A , operating temperature. A variety of mounting hardware and connections for the anode and cathode ends are available.

Other high voltage silicon rectifiers from Varo include versatile, low cost axial-lead or end-cap packages in 15 kV to 30 kV ratings for monochrome or small screen color TV.

Write for your free copy of our Applications Bulletin VSP 108, "Selecting the proper rectifier for TV high voltage circuits."



VARO

VARO SEMICONDUCTOR, INC.

P.O. BOX 676, 1000 N. SHILOH, GARLAND, TEX. 75040

214/272-4551, TWX 910-860-5178

Varo Sales Representatives

AL Buchanan & Abrams Assoc. 305-423-8995 • AZ W. W. Posey Co. 505-294-8400 • AR Whiteside Sales 214-231-9771 • CA (NO) W. W. Posey Co. 415-948-7771 • CA (SO) Corcoran Assoc. 213-823-2425 • CO J. F. Hurlbut Co. 303-279-7138 • CT Comp Rep Assoc., Inc. 203-239-9762 • DE Tom Davis Marketers 302-998-0123 • FL Buchanan & Abrams Assoc. 305-423-8995 • GA Buchanan & Abrams Assoc. 305-423-8995 • IL (NO) Olson Sales Co. 312-627-3802 • IL (SO) Coombs Assoc. 314-567-3657 • IN Technical Reps, Inc. 317-546-4967 • KS Coombs Assoc. 314-567-3657 • KY Technical Reps, Inc. 317-546-4967 • LA Whiteside Sales Co. 214-231-9771 • ME Comp Rep Assoc., Inc. 617-444-2484 • MD Tom Davis Marketers 703-591-7390 • MA Comp Rep Assoc., Inc. 617-444-2484 • MI Davis-Martensen Co. 313-474-8300 • MN Loren F. Green Assoc. 612-781-1611 • MS Buchanan & Abrams 305-423-8995 • MO Coombs Assoc. 314-567-3657 • NJ (NO) Cooper-Simon & Co. 516-487-1142 • NJ (SO) Tom Davis Marketers 302-998-0123 • NM W. W. Posey Co. 505-294-8400 • NY (METRO) Cooper-Simon & Co. 516-487-1142 • NY (UPST) Bob Dean, Inc. 607-272-2187 • NC Buchanan & Abrams Assoc. 305-423-8995 • OH (NO) J. C. Hofstetter Co. 216-241-4880 & 216-725-4477 • OH (SO) J. C. Hofstetter Co. 513-298-0662 • OK Whiteside Sales Co. 214-231-9771 • OR C. K. Shanks & Assoc. 503-292-5656 • PA (E) Tom Davis Marketers 302-998-0123 • PA (W) J. C. Hofstetter Co. 412-561-5454 • RI Comp Rep Assoc., Inc. 617-444-2484 • SC Buchanan & Abrams Assoc. 305-423-8995 • TX Whiteside Sales Co. 214-231-9771 & 713-498-2555 • VA Tom Davis Marketers 703-591-7390 • WA C. K. Shanks & Assoc. 503-292-5656 • WI Olson Sales Co. 312-627-3802 • CANADA • ONT Cantronics, Ltd. 416-661-2494 • QUE Cantronics, Inc. 514-733-0749

INFORMATION RETRIEVAL NUMBER 87

INSTRUMENTATION

FET multitester gives voltage-doubling probe

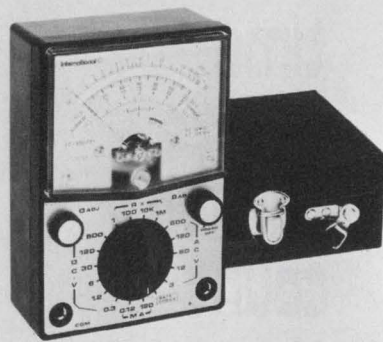

International Components Div. of IESC, 10 Daniel St., Farmingdale, N.Y. 11735. (516) 293-1500. \$64.95; stock.

IC 500 FET multitester features: 10- Ω input impedance in the dc V range; a dc voltage range-doubling probe that raises input impedance to 20 M Ω ; a single function-selection knob; a center zero for accurate null detection and for positive and negative voltage measurements without having to switch leads; and a total of 23 useful ranges. The instrument comes complete with carrying case, test leads and alligator clips. Rated accuracy is $\pm 3\%$ fs for dc and $\pm 4\%$ fs for ac.

CHECK NO. 316

100-MHz pulser gives 2.5-ns rise time

Test & Measuring Instruments, 224 Duffy Ave., Hicksville, N.Y. 11802. (516) 433-8800. \$1440.

For those working with TTL/ECL, the PM5771 offers rise and fall times to 2.5 ns. Internally-triggered pulse-repetition time is selectable in nine ranges from 1 Hz to 100 MHz, with continuous adjustment between ranges; external triggering and gating to 50 MHz is practical. Output amplitude is continuously adjustable from 80 mV to 5 V, from 50 Ω source resistance, and to 10 V as an open-circuit current source. Pulse width and delay are both continuously variable in eight ranges from 5 ns to 100 ms. Jitter for either is less than 703 ps (0.1%).

CHECK NO. 372

Waveform recorder digitizes and stores

Biomation, 10411 Bubb Rd., Cupertino, Calif. 95014. (408) 255-9500. \$5200; 60 days.

This multichannel waveform recorder, the Model 1015, digitizes a signal and stores it in a semiconductor memory. The unit can record four simultaneous analog input signals with bandwidths up to 25 kHz and a resolution of one part in 1024. Total capacity is 4096 by 10 bits. Numerous selectable record rates are provided along with a digitally adjustable delay of as much as 10 times the record length. A "pretrigger" recording capability permits the trigger to be received before, during, or after the signal has occurred to ensure that the leading baseline and rise of the signal is captured in memory.

CHECK NO. 373

Compact unit displays IC logic states

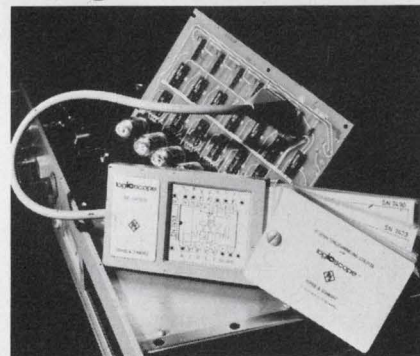

Rohde & Schwarz, 111 Lexington Ave., Passaic, N.J. 07055. (201) 773-8010. \$260.

The Logiscope, Type IFP, is a pocket-sized instrument for rapid diagnostic and functional testing of DTL and TTL ICs. It simultaneously displays the logic state of all 14 or 16 pins of an IC soldered into a module. Single pulses down to 1 ms produce a visible flash. The IFP simultaneously displays a reference diagram of the IC under test and the logic state on a 2-3/8 \times 2-1/8 display screen. The Logiscope derives its operating voltage from the test item, locating automatically the positive and the negative poles. Reference diagram cards for most common logic ICs comes with the Logiscope.

CHECK NO. 374

Digital data generator outputs serial/parallel



Moxon Inc./SRC Div., 2222 Michelson Dr., Irvine, Calif. 92664. (714) 833-2000. \$995; 24 wk.

This digital data generator, Model 901, features 16-pushbutton selections of logic ZEROs and ONES in either serial or parallel form and offers output levels adjustable from 0 to ± 15 V over dc to 15 MHz. The dynamic and "hard-wired" parallel outputs are available on a multipin connector. "Hard-wired" outputs go directly to the 16 programming switches with the ONE and ZERO logic levels available for any level of external programming desired. The dynamic or shift register parallel outputs are controlled by a mode switch for static, one-bit, one-cycle or continuously repetitive patterns.

CHECK NO. 375

OEM servo recorder costs \$250 in quantity

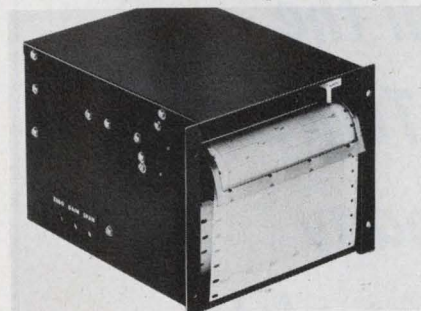

Esterline Angus, P.O. Box 24000, Indianapolis, Ind. 46224. (317) 244-7611. \$250 (quantity).

Need a servo recorder? Here's an ultra-reliable, dedicated, 8-in. unit, intended for quantity OEM customers. The recorder offers a guaranteed 10-million cycle MTBF, a foolproof disposable pen unit, two circuit cards that contain all the electronics, and a wide range of chart speeds. Specs include sensitivity to 100-mV full scale (10 mV optional), response of 0.5 sec. and accuracy of $\pm 0.5\%$ span.

CHECK NO. 376

\$995, 5-1/2-digit DMM has 26 ranges

Syston-Donner, 10 Syston Dr., Concord, Calif. 94518. (415) 682-6161. \$995; 45 days.

Model 7205, 5-1/2-digit DMM, features lead compensation for resistance measurements, ac-voltage response to 1 MHz, an in-line, in-plane Sperry display, and 26 ranges; 10 of dc and ac current, 10 of ac and dc volts, and 6 resistance ranges. Overrange is 30% and input impedance is greater than 1000 M Ω on the three, lower dc-voltage ranges. Common-mode and normal-mode rejection is greater than 140 dB and 60 dB, respectively.

CHECK NO. 377

Logic tester clamps on DIP

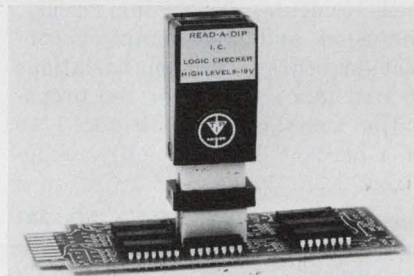

Micro Electronic Systems, 8 Kevin Dr., Danbury, Conn. 06810. (203) 746-2525. \$125; 60 days.

READ-A-DIP logic checker is powered from the chip and seeks V_{cc} and ground automatically. The unit tests 14/16 pin TTL/DTL DIPs. Readout of logic states is via an LED display.

CHECK NO. 378

Universal counters are programmable

Schlumberger, 12 Place des Estats Unis, 92120 Montrouge, France.

FH 2524 and FH 2525 are two new universal programmable counters handling 160 and 520 MHz, respectively. Besides frequency, period and multiple ratio, these instruments offer unique time interval measurement facilities: in the one-shot mode, resolution is 100 ns; an interesting feature is the hold off position allowing an adjustable inhibition of the stop channel from 100 μ s to 100 s. Resolution can be higher than 100 ps in the averaging mode.

CHECK NO. 379

THE LOGICAL PCB LIGHTS

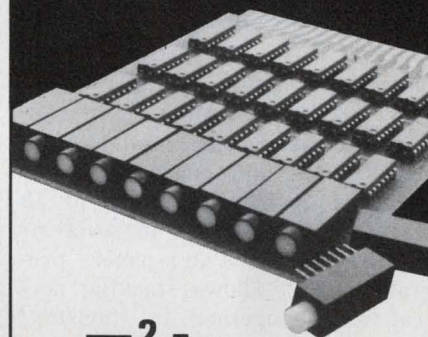

T² Lite

LED & Incandescent Lights with Built-in TTL or ECL Integrated Circuits

- Standard Dual-In-Line package contains complete logic I.C. plus visual indication
- Choice of standard 74 or 74H Series I.C.
- LED's feature built-in series resistor
- Long life incandescent lamps include built-in keep alive bias

Convenient combination package reduces cost, saves space and speeds up assembly. Units are available for immediate delivery with a wide choice of lens colors.

Call or write for more information today!

the little light people

DATA DISPLAY PRODUCTS

5428 W. 104th St., Los Angeles, Ca. 90045
(213) 641-1232

INSTRUMENTATION

Data unit generates up to 64 eight-bit bytes

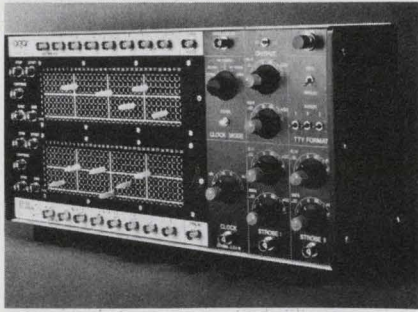

Adar Associates, 85 Bolton St., Cambridge, Mass. 02140. (617) 492-7110. About \$2500.

EC-22 pattern generator is plug-board-loaded and generates 32 or 64 eight-bit bytes at rates of 10 Hz to 8 MHz—either in serial or parallel form. Patch-panel program control allows stacking several units together in “master/slave” configuration for generation of arbitrary long sequences, wide output words and program nesting. 100 diode pins are supplied with each plugboard. Size is 17 × 7-5/8 × 6 in.

CHECK NO. 380

Unit locates faults before they occur

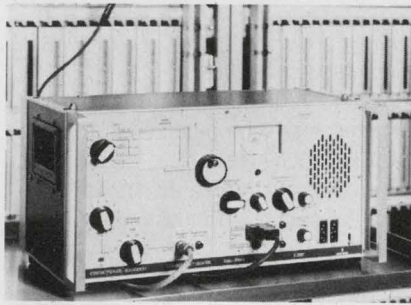

Siemens, 186 Wood Avenue S., Iselin, N.J. 08830. (201) 494-1000. About \$2000; stock.

The K2007 contact fault locator is claimed to be the first such unit to recognize early-stage contact resistance variations in switches, solder joints, PC boards, etc. The new device operates over a 3-kHz to 10-MHz range. It detects and reports, via metered and audible measurements, developing breaks, corrosion and weakening of contact pressures. Sudden variations in resistance that alter the propagation constant by as little as 1/10 of a percent can be readily recognized.

CHECK NO. 381

80-MHz counter/timer sells for \$595

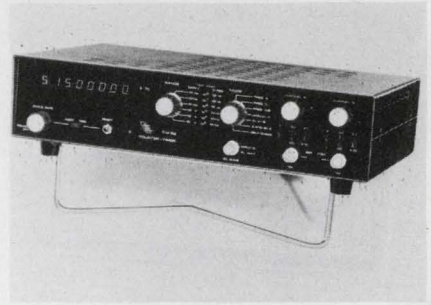

Analog Digital Research, 777 Warden Ave., Scarborough, Ontario, Canada, \$595; stock to 30 days.

CM52 universal counter/timer has two matched, dc to 80-MHz input channels and measures frequencies, single or multiple-period averages, frequency ratios, and time intervals. An “A gated by B” mode allows the CM52 to be used as a gateable totalizer. The CM52 will operate from either standard line voltage or an external 12-V dc source, allowing portable operation. A six-digit LED display is standard, and this can be expanded to a maximum of nine digits.

CHECK NO. 382

**PERSONNEL
RECRUITMENT
ADVERTISING
IN
Electronic Design
REACHES THE
RIGHT PEOPLE
AT A LOWER COST
PER THOUSAND**

*Call the
HOTLINE
today
for complete
information:
(201) 843-0550
extension 209*

4-function calculator offered in kit form

Heath Co., Benton Harbor, Mich. 49022. (616) 983-3961. \$79.95.

The IC-2108 Desk-Top Calculator Kit features a low-profile case with bright 1/2-in. readout tubes in an eight-digit display. The unit is a complete four-function calculator with both floating and fixed decimal. A Constant-key permits chain calculations and a Clear-Entry key allows removal of an entry from the display window without disturbing prior calculations. Negative answer, entry and result overflow indicators are automatically displayed. The color-coded keyboard slopes to the desk for comfortable arm positioning.

CHECK NO. 383

5-1/2-digit DMM offered for systems use

John Fluke, P.O. Box 7428, Seattle, Wash. 98133. (206) 774-2211. \$1995.

This 5-1/2-digit DMM, Model 8375A, is offered as a systems-oriented instrument. The standard unit measures dc volts, true rms ac volts and resistance and includes a self-test feature. Other specs include autoranging, auto-polarity, a switched four-pole filter, five ranges of dc volts, from 1 μ V to 110 V, four ranges of true rms ac volts, from 10 μ V to 1100 V, and seven ranges of resistance, from 100 $\mu\Omega$ to 12 M Ω .

CHECK NO. 384

Transient recorder stores waveforms

Inter-Computer Electronics Inc., P.O. Box 507, Lansdale, Pa. 19446. (215) 822-2929. \$9850; 6 wks.

Model PTR-9200 pulse and transient recorder digitizes input signals, stores the information in a digital memory and transfers the stored information into a computer for processing. The unit records transients and repetitive signals, accepts dual differential inputs of ± 50 mV to ± 5 V fs, and stores 110 points of baseline and leading edge of signal in the pretrigger mode. Memory output speed is dc to 4 MHz and sampling interval is 10 ns to 50 s.

CHECK NO. 385

Digital IC tester diagnoses failures

Sitek, Inc., 1078 W. Evelyn Ave., Sunnyvale, Calif. 94086. (408) 735-9800. \$4250; 8 wks.

The Model 3200 digital IC tester is for incoming inspection and evaluation of semiconductor devices. Test frequency of the unit is 200 kHz. The instrument performs both parametric and functional tests on almost every type of digital IC made, including DTL, TTL, ECL, MOS, CMOS, ROMs, RAMs, SSI, MSI, LSI, and more. It will accept devices with up to 24 pins, and is expandable to 34 pins. Tests performed include power consumption, fan in, fan out, function and threshold. Test conditions for the Model 3200 are programmed by interface assemblies that are preprogrammed for a specific device, or can be supplied blank to be programmed by the user.

CHECK NO. 386

Function generator is also a 15-MHz counter



United Systems, 918 Woodley Rd., Dayton, Ohio 45403. (513) 254-6251. \$455.

Model 304A is a combination sine-square wave generator and 15-MHz counter. The instrument provides output signals from 10 Hz to 1 MHz in five decade ranges. The actual output frequency is counted by the internal counter and is shown on a four-digit LED display. A three-position pushbutton switch allows the selection of waveform shape: sinusoidal, symmetrical square wave or square wave with negative peak referenced to ground. In the latter mode, the 304A can drive up to five DTL/TTL inputs. As a digital counter, sensitivity is 50 mV rms from 5 Hz to 15 MHz.

CHECK NO. 387

Tung-Sol® Modular Bridge Rectifiers Have Highest Surge Ratings

Junction sizes enable Tung-Sol modular bridge rectifiers to withstand single cycle surges of 300 to 400 amperes. These exceptionally high ratings provide circuit designers with maximum protection against overloads. Check all of the high-performance characteristics of Tung-Sol bridge rectifiers.

Single Phase Bridges

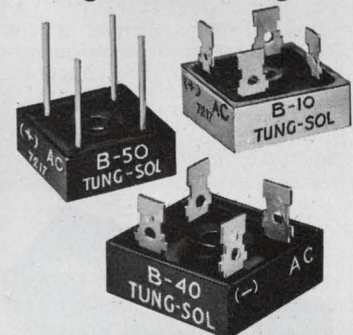

B-50 Series—DC rating: 10A @ 75°C case. Forward surge rating: 300A @ rated load. Ratings from 50 to 600 PRV per leg. Epoxy case construction.

B-40 Series—DC rating: 15A @ 75°C case. Forward surge rating: 300A @ rated load. Ratings from 50 to 1,000 PRV per leg. Epoxy case construction.

B-10 Series—DC rating: 30A @ 75°C case. Forward surge rating: 400A @ rated load. Ratings from 50 to 1,000 PRV per leg. Aluminum case construction.

Three Phase Bridges

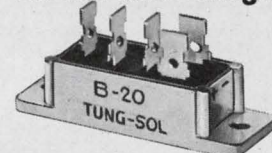

B-20 Series—DC rating: 35A @ 75°C case. Forward surge rating: 400A @ rated load. Ratings from 50 to 1,000 PRV per leg.

Write for complete information.

SILICON PRODUCTS SECTION
WAGNER ELECTRIC CORPORATION

630 West Mt. Pleasant Ave. Livingston, N.J. 07039

TWX: 710-994-4865 PHONE: (201) 992-1100

(212) 732-5426

Trademark TUNG-SOL Reg. U. S. Pat. Off. and
Marcas Registradas

INFORMATION RETRIEVAL NUMBER 91

12 BIT A/D

with no nonsense specifications

Linearity confusion ends when you specify MNC A/D's. All errors of offset, gain error, and TC drift are covered by guaranteeing linearity and accuracy over the full operating range ... 0 to 70C, -55 to +125C. No adjustment required to reach specified accuracies.



With MNC's A/D converters you get:

- ½ bit linearity guaranteed over the complete range ...
MN515 0 to 70C
MN515H -55 to +125C
- Serial and Parallel Output.
- 50 µsec Total Conversion Time.
- 6 user Selectable Input Ranges.
- Output Storage Register included in MN516.

Price for Model MN515 in quantities 1-24 is \$199; Model MN515H in quantities 1-24 is \$375. Delivery in two to four weeks.

For complete technical specifications write or call: Tel: (617) 753-4756



Micro Networks
CORPORATION
5 Barbara Lane
Worcester, Mass. 01604

INSTRUMENTATION

3.5-digit DMM gives count of 5000

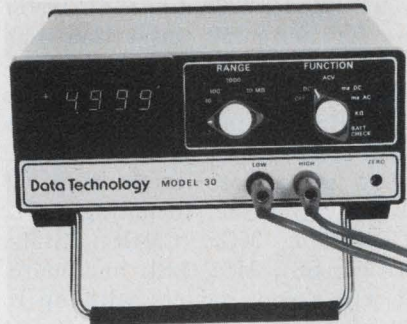

Data Technology, 2700 S. Fairview, Santa Ana, Calif. 92704. (714) 546-7160. \$279; stock to 30 days.

500% overrange and four-digit readout extends the capability of a three-digit DMM—Model 30—by 2-1/2 times over conventional 3-1/2-digit meters. The unit uses a Sperry display, with 1/3-in. digits and is a five-function, 23-range instrument. The five functions include: five dc voltage ranges from 500 mV to 1200 V; five ac voltage ranges from 500 mV to 1000 V; five resistance ranges from 500 Ω to 50 MΩ; four ac and dc current ranges from 500 µA to 2 A. Input resistance is greater than 10⁹ Ω on basic dc voltage ranges; input impedance is 20 MΩ shunted by 60 pF on basic ac voltage ranges; CMR is 100 dB min.

CHECK NO. 388

Ohms tracer audibly signals resistance

Ecos Electronics, 205 W. Harrison St., Oak Park, Ill. 60304. (312) 383-2505. \$56.00; stock.

Pocket-size Model 4371 Ohm-Tracer has a 0 to 5000-Ω resistance testing range and 2% accuracy. Its internal design provides a low testing voltage of 0.08 V dc, making it ideal for in-circuit testing of solid-state circuitry, with no danger of creating false signals or damaging components. Ohm-Tracer can also be used as a continuity tester. There are no meters to watch: a volume-controlled audible alarm signals less than calibrated resistance. Circuit is self-adjusting to insure accuracy as battery power diminishes. Battery life is 200 hours.

CHECK NO. 389

Logic pulse generator sells for \$195

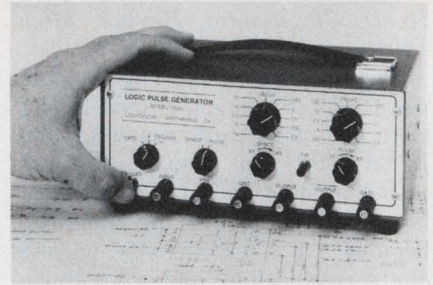

Logicpulse, 18758 Bryant St., Northridge, Calif. 91324. (213) 993-0225. \$195; stock.

With a TTL compatible input/output, the 101A generates pulses from 50 ns to 500 ms and spaces from 150 ns to 500 ms, both extendable to over one minute with user-installed capacitors. It can also produce synchronized pulses adjustable down to zero width—very useful for testing clocking margins. Duty cycle is unlimited. Rise and fall times are 5 ns to 50% points, 10 ns to 10 and 90% points. True and complemented outputs will sink 50 mA and will drive 50-Ω transmission lines. The 101A supplies regulated +5 V, 500 mA for powering breadboards.

CHECK NO. 390

50-W sweeper ranges from 225 to 400 MHz

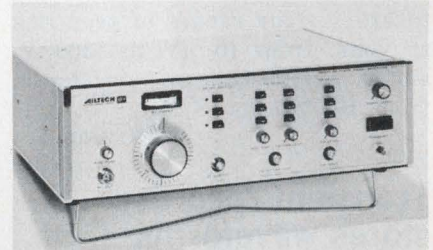

Ailtech, 19535 E. Walnut Dr., City of Industry, Calif. 91748. (213) 965-4911. \$5950; 4-6 mos.

Model 473 is a power signal generator, capable of being swept over its entire frequency range of 225 to 400 MHz. The unit can be used as a cw signal source, linear sweeper, or as an FM/AM generator. The instrument maintains a level from 1 to 50 W to within 0.5 dB over the band. The AM function can be used simultaneously with FM or sweep. A reflected power limiter pre-empts the forward power leveling circuit and maintains the reflected power at 10 W.

CHECK NO. 391

550-MHz counter is sensitive to 10 mV



Miida Electronics, 2 Hammarskjold Plaza, New York, N.Y. 10017. (212) 973-7152. \$950.

Model 5108, 9-digit uhf counter, offers 10-mV rms sensitivity and a frequency range of 10 Hz to 550 MHz. Attenuator dynamic range is 35 dB with auto-attenuation and automatic noise suppressor, and an additional 20 dB with manually-switched attenuator. TCXO aging rate is 5×10^{-8} /day. Four decades of resolution are provided, from 1 kHz at 16 ms gate time, to 1 Hz at 16 s.

CHECK NO. 392

Function generator offers internal sweep



Clarke-Hess, 43 W. 16th St., New York, N.Y. 10011. (212) 255-2940. \$475; stock.

Model 750 function generator, with internal sweep, offers all standard function generator outputs plus a ramp generator, tone burst, external FM and phase-lock synchronization. Standard frequency range is 1 Hz to 2 MHz, and the 750 can supply swept frequencies from below 1/10th of the lowest dial setting up to twice the upper dial setting. Over-all operation is thus possible from 1 millihertz to 4 MHz. The main generator has two isolated 50-Ω outputs separated in level by 30-dB. The high output supplies 20-V pk-pk into an open circuit.

CHECK NO. 393

Phase angle voltmeter is all digital



North Atlantic Industries, Terminal Dr., Plainview, N.Y. 11803. (516) 681-8600. \$3450.

Model 225 digital phase angle voltmeter is said to be the first such unit that's all-digital. It features a 4-1/2-digit display, remote BCD and analog outputs, and local or remote programming. The unit measures total voltage to 500 V rms from 10 Hz to 100 kHz, and provides phase-sensitive voltage and phase angle measurements at any two (optionally four) spot frequencies within the 30 Hz to 30-kHz band. In phase-sensitive mode, voltage accuracy is 0.1%, and phase-angle accuracy at mid-band frequencies (around 400 Hz) is 0.25 degrees.

CHECK NO. 394

A/d converter line offers up to 14 bits

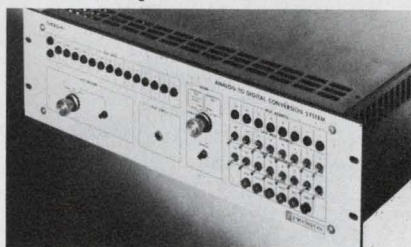

Preston Scientific, 805 E. Cerritos Ave., Anaheim, Calif. 92805. (714) 776-6400. 14-bit version: \$1200.

Model GMAD-4 a/d converter features a conversion time of 20 μs—equivalent to a conversion rate of 50 kHz. The unit also provides a choice of operating resolutions, accuracies and number of input channels, plus digital input and output signals for versatile system interfacing. The GMAD-4 is standard in three resolutions and accuracies: 14 binary bits plus sign, for 0.01% accuracy; 11 binary bits plus sign, for 0.05% accuracy; nine binary bits plus sign, for 0.1% accuracy.

CHECK NO. 395

NEW SHORTER CASE! SCHAUER 1-WATT ZENERS

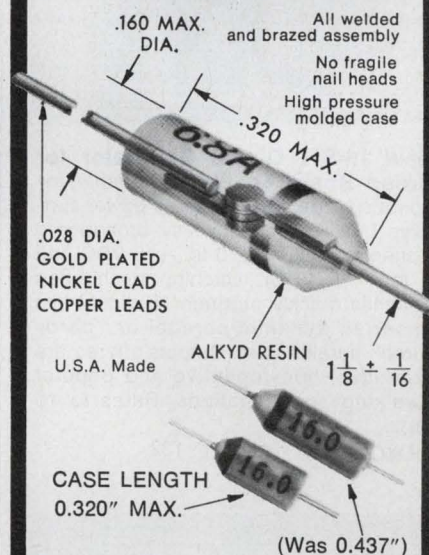

SAME LOW PRICES FOR 1% TOLERANCE ZENERS

ANY VOLTAGE FROM 2.0 TO 18.0

Quantity	Price Each
1-99	\$1.07
100-499	.97
500-999	.91
1000-4999	.86
5000 up	.82

IMMEDIATE SHIPMENT

Send for rating data and 20%, 10%, 5% and 2% tolerance prices.

Semiconductor Division

SCHAUER

MANUFACTURING CORP.

4511 Alpine Ave., Cincinnati, Ohio 45242
Telephone 513/791-3030

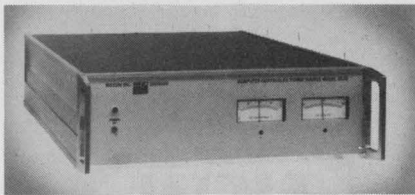

New Computer Compatible, Programmable DC Power Source. Automatic systems use. Output 100V @ 0.5A or 50V @ 1A. 16-bit binary or 8-4-2-1 BCD. Hi speed — over 10 kHz. Noise and ripple 800 uv p-p max. Load transient recovery 30 μ sec. Data circuit interface selection, programmable current limiting. Hi AC/DC isolation w/guard shield. Data line isolation. MOXON, SRC DIV. CIRCLE 121



New 16-BIT Digital Generator for Bread-Board Testing — Simple-to-operate Model 901 has three power supplies built-in for fast, easy breadboard testing (0 to 7 VDC, 0 to +15 VDC and 0 to -15 VDC). Latching pushbutton switches quickly program 16 digital bits in serial, dynamic parallel or "hard-wired" parallel form. Outputs offered are repetitive, non-repetitive and popular "walking" combinations. Rates to 15 MHz. MOXON/SRC CIRCLE 122



New Time Code Translator/Generator — Precision unit provides *simultaneous* and *independent* generation and translation of any time code format. All modular plug-in design and wire-wrap interconnection eliminates "mother boards" for easier maintenance and field modification. Seven-segment gas discharge displays present outstanding readability. Days, pulse rate and parallel outputs are standard. MOXON/SRC CIRCLE 123



Moxon Inc/SRC Division
2222 Michelson Drive
Irvine, California 92664
Phone: (714) 833-2000

COMPONENTS

Three position switch locks to prevent errors

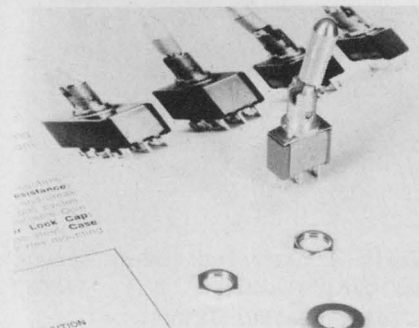

C & K Components, 103 Morse St., Watertown, Mass. 02172. (617) 926-0800. \$0.80 (100-499).

C & K's subminiature, locking lever switches have lock-slots milled into the tops of their bushings that serve to lock the lever into any one of three positions. To move the switch from one position to another, it is necessary to pull on the lever. This feature prevents accidental switching. The switch is available in over thirty configurations of one to four poles. The switches are UL approved.

CHECK NO. 396

UL approved relay latches mechanically

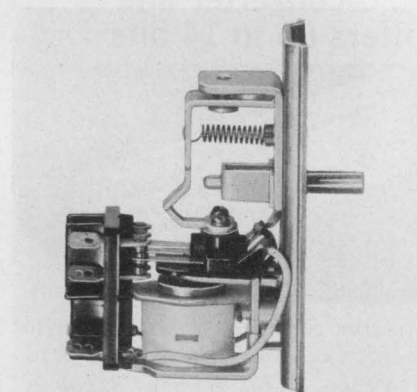

Liberty Controls, 500 Brookforest Dr., Shorewood, Ill. 60431. (312) 242-2409.

An electrical pulse to this UL-approved relay will set and mechanically hold it in the operated position. The relay is manually reset by a button on the front of the unit. Other features include: combination quick-connect and solder lugs or PC terminals, 5 or 10-A contacts, and coils from 5 to 110-V dc or 6 to 230-V ac. Contacts come in single, double and three-pole arrangements.

CHECK NO. 397

Rotary position Xformer is linear to 18 seconds

Pickering & Co., 101 Sunnysvale Blvd., Plainview, L.I., N.Y. 11803. (516) 681-0200.

Pickering's rotary differential transformer can be calibrated over a displacement range from 0 to 10 up to 0 to 70 degrees. Maximum nonlinearity in the 0 to 10 degree range is 18 seconds. Model 23501 comes with bearings and Model 20600 without bearings. Some of the features are: a stepless output, a very-low null voltage and wide range of excitation frequencies (400 Hz to 20,000 Hz).

CHECK NO. 398

Hall-effect IC switches at 100,000 times per s

Micro Switch, 11 W. Spring St., Freeport, Ill. 61032. (815) 232-1122.

The 6SS switch has a Hall sensor, trigger and amplifier on a single silicon chip. The switch is magnetically operated and operates over a temperature range of -55 to +125 C. The switch can function at speeds up to 100,000 operations/s. Each output of the 6SS switch can sink 4 mA with a maximum output voltage of 0.4 V. The switch accepts supply voltages of 9 V dc (continuous) and 10 V dc (pulsed). Its maximum allowable load voltage is 10 V dc at 10 mA. There is no limit to the magnetic flux that the circuitry can endure. Typical rise time is 0.1 μ s and fall time is 0.2 μ s.

CHECK NO. 399

GaP LED improves efficiency 3 to 5 times

Xciton Corp., 5 Hemlock St., Latham, N. Y. 12110. (518) 783-7726. \$0.69 (1000 up); stock.

Xciton GaP LED lamps offer three to five times the efficiency of equivalent GaAsP devices (Monsanto MV5020 or Litronix RL-2). The XC524 has typical brightness of 5 mcd at 10 mA. The GaAsP equivalents offer only 1.5 mcd at 20 mA as typical values for similar lens configurations. The higher efficiency can reduce power consumption up to 80%. The devices are directly compatible with TTL and MOS logic.

CHECK NO. 400

Two switches mount on a single shaft

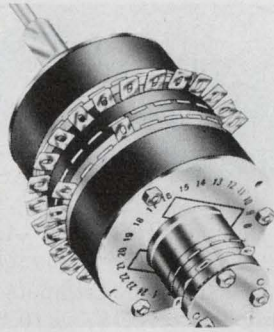

RCL Electronics, 700 S. 21st St., Irvington, N.J. 07111. (201) 374-3311.

Two miniature rotary switches piggybacked onto concentric shafts can save substantial panel space. The unit combines a 1-3/8-in. D switch that has 12 or 24 positions with a 1/2-in. D switch of 6, 10 or 12 positions. The larger diameter switch can accommodate up to 20 decks. The smaller switch can hold up to 12 decks. Many combinations of numbers of poles and types of contacts are available.

CHECK NO. 401

Solid-state relay output switches at zero points

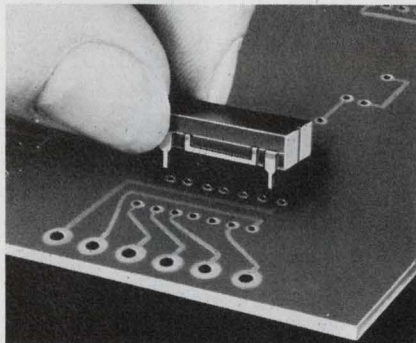

Grigsby-Barton, 3800 Industrial Dr., Rolling Meadows, Ill. 60008. (312) 392-5900.

The Synchro-DIP is a spst ac solid-state relay mounted in a modified TO-116, four-lead DIP plastic package. It provides direct load drive and operates directly off an ac line. Input control terminals are LED coupled from the output load terminals and are TTL compatible. The output switches with an integral number of half cycles and at voltages to 240 V ac. The LED-coupled input is rated for 2 to 32 V dc, and the maximum output is 400 V ac at 500 mA.

CHECK NO. 402

Optocoupler packaged in chip size for hybrids

Spectronics, Inc., 830 E. Arapaho Rd., Richardson, Tex. 75080. (214) 234-4271. \$5.50: SPX-1003 (1000 up); 30 days.

A new series of miniature optocouplers for isolation applications in hybrid packages are only about 1/16 in. square. Each contains a LED and sensor in one package. They may be mounted directly to a substrate. The sensor can be a photodiode (SPX-0003), a silicon npn phototransistor (SPX-1003) or a silicon photo-Darlington (SPX-2003).

CHECK NO. 403

Nine-digit display has seven-segment gas units

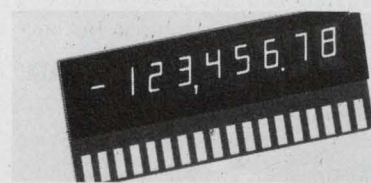

Sperry, P.O. Box 3579, Scottsdale, Ariz. 85257. (602) 947-8371. \$15.70 (100 up); samples from stock.

Sperry's Model SP-425-09 nine-digit display, with a character height of 1/4 in., is designed for multiplex operation, and it interfaces directly with MOS/LSI circuits. The numeric panel is a planar neon gas-discharge device. Though Sperry considers the handheld desk calculator to be the primary market, the units lend themselves to many other applications. The display is only 2.89 x 0.769 x 1.24 in. These dimensions include the standard edge board-connection contacts. A decimal-point and comma are provided with each digit. The natural color of the characters is orange, but red is available with filters. Each digit is formed from seven segments. All cathodes (segments) are internally bussed, thus only nine cathode connections are required: one for each segment, plus the decimal point and the comma. A separate anode connection is provided for each digit position. Characters are displayed by successively applying a positive signal to the anodes corresponding to each character position. At the same time, current is drawn from the appropriate cathode buss.

CHECK NO. 404

DOUBLE-BALANCED MIXERS

Great Value at

\$7.95
500 piece quantities.

\$9.95 in 6-piece quantities.

DC-500MHz
6dB conversion loss
40dB isolation
EMI shielded case

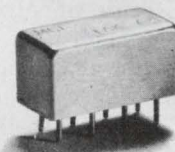

A breakthrough in technology and high production volume enables Mini-Circuits Laboratory to offer these new products at an unprecedented low price.

In today's tough competitive market can you afford not to use these remarkably low priced and high performance units?

Ruggedness and durability are built in the SRA-1. These new units are packaged within an EMI shielded metal enclosure and hermetically sealed header. They use well matched hot-carrier diodes and uniquely designed transmission line transformers.

We invite you to convince yourself. Place your order now and check our delivery, product performance and reliability.

Mini-Circuits Laboratory

2913 Quentin Rd., Brooklyn, N.Y. 11229
(212) 252-5252, Int'l Telex 620156
A Division Scientific Components Corp.

FRANCE: S.C.I.E., *31, rue George-Sand, Palaiseau 91, France. GERMANY, AUSTRIA, SWITZERLAND: Industrial Electronics GmbH, *Klüberstrasse 14, 6000 Frankfurt/Main, Germany *UNITS IN STOCK

ENGLAND: Dale Electronics: Dale House, Wharf Road, Frimley Green, Camberley, Surrey. JAPAN: Denisho Kaisha, Ltd.: Eguchi Building, 8-1, 1-Chrome, Hamamatsucho, Minato-Ku, Tokyo. SPAIN: Suministros Electricos: Maldonado, Fernando el Catolico 63, Madrid, Spain. ISRAEL: Hamashbir Electronics, 76 Giborei Israel St., Tel-Aviv, Israel. *UNIT IN STOCK.

INFORMATION RETRIEVAL NUMBER 95

Tiny Xformer responds ± 3 dB to 250 kHz

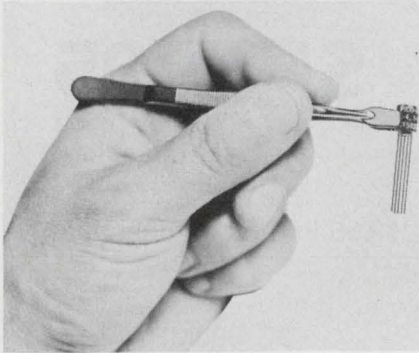

Pico Electronics, 316 W. First St., Mount Vernon, N.Y. 10550. (914) 699-5514. Stock to 1 wk.

Pico's F series of ultra-miniature audio transformers measure only $1/4 \times 1/4$ in. Primary and secondary impedance range from 5 to 30 k Ω . The response is ± 3 dB from 400 Hz to 250 kHz; the units can handle 100 mW at 1 kHz and they conform to MIL-T-27. Also inductors to 10 H come in the same size package. The units can take thermal shock in accordance with MIL-STD-202D.

CHECK NO. 405

DIP audio-alarm unit provides 80-dB sound

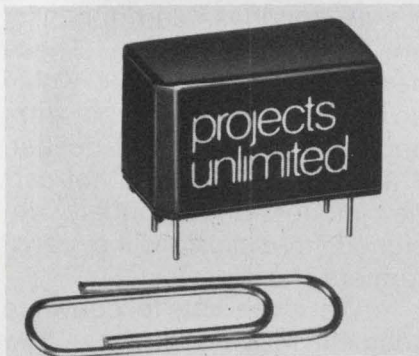

Projects Unlimited, 3680 Wyse Rd., Dayton, Ohio 45414. (513) 890-1918.

Dip-Alarm, a solid-state audio indicator, plugs into a standard 16-pin DIP socket or PC board on 0.3×0.7 in. centers. These units contain no moving contacts, thus eliminating problems of arcing, electrical interference and rf noise. Sound output is 80 dB in the range of 400 Hz. Units come in a range from 1.5 to 15 V dc and operate at -55 to 55 C. They weigh slightly under 8 g.

CHECK NO. 406

Rotary switch handles 10 A with extra contact

Janco, 311 Winona Ave., Burbank, Calif. 91503. (213) 845-7473.

A small rotary selector switch, which is totally enclosed and explosion proof, is now available with an auxiliary snap-action switch affixed to the back. This arrangement enables the user to interrupt and carry 10 A with no danger to the small rotary switch, and at less cost than an equivalent power switch. To rotate from one position to another, the user must push the knob. This allows the auxiliary snap-action switch to break the circuit. Once the desired position is reached, the auxiliary switch closes to safely allow the current through the selected rotary-switch contact.

CHECK NO. 407

Temperature probe can withstand 1400 F

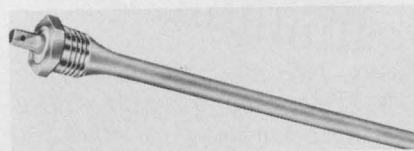

RCL Inc., 700 S. 21 St., Irvington, N.J. 07111. (201) 374-3311.

The high-temperature probe has a maximum operating temperature of 1400 F. It is available in many variations of length, diameter and mounting flanges. The probe can withstand high altitudes in addition to the high temperature tolerance.

CHECK NO. 408

Isolation transformers provide low leakage

Elcor, 2431 Linden Lane, P.O. Box 986, Silver Spring, Md. 20910. (301) 589-6614.

Option-H Isoformers are a new series of isolation power transformers designed specifically for medical and other low-leakage applications. A large air-gap between the secondary winding and the core reduces interwinding capacitance and the possibility of primary-to-secondary shorts. Leakage currents as low as 3 to 5 μ A are typical in the kVA range. Ratings range from 40 VA to 6 kVA. These transformers exceed the requirements of UL 544 and the AAMI safe-current-limit standard.

CHECK NO. 409

Trimmer pots are front-panel mountable



Weston Components Div., Archbald, Pa. 18403. (717) 876-1500.

The 523 series of trim pots requires only $0.5 \times 0.187 \times 0.1$ in. of behind-panel space and as many as 25 trimmers can be mounted on a one-inch-square panel. A printed-circuit mounting line (522 series) with similar specifications is also offered. Standard resistance values of 10 Ω to 1 M Ω are available. The potentiometers have an operating temperature range of -55 C to $+150$ C, essentially infinite resolution and temperature coefficients of ± 100 ppm/ $^{\circ}$ C.

CHECK NO. 410

Incandescent lamp has 25,000 hr life

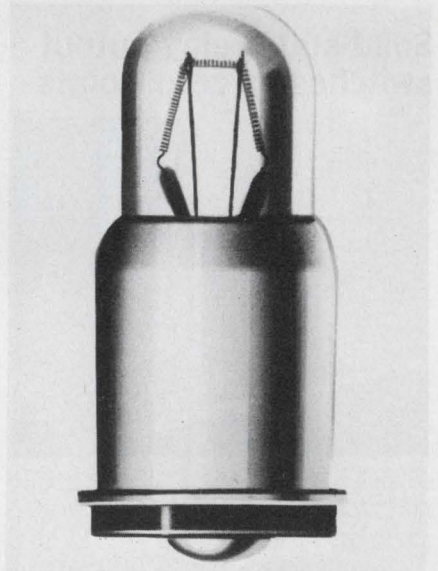

Industrial Electronic Engineers, Inc., 7720 Lemona Ave., Van Nuys, Calif. 91405. (213) 787-0311. \$0.25 (1000 up); stock.

The H540, an incandescent, sub-miniature lamp, operates on 40 mA at 5 V. This makes it suitable for direct drive by many TTL buffer gates. The lamp has an average life of 25,000 hr and a brilliance of 0.03 cp. The bulb size is T 1-3/4, and it is available in all the popular socket-base styles.

CHECK NO. 411

Solid-state rectifiers replace tube types

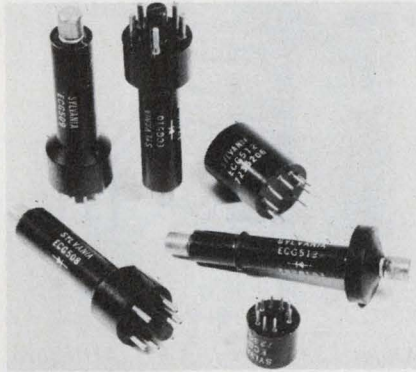

GTE Sylvania Inc., 730 3rd Ave., New York, N.Y. 10017. (212) 551-1000.

GTE's ECG series of solid-state rectifiers directly replace electron tubes in television application. Types ECG508/R-3A3, ECG509/R-3AT2, and ECG510/R-3DB3 are high-voltage rectifiers. ECG511/R-2AV2 is a focus rectifier; ECG512/R-DW4 is a damper diode, and ECG513 is a 45-kV stick rectifier. The devices are packaged individually with a data sheet giving mechanical and electrical ratings and a list of tube types they replace.

CHECK NO. 412

Convert any meter to relay operation

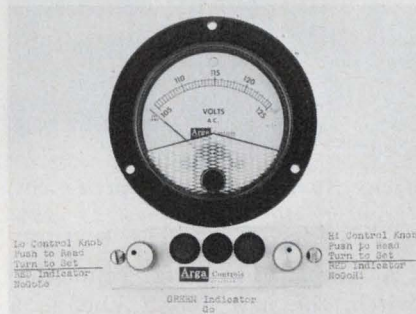

Arga Controls, 35 E. Glenarm, Pasadena, Calif. 91105. (213) 682-3314. \$75 to \$150.

Arga's new meter-relay converter permits any meter to be used as a meter relay. To change the limit, you rotate the control knob. To set the limit, you push the control knob. The converter is a completely solid-state device. There are no contacts or contact arms on the meter, and the meter needle is free to move anywhere on the scale. The output relay can handle 5 A at 120 V. Single-limit and dual-limit types are available.

CHECK NO. 413

WRITE or PHONE TODAY FOR THIS FREE ILLUSTRATED CIRCUIT DESIGN CATALOG!



Here, in one idea-crammed catalog, are countless low-cost breadboard design pointers and test equipment that let you design, build, layout and test any combination of i.c. and discrete components without soldering and in complete safety. Plus, you'll find tremendous savings on many hard-to-find semiconductor components. Catalog includes . . .

- Inexpensive Circuit Design Testers
- Plug-In Socket Boards
- Logic Tester Probes
- Breadboard/Sockets
- Breadboarding Systems
- Sophisticated Circuit Design/Interface Test Systems
- Power Supplies
- Pulse Generators
- Plus many, many more

Write or phone for your copy today! It's absolutely FREE!



EL INSTRUMENTS, INCORPORATED

61 First Street/Derby, CT 06418 • phone 203/735-8774

INFORMATION RETRIEVAL NUMBER 96

DIP REED RELAYS

Available in all standard configurations
From distributor stock

Elec-Trol's totally encapsulated DIP REED RELAYS can be driven directly by TTL logic. Available in 1 and 2 Pole Form A, 1 Form B, 1 Form C with 5 through 24 VDC standard coil voltages. Contact ratings up to 10 watts. Available in .225" and .275" heights. Clamping diode and electrostatic shielding optional.

Phone, wire or write.

ELEC-TROL, INC.

26477 N. Golden Valley Road
Saugus, California 91350
(213) 788-7292
TWX 910-336-1556



1973-74
eem
VOL. TWO

INFORMATION RETRIEVAL NUMBER 97

Solid-state beeper gives 85 ±5 dB of sound

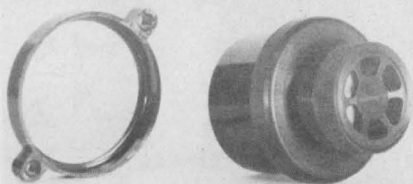

C. A. Briggs, P.O. Box 151, Glenside, Pa. 19038 (215) 885-2244.

The model 10-24 two-tone beeper is an audible signalling device that uses a sound transducer with a "piggy-back" mounted solid-state audible signal generation module. This provides a choice of two audible signals—either a continuous note or a pulsed sound. The base signal is either 1 kHz or 3 kHz, and contains approximately 30% harmonic content. The sound pressure level created is 85 ±5 dB at 1 m distance. The model 10-24 operates over the range of 10 to 24 V dc and draws a current of 30 mA at 12 V dc.

CHECK NO. 414

Kelvin probe aligns in one step

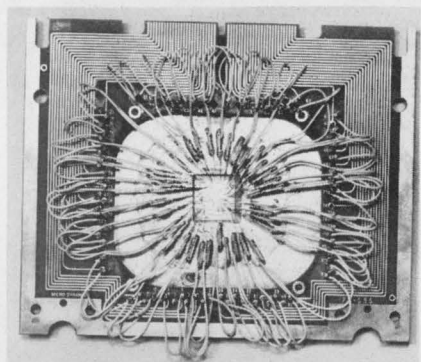

Microdynamics, 9855 Dupree, South El Monte, Calif. 91733. (213) 579-1166. 3 wks.

Each of these true Kelvin contacts, for use in probing thin and thick-film parts and hybrid circuits, are made of two, hardened beryllium-copper and gold-plated blades. The 3-mil thick blades are separated by 1/2-mil of dielectric. Kelvin contacts are desirable when testing low-resistance circuits. This new probe eliminates the need for two separate probe and alignment operations. It is especially useful in the laser trimming of resistors.

CHECK NO. 415

4 PDT, PC switch provides BCD outputs

AMP Inc., Harrisburg, Pa. 17105. (717) 564-0101.

The AMP hexadecimal switch is housed in a 16-pin DIP for PC board mounting and it has four cam-operated, form-C switches. The 16 cam positions are binary encoded and the output is in BCD and its complement. A slot in the end of the switch housing provides screwdriver access to rotate the cam. A minimum of 2 oz.-in. torque is required to overcome the switch-position detent. The gold-plated, phosphor-bronze contacts have a resistance of less than 50 mΩ, and with a 100-mA resistive load, the contacts are rated at 28 V dc and have a life of 2000 cam rotations.

CHECK NO. 416

Speed changer switches speed on the fly

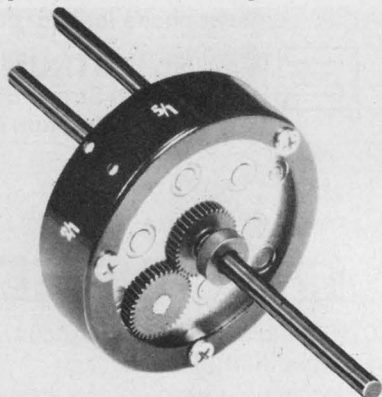

Inscorp., Main St., Groton, Mass. 01450. (617) 448-6369.

The Inscorp Model 06750 speed changer is a low-cost (price not given), six-speed transmission intended for instrument applications. Output speed is changed by grasping the rotary turret between thumb and forefinger, moving it approximately 1/8 in. away from the output shaft, and then turning it to the desired ratio printed on the cover of the turret. An optional assembly provides a panel-mounted pull-and-turn knob. Either way, it is unnecessary to stop the motor to change speed. The units require only 2-1/2 × 1-1/2 in. space. They feature AGMA No. 9 instrument-quality steel gears and are rated at 25 oz.-in. of torque at 1800 rpm. Four different combinations of reduction ratios are available.

CHECK NO. 417

Socket holds LEDs for easy viewing

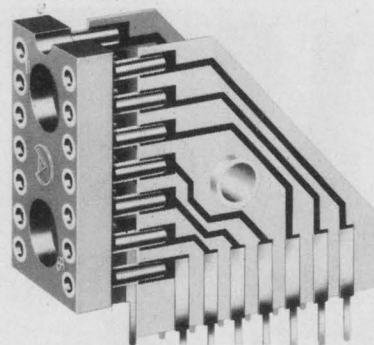

Augat, 33 Perry Ave., Attleboro, Mass. 02703. (617) 222-2202.

Augat's vertical-mount, LED, numeric-display socket accepts 14 and 16-pin packages with flat leads or round 0.016 to 0.021-in. D leads. LEDs can be mounted at 45, 60 and 90 degree angles and the sockets may be ganged with 0.4 in. spacing between centers. The socket material is a glass-filled nylon. Contacts are made of beryllium-copper and plated with gold over nickel. The sleeves are tin-plated brass.

CHECK NO. 418

Hall-effect switch has 0.5 μs rise and fall time

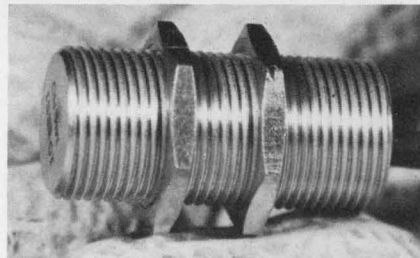

Micro Switch, 11 W. Spring St., Freeport, Ill. 61032. (815) 232-1122. \$4 (OEM qty).

A threaded-bushing solid-state switch, the new 103SS line, is a Hall-effect chip encased in an inch-long package that is moisture and shock resistant. The 103SS also features a 1/16-in. operating gap. The IC chip has been life tested to over four-billion operations. The switch is not rate sensitive and can operate up to 100,000-times per second. Ratings for the switch include: a continuous 9-V-dc supply or 10 V dc when pulsed, an output load of 10 mA, an output voltage of 0.4 V, switching rise and fall times of 0.5 ms and an operating temperature range of -55 to +105 C.

CHECK NO. 419

application notes

Choosing a DVM

A 68-page application note, "Selecting the Right DVM," helps the user match his application with the capabilities of various DVMs. The booklet starts with a discussion of the fundamental building blocks that make up the typical DVM. A/d conversion techniques, noise rejection, signal conditioners and converters and sample-and-hold are discussed. A section is devoted to systems operation; another section tells how to interpret the more difficult to understand specifications. Six sections in the appendix include self-test questions and answers, and basic tutorial information such as guarding and effects of distortion on average and peak reading meters. Hewlett-Packard Co., Palo Alto, Calif.

CHECK NO. 420

Sound systems

"Sound Systems" offers basic data for the design of sound reinforcement systems. Path of signal is traced from the source through components in systems that range from elementary to complex. Flow diagrams are shown in the eight-page brochure as well as tables and a checklist. Dukane Corp., St. Charles, Ill.

CHECK NO. 421

Microwave oscillators

"High-Power Transistor Microwave Oscillators" describe a simplified approach to the design of transistor microwave power oscillators. RCA Solid State Div., Somerville, N.J.

CHECK NO. 422

Neon-lamp switches

The design of a television receiver horizontal-oscillator drive circuit using a neon lamp for switching is the feature article in *Signalite Application News*. Signalite, Neptune, N.J.

CHECK NO. 423

High-voltage power supplies

A 16-page bulletin, "Standard Test Procedures for High-Voltage Power Supplies," describes loading methods for both constant and changing load; test setups and procedures for voltage calibration; and test setups and methods for both static and dynamic output-voltage regulation. The bulletin contains instructions for checking output-current regulation, ripple, temperature coefficient and stability. Spellman High Voltage Electronics Corp., Bronx, N.Y.

CHECK NO. 424

Lamp reliability study

Results of laboratory tests studying the relative reliability of 327 and 387 subminiature incandescent lamps are detailed in a 22-page report. The study is constructed in two major parts—a series of five comparative tests between the company and other manufacturers and a series of noncomparative tests performed only on the company's lamps. Chicago Miniature Lamp Works, Chicago, Ill.

CHECK NO. 425

OUR CLAIM TO FAME... TRIMLINE ENCLOSURES

- RUGGED—FUNCTIONAL CONSTRUCTION ■ ESTHETICS KEYED TO MODERN SYSTEMS
- PROMPT SERVICE & AVAILABILITY ■ ECONOMICAL PRICING





Assorted rear panel accessory options

1. Side Hinged Door Panel (SHP Series)
 2. Formed Panel (FP Series)
 3. Perforated Formed Panel, 1/16" dia. holes on 1/4" staggered centers (PFP Series)
 4. Formed Louvred Panel (FPL Series)
- Standard 1/4" & 3/16" flat panels also available (ARP, MAP, RP Series)

TIC Series Construction Details (front and rear identical)

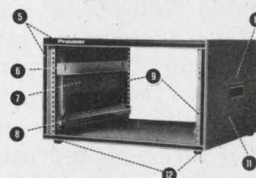
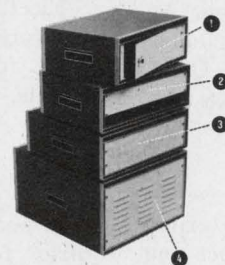
5. Trim: Extruded, anodized aluminum with black vinyl inlay
 6. Chassis/Shelf Support (accessory)
 7. Welded stiffener channel and hand grip support
 8. Full extension slides with mounting hardware (accessory)
 9. Recessed panel mounting channels and structural supports (4 per case) Standard EIA & WE hole spacing provide for frontal mounting and internal equipment mounting. Hardware supplied
 10. Carrying Grip with vinyl inlay
 11. Case Body, welded, formed steel (20 ga.) with welded 16 ga. channel gusseting and channel stiffeners
 12. Non-marring feet
- Standard Finishes: Textured Vinyls, 13 colors
Semi-gloss Enamels, 10 colors



 Complete catalog and prices on request . . .

PREMIER METAL PRODUCTS COMPANY
337 Manida Street, Bronx, New York 10474 (212) 991-6600

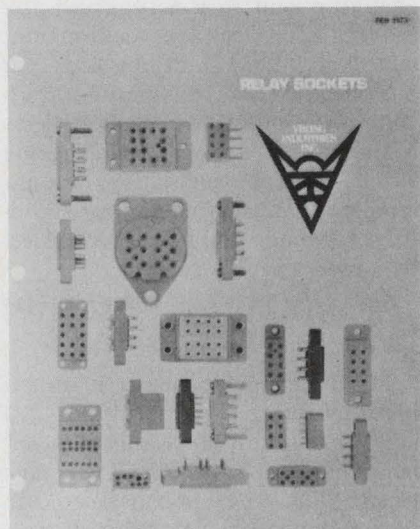

Relay sockets

Relay socket connectors and related hardware are described in a catalog. Viking Industries, Inc., Chatsworth, Calif.

CHECK NO. 426

Transformers

The Scott-T series of instrument transformers designed for bridging, isolation and calibration applications is described in a four-page bulletin. Singer Instrumentation, Los Angeles, Calif.

CHECK NO. 427

Plotter-user newsletter

The first issue of *PLOTTER* includes a discussion of numerical control applications, how to convert existing programs for plotting, and a simple program in the company's BASIC for computer drawing. Future issues will contain plotter applications, programs and new product information. An enrollment application is included. Hewlett Packard, Palo Alto, Calif.

CHECK NO. 428

I/O connectors

A guide features several series of precision-engineered wrap/crimp I/O connectors, socket contact and IC headers. Descriptions, specifications and drawings are given for the RGR series of hi-density grid-spaced crimp removable connectors. U.S. Components, Bronx, N.Y.

CHECK NO. 429

Filters

B-series, K-series and EMI/RFI filters are described in a 12-page catalog. Performance curves, specifications, drawings and prices are included. Corcom, Chicago, Ill.

CHECK NO. 430

Small-size blowers

Blowers that comply with OSHA noise requirements are featured in an eight-page brochure. Paxton Products, Santa Monica, Calif.

CHECK NO. 431

Photomultiplier tubes

Photomultiplier tubes for applications ranging from space exploration and oil-well logging to laser communications are described in an eight-page catalog. A listing of the tube characteristics is reproduced in tabular form. Two performance curves show typical quantum efficiency vs wavelength for six common photocathode materials and equivalent noise input vs wavelength for five devices. Varian LSE, Palo Alto, Calif.

CHECK NO. 432

CRT terminals

A four-page, two-color short-form catalog describes 15 standard series-200 CRT-display controllers and 69 optional configurations, plus free-standing keyboards and video monitors. Ann Arbor Terminals, Ann Arbor, Mich.

CHECK NO. 433

Electronic cabinets

Electronic cabinets, consoles and enclosures are illustrated in a six-page, four-color brochure. System Metals, Chatsworth, Calif.

CHECK NO. 434

Power supplies

A six-page foldout catalog features four standard off-the-shelf dc supplies—rack-mounted CVDC, open frame series-regulated, premium IC regulated and constant-voltage supply. Sola Electric, Elk Grove Village, Ill.

CHECK NO. 435

Lightweight wire

A series of military-wire specification sheets features lightweight, high-performance wire, insulated with the company's Tefzel ETFE fluoropolymer. Du Pont, Wilmington, Del.

CHECK NO. 436

Quartz-crystal oscillators

Technical characteristics and typical specifications plus dimensional data for TO-5 and flat-pack devices are outlined in a four-page quartz-crystal and crystal-oscillator brochure. The brochure provides graphs, schematics and formulas, and it describes typical parameters at various frequencies. Statek Corp., Orange, Calif.

CHECK NO. 437

Epoxy tubing

A bulletin covers industrial and electronic applications for centrifugally cast epoxy tubing. Resdel Corp., Rio Grande, N.J.

CHECK NO. 438

Packaging hardware

A short-form catalog illustrates socket cards, kit cards, socket panels, card files, sockets and strips, IC packaging drawers and wiring. Scanbe Manufacturing Corp., El Monte, Calif.

CHECK NO. 439

Cassette data logger

A 16-page brochure describes a battery-operated data-logging system. Electrical and mechanical specifications, performance and application data are listed. A cassette reader that allows the user to transcribe the digital data on the cassette to computer-compatible media is described. Datel Systems, Canton, Mass.

CHECK NO. 440

Solid-state buyers guide

Solid State Processing & Production Buyers Guide & Directory lists over 1000 companies and 10,000 company/product items. All references are direct; no coded symbols are used, thereby making the task of finding an item both simple and quick. The technical index offers an aid in providing leads to the listed materials, equipments and operations. Symcon Conferences, Inc., 14 Vanderventer Ave., Port Washington, N.Y.

Hybrid circuit soldering

A catalog describes techniques, processes and equipment related to bulk soldering of substrates in laboratory and in production quantities. Browne Corp., Santa Barbara, Calif.

CHECK NO. 441

Avionics racking hardware

A standard avionics racking catalog covers the Box-Mount line of black-box support equipment built in accordance with ARINC 404 specifications. The 40-page catalog includes drawings for Class A hard-tooled trays, connector plates, metering plates and rubber seals and accessories. Linear and metric measurements are listed and weights are in grams as well as pounds. Hollingsead-Pryor Enterprises, Santa Fe Springs, Calif.

CHECK NO. 442

Copper-clad laminates

Copper-clad laminates and prepreg materials are illustrated in an eight-page brochure. Tables provide thickness and shearing tolerance specs, characteristics and comparative data. Norplex Div., La Crosse, Wis.

CHECK NO. 443

Microwave switches

Microwave switches, limiters and attenuators designed for octave and multioctave-bandwidth use from 0.2 to 18 GHz are described in a 28-page catalog. Crown Microwave, Billerica, Mass.

CHECK NO. 444

Communication tubes

A price list covers more than 1900 types of klystrons, magnetrons, special-purpose tubes, CRTs, receiving tubes, vidicons, image orthicons, solid-state tube replacements and microwave diodes. JSH Electronics, Culver City, Calif.

CHECK NO. 445

Connectors

Photographs and descriptions are included in a four-color brochure that describes connectors, terminals and cables. For easy reference the product lines are broken down into nine separate categories. Malco, Chicago, Ill.

CHECK NO. 446

The Blow Hard. It's 10" in diameter, only 3½" in depth, yet produces a gale force of 575 cfm. We call it, "The Condor."

Now available in 9 new models, 50/60 Hz, 115 or 230 VAC versions. The Condor speaks softly, noise level just 49 db (SIL), but carries away loads of hot air. 575 cfm for intake or exhaust.

It's ideal for cooling and flushing in computers, relay racks, transmitter packages or wherever space-weight considerations are critical. Equipped with long-life stainless steel ball bearings.

Other airmovers? Of course!

Send for our full-line catalog No. ND4r. It's free, and contains performance data, electrical and mechanical specifications on more than 100 units.

And valuable application information too.

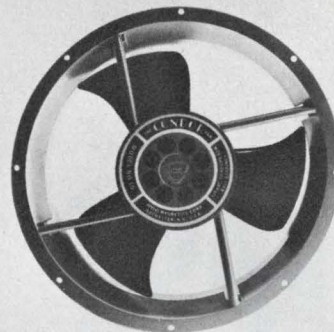

For immediate service, contact us at IMC Magnetics Corp., New Hampshire Division, Route 16B, Rochester, N.H. 03867, tel. 603-332-5300. Or the IMC stocking distributor in your area. There are more than 50 nationwide and overseas.



INFORMATION RETRIEVAL NUMBER 99

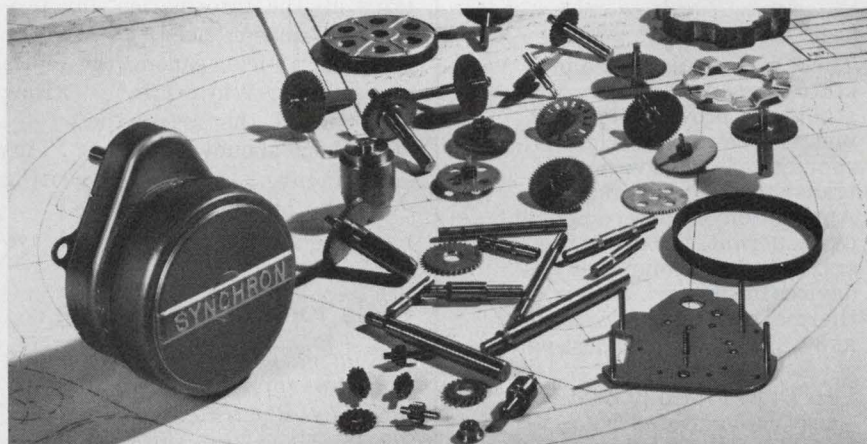

Synchron[®]. Your own personal timing motor.

Every Hansen synchronous timing motor is built for a designer like you. To specific requirements, with our confidential help.

We have several thousand models designed, tooled, and ready-to-build in any quantity. In five major styles.

Many speeds. Torque from 8 to 98 oz.-in. at 1 rpm. All competitively priced.

Add Hansen to your design staff. Call or write for complete specs, or contact one of our representatives below.

MALLORY



HANSEN MANUFACTURING CO.
a division of P. R. MALLORY & CO. INC.
Princeton, Indiana 47670

Hansen Representatives: Carey & Associates, Houston and Dallas, Texas; R. S. Hopkins Co., Sherman Oaks, Calif.; Melchior Associates, Inc., San Carlos, Calif.; The Fromm Co., River Forest, Ill.; John Orr Associates, Grand Rapids, Mich.; H. C. Johnson Agency, Inc., Rochester, N.Y.; Winslow Electric Co., Essex, Conn.; Kiley Electric Co., Villanova, Pa.; and Herbert Rude Associates, Inc., Teaneck, N.J.



INFORMATION RETRIEVAL NUMBER 100

5 Remarkable Little Ovens from Texas Instruments, \$15.

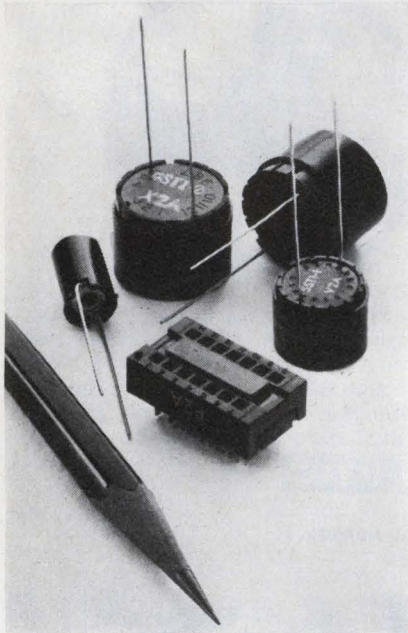

These self-regulating solid-state component temperature stabilizers provide a low cost means of controlling the environment of a wide variety of transistors, diodes, and ICs. Application of these component ovens permits the use of less expensive semiconductor devices by improving their thermal characteristics as much as 30:1. See how much less you get for your money.

Less Bulk. Typically 1/10th the size of conventional ovens.

Less Headaches. Solid state ovens have no moving parts—are more reliable—aren't handicapped by a limited cycle life.

Less RFI. In fact, there's no RFI since the ovens eliminate the need for thermostats and SCR's which create undesirable radio frequency interference.

Less Money. Costs \$3 to \$5 instead of the \$5 to \$250 you're paying now.

Send \$15 for your 5-piece Oven Sampler to Commercial Controls Marketing, MS 12-33, Attleboro, Mass. 02703. Or write for the literature.

TEXAS INSTRUMENTS
INCORPORATED

INFORMATION RETRIEVAL NUMBER 101

NEW LITERATURE

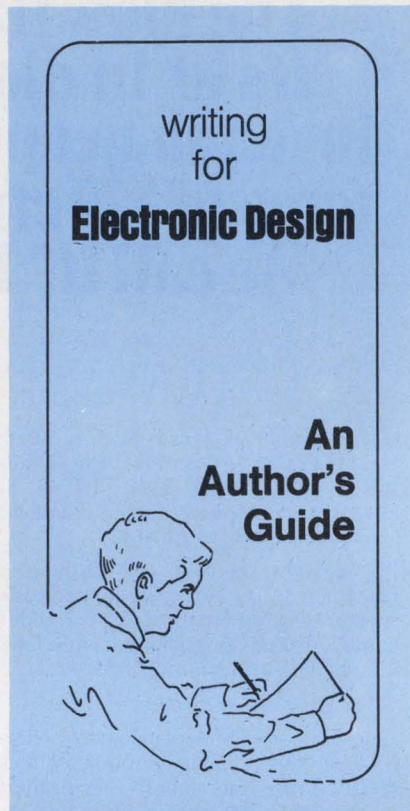

Interested in writing?

"How to Write for Electronic Design—An Author's Guide," contains all the information any prospective author needs to write a technical article. Among the topics covered are: Why write? . . . How long should the article be? . . . What form should it take? . . . Tips on structure . . . Tips on writing . . . Tips on getting it done.

CHECK NO. 190

Tools for wrapped wiring

Manual devices for wrapping and unwrapping of wire terminations are illustrated in a catalog. Specifications are presented on hand wrapping and unwrapping tools, manual wrapping and unwrapping guns and accessories and wrap and unwrap tool kits. Jonard Industries, Bronx, N.Y.

CHECK NO. 191

Evaporation sources

"Vacuum Evaporation Sources," a 24-page brochure, features evaporation sources including evaporation filaments and boats. Materials Research Corp., Orangeburg, N.Y.

CHECK NO. 192

Cable/connector systems

An illustrated, 20-page, four-color design guide details several connector formats, including PCB card-edge, socket, DIP and Scotchflex circuit card headers. Typical properties, dimensions and mounting instructions are given. Performance in vibration and thermal environments (including test summaries), zip cable and daisy-chain applications, and assembly accessories are included as well as a guide to selecting flat cable. 3M Co., St. Paul, Minn.

CHECK NO. 193

ANSI standards

The American National Standards Institute offers a 162-page catalog which lists titles and prices of standards as well as recommendations of the ISO (International Organization for Standardization), IEC (International Electrotechnical Commission) and COPANT (Pan American Standards Commission). Information on how to purchase standards and abbreviations and legends are included. American National Standards Institute, New York, N.Y.

CHECK NO. 194

4-1/2-digit DMM

Performance characteristics, design features and specifications of the model 245, a 4-1/2-digit, portable digital multimeter, are presented in an eight-page brochure. Data Precision, Wakefield, Mass.

CHECK NO. 195

Data communications

Data-communications products, including Bell-compatible data sets, high-speed spectrum shift modems, time-division multiplexers and error-rate test sets, are featured in a short-form catalog. Syntech Corp., Rockville, Md.

CHECK NO. 196

Motor reference data

Arranged for quick, easy reference, Bulletin MR101-R5 provides condensed data and specifications on miniature synchronous motors, stepper motors and accessories, dc and governed motors. Included are reversible synchronous motors and a dc instrument drive motor. North American Philips, Cheshire, Conn.

CHECK NO. 197

Rf microwave transistors

A short-form guide to rf and microwave power transistors presents summary specifications for high-performance transistors for military, microwave and land mobile applications, covering the frequency range of 1.6 MHz to 3 GHz. The guide covers power output from 1 W to 200 W. Communications Transistor Corp., San Carlos, Calif.

CHECK NO. 198

Pushbutton switches

Operation, specifications and pricing of illuminated and nonilluminated pushbutton switches are described in a data sheet. Engineering specifications, performance data, line drawings, photographs and a lens selection guide are featured. Oak Industries, Inc., Switch Div., Crystal Lake, Ill.

CHECK NO. 199

Batch processing

How to reduce the cost of computerized electronic circuit simulation through batch processing is the subject of two publications. Both brochures describe the use of the AEDCAP system on the nationwide time-sharing services of National CSS. Batch processing is recommended where interactive processing is not required and typically reduces costs by 60%. SofTech, Waltham, Mass.

CHECK NO. 200

Trimming instruments

The 73 series of instruments for resistor trimming control applications are described in a two-page bulletin. James G. Biddle Co., Plymouth Meeting, Pa.

CHECK NO. 201

Lasers and accessories

A handy reference source for laser selection, a 32-page catalog contains a line of helium-neon and cadmium lasers with outputs extending from ultraviolet and blue to red and infrared wavelengths. Also listed are laser power meters, solid-state power supplies, photometers, a counter timer and other accessories, as well as nuclear physics demonstration kits and holography kits. Metrologic Instruments, Bellmawr, N.J.

CHECK NO. 202

Resistors

A short-form Resistor catalog contains 5980 catalog items with 616 different resistance values (from 0.1 Ω to 250,000 Ω) and 15 wattage ratings (from 1 to 120 W). The eight-page catalog contains basic descriptions and physical sizes. Sprague Electric Co., North Adams, Mass.

CHECK NO. 203

Guide to cassettes

"The TDK Guide to Cassettes," a 48-page booklet, offers a short course in tape-recording terminology and technology, including an explanation of the various types of tape formats, their relative merits and applications. TDK Electronics, Long Island City, N.Y.

CHECK NO. 204

Solder selection guide

A six-page brochure describes and illustrates in full-color photographs typical soldering problems and the company's solders, fluxes and chemicals. All of the products are categorized and listed in tables for quick-reference, comparison and selection. Basic properties and application data are included. Multicore Solders, Westbury, N.Y.

CHECK NO. 205

Microwave instruments

Instruments, YIG-devices, ferrites, rotary joints, electromechanical switches and transmission line components are described in a 104-page catalog. Specifications for 250 instruments and components are given. Sivars Lab, Stockholm 42, Sweden.

CHECK NO. 206

Microcircuits

"The Microcircuit Designer's Handbook," a slick 28-pager, provides guidelines for converting discrete-component circuits into thick-film microcircuits. Applications, designing, production and product reliability are illustrated. An exhibit of Beckman's hybrid circuits, similar to those shown in this brochure, is entitled "Gold Through the Ages in Art in Industry" and is on display at the Metropolitan Museum of Art in New York City until July 4. Beckman Instruments, Fullerton, Calif.

CHECK NO. 167

**Need rotary switches?
2-million combinations,
72-hr. delivery
from your
Oak Moduline™ distributor.**

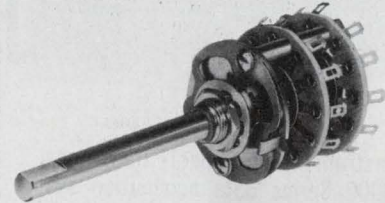

Quick-and-easy ordering of Oak-quality rotary switches in lots of 1 to 99. The Moduline system lets you specify switch components by number (no drawings needed). Your order is shipped within 3 days. Contact these Moduline distributors:

DRW

MASSACHUSETTS, Watertown. (617) 923-1900*
NEW YORK, Farmingdale..... (516) 249-2660*

HALL-MARK

ALABAMA, Huntsville..... (205) 539-0691
FLORIDA, Orlando..... (305) 855-4020*
GEORGIA, Atlanta..... (404) 963-9728
ILLINOIS, Chicago..... (312) 437-8800
KANSAS, Kansas City..... (913) 888-4747
KANSAS, Wichita..... (316) 682-2073
MARYLAND, Baltimore..... (301) 265-8500
MINNESOTA, Minneapolis... (612) 925-2944
MISSOURI, St. Louis..... (314) 521-3800
NORTH CAROLINA, Raleigh... (919) 832-4465
NEW YORK, New York..... (516) 293-7500
OHIO, Dayton..... (513) 278-6963
OKLAHOMA, Okla. City... Enterprise 50094
OKLAHOMA, Tulsa..... (918) 835-8458
PENNSYLVANIA, Philadelphia. (215) 355-7300
TEXAS, Austin..... (512) 454-4839
TEXAS, Dallas..... (214) 231-6111
TEXAS, Houston..... (713) 781-6100
WISCONSIN, Milwaukee..... (414) 476-1270

INDUSTRIAL COMPONENTS

MINNESOTA, Minneapolis... (612) 831-2666*

SOLID STATE

TEXAS, Dallas..... (214) 352-2601*
TEXAS, Houston..... (713) 785-5205

WEATHERFORD

CALIFORNIA, Glendale..... (213) 849-3451*
CALIFORNIA, Palo Alto..... (415) 493-5373

*Assembly Locations

OAK Industries Inc.
Crystal Lake, Illinois 60014

PHOENIX DATA'S NEW 6000 SERIES DATA ACQUISITION SYSTEMS

FEATURING . . .

- High Speed
- High Stability/°C
- Moderate Cost

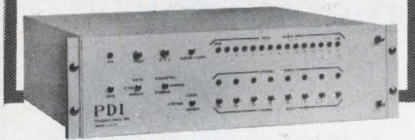

Phoenix Data's new 6000 Series

Instruments in Phoenix Data's new 6000 Series data acquisition systems can be matched exactly to the capabilities and characteristics of the control unit or data storage device. Three subgroups feature, respectively, high speed, high temperature stability, and moderate cost. All three offer resolution from 8 to 15 binary bits and will accommodate up to 256 inputs in a single chassis. These features combined with a single channel, random, and sequential address capabilities make the 6000 Series units adaptable to an almost endless variety of system applications.

6900 SERIES. Multiplexing rates to 1 MHz for an 8 bit, 400 KHz for a 12 bit, and 250 KHz for a 15 bit model. This system was designed primarily for applications where the analog input bandwidths are high.

6700 SERIES. Highest thermal stability with less than 0.001%FSR/°C or 10 PPM. This system was designed specifically for applications where wide temperature variations might be encountered and high accuracy must be maintained.

6400 SERIES. An attractive compromise between thruput rate, temperature stability, overall cost. Lowest priced, it offers moderate thruput rates, thermal stability and was designed for applications where cost is a major factor.

If it's stability, accuracy, speed, or all-around quality you need in Data Conversion, contact Phoenix Data now!



PHOENIX DATA, INC.

3384 W. OSBORN RD. PHOENIX, AZ 85017
Ph. (602) 278-8528, TWX 910-951-1364

INFORMATION RETRIEVAL NUMBER 103

bulletin board

Datapoint has announced the availability of **BASIC language on the Datapoint 2200** with the development of necessary software and documentation. The BASIC language is interactive with line-at-a-time entry for storage and/or immediate execution. It is a stand-alone system requiring only a 16-k Version II Datapoint 2200. Input can be entered via the keyboard or cassette tapes. Output can be routed to the screen, cassette tapes or to an optional printer.

CHECK NO. 207

Advanced Memory Systems has announced a series of **plug-compatible, solid-state memories** for DEC's PDP-11 digital computers, Model /15 and /20. The basic 4-k or 8-k × 16 or 18 bits (one or two memory boards, respectively) have an associated driver/control/power supply board, all incorporated into a fully compatible connector block to permit immediate plug-in and operation.

CHECK NO. 208

Texas Instruments has introduced a **solid-state motor starter** that can withstand heavy motor start-up current surges for millions of cycles and has proven immunity to power transients common in manufacturing plants. The devices are available for three-phase service up to 10 hp, 600 V ac, 60 Hz (reversing or nonreversing) or up to 45 A, 600 V ac in heater contactor configurations. Size is approximately equivalent to a NEMA size-1 general-purpose motor starter.

CHECK NO. 209

Lindberg, div. of Sola Basic has announced a **three-year warranty on the heating-element assemblies** used in all its diffusion process systems. Called Disposalcore, it is warranted for 12 months on a no-charge basis, and an additional 24 months, prorated over the three years.

CHECK NO. 210

IN-FORM, a software package that provides its 804 intelligent terminal with off-line data-capture capability to cassette, dynamic recall and extensive keyboard editing features plus remote batch communication, has been announced by Sanders Data Systems, Inc. The IN-FORM and the 804 terminal system has a monthly lease of \$401 to \$478, depending on lease agreement, and purchase price of \$12,780.

CHECK NO. 214

An option for **Redactor editing typewriters** to give them the capacity to index more "bits" of information has been announced by Redactron Corp. The option increases the number of reference codes from 99 to 899 and is priced at \$80.

CHECK NO. 215

OPCOA, Inc., has announced a low-cost **green LED numeric display and its complement**—the SLA-18, seven-segment numeric with decimal point, and the SLA-20, plus/minus one. Types SLA-18/20 are 7.50 (1-9, \$6.25 (10-99) and \$5.15 (100-999).

CHECK NO. 216

Hughes Aircraft Co. has augmented its line of **automatic test equipment** with digital fault analysis (DFA) software capability and is offering test systems with on-line fault diagnostics for use in circuit testing.

CHECK NO. 217

Microelectronics Div. of Rockwell International Corp. has introduced a **single circuit containing virtually all the mathematical functions of electronic calculators** requiring five or more circuits.

CHECK NO. 218

Panduit Corp. has announced that three new sizes (1 × 4 in., 3 × 5 in. and 4 × 5 in.—width × height) have been added to its line of **Panduct plastic wiring ducts**.

CHECK NO. 219

Danelcor, Inc., has developed a series of **solid-state components** designed as replacements for the vacuum tubes in the EAI 231R analog computer.

CHECK NO. 220

vendors report

Annual and interim reports can provide much more than financial-position information. They often include the first public disclosure of new products, new techniques and new directions of our vendors and customers. Further, they often contain superb analyses of segments of industry that a company serves.

Selected companies with recent reports are listed here with their main electronic products or services. For a copy, circle the indicated number.

North American Rockwell. Aerospace, avionics, monitoring and control systems, microelectronic components, calculators and LSI and MOS.

CHECK NO. 221

Diebold Venture Capital Corp. Computers and systems, DPMS, printer comparators, temperature sensors, peripheral equipment, software, read-only memories, systems measurement products and system design services, microwave communications systems and instrumentation and medical electronics.

CHECK NO. 222

Erie Technological Products, Inc. Capacitors, carbon products, piezoelectric devices, crystals, oscillators, filters, rectifiers, multipliers, power sources, resistors, potentiometers and test and medical instruments.

CHECK NO. 223

Hazeltine Corp. Video display computer terminals, computer peripherals, electronic color analyzers and processing systems, avionics, air-traffic control systems, displays, scan converters and office products.

CHECK NO. 224

Bunker Ramo Corp. Data processing, telecommunications, aerospace and connectors.

CHECK NO. 225

San Fernando Electric Manufacturing Co. Filters, ceramic capacitors, inductors and wound capacitors.

CHECK NO. 226

Visual Sciences, Inc. Facsimile equipment and transceivers.

CHECK NO. 227

Basic Inc. Power and interface devices for telephone systems, power sources, PC cards, subassemblies and precision ceramics.

CHECK NO. 228

Rosemount Inc. Air-data sensors and measuring instruments.

CHECK NO. 229

Astrosystems, Inc. Computer peripheral and conversion equipment, synchro/resolver instrumentation, automatic test equipment, encoders and switches.

CHECK NO. 230

Corning. Optical glass, lens systems, illumination products, resistors, ICs, CRTs, emission-control devices and instrumentation.

CHECK NO. 231

Xerox Corp. Integrated systems of copiers, duplicators and accessories, transceivers, Xeroradiography systems and microfiche equipment.

CHECK NO. 232

Union Carbide Corp. Chemicals and plastics, polyethylene, packaging films, batteries, carbon products, ferroalloys and purified gases and metals.

CHECK NO. 233

Hoffman Electronics Corp. Navigation products, minicomputers and audio-visual systems, solderless terminals and connectors, consumer antennas and closed-circuit TV systems.

CHECK NO. 237

Superior Electric. Motors and electronic drives, numerical control equipment, variable voltage transformers and automatic voltage regulators.

CHECK NO. 238

TRW Inc. Electronic and aerospace components, systems and services.

CHECK NO. 239

CTS Corp. Data processing, components and communications equipment.

CHECK NO. 240

Trio Laboratories, Inc. Power supplies.

CHECK NO. 317

POWER PROBLEMS? MONITOR/CONTROL YOUR AC/DC POWER

EQUIPMENT MAY BE USED TO OPERATE ALARMS OR DISCONNECT LOADS WHEN PRESET HI/LO IS EXCEEDED.

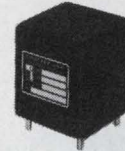

VOLTAGE MONITORS—
Available for single or three phase "WYE" or "Delta" systems. "RMS" type sensing or time delayed operation. All standard line voltages.

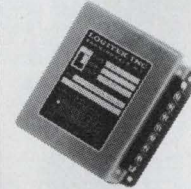

FREQUENCY MONITORS
—Standard units sense 50, 60, 400 Hz at all standard line voltages. Time delayed operation.

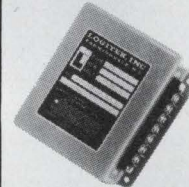

PHASE ROTATION —
Activates on improper rotation or loss of phase for "WYE" or "Delta" power system. Visual indication of proper installation available on some models.

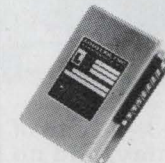

POWER MONITORS —
Combined monitoring of single or three phase voltage frequency and three phase sequence. "WYE" or "Delta" models available.



TIME DELAYS AND INTERVAL TIMERS — AC and DC models both fixed and adjustable types.

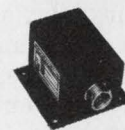

SOLID STATE FLASHERS AND REPEAT CYCLE TIMERS — for aircraft navigational lights, instrument panels, warning lights and process controls.

SPECIFICATIONS:

ACCURACY $\pm 1\%$

TEMP. -55°C TO $+125^{\circ}\text{C}$
 -10°C TO $+70^{\circ}\text{C}$

OTHER MIL R5757D



WRITE FOR
DETAILED LITERATURE

LOGITEK INC.

42 Central Drive
Farmingdale, New York 11735
(516) 694-3080

Buy Bonds where you work ...now that you can.



1903—a time of no credit, a 12-hour
workday, and no Payroll Savings Plan.

It's sort of like your grandfather telling you he used to walk 15 miles through the snow to get to school.

But it's true: today's working men and women have more advantages than their grandparents.

One of them is the Payroll Savings Plan—the easy, safe, automatic way to build a nest egg for the future.

When you sign up for the Payroll Savings Plan, an amount you specify is automatically set aside from your paycheck and used to

buy U.S. Savings Bonds.

That way, even if you spend all your take-home pay, you're still building a steady savings.

Grandpa would approve.



Take stock in America.

Buy U. S. Savings Bonds

Now E Bonds pay 5½% interest when held to maturity of 5 years, 10 months (4% the first year). Bonds are replaced if lost, stolen, or destroyed. When needed they can be cashed at your bank. Interest is not subject to state or local income taxes, and federal tax may be deferred until redemption.

 The U. S. Government does not pay for this advertisement. It is presented as a public service in cooperation with The Department of the Treasury and The Advertising Council.

Electronic Design

ELECTRONIC DESIGN's function is:

- To aid progress in the electronics manufacturing industry by promoting good design.
- To give the electronic design engineer concepts and ideas that make his job easier and more productive.
- To provide a central source of timely electronics information.
- To promote communication among members of the electronics engineering community.

Want a subscription? ELECTRONIC DESIGN is sent free to qualified engineers and engineering managers doing design work, supervising design or setting standards in the United States and Western Europe. For a free subscription, use the application form bound in the magazine. If none is included, write to us direct for an application form.

If you do not qualify, you may take out a paid subscription for \$30 a year in the U.S.A., \$40 a year elsewhere. Single copies are \$1.50 each.

If you change your address, send us an old mailing label and your new address; there is generally a postcard for this bound in the magazine. You will have to requalify to continue receiving ELECTRONIC DESIGN free.

The accuracy policy of ELECTRONIC DESIGN is:

- To make diligent efforts to ensure the accuracy of editorial matter.
- To publish prompt corrections whenever inaccuracies are brought to our attention. Corrections appear in "Across the Desk."
- To encourage our readers as responsible members of our business community to report to us misleading or fraudulent advertising.
- To refuse any advertisement deemed to be misleading or fraudulent.

Microfilm copies are available of complete volumes of ELECTRONIC DESIGN at \$19.00 per volume, beginning with Volume 9, 1961. Work is now in process to complete the microfilm edition of Volumes 1-8. Reprints of individual articles may be obtained for \$2.00 each, prepaid (\$.50 for each additional copy of the same article) no matter how long the article. For further details and to place orders, contact the Customer Services Department, University Microfilms, 300 North Zeeb Road, Ann Arbor, Michigan 48106 telephone (313) 761-4700.

Want to contact us? If you have any comments or wish to submit a manuscript or article outline, address your correspondence to:

Editor
ELECTRONIC DESIGN
50 Essex Street
Rochelle Park, N.J. 07662

HERE ARE THE SUPER WINNERS OF Electronic Design's '73 SUPER TOP TEN CONTEST

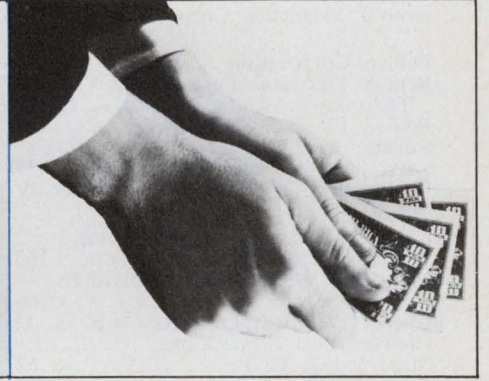
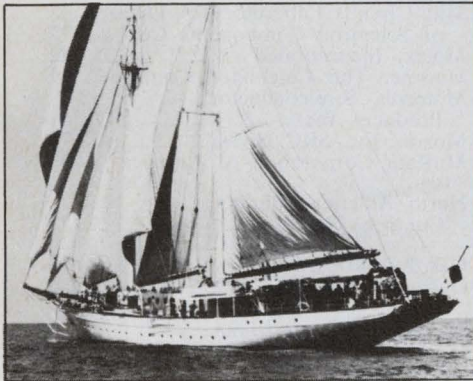

FIRST PRIZE PAUL SAUNDERS

Paul Saunders, 29, and his wife Stella write that they both love sailing and are looking forward with great enthusiasm to their Caribbean windjammer cruise and \$1,000 cash prize. Paul is presently doing consultant electronic design work during the day and spends his evenings at the University of Hartford. As part of the prize, the Saunders will also receive free jet transportation to and from the windjammer's home port in Antigua.



SECOND PRIZE JACK VANOOSTERHOUT

Jack VanOosterhout received a BSEE from Bradley University in 1967 and is studying for an MBA at Ball State University. Formerly with Eastman Kodak, Jack is employed as a Project Engineer at Ball Corporation Technical Division where he is in charge of electro-optical instrumentation and pattern recognition. His prize: a 17" portable color TV set.



FOURTH PRIZE BILL FRAZEE

Bill Frazee graduated from the University of Texas with a BS in electrical engineering. He has been employed by Texas Instruments as a Memory Systems Engineer and is presently working for Fairchild Semiconductor as an Applications Engineer. Bill is 32 years old, married, and has two children. Their home is in Plano, Texas. Bill's prize: a Bulova electronic timepiece.



THIRD PRIZE JOHN HAWKS

John Hawks, BS, MS and now MBA, is currently responsible for establishing electrical standards for the Communication Systems Business Division, General Electric Co., Lynchburg, Va. He is a registered professional engineer, a senior member of IEEE, holds a patent on a data input device, and is author of several technical papers. His prize: a Bulova electronic timepiece.



FIFTH PRIZE LOUIS E. FRENZEL, JR.

Louis E. Frenzel, Jr. is Assistant Vice-President-Director of Instruction and Product Research for McGraw-Hill Continuing Education Company (National Radio Institute and the Capitol Radio Engineering Institute). He received a Masters degree from the University of Maryland in May, and recently engineered a digital minicomputer kit and a universal breadboarding system for both linear and digital circuits. His prize: a Bulova electronic timepiece.

95 other lucky winners will be notified by mail.

**NEXT TIME YOU CAN BE A WINNER. WATCH FOR NEXT YEAR'S
CONTEST ANNOUNCEMENTS.**

advertiser's index

Advertiser	Page	Advertiser	Page	Advertiser	Page
ACDC Electronics, Inc.	145	Dynascan Corporation	117	Ledex, Inc.	165
Abbott Transistor Laboratories, Inc.	6	EEM	163	Licon, Division of Illinois Tool Works, Inc.	13
Ailtech, A Cutler-Hammer Company	127	EEP Corp.	193	Logitek, Inc.	187
Airpax Electronics, Controls Division	155	EL Instruments, Inc.	179	MCL, Inc.	149
Allied Electronics, Division of Tandy Corp.	14	EMN Company	169	Marco-Oak, Subsidiary of Oak Industries, Inc.	133
American Electronic Laboratories, Inc.	159	Elec-Trol, Inc.	179	Microswitch, A Division of Honeywell	19
Arnold Magnetics Corp.	193	Electro Scientific Industries	20	Micro-Networks Corporation	174
Belden Corporation	4, 5	Electronic Design	189	Mini-Circuits Laboratory, A Division of Scientific Components Co.	177
Bendix Electrical Fuel Injection Division	191	Fairchild Semiconductor, A Division of Fairchild Camera and Instrument Corporation	111, 112, 113	Molex, Incorporated	82
Bodine Electric Company	131	Fairchild Systems Technology, A Division of Fairchild Camera and Instrument Corporation	96, 97	Monroe, The Calculator Company	59
Bourns, Inc. Trimpot Products Division	27	Federal Scientific Corporation	190	Motorola Semiconductor Products, Inc.	17, 51
Burroughs Corporation	Cover IV	Ferroxcube Corporation	141	Moxon, Inc. SRC Division	176
CELCO (Constantine Engineering Laboratories, Inc.)	163	Fluke Mfg. Co., Inc., John	22	MuRata Corporation of America	193
Centralab, the Electronics Division of Globe Union, Inc.	66	Grayhill, Inc.	163	North American Philips Controls Corp.	151
Cherry Electrical Products Corp.	23	Hansen Manufacturing Co.	183	Oak Industries, Inc.	84, 85, 185
Cimron, Lear Siegler, Inc.	9	Hayden Book Company, Inc.	64, 65, 82, 193	Optron, Inc.	30
Clare & Co., C. P.	62	Heinemann Electric Company	31	Paktron, Division Illinois Tool Works, Inc.	11
Clare-Pendar	33	Hewlett-Packard	1, 15, 34, 35 thru 50, 88, 89, 125, 129, 146, 147, 157	Phoenix Data, Inc.	186
Constantine Engineering Laboratories Company	163	IMC Magnetics Corporation	183	Plessey Semiconductors	8
Dale Electronics, Inc.	Cover II	Indiana General	153	Power/Mate Corp.	193
Data Display Products	171	Intech, Incorporated	158	Precision Monolithics, Incorporated	18
Delco Electronics, Division of General Motors Corporation	118, 119	International Rectifier	63	Premier Metal Products Company	181
Dynage Inc	167	Johanson Manufacturing Corp.	7, 193	RCA Solid State Division	102, 103, 123, 161
		Lambda Electronics Corp.	Cover III	Radio Materials Company	193
				Rogers Corporation	133

Design Data from Manufacturers

Advertisements of booklets, brochures, catalogs and data sheets. To order use Reader-Service Card. (Advertisement)

The First 500-Line Real-Time Spectrum Analyzer-Averager

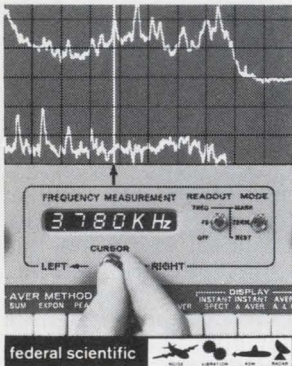

New UA-500, the most powerful analyzer of its type, offers the only standard built-in dual memory averager. Unique digital cursor reads directly in Hz. Portable, small (8-3/4"), for field and lab. **Fastest speed** minimizes test time, presents flicker-free display: real-time to 10 KHz, max. range of 100 KHz, 20 sweeps/sec display rate. **Best possible resolution:** sharpest analysis filter (proprietary 24dB/octave slope) so that 500-line analyzer has effective **650 lines**. Dual memory averager allows simultaneous display of continually updated exponential average & previously stored average. To **verify quality of data**, instantaneous spectra can be viewed on the same CRT as average . . . input time function can also be displayed. Plus other standard features: transient capture, exponential & peak averaging, lin-log scales both vertical & horizontal, complete plotter set-up & recording, computer compatibility with remote sensing or control.

Federal Scientific Corporation
An Affiliate of Nicolet Instrument
615 West 131st St., New York, N.Y. 10027

(212) 286-4400

CIRCLE NO. 171

Scanbe Manufacturing Corp.	55
Schauer Manufacturing Corp.	175
Semtech Corporation	137
SenSitrol, Inc.	133
Signetics Corporation	57, 67 thru 74
Siliconix, Incorporated	86
Simpson Electric Company	134
Sprague Electric Company	10
Stackpole Carbon Company	80
Statek Corp.	193
TEC, Incorporated	116
TRW Semiconductors, An Operation of TRW Electronic Components	24
Tektronics, Inc.	75, 79, 81, 83
Teledyne Relays, A Teledyne Company	2
Teledyne Semiconductor	12
Teletype Corporation	53
Texas Instruments, Incorporated	21, 184
Thomson CSF	16
Times Wire & Cable Company	60, 61
Toyo Communications Equipment Co., Ltd.	191
United Detector Technology, Inc.	195
Vactec, Inc.	76
Varo Semiconductor, Inc.	170
Wagner Electric Company	173
Wang Laboratories, Inc.	149
Wiley-Interscience	143
Zeltex, Inc.	194

DO COLLEGES HELP BUSINESS AS MUCH AS BUSINESS HELPS COLLEGES?

Yes, they do. But not in the same proportion.

Business contributes about 15% of the total voluntary support received by colleges.

But today, business gets half the college-trained people who are employed. Tomorrow, it will need even more.

As a result, businessmen should think seriously about increasing the level of corporate giving to education. Can you, as a businessman, think of a better investment?

For the latest national figures on corporate giving to higher education, write on your letterhead for "CFAE Survey of Corporation Support of Higher Education," and enclose \$2.00 to help cover costs. Mail to: Council for Financial Aid to Education, 6 East 45th Street, New York, N.Y. 10017.

Give to the college of your choice. Now.



Advertising contributed for the public good.

Electronic Design

Advertising Sales Staff
Tom W. Carr
Sales Manager

Rochelle Park, N.J. 07662
Robert W. Gascoigne
Daniel J. Rowland
50 Essex Street
(201) 843-0550
TWX: 710-990-5071

Philadelphia
Thomas P. Barth
50 Essex Street
Rochelle Park, N. J. 07662
(201) 843-0550

Boston 02116
50 Essex Street
Rochelle Park, N. J. 07662
(201) 843-0550
(617) 482-7989

Chicago 60611
Thomas P. Kavooras
Berry Conner, Jr.
200 East Ontario
(312) 337-0588

Cleveland
Thomas P. Kavooras
(Chicago)
(312) 337-0588
(call collect)

Los Angeles 90303
Stanley I. Ehrenclou
Burt Underwood
2930 Imperial Highway
Inglewood, Calif
(213) 757-0183

San Francisco 94022
Jerry D. Latta
P.O. Box 1248
Los Altos, Calif.
(415) 965-2636

London W. 1
For United Kingdom and Holland
Brayton C. Nichols
For Eastern Europe
Peter Kehr
The American Magazine Group
9 Warwick Street
London, W. 1, England
Phone: 437 5462
Cable: Ammagnic, London

Tokyo
Haruki Hirayama
Electronic Media Service
5th Floor, Lila Bldg.,
4-9-8 Roppong,
Minato-ku
Phone: 402-4556
Cable: Electronicmedia, Tokyo



Revolutionary New!!

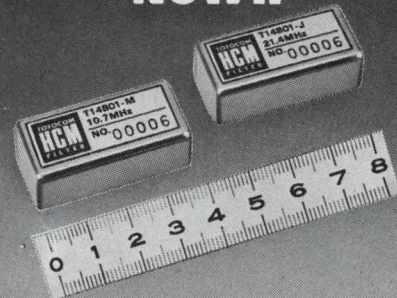

TOYO HCM FILTER T-1 SERIES

• FEATURES:

- These filters provide guaranteed rejection of 90dB. Their volume is 46.3% that of widely used 8-element conventional filters. Their height is only 12mm.
- Terminating conditions are uniform, allowing these filters to be used in a wide range of applications. These filters are fully compatible with other filters in terms of electrical characteristics. Ample consideration has been given to mechanical compatibility.
- Stringent environmental tests (shock and vibration tests) assure adequate quality control levels.



EXPORT DEPARTMENT:
TOYO BUILDING, NO. 8-12-20, JINGUMAE,
SHIBUYA-KU, TOKYO, JAPAN.
CABLE: EXPORTOYOCOM-TOKYO
TEL: (03) 408-3355
TELEX: 02422001

INFORMATION RETRIEVAL NUMBER 107

ELECTRICAL ENGINEERS

Automotive Breakthrough

Advanced electronic fuel injection programs at Bendix have created exceptional opportunities at all levels for Electrical Engineers with BS or MS degrees. Experience desired includes solid state electronic circuit analysis, design and development, electro-mechanical and electronic feedback, control systems development, automotive electronic applications.

Send resume to Mr. D. Houser,
Electronic Fuel Injection Division,
The Bendix Corporation, 900 West
Maple Road, Troy, Michigan 48084.



Electronic Fuel Injection Division

An equal opportunity
employer, male/female

INFORMATION RETRIEVAL 901

product index

Information Retrieval Service. New Products, Evaluation Samples (ES), Design Aids (DA), Application Notes (AN), and New Literature (NL) in this issue are listed here with page and Information Retrieval numbers. Reader requests will be promptly processed by computer and mailed to the manufacturer within three days.

Category	Page	IRN	Category	Page	IRN	Category	Page	IRN
Components			data generator	171	375	logic cards	152	301
alarm, audio	178	406	data generator	172	380	marking inks	151	296
beeper	180	414	fault locator	172	381	miniature connectors	152	302
display, numeric	177	404	generator/counter	173	387	mounting pads	151	295
lamp, incandescent	178	411	IC tester	173	386	photomask blanks	152	300
lamp, LED	176	400	logic probe	170	374	plating, system	152	299
optocoupler	177	403	logic tester	171	378	probes, micro	154	308
rectifiers	179	412	multimeter	170	371	probes, test	152	297
probe, Kelvin	180	415	ohms tester	174	389	resist applicator	150	294
relay, latching	176	397	pulse generator	170	372	wire stripper	155	320
sockets, LED	180	418	pulse generator	174	390			
speed changer	180	417	rf sweeper	174	391	new literature		
switch, locking	176	396	recorder	171	376	ANSI standards	184	194
switch, Hall-effect	180	419	voltmeter	175	394	author's guide	184	190
switch, PC	180	416				avionics racking		
switch, rotary	177	401	Microwaves & Lasers			hardware	183	442
transducer, rotary	176	398	amplifiers	148	289	batch processing	185	200
transformer	178	409	coupler, bidirectional	142	250	blowers	182	431
			ferrite modulator	144	277	cabinets, electronic	182	434
			mixer/preamp	147	283	cable/connector		
Data Processing			mixers, double-balanced	144	274	systems	184	193
analyzer, spectral	165	353	oscillators, GaAs	142	271	cassette data logger	182	440
calculator, pocket	162	344	p-i-n diodes	147	284	circuit soldering	183	441
cassette, computer	168	369	power amps, vhf	147	281	communication tubes	183	445
compiler, Fortran	162	346	radar transponder	142	273	connectors	183	446
controller, industrial	168	365	receiver, millimeter	144	275	connectors, I/O	182	429
converter, code	166	360	receiver, spectral	148	291	DMM, 4-1/2-digit	184	195
coupler, acoustic	164	348	relay, rigid cable	148	287	data communications	184	196
data acquisition	162	345	TWT amplifier	144	280	epoxy tubing	182	438
digitizer, coordinate	166	359	transceivers, Doppler	148	286	evaporation sources	184	192
facsimile, remote	167	361	transistor	148	288	filters	182	431
interface, computer	162	342	transistor, broadband	144	278	guide to cassettes	185	204
interface, relay	164	351				hardware, packaging	182	439
microcomputer	168	364	Modules & Subassemblies			laminates	183	443
modem, data	164	349	converter, a/d	160	337	lasers	185	202
peripheral, FFT	167	362	converter, F-to-V	156	324	microwave instruments	185	206
power source	169	318	converters, s/d	159	333	motor reference data	184	197
reader, badge	165	354	displays, LED	156	323	newsletter	182	428
reader, card	169	370	filters, active	158	328	oscillators	182	437
recorder, analog	166	355	filters, active	158	331	photomultipliers	182	432
recorder, data	167	363	frequency synthesizer	158	332	power supplies	182	435
terminal, CRT	166	358	image intensifier	160	340	resistors	185	203
terminal, intelligent	164	350	power supplies	158	330	sockets, relay	182	426
			power-supply cards	160	338	solder	185	205
ICs & Semiconductors			power supply modules	158	327	switches, microwave	183	444
display, LED	136	257	rectifier, full wave	156	322	switches, push-button	185	199
linear arrays	138	262	relay, solid state	156	326	terminals, CRT	182	433
linear ICs	140	268	relay, solid state	160	336	tools for wrapped wiring	184	191
multiplexers, CMOS	138	258	sample/hold unit	156	325	transformers	182	427
op amp	136	256	sensor, photoelectric	158	329	transistors, rf	185	198
op amp, FET	140	265	speed/position control	159	334	trimming instruments	185	201
photodiode, vacuum	138	263	transmitter, IC	160	335	wire	182	436
RAM, 64-bit	138	261				application notes		
transceivers, bus	138	260	Packaging & Materials			DVMs	181	420
			adhesive, ceramic	154	309	lamp reliability study	181	425
Instrumentation			conductive putty	154	305	oscillators, microwave	181	422
a/d converter	175	395	connectors	155	310	power supplies	181	424
calculator	173	383	glass, low melting	154	307	sound systems	181	421
calculator, pocket	162	344	gold solution	154	306	switch, neon-lamp	181	423
counter	172	382	heat pipes	150	293			
counters, universal	171	379	heat sink, DIP	154	304			
DMM	171	377	LED indicator	152	298			
DMM	173	384	lamp, puller	154	303			

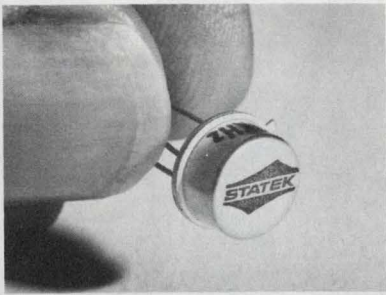

Quartz crystals in TO-5s for 95¢. Use them for oscillators, filters, tone generators, timers. They're rugged, accurate, highly resistant to vibration & shock. Prices low as \$.95 in 100 k qty's. Send your written applications. We'll send a sample. Or, write for literature. Statek Corp., 1233 Alvarez Ave., Orange, Calif. 92668. (714) 639-7810.

INFORMATION RETRIEVAL NUMBER 181

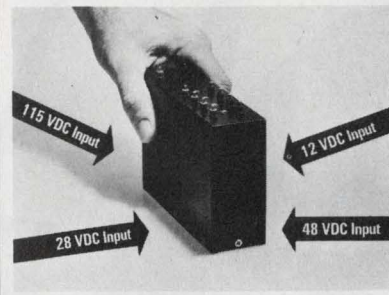

DC-DC Regulated Power Converters—packaged into pretested, encapsulated miniature packages with 6 watts/in². Modular design allows you to specify your own custom system without engineering charges. Inputs of 12, 28, 48, & 115 VDC with up to 6 outputs. Immediate delivery. Arnold Magnetics, Culver City, Ca. 90230. (213) 870-7014.

INFORMATION RETRIEVAL NUMBER 182

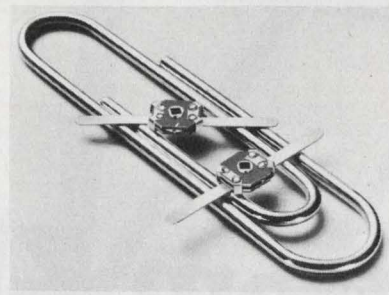

Thin-Trim variable capacitors provide a reliable means of adjusting capacitance without abrasive trimming or interchange of fixed capacitors. Series 9401 has high Q's and a range of capacitance values from 0.2-0.6 pf to 3.0-12.0 pf and 250 WVDC working voltage. Johanson Manufacturing Corporation, Boonton, New Jersey (201) 334-2676.

INFORMATION RETRIEVAL NUMBER 183

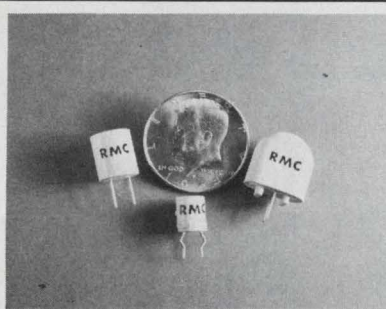

Ceramic resonators for low-cost frequency-stable generators and oscillators. Stability is better than 0.3% deviation from the 25°C frequency over the temperature range of -20°C to +65°C. Frequency Range: 185- to 500-KHz. Standard Tolerance: ± 1 KHz. Radio Materials Company, 4242 W. Bryn Mawr, Chicago, Ill. 60646 Tel. (312) 478-3600

INFORMATION RETRIEVAL NUMBER 184

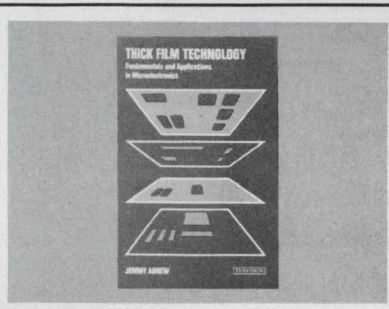

Thick Film Technology—Fundamentals and Applications in Microelectronics, by Jeremy Agnew. From design to finished product, this book details each processing phase, describing what to do and what pitfalls to avoid. 176 pp., 6 x 9, illus., cloth, \$8.50. Circle number for 15-day examination copy. Hayden Book Company, Rochelle Park, N.J. 07662.

INFORMATION RETRIEVAL NUMBER 185

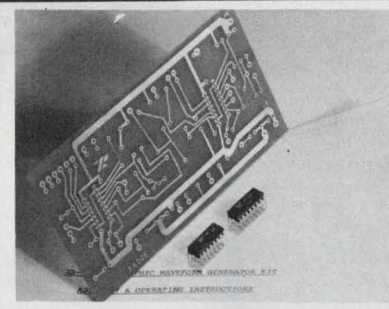

XR205K Monolithic Waveform Generator Kit—only \$28.00. Includes two XR205K waveform generator IC's, etched and drilled PC board, assembly instructions plus parts list, schematic, layout diagram, technical data and applications notes. EEP Corporation, 10180 Jefferson Blvd., Culver City, CA. 90230. 213/838-1912.

INFORMATION RETRIEVAL NUMBER 186

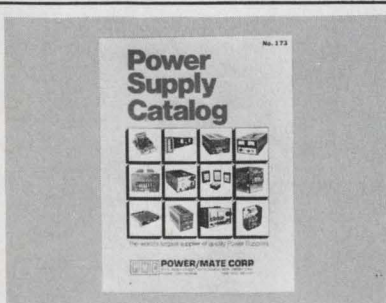

Free catalog of 34,500 power supplies from the worlds largest manufacturer of quality Power Supplies. New '73 catalog covers over 34,500 D.C. Power Supplies for every application. All units are UL approved, and meet most military and commercial specs for industrial and computer uses. Power Mate Corp. (201) 343-6294.

INFORMATION RETRIEVAL NUMBER 187

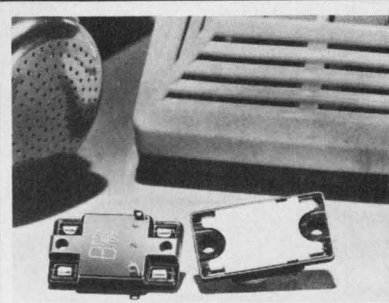

New Posistors provide both heat and temperature control in one compact semi-conductor package. Eliminates hot wires - bimetalic thermostats. For small appliances, ovens, controls. Offers very smooth and precise temperature control with capacities to 100 watts. Murata, 2 Westchester Pl., Elmsford, N.Y. 10523. 914-592-9180.

INFORMATION RETRIEVAL NUMBER 188



The 40X Opto-Meter is a Radiometer/Photometer combining accuracy and reliability. It is supplied complete with a radiometric head to provide a flat spectral response from 450nm to 950nm, and a photometric head that yields a spectral response comparable to the human eye. United Detector Technology, 1732 21st St., Santa Monica, Ca.

INFORMATION RETRIEVAL NUMBER 189

from ZELTEX...

14-Bit DAC's from \$85

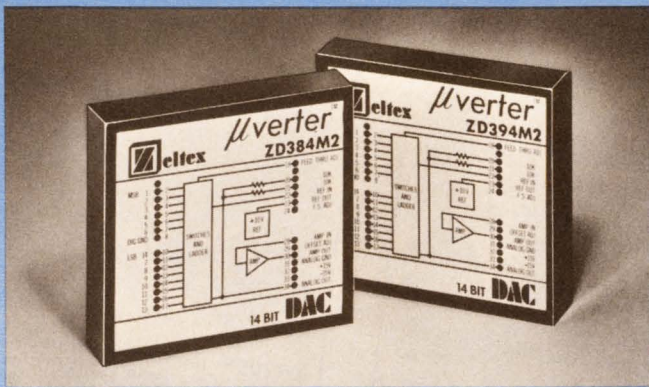

LOW COST 14-BIT DAC's—The new ZD300 Series include ten new models that offer excellent linearity, fast settling, current and voltage outputs, bipolar and unipolar coding, slaveable reference, and two quadrant multiplication. Prices range from \$85 to \$179 in single quantities.

FAST SETTLING TIMES (1 us)—Settling times as fast as 1 us for current output models and 2 us for voltage output DAC's makes the ZD300 Series useful in a variety of data conversion applications.

UNIPOLAR, BIPOLAR OUTPUTS—Unipolar and bipolar operation is specified at 0 to 10V, and $\pm 10V$, respectively. Current output models are rated at 0.2 mA. Voltage output models also feature current output capability as well as two-quadrant multiplication-up to 100 kHz.

LINEARITY 0.005%—High performance units feature linearity error of only 0.005% of full scale. Moreover, the extremely low linearity temperature coefficient of only 0.0005%/°C ensures high resolution accuracy.

SMALLEST 14-BIT DAC's—The ZD300 Series modular DAC's measure only 1.96 x 1.76 x 0.40 inches high—less than 1.4 cubic inches in volume. Low profile, DIP pinning compatibility and interchangeability of models make the series highly desirable for OEM usage.

APPLICATIONS—The versatility of the ZD300 Series makes them an excellent choice for use in process-control systems, automated test equipment, servo/synchro/resolver systems, and biomedical instrumentation.

Multiplying capabilities further enhance their use for CRT character generation, digital modulation, and polar-to-rectangular coordinate conversion.

Zeltex INC. LEADERS IN DATA CONVERSION TECHNOLOGY

CALL or WRITE TODAY for detailed data on these and other ZELTEX Conversion and Linear products.

1000 CHALOMAR ROAD • CONCORD, CALIFORNIA 94518 • (415) 686-6660 TWX 910 - 481-9477

INFORMATION RETRIEVAL NUMBER 108

Do you face a make or buy decision on power supplies?

BUY LAMBDA'S NEW LT SERIES

a 5V, 7A power supply
with overvoltage protection for \$80

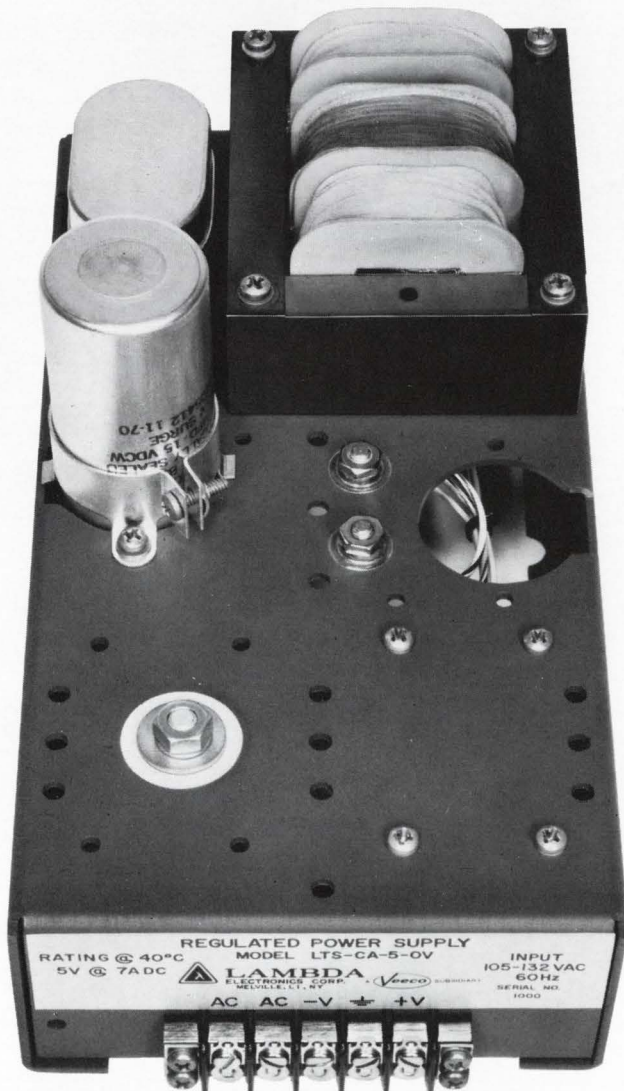

Only 13 components
Line regulation—0.02% Load regulation—0.15%
Ripple and Noise—1.5 mV RMS
Temperature coefficient—0.01%/°C
Lambda's long life voltage regulating ferroresonant transformer
Open construction
Lambda's 100,000 hours MTBF power hybrid voltage regulator
MIL-R-11 composition resistors
Heavy duty barrier strip
MIL-R-26 type wire wound resistors
Convection cooled chassis
Computer grade hermetically sealed 10-year life electrolytic capacitors
Efficiencies up to 55%
Under test for listing in Underwriters' Laboratories recognized components index
1 Day delivery

5-YEAR GUARANTEE

LTS-CA SINGLE OUTPUT MODELS

4²⁹/₃₂" x 4¹⁵/₁₆" x 9⁵/₁₆"

MODEL	FIXED VOLT. RANGE VDC	MAX. AMPS AT AMBIENT OF: 40°C	PRICE
LTS-CA5-0V*	5±1%	7.0	\$80
LTS-CA-6	6±1%	6.6	80
LTS-CA-12	12±1%	4.4	80
LTS-CA-15	15±1%	4.0	80
LTS-CA-20	20±1%	3.1	80
LTS-CA-24	24±1%	2.6	80
LTS-CA-28	28±1%	2.2	80

*Includes fixed overvoltage protection at 6.8V±10%

LTD-CA DUAL OUTPUT MODEL

4²⁹/₃₂" x 4¹⁵/₁₆" x 9⁵/₁₆"

MODEL	FIXED VOLT. RANGE VDC	MAX. AMPS AT AMBIENT OF: 40°C	PRICE
LTD-CA-152	±15±1%	2.0	\$110
LTD-CA-122	±12±1%	2.0	110

A-C INPUT: 105-132 Vac, 59.7 to 60.3 Hz (STD. Comm'l Line Frequency Spec.), consult factory for operation at other frequencies.

Send for 1973 Power Supply Catalog
and Application Handbook

LAMBDA ELECTRONICS CORP.

MELVILLE, NEW YORK 11746 515 Broad Hollow Road Tel. 516-694-4200 ARLINGTON HEIGHTS, ILL. 60005 2420 East Oakton St., Unit Q Tel. 312-593-2550
NORTH HOLLYWOOD, CALIF. 91605 7316 Varna Ave. Tel. 213-875-2744 MONTREAL, QUEBEC 100C Hymus Blvd., Pointe-Claire, Quebec-730 Tel. 514-697-6520
PORTSMOUTH, HANTS, ENG. Marshlands Road, Farlington Tel. Cosham 73221 VERSAILLES, FRANCE 64a 70 rue des Chantiers 78004 Tel. 950-2224

the BEST costs LESS



SELF-SCAN® Alphanumeric, single register Panel Displays... under 7¢* a dot...and the price includes all drive electronics

ECONOMY—SELF-SCAN Panel Displays have the lowest cost by any measure...dot, character, panel, or complete assembly. Price quoted in headline includes all panel drive electronics, character generator, bezel with mounting hardware and filter.

LEGIBILITY—Display characters are sharply delineated. No pincushioning, fuzzing or loss of focus.

BRIGHTNESS—Achieved by orange red colored dots intense enough to stand out brighter and sharper yet subtle enough to prevent possible eyestrain during long viewing periods.

VISIBILITY—Assured from 12 feet or 25 feet depending on character size .120° viewing angle means high visibility.

BETTER PACKAGING—1.34" max. depth without memory, 1.96" max. depth with memory permits installation in small space areas. SELF-SCAN Panel Displays can be mounted singly or in combinations.

Call or write Burroughs Corporation, Electronic Components Division, P.O. Box 1226, Plainfield, New Jersey 07061. Phone (201) 757-3400. A Burroughs sales engineer will stop by your office to back our claims with hard facts and figures.

*Based on SSD 0132-0030 one thousand piece price.

Burroughs

