

Electronic Design 10

VOL. 22 NO.

FOR ENGINEERS AND ENGINEERING MANAGERS

MAY 10, 1974

Can you count on your digits? With counters, that's what you'd like to know. But the last few digits in that long display may be meaningless. Crystal aging,

temperature drift and trigger errors can clobber accuracy. And inputs that fall under 100 Hz or zip past 0.5 GHz bring new trouble. Check into counters on p. 58.

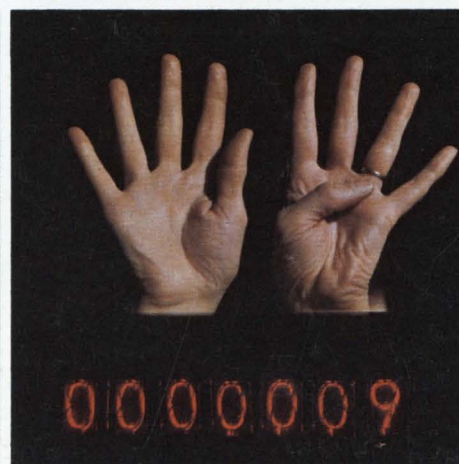
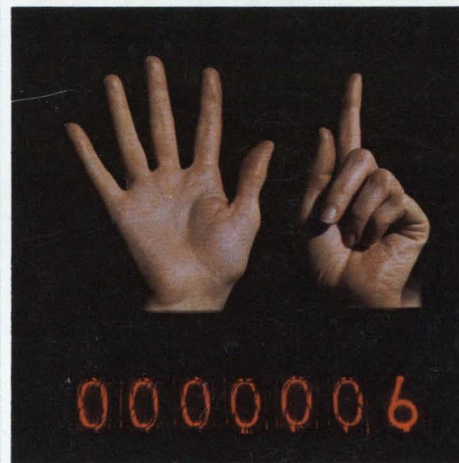
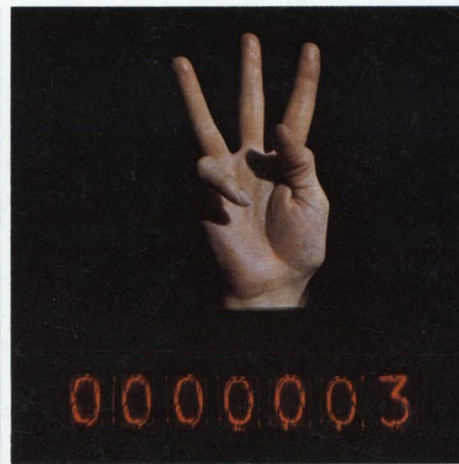



Ultra reliability in
ultra-miniature
transformers...

...and they're off the shelf!

PICO Electronics' patented construction combines mass production with the utmost in reliability to produce the smallest possible transformer.

These little giants handle up to 600 milliwatts at 1 KHz and 1.5 watts at 10KHz. They cover the frequency range of 300Hz to 250KHz. Primary or Secondary impedances of 3.2 ohms to 250K

ohms. Pulse applications $.05\mu\text{s}$ to $100\mu\text{s}$. Construction can be TO-5 plug-in, insulated flexible leads or flat pack ribbon style.

Pico Electronics is a Q.P.L. source. All transformers are hermetically sealed in a metal case and in strict compliance with MILT-27 specifications. Every Pico device has the added reliability feature of being guaranteed for 25 cycles of ther-

mal shock (MIL-STD-202D, method 107C).

Industrial and Commercial designs are also available for maximum economy.

Over 600 standard transformers to choose from . . . Delivery—stock to one week . . . specials take a little longer—9 days.

Send for free 36 page catalog.

PICO Electronics, Inc.

50 South MacQuesten Pkwy., Mt. Vernon, New York 10551 • Telephone 914-699-5514

INFORMATION RETRIEVAL NUMBER 242

THE \$5.00 FUNCTION GENERATOR

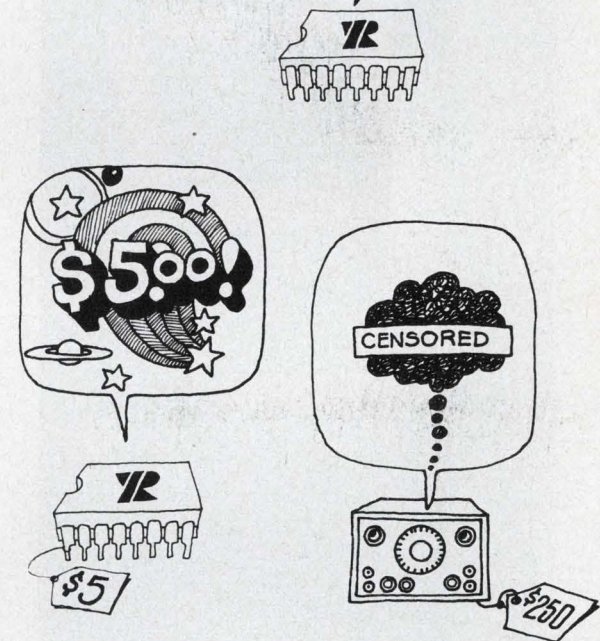
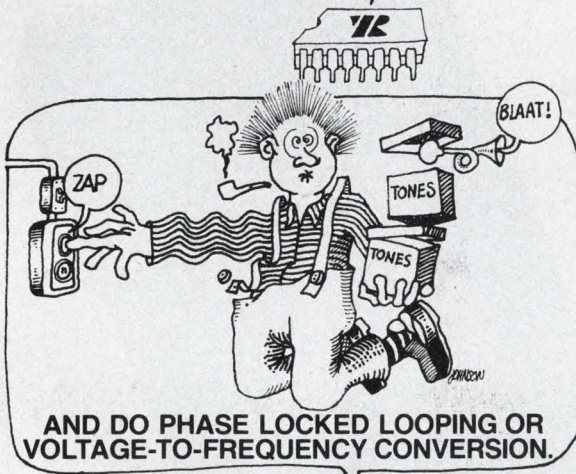
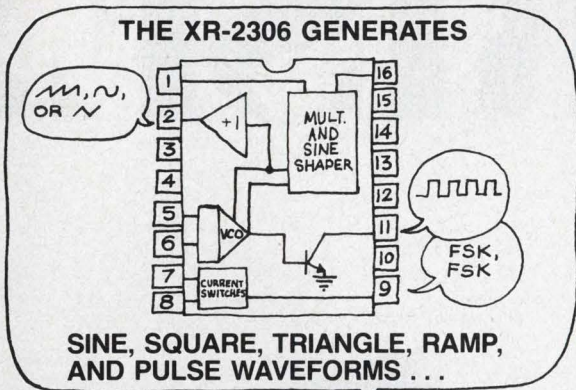

The XR-2306 monolithic function generator shows how easy and inexpensive it is to build lab-quality function generators and signal generators into instrumentation, control and communication systems.

Add a passive network, a small potentiometer or two, and any power supply from 10V to 26V—split or single—to the XR-2306 and you have a neat little function generator that sweeps linearly through a 3,000:1 range typically. AM, FM and frequency-shift the waveforms if you like. Or build AM, FM, FSK, PSK and tone signal generators, voltage-to-frequency converters and phase-locked loops.

The XR-2306 does it all with a minimum of extra parts because the VCO, analog multiplier and sine shaper of a

quality bench instrument are on the monolithic chip.

Total harmonic distortion typically is only 2.0% without adjustment and 0.5% with adjustment. Stability is excellent, typically 20ppm/°C and supply sensitivity a mere 0.01%/V. Furthermore, the VCO frequency range is 0.01 Hz to more than 1 MHz, amplitude modulation capability is 100%, and duty cycle is adjustable from 0.1% to 99.9%.

Building a function generator into a system with our circuit costs only one-tenth as much as buying an instrument. It costs as little as \$4.95 in 100-up quantities. But we wouldn't kid you. If you really want an instrument that looks like a Wavetek, you'll have to add a power supply, a box and big knobs.



EXAR SPEAKS YOUR LANGUAGE

EXAR INTEGRATED CIRCUITS Products of R.ohm Corp. 16931 Milliken Ave., Irvine, CA 92705 (714) 546-8780 TWX 910-595-1721

EXAR REPRESENTATIVES: Arizona/Colorado/New Mexico BARNHILL FIVE (602) 947-7841 California - North LOGAN SALES (415) 369-6726 California - South DE ANGELO & ROTHMAN CO. (213) 398-6239 Washington/Oregon SDR SQUARED (206) 747-9424 Illinois/Wisconsin M & S SALES (312) 992-1053 Ohio/Indiana/Kentucky MC FADDEN SALES (614) 221-3363 New York City M. O. S. ASSOCIATES (516) 694-5923 Pennsylvania/Southern New Jersey HARRY NASH ASSOCIATES (215) 657-2213 Oklahoma/Texas/Louisiana/Arkansas EVANS & MC DOWELL (214) 238-7157 Michigan D.E.M. ASSOCIATES (313) 755-6660 North Carolina/South Carolina/Virginia/Maryland COMPONENT SALES (301) 484-3647 Maine/New Hampshire/Vermont/Massachusetts/Connecticut COMPONENT SPECIALISTS (617) 667-4181 Minnesota ELECTRONICS INNOVATORS (612) 884-7471

INFORMATION RETRIEVAL NUMBER 2

SURPRISE!

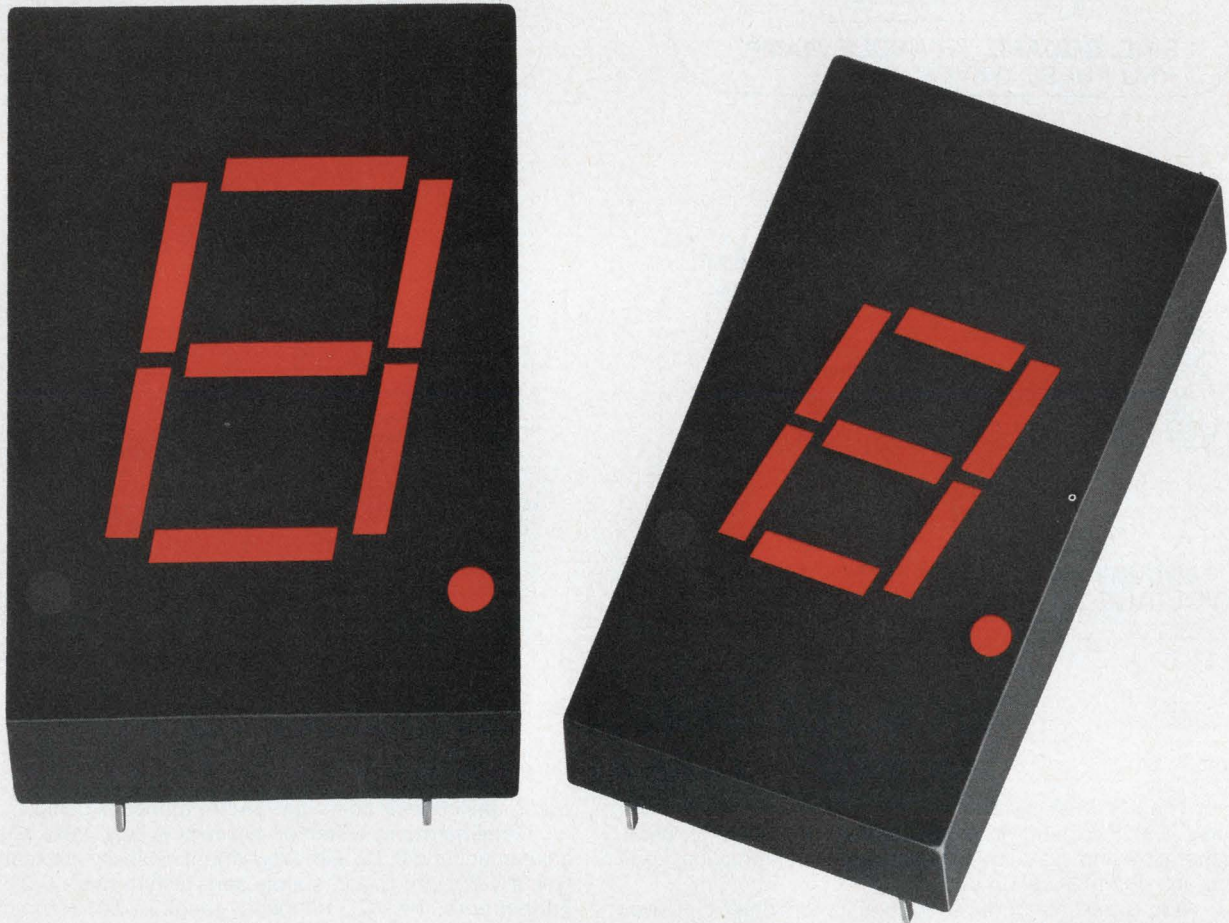

HP displays are bigger than ever!

Now you can get a big, readable 0.43 inch LED display without sacrificing the simplicity and economy of single chip per segment design.

Bright enough to clearly see 20 feet away. HP's 5082-7750 series display features the same wide viewing angle, excellent readability and the same pin configuration as our 0.3 inch 5082-7730 series displays.

Just \$3.50 each in 100 quantities.*

Contact Schweber, Hall-Mark or the Wyle Distribution Group for immediate delivery. Or, write us for more details. This is one display you won't want to miss.



Sales and service from 172 offices in 65 countries.
1501 Page Mill Road, Palo Alto, California 94304

01403

*Domestic USA price only.

INFORMATION RETRIEVAL NUMBER 3

Electronic Design 10

VOL. 22 NO.

FOR ENGINEERS AND ENGINEERING MANAGERS

MAY 10, 1974

NEWS

- 21 **News Scope**
- 24 **New optical and acoustic IC elements** are generating new families of microelectronic devices.
- 30 **A superconducting Schottky diode** promises a tenfold decrease in mixer noise and a thousandfold reduction in local oscillator power.
- 32 **Organic materials** investigated for superior semis and memories.
- 34 **Thermal-imaging furnaces** grow crystals from 'difficult' materials.
- 38 **Triple-varactor IC** promises to better the AM car radio.
- 43 **Washington Report**

TECHNOLOGY

- 58 **FOCUS on Electronic counters:** Tradeoffs, subtleties and guideposts in the evaluation of counter specifications, form the heart of this comprehensive report, which also takes a look at the latest equipment.
- 82 **Heed the limitations of MOS I/O circuitry,** and you'll avoid electrostatic damage to ICs and eliminate noise problems and excessive power dissipation.
- 92 **Use CAD to optimize broadband amp design** and to eliminate performance guesswork. It's convenient and S-parameters are stored in an rf-tailored CAD program.
- 102 **Split a temperature degree to 10 $\mu^{\circ}\text{C}$.** Use a linear-dc-feedback circuit, watch the grounding and thermal, magnetic and electric shielding, and put in only quality components.
- 110 **Pick the right DAC** by cutting through spec confusion. Meanings vary from vendor to vendor. Here's a guide that may save you time and trouble.
- 116 **View two video sources on one CRT.** Digital logic selects and disables each source during vertical sync to display the signals without bars and streaks.
- 124 **Let the engineers run the company,** not the other way around, and both will profit. Executive tells how he gets creative engineering by sacrificing 'textbook' efficiency.
- 130 **Ideas for Design:** Op amp in current-differencing mode becomes a noninverting audio mixer . . . Audible gas alarm uses CMOS gates to provide time delays and transient protection . . . Short subroutine computes standard component values from nonstandard . . . Switched op amps and sign detector convert two-quadrant to four quadrant operation.
- 138 **International Technology**

PRODUCTS

- 141 **Integrated Circuits:** Hi-fi amplifier IC sets power mark of 15 W with less than 1% distortion.
- 156 **Instrumentation:** Multifeatures at a mini price come with 3-1/2-digit DMM.
- 164 **Instrumentation:** Fastest storage scope gives full bandwidth.
- 166 **Instrumentation:** IC tester programs with optically coded cards.
- 146 Modules & Subassemblies
- 168 Data Processing
- 178 Components
- 184 Packaging & Materials
- 192 Microwaves & Lasers
- 198 Discrete Semiconductors
- 202 Power Sources

Departments

- 47 **Editorial:** Good news Bad news
- 7 Across the Desk
- 208 Application Notes
- 210 New Literature
- 220 Advertisers' Index
- 222 Product Index
- 224 Information Retrieval Card

Cover: Photo by William Skeahan, courtesy of Systron Donner

ELECTRONIC DESIGN is published biweekly by Hayden Publishing Company, Inc., 50 Essex St., Rochelle Park, N. J. 07662. James S. Mulholland Jr., President. Printed at Brown Printing Co., Inc., Waseca, Minn. Controlled circulation postage paid at Waseca, Minn., and New York, N. Y., postage pending Rochelle Park, N. J. Copy-right © 1974, Hayden Publishing Company, Inc. 84,392 copies this issue.

From CPU 8080 Microcom

Intel's new 8080 n-channel microcomputer is here—
incredibly easy to interface, simple to program and with up
to 100 times the performance of p-channel
MOS microcomputers.

Best of all, the 8080 is real—in production
at Intel and available in volume quantities,
today. It's also available through distributors
along with a growing line of peripheral
circuits and a new version of the
Intellec 8, a program and hard-
ware development
system for the 8080,

all supported with software
packages, design documenta-
tion and manuals, and backed
by more than 100 man years
of microcomputer expertise.

The 8080 is the inevitable
successor to complex custom
MOS and many large discrete
logic subsystems. It is the
industry's first general purpose
n-channel microcomputer and
the first high performance
single-chip CPU, with extremely
simple interface requirements and
straightforward programming. It runs a
full instruction cycle in 2 microseconds.

As such, the 8080 extends the economic
benefits of Intel's p-channel microcom-
puters to a new universe of systems that need
fast, multi-port controllers and processors. These
systems include intelligent terminals, point of sale
systems, process and numeric controllers, advanced



to software, the puter is here.

calculators, word processors, self-calibrating instruments, data loggers, communications controllers, and many more.

You can use 256 input and 256 output channels, handle almost unlimited interrupt levels, directly access 64 kilobytes of memory, and put many satellite 8080 processors around a single memory.

Interfacing is minimal and design is easy with the 8080 because all controls are fully decoded on the CPU chip itself and inputs and outputs are TTL compatible. There are separate data, address and control buses.

The 8080 microcomputer has 78 basic instructions, including the 8008 set plus new ones that make possible such features as vectored multi-level interrupt, unlimited subroutine nesting and very fast decimal and binary arithmetic.

Program development for the 8080 can be done either on a large computer using the Intel software cross products (PL/M systems language compiler, macro-assembler and simulator), or on an Intellec 8 development system with a resident monitor, text editor and macro-assembler.

The new 8080 product family includes performance matched peripheral and memory circuits configured to minimize design effort and maximize system performance. Large, low cost RAMs, ROMs, PROMs and I/O devices are available now and we will soon announce other 8080 LSI support circuits.

The 8080 is easier to use and more economical than any high performance microcomputer in sight. It's here now, in volume, from the inventors of the microcomputer and the people who lead the industry in production and design support.

Intel Corporation, 3065 Bowers Avenue, Santa Clara, California 95051.
(408) 246-7501.

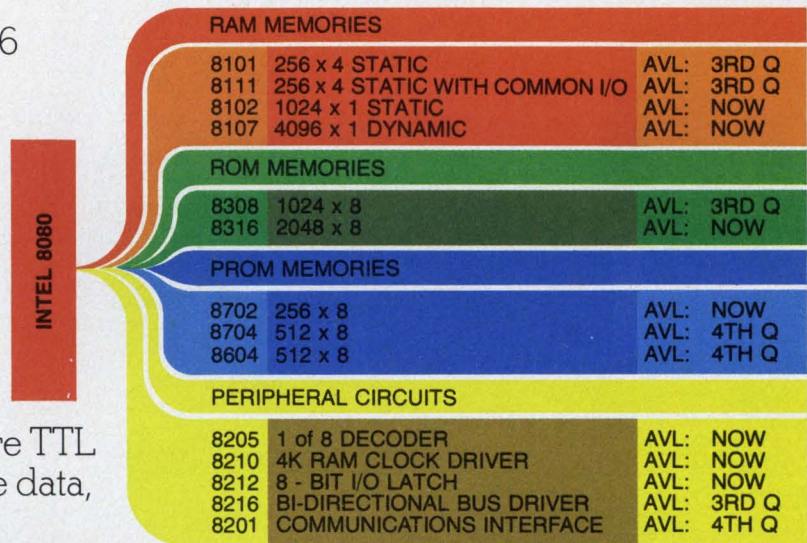

INTEL 8080 PRODUCT FAMILY

intel® Microcomputers. First from the beginning.

CABLE-BILITY WOVEN'S FLAT GOT IT!

Ribbon Cable IC Interconnects Custom Harnesses

A total source for flat interconnect systems, Woven Electronics offers unlimited design capabilities combining signal/power transmission with specialized functions. Independently insulated conductors give tighter transmission control, more protection, allow easy lead exposure.

Specify sizes, color coding, insulations, custom break-outs without restrictions of other cable forms.

Cable and ability. Get the best of both from one source.

WOVEN ELECTRONICS

P.O. Box 189
Mauldin, South Carolina 29662

Vice President, Publisher

Peter Coley

Editors

Editorial Offices

50 Essex St.

Rochelle Park, N.J. 07662

(201) 843-0550

TWX: 710-990 5071

Cable: Haydenpubs Rochellepark

Editor-in-Chief George Rostky

Managing Editors:

Ralph Dobriner

Michael Elphick

Associate Editors:

Dave Bursky

Jules H. Gilder

Morris Grossman

Seymour T. Levine

John F. Mason

Stanley Runyon

Edward A. Torrero

Richard L. Turmail

Contributing Editors:

Peter N. Budzilovich

Robert Wollins

Editorial Field Offices

East

Jim McDermott, Eastern Editor

P.O. Box 272

Easthampton, Mass. 01027

(413) 527-3632

West

David N. Kaye, Senior Western Editor

2930 West Imperial Highway

Inglewood, Calif. 90303

(213) 757-0183

Northe K. Osbrink, Western Editor

112 Coloma St.

Santa Cruz, Calif. 95060

(408) 426-3211

Washington

Heather M. David, Bureau Chief

2506 Eye St., N.W.

Washington, D.C. 20037

(202) 338-3470

Editorial Production

Marjorie A. Duffy

Art

Art Director, William Kelly

Richard Luce

Anthony J. Fischetto

Production

Manager, Dollie S. Viebig

Helen De Polo

Anne Molfetas

Christopher G. Hill

Circulation

Manager, Nancy L. Merritt

Information Retrieval

Peggy Long

Promotion

Manager, Jeffrey A. Weiner

Karen Kerrigan (Reprints)

across the desk

'Troublemaker' engineer gets a pat on the back

Congratulations on your editorial "The Troublemakers" (ED No. 1, Jan. 4, 1974, p. 97). You made an important point: that engineers need to speak out about shoddy products. Although they'll appear to be troublemakers, they will be serving the public. The editorial is admirable because it bucks the Establishment by recommending a new constraint on American industry.

However, it seems to advise engineers to speak out and risk getting fired, like the three engineers on the BART program. I know that's not what you really mean. I think what you mean is that engineers should create a professional environment in which they can speak out with impunity.

Professional Activities Committees of the IEEE are springing up all over the country. Our goal is to have such a committee in all 260 sections of the IEEE. They are working to secure for the engineer the professional environment in which he can do a proper job and thereby serve the public interest as well as his own.

Robert Bruce

Member, L.I. Section IEEE, PAC
15 Johnstone Road
Great Neck, N.Y. 11021

Hughes claims credit for circuit hardener

The article "Protect Against Nuclear Transients" (ED No. 4, Feb. 15, 1974, p. 64F) described a very powerful technique for the hardening of multivibrator

circuits against the effects of transient nuclear radiation.

This technique was first used by Hughes Aircraft Co. as early as 1967 and has since been registered with the United States Patent Office. Hardening is basically a noise-filtering technique, designed to minimize the effects of radiation-induced photocurrent. It is quite useful, however, in any environment with excessive noise spikes.

Many of today's military satellite and missile systems employ the hardening method by use of discrete and/or hybrid circuit technology. The technique is also being used in MSI/LSI applications.

Ross M. Orndorff
Senior Staff Engineer

Hughes Aircraft Company
Aerospace Group
Culver City, Calif. 90230

'Microhenries' is correct

In "Focus on Small Motors" (ED No. 20, Sept. 27, 1973, pp. 52-64), the inductance values on p. 58 are incorrect. The table should have the heading listed in microhenries, or individual listings shown as 10^{-3} instead of 10^3 .

H. R. Kinder

Member of Technical Staff
Rockwell International
3370 Miraloma
Anaheim, Calif. 92803

Another WOM . . . phew!

I read your summary of interesting uses for that new IC, the

(continued on page 16)

giga-trim capacitors for microcircuit designers

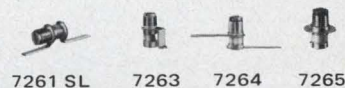
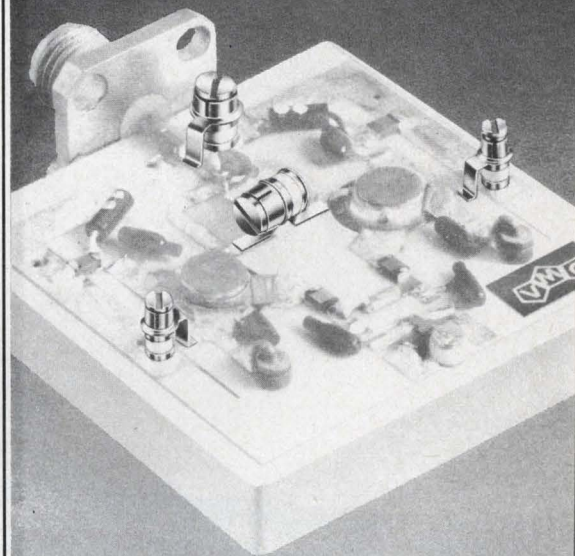

Giga-Trim® (gigahertz-trimmers) are tiny variable capacitors which provide a beautifully straight forward technique to fine tune RF hybrid circuits and MIC's into proper behavior. They replace time consuming cut-and-try adjustment techniques and trimming by interchange of fixed capacitors.

Applications include impedance matching of GHz transistor circuits, series or shunt "gap-trimming" of microstrips, external tweaking of cavities, and fine tuning of crystal oscillators.

Johanson

MANUFACTURING CORPORATION

BOONTON, NEW JERSEY 07005
201 / 334-2676

Electronic Design welcomes the opinions of its readers on the issues raised in the magazine's editorial columns. Address letters to Managing Editor, Electronic Design, 50 Essex St. Rochelle Park, N.J. 07662. Try to keep letters under 200 words. Letters must be signed. Names will be withheld on request.



digital

DECkit

digital
dec products

Interface your PDP-11 with a screwdriver.

Attention all you PDP-11 owners out there.

We've been watching you.

And a lot of you are doing the same kind of interfacing.

Hooking up standard peripherals. Converting analog signals to serial ASCII. Directly accessing storage memory. Hooking up remote instruments and custom peripherals that have BCD outputs. Doing the same thing over and over.

Hold it.

Our new DECKits can save you a lot of time and frustration.

DECKits are instant interfaces — basically just a few modules and a PDP-11 systems unit.

Just plug the modules into the systems unit, screw the unit into the PDP-11, and attach the connectors. Your equipment is interfaced.

There's no design time. No breadboarding.

No wirewrapping. The modules and design for each kit have been pretested and fully documented and are ready to solve your interface problem.

Start your interface now. Pick up your pencil and circle our number on the readers service card. We'll send you a complete description of all the DECKit interfaces now available.

We're Digital Equipment Corporation, Logic Products Group, Maynard, Massachusetts 01754. (617) 897-5111, extension 2785.

In Canada: P.O. Box 11500 Ottawa, Ontario, K2H 8K8. (613) 592-5111.

In Europe: 81 Route de l'Aire, 1211 Geneva 26. Telephone: 42 79 50.

**We think interfacing is so important,
we've devoted an entire department to it.**

digital

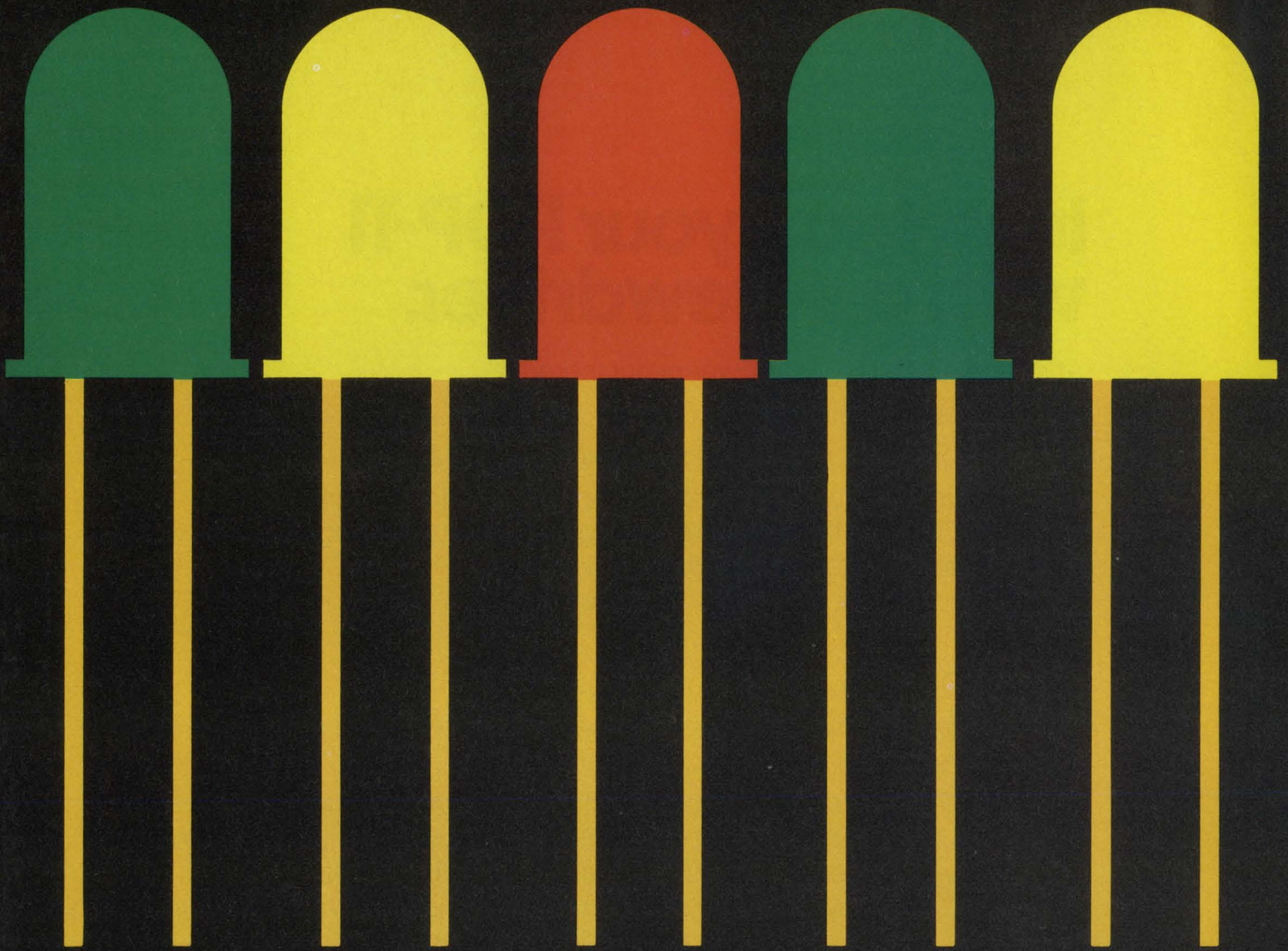

INTRODUCING LEDs...

Motorola offers you more than a dozen red, green and yellow LEDs in 15 individual packages . . . engineered to meet 90% of your application needs.

Data sheet spec'd.
In production.

We're also offering 25,000 discrete and integrated circuit devices. 1,050 linear integrated circuits. 7,100 power transistors. 6,400 rectifiers and diodes, etc. . . . enough to satisfy an overwhelming percentage of those

other design needs. Together, our LED standards make convenient, flexible component packages unmatched by most others and ready for most any design need.

Our established history of introducing hundreds of thousands of semiconductors for a corresponding number of applications and designs has made us experts in high-volume pro-

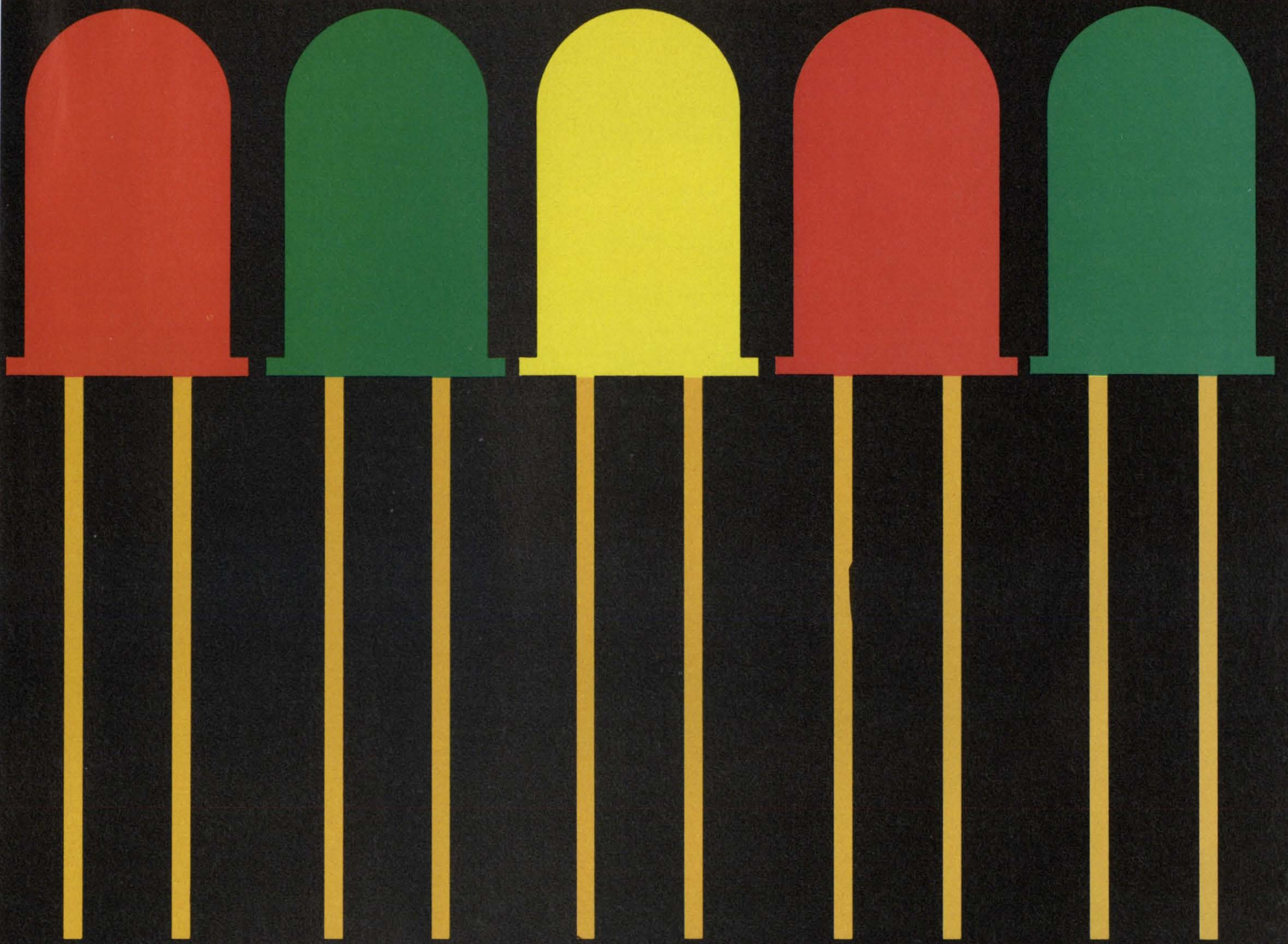

plus all other semiconductors

duction of popular devices . . . including LEDs.

"Production House of the Industry" is what we're called. We'll be here long after specialty houses have dimmed their lights.

We can't wait to show you how easy it is to get all your LEDs (and the 25,000 other standards) from one supplier. A special literature package is waiting —

the new Optoelectronic Selector/Cross-Reference Guide and the Semiconductor Master Selector Guide.

Box 20912, Phoenix, AZ 85036

Contact your franchised Motorola distributor or factory representative for the right answers on LED delivery.

Get it all together — right now...

obvious
From Motorola, the [^]LED producer.

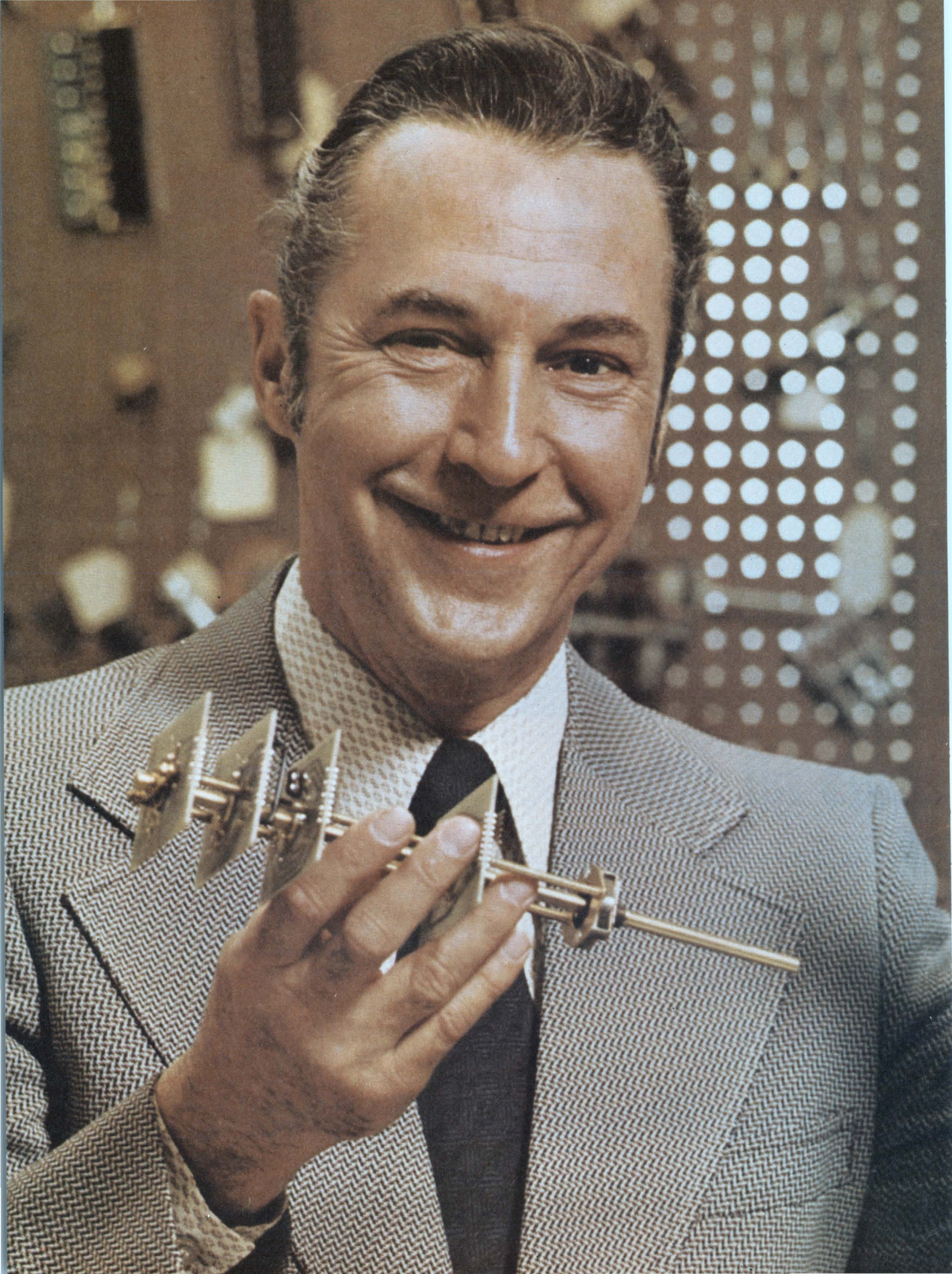

Bern Golbeck's nifty idea gave a crisp new feel to rotary switches.

A few years back, Oak's Director of Engineering, Bern Golbeck, had a hunch. Use two ball bearings instead of one, and let them index a simple starwheel. This would give crisp detenting while greatly reducing the wear on any single moving part.

It worked. The two ball bearings, controlled by flat springs, travel independently over notches in the starwheel. Detenting is smooth, even and sure.

Positioning is precise. And it gives a crisp, uniform feel that you're sure to recognize.

We call this fancy detent system Unidex,[®] and it's just one of many improvements Oak engineers like Bern have pioneered. Since Unidex, we've added molded rotors and molded sections to our rotaries—innovations that are now benchmarks of the industry. And today we're busy incorporating PC board mountings into almost all our switch designs for the quickest and simplest installation possible.

We think you and the people who use your products will notice the difference great ideas like Unidex make. Just try, for example, the storage select switch on an IBM System/370 Model 145 operator's console. Or the sweep selector on a new Hewlett-Packard 1220A oscilloscope. You'll feel it.

While you're at it, write Dave Clifton at Oak. He'll send you free literature detailing the broadest line of quality rotaries in the industry. And he'll pass along some of Bern's helpful ideas on how to choose the right rotary switch for your job.

OAK Industries Inc.

SWITCH DIVISION / CRYSTAL LAKE, ILLINOIS 60014
TELEPHONE: 815 • 459 • 5000 ■ TWX: 910 • 634 • 3353 ■ TELEX: 72 • 2447

INFORMATION RETRIEVAL NUMBER 9

“Nice going Bern”

We're very big on small

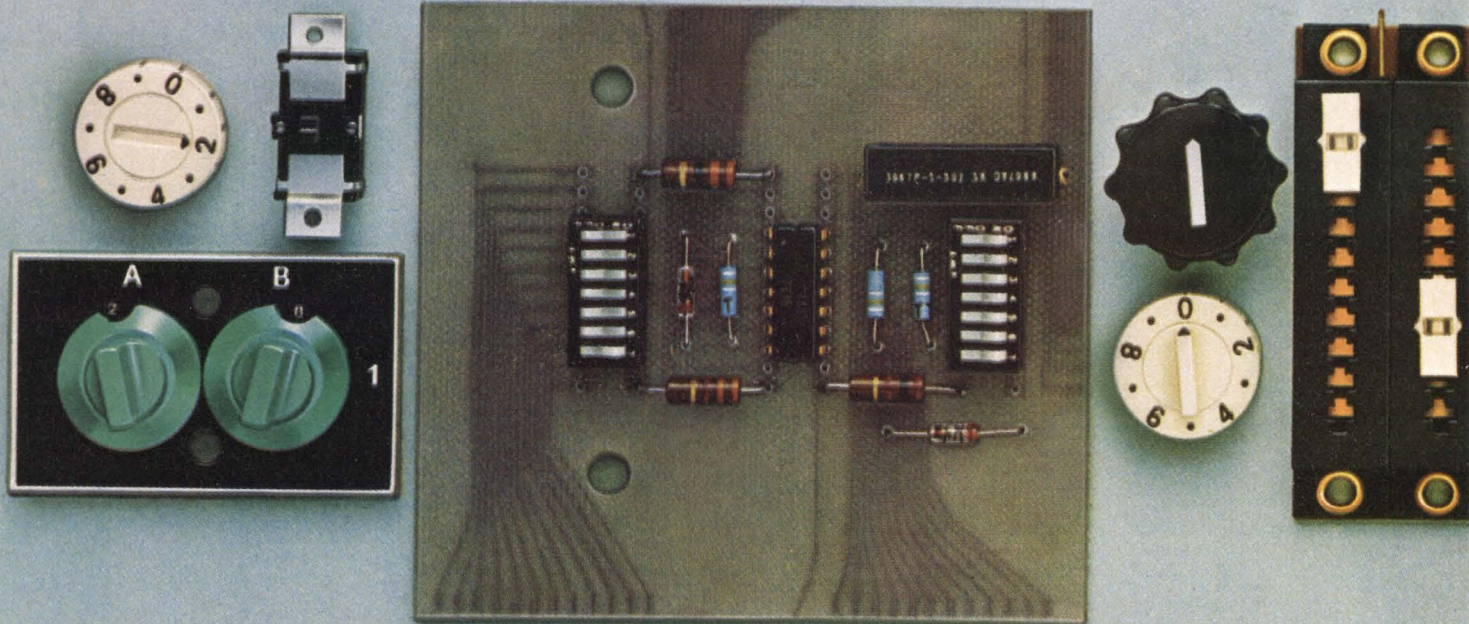

When it comes to miniaturized switches, you'll find true AMP innovation. And because they're made by AMP, you know you're getting economy and reliability.

Take our multipole switch for pc boards, a new addition to our dual in-line switch group. It increases our ability to give you an even wider variety of configurations in high-density DIP switches. From double-, triple-, 4- and 5-pole single-throw to single-pole double-throw 4-terminal form Z.

What else is new? Our 2-, 3- or 4-position switches, each having double-pole double-throw capability. In a single dual in-line enclosure. They're only .275" high, which includes the screwdriver-operated actuator.

For low-cost applications, consider AMP's unique pull-to-set slide switch. It's available as a module for mounting on pc boards. Or preassembled as a programmable matrix slide switch.

In addition, we have a complete line of matrix rotary switches and switch kits designed for panel mounting. They're simple and economical ways of manually programming various types of electrical/electronic equipment. Without external switch wiring.

Our pc board rotary switch gives you a wide choice of outputs. Plus truly versatile application possibilities. While our 5-position slide switch permits maximum slide positions in a minimum switch size.

So think small. Think AMP mini-switches. Call (717) 564-0101. Or write AMP Incorporated, Harrisburg, Pa. 17105.

AMP
INCORPORATED

AMP is a trademark of AMP Incorporated.



switches

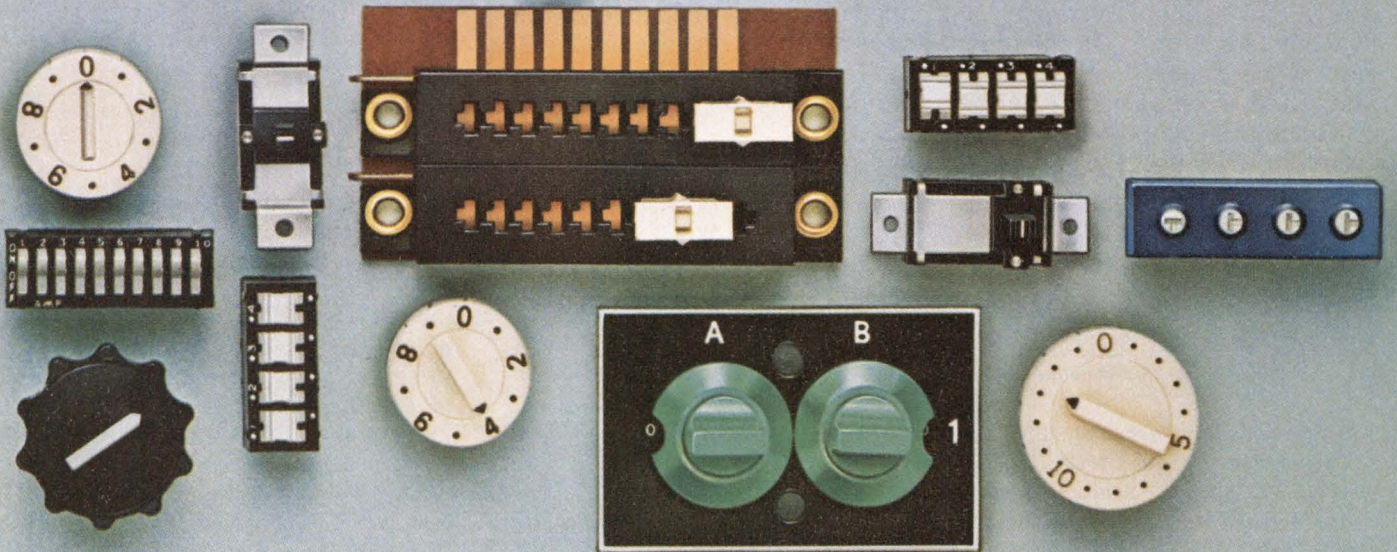

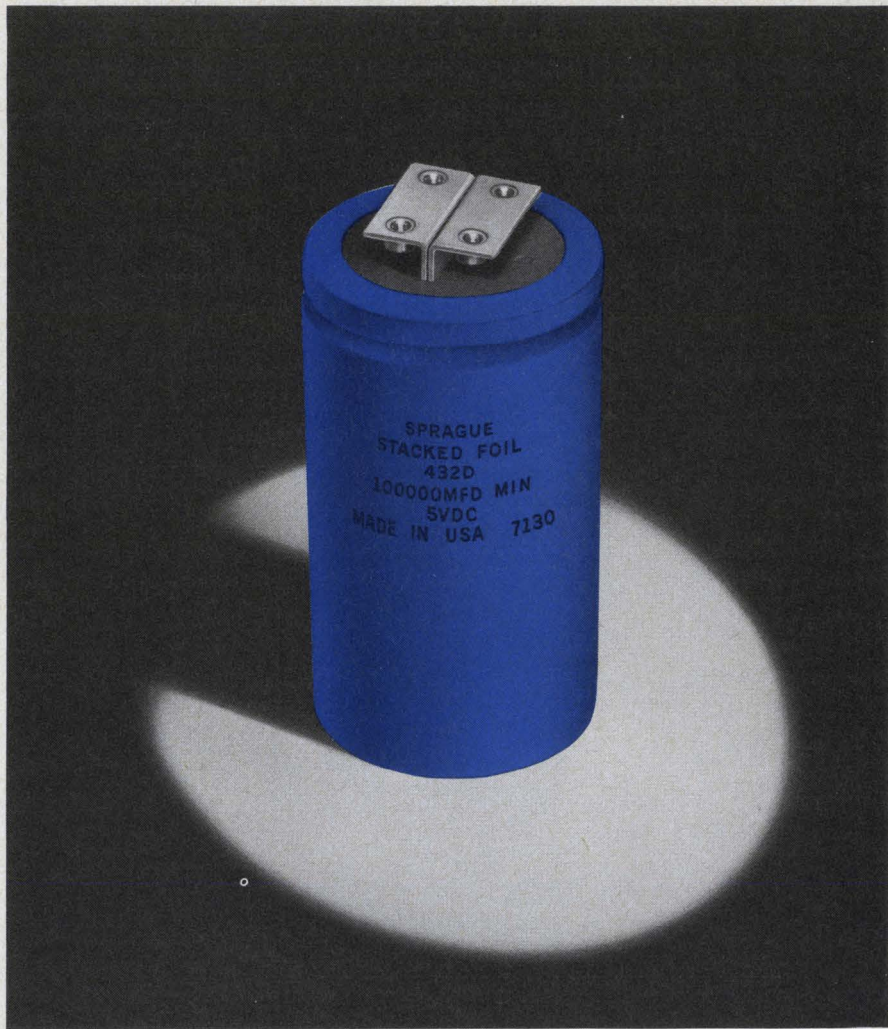

Stacked...with beautiful curves!

(stacked-foil construction with ultra-low impedance, ultra-low ESR, ultra-low inductance)

Revolutionary new Type 432D COMPULYTIC® Aluminum Electrolytic Capacitors offer capacitance values to 100,000 μ F with equivalent series resistance of typically less than 0.001 ohm and inductance of only 1 nH in a 3" x 5 $\frac{5}{8}$ " case. This same capacitor will handle 93 amperes of ripple current at 65 C and 1 kHz.

Impedance limits at 10 kHz are as low as 0.001 ohm with typical values of only half of the specified limits.

Now available in two additional smaller case sizes for space-saving applications in smaller-wattage power supplies, with typical impedance of five milliohms.

For complete technical data, write for Engineering Bulletin 3443 to: Technical Literature Service, Sprague Electric Co., 347 Marshall St., North Adams, Mass. 01247.

Terminals are ideal for use with laminated-bus power distribution systems found in modern EDP equipment, where the low ESR and impedance of Compulytic capacitors help insure continued operation of logic circuits even during momentary power outages.

Sprague Type 432D Capacitors are available in nine voltage ratings from 5 to 50 volts d-c, and are designed for operation over the temperature range from -40 to +85 C.



THE BROAD-LINE PRODUCER OF ELECTRONIC PARTS

INFORMATION RETRIEVAL NUMBER 11

ACROSS THE DESK

(continued from page 7)

Write-Only Memory.

Imagine the technological breakthrough that would result if the WOM were combined with other noteworthy developments, such as the noninductive choke and the infinite-leakage capacitor.

With a WOM's use of the "MAYBE" Gate (for any combination of inputs, its output may be a ONE or a ZERO) or its complement, the "NMAYBE" Gate, digital electronics will have attained the same high level of achievement as our Federal Government.

Is it true that the WOM can be erased with a garlic clove (to allow room for storage of this letter)? If so, we have a really "volatile" WOM—phew!

The WOM reminds me of a classified envelope I once received. It was marked: "Secret, Destroy Before Reading."

J. R. Judkins

Chief Electrical Engineer

Esterline Angus

Box 24000

Indianapolis, Ind. 46224

What next?

I don't really see much commercial potential for the WOM. However, I'm sure that an EOM (Erase-Only Memory) would go like hotcakes in government purchasing circles right now.

Ivan Berger

Popular Mechanics

224 W. 57 St.

New York, N.Y. 10019.

Correction

There are, it seems, two component companies with the same name: International Components Corp. The wrong one was listed in the New Products section of the March 15 issue as the manufacturer of polyester capacitors (see "Polyester Capacitors Wound Non-inductively," ED No. 6, March 15, 1974, p. 218).

The correct company, in this case, is: International Components Corp., 10 Daniel St., Farmingdale, N.Y. 11735. (516) 293-1500.

**A
LOT
MORE
FOR A
LITTLE
LESS**

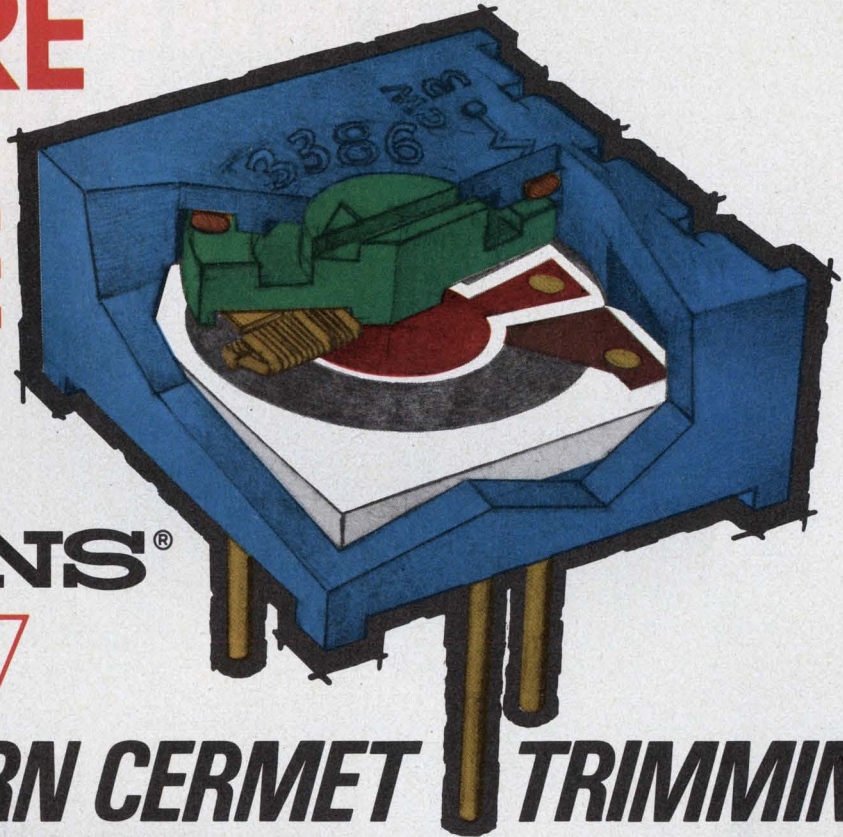

BOURNS®

NEW

**SINGLE-TURN CERMET TRIMMING
POTENTIOMETER**

- VASTLY IMPROVED ADJUSTABILITY
- TWELVE TERMINAL STYLES
- SEALED FOR WAVE SOLDERING

45¢
in production quantities

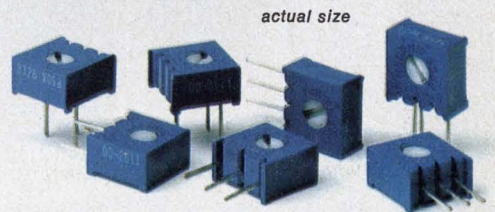

Meet Bourns new Model 3386, a product that both buyer and engineer can love . . . with super adjustability that makes for easy, accurate trimming, AND at a budget balancing price. Most importantly, it's a BOURNS product . . . and that means **QUALITY** and **PERFORMANCE** you can believe-in, and **SERVICE** you can depend-on.

SIGNIFICANT SPECIFICATIONS

- typical CRV less than 1% • infinite resolution • TC of $\pm 100\text{PPM}/^\circ\text{C}$ to 200K ohms • power of .5 watt at 85°C • thin $\frac{3}{8}$ " square size



For complete details, contact your local Bourns representative or distributor, or the factory direct.



TRIMPOT PRODUCTS DIVISION • 1200 COLUMBIA AVE., RIVERSIDE, CALIF. 92507

INFORMATION RETRIEVAL NUMBER 12

The Nationwide Network:



18 manufacturers reps with 31 offices and 95 sales engineers; plus, over 300 stocking distributors.

Bud puts its products where you are: Nearly 3000 types of racks, cabinets, enclosures and accessories. They're built. Stocked. Ready to go. Ready for you. Now!

There's a Bud Distributor close at hand. Get his name. Call 800/645-9200, toll free. You'll get what you want,

where and when you want it.

That's why Bud is number one in the ratings. No one in the industry can match this immediate, off-the-shelf availability of product line.

No one can match Bud's well-knit Representative-Distributor organization: 18 Sales Representative companies

with 31 offices; 95 sales engineers working with more than 300 Distributors.

Distribution. Technically knowledgeable people. The industry's largest product line. Quality, value, availability. If that's what you're looking for, want... go Bud!

THE BUD NETWORK OF SALES REPRESENTATIVES: CONTACT THEM FOR ADDITIONAL INFORMATION.

JACK BERMAN CO., INC.

8295 So. Lacieneaga Blvd.
Inglewood, Calif. 90301
213-678-1281

Territory: *Arizona, Southern California, Southern Nevada*

CARTWRIGHT & BEAN CO.

560 South Cooper
P.O. Box 4760
Memphis, Tennessee 38104
901-276-4442

90 West Wieuca Square
Suite 155
Atlanta, Georgia 30342
404-255-5262

P.O. Box 1188
617 W. Judge Dr.
Chalmette, La. 70043
504-279-4598

200 E. Marks Street
Orlando, Fla. 32803
305-422-4531

625 Harwyn Drive
Charlotte, N.C. 28215
704-333-6457

P.O. Box 11209
2415 "G" Crabtree Blvd.
Raleigh, N.C. 27604
919-832-7128

1241 N.W. 75th Terrace
Plantation, Fla. 33313
305-791-3989

P.O. Box 3730
5250 Galaxy Drive-Suite J
Jackson, Mississippi 39207
601-981-1368

8501 Kingston Pike
Knoxville, Tenn. 37919
615-693-7450

Territory: *Alabama, Arkansas, Florida, Georgia, Louisiana, Mississippi, North Carolina, South Carolina, Tennessee*

EARL & BROWN CO., INC.

2047 - 14th Ave. W.
Seattle, Washington 98109
206-284-1121

2041 S.W. 58th Ave.
Portland, Oregon 97225
503-292-9145

Territory: *Northern Idaho, Northern Montana, Oregon, Washington, Alaska*

GNB ASSOCIATES, INC.

4761 West Touhy Ave.
Chicago, Illinois 60646
312-673-4050

Territory: *Northern Illinois, Eastern Wisconsin*

THE CLARK R. GIBB CO.

1311 West 25th St.
Minneapolis, Minnesota 55405
612-377-1200

Territory: *Minnesota, North Dakota, South Dakota, Western Wisconsin*

LINDBERG COMPANY

6021 E. Evans Ave.
Denver, Colorado 80222
303-758-9033
209 San Pablo, S.E.
Albuquerque, New Mexico 87108
505-345-2489

431 South Third East
Salt Lake City, Utah 84111
801-364-6409

Territory: *Colorado, Utah, Wyoming, Southern Idaho, Eastern Montana, New Mexico, El Paso, Texas*

LUND & COMPANY

2616 Manor Way
P.O. Box 35566
Dallas, Texas 75235
214-358-4335

Territory: *Oklahoma, Texas*

MARLOW ASSOCIATES, INC.

1991 Lee Road
Cleveland, Ohio 44118
216-932-0900

1427 Parkman Pl.
Xenia, Ohio 45385
513-426-6270

Territory: *Ohio, Western Pennsylvania, West Virginia*

MARSEY SALES, INC.

206 Park Avenue
Rochester, New York 14607
716-442-9700

Territory: *Upper New York*

MULLIN TECHNICAL SALES, INC.

945 Great Plain Avenue
Needham, Massachusetts 02191
617-444-4780

Territory: *Maine, New Hampshire, Vermont, Massachusetts, Rhode Island, Connecticut*

PALATINE ENGINEERING SALES INC.

1573 N. Warson Rd.
St. Louis, Missouri 63132
314-426-7055

7520 West 63rd St.
Suite 10
Overland Park, Kansas 66202
913-262-5643

720 Third Ave., S.E.
Cedar Rapids, Iowa 52403
319-365-8071

510 W. Allison St.
Andover, Kansas 67002
316-683-7512

Territory: *Southern Illinois, Kansas, Missouri, Nebraska, Iowa*

DAVID H. ROSS COMPANY

1095 Industrial Road
San Carlos, California 94070
415-591-4411

Territory: *Northern California, Northern Nevada*

SOUTHERN SALES CORP.

1111 East 54th St.
Indianapolis, Indiana 46220
317-257-7575

Territory: *Indiana, Kentucky*

JACK M. THORPE CO.

21537 Harper Ave.
St. Clair Shores, Mich. 48080
313-779-6363

Territory: *Michigan*

TRINKLE SALES, INC.

1010 Haddonfield-Berlin Road
Cherry Hill, New Jersey 08002
609-795-4200
215-922-2080 (Philadelphia)

Territory: *Eastern Pennsylvania, Southern New Jersey, Delaware, Maryland, District of Columbia, Virginia*

WILLGOLD ELECTRONIC SALES CORP.

P.O. Box 27
100 North Village Avenue
Rockville Centre, New York 11571
516-764-4022

Territory: *Northern New Jersey, Metropolitan New York, Long Island, Westchester County*



"The Housing Authority"

BUD RADIO, INC.
4605 E. 355th St. Willoughby, Ohio 44094
216/946-3200 TWX 810-427-2604

B8006-BR

A startling announcement:

TRW's new
Schottky Power
Rectifier



gives a
0.5V forward
voltage drop

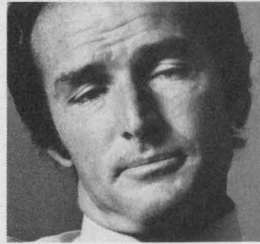

at 50 amps

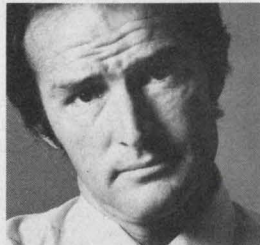

at a T_j of...125°C!

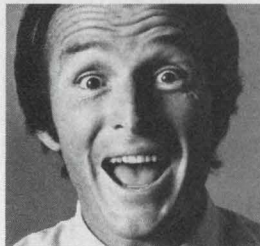

If that doesn't startle all power supply designers, nothing will.

Here's the first, and only, Schottky power rectifier that doesn't fssst-out at 100°C—let alone, higher! In fact, TRW's new device actually operates at a T_j of 125°C with a 0.5V_f at 50 amps.

Maybe you have heard discouraging talk about similar devices made by other companies. Or tried one, yourself. If so, you may have experienced "mysterious failures." Certainly you had

failure when T_j reached 100°C. And it was no mystery: the thing melted!

But this is different. This is made by TRW. After 5 years R&D to be sure it would work. And it does! At 100° At 125° With 35V reverse operating voltage.

Ask the nearest distributor for TRW's new Schottky power rectifier. Part number SD 51. Or contact John Powers, TRW Semiconductors, an Electronic Components Division of TRW, Inc., 14520 Aviation Boulevard, Lawndale, California 90260.

TRW® SEMICONDUCTORS



Almo Electronics
Bell Industries
Cramer Electronics Inc.
De Mambro Electronics

Eastern Radio Corp.
Electronics Marketing Corp.
Elmar Electronics Inc.
Hall-Mark Electronics Corp.

Harvey-Michigan Inc.
Liberty Electronics
Powell Electronics
Pytronics

Semiconductor Concepts Inc.
Summit Distributor
R. V. Weatherford Co.
Westates Electronics Corp.

INFORMATION RETRIEVAL NUMBER 14

First X-ray waveguide opens three new application areas

The first X-ray waveguide has been developed by IBM scientists. The discovery makes possible these applications: The use of light-pipes to guide X-rays, the fabricating of resonant cavities for X-ray lasers and the construction of X-ray focusing devices.

According to Eberhard Spiller, a staff member at IBM's Watson Research Center, Yorktown Heights, N.Y., researchers fabricated the new waveguide by sandwiching a layer of boron nitride 300 to 500 Å thick between a substrate and a cover layer of sapphire. A raised, thicker region of the cover layer defines the length of the boron nitride that acts as a waveguide. The thinner regions serve as areas for the input and output of X-rays, Spiller says.

The wavelength of the X-rays is 1.54 Å, and the waveguide itself is 0.3 mm long. The length of an equivalent waveguide for red light would be about 1 m.

In speculating why no one has fabricated an X-ray waveguide until now, Spiller notes that as the wavelength decreases, potential waveguide materials absorb radiation more and more strongly. It was just assumed that this continues indefinitely, he says. But it does not.

Beyond an absorption maximum at about 1000 Å, Spiller explains, absorption tends to grow progressively smaller, particularly in materials of low atomic weight, even though the refractive index increases. This is in marked contrast with what happens in the visible and long-wave ultraviolet region, where absorption losses tend to increase with higher indices of refraction.

To build waveguides, a relatively high index of refraction is important, because the guiding material must have a higher index than that of the surrounding material,

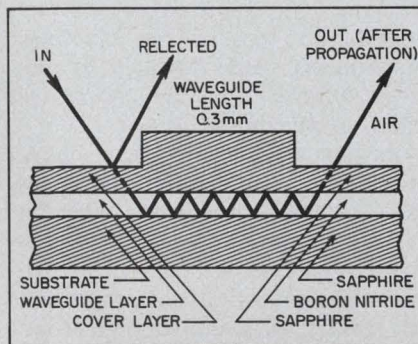

X-ray waveguide developed by IBM consists of boron nitride sandwiched between two sapphire layers. The length of the protrusion on the upper layer determines the waveguide length.

or cladding. It is this condition that allows total internal reflection at the film/cladding boundary and permits the light to zigzag down the film in one or more different patterns, or modes.

In operation, an incident X-ray beam strikes the sapphire cover of the waveguide at a very shallow angle. Although most of this beam is reflected, a certain fraction of the beam penetrates the cover layer and excites a waveguide mode in the boron-nitride film.

Spiller notes that an order-of-magnitude increase in the propagation length of the waveguide is theoretically possible. This could be achieved, he says, by use of different materials. He also reports that moderately flexible guidance of X-rays over several meters might be achieved by use of capillary waveguides.

More bipolars eligible for flip-chip conversion

Any bipolar IC that has bonding pads on normal 8-mil centers can now be converted into a flip chip for high-density packaging. Pre-

viously flip chips were not built with solder bumps any closer than 12-mil centers, notes Don Brownell, product engineer at Motorola Semiconductor in Mesa, Ariz.

The procedure calls for a contact-opening etch over the wire bond pad. Over this opening are evaporated layers of chrome, copper and gold. Then layers of lead and tin are evaporated over the gold to provide the solder. The chip is heated to about 320 C to reflow the solder into a sphere. The result is a sphere, or bump, of solder on the bonding pad.

Brownell points out that the flip chip will cost about 30 to 50% more than a standard chip ready for wire-bonding. The main advantages are that no special layout is needed; any standard circuit can be used. And thousands of ICs are now available to flip-chip users.

However, the procedure is not suitable for surface devices. "MOS would be ruined by the process," Brownell says.

Touch communications investigated by Army

How can you send instructions to a soldier on the battlefield at a distance without using light or sound?

You can send signals he can feel.

You tape to his forearm a small slab of plastic that has imbedded in it two small pin electrodes. In response to signals from a transmitter, the electrodes transmit a very mild stimulus to the wearer's skin. The sensation can vary from a light tingle to a sting, depending on the voltage of the impulse, says Herbert S. Bennett, project manager for the cutaneous communications project now under way at the Communications and Automatic Data Processing Laboratory of the Army Electronics Command, Fort Monmouth, N.J.

The Army wants such a communications device for use in environments with high-intensity light and sound—tanks and helicopters—and for sentry duty, where light or sound may attract the enemy.

For example, a tank commander wants to give his driver instructions. So he grips a lever with his left hand, and it sends one impulse to the driver's left arm. This tells him to look to the left. Two signals

might mean to turn to the left. Another device might be strapped to the driver's right arm, and one to his leg.

Short transmission might be by wire, Bennett says. For sending instructions over greater distances, radio might be used—"any tactical radio link that's best for the situation." Signals could also be sent simultaneously to a number of receivers.

The ideal device would require very little power, yet provide a sensitive threshold. The best electrical impulse for this, Bennett says, is a constant-current, biphasic-interrupted square-wave signal. The transducer unit is a constant-current signal generator.

There are 300 pulses per second, with each biphasic pulse lasting 0.5 ms.

Digital memory sought from organic materials

With a new concept for use of organic materials, Battelle Laboratories is developing a high-density digital memory that could handle 10^4 bits/ms.

In a program sponsored by NASA's Langley Research Center, Battelle scientists in Columbus, Ohio, are building a memory that is based on the reversible reaction between two geometric isomers of organic materials. These molecules, altered by laser light, can be manipulated to produce phase holograms, because the two isomers reflect laser light differently.

Battelle expects its memory to be commercially available in two years.

Organic materials are attractive for use in digital memories because they are economical (see p. 32). They offer the following advantages:

- Low-energy formation of holograms, permitting the use of compact, economical lasers.
- A large refractive index difference that allows multiple hologram superposition.
- The use of convenient laser wavelengths.
- Custom fashioning of materials to produce desired optical properties and hologram thickness.

According to Richard A. Nathan, head of the development effort, ir-

radiation of the material with the light of one wavelength brings about a chemical reaction. This causes a change in the index of refraction and creates a hologram. Irradiation with the light of a second wavelength erases the hologram and returns material to its original state.

Each hologram would have a capacity for a million bits of information per square millimeter. This density would be achieved by stacking 100 10^4 -bit pages of information on top of one another. Stacking is made possible by the large difference in the refractive index of the material.

Results to date, Nathan notes, provide a strong indication that this system possesses optimum characteristics for optical memories. He points out that while all materials have limiting properties, the ability to tailor organic compounds far exceeds the ability to adjust independently the characteristics of inorganic single-crystal materials, which are also being investigated.

Parts labeling speed raised to 20,000/hr

A substantial advance is reported in the speed of labeling axial lead components that require orientation—like diodes and rectifiers. A marking system developed by Markem Corp., Keene, N.H., is said to process up to 20,000 items an hour.

The speed of the Marken U1220 system has been achieved through two developments: (1) A new system that checks diode polarity and automatically orients the part for marking, and (2) The replacement of 30-foot, ink-curving ovens with a 44-inch, 2-kW infrared oven that cures the ink in six seconds instead of two hours.

CCD memory ICs heading for market

Several manufacturers are expected to announce development of charge-coupled-device memory ICs by September.

Rumors about a 16-k-bit device from Signetics have been confirmed by the company's MOS market-

ing manager, Robert Dwyer. According to Dwyer, the new memory device will be a shift register with no taps. It is a dynamic device that will be housed in an 8-pin mini DIP. The range of operating frequencies will be from 1 kHz to 6 MHz.

The Signetics device is to be in production next year, selling for about 0.1 cent/bit.

Other companies expected to introduce memory devices in September include Fairchild, Intel and RCA.

RCA's Aviation Div. and Memory Products Group, both in Van Nuys, Calif., have expressed great interest in the Signetics device as a replacement for drum memories and delay lines in video terminals.

Burroughs, Xerox, Univac and several add-on memory manufacturers are also interested, Dwyer says.

A roving course offered on microprocessors

A "traveling school" has been organized to teach engineers at their place of work how to use microprocessors.

The course, sponsored by Automata Systems Corp., South Hempstead, N.Y., costs \$2500, regardless of the number of engineers who attend. Classes last five days and are tailored to each company's needs. Unlike other microprocessor courses offered by device manufacturers, Automata says, this one can be oriented to any computer chip.

Demand for engineers reported on rise

June engineering graduates should have an easier time getting a job this year than in recent years, reports the Engineering Manpower Commission of the Engineers Joint Council.

A survey of the nation's leading engineering schools by the commission shows demand for bachelor-degree students running stronger on 95% of the campuses, with half of the schools describing employer interest as "much higher" than it was last year. Stronger demand for master-degree (89%) and doctorate graduates (77%) is also reported.

SerenDIP-itous reminder

A versatile family of solid state DIP relays



Serendipity is a gift for finding valuable or pleasant things you hadn't looked for. Teledyne, the world's largest maker of solid state relays makes serendipity for engineers — We make SERENDIP®s.

The SERENDIP® family includes four kinds of solid state DIP relays for different jobs. They up-grade, with all the advantages of solid-state — total input/output isolation, low-level logic input compatibility, fast response time, no "contact bounce" (drive IC's directly), and long life dependability. All this in low profile TO-116 DIP packs with equally low cost.

About those different jobs. The 640-1 features bi-polar output, AC or DC up to 50v/80Ma, with low ON resistance — 2 ohms typical. Use it for isolated line drivers and data couplers, A/D converters, modulators and demodulators.

The 641 is a small AC powerhouse — 1 AMP Triac output, 140 or 280 VAC with a 10 AMP surge rating. Try it for lamp or inductive load control — solenoids, motors, transformers, etc. And the 641 is now UL recognized.

The 643's are DC versions capable of switching up to 60v/400Ma or 250v/100Ma. They actually exceed current and voltage switching capabilities of opto-isolators. In communications, use them for keyer switching — or as telegraph relays.

Finally, the 644 is a low offset voltage unit that solves switching problems in instrumentation applications. Use it for low level transducer signal switching, series choppers, scanners, sample-and-hold, multiplexing, etc.

The SERENDIP® family — a pleasant reminder from Teledyne Relays. Ask your rep or distributor, or call us.

 **TELEDYNE RELAYS**

3155 West El Segundo Boulevard Hawthorne, California 90250
Telephone (213) 973-4545

INFORMATION RETRIEVAL NUMBER 15

Optics and acoustics generate new microelectronic devices

New optical and acoustic IC elements and devices are ushering in new families of microelectronics devices.

The current status and potential of these devices—with developments in surface-acoustic-wave elements leading the way—were described by researchers at the Symposium on Optical and Acoustical Microelectronics in New York City. New devices highlighted included these:

- Acoustical signal-processing elements performing complex signal-processing functions in small, simple configurations.

- Optical and acoustic imaging and picture-element processing devices.

- A new opto-acoustic storage medium that uses ultrasonic echo techniques.

- Lasers and detectors that can be integrated into monolithic structures.

The devices that are farthest

Jim McDermott
Eastern Editor

along in development are the hf and uhf acousto-electric elements. These devices, reports Ernest Stern, leader of the Microsound Group at the MIT Lincoln Laboratory, Lexington, Mass., and author of a Session I paper on "New Directions and Applications for Acoustical Microelectronics," combine the piezoelectric/acoustic properties of a piezoelectric material, like lithium niobate, with a semiconducting material, like silicon.

In these devices, Stern explains, the acoustic surface wave interacts with electrons in the semiconductor to produce a variety of effects. An example, Stern says, is an acousto-electric convolver, which is useful in spread-spectrum communications and other noisy environments. In this device a surface wave is generated from a reference signal at one end of a tiny piezoelectric slab—lithium niobate, say—while at the other end a signal and accompanying noise are introduced.

These waves overlap, and they

interact with the silicon overlay to produce a signal whose amplitude is proportional to the overlapping areas of the signals. The convolver both multiplies and integrates simultaneously.

MIT device described

The newest device produced at the Lincoln Laboratory, Stern says, is a convolver made of a block of lithium niobate about two inches long, with interdigitated surface-wave transducers at each end.

"We etch the surface of the niobate, leaving tiny islands or mesas, of the material some 2000 Å high," Stern reports. "A wafer of silicon is pressed against these mesas, and as the acoustic waves propagate through them—like waves through pilings—the piezoelectric field associated with the surface waves interacts nonlinearly in the silicon to produce the electrical convolution function."

The convolution signal is generated between the silicon and the bottom of the lithium niobate. The input is a reference signal, with a center frequency of 200 MHz and a bandwidth of 65 MHz, and the

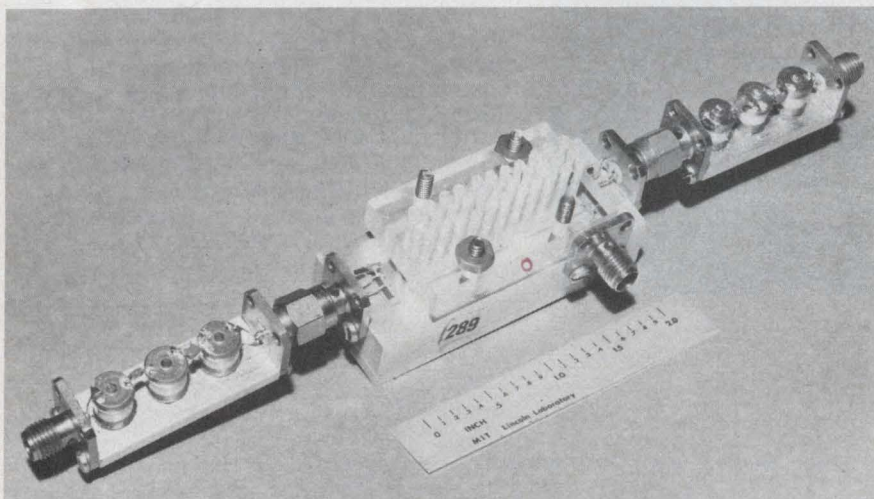

This acousto-electric convolver has a piezo-element of lithium niobate and a silicon overlay. Developed at Lincoln Laboratory the device has a 200-MHz center frequency, a 65-MHz bandwidth and correlation gain of 500.

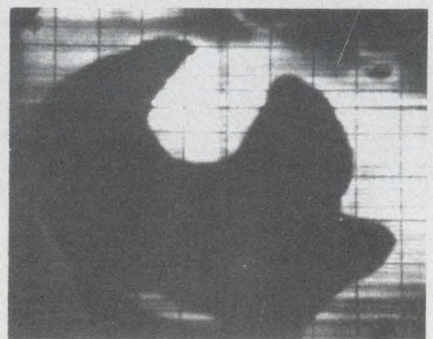

The image of a small wrench was made with an electronically focused acoustic imaging device.

The first modular instrumentation calculator.

Just \$5905 as shown.

It's our 31/53 Calculator Instrumentation System

A powerful, yet inexpensive calculator combined with our TM 500 power supply and system software. You add the instrumentation modules you need. It's all there and it's portable. Now that's versatility!

With our 31 Calculator, you can read input from our DMM's and counters. You can log data selectively, calculate results and output data or trigger signals.

Programming? Little more than natural math. Go ahead, write your own. Also, our standard software gives you data logging (on the optional printer) and data capture on the 31 at operator selected intervals.

For numerical monitoring or

analysis, there's our 21/53 for \$2895 less plug-ins. And in case you wondered, our TM 500 plug-ins are less expensive, too.

Energy monitoring.

Quality control testing. Laboratory and production instrumentation.

The applications go on, and so does our system's potential. Just add the main-

frames and modules you need. We have a graphic calculator system, too. Let our sales engineer fill you in. Pick up your phone and call our nearest center. Or write

Tektronix, P.O. Box 500, Beaverton, Oregon 97005

Our programmable calculators. Natural. Powerful. Significantly less expensive.



convolution interaction length is about 3.3 cm, or 10 μ s.

There is a correlation gain of greater than 500 in the device—which is “very good,” Stern points out. This gain means that the signal correlates with its reference but the noise doesn’t, so the signal is raised out of the noise by the correlator.

“I see correlation gains with this technique ultimately as much as 2000, with bandwidths of 300 MHz,” Stern says.

New scanning techniques

A new development in acoustic-wave technology that shows considerable promise is the scanning of optical or acoustic images produced by illumination of an object with low-frequency sound, according to Dr. Gordon S. Kino, author of a symposium paper on “The Application of Acoustic Surface Waves to Optical and Acoustic Imaging.” In the optical imaging devices, semiconductor photoconductors are deposited on the surface of a piezoelectric delay line or very close to it.

“If you illuminate the photoconductor,” Kino says, “you can use an acoustic pulse traveling along the delay line to essentially read off the conductivity of one line of the image. This contrasts with the CCD’s, in which the charge is transferred along a linear array.”

The sonic method of scanning optical images has substantial advantages, Kino notes.

“First,” he says, “you can do signal processing rather easily. You can obtain a Fourier transform of the optical image, which means that you can limit bandwidth without losing much information.

Kino sees applications in systems where it is desirable to limit the TV bandwidth, such as the picture telephone. He points out that this device also appears suitable for infrared imaging—an area where there aren’t any very good scanning systems for the long infrared range.

Another development, Kino reports, is the use of acoustic-wave devices to convert acoustic images to optical. This would be useful in nondestructive testing. And the system can electronically focus acoustic images, Kino notes, eliminating the need for acoustic lens.

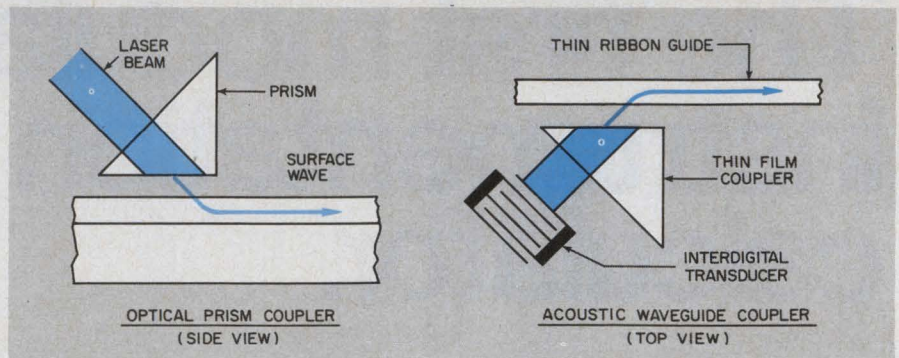

The transfer of technology from optical microelectronics to acoustic devices is demonstrated by the acoustic waveguide coupler, which was adopted from the optical prism coupler. The latter is a thin-film device.

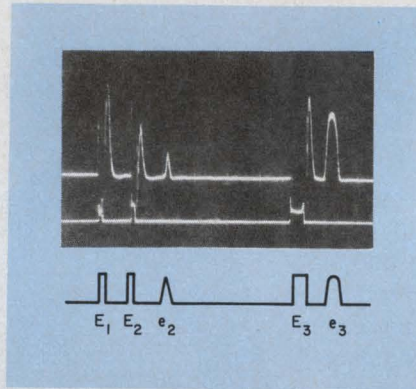

Two electric field pulses (E_1 , E_2) applied to CdS give echo e_2 . Third pulse (E_3) gives echo e_3 . Work on this new storage technique was done at IBM’s Watson Lab.

The two dimensional version of the acoustic-image system has a square array of piezoelectric detectors. The individual transducers are connected to a tap on an acoustic-wave delay line. There are two delay lines, one for the X scan and one for the Y scan, so that a raster scan is provided.

But because the system remembers the phase of signals as well as the amplitude, any delay in the image information that produces an out-of-focus picture can be compensated for by the sending of signals with parabolic variations of phase—chirp signals—along the delay lines.

Storage phenomenon studied

A new nonlinear phenomenon in photo-sensitive-piezoelectric crystals, like cadmium sulfide—the application of rf pulses to create polarization that is capable of re-radiating echo signals—is reported potentially useful as a storage tech-

nique, as well as an electronically variable delay line and a signal processor. The technique was explained in a Session 10 paper on “Electric Field Echoes in Piezoelectric Materials,” by N. S. Shiren of the IBM Research Center, Yorktown Heights, N.Y., co-author with R. L. Melcher, D. K. Garrod and T. G. Kazyaka.

The application of visible light to the sulfide crystals excites electrons, some of which are trapped on impurities, Shiren notes. When the light is removed, the electrons remain in the traps, more or less uniformly distributed throughout the crystal. If two successive microwave pulses are then applied to the sulfide, ultrasonic waves are generated. The wave of the first pulse and the electric field of the second redistribute the trapped electrons into a pattern that has the same spatial variation as the ultrasonic wave.

This space-charge pattern lasts for many weeks at 4° K. The information is retrieved by application of a third pulse that causes the spacial distribution of stored electrons to radiate an electric field echo of the original write pulses. The recording can be erased by application of visible light.

The new storage technique can be directly used as an electronically variable delay line in long-range radar applications. Shiren says.

Optical and acoustical monolithic or integrated circuits have several common features, according to Prof. A. A. Oliner of the Polytechnic Institute of New York. These have already led to useful transfer of ideas and technologies between the two devices, he reports.

Due to a major industry breakthrough it is now possible to automate the hamburger.



Until now, it was just too expensive and complex to use a computer for everyday, routine jobs.

The new NAKED MINI[®]/LSI from Computer Automation eliminates this problem. Because you can now buy this full-scale 16-bit computer for only \$990 in quantities of 200.

What this price breakthrough does for the hamburger business (or any other enterprise) is mind-boggling. Because for the first time it is economically feasible to run an entire fast-food operation with one NAKED MINI/LSI. It can keep inventories of all ingredients so there's a minimum of waste. Tell the head office what to supply, where and when. Pin down customer preferences in specific locations. Schedule personnel for peak or slack business hours. Record receipts and keep track of the dollar volume per hour.

But that's only the beginning. Because in any modern business, your profits depend on how well you control margin. Our new mini

gives you the power you need: a full-scale LSI processor with 168 instructions, 4K x 16 memory, plus fully implemented input/output for low-

cost interfacing.

And bit by bit, our NAKED MINI/LSI can take over other operations. Like check-out and stock control in retail stores. The bank teller's job. Gas stations. You name it.

There's no telling where and how an OEM can use our pizza-size NAKED MINI/LSI. Especially since price is no longer the object. And if all this has whetted your appetite, contact us to explore your possibilities. Because \$990 for a full-blown computer is great food for creative OEM thinking.

Write or call: Computer Automation, Inc., 18651 Von Karman, Irvine, California 92664. Tel. (714) 833-8830. TWX 910-595-1767.

THE NAKED MINI[®] COMPANY
Computer Automation, Inc.

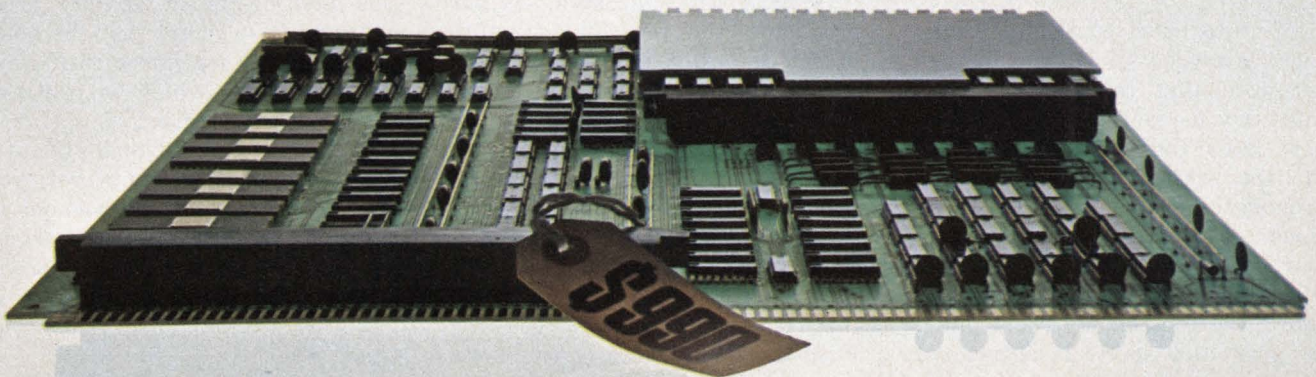

*NAKED MINI is a registered trademark of Computer Automation, Inc.

In a Session 1 paper on "Optical and Acoustical Microelectronics Similarities and Differences," Oliner points out that the wavelengths involved in both optical and acoustic microelectronics are roughly comparable—on the order of a micrometer. Planar surface waves are also common to both, he says, with strong similarities in propagation and guiding properties.

An acoustic design example

As an example of how the design principles of one area can be applied to the other, Oliner cites the development of an acoustic coupler from an optical coupler design (see figure on p. 26).

The optical prism coupler converges a laser beam that is perhaps 1000 wavelengths wide into a surface wave that goes from a three-dimension beam to a two-dimensional surface wave, with a beam thickness on the order of one wavelength. The efficiency of the device is good, Oliner notes—about 80% in theory and 70% experimentally.

A broadbeam, two-dimensional acoustic wave has been converted to a narrow waveguide by use of the acoustic analog of the optical coupler. The beam excited by the acoustic transducer was some 10 or 20 wavelengths wide, while that of the waveguide was on the order of a couple wavelengths. This turns out to be the best known way of exciting the thin ribbon acoustic waveguides, Oliner says. Experimental data show it to have 65% efficiency.

The acoustic coupler is not a three-dimensional prism but a thin, triangular-shaped deposited film. The waveguide is a thin, flat ribbon on top of the same substrate.

A better laser investigated

In integrated optical circuits there is a need for both lasers and detectors that can be integrated into the monolithic structure. A new laser for this purpose, still in the research stage, shows promise of overcoming the limitations of gallium-arsenide lasers now used for optical circuits. The life of gallium-arsenide lasers is short, the controllable beam quality poor and spectral output not

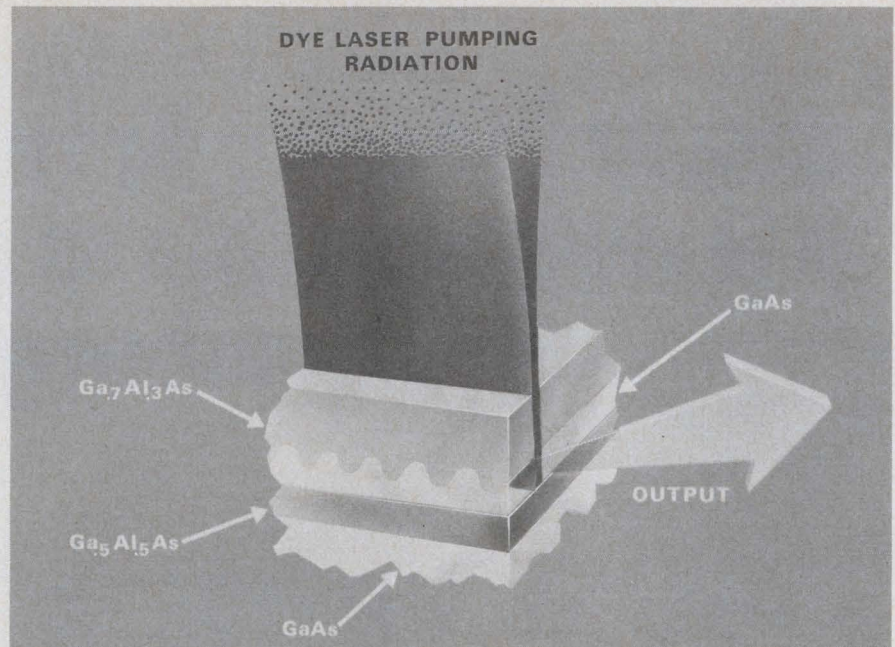

The distributed feedback gallium arsenide/gallium-aluminum-arsenide laser promises to better present GaAs lasers. Developed at Bell Labs, the improvements include longer life and smaller bandwidth.

easily controlled.

The new laser, described by C. V. Shank, a staff member at Bell Laboratories, Holmdel, N.J., in a Session 9 paper on "Thin-Film Distributed Feedback Lasers" uses periodic variations in the optical waveguide to provide a feedback that is integral with the gain medium.

The device, as Shank describes it, is a heterostructured distributed-feedback laser in which Bell has been investigating the gallium-arsenide/gallium-aluminum-arsenide system. The laser has a gallium-arsenide substrate, with the gallium-aluminum-arsenide layer grown on top and a second gallium-arsenide layer over the aluminum arsenide.

The key to the structure is an optical corrugation of about 1000 Å that provides the feedback, Shank notes.

"What's new," he says, "is our producing the periodic structure in the interface between the gallium arsenide and gallium aluminum arsenide—actually within the grown crystal."

Present gallium-arsenide lasers may oscillate anywhere within a broad bandwidth of a couple hundred angstroms. Control of the exact frequency of oscillation within this bandwidth is not possible. With the Bell structure, the device

has a bandwidth of about 0.8 Å and the operating frequency can be adjusted.

A new type of indium-gallium-arsenide detector that has been incorporated in an IC waveguide by researchers at the Lincoln Laboratory has considerable potential for wide-bandwidth applications, according to G. E. Stillman, a laboratory staff member and co-author with C. M. Wolfe, J. A. Rossi and J. L. Ryan of a Session 9 paper on "GaAs Schottky Barrier Avalanche Diodes for Integrated Waveguide Photodetectors at 0.905 μm."

The gallium-arsenide Schottky detector, Stillman says, is "actually detecting below what you think is the band edge of that material."

"It's due to an electro-absorption effect in these reverse-biased diodes," he explains. "We've made measurements of the ionization coefficients in gallium arsenide and have found that the holes have a higher ionization coefficient than electrons, which is contrary to widely accepted belief."

"While we haven't made quantitative noise measurements yet, you can see a distinct improvement in the noise at the 0.905-μm wavelength, as opposed to shorter wavelengths, where you get more contribution to the noise from electrons. ■■"



INGENUITY

in creating gearmotors.

Inventive skill. Imagination. Individually applied to a multitude of uniquely different gearmotor functions.

For computers and peripheral equipment. Vending machines. Commercial and consumer appliances. Business equipment. And more.

With a penchant for detail—from initial design concept through manufacturing and on-time delivery—that our OEM customers appreciate.

And with personalized attention from sales engineers whose first concern is making sure each gearmotor function is performed at top over-all economy... and that each customer gets on-the-dot service.

That's why leading manufacturers turn to Molon.

For innovations in rotary electrical motion... stemming from Molon Ingenuity in creating gearmotors. From 1/100 to 1/10 hp.

And that's not all you get at

 **MOLON**

3737 INDUSTRIAL AVE., ROLLING MEADOWS, ILL. 60008 312/259-3750

Superconducting diode promises tenfold decrease in mixer noise

A tenfold reduction in mixer noise and a thousandfold reduction in local oscillator power requirements appear possible through the union of semiconductor and superconductor technologies.

Aerospace Corp., El Segundo, Calif., is constructing Schottky diodes, for use in mixers, that use gallium arsenide (GaAs) as the semiconductor and lead as the metal. When the diode is cooled below 7.23 K, the lead superconducts, creating a superconductor semiconductor junction.

According to Dr. Arnold H. Silver, director of the Electronics Research Laboratory at Aerospace: "The doping of the semiconductor as shown in Fig. 1 is chosen sufficiently large so that electron tunneling dominates the volt-ampere behavior of the diode. For applied voltages of less than superconducting energy gap, the diode exhibits a very high degree of nonlinearity in its volt-ampere characteristic. It is this nonlinearity that the diode exploits."

Nonlinearity up 200 times

The volt-ampere characteristic of a Schottky diode can be stated approximately as

$$I = I_0 [\exp(SV) - 1],$$

in which I is the current through the diode, I_0 is a material-related constant, V is the voltage impressed upon the diode and S is a measure of the nonlinearity of the diode.

For a normal Schottky diode, S is between 20 and 40. With a super-Schottky diode, cooled to 1.35 K, S has been measured as high as 8200 at Aerospace. Dr. Michael F. Millea, a member of the technical staff at Aerospace, explains:

"With the high degree of nonlinearity in the volt-ampere characteristic of the super-Schottky mixer diode, the operating point on the curve comes way down. Instead

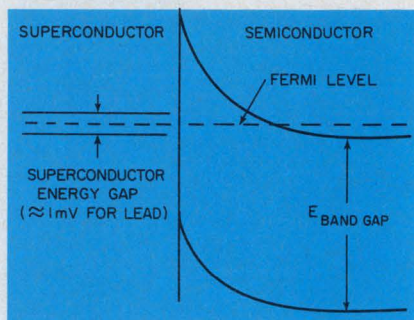

1. Energy-level diagram of superconductor-semiconductor junction shows the narrow superconductor energy gap lining up with the Fermi level of the semiconductor. In the case of the super-Schottky diode, the superconductor is lead and the semiconductor is GaAs. The GaAs doping is sufficiently large so that electron tunneling dominates volt-ampere behavior of the diode.

of operating at about 1 V and 1 mA, we operate at about 1 mV and 1 μ A. Thus the local oscillator power requirement reduces from 1 mW to 1 nW."

In addition, Dr. Malcolm McColl, a member of the technical staff at Aerospace, notes that the shot noise in the diode is reduced to about 1/1000th of the level of a conventional Schottky diode.

Experimental mixers have been constructed at X band. Mixer noise temperatures on the order of 80 K

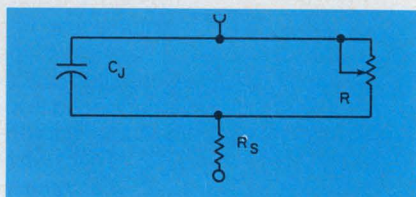

2. Equivalent-circuit parameters for super-Schottky diode depend upon device geometry. For GaAs, the spreading resistance (R_s) is about 3 Ω . R varies over a 100:1 range in the experimental diode. At X band, the reactance ($1/\omega C_j$) of the junction is about 30 Ω for a 5- μ junction. C_j is the junction capacitance.

have been observed with super-Schottky diodes. With conventional Schottky diode mixers at room temperature, typical mixer noise temperatures run at 600 K.

"Our goal," Silver notes, "is a 100-GHz mixer with only 2-K noise temperature. Of course, to be able to use this, we would need a second-stage amplifier of under 10-K noise temperature."

Silver looks to new parametric amplifier designs to supply the necessary i-f second stage.

Present models of the super-cooled diode look like a 5- μ -diameter mesa covered with lead and surrounded by a deep canyon. This mesa sits in a hole in the GaAs substrate. The substrate around the mesa is coated with a layer of silicon oxide.

With the present junction size, the largest swing in effective diode resistance is 100:1. To get efficient mixing, Silver would like the resistance to swing 1000:1. He says that with reduction of the junction diameter to about 2 μ , large resistance swings should be possible. And since the size of the resistance swing is proportional to the size of the operating range on the volt-ampere characteristic curve, other improvements can be taken. One would be to use a superconductor with higher transition temperature than lead. Another is to straighten out the nonlinearities at the low voltage end of the characteristic curve—a step that will be possible when some existing surface impurity problems are solved, McColl says.

To reduce the spreading resistance of the diode junction, Silver plans to construct future models with indium antimonide (InSb) instead of gallium arsenide as the semiconductor. InSb would yield a spreading resistance of only 0.003 Ω . With GaAs, the spreading resistance is about 3 Ω .

Conventional photolithographic resist techniques are being used to construct the diodes. ■■

David N. Kaye
Senior Western Editor

New!

"The Persuader"

For complete S190 data and/or sample switches, visit the N.C.C. Show C.P. Clare Booth No. 934-936 or call your closest Clare-Pendar sales office:

- ALABAMA**
Huntsville: C. P. Clare & Co. (205) 534-5438
 - ARIZONA**
Phoenix: Spectrum Assoc. (602) 997-6324
 - ARKANSAS**
Fort Smith: J. R. Masterson (501) 646-7756
 - CALIFORNIA**
Mountain View: C. P. Clare & Co. (415) 968-2831
Santa Ana: Spectrum Assoc. (714) 835-4114
 - FLORIDA**
Ft. Lauderdale: R. I. Smith Assoc. (305) 772-5100
Largo: R. I. Smith Assoc. (813) 585-2980
 - GEORGIA**
Atlanta: Austin Brown & Assoc. (404) 457-6381
 - ILLINOIS**
Chicago: C. P. Clare & Co. (312) 262-7700
 - INDIANA**
Ft. Wayne: Baehr Greenleaf & Assoc. (219) 447-1608
 - KANSAS**
Shawnee Mission: Lowell-Kangas Assoc. (913) 631-3515
 - MARYLAND**
Ellicott City: Doss Electronics, Inc. (301) 465-1336
 - MASSACHUSETTS**
Needham: C. P. Clare & Co. (617) 449-4780
 - MICHIGAN**
Southfield: C. P. Clare & Co. (313) 356-3988
 - MINNESOTA**
St. Paul: Repor, Inc. (612) 645-8618
 - MISSOURI**
St. Louis: Lowell-Kangas & Assoc. (314) 821-4050
 - NEW YORK:**
Great Neck: C. P. Clare & Co. (516) 466-2100
Fayetteville: C. P. Clare & Co. (315) 637-3939
 - NORTH CAROLINA**
Charlotte: R. W. Chapman & Co. (704) 525-2421
Raleigh: R. W. Chapman & Co. (919) 782-2624
 - OHIO**
Cleveland: Baehr Greenleaf & Assoc. (216) 221-9030
Cincinnati: Baehr Greenleaf & Assoc. (513) 891-3826
Columbus: Baehr Greenleaf & Assoc. (614) 486-4046
 - PENNSYLVANIA**
Ft. Washington: C. P. Clare & Co. (215) 643-5321
Pittsburgh: Foster-McClinton, Inc. (412) 561-4803
Erie: Foster-McClinton, Inc. (814) 455-9111
 - SOUTH CAROLINA**
Greenville: R. W. Chapman & Co. (803) 232-5391
 - TEXAS**
Dallas: Robert E. Nesbitt Co. (214) 357-4601
Houston: Gettys-Eads-Adair, Inc. (713) 781-3005
 - VIRGINIA**
Richmond: Advance Control Equipment (804) 264-2588
 - WEST VIRGINIA**
Huntington: Foster-McClinton, Inc. (304) 736-5161
 - WISCONSIN**
Wauwatosa: Larson Assoc. (414) 258-0529
- INFORMATION RETRIEVAL NUMBER 19**

Rugged...versatile

New!

"The Persuader"

The S190 switchlight outguns everything its size... costs only \$1.62*

In every era, new products come along to keep the competition honest, with all the cards on the table. So we invite you to compare our S190 series with other switchlights. Check our variety of lens colors and easy mount panel adaptors... our wide terminal spacing for easy and fast wiring: solder, quick connect, PCB...our no-tool lamp replacement, long life wiping contacts, rugged molded case. Consider the low cost when you realize that the S190, with its 2 Form C action, has greater circuit flexibility than most switchlights on the market. And it's easily available at your local distributor! Call our sales office in your area for applications assistance... we're located in major cities, world wide. Clare-Pendar Co., Box 785, Post Falls, Idaho 83854, (208) 773-4541.

*In quantities of 1000



CLARE-PENDAR
Switchlights & Keyboards



Organic materials investigated for superior semis and memories

The development of single molecules that would function as electronic devices is being pursued at IBM's Watson Research Center, Yorktown Heights, N.Y.

Called organic or molecular semiconductors, the new devices promise performance far superior to any semiconductor or memory in existence today.

At this stage, the IBM researchers are hopeful that molecular semiconductors will do the following:

- Yield superintegrated devices composed of molecular elements.
- Make it possible to integrate logic circuitry on top of an associated display—such as in calculators—because the molecular semiconductor would be transparent.
- Result in computer memories with switching times on the order of 10^{-15} sec.

Experimental rectifiers are expected within a year, but it could take 10 or 15 years to get an off-the-shelf molecular semiconductor, says Philip E. Seiden, director of physical sciences at the Watson Research Center.

Progress at IBM, Seiden says, depends on whether fabrication problems can be overcome, whether it will be possible to manufacture the devices cheaply and whether there will be a need for them.

"I suspect that requirements will be met, but no one really knows," Seiden says.

Molecular rectifier sought

The present work, he notes, is centered on the development of a molecular rectifier. A plan for constructing a hypothetical rectifier has already been drawn up, and theoretical calculations have proved its feasibility, the researcher reports.

In describing the rectifier, he notes that it would consist of a

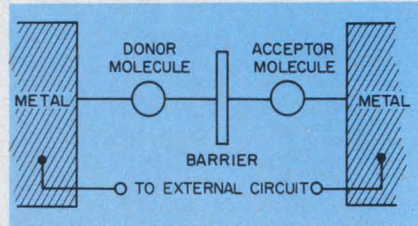

A molecular diode can be made from organic donor and acceptor molecules that are separated by an insulating chemical bridge.

molecule, one end of which—the acceptor—would easily accept an electron, while the other end—the donor—would easily give one up. With electron current flowing toward the acceptor end, the electrons would be taken up, continue along the molecule and be passed along to the remainder of the circuitry by the donor end. Current flowing in the opposite direction would, however, be blocked; electrons approaching the donor end of the molecule would be rejected, he continues.

Fabrication difficult

Seiden admits that the actual construction of the molecular rectifier could be complicated by the fact that the properties of molecules may not be localized at one end or another. To avoid interaction between the donor and acceptor ends of a molecule—the equivalent of a short-circuit—an insulating chemical bridge would be placed between them.

Another problem is: How do you connect wires to molecules? Seiden thinks that a technique developed in the 1930s may help overcome this one. A molecule with one hydrophilic end and one hydrophobic would be used. If such a molecule is deposited on water, the hydrophilic ends will be attracted to the water, while the hydrophobic ones will stick out. Then a metal layer can be

evaporated onto a glass plate for insertion in the water. Since the metal is polar, the hydrophilic ends will stick to the metal. Another layer of metal can then be deposited, and the molecule will wind up sandwiched between two metal plates, to which wires can be attached.

Fabrication of the first molecular rectifier should be completed in about a year, Seiden predicts. Once that is done, other structures, such as those used in memories, will be easier to make, he says.

Molecular memory studied

To make a memory, Seiden notes, identical structures are used for the donor and acceptor ends. The only difference is that one end will have two extra electrons. The presence or absence of these electrons could then be used to represent the presence of a ONE or a ZERO.

Such a memory would be very fast, because it is only necessary to move these electrons from one side of the molecule to the other. The theoretical switching speed would be about 10^{-15} sec. This is so fast, that the actual switching time would probably be limited by the external impedance of the circuit to which it is connected.

While this sounds bad, Seiden points out that there is an advantage—conventional gain-bandwidth rules don't apply. Normally in any circuit where the switching mechanism determines the intrinsic properties of the material, the faster you switch the lower the gain and the larger the bandwidth that is necessary. That's not true with a molecular memory, Seiden reports. The faster a molecular memory cell is switched, the larger the gain, until the impedance of the external circuit is characteristic of the impedance of the material. ■■



Put it all together with Buchanan[®] Terminal Blocks!

10 ways we can help you solve your design problems:

- 1. Eliminate lugging!**
Just insert wire and tighten the screw.
UL and CSA listed.
- 2. Save space!**
Terminate up to 48 circuits per foot; wires from #30 thru 600 mcm.
- 3. Work at high temperatures!**
Up to 302 F with Buchanan phenolic blocks; also resist moisture, solvents, shock, radiation.
- 4. Choose your mounting method!**
Flat base blocks for direct mounting; dovetail bases if you want a channel; combination bases for either way.
- 5. Assemble quickly!**
Snap off sections from pre-assembled lengths of 6 to 25 . . . or order the exact number you want!
- 6. For aluminum wire, too!**
Al-Cu contacts are UL listed for aluminum or copper wire, #18 thru #4/0.
- 7. Identify circuits quickly!**
Four marking methods: Directly on block; on painted area; removable vinyl strip; or pressure-sensitive tape.
- 8. Meet non-tracking requirements!**
Nylon or polypropylene blocks meet automotive non-tracking requirements—yet provide close spacing for tight layouts.
- 9. Get dead-front safety!**
See-thru covers snap over contacts—permit viewing with protection.
- 10. Bridge other components!**
Steel and pre-punched aluminum channels are available for dovetail or combination base blocks.

Want to cut design time? Our literature can really help you. Ask for a catalog and "What You Should Know About Terminal Blocks." Phone (201) 964-4400 or write us at Dept. ED-3.



**CONTROL PRODUCTS
DIVISION**

Amerace Corporation
Control Products Division
2330 Vauxhall Road
Union, New Jersey 07083

Thermal imaging furnaces grow crystals from 'difficult' materials

For years physicists have had to reject certain materials with excellent potentials for becoming good single crystals, because they were too difficult to grow. Or they couldn't be grown at all. Two new furnaces designed, built and tested by the Air Force Cambridge Research Laboratory in Bedford, Mass., have made these formerly rejected materials available to the designer, with new, badly needed performance characteristics.

One furnace is a vertical thermal-imaging system, which uses a variation of the Czochralski, or pulling, technique. The other, also thermal-imaging, is called a clam-shell furnace and uses the float-zone approach.

"These furnaces are the most sophisticated thermal-imaging crystal growers in the world," says William G. Field, who, with John L. Sampson, another research physicist at the laboratory, designed the furnaces.

Several materials have been tested, and good crystals have been grown:

- Yttria, with a melting point of 2450 C. (Steel melts at 1400 C.) It can be used as a host material for medium-gain lasers, as a possible cubic substrate material and as a window for infrared applications out to at least 6 μm .

- Yttrium aluminum garnet. Crystals have been grown easily without the impurities that have been so difficult to eliminate with other techniques. These include iridium, which was contained in the crucibles used.

- Rutile, or titanium dioxide. It has potential as a polarizing material for lasers. Crystal-growing

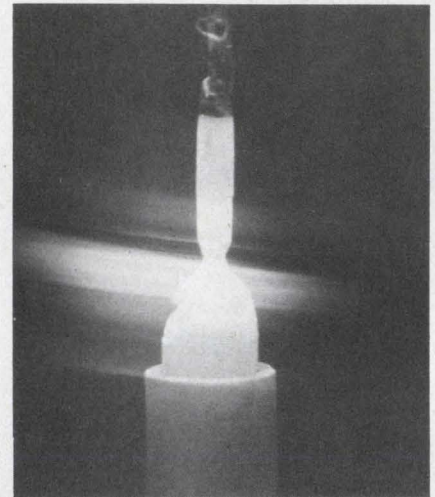
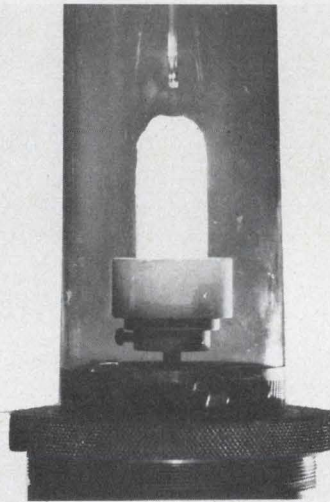

The top of the slug is melted by focused light. A seed crystal is then positioned above the molten cap (left), dipped into the cap (right) and then pulled slowly up to form a single crystal.

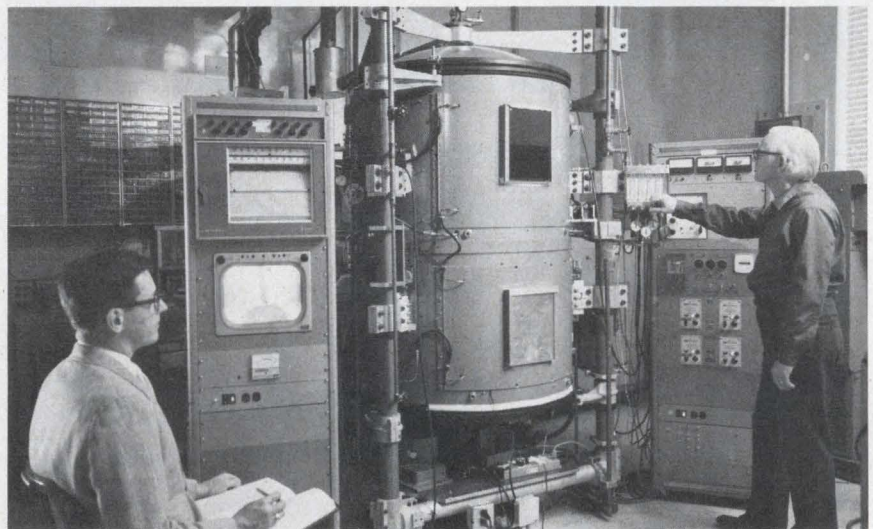

Thermal imaging furnace grows crystals with clean light, high temperature and in a variety of selectable atmospheres.

of rutile hasn't been practical before, because the process calls for growth in 100% oxygen.

Both furnaces satisfy the five requirements for growing superior crystals:

1. The heat must be clean and

not contaminate the material.

2. High temperatures must be attainable (3000 C).

3. Various atmospheres must be usable.

4. A crucible, or container for holding the material, should not be

John F. Mason
Associate Editor

MOSTEK's MK4008-9 1K dynamic RAM makes it easy to convert your 1μ sec static system... and reduce costs by 50%.

It's a simple design conversion from a 2102-type static system to MOSTEK's MK 4008-9. And the savings are big. MOSTEK's 1K dynamic RAM is priced at only \$3.50 in quantities over one thousand.

The design conversion is easy since the MK 4008-9 is a functional, pin-for-pin replacement for the 2102. And the memory matrix is wired exactly the same, except for an

additional — 12V power supply for the MK 4008-9. There's no sacrifice in performance. The MK 4008-9 offers an improved access time of 800 nsec and an equivalent write cycle time of 1μ sec. Refresh can be accomplished with the addition of only a few TTL packages.

The big benefit for your system is lower total cost. Even with the addition of refresh circuitry, the total cost of using

MOSTEK's MK 4008-9 will be at least 50% less than the comparable static circuit.

Find out how your system can benefit from this combination of performance and low cost. Call MOSTEK's Marketing Group at (214) 242-0444 for more information or write for MOSTEK's application report "Designing An Asynchronous Memory System Using the MOSTEK MK 4008-9," 1215 W. Crosby Road, Carrollton, Texas 75006.

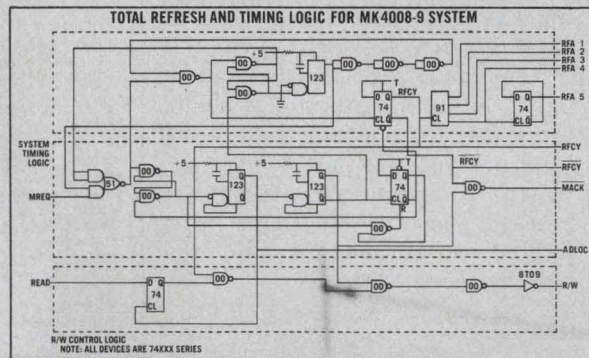

From Applications Note "Designing an Asynchronous Memory System."

MOSTEK

MOSTEK moves forward...in memories.

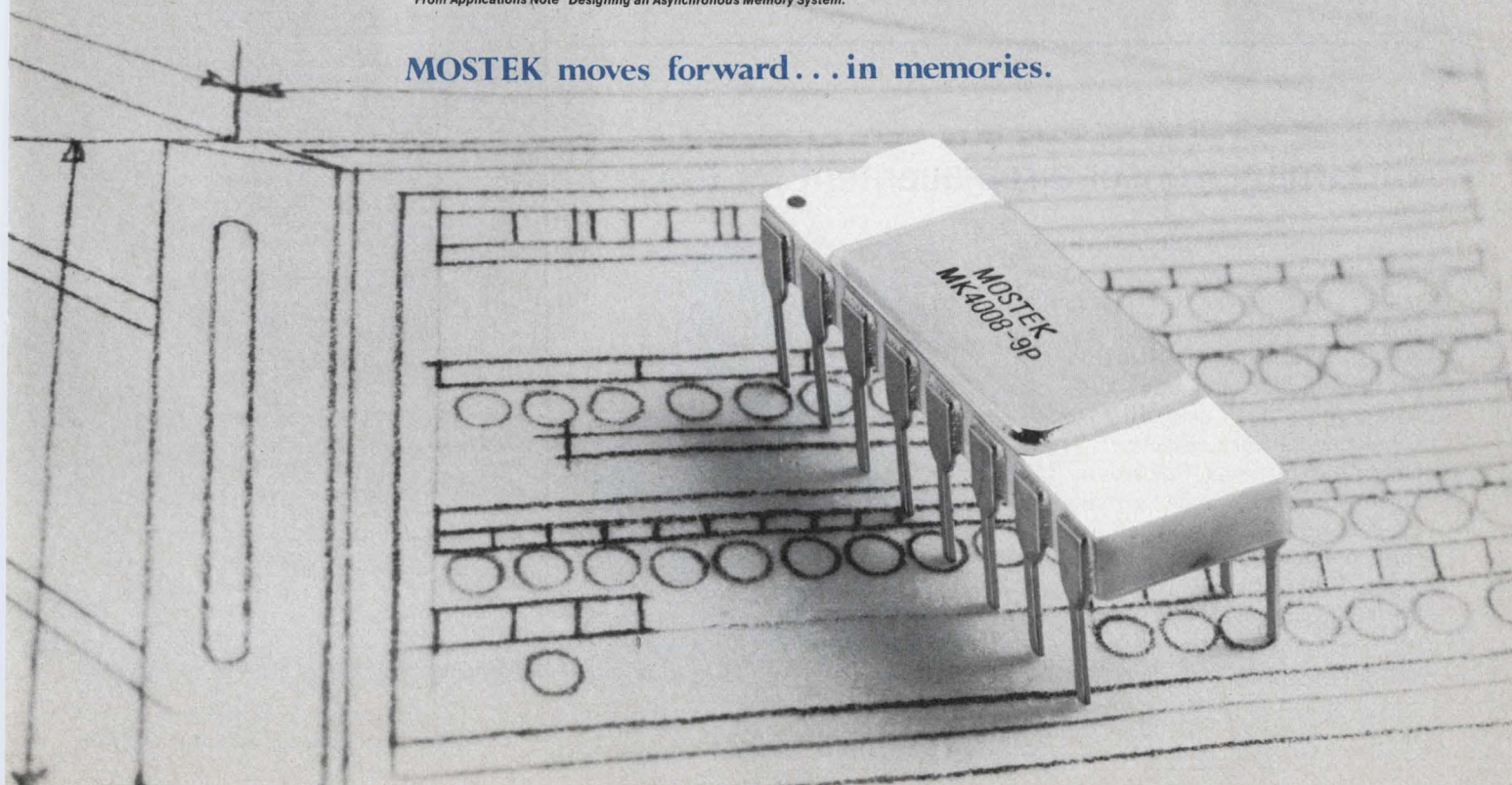

a requirement.

5. The operation must be precisely instrumented.

Problems barred progress

Formerly materials such as yttria, yttrium aluminum garnet and rutile did not lend themselves to crystal-growing because their melting temperatures were so high the crucible used to hold the potential crystal would melt before the crystal slug would. Or there would be a chemical reaction between the crucible and the crystal material.

Another frequent problem was that the material had to be grown in a special environment, such as oxygen or a vacuum, and this wasn't possible with existing techniques. Meanwhile the development of certain devices—optical waveguides, lasers, masers, the smart bomb, range-finders and semiconductors—could not progress markedly without new crystals.

Waiting for the right crystal to come along for a long time has been the medium-gain laser, needed by the military and the communications industry.

Mirrors and light used

The vertical thermal-imaging furnace is built with two para-

boloidal mirrors and a strong xenon light. The lamp is at the focal point of the bottom paraboloidal mirror, which collects the light from the lamp and produces a parallel beam. The beam is collected by the mirror at the top and is refocused at its focal point.

The material to be melted is placed at the focal point of the light. Since the system is reflective, not refractive, there is no chromatic aberration, and infrared rays are imaged at the same point as visible rays.

For control of the atmosphere, the whole operation takes place in a cylindrical fused quartz tube. The tube doesn't overheat because light isn't focused on it but passes right through it.

The need for a crucible is eliminated by the intensity and precise focus of the light. The slug of material to be melted is positioned so that only its top is heated. The crystal seed is lowered into the melted material and pulled slowly up where it freezes and forms a crystal.

The clam-shell furnace uses two paraboloidal mirrors and a xenon arc light. The mirrors reflect the light and focus it on the material, which is in powder form but pressed into a rod shape. The lights are turned on, and the powder melts. ■■



Your closest SIGNETICS distributor is...

ARIZONA
Phoenix: Hamilton/Avnet Electronics (602) 275-7851
Phoenix: Kierulff Electronics (602) 273-7331

CALIFORNIA
Culver City: Hamilton Electro Sales (213) 870-7171
El Segundo: Liberty Electronics (213) 322-8100
Los Angeles: Kierulff Electronics (213) 685-5511
Mountain View: Hamilton/Avnet Electronics (415) 961-7000
Palo Alto: Kierulff Electronics (415) 968-6292
San Diego: Cramer Electronics (714) 565-1881
San Diego: Hamilton/Avnet Electronics (714) 279-2421
San Diego: Kierulff Electronics (714) 278-2112
Sunnyvale: Cramer Electronics (408) 739-3011

CANADA
Downsview: Cesco Electronics (416) 661-0220
Downsview: Cramer Electronics (416) 661-9222
Montreal: Cesco Electronics (514) 735-5511
Montreal: Hamilton/Avnet Electronics (514) 735-6393
Ottawa: Cesco Electronics (613) 729-5118
Ottawa: Hamilton/Avnet Electronics (613) 725-3071
Quebec City: Cesco Electronics (418) 524-3518
Vancouver: Bowtek Electric Co. Ltd. (604) 736-7677

COLORADO
Denver: Cramer Electronics (303) 758-2100
Denver: Hamilton/Avnet Electronics (303) 534-1212

CONNECTICUT
Hamden: Arrow Electronics (203) 248-3801
Georgetown: Hamilton/Avnet Electronics (203) 762-0361
North Haven: Cramer Electronics (203) 239-5641

FLORIDA
Hollywood: Hamilton/Avnet Electronics (305) 925-5401
Hollywood: Schweber Electronics (305) 927-0511
Orlando: Hammond Electronics (305) 241-6601

GEORGIA
Atlanta: Schweber Electronics (404) 449-9170
Norcross: Hamilton/Avnet Electronics (404) 448-0800

ILLINOIS
Elk Grove: Schweber Electronics (312) 593-2740
Elmhurst: Semiconductor Specialists (312) 279-1000
Schiller Park: Hamilton/Avnet Electronics (312) 678-6310

INDIANA
Indianapolis: Semiconductor Specialists (317) 243-8271

KANSAS
Lenexa: Hamilton/Avnet Electronics (913) 888-8900
Lenexa: Hall-Mark Electronics (913) 888-4747

MARYLAND
Hanover: Hamilton/Avnet Electronics (301) 796-5000
Rockville: Pioneer Washington Electronics (301) 424-3300
Rockville: Schweber Electronics (301) 881-2970

MASSACHUSETTS
Burlington: Hamilton/Avnet Electronics (617) 273-2120
Newton: Cramer Electronics (617) 969-7700
Waltham: Schweber Electronics (617) 890-8484

MICHIGAN
Detroit: Semiconductor Specialists, Inc. (313) 255-0300
Livonia: Hamilton/Avnet Electronics (313) 522-4700
Troy: Schweber Electronics (313) 583-9242

MINNESOTA
Edina: Hamilton/Avnet Electronics (612) 941-3801
Minneapolis: Semiconductor Specialists (612) 854-8844

MISSOURI
Hazelwood: Hamilton/Avnet Electronics (314) 731-1144
St. Louis: Hall-Mark Electronics (314) 521-3800

NEW MEXICO
Albuquerque: Cramer Electronics (505) 265-5767
Albuquerque: Hamilton/Avnet Electronics (505) 765-1500

NEW YORK
Buffalo: Summit Distributors (716) 884-3450
Farmingdale, L.I.: Arrow Electronics (516) 694-6900
Rochester: Schweber Electronics (716) 328-4180
Syracuse: Hamilton/Avnet Electronics (315) 437-2642
Westbury: Hamilton/Avnet Electronics (516) 333-5800
Westbury: Schweber Electronics (516) 334-7474

NORTHERN NEW JERSEY
Cedar Grove: Hamilton/Avnet Electronics (201) 239-0800
Saddlebrook: Arrow Electronics (201) 797-5800

SOUTHERN NEW JERSEY AND PENNSYLVANIA
Cherry Hill, N.J.: Milgray-Delaware Valley (609) 424-1300
Moorestown: Arrow/Angus Electronics (609) 235-1900
Mt. Laurel, N.J.: Hamilton/Avnet Electronics (609) 234-2133

CENTRAL NEW JERSEY AND PENNSYLVANIA
Somerset, N.J.: Schweber Electronics (201) 469-6008

NORTH CAROLINA
Greensboro: Hammond Electronics (919) 275-6391

OHIO
Beechwood: Schweber Electronics (216) 464-2970
Dayton: Hamilton/Avnet Electronics (513) 633-0610
Cleveland: Arrow Electronics (216) 464-2000
Cleveland: Pioneer Standard Electronics (216) 587-3600
Kettering: Arrow Electronics (513) 253-9176

TEXAS
Dallas: Cramer Electronics (214) 350-1355
Dallas: Hamilton/Avnet Electronics (214) 661-8661
Houston: Component Specialties (713) 771-7237
Houston: Hamilton/Avnet Electronics (713) 526-4661

UTAH
Salt Lake City: Alta Electronics (801) 486-7227
Salt Lake City: Hamilton/Avnet Electronics (801) 262-8451

WASHINGTON
Bellevue: Hamilton/Avnet Electronics (206) 746-8750
Seattle: Cramer Electronics (206) 762-5722

CID image sensor a replacement for tubes

An image sensor fabricated with charge-injection-device (CID) technology is designed to replace tube imagers. Containing 10,000 elements in a 100-by-100 array, the imager has a dynamic range of about 500 to 1, according to its developer, General Electric's Opto-electronic Systems Operation. The large dynamic range provides a gray scale capability that exceeds that of conventional image tubes.

The small size of the CID sensor makes it ideal for applications such as surveillance, process control and character readers. ■■

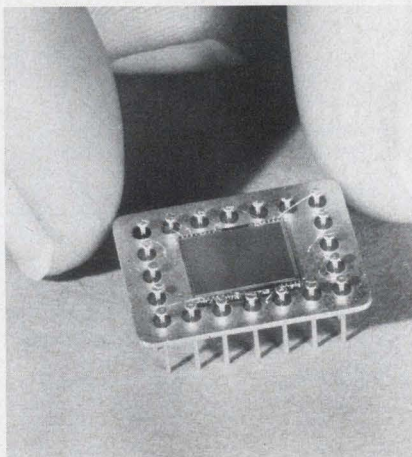

Open up your options in Linear ICs.

What you need, to free up your buying power, is a good strong alternative to single-source linear supplies. Because nothing breaks you out of most price/delivery binds, like that simple basic: freedom of choice.

The key to Buyers' Lib is Signetics. With a major commitment in linear products. For years we've been established in the linear business, in a big, broad-line way.

Volume we've got—our production capacity's doubled in the past year. And variety that just won't stop. A solid line of standard devices to back up a wide range of purchasing requirements. To help you cut delays, wipe out stoppages, and get your system delivered (and paid for) sooner.

But maybe the biggest spread between Signetics and other so-called "single" sources is—



service. First, a nationwide network of linear-wise distributors—every region with at least one office within easy call. Second, the industry's most thorough cataloging and applications material. Plus on-the-spot assistance from our traveling platoon of technical specialists—always on the road, for on-site problem solving.

Straight goods, straight talk. And that means anytime we get a sudden run, putting a specific device in short supply, you'll get realistic commitments. Probably the most important option you can pick up from any supplier, when you lift the phone to source linear from Signetics.

Signetics Corporation, a subsidiary of Corning Glass Works, 811 E. Arques Ave., Sunnyvale, California 94086, (408) 739-7700.



Available through your local distributor. Now.

Comparators

μ A710 7520
 μ A711 7521
NE526 7522
NE527 7523
NE529 7524
NE522 7525
NE521 75S207
75S208

Memory Interface

3207
3207-1
3207A
3207A-1

Peripheral Interface

75450

75451

75452
75453
75454
 μ A733
75S107
75S108

DM8880
DM7820
DM8820
DM7830
DM8830

NE501
NE592

Op Amps

μ A709
 μ A740
 μ A741
 μ A747
 μ A748
LM101A
LM201A
LM301A
LM107
LM207
LM307
LM308
MC1456

MC1556

NE510
NE511
NE515
NE531
NE536

Voltage Regulators

μ A723
NE550

Timers

NE555
NE556

PLL's

NE560
NE561
NE562
NE565
NE566
NE567

Consumer

NE540
NE546
ULN2111
PA239
MC1496

signetics

INFORMATION RETRIEVAL NUMBER 22



the first production Serial Analog Memory

RETICON
SAM-64

"SAM™ DID IT."

The SAM™64 is the first of a family of monolithic Serial Analog Memory devices to be introduced by RETICON. It provides 64 independent capacitive memory cells, each of them individually addressable by two independent shift registers. The Read-in register sequentially time samples the analog input signal and stores it in the memory cells. The Read-out register then reconstructs the stored information to its original form. Any desired delay may be achieved by simply delaying the initiation of the Read-out register or by varying clocking rates while maintaining constant relation between the initiation of Read-in and Read-out.

Time base correction (or delay as shown in the photo) to compensate for wow and flutter of recording systems can be easily achieved. Other applications include real time Fourier transforms, digital filtering, drop-out correction, bandwidth/time compression or expansion, analog FIFO, chirp Z transforms and many others.

Several devices may be cascaded to store a complete TV line. Over 10 MHz sampling rates and 50 dB S/N ratio have been achieved.

The SAM-64 comes in a 16 lead ceramic/gold dual-in-line package, available from inventory. Call for more information.

RETICON®

Reticon Corporation • 450 E. Middlefield Rd. • Mt. View, California 94043
(415) 964-6800 HOTLINE (415) 964-3033 TWX 910-379-6552

INFORMATION RETRIEVAL NUMBER 23

Triple-varactor IC promises to better the AM car radio

A triple varactor IC in pilot production at Motorola Semiconductor may make possible the design of a better automobile radio set—one that is smaller and easier for the driver to tune.

In today's AM car radio the design is controlled largely by the size and shape of the tuning mechanism. It's necessary to tune three stages simultaneously: the rf amplifier, local oscillator and mixer.

With a matched three-varactor IC, the mechanical linkages to couple the tuning dial to a variable capacitor or inductor would be eliminated. The set could have signal-seeking capability at the touch of a button.

Motorola's MVAM-1 silicon tuning diode, in production at Phoenix, Ariz., consists of a monolithic chip with three diodes that have a common cathode and separate anodes. The unit is in a four-lead rectangular plastic package that measures 0.2 by 0.26 in.

High maximum capacitance

The MVAM-1 has a high maximum capacitance to overcome the highly capacitive load of the car antenna—which is often as much as 90 pF. The capacitance range is from 20 to 400 pF—with a min/max C ratio of over 15—enabling the IC to cover the broadcast band in one sweep.

The matching between the capacitance-voltage (C-V) curves of the diodes is better than 1.5%—

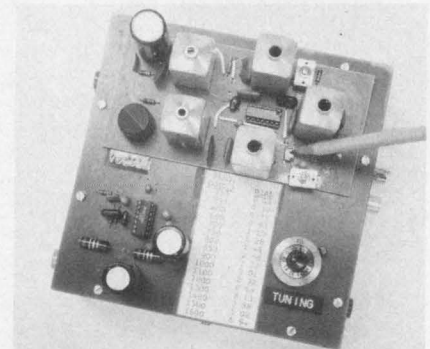

Experimental voltage-tuned broadcast receiver uses Motorola's triple varactor IC to replace the conventional variable tuning capacitor. The IC will go into future car radios.

necessary for good tracking between receiver oscillator, mixer and rf amplifier. Finally, the Q is better than 150 at 1 MHz under worst-case conditions, Motorola says.

The most desirable voltage range for an auto-radio varactor would be 1 to 8 V, since 8 V is regarded as the maximum level that can be regulated in a 12-V system. The triple-varactor IC requires a maximum of 25 V; Motorola engineers found the C-V curve for a 1-to-8-V diode too sharp for a volume production device.

The projected quantity price of the varactor is about \$1, and the first radios using it should appear in 1977 cars, Motorola says.

The MVAM-1, according to the company, is the first application of ion-implantation techniques to varactor diode fabrication.

Conventional diffusion impractical

"The two most important reasons for using ion implant in making this device," reports Rocky Kansal, production engineer for Motorola, "are controlling the shape of the C-V curve and providing consistency from unit to unit. The maximum capacity is increased somewhat in the process. But matching between the diodes is largely due to the monolithic construction."

Motorola engineers say the device could not have been produced by conventional diffusion techniques. The ion-implantation process used is rather complicated, requiring more than one implant.

Kansal notes: "The basic design is easy, but getting the smooth C-V gradient was tough. Not only do the implants have to have the right purity of doping, but they have to be driven to the right levels—one on top of the other.

About five years ago, when pressures from designers led to a search for a method of making auto-radio varactor assemblies, Motorola tried to use computer matching of discrete diodes but found it impractical. Wayne Holst, section manager for Motorola says today: "Monolithic construction was the only way we could get accurately matched sets. It turned out that the necessary matching precision and product uniformity just didn't lend itself to a computerized sorting system." ■■

Which Heinemann overvoltage protector should watch over your electronics?



Below 5 amp dc Our tiniest hybrid (a thick-film microcircuit) packs a sensing amplifier, control circuit, and SCR "crowbar". When voltage equals the protector's rating, the SCR fires, shunting the load to ground in 500 nanoseconds—before any damage can be done.

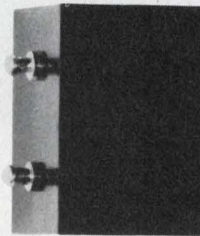
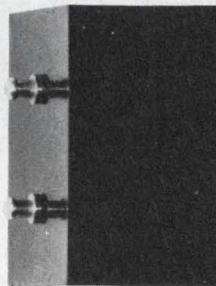

5-30 amp dc These protectors are made from discrete electronic components, but they offer the same protection and economy as the hybrids. Series 10 can handle up to 10 amp. Series 30 is good for 30 amp. Both are available in a range of trip voltages.

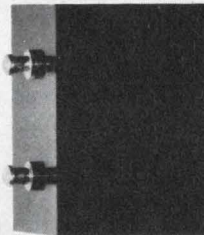

Up to 1 amp ac A 200V trip rating makes our Series 1 protector ideal for electronic equipment operating from a 117V line.

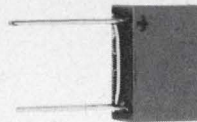

Transient clipper This device absorbs the energy of a transient while clamping the line to a predetermined voltage, allowing your circuits to continue operating during a voltage transient.

You can't build protectors like these for anywhere near our low prices. And our single-package design eliminates all the multi-component assembly and mounting problems of do-it-yourself units. For complete technical data, have us send you Bulletin 3372. Heinemann Electric Company, Brunswick Pike, Trenton, N.J. 08602.



HEINEMANN

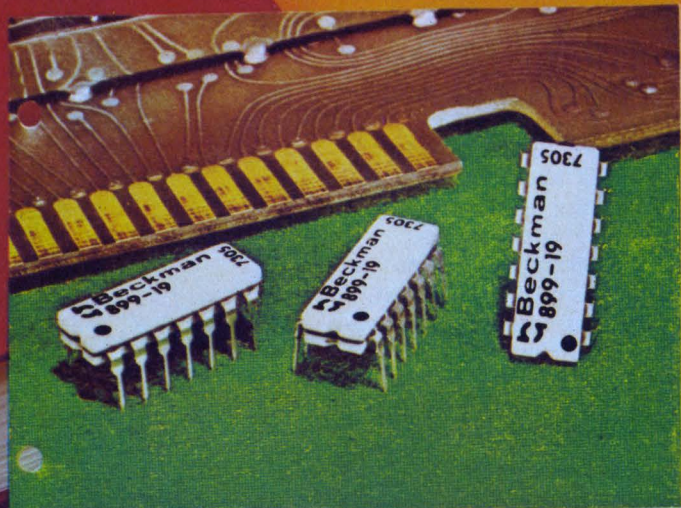
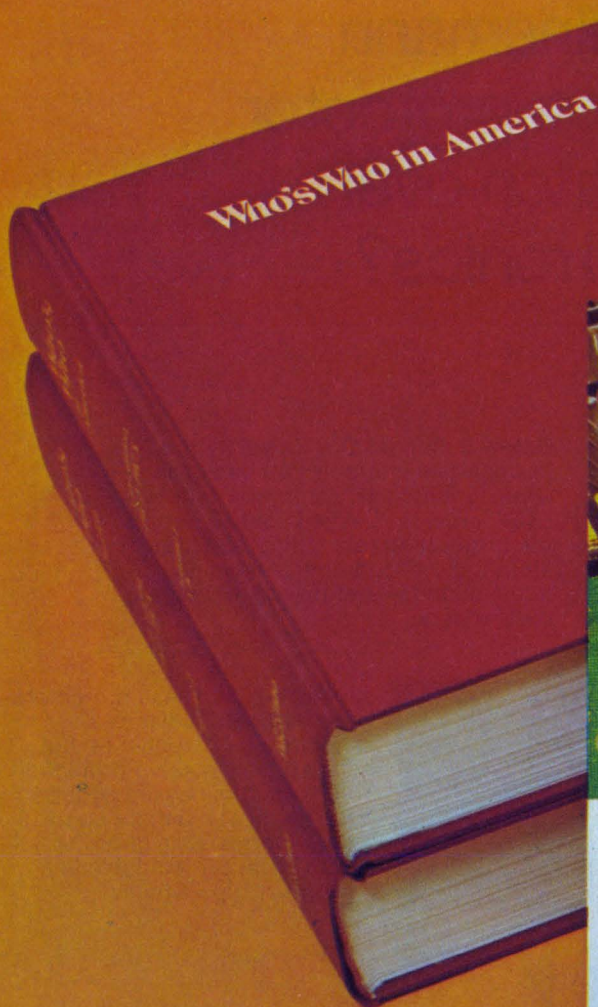

Beckman Resistor Networks
Technical Bulletin • December 1973

Beckman

The two-volume set is famous as a living, changing record of persons whose accomplishments are notable and important in American life. The catalog is growing famous, too. Because it details the Beckman RESNET™ DIP resistor network line—No. 1 in worldwide brand preference.

For good reasons, you should think of Beckman resistor networks, too, for any applications involving pull-up/pull-down, digital pulse squaring, line termination, current limiting, ECL terminators, and interface networks.

Why? Consider this. Production is totally automated. Laser tailoring is computer-controlled. Every part is 100% inspected, in process and during final assembly. Packages are dimensionally uniform, which means Beckman RESNET DIPs are ideal for automatic insertion techniques.

Then, we offer the broadest available line of standard resistor networks—both 14- and 16-pin versions. And these are kept in full stock by our distributors all around the country.

Another reason we're No. 1 in preference is our materials technology. We have 20 years in developing, improving and manufacturing our cermet materials. This shows up on your end as performance... accuracy... reliability.

Of course, if you need custom resistor networks, think of Beckman again. We offer them to suit virtually any market application. And custom applications assistance, as well. (If you need immediate literature, or the phone number of your local Beckman/Helipot representative, call toll-free 800-437-4677.)

Look into Beckman RESNET DIPs. Our achievement can help you with your achievement.

There's a standard source for What's What in resistor networks, too.

Beckman Electronic Component Distributors

EASTERN REGION

Arrow/Angus
P.O. Box 126
Moorestown, N.J.
(609) 235-1900
(215) 928-1800

Arrow Electronics, Inc.
5207 East Dr.
Baltimore, Md.
(202) 737-1700
(301) 247-5200

Arrow Electronics, Inc.
900 Route 110
Farmingdale, N.Y.
(516) 694-6800

Arrow Electronics, Inc.
295 Treadwell St.
Hamden, Conn.
(203) 248-3801

Arrow Electronics, Inc.
No. 15 A Street
Burlington, Mass.
(617) 273-0100

Arrow Electronics, Inc.
285 Midland Ave.
Saddle Brook, N.J.
(201) 797-5800

Harvey R & D Electronics
44 Hartwell Ave.
Lexington, Mass.
(617) 861-9200

Kierulff Electronics, Inc.
49 Bestpage Rd.
Hicksville, N.Y.
(516) 433-5530

Kierulff Electronics, Inc.
5 Industrial Dr.
Rutherford, N.J.
(201) 935-2120

Lynch-Gentry Associates, Inc.
1932 Drew Street
Clearwater, Fla.
(813) 443-2697

Lynch-Gentry Associates, Inc.
3470 Bowman Dr.
Winter Park, Fla.
(305) 671-7649

**Marshall Industries
G. S. Marshall Products Group**
88 Needham St.
Newton Highlands, Mass.
(617) 965-5115

**Marshall Industries
G. S. Marshall Products Group**
230 Sherwood Ave.
Farmingdale, L.I., New York
11735 (516) 293-4141

M & C Sales
1106 Burke St.
Winston-Salem, N.C.
(919) 723-1001

M & C Sales
904 Bob Wallace Ave.
Huntsville, Ala.
(205) 539-8476

Ossmann Component Sales Corp.
395 Cleveland Dr.
Buffalo, N.Y.
(716) 832-4271

Ossmann Component Sales Corp.
411 Washington Ave.
Kingston, N.Y.
(914) 338-5505

Ossmann Component Sales Corp.
280 Metro Park
Rochester, N.Y.
(716) 442-3290

Ossmann Component Sales Corp.
132 Pickard Building
Syracuse, N.Y.
(315) 454-4477

Ossmann Component Sales Corp.
1911 Vestal Parkway East
Vestal, N.Y.
(607) 785-9949

CENTRAL REGION

Magnuson Electronics
2420 Oakton St.
P.O. Box 130
Mount Prospect, Ill.
(312) 956-0700

Magnuson Electronics
1246 West 7th St.
St. Paul, Minn.
(612) 227-8495

Norvell Electronics
10210 Monroe Dr.
Dallas, Tex.
(214) 350-6771

Norvell Electronics
6440 Hillcroft Ave.
Houston, Tex.
(713) 774-2568

Norvell Electronics
3340 S. Memorial Dr.
Tulsa, Okla.
(918) 663-1247

Sheridan Sales Co.
Box 37826
Cincinnati, Ohio
(513) 761-5432

Sheridan Sales Co.
Box 4457
Cleveland, Ohio
(216) 524-8120

Sheridan Sales Co.
Box 423
Dayton, Ohio
(513) 277-8911

Sheridan Sales Co.
33708 Grand River Ave.
Farmington, Mich.
(313) 477-3800

Sheridan Sales Co.
P.O. Box 677
Florissant, Mo.
(314) 837-5200

Sheridan Sales Co.
Suite 5009
1717 Penn Ave.
Wilksburg, Penn.
(412) 244-1640

WESTERN REGION

Almac/Stroum Electronics
8888 S.W. Canyon Rd.
Portland, Ore.
(503) 292-3534

Almac/Stroum Electronics
5811 Sixth Ave. South
Seattle, Wash.
(206) 763-2300

**Marshall Industries
G. S. Marshall Products Group**
5633 Kendall Court
Arvada, Colo. 80002
(303) 423-9670

**Marshall Industries
G. S. Marshall Products Group**
835 W. 22nd Street
Tempe, Ariz. 85282
(602) 968-6181

**Marshall Industries
G. S. Marshall Products Group**
9674 Telstar Ave.
El Monte, Ca.
(213) 686-0141

**Marshall Industries
G. S. Marshall Products Group**
17975 Sky Park Blvd.
Irvine, Ca. 92707
(714) 556-6400

**Marshall Industries
G. S. Marshall Products Group**
8057 Raytheon Rd.
San Diego, Ca.
(714) 278-6350

**Marshall Industries
G. S. Marshall Products Group**
788 Palomar Ave.
Sunnyvale, Ca.
(408) 732-1100

Wyle Distribution Group:

Elmar Electronics
6777 East 50th Avenue
Commerce City, Colo.
(303) 287-9611

Elmar Electronics
2288 Charleston Road
Mt. View, Ca.
(415) 961-3611

Liberty Electronics
124 Maryland Street
El Segundo, Ca.
(213) 322-8100

Liberty Electronics
3130 North 27th Avenue
Phoenix, Ariz.
(602) 257-1272

Liberty Electronics
8248 Mercury Court
San Diego, Ca.
(714) 565-9171

Liberty Electronics
5305 Second Avenue South
Seattle, Wash.
(206) 763-8200

Beckman®

HELIPOT DIVISION

CAUTION: 50,000 VOLTS

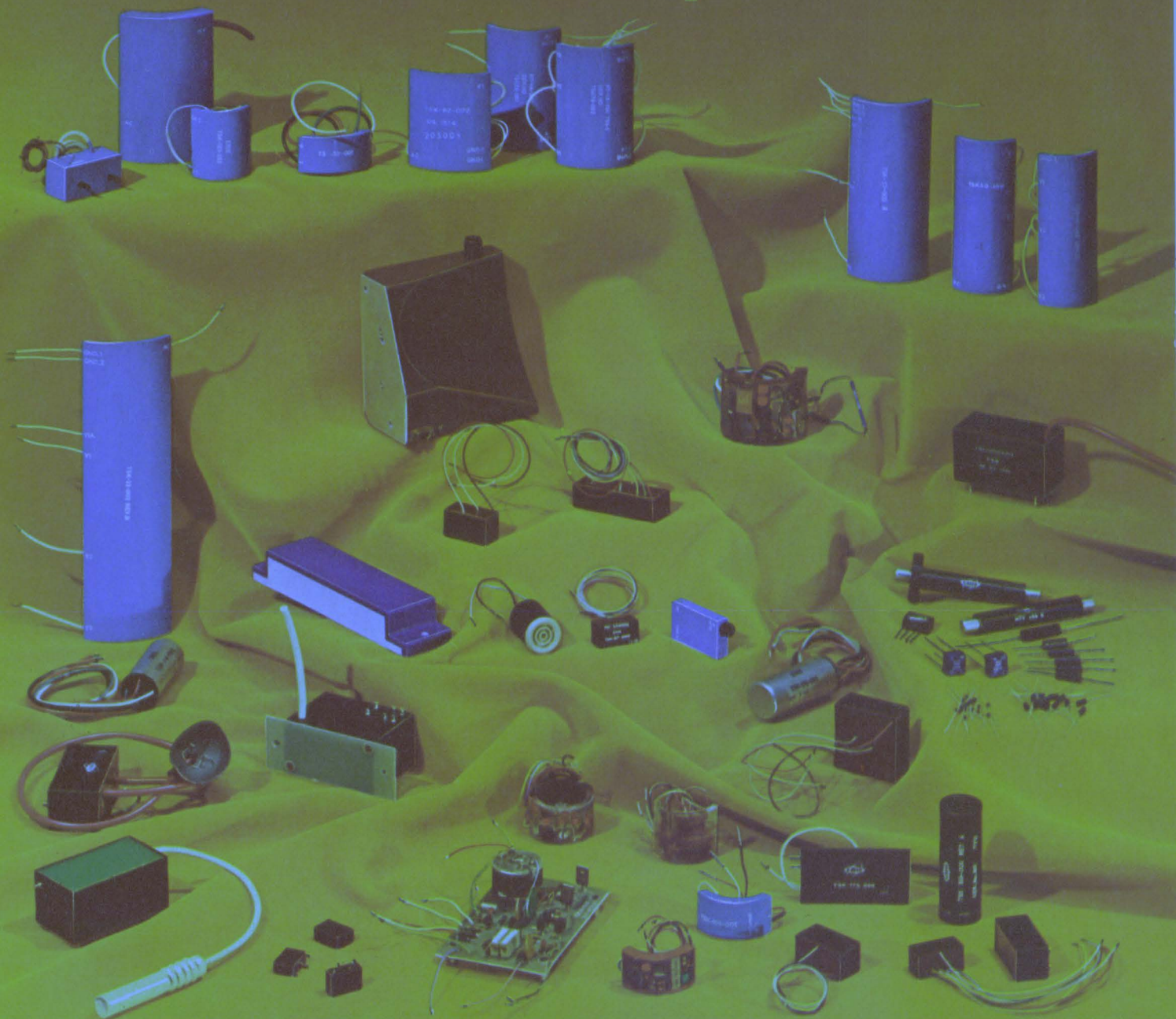

LET ERIE DESIGN and BUILD YOUR HIGH VOLTAGE POWER SUPPLIES and VOLTAGE MULTIPLIERS

When you talk about designing and packaging miniature, low current High Voltage Power Supplies and Voltage Multipliers, the name ERIE should come to mind first. Why? *No other manufacturer of these sophisticated devices has its own capacitor and rectifier technology in-house.* Only ERIE does it all. Our many years experience in producing State of the Art high voltage capacitors and high voltage silicon rectifiers — plus an unsurpassed technology in circuit designing, packaging and encapsulation, makes ERIE an ideal source for your high voltage component needs. From very low input voltages, ERIE can produce output voltages up to 50,000 volts. Application for these compact, high reliability devices includes night-vision image intensification systems, Apollo TV cameras, CRT displays, Avionics systems exposed to rugged environments. Industrial, commercial and military equipments . . . an almost infinite variety of applications. So bring ERIE in early. Let us design and build *your* High Voltage Power Supplies and Voltage Multipliers. We're equipped to handle large or small volume orders . . . in-house.

Write for our 32-page catalog . . .
High Voltage Components and
Devices . . . or for technical
assistance, call
613/392-2581

ERIE TECHNOLOGICAL PRODUCTS, INC.
Erie, Pennsylvania 16512

ERIE

washington report



Heather M. David
Washington Bureau

U.S. considers robot exploration of moon

NASA has no approved plans to send either manned or automated spacecraft back to the moon, but it is considering sending eight automated spacecraft there between 1979 and 1991. These include a lunar polar orbiter in 1979, two lunar orbiters in the 1980s, two lunar rovers in the 1980s that would travel as far as 60 miles in a year on the moon, a lunar "halo" satellite to assure communications with the hidden side of the moon, and, in 1990 and 1991, two lunar rovers that would return samples to earth from any point on the moon, including the hidden side, where samples have not yet been taken. NASA has drawn up a "wish list" of 810 payloads to be sent up through 1991, if Congress approves and the budget permits.

Engineering panel says R&D benefits go unused

Government research programs fail to take the essential steps that American industry successfully uses to bring the fruits of technology it develops to the marketplace, a special committee of the National Academy of Engineering says. The committee suggests that the Government should spend \$1-billion annually toward converting into practical results the technical information it develops through its many R&D programs. According to the report, only \$43-million out of \$17-billion spent on Federal R&D went to technology utilization programs in fiscal 1973. And beyond such things as jet aircraft, antibiotics and sophisticated communication systems, "the vast technology generated by mission-oriented Federal R&D programs since World War II has not resulted in significant secondary applications to improve employment levels, foreign trade, industrial productivity or the quality of life in the nation," the committee says.

Defense agency backs packet-switching communications

Of three options considered for the Defense Dept.'s standard message communications system for the 1980s, a packet switching system appears the most interesting, according to the vice director of the Defense Communications Agency, Maj. Gen. Robert D. Terry. Agency engineers, he says, have concluded that circuit switching cannot accommodate the projected number of calls—up to 150,000 an hour—and that storing and forwarding techniques may be too slow and inadequate. The packet switching network, however, could package information into small packets, on the order of 1000 bits, transmit it from different sources over main trunk routes and assemble related packets in proper sequence at the destination switch, General Terry says.

Although such a system would be expensive, some of the engineering

work on the packet-switching network has already been done by the Defense Advanced Research Projects Agency, and most of the risks are known. The Defense Communications Agency is trying to persuade top echelons of the Defense Dept. that establishment of such a single message network would save \$1-billion to \$2-billion over costs that would be incurred if the military built a variety of dedicated networks.

NASA studies earth-observatory satellite

Three companies have been selected by NASA to perform parallel systems definition studies on a new earth-observatory satellite. The companies—General Electric, Grumman and TRW—will report to the space agency in six months on possible design of a low-cost, modular spacecraft weighing 3-1/2 tons that could be used in the observation of the earth's environment, its weather, oceans, resources and land use. The spacecraft would be designed for launching and retrieval by the space shuttle.

Capital Capsules: The Army Edgewood Arsenal, near Baltimore, Md., is seeking companies to develop a passive long-path infrared (Lopair) remote sensing alarm for detection of hazardous chemical agents in the atmosphere. . . . The Senate Subcommittee on Antitrust and Monopoly and the Justice Dept. are looking into the acquisition of the television division of Motorola by Matsushita of Japan, at the request of Sen. Birch Bayh (D-Ind.). Bayh said the sale could lessen competition in the TV receiver industry and result in hundreds, if not thousands, of U.S. jobs being exported abroad. . . . Instrumentation devices for measuring electromagnetic pulses and capable of handling a bandwidth of dc to 100 MHz with 5-kV peak voltages will be developed by the Air Force Special Weapons Center. Contractors are being sought. . . . AiResearch Manufacturing Co. has received a NASA contract to design and build a mini-Brayton rotating unit for converting radioisotopic energy to electricity. NASA hopes to reduce the costs of electricity production by isotopic power systems by increasing the efficiency of the conversion cycle. Present systems operate at efficiencies of 6%, resulting in power costs of about \$20-million per kilowatt of electricity—a figure NASA hopes to cut by one-fourth. . . . The Defense Dept. has approved the Air Force's plan to build the long-awaited 414 L over-the-horizon radar system to detect incoming bombers. The service will contract for construction of one operational radar system at an as-yet-unspecified site in the northern U.S. . . . The Pentagon has developed a sensor that would notify a ground station if an American satellite were attacked. It will test it on an early-warning satellite in the near future. . . . Work on detectors, target discrimination, data processing and other critical components in both the optical and radar portion of the spectrum is being accelerated with the goal of giving the U.S. the ability of detecting, tracking and identifying all objects in space up to 20,000 nautical miles. The present space surveillance network reaches only to 2000 to 300 miles. . . . A survey of all imaging systems for day and night operations is being conducted by the Army Combat Developments Experimentation Command. It's looking for a passive system sensitive to wavelengths from 0.4 to 1.1 μm , sufficient to image scenes from bright daylight to low-light conditions at ranges of 5 kilometers or more. . . . A new industry advisory committee to study export controls on electronic instrumentation has been convened by the Commerce Dept. It will make recommendations on the liberalization of export controls on a variety of electronic products. . . . The Dept. of Health, Education and Welfare is planning a study of the effects of electromagnetic interference on medical devices, with the objective of developing an electromagnetic compatibility standard for the devices.

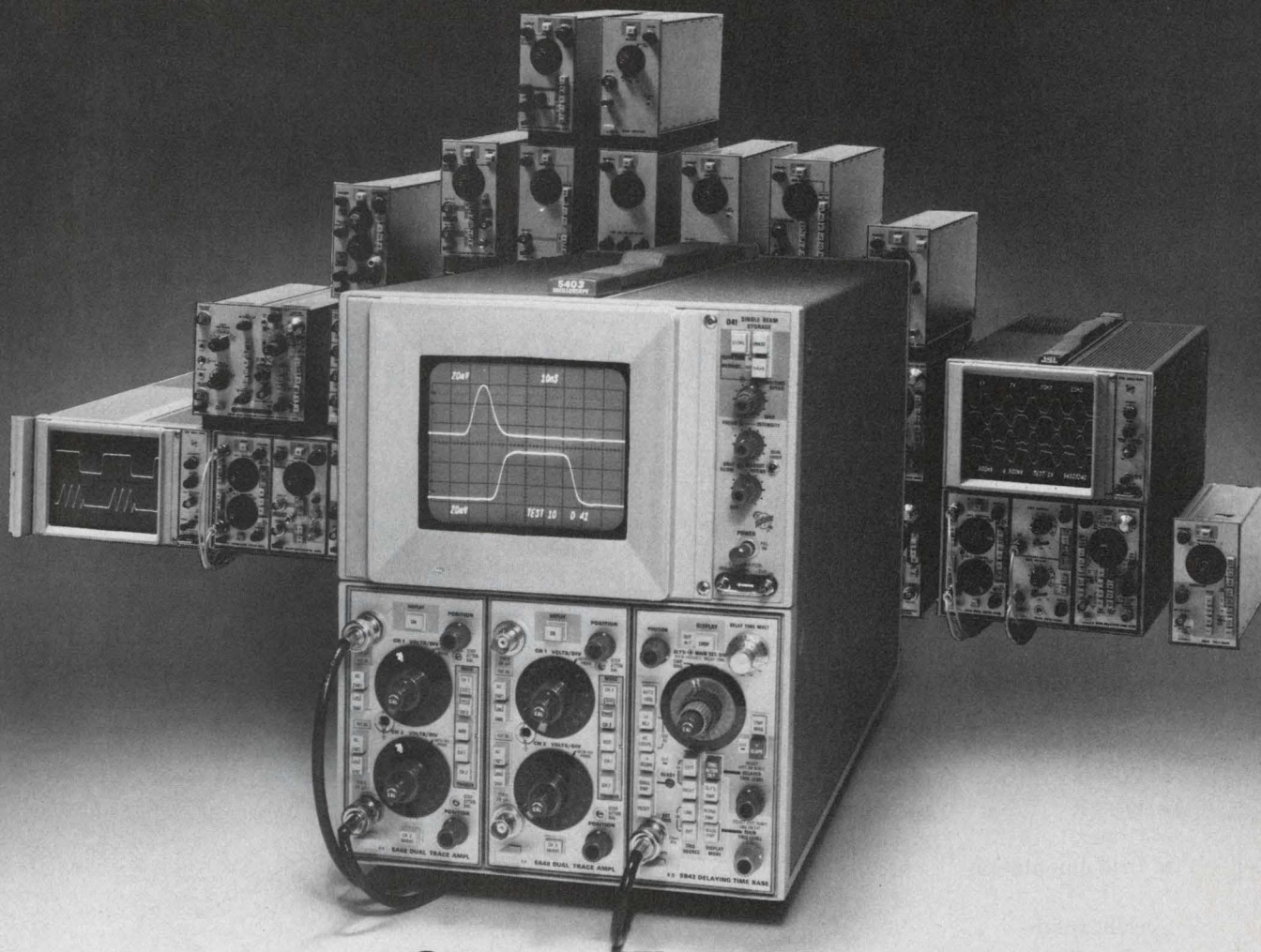

Capture Those Hard to View Signals at Low Cost

Single shot events; high speed, low repetition rate signals; changes in successive sweeps, very slow signals; repetitive signals obscured by random noise—all of those hard to display waveforms are easy to view using the new 5403/D41 Variable Persistence Storage Oscilloscope from Tektronix.

You vary waveform storage time for the 5403/D41 simply by turning a dial. Normal intensity viewing time ranges from milliseconds up to 5 minutes and a waveform can be saved for up to an hour by simply pushing a button.

With a writing speed of 5 div/ μ S, 60 MHz bandwidth and the added convenience of a 3 plug-in mainframe, the 5403/D41 saves you hundreds of dollars over the price of other variable persistence storage oscilloscopes. Complete with 60 MHz vertical amplifier and 10 ns/div time base, the 5403/D41 is priced from only \$2450. What's more; with the flexible, easy-to-use 5403/D41 you can add unique

convenience features: CRT readout of deflection factors, and user programmable CRT readout of test identification data.

Versatile, Modular Family. The 5403/D41 Variable Persistence Storage Oscilloscope is the latest addition to the versatile, modular 5000 Series. With this flexible family you can tailor the oscilloscope best suited to your measurement needs by choosing from 2 mainframes (60 MHz or 2 MHz bandwidth), 7 display modules, and 21 diverse plug-ins. 5000 Series measurement flexibility includes a 60 MHz dual trace amplifier, a 10 ns/div sweep rate delayed time base, an easy-to-use dc to 1 GHz sampler, a dc to 100 kHz spectrum analyzer, a 10 μ V/div differential amplifier, a differential comparator accurate to 0.20%, a four trace amplifier (8 traces with two amplifiers), and a semiconductor curve tracer.

The flexible 5000 Series is designed to handle your present measurements and is expanding to meet your future needs.

To learn more about the new 5403/D41 Variable Persistence Storage Oscilloscope and how this low cost instrument can make difficult signals easy to measure, contact your local Tektronix Field Engineer or write Tektronix, Inc., P.O. Box 500, Beaverton, Oregon 97005. In Europe write Tektronix, Ltd., P.O. Box 36, St. Peters Port, Guernsey, C.I., United Kingdom.

INFORMATION RETRIEVAL NUMBER 27
FOR DEMONSTRATION, CIRCLE 210

TEKTRONIX®
committed to
technical excellence

A New Standard For Accuracy!

3½ Digit A/D Converter

The LD110/LD111 A/D converter sets the pace for accuracy with a specification of 0.05% of reading, ± 1 digit. The set consists of two ICs, and with the addition of a reference voltage and clock becomes a full 3½-digit analog-to-digital conversion system. LD110/LD111 features and specifications make the converter set an ideal choice for digital display processors in

- DPMs
- Thermometers
- DVMs
- Scales
- Controllers
- Tachometers
- Instrumentation

Specifications

- Accuracy of 0.05% of reading, ± 1 count
- $Z_{IN} > 1000 \text{ M}\Omega$
- 4 pA typical input bias current (25°C)
- 100 μV resolution (200.0 mV range)
- 40 dB NMRR @ 60 Hz

Features

- Auto-zero minimizes effect of offset, drift and temperature
- Auto-polarity
- Sampling rates from 1/3 to 12 samples/second
- Two voltage ranges: 2.000V and 200.0 mV
- TTL-compatible outputs
- \$28.60 per set (100-set price)

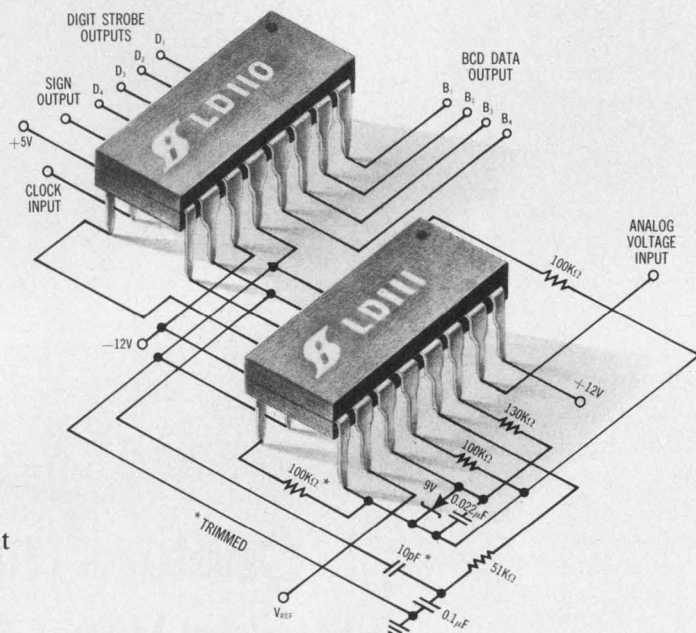

The unique conversion technique uses a single reference and a single full-scale adjustment to achieve a highly-accurate strobed 3½-digit output of up to 3100 counts plus sign. LD111 analog processor employs monolithic PMOS/bipolar construction and interfaces directly with the LD110 digital processor, which has a monolithic PMOS structure. For further information

write for data

IC Applications: (408) 246-8000, Ext. 120



Siliconix incorporated

2201 Laurelwood Road, Santa Clara, California 95054

INFORMATION RETRIEVAL NUMBER 28

Good news Bad news

It finally caught up with us—as we knew it would. Everybody knows there are shortages of almost anything you can name. In the electronics industry we may worry about shortages of copper, capacitors, power transistors or a whole array of other components or materials. In the publishing industry, we worry about paper. Boy, do we worry. Unlike gasoline, which now seems to be plentiful but very expensive, paper is scarce and very expensive. And the price keeps going up. Well, we've been paying more . . . and more . . . and more—and then we simply couldn't get enough of the paper we wanted. It seems that somebody forgot to make enough trees—and enough mills to change the trees to pulp and then to paper stock.

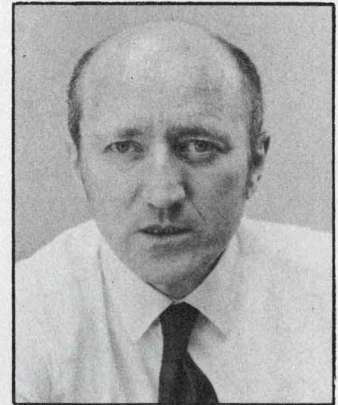

So in this issue, you'll find two types of paper—a coated stock and an uncoated stock. The coated stock is what we've been using in the past. The uncoated stock is new—and frightfully expensive. It costs more than twice as much as the coated stock we formerly used. That's the bad news. For us.

The good news is for you. The new paper, called bible stock, is easier to read because it's free of glare, as it's uncoated, and it lasts a heck of a lot longer before yellowing. In the trade it's called a "free sheet." But it is cost-free by no stretch of the imagination. Conventional paper, the kind we have been using, is called groundwood paper as it's ground from the entire tree. They grind up the bark and all. Free sheet uses only the inner white wood. So it's stronger and it keeps its whiteness many years longer.

We hope we won't have to give you this luxury stock forever. It costs an arm. Meanwhile, we'd like to hear your views. Give us a call. Send us a letter. Or jot down your comments on the Information Retrieval Card.

A handwritten signature in cursive script that reads "George Rostky".

GEORGE ROSTKY
Editor-in-Chief

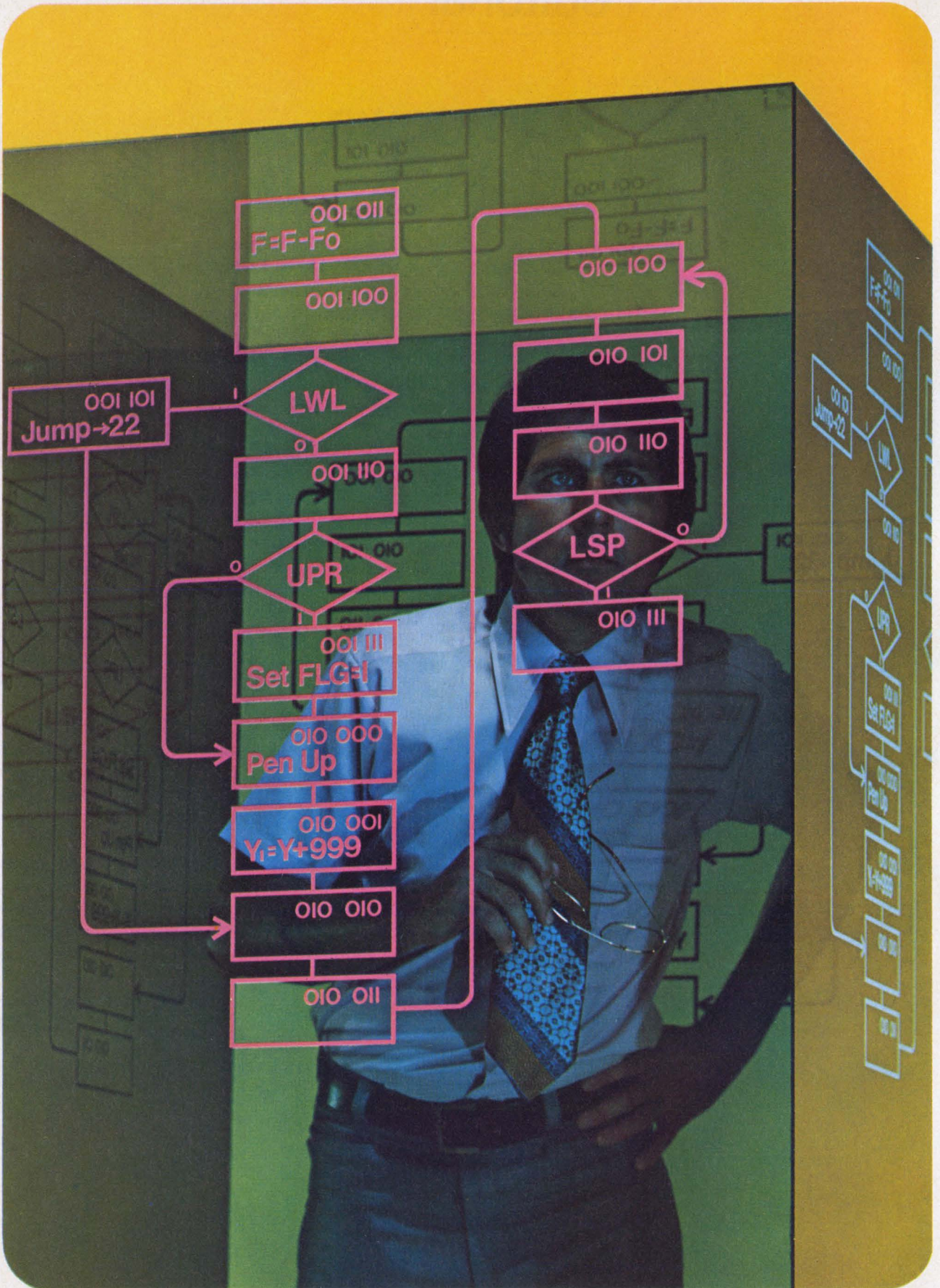

**Now — Put Yourself Inside Your Designs.
See Your Logic Programs In Action.
See Negative Time.**

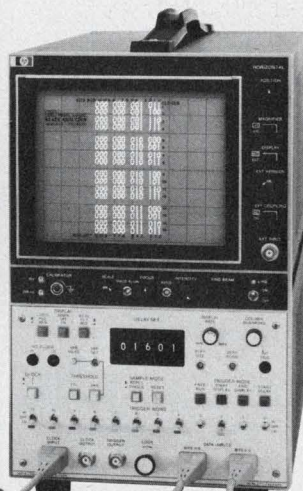
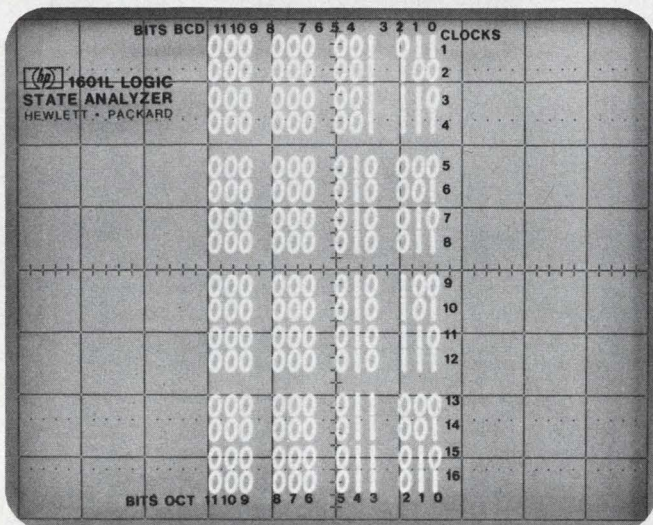

**Breakthrough...
The HP 1601L
Logic Analyzer...**



Here's a functional tester that can make a world of difference in helping you solve your digital design or test problems. With HP's 1601L you actually see each word displayed in "1's" and "0's", as shown here. Sixteen words at a time, each twelve bits wide. **Now see what's really happening.** See each sequential step of your design, or of the equipment you're analyzing for problems. Display your digital words in "1's" and "0's," in hexadecimal, BCD or octal format. Select positive or negative logic corresponding to the type of circuitry you're working with, and adjust threshold over the $\pm 10V$ range provided. Think of all the time you'll save in design and troubleshooting. **See your logic in action.** "Step inside" your design and watch it pace through its sequences. If a "glitch" should occur, end your display and look **back** in time to see what events lead up to the problem. Diagnostics couldn't be easier. **See dynamic data flow, negative time, much more.** The 1601L displays an action portrait. Dynamically timed by your strobe signal (up to 10 MHz), you can

delay the start of display up to 10^5 bits and really track your system's performance. If a problem develops, look back from the problem word (negative time) at least 15 words. Your oscilloscope will help you find the component or circuit at fault; the 1601L provides a trigger for your scope making fault isolation even easier. **See things you've never seen before.** See those digital events you've always wanted to see. For all this capability the 1601L is priced at only \$2800*. Or, consider the 5000A, a unit with LED display, two channels, thirty-two bits. It sells for only \$1960*. Your local HP field engineer will be happy to arrange a "hands-on" demonstration in your office or lab.

*Domestic U.S. prices only.



Sales, service and support in 172 centers in 65 countries.
Palo Alto, California 94303 Offices in principal cities throughout the U.S.

08318 A

Need a DMM with a difference? ...Keithley's got 'em!

Tired of "general purpose" Digital Multimeter performance? Want that something extra that'll make your job easier? Then we've got the Multimeters for you. Take our new 5-1/2 digit, $10\ \mu\text{V}$ resolution, \$750, ac/dc Model 190...or our new 5-function, 32-range Model 165. It's even got a built-in 1 mA source for semiconductor testing. Then there's our model 171...a real do-it-all DMM. $4\frac{1}{2}$ digits, $1\ \mu\text{V}$ resolution, dc volts, ac volts, ac/dc amps, ohms too.

But the Keithley family doesn't end there. We can give you resolution to 30 nanovolts, or let you measure currents of 10^{-15} amp, or resistances to over 10^{14} ohms...we've even got a DMM that has the read-out in a probe.

If you have a job that needs a DMM and then some, we can help. Send for our Digital Multimeter selector guide or call for a demo now. Phone (216) 248-0400



Our latest "How sweet it is" proclamation is on a marble base paperweight. It's free when you request a DMM demo. Get one now!



**KEITHLEY
INSTRUMENTS**
U.S.A.: 28775 AURORA ROAD, CLEVELAND, OHIO 44139
EUROPE: 14, AVENUE VILLARDIN, 1009 PULLY, SUISSE

INFORMATION RETRIEVAL NUMBER 30

Even when it was only \$35 an ounce, gold was expensive. That's why we started long ago to reduce the amount of gold in our contacts to a minimum.

In 1958 we developed a really reliable gold dot contact. And no matter what anyone else says, only silver and copper are better electrical conductors than gold

(but gold doesn't oxidize or corrode).

Over the years we've been able to reduce the cost because we reduced the gold.

And we've been reducing the amount over the years without reducing the mechanical or electrical quality of our connectors.

Now, after all these years, we

find out that we not only reduced cost but we've been making our own small contribution to solving our country's gold problem.

And all because we wanted to design a more economical, more reliable gold-contact connector.

GTE SYLVANIA

INFORMATION RETRIEVAL NUMBER 31

Our small contribution to solving the gold problem.





...when one has a sure thing it is hard to resist showing off a little. Just as the royal flush is a guaranteed winner in poker, Futaba parts mean the same certainty for most major Japanese manufacturers. Precision manufacturing and reliability of performance are two reasons. Another great reason is constancy of supply. No matter how good parts are, this means nothing if they are not available when needed. With modern, high-capacity manufacturing facilities, this is where Futaba holds a real winning hand. Futaba parts—just ask for them.



Standard keyboard switches and key tops available from FUTABA stock for instant keyboard layout on your mounting plate.

OTHER FUTABA PRODUCTS:

- Press die sets.
- Mold bases for plastics.
- Material feeders for press work.
- Automatic stopping devices for automatic machinery.
- Radio control for hobby aircraft, race cars, etc.

**WE DON'T MEAN
TO SHOW OUR HAND, BUT...**



"FUTABA—THE BRIGHT PRODUCER"

● For additional information, please contact:

FUTABA INDUSTRIES U.S.A.
630 West Carob Street, Compton, California 90220, U.S.A.
Phone: (213) 537-9610 Telex: 69-1227

FUTABA ELECTRONIC INDUSTRIES LIMITED
Super Bldg., 1-11-5, Sotokanda, Chiyoda-ku, Tokyo, Japan. Phone: 255-5881
Telex: J26532

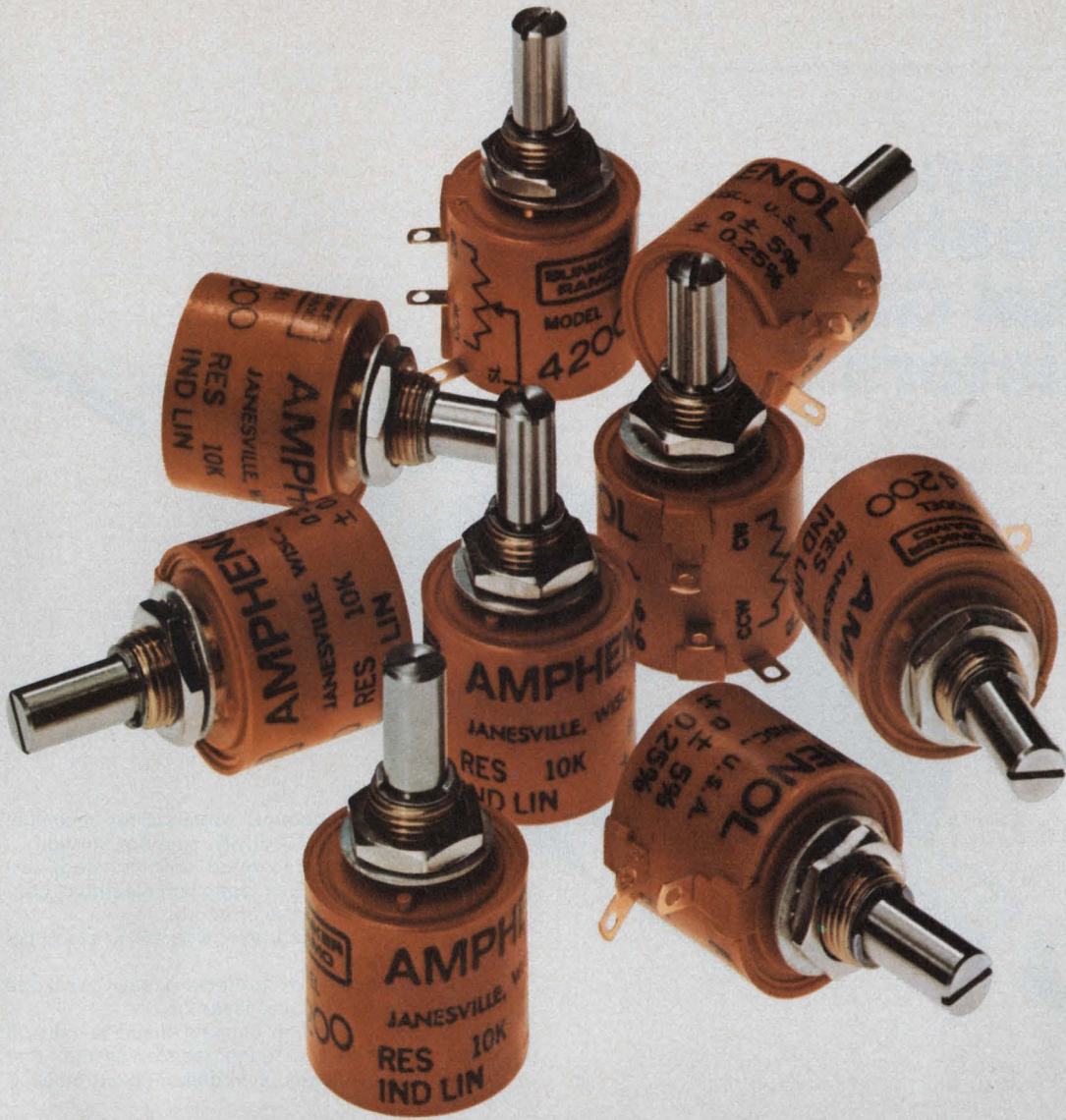

We promised higher performance at a lower price and we're delivering.

Less than a year ago we announced Scot Pot—a 10-turn, wirewound, 7/8-inch diameter, 3/4-inch short potentiometer to meet high performance specifications. We promised to deliver at an astonishingly low price.

And we've kept our promise.

We are mass-producing Scot Pot and it's now available off your distributor's shelf. Scot Pot has been thoroughly tested by an independent testing laboratory to VRCI standards and meets all the high performance criteria you set. A copy of the test report is available upon request.

Scot Pot guaranteed performance will

exactly replace, form, fit and function, the part you're now using—or having trouble getting. So save yourself some time, cost and a lot of headaches. Scot Pot is here now.

Right now, today, you can get a few hundred Amphenol Scot Pots from one of our distributors. And for large quantity orders we'll deliver in time to satisfy your most demanding schedules. For immediate action call us at 312/261-2000. Or write the Amphenol Scot Pot Department, 2801 S. 25th Avenue, Broadview, Ill. 60153.

ScotPot

**BUNKER
RAMO**

AMPHENOL

INFORMATION RETRIEVAL NUMBER 33

Design refresher on Metal Glaze™ resistors



1. Solid ceramic substrate for maximum heat conductivity, superior strength.
2. High-temp. soldered (not crimped) termination gives optimum electrical contact, 20-lb. pull strength.
3. Automated helix with 100% electrical test.
4. Molded jacket protects against breakage during machine insertion.
5. Metal Glaze thick-film element fused to core at 1000°C. Provides a tough resistor system that withstands overloads, environmental extremes.

An all-purpose resistor? Not *quite*. But if you're designing any type of low-power circuitry, it usually pays to look at Metal Glaze.

Mechanically, these resistors are nut tough. Electrically, they offer excellent load life stability. And thermal characteristics are outstanding, giving you lower operating temperatures, greater reliability. In fact, you can often *double-rate* Metal Glaze resistors. So you can use smaller resistors, save board space.

The quality and cost effectiveness of Metal Glaze resistors have been proven *billions* of times over—in all types of electronic equipment, worldwide. Available in ratings ≤ 5 watts, $\geq 1\%$ tolerance, and ranges as low as 1 ohm.

Complete resistor choice. TRW offers you a total resistor capability—carbon comp., thin-film, Metal Glaze, wirewound, networks. For complete specs and application data on Metal Glaze, contact your local TRW sales representative (or TRW/IRC's Boone, N.C., plant—(704) 264-8861). Or *write* TRW/IRC Resistors, an Electronic Components Division of TRW, Inc., 401 N. Broad St., Philadelphia, Pa. 19108.

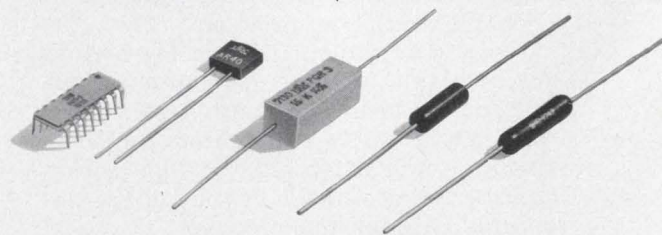

TRW® IRC RESISTORS

™Metal Glaze is TRW/IRC's trademark for its thick-film resistors.

Still fighting snap, crackle and pop?

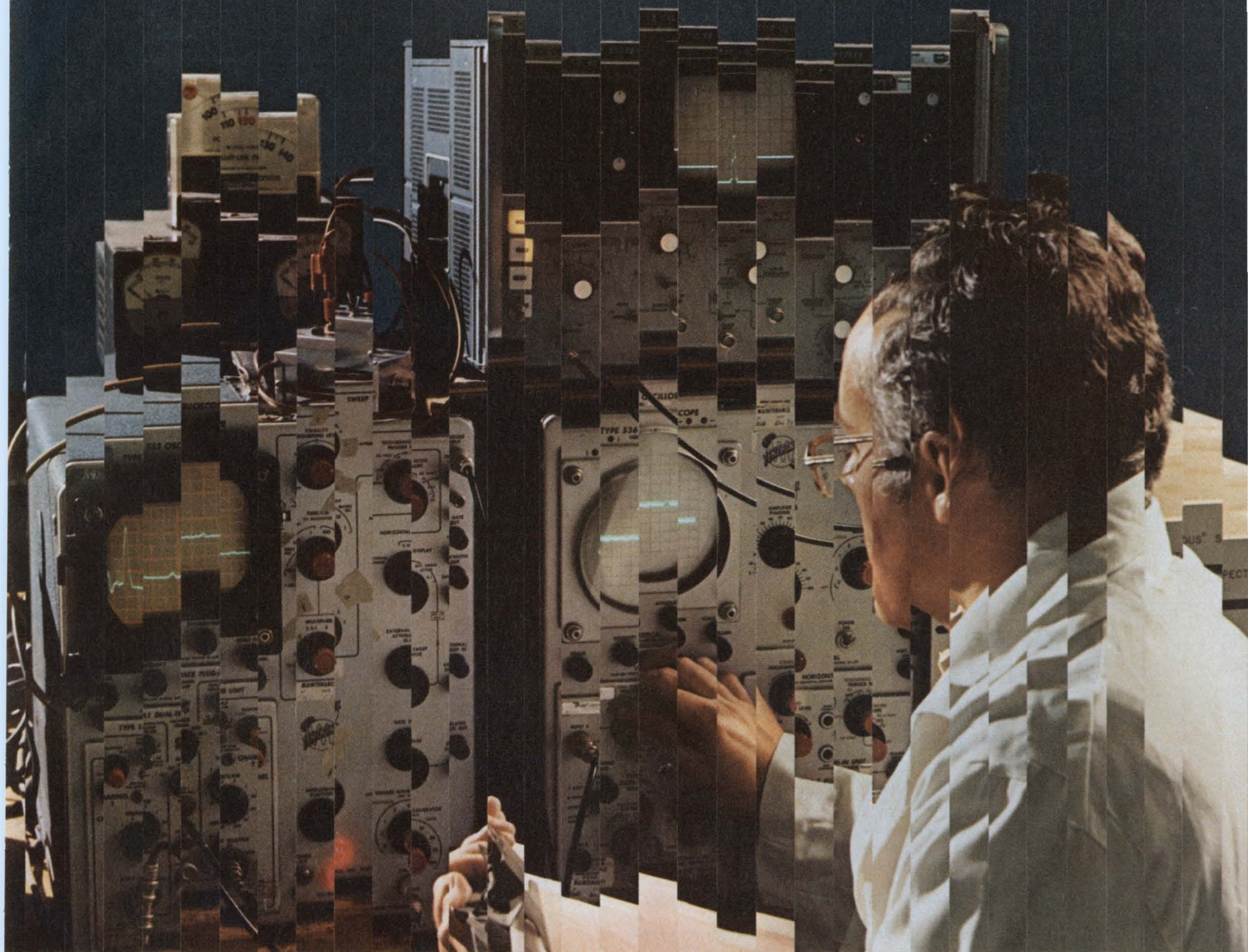

Noise has a way of showing up in circuits. Bendix has a way of preventing it. Filter connectors. Boasting some of the best attenuation curves available, Bendix filter connectors solve a wide range of low-pass filter problems. Small wonder Bendix is first choice in the fight against snap, crackle and pop.

These versatile connectors, production tooled, are available in a wide range of cylindrical and rectangular configurations designed to meet most any industrial, commercial and military application.



Configurations that can be intermateable with most MIL-Spec and popular commercial connectors and special designs for advanced state-of-the-art equipment. There's sure to be one that meets your attenuation and frequency requirements. You'll like what you hear when it comes to the price, too. And that goes for delivery as well.

Write for our new catalog. It's yours for the asking. The Bendix Corporation, Electrical Components Division, Sidney, New York 13838.



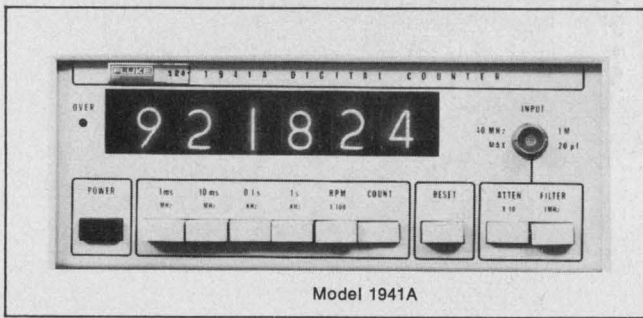

New Fluke Counter

- \$299, 5 Hz to 40 MHz
- Measure frequency, read rpm directly or totalize events
- Big six digit display clearly readable from a distance
- Switchable low pass filter and attenuator for noisy electrical environments
- Optional BCD output and programmable offset
- 40 mV sensitivity
- Fluke quality at a rock bottom low price
- Functional "burn-in" to eliminate marginal parts
- World-wide network of Fluke service centers to provide 48 hour turn-around repairs



FLUKE, P. O. Box 7428, Seattle, Washington 98133. Phone (206) 774-2211.

INFORMATION RETRIEVAL NUMBER 221

Calibrate your transmitter instantly with Fluke's new 1980A Telecommunications Counter



Model 1980A with rechargeable battery pack and carrying case.

- TCXO frequency reference—ready for use at turn-on
- Battery-powered, compact, lightweight—travels easily to any remote site
- Meets FCC requirements—TCXO stability permits long recalibration intervals
- Ignores modulation—reads carrier to ± 10 Hz at 500 MHz within 1 second
- Extremely sensitive—with whip antenna on input, reads nearby Xmitter frequency
- A price everyone can afford—\$795 (ask about our lease plan)



For data out today, dial our toll-free hotline, 800-426-0361

John Fluke Mfg. Co., Inc., P. O. Box 7428, Seattle, WA 98133

INFORMATION RETRIEVAL NUMBER 222

Imagine a DC to 80 MHz super stable six function counter/timer for \$695. Only Fluke has it!

- DC to 80 MHz, expandable to 515 MHz for \$300 more. 50 mV sensitivity.
- Measures frequency, frequency period, single period, multiple period average, time interval, totalize and gateable totalize.
- Features Fluke's unique variable trigger level control center.
- Standard temperature dependence from 0 to 50°C, 2×10^{-6} . Optional, 3×10^{-7} .
- 7 digit LED display, 8 & 9 digits optional.
- Matched input channels featuring full control of coupling, slope and trigger level.
- Units annunciation, overflow, gate and trigger level status lamps.
- Outputs include gate, clock, marker and optional BCD.



Model 1952A



For data out today, dial our toll-free hotline, 800-426-0361

John Fluke Mfg. Co., Inc., P. O. Box 7428, Seattle, WA 98133

INFORMATION RETRIEVAL NUMBER 223

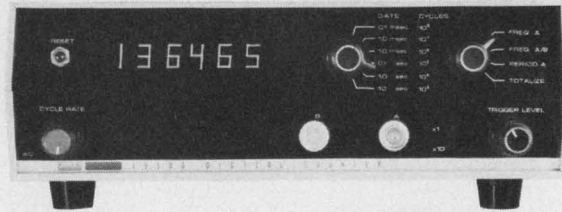

Model 1950A

New Five Function Counter, \$445

Gives you a price-performance trade-off you'll hardly believe

- 5 Hz to 50 MHz with 50 mV sensitivity
- Measure frequency, single period, multiple period averages, ratios or totals
- Six digit LED display with automatic annunciation
- Variable trigger level control with status lamps
- Operates from line or 12 VDC. Weighs 5 lbs.
- Low cost optional TCXO for instant-on full time accuracy
- Optional BCD output for printer drive
- World-wide network of factory service centers



For data out today, dial our toll-free hotline, 800-426-0361

John Fluke Mfg. Co., Inc., P. O. Box 7428, Seattle, WA 98133

INFORMATION RETRIEVAL NUMBER 224

THE FIRST PRACTICAL DATA-ACQUISITION MODULE:

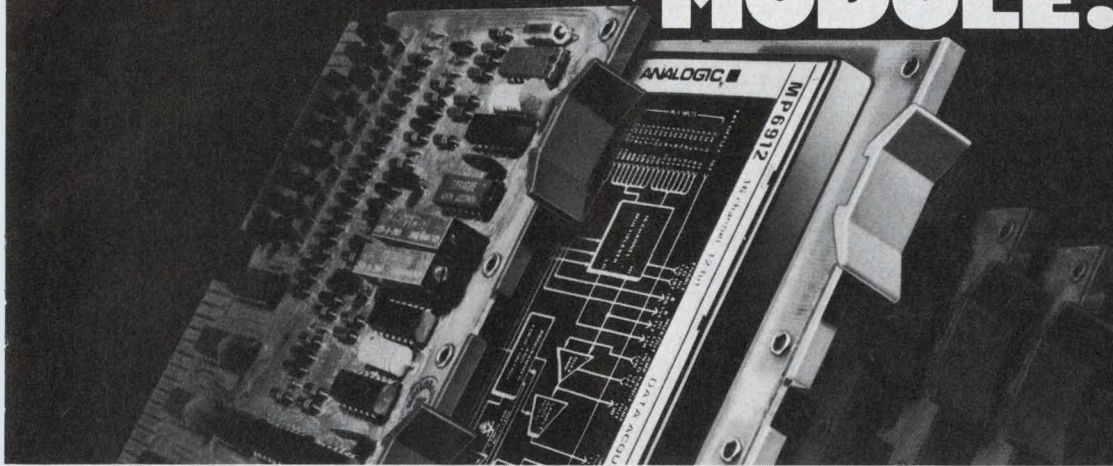

**Complete 12-bit,
16-channel
system fits 0.5"
card spacing--
anywhere.**

**Better
performance,
at lower cost,
than individual
module
combinations.**

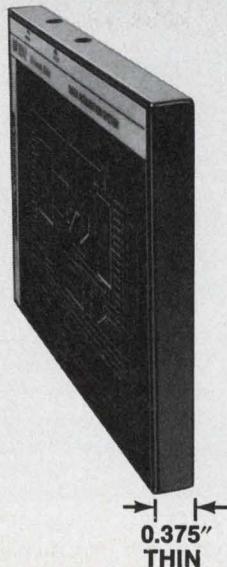

0.375"
THIN

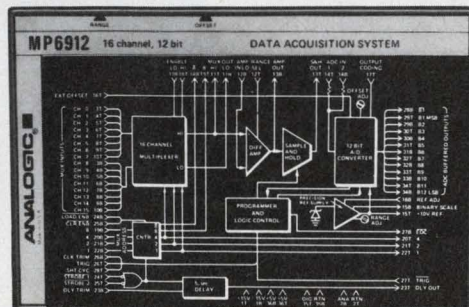

On a minicomputer motherboard, medical instrument or process control system . . . mounted on a single small card . . . plugged directly into a card-cage connector—there's always room for the 0.375"H x 4.6"W x 3.0"L Model MP6912: With space at a premium, this remarkable plug in, easily serviceable high-performance / low-cost system is your first really practical alternative to either in-house design or larger more costly systems. Particularly since you'd actually pay *more* to get comparable performance from individual modules that need .3-5 times the "real estate".

You get a 16-channel multiplexer (expandable to 256 channels), fast sample and hold, and a 12-bit A/D converter (accuracy $\pm 0.025\%$ at a 100kHz thrupt rate), integrated with complete programming, control, and timing logic. (That's what we call the first *practical* data acquisition module.)

What you don't get is equally important: error accumulation; module interconnection costs and headache; redesign challenges

every time the application changes; and testing, documenting, and quality-controlling at the module level.

The MP6912 is an optimized design: 100% shielding on all six sides to minimize interference; minimum parts count for inherently high reliability; an exceptional 100kHz basic throughput rate that can be "short cycled" up to 450kHz; buffered outputs for trouble-free digital interconnection.

A companion D.C. to D.C. converter, the MP3020, which is powered by the +5V logic supply is also available to provide all the power needed for the MP6912 in a compatible 0.375" thin package.

Write for our 16-page designer's guide to the MP6912—applications and timing diagrams, set-up and calibration procedures, etc. and see why the Analogic alternative makes sense. Analogic, Audubon Rd., Wakefield, Mass. 01880; phone (617) 246-0300.

Northeast, 617-235-2330, 203-966-2580, 315-466-0220, 201-652-7055, 212-947-0379

Mid Atlantic, 215-272-1444, 215-687-3535, 703-790-5666, 301-252-8494

Midwest, 314-895-4100, 913-362-0919, 216-267-0445, 513-434-7500, 313-892-2500, 412-892-2953, 312-283-0713, 414-476-1500, 317-844-0114

South, 713-785-0581, 214-620-1551, 305-894-4401, 919-227-3639, 205-534-9771, 305-773-3411, 813-867-7820

West, 303-744-3301, 505-523-0601, 602-946-4215, 505-292-1212, 714-540-7160, 415-398-2211, 206-762-7664, 503-643-5754,

Canada, 613-836-4411, 604-688-2619, 416-499-5544, 514-636-0525, 902-434-3402

ANALOGIC
... The Digitizers

FOCUS

on
Electronic
counters

If time is of the essence, a time-measuring instrument should be essentially perfect. And while no counter is, some come pretty close. Name your performance, and you've practically got it—from direct counting to 0.5 GHz, to automatic operation, to low-cost, portable units.

But even the best of counters can cause problems. Most troubles center on the counter's two most touchy sections: the input stages and the time base. It's these that cause headaches for the counter designer—and the specifier.

Consider the input section. Upon it rests such counter performance as sensitivity, dynamic range, noise immunity, input impedance, overload capability and protection, and waveform-handling characteristics. And if these aren't enough, the input stages are partly responsible for accuracy—a counter's most important spec.

Then there's the time base—the heart of any counter. The time-base oscillator, usually crystal controlled, is the final determinant of accuracy—and the focal point of the most imaginative of the spec writers' outpourings.

When the time base beats steadily, without deviation or drift in the master frequency, then—if other factors are ignored—the counter measures with at least its initial accuracy. When time, temperature and line-voltage variations team up to assault the reference, accuracy will wander, and recalibration may become necessary.

The problem, of course, is not just to determine how much temperature drift to expect in a given time, how much aging of the crystal will occur, or what effect line-voltage variations will have. The problem is really to determine the final, absolute accuracy of the measurement. To find out, let's start at the input jack and trace

our way through the counter to the final results—the display.

Sensitivity: How much is too much?

Before you connect your signal to a counter's input, you'd like to know whether the signal can trigger the input circuitry—usually a Schmitt trigger preceded by a preamp. And this is what a sensitivity spec should tell you: the minimum signal that will be reliably counted.

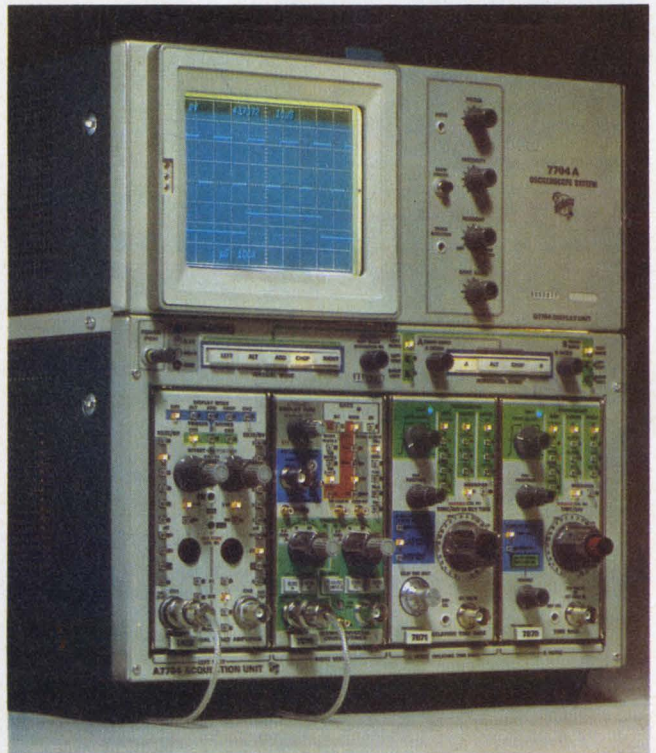

With the Tektronix 7D15—a universal counter/timer for the 7000-Series scope—you can display the count interval and a replica of the gating signal.

Stanley Runyon
Associate Editor

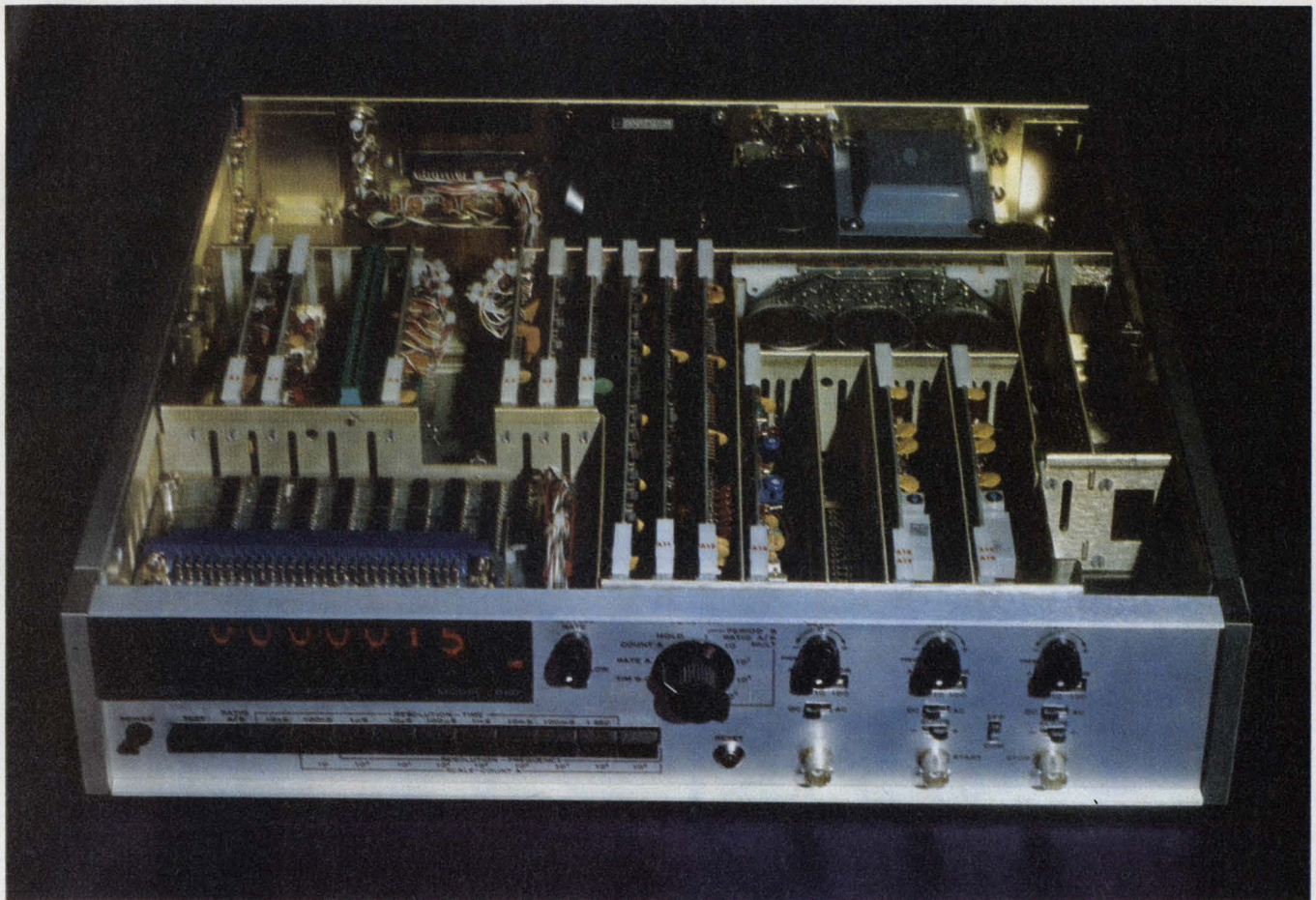

Over 200,000 combinations are possible with Systron-Donner's 6150 expandable counter-timer. Any of the

models in the series can be extended in frequency range—to 3 GHz—with plug-in PC cards.

But a sensitivity spec of, say, 50 mV doesn't tell the whole story. First, is this a "typical" spec or is it guaranteed? If it's typical, this may mean that a unit pulled off the assembly line at random at 3 P.M. on Friday, Feb. 29, just happened to meet the spec.

Second, is 50 mV a maximum spec or is it the mid-range value? In general, a counter's sensitivity doesn't remain constant across the input frequency range; it meanders in a curve that resembles an upside-down amplifier frequency response. Thus sensitivity usually gets worse at each end of the range. And local dips and peaks in the sensitivity curve can result in hot spots or regions of depreciated sensitivity.

So it's best to ask a vendor for a curve of input sensitivity vs range—not just for the frequency function, but for all functions. While you're at it, ask if the 50-mV spec is rms or peak to peak.

In applications such as communications—where most signals are sinusoidal—an rms spec is appropriate. On the other hand, if you're dealing with digital applications—where pulses are common—the rms spec won't do you much good, and a peak-to-peak value makes more sense. If

peak-to-peak isn't given, multiply the rms value by $2\sqrt{2}$, and you're in business.

A little curiosity may dig out some other useful information—such as the fact that the sensitivity of the second or third channel is less than that of the first. Or the fact that too much sensitivity can hurt you.

A sensitivity spec of 1 mV out to 500 MHz is certainly impressive. But if you don't need it, such sensitivity and high speed can result in overkill: Not only will the instrument count your signal, but it will also throw in some extra counts of noise, transients, RFI and other extraneous signals.

Of course, to counter noise you can always buy a unit that has age or one with a filter or attenuator or trigger control in the input. But with a filter you'll probably have to trade off counting speed. And with an attenuator you'll need a stronger input signal.

If you're lucky enough to have a solid signal (not usually the case at high frequencies), obviously you won't need high sensitivity. What you might need, however, is some input protection.

A hefty signal is nice to have, all right. Except when the signal zaps your sensitive input

circuit and a stiff repair bill follows. The bill can turn out to be about \$400 for a high-sensitivity, high-frequency instrument.

So check out a counter's input protection and overload characteristics before you buy. Protection can take many forms, from a simple limiting diode to the opening of a relay. Be sure to check out the effect of the protection, if any, on the counter's input impedance.

Input capacitance counts

Often what the spec sheet doesn't tell you the instrument does. That "high" 1-M Ω input impedance prominently displayed in the specs can plunge to around 100 k Ω —or less—when input protection begins to take effect. The spec sheet often "forgets" to mention this—but you'll find out soon enough when your signal source gets



Fluke's 1900 Series ranges from the 40-MHz 1941A—a frequency/totalizer/rpm box—to the 1980A, a 512-MHz portable telecommunications counter.

loaded down or, worse, short-circuited.

Though shorts probably don't occur often, input loading does. Like most instruments, counters have input capacitance that causes impedance to vary inversely with input frequency.

If you know the capacitance, then Z_i can be easily determined for your anticipated range of frequencies. Unfortunately the capacitance may not stay put. In fact, C_i may vary with input control settings and from channel to channel.

Adding to the problem is the fact that input impedance also depends on the attenuator position, on the setting of the function switch and, possibly, on which channel you use.

Under about 200 MHz, most counters specify Z_i at 1 M Ω , shunted by so many picofarads. At

higher frequencies, a 50- Ω termination is usually specified. When a counter has more than one input channel, and channel 1 is classified as "high" impedance, don't assume the other channel is too. It may be 50 Ω .

Another point to watch for: High-impedance inputs can often handle high voltages—115 V, or higher. But 50- Ω inputs are usually limited to around 5-V rms. Watch out.

At high frequencies, VSWR becomes important and should be spelled out along with Z_i . Of course, the lower the VSWR, the better. But a low VSWR at one frequency doesn't guarantee a low value at the next. Find out just what the variations are over your range of frequencies. While you are working with ranges, take time out to determine what range of input frequencies, amplitudes and waveforms the counter will handle. Surprises may be in store.

First, a headlined frequency range may not apply to all channels. Second, in universal counter-timers, don't assume because an instrument will measure a frequency of 50 MHz, it will totalize pulses at 50 MHz or handle time intervals of 20 ns. It may not.

Next, how does the instrument react when the input isn't a pure sinusoid? Suppose your input is a pulse, square wave or even a pulsed or modulated signal—AM or FM. What then?

Most frequency-only meters have ac-coupled inputs. This is fine when inputs are sinusoidal and don't go too low in frequency. But if frequency is low (< 20 Hz) or the input is an aperiodic pulse train, or one with low or variable duty cycle, then you'll need dc coupling.

Naturally, universal machines—those that perform timing functions as well as frequency—need both ac and dc coupling. To fulfill the claim of universality, this instrument must also be able to control both trigger level and trigger slope. And here's where headaches begin.

Triggering: The No. 1 counter problem?

To some of us, the word trigger (with a capital T) invokes fond childhood memories of a Western hero. But to a counter manufacturer, trigger may be a dirty word. Here's why.

Practically every counter or timer uses a Schmitt trigger to shape the input signal and—by use of the Schmitt's built-in hysteresis—to provide some noise immunity. If the input signal has sufficient noise riding on it, or if the input amplifier drifts, or if something causes the Schmitt's trigger level to drift, trigger errors can occur.

Though trigger errors are rare in the frequency or count modes, they aren't so rare when you measure period, ratio or time interval.

Unfortunately, specs that spell out noise im-

munity and trigger errors are often missing from the data sheet. Since these are hard to define and even harder to measure, some vendors "solve" the problem by simply ignoring it.

But time, temperature and line voltage never forget—they vary. All too often, they gang up to shove around the trigger point—and the final count.

To overcome the problem, many counters provide trigger-level controls (not to be confused with sensitivity controls, or attenuators) or they use age to provide an amplifier gain based on the input level.

With the manual trigger-level control, the hysteresis window of the Schmitt can be moved, with respect to a signal's zero crossing, to optimize noise immunity without a sacrifice of sensi-



Snap-on, rather than plug-in, describes Hewlett-Packard's family of vertical-stacking modules. Units include counters, a counter-timer and a DMM/counter.

tivity. Warning indicator lamps or other means may (and should) be provided to check the trigger point.

Trigger errors become important only when the input signal controls the counter's main gate—as it does in the period, time interval and ratio modes. When only one, or just a few, periods are measured, trigger error can become critical.

If you've got to measure low frequencies with high resolution in a short time, you'll probably use a phase-lock or a reciprocal-taking counter—the latter an instrument that measures one or a few periods and then calculates and displays the reciprocal of the measured period.

When a single period is measured, trigger-

level uncertainty can introduce a 0.3% error when noise or distortion is 40 dB below the measured (sinusoidal) signal. This error usually diminishes with square or pulse waveforms.

Thus a signal confidently displayed as 1.0000000 Hz may actually fall anywhere between 0.997 and 1.003 Hz if the signal is only 1% (40 dB) noisy.

To improve the error, period averaging is often used, a technique whereby more than one period is measured. Since the uncertainty remains constant, the trigger error is divided by the number of periods selected. Measurement time, of course, is lengthened with averaging.

Thus, with averaging, 10 periods of a 1-Hz signal may take 10 s in a reciprocal counter. But the error might be reduced to 0.03%. Compare this with a conventional counter in which the error could be 10% for 10 s and 1% for 100-s averaging.

More trigger errors

A note of caution: With period averaging, digital noise can be fed back into the amplifier or analog circuitry if the analog and digital stages or grounds aren't adequately isolated. The result: appreciable jitter, even with averaging.

Another factor, slew rate, enters the picture when you make time-interval measurements. In this mode the maximum trigger error is given by the level uncertainty, divided by the slope of the input signal in volts per microsecond.

Obviously the faster the leading or trailing edges of the input, the less the rise, and fall times contribute to the total measurement time, and the less the error. If the error works out to be less than the maximum resolution of the counter in the time-interval mode (100 ns, for example), the slew-rate error is negligible, and other errors dominate.

Another type of trigger error results from the built-in hysteresis of a counter's Schmitt circuit. The counter doesn't trigger at the same point on both positive and negative slopes of the input signal. If the trigger polarity is switched for some reason—say by a computer program in an ATE setup—bad readings can result.

One spec that's rarely given is the trigger threshold band—a spec that spells out the effects of unequal input charging upon the trigger setting.

With a high threshold band, low settings of a sensitivity control will produce incorrect counts. The count will remain incorrect as the control is increased, until a point is reached at which reliable counting begins.

To eliminate the problem, some counters are designed so that the input circuit looks like a



Remote programmability, BCD outputs and 600-MHz operation mark Heath/Schlumberger's SM-110C frequency counter.

true, differential amplifier to the incoming signal.

In these units, the threshold band is low—about 1 mV—which means that charge effects won't move the trigger setting by more than 1-mV. Thus as sensitivity is increased, the instrument initially doesn't count at all; when it does, the count will be correct.

While you're investigating trigger errors, try this: Remove your input signal, turn the sensitivity way up and run through all functions.

If the display starts counting merrily away, chances are your counter has decided to give you more for your money—in the form of internal, spurious voltages. Enough said.

Short gate times are prone to another major inaccuracy besides that of the trigger error, and that's the familiar ± 1 -count error. Let's take a look at it.

Don't count on a 1-count error

The ubiquitous ± 1 -count ambiguity of counters and other digital instruments has become so familiar to engineers that it's usually taken for granted, and little or no time is spent thinking about it.

But watch out. Just because the ± 1 -count error is missing from the data, don't assume it's implied. The error can be more—much more, in fact.

If a counter's gate opens and closes too slowly compared with the period of the highest measured frequency, the error can zoom to ± 10 counts, or ± 20 , or ± 50 .

Thus ± 1 -count is as good as the error gets. If a bold headline shouts "500-MHz direct count," and in the din hides the absence of a

± 1 -count error, be suspicious.

The ± 1 -count ambiguity occurs, of course, because the signal that opens and closes the main gate isn't synchronized with the signal that passes through the gate and is eventually counted.

Carried to the extreme, the 1-count error of a short measurement can be ridiculous. For instance, try to measure a frequency of 1 Hz in one second with a conventional counter. The reading might be 0.0001, or it might be 0.0000—a mighty large error, wouldn't you say?

To avoid large errors, a reciprocal or phase-lock counter can be used. With a 10-MHz clock, a reciprocal counter can resolve a 1-Hz signal to seven decimal places in one second. Naturally the ± 1 -count ambiguity is still there. But the error plunges to 1 count in the seventh decimal place—practically negligible.

If a vendor often forgets to mention the gate error, he'll probably make up for it (or distract you into forgetting about it) by calling attention to another part of his machine—the time base.

While the time base is a major source of error in counters (along with the trigger and ± 1 -count), it's also the major source of creative spec writing.

Many counters are sold on the basis of the exponent in the number that calls out the stability of the time base. So vendors spend long hours dreaming up ways to stretch the exponent or chop off a few more parts in 10^8 from the stability spec.

But excellent clock stability doesn't guarantee very accurate measurements. You've got to know how to use and maintain the stability. And the rest of the counter must be compatible with the clock. Let's look deeper.

Wanted: Dependable digits

Time-base stability is important, of course, because a counter measures essentially by comparing an unknown quantity to the time base. Initial error plus drift in the base therefore show up directly as a measurement error.

Since most time-base oscillators are crystal-based, stability boils down to that of the crystal. Crystal stability, in turn, boils down to three drifts: that of time, temperature and voltage.

All crystals age. Over the long term, crystal aging causes a slow, cumulative drift in an oscillator's frequency. Therefore, a long-term stability figure is a must in the spec repertoire of all counters.

But exactly what is "long-term"? The answer varies with vendors and within a given product line. Long term can be an hour, day, month or year. And since crystals generally age exponentially, you can't multiply one vendor's daily drift



The 351D Autohet, from EIP Inc., combines high sensitivity with high FM tolerance in a 20-Hz-to-18-GHz auto-

matic heterodyne. The 11-digit LED unit can resolve frequencies to 1 Hz in 1 s.

by 365-1/4 to compare it with another vendor's yearly excursion—or to find out what a crystal will be doing a year from now.

Because time-base stability is so strongly promoted as a competitive selling point, there's a tendency to equate stability with accuracy and to forget that other factors also affect accuracy.

But crystal stability—in itself—doesn't pinpoint what accuracy to expect in a counter.

What, then, does the long-term spec tell you? Simply this: It tells how often a counter must be recalibrated to maintain initial accuracy—even if the vendor doesn't spell this out.

Since drift is cumulative, periodic adjustment is necessary to bring the time-base oscillator back to its original frequency and, consequently, the counter to its initial accuracy. Thus a counter's accuracy must be considered as a function of time from the last calibration; conversely the calibration period must be known to define accuracy positively.

Bear in mind that a crystal ages continuously—whether power is on or off. Even instruments that have been gathering dust on the shelf need calibration before use.

What errors can you expect if you don't calibrate? If an 8-digit counter's stability spec is given as 2×10^{-8} per day and 3×10^{-7} per month, and you want to measure 50 MHz with a 1-s gate (50.000000 MHz), the error—with no calibration for one day—would be $2 \times 10^{-8} \times 50 \times 10^6 = \pm 1$ Hz. With no calibration for one month, the drift error is $3 \times 10^{-7} \times 50 \times 10^6 = \pm 15$ Hz—not insignificant.

To each of these errors, of course, must be added the ± 1 -count ambiguity (or more) and the often forgotten initial accuracy of the internal frequency standard.

Initial accuracy tells how close the standard

frequency is to a known primary or secondary reference frequency, and it is related to the setting error, or set tolerance, of the internal standard. (It's just possible that the standard, with a specified accuracy of 1 part in 10^7 , can be set up to only three parts in 10^7 —even by skilled operators.)

After you've pinned down the long-term spec, go after the one that spells out short-term stability—that is, the amount of noise, random frequency fluctuations and phase variations that every oscillator generates.

Short-term instability, or fractional frequency deviation, can limit the accuracy of a measurement if the deviations are greater than the known (calibrated) inaccuracy in the average time-base frequency.

Again, one man's "short" is not the same as another's. Since short-term instability averages out with time, the spec can be made to look better simply by measuring it over a longer time interval.

Thus any short-term spec must include the measuring period, and this period must relate to that of actual measurements to be meaningful. Be suspicious of a short-term stability given for, say, 10 minutes, or more. It may look good, but if your gate time is around 1-s—a common figure—the 10-minute spec is useless.

At gate times shorter than a second, it's true that short-term noise will increase. But the resolution of a counter decreases as gate time shortens, so that short-term fluctuations usually become insignificant compared with the ± 1 -count error—or with temperature effects. It's for this reason vendors feel justified in omitting a short-term spec when tempco is likely to dominate.

If aging isn't bad enough, crystals are also

notoriously vulnerable to changes in temperature. Those that operate at "room" temperature—that is, those mounted in a can and exposed to whatever temperature variations are present within the counter—typically vary from ± 1 to ± 5 parts in 10^6 over 0 to 50 C.

Temperature-compensated crystal oscillators (TCXOs), which use additional components or circuit design to buck out crystal drift, offer about a fivefold improvement over room-temperature types.

For even greater stability—about ± 5 parts in 10^8 , or better, in well-designed units—the crystal is housed in an oven whose temperature is somehow controlled and stabilized over ambients of 0 to 50 C.

For the ultimate in time-base stability, you go for an oven option, or maybe even a double oven, and couple it with a selected, ultra-stable crystal for the promise of perhaps five parts in 10^{10} daily stability. Then you rush into the lab, hook up your gear, make your measurement and, pow, a totally unexpected drift or instability hits you—like a ton of crystals. What went wrong? Any number of things could have happened.

First, take a closer look at the oven. If it's thermostatically controlled—"stabilized" by on/off switching of the heat source—you can expect short-term cycling of the internal temperature as the thermostat opens and closes. The question is, how much to expect. To sidestep this problem, look for a proportional oven—one in which the heat flow is proportional to the difference between the actual and desired oven temperatures.

After you've checked your oven, look into this: How much warmup time did you allow before you made your measurement. If you arbitrarily selected, say, one hour for warmup—because the vendor was unclear or forgot to mention how long his time base needs to stabilize or to reach the specified aging rate—then look deeper.

Some counters with ovens need 30 days under power to age into the much-promoted stability spec. Others need a day or even less. Some vendors list two warmup periods—one to reach the stated aging rate and another to get within a specified deviation of the "final" frequency. Still others list nothing or define their own terms. And in the warmup game, triple asterisks and other fine-point specs abound; so caution is the best "counter move."

Perhaps you did allow sufficient warmup time, and maybe you found the oven's temperature to be rock-stable. Why then the wander in the last digit or two? The culprit could be line-voltage variations.

Since no power supply regulates perfectly, it's to be expected that changes in line voltage will affect the time-base frequency. Just how much,

though, should be spelled out in the oscillator specs—usually for $\pm 10\%$ line shifts. If the line-voltage coefficient swamps out the daily aging rate, ask why. A further point: Some units need some stabilization time after line shifts occur. Find out how much.

To sum up, a time base's accuracy depends on short and long-term stability, on temperature and line-voltage variations, and not only on the period but also the conditions of calibration.

Thus during calibration—the vendor's, as well as yours—you should know such items as the accuracy of the primary or secondary frequency standard, the room temperature and line voltage, the counter's age and the adjustability characteristic of the counter's time base.

Which time base should you buy—room temperature, TCXO or oven? To answer, be influenced by your needs, not by glamorous specs.

If you'll use the counter mostly in the field, where it will get banged around and can't be kept continuously plugged in, and where the line jumps all over the place, it doesn't make sense to buy an extremely stable, sensitive oven that needs hours or days of warmup and that will be swamped out anyway by line variations.

If you can't calibrate frequently or don't have access to WWV or an atomic standard, you're wasting your money on an ultra-stable clock.

Finally, if you're working to only 0.1 or 1.0 ppm—the requirement of many FCC accuracy specs—the TCXO will probably suffice. For other accuracies, Fluke offers this rule of thumb: Time-base stability should be five times the required measurement accuracy.

While it's obvious that accuracy depends on a counter's time base, it's not so obvious that accuracy doesn't necessarily depend on another important counter spec: the number of digits.

The more digits the better—or is it?

As with any instrument using a digital display, it's all too easy to equate a counter's accuracy with its resolution. But an 8-digit machine may not be 10 times more accurate than a 7-digit unit, which, in turn, may not be more accurate than a 6-digit counter—and so on.

While it's true that the error of the ± 1 -count ambiguity gets worse by a factor of 10 for each digit less in a counter, the bulk of the total error can usually be traced to that of the time base or trigger. (The exception, of course, occurs at very short gate times, where a 1-count error can dominate.)

If the crystal ages too fast for the number of digits, or the counter hasn't been calibrated in a while, or tempco joins with line shifts and aging to knock the reference frequency all over the place, then don't depend on the last one or



In Newport's Model 700 counter-timer, an IC ROM controls the unit's annunciator and the location of the

two digits—except possibly as a pseudorandom code generator.

To be useful, a counter's register size should be compatible with both the tempco and aging of the time base—specs such as one part in 10^6 and 8 digits just don't go together.

Just what resolution can you expect in a direct counter from a given display size? You really can't tell. Resolution is a function of not just the display size but a counter's gate times (for frequency measurements) and clock frequency (for period measurements).

For high resolution of very low frequencies, like 5.32189 Hz, unduly large gate times are needed to shove the 5 over to the most significant digit. With a 6-digit display, for example, you'd need a ridiculous 100,000 seconds.

In a given display, resolution increases with gate time, but the maximum frequency that can be read goes down. Thus a 1-s gate can resolve 1 Hz—without spillover—provided the display has at least as many digits as the input frequency expressed in hertz. With a 10-s gate, resolution goes to 0.1 Hz, but the maximum displayed frequency drops by a factor of 10.

Counters that prescale—that is, divide the input frequency by an integer to handle very high frequencies—trade off resolution or measuring time. With a scale factor of 10, resolution for one second is 10 Hz. Conversely, to keep a resolution of 1 Hz requires a 10-s measuring time.

Frequencies that extend above 500 MHz and go into the microwave region (to about 40 GHz) bring a new set of problems—and a new set of counters.

Microwaves need new solutions

Though there are four types (excluding pre-scalers), all microwave counters basically work

by shifting the high-frequency input down to one that can be directly counted. How the translation is done distinguishes the four types.

In manual heterodyne converters, multiples of a known reference frequency are mixed with the unknown, and the mixer difference frequency is directly counted and displayed. The user turns a dial to select the right harmonic, then adds the displayed number to the dial reading to determine the unknown frequency. At present, manual heterodynes can handle frequencies to about 18 GHz.

The heterodyne technique can be automated by use of an electronically controlled filter in place of the manual tuning. With this counter, no calculations are necessary. Until recently, heterodynes couldn't handle pulsed rf signals—for that you had to go to a transfer oscillator.

To measure at the acme in frequencies—to about 40 GHz—you'll need a manual transfer oscillator. With this unit, the user beats the unknown input against an unknown harmonic of a tunable oscillator. An oscilloscope or meter, usually built in, displays the beat frequency, which is adjusted by the user for a zero beat, or null. A counter then displays the fundamental of the tunable oscillator.

Since both the input frequency and the harmonic number are unknown, coming up with the right frequency gets to be pretty tricky and also time-consuming. This makes the manual transfer oscillator probably the most difficult microwave counter to use.

If you don't use the right harmonic or recognize a proper zero beat on the manual type—or if noise gives a broad null instead of a sharp one—your answer can fall way out in left field.

To alleviate these difficulties, some counters provide features to simplify the measurement. Others automate the transfer process.

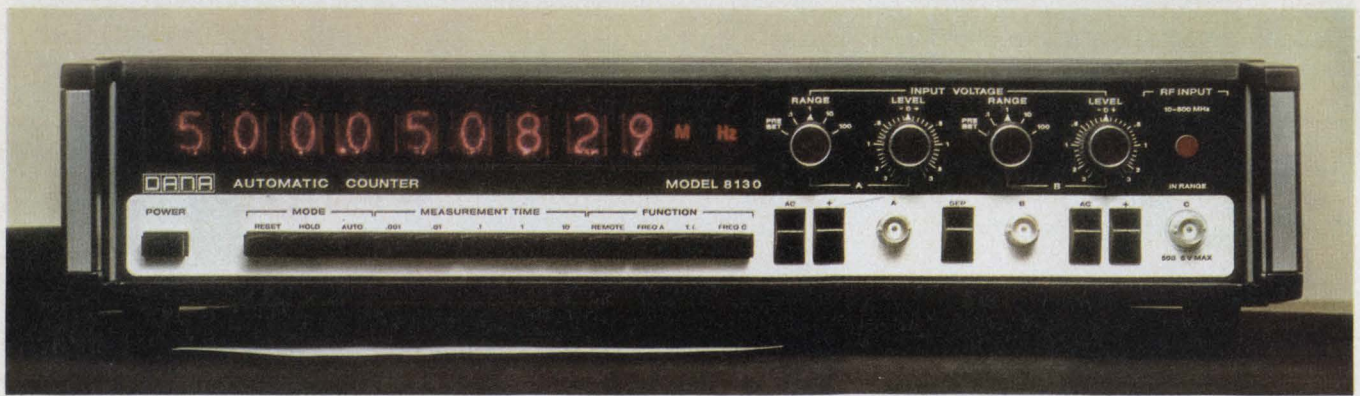

Dana's 500-MHz 8130 automatic counter is one of six models in the company's 8100 Series. With this family,

Automatic transfer oscillators replace manual tuning with a VCO in a phase-locked loop. The VCO is automatically adjusted until the loop locks. Then, the harmonic number is automatically calculated and used to display the correct unknown frequency.

What does the automatic transfer oscillator trade off? For one, it "only" works to about 20 GHz. For another, it can't handle pulsed rf. If your signal contains unwanted FM, as many signals do, you may have problems—the limited bandwidth of the phase-locked loop makes the automatic unit susceptible to FM, so the lock can be easily broken.

Automatic units may not be

With automatic counters (lower frequencies as well as microwave), a question naturally arises: What is automatic? Some units autorange frequency, but not level. Other "fully automatic" units have a suspicious number of front-panel knobs. And even units that are automatic, for the most part, may have one or two knobs to set.

In any case, here are some questions to ask with automatics: Over what frequency range are totally automatic readings made? What overload can be tolerated? What is the sensitivity and dynamic range of the unit? Does the counter lock onto the strongest signal or can it be fooled by a harmonic? What waveshapes can the input signal take?

And more questions: How fast can the unit measure? You'd like to know in automatic test systems. But don't confuse total measuring time for a specified resolution with acquisition time—they're not the same. What about FM and AM tolerance—how much deviation can be handled at each expected input frequency and modulation frequency? (Note that modulating frequencies can extend to several hundred kilohertz, not just 1 or 2 kHz.)

Finally, if programmability is important, what are the unit's characteristics in this regard?

the user sets the measurement time, rather than the gate time, and computing circuits do the rest.

What are the output levels? Are the levels buffered? Stored? Are all modes programmable? What coding scheme is used—BCD, ASCII, or what? What input signals are needed? All these, and more, should be checked out.

After you've screened all the performance specs, you'll probably look into features that make an instrument easier to use or more versatile, like self-testing. You'll probably investigate types of display storage—along with the display itself to make sure the readout is legible under bright sunlight or whatever your ambient will be. And, of course, you'll want to pin down a unit's reliability—as well as the vendor's.

Counters come in all sizes and shapes and in all price ranges. Some just count events. Others tack on a time base to become frequency meters. And some units do everything—count, measure frequency, period, time interval, average, start/stop, compute, and so on.

Most counters automatically position and display decimal point and units—but a few don't. One class—the preset counter—may not even have a display. It counts events and outputs a signal when a preset number is reached.

Some counters are bidirectional—the count can go in either direction, up or down, depending on the status of a control signal or depending on which of two inputs is active. (With two-input bidirectionals, ask what happens when both inputs are active simultaneously.)

And a growing, new class of counters is the panel-mounted, system-oriented unit (really a type of DPM). These are usually single-function devices used mainly to totalize or read frequency. Some have adjustable time bases, so that readouts can be in arbitrary units (rpm, gallons/second, etc.).

With DPM-type and other systems units, check into such capabilities as a synchronizing gate input, bus-organized outputs, the ability to accept various logic-level inputs, and interrupt.

If you're working in an industrial environment and are merely totalizing at a low count

rate (less than 100 pulses a second), perhaps you don't need an electronic counter at all. A simple electromechanical type may do the job.

The portable counter is another class that is growing in importance, especially to check mobile radio frequencies. Some are portable because they're battery-operated. Others are portable because the vendor says so.

With portables, check into the specified battery life—is it standby or operational, or is it a combination of both? What does "normal" working and temperature conditions mean? Is the battery pack optional? How long does charging take?

Plug-in counters are still around in force. Manufacturers of plug-ins extoll their virtues. Companies that don't make them, say plug-ins are obsolete. Other vendors offer both types.

Plug-in or not, don't forget to examine such items as maintainability and reliability.

At some point any counter will need repair. So you'd like to know how frequently a unit will need fixing and how easy it will be to fix. An MTBF figure may give you some idea of repair frequency, but then again an MTBF can be statistically manipulated to look good.

Instead, ask some pointed questions. Like: How about lending me the unit? Can I lift the lid and peek inside? Can I repair it myself in the field? Are the components standard, off-the-shelf types or do I have to learn Japanese (or the vendor's coding system) to replace them?

And don't forget a vendor who is here today may not be tomorrow. So check him out, too. What's his reputation? What will he do when you tell him the unit doesn't meet specs—or just doesn't work? Does he have service centers? How many and where are they?

At the top: Microwave counters

Tumbling prices have brought the price of 7-digit, 80-MHz units to about \$250. But you can still easily spend over \$6000 for an automatic, microwave unit. Here's a sampling:

At EIP Inc., a Danalab subsidiary, check out the company's newly unveiled Series 350D Autohet—a 20-Hz-to-18-GHz automatic frequency counter whose chief claim to fame is -20 to -30 dBm sensitivity, coupled with 40-MHz of FM tolerance at any carrier and at any modulation rate to 10 MHz.

Other salient features of the 350D include an 11-digit LED display, 1-Hz resolution in 1 s and a board-exchange program. The 12.4-GHz version, the 350D, costs \$4700; the 18-GHz model, the 351D, goes for \$5100.

Eldorado Electrodata markets the 988AL, a 13.4-GHz unit, and the 989AL, an 18-GHz box (suffix L denotes the optional mid-range, 25 to



The 8510 is a 50-MHz universal counter from Monsanto. The unit autoranges for maximum resolution.

625 MHz). Both units are automatic, show 11 digits and have an input-level indicator. Tolerance to FM is high, since the heterodyne technique is used (no phase lock), but no number is given on the spec sheet. Prices are \$4450 for the 88 and \$4850 for the 89.

Hewlett-Packard—the big gun in counters of all types—competes in the automatic microwave marketplace with its 5340A, a 10-Hz-to-18-GHz unit (23 GHz, optional).

Outstanding specs and features of the 8-digit 5340A include one 50- Ω input jack for all frequencies, input protection to 30 dBm ± 7 V dc (1-W total), and a dynamic range of 32 to 42 dB and sensitivity of -25 to -35 dBm, depending on input frequency.

The 5340A locks onto the strongest signal present in the 250-MHz-to-18-GHz range, so long as that signal is 20 dB higher than the rest. And the unit gives no reading until the phase lock is established. If lock is broken, the readings stop. Reset is automatic. Acquisition time is listed as less than 150 ms "mean typical."

FM tolerance of the HP 5340A varies widely with modulating frequency, input frequency and other factors. Check the spec sheet. The 5340A sells for \$5600.

Systron-Donner offers a choice of microwave units. The company's automatic computing transfer oscillator, the 6016, ranges from 20 Hz to 18 GHz and offers 9 digits, pushbutton-selectable resolution of 1 Hz to 1 MHz, and sensitivity of -3 to -13 dBm over 9 to 18 GHz and 10 mV to 200 MHz. The 6016 costs \$4875.

Below 1 GHz: Take your pick

Below the microwave region, many other vendors appear on the scene with many counter types. Check into these lines:

Ballantine Laboratories' 5500A Autometronic is a 90-MHz box with an internal ROM to control automatic ranging and resolution. The \$650 unit can autorange on a single time interval.

Other Ballantine units extend to 512 MHz.

Dana Laboratories offers five models in its 8000B Series, each of which totalizes and measures frequency, period and multiple period average. Dana's 8100 series are automatic counters (to 500 MHz) in which measurement times are set instead of gate times—the counters then compute an unknown low frequency with high resolution. Prices range from \$1245 to \$3545 (both series).

Single-purpose capability marks Eldorado Electrodata's line of communications frequency meters and time-interval counters. But the company's newly announced 1608 is a 50-MHz box that measures frequency, period, ratio, time interval, rpm and total events—all for \$575.

For industrial panel-meter counters and frequency meters, check into those offered by Electronic Research Co. (ERC). Latest member of ERC's family is the Series 2320—a 100-kHz totalizer with CMOS, TTL or other logic inputs or a 50-kHz unit with zero-crossing inputs.

The John Fluke Manufacturing Co. took a broad jump into the counter market about a year ago with a full range of units. The company's 1900 Series sweeps from the 40-MHz, \$299, 1941A frequency counter, to the 1980A—a 515-MHz vhf/uhf telecommunications box that sells for \$795. Most versatile is the 1952B universal counter/timer, a 100-MHz, 9-digit unit with three levels of remote capability. The 52B sells for \$795.

If you want to build your own counter, Heath/Schlumberger will ship you the parts, or the company will wire it for you. Latest in the Heath line is the 30-MHz IB-1100, \$169.95 in kit form. Another kit, the IB-1103, uses a frequency multiplier to make high-resolution readings of low frequencies. In the wired series, Heath offers the SM-128—a 110-MHz autoranger that sells for \$325 with the standard time base.

With probably the broadest line in the industry—and the sales leadership—Hewlett-Packard continues to turn out new counters. Hot off the assembly line at HP is the 5345A—successor to the 5245, of which over 20,000 were sold.

For \$3450, the HP 5345A offers these features, among many others:

- Reciprocal technique measures any frequency from 1 Hz to 500 MHz in 1 s, and with 9-digit resolution.
- 500-MHz clock resolves one-shot time intervals to 2 ns.
- Time-interval averaging resolves repetitive intervals to 1 ps.
- Direct-coupled inputs give 10-mV sensitivity from dc to 500 MHz.

And with a frequency-converter plug-in, the HP 5345A makes automatic measurements of pulsed rf and microwaves.

Two eye openers from HP are barely two months old and bring the company into low-cost frequency counters for the first time. At a price of \$249, the 5381A gives 7-digit, 80-MHz performance; another \$200 buys 225-MHz, 8-digit performance in the form of the 5382A.

Representative of frequency counters built especially to field test mobile radios, is Marconi's TF 2424A. This unit operates from 10 Hz to 512 MHz with 10-mV sensitivity, and operates from internal batteries. Another Marconi unit, the TF 2410, counts frequency directly to 120 MHz or ranges to 3.4 GHz with a heterodyne plug-in. Sensitivity can go as low as 1 mV.

Newport's Itron Div. is significantly active in the under \$1000 market. For instance, the company's Model 700 counter/timer handles 100 MHz (1 GHz with optional prescaler), displays

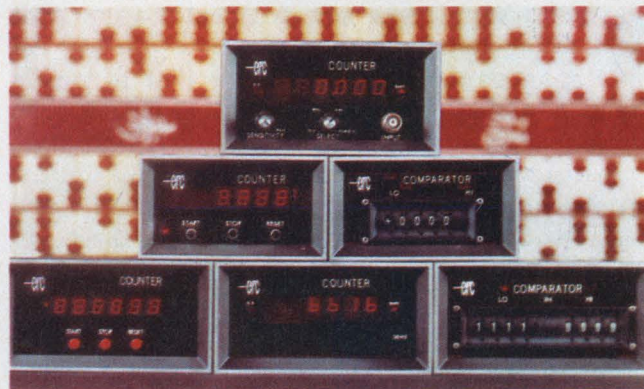

Panel-mounted counters—from ERC—are intended for industrial and systems applications. Features include remote start/stop, reset and hold.

9 digits and uses programmed ROMs instead of the less-reliable, hard-wired switch wafers. The price? Just \$899.

With 27 pages of counters in its 1974 catalog, Systron-Donner has just about something for everybody. The company's 6220 handles low frequencies (20 Hz to 2 MHz) with high resolution by use of a phase-lock/multiplier technique. The \$450 unit includes age and autoranging among its features.

Systron's 6150 Series of counter/timers is probably the acme of versatility. The series spans four frequency ranges: 50, 200, 512 and 3000 MHz, and can be specified with any of five oscillators—plus loads of plug-in cards for tailored performance. In fact, says Systron, over 208,000 different counters can be put together with the 6150 series.

If you've got a Tektronix 7000-Series scope with digital CRT readout, you can fill one of the holes with the company's 7D14 525-MHz fre-

quency counter or its 7D15 universal counter/timer. With these plug-ins you can easily make gated measurements—such as counting events in a burst—while you watch the count interval and trigger signal on the screen.

Several counters claim membership in the Tektronix TM 500 Series—a group of small, modular instruments that can be used individually or in any combination. Two such units are the \$895 DC 502, a 550-MHz box (with built-in pre-scaler) that boasts a 1-mV rms trigger sensitivity to 450 MHz (2 mV to 550 MHz); and the \$1195 DC 505, which offers a 10-ns clock period, A to B time-interval averaging with 100-ps resolution and 225-MHz bandwidth.

Philips Test and Measuring Instruments offers the Philips line of test equipment. For frequency-only measurements, check out the PM 6645, a

512-MHz unit (expandable to 12.6 GHz) with agc and noise suppression to prevent ambiguous readings. The 6645 sells for \$1690.

Competing strongly in the counter marketplace are the United Systems' (a Monsanto subsidiary) Digitec and Monsanto brands. The lines run from panel meters to preset to computing to reversible counters.

Freshly unwrapped at Monsanto is the 8500 family of universal machines, a member of the company's High Technology (HT) Series. Four models in the family now cover 50, 150, 550 and 1000 MHz, and each unit features 9 digits with pushbutton selection of desired resolution. Unique to the 8500 is the capability to autorange not just frequency, but time interval and period as well. Prices range from \$650 for the 50-MHz unit, to \$1295 for the 1-GHz model. ■■

Need more information?

The products cited in this report don't represent the manufacturers' full lines. For additional details, circle the appropriate information retrieval number:

Bench, systems, portable and other counters

- Atec Inc., 1125 Lumpkin St., Houston, Tex. 77024. (713) 468-7971. **Circle No. 401**
- Ballantine Labs, Box 97, Boonton, N.J. 07005. (201) 335-0900. (Roger Stagnol). **Circle No. 402**
- Berkeley Instruments, Inc., 1701 Reynolds St., Santa Ana, Calif. 92705. (714) 556-0623. (Ed Zimmer, Jr.). **Circle No. 403**
- Compton Electronics, P.O. Box 5326, Compton, Calif. 90224. (213) 636-4887. (David Waters). **Circle No. 404**
- Counterscan Systems, P.O. Box 536, Sutton, Neb. 68979. (402) 773-3875. (Allen D. Spangler). **Circle No. 405**
- Curtis Instruments, Inc., (electrochemical totalizer), 200 Kisco Ave., Mount Kisco, N.Y. 10549. (914) 666-2971. (Edward M. Marwell). **Circle No. 406**
- Dana Labs, Inc., 2401 Campus Dr., Irvine, Calif. 92664. (714) 833-1234. (Hank Beech). **Circle No. 407**
- Display Electronics, P.O. Box 1044, Littleton, Colo. 80120. (303) 781-7922. **Circle No. 408**
- Durant Digital Instruments (electromechanical), A Cutler-Hammer Co., 901 S. 12th St., Watertown, Wis. 53094. (414) 261-4070. **Circle No. 409**
- ENM Co. (preset counters), 5350 Northwest Hwy., Chicago, Ill. 60630. (312) 775-8400. (Nick Polydoris). **Circle No. 410**
- Eldorado Electrodata, 601 Chalamar Rd., Concord, Calif. 94518. (415) 686-4200. (John A. Roth). **Circle No. 411**
- Electronic Research Co., Div. of Textron, Inc., Box 913, Shawnee Mission, Kan. 66202. (913) 631-6700. (Eldon Hallblade). **Circle No. 412**
- John Fluke Manufacturing Co., 7001 220th S.W., Mountlake Terrace, Wash. 98043. (206) 774-2322. (Bob Richardson). **Circle No. 413**
- General Radio, 300 Baker Ave., Concord, Mass. 01742. (617) 339-4400. (Bill Reich). **Circle No. 414**
- Heath Co., Benton Harbor, Mich. 49022. (616) 983-3961. (Dave Altwies). **Circle No. 415**
- Hecon Corp. (electromechanical), P.O. Box 247, Eatontown, N.J. 07724. (201) 542-9200. (Willi Fuellemann). **Circle No. 447**
- Hewlett-Packard, 1501 Page Mill Rd., Palo Alto, Calif. 94304. (415) 493-1501. **Circle No. 416**
- Instrument Displays, Inc., Sub. of Keltron Corp., 225 Crescent St., Waltham, Mass. 02154. (617) 894-1577. (Ted Chadrurjian). **Circle No. 417**
- JMR Electronics (totalizers, presets), 1424 Blondell Ave., Bronx, N.Y. 10461. (212) 792-9620. (Joseph Geon). **Circle No. 418**
- Kessler-Ellis Products Co. (totalizers), 120 First Ave., Atlantic Highlands, N.J. 07716. (201) 291-0500. (C. G. Ellis). **Circle No. 419**
- MITS Inc., 6328 Linn, N.E., Albuquerque, N.M. 87108. (505) 265-7553. **Circle No. 420**

- Marconi Instruments, 111 Cedar Lane, Englewood, N.J. 07631. (201) 567-0607. (Keith Elkins). **Circle No. 421**
- Matsushita Communication Industrial Co., Ltd., 880 Tsunashima, Kohoku, Yokohama, Japan. (H. Kawai). **Circle No. 422**
- Newport/Itron, 630 E. Young St., Santa Ana, Calif. 92705. (714) 540-4914. (Lyell Kinney). **Circle No. 423**
- Ortec Inc., An EG&G Co., (NIM timer/counters), 203 Midland Rd., Oak Ridge, Tenn. 37830. (615) 482-4411. **Circle No. 424**
- Philips Test & Measuring Instruments Inc., A North American Philips Co., 400 Crossways Park Dr., Woodbury, N.Y. 11797. (516) 921-8880. (Stu Rauch). **Circle No. 425**
- Practical Automation Inc. (preset counters), Trap Falls Rd., Shelton, Conn. 06484. (203) 929-1495. **Circle No. 425**
- Schlumberger Instruments et Systems, 12 Place des Etats Unis, 92120 Montrouge, France. (A Westermann). **Circle No. 426**
- Simpson Electric Co., 5200 W. Kinzie St., Chicago, Ill. 60644. (312) 379-1121. (M. Buehring). **Circle No. 427**
- Sodeco, Div. of Landis & Gyr (electromechanical), 4 Westchester Plaza, Elmsford, N.Y. 10523. (914) 592-4400. (Armand Bassi, Jr.). **Circle No. 428**
- Spectronics, Inc. (Yaesu), 1491 East 28th St., Signal Hill, Calif. 90806. (213) 426-2593. **Circle No. 429**
- Systron-Donner, One Systron Dr., Concord, Calif. 94520. (415) 682-6161. (Gail M. Dishong). **Circle No. 430**
- Tektronix, P.O. Box 500, Beaverton, Ore. 97005. (503) 644-0161. (Bob Metzler). **Circle No. 431**
- Traco, 509 Rolling Hills Rd., Somerville, N.J. 08876. (201) 725-5333. **Circle No. 433**
- Tucker Electronics, 1717 Jupiter Rd., Garland, Tex. 75040. (214) 348-8800. (David Fletcher). **Circle No. 434**
- United Systems Corp., Subs. of Monsanto, 918 Woodley Rd., Dayton, Ohio 45403. (513) 254-6251. (Mike Elovitz). **Circle No. 435**
- Veeder-Root (electromechanical), 70 Sargeant St., Hartford, Conn. 06102. (203) 527-7201. (O. T. Olsen). **Circle No. 436**
- Vorne Industries, Inc. (preset counters), 5023 W. Belmont Ave., Chicago, Ill. 60641. (312) 725-3077. **Circle No. 437**
- Weston Instruments Inc., 614 Frelinghuysen Ave., Newark, N.J. 07114. (201) 243-4700. (Bob Bilby). **Circle No. 438**
- ### Microwave counters (1 GHz and up)
- Dana Labs, Inc., 2401 Campus Dr., Irvine, Calif. 92664. (714) 833-1234. (Hank Beech). **Circle No. 439**
- EIP, Inc., 3130 Alfred St., Santa Clara, Calif. 95050. (408) 244-7975. (A. M. Schiavo). **Circle No. 440**
- Eldorado Electrodata, 601 Chalamar Rd., Concord, Calif. 94518. (415) 686-4200. (John A. Roth). **Circle No. 441**
- Hewlett-Packard, 5301 Stevens Creek Blvd., Santa Clara, Calif. 95050. (408) 246-4300. **Circle No. 442**
- Newport/Itron, 630 E. Young St., Santa Ana, Calif. 92705. (714) 540-4914. (Lyell Kinney). **Circle No. 443**
- Power Waves, Inc., P.O. Box 1353, Asbury Park, N.J. 07712. (201) 774-8322. (I. Ulman). **Circle No. 444**
- Systron-Donner, One Systron Dr., Concord, Calif. 94520. (415) 682-6161. (Gail M. Dishong). **Circle No. 445**
- United Systems Corp., Subs. of Monsanto, 918 Woodley Rd., Dayton, Ohio 45403. (513) 254-6251. (Mike Elovitz). **Circle No. 446**

This chip
is the world's first
SOS processor.



It makes all the
stuff on the next page
possible.

Silicon-on-sapphire isn't new. The aerospace industry and the military have recognized its high-speed, high-density and high-reliability characteristics for years.

But no one was ever able to use it in a computer processor.

Until now.

Now General Automation designers have built the world's first commercial processor using SOS technology.

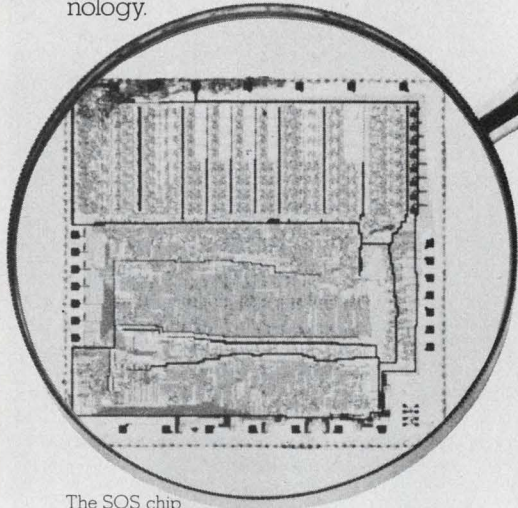

The SOS chip magnified 16 times.

They've placed 2000 gates or the equivalent of 4000 to 5000 transistors on a single semiconductor chip.

An 800 times size reduction from its predecessor product, the SPC-12.

The world's first microcomputer.

That tiny SOS chip has made it possible to bring you the LSI-12/16. A complete digital automation microcomputer with from 1K to 32K bytes of semiconductor memory.

We call it the world's first microcomputer because it's the only

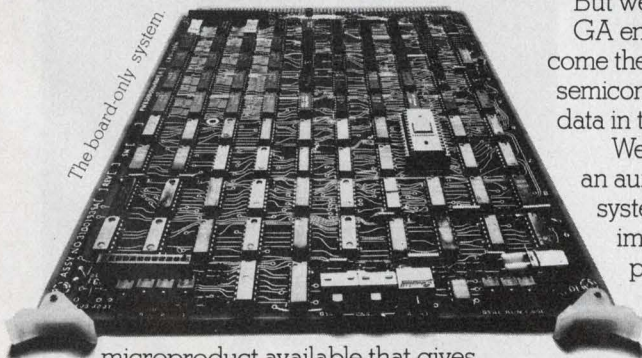

The board-only system.

microproduct available that gives you the performance, the systems features, the reliability and the applications support you would normally expect from a minicomputer.

More work, less money.

In the past this kind of size reduction

always meant you had to make major concessions in performance.

With SOS you make none.

The LSI-12/16 has an instruction execution cycle time of 2.64 microseconds.

It's faster than any microprocessor on the market.

It's more powerful. And lower in cost. In board-only configuration with 1K memory, it costs only \$495 in minimum OEM quantities of 1000 per year. In short, we offer all the performance of a minicomputer at microprocessor prices.

Breakthroughs across the board.

The LSI-12/16 is the first microproduct to successfully put all of the following on a single board:

A processor, power fail/auto

unique built-in ROM patch that lets the user retrofit new instructions to any ROM.

Custom tailoring.

There's one more advantage the LSI-12/16 has that no other microproduct can offer.

It's the systems backup and application expertise that General Automation gives you. Helping solve customer problems has always been our long suit. It still is.

We can customize I/O boards and match the LSI-12/16 exactly to your requirement.

Our microcomputer is available in one of two different configurations:

As a board-only system, packaged with memory, control console and processor on a single 7-3/4 by 10 inch printed circuit board.

Or the same board packaged in an enclosure with power supply, battery backup for semiconductor memory and card slots for additional I/O boards.

For more information, write

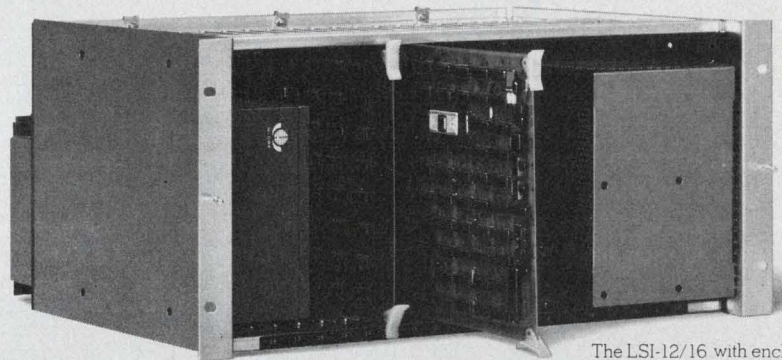

The LSI-12/16 with enclosure.

restart, remote cold start, 16 bit parallel I/O interface and up to 2K bytes of semiconductor memory.

But we didn't stop there.

GA engineering has also overcome the problems associated with semiconductor memory. Like loss of data in the event of power failure.

We handled that by developing an auxiliary battery backup system that will activate immediately upon loss of power and will retain the contents of memory for up to 15 hours.

In case you're interested in more memory, we've designed a piggyback board that will give you an additional 2K of RAM or 8K of ROM.

And if there's ever an error in ROM programming, it can be corrected. The LSI-12/16 has a

General Automation, 1055 South East Street, Anaheim, California 92805. Or call us at (714) 778-4800.

Our European headquarters is at Centre Silic, Cidex L242, 94533 Rungis, Paris, France. Call 686-7431.

GENERAL AUTOMATION

A new generation of computer processors is beginning. All because of this.



See the LSI-12/16 at the National Computer Conference.

ELECTRONIC COUNTER MEASURES*



*Against
Mushrooming
Production
Costs

Designed for use in industrial environments, ERC's Series 2320 Digital Counters have remote control inputs, BCD outputs, LED displays, all-aluminum enclosures, and input count rates of 100 KHz (digital) or 50 KHz (analog). They're components in ERC's comprehensive line of reasonably-priced system building-blocks; panel instruments that deliver digital accuracy with ERC dependability. Call us...we're the experts in automation problem solving.

PEOPLE DOING THINGS THAT MATTER . . . IMAGINATIVELY

electronic research co. • a textron div.

Mail to: P.O. Box 913
Shawnee Mission, Kansas 66201
TWX: (910) 749-6477
Telephone: (913) 631-6700

erc

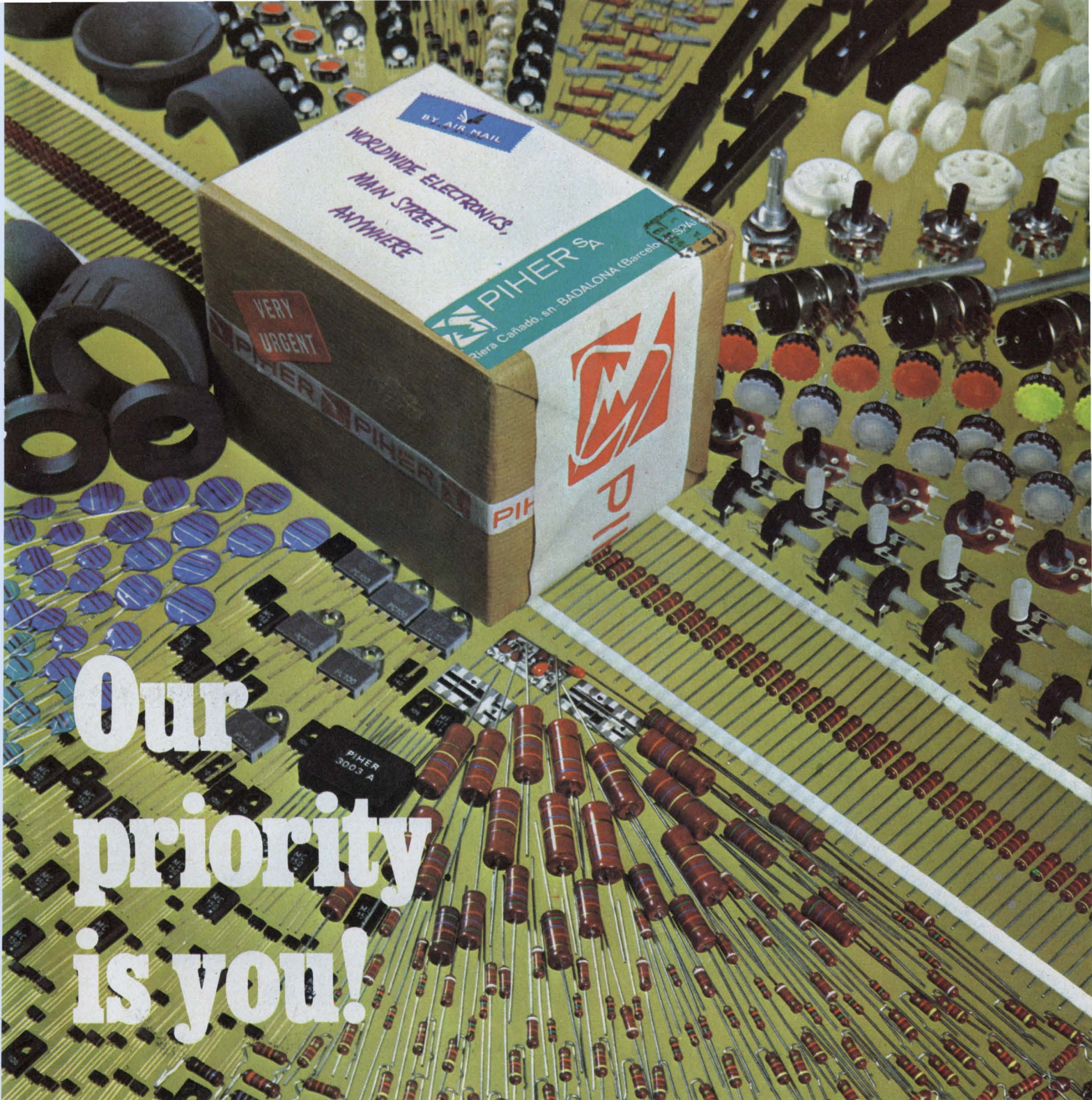

**Our
priority
is you!**

When you deal with Piher you know you are dealing with one of Europe's foremost component manufacturers – and that's important to you, the customer. Because we only manufacture for you. No question of giving you long delivery dates because we divert components for our own product lines. We haven't any. Our component manufacture is for you – totally.

We have a wide range of high quality components – at really competitive prices. Demand for our carbon film resistors, for instance, is so high that our current production is committed months ahead. Our new manufacturing plant in the U.S.A. – operational early in 1974 – will help speed resistor deliveries. But we have other, shorter-term delivery components available. Trimmer,

spindle and rotary potentiometers, semi-conductors, ferrites, capacitors – all high quality items.

Send for our data sheets if you want to be kept in touch with the Piher range. Find out more about us, it pays.



Head Office—Spain - Riera Cañadó, s/n. Apartado de Correos 53, Badalona (Barcelona) Spain. Tel: 389 03 00. Telex: 59521

PIHER International Corp. 1239 RAND ROAD, DES PLAINES, ILLINOIS 60016. Tel: 312-297 1560. Telex 282514

**This is
not an
Augat
board.**



**It's
better.**

The more creative your mind, the better you'll like our dual-in-line socket boards and cards. Because they give you more design freedom than Augat's.

For example, we put both 14- and 16-pin sockets on the same board. We build in a unique "wire wrappable" section for discrete

components. Also a "universal" section to take unusual components. And power decoupling. And "wire wrappable" test points. And so on, and so on.

Everything to serve you better.

**We're EECO. We'll see
you through.**

EECO

1441 East Chestnut Avenue
Santa Ana, California 92701
Phone 714/835-6000
Also from G. S. Marshall Company nationwide.

FREE SOCKET BOARD AND PACKAGING
HARDWARE CATALOG!

We'll send it to you if you'll send us the
information below.

Name _____

Position _____

Company _____

Address _____

INFORMATION RETRIEVAL NUMBER 41

Start with our new Blue Streak™ cable

... it's loaded with features designed to lower your installed costs. For instance, every fifth conductor is color coded for quick identification and the Blue Streak immediately identifies polarity. The unique cable construction permits clean conductor separation for breakouts and easy insertion into connector assemblies. Available in 50 conductors or less — solid or stranded wire — this U/L listed self-extinguishing cable is the perfect companion for the new one-piece connectors.

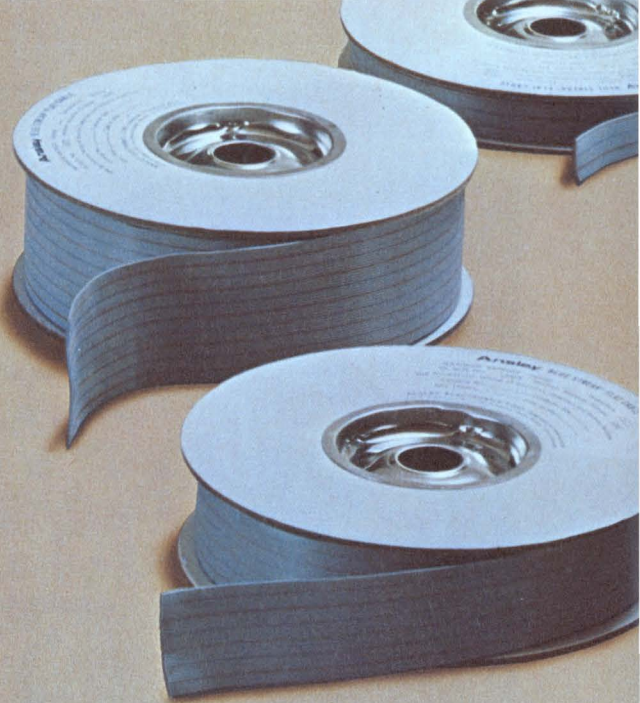

New cable connector system...It's designed to lower your installed costs.

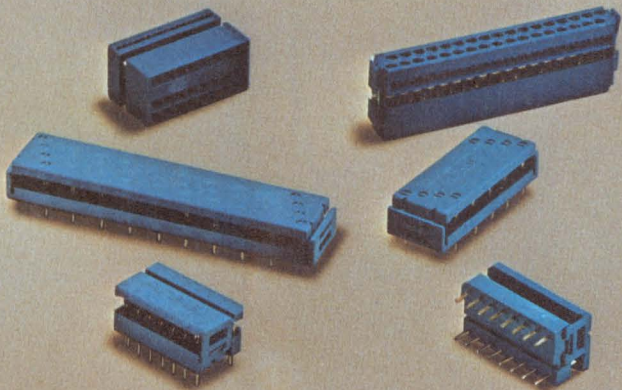

A perfect crimp every time

... because our Blue Streak hand tools feature the Shure-Stake® principle which makes the tool responsible (not the installer) for the compression connection. Your installer must complete the set compression stroke before the connector can be removed. It's as fool proof and reliable as a compression connector tool can be. A full line of bench mounted tools with interchangeable dies are also available.

The Ansley Team — One Piece Connectors — Shure Stake® Hand Tools and Blue Streak™ Cable — all combine to offer you the most reliable connection package at the lowest installed cost.

Ansley

ANSLEY ELECTRONICS CORP.
Subsidiary of Thomas & Betts Corporation

3208 Humboldt St., Los Angeles, Ca. 90031
Tel. (213) 223-2331, TWX 910-321-3938

SOLD COAST TO COAST THROUGH AUTHORIZED ANSLEY DISTRIBUTORS.

INFORMATION RETRIEVAL NUMBER 42

Our new insulation displacing flat cable connectors install in 1/3 the time

... simply because they come to you in *one* piece. Two benefits result; assembly of the connector itself is eliminated and the time consuming job of lining up the cable on the connector is no longer necessary.

To install — simply insert the cable end into the connector and crimp. It's that easy — fast — and reliable! Speaking of reliable — our new connectors feature an exclusive "tulip" contact design which provides 4 contact points per conductor. In addition, the front of the "tulip" contact is designed to act as a strain relief on the wire.

We'll be more than happy to send you a test report on contact reliability.



For built-in reliability, design with "Scotchflex" Flat Cable/Connector Systems.

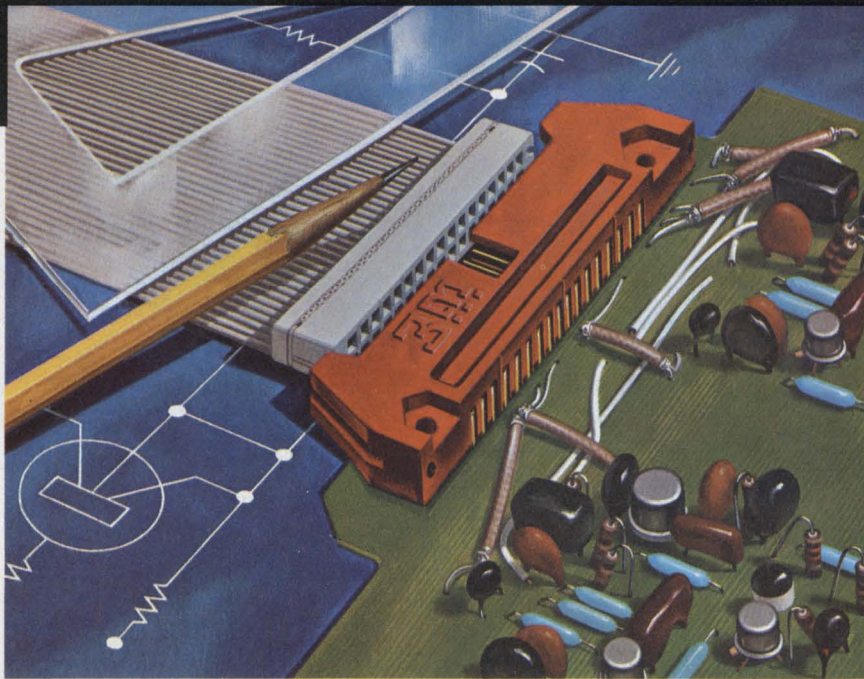

"SCOTCHFLEX" IS A REGISTERED TRADEMARK OF 3M CO.

"Scotchflex" Flat Cable and Connectors can offer you trouble-free packaging for your next generation equipment.

There's built-in reliability for your circuit inter-connects. Our flat, flexible PVC Cable has up to 50 precisely spaced conductors. The gold plated U-contacts are set into a plastic body to provide positive alignment. They strip through the insulation, capture the conductor, and provide a gas-tight pressure connection.

Assembly cost reductions are built-in, too. "Scotchflex" Connectors make up to 50 simultaneous connections without stripping or soldering. No special training or

costly assembly equipment is needed.

Off-the-shelf stock offers you flat cable in a choice of lengths and number of conductors from 14 to 50. Connector models interface with standard DIP sockets, wrap posts on .100 x .100 in. grid, or printed circuit boards. Headers are available to provide a de-pluggable inter-connection between cable jumpers and printed circuit boards (as shown). Custom assemblies are also available on request.

For full information on the "Scotchflex" systems approach to circuitry, write to Dept. EAH-1, 3M Company, St. Paul, Minn. 55101.

3M
COMPANY

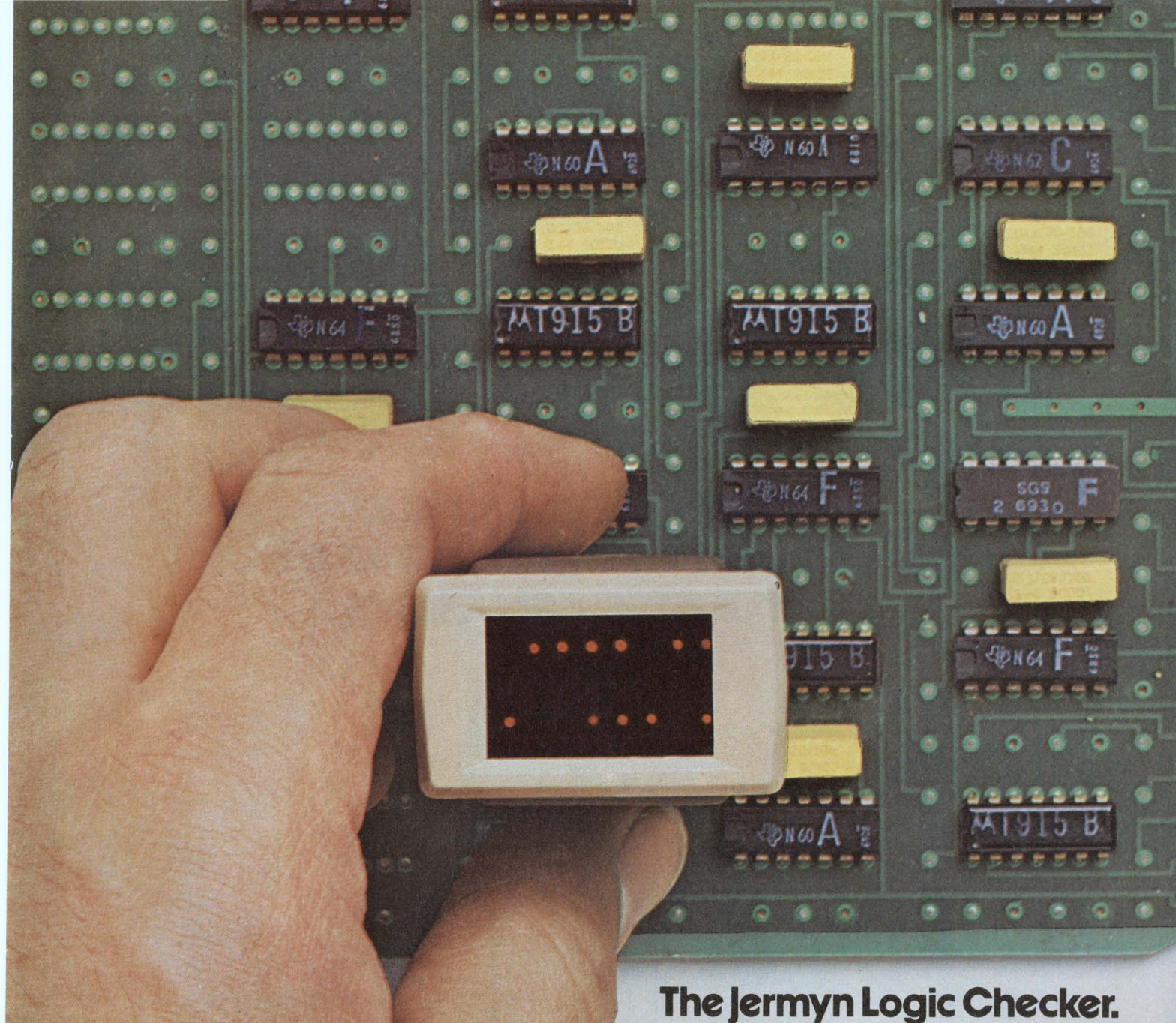

The Jermyn Logic Checker.

It costs \$85.00.

If you work with logic IC's, it'll save that amount of time and trouble in the first couple of weeks.

After that, you'll wonder how you ever managed without it.

It clips over a 5v IC (up to 16 pins) and shows you immediately the logic state of each pin.

It does this without a separate power source, because it takes its power from whichever two pins on the IC carry the 5v supply. Then it monitors all the other IC terminals and shows their logic state on an array of 16 light emitting diodes.

Lamp on means logic state 1 (or open circuit).

Lamp off means logic state 0 (or ground).

Unused terminals and the 5v supply pin also show logic state 1.

The checker is suitable for most TTL and DTL devices, and (of course) it gives exactly the same reading whichever way round you clip it.

With very little practice you'll be able to check 10 or more IC's in a minute. Compare that with other methods, using a single probe and a CRO for example.

The Jermyn logic checker weighs 1½oz, is only 2.6ins long and takes only 250mA with all lamps on. It's completely British made and designed, which is why we can sell it at the remarkably reasonable price of \$85.00 (plus 75¢ postage and packing)

Send a check \$85.75 (please add California Sales tax where appropriate) and you'll get yours by return mail, or ask for a leaflet.

Jermyn

712 Montgomery Street San Francisco California 94111
Telephone 415-362-7431

London (0732) 50144 Munich (089) 39 88 01 Paris 744 29-71



AVX Sky Caps

from the world's
largest manufacturer of
ceramic capacitors



Sky Cap® is a dip-coated version of the best in multilayers. That's because nobody makes more or better multilayers than AVX.

Production of hundreds of millions of Ceralam® parts is proof of AVX's capability and competence.

Sky Caps come in six basic sizes and a new rectangular configuration with ¼-inch lead spacing. Capacities range between 2.2 pf and 4.7 MF. Standard tolerances. Temperature coefficients include NPO, X7R, and Z5U.

Working voltages of 50, 100 and 200 volts — with 25 to 500 volt ratings available on special order. In-line quality control assures the performance you require and expect.

Prices?

Very competitive in production quantities.

Availability?

Nationally from authorized distributors in 50 locations.

For complete information, request a copy of the AVX Short Form Catalog. Write, AVX Ceramics Corporation, P.O. Box 867, Myrtle Beach, S.C. 29577. Telephone: (803) 448-3191. TWX: (801) 661-2252. Or D.I.A.L. EEM toll-free (800) 645-9200 (In N.Y. State, call collect (516) 294-0990).

Specify Sky Caps — you get quick delivery, top quality and a price you'll like.



THE CERAMIC CAPACITOR MANUFACTURER

Braintree, MA.

INFORMATION RETRIEVAL NUMBER 45

Introducing the new standard of quality in cermet film fixed resistors.



Now Allen-Bradley quality is available in cermet film fixed resistors. We coupled 40 years of know-how in reliable fixed resistor mass production with 15 years of experience in metal film resistive elements.

The result will change your thinking about film resistor suppliers.

Features? Capless design that does away with problems associated with end cap construction. And an alumina core with superior thermal characteristics and physical strength to resist fractures. Solderable/weldable leads. Even dual markings that are easy to read.

Now available in preferred number values from 10 ohms to 1 meg; 1% tolerance; $\frac{1}{4}$ watt at 70°C, $\frac{1}{8}$ watt at 125°C; Size 0.250 L. by 0.090 D. Approved to MIL-R-10509 for style RN55, characteristic D. With tape reel packaging if you prefer.

For complete technical information on the Type CC cermet film fixed resistor, write Allen-Bradley Electronics Division, 1201 South Second St., Milwaukee, Wisconsin 53204.

There's more to resistors than resistance.

Actual Size



EC68



ALLEN-BRADLEY
Milwaukee, Wisconsin 53204

INFORMATION RETRIEVAL NUMBER 46

This 10 MHz Triggered Scope is 1/3 the size of comparably performing scopes.

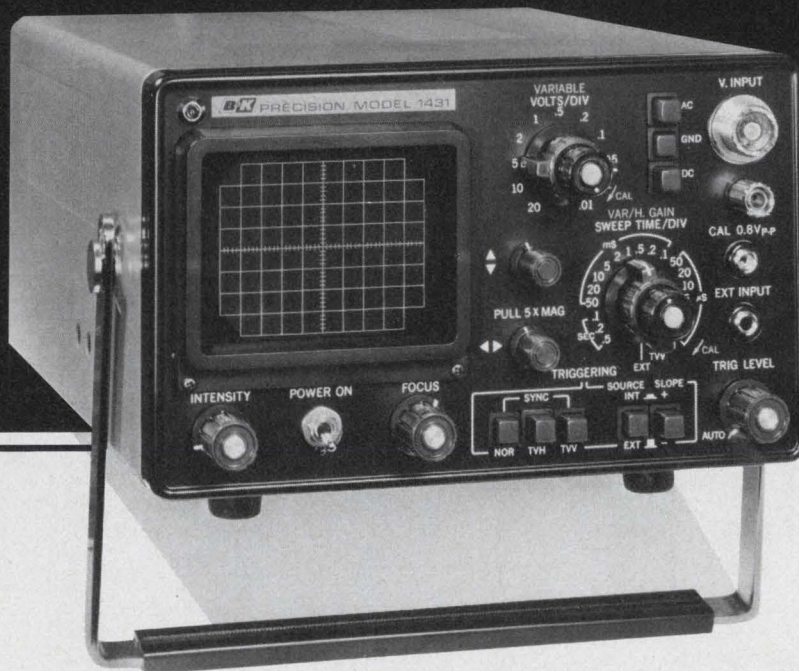

MODEL 1431 \$400.00

It's a lightweight 13 pounds in your hand and a heavyweight performance wideband scope with a 35 nanosecond rise time on your bench or jobsite. Whether you're servicing or designing industrial equipment or TV, there's the right sweep speed and sync for easiest operation. If you know our Model 1460, the leader in wideband 5" CRT scopes, you know our new 3" Model 1431 which gives you the same high performance in one third the size. (Only 4 $\frac{3}{4}$ "Hx7 $\frac{7}{8}$ "Wx12 $\frac{7}{8}$ "L)

Servicing, production, inspection, quality control and lab applications are all easier with this versatile all solid-state instrument. Triggering is accomplished with only 0.5V peak-to-peak. Ten millivolts per division sensitivity, 0.5 usec/cm to 0.5 sec/cm automatic and triggered sweep in 19 calibrated ranges, and external trigger input are just a few of the reasons you'll like it.

If you have been waiting to buy a portable scope until you could get all the features you'll ever need at a price you want to pay, you've been waiting for Model 1431. Contact your distributor or write Dynascan Corporation.



Shown with optional carrying cover and probe pouch.

B&K PRODUCTS OF
DYNASCAN
1801 W. Belle Plaine Ave.
Chicago, IL 60613 • (312) 327-7270

ZENER DIODE

WALL CHART from DICKSON

When it comes to Zeners, Dickson has your number and then some. And, they are all included on this handy wall chart selection guide.

From low-cost commercial to highly sophisticated, ultra-reliable applications, Dickson has the exact voltage regulating (Zener) or reference (TC) diode you need. And, even if it's one of our .11¢ devices, you have the assurance that every Dickson zener has the quality that can only come from the leader in hi-rel devices.

Dickson offers 48 popular JEDEC series, plus thousands of custom or

proprietary devices in one of the most extensive lines of commercial and military zeners available. With this product versatility, it's no wonder Dickson is looked upon as the preferred Zener House by a continually growing number of major equipment and systems manufacturers. If you use Zeners, consider the extra quality and fast-service benefits you'll receive from "the specialists"...Dickson.

ZENER WALL CHART

For your copy, simply drop us a note on your letterhead.

"The
Specialists"



DICKSON ELECTRONICS CORPORATION

a member of the Siemens group

P.O. BOX 1390 • 8700 EAST THOMAS ROAD
SCOTTSDALE, ARIZONA 85252
PHONE 602-947-2231 • TWX 910-950-1292

INFORMATION RETRIEVAL NUMBER 48

Heed the limitations of MOS I/O circuitry, and you'll avoid electrostatic damage to ICs and eliminate noise problems and excessive power dissipation.

Keep your eye on the I/O characteristics of MOS integrated circuits if you want to avoid some of the most common problems encountered with these ICs. Here are problems that require analysis and preventive measures in the design stage:

- Electrostatic damage to inputs during handling and soldering operations.
- Crosstalk and impedance difficulties at the input when dynamic logic is used.
- Excessive input power requirements.
- Excessive output power dissipation.

Let's see how to meet problems like these and, at the same time, come up with I/O circuitry that can interface easily with other logic families.

Fig. 1 shows a typical p-channel input inverter/buffer. The circuit is representative of data, clock and control-line inputs for both static and dynamic logic. It consists of a series-diffused resistor with a nominal value of 2 k Ω (for clocks, the resistance is about 100 to 200 Ω); the associated substrate diode; a distributed junction and gate-to-source overlap capacitance; a high threshold field-turn-on MOS transistor (modeled as a zener diode), and the gate of the input inverter transistor.

Because of their high dc impedance, MOS inputs can be damaged by static-charge accumulation. The resistor, capacitor, substrate diode and field-turn-on transistor protect the gate of the input transistor from damage. The field-turn-on device is activated when the input voltage exceeds $V_{SS} - 24$ V, where V_{SS} is the substrate voltage. Thus the accumulated charge drains off to the substrate long before the gate can be damaged from excessive voltage.

The 2-k Ω resistor and the distributed capacitor—about 5 pF—slow fast-rising transient-voltage spikes, so that the high threshold device has sufficient time to turn on and dissipate the associated excess charge. The substrate diode

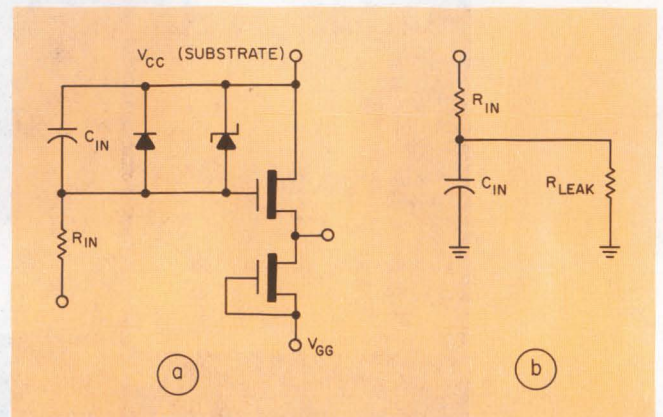

1. Typical p-channel MOS input structure (a) can be simplified to an equivalent circuit (b).

clamps the input to prevent any positive-going voltage excursions in excess of $V_{SS} + 0.7$ V.

But even with this protection, problems can arise with MOS circuits if you do the following:

- Solder pins with an unisolated soldering iron.
- Wear silk smocks while handling MOS devices.
- Leave MOS input pins unterminated on a printed-circuit board.

Soldering should be done with properly grounded soldering equipment. Also workers handling MOS devices or PC boards with unterminated MOS inputs should not wear silk smocks. Silk and other materials tend to pick up large amounts of static charge as the wearer moves around.

All MOS input pins should be terminated before the traces connected to them leave the printed-circuit board. An unterminated trace is equivalent to leaving the MOS input pin open, even though the MOS device is soldered to the board. Termination can be accomplished with a TTL buffer, a pull-up resistor to V_{CC} or the output of another MOS device.

Shipment of PC boards with unterminated MOS inputs should be done with the same care used to ship individual devices—the traces at the edge connector of the PC board should all be shorted together. MOS devices are shipped from

Joe Kroeger, Manager of MOS Systems Applications, Bruce Threewitt, Manager of MOS Device Applications, Signetics, 811 E. Arques Ave., Sunnyvale, Calif. 94086.

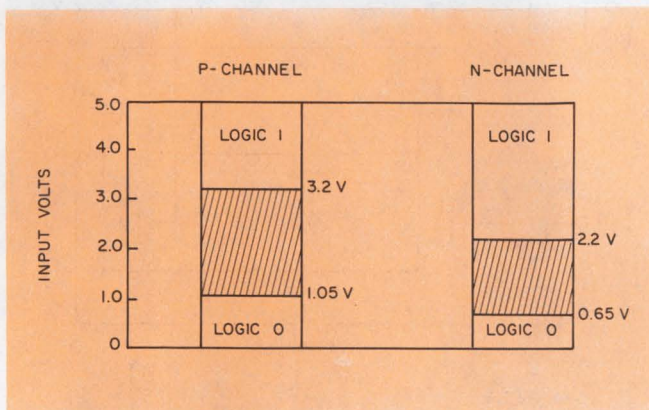

2. The input logic swing is wider for a p-channel circuit (left) than for an n-channel (right).

the manufacturer in a low-impedance environment, such as conducting foam, shunts or conducting tubes. They should be stored by the user the same way.

A noncatastrophic failure mode occurs when input pins that are left open are assumed to be at a logic ONE level (as are open inputs for TTL circuits). Instead, floating MOS inputs are neither ZERO nor ONE. For example, control inputs—such as $\overline{\text{RECIRCULATE}}$ for a shift register—that are left open might cause a device to be in the wrong operating mode if sufficient charge is accumulated to reach the input switching threshold voltage. The device would not necessarily be damaged but would appear to malfunction. Unused input pins may be terminated directly to a supply voltage without a pull-up resistor.

Deriving an equivalent circuit

The input voltage requirements for normal operation can be seen from an equivalent circuit. Since the dc gate input impedance is characteristically very high, the input equivalent circuit can be derived from the behavior of the input-protection network. This derivation assumes that the input voltage swing is restricted to the normal operating range of $V_{CC} + 0.3$ V to $V_{CC} - 18$ V. In this range the substrate diode is reverse-

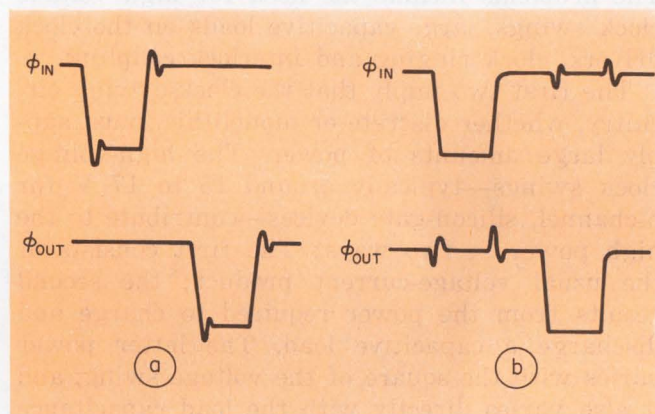

3. Typical clock noise problems consist of ringing (a) and crosstalk (b).

biased, and the high threshold field-turn-on device is inactive. These components consist of very clean pn junctions, which exhibit very small leakage currents. When these junctions are modeled as a large-value, lumped resistance in parallel with the input capacitor, the equivalent circuit of Fig. 1b results.

Since R_{LEAK} is very large—approximately 10^{14} Ω —it can be ignored in most input circuit analyses. Then the input behaves like a series RC network returned to the substrate. As a result, the output fanout (the number of MOS inputs that can be driven from one driver) is limited only by the rise and fall-time constraints in the system; the resulting load impedance presented to a data or clock driver by multiple MOS chips is the parallel combination of series RC networks, which exhibit no dc current component.

The voltage requirements at the MOS inputs are of primary concern, since the device is voltage-controlled. In Fig. 2 a bar chart shows the input voltage requirements for both p and n-channel integrated devices. The levels for p-channel devices assume a V_{CC} of 5 V. Since V_{CC} is the substrate reference voltage for p-channel devices, the input voltage requirements track variations in V_{CC} . For example, $V_{\text{IL(MAX)}} = 0.80$ V for $V_{CC} = 4.75$ V, and $V_{\text{IL(MAX)}} = 1.3$ V for $V_{CC} = 5.25$ V. If the specification limits were restated with respect to V_{CC} , they would be

$V_{IH(MIN)} = V_{CC} - 1.8 \text{ V}$ and $V_{IL(MAX)} = V_{CC} - 3.95 \text{ V}$. Because the ground pin for n-channel devices is the substrate reference, the input voltage values specified include the V_{CC} variations. These have little effect on the switching threshold.

The 'dynamic dilemma'

Several factors contribute to what can be called the "dynamic dilemma." The quandary arises when, to take advantage of dynamic-logic speed and low standby power, the designer must contend with inherent dynamic-logic problems. The problems include the need for high voltage clock swings, large capacitive loads on the clock drivers, clock ringing and interlock coupling.

The first two imply that the clock-driving circuitry, whether discrete or monolithic, must supply large amounts of power. The high-voltage clock swings—typically around 15 to 17 V for p-channel, silicon-gate devices—contribute to the high power in two ways: The first consists of the usual voltage-current product; the second results from the power required to charge and discharge a capacitive load. The latter power varies with the square of the voltage swing, and it also varies directly with the load capacitance and the operating frequency.

The load presented by the clock inputs in a dynamic system is reactive in nature, with no dc load component. Hence any parasitic series or parallel inductance tends to cause ringing on the clock edges. Because the p-channel MOS substrate is tied to V_{CC} , ringing during the clock transition from low to high can adversely affect the device. An example of this clock overshoot in dynamic shift registers is shown by the waveforms in Fig. 3.

In general, the isolation diodes—which electrically isolate individual transistors—will be forward-biased if any input, including the clocks, becomes more than 0.3 V more positive than the substrate potential—in this case V_{CC} . In memory devices, forward-biasing of the substrate diode may cause sporadic loss of data. For n-channel devices—which tie the substrate to ground—in-put undershoot, rather than overshoot, is critical.

Crosstalk and what to do about it

Another noise problem becomes apparent in the use of multiple-phase clocks in a dynamic logic system. Fig. 3b shows an example of crosstalk or interclock coupling in a two-phase dynamic device. Two main factors cause crosstalk. The first involves parasitic coupling capacitors, and the second relates to the impedance seen looking back into monolithic clock drivers.

Parasitic coupling capacitors are distributed throughout the system on the monolithic clock-

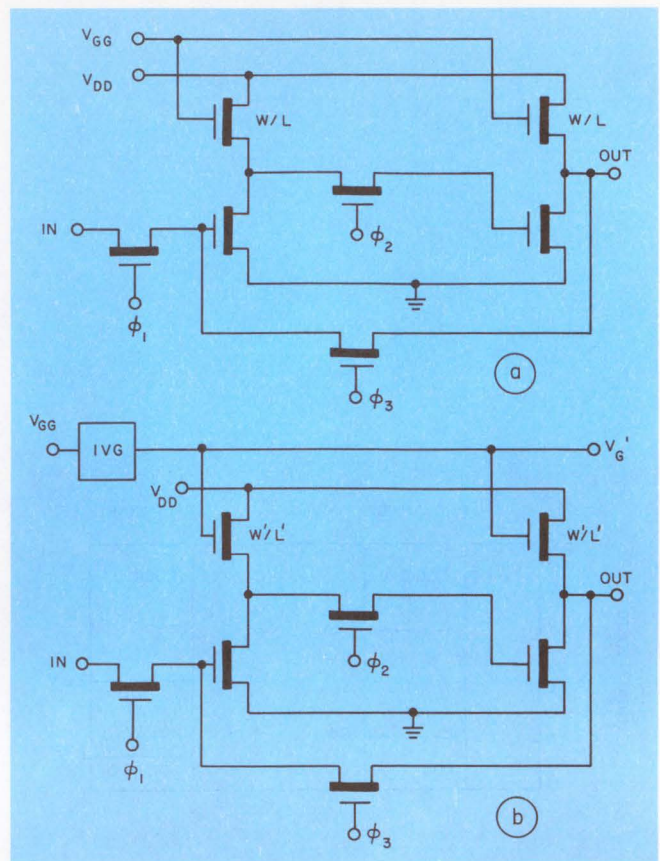

4. Power for a static shift register can be reduced, from that for a conventional design (a), with an IVG, or intermediate voltage generator (b).

driver circuit, on the printed-circuit boards, in back-plane wiring and on the MOS IC itself, due to the proximity of the two clock phases. The distributed capacitance couples the two clocks whenever either changes levels.

Careful system design and layout can significantly reduce crosstalk caused by parasitic capacitors. Here are three practical rules:

1. Use a separate monolithic clock driver for each phase of multiphase dynamic circuits.
2. Don't run clock lines for different phases in close proximity.
3. Minimize the crossover capacitance on MOS ICs.

Observance of Rule 1 eliminates clock-coupling on the driver circuit, because both ends of the coupling capacitor on the driver chip are driven by the same signal. Rule 2 helps minimize the stray capacitance coupling the clocks on the printed circuit. And Rule 3, of course, can be observed only by the manufacturer.

With regard to the second possible cause of crosstalk—the impedance seen looking back into monolithic clock drivers—when the clock drivers complete switching from low to high, the edge-current source shuts off and exhibits a high impedance. As a result, the phase in the logic ONE state becomes noise-sensitive when the

other phase switches. The differentiated waveform is superimposed on the quiescent—high-level—clock. If the negative-going spike is large enough, it becomes a “phantom” clock. If the positive-going portion of the spike is large enough, it can cause the isolation substrate diodes to be forward-biased, just as with rising clock edge overshoot.

Device manufacturers have made significant strides in densensitizing dynamic logic devices to positive-going clock noise. For example, dynamic shift registers have been redesigned so that clock overshoot cannot forward-bias the substrate diodes. Negative-going clock noise while the clock is high, however, remains a logic system problem. Experience shows that most user problems with typical dynamic shift registers can be traced to clock overshoot and crosstalk problems. A reliable serial memory system cannot be achieved without clean clock signals.

Memory devices using static logic are generally less noise-sensitive on the inputs than dynamic memories; all inputs are buffered before they are used on the chip. As a result, the memory cells themselves are isolated from noise on input lines. In addition the cells in static memories are latches and do not depend solely on stored charge for memory. Thus a relatively large input noise spike is required to change the state of the cell.

Moreover it is simpler to generate the low-voltage signals required for static devices with acceptable noise levels than to generate the higher voltage signals needed for dynamic logic. These features of static logic memories make them easier to use in systems, but at the expense of increased chip size and manufacturing cost.

Power structures affect chip size

MOS logic is used most in applications that require high density and low power. Hence the power dissipation of MOS devices emerges as an important consideration. On-chip gain for MOS circuits decreases with increasing junction temperature, causing worst-case power dissipation at low ambient temperatures.¹

Fig. 4 shows a circuit technique to reduce the power consumed by complex logic functions while minimizing chip size. The figure compares a standard static-shift-register (SSR) cell and an SSR cell using an intermediate voltage generator (IVG).

The load devices are denoted by geometry ratios W/L . A large enough length, L , achieves a sufficiently large value of resistance. The same large resistance can be obtained by use of a smaller gate voltage and a shorter length, as in Fig. 4b, where the IVG provides the smaller voltage. Use of the IVG technique allows a

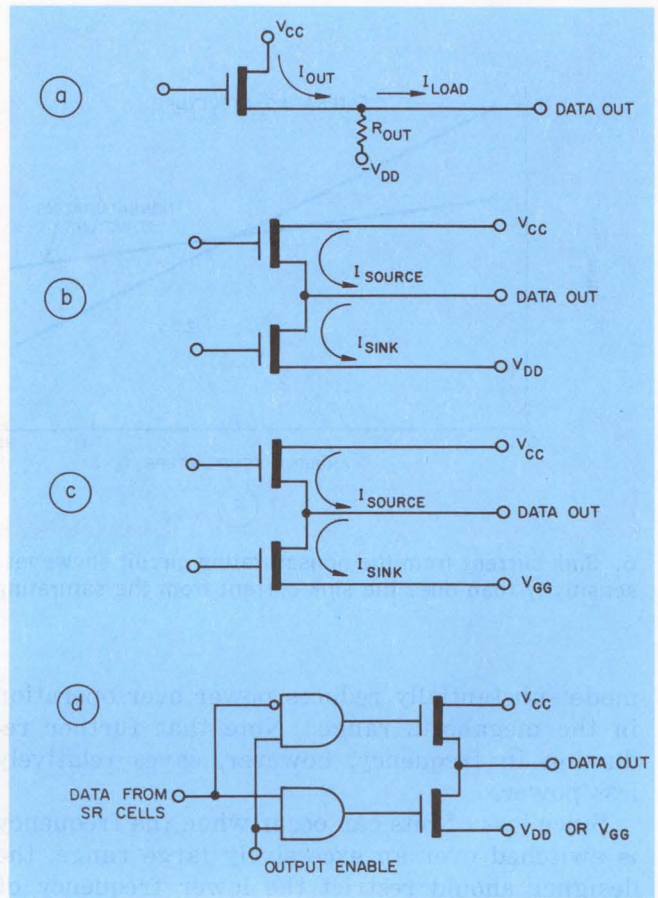

5. Output circuitry includes the bare-drain structure (a), and nonsaturating and saturating push-pull structures (b and c, respectively). A recent proprietary circuit is Signetics' three-state structure (d).

smaller geometry for the load device, and thus a smaller chip. A larger resistance can be constructed with the same geometry to reduce power consumption.

Another technique for conserving power uses a nonsaturating load design. In this case the main dc power path occurs between V_{CC} —which is +5 V—and V_{DD} —which is either ground or -5 V. The higher voltage supply, V_{GG} , provides power for load device gates and some peripheral logic, and it requires only a small amount of current. As a result, the major current component is multiplied by 5 V—or 10 V if V_{DD} is -5 V—instead of 17 V, as it is for saturated-load device designs. The tradeoff is the extra pin required for the additional power.

Minimize power dissipation

Several methods for minimizing system power dissipation are available to the user of MOS circuits. Dynamic logic devices tend to dissipate more power at higher frequencies than at lower. The power vs frequency characteristic for dynamic shift registers, for example, shows that operation around 100 kHz in the standby

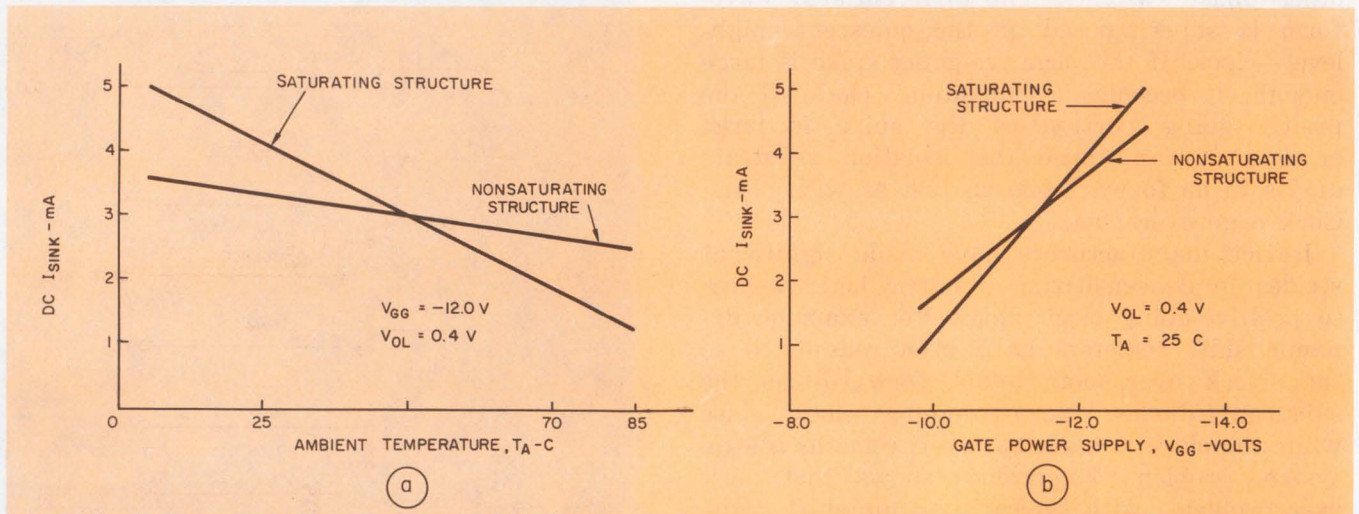

6. Sink current from the nonsaturating circuit shows less sensitivity than does the sink current from the saturating

circuit. The decreased sensitivity relates to both ambient temperature (a) and gate supply voltage (b).

mode substantially reduces power over operation in the megahertz range.¹ Note that further reduction in frequency, however, saves relatively less power.

Since loss of bits can occur when the frequency is switched over an excessively large range, the designer should restrict the lower frequency of operation to a value within two orders of magnitude of the upper frequency. A reduction in operating frequency from the megahertz range to less than 100 kHz realizes most of the power advantages. Below this range, power is relatively insensitive to frequency variations.

In addition to lowering the frequency of operation, the designer can save power by minimizing the clock pulse width, thereby reducing the amount of time that load resistors are on during a given clock cycle. This technique does not reduce the power consumed in dynamic RAMs, where power depends more on the number of clock edges occurring in a time period. But since information is stored on substrate capacitors, a second power supply—usually called V_{DD} —can be shut off when the RAM is not cycling. This technique saves considerable power in large memory systems, but only a small amount of power on individual units; when the clocks are not cycling, the major power component is proportional to leakage current.

While the power consumption of static-logic devices is less sensitive to frequency variation, some power savings can be realized. For example, the static shift-register power vs frequency characteristic¹ reveals that power dissipated at frequencies of less than about 100 kHz is about half that at maximum frequency. This allows the system designer to save power by shutting off the clocks in the standby mode. Care must be taken, however, to ensure static opera-

tion by doing the stopping in the proper clock state.

Some savings in power dissipation can be obtained in static RAMs by reduction of the power-supply voltage. As with dynamic RAMs, you can reduce the power in static RAMs by pulsing the V_{DD} supply voltage, if the RAM is designed with enhancement-mode load devices. Data will be lost if the design uses depletion-mode load devices, however.

For MOS products that do not have separate substrate bias inputs, the sequence in which power supplies are turned on is not critical, so long as the isolation diodes on the chip remain reverse-biased. The crucial factor is that, for p-channel devices, no device pin should go more positive than the V_{CC} pin; or, for n-channel devices, more negative than the ground pin. Those p-channel devices that have separate substrate bias inputs require the substrate bias supply to be turned on before V_{CC} , and to be turned off after V_{CC} .

Output structures: Several types

Several output structures are commonly used in MOS circuit designs (Fig. 5). These are the current-sourcing (bare-drain) output (Fig. 5a), the totem-pole, or push-pull, outputs (Fig. 5b and c) and the three-state output structure (Fig. 5d).

The current-source output is most commonly used in MOS dynamic memory devices, where optimum speed represents a major design goal. The propagation delay through this structure is relatively short compared with the other outputs. High-speed dynamic RAM designs rely on current-sensing bipolar sense amplifiers to interface this type of output to standard logic voltage

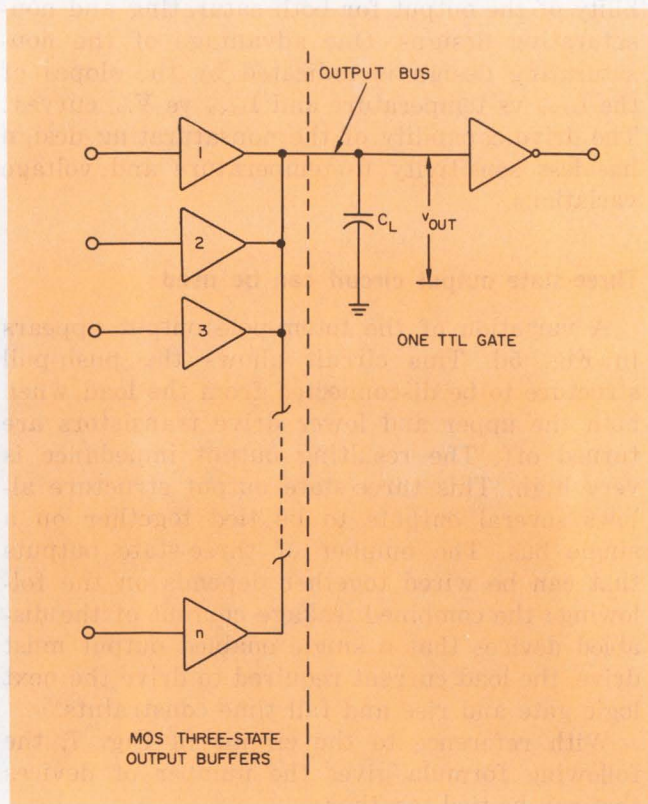

7. Several three-state outputs can be tied together to drive a standard TTL gate.

swings.

The outputs of simpler dynamic shift registers are designed with a sufficiently large value of I_{OUT} to allow for easy interfacing with TTL logic circuits simply by addition of an external pull-down resistor, R_{OUT} . Dc considerations determine the minimum value of R_{OUT} , as shown by this formula:

$$R_{OUT} = \frac{V_{OH(MIN)} + V_{DD}}{I_{OUT} - I_{LOAD}}, \quad (1)$$

where $V_{OH(MIN)}$ is the desired minimum output voltage with respect to ground in the logic ONE state, V_{DD} is the negative supply voltage to which R_{OUT} is returned, I_{OUT} is the minimum current that the MOS output will supply for a given $V_{OH(MIN)}$, and I_{LOAD} is the current required by the output load when the output voltage equals $V_{OH(MIN)}$.

The current-source structure allows the outputs to be wired-ORed for simpler system configurations. One disadvantage in the use of this output is that an external component is required to interface the structure to another device. Another disadvantage is that the device supplies drive current only during a transition from low to high levels. In addition the drive current is shared between the external resistor and the output load impedance, since the external resistor cannot be switched off.

The totem-pole or push-pull outputs are the

most commonly used output structure for silicon-gate MOS designs. The two versions shown differ in the operating mode of the circuitry that drives them. The totem-pole output of Fig. 5b is driven by nonsaturating logic; the resulting output voltage swings from V_{CC} to V_{DD} . Since V_{DD} is smaller in magnitude than V_{GG} , the nonsaturating totem-pole output dissipates less power for a given output current than the saturating structure of Fig. 5c. The latter structure has an output voltage swing between V_{CC} and $V_{GG} + 2|V_T|$.

Both push-pull structures supply edge current in both directions for enhanced capacitive-load drive. While the output is being pulled toward V_{DD} or V_{GG} by the lower device, the upper device is turned off. Conversely, as the output is being pulled toward V_{CC} by the upper device, the lower device is turned off. Consequently the entire drive-current capability of the output is supplied to the load rather than being shared with an inactive pull-down or pull-up resistor.

When push-pull output circuits are interfaced with other logic families, the MOS output voltage range may be greater than the normal input voltage range of the driven logic circuit. Hence damage is possible to the input structure of the logic circuit. Concern about the output voltage swing of MOS devices generally focuses on the following: the logic-ZERO level voltage and the associated sink-current characteristics of saturating structures and those nonsaturating outputs where V_{DD} is more negative than the most negative supply voltage of the driven device.

Fig. 6 shows typical sink-current characteristics of push-pull outputs. Since chip size constraints preclude building overly large output buffers on MOS circuits, the current-sinking capability of MOS outputs is never large enough to damage a driven device's input clamp diode. For this reason the input network of MOS-driven logic gates can be adequately protected by a modest sized clamp diode capable of continuously conducting 3 to 5 mA of current. Most bipolar logic families have sufficient clamps already on the chip. Those that have none require an external clamp diode from the MOS output to the most negative supply voltage (usually ground) of the MOS-driven logic gate.

The sink current curves show that the worst-case drive capability occurs at high ambient temperatures and at the minimum supply voltages. This result is to be expected since g_m , which decreases with rising temperature, and the gate supply voltage directly affect the current capability of the output transistors. Note that maximum drive capability is required when MOS is interfaced to TTL at room temperature rather than at $T_A = 70$ C. Fig. 6b shows that a reduction in V_{GG} drastically decreases the drive-current capa-

DO-IT-YOURSELF grabber



NEW

- Simplified Assembly
- Versatile
- Comfortable Finger Grip Action
- Completely Field Serviceable
- Molded of Tough Lexan*

Model 3925
Mini Test Clip
Shown Actual Size

This test clip with gold plated hook is excellent for rapid testing of components and Wire Wrap pins. Clip is completely insulated to point of connection. Build any combination of test leads with wire up to .090 dia. Easy and comfortable to operate. Molded of rugged Lexan to resist melting when soldering. Write for literature and prices.



MODEL 3925
hooks onto components or slips over square Wire-Wrap pins

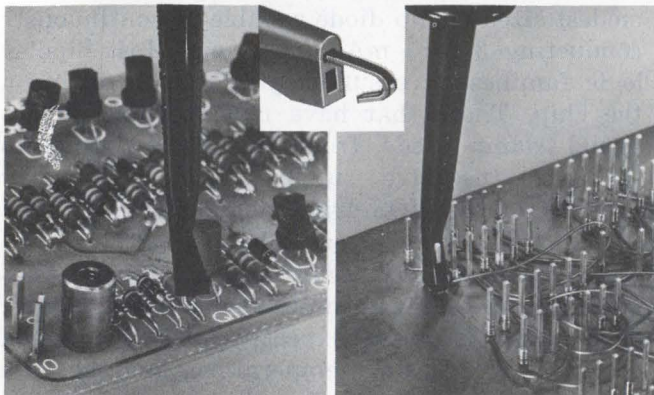

*Lexan is a General Electric trade-mark. †Registered trade-mark of Gardner-Denver Co.



POMONA ELECTRONICS

A Division of ITT

1500 East Ninth St., Pomona, Calif. 91766
Telephone (714) 623-3463

INFORMATION RETRIEVAL NUMBER 49

bility of the output for both saturating and non-saturating designs. One advantage of the non-saturating design is indicated by the slopes of the I_{SINK} vs temperature and I_{SINK} vs V_{GG} curves: The drive capability of the nonsaturating design has less sensitivity to temperature and voltage variations.

Three-state output circuit can be used

A variation of the totem-pole output appears in Fig. 5d. This circuit allows the push-pull structure to be disconnected from the load when both the upper and lower drive transistors are turned off. The resulting output impedance is very high. This three-state output structure allows several outputs to be tied together on a single bus. The number of three-state outputs that can be wired together depends on the following: the combined leakage current of the disabled devices that a single enabled output must drive, the load current required to drive the next logic gate and rise and fall time constraints.

With reference to the circuit in Fig. 7, the following formula gives the number of devices that can be tied together:

$$n = \frac{I_{O(MOS)} - I_{IN(TTL)} - (C_{IN} + C_{DIST}) \frac{dv_{OUT}}{dt} + I_{LK(MOS)}}{I_{LK(MOS)} + C_{OUT} \frac{dv_{OUT}}{dt}} \quad (2)$$

where $I_{O(MOS)}$ is the MOS output current available; $I_{IN(TTL)}$ is the input current required by the TTL gate; C_{IN} and C_{DIST} are the TTL input capacitance and the distributed stray wiring capacitance, respectively; $I_{LK(MOS)}$ is the leakage current of one disabled MOS output; C_{OUT} is the output capacitance of one MOS output; and dv_{OUT}/dt is the desired output voltage slew rate.

An example of a calculation that uses Eq. 2 follows: Assume $C_{IN} + C_{DIST} = 10$ pF, $dv_{OUT}/dt = 1$ volt/15 ns = 0.06 V/ns, $C_{OUT} = 5$ pF, $I_{O(MOS)} = 1.6$ mA, $I_{IN(TTL)} \leq 40$ μ A and $I_{LK(MOS)} = 1$ μ A. Insertion of these values into Eq. 2 yields $n = 1.001/0.301 = 3.3$.

With the modest slew-rate requirement in this example, one three-state MOS output can drive one TTL load and three other MOS outputs. A larger value for $I_{O(MOS)}$ would be required to increase the fanout with this load. One way to increase the value is to use nominal supply voltages rather than minimums and to restrict the upper temperature limit to less than 70 C, since the $I_{O(MOS)}$ specification assumes worst-case voltages and temperature. ■■

Reference

1. Kroeger, Joe, and Threewitt, Bruce, "Review the Basics of MOS Logic," *Electronic Design* No. 6, March 15, 1974, pp. 98-105.

Digitec introduces another product in the **HT** SERIES *(a breakthrough in High Technology)*

a new, portable Digital Multimeter.

Digitec's new Model 2110, 3½ Digit Multimeter is the latest product in the new HT Series (High Technology). This new family is the realization of a long term R & D program producing digital instrumentation with the ultimate in reliability and performance. These demanding standards have been achieved by using field proven technology combined with proprietary design, state-

of-the-art components and advanced production techniques. The application of human engineering principles, enables simple and self evident use of the instrument. Our proudest achievement, the HT series instruments are housed in attractive, designer-styled, enclosures that protect and enhance the advanced technology they contain.



Model 2110 Digital Multimeter

\$219.

Features: DC ranges to 1000 volts with autopolarity, sensitivity 0.1mV / AC ranges to 500 volts, sensitivity 1mV / Ohms ranges to 20M Ω , sensitivity 0.1 Ω / Monsanto, easy-to-read, long life LED's / 115/230VAC, 50 to 400Hz line operation or self-contained batteries yielding 8 hrs. continuous operation / Built-in automatic battery charger / Batteries optional \$35.00 / Compact, lightweight and rugged / Ideal for bench or field operation / "Off-the-shelf" availability from your local Digitec Representative.

UNITED SYSTEMS CORPORATION
918 Woodley Road, Dayton, Ohio 45403
Ph (513) 254-6251 Twx. (810) 459-1728
a subsidiary of

Monsanto

Digitec



MECL 10,000 or...Schottky TTL?

A few tips to help you become a winner!

10K or Schottky TTL . . . which logic form offers the best performance per dollar? And, just how competitive will that design be? We now have available an objective study that evaluates many of the points which you should consider when selecting a logic family for use in high speed systems or subsystems. Here are a few items from that comparison.

Propagation delay

MECL 10,000 circuits are faster than comparable Schottky parts.

PART	SPEC.	MECL (NS)	TTL-S	RATIO
Gate	Typ.	2.0	3.0	1.5
	Max.	2.9	5.0	1.7
Flip-Flop	Typ.	3.0	5.0	1.7
	Max.	4.5	7.0	1.6
MSI	Typ.	4.0	8.0	2.0
	Max.	6.0	12.0	2.0
LSI ALU	Typ.	8.0	14.0	1.75
	Max.	11.0	22.0	2.0

Toggle Rates

MECL 10,000 flip-flops are faster than Schottky TTL equivalents.

CIRCUIT	SPEC.	MECL (MHz)		TTL-S
Dual "D" Flip-Flop	Min.	125	200	—
	Typ.	160	225	90
Dual J-K Flip-Flop	Min.	125	80	
	Typ.	140	125	
4-Bit Shift Register	Min.	150	75	
	Typ.	200	110	

Circuit power vs frequency

MECL 10,000 power dissipation is constant with frequency.

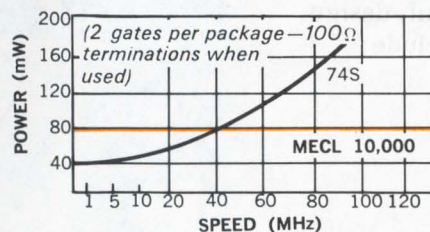

Additional design considerations

High speed, high performance systems require techniques geared to handle high-frequency signals. MECL 10,000 is designed for high speed environments and provides advantages that are not available from any form of TTL. Advantages such as: lower logic swings to reduce crosstalk between lines . . . complementary outputs eliminating additional inverter devices . . . wired-OR connections to cut back propagation delays . . . open-emitter outputs for system flexibility . . . and the capability of driving transmission lines without the necessity for auxiliary line drivers.

Competition — today and next year

In addition to engineering merits, you must consider the competitive life of your design. The product life cycle must incorporate cost-performance advantages over present competitive equipment and be flexible to take advantage of future technologies offering greater performance.

MECL 10,000 is an open-ended technology. You may apply MECL III as needed and take advantage of latest state-of-the-art circuits such as 1 GHz flip-flops and sub-nanosecond gates.

The choice is yours!

For your copy of the comparison study, write to Motorola Semiconductor Products Inc., P.O. Box 20912, Phoenix, Arizona 85036 and ask for MECL Design File #4. Better yet, call your local Motorola distributor for immediate evaluation devices. You'll find out first-hand why MECL 10,000 is specified for new designs . . . and upgrading of present systems.

MECL, MECL 10,000 and MECL III are trademarks of Motorola Inc.



MOTOROLA MECL
... new logic capabilities for the 70's!
INFORMATION RETRIEVAL NUMBER 51

Use CAD to optimize broadband amp design and to eliminate performance guesswork. It's convenient, and S-parameters are stored in an rf-tailored CAD program.

Combine computer-aided-design (CAD) with S-parameter characterization of transistors, and what do you get? A faster and more efficient method than classical trial-and-error schemes for the design of wideband amplifiers. Furthermore there's no need to guess how the circuit will perform or how parasitics will influence the final design—CAD programs can supply the answers accurately.

Other advantages? You don't need extensive breadboarding or costly test setups. Nor do you have to generate your own computer routines. If you use SPEEDY, a fast, frequency-domain, circuit-analysis routine, the only equipment required is a terminal connected by a phone line to a GE time-shared computer.

For improved performance, automate

Advances in microwave transistors,¹ coupled with hybrid thin-film technology, have changed the designers' view of wide bandwidth. Ten years ago a 100-MHz amplifier was considered good, and 500 MHz was outstanding. Today 2000-MHz wideband amplifiers are feasible.²

These low power, low noise, amplifiers must satisfy strict requirements for gain flatness and impedance match—practically impossible to accomplish without feedback and matching techniques. The use of S parameters, together with CAD programs, is a necessity to solve complex design problems with their numerous frequency-dependent variables.³

Transistor selection is one of the most important considerations for a successful design. The major transistor specifications include:

- Maximum available gain, G_{ma} .
- Noise figure.
- Bandwidth.
- Impedances, input and output.
- Power output.
- Distortion.

S parameters for an FMT 4575 chip transistor

f	S_{11}		S_{21}		S_{12}		S_{22}	
	mag.	angle	mag.	angle	mag.	angle	mag.	angle
100	0.7	-34	16.7	155	.015	71	0.94	-12
500	0.49	-114	8.96	112	.041	52	0.63	-27

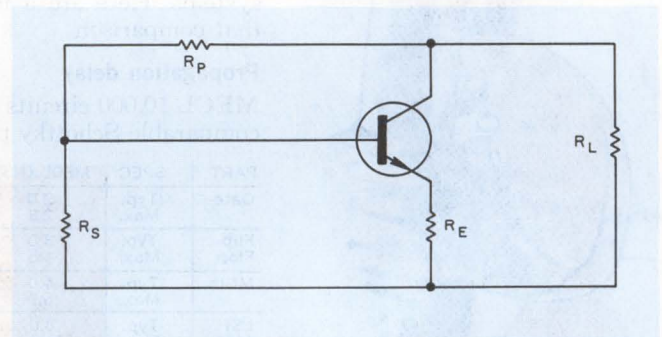

1. Shunt feedback (R_p) reduces input-output impedances in a CE stage, while series feedback (R_s) increases them.

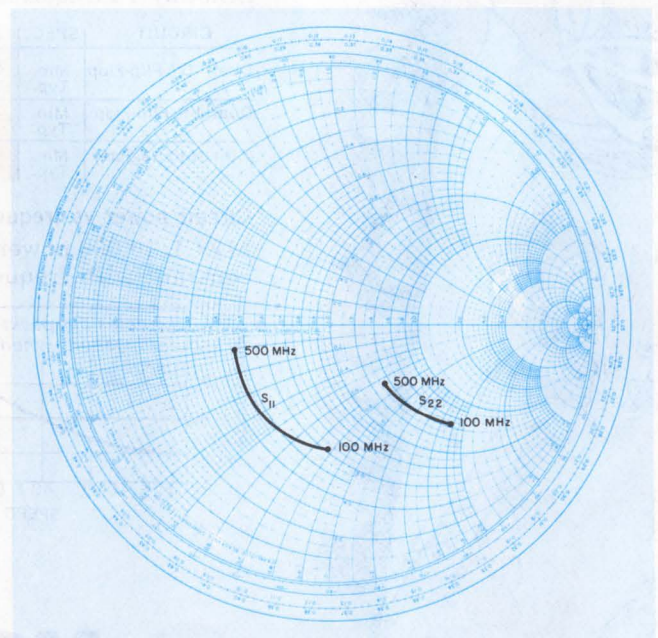

2. S parameters for an FMT 4415 chip transistor operating at $V_{CE} = 10$ V and $I_C = 20$ mA.

Petre Sturzu, Product Engineer, Fairchild Semiconductor, Palo Alto, Calif. 94304.

An investigation of the S-parameters of the transistors is necessary. Fortunately most semiconductor manufacturers supply S-parameter information for high-frequency devices. Most Fairchild transistors, characterized with S parameters, are stored in the GE Timeshare computer, and may be accessed if you address the program by "SDATA."

A numerical evaluation of forward transducer gain S_{21} is required, in conjunction with a graphical analysis of magnitudes and angles of the input and output impedance of the device. Two purposes are served:

- (1) You can obtain the maximum value of S_{21} under matched condition (G_a max) at the high end of the band, where the effect of feedback must be diminished.
- (2) You can choose the best feedback configuration.

Shunt and series-feedback analysis

For example, consider a design for a low-noise amplifier with 15-dB gain over 5 to 500 MHz. A Fairchild FMT 4005 or FMT 4575 may be considered for this application. An FMT 4575 chip transistor has the set of parameters shown in the table for $V_{ce} = 8$ V, $I_c = 8$ mA in common-emitter (CE) configuration.

Since the device has a forward gain of $S_{21} = 19$ dB at 500 MHz, you can afford to lose some gain with a feedback network that will lower the high output impedance, ($S_{22} = 0.94 \angle -12^\circ$ at 100 MHz).

Two basic forms of feedback for a common-emitter configuration are shown in Fig. 1.

The application of shunt feedback (R_p) to an amplifier stage lowers the input and output impedances, while the application of the series feedback (R_s) increases them. The use of both types gives the designer flexibility to achieve gain flatness and good match.⁴ Improvements in the amplifier frequency response are obtained if the feedback is negative.⁵

Also note that S_{12} and S_{21} are frequency-dependent in both magnitude and angle. For the ideal case, S_{21} should have an angle of 180° to

have pure negative feedback through a resistive element. As shown in the table, at 100 MHz the angle of S_{21} is $+155^\circ$; at 500 MHz, $+112^\circ$. This complication can be very serious, since some other phase shift in the feedback network caused by reactive elements or parasitics may produce positive feedback, and thus potential instability problems. Also, S_{12} should be as low as possible, to avoid any internal feedback through the transistor itself that will interact with the external feedback.

In any feedback design, stability should be considered.^{6,7} This is expressed by the Rollet's stability factor K, a figure that indicates whether the stage will oscillate for some combination of source and load impedance:

$$K = \frac{1 + |S_{11} S_{22} - S_{12} S_{21}|^2 - |S_{11}|^2 - |S_{22}|^2}{2 |S_{12} S_{21}|}$$

The stability factor should be checked at all frequencies—both inside and outside the band under consideration. If $K > 1$, the amplifier is unconditionally stable, and no source or load impedance will cause the amplifier to oscillate. This is the case for the design examples that follow, where stability is calculated with the SPEEDY program and printed together with the over-all S parameters. In addition negative feedback reduces the sensitivity of the circuit to transistor parameter variations and also reduces amplifier distortion.

Feedback design is started with an estimate of gain—but bear in mind that feedback and gain are always interrelated. The value of gain is calculated first at the low end of the band. The reactive elements present in the feedback network have a minimum and often negligible effect. The calculation is relatively simple, because only resistors are involved. The value of gain has to be kept constant over the desired bandwidth.

Consider a practical case of a common-emitter stage with an FMT 4415 transistor. For the device at $V_{CE} = 10$ V and $I_c = 20$ mA, the plotting of S parameters on the Smith Chart gives $Z_{11} = 20$ to 30Ω and $Z_{22} = 70$ to 90Ω —as represented in Fig. 2 for 100-to-500-MHz bandwidth. The input impedance is lower than 50Ω and the out-

SPEEDY: A CAD program for rf and microwave circuits

SPEEDY, a time-sharing computer program, is a fast, frequency-domain, high-frequency circuit-analysis and optimization routine, based on the cascade-loading principle. Designed for circuits whose elements can be characterized by two-port parameters, the program requires a data file that describes the circuit to be analyzed, including commands on how each element is connected to the rest of circuit and values of components. SPEEDY accepts measured two-port scattering parameters for transistors.

Thirty two-port circuit elements are included in the SPEEDY file, along with circuit configuration and a method of coding them for the data file. To apply SPEEDY to a design analysis, the circuit is first reduced to simple elements or

blocks; selection is from the 30 circuit elements tabulated in the data file. Each element is assigned an arbitrary integral line number from 1 to 96. The computer is accessed, and the line number and appropriate circuit element identification are typed in.

A second command then indicates how the element is connected; values for each component are given. Finally, the number 97 is typed in, followed by the command PRINT.

Number 99 is then typed in, followed by the frequency information, number of transistors in the circuit and appropriate transistor parameters. This completes the data file.

The following illustrates a simple passive network analysis:

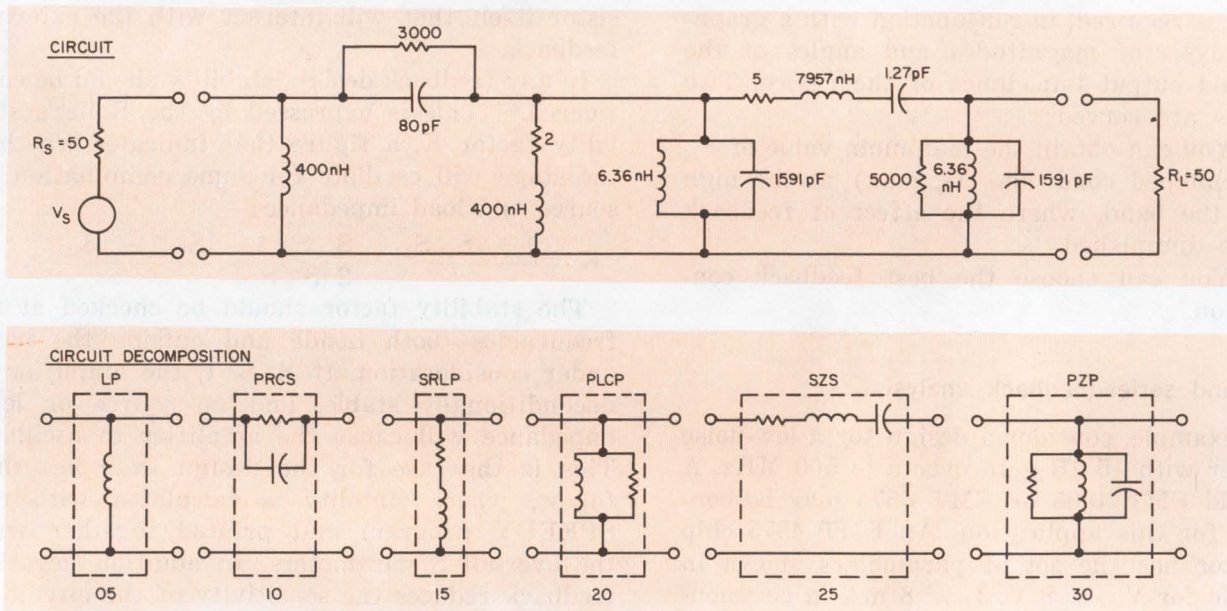

put impedance higher than 50Ω . For a power device, the input impedance can be as low as a few ohms. Neglect the angles, to simplify the discussion. The only way to match this low input impedance over a wide band is by resistive series feedback, which increases the output impedance, Z_{22} , while decreasing the forward gain, S_{21} . Shunt feedback will bring this relatively high output impedance back to 50Ω , while the input impedance is also reduced. Again, S_{21} is reduced, but this is the initial value of gain at the low end of the band.

An approximate formula—if we assume that β of the device is ∞ —can give the initial value for gain:

$$A = \frac{R_p - R_e}{R_L - R_e},$$

where A is the gain ratio.

Suppose $R_e = 4 \Omega$ and $R_p = 300 \Omega$. Assume input and output matched conditions, $R_s = R_L = 50 \Omega$:

$$A = \frac{300 - 4}{50 + 4} = \frac{296}{54} = 5.5 \text{ (14.8 dB)}.$$

The difficulty is to keep this value constant over a wide bandwidth. Because the S parameters of any transistor are frequency-dependent, the feedback network must have a selective effect—that is, it must include reactive elements. The problem is hard to handle analytically without

Line Numbers

Use any integer line number between 1 and 96 for the circuit description. (Table 1)

Lines 97 and 99 must be used for the printout command (Table 5) and frequency input.

SAVE
READY

Sample Run

ØLD SPEEDY
READY
RUN

SPEEDY 16:29EST 12/27/72

FILENAME? EXAMPLE 1

05 LP,CC,400
10 PRCS,CC,3000,80
15 SRLP,CC,2,400
20 PLCP,CC,6.36,1591
25 SZS,CC,5,7957,1.27
30 PZP,CC,5000,6.36,1591
97 PRNT,SØ
99 45,55,1,0,0

Circuit Element Commands
Interconnection Commands
Element Value (L=400 nH)
Element Values (R=3000Ω, C=80 pF)

Printout Option SØ (See Table 5)
Number of Transistors in the Circuit
Transistor Parameter Option (Zero for passive network)

Frequency Step
Stop Frequency
Start Frequency

Save File

Program Name

*** ØVERALL S PARAMETERS ***

FREQ. MHZ	S21 (DB)	S11 MAG ANGLE	S21 MAG ANGLE	S12 MAG ANGLE	S22 MAG ANGLE	K FACTR
45.0	-44.13	0.97/ -88.3	0.01/ -56.1	0.006/ -56.1	1.00/ 158.3	
46.0	-37.98	0.97/ -96.5	0.01/ -63.2	0.013/ -63.2	1.00/ 152.5	
47.0	-30.17	0.97/ -108.6	0.03/ -74.4	0.031/ -74.4	1.00/ 142.7	
48.0	-19.39	0.96/ -131.4	0.11/ -96.7	0.107/ -96.7	0.99/ 122.3	
49.0	-4.04	0.69/ 152.9	0.63/ -171.4	0.628/ -171.4	0.70/ 54.8	
50.0	-0.56	0.07/ 4.3	0.94/ 52.4	0.937/ 52.4	0.11/ -29.4	
51.0	-2.83	0.60/ 43.2	0.72/ -80.0	0.722/ -80.0	0.58/ -38.3	
52.0	-17.60	0.98/ -28.9	0.13/ -161.0	0.132/ -161.0	0.98/ -117.1	
53.0	-28.02	0.99/ -50.5	0.04/ 176.2	0.040/ 176.2	1.00/ -139.3	
54.0	-35.34	0.99/ -61.5	0.02/ 165.2	0.017/ 165.2	1.00/ -149.6	
55.0	-40.94	0.99/ -68.6	0.01/ 158.4	0.009/ 158.4	1.00/ -155.6	

FILENAME? STOP

For a copy of Fairchild's 24-page booklet detailing SPEEDY, circle Reader Service No. 450.

a computer because of the many variables. Here's where the SPEEDY program is a useful tool.⁸

Factors influencing low-noise design

When low noise is critical, the feedback network has to be examined carefully. Feedback usually further degrades noise performance, unless sophisticated feedback techniques, with only reactive elements, are used.

To avoid feedback in low-noise multistage amplifiers, the interstage network can be used to obtain the flat gain response. The input of one stage is properly mismatched with the output of the previous stage. In this way, a desired band-

width is obtained. This design approach is discussed in the Hewlett-Packard application note "AN 154 S-parameter Design," which also covers the tradeoff between maximum gain and minimum noise when the constant-gain circle and constant-noise circle techniques are used.

Wideband amplifiers require some resistive elements used in series or in shunt, together with some reactive elements in the feedback loop for matching purposes. When low noise is required, the emitter is generally grounded to avoid any dissipative loss. Consequently shunt feedback must flatten the normal 6-dB slope of the transistor's G_{ma} , while maintaining a wideband match. Some small series feedback is pres-

ent because of the parasitics, especially the series inductor in the emitter-to-ground connection. In general, the use of additional matching networks is necessary, mostly at the high end of the band, where the feedback effect must be diminished to preserve gain.

Analysis of a hybrid microwave amp

Let's consider a hybrid microwave amplifier design. With SPEEDY, we'll analyze two configurations used in Fairchild FMA amplifiers. Figs. 3 and 4 show a low-noise amplifier with shunt feedback and an inductor in the feedback loop; the only difference between the two is the position of the inductor. In Fig. 3a the inductor is introduced in the collector of the transistor, and it becomes part of the matching network.

In Fig. 4a the inductor is in series with the shunt feedback resistor. After the value of the inductor in both cases is computer-optimized for a flat response, $L_1 = 11$ nH for circuit 3a, and $L_2 = 55$ nH for circuit 4a. The complete description of the circuit file is presented in Figs. 3b and 4b, which also include some additional matching elements and parasitics that are present in the circuit. Figs. 3c and 4c present the over-all S-parameter computation performed by SPEEDY. Both circuits show very close electrical performance, so far as flatness and VSWR are concerned.

For a thin-film approach, circuit 3a is preferred, because it requires a much smaller value for the feedback inductor. For the fabrication of the 55-nH inductor in circuit 4a, an area of about 65×65 mil on the thin-film substrate is required (approximately seven turns with

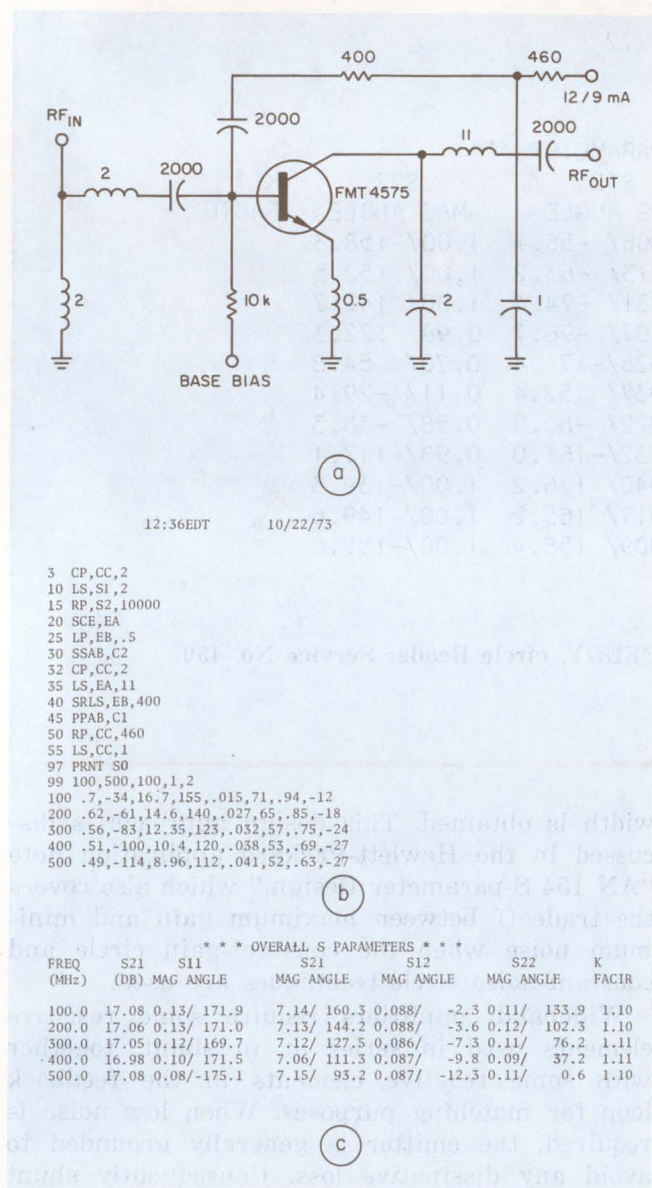

3. This shunt feedback arrangement employs an inductor in the collector circuit (a). The SPEEDY circuit file is tabulated in b and S-parameter computation in c.

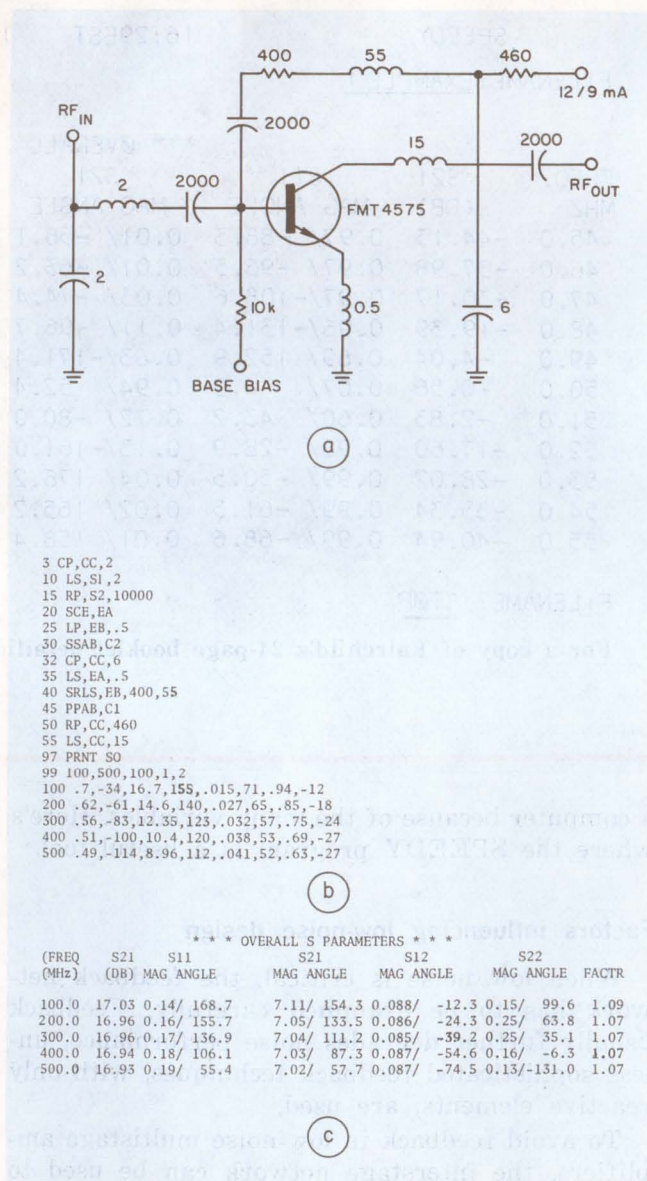

4. An inductor is placed in series with the shunt feedback resistor (a). The SPEEDY circuit file is shown in b with S parameters in c.

2.5-mil line width and spacing). Circuit 3a has another advantage: the inductor L_s from line 35 of Fig. 3b can be replaced with a high-impedance transmission line—for example, $Z_o = 115 \Omega$ (2.3-mil line on a 25-mil alumina), as shown in Fig. 4a. This transmission-line approach is harder to use in circuit 4a because the inductor is large.

A new circuit file that uses a transmission-line model—instead of the inductor—is shown in Fig. 5a, with the SPEEDY analysis in b. For circuits built with discrete components, circuit 4a is best, because it is less sensitive to parasitic inductances. In microstrip and most thin-film hybrid amplifiers, circuit 5a should be used. Figs. 5b and 5c indicate that the result is practically identical for the two models. Obviously the coil approach is recommended to save space. The circuit

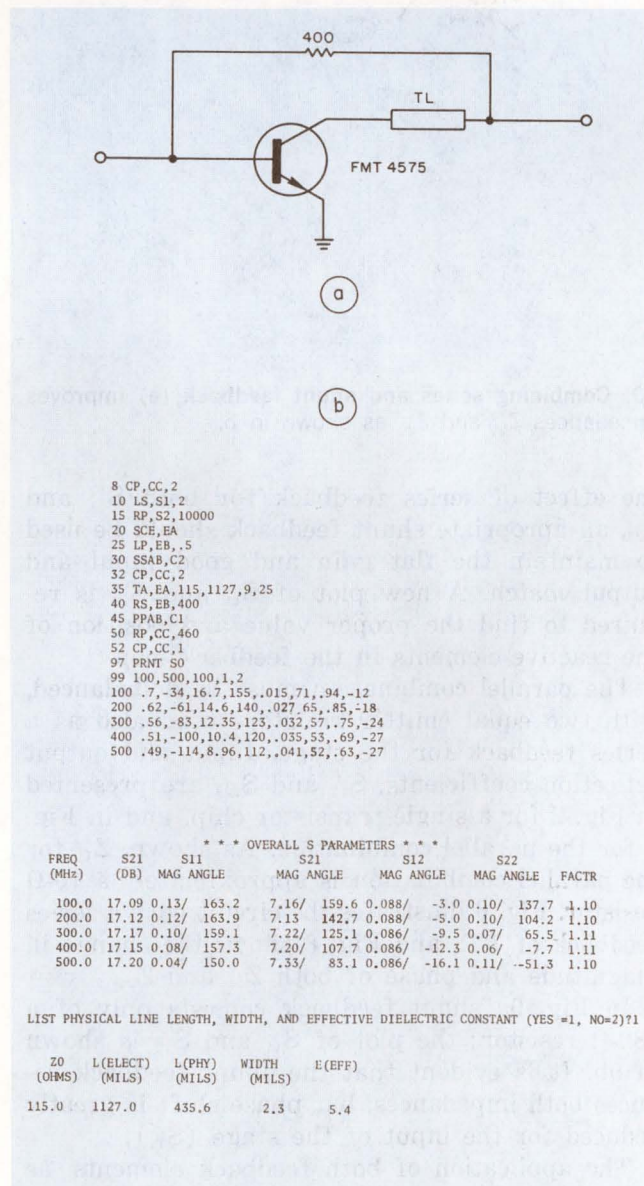

5. A transmission line (TL) replaces the feedback inductor (a). The SPEEDY circuit file and S-parameters are tabulated in b.

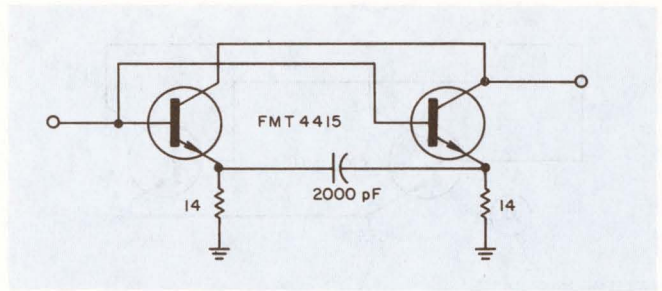

6. When two or more transistors are placed in parallel for a medium-power design, two equal emitter resistors are included for dc balance.

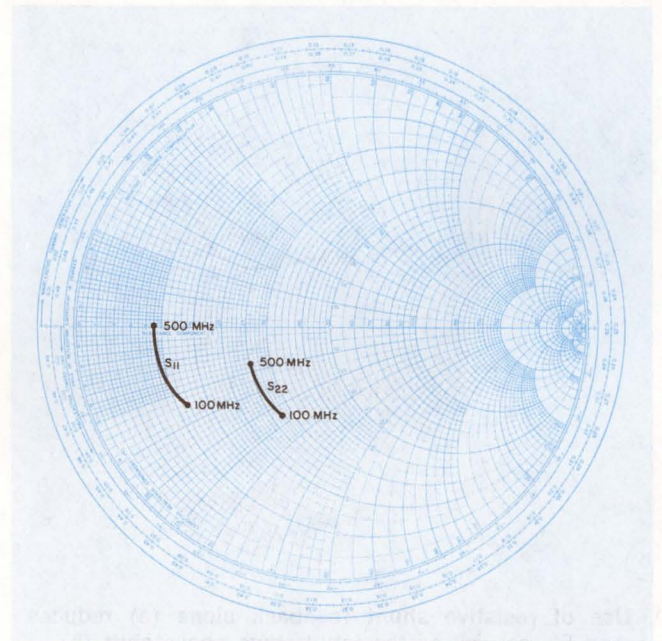

7. Input and output reflection coefficients, S_{11} and S_{22} . These are for a parallel combination of two FMT 4415 transistor chips.

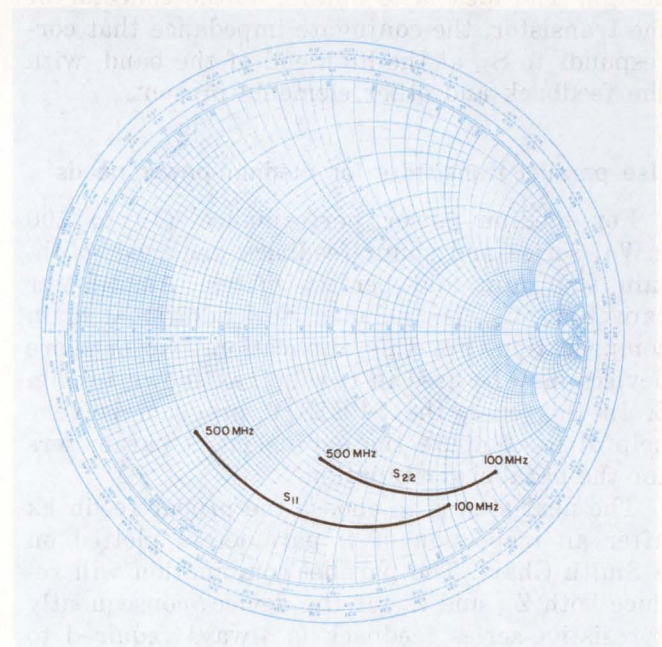

8. Both Z_{11} and Z_{22} increase when series feedback is applied to the parallel-chip combination.

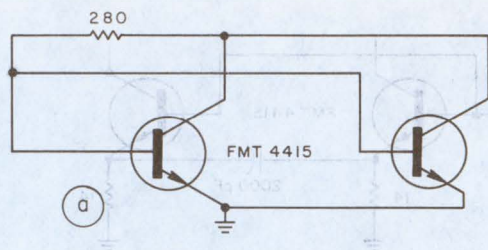

When two or more transistors are placed in parallel for a medium-power design, two equal emitter resistors are included for balance.

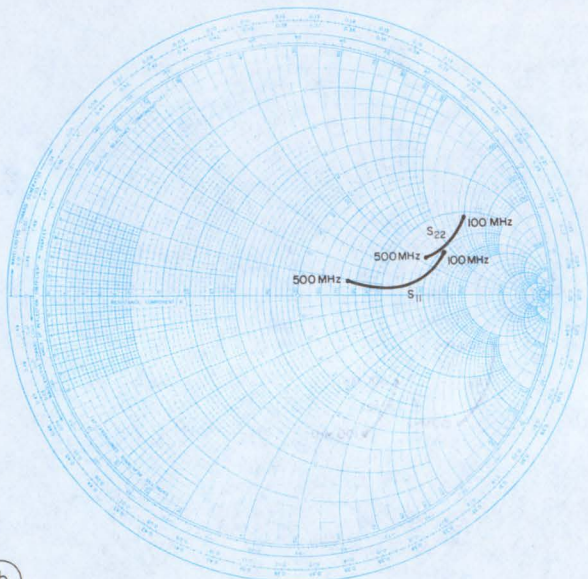

9. Use of resistive shunt feedback alone (a) reduces S_{11} and S_{22} as well as the input-stage phase shift (b).

of Fig. 5a or Fig. 3a is useful for any microwave, low-noise, wideband, bipolar transistor-amplifier design. The idea is to obtain, at the collector of the transistor, the conjugate impedance that corresponds to S_{22} at the high end of the band, with the feedback and other elements present.

Use parallel transistors for medium-power needs

For medium-power performance (10 to 100 mW), series and shunt feedback are used to obtain flat gain and perfect match. An emitter capacitor, C_E , is included for additional gain compensation. For this application, two or more devices may be used in parallel, as shown in Fig. 6. In this case, the SPEEDY program is very helpful to compute the equivalent S parameters for the parallel combination.

The next step is to choose the proper feedback after an inspection of S parameters plotted on a Smith Chart. The parallel combination will reduce both Z_{11} and Z_{22} of the device; consequently a resistive-series feedback is always required to match the input. Naturally this feedback will sacrifice some gain and noise. After you examine

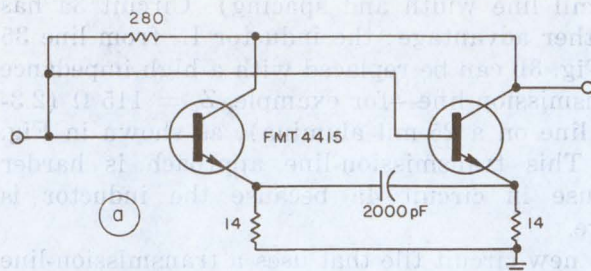

A new model—instead of the inductor—is shown in Fig. 6 with the SPEEDY program. For circuits built with discrete components, inductor is best because it is less sensitive to parasitic inductance in connecting wires than a thin hybrid capacitor.

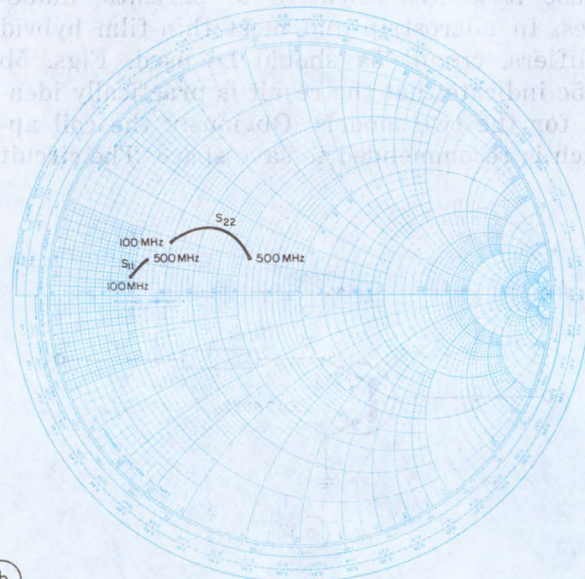

10. Combining series and shunt feedback (a) improves impedances Z_{11} and Z_{22} as shown in b.

the effect of series feedback for both S_{11} and S_{22} , an appropriate shunt feedback should be used to maintain the flat gain and good input and output match. A new plot of S_{11} and S_{22} is required to find the proper value and position of the reactive elements in the feedback loop.

The parallel combination must be dc-balanced, with two equal emitter resistors used also as a series feedback for the stage. Input and output reflection coefficients, S_{11} and S_{22} , are presented in Fig. 2 for a single transistor chip, and in Fig. 7 for the parallel combination. As shown, Z_{11} for the parallel combination is approximately a 10- Ω resistor. Fig. 6 illustrates the circuit with a series feedback of 7 Ω , and Fig. 8 shows the change in magnitude and phase of both Z_{11} and Z_{22} .

In Fig. 9a shunt feedback consists only of a 280- Ω resistor; the plot of S_{11} and S_{22} is shown in 9b. It is evident that the shunt feedback reduces both impedances, but phase shift is greatly reduced for the input of the stage (S_{11}).

The application of both feedback elements, as shown in Fig. 10a, greatly improves both impedances Z_{11} and Z_{22} , as shown in Fig. 10b.

Two conclusions can be drawn from Fig. 10b:

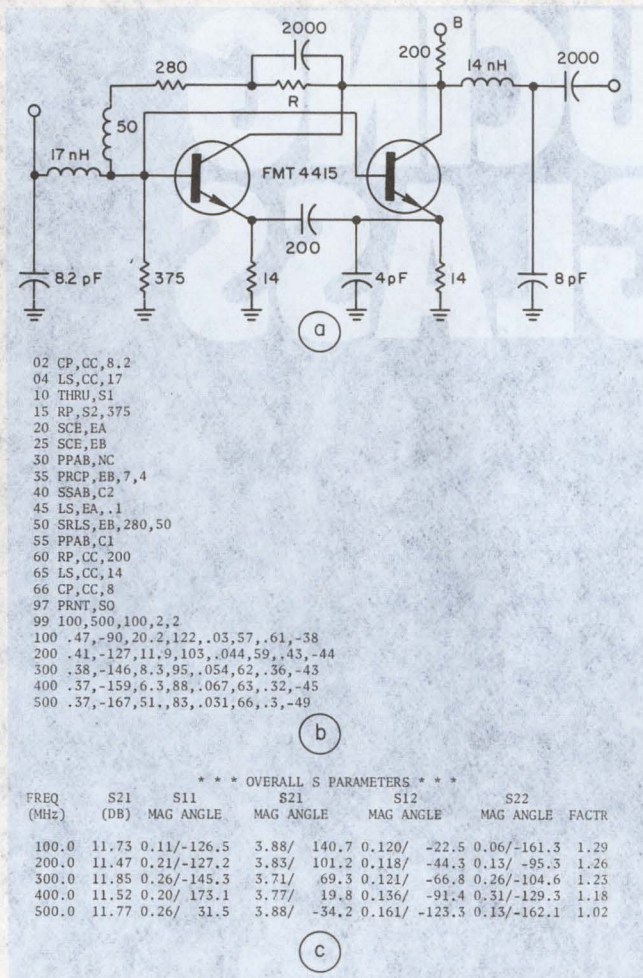

11. The final circuit design (a) and its circuit file (b). It offers 11-dB gain up to 500 MHz.

(1) Z_{22} , the output impedance, is almost perfect. To obtain a flat gain, an inductor is placed in the shunt feedback to reduce the feedback effect toward the high end. To avoid phase shift of S_{22} , this inductor must be used as shown in Fig. 4a, and not in series with the collector of the device as shown in Fig. 3a. If circuit 3a is used, the amplifier becomes potentially unstable and very difficult to match.

(2) By examination of S_{11} , the proper input matching network can be selected, as described in lines 02 and 04 of the circuit file (Fig. 11b). The final circuit, with an additional matching network, is presented in Fig. 11a, the circuit file in b and the computed results in c.

The completed circuit design delivers a flat gain of 11 dB with a VSWR < 2:1 up to 500 MHz. The design used in the output stage of the Fairchild FMA 134 hybrid amplifier (TO-3 package) provides a gain of 20 dB min. with ± 1 -dB flatness and $P_o = +17$ dBm for a 1-dB gain compression point.

As a final example, a single-stage wideband amplifier designed for 1-GHz bandwidth is presented using a Fairchild FMT 4575 chip tran-

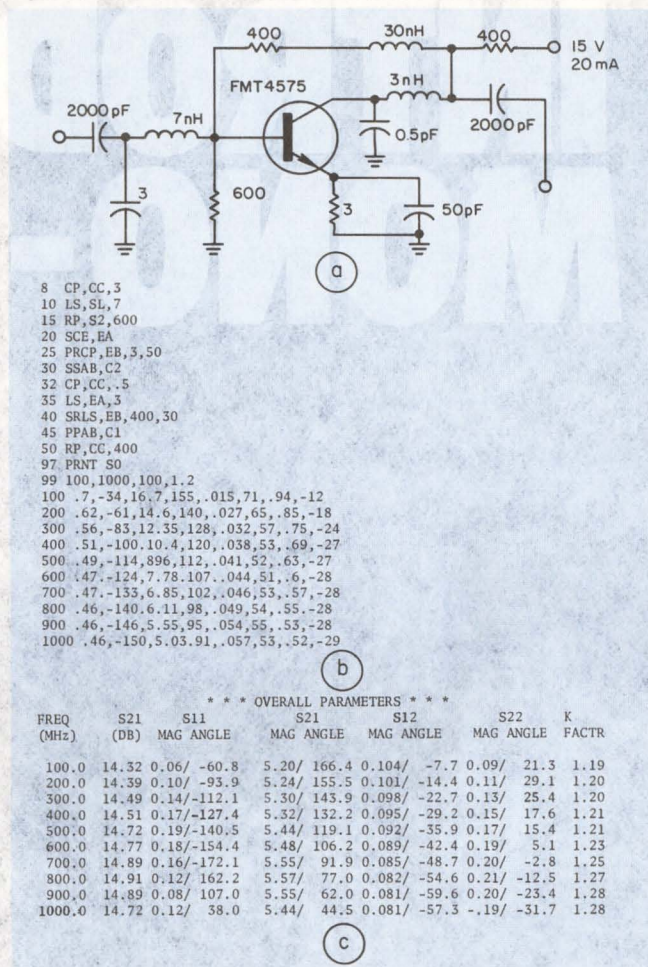

12. A single-stage, 1-GHz bandwidth amplifier (a), with circuit file (b) and performance results (c).

sistor. The design can be packaged in a standard TO-8 can. The rf circuit is presented in Fig. 12a, the circuit file in Fig. 12b and the results in Fig. 12c. ■■

Acknowledgement

The author wishes to thank Dr. George Bechtel, George Vendelin and Wil Alexander for helpful suggestions.

References

1. Archer, J. A., "Design and Performance of Small-Signal Microwave Transistors," *Solid State Electronics*, Vol. 15, Pergamon Press, printed in Britain, 1972, pp. 249-258.
2. Sturzu, Petre, "Hybrid Technology Combined with CAD Programs Can Push Wide-Band Amplifier up to 12 Octaves," to be published in *Microwaves*, June, 1974.
3. Besser, Les, "Combine S Parameters with Time-Sharing and Bring Thin-Film, High-Frequency Amplifier Design Closer to a Science than an Art," *Electronic Design*, No. 16, Aug. 1, 1968.
4. Egenstafer, Frank L., "Design Curves Simplify Amplifier Analysis," *Electronics*, Aug. 2, 1971.
5. Ghausi, M. S., "Principles and Design of Linear-Active Circuits," McGraw-Hill, New York, 1965.
6. Rollett, J. M., "Stability and Power Gain Invariants of Linear Two Parts," *IRE Trans., PGCT*, Vol. CT-9, March, 1962, pp. 29-32.
7. Froehner, W. H., "Quick Amplifier Design with Scattering Parameters," *Electronics*, Oct. 16, 1967.
8. Fairchild Semiconductor, "SPEEDY, A Computer-Aided Design Program for RF and Microwave Circuits," May, 1973.

INTRODUCING MONO-GLASS

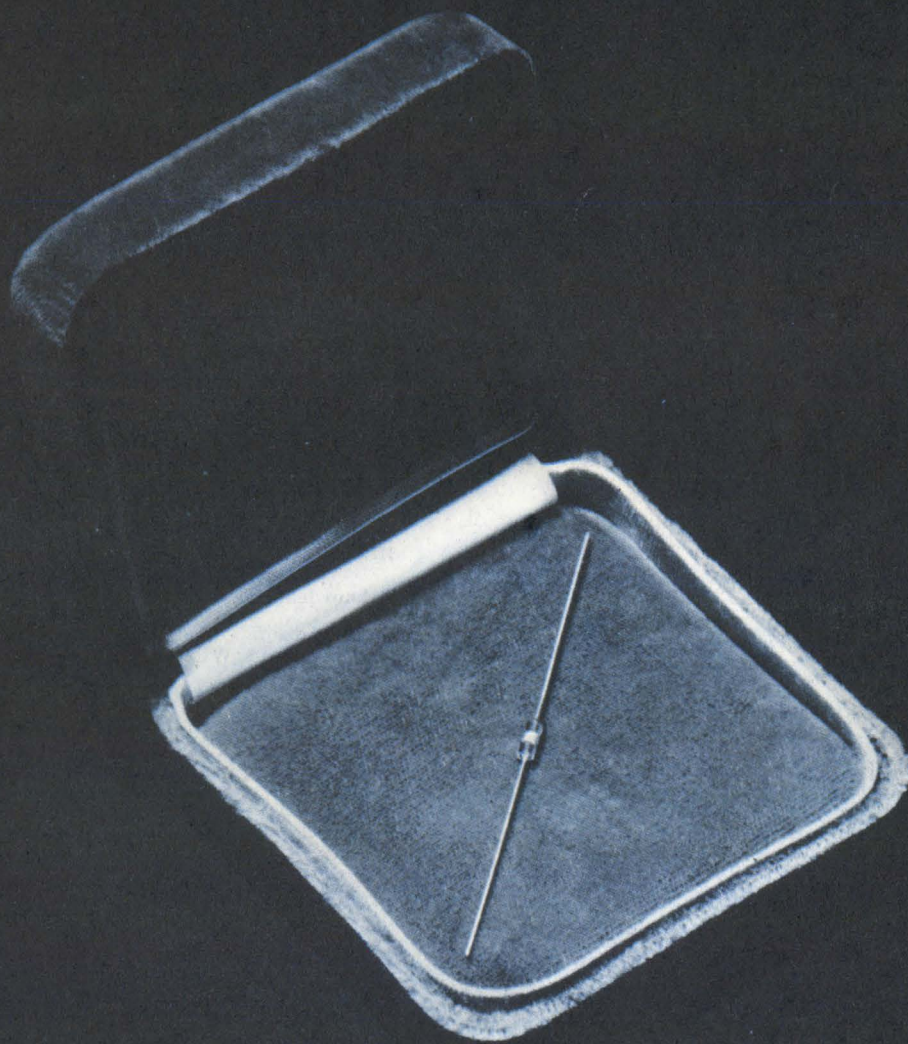

A JEWEL OF A CAPACITOR

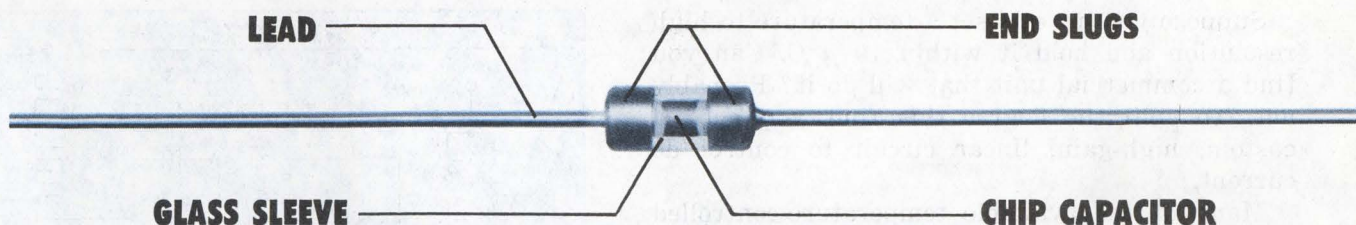

U.S. Capacitor Corp. has done something elegant for high volume capacitor users . . . **MONO-GLASS.**

This glass encapsulated monolithic ceramic capacitor offers something special: for the Design Engineer looking for cost reduction and dependability; for the purchasing agent looking for low price with fast delivery; for the incoming Q.C. inspector who is looking for reliability.

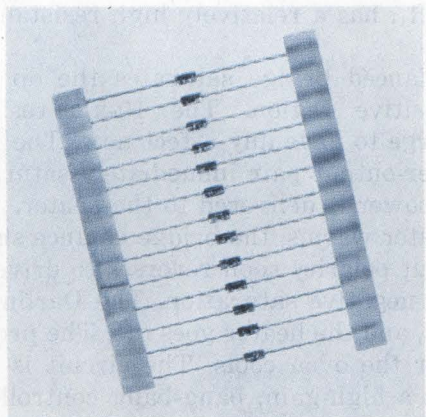

AUTOMATIC INSERTION:

If you use it, you know the substantial savings in time and cost. MONO-GLASS is designed for automatic insertion with the same equipment used for diodes and resistors. Reel packed and ready for your machines.

DURABILITY:

Our hermetically sealed, glass-to-metal construction offers these advantages: solderless internal contacts that won't reflow in your wave-soldering process; no glass fracturing during lead forming—stress is transferred to the end slugs rather than the glass sleeve.

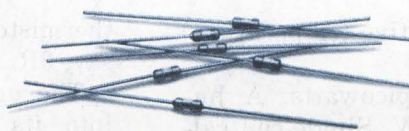

HIGH VOLUME; LOW PRICE

USCC's production capability for chip capacitors is second to none. MONO-GLASS is produced by a simple assembly technique. Combine these two and you get the best possible delivery for high quantity requirements, at a budget price.

WIDE SELECTION:

Four case sizes are available200 x .100; .250 x .100; .300 x .150 and .400 x .150. The 50 and 100 WVDC units offer up to .01 mfd in COG dielectric, to .18 in X7R and up to 1.0 mfd in the Y5V dielectric.

RELIABILITY:

USCC is the proven leader in state-of-the-art, demonstrated on N.A.S.A. life support and guidance systems. Commercial as well as military aerospace applications benefit from the high reliability features of our products—the best available.

MONO-GLASS is our lowest priced ceramic axial lead capacitor, offering a new quality capability for communications, navigation and guidance, computer business machines or anywhere that high volume, low price is required.

Write or call for an evaluation sample, more technical data or applications help for your special requirements. Remember, USCC-Centralab.



USCC

USCC/Centralab

Electronics Division ■ Globe-Union, Inc.



2151 North Lincoln Street ■ Burbank, California 91504

(213) 843-4222 ■ TWX: 910-498-2222

INFORMATION RETRIEVAL NUMBER 52

Split a temperature degree to $10 \mu^{\circ}\text{C}$. Use a linear-dc-feedback circuit, watch the grounding and thermal, magnetic and electric shielding, and put in only quality components.

Suppose you have to set a temperature to high resolution and hold it within $10 \mu^{\circ}\text{C}$. Can you find a commercial unit that will do it? Probably not. To split the degree this fine, you need a custom, high-gain, linear circuit to control dc current.

Many of the available temperature-controlled instrument ovens are of the bang-bang variety. The rest, though called proportional controllers, may not even hold to a degree centigrade. Such controllers often use SCR drives for the heating elements, and the 60-Hz pulsing of the power to the heater could easily overshoot a $10\text{-}\mu^{\circ}\text{C}$ requirement.

Yet many applications exist for a temperature controller with microdegree capability.¹ Examples include studies in the following fields:

- Laser microinterferometry.
- Zener-reference temperature compensation.
- Crystal growing.
- Transition points of positive-temperature-coefficient ceramics.
- Biological calorimetry in picowatts. A human cell operates at about 1 nW. Single-cell calorimetry is a possibility.

Replace energy at the rate lost

To control temperatures above ambient, you must replace the energy at the same rate that the system loses it. If a perfect heat insulator were available, the energy could be raised to the desired level and the current shut off. The job would be done. But any oven left without power eventually assumes the temperature of its surroundings.

The simplified schematic of a dc feedback loop, as used in the MIT Nutrition and Food Science oven, meets the requirements of a microdegree controller (Fig. 1). Assume that the lag-compensation potentiometer is at its lowest setting and that the system has just been turned on. With the oven cold, the negative-temperature-coefficient

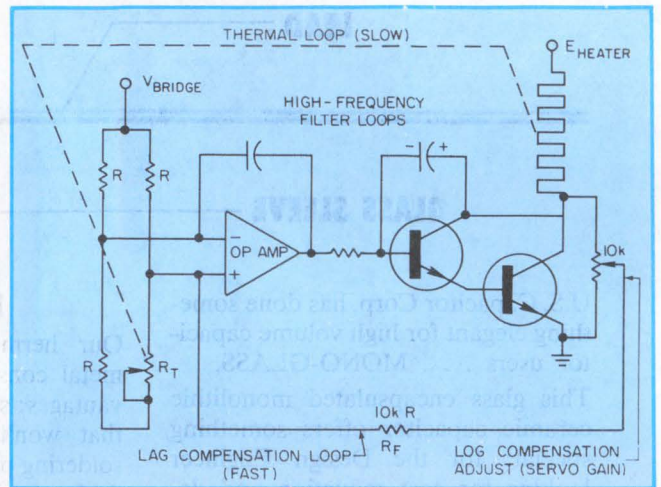

1. The temperature controller's simplified feedback system shows the thermal and electric feedback paths.

thermistor, R_T , has a relatively high resistance—say, $3R$.

The unbalanced bridge saturates the op amp into its positive region. The 10-kR resistor, R_F , is too large to have any effect now. The Darlington power-output pair immediately saturates, and full dc power is delivered to the heater.

As the heater warms, the bridge balance shifts, and its output polarity soon reverses to drive the op amp into negative saturation. The Darlington pair cuts off, and the heater goes off. The process repeats after the oven cools. The circuit is now operating as a high-gain, bang-bang controller—which, of course, is not the objective.

The high gain of the op amp, the gain of the Darlington pair and the thermal lag between heater and sensor create an ideal condition for the oscillations. To stop this, either the gain must be reduced or the thermal time lag brought to zero. The latter is not possible, but the former is. The lag-compensation control can reduce the dc gain of the system.

Note that, because the Darlington circuit inverts, the lag-compensator adjustment provides negative feedback to the noninverting input of the op amp.

The capacitors shown in the op-amp's feedback

Dr. James Williams, Dept. of Nutrition and Food Science, MIT, Cambridge, Mass. 02139.

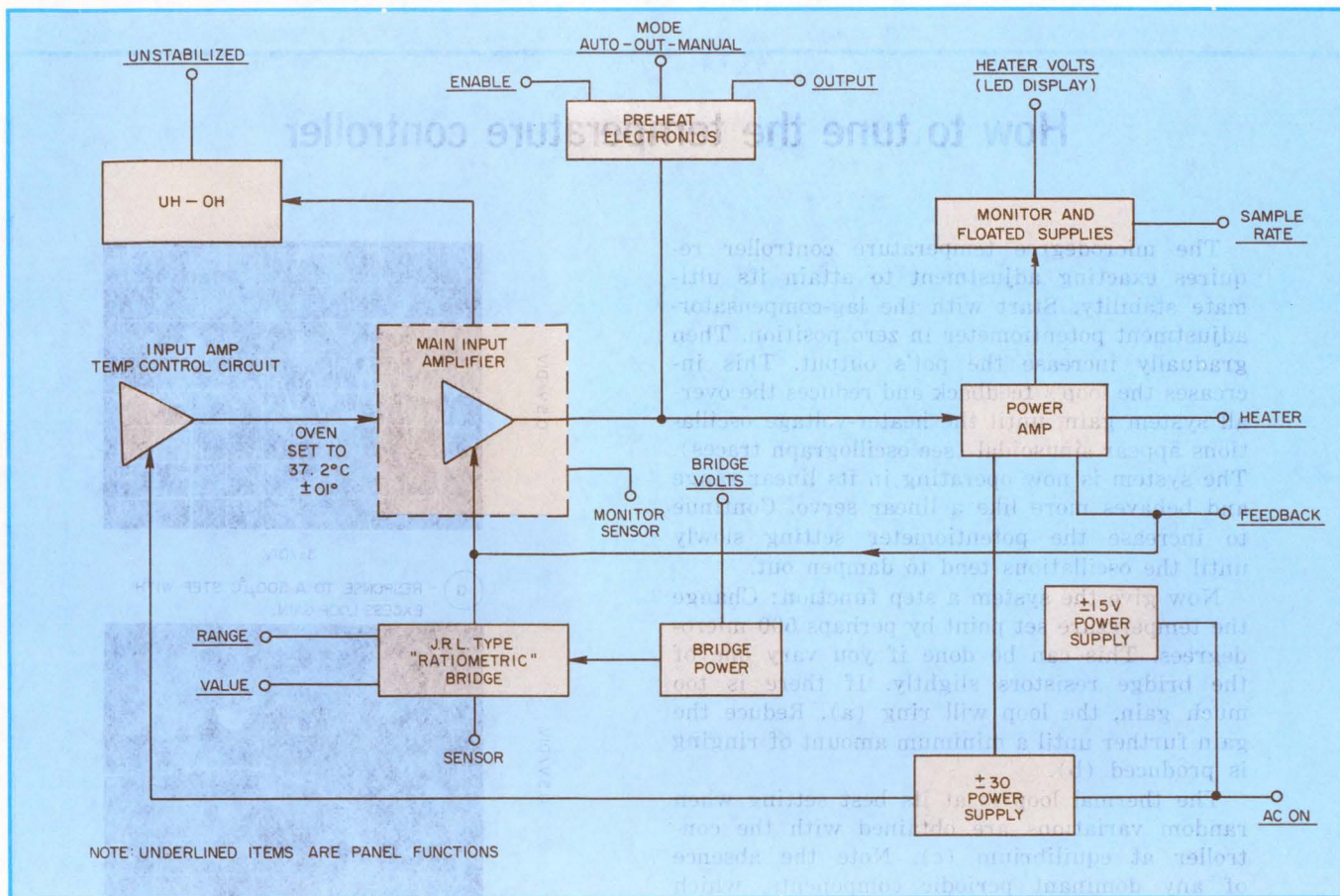

2. **Auxiliary circuits**, such as a separate temperature control for the main input amplifier and a preheater,

path limit the high-frequency response of the circuit and help provide rejection of 60 Hz and any other unwanted high-frequency components.

After the gain is reduced so the system ceases to bang-bang between saturation points of the op amp, the objective is to retain the maximum possible gain. However the system must avoid any tendency to self-oscillate sinusoidally. Typically such oscillations occur in the 1-Hz range. Any tendency toward periodicity in the heater voltage indicates that the system loop gain is still too high. The feedback must be adjusted until the heater voltage shows only small, random, variations (see box).

Input circuit is critical

The principles of the feedback circuits in this microdegree temperature controller are, of course, not new (Fig. 2). Success depends upon meticulous wiring, assembly and component selection.

The controller can't be a clip-lead-and-breadboard job. Don't use a shield as a current carrier, don't ground both ends of a shield, and don't use BNC connectors. Banana plugs are better. Better yet, use securely soldered joints. Shielded leads

are essential for stability and convenience. All power is regulated and the bridge supply is variable.

to sensors and instruments should expose a minimum of unshielded wire.

Protect all input components and circuits from any widely varying ambient changes, and observe all the traditional grounding rules. A ground loop of only 2 in. of wire can cause a 10% change in heater current. Use only the most stable and reliable components, especially in the input circuit. Substitutes for the key components are not advised.

Coddle the input circuits

The input circuit is critical to the long-term stability of the temperature controller. Thus the input-sensor bridge circuit and the input amplifier must receive special treatment.

The sensor bridge is different from the ordinary Wheatstone bridge. The sensor bridge arrangement, developed by Julie Research Laboratories in New York City, uses a fixed-impedance, Kelvin-Varley divider² as one variable element in the bridge over many decades of resistance, and each decade has a linear resistance scale. The input bridge can accommodate a wide range of thermistor resistances and corresponding selected temperatures. This bridge arrangement, and the

How to tune the temperature controller

The microdegree temperature controller requires exacting adjustment to attain its ultimate stability. Start with the lag-compensator-adjustment potentiometer in zero position. Then gradually increase the pot's output. This increases the loop's feedback and reduces the overall system gain, until the heater-voltage oscillations appear sinusoidal (see oscillograph traces). The system is now operating in its linear range and behaves more like a linear servo. Continue to increase the potentiometer setting slowly until the oscillations tend to dampen out.

Now give the system a step function: Change the temperature set point by perhaps 500 microdegrees. This can be done if you vary one of the bridge resistors slightly. If there is too much gain, the loop will ring (a). Reduce the gain further until a minimum amount of ringing is produced (b).

The thermal loop is at its best setting when random variations are obtained with the controller at equilibrium (c). Note the absence of any dominant periodic components, which would indicate that the loop was trying to oscillate.

An interesting phenomenon occurs after the oven walls first reach their equilibrium control point. Although the temperature across the walls is constant, the current through the heater drops at a perceptible rate. This seeming paradox occurs because less and less energy is taken from the walls as the oven's contents approach saturation, and the controller backs off the heater power to maintain control. When saturation finally occurs, the voltage level across the heater stabilizes about a point that is dependent ultimately on room ambient and the oven's insulation characteristics. The controller's corrections are random adjustments about the equilibrium heat level as ambient changes and other fluctuations occur. Once saturation is attained, it's wise to check the lag-compensation gain setting, again, after several hours or days.

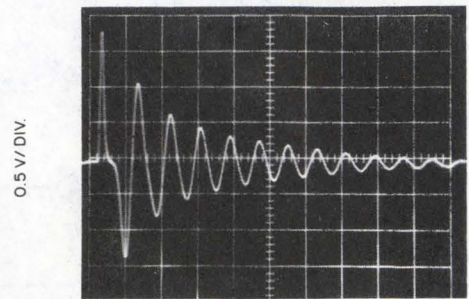

(a) - RESPONSE TO A $500\mu\text{C}$ STEP WITH EXCESS LOOP GAIN.

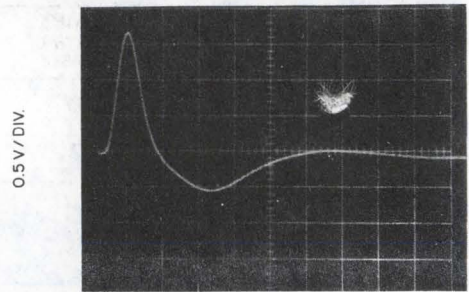

(b) - RESPONSE TO A $500\mu\text{C}$ STEP WITH CORRECT LOOP GAIN.

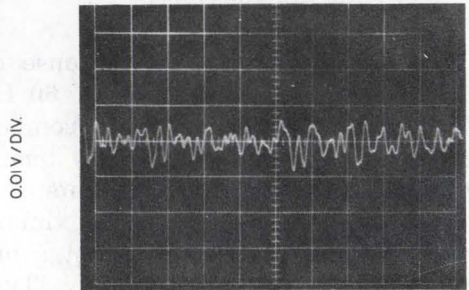

(c) - RANDOM HEATER ADJUSTMENTS TO MAINTAIN OVEN TEMPERATURE, WHEN LOOP GAIN IS CORRECT.

NOTE: ALL READINGS ARE AC COUPLED TO OSCILLOSCOPE. DC LEVEL APPROXIMATELY 5V.

very stable precision resistors used in the fixed arms, make the system easy to use. Of course, all the other components in the input bridge must also be of the highest quality to ensure long-term stability. The region of $10\mu\text{C}$ stability tolerates no compromise.

Experience with the system shows that sensors that operate in the 1-k Ω range should not be used, if you wish to attain the highest stability. The higher resistance ranges are less subject to See-

back effects and connector and switch contact-resistance variations. The MIT oven uses a Yellow Springs Instrument Co. Sensor, No. 44014.

The system's input amplifier is particularly coddled (Fig. 4). The amplifier is shielded from the ambient electrostatically, magnetically and thermally. An instrument oven that uses a detuned version of the main temperature-control circuit keeps out any thermal transients of the ambient and rate coupling from the system's

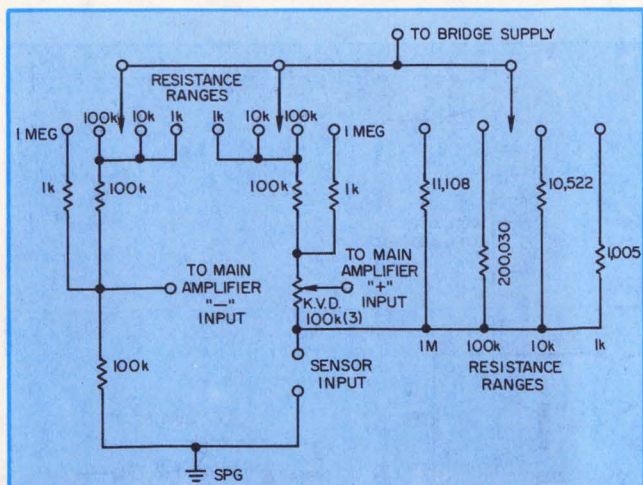

- NOTES:
1. RESISTORS ARE JULIE RSCH. LABS NO. R-44-1 PPM °C T.C. 0.005% ACCURACY.
 2. SWITCH IS DAVEN NO. 736 (LOW CONTACT RES. AND LOW THERMAL EMF TYPE).
 3. KELVIN-VARLEY DIVIDER IS ELECTRO-SCIENTIFIC INDUSTRIES NO. DP 1311 5 DECADE 100k Ω.

3. The sensor bridge uses a Kelvin-Varley divider in one of its arms to provide a linear resistance scale and to enable the bridge to match a wide range of temperatures and sensors.

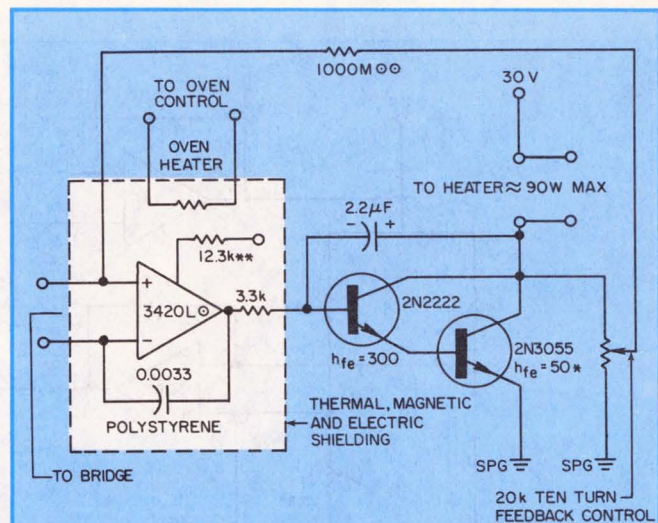

- * SELECT FOR h_{fe}
- ** SELECT FOR MINIMUM OFFSET
- BURR-BROWN
- ⊙ VICTOREEN

4. The main input amplifier is thermally, magnetically and electrically shielded. A separate heat regulator circuit (Fig. 6) provides the thermal isolation and very special attention is paid to grounding.

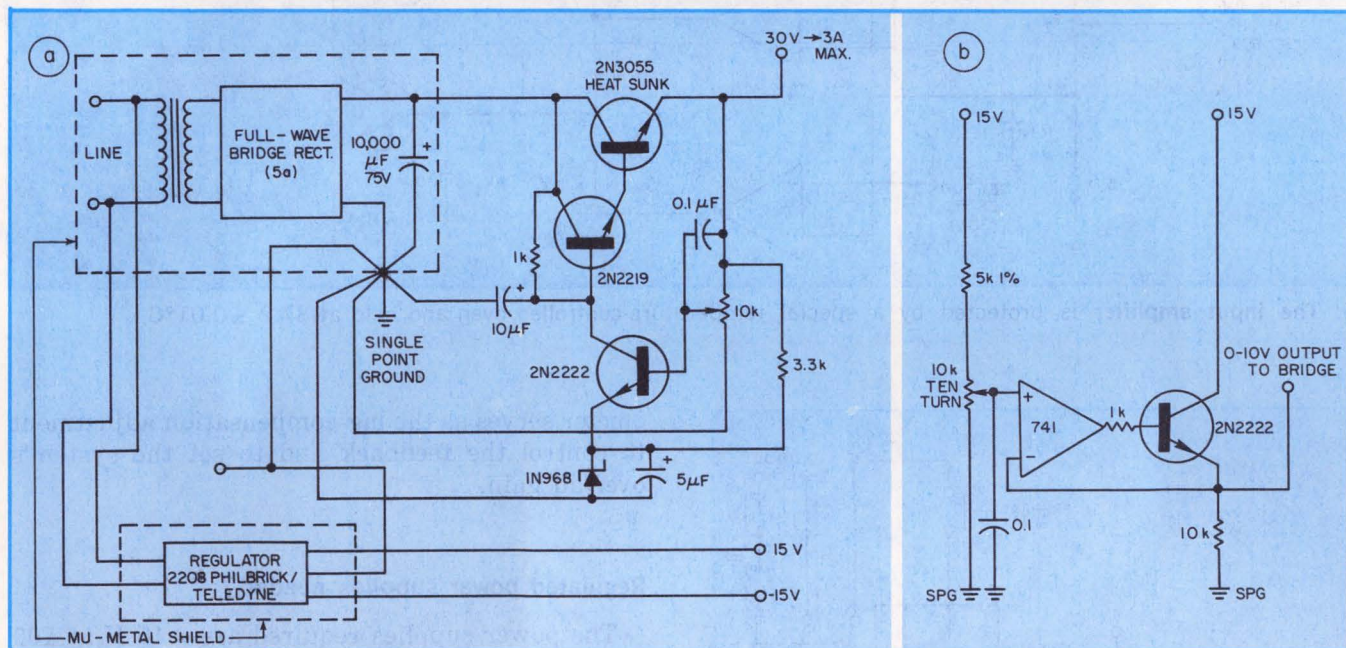

5. Power supplies for the heater element and amplifiers (a) and bridge (b) are regulated. The ± 15 -V supply

for the amplifiers is enclosed in a Mu-metal magnetic shield.

heater. The oven is set to maintain 37.2 ± 0.01 C.

A Burr-Brown 3420L amplifier, with 1-pA bias current and a 90-dB common-mode rejection ratio, allows the use of high-impedance input sensors. And the amplifier's $1\text{-}\mu\text{V}/^\circ\text{C}$ offset drift, combined with the ± 0.01 -C controlled oven, leaves only the sensor noise as the dominant error factor.

Also, every connection to the amplifier is shielded. Finally the 3.3-kΩ resistor at the ampli-

fier's output helps prevent excessive loading and heating of its output transistors. This resistor also maintains the amplifier's gain and reduces the possibility of a thermal "tail" within the module.

Fig. 4 also shows the power amplifier, which consists of a 2N2222 transistor that drives a 2N3055 in a Darlington configuration. The output amplifier can control a 90-W-maximum heater with a 30-V power supply. A 10-turn potenti-

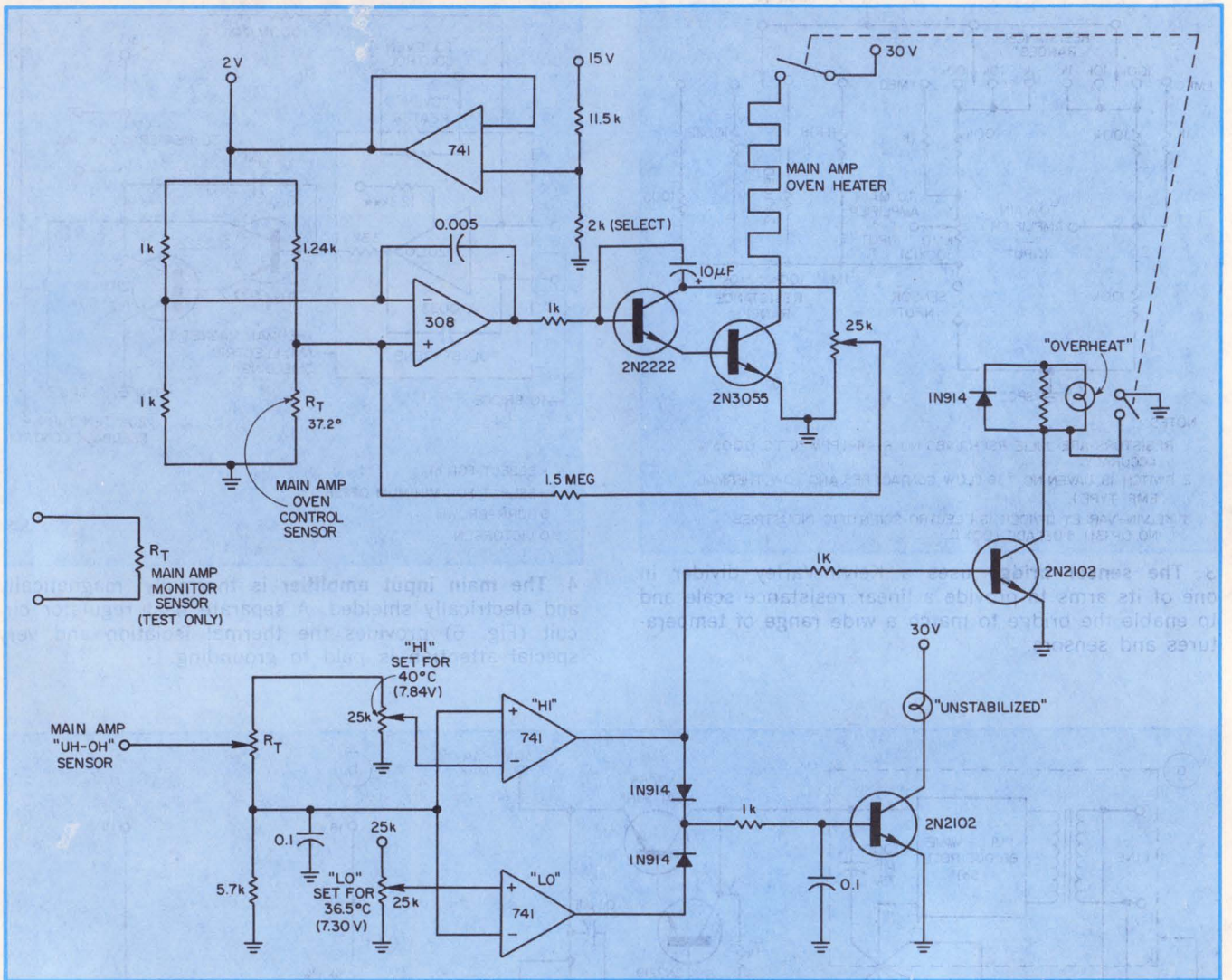

6. The input amplifier is protected by a special temperature-controlled oven and held at $37.2 \pm 0.01^\circ\text{C}$.

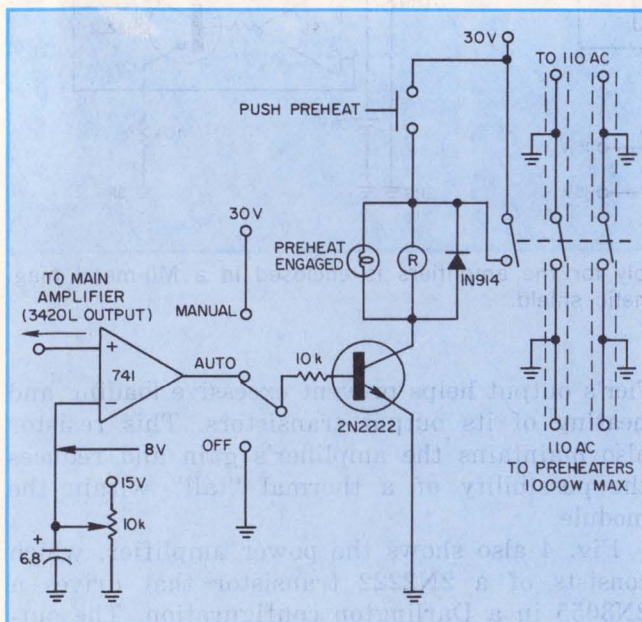

7. A preheater circuit for high-heat-capacity systems greatly speeds the temperature controller's start-up.

ometer serves as the lag-compensation adjustment to control the feedback and to set the system's over-all gain.

Regulated power supplies needed

The power supplies required are $\pm 15\text{ V}$ at 100 mA for the system's various op amps and other circuits, $+30\text{ V}$ at 3-A max for heater power (Fig. 5a) and a 0 to 10-V source for the bridge (Fig. 5b). The $\pm 15\text{ V}$ is derived from a Philbrick 2208 module, and the $+30\text{-V}$ supply provides 1% regulated power with a classic series-pass arrangement. The 2N3055 series transistor is mounted on the unit's rear panel to keep out the transistor's heat. Both the ± 15 and $+30\text{-V}$ supplies are Mu-metal shielded to keep the transformer field from interfacing with the sensitive amplifiers.

The bridge supply is simply a unity-gain, op-amp follower that is boosted with a 2N2222 out-

put (Fig. 5b). The 2N2222 transistor is inside the feedback loop to take care of the transistor's drifts. The 741 amplifier input is derived from a 10-turn potentiometer that has 10 V across it. Thus the output voltage to the bridge can be read directly on a turns-counting dial, since the 741 loading on the pot is negligible. It is best to keep the bridge voltage low to avoid drift and noise problems. The sensor manufacturer's specs should be consulted for the best setting.

The combination of very small input currents and large heater currents can provide serious grounding problems unless a single-point-return technique is employed. A $1/4 \times 4 \times 1.5$ -in. tinned-copper plate serves as the ground "point." All returns terminate at this plate, and no ground busses are used in the unit.

Auxiliary circuits are important, too

The rest of the circuits are auxiliary to the main input amplifier, power amplifier and power supplies, but they make important contributions to the system's stability and ease of use.

The input-amplifier oven circuit operates similarly to the main system (Fig. 6). The whole circuit is inside a 5×3 -in. aluminum cylinder, with a 0.5-in. wall enclosed in a small Thermos bottle. An aptly named "UH-OH" (Underheat-Overheat) circuit provides a go-no-go indication of the oven's status. A double-limit comparator, which uses two 741 amplifiers, monitors the voltage established by the UH-OH thermistor sensor and a 5.7-k Ω resistor. If the voltage goes out of the bounds set by the low and high potentiometers, an "Unstabilized" indicator will light. Further, if the high comparator is tripped by the oven overheating, a relay latches and removes the heater power from the control circuit.

The Unstabilized indicator lights when the instrument is turned on. When the oven comes up to temperature, the bulb goes out. Thereafter if the bulb comes on again, a circuitry malfunction is indicated.

A second bulb connected across the relay contacts, when lighted, indicates that the failure was due to oven runaway. This elaborate protection scheme was considered necessary because the input amplifier is a key item in the system's performance, and it can be readily damaged by a runaway oven.

A preheater speeds the work

A preheater circuit can be provided to raise the temperature of a high-heat-capacity system rapidly (Fig. 7). Such a circuit has 1000-W auxiliary heaters. Once the operating temperature is reached, the preheater turns off automatically.

A 741 amplifier in the preheater acts as a com-

Some hints on oven design

Thick oven walls help to keep the temperature stable. Cylindrical shapes are good, if you wind the heaters more densely near the ends, but spheres are the best choice for an oven's shape. Styrofoam and fiberglass are cheap and effective insulation, but Dewar flasks are best. Cascaded ovens (one inside another) are a must for ultra-high stabilities over a long time.

Baths are also helpful, because it is easy to get huge thermal capacity with them. Stir them to enhance the bath's isothermal integrating characteristic. But watch out for dead spots and layering effects. The goal is an evenly distributed heater, such as a concentric spiral.

To obtain better than 100- $\mu^\circ\text{C}$ stabilities, you must pressure-seal dry ovens. Since $PV = nRT$, atmospheric-pressure changes produce temperature shifts.

It's common practice to specify a temperature controller in terms of temperature gain. This is defined as the ratio of ambient-temperature change to the change in the controlled environment. Hence a 1°C ambient shift will result eventually in a 10- $\mu^\circ\text{C}$ oven shift for a temperature-gain specification of 100,000. But this spec, alone, has limited usefulness because the effects of an ambient temperature shift may take hours to stabilize.

parator and swings into positive saturation when the temperature controller is turned on. When the preheater's switch is in the auto position, a 2N2222 transistor actuates a relay when the Push-Preheat button is depressed. The relay latches and delivers power. When the oven gets to the selected control point, the 3420L main input amplifier swings negative, the 2N2222 cuts off and de-energizes the relay. The main temperature-controller circuit then automatically takes over.

From the block diagram of Fig. 2, we see that the heater voltage of the controller is monitored by a digital voltmeter. Though the specific unit used in the MIT oven is homemade, almost any good 3-digit voltmeter will do. The heater has low impedance, so the voltmeter input resistance need not be greater than about 10 k Ω . This output monitor should float above ground and be well-isolated from the rest of the controller. ■■

References:

1. Williams, J., "Temperature Controlling to Micro-Degrees," MIT Educational Research Center, Oct., 1971.
2. Julie, Loebe, "Laboratory Manual for DC Measurements," Julie Research Laboratories, New York City.

ASSEMBLED COUNTERS WE'VE PUT TOGETHER THE HIGH YOU'VE COME TO EXPECT

**the \$225, 30 MHz, 6-digit
autoranging counter**

**the \$325, 110 MHz, 7-digit
autoranging counter**

**the \$395, 110 MHz, 7-digit,
high stability, autoranging counter**

**the \$495, 200 MHz, 7-digit
counter**

**the \$625, 200 MHz, 7-digit,
high stability, programmable counter**

**the \$795, 600 MHz, 7-digit,
high stability, programmable counter**

FROM HEATH: PERFORMANCE AND LOW COST FROM US OVER THE YEARS



SM-118A



SM-128A



SM-128B



SM-110A

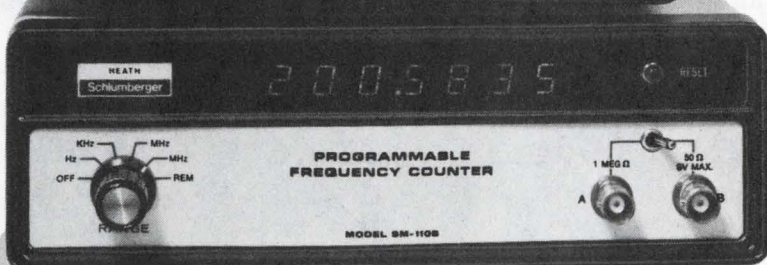

SM-110B

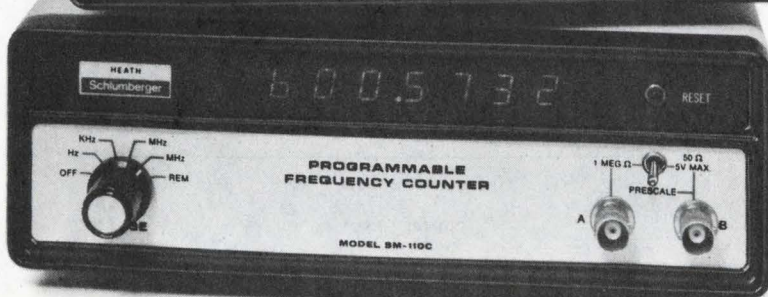

SM-110C

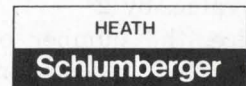

HEATH COMPANY

*we haven't forgotten
what you want*

Pick the right DAC by cutting through spec confusion. Meanings vary from vendor to vendor. Here's a guide that may save you time and trouble.

Did you ever buy a digital-to-analog converter by basing your decision on the manufacturer's specs, hook it into your system and find out it didn't come up to par?

Most engineers get on the phone and complain to the manufacturer when this happens. Often they're told to ship the DAC back for readjustment or exchange. And sometimes the vendor tests the unit in his shop, only to report that it meets the specs.

What do you do now? More important, why did you pick the unit for your application? Are you and the vendor interpreting the specs in different ways? Is the manufacturer performing his tests as you expect him to?

Knowing how some of the more critical DAC specs are defined and tested can save a lot of time and trouble. Add to that careful analysis of your application, picking the right DAC for the job need not be a frustrating experience. Let's start with the basics.

The DAC output, an analog voltage or current, is proportioned by the input digital code. An ideal unipolar binary-weighted DAC illustrates the scaling aspect (Fig. 1). The switch settings permit only the most significant bit (MSB), weighted 2^{-1} , to contribute to I_{ladder} . This produces a half-scale output.

Full-scale output, a theoretical and unattainable value, is 1 bit (one step or quantum) greater than the all ONEs output, V_{max} . The 3-bit DAC of Fig. 1 generates 2^3 discrete values of I_{ladder} in response to the digital inputs, but only $2^3 - 1$ analog step changes. Thus you can determine the value of a least significant bit (LSB) by dividing the all ONEs output, which can be adjusted to a convenient value, by $2^3 - 1$.

In practice, the number of bits a DAC can resolve is limited by component imperfections: excessive bit resistor tolerances, finite bit switch resistance or a poorly regulated reference source

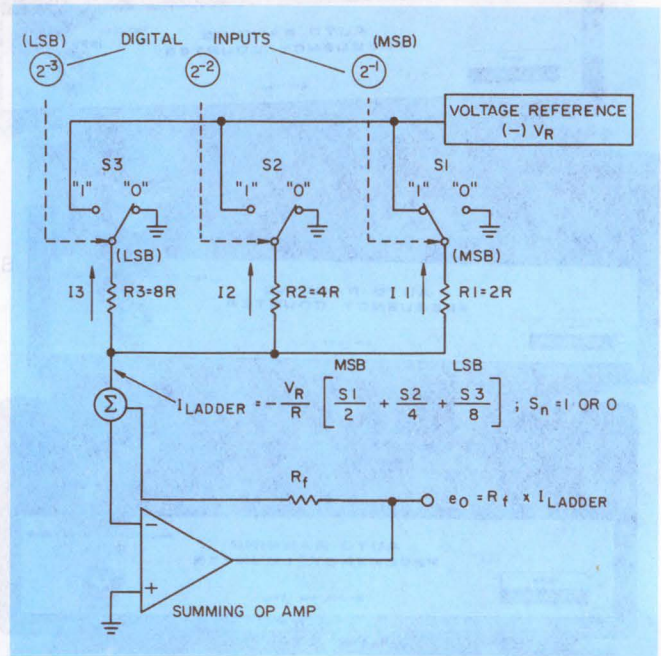

1. A simplified version of an ideal 3-bit DAC shows all the currents being summed for the output.

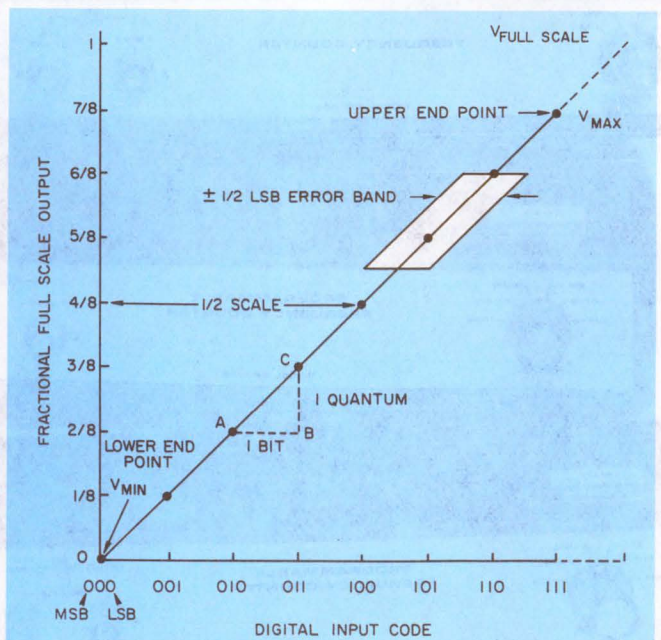

2. The transfer curve of the DAC in Fig. 1 has a slope of 1 and shows how the error band is determined.

William D. Miller, Applications Engineer, Hybrid Systems, 87 Second Ave., Northwest Pk., Burlington, Mass. 01803.

(V_R). These lead to unacceptable levels of bit current error.

Let's look at some definitions

A DAC with n input bits is said to have n -bit resolution. Greater resolution means smaller steps with finer granularity. If, for example, V_{max} is set for 10.23 V, a 10-bit DAC provides 10-mV steps. An 11-bit DAC with the same setting would provide 5-mV steps. As step size decreases with greater resolution, component tolerances become more important. Finally they become the limiting factor. DAC resolving power.

Linearity error defines the effects of imperfect bit weighting and describes an error band about a straight line, relative to full scale. In the transfer characteristic of Fig. 2, each dot relates a discrete analog output to its associated digital code. The line that joins these points, an end-point straight line—since it passes through the end points V_{max} and V_{min} —is the artificial locus of midpoint values of the error band. The ± 0.5 -LSB error band illustrates this point.

But another method exists for specifying linearity: the best straight line (Fig. 3). This line is drawn through the array of output levels to minimize the positive and negative errors; it does not necessarily pass through zero, V_{min} or V_{max} . A user is often dismayed because he calibrates at zero and full scale, and sees as much as a two-quantum change for a 1-bit digital change. All you can infer is that the end points of the best straight line will lie within 0.5 LSB of the end-point straight line. Warning: Know how your supplier specifies linearity error.

There are different kinds of linearity. *Integral linearity* describes the errors in bit-current summation and is thus analogous to integration.

Differential linearity is similar to the local derivative. Ideally a 1-bit code change produces a one-quantum output change; since each quantum is equal, a constant slope of 1 results (Fig. 2). An imperfect DAC transfer characteristic (Fig. 3) displays a slope of 2 during the change from code 3 to code 4. Thus a two-quantum change is possible, accompanied by a missing level but with no loss of monotonicity.

Monotonicity demands that for an increasing digital code, the output must never decrease. Thus a 1-bit differential linearity error can cause a missing level. An error of less than 1 bit maintains the code and monotonicity. This parameter is particularly important in digital servo loops.

In general, an integral linearity error of ± 0.5 LSB ensures that the differential-linearity error will not exceed ± 1 LSB. This, in turn, guarantees monotonicity. On the other hand, a differen-

tial-linearity error of less than ± 1 LSB limits the integral-linearity error to ± 0.5 LSB if bit independence exists—that is, each bit, whether on or off, must not affect the current contribution of any other bit. In well-designed commercial DACs, bit independence is available.

Testing linearity

Fig. 4 shows a simple method for dynamic testing of differential linearity. The output of the

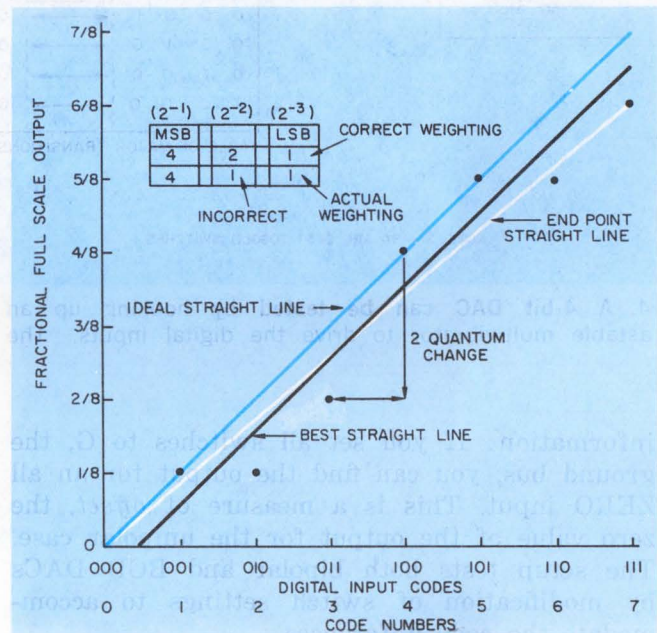

3. Deviations from the ideal linearity curve for a typical DAC can still stay within ± 0.5 LSB if the best-straight-line is drawn through the points. The end-point-straight-line joins the zero and full scale values and thus passes through zero and the actual full scale.

DAC drives the ac-coupled oscilloscope's Y-axis input, whose sensitivity is adjusted to display a 1-LSB signal. The astable multivibrator serves two purposes: It synchronizes the scope horizontal sweep, and provides a digital pulse train and its complement to switches S_1 through S_4 . However, there must be as many switches as there are DAC bits.

The complement rail, \bar{Q} , drives all lower-order bits. The Q rail drives the highest-order bit, while bits of still higher order are grounded. The amplitude of the resulting scope display will be the difference between the sum of lower-order bits and the highest-order bit under test.

If bit independence has been established, integral linearity is also known. However, the only way to verify integral linearity is to measure the DAC output for every combination of input code—a time-consuming job.

The test setup of Fig. 4a provides additional

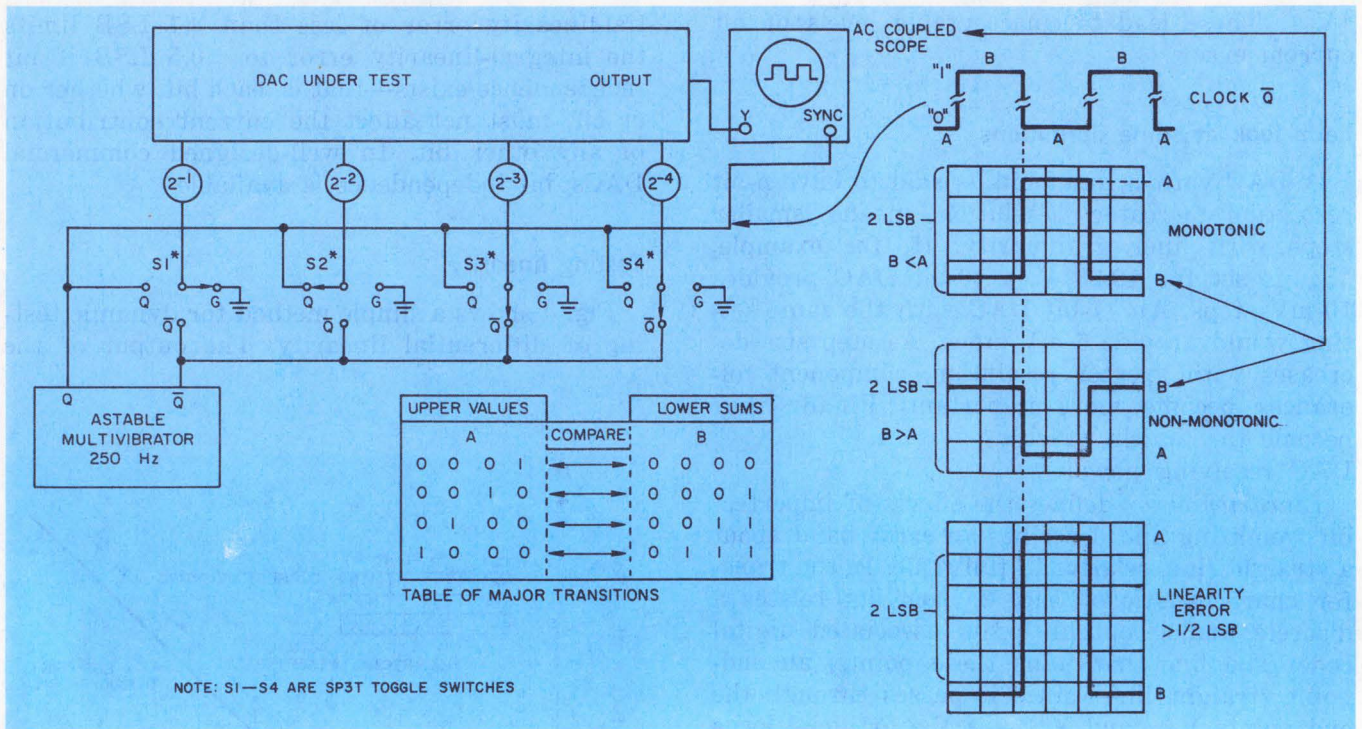

4. A 4-bit DAC can be tested by hooking up an astable multivibrator to drive the digital inputs. The

waveforms displayed on a scope can show monotonicity or linearity errors.

information: If you set all switches to G, the ground bus, you can find the output for an all ZERO input. This is a measure of *offset*, the zero value of the output for the unipolar case. The setup tests both bipolar and BCD DACs by modification of switch settings to accommodate the code differences.

The slope of the transfer characteristic, which includes the gain, offset and integral-linearity errors, establishes the *accuracy* of a DAC. Each component of accuracy is temperature and power-supply dependent. The coefficients of variation for these parameters are usually part of a DAC specification sheet.

Settling time—the time a DAC output needs to assume a new value after a change in an input code—can appear as a percentage of full scale, a fraction of an LSB or with no error band at all. How the output transient settles depends on whether the DAC provides a current or voltage output. The transient generated by a current-output DAC is a digital spike that decays quickly and cannot be extrapolated by a simple RC response. But a voltage-output DAC uses an output amplifier. It is slower and usually tends to resemble the decay of a classical first-order RC network.

Glitches—the spikes generated in the output by bit switching—are seldom mentioned in spec sheets. The knowledgeable user knows they exist, but he cannot estimate which code change will produce the biggest spike. If spiking is a problem, as it might be in display or component test

systems, call your DAC manufacturer. He will define the “spikiness” of his module or he’ll let you do it by lending the unit to you for a short time.

Power-supply rejection should be considered when the system power-supply voltages are different from the specified nominal supply voltages. If, for example, you plan to operate a DAC specified at ± 15 V dc from ± 12 V dc power supplies, linearity could suffer. Ac variations superimposed on the dc rails are another source of error, since they can produce erratic performance similar to ground-loop effects. Also, know the sensitivity of your DAC to power supply variations for both static voltage change and frequency.

Determine the parameters you need

DAC user requirements can be broken down into two broad categories: One requires a specific value of analog output current or voltage for a specific digital input code. The other requires a uniform change of output for each 1-bit change of input. The additional constraints of speed and stability over temperature and time are usually known to the designer.

The first requirement relates to accuracy, and this is what the designer must buy, because he is seeking an absolute level of output for a given input. Accuracy includes the end-point values. Accuracy calls for strict control of integral linearity, gain and offset. The circuit of Fig. 5, a digitally programmable voltage source, illus-

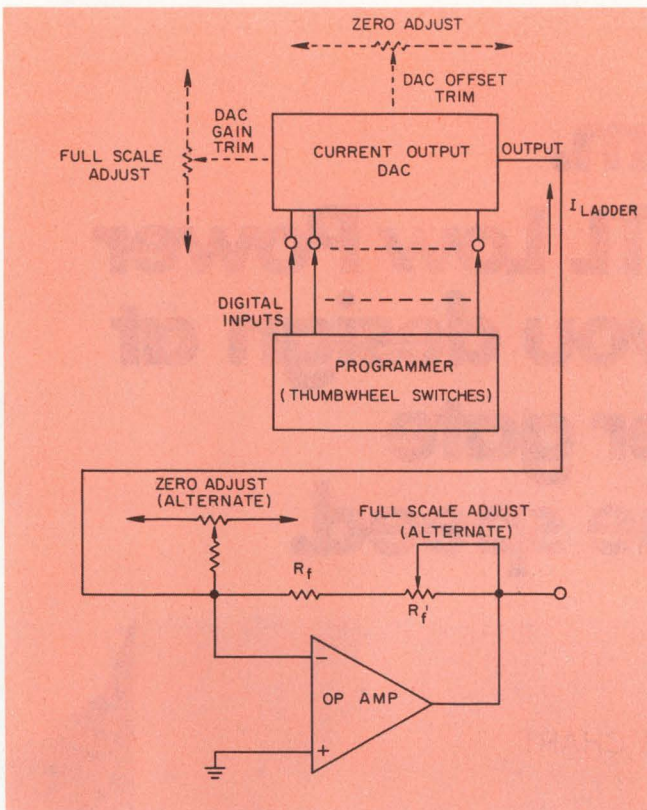

5. A digitally programmed voltage source can be built with a current output DAC, an op amp and some thumbwheel switches.

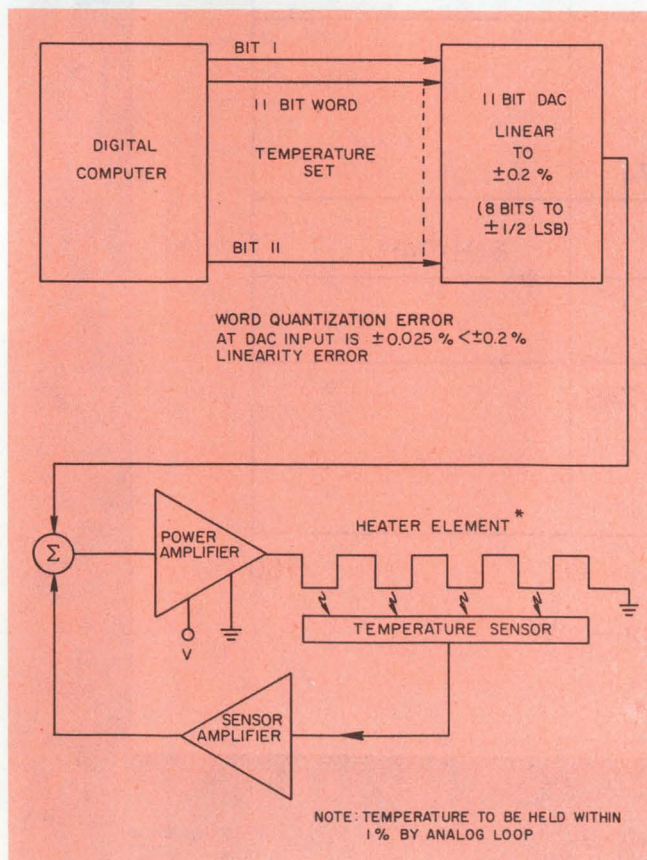

6. Computer words can control the temperature of a heating element by controlling the inputs to a linear DAC.

trates the type of application for which all points on the transfer characteristic must be defined and fixed. When accuracy is required, integral linearity must be characterized relative to an end-point straight-line fit. If external adjustments are not permitted, the DAC will be very costly, since it must be factory-calibrated and stable with temperature and time.

By changing the rules a little and permitting external gain and offset adjustments to force the end points to the required transfer function, we still rely upon integral linearity relative to an end-point straight line. But in this case, a DAC specified with respect to the best straight line can produce an error of less than 1 LSB. If this is unacceptable, a DAC with improved best-straight-line linearity—a binary order-of-magnitude improvement—provides the same level of error as its end-point-straight-line counterpart. This approach can be cost-effective up to 11-bit end-point-straight-line linearity, since DACs with 12-bit linearity are moderately priced. Above 12-bits, though, DAC costs accelerate.

Graphic displays often use DACs for raster or character generation. Best-straight-line linearity is preferred for this application, since only the equal incremental changes are important. End-point values can be set by the CRT driver-amplifiers. Of course, spikes in the DAC output are of concern and must often be canceled by some form of deglitching circuitry. Differential linearity is also important in other applications, such as digital servo loops, since double-valued outputs produce incorrect results.

An interesting requirement often placed upon DACs used in graphic displays is that their linearity error must be many times less than their resolution would suggest. For example, an 8-bit DAC, though required to resolve one part in 256, might be specified to 11-bit linearity, thereby reducing the error to about 0.05%. You can do this by trimming an 8-bit DAC to the required linearity.

But trimming is difficult, inefficient and expensive for most manufacturers. Instead, many offer DACs with 12-bit resolution and calibrate them dynamically to 8-through-12-bit linearity. This, of course, provides the widest coverage from a single design and saves the manufacturer money. The saving is reflected in the cost to you.

It is also worth mentioning the opposite case: a DAC with 11-bit resolution and 8-bit linearity. This unit might see use in the previously mentioned digital servo loop. In Fig. 6, the DAC input is an 11-bit computer word, while the DAC output controls a heater element that must hold temperature constant to within a percent or so. Loop accuracy is less demanding than the 11-bit input would imply, and the DAC cost should be proportionately lower. ■■

Ahem.
Our new 9LS/TTL Low Power Schottky lets you design at 2mW per gate at twice the speed.

TTL SPEED-POWER CHART

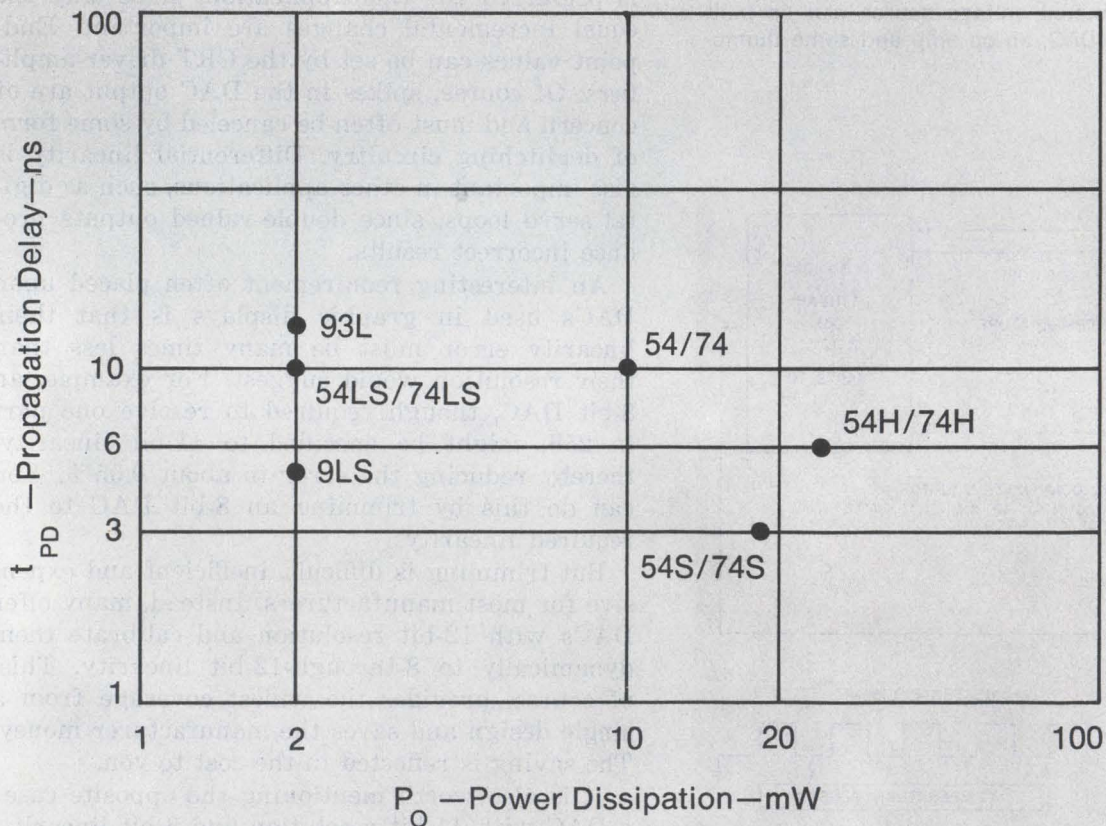

Not *half* the speed of Standard TTL. Or even the *same* speed.

Fairchild's new 9LS/TTL actually gives you only 5ns typical delay per gate, or 10ns worst case.

Twice the speed of both Standard 54/74 and Low Power Schottky 54LS/74LS devices.

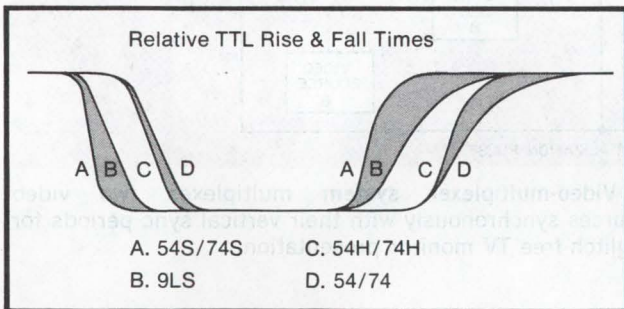

The fast 5ns difference.

You already know of the blessings of plain low power. Reduced energy demand. Less heat. Lower noise. Simplified system design. High fanout. And easy MOS-to-TTL interface.

Now, with our new 9LS, you get everything you want low power for — plus pin-for-pin compatibility and more speed than even 54H/74H.

Of course, if you don't need

Device	Description	100 up*	Device	Description	100 up*
9LS00	Quad 2-Input NAND Gate	.48	9LS22	Dual 4-NAND Gate (Open Collector)	.48
9LS02	Quad 2-NOR Gate	.48	9LS32	Quad 2-OR Gate	.48
9LS03	Quad 2-NAND Gate (Open Collector)	.48	9LS74	Dual "D" Flip-Flop	.77
9LS04	Hex Inverter	.53	9LS109	Dual JK Edge Triggered Flip-Flop	.77
9LS05	Hex Inverter (Open Collector)	.53	9LS112	Dual JK Edge Triggered Flip-Flop	**
9LS10	Triple 3-NAND Gate	.48	9LS113	Dual JK Edge Triggered Flip-Flop	**
9LS11	Triple 3-AND Gate	.48	9LS114	Dual JK Edge Triggered Flip-Flop	**
9LS15	Triple 3-AND Gate (Open Collector)	.48			
9LS20	Dual 4-NAND Gate	.48			

*Plastic DIP **Coming soon

extra speed, there's our admirable line of 93L. It's slower, but it's also extra economical.

Get the book free.

We've put together a whole book on Low Power TTL. And it's yours free.

Just drop us a note. Or call your nearest Fairchild Sales Office or local Distributor today.

**MADE IN
FAIRCHILD**

Semiconductor Components Group, Fairchild Camera & Instrument Corp., 464 Ellis St., Mountain View, CA 94040. Telephone (415) 962-5011. TWX: 910-379-6435.

View two video sources on one CRT.

Digital logic selects and disables each source during vertical sync to display the signals without bars and streaks.

An all-digital circuit allows you to see two sources of nonsynchronous video on one CRT monitor. The video is multiplexed so each source is seen with the switching transients, glitches and blanking bars hidden within the vertical sync interval.

The circuit gates the first video signal in coincidence with the leading edge of one of its vertical sync intervals. This signal remains on for some preselected time and is then gated off in coincidence with the sync interval. Meanwhile the other signal (temporarily disabled) is gated on in coincidence with its next vertical sync interval.

The system is set up by a pulse (from a one-shot connected to a reset switch) that sets the time-control flip-flop and resets the counter in the period selector (Fig. 1). The counter waveform provides one of the three enabling inputs to gate A. A second input is the logic ONE when gate B is inactive. The third input to gate A comes from sync separator A during the vertical sync interval from video source A.

The three inputs—combined by G_1 —produce a train of video-A sync pulses during the preselected time interval (Fig. 2). The leading edge of the first sync pulse in the train triggers one-shot MM_1 , while succeeding pulses retrigger MM_1 . The period of MM_1 is set for a time slightly greater than that of one TV field—about 18 ms. The Q output of MM_1 operates solid-state relay K_1 through an open-collector driver. The relay connects the video input to the selected video terminal.

Flip-flop controls signal cutoff

The period of MM_1 could be set more precisely—to open K_1 in step with the vertical sync of video-source A. However, use of the clear function of MM_1 , plus some digital circuitry, does a

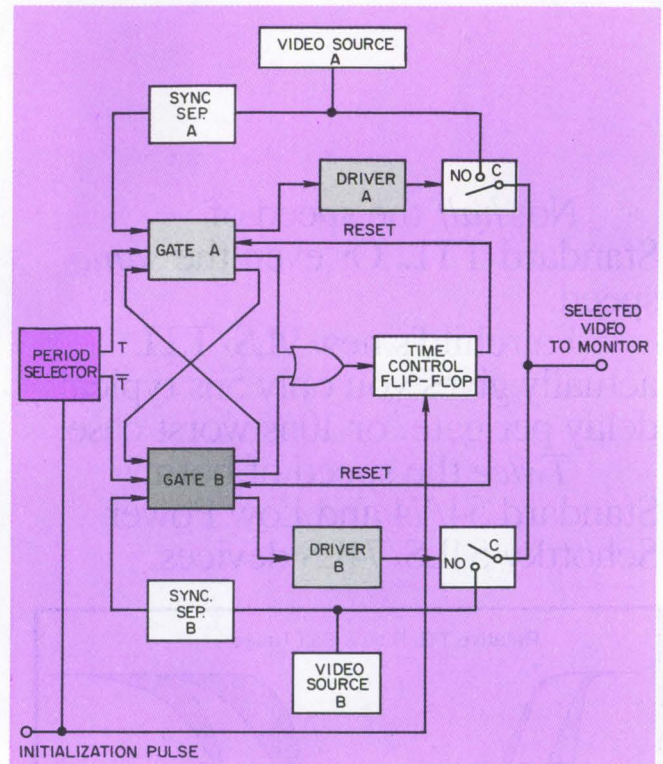

1. Video-multiplexer system multiplexes two video sources synchronously with their vertical sync periods for a glitch-free TV monitor presentation.

better job. The Q output of the flip-flop, when high, enables MM_1 and one input to G_3 . The second input to G_3 , waveform H, is enabled during the vertical-sync intervals of video-source A. The output of G_3 is a sync train of opposite polarity to waveform E, but is of greater duration (Fig. 3).

The combination of waveforms E and H at G_5 causes the output of G_5 to remain high until the appearance of the first video-A sync pulse that lies outside the timing interval set by waveform D. At this point there is no signal at E to cancel the signal at H, and G_5 will be enabled. The output of G_5 , waveform J, is fed to a dual input OR gate, G_7 . And the output, K, clocks the flip-flop, in turn.

When clocked, the flip-flop changes state and causes MM_1 to be reset. Thus the viewing period for video-source A ends. The state change also

George J. Yates, Senior Electronics Technician, University of California, Los Alamos Scientific Laboratory, P.O. Box 1663, Los Alamos, N.M. 87544.

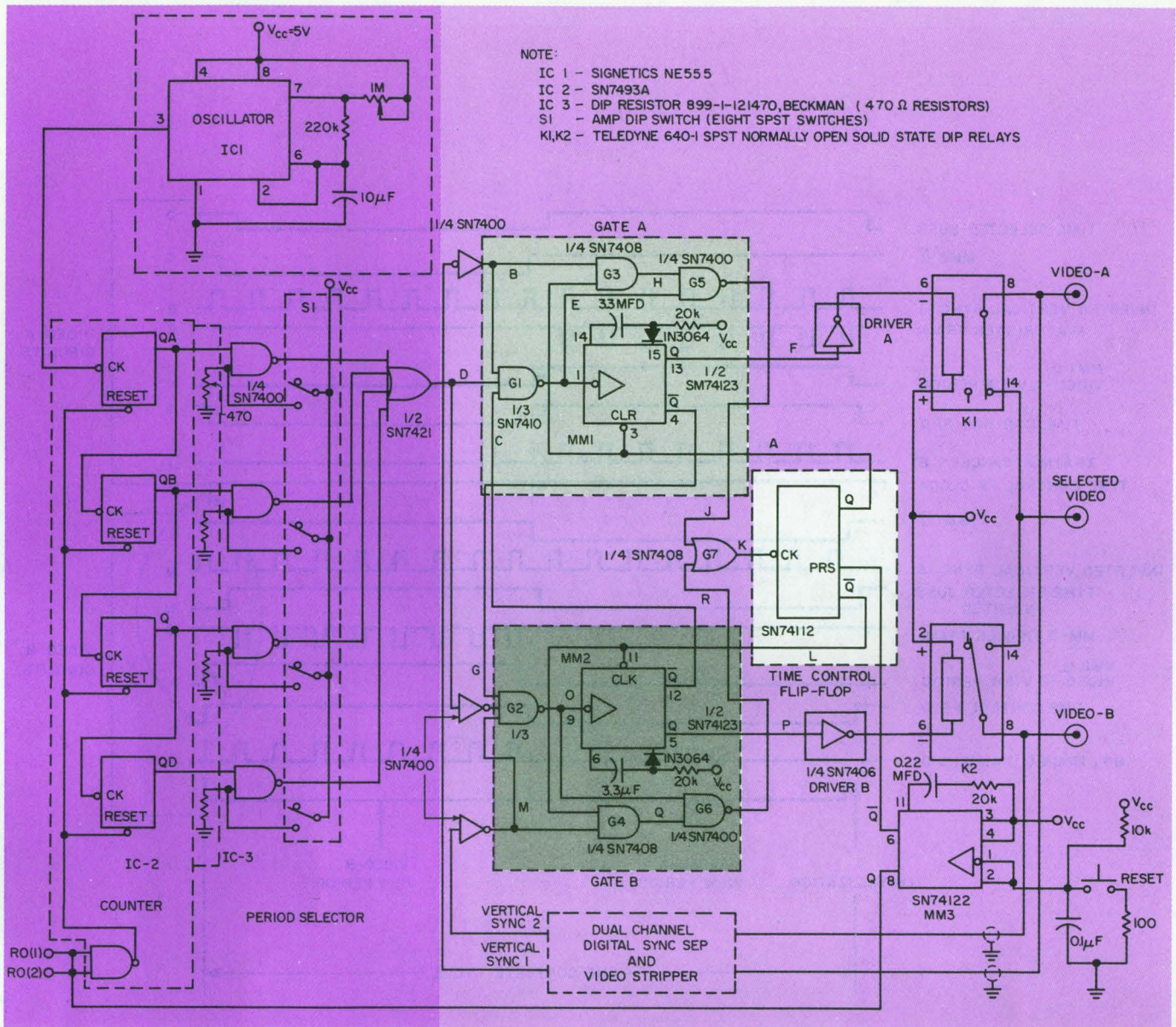

2. Signals from the timing section, point D, plus vertical sync pulses, gate the video source to the output terminal. The time-control flip-flop cuts the signal off

causes G_3 to be disabled so train H is cut off.

With MM_1 reset, input G to gate G_2 is enabled. The second input to G_2 was enabled when the counter changed state (waveform N). The third input to G_2 is enabled during the sync intervals of video-source B. Then relay K_2 is closed so video-source B is selected, since MM_2 is now enabled and provides the necessary drive to the inverter.

During the switchover interval between the two video channels, a gap is created during which no video is presented to the monitors. Most standard TV monitors use integration techniques to generate the vertical sync pulses, which, in turn, are used to initiate the vertical-flyback interval. The gap leaves the integrator in its charged state, which creates a longer-than-normal vertical sync pulse.

The \bar{Q} outputs of MM_1 and MM_2 assure that G_1

at the start of the first vertical sync period that follows timer cutoff. Successive sync pulses retrigger MM_1 and MM_2 to activate the respective relay.

and G_2 cannot be enabled simultaneously. The solid-state relay's response time is typically 10 μ s. Thus it introduces no observable switching transients.

Glitches at the output of G_5 may occur, if waveforms E and H are not exactly in time phase and opposite in polarity. Remedies for this situation include RC or LC filtering, as well as adjustment of the propagation delay.

Viewing time is manually selectable

The waveforms that drive the time-selection flip-flop are ORed, so that the flip-flop changes state when the first vertical sync pulse of either video channel is encountered after the preselected time interval. The time interval is generated by the NE555 timer, which is connected as an astable circuit that oscillates at a frequency of

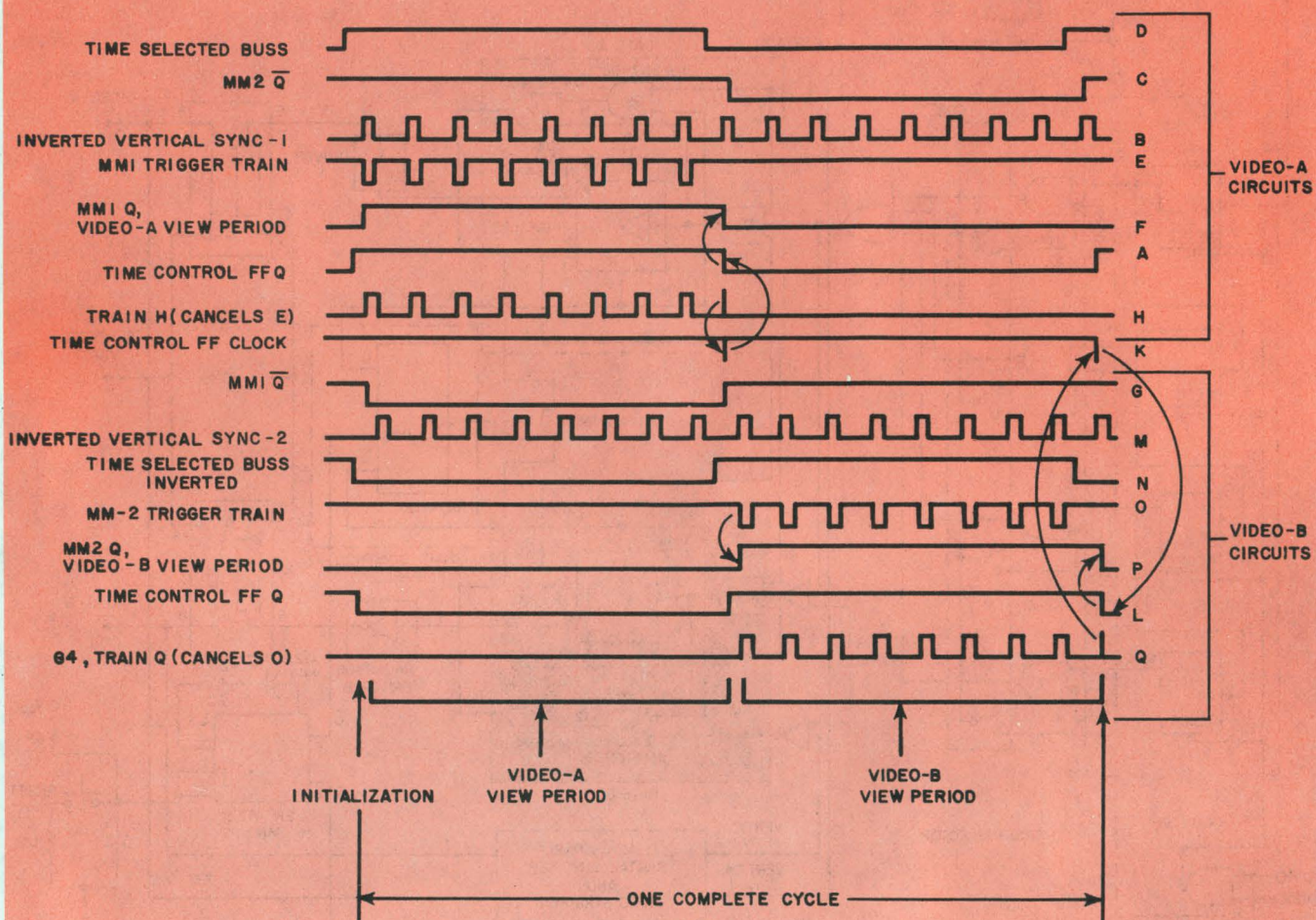

NOTE: ARROWS INDICATE ORDER OF WAVEFORM INITIATION

3. The presence of waveforms C, B and D at G_1 triggers MM_1 to operate relay K_1 . When signals E and H no longer cancel, a pulse is generated to clock the flip-flop.

Thus the viewing interval ends on the first channel. Similar events occur in the second channel during the opposite state of the timer signal.

1/6 Hz.

A 4-bit binary counter subdivides the oscillator frequency by two at Q_A , four at Q_B , eight at Q_C and 16 at Q_D . The user closes one of four switches, S_A to S_D , to select a viewing time that ranges from 6 s to 2.5 min. with the components shown. Change the timing components of IC_1 if different viewing periods are desired.

The sync separators shown are described in an Idea for Design by the author, "Digital Non-integration Method Boosts Response Time of Vertical Sync Separator" (ED No. 19, Sept. 14, 1972, pp. 156-157). ■■

Acknowledgement

This article describes work performed under the auspices of the U.S. Atomic Energy Commission, Contract W-7405-ENG. 36.

this is one of the two best 5½ digit multimeters ever made . . .

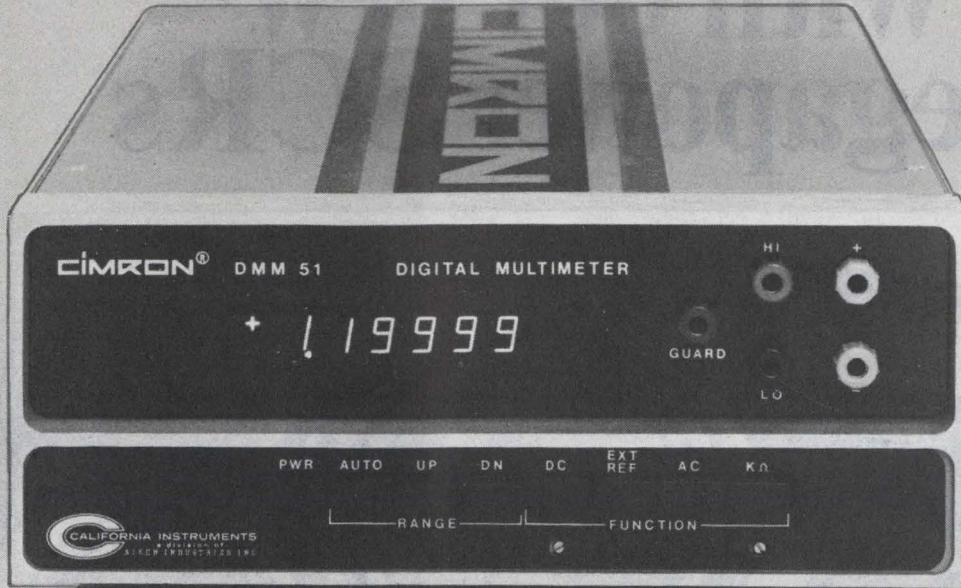

DMM-51
\$795

Compare the price/performance features of the DMM-51 with units offered by the other big three DMM manufacturers. No other 5½-digit multimeter that's anywhere near the price of the DMM-51, provides the wide choice of functions available on this, the lowest cost, autoranging, 5½-digit meter on the market.

The basic unit measures DC volts and DC/DC 3-wire ratios with 1 μ volt sensitivity. To this you can add your choice of: resistance to 1 milliohm and AC volts—choice of averaging or true RMS; 4-wire bipolar ratio; AC and DC current; high voltage DC to 30 KV; and fully isolated data outputs. And, you can buy them with the DMM-51 or add them later.

and **CIMRON** makes the other one, too.



DMM-50
\$1195

The world's finest 5½-digit systems multimeter combines all the features and functional capability of the DMM-51 . . . plus the unique Saint Logic A/D conversion technique affording high speed, high accuracy measurements even when measuring extremely noisy inputs. When equipped with the Data Output/Remote Control option, data is available in both parallel and serial-character format. The DMM-50 is the ideal systems DMM whether you're interfacing to a computer or a printer. It's also available with directly compatible interfaces which eliminate the cost of changing software and cabling, and provide you with a second source if you're already committed to a competitive DMM.

For complete details, call or write:



5150 CONVOY ST. • SAN DIEGO, CA 92111 • (714) 279-8620

FOR DMM 50, CIRCLE 206

FOR DMM 51, CIRCLE 207

Open a Savings Account with our new megapower SCRs



When you invest in IR's new Megapower SCR Family Savings Plan you start earning dividends three important ways.

First, you can eliminate over 70% of the devices and parts normally needed (see the 3-phase converter "savings account" below for full details). That gives you a lower total system cost, plus more reliability.

Second, having fewer parts cuts assembly time sharply, increases reliability and makes your field servicing that much easier, too.

Third, Megapower SCRs give you more production power with only a minimum change in your equipment size.

If you want to parallel Megapower SCRs, there's a special bonus. Our epitaxial process

yields SCRs of virtually identical switching characteristics, so you eliminate expensive current balancing equipment. It also produces the high voltage SCRs you need. Specifically: 700A(av), 500 to 2100V; 850A(av), 500 to 2000V; 1000A(av), 500 to 1500V, and 1600A(av), 500 to 1200V.

There is also an extra dividend in overall productivity because Megapower SCRs will keep your equipment on line longer. Their surge capability is so high, they can ride through massive overloads without resorting to protective fuses.

Open a savings account today. Call your IR branch office, or bank headquarters (213) 678-6281; Telex: 67-4666. International Rectifier, 233 Kansas Street, El Segundo, CA.

IR'S 4800 Amp, 3-PHASE CONVERTER SAVINGS ACCOUNT

Parts Per Assembly	4800A Assy. Using 3-550A SCRs Per Leg	4800A Assy. Using 1-1600A SCR Per Leg	Parts Saved Per Assy.
1. SCRs	18	6	12
2. Heat Sinks	21	9	12
3. Clamps	18	6	12
4. Fuses	18	6	12
5. Balancing Reactors	18	0	18
6. Trigger Pulse Pwr. Amplifiers	6	0	6
7. Isolated Gate Drive Windings	18	6	12
Totals	117	33	84

International Rectifier

International Rectifier, 233 Kansas Street, El Segundo, CA 90245. ... *the innovative power people*



INFORMATION RETRIEVAL NUMBER 55

"Augat's interconnection system appeared to have more advantages for use in the AN/TPX-42A Air Traffic Control System.

"Our extensive testing confirmed it."

Robert A. Mesard, Group Leader
Transportation Systems Division
A.I.L. Division of Cutler Hammer.

"When work began on the AN/TPX-42A, we started looking for an interconnection system that offered high reliability and design flexibility, without sacrificing lower initial costs or low field maintenance.

"Our program staff ran detailed reliability and cost analyses of the four basic interconnection systems under consideration: P.C. boards, multi-layering, welded wire-stitching, and wire-wrapped plug-in panels.

"The system meeting all of our requirements was wire-wrapped plug-in panels. We compared several manufacturers of socket panels and selected the Augat panel based on overall quality, range of products, and their willingness to respond to our needs.

"Our findings were incorporated into our proposal to the Air Force. But as the wire-wrapped plug-in panel concept was comparatively untried in U.S.A.F. equipment, they requested additional testing. So we ran a series of in-depth reliability and stability studies and tests as part of our systems qualification and reliability demonstration program.

"After 13,200 test hours, we

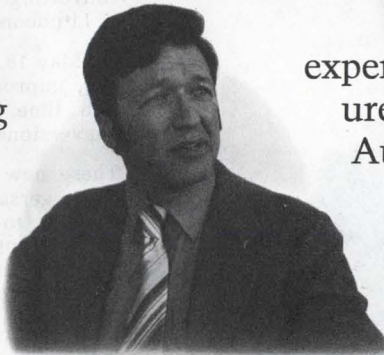

Robert A. Mesard

experienced no mechanical failure or intermittence with the Augat system.

"Electronic Systems Division of U.S.A.F. accepted these findings and approved the Augat system.

"We now have used substantial production quantities of Augat panels without a single contact failure."

Augat first pioneered the socket-panel concept in 1965, and the exclusive precision-machined tapered-entry contact has made Augat the reliability standard for the plug-in interconnection industry.

A.I.L.'s record of not a single contact failure is one of the reasons why Augat supplies more panels than all other manufacturers combined.

As the world's leading manufacturer of wire-wrapped panels and other IC interconnection products, Augat is ready and willing to help with all your interconnection requirements.

Call or write today for free brochure and complete product information. Augat, Inc., 33 Perry Ave., Attleboro, Mass. 02703. Represented and distributed internationally.

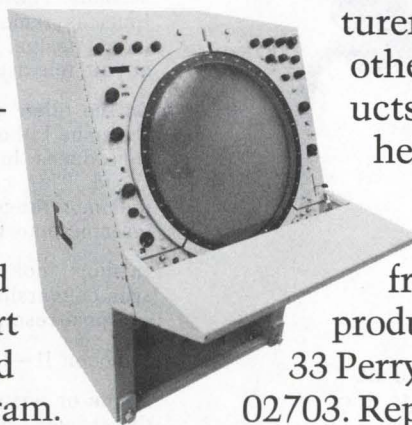

The AN/TPX-42A

"See us at Nepcon East, Booth No. 4332"

AUGAT®

INFORMATION RETRIEVAL NUMBER 56

Europe — Augat International, Inc., Boulevard A. Reyers, 103, 1040 Brussels, Belgium, Tel. (02) 36-93-99.
Japan — Kyokuto Boeki Kaisha Ltd., New Otemachi Bldg., 2-1, 2-Chome Otemachi, Chiyoda-Ku, Tokyo 100-91, Japan, Tel. (03) 244-3788.

“On May 16, 1974 every scan conversion system in the world becomes obsolete.”



—Dr. Steven R. Hofstein, President,
Princeton Electronic Products, Inc.

The second revolution in image storage technology begins with the advent of the Lithocon® II.

The first revolution began five years ago when our company introduced the Lithocon silicon storage tube—the first practical electronic medium for storing, processing and scan-converting electronic images. These advances culminate in Lithocon II.

On May 16, 1974, you can see CRT displays with extraordinary improvements in image fidelity, gray scale and retention time, using Lithocon II Scan Converters or scan conversions by our new Lithocon II systems.

These new performance levels make Lithocon II systems more versatile. They extend the use of low-cost image systems to new and more demanding image processing applications. Indeed, no matter what your application may be, look first to the Lithocon II storage tube for your imaging technology.

Like electronic “photograph”. You won't believe you're looking at a picture from an image storage tube. It will have the gray scale, the dynamic range, that you would normally expect from a high-resolution video camera. A picture so smooth, so uniform, that visitors who have seen prototypes in our laboratory have said, “It looks like a photograph.”

This electronic “photograph,” however, can be erased and re-used through thousands of video “exposures” without damage or deterioration.

No other technology approaches Lithocon II systems in performance, or in answering so wide a range of application requirements. For example, in medical, diagnostic and clinical environments, the doctor can count on consistent, reproducible X-ray, ultrasonic or nuclear camera images, reproduced by the Lithocon II's wide dynamic range (64 gray levels) and high resolution. These same features make practicable X-ray baggage inspection at airports.

With Lithocon II's unique features, you no longer have to make a trade-off between editing speed, retention time and erase speed. Our new Lithocon II system lets you have over two hours storage time with the ability to store TV images, and still get single-frame erase—full screen in 33 milliseconds. These are the features you need for such applications as remote industrial process monitoring, computer-aided design, medical electronics and cable and closed-circuit television systems.

At the other end of the scale, for slow-scan applications, the same Lithocon II system is operated in a manner which reproduces high quality images independent of writing speed. This capability comes at no cost to the user in dynamic range, erase time (33 msec.) or retention time (greater than two hours).

In short, look to Lithocon II for your low-cost, high-quality scan conversion. With a guaranteed long life cycle. And the sharpest resolution available today.

Lithocon II—for stored images that don't look stored.

Phone or write us today about your application. We'll put the answer right before your eyes.



PRINCETON ELECTRONIC PRODUCTS, INC.

P.O. Box 101, North Brunswick, New Jersey 08902
(201) 297-4448

REI has one question for people who buy electronic test equipment.

Why?

When you need it fast . . . rent it. Purchasing equipment usually involves long delivery lead times. When you rent your electronic equipment from REI it's a safe bet that you can get what you need within 36 hours of the time you call in your order, sometimes sooner. This fast service is possible because we maintain 9 Instant Inventory Centers throughout the U.S. and Canada, stocking millions of dollars worth of equipment.

When you need it for only a short time . . . rent it. Need equipment for a short-term project? Rent it from REI. When you don't need it any more, return it to us. It's the easy, low-cost way to use the equipment you need for just the time that you need it.

When you care about what it costs . . . rent it. Renting from REI can be less expensive than purchasing. There's no capital investment to adversely affect your company's cash flow. This means you'll get more mileage from your equipment budget. And, since you can treat your monthly payments as an expense in most situations, you'll also achieve tax advantages from renting.

All REI rental equipment is guaranteed to meet manufacturers' specifications and is operationally checked out prior to shipment. Routine maintenance is provided free of charge. Certification and calibration are available upon request. Our flexible arrangements include rental, rental-purchase and leasing packages to give you the use of equipment from one week to three years or more.

Get your free copy of our 1974 catalog that lists virtually every item in our rental inventory. Use reader service card, or write Rental Electronics, Inc., 99 Hartwell Ave., Lexington, MA 02173. For immediate information, call your local REI Instant Inventory Center listed below. Once you rent from REI, you may never buy electronic test equipment again.

Rental Electronics, Inc.

A PEPSICO LEASING COMPANY

Burlington, MA (617) 273-2770 • Gaithersburg, MD (301) 948-0620 • Oakland, NJ (201) 337-3757 • Ft. Lauderdale, FL (305) 771-3500
Des Plaines, IL (312) 827-6670 • Dallas, TX (214) 661-8082 • Mountain View, CA (415) 968-8845 • Anaheim, CA (714) 879-0561
Rexdale, Ontario (PLC Leasing Ltd.) (416) 677-7513



Think about renting. It's the smart way to go.

Let the engineers run the company, not the other way around, and both will profit. Executive tells how he gets creative engineering by sacrificing 'textbook' efficiency.

Few people on the job have enough drive to decide for themselves what they ought to be doing in a company. Most want to be told. Our company is run for the few who want to decide for themselves.

We have no formal company structure. We allow those with the most incentive and creativity to lead the company, instead of organizing the company to direct the least aggressive employees.

Our philosophy has proved—to our satisfaction, at least—that keeping competent engineers is not too difficult if a company is willing to sacrifice conventional notions of efficiency for motivation.

The idea that people work because it's their duty, even if they don't like what they're doing, is one definition of the work ethic. The biggest challenge that workers had in the 20s, 30s, 40s and 50s was to see how efficient they could be. Today that's not enough to hold a man to his job; he must be motivated to stay.

Three years ago Teradyne decided that individual motivation was more important than the textbook definition of company efficiency. We split up the company into small groups; that's less efficient, on the surface, but we felt it might add to the general motivation to create ideas and projects, and so be worthwhile.

The number of successful products we've created since then has been very high, compared with the previous three years when we had one engineering organization controlled by one or two men. The system is working for the company as well as the individual.

Accommodating the go-getters

Our philosophy is that a creative individual's objectives are likely to center on freedom of action, a sense of personal involvement in an interesting task and the sharing of any success he helps to bring about. So we ensure freedom

Alexander V. d'Arbeloff, President, Teradyne, Inc., Boston, Mass. 02111.

Alexander V. d'Arbeloff

Alex d'Arbeloff is President of Teradyne, Inc., a manufacturer of automatic test equipment founded by him and his partner, Nick DeWolf, in 1960. From its two-man beginning Teradyne has grown to an international company with annual sales of over \$40-million and one of the world's leading suppliers of computer-controlled test systems for the electronics industry.

After graduating from M.I.T. in 1949 with a B.S. in Business and Engineering Administration, and after a term of military duty, Mr. d'Arbeloff joined Benrus Watch Company, where he was involved in manufacturing and quality control. In 1956 he joined National Research Corporation in production control, and in 1957 he joined Artisan Metal Products Corporation, where he became manager of the Hi-Speed Equipment Division.

Mr. d'Arbeloff lives in Brookline, Massachusetts, with his wife Brit and their four children.

to action by introducing the supervisory and sales
personnel staffs surrounding him. He believed the
sense of personal involvement by bringing them
into the most direct contact with our customers
problems. And we treated the creative and technical
people who work best alone—those who created the
person who works best through others.
Of course, the challenge to the company man-
agement is to coordinate a variety of creative
talents—both technical and non-technical—to solve
our customers' problems. It's absolutely essen-
tial that the objectives of our employees be in har-
mony with the overall company objectives. That's

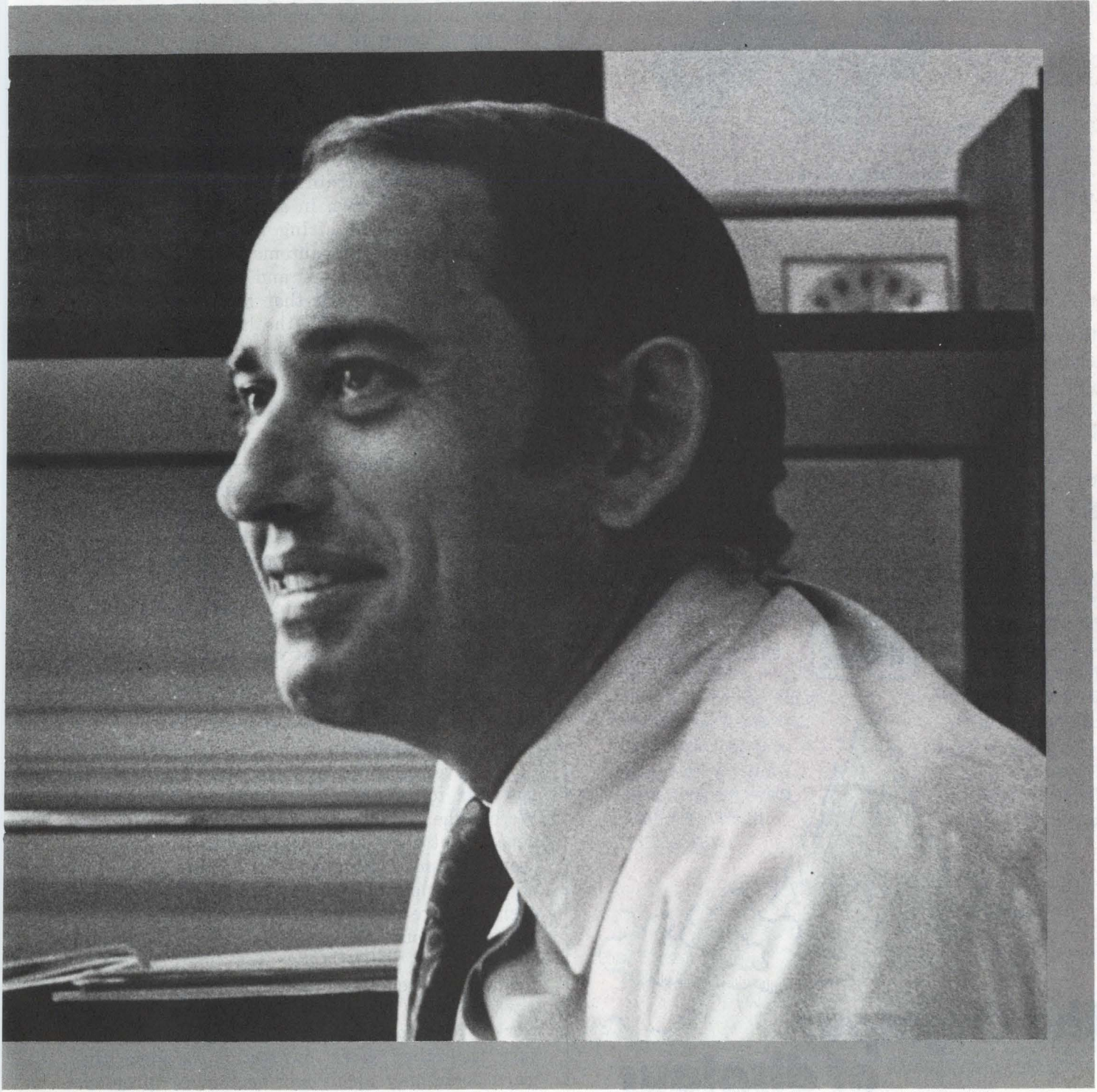

IEE-HERCULES™

LIGHT EMITTING DIODE DISPLAYS

- Slim profile, single plane, DIP packaged
- Character & color versatile • Code & logic compatible (with self-contained options) • Easily readable over wide angles • Durably designed for minimum power & low cost per digit • Simply installed with IEE-ATLAS Universal Mounting Hardware

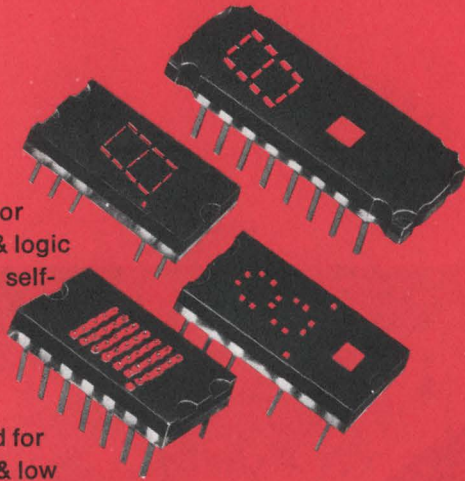

For your every man/machine interface requirement, IEE has a solution. From "the Olympus of Displays," the world's most diversified selection of display products, technologies, and design expertise, IEE offers you your choice of: • Multiple Message Displays -- rear projection; annunciators; mini-CRT's • Dynamic Message Displays -- 64 & 256 character, dot matrix panels • Numeric & A/N Displays -- line filament; neon; transilluminated;

LED's (with integrated electronics); liquid crystals; gas discharge; fibre-optics • Subminiature Lamps -- LED & incandescent • Low Profile Switches -- completely sealed, illuminated, custom arrays • Peripheral Accessories -- universal mounting hardware; bezels; interface circuitry • Customized Products & Multi-Function Systems.



Never has so much been available to so many from a single source. Hadn't you better write or call today for your copy of IEE's Product Selector?

the Olympus of displays

Industrial Electronics Engineers, Inc.
7740 Lemona Ave., Van Nuys, Calif. 91405
Phone: (213) 787-0311

European Office: 6707 Schifferstadt, Eichendorff-Allee 19, Germany.

of action by minimizing the supervisory and supporting staffs surrounding him. We heighten his sense of personal involvement by bringing him into the most direct contact with our customers' problems. And we reward the creative individual who works best alone no less than we reward the person who works best through others.

Of course, the challenge to the company management is to coordinate a variety of creative talents—both technical and nontechnical—to solve our customers' problems. It's absolutely essential that the objectives of our employees be in harmony with the over-all company objective. That's a key point in deciding what an individual's project is going to be.

Allocating jobs to please people and to keep the company progressing has not been difficult. So far, we've always been able to accommodate the go-getters.

To make our small engineering-group system work, we have to train new graduate engineers to work on their own in about a year. We don't have much trouble hiring good engineers. The business we're in—automatic measurements, high-speed measurement and automatic controls—is the kind of work that most engineers are attracted to because it's the latest and the most exciting area of electronics.

Graduates learn to 'solo'

About 20% of the people we hire are recommended by engineers who knew them in school. We hire some through a summer program we run; we employ bright undergraduates for part-time work and hire some when they graduate. We also run a co-op program with engineering schools.

One of the problems, of course, in hiring a lot of young engineers is that they haven't seen the engineering alternatives. But the one big advantage we do have in breaking in students is that we don't have a lot of guys with habits they've picked up in other places.

In our work, design is only a small percentage of the over-all problem; we also have to find out what to design, and that takes a lot of time. We put the new engineers to work in our testing department for the first few months. This lets them find out a lot about the company, how we do things and what kind of mistakes the present designers are making. At the same time the recruits find out how to get things done in the company.

These new engineers work in applications for a while before trying their hand at design. They work with programming devices, and we make sure that they work on testers because they learn something about our customers' problems when they test equipment.

Engineering applications work gives the engineers some personal contact with the customer and what his needs are. Here the engineer has a chance to get direct feedback from the user of equipment instead of having it filtered through management or marketing.

After a year or so, these engineers might start designing products. We try to unite new people with skills in engineering and new people with skills in marketing to see if, by joint action, they can get a product under way.

Each project that our company undertakes should lay the foundation for the next. Therefore the human and financial resources committed to any project must not only generate the answers to the customers' specific problems but must also add to the skills and competence available for future customers. Only in this way can we accommodate the go-getters.

Freedom viewed as promotion

In small engineering groups, like those at our company, the designer does his own support work, which cuts costs and increases the company's over-all chances for success. Some designers would like to draw little circle diagrams on paper, drop the paper into a hopper and get a working product a day later. That's not realistic, because it would cost too much. If the product costs a lot of money, the freedom of the engineer to work out his own idea becomes much more limited.

For example, if I had an idea for a modified 747, I'm sure that the Boeing Co. would have to get approval from its president, board of directors and everybody else down the line before anything could get done. On the other hand, if I had something that I could do totally by myself, it would be pretty easy to get approval, because all I'm risking is my own salary.

Electronics is the kind of industry where prototypes can be built inexpensively. All you need is the basic packaging system. It's better if engineers do much of their own work, because they'll likely come up with more of their own ideas, and this, in turn, will give the company more products.

The engineer is better off, too, under this arrangement because he'll have much more freedom. And freedom is one of his rewards. Money is the other, of course. It's sheer hypocrisy for a company to tell you how good you are but fail to pay you accordingly.

As between the two rewards, though, I think freedom is more important—freedom to determine what you work on instead of being told. The engineer with this freedom is really his own boss. You don't have to manage people to have freedom of decision. ■■

IEE-AURORA™

INCANDESCENT FLATPACK DIGITAL DISPLAYS

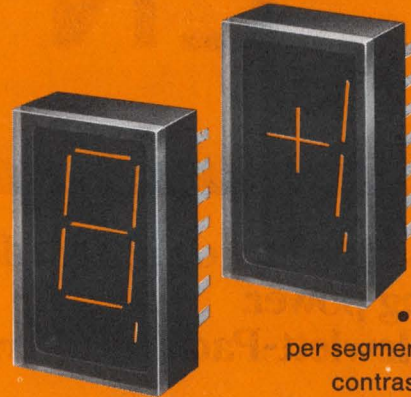

- Choice of 1/2" or 5/8" high, 7 segment characters • 4,500 F/L of "morning dawn" brightness
- Low power -- 15 MA per segment @ 5 VDC • Sharp contrast and excellent, 120° readability in high ambient/sun lighting
- Convenient slim profile, standard DIP packaging • 100,000 Hours average life

From the very beginnings of information display, IEE has been a leader in the innovative design, successful introduction, reliable manufacture, condensed packaging, and effective application of high quality, display devices and integrated systems for commercial, industrial and military use. Based on two decades of experience, and a dedication to quality, IEE today offers: • the world's most diversified selection of display products • the design, human

factors, and systems integration expertise to fulfill your most sophisticated requirements • the pricing, product availability, and productive capacity to meet your most demanding schedules • and the ingenuity and sincere desire to help solve your most complex display problems. In-



formation Display is OUR business; why not contact the experts for YOUR solutions? Call or write today for information regarding introductory offers on prototype evaluation quantities of many of IEE's display products

the Olympus of displays

Industrial Electronics Engineers, Inc.
7740 Lemona Ave., Van Nuys, Calif. 91405
Phone: (213) 787-0311

European Office: 6707 Schifferstadt, Eichendorff-Allee 19, Germany.

ENTER ↑

This is your key to unprecedented calculating power. Only Hewlett-Packard offers it.

In 1928 a Polish mathematician, Dr. Jan Lukasiewicz, invented a parenthesis-free but unambiguous language. As it's evolved over the years it's come to be known as Reverse Polish Notation (RPN), and it's become a standard language of computer science.

Today, it's the only language that allows you to "speak" with total consistency to a pocket-sized calculator. And the only pocket-sized calculators that use it are Hewlett-Packard's.

ENTER↑ is the key to RPN because it enables you to load data into a 4-Register Operational Stack with the following consequences:

1. You can *a/ways* enter data the same way, i.e. from left to right, the natural way to read any expression.
2. You can *a/ways* proceed through your problem the same way. Once you've entered a number you ask: "Can I operate?" If yes, you perform the operation. If no, you press **ENTER↑** and key in the next number.
3. You can see *all* intermediate data anytime, so you can check the progress of your calculations *as you go*.
4. You almost never have to re-enter intermediate answers—a real time-saver, especially when your data have eight or nine digits each.
5. You don't have to think your problem all the way through beforehand to determine the best method of approach.
6. You can easily recover from errors since each operation is performed sequentially, immediately after pressing the appropriate key, and all data stored in the calculator can be easily reviewed.
7. You can communicate with your calculator efficiently, consistently and without ambiguity. You always proceed one way, no matter what the problem.

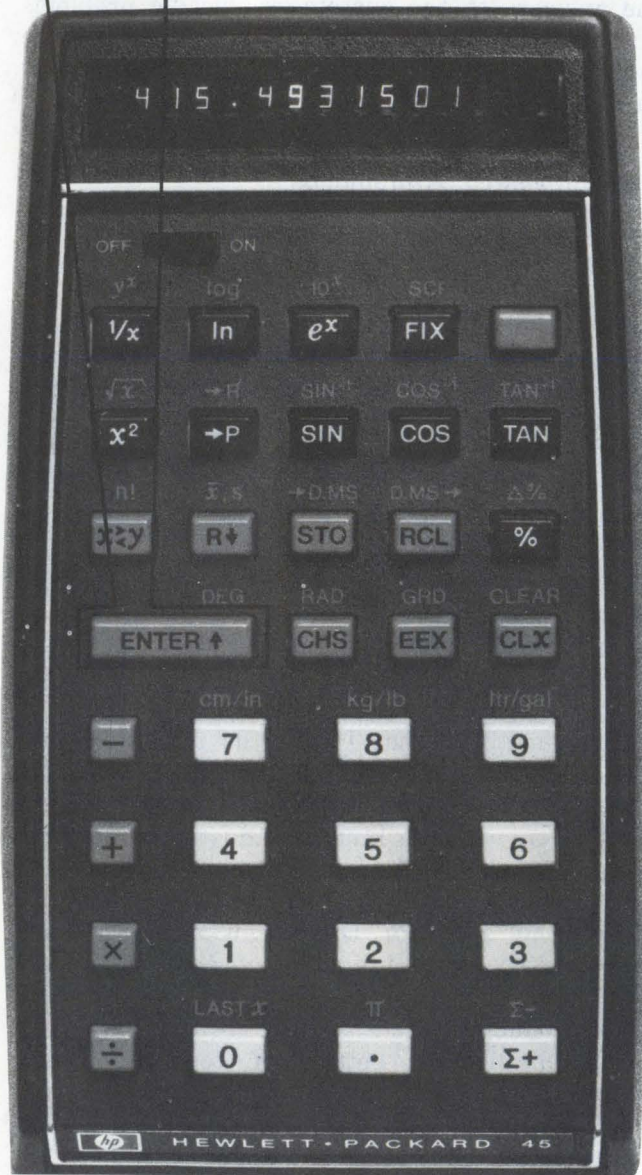

The HP-45 uses RPN.

That's one reason it's the most powerful pre-programmed pocket-sized scientific calculator. Here are 8 others:

1. It's pre-programmed to handle 44 arithmetic, trigonometric and logarithmic functions and data manipulation operations beyond the basic four (+, -, ×, ÷).

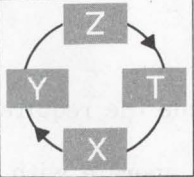
2.  It offers a 4-Register Operational Stack that saves intermediate answers and automatically retrieves them when they are required in the calculation.

3.  It lets you store up to nine separate constants in its nine Addressable Memory Registers.

4. It gives you a "Last X" Register for error correction or multiple operations on the same number. If you get stuck midway through a problem, you can use the "Last X" Register to unravel what you've done.

5.  It displays up to 10 significant digits in either fixed-decimal or scientific notation and automatically positions the decimal point throughout its 200-decade range.

6.  It converts angles to degrees/minutes/seconds. In seconds.

7.  It converts polar coordinates to rectangular coordinates... or vice-versa. In seconds.

8.  Its Gold "Shift" Key doubles the functions of 24 keys which increases the HP-45's capability without increasing its size.

The HP-35 uses RPN too.

If the HP-45 is the world's most powerful pre-programmed pocket-sized scientific calculator, the HP-35 is runner-up. It handles 22 functions, has a 4-Register Stack, one Addressable Memory Register and also displays up to 10 digits in either fixed-decimal or scientific notation.

*Domestic U.S.A. prices, not including applicable state and local taxes.

New low prices.



HP-45: \$325*

HP-35: \$225*

Now the exceptional value of these exceptional instruments is even more apparent, because we've cut their prices by \$70*. You can now own the world's most powerful pocket-sized pre-programmed scientific calculator, the HP-45, for only \$325*. The HP-35 now costs just \$225*.

Send for our booklet "ENTER vs. EQUALS."

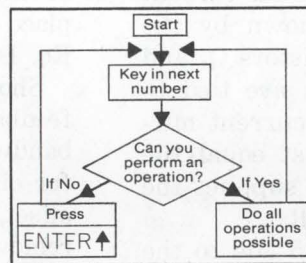

It demonstrates the superiority of Dr. Lukasiewicz' language by comparing it to other calculators' systems on a problem-by-problem basis, and it explains the algorithm shown left which lets you evaluate any expression on a calculator that uses RPN and an Operational Stack. This booklet is must read-

ing for anyone seriously interested in owning a powerful pocket-sized calculator.

The coupon gets you detailed specifications of either the HP-45 or the HP-35 plus the booklet.

Just check what you want and send it along. We'll get your information back to you by return mail.

Hewlett-Packard makes the most advanced pocket-sized computer calculators in the world.



Sales and service from 172 offices in 65 countries.
Dept. 232G 19310 Pruneridge Ave., Cupertino, CA 95014.

614/10

Hewlett-Packard
Dept. 232G
19310 Pruneridge Avenue
Cupertino, CA 95014

- Please send the booklet, "ENTER vs. EQUALS":
- Detailed specifications on your HP-35.
 - Detailed specifications on your HP-45.
 - HP-35(s) at \$225* each plus state and local taxes. (Check enclosed.)
 - HP-45(s) at \$325* each plus state and local taxes. (Check enclosed.)

Name _____

Company _____

Street _____

City _____ State _____ Zip _____

Op amp in current-differencing mode becomes a noninverting audio mixer

Uncompensated op amps of the 101/748 family can be operated in a current-differencing mode, which allows their use as noninverting summers (mixers) for audio applications.

The scheme makes use of the internal current mirror and the output stage, as shown by the simplified schematic (Fig. 1). Transistors Q_1 and Q_2 are cut off, because their inputs are tied to V^- . Since Q_5 , Q_6 and Q_7 make up a current mirror, current flow I_f through Q_6 must equal the reference input, I_b . The output stage supplies the necessary current through resistor R_f .

Ac signal currents applied to pin 5 add to the dc bias (Fig. 2). For a mirror transfer gain of unity and linear combination of the currents, the resulting output voltage e_o is proportional to the product of R_f and the composite signal current, so that

$$e_o = e_1 \frac{R_f}{R_1} + e_2 \frac{R_f}{R_2} \quad (1)$$

Choose R_b to provide a suitable reference bias current, I_b , from

$$R_b = \frac{V_{CC} - 2V_{BE}}{I_b} \quad (2)$$

The value used, 300 k Ω , provides a 100- μ A bias. For circuit operation from a single-ended supply (Fig. 2a), make R_f one half the value of

R_b . Choose R_1, R_2, \dots, R_n to provide the required signal gains.

With $R_f = R_b$, the circuit will operate with a split power supply (Fig. 2b). The absolute value of the negative supply voltage, V^- , is used in place of V_{CC} in Eq. 2 to compute the value of R_b . Eq. 1 still applies for gain calculations.

Short lead lengths to pin 5 prevent parasitic feedback from the output. Adjust the circuit bandwidth with C_c . However, C_c is not necessary for circuit stability. Trim R_b for zero output dc offset, if desired, or use a blocking capacitor to remove the dc component.

Walter G. Jung, 1946 Pleasantville Rd., Forest Hill, Md. 21050.

CIRCLE No. 311

Reference

Fredericksen, et al, "The LM 3900—A New Current-Differencing Quad of \pm Input Amplifiers," National Semiconductor Corp., AN-72, September, 1972.

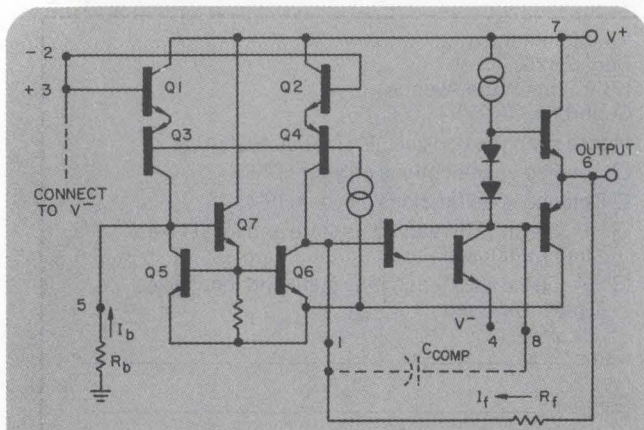

1. These connections convert 101/748 op amps to current-differencing mode amplifiers. Node 5 provides noninverting summation of ac signals.

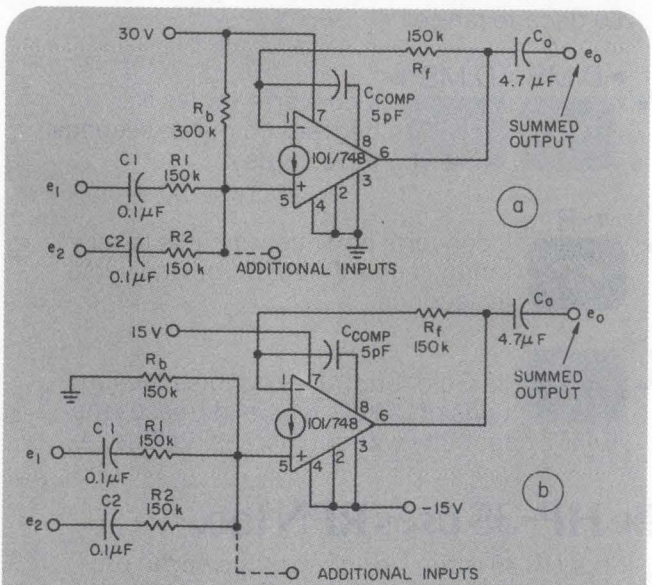

2. Practical noninverting summers operate from single (a) or split (b) power supplies. Coupling capacitors C_1, C_2, \dots, C_n , in conjunction with their respective input resistors, determine the 3-dB, low-frequency cut off point.

A new 310-Type 3. Made to take a fall.

The rugged new "drop-resistant," hand size Triplet Model 310, Type 3 is priced at just \$48.

The latest addition to the rugged Triplet 310, general purpose, multi-range V-O-M family—the Model 310, Type 3—has impressive new features. Its case is made of nearly-indestructible thermoplastic ABS and the clear front material is a high impact-resistant polycarbonate thermoplastic. The low Ohms range Rx1 has been fused to protect against damaging overloads. These two improvements should eliminate over half of all repair requirements resulting from field use damage.

But that's not all. The case of the new Triplet 310, Type 3 sports an elegant new non-slip "finger-tread" surface finish. The meter movement brackets and pointer feature a new rugged design as well as newly designed lead jacks and Model 10 jack. Added to this, the front range and tester dial markings are changed to read easier when used with Triplet's Model 10 Clamp-on-Ammeter.

Outstanding features:

1. Drop-resistant, hand size V-O-M with high impact thermoplastic case.
2. 20,000 Ohms per Volt DC and 5,000 Ohms per Volt AC; diode overload protection with fused Rx1 Ohms range.

3. Single range switch; direct reading AC Amp range to facilitate clamp-on AC Ammeter usage.

The durable new 310, Type 3, self-shielded for checking in strong magnetic fields, is an extra-rugged, high-torque, bar-ring instrument with spring back jewels. An interchangeable test prod fits into the top of the tester, making it a common probe and freeing one hand. All this for only \$48.

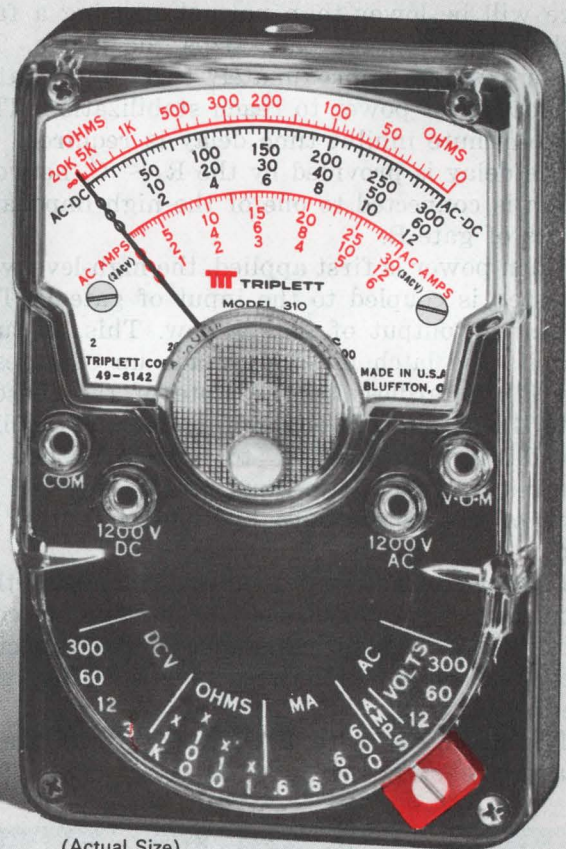

(Actual Size)

For more information or a free demonstration, call your Triplet distributor or sales representative. For the name of the representative nearest you, dial toll free (800) 645-9200. New York State, call collect (516) 294-0990. Triplet Corporation, Bluffton, Ohio 45817.

TRIPLET
ALL YOU'LL EVER NEED IN V-O-M's.

Triplet. The easy readers.

INFORMATION RETRIEVAL NUMBER 62

Audible gas alarm uses CMOS gates to provide time delays and transient protection

One CMOS IC—a quad two-input NOR gate (MC14001)—forms the nucleus of a smoke detector circuit that sounds an audible alarm. The gate provides the basic functions: a high-impedance buffered input, an inhibit time delay and a latch to trip and hold an alarm.

The sensor, a TGS-109, is an n-type semiconductor device that increases conduction in the presence of combustible gasses. But, when the sensor is unpowered for any appreciable time and power is then reapplied, the initial resistance will be lower than normal, causing a false high output voltage that trips the alarm. The sensor requires approximately two minutes after application of power to reach stabilization. Thus a two-minute inhibit time delay is required.

The delay is provided by the $R_3 - C_3$ network, which is connected to one of the high impedance inputs of gate B.

When power is first applied, the high-level voltage step is coupled to the input of gate B. This forces the output of gate B low. This, in turn, inhibits the latch flip-flop (made up of gates C and D) regardless of the state of the sensors. Gate B's output will be low for the time required for delay capacitor C_3 to charge. When C_3 charges fully, the gate input will be low and the state of the sensor output will now control the latch.

The approximately two-minute time delay thus depends on the tolerance of the timing components, the leakage resistance of the capacitor and the threshold tolerance of the CMOS gate used.

The latch, set with a ONE input to gate C, causes the output of gate D to go high. This

CMOS gate output can source approximately 0.8 mA to the base of the npn buzzer drive transistor, thus turning on the alarm and still maintaining the required high-level output to latch gate C. The latch can be reset manually by a pushbutton switch, S_1 , to turn off the alarm.

With the component values shown and the sensor powered by 100 V ac rms, a typical output voltage in fresh air would be approximately 10 V rms. In the presence of 0.1%-by-volume concentration of test gas ($I_{\text{isobutane}}$), the output voltage ranges from 30 to 50 V rms. This ac signal is rectified, filtered, and zener-diode-coupled to produce dc output voltages of approximately 0.5 V for the no-gas condition, and 15 V for the gas present condition (for a sensor output of 30 V rms), respectively.

The level-adjust potentiometer, R_1 , sets the dc output to levels compatible with the CMOS buffer NOR gate (less than approximately 1/3 of V_{DD} for a logic ZERO, and greater than 2/3 of V_{DD} for a logic ONE input).

The low-pass filter, formed by R_2 and C_2 ensures that short transient waves of smoke—from a cigarette, pipe or cigar, say—will not trip the alarm. If the smoke detectors are remote from the electronics, as in this example, the R_2 and C_2 network will filter higher-frequency noise that may be present on the long lines. The R_4 and C_4 network associated with the latch ensures that the latter will be in the proper state when power is first applied.

Al Pshaenich, Applications Engineer, Motorola Semiconductor Products Div., Phoenix, Ariz. 85008

CIRCLE NO. 312

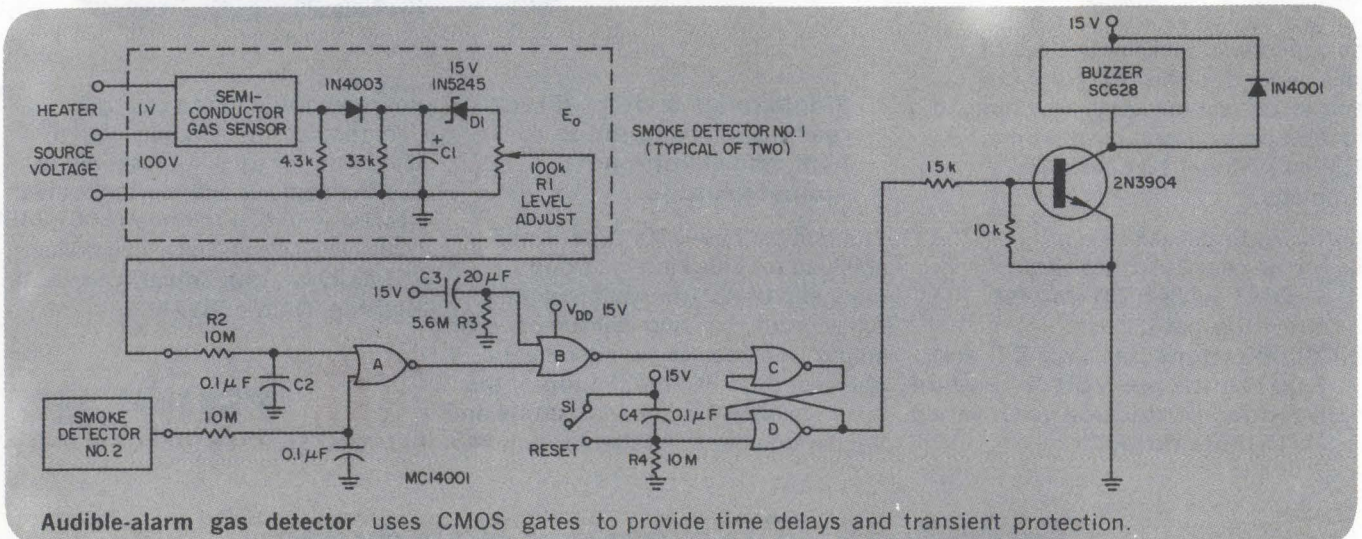

POWER FOR YOUR IC'S OR OP AMPS



5 VOLTS				±15 VOLTS			
OUTPUT CURRENT AMPS	SIZE INCHES	PRICE	MODEL	OUTPUT CURRENT AMPS	SIZE INCHES	PRICE	MODEL
.5	3.5 x 2.5 x 1.4	\$55	5EB50	.1	3.5 x 2.5 x 1.4	\$55	DB15-10
1.0	3.5 x 2.5 x 1.6	75	5EB100	.15	3.5 x 2.5 x 1.4	65	DB15-15
2.0	3.5 x 2.5 x 2.4	115	5EB200	.2	3.5 x 2.5 x 1.4	75	DB15-20
2.5	3.5 x 2.5 x 2.4	130	5EB250	.4	3.4 x 5.1 x 5.1	85	TD15-40
5.1	3.4 x 5.1 x 6.6	150	A5MT510	1.0	3.4 x 5.1 x 5.1	125	TD15-100
9.0	3.4 x 5.1 x 9.3	180	A5MT900	1.6	3.4 x 5.1 x 6.6	150	TD15-160
12.0	3.4 x 5.1 x 13.3	200	A5MT1200	2.5	3.4 x 5.1 x 9.3	160	TD15-250
22.0	5.1 x 7.4 x 11.3	270	A5HT2200	4.5	3.4 x 5.1 x 13.3	225	TD15-450
32.0	5.1 x 7.4 x 16.0	320	A5HT3200	8.5	5.1 x 7.4 x 11.3	299	TD15-850

Line/Load Regulation: $\pm 0.1\%$ or better; Ripple: 1.5 mv or less; Input: 105-125 VAC

Three day shipment guaranteed. Complete details on these plus a comprehensive line of other power supplies and systems are included in the Acopian 73-74 catalog. Request a copy.



Corp., Easton, Pa. 18042. Telephone: (215) 258-5441.

INFORMATION RETRIEVAL NUMBER 63

Short subroutine computes standard component values from nonstandard

Design calculations seldom give standard component values. But since the standard values are nearly equally spaced on a logarithmic scale, it's simple to compute with a short subroutine two standard values—one greater than and one less than any nonstandard value—and to have the program choose the closest match for your design.

The subroutine is entered with a nonstandard value for R and the desired tolerance (0.1, 0.25, 0.5, 1, 2, 5, 10, 20) in percent for O (6). After computing the two values, the program checks the relationship of R and the geometric mean of the standard values. The program selects the higher standard value if the input is greater than the geometric mean; otherwise the lower value is used. The standard value is then returned in R.

Although R may suggest resistor, the routine works on any positive value including capacitor values. The routine accepts tolerances of 0.1, 0.25, 0.5, 1, 2, 5, 10 and 20% and covers the full range

```

0110 LET O[4]=1.19927E-2*INT(1+1.5*O[6]+.004*O[6]^2)
0120 LET O[3]=INT(LOG(R)/LOG(10)-INT(2.2-3*O[4]))
0130 LET R=R/10^O[3]
0140 FOR O=1 TO 2
0150 LET O[0]=INT(EXP(O[4]*(INT(LOG(R)/O[4])+O-1))+.5)
0160 LET O[5]=1.88E-5*O[0]^3-.00335*O[0]^2+.164*O[0]-1.284
0170 LET O[0]=O[0]+INT(O[5]*INT(3*O[4]+.8))
0180 NEXT O
0190 LET R=10^O[3]*O[R/SQR(O[1]*O[2])]+1]
0200 RETURN
    
```

Brief subroutine calculates standard component values based on an equally spaced logarithmic scale.

of component values.

An additional advantage is that the routine does not require a stored table of standard values.

Jerry K. Brown, Staff Engineer, Teledyne Avionics, P.O. Box 6400, Charlottesville, Va. 22906.

CIRCLE NO. 313

Switched op amps and a sign detector make 2-quadrant divider a 4-quadrant

Most analog divider chips provide two-quadrant operation—that is, the function X/Y is valid only if $Y < 0$. This restriction on the input variable can be eliminated with two switched unity-gain amplifiers and a sign detector.

The basic circuit uses a precision switched amplifier with a constant input impedance at the Y input, and a simple switched amplifier connected to the output of the divider (Fig. 1). A sign detector controls the amplifiers to ensure proper polarity at the divider input and the circuit's output terminal. An absolute-value detector could replace the input op amp, but its use would increase the complexity of the circuit.

The FET switch, Q_1 , is enclosed in a feedback loop for two reasons (Fig. 2):

1. Output errors caused by current flow through the FET's on resistance are eliminated.
2. Errors due to the effects of signal source resistance are minimized, as long as the signal

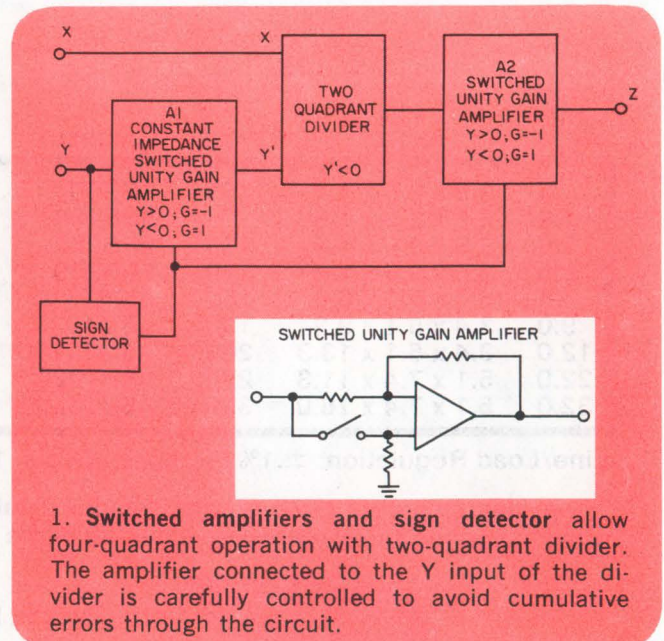

Careful there . . .
you're likely
to start
something.



Just a
"flutter" of pressure
. . . and SNAP!

Less than 2 grams of force actuates this Cherry snap-action miniature switch. Outside, the external aluminum actuator is purposely 2% long to provide this unusually low operating force. Inside, an extra internal actuator further reduces operating force while maintaining solid contact mating pressure for reliable performance.

The "flutter force" switch is only one of Cherry's E22 series of unique miniatures. All are rated 3 amps, 125 VAC. All are also available in gold "crosspoint" configuration for low energy solid state circuits.

A switch in your hand is worth two in the tree, so . . . SNAP UP A FREE SNAP-ACTION SAMPLE.

Just TWX 910-235-1572 . . . or PHONE 312/689-7704 and ask Frank to give you facts on miniature switches . . . or circle appropriate reader service number.

E22-75HX
5 grams LIGHT
FORCE actuation



E22-55HX
3.5 grams LIGHTER
FORCE actuation



E22-85HX
Less than 2 grams
"FLUTTER
FORCE" actuation



CHERRY 

CHERRY ELECTRICAL PRODUCTS CORP.
3609 Sunset Avenue, Waukegan, Illinois 60085



Cherry affiliates worldwide • Hirose Cherry Precision Co., Ltd., Tokyo • G. W. Engineering Pty. Ltd., Sydney
Cherry Electrical Products (U.K.) Ltd., St. Albans, Herts • Cherry Mikroschalter GmbH, Bayreuth, Germany

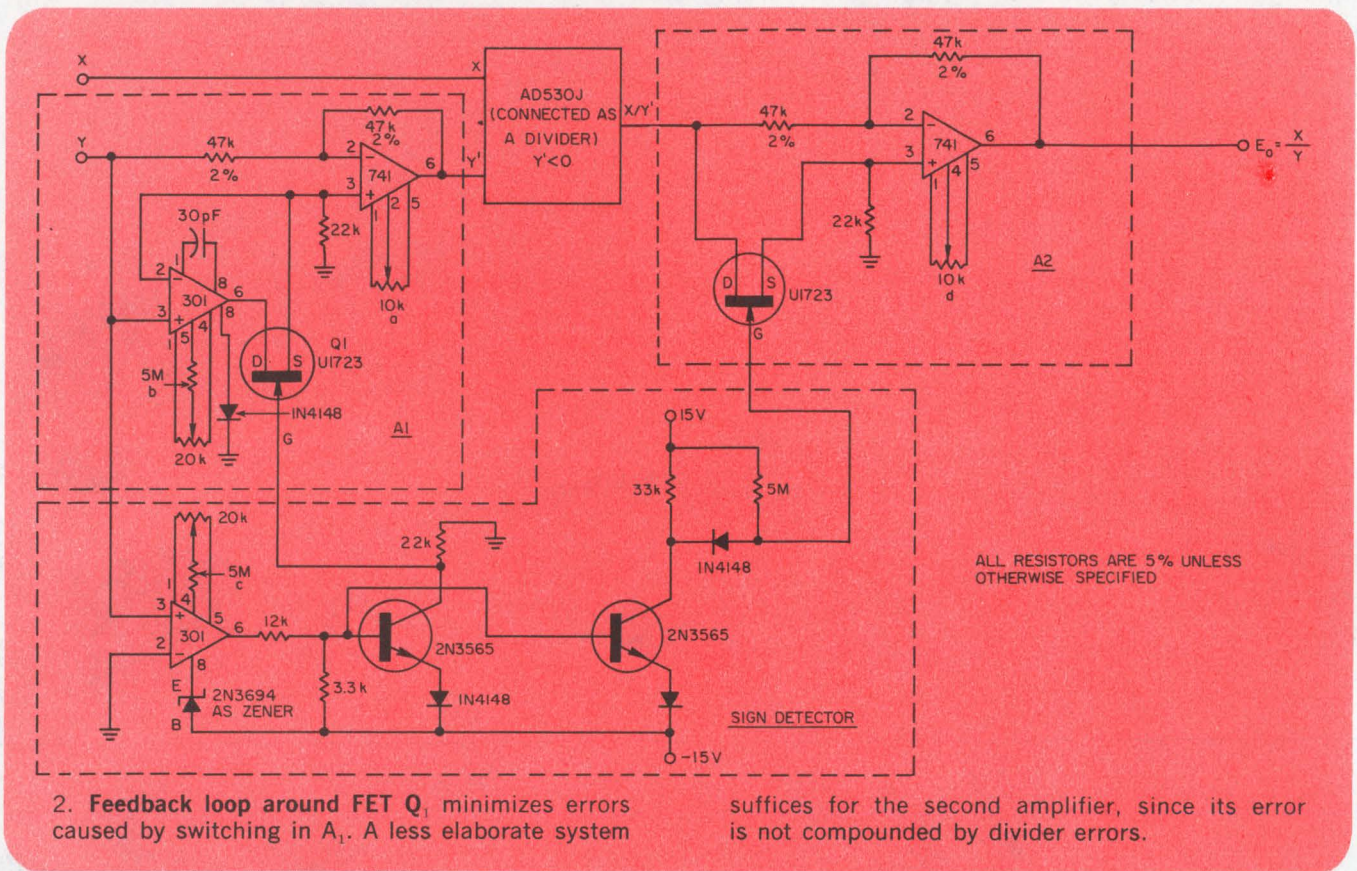

impedance remains constant.

The FET can be placed inside the loop because the voltage at pin 3 of the 741 is always negative. And the diode clamps the output of the 301 to approximately zero volt when the feedback loop opens. The second switching amplifier is less precise, since any error here is not compounded with divider errors.

The allowable X and Y inputs are ± 10 V, to ensure proper pinch-off levels at the FET switches. The output range is 15 V to -10 V for the

same reason. The divider obeys the equation

$$V_{out} = V_x/V_y.$$

And with a symmetrical output range of ± 10 V,
 $10 V_x/V_y \leq 10$ V
 or $V_x \leq V_y$.

The divider accounts for most of the circuit error. With $V_{out} = 10$ V and $V_y = 10$ V, the error is 100 mV. With $V_{out} = 5$ V and $V_y = 5$ V, the error is 10 mV.

Eric Burwen, Staff Engineer, G & S Systems, 279 Cambridge St., Burlington, Mass. 01801.

CIRCLE NO. 314

IFD Winner of January 4, 1974

Yoshiji Kurahashi, Product Development Manager, Exar Integrated Systems, Inc., 750 Palomar Ave., Sunnyvale, Calif. 94086. His idea "Less than 1.5% Distortion Over 1000:1 Range Provided by Swept-Frequency Oscillator" has been voted the Most Valuable of Issue Award.

Vote for the Best Idea in this issue by circling the number for your selection on the Information Retrieval Card at the back of this issue.

SEND US YOUR IDEAS FOR DESIGN. You may win a grand total of \$1050 (cash)! Here's how. Submit your IFD describing a new or important circuit or design technique, the clever use of a new component or test equipment, packaging tips, cost-saving ideas to our Ideas for Design editor. Ideas can only be considered for publication if they are submitted exclusively to ELECTRONIC DESIGN. You will receive \$20 for each published idea, \$30 more if it is voted best of issue by our readers. The best-of-issue winners become eligible for the Idea of the Year award of \$1000.

ELECTRONIC DESIGN cannot assume responsibility for circuits shown nor represent freedom from patent infringement.

Dialight sees a need:

(Need: The right switch for the right price.)

See Dialight.

For the switch buyer, choice of function and esthetics, reliability, ease of mounting, and low cost are his prime concerns. He may need a pushbutton switch for panel, sub-panel or snap-in mounting. He may need a choice of bezels with or without barriers in black, gray, dark gray or white. He may need a legend that's positive, negative, or hidden until ener-



gized...one that's white when "off" and red, green, amber, blue or light yellow when "on"...or colored both "on" and "off." He may need a highly reliable switch proven in thousands of installations. Matching indicators with same front-of-panel appearance are also available. Obtainable from our world-wide distributor network.

The cap has a metal insert designed for proper heat dissipation. Cap is illuminated by a T-1 3/4 incandescent lamp in voltage range to 28V. Lamp can be easily replaced without special tools from front of panel.

More than 12 colors available in round, square, or rectangular shapes in six basic sizes—1/2" to 1 1/2". Choice of engraved, hot stamped or replaceable film legends with positive or negative presentations.

Available with or without bezels. Bezel allows for simple snap-in mounting. Without bezel, switch can be used for panel or sub-panel mounting.

Terminals are gold plated for oxidized free solderability, and come in choice of solder blade or pc terminations.

NOW LISTED IN UNDERWRITER'S
RECOGNIZED COMPONENTS INDEX.

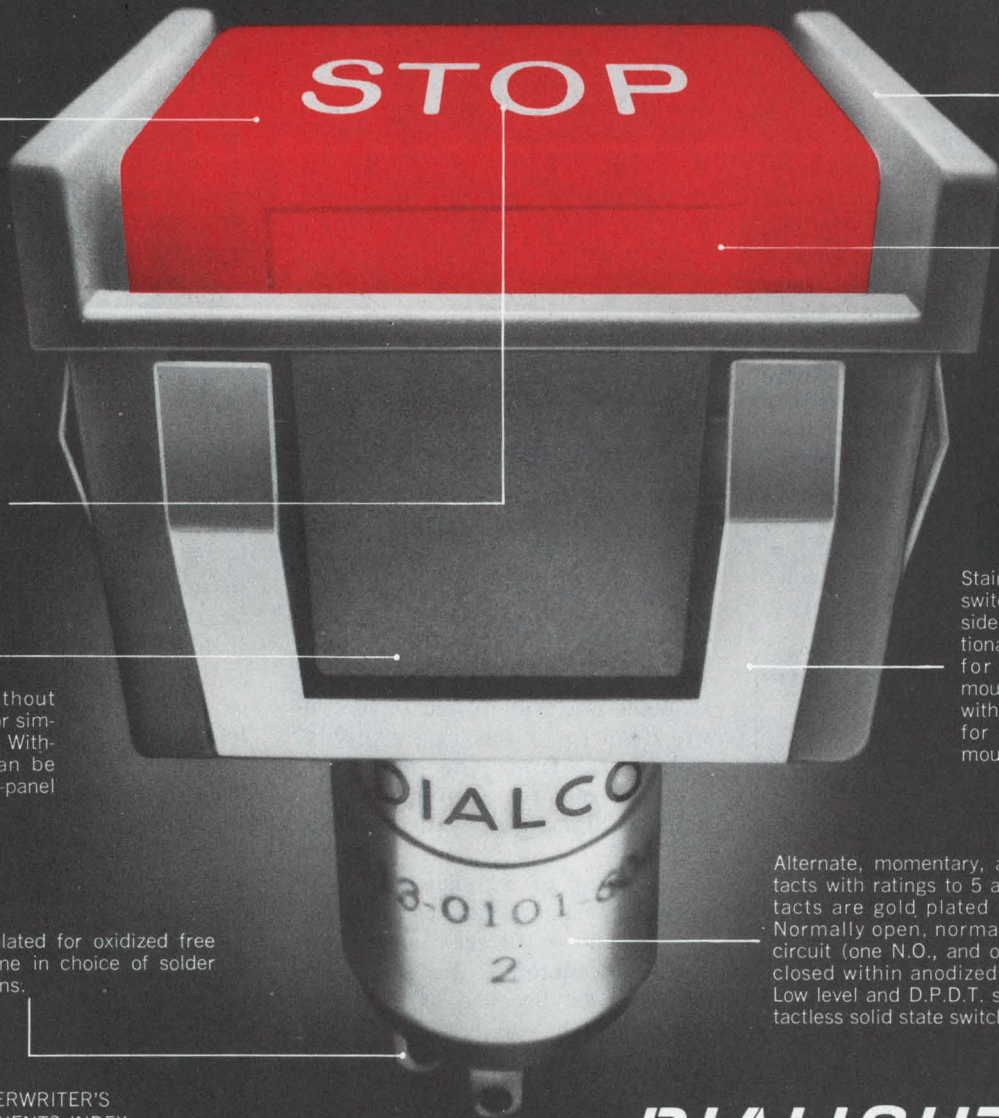

Bezels available in black, gray, dark gray or white and in round, square or rectangular shapes.

Fingertip grip simplifies insertion or replacement of pushbutton cap.

Stainless-steel clips lock switch into panel on four sides. No tools or additional hardware required for installing. Panel mounting switches come with required hardware for panel or sub-panel mounting.

Alternate, momentary, and snap-action contacts with ratings to 5 amps. All switch contacts are gold plated for high reliability. Normally open, normally closed, and two-circuit (one N.O., and one N.C.). Totally enclosed within anodized aluminum housing. Low level and D.P.D.T. snap action, and contactless solid state switches also available.

DIALIGHT

Dialight Corporation, A North American Philips Company • 60 Stewart Avenue, Brooklyn, N.Y. 11237 (212) 497-7600

New circuits simplify inductance simulation

Experiments in England to replace inductors with active filters have led to the development of a range of "immittance-converter" circuits. Each usually consists of at least two operational amplifiers with resistors and capacitors.

The characteristics of the circuits are such that if the outputs of two of them are connected, the circuit between the two inputs is equivalent to a floating (ungrounded) inductor.

At the British Post Office Research Department in London, immittance-converter designs have been developed that need only one operational amplifier each, thereby at least halving the number of amplifiers needed for inductance simulation. Fig. 1 shows three of these new circuits. Fig. 2 is an example of a third-order filter in which two converters (Fig. 1b) simulate an inductance. The component values in Fig. 2 were computed from the following relationship: If the outputs of a pair of these converters ($R_1, C_1 + \text{amp}$ and $R_1', C_1' + \text{amp}$) are joined by a resistor R_0 ,

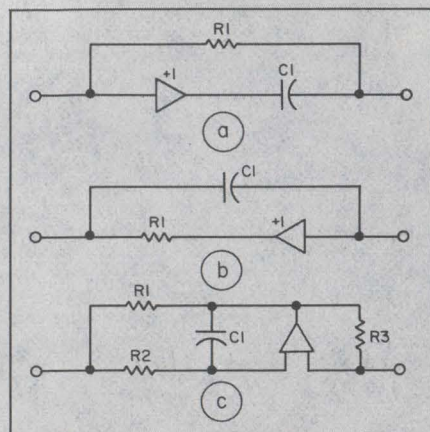

1. Immittance-converter circuits require only one operational amplifier each.

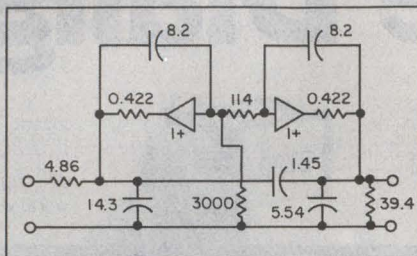

2. Third-order filter in which two converters simulate an inductance.

and if $R_1 C_1 = R_1' C_1'$, the circuit will simulate an inductance $R_1 C_1 R_0^2 / (R_0 - R_1 - R_1')$ in series with a resistance $R_0 (R_1 + R_1') / (R_0 - R_1 - R_1')$, all shunted by a resistance R_0 .

Improved spectrometer aids noise suppression

An attractive spectrometer for absorption measurement systems that employ electron paramagnetic resonance has been developed at the University of Delft in the Netherlands.

In general, noise in this type of detection system and its microwave source limits the sensitivity. FM noise from the microwave source predominates over the other noise at high incident cavity power levels.

Reduction of FM noise over the entire spectrum can be obtained by well-known, direct cavity-stabilization techniques, but they are seldom used because of difficulty in tuning the cavity. The method developed at the University of Delft uses the cavity for stabilization.

The microwave source in the Delft spectrometer is a reflex

Videotape recorder upgraded in Britain

With ferrite heads and a new helical recording format, the Cintel 9000 videotape recorder, introduced by Rank Cintel of Britain, is reported to give improved performance and considerable operating savings. Degradation through re-recording is said to be reduced and tape consumption minimized. A narrower video track reduces tape consumption to 53% of that of a quadruplex machine.

Dry-film photoresist available for PCs

Kalle AG of Wiesbaden, West Germany, has begun worldwide marketing of its KS-88 negative working dry-film photoresist for printed-circuit applications, including PCs with plated-through holes. The film is developed in water-based solutions and is laminated to the substrate with conventional equipment. Fast exposure and processing and excellent image characteristics are reported.

klystron tuning. The open-loop gain of the control system, which is proportional to the sensitivity, increases when the microwave attenuation decreases; this increases incident cavity power.

With the increase in incident cavity power, the rise in the open-loop gain is partly compensated for by a decrease of sensitivity. This compensation also increases the gain margin of the control system, which gives a larger allowable open-loop gain and yields improved tuning.

Tests with the improved spectrometer show that the electron paramagnetic resonance signal remains essentially constant, but the noise is efficiently suppressed. A spectrometer sensitivity 10 times better than that of commercial high-sensitivity E-line spectrometers has been reported.

CONVERT 8 BITS IN 6 MICROSECONDS FOR \$25.....

it's easy!

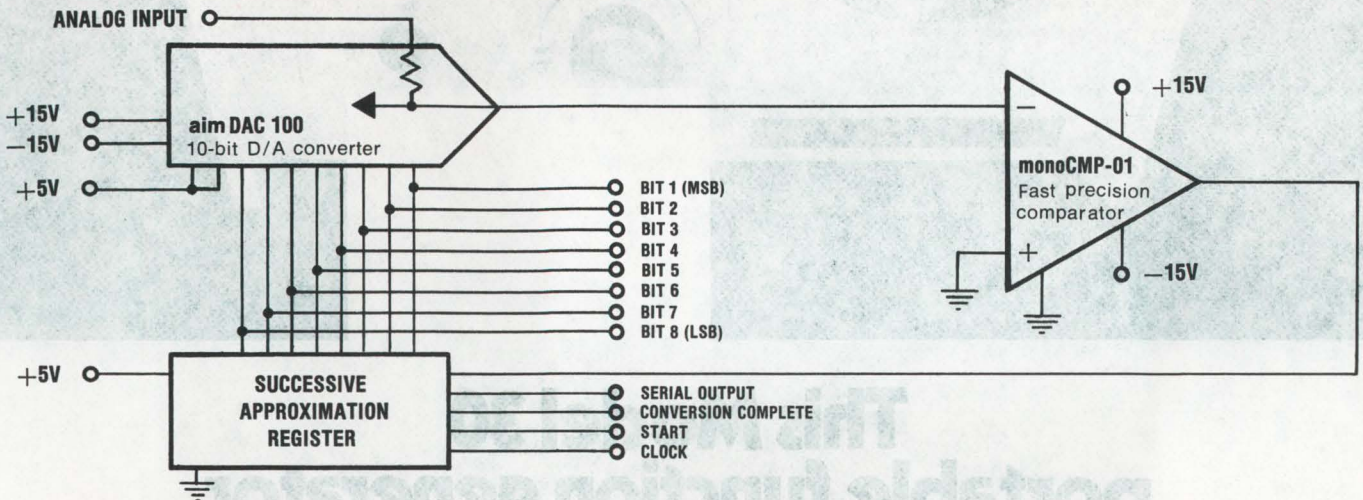

THREE IC'S BUILD A FAST A/D CONVERTER - FOR UNDER \$25!

It's easy with high performance analog components from Precision Monolithics—start with PMI's aimDAC100 Low Cost D/A Converter—with its internal precision reference voltage, 10-bit resolution, choice of linearities and high speed current output, it's ideal for all D/A and A/D applications. Next, add the PMI monoCMP-01 Precision Comparator with its fast 90ns response, low Vos, drift and superior stability—complete your converter with a

successive approximation logic chip and that's it! Sound easy? You bet—and 10-bit versions can be built for under \$40! Circuit construction and performance are fully detailed in our new Application Note: pre-drilled demonstration circuit cards are available free by contacting your local PMI rep or stocking distributor—call him today and find out how easy A/D conversion can be!

SPECIFICATIONS		PRICES
aimDAC 100 DDT1*	0.30% Linearity Max-0/70°C	\$ 9.95 @ 100 pcs.
aimDAC 100 CCT1*	0.20% Linearity Max-0/70°C	\$12.00 @ 100 pcs.
aimDAC 100 BCT1*	0.10% Linearity Max-0/70°C	\$17.00 @ 100 pcs.
aimDAC 100 ACT1*	0.05% Linearity Max-0/70°C	\$26.00 @ 100 pcs.
*Specify T1 for 0 to 10 Volt usage; T2 for 0 to 5 Volt usage.		
monoCMP-01CJ	Vos 2.8 mV Max	\$3.25 @ 100 pcs.
monoCMP-01EJ	Vos 0.8 mV Max	\$7.50 @ 100 pcs.

PRECISION MONOLITHICS REPRESENTATIVES

Alabama (205) 539-4411	Maryland (301) 944-8262	North Carolina (919) 725-5384
Arizona (602) 992-9884	Massachusetts (617) 890-0011	Ohio, North (216) 461-8333
California, North (415) 948-6533	Michigan (313) 557-1934	Ohio, South (513) 293-3145
California, Los Angeles (213) 340-1745	Minnesota (612) 646-7217	Pennsylvania, East (215) 644-3477
California, South (714) 830-3939	Missouri, St. Louis (314) 731-5799	Texas (214) 363-8591
Colorado (303) 771-4920	Missouri, Kansas City (816) 761-6543	Virginia (703) 548-7818
Connecticut (203) 634-0179	New Jersey, North (516) 567-5900	Washington (206) 624-9020
Florida, Ft. Lauderdale (305) 776-4800	New Jersey, South (609) 966-4070	Wisconsin (414) 933-2733
Florida, Orlando (305) 425-5505	New Mexico (505) 265-5655	Canada, Toronto (516) 864-2666
Illinois, North (312) 774-3535	New York, New York City (516) 567-5900	Canada, Vancouver (714) 979-4894
Indiana (513) 252-9981	New York, Upstate (716) 464-8636	

AUTHORIZED DISTRIBUTORS

NEW YORK METROPOLITAN AREA Harvey Radio, Woodbury, N.Y.: (516) 921-8700 • NEW ENGLAND AREA Gerber Electronics, Dedham, Mass.: (617) 329-2400 • UPSTATE NEW YORK Harvey Federal Electronics, Binghamton, N.Y.: (607) 748-8211 • NORTHEAST Newark Electronics, Woburn, Mass.: (617) 935-8350 • BALTIMORE-WASHINGTON Whitney Distributors, Baltimore, Md.: (301) 944-8080 • PHILADELPHIA Hallmark Electronics, Huntingdon Valley, Pa.: (215) 355-7300 • MICHIGAN RS Electronics, Detroit, Mich.: (313) 491-1000 • SOUTHEAST Kirkman Electronics, Winston-Salem, N.C.: (919) 724-0541 • EAST CENTRAL Pioneer/Cleveland, Cleveland, Ohio: (216) 587-3600 • Pioneer/Dayton, Dayton, Ohio: (513) 236-9900 • CENTRAL Hallmark Electronics, Elk Grove Village, Ill.: (312) 437-8800 • Minneapolis, Minn.: (612) 925-2944 • St. Louis, Mo.: (314) 521-3800 • TEXAS-OKLAHOMA Sterling Electronics, Houston, Texas: (713) 623-6600 • Dallas, Texas: (214) 357-9131 • SOUTHWEST Sterling Electronics, Albuquerque, N.M.: (505) 345-6601 • Phoenix, Ariz.: (602) 258-4531 • WEST Westates Electronics Corp., Chatsworth, Calif.: (213) 341-4411 • Sterling Electronics, San Carlos, Calif.: (415) 592-2353 • Intermark Electronics, Sunnyvale, Calif.: (408) 738-1111 • Denver, Colo.: (303) 936-8284 • Salt Lake City, Utah: (801) 359-0531 • San Diego, Calif.: (714) 279-5200 • Santa Ana, Calif.: (714) 540-1322 • Almac-Stroum, Seattle, Wash.: (206) 763-2300 • Portland, Ore.: (503) 292-3534.

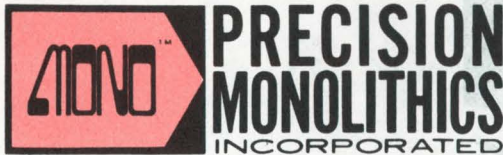

1500 SPACE PARK DRIVE, SANTA CLARA, CALIFORNIA 95050
TEL. (408) 246-9225 • TWX 910-338-0528 • CABLE MONO

INFORMATION RETRIEVAL NUMBER 66

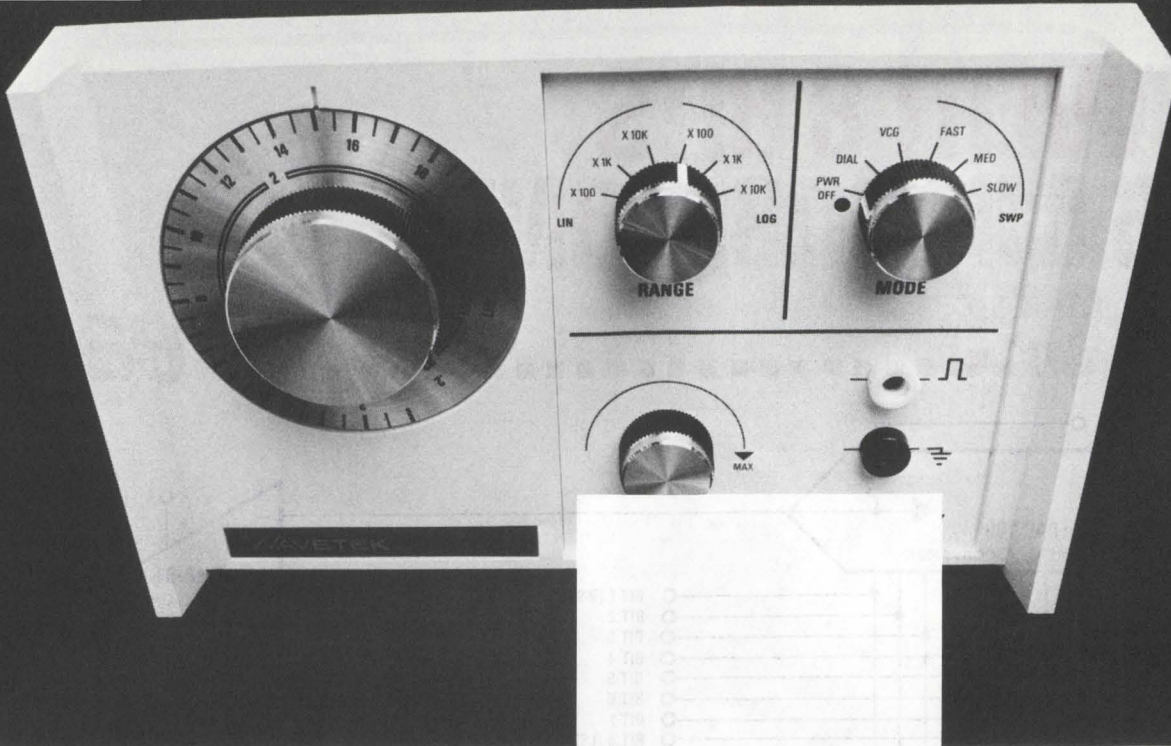

**This Model 30
portable function generator
goes from
2 Hz to 200 kHz with
sines, squares, triangles,
and linear
or log sweeps.**

**And it goes for
\$149.⁹⁵**



WAVETEK®

P.O. Box 651, San Diego, Calif. 92112
TWX 910-335-2007, Tel. (714) 279-2200
INFORMATION RETRIEVAL NUMBER 67

Hi-fi amplifier IC sets power mark of 15 W with less than 1% distortion

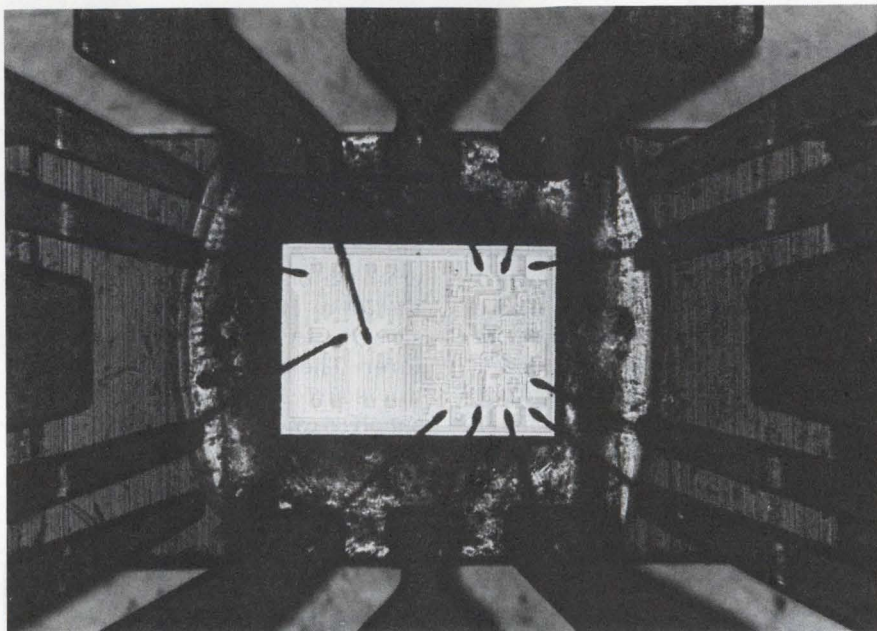

SGS-ATES Semiconductor, 435 Newtonville Ave., Newtonville, Mass. 02160. (617) 969-1610. P&A: See below.

The highest power yet obtained from monolithic hi-fi amplifiers is available with SGS-ATES Semiconductor's TDA2020 integrated circuit. The new amplifier puts out 15 W with less than 1% distortion when it drives a 4- Ω load.

With the same 4- Ω load, an output power of 20 W can be achieved with less than 10% distortion. Alternatively, with an 8- Ω load, the power supplied with 1 and 10% distortion is, respectively, 10 and 13 W.

Prior to the introduction of the TDA2020, the highest power available from equivalent-function monolithic amplifiers was 10 W. This can be obtained from the SGS-ATES TCA940 amplifier and also from the LM384, from National Semiconductor, 2900 Semiconductor Dr., Santa Clara, Calif. 95051.

The SGS-ATES TCA940 delivers 10 W into a 4- Ω load with 10% distortion. The National Semiconductor LM384 supplies the 10 W into an 8- Ω load with 1% distortion.

The new TDA2020 consists of a power op amp that operates from supply voltages of ± 17 V. The op amp delivers a typical output current of 2 A and a maximum of 3.5 A. It has a 1-M Ω input impedance and a 90-dB open-loop voltage gain.

When used as a hi-fi amplifier, the circuit's output can be connected directly to a 4 or 8- Ω loudspeaker. The direct connection, which eliminates the bulky capacitors required in conventional designs, is possible because of the split-supply operation.

The TDA2020 requires several passive components for a typical hi-fi application. Five capacitors and three resistors are needed to decouple the power supply, set the closed-loop gain, determine the high-frequency rolloff and bypass

unwanted high frequencies.

The TDA2020 contains short-circuit protection that limits the power dissipated by the output transistors. In addition a conventional thermal-shutdown circuit is included to reduce the drive of the output transistors, should the chip temperature reach a maximum value.

The chip internally dissipates 10 W. To handle this power, the IC uses a special low-thermal-resistance DIP. The chip attaches directly to a copper slug that forms part of the top side of the package. This arrangement yields a junction-to-case thermal resistance of 3 C/W. Thermal contact to an external heat sink is made from the top of the 14-pin DIP.

The TDA2020 costs \$7 in quantities of 100 to 999. For quantities over 100,000, the unit drops to about \$3. Sample quantities of the IC can be expected in July.

CIRCLE NO. 255

Linear ICs designed for color-TV rcvrs

RCA Solid State, Route 202, Somerville, N.J. 08876. (201) 722-3200. CA1398E: \$2.15; CA3125E: \$2.46 (100-999).

Two linear ICs are available for color-TV receivers. They are a TV chroma processor and a TV chroma demodulator. The processor circuit, called the CA1398E, incorporates chroma-amplifier and gain-control, color-killer, subcarrier oscillator, hue-control and ACC circuits. The demodulator circuit, called the CA-3125E, has three separate demodulators with independent phase control and it can function in RGB systems.

CIRCLE NO. 256

FET op amps come with low price tag

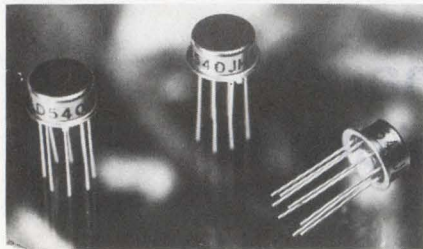

Analog Devices, Route 1 Industrial Park, P. O. Box 280, Norwood, Mass. 02062. (617) 935-5535. P: See below.

Two low-cost versions of the company's AD 540 FET-input op amp are priced as low as \$5.95 in 100 quantities. Called the AD540K and AD540S, the new op amps feature a maximum bias current of 25 pA, maximum offset of 20 mV, maximum drift of 25 $\mu\text{V}/^\circ\text{C}$, maximum gain of 50,000 and a minimum CMRR of 70 dB. The op amps are internally compensated.

CIRCLE NO. 257

2048-bit bipolar pROM accesses in 50 ns

Intersil, 10900 N. Tantau Ave., Cupertino, Calif. 95014. (408) 257-5450. \$45 (100-999); stock.

A 2048-bit programmable ROM, the IM5604, has a typical access time of 50 ns, and it requires less than 275 μW per bit. The new pROM is fully decoded and it is organized as 512 words by 4 bits.

CIRCLE NO. 258

14-stage CMOS counter operates on 1.1 V

RCA, Route 202, Somerville, N.J. 08876. (201) 722-3200. \$12.50 (1000).

A COS/MOS 14-stage ripple-carry binary counter can operate from a supply in the range of 1.1 to 6 V. A developmental device called the TA6179, the new device is a functional equivalent, lower voltage version of the CD4020A 14-stage counter. The new counter comes in a 16-lead DIP.

CIRCLE NO. 259

Hall-effect sensors boast 1 V/kG spec

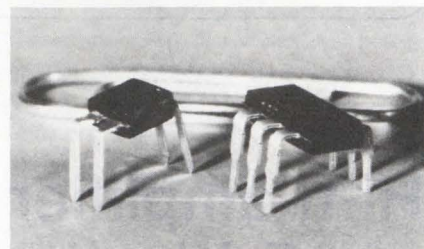

Micro Switch, 11 W. Spring St., Freeport, Ill. 61032. (815) 232-1122. 99¢ to \$1.25 (volume quantity).

Two Hall-effect devices, each consisting of a sensor and amplifier, list an output sensitivity of about 1 V per kilogauss. The devices consist of a single, linear-output model—the 63SS2-1—and a version with a differential output—the 53SS4. The sensors operate on only 3.5 mA compared to the 50 to 100 mA for conventional sensors, according to the manufacturer. The output from the sensors can source up to 20 mA. Power supplies can range from 4 to 10 V dc.

CIRCLE NO. 260

Workhorse Spectrum Analyzer... 100Hz to 25MHz

The new Nelson Ross Model 236 is a multi-purpose, easy to use, workhorse Spectrum Analyzer with outstanding performance features and an exceptionally low price of \$3275.

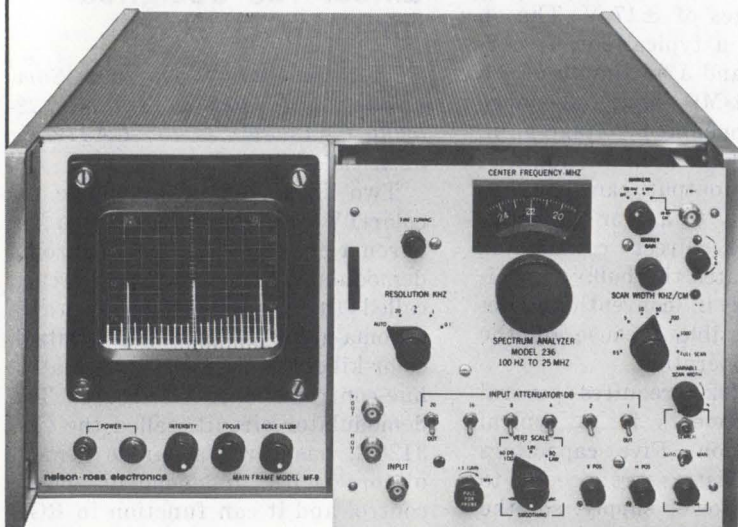

- Preset 0-25MHz quick-look scan and 0-10MHz adjustable scan widths
- 100Hz resolution, automatic and adjustable modes
- -105 dbm (1.25 μV) sensitivity
- >60 db dynamic range for IM and Harmonic Distortion analysis
- Self-checking: Crystal frequency marker combs at 1MHz and 100KHz intervals. Absolute level reference

Numerous other versatile NR Spectrum Analyzers are available from sub-audio through microwave, 0.5Hz to 6.5GHz; complete free standing analyzers with interchangeable plug-ins, or just the plug-in analyzers for your TEK and HP scopes.

Call or write to the "Specialists"; complete specifications are yours for the asking; or, circle the reader service number.

**nelson • ross
electronics**

A DIVISION OF POLARAD ELECTRONICS CORP.
5 Delaware Drive, Lake Success, N.Y. 11040
516-328-1100 • TWX: 510-223-0414



If you're into control applications, We'll give you one-million good reasons to spend 19¢.

Here they are. MA47110s, MA47111s and MA47120s. Hermetically sealed glass packaged PIN diodes from Microwave Associates. 19¢ apiece in quantities of 1,000,000.

These rugged, application-oriented diodes are designed for use as switches and current controlled attenuators in constant impedance AGC circuits, such as those found in CATV and other communications systems. But the MA47111 gives you even lower intermodulation products than the MA47110.

The MA47120 is what you're looking for if you work with modulating circuits and matrix switching at frequencies as low as 1 MHz.

And all three of them give you uniformity and

repeatable performance. Even under extreme environmental conditions.

That means they're ideally suited for control applications. Like RF switching, limiting, duplexing, phase shifting, variable attenuation, modulation and pulse forming.

If you have a prototype to test, we'll be glad to send you some free samples. Because we're sure you'll be more than satisfied with what you can get for 19¢.

Microwave Associates, Inc., Northwest Industrial Park, Burlington, Mass. 01803, 617-272-3000; Dunstable Woodside Estate, Dunstable, Beds., United Kingdom, Tel: Dunstable 601441.



**MICROWAVE
ASSOCIATES**

ENI

THE WORLD'S LEADER IN SOLID STATE POWER AMPLIFIERS

Covering the frequency spectrum of 10 kHz to 560 MHz, ENI offers a full line of solid state power amplifier models with outputs ranging from 300 milliwatts to more than 1000 watts.

Capable of being driven by virtually any signal generator, frequency synthesizer or sweeper, ENI amplifiers are versatile and flexible sources of power for a wide variety of applications.

Completely broadband and untuned, these highly linear units will amplify inputs of AM, FM, SSB, TV and pulse modulations with minimum distortion. Although all power amplifiers will deliver their rated power output to a matched load, only ENI power amplifiers will deliver their rated power to any load regardless of match. ENI units are designed to internally absorb reflected power from a mismatched load.

Write to us for a copy of our **complete** catalog of amplifiers and power multicouplers.

3 WATT/MODEL 500L

- Flat 27 dB gain 2 MHz to 500 MHz
- 1.7MHz to 560MHz usable coverage
- Thin film construction
- 8dB noise figure
- Failsafe

40 WATT/MODEL 240L

- 20kHz to 10MHz coverage
- More than 40w linear power output
- Up to 150w CW & pulse output
- Works into any load impedance
- Metered output

20 WATT/MODEL 420L

- 150 kHz to 250MHz coverage
- 20 Watts power output
- Low noise figure
- 45db \pm 1.5dB gain
- Class A linearity

100 WATT/MODEL 3100L

- 250 kHz to 105MHz coverage
- More than 100w linear output
- Up to 180w CW & pulse
- Works into any load
- Unconditionally stable



ENI, 3000 Winton Road South,
Rochester, New York, 14623.
Call 716-473-6900.
Or TELEX 97-8283 ENI ROC.

INTEGRATED CIRCUITS

60-Hz line forms reference for clock IC

American Microsystems, 3800 Homestead Rd., Santa Clara, Calif. 95051. (408) 246-0330. \$14 (100-999); stock.

The S1998—an LSI clock circuit that performs the functions of a synchronous-motor timer—can be used with a standard 50/60-Hz power line as the frequency reference. The ion-implanted PMOS circuit also provides the functions of "alarm," "snooze" and "sleep" and it can drive directly liquid-crystal and fluorescent-type tube displays. The S1998 can operate from a supply of -21 to -29 V, drawing 15 mA. The IC comes in a 40-pin DIP.

CIRCLE NO. 261

Audio amps output 3-5 W

Plessey Semiconductors, 1674 McGaw Ave., Santa Ana, Calif. 92705. (714) 540-9979. 414A: \$3.30; 415A: \$4.30 (100-999).

The SL414A and 415A are high-gain audio amplifiers that contain preamplifier stages. The units have output powers of 3 and 5 W, respectively, when connected to an 8- Ω load. Other features include an input impedance of 100 M Ω , dc input current of 100 nA, preamp voltage gain of 24 dB, a main-amp voltage gain of 26 dB and a supply range of 16 to 24 V.

CIRCLE NO. 262

1024-bit pROMs access in 45 ns

Fairchild Semiconductor, 464 Ellis St., Mountain View, Calif. 94042. (415) 962-3816. \$22 (100-999).

Two TTL 1024-bit programmable ROMs, called the 93416 and the 93426, are fully decoded, high-speed devices organized as 256 words \times 4 bits. The 93416 has uncommitted collector outputs, while the 93426 has three-state outputs. The pROMs have a typical access time of 45 ns at 25 C and 5 V. They also have two chip-select inputs for memory expansion and wired-OR capability.

CIRCLE NO. 263

Tachometer IC ends contact problems

ITT Semiconductors, 3301 Electronics Way, West Palm Beach, Fla. 33407. (305) 842-2411. \$1.53 (100-999).

A monolithic bipolar tachometer circuit, the SAK-115, uses a monostable flip-flop to convert an input signal into square pulses of constant voltage and duration. As a tachometer circuit, the new IC can be used to build a contactless meter that responds to rpms up to 600,000. The SAK-115 operates over the -40 -to- 85 -C temperature range.

CIRCLE NO. 264

Precision op amps work off 2-to-20-V supplies

RCA Solid State, Route 202, Somerville, N.J. 08876. (201) 722-3200. \$1.85 to \$10.50 up (1000).

Six precision op amps, called the CA108 through 308, can be used as direct replacements for like-numbered industry-standard amplifiers. These op-amps permit the use of source impedances as high as 10 M Ω without excessive drift. The amplifiers have sufficient supply rejection to operate from unregulated power supplies within a range of ± 2 to ± 20 V.

CIRCLE NO. 265

ECL 10,000 line increases by six

Signetics, 811 E. Arques Ave., Sunnyvale, Calif. 94086. (408) 739-7700.

Six ECL-10,000-series devices have been added to the company's high-speed ECL line. These are the 10103 quad 2-input OR gate, the 10108 dual 4-input AND/NAND gate, the 10135 JK/MS flip-flop, the 10141 4-bit universal shift register, the 10216 line receiver, and the 10231 dual D/MS flip-flop. All devices are available in both an epoxy and ceramic DIP except the 10141 which is available only in the latter package. The 10108 is a Signetics-originated device. Unlike standard OR/NOR logic provided by most ECL gates, the 10103 is an AND/NAND device that uses internal series-gating techniques. Typical propagation delay for the 10108 is 2.8 ns.

INQUIRE DIRECT

inverter-rated™

Ferramic® components
guarantee circuit
performance

cool power!

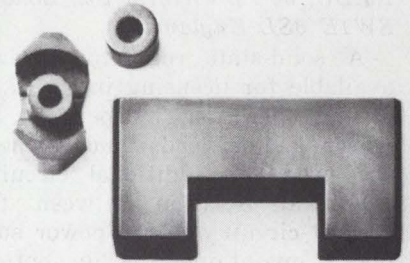

Typical power dissipation vs temperature curves
under high drive conditions

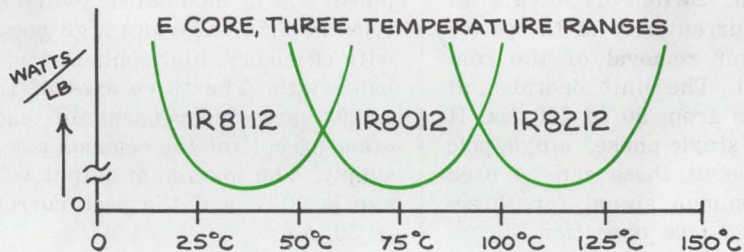

Three temperature ranges

Inverter-Rated components are now available in three temperature ranges. You can select components matched to your temperature requirements and get the highest efficiency possible in your inverter designs.

By specially processing our components for low loss at the temperature you require, we can offer you better performance under all circuit conditions. And significantly improved characteristics in high temperature applications.

Ferrite components for inverters

Our *Inverter-Rated* ferrites are designed specifically for your inverter applications. You get highest efficiency

in the full range of shapes—E Cores, U Cores, Toroids, Pot Cores and Cross Cores. And each of these *Inverter-Rated* components is tested under inverter conditions to assure performance in your circuit. So your inverter design is based on specified and guaranteed electrical characteristics—not just routine magnetic parameters.

New design data

Our new design guide gives you the facts you need to apply the latest ferrite technology to your inverter circuits. We speak your language with complete component specifications, temperature characteristics, application information. We spell out the circuit characteristics of our components and give you guaranteed circuit parameters.

To learn more about our *Inverter-Rated* components

and how they can improve your inverter designs, just check the reader service cards. Or call (201) 826-5100 and talk to the men who developed this ferrite technology. Either way, if you're talking inverters, talk to the ferrite component experts.

That's us.

Indiana General
Electronic Products
Keasbey, N.J. 08832

National distribution
through Permag
locations in Atlanta,
Boston, Chicago,
Dallas, Detroit-
Toledo, Los Angeles,
New York, and
San Francisco.

indiana general

a division of Electronic Memories & Magnetics Corp.

INFORMATION RETRIEVAL NUMBER 71

Solid-state contactor uses opto-coupling

NRDC, 66-74 Victoria St., London SW1E 6SL England.

A solid-state contactor design, available for licensing in the U.S., offers operation independent of power factor loads and without the need for additional circuits. Electrical isolation between the control circuit and the power supply is maintained by an optical coupling. The control signal is 5 to 20 mA and the thyristors or triac conduct at the first voltage zero after application of the control signal. Switch-off occurs at the first current zero of the power supply after removal of the control signal. The unit operates at frequencies from 50 to 400 Hz. It is an ac single-phase, single-pole unit. Three of these can be used with a common signal for three-phase, three-pole operation.

CIRCLE NO. 266

Three axis servo amp delivers 30 A peak

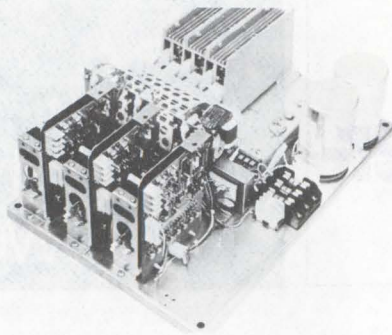

Westamp, 1542 15 St., Santa Monica, Calif. 90404. (213) 393-0401. \$1750; 8 to 12 wk.

The Model A6293-3B46 servo amplifier is designed for the control of low inertia dc motors. The pulse width modulated switching type amplifier provides high power with efficiency, high gain, and wide bandwidth. The three axes of the A6293 are independent of each other except for the common power supply. The maximum output voltage is 90 V and the peak current is 30 A.

CIRCLE NO. 267

Multiplying DAC covers four quadrants

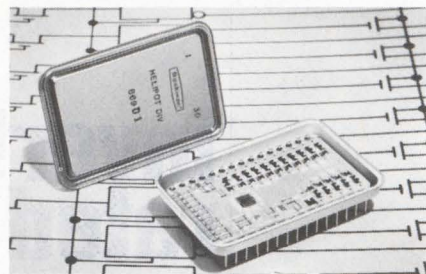

Beckman, 2500 Harbor Blvd., Fullerton, Calif. 92634. (714) 871-4848. From \$150 to \$240; stock.

Model 869 four-quadrant multiplying DAC has 13-bit resolution and three temperature tested accuracy codes. Its accuracy is $\pm 0.1\%$ over -55 to 125 C. The reference voltage is externally supplied and can range from dc to 10 Hz (± 10 V). The unit is compatible with TTL 2's complement or offset binary input formats and uses MOS circuitry to achieve low power dissipation. The package is hermetically sealed and pricing depends on accuracy code.

CIRCLE NO. 268

THINK SINGER OEM Printer Mechanisms for your Remote Time Sharing Terminal

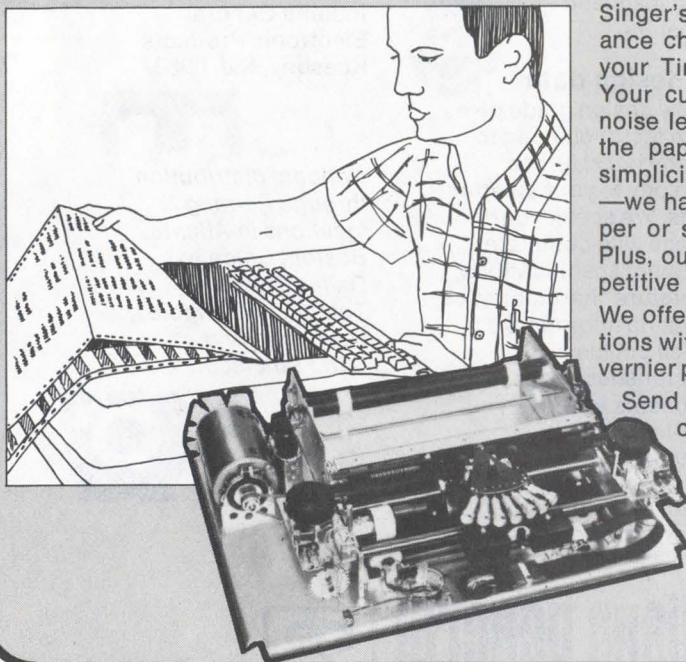

Singer's Model 30 OEM Printer Mechanism has the performance characteristics and high reliability you need to assure your Time Sharing Terminal's success in the marketplace. Your customers will like the 30 char/sec print speed, low noise level, high quality impact printing and the flexibility of the paper handling system. And, the mechanism's design simplicity and high reliability make servicing extremely simple—we have eliminated all conventional clutches, brakes, stepper or servo motors and complex mechanical mechanisms. Plus, our low price will make your terminals both more competitive and more profitable.

We offer the Model 30 in both 80 and 132 column configurations with a broad range of options, including forms-feed, tab, vernier platen, and an integrated paper-tape punch and reader.

Send for our new catalog and/or request a demonstration; call, write or circle the reader service number.

Singer-International Teleprinter Corp., 286 Eldridge Road, Fairfield, New Jersey 07006, (201) 785-4450, TWX 710-988-3658.

SINGER
INTERNATIONAL TELEPRINTER CORP.

39

For PBX, computer memory
and instrument power
supply applications

turn to CTS

for cermet resistor networks

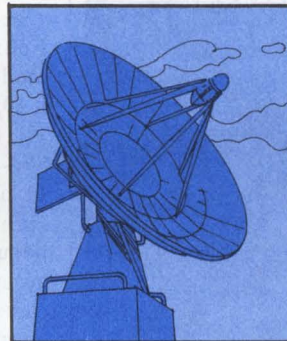
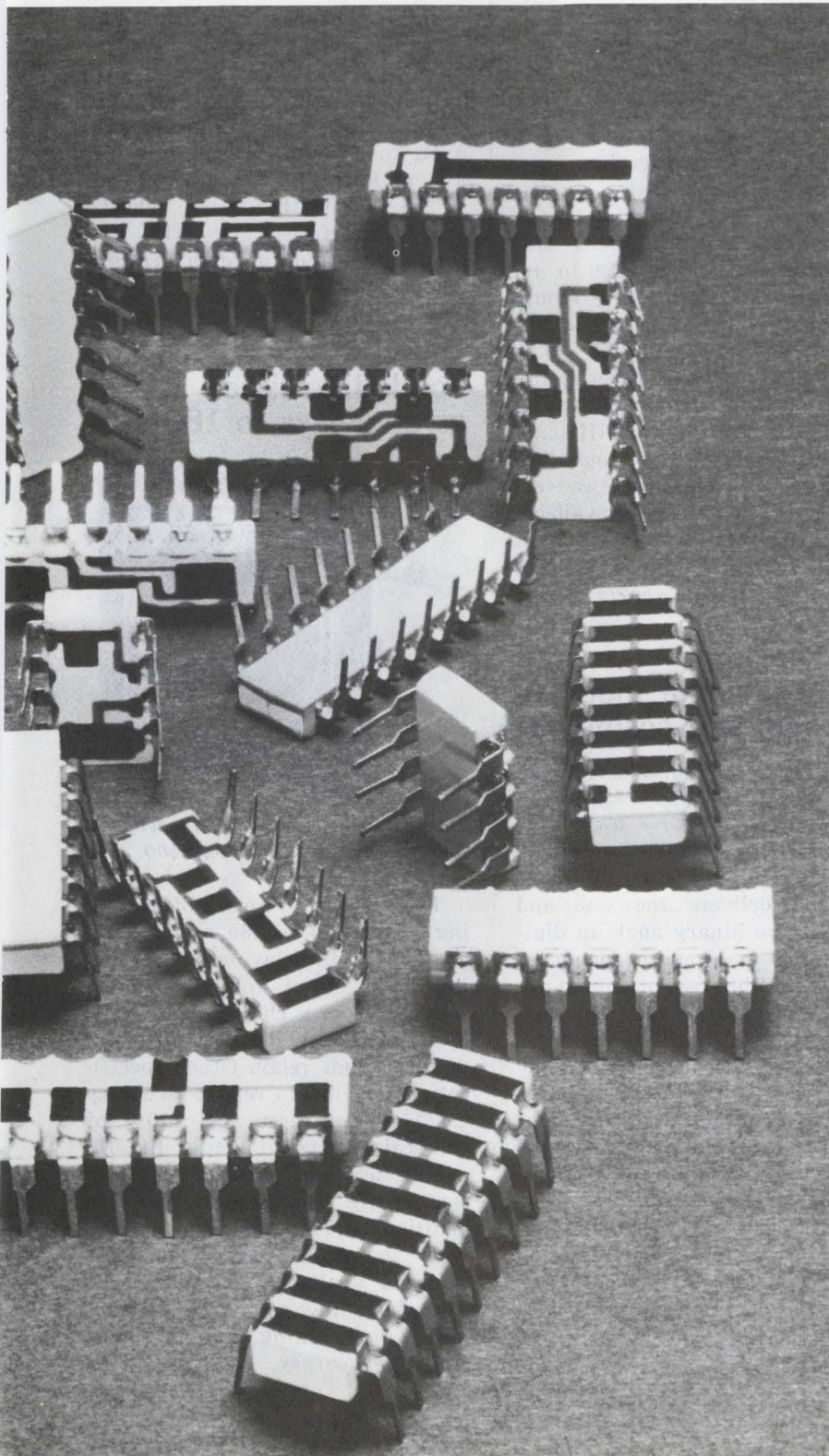

Save Space. Money. Time. It's easy with CTS Series 760 DIP Cermet Resistor Networks. Four popular packages . . . 8, -4, -16 and -18 lead styles . . . provide an infinite number of circuit combinations.

Compact, low profile design puts the squeeze on PCB space. Cost cutters, too. All designs eliminate lead forming and lead trimming for low cost automatic insertion along with IC's and other DIP components. Time saving? One 18-lead CTS 760 Series package can replace up to 32 separate components.

Available without organic cover coat, so you can trim for circuit balance. Precision .100" leads; rated up to 2 watts on 18 lead style; 5-lbs. pull strength on all leads.

Immediate delivery on standards. Custom designs to specifications. Be a saver. Turn to CTS of Berne, Inc., 406 Parr Road, Berne, Indiana 46711. Phone: (219) 589-3111.

CTS CORPORATION
ELKHART, INDIANA



A world leader in cermet and variable resistor technology.

AMERICAN MADE

1% Tolerance SCHAUER 1-Watt ZENERS

**Immediate Shipment
Low Prices**

ANY voltage from 2.0 to 16.0

Quantity	Price each
1-99	\$1.07
100-499	.97
500-999	.91
1000-4999	.86
5000 up	.82

All welded and
brazed assembly

No fragile
nail heads

Gold
plated
leads

Write for complete
rating data and other
tolerance prices.

Buy the kit- Save a lot



Kit contains a 51-piece assortment of SCHAUER 1% tolerance 1-watt zeners covering the voltage range of 2.7 to 16.0. Three diodes of each voltage packaged in reusable poly bags. Stored in a handy file box. Contact your distributor or order direct.

A \$54.57 value for
ONLY \$24⁵⁰

Semiconductor Division

SCHAUER Manufacturing Corp.

4511 Alpine Ave. Cincinnati, Ohio 45242
Telephone: 513/791-3030

INFORMATION RETRIEVAL NUMBER 74

MODULES & SUBASSEMBLIES

Hybrid a/d converters come in four models

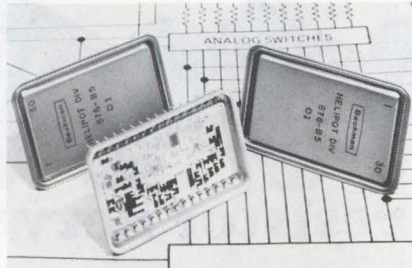

Beckman Instruments, 2500 Harbor Blvd., Fullerton, Calif. 92634. (714) 871-4848. \$160 to \$270 (1 to 9).

The series 876 a/d converters are medium speed, general purpose, successive approximation units. Four preset input voltage range models are available: Model 876-U10, 0 to +10 V; 876-U5, 0 to +5 V; 876-B10, -10 to +10 V and 876-B5, -5 to 5 V. Each model has 11-bit resolution (10 bits plus sign) and provides TTL serial and parallel outputs. Series 876 units accept clock rates to 1 MHz and can operate in a continuous conversion mode or single shot conversion mode. Each model is available in three accuracy grades specified over -55 to +125 C.

CIRCLE NO. 269

Binary-to-angle modules give sine and cosine out

Transmagnetics, 210 Adams Blvd., Farmingdale, N.Y. 11735. (516) 293-3100. \$695; 6 to 8 wk.

Model 1500 binary-to-angle converter accepts 14 bits of input data and delivers the sine and cosine of the binary angle in digital form as well as the quadrant sign with 14-bit resolution and 12-bit accuracy. The Model 1501 converter accepts 14 bits of input information and provides the sine and cosine of the angle as a dc voltage with an accuracy of 6 minutes. Lastly, Model 1502 accepts 4096 ACP pulses plus 1 ARP pulse and converts this data into two dc voltages representing the sine and cosine of the angle. The accuracy is 5 minutes. In all cases, the indicated output angle is in absolute form. All modules are 3.19 x 3.44 x 0.82 in.

CIRCLE NO. 270

S/d converter resolves 16-bits and has 2 speeds

ILC Data Device, 100 Tec St., Hicksville, N.Y. 11801. (516) 433-5330

Model SDC-36 S/D is a two-speed synchro-to-digital converter. It has an accuracy of $\pm 0.41\%$, worst case; 16-bit resolution; 1:36 and 2:36 speed ratios as standard; and transformer isolation. All two-speed combining is provided within the 2.625 x 3.12 x 0.82 in. modules that form the converter. A type II servo loop is used for high dynamic performance. With a K_v of ∞ , there is no lag error for constant velocity inputs; with a K_a of 8000, acceleration errors are a low 1-LSB lag for each $45^\circ/\text{sec}^2$ (of the coarse shaft). Logic interfaces are DTL/TTL compatible, and the data are continuously available.

CIRCLE NO. 271

Solid-state timer gives delays to 180 s



Tempo Instrument, Plainview, N.Y. 11803. (516) 694-4400. \$13 (large qty).

The series 777 timers offer timing ranges up to 180 s. They are available with delay-on-pull-in timing logic. Input voltages can be selected from a choice of 115, 220 V ac, or 125 V dc. Standard output is a spdt relay. Other specifications include: repeat accuracy $\pm 5\%$, setting accuracy $\pm 10\%$ of full scale, electrical contact life 10^5 operations min. and mechanical contact life 10^7 operations min. In addition to 72 standard models, a wide choice of special modifications is available on volume orders, including variations in timing logic, timing range, input voltage, accuracy, etc.

CIRCLE NO. 272

The world of temperature and resistance... Applications open up endless possibilities

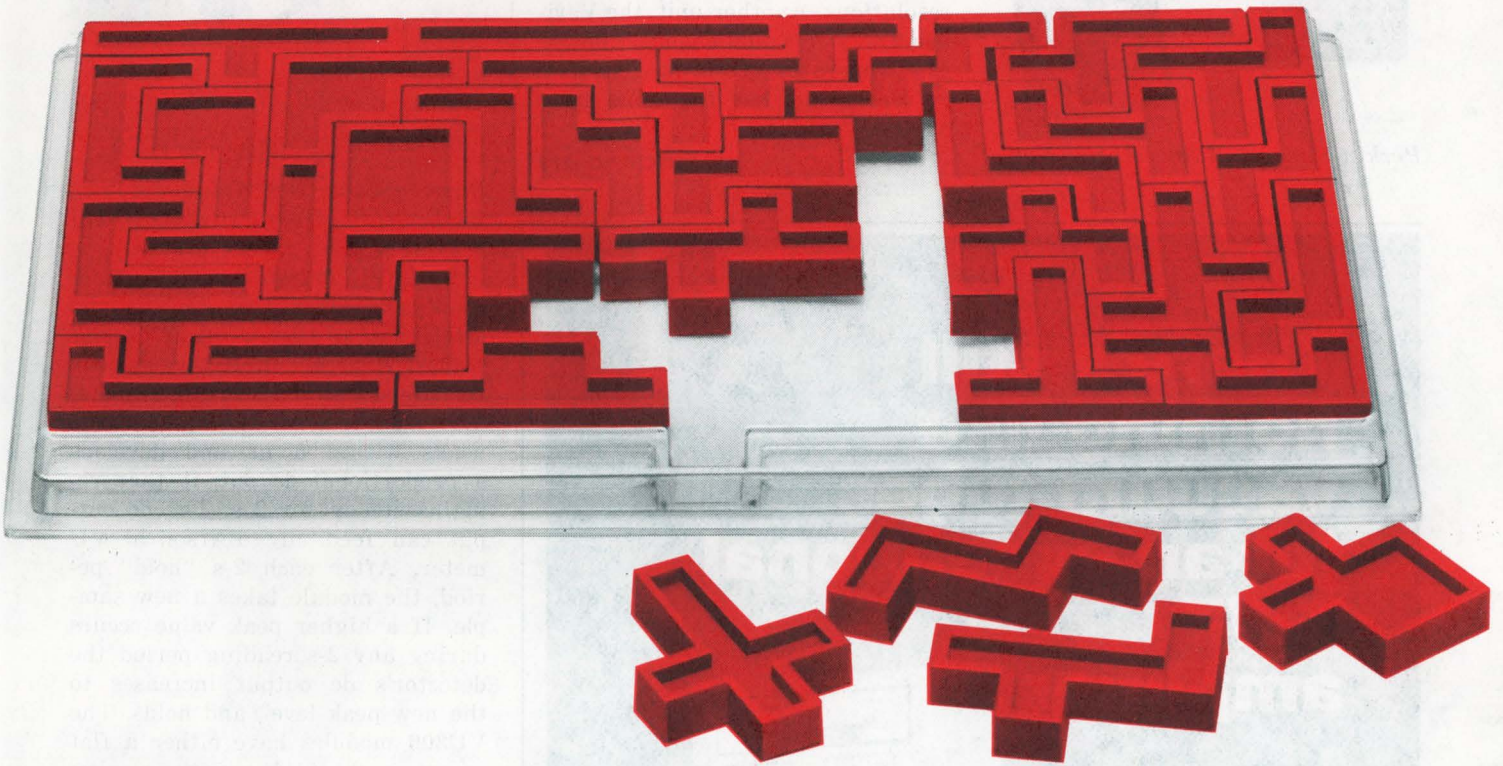

Resistance variation ratio of over 10^7 , 20°C value. Optimally selectable curie temperature, the point where resistance changes sharply, from -50°C to $+190^\circ\text{C}$. Sharp resistance variation characteristics. How these advantages can be put to work depends on you. The TDK PTC thermistor possesses outstanding characteristics not found in any other competing products, giving it a wider and greater range of possibilities never dreamed possible before.

Already, the PTC thermistors are being utilized for many applications, ranging from household appliances to industrial equipment, including automatic degaussing of color TV CRT, constant-heat generation, over-current protection, circuit protection, heat sensing, liquid level detection, etc.

The PTC thermistor, non-contact thermoresistor, is the valuable aid in the circuit which you may have under design or one which you may want to improve. From this small extra consideration, great

benefits can be derived. TDK stands ready to help you. What are your needs? You will find TDK happy and able to meet them.

Here are some typical performance building-blocks obtained from TDK PTC thermistors:

Current limiting characteristic
Constant-temperature heating characteristic

Constant-current characteristic

On-Off characteristic

Delaying action

Capacity to take large transient onrushing current

Thermal cut-out and reusable temperature fuse applications

Restorable and semi-permanent due to non-contact element

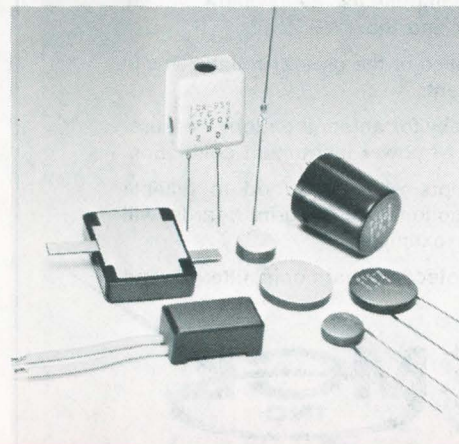

TDK[®]

TDK ELECTRONICS CO., LTD.

14-6, 2-chome, Uchikanda, Chiyoda-ku, Tokyo 101, Japan

Telex: J24270, J26937 (TODENKA)

Cable: TDKCORE TOKYO

TDK ELECTRONICS CORP.

LOS ANGELES BRANCH

931 South Douglas Street, El Segundo, California 90245

Phone: (213) 644-8625

Telex: WUD 653-456 (TODENKA ELSD)

CHICAGO BRANCH

2906 West Peterson Avenue, Chicago, Illinois 60659

Phone: (312) 973-1222

Telex: TWX 910-221-4211 (TDK CHGO)

PTC THERMISTOR

MODULES & SUBASSEMBLIES

DACs are accurate to ± 0.5 LSB over MIL temp

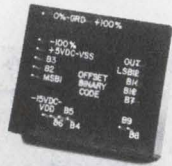

Perkin-Elmer, Main Ave., Nor-

walk, Conn. 06856. (203) 762-4786. From \$150; stock to 8 wk.

The Varidac-1, a miniaturized transformer-based d/a converter, offers absolute accuracies of $\pm 1/2$ LSB over the -55 to $+125$ C temperature range. The device is available in standard 11 and 12-bit resolutions. Another unit, the Varidac-2, is a dual-channel device that operates from a common reference but has the same specs as the Varidac-1.

CIRCLE NO. 273

Peak VU detector module delivers true level out

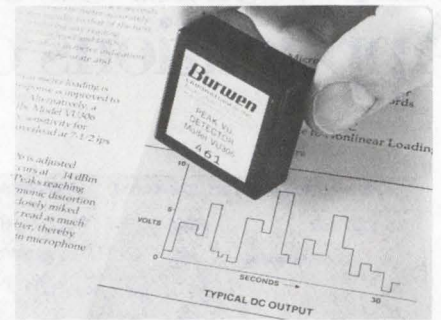

Burwen Labs, 209 Middlesex Tpk., Burlington, Mass. 01803. (617) 273-1488. \$85; stock.

Peak VU detector module, Model VU306, measures true sound levels, rather than average or rms values. A precision full-wave peak rectifier within the VU306 module measures individual signal peaks within $5 \mu s$ and develops a proportional dc output that remains steady for 2 s. The dc output can feed any d'Arsonval VU meter. After each 2-s "hold" period, the module takes a new sample. If a higher peak value occurs during any 2-s reading period the detector's dc output increases to the new peak level, and holds. The VU306 modules have either a flat or pre-emphasized response to simulate FM, RIAA, or slow speed tape recorder pre-emphasis. The modules are 1.5-in.-square-by-0.65-in.-high, operate from ± 15 V dc supplies, and deliver 0 to $+2$ V dc in series with 5.6 k Ω . Also, 0 to $+10$ V dc is available for other uses. The detector provides 0.1 dB response from 10 Hz through 30 Hz, and handles an input signal range of 0.58 V (-2.4 dBm) or higher.

CIRCLE NO. 274

Temperature controllers cover 35 to 2000 F

Burling Instrument Co., P.O. Box 298, 16 River Rd., Chatham, N.J. 07928. (201) 635-9481. \$40; 10 day.

The H-1S series of temperature controls has UL-approval over the range of 35 to 2000 F. The units also meet applicable OSHA requirements. The H-1S units feature rugged construction, adjustable setpoint, automatic or manual reset, snap-action switches, and availability with FM approval.

CIRCLE NO. 275

There's still nothing like vacuum tubes for an exceptional TWT amplifier



Sure our amplifier uses solid state components—everywhere, in fact, except in the high voltage regulator and the TWT itself.

Why a vacuum tube regulator? Because of the greater reliability with this inherently high voltage component.

It qualifies our TWT amplifier especially for antenna pattern measurement, EMI susceptibility testing and r-f power instrument calibration.

But we utilize contemporary concepts when they add to reliable performance. Our modular construction and plug-in boards will accommodate a variety of TWTs for example.

And we can and do add VSWR protection, harmonic filtering and variable output, where required.

Octave band width 10, 20, 100 and 200 watts TWTAs from 1 GHz to 18 GHz. For detailed specifications write MCL, Inc., 10 North Beach Avenue, La Grange, Illinois 60525. Or call (312) 354-4350.



Pick from the best of film and ceramic capacitors

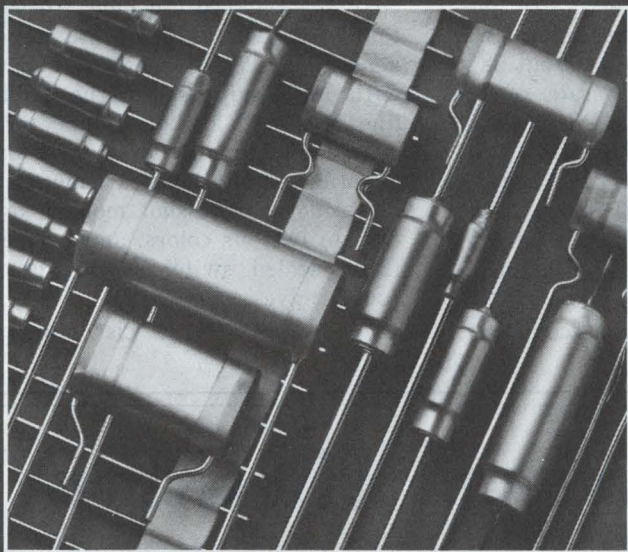

In film capacitors, it's Paktron. Our polyester and polypropylene Micromatic® capacitors are axial lead innovations. Both are self-encased and wound on their own leads. Both are ideal for automatic PC board insertion. Our Filmatic® self-encased polyester capacitor is well established and widely accepted in consumer electronics and industrial applications. Write for test samples and free catalog.

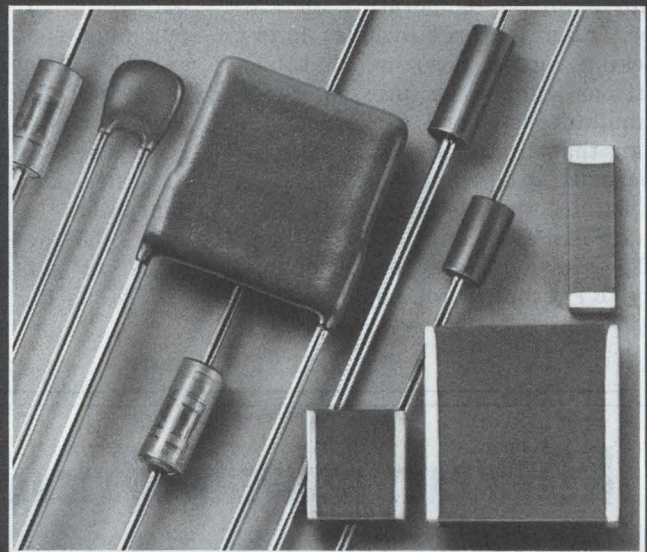

In ceramic capacitors, it's EMCON. Our unique monolithic chip capacitors offer extra high values of capacitance per unit. A wide range of styles, voltages, temperature ranges, capacitance values and terminations. That goes for our axial lead dipped, molded and glass-enclosed capacitors too, with automatic insertion for highly automated production lines. Then, there are our popular EMCAP® capacitors. In ultra-stable, stable and general purpose styles. Write for test samples and free catalog.

PAKTRON®
innovators in film capacitors

PAKTRON, Division Illinois Tool Works Inc.,
900 Follin Lane, S. E., Vienna, Virginia 22180.
Phone (703) 281-2810. TWX 710-833-0682.



EMCON® formerly
Electro
Materials
competence in ceramics

EMCON, Division Illinois Tool Works Inc.,
11620 Sorrento Valley Road, San Diego, Calif. 92121.
Phone (714) 459-4355. TWX 910-322-1130.

The Innovative Electronic Group of ITW... PAKTRON ■ EMCON ■ LICON

© ILLINOIS TOOL WORKS INC. 1974

INFORMATION RETRIEVAL NUMBER 77

Thermocouple selector handles 72 points

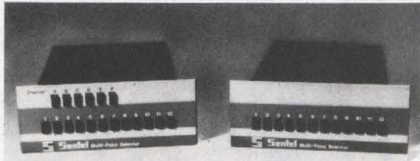

Sentel, 4015 Fabian Way, Palo Alto, Calif. 94303. (415) 324-1761.

The Model 100 thermocouple multipoint selector system is compatible with all presently available analog and digital temperature indicators. It permits random manual selection of up to 72 thermocouples into a single temperature indicator. Other features include: interlocking inputs, assuring that two buttons cannot be pressed down simultaneously, and a thermal design that limits errors caused by thermal gradients between the junctions to less than 0.1 C. Two additional systems, Models 200 and 300, are available for thermistor and RTD multipoint applications.

CIRCLE NO. 276

High speed d/a converter settles in under 1 μ s

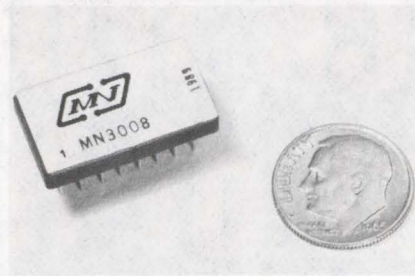

Micro Networks, 5 Barbara Lane, Worcester, Mass. 01604. (617) 756-4635. For 1 to 24 units: \$79 (3008), \$119 (3008H); 2 to 4 wk.

The MN3008, hybrid 8-bit d/a converter, has a worst-case settling time of 1 μ s. The unit is complete with internal reference and output amplifier. Input logic levels are TTL compatible. Output is 0 to +4 V. The slew rate of the converter is 30 V/ μ s. The MN3008 is packaged in a 16-pin hermetically sealed DIP. The "H" version guarantees $\pm 1/2$ LSB linearity over -55 to $+125$ C without any initial or subsequent adjustments by the user.

CIRCLE NO. 277

Tone encoded keyboards provide 16 combinations

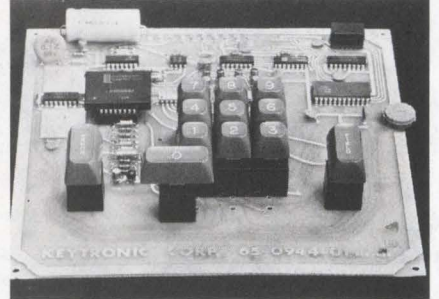

Keytronic Corp., Bldg. 14 Spokane Ind. Pk., Spokane, Wash. 99216. (509) 924-9151.

Tone encoded keyboards are available with up to 16-key combinations. Characteristics of keyboards produced include: better than 1% tolerance on all tones generated, 2 W speaker output with an equalizer for the phone line tone and keyboard tone, programmable tone codes, tone pulse duration of any desired time, two-key rollover, two-shot molded keytops in various colors, and hermetically sealed switches warranted for five years.

CIRCLE NO. 278

NOW FAST DELIVERY OF VISHAY BULK METAL™ .01% RESISTORS!

TAKE YOUR CHOICE:

These Standard .01% Bulk Metal™ Resistors DELIVERED FROM STOCK!

*Stock values (OHMS) 50, 100, 120, 200, 240, 250, 350, 500, 1K, 1.5K, 2K, 2.5K, 3K, 4K, 5K, 6K, 8K, 10K, 12K, 15K, 16K, 18K, 20K, 25K, 30K, 40K, 50K.

In addition, we have in stock over 700,000 resistors in other values and tolerances.

*We are continually adding new values. Call our Hot Line (215) 644-1927 for latest listing. Above values generally in stock.

or

10-DAY DELIVERY

of ANY special value and/or tolerance (even .005%) with our BULK METAL™ express service... VISHAY'S new 10-day accelerated delivery of S-102 resistors (at a premium)

EITHER WAY—YOU'LL GET BULK METAL™ RESISTORS WITH ALL THESE SPECS:

TEMPCO

1 ppm/°C
(0°C to 60°C
for ALL values)

STABILITY

25 ppm/yr.
(50 ppm max.
over 3 yrs.)

RISE TIME

down to 1
nanosecond

INDUCTANCE

0.08 μ H

... No Wirewound or Film Resistor Will Give This Performance!



VISHAY RESISTIVE SYSTEMS GROUP

OF VISHAY INTERTECHNOLOGY, INC.

63 LINCOLN HIGHWAY, MALVERN, PA. 19355

Product Improvement Begins With VISHAY BULK METAL™ Resistors

Frame them any old way

Or any new way.

Then sit back and watch your Ise display electronics get your ideas across. Beautifully.

In an eye-easy fluorescent green glow.

At the same time, they're low on voltage and current drain.

High on stability.

Pick the readouts that offer more of everything, including variety, for a whole host of digital display ideas.

They're a difference you can see.

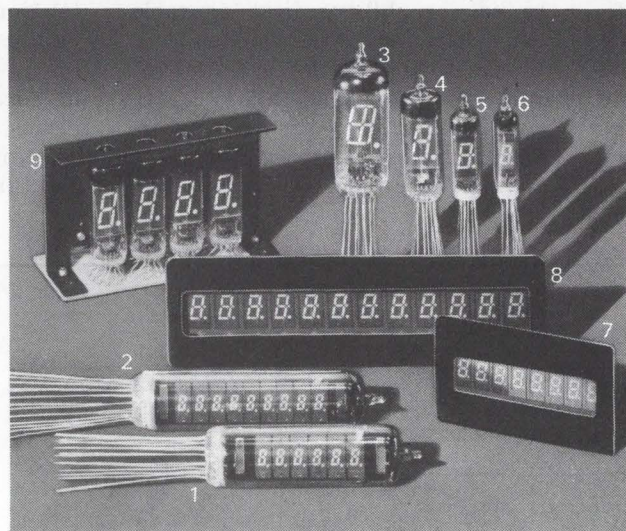
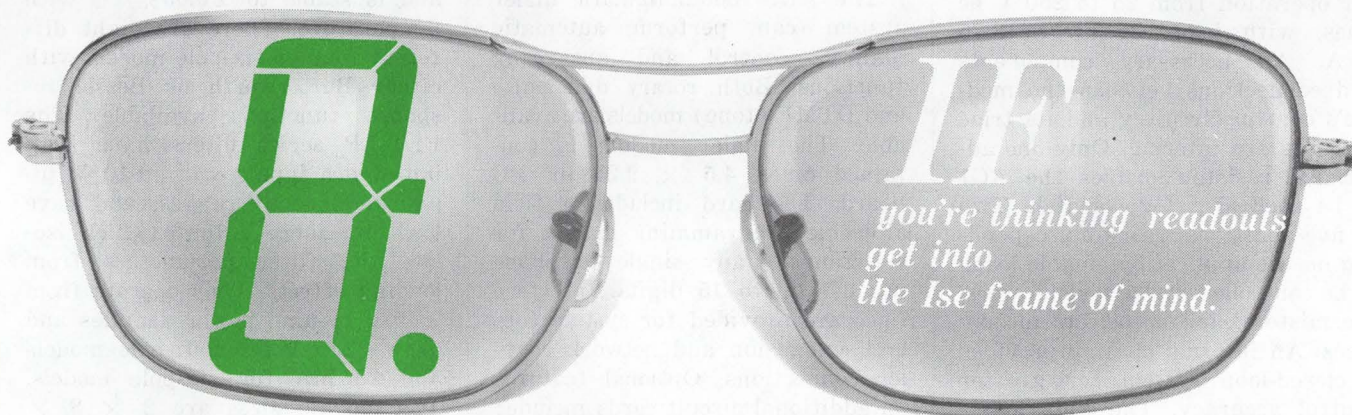

1. DP60A
2. DP90A
3. DG19E
4. DG12H
5. DG10F1
6. DG 8F
7. DP 89A
8. DP127F
9. DMCL12H (NEW)

Display module w/counter & latch

- Fluorescent green glow.
- 12-pin connector.
- Three performance perfect models.
- Custom ROM programming with other than BCD and seven-segment output.

The Brighter Side of Electronics



Creator of Fluorescent Digital Display:

ISE ELECTRONICS CORP. P.O. Box 46 Ise-city, Mie Pref., Japan
Tel: (05963) 5-2121 Telex: 4969523

International Sales Div.:

ISE INTERNATIONAL CORP. 2-7-7, Higashi-Shinbashi, Minato-ku, Tokyo, Japan
Tel: 433-6616~9 Telex: J26546 Cables: "ISEWORLDREP" TOKYO

Sales & Technical Office:

ISE CORP. OF AMERICA 1472 West 178th Street, Gardena, Calif., 90248 U.S.A.
Tel: (213) 532-0470 Telex: 230674910

Representative: Paris, Munich, Amsterdam, Stockholm, Vienna, Milan, Bombay, Hong Kong, Taipei.

INFORMATION RETRIEVAL NUMBER 79

Power control module handles 3.75 kVA loads

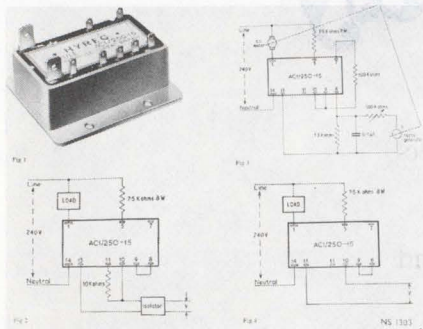

Westinghouse Brake and Signal Co. Ltd., Chippenham, Wiltshire, England.

The AC1/250-15 single-phase ac closed-loop controller is designed for operation from 25 to 250 V ac lines, with loads of up to 3.75 kVA. All necessary components and connections between the module's control circuitry and its triac rectifier are internal. Only one additional resistor enables the AC1 to be used as a logic switch. Two to five additional resistors, depending on the application, enable loads to be controlled by tachogenerators, thermistors, and optoelectronic devices. An internal op amp provides a closed-loop system for greater control accuracy. The unit measures 59 × 51 × 32 mm, including all connector terminals and mounting plates. The module is rated at 15 A with a maximum nonrepetitive peak on-state current rating of 155 A. Maximum repetitive and nonrepetitive peak voltages are 600 V and 700 V, respectively. The supply frequency range can vary between 40 and 60 Hz.

CIRCLE NO. 279

A/d converters provide ±0.1 LSB nonlinearity

Teledyne Philbrick, Allied Dr. at Rte. 128, Dedham, Mass. 02026. (617) 329-1600. \$48 (unit qty.); stock.

Models 4116 and 4117 analog-to-digital converters deliver 8-bit binary outputs or 2-1/2 digit BCD coded outputs, respectively. These units have a differential nonlinearity of ±0.1 LSB, guaranteed maximum and an overrange capability.

CIRCLE NO. 280

Telephone dialer uses numbers up to 15 digits

Advanced Terminal Systems, P.O. Box 90121, Los Angeles, Calif. 90009. (213) 644-5321.

The ADS-1600 automatic dialer system can perform automatic dialing, control and answering functions. Both rotary dial pulse and DTMF (tone) models are available. The dialer module is contained on a 4.5 × 9.25 in. PC board. The card includes a field alterable programming matrix for selection of any single telephone number up to 15 digits. Interface lines are provided for system control, expansion and network coupler connections. Optional features on additional circuit cards include: data access arrangement, positive dial tone detection, special interdigit dial tone delays, automatic re-dial capability, field alterable expanders for additional numbers, ROM number storage modules and WE-801 equivalent ACU adaptor with RS-232C/366 computer interface, automatic answer, and abandon call retry timers.

CIRCLE NO. 281

Low-pass active filters use resistive tuning

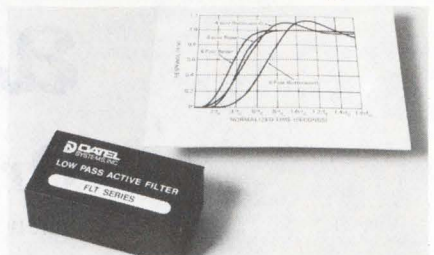

Datal, 1020 Turnpike St., Canton, Mass. 02021. (617) 828-8000. \$79 (4 pole), \$109 (6 pole); stock.

The FLT series of four and six pole low-pass filters operates over a 50 to 1 tuning range. They require a single resistor per pole for tuning. When 1% metal-film resistors are used, the cutoff frequency can be set within ±3% and is stable to ±0.05%/°C with temperature. There are eight different four or six-pole models with either Butterworth or Bessel response functions available. The FLT-LP series filters have high impedance inputs with ±10 V input and output ranges, and have low impedance outputs which isolate the filter parameters from loading effects. They operate from ±15-V op-amp power supplies and draw 22 mA for four-pole models and 28 mA for six-pole models. The module sizes are 2 × 3 × 0.99 in. or 1.37 × 2.87 × 0.99 in. depending on the model. The filters have cutoff frequencies extending from 1 Hz to 50 kHz. The gain is internally set to +1. The initial output offset voltage of ±2 mV can be adjusted to zero by means of an external trimming potentiometer. The operating temperature range is 0 to +70 C.

CIRCLE NO. 282



ANALOGY
LET THE INTECH A403 EXORCISE YOUR SYSTEM. IT WILL DELIVER ±100V @ ±100mA AT A SPEED EVEN THE DEVIL CAN'T KEEP UP WITH. COMES IN A SMALL ECONOMY SIZE PACKAGE (1.6"×3"×1") AT A SMALL, ECONOMY SIZE PRICE.

intech INCORPORATED
(408) 244-0500
1220 COLEMAN, SANTA CLARA CA 95050

ANNOUNCING IMMEDIATE DELIVERY ON MICROPLATE CERAMIC CAPACITORS

...FROM MEPCO/ELECTRA

No lead time problems. We maintain a large and varied stock of microplate ceramic capacitors to meet your specifications. These devices offer extremely high capacitance per unit volume. The unique design and technology employed in their manufacture provide unusually tight capacitance tolerances ($\pm 2\%$ or 0.25pF on values less than 10pF). *Our silver free metalization process which eliminates silver migration*, assures very low losses and negligible DC leakage.

Other design features include; Wide range of controlled T.C.'s. Working voltage of 100 VDC. Ideal for high-volume assembly.

For more information, call (201) 539-2000 or write Mepco/Electra Inc., Morristown, N.J. 07960.

Talk to the
man from
MEPCO/
ELECTRA



MEPCO/ELECTRA, INC.
A NORTH AMERICAN PHILIPS COMPANY

Sold through
North American Philips
Electronic Component
Corporation

Plant Locations:
Morristown, New Jersey
San Diego, California
Mineral Wells, Texas
Canandaigua, New York
Oakland, California.



Mission

IMPOSSIBLE?

WANTED:

2 Watts Output
High Linearity
Ultra Wideband
No Tuning
All Solid State
Low Distortion
High Gain
Low, Low Cost

RESULT: M502C

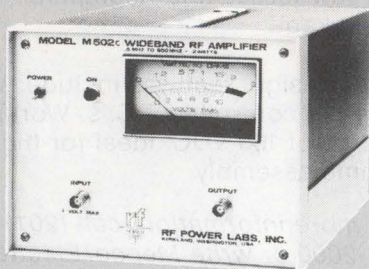

We have removed the I.M. and made it **Possible!**

Our M502 produces over 2 watts of linear power output from 0.5 to 500 MHz without tuning.

Order Yours Today



R.F. POWER LABS, INC.
11013-118th Pl. N.E.
Kirkland, Wa. 98033
(206) 822-1251

OVERSEAS OFFICES:

Australia-Scientific Devices; England-Wessex; Finland-Into Oy; France-REA; Holland-Air-Parts Itn'l; India-Electronic Enterprises; Israel-RDT; Italy-Motordiesel; Japan-Seki; New Zealand-S.D. Mandeno; Norway - Morgenstjerne; Portugal - Rualdo; So. Africa - Baker; Sweden-Wentzel; Switzerland-Silectra.

Multifeatures at a mini price come with 3-1/2-digit DMM



Tekelec, 31829 W. La Tienda Dr., Westlake Village, Calif. 91361. (213) 889-2834. \$179; stock to 2 wk.

A low \$179 now buys you a 3-1/2-digit, seven-function, 27-range digital multimeter. The Multex TA 357 from Tekelec includes automatic polarity, range-scale switches and 100- μ V ac or dc voltage sensitivity. The dc accuracy of 0.1% + 0.05% of fs tops the best presently available in a low-cost DMM.

Several features in the TA 357 exist in no other low-cost DMM. A two-range conductance function permits leakages as small at 10^{-12} mho to be measured. Also, a built-in bias supply lets the user measure three ranges of leakage currents with 10^{-11} A sensitivity. A test switch causes the ac line voltage to be displayed; there is no need to poke probes in the line socket.

The transmissive liquid-crystal display used in this unit also indicates the test function selected. The digit height is 0.4 in.

The highest voltages measurable with the usual input probes are 199.9 V ac and dc. However, a feature of the TA 357 is a high-voltage probe that allows measurements up to 20 kV ac. Input protection when the high voltage probe is not used is 848 V ac pk-

pk or 300 V dc.

Four ac and four dc voltage ranges can be selected, with 0.1999 V the lowest. Accuracy on the two lower ac ranges is 1% + 0.15% of fs and on the two higher ranges 1.5% + 0.15%. The frequency range on ac is 40 Hz to 20 kHz.

Current ranges, both ac and dc, go from 0.1999 to 199.9 mA. The maximum input current is 250 mA (fused). When the DMM is overloaded on any function, the display flashes all digits.

Resistance ranges go from 0.1999 to 199.9 k Ω . The zero setting is adjusted with a pot.

The meter weighs 1.75 lb. and is housed in a molded plastic case $9.5 \times 5.25 \times 2.5$ in.

The meter does not have a battery pack but is available with power requirements of either 117 V ac, 60 Hz, or 220 V ac, 50 Hz.

The closest competitor to the TA 357 is the Model 134 from Data Precision (Audubon Road, Wakefield, Mass.) The 134 costs \$10 more and offers two more conventional resistance ranges than the TA 357 does, but none of its special ranges. Higher voltage ranges are available on the 134 but not the lowest range of the 357. The 357 also has better basic accuracy on all ranges.

For Tekelec **CIRCLE NO. 253**
For Data Precision **CIRCLE NO. 254**

Stop Nuisance Tripping!

Type UPG/APG Electromagnetic Circuit Protectors with patented Inertial Delay.

Typical XFMR Transients
(Peak currents to 20X
nominal) results in
NUISANCE TRIPS. Solution:
Use Airpax Inertial Delay.

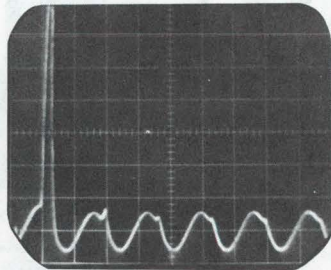

Airpax Type UPG/APG circuit protectors assure positive protection without nuisance tripping. This is accomplished by an exclusive Airpax inertial delay that provides tolerance of short duration inrush currents without decreasing steady state protection.

The UPG/APG line of low cost, compact circuit protectors offers series, shunt, and relay configurations with a choice of delays and ratings. Ratings are from 20 milliamperes to 30 amperes, 250 volts maximum at 60Hz, 250 volts at 400Hz, and 65 volts dc maximum. A SPDT auxiliary switch, for remote signalling or alarm, rated at 5 amperes, can be supplied with series trip types.

Available in 1, 2, and 3 pole versions, UPG/APG circuit protectors offer a choice of toggle, rocker arm, or thumbwheel actuators. All multipole assemblies can be furnished with a mix of current ratings, delays, internal circuit configurations, and terminal styles.

To get the full story on Airpax Type UPG/APG electromagnetic circuit protectors, write for Bulletin 2003.



AIRPAX™

Airpax Electronics
CAMBRIDGE DIVISION
Cambridge, Maryland 21613
Phone (301) 228-4600

Monitor offers storage, variable persistence



Tektronix, P.O. Box 500, Beaverton, Ore. 97005. (503) 644-0161. \$1675.

The 605 Variable Persistence XYZ Storage Monitor can hold a display for periods from a fraction of a second to greater than 5 min. Even longer display times are possible in the "save" mode. The 605 can also serve as a conventional nonstorage display. X and Y channels have a 3-MHz bw and the Z channel 5 MHz. Max writing speed is greater than 1 div/ μ s.

CIRCLE NO. 283

Voltmeter handles peak, rms, average

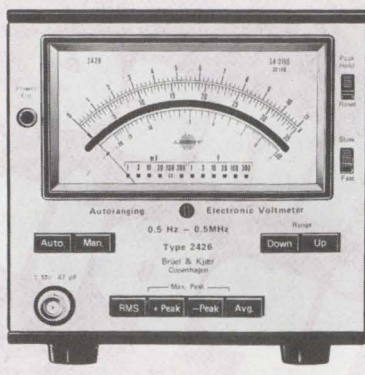

B & K Instruments, 5111 W. 164th St., Cleveland, Ohio 44142. (216) 267-4800. \$995.

The Autoranging Electronic Voltmeter, Type 2426, is a small size, general-purpose meter for indication of + peak, - peak, max. peak, true rms and average value of signals. Features include: linear frequency range from 0.5 Hz to 500 kHz; sensitivities from 1 mV to 300 V (full scale defl.); calibrated amplification 60 dB; ac and dc outputs; BCD output with range information; and BCD input for external range selection.

CIRCLE NO. 284

Just \$249 buys 80-MHz frequency counter



Hewlett-Packard, 1501 Page Mill Rd., Palo Alto, Calif. 94304. (415) 493-1501. 5381A: \$249; 5382A: \$450.

Low prices mark these two new counters. Both use crystal time bases, have 25-mV sensitivity, and make ratio as well as frequency measurements. The 80-MHz Model 5381A presents a 7-digit display. The Model 5382A counts to 225 MHz and displays 8 digits. Resolution of either instrument is 10 Hz at 0.1 s gate time, 1 Hz at 1 s, and 0.1 Hz in 10 s.

CIRCLE NO. 285

INNOVATIVE SWITCHES by CDI

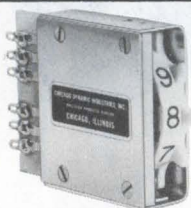

Sealed Switch Module. Completely sealed and/or RFI shielded.



Series TSM Mini Thumb-wheel switch mounts on 1/2" centers. Retrofits most miniature thumb-wheel switch panel openings.



Series SL (Pat. Pending) Linear Slide Switch. Up to 100 or more positions. Mounts EITHER left/right OR up/down. Single or multiple position selectors.



No Down-Time Rotary Switch. 5-Second wafer replacement. Mfd. under Tabet U.S. Patent 2,956,131 & others.

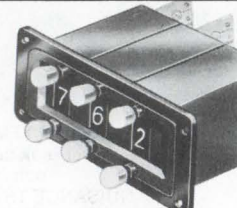

Miniature Add/Subtract Pushbutton units retrofit most mini-thumb-wheel switch panel openings. Pat. #3,435,167.



Series SP Rotary Switch. Economical, flexible, compact. More options on one wafer than previously available.

CDI earns its reputation every day for Consistently High Quality, Consistently Good Delivery. Request catalog.



CHICAGO DYNAMIC INDUSTRIES, INC.
PRECISION PRODUCTS DIVISION

1725 Diversey Blvd., Chicago, Illinois 60614 Phone (312) 935-4600, TELEX 25-4689



SPERRY™ Displays are now Beckman Displays



There's a new name for one of the most popular lines of displays and readout accessories — Beckman. You can look for even faster service . . . even better design assistance . . . even more display ideas. Now, from Beckman, Information Displays Operations, P. O. Box 3579, Scottsdale, Arizona 85257, Phone (602) 947-8371.

Beckman®

**INSTRUMENTS, INC.
INFORMATION DISPLAYS OPERATIONS**

There's more eye appeal in Beckman Displays!

FOR THE NAME OF YOUR BECKMAN DISPLAYS DISTRIBUTOR OR SALES OFFICE

CALL TOLL-FREE 800-645-9200

(IN N.Y. STATE, CALL COLLECT, 516-294-0990)

Beckman Instruments, Inc., Information Displays Operations, P. O. Box 3579, Scottsdale, Arizona 85257. Telephone (602) 947-8371.

INFORMATION RETRIEVAL NUMBER 85

Counters combine FM tolerance, sensitivity



EIP Inc., 3130 Alfred St., Santa Clara, Calif. 95050. (408) 244-

7975. \$4300 to \$5100.

The 350D Series is claimed to be the first microwave counter to provide a sensitivity of -30 dBm and an FM tolerance of 40-MHz pk-pk, worst case. The new series provides these capabilities in one box which automatically measures frequencies from 20 Hz to 18 GHz. Other specs include hundreds of readings per second under program control; a reprogrammable YIG; and i-f offset.

CIRCLE NO. 286

4-3/4-digit DPM slated for OEM applications

Newport Labs, 630 E. Young St., Santa Ana, Calif. 92705. (714) 540-4914. \$385 to \$450; stock to 3 wk.

Model 2000AS Digital Panel Meter is a moderate speed (to 20 readings/second) a/d converter designed to monitor outputs from process transmitters, signal conditioners and transducers. Readings may be scaled as desired for direct readout in engineering units. The unit features true differential inputs and BCD parallel data outputs. Full scale ranges from 400 mV to 400 V provide resolutions to 10 μ V per digit.

CIRCLE NO. 287

\$185 unit counts to 40 MHz



Scarpa Laboratories, 46 Liberty St., Braintree Station, Metuchen, N.J. 08840. (201) 549-4260. \$185; 2 wk.

Model SC-1A 40-MHz Frequency Counter reads to 8-digit accuracy by overranging. Featured are a 7-segment, 5-digit LED readout, a precision 10-MHz quartz crystal timebase, counter reset within 200 ms of completed count, leading zero suppression and 50-mV input sensitivity.

CIRCLE NO. 288

Logic tester checks 4075 inputs

Media III, 2454 E. Fender St., Fullerton, Calif. 92631. (714) 870-7660. \$9800; 30 days.

The Unitester can test logic boards with up to 4075 inputs and 116 outputs. Testing is on a comparison basis which eliminates the expensive initial set up and troubleshooting costs associated with computer based test systems. The basic clock rate is 25 MHz so that test patterns can be generated at TTL speeds. Variable clock rates are available. The Unitester is a desktop assembly, weighing less than 50 lb.

CIRCLE NO. 289

3,693 Indicator Lights in 1 LED Package

That's our new "SAVAGE" unit. A different concept in LED indication. RELAMPABLE . . . red, green, and amber LED (ours or others) . . . 2 to 28 volts . . . with or without resistors . . . snap-on flat and domed



Flat



Domed



the combination that best suits your application . . . body only . . . body and lens . . . body and lens and LED . . . body and lens and LED and resistor.

We said inexpensive. 89¢ in 2K quantities WITH red LED, 40¢ without LED. Attack your application with the "SAVAGE" approach. You can't beat our combination. TEST US. Call us, or contact your nearest Sloan Company distributor or representative.

1974-1975
eem
Vol. TWO



THE SLOAN CO.

7704 San Fernando Road
Sun Valley, California

Phone: (213) 875-1123 / TWX 910-498-2250

lenses producing 180° visibility. The "SAVAGE" unit offers you an inexpensive nylon-bodied unit that provides push-in panel mounting in a 1/4" hole on 3/8" centers or PC mounting either vertical or horizontal.

Order your "SAVAGE" unit in

RF Microwattmeters— Analog and Digital— FS Sensitivities from 10 nW to 10 mW



MODEL
42B/42BD

Boonton rf microwattmeters offer unrivalled sensitivity: 10 nW fs to 10 mW fs; from 200 kHz to 18 GHz, at highest stability ever attained at these sensitivities. Analog (42 B) or digital (42 BD) versions, both with linear DC outputs and logic-level programmability. BCD outputs are standard on digital version, autoranging and dB display (0.01 dB resolution) optional. Boonton Electronics, Parsippany, N.J. 07054

INFORMATION RETRIEVAL NUMBER 230

Wide-Range Programmable Capacitance Meters



MODEL
72B/72BD

Boonton analog (72B) and digital (72BD) provide rapid, accurate, 3-terminal and differential measurements, at 1 MHz, from 1 pF fs. Measures semiconductor-junction capacitance at low (15 mV) test level, with provision for external DC bias. Phase-sensitive detector measures accurately even at $Q=1$. Logic-level range programmability and fast-tracking DC output are ideal for ATE. Model 72BD has standard BCD output and autoranging. Boonton Electronics, Parsippany, N.J. 07054

INFORMATION RETRIEVAL NUMBER 231

Direct Capacitance Bridge 0.00005 to 1000 pF and 0.01 to 1000 mho



MODEL
75D

Boonton Model 75D Direct Capacitance Bridge is designed for 1 MHz capacitance and loss measurement. Capacitance range, 0.00005 pF to 1000 pF; basic accuracy, 0.25%. Conductance range: 0.01 mho to 1,000 mho, basic accuracy, $\pm 5\%$. Internal bias from -6 V to +150 V. Adjustable test level, 1 mV to 250 mV, at 1 MHz. Two modes of operation allow either conventional capacitance and loss measurements or one-control balance for capacitance only. 3-terminal input configuration. Boonton Electronics, Parsippany, N.J. 07054

INFORMATION RETRIEVAL NUMBER 232

INFORMATION RETRIEVAL NUMBER 233

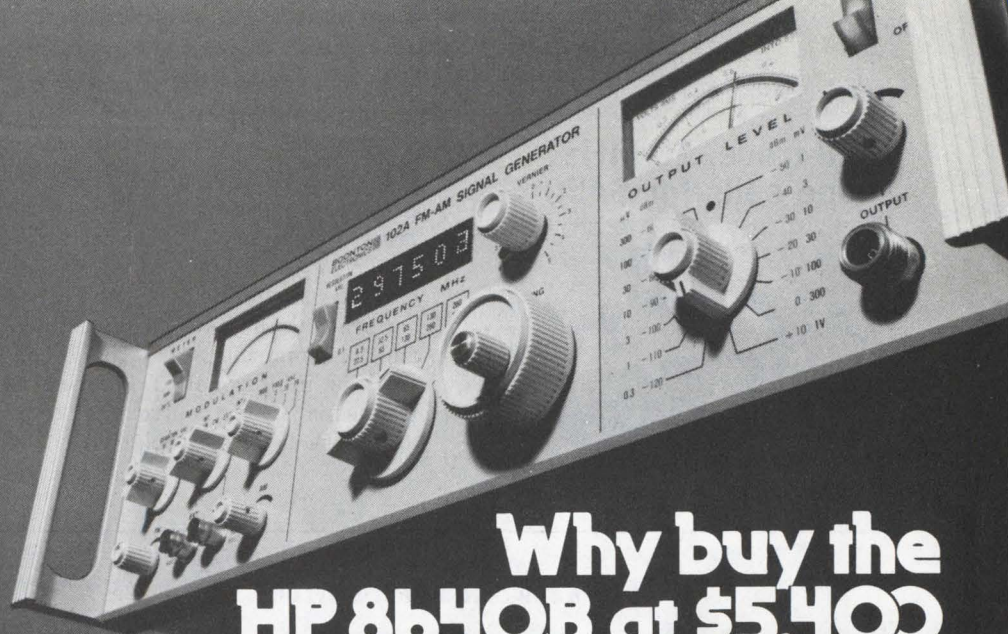

Why buy the HP 8640B at \$5,400 when \$2,205 less will get you Boonton's competitive 102A signal generator?

Our Model 102A, at \$3,195, has everything you need for just about any AM/FM application — plus seven performance and convenience features you won't get in the HP \$5,400 design.

What did we leave out?

Phase-lock synchronization, for one (but our dc-coupled FM channel can be externally locked if you need better stability than our typical 4 ppm); and narrow-pulse modulation (belongs in a different class of generators).

What did we add?

Four different signal-generation techniques — for optimum performance in each band, from 4.3 to 520 MHz, without the usual compromises in noise, stability, or residual-distortion characteristics.

The most logical panel layout and convenient control setup you've ever seen. And a unique adjustable "feel" main drive mechanism for narrow-band receiver setting with ease — even without our electrical vernier.

Separate meters for modulation and output — no annoying autoranging or out-of-range annunciators . . . we don't need them.

15 minute warmup to typically

meet 10 ppm/10 minute stability — made possible by low internal dissipation (only 30 watts; no fan!)

Wider FM deviation at low carrier frequencies than any other design in this class (how does 2 MHz peak-to-peak grab you?)

A detected-AM-output option, to verify our negligible phase-shift for VHF-omni testing.

Versatile modulation features — like five internal frequencies, 30% and 100% AM scales, and true-peak-responding AM and FM metering.

All these performance pluses are coupled with low spurious and close-in noise, excellent low-frequency phase integrity, really effective leveling, a low and flat VSWR curve, accurate wide-range attenuation, high output power . . . all of it buttoned up tight for low leakage in a lightweight 30 pound package.

. . . and it's all yours for \$3,195. Get the full specs today — before you spend 70% more . . .

For complete data or a demonstration write or call Boonton Electronics Corp., Rt. 287 at Smith Road, Parsippany, N.J. 07054, (201) 887-5110.

BOONTON

Dual-trace, 10-MHz scope sells for \$450

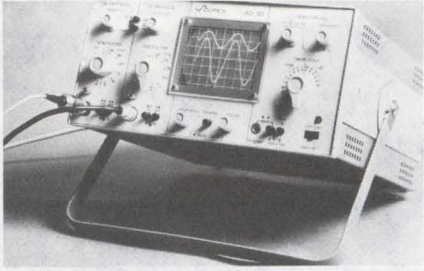

Jermyn, 712 Montgomery St., San Francisco, Calif. 94111. (415) 362-7431. \$450; stock.

Scopex 4D-10 is a dual-trace, 10-MHz scope. Specs include a dual-trace display at "A" channel, sensitivity of 10 mV/cm, all solid-state circuitry including MOS, and direct calibration in volts/cm and time/cm. The omission of variable controls is intentional. Triggering is by means of one control that operates both level and polarity.

CIRCLE NO. 290

Microprobe thermometer takes spot readings

Bailey Instruments, 515 Victor St., Saddle Brook, N.J. 07662. (201) 845-7252. \$355 (0 to 400 C); stock.

Temperature of beam lead devices, flip chips and miniature components is measured with Model BAT-7R by a contact method which is said to eliminate positional ambiguity. The unit can use microthermocouples as small as 0.005-in. Four ranges on the 6-in. meter cover 0 to 400 C and accuracy is within 1 C.

CIRCLE NO. 291

**When a standard switch won't do...
take advantage of P&B's
free engineering program**

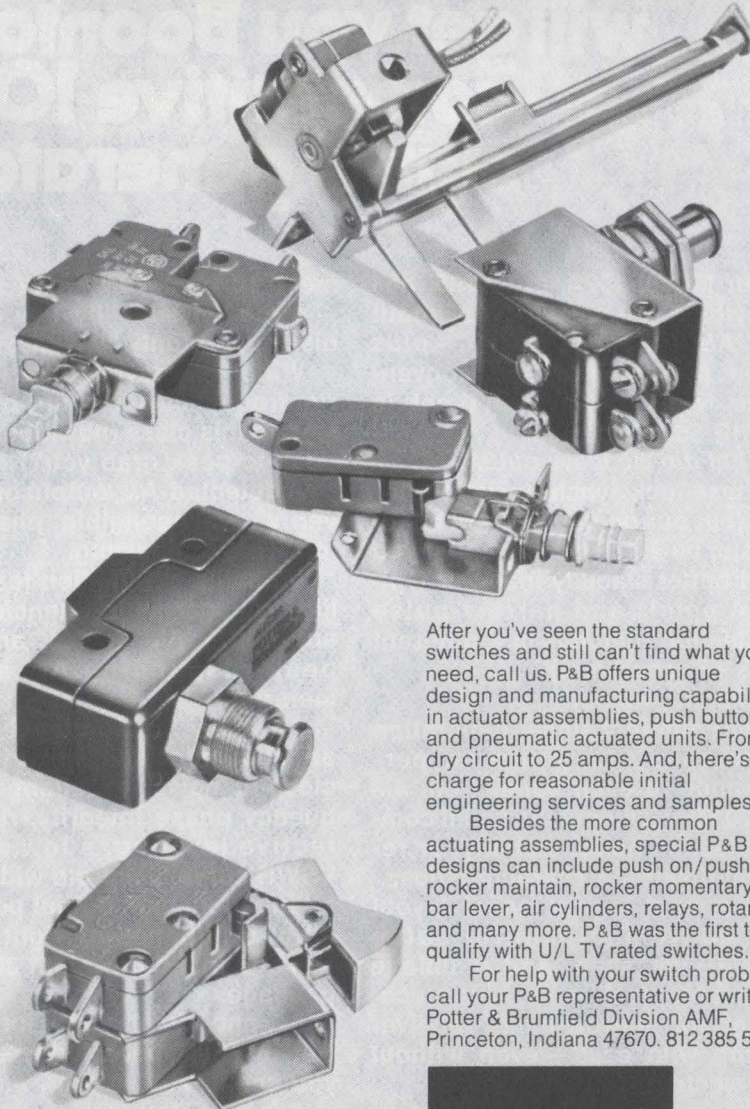

After you've seen the standard switches and still can't find what you need, call us. P&B offers unique design and manufacturing capabilities in actuator assemblies, push buttons and pneumatic actuated units. From dry circuit to 25 amps. And, there's no charge for reasonable initial engineering services and samples.

Besides the more common actuating assemblies, special P&B designs can include push on/push off, rocker maintain, rocker momentary, bar lever, air cylinders, relays, rotary, and many more. P&B was the first to qualify with U/L TV rated switches.

For help with your switch problem, call your P&B representative or write Potter & Brumfield Division AMF, Princeton, Indiana 47670. 812 385 5251.

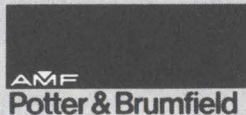

Synthesizer covers 0.5 to 18 GHz in 6 bands



Watkins-Johnson, 3333 Hillview Ave., Palo Alto, Calif. 94304. (415) 493-4141.

The new WJ-1250 Microwave Frequency Synthesizer provides programmable 500-MHz-to-18-GHz coverage in six standard bands. These increments are provided by front-panel plug-in sources. Standard bands are 0.5 to 1, 1 to 2, 2 to 4, 4 to 8, 8 to 12.4 and 12.4 to 18 GHz. Frequency programming is accomplished through the front panel keyboard or a BCD command applied to the rear panel connector.

CIRCLE NO. 292

Function generator weighs in at 2 lb.

Exact Electronics, Box 160, Hillsboro, Ore. 97123. (503) 648-6661. \$245; stock.

The Model 190 Function Generator offers waveforms at frequencies of 0.1 Hz to 1 MHz. Weighing in at just 2 lb., and housed in a high-impact plastic case, the unit produces sine, square, triangle, pulse and ramp waveforms, plus provisions for VCF (voltage controlled frequency) input, dc offset and TTL pulse output. Only 7-3/8 x 2-7/8 x 8-1/2 in., the Model 190 can be carried inside a briefcase.

CIRCLE NO. 293

Why Remex is the cat's pajamas in punched tape systems

- You get the fit you need
- We tailor systems for you
- And they don't cost all that much

Remex works with you to provide the right punched tape capabilities for the job to be done. And the price is low.

Take the reliable Remex 2000, 6000 and 7000 Series punched tape readers and reader/spoolers. They're fast, accurate and adaptable, with speeds of 150, 300 and 500 cps. Plus an advanced reading system which can read highly transparent tapes without adjustments. Plus a low cost, high performance servo system tailored to your specific job. All this with one common, easy-to-use interface.

Or take the Remex Series 6375 combo and 1075 Series perforator which gives you a 75 cps punch at the price of some 60 cps units.

Whatever you need in P/T, what you get is proven reliability, outstanding price/performance and cooperation you can't buy elsewhere at any price. It's what you'd expect from a long-established, major-factor-in-the-business company.

MAKIN' WHOOPIE. In new product development, Remex is here with bells on. Such as with our new floppy disk drives and systems, and our compatible digital cassette systems that can turn any punched tape system into a real performance tiger.

For information, contact Remex, 1733 Alton St., Santa Ana, California 92705 (714) 557-6860. *In Europe and the U.K., contact S.p.A., Microtecnica, Torino, Italy.*



RRS-6500 Reader with advanced photoelectric reading system

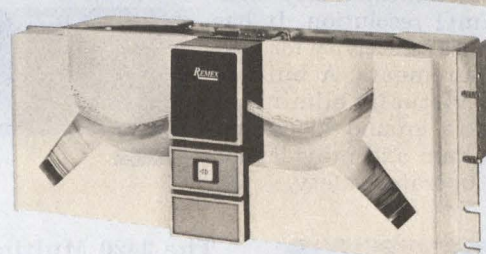
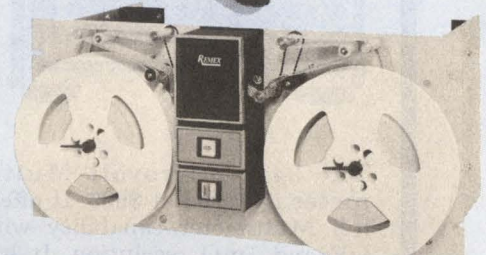

RRF-6300 bidirectional fanfold tape reader, reads to 300 characters per second

RAF-6375 Perforator/Reader combines 75 characters/second perforating, 300 characters/second reading, in a single low-cost system

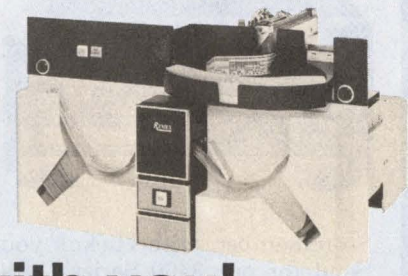

We work with you!

REMEX



The Hickok challenge: match our features, beat our price.

Most people know that the Hickok line of Digital Multimeters is one of the best performing on the market. The hard fact is, you can spend a lot more for a Multimeter and still not get all the features we offer. That's why, spec for spec, Hickok is your best all-around dollar investment.

All of our 3400 series Digital Multimeters come with 4¾ digits, an optional 300% overranging that enables you to read to 39999 on all five functions, an accuracy of .01%, a front panel control to vary the reading rate from 2 per second to one reading every five seconds and a solid 3-year warranty.



The Standard 3400 Multimeter is priced at just \$595. It's a rugged, non-temperamental, hard-working tool with a 10 μ V resolution built-in. It handles DC voltage from 10 μ V-1200V; AC voltage from 10 μ V-1000V RMS; resistance from 10m Ω -20M Ω and DC/AC current from 10nA-2A.

The 3410 Microvolt Multimeter is priced at \$695. It offers full Multimeter capability with μ V and 1m Ω resolution. It has 10 times more sensitivity for low-level measurements. A built-in guard box virtually eliminates errors due to ground loops and power line hum and provides for additional operator safety.



The 3420 Multimeter/Counter costs \$750. There is enough measurement capability in this one compact unit to replace a four-digit multi-meter as well as a five-digit frequency counter. Time base is from 100 seconds to 10 milliseconds; 100 mV sensitivity at 20 MHz.



So remember, with Hickok your dollars will go as far as they can. Send for our 3400 Series Data Sheet for complete specifications on our digital Multimeters.

HICKOK
the value innovator

Instrumentation & Controls Division
The Hickok Electrical Instrument Co.
10514 Dupont Avenue - Cleveland,
Ohio 44108
(216) 541-8060 - TWX: 810-421-8286

Fastest storage scope gives full bandwidth



Tektronix, Inc., P. O. Box 500,
Beaverton, Ore. 97005. (503) 644-
0161. \$3850.

Zooming along at a writing speed of 1350 cm/ μ s, the Tektronix 466 zips past all others to become the world's fastest storage scope. At this speed, you can grab and hold single-shot pulses—with no tradeoff in the portable unit's full 100-MHz bandwidth.

What you do trade off, though is scanning size: The top speed comes with a reduced scan of 3.6 \times 4.5 cm. At the full scan of 5.4 \times 7.2 cm, writing speed drops to 135 V/ μ s.

At the top speed, the 466 gives over 15 s of viewing time at the full stored intensity (no spec given for intensity), and up to 25 times that at reduced intensity.

Vertical deflection sensitivity of the dual-trace Tek 466 is 5 mV/div. Sweep speeds range from 0.5 μ s/div to 0.5 s/div in 22 calibrated steps. With the \times 10 magnifier, sweep rate of the unit jumps to 5 ns/div. (Tek's divisions are 0.9-cm wide.)

Three storage modes are offered by the Tek unit: variable persistence, fast transfer and nonstore. The first mode is for slow or fast repetitive signals, the second for high-frequencies and single-shot transients, and the third mode gives a conventional display.

Standard 1-M Ω probes (with \times 1 or \times 10 selection) come with the 466. Depending on the length of the selected probe, capacitance varies from 100 to 135 pF on \times 1 and 13 to 17 pF on \times 10.

For Tektronix **CIRCLE NO. 250**
For Hewlett-Packard **CIRCLE NO. 251**

SEMICONDUCTIVE CAPACITOR

High Reliability Ceramic Capacitors with Sturdy Lead Construction

Produced by Proprietary Formulations and Processes. (U.S. Pat. No. 3704266)

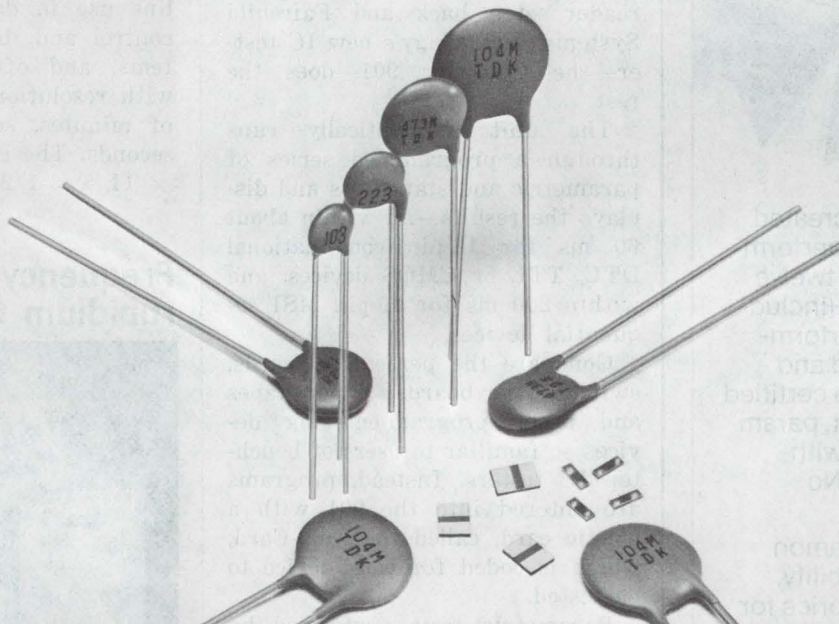

TDK is acclaimed as the leading ferrite and ceramic producer in the electronics industry. Ceramic semiconductor capacitors developed by TDK have an electrode structure that permits a solder connection to the lead wires capable of withstanding much more lead flexing than conventional ceramic capacitors in intergranular insulating type or barrier layer type structure. These ceramic semiconductor capacitors are produced by the TDK's proprietary methods of reduction and reoxydation of barium titanate powder prepared according to a U.S. patented formulation.

TDK's ceramic semiconductor capacitors are commercially available in two working voltages of 25 and 50 volts, dc. TDK's capacitors have better insulation resistance and are smaller than conventional ceramic capacitors. Ceramic semiconductor capacitors are also available in chip types capable of bonding directly to PCB substrates in hybrid microelectronic circuits.

Features:

1. Ceramic semiconductor capacitors are smaller than conventional ceramic capacitors of the same capacitance value.
2. Excellent temperature characteristics.
3. High insulating resistance.

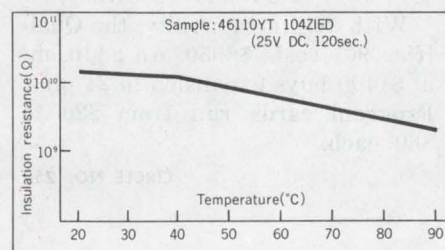
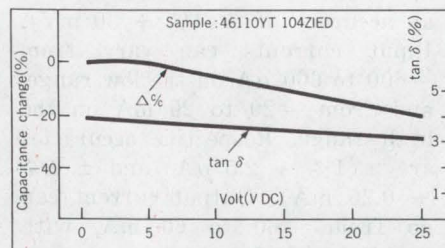

TDK

TDK ELECTRONICS CO., LTD.

14-6, 2-chome, Uchikanda, Chiyoda-ku, Tokyo 101, Japan

Telex: J24270, J26937 (TODENKA)

Cable: TDKCORE TOKYO

TDK ELECTRONICS CORP.

LOS ANGELES BRANCH

931 South Douglas Street, El Segundo, California 90245

Phone: (213) 644-8625

Telex: WUD 653-456 (TODENKA ELSDI)

CHICAGO BRANCH

2906 West Peterson Avenue, Chicago, Illinois 60659

Phone: (312) 973-1222

Telex: TWX 910-221-4211 (TDK CHGO)

The Crystal Filter with a Pedigree



Every crystal filter created by Damon is 100% performance tested. Ten to twelve critical parameters (including temperature performance) are measured and recorded. You get a certified performance report, parameter by parameter, with each Damon filter. No extra charge.

You may think of Damon filters as high-reliability, high-quality, high-price for aerospace and defense applications. You're only half right. New production capabilities, competitive prices and prompt delivery are making us a lot of industrial friends too—without compromising our high standards.

Damon: The economical crystal filter with aerospace blood lines.

Damon also manufactures a full line of VCXO's.

To receive a complete new Crystal Filter Catalog, write or call Ed Doherty, ext. 666.



DAMON
ELECTRONICS DIVISION
80 WILSON WAY, WESTWOOD, MASS. 02090 TEL: (617) 449-0800

INSTRUMENTATION

IC tester programs with optically coded cards



Fairchild Systems Technology, 3500 Deer Creek Rd., Palo Alto, Calif. 94304. (415) 493-5011. See text.

Just insert the appropriate coded plastic card into the optical reader, step back and Fairchild Systems Technology's new IC tester—the Qualifier 901—does the rest.

The unit automatically runs through a programmed series of parametric and state tests and displays the results—all within about 60 ms for 16-pin combinational DTL, TTL or CMOS devices, and within 200 ms for 16-pin MSI sequential devices.

Gone are the personality cards, switches, keyboards, paper tapes and other program-entering devices so familiar to users of benchtop IC testers. Instead, programs are entered into the 901 with a plastic card, called the Qual-Card, which is coded for each device to be tested.

Parametric tests performed by the Qualifier 901 include input leakage, power dissipation, fan-out and noise margin. Output tests are accomplished by state comparison, with output-state transitions monitored by a Grey counter.

Both the input and output voltages range from 0 to 10 V, with an accuracy of $\pm(1\% + 30 \text{ mV})$. Input currents can vary from -600 to $600 \mu\text{A}$ on the low range, and from -20 to 20 mA on the high range. Respective accuracies are $\pm(1\% + 2.5 \mu\text{A})$ and $\pm(1\% + 0.25 \text{ mA})$. Output current can go from -60 to 60 mA , with $\pm(1\% + 0.25 \text{ mA})$ accuracy.

With 16-pin capability, the Qualifier 901 costs \$6950. An additional \$1400 buys expansion to 24 pins. Program cards run from \$20 to \$60 each.

CIRCLE NO. 252

Digital clock sells for \$299



Thiem Industries, 1918 W. Artesia Blvd., Torrance, Calif. 90504. (213) 321-1911. Start at \$299; 45 day.

Series M digital clock provides time-of-day, elapsed time, or count-down/up time with digital output logic and/or digital display. The unit is designed for on-line use in data logging, process control and digital computer systems, and offers a 24-hr range with resolution of minutes, tenths of minutes, seconds or tenths of seconds. The clock measures $8\text{-}1/2 \times 11 \times 3\text{-}1/2\text{-in.}$ and weighs 6 lb.

CIRCLE NO. 294

Frequency standard uses rubidium for accuracy



Rohde & Schwarz, Pressestelle 80001, Munchen 80, Muhldorfstr 15, West Germany.

The XSRM rubidium frequency standard has a volume of only 20 cubic centimeters. The long-term drift of the 5-MHz output frequency is below 5×10^{-11} per month. The frequency standard uses the atomic resonance of the alkali metal rubidium (RB 87) at 6.834 GHz for the continuous adjustment of a highly stable 5-MHz crystal oscillator. This resonance is very sharp and highly resistant to environmental influences. The modular design ensures easy servicing since all components are accessible during operation.

CIRCLE NO. 295



NEW Simpson 360 Digital VOM

Handy and rugged enough for the field — accurate and versatile enough for the lab. And its simplicity and readability make it perfect for production line testing.

- 3-1/2" digit, non-blinking, auto-polarity 0.33" LED display
- AC line or battery operation
- 29 popular ranges including "low-power" ohms
- Analog indicator for scanning nulls and peaks
- Analog output signal permits interfacing with recorders and other instruments
- Up-down integration analog/digital conversion assures superior stability, accuracy and noise immunity

Supplied with test leads, AC line cord, operator's manual, without batteries \$295



SIMPSON ELECTRIC COMPANY

853 Dundee Avenue, Elgin, Illinois 60120 • (312) 695-1121
 CABLE: SIMELCO • Telex: 72-2416
 IN CANADA: Bach-Simpson, Ltd., London, Ontario
 IN ENGLAND: Bach-Simpson (U.K.) Ltd., Wadebridge, Cornwall
 IN INDIA: Ruttonsha-Simpson Private, Ltd., Vikhroli, Bombay

ORDER NOW FROM YOUR LOCAL ELECTRONICS DISTRIBUTOR OR WRITE FOR NEW CATALOG 4200

INFORMATION RETRIEVAL NUMBER 93

LOOK TO US FOR TOTAL CAPABILITY

EMI FILTERS

Pi Filters

Bushing sizes from .156 hex. to .500 hex.
Rated 50 Vdc to 2500 Vdc



L Section Filters

Available in these outside diameters .250, .312, .375 & .690
Rated from 10 to 25 amps and from 50 Vdc to 240 Vac



L, Pi, T Section Styles
.375, .410, .690 max. o.d.
Ratings range from 50 Vdc to 150 Vdc 125 Vac to 240 Vac 10 amps to 25 amps



Multi-section Filters
6 section, 12 section and many custom styles. U. L. types also available.

L Filter
Solder Mount
Rated 500 Vdc

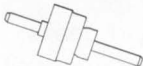

Pi Filters
Solder Mount
Rated 250 Vdc to 500 Vdc

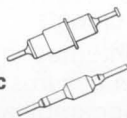

—EMC CONSULTING—
APPROVED TESTING
FACILITIES TO MEET :

MIL-STD-461 HEW 90-602
MIL-I-6181 FCC PARTS 15 & 18

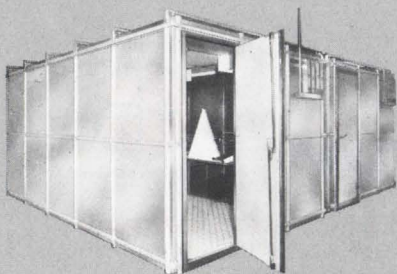

SPECTRUM CONTROL INC.

152 EAST MAIN ST. • FAIRVIEW, PENNSYLVANIA 16415
specialists in electromagnetic compatibility

SPECTRUM CONTROL, INC. has purchased the ALLEN BRADLEY COMPANY'S entire line of filters and capacitors, as well as their technology and patent rights. This acquisition now gives SPECTRUM CONTROL the broadest line of EMI/RFI filters and feed-thru capacitors in the electronics industry. We also hold more QPL listings to MIL-F-15733 than any other filter manufacturer. So whenever you need total capability, look to SPECTRUM CONTROL.

FEED-THRU CAPACITORS

The most complete ranges of sizes, cap. values, and ratings, for your selection. MIL-C-11015 types.



CERAMIC TRIMMERS

A full line of variable capacitors available in .218, .375 & .500 dia. MIL-C-81 types.

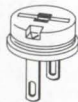

MULTI-LAYER FEED-THRU CAPACITORS

These unique components are available in a wide range of capacitance values to 1 MFD.

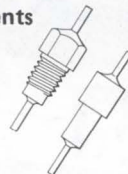

Multi-layer feed-thru capacitors and miniature feed-thru filters designed for filtered connector pins.



CERAMIC CHIP CAPACITORS

Available in sizes from .080 x .050 x .050 to .375 x .285 x .090 and the following dielectric characteristics: COG, X7R, X7S and X7U.

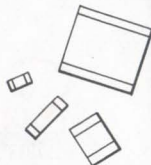

DATA PROCESSING

Low-cost paper-tape reader offered

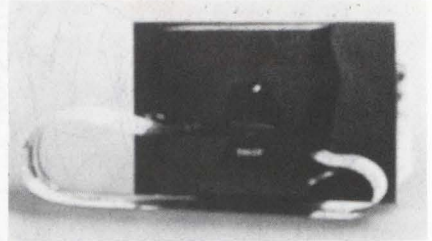

Tally Corp., 8301 S. 180th St., Kent, Wash. 98031. (206) 551-5500. \$275; stock.

A photoelectric tape reader named the R-2050 offers asynchronous reading speeds up to 250 characters per second. The reader features adjustment-free operation and uses a standard bulb as a light source. The Model R-2050 reads 5, 7, or 8-level tape interchangeably; tapes can contain up to 60% transmissivity. And the unit is DTL and TTL compatible.

CIRCLE NO. 296

Disc-refreshed display system shows color

Data Disc, Inc., 686 W. Maude Ave., Sunnyvale, Calif. 94086. (408) 732-7330. See text; 90 days.

Computer graphics are available for General Automation's SPC-16 minicomputers (Models 30, 50, and 70). The graphics are generated by the 6600 system from data supplied by the computer. The 6600—a disc-refreshed display system—uses standard television-type monitors. As many as 16 high-resolution displays can be driven by independent video channels. Color TV monitors that have R.G.B. inputs can provide displays with seven colors plus black. Video channels can be combined for form overlay or protected data displays. Gray scale capability is available at four or 16 levels which, when used on color monitors, can provide up to 4095 colors. Graphs and charts are made up of over 250 k individually addressable display points. Up to 3200 alphanumeric characters can be displayed on the screen at one time. The character entry rate is 30 pages per second. Systems price depends on the number of terminals and accessories used. A 16-terminal system costs about \$5800 a terminal.

CIRCLE NO. 297

yes,
yes,
no,
yes,
no.

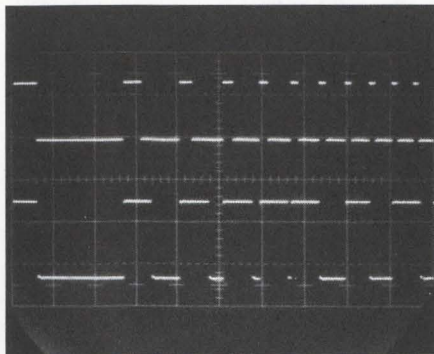

Upper trace: Constant Duty Cycle pulses over a 10:1 frequency range.
Lower trace: Normal pulses over same range.

"Standard pulses with predetermined width are fine for most requirements, but when I'm changing repetition rates I have to fiddle with the width control to make sure that I don't lose the pulse. Does your 'Constant Duty Cycle' mode let me set width as a percent of pulse period so I can change rep rates *without* tweaking the other controls?" (YES)

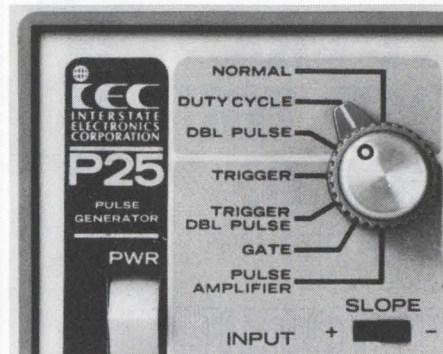

A single control selects all 7 modes.

"That Duty Cycle mode could come in handy, but I also want the regular pulses that I'm used to, and double pulses, and 50% squarewaves to 50 MHz. How about trigger, gate, triggered double pulse, and pulse shaping? (And all of these modes better be easy to set!)" (YES)

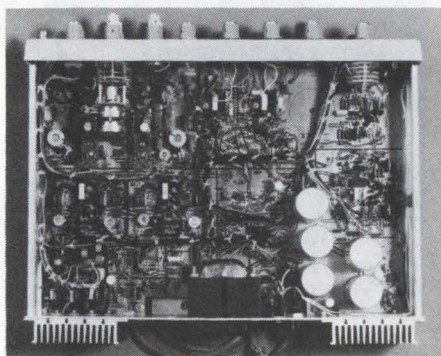

All components are fully accessible.

"Reliability and maintainability count, too. I want a generator that works! But in case it needs service I'd like to specify plug-in sockets for dual in-line IC's, and a parts list minus factory widgets. If I put my money on your model, will my QC man hate me?" (NO)

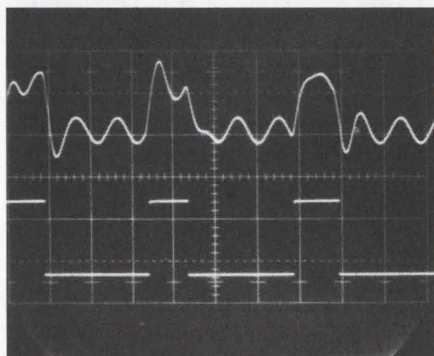

Upper trace: distorted, noisy input.
Lower trace: pulse generator output (Pulse Amplifier Mode).

"My application calls for pure pulses with a bare minimum of overshoot and squiggles. And I need to clean up distorted signals — you know, send in a crummy pulse train and get out a nice squared-up pulse with the offset, amplitude, and rise/fall times I've set up on the generator. Can do?" (YES)

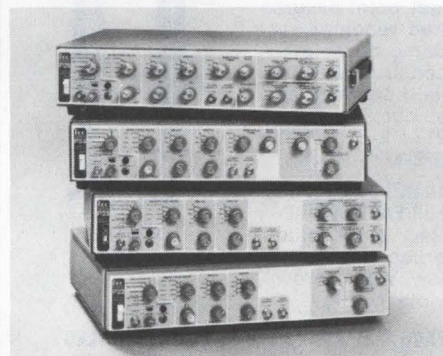

Four SERIES 20 models are available from \$575.

"Your \$1095 P25 Pulse Generator has it all, including simultaneous positive and negative outputs, each with adjustable d-c offset and variable rise/fall times from 5 nanoseconds. But if I only need a single output or faster, fixed rise times, am I out of luck?" (NO)

ask a 50-MHz pulse generator these 5 questions if the answers are yes, yes, no, yes, no, it's INTERSTATE

the Interstate man with all the answers is John Norburg—call collect (714) 772-2811



INTERSTATE ELECTRONICS CORPORATION
Subsidiary of A-T-O Inc.

U.S. HEADQUARTERS: Dept. 7000, Box 3117, Anaheim, CA. 92803; OVERSEAS SALES OFFICES: AUSTRALIA, Parameters Pty., Ltd.; BELGIUM-LUXEMBOURG, Regulation-Mesure S.P.R.L.; FINLAND, Havulinno Oy; FRANCE, Tekelec Airtronic, S.A.; ITALY, Tekelec Airtronic; ISRAEL, Radat International Company Ltd.; JAPAN, Asahi & Co., Ltd.; NETHERLANDS, Tekelec Airtronic, N.V.; NEW ZEALAND, David J. Reid, Ltd.; REPUBLIC OF CHINA, Bons International Co., Ltd.; SPAIN, Telco, S.L.; SWEDEN, M. Stenhardt AB.; SWITZERLAND, Traco Trading Co., Ltd.; UNITED KINGDOM, Euro Electronic Instruments, Ltd.; WEST GERMANY, Tekelec Airtronic GMBH; CANADA, Radionics, Limited. TWX U.S.A. 910-591-1197 TELEX U.S.A. 655443 & 655419

INFORMATION RETRIEVAL NUMBER 96

NEW E-Z-HOOK XL CAN GET YOU OUT OF DEEP TROUBLE

Our new XL "ExtraLong" 5" E-Z-Mini-HOOK reaches through wiring nest a full 4" to make safe, short-free connections. . . . either vertically or horizontally with one hook. Single contact point assures true readings. Same durable construction and field serviceability as our standard 2 1/4" long X-100W E-Z-Mini-Hook.

10 RETMA COLORS FOR EASY CODING
Red, black, blue, green, orange, yellow, white, brown, violet or gray.



ACTUAL SIZE

EACH SIZE AVAILABLE IN TWO TIP STYLES



SQUARE HOLE
For hooking laterally to component leads or slipping vertically over square Wire-Wrap* pins.



RECTANGULAR HOLE
For hooking laterally to component leads or slipping vertically over rectangular pins.

EXCLUSIVE FIELD SERVICEABLE FEATURE

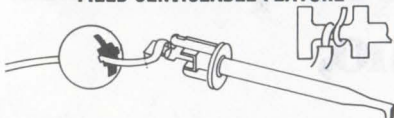

Damaged lead wire is replaced easily and quickly. No need to replace entire part.

*TRADEMARK GARDNER-DENVER

As Advertised in
REM—Sect. 2100, pages 365 to 369 and
EEM—Vol. 3, Sect. 2100 pages 2957
to 2965

Send for complete catalog & price list.

E-Z-HOOK DIVISION OF
TEKTEST, INC.

114 E. St. Joseph St., Arcadia, Ca. 91006
(213) 446-6175
(213) 285-6154 TWX 910 582 1614

INFORMATION RETRIEVAL NUMBER 97

DATA PROCESSING

Replace drum memories with plug-in unit

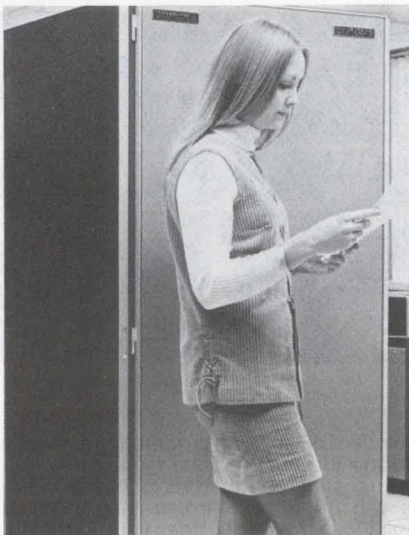

Fabri-Tek Inc., 5901 S. County Rd. 18, Minneapolis, Minn. 55436. (612) 935-8811.

Either of two plug-compatible core memory systems replaces drum memory for GE-Pac 4010 and 4020 computers. Use of the model SC4852 memory provides bit transfer rates to 3.3 MHz (with the GE high speed coupler) and eliminates access-time delay. A single cabinet that measures 72 x 32 x 32-in. can house over 800-k words of SC4852 or SC4510 memory. Add-on cabinets permit expansion to 2-M words. No operating system changes are required for either system.

CIRCLE NO. 298

Programmable calculator drives CCTV display

Unicom, 1275 Bloomfield Ave., Fairfield, N.J. 07006. (201) 575-1696. See text.

The LDP-1 calculator is controlled by conversational Basic and displays results on a CCTV monitor (64 char. by 16 lines). The desk-top unit weighs 32 lb and includes interfaces for TTY, line printer and the IBM Selectric Printer. The unit performs mathematical and trigonometric functions, has an 11-digit decimal number with ± 999 exponent and allows user-defined keys. A single cassette transport stores programs. The computer sells for \$4500 with 4-k user memory plus 12-k Basic language compiler ROM.

CIRCLE NO. 299

Hand-geometry helps identify individuals

Identimation Corp., 408 Paulding Ave., Northvale, N.J. 07647. (201) 767-0213.

The Identimat 2000 D verifies a person's identity from hand geometry characteristics. The unit compares the measurements with information encoded on an identity card. The 2000 D transmits data in computer compatible format (110 to 2400 baud). The processor stores access level privileges, time of day and day of week entry authorizations as well as the person's ID number. Lost cards present little problem unless the new owner's hand geometry matches that of the original owner.

CIRCLE NO. 300

Portable unit loads PDP-11 memory

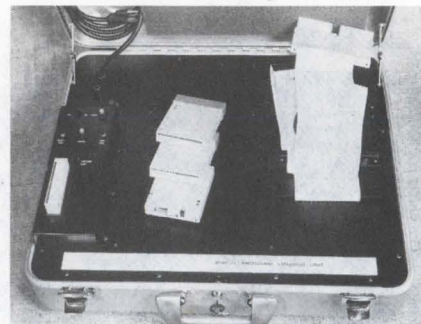

Applied Data Communications, 1509 E. McFadden Ave., Santa Ana, Calif. 92705. (714) 547-6954. See text.

The model 41-104 ROM controlled PDP-11 program loading unit loads 8-k of core from the magnetic tape cartridge in less than one minute. The portable loader is pushbutton activated to automatically control the processor and perform the absolute core load function. Up to 55,000 PDP-11 words can be loaded from one cartridge. This portable unit is intended for field service or initial installation use to perform initial processor loading or core refresh. In addition to diagnostic program absolute load, a library file management program is offered. The unit is software controllable as a read/write serial peripheral and will create its own cartridges. Single unit price is \$2510 including the termination. The 5-foot Unibus cable is \$200 with other lengths available.

CIRCLE NO. 301

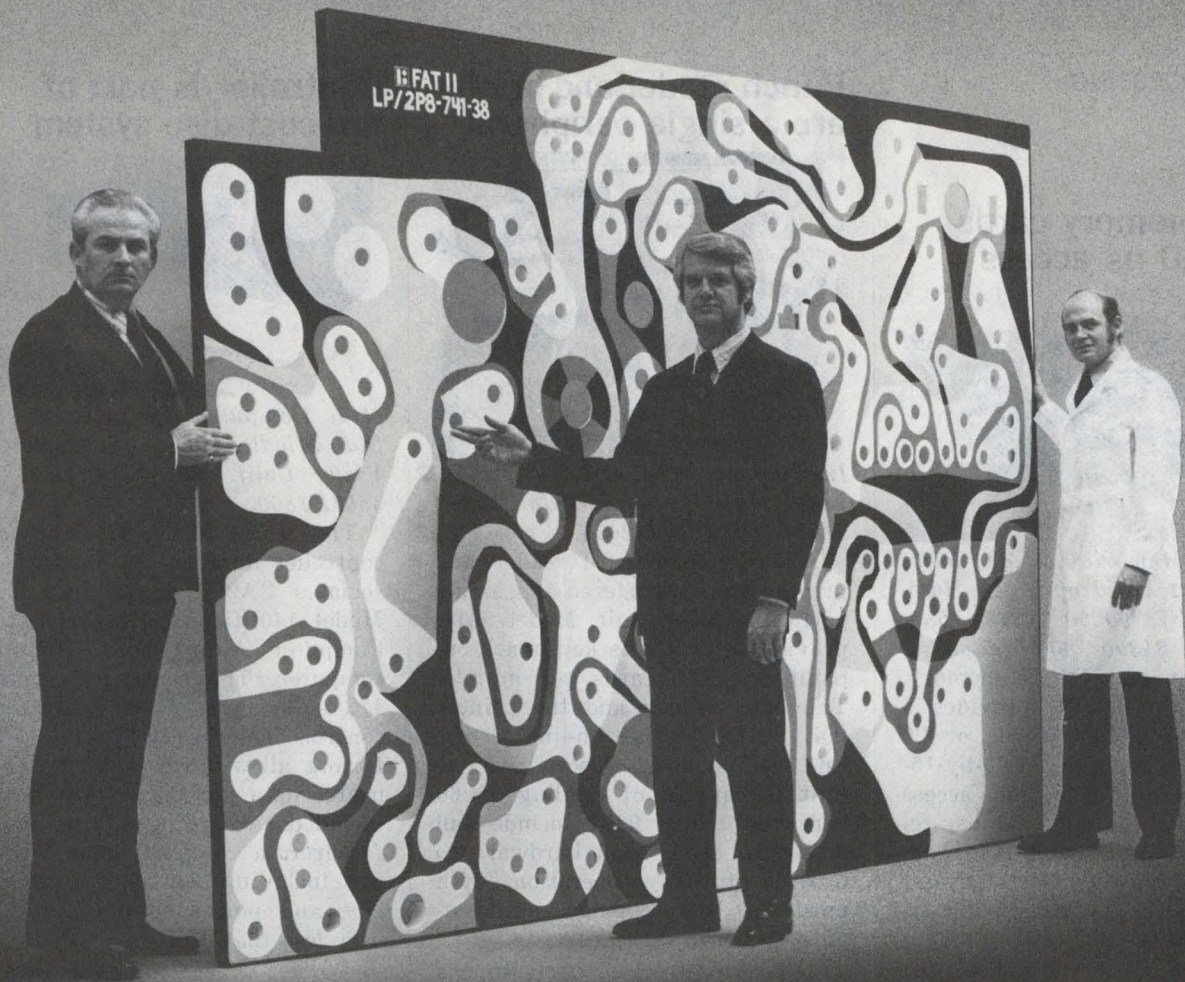

**When ACD brings a new
board out of the lab—it's ready.**

FAT'S Ready.

FAT™—Fully Additive Technology—is the volume user's ticket to cost efficiency. And it's ready now to be mass produced.

Why do we make a big thing out of being ready? Our reputation. Even though our FAT board is less expensive than conventional boards—we want you to know it's a precision piece of circuitry. And even though the holes are pierced instead of drilled, you'll find them ACD reliable. We've been

perfecting the undrilled hole for years—we're pros at the pierced through process. With FAT you'll find no slivering or undercut characteristics that can cause bad circuitry.

So if you're a volume house looking for economical per-board cost, don't need conventional, multilayer or exotic boards, or require military documentation, you should call us. We're ready to quote production orders on our FAT boards right now.



ADVANCED CIRCUITRY

4811 West Kearney Street, Springfield, MO 65803 • (417) 862 0751

NMOS memory cards offer 150 ns access

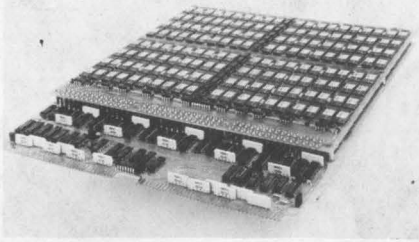

Electronic Memories & Magnetics Corp., 12621 Chadron Ave., Hawthorne, Calif. 90250. (213) 644-9881. From \$4390; 60-90 days.

A high-speed NMOS memory, the Microram 3000N, provides a maximum of 16,384 words or 20 bits word on a single 11.75-by-15-in. PC board. Cycle and access times are 300 ns and 180 ns, respectively. Also available is a high-speed version, the Micromemory 3000N-1, which cycles in 180 ns and accesses in 150.

CIRCLE NO. 302

Punch reader and printer are a single peripheral

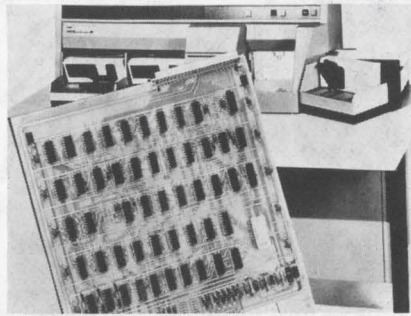

Instrument Technology Corp., 18811 Napa St., Northridge, Calif. 91324. (213) 886-2034.

A key punch, card reader and printer are now offered as a single peripheral. The unit, Model 9311, provides an off-line key punch capability of 35 cards per minute. The card reader and the printer may be used either on-line or off-line, at the user's discretion. The unit is capable of reading at 60 cards/min. The 9311 includes all software, cables and hardware to provide turnkey operation with most of the popular minicomputers.

CIRCLE NO. 303

Controller is part of low-cost disc system



Mini Computer Technology, 1901 Old Middlefield Way, Mountain View, Calif. 94043. (415) 965-4567. \$800.

The Model FDC 101 floppy-disc controller interfaces a Shugart Associates SA901 or Century Data Model 140 floppy disc drive to a Computer Automation LSI minicomputer. The controller requires 1/2 slot in the CPU chassis and controls one or two drives. The format allows over 342-k bytes of usable data per drive. Software is included. According to the manufacturer, a complete memory system including controller, drive, cables and power supply costs the user less than \$1750.

CIRCLE NO. 304

ALCOSWITCH®

New! Three & four position Slide Switches with positive detent and contact wiping action. Designed for use on calculators, communication equipment, and test instruments. For PC applications. Rated at 0.25 amps @ 125 VAC.

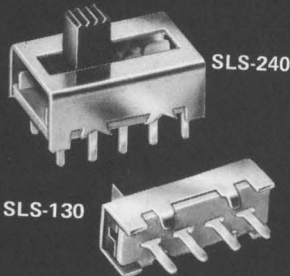

ALCO ELECTRONIC PRODUCTS, INC.
1551 Osgood Street, North Andover, Mass. 01845

INFORMATION RETRIEVAL NUMBER 99

ALCOSWITCH

Molded-in heat sink terminals with gold finish. Fine silver contacts. Internal and external isolation barriers between poles & terminals. Anti-push-in toggle. PC or wired terminals. Many lever options. Rated 3 amps @ 250VAC or 6 amps @ 115VAC.

1, 2, 3, AND 4 POLES
NEW MTA SERIES

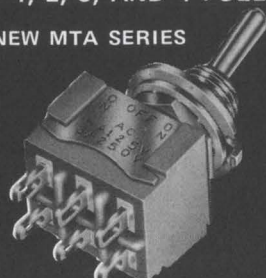

ALCO® ELECTRONIC PRODUCTS, INC.
1551 Osgood Street, North Andover, Mass. 01845

INFORMATION RETRIEVAL NUMBER 100

Recruitment Advertising gets READ ... in Electronic Design

RATES

1 page	\$2,140.
3/4 page (3 cols.)	1,620.
1/2 page (2 cols.)	1,080.
1/4 page (1 col.)	540.
1/8 page (1/2 col.)	270.
1/16 page (1/4 col.)	135.
One column inch	54.

DATA

Four column make-up. Column width: 1-3/4". Each issue mails two weeks prior to the issue date. Closing dates for camera-ready mechanicals or film is one week before mailing date. If desired, Electronic Design will set type at no charge (closing date is 2 weeks prior to mailing date).

84,000 DESIGN ENGINEERS AND ENGINEERING MANAGERS

Call the Recruitment Hotline: (201) 843-0550 X203 or clip & mail this coupon to: Recruitment Manager, Electronic Design, 50 Essex St., Rochelle Park, N.J. 07662.

I'm interested in placing recruitment advertising in electronic design.

Issue _____ Size of ad _____
 My copy is enclosed I need more information
 Name _____ Title _____
 Company _____ Telephone _____
 Address _____
 City _____ State _____ Zip _____

TYPE - 256 x 1 Static SOS/CMOS Ram

NUMBER - INS4200

READ CYCLE TIME - 180 nS

WRITE CYCLE TIME - 140 nS

QUIESCENT POWER DISSIPATION - 40 μ W @ 10 V

INPUT CAPACITANCE - 6.5 pF

SUPPLY VOLTAGES - 5 to 15 volts

OUTPUT - Three-state TTL compatible, full address
decoding and bipolar compatible pin-outs.

PACKAGE - 16 pin dual-in-line

PRICE - Mil Range (100-999) \$38.00

Comm. Range (100-999) \$21.00

256X1 CMOS RAMS

Only Inselek makes the lowest power, highest speed 256x1 Static SOS/CMOS RAM currently available. And the price is only \$38.00 in the military range and \$21.00 for the commercial version (100-999).

Excellent prices when you consider the added benefits you're getting with our proven SOS technology . . . exceptional reliability, high speed and low power. With an Inselek INS4200 Ram, a minimum number of additional components are required due to the 3 chip select inputs, especially when employed with large memory arrays. For the applications minded engineer or manager, you'll be glad to know that they're perfect for use in point-of-sale systems, mini & micro computers, computer peripherals, calculators & portable electronic systems. One more point. The Inselek INS4200 Ram is fully compatible with other CMOS and TTL devices. Check the specs above and then contact Bob Burlingame, your applications engineering specialist at

Inselek. Bob will be glad to discuss your specific requirements. Call Bob collect at (609) 452-2222, or write him at INSELEK, Inc., 743 Alexander Road, Princeton, New Jersey 08540.



SALES OFFICES IN:
CONCORD, MASS. (617) 369-5298
LOS ANGELES, CALIF. (213) 889-2788

DISTRIBUTORS

West Coast - WESTATES (213) 341-4411 • New England - GREEN SHAW (617) 969-8900 • Mid-Atlantic - WILSHIRE ELECTRONICS (609) 786-8990

PERMANENTLY POLED PYROELECTRIC.

IR DETECTOR FEATURES:

- Responsivity independent of operating temperatures or fluctuations
- High sensitivity
- High temperature range
- Low cost

Typical Electrical Characteristics for (1mm x 1mm Area)	
Responsivity @ 15Hz	600 volts/watt
@ 90Hz	150 volts/watt
NEP (500°K,15,1)	6.0×10^{-4} watts
D* (500°K,15,1)	1.5×10^4 cm Hz ^{1/2} watt ⁻¹
Detector Capacitance	20 pf
Output Impedance	10,000 ohms

Here is the latest product of Barnes' continuing materials research in pyroelectric technology.

A new infrared detector with permanently polarized elements . . . no depoling due to high temperatures or incident radiation. Packaged in two configurations, it's the ideal detector for radiometers . . . laser power measurements . . . thermometers . . . with a construction qualified for space applications.

There's more. Write Detector Products Group, 30 Commerce Road, Stamford, Connecticut 06904, or call (203) 348-5381 today.

BARNES ENGINEERING

DETECTOR PRODUCTS GROUP

INFORMATION RETRIEVAL NUMBER 103

TRIMLINE ENCLOSURES BY PREMIER METAL PRODUCTS CO.

337 Manida St., Bronx, N.Y. 10474/(212) 991-6600

OVER 1300 ITEMS IN OUR CATALOG



Complete catalog
and prices on request.

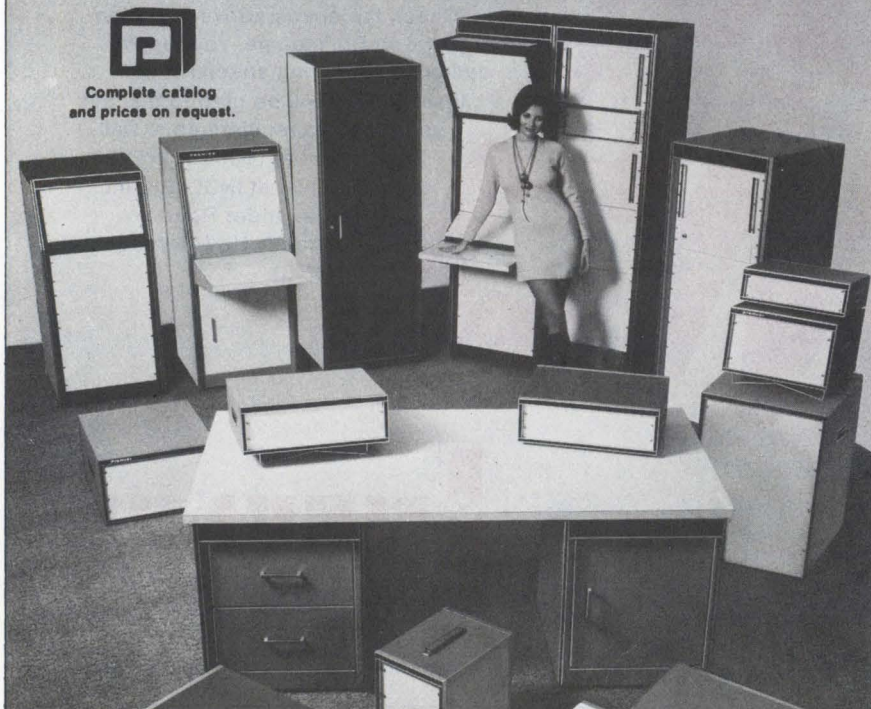

INFORMATION RETRIEVAL NUMBER 104

DATA PROCESSING

Recorder gives hard copy from voice band TV pix



Alden, Alden Research Center, Westboro, Mass. 01581. (617) 366-8851. \$795; 60-90 days.

The 400 "Push to Print" recorder prints 2.3-in. pictures at a frame rate of 8 s at 15 sweeps/s on Alfax electrosensitive paper. It receives voice band TV transmissions via radio or standard telephone voice grade communications link with no delay in receipt of picture or data. The recorder is complete with synchronous sweep drive, chart drive, internal writing amplifier, power supply and manual framing. A contrast control allows the operator to adjust the clarity and contrast of the printed picture.

CIRCLE NO. 305

S/d converter plugs into PDP-8 mini

G & S Systems Inc., 279 Cambridge St., Burlington, Mass. 01803. (617) 273-0856. See text.

A 12-bit synchro-to-digital converter for PDP-8 use reduces design and manufacturing cost to digitize shaft angle information. The converter plugs directly into a Digital Equipment Corp. PDP-8 Omnibus. The converter is packaged on a single standard PDP-8 PC card. Accuracy is ± 5 arc minutes with tracking rates on the synchro, or resolver, of up to 1800 rpm. Options include resolvers, Inductosyns and a two-speed software interface. Depending on options, the synchro-to-digital converter is priced from \$1000 to \$1300 in single quantities.

CIRCLE NO. 306

Wherever you are Staco Switches Make Things Happen

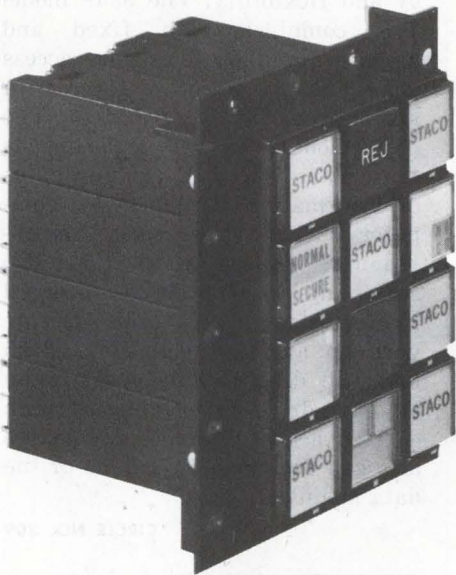

Flexible—Jet plane or rapid transit train...Staco switches make things happen when they should. Mount in matrix array or individual switch stations. Four-lamp or single lamp illuminated colorful message panels that really communicate. Choice of circuitry, switch action, and legend style to meet your particular needs.

Durable—Design qualifications, premium grade materials, precious metal contact alloys make for reliable, trouble-free operation. Careful workmanship and thorough testing assure highest quality switches every time.

Available—Realistic delivery schedules you can depend on will help you to meet your production schedule. Check the total cost...purchase, installation, and maintenance...and you'll find it costs nothing extra to order the very finest.

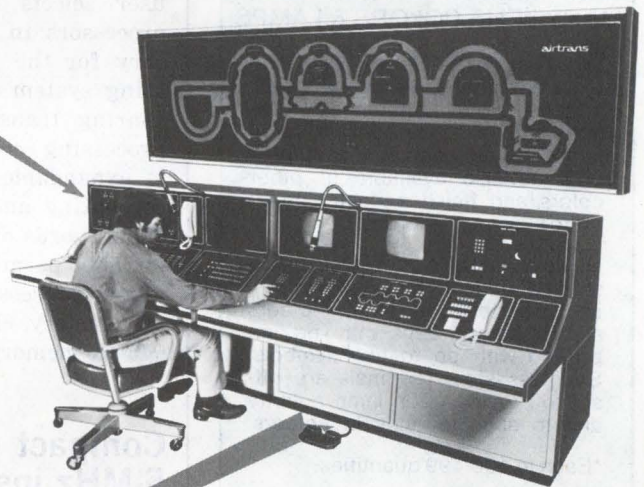

Get full details—Write today for free general catalog giving complete specifications along with a handy Product Selection Guide.

When you think switch...
think STACOSWITCH

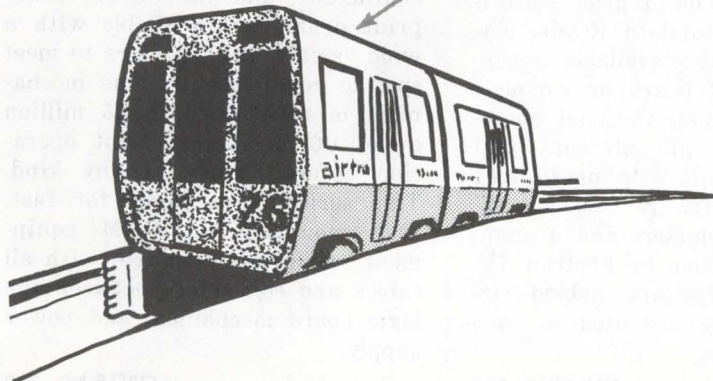

STACOSWITCH
a STACO, INC. company

1139 BAKER STREET, COSTA MESA, CALIF. 92626
(714) 549-3041 TWX: 910/595-1507

Other STACO Company products: Fixed Ratio Transformers, STACO, INCORPORATED, Richmond, Indiana; Variable Transformers, STACO, INCORPORATED, Dayton, Ohio.



**PRICES CUT
37% to 66%**



**REPLACEABLE
CARTRIDGE LITES**

Now only **40¢ to 86¢***

**IMMEDIATE DELIVERY ON
MANY LENS COLORS & LAMPS**

Low-cost RCL Series Cartridge Lites are offered in 3 lens styles, 10 lens colors, a full range of voltages and incandescent or neon lamps. Clear anodized aluminum body is also available in other colors and finishes—including iridite—on special order.

Devices mount in panel with spring steel clip, lead wire connectors or solderless cartridge holders shown below. Lens may be imprinted with up to two symbols. Stainless steel terminals are offset to provide neon lamp polarity and to align legends in holders.

*Each in 100-499 quantities.



**PRICES ALSO REDUCED ON
CARTRIDGE LITE HOLDERS**

Save 33% to 67%... RCLH Series Holders now priced from 25¢ to 70¢. Available in front- and rear-mounted versions, solder cup and turret lug terminals and printed circuit board mounting.



9800 N. ORACLE ROAD
TUCSON, AZ. 85704
(602) 297-1111
TWX 910-952-1377

DATA PROCESSING

Computers feature decentralized functions



Xerox Corp., 701 S. Aviation Blvd., El Segundo, Calif. 90245. (213) 679-4511.

The 550 and 560 are 32-bit medium scale computers that feature decentralized architecture. A single system control processor orchestrates the arithmetic and input-output processors. The more powerful 560 handles up to 128 time-sharing users while local and remote batch is in progress. The user selects the number of I/O processors in basic clusters necessary for the job. The CP-V operating system supports batch time-sharing transaction and real-time processing concurrently. The 560 is expandable to a mixture of 22 computing and I/O processors and 256-k words of memory. The smaller 550 permits expansion to 17 mixed processors and 256-k words of memory. Both machines have 645-ns memory cycle times.

CIRCLE NO. 307

Compact processor has 5-MHz instruction rate

Akers Electronics, 3191 Horten, Norway.

The MIPROC CPU, a three-package system, has a 70-instruction repertoire that includes hardware multiply/divide. Average instruction execution time is 200 ns; memory data capacity are 256, 16-bit words. The program store is made up of standard ROMs. The processor is also available assembled on a PC board or complete with front panel. Optional equipment includes an interrupt unit and an a/d unit with up to four converters. Software packages include two assemblers and a simulator, all written in Fortran IV. Monolithic chips and hybrid circuit technology are used in each of the modules.

CIRCLE NO. 308

Fixed-head storages improves virtual memory

IBM, Data Processing Div., 1133 Westchester Ave., White Plains, N.Y. 10604. (914) 696-1900. \$4400; August.

A data module with fixed head storage enables IBM 3340 disc drives to store and retrieve information with increased efficiency and flexibility. The 3348 model 70F combines both fixed and movable read/write heads, access arms and recording surfaces in a single removable cartridge. The data module has 30 fixed heads that make one-half million bytes of information available to a computer with no time delay for positioning access arms. It also stores up to 69.3 Mbytes served by movable heads that operate with an average seek time of 25 ms. The data module operates on any two-drive 3340 equipped with a fixed head feature. These drives also can use earlier versions of the data module.

CIRCLE NO. 309

Digital printers rated at 3 M to 25 M cycles

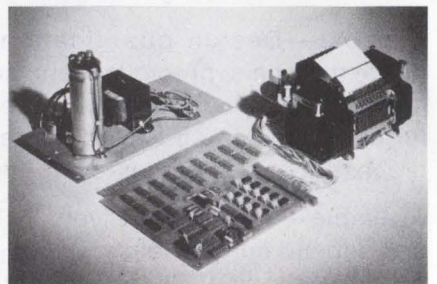

Keltron Corp., 225 Crescent St., Waltham, Mass. 02154. (617) 894-0525.

The DM-300 Series is a medium speed, 3-line/s printer, capable of printing up to 18 columns. The print drum has 13 positions per column and can print 40 different characters and numbers. Other print drums are available with a wide variety of characters to meet specific requirements. The mechanism is rated at 3 to 25 million cycles of continuous print operation before failure of any kind. This series is packaged for fast, easy mounting on OEM equipment and comes complete with all cables and connectors between the logic board mechanism and power supply.

CIRCLE NO. 310

Centralab perspectives

FOR USERS OF ELECTRONIC COMPONENTS



CENTRALAB

Electronics Division

GLOBE-UNION INC.

5757 NORTH GREEN BAY AVENUE
MILWAUKEE, WISCONSIN 53201

Centralab Distributors now have twice as many monolithic capacitors in stock.

To provide a wider selection of monolithic ceramic capacitors, Centralab doubled its line. Distributors now have 288 standard chip, axial and radial lead capacitors -- all ready for off-the-shelf delivery.

If you're specifying or buying monolithic capacitors, you know that the last few years have produced its share of headaches. The use of these devices has expanded so rapidly that problems of availability and delivery have been more the rule than the exception. Recognizing your needs, Centralab, in 1973, initiated a program that today gives you a broader selection of monolithics competitively priced and with no waiting for delivery.

There's no compromise in the Centralab line of standard monolithic ceramic capacitors. It now includes chip, axial and radial lead types. They are available in 288 standard values — that's twice the number previously offered. And 244 values are directly cross referenced to major competitive units, making them not only an excellent first choice but an ideal second source.

In the new broad Centralab line you can select from 58 values of Ceramolitic[®] chip capacitors in 100 VDCW types, rated from 10 pf to .039 mf with COG (NPO) and X7R temperature characteristics, and tolerances of $\pm 5\%$ and $\pm 10\%$.

Tubular axial lead types are available in 84 values for 100 VDCW, rated 1 pf to .1 mf with COG (NPO) and X7R temperature characteristics and tolerances of ± 0.5 pf or $\pm 10\%$.

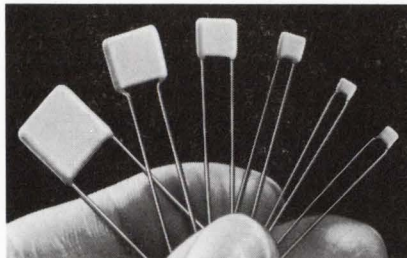

The radial lead, epoxy coated Mono-Kap[™] is offered in general purpose, temperature stable and

ultra stable types. You can select from 50 or 100 VDCW with COG (NPO), X7R, and Y5V characteristics. Tolerances include ± 0.5 pf, $\pm 10\%$, $\pm 20\%$ or $+100 -0\%$ (GMV).

But breadth of line is only one reason you can count on Centralab for monolithics. Availability is another. Every Centralab Distributor has this comprehensive line available for immediate delivery. Long the source of highly reliable ceramic disc and special purpose capacitors, he is also the man to see for superior, top performing monolithics. Ask him for the new catalog that gives complete technical details on 288 values and our cross reference for major competitive monolithics. Then see why Centralab standard monolithics are the best headache remedy in the business.



In addition to stocks of monolithic ceramic capacitors at Centralab Distributors, this 20,000 square foot warehousing facility in Milwaukee maintains an extensive back-up inventory exclusively for distributor orders.



Reliability is a thousand relays when you need them.

These days, buying reliable relays isn't enough. They have to be available when you need them. And when you need a lot of relays you want a supplier who won't let you down. You can count on GTE Automatic Electric to supply the quantities you need, on the schedule we promise.

We'll match our delivery record with anyone.

In the past year, we met our scheduled delivery promises on almost 100% of all relay orders. That's on all types of orders in all types of situations. So, when we give you a delivery promise, you can count on it without a lot of time-consuming expediting, without "check-up calls."

Don't think our record means you have to put up with long lead times either. We'll quote you shorter delivery schedules than just about anybody. And we'll make those schedules, too. On big orders — or little ones.

Quick off-the-shelf delivery.

You can get over 200 kinds of relays from our stock, whether it's a little correed or a stepping switch with 400 contacts. So we can promise delivery of inventoried items in just a few days. Over one-third of our orders are "rush" and "off-the-shelf." That means we're really



geared to respond fast when you need help.

How can we do it?

When everything else seems to be on allocation, how can GTE Automatic Electric be improving delivery times? Good question. The answer is improved manufacturing facilities to keep up with our increasing sales of high-quality relays. We take full advantage of high volume production equipment and techniques. And we have long-term commitments from our material suppliers. The more relays you need, the more you need us.

Delivery programs for special occasions, too.

Our "sample service" gives top priority for prototypes or evaluation models. We ship custom-built samples in as little as two weeks. We also have a "programmed order plan" for trimming your bulging inventories. Just give us an annual order, and a delivery schedule. We produce and ship to meet your needs. And these delivery services are offered at no increase in price. We don't make you pay extra for service you deserve.

An expensive relay is one that's not there when you need it.

Call one of our regional offices to set up a delivery program you can trust. You'll find our prices are more than just competitive.

Northlake, Illinois:
312-562-7100 Ext. 324

North Hollywood, California:
213-766-5203

Stamford, Connecticut:
203-329-0981

Falls Church, Virginia:
703-533-0636

GTE Automatic Electric,
Northlake, Illinois 60164.

GTE AUTOMATIC ELECTRIC

11 audios 6 packages countless applications

Visit our hospitality suite
Chicago Spring Conference,
June 10th and 11th, 1974.

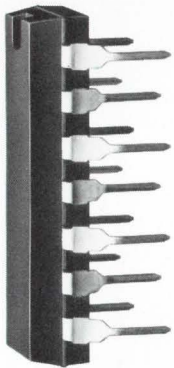

TBA 820
2W - 12V - 8Ω
0.75W - 6V 4Ω

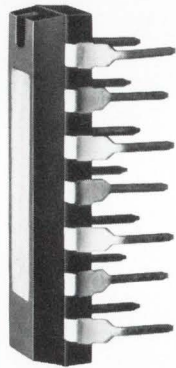

TAA 621 A12
2.2W - 18V - 16Ω

TAA 611 B12
1.15W - 9V - 8Ω

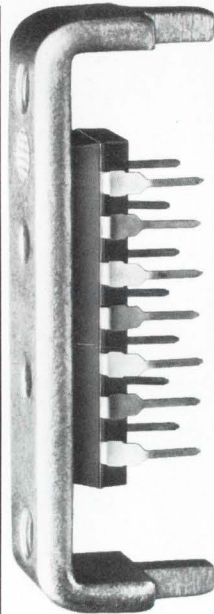

TBA 641 B11
4.5W - 14V - 4Ω

TAA 621 A11
4W - 24V - 16Ω

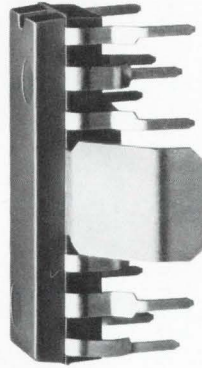

TBA 810S
6W - 14.4V - 4Ω
Thermal shut-down

TBA 800
5W - 24V - 16Ω
4.7W - 18V - 8Ω

TCA 830
3.4W - 12V - 4Ω
2W - 9V - 4Ω
Thermal shut-down

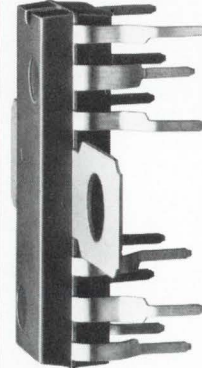

TCA 940
10W - 20V - 4Ω
6.5W - 20V - 8Ω
Fully protected

TBA 810AS
6W - 14.4V - 4Ω
Thermal shut-down

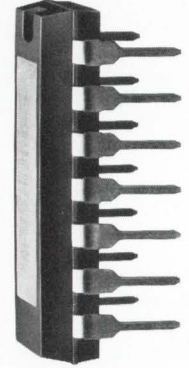

TDA 2020
15W - ±15V - 4Ω
(THD = 1%)

10W - ±15V - 8Ω
(THD = 1%)
Fully protected

Intercom systems. Two-way radios. Paging systems. Walkie-talkies. Alarm systems. Loudspeaking telephones. Telephone answering systems... And, of course, battery or line operated TVs, record players, car radios, tape recorders, home radios, stereo equipment... You name the audio application - we have the monolithic audio

amplifier to meet your particular requirements for cost and performance.

SGS-ATES is the world's largest supplier of monolithic audio power amplifiers. Our range covers more devices than can be offered by any other manufacturer, and includes circuits featuring thermal shut-down, complete short-circuit

protection and output power up to 20W.



SGS-ATES Semiconductor Corporation
435 Newtonville Avenue
Newtonville, Mass. 02160
Phone: 617-9691610

Terminal replaces or controls hardcopy units

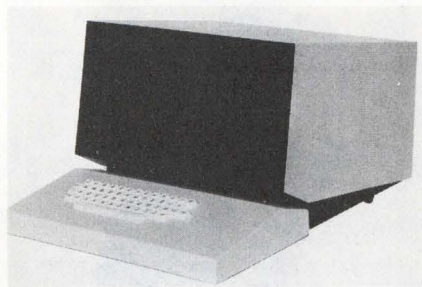

Information Design, Civil Air Terminal, Bedford, Mass. 01730. (617) 274-0190.

Named Keyview this CRT terminal can be used as a versatile TTY substitute. The unit displays up to 32 lines of 64 to 96 dot-matrix characters on a 12-in. CRT. A MOS memory provides the necessary storage and roll-up. A computer controlled cursor is also furnished for editing purposes. Normal transmission speed is 4990 baud with options to 49,990 baud. The terminal is compatible with TTY devices for hardcopy output activated by computer or operator. Important options include graphic plotting, remote monitor operation and daisy-chain capability.

CIRCLE NO. 320

Advanced disc memory system has 384 track/in.

California Computer Products, 2411 W. La Palma, Anaheim, Calif. 92801. (714) 821-2011.

The Trident disc-drive family provides high-speed random-access storage available initially in 25, 50 and 80 Mbyte capacities at what is said to be substantially lower cost-per-byte ratio than current products of equivalent capacity. Storage medium is a five-high disc pack (three standard 3336-type discs plus two cover discs) mounted on a 3330-type-spindle that provides five surfaces for data recording and a sixth surface to accommodate servo track positioning. The Trident series features 384 track-per-inch recording density, 822 cylinders and an 806 k-byte/s data transfer rate. The drives are designed as self-contained, rack-mountable enclosures 17.7 wide × 10.5 high × 31.5 in. deep. Each drive includes a complete air flow system, power supply, control and data electronics.

CIRCLE NO. 321

Can a high-quality socket-maker produce a good, low-cost IC Socket?

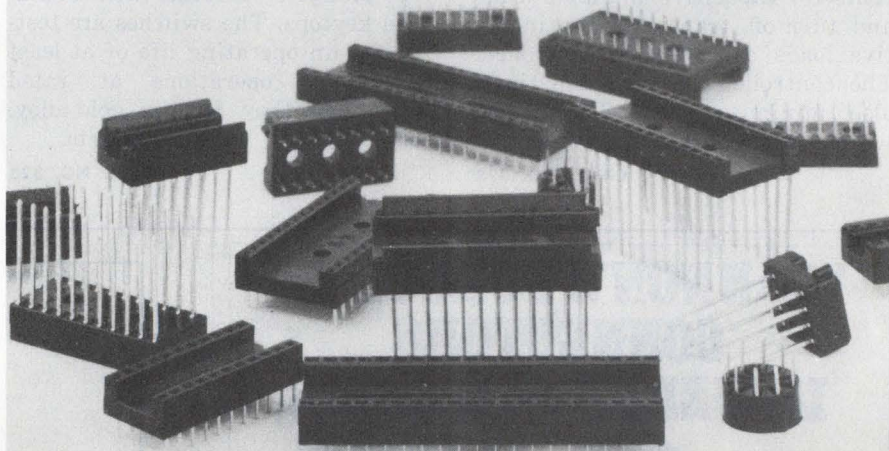

RN does.

We use our know-how and experience to make quality IC sockets at competitive prices. We call them the inflation fighters. They're for production applications where gold plating isn't really needed. Nor its cost. Where glass-filled nylon gives you all the body required. And where typical R-N quality can give you an edge. Interested? See the Socket People.



ROBINSON NUGENT INC.
800 EAST EIGHTH STREET
NEW ALBANY, INDIANA 47150
(812) 945-0211/TWX 810-540-4082

Rise and fall times controlled in relay

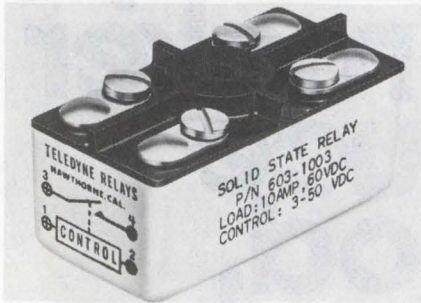

Teledyne Relays, 3155 W. El Segundo Blvd., Hawthorne, Calif. 90250. (213) 973-4545. \$15.50 (1000 up); 2-6 wks.

Series 603, solid-state, optically isolated, dc relays have controlled rise and fall times. In-rush currents for capacitive and lamp loads and turn-off transients for inductive loads can thus be controlled. The controlled rise and fall times also minimize EMI. The relays handle loads to 5 A at 50 V dc.

CIRCLE NO. 322

Keyboard switch has low profile

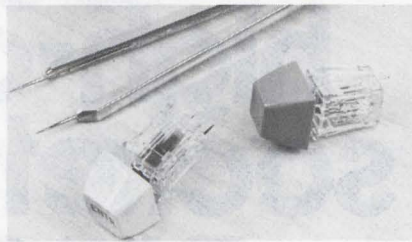

Oak Industries Inc., Crystal Lake, Ill. 60014. (815) 459-5000.

A new series of compact keyboard switches, designated Series 475, is housed in a package that measures 0.5 × 0.5 × 0.685 in. They are low-profile versions of the Series 400 switch, with most of the features of their taller counterpart. Snap-in mounting is standard. The switches come in momentary SPST and DPST models, as well as alternate SPST. All plungers interface with standard keytops. The switches are tested for an operating life of at least 20-million operations at rated load, and they feature gold-alloy, crossbar-type wiping contacts.

CIRCLE NO. 323

Precision lamp has bi-convex lens



Gilway Co., Inc., P.O. Box 467, Byfield, Mass. 01922. (617) 465-7568. \$2.98 (1000 up); stock.

The 8001 is a T-4 lamp with a precision molded bi-convex lens. The low-voltage, high-current filament is precision wound to make a rugged filament that is located on the center line of the envelope. The 1/2-20 UNF-2A base allows for interconnection to a fiber optic assembly. The lamp is rated at 5 V and 0.775 A with a 5000-h life.

CIRCLE NO. 324

"CANNON'S BURGUN-D CONNECTORS LOWERED OUR COSTS, and upped my salary."



"Burgun-D's universality and Cannon's automatic strip and crimp machine can do the same for you. Find out how in Cannon's 'Secrets of Connector Success.' And get ready to improve your life style."

Contact ITT Cannon Electric, International Telephone and Telegraph Corporation, 666 East Dyer Road, Santa Ana, CA 92702. (714) 557-4700.

CANNON ITT

INFORMATION RETRIEVAL NUMBER 111

Mini Bus[®] by Rogers

For noise and cost reduction

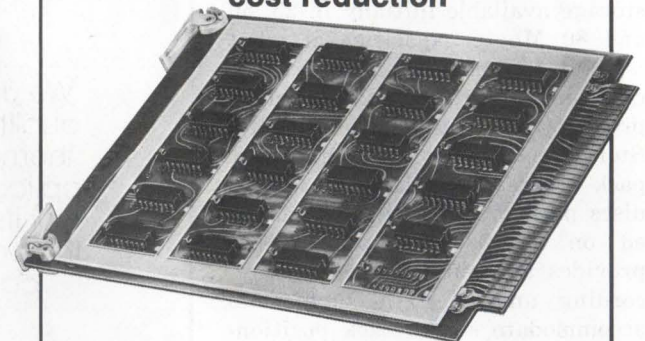

A small, voltage-distributing busbar for PC card application, each Mini/Bus gives you built-in capacitance . . . noise-cutting capacitance that means more reliable, compact circuit packaging at a fraction of multilayer prices. Write for data.



Rogers Corporation / Rogers, Conn. 06263

INFORMATION RETRIEVAL NUMBER 112

ELECTRONIC DESIGN 10, May 10, 1974

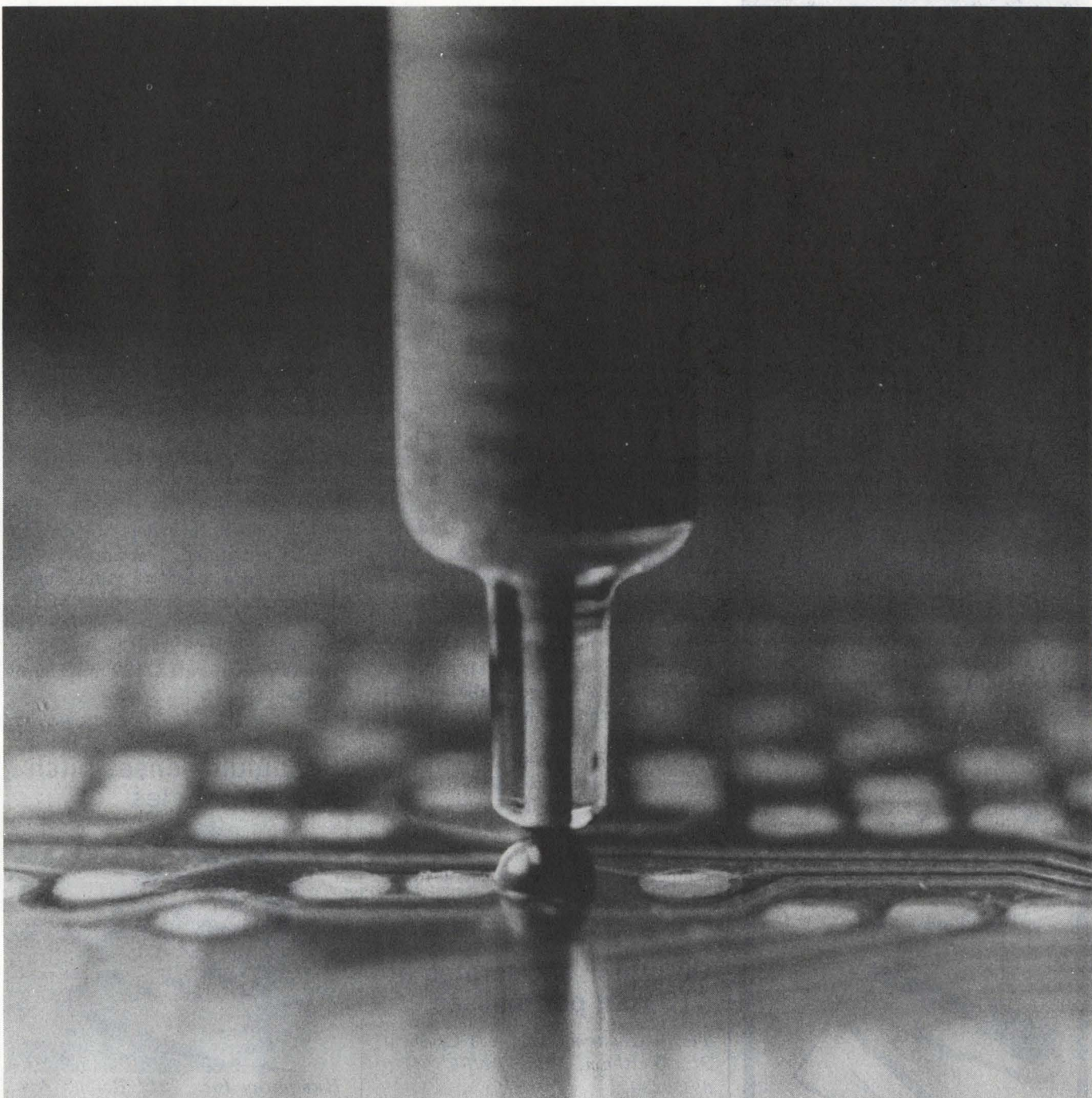

Let's get to the point.

The point of precise application. Alpha solder creams can be preplaced by spraying, screening, masking, automatic dispensing, roller transfer and by hand.

Precisely. Very precisely.

In controlled quantities, right where you want it. Application and use is limited only by your imagination.

Reliacream and Reliapaste are available with rosin or acid flux bases in all degrees of activation from WW rosin to super activated inorganic acid. Prealloyed standard and special alloy powder combinations.

Alpha solder creams are for precise control of deposit size. If you want the fine points, call Alpha at (201) 434-6778.

alphametals^{Inc.}

56 Water Street, Jersey City, N.J. 07304 (201) 434-6778 Chicago, Santa Fe Springs



THERMISTORS

OBTAIN STATE-OF-THE-ART PERFORMANCE AT COSTS LOWER THAN YOUR PRESENT COMMERCIAL PRODUCT:

**BEADS
PROBES
FLAKES
RODS
ASSEMBLIES**

FAST RESPONSE ASSEMBLIES (TO 3ms)

HI-TEMP UNITS (TO 450°C)

SPECIAL CURVE MATCHES

0.05% TOLS. AND INTER-CHANGEABILITY

PRECISION CALIBRATIONS

DESIGNED TO MEET MIL-T-23648

QUICK REACTION TO SPECIAL APPLICATIONS AND ASSEMBLIES!

THERMOMETRICS INC.
15 JEAN PLACE
EDISON, N.J. 08817
(201) 548-2299

COMPONENTS

Thick-film networks match to 0.5% ratio

Dale Electronics, Inc., P.O. Box 609, Columbus, Neb. 68601. (402) 371-0080.

A new series of single-in-line, thick-film networks, designated as Series CSP (E & F), provides from three to nine resistors in flame-retardant packages. Models are available with 4, 6, 8 and 10 terminals and a choice of 0.100 and 0.125-in. spacing. Built-in stand-offs facilitate board washing and wave soldering. The networks operate in a temperature range from -55 to 150 C and have a resistance range from 10 Ω to 1 M Ω with a temperature coefficient of ± 200 ppm. Individual resistors in each network are rated at 1/8 W, with total network ratings from 1/2 to 1-1/4 W. Tolerances from $\pm 1\%$ to $\pm 20\%$ are available. The units are coated with a specially formulated epoxy, and they are tested for environmental performance according to MIL-R-83401. They can be supplied with a choice of two internal configurations and with ratio matching of 0.5% and temperature coefficient tracking of 50 ppm/ $^{\circ}$ C.

CIRCLE NO. 325

Dc motor accelerates at 410 rpm per millisec

Torque Systems, Inc., 225 Crescent St., Waltham, Mass. 02154. (617) 891-0230.

The Snapper Series 3220 frame motors are rated for a continuous output of 1/8 hp without forced cooling. The new series complements the existing line of dc servo motors available in 1/20 to 2-hp ratings. These economically priced (not given) motors provide a high acceleration of 410 rpm per ms (43,000 rad/s²). Peak rated torque is 300 oz-in. No-load speed at rated voltage is 2500 rpm. Higher speeds can be achieved when the motor is driven by a current-limited amplifier. Five versions of the 3220 series provide torque-current ratios of 13.5 to 34 oz-in/A. They draw from 22.2 to 8.8 A at peak torque. The motors are 3-1/4-in. diameter.

CIRCLE NO. 326

Pushbutton switch held by magnetic field

Alco Electronic Products, 1551 Osgood St., North Andover, Mass. 01845. (617) 685-4271. \$2.76 (500 up); stock.

Model MSPM-101BP/CP magnetic pushbutton switches have a push/pull maintained action. Their miniaturized, cylindrical-steel cases are 39/64-in. long, which doubles as a magnetic shield. Terminals are pin-type. Contact is made by depressing the plunger where it is held closed by a magnetic field. Contact is broken by exerting minimal pull on the plunger. Contacts are hermetically sealed, glass encapsulated reeds and the unit is explosion-proof. A standard 1/4-in. diameter threaded bushing allows simplified mounting. No springs are used in this series. Life expectancy is in excess of 1/2-million operations. Black or red snap-on buttons can be specified. Contacts are rated 100 mA at 50 V dc.

CIRCLE NO. 327

Pendulum senses pitch and roll angles



Humphrey Inc., 9212 Balboa Ave., San Diego, Calif. 92123. (714) 565-6631.

The CP15-0401-1, a 1-in. diameter subminiature pendulum with a range of from 3 to 20 degrees and an accuracy of ± 0.75 degrees, has a potentiometric output and provides a stable vertical reference for monitoring and control of pitch and roll angular displacement. It can replace expensive vertical gyros where linear accelerations are not a problem. The hermetically sealed, fluid damped unit is capable of withstanding up to 30-g shock, and has a natural frequency of 3.2 Hz. It weighs approximately 5 oz and measures 1.0-in. diameter by 1.0-in. long.

CIRCLE NO. 328

YOUR EDUCATION REPRESENTS AN IMPORTANT PERSONAL INVESTMENT--

WHAT HAVE YOU DONE WITH IT SO FAR?

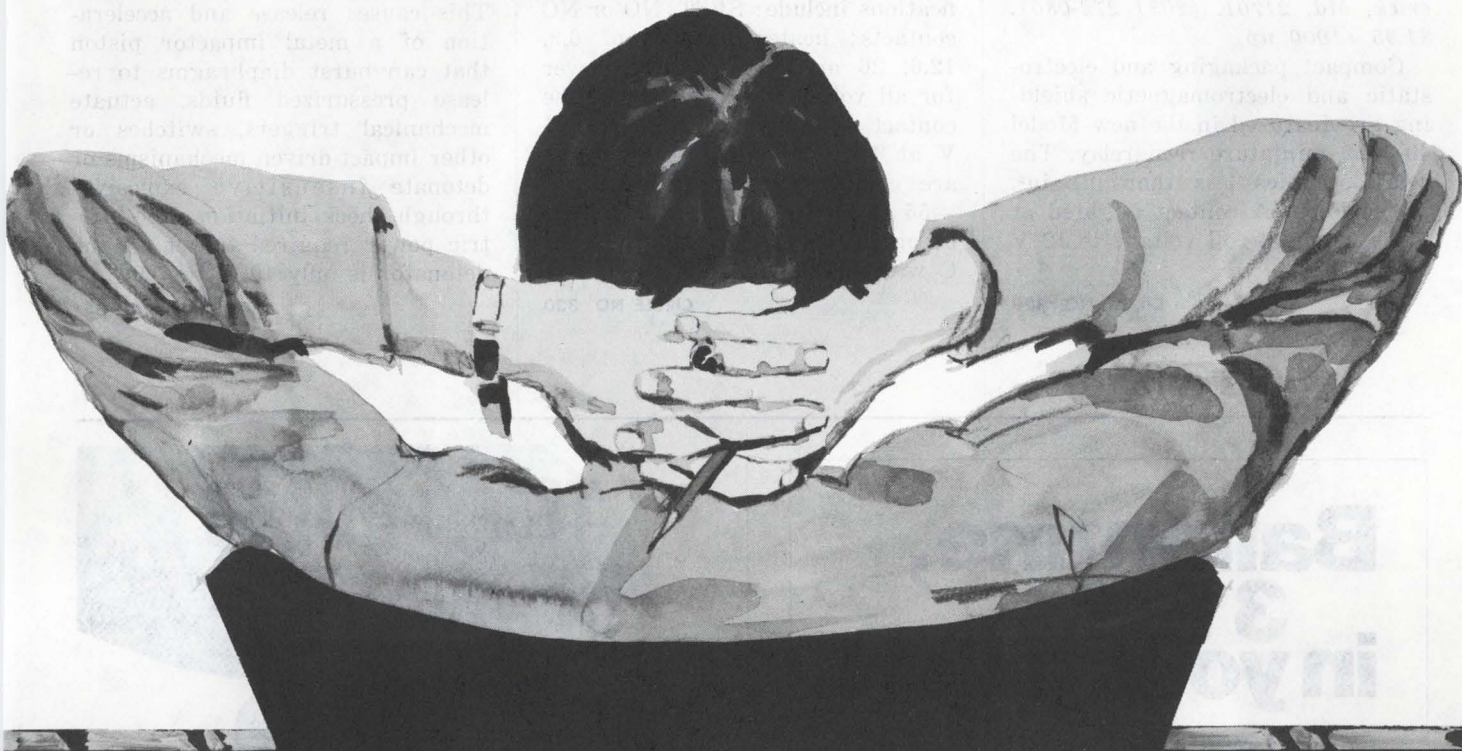

"Got a job" isn't quite the full answer, is it? You're *you*. And there's more to life than just "a job" — or should be.

What could you expect if you joined us? A quality of life that means the difference between "a job" and a way of living.

We design and manufacture complete electronic systems of various kinds for business, industry and government. It is our practice to hire very able people and then put them to work doing what they most like to do.

Because we are a large company, we offer a total career growth-potential that is as big as we are. And because we work in relatively small product-oriented divisions, your abilities and contributions are highly visible from the time you join us, with prompt recognition of superior performance.

Whether you work for us in California, New York,

Ohio, Florida, Kansas or Delaware, you'll find yourself looking forward to coming to work in the morning. And your technology won't become obsolescent in 5 or 10 years, because, to remain a leader, we must continue to work on the far edge of the current state of the art.

Professional involvement . . . continuing development as an engineer . . . an environment of individual responsibility that encourages new ideas and rewards initiative. These are good dividends on the personal investment you've already made on your education!

If you're not realizing them now, write:

**NCR Worldwide Headquarters, Dept. ED-5
Corporate Executive &
Professional Placement
Dayton, Ohio 45479**

NCR

An Equal Opportunity Employer M/F

Reed relay has magnetic and electric shielding

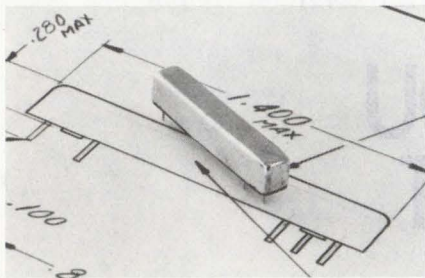

North American Philips Controls Corp., E. Church & 2nd Sts., Frederick, Md. 21701. (203) 272-0301. \$1.95 (1000 up).

Compact packaging and electrostatic and electromagnetic shielding are featured in the new Model 49-0022 miniature reed relay. The relay occupies less than 0.1 in³. The 1-Form A contact is rated at 7 W. Nominal coil voltage is 12 V dc.

CIRCLE NO. 329

Thermostatic delays use rugged contacts

Amperite Co., Inc., 600 Palisade Ave., Union City, N.J. 07087. (201) 864-9503. \$6 (OEM qty).

According to Amperite, their long-delay thermostatic relays (to 5 min) use 10-A contacts and rate them at 3 A. Also extra-large, sturdy heaters add to the ruggedness of construction. And the relays are not affected by altitude, moisture or other atmospheric conditions because they are hermetically sealed in glass. They are also explosion-proof and highly resistant to vibration. Other specifications include: SPST, NO or NC contacts; heater voltages of 6.3, 12.6, 26 or 115-V; heater power for all voltages is 2.3 W; and the contact voltage drop is about 0.1 V at 1 A. Ambient temperatures are compensated for a range of -55 to 80 C, but the timers may be operated between -80 to +125 C without damage.

CIRCLE NO. 330

Safe detonator finds civilian uses

Systems, Science and Software, P.O. Box 1620, La Jolla, Calif. 92037. (714) 453-0060.

A miniature detonator for commercial and military applications, capable of being fired from 6 or 12-V batteries, has a wide range of potential uses, from actuating air bags in automobiles to triggering ejection seats in military aircraft. The detonator is safe to handle and use, since it eliminates the need for a primary explosive. Instead, a wire is heated electrically to ignite a secondary explosive. This causes release and acceleration of a metal impactor piston that can burst diaphragms to release pressurized fluids, actuate mechanical triggers, switches or other impact-driven mechanisms or detonate insensitive explosives through shock initiation. The electric power required to set off the detonator is only 10 A for 200 μ s.

CIRCLE NO. 331

Ballantine, 3 to 1 in your favor!

New 15MHz Precision Voltmeter
replaces three old designs
100 μ V sensitivity
unmatchable performance
from \$365

Call your local Ballantine field engineer.



BALLANTINE LABORATORIES, INC.
P.O. Box 97, Boonton, New Jersey 07005
201-335-0900, TWX 710-987-8380

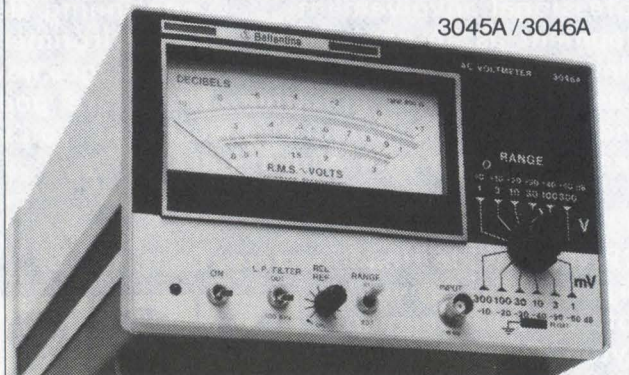

INFORMATION RETRIEVAL NUMBER 115



One cubic inch . . . that's all the space it needs. But it sends a strong, reliable signal up to 6.5 V/1000 RPM. Maximum deviation from linearity will not exceed 1% assuring high degree of accuracy. Low friction and rotor inertia will not load down equipment. Speeds to 5,000 RPM.

INLAND MOTOR DIVISION OF KOLLMORGEN CORP.
Radford, Va. 24141 • (703) 639-3973 • TWX 710-875-3740

INFORMATION RETRIEVAL NUMBER 116

ELECTRONIC DESIGN 10, May 10, 1974

If anybody can hand you the ready-made P/C connector you need,

we can.

That's because we have more of them on the shelf than anybody else we know. We have them from .050 contact centers through .156, from 6 to 210 contacts, with full bellows, semi-bellows and cantilever designs, with gold saving AuTac™ plating, low insertion force contacts, in micro miniatures, dual and single read-outs... and on and on and on.

We've been at this 23 years. And — because we don't compromise on quality

when we make our connectors — we don't like to see your P/C designs compromised by a make-do connector. So, we have a lot of them.

They're all cataloged in our latest 44-page brochure. Send for your free copy so you'll have it when you need it.

Or, if you need help right now, just pick up your phone and call Customer Service. (213) 341-4330.

Ok. Send me:

- Details on your line of P/C connectors.
 and, come to think of it, your low cost circular connectors, too.

Name

Title

Company

Address

City

State

Zip



Viking

CONNECTORS

Viking Industries, Inc./21001 Nordhoff St./Chatsworth, Calif. 91311



Air conditioners cool electronic enclosures

Kooltronic Inc., P.O. Box 504, Princeton, N.J. 08540. (609) 799-1466.

Where the air within electronic enclosures must be cooled as much as 50 F below ambient temperature, fans or blowers won't do the

job. Air conditioners, which measure 17-in. wide, 17-in. deep and only 8-3/4-inches high, are available. They fit into the usually wasted space at the top or bottom of the rack, so that only 7 in. of panel space are consumed. Or vertically mounted units, which can be installed at the rear of the rack, occupy no front-panel space at all. They come in six different cooling capacities that range from 1400 to 5500 BTU/h and dissipate from 410 to 1610 W.

CIRCLE NO. 332

Card file holds up to 840 ICs

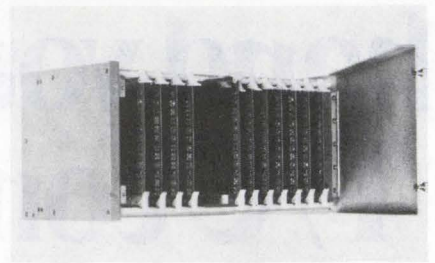

Scanbe Canoga Industries, 3445 Fletcher Ave., El Monte, Calif. 91731. (213) 579-2300.

Scanbe's standard 8-3/4-in. EIA file accommodates up to 14 socket cards with provisions for 60 ICs each. Either a motherboard assembly or connectors may be used in the file. An I/O panel is optional. The panel can mount up to eight, 120-pin, rack-and-panel connectors and one 3-pin power connector. The motherboard has provisions for mounting 56-ceramic, 28-axial-lead and two electrolytic capacitors, and it features dual- V_{cc} planes that can distribute one or two supply voltages, which are decoupled. The I/O panel can swing up for easy access to all wiring between the card connectors and I/O connectors. The file uses nylon card guides and extruded-aluminum mounting bars.

CIRCLE NO. 333

Foam material absorbs sound over broad range

Ferro Corp., 34 Smith St., Norwalk, Conn. 06852. (205) 853-2123.

Coustifoam 3-D is a lightweight, flexible acoustic foam that absorbs noise over a broad frequency range. This foam features a random coefficient of absorption that is the equivalent of 2 lb/ft³ of fibrous glass. At 500 Hz, for instance, the absorption coefficient or 1-in-thick Coustifoam is 0.7; at 1000 Hz, nearly 1.0. Where decorative appearance is desired, embossed patterns are available and the material is easily installed with a knife or scissors and adhesive. Coustifoam can also be die-cut. And it can be easily formed to compound curves with minimum wrinkling. Standard thicknesses are 1/2 and 1 in., and they come in 200 and 100-ft rolls, 54-in. wide, untrimmed. Nominal foam density is 2 lb/ft³.

CIRCLE NO. 334

DELAY LINES

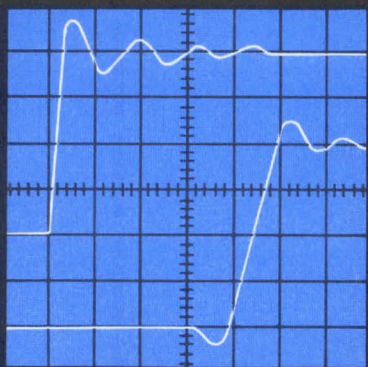

**60 OFF-THE-SHELF
DIP MODELS... TO
250 NSEC...
THOUSANDS OF
SPECIALS
SHIPPED
MONTHLY BY**

PULSE ENGINEERING!

Choose from our broad standard line or let us build to your specifications. We're geared to large volume production and delivery.

Write for complete information or send your specifications for quote-

DELAY LINES • MICROELECTRONICS MINIATURE MAGNETICS

Call your nearest regional office:

ABINGTON, PA.
(215) 887-4343

BOCA RATON, FLA.
(305) 391-3803

SANTA CLARA, CALIF.
(408) 248-6040

WALTHAM, MASS.
(617) 894-0950

CHICAGO, ILL.
(312) 992-3720

STUDIO CITY, CALIF.
(213) 872-0735

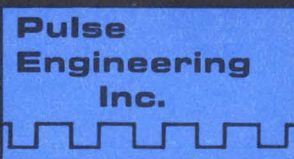

Pulse Engineering

P.O. Box 12235 • San Diego, Calif. 92112
Phone 714-279-5900 • TWX 910-335-1527

A Varian Subsidiary

THE CREATIVE CHALLENGE:

exploring the universe of design possibilities of engineered metallic mesh, mazes and matrices.

NO. 2

EMI & INTERACTION SHIELDING in Computers, Process Controls, & Instruments

The understandable tendency to associate EMI (Electro-Magnetic Interference) exclusively with communications equipment—radio receivers, telephones, radar, etc., is a hangover from the days when the term "RFI" (Radio-Frequency Interference) was used; and, indeed, the earliest applications of shielding were all concerned with attempts to exclude unwanted noise from RF Circuits.

That narrow viewpoint was appropriate in 1944, when we developed the electronics industry's very first RFI gasket, but now, thirty years later, we find ourselves shielding such "high-level" devices as digital logic circuits in computers, process controls, and instruments of all kinds. *In fact, it is difficult to find a single class of electronic devices that does not require effective shielding, in some environments.*

True, the sub-microvolt front end of a communications receiver cannot function in any environment (except a "shielded room") without effective EMI attenuation. But anyone who has developed or applied high-density digital circuitry knows that *high-level circuitry, too, can be plagued by EMI, despite the fact that its minimum signal/noise tolerance is at least 100 times (40 dB) higher than that of communications equipment.*

It's all a matter of *environment*. The EMI source from which a communications receiver must be shielded may be a sparking commutator 8 feet away; but the back-plane wiring of a digital minicomputer may be only 8 inches away from the switching regulator in its own power supply! What is more, broadband digital circuits are sensitive to noise over a much wider spectrum than tuned receiver circuits. And digital circuits are very often used in *close proximity* to other *high-speed (fast-pulse) digital devices*—printers, teletype-

writers, etc. In industrial environments, it is not uncommon to find broadband noise fields that are 50-60 dB stronger than those inside a communications center. *Clearly, the 100:1 sensitivity advantage of digital circuitry can be wiped out by a 1000:1 increase in environmental noise level.*

What has all this to do with knitted wire mesh? Simply this: *knitted wire mesh is the most versatile engineered material ever developed for providing the EMI "barrier," or "seal" in a shielding assembly.* It is available in an almost unlimited range of metallic materials, and can be combined with elastomers, to form resilient, highly compressible, close-tolerance, easily installed EMI seals. Mesh can be made air-permeable, for dust filtration. It can be made transparent to light—yet *opaque* to EMI. It can be supplied in a wide range of standard and custom shapes, sizes, and forms. A few of these are shown in Figure 1—but don't let your imagination bog down there. Accept the creative challenge, work with us, and the sky's the limit.

In Figure 2, we have shown three Fourier Spectra of EMI generated by environmental and interactive EMI sources in digital process controls. Note the broad range over which the interference may exceed 1 Volt. In such an environment, it often takes *weeks* to "debug" a system that worked perfectly in the lab!

And any system may, even after costly debugging, encounter a *new source* of EMI, and go sour all over again...

Note: By now, if you are a conscientious designer, you have begun to develop "EMI Anxiety"—the neurotic fear that somewhere out there, evil men are waiting, with megawatt/gigaband/white-noise sources, all focused on your device. These feelings, we are happy to tell you, are far from fantasy. Fortunately, help is available. METEX maintains a free EMI counselling and therapy clinic, at which knitted-wire-mesh techniques are applied—analytically and effectively.

As a first step, write—*today*—for our quarterly engineering publication, "**The Creative Challenge**"—free to engineers and designers whose responsibility includes outwitting today's troubled electromagnetic environment. You'll begin to feel better immediately... and, when our free Design Kit arrives, you will find new courage to apply the samples, photos, and data it contains.

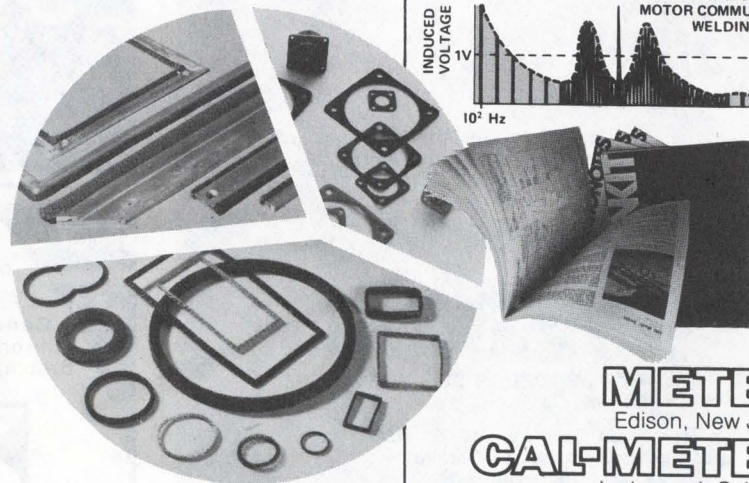
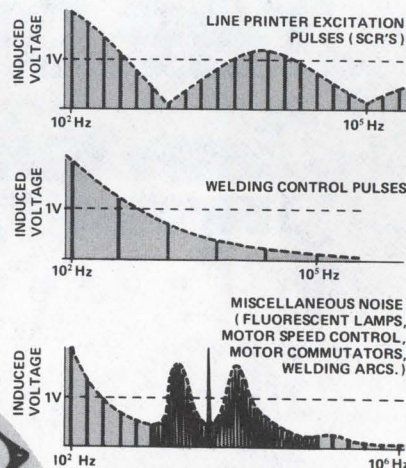

METEX
Edison, New Jersey
CAL-METEX
Inglewood, California

Engineering and Production Facilities on both coasts.

Safety sphere collects clipped leads



Design Products Corp., 1925 W. Maple Rd., Troy, Mich. 48084. (313) 647-1770.

A clear plexiglas sphere allows the safe clipping of leads from electronic components. Lead ends, when cut inside the sphere, are prevented from flying about and trapped in the bottom of the sphere.

CIRCLE NO. 335

Hot-melt masking material is reusable

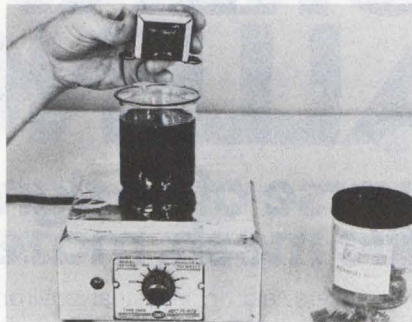

Emerson & Cuming Inc., Canton, Mass. 02021. (617) 828-3300. \$2.95 per lb; (25 lb up).

Eccocoat MH-10 is a transparent protective coating that is applied from a hot melt. It has the toughness of a rubbery polymer, but it is readily cut and is easily stripped off. MH-10 is particularly suitable as a masking material prior to potting, dipping and impregnating operations. And it retains its rubbery properties up to approximately 150 C. It is economical to use since in many production operations it may be recovered and reused.

CIRCLE NO. 336

Hard cable takes temperature extremes

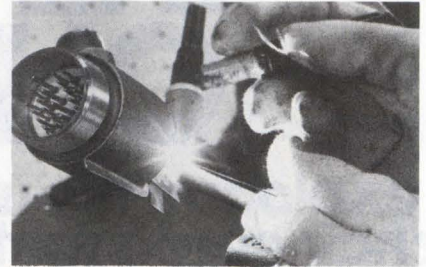

Simmonds Precision, Engine Systems Div., Norwich, N.Y. 13815. (607) 334-3264.

At the temperature of 1500 F or the coldness of liquid gases, the new GLA Pyromite all-metal cable assemblies continue to transmit signals without fail. In addition, these hard cables are hermetically sealed and absorb no gases or liquids. And corrosion and radiation resistance of the assembly can be tailored to the use. The cable can be ordered with up to 23 parallel conductors, or in coaxial or triaxial designs. Many different constructions are possible to handle voltages from signal levels to better than 6 kV.

CIRCLE NO. 337

THE ONE



VS-90B Sweep Generator

- *5 to 2350 MHz *variable sweep rates
- *built-in attenuators

The VS-90B is a multi-band sweep signal generator. RF output is 0.7 volts rms with a flatness of ± 0.5 dB at maximum sweep width. Built-in marker system accepts single frequency and harmonic frequency plug-in markers. Sweep rates variable from 0.05 to 60 Hz.

Texscan

A WORLD LEADER IN ELECTRONICS
"And Coming On Strong"

Texscan Corporation
2446 North Shadeland Avenue
Indianapolis, Indiana 46219
Ph: 317 357-8781
TWX: 810-341-3184 Telex: 272110

INFORMATION RETRIEVAL NUMBER 120

If you need DIGITAL CLOCKS look to Chrono-log

for

the features you need at off-the-shelf prices. LED, NIXIE® or BCD displays. Time ranges from milliseconds to years. Outputs can be parallel and or serial BCD, modulated carrier, level shift or video. DC, AC or internal battery operation. "Naked" cards for OEM's.

For Digital Clocks, Time Code Generators and Readers, write or call Chrono-log Corp., 2583 West Chester Pike, Broomall, Pa. 19008 Phone: (215) 356-6771.



CHRONO-LOG
CORPORATION

INFORMATION RETRIEVAL NUMBER 121

NOW, YOU CAN BUY A COMPUCORP 324 MICRO SCIENTIST FOR ONLY \$495.

You Save \$400 Off the Suggested Retail Price of \$895.

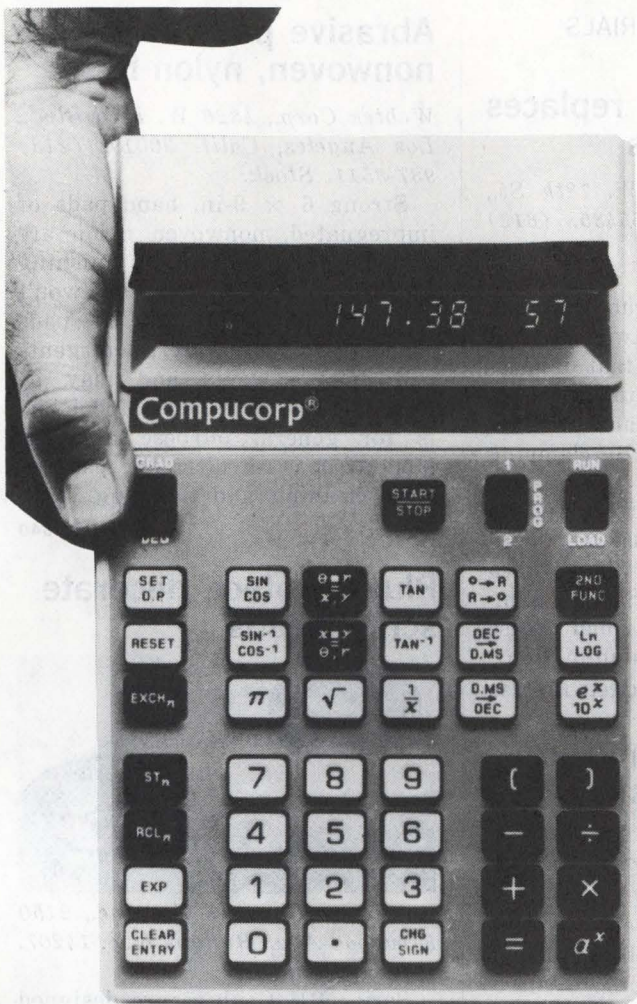

You can now get the world's first programmable Micro Computer for only \$495. The Compucorp Micro Scientist allows you to have two different 80-step programs in memory at the same time. Which means repetitive calculations are a snap.

You get 13-digit accuracy and a big, bright 10-digit display. An algebraic keyboard and nested parentheses.

Built-in special function keys for polar to rectangular, rectangular to polar, trig functions, logs and anti-logs. Plus you can do register arithmetic in or out of all 10 registers.

A 90-day warranty on parts and labor at no cost. Plus service agreement option, of course.

SPECIAL OFFER: A Remington 663D Calculator with the purchase of TWO Compucorp Micro Computers.



The Remington 663D is worth \$38.95. And you can also include the Compucorp 344 Micro Statistician, with its host of statistical operation keys, for \$495 versus the suggested retail price of \$895.

Olympic Sales Company is one of the largest distributors of Compucorp Micro Computers, Hewlett-Packard and Texas Instruments pocket calculators and represents many other lines. Because we deal in volume, we can pass the savings on to you.

To get your Compucorp 324 Micro Scientist for only \$495, simply phone (213) 381-3911 today and we'll ship it C.O.D. Or write us at 216 South Oxford Avenue, Los Angeles, CA 90004. To speed up shipment, please send \$25.00.

Easiest of all, mail in the coupon. And don't forget to tell your associates so you can get a free Remington 663D electronic calculator.



OLYMPIC SALES COMPANY, INC. 216 S.Oxford Ave, Los Angeles, CA 90004 • Phone (213) 381-3911 • Telex 67-3477 • Cable Address "OLYRAV" LSA

____ Please send me C.O.D. ____ Compucorp 324 Scientist(s) @ only \$495.

____ Please send me C.O.D. ____ Compucorp 344 Statistician(s) @ only \$495.

____ Remember, if I buy more than one, you also owe me a Remington 663D for every two orders.

____ Also send me your calculator catalog including Compucorp Micro Computers, and calculators from H-P, Texas Instruments, and others so I can get the best possible deal on them, too.

____ To speed up shipment, I've enclosed \$25.00. OSC-1

Name _____

Organization _____

Address _____

City _____ State _____ Zip _____

Phone () _____ ED

MINIATURE CERAMIC Trimmer Capacitors

FOR PRINTED
CIRCUIT BOARDS



These new miniature trimmer capacitors are a snap fit on printed wiring boards, and are low cost for industrial and commercial applications!

Their compact form factor conserves mounting space, and they are available in a variety of mounting configurations.

Straight line capacitance curve for easy circuit trimming.

Available in capacitance ranges from 2.0-6.0 pF to 6.0-70.0 pF in 31 standard ratings with temperature coefficient of capacitance ranging from NPO to -1400 ppm/°C.

Engineering Bulletin 301 gives complete information, including a cross reference table. Write for it today!

**SPRAGUE
GOODMAN**

**Sprague-Goodman
Electronics, Inc.**

(An Affiliate of the Sprague Electric Company)
371 Willis Ave., Mineola, N.Y. 11501
516/746-1385

PACKAGING & MATERIALS

Silicone rubber replaces thermal greases

Bergquist Co., 4350 W. 78th St., Minneapolis, Minn. 55435. (612) 925-2322.

Sil-Pad, made of a specially compounded silicone rubber, has a thermal conductivity twice that of mica and seven times that of polyester film, according to its manufacturer. It is elastic and provides a cushion to absorb clamping stress and prevents damage to components. Mica is rigid. And its elasticity also allows use on curved or rough surfaces, while mica tends to split. Also, Sil-Pad eliminates the need for thermal grease and avoids solder contamination.

CIRCLE NO. 338

Card cage intermixes different sized modules

Vector Electronic Co., 12460 Gladstone Ave., Sylmar, Calif. 91342. (213) 365-9661. \$32.63: CCM-14A; \$2.51 to \$2.75: Modules (500 up).

A new off-the-shelf card-cage system allows designers to intermix 1, 2, 3 or 4-in.-wide circuit modules at any point in the design, prototype or production states without modifying the cage structure or guides. Called the CCM-14A, the cage was inspired by the A.E.C. Nuclear Instrument Module (NIM) design which established a standardized system of modules and cages. Unlike NIM, the CCM-14A has modules in 1-in.-width increments rather than 1.37 in. and holds cards with printed-tab plugs. The 19-in.-wide, by 5-7/32-in.-high, by 9-in.-deep cage has movable struts on the rear, which allow vertical and longitudinal adjustments to accommodate a wide variety of connectors. The struts are preloaded with nuts to allow the connectors to be mounted wherever desired without drilling holes. The modules, which accept standard 4-1/2-in.-wide by 6-1/2-in.-deep cards, have a removable front panel that allow cut-outs for switches, controls, and lamps to be made, even after the board is loaded. For high insertion-force connectors, each front panel has a jack screw, which jacks the card in and out.

CIRCLE NO. 339

Abrasive pads have nonwoven, nylon base

Webtek Corp., 4326 W. Pico Blvd., Los Angeles, Calif. 90019. (213) 937-3511. Stock.

Strong 6 x 9-in. hand pads of impregnated, nonwoven nylon are abrasive for cleaning and finishing applications. The nylon webs won't splinter, tear or rust. The pads can be used with water, detergents and most solvents and may be rinsed clean for reuse. Model 601 is for general purpose use and Model 603 is an ultra-fine pad for light cleaning and finishing.

CIRCLE NO. 340

Plugs protect, decorate screw heads

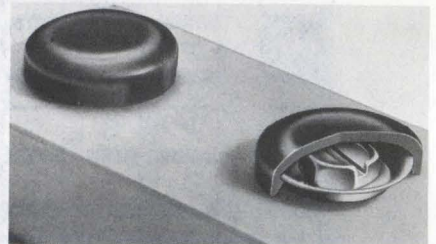

Protective Closures Co., Inc., 2150 Elmwood Ave., Buffalo, N.Y. 14207. (716) 876-9855.

Series RH Caplugs are designed to protect raised screw and bolt heads and improve the appearance of the product. Each Caplug consists of a black, low-density, polyethylene cap and a flanged, metal washer, which replaces the flat washer under the head of the fastener. The cap is then snapped over the washer flange.

CIRCLE NO. 341

Plastic light filter passes infrared

Glendale Optical Co., Inc., 130 Crossways Park Dr., Woodbury, N.Y. 11797. (516) 921-5800.

A new plastic absorptive filter for infrared blocks all visible light. The filter transmits in the near infrared portion of the spectral region. It has zero transmittance from 400 to 700 nm; 80% transmittance at 825 nm; and 89% transmittance from 850 to 1100 nm. The 3-mm-thick filter is available in 2 x 4-1/4-in. plates. For large quantities, other thicknesses and sizes are available on special order.

CIRCLE NO. 342

Think of the advantages.

The trimmed FET-input opamp is no longer a costly, unreliable hand-produced item. Intersil has developed a family of monolithic J-FET op amps which can be automatically, electronically nulled on-chip using Intersil's exclusive Avalanche-Induced-Migration technology. This gives you three big advantages: Ultra low drift performance, much higher reliability, and cost only $\frac{1}{3}$ to $\frac{1}{2}$ that of the hybrids.

Compare these specs.

They're called the Intersil 8007-1/2/3/4/5 series of monolithic IC ultra low drift FET op amps.

And they provide a price/performance package that can't be beat.

PART NO.	TEMPERATURE DRIFT	OFFSET VOLTAGE	I_B	100 pc PRICE
8007-1	$5\mu V/^\circ C$	2mV	10pA	\$49.50
8007-2	$15\mu V/^\circ C$	2mV	10pA	\$19.50
8007-3	$30\mu V/^\circ C$	4mV	10pA	\$ 9.50
8007-4	$10\mu V/^\circ C$	10mV	10pA	\$23.50
8007-5	$15\mu V/^\circ C$	10mV	10pA	\$14.00

Intersil



Low drift monolithic FET op amps.

Now mass produced.

Get 'em here.

Intersil stocking distributors.

Elmar/Liberty Electronics.
Schweber Electronics.
Semiconductor Specialists.
Weatherford.

Intersil area sales offices.

Boston (617) 861-7380.
Chicago (312) 371-1440.
Los Angeles (213) 532-3544.
Minneapolis (612) 925-1844.
New York (201) 567-5585.
San Diego (714) 278-6053.
San Francisco Bay Area
(home office) (408)
257-5450.
Upstate New York
(315) 463-3368.

Representatives in all major cities.

Some other significant specs: $6\mu V/\text{sec}$ slew rate, $\pm 12V$ input voltage range and 90dB CMR. All devices operate from 0 to $+70^\circ C$ and are packaged in a TO-5 can. Only from Intersil, of course. 10900 North Tantau Ave., Cupertino, CA 95014.

Backshell for MIL plugs provides RFI shielding



Amex Electronic Systems Inc., 5319 146th St., Lawndale, Calif. 90260. (213) 679-8225.

A new series of field-repairable backshells for MIL-C-83723 and MIL-C-38999 connectors mates with shell sizes 8 through 24 in both straight and 90° configurations. Backshells provide an extremely low resistance path from cable, shield braid to connector shell, as well as excellent rf shielding. The design also includes a strain relief.

CIRCLE NO. 343

Helical contact provides low-ohm connection

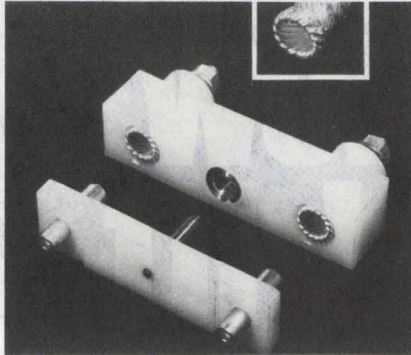

Elcon, 180 N. Wolfe Rd., Sunnyvale, Calif. 94086. (408) 732-5400.

A universal panel disconnect, the PD-20, uses a helical contact that provides many points of contact for its mating male pin. This feature provides low contact resistance and a low temperature rise for high-current applications. A 2000-A load for one minute results in only a 75-mW drop. Insertion and retraction forces are 5 lb. The connector can withstand severe environments such as salt, fog and temperature extremes of -65 to 185 F.

CIRCLE NO. 344

Seals use ferrofluid without rubbing contact

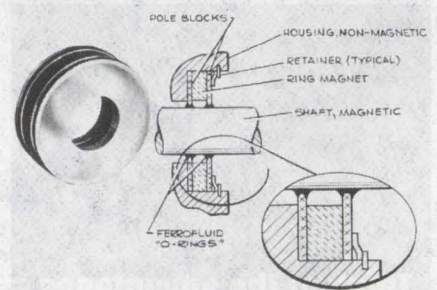

Ferrofluidics Corp., 144 Middlesex Turnpike, Burlington, Mass. 01803. (617) 272-5206. \$0.56 (1 million); stock to 45 days.

A series of ferrofluidic exclusion seals (Ferrometic) that range in sizes from 3/16 to 12-in. shaft diameters is a direct replacement for lip and face seals, labyrinths and other types. In addition, the magnetic-fluid sealant resists and repels abrasives such as taconite, pulp fibers, fiberglass, grinding dust, and other hard materials. These seals include a permanent-magnetic source, focusing pole rings and magnetic fluid sealant. There is no rubbing contact.

CIRCLE NO. 345

"CANNON® ZERO FORCE DL CONNECTORS GAVE OUR COSTS A CUT, and me a boost."

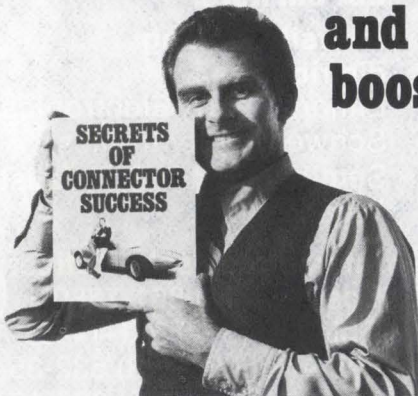

"No wonder. The combination of a 10,000 cycle life and lower cost than other rectangular connectors made Cannon Zero-force DL's the easy choice for a tough application. It's all told here in 'Secrets of Connector Success.' Get yourself a copy, and save some wear and tear."

Contact ITT Cannon Electric, International Telephone and Telegraph Corporation, 666 East Dyer Road, Santa Ana, CA 92702. (714) 557-4700.

CANNON ITT

INFORMATION RETRIEVAL NUMBER 124

THE 25 YEAR METERS...

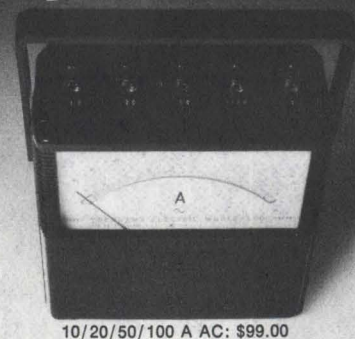

10/20/50/100 A AC: \$99.00

YEW's Precision Portables!

95% of all YEW precision portables that are returned for calibration certification are within original specifications, even after 25 years of use. We have even had instruments dating back 50 years within original specifications. That is long term reliability and that is why YEW is the world's largest manufacturer of precision portables.

Add taut band 0.5% accuracy, high quality and low cost, fast service, a vast selection of models and 25 years from now, you'll be glad that you tried a YEW portable. Prices start at \$95.

1% Portables also available. Prices start at \$37.

YEW
Yokogawa Electric

Yewtec Corporation
1995 Palmer Ave., Larchmont, N. Y. 10538
Telephone: 914 834-3550

60 Years of Measuring and Recording Instrumentation

INFORMATION RETRIEVAL NUMBER 125

Terminal block stacks two decks high

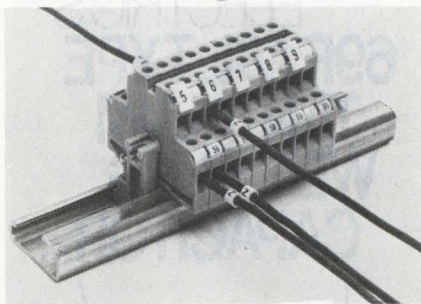

Electrovert Inc., 86 Hartford Ave., Mount Vernon, N.Y. 10553. (914) M04-6090.

The DK4 modular terminal block is arranged in a piggy-back, double-deck fashion. Thus twice as many wires, sizes AWG 18 through 12, can be attached in a given width. The block is less than 1/4-in. wide and it is rated 300-V at 10 A.

CIRCLE NO. 346

Plastic gloves now in heavier gauge material



Edmont-Wilson, Div. of Becton, Dickinson & Co., 2385 Walnut St., Coshocton, Ohio 43812. (614) 622-4311. See text.

New heavier-gauge Poly-D polyethylene disposable gloves are now 0.00175-in. gauge, or 40% thicker than the regular style. They are available in an economical and convenient 1000-glove dispenser at a cost of about 1.6 cents per glove. Gloves come mounted on a continuous roll with paper backing. As the backing paper is pulled from the box, the gloves are easily peeled off, ready for wear. Paper backing can be used as toweling to dry hands before donning gloves.

CIRCLE NO. 347

We chose to call our new Real-Time Spectrum Analyzer Omniscient* and we'll continue to!

With a name like that you have to measure up, and the EMR Model 1510 does. It goes anywhere, does any job ... It's a Fourier Analyzer, a Spectrum Averager and a Display in one convenient, portable package. And most important, it performs its tasks digitally ... no interactive controls to fumble with ... no complicated computer interface problems.

But to be Omniscient there must be more ... and there is!

- Switch it on, it's ready to operate without calibration
- Analyze a signal repeatedly and get repeatable answers ... over and over again
- 60 dB dynamic range at the input and no gimmicky
- Foolproof LED display of signal amplitude, frequency and averaging time
- Control setting status appears on graticule of CRT for permanent photographic record
- Availability of many options ... Peak Hold, 3-D Display, Computer Interface, Low Frequency Sync, Any Window, etc.

*Possessed of universal or complete knowledge

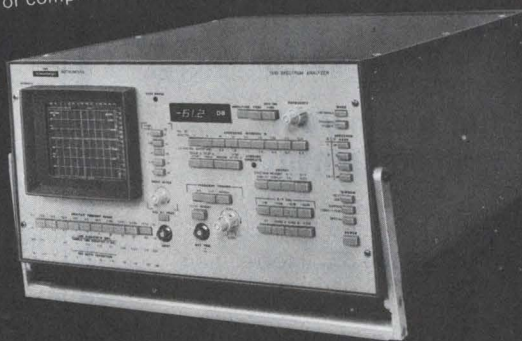

Well ... What else could we call it?

Write today for a comprehensive technical brochure or call for a demonstration.

EMR EMR
Schlumberger

EMR Telemetry
Weston Instruments, Inc.
Box 3041, Sarasota, Florida 33578
813-958-0811

New WWVB TIME CODE RECEIVER

...any way you want it!

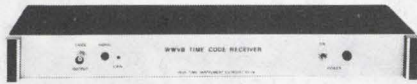

Cabinet or rack mount...

unit 1 3/4" high, with integral power supply, includes antenna.

PRICE \$490.00 MODEL 60-T



For systems use...

size is only 1 1/2" high x 8" x 3". Requires ± 9 to ± 18 VDC. Supplied with antenna.

PRICE \$390.00 MODEL 60-T



For use in your own equipment

Size: 7 1/4" x 2" x 3/4" high. Voltage: ± 9 to ± 18 VDC.

PRICE \$180.85 MODEL 86-1

All units guaranteed

to operate anywhere within 1800 miles of WWVB transmitter.

- TTL compatible output.
- Integrated circuits thruout.

WRITE FOR LITERATURE

**TRUE TIME
INSTRUMENT CO.**

429 Olive Street
Santa Rosa, Calif. 95401

MICROWAVES & LASERS

Detector family boasts wide band

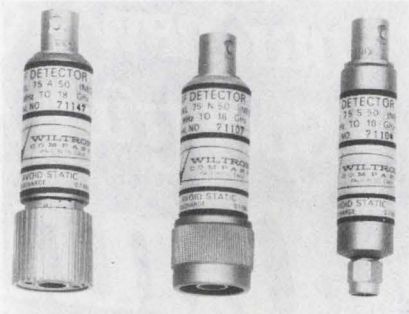

Wiltron Co., 930 E. Meadow Dr., Palo Alto, Calif. 94303. (415) 321-7428. Type N and SMA connectors: \$170; 2 wk.

The Model 75 Series of detectors spans the entire 10-MHz-to-18.5-GHz frequency range with a ± 1 -dB flatness. Also the series is offered with the most common connectors: Type N, APC and SMA. The new series reportedly contains the only Ku-band detector with field-replaceable diodes.

CIRCLE NO. 348

Balanced-mixer series spans 0.5 to 18 GHz

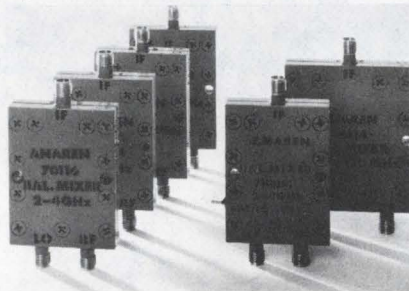

Anaren Microwave, 185 Ainsley Dr., Syracuse, N.Y. 13205. (315) 476-7901. \$185 up; stock to 5 weeks.

A family of biased and unbiased mixers covers the 0.5-to-18-GHz frequency range in 11 overlapping bands. The mixers are available in standard octave bands and in 1.3-to-2.6, 2.6-to-5.2, 5.2-to-10.4 and 8-to-16-GHz straddle bands. Also available is a multi-octave model that covers the 1.5-to-12.4-GHz frequency range. Typical specs are provided by the 7H0140 model, biased at 1.6 mA, and the unbiased 70140. Both units cover the 1.3-to-2.6-GHz range, provide a LO/rf isolation of 10 dB and have a conversion loss of 6 to 6.5 dB. LO power can be 0 dBm with the biased model.

CIRCLE NO. 349

GENERAL ELECTRIC'S 69F MIL TYPE TANTALUM WET SLUG CAPACITOR...

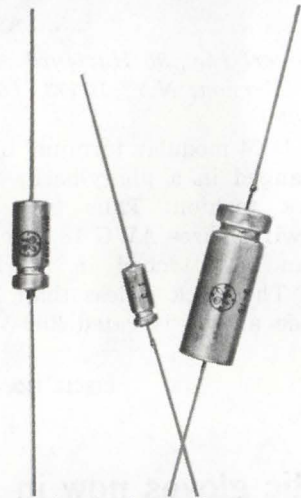

Four series to choose from:

69F — Unique patented double O-ring elastomer seal, with proved superiority over other elastomer seal designs.

69F2000 — Provides two-to-three times more capacitance in the same case size, with the patented double O-ring elastomer seal.

69F3000 — Glass-to-metal hermetic seal. Fully qualified to MIL-C-3965/24, Style CL66/67.

69F4000 — Glass-to-tantalum hermetic seal. Fully qualified to MIL-C-39006/9C, Style CLR65.

Same quality features in all four:

- High Volumetric Efficiency — for minimum size and weight.
- Low Leakage Current — for timing applications.
- Broad dual rated temperature range — from -55 C to $+85/125$ C.
- Thixotropic gelled electrolyte — for maximum stability throughout extreme temperature ranges.

For more information on these, or any other General Electric capacitors, call your nearest GE sales office, or write Section 430-52, Schenectady, N. Y. 12345.

MAKE SOMETHING OUT OF IT!

GENERAL  ELECTRIC

INFORMATION RETRIEVAL NUMBER 128
ELECTRONIC DESIGN 10, May 10, 1974

90° hybrid improves amplitude balance

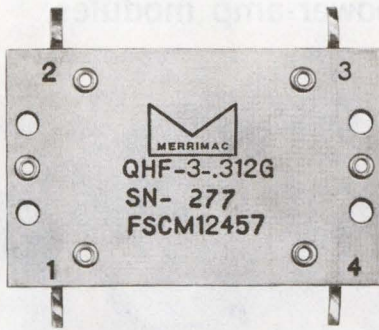

Merrimac Industries, Inc., 41 Fairfield Pl., West Caldwell, N.J. 07006. (201) 228-3890. \$60; stock.

A stripline quadrature hybrid for the 225-to-400-MHz frequency range provides improved amplitude equality. Called the QHF-3-.312G, the new hybrid consists of a three-section coupler with an amplitude unbalance of only ± 0.2 dB typical and 0.25 dB maximum. These values reportedly represent approximately one-half the typical amplitude levels of more conventional devices such as quarter-wave couplers. Other features include a typical isolation of 25 dB and typical insertion loss of 0.25 dB. The hybrid can handle 200 W average and 1 kW peak. Phase quadrature tolerance at 90° is $\pm 2^\circ$ for -3-dB coupling.

CIRCLE NO. 350

Stripline modules offer switching functions

Varian Solid State East Div., Salem Rd., Beverly, Mass. 01915. (617) 922-6000.

The VAM series consists of several combinations of microwave silicon diodes and stripline circuits mounted in hermetically sealed packages. The VAM-1000, VAM-2000 and VAM-3000 models are one, two and three-diode modules, respectively, for use as single-pole, single-throw switches and attenuators for the 0.5-to-18-GHz frequency range. Also available are the VAM-2200 and VAM-2400 featuring two-diodes, single-pole, double-throw switches for X-band and Ku-band applications. In addition the VAM-4000 and VAM-4500 limiter modules provide receiver protection at kilowatt levels between 2 and 18 GHz.

CIRCLE NO. 351

syntronic

1..10..or 1,000

Precision yokes... produced to your exact requirements... to perform just like the prototype. We have the know-how, specialized experience and production flexibility to make one part, or a thousand. If you are designing or building a display, ask us to put our 25 years of experience to work for you.

SYNTRONIC INSTRUMENTS, INC.
100 Industrial Road, Addison IL 60101
Phone (312) 543-6444



**Better
Contacts
Truer
Positions
No Plated-
Thru Holes**

EMC's Pin-in-Board

Still best! EMC's high density Wire-Wrap® non-warping epoxy panels assure accurate true position, especially on 1/16" boards. Edgeboard finger patterns, power and ground planes, and new TIP-DIP™ for double density! Funnel-Entry* design simplifies lead insertion; Nurl-Loc® terminals* prevent twist during wrap. Standard and Custom panels for every requirement, too.

ELECTRONIC MOLDING CORP.
96 Mill St., Woonsocket, R. I. 02895
Phone (401) 769-3800

**Write or phone for latest
Computer Products Catalog**



*Patented

INFORMATION RETRIEVAL NUMBER 130

MICROWAVES & LASERS

Gunn oscillators output up to 250 mW

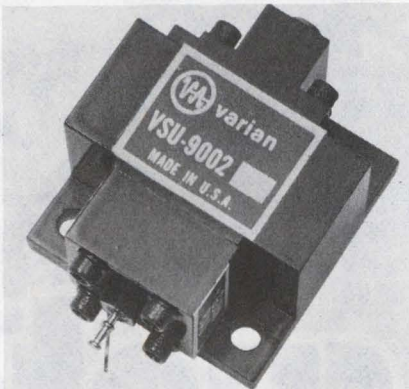

Varian, 611 Hansen Way, Palo Alto, Calif. 94303. (415) 493-4000.

The VSU-9002 series of Gunn-effect oscillators delivers cw output power ranging from 5 to 250 mW. Primarily intended for parametric amplifier use, each oscillator comes factory adjusted for a selected combination of frequency and output power. Standard models are tunable ± 100 MHz from the specified frequency, which can range from 12.4 to 18.0 GHz.

CIRCLE NO. 352

Modular amplifiers have a 12-dB gain

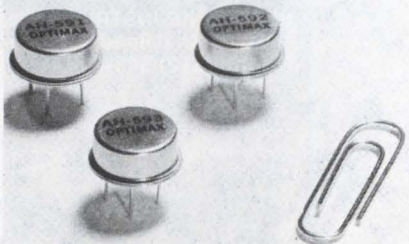

Optimax Inc., P. O. Box 105, Advance Lane, Colmar, Pa. 18915. (215) 822-1311. \$29 up (1-99); stock to 2 weeks.

A line of thick-film "plug-in" amplifiers for the 10-to-400-MHz frequency range is designed to meet the requirements of MIL-HDBK-217A specifications with an MTBF of 1.44×10^6 hours. They are hermetically sealed in TO-8 packages with four pins for direct insertion into microstrip circuitry. Called the AH-590 series, the amplifiers have a minimum gain of 12 ± 1 dB, typical noise figure as low as 4.5 dB and power output for 1-dB gain compression as high as 15 dBm.

CIRCLE NO. 353

Single supply powers power-amp modules

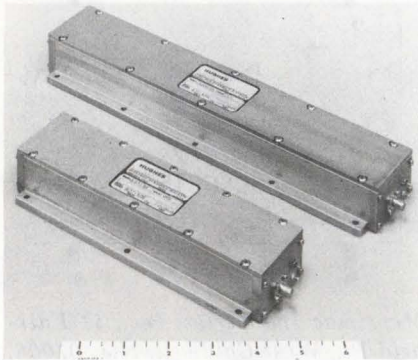

Hughes Electron Dynamics Div., 3100 W. Lomita Blvd., Torrance, Calif. 90509. (213) 534-2121. \$995 up; stock to 45 days.

A series of transistorized linear power-amplifier modules, operating in the 1.7-to-2.4-GHz frequency range, features internal voltage regulation and requires only a single dc supply. The series consists of the following units: the Model 46311H with 0.8 W at 28 dB; the Model 46312H with 0.4 W at 25 dB; and the Model 46313H with 0.12 W at 20 dB. The units are protected against overvoltage, undervoltage, reverse polarity and overdrive.

CIRCLE NO. 354

1-GHz log amps limit rise times to 10 ns

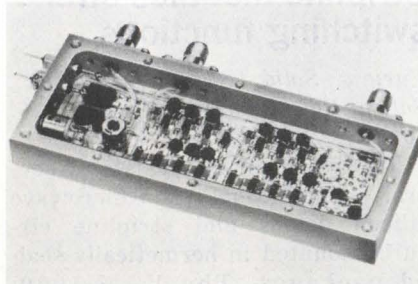

RHG Electronics Laboratory, Inc., 161 E. Industry Ct., Deer Park, N.Y. 11729. (516) 242-1100. \$1100 to \$1400; 75 days.

A series of hybrid IC log amplifiers features center frequencies from 300 to 1000 MHz and bandwidths to 200 MHz. The log amps have less than 10-ns rise times and they have virtually identical log curves over octave bandwidths. Called the ICLT series, the units have a 60-dB dynamic range with linearities to ± 1 dB.

CIRCLE NO. 355

best buy

4½ digit MULTIMETER



\$675

No other 4½ digit DMM offers as many standard features, as much proven reliability and overall performance as the Model 2440.

100µ V to 1000 VDC (accuracy ±0.007% of reading ±1 l.s.d. for six months.) The most accurate 4½ digit meter available.

100µ V to 500 VAC

2-wire and 4-wire resistance, 100 milliohms to 12 megohms

DC/DC ratio, AC/DC ratio

Standard features include:

- Auto-Ranging
- Remote-Ranging
- Auto-Zeroing
- Remote-Triggering
- Isolated BCD output

Documented by full test data and Certificate of Conformance.

DATA PRECISION
...years ahead

CALL YOUR LOCAL OFFICE FOR A DEMONSTRATION

AL (205) 533-5896
AZ (602) 994-9519
CA/W (408) 733-9000
CA/S (714) 540-7160
CO (303) 449-5294
CT (203) 525-7647
FL (813) 294-5815
GA (404) 457-7117
HI (808) 262-6286
IL (312) 593-0282
IN (317) 293-9827
MA (617) 273-0198
MD (301) 552-2200
MI (313) 482-1229
MN (612) 781-1611
MO/W (816) 737-0066
MO/E (314) 731-2331
NC (919) 787-5818
NJ/S (215) 925-8711
NJ/W (201) 863-5660
NM (505) 265-8471
NY/W (315) 446-0220
NY/S (516) 482-3500
OH/W (216) 725-4560
OH/S (513) 298-3033
OR (503) 238-0001
TX/W (214) 234-4137
TX/S (713) 461-4487
UT (801) 268-3181
WA (206) 763-2210
CAN/W (416) 661-1404
CAN/E (514) 731-9328

Data Precision Corporation
Audubon Road
Wakefield, Ma. 01880
(617) 246-1600

INFORMATION RETRIEVAL NUMBER 131

NEW Acrylic Case PANEL METERS from HOYT



3

MODEL 2430 DC / 2431 AC

- Acrylic front Noryl back
- Choice of shielded DC 2% Accu-ring or standard movements DC & AC Types
- Interchanges with standard 2", 3 stud mounting meters



6

MODEL 2260 DC / 2261 AC

- Projected front Acrylic case
- Mounts on panel or through rectangular hole from behind panel
- Choice of Hoyt Hi-Torque movements



6

MODEL 2360 DC / 2361 AC

- Acrylic case stylized front
- Resistant to chemicals and hydrocarbons
- Choice of case colors

HOYT

QUALITY INSTRUMENTS
SINCE 1904

HOYT ELECTRICAL INSTRUMENT WORKS, INC.
BURTON-ROGERS COMPANY, Sales Division
556 Trapelo Road, Belmont, Mass. 02179
(617) 489-1520

INFORMATION RETRIEVAL NUMBER 132

INFORMATION RETRIEVAL NUMBER 133 ►



In computer systems, Licon® switches go where the action is.

Computer efficiency depends on the reliability of each component within the system. That's why you'll find proven Licon switches controlling the action in all types of systems. The double-break, double-reliable Butterfly® switch assures dependability everytime.

Licon saves design time, too. Provides single-source selection from a broad range of switches: lighted and non-lighted pushbuttons, miniature and sub-miniature snap-action types.

Want to individualize? Replace several switches with one? Or meet a multi-functional requirement in a standard way? You can, with "added value" from Licon.

Licon switches: where the action is in computers, business machines, medical electronics, industrial controls. Request full details today from your rep or distributor. Or write for literature.

ITW LICON®

Division Illinois Tool Works Inc.
6615 W. Irving Park Rd., Chicago, Ill. 60634
Phone (312) 282-4040 TWX 910-221-0275



LICON

puts ideas to work
in electronics

The Innovative Electronic Group of ITW...
LICON • EMCON • FAKTRON

© ILLINOIS TOOL WORKS INC. 1974

New . . . Fast . . . DC to 75 MHz

Bit-Block-Burst Error Rate Modular Testing Equipment

TRANSMITTER . . . Six pseudo-random codes with frame sync and clock. RZ and NRZ formats. Encode/decode modes. Trigger level LED indicators.

RECEIVER . . . Automatic synchronization to

received code. Bit error rate, block error rate (10, 100, 1000 bits), burst error LED. Four-digit LED counter.

Phase adjust and phase/amplitude LED indicators.

RELATED MODULES . . . Error preamble inject, special bi-polar code generators, level converters and fixed-word generators.

Seeing is believing. Let us show you, now! Call or write.

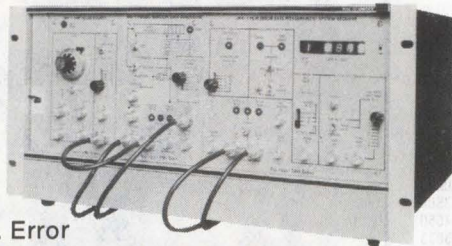

tau-tron
inc

11 Esquire Road, North Billerica, Mass. 01862 Tel: (617) 667-3874

INFORMATION RETRIEVAL NUMBER 134

Perfect mate for Integrations— Micro-Vectorbord® Tenth-Tenth Pattern "P"

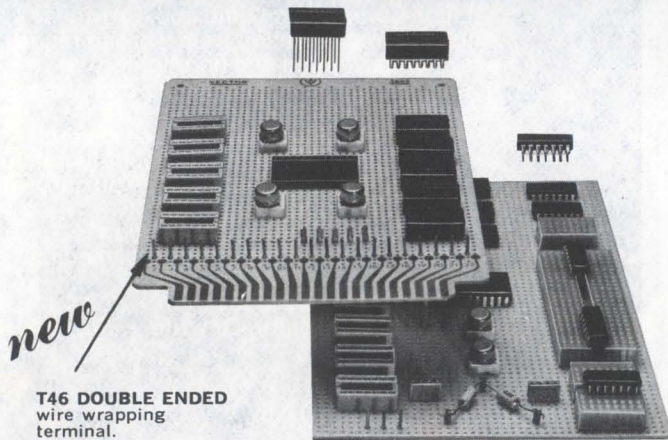

T46 DOUBLE ENDED
wire wrapping
terminal.

Precision punched .042" holes spaced .1" x .1" available in sheets of various sizes up to 8½" wide by 35" long, ¼" thick Epoxy Glass, Epoxy Paper, Phenolic.

Copper Clad and Non-Clad. Also available in Plugboards with etched or Elco Varicon contacts, buses, ground planes.

MINIATURE PUSH IN TERMINALS FOR .042" HOLES.



T44



T49



K24



T42-1



R32



R41

Vector

Send for complete literature

ELECTRONIC CO., INC.

12460 Gladstone Ave., Sylmar, California 91342

Phone (213) 365-9661 • TWX (910) 496-1539



31A 103

INFORMATION RETRIEVAL NUMBER 135

MICROWAVES & LASERS

Hf tester checks receivers

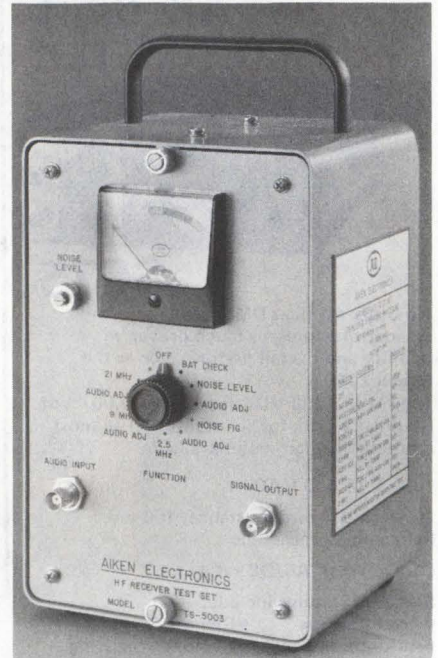

Aiken Electronics, 7411 50th Ave.,
College Park, Md. 20740. (301)
779-7600. \$595 up; stock to 90
days.

A receiver test set, the battery-operated Model TS5003, permits evaluation of noise figure, dynamic range and over-all gain for receivers in the 2-to-32 MHz frequency range. Meter calibration is ± 6 dB in 1 dB steps from a center scale reference. The test set specs signal output level as KTB+19 dB for noise figure and KTB + 67 dB for intermodulation. Operating life is 6 months normal usage—240 hours at 2 hours per day.

CIRCLE NO. 356

S-band transistor delivers 10 W cw

RCA, Route 202, Somerville, N.J.
08876. (201) 722-3200. \$200 (25-
99); stock.

The RCA2310 transistor supplies 10 W cw at 24 V for operation at 2.3 GHz. The device is believed to offer the highest output power for a single transistor at this frequency. The new transistor is designed for telemetry applications in the 2.2-to-2.3-GHz range, and it operates from supplies in the 22-to-24-V range. The device comes in the company's HF-46 ceramic-metal package.

CIRCLE NO. 357

Ka-band sweeper spans 18 to 22 GHz

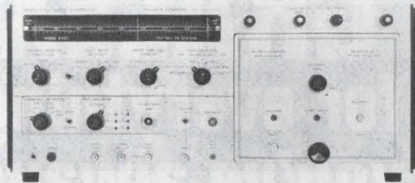

Wiltron Co., 930 E. Meadow Dr., Palo Alto, Calif. 94303. (415) 321-7428. \$3300 up; 6 weeks.

The Model 6132C sweeper provides a leveled 5-mW test signal for the 18-to-22-GHz frequency range. The sweeper reportedly provides the first solid-state coverage of Ka band. Flatness is ± 0.5 dB. Harmonic and spurious signals are, respectively, 30 and 60 dB below the carrier signal.

CIRCLE NO. 358

Miniature hf antenna maintains sensitivity

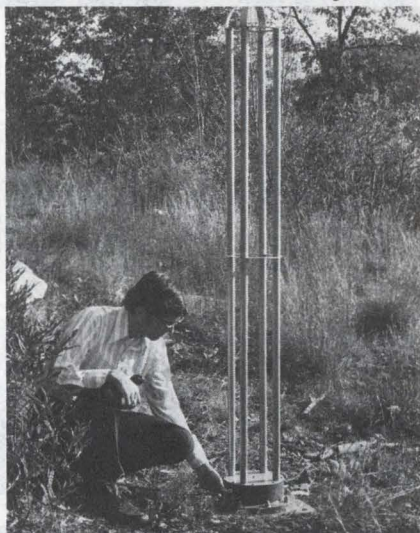

Adams-Russell Co., 1380A Main St., Waltham, Mass. 02154. (617) 899-9770. \$1750.

A miniature high-frequency antenna provides receiving sensitivities comparable to full-size elements. Called Actenna, the new antenna measures only 81 in. tall, covers 2 to 32 MHz without tuning and reportedly has sensitivity limited only by external atmospheric noise in most applications. The antenna has an effective directivity rating of 4.8 dBI over an infinite ground plane and a VSWR of better than 1.5 across the band. Unit-to-unit gain and phase tracking are ± 0.5 dB and ± 1 degree, respectively.

CIRCLE NO. 359

Double-balanced mixer has i-f to 2 GHz

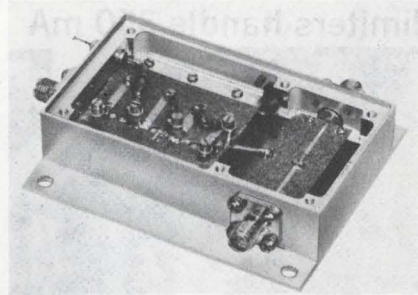

RHG Electronics Lab, 161 E. Industry Court, Deer Park, N. Y. 11729. (516) 242-1100. \$750 up; 40 days.

A series of double-balanced mixer-preamplifiers features an i-f range to 2 GHz. A typical unit, the Model DM4-8/2000 for the 4-to-8 GHz range, has an i-f bandwidth of 100 MHz, nominal noise figure of 12.2 dB and a gain of 20 dB. The unit operates from a 12-V supply and draws 35 mA typical.

CIRCLE NO. 360

Get your free 1974 guide to RCA electronic instruments.

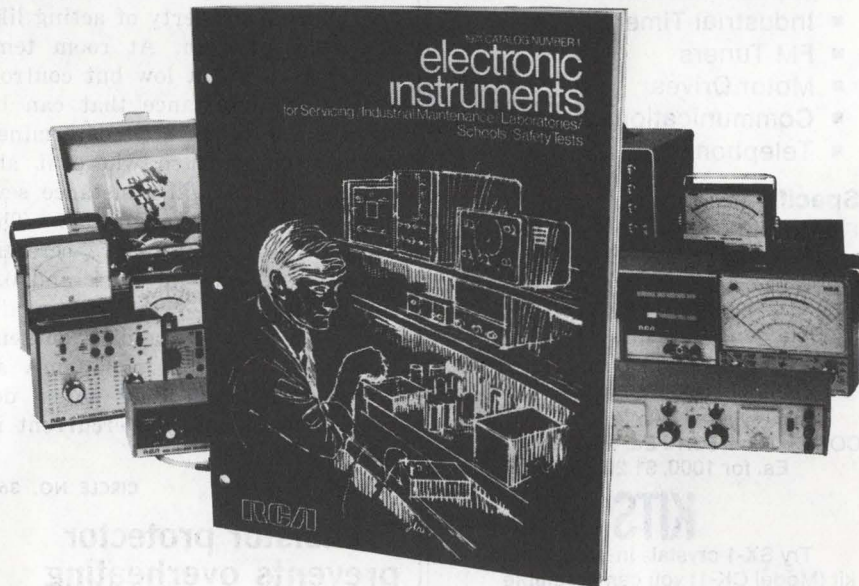

This handy guide provides data on instrument specifications, accessories, and pricing — hard facts that will help you select RCA instruments to meet your specific needs.

You can get a free catalog from any one of the more than 1,000 RCA Distributors worldwide, or write to RCA, Commercial Engineering,

Section 57E10, 415 South 5th St., Harrison, N.J. 07029.

RCA, Commercial Engineering
Section 57E10
415 South 5th Street
Harrison, N.J. 07029

Please send a free copy of the 1974 RCA electronic instruments catalog 1Q1218G.

Name _____
Company _____
Title _____
Address _____
City/State _____ Zip _____

Specialists demand the best tools of their trade.

RCA Electronic Instruments

INFORMATION RETRIEVAL NUMBER 136

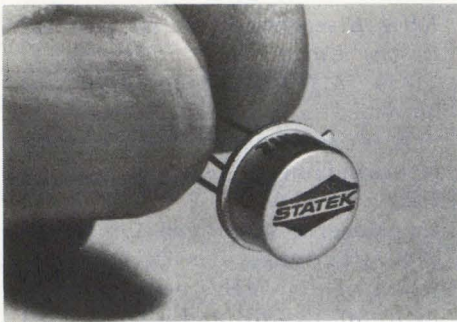

GET CRYSTAL STABILITY AT RC/LC PRICES WITH STATEK CRYSTALS

Typical Applications

- Tone Telemetry
- Ultrasonic Alarms
- Industrial Timers
- FM Tuners
- Motor Drives
- Communications Equipment
- Telephone Carrier Equipment

Specifications

FREQUENCY RANGE - 10 kHz to 250 kHz in 20 Stock Frequencies

STABILITY - 0°C to 50°C 0.045%
-40°C to +85°C 0.07%
(Better specifications available.)

RUGGEDNESS - Withstands up to 1000G Shock, 50G Random Vibration, 10 to 2000 Hz

COST - From \$2.15 Ea. for 250; \$1.70 Ea. for 1000, \$1.20 Ea. for 10,000

KITS

Try SX-1 crystals in an oscillator kit (Model CK-1) you can assemble in minutes. \$27 Each.

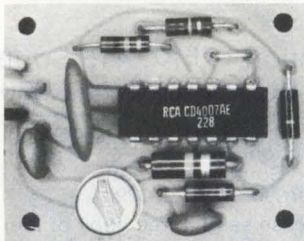

ASSEMBLED CK-IV KIT

See all the Statek Products at the Design Engineers Electronic Components Show, May 13-15, 1974, Statler-Hilton, Washington, D.C.

STATEK CORPORATION
1233 Alvarez Avenue
Orange, California 92668
Phone: (714) 639-7810
Telex 65-5430

INFORMATION RETRIEVAL NUMBER 137

DISCRETE SEMICONDUCTORS

Solid-state current limiters handle 350 mA

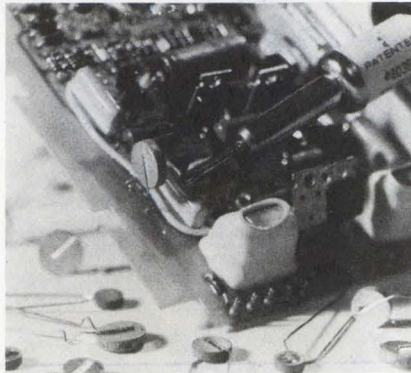

Texas Instruments, Attleboro, Mass. 02703. (617) 222-2800.

The current limiting switches of the 3GT series are electrically conducting ceramic elements made from specially formulated barium titanate. The PTC material's formulation and processing give it the unusual property of acting like a thermal switch. At room temperature it has a low but controllable base resistance that can be maintained up to a predetermined higher temperature where it abruptly increases in resistance several orders of magnitude. The 3GT current limiters are ceramic discs about 0.25 in. thick and 0.5 in. in diameter. They are available with several standard current capacities from 50 to 350 mA at voltages up to 120 V ac or dc. Trip time at 500% overcurrent is about 8 s.

CIRCLE NO. 361

Transistor protector prevents overheating

Multi-State Devices, 1330 Trans Canada Highway, Dorval, Quebec H9P1H8, Canada. (514) 842-5281. \$0.40 (1000-up); stock.

Power transistors are protected from overheating with a proportional control device called Moxie. The device reduces power transistor drive in direct proportion to overheating—either through negative feedback or shunt attenuation. The principle is based on smooth resistance changes from greater than 0.1 MΩ to less than 100 Ω whenever the device exceeds a specified transition temperature. Four Moxie types, with transitions at 57, 65, 75 and 85 C, are currently available.

CIRCLE NO. 362

GRALEX

for everything
you've always
wanted in
DPMs



- 2½, 3½ and 4½-digit models
- Right-on-spec performance
- Easy-to-read displays
- Off-the-shelf interchangeability (for replacement of most other DPMs—panel cut-outs, connectors, wiring, specs, etc.)
- Down-to-earth prices
- Right-on-time deliveries
- Keep-on-working reliability (backed up by our 1-year full warranty on parts and labor!)

GRALEX INDUSTRIES

DIVISION OF GENERAL MICROWAVE CORP.
155 Marine St., Farmingdale, N.Y. • 516-694-3607

INFORMATION RETRIEVAL NUMBER 138
ELECTRONIC DESIGN 10, May 10, 1974

Tiny LED seven segment display uses 800 μ A

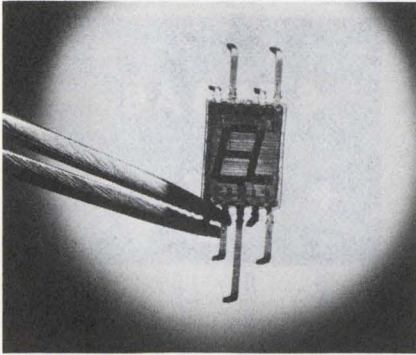

Monsanto, 3400 Hillview Ave., Palo Alto, Calif. 94304. (415) 493-3300. From \$1.20 (1000 up); stock.

The MAN31s, 0.09 in. high LED 7-segment displays, use diffused planar gallium arsenide phosphide segments encapsulated in a high contrast red epoxy package. The displays require between 600 to 800 μ A per segment. Three array versions are available—the MND 931, 931-1 and 931-2. The 931 is a nine-digit unmagnified assembly, the 931-1 and 931-2 are magnified versions with apparent heights of 0.115 and 0.13 in., respectively. Each display has a typical brightness of 6.5 microcandelas at a 0.8 mA drive current and a 150° viewing angle.

CIRCLE NO. 363

Bridge and single phase rectifiers handle 75 A

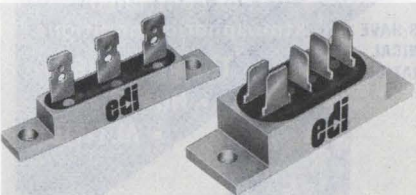

Electron Devices Inc., 21 Grey Oaks Ave., Yonkers, N.Y. 10710. (914) 965-4400. From \$1.65 (single phase), from \$3.20 (three phase).

Two rectifiers have been added to the PJC and PJT Minibrige series of rectifiers. One is for single-phase, full-wave, center-tapped circuits and the other for three-phase, full-wave applications. Universal, three-way terminals permit use of quick-connect terminals, and wrap-around or solder connections. Electrical ratings are: PIV = 50 to 600 V at 25 A. And, the units have a 400-A single cycle surge rating.

CIRCLE NO. 364

ENM COMPAC®

that
american
made
counter
that made
americans ponder



Resetable Model E3B
5-Digit, Base Mount

The electric Model E2B is the Grand Daddy of ENM's CompaC® Series. Not only did it sire a whole new line of value engineered digital counters and indicators, it caused engineers to re-evaluate their specification and buying habits.

The Model E2B combines reliability, versatility through interchangeable components, a unique reciprocating Delrin verge ratchet drive and U.L. and C.S.A. standards—and delivers all this, on time, for less than you're probably paying for less of a counter.

If you're being squeezed to design a better product for less money, ponder ENM's Model E2B. In its own small compact way, it can do big things for you. And it's All-American made.

Resetable Model E3B

Knob reset. 5-digit universal base mount or back of panel—115, 230, 24 V. AC.; 110, 24, 12, 6 V. DC. Case width 1.72". Speed rating 600 cpm. Priced from \$4.30 in 1000 lot quantities to \$8.60 in single lots (115 V.).

Model E2B

5 or 6-digit universal base mount or back of panel—115, 230, 24 V. AC.; 110, 24, 12, 6 V. DC. 7-digit universal base mount—115 V. AC. Case width 1.72". Speed rating 600 cpm. Priced from \$2.65 in 1000 lot quantities to \$6.00 in single lots (115 V.).



Model E2B
6-Digit,
Base Mount

CompaC Digital Counter Buyers Guide
Write for it today, so you won't be wrong tomorrow.

ENM COMPANY

5340 Northwest Highway, Chicago, Ill. 60630 • Telephone: (312) 775-8400

Seven-segment LED digits are 0.6 in. high

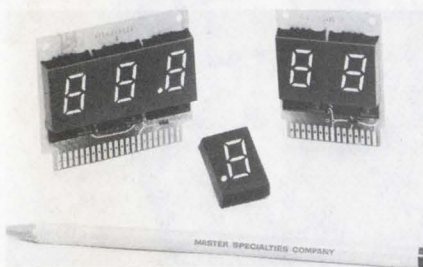

Master Specialties, 1640 Monrovia Ave., Costa Mesa, Calif. 92627. (714) 642-2427. \$11.55 (lge. qty.); 4 wk.

The Series 500 plug-in LED displays have 0.6 in. high red seven segment numeric characters. They are designed for viewing distances of up to 25 feet. A four-segment display with + and - and the numeral one is also available. Common screens and bezels are available. Each multidigit readout assembly is packaged on a printed circuit board with decoder/driver circuitry for each digit.

CIRCLE NO. 365

Optical mark sensor detects 0.01 in. spots



Ultra Sensors Inc., 12006 Riverwood Dr., Minneapolis, Minn. 55337. (612) 890-8414.

The Cyclops is an in-line, vertical stacking miniature sensor. This mark-sensor has no minimum field-of-vision. Thus, a 0.005 in. radius spot can be sensed on a reflective surface. It uses a GaAs LED and a silicon npn phototransistor. The sensor has a max diameter of 0.281 in. and a length of 0.55 in. Collector-emitter voltage is 40 V max and the diode has a peak emission wavelength of 9000 Å.

CIRCLE NO. 366

Bridge rectifier modules handle up to 3 A

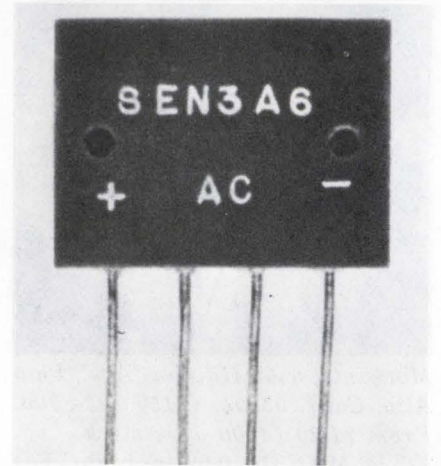

Sensitron, Div. of RSM Electron Power, 221 W. Industry Ct., Deer Park, N.Y. 11729. (516) 586-7600. From \$0.97 (100 up); stock to 1 wk.

The SEN 3A6 series of single-phase subminiature 3-A bridge rectifiers handle 3 A continuous at 25 C ambient temperature. They can be derated at 1.5 A at 100 C ambient. The bridges are available in 50 through 800 V modules.

CIRCLE NO. 367

If you think there
are no other ways to cut your
POWER SUPPLY
costs, get proven performers and
realistic delivery...
you didn't figure on



QUAD-MOD
Versatile multiple output
OEM Power Supplies

from **\$135.00**



TODD PRODUCTS CORP.
123 Milbar Blvd., Farmingdale, N.Y. 11735 • (516) 293-3440

INFORMATION RETRIEVAL NUMBER 140

WEBBER
Environmental Chambers
STANDARD AND SPECIAL UNITS • 8 EXCLUSIVE PATENTS

For controlled
atmospheric conditions

- TEMPERATURE
- HUMIDITY
- ALTITUDE

**ALL UNITS HAVE
MECHANICAL
REFRIGERATION**



Interior: 30' x 10' x 10'.
Range: -100° F to
+250° F with humidity



Shock test
chamber.
Programmed from
-125° F to +300° F



Altitude chambers
in any size and
combination of
temperatures



For
pharmaceutical
storage
and other
applications



Agree models
in all sizes and
temperature ranges



Write for new
brochure No. 6900
Forty-eight pages of
helpful data on Webber
environmental chambers

phone
317-357-8681

Webber MANUFACTURING CO. INC.
P. O. BOX 217 • Indianapolis, Indiana 46206

INFORMATION RETRIEVAL NUMBER 141

ELECTRONIC DESIGN 10, May 10, 1974

Inverter SCRs handle up to 125 A or 1200 V

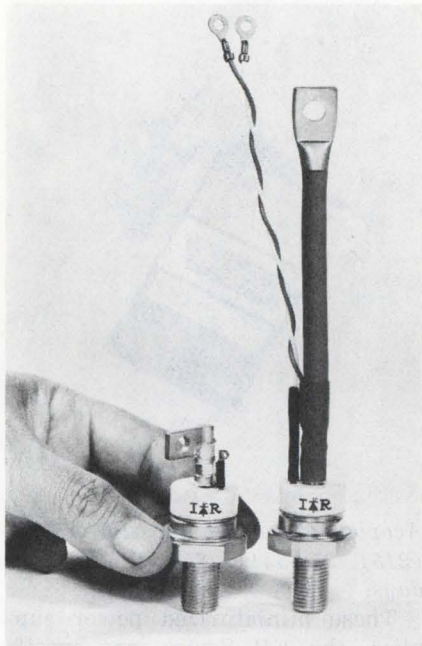

International Rectifier, 233 Kansas St., El Segundo, Calif. 90245. (213) 678-6281. 81RL50: \$68; 4 wk.

The 81RL and 81RLB series of 125-A fast switching inverter SCRs uses accelerated cathode excitation. The series of units handles blocking voltages to 1200 V, plus high di/dt and high dv/dt. Maximum turn-off time is 30 μ s for the 81RL and 40 μ s for the 81RLB. The units are housed in JEDEC outline TO-94 or JEDEC outline TO-49 cases.

CIRCLE NO. 368

Avalanche photodiode has 0.5 mm active area

EMI Electronics, Blyth Rd., Hayes, Middlesex, England.

The type S 30506 photodiode is a high-speed, light-sensitive detector with a photoactive area of approximately 0.5 mm diameter. The device is a solid-state analog of a conventional photomultiplier covering the range from 4500 to 11,000 Å. Internal current gain is obtained by reverse biasing the detector near the avalanche breakdown voltage. This significantly improves sensitivity of photodetection systems to weak light signals. This sensitivity is not reduced in the presence of high background constant radiation. The fall time (90% to 10%) is only 6 ns.

CIRCLE NO. 369

Dual speed capability ...plus more torque than ever before!

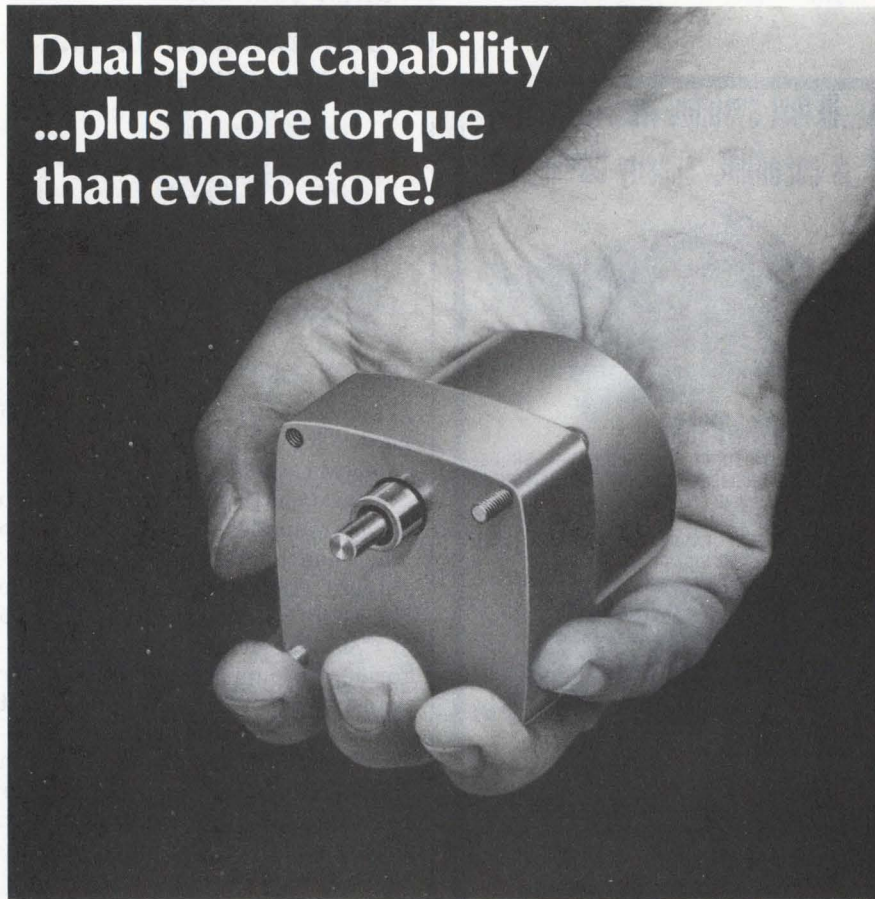

Meet the 86600...workhorse of our economy-priced synchronous motor family.

Designing medical or scientific instruments, computer peripherals, environmental control units or other devices needing a better synchronous drive? Take a look at our new, compact 86600 economy-priced synchronous motor. Its increased power can open up whole new design possibilities for you.

Greater Torque

A UL recognized component and built to NEMA type 2-11 configuration, the 86600 gives you 5.5 oz-in at 600 rpm rotor speed. You have a selection of 10 gear trains to handle torque loads up to 200 oz-in.

Dual Speed Capabilities

High torque isn't the only advantage you'll gain. You can use the

86600 either as a single speed electrically reversible motor, or you can specify it in a variety of unidirectional dual speed combinations. Either way, the 86600 is reliable, efficient and compact. A real space saver! Models are available for 120 VAC, 24 VAC, or 230 VAC.

All in the Family

If your requirements call for something else, remember that NAPCC offers a full range of synchronous motors—starting at .75 oz-in at 300 rpm rotor speed. Chances are we can fill your needs off the shelf. If not, we have the capabilities to design and build a motor to your specifications. Try us.

Write for details today!

A. W. HAYDON CO. PRODUCTS

NORTH AMERICAN PHILIPS CONTROLS CORP.

Cheshire, Conn. 06410 • (203) 272-0301

INFORMATION RETRIEVAL NUMBER 143

...in test systems where integrity is essential, specify cunningham

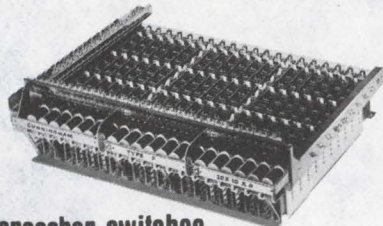

crossbar switches

FROM TEN TO THREE HUNDRED 6 WIRE CROSSPOINTS. EXTREMELY LOW PATH RESISTANCE, LOW NOISE AND MINIMAL THERMAL EMF. MINIMUM OF 20 MILLION OPERATIONS/CROSSPOINT LIFE EXPECTANCY. HANDLES LOW LEVEL AND BROADBAND SIGNALS.

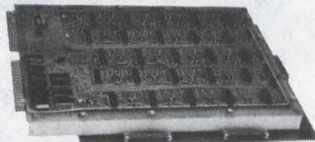

reed matrix

STANDARD 5X10 (50 CROSSPOINT) MATRIX FOR GROUP TO GROUP SWITCHING. INTERMEDIATE FREQUENCY (IF) HANDLES DC TO 4 MHz SIGNALS. HIGH FREQUENCY (HF) CAPABILITY OF 60 MHz WITH SHIELDED SIGNAL PATHS.



matrix controller

INTERFACES A SWITCH MATRIX TO ANY 16 BIT ADDRESS DEVICE. FACILITATES A WIDE VARIETY OF SWITCH MATRIX APPLICATIONS BY PROGRAMMABLE REMOTE AND MANUAL CONTROL. ESPECIALLY USEFUL IN AUTOMATIC TESTING OR TELEMETRY SWITCHING.



scanners

FOR SEQUENTIAL OR RANDOM CONNECTION OF INSTRUMENT LEVEL SIGNALS. REED SCANNERS OFFER HIGH SPEED SWITCHING FOR DATA LEVELS. CROSSBAR SCANNERS BEST FOR LOW THERMAL OR LOW NOISE DATA ACQUISITION SYSTEMS. BOTH FEATURE LOCAL AND REMOTE CONTROL.

applications assistance

FOR ADDITIONAL DATA OR APPLICATIONS ASSISTANCE, CALL THE CUNNINGHAM CORPORATION, HONEOYE FALLS, NEW YORK: (716) 624-2000.

Cunningham Corporation

SUBSIDIARY OF GLEASON WORKS

POWER SOURCES

Open-frame units start and operate arc lamps

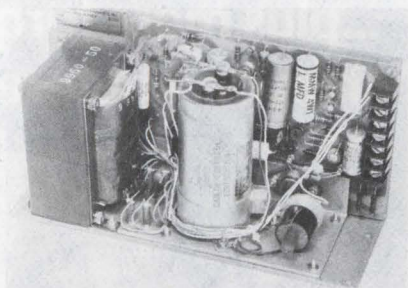

Electronic Measurements Inc., 405 Essex Rd., Neptune, N.J. 07753. (800) 631-4298.

Two open-frame Xenon arc-lamp power supplies are designed to start and operate all types of tri-voltage electrode lamps. Both the EMX335 (35 W) and EMX375 (75 W) Models include a trigger transformer to supply high voltage for lamp starts, efficient open-circuit boost voltage and a series-pass current regulator. Lamp illumination can be controlled to supply either constant current or constant power. Ripple stability and regulation are to within 0.1%.

CIRCLE NO. 370

Static inverter meets FAA qualifications



Avionic Instruments Inc., 943 E. Hazelwood Ave., Rahway, N.J. 07065. (516) 239-6444.

Model 1A250-1B static inverter, rated at 250 VA, is qualified to FAA approved TSO-C73, RTCA DO-138, and MIL-E-5400, Class 2. The unit is solid state, has no moving parts and is designed primarily to provide 400-Hz power aboard aircraft. The unit offers 73% minimum efficiency and provides two outputs: 115 V, 400 Hz and 26.5 V, 400 Hz. It will operate in altitudes up to 50,000 ft. unpressurized, and in a temperature range of -85 to +71 C.

CIRCLE NO. 371

Small power supplies mount on chassis

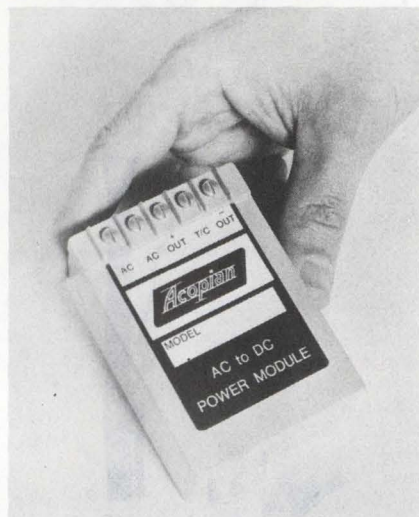

Acopian Corp., Easton, Pa. 18042. (215) 258-5441. \$55 to \$135; 3 days.

These miniaturized power supplies, the EB Series, are specifically designed for chassis or assembly mounting. The units have screw terminals on the side opposite the mounting surface and may be mounted to metalwork without any need for pin clearance holes, sockets, or standoffs. Encapsulated construction and short-circuit protection minimize the possibility of accidental damage. The series includes supplies with outputs ranging from 1 to 28 V, at currents to 2.5 A. Dual output models provide ± 12 or ± 15 V tracking outputs rated from 100 to 500 mA/output.

CIRCLE NO. 372

Plug-in module supplies CRT high voltage

James Millen Manufacturing Co., Inc., 150 Exchange St., Malden, Mass. 02148. (617) 324-4108.

The No. 90202-D high-voltage power supply is designed to provide up to 1400 V dc accelerating potential, plus filament-heating power for small and medium-sized CRTs. With a 1.1-mA external dc load, the ripple voltage is less than 1.5 V; with an output of 3.0 mA, the ripple voltage is less than 3 V rms. Since the power-supply unit is not regulated or stabilized, the output voltage is proportional to the input voltage. Size is 3-11/16 \times 3-1/8 \times 2-1/8 in. and weight is 1-3/4 lb.

CIRCLE NO. 373



run
long,
strong
and profitably

Bodine FHP motors and gearmotors

Bodine's K-2 line has a history of dependability, long life, and consistent motor-to-motor performance. You get greater economy in the long run. Ball bearing rotors and individual run-in are standard. Performance options include high starting torque for inertia loads, low inertia rotor for fast response in servo applications, dynamic braking capability, torque motor application, and reluctance synchronous operation. Two new bulletins from Bodine covering K-2 motors and gearmotors are now available. Get both from . . .



Bodine Electric Co., 2528 West Bradley Pl., Chicago, Ill. 60618
INFORMATION RETRIEVAL NUMBER 145

Here's **HOW**
to choose the right
ROTARY SWITCH
for your needs!



SELECTOR GUIDE - ROTARY SWITCHES

SWITCH TYPE	1	2	3	4	5	6	7	8	9	10	11	12	13	14	15
1. NUMBER OF POSITIONS	2	3	4	5	6	7	8	9	10	11	12	13	14	15	16
2. CONTACTS PER POSITION	1	2	3	4	5	6	7	8	9	10	11	12	13	14	15
3. CONTACT TYPE	1	2	3	4	5	6	7	8	9	10	11	12	13	14	15
4. CONTACT MATERIAL	1	2	3	4	5	6	7	8	9	10	11	12	13	14	15
5. CONTACT SPACING	1	2	3	4	5	6	7	8	9	10	11	12	13	14	15
6. CONTACT WIDTH	1	2	3	4	5	6	7	8	9	10	11	12	13	14	15
7. CONTACT HEIGHT	1	2	3	4	5	6	7	8	9	10	11	12	13	14	15
8. CONTACT LENGTH	1	2	3	4	5	6	7	8	9	10	11	12	13	14	15
9. CONTACT AREA	1	2	3	4	5	6	7	8	9	10	11	12	13	14	15
10. CONTACT PERIPHERY	1	2	3	4	5	6	7	8	9	10	11	12	13	14	15
11. CONTACT SPACING	1	2	3	4	5	6	7	8	9	10	11	12	13	14	15
12. CONTACT WIDTH	1	2	3	4	5	6	7	8	9	10	11	12	13	14	15
13. CONTACT HEIGHT	1	2	3	4	5	6	7	8	9	10	11	12	13	14	15
14. CONTACT LENGTH	1	2	3	4	5	6	7	8	9	10	11	12	13	14	15
15. CONTACT AREA	1	2	3	4	5	6	7	8	9	10	11	12	13	14	15
16. CONTACT PERIPHERY	1	2	3	4	5	6	7	8	9	10	11	12	13	14	15

FREE!
11" x 17" WALL CHART

With this handy new guide, you can cross-check over 50 basic specifications against each of our 15 switch "families". In just a few minutes, you can narrow your applications down to a few possibilities...save hours of catalog search and research! Covers our Rotary Switch lines from 10A-240V to 200A-600V. Send for your free copy today.



INFORMATION RETRIEVAL NUMBER 146

ELECTRONIC DESIGN 10, May 10, 1974

12 BIT A/D CONVERTERS . . .

Just 2 years
ahead
in . . .
SIZE
COST and
PERFORMANCE

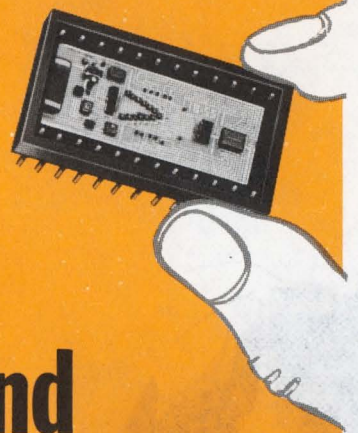

Micro Networks has continually led in the production availability of dip packaged and MIL-range D/A and A/D's.

Model MN5200 successive approximation converter is the industry's first 12 bit A/D in a dip, complete with internal reference and guaranteed $\pm 1/2$ LSB linearity.

MN5200 Series converters are:

- Totally adjustment free . . . and factory trimmed.
- Hermetically sealed 24 pin dip package.
- Low Power . . . 700mw.
- High Speed . . . 50 μ sec conversion time.
- $\pm 1/2$ LSB linearity for 0 to 70C.
- Available to full MIL operation -55 to +125C ("H" Models only)

Prices:

- MN5200 (1 to 24) . . . \$225.
- MN5200H (1 to 24) . . . \$375.



Available from stock. Full technical data available. Write or call . . . today.

Micro Networks Corporation
5 Barbara Lane • Worcester, Mass. 01604 / Tel: (617) 753-4756

INFORMATION RETRIEVAL NUMBER 147

Electronic Design's

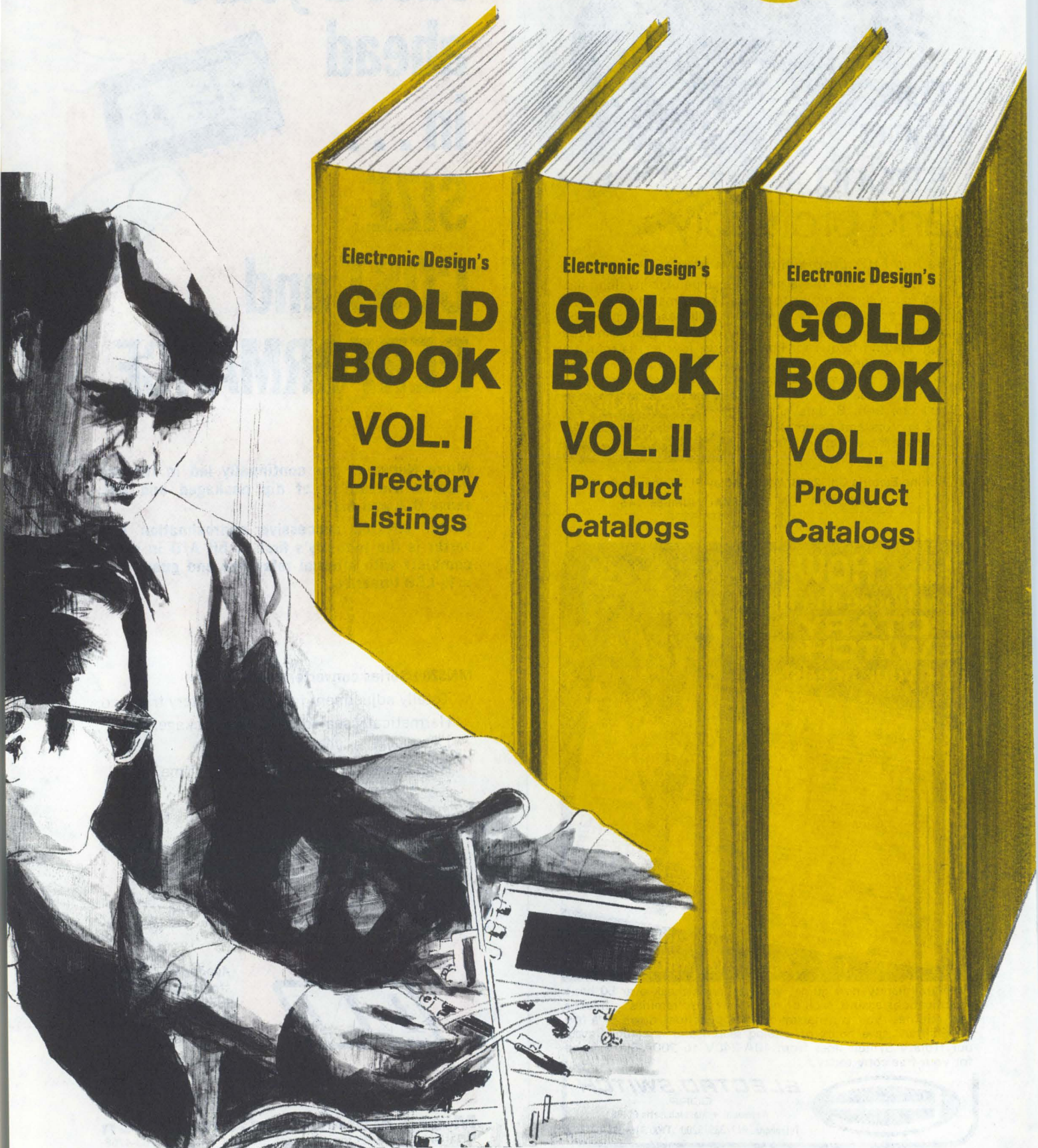

GOLD BOOK

IS TAKING SHAPE

INDUSTRY RESPONSE HAS PUSHED THE SIZE UP TO 3 VOLUMES!

We promised that *Electronic Design's* GOLD BOOK would make all other directories seem obsolete. Response from electronics manufacturers has been so enthusiastic that three volumes are required for the first edition!

Volume I contains directory listings — who makes what and where to find it. Volume II and III contain product information — catalog-type material, application data, product specs, technical details. When you see and use *Electronic Design's* GOLD BOOK you'll wonder how you ever got along without it. It's the one-step reference and purchasing tool that will save you many hours as you search for the exact products to meet your needs.

COMING YOUR WAY

JULY 1974

ANOTHER SERVICE FOR READERS FROM

Electronic Design

custom options at compact prices

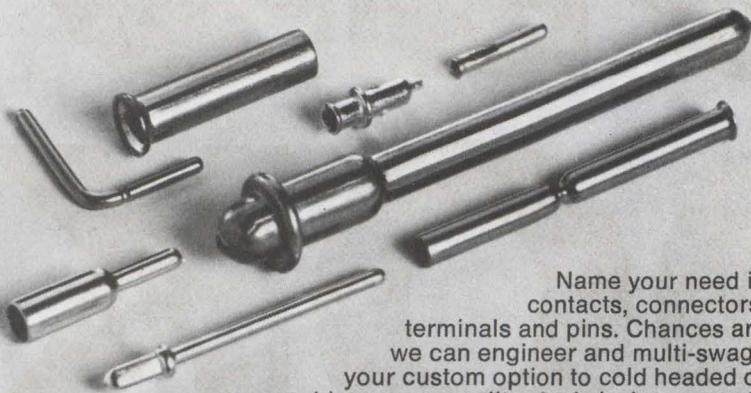

Name your need in contacts, connectors, terminals and pins. Chances are we can engineer and multi-swage your custom option to cold headed or machine screw quality. And slash your costs 40% or more. Delivery is when you want it, too. Get all the details in our new catalog. Write or call.



bead electronics

A Division of Bead Chain Manufacturing Co.
58 Mountain Grove St., Bridgeport, Conn. 06605
Phone: (203) 334-4124

"See us at Nepcon 74 East Booth 4734"

INFORMATION RETRIEVAL NUMBER 148

Our single-chip concept:

Copper grid distributes current most efficiently for lowest $V_{CE(sat)}$.

Integral solid copper leads and heat sink make pre-bond chip test and inventory possible.

Meet stringent MIL requirements best with the NPN silicon transistor that's single-minded about performance. The concept: a unique single-chip design that packs the highest current rating in its class... keeps saturation voltage low and eliminates second breakdown problems. $V_{CE(sat)}$ is .60V max. @ 50 Amps, and guaranteed at 90 Amps. $E_{S/b}$ is 6 joules. And because its very simplicity allows pre-rating

One bigger, beefier chip.

Void-free bonding techniques eliminates hot spots.

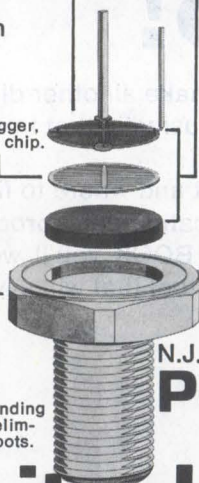

and pre-testing, you can order our PT 7511 device off-the-shelf for switching regulators, motor controls and other hi-rel power circuits. For tech. data and application assistance, write or call, PowerTech, Inc., 9 Baker Ct., Clifton, N.J. 07011; (201) 478-6205

PowerTech
BIG IDEAS IN
BIG POWER

Top of its class. 200v, 90A silicon transistor

INFORMATION RETRIEVAL NUMBER 149

POWER SOURCES

Unregulated dc supplies are offered



Standard Power, Inc., 1400 S. Village Way, Santa Ana, Calif. 92705. (714) 558-8512. \$17 to \$50 (50-99).

This new series, called "Black Line" consists of unregulated dc power supplies. Four types are available in power ratings from 15 up to 200 W, at a variety of voltage outputs. All models feature a floating output and may be referenced to another low voltage, common ground, or placed in series with another dc voltage source for maximum versatility. Maximum ripple is 3% in all models.

CIRCLE NO. 374

Mini lab supplies output to 1 A



Instant Instruments Inc., 306 River St., Haverhill, Mass. 01830. (617) 373-9260. \$49 to \$69; stock.

This pocket-sized series of lab power supplies offers miniature size (15.5 in.²), continuous operation, and short-circuit and over-voltage protection. Five models are available. Specs include 105 to 125 V ac, 50 to 400-Hz input voltages; 5 V dc at 1000 mA or ± 15 V dc with either 100 to 200 mA/dc outputs; 0.05% max. (0-100%) load regulation; and 1-mV max. ripple and noise.

CIRCLE NO. 375

Dc-to-ac inverters offer environmental shield

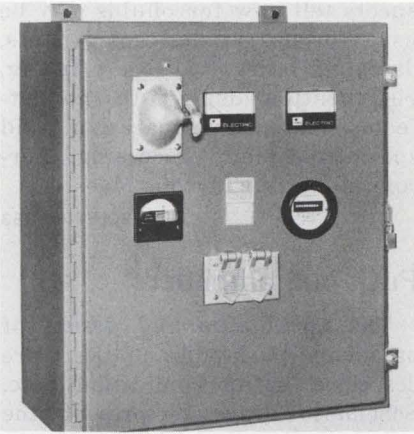

Nova Electric, 263 Hillside Ave., Nutley, N.J. 07110. (201) 661-3434. From \$525; 30 to 60 day.

The Verter-seal dc-to-ac inverters are environmentally protected and completely sealed units. Typical electrical specifications include: power levels of 125, 250, 500 and 1000 VA; dc input voltages of 12, 24, 48, 150 and 250 V; output frequencies of 50, 60 or 400 Hz. Output voltage regulation is $\pm 1\%$ for line and load changes and harmonic distortion is less than 6%. Operating temperature range is -20 to $+50$ C. Input transient protection is available up to 10 kV.

CIRCLE NO. 376

Supply drives Self-Scan display



Texas Digital Systems, Inc., P. O. Box 3701, Bryan, Tex. 77801. (713) 822-5446.

The 9760-PS power supply provides designers who use the Burroughs' Self-Scan display with a single source to operate a 16 or 30 two-character Self-Scan (with or without memory) and power additional TTL or MOS circuitry. Output voltages are 250 V at 30 mA, -12 V at 200 mA, and 5 V at 1 A. Regulation is within 5% for an input of 105 and 125 V ac. The 9760-PS weighs less than 2 lb. and measures approximately $6 \times 4 \times 2$ in.

CIRCLE NO. 377

NEW! INSTANT FREQUENCY DIFFERENCE!



Tracor Model 527A measures frequency difference instantly, precisely. For precisely \$2850. Front-panel meter reads directly to parts per 10^{11} . Allows adjustment of two oscillators to the same frequency, adjustment to a specific offset, determination of offset—all instantly. Plus both short-term and long-term stability analysis. Internal oscilloscope extends precision to 1×10^{-12} . Reference and signal frequencies need not be the same. Write or call for full technical and application information.

Tracor Industrial Instruments

6500 Tracor Lane • Austin, Texas 78721 • AC 512/926-2800

INFORMATION RETRIEVAL NUMBER 150



It's logical

Panasonic's new R-relay makes a lot of sense. It's the smallest reed-type relay you can buy with a latching function (memory). And it's available in a form C (SPDT) contact closure.

When we set out to build our logical relay, we decided not to refine old ideas. Instead we invented (and patented) a relay of revolutionary design and construction with features no other relay has. We used an easily manufactured plastic bobbin instead of the expensive glass capsule used in every other reed relay. We included a barium ferrite permanent magnet to provide latching (logic) function. And we molded it together in one piece of hermetically sealed heat-resistant epoxy resin that occupies less than one-sixth of a cubic inch. Our relay

has a mechanical life of over a billion operations performed as rapidly as 500 Hz. It operates with an extraordinarily wide range of currents—from a few microamps up to a full amp. It's even available in a two-coil bi-stable configuration.

Do you need to mount a relay on a circuit board with a high parts density? Do you need a relay that needs no maintenance over an extra long life? One with higher sensitivity in low power semiconductor circuits? Or one that can withstand currents up to a full amp? Perhaps you need a relay with negligible contact bounce, rapid response, and high operational frequency. If you do, send for more information about Panasonic's unique R-relay. It's the logical thing to do.

**Matsushita Electric Corp. of America
Industrial Division**
200 Park Avenue, N. Y., N. Y. 10017
Telephone: (212) 973-8210

Attn: Tom Gottlick
 Please send R-relay literature.
 Please have an engineer call.

Name _____ Title _____
Company _____
Address _____
City _____ State _____ Zip _____

Panasonic
our technology is all around you

INFORMATION RETRIEVAL NUMBER 151

DESIGN ENGINEERS:

Custom's Capacitors have what you need

Do you deal with specifications like these in your work:

- capacitance over 40 pf up
- frequencies in MHz
- voltage over 1000 VDC

Then reconstituted mica capacitors are what you need.

Do you work with energy density of .05-.25 joules/in.³, at high voltage?

Reconstituted mica capacitors will best fill your requirements.

Looking for high voltage in small packages?

You need reconstituted mica capacitors!

Another of the many advantages of reconstituted mica capacitors is excellent performance under environmental extremes.

Custom can meet your needs better, because each process in our capacitor production begins and ends with quality control to avoid failure in the field. Let us show you how we can fill your requirements.

See our page in *Electronic Buyer's Guide and EEM* and write for **FREE product sheets today.**

P.S. Oil exploration personnel: Custom can help you with your logging tool problems.



CUSTOM ELECTRONICS, Inc.
4 Browne St., Oneonta, N.Y. 13820
PH: (607) 432-3880 TWX: 510-241-8292

application notes

SCR converter performance

"Tech Tips 1-3," an illustrated six-page brochure, cautions designers of high-kVA or special power-shaping SCR converters to consider the problems that gating variations can cause as a result of their effect on thyristor dynamic characteristics. Westinghouse, Youngwood, Pa.

CIRCLE NO. 378

Microwave counters

A 16-page catalog describes two block diagrams used in microwave counters—the heterodyne and the transfer oscillator converters—and how these block diagrams are automated so that a microwave frequency measurement can be made by simply connecting an unknown signal to the input and reading the display. A special section describes the operation of YIG filters. EIP, Santa Clara, Calif.

CIRCLE NO. 379

Process industry bulletins

More than 50 technical application papers for the process industries are listed in a bulletin. The publication is categorized by end application in fields related to water quality, air quality, process monitoring, vehicle exhaust and power-plant boiler-water analysis. Beckman Instruments, Fullerton, Calif.

CIRCLE NO. 380

Spectrum analyzer

A 32-page pocket-sized booklet describes ways to use a real-time spectrum analyzer. The booklet is illustrated with drawings, and scope and equipment photos. Signal Analysis Operation, TID, Honeywell, Hauppauge, N.Y.

CIRCLE NO. 381

Precision resistors

An application bulletin describes how precision resistors are used in a/d converters to reduce size and improve specs. Vishay Resistor, Malvern, Pa.

CIRCLE NO. 382

Magnetic fluids

Eight separate application sheets tell how ferrofluids may be used for operational components, damping, lubrication, printing, visualization/display, thermal effects, material separation and specialized plant processing. Ferrofluidics, Burlington, Mass.

CIRCLE NO. 383

Push-pull amplifiers

The advantages and design of broadband push-pull amplifiers are described in an application note. Schematic drawings present the complete electrical circuit for 60 or 120-W push-pull amplifiers, and layouts for components, heat sinks and circuit board. TRW Semiconductors, Lawndale, Calif.

CIRCLE NO. 384

Test programming

An 80-page handbook discusses test programming for the company's Datatester 4700, 4000 and 200 test systems. It discusses the transition count testing technique, preprogramming preparation, program approaches and program examples. Data Test Corp., Concord, Calif.

CIRCLE NO. 385

Transformers

A 24-page catalog and selection guide covers ac and dc-operated linear variable differential transformers (LVDTs). Cutaway sections, graphs and performance tables provide details. Proximity transducers, rotary variable differential transformers, as well as LVDT calibrators and accessories, are described. Schaevitz Engineering, Camden, N.J.

CIRCLE NO. 386

SCRs

The method of selecting SCRs for single-phase dc motor drives is described in an application note. The literature discusses turn-off time, test conditions vs circuit conditions, alternative methods for effecting turn-off times and high power systems. Two circuit diagrams and five graphs illustrate the explanations. International Rectifier, El Segundo, Calif.

CIRCLE NO. 387

HUNT: THE CASE PLACE



Need thyristors (triacs and SCR's) in a variety of cases? You can get 'em at the case place. Write Hunt for a brochure, or call toll-free 800-645-9200.



HUNT ELECTRONICS

2639 Mañana, Dallas, Texas 75220
(214) 350-5571

oem

INFORMATION RETRIEVAL NUMBER 153

MICROTEMP Time Delay MultiProtector

MICROTEMP Thermal Cutoff senses excessive ambient temperature and interrupts circuit.

Wirewound resistor senses sustained excessive current creating temperature increase to trigger MICROTEMP.

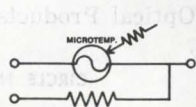

The 5P Series
MultiProtector
Package

The wide selection of MICROTEMP temperature ratings and resistor values provide an infinite selection of time delay factors. Small overload surges are ignored by the MultiProtector. Available in convenient terminations or packages for installation ease, MICROTEMP Time Delay MultiProtectors are custom designed to fulfill your specific current and/or thermal overload condition. For illustrated brochure and details regarding your application, call or write:

MICRO DEVICES CORP.
1881 Southtown Blvd., Dayton, Ohio 45439
Ph. (513) 294-0581 Telex 28-8087

INFORMATION RETRIEVAL NUMBER 154

GOOD NEWS

COMPLETE FLOPPY DISK OPERATING SYSTEMS
WITH STANDARD SOFTWARE

FOR
COMPUTER
AUTOMATION
ALPHA 16's
under
\$3,500
in OEM quantities

FOR
DATAPoint 2200's*
under
\$3,000
in OEM quantities
(includes printer interface for
Centronics or Diablo HyType
printers)



1/2 SECOND RANDOM ACCESS TO
262,000 BYTES OF DATA

Would you like high speed (6 msec track-to-track access time), high density storage (up to 262 K bytes) for your Computer Automation Alpha 16 or Datapoint 2200 for about the same price as what you're paying for slower paper tape, cassette, small tape and card systems? Here's what Kennedy Data Systems will deliver at the prices and delivery shown above: 2 Century Data System 110 Disk Drives, our own thoroughly field-proven highly reliable controller with built-in system power supply and interface electronics and all cables and hardware for table or rack mounting --- plus standard software. For the Datapoint 2200 we even include printer interfaces for the Centronics or Diablo HyType printers.



If you use an intelligent terminal or mini, chances are we have a floppy disk system to meet your needs. Call or write today for the whole story.

KENNEDY DATA SYSTEMS, INC.

31829 W. La Tienda Drive
Westlake Village, California 91361
(213) 889-4455

*Registered Trademark of Datapoint Corporation

INFORMATION RETRIEVAL NUMBER 155

New forced air cooling package dissipates 450 watts; costs only \$6.50*

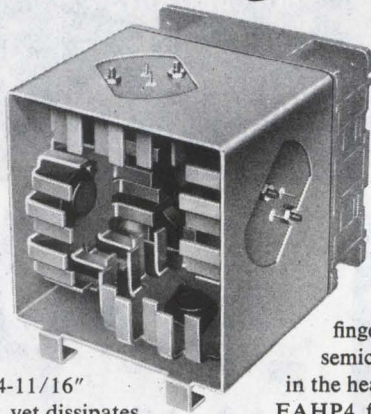

*1000-pc qty.; fan not included.

Our new Series FAHP4 blower package measures only 3-3/4" x 5-3/16" x 4-11/16" and weighs only 14 ounces, yet dissipates 450 watts in a 25°C ambient with a case rise of less than 95°C. The secret to its high performance and low cost is the use of four standard IERC HP3 staggered

finger heat sinks. Since the semiconductor hole pattern is in the heat sinks we assemble the FAHP4 from standard off-the-shelf heat sinks and shrouds. Ask for our new data sheet. IERC, 135 W. Magnolia Blvd., Burbank, Calif. 91502, a subsidiary of Dynamics Corporation of America.

IERC



Heat Sinks

INFORMATION RETRIEVAL NUMBER 156

PICTURE, PATTERN, OR PLOT

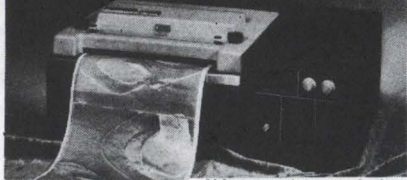

Alden recorder reproducing scanning electron microscope image of a 1 mil wire bond to an IC

Get sharp recordings displaying three dimensions and yielding greater detail and informational content than your present display with ALDEN COMPONENT FACSIMILE RECORDERS.

- Synchronizes easily with your scanning sensor or transducer
- Available in print-out widths from 2" to 48"
- Speeds range from 8 RPM to 3600 RPM
- Presentations, linear or non-linear . . . simply
- Used with a broad variety of systems such as ultrasonic/infrared flaw detectors, spectrum analyzers, computers, television, medical instrumentation and scanning radiometers, etc.

Call or write for free descriptive catalog.

ALDEN

ELECTRONIC & IMPULSE RECORDING EQUIPMENT CO., INC.

Westboro, Mass. 01581 Tel.: (617) 366-8851

INFORMATION RETRIEVAL NUMBER 157

Compact High-Level Stability!

TEMPERATURE COMPENSATED X-TAL OSCILLATORS

Now, a highly stable crystal oscillator which does not have a temperature controlled oven.

Applications are manifold, including mobile radio equipment, tv satellite equipment, and general communication equipment.

FEATURES: ● Compact, with high stability ● Low power consumption ● Short start-up time ● Low aging characteristics.

House of Crystal...Kinseki

1 Hz TO 270 MHz KSS TCXO SERIES



STANDARD TECHNICAL DATA

Item	Type	TCXO-3E	TCXO-4F	TCXO-5A
Frequency range		55MHz~110MHz	55MHz~270MHz	1Hz~500kHz
Dimensions L x W x H (mm)		65 x 40 x 24	65 x 55 x 24	55 x 60 x 35
Weight (g)		120	140	160



For catalogue please write to:

Kinseki Laboratory Ltd.

2-23-17, MIYASAKA, SETAGAYA-KU, TOKYO, JAPAN

INFORMATION RETRIEVAL NUMBER 158

new literature

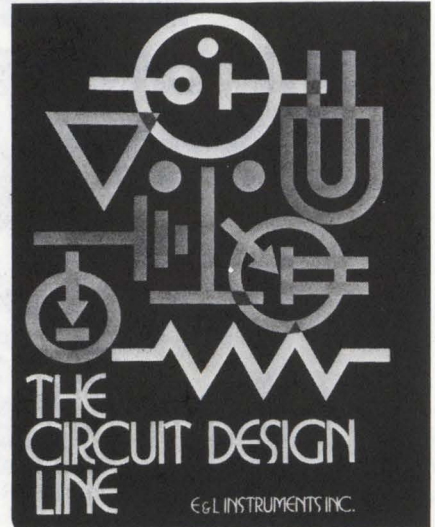

Breadboards

A 20-page catalog of circuit design and breadboarding equipment features the ADAM modular breadboarding system, two op-amp designers, the digi-designer (in kit form or assembled), instruction and teaching manuals, the SK-10 solderless component socket, PC boards, socket boards, power supplies, pulse generators and logic probes. E&L Instruments, Derby, Conn.

CIRCLE NO. 388

Direct-view storage tubes

The principles of operation, applications and specification of direct-view storage tubes are covered in an eight-page brochure. ITT Electro-Optical Products Div., Roanoke, Va.

CIRCLE NO. 389

Transparent photomasks

A six-page color foldout gives descriptions and specifications for transparent photomasks. Ulvac, Chuo-ku, Tokyo 104, Japan.

CIRCLE NO. 390

1-GHz transistors

A line of 1-GHz transistors is described in an eight-page data sheet. The data sheet provides ratings and electrical characteristics, package dimensions and representative power curves for each device. TRW Semiconductors, Lawn-dale, Calif.

CIRCLE NO. 391

NEW

5000-Watt Amplifier Operates with any Mismatched Load

Amplifier Research now offers the only commercially available 5000-watt broadband amplifier capable of operating into any mismatched load without damage or shutdown. Model 5000LA, with its unique protective circuitry for maximum reliability, provides 5000 watts of swept power output from 1-100 MHz. This powerful unit is ideal for antenna and component testing, equipment calibration, EMI susceptibility testing, biological research, and a variety of other lab applications. For complete information, write or call Amplifier Research, 160 School House Road, Souderton, PA 18964. Phone: 215-723-8181.

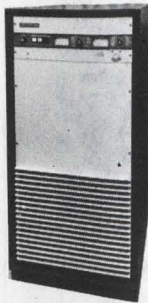

**AR AMPLIFIER
RESEARCH**

INFORMATION RETRIEVAL NUMBER 159

Murata's Posistors® can.....



...heat, switch, start motors, control temperature, limit current, sense, aid automotive anti-pollution devices, control and on and on. They're small but powerful positive temperature coefficient devices that can handle hefty loads with a degree of reliability that mechanical switching contacts find impossible to imitate. Let us give you a few ideas as to how Posistors can fit into your scheme of things... just circle the reader service number below.

muRata MURATA CORPORATION OF AMERICA
2 Westchester Plaza, Elmsford, New York 10523
Telex: MURATA EMFD 137332 / Phone: 914/592-9180
A Subsidiary of Murata Mfg. Co., Ltd., Japan

INFORMATION RETRIEVAL NUMBER 160

ELECTRONIC DESIGN 10, May 10, 1974

missing links

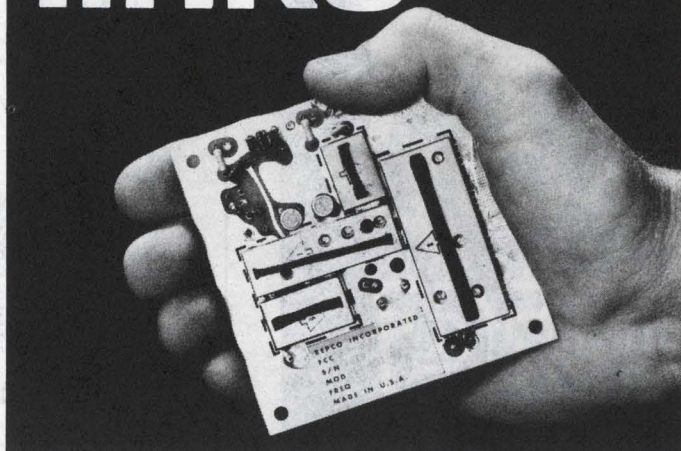

Radio Links...!! We Got 'Em

If you're designing telemetry or data acquisition systems requiring tone, voice, or low-speed digital data transmission... or combinations... and don't have Repco's modular radio links in the design, you're missing a lot. Low cost, small size, reliability, easy installation, low battery drain, and virtually unlimited design freedom.

These stable, FCC type accepted radio links are made up of plug-in modules, each a complete state-of-the-art circuit. Servicing is as uncomplicated as unplugging a module and re-plugging another.

Take a look at the specs to see what isn't missing:

Transmitters (Typical)

2 millisecond turn on time, .5 up to 25 watt RF output available. Current drain as low as 180 ma.; 12v and 15v models available, size 3.32" x 3.32" x 1".

Receivers (Typical)

12v and 15v models, current drain as low as 4.6 ma. (standby). Frequency stability VHF $\pm .001\%$ - UHF $\pm .00005\%$ (-30 to +60°C) Size 3.32" x 3.32" x 1".

For use under FCC parts 21, 81, 89, 91, 93, 95(A), and U.S. Government Services (non-tactical).

Write today

for complete information on low (25-50MHz), mid (66-88MHz), high band (132-174MHz), and UHF (450-470MHz) transmitters and receivers. All at prices which will surprise you.

REPCO Incorporated

Special Products Department
P.O. Box 7065
Orlando, Florida 32804
Telephone (305) 843-8484

Repco

INFORMATION RETRIEVAL NUMBER 161

triacs

3/4" PRESS-FIT Series (IT(RMS)) to 600 Volts

Ideally suited for solid state switches, motor speed controls, lighting, heating and cooling controls.

Hutson's power triac series is available in hermetically-sealed 3/4" Press-Fit, STUD MOUNT, and TO-3 packages.

If you need a TRIAC or SCR, Hutson's state-of-the-art technology assures reliability and economy. All Hutson TRIAC's and SCR's are available as void-free, glass-passivated chips or in all popular package configurations. Call or write Hutson for complete information.



Box 34235 • 2019 W. Valley View
Dallas, Tex. 75234 (214) 241-3511
TWX 910-860-5537

Representatives:

New York City 201/399-4350. Seattle 206/454-0300. Los Angeles 213/240-3151. Dallas 214/231-6181. Baltimore 301/944-8262. Denver 303/757-7679. Ft. Lauderdale 305/772-5100. Chicago 312/286-1500. Detroit 313/499-0188. Syracuse 315/699-2671. Indianapolis 317/888-2260. Atlanta 404/427-0241. Canada 416/638-1322. Beaverton 503/643-1644. Dayton 513/433-2511. Phoenix 602/968-9037. Minneapolis 612/866-3035. Waltham 617/890-8040. Kansas City 816/765-2998

Distributors:

Elizabeth 201/345-2420. Los Angeles 213/240-3151. Denver 303/934-5505. Chicago 312/323-9670. Canada 416/635-9880. Rochester 716/454-7800. Belgium 02362135. Brussels 02352135. Denmark (01) 295622. Norway 472702272. Spain 234-62-62. Sweden 08-26-5940. Switzerland 051-852201.

NEW LITERATURE

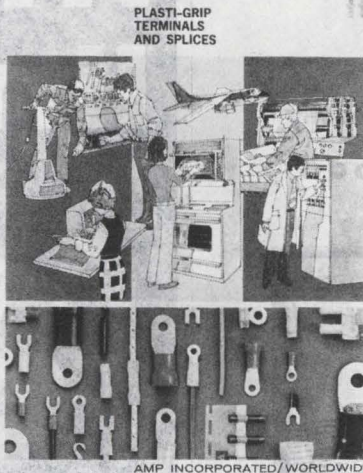

Terminals and splices

A 14-page catalog contains descriptions, electrical and mechanical specifications and dimensional data for the plasti-grip preinsulated solderless terminal and splice line. AMP, Harrisburg, Pa.

CIRCLE NO. 392

Switch handbook

An engineering handbook on miniature rotary switches includes color-coded sections on commercial and standard switches. The handbook includes layout diagrams for PC terminal switches, millimeter conversions of drawings, and easy reference charts to switches from one deck to 20 decks and with one pole to 12 poles per deck. RCL Electronics, Irvington, N.J.

CIRCLE NO. 393

CRTs

A short-form catalog gives electrical and mechanical specifications for 40 different CRT types available for industrial and instrumentation applications. Amperex Electronic, Slatersville, R.I.

CIRCLE NO. 394

Tantalum capacitors

Precision, microminiature polar capacitors capable of general filtering, coupling, bypassing and non-critical RC timing applications are featured in a 20-page catalog. Electrical and mechanical specifications are given. Corning Components, Corning, N.Y.

CIRCLE NO. 395

Power supplies

A 32-page handbook tells how to get the most from programmable power supplies. Signal processing capability and equations to define gain, linearity, offset, speed, bandwidth, accuracy, etc., are included. Kepco, Flushing, N.Y.

CIRCLE NO. 396

Hollow cathode devices

Hollow cathode discharge devices, used in atomic absorption spectroscopy, are featured in a 48-page catalog. Westinghouse, Electronic Tube Div., Elmira, N.Y.

CIRCLE NO. 397

DIP sockets

DIP sockets with built-in heat sinks are described in a four-page bulletin. Specs for each of the three socket series, plating options, electromechanical and environmental characteristics and the various heat-sink extrusions that are available are included. Teradyne Components, Lowell, Mass.

CIRCLE NO. 398

Spectrophotometers

Physical and performance characteristics of UV-Vis, UV-Vis-NIR, atomic absorption and Raman spectrophotometers are covered in a 12-page catalog. Varian, Instrument Div., Palo Alto, Calif.

CIRCLE NO. 399

High-voltage rectifiers

The 1N3282 series of high-reliability, high-voltage glass rectifiers are featured in a data sheet. Codi Semiconductor, Fair Lawn, N.J.

CIRCLE NO. 451

McMOS data book

Over 300 pages of product data, basic technology information, application information and product selector guides are included in the "McMOS Integrated Circuits Data Book." Some of the circuits included are the MC14581 arithmetic logic unit, the MC14582 look ahead carry block, 64-bit RAM and 1024-bit ROM CMOS memory devices and a successive approximation register. The book costs \$2.50. Motorola, P.O. Box 20924, Phoenix, Ariz. 85036.

INQUIRE DIRECT

it takes more

Than a neon lamp to solve a circuit problem like this . . .

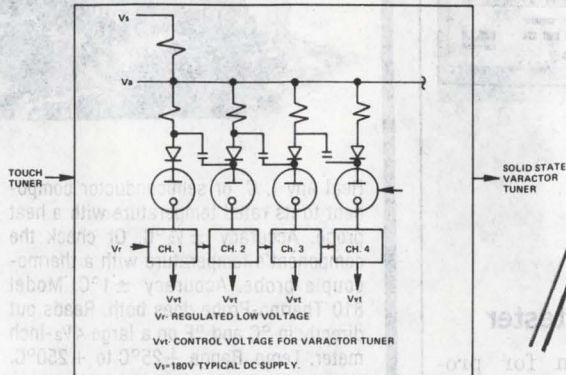

When the new varactor tuning systems for color TV sets were designed, components were required to perform two functions — illuminating the channel selector and transferring precise, regulated voltage to the solid state tuner. Reliable performance, long life and low cost were design objectives.

Design engineers evaluated and selected a circuit component similar to the Signalite A-221C. This dual function neon device effectively acts as a visual indicator and a sequential switch. The A-221C provides excellent light output and exhibits stable breakdown and maintaining voltages throughout its long life.

It takes application help from a group of gas discharge specialists . . .

... yours for the asking!



SIGNALITE DIVISION
GENERAL INSTRUMENT CORP.

Contact us at 1933 Heck Ave.,
Neptune, New Jersey 07753
(201) 775-2490

CC1

INFORMATION RETRIEVAL NUMBER 163

i'm free



I'M A MAIL-LITE SHIPPER

1 CASE of Mail-Lite FREE when you buy my \$50 table model heat sealer.

2 CASES of Mail-Lite FREE when you buy my \$100 floor model heat sealer.



MAIL-LITE



FLOOR MODEL \$100 OFFER



TABLE MODEL \$50 OFFER

Labor Savings: Can be heat sealed closed in 2 seconds
Postal Savings • Waterproof • Plikerproof • Lightweight • Clean



WRITE TODAY FOR INFORMATION ON OUR MAIL-LITE SHIPPERS AND THE SPECIAL HEAT SEALER OFFER.

Sealed Air Corporation

19-01 State Highway 208, Fair Lawn, New Jersey 07410

INFORMATION RETRIEVAL NUMBER 164

DESIGN CHALLENGE

#2 Design, to very tight tolerances, a "card mover" for a high speed data processing system.

DATA GIVEN

Minimum belt tensile strength, 500 lbs. Respective width, length and thickness tolerances: $\pm .010$, $\pm .062$, $\pm .001$. Belt to track within .032. Special materials and construction called for. Surface friction must not change in damp or cold environment.

SOLUTION

A Tilton medium Super-Speed Endless Belt with special cast-on surface. Belt precision ground and cut to meet or exceed all requirements. For details, request Tilton Case History #2.

CHALLENGE:

... an ASB applications engineer to solve your light to medium conveying and power transmission problems.

ARTHUR S. BROWN MFG. CO.

Tilton, N.H. 03276 Phone (603) 286-4376

INFORMATION RETRIEVAL NUMBER 165

Have you
ever seen
a button
that fits
your
finger?

We now offer the new
**LIGHTED PUSH-
BUTTON SWITCH**
SERIES LPS-100

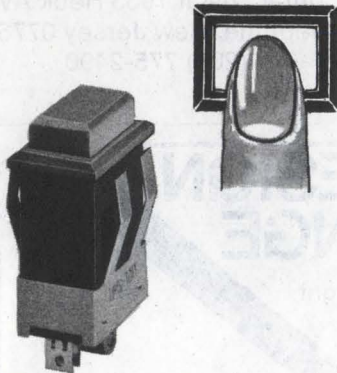

(Actual size)

FEATURES:

- Small space—only .750" x .550" mounting space and 1.100" behind panel.
- Snap-lock mounting.
- Matrix mounting is available.
- Momentary or alternate actions. DPST, SPST, N.O., N.C.
- Light touch button—operation force 8 oz.
- Clean Color Button—Transparent cap with white diffusion filter. —Permit insertion of film with any LOGO or picture.
- Front lamp replacement.

• Ask informations to:

WAMCO Technical Sales, Inc.

705 W. 16th Street, Costa Mesa, California
92627 TEL:(714)642-5100 TELEX:678459

**OSHINO ELECTRIC LAMP
WORKS, LTD.**
TOKYO, JAPAN

INFORMATION RETRIEVAL NUMBER 166

NEW LITERATURE

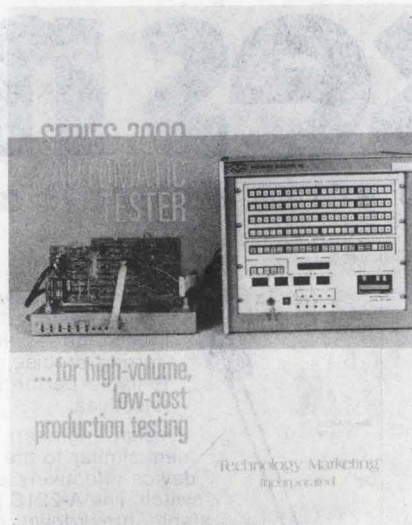

Computerized card tester

An automatic system for production or R&D testing of PC cards and other assemblies is highlighted in an eight-page brochure. Technology Marketing, Costa Mesa, Calif.

CIRCLE NO. 452

Rf power transistors

A 100-W PEP and cw rf power transistor is described in a four-page data sheet. Electrical specifications, nine performance curves and package dimensions are included. TRW Semiconductors, Lawndale, Calif.

CIRCLE NO. 453

Microwave components

An 80-page catalog lists more than 200 standard, passive, coaxial components. The catalog is divided into three major sections: switches, filters and attenuators, and terminations and detectors. R L C Electronics, Mount Kisco, N.Y.

CIRCLE NO. 454

Resistor networks

Single-in-line resistor networks are covered in a four-page bulletin. Sketches depict a standard network and give visual data about the complete package. Mepco/Electra, Morristown, N.J.

CIRCLE NO. 455

Cable tie installation tool

A pneumatic, hand-operated cable tie installation tool is described in a four-color bulletin. Panduit, Tinley Park, Ill.

CIRCLE NO. 456

PINPOINT HEAT

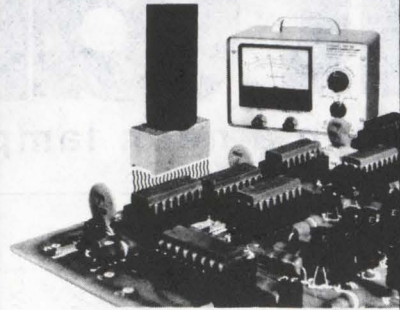

Heat any I. C. or semiconductor component to its rated temperature with a heat probe. Accuracy $\pm 1/2^\circ\text{C}$. Or check the component's temperature with a thermocouple probe. Accuracy $\pm 1^\circ\text{C}$. Model 810 Thermo-Probe does both. Reads out directly in $^\circ\text{C}$ and $^\circ\text{F}$ on a large $4\frac{1}{2}$ -inch meter. Temp. Range $+25^\circ\text{C}$ to $+250^\circ\text{C}$.

PRICE \$272.50 F.O.B. South Laguna

Models with other temperature ranges available. For details write to:

**MTI MICRO-TECHNICAL
INDUSTRIES**

P. O. Box 287 South Laguna, CA 92677
(714) 545-3734

INFORMATION RETRIEVAL NUMBER 167

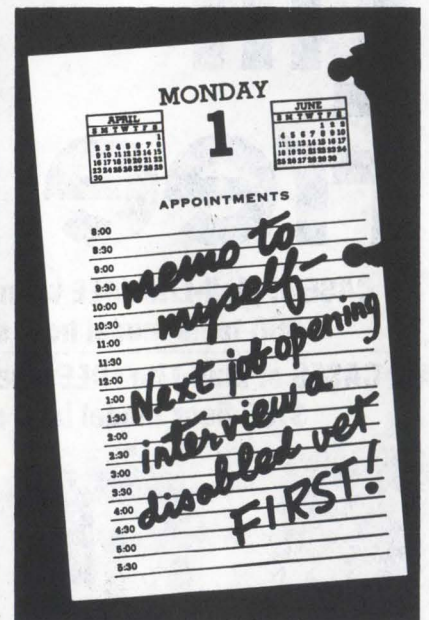

The President's Committee
on Employment of the Handicapped
Washington, D.C. 20210

TOYO HCM FILTER T-2 SERIES

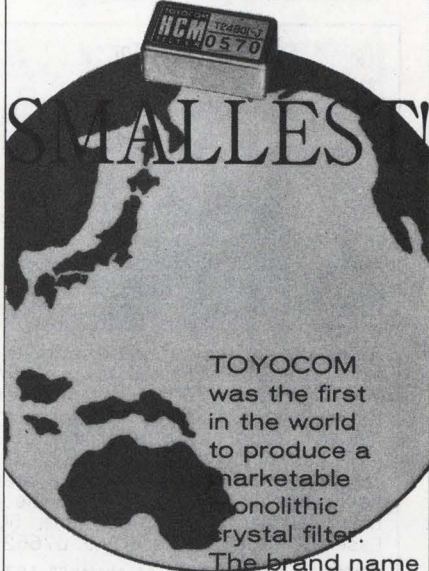

TOYOCOM was the first in the world to produce a marketable monolithic crystal filter. The brand name was designated TOYO HCM FILTER.



EXPORT DEPARTMENT:
TOYO BUILDING, NO. 6-12-20, JINGUMAE,
SHIBUYA-KU, TOKYO, JAPAN
CABLE: EXPORTOYOCOM-TOKYO
TEL: (03) 406-3355
TELEX: 02423001

INFORMATION RETRIEVAL NUMBER 168

The Ultimate in Ignition Systems!

★ **ELIMINATES BREAKER POINTS.**
Perfect Timing and Dwell never change!

★ **Eliminates Tune-ups.**
Never wears out or needs any Maintenance.

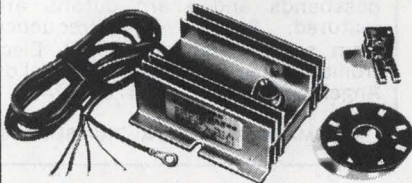

★ The Most Advanced "OPTO-ELECTRIC SYSTEM"

● The Allison Breakerless System eliminates the Points and Condenser, replacing them with an Opto-Electronic Trigger, using a Light-Emitting Diode and Phototransistor. Also completely eliminates wiper-arm "friction" wear. The only "TRUE" Electronic Ignition... that you can install for under \$100. Gives 40-times more Timing Accuracy than ANY system using mechanical Breaker-Points! Unlimited RPM. Smoother running. (No timing fluctuation as with Magnetic units). Unaffected by Temperature, Moisture, or Vibration! All Solid-State Components. Easier Starting under any condition! Increased Horsepower. Sparkplugs last longer. Perfect timing increases engine Efficiency and Gas Mileage up to 30%!

● Quick and Easy Installation!

★ Tested and Proven reliability.

Only \$49⁹⁵ ● SATISFACTION GUARANTEED!

● Complete. ● 1-YEAR FACTORY WARRANTY.

(State Make, Year, Engine Size). (Calif. Res. add Tax).

● CONVERT YOUR "C-D" UNIT TO BREAKERLESS!
"TRIGGER-UNIT" ONLY \$34.95

★ Send Postcard for FREE BROCHURE Today.

ALLISON AUTOMOTIVE CO.

P.O. Box 881-F, TEMPLE CITY, CAL. 91780

INFORMATION RETRIEVAL NUMBER 169

ELECTRONIC DESIGN 10, May 10, 1974

Memory products

Memory cores, stacks and systems are described in a bulletin. High-performance core memory stacks and systems and 18 and 20-mil lithium ferrite cores are included. Ferroxcube, Saugerties, N.Y.

CIRCLE NO. 457

Wires and cables

A 72-page catalog contains feature and application information on power and control cables, portable cables, flexible cords, fixture and motor leads, electronic wires and industrial automation and communication cables. General Electric, Wire and Cable Products, Bridgeport, Conn.

CIRCLE NO. 458

Adhesives

Contact cements are highlighted in a two-page brochure. The brochure lists typical end uses and illustrates applications. Overlap shear strengths and 180° peel strengths at various operating temperatures are listed in easy-to-read table form. 3M, St. Paul, Minn.

CIRCLE NO. 459

Silicon rectifiers

A line of 800-A hockey-puk power silicon rectifiers, the 801PD and 801PD-B series, is described in a data sheet. Eleven graphs, a dimensioned outline drawing and a photograph of the device are shown. International Rectifier, Semiconductor Div., El Segundo, Calif.

CIRCLE NO. 460

Mercury relays

A 16-page mercury displacement relay catalog contains photos, line drawings, specifications and features. The relays are rated from 20 to 100 A. Magnecraft Electric, Chicago, Ill.

CIRCLE NO. 461

Back plane connectors

A back plane connector system is described in a bulletin. The literature contains electrical and mechanical specifications, a dimensioned outline drawing and three photographs of the system. Malco, Chicago, Ill.

CIRCLE NO. 462

New Digital Photometer/ Radiometer \$865.00

80X Digital Opto-Meter™

The 80X Digital Opto-Meter™ is a portable photometer/radiometer with eight ranges of sensitivity to 10⁻¹⁰ watts. This instrument with 3½ digit display offers AC or battery operation. The new 80X Digital Opto-Meter™ is supplied complete for radiometric and photometric measurements... \$865.00.

Write or call today, United Detector Technology, 1732 21st Street, Santa Monica California 90404, telephone number: (213) 829-3357.



UNITED DETECTOR TECHNOLOGY, INC.



INFORMATION RETRIEVAL NUMBER 170

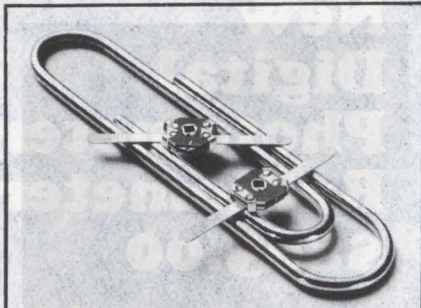

Thin-Trim variable capacitors provide a reliable means of adjusting capacitance without abrasive trimming or interchange of fixed capacitors. Series 9401 has high Q's and a range of capacitance values from 0.2-0.6 pf to 3.0-12.0 pf and 250 WVDC working voltage. Johanson Manufacturing Corporation, Boonton, New Jersey (201) 334-2676.

INFORMATION RETRIEVAL NUMBER 181

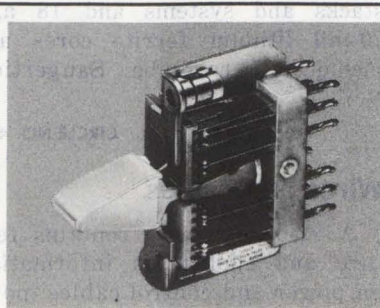

Miniature Lever Switches. Widely accepted switch for audio and general control applications. 2 or 3 position switch with locking and non-locking action in all combinations and stop action. Up to 8PDT contact arrangement each side. Pye TMC Canada, 15 Sheffield Street, Toronto, Ontario. (416) 249-7044.

INFORMATION RETRIEVAL NUMBER 184



A collector's item . . . 20th anniversary issue of Electronic Design (11/23/72) salutes 25th anniversary of the transistor, features milestones in design over past quarter century. Rare nostalgic view of industry. Fascinating reading. \$2 per copy pre-paid. Checks, money orders: Electronic Design, Promotion Mgr., 50 Essex St., Rochelle Park, N.J. 07662.

INFORMATION RETRIEVAL NUMBER 187

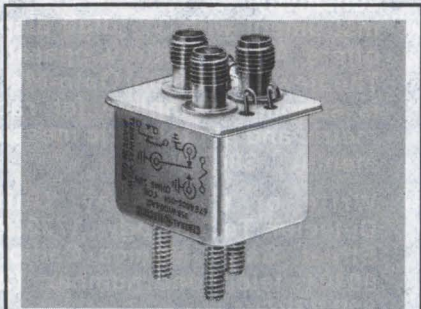

For critical RF switching GE offers space-proven relays with co-axial connections. Welded construction, hermetically sealed, removes dangers of exposed arcing of open relays. Reliability failure rates to .01%/10,000. RF switching up to 150 watts and auxiliary contacts for microvolt signals to 2 amps. Less than 1 cu. in. GE, Waynesboro, Va.

INFORMATION RETRIEVAL NUMBER 182



Solid state ac flashers—Low cost from \$1.95—and brand new. Why settle for thermal type flashers due to cost? Designed to operate incandescent, inductive, or resistive loads up to 1 amp (120 watts). Virtually infinite life. Request data on Type FS127. SSAC PRECISION PRODUCTS, INC., P.O. Box 395, Liverpool, N.Y. 13088. (315) 699-2551.

INFORMATION RETRIEVAL NUMBER 185

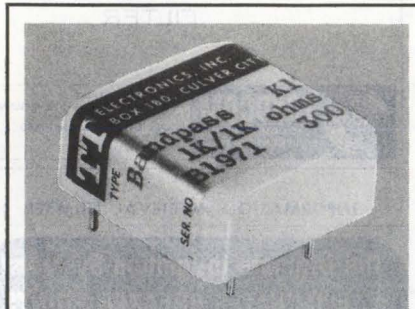

Miniature filters for Highpass, Low-pass Bandpass and Band Reject signal conditioning applications are described in the new catalog. Flat passbands and sharp cutoffs are featured. Specify any frequency from sub-audio to UHF. TT Electronics, Inc., 2214 Barry Ave., Los Angeles 90064. (213) 478-8224.

INFORMATION RETRIEVAL NUMBER 188

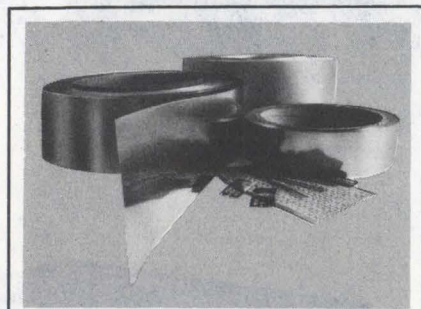

IN ELECTRONIC ALLOYS, WE SPEAK YOUR LANGUAGE, EXACTLY. We specialize in magnetic and controlled expansion alloys. Nickel-irons, stainless steels, beryllium, copper, down to .0005" thick. Rigid chemical and physical property control. Lots 5 lbs. - 5 tons. Photoetching also our specialty. Magnetics, Butler Pa. 16001.

INFORMATION RETRIEVAL NUMBER 183

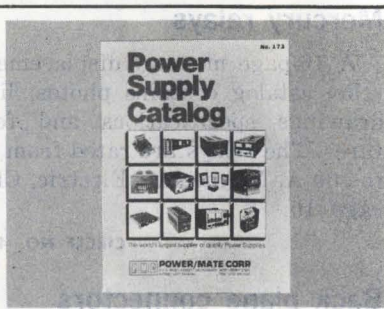

Free catalog of 34,500 power supplies from the worlds largest manufacturer of quality Power Supplies. New '74 catalog covers over 34,500 D.C. Power Supplies for every application. All units are UL approved, and meet most military and commercial specs for industrial and computer uses. Power Mate Corp. (201) 343-6294.

INFORMATION RETRIEVAL NUMBER 186

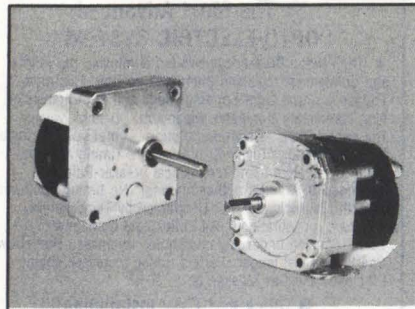

MK gearmotors—1 to 800 RPM, torque to 50 lb., ins. Others to 350 lb. ins. High start or running torque motors. Brakes, fans, motor covers, lead lengths, connectors, overload protection, output shaft machining, special bearings, permanent lub, etc., Merkle-Korff Gear Co., 11500 W. Melrose Ave., Franklin Park, Ill. 60131. Phone: (312) 455-8333.

INFORMATION RETRIEVAL NUMBER 189

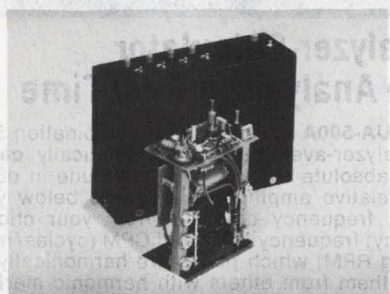

Modular DC-DC power converters. Designed to meet military/aerospace specs . . . priced for industrial applications. 12, 28, 48, 115 VDC inputs. 1-6 isolated, regulated (1% & 0.1%) outputs. 1-500 watts. Efficiencies to 85%. 1200 design-as-you-order configurations using standard modules. Arnold Magnetics, Culver City, Ca. (213) 870-7014.
INFORMATION RETRIEVAL NUMBER 190

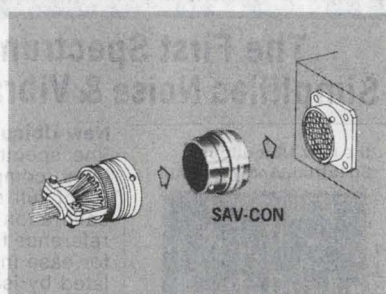

New connector saver. A double ended interface connecting device with a one piece pin/socket contact. Called SAV-CON. Prolongs service life of test cable connectors and saves wear and tear on equipment connectors. Available for all popular circular connectors. Glenair Inc., 1211 Air Way, Glendale, California, 91201. (213) 247-6000.
INFORMATION RETRIEVAL NUMBER 193

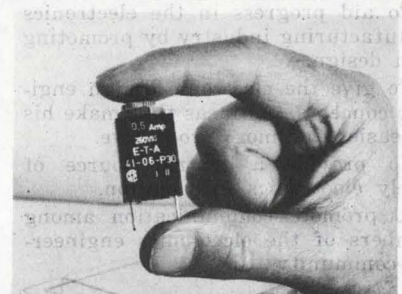

Overcurrent Protector, manual reset eliminates fuse replacement. Convenient panel mounting. 15 fractional ratings from 0.1 to 3 amp. Other models up to 400 amp. Trip-free and fool-proof, UL and CSA approved. High quality, low cost-\$1.12 ea. in 1000 lots. E-T-A Products Co. of America, 6284 N. Cicero Ave., Chicago, Ill. 60646. Tel. (312) 545-1553.
INFORMATION RETRIEVAL NUMBER 196



Serious lock-in, ridiculous price.
\$1050
New Ortec 9501 lock-in amplifier has 0.5Hz-150kHz auto-tracking freq. range, 60dB dynamic reserve, 10 μ V f.s. sensitivity. Optional preamps, filters, oscillator, etc. Other lock-ins/applications in FREE GUIDE. Ortec Inc., Oak Ridge, Tenn 37830. (615) 482-4411.

INFORMATION RETRIEVAL NUMBER 191



Ruggedest 250° meter costs less. 40,000 mg-mm torque gives rock-steady indication on panels of rec vehicles, trucks, heavy equipment. Takes push-on pointers. Caseless design withstands rough handling. $\pm 2\%$ lin. tracking. $\pm 0.75\%$ hysteresis. Beede Electrical Instrument Co., Penacook, NH 03301. (603) 753-6362.

INFORMATION RETRIEVAL NUMBER 194

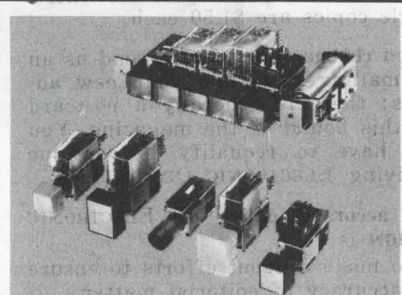

Illuminated Push Button Switches series 200. Up to 6PDT bifurcated contacts. Switches available with locking, non-locking and interlock actions and can be mixed in any order on mounting bar. Pye TMC Canada, 15 Sheffield Street, Toronto, Ontario. (416) 249-7044.

INFORMATION RETRIEVAL NUMBER 197

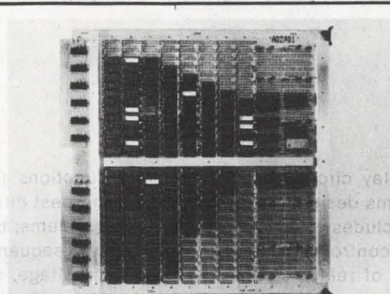

IBM 360/370 Interface (IBMINT). A simplified interface for attaching one or more I/O devices (terminals, OMRs/OCRs, printers, minis, etc.) directly to an IBM 360/370 channel is now available for as little as \$2450 in quantity. COMPUTER INFORMATION SYSTEMS, 2084 N 1200 E, Logan, Utah 84321. 801 +752-8100.

INFORMATION RETRIEVAL NUMBER 192



Model SP-465 WWVB time synchronizer. Model SP-465 WWVB Time Synchronizer provides an economical method for disseminating time and frequency information in synchronization with NBS. Time Accuracy of 1 millisecond and frequency synchronization to 1 part 10¹⁰. Data-metrics, 340 Fordham Rd, Wilmington, MA 01887. (617) 658-5410.

INFORMATION RETRIEVAL NUMBER 195

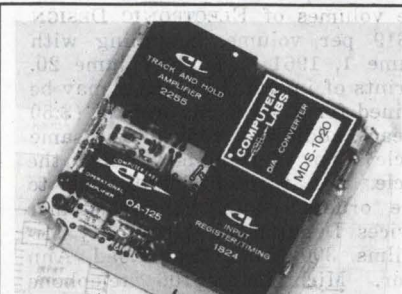

The new Computer Labs RDA Series D/A's eliminate harmonic distortion and produce clean "glitchless" pictures for reconstructed TV or other video signals. Input word rate for all models is 15 MHz with accuracies to $\pm 0.05\%$. Min. settling time to either 8-bit or 10-bit accuracies. Computer Labs, 1109 S. Chapman St., Greensboro, N.C. 27403.

INFORMATION RETRIEVAL NUMBER 198

ELECTRONIC DESIGN's function is:

- To aid progress in the electronics manufacturing industry by promoting good design.
- To give the electronic design engineer concepts and ideas that make his job easier and more productive.
- To provide a central source of timely electronics information.
- To promote communication among members of the electronics engineering community.

Want a subscription? ELECTRONIC DESIGN is sent free to qualified engineers and engineering managers doing design work, supervising design or setting standards in the United States and Western Europe. For a free subscription, use the application form bound in the magazine. If none is included, write to us direct for an application form.

If you do not qualify, you may take out a paid subscription for \$30 a year in the U.S.A., \$40 a year elsewhere. Single copies are \$1.50 each.

If you change your address, send us an old mailing label and your new address; there is generally a postcard for this bound in the magazine. You will have to requalify to continue receiving ELECTRONIC DESIGN free.

The accuracy policy of ELECTRONIC DESIGN is:

- To make diligent efforts to ensure the accuracy of editorial matter.
- To publish prompt corrections whenever inaccuracies are brought to our attention. Corrections appear in "Across the Desk."
- To encourage our readers as responsible members of our business community to report to us misleading or fraudulent advertising.
- To refuse any advertisement deemed to be misleading or fraudulent.

Microfilm copies are available of complete volumes of ELECTRONIC DESIGN at \$19 per volume, beginning with Volume 1, 1961 through Volume 20. Reprints of individual articles may be obtained for \$2.00 each, prepaid (\$.50 for each additional copy of the same article) no matter how long the article. For further details and to place orders, contact the Customer Services Department, University Microfilms, 300 North Zeeb Road, Ann Arbor, Michigan 48106 telephone (313) 761-4700.

Want to contact us? If you have any comments or wish to submit a manuscript or article outline, address your correspondence to:

Editor
ELECTRONIC DESIGN
50 Essex Street
Rochelle Park, N.J. 07662

The First Spectrum Analyzer-Calculator Simplifies Noise & Vibration Analysis in Real Time

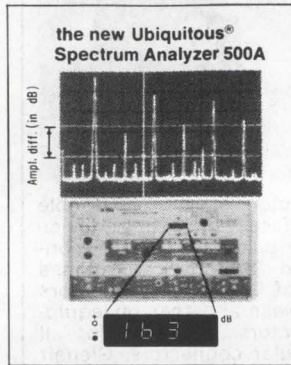

New Ubiquitous® UA-500A is world's first combination 500-line spectrum analyzer-averager that automatically **calculates** (computes): absolute frequency & amplitude in dB or % of full scale; relative amplitude above and below your calibration signal; frequency deviation from your chosen reference frequency; frequency in Hz and CPM (cycles/min.) for ease in reading RPM; which peaks are harmonically related by isolating them from others with harmonic markers or eliminating all else from the CRT display. Applications simplified include: machine diagnosis, rotating machine analysis, noise source identification, mechanical signatures, underwater acoustics, and noise reduction. Built-in dual memory averager allows comparison of past & present data. Small, portable, only 8 3/4" high. Highest speed: real-time 100% analysis to 10kHz. Thirteen ranges from 0-10Hz to 0-100kHz providing analysis bandwidths of .02Hz to 200Hz (also 0-5mHz direct input). Simplest to use.

CIRCLE NO. 171

Federal Scientific Corporation An Affiliate of Nicolet Instrument
615 West 131st St., New York, N.Y. 10027 (212) 286-4400 TWX: 710 581 4059

FFT Analyzer Provides Instant Results; Allows Continuous Viewing and Editing



Designed for operation by engineers rather than computer experts, the "DSP" Digital Signal Processor is portable and provides instant, Real Time answers for 12 distinct signal-analysis functions. It conditions and analyzes **two** signals, correlates their mutual properties, and displays results in a broad variety of forms and formats. Real Time operation is to 60 kHz. By means of a "joystick"-controlled cursor, data is traced for instant, **calibrated** 6-digit LED readout of frequency, amplitude, time and phase. Accepts analog waveforms or digital data for 57 analysis ranges from 10 Hz to 150 kHz with resolution narrow as 0.01 Hz. Averages up to 4096 ensembles. Throughput over 300,000 words/sec.

CIRCLE NO. 172

Spectral Dynamics Corporation
P.O. Box 671, San Diego, CA 92112
(714) 565-8211

PRACTICAL RELAY CIRCUITS

By Frank J. Oliver

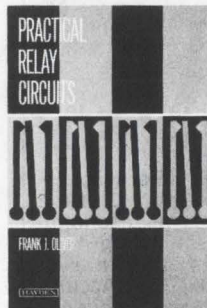

Uniquely groups various relay circuits according to the functions they perform, enabling the systems designer to quickly select the best circuit for his specific purposes. Includes arc and RFI suppression systems; time delay function; audio tone control and resonant-reed relays; sequential relays; protective functions of relays against overload overvoltage, and overcurrent, pulse generation and detection; logic circuits; and more. Particularly important is coverage of pulse-operated relay systems now extensively used with automated control systems. Illustrated with many circuit diagrams using the latest American National Standard graphical symbols. 363 pp., 6 x 9 1/4, illus., cloth, \$14.95. **Circle the reader-service number to order a 15-day examination copy.**

CIRCLE NO. 173

HAYDEN BOOK COMPANY, INC., 50 Essex St., Rochelle Park, N.J. 07662

Manufacturers

Advertisements of booklets, brochures, catalogs and data sheets. To order use Reader-Service Card (Advertisement)

FAST FOURIER TRANSFORM PROCESSOR FOR \$6,000



The 306/MFFT Fast Fourier Transform Processor is delivered with all control programs and plugs directly into any Data General Nova computer. It offers a complete Fourier Transform capability including Forward and Inverse FFT, Spectral magnitude, Hanning Weighting, and Complex Multiplication. Arrays from 16 to 16,384 real samples can be processed. An array of 1024 real samples is transformed in only 139 ms.

Time domain signal processing functions, such as correlation and convolution, can be calculated utilizing the high speed array operations X , $+$, $-$, \sqrt and Σ .

Call or write today for brochures on 306/MFFT or Elsytec's complete line of Fourier Spectrum Analyzers and Higher Speed Hardware Fast Fourier Transform Processors.

ELSYTEC INC.

212 Michael Drive, Syosset, New York 11791 (516) 364-0560

CIRCLE NO. 174

Measure Vector Angle, Magnitude And Components



The new Princeton Applied Research Model 129A Two Phase Lock-In/Vector Voltmeter, enables you to simultaneously measure the magnitude and phase angle with respect to a reference signal of virtually any low-level signal within its range of 0.5 Hz to 100 kHz—even if the signal is buried 60 dB beneath background noise. At the flip of a switch, you can also measure the in-phase and quadrature components of the vector. The Model 129A features fully automatic reference tracking, independent output expansion and filtering for each channel. Complete specifications are contained in bulletin T-314, available on request.

CIRCLE NO. 175

PRINCETON APPLIED RESEARCH CORPORATION

P.O. Box 2565
Princeton, New Jersey 08540 (609) 452-2111

New Precision Low Frequency Analyzer



A new brochure describes Quan-Tech's new Model 2449 Wave and Spectrum Analyzer which covers frequency measurements from 10 Hz to 50 KHz in one range with 1 Hz resolution. Frequency readout: 5 digit LED display. Electronic tuning with sweep increments of 5 or 50 KHz can be initiated at any starting frequency in the spectral range. Selectable sweep periods of 50 or 500 seconds. Select a 7 Hz bandwidth for high precision frequency measurements—a 1000 Hz bandwidth for high scan capability—or a 100 Hz bandwidth for a compromise between resolution and scan speed. Dynamic range greater than 75 dB, full scale input signal voltage from 30 μ V to 300 V in 15 ranges. Priced at only \$2050., the instrument is portable—weighs 20 lbs. Option provides 115 VAC for lab use or 12 VDC for field use. Front and rear covers available. Delivery: 30 days.

CIRCLE NO. 176

Quan-Tech

Div. Scientific-Atlanta, Inc.
Randolph Park West, Route #10
Randolph Township, N.J. 07801, Phone #201-361-3100

Electronic Design

Advertising Sales Staff

Tom W. Carr
Vice President &
Sales Manager

Rochelle Park, N.J. 07662

Robert W. Gascoigne
Daniel J. Rowland
(Recruitment, Quick Ads, Classified)
50 Essex Street
(201) 843-0550
TWX: 710-990-5071

Philadelphia

Thomas P. Barth
50 Essex Street
Rochelle Park, N.J. 07662
(201) 843-0550

Boston 02178

Gene Pritchard
P.O. Box 379
Belmont, Mass. 02178
(617) 489-2340

Chicago 60611

Thomas P. Kavooras
Berry Conner, Jr.
200 East Ontario
(312) 337-0588

Cleveland

Thomas P. Kavooras
(Chicago)
(312) 337-0588
(call collect)

Los Angeles 90303

Stanley I. Ehrenclou
Burt Underwood
2930 Imperial Highway
Inglewood, Calif.
(213) 757-0183

San Francisco 94022

Jerry D. Latta
P.O. Box 1248
Los Altos, Calif.
(415) 965-2636

London

For United Kingdom and Europe

John Ashcraft
John Ashcraft & Co.
12, Bear St.
Leicester Square
London WC2H 7AS England
Phone: 01-930-0525
W. J. M. Sanders
John Ashcraft & Co.
Herengracht 365
Amsterdam C., Holland
Phone: 020-24-09-08

Tokyo

Haruki Hirayama
Electronic Media Service
5th Floor, Lila Bldg..
4-9-8 Roppong
Minato-ku
Phone: 402-4556
Cable: Electronicmedia, Tokyo



advertiser's index

Advertiser	Page
AMP, Incorporated	14, 15
AVX Ceramics Corporation	78
Acopian Corp.	133
Airpax Electronics, Cambridge Division	157
Alco Electronic Products, Inc.	172
Alden Electronic & Impulse Recording Equipment Co., Inc.	210
Allen Bradley Co.	79
Allison Automotive Company	215
Alpha Industries, Inc.	179
Amerace Corporation	33
Amphenol, Bunker-Ramo Corp.	53
Amplifier Research Corporation	211
Analogic Corporation	57
Ansley Electronics Corp.	75
Arnold Magnetics Corp.	217
Augat, Inc.	121
Ballantine Laboratories, Inc.	182, 224
Barnes Engineering Company	174
Bead Electronics	206
Beckman Instruments, Inc. Helipot Division	40, 41
Beckman Instruments, Inc., Information Displays Operations	159
Beede Electrical Instrument Co.	217
Bendix Corporation, The, Electrical Components Division	55
Bodine Electric Company	203
Boonton Electronics Corporation	161
Bourns, Inc., Trimpot Products Division	17
Brown Mfg. Co., Arthur S.	213
Bud Radio, Inc.	18, 19
CTS Corporation	147
California Instruments Company	119
Centralab, The Electronics Division of Globe-Union, Inc.	176A
Cherry Electrical Products Corp.	135
Chicago Dynamics Industries, Inc.	158
Chrono-Log Corp.	186
Clare-Pendar	31
Computer Automation, Inc.	27
Computer Information Systems	217
Computer Labs, Inc.	217
Cunningham Corporation	202
Custom Electronics, Inc.	208
Damon Electronics Division	166
Data Precision Corporation	195
Datametrics	217
Dialight Corporation	137
Dickson Electronics Corporation	81
Digital Equipment Corporation	8, 9
Dynascan Corporation	80
ECCO	74
EMN Company	199

Advertiser	Page
EMR Telemetry, Weston Instruments, Inc.	191
E-T-A Products Co. of America	217
E-Z Hook	170
Electro Switch Corp.	203
*Electronic Design	40
Electronic Molding Corporation	194
Electronic Navigation Industries	144
Electronic Research Corporation	72
Elsytec, Inc.	219
Erie Technological Products, Inc.	42
Exar Integrated Systems	1
Fairchild Semiconductor, A Division of Fairchild Camera and Instrument Corporation	114, 115
Federal Scientific Corporation	218
Fluke Mfg. Co., Inc., John	56
Futaba Industries	52
GTE Automatic Electric	176C, 176D
GTE Sylvia	51
General Automation, Inc.	70, 71
General Electric Company	192, 216
General Instrument Corporation	120, 121
Glenair, Inc.	217
Gold Book, The	204, 205
Gralex Industries, Division of General Microwave Corp.	198
Hayden Book Company, Inc.	218
Heath/Schlumberger Instruments	108, 109
Heinemann Electric Company	39
Hewlett-Packard	2, 48, 49, 128, 129
Hickok Instrumentation and Controls Division	164
Hoffman Engineering Company	224
Hoyt Electrical Instruments Works, Inc.	195
Hunt Electronics	209
Hutson Industries	212
ISE International Corporation	153
ITT Cannon Electric, International Telephone and Telegraph Corporation	178, 190
Indiana General, Electronic Products	145
Industrial Electronics Engineers, Inc.	126, 127
Inland Motor Division, Kollmorgen Corporation	182
Inselek, Inc.	173

Advertiser	Page
Intech, Incorporated	154
Intel Corporation	4, 5
International Electronic Research Corporation	210
International Rectifier	120
Intersil	189
Interstate Electronics Corporation	169
Jermyn Industries	77
Johanson Manufacturing Corp.	7, 216
Keithley Instruments, Inc.	50
Kennedy Data Systems, Inc.	209
Kinsekisha Laboratory Ltd.	210
LVC Industries, Inc., Co-ord Switch	224
Licon, Division of Illinois Tool Works, Inc.	195
Litton Industries, Advanced Circuitry	171
3M Company	76
MCL, Inc.	150
Magnecraft Electric Company	Cover III
Magnetics, Inc.	216
Merkel-Korff Gear Co.	216
Mepco/Electra, Inc.	155
Metex Corporation	185
Micro Devices Corp.	209
Micro Networks Corporation	203
Micro-Technical Industries	214
Microwave Associates	143
Mini-Circuits Laboratory	223
Molon	29
Mostek Corporation	35
Motorola Semiconductor Products, Inc.	10, 11, 90, 91
MuRata Corporation of America	211
NCR Corporate Executive & Professional Placement	181
Nelson Ross Electronics	142
North American Philips Controls Corp.	201
Oak Industries, Inc.	12, 13
Olympia Sales Company, Inc.	187

recruitment and classified ads

Advertiser	Page
Ortec, Inc.	217
Oshino Electric Lamp Works, Ltd.	214
Paktron, Division Illinois Tool Works, Inc.	151
Panasonic Matsushita Electric	207
*Philips Industries	41
Pico Electronics, Inc.	Cover III
Piher International Corp.	73
Pomona Electronics, A Division of ITT	88
Power/Mate Corp.	216
Power Tech, Inc.	206
Potter & Brumfield, Division of AMF Incorporated	162
Precision Monolithics Incorporated	139
Premier Metal Products Company	174
Princeton Applied Research Corp.	219
Princeton Electronic Products, Inc.	122
Pulse Engineering, Inc.	184
Pye TMC Canada	216, 217
Quan-Tech, Division of Scientific Atlanta, Inc.	219
RCA Electronic Components	197
RCA Solid State	Cover IV
R. F. Power Labs, Inc.	156
Remex, Ex-Cello Corporation	163
Rental Electronics, Inc.	123
Repco, Inc.	211
Reticon Corporation	38
Robinson Nugent, Incorporated	177
Rogers Corporation	178
SGS-Ates Semiconductor Corporation	176D
SSAC Precision Products, Inc.	216
Schauer Manufacturing Corp.	148
Sealed Air Corporation	213
Signalite, Division of General Instrument Corporation	213
Signetics Corporation	36, 37
Siliconix, Incorporated	46
Simpson Electric Company	167
Singer-International Teleprinter Corp.	146
Sloan Co., The	160
Spectral Dynamics Corporation	218
Spectrum Control, Inc.	168
Sprague Electric Company	16
Sprague-Goodman Electronics, Inc.	188
Stacoswitch	175

Advertiser	Page
Statek Corp.	198
Syntronic Instruments, Inc.	193
Systron-Donner	224
TT Electronics, Inc.	216
TDK Electronics	149, 165
TEC, Incorporated	176
TRW/IRC Resistors, An Electronic Component Division of TRW, Inc.	54
TRW Semiconductors, an Electronic Components Division of TRW, Inc.	20
Tau-Tron, Inc.	196
Tektronix, Inc.	25, 45
Teledyne Relays, A Teledyne Company	23
Texscan Corporation	186
ThermoMetrics	180
Todd Products Co.	200
Toyo Communication Equipment Co., Ltd.	215
Tracor, Inc.	207
Triplett Corporation	131
Truetime Instrument Company	192
USCC/Centralab Electronics Division, Globe-Union, Inc.	100, 101
United Detector Technology, Inc.	215
United Systems Corporation	89
Vector Electronic Co., Inc.	196
Viking Industries Inc.	183
Vishay Resistive Systems Group	152
Wavetek	140
Weber Mfg. Co., Inc.	200
Woven Electronics	6
Yewtec Corporation	190

*Advertisers in non-U.S. edition.

SAME DAY SHIPMENT
Minis & Peripherals
PDP SPECIALISTS
8, 8I, 8L & 11

NEW 300 LPM
PRINTERS

PDI CARD READERS
BRPE PUNCHES

\$750 Minis

TELETYPE 35 & 37
DEC & HONEYWELL Modules
617/261-1100
 Send for Free Report "Maintenance of Computers"
AMERICAN USED COMPUTER CORP.
 P.O. Box 68, Kenmore Sta.
 Boston, MA 02215
 Members Computer Dealers Association

CIRCLE NO. 240

SCOPES UNLIMITED
 IS NOT
LIMITED TO SCOPES
 Complete line of new and used electronic test equipment.
SCOPES UNLIMITED, INC.
 1938 S. Anaheim Blvd.
 Anaheim, Ca. 92805
 (714) 772-0330
 East Coast Office (617) 894-5670



**Take
stock
in America.**

Buy U.S. Savings Bonds

Now E Bonds pay 5½% interest when held to maturity of 5 years, 10 months (4% the first year). Bonds are replaced if lost, stolen, or destroyed. When needed they can be cashed at your bank. Interest is not subject to state or local income taxes, and federal tax may be deferred until redemption.



The U. S. Government does not pay for this advertisement, it is presented as a public service in cooperation with The Department of the Treasury and The Advertising Council.

product index

Information Retrieval Service. New Products, Evaluation Samples (ES), Design Aids (DA), Application Notes (AN), and New Literature (NL) in this issue are listed here with page and Information Retrieval numbers. Reader requests will be promptly processed by computer and mailed to the manufacturer within three days.

*Appears in the International Technology Section outside the USA.

Category	Page	IRN	Category	Page	IRN	Category	Page	IRN
Components			Data Processing			DPM	160	287
capacitor	101	52	access control unit	170	300	DPMs	198	138
capacitor	208	152	calculator, prog.	170	299	digital clock	166	294
capacitors	7	6	card reader-punch	172	303	digital counter	72	39
capacitors	155	81	computer, 16-bit	27	17	digital multimeters	168	95
capacitors	176A	107	computers	176	307	electronic instrument	197	136
capacitors, ceramic	79	46	controller, disc	172	304	function generator	140	67
capacitors, ceramic	151	77	converter, s/d	174	306	function generator	162	293
capacitors, ceramic	165	91	data-acquisition module	57	37	generator, pulse	158	283
capacitors, electrolytic	-6	11	display, color	168	297	IC tester	166	252
capacitors, trimmer	188	122	loader, program	170	301	logic analyzer	49	29
components	73	40	memory, core	170	298	logic checker	77	44
components	145	71	memory, disc	177	321	logic tester	160	289
components, high-voltage	42	26	memory, NMOS	172	302	meter, front panel	207	150
delay lines	184	118	microprocessor	176	308	meters	190	125
detonator	182	331	printer, digital	176	310	multimeter	224	211
displays	153	79	printer, mechanism	146	72	multimeter, 4-1/2-digit	195	131
displays	159	85	radio links	211	161	multimeters,		
gearmotor	29	18	punched tape sys	163	89	5-1/2-digit	119	55
heat probe	214	167	reader, paper tape	168	296	oscilloscope	45	27
lamp with lens	178	324	recorder, facsimile	174	305	oscilloscope	80	47
motor, 1/8 hp servo	180	326	scan conversion system	128	60	oscilloscope	162	290
motors	201	143	storage disc	176	309	panel meters	195	132
motors	203	145	terminal, CRT	177	320	photometer/radiometer	215	170
multiplier, time-delay	200	140				pulse generator	169	96
neon lamp	213	163	Discrete Semiconductors			receiver, time code	192	127
networks	180	325	bridges, rectifier	200	367	recorders	210	157
posistors	211	160	detector, IR	174	103	signal generator	161	87
potentiometer	53	33	diodes, p-i-n	143	69	spectrophotometer (NL)	212	399
potentiometers, trimming	17	12	diodes, zener	81	48	spectrum analyzer	142	68
pushbutton switch	180	327	diodes, zener	148	74	spectrum analyzer	191	126
reed relay	182	329	display, flatpack	127	59	standard, frequency	166	295
relay	207	151	display, LED	199	363	standards	224	213
relay, solid-state	178	322	display, LED 7 seg	200	365	storage scope	164	250
relays	III	243	displays	2	3	synthesizer	162	292
relays	176C	108	LED display	126	58	test clip	88	49
relays, DIP	23	15	LEDs	11	8	thermometer	162	291
resistor networks	41	25	LEDs	160	86	transmitter	196	134
resistor networks	147	73	limiter, current	198	361	VOM, digital	167	93
resistors	35	21	opto-electronic system	215	169	VOMs	131	62
resistors	54	34	photodiode, avalanche	201	369	voltmeter	158	284
resistors	152	78	protector, Xsistor	198	362	voltmeter	182	115
sensor, angular	180	328	rectifier, power	20	14			
switch handbook (NL)	212	393	rectifiers, bridge	199	364	Integrated Circuits		
switch, keyboard	178	323	SCRs	78	45	amplifier	IV	244
switch, rotary	203	146	SCRs, high current	201	368	amplifier IC, hi-fi	141	255
switches	15	10	sensor, optical	200	366	amplifiers, audio	144	262
switches	52	32	transistor, silicon	206	149	analog memory devices	38	23
switches	135	64	triac	212	162	clock IC	144	261
switches	137	65				counter, CMOS	142	259
switches	158	84	Instrumentation			op amps, FET	142	257
switches	162	88	amplifier, 500-W	211	159	op amps, precision	144	265
switches	175	105	amplifier, rf power	156	82	pROM, bipolar	142	258
switches	195	133	amplifiers, power	144	70	pROMs, 1024-bit	144	263
switches	202	144	clocks, digital	186	121	processor, SOS	71	38
switches, pushbutton	214	166	computerized card			RAMs, CMOS	173	102
switches, rotary	13	9	tester (NL)	214	452	sensor, hall effect	142	260
switches, slide	172	99	counter	89	205	tachometer IC	144	264
switchlight	31	19	counter	158	285	thermistors	149	75
tantalum capacitors (NL)	212	395	counter	160	288	thermistors	180	114
terminal blocks	33	20	counters	109	53	transistors, 1-GHz (NL)	210	391
time delay, thermal	182	330	counters	160	286			
transformers	II	242	counters	199	139	Microwaves & Lasers		
			DMM	50	30	amplifiers	194	353
			DMM, 3-1/2 digit	156	253	amplifiers, log	194	355

Category	Page	IRN
antenna, miniature	197	359
detector	192	348
hybrid, 90°	193	350
mixer	192	349
mixer	197	360
modules, stripline	193	351
oscillators, Gunn	194	352
power supply	194	354
sweeper, Ka-band	197	358
test set, receiver	196	356
transistor, S-band	196	357

Modules & Subassemblies

amplifier, TWT	150	76
amplifier, servo	146	267
contactor, solid-state	146	266
controller, temp	150	275
converter, a/d	46	28
converter, s/d	148	271
converters, a/d	139	66
converters, a/d	148	269
converters, a/d	154	280
converters, a/d	203	174
converters, d/a	150	273
converters, d/a	152	277
converters, angle	148	270
DAC, multiplying	146	268
detector, peak VU	150	274
dialer, telephone	154	281
filter	215	168
filter, crystal	166	92
filters, active	154	282
ICs, linear	141	256
module, power control	154	279
keyboard, tone-coded	152	278
oscillators	210	158
selector, thermocouple	152	276
timer, solid state	148	272

Packaging & Materials

acoustical material	184	334
air-conditioners	184	332
backshells, MIL plugs	190	343
bus	178	112
cable	6	5
cable/connector systems	76	43
cable, temp resistant	186	337
card-cage system	188	339
card file	184	333
cases	209	153
circuit board	196	135
circuit boards	171	98
circuit protectors	157	83
connector, low-ohm	190	344
connectors	178	111
connectors	190	124
connectors	206	148
connectors, filters	55	35
contact, gold-dot	51	31
enclosures	19	13
enclosures	174	104
enclosures	224	212
endless belt	213	165
environmental chambers	200	141
heat sealer	213	164
heat sinks	210	156
hooks	170	97
infrared pass filter	188	342
interconnecting systems	128A	221
masking material	186	336
matrix boards	224	214
metallic mesh	185	119
pads, cleaning	188	340
pin-in-board	194	130
plastic gloves	191	347
preforms	179	113
rental equipment	129	61
safety sphere	186	335

Category	Page	IRN
seal, ferrofluid	190	345
socket, IC	177	110
screw-head plugs	188	341
terminal block	191	346
terminal, heat sink	172	100
terminals and splices (NL)	212	392
thermal gasket	188	338
transparent photo-masks	210	390
yoke, precision	193	129

Power Sources

arc-lamp supply	202	370
CRT supply	202	373
display supply	207	377
inverter, dc-to-ac	207	376
lab supplies	206	375
power supplies	133	63
power supplies	202	372
power supplies (NL)	212	396
power supply	209	154
protector, overvoltage	39	24
static inverter	202	371
unregulated supplies	206	374

application notes

adhesives	215	459
back plane connectors	215	462
breadboards	210	388
CRTs	212	394
cable tie installation tool	214	456
computerized card tester	214	452
DIP sockets	212	398
direct-view storage tubes	210	389
high-voltage rectifiers	212	451
hollow cathode devices	212	397
memory products	215	457
mercury relays	215	461
microwave	214	454
power supplies	212	396
rf power transistors	214	453
resistor networks	214	455
silicon rectifiers	215	460
spectrophotometer	212	399
switch handback	212	393
tantalum capacitors	212	395
terminals and splices	212	392
transistors 1-GHz	210	391
transparent photomasks	210	390
wires and cables	215	458

new literature

magnetic fluids	208	383
microwave counters	208	379
precision resistors	208	382
process industry bulletins	208	380
push-pull amplifiers	208	384
SCR converter performance	208	378
SCRs	208	387
spectrum analyzer	208	381
test programming	208	385
transformers	208	386

DOUBLE-BALANCED MIXERS

Great Value at

\$7.95
500 piece quantities.

\$9.95 in quantities of 1 to 49 pieces

DC-500MHz
6dB conversion loss
40dB isolation
EMI shielded case

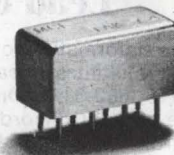

A breakthrough in technology and high production volume enables Mini-Circuits Laboratory to offer these new products at an unprecedented low price.

In today's tough competitive market can you afford not to use these remarkably low priced and high performance units?

Ruggedness and durability are built in the SRA-1. These new units are packaged within an EMI shielded metal enclosure and hermetically sealed header. They use well matched hot-carrier diodes and uniquely designed transmission line transformers.

We invite you to convince yourself. Place your order now and check our delivery, product performance and reliability.

Mini-Circuits Laboratory

2913 Quentin Rd., Brooklyn, N.Y. 11229
(212) 252-5252, Int'l Telex 620156
A Division Scientific Components Corp.

*FRANCE: S.C.I.E., *31, rue George-Sand, Palaiseau 91, France. *GERMANY, AUSTRIA, SWITZERLAND: Industrial Electronics GMBH, *Klüberstrasse 14, 6000 Frankfurt/Main, Germany *UNITS IN STOCK

ENGLAND: Dale Electronics: Dale House, Wharf Road, Frimley Green, Camberley, Surrey. JAPAN: Denisho Kaisha, Ltd.: Eguchi Building, 8-1, 1-Chrome, Hamamatsucho, Minato-Ku, Tokyo.

*UNIT IN STOCK.

INFORMATION RETRIEVAL NUMBER 180

The first

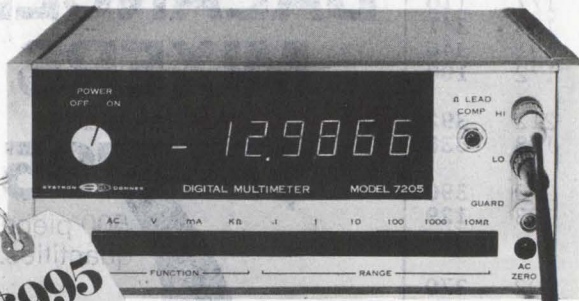

\$995
fully loaded

at this price!

$\pm 1\mu V$ resolution

5 full functions

26 ranges

Lead-compensated ohms

For immediate information on Systron-Donner's new Model 7205 5½-digit Multimeter, call us collect on our **Quick Reaction** line: (415) 682-6471. Or you may contact your Scientific Devices office or S-D Concord Instruments Division, 10 Systron Drive, Concord, CA 94518. **Europe:** Systron-Donner GmbH, Munich, W. Germany; Systron-Donner Ltd., Leamington Spa, U.K.; Systron-Donner S.A., Paris (Le Port Marly) France. **Australia:** Systron-Donner Pty. Ltd. Melbourne.

SYSTRON  **DONNER**

INFORMATION RETRIEVAL NUMBER 211

automatic transfer standards

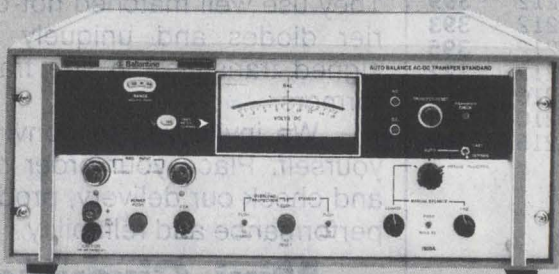

The 1600A Auto-Balance AC/DC Transfer Standard. Precise repeatable measurements every 30 seconds. Traceable to NBS. Takes tedium and guesswork out of 100 ppm transfer measurements in Lab, QA and production.

0.25 V to 1 kV rms, dc to > 100MHz: \$4500



Ballantine Laboratories, Inc.

P.O. Box 97, Boonton, New Jersey 07005
201-335-0900, TWX 710-987-8380

INFORMATION RETRIEVAL NUMBER 213

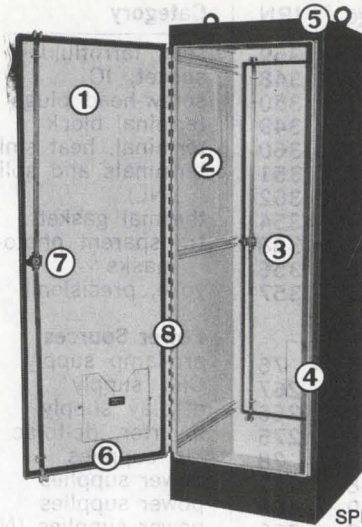

MEETS
NEMA 12 & 13
SPECIFICATIONS

1. Single door or double doors on front or front and back. 2. Numerous interior panels/relay rack angles available. 3. Heavy gauge steel. 4. All seams continuously welded. 5. Lifting eyes for easy handling. 6. Neoprene door gasket with oil resistant adhesive and steel retaining strips. 7. 3-point latching mechanism, oil tight key locking handle. 8. Heavy gauge continuous hinges. For detailed specifications on over thirty different sizes, write for latest bulletins.

Hoffman®

HOFFMAN ENGINEERING COMPANY
Division of Federal Cartridge Corporation
Anoka, Minnesota, Dept. ED-74

ELECTRICAL ENCLOSURES

INFORMATION RETRIEVAL NUMBER 212

IT'S YOUR MOVE TO BETTER MATRIX BOARDS

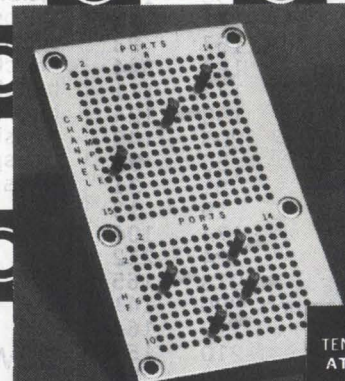
.125 CENTERS	RELIABILITY • ECONOMY AND STANDARDIZATION		UP TO 8 DECK SWITCHING
	.250 CENTERS	.100 CENTERS	BUSSED CONTACT
ISOLATED CONTACT			DUAL CONTACT STRIPS
CLOSED ENTRY DESIGN			MIXED CONTACTS
SHORTING PINS	TERMINAL OPTIONS	MOUNTING OPTIONS	CODED PANELS
WRITE FOR CATALOG	DIODE PINS	LIGHTED PINS	COLORLED PANELS

SPECIAL TENTH INCH MATRICES AT \$.08 PER POINT

CO-ORD SWITCH

A DIVISION OF LVC INDUSTRIES INC.
135-25 37th AVE., FLUSHING, N.Y. 11354 • 212-939-9777

INFORMATION RETRIEVAL NUMBER 214

ELECTRONIC DESIGN 10, May 10, 1974

AMP CHAMPS

THE RELAYS WITH MAXIMUM POWER SWITCHING CAPABILITIES

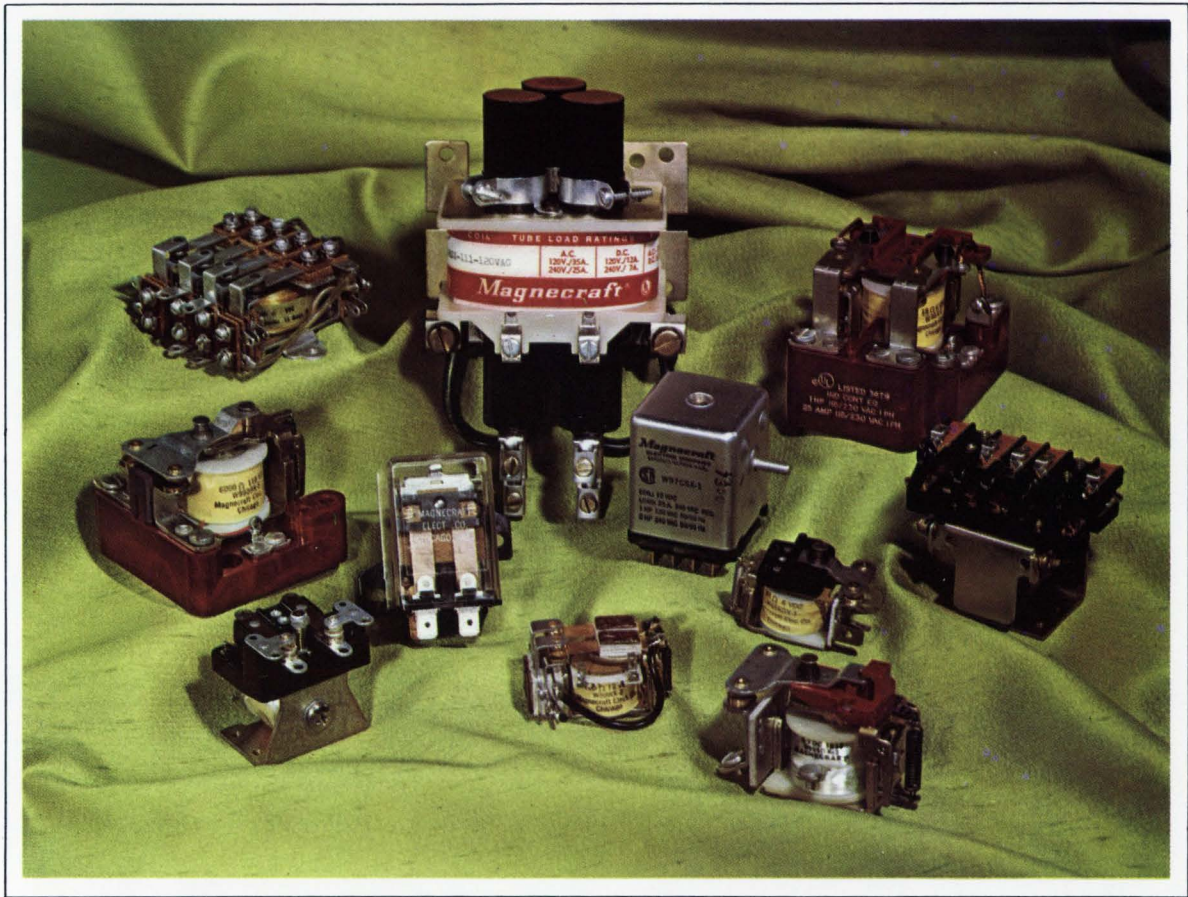

When it comes to switching real power we call our team the Amp Champs. Contacts are rated from 15 – 100 amps at 28VDC or 115/220VAC with a wide variety of contact combinations and packaging techniques. Each relay is designed to function with absolute reliability for long life at lowest cost. Versions offered include the space saver, UL listed, auxiliary contact, magnetic blowout for DC switching, enclosed plug-in or stud mounting, hermetically sealed, and mercury displacement power relays. Over 230 different types of power relays are in stock for immediate delivery thru our chain of nationwide distributors and Magnecraft's main plant. If you don't find what you need here, we will make it for you!

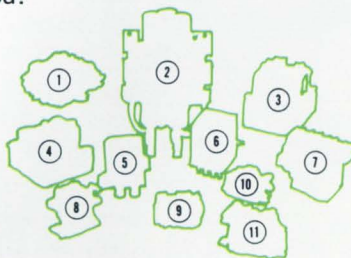

- 1) 15 amp Class 94 2) 35 amp Mercury Displacement Class BSX
- 3) UL 25 amp Class 99 4) 20 amp Class 99DB with blowout magnet
- 5) 20 amp Class 89CQ 6) 25 amp Class 97 7) 20 amp Class 93
- 8) 15 or 30 amp Class 96 9) 15 amp Class 88R 10) 50 amp Class 88KD 11) 50 amp Class 99SD



Free!
STOCK CATALOG

To help specify all your relay needs, ask for Magnecraft's new 1974 Stock Catalog with the most diversified line of over 1060 relays. A Power Relay Catalog with specific data drawings, and photos on all the various relays will accompany the Stock Catalog.

Find Magnecraft Relays in EEM sec. 4500.

Magnecraft ELECTRIC COMPANY

5575 NORTH LYNCH AVENUE • CHICAGO, ILLINOIS 60630 • 312 • 282-5500 TWX 910 221 5221

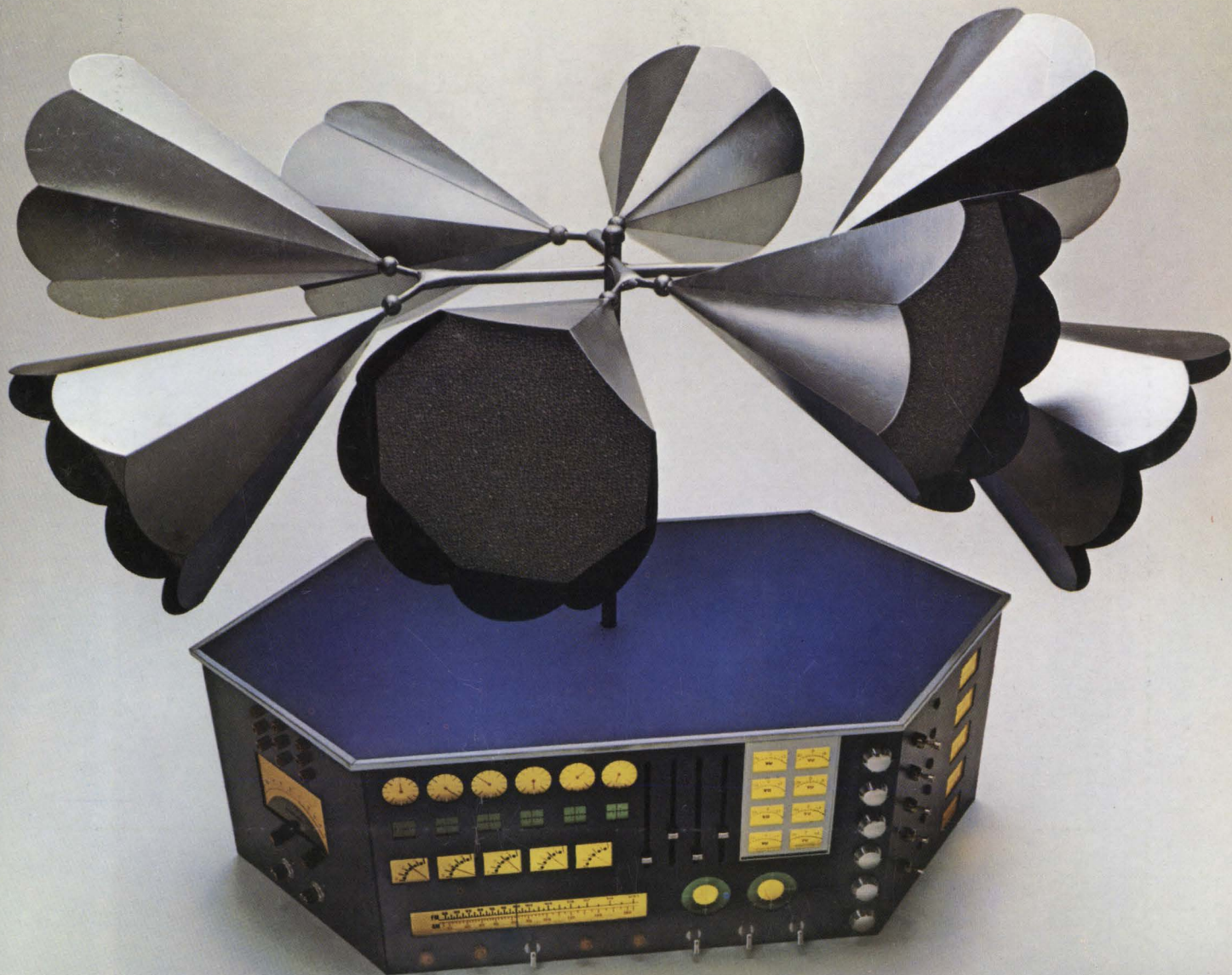

The octophonic amplifier. If you want to create one tomorrow, we're ready with your power transistors today.

No matter what product you want to design — from stereo amps to ignition systems to electronic ranges — there's one thing you want to remember. Nobody's design is any better than the devices that go into it.

And at RCA, we've got the devices that make the difference. Ready now to help your product perform the way you designed it. In numbers all the way from

one to one million and beyond.

We're a commodity supplier of power transistors; a recognized leader in CMOS building blocks; developers of liquid crystal displays; a leading producer of linear IC's; technology innovators of RF power components; and a major supplier of thyristors.

In addition to comprehensive technical product data, RCA also gives you professional and experi-

enced field engineering and applications support. As well as a commitment to excellence in everything from research to manufacturing.

So whatever you're into, and whatever you need, check with us first. Chances are one or more of our products anticipate your needs. A good place to start is to check our handy product line guide. Write: RCA Solid State, Section 57E10, Box 3200, Somerville, N.J. 08876.

RCA Solid State