

# Electronic Design 5

VOL. 25 NO.

FOR ENGINEERS AND ENGINEERING MANAGERS

MARCH 1, 1977

**Today's scientific calculators:** They've got more functions and more of the hand-held ones are programmable. Some hand-helds even come with memories that

retain data when they're turned off. Others include solar-array battery chargers and hard-copy printouts. Battery life is still a problem. For details, see p. 20.



# Unique wrap-around wiper offers superior setting stability...

Wrap-around, multi-finger wiper reduces contact resistance variation and open circuit problems. Micro-photograph shows trimmer wiper magnified 28X.

## ... here today at no extra cost in every Trimpot® Potentiometer

Bourns multi-fingered, wrap-around wiper design delivers more consistent, more reliable performance. More stable **during** setting ... more stable in your circuit.

The unique wrap-around design significantly reduces CRV fluctuations and open circuit problems due to thermal and mechanical shock ... by maintaining a constant wiper pressure on the element. As you can see in the enlarged photograph of a sectioned single-turn trimmer, the wiper is shaped so that its upper section works somewhat like a lever arm, keeping the contact fingers under constant tension.

Bourns wrap-around wiper design is essentially self-aligning and self-retaining. Therefore, more reliable ... because there is very little chance of error during manufacture. Designs that do not "wrap-around" usually require very critical heat-staking procedures to lock the wiper into a plastic slot in the rotor (slider). Our tests indicate that such designs are much less resistant to thermal and mechanical shock, and are often mis-assembled.

### HERE'S PROOF:

Send for a copy of our new engineering report on TRIMMER PERFORMANCE. Tell us about your application, and we'll provide qualification samples that best suit your needs.

Bourns reliability is available at ordinary prices ... off-the-shelf from nearly 100 local distributor inventories ... plus our largest-ever factory stock. TRIMMER PRODUCTS, TRIMPOT PRODUCTS DIVISION, BOURNS, INC., 1200 Columbia Avenue, Riverside, California 92507. Telephone 714 781-5320 — TWX 910 332-1252.

### Swage-Bond™ ... a revolution in trimmer reliability

Bourns exclusive Swage-Bond process virtually eliminates pin termination failure ... and provides a marked improvement in temperature coefficient consistency. In the Swage-Bond process, the P.C. pins are secured **through** the trimmer substrate, with a high-pressure compression swage on both the top and bottom sides. The pressure locks the pins solidly into the element, and thoroughly bonds them to the termination material. Compare Swage-Bond™ to less reliable clip-on termination designs.



### The seal that seals ... without springback

Bourns trimmers stay sealed when others fail. We know. We've tested them all. Bourns uses a chevron-type sealing technique, that seals without O-rings ... eliminating the windup and springback that frequently occurs with such seals. The result is faster and more precise adjustability ... with a seal that really works.

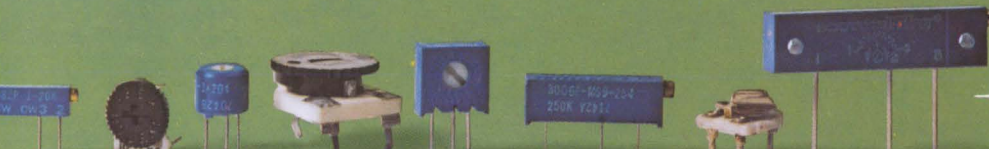

Int'l Mktg. Offices: European Hdqtrs. — Switzerland 042/23 22 42 • Belgium 02/218 2005 • France 01/2039633 • Germany 0711/24 29 36 • Italy 02/32 56 88 • Netherlands 70/87 44 00 • United Kingdom 01/572 6531 • Japan 075/921 9111 • Australia 02/55-0411 03/95-9566

# SURPRISE!



## Our New Display Can Say A Lot For You

Our new HDSP-2000 Alphanumeric Display can spell it out for you in bright, crisp LED characters. The full 5x7 dot matrix can display ASCII or custom character sets including lower case and symbols.

Compact and complete with on-board electronics, the HDSP-2000 dramatically reduces display system size and complexity. Each 12 pin DIP contains 4 characters with row drivers and storage. End stackable and easy to interface, they're ideal for "smart" instruments, medical systems or business terminals, military applications, and almost any mobile, portable or hand-held device.

The price is \$47.00\* per 4-character cluster in quantities of 125 clusters. They're in stock today at HP's franchised distributors. In the U.S. contact Hall-Mark, Schweber, Wilshire or the Wyle Distribution Group (Liberty/Elmar) for immediate delivery. In Canada, contact Zentronics, Ltd. \*U.S. Domestic price only.

**HEWLETT  PACKARD**

Sales and service from 172 offices in 65 countries.  
1507 Page Mill Road, Palo Alto, California 94304

## TO-5 RELAY UPDATE

# The Relay of Tomorrow is here today: the Centigrad.

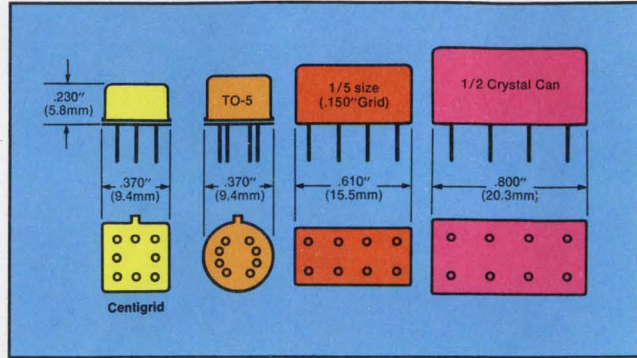

Out of Teledyne's TO-5 relay technology has evolved the Centigrad® — the ultimate subminiature relay. It combines the proven TO-5 relay design concept and internal construction into an even more compact package. Low profile height — just .230" (5.84mm) — with terminals spaced on a .100" (2.54mm) grid permitting direct pc board mounting without the need for lead spreading.

Add to this the same low coil power consumption as the TO-5 relay, with obvious thermal and power

supply advantages. And for RF switching, the Centigrad's low inter-contact capacitance and contact circuit losses provide high isolation and low insertion loss up through UHF frequencies.

To top it all off, the Centigrad is qualified to levels "L" and "M" of MIL-R-39016, including the internal diode suppressed versions.

For complete specification data on the Relay of Tomorrow, contact Teledyne Relays, the technology leader in the relay industry.

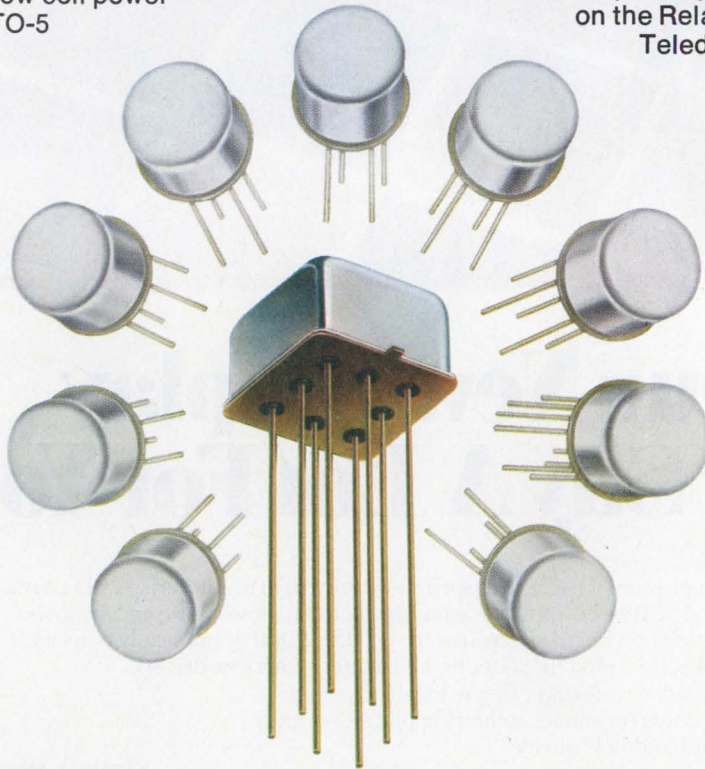

 **TELEDYNE RELAYS**

3155 West El Segundo Boulevard, Hawthorne, California 90250, Telephone (213) 973-4545

CIRCLE NUMBER 3

---

## NEWS

- 17 **News Scope**
- 20 **Today's scientific calculators** offer greater computing power and cost a lot less than ever before.
- 32 **Current-mode logic** is packed densely to raise speed and cut power consumption.
- 35 **Washington Report**

---

## TECHNOLOGY

- 41 **Microprocessor Design**
- 54 **Powerful calculators for the blind** are now possible with a low cost interface circuit. And variants are useful to the sighted as well.
- 60 **Simplify low-cost  $\mu$ P selection** with tabulated data. By putting specs and system performance into tables you can zero in on the optimum processor.
- 68 **Control your analog variables digitally.** Once you've got a sensor that transduces your analog variable to frequency, close the loop with a  $\mu$ P.
- 72 **Resolving DMM accuracy:** Though many engineers argue otherwise, more digits can bring more accuracy. The problem really lies in what is meant by 'accuracy.'
- 74 **Ideas for Design:**  
Digital-integrator for intrusion systems discriminates against false signals.  
TTL oscillator interfaces data for display by a television set.  
Timer pulses coasting to a stop heighten electronic game realism.
- 80 **International Technology**

---

## PRODUCTS

- 83 **Integrated Circuits:** Encoding/decoding circuit handles audio signals of up to 3.3 kHz.
- 86 **Instrumentation:** Miniature 250-MHz counter works from NiCd batteries.
- 88 **Packaging & Materials:** Inexpensive metal enclosures come in a variety of sizes.
- 90 Discrete Semiconductors
- 91 Power Sources
- 93 Microwaves & Lasers
- 94 Modules & Subassemblies
- 95 Data Processing
- 96 Components

---

## DEPARTMENTS

- 53 **Editorial:** Teamwork
- 7 Across the Desk
- 97 Application Notes
- 98 New Literature
- 99 Bulletin Board
- 102 Advertisers' Index
- 104 Product Index
- 104 Information Retrieval Card

**Cover:** Photo by Keith Peterson, courtesy Hewlett-Packard, Corvallis, OR

# First, the good news.

Advanced Micro Devices announces the Am2901A. It's just like our Am2901. It's a plug-in replacement. Only better. In fact, it's the best 4-bit TTL microprocessor slice you can buy.

If you thought our Am2901 was terrific, wait'll you hear this: The Am2901A is at least 20% faster through every path over the full operating temperature range.

Power dissipation has been reduced by more than 30% at 125°C. Drive on the "Y" outputs has been increased to 20mA. That's 30% better.

We even raised the input low level from .7 to .8 volts to give you increased noise immunity.

And best of all, you can buy the Am2901A for the same low price as the Am2901. And since the two are pin-for-pin replacements, if you designed your system with Am2901's, you can easily make it faster and better with the Am2901A.

# And now, the good news.

As of March 1, 1977, Advanced Micro Devices' AM2901DC and AM2901APC will cost \$14.70 in 100-up quantities.

But that shouldn't surprise you. Remember?

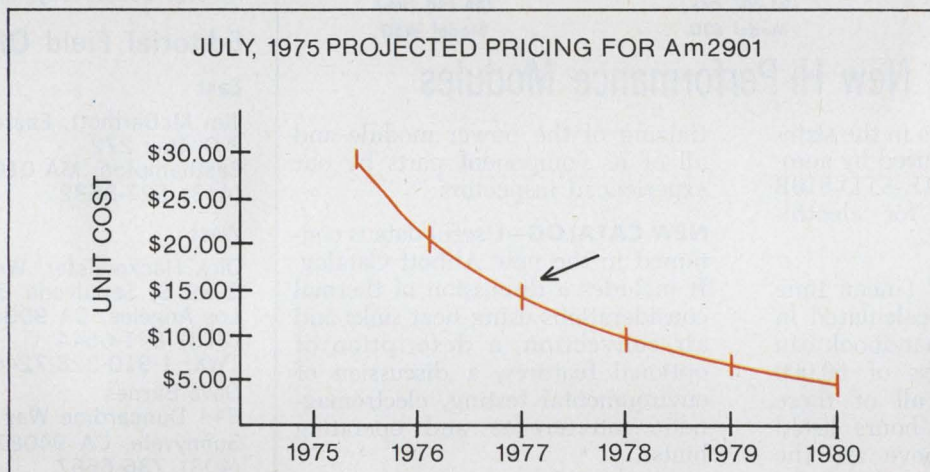

That's it. We've got a great new part, and you've got a great new price.

Good good.

## Advanced Micro Devices

Bipolar LSI. N-channel, silicon gate MOS. Low-power Schottky.  
Multiple technologies. One product: excellence.



Advanced Micro Devices • 901 Thompson Place, Sunnyvale, California 94086 • Telephone (408) 732-2400 •  
Distributed nationally by Hamilton/Avnet, Cramer and Schweber Electronics, and regionally by Arrow, Bell and Century Electronics.

CIRCLE NUMBER 7

# When You Buy a Power Supply, Why Not Get the Best?

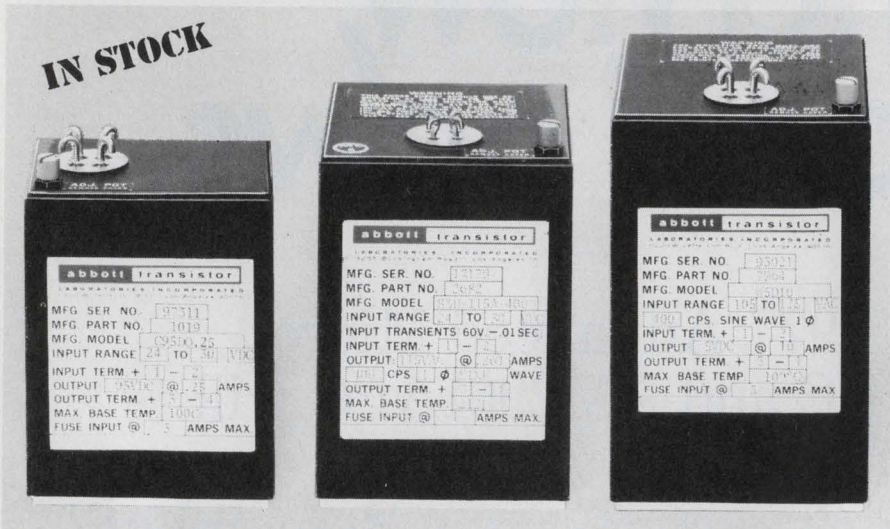

**IN STOCK**

28 VDC to DC  
(55,463 Hrs.)  
Model C95D

28 VDC to 400 A  
(61,387 Hrs.)  
Model S3D

400 A to DC  
(56,148 Hrs.)  
Model W5D

## Abbott's New Hi-Performance Modules

are designed to operate in the stringent environment required by aerospace systems — MIL-STD-810B and MIL-STD-461A for electromagnetic interference.

**RELIABILITY** — MTBF (mean time between failures) as calculated in the MIL-HDBK-217 handbook can be expected in excess of 50,000 hours at 100°C for all of these power modules. The hours listed under the photos above are the MTBF figures for each of the models shown. Additional information on typical MTBF's for our other models can be obtained by phoning or writing to us at the address below.

**QUALITY CONTROL** — High reliability can only be obtained through high quality control. Only the highest quality components are used in the construction of the Abbott power module. Each unit is tested no less than **41 times** as it passes through our factory during fabrication — tests which include the scru-

tinizing of the power module and all of its component parts by our experienced inspectors.

**NEW CATALOG**—Useful data is contained in the new Abbott Catalog. It includes a discussion of thermal considerations using heat sinks and air convection, a description of optional features, a discussion of environmental testing, electromagnetic interference and operating hints.

**WIDE RANGE OF OUTPUTS** — The Abbott line of power modules includes output voltages from 5.0 volts DC to 740 volts DC with output currents from 2 milliamperes to 20 amperes. Over 3000 models are listed **with prices** in the new Abbott Catalog with various inputs:

- 60A to DC
- 400A to DC
- 28 VDC to DC
- 28 VDC to 400A
- 12-28 VDC to 60 A

Please see pages 1037-1056 Volume 1 of your 1975-76 EEM (ELECTRONIC ENGINEERS MASTER Catalog) or pages 612-620 Volume 2 of your 1975-76 GOLD BOOK for complete information on Abbott Modules.

Send for our new 60 page FREE catalog.

**abbott transistor**

**LABORATORIES, INCORPORATED**  
general offices eastern office

5200 W. Jefferson Blvd./Los Angeles 90016  
(213) 936-8185 Telex: 69-1398

1224 Anderson Ave./Fort Lee, N.J. 07024  
(201) 224-6900 Telex: 13-5332

CIRCLE NUMBER 4

Sr. Vice President, Publisher  
Peter Coley

### Editors

Editorial Offices  
50 Essex St.  
Rochelle Park, NJ 07662  
(201) 843-0550  
TWX: 710-990-5071  
Cable: Haydenpubs Rochellepark

Editor-in-Chief George Rostky

### Managing Editors:

Ralph Dobriner  
Michael Elphick

### Senior Associate Editor

Stanley Runyon

### Associate Editors:

Sid Adlerstein  
Dave Bursky  
Morris Grossman  
John F. Mason  
Andy Santoni  
Max Schindler

### Contributing Editors:

Peter N. Budzilovich, John Kessler  
Alberto Socolovsky, Nathan Sussman

### Editorial Field Offices

#### East

Jim McDermott, Eastern Editor  
P.O. Box 272  
Easthampton, MA 01027  
(413) 527-3632

#### West

Dick Hackmeister, Western Editor  
8939 S. Sepulveda Blvd., Suite 510  
Los Angeles, CA 90045  
(213) 641-6544  
TWX: 1-910-328-7240  
Dave Barnes  
844 Duncardine Way  
Sunnyvale, CA 94087  
(408) 736-6667

### Editorial Production

Marjorie A. Duffy, Production Editor  
James Keane, Copy Editor

### Art

Art Director, William Kelly  
Richard Luce, Anthony J. Fischetto

### Production

Manager, Dollie S. Viebig  
Helen De Polo, Anne Molfetas

### Circulation

Director, Barbara Freundlich  
Trish Edelmann

### Information Retrieval

Paula Greenleaf

### Advertising Promotion

Susan G. Apolant

### Reprints

Maxine Correal



# Across the Desk

## Sad circuit

Though my forte is analog, I have invented a new breakthrough in digital memory circuits. In fact, I have already made this invention available to a contralto friend, who used it the other night during her performance of Mahler's heart-rending "Kindertotenlieder."

The new circuit, based on an ultra-thin process (about  $10^{-8}$  cm) is a Read-Only Memory for people who worry a lot. It's called Angst-ROM.

*Bob Pease*

National Semiconductor  
Santa Clara, CA 95051

## Error causes permanent pull-up

In "Control Logic for  $\mu$ Ps Enables Single-Cycle-Operation" (ED No. 21, Oct. 11, 1976, p. 76), the circuit in Fig. 1 has a possible error, which I feel would cause the circuit not to operate as stated in the article.

It is stated: "A gated latch, consisting of gates  $G_1$  through  $G_5$ , stops the processor by pulling RDY low at the proper time after switch  $S_1$  has been moved from run to halt." If one studies the circuit hookup of  $S_1$ , as shown in this article, he will realize that there is a possible wiring error. Gates  $G_1$  and  $G_2$  are permanently pulled up to 5 V no matter what position  $S_1$  is in. The logical input level at  $G_1$  and  $G_2$  could not be changed by the position of  $S_1$ .

*Dominic Memoli*  
Design Engineer

Vocational Training Center  
and Workshop  
230 Hanse Ave.  
Freeport, LI, NY 11520

*Ed. Note: Sharp-eyed reader Dominic Memoli is correct. The  $S_1$  switch should be connected as shown here. Both our art department and their checker have been given demerits and promise to sin no more.*

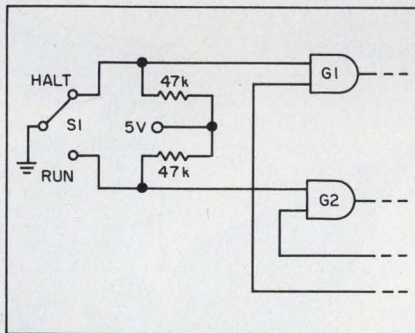

## Match the capability with the right circuit

An "Idea for Design" article by John Okolowicz, entitled "Delay Circuits Keep Headlights On when Needed; Turn Them Off if You Forget" (ED No. 18, Sept. 1, 1976, p. 114), states: "If the light switch is turned off first, no delay results." This is a desirable capability of such a circuit; but the circuits shown do not provide this capability.

A simple modification of Mr. Okolowicz's circuit (see Fig.) will permit all capabilities described in the original text to be provided.

Normally, a spare contact is not available on an automobile's igni-  
(continued on page 14)

Electronic Design welcomes the opinions of its readers on the issues raised in the magazine's editorial columns. Address letters to Managing Editor, Electronic Design, 50 Essex St. Rochelle Park, N.J. 07662. Try to keep letters under 200 words. Letters must be signed. Names will be withheld on request.



## OPTRON OPTICALLY COUPLED ISOLATORS

NEW JAN 4N22A SERIES  
OFFERS  
HIGHEST RELIABILITY

You can't buy a more reliable optically coupled isolator than one of OPTRON's new JAN 4N22A series. The popular JAN 4N22A, 4N23A and 4N24A all feature fully qualified JANTX and JANTXV ratings.

These new OPTRON isolators consist of a high efficiency, solution grown gallium arsenide LED and a silicon N-P-N phototransistor in a hermetically sealed 6-pin TO-5 package. Minimum input-to-output isolation voltage for the series is 1000 volts and minimum current transfer ratios range from 25% for the 4N22A to 100% for the 4N24A.

New "A" version OPTRON isolators are a significant improvement over the older 4N22 series since the case is isolated from the sensor and LED to eliminate the need for an insulating spacer in many applications.

OPTRON also offers a new JEDEC registered series of high reliability isolators in a 4-pin TO-18 package. The 3N243 series includes three devices with the same reliability and similar characteristics as the JAN 4N22A TO-5 series, yet in a smaller package.



3N243

In addition, OPTRON's complete line of optically coupled isolators includes other immediately available standard devices in high-rel metal cans and low cost DIP and other plastic configurations for almost every application.

Detailed technical information on optically coupled isolators and other OPTRON optoelectronic products... chips, discrete components, limit switches, reflective transducers, and interrupter assemblies... is available from your nearest OPTRON sales representative or the factory direct.



**OPTRON, INC.**

1201 Tappan Circle  
Carrollton, Texas 75006, U.S.A.  
TWX-910-860-5958  
214/242-6571

# Texas Instruments gives you *more good reasons to buy a programmable calculator now.*

PC-100  
Printer  
**\$199<sup>95\*</sup>**

SR-52  
Card programmable  
**\$249<sup>95\*</sup>**

**FREE**  
**\$59<sup>90\*</sup>**  
WORTH OF  
SOFTWARE



SR-56  
Super slide rule  
Key programmable  
**\$109<sup>95\*</sup>**

**\$10**  
REBATE

# New low prices on SR-52, PC-100.

(Now you can get an SR-52 with PC-100 Printer for less than \$450.)

## Free software with your SR-52.

## \$10 rebate on SR-56 purchase.

**SR-52.** The card programmable calculator with computer-like power. 224 program steps and 22 data memories let you solve complex problems. Fast. With less chance of error. You can load complete programs from small magnetic cards in just two seconds. Process and record data or perform complicated calculations automatically. Select a program from the SR-52 Basic Library, which includes 22 prerecorded program cards. There's also a wide variety of optional prerecorded libraries—or you can record your own programs.

Programming is easy with TI's exclusive AOS (Algebraic Operating System). You enter expressions—both numbers and functions—from left-to-right, just as you would write them out on paper.

Now you have the opportunity to own an SR-52 at a lower price than ever before. And, if you buy your SR-52 anytime between January 20, 1977 and March 31, 1977, Texas Instruments will send you two software libraries—a \$59.90 value

—free.† Choose from Mathematics, Statistics, Finance, or Electrical Engineering. See details in coupon below.

**SR-56.** A powerful, super slide rule calculator that's key programmable, too. 74 preprogrammed functions and operations easily handle tough scientific problems. 100 programming steps plus 10 memories allow you to obtain results once requiring the assistance of a computer. Yet no programmable is easier to master. There's no special entry sequence to learn with TI's unique AOS (Algebraic Operating System). AOS allows easy left-to-right entry of expressions, both numbers and functions. Build your own programs and use them again and again. Or select one from the SR-56 Applications Library. 56 different programs in mathematics, statistics, finance, electrical engineering, and more are contained in the 192-page Library. Select a program, follow the listing, and you can begin immediately to solve your own problems.

Buy an SR-56 anytime between January 1, 1977 and March 31, 1977 and Texas Instruments will send you a \$10 rebate.† See details in coupon below.

**PC-100.** TI's PC-100 Printer will turn your SR-52 or SR-56 into a quiet, high-speed printing calculator. Hard copy printout provides intermediate results, answers, or will print an entire program listing at the press of a key. In addition, a simple program allows you to print the calculator's entire data memory content.

Your SR-52 or SR-56 plugs directly into the PC-100. Turn the key and you are ready to print. A quiet, reliable thermal printer operates at 3 lines per second, printing 10 significant digits, exponents, decimal points, symbols, and signs.

At its new, low price, the PC-100 is now an even greater value. See it today at your Texas Instruments retailer and learn how inexpensively you can add new versatility to your TI programmable calculator.



†Offers good in United States and Canada only. Offers void where prohibited by law.

\*U.S. suggested retail price, may vary elsewhere.

### TEXAS INSTRUMENTS INCORPORATED

#### SR-52 FREE Software. Expires March 31. M

Indicate choice of 2 software libraries below and (1) return this completed coupon along with (2) your completed SR-52 serialized customer information card (packed in box) and (3) a dated copy of proof of your purchase, verifying purchase between Jan. 20 and March 31, 1977, to:

**SR-52 Software Offer**  
P. O. Box 1210  
Richardson, Texas 75080

Name \_\_\_\_\_

Address \_\_\_\_\_

City \_\_\_\_\_ State \_\_\_\_\_ Zip \_\_\_\_\_

SR-52 Serial No. \_\_\_\_\_ (from back of calculator)

Math     Statistics     Finance     EE

Texas Instruments reserves the right to substitute software libraries of equal value based upon availability. Please allow 30 days for delivery. ED1B

#### SR-56 \$10 Rebate. Expires March 31. M

Texas Instruments will rebate \$10.00 of your original SR-56 purchase price when you (1) return this completed coupon, (2) along with your completed SR-56 customer information card (packed in box), and (3) a dated copy of proof of your purchase, verifying purchase between Jan. 1 and March 31, 1977, to:

**SR-56 Rebate Offer**  
P. O. Box 1210  
Richardson, Texas 75080

Name \_\_\_\_\_

Address \_\_\_\_\_

City \_\_\_\_\_ State \_\_\_\_\_ Zip \_\_\_\_\_

SR-56 Serial No. \_\_\_\_\_ (from back of calculator)

Please allow 30 days for rebate. ED1B



HAYDEN

# in personal computing books!

## See for yourself the reasons why:

**1. MICROPROCESSORS: New Directions for Designers** by Edward A. Torrero, #5777-6, paper, 1975, 144 pp., 8½ x 11, illus., \$10.95.

**2. GAME PLAYING WITH COMPUTERS** Rev. 2nd Ed., by Donald D. Spencer, #5103-4, cloth, 1976, 320 pp., 6 x 9, illus. \$16.95.

**3. FUNDAMENTALS AND APPLICATIONS OF DIGITAL LOGIC CIRCUITS** by Sol Libes, #5505-6, paper, (\$6.95), #5506-4, cloth, (\$9.95), 1975, 192 pp., 6 x 9, illus.

**4. COMPUTERS IN ACTION: How Computers Work** by Donald D. Spencer, #5861-6, paper, 1974, 160 pp., 6 x 9, illus., \$5.50.

**5. COMPUTERS IN SOCIETY: The Wheres, Whys and Hows of Computer Use** by Donald D. Spencer, #5915-9, paper, (\$5.50), #5916-7, cloth, (\$7.50), 1974, 208 pp., 6 x 9, illus.

**6. PROGRAMMING PROVERBS** by Henry F. Ledgard, #5522-6, paper, 1975, 144 pp., 6 x 9, illus, \$6.50.

**7. PROGRAMMING PROVERBS FOR FORTRAN PROGRAMMERS** by Henry F. Ledgard, #5820-9, paper, 1975, 144 pp., 6 x 9, illus., \$6.50.

**8. COBOL WITH STYLE: Programming Proverbs** by Louis J. Chmura, Jr., and Henry F. Ledgard, #5781-4, paper, 1976, 144 pp., 6 x 9, illus. \$5.45.

**9. MINICOMPUTERS: Structure and Programming**, by T.G. Lewis and J.W. Doerr, #5642-7, cloth, 1976, 288 pp., 6 x 9, illus., \$12.95.

**10. PATTERN RECOGNITION** by M. Bongard, #9165, cloth, 1970, 256 pp., 6 x 9 illus., \$14.90.

**11. DIGITAL SIGNAL ANALYSIS** by Samuel D. Stearns, #5828-4, cloth, 1975, 288 pp., 6 x 9, illus., \$19.95.

**12. BASIC BASIC: An Introduction to Computer Programming in BASIC LANGUAGE** by James S. Coan, #5872-1, paper, (\$7.95), #5873-X, cloth, (\$9.95), 1970, 256 pp., 6 x 9, illus.

**13. ADVANCED BASIC: Applications and Problems**, by James S. Coan, #5856-X, cloth, (\$8.95), #5855-1, paper, (\$6.95), 1976, 192 pp., 6 x 9, illus.

**14. FORTRAN FUNDAMENTALS: A Short Course** by Jack Steingraber, #5860-8, paper, 1975, 96 pp., 6 x 9, illus., \$4.95.

**15. DIGITAL TROUBLESHOOTING: Practical Digital Theory and Troubleshooting Tips** by Richard E. Gasperini, #5708-3, paper, 1976, 180 pp., 8½ x 11, illus., \$9.95.

**16. DIGITAL EXPERIMENTS** by Richard E. Gasperini, #5713-X, paper, 1976, 192 pp., 8½ x 11, illus., \$8.95.

## Write for 15-day examination copies of any of these books!

*At the end of 15 days, please remit payment plus postage and handling, or return the books and owe nothing. Prices subject to change without notice. If payment*

*accompanies order, we pay postage and handling. Outside USA, cash must accompany order — include \$2.00 per book for shipping and handling.*



**Hayden Book Company, Inc.**

50 Essex Street, Rochelle Park, New Jersey 07662

phone: (201) 843-0550



# Hot-molded resistors provide low temperature coefficient and unmatched reliability.

The Resistance Temperature Coefficient of Allen-Bradley hot-molded fixed resistors is typically less than 200 PPM over the entire resistor range shown in the normal equipment operating temperature of +15°C to +75°C. Excellent RTC ratings have always been an Allen-Bradley benefit. And consistency of Allen-Bradley resistors means repeatable results and tight performance patterns. Allen-Bradley resistors offer the **lowest cost—on the board—**where it counts!

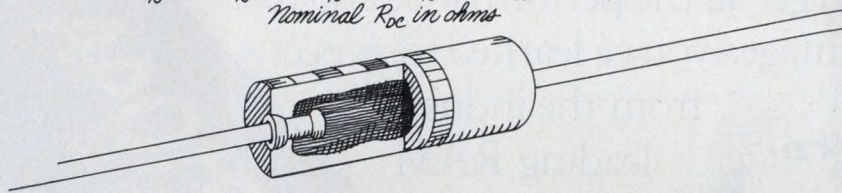
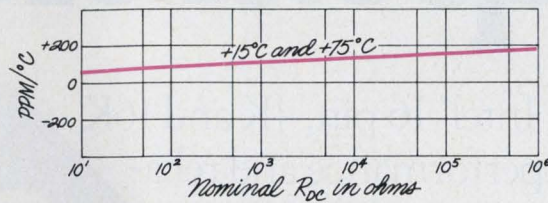

### *Reliability*

is unsurpassed. Over 700 million unit test hours without a single failure.

### *No coatings*

Insulation and resistance element integrally molded into one solid structure.

### *Pulse-handling*

characteristics offer outstanding protection against surges and transients.

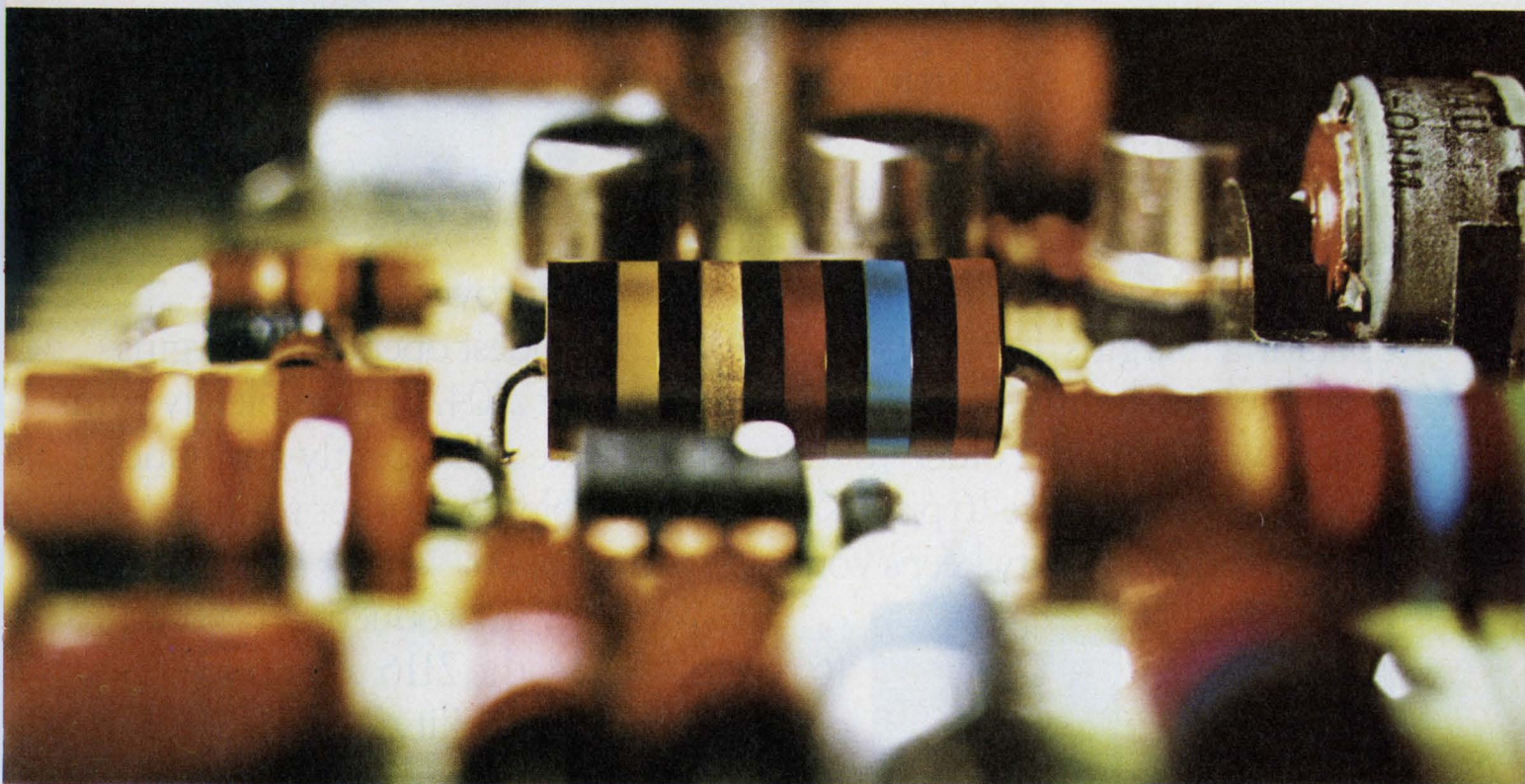

## Quality in the best tradition.



**ALLEN-BRADLEY**

Electronics Division  
Milwaukee, Wisconsin 53204

CIRCLE NUMBER 9

# Intel delivers compatible 4K

Standardize on Intel® 16 pin, 4K and 16K RAMs, and get all the performance and reliability advantages you've learned to expect

from the industry's leading RAM producer.

It all starts with our

volume-produced 2104A 16 pin 4K RAM. There isn't a faster 4K anywhere — nor lower power. And because the

2104A has significantly lower current spikes than other 4Ks, there's less system noise and improved operating margins. In fact, the 2104A has the widest operating margins available — including  $\pm 10\%$  on all supplies. The 2104A is completely compatible with both the older 4096 type metal gate and recently-announced 4027 type silicon gate 16 pin 4K RAMs available from other sources. Planned compatibility keeps your alternatives open.

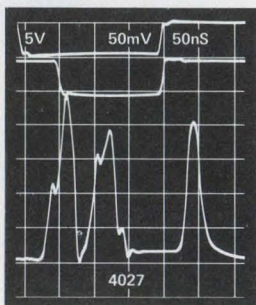
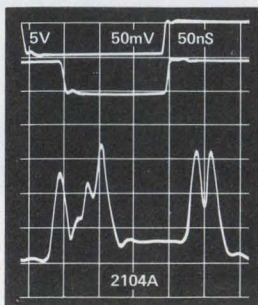
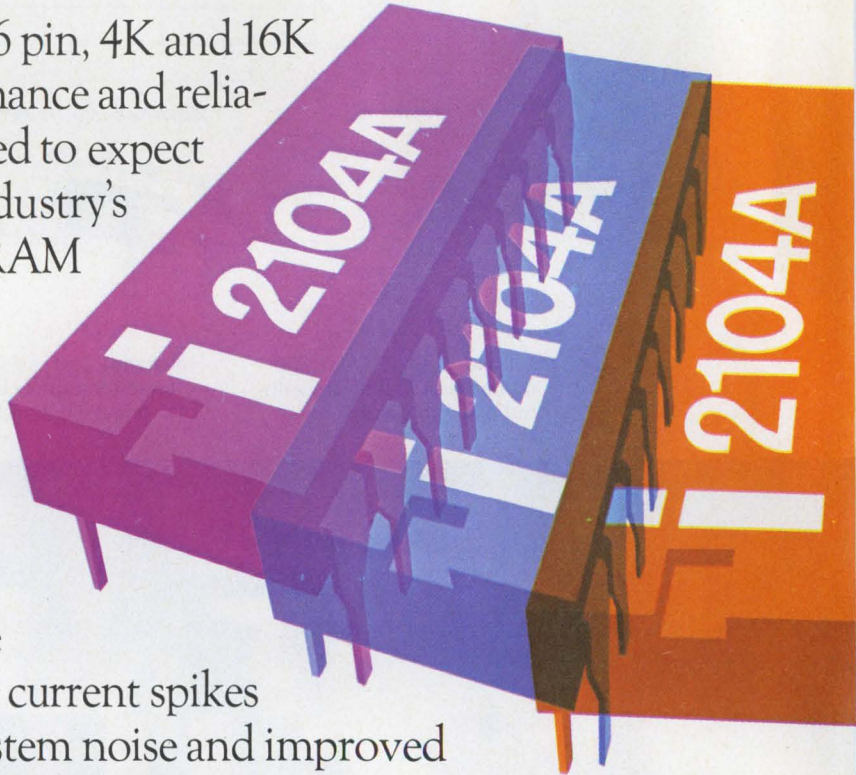

We're now in production on our 16 pin 16K RAM, the 2116. Again we've planned for compatibility. The 2116, 16K is completely interchangeable with our 4K 2104A. The 2116 provides four times the density per package at half the power per bit. Like the 2104A, it provides a  $\pm 10\%$  margin on power supplies. And because the 2116 includes an output latch identical to all 16 pin 4K RAMs,

# the first and 16K RAMs.



the need for external latches is eliminated and conversion from 4K to 16K is simplified. You can choose from several refresh modes including 4K compatible 64 cycle or RAS-only 128 cycle. The 64 cycle refresh improves memory throughput by doubling the time between refresh cycles. This mode also enhances page mode operation and reduces refresh standby power by 15% or more without any increase in operating power. And to make your design job even easier, we've provided the 3242

Address Multiplexer/Refresh Counter.

Whether you're looking for the performance advantage in 16 pin 4K RAMs or for the easiest way to get a 16K into your new designs, you'll find Intel delivers your best choice—the 2104A or 2116.

INTEL 16 PIN, 4K & 16K RAMs				
Part Number	Mem. Capacity	Max. Access Time (ns)	Cycle Time (ns)	Max. I <sub>DD</sub> (mA)
2104A-1	4K	150	320	35
2104A-2	4K	200	320	32
2104A-3	4K	250	375	30
2104A-4	4K	300	425	30
2116-2	16K	200	350	69
2116-3	16K	250	375	68
2116-4	16K	300	425	65

For Data Sheets and our 16-page Application Note, use the reader service card or write Intel Corporation, 3065 Bowers Avenue, Santa Clara, California 95051.

**intel® delivers.**

# Our newest air variable capacitor's biggest feature:



**It's small size.**

As you can plainly see, our new air variable capacitor is nearly as small as many sub-miniature ceramic trimmers. It also features the same mounting configuration which means you can use it in many of the same applications.

But small size isn't the only reason for buying our new Micro T™ capacitor. Because it's air variable, it offers you

great stability. Q is typically 1000 at 100 MHz. TC is  $+45 \pm 45$  PPM/°C. And it's available in maximum capacities of 3, 6.5, 12.7, and 19.0 pF in either vertical or horizontal tuning PC and stripline mounting versions. What's more, it gives you all this for a very small price.

E. F. Johnson Company/Dept. E.D., Waseca, MN 56093

Please send me technical information on sub-miniature air variable capacitors.

Please send me samples. You can call me at \_\_\_\_\_

Name \_\_\_\_\_

Firm \_\_\_\_\_

Address \_\_\_\_\_

City \_\_\_\_\_ State \_\_\_\_\_

Zip \_\_\_\_\_

For fast service, contact your local Johnson Distributor.



**JOHNSON**

CIRCLE NUMBER 12

## ACROSS THE DESK

(continued from page 7)

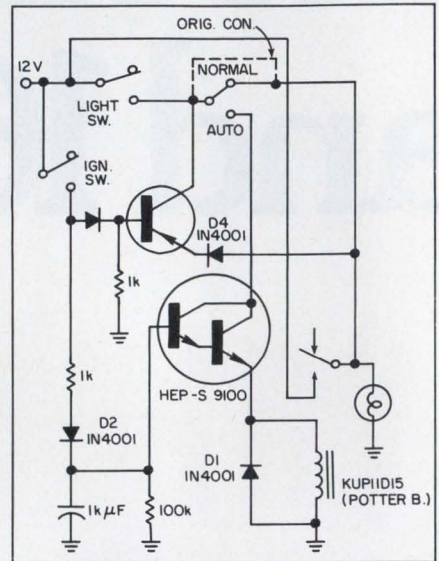

tion switch, so  $D_2$  is added to the circuit to prevent discharge of  $C_1$  through other accessory circuits.  $D_3$  isolates  $Q_1$  from the 1000- $\mu$ F capacitor;  $D_4$  in the  $Q_1$  emitter circuit permits  $Q_1$  to be turned off by the +12-V source with  $D_3$  in the base circuit.

*William R. Sloan  
PE, Indiana*

4935 Ivy Brook Dr.  
Fort Wayne, IN 46815

## Misplaced Caption Dept.



The damn circuit breaker always seems to go just when I get to an interesting part of a book.

Sorry. That's Georges de la Tour's "The Education of the Virgin," which hangs in the Frick Collection in New York City.

CIRCLE NUMBER 13 ►



# We never compromise

ON QUALITY, OF COURSE . . . WHY SHOULD YOU ?



## THE TABOR 608A 3 1/2 DIGITS DIGITAL MULTIMETER

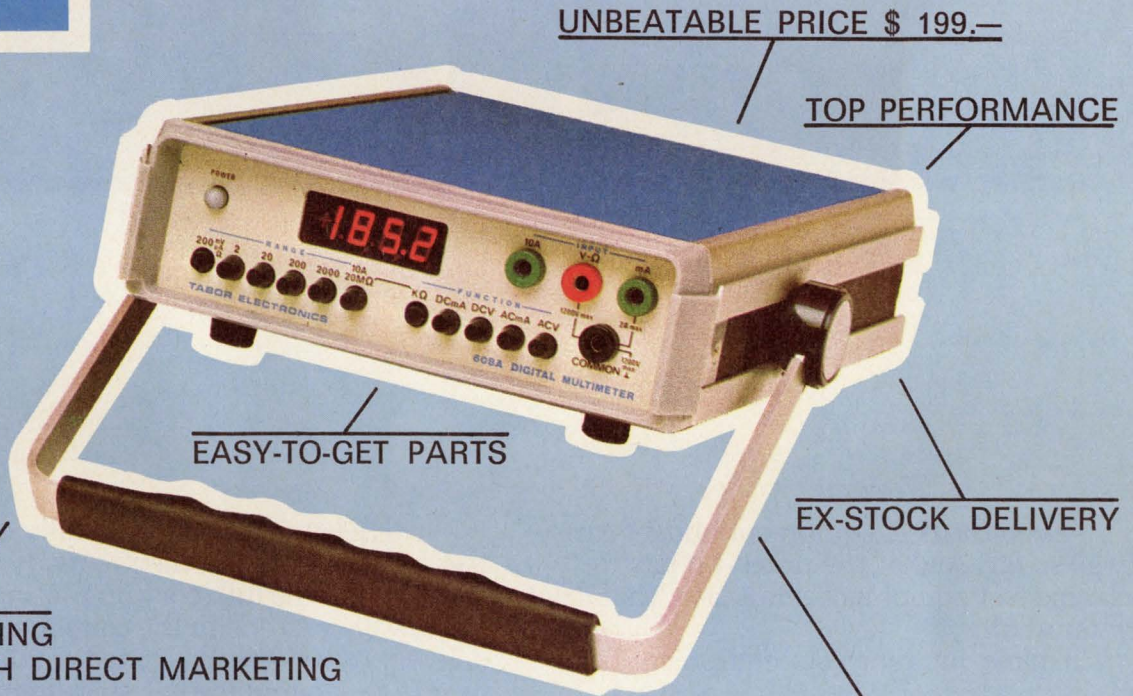

UNBEATABLE PRICE \$ 199.-

TOP PERFORMANCE

EASY-TO-GET PARTS

EX-STOCK DELIVERY

NET SAVING THROUGH DIRECT MARKETING

EXTENDED WARRANTY PERIOD INSTANT SERVICE.

- 28 ranges of volts, amps and ohms
- 0.1% accuracy.
- Bright LED readout
- Auto Polarity
- Auto Zero
- Overrange indication
- Overload Protected
- Compact, rugged all metal case
- Line operation
- LSI/MOS reliability

CHECK ENCLOSED FOR..... UNITS.

PLEASE SEND COMPLETE SPECS.

Name .....

Title ..... Phone .....

Company .....

Address .....

City .....

State..... Zip.....

in the U.S. call : (516) 643-4500 ARROW ELECTRONICS INTERNATIONAL, 38 Kean St. West Babylon, L.I. N.Y. 11704

**You can buy  
this Spectrum Analyzer  
and take a big chunk  
out of your budget.**

**You can rent  
this Spectrum Analyzer  
and get more  
equipment out of  
your budget.**

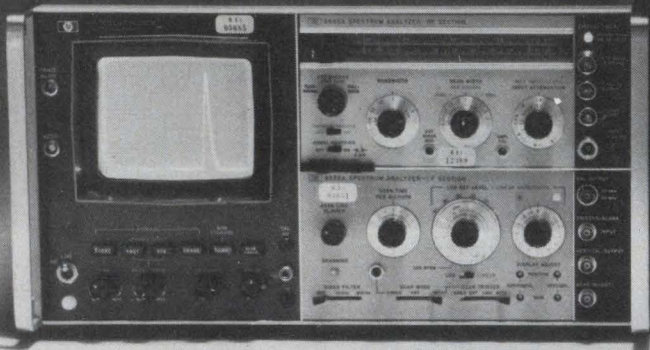

Even the best equipment budget can only go so far. And at the price you pay for electronic test equipment nowadays, that's not very far at all.

Unless you rent your equipment from REI.

When you rent from us, there's no large cash outlay. You pay only for the time you have your instruments, and you return them when you're through. So you never have to spend your money on idle equipment.

Getting more for your money is just one reason for renting from REI. Immediate delivery is another. We have over \$10 million in inventory in fully stocked centers around the country. And, when you have short-term needs, you can rent equipment for just as long as you need it, and make it pay for itself.

REI stocks over 8,000 fully checked-out test instruments, and they're ready whenever you are. For the full story on renting, as well as our low prices, send in the coupon for prompt delivery of our free illustrated catalog... or call us now for your immediate requirements.

Rental Electronics, Inc.  
99 Hartwell Avenue, Lexington, Mass. 02173  
Please send me your free instrument rental catalog:

Name \_\_\_\_\_ Title \_\_\_\_\_

Company \_\_\_\_\_

Address \_\_\_\_\_

City \_\_\_\_\_ State \_\_\_\_\_ Zip \_\_\_\_\_

Tel. Number \_\_\_\_\_

**Rental Electronics, Inc.** 

Burlington, MA (617) 273-2770 • Gaithersburg, MD (301) 948-0620 • Oakland, NJ (201) 337-3757 • Ft. Lauderdale, FL (305) 771-3500  
• Des Plaines, IL (312) 827-6670 • Dallas, TX (214) 661-8082 • Mountain View, CA (415) 968-8845 • Anaheim, CA (714) 879-0561  
• Rexdale, Ontario (416) 677-7513

CIRCLE NUMBER 14

MARCH 1, 1977

## Digital wristwatch contains a scientific calculator

The first wristwatch to incorporate a scientific calculator minimizes current drain with CMOS and a liquid-crystal display. Competitive products from Pulsar, Unisonic and Uranus have LED displays and can perform only simple mathematical operations.

Announced by National Semiconductor's Consumer Product Division, Sunnyvale, CA, and the Winder Watch Co., Los Angeles, the watch features an eight-digit, fully scientific calculator that displays the six most significant digits without any buttons being pressed. The remaining two can be shown by pressing a button. In addition, the calculator has a memory in which eight digits can be stored.

Not only can the watch process natural and common logarithms and their antilogs as well, but it can also compute the angular and inverse functions of sine, cosine and tangent.

The calculator is preprogrammed to perform square-root reciprocal and  $\pi$  functions as well to change signs.

Although the wrist machine normally operates in the floating-point mode, any number from  $10^{-99}$  to  $10^{99}$  may be entered via a scientific-notation key. In this case the display presents a one, two or three-digit mantissa with two digits for the scientific notation.

The calculator keyboard is activated by a pointed object like a stylus or a ball-point pen.

Of the 20 keys on the keyboard, the calculator operations use 19. Eighteen of these calculator keys are dual-function while one is a "function" key for accessing a second function on the individual keys.

Operating any of the calculator keys instantly puts the watch into the calculator mode. It remains in this mode until a "watch" key is

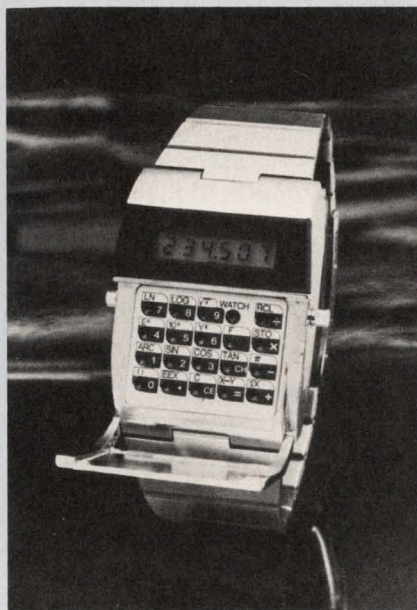

depressed. The device then returns to the timekeeping mode.

In this mode the watch can display hours, minutes, seconds, the month, the day of the week and the date. The latter three functions are controlled by a built-in automatic calendar.

To reduce power consumed during calculations, the chip is designed to sacrifice some computation speed. Consequently, some calculations can take as long as 13 s before an answer is displayed. While the calculator is processing the figures, an indicator blinks.

The watch uses only two batteries, not six as in competing units. Two backlights make the display readable at night. Suggested selling price is \$350.

### Do-it-yourself with MOS and bipolar IC

A monolithic array of unconnected transistors, resistors, and capacitors developed at Stanford University's Integrated Circuits Laboratory incorporates bipolar

and MOS devices on a single substrate. By masking one customizing aluminum interconnect pattern onto the die, the array can be transformed quickly into virtually any simple digital or linear circuit.

Called the Kitchip, the device was described at the International Solid State Circuits Conference in Philadelphia last month. Stanford isn't selling the device on the open market. "But if someone were willing to tool up, it could be a commercial product," says Stephen R. Combs, a graduate student at the California school and Kitchip project leader.

"The Kitchip brings high-performance, low-cost ICs to a previously unaddressed class of applications, namely small-scale, low-volume circuits," says James D. Meindl, a Stanford professor and Combs' advisor. "The ready availability of an advanced integrated circuit that combines linear, quasi-linear, digital, and analog multiplex functions on a single chip should have significant impact," he says—especially when combined with quick turnaround from design to production.

According to Meindl, 22 circuits have been fabricated on an early version of the Kitchip in the past year. But that version has a major limitation: It is all bipolar. Yet it still made possible a number of products that could not be built with commercially available ICs, says Meindl. Important biomedical applications include a complete, four-channel, implantable ultrasonic blood velocity meter; an implantable pressure, biopotential and temperature telemetry system; and a micropower command receiver. But at the same time, he adds, "more complex future systems will require both MOS and bipolar circuitry."

Until now, mixed MOS and bipolar processing on a single chip has been used in such commercial products as RCA's 3140 bipolar-FET op amp, but not in uncommitted transistor arrays. Only bipolar devices are available in mask-customized arrays, such as the ones supplied by Interdesign, Exar, and Stewart-Warner.

The devices available on the Kitchip include n and p-type transistors that are bimodal—that is, they can be wired on the final mask to function as MOSFET or bipolar

devices. In addition, there are VMOS switches for signal multiplexing, low and high-value resistors, and a junction FET. Each die contains over 200 bimodal, 12 committed-pnp, 8 JFET, and 4 high-current n-type transistors. The devices are laid out on a 160-mil-square chip so that a number of common analog circuit blocks such as balanced multiplexers, active-load differential pairs and current mirrors can be formed easily.

Since the operational mode of any of the bimodal transistors is determined only by the metal interconnection pattern, such combinations as low-power CMOS or complementary bipolar logic with high-performance MOS or bipolar linear circuits can be manufactured on the same chip.

## A 7-1/2-digit DVM —another first

The first 7-1/2-digit (14,000,000-count) voltmeter available in the U.S. is being marketed by Guildline Instruments Inc. of Larchmont, NY. Guildline calls the \$3995 instrument the Model 9577. Schlumberger's Solartron Electronic Group Ltd. of Hampshire, England, which makes the unit, has been marketing it in Europe since last year as the Model 7075 Maestro. Solartron ships it to Guildline, which tweaks in its calibration pots and handles its sales and service in the U.S.

Until now, the highest-resolution DVM available in the U.S. was the 6-1/2-digit Model 6900 by Dana Laboratories Inc. of Irvine, CA, and marketed by Dana and Keithley Instruments Inc. of Cleveland. The Guildline/Solartron's higher resolution is useful in making transfer measurements (comparing one voltage with another). But a rated accuracy of 3 parts-per-million of reading plus 15  $\mu$ V on the 10-V range, for example, translates into a possible error of  $\pm 52$  counts. That uncertainty makes the last digit meaningless in absolute measurements.

The 9577 measures dc voltages, true-rms values of ac voltages, resistances, ratios of dc/dc and dc/ac voltages and temperature (with an external resistance thermometer). Maximum resolution is 1  $\mu$ V or 1 m $\Omega$ .

## PCB dielectric replaced by a safer fluid

A new PCB-free dielectric fluid, Dielektrol, developed by General Electric in Hudson Falls, NY, is now used to impregnate capacitors. The fluid (phthalate ester) virtually eliminates environmental risk, while matching and even exceeding the performance of PCB. Moreover, it fits existing material and manufacturing processes and doesn't add substantially to cost.

The fluid is nontoxic, biodegradable and neither persists, nor accumulates in the environment or in the tissue of living organisms. And it presents no hazards when incinerated or placed in approved landfills.

Environmental testing on mammals, fish, birds and micro-organisms uncovered no apparent damage. Massive doses of Dielektrol fluid were consumed, inhaled or contacted by skin or eye tissue, but revealed no harmful effects. Chronic toxicity tests—assessing the effects of smaller doses over longer periods of time—are in process.

The fluid provides electrical properties similar to PCB throughout the normal temperature ranges, and has a low dissipation factor even after extensive life tests.

However, the fluid is combustible. Dielektrol I (used in smaller-sized capacitors) has a flash point at approximately 165 C, and Dielektrol II (used in power capacitors) at over 250 C. Like all other PCB replacements developed to date, Dielektrol is classified IIIB-combustible.

Nearly all capacitor designs that use Dielektrol I feature General Electric's patented internal pressure-sensitive interrupter. Dielektrol II tends to self-extinguish, because of its higher flash point. Also, power capacitors using Dielektrol II must be properly fused.

## Recorded messages to be stored in bubble memory

A recorded-message machine that stores its message in a magnetic bubble memory is being tested in a Detroit switching office of the Michigan Bell Telephone Company. Called the 13A announcement

system, the Bell Labs machine records and announces standard, repetitive 12 or 24-s "call assist" messages for up to 500 telephone lines—all at the same time.

The 13A has a number of advantages over its predecessors, which record on a magnetic drum, according to a Bell Labs spokesman. While messages on a magnetic-drum unit eventually degrade and must be re-recorded message quality in the bubble memory remains good. And where the earlier system can handle but one message, the 13A records and announces up to eight.

The improved message recorder stores each message on a separate PC board, which holds two magnetic bubble packages. Each package, about half the size of a cigarette pack, contains four bubble chips. The chip can store up to 68,121 bits of information.

Before speech is stored in the magnetic bubbles, it is electronically encoded into digital information. The storage capacity of each package is 12 s of digitized speech. A special electronic decoder reconstructs the voice signals when needed.

## Antenna receives sub signals at 100-m depth

A superconducting receiving antenna for submarines that has been tested to 100-m depth overcomes the receiving limitations of current long-range submarine-communications systems. These systems operate in the 3 to 30 kHz vlf band. At those frequencies, radio waves do not penetrate very deeply into the sea.

Three superconducting quantum-interference devices (SQUIDS) make up the antenna, which was developed and tested by scientists at the Naval Research Laboratory, Washington, DC. These highly sensitive, magnetic-field sensors can receive signals in the 30 to 300 Hz elf band, which penetrate much more deeply into the sea than the higher-frequency signal.

Elf signals from the Navy's Clam Lake, Wisconsin high-power transmitter were successfully received by the SQUID antenna at a surface field site, as well as 100 m below the ocean surface.

# bare facts

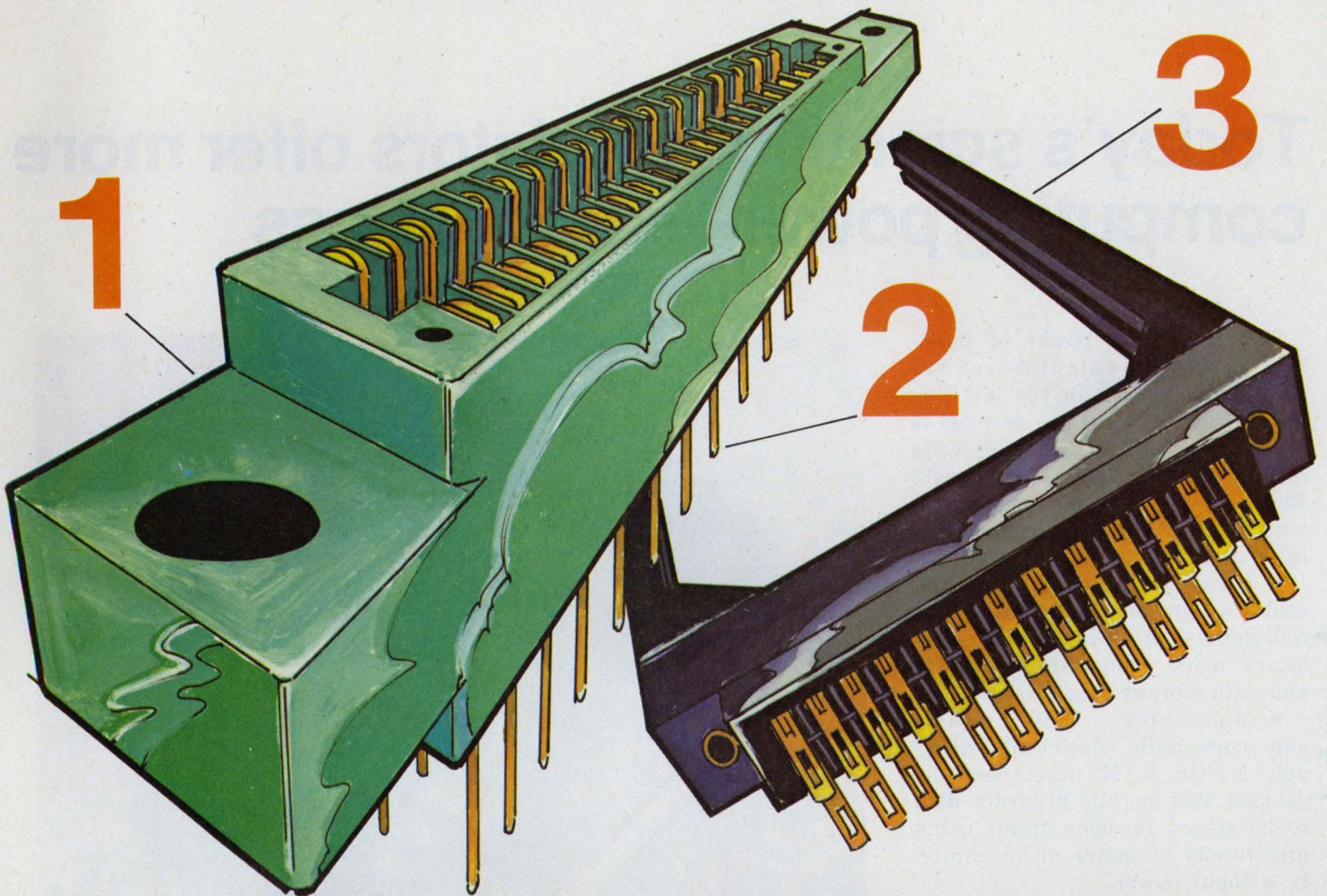

**1** Card-edge connectors for any application you may have. And thanks to our gold miser's selective plating, they're available at a price that's probably less than you expected to pay. Ready at your local distributor whenever you need them, wherever you need them.

**2** Contact spacings are .100", .125", .156" and .200" with contacts numbering from 6 to 100. Included are crimp, solderless wrap and solder terminations. Contacts are bifurcated bellows and cantilever. Really everything you've ever wanted in a card-edge connector and then some. The list goes on and on — like our capability to customize or completely design and manufacture a new connector just for you.

**3** Quality and reliability are assured by completely controlled in-house manufacturing processes — from stamping, plating and molding through final assembly. Many of our card-edge connectors meet stringent military specifications and are QPL approved to MIL-C-21097.

These bare facts prove we can give you great connections . . . worldwide.

Elco Corporation  
2250 Park Place, El Segundo, Ca. 90245  
TWX 910-325-6602  
213 675-3311



**Elco Corporation**

a Gulf + Western manufacturing company

## Today's scientific calculators offer more computing power—and cost less

The computing power of hand-held scientific calculators has doubled or trebled in the last two years. But their cost has dropped to one-third or less of what they were priced at that time. The reason? Rapid progress in diverse technological areas contributing to calculator design features.

- More computing and peripheral circuitry has been packed onto individual LSI chips, giving calculators more computational power and data storage capabilities.

- Microampere CMOS RAMs and nonvolatile electrically alterable MNOS RAMs have been developed that permit program data to be stored for long terms using microwatts of power or indefinitely without power.

- Power requirements have been lowered with more efficient circuitry and displays and by incorporating dissipative off-chip components into the chips.

- Small, low-power printers have been developed that are suitable for hand-held machines.

- More rugged rechargeable nickel-cadmium (NiCd) batteries have been developed that overcome early-failure problems caused by excessive recharging, inadvertent polarity reversal and cell shorting.

- The reliability of liquid-crystal displays (LCDs) has been improved, so once again they are turning up in a growing number of new calculators. Their low current drain—plus the use of CMOS—permits watch-type button cells to be used that power the units for months at a time.

- Solar-cell costs have been lowered and their efficiency raised



**New algorithms, improved arithmetic and added operating functions** are increasing the computing power of new generations of calculators. In this TI SR-56, computational capability is enhanced through the incorporation of a 100-step program that is executed by simple key entry.

enough for them to be incorporated into calculators with LCDs and CMOS circuitry to keep the batteries charged.

The net effect of these and other advances has been to establish a number of significant industry trends.

First of all, the prices of scientific calculators continue to drop from the most costly to the cheapest units. But because of the higher chip densities and improved algorithms and calculator architectures, computing power has been rising constantly.

For example, on the high end, Hewlett-Packard's newest mag-

netic-card programmable unit, the HP-67, costs \$450—\$345 less than HP's first model, the 65, which came out just two years ago. But the 67 (or the 97, its printer equivalent) has over three times the memory, power and program capacity of the 65, points out Glenn Theodore, product line manager at HP's Corvallis, OR, plant.

"The 67 has 224 steps, versus only 100 for the 65. But the 67's program capacity is well over 300," Theodore adds. The reason is that all calculator functions occupy but one step of a program memory on the 67 and 97, even though entering those functions requires multi-

# This time it's Model 248. A new 4<sup>1</sup>/<sub>2</sub>-digit miniature DMM offering True RMS measurement and 10 $\mu$ volt sensitivity for only \$345.

The Model 248 is further proof of Data Precision's continuing commitment to bring you today's most accurate and reliable instruments at the lowest possible price.

No other True RMS 4<sup>1</sup>/<sub>2</sub>-digit portable multimeter combines such high performance, size and price with so many measurement functions.

You'll get sensitivity to 10 microvolts DC and AC, unsurpassed  $\pm 0.05\%$  basic accuracy, guaranteed for one year, in a truly portable, easy to read instrument.

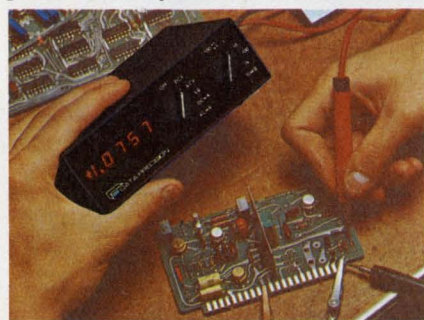

Measuring just 5<sup>1</sup>/<sub>2</sub>" x 1<sup>3</sup>/<sub>4</sub>" x 3<sup>1</sup>/<sub>2</sub>", and weighing only 1.3 pounds, our 248 is the only rechargeable portable 4<sup>1</sup>/<sub>2</sub>-digit DMM that brings you the advantage of True RMS voltage measurements from 10 microvolts to 500V and current from 10 nanoAmps to 2A. With a maximum crest factor of 5 at nominal range input and 2<sup>1</sup>/<sub>2</sub> at the 100% over-

range level, the 248 measures all but the most bizarre analog waveforms at 2<sup>1</sup>/<sub>2</sub> readings per second. With only 2 controls—Function and Range—and the bright 0.33" LED display for easy reading in any light, you'll save time on



every job. And Data Precision's overload protection circuits make it forgiving of mistakes.

Everything you need to put the 248 into service is supplied with the instrument. Nothing else to buy. No extra costs. Standard accessories include the rechargeable NiCd battery module, a pair of test leads, line cord with



charger, carrying case, and full instruction manual and test data.

The Model 248 is available throughout the world from Data Precision representatives. And service is available from any of our world-wide service centers.

For complete information or a demonstration, contact your local Data Precision representative or Data Precision Corporation, Audubon Road, Wakefield, MA. 01880, USA, (617) 246-1600. TELEX (0650) 949341.



Price U.S.A.

# We've done it again.

**DATA PRECISION**<sup>®</sup>  
...years ahead

ple keystrokes.

This feature is called "all-merge" codes. For example, if a function requires a shift key plus another key, the operation occupies only one program step. This capability is particularly important for storage and recall operations from data registers, Theodore notes, which are the most frequently used functions in programming. In the HP-65, only a limited number of functions can be merged.

The 67's program capacity is further enhanced by such programming functions as indirect addressing. The address of a label or a data register can be stored in the indirect or I register.

The program instruction can call for STORE Indirect or GO TO indirect, in which case the machine will store the address into or retrieve it from the I register. Thus, the user can decrement, for instance, in a loop in which you might want to store successive pieces of data in successive data registers.

### HP's reader-prompter

The third significant advance in the HP-67 is the "smart" card reader. This magnetic reader can record not only programs but also data for reentry into the calculator. It also prompts the user for proper operation—that is, the card has two sides and each side may contain either data or program information, but not both at once.

If the card must be passed first through side 1 and then through side 2 to load the program memory, the card can be entered without worrying about which side is being read. It will load whatever is on the card into the proper location.

Advantages of the merged-key code have been incorporated by Mostek into a new key-programmable 12-digit calculator design that combines the company's MK 50075 ALU chip with its MK 50107, 50108, 50109 and 50110 ROMs. The combination provides a 100-step program memory, but the merged-key code packs considerably more than 100 keystrokes into it, says Mike Andrakin, Mostek software specialist. The shift, inverse, hyperbolic and program keys occupy no storage, but rather are merged with the keystroke that follows. Texas Instruments' mag-

netic-card, programmable SR-52 (\$249.95) has 224 program memory locations like the HP-67, but it doesn't have all-merged code. Even so, loading the program memory doesn't affect 20 other memory registers, the program flags, the program counter or the display format.

By remembering which half of the program memory was read last, it is possible to load a program without affecting the internal processing registers or the displayed number. In other words, if a program exceeds the 224 steps, it can be partitioned into segments that separately fit into the program memory. The program is then exe-



Metric-to-English measure conversions are a special feature of this National Semiconductor 4660 unit. It is totally programmed.



A complete 224-step program can be loaded from a small magnetic card into this TI SR-52 in two seconds.

cuted by sequentially reading and running the load segments.

The SR-52 stores 224 program instructions with two passes of its magnetic card. Side A is read into program memory locations 000 to 111, while side B is entered into locations 112 to 223.

Texas Instruments has been able to improve the algebraic manipulation of its latest series of machines by means of, in the company's words, an enhanced algebraic operating system (AOS), which is compatible with Fortran.

The earlier TI calculators used an algebraic notation with a hierarchy that put multiplication and division on a higher level than addition and subtraction.

But the new AOS puts powers of numbers on a higher level than multiply and divide, notes Rod Wilmont, TI's product manager for professional calculators. "With the AOS you can do the following:  $1 + 2 \times 3^4$ . The calculator will store all of the operations and numbers and enter the power of four," says Wilmont.

The limitation of the earlier TI algebra was due, in part, to the lack of sufficient storage registers, Wilmont adds. For example, the SR-50 had only one register in which to store a single number. But the improved circuit density of the SR-52 chips makes room for 10 internal processing registers to hold operands for calculations in progress.

### Most powerful machines today

The HP-67 and the TI SR-52 are the only magnetic-card programmable calculators available.

With their magnetic cards, the HP-67 and TI's SR-52 are the most powerful hand-held calculators today. But soon they will be challenged by a calculator from National Semiconductor that will use solid-state program cartridges instead of cards. These cartridges will contain 4096-step ROMs. Each ROM will provide a library of engineering, or math or statistical programs.

Slated to be available this spring for about \$400, the 7100 will have not only 4096 steps available in the program cartridge but also 240 steps of mainframe program storage in pseudo-nonvolatile CMOS RAMs. According to Bob Johnson,



three  
The ~~one~~ and only...

Three Series of Amphenol® connectors are now qualified to MIL-C-26482, MIL-C-38999 and MIL-C-83723.

One company offers connectors qualified to all three specs—Amphenol Connector Systems, Bunker Ramo Corporation.

These three connector series are preferred under military standard MIL-STD-1353A. They're designed for general-purpose and high-density applications in ground-support and airborne equipment.

**Polymer retention is a big plus.** Each of these Amphenol connectors uses a one-piece, molded polymer retention disc. (It's an advanced design we pioneered. For a closer look at how it works, see the cross-sectional view at lower left.) Polymer retention eliminates as many as 128 troublesome metal clips. And you know the fewer parts there are, the less can go wrong.

**To learn more, call or write.** Ask about the wide range of shell sizes, insert arrangements and termination tooling available for the Amphenol Connector 118, 418 and 518 Series. And ask for a free catalog, too. Call Vince Pusateri, (312) 986-3761. Or write: Amphenol Connector Systems, Bunker Ramo Corporation, 900 Commerce Drive, Oak Brook, Illinois 60521.

MIL-C-83723/Series III  
Amphenol Connector 518 Series

MIL-C-38999/Series I & II  
Amphenol Connector 418 Series



MIL-C-26482/Series 2  
Amphenol Connector 118 Series

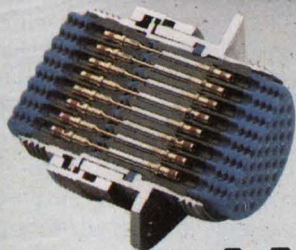

The right idea  
at the  
right time.

**AMPHENOL** Connector Systems **BUNKER RAMO**®

product manager for professional calculators, 256 program addresses will be available for accessing programs in the solid-state cartridges through the 240 steps built into the calculator. The 7100 has 480 user-writable program steps, all of which use fully merged instructions.

In addition, 37 working registers that are all addressable and four levels of subroutines are built into the 7100. Thus, subroutines can call subroutines, which gives it additional power, says Johnson.

One of the prime functions of a magnetic card is to record calculator programs and store them away. In the 7100, however, a plug-in cartridge like the one for the 4000-step ROM replaces the magnetic card, and a 240-step MNOS electrically alterable ROM replaces a program memory. This ROM stores the 240 steps from the mainframe memory. Of if desired, the blank EAROM can be plugged in to make 480 steps available to the mainframe. The 240 mainframe program steps are stored in CMOS RAMs, and as long as the battery is charged to any degree, the program will remain intact. The same condition holds true for the 32 data-storage registers.

### A trend to nonvolatile storage

The 7100's incorporation of either pseudo-volatile or nonvolatile memories to store programs when the calculator is off is an example of a growing trend. Another example is an HP calculator with a pseudo-volatile memory, the 25C. It is key programmable with reverse Polish notation and uses 49 program steps. Also, the 25C has a CMOS memory that retains 49 program instructions, plus all the data in eight addressable registers and the Last-X register.

When switched off, the calculator's programs and data are held by power from the rechargeable cells. If the batteries are removed, a capacitor furnishes temporary power.

Rockwell Microelectronic Device Division in Anaheim, CA, is currently developing a single-chip key-programmable scientific calculator that will have provisions for interfacing with a program-holding CMOS RAM. Called the A7000, the chip is expected to be available on



**Three times the memory, power and program capacity of the HP-65 is designed into the new \$450 HP-67.**

a sample basis by May.

A somewhat different approach is taken by Casio in its PRO-101 programmable unit, which has 256 program steps that can be divided up for a maximum of 15 programs. Designed for numerical rather than scientific calculations, the PRO-101 has a CMOS memory for program storage that is powered by three separate silver oxide button batteries. Should the main batteries—four AA primary or rechargeable cells—go dead, or optional ac power be turned off, the oxide batteries can retain data up to 12 months, according to Casio—provided no new programs are entered.

True nonvolatile storage has been demonstrated by General Instrument in a prototype calculator that interfaces GI EAROMs with one of the company's programmable calculator chip sets.

For the designer who doesn't need, or can't afford, the luxury



**A thermal printer aids programming and debugging in the HP-97 card-programmable machine.**

of a magnetic-card programmable calculator, the key-programmable type machines offer the next best solution.

Key-programmables without a semipermanent storage feature like that of the 25C—TI's SR-56 and the HP-25—are being challenged by a new generation of powerful lower-cost machines. The SR-56 costs about \$100 and the HP-25 \$175. But APF Electronics' Mark 90, which has 70 preprogrammed functions, costs \$69.95 and has 72 program steps with conditional and unconditional branching, looping and full editing. The editing operation includes stepping forward, backward, inserting, deleting, and No Operation. Single-step execution is also provided.

For added flexibility, the Mark 90 has 10 separate user-accessible data memories, which can be addressed individually or simultaneously.

For the user willing to write his own programs, a machine like the Mark 90 can be very cost-effective. But if a variety of complex engineering programs are required, the software already available from TI or HP may be worth the added calculator investment.

### Two-year price plunge

Over the past two years, prices for a wide variety of these lower-cost nonprogrammable calculators have even taken a tumble. But the computing power has risen. Two years ago, for example, the cheapest scientific unit with a few simple trig functions sold for about \$50. Today, a comparable machine sells for about \$20 and has 20 to 25 preprogrammed functions, including hyperbolics, factorials, roots and exponentials.

The higher-priced machines of today's nonprogrammable lines can be useful to the user who doesn't need the power of a programmable. One example is the \$69.95 Kingspoint 6010 (see photo), which is preprogrammed with more than 50 scientific and statistical functions. It has a 12-digit display—10 mantissas and 2 exponents—and operates in either floating-point or scientific notation. A seven-operating-register system permits problem entry in true algebraic mode notation and enables solutions without the use of memory. Ten

# AMP component sockets are sealed with silicone rubber. And can be inserted at up to 7,000 an hour. You can't beat that.

AMP component sockets. They're the ones that come in strip form. You can insert them at high speed and cut your costs. Use a bench press or, for really fast loading, a N/C machine. AMP can furnish the applicator and interface module for compatibility with most N/C machines.

And AMP keeps your product out of trouble by sealing its component sockets with silicone rubber. Which ends solder flux contamination and solder flooding.

Of course, they provide easy pluggability with either rectangular integrated circuit leads or .016 inch-.019 inch diameter leads. Their small head diameters permit .100 inch center-to-center mounting. Our sockets help you save on board costs too, as they seat securely in wide tolerance holes.

For more data on AMP component sockets, ask your AMP Sales Engineer. He's ready to help you in any way possible.

Or write or call AMP Incorporated,  
Harrisburg, PA 17105.  
(717) 564-0100.

CIRCLE NUMBER 18

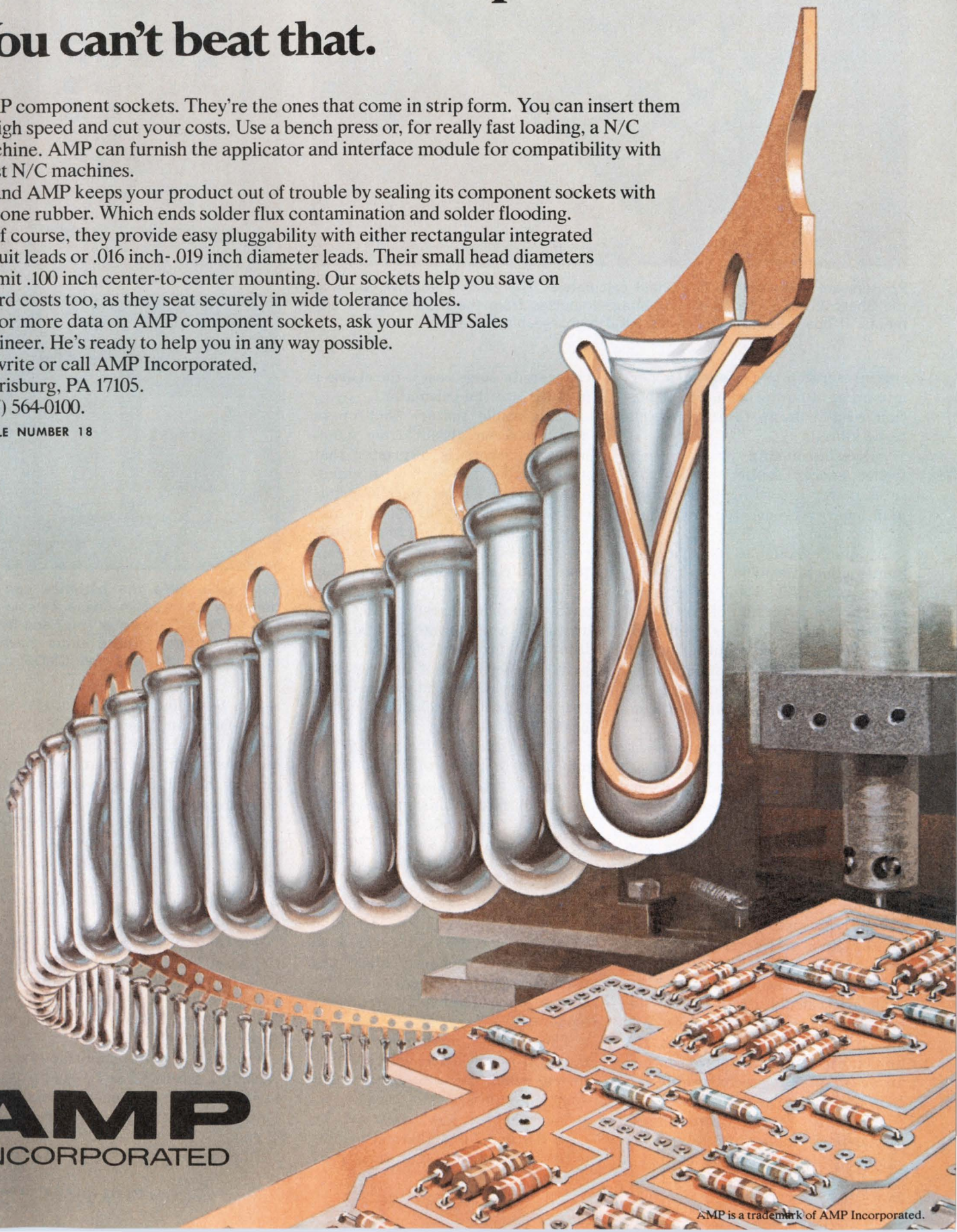

**AMP**  
INCORPORATED

AMP is a trademark of AMP Incorporated.



**Printers are appearing in hand-held calculators.** The electro-sensitive paper in the Sharp EL-8151 responds to voltage impulses from the printer matrix elements. It operates from the unit's NiCd rechargeable batteries.

special scratch-pad memories permit up to 10 intermediate calculation results or up to 10 constants to be stored.

A special on-chip, processor-controlled energy saving system allocates power according to the minimum energy needed for each phase of operation.

Another example is National Semiconductor's 4660 (see photo), which costs \$59.95 and is an algebraic-notation version of National's RPN-notated 4640. It is a scientific machine with 45 preprogrammed functions, including summations, factorials, polar-to-rectangular conversions and metric/English conversion functions.

The power needed to operate calculators has been substantially reduced within the last two years by two design improvements. First, dissipative discrete display-drive elements such as transistors and resistors have been eliminated by placing their functions on the chips in more efficient configurations. Second, the computational circuitry on the chips has been designed to require less energy.

For these reasons, many of the scientific calculators in the low-to-medium-price-fields—but not TI's and HP's—are now sold with AA dry batteries and the option to buy an ac adaptor or rechargeable AA cells and a charger.

However, the higher-priced, higher-performance machines are supplied with rechargeables and a

charger. In some cases, the charger is built into the calculator.

A desirable feature that up to now has been absent from hand-held calculators is a printer that uses a paper tape roll with standard office-machine, parallel-print-out format. This development has been held up by the lack of a low-cost, lightweight print mechanism that requires low power to operate.

But now two types of printers with suitable characteristics are available and being incorporated into new products. One of these printers uses a roll of electro-sensitive paper while the other has a thermal print mechanism using heat-sensitive paper.

The electro-sensitive printer has appeared in three of Sharp Electronics Corp.'s standard eight-digit, four-function business calculators. Two models—the \$79.95 EL-8051 and the \$99.95 EL-8151 (see photo)—use a 12-digit printer and 13-digit printer, respectively. Extra digits are for data entry.

A third machine, the EL-1163 (\$119.95) is a 10-digit model with a summation memory. All Sharp machines can be operated in either a print-and-display or display mode.

The printers operate directly off the built-in NiCd rechargeable batteries, which can give up to about 4000 lines in the print mode.

Thermal printers are used by both HP and TI. A thermal printer—the same same that in the HP-97

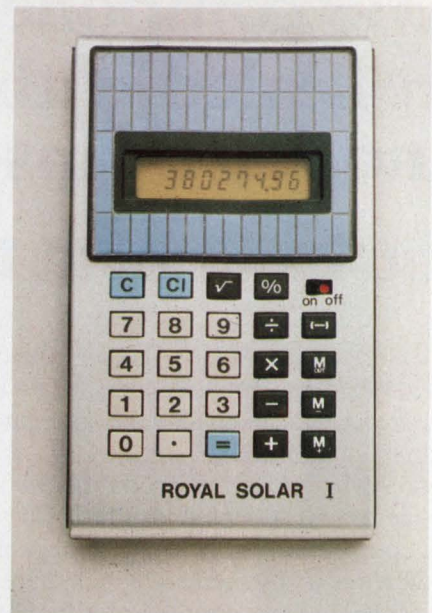

**Solar cells keep the batteries continuously charged in these calculators by Royal Typewriter (top) and by Sharp (bottom).** These units have liquid-crystal displays and CMOS.

—will be included in a new HP-10 seven-function business calculator with algebraic notation. The HP-10, which will be about the same size as the HP-65, is scheduled for delivery about May 1.

The HP-97 card-programmable unit uses a thermal printer that can operate solely on batteries for three to five hours. It prints up to 21 characters wide using a 5 × 7 dot matrix.

Thermal printers are also used in TI's \$295 PC-100 peripheral unit in which an SR-52 or SR-56 can be locked. The printer uses a 2.5-in. thermal tape that prints up to 20 characters per line.

Calculator chip manufacturers, including Rockwell and General Instrument, have developed calculator-chip sets with a printer-drive option.

Liquid crystal displays (LCDs)

# Just as you can count on Newton's law,



## you can count on Synchron<sup>®</sup> motors.

The synchronous motor you install in your product is likely to be the most important single component. So everything about that motor should be exactly right for your product. The speed, the torque, the price and the delivery, of course. The performance, the quality and the dependability. But, especially, its rightness for you.

What's exactly right for someone else may be exactly wrong for you. That's why it's almost impossible to find a ready-made synchronous motor



that meets your specs in every way.

We custom-make every Synchron motor. At a competitive price. To fit your needs, not ours. Delivered on time. Designed and built right, to do the job right. That's the only way we do business.

Call or write for our specification sheets and the name and location of our representative in your area.

Choose from five principal styles of Synchron motors—60 or 50 Hz—from one revolution per week to 900 rpm—from 8 thru 98 oz-in torque at 1 rpm—from hundreds of different outputs.

**MALLORY**



**HANSEN MANUFACTURING CO.**  
a division of P. R. MALLORY & CO. INC.  
Princeton, Indiana 47670

We make every Synchron motor as if our name were on your product

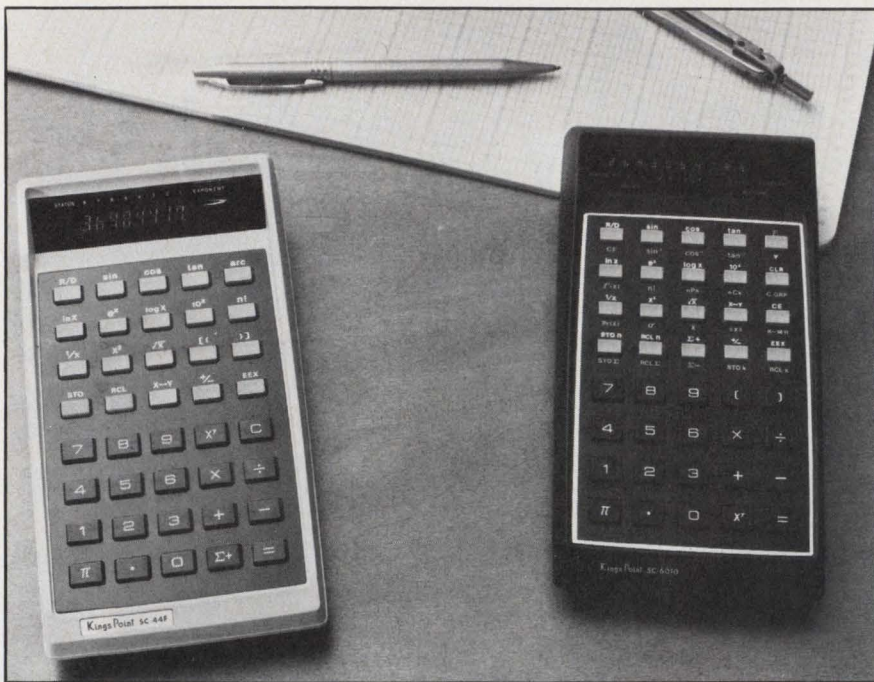

**Extensive scientific and statistical functions** are programmed into the Kingspoint SC-6010 (right). The SC-44F (left) has scientific and factorial functions and a plasma display.

with enhanced reliability are now appearing in consumer CMOS calculators produced by such Japanese firms as Sharp, Teal, Casio and Sanyo. In these designs, standard AA primary or rechargeable cells, which have been industry standards, are eliminated. The combined current drain of the CMOS computing circuitry and LCD display is low enough to permit them to be powered by two or three button cells of the type used in watches. Battery life is at least six months. The use of button-cell batteries permits the design of attractive, slim cases.

If the reliability of these new displays can be demonstrated in practice, says Chung Tung, R&D engineering manager at Hewlett-Packard's Corvallis Division, OR, they should eventually be adopted by the scientific calculator industry for preprogrammed and key-programmable units that don't have magnetic-card readers. Such calculators can use throw-away batteries.

Because the calculators with LCD displays draw little current, it is feasible to use rechargeable button cells and keep them charged up with the energy from a solar-cell array.

Two consumer LCD/CMOS calculators, Sharp's Sun Man and

Royal Typewriter's Royal Solar I (see photo) are the first to appear in this country with silicon solar cells integrated into the calculator package.

The Sun Man (\$99.95) is an eight-digit, six-function calculator with a rechargeable three-cell 3.6-V battery that "will never have to be

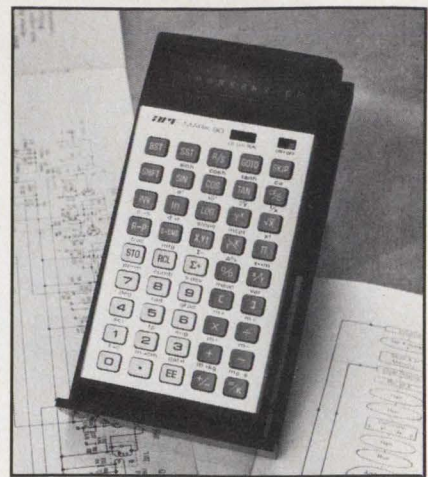

**More than 70 key-accessible preprogrammed functions** and a 72-step program memory with editing functions are designed into this low-cost APF Electronics Mark 20 machine.

replaced," says the manufacturer. The display requires 70 mW. Capable of operating for 50 hours without charging, the calculator requires two hours' exposure to window light for a full recharge.

The Royal Solar I (\$99.95) has an eight-digit display with indicators for "memory in use," minus sign and "overflow." It has an independent memory register and uses two rechargeable NiCd button cells in series for a full-charge voltage of 2.4 V. ■■

## Want more information?

Readers interested in learning more about the individual calculators mentioned in this article or of similar machines may contact the manufacturers and suppliers listed below. Types of calculators are indicated by the letters following the listing: K—key programmable; M—magnetic-card programmable; N—nonprogrammable.

**APF Electronics, Inc.**, 444 Madison Ave., New York, NY 10022. (212) 758-7550. K, N **Circle No. 411**

**Calculmatic-Leisurecraft Products, Ltd.**, 909 Third Ave., New York, NY 10022. (212) 686-0096. N **Circle No. 412**

**Canon, Inc.**, 10 Nevada Dr., Lake Success, NY 11040. (516) 488-6700. N **Circle No. 413**

**Casio, Inc.**, 15 Gardner Rd., Fairfield, NJ 07006. (201) 575-7400. K, N **Circle No. 414**

**Colex International**, 1229 W. Washington Blvd., Chicago, IL 60607. (312) 733-1200. N **Circle No. 415**

**Commodore Business Machines**, 901 California Ave., Palo Alto, CA 94306. (415) 326-4000. K, N **Circle No. 416**

**Hewlett-Packard**, 1000 N.E. Circle Blvd., Corvallis, OR 97330. (503) 757-2000. K, M, N **Circle No. 417**

**Ibico, Inc.**, 50 Lively Blvd., Elk Grove, IL 60007. (312) 640-7333. N **Circle No. 418**

**Kingspoint Corp.**, 104 Harbor Dr., Jersey City, NJ 07305. (201) 432-7707. N **Circle No. 419**

**National Semiconductor**, 1177 Kern Ave., Sunnyvale, CA 94086. (408) 732-5000. **Circle No. 420**

**Netronics R&D Ltd.**, 333 Litchfield Rd., New Milford, CT 06776. (203) 354-9375. K (Kit) **Circle No. 421**

**Panasonic**, 1 Panasonic Way, Secaucus, NJ 07094. (201) 348-7170. N **Circle No. 422**

**Royal Typewriter Co.**, 150 New Park Ave., Hartford, CT 06106. (203) 523-4811. N **Circle No. 423**

**Sanyo Electric**, 1200 W. Artesia Blvd., Compton, CA 90220. (213) 537-5830. N **Circle No. 424**

**Sharp Electronics Corp.**, 10 Keystone Pl., Paramus, NJ 07652. (201) 265-5600. N **Circle No. 425**

**Sinclair Radionics, Inc.**, 115 E. 57th St., New York, NY 10022. (212) 688-6623. N **Circle No. 426**

**Teal Industries**, P.O. Box 5505, Carson, CA 90749. (213) 532-9631. N **Circle No. 427**

**Texas Instruments**, P.O. Box 5012, MS 84, Dallas, TX 75222. (214) 238-3741. K, M, N **Circle No. 428**

**Unisonic Products, Inc.**, 115 Broadway, New York, NY 10006. (212) 255-5499. N **Circle No. 429**

**Unitrex of America, Inc.**, 689 Fifth Ave., New York, NY 10001. (212) 688-3400. N **Circle No. 430**

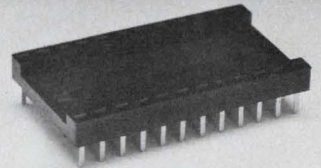
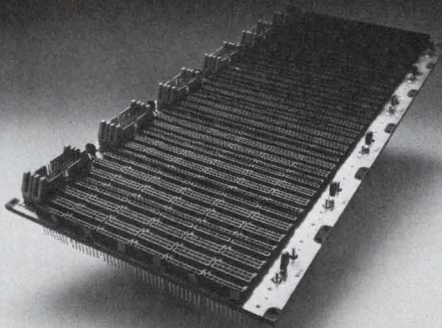
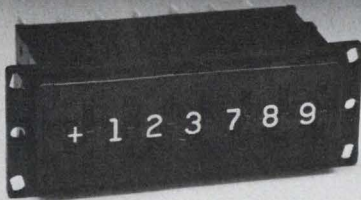
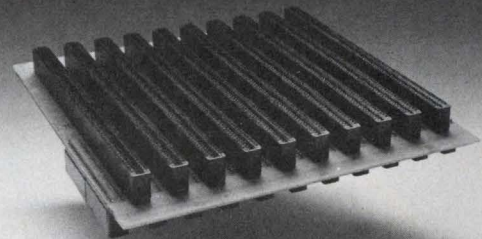
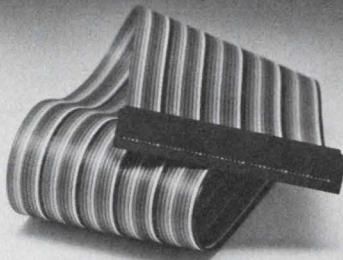

# THE OEM CONNECTION

When you do business with SAE, you're well connected. We make edgeboard connectors, flat flex cable interconnection systems, switches, logic panels, backplanes and IC sockets. And that's just the beginning.

We also supply complete wiring and sub-assembly services, printed circuits, card files, MIL-C-5015 and other extreme environment connectors, transformers, chokes, delay lines and RF filters.

We're a growing, broad-line supplier of elec-

tronic OEM hardware, ready to quote and deliver anything from a wide selection of individual components to a completely assembled interconnection system.

Component specs are in our catalog, and guidance on ways to save time and money is as close as an SAE sales rep. If you haven't yet made The OEM Connection, do it now. Write Stanford Applied Engineering, 340 Martin Avenue, Santa Clara, California 95050. Phone (408) 243-9200. TWX 910-338-0132.



Plants at Santa Clara and Costa Mesa, California, West Babylon, New York and Boulder, Colorado.

CIRCLE NUMBER 20

LINEAR INNOVATIONS  
FROM TI

# BIFEEET

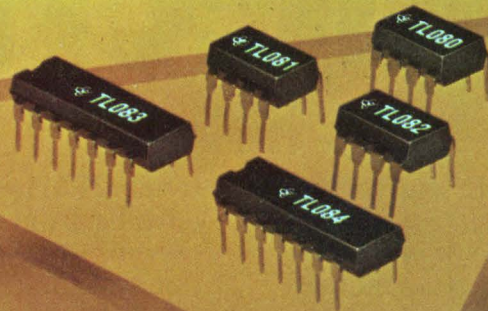



# First BIFET op amp family. TI's new TL080 series.

## High performance single, dual and quad op amps.

Here's a unique solution to your operational amplifier design needs ... Texas Instruments new TL080 op amp family.

The first BIFET op amp family ever. With two singles; two duals and a quad that can meet most of your op amp requirements:

Both singles have offset voltage null capability. The TL080 requires external frequency compensation. The TL081 has internal compensation.

The duals, TL082 and TL083, both offer internal frequency compensation. The TL083 also provides offset voltage null capability.

The quad, TL084, has internal frequency compensation. It's the industry's first four-in-one BIFET op amp.

### High performance

Each device in the TL080 series uses BIFET technology combining well-matched, high-voltage JFET and bipolar transistors on a monolithic integrated circuit. For the outstanding DC performance of Super Beta and excellent AC characteristics:

- 0 Input bias current—0.4 nA max at 25°C; 10 nA max at 70°C.
- 0 Input offset voltage—15 mV max at 25°C; 20 mV max at 70°C.
- 0 Unity gain bandwidth—3 MHz typ.
- 0 Slew rate—12V/ $\mu$ s typ.
- 0  $I_{cc}$  per op amp—2.8 mA max.

These same parameters apply for each member of the family; the entire series has identical AC and DC specs. For the greatest versatility and broadest user selectivity ever offered in operational amplifiers.

### Additional advantages

If you check these specs, you'll find they're the best ever seen at these low prices. And the TL080 series' high performance is specified across the full temperature range.

TL080 Series BIFET Op Amp Prices		
Prices for each part in 100-piece quantities. Plastic packages; commercial temperature range (0° to 70° C):		
Device	Price	Price per Op Amp
TL080	\$1.04	\$1.04
TL081	0.52	0.52
TL082	0.91	0.455
TL083	1.17	0.585
TL084	1.30	0.325

Even greater performance is available when you order the "A" or "B" versions. For example, the TL081AC has the same 6.0 mV input offset voltage as the  $\mu$ A741C.

The new TL080 series also features:

- 0 Function-for-function pin-outs with its most popular op amp counterparts.

- 0 The first high performance duals and quads ever available.
- 0 And prices competitive with many general purpose, non-BIFET devices.

So you can take advantage of their improved performance without the penalty of greatly increased costs. For example, the 100-piece price of the TL081CP is only 52¢.

### Dual-in-line packages

The complete TL080 family is offered in dual-in-line packages for the extra bonus of lower testing and insertion costs. The TL080, 081 and 082 are available in 8-pin plastic DIPs and TO-99 metal cans; the TL083 and 084 in 14-pin plastic DIPs.

It makes sense to check out the greater savings and versatility you can realize with TI's new BIFET op amp family.

### Brochure available

Just mail the coupon below for a free copy of TI's brand new 20-page "BIFET Op Amp" brochure. It's packed with data sheets, applications circuits, detailed comparative specifications and price information.

The complete TL080 series of BIFET op amps is available now from Texas Instruments and your local authorized TI distributor.



### Texas Instruments TL080 Series BIFET Op Amps

Device	# of Op Amps	Internal Compensation	Offset Voltage Null	Pin-out Equivalents
TL080	1	No	Yes	$\mu$ A748; LM301A; LM308
TL081	1	Yes	Yes	$\mu$ A741; LF13741; CA3140; LF355
TL082	2	Yes	No	LM358; MC1458; RC4558
TL083	2	Yes	Yes	$\mu$ A747
TL084	4	Yes	No	LM324

Texas Instruments Incorporated  
Inquiry Answering Service  
P.O. Box 5012, M/S 308  
Dallas, Texas 75222

Please send me TI's new BIFET Op Amp Family brochure and information on the following:

- All Linear Control Circuits
- Voltage Regulators
- Switching Regulators
- TL181 Series Analog Switches
- TL600 Series Analog Switches

NAME \_\_\_\_\_ TITLE \_\_\_\_\_

COMPANY \_\_\_\_\_

ADDRESS \_\_\_\_\_

CITY \_\_\_\_\_ STATE \_\_\_\_\_ ZIP \_\_\_\_\_

ED

TEXAS INSTRUMENTS

INCORPORATED

CIRCLE NUMBER 21

# Current-mode logic is packed densely to raise speed and cut power drain

Current-mode logic is as fast as emitter-coupled logic and, because it doesn't have ECL's emitter-follower output drivers, dissipates less power. But without drivers, CML can't drive long lines. This problem has been solved in Honeywell's latest large-scale computer, the Model 66/85, which features a small circuit-board assembly that keeps lead lengths between integrated circuits down to an average of less than half an inch.

With gate-propagation delays of about 1.5 ns, CML is also five times faster than standard TTL, yet consumes about half the power, roughly 12 mW per chip, says Jerry Rauser, manager of the bipolar and MOS circuit development group at Honeywell's Solid State Electronics Center in Minneapolis. So to take "maximum advantage" of these properties, adds Lee E. Sheehan, vice-president and general manager of Honeywell's U.S. Information Systems Group, a special micro-package was created by the company's large-scale system designers in Phoenix to house up to 110 chips in one assembly.

## Laying it on

The circuits are mounted on a ceramic-substrate "board" carrying silk-screened gold-paste conductive paths and dielectric insulating layers. There are four wiring layers—one in the x direction and one in the y direction for signals, a power bus, and a ground bus that also serves as a heat sink and a mounting surface for the ICs.

The result, according to Sheehan, is a thick-film, ceramic substrate circuit assembly, only 80 mm (about 3 in.) square and 2 mm thick, but with almost the same amount of circuitry contained on a conventional 12-in. square printed-circuit board using TTL. The assembly is cooled by water pumped at less than 5 psi through a heat exchanger that mounts against the

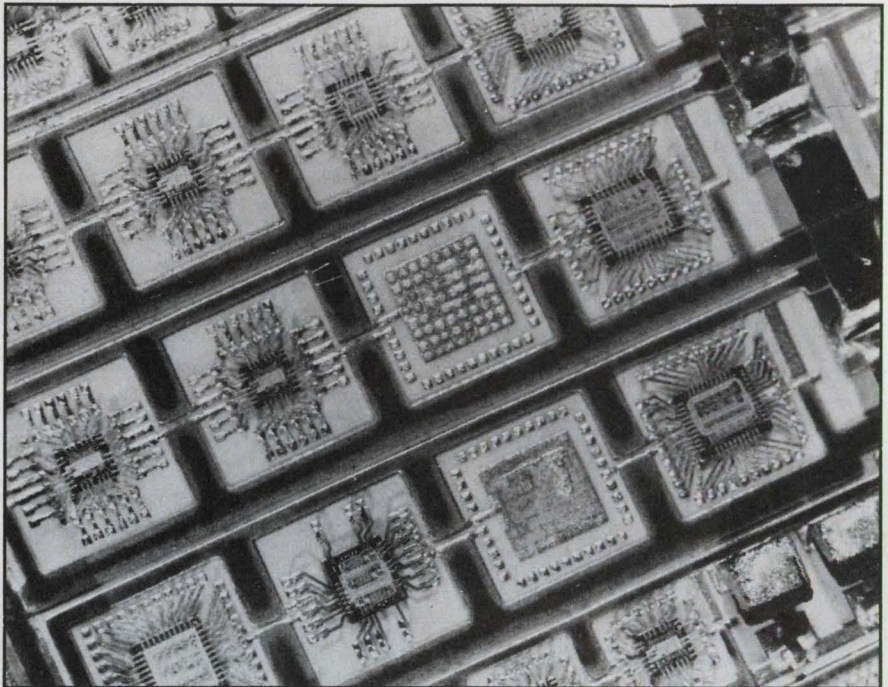

**Current-mode logic circuits** are fast and dissipate little power, but don't have the capacity to drive long lines. Honeywell's 66/85, however, overcomes this problem with high-density packaging and multilayer wiring on a ceramic substrate. Each assembly holds up to 110 CML chips.

ceramic side of the board.

The CML circuits are similar to ECL circuits except for the output configuration. And since manufacturing processes for CML, ECL and other bipolar logic families are also similar, the cost of manufacturing the CMLs is comparable, says Rauser. For now, Honeywell is making all of its own CML chips, but "we do intend to source CML circuits from outside vendors," according to Sheehan, adding that Texas Instruments and Nippon Electric are two possible sources.

Honeywell's first application for this logic family, the 66/85 computer, is designed for general-purpose information processing. In a typical configuration, the \$6-million machine will have 1-million words of MOS memory, a system console, two card readers and one card punch, two high-speed line print-

ers, a dual-control, dual-channel magnetic tape subsystem with twelve 1600-bit/s tape units, 3.2-billion bytes of mass storage through two disc subsystems, and two front-end network processors. The systems will be available for installation this fall.

The 66/85 is designed to handle host-processor functions in distributed systems, as well as general-purpose applications. In a distributed system, which is characterized by multiple computers in relatively independent locations, the host processor provides supporting services and guidance to the other processors. Also, Honeywell's line of distributed-system-oriented products has recently been expanded by the introduction of three medium-to-large-scale processors as well as the 66/85, a front-end processor, and a series of terminals. ■■

# The most significant price breakthrough in DOUBLE-BALANCED MIXERS!

...from Mini-Circuits of course!

**\$2.95**  
500 pieces  
\$3.95 (10-49)



Model SBL-1

For demanding industrial and commercial applications, where low-cost and high-performance are critical; model SBL-1 will fill your need.

Don't let the low price mislead you. As the world's number one supplier of double-balanced mixers, Mini-Circuits' has accumulated extensive experience in high-volume production and testing, a key factor in achieving a successful low cost/high performance line of products.

The tough SBL-1 covers the broad frequency range of 1-500 MHz with 6 dB conversion loss and isolation greater than 40 dB. Only well-matched, hot-carrier diodes and ruggedly constructed transmission-line transformers are used. Internally, every component is bonded to the header and metal case for excellent protection against shock, vibration and acceleration.

Here are some of the steps taken to ensure quality: Every SBL-1 is RF tested four times, every solder connection is 100 per cent inspected under a high power microscope, all transformer leads are double-wrapped, and all components are rated for more than +100°C operation. Of course, our one-year guarantee applies to these units.

**Model SBL - 1 Metal Case, Non-Hermetic Seal**

Frequency Range, MHz		Typ.		Max.	
LO	RF	LO-RF	LO-IF	LO-RF	LO-IF
1-500	1-500	5.5	45	7.5	30
Total Range		6.5		8.5	
Isolation, dB		Typ.		Min.	
Lower Band Edge to	LO-RF	50	40	35	25
One Decade Higher	LO-IF	45	30	30	20
Mid Range	LO-RF	45	30	30	20
	LO-IF	40	25	25	20
Upper Band Edge to	LO-RF	35	25	25	20
One Octave Lower	LO-IF	30	20	20	15
Signal, 1dB Compression Level +1dBm					
Impedance, All Ports 50 ohms					
Electronic Attenuation Min (20mA) 3dB					

World's largest manufacturer of Double-Balanced Mixers

**Mini-Circuits**

MINI-CIRCUITS LABORATORY A Division of Scientific Components Corp.  
837-843 Utica Avenue, Brooklyn, NY 11203 (212) 342-2500 Int'l Telex 620156 Domestic Telex 125460

**International Representatives:**  AUSTRALIA: General Electronic Services, 99 Alexander Street, New South Wales, Australia 2065.  ENGLAND: Dale Electronics, Dale House, Wharf Road, Frimley Green, Camberley Surrey.  FRANCE: S. G. I. E. - D. J. M. E. S., 31 Rue George, Sand 91120 Palaiseau, France.  GERMANY, AUSTRIA, SWITZERLAND: Industrial Electronics CMBH Klüberstrasse 14, 6000 Frankfurt, Main, Germany.  ISRAEL: Vectronics Ltd., 69 Gordon Street, Tel Aviv, Israel.  JAPAN: Densho Kaisha, Ltd., Fourth Building, 8-1-1 Chome, Hamamatsucho Minato-ku, Tokyo.  EASTERN CANADA: B. D. Hummel, 2224 Maynard Avenue, Utica, NY 13502 (315) 736-7821.  NETHERLANDS, BELGIUM, LUXEMBOURG: Galmex, Veldweg 11, Haltern, Holland.  NORWAY: Datamatik AS, Østensjøveien 62, Oslo 6, Norway.

**U.S. Distributors:**  NORTHERN CALIFORNIA: Cain-White & Co., Foothill Office Center, 105 Fremont Avenue, Los Altos, CA 94022 (415) 948-6533.  SOUTHERN CALIFORNIA, ARIZONA: Crown Electronics, 11440 Collins Street, No. Hollywood, CA 91601 (213) 877-3550.

CIRCLE NUMBER 22

introducing:

# A MULTI-OUTPUT POWER SUPPLY

## KEPCO MPS 620M



Price:  
**\$475.00**

### THREE STABILIZED OUTPUTS

0 to 6V d-c @ 5A	Crowbar Protected
0 to +20V d-c @ 1A 0 to -20V d-c @ 1A	Tracking

**a convenient bench top power supply offering the voltage/  
current combination required for IC's & microprocessors**

- FEATURES:**
- 10-turn controls for high resolution control of the 0—6V output and the tracked 20V outputs.
  - Adjustable crowbar for the 0—6V output ... with indicator.
  - Remote error sensing connections on the panel to accommodate a 1 volt drop in the load wires from the 0—6V output.
  - Full range adjustment of voltages and rectangular current limits (not a "slot" supply, no "foldback" current limiting, and no derating to an ambient of +50°C).
  - All three outputs available simultaneously and at full rating.
  - Convection cooled.
  - Two large recessed meters with switch, to monitor voltage and current.
  - Rack mountable in a 5¼" rack space (¾ width).

**KEPCO**® For complete specifications, write Dept. BTF-05

KEPCO, INC. • 131-38 SANFORD AVENUE • FLUSHING, N.Y. 11352 U.S.A. • (212) 461-7000 • TWX # 710-582-2631 • Cable: KEPCOPOWER NEWYORK

CIRCLE NUMBER 23

# Washington Report

## Defense sets new program review

Military programs now will have to undergo a formal review by top Pentagon officials even before study contracts can be awarded, according to a new Defense Department directive.

Called "Milestone Zero" by the Pentagon, this point of review is expected to be applied this year to several programs involving the electronics industry. These include a new Air Force reconnaissance aircraft known as the RFX, the Navy's Wide Aperture Array Sonar System for nuclear submarines, and a new radar satellite.

The move, which was demanded by Congress and resisted by the Pentagon, is required for all federal agencies under Circular A-109 issued last year by the White House Office of Management and Budget. That circular is intended to formalize procurement processes throughout the federal government and end the current practice of permitting contractors to help write the specifications for new programs based on their own government-funded studies.

The Defense Systems Acquisition Review Council will continue to review programs at three other decision points: advanced development, full-scale engineering development and production. In the past, no review was required until initial studies were completed and the Pentagon was ready to begin advanced development.

## Air Force takes laser weapons lead

The Air Force is emerging as the front runner in the Defense Department's ultra-secret high-energy laser weapons program under the new defense budget, which severely cuts back Army and Navy funding for that effort. Although a 10% cut in the program—from \$166 million to \$150 million—has been ordered by Defense, the Air Force share remains steady at just under \$80-million.

Moreover, the Air Force has been authorized to begin what the Pentagon calls a focused technology effort aimed at a decision in the early 1980s on whether to begin work on prototype laser weapons. Possible uses: aircraft and spacecraft defense, and anti-ballistic-missile applications.

## Soviet moves spur U.S. space defense studies

Following four confirmed attempts last year by the Soviet Union to intercept and destroy its own satellites, the Air Force has funded industry to study ways to protect U.S. satellites from enemy attacks. Testifying before Congress that the Soviet moves jeopardize "the heretofore accepted sanctuary of space," Gen. George Brown, chairman of the Joint Chiefs of Staff, warned that the U.S. would have to improve the detection and

maneuverability capabilities of its own spacecraft.

Among the firms already funded, according to the Air Force, are Space Applications, Inc., La Jolla, CA, which performed a \$60,000 study to evaluate charge-coupled device (CCD) arrays for a terminal optical warning sensor; Westinghouse Electric, which completed a \$750,000 study of an impact sensor to detect non-nuclear, pellet-type warhead attacks against spacecraft; and Rockwell International and TRW, which completed parallel \$50,000 studies to identify maneuvering systems for communications satellites.

Communications satellites are considered particularly vulnerable because of their stationary positions 22,300 miles above earth. Rockwell also conducted a \$50,000 study to investigate the Navstar global positioning satellite's maneuverability.

## **Congress takes up defense budget cuts**

A preliminary Congressional markup of the defense budget by March 15 is expected to include the reductions proposed by the Carter administration to the original budget submitted last month (see "Washington Report," ED No. 4, Feb. 15, 1977, p. 57).

The cuts, which are expected to total more than \$2-billion, will defer spending on many major programs, but not terminate them. The B-1 bomber and M-X missile will be stretched out at least a year, and the previous administration's plan for accelerating fighter aircraft procurement will be put off until the following fiscal year at the earliest.

## **GE starts work on expanded military comsat**

The first three of a planned 12 Defense Satellite Communications System (DSCS) III spacecraft will be developed by General Electric for the Air Force's greatly expanded network of military communications satellites. The new satellites will have twice the operational lifetime of the Air Force's DSCS II satellites—10 years—and six communications channels instead of four.

The DSCS III satellites will weigh nearly a ton in orbit and operate at X-band with electronically scanned multibeam antennas. The first launch is scheduled for 1979. The first two launches will use conventional Titan II-C launch vehicles, but future DSCS III satellites will be put into orbit by NASA's Space Shuttle.

The 12 satellites are expected to cost \$250-million, and the total DSCS III program, including ground stations, will exceed \$1-billion, the Air Force estimates.

**Capital Capsules:** The U.S. Postal Service must move quickly to electronic-message systems or face continuing service deterioration and be forced to depend on subsidies, according to the National Academy of Sciences' National Research Council. Electronic systems could replace nearly half of all first-class mail, the council estimates. . . . A study of gallium arsenide solar cells will be launched by North Carolina A&T State University, Greensboro, NC, under a program sponsored by NASA and Rockwell International Corp. The study will be performed by the university's new Solid State Electronics Laboratory. . . . System Development Corp. is analyzing acoustical data from the ocean depths as part of the Navy's Fixed/Mobile Experiment for antisubmarine warfare, funded by the Defense Advanced Research Projects Agency.

# For Your D/A Converter Analysis,

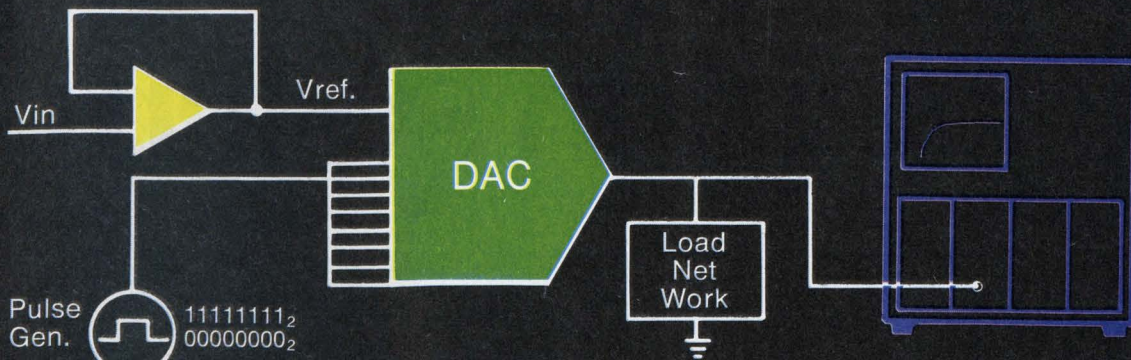

Use this dual-trace scope to make easy, accurate D/A converter settling time and amplitude measurements... and to analyze and verify the performance characteristics of other high-speed components.

Configured in a 7904 mainframe, the 7S14 Sampling plug-in lets you examine settling time anomalies as narrow as 500 ps, to vertical sensitivities down to 2 mV/div. The internal delaying time base lets you select the whole waveform, or any portion, for observation.

The 7D12/M2 Strobbing Voltmeter and 7B92A Dual Time Base plug-ins help you easily measure the overall amplitude of the device output, and the P6201 Active Probe conveniently captures the DAC's output with minimum circuit loading.

## Get Reliable, Repeatable Settling Time Measurements

No significant distortions will be introduced into your settling time measurement because the 7S14 Sampler minimizes the scope's vertical amplifier recovery time effect. The high-impedance probe minimizes loading the circuit under test.

With high vertical sensitivities, small perturbations can be measured to less than 1 least significant bit depending upon circuit loading.

The result is accurate measurements time after time.

**Put Together a Complete System** You can measure overall output amplitude to within 0.25% with the strobbing voltmeter and dual time base plug-ins included in the plug-in scope system. And it couldn't be easier: the intensified zone generated by the time base points out

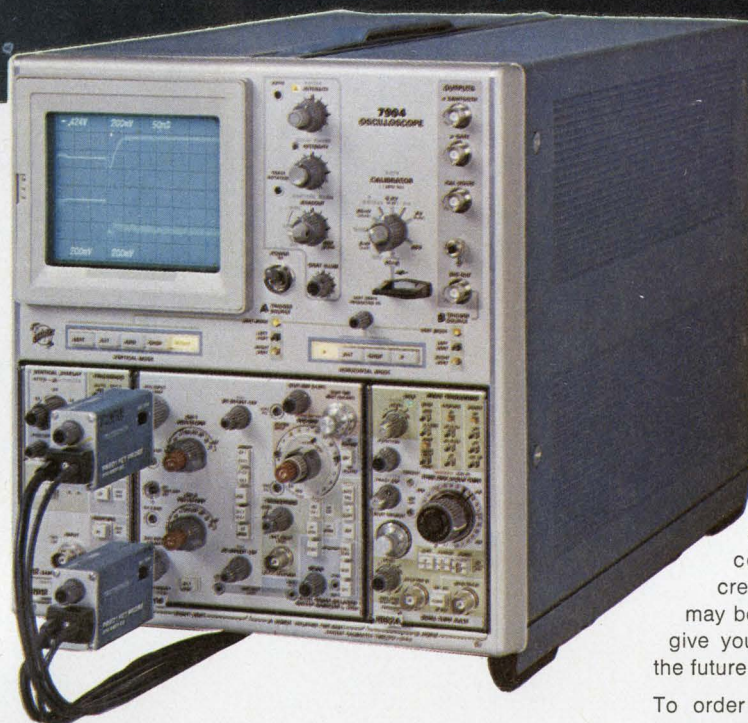

## Expand Your System to Include Real-Time Performance

By adding a 7A24 Dual Channel Amplifier plug-in, you'll have a real-time system with two channels of 350-MHz performance and sweep speeds as fast as 500 ps/div. Or you can also choose from other amplifier plug-ins that will give the full mainframe bandwidth of 500 MHz.

Your oscilloscope needs may change as the speed of system components continues to increase. So whatever your choice may be, a Tektronix plug-in scope can give you unmatched value now and in the future.

To order the plug-in system described here or to receive selection assistance, call your local Tektronix field office.\* For a full product demonstration, clip the logo from this ad to your letterhead and send it to us at Tektronix, Inc., P.O. Box 500, Beaverton, OR 97077. We'll have a Field Engineer contact you. Or circle the bingo number, and we'll send you a copy of our application note, "D/A Converter Measurements: A Sampling Oscilloscope's Approach."

## pick this plug-in scope

which part of the waveform you're measuring and the amplitude is read out digitally on the crt.

## Extend Your System's Sampling Performance

This sampler allows you to display time windows as narrow as 500 ps at sweep speeds to 100 ps/div. Choose from 4 other sampling plug-ins and 10 sampling heads for time window measurements ranging from 25 ps to 1 ns. All these sampling plug-ins, including the 7S14, will operate in any 7000 Series Mainframe. All will significantly minimize the recovery time limitations you might encounter with amplifiers in a real-time scope. And some sampling plug-ins include TDR capability.

## The 7000 Series... more than an oscilloscope.

\*Ordering information:

7904 Oscilloscope .....	\$4,500.
7S14 Sampler .....	\$2,650.
7D12/M2 Strobbing Voltmeter .....	\$1,550.
7B92A Dual Time Base .....	\$1,795.
P6201 Active Probe .....	\$ 680.

U.S. sales prices FOB Beaverton, OR.

**Tektronix**  
COMMITTED TO EXCELLENCE

# Less than you've ever acquisition system.





# dreamed of in a data

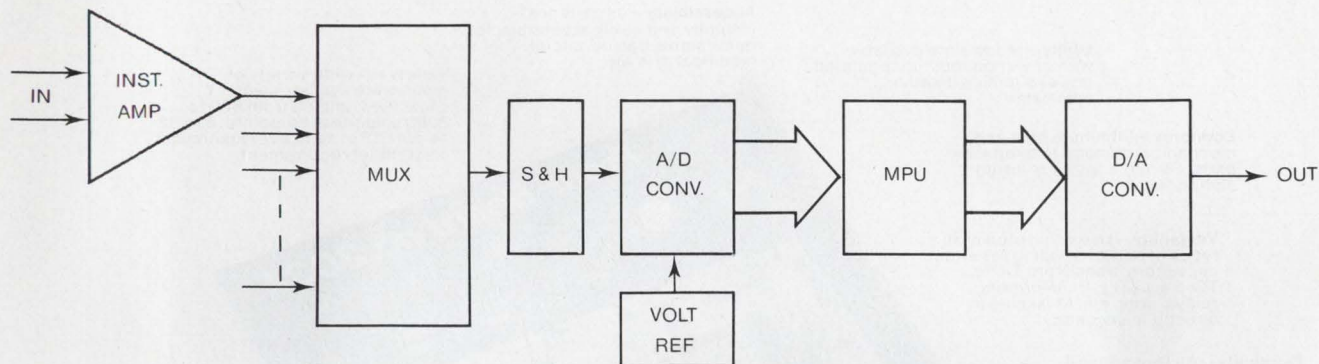

In a world of more more more, here's a proud less less less.  
Less chips.  
Less money.  
Less hassle.  
Less of everything you could do without in data acquisition.

Introducing National's new monolithic data acquisition products.

Now, everything you need for a complete low cost data acquisition system.

And underline low cost.

You can buy the complete system as diagrammed above (sans MPU, of course) for a paltry \$33.90.

Most of these products are Bi-FET™ which we invented. And they're unique in the industry.

This kind of technology could have something to do with the way we're playing king of the hill and winning in the linear business these days.

Anyway, it ain't hurtin' none.

National Semiconductor Corporation  
2900 Semiconductor Drive  
Santa Clara, CA 95051

Gentlemen:

Please send further information about the following:

- LF 13508/9 multiplexer (\$6.40)
- LF 13300 integrating A/D analog building block (\$6.25)
- MM 5863 (ADB1200P) 12 bit A/D building block (\$5.50)
- LM DAC08/LM 1408 8-bit high speed D/A converter (\$3.35)

The following are previously existing products.

- LF 352 instrumentation amp (\$5.50)
- LF 398 sample and hold (\$3.65)
- LM 399 precision reference (\$3.25)
- All of the above

Note: All prices are for quantities of 100 or more.

Name \_\_\_\_\_

Company \_\_\_\_\_

Address \_\_\_\_\_

City \_\_\_\_\_ State \_\_\_\_\_ Zip \_\_\_\_\_

**National Semiconductor Linear Products**

# IF YOU'RE NOT DESIGNING WITH A CSC PROTO-BOARD, LOOK AT ALL YOU'RE MISSING.

**Utility**—Models are available with or without built-in regulated power supplies (fixed or adjustable).

**Economy**—Eliminate heat and mechanical damage to expensive parts. Save money by re-using components.

**Versatility**—Use with virtually all types of parts, including resistors, capacitors, transistors, DIP's, TO-5's, LED's, transformers, relays, pots, etc. Most plug in directly, in seconds.

**Durability**—All Proto-Board models are carefully constructed of premium materials, designed and tested for long, trouble-free service.

**Expandability**—Proto-Board units can be instantly interconnected for greater capacity.

**Visibility**—All parts are instantly and easily visible, for quick circuit analysis and diagramming.

**Speed**—Assemble, test and modify circuits as fast as you can push in or pull out a lead. Save hours on every project.



**Accessibility**—All parts are instantly and easily accessible, for quick signal tracing, circuit modifications, etc.

**Variety**—A wide variety of models are available with capacities ranging from 630 to 3060 solderless tie-points (6 to 32 14-pin DIP's), to fit every technical and budget requirement.

**Adaptability**—Use in design, packaging, inspection, QC, etc. Works with most types of circuits, in many, many applications.

**Flexibility**—Use independently, or in conjunction with other accessories, such as scopes, counters, CSC Proto-Clip™ connectors, Design Mate™ test equipment, etc. One Proto-Board unit can serve a thousand applications.

Whatever type of electronic circuits you work with, you can do more in less time with CSC's solderless Proto-Board systems. As fast and easy as pushing in or pulling out a lead, you can design, test and modify circuits at will. Components plug into rugged 5-point terminals, and jumpers, where needed, are lengths of #22 AWG solid wire. In the same time you took to read this ad, you could be well on your way to assembling a new circuit. For more information, pick up your phone and call your dealer—or order direct.

See your CSC dealer or call 203-624-3103 (East Coast) or 415-421-8872 (West Coast) 9 AM to 5 PM local time. Major credit cards accepted. Add \$2.50 for shipping and handling in the U.S. and Canada on direct orders of \$50.00 or less; \$3.00 for orders over \$50.00. On all foreign orders add 15% to cover shipping and handling.

CONTINENTAL SPECIALTIES CORPORATION



EASY DOES IT

44 Kendall Street, Box 1942  
New Haven, CT 06509 • 203-624-3103 TWX: 710-465-1227  
West Coast office: Box 7809, San Francisco, CA  
94119 • 415-421-8872 TWX: 910-372-7992

## CSC PROTO-BOARD SOLDERLESS BREADBOARDS

MODEL NUMBER	NO. OF SOLDERLESS TIE-POINTS	IC CAPACITY (14-PIN DIP'S)	MANUFACTURER'S SUGG. LIST	OTHER FEATURES
PB-6	630	6	\$15.95	Kit—10-minute assembly
PB-100	760	10	19.95	Kit—with larger capacity
PB-101	940	10	29.95	8 distribution buses, higher capacity
PB-102	1240	12	39.95	Large capacity, moderate price
PB-103	2250	24	59.95	Even larger capacity; only 2.7¢ per tie-point
PB-104	3060	32	79.95	Largest capacity; lowest price per tie-point
PB-203	2250	24	75.00	Built-in 1%-regulated 5V, 1A low-ripple power supply
PB-203A	2250	24	120.00	As above plus separate 1/2-amp +15V and -15V internally adjustable regulated power supplies

© 1976 Continental Specialties Corp.  
Prices and specifications subject to change without notice.

CIRCLE NUMBER 27

# Microprocessor Design

## 16-bit bipolar microcomputer family is 10 times faster than MOS-based systems

Designed to be six to ten times faster than available MOS microcomputers, a 16-bit bipolar  $\mu\text{C}$  under development by Parts Purchasing Corp. will be more than just another chip set. Included with the circuits, which are expected to be available in 1978, will be a floppy-disc operating system, an assembler, a linking loader, an editor, a 125-program library and a high-level system compiler that can reside in 8 kwords of ROM.

The  $\mu\text{C}$  chip set, organized to make use of a register-oriented architecture, will have a pipeline memory unit to attain the high speed. Major applications for the  $\mu\text{C}$  are expected to be communications processors and controllers, where bit and byte-manipulation capabilities are necessary.

Developed at a reported cost of more than \$3 million by Transitron of Wakefield, MA,

then cancelled as it neared the manufacturing stage in mid-1976, the Model 1601  $\mu\text{C}$  is now being readied for production in 1978 by Parts Purchasing, a Fort Lee, NJ, firm that bought out Transitron's Microcomputer Division late last year.

The hardware includes eight general-purpose and three special-purpose registers, the program counter, stack pointer, and processor-status register. While an instruction is being executed, pipelined main memory fetches the next instruction. The vectored priority-interrupt system handles outside interrupts as well as the interfaces for floppy discs, card readers, 600-line-per-minute printers; and up to three TTYS.

Multiple addressing modes reportedly increase the basic instruction set of 96 commands to a

*(continued on page 42)*

### Cosmac evaluation kit contains all hardware



With a CDP1802 Cosmac microprocessor and all other parts necessary to build a minimum microcomputer, the CDP18S020 evaluation kit requires just a power supply and terminal. Control logic and built-in displays provide facilities required for program debugging.

A RAM memory consisting of 256 bytes is included, as well as space for 30 additional memory ICs (for a total of 4 kbytes). The ROM memory consists of 512 bytes holding a utility program that performs commonly required functions: memory inspection and modification, start of program execution at a given location and terminal interfacing.

Controls on the evaluation board include a run program button to start program execution at memory location 0000, and a run utility button to start the utility program. A reset button initializes the CPU and board logic, and a continuous step control permits single-stepping through one machine cycle each time the run program button is depressed.

A  $6 \times 4$  in. area of the board is free for I/O devices the user wants to add. ICs of various pin counts can be inserted into prepared positions and jumpered to an uncommitted 44-pin connector built on the board. The manual supplied with the CDP18S020 Evaluation Kit provides assembly instructions, operating procedures and data. In addition, the manual contains a set of memory, control, I/O and software-application notes that will be updated periodically.

The CDP18S020 evaluation kit costs \$249 and is available from stock. RCA Solid State Div., Rte. 202, Somerville, NJ 08876. (201) 685-6423.

## MICROPROCESSOR DESIGN

(continued from page 41)

repertoire of 550 effective instructions by means of unindexed, pre-indexed, and post-indexed addressing in combination with absolute, relative, and based addressing up to 32 kwords.

Many of the  $\mu C$ 's instructions execute in 200 ns. A register-to-register add takes 400 ns; a 16-bit multiply, 7  $\mu s$ ; and a 16-bit divide, 12  $\mu s$ .

Branch instructions can read or test any bit in main memory without tedious masking operations. Any individual bit can also be set or reset directly without masking. Three types of multiply and divide instructions give either a signed 15-bit result, an unsigned 16-bit result, or a signed 31-bit double precision result.

All the software except the compiler was done and tested by Transitron, according to Marty Gordon, who headed the original project there. Parts Purchasing commissioned Computer Linguistics of Colony, NY, to build the CL/1 compiler to allow high-level writing of systems software by OEM.

"CL/1 is a high-level language that combines

data structuring as in COBOL and PL/1 with a procedural language much like BASIC," says Steve Herrick, President of Computer Linguistics. "It is less forgiving than most interactive BASICs, but delivers much tighter code. And it does allow bit and byte manipulation."

"The  $\mu C$  will first be available on an 8 x 9 in.-card," says Paul Tava, a consultant to Rudolph D. Pola. "This will contain the CPU's six chips (four-bit RALUs, a control ROM, and the micro control unit), 1 k 16-bit words of RAM, timing, decode, bus drivers, and a control-panel interface. The 8 k of compiler ROM can be rolled in and out of the  $\mu C$ 's 32 k of addressable area, as needed, and is sold as an option on another card."

Only three other 16-bit bipolar "microcomputers" have been even quietly announced. The SBP9900 single chip and the 74S481, multiple-chip set, both from Texas Instruments, Dallas, TX, use memory locations in place of "hardware" working registers, and the 9440 from Fairchild, Mountain View, CA, is a single-chip I<sup>2</sup>L unit. Reportedly, the 9440 will emulate the Nova minicomputer instruction set. Parts Purchasing Corp.

Fairchild  
Texas Instruments

CIRCLE NO. 503

CIRCLE NO. 504

CIRCLE NO. 505

## CMOS microcomputer card handles 12-bit data words

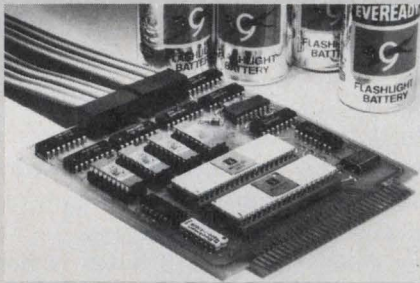

Designed for use in battery-powered equipment, the LP-12 CMOS microcomputer provides almost full minicomputer power. The 12-bit CMOS computer uses the 6100  $\mu P$  and is instruction-set compatible with Digital Equipment Corporation's PDP-8E.

Housed on a 4 x 5-in. PC board are the  $\mu P$ , 256 words of RAM, a socket for the 1 k x 12 ROM (IM6312), a 12-bit latched input port, a 12-bit latched output port and a programmable interval timer. The operating current drain of the LP-12 is less than 20 mA at 5 V, typically.

Memory and I/O expansion cards are available for applications requiring additional capacity. All cards in the family are the same size as the processor board and have the same 64-pin edge connectors. Complete development support, including control panel, system monitor, ROM simulator and TTY interface, is available.

The LP-12 costs \$195 when purchased in 100-piece quantities and is available from stock. Cybertek, Inc., 222 150th Ave., Madeira Beach, FL 33708. (813) 392-3467.

CIRCLE NO. 506

## Central $\mu P$ -based system controls remote station network

A  $\mu P$ -based system that controls in real time a number of remote stations via data-communication links has been introduced by Northwest Digital Systems, Bellevue, WA. The System 808 can be customized for individual data-acquisition requirements with a wide variety of function-oriented PC cards. To date, the unit has been used

(continued on page 44)

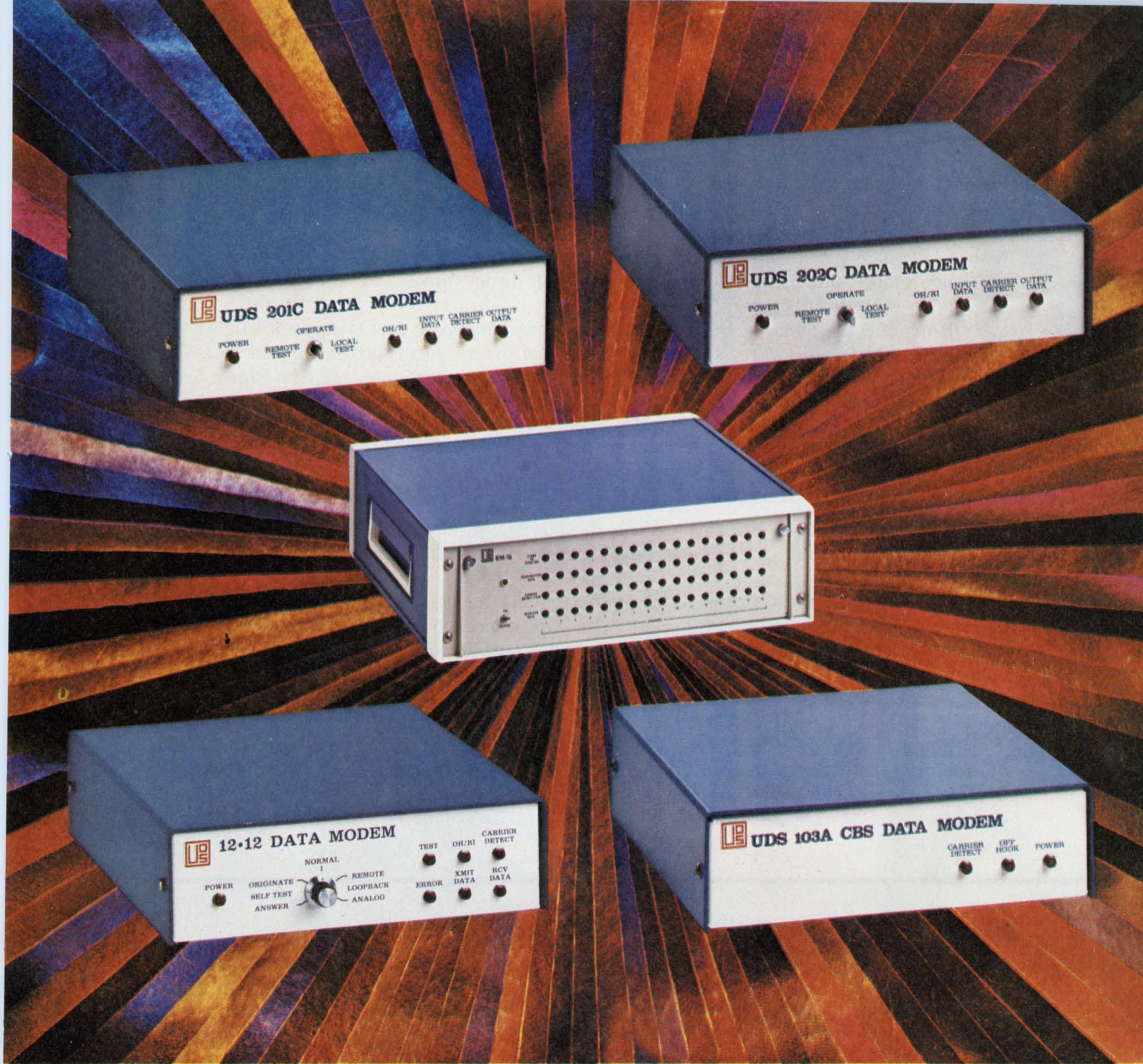

## UNIVERSAL MODEMS

Making data move is the name of the game in today's switched or dedicated-line networks. If you're moving it at any speed up to 2400 BPS, Universal Data Systems has the proper modem for reliability, economy and efficiency in your system.

UDS has more than 30,000 modems in active field service, and the total is growing by more than 1,000 units per month. Our product line includes CMOS 201s, plus 103s, 202s, ACUs and the new 12-12, which permits full-duplex 1200 BPS communication over only two wires. UDS also offers the multiple modem RM-16, which contains up to 16 units in any configuration mix you desire.

In addition to our products, we're extremely proud of our customer service. Check us out: Call us on the telephone. You'll like what you hear.



# universal data systems

member of  
IDCMA

4900 Bradford Drive • Huntsville, Alabama 35805 • Telephone (205) 837-8100 • TWX 810-726-2100

Created by Hall & McKenzie Advertising, Winter Park, Florida

CIRCLE NUMBER 28

## MICROPROCESSOR DESIGN

(continued from page 42)

successfully in power plants, sewage-treatment plants, pulp mills and wood-processing shops.

A remote station can be equipped with a multiplexer unit, which receives commands from a master control unit and, controlled by program subroutines, carries out required tasks. For easy updating, programs are stored in erasable PROMs. And by virtue of its  $\mu$ P, the remote multiplexer unit can carry out tasks under the control of its own internally stored programs.

Built around the 8080A  $\mu$ P, the System 808 has a memory capacity of up to 65 kbytes. Besides complete software support, the system offers surge protection, noise isolation, and various parity and redundancy checking routines for data transmission. Security codes for selective access are also provided on request from the company.

---

### Analog I/O subsystem provides 64 channels

Designed for the National IMP-16  $\mu$ P, the HMBL/06 analog system provides 32 analog-input channels as well as 32 analog-output channels. Each channel can be addressed individually.

The HMBL/06 card set consists of four 8.5 x 11-in. printed-circuit cards that plug directly into a standard IMP-16P cage. The card set can be subdivided into the data-acquisition/control board and the d/a converter output boards. The HMBL/06-1 board contains the 32 multiplexed analog-input channels and the control circuits for the 32 analog-output channels. The HMBL/06-2 board has 11 d/a converters with a set of latches for each output channel. Resolution of the entire system is 12 bits.

Although the HMBL-06 card set is designed specifically for the IMP-16, it can be adapted to most microprocessors. Single-unit prices for the cards start at \$1160 for the 06-1 and go to \$1350 for the 06-2. Delivery takes 3 weeks.

AD Engineering, P.O. Box 153, Lilburn, GA 30247. Bernard Drew, Jr. (404) 534-9895.

CIRCLE NO. 507

---

### Complete microcomputer makes use of EXORciser boards

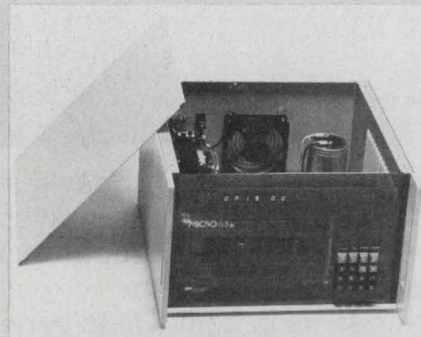

A revised version of Electronic Product Associates' Micro-68, called the 68b, offers all the features of the Micro-68 and then some. Also based on the 6800  $\mu$ P, the 68b is housed in an aluminum cabinet and has a 13-slot motherboard that is compatible with Motorola's EXORciser modules. The cabinet also contains a 20-A power supply.

The Micro 68b comes completely assembled with hex keyboard, six-digit LED display, 8 kbytes of RAM, a 1-kbyte monitor ROM and a CRT/TTY and audio-cassette interface. Price for everything is \$1878, and delivery

of the microcomputer system is from stock.

Electronic Product Associates, 1157 Vega St., San Diego, CA 92110. Patti Neumann (714) 276-8911.

CIRCLE NO. 508

---

### Arithmetic program in chip form aids 8080 calculations

Available in an 8708 EPROM-compatible package, the FP708 arithmetic package gives 8080-based microcomputers arithmetic capability. Designed to be compatible with the Intel SBC 80/10 OEM or SDK 80 microcomputer systems, the chip plugs into one of the

(continued on page 46)

# ANOTHER MYTH EXPLODED:

All solenoids are NOT created equal.

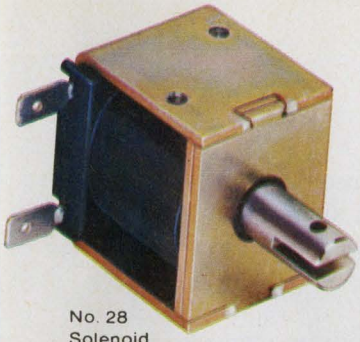

No. 28  
Solenoid

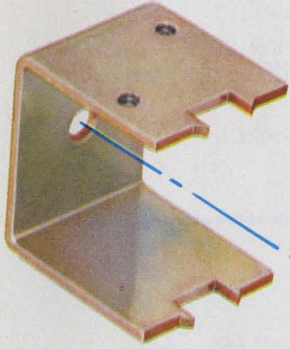

New Uni-Guard II molded bobbin and coil covers are Valox® 420 SE-O... to meet or surpass all U/L and CSA component recognition requirements; also meet tough U/L flammability spec 94V-0.

New Uni-Guard II construction minimizes wear by holding concentricity between plug and plunger... and minimizes double seating.

New Uni-Guard II coil cover gives snug, protecting fit, yet leaves space for addition of thermal cutouts or diodes.

Dual endplates on model shown improve mechanical strength and magnetic efficiency.

Bright Nickel plated plunger for low friction, corrosion resistance.

Lugs are press fitted and ultra-sonically welded to bobbin to withstand eight pound pull test.

Endplates are swage formed and staked to field piece to provide continuous magnetic flux field for most efficient operation.

Only Guardian solenoids have new Uni-Guard® II molded bobbin and coil covers that give you savings of up to 25%... with at least 25% longer life. How long? Up to 5 million operations. This new construction is now available on nearly all Guardian box frame and U-frame solenoids. Including pull type, push type and solenoid switches. All have .187" or .110" QC lug or solder lug termination for easier, faster, less expensive installation. And Guardian has more types available from stock than anyone else.

Variations and options? Get them from Guardian. Return springs, plunger configurations, anti-bottoming or silencers, voltages, termination, mounting, coil finishes... you spec it and Guardian's ready to produce it.

Let the Guardian Angel show you why Guardian is No. 1 in solenoids. Send for your free copy of this 72 page catalog.

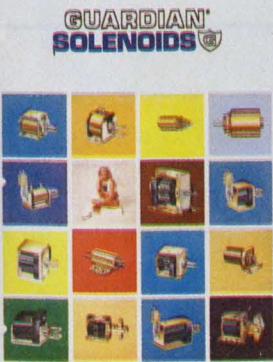

This mark indicates recognition under the component program of Underwriters Laboratories, Inc.

# GUARDIAN®

GUARDIAN ELECTRIC MANUFACTURING CO.  
1550 West Carroll Ave., Chicago, Illinois 60607 • 312/243-1100  
CIRCLE NUMBER 29

## MICROPROCESSOR DESIGN

(continued from page 44)

existing 8-k PROM sockets on the board (location  $\phi C\phi\phi H$ ).

The FP708 is faster than a calculator chip, accurate up to 5 digits and requires no scratch-pad memory. It performs 16-bit binary floating-point arithmetic, such as adding, subtracting, multiplying, dividing, squaring and square-rooting. It also executes binary (16-bit)-to-BCD (five-digit), BCD-to-binary, floating-to-fixed-point, fixed-to-floating-point conversions, and utility operations.

No additional memory overhead is required to support the FP708 other than a maximum 26 bytes of stack memory. Typical execution times range from 0.4 ms for an add to 6.5 ms for a square-root operation. The single-chip FP708 is available from stock at a cost of \$260. A 4-chip set, the FP702, that is compatible with the 1702A EPROM will be available soon.

Novonics, 602 Sciandro Dr., Greensburg, PA 15601. David Reese (412) 423-6633.

CIRCLE NO. 509

## Single-chip F-8 microcomputer has 2-k $\times$ 8 storage on chip

With complete F-8 software and hardware compatibility and 2 k  $\times$  8 of mask-programmable ROM, the 3870 is a full microcomputer on a chip. Operating from a +5-V supply, the NMOS device can execute all F-8 instructions.

Systems built with the 3870 but eventually requiring more memory (ROM, RAM or PROM) or I/O can simply upgrade to the expandable MK3850 (F-8 CPU) without major redesigning or software development. Features included on the 3870 include 2 kbytes of mask-programmable ROM, 64 bytes of scratchpad RAM, a modulo "N" binary timer and multiple-clock modes.

The supply's  $\pm 10\%$  tolerance allowance provides compatibility with any standard TTL-logic environment.

Four modes of vectored interrupts are available, as well as a 4-MHz single-phase clock. Power dissipation is 300 mW, typical.

A complete line of developmental tools supports the 3870: the software development board (SDB-50/70), the application interface module (AIM-70) and the emulator-70 for field prototyping. Cost is less than \$10 for plastic devices in quantities of 1000 units. The single-chip MK3870 will be available in 30 to 60 days in a 40-pin plastic or ceramic DIP. Mostek, 1215 W. Crosby Rd., Carrollton, TX 75006. Don Ward (214) 242-0444.

CIRCLE NO. 510

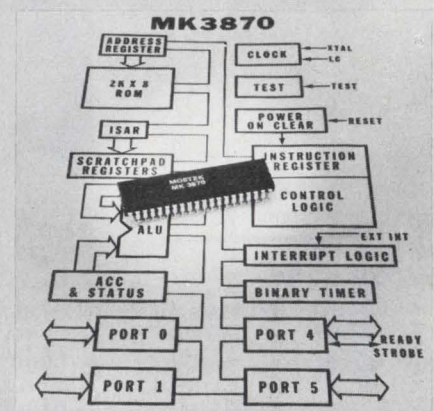

## Micro Capsules

Simplified versions of the PPS4/1 Series of  $\mu$ Ps, housed in 28-pin DIPs, will be popping up by mid-1977 from Rockwell, Anaheim, CA. One version of the Model A75 will offer 640 bytes of ROM and 64  $\times$  4 bits of RAM, and cost well under \$10 in 1000-unit quantities. Another version, still being developed, will offer a high-speed counter on the chip. . . An enhanced 6502  $\mu$ P, dubbed the 6552, will be available shortly from MOS Technology, Norristown, PA. The circuit is expected to handle a 6-to-7-MHz clock, yet be compatible with all 6502 systems. . . Joining forces with the Delco Div. of General Motors, Motorola, Austin, TX, has landed a major contract for microprocessor products. The result will be full microprocessor systems in every GM car to control all engine braking and dashboard functions. . . A microprocessor two to three-times faster than the 1802  $\mu$ P from RCA, Somerville, NJ, should be coming out of the company's ovens by mid-year. The enhanced version reportedly will use silicon-on-sapphire CMOS technology to get the speed boost.



# New Simpson Autoranging DMM

Automatically selects the range and positions  
the decimal point for highest accuracy.  
Makes measurements easier, faster.



## Model 465

- Automatic Range Selection
- Range HOLD for Fast Repeated Tests
- 0.1% DC V accuracy
- 3½ Digit, 0.43" LED Readout with Autopolarity, Floating Decimal, Zero Blanking
- Custom MOS/LSI Integrated Circuitry
- Pushbutton Function Selection
- Measures:
  - DC voltage from 100 uV to 1000 volts
  - AC voltage from 100uV to 600 volts
  - High power ohms from 1 ohm to 20 megohms
  - Low power ohms from 1 ohm to 2 megohms
  - DC current from 100 nA to 10 amps
  - AC current from 100 nA to 10 amps

- Choice of Battery/AC Line Combination or AC Line Operation Only
- High-impact Shock-Resistant Case with Tilt-View, Adjustable Handle
- Conforms to Applicable ANSI C39.5 Requirements

**Model 465A** for 120/240 VAC (50-400 Hz) power line operation; with test leads, line cord and manual. . . . \$295.00

**Model 465D** for battery operation (batteries not supplied) and 120/240 VAC (40-400 Hz) power line operation; with test leads, line cord and operator's manual . . . . \$332.00

*Full Line of Accessories Available*

See Your Local Electronics Distributor or Write for Bulletin

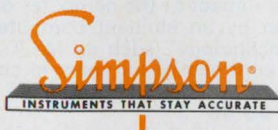

## SIMPSON ELECTRIC COMPANY

853 Dundee Avenue, Elgin, Illinois 60120  
(312) 697-2260 • Cable SIMELCO • Telex 72-2416  
IN CANADA: Bach-Simpson, Ltd., London, Ontario  
IN ENGLAND: Bach-Simpson (U.K.) Ltd., Wadebridge, Cornwall  
IN INDIA: Ruttonsha-Simpson Private, Ltd., Vikhroli, Bombay

CIRCLE NUMBER 30

KATY INDUSTRIES



INDUSTRIAL  
EQUIPMENT  
GROUP

**NO OBLIGATION to say "no" to avoid getting unwanted books!**

**NO OBLIGATION to say "yes" to three books a year!**

**NO OBLIGATION to buy books—now or ever!**

# Electronic Design<sup>®</sup>

## *Book Club*

*(The new NO OBLIGATION book club!)*

As an *Electronic Design* subscriber, you're already a member of the most painless book club in the business! All you do is sit back and watch the pages of *Electronic Design* for the books you want to buy, then

use the handy order form below. You'll be getting great discounts on the best books in your field from leading publishers.

***We're really the NO OBLIGATION book club!***

For the engineer designing microprocessors into his company's products . . .



### Microcomputer Design

Martin Research

Thousands of copies of this innovative book on microprocessors have been purchased by engineers and designers around the world. Now revised and expanded, *Microcomputer Design* features full schematics and circuit descriptions for the 8080-based central processing unit of the MIKE 3 microcomputer. Also included are vectored interrupts for all 8-bit central processing units; efficient bus structure design; and interfacing to timers, A/D converters, keyboards, digits, and other I/O devices. Used as a text in many college courses, *Microcomputer Design* is also a popular book with advanced home computer hobbyists. Martin Research list price: \$25.00

**Subscriber's club price: \$19.95**

**Order #S125**

" . . . this book will come to be regarded as a towering milestone in the history of attempts to understand the significance of computers."—Daniel D. McCracken, from a review in *Datamation*

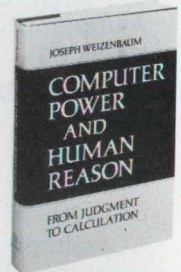

### Computer Power and Human Reason: From Judgment to Calculation

Joseph Weizenbaum

The "artificial intelligensia" has gone too far, Joseph Weizenbaum of M.I.T. argues in this eloquent and powerful indictment of a runaway computer technology which seems bent on equating mind with machine.

Back in the 1960's, when Weizenbaum created ELIZA, his natural language processing system, he was appalled at the way his system was misunderstood by many people. It caused him to question the meaning of the computer itself and resulted in a profound study of the impact of the computer on the mind and soul of man. Written by an eminent computer scientist seated in a "temple of technology" such as M.I.T., this book will be a point of heated controversy for years to come. W. H. Freeman list price: \$9.95

**Subscriber's club price: \$8.45**

**Order #S118**

**Future Facts:  
The Way Things  
are Going to  
Work in the  
Future in Tech-  
nology, Science,  
Medicine & Life**

Stephen Rosen

Better than the wildest science fiction, it presents forecasts based on present technology — synthetic blood; chemical light; from N.Y. to L.A. in 21 minutes; enzymes to stay young; geothermal power; flying trains; moving sidewalks; memory expansion; other fantastic future facts! Simon & Schuster list price: \$14.95

**Subscriber's club price: \$11.95  
Order #S124**

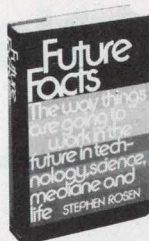

**The Psychology  
of Computer  
Programming**

Gerald M. Weinberg

"The best book about programming yet to be published . . ." —*Datamation*. This fascinating book reveals the human factor in programming. Explores the behavior and thought processes of programmers in their daily work. Here is must reading for every computer professional. Van Nostrand list price: \$9.50

**Subscriber's club price: \$8.50  
Order #S102**

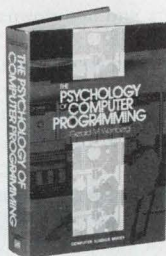

**400 Ideas  
for Design,  
Volume 3**

Electronic Design

A priceless collection of the best contributions to *Electronic Design's* "Ideas for Design" section. These design ideas will save you hours of work—lead you to valuable new work habits. The ideas range from complex to very simple approaches in different design areas. Hayden list price: \$13.95

**Subscriber's club price: \$11.85  
Order #S119**

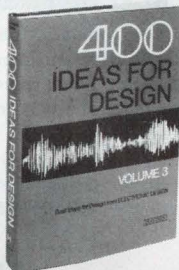

**Writing  
At Work:  
Do's, Don'ts,  
and How To's**

Ernst Jacobi

"Jacobi's book is great . . . a new, original, readable, usable book on writing for business and professional people." *Jim Lufkin, Mgr., Professional Publications, Honeywell*. This lively, entertaining book shows you how to change your entire attitude toward writing documents and technical reports, making it easier and more enjoyable for you. Hayden list price: \$10.95

**Subscriber's club price: \$9.25  
Order #S126**

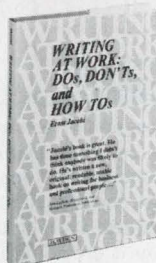

**Assembly  
Level  
Programming  
for  
Small  
Computers**

Walter J. Weller

Gradually builds your skills in every aspect of assembly level programming applicable to a wide range of minicomputers. Improves your problem-solving abilities with practical problems in real time control, monitoring, and data acquisition. Lexington Books list price: \$14.95

**Subscriber's club price: \$12.70  
Order #S101**

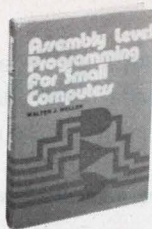

**High-Frequency  
Amplifiers**

Ralph S. Carson

Systematic formulas and techniques take the sweat and error out of calculating transistor parameters . . . stability . . . power gains . . . tunability . . . bandwidths . . . every step of amp design! Uses Smith Chart on transmission lines, matching and microstrip networks, parameter variations. Includes scattering parameters. Wiley list price: \$14.95

**Subscriber's club price: \$11.95  
Order #S123**

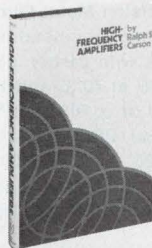

**Digital  
Signal  
Analysis**

Samuel D. Stearns

"Highly recommended for practicing engineers" —*IEEE Transactions*. Featuring a Foreword by Richard Hamming, this ideal master handbook on signal processing contains recent advances, new design material, and a comparison between continuous and digital systems extremely helpful to newcomers. Hayden list price: \$19.95

**Subscriber's club price: \$15.20  
Order #S120**

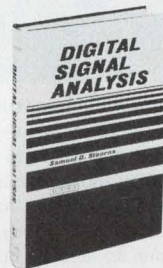

**Just published!**

The first authoritative study of the computer's great potential for crime, by "the leading expert on the history of computer crime." —*Fortune*

**Crime by  
Computer**

Donn B. Parker

Fascinating case histories reveal startling new kinds of million-dollar fraud, theft, larceny, and embezzlement. Who's doing it, why, how, and how to stop them. Explores invasion of personal privacy, computer intimidation, and the future of white-collar crime. "Must reading for those involved in electronic data processing . . ." —*Publisher's Weekly*. Scribner's list price: \$10.95

**Subscriber's club price: \$9.30  
Order #S117**

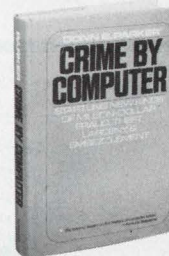

**Power  
Semiconductor  
Circuits**

S. B. Dewan & A. Straughen

Complete coverage of the design of converter power circuits, including the specification of required thyristors and diodes. Treats various kinds of converters chapter by chapter. All methods have been applied to the design of industrial equipment. Wiley list price: \$26.50

**Subscriber's club price: \$19.95  
Order #S122**



**ELECTRONIC  
DESIGN  
BOOK CLUB**

50 Essex Street  
Rochelle Park, New Jersey 07662

**Order Form**

Your new NO OBLIGATION book club is a great idea! Please send the following book(s) on 10-day examination. At the end of that time, I will send payment plus postage and handling (and state sales tax where applicable) or return the book(s) and owe nothing.

As a subscriber to *Electronic Design*, I understand that I am under no obligation to buy a specific number of books to continue to take advantage of your discounts.

FILL IN BOOK ORDER NO. AND TITLE BELOW:

Order #	Title	PRICE

Sales tax: N.J.—5%, Ca.—6%, Fla.—4%      Sales Tax \_\_\_\_\_  
Outside USA, add \$2.00 shipping & handling      Total \_\_\_\_\_

**SHIP TO:**

Name \_\_\_\_\_  
Firm/Institution \_\_\_\_\_  
Address \_\_\_\_\_  
City/State \_\_\_\_\_ Zip \_\_\_\_\_

To take advantage of our subscriber's club price, you must fill in your *Electronic Design* subscription number (the long number over your name at the top of your address label on the front of this issue).

(Yes... We need all 29 numbers and letters)

**CREDIT CARDS ACCEPTED—Customer pays postage and handling**  
CHECK ONE:  Master Charge     BankAmericard  
Acct. No. \_\_\_\_\_  
Expiration Date \_\_\_\_\_  
InterBank No. \_\_\_\_\_ (Master Charge ONLY)  
Signature \_\_\_\_\_  
 Payment (check or money order) enclosed.  
 Company Purchase Order — staple to this card.  
This order card good only until June 30, 1977.

# Panasonic® Component News

Our technology is all around you

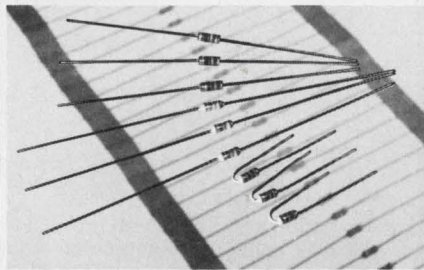

## 1/8W Miniature Fixed Resistors.

Both carbon film (ERD-10T: 1/8W at 70°C, 4.7 thru 220 Kohms with 2% or 5% tol.) and carbon composition (ERC-18G: 1/8W at 70°C, 10 thru 1 megohms with 5% or 10% tol.). These low cost, high performance resistors meet or exceed spec. RC05 of MIL-R-11 spec.

CIRCLE NUMBER 131

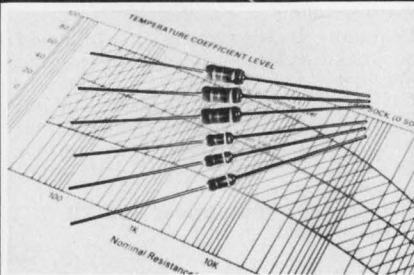

## Precision Metal Film Resistors.

Commercial metal film resistor (in equal sizes with carbon composition), ERO-25C (1/4W at 70°C and 1/8W at 125°C, TCR:  $\pm 50$  or  $\pm 100$  ppm/°C, TOL:  $\pm 0.5\%$  or  $\pm 1\%$ ), ERO-50C (1/2W at 70°C and 1/4W at 125°C, TCR:  $\pm 50$  or  $\pm 100$  ppm/°C, TOL:  $\pm 0.5\%$  or  $\pm 1\%$ ) are available to meet MIL-R-10509 spec. Characteristic D.

CIRCLE NUMBER 132

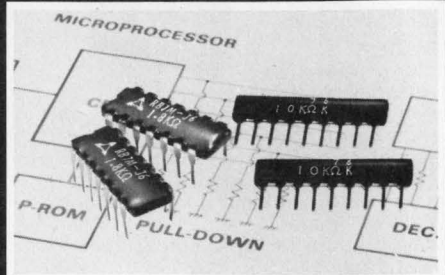

## SIP/DIP Resistor Networks,

available in the popular configurations at low cost for such typical applications as pull-ups and pull-downs or line terminations.

SIP: 4 to 12 resistors, 100Ω to 1 meg Ω with tol of 5, 10 or 20%

DIP: 7 or 13 resistors, 100Ω to 10 KΩ with tol of 5, 10 or 20%

CIRCLE NUMBER 133

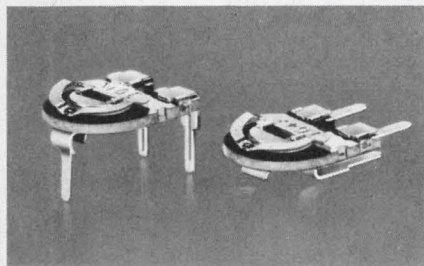

EVN-KOA and EVN-K4A series, highly reliable 8mm dia. trimming potentiometers available from large scale, completely automated production. Mounting pitch is compatible with Piher PT10h (2.5)/PT10v series and CTS X260/U260 series.

CIRCLE NUMBER 134

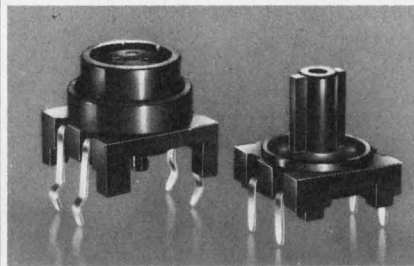

Momentary Push-On Light Touch Switch, EVQ-P series features short push stroke (0.4  $\pm$  0.1mm), light push force (130  $\pm$  40 grams) and long million time operating life. EVQ-PAR11K has snap in terminal with 13mm sq. body and EVQ-PBR12K of 12mm sq. and pc board terminal.

CIRCLE NUMBER 135

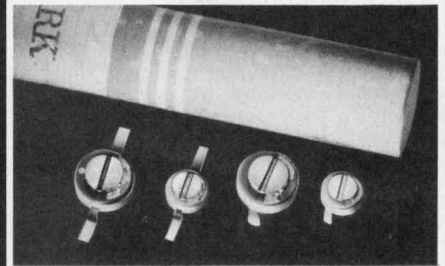

Thin Type Trimmer Capacitor ECV-1NW series, has wide variation adding SLF and high Q types. Small in size, excellent resettability, solid construction and low cost.

Dia.	Height	Cap range	
.138"	.059"	3-10pF,	4.5-30pF, 5-35pF
.197"	.079"	2.5-10pF,	5-25pF, 5.5-40pF

CIRCLE NUMBER 136



Snap in terminal and safety top vent of large aluminum lytic "TS series", provides stable mounting on pc board and reliable performance. Capacitance Tol.: -10 to +50%, Life: 1,000 hours at 85°C, Capacitance Range: 220 to 10,000  $\mu$ F, Working Voltage: 16 to 200Vdc, Terminal Pitch: .394" common to all can size.

CIRCLE NUMBER 137

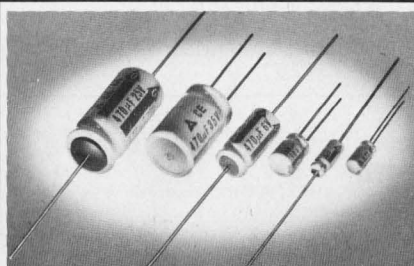

Miniature aluminum electrolytic capacitor Z series, features low impedance and leakage current. Max. Leakage Current: .002CV + 1  $\mu$ A, Life: 2,000 hours at 85°C, Capacitance Tol.:  $\pm 20\%$ , Capacitance Range: 0.1 to 2,200  $\mu$ F, Working Voltage: 6.3 to 50Vdc.

CIRCLE NUMBER 138

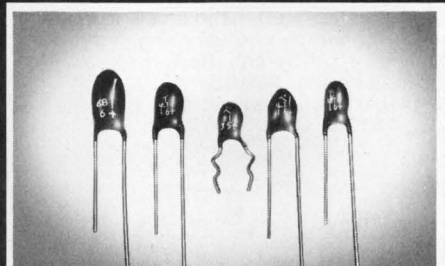

SQ series, epoxy resin dipped solid tantalum capacitor features long life of 2,000 hours at 85°C. Ideal for both consumer and industrial applications. Max. Leakage Current: 0.01CV or 0.5  $\mu$ A, whichever is greater, Capacitance Tol.:  $\pm 20\%$ , Capacitance Range: 0.1 to 220  $\mu$ F, Working Voltage: 3.15 to 50Vdc.

CIRCLE NUMBER 139

PANASONIC COMPANY, Division of Matsushita Electric Corporation of America.

Industrial Components Department, 1 Panasonic Way, Secaucus, New Jersey 07094 Tel: (201) 348-7000 TWX: 710-992-8920

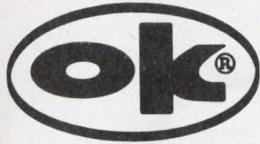

**WIRE WRAPPING TOOL**

For AWG 30, .025" (0,63mm) sq. post,  
"MODIFIED" wrap, positive indexing,  
anti-overwrapping device

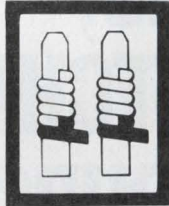

**OK MACHINE & TOOL CORPORATION**

3455 Conner St., Bronx, N.Y. 10475 / (212) 994-6600 / Telex 125091

**NEW**

**HOBBY-WRAP  
Model BW-630**



Battery  
**wire  
wrapping  
tool**

**\$34<sup>95</sup>**  
ONLY (batteries  
not included)  
**COMPLETE WITH BIT  
AND SLEEVE**

**NEW**

**HOBBY-WRAP  
Model BW-630**



Battery  
**wire  
wrapping  
tool**

**\$34<sup>95</sup>**  
ONLY (batteries  
not included)  
**COMPLETE WITH BIT  
AND SLEEVE**

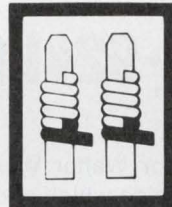

**WIRE WRAPPING TOOL**

For AWG 30, .025" (0,63mm) sq. post,  
"MODIFIED" wrap, positive indexing,  
anti-overwrapping device.



**OK MACHINE & TOOL CORPORATION**

3455 Conner St., Bronx, N.Y. 10475 / (212) 994-6600 / Telex 125091

CIRCLE NUMBER 34

# GET FETs

## FOR RF, AUDIO, VIDEO,

## MIXERS,

## SIGNAL SWITCHING, CURRENT SOURCES, HIGH VOLTAGE

Dial **(415) 968-9241** for samples or design help

It's that simple. Just ask for Walter Wong. He'll be glad to help you decide which of our broad FET line will meet your need and how to use it best. Or drop him a line on your company letterhead. He'll send you sample by return mail.

**FETs for all applications.** Whatever you're designing—if it's a function FETs can handle—you can be sure we'll have a FET with the precise characteristics to meet your need. You can be sure, too, that the performance of production orders will be consistent with the samples you test.

**Profit by our experience.** We've been making

FETs longer than anyone else. We have a longer reliability history (ask about our involvement in Hi Rel programs, for instance). We lead the industry in high voltage FETs; in monolithic duals for matched performance. And we're price-competitive across the board.

**Ask for applications help.** If you'd like design assistance in the best use of FETs for your specific application, just ask. If your need is more general, our FET Application Data Book is just off the press. It, too, is yours for the asking. So dial our number today and ask.

 **TELEDYNE SEMICONDUCTOR**

1300 Terra Bella Avenue, Mountain View, California 94043 Tel: (415) 968-9241 TWX: 910-379-6494 Telex: 34-8416  
SALES OFFICES:  
DOMESTIC: Salem, N.H. (603) 899-9551; Stony Brook, N.Y. (516) 751-5640; Des Plaines, IL (312) 299-6196;  
Los Angeles, CA (213) 826-6639; Mountain View, CA (415) 968-9241 • INTERNATIONAL: Hounslow,  
Middlesex, England (44) 01-897-2503; Tiengen, West Germany 7741-5066; Kowloon, Hong Kong 3-240122;  
Tokyo, Japan 03-405-5738.

# Teamwork

Charlie knew there were no more one-man shows. Business is too complex, these days, for one guy to do everything himself. Teamwork is essential.

So Charlie structured his company around teams. He had groups of engineers developing a system, instead of having one guy do the whole job.

But Charlie was a perfectionist. Nothing was ever quite good enough for him. So he challenged everything—and everybody. Instead of asking why something was done, he would assume it was done wrong. He always put his people on the defensive. And though he didn't do it deliberately, he always left his people feeling that anybody working for him must be slightly stupid.

When Charlie let a fellow know how badly he did something, he unwittingly suggested that somebody else might be doing it well. So he created a high coefficient of friction among his people. Before long, out of motives of self defense, Jack spent a good bit of time finding fault with Dave, who tried to find what Mac did wrong.

When members of a team met to discuss their projects, each man was busy protecting himself and stabbing the other fellow. It was obvious to Jack that he looked stronger if Dave looked weaker; and Dave felt more comfortable when Mac's mistakes were exposed.

Charlie, in turn, saw every exposed weakness as a revelation of Holy Truth and Progress. So he felt proud. He could see that his team concept was really working. But he was wrong.

He had indeed created teams. But he had also created an atmosphere that destroyed teamwork.



A handwritten signature in dark ink, reading "George Rostky". The signature is fluid and cursive, with a long horizontal stroke at the end.

GEORGE ROSTKY  
Editor-in-Chief

## Powerful calculators for the blind are now possible with a low-cost interface circuit. And variants are useful to the sighted as well.

When you use your calculator, or read an instrument in your lab, do you ever wonder how blind engineers get along? Until recently "talking" calculators have made some limited computing available to the blind—but at a steep price. Now a Braille interface, adaptable to almost any calculator, can be assembled at a parts cost well below \$100.

Furthermore, you can apply essentially the same circuit to everyday lab problems, such as converting digital instrument readings into numerical control outputs for motors and other mechanical actuators. With some additional buf-

fering, you can also use the interface to display calculator or other LED displays on a video monitor, or TV screen.

The described Braille interface is used with a Texas Instruments SR-52 programmable calculator because of its powerful instruction set, magnetic-card programming and keyboard design. The keyboard's uniformly spaced rows and columns of keys, with tactile feedback, are well suited for operation by blind users. Moreover, a connector that permits attachment of a printer (Model PC-100) makes buffered control signals available, and thus simplifies interfacing.

The necessary segment-drive and timing signals for the interface are brought out through a small connector at the side of the calculator without impairing the instrument's normal use. The

Claus P. Janota, Research Assistant, Applied Research Laboratory, P.O. Box 30, State College, PA 16801.

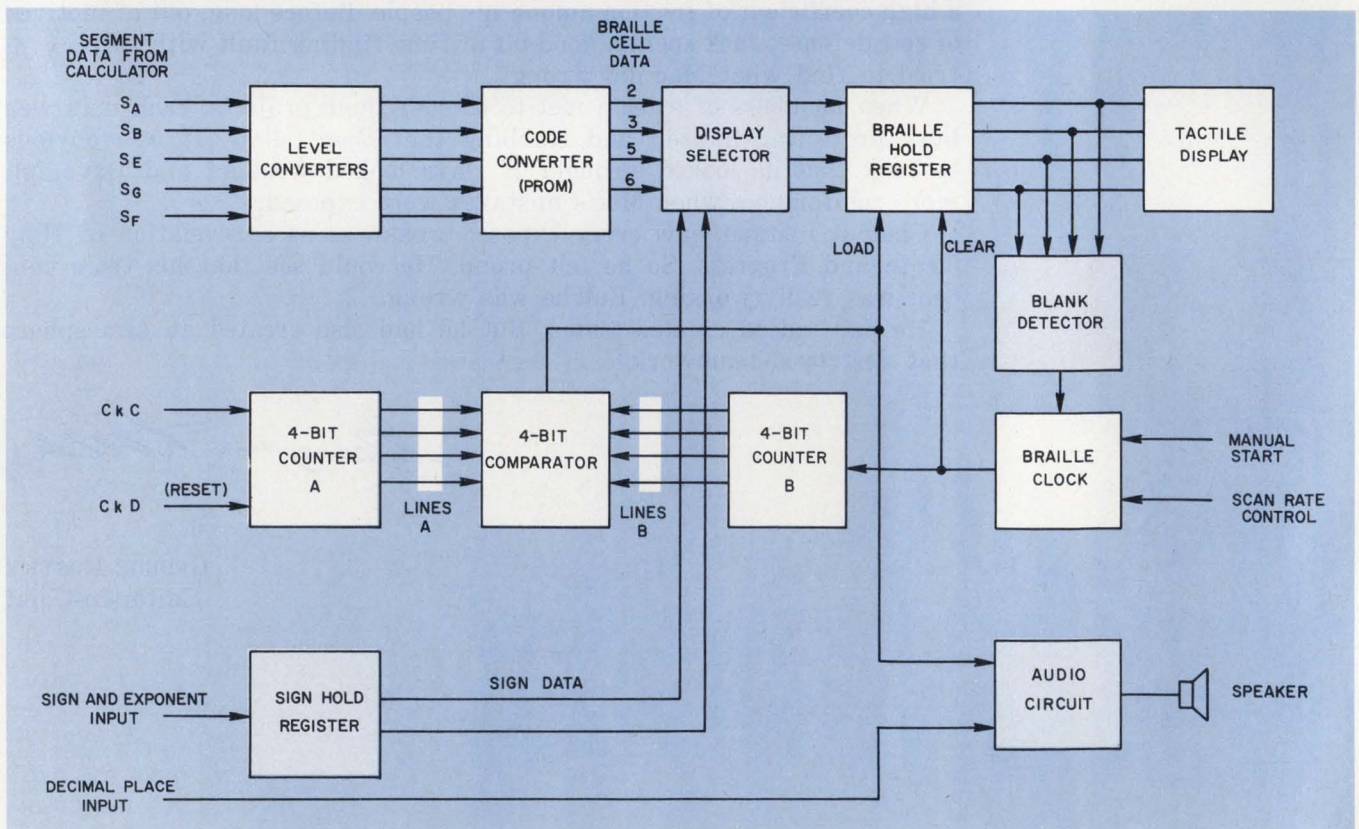

1. The highlighted components in the block diagram convert 7-segment numerals to 4-point Braille. The rest of

the circuit takes care of punctuation, such as minus signs and the decimal point.



display content of the SR-52 is available at the printer connector, but in such a complex form that it is easier to tap the LED drivers directly.

After clamping the calculator atop the interface circuitry, the blind user enters data, instructions and programs in the usual manner. He then initiates a Braille display sequence with a precision snap-action switch, and selects the speed at which he wants to scan the calculator's display. The output appears at a set of metal pins that are raised sequentially to represent the numeric data, including signs.

### Get your scalpel ready

The surgery needed to modify the calculator is a snap, whether you want to build a Braille display or apply the interface for numerical control. You obtain the inputs from five drive lines for the calculator's seven-segment display ( $S_A$ ,  $S_B$ ,  $S_E$ ,  $S_G$ ,  $S_F$  in Fig. 1). You can leave out the bottom and lower-right segments of the display without causing any ambiguity. The five lines are first conditioned in the "level converter" which transforms the low segment-drive voltage to the 5.5 V required by the CMOS circuitry of the interface.

Now you can use the five drive lines as addresses to a programmable read-only memory. You obtain the proper combination of the four Braille display signals at the PROM's output.

Four dots (2, 3, 5 and 6 of the complete six-dot Braille format) are sufficient to output numeric data, as well as the minus sign and some punctuation.

As the calculator scans the ten mantissa and two exponent digits, the corresponding Braille signals change accordingly. A scan cycle lasts about 1.3 ms and consists of 16 character slots. The first four aren't used to display characters. The scan travels from the most to the least-significant digit, with the exponent following the latter immediately.

Two clock pulses are available from the calculator's printer interface: The display-cycle clock, CKD, signals the beginning of each display cycle, and the character clock, CKC, starts each character slot. Unlike the nearly simultaneous visual display of all 12 output digits, the tactile (Braille) output is displayed serially. A single Braille character can therefore replace the 12 LED digits of the calculator.

By displaying the characters serially, you not only save a lot of money, but actually make it easier for the blind user. He can keep his finger in the same position, sensing one digit after the other.

The calculator's scan rate of 1.3 ms/cycle is, of course, much too fast for Braille sensing. Experiments have shown that the blind user is most comfortable with a display rate of 0.5 to 2 s

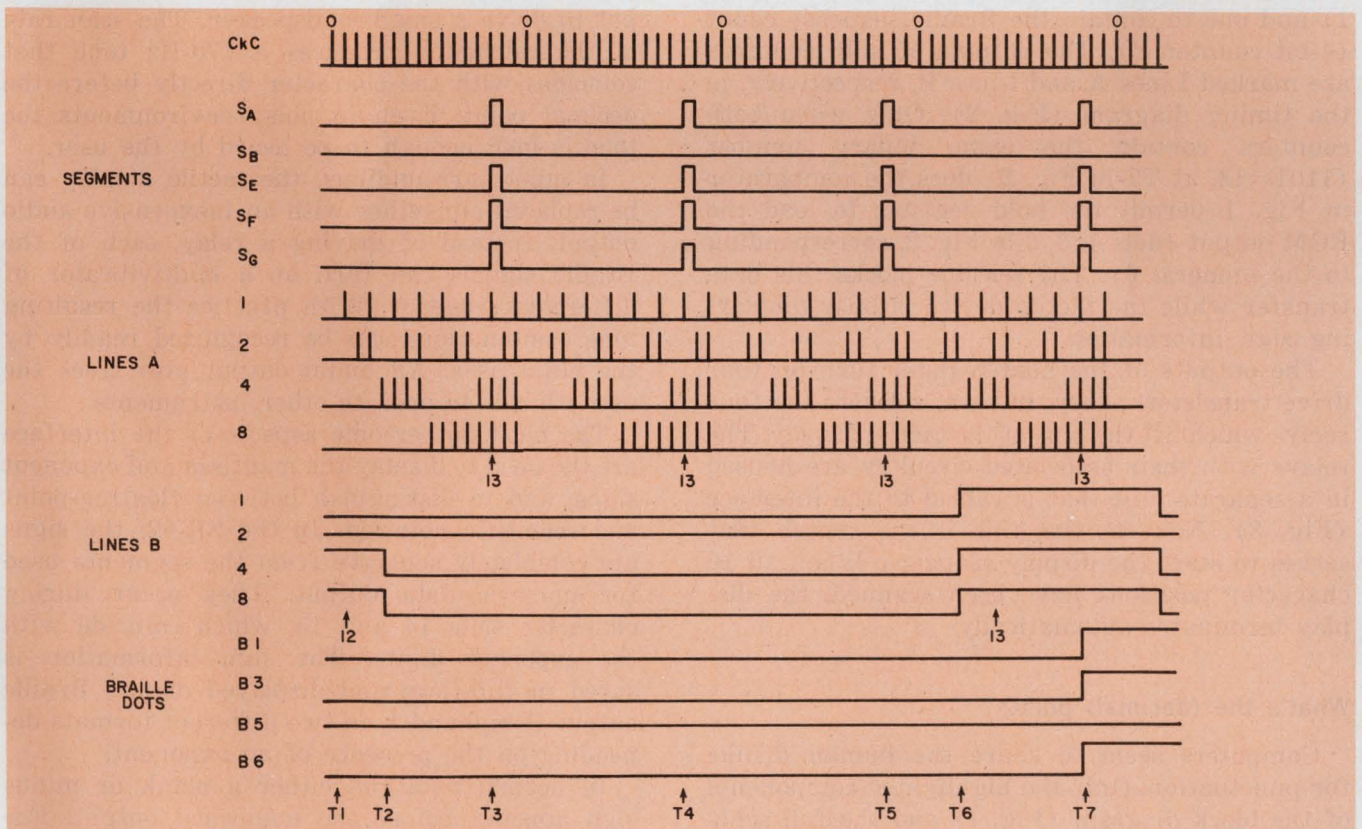

2. To activate the Braille relays, the calculator count (A) and Braille count (B) must be equal (T7). Count A

is also "13" at T3, T4 and T5, but count B is not until T6. The actual clock rate of B is much slower than shown.

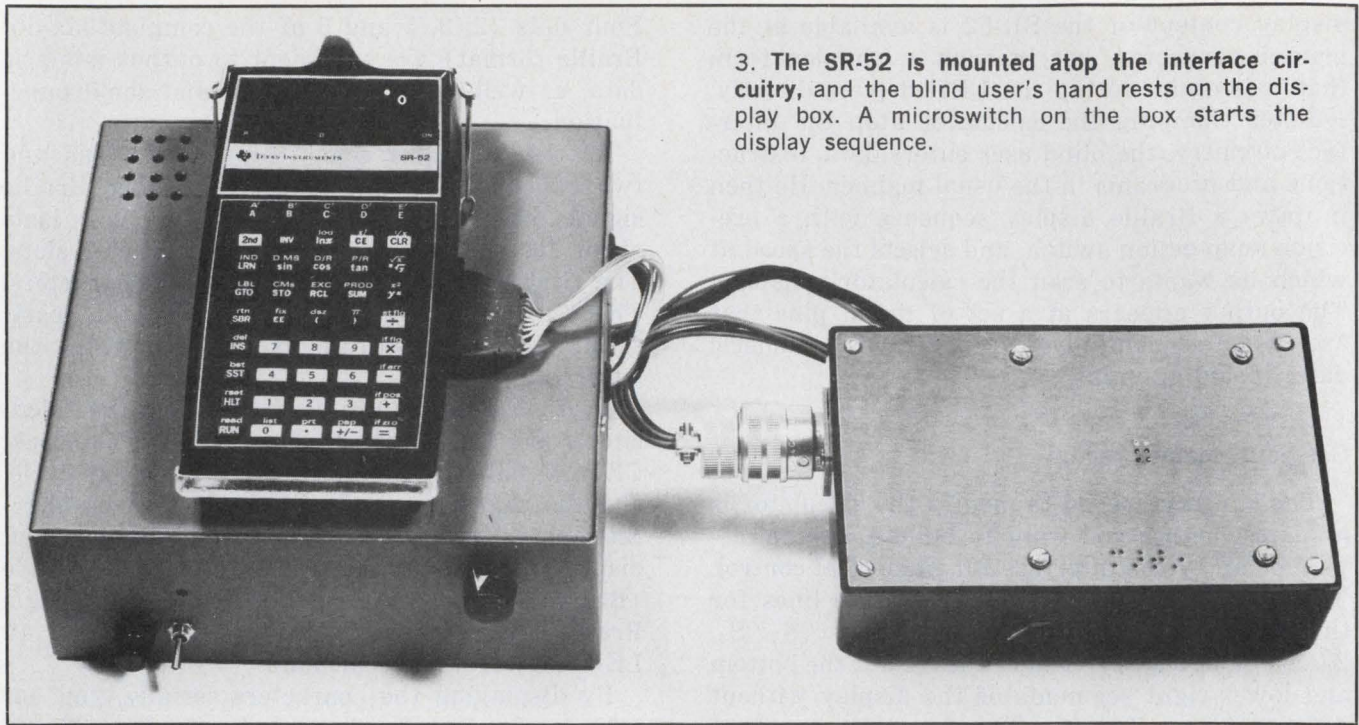

3. The SR-52 is mounted atop the interface circuitry, and the blind user's hand rests on the display box. A microswitch on the box starts the display sequence.

for each character. The interface circuit must then activate the Braille display just when the right character is being strobed on the optical display.

You can solve the timing problem by using two 4-bit counters: One to keep track of the optical display character position (4-bit counter A, Fig. 1) and one to contain the Braille sequence count (4-bit counter B). The outputs of both counters are marked Lines A and Lines B, respectively, in the timing diagram (Fig. 2). Only when both counters contain the same binary number (1101=13, at T7 in Fig. 2) does the comparator in Fig. 1 permit the hold register to load the ROM output (dots 1, 3, 6 in Fig. 2, corresponding to the numeral 6). The selector blocks this data transfer while the tactile device is busy displaying sign information.

The outputs of the hold register turn on four drive transistors; they, in turn, activate the four relays which lift the pins of the tactile display. The relays with their associated circuitry are housed in a separate unit that is cabled to the interface (Fig. 3). Next to the pins is the switch that serves to start the display sequence. When all 16 character positions have been scanned, the display terminates automatically.

### What's the (decimal) point?

Computers seem to share the human dislike for punctuation. Only the highlighted components of the block diagram (Fig. 1) and the full schematic (Fig. 4) handle numerals. All the remaining components keep track of punctuation. The

decimal-point display of the SR-52 is really another segment of the associated digit, but is displayed simultaneously rather than serially. Tactile display of the decimal point would have required either another relay, or an additional display period. It is easier to AND the decimal point pulse of the calculator with the comparator output to drive a small loudspeaker. The scan rate of the calculator produces a 770-Hz tone that coincides with the character directly before the decimal point. Even in noisy environments the tone is loud enough to be heard by the user.

In quiet surroundings, the tactile display can be replaced altogether with an inexpensive audio output. Instead of driving a relay, each of the Braille signals can turn on a multivibrator of different frequency. With practice the resulting tone combinations can be recognized readily by the blind user. An audio output also frees the user's hands to operate other instruments.

The most bothersome aspects of the interface are the need to display the mantissa and exponent signs, and to distinguish between floating-point and scientific notation. In the SR-52, the signs are completely separate from the segments used for numeric data output. They occur during character slots 14 and 15, which coincide with the exponent digits. The sign information is saved in flip-flops and displayed during Braille output slots 0 and 1, in two different formats depending on the presence of an exponent.

In normal notation, either a blank or minus sign appears before the numerical output. For scientific notation, two signs are always generated, with the mantissa sign preceding the ex-

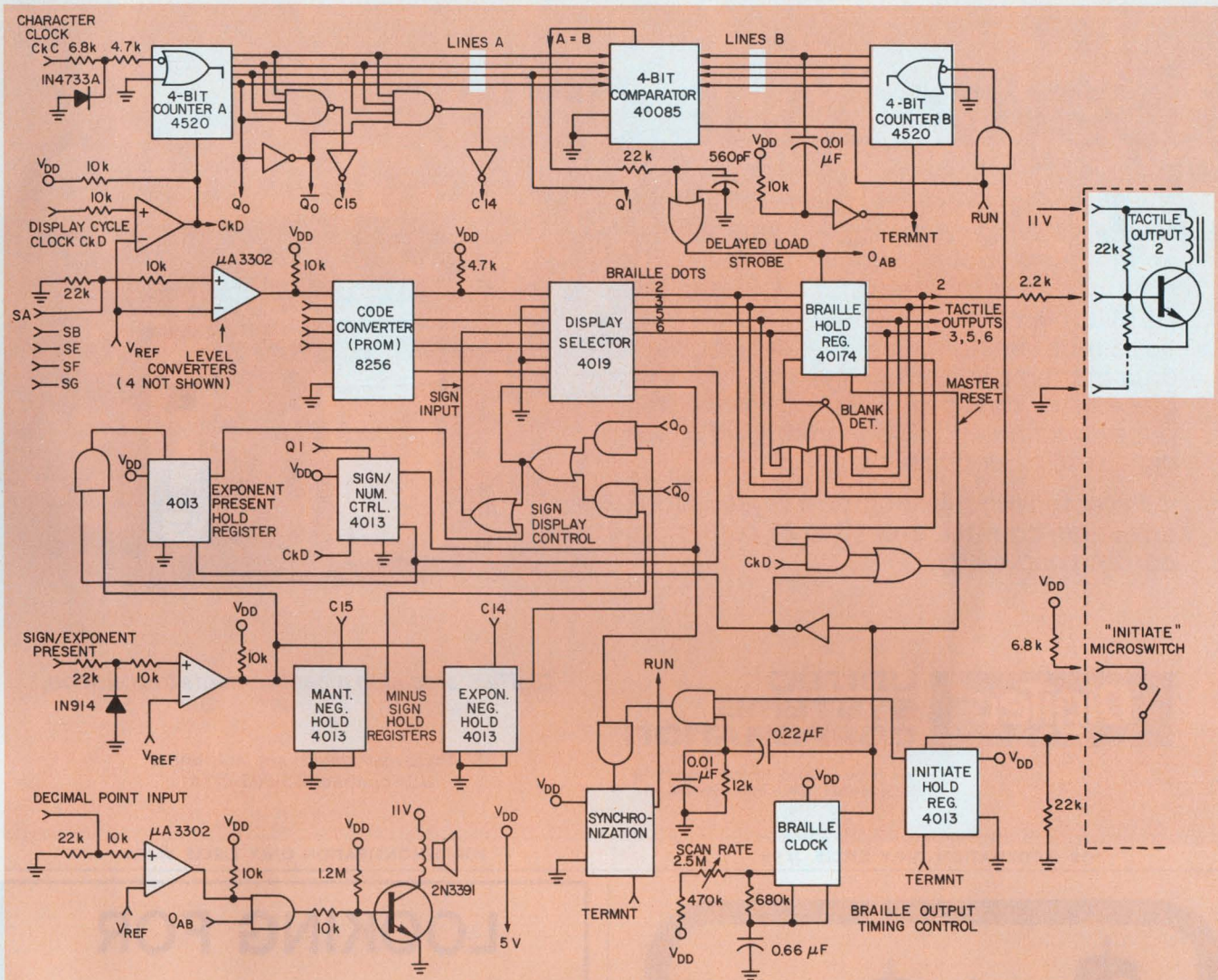

4. In the full schematic, the same circuit components are highlighted as in the block diagram of Fig. 1. Inputs

from the SR-52 are located along the left edge. Only one of the four Braille relays is shown.

ponent sign. The normal Braille plus-sign was replaced with an apostrophe (dot 3 only) to save circuitry. When an apostrophe or two minus signs appear at the beginning of the readout, the user interprets the last two digits as an exponent.

At the normal display rate of one character per second, the resulting display cycle of 16 seconds can be frustrating, if the user selects only a small number of digits with the "fix" key of the SR-52. To complete a display cycle more quickly, the Braille counter advances at a much faster rate whenever a blank character occurs. This feature is also helpful during slow computations. The visual display then remains blank, and a very quick Braille display cycle results, with no pins being raised. When the blind user initiates a new display cycle a few seconds later, he can easily determine when processing is completed.

The SR-52 indicates computational errors by a blinking display. The resulting Braille display can be jittery depending on the relationship between the Braille output rate and the blinking

rate. To verify the error condition, the blind user may have to initiate another display cycle, or change the output rate.

The interface circuit was implemented primarily with CMOS (series 4000) logic to reduce power supply requirements. A single voltage-regulator chip ( $\mu A78MG$ ) can therefore power all 17 integrated circuits. Only the PROM is bipolar, with a  $32 \times 8$  configuration to match the requirement ( $32 \times 4$  bits). The same PROM can also be programmed to allow conversion from BCD and 1-2-2-4 code to Braille, for interfacing with counters and digital voltmeters. To transfer data from a LED display to a serial link such as the RS232C, the PROM is coded with the ASCII information, and storage registers are added.

Because the Braille interface is external to the calculator, it can be used to drive other displays or communications lines. For example, calculators like the SR-52 can be interfaced easily with a speech synthesizer to produce a powerful "talking" scientific calculator. ■■

# Beyond the ordinary!

DigiTec printers are precision crafted instruments, offering reliability, workmanship and features that distinguish them from the ordinary. Ideal for laboratory, systems or OEM applications. Their sought-after features include: floating decimal, selective data blanking, systems interface, red and black print, data grouping and front panel paper loading and ribbon changing without exposure of electronic components.

Selected models include a crystal clock, an events counter, and 10 to 21 column recording capability.



**DigiTec** UNITED SYSTEMS CORPORATION

918 Woodley Road, Dayton, Ohio 45403  
(513) 254-6251, TWX (810) 459-1728

*DigiTec: precision measurements to count on.*

*These instruments available under  
GSA contract GS-00S-27741.*

FOR INFORMATION ONLY CIRCLE #95

FOR DEMONSTRATION ONLY CIRCLE #112



**buy  
better  
dc  
micromotors**

Portescap gives you better precision, better performance, better life, better value. So when you're looking for dc micromotors or servomotors for high reliability applications such as small printers, tape cassette drives, medical and avionic instruments, etc. take time to look at Portescap Swiss made micromotors, servomotors, gear boxes, tachometers, tachometer generators and motor generators.

Frame sizes from 15 mm through 34 mm. Stall torques from 0.08 oz. in. to 15.0 oz. in. No load speeds to 17,500 rpm. Time constants as low as 9ms.

*Phone or write for application engineering assistance and additional information.*

**Portescap U.S.**  
Member of the Portescap Group  
730 Fifth Avenue  
New York, New York 10019  
In New York: (212) 245-7715  
In San Francisco: (415) 886-1618

CIRCLE NUMBER 36

## LOOKING FOR A DISTRIBUTOR NEAR YOU?

Electronic Design's GOLD BOOK lists 5,700 distributors with access both **alphabetic**, by distributor name, and **geographic** by location.

When you need  
information . . .

**Electronic Design's  
GOLD BOOK  
IS THE PLACE  
TO LOOK**

# NOW: 1 TV SET = 1 CHROMA CHIP!

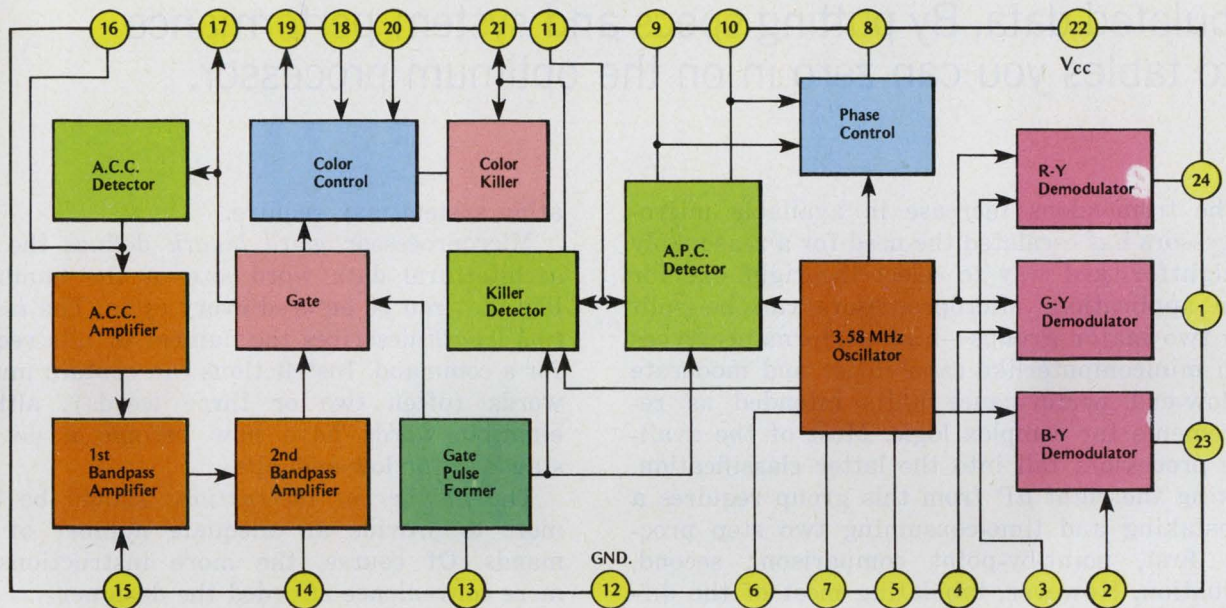

## We're shipping what others are still developing.

Here's true high technology—you cut component count, assembly time, design time. And get **every color processing function except video power output** from one MSI device, the  $\mu$ PC580C. While most other sources are still perfecting two-IC chroma, NEC's single-chip, plastic, 24-pin DIP is already user-proven in NTSC color TV. And being shipped in volume to TV manufacturers world wide.

**In one chip, you get all these:** ACC level and color killer setting automatically performed, eliminating variable resistors. Plus a triaxial color demodulator that lets you set the external axis. And, NEC gets rid of the tuning coils for you.

**And more:** The DC control system for color adjustment not only eases wiring, but greatly improves anti-interference characteristics. You get it all—ACC bandpass and color burst amps, color killer, phase-locked subcarrier regeneration, triaxial chroma demodulator, gating, detector, oscillators—everything but video output power stages. Ahead of its time? No way. You're ready, and so are we, with product in volume, high volume, and of super high quality.

The  $\mu$ PC580C is just one sample of NEC's high technology, quality, and deliverability across the entire semiconductor spectrum. For more information, contact us.

**This is what we're doing for TV. NOW: what can we do for you?** With 60,000 employees, our 78-year old firm is shipping world-wide, high volumes of such products as:

ECL	TTL	MOS
Linear	Zeners	Discretes
Diodes	Rectifiers	Thyristors
Optoelectronics	Power transistors	

**Quality? QUALITY!** NEC's QC is the best in the world. Has to be, for us to have gained the customer confidence that's made us a major world source of semiconductors.

**How can we help you?** What do you need in semiconductors? Send a letter or give us a call about your needs. We could have some exciting answers for you. NEC America, Inc., Electron Devices Division, 3070 Lawrence Expy., Santa Clara, CA 95051, (408) 738-2180. We have representatives in major U.S. cities.

**NEC**  
**NEC America, Inc.**

CIRCLE NUMBER 37

## Simplify low-cost $\mu$ P selection with tabulated data. By putting specs and system performance into tables you can zero in on the optimum processor.

The tremendous increase in available microprocessors has escalated the need for a reasonably straightforward way to select the right one for your application. Microprocessors can be split into two major groups—high-performance types with minicomputerlike capabilities and moderate to low-end performance units intended as replacements for complex logic. Most of the available processors fall into the latter classification. Picking the right  $\mu$ P from this group requires a painstaking and time-consuming two step process: first, point-by-point comparison; second, evaluation. However, tabulating most of the different  $\mu$ P specifications into three major areas—general-processor characteristics, minimum usable system characteristics and maximum usable system characteristics—makes selection of the one or two most likely candidates from a dozen or more very easy.

### You'll need more than just tables

Once the best prospects have been selected, you can evaluate them by using applications-oriented comparisons of software and timing called benchmarks. Benchmarking depends heavily on your application, and many experts agree that a general test of execution time really doesn't provide a true comparison.

Don't just pick the  $\mu$ P with the lowest cost. You must also know how much you need in support circuitry, memory, power supplies, input/output requirements, among other things—everything that's necessary to make a completely operating system.

Of course, evaluate the general characteristics of each  $\mu$ P. Some of the important parameters such as word length, cycle times, memory capacity availability of working registers, manipulation capabilities and the available instructions make a good starting point for  $\mu$ P selection. Table 1 summarizes the characteristics of four and eight-bit processors, without regard to what an oper-

ating system may require.

Microprocessor *word length* defines the basic architectural data word size of the number of bits that can be entered every cycle. The *instruction length* describes the number of bits required for a command. Instructions can contain multiple words (often two or three words), although eight-bit words have now become a de facto standard for low-end  $\mu$ Ps.

The *number of instructions* should be 50 or more to provide an adequate number of commands. Of course, the more instructions, the more convenience afforded the designer.

The speed at which a  $\mu$ P can complete an instruction, or its cycle time, must often be factored into the selection process. To give you a rough idea of various  $\mu$ P speeds, *best*, *average* and *worst-case cycle times* are provided in Table 1. Actual  $\mu$ P performance must be evaluated on an instruction-by-instruction basis since each  $\mu$ P's instruction-cycle duration will be different even for equivalent commands. In some cases, similar instructions on different  $\mu$ Ps can require twice as much time on unit A as on unit B.

### Separate the program and data

In many cases, the  $\mu$ P offers *separate program and data memories* so that the instructions and data are contained in two different memories. By separating memories in small systems, programs can be efficiently packed in read-only memory (ROM) storage while data held in random access memory (RAM) can be separately organized and addressed.

The addressing range of the  $\mu$ P is determined by the *range of the program counter (PC)*. Maximum program sizes range from 50 to 80% of the maximum PC range, and efficient  $\mu$ Ps have a majority of single-cycle instructions to keep program sizes small. However, since most  $\mu$ Ps also have multicycle instructions, the range of the PC doesn't always indicate the maximum number of instruction words.

If when a  $\mu$ P uses a separately addressed RAM *data memory* to hold changing data values typical requirements are for less than 256 words of

Table 1. Basic microprocessor characteristics

	TI	Rockwell	National	National	National	AMI	Rockwell	Intel	GI	GI	Fairchild	National	Intel
Characteristic	TMS 1000, 1100, 1200 1300	PPS4/1	MM 5781/82	MM 5799	MM 5734	9209	PPS4/2	MCS-40	1640	1650	F8	SC/MP	8048
Word length	4	4	4	4	4	4	4	4	8	8	8	8	8
Instruction length	8	8	8	8	8	8	8	8	12	12	8	8	8
Number of instructions	46	50	45	45	45	28	50	60	27	27	70	46	96
Typical cycle time ( $\mu$ s)	12	24	10	10	14	15	5	10	1	1	6	20	2.5
Minimum cycle time ( $\mu$ s)	12	23	10	10	14	15	5	10	1	1	2	10	2.5
Maximum cycle time ( $\mu$ s)	12	60	20	20	28	30	10	20	2	2	13	46	5
Separate program/data memory	Yes	Yes	Yes	Yes	Yes	Yes	Yes	Yes	Yes	Yes	Yes	No	Yes
Program counter range (words)	2 k	1.3 k	2 k	1.5 k	630	756	4 k	8 k	256	512	65 k	65 k	4 k
Data memory range (words)	64/128	96	1 k	1 k	55	64	256	1 k +	32	32	65 k	65 k	320
Number of interrupts	0	0	0	0	0	0	0	1	0	0	Mul	1	2+
Number of levels of interrupt	0	0	0	0	0	0	0	1	0	0	1	1	1
Number of working registers	2	5	4	1	0	1	1	24	32	32	16	1	8/16
Number of register banks	-	-	-	-	-	0	-	2	-	-	-	-	2
Bit manipulation instruction	Yes	Yes	No	No	No	Yes	Limited	Limited	Yes	Yes	No	No	Yes
Nibble manipulation	Yes	Yes	Yes	Yes	Yes	Yes	Yes	Yes	Yes	Yes	No	No	Yes
Byte manipulation	No	No	No	No	No	No	No	No	Yes	Yes	Yes	Yes	Yes
Decimal arithmetic	No	Yes	Yes	Yes	Yes	No	Yes	Yes	No	No	Yes	Yes	Yes
Binary arithmetic	Yes	Yes	Yes	Yes	Yes	Yes	Yes	Yes	Yes	Yes	Yes	Yes	Yes
Indirect addressing	No	Yes	No	No	No	No	Yes	Yes	No	No	Yes	No	Yes
Indexing	No	No	No	No	No	No	No	No	No	No	No	Yes	No
Address stack depth	1	2	2	2	1	2	2	7	2	2	1	3	8
Full range jump	No	Yes	Yes	Yes	Yes	Yes	Yes	Yes	Yes	Yes	Yes	Yes	Yes
Relative jump	No	Yes	No	No	No	No	No	No	No	No	Yes	Yes	No
Number of conditional jumps	1	30	10	10	8	5	5	16	3	3	9	3	14
I/O expandability	Limited	No	Limited	Limited	No	No	Yes	Yes	Limited	No	Yes	Yes	Yes
Memory expandability	No	No	Yes	No	No	No	Yes	Yes	No	No	Yes	Yes	Yes

RAM (see Table 1). Most low-end  $\mu$ Ps use separately addressed data and memory to facilitate organization of data values.

Often during processing, an external device may have to communicate with the  $\mu$ P. One way to do so is to interrupt the processor. The *number of interrupts* the  $\mu$ P can handle tells you how many devices can signal at the same time and be ranked and handled in turn. Every interrupt handled by the processor can be assigned a priority and the *number of interrupt levels* used to determine which input gets serviced first, second, and so on by the processor.

### Interrupts come from many sources

However, a  $\mu$ P may have many sources of interrupts—but only one level. An example of a single level is the ability of a device to stop the main processing program and jump to a special service routine that is followed when an interrupt occurs. But if during execution of this new program a more urgent interrupt comes in (a higher priority), the complete interrupt routine being executed must be completed, and operation returned to the main program before the next interrupt can be handled.

On the other hand, more powerful machines are designed to accept another interrupt command even as they execute an interrupt. The process of storing the current routine and jumping to the next is called nesting and the number of possible levels is determined solely by the number of registers used to store the nested information. As you can see from Table 1, most low-cost  $\mu$ Ps have only a single level of interrupt capability.

Data entering the processor are usually fed into one of the *working registers*. These registers are as long as a CPU word and can be manipulated by the instructions (the accumulator is considered a working register). Working registers often serve as a source or destination for data manipulated by an accumulator as well as data coming from or going to either an I/O-port, memory or the arithmetic-and-logic section. Ideally, all working registers should be accessible by all register instructions; when they are, they are called symmetrical.

Often, processor operations require that only a single bit in a word be altered. The ability of a  $\mu$ P to perform *bit manipulation*—setting, resetting, testing and so on—is a must for many I/O applications. Although you can circumvent this manipulation by using logic operations for setting, resetting and shifting data into the carry bit for testing, you will need more time for processing.

To process data in four-bit chunks (often referred to as nibbles), some  $\mu$ Ps permit *nibble*

*manipulation*—especially  $\mu$ Ps intended to handle binary-coded decimal data. A good eight-bit  $\mu$ P should be able to handle both sizes of data words. Eight-bit processors, of course, have flexible *byte-manipulation* capabilities, but the mark of a good eight-bit unit is its ability to manipulate four-bit chunks of data.

Since a great deal of data appear in BCD form, the ability of a  $\mu$ P to do *decimal arithmetic* can be very important. Man-to-machine interfaces can be simplified if  $\mu$ Ps can handle BCD data without having to convert to binary for each operation. Nevertheless, every processor chip is designed to handle *binary arithmetic*.

Accessing the available memory of each  $\mu$ P system is often done with direct addressing. But in cases where the address is not within the direct range, *indirect addressing* is available on some  $\mu$ Ps to permit the unit to fetch an operand or data word from any memory location. Sometimes, an additional addressing scheme, called *indexing*, is available.

Indexing lets the  $\mu$ P add the contents of a pre-designated register to the current address value and use the resulting sum as the new address. This technique is most advantageous when program memories are greater than 8-k words since addresses can be quickly modified. Indexing permits a block of memory to be rapidly pointed to from the current address, and is useful when you must access multiple data fields and tables without changing the basic address.

### Stack depth limits subroutine nesting

During execution, a program will often jump to one or more subroutines. Depending upon the *address-stack depth*, the number of jumps can be restricted. This number can be especially important if subroutines must be nested. Three jumps should be the absolute minimum. Seven jumps are desirable if an interrupt operation must also be considered. Not only is the program-counter value stored in the stack, but during an interrupt all processor-status information can be stored there automatically.

Whenever the processor departs from sequential program flow, it jumps to a new address. If a *full-range jump* is possible (a jump to anywhere in the program up to full addressing range), simple programs can be written. Without an available full-range jump, multiple-page jumps are often required to reach the desired program point.

Program operation may be transferred to a location plus or minus some number of instructions from the location of the jump. When this type of *relative jump* is available, addressing can be made very simple. But when a program is developed with a symbolic assembler, relative jump



Table 2. Minimal system characteristics

	TI	Rockwell	National	National	National	AMI	Rockwell	Intel	GI	GI	Fairchild	National	Intel
Characteristic	TMS 1000, 1100, 1200 1300	PPS4/1	MM 5781/82	MM 5799	MM 5734	9209	PPS4/2	MCS-40	1640	1650	F8	SC/MP	8048
Number of required ICs	1	1	3	1	1	1	2	4	1	1	2	6+	1
Program memory size	1k/2k	1.3k	2k	1.5k	630	756	2k	1k	256	512	1k	2k	1k
Data memory (word)	64/128	94	160	96	55	64	128	80	32	32	64	256	64
PROM development available	Yes	Yes	No	No	No	No	Yes	Yes	Yes	Yes	Yes	Yes	Yes
PROM/ROM systems-identical (*Phys) (**Elec)	No Yes	No No	No No	No No	No No	No No	No Yes	No Yes	No Yes	No Yes	No Yes	Yes Yes	Yes Yes
I/O lines	23/25/28	31	18	18	24	33	36	21	24	24	32	23	27
I/O lines that can be inputs	4	31	5	5	4	9	30	17	24	24	32	11	24
Strobes, controlling flags and test lines	0	0	5	4	2	12	0	1	5	0	0	9	5
I/O lines that can be outputs	19/21/24	18	13	13	1	8	30	20	24	24	32	12	24
Bidirectional buses (I/O)	No	No	No	No	No	No	Yes	No	Yes	No	No	Yes	Yes
Timers	No	No	No	No	No	No	No	No	No	No	Yes	No	Yes
Timer resolution	-	-	-	-	-	-	-	-	-	-	8	-	8
Timer accuracy $\mu$ s/bit	-	-	-	-	-	-	-	-	-	-	15.5	-	80
Event counter	No	No	No	No	No	No	No	No	Yes	Yes	No	No	Yes
Serial I/O	No	Yes	Yes	Yes	No	No	No	No	No	No	No	Yes	No
Clock on chip	Yes	Yes	No	Yes	Yes	Yes	Yes	No	Yes	Yes	Yes	Yes	Yes
Clock R/C controlled	Yes	Yes	No	Yes	Yes	Yes	No	No	Yes	Yes	Yes	Yes	Yes
Reset on chip	Yes	Yes	Yes	Yes	Yes	Yes	No	No	Yes	Yes	Yes	No	Yes
Reset separate pin	No	Yes	No	No	No	Yes	Yes	Yes	Yes	No	Yes	Yes	Yes
Power consumption (mW)	75	70	200	150	125	160	800	1000+	N/A	N/A	600	1000+	400
Low-power standby	No	No	No	No	No	No	No	Yes	No	No	No	No	Yes
Operating supply voltage	15 V	15 V	9 V	9 V	9 V	15 V	5 V, -12 V	15 V	15 V	5 V	5 V, -12 V	5 V, -12 V	5 V
Technology	PMOS	PMOS	PMOS	PMOS	PMOS	PMOS	PMOS	PMOS	NMOS	NMOS	NMOS	PMOS	NMOS
Package pin count	28/40	42	24/24	28	40	40/28	42/42	28	40	28	40/40	40	40

\*Physical refers to pin compatibility between ROM and PROM parts.

\*\*Electrical refers only to code compatibility.

instructions aren't as necessary. And, care must be taken in programming when relative jumps are used with multicycle instructions since a jump may inadvertently specify a noninstruction location.

External-system hardware can often determine when a jump occurs, and the *number of conditional jumps* can become important in many control applications. Conditional jumps are often performed after testing the carry flip-flop, special flags, test lines, accumulator bits, register values, and so on. The more conditional jumps available, the better.

The ease of *memory expansion*—if it can be expanded—can be an important factor, especially if high-level development languages are used. Memory expandability can often be likened with *I/O expandability*, since there are many combination circuits that contain RAM or ROM (or both) and I/O ports. However, a high degree of expandability permits dedicated peripheral I/O devices to feed into a single  $\mu\text{P}$ , which can cut system cost in the long run.

#### Look closely at a minimal system

Moving from basic processor characteristics to minimum usable system characteristics should give you a better idea of what's necessary to get a system going. Often, the *minimum number of required ICs* needed to support a system, including the  $\mu\text{P}$ , can be an eye opener.

As shown in Table 2, the number can range from one (just the  $\mu\text{P}$ ) to more than six. The basic system includes the circuitry to generate the clock, handle 16 lines of I/O plus program and data-memory (ROM and RAM) storage.

While one-chip systems are often desirable, the basic system should be flexible and expandable. In many of the small systems, the *program memory* is on the processor chip. In general, at least 1 kword is desirable since it can cover about 70% of all current low-end applications. The *data-memory size* should also be as large as possible—64 bytes is comfortable, and no less than 32 bytes should be considered.

Being able to use programmable ROMs to develop programs is an absolute must. (Of course, the ultimate production line will use masked ROMs.) Without *PROM development*, the only other alternative is software simulation, which can cause several ROM mask iterations before all bugs are eliminated. If possible, *PROM/ROM systems* with identical pinouts for ROMs and PROMs should be used—they minimize the number of circuit alterations and allow rapid field changes with little work.

To control the transfer of data between the  $\mu\text{P}$  and peripherals, use the special *I/O lines* available from the  $\mu\text{P}$ . However, lines for interfacing

only to specialized chips in multichip CPU organizations don't count.

#### I/O lines help determine flexibility

The number of *I/O lines that serve as inputs or outputs* can make the system more or less flexible than is readily apparent. For example, if a unit has 25 I/O lines but only four can be used as inputs, additional I/O devices may be required for certain applications to get more input lines—even though some output lines aren't used.

Special lines such as *strobes, test lines, flags and control lines* are convenient extensions of the I/O capabilities and should be considered a "bonus" for the extra control functions they provide. In many cases the I/O lines help control the data flow on a *bidirectional bus* that mates with all memory and peripheral circuits. However, some  $\mu\text{Ps}$  use separate input and output buses to simplify their hook-up to systems.

Processors specifically designed for control applications often have a *timer* that can accumulate elapsed time. It can be an independent register fed by the system clock. To be a useful subsystem, the timer should: (a) operate independently of and simultaneously with the  $\mu\text{P}$  and (b) indicate an overflow by means of an interrupt when the terminal value is reached. These features, along with the control instructions included in the command set, allow total asynchronous operation between the timer and  $\mu\text{P}$ .

The *timer resolution and accuracy* must also be examined. For instance, an eight-bit timer register can accumulate 256 timing intervals, each as long as the period of the clock. When intervals of time longer than 256 periods must be timed, a software counter must be created to count the number of times the register timer overflows. By knowing the software counter status and how long the service routine takes, you can measure very exact long-time intervals.

Often you don't want to count clock pulses, but rather the occurrences of an external event. To this end some  $\mu\text{Ps}$  include an *event counter* on the chip—it increments a register every time a transition occurs on the input line specifically enabled to record external event—and not clock—pulses. Instead of, or in addition to, offering parallel I/O capability, some devices provide a *serial I/O* capability. And when available, the serial I/O port should be capable of independent and asynchronous operation; otherwise it is little better than a software-controlled shift register.

#### Choose between internal or external clocks

To do all the timing, all processors need some form of *clock*. Many have the circuitry already built into the  $\mu\text{P}$  chip, with just the crystal or a

**Table 3. Maximum operating system options**

	TI	Rockwell	National	National	National	AMI	Rockwell	Intel	GI	GI	Fairchild	National	Intel
System support	TMS 1000, 1100, 1200 1300	PPS4/1	MM 5781/82	MM 5799	MM 5734	9209	PPS4/2	MCS-40	1640	1650	F8	SC/MP	8048
Standard memory interfacing	No	No	Limited	Limited	No	No	No	Yes	No	No	Yes	Yes	Yes
Custom memory components with I/O	No	No	No	No	No	No	Yes	Yes	No	No	Yes	No	Yes
General purpose I/O peripheral	No	No	No	No	No	No	Yes	Yes	No	No	Yes	No	Yes-2
UART/USART	Yes	No	No	No	No	No	Yes	Yes	No	No	No	Yes	Yes
Keyboard display peripheral	Yes	No	On chip	On chip	On chip	On chip	Yes	Yes	No	No	No	No	Yes
DMA peripheral	No	No	No	No	No	No	No	No	No	No	Yes	No	Yes
Interrupt peripheral	No	No	No	No	No	No	No	Yes	No	No	Yes	No	Yes-2
Printer peripheral	No	No	Yes	Yes	No	No	Yes	No	No	No	No	No	No
Timer peripheral	No	No	No	No	No	No	No	Yes	No	No	Yes	No	Yes
Slave processor	Yes	No	No	No	No	No	No	No	No	No	No	No	Yes

resistor and capacitor needed to set the clock frequency.

For nonprecision applications, the R-C combination is truly a low-cost alternative. Once started, the minimal system should be easy to *reset*. This capability is often overlooked when a system is being selected. If the signal isn't generated on the chip or with a simple R-C network (during power-up), you must use a comparatively elaborate one-shot circuit that increases system cost.

Operating cost, or *power consumption*, can often limit the choice of usable  $\mu$ Ps. Depending upon the technology used to build the  $\mu$ P and the clock frequency, power consumption can vary a factor of 10 or more. In case of power failure, some  $\mu$ Ps can be transferred into a sort of *standby*, or "idle" mode to minimize power consumption.

Even the operating *supply voltages* play an important part in device selection—TTL-compatible (+5 V), single-supply operation is the most common requirement, but many processors or memory circuits require one or two additional supplies. The cost of additional power supplies must be added to the basic system cost.

To guarantee system operation, stay with well established technologies and avoid nonstandard packages whenever possible. Exotic technologies may be just beyond the current production capabilities while nonstandard packages may cause production handling problems.

If the  $\mu$ P family of components is expandable, the manufacturers should, ideally, have a large assortment of memory and I/O circuits available. Some of the more commonly sought-after peripheral and I/O support features are listed in Table 3. As indicated, many of the inexpensive  $\mu$ Ps do not offer much in the way of peripheral support.

There are two major approaches to memory support for low-cost systems—off-the-shelf and custom memories. The custom memories are usually a form of ROM, PROM or RAM with a built-in I/O capability while the off-the-shelf units can be ROMs, RAMs or combinations thereof. Custom circuits can usually replace two or three standard memories with just a single circuit and thus decrease system cost.

I/O peripheral circuits can shave cost to the bone. Some peripheral control circuits are even more complex than the  $\mu$ P. These peripheral controllers usually operate independently of the  $\mu$ P and, since they permit the processor to perform another function simultaneously, often speed up system performance. ■■

**Bibliography**

1. Raphael, H., "Evaluating a Microcomputer Input/Output Performance," *Electronics*, Aug. 19, 1976.
2. Raphael, H., "Interfacing  $\mu$ C Displays: Trade Offs and Techniques for Two Basic Strategies," *Digital Design*, September, 1976.
3. Raphael, H., and Hou, S., "Test Equipment For Microcomputers," *Machine Design*, Aug. 26, 1976.

# Rockwell one-chip computers give you the right fit at the right price.

## Right now.



If you're designing a system or subsystem requiring as few as 10 TTL circuits, cost alone is reason enough to consider a Rockwell one-chip computer.

A wide choice of Rockwell one-chip computers is available right now. And the line-up of compatible one-chips is growing fast.

From Rockwell's PPS-4/1 family, you select the most cost-effective computer for your application.

### More on-chip I/O eliminates extra interface devices.

All of Rockwell's one-chip computers offer powerful, user-oriented I/O ports that eliminate costly interface circuitry in overall systems.

I/O features, including bidirectional ports, flexibly designed drivers and receivers, and serial input/output ports, provide you with powerful system options.

Many types of displays can be driven directly. Analog-digital conversion is easy. And serial I/O ports offer a new dimension of capability by giving you simple, "no-cost" interfacing for multi-computer systems.

### Rockwell flexibility assures cost-effective design.

Rockwell's one-chip computers give you design options you couldn't afford with other logic approaches.

During the design stage you can add or reduce functions, allocate I/O differently and make dozens of other changes by simple reprogramming or by moving to another software-compatible chip within the family.

### Powerful instruction sets increase efficiency.

Rockwell's instruction sets provide ROM efficiencies of typically 2 to 1 over other microcomputers. For example, some one-byte multi-function Rockwell instructions perform operations requiring five instructions in other systems.

More than 80% of Rockwell's instruction

types can be executed in one byte and in a single cycle. Special ROM instructions allow many subroutine calls to be handled in one byte. Table look-up instructions for MM77 and MM78 chips provide easy look up of stored data and easy keyboard decoding with minimal programming.

### The PPS 4/1 family of one-chip computers.

Model	MM76	MM77	MM78	MM75	MM76C	MM76D	MM76E
Description	Basic 76	Basic 77	Jumbo 77	Economy 76	High speed counter <sup>2</sup>	12-bit A/D converter	Expanded 76
ROM (x8)	640	1344	2048	640	640	640	1024
RAM (x4)	48	96	128	48	48	48	48
Total I/O lines	31	31	31	22	39	37	31
Cond. Interrupt	2	2	2	1	2	2	2
Parallel Input	8	8	8	4	8	8	8
Bidirectional Parallel	8	8	8	8	8	8	8
Discrete	10	10	10	9	10	10	10
Serial	3	3	3	—	3	3	3
In-line package	42 pin quad	42 pin quad	42 pin quad	28 pin dual	52 pin quad	52 pin quad	42 pin quad
Availability	Now	Now	Now	2Q/77	2Q/77	3Q/77	16 wk ARO

Power supply is 15v except low voltage version of Basic 76 available 3Q/77. Typical power dissipation is 70mw.

<sup>2</sup>Two 8-bit or one 16-bit presetable up/down counter with 8 control lines.

### Rockwell design aids also help lower your system cost.

To help control development costs, Rockwell makes available a universal Assembler that lets you assemble, edit, develop and debug programs, as well as load PROMs. Special development circuits enable prototyping.

Your Assembler can also handle incoming inspection and factory testing. And the same Assembler can be used to develop systems based on all Rockwell one-chip and multi-chip microprocessors.

For the full story on Rockwell one-chip computers, and how quickly they can be a part of your new product, write on your company letterhead to: Marketing Services, D/727-B, Microelectronic Device Division, Rockwell International, P.O. Box 3669, Anaheim, CA 92803, U.S.A. or phone (714) 632-3729.



Rockwell International

# Control your analog variables digitally.

Once you've got a sensor that transduces your analog variable to frequency, you can close the loop with a  $\mu P$ .

You can control analog functions by discrete steps within a closed loop. Temperature, for example, is a continuous variable well suited to digital feedback control. One digital system for servo control of temperature uses a thermistor-controlled oscillator as the sensor, and gates, counters and a clock for the controller. Or, if you want the controller to be remarkably effective while also adaptable, you can easily design one that uses a microprocessor.

For an example of a basic digitally controlled closed loop, look at the system in Fig. 1. The sensor is a thermistor whose resistance,  $R_{th}$ , is inversely proportional to the oven's temperature. Since the frequency,  $f_b$ , of the unijunction-transistor (UJT) oscillator is inversely proportional to  $R_{th}$ , this frequency is directly proportional to the temperature. The  $f_b$  is compared to the constant frequency of the clock,  $f_c$ . The comparator is simply an AND gate whose output follows  $f_b$  when  $f_c$  is high, as shown in Fig. 2.

The clock signal is differentiated to extract its positive-going edge, which pulses the clear input of the counter. Thus, the counter is clear at the start of each counting period.

Output pulses from the comparator increment the counter. If the counter reaches a preset limit, its control output turns off the SCR powering the heater.

Therefore, if the counter overflows,  $f_b$ —thus the temperature—is too high and the heater is turned off. If, on the other hand, the count doesn't reach the limit, the temperature is too low. The counter's control output then keeps the SCR on and the heater stays energized.

## Any microprocessor will do

The digital controller can be made more flexible by incorporating almost any microprocessor. The most widely used, Intel's 4-bit system, which includes the 4201 system clock, 4040 CPU and 4308 ROM with I/O ports (Fig. 3) works well. You can enter the reference temperature through

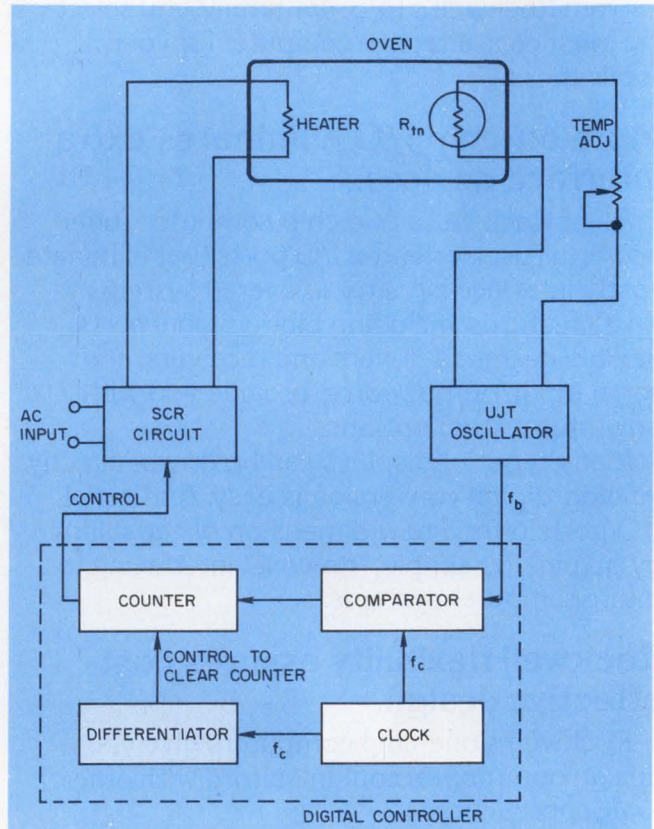

1. The basic digital controller compares two frequencies. One frequency represents the desired temperature while the other pulse train represents the actual temperature.

input-port 0 and control the SCR circuit via output-port 1 on the ROM chip. Send the feedback-frequency signal from the UJT oscillator to the CPU's test input. Use the ROM to store the system's control program and then you can start the system with an interrupt.

Looking at the system from the  $\mu P$ , code for the required temperature is entered through the input port, and an interrupt starts the system. Since  $f_b$  is directly proportional to temperature, its pulse period is inversely proportional. Thus, the time the CPU's test input stays high is also inversely related to temperature.

While its test input is high, the  $\mu P$  executes a counting loop whose result is feedback count. Then, the feedback count,  $c_b$ , and the reference code are compared (Fig. 4). If  $c_b$  is lower than or equal to the reference,  $c_r$ , the temperature is too

A. Singh, Assistant Director, Metropolitan Technical Institute, Saddle Brook, NJ 07662, and Dr. R. Mekel, Professor of Electrical Engineering, The City College of New York, 139 St. and Convent Ave., NY 10013.

**Table 1. Program for  $\mu$ P feedback temperature control using Intel's MCS-40 system**

Label	Operation	Explanation
	NOP NOP JUN START FIMO,00 SRCO RDR XCH 15 FIM2, 10	; Restart  ; Initialization
PWROFF:	CLB SRC 2 WRR	; Power off
BEGIN:	JCN TN, COUNT JUN BEGIN	; Count $f_b$
COUNT:	IAC JCN TN, COUNT SUB 15 JCN CN, PWRON JUN PWROFF	; Compare $c_b$ and $c_r$
PWRON:	LDM O1 SRC 2 WRR	; Power on
START:	EIN	; Interrupt enable

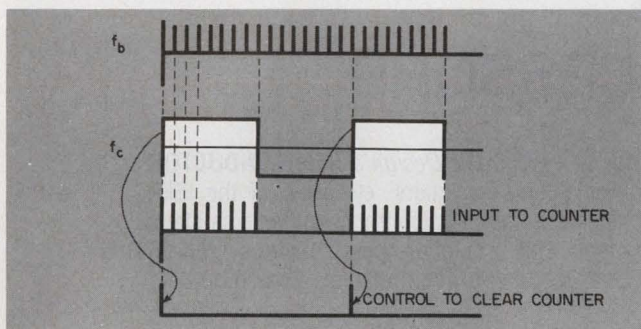

2. Pulses representing the sensed temperature are gated into the controller's counter by the reference waveform. The counter is cleared at the start of the reference wave.

high, so the SCR stays off. If  $c_b$  is higher than  $c_r$ , the temperature is too low, so the heater is turned on. This control strategy is implemented in the flow chart of Fig. 5.

A variable resistance in series with the thermistor (Fig. 1) tunes the UJT oscillator's frequency to correspond to the reference-frequency code, which should be designed to give maximum accuracy. The basic program, shown in Table 1, contains 16 temperature settings. But, by altering the program slightly, you can increase the number of settings up to the maximum the ROM will allow. ■■

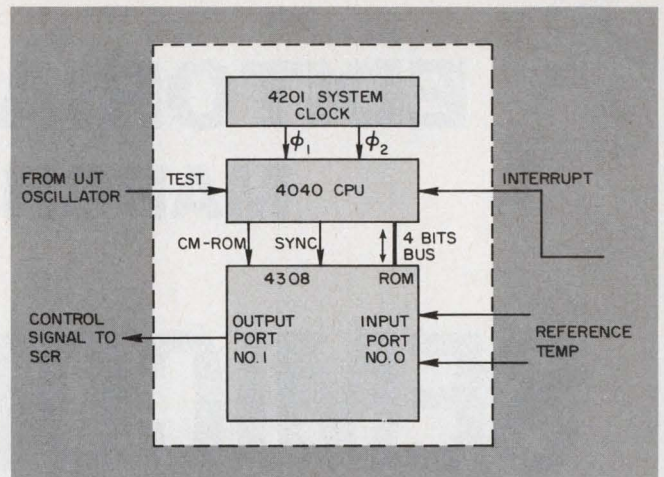

3. The  $\mu$ P-based controller stores the reference in an index register. The control signal is delivered to the system from ROM output port 1, while the sensor signal enters the CPU via its test input.

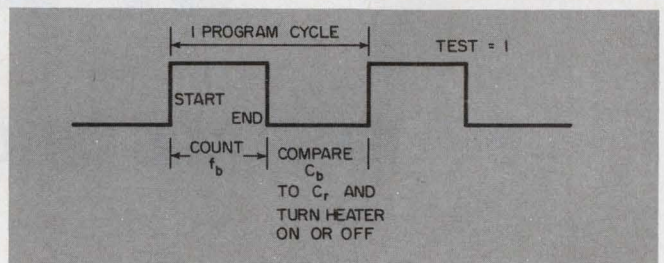

4. The  $\mu$ P controller's program cycle has two phases. In the first part the temperature-proportional frequency is counted. Then count and reference are compared.

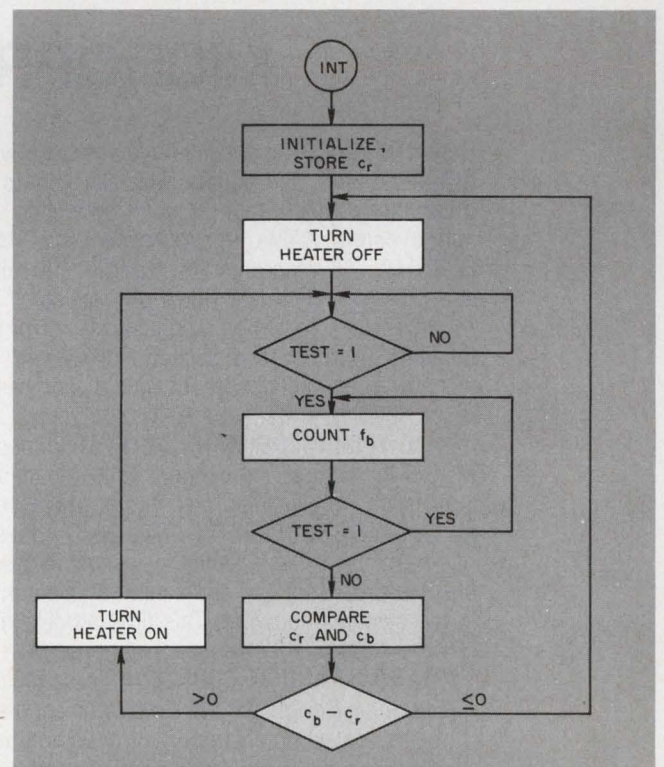

5. The flow chart leads to one crucial test—that for  $C_b - C_r$ . When the result is positive, the temperature is too low and the heater is activated; when negative or zero, the test result shuts off the heater.



**EDITORIAL PREVIEW**  
**MARCH 29 ISSUE**

# SEMICONDUCTOR SPECIAL



**SOLID-STATE CIRCUITS CONFERENCE**



**IC TECHNOLOGIES UP-DATE**



**MICROPROCESSORS**

Here it comes . . . the issue you've been waiting for . . . *Electronic Design's* **SEMICONDUCTOR SPECIAL**. First, the editors will take you to Philadelphia for a designers' eye view of the IEEE International Solid-State Circuits Conference. It's a major wrap up of such timely subjects as static and dynamic RAMs, master-slice LSIs, 100-ps bipolar logic, higher-speed designs, MNOS EAROMS, I<sup>2</sup>L macromodels, CMOS C<sup>2</sup>L microprocessors, user-programmable microcomputers and MOS sampled-date signal processing.

Speakers from here and abroad — from such countries as Japan, Belgium, France, Holland, England, Germany and Canada will present over 80 exclusive reports. The impact of solid-state technology on national security and the increasing acceptance of LSI overseas for consumer projects is the keynote of the Feb. 16-18 conference.

**IC TECHNOLOGIES UP-DATE.** This special report zeros in on recent progress in bipolar and MOS technologies. Their tremendous impact on consumer markets continues to increase. Emphasis is on such frontier integrated circuit processes as I<sup>2</sup>L, CMOS/SOS, VMOS and others.

**MICROPROCESSORS.** "The 3000 Series Bit Slice" — part 12 of *Electronic Design's* popular microprocessor basic series — describes the operation and advantages of one of the first bipolar bit-slice processors. A companion article continues *Electronic Design's* series on microprocessor-based systems software. This time processing speed and I/O interfaces are examined.

**STAND UP AND BE COUNTED!** Please tell us what you like, don't like, or would like to see in *Electronic Design*. (There's a convenient place to do it on the Reader Inquiry Card.) Your comments are extremely important to us and bear considerable weight in our editorial planning.

## SEMICONDUCTOR SPECIAL

**ANOTHER REASON WHY ELECTRONIC DESIGN IS THE BEST READ ELECTRONICS PUBLICATION IN THE WORLD!**



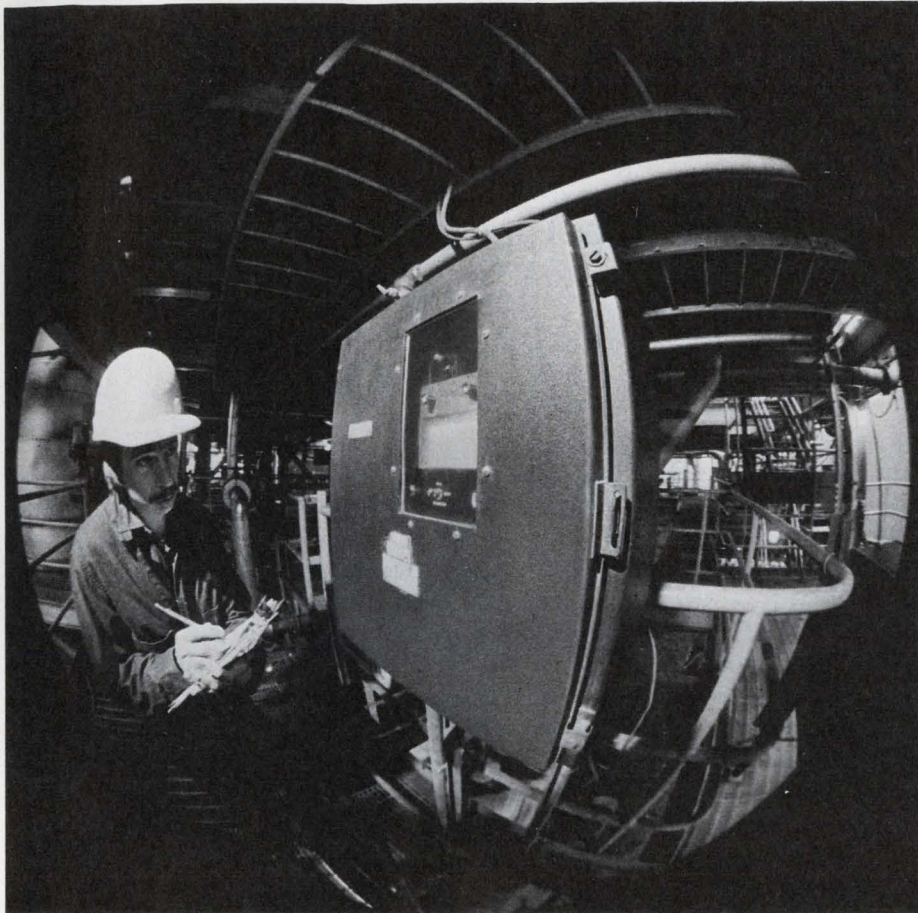

## There's a Hoffman enclosure for almost every electronic application you can think of.

One company uses our NEMA 12 enclosures to house water-testing instrumentation. Whatever your electronic application, Hoffman probably offers an enclosure to match it, whether it's for servo controls or sensitive instruments.

Hoffman electronic rack enclosures, consoles, instrument boxes, and a full range of NEMA types are just some of the components in a broad-spectrum 1700-product line. All are quality-built in the materials, finishes, and sizes your application requires.

There's a Hoffman enclosure for almost every electronic application you can think of. Check with your Hoffman distributor, or write directly for specifications — we'll match our enclosures with your thinking any time you like.

For complete data write:  
**HOFFMAN ENGINEERING COMPANY**  
 Division of Federal Cartridge Corporation  
 DEPT. ED672, ANOKA, MN 55303

**Hoffman**<sup>®</sup>  
 ELECTRICAL ENCLOSURES

CIRCLE NUMBER 41

# new from Hayden!

*"... well-organized, extremely well written . . . highly recommended for practicing engineers..."*

IEEE Transactions

## DIGITAL SIGNAL ANALYSIS

**Samuel D. Stearns**

This is an ideal master handbook on today's signal processing procedures and systems, containing recent advances, new design material, and a comparison between continual and digital systems that's extremely helpful to newcomers to the field. Featuring a foreword by Richard Hamming, the book contains a review of linear analysis; sample-data systems; analog-to-digital and digital-to-analog conversion; the discrete Fourier transform and the fast Fourier transform algorithm; spectral computations; non-recursive and recursive digital systems; computer simulation of continual systems; analog and digital filter designs, and more. 288 pages

*"Jacobi's book is great . . . a new, original, readable, usable book on writing for business and professional people. . . ."*

Jim Lufkin, Mgr. Professional Publications, Honeywell.

## WRITING AT WORK: Dos, Dont's, and How Tos

**Ernst Jacobi, Xerox Corporation.**

This guide to better writing follows its own principles by being lively, informative, and easy to read. More than a collection of pat rules and formulas, the book is a storehouse of practical advice for business and professional people to make their writing sharper, more interesting, and more informative. It shows you how to overcome procrastination and change your entire attitude toward writing, making it easier and more enjoyable for you! 208 pages.

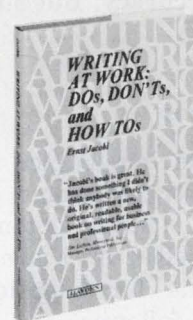
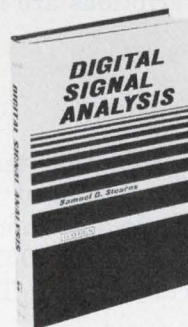

**HAYDEN BOOK COMPANY, INC.**  
 50 Essex Street, Rochelle Park, New Jersey 07662

### Order today—15-day examination!

Please send me the following book(s) to read and use FREE for 15 days. At the end of that time, I'll either send the amount indicated, plus postage and handling, or return the book(s) with no obligation.

- DIGITAL SIGNAL ANALYSIS, #5828-4, \$19.95  
 WRITING AT WORK, #5730-X, \$10.95

Name \_\_\_\_\_

Company/Institution \_\_\_\_\_

Address \_\_\_\_\_

City/State/Zip \_\_\_\_\_

**SAVE MONEY! Payment Enclosed.** Publisher will pay all shipping and handling charges. Same 15-day return privilege and full refund if not satisfied.

## Resolving DMM accuracy: Though many engineers argue otherwise, more digits can bring more accuracy. The problem really lies in what is meant by 'accuracy.'

Is a DMM with 4-1/2 digits inherently more accurate than one with 3-1/2 digits? Contrary to popular opinion, the answer is "Yes"—at least for meters with sensing accuracies of the order of 0.1% of the reading, or better.

Practically speaking, inaccuracy in a DMM reading is the total ambiguity of the displayed value. It consists of a series of terms: the basic front-end sensing accuracy of the meter (through the converter), temperature coefficient, drift with time, short-term stability and resolution. The nominal accuracy usually quoted for a meter is its sensing accuracy.

When accuracy is of primary importance, most users remember to account for tempco and drift with time, but all too often overlook the resolution. In fact, on dc scales with 0.1% nominal accuracy it is not uncommon for resolution beyond 3-1/2 digits to be referred to as "empty," or superfluous, resolution, with no contribution to increased accuracy. But such descriptions are far from true.

### Defining terms

Before the importance of the resolution term can be illustrated, some ground rules must be established. (Some potential confusion should also be dispelled by the new ANSI C39.6 DMM standard due for adoption during 1977.) The rules are as follows:

- Define accuracy as a percentage of the reading, not as a percentage of full scale (with or without overrange).
- Assume that both gross instability in the least-significant digit (or last few digits) and the dead zone around zero aren't problems for the DMM under consideration.
- Remember that resolution, the smallest detectable variation in the measured quantity, changes with the scale setting.
- Bypass the confusion caused by the term, "overrange," by defining full scale as the maxi-

imum value that can be displayed at a given scale setting. In other words, a scale with a maximum reading of 1.999 is called a 2-V scale, not a 1-V scale with 100% overrange.

Suppose you need to make dc voltage measurements with a maximum inaccuracy approaching 0.1%. Will a 3-1/2-digit meter with a stated accuracy of 0.1% of the reading  $\pm 1$  count and with scales of 2000 V, 200 V, 20 V and so on, meet your requirements? Is a 4-1/2-digit, 0.1% meter with the same ranges an improvement? Or do you really need a 4-1/2-digit, 0.01% instrument?

### Which fork to take?

Figure 1 shows how a  $\pm 1$ -count factor, when added to the basic percentage accuracy, causes the total error in the displayed value to vary with the percentage of full-scale reading. At the low end of the range, the  $\pm 1$ -count factor dominates the total error of the 3-1/2-digit meter. At 10% of full scale, for example, the resolution factor pushes the total inaccuracy to 0.6%. Obviously, the meter falls far short of the 0.1% accuracy requirement—even before you account for tempco and drift with time.

The 4-1/2-digit meter represents a four-times improvement at 10% of full scale, the worst case. Below that point you must, of course, drop to the next scale to maintain accuracy. Chances are the 0.15% maximum error will be close enough to the 0.1% requirement. Note, however, that if 0.1% or better is required across the whole range, you may need a 4-1/2-digit, 0.01% meter—a far cry from what you might have assumed from a casual examination of accuracy.

Of course, if the count uncertainty increases to  $\pm 2$  or even  $\pm 3$  counts, the situation becomes dramatically worse (Fig. 2). Such uncertainties may well be encountered on ac scales. Also note that the resolution term in the total-error equation becomes even more substantial in those DMMs that fall short of the so-called 100% overrange case—that is, where the maximum full-scale reading is 1199 or 1499, rather than 1999.

Obviously, then, more digits do improve the ac-

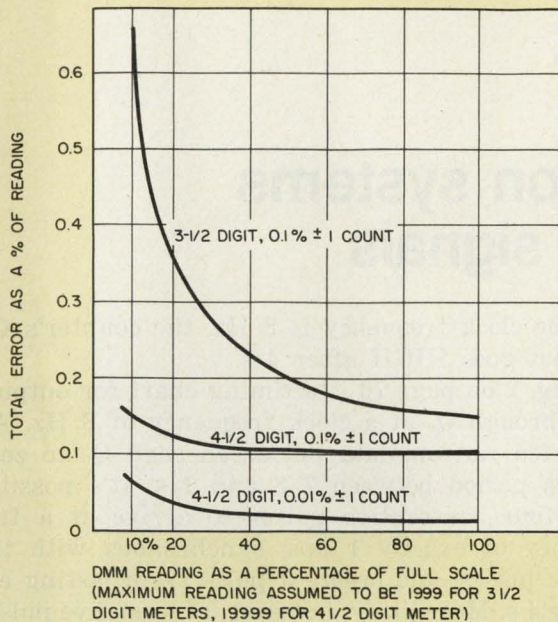

1. How the  $\pm 1$ -count uncertainty affects a DMM's accuracy: Error soars at the low end of the scale of a 0.1%, 3-1/2-digit meter. A 0.1%, 4-1/2-digit unit, however, gives four times better accuracy.

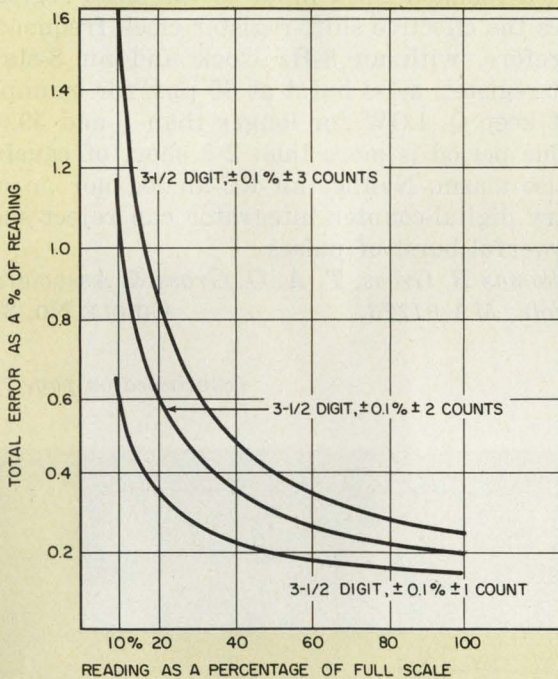

2. When the count uncertainty increases, as it does in many ac meters, errors get worse. In 3-1/2-digit DMMs, still more error is piled on when 100% overrange doesn't mean a count of 1999.

accuracy in a value displayed by a DMM. An overall accuracy approaching 0.1% requires a 4-1/2-digit meter, while 0.01% requires 5-1/2 digits. By their very nature, 3-1/2-digit DMMs are restricted to accuracies on the order of 0.5%. ■■

## How do you resolve two signals spaced 1 Hz apart at 2 MHz?

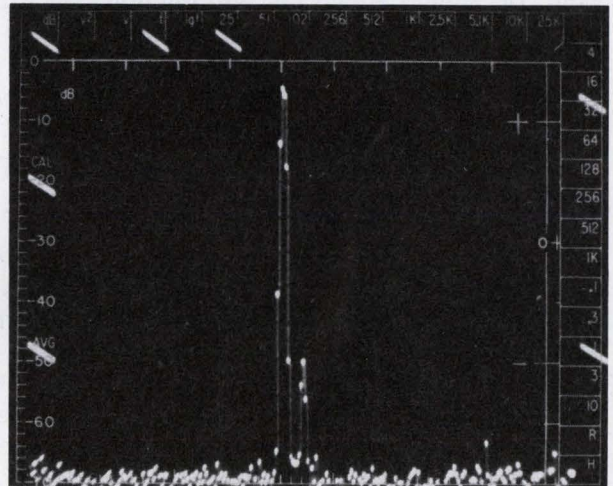

With an EMR Model 1510 Digital Real-Time Spectrum Analyzer and EMR Model 1520 Digital Spectrum Translator. Simply add the optional EMR Model 1521 Range Extension Module to the 1520 Translator, and you have real-time spectrum analysis at frequencies up to 2 MHz!



The CRT photograph illustrates the result. The input signal consisted of two discrete frequencies spaced 1.0 Hz apart, with a 50 dB difference in amplitude. The frequency range covered is 25.6 Hz centered about 1.990000 MHz, and the frequency resolution is 0.1 Hz!

Only EMR offers that much resolution at frequencies up to 2 MHz in real time.

So if you have an analysis problem requiring high-resolution/high-frequency real-time spectrum analysis, contact EMR... we will arrange for a demonstration or detailed information.

Sangamo Weston, EMR Telemetry Division  
P.O. Box 3041, Sarasota, FL 33578  
813-371-0811

SANGAMO WESTON

Schlumberger

CIRCLE NUMBER 44

# Ideas for Design

## Digital-integrator for intrusion systems discriminates against false signals

Many optical intrusion-sensor systems switch a comparator when a target moves in the optical field of view. However, automobile headlights passing in the night or cloud shadows during the day can cause false alarms. Therefore, some improved systems count several zero-voltage crossings of the comparator output in a given time before "sounding" an alarm. A generally accepted norm is four crossings in 4 s.

Such systems, however, fail to account for the frequency of the zero crossings. The systems can't distinguish between a short burst of pulses generated by static and the slower pulse rate created by an intruder.

Fig. 1 employs a digital-integrator system that not only can be set for a minimum zero-crossing frequency, but also can reject high-frequency bursts.

The circuit's clock frequency determines the low-frequency limit, and coupling the zero-crossing data into the shift-register's clock input rejects the high frequencies. An eight-stage shift register (CMOS 4015A) temporarily stores the entry of intrusion data into the system. And an eight-input NOR gate (CMOS 4078B) and a binary counter (CMOS 4024A) determine the presence and duration of the intrusion signals. The NOR-gate output allows the counter to count clock pulses when the gate's output goes LOW.

If the clock frequency is 8 Hz, the counter's  $Q_{15}$  output goes HIGH after 4 s.

Fig. 2 on page 76 is a timing chart for outputs  $Q_1$  through  $Q_8$  at a clock frequency of 8 Hz. An isolated random-data pulse can send  $Q_8$  to zero for a period between 7/8 and 1 s. It's possible for four consecutive pulses to arrive at a frequency of exactly 1 pps, synchronous with the clock pulses, and create a pulse train lasting exactly 4 s. More likely, however, at least five pulses are required to keep  $Q_8$  LOW for 4 s. Thus, the condition for an alarm to sound is best stated as "more than four pulses arriving at a rate faster than 1 pps, but not so fast that  $Q_8$  can return to a HIGH level before 4 s has elapsed."

Coupling the data-input and clock pulses to form a common clock input to the shift register raises the effective shift-register clock frequency. Therefore, with an 8-Hz clock and an 8-stage shift register, a 1-s burst at 60 pps, for example, can't keep  $Q_8$  LOW for longer than 1 and 59/60 s. This period is more than 2 s short of causing a false alarm. Neither an RC-analog nor an ordinary digital-counter integrator can reject such a powerful burst of pulses.

Thomas B. Gross, T. A. O. Gross & Associates,  
Lincoln, MA 01773.

CIRCLE No. 311

(continued on page 76)

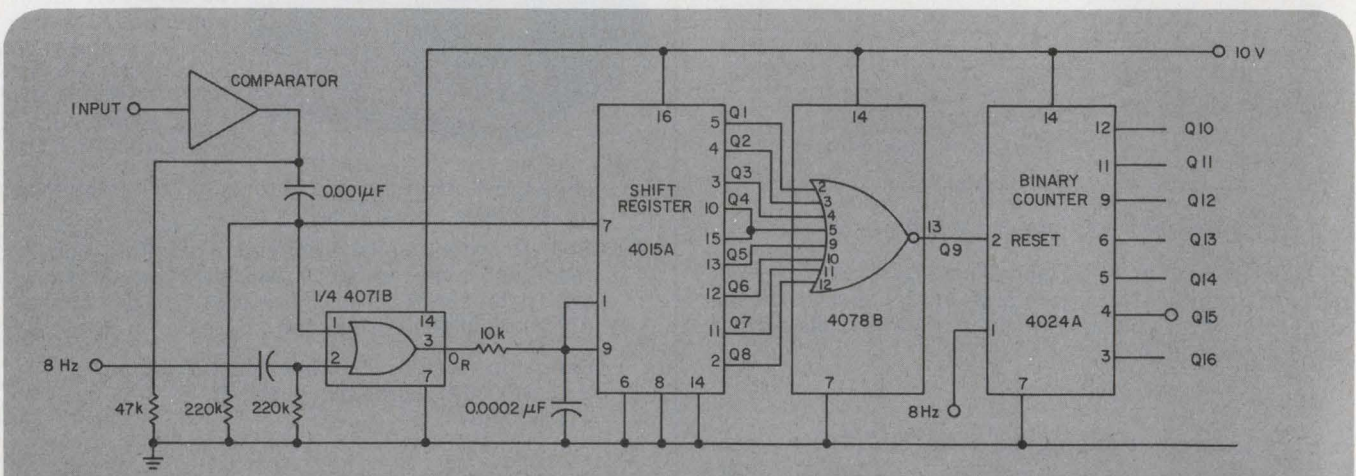

1. In this digital integrator, inputs from a comparator enter a serial-in/parallel-out shift register and are shifted through eight stages by positive-

going clock transitions or data pulses. When  $Q_8$  is LOW because of data in the register, the binary-counter counts clock pulses.

If you need panel instruments with **custom** dials, cases, accuracy, tracking, resistance, response time, or practically any combination of unusual specs...

Buy  
**Triplett's**  
designed-for-you  
**Panel**  
**Instruments**

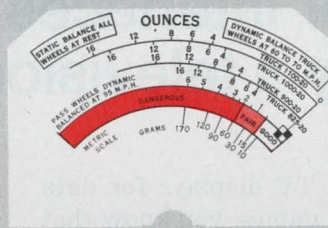
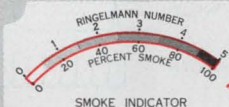
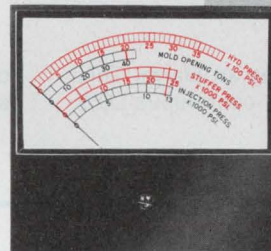
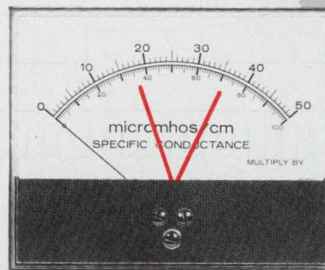
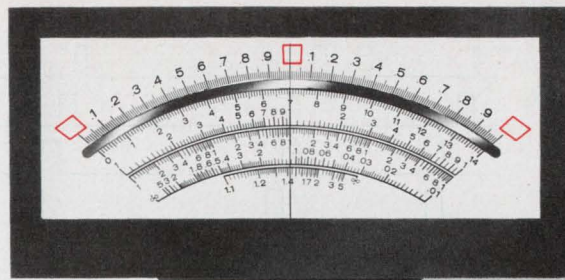

Although we stock some 1369 different styles, sizes and types of standard panel instruments, a very large proportion of our customers buy custom instruments.

Because they need:

**custom dials**

reading in such units as pH, roentgens, mm Hg, rpm, %, inches.

**custom cases**

square, round, rectangular, edge-wise (horizontal and vertical), wide, narrow, shallow.

**custom accuracy**

to within 1/2% with mirror scales and knife-edge pointers.

**custom tracking**

to match the specific needs of existing or new instrument designs.

**custom resistance**

for low circuit loading with tolerances as low as  $\pm 1\%$ .

**custom damping**

to meet stringent electrical and vibration requirements.

For instance, one of our customers had us design and manufacture a custom instrument to replace — in every detail of physical and electrical specifications — one which he was using on a delicate piece of medical instrumentation. Rejects from his previous source had risen to over 20%. He rejected only 3 of the first hundred we shipped—with almost negligible rejections from the many hundreds we've shipped since.

What custom panel instrument specifications do you need to make your

product more reliable, more accurate, more rugged and — in the long run — less expensive? For quick, dependable delivery of small quantities of Triplett's "designed-for-you" panel instruments, contact your Triplett Sales/Service/Modification Center. For prototypes or production quantities, contact your Triplett representative. He'll put you in touch with our Instrument Designers/Engineers who'll help you analyze the problem and suggest the optimum cost/result solution.

**TRIPLETT**  
BLUFFTON, OHIO 45817  
Manufacturers of the World's  
most complete line of V-O-M's

CIRCLE NUMBER 121 FOR INFORMATION  
CIRCLE NUMBER 122 FOR FREE DEMONSTRATION

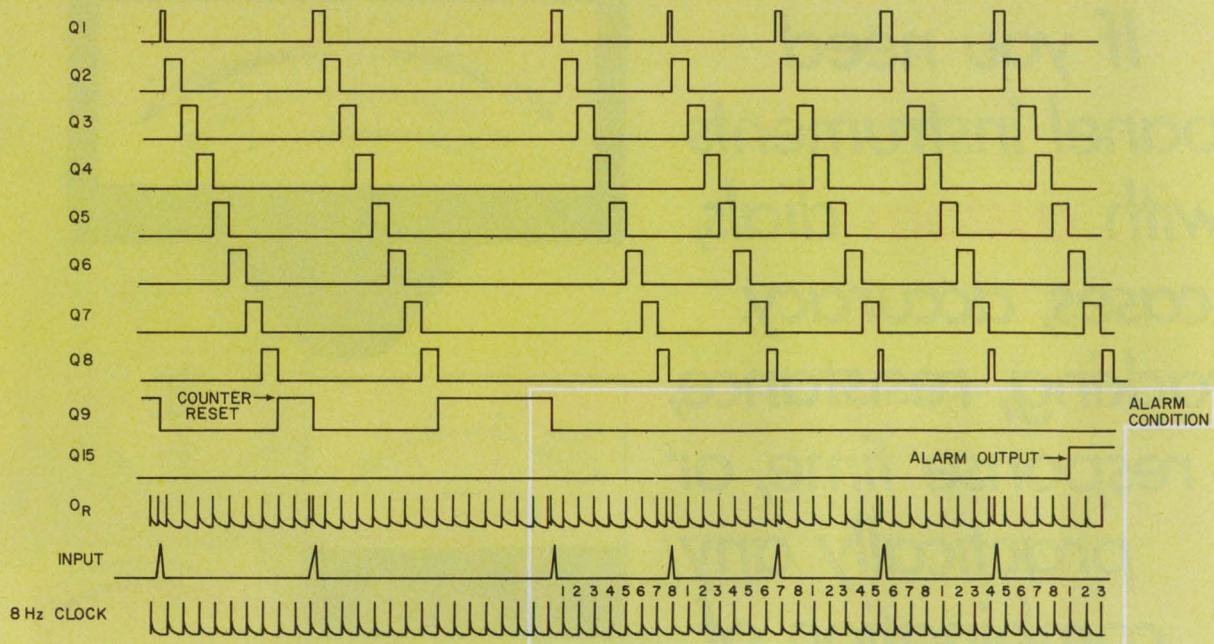

2. A high logic level at  $Q_{15}$  signifies an alarm. This condition occurs after 4 s of a continuous-LOW

output at  $Q_9$ , when four or more pulses enter the shift register faster than 1 pps.

## TTL oscillator interfaces data for display by a television set

If you have worked with TV displays for data terminals or even electronic games, you know that interfacing to the TV can be a tough problem. Direct connection into the video section of the television is generally a nuisance. Moreover, many television sets aren't transformer-isolated from the power lines, so direct connection to the video circuit can be dangerous to humans and equipment alike. And, of course, broadcasting your composite video signal to the television can generate unwanted rf radiation.

A TTL oscillator running near its maximum switching frequency has harmonics well into the TV-band frequencies. To interface a TV, simply mix the oscillator with the composite video signals and feed the combination into the TV-antenna jack (Fig. 1). The TV set will detect and display the signal in a normal fashion. The mixer and i-f sections of the set pass the TTL signal, and the video section detects and locks onto the superimposed video information.

Three gates of a 74LS04 form the oscillator circuit. Capacitor  $C_1$  allows fine-frequency adjustment to a specific television channel and helps stabilize the circuit. Potentiometer  $R_1$  acts as the

mixing input and provides adjustment of the contrast ratio for the best viewing. A fourth gate buffers and helps stabilize the oscillator.

To avoid interference problems, place the circuit in a small metal box and mount the box on the back of the TV. Run the power—which can also be supplied by a small battery within the box—and the composite signal in shielded cables.

*Harry L. Latterman, Digital Design Engineer, Courier Terminal Systems, 2202 E. University Dr., Phoenix, AZ 85038.*

CIRCLE NO. 312

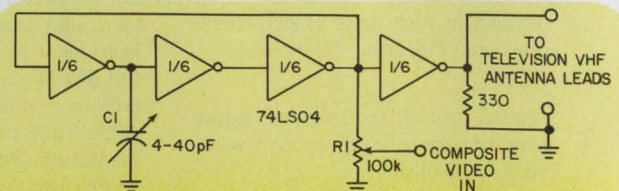

A simple oscillator circuit can provide interfacing to an ordinary TV set for displaying games and data-terminal or computer outputs. Capacitor  $C_1$  adjusts the frequency to match available channels, and  $R_1$  sets the contrast ratio of the display.

# EVERYTHING YOU NEED TO KNOW ABOUT BUYING A PROM PROGRAMMER IN SIX EASY LESSONS.

1. **Select a programmer that's universal — as opposed to one that's dedicated.** Choose a programmer that can program all 200 plus PROMs currently available on the market. This eliminates the need to buy additional programmers to accommodate different PROMs and gives you maximum flexibility — unrestricted by PROM type or manufacturer.

A universal programmer does away with unnecessary investments in costly capital equipment.

2. **Select a programmer that can program generic PROM families with a single personality card set.** Many programmers require multiple card sets to program PROMs with identical family characteristics. These extra card sets can cost as much as \$400.00 each. A programmer that uses generic personality card sets will eliminate this requirement and save you time and money.

3. **Select a programmer system that's approved by PROM manufacturers.** Make sure the programmer manufacturer can supply you with approved programming specifications. Otherwise you run the risk of wasting PROMs and time.

Approved specifications reduce your programming costs and help you reach 100% yields.

4. **Select a programmer that you can calibrate.** This will eliminate the need to return the programmer to the manufacturer for costly calibration. Programmers you can calibrate will continually perform to PROM manufacturers' specifications. This saves time, saves money, increases yields and assures you of uninterrupted production.

5. **Select a programmer manufacturer that will help you reach 100% yields.** A good manufacturer will keep you updated on new PROMs and programming specification changes based on the latest input from PROM manufacturers. A good programmer will also be supported by a direct factory sales and service organization staffed by knowledgeable people who know the products and can answer any of your questions.

6. **Select a programmer capable of ROM emulation.** ROM emulation saves time and money during software development and insures that the first PROM you program works.

## ONLY DATA I/O AND DATA I/O PROGRAMMERS PROVIDE ALL OF THESE BENEFITS.

*Programmers from \$1095.00.*



**HOW TO SELECT THE RIGHT PROM PROGRAMMER FOR YOUR NEEDS.**

Let us send you our fact-filled tabloid **HOW TO SELECT THE RIGHT PROM PROGRAMMER FOR YOUR NEEDS.** For your free copy, simply circle reader card or contact Data I/O Corporation, P.O. Box 308, Issaquah, WA 98027. 206/455-3990.

# DATA I/O

THE PROM PROGRAMMER PEOPLE.

*For more information, Circle No. 151.*

# Timer pulses coasting to a stop heighten electronic game realism

An electronically simulated game of roulette can be made more realistic, if the circuit duplicates the action of a real wheel as it slows its spin before finally stopping. And similarly, the excitement of an electronic dice game is heightened, if the flashing numbers come to rest slowly rather than abruptly.

Once again the ubiquitous 555 timer comes to the rescue. The circuit in the figure produces a slowly diminishing clock rate, while maintaining a constant output pulse width. When  $S_1$  is pressed, capacitor  $C$  charges to  $V_{CC}$  almost immediately and the 555 oscillates at its highest frequency. After  $S_1$  is released,  $C$  supplies charge to  $C_1$ . But as  $C$  discharges,  $C_1$  takes longer and longer to reach  $2/3 V_{CC}$ , the trip point of the internal comparator, so the oscillation frequency slows.

The discharge time,  $t_{pw}$ , as  $C_1$  discharges to  $1/3 V_{CC}$  via  $R_2$  and the open-collector output (pin 7) remains constant, so the output pulse width,  $t_{pw}$ , remains constant, but the time between pulses increases until  $C$  no longer can supply enough charge to recharge  $C_1$  to  $2/3 V_{CC}$ . When oscillations cease, the pin-3 output of the 555 remains HIGH.

For small output-pulse widths ( $C_1$  small),  $C$  can be a relatively small electrolytic. For example, if  $R_1$  and  $R_2$  are each 470 k $\Omega$  and  $C_1$  is 0.01  $\mu F$ , then  $C$  need only be 35  $\mu F$  for a 30-s coast time. The frequency then starts at 100 Hz with 3-ms negative-going pulses and gradually

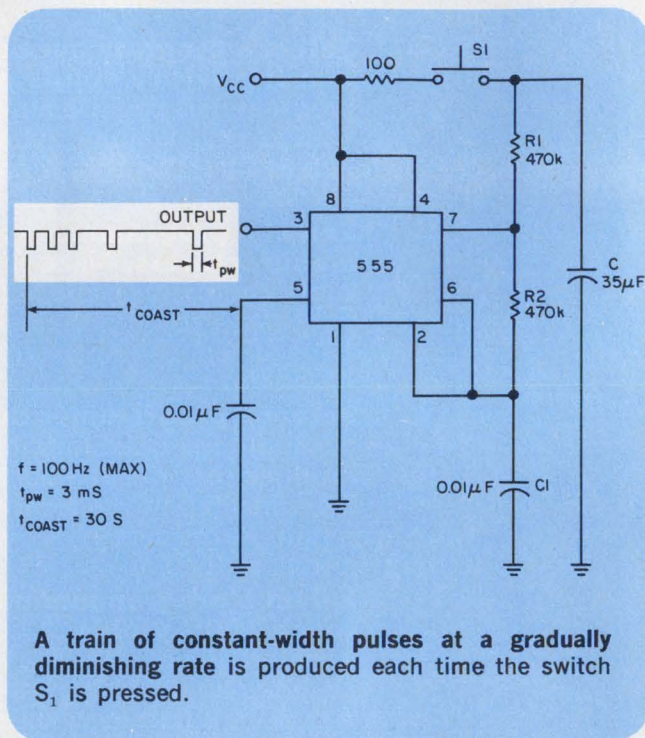

coasts down to zero frequency, while maintaining the 3-ms pulse width over the total 30-s period.

*William D. Kraengel, Jr., Electronics Engineer, Ground Systems Equipment Corp., 65 Sunset Rd., Valley Stream, NY 11580.*

CIRCLE NO. 313

**IFD Winner of October 25, 1976**

**Maynard J. Kuljian**, Product Manager, Applied Materials, 3050 Bowers Ave., Santa Clara, CA 95051. His idea "Battery Monitor Operates on only a Few Microamperes" has been voted the Most Valuable of Issue Award.

**Vote for the Best Idea in this issue** by circling the number for your selection on the Reader Service Card at the back of this issue.

**SEND US YOUR IDEAS FOR DESIGN.** You may win a grand total of \$1050 (cash)! Here's how. Submit your IFD describing a new or important circuit or design technique, the clever use of a new component or test equipment, packaging tips, cost-saving ideas to our Ideas for Design editor. Ideas can only be considered for publication if they are submitted exclusively to ELECTRONIC DESIGN. You will receive \$20 for each published idea, \$30 more if it is voted best of issue by our readers. The best-of-issue winners become eligible for the Idea of the Year award of \$1000.



# Designing with Ferrites?

## Here comes help

**PERFORMANCE**—We have the best specs available anywhere because our ferrite materials are developed to match your circuit requirements. For example, we're the people who control temperature characteristics to give you low loss components in three temperature ranges, TC matched to inexpensive capacitors, or an inductance factor that's stable from  $-30$  to  $+75^{\circ}$  C.

**PRICE**—But you may not need the hottest specs. Our help also includes a new *Cost Saver*<sup>™</sup> line that can give you the hottest price. We do it with high volume runs of popular shapes and materials.

**BOTH**—Our new Catalog 209 describes the higher performance you can get with our products—and the lowest prices in town if your standard requirements can be met in a popular size. For your copy of Catalog 209, please call, write, bingo, or contact your local Permagan distributor.



**EMM** indiana general  
a division of Electronic Memories & Magnetics Corp.  
Keasbey, N.J. 08832 • (201) 826-5100

## Redesigned FET looks promising for audio use

High-power, high-frequency static-induction transistors (SITs) from Japan look like promising broadband devices. Audio units containing the SIT have demonstrated low noise, low distortion and high power capacity.

Fabricated at Tohoku University's Research Institute of Electrical Communication and the Semiconductor Research Institute in Sendai, the SITs are redesigned field-effect transistors (FETs) with only a small distance between gate and source that reduces the series-channel resistance. Characteristics include high input impedance, high transconductance and negative temperature coefficients.

Like the standard FET, the SIT uses a flow of carriers from the source electrode to the drain that is controlled by the gate-electrode voltage. Impurity concentrations in the SIT channel region are very low so the region between the gate and drain is depleted by only a small drain voltage.

Increased drain voltage reduces the potential barrier that controls the flow of carriers, and the barrier moves towards the source elec-

trode. Drain current increases.

Two versions of the SIT have been made. One is a 200-MHz, 40-W, UHF SIT that can operate at 1 GHz and produce 6-W output. Its upper-limit frequency is more than 2 GHz. The other is a microwave device with a maximum frequency of more than 29 Hz.

The source and gate of both versions lie on one surface, directly connected by an impurity region. For the microwave transistor, the source width is less than 2  $\mu\text{m}$ . The structure of the device depends on etching accuracy, not on mask alignment.

The UHF SIT has a drain-gate breakdown voltage greater than 300 V, a source-gate breakdown voltage greater than 100 V, a maximum drain current greater than 2 A, an input capacitance less than 30 pF and a maximum frequency of 1 GHz.

With the results obtained from present SITs, Japanese researchers believe it will soon be possible to obtain 30 W at 1 GHz. However, for an output of 100 W at 2 GHz, a new structure will have to be developed.

## Stripline packaging made simpler, cheaper

A microwave technique for stripline packaging eliminates conventional heavy and expensive machined castings as well as the undesirable air gap between the two clamped dielectric faces of the stripline. Developed by Exacta Circuits of Selkirk, Scotland, the microwave-bonded packaging method is based on simple bonding and plating operations.

The simplest form of microwave-

bonded packaging is incorporated in a single-function passive component, such as a coupler or filter. The copper circuit is produced on a dielectric polytetrafluoroethylene (PTFE) substrate with print and etch techniques.

A top PTFE layer is then bonded to the substrate. To do this, a copolymer film with a dielectric constant close to that of the PTFE material is inserted between each

half of the dielectric structure. A permanent bond is then made under heat and pressure.

Since the copolymer film flows and conforms to the surface irregularities of the copper pattern, air gaps are eliminated and a sealed, strong homogenous bond with a uniform dielectric constant throughout is provided.

The exposed edges of the composite PTFE package are then metalized. First, a 5- $\mu\text{m}$  layer of copper is deposited on the PTFE with a chemical-mechanical bond. The thickness is then built up to 40  $\mu\text{m}$  by an additional electroplated deposition of copper. This deposit has excellent adhesion and provides a light, pore-free metalization that completely shields the component. (A metal casing isn't needed.) A final finish of gold, nickel or tin-lead is added.

## New fabrication method speeds up ECL counters

A new way to build high-speed logic devices has enabled its developer, Toshiba Ltd. of Tokyo, to construct ECL divide-by-four counters capable of operating at 1.4 GHz.

Three features of the technique help increase the operating speed:

- Spacing between the aluminum conductors is reduced to only 2  $\mu\text{m}$  by applying a dual-space lift-off technique developed by Toshiba. This improves the high-frequency characteristics of the transistors fabricated in the IC chip.

- Shallow and uniform-base regions are created with a boron-ion implantation. This increases the transistor's cut-off frequency. Arsenic-doped oxide and polycrystalline silicon doped with arsenic layers are used as the diffusion source for the emitter diffusion. This results in a shallow emitter and a higher impurity concentration.



# nichicon

## The pulse of the industry.

A great name in automobiles, CB's, stereos, electronic ignitions, digital clocks, gauge alert devices, testing equipment, burglar alarms, electronic fuel injections, engine sensors, intermittent wipers, wheel lock, cruise controls, traction controls, controls, light dimmers...

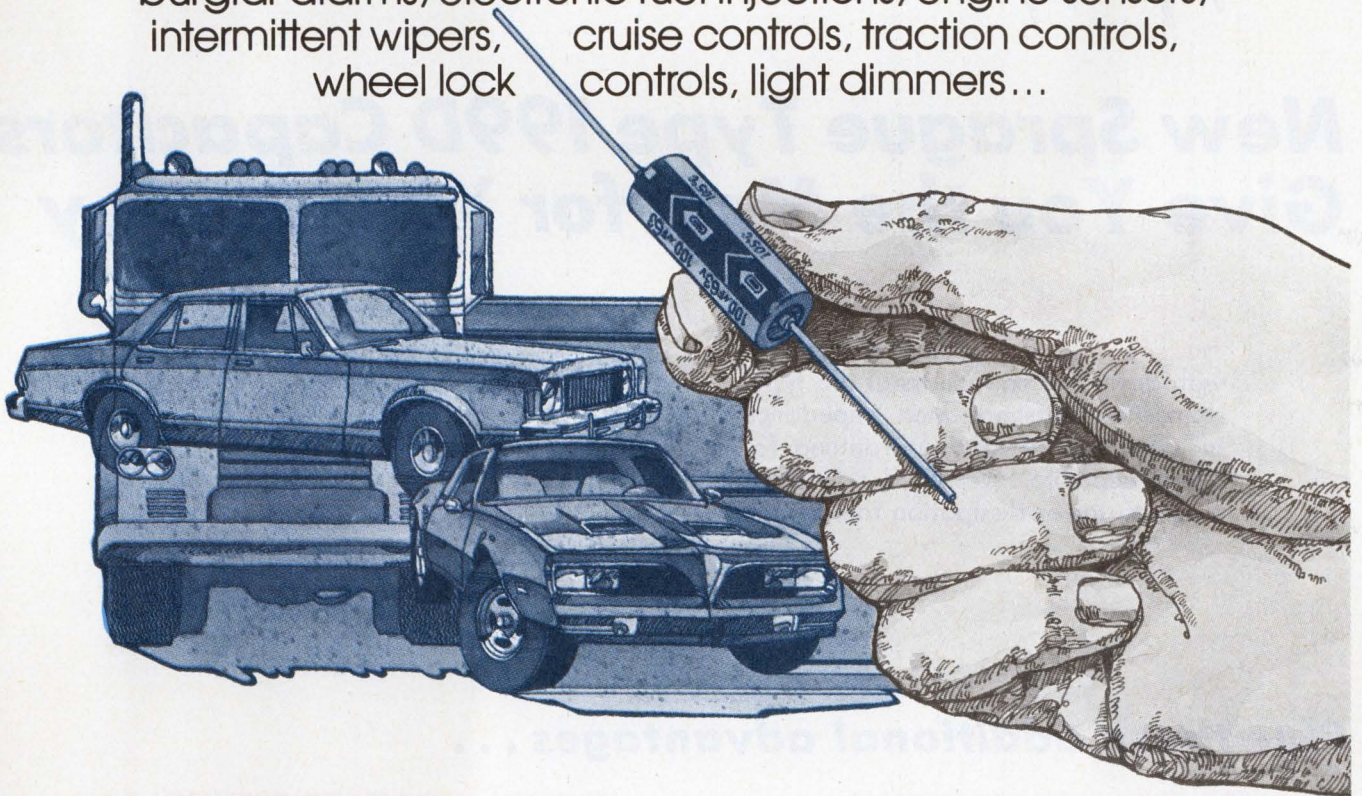

If you're into designing, evaluating or specifying automotive-related electronics, Nichicon (America) Corporation is ready for you. Whether it's for mobile circuits, testing equipment, under-the-hood or on-the-axle applications. Nichicon is ready to schedule delivery on one of the broadest lines of highly reliable capacitors now available.

We can provide you with a complete selection of aluminum electrolytic capacitors to handle your toughest automotive electronic needs. These Nichicon capacitors have high-reliability levels that handle higher engine-operating temperatures and extended periods of on-the-road use.

For example, our R-10 High Temperature Miniature Aluminum Electrolytic Series. Designed and tested for under-the-hood applications, it calls for an extended operating-temperature range (-40°C thru +105°C), low impedance at low temperature, a tighter capacitance tolerance, an all-welded construction and improved electrolyte and end seal.

We'd like to tell you a lot more about our general purpose and special application series of aluminum electrolytic capaci-

tors. Simply because there's a lot more to tell.

Write us or call direct for your free catalogs today. We have engineering samples available to qualified respondents writing to Nichicon (America) Corporation, 6435 N. Proesel Ave., Chicago, IL 60645. Phone (312) 679-6530.

**PRODUCTION ITEMS:** Aluminum Electrolytics: Miniature Aluminum Electrolytics, Non-Polar, Bi-Polar, Low Leakage, Computer Grade Can Types, Industrial Grade Can Types; **Polyester Film:** Polyester Film, Metallized Polyester Film; **Ceramic Discs;** **Paper Tubular;** **Oil-Filled** (without P.C.B.'s).



Nichicon (America) Corporation: 6435 N. Proesel • Chicago, IL 60645 • (312) 679-6530  
Division NICHICON CAPACITOR LTD., Kyoto, Japan

# BEST COST/PERFORMANCE

## resin-coated SOLID-TANTALUM

# CAPACITORS

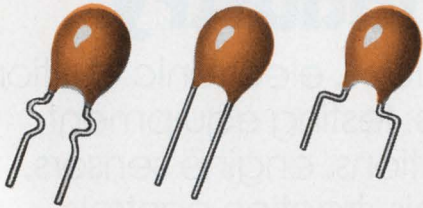

## New Sprague Type 199D Capacitors Give You the Most for Your Money

**LOWEST COST, YET IMPROVED PERFORMANCE.** Prices competitive with any other capacitors of this type, domestic or offshore. Max. impedance in ohms @ 10 kHz guaranteed for every capacitor. Lower d-c leakage currents, lower dissipation factor.

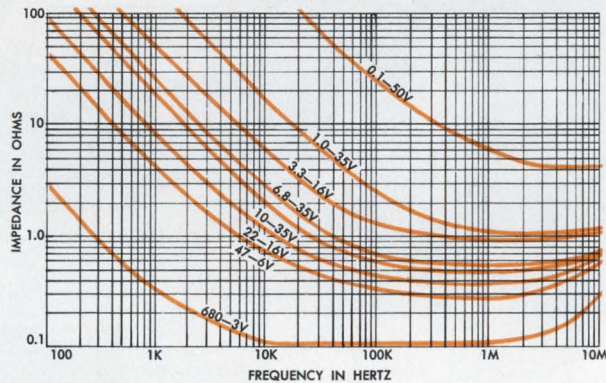

### Plus these additional advantages . . .

#### **SUPERIOR EPOXY ENCAPSULANT**

Flame-retardant, moisture-resistant resin will not crack or chip under temperature extremes.

#### **CHOICE OF LEAD CONFIGURATIONS**

Straight, hockeystick, or lock-in crimp with .100", .200", .250" lead spacing.

#### **STANDARD TOLERANCES: $\pm 20\%$ , $\pm 10\%$**

$\pm 5\%$  available on special order.

#### **PROVEN CAPACITOR TECHNOLOGY**

From the pioneer in solid-electrolyte tantalum capacitors.

#### **RAPID DELIVERY**

Up to 999 pieces off-the-shelf from Sprague Industrial Distributors. Larger quantities 4 to 8 weeks ARO.

For price and availability information call your Sprague district office or sales representative. For complete technical data, write for Engineering Bulletin 3547B to: Technical Literature Service, Sprague Electric Company, 347 Marshall Street, North Adams, Mass. 01247.

**THE BROAD-LINE PRODUCER OF ELECTRONIC PARTS**

CIRCLE NUMBER 49



45E-6144R3

# New Products

## Encoding/decoding circuit handles audio signals of up to 3.3 kHz

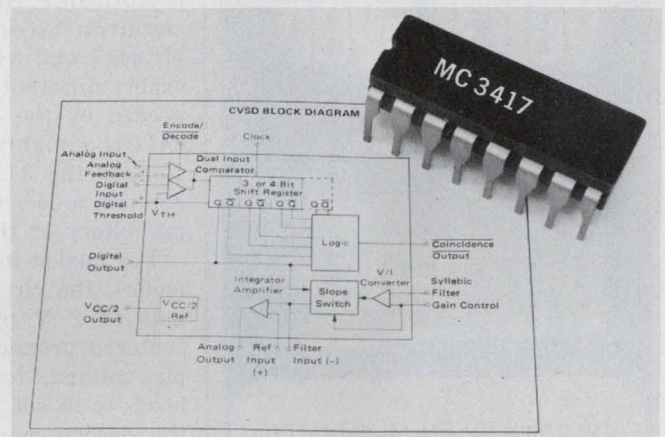
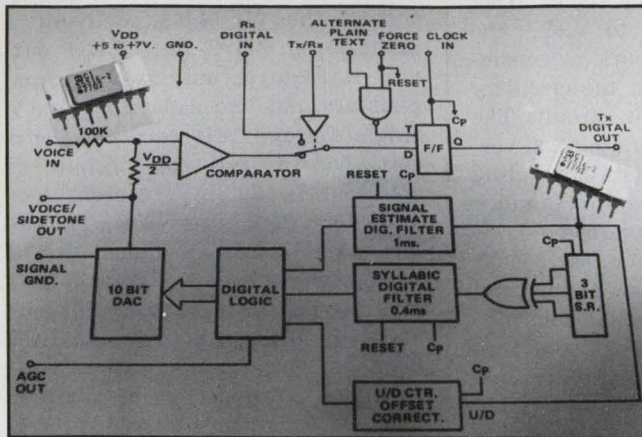

Harris Semiconductor, P. O. Box 883, Melbourne, FL 32901. Ron Gadway (305) 724-7045. P&A: See text.

Capable of either encoding analog inputs into serial digital output signals or of decoding digital signals into analog outputs, an all-CMOS circuit, using continuously variable-slope delta modulation (CVSD), can handle analog signals of up to 3.3 kHz. Introduced by Harris Semiconductor, the circuit comes in two versions—identical except that the 55516 uses a 16-kHz clock and the 55532 uses a 32-kHz clock.

While Harris was developing its CVSD encoders/decoders, Motorola was designing similar units—the MC3417 and 3418. Although not pin-compatible with the Harris circuits, the Motorola devices perform an identical task—converting analog inputs into serial digital outputs and visa-versa.

For analog encoding, the Harris circuits are designed to handle a maximum input of 1.4 V rms, while presenting an input impedance to the source of 100 k $\Omega$ . The signal, however, must be ac-coupled to the encoder input since it appears in series with half the supply voltage.

When used as a decoder, the circuits deliver a 1.4-V rms signal while again presenting an impedance of 100 k $\Omega$  to the load. However, the zero signal-reference level on the output is at one-half the supply voltage.

The CVSD circuits require a clock signal to perform either operation. When the units are used to decode signals, the clock must be phased with the digital input so that a positive clock transition occurs near the middle of each received data bit.

The operating mode is determined for both circuits by a single logic-controlled input line. In addition several other control lines permit the user to force a zero in resetting registers and causing the unit to either go into its "quieting mode" or have an alternate plain-text pattern (quieting pattern) transmitted. (A quieting pattern is an idle-channel audio output of alternate 12-mV steps of 1's and 0's at one-half the clock rate.)

Typically, digital input levels for ONE and ZERO are 4.5 V and 1.5 V, respectively. Digital output levels are usually 5.5 V and 0.5 V, respectively. Also, an automatic-gain-control logic output can go to

Motorola Semiconductor Products, P.O. Box 20912, Phoenix, AZ 85036. Steve Faulkner (602) 962-2294. P&A: See text.

0 whenever the recovered signal reaches one-half of the full-scale value.

The output signal-to-noise ratio of the encoder/decoder depends on both input frequency and amplitude. For a 300-Hz, 1.4-V-rms input, the SNR is 20 dB min, while at 1000 Hz and 500 V rms it drops to 14 dB. And, the reconstituted signal amplitude will be within  $\pm 0.5$  dB of the original input value. Of course, the lower the input-signal frequency, the lower the distortion since more samples can be taken per period. Signal resolution is specified at 0.1% of the supply voltage, and either unit is designed to operate from 5-to-7-V supplies. When biased at 6 V, the circuit draws a typical supply current of only 1 mA.

Three versions of the Harris encoder/decoder are available: an industrial unit that operates over  $-40$  to  $+85$  C (-9 suffix), a MIL device for  $-55$  to  $+125$  C (-2 suffix), and a fully inspected MIL

(continued on page 84)

# RF Power Amplifiers?

## One unit may be all you'll ever need.

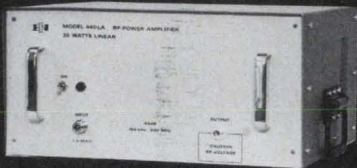

If you have the ENI Model 440LA ultra-wideband solid state power amplifier, all you need is a laboratory signal generator and you've got the ultimate in linear power for such applications as RFI/EMI testing, NMR/ENDOR, RF transmission, ultrasonics and more.

Capable of supplying more than 40 watts of RF power into any load impedance, the 440LA covers the frequency range of 150 kHz to 300 MHz.

We could mention unconditional stability, instantaneous failsafe provisions and absolute protection from overloads and transients, but that's what you expect from any ENI power amplifier, and the 440LA is no exception!

Our catalog contains complete specifications on the 440LA as well as the entire line of ENI amplifiers, and is available without obligation, of course.

For further information or a demonstration, contact ENI, 3000 Winton Road South, Rochester, New York 14623. Call 716-473-6900, or Telex 97-8283 ENI ROC.

# ENI

The World's Leader  
in Power Amplifiers

CIRCLE NUMBER 50

## INTEGRATED CIRCUITS

(continued from p. 83)

unit, also for the  $-55$  to  $+125$ -C range (-8 suffix). All units are available in 14-pin DIPs for \$27, \$61.50 and \$83, respectively (100-up prices). Flat-packs are available at a cost of \$54, \$109 and \$158, respectively. Delivery is from stock.

Either Motorola circuit can encode or decode signals at clock rates of up to 200 kHz and handle audio signals of up to 4 kHz and deliver commercial telephone-grade performance. However, the external circuitry necessary to make the MC3417 and 3418 work is considerably different from the circuitry needed by the Harris circuit. The 3417 is a slightly more general version of the 3418—its companding algorithm does not require as much prehistory of the waveform.

For analog inputs (in the encode mode), the circuit can handle signals of 2 V pk-pk that must be centered around one-half the supply voltage, for proper threshold levels to be set. Analog outputs (in the decode mode) are 2-V pk-pk, maximum, and also centered at one-half the supply voltage. Input and output impedances are approximately 100 k $\Omega$  and 600  $\Omega$ , respectively.

All logic control inputs and outputs are CMOS or TTL-compatible, with a drive-current capability of 3.5 mA, maximum, for low levels and  $-0.38$  mA, minimum, for high levels. An offset voltage of 20 mV, maximum, for the 3417 and 2 mV, maximum, for the 3418 appears at the output, in addition to the level-shift mentioned earlier.

When biased at 12 V and operating at a 37.5 kilobit clock and a 1-kHz input with c-message weighting, the signal-to-noise ratio ranges from 20 to 33 dB, depending upon input level (inputs vary over a  $-48$  to  $+18$  dBm range). Signal resolution (sensitivity) depends on the supply voltage and can be as small as 5 mV.

The 3417 and 3418 are built with I<sup>2</sup>L technology and can operate from 4.75-to-15-V supplies. Power consumption with a 5-V supply is a low 20 mW. Available in a 16-pin ceramic DIP, the 3417 costs \$6.95 and the 3418, \$7.95. Either type is available from stock.

Harris Semiconductor

Motorola

CIRCLE NO. 302  
CIRCLE NO. 303

## 3-1/2-digit DVM IC needs just 5 parts

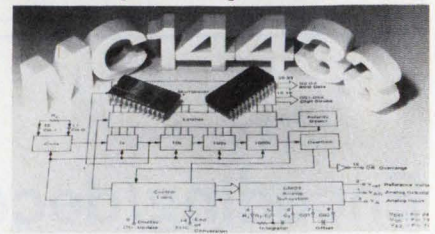

Motorola, 3501 Ed Bluestein Blvd., Austin, TX 78721. (512) 928-2600. From \$9.97 (100-up); stock.

A single-chip CMOS a/d converter, the MC14433, delivers a multiplexed 3-1/2-digit BCD output. It requires only two external resistors and two capacitors and a single voltage reference. The circuit has a full-scale range of  $\pm 199.9$  mV (200-mV reference) or  $\pm 1.999$  V (2-V reference). The device boasts an input impedance of more than 1000 M $\Omega$ . Typically dissipating only 8 mW, the unit operates well with both LED and LCD displays. Accuracy is  $\pm 0.05\%$  of reading, autopolarity is built-in and overrange or underrange signals are available. The MC14433 is packaged in a 24-pin DIP in either plastic ("P" suffix) or ceramic ("L" suffix).

CIRCLE NO. 306

## Line transceivers use differential data lines

Texas Instruments, P.O. Box 5012, Dallas, TX 75222. Dale Pippenger (214) 238-2011. From \$1.97 (100-up); stock.

Four differential line transceivers, the SN55118, SN55119, SN-75118 and SN75119, interface between TTL digital systems and differential data transmission lines. They are especially useful for party-line (data-bus) applications. Each circuit combines a three-state differential line driver and a differential-input line receiver in one package, both of which operate from a 5-V supply. Driver inputs and receiver outputs are TTL compatible. The SN55118 and SN-55119 operate over  $-55$  to 125 C and the SN75118 and SN75119 operate between 0 and 70 C. The 55118 and 75118 come in 14-pin DIPs and the 55119 and 75119 come in 8-pin mini-DIPs. Both the 75118 and 75119 are housed in plastic.

CIRCLE NO. 307

## Clock generator delivers MOS and TTL-levels

National Semiconductor, 2900 Semiconductor Dr., Santa Clara, CA 95051. Hashmukh Patel (408) 737-5000. From \$4.50 (100-up); stock.

A clock generator, the DP4201, is designed for use with the 4004 family of microcomputers. The unit meets the signal requirements for 4004 and 4040 microprocessor components in the four-bit integrated processing system, and in MCS-4 and MCS-40 microcomputer based systems. Used with an external crystal, the DP4201 generates TTL and MOS-level clock signals. It also has a power "ON" and external reset control, plus a single-step function. The clock generator has a frequency range from dc to 6 MHz and is available in either a ceramic (DP4201-J) or a molded epoxy (DP-4201-N) DIP.

CIRCLE NO. 308

## A/d converter pair gives 3-1/2 or 4-1/2 digits

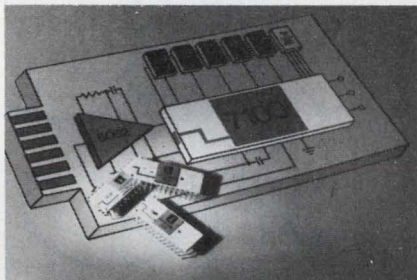

Intersil, 10900 N. Tantau Ave., Cupertino, CA 95014. (408) 996-5000. \$10.50/pair (100-up); stock.

To complement the 8052 analog signal processor, the 7103 digit processor provides all necessary logic circuitry for a  $\pm 1999$  count a/d converter. "A" versions, the 7103A and 8052A, provide circuitry for a  $\pm 19999$  count instrument. Both pairs provide a multiplexed BCD output suitable for LED displays. The 7103/7103A functions include auto-zero, auto-polarity switches, converter, latches, multiplexer and associated logic. When paired with an 8052, the converter thus formed has JFET-input buffer amplifiers and a JFET-input integrator, which typically contribute less than 5 pA of input leakage and provide a 1000- $\Omega$  input impedance.

CIRCLE NO. 309

## Ledex Linear Solutions... off-the-shelf or tailor-made.



Whatever your linear actuation needs, check with Ledex for the answer. Over 100 design variations are waiting on the shelf to insure 48 hour delivery of your prototypes.

Models range from a space saving  $1/2" \times 1/2"$  tubular solenoid to a hefty  $3 3/8"$  pancake solenoid that will develop up to 350 pounds of force. You'll probably want something in between and we've got it with our full line of Tubular, D-Frame and Pancake Solenoids.

If your application calls for something special, we'll put over thirty years of solenoid experience to work for you to find the optimum solution.

The optimum solution could be something other than a linear solenoid. That's why we make a full line of Rotary Solenoids, Stepping Motors and Electro Proportional Solenoids. And that's an option no other manufacturer can give you!

Write or call today for our 36 page Linear Actuation Line catalog and price sheet.



Ledex Inc.

123 Webster Street, Dayton, Ohio 45401 (513) 224-9891

CIRCLE NUMBER 51

# Miniature 250-MHz counter works from NiCd batteries



Data Precision, Audubon Rd., Wakefield, MA 01880. (617) 246-1600. P: See text; 30 days.

Measure frequencies directly up to 250 MHz in the field without line power and with an instrument that measures only 5-1/2 × 1-3/4 × 3-1/2 in., and weighs just 1-1/4 lb. Impossible? Well, not only does Data Precision's 585 miniature counter enable you to accomplish all that, it doesn't cost an arm and a leg, either. The price is \$345.

Internal, rechargeable NiCd batteries give the counter up to four hours of operation on a single charge. Both the batteries and the charger are included in the price, as is a vinyl carrying case.

One other counter, also small, works from rechargeable batteries—the FM-7 from Non-Linear Systems. But unless accompanied by the SC-5 prescaler, the tiny FM-7 (2.7 × 1.9 × 4 in.) can reach only 60 MHz. Combine the FM-7 with the SC-5 and you can measure as high as 512 MHz—twice as high as the Data Precision counter.

Although the FM-7/SC-5 beats

the 585 on price by \$23, it offers one less digit (seven), two less gate periods, less sensitivity and no input attenuator. Data Precision's counter offers three gate periods: 0.1, 1 and 10 s. Resolutions are 10, 1.0 and 0.1 Hz, respectively. Non-Linear's FM-7 comes with just one 1-s gate period.

Sensitivities of the competing units stack up as follows: for the 585, 10 mV rms from 10 Hz to 10 MHz and 50 mV rms beyond; for the FM-7, 30 mV rms to 30 MHz and 100 mV rms to the top. The input sensitivity of the prescaler is 30 mV.

If noise is a problem, as it often is in the field, you can attenuate the 585's input by a factor of 10 or 100 with a front-panel slide switch. Another slide switch lets you set the input impedance to 1 MΩ/25 pF or 50 Ω.

There are no input controls on the Non-Linear FM-7/SC-5. Impedance is 1 MΩ/50 pF (below 0.5 V rms) on the FM-7 and 50 Ω on the prescaler.

How long you can work without

recharging is a major concern, of course, with any portable equipment. The 585's four-hour operating time outstrips the FM-7's two-hour operating time (3 hours for the prescaler, which has its own battery supply).

The 585 drifts 5 ppm from 10 to 40 C. For more stability, a temperature-control crystal oscillator is available. The 585's time base stays at 0.01 ppm/s, 0.6 ppm/month and 4 ppm/year. The FM-7/SC-5's tempo is 10 ppm over the wider span of 0 to 40 C, and its time stability better than 10 ppm/year.

Data Precision CIRCLE NO. 304  
Non-Linear Systems CIRCLE NO. 305

## Logic analyzer becomes word generator too

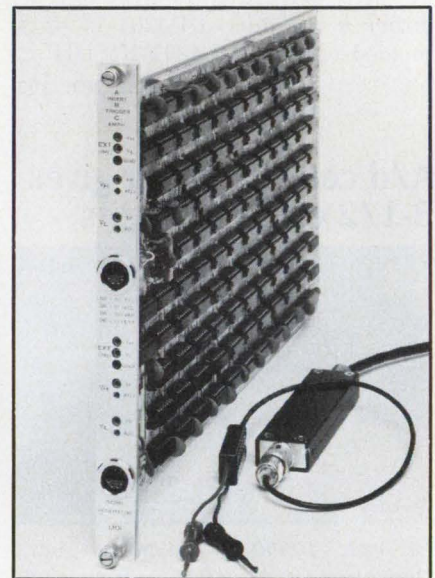

EH Research Laboratories, 515 11th St., Box 1289, Oakland, CA 94604. (415) 834-3030. \$1120 w/o probes; 90 days.

Model 1301 word generator plugs into the company's Model 1320 Digiscope logic analyzer. With the 1301, the Digiscope not only receives data, but can also generate data at up to 50-MHz rates. The unit under test can be stimulated with a desired input pattern, and the same instrument records the output response. Each word generator plug-in has two independent stimulus channels consisting of up to 100 bits of serial data per channel. The output drive signal is provided through active remote Model 1392 driver probes. Logic levels are adjustable over a range of +11 V.

CIRCLE NO. 310



## Signal generator delivers 1000 MHz



Systron-Donner, 10 Systron Dr., Concord, CA 94518. (415) 676-5000. \$4150; 30 days.

Systron-Donner has entered the signal-generator market with a synthesized design that covers the 100-Hz-to-1000-MHz range. Model 1702 features 100-Hz resolution,  $\pm 1$ -dB output-level accuracy, and a residual AM noise of less than 0.1% at +13 dBm. Frequency is selected with digital-switch controls and output levels are displayed on a calibrated output attenuator. A three-digit calibrated LED readout displays FM-AM deviation. Modulation modes can be operated internally, externally, or in combination. Output level is variable from 1 V to 0.1  $\mu$ V.

CIRCLE NO. 320

## Scope probe offers 'slim-body' styling



B&K Precision, 6460 W. Cortland Ave., Chicago, IL 60635. (312) 889-9087. \$30; stock.

A new oscilloscope probe features modern slim-body construction and 10:1/direct capability. Model PR-35 is designed for any scope using a BNC connector and having a bandwidth up to 15 MHz and an input capacitance of 10 to 35 pF. The probe is constructed with a steel inner structure, encapsulated by a rugged plastic shell. "Pull-apart" hidden-switch design prevents accidental position switching of the 10:1/direct switch. PR-35 has an impedance of 10 M $\Omega$ /18 pF (10:1) and 1 M $\Omega$ /120 pF (1:1). Maximum voltage is 500 V pk-pk.

CIRCLE NO. 321

# Still chained to wire?



## Break the wire habit with Repco's modular RF links and discover new design freedom.

Repco's modular RF links are used in hundreds of applications including remote and supervisory control, voice communications, alarm and reporting systems... all become more versatile and effective through the use of Repco's rugged, reliable RF transmitters and receivers.

Repco's RF links are packed with performance features: multiple transmission modes designed to carry tone, voice or low-speed digital data; a wide VHF/UHF frequency range; all units meet FCC and DOC requirements.

Best of all, Repco's RF links are economical. They beat hard wire system costs over the long haul, thus affording you maximum performance at minimum expense. Now is the time for you to link up... with Repco's versatile RF links! Write or call today for free specs brochure, application booklet and special evaluation offer.

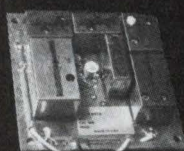

TX

# Repco Inc.

A subsidiary of Scope, Inc.  
1940 Lockwood Way  
Orlando, FL 32804  
(305) 843-8498

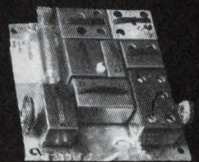

RX

World's leading manufacturer of modular communication products.

CIRCLE NUMBER 53

# New Slim-Body scope probes from B&K-PRECISION ...cost effective and really rugged!

B&K-PRECISION's new line of 10:1 direct scope probes is designed to be compatible with most scopes available, up to 50MHz. All are rated at 500Vp-p. B&K-PRECISION slim-body probes range in price from \$25-\$35.



Model	Connector	Bandw.	Matches
PR30	UHF	10MHz	15-120pF
PR31	BNC	10MHz	15-120pF
PR34	UHF	15MHz	10-35pF
PR35	BNC	15MHz	10-35pF
PR36	BNC	50MHz	10-35pF

Available for immediate delivery at your local distributor. Write for a free copy of the latest B&K-PRECISION catalog.

**B&K PRECISION**  
**DYNASCAN**  
**CORPORATION**

6460 West Cortland Avenue  
Chicago, Illinois 60635 • 312/889-9087  
In Canada: Atlas Electronics, Ontario

CIRCLE NUMBER 54

## PACKAGING & MATERIALS

# Inexpensive metal cabinets come in a variety of sizes

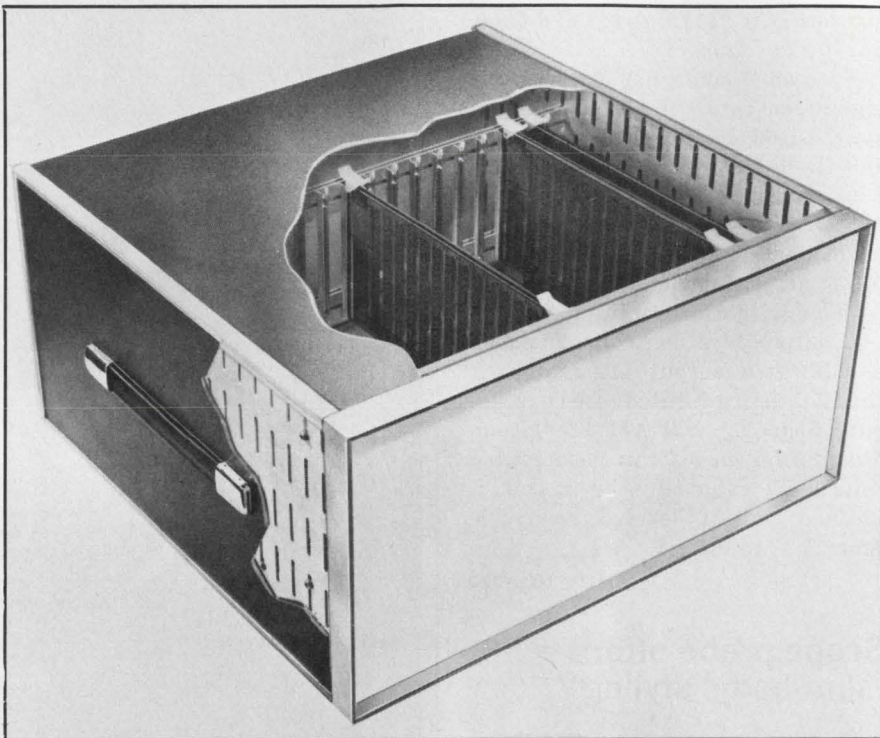

Vector Electronic Co., 12460 Gladstone Ave., Sylmar, CA 91342. (213) 365-9661. P&A: See text.

Capable of holding almost any type of circuit board, the Vector-Pac series of metal enclosures offers many features not available in cabinets costing much more.

The cabinets come in more than 15 sizes, and, with the wide variety of internal hardware available, can accept almost any size circuit card. All units are available with clear or black-anodized aluminum finishes or with mar-resistant textured vinyl covers in 10 off-the-shelf colors. Cabinet sizes range from 2.76 × 12.73 × 10.4 in. for the VP3-12-10 to 9.01 × 17.58 × 21.6 in. for the VP9-17-21.

Prices for the cabinets start at \$59.75 for an unassembled VP3-12-10. Hardware is also available so that circuit cards can be mounted either front to back or sideways within the cabinet.

The internal cabinet structure consists of 0.08-in.-thick aluminum sidewalls joined by four multipur-

pose struts. Available in 17 sizes, the sidewalls have repeating patterns of 1.2 × 0.15-in. vertical slots on 0.75-in. centers, which also hold the card struts. Thirteen variations of the basic enclosure are possible, with such options as front-panel removal of internal circuit cards or a recessed front panel.

Side-trim extrusions on the cases provide channels for upper, lower and side panels of 0.062-in.-thick aluminum. Extruded bezels can accommodate either a vertical or sloped front panel. The interlocking extrusions and panels can be secured with two screws in the rear frame. And the bottom cover of the cabinet comes with non-mar rubber feet.

The cabinets may be purchased with or without the interior structure assembled. Internal struts and card supports normally add \$40 to \$60 to the cabinet's basic \$60 to \$90 cost. Delivery of standard units is from stock to 4 weeks.

CIRCLE NO. 301

## Thermal seals replace the 'greasy kid stuff'

Bergquist Co., 4350 W. 78th St., Minneapolis, MN 55435. (612) 835-2322. See text; stock.

Applying heat-sink compound can be not only messy, but often inadequate. And, of course, it does not provide electrical insulation. Sil-Pads 400 are a laminate of silicone rubber and fiberglass. They resist leaking and cut-through, yet retain low thermal resistance. The gasket-like pads are easy to apply, accommodate surface irregularities, and tolerate soldering temperatures. A wide variety of shapes is available, and die charges for special shapes run typically \$30.

CIRCLE NO. 322

## Film diffuses light from LEDs

3M Co., P.O. Box 33600, St. Paul, MN 55133. (612) 733-9534. \$3.10/ft<sup>2</sup> (1-up); 3 wk.

A series of four kinds of polyester films mounts in front of LEDs to diffuse their light. They have a transmitted gain, defined as brightness in ft-L divided by illumination in ft-C, of either 3 or 5, and come in two thicknesses. The light-diffusing films come in rolls, with widths of 11 in. The 3-mil thick types are: LDF3003N (gain, 3) and LDF5003N (5). The 8-mil types are LDF3008N (3) and LDF5008N (5). They transmit 55% of the incident light and have a neutral-gray color.

CIRCLE NO. 323

## Desolder tool yanks DIPs from board top

Edsyn Inc., 15958 Armenta St., Van Nuys, CA 91406. (213) 989-2324. \$95.45; stock.

The DE180 extractor with an AV125 desoldering tip removes DIPs from the component side of PC boards—gripping either from the side, or from the ends. You place the heating head directly over the DIP package, align the removal claws, and built-in springs automatically lift the package as the solder melts. The desoldering tool is designed for use with Edsyn's Atmoscope system.

CIRCLE NO. 324

## Nothing is Faster and Easier than ACE<sup>®</sup> for circuit breadboarding.

Used to be you'd get a circuit idea, lay out a pc board, print it, solder everything together, troubleshoot, change your layout, try a new board, and spend absolutely too much time breadboarding. Now A P ACE All Circuit Evaluators let you breadboard in a fraction of the time. Make your changes immediately. Keep full leads on your components. Avoid the heat damage possible with repeated soldering and desoldering. And have a pattern for your board—if you need a board—sitting in front of you. In about as long as it takes to sketch a schematic. Get cooking with ACE. ACE. The All Circuit Evaluator from A P Products.



Part No.	ACE Model No.	Tie Points	DIP Capacity	No. Buses.	No. Posts	Board Size (inches)	Price Each
923333	200-K (kit)	728	8 (16's)	2	2	4-9/16x5-9/16	\$18.95
923332	208 (assem.)	872	8 (16's)	8	2	4-9/16x5-9/16	28.95
923334	201-K (kit)	1032	12 (14's)	2	2	4-9/16x7	24.95
923331	212 (assem.)	1224	12 (14's)	8	2	4-9/16x7	34.95
923326	218 (assem.)	1760	18 (14's)	10	2	6-1/2x7-1/8	46.95
923325	227 (assem.)	2712	27 (14's)	28	4	8x9-1/4	59.95
923324	236 (assem.)	3648	36 (14's)	36	4	10-1/4x9-1/4	79.95

Order from your A P distributor today.  
Our distributor list is growing daily.  
For the name of the distributor nearest you  
call Toll-Free 800-321-9668.



Send for our complete A P catalog.  
The Faster and Easier Book.

**A P PRODUCTS INCORPORATED**  
Box 110-F Painesville, OH 44077 (216) 354-2101 TWX: 810-425-2250

CIRCLE NUMBER 55

## 98% EFFICIENT AC LINE REGULATORS

TOPAZ AC Line Regulators solve brownout problems once and for all. Whether your application is a large computer system or a small instrument, TOPAZ regulators are the best solution.

Here's why:

- **98% EFFICIENCY** reduces heat losses and feeder costs.
- **FAST RESPONSE** (less than one cycle) prevents problems caused by short term voltage changes.
- **NO DISTORTION** is added to the output wave form.
- **SMALL SIZE AND WEIGHT** ease handling and reduce space requirements.
- **SILENT OPERATION** permits use in office areas without the annoying noise common to constant voltage transformers.
- **OUTPUT VOLTAGE** is unaffected by input frequency variations.

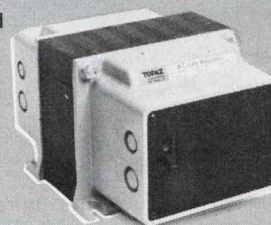

600 VA to 100 kVA  
Priced from \$265.

All this plus TOPAZ noise suppression and quality at prices lower than you'd pay for regulators without these features. Put an end to brownout problems. Send for our brochure or give us a call today.

**TOPAZ** SOLUTIONS TO POWER PROBLEMS  
ELECTRONICS

3855 Ruffin Road, San Diego, California 92123—(714) 279-0831—TWX (910) 335-1526

CIRCLE NUMBER 56

## DISCRETE SEMICONDUCTORS

### Fast switching Xistors have $t_{on}$ of 0.45 $\mu$ s

Solitron Devices Inc., 1177 Blue Heron Blvd., Riviera Beach, FL 33404. (305) 848-4311. \$12: 14304, \$15: 14305 (1-99); 2 wks.

Two new 20-A, fast-switching npn silicon power transistors, SDT 14304 and 14305, are packaged in either the standard TO-3 or TO-61/I cases and feature single-planar chip construction. Switching time is  $t_{on} = 0.45 \mu$ s,  $t_s = 2.5 \mu$ s and  $t_f = 0.45 \mu$ s. Other typical specifications include  $V_{CEO}$  (sus) from 300 V (SDT 14304) to 400 V (SDT 14305);  $I_C$  (cont) is 10 A and  $I_C$  (peak), 20 A;  $h_{FE}$  of 15 to 75 at 5 A, 5 V;  $f_T = 7$  MHz; and thermal resistance is  $R_{\theta JC} = 0.8$  C/W. The transistors are designed for applications including push-pull inverters, switching regulators and pulse-width modulators.

CIRCLE NO. 325

### SCR bridges feature low thermal resistance

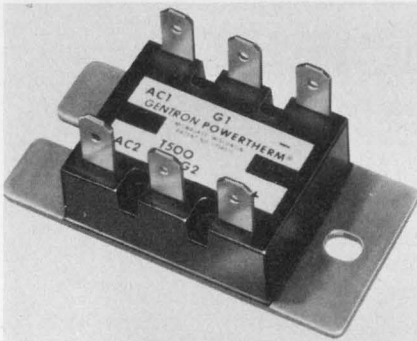

Gentron Corp., 6667 N. Sidney Pl., Milwaukee, WI 53209. (414) 351-1660.

New 25-A SCR Powertherm bridge-rectifier circuits, the T500 series, with the low thermal resistance of 0.5 C/W, are available in 120, 230 and 460-V types. Heat-sink mounting plates are electrically isolated; breakdown to the plate exceeds 2500 V. Eight circuit combinations are offered. Options such as voltage-transient suppression and free-wheeling diode protection are available. The Powertherm package also lends itself to special custom power circuits that include both active and passive components.

CIRCLE NO. 326

### Aerospace-rectifier prices reduced

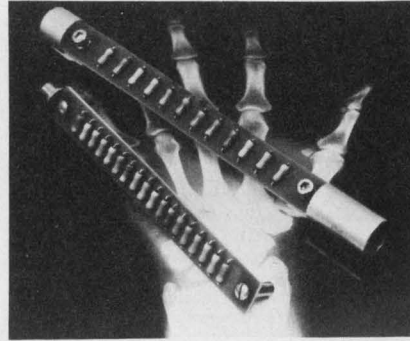

Semtech Corp., 652 Mitchell Rd., Newbury Park, CA 91320. (213) 628-5392. \$17 to \$23 (100 up); 10 days.

X-way Stic, a new series of open rectifier sticks specifically designed for X-ray power supplies, consists of hermetically sealed Metoxilite multichip avalanche rectifiers mounted on a PC board. These rectifiers, originally developed for high-reliability aerospace programs, are now available at reduced prices. They can be efficiently used in most standard single and polyphase circuits. Individual rectifiers have PIVs of 100, 125 or 150 V and handle an average rectified current of 150 mA at 55 C (in oil).

CIRCLE NO. 327

### Bridge rectifier takes 1000-A surges

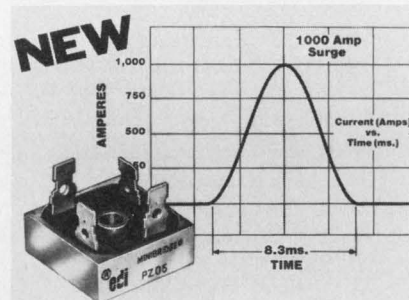

Electronic Devices Inc., 21 Gray Oaks Ave., Yonkers, NY 10710. (914) 965-4400. \$10 (1000 up).

Called the PZ Series Minibrige rectifier, the unit can withstand a 1000-A surge current. The new bridge has a peak reverse-voltage rating to 400 V, a 30-A current rating, 0.25-in. quick-connect terminals and a small 1-1/8 x 1-1/8-in. size. The high surge capability of the design makes the rectifier particularly suited for use in high-capacitive load circuits.

CIRCLE NO. 328

### Conveniently packaged SCRs interconnect easily

Semikron International Inc., 542 Columbian St., South Weymouth, MA 02190. (617) 337-7220. \$38; 40A, 600 PIV (100 up).

Semipack offers the engineer a modular building block that is electrically isolated and mechanically compatible for heat-sink mounting. The units can be connected into single, three-phase or other circuit configurations with small bus-interconnects. Heat sinks are available from the manufacturer. The modules are available in ratings from 10 to 90 A per device with up to 1600 PIV. Both standard and fast SCRs, and also diodes, are packed in Semipack. The center-to-center dimension of mounting holes is 3-1/8 in.

CIRCLE NO. 329

### Npn Darlingtons handle 100 W at 600 V

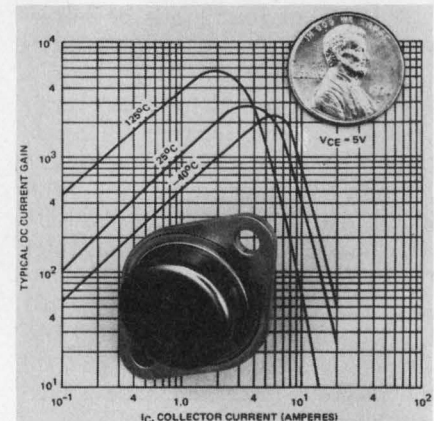

International Rectifier, 233 Kansas St., El Segundo, CA 90245. (213) 322-3331. \$5.29 to \$7.06 (100-999); stock.

Npn power Darlingtons with power ratings to 100 W and collector-emitter voltage ratings to 500-V (sustaining) are designated IR4039, 4041, 4059 and 4061. The new units offer triple-diffused processing to achieve the high-voltage operation. Rise time for the Darlingtons is 2  $\mu$ s, storage time 4  $\mu$ s and fall time 2.6  $\mu$ s in typical applications. Continuous collector-current rating for all units in the line is 20 A. The units are packaged in industry-standard JEDEC TO-3 metal cases with maximum thermal resistance (junction-to-case) of 1.25 C/W.

CIRCLE NO. 330

## POWER SOURCES

Does your  $\mu$ P system need another voltage?

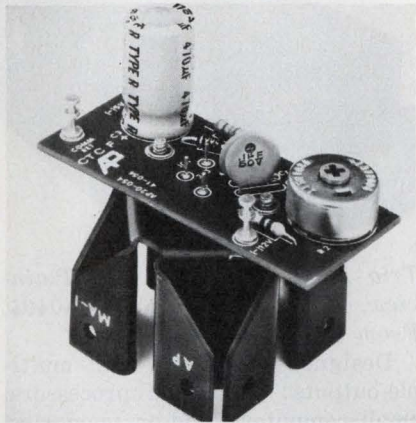

Adtech Power, Inc., 1621 S. Sinclair St., Anaheim, CA 92806. George Mousel (714) 634-9211. \$8.95 (1000 qty); stock.

Particularly intended for  $\mu$ Ps, the MA series of output adapters takes an existing  $\pm 12$  or  $\pm 15$ -V-dc (regulated or unregulated) voltage and delivers  $\pm 5$  to  $\pm 9$  V at 1.0 A. Available in two models, the MA-1 for negative output and the MA+1 for positive output, the adapters also operate from  $\pm 16$  to  $\pm 24$ -V-dc power supplies, to give  $\pm 5$  V at 0.5 A. Both devices can be operated from a 12-V battery to provide 5 to 9 V at 1 A for stand-by power. Units measure  $3 \times 2 \times 2.6$  in.

CIRCLE NO. 331

## On-board switchers deliver 3.5 W

CEA, 1 Aerovista Park, San Luis Obispo, CA 93401. (800) 235-4151. \$120; stock to 2 wks.

Two switching dc supplies, the TL5-700 delivering 5 V at 0.7 A and the TLD 15-125 delivering  $\pm 15$  V at 0.125 A, are intended for recessed PC board mounting. The  $0.5 \times 2.5 \times 2.5$  in. (excluding tabs and terminals) modules handle 3.5 W from  $-20$  to  $+71$  C. Operating from 105-to-125-V, 50-to-400-Hz or 140-to-170-V-dc input, they feature  $\pm 0.01\%$  tempo, 30-C base rise, 50- $\mu$ s response time and greater than 50-M $\Omega$  and 500-V-dc isolation. Line and load regulation is  $\pm 0.03\%$  for the 5-V unit and  $\pm 0.01\%$  for the 15 V. Both devices are current limited with foldback.

CIRCLE NO. 332

# MEET OUR family of HIGH VOLTAGE TEST PROBES

In 1967 we introduced the first high voltage test probe with a built-in meter. It became so popular that we have been adding new models ever since. Now there are five different versions to satisfy the demands of radio, television, appliance, audio, and electrical repair men in a wide variety of high voltage testing applications.

The five models are briefly described below. Our general catalog contains complete applications information, illustrations, specifications, and prices. Write for your free copy.

**MODEL 4242**—42,000 volts DC. Negative ground.

**MODEL 3157**—15,000 volts DC. Negative ground.

**MODEL 4312**—15,000 volts DC. Positive ground.

**MODEL 3163**—6,000 volts DC. Negative ground.

**MODEL 3200**—10,000 volts AC.

AVAILABLE THROUGH YOUR  
FAVORITE ELECTRONIC PARTS DISTRIBUTOR

## ITT POMONA ELECTRONICS

1500 East Ninth St., Pomona, Calif. 91766  
Telephone (714) 623-3463, TWX: 910-581-3822

CIRCLE NUMBER 58

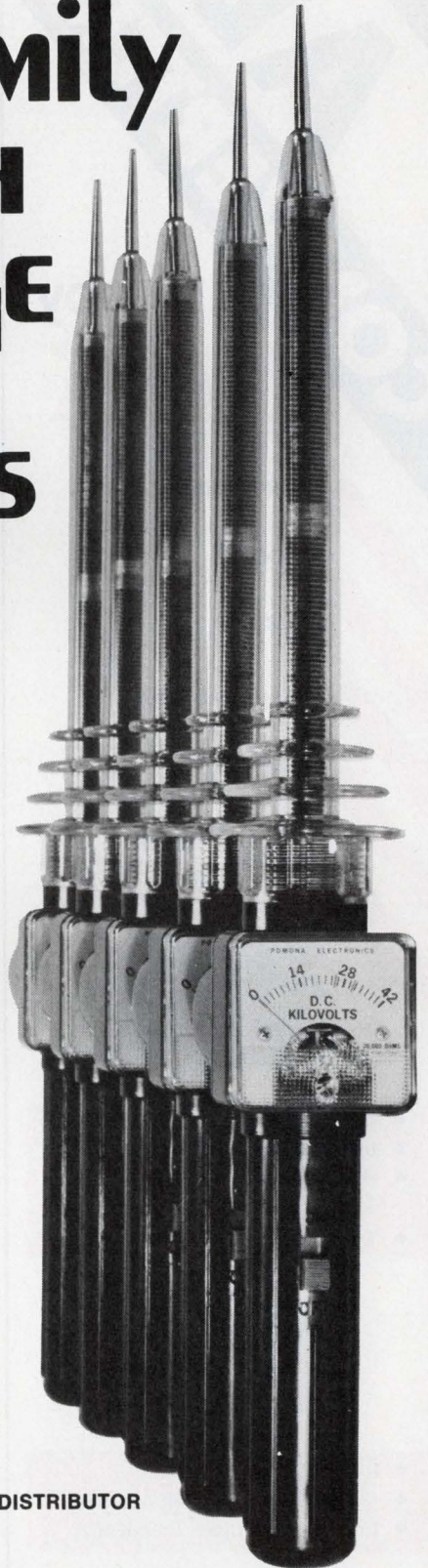

MILITARY APPLICATIONS

# AD CONVERTERS

by

## MSK

Accuracy

Speed

Size

Repairability

Military

Temp. Range

-55°C to +125°C

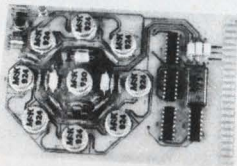

- 4 Bit/50 nSec; Low Cost
- Ideal for Radar Scan Converters
- Holds Absolute Accuracy Over Temperatures
- Tracks a 10 MHz Analog Input

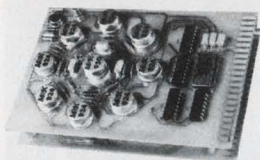

- 9 Bit/200 nSec.
- < 2 Bit Drift Over Temperature
- Insensitive to Clock Frequency

For Further Information Call or Write  
**M.S. Kennedy Corp.**  
 Pickard Drive, Syracuse, New York 13211  
 Tel. 315-455-7077

CIRCLE NUMBER 59

## POWER SOURCES

### Efficient switchers give you isolation

Gould, 3631 Perkins Ave., Cleveland, OH 44114. W. Roth (216) 361-3315. \$125 (1-9); stock.

You get efficiencies of from 75 to 85% from MMG-type switching power supplies. The units operate from 110/120 V or 220/240 V  $\pm 10\%$ , 50 or 60 Hz, and use optical coupling to provide 4-kV-rms isolation (5.7-kV pk) between input and output. Four models provide dc outputs of 5, 12, 15, or 24 V at currents from 1.4 to 5 A. Output voltages are adjustable  $\pm 10\%$  by a multiturn potentiometer. Units can be used in series or parallel. Regulation is 0.1% max. for the worst-case combination of 0-to-100%-load-change and  $\pm 10\%$ -line-change. Ripple does not exceed 10-mV rms or 50-mV pk-pk measured over a 30-MHz bandwidth. For a step load-change of 100% to 10% or 10% to 100%, the voltage deviation is typically 300 mV and returns within the regulation band in approximately 2 ms. The operating temperature range is -10 to +70 C, with full-output ratings to +50 C and derating of 2.5%/°C thereafter. Dimensions of the 1.2-lb units are 6.3 x 3.5 x 1.3 in. Remote sensing plus over-current and overvoltage protection are standard.

CIRCLE NO. 333

### $\mu$ P supplies carry UL recognition

Deltron Inc., Wissahickon Ave., North Wales, PA 19454. J. Phillips (215) 699-9261. \$99-\$142; stock.

Containing 20 models, Quad series  $\mu$ P power supplies are now UL recognized per UL 478. Each dc supply in the series provides four outputs. All offer a 5-V output and another output in the 5-to-24-V range. Other voltages of from  $\pm 12$  to  $\pm 15$  V, 12 V and 9 to 12 V are available. All units feature line-and-load regulation of 0.1% and ripple and noise of 1.5-mV rms. Features included are barrier-block output terminals and infinite-resolution adjustments. All units are capable of 115/230-V-ac-operation.

CIRCLE NO. 334

### 475-W switcher gives you four output rails



Trio Labs, 80 Dupont St., Plainview, NY 11803. (516) 681-0404. From \$635; 2-4 wks.

Designed specifically for multi-outputs: for microprocessors, small computers, add-on memories, etc., the Model 675 features a main 2 or 5-V output for logic, a second 12-V output for memory, and two additional 15-V outputs for accessory power needs. The unit weighs 15 lb, has an efficiency of over 60%, an MTBF exceeding 30,000 h, is UL recognized, and measures 5 x 8 x 14.33 in.

CIRCLE NO. 335

### Unit calibrates four thermocouples to 0.1 deg

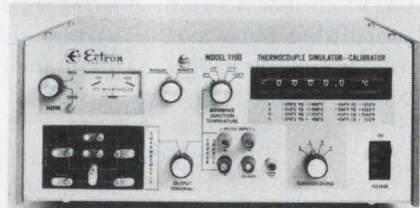

Ectron Corp., 8159 Engineer Rd., San Diego, CA 92111. (714) 278-0600. \$1970; stock to 30 days.

The Model 1100 thermocouple simulator/calibrator allows the user to simulate any of four common thermocouple types (E, J, K and T) over the entire range of NBS tables. The desired temperature is dialed directly in degrees C or F on five decade thumbwheel switches and the proper voltage automatically appears on output terminals constructed of the chosen thermocouple type material. Conformity to NBS tables is within 0.1°. The instrument may also be used as a precision linear dc standard with a resolution of 1  $\mu$ V, or as a high-precision differential voltmeter. Optional features include remote programming and a rack-mounting kit.

CIRCLE NO. 336

## MICROWAVES & LASERS

### Tiny thin-film VCO beats tough specs

Watkins-Johnson Co., 3333 Hillview Ave., Palo Alto, CA 94304. (415) 493-4141.

Miniature thin-film VCO, Model WJ-V201, is varactor tuned over the 2-to-4-GHz band. It weighs in at a feather-light 1.5 oz (42.5 grams) and offers MIL-spec performance. Its output of 10 mW is obtained with 15 V dc, 120 mA max, input power. Available options include a TO-8 package.

CIRCLE NO. 337

### Rotary joint turns on high power levels

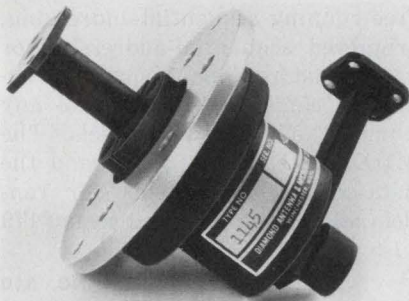

Diamond Antenna & Microwave Corp., 35 River St., Winchester, MA 01890. (617) 729-5500. 10 wks.

Model 1145 Ka-band rotary joint features a frequency coverage of 26.5 to 40 GHz, and if pressurized handles 3-kW peak, 500-W cw. The L-type unit is 3 in. long and weighs 1-1/4 lb. Similar units for 18 to 26.5 GHz and lower frequencies have also been announced. Prices depend on specific features.

CIRCLE NO. 338

### Directional couplers now coaxed to 26 GHz

Narda Microwave, Plainview, NY 11803. J. P. Schindler (516) 433-9000. \$450.

Coax stripline couplers can now take over from waveguide units in the 18-to-26.5-GHz range. The Model 4017 is available in 6 and 10-dB values, and handles 30 W av, 2 kW pk min. Insertion loss (excluding coupled power) is 0.5 dB max, operating temperature without degradation is 105 C.

CIRCLE NO. 339

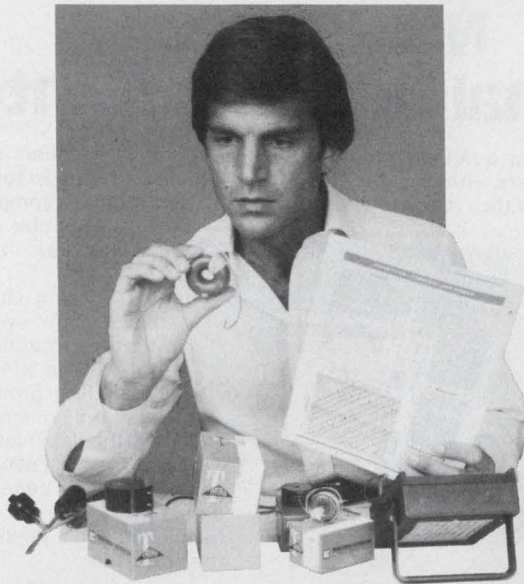

## Toroidal Inductors

### Triad Quality In More Ratings... More Constructions

Stocked in five series, Triad toroidal inductors offer optimum combinations of size, power and "Q" — and the highest measure of stability with voltage and temperature variations. Every rating in each series is available in either a strong plastic coating with standard leads, or encapsulated with gold plated fixed terminals per specification MIL-T-27C. The EK and EC series are two of our most popular.

Write today for our Engineering Bulletin on Inductors. Then, for the fastest, most personal service, call your nearest Triad distributor. He can give you Triad quality in a complete line of transformers.

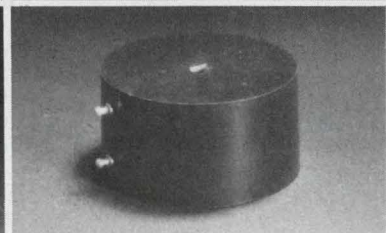
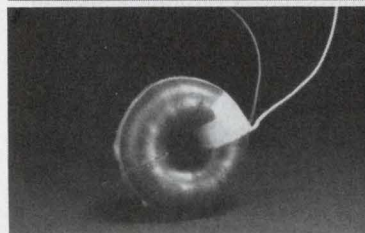
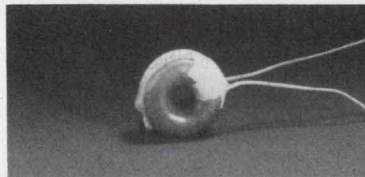

**TRIAD-UTRAD**  
Litton Distributor Services

305 North Briant Street, Huntington, Indiana 46750

CIRCLE NUMBER 60

# Gulton's New Quiet Non-Impact Thermal Numeric Printer

Featuring...ultra quiet operation...seven columns of numbers or six columns of numbers with  $\pm$  sign...fast paper roll loading...up to four line per second print rate...complete with interface electronics...compatible with all popular digital panel meters.



Introducing Gulton's answer to noisy, complicated mechanical printers. The NP-7 panel-mounting printer requires only one moving part, the paper advance motor, which sends the paper silently beneath a non-impact thermal print head. You'll be pleased at the price, too.

Write or call for detailed catalog.

**gulton**<sup>®</sup>

Measurement & Control Systems Division  
Gulton Industries Inc., East Greenwich, Rhode Island 02818  
401-884-6800 • TWX 710-387-1500

CIRCLE NUMBER 61

## MODULES & SUBASSEMBLIES

### Units boost acquisition to 48 channels

Datel Systems, 1020 Turnpike St., Canton, MA 02021. Eugene Zuch (617) 828-8000. \$199 (1-9 qty); 4 wks.

MDXP-32 and MDXP-32-1 are companion devices to the company's MDAS-16 and MDAS-8D modular data-acquisition systems. Both are expander modules containing 32 analog multiplex channels for extending the MDAS-16 from 16 to 48 single-ended channels and the MDAS-8D from 8 to 24 differential channels, using single-level multiplexing. With the MDXP-32 you can operate the expanded system in three modes: free-running sequential-addressing, triggered sequential-addressing or random-addressing. Sequential operation can be short-cycled to any number of desired channels. The MDXP-32-1 is used to expand the data-acquisition systems for random addressing only and costs \$179 (1-9 qty).

CIRCLE NO. 340

# AUTHOR'S GUIDE

writing  
for  
**Electronic Design**

An  
Author's  
Guide

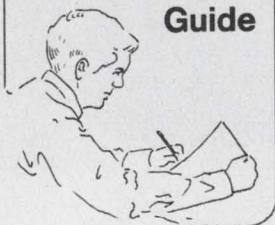

If you've solved a tricky design problem, if you have developed special expertise in a specific area, if you have information that will aid the design process... share it with your fellow engineer-readers of *Electronic Design*.

Articles you have authored not only raise your own professional status, but help build your company image as well. The readers benefit, your company benefits.

To help you prepare material that meets *Electronic Design's* high editorial standards, our editors have prepared a special author's guide entitled "Writing for *Electronic Design*." It covers criteria for acceptability, form, length, writing tips, illustrations, and payment for articles published. It's available without cost.

It's easy to write for *Electronic Design*, but it's often hard to get started. Send for your copy of our Author's Guide today.

**Circle No.  
250**

### Small d/s drives torque receiver

Computer Conversions Corp., 6 Dunton Court, East Northport, NY 11731. (516) 261-3300. \$575 (singles); 4-to-6 wks.

You can drive torque-receiver synchros (up to 3 VA) with the DSC series of 14-bit d/s converters. The 2.6 x 3.1 x 1-in. devices are the smallest of their type to provide  $\pm 5$ -minute accuracy when driving this heavy a load (size-11 TR). These units accept a 14-bit natural-binary angle and convert it into a 3-wire-synchro or 4-wire-resolver signal. Standard output voltages are 11.8 or 90 V, 60 or 400 Hz. Digital inputs are TTL/DTL compatible and the synchro output and reference are transformer isolated. The output is short-circuit protected and  $\pm 15$  and +5-V-dc power supplies are required. Converters in the series operate from 0 to 70 or -55 to +85 C.

CIRCLE NO. 341



## DATA PROCESSING

### This computer terminal is ready to move about



*Informer, Inc., 8322 Osage Ave., Los Angeles, CA 90045. Will Little (213) 649-2030. \$1890; 6 wks.*

The Model D301 compact desktop CRT display with keyboard was specifically designed to be truly mobile. It is intended for IBM 3740 or similar applications, and can be plugged directly into the computer, or into a telephone line. With a weight of only 10 lb, even the frailest secretary can put the electronic genie in its place.

CIRCLE NO. 344

### PROM programmer is versatile, low-cost



*Shepardson Microsystems Inc., 20823 Stevens Creek Blvd., Bldg. C4-H, Cupertino, CA 95014. (408) 257-9900. \$850.*

If you already have a computer terminal, the Model 2708 PROM programmer may save you some money. This intelligent device permits use of an RS232 or current-loop terminal for programming type-2704 and 2708 PROMs. You can move, alter and store data in the programmer's buffer, be they binary, octal, decimal or hex. The Model 2708 reads or outputs the PROM data in ASCII, BNPF or BHLF, and automatically adapts to the terminal's speed up to 600 baud.

CIRCLE NO. 345

### Field/lab instrument clocks 12 Mbit/s

*Pioneer Magnetics Inc., 1745 Berkeley St., Santa Monica, CA 90404. (213) 829-3305. \$9895, 12 wks.*

If your rotating memories need a portable clock and sector writer, the compact (18-1/2 x 11 x 15-1/4 in.) PM2390 may be worth a spin. It records open or closed clock tracks at bit rates up to 12 Mbit/s, and eliminates bit-to-bit jitter, closure error, and cumulative phase error. The PM2390 permits the measurement of amplitude and frequency modulation, area and pinhole defects, and servo performance.

CIRCLE NO. 346

### Interface ties tape systems to PDP-11

*Emerson Electric Co., 3300 S. Standard St., Santa Ana, CA 92702. Ron Carroll (714) 545-5581. \$1500 (1 up); 8 to 12 wks.*

Emerson Tape-Pac recorder systems can now be interfaced efficiently with PDP-11 systems through the Model 2061 interface adaptor. It is contained in two modules that can be installed in the PDP-11, using the DEC M920 Unibus jumper module. You can connect two of Emerson's Model 2050-PE formatters to a single Model 2061 adaptor, and each formatter can handle four tape drives. The Model 2061 operates off existing software, and is software-transparent to DEC's TM11/TU10 tape drives.

CIRCLE NO. 347

### Convert mag-card data to paper tape

*Tycom Systems Corp., 26 Just Rd., Fairfield, NJ 07006. Peter Polizano (201) 227-4141. \$8500; 4 wks.*

If you want to convert magnetic-card data to paper tape, the IBM MCST-compatible Model PTR/P will do it at 50 characters per second. Although intended to handle ASCII the PTR/P can accommodate any code through its built-in code converter. An editor option skips characters, words, or paragraphs. The RS-232 output offers speeds from 75 to 2400 baud.

CIRCLE NO. 348

## Industry Standard A/D and D/A 12-Bit Converters

### Now in Hermetic Packages

The Micro Networks DAC 80 and ADC 80 combine low cost and high performance to make them your best buy for industrial control and instrumentation applications

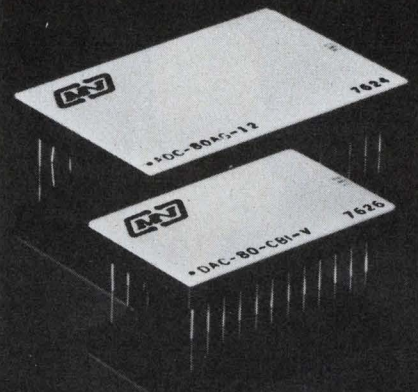

**DAC 80**  
**\$19.50\***

**ADC 80**  
**\$47.50\***

\* in 100 quantities



Micro Networks Corporation  
324 Clark Street, Worcester, MA 01606  
(617) 852-5400 TWX 710-340-0067

CIRCLE NUMBER 62

## COMPONENTS

### Single-turn trim caps feature zero tempco

Sprague Electric Co., North Adams, MA 01247. (413) 664-4411. \$0.20 to \$0.80 (25,000 up); 4 to 6 wks.

Plastic-film single-turn trimmer capacitors called Filmtrim are available in three basic body sizes: 8, 10 and 16 mm and each can be had in top-mount or side-mount configurations. In both configurations, screwdriver slots are provided at either end of the adjust shaft. The capacitors are furnished with three different dielectric materials—polytetrafluoroethylene, polypropylene and polycarbonate—and cover a broad range of capacitance values from 1.4 to as high as 300 pF. Essentially zero temperature coefficient of capacitance is featured.

CIRCLE NO. 349

### Plug-in transformers feature circuit breaker

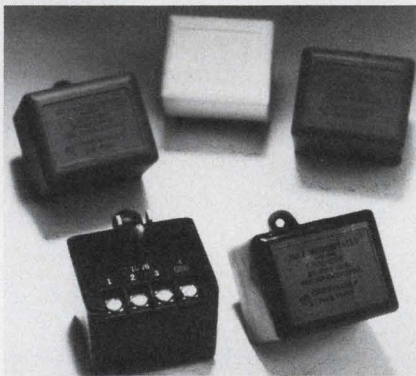

Adult Inc., 1700 H. Freeway Blvd., Minneapolis, MN 55430. (612) 560-9300. \$4 (OEM qty).

UL-listed plug-in transformers with four output terminals provide a center-tapped 24-V-ac output and a power ground. Other features include extremely low interwinding capacitance—less than 30 pF—for line-noise rejection; primary and secondary windings are nonconcentric for increased dielectric isolation; and the core is grounded for reduced line-noise transfer (without electrostatic shielding). An integral thermal circuit-breaker with automatic reset protects against short-circuits. Two models—7 VA to 10 VA—are available.

CIRCLE NO. 350

### Solid-state relays handle 800-V transients

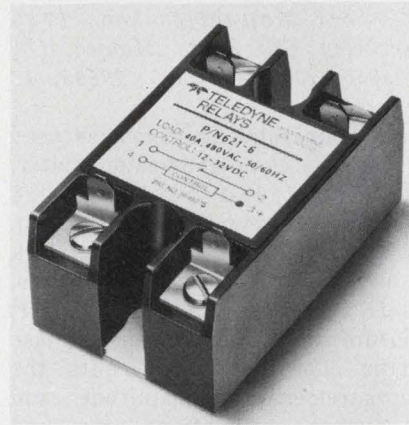

Teledyne Relays, 3155 W. El Segundo Blvd., Hawthorne, CA 90250. (213) 973-4545. \$22.10 (1000 up).

The 621 Series of optically isolated high-voltage ac solid-state relays are designed for high line voltages of 480 V rms (45 to 70 Hz). The relays feature a transient peak voltage rating of 800 V capable of handling three-phase line voltages encountered in European systems. The 800-V peak rating also permits the effective use of MOV transient suppressors to protect the relays against overvoltage transients. The relays meet UL and CSA safety requirements and the more stringent VDE and IEC European specifications. Six models with load current ratings of 15, 25 and 40 A are available, each with input control voltages of 3 to 14 V dc or 12 to 32 V dc. All have peak surge current ratings of up to 10 times the maximum steady state rating for 16 ms.

CIRCLE NO. 351

### Silicon chip capacitors provide high-values/area

Microwave Associates, South Ave., Burlington, MA 01803. (617) 272-3000. \$1.00 (1-99); stock to 2 wks.

The MA-4M0000 series of silicon MIS chip capacitors uses a nonoxide insulator as the dielectric layer. This series exhibits higher capacitance per unit area than capacitors using oxide layers, because of the larger dielectric constant. Refractory metallization with gold contacts provides excellent metal-to-semiconductor adhesion. All chip capacitors in this series are saw-cut from the wafer.

CIRCLE NO. 352

### Thin-film resistor chips epoxy or reflow attached

California Micro Devices Corp., 733 Palomar Ave., Sunnyvale, CA 94086. (408) 738-3214. Typically \$0.10 (OEM qty); 4 wks.

Thin-film chip resistors, Type RX, for hybrid microelectronics applications are designed to be bonded with conductive epoxy or reflow-solder techniques. The resistors employ a glass substrate and the company's TN II tantalum-alloy resistive material. The devices exhibit a low TCR of  $-200$  ppm/ $^{\circ}$ C, low noise and high stability that exceeds the requirements of MIL-R-55342. Power dissipation is 100 mW at 70 C with a dc operating-voltage rating of 100 V. The chip measures  $75 \times 40$  mils and is 20-mils thick. The bonding areas are plated gold, 1.5 microns thick and measure  $20 \times 34$  mils. The resistor element is passivated with silicon nitride. Resistance values are available to 25 M $\Omega$  in a variety of tolerances.

CIRCLE NO. 353

### Assemble PB switches with designer's kit



Arrow Hart Inc., 103 Hawthorn St., Hartford, CT 06105. (203) 249-8471. \$22.99 (unit qty).

A versatile lighted and unlighted pushbutton-switch demonstrator kit is available for designers. Pushbutton switches can be built for prototypes or testing new equipment such as instruments, transportation panels, computers and communications equipment. The kit contains nine lenses in a variety of colors. Included are three actuators to accommodate the three lense shapes (square, round and rectangular) for momentary and alternate switch actions. Six snap-on blocks with NO or NC contact are part of the kit. Contacts are rated 5 A, 125 V ac; 2 A, 250 V ac; and 5 A, 28 V dc, resistive.

CIRCLE NO. 354

## Application Notes

### Magnetic sensors

How to select the proper magnetic sensor for a given application is covered in an eight-page catalog. Dimensions and detailed specifications are provided. Electro Corp., Sarasota, FL

CIRCLE NO. 355

### Low-noise amplifier

The design and construction of a single-stage, state-of-the-art bipolar-transistor amplifier at 4 GHz is described in a brochure. It includes design data, describes I/O-matching networks, computer simulation, performance and construction. Hewlett-Packard, Palo Alto, CA

CIRCLE NO. 356

### Memory refresh

"Introduction to Refreshing TI 4-k Dynamic RAMs" reviews refresh principles and their implementation. It compares static and dynamic RAMs in terms of speed, power consumption, refresh requirements, relative costs, and power-supply requirements. Texas Instruments, Dallas, TX

CIRCLE NO. 357

### Equalizers and filters

Subjects covered in an applications manual on group-delay equalization in communication systems include definition of group delay, passive vs active designs, frequency effects, computer optimization, and how to specify. Comstron Seg, Freeport, NY

CIRCLE NO. 358

### Array programming

A full explanation of SWAP (Stewart-Warner Array Programming), pricing and entry information and technical diagrams are given in a four-page brochure. Stewart-Warner, Sunnyvale, CA

CIRCLE NO. 359

Before you buy

# COMPARE MODULATION METERS

We invite you to use Radiometer's Type AFM2 or AFM3 in your laboratory on a 10 day trial. Check features, specifications and especially performance in your own precise measurements of FM deviation and AM modulation on carriers from 5 MHz to over 1 GHz. Determine distortion levels of signal generators or transmitters and make sensitive measurements of incidental AM or incremental FM on carriers.

You can check all these and more.

For details contact us at  
811 Sharon Drive,  
Cleveland, Ohio 44145  
Phone 216/871-8900

 THE LONDON COMPANY

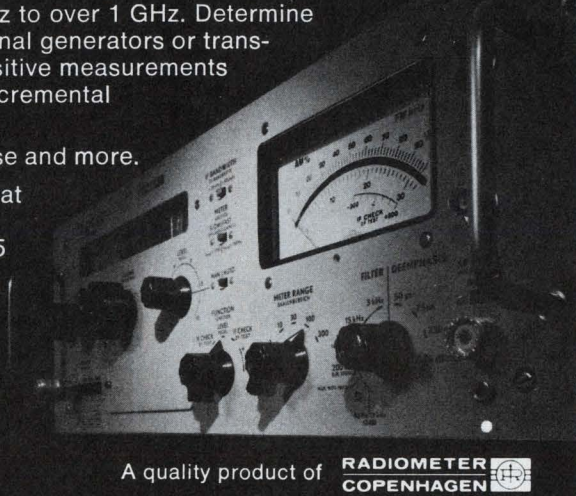

A quality product of RADIOMETER COPENHAGEN 

CIRCLE NUMBER 64



electrocube solutions...

## POLYSULFONE



## WHEN THINGS GET HOT



When your application specifies 150°C, specify Electrocube's new Polysulfone capacitors. You have a wide choice of extremely stable units in six case styles ... capacitances from 0.0010 to 50 mfd, and standard ratings to 600 VDC. Get more information today on this miniature series from Electrocube, 1710 So. Del Mar Ave., San Gabriel, California 91776; Tel. (213) 573-3300; TWX: 910-589-1609

CIRCLE NUMBER 65

NEW-REVOLUTIONARY TOOL

# SLIT WRAP

WRAPS  
INSULATED WIRE  
FOUR TIMES FASTER

NO Prestripping  
NO Precutting  
Spool Fed Wire

Users say:

"Your P180 tool really does just what you said it would—we're very satisfied."

"We're shifting nearly all our wrapping over to Slit-N-Wrap."

The spooled wire passes thru the tool past a slitting edge next to the wrap post. A narrow longitudinal cut is made in the insulation where it passes the square post corner. The bared copper is indented by the sharp edge. (7 turns equal 28 contacts.) Insulation is slit where wrapped, but not between terminal posts when fed straight out of the tool.

Model P180 with two 100' spools of 28 gage wire \$24.50

Battery powered Model P160-4T includes charger and wire \$75.00

110V Model P160-4TI \$80.00

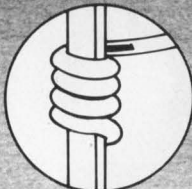

view of unwrapped wire end .025 sq. post

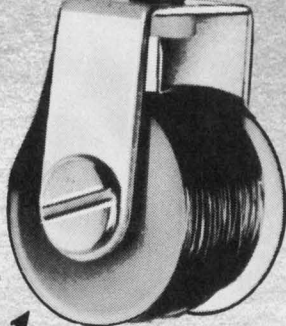

**Vector**  
ELECTRONIC COMPANY  
12460 Gladstone Avenue  
Sylmar, CA 91342

If unavailable locally, factory order. Add \$2.00 shipping and handling charge.  
California residents add 6% sales tax.  
491076

CIRCLE NUMBER 66

## New Literature



### Peripheral equip supplies

A 56-page catalog describes 200 replacement and enhancement items for use with Digital Equipment's peripherals. Communications Services, Northboro, MA

CIRCLE NO. 360

### MOS ICs

Standard MOS-integrated-circuit and LCD-display products are covered in a 32-page catalog. The catalog includes an industry cross-reference guide and block diagrams. American Microsystems, Santa Clara, CA

CIRCLE NO. 361

### Components

A literature package includes a catalog describing the company's line of components, another describing test systems and the third jackfields. ADC Products, Minneapolis, MN

CIRCLE NO. 362

### Core memory system

The SEMS-9-PI planar core memory system is featured in a data sheet. Electronic Memories & Magnetics, Chatsworth, CA

CIRCLE NO. 363

### Semiconductors

A 175-page semiconductor catalog and replacement guide offers replacements for over 75,000 part numbers from major semiconductor manufacturers. Workman Electronic Products, Sarasota, FL

CIRCLE NO. 364

### Radio performance analyzer

A 16-page radio performance-analyzer catalog describes a telecommunication instrument used to test microwave-radio performance. Scientific-Atlanta, Atlanta, GA

CIRCLE NO. 365

### Discrete semiconductors

Discrete semiconductor components are shown in a 36-page catalog. General Instrument, Semiconductor Div., Hicksville, NY

CIRCLE NO. 366

### Recorder supplies

A 66-page catalog describes recorder paper, pens and other consumable supplies available for HP's plotters, X-Y, strip-chart, oscillographic recorders and magnetic-instrumentation tape recorders. Hewlett-Packard, Palo Alto, CA

CIRCLE NO. 367

### Digital indicators

A brochure describes the series 50GS selectable-parameter digital indicators. Consolidated Controls, Bethel, CT

CIRCLE NO. 368

### Coaxial cable assemblies

Specifications, technical data and prices for coaxial cable assemblies are given in a 12-page catalog. Pasternack Enterprises, Huntington Beach, CA

CIRCLE NO. 369

### D/a converters

Series 877-80 d/a converters are described in a six-page bulletin. Block diagrams, typical connection configurations and tables round out the bulletin. Beckman Instruments, Fullerton, CA

CIRCLE NO. 370

## Logic analyzers

Microprocessor and logic analyzers are covered in a 12-page brochure. Operational features of each model and photographs illustrating display modes for each product are included. Biomation, Cupertino, CA

CIRCLE NO. 371

## $\mu$ C products

Microcomputer products, software and development systems are presented in a catalog. Control Logic, Natick, MA

CIRCLE NO. 372

## Bench-top LSI tester

Complete with photos, illustrations and block diagrams, a six-page brochure describes the operational performance, characteristics and specifications of the MD-104 LSI tester system. Macrodata, Woodland Hills, CA

CIRCLE NO. 373

## Film capacitors

Size, performance, electrical characteristics and rating information for metallized polycarbonate capacitors are included in a catalog. Union Carbide, Greenville, SC

CIRCLE NO. 374

## 245 and 400-A SCRs

Fast-switching inverter SCRs rated for operation at 245 and 400-A rms are described in an eight-page data sheet. International Rectifier, Semiconductor Div., El Segundo, CA

CIRCLE NO. 375

## Synchros, resolvers

Brushless synchros and resolvers for machine-tool and airborne equipment are described in a bulletin. Clifton Precision, Clifton, Heights, PA

CIRCLE NO. 376

## Film resistors

Specifications and dimensional information for high-performance film resistors can be found in a 20-page catalog. Caddock Electronics, Riverside, CA

CIRCLE NO. 377

# Bulletin Board

Two free program libraries with a suggested retail price of \$59.90 are available to purchasers of the Texas Instruments SR-52 magnetic-card programmable calculator between Jan. 20 to March 31, 1977. The prerecorded libraries cover mathematics, statistics, finance or electrical engineering.

CIRCLE NO. 378

Philips Telecommunications has introduced a **coaxial cable transmission system**, that meets the increasing demand for additional channel capacity by providing 18 MHz of traffic-handling bandwidth at 12-MHz cost.

CIRCLE NO. 379

Digital Systems' **Model 140 distributed processing computer** with two CPUs, 128-k main memory and two DMA channels has been reduced from \$72,600 to \$60,800. Model 150 with three CPUs, 256-k main memory and three DMAs has been reduced from \$157,680 to \$120,960.

CIRCLE NO. 380

Rapidata has announced the **1+1 data access**, which serves time-critical applications that require around-the-clock data access. With this implementation on its RAPIDTEN systems, Rapidata becomes the first time-sharing company to offer this capability on DEC systems.

CIRCLE NO. 381

Data Translation has reduced the price of its **analog I/O system interface, Model DT1751**, from \$1195 to \$895.

CIRCLE NO. 382

National Semiconductor has reduced the price of its **16-bit single-chip PACE  $\mu$ P**, Model ISP-16A/520D, from \$40 to \$20 (100 qty.), from \$30 to \$15 (1000 qty.), and from \$26 to \$13 (5000 qty.).

CIRCLE NO. 383

## Engineers: Imagine Southern California

**Hughes/Missile Systems is looking for a lot of good engineers. With imagination.**

Hughes Aircraft Company/Missile Systems Group, Canoga Park, California, is a highly respected, prestigious firm, noted for leadership in technology and for a long-term record of stability and growth. Creative engineering is our business, and we do it in a campus-like facility. You'll have a real chance to apply your skills to major missile programs:

### \*Circuits Engineers

Experience in design, development of RF/IF, digital, analog circuits for missile-guidance systems. Must know applicable state-of-the-art components.

### \*Systems Analysts

Tasks involve system function design, solving systems-engineering problems. Experience in signal processing, controls, assembly language, performance analysis, weapon-system integration.

### \*Electronic Product Engineers

Develop conceptual product designs for state-of-the-art electronic systems, and mechanize designs in low-cost hardware.

### \*RF Systems Engineers

Experience must include microwave-systems design and test, with emphasis on digital signal processing.

Degree from an accredited institution required. Send resume to: Engineering Employment, Hughes Aircraft, Fallbrook at Roscoe, Canoga Park, CA 91304.

# HUGHES

HUGHES AIRCRAFT COMPANY

MISSILE SYSTEMS GROUP

US citizenship required  
Equal opportunity M/F/H/C employer

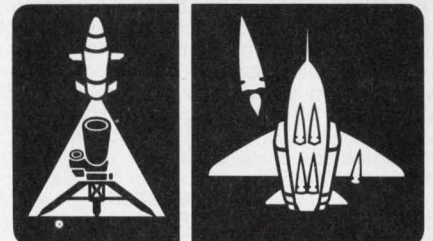

CIRCLE NUMBER 67

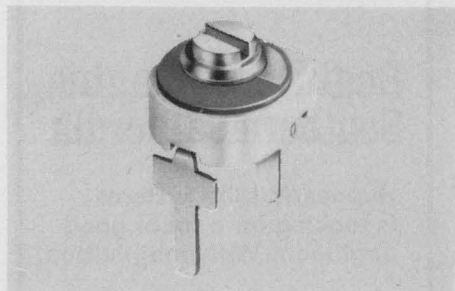

**MINIATURE CERAMIC TRIMMER CAPACITORS** 9371 series of ceramic trimmer capacitors are compact, economical and rugged. They are 50% smaller than other trimmers of this type yet provide high capacitance values. Available in 4 capacitance ranges, 1.5 to 4, 3.0 to 10, 3.5 to 18 and 5.0 to 25 pf with Q's > 300 at 10 MHz. They have an overall diameter of .225" with .215" above board height. JOHANSON MANUFACTURING CORPORATION, Rockaway Valley Road, Boonton, N.J. 07005 201-334-2676

TRIMMER CAPACITORS

181

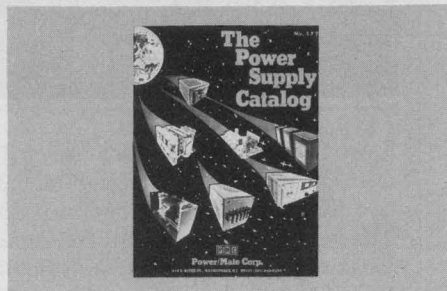

**Free New '77 catalog** contains over 34,500 quality power supplies from the world's largest manufacturer, Power/Mate Corp. Power Supplies for every application including submodulars, open frame, variorated, encapsulated, laboratory & system. All units UL approved and meet most military and commercial specs for industrial and computer uses. Power/Mate Corp., 514 S. River St., Hackensack, NJ 07601 (201) 343-6294

POWER SUPPLIES

184

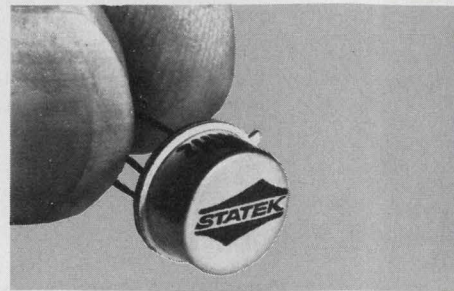

**Don't count down.** Use SX-1 10 kHz - 300 kHz Quartz Crystals \* 18 stock frequencies \* 0.185" high TO-5 \* 1000g shock \* \$2.00 ea. in 1000 qty. ( $\pm$  0.01% accuracy) \* Details in Gold Book & EEM \* STATEK CORP. \* 1233 Alvarez Ave. \* Orange, Calif. 92668 \* (714) 639-7810 \* Telex 67 8394

QUARTZ CRYSTALS

187

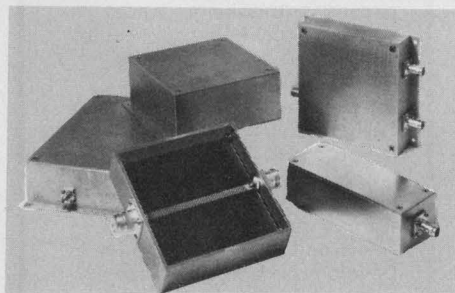

**LOW COST RFI SHIELDED CASES.** COMPAC line includes blank case assemblies without connectors in 13 sizes, standard cases with flange mounted RF connectors and RFI filter feedthroughs, and custom made cases. Effective from 60 dB to  $\geq$  100 dB at 100MHz. Greater shielding with available gaskets. The cases are made from extruded aluminum alloy, completely finished with a chemical film per MIL-C-5441B for excellent conductivity. (From \$9.85) COMPAC, 222 Middle Country Rd., Smithtown, N.Y. 11787, 516-360-3837

RFI SHIELDED CASES

182



**INTEGRITY AND RECOVERY IN COMPUTER SYSTEMS**, by T. K. Gibbons. Here is a step-by-step guidebook that places at your fingertips all the techniques and strategies you need for locating and correcting errors and failures and for re-establishing complete system integrity and reliability as quickly as possible. #5454-8, 144 pp., \$9.95. Circle the Info Retrieval Number to order your 15-day exam copy. When billed, remit or return book with no obligation. **Hayden Book Co., 50 Essex St., Rochelle Park, N.J. 07662.**

INTEGRITY & RECOVERY

185

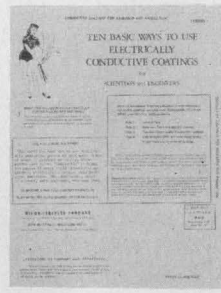

**Why not try SILVER?**  
**FREE facts**

**Solve some of your toughest production and research problems** with our highly conductive silver paints and glues. Just Ohm's Law and common sense. Thousands of users. Proven dependable for 26 years. Make wires, rf shields. Dependable contacts on plastic, skin, iron. Detect cracks, count, change pc boards and pots. Simplify, shrink, put one component on another. **FREE 8-page crash course** in saving with silver. Circle number below. Micro-Circuits, R1 Box 518, New Buffalo, Mi. 49117.

SILVER PAINT

188

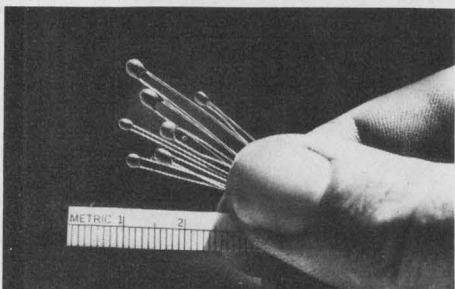

**Chip Thermistors** with leads and coating are highly reliable, exceptionally predictable, low cost components with small and miniature dimensions more compatible with modern circuit design. R @ 25°C 30 ohms to 3 meg ohms, tolerances  $\pm$  10% to  $\pm$  1%. Curved matched interchangeables  $\pm$  1°C to  $\pm$  .3°C. Point matched interchangeables for temperature control R, to  $\pm$  1%. WESTERN THERMISTOR Corporation, 403 Via El Centro, Oceanside, CA 92054. (714) 433-4484.

THERMISTORS

183

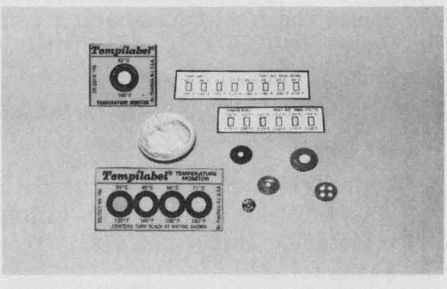

**HOW TO PUT A LOW-COST TEMPERATURE GAUGE ON EVERYTHING.** Reliable, self-adhesive Tempilabel Temperature Monitors - available in many sizes, types, and 6 new miniature sizes. Temperature ranges: 100°F (33°C) to 600°F (316°C). 1% accuracy guaranteed. Monitors with 1, 4, 6, or 8 ratings on ea. with various increments. Indicator window(s) turns from light grey to black when specified temperature is reached. Can be attached to report. Free catalog. Tempil Div., Big Three Industries, So. Plainfield, NJ 07080. (201) 757-8300.

TEMPIL TEMPERATURE MONITORS

186

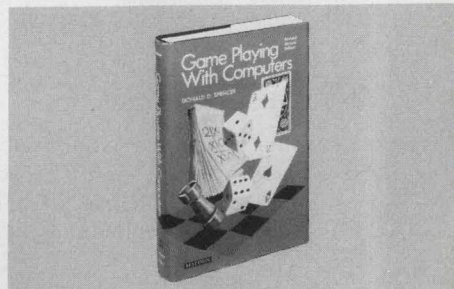

**GAME PLAYING WITH COMPUTERS**, Revised Second Edition, by Donald D. Spencer. This volume presents over 70 games, puzzles, and mathematical recreations for a digital computer. The reader will also find brand-new "how to" information for applying mathematical concepts to game playing with a computer. #5103-4, 320 pp., \$16.95. Circle the Info Retrieval Number to order your 15-day exam copy. When billed, remit or return book with no obligation. **Hayden Book Co., 50 Essex St., Rochelle Park, N.J. 07662.**

GAMES-PLAYING GUIDE

189

# Electronic Design

ELECTRONIC DESIGN's function is:

## Advertising Sales Staff

Tom W. Carr, Sales Director  
Jean Bunfield, Sales Coordinator

## Rochelle Park, NJ 07662

Robert W. Gascoigne  
Daniel J. Rowland  
Thomas P. Barth  
50 Essex St.  
(201) 843-0550  
TWX: 710-990-5071

## Philadelphia

Thomas P. Barth  
(201) 843-0550

## Boston 02178

Gene Pritchard  
P.O. Box 379  
Belmont, MA 02178  
(617) 489-2340

## Chicago 60611

Thomas P. Kavooras  
Berry Conner, Jr.  
200 East Ontario  
(312) 337-0588

## Cleveland

Thomas P. Kavooras  
(312) 337-0588

## Los Angeles 90045

Stanley I. Ehrenclou  
Burt Underwood  
Neil Canavin  
8939 Sepulveda Blvd.  
(213) 641-6544

## Texas

Burt Underwood  
(213) 641-6544

## San Francisco

Robert A. Lukas  
3579 Cambridge Lane  
Mountain View, CA 94040  
(415) 965-2636

## England

Constance McKinley  
50 Essex St.  
Rochelle Park, N.J. 07662  
Phone: (201) 843-0550

## Europe

Sanders, W. J. M.  
Raadhuisstraat 24  
Graft-De Ryp, Holland  
Phone: 02997-1303  
Telegrams: Euradteam-Amsterdam  
Telex: 13039-SIPAS

## G. Nebut

Promotion Presse Internationale  
7 ter Cour des Petites Ecuries  
75010 Paris, France  
Telephone: 5231917, 1918, 1919  
Dieter Wollenberg  
8111 Baldham/Muenchen  
Erikastrabe 8  
Germany  
Telephone: 0 8106/4541  
Telex: 5215532 auri d

## Tokyo

Haruki Hirayama  
Electronic Media Service  
5th Floor, Lila Bldg.,  
4-9-8 Roppongi  
Minato-ku, Tokyo, Japan  
Phone: 402-4556  
Cable: Electronicmedia, Tokyo

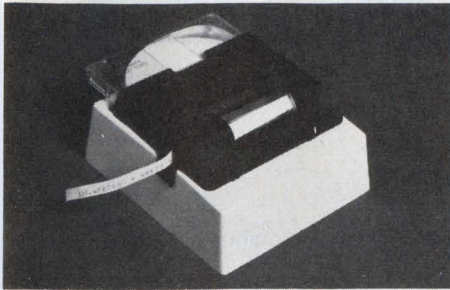

**THERMAL PRINTER** provides economical output for data generating devices. Designed for OEM instrumentation and data terminal applications, the printer employs a 4x5 dot matrix print head, prints at a rate of 10 characters/second, and can interface with BCD or ASCII coded systems. Power required, 15 V DC. Price of basic printer (quantities of over 100) is under \$50. Canon Business Machines, Inc., 3191 Red Hill Avenue, Costa Mesa, California 92626.

THERMAL PRINTER

190

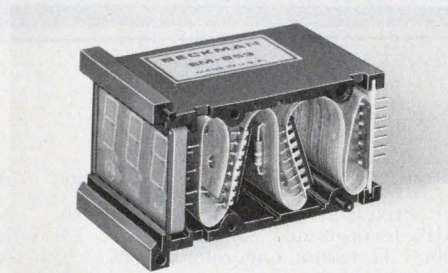

**New way to pack added security** into your design. R/flex circuits do several jobs at once and accordion fold to fit. Eliminate multiple circuit boards and jumpers; mount components directly on circuit. Made in 1 to 6 layers, various sizes and shapes, with or without plated-through holes. Rogers Corp., Chandler, AZ 85224 (602) 963-4584. (EUROPE: Mektron NV, Ghent, Belgium; JAPAN: Nippon Mektron, Tokyo)

FLEXIBLE CIRCUITS

193

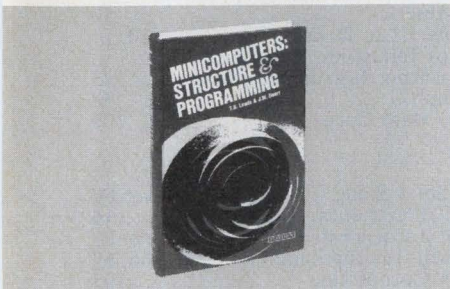

**MINICOMPUTERS: Structure and Programming**, by T. G. Lewis and J. W. Doerr. An introduction to computer science using small computers, this book thoroughly covers all the essentials needed to understand and use minicomputers: assembly language, machine architecture, and small machine algorithms. #5642-7, 288 pp., \$12.95. Circle the Info Retrieval Number to order your 15-day exam copy. When billed, remit or return book with no obligation. Hayden Book Co., 50 Essex St., Rochelle Park, N.J. 07662.

MINICOMPUTERS TEXT

191



**MAGNETIC SHIELDING** Take advantage of Eagle's 23-year background in shield design and production. Custom and standard models. Full service includes design, engineering, fabrication, heat treating, finishing, testing. Also wide selection of sheet and foil so you can form your own shields. For helpful design and cost data, request Bulletin E-77. Eagle Magnetic Co., Inc., Box 24283, Indianapolis, IN 46224, 317-297-1030.

MAGNETIC SHIELDING

194

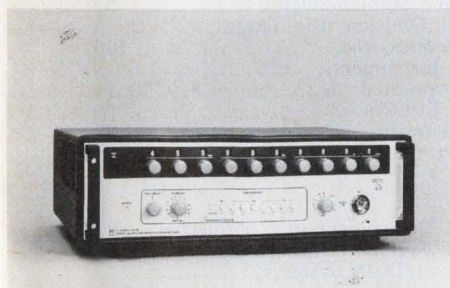

**FREQUENCY SYNTHESIZERS.** GenRad offers the best combination of low-phase noise, fast switching speed and price. Frequency range is dc to 500 MHz. Important features: non-harmonic spurs > 80 dB down; a-m, fm and pm capabilities; built-in search sweep; programmable (BCD parallel) frequency control; and optional resolution to 0.1 Hz. GenRad, 300 Baker Ave., Concord, MA 01742, (617) 369-8770.

FREQUENCY SYNTHESIZERS

192

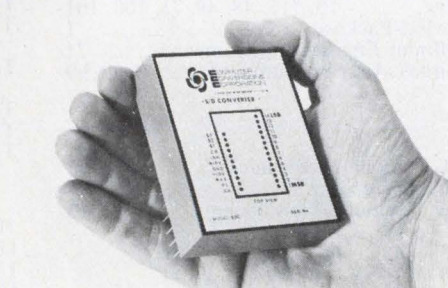

**"Synchro to digital converters** - 10, 12, or 14 bit output, errorless tracking up to 4 r.p.s., accuracy  $\pm 4$  min. of arc  $\pm .9$ LSB, resolution - 1.3 minutes, 60 or 400 Hz input, Module 2.6 x 3.1 x .82" H, Price From \$350 in qty. Other CCC products are Synchro to BCD or DC, Digital or DC to Synchro Converters, Solid State C.T.'s or CDX's, and Absolute Encoders. Send for Free Catalog & Application Notes. Computer Conversions Corp., East Northport, NY 11731 (515) 261-3300.

SYNCHRO TO DIGITAL

195



# Electronic Design

ELECTRONIC DESIGN's function is:

- To aid progress in the electronics manufacturing industry by promoting good design.
- To give the electronic design engineer concepts and ideas that make his job easier and more productive.
- To provide a central source of timely electronics information.
- To promote communication among members of the electronics engineering community.

**Want a subscription?** ELECTRONIC DESIGN is sent free to qualified engineers and engineering managers doing design work, supervising design or setting standards in the United States and Western Europe. For a free subscription, use the application form bound in the magazine. If none is included, write to us direct for an application form.

If you do not qualify, paid subscription rates are as follows: \$30.00 per year (26 issues) U.S., \$40.00 per year (26 issues) all other countries. Single copies are \$2.00 U.S., \$3.00 all other countries. The Gold Book (27th issue) may be purchased for \$30.00 U.S. and \$40.00 all other countries.

If you change your address, send us an old mailing label and your new address; there is generally a postcard for this bound in the magazine. You will have to requalify to continue receiving ELECTRONIC DESIGN free.

**The accuracy policy** of ELECTRONIC DESIGN is:

- To make diligent efforts to ensure the accuracy of editorial matter.
- To publish prompt corrections whenever inaccuracies are brought to our attention. Corrections appear in "Across the Desk."
- To encourage our readers as responsible members of our business community to report to us misleading or fraudulent advertising.
- To refuse any advertisement deemed to be misleading or fraudulent.

Microfilm copies are available of complete volumes of ELECTRONIC DESIGN at \$19 per volume, beginning with Volume 1, 1952 through Volume 20. Reprints of individual articles may be obtained for \$3.00 each, prepaid (\$5.00 for each additional copy of the same article) no matter how long the article. For further details and to place orders, contact the Customer Services Department, University Microfilms, 300 North Zeeb Road, Ann Arbor, Michigan 48106 telephone (313) 761-4700.

**Want to contact us?** If you have any comments or wish to submit a manuscript or article outline, address your correspondence to:

Editor  
ELECTRONIC DESIGN  
50 Essex Street  
Rochelle Park, N.J. 07662

## Advertiser's Index

Advertiser	Page	Advertiser	Page
A P Products Incorporated.....	89	Micro Circuits Co.....	100
AMP, Incorporated .....	25	Micro Networks Corporation.....	95
Abbott Transistor Laboratories, Inc....	6	Mini-Circuits Laboratory, A Division of Scientific Components Corp. ....	33
Advanced Micro Devices.....	4, 5	NEC America, Inc.....	59
Allen Bradley Co.....	11	National Semiconductor Corporation .....	12, 13
B & K Products of Dynascan Corporation .....	88	Nichicon (America) Corporation.....	81
Bourns, Inc., Trimpot Products Division .....	Cover II	O. K. Machine & Tool Corporation..	51
Bunker Ramo Connector Division....	23	Optron, Inc. ....	7
Canon Business Machines.....	101	Panasonic Company, Division of Matsushita Electric Corporation of America .....	50
Compac .....	100	*Philips ELA Division.....	10, 11
Computer Conversions Corp.....	101	*Philips Industries, Test and Measuring Instruments Dept.....	45
Continental Specialties Corporation....	40	Portscap .....	58
Data I/O Corporation.....	77	Power/Mate Corp. ....	100
Data Precision Corporation.....	21	RCA Solid State.....	Cover IV
*EMI SE Labs .....	85	Rental Electronics, Inc.....	16
Eagle Magnetic Co.....	101	Repco, Incorporated .....	87
Elco Corporation .....	19	Rockwell International .....	66, 67
Electrocube Corp. ....	97	Rogers Corporation .....	101
Electronic Design .....	70, 94	Sangamo Weston, EMR Telemetry Division .....	73
Electronic Navigation Industries.....	84	Simpson Electric Company.....	47
GenRad .....	100	Sinclair Radionics, Ltd.....	Cover III
Gold Book, The.....*	8, *9, 58, 103, 104	Sprague Electric Company.....	82
Guardian Electric Manufacturing Company .....	45	Stake Corp. ....	100
Gulton Industries, Inc.....	94	Stanford Applied Engineering, Inc....	29
Hansen Manufacturing Co., Inc.....	27	Tabor Electronics Ltd.....	15
Hayden Book Company, Inc. ....	10, *16, 48, 49, 71, 100, 101	Tektronix, Inc. ....	37
Hewlett-Packard .....	1	Teledyne Relays, A Teledyne Company .....	2
Hoffman Engineering Company.....	71	Teledyne Semiconductor .....	52
Hughes Aircraft Company.....	99	Tempil Division, Big Three Industries, Inc. ....	100
ITT Pomona Electronics.....	91	Texas Instruments, Incorporated .....	8, 9, 30, 31
Indiana General .....	79	Topaz Electronics .....	89
Intel Memory Components.....	12, 13	Triad-Utrad .....	93
Johanson Manufacturing Corp.....	100	Triplett Corporation .....	75
Johnson Company, E. F.....	14	*U. S. Department of Commerce.....	93
Kennedy Corporation, M. S.....	92	United Systems Corporation.....	58
Kepeco, Inc. ....	34	Universal Data Systems.....	43
Ledex, Inc. ....	85	University of Texas.....	104
London Company, The.....	97	Vector Electronic Company.....	98
		Western Thermistor Corporation.....	100

\*Advertisers in non-U.S. edition



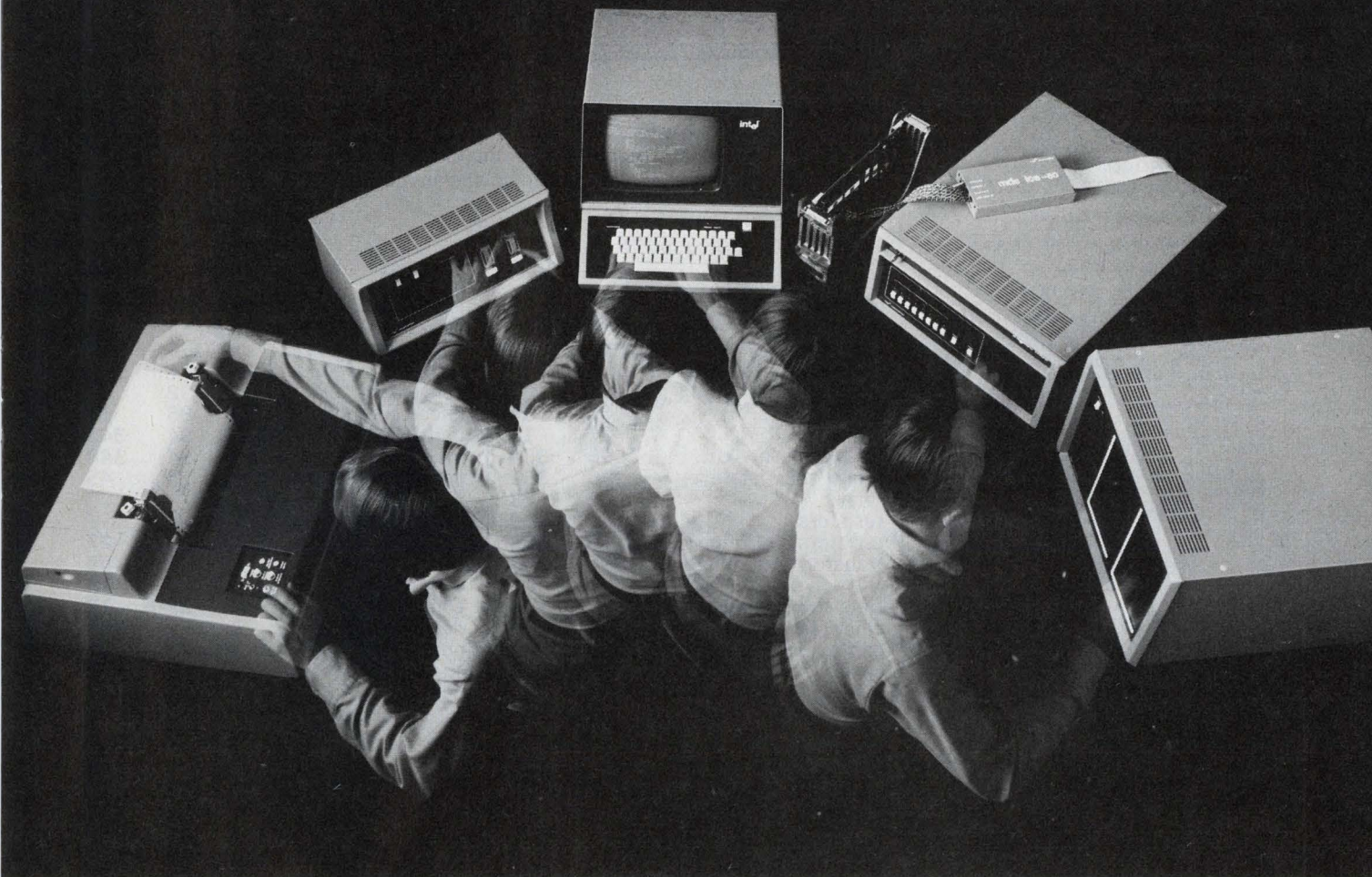

## Intel delivers resident PL/M for the Intellec<sup>®</sup> Microcomputer Development System. Say goodbye to monthly computer bills.

Now Intel has a resident PL/M compiler available with the Intellec microcomputer development system. Resident PL/M can give you a competitive edge because it can drastically cut your software development time and help you get new products to market quicker.

Having PL/M resident on the Intellec system means the end of monthly computer time sharing bills too. And eliminates delays waiting for computer availability. It makes it easier than ever to take advantage of a high level programming language.

You can lease an Intellec system for \$610\* a month with ICE-80,<sup>™</sup> dual diskette drives,

CRT terminal, line printer and resident PL/M compiler.

Or if you already own an Intellec system you can add resident PL/M for \$975\*. Once. Not monthly.

That gives you everything you'll need for fast, reliable programming of Intel<sup>®</sup> 8080 or 8085 microcomputers or our SBC-80 Single Board Computers and System 80 packaged microcomputer systems.

Under the new Intellec ISIS-II diskette operating system, PL/M provides the capability for fully modular programming. This means that programs can be developed and debugged in small, manageable modules,

and easily linked together, or linked with general purpose subroutines from a software library. And because the Intellec system supports your total development task, you save the cost and inconvenience of separate systems for hardware and software development and systems integration.

To arrange a demonstration of the Intellec system with resident PL/M contact your Intel sales office. For additional information use the reader service card or write Intel Corporation, 3065 Bowers Avenue, Santa Clara, California 95051.

**intel<sup>®</sup> delivers.**

\*Domestic U.S.A. prices only.

CIRCLE NO. 161 FOR TECHNICAL INFORMATION  
CIRCLE NO. 162 FOR TECHNICAL INFORMATION AND A DEMONSTRATION

## classified ad

### SHORT COURSE MICROCOMPUTERS: PRINCIPLES AND APPLICATIONS

EL PASO — JUAREZ

THE UNIVERSITY OF TEXAS  
at EL PASO

MAY 23 — 27, 1977

Four day course plus Monday evening introductory sessions. Course stresses both hardware and software considerations of the design and application of microprocessors to real world problems. The course begins at an introductory level and includes programming considerations, I/O programming and design, memory module architecture, system evaluation, cost analysis, and a general discussion of applications. The lecture topics will be illustrated using laboratory workshops.

#### TUITION

\$375

#### WHICH INCLUDES:

NOTES, CLASS MATERIALS,  
AND

TUESDAY EVENING FIESTA

For additional information  
call or write

Dr. Glenn A. Gibson

Electrical Engineering Department  
The University of Texas at El Paso  
El Paso, Texas 79968  
(915) — 747-5472

## KEEP

Electronic Design's

# GOLD BOOK HANDY

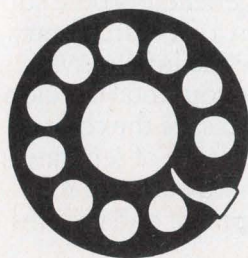

## When You Call

Save time when you contact suppliers. Check their catalog pages first in *Electronic Design's* GOLD BOOK. Maybe the information you need is right at your fingertips.

# Product Index

**Information Retrieval Service.** New Products, Evaluation Samples (ES), Design Aids (DA), Application Notes (AN), and New Literature (NL) in this issue are listed here with page and Reader Service numbers. Reader requests will be promptly processed by computer and mailed to the manufacturer within three days.

Category	Page	RSN	Category	Page	RSN
<b>Components</b>			<b>Modules &amp; Subassemblies</b>		
capacitors	14	12	converter, a/d and d/a	95	62
capacitors, chip	96	352	converter, d/s	94	341
capacitors, trimmer	96	349	converter, polar/x-y	94	342
inductors, toroidal	93	60	converters, a/d	92	59
micromotors, dc	58	36	linear actuator	85	51
motors	27	19	multiplexer	94	343
PB-switch kit	96	354	multiplexers	94	340
relay, solid state	96	351	panel instruments	75	45
relays	2	3			
resistors	11	9	<b>Packaging &amp; Materials</b>		
resistors, thin-film	96	353	breadboards	40	27
transformers, plug-in	96	350	breadboards	89	55
			component sockets	25	18
<b>Data Processing</b>			connectors	23	17
clock/sector writer	95	346	desoldering tool	89	324
computer terminal	95	344	enclosures	71	41
converter, card/tape	95	348	enclosures, metal	88	301
modems	43	28	heat-sink pads	89	322
PROM programmer	95	345	wire-wrapping tools	51	34
printers	58	95			
tape-drive interface	95	347	<b>Power Sources</b>		
			power supply	6	4
<b>Discrete Semiconductors</b>			power supply, dc	91	331
Darlingtons, power	90	330	power supply, dc	91	332
FETs	52	35	power supply, dc	92	335
rectifier, bridge	90	328	switching supplies	92	333
rectifiers, high-voltage	90	327			
SCR bridges	90	326	<b>new literature</b>		
SCR modules	90	329	coaxial-cable assemblies	98	369
transistor, power	90	325	components	98	362
			core-memory system	98	363
<b>Instrumentation</b>			d/a converters	98	370
DMM	15	13	digital indicators	98	368
DMM	47	30	discrete semis	98	366
meters, modulation	97	64	film capacitors	99	374
rf power amplifiers	84	50	film resistors	99	377
scope probe	87	321	logic analyzers	99	371
signal generator	87	320	LSI tester, bench-top	99	373
test probes	91	58	MOS ICs	98	361
word generator	86	310	peripheral-equip supplies	98	360
			radio-performance		
<b>Integrated Circuits</b>			analyzer	98	365
chroma chip	59	37	recorder supplies	98	367
circuit, DVM	84	306	semiconductors	98	364
converter, a/d	85	309	synchros, resolvers	99	376
displays	1	2	245 and 400-A SCRs	99	375
encoder/decoder, analog	83	302	$\mu$ C product	99	372
generator, clock	85	308			
isolators	7	5	<b>application notes</b>		
transceivers, line	84	307	array programming	97	359
			equalizers and filters	97	358
<b>Microprocessor Design</b>			low-noise amplifier	97	356
kit, evaluation	41	502	magnetic sensors	97	355
microcomputer	44	508	memory, refresh	97	357
microcomputer, CMOS	42	506			
microcomputer,					
single-chip	46	510			
program, arithmetic	44	509			
subsystem, analog I/O	44	507			
$\mu$ P, bipolar	41	503			
<b>Microwave &amp; Lasers</b>					
coupler, coax k-band	93	339			
VCO, miniature	93	337			

# The Sinclair DM2 digital multimeter.

3½ digits...

5 functions...

Fully portable...

Under \$100!



The DM2 provides full digital multimeter facilities for every application including field servicing, testing and laboratory work. Over 15,000 are already in service.

#### Display

Full 3 1/2 digit display reading to  $\pm 1999$ . Large, high-brightness 8 mm LEDs giving clear readings with maximum reliability. Automatic polarity and out-of-range indication.

#### Ranges

5 functions giving 22 ranges.

DC volts -1 mV to 1000 V  
AC volts -1 mV to 500 V  
DC current -0.1  $\mu$ A to 1 A  
AC current -1  $\mu$ A to 1 A  
Resistance -1  $\Omega$  to 20 M $\Omega$   
10 M $\Omega$  input impedance

#### Accuracy

High stability integrating A to D converter. Basic accuracy 0.3%  $\pm 1$  digit.

#### Convenience

Automatic polarity. Push-button selection of both functions and ranges from a single-input terminal pair.

#### Construction

Very rugged mechanical construction with all solid-state components. Fully protected against overload.

#### Portability

Measures only 56 mm x 160 mm x 224 mm, weighs only 1.25 kg. Basic operation from dry cells providing complete independence of AC supply. Line operation available via optional AC adaptor/charger.

#### Optional extras

Rechargeable battery pack \$19.95.  
Carrying case \$9.95.  
AC adaptor/charger \$4.95.

#### 12-month no-quibble guarantee

#### Send for more information - now!

If you want more information about the Sinclair Multimeter, clip the coupon. We'll mail you a fact-pack - giving full

specifications, and an up-to-date list of stockists.

## sinclair

Sinclair Radionics Inc.,  
Galleria, 115 East 57th Street,  
New York, N. Y. 10022, USA.  
Tel: (212) 355 5005.

To: Sinclair Radionics Inc.,  
Galleria, 115 East 57th Street,  
New York, N. Y. 10022, USA.

Please send me more information on the  
Sinclair DM2 Multimeter.

Name \_\_\_\_\_  
Address \_\_\_\_\_  
City \_\_\_\_\_  
State \_\_\_\_\_  
Zip \_\_\_\_\_

Certain territories still available for stocking representation.  
Enquiries to Chris Childs at Sinclair Radionics Inc., New York.

CIRCLE NUMBER 263

New option from the Powerhouse ...

# RCA 2N3055.

# Now pay less and still get more.

RCA gives you a new choice in Power Transistors. The 2N3055H is the industry's original hometaxial workhorse. It still offers unique RCA features. And it still sports the ultimate in SOA characterization.

The 2N3055 is our new epitaxial version of the hometaxial "H". It lets you trade in a little SOA for a lower price. Without having to trade in all the features that made RCA the leading choice in 2N3055's in the first place.

The RCA epitaxial version still offers you more than other similarly priced 2N3055's.

What extras do you get? Rugged steel headers (they give you aluminum). Clip-lead connectors (they give you wire bonds). Plus real-time process controls.

The RCA epitaxial - hometaxial option is available in three voltages. And if your choice is epitaxial you can have complementary pairs at all three levels.

They're all available now from your local

#### Buy as much SOA as you need.

NPN	PNP	V <sub>ceo</sub>	SOA	Beta	1K Price
RCS617	RCS618	80	2.87A@40V	20-70@5A	0.88
2N3055	MJ2955	60	2.87A@40V	20-70@4A	0.55
2N6569	2N6594	40	2.87A@40V	15-200@4A	0.50
2N6254		80	1.87A@80V	20-70@5A	1.20
2N3055H		60	1.95A@60V	20-70@4A	0.95
2N6253		45	2.55A@45V	20-150@3A	0.55

\*Optional distribution resale price. U.S. only.

RCA Distributor or Representative. Or send for complete data.

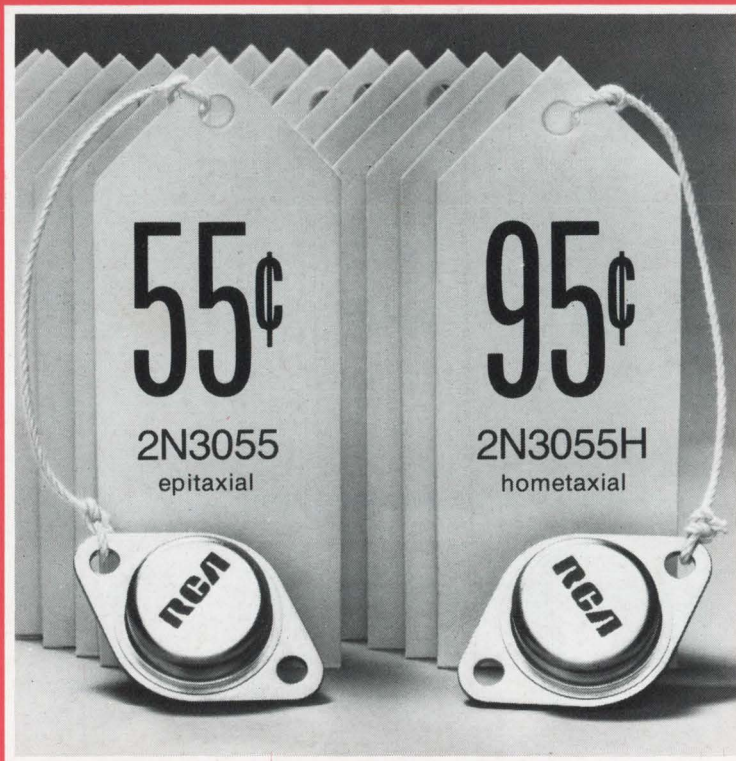

Write: RCA Solid State, Box 3200, Somerville, NJ 08876; Sunbury-on-Thames, Middlesex TW16 7HW, England; Ste.-Anne-de-Bellevue, Quebec, Canada; Fuji Bldg., Tokyo, Japan.

**RCA Power experience is working for you.**

# RCA