

Electronic Design[®] 6

VOL. 25 NO.

FOR ENGINEERS AND ENGINEERING MANAGERS

MARCH 15, 1977

Miniature-switch specifications sweep details under the carpet. Size, life and load capability are intricately interwoven, not simple to unravel. And installation data

are seldom laid bare in catalogs. However, miniatures can be tidily tacked into place, and if handled properly, wear well a long time. Get unpadded basics on p. 66.



Swage-Bond™ ... a revolution in trimmer reliability!

... here today at no extra cost in every Trimpot® Potentiometer

Historically, pin-to-element termination problems have been one of the primary causes of trimmer failure ... especially during handling and PC board process operations. Bourns exclusive Swage-Bond™ process virtually eliminates pin termination failure ... truly a revolution in trimmer reliability. Furthermore, Swage-Bonding results in a marked improvement in temperature coefficient consistency.

Other trimmer manufacturers utilize a simple clip-on termination. Some solder this connection, some rely on tension pressure alone. In the Swage-Bond process, the P.C. pins are secured **through** the substrate, with a high-pressure compression swage on both top and bottom sides. The pressure of the swage locks the pin solidly into the element, and thoroughly bonds it to the thick-film termination material.

Swage-Bond™ eliminates pin termination failure, provides more reliable tempco. Microphotograph shows trimmer element magnified 20X.



The seal that seals ... without springback

Bourns trimmers stay sealed when others fail. We know. We've tested them all. Bourns uses a chevron-type sealing technique, that seals without O-rings ... eliminating the windup and springback that frequently occurs with such seals. The result is faster and more precise adjustability ... with a seal that really works.



Wrap-around wiper for better setting stability

Bourns multi-fingered, wrap-around wiper delivers more consistent, more reliable performance. The unique design significantly reduces CRV fluctuations and open circuit problems due to thermal and mechanical shock ... by maintaining a constant wiper pressure on the element. Compare the ruggedness of Bourns design with the common "heat-staked" wiper designs. Compare performance. Specify Bourns.

HERE'S PROOF:

Send for a copy of our new engineering report on TRIMMER PERFORMANCE. Tell us about your application, and we'll provide qualification samples that best suit your needs.

Bourns reliability is available at ordinary prices ... off-the-shelf from nearly 100 local distributor inventories ... plus our largest-ever factory stock. TRIMMER PRODUCTS, TRIMPOT PRODUCTS DIVISION, BOURNS, INC., 1200 Columbia Avenue, Riverside, California 92507. Telephone 714 781-5320 — TWX 910 332-1252.



International Marketing Offices: European Headquarters — Switzerland 042/23 22 42 • Belgium 02/218 2005 • France 01/2039633 • Germany 0711/24 29 36 • Italy 02/32 56 88 • Netherlands 70/87 44 00 • United Kingdom 01/572 6531 • Norway 2/71 18 72 • Sweden 764/20 110 • Japan 075/921 9111 • Australia 02/55-0411 03/95-9566 • Israel 77 71 15/6/7

CIRCLE NUMBER 246

The sweep signal generator world has a new leader to look up to. Model 2002 sweeps from 1 to 2500 MHz in four bands. Or it can sweep the entire range using the band stacking option. It has more flexibility than any broadband sweeper

we've made, along with +13 dBm output, ± 0.5 dB flatness, 0.005% marker accuracy, and $\pm 1\%$ display linearity. Look at the Model 2002 from any angle and you'll become a follower. Send us \$2700 and you'll become an

owner. Circle our reader service number for details. WAVETEK Indiana Incorporated, P.O. Box 190, Beech Grove, Indiana 46107. Telephone (317) 783-3221. TWX 810-341-3226.

WAVETEK®

CIRCLE NUMBER 2

The new 2002 will sweep you off your feet.

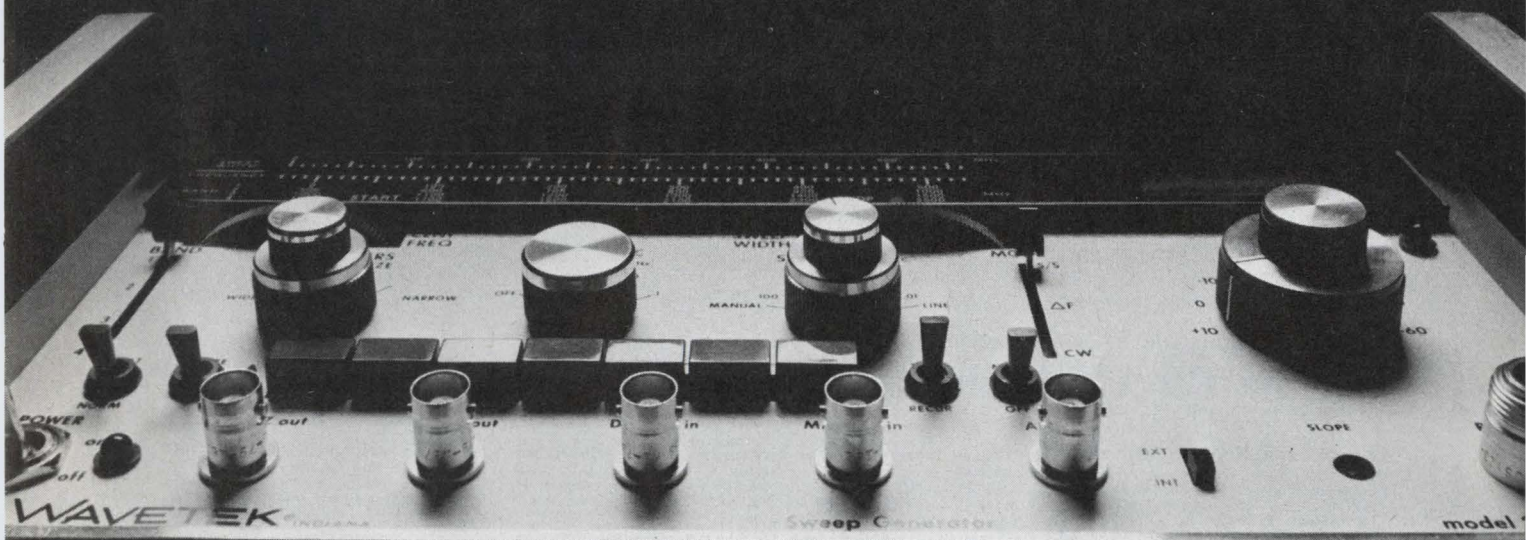

Surprise! \$2.95 (10-49)

Wideband Transformers

- SURPRISE! Wide bandwidths, .015-600 MHz**
- SURPRISE! Low insertion loss, 0.5 dB**
- SURPRISE! Microminiature, .230" x .270" x .300"**
- SURPRISE! One week delivery**

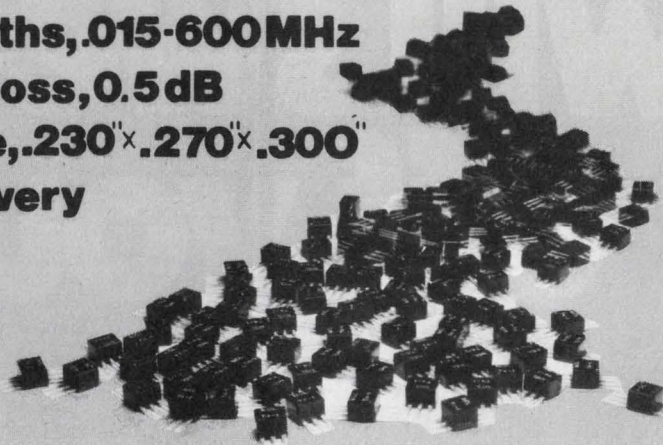

DESIGNERS KIT AVAILABLE:
 2 TRANSFORMERS OF EACH TYPE
 T1-1, T2-1, T4-1, T9-1, T16-1
 KIT # TK-1... **\$32.00**

NO "MAKE OR BUY" DECISION HERE... it costs less to buy Mini-Circuits wideband transformers and there's no delivery delay. Impedance levels from 12.5 to 800 ohms with insertion loss typically less than 0.5 dB

MODEL	T1-1	T2-1	T4-1	T9-1	T16-1	
Impedance Ratio (50 Ω pri. imp.)	1	2	4	9	16	
Bandwidth (MHz)	1 db loss	2-50	.05-200	2-100	2-40	5-20
	3 db loss	.15-400	.015-600	.2-350	.15-200	.3-120
Price (10-49)	\$2.95	\$3.45	\$2.95	\$3.45	\$3.95	

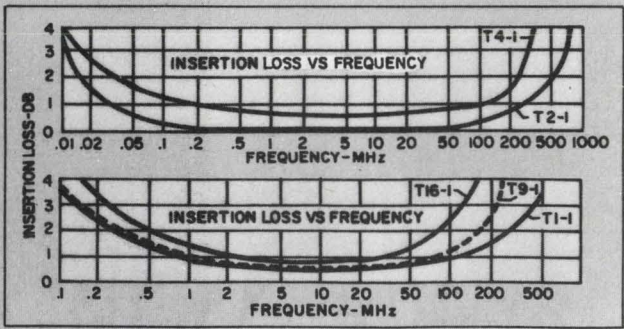

For complete specs, performance curves and drawings, see pgs 192-193 of the 1976-77 MicroWaves Product Data Directory.

World's largest supplier of double balanced mixers
Mini-Circuits Laboratory
 A Division Scientific Components Corp

837-843 Utica Avenue, Brooklyn, NY 11203
 (212) 342-2500 Int'l Telex 620156 Dom. Telex 125460

- International Representatives:** AUSTRALIA General Electronic Services, 99 Alexander Street, New South Wales, Australia 2065; ENGLAND Dale Electronics, Dale House, Wharf Road, Frimley Green, Camberley Surrey; FRANCE S. C. I. E. - D. I. M. E. S., 31 Rue George - Sand, 91120 Palaiseau, France; GERMANY, AUSTRIA, SWITZERLAND Industrial Electronics GMBH, Klüberstrasse 14, 6000 Frankfurt/Main, Germany; ISRAEL Vectronics, Ltd., 69 Gordon Street, Tel-Aviv, Israel; JAPAN Densho Kaisha, Ltd., Eguchi Building, 8-1 1 Chome Hamamatsucho Minato-ku, Tokyo; EASTERN CANADA B. D. Hummel, 2224 Maynard Avenue, Utica, NY 13502 (315) 736-7821; NETHERLANDS, BELGIUM, LUXEMBOURG: Coimex, Veldweg 11, Hattem, Holland; NORWAY Datamatik AS, Ostensjoveien 62, Oslo 6, Norway
- US Distributors:** NORTHERN CALIFORNIA Cain-White & Co., Foothill Office Center, 105 Fremont Avenue, Los Altos, CA 94022 (415) 948-6533; SOUTHERN CALIFORNIA, ARIZONA Crown Electronics, 11440 Collins Street, No. Hollywood, CA 91601 (213) 877-3550

NEWS

- 21 **News Scope**
- 26 **Distributed microprocessors cut use of electricity** in building by more than a third.
- 30 **Storing energy for peak power use** is a job for the new 'super' batteries now under development.
- 43 **Washington Report**

TECHNOLOGY

- 51 **Microprocessor Design**
- 66 **FOCUS on miniature switches:** Small switches suffer from all the specification problems of their normal-sized brothers, and they present some extra hazards when you handle and install them.
- 78 **Avoid relay-specification pitfalls.** Don't depend solely on published information. The catalogs leave out too much data essential for proper design.
- 82 **Revisiting the cross-field inductor:** Ordinary ferrite pot cores improve this useful device, which offers high Qs in tuned circuits and other advantages.
- 88 **Design EMI shielding more accurately** by taking aperture effects into account. They can be appreciable, even at low rf frequencies.
- 94 **Predict printed-circuit dc performance** with a circuit-analysis program and a measured voltage-drop matrix. You can expect over-all accuracies around 5%.
- 98 **Jim Wolfe of Centralab** speaks of decentralizing engineering.
- 104 **Ideas for Design:**
 - Circuit provides a Gaussian response with a multifunction converter and op amp.
 - Circuit that latches/unlatches magnetic devices uses almost zero standby current.
 - Diode-feedback comparator circuit regulates a LED's drive current.
 - Time-interval meter reads digitally to 99.9 ms on a DVM IC.

PRODUCTS

- 113 **Modules & Subassemblies:** Industry's first 18-bit modular DAC fits in palm-sized case.
- 114 **Modules & Subassemblies:** Low-noise vhf synthesizer is small and inexpensive.
- 120 **Data Processing:** Versatile PROM programmer takes on all memories.
- 123 **Integrated Circuits**
- 126 **Power Sources**
- 129 **Discrete Semiconductors**
- 130 **Packaging & Materials**
- 132 **Instrumentation**
- 134 **Components**

DEPARTMENTS

- 63 **Editorial:** My friend
- 7 **Across the Desk**
- 136 **Application Notes**
- 136 **Vendors Report**
- 137 **New Literature**
- 146 **Advertisers' Index**
- 148 **Product Index**
- 148 **Information Retrieval Card**

Cover: Photo by Art Director, Bill Kelly. Switches courtesy of Alco Electronic Products, AMF/IUD Electronics, AMP, Cherry Electrical Products, Chicago Switch, C & K Components, Cutler Hammer, C-W Industries, Dialight, Digitron, EECO, Globe Union/Centralab, Grayhill, Janco, Licon, Micro Switch, RCL, Stackpole, Switchcraft, TEC.

The Microprocessor Buyer's Guide.

(From the people who brought
you the Buyer's Market.)

Advanced Micro Devices • 901 Thompson Place, Sunnyvale, California 94086 • Telephone (408) 732-2400 •
Distributed nationally by Hamilton/Avnet, Cramer and Schweber Electronics, and regionally by Arrow, Bell and Century Electronics.

Advanced Micro Devices, the people who made it easy for you to get into microprocessing, make it even easier with this one-page, scrupulously objective buyer's guide.

One.

The best way to make a microprocessor system is the 8080 way. It's the most popular architecture; it has the best support. The flexibility, the upgrade capabilities are better than any other microprocessor.

Two.

The best 8080A is a 9080A. Look:

Ours and Theirs.

(The 8080A & 9080A)

Specification	Intel	AMD
Minimum Instruction Cycle Time	1.3 microseconds	1 microsecond
Maximum Power Dissipation (at 1.3 microsec. 0-70°)	1307 milliwatts	829 milliwatts
Output Drive	1.9mA @ .45V	3.2mA @ .4V
Minimum Input High Voltage	3.3V	3.0V
MIL-STD-883	Special	Standard

Three.

Save shoe leather and heartache. We've already done the shopping. Advanced Micro Devices builds all the really important 8080 peripherals that you-know-who invented, a whole bunch that we invented, plus all the memories you'll ever need. And in our traditional heart-warming way, we add a little reliability and performance. (Everything we make is MIL-STD-883 for free.)

Four.

Don't let anyone in this business tell you what to do. You're the customer.

Now, paste this message on the inside of your purchase order book. Or, failing that, write or call Advanced Micro Devices, the Buyer's Market.

Ours and Ours.

(Am9080A System Circuits)

AMD Part Number	Description	Availability
CPU		
Am9080A/-2/-1/-4	0 to +70°C	Now
Am9080A/-2/-1	-25 to +85°C	Now
Am9080A/-2	-55 to +125°C	Now

STATIC READ/WRITE RANDOM ACCESS MEMORIES		
Am9101A/B/C/D	256 x 4, 22 Pin	Now
Am91L01A/B/C	256 x 4, 22 Pin	Now
Am9102A/B/C/D	1K x 1, 16 Pin	Now
Am91L02A/B/C	1K x 1, 16 Pin	Now
Am9111A/B/C/D	256 x 4, 18 Pin	Now
Am91L11A/B/C	256 x 4, 18 Pin	Now
Am9112A/B/C/D	256 x 4, 16 Pin	Now
Am91L12A/B/C	256 x 4, 16 Pin	Now
Am9131A/B/C/D/E	1K x 4, 22 Pin	Now
Am91L31A/B/C/D	1K x 4, 22 Pin	Now
Am9141A/B/C/D/E	4K x 1, 22 Pin	Now
Am91L41A/B/C/D	4K x 1, 22 Pin	Now

DYNAMIC READ/WRITE RANDOM ACCESS MEMORIES		
Am9050C/D/E	4K x 1, 18 Pin	Now
Am9060C/D/E	4K x 1, 22 Pin	Now

MASK PROGRAMMABLE READ-ONLY MEMORIES		
Am9208B/C/D	1K x 8, 250 nsec. max.	Now
Am9216B/C	2K x 8, 300 nsec. max.	Now
Am8316A	2K x 8, 850 nsec. max.	Now
Am8316E	2K x 8, 550 nsec. max.	Now

ERASABLE READ-ONLY MEMORIES		
Am1702A	256 x 8, 1.0 μsec.	Now
Am2708	1K x 8, 450 nsec.	1st Q. 1977

CPU: 9080A = 480 nsec. -2 = 380 nsec. -1 = 320 nsec. -4 = 250 nsec.
MEM: A=500 nsec. B=400 nsec. C=300 nsec. D=250 nsec. E=200 nsec.

SECOND SOURCE SUPPORT		
Am8212	8-bit I/O Port	Now
Am8216	Non-Inverting Bus Transceiver	Now
Am8224	Clock Generator	Now
Am8226	Inverting Bus Transceiver	Now
Am8228	System Controller	Now
Am8238	Extended Write System Controller	Now
Am8251	Prog. Communications Interface	Now
Am8255	Prog. Peripheral Interface	Now
Am8257	Direct Memory Access Controller	3rd Q. 1977

IMPROVED SUPPORT			
		REPLACES	
Am8224-4	High-Speed Generator	N/A	Now
Am8238-4	High-Speed System Controller	N/A	Now
Am9511	Arithmetic Processing Unit	N/A	3rd Q. 1977
Am9517	Multi-mode DMA Controller	8257	3rd Q. 1977
Am9519	Universal Interrupt Controller	8259	3rd Q. 1977
Am9551/-4	Prog. Communications Interface	8251	Now
Am9555/-4	Prog. Peripheral Interface	8255	Now
Am25LS138	1-of-8 Decoder	8205	Now
Am25LS139	Dual 1-of-4 Decoder	8205	Now
*Am25LS273	8-bit Common Clear Register	N/A	2nd Q. 1977
*Am25LS373	8-bit Transparent Latch	8212	4th Q. 1977
*Am25LS374	8-bit 3-State Register	8212	Now
*Am25LS377	8-bit Common Enable Register	8212	2nd Q. 1977
*Am25LS2513	Priority Encoder	8214 & 8212	Now
*Am25LS2537	1-of-10 3-State Decoder	8205 (2)	Now
*Am25LS2538	1-of-8 3-State Decoder	N/A	Now
*Am25LS2539	Dual 1-of-4 3-State Decoder	N/A	Now

*All combine high performance and low power in space saving 20-pin package.



Advanced Micro Devices

Bipolar LSI. N-channel, silicon gate MOS. Low-power Schottky.
Multiple technologies. One product: excellence.

CIRCLE NUMBER 8



The image shows several Thin-Trim capacitors, which are small, circular components with two leads, arranged on a green background. In the upper right, a portion of a Pulsar Watch circuit board is visible, showing various electronic components and a central crystal. The text 'USA' is visible on the watch case.

Thin-Trim[®] capacitors

Tucked in the corner of this Pulsar Watch is a miniature capacitor which is used to trim the crystal. This Thin-Trim capacitor is one of our 9410 series, has an adjustable range of 7 to 45 pf, and is .200" x .200" x .050" thick.

The Thin-Trim concept provides a variable device to replace fixed tuning techniques and cut-and-try methods of adjustment. Thin-Trim capacitors are available in a variety of lead configurations making them easy to mount.

A smaller version of the 9410 is the 9402 series with a maximum capacitance value of 25 pf. These are perfect for applications in sub-miniature circuits such as ladies' electronic wrist watches and phased array MIC's.

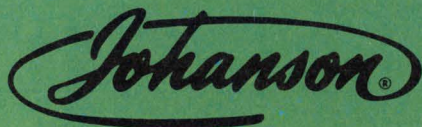

The logo for Johanson Manufacturing Corporation, featuring the name 'Johanson' in a stylized, cursive script enclosed within an oval border.

Johanson Manufacturing Corporation
Rockaway Valley Road
Boonton, New Jersey 07005
(201) 334-2676 TWX 710-987-8367

Sr. Vice President, Publisher

Peter Coley

Editors

Editorial Offices
50 Essex St.
Rochelle Park, NJ 07662
(201) 843-0550
TWX: 710-990-5071
(HAYDENPUB ROPK)
Cable: Haydenpubs Rochellepark

Editor-in-Chief George Rostky

Managing Editors:

Ralph Dobriner
Michael Elphick

Senior Associate Editor

Stanley Runyon

Associate Editors:

Sid Adlerstein
Dave Bursky
Morris Grossman
John F. Mason
Andy Santoni
Max Schindler

Contributing Editors:

Peter N. Budzilovich, John Kessler
Alberto Socolovsky, Nathan Sussman

Editorial Field Offices

East

Jim McDermott, Eastern Editor
P.O. Box 272
Easthampton, MA 01027
(413) 527-3632

West

Dick Hackmeister, Western Editor
8939 S. Sepulveda Blvd., Suite 510
Los Angeles, CA 90045
(213) 641-6544
TWX: 1-910-328-7240

Dave Barnes
844 Duncardine Way
Sunnyvale, CA 94087
(408) 736-6667

Editorial Production

Marjorie A. Duffy, Production Editor
James Keane, Copy Editor

Art

Art Director, William Kelly
Richard Luce, Anthony J. Fischetto

Production

Manager, Dollie S. Viebig
Helen De Polo, Nancy Hurey

Circulation

Director, Barbara Freundlich

Information Retrieval

Paula Greenleaf

Advertising Promotion

Susan G. Apolant

Reprints

Maxine Correall

CIRCLE NUMBER 4

Across the Desk

Two left out are now included

The Focus on Keyboards (ED No. 22, Oct. 25, 1976, p. 122) was very interesting, but left out two manufacturers:

Data Interfaces, Inc.
12 Cambridge Ave.
Burlington, MA 01803

CIRCLE NO. 318

Mechanical Enterprises, Inc.
8000 Forbes Place
Springfield, VA 22151

CIRCLE NO. 319

Data Interfaces offers adapters that go between other brands of keytops and their double crosspoint switches, as well as standard keyboards.

One subject the Focus didn't consider is separate switches and encoders for those of us that "roll our own" keyboards. More information in this area would be desirable. For instance, I have not been able to locate an encoder for use with electronic keyswitches.

William B. Rossman

Cascade Research Associates
P.O. Box 534
274 28th Ave.
Longview, WA 98632

Computer hierarchy doesn't do it all

Your recent article on micro-computer and microprocessor applications (ED No. 22, Oct. 25, 1976, p. 66) gives an excellent overview of their use in new equipment. However, the section on the Airtrans system at the Dallas-Fort Worth Airport is misleading in that it implies that the system is totally controlled by a hierarchy of computers. In fact, the system is structured like the Washington,

DC, Metro subway system mentioned earlier in the article. Airtrans also has three interfacing major subsystems:

- Automatic Vehicle Supervision (AVS) supplied by Vought, the prime contractor. This subsystem consists of the central processor and eight satellite computers. This subsystem can reduce vehicle velocities to reduce bunching, modify station dwell times, change the routes of the vehicles, and provide central control with vehicle-tracking and support-system information.

- Automatic Vehicle Operation (AVO) supplied by subcontractor General Railway Signal. The AVO subsystem controls vehicular speed regulation, station stopping, door operation and dwell, and route selection.

- Automatic Vehicle Protection (AVP), also by General Railway. The AVP subsystem sets and enforces safe speed limits for each vehicle as well as prevents conflicting route movements.

The AVO and AVP subsystems will continue to function and provide complete automatic operation even if the central and satellite computers are disabled.

Samuel J. Macano

Senior Design Engineer

General Railway Signal Co.
801 West Ave.
Rochester, NY 14602

You missed it—we've got it

Jim McDermott's otherwise excellent article, "Focus on Adhesives and Coatings" (ED No. 23, Nov. 8, 1976, p. 40), missed an important type of EMI-combative

(continued on page 10)

The finest

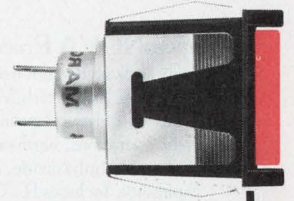

lighted pushbutton

switches and indicators are

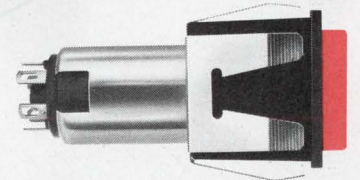

also the easiest to install



Snap!

- Snap-in instant panel mounting
- Choice of sizes, colors, and lens styles
- Flush or barrier configurations
- Re-lampable from front of panel.

Lighten your decisions contact . . .

ILLUMINATED PRODUCTS INC.

A subsidiary of OAK Industries Inc.

2620 South Susan St., P.O. Box 11930
Santa Ana, California 92711
Tel: (714) 540-9471 • TWX 910-595-1504

OAK

COMPONENTS GROUP

CIRCLE NUMBER 5

Electronic Design welcomes the opinions of its readers on the issues raised in the magazine's editorial columns. Address letters to Managing Editor, Electronic Design, 50 Essex St., Rochelle Park, NJ 07662. Try to keep letters under 200 words. Letters must be signed. Names will be withheld on request.

Here's how Data General's microNOVA system stacks up against the competition.

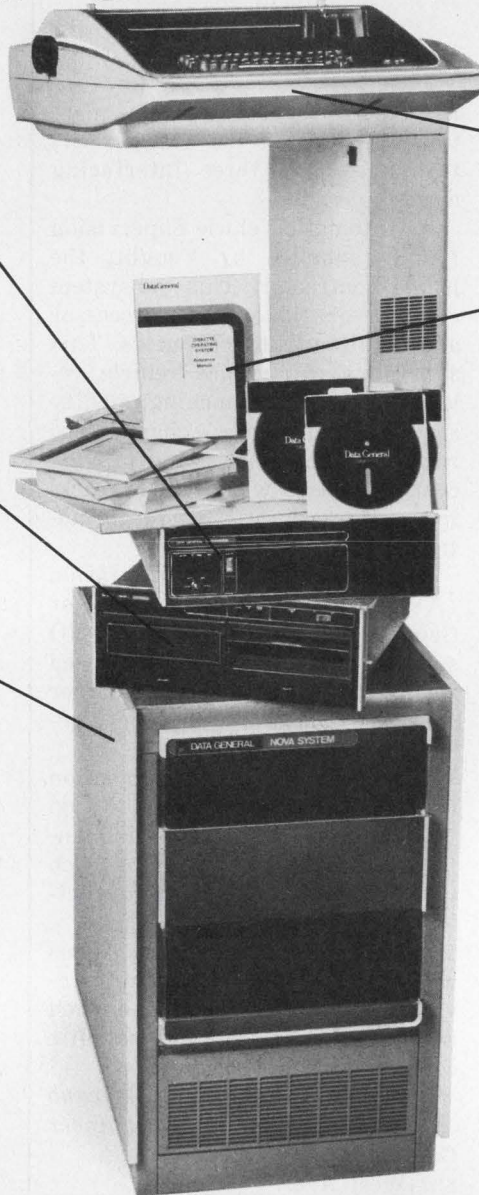

microNOVA Processor:
Fully packaged 9-slot micro-computer, 16K words MOS memory, 2.4-microsecond arithmetic operations, hardware stack facility, multiply/divide, DMA capability. Includes RTC, PF/AR and APL. Supports up to 32K words RAM/PROM memory.

Dual-diskette subsystem:
Integral DMA controller, compact 630KB capacity.

Cabinet:
37 inches high, holds all rack mounted components.

DASHER
terminal printer:
30 cps, 132-columns, typewriter keyboard, upper/lower case.

Systems Software:
Multitasking Disc Operating System, Real-Time Operating System, FORTRAN IV, Extended BASIC, Macro Assembler, Utilities.

\$10,970
List*



Data General, Westboro, MA 01581
Sounds like smart business. Send me more information.

NAME _____

TITLE _____

COMPANY _____

ADDRESS _____ TEL. _____

CITY _____ STATE _____ ZIP _____

NOVA is a registered trademark of Data General Corporation.
DASHER is a trademark of Data General Corporation.

The facts speak for themselves. For \$10,970, Data General's new microNOVA gives you more system, software and support than any other comparable computer. And we deliver in 60 days.

Any way you look at it, it all stacks up in your favor. For more information and our brochure, call our toll free number, 800-225-9497, or, fill out and return the coupon.

*Quantity and OEM discounts available.

Data General
It's smart business.

Data General, Westboro, MA 01581, (617) 485-9100. Data General (Canada) Ltd., Ontario. Data General Europe, 15 Rue Le Sueur, Paris 75116 France. Data General Australia, Melbourne (03) 82-1361.

CIRCLE NUMBER 7

Here's how Data General's NOVA 3/D system stacks up against the competition.

Systems Software:

Multitasking real-time disc operating system, FORTRAN IV, Extended BASIC, ALGOL, SORT/MERGE, and Utilities.

NOVA 3/D Processor:

Hardware-protected dual partitions, 700-nanosecond arithmetic operations, 48K-word MOS memory with parity, RTC, and APL.

Video Display:

1920-character screen, upper/lower case characters, detached keyboard, numeric keypad, programmable function keys and character highlighting, display rotates on two axis.

Cabinet:

72-inch high, holds all rack mounted components.

DASHER

Terminal Printer:
60/30 cps; 132-columns; type-writer keyboard, upper/lower case.

Diskette Subsystem:

315KB for program/data interchange, diagnostics and software distribution; convenient, industry-standard offline storage.

Cartridge Disc Subsystem:

10 megabytes (5 fixed, 5 removable); 50 ms. average access time, shares controller with diskette.

\$37,610
List*

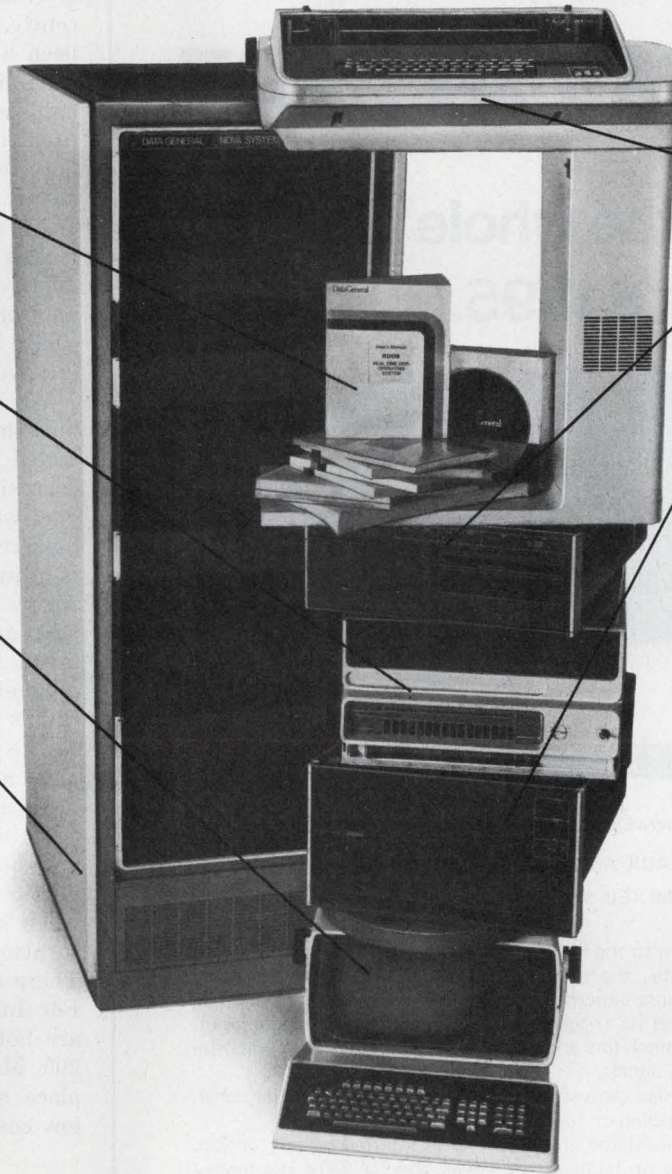

The facts speak for themselves. For \$37,610, Data General's new NOVA 3/D gives you more system, software and support than any comparable computer. And we deliver in 60 days.

Any way you look at it, it all stacks up in your favor. For more information and our brochure, call or fill out and return the coupon.

*Quantity and OEM discounts available.

Data General, Westboro, MA 01581
Sounds like smart business. Send me more information.

NAME _____

TITLE _____

COMPANY _____

ADDRESS _____

TEL. _____

CITY _____

STATE _____

ZIP _____

NOVA is a registered trademark of Data General Corporation.
DASHER is a trademark of Data General Corporation.

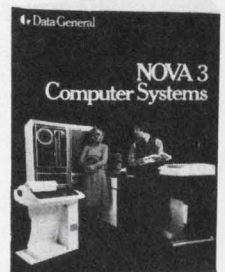

Data General
It's smart business.

Data General, Westboro, MA 01581, (617) 485-9100. Data General (Canada) Ltd., Ontario. Data General Europe, 15 Rue Le Sueur, Paris 75116 France. Data General Australia, Melbourne (03) 82-1361.

CIRCLE NUMBER 6

Alternate Timebase Display

Gives you the whole picture
for \$1395.*

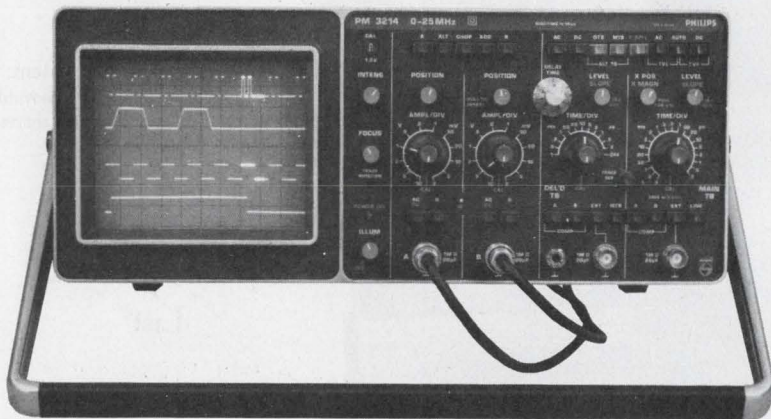

Continuous indication of where DELAYED T.B. measurements are taken.

- Eliminate BACK-AND-FORTH SWITCHING
- Forget MIXED-SWEEP limitations

The PM 3214 is the latest addition to the Philips oscilloscope family. At 25 MHz and 2mV sensitivity, the PM 3214 incorporates all the triggering facilities found on the latest, most expensive oscilloscopes available: AC, DC, TV and an auto position that derives its trigger from the peak to peak signal input. Trigger selection from either channel, line and external sources as well as composite triggering for ASYNCHRONOUS signals.

Composite triggering in A-B display derives its source from the differential signal, allowing measurement of signals riding on high AC or DC components.

The 18.5 lb. portable is double insulated and even has an internal battery option. Supplied with two probes and a protective front cover, the PM 3214 is a money saving solution to many oscilloscope requirements.

If you don't need DELAYED TIMEBASE the economy priced PM 3212 has all the triggering and overall performance of the PM 3214 at only \$1,155.00*.

For immediate detailed information utilize our toll-free Hotline number: 800 632-7172 (New Jersey residents call collect), or contact: Philips Test & Measuring Instruments, Inc.

In the U.S.:
85 Mc Kee Drive
Mahwah, New Jersey 07430
Tel. (201) 529-3800

In Canada:
6 Leswyn Road
Toronto, Ontario, Canada M6A 1K2
Tel. (416) 789-7188

* U.S. Domestic Price Only

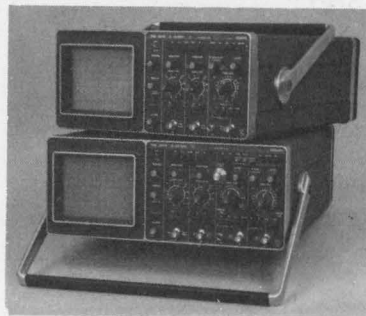

PHILIPS

CIRCLE NUMBER 9

ACROSS THE DESK

(continued from page 7)

coating: one that is both conductive and ferromagnetic. Until recently, useful coatings have not been available, for several reasons. Ferromagnetic metals (iron, cobalt, and nickel) are not usually used as rf shields because they don't conduct as well as copper or silver, especially at the frequencies used. Also, ferromagnetic metals have not been used in conductive composites such as paint and plastics because they oxidize easily and their oxides are nonconductive.

We produce a line of alloy and pure metal particles that are protected against oxidation and other corrosion so that they remain conductive in paints and plastics. The bulk resistivity of these composites is adjustable, and can be optimized for a given set of conditions so that large rf losses occur in the material. These losses arise both from magnetic hysteresis and from Ohm's Law—eddy-current effects.

The applications of these materials are generally different from applications of silver or copper-containing composites. The latter are used where low-loss rf conduction is required, the former when high-loss electromagnetic absorption is the desired effect. There are some exceptions to this. For instance, pure nickel powders are not ferromagnetic above about 200 MHz; and they also can replace silver in applications where low cost is a deciding factor.

William A. Manly
Director

Product Development

The Cobaloy Co.
626 Great Southwest Pkwy.
Arlington, TX 76011

If I don't simplify it, the picture will

The circuit for starting a teleprinter motor on receipt of the incoming data (ED No. 8, April 12, 1976, p. 122) seems unnecessarily complicated. This is an obvious application for a 555 timer connected as a retriggerable one-shot.

In the circuit shown here, receipt of data causes momentary

(continued on page 15)

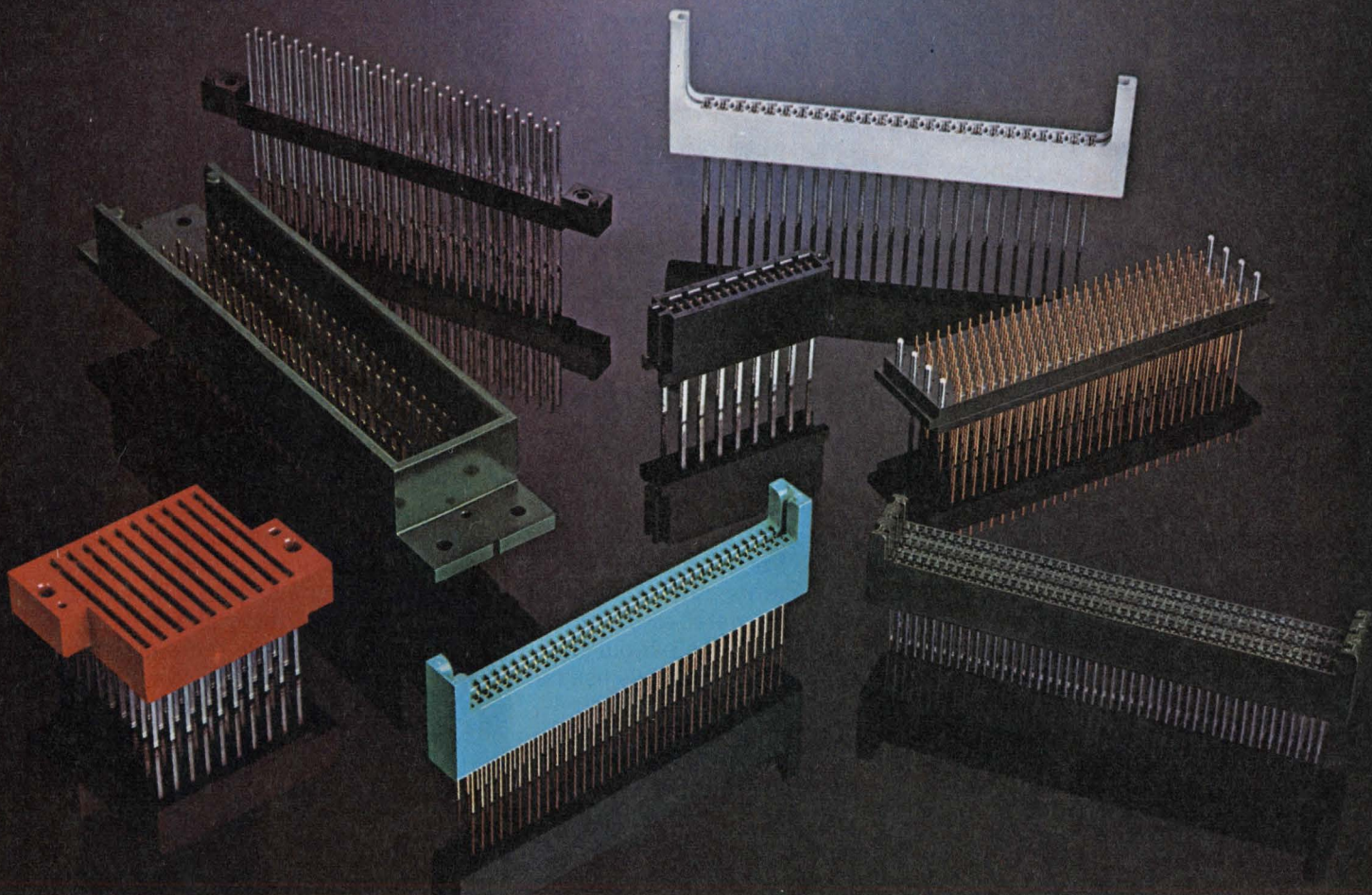

Special connectors are an old family custom.

We've been designing and manufacturing connectors for special custom applications for a long time. In fact, that's how we started in the business.

Over the years we've built up the special tooling skills and design expertise needed to produce the best connector at competitive prices.

Our in-house manufacturing capability makes for tight quality control. We can produce every part in-house—from the plastic body to the gold dot on the contact.

And we know our gold dots. We're the people who developed the most reliable system on the market.

We're not limited to any one design or manufacturing approach, either. We've made them all—bifurcated bellows, cantilever, single-beam contacts, thermoplastic or thermoset plastic.

But don't wait until after you've firmed up your design to call us. Our engineers and toolmakers show you ways to save money while getting a more reliable product.

They might even be able to fill your needs with a member of our off-the-shelf connector family.

Contact GTE Sylvania, CPO, Titusville, Pa. 16354. Phone 814-589-7071.

Good connections run in our family.

GTE SYLVANIA

THE FASTEST, MOST DEPENDABLE, MOST VERSATILE STRIP CHART RECORDER ANYWHERE.

It's the new GOULD/Brush 110 with a thermal pen unmatched in the quality of its easy-to-read blue traces.

It produces clear, crisp, dry traces at all speeds. With no smudges, no smears, no skips, no puddles.

The pen tip warms up in just milliseconds. So it can produce accurate traces even during a series of short movements. And response time is exceptional. Full-scale response time is 250 milliseconds, which enables it to record fast-changing signals more faithfully than most other strip charts.

When it comes to reliability, we back up our promise with a lifetime pen guarantee. One reason we can make such a strong guarantee is that the special ceramic pen tip is virtually wear-free. No frequent, costly pen replacements. And although other pens are sometimes damaged by excessive off-scale input signals, ours is not because we use hard-electronic limiters and soft mechanical stops.

Then take versatility. The 110 has features that let you tailor it to your exact application. For example, you can choose from ten

chart speeds. A selection of plug-in signal conditioners accommodate a wide range of input signals. Charts may be pulse-driven by an external device. And an optional solid state electronic chart integrator follows positive and negative signals up to 4 times full scale on the analog channel.

We don't believe there's another strip chart recorder in the market that is as fast, dependable and versatile. But don't take our word for it. We'll be happy to give you a demonstration anytime, anywhere. Once you see it, we think you'll believe it too.

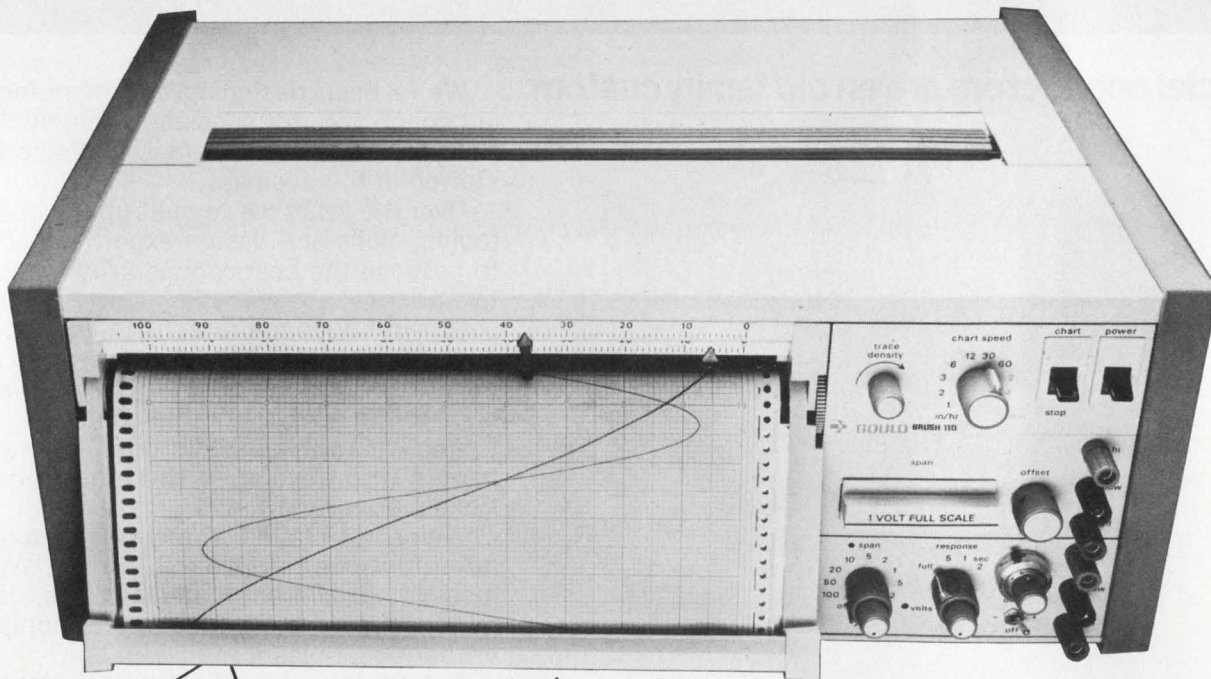

For brochure
call toll free at
(800) 325-6400
Extension 77
In Missouri:
(800) 342-6600

The GOULD/Brush
thermal pen with
a lifetime guarantee.

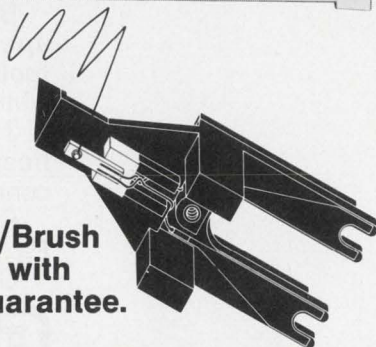

Call your nearest Gould Sales Engineer for a demonstration. Or write Gould, Inc., Instrument Systems Division, 3631 Perkins Avenue, Cleveland, Ohio 44114. Or Gould Allco S.A., 57 rue St. Sauveur, 91160 Ballainvilliers, France.



Licon® non-lighted PB switches offer you the greatest possible value with good-as-gold quality and reliability at terrific prices!

Know something?

Our Licon lighted PB's have been glowing so brightly that they've cast our *non*-lighted PB's into undeserved shadow.

And therein lies an opportunity you may have been missing. Because, quite frankly, Licon non-lighted PB's are a terrific deal in every way!

You'll find that there's one for just about every .25 to 10 Amp switching application you can dream up. Plenty of sizes to choose from, even down to our Series 78, which is possibly the smallest non-lighted PB made. Variety of key tops, lens cap colors and bezel mountings. Momentary and alternate types of action. Choice of terminal configurations in single or double pole. U.L. listed and C.S.A. approved.

Most non-lighted PB models feature Licon's exclusive, ultra-reliable Butterfly® switching mechanism.

Best of all, though, is the pleasant surprise you get when you check Licon pricing on 1,000-piece and larger orders. Look into it. You'll be pleased.

Contact your local Licon distributor or call or write for our Switch Catalog: Licon, 6615 West Irving Park Road, Chicago, Illinois 60634. Phone (312) 282-4040. TWX 910-221-0275.



LICON

A DIVISION OF ILLINOIS TOOL WORKS INC.

CIRCLE NUMBER 12

Golden Opportunity Pushbutton Switches!



They're good... no matter how bad

TW MEETS MIL-S-83731. OFFERS SWITCHING VERSATILITY OF LARGER TOGGLES WITH ADVANTAGE OF SMALL SIZE, PANEL SEALING. IDEAL FOR APPLICATIONS LIKE ON/OFF SWITCH IN THIS MANPACK EQUIPMENT.

SERIES 1 ROUND LIGHTED PUSHBUTTONS OFFER FLUSH MOUNTING, PANEL SEALING AND VERSATILE SWITCH CIRCUITRY; INCLUDING SOLID STATE. MIL SPEC QUALITY (MIL-S-22885) AT COMMERCIAL PRICES FOR CONTROL CONSOLES.

DS SERIES PUSHBUTTONS. COMPACT .75 INCH SQUARE DESIGN OFFERS PLUG-IN DESIGN AND 4 LAMP DISPLAY. RFI ATTENUATION. MIL-S-22885.

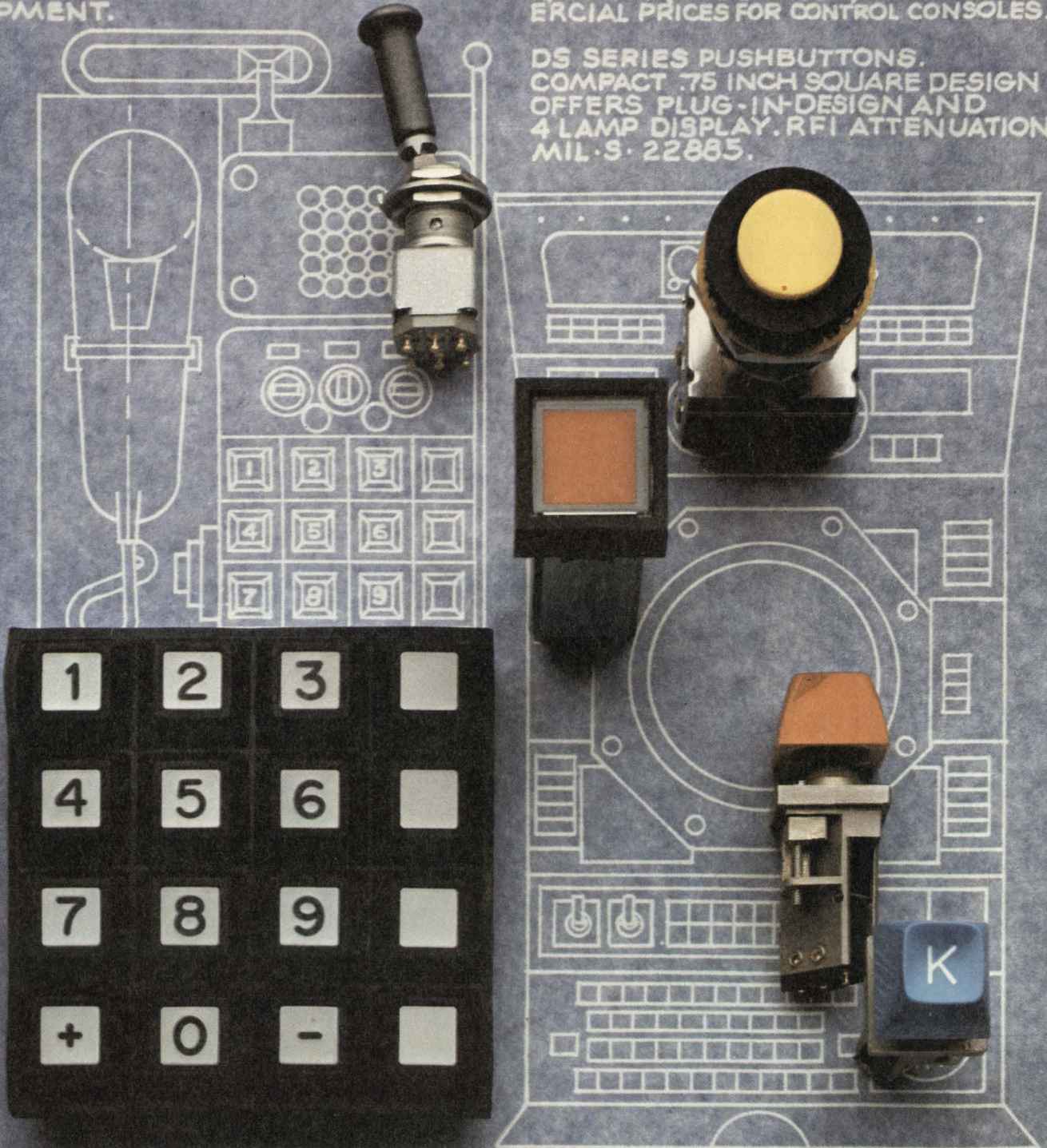

PX KEYBOARDS. TOTALLY SEALED WHEN MOUNTED, WITH ZERO DEPTH BEHIND PANEL, PX IS A NATURAL CHOICE FOR MANPACK EQUIPMENT SWITCH MATRICES.

PANEL SEALED KS KEY SWITCHES. USE OF SPDT SNAP-ACTION SWITCHES (MIL-S-8805) AND FRONT-OF-PANEL REPLACEMENT, MAKE KS IDEAL FOR RUGGEDIZED CONTROL PANEL KEYBOARD APPLICATIONS.

things get.

The five switches you see here have all been designed to operate reliably under extremely rugged environmental conditions. Exactly the kinds of environments where Command, Communications & Control Systems are required to work.

But if these switches aren't exactly what you need, you're not out of luck.

Because they're only a sampling of literally thousands of MICRO SWITCH listings available to fill your needs. Including toggle switches. Lighted pushbuttons. Unlighted pushbuttons. Key switches. Sealed keyboards. Plus hermetically and environmentally sealed limit, proximity and basic switches.

All of them available almost anywhere in the world, through over 500 MICRO SWITCH Authorized Distributors and Branch Offices.

And if that still isn't enough, our Application Engineers will work with you to modify an existing MICRO SWITCH product to your needs. Or come up with a new one, through our field and factory engineering staff.

If you'd like more information on the devices you see here, or more information on how we can help, write or call your nearest MICRO SWITCH Branch Office or Authorized Distributor.

MICRO SWITCH

FREEDPORT, ILLINOIS 61032

A DIVISION OF HONEYWELL

MICRO SWITCH products are available worldwide through Honeywell International.

ACROSS THE DESK

(continued from page 10)

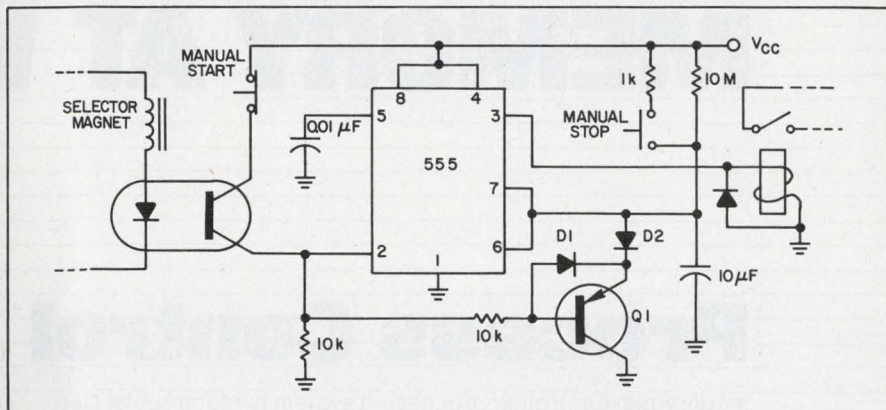

interruptions in the selector-magnet current. At the first interruption, the phototransistor in the optical coupler turns off, and pin 2 of the 555 falls to ground to start the timing cycle. Each interruption also turns on Q_1 , which discharges the timing capacitor and prevents the circuit from timing out until 110 seconds after the last data character. Diode D_1 protects the emitter junction of Q_1 from excessive reverse voltage, and D_2 prevents the capacitor from being

charged through D_1 .

Supply voltage should be between 5 and 15 V. Up to 200 mA, the circuit will deliver a volt or two less than the supply voltage to the relay coil. The relay can either switch the teleprinter motor directly if its contact ratings are adequate, or control a larger relay.

Craig R. Allen

Naval Electronics Laboratory
Center
Code 3400
San Diego, CA 92152

Misplaced Caption Dept.



Congratulations. You won the medal for the best circuit design of the year.

Sorry. That's Hans Holbein the Younger's "Sir Thomas More," which hangs in the Frick Collection, New York City.

◀ CIRCLE NUMBER 180 for DATA
◀ CIRCLE NUMBER 236 for SALESMAN CALL

Skip interference may be considerable by '78

In reference to your "Washington Report" concerning the sunspot effect on the Citizen's Band (ED No. 17, Aug. 16, 1976, p. 45): You are in error in indicating that the interference due to skip is not as bad as feared; the report is based on the assumption that we are at the peak of the sunspot cycle.

On the contrary, we are at the bottom of sunspot cycle 20 with the beginning of sunspot cycle 21 expected to take place some time next year. Its peak is expected to occur around 1982.

Therefore, in the next two to three years, considerable skip interference will be noticed, with complete worldwide interference two to three years before and after the peak—at which time communication in the 27-MHz CB band will be next to useless.

Joseph F. Mibelli, WA4JLX
Chief Electronics Engineer

Coulter Electronics, Inc.
590 W. 20th St.
Hialeah, FL 33010

MEMORY AT WORK

Process Control Loss of power on

a computer-controlled processing system is real trouble. Get back on line fast—or risk losing an entire batch or run. EMM's reliable MICROMEMORY core memories take care of that. Just push your restart button and you're up and operating. No program reloading. No back-up batteries to worry about. We have designs for 4-bit, 8-bit and 16-bit microprocessors—even larger systems with capacities to 32K x 18. We make semiconductor memories, too. But for process control you need reliable MICROMEMORY core memory.

EMM

COMMERCIAL MEMORY PRODUCTS

A Division of
Electronic Memories & Magnetics Corp.
12621 Chadron Ave., Hawthorne, Calif. 90250
(213) 644-9881



MEMORY AT WORK

The First Family of 4K Static RAMs

In the semiconductor business, there are more promises than products. Not at EMM SEMI. Others promised you a family of 4K static RAMs. We delivered. In volume. Military and commercial. We've been delivering for over two years. The first 18-pin 5-volt 4K static memory components (SEMI 4801, 4804). The only 150 ns, 8080-compatible 4K static components (SEMI 4104, 4200). The only 80 ns 4K static component in production (SEMI 4200C). The only 4K static device with enough speed and power dissipation for megabyte applications. (SEMI 4402). Others talked. We delivered the First Family of 4K static RAM components. One of them will fit your need. See your local EMM SEMI distributor or call us today.

EMM SEMI
a subsidiary of

Electronic Memories & Magnetics Corporation
3883 North 28th Avenue, Phoenix, Arizona 85017
(602) 263-0202

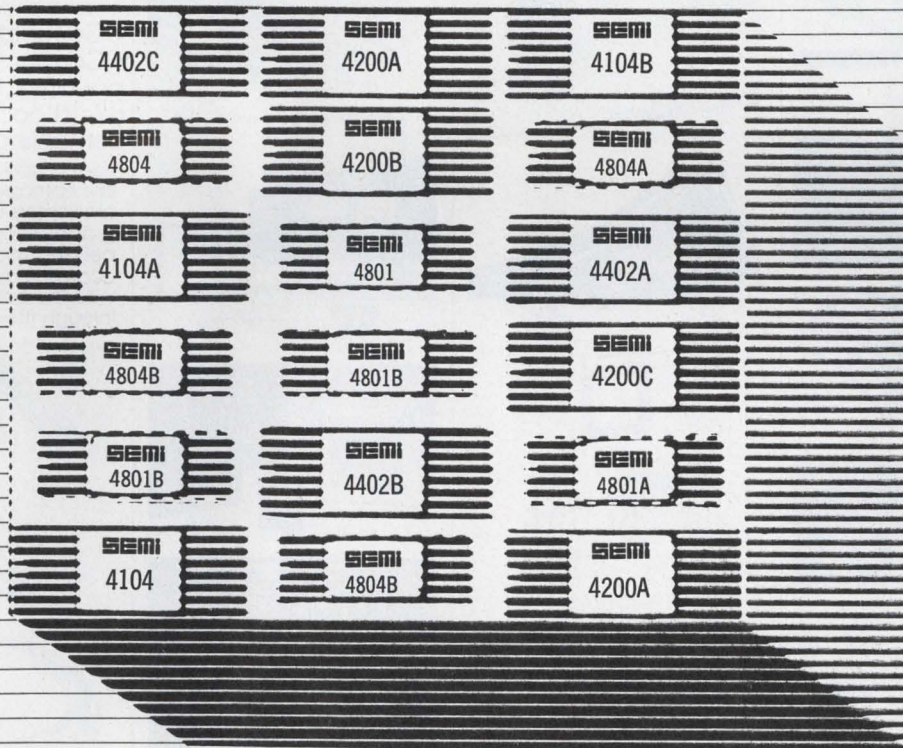

ARROW ELECTRONICS: Woburn, MA; Hamden, CT; Poughkeepsie, NY; Farmingdale, NY; Saddle Brook, NJ; Moorestown, NJ; Baltimore, MD; Fort Lauderdale, FL; Dayton, OH; Cleveland, OH; New Berlin, WI; Bloomington, MN. **CENTURY ELECTRONICS:** Denver, CO; Albuquerque, NM; Salt Lake City, UT. **SEMCOMP:** Newport Beach, CA; Sunnyvale, CA. **STERLING ELECTRONICS:** Watertown, MA; Amboy, NJ; Metairie, LA; Dallas, TX; Houston, TX; Albuquerque, NM; Phoenix, AZ; San Diego, CA; San Carlos, CA; Seattle, WA.



CIRCLE NUMBER 15

EMI/RFI shielding materials...components... sub-systems

The beginning of any answer to your EMI/RFI problems is right here.

GASKETS AND GASKET MATERIALS

- Strip Gasketing...with and without environmental seal
- Sheet Gasketing...with pressure seal
- Standard Gaskets...including connector and waveguide gaskets...environmental or pressure seal optional
- Custom Gaskets...designed and factory-fabricated to customer specifications

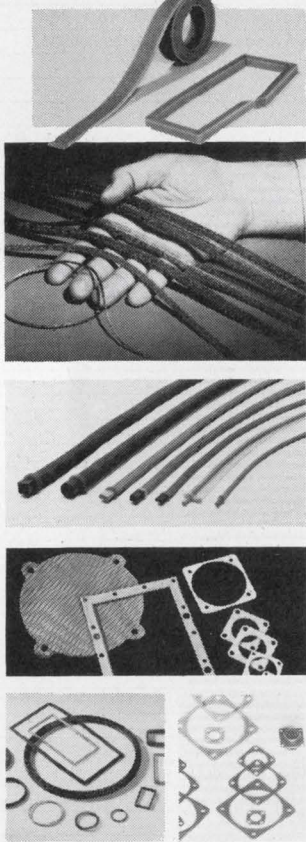

SHIELDING AND CONDUCTIVE COMPONENTS

- Static Discharge Buttons
- Grounding Components
- Cable Shielding Tapes
- Flexible Cable-Shielding Covers
- Shielded Raceways
- Shielded Conduit Fittings

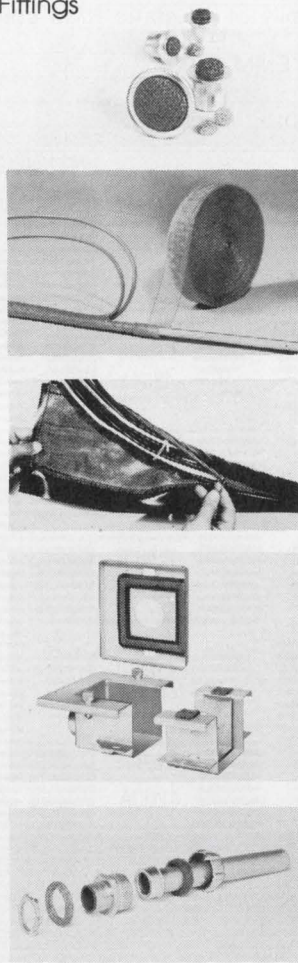

SHIELDING FRAMES AND ASSEMBLIES

- Shielded Frames...ready-to-mount...pressure or weather seal optional
- Custom-Fabricated Frame Lengths...ready for customer assembly
- Bulk Frame-Strip Gasketing
- Shielded Windows...ready to install...custom-fabricated
- Shielded Ventilating Panels
- Shielded Air Filters

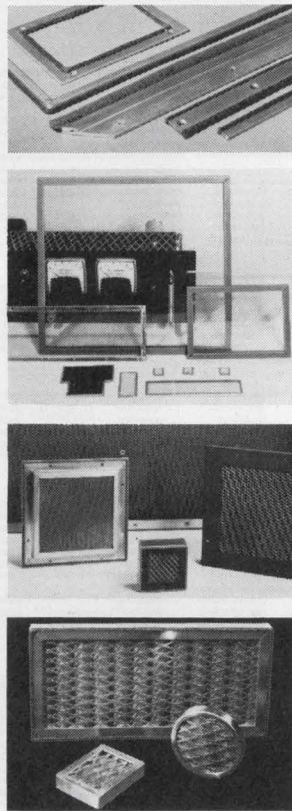

CONDUCTIVE-ELASTOMER EMI/RFI XECON® GASKETS AND COMPOUNDS*

- Composite EMI/Pressure-Seal Gasketing...7 durometer ratings...sheets, strips, custom die-cut gaskets, molded gaskets
- Armored Xecon™ High-Tensile-Strength Gasketing
- Vulcanized Xecon™ Pressure-Seal Gaskets
- O-Ring Gaskets for Waveguides
- Standard Connector Gaskets
- Conductive Adhesive
- Conductive Compounds...for EMI/RFI shield coating, caulking, cementing

*Xecon gasketing compounds are homogenous conductive elastomers consisting of high-grade silicone in which are suspended microscopic silver-coated glass particles that provide the conductive path through the gasket.

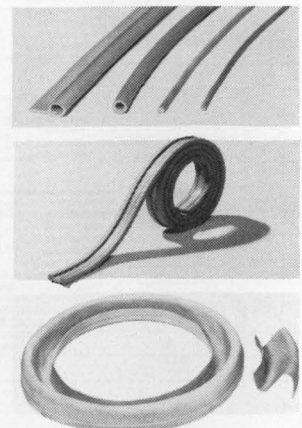

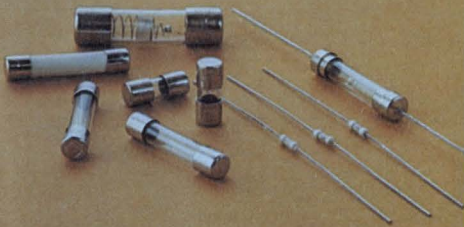

Littelfuse

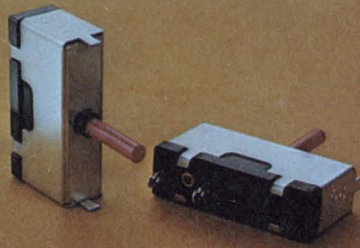

Littelfuse



Littelfuse



Littelfuse

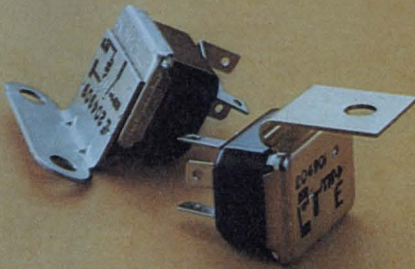

Littelfuse

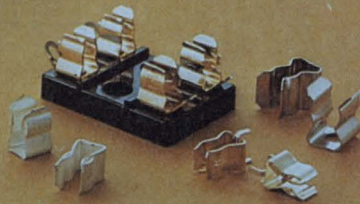

Littelfuse



Littelfuse



Littelfuse



Littelfuse



Littelfuse



Littelfuse



Littelfuse



Littelfuse

We're a whole lot more than fuses.

Everybody knows Littelfuse makes fuses...and a complete line of related devices like fuseholders, fuse clips, fuse blocks, and circuit breakers.

But that's only one side of our story. We're switches, relays, and indicator lights, too.

In fact, our Littelite line includes the widest selection of cartridge lamps and lampholders, sub-miniature and miniature lamp-holders, and Snap-mount Plastic Lites you'll find anywhere. And they're available off-the-shelf from a nationwide network of Littelite distributors.

Switches and Relays? We make all shapes and sizes, designed to fit a variety of applications—from appliances to computers.

To find out what our products can do for yours, just give us a call or send for our Catalog No. GL-77. We can show you a whole lot more than fuses.

1927-1977 **50** YEARS

LITTELFUSE
SUBSIDIARY OF
Tracor

800 East Northwest Highway
Des Plaines, Illinois 60016
312/824-1188

CIRCLE NUMBER 17

Amphenol® 17-Series rear-release connectors, contacts, and crimpers.

A family that
works together
to save
together.

Cut your assembly costs with a total termination systems approach. Our 17 Series has everything you need for rear-release, input/output connections for data transmission. You get the lowest possible installed cost.

First, the connectors: 50% less costly to assemble. These rear-release connectors permit fingertip contact insertion. Without insertion tools. You can snap several of our crimp Poke-Home® contacts in place in the time normally required for a single contact inserted with a tool. So you can cut labor costs in half—at least. And no special skills or training are needed either.

Some important electrical improvements, too. Our 17 Series connectors have a shrouded rear-release insert to prevent shorting and arc-over. No potting or sleeving is required. These connectors meet EIA Standard RS-232C for data-communication input/output connectors and have an insulation resistance greater than 5000 megohms, per MIL-STD-202A, Method 302.

Second, the contacts: big savings for volume users. With our 15,000-contact capacity reels, you can save a bundle over loose contacts.

Finally, the crimpers: high-speed for lowered costs. Our new hand crimp tool makes accurate, identical crimps—time after time. And our semi-automatic crimping machine can turn out up to 2000 terminations per hour.

Get them all—connectors, reeled contacts, crimpers. And get them now. Five basic contact configurations in 17 Series connectors are now available. So is all termination equipment, backshells, and accessories. For more details, contact: Bob Ashley, Amphenol Connector Systems, Bunker Ramo Corporation, Dept. 0000, 900 Commerce Drive, Oak Brook, Illinois 60521.

The right idea
at the
right time.

Hand crimpers
and semi-automatic
crimping machine.



AMPHENOL Connector Systems **BUNKER RAMO**®

MARCH 15, 1977

NMOS memories--they're faster and run cooler

Power reductions as large as 80%, density boosts of 2 to 1 and speed improvements by factors of three signalled advances in NMOS memory design at last month's Solid-State Circuits Conference.

The size of a new static memory cell developed by designers at Mostek, Carrollton, TX, has been reduced so much—to just 2.75 mil²—that a 4-k RAM chip, the MK4104, can measure 136 × 184 mil. But what's even better, the power dissipation has dropped drastically to a mere 80 mW in the active state—about 20% of the power normally required by an NMOS 4-k RAM.

In Santa Clara, CA, Intel engineers have pushed NMOS to bipolar speeds in their new 4-k static RAM. Access times have been cut to 45 ns (about one-third that of other NMOS RAMs), typical, and power dissipations held to nominal

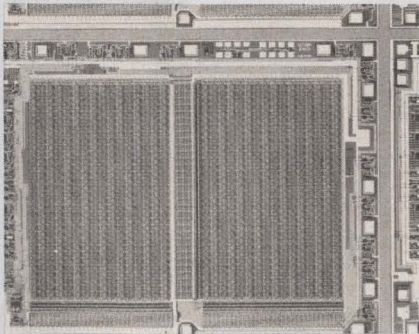

Requiring only 80 mW, this 4-k RAM from Mostek accesses in 150 ns.

MOS levels of 500 mW.

Just down the road from Intel, designers at American Microsystems are the first to apply VMOS devices to memory arrays, claims Thurman Rogers, AMI's program director of VMOS and developer of the process. A 1-k static RAM family introduced at the conference will have access times of less than 50 ns and chip sizes as small as 80 × 55 mil.

Read and write speeds in Mostek's RAM haven't been compromised to get the low power. Typical access time is 150 ns, and a full read-write cycle requires 260 ns. The small-area cell uses high-impedance load devices that are made from polysilicon by means of a simple modification of the standard silicon-gate process.

The high-impedance poly regions permit a compact layout—about twice as dense as previous NMOS static-memory cells. Also, the high-value load resistors permit data retention at low values of V_{dd} —as low as 2 V. And when the chip is not enabled, the RAM has a standby mode that cuts power to a scant 8 mW.

The performance of Intel's RAM is achieved by combining device scaling and substrate bias, and reducing gate-oxide thicknesses. Polysilicon gate lengths are kept under 4 microns and oxide thick-

nesses to well under 1000 Å. Rather than sacrifice a pin, the substrate bias is generated on the chip. Cell size for the RAM is 3.75 mil².

American Microsystems' VMOS process is used in the company's 1401, a 1-k RAM. Cell sizes have been kept to 3 mil² so that larger static arrays can soon be made available.

The VMOS arrays' performance also approaches that of bipolar arrays—access times of 28 to 45 ns are expected for 1-k chips.

By applying the same VMOS technique to ultra-violet, erasable ROMs or PROMs, arrays of up to 64 k can be easily attained, AMI claims, since cell sizes are less than 0.36 mil².

UV PROMs made with the VMOS technique can be programmed with a 15-V, 100-ms pulse instead of the 26-V pulses normally required for the NMOS versions. Moreover, the VMOS cell requires only 36% of the area needed by currently available NMOS PROM cells.

Computer-scaling the VMOS cell can reduce its area even further for both the ROM and RAM designs. For instance, the 1401 RAM's chip area has been experimentally reduced from 81 × 125 mil to 69 × 100 mil. As a result, the speed improves by 20% to an access time of 34 ns.

A second scaling application on an experimental RAM reduces the size to 80 × 55 mil and improves the speed to 28 ns. Thus, a larger array such as a 4-k RAM can easily be fabricated on a chip whose area is less than 25,000 sq. mils.

Simulated operations help oil tanker officers

In light of the recent spate of oil tanker mishaps around the world, officers of Texaco's 160-vessel tanker fleet are receiving additional, specialized training at La Guardia Airport's Marine Air Terminal in Flushing, NY. Their "trainer" is a computerized ship-handling system owned and operated by Marine Safety International.

Designed and built by Sperry Systems Management, a division of Sperry Rand Corp., the simula-

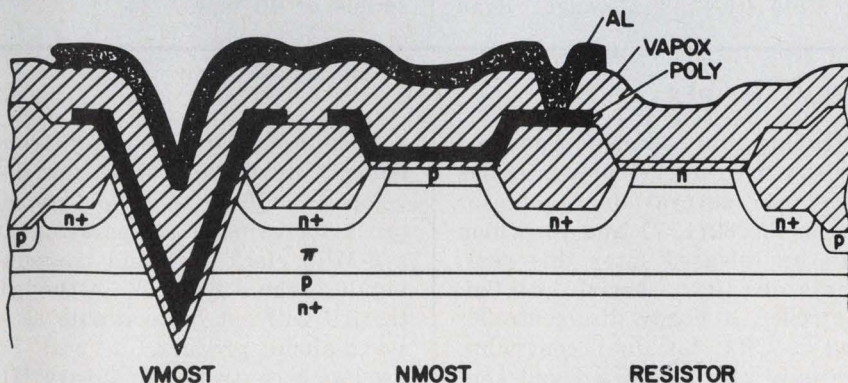

The VMOS transistor, when used in RAMs, keeps cell size to 3 mil².

tor features a full-scale replica of a ship's bridge, including wheelhouse and chart room, and is equipped with all navigational, propulsion-control and communications equipment normally found on board.

The ship's master or conning officer operates the simulator from the wheelhouse and responds to images projected on a 12-by-60-ft curved screen. So the view from the bridge is precisely what it would be if the ship actually were being maneuvered in the geographical area being simulated.

Imagery is provided by a wide-angle optical probe, with three television cameras and a single-lens system, which "tracks" a 15-by-30-ft model board of the simulated geographical area.

As the probe tracks the board in response to helm and engine orders executed on the bridge, it transmits video signals to three closed-circuit TV projectors below the wheelhouse, which project life-size, dynamic video images onto the panoramic screen.

The actual movements of the probe are correlated by a Varian 620-100 minicomputer to correspond precisely to the hydrodynamic characteristics of the ship type being imitated.

A dynamic presentation of a real harbor—also under computer control—includes all the navigational aids, and topographical and physical features of the area, including shore building, lighthouses, piers, jetties, rocks, cliffs and islands.

Engineers: prepare for a taxing time

Did you know that you can deduct \$2500 on your federal tax return for premoving expenses, such as house-hunting trips and temporary-living expenditures?

And did you know that if you are called in for an audit and there are two IRS representatives instead of one, that one or both are Special Agents, which means that the IRS suspects something "criminal" in your return?

Detailed explanations of these and other issues, which are designed to "demystify" the inner workings of the IRS for the engineer, are set forth in "The Engineer &

Federal Taxes"—a 44-page booklet sponsored by the United States Activities Board of the Institute of Electrical and Electronics Engineers.

Authored by Paul Opalack, a CPA, and Paul S. Richter, a tax and patent attorney, the booklet is primarily for engineers who wish to prepare their own returns. Priced at \$3 for IEEE members and \$6 for nonmembers, it can be ordered postpaid from: IEEE Service Center, 445 Hoes Lane, Piscataway, NJ 08854.

Now pilots will know where lightning strikes

Severe storm turbulence, the bane of aircraft pilots everywhere, can now be avoided with a passive weather-mapping system that displays the location and range of electrical activity in thunderstorms. The new kind of mapping system, called the Ryan WX-7 stormscope, is especially helpful to single-engine aircraft—no weather radar is available for these planes.

Each stroke of lightning is displayed as a bright green dot on the face of a high-intensity CRT. During a thunderstorm, the lightning strokes gather in groups in the central area of the storm. So storm intensity can be gauged on the scope by the size of the dot clusters.

The location of the dot clusters on the scope gives the position of the storm relative to the plane. The display has ranges of 20, 50 and 100 nautical miles.

Named after its inventor, Paul A. Ryan, president of Stormscope in Columbus, OH, the WX-7 picks up energy from the lightning at various frequencies below 200 kHz. Although frequencies are present up into the MHz range, Ryan

found that the lower frequencies provide better data for processing into range and bearing data.

The lightning strokes are pinpointed by a special automatic direction-finding system that can scan a full 360° very quickly.

To obtain the storm's distance from the plane—or "pseudo-distance," as Ryan calls it—the system sensitivity is calibrated so that the intensity of received signals is a prime measure of how far away lightning has struck.

The received signals are processed in a hybrid analog-digital computer—first by the analog system with proprietary techniques to enhance range information that is inherent in the signals. Then the signals are fed to the digital portion, which enhances the image and temporarily stores the dot pattern presented on the scope. Where there is a lot of storm activity, the display becomes animated because the dots automatically update themselves as new data come in.

Zinc-chlorine batteries being readied for cars

Two experimental zinc-chlorine batteries are being developed for vehicular use by Energy Development Associates (EDA), a joint venture of Gulf & Western Industries and Occidental Petroleum, under a contract with Energy Research and Development Administration. The 50-kWh batteries are capable of cycling either to a complete discharge or in a partial-depth-of-discharge mode.

Eventually, EDA predicts a 40-kWh battery will be able to propel a four-passenger car 150 to 200 miles on a single charge, with an average speed of 50 mph and peak speeds of 70 mph.

News Briefs

Quadrupling the component density used in the 8080, Intel has developed several dual-processor chips, the 8271, 73 and 75, which will be released later this year. These circuits, a serial data link controller, a floppy disc controller and a CRT terminal controller, are only 218 × 244 mil, but contain over 22,000 transistors.

Combining CMOS and SOS technology, Hewlett-Packard has developed a 16-bit parallel microprocessor capable of operating at a 6-MHz clock rate and consuming less than 400 mW. Although the μ P will not be available as a stand-alone product, it will be used as a controller in future HP equipment.

Chances are, we already have the packaging you want. That's the beauty of our single-chip design and packaging concept: freedom of choice. Because our ultra-low $V_{CE(SAT)}$ modules are pre-rated, pre-tested and inventoried, we can put them in any package to meet any need...help you optimize size, weight and performance *without* long lead times for custom packaging. Whether you need 5 or 500 pieces, we'll welcome the opportunity to discuss your special needs. For application notes and further information, call Sales Engineering, PowerTech, Inc., 0-02 Fair Lawn Ave., Fair Lawn, N.J. 07410; (201) 791-5050.

TYPICAL PACKAGE SELECTIONS		
I _c	P _D	TYPE
1200A	2100W	PPS 1200
500A	625W	PP 500
250A	325W	PPS 250
150A	325W	TO-114
90A	325W	TO-63

Copper grid distributes current most efficiently for lowest $V_{ce(sat)}$.

Two choices: 570 mil diam. or 820 mil diam. single chips!

Void-free bonding techniques eliminates hot spots.

Integral solid copper leads and heat sink make pre-bond chip tests and inventory possible.

All packages are solid copper.

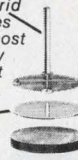

HIGH CURRENT TRANSISTOR PACKAGING UNLIMITED



PowerTech, Inc.
 "BIG IDEAS IN
 BIG POWER"

**Rockwell
one-chip computers
give you the right fit
at the right price.**

Right now.



If you're designing a system or subsystem requiring as few as 10 TTL circuits, cost alone is reason enough to consider a Rockwell one-chip computer.

A wide choice of Rockwell one-chip computers is available right now. And the line-up of compatible one-chips is growing fast.

From Rockwell's PPS-4/1 family, you select the most cost-effective computer for your application.

More on-chip I/O eliminates extra interface devices.

All of Rockwell's one-chip computers offer powerful, user-oriented I/O ports that eliminate costly interface circuitry in overall systems.

I/O features, including bidirectional ports, flexibly designed drivers and receivers, and serial input/output ports, provide you with powerful system options.

Many types of displays can be driven directly. Analog-digital conversion is easy. And serial I/O ports offer a new dimension of capability by giving you simple, "no-cost" interfacing for multi-computer systems.

Rockwell flexibility assures cost-effective design.

Rockwell's one-chip computers give you design options you couldn't afford with other logic approaches.

During the design stage you can add or reduce functions, allocate I/O differently and make dozens of other changes by simple reprogramming or by moving to another software-compatible chip within the family.

Powerful instruction sets increase efficiency.

Rockwell's instruction sets provide ROM efficiencies of typically 2 to 1 over other microcomputers. For example, some one-byte multi-function Rockwell instructions perform operations requiring five instructions in other systems.

More than 80% of Rockwell's instruction

types can be executed in one byte and in a single cycle. Special ROM instructions allow many subroutine calls to be handled in one byte. Table look-up instructions for MM77 and MM78 chips provide easy look up of stored data and easy keyboard decoding with minimal programming.

The PPS 4/1 family of one-chip computers.

Model	MM76	MM77	MM78	MM75	MM76C	MM76D	MM76E
Description	Basic 76	Basic 77	Jumbo 77	Economy 76	High speed counter ²	12-bit A/D converter	Expanded 76
ROM (x8)	640	1344	2048	640	640	640	1024
RAM (x4)	48	96	128	48	48	48	48
Total I/O lines	31	31	31	22	39	37	31
Cond. Interrupt	2	2	2	1	2	2	2
Parallel Input	8	8	8	4	8	8	8
Bidirectional Parallel	8	8	8	8	8	8	8
Discrete	10	10	10	9	10	10	10
Serial	3	3	3	—	3	3	3
In-line package	42 pin quad	42 pin quad	42 pin quad	28 pin dual	52 pin quad	52 pin quad	42 pin quad
Availability	Now	Now	Now	2Q/77	2Q/77	3Q/77	16 wk ARO

Power supply is 15v except low voltage version of Basic 76 available 3Q 77. Typical power dissipation is 70mw.

²Two 8-bit or one 16-bit presettable up/down counter with 8 control lines.

Rockwell design aids also help lower your system cost.

To help control development costs, Rockwell makes available a universal Assembler that lets you assemble, edit, develop and debug programs, as well as load PROMs. Special development circuits enable prototyping.

Your Assembler can also handle incoming inspection and factory testing. And the same Assembler can be used to develop systems based on all Rockwell one-chip and multi-chip microprocessors.

For the full story on Rockwell one-chip computers, and how quickly they can be a part of your new product, write on your company letterhead to: Marketing Services, D/727-B, Microelectronic Device Division, Rockwell International, P.O. Box 3669, Anaheim, CA 92803, U.S.A. or phone (714) 632-3729.



Rockwell International

To cut a building's energy use, call on 'Judy' the μ P system

How do you cut a building's use of electricity by over a third and its kilowatt-hour consumption by nearly a half? Simple. You sprinkle four microprocessors around the facility to control the building's energy use, monitor its security and manage equipment operation.

Called "Judy," a system of four microprocessors distributed around a 50,000-sq-ft underground federal building in Denton, TX, has cut demand for electricity 38% and its actual kilowatt-hour consumption 49%. What's more Judy has managed to save an extra \$50,000 a year by filling the void left by the elimination of the security force. The system is expected to pay back its \$15,000 cost in less than a year.

Although the four National Semiconductor SC/MP processors form the nucleus that is named Judy each is actually independent of the other, with its own RAM, ROM and duties.

SC/MP 1 is responsible for managing the building's equipment. SC/MP 2 is responsible for controlling the security of the building. SC/MP 3 accepts, formats and stores all the messages that Judy sends out. And SC/MP 4 is the communication control—it dials the phone, sends out messages, answers the telephone and corrects transmission errors.

War games conserve energy

Judy's μ P No. 1 monitors a variety of alarm points for smoke, intrusion, sump level, pneumatic pressure and fresh air. These points need only open or close switches. The microprocessor also controls the heating and cooling

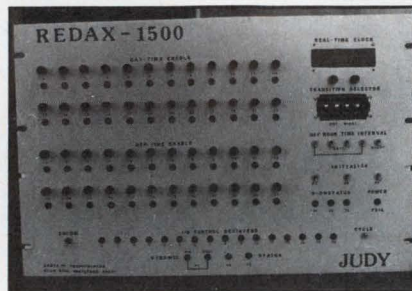

Judy's Question-and-Answer Control Panel. This array of LEDs and push-button switches is an inexpensive terminal to implement the system's command line mnemonic interpreter in firmware. Questions put to the operator via LEDs are answered by selecting mnemonic pushbuttons, thus setting SC/MP 1's strategy in a "war game" for energy conservation.



This is not a telephone, but is an input keypad to a distributed-intelligence network that watches over a government building in Denton, Texas.

machinery and lighting as well. To do all this efficiently, Judy's designers, Radix II, Inc., Oxon Hill, MD, chose to implement μ P 1 as a "war-gaming instrument."

Inside and outside temperature readings are applied as input to firmware "predict-or-correct" algorithms. A particular game strategy

is commanded by the operator, who, in programming her, considers such parameters as the season and recent temperature trends.

Every weekday morning, all the equipment under SC/MP 1's control is cycled so as to keep the building's electrical load as low and as constant as possible. Employees begin arriving at 8:00 a.m., but SC/MP 1 starts to "bring the building up" two hours before—and very slowly so as to cause only the smallest demand increment on the power company. Just turning on the lights takes half an hour.

"In an uncontrolled building," explains Dr. G. Lamers, President of Radix II, "demand peaks constitute at least 20% to 30% of the total electric bill. The power utility must provide this level of service at all times, whether it's used or not." Over a three-month period, Judy reduced the peak-energy demand of her building by 38%.

To determine the building's current rate of electrical consumption, Judy monitors the power company's rotating-demand meter wheel. Based on that rate, the SC/MP 1 makes strategic decisions to switch equipment on or off; only the minimum pieces of equipment are activated at any given time. As a result, the building's actual kilowatt-hour consumption has been cut nearly in half.

All told, Judy's energy management has reduced the Denton Federal Building's electric bill to about one third. "After three months of operation, Judy has saved the taxpayers \$5500 over the same period last year," says building manager Robert Kuykendall. "She's saving \$1800 a month in energy costs alone; at this rate, she will pay for herself within a year."

Judy's SC/MP No. 2 secures the building by controlling access

Dick Hackmeister
Western Editor

What this country needs is a good \$39 DPM.

And we've got it.

The AD2026 from Analog Devices. Priced at \$39 in hundreds*, it's the first real alternative to the measurement grade analog panel meter. And the first to give you all the advantages of a DPM at a practical price. Advantages like visual appeal, accuracy, resolution, small size and reliability.



The AD2026 is a three digit, logic powered DPM that measures and displays voltages from -99mV to $+999\text{mV}$ on 0.5" LEDs. It consumes only $\frac{3}{4}$ Watts of 5V power. And because the AD2026 can be scaled with a simple resistive divider on its input pins, you can get direct readout in any engineering unit with equal or better resolution than APMs.

With an accuracy of 0.1% of reading ± 1 digit, the AD2026 is again far superior to conventional APMs, where their inherent inaccuracy usually limits the total performance of the instrument.

The AD2026 conserves on space, too. Its small front panel size of 3.4" x 2.0" and only 0.64" needed behind the panel makes it smaller than $3\frac{1}{2}$ " scale APMs. But its performance outclasses $4\frac{1}{2}$ " APMs.

When it comes to reliability, the AD2026 is unsurpassed. Its I²L technology combines most of the active analog and digital circuitry on *one* chip. The AD2026 has only 14 components and a MTBF of 250,000 hours at 25°C. In a 24-hour-a-day application, you shouldn't expect a failure for 28 years.

A new commercial tester automatically tests all AD2026's for defects such as bad components and solder shorts. It also fully tests both the LSI chip and the complete DPM. Following 168 hours of failure free burn-in, the units are again 100% tested.

The AD2026. Its low price (\$39/100s), small size, superior performance, and remarkable reliability make it the only sensible alternative to APMs. Which is just what this country needed.

Check it out. Return the coupon with your check or money order today to order an evaluation sample at the low 1-9 quantity price of \$62. And when you receive your evaluation samples you will also receive a Credit Certificate for \$23 redeemable when you place your order for the first hundred or more AD2026's.

ANALOG DEVICES

The real DPM company.

Box 280, Norwood, MA 02062
Telephone: East Coast: (617) 329-4700,
Midwest: (312) 894-3300,
West Coast: (213) 595-1783,
Texas: (214) 231-5094.



Please send me _____ AD2026 for testing and evaluation at the low (1-9) price of \$62. (Enclose check or money order.)

Enclosed is my purchase order for 100 AD2026 DPMs at the unbelievably low price of \$39 in 100s.

I'm not ready to order my AD2026 DPM for testing and evaluation, but I would like to receive all available technical information.

ED 3/15

P.O. # _____

Name _____

Company _____

Telephone _____

Address _____

City _____

State _____

Zip _____

*Substantial quantity discounts available.

through as many as 256 doors, including the door to its own room. Each door is equipped with its own μ P and a hexadecimal keypad.

To get into the building or any of the secured rooms within it, an individual must enter the correct prefix code, respond to a pattern of unidentified lights, enter a valid identification code and be in the correct time window. A certain number of honest mistakes is permitted, but if the door μ P suspects the person outside doesn't know what he or she is doing, it notifies the SC/MP 2, which activates an alarm.

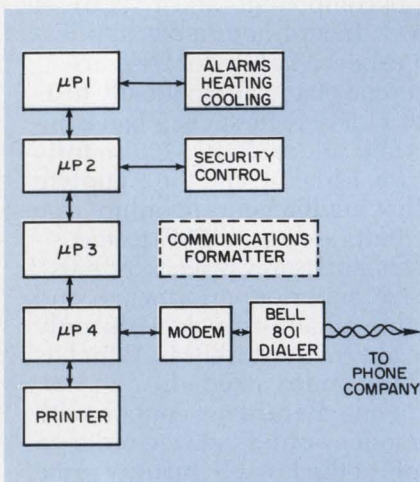

Distributed μ P system can grow to 250 μ Ps. Each section has its own RAM, PROM and job to do.

If the individual meets all entrance criteria, he or she is admitted, and this information is printed at a security station 50 miles away in Dallas. The inside of the main door also has a keypad that will log a person out when he leaves again.

To save cost, Judy has no teleprinter or ASCII keyboard. She is equipped with a panel of pushbuttons and LEDs (see photo)—this panel is the operator interface. With this panel, the operator can alter Judy's programmed strategies in both energy-saving war games and building security.

All programs reside in system firmware. Judy's language is a process-control language invented around Basic. It is a Command Line Mnemonic Interpreter—a high-level language for the operator who is unfamiliar with computer programming. LEDs repre-

sent canned queries to the operator, and pushbuttons represent input mnemonic responses.

Judy's third microprocessor is her print formatter. It receives and buffers messages from any part of the microprocessor network in Denton and formats the text for a 40-column printer. A large font is provided for emergency messages, and a smaller font for routine messages. The formatter queues up the prioritized messages for transmission over telephone lines. The messages can be sent to any of 256 locations equipped with a telephone, modem and 40-column printer.

Any event taking place at Judy's installation in Denton is reported to "George," a minicomputer in Dallas 50 miles away. They dial each other automatically, "talk" over regular phone lines and leave hard-copy memos to each other.

Microprocessor No. 4 is responsible for sending Judy's messages out to George or other remote locations. Because the telephone lines used might be low-grade, Radix II combined error-reduction and correction techniques—parity bits, cyclical-redundancy-check characters and Fourier transformation of the transmitted data.

Judy, call George

Once SC/MP 4 has received a message for transmission, it goes about its assigned task relentlessly. Using a Bell 801 Automat Call unit, it repeatedly dials the receiving station until it gets connected.

The data to be transmitted are then provided with odd parity bits. A cyclical-redundancy-check character is generated and appended; finally, the message undergoes a firmware-resident Fourier transformation to desensitize it to transmission errors. This transformation converts the message from the time domain into the frequency domain, so that, for a 1024-bit message, each bit represents only 1/1024 of its actual value. Thus, Judy's communications link is capable of tolerating a significant error rate.

If the message cannot be reconstructed by the receiving station or it is garbled, Judy requests subsequent transmissions until the message is received correctly. ■■

IEE/SCHADOW PUSH BUTTON SWITCHES

Whom to Contact for
Service in your area.

ARGUS SALES
P.O. Box 26819, Tempe, AZ 85282
(602) 967-8709

BEACON
2285 Peachtree Road N.E., Atlanta, GA 30309
(404) 351-3654

BEACON-NORTH
7115 Leesburg Pike, Falls Church, VA 22043
(703) 534-7200

W. PAT FRALIA COMPANY
P.O. Box 12625, Fort Worth, TX 76116
(817) 640-9101

ILIS, INC.
5420 North Milwaukee Ave., Chicago, IL 60630
(312) 631-1122

R. C. NORDSTROM COMPANY
P.O. Box 32, Lathrop Village, MI 48075
(313) 559-7373

NYCOM
2002 Teall Avenue, Syracuse, NY 13206
(315) 437-8343

RAY PERRON & COMPANY, INC.
159 Morse Street, Norwood, MA 02062
(617) 762-8114

C. K. SHANKS & ASSOCIATES, INC.
3176 Southwest 87th Avenue, Portland, OR 97225
(503) 292-5656

DAVID SONKIN ASSOCIATES, INC.
10 Fiske Place, Mt. Vernon, NY 10550
(914) 668-9809

M. A. STOLAROFF COMPANY
4622 West Slauson Avenue, Los Angeles, CA 90043
(213) 295-7781

TRI-TRONIX
2403 San Mateo Blvd. NE,
Suite 2, S. Bldg. Albuquerque, NM 87110
(505) 265-8409

WAUGAMAN ASSOCIATES, INC.
4800 Van Gordon, Wheatridge, CO 80033
(303) 423-1020

WESELOH & ASSOCIATES
P.O. Box 4189, Mt. View, CA 94040
(415) 961-0565

WYNCOTE INSTRUMENTATION
365 East Butler Avenue, Ambler, PA 19002
(215) 643-2440

SALES REPRESENTATIVES

IMPACT SALES COMPANY, INC.
66 Needham Street, Newton, MA 02161
(617) 964-7740

INTEGRATED ELECTRONICS
5750 Logan Street, Denver, CO 80216
(303) 534-6121

RADIO SUPPLY COMPANY
131 Laura, Wichita, KS 67202 • (316) 267-5216

R. M. ELECTRONICS
4860 South Division, Kentwood, MI 49508
(616) 531-9300

SAGER ELECTRICAL COMPANY
172 High St., P.O. Box 2323, Boston, MA 02107
(617) 542-2281

SOUTHWEST ELECTRONICS
12725 Royal, Stafford, TX 77477 • (713) 494-6021

SUBURBAN SUPPLY
117 Benedict Street, Waterbury, CT 06701
(203) 757-1251

TARGET ELECTRONICS
949 Stierlin Road, Mt. View, CA 94043
(415) 961-1170

TIME ELECTRONICS WEST
900 West Olive Street, Inglewood, CA 90301
(213) 649-6900

TREEKO SALES
4937 Hartford Avenue, Beltsville, MD 20705
(301) 937-8260

WESTERN ELECTROMOTIVE
12421 West Olympic Boulevard, Los Angeles, CA 90064
(213) 820-3777

ZEPHER ELECTRONIC SALES CORPORATION
697 Industry Drive, Seattle, WA 98188
(206) 575-0922

QAR INDUSTRIAL ELECTRICAL SALES, INC.
621 South Columbus Avenue, Mount Vernon, NY 10550
(914) 699-2224

DISTRIBUTORS



Or contact the factory

IEE/SCHADOW inc
8081 Wallace Road
Eden Prairie, MN 55343
612/944-1820

CREATIVE SWITCHES

“that turn your product on”

alternate action staple

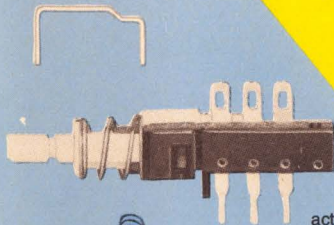

actual size

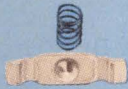

spring loaded contact

The finest engineered switch mechanism available today... automation and precision in the manufacturing processes provide superior switch quality at lower cost. Better switch!

THE BASIC SWITCH

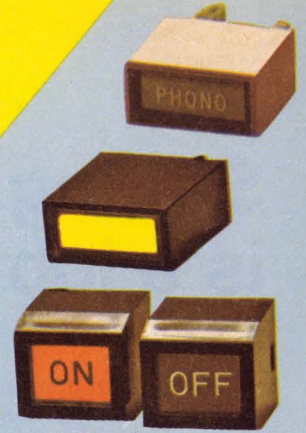

Mechanical reflecting indicator buttons that use no electrical energy, generate no heat... They work on the principle of reflecting ambient light through a clear plastic lens, with or without graphics.

RIGHT...ON THE BUTTON

SCHADOW

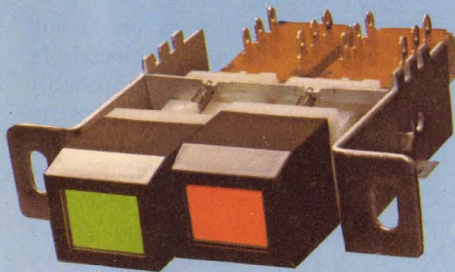

A "lamp less" push button switch, Series CA 110, with bright color indicators, with or without graphics, to mechanically indicate changing functions. Can be stacked 15 switches wide X 10 high per chassis.

NON ILLUMINATED SWITCHES

ILLUMINATE at low cost by installing a snap-fit lampholder and lamp in C Series and Miniature F Series (not pictured).

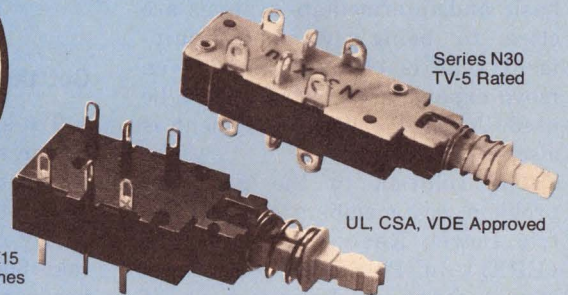

Series NE15 Line Switches

Series N30 TV-5 Rated

UL, CSA, VDE Approved

Adaptable to all standard and mechanical reflective indicator buttons.

Also available: up to 15 amp line switch (not pictured).

POWER SWITCHES

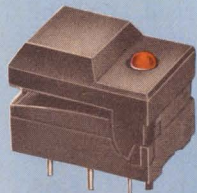

A remarkable new modular electronic switch input component for use with dual in-line packages (DIP). The inner construction, in connection with standard TTL-IC's, eliminates more costly and troublesome conductor plate sandwiched switches. SPDT. Lends itself to economical PC board designs and assembly techniques of sophisticated electronic equipment.

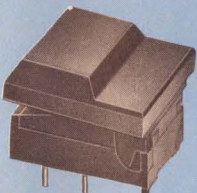

DIGITAST MODULAR ELECTRONIC SWITCH INPUT COMPONENT

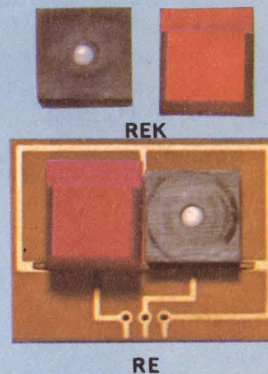

The economical answer for an electronic switch input component to use with standard dual-in-line packages (DIP's), ideally designed for incorporation into a broad variety of electronic devices including advanced micro-processor controlled equipment. Series R is compatible with TTL, CMOS Logic. Redundant contacts insure required reliability. SPST. SPDT. Available modular or mounted on PCB.

SERIES R ELECTRONIC SWITCH INPUT COMPONENT

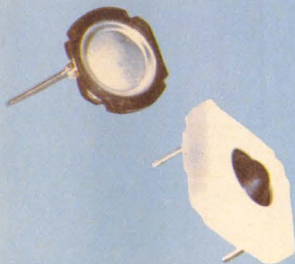

New Disc Switch... totally sealed... self-cleaning... high switching power. Provides instant positive contact. By applying pressure on the upper dome, it collapses momentarily, making instant and simultaneous contact with the lower diaphragm in at least three different points in the circular area.

DISC SWITCH

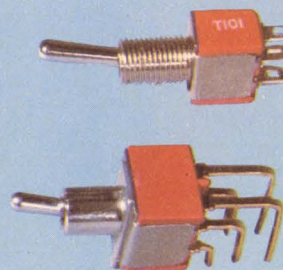

We can supply a complete line of toggles, rockers and miniature momentary push buttons. UL approved, meeting industry standard mounting specifications. PC spikes, right angle PC spikes, solder lugs.

Advanced mechanical superiority and exacting precision with very competitive pricing.

TOGGLES AND ROCKERS

Send for our complete full color catalog describing these and other switching configurations in the Schadow line.



IEE / SCHADOW inc
A SUBSIDIARY OF IIT

8081 Wallace Road, Eden Prairie, Minnesota 55343
612/944-1820 • TWX 910-576-2469 • TELEX 29-0556

Storing energy for peak power is a job for 'super' batteries

Today, when more power is needed than a utility company's basic system can provide, intermediate-load facilities are switched on. This equipment—usually fossil-fueled, for making steam—is generally older, less efficient, and thus more costly to operate. For *real* peak-load demands—when both the basic and intermediate systems are close to being swamped—equipment that is older still and even more expensive to operate must be used. As a rule, this equipment is also fossil-fueled.

The solution to the peak-load problem, say members of the Electric Power Research Institute (EPRI) in Palo Alto, CA, is to store energy in large arrays of "super" batteries.

Energy can be generated at night during hours of low demand by the more economical basic power-generating equipment, then stored in the giant batteries to augment peak power demands the next day.

Eventually, super batteries may handle up to 5% of the nation's

total electric energy needs and up to 17% of peak-time electricity, according to a study supported by EPRI and the Energy Research and Development Administration (ERDA). (EPRI was formed by the nation's power utilities in 1972 to carry out programs to improve the production of electric power.)

Get them together

To supply a large amount of power, super-battery modules might be clustered like cars in a parking lot. With an individual storage capacity of, say 3 kWh/ft³, it would take 3000 ft³ of these batteries to produce 100,000 kWh of power.

A unit about the size of a file drawer, which is now being developed by General Electric, will have about 10 kWh. A standard lead-acid battery of the same dimensions would be hard pressed to provide a storage capacity of 5 kWh. Several of GE's units will be put into a desk-sized module capable of storing more than 100 kWh of electricity.

"We can't say how much these batteries will save the utilities in

every case," says EPRI's Dr. Fritz Kalhammer. "That depends on the cost of fuel and the efficiency of the peak-load equipment. We do know, though, that the savings would be considerable."

By the year 2000, according to utilities spokesmen throughout the country, storing energy won't be just a shrewd money saver. It will be required. The use of electricity in the United States will probably shoot up to 3.8 times the quantity used now, while the use of oil for generating this power will drop by a third. As a result, an estimated 1000-billion kWh of peak power will have to be fueled annually by alternative means such as wind and sun, both of which will have to be stored. And whatever the source, some of the energy will have to be stored to handle peak loads.

According to the Institute, facilities will be needed for storing up to 100,000 MW of energy that can be discharged, on the average, for 2000 hours a year.

The arguments for batteries

Batteries are uniquely versatile and rapid in their response to elec-

John F. Mason
Associate Editor

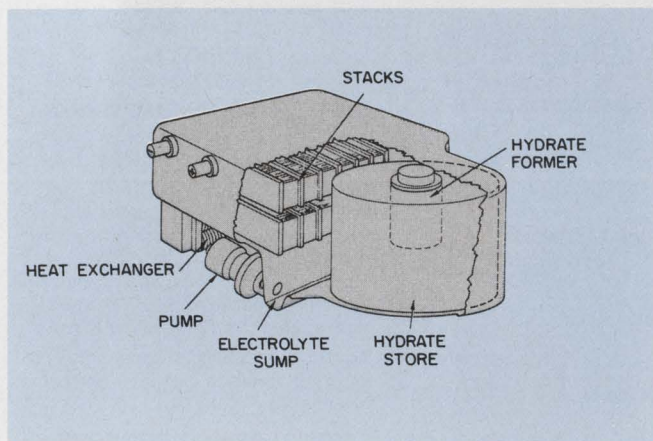

When the zinc-chlorine battery is charged, zinc is released and deposited on graphite electrodes. Released chlorine is moved to a chamber where it is cooled and stored in hydrate form. While the battery is discharging, chlorine released from a mix of chlorine hydrate and

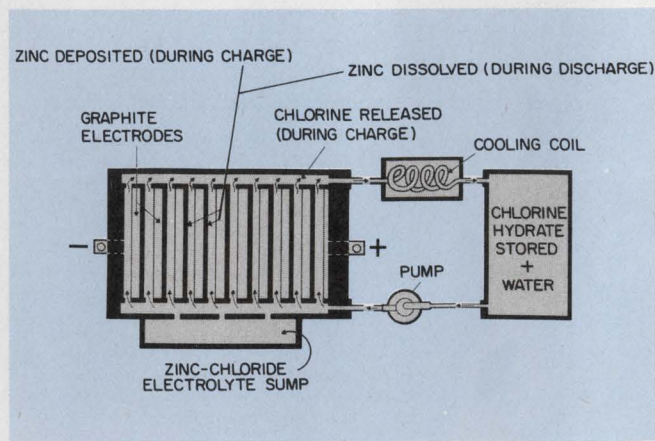

water is pumped back into the graphite-electrode compartment. The zinc is then dissolved by the chlorine to form zinc chloride in an ion exchange that releases electrical energy. A 300-kilowatt-hour battery will be tested this year with a 100-MWh battery to be built in 1980.

Chip City.

Engineers whose job descriptions include designing far-out hybrid circuits are invited to shop at PMI's Chip City.

We've got lots of chips for you, and will gladly sell you any quantity, large or small. Op amps. DACs. Comparators. References, including our new REF-01 (+10V) and REF-02 (+5V) chips. All triple passivated, all 100% visually inspected, all 100% electrically tested to guaranteed limits. Obviously, we can't test for temperature drift (since the chips aren't packaged), but we can assure you they will all operate over the full MIL temp range.

FREE CATALOG

We've just put the finishing touches on a catalog listing all the chips we sell. It will be a useful reference and will give you the specs you'd expect to see for packaged IC's. Write, wire or phone for your copy. It's free.

Precision Monolithics Incorporated

1500 Space Park Drive,
Santa Clara, CA 95050

(408) 246-9222. TWX 910-338-0528.



CIRCLE NUMBER 23

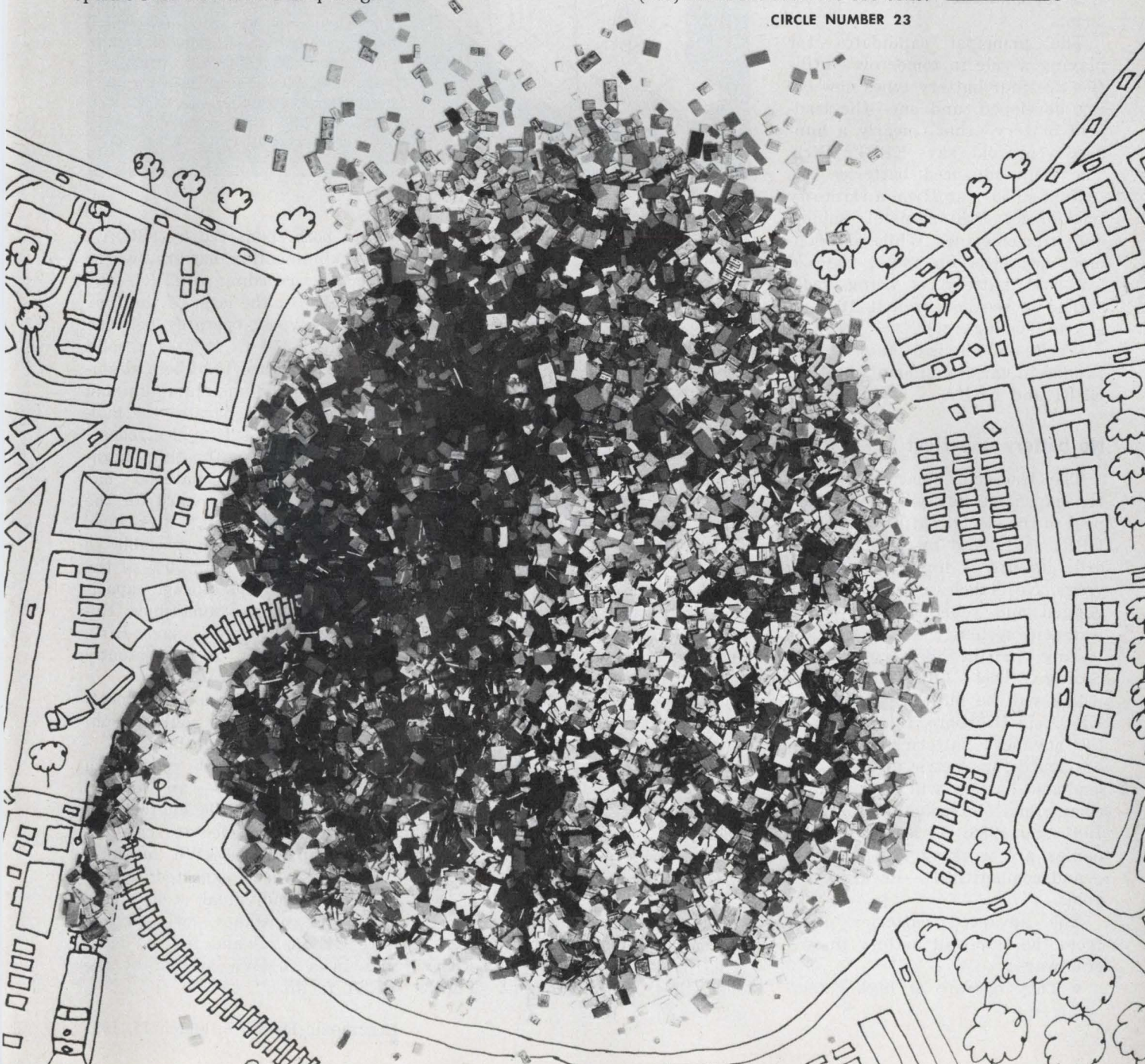

tric systems' needs, says James R. Birk, EPRI's project manager for advanced-battery development. They can respond to demands within minutes and match the incremental changes in load with no penalty in efficiency. By contrast, a standby generator's efficiency is best only at one output.

The use of batteries to store power is attractive to environmentalists. Regardless of their size, batteries make little, if any, noise. They create almost no emission, and don't need extensive excavation. Moreover, neither fuel nor waste would have to be carried to and from battery sites. Even the land requirement would be relatively modest: about a half-acre for a 20 MWh battery storage installation.

The principal candidates for playing a role in tomorrow's utilities are four battery types now being developed, and one—the lead-acid battery—that's nearly a hundred years old, says EPRI's Birk. The four advanced batteries are sodium-sulfur, sodium-antimony trichloride, lithium-metal sulfide, and zinc-chlorine. While development proceeds on these, the old lead-acid battery is being redesigned to see how well it fits into a load-leveling role.

Work on all five batteries is funded in varying amounts by both EPRI and ERDA.

No battery is perfect

The lead-acid super battery is too expensive for widespread appeal to the electric utility industry, EPRI says. And by utility standards its life is limited—about 10 years. Nevertheless, the battery is rugged and reliable. By 1979, a lead-acid system will be ready for testing in the Battery Energy Storage Test (BEST) facility, which will be built by EPRI and ERDA in Hillsboro, NJ, to test all the advanced batteries now being developed for electric utilities. The lead-acid battery will be ready for commercial introduction between 1981 and 1983. At least five companies are working independently—and competitively—toward these goals.

The advanced batteries differ from the lead-acid battery in several ways:

- They operate at higher tem-

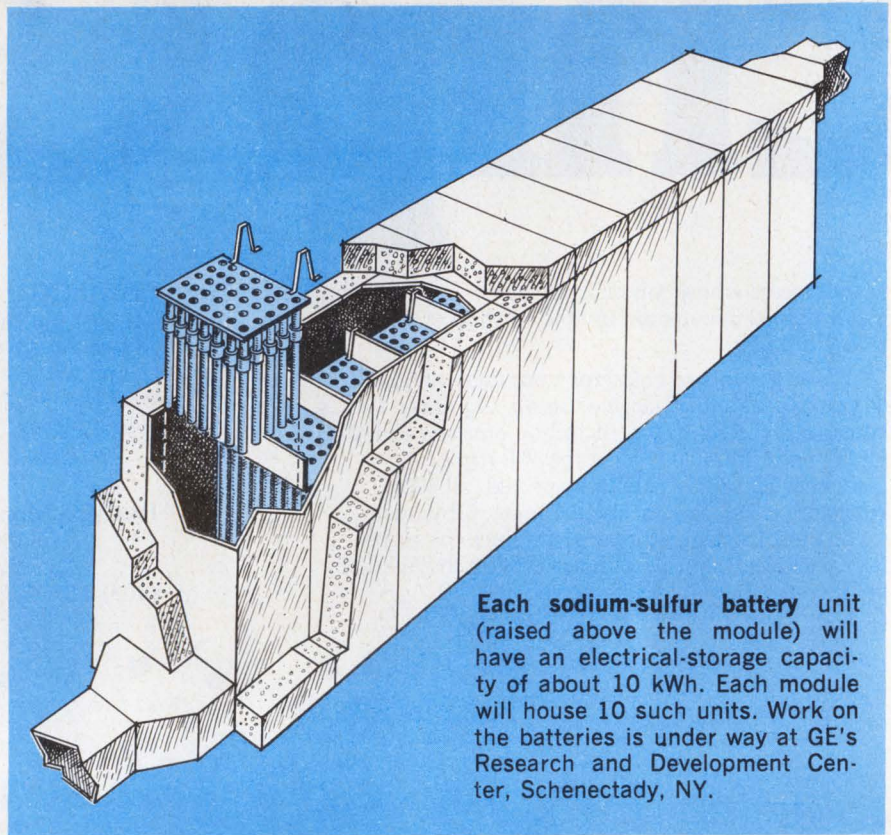

Each sodium-sulfur battery unit (raised above the module) will have an electrical-storage capacity of about 10 kWh. Each module will house 10 such units. Work on the batteries is under way at GE's Research and Development Center, Schenectady, NY.

peratures—lead-acid operates at 20 to 30 C while the advanced batteries operate at from 50 to 450 C.

- Their energy and depth of discharge are both greater.
- Their cell size is much smaller.
- Their active materials are cheaper.

High operating temperatures are good *and* bad. They're beneficial because they permit the liquid-electrolyte materials to be used instead of solid materials, which are subject to morphology changes (sometimes called sluffing of materials). In time, the active material in solid electrodes deteriorates.

Liquids, on the other hand, have no hysteresis effect; a liquid doesn't remember from one cycle to the next what happened, thus making it possible, theoretically at least, for the electrolyte material to have a very long life.

High temperatures are bad because they accelerate corrosion. The materials used become more reactive.

The four other candidates

The sodium-sulfur banner is being carried by three groups: General Electric, sponsored by EPRI, and Dow Chemical and Ford

Motor, both sponsored by ERDA.

A sodium-sulfur battery, whose materials, according to EPRI, may very well cost the least of the four advanced types, operates between 300 C and 350 C. It uses a solid (ceramic) electrolyte of beta alumina (made of sodium, aluminum and oxygen), which separates the molten sodium and sulfur electrodes.

"Coming up with this high-quality electrolyte material has been a major step forward for the sodium-sulfur battery," Birk says. A year ago it wasn't possible to make use of more than 50% of the sodium-sulfur cell's storage capacity—"what people sometimes call 'depth of discharge,'" says Birk. "Now the figure is consistently 85%."

Also, the cell life has been boosted to more than 8000 hours of continuous charge and discharge.

Currently, GE's lab cells—each about 1 in. × 8 in.—can store 32 Wh. But considerable engineering design will be needed to scale the battery up to 100-kWh modules, Birk notes—each expected to employ 350 individual cells. "By 1981," he continues, "we hope to have GE install and test 50 modules in a 5-MWh system at the BEST facility."

This switch doesn't need an umbrella

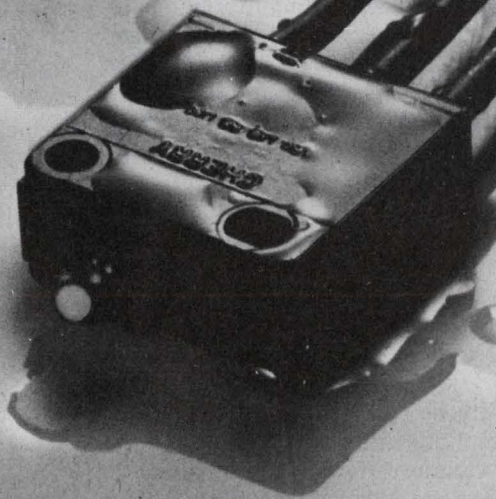

If your product must work outdoors this sealed Cherry switch will work!

We built an umbrella *around* a switch . . . by putting our subminiature snap-action switch inside a sturdy housing and injection molding epoxy plastic that encapsulates the switch and leads to seal out dirt and moisture.

It's watertight and weatherproof. Making it the ideal switch for use in autos, trucks, boats, snowmobiles, power mowers, outdoor vending machines . . . just about any product subjected to extreme weather, dust, dirt, grease, grime or spray.

The watertight, weatherproof "inside switch" is our reliable E62 subminiature, proven over more than a decade in millions of demanding applications. In this new sealed switch design, its stainless steel coil spring mechanism and reliable rock-wipe contact action are protected by a double enclosure plus a rubber boot on the actuator. So that when it rains . . . it works!

TEST A FREE SAMPLE OF THIS NEW SEALED SWITCH. Just PHONE (312) 689-7700 or TWX (910) 235-1572, or write on your letterhead.

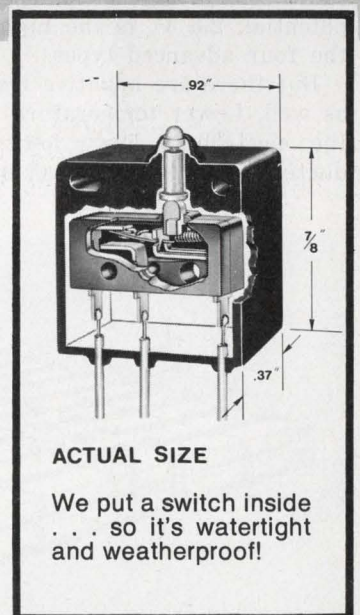

ACTUAL SIZE

We put a switch inside
. . . so it's watertight
and weatherproof!

CHERRY



CHERRY ELECTRICAL PRODUCTS CORP.
3609 Sunset Avenue, Waukegan, Illinois 60085

SWITCHES and KEYBOARDS — Available locally from authorized distributors.

Meanwhile, two problems remain to be solved: Deterioration of the glass seals, which react with sodium, and the corrosiveness of sulfur, which reacts with the metal container housing the electrode. If the problems can be cleared up, a full-scale battery module will be fabricated and tested in 1978.

Instead of beta alumina, Dow Chemical uses a very thin glass capillary as a solid electrolyte, 70 microns in diameter, with a wall thickness of 10 to 15 microns. "Both beta-alumina electrolyte and the glass capillary look very promising," Birk says.

Sodium-antimony trichloride, which is being developed by ESB, Inc., is a kind of offshoot of the sodium-sulfur battery. It's got the same sodium electrodes and the same beta-alumina electrolyte. But instead of sulfur in the positive electrodes, it uses a mixture of sodium chloraluminat and antimonie trichloride. The idea behind choosing the materials, Birk says, is to use something that melts at a lower temperature than sulfur and thereby avoid some of the problems, like heightened corrosiveness, that accompany high temperature. The sodium-antimony trichloride battery operates at 200 C, not 300 to 350 C.

The seal is also different. Instead of glass, silicone rubber is used, which, according to Birk, is easier to work with. Furthermore, the battery type's cell-operating potential, 2.6 V, is the highest of the four advanced types.

But there are negative tradeoffs as well. Lower temperature means the electrolytes have lower conductivity, therefore must operate

at lower current densities—less milliamps per square centimeter. So to get more current, the electrolyte area must be enlarged, which, in turn, jacks up the cost. As a result, according to Birk, the sodium-antimony trichloride battery costs more than the sodium-sulfur. The availability of antimony itself is even in doubt.

The lithium-metal (iron) sulfide battery has a long life (1000 cycles, to sodium-sulfur's 400), but operates at a high temperature (400 to 450 C). Another minus—lithium is not only expensive but scarce.

Lithium systems on the way

Nevertheless, four giant organizations are developing lithium-metal systems and hope to have them tested at the BEST facility by 1981: Atomics International, Rockwell International, Argonne National Laboratory and General Motors.

Since 1972, these manufacturers have been shifting gradually from liquid-lithium and sulfur electrodes to solid lithium-silicon and iron-sulfide electrodes. This change is necessary to eliminate capacity degradation caused by electrode materials migrating or dissolving into the electrolyte.

Atomic International reached a milestone last year by operating a 150-Wh cell for nearly 1000 cycles and 10,000 hours. AI has now tested a 1-kWh cell, and is building a 2.5-kWh full-scale, load-leveling cell.

Zinc-chlorine, which operates at near ambient temperature (50 C) and uses a water-based electrolyte,

will probably be the first of the big four to make it to the BEST test facility, EPRI's Birk believes.

The battery is complex, he adds, because of its flowing, water-based electrolyte, and its external storage of chlorine—aspects which may lead to a cost penalty. The system is, however, farther along in development than the others and has performed well in sizes larger than any of the advanced batteries.

Under development since the late 1960s, the zinc-chlorine battery got a shot in the arm last month when EPRI awarded a contract for more work to Energy Development Associates (EDA), a joint venture of Gulf & Western Industries Inc., and Occidental Petroleum Corp. The two companies already had spent \$10-million of their own funds on the project. Under the terms of the new contract, they will invest \$3.8-million more, which EPRI will match.

The goal is to design, develop and fabricate a 10-MWh zinc-chlorine system. An efficient 1-kWh battery has been tested successfully by EDA and cycled 100 times. "On a four-hour charge/four-hour discharge regime, the zinc-chlorine prototype battery demonstrated a 78% energy efficiency with no degradation in performance over the first 100 cycles," says A. A. Guffey, executive vice president of Hooker Chemical, a subsidiary of Occidental Petroleum.

"During 1976, we scaled up in battery size and are now testing a 20-volt, 20-kilowatt-hour system. This year, we plan to build a 100-volt per 100 kilowatt-hour battery module for evaluation as the basic building block of megawatt-hour-level systems. We also will assemble three of these 100-kilowatt-hour modules in 1977 into a 300-kilowatt-hour battery to demonstrate the interfacing of the modules for test next year," Guffey notes.

"Our 1978-79 commitments call for assembling a 10-megawatt-hour system for testing during 1979 and 1980 at the BEST facility. The evaluation will be conducted at the Public Service Electric and Gas substation in Hillsboro, NJ. With success at BEST during 1979, the first 100-MWh battery array will be built in 1980," the Gulf & Western executive predicts. ■■

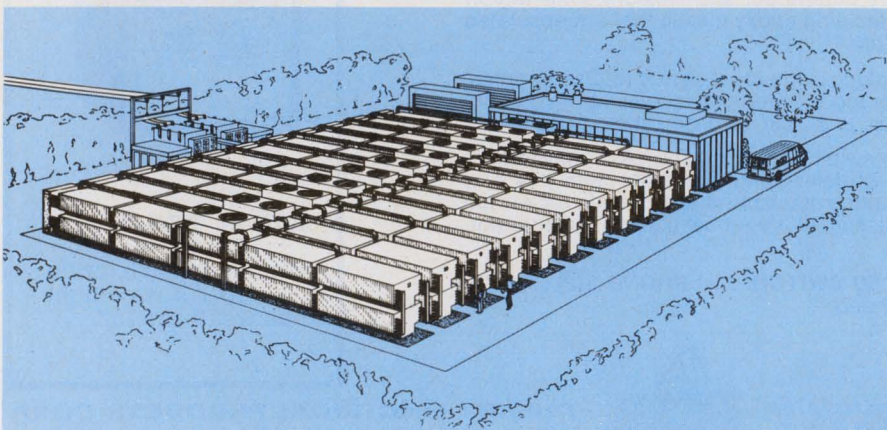

Rows of battery modules will store electric energy generated at night during hours of low demand, and discharge it during periods of peak load.

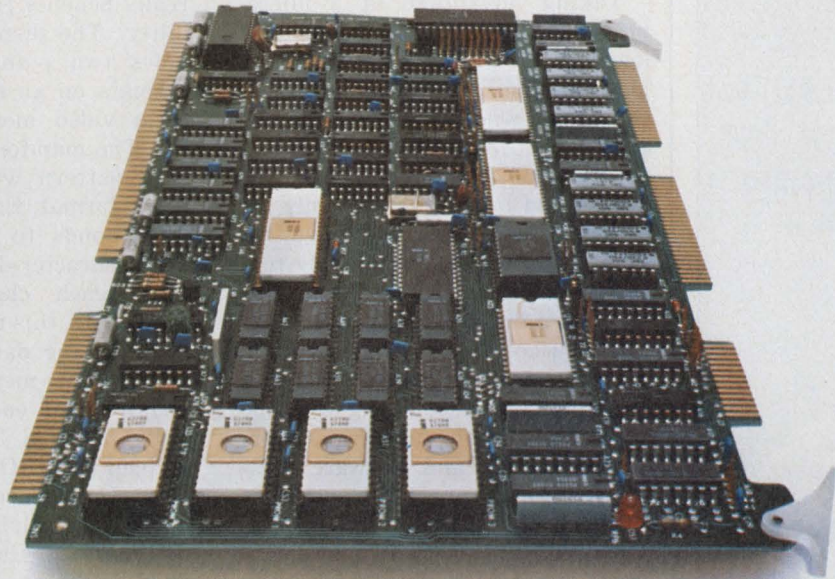

Intel delivers real time microcomputer multiprocessing. The new SBC 80/20 Single Board Computer.

SBC 80/20 delivers system throughput and design flexibility previously unobtainable on a Single Board Computer. Like our low cost industry standard SBC 80/10, the SBC 80/20 has everything you need—CPU, EPROM, RAM and programmable parallel and serial I/O—all on a single 6.75" x 12.0" board. And because the SBC 80/20 also has dual bus architecture, multiprocessor bus control, programmable eight level vectored interrupt and programmable timers, it is your best choice for real time multiprocessing and other high performance applications.

SBC 80/20 increases system throughput and improves system reliability by allowing tasks to be segmented in a true parallel processing

configuration. Operate up to sixteen SBC 80/20 systems simultaneously without tying up the system bus when using on-board memory and I/O. And when access is required to resources sharing the system bus, on-board multiprocessing logic provides the necessary bus priority control.

SBC 80/20 has eight levels of programmable vectored priority interrupt making it possible to immediately respond to critical I/O requirements. Priority assignments and priority algorithms are under program control and can be dynamically reconfigured as system requirements change.

SBC 80/20 has two programmable timers that increase throughput by relieving the CPU of timing and event counting operations. Each timer may

be programmed by system software to operate as a real time clock, interval timer, or event counter.

To protect data integrity, the SBC 80/20 includes an auxiliary memory power bus and all the logic necessary for implementation of a battery back-up system.

Ask for our new 24-page brochure describing the entire family of Intel® SBC 80 Single Board Computers, System 80 packaged systems and expansion boards. For your copy or for a demonstration contact your local Intel representative, use the reader service card or write: Intel Corporation, 3065 Bowers Avenue, Santa Clara, California, 95051.

intel delivers.

RCL

OFFERS A
LOW COST
REPLACEMENT
FOR "OBSOLETE"*
OPEN DECK
WAFER SWITCHES

*Not all, but most... ask us!



RCL'S
ENCLOSED,
LOW PROFILE
PC SWITCH...
FROM
STOCK!

Send For New '77 Catalog or Call
our Hotline For Name Of Your
Local Representative Or Stocking
Distributor.

(201) 374-3311

AMF

RCL Electronics

General Sales Office:
700 So. 21st Street
Irvington, N. J. 07111

CIRCLE NUMBER 26

NEWS

μ P-based computer system sells for under \$1000

Taking advantage of a micro-processor's flexibility, speed, and low cost, ECD Corp. of Cambridge, MA, has built a general-purpose computer with a base price of \$987.54. Built around MOS Technology's 6512A microprocessor, the MicroMind is designed not only for personal computing, but also for such OEM applications as environmental-chamber controls, text editing and animated sign controls.

The MicroMind package includes a keyboard, CPU, display processor and video interface, along with the necessary power supplies, system documentation, and software package. An interconnect bus system is designed for expandability and multiprocessing; up to 16 microprocessors can be connected to the bus for parallel processing.

The CPU board contains 8 kbytes of dynamic RAM and sockets for an additional 8 kbytes. Its memory capacity can be expanded by adding 32-kbyte memory-expansion boards. And even though a 16-bit-address microprocessor like the 6512A can only address 64 kbytes of memory directly, a memory-mapping option allows the MicroMind to have a total addressable memory area of 64 Mbytes.

It's in the keyboard and display processors that the MicroMind

really benefits from its added flexibility. The display processor provides two point-plotting graphics formats on an external CRT, such as a video monitor or television set. The map format displays a bit-map pattern with a 128 by 160-point format. Each picture element corresponds to a bit in memory. The character-display format displays each character in a dot matrix. In this mode, a text memory holds the data to be displayed, and a font memory contains the definition of each character.

By using a RAM font memory instead of a ROM character generator, the MicroMind system can display any alphabet, character set or type face. Each character is defined by the appropriate set of dots within a 8-wide and 12-high dot matrix.

The MicroMind keyboard has 80 keys, each of which has a function defined by software. To match the flexibility of displayed characters, the key caps can be relabeled.

Additions to an improved MicroMind now being developed at ECD include an extension of BASIC high-level programming language—called notso Basic. A line printer to provide hard-copy printout from the system is also in the works. ■■

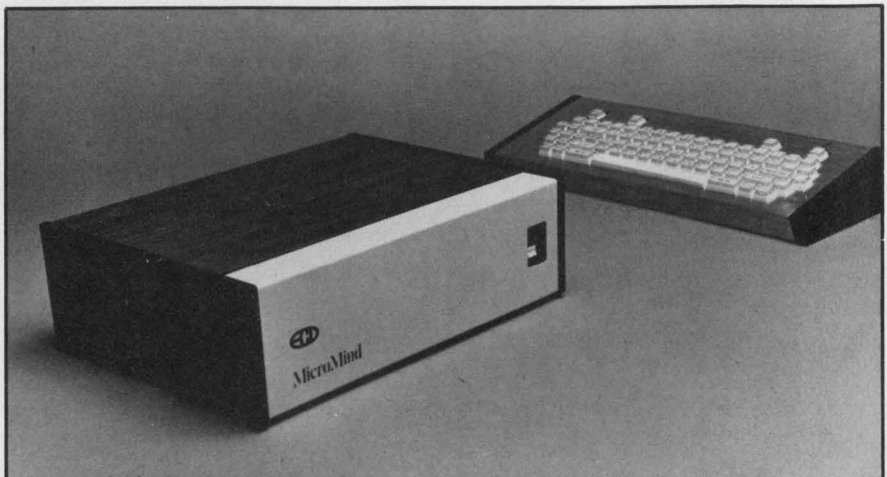

The MicroMind package is a general-purpose computer system that includes a 6512A microprocessor, a character and graphics display processor, an input-output interface board, power supply and keyboard.

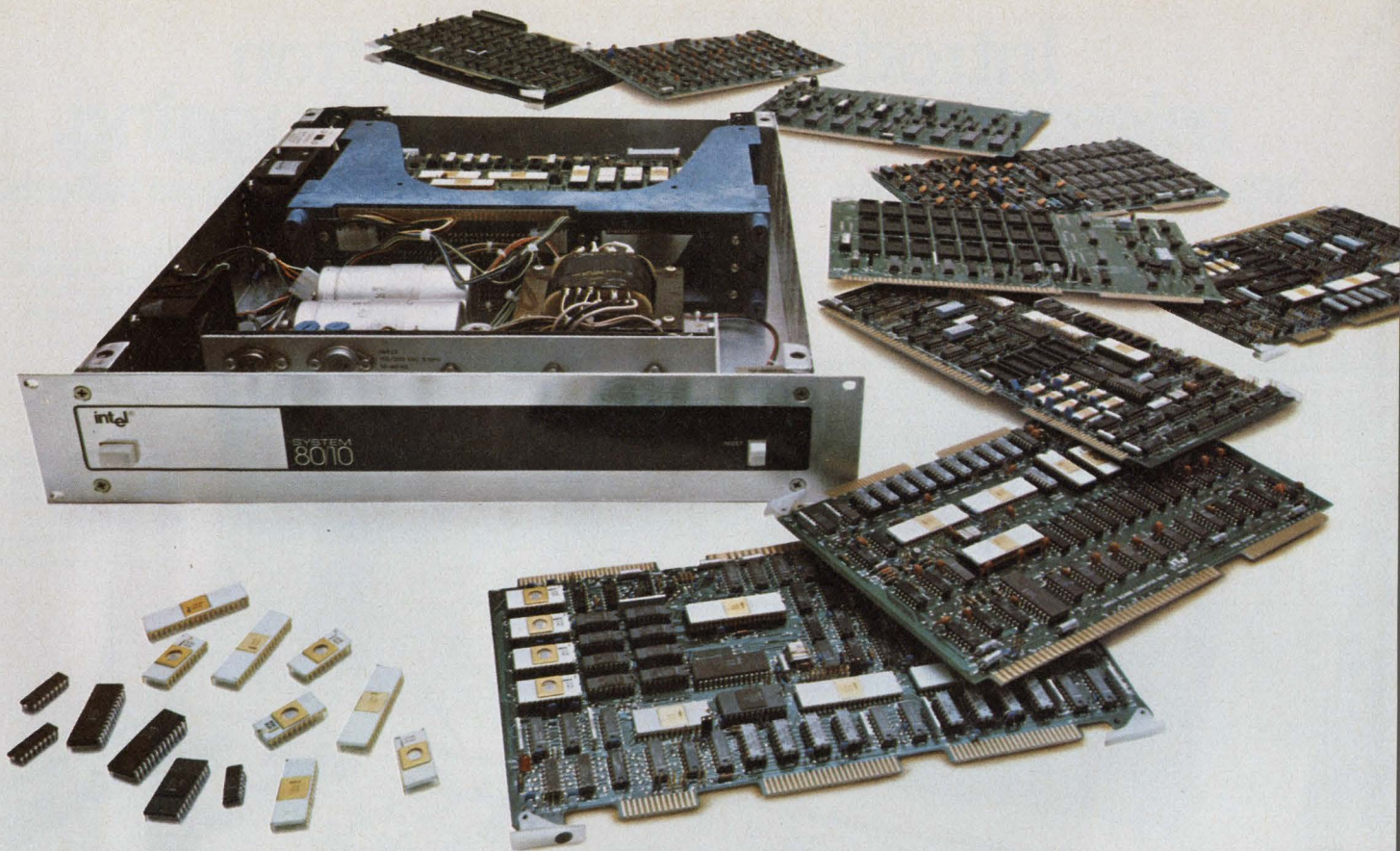

Intel delivers microcomputer systems that take the risk out of becoming successful.

Intel takes the risk out of becoming successful by providing economic, flexible and reliable microcomputer hardware and software solutions for your moderate and high volume requirements.

For most moderate volume microcomputer applications, it makes economic sense to buy an assembled and tested microcomputer system. That's why we offer two Single Board Computers (SBC 80/10, SBC 80/20) and two packaged systems (System 80/10, System 80/20). When you decide it's more economical to do the job "in-house," we'll make arrangements for you to use our bill of material, fab and assembly drawings, and artwork. And since we manufacture *all* the essential components — CPU, EPROMs, ROMs, RAMs, programmable I/O, and other LSI devices in volume, you can order the components from us and continue to take advantage of quantity discounts. *No penalty for success.*

Intel® microcomputer systems are flexible and easily configured to your specific needs. Expanding your system or reconfiguring the I/O is easy. All Intel microcomputer systems are supported by a complete line of I/O and memory expansion boards, diskette and DMA controllers, power supplies, card cages, and accessories. And since I/O, communications, timer and interrupt control functions are programmable, you can reconfigure the system to match your application by altering a few bytes of memory instead of redesigning system hardware.

And Intel delivers more than microcomputer systems that give you the cost/performance advantage. In addition we provide Intellec® Microcomputer Development System support to get you to market sooner. Intellec resident PL/M, the high level microcomputer language, can cut man months off your software development schedule. Intellec ISIS-II Diskette Operating Software, with

linkage and relocation capabilities, will save more programming time. Develop programs in small manageable modules — then link them together or link them with general purpose subroutines from a software library. Reduce system integration and checkout time with the Intellec resident ICE-80™ In-Circuit Emulator. Develop, symbolically debug and execute high level and assembly language programs directly on your System 80 or SBC 80 based prototype.

From hardware and software development all the way through production, Intel gives you the competitive advantage. For a copy of our new 24-page brochure or a demonstration contact your local Intel representative, use the reader service card, or write: Intel Corporation, 3065 Bowers Avenue, Santa Clara, California 95051.

intel® delivers.

Introducing push-button microprocessor system debugging.

HP's 1611A Logic State Analyzer ... Dedicated to all 8080 or 6800 based systems.*

View program flow in mnemonics. With CRT data and addresses selectable in either hexadecimal or octal formats and external lines in 1's and 0's.

Maintain testing control. LED indicators show status at all times. You can monitor system operation at normal speed or stop the microprocessor and give control to the 1611A for single or multiple keyed steps.

Enter data quickly and easily. The hexadecimal keyboard makes trigger and qualifier data entry as easy as operating a calculator. And the CRT display gives you a quick visual check on your entries.

Choose your display. Either mnemonic or absolute (op codes). Roll the display to view any 16-line slice of the 64-byte memory.

Pinpoint virtually any specific event. Trigger on address, data, or external signals... or on any combination of the three. You can also qualify the trigger by bracketing the address and opting to trigger on the nth occurrence of the trigger word. TRIGGER ENABLE and DISABLE keys act as arm and disarm circuits providing unparalleled pinpointing flexibility.

Move the display window. Delay up to 65,472 qualified clocks or memory transactions from the trigger word. Or, pre-trigger to see up to 63 bytes leading up to the trigger word (negative time).

Obtain program and timing data. Qualify the display with TRACE TRIGGER and see only those bytes that match your trigger inputs... all write instructions, for example. Press COUNT TRIGGERS and the 1611A displays the number of trigger occurrences between the TRIGGER ENABLE and TRIGGER DISABLE entries. Push TIME INTERVAL and you get a display of actual elapsed time between selected points in your program on your hardware.

The 1611A should be on hand when you start up your microprocessor-based system. Imagine the time you'll save with push-button operation and an unparalleled view of your system's operation; viewing things dynamically that you never could see before. And there's more... self test; trigger outputs to drive external equipment; error messages to warn of improper operation or setup; and the choice of two initial "μP personality modules" that let you tailor the 1611A to either 8080 or 6800 based systems.



Let HP's 1611A, priced at \$5,000** help you speed development, production-line testing or service. Ask your local HP field engineer for all the details. Ask him about HP's digital seminars too. He can tell you when one will be held in your area and how you can attend.

*and more modules for other microprocessors to come.
**Domestic U.S.A. price only.

HEWLETT  PACKARD

Sales and service from 172 offices in 65 countries.

1507 Page Mill Road, Palo Alto, California 94304
For assistance call Washington (301) 948-6370, Chicago (312) 677-0400
Atlanta (404) 434-4000, Los Angeles (213) 877-1282

CIRCLE NUMBER 28

Managing the data domain.

AIRPAX MAGNETIC CIRCUIT BREAKERS

meet U.L., C.S.A., and
military requirements.

The choice of a protective device for any application involves voltage, current, trip time delay, and short circuit ratings. Such mechanical variables as number of poles, termination, mounting, size, and type of actuation are also involved. Before final selection is made, however, be sure to consider applicable U.L., C.S.A., and military requirements. Chances are that Airpax has the magnetic breaker you need . . . qualified, recognized, or listed for your specific requirements. **Other Advantages.** Airpax magnetic circuit breakers have accurate trip currents. They are not sensitive to ambient temperatures, can be used as ON-OFF switches, and come in single or multipole packages. Some even have a pilot light in the handle and snap-in mounting. **Full Details Available.** For further information on the full line of Airpax circuit breakers, plus U.L., C.S.A., and military listings, request Short Form Catalog 2013 from your local Airpax representative, or contact Airpax Electronics, Cambridge Division, Cambridge, Maryland 21613. Phone (301) 228-4600. Telex: 8-7715. TWX: (710) 865-9655. Other factories in Europe and Japan. European Sales Headquarters: Airpax S.A.R.L., 3 Rue de la Haise, 78370 Plaisir, France.

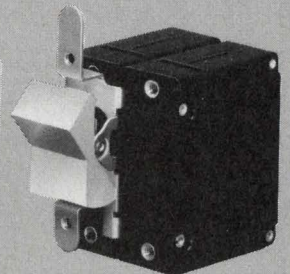
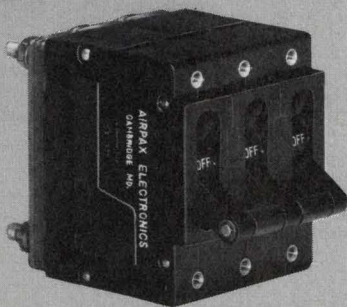
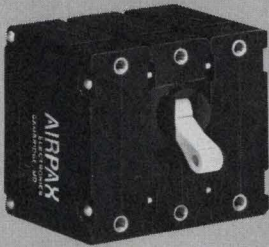
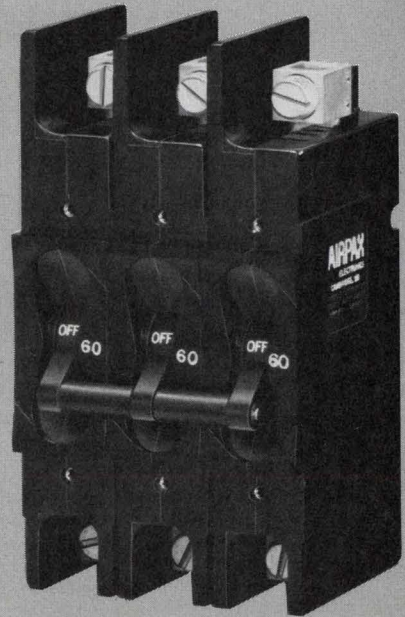

CIRCLE NUMBER 29

AIRPAX™

THE PRO IN PROTECTION

MPU Clock

MC6875 — 2 ϕ M6800 clock gen.

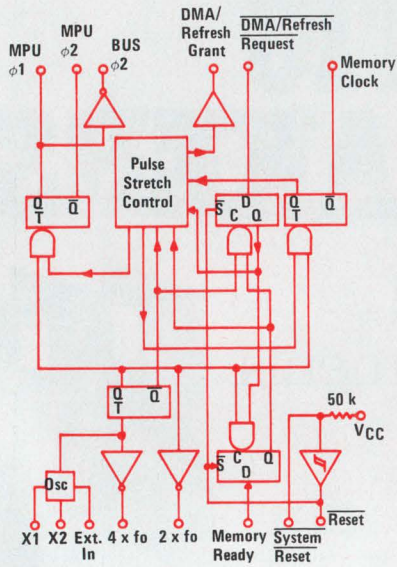

MC6875

Address Bus Extenders

MC6885/MC8T95 — Hex non-inv. bus ext. (6)
 MC6886/MC8T96 — Hex inv. bus ext. (6)
 MC6887/MC8T97 — Hex non-inv. bus ext. (4-2)
 MC6888/MC8T98 — Hex inv. bus ext. (4-2)

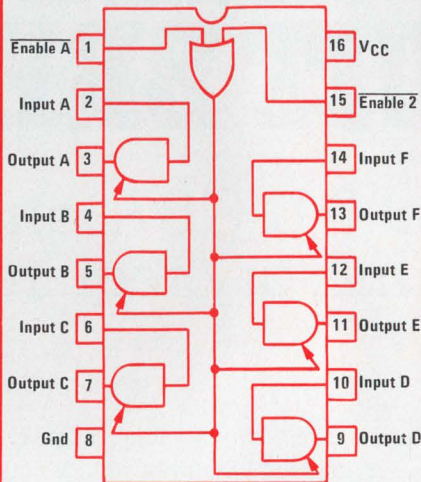

MC6885/MC8T95

Mag Tape Interface

MC3467 — Triple mag tape preamp
 MC3468 — Mag tape memory read amp
 MC75325 — Quad memory driver

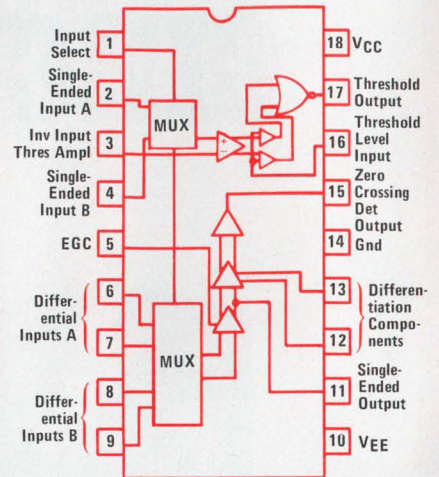

MC3468

Memory Drivers

MC3459 — Quad address buffer
 MC3460 — Quad clock buffer w/refresh
 MC75365 — Quad clock buffer
 MC3245 — Quad clock buffer w/refresh
 MMH0026 — Dual ac-coupled clock dvr.
 MC3232A — Address mux/refresh counter
 MC8T95-98 — Hex 3-state address buffers

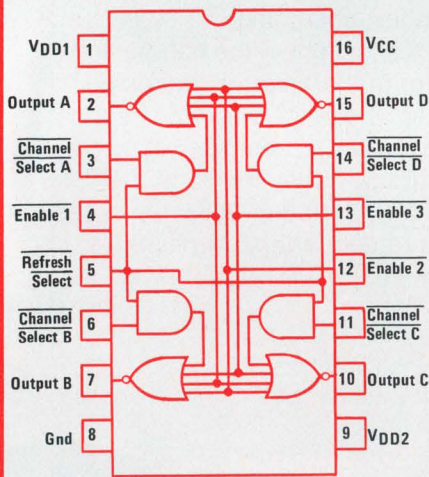

MC3460

Peripheral Drivers

MC75451-54 — Dual 30V peripheral dvr.
 MC75461-64 — Dual 35V peripheral dvr.
 MC1411-16 — 7 Darlington dvr. arrays
 MC1472 — Dual 70V NAND dvr.

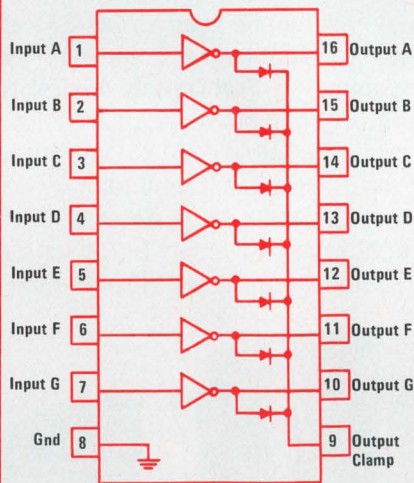

MC1411

Data Bus Extenders

MC6880/MC8T26 — Quad inv. data bus ext.
 MC6881/MC3449 — Triple data bus switch
 MC6889/MC8T28 — Quad non-inv. bus ext.

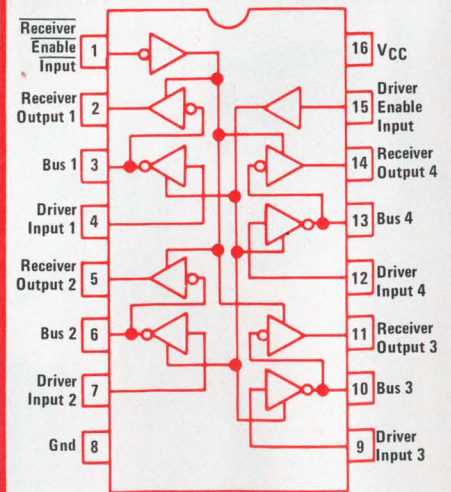

MC6880/MC8T26



MOTOROLA

Introducing MPU Interface IC's so complicated they're simple.

Data Comm Drivers and Receivers

- MC1488-89A — Quad RS-232C dvr. & rcvrs.
- MC3486,87 — Quad RS422 dvr. & rcvrs.
- MC3440-46 — Quad 488-1975 Transceiver
- MC3437,38 — Minicomp Bus rcvr.
- MC8T13-24 — IBM comp bus dvr. & rcvrs.
- MC3416 — 4 x 4 balanced SCR crosspoint

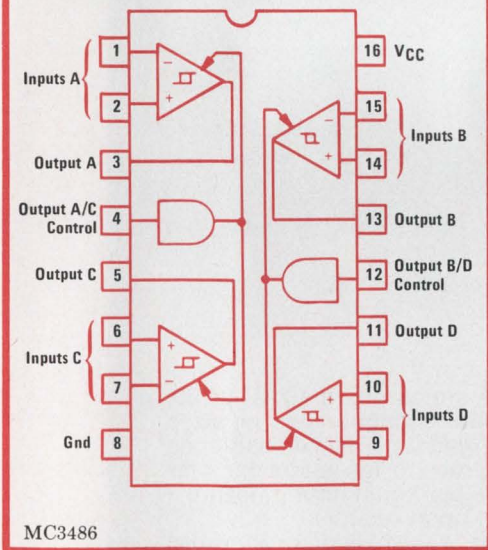

Simple to use. Simple to get.

Motorola's put all the complex functions you need to organize your '6800-oriented system to the nth° into these interface IC's. Neatly. Nicely.

No more jury-rigs and mazes of this, that and the other.

All you do is plug them in and address, extend, clock, drive, etc. to your PIA, ACIA, SSDA, etc.

Simple, right?

And they're available, samples or off-the-shelf, right now, at the right price from factory or authorized distributor.

We know, and you know, it takes a lot more than just an MPU and some memories to build a good system.

But we've made it as simple and easy as possible for you to build it.

Motorola Semiconductor Products, Inc., Box 20912, Phoenix, AZ 85036.

Semiconductors
—and you thought we were just a production house



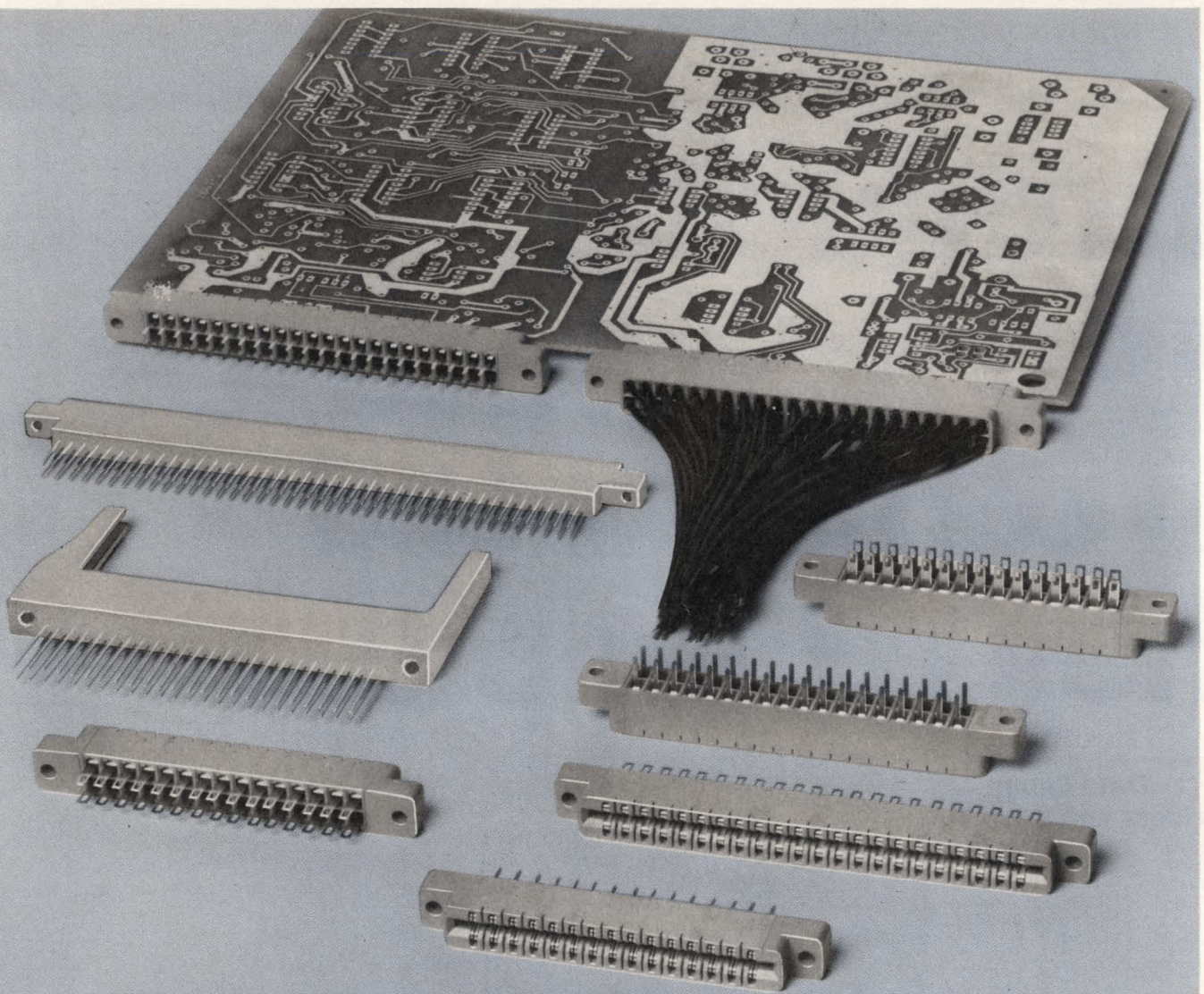

Malco's New Card-Edge and Edgemate™ Connectors!

How to get the edge on your design requirements.

Malco gives you more ways than one. Like our new series 365 and 366 Card-Edge connectors. The 365 has crimp contacts on .156" centers for dual 15, dual 18, and dual 22 configurations. The 366 has crimp contacts on .125" centers for dual 24, dual 36, and dual 40 configurations. Connectors are also available for single readout applications. The .156" x 200 grid are discrete-type connectors with either wire hole tails for solder-to-round wire, or P. C. tails for solder-to-P. C. board, single and dual readout contact applications. Contacts are bifurcated and non-bifurcated. Contact material is phosphor bronze. Plating is 10 microinches gold over nickel or bright tin lead.

Malco's cost-conscious design engineers developed the Edge-Mate card edge connector system .125" spacing in answer to a need for reliability at a reasonable cost without sacrificing performance.

The Edge-Mate discrete series offers sizes 40/80, 36/72, and 51/102 in dual configurations or sizes 36, 40, and 51 for single readout applications. It has reliable one piece construction insulators for pre-loaded single beam contacts for uniform pressure—other sizes are available upon request.

For complete information write Malco, 12 Progress Drive, Montgomeryville, Pennsylvania 18936 or call (215) 628-9800.



MALCO
A Microdot Company
Helping industry put things together.™

Washington Report

Weapons costs approach \$200-billion

Major increases in weapons procurement in the 1980s—such as two more Trident submarines and a doubling of F-16 fighters to 1368—have been revealed in the latest Selected Acquisition Reports (SAR) submitted to the Congress by the Pentagon. The additions, which also include more FFG-7 frigates, F-14A fighters, P-3C patrol aircraft and E-2C airborne early-warning aircraft, drive up the projected cost of the 45 largest military systems to nearly \$200-billion. That's the biggest cost growth revealed in the quarterly SARs since 1970.

Scheduled to be procured in fiscal year 1984, the two additional subs will raise the number in the Trident program to 13. Each will be equipped with 24 MIRVed missiles. Four Tridents are currently under contract with General Dynamics Electric Boat Div. The missile, produced by Lockheed Missiles & Space Co., made its first two flight tests in January and February.

The Trident subs are expected to assume increasing importance as a U.S. strategic deterrent if President Carter carries out his plan to delay the B-1 bomber and M-X missile programs by a year or more.

NASA eyes electronic advances

A synthetic aperture radar (SAR) image processor, a multispectral-scanner data processor, and a family of microprocessors for future spacecraft are three of NASA's new electronic-development programs planned for fiscal 1978, the space agency has told Congress.

The SAR image processor would use digital charge-coupled devices to convert 120-Mbit/s satellite data into images in real time and, according to NASA, would reduce the cost per image from \$12,000 to \$280. (An analog CCD processor is being considered for the Landsat earth resources satellite.)

Space station to cost up to \$3-billion

A minimum-capability space station based on present technology could go into operation by 1985 for \$1-billion to \$3-billion, reports NASA's two study contractors on the project, Grumman Aerospace Corp., and McDonnell Douglas Astronautics Co. Each company has a \$700,000 concept-formulation contract.

A basic station capable of accommodating a crew of four or six will cost \$1-billion, according to preliminary findings. Another \$2-billion will be required for conducting specific missions in low earth orbit, such as

processing materials, erecting large structures in space, generating power, conducting life-sciences experiments, and advanced communications. The station will be put into orbit in modules by the reusable Space Shuttle.

NBS finds VSWR variations in connectors

Subminiature, Type A (SMA) coaxial connectors—the most commonly used types in military and communications microwave equipment—have excellent repeatability up to 18 GHz, but the voltage-to-standing-wave ratio (VSWR) varies drastically among connector types, according to tests conducted by the National Bureau of Standards.

Test values of VSWR, which measures impedance mismatch between cable and connector, ranged from 1.1 to 1.03 at 4 GHz and from 1.2 to 1.5 at 18 GHz. Typical insertion loss varies with frequency, and is equivalent to 1 and 2 cm of Type 141 coaxial line length at frequencies up to 12 GHz, and increases to the equivalent of 10 cm of line length at 18 GHz.

Flying command post due in 1979

The Air Force's first full-capability Advanced Airborne Command Post, a Boeing 747 outfitted with uhf and shf communications-satellite terminals as well as its standard communications equipment, is now expected by the summer of 1979. The first of these aircraft, dubbed the E-4B, has undergone flight tests by prime contractor Boeing and is being outfitted with the satellite terminals by E-Systems of Greenville, TX.

The tested E-4B will join the current fleet of three E-4A flying command posts, which lack the E-4B's satellite communications capability. The aircraft are intended to be used by the President and Secretary of Defense to direct military operations from the air in case of nuclear attack. Two more E-4Bs will be delivered before the companies upgrade the current E-4As to the full-capability configuration. The whole program is due to be completed in 1983 at a cost of nearly \$150-million per aircraft, which makes the flying command post the most expensive aircraft in history.

President Carter last month became the first President to fly in an E-4A. President Nixon had once flown in the earlier model EC-135 flying command post.

Capital Capsules: Even though it isn't operational yet, the Air Force's **Cobra Dane phased-array radar** was used to track the recent Soviet missile tests in the Pacific. The system is currently being installed by Raytheon on Shemya Island in Alaska, at the western tip of the Aleutian islands and just 450 miles away from the Soviet Union. The system reportedly can also detect and track 200 objects in space simultaneously. . . . One of the Carter administration's first opportunities to spell out its future procurement plans for industry will be at the **Electronic Industries Association's annual "Doing Business with the Government" seminar in Washington March 15 to 17**. Also on the agenda is how the new A-109 procurement circular standardizing federal procedure will impact industry. . . . Despite opposition from local environmentalists, Michigan's Upper Peninsula remains the Navy's first choice for its **Seafarer ELF communications system**. The draft environmental impact statement has been completed and public hearings are planned in late March and April.

New from Centralab...

IMPS PUSHBUTTON SWITCHES

A new miniature modular building block system that offers microprocessor control designers more of what they need.

To meet the special digital and analog needs of today's μ P-based controls, Centralab offers design engineers a whole new system of modular push-button switch building blocks. We call it IMPS — Integrated Modular Panel System. IMPS saves PC board and panel area and simplifies front panel design, cuts assembly costs, reduces back-panel space requirements, and meets the digital-analog needs of μ P-based controls. Check these space saving, cost-cutting features.

Simplify front panel interface.

All IMPS switches regardless of function, are uniform in size, simplifying design and selection of front panel hardware. They have high volumetric efficiency, occupying .505" x .388" PC board area and require only .608" of space between PC board and front panel.

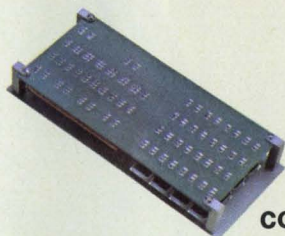
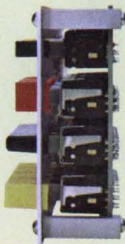

**Cut
assembly
costs.**

IMPS switches may be mounted on the front panel, and are designed for automatic wave soldering installation and PC board cleaning. Insert molded terminals prevent flux and solder wicking and contact contamination. Integral PC board stand-offs provide for efficient board cleaning.

Meet analog and digital needs.

IMPS switches are available with momentary, push-push and interlocking actions, with a long-life contact system that switches both digital and analog signals. To accommodate critical signal requirements, housings are high-insulation molded plastic with UL 94V-0 rating.

Available options.

Optional installations include ganged assemblies, front-panel mounting and wire-wrapping.

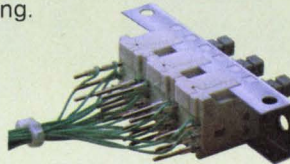

All IMPS pushbutton switches are built to Centralab's highest quality standards (see specifications at right). They're priced as low as 41 cents in 1,000 quantity. For full technical details, samples and quotation, call (515) 955-3770, or write to the address below.

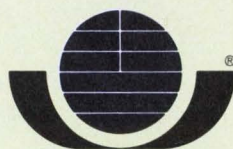

CENTRALAB

Electronics Division

GLOBE-UNION INC.

P.O. BOX 858

FORT DODGE, IOWA 50501

CIRCLE NUMBER 32

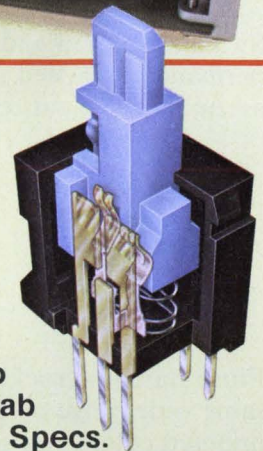
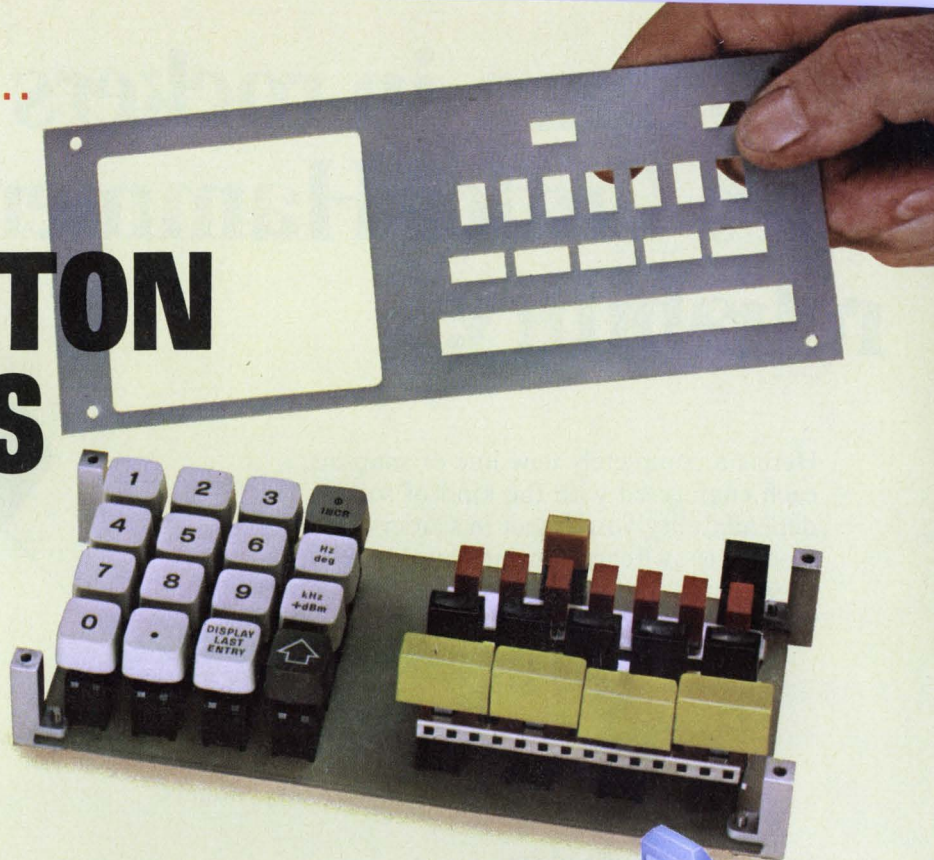

Built To Centralab Quality Specs.

IMPS Pushbutton Switches combine compact size, low cost and highest quality throughout.

- Silver or gold inlay wiping contacts for long-life and low-contact resistance.
- Less than 2 milliseconds contact bounce.
- SPST, SPDT, DPST, and DPDT switch contacts.
- Printed circuit, DIL socket or wire-wrap terminations available.
- 2.5 to 3.5 oz. actuation force (momentary).
- Choice of button interface — square or blade shaft (shown) — permits use of a variety of Centralab and industry standard buttons and keycaps.
- 10, 15, 20 or 25mm center-to-center spacing.

New snap-in rockers with Cutler-Hammer reliability.

Here's a completely new line of snap-ins, each engineered with the kind of solid dependability you expect in Cutler-Hammer Rockette® switches. Bright metal bezels, illuminated and non-illuminated, A-c and D-c capabilities up to 20 amps.

Sub-panel rockers in a variety of colors, rocker or paddle designs in standard, special, or proprietary models.

Switches snap in and stay in permanently. Speed up assembly time, cut costs.

Flush-mounted rockers in the same wide range of designer-oriented colors and styles. One- and two-pole models.

Illuminated single-pole rockers. Choice of red, green, amber, white, or clear. Hot-stamped legends indicate switch functions.

For more information, call your Cutler-Hammer Sales Office or Switch Distributor.

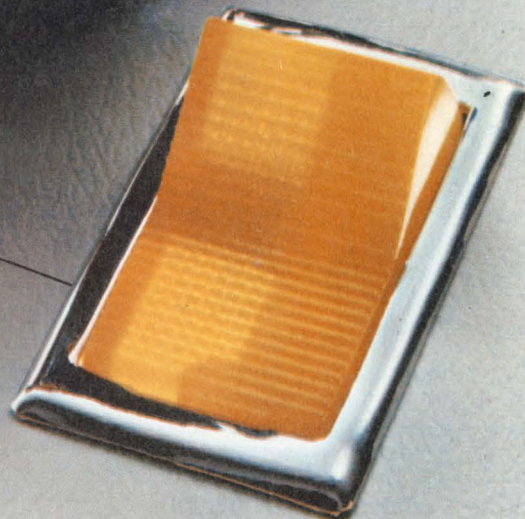

CUTLER-HAMMER
SPECIALTY PRODUCTS DIVISION, Milwaukee, Wis. 53201

CIRCLE NUMBER 33

 **Switch to No. 1**

How to get the benefits of CMOS in your static RAM sockets:

Unplug your 2102's

Plug in our CMOS 5102's.

It's truly simple. Our 1Kx1 SY5102 static RAM is a pin-compatible CMOS replacement for the popular but power hungry 2102.

With our new 5102 you can just replace parts in your existing designs and immediately cut power—both operating and standby. And the standby requirement is only 1 (one!) mW at 5 Volts. No power-down circuitry needed.

Whenever our 5102 is not enabled, it's in standby. You can use power-down circuitry if you want, but it's not required. Terrific for systems that use battery backup. It runs at 5V, keeps memory alive at 2V!

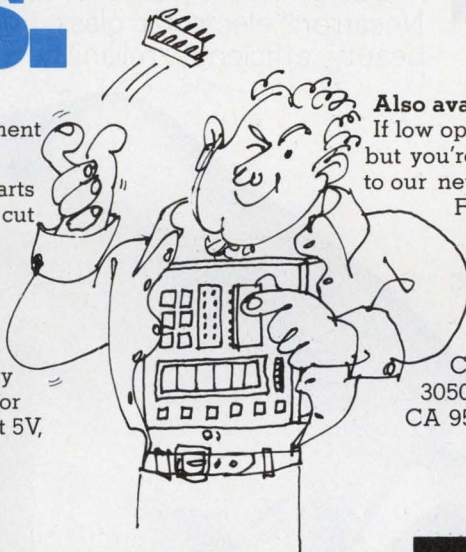

Also available: SY21L02

If low operating power is interesting to you, but you're building low-cost memories, turn to our new SY21L02 N-Channel static 1K RAM. It needs only 15mA operating.

The data sheet will give you all the details.

For data sheets, samples or information about either SY5102 or our SY21L02, call or write Bob Cushman. (408) 984-8900.

3050 Coronado Drive, Santa Clara, CA 95051.

Synertek Saves.

 **Synertek.
Solutions.
Not problems.**

PPG helps keep things under control.

With glass.

PPG electronic glass with a permanent, transparent, electrically conductive, metallic oxide coating. PPG provides two different coated glasses for two separate custom products: touch control panels and electronic displays.

Touch control for devices and appliances like calculators, ranges, TV receivers, and



dozens of other kinds of electronic equipment.

And for visual displays on digital clocks, wristwatches, calculators, and on any other instrumentation your fertile mind can create.

One brand of PPG electronic glass is Nesatron® glass. Its coating has a hardness and

durability far superior to evaporated coatings. It is applied at relatively low temperatures, so the process has no effect on the flatness of the glass substrate. It can be readily etched to create diagrams, letters, numbers, or any other design that suits your purposes.

The other PPG electronic glass is Nesa® glass. Because of its durability, it is ideally suited for use in electronic controls, and offers you the opportunity to abolish buttons, knobs, dials, and switches.

Design with PPG Nesa® and Nesatron® electronic glass. For beauty, efficiency, reliability.

And we'll help with complete information: Just write Industrial Glass Products, PPG Industries, Inc., One Gateway Center, Pittsburgh, Pa. 15222.



PPG: a Concern for the Future

PPG
INDUSTRIES

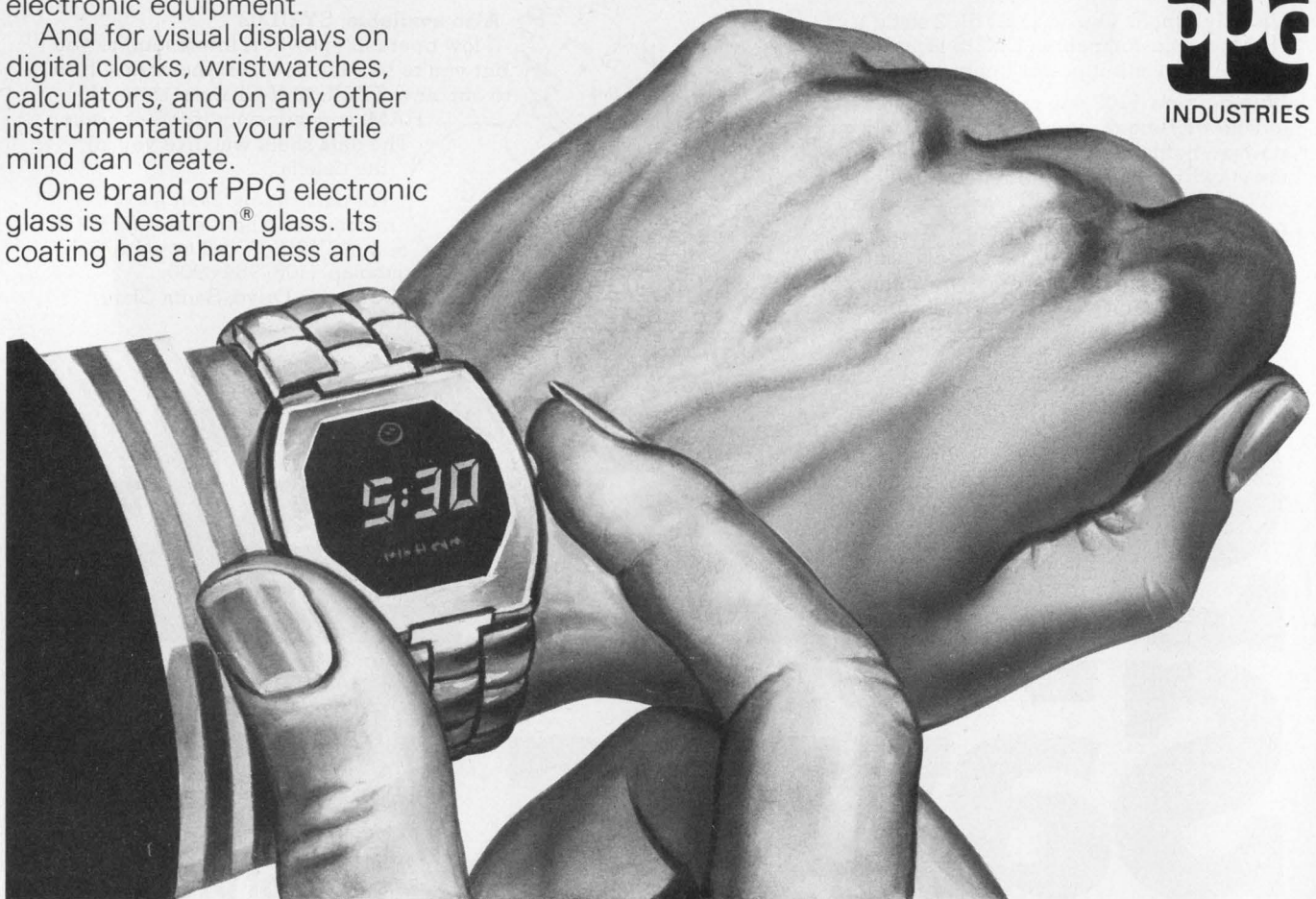

CIRCLE NUMBER 35

Last week Helen Kratzer had visitors from Hamilton- Junior Corn had a new calf- and Wabash made one million coils.

It was a typical week in Wabash, Edna Fitch and Gladys Sands made 4 pots of their famous chicken noodle soup for the church supper, Tommy Butcher had to stay after school again and things were humming over at the Wabash plant.

Coils, ranging in size so small that 150 can be placed in a teaspoon to some weighing over 10 lbs. were moving off high speed production lines.

No wonder. Wabash is the country's largest maker of molded coils including epoxy, nylon,

and engineered thermoplastic and thermoset material with over 20 standard epoxy formulations and hundreds more that can be adapted for specific application such as heat, cold, rain, salt and sun.

Things change quickly nowadays. But two things you can count on. Whether it's next week or next year, Edna and Gladys' chicken soup will still be the best around—and Wabash will still be the nation's leader in coil manufacturing.



Shown: custom engineered thermoplastic and thermoset molded coils for automotive applications.

Coils, Relays & Transformers
wabash
of
Wabash, Indiana
and Huntington, Indiana; Farmington, Missouri;
Tipton, Iowa and South Boston, Virginia
For information and quotes write or call:
Wabash, Inc., Dept. CB-1, 810 N. Cass St., Wabash, Ind. 46992 Tel: 219/563-3111 TWX 810-290-2724
CIRCLE NUMBER 36

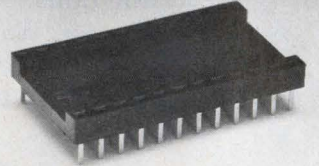
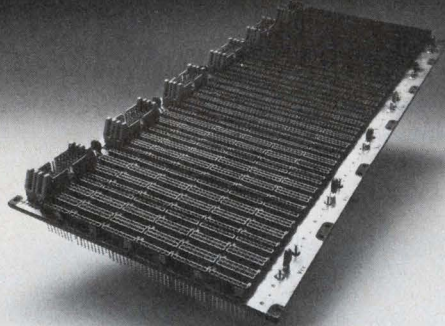
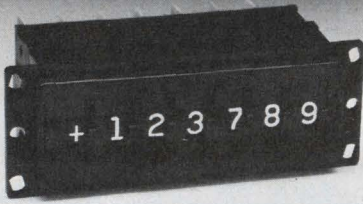
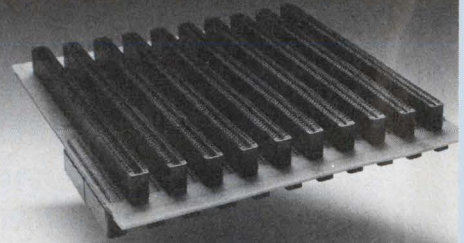
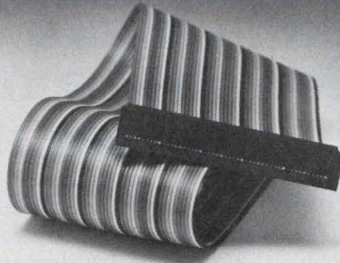

THE OEM CONNECTION

When you do business with SAE, you're well connected. We make edgeboard connectors, flat flex cable interconnection systems, switches, logic panels, backplanes and IC sockets. And that's just the beginning.

We also supply complete wiring and sub-assembly services, printed circuits, card files, MIL-C-5015 and other extreme environment connectors, transformers, chokes, delay lines and RF filters.

We're a growing, broad-line supplier of elec-

tronic OEM hardware, ready to quote and deliver anything from a wide selection of individual components to a completely assembled interconnection system.

Component specs are in our catalog, and guidance on ways to save time and money is as close as an SAE sales rep. If you haven't yet made The OEM Connection, do it now. Write Stanford Applied Engineering, 340 Martin Avenue, Santa Clara, California 95050. Phone (408) 243-9200. TWX 910-338-0132.



Plants at Santa Clara and Costa Mesa, California, West Babylon, New York and Boulder, Colorado.

CIRCLE NUMBER 37

Microprocessor Design

Should you use static or dynamic RAMs? Only the system can say for sure

When designing a microprocessor memory system, the choice of a RAM is more than a simple question of dynamic versus static. "It's no use comparing dynamic and static data sheets," says Daryl Koker, memory applications manager at Mostek. "It isn't a device comparison at all—it's a system consideration."

While dynamic RAMs offer greater bit density than static RAMs—1 sq. mil per bit versus 4 to 5 sq. mils—and are cheaper, there are other more important parameters to consider before committing to one family or the other.

The cost of power now runs about \$1.25/W, and dynamic memory systems use only one-third the power of static memory systems. But, as always, to avoid that cost, some complex peripheral circuitry must be added to the dynamic system.

Peripheral circuitry cost is essentially a step function—design and build it into a system just once, and it will accommodate a wide range

of memory system sizes. But the cost of power increases linearly with memory size.

In a small system, designing and providing peripheral logic to support dynamic chips may be very expensive. Interfacing dynamic memories to the rest of the system can also be complex: Three separate power supplies are usually needed (+12 V_{dd}, +5 V_{cc}, -5 V_{bb}) and designing the address-scanning and clocking logic can be time-consuming.

Static memories, however, are ideal for small systems. Directly TTL-compatible, they often require just a single +5-V power supply and need only to be addressed by the central processing unit (CPU). And the design effort is quick and easy.

On the other hand, says Koker, large memory systems simply can't justify the power required by an array of static devices. Hardware is expensive, dissipated heat is adverse to reliability,

(continued on page 52)

Computer-in-a-book easily expands to complete system

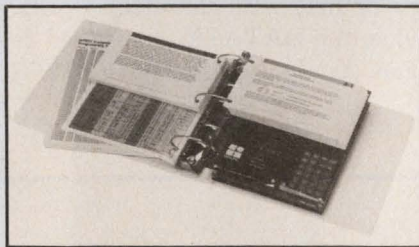

Originally designed to serve as an instructional course for engineers and/or hobbyists, the Iasis ia7301 computer-in-a-book will soon be expanded into a complete microcomputer family. Additional memory and interface cards, capable of increasing capacity from 1 to 65 kwords of memory and from 2 to 256 I/O ports, are now available. Soon to be announced are cards for CRT-display driving, full keyboard interfacing and floppy-disc interfaces.

The ia7301 consists of a 250-page programming course, an 8080-based microcomputer and a hex keyboard—all in a standard three-ring looseleaf. The μ C board holds a cassette-tape interface, 1 kbyte of RAM, 1 kbyte of PROM, 8 seven-segment LED displays, 3 indicators and a 25-key keypad.

Available completely assembled and tested, the ia7301 also includes a hex-conversion card and a machine-language coding pad. The computer requires +5 and +12 V, and all interfaces are made via a 28-pin edge connector. The computer-in-a-book costs \$450, and delivery is 4 weeks.

Iasis, 815 W. Maude Ave., Sunnyvale, CA 94086. Charles Hornisher (408) 732-5700.

CIRCLE NO. 417

MICROPROCESSOR DESIGN

(continued from page 51)

and end users are increasingly conscious of the cost of power.

Dynamic memories run cooler than statics and, since they can be packed more tightly together, save on costly board area. The large-systems manufacturer strives to get the highest possible memory size-to-package ratio and, once the peripheral circuits have been designed and built into a memory, can add address multiplexing logic to accommodate packages of ever-increasing density.

Because of lower over-all hardware cost, dynamic memories gravitate toward bulk-storage applications. And since static memory systems cost less to design, they are more efficiently used in applications requiring a minimal hardware outlay.

Traditionally, RAM manufacturers have addressed their biggest markets first—the large-system houses that buy high volumes of dynamic RAMs. Low-volume static-RAM users must wait for the higher-density memory products.

Today, 16-kbit dynamic memories, like Mostek's MK 4116, are available in production quantities. But for someone working with static parts, the maximum density currently available is only 4 kbits. However, since dynamic RAMs usually precede static-RAM development, many

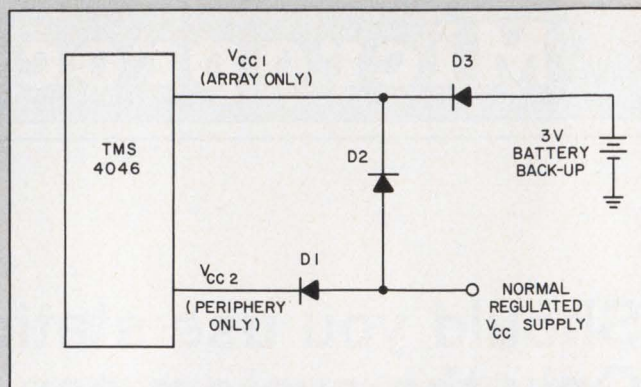

static and dynamic 4-kbit RAMs are currently available.

In addition to the present repertoire of clocked static RAMs and self-refreshing dynamic devices, a number of schemes will be introduced to combine the ease of static RAM system design with the power-saving aspects of dynamic RAMs, predicts a spokesman for Texas Instruments.

For example, Texas Instruments will bring out 4-k static RAMs, the TMS 4046 and 4047. These products have split internal power requirements—the actual memory array is powered independently of the decode, read, write and chip-enable circuitry. Most of the overhead power is eliminated, and the device's memory array can be kept "alive" with only a few milliwatts per package, versus hundreds of milliwatts for currently available static RAMs.

Program 6502 systems with resident assembler/editor

A resident-software-assembler program, the DATA1K, provides 6502-based systems with full assembly-language capability. The DATA1K assembler/text editor requires about 4500 words of RAM and comes on either paper tape or magnetic cassette. Available at a cost of \$250, which includes a one-year update service, the DATA1K is shipped from stock. Johnson Computer, P.O. Box 523, Medina, OH 44256. Kevin Johnson (216) 725-4560.

CIRCLE NO. 418

16-channel multiplexer handles synchronous/asynch data

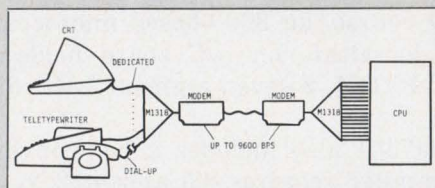

Handling up to 16 asynchronous or synchronous digital data channels—or any mixture of both types—the μ P-based M1318 Multitran multiplexer lets remote job entry terminals, synchronous video-terminal controllers and interactive asynchronous terminals communicate over a single voice-grade telephone line. The M1318 may connect terminals via dial-up or dedicated modems,

short-haul data sets, or direct EIA cabling.

Aided by an 8080 microprocessor, the M1318 also provides optimum multiplexing capabili-

(continued on page 54)

Status symbols



**the first thing
pushbutton controls
indicate is the
quality of your product**

In a world where first impressions mean so much, why settle for esthetically (and functionally) inferior pushbutton switches, when you can choose EAO pushbutton controls at competitive prices? EAO holds the line on price, AND quality. With EAO on your panel you don't have to accept second-class appearance or performance... hot spots, fuzzy legends, tinny-looking bezels, uncoordinated configuration and size, and faulty human engineering. EAO controls enhance your product.

And EAO gives you complete design freedom. You can select mechanical or electronic switches... combine up to 9 lens colors with bezels in rectangular, round, square or dual

rectangular shapes... choose switch and contact combinations from 1 to 4 poles momentary or alternating action... even harmonize the full range of lighted and non-lighted pushbutton controls with compatible key lock designs.

Available contact arrangements and contact materials have ratings from low-level to 10A @ 250 VAC. No matter how complex or wide-range your needs, EAO Status Symbols allow you to single-source all requirements.

Write or call today for samples, technical data, and prices on these and other Unimax LPB switches. Unimax Switch Corp., Ives Road, Wallingford, Connecticut, 06492; Tel. (203) 269-8701.



Unimax Switch

MICROPROCESSOR DESIGN

(continued from page 52)

ty for small-to-medium sized networks. The byte-interleaved M1318 can handle asynchronous low-speed inputs at data rates of 75, 110, 134.5, 150, 300, 600 and 1200 bps, on either dial-up or dedicated lines. It can also accommodate synchronous high-speed data rates of 1200, 2400, 4800 and 9600 bps.

The basic unit consists of an interface module, chassis, cabinet and power supply and measures $9.5 \times 18 \times 13.8$ in. A complete 16-channel, point-to-point multiplexing network between a terminal cluster and a computer center with mixed synchronous and asynchronous inputs, costs approximately \$10,000.

Computer Transmission Corp., 2352 Utah Ave., El Segundo, CA 90245. J. Robert McConlogne (213) 973-2222.

CIRCLE NO. 419

Minimize programming with μ P-controlled laser-trim system

For the engineer who wants to maintain a dialogue with a laser trimmer without resorting to time-consuming computer programming, a μ P-controlled system permits working programs to be stored and retrieved easily with a dual floppy-disc memory. The Model 1080 from Quantrad, El Segundo, CA, comes with software that is compatible with interactive and adaptive programming languages and is fully operational with IEEE/ASCII instrumentation interface.

Considered a low-cost approach to the high production of thick and thin-film resistor trimming, the system combines a krypton-pumped Q-switch YAG laser with closed-loop galvanometer beam-positioning at a basic price of \$85,000.

The μ P in control is the 8080—chosen, Quantrad's chief scientist says, because it was the only multiple-source μ P around when the system was being designed, and because of the μ P's wealth of available software.

For active or functional trimming, the Model 1080 is capable of full computer control and instrumentation interface. Critical operational parameters of the laser are displayed on the monitor in real time, such as laser-pump current, laser power and, as safety measures, the flow rate of the cooling water and the temperature of the water.

CIRCLE NO. 420

Reduce 8080 program development with flexible microcomputer

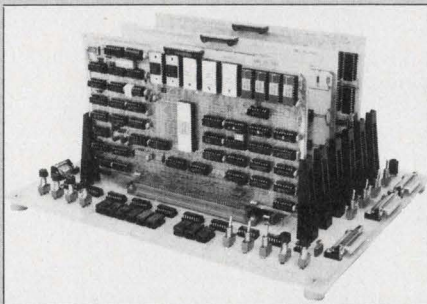

Designed to shorten the time needed to design an 8080-based system, the QMS development system is a flexible design with seven basic boards: an 8080-based processor board, a system-extender board, four different memory boards and an EPROM adapter board. Two motherboards are also available.

The processor board, the QMS 80-1180, contains an 8080 μ P, 2 kbytes of RAM, 1500 bytes of PROM, an RS-232/20 mA interface, a 1-MHz clock and baud-rate selector, and a comprehensive monitor program. The extender board,

QMS 80-1401, provides a fully mnemonic direct assembler that does instruction decode, tables, program printout, program trace, ASCII manipulation and priority interrupts.

RAM boards are available in capacities ranging from $4 \text{ k} \times 8$ to $16 \text{ k} \times 8$ in Models QMS 00-1250, 1230, 1201A, 1201B. The EPROM adapter board, which plugs into the PROM

(continued on page 56)

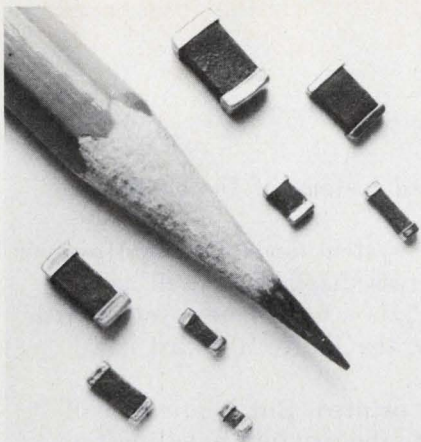

MIDGET®

Chip Capacitors with ratings to 100 μ F!

SPRAGUE TYPE 194D solid-
Electrolyte tantalum chip capacitors
are available in 8 different sizes to
ensure the most efficient use of sub-
strate space in hybrid circuit layout.
The smallest size, a tiny .100" x .050"
x .050", has a capacitance range up to
2.2 μ F @ 4 WVDC, while larger chips
have capacitance values to 100 μ F.

Completely compatible with mech-
anized hybrid circuit assembly equip-
ment, without the problems normally
associated with flexible terminal lead
wires or unprotected anode contacts,
MIDGET capacitors can be attached
to substrates by dip-soldering, reflow
soldering, epoxy bonding, or other
conventional methods.

The capacitor elements of Type
194D capacitors are completely cov-
ered with a silicone encapsulant to
minimize undesirable parametric
changes or failures due to mechanical
degradation. Operating temperature
range is -55°C to $+125^{\circ}\text{C}$.

*For complete technical data, write
for Engineering Bulletin 3534 to:
Technical Literature Service,
Sprague Electric Co., 347 Marshall
Street, North Adams, Mass. 01247.*

49E-6103

SPRAGUE®

THE MARK OF RELIABILITY

CIRCLE NUMBER 39

ELECTRONIC DESIGN 6, March 15, 1977



the EMI suppressors

Series JX2000/3000 Subminiature Filters... Broadest Line of Ultra-Small Interference Control Components Available... in 4 weeks or Faster!

- Excel in IR @ 125°C . . . 50-500 megohms; good improvement over industry standard of 5-50 megohms.
- High performance filters available in 5 different circuits—Feed-thru, L, Pi, T, 2L . . . for a wide variety of applications, including power and control lines.
- JX2000 Series, up to 15 amperes and 200 VDC @ 125°C ; JX3000 Series, up to 15 amps @ 125 VAC/400 Hz/ 125°C .
- Qualified to meet MIL-F-15733/23 and MIL-F-15733/26.
- Hermetically-sealed . . . with glass-to-metal seals in corrosion resistant metal cases.
- Small in size yet big in reliability . . . particularly useful for industrial and military high-density packaging applications.
- High insertion loss characteristics and excellent stability, even under adverse environmental conditions, over operating temperature range of -55°C to $+125^{\circ}\text{C}$.
- Threaded-neck construction . . . effectively isolates input and output terminals.

selected units NOW available
OFF-THE-SHELF from your
Sprague Industrial Distributor

*For complete information, write for Engi-
neering Bulletin Series 8132 to: Technical
Literature Service, Sprague Electric Company,
347 Marshall St., North Adams, Mass. 01247.*

THE BROAD-LINE PRODUCER OF ELECTRONIC PARTS

SPRAGUE®

THE MARK OF RELIABILITY

CIRCLE NUMBER 40

MICROPROCESSOR DESIGN

(continued from page 54)

sockets on the processor board, permits UV PROMs to be used instead of fusible-link PROMs.

Both three-slot and six-slot motherboards are available for system development. However, the six-slot board, the QMS 00-1501, contains data and address displays as well as many control switches. The three-slot board, the QMS 00-1510, is a bare-bones system with no display and just three control switches. All boards except the EPROM board use 100-pin edge connectors.

Due to international currency fluctuations, prices cannot be printed. But inquiries will be answered. The company is also inviting U.S. distributors to inquire into handling the equipment line.

Quarndon Electronics, Slack Lane, Derby DE3 3ED, England. Telephone 32651. Telex 37163.

CIRCLE NO. 421

Support circuits added to 8080 repertoire simplify system design

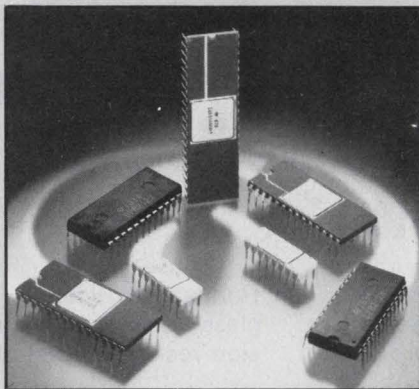

An expanded line of interface and support circuits for the 8080A microprocessor plus two additional versions of the 8080A μ P have been introduced by National Semiconductor. The INS8080A-1 and INS8080-2 offer 1.3 and 1.5- μ s cycle times.

The interface devices include an 8-bit I/O port (DP8212), a clock generator and driver (DP8224), and a single-chip system controller (DP8228) and bus driver (DP8238), all built with Schottky bipolar technology. Two other interface circuits, an interface latch element (DP8301) manufactured by silicon-gate CMOS process and an 8-bit bidirectional bus transceiver (DP8304) fabricated by low-power Schottky process, are also

available from the company.

Three I/O buffer drivers will soon be ready for both 8080A and general μ P applications. The DP8216 and DP8226 are 4-bit parallel transceivers and the DP8304 is an 8-bit bidirectional bus transceiver. The DP8304 will provide high, active outputs to both ports, as well as sink 50 mA on the bus port and 5 mA into low-power Schottky loads. Prices for the circuits start at \$2.90 (in 100-unit lots) for the 8212, and delivery is from stock to 60 days.

National Semiconductor Corp., 2900 Semiconductor Dr., Santa Clara, CA 95051. Chuck Troiani (408) 737-5873.

CIRCLE NO. 422

Micro Capsules

Cutting corners for high-volume users of its 1802, RCA in Somerville, NJ, has trimmed down the 40-pin μ P so it can fit into a 28-pin DIP. Tentatively called the 1803, the new unit will lose some flag lines, an N line, the DMA interface and some other features, but otherwise be compatible with the 1802. . . . A complete microcomputer on a chip is being readied for introduction in late April by Signetics, Sunnyvale, CA. The chip will contain 2 kbytes of mask-programmable memory, have 31 I/O lines and be program-compatible with the company's 2650 μ P. . . . An 8085-based microcomputer kit, under development by Intel, Santa Clara, CA, will be patterned after the company's successful SDK-80 and should be available by mid-year. . . . Look for a complete Basic interpreter to come from Motorola, Phoenix, AZ, in the next month. The interpreter is expected to require 8 kwords and cost under \$300.

**Need power-switching inductors
for switching regulators?**

TRW/UTC has a stock answer.

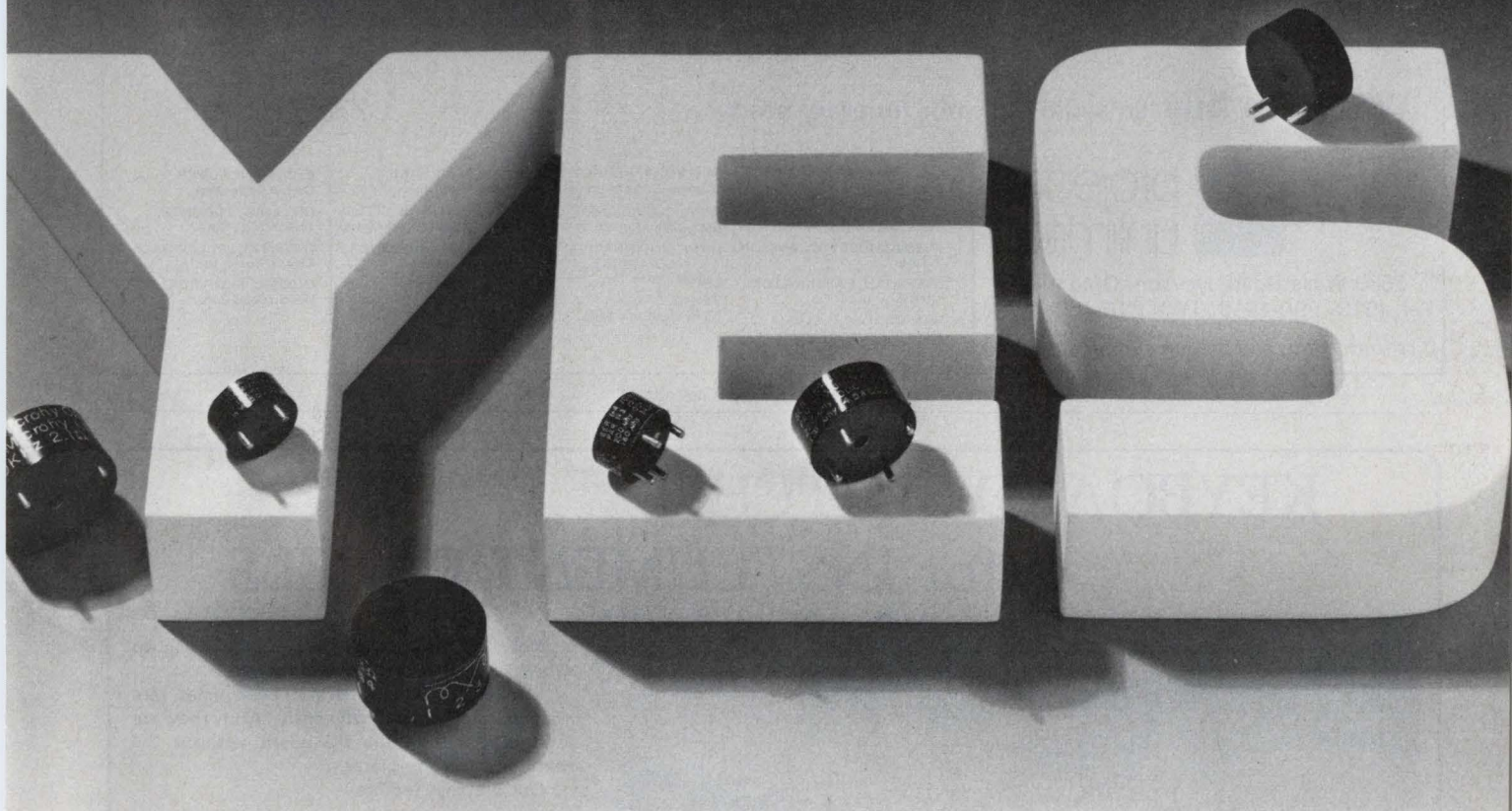

Introducing the SR series, a family of miniature high-performance, power-switching inductors.

Our SR Inductors reduce size and weight. Now you have off-the-shelf power-switching inductors with performance advantages over your in-house capabilities.

Low temperature rise and low loss characteristics combine to give the SR series high performance with maximum reliability. With an inductance range of 8 to 10,000 UHy, a DC current range from .8 amps to 15 amps, SR Inductors have low losses in the 3 to 100 KHz frequency range, making them ideal for use in switching regulators and AC filter-choke applications.

Compact and easy to install, the SR family has pin

terminals for mounting on PC boards. Available with double windings, which when brought out to four terminals permit series, parallel, center-tapped or transformer connections.

Available from stock in three sizes. Type SRA measures 7/8-in. OD by 7/16-in. height; SRB measures 1-3/16-in. OD by 9/16-in. height; and SRC measures 1-3/8-in. OD by 3/4-in. height.

Check your authorized TRW/UTC local distributor for immediate off-the-shelf delivery or contact TRW/UTC Transformers, an Operation of TRW Electronic Components, 150 Varick Street, New York, N.Y. 10013. Area Code: 212 255-3500.

TRW UTC TRANSFORMERS

ANOTHER PRODUCT OF A COMPANY CALLED TRW

CIRCLE NUMBER 41

Model
AI-400

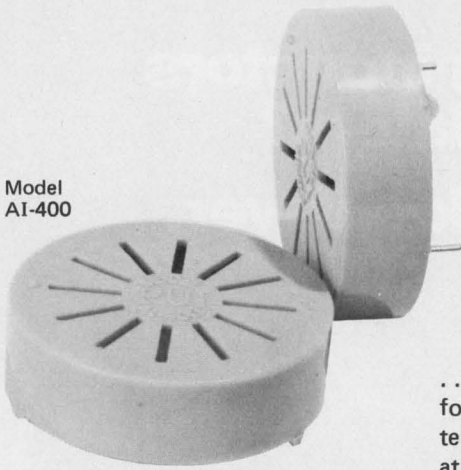

Actual Size

WE'RE WARNING YOU...SM

... this is a lot of buzzer in a little package! Designed with two pins ... for PC board mounting and wave soldering. Easy to use for computer terminals, medical equipment, point-of-sale terminals. Rated to 90 dbA at 2.9 kHz; 5 to 30 vdc; draws just 10 mA maximum current. Sturdy yellow plastic case; 1.625" (41.3mm) overall diameter. Ask for free catalog and a demonstration.

Where to buy an audio indicator for every need:



projects[®]
unlimited

3680 Wyse Road, Dayton, Ohio 45414
Tel. (513) 890-1918, TWX 810-450-2523

Distributorships and sales territories available.

CALIFORNIA, COSTA MESA
MarVac Electronics

COLORADO, DENVER
Waco Electronics Inc.

MASSACHUSETTS, SHARON
Adcour

MICHIGAN, FARMINGTON
CMP Distributor Co.

MISSOURI, ST. LOUIS
Olive Industrial Elec.

NEW YORK, ROCHESTER
Osmann Component Sales

OHIO, CLEVELAND
CMP Distributor Co.

OHIO, CINCINNATI
COLUMBUS
Hughes Peters, Inc.

TEXAS, DALLAS
K. A. Electronic Sales

UTAH, SALT LAKE
Newark Electronics

WASHINGTON, SEATTLE
Frank Jackson & Associates

WISCONSIN, MILWAUKEE
Taylor Electric Co.

B. C., VANCOUVER
Deskin Sales Corp.

ONTARIO, TORONTO
Deskin Sales Corp.

ONTARIO, WILLOWDALE
Electro Sonic, Inc.

QUEBEC, MONTREAL
Deskin Sales Corp.

CIRCLE NUMBER 42

KEYBOARD SWITCHES for INSTRUMENT PANELS

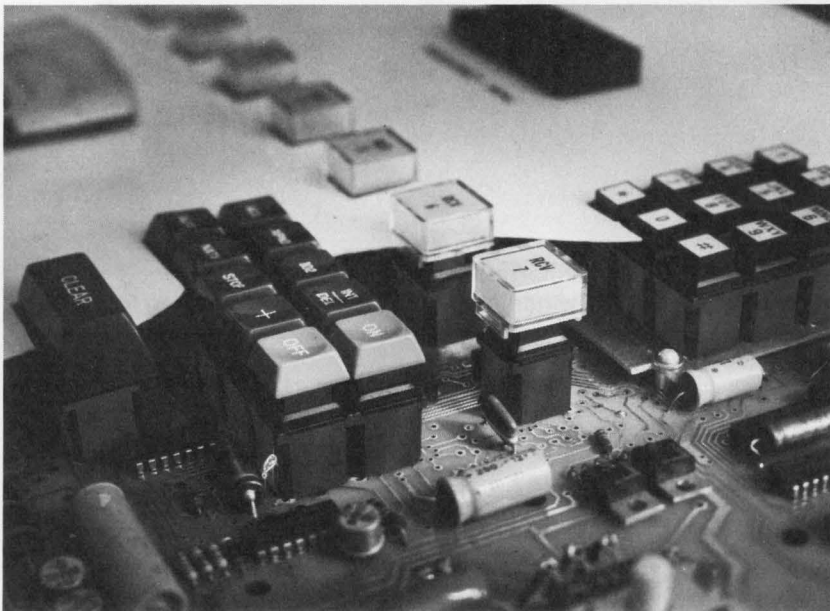

Now is the time to stop hand wiring to *expensive* panel-mounted switches.

Mechanical Enterprises' keyswitches are available at about *half-the-cost*. And, they are *self-supporting* on the PC board without the need for metal sub-plates.

Our switches feature —

- Sealed contacts or inexpensive gold bar mechanical contacts
- 3/4" or 5/8" spacing, or stand-alone
- Selection of legending systems including doubleshot keytops
- Lighted models in three lens styles, all relampable from front
- Single or double pole, NO or NC
- Momentary or alternate action
- Wave solderable
- 20 million cycle life at TTL loads with guaranteed low bounce

Please phone for a free sample with keytop.



Mechanical Enterprises, Inc.

8000 Forbes Place Springfield, Virginia 22151 (703) 321-8282 TWX 710-832-0942

Germany - NEUMULLER GMBH, MUNICH / U.K. - TEKDATA Ltd., STOKE-ON-TRENT / France - TEKELEC AIRTRONIC, SEVRES / Switzerland - DIMOS, AG ZURICH

CIRCLE NUMBER 43

No matter what your viewing pleasure, you'll find it at Digital.

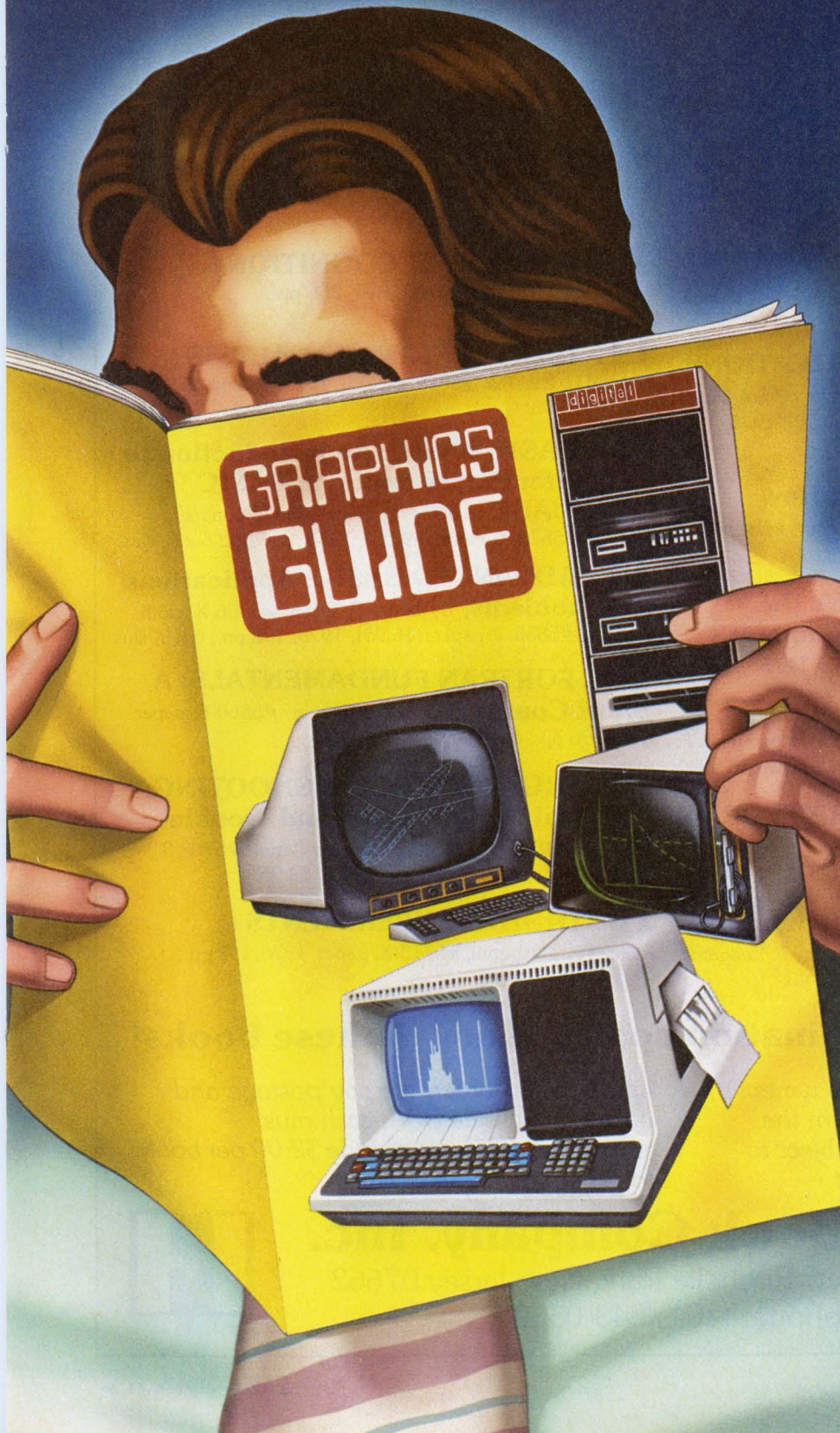

If you're looking into graphics systems, look at the company that offers you more graphics hardware, software and service than anyone else. Look at Digital.

We give you the chance to design your program first, then choose the right size graphics system to fit it. For example, you can choose our low cost VT55 graphics terminal. Or our medium performance VT11 and high performance VS60 display systems. Choose between our PDP-11/04, 11/34, 11/55 and 11/70 computers. Choose either stand-alone systems or intelligent terminals. You can even choose between our GT41, 43, 46 and GT62 processor-based systems.

And, since you're choosing Digital today, you never have to worry about adding more capability tomorrow. Because every piece of DECgraphic-11 equipment is hardware and software compatible. What's more, every system uses standard FORTRAN subroutines. So you can write your applications programs, then add on more equipment at any time. Without adding on more software.

Finally, choosing Digital means choosing the number one minicomputer manufacturer in the world. With over 4,000 sales, software and support specialists ready to lend you a hand in over 350 different cities around the world.

For all the graphic details, contact your nearest Digital sales office. Or fill out the coupon and mail to Digital Equipment Corporation, MR2-4/E14, Marlborough, MA 01752. Telephone: (617) 481-9511, ext. 6933. European headquarters: 81 route de l'Aire, 1211 Geneva 26. Tel: 42 79 50. In Canada: Digital Equipment of Canada, Ltd.

Digital Equipment Corporation,
MR2-4/E14, Marlborough, MA 01752

- I am interested. But my need is long range. Please send me graphics literature.
- I am very interested. Please have your nearest sales engineer contact me.

Name _____

Title _____

Company _____

Address _____

City _____

State _____ Zip _____

Phone _____ Ext. _____

digital ED3157



HAYDEN

in personal computing books!

See for yourself the reasons why:

1. MICROPROCESSORS: New Directions for Designers by Edward A. Torrero, #5777-6, paper, 1975, 144 pp., 8½ x 11, illus., \$10.95.

2. GAME PLAYING WITH COMPUTERS Rev. 2nd Ed., by Donald D. Spencer, #5103-4, cloth, 1976, 320 pp., 6 x 9, illus. \$16.95.

3. FUNDAMENTALS AND APPLICATIONS OF DIGITAL LOGIC CIRCUITS by Sol Libes, #5505-6, paper, (\$6.95), #5506-4, cloth, (\$9.95), 1975, 192 pp., 6 x 9, illus.

4. COMPUTERS IN ACTION: How Computers Work by Donald D. Spencer, #5861-6, paper, 1974, 160 pp., 6 x 9, illus., \$5.50.

5. COMPUTERS IN SOCIETY: The Wheres, Whys and Hows of Computer Use by Donald D. Spencer, #5915-9, paper, (\$5.50), #5916-7, cloth, (\$7.50), 1974, 208 pp., 6 x 9, illus.

6. PROGRAMMING PROVERBS by Henry F. Ledgard, #5522-6, paper, 1975, 144 pp., 6 x 9, illus, \$6.50.

7. PROGRAMMING PROVERBS FOR FORTRAN PROGRAMMERS by Henry F. Ledgard, #5820-9, paper, 1975, 144 pp., 6 x 9, illus., \$6.50.

8. COBOL WITH STYLE: Programming Proverbs by Louis J. Chmura, Jr., and Henry F. Ledgard, #5781-4, paper, 1976, 144 pp., 6 x 9, illus. \$5.45.

9. MINICOMPUTERS: Structure and Programming, by T.G. Lewis and J.W. Doerr, #5642-7, cloth, 1976, 288 pp., 6 x 9, illus., \$12.95.

10. PATTERN RECOGNITION by M. Bongard, #9165, cloth, 1970, 256 pp., 6 x 9 illus., \$14.90.

11. DIGITAL SIGNAL ANALYSIS by Samuel D. Stearns, #5828-4, cloth, 1975, 288 pp., 6 x 9, illus., \$19.95.

12. BASIC BASIC: An Introduction to Computer Programming in BASIC LANGUAGE by James S. Coan, #5872-1, paper, (\$7.95), #5873-X, cloth, (\$9.95), 1970, 256 pp., 6 x 9, illus.

13. ADVANCED BASIC: Applications and Problems, by James S. Coan, #5856-X, cloth, (\$8.95), #5855-1, paper, (\$6.95), 1976, 192 pp., 6 x 9, illus.

14. FORTRAN FUNDAMENTALS: A Short Course by Jack Steingraber, #5860-8, paper, 1975, 96 pp., 6 x 9, illus., \$4.95.

15. DIGITAL TROUBLESHOOTING: Practical Digital Theory and Troubleshooting Tips by Richard E. Gasperini, #5708-3, paper, 1976, 180 pp., 8½ x 11, illus., \$9.95.

16. DIGITAL EXPERIMENTS by Richard E. Gasperini, #5713-X, paper, 1976, 192 pp., 8½ x 11, illus., \$8.95.

Write for 15-day examination copies of any of these books!

At the end of 15 days, please remit payment plus postage and handling, or return the books and owe nothing. Prices subject to change without notice. If payment

accompanies order, we pay postage and handling. Outside USA, cash must accompany order — include \$2.00 per book for shipping and handling.



Hayden Book Company, Inc.

50 Essex Street, Rochelle Park, New Jersey 07662

phone: (201) 843-0550



A/D converters.

Only Intersil makes this many.



	AVAILABLE FROM STOCK							FIRST QTR. '77		
	8052/ 8053	8052A/ 8053A	8052/ 7101	8052/ 7103	8052A/ 7103A	LD111/ LD110	LD111/ LD114	8052A/ 7104	MONOLITHIC CMOS	
									7106	7107
DISPLAY										
3½ Digit LED	✓			✓		✓	✓			✓**
3½ Digit LCD	✓		✓	✓						
4½ Digit LED		✓		*	✓					
4½ Digit LCD		✓								
DATA PROCESSING										
3½ Digit BCD	✓		✓	✓		✓	✓		✓	
4½ Digit BCD		✓			✓					
16 Bit Binary		✓						✓		
UART Compatible				✓	✓			✓	✓	
Price @ 100 pcs	\$9.00	\$10.50	\$11.00	\$10.50	\$12.50	\$13.90	\$20.15	\$15.00	\$8.80	\$9.25

* 8052/7103 has 4½ digit resolution. ** 7107 drive displays directly.

A complete family for every application.

Look over Intersil's line of A/D converter products. Find exactly what you need for instrumentation, control or data processing. All devices feature auto-zero, auto-polarity and single references. All are suitable for MUXed inputs.

Intersil means leadership in dual- or single-chip devices. Our new 7106 and 7107 monolithic CMOS converters will include all display drive circuitry on-chip. For interfacing microprocessors, the 8052/7101 has 3½ digit parallel BCD output plus polarity and over-range, and can be MUXed or tristated to your bus. The 8052/7103 has UART-compatible outputs and inputs for remote 2-wire use. And the 8052/7104 will offer both these features with built-in tri-state byte or word outputs.

A library you must have before you begin a design:

1. "Interfacing A/D Converters and Microprocessors," by Peter Bradshaw.
2. "Selecting Between Integrating and Successive Approximation A/D Converters," by Dave Fullagar.
3. "Do's and Don'ts of Applying A/D Converters," by Bill O'Neil.
4. "A Complete Error Analysis of the Integrating A/D Converter," by Lee Evans.

Get them all from the leader, Intersil, 10900 North Tantau Ave., Cupertino, CA 95014.

Need a specialized A/D circuit?

If you digitize analog data, you should talk to Intersil. A leading DMM manufacturer spoke to Intersil and others, and selected Intersil to develop and produce a dedicated single-chip, low noise CMOS A/D converter. Intersil provides a selection of custom features such as:

- Output format selection (LCD, BCD, LED, Binary, Etc.)
- Low noise (10µV p-p) vs. cost
- Accuracy vs. cost
- Specialized power supply requirements
- UART, PIE and microprocessor controllability
- Auto-ranging vs. dedicated ranges

Call Skip Osgood (408)996-5000 today about your needs. Many of your requirements may already be designed.

Intersil



Intersil stocking distributors
 Advent Electronics, Inc., (Indianapolis)
 Arrow Electronics
 Century Electronics
 Elmar/Liberty Electronics
 Harvey (Upper N.Y.)
 Intermark (San Fran., Seattle)
 Kierulff Electronics (Mass.)
 R.A.E. Ind. Elect. Ltd. (Van. B.C.)

RESCO (Raleigh, N.C.)
 Schweber Electronics
 Sheridan Assoc.
 Diplomat (Fla.)
 Weatherford
 Zentronics (Canada)
Intersil area sales offices
 Boston (617)861-6220
 Chicago (312)986-5303

Dallas (214)387-0539
 Los Angeles (213)532-3544
 Ft. Lauderdale (305)772-4122
 Minneapolis (612)925-1844
 New York (201)567-5585
 San Francisco Bay Area (408)984-2170
 Upstate New York (607) 754-7406
 Toronto, Canada (416)457-1014
Representatives in all major cities.

Datel's Miniature 16-Channel Data Acquisition Module

MODEL MDAS-16

- 16 Channels Single Ended or 8 Channels Differential
- 12 Bits Resolution
- 50 kHz Throughput Rate
- Tri-State Outputs
- Low Cost — \$295
- Miniature Size

COVERED BY GSA CONTRACT

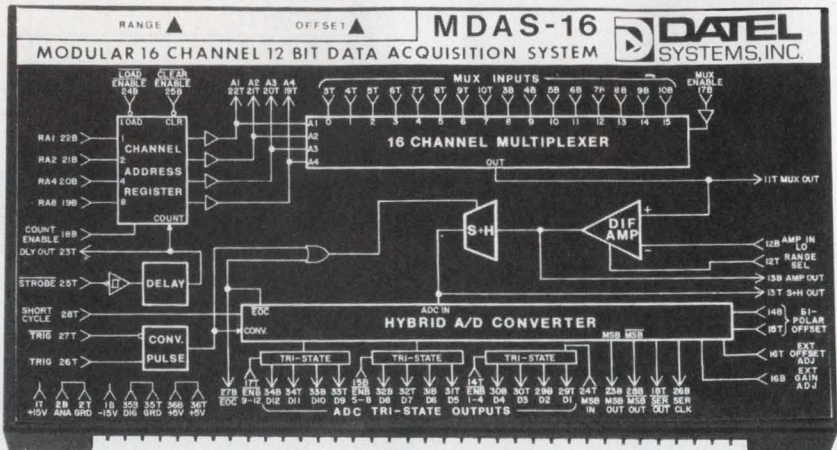

You'll find complete specifications on this product and more than 300 data conversion circuits and systems in Gold Book.

Just check Gold Book's Volume 3. That's Datel's complete Engineering Product Handbook, in its own separate volume. More than 290 pages of D/A & A/D Converters, Multiplexers, Sample-Holds, Op Amps, Power Supplies, Digital Panel Meters, and Printers, Digital Panel Instruments, Data Loggers, Digital Cassette Recorders, and Data Acquisition Systems. Each fully detailed on individual data sheets. And it's available to you in Gold Book.

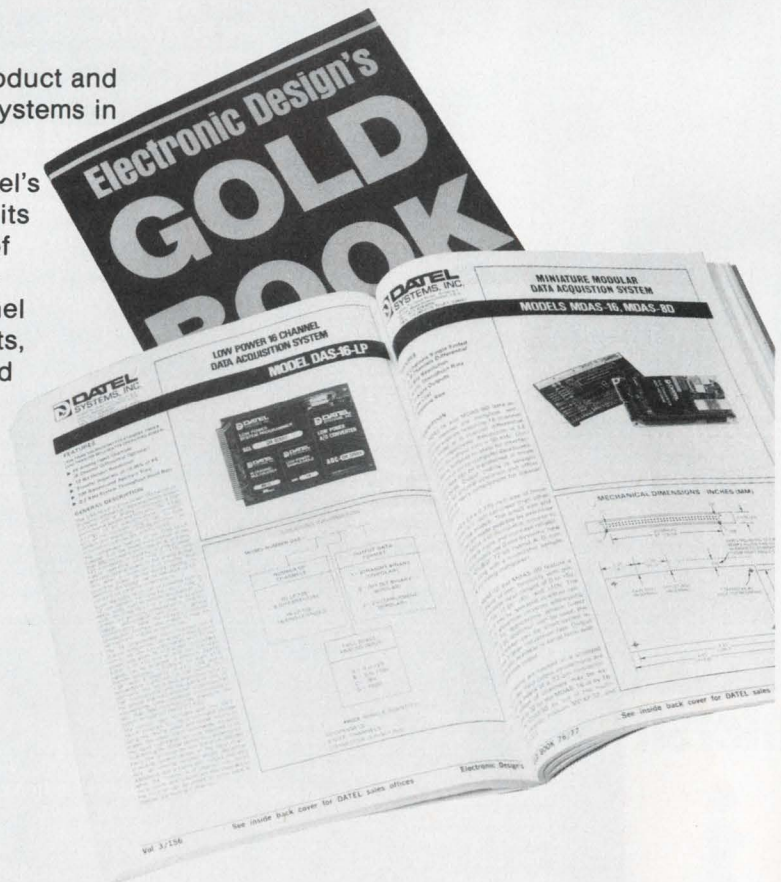

DATTEL
SYSTEMS, INC.

1020 Turnpike St., Canton, MA 02021
Phone: (617) 828-8000

• Santa Ana, CA (714) 835-2751, (L.A. Exchange) (213) 933-7256 • Sunnyvale, CA (408) 733-2424 • Gaithersburg, MD (301) 840-9490

CIRCLE NUMBER 47

My friend

Jack is a true friend. Whenever I demonstrate one of my usual signs of brilliance, he's right in there to tell me how smart I am. And if I ever make a mistake, rare as that may be, he lets me know that it was a unique departure from my norm.

Always smiling, always ready with a kind word or enthusiastic praise, Jack is the kind of guy anybody would treasure as a friend.

Charlie is different. Sometimes I can't stand him. If I make a mistake, especially one that might be important, Charlie's always ready to tell me where I went wrong—and why. Yes, I know he does it gently and with understanding, but he frequently makes me feel I'm not as smart as I really am. Sometimes, in fact, he blows away the clever reasons I use to justify some of my actions that he thinks are stupid. When, for example, I explained away a nutty action on the grounds that nobody had informed me of company policy on the matter, he gently informed me that ignorance of company policy is not a particularly fine excuse for stupidity. As if I didn't know.

You can well imagine what Charlie said when I explained one of my actions on the grounds of tradition (it was what was usually done in such cases). And he just laughed in my face when I told him I did something because that's what our competitors did. After all, we're living in a hard business world, and we're forced to be a bit clever because our competitors are a bit dishonest—or they would be if we gave them half a chance.

While Jack always lets me know how brilliantly I do things, Charlie frequently lets me know how I could do things better. And that's often painful. I admit that, in some ways, I am a better human being, and I'm certainly better in my profession, as a result of Charlie's chiding. But heck, friends are supposed to make you feel good. Aren't they?

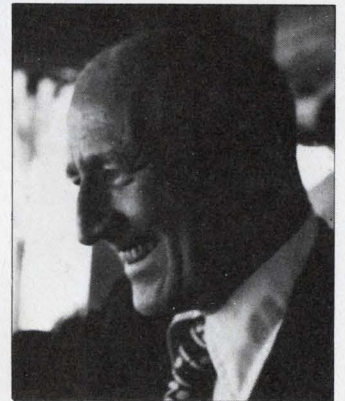

GEORGE ROSTKY
Editor-in-Chief



SPECIAL REPORT: MICROPROCESSOR PERIPHERAL CHIPS

With all the recent editorial attention given to microprocessor chips, on memories and central processing units, readers have asked that "equal time" be devoted to devices that make a system work . . . to interfacing. Our May 10 report will cover the new breed of complex LSI circuits that are designed to support microprocessors (some of which are becoming more complex than the microprocessor itself). Among the circuits covered will be floppy disc controllers, UARTs, specialized interface circuits, programmable timers and mixed ROM and RAM input-output circuits.

ALSO IN THE MAY 10 ISSUE — ANOTHER INSTALLMENT IN OUR MICROPROCESSOR BASICS SERIES: SOFTWARE FOR MICROPROCESSORS

One of the most important subjects to appear in *Electronic Design* — and one of the most popular — will continue in the May 10 issue. "Software for Microprocessors" is gutsy, important, how-to information. The series assumes no prior knowledge, works systematically with building blocks to give hardware designers fluency in low level machine or assembly language. Software is a vital part of any computer. For a specific application, instructions and hardware/software tradeoffs may determine the microprocessor selection. Don't miss this installment. (The series began in *Electronic Design's* January 4 issue.)

Electronic Design — BEST READ ELECTRONICS PUBLICATION IN THE WORLD!

We'll flip you over your ceramic capacitor specs... **heads you win** **tails you win**

Heads are our standard line of MONO-KAPS™. Radial-leaded, epoxy-coated monolithic ceramic capacitors with noble-metal electrodes whose proven formulation has not been modified or compromised. They meet MIL requirements, and are available off-the-shelf in a broad range of capacitances and voltage ratings to meet your specific needs.

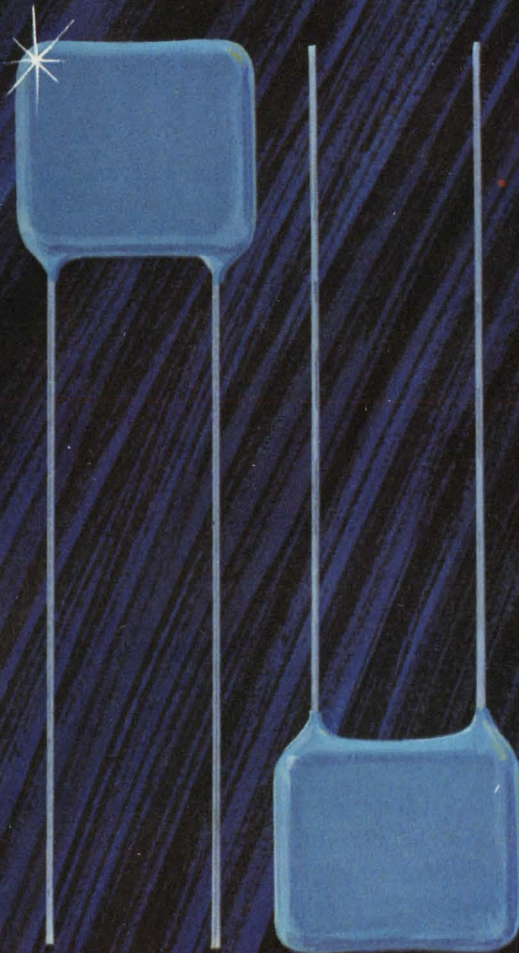

Tails are our BME-Radials™. They protect you from the noble metal cost spiral, and save you money right up front. They are the product of our unique BME capacitor technology which eliminates noble metal entirely from electrodes and terminations. But they'll meet most of the same circuit requirements with no sacrifice.

So you see, it's up to you — MONO-KAPS or BME-Radials. Both are immediately available in quantity from the only people who give you the choice. Either will do the job without compromise. Call or write for all the details today.



CENTRALAB/USCC 4561 Colorado Blvd. • Los Angeles, CA 90039 • (213) 240-4880
Electronics • GLOBE-UNION INC.

SEE OUR COMPLETE CATALOG IN EEM: PAGES 317 TO 335, AND GOLD BOOK PAGES 103 TO 121; OR contact us directly.



on Miniature Switches

Small switches can give you big headaches.

Along with the problems encountered when specifying and applying standard-sized switches, miniatures present extra difficulties, particularly during installation.¹⁻⁵ Moreover, the smaller they become, the more they cost. Clearly then, you should specify the largest "miniature" switch the available space can accommodate.

But what's a miniature switch? The definition changes continuously. As the average size of electronic components shrinks, the definition of the word "miniature" changes. Today, double-pole toggle switches with about 1/2-in.-cube bodies, usually with 1/4-in.-diameter bushings, are popularly called miniatures, say experts at Alco. These same switches were called subminiatures, or even ultraminiatures, five or ten years ago. For example, toggle switches like Alco's TT Series with approximately 3/8-in.-cube bodies, although called subminiatures today, may well be the miniatures of tomorrow.

Speaking for European manufacturers, Carl Evington, Product Manager of A. B. Electronic Components Ltd. (Wales, U. K.) defines today's miniature as any switch that occupies a panel area of about 30-mm (1-3/16-in.) diameter. In Evington's view, a subminiature switch occupies about 20-mm diameter; a microminiature (ultraminiature?) 10 mm or less. All of these dimensions include projecting solder clips. There are no hard and fast rules, however, for these categories, and the labels are applied loosely.

Biggest problem is installation

But whether the units are miniature, subminiature or microminiature, the biggest problem

stems from improper installation. Seldom are miniature switches hermetically sealed; consequently, immersing or spraying degreasing solvents often carries contaminants into the switch and onto the contact surfaces. Excessive heat applied to the switch terminals often causes the terminals to expand and crack the seals, so more paths are created for the entry of contaminants. In particular, soldering flux enters the switch via wicking action. Neither molded-in terminals nor epoxy seals can provide protection when terminals are overheated.

Flux and other contaminants that end up on the contacts can cause a permanently open circuit, or worse, an intermittent condition. Once contaminants enter the switch, the damage is generally irreversible. But catalogs seldom warn of these dangers or how to cope with them. Miniature switches designed to mount on panels or other places where they are hand-soldered into the circuit should be handled according to the following rules:

- Don't immerse or spray to preclean. Switches should be ready for soldering as received from the manufacturer.
- Use a small iron—25 to 40 W.
- Use small-diameter solder and a minimum of flux.
- Apply the iron for no more than 2 s.
- Don't solder with the terminals upright.

Observe those rules, and no after-cleaning should be needed.

Ideally, when a miniature switch must mount onto a PC board, the designer should be able to handle the switch as he would any other component. But he can't with far too many switches—even when the switches are adapted with PC-mounting terminals and tabs. Usually, the adaptation doesn't go far enough.

Morris Grossman
Associate Editor

Many switches originally designed for hand soldering to the terminals, one at a time, can't take the heat when all the terminals are wave-soldered simultaneously. The switch can't take the heat even when the temperature at each terminal is correct. Not only can internal heat build-up break terminal seals, but it also can distort, relax spring tension, misalign contacts and cause many other problems.

Switches adapted but not specifically designed for PC mounting tend to retain contaminants that enter the switch's housing during normal PC cleaning processes. They can't be cleaned with all the other components. Although such switches can be temporarily sealed for wave-soldering and board cleaning, this extra preparation is costly. And hand-soldering the switch on a completed PC board is also expensive and time-consuming.

Such problems are neatly solved with a two-piece design in Chicago Switch's Mr. Clean miniatures, intended for wave-soldering applications. Only the lower-base half of the switch is

wave-soldered to the PC board; the unit's over-center, snap-action mechanism is not attached. After a thorough cleaning process, with the contacts completely accessible, the upper half of the switch is snapped by hand to the base.

Other manufacturers, such as Cutler-Hammer's Control Switch Division, make it easy to clean contacts by designing their PC-mountable switches with an "open" construction that allows the cleaning fluid to flow easily into and out of the switch structure and to remove contaminants.

Keep your options open

After you have considered the special difficulties in installing miniature switches and examined the available switch designs that may help with these problems, you still have three selection criteria to fulfill—size, electrical rating and life. Leave those to the last and you may find that you have locked yourself in.

If you need a 24-position switch that can carry

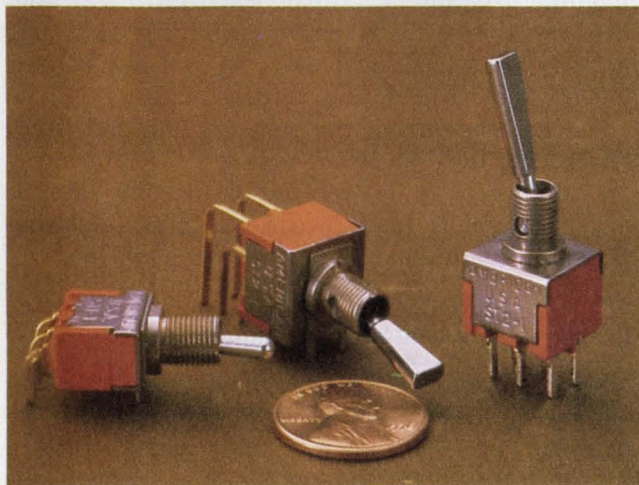
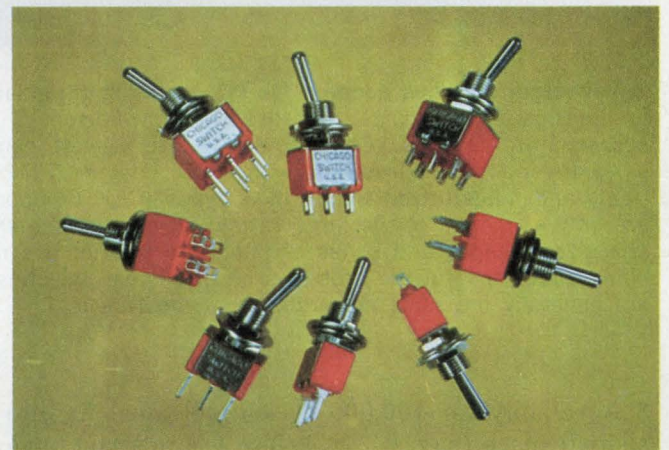
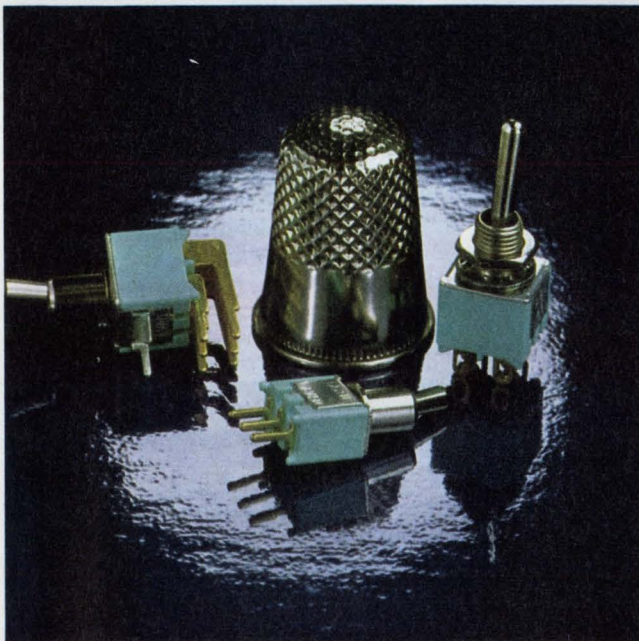

Miniature versions of toggle switches abound. Some come with PC-type terminals—both straight and angled—and others come with conventional terminals for hand soldering. Bat handles, short and long handles, and many unconventional custom-handle styles can be obtained. Among the manufacturers who supply miniature toggles are (from top left, counterclockwise) Alco, American Switch, Micro-Switch and Chicago Switch.

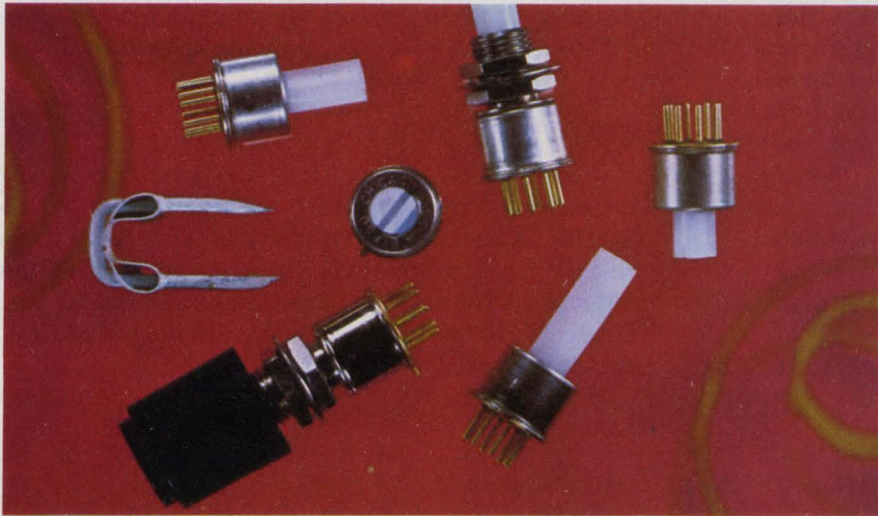
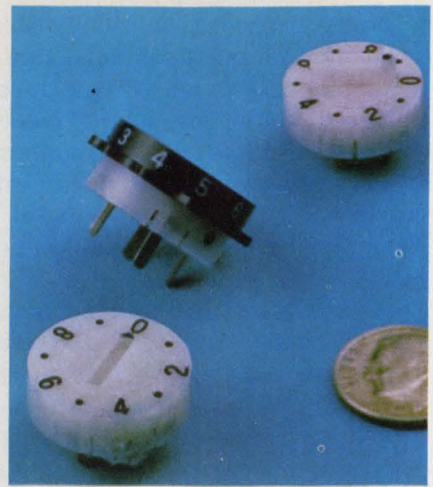
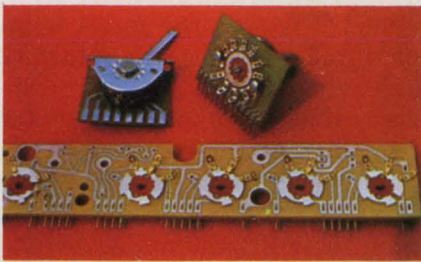

Small rotary switches adapted for PC mounting (Standard Grigsby—top left) and enclosed and ganged rotaries (McGraw-Edison, S Series—top center), subminiature rotaries (Chicago Switch, TO-5—left center), tiny thumb or screwdriver-actuated rotaries with BCD coding (AMP 642-1 Series—top right) and miniaturized thumbwheel types (C&K Components—bottom right) are only a fraction of the large variety of miniature rotary switches available. The sizes, shapes and styles of miniature rotaries are many and continually being added to. But the problems of specifying, selecting and installing them are generally the same no matter what the type is.

3 A reliably for 100,000 cycles and must fit into a small space (say, $1/2 \times 1/2 \times 1/4$ in.) you have a tough problem to solve. At this late point you can't go to a manufacturer's catalog and pick a switch with optimum specifications. Trade-offs among size, electrical rating and life must be made—the earlier the switch is selected, the wider the options.

To make effective trade-offs, however, you need more information than you can find in most catalogs. Right off, you should realize that space limitation and the inability to anticipate all possible combinations of uses force the manufacturer to list only the most obvious conditions, and then often in a nominal or "coded" form. This lack of details often can lead to misapplications.

For simplicity, a manufacturer may give a certain miniature switch a 2-A rating. It's true that the switch can carry 2 A safely, but switch only 100 mA at 12 V ac—and then only if the temperature is no higher than 40 C. These important details may not be listed or may be buried in footnotes and tables. The life of the switch may be listed as 100,000 cycles, but this value may be

the mechanical life without an electrical load—another fact sometimes left out or mentioned only in a footnote.

However, a more conscientious manufacturer may list this switch's life as 25,000 cycles when switching 100 mA, because thereafter the contact resistance exceeds, say, 0.15 m Ω . But what if your circuit can tolerate 1 Ω ? A telephone call to the manufacturer might inform you that a 1- Ω end-of-life will raise the effective switch life to 50,000 cycles—just what you need. But you don't know any of this without that telephone call.

On the other hand, the same switch can carry 250 mA at 12 V ac if the end-of-life criterion is 1- Ω and the life is derated to 10,000. Maybe you're willing to trade life for higher switching current. But to do so, you need information.

Catalog ratings can be misleading

The load and life ratings shown in many catalogs usually don't apply to most applications. The interplay of environment, duty cycle, failure criteria, actual load and contact material is com-

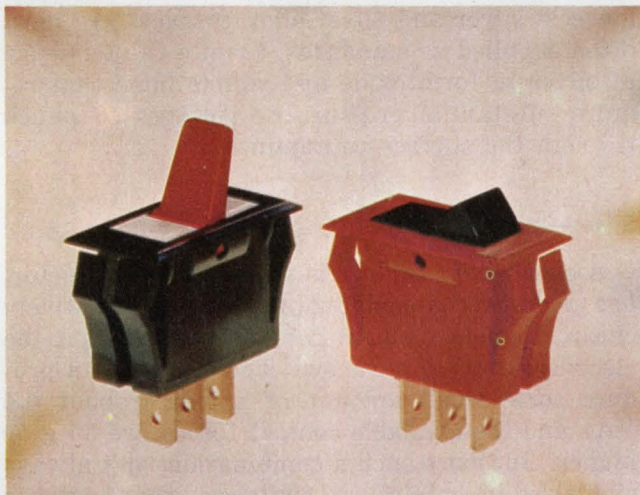
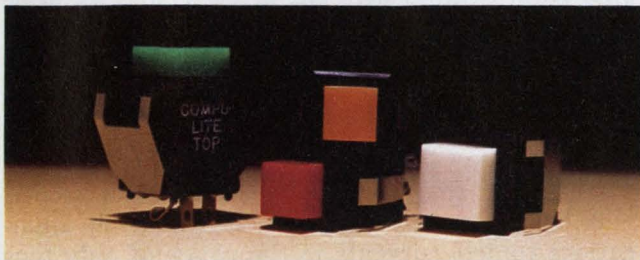
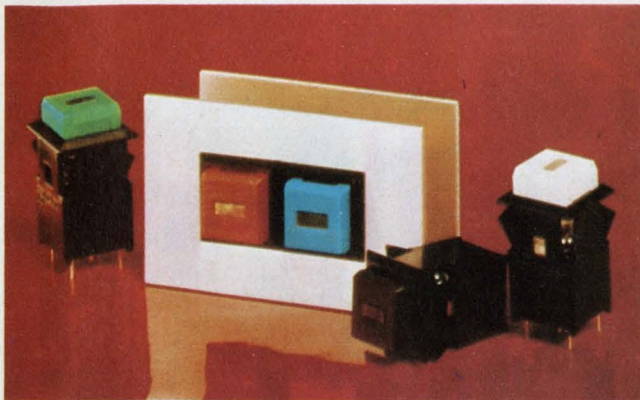

Pushbutton, rocker and paddle switches—some lighted—and low-cost versions for home appliances, also have followed the path to “miniaturization.” However, the size of the human finger provides a lower limit to size. Small pushbuttons are represented by (top down) Licon’s Type-05 and Compu-Lite’s “shorty” switches; both can be LED-illuminated. And Cutler Hammer’s and Carling Switch’s small paddles and rockers are adapted particularly to electrical appliances.

licated with an almost infinite variety of possible combinations. The complete specs and tables for a single switch type could easily fill a sizable book.

Reliable manufacturers normally have enough test data to provide reasonable estimates of switch performance under almost any set of specified conditions—high temperature, low temperature, high humidity, corrosive atmosphere or high altitude. Or vendors will obtain such information for a sufficiently interesting order. Don’t hesitate to ask for supporting data. And be ready to pay for unusual requirements. Over the long run, you will save quite a bit.

Be wary of vendors who waffle when asked clear questions. Some are merely running machine shops without competent electrical back-up or any real knowledge of switch technology. Be wary, too, of numbers that look too good to be true: Ask for supporting evidence.

The old numbers game

The search for ways to make spec numbers appear bigger and better is an ongoing pastime. At one point, for example, dielectric strength for switches was commonly defined as the voltage at which 1-mA leakage occurred—still a standard in most MIL specs. To improve the numbers, some manufacturers have established their own higher-current leakage. Others have come up with a parameter called “voltage breakdown”—the voltage required to strike an arc and maintain it between two conducting members. This spec is unnecessary if the more difficult 1-mA criterion is observed.

Another example of creative spec writing revolves about the life of rotary switches. A complete cycle of operation for a rotary switch calls for rotating from position one through all active positions and returning to the starting point. However the search for “improved” numbers has created the term, “circuit operations,” so a 12-position, 25,000-cycle switch ends up with an impressive life of $12 \times 25,000 \times 2$ circuit operations. Fortunately, a knowledgeable designer isn’t likely to be fooled by such a blatant ploy.

If a vendor makes a claim that seems far out of line compared with what other vendors offer, greet it with skepticism. Ask him to substantiate the claim. If his design improvement, new material or process truly and dramatically improves the switching function, he will be most happy to demonstrate his claim.

Contact-system design, switch materials, actuator mechanisms and other switch parts have been so thoroughly investigated by most reliable manufacturers over the years that real breakthroughs can be expected to be rare. So be from Missouri!

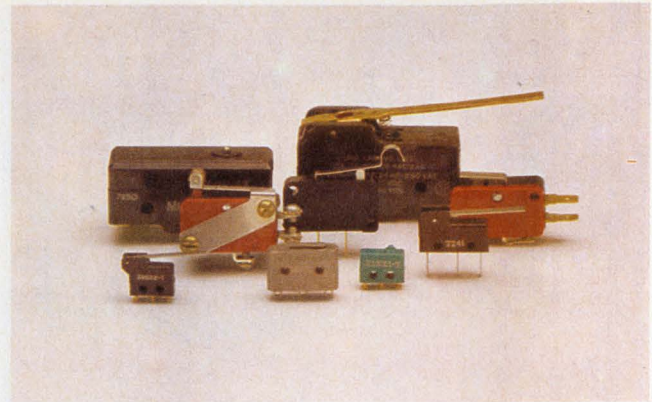
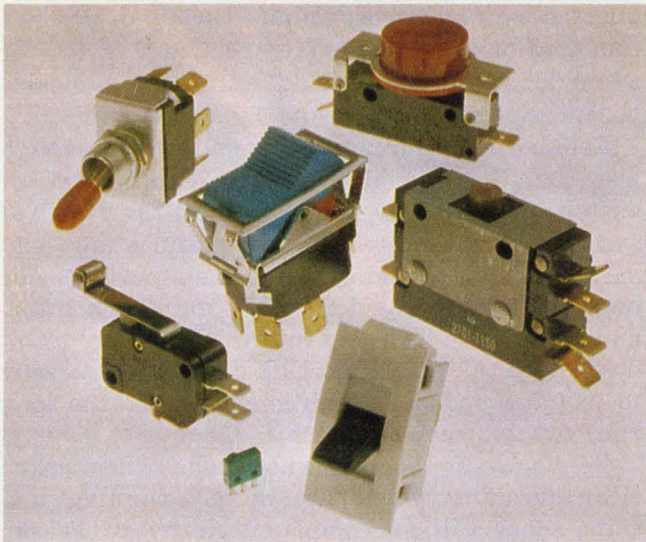

Snap-action switches were one of the first types to be miniaturized. Micro Switch, a pioneer in miniaturized snap-action switches (right), shows off some of its tiny versions next to standard sizes, as does McGill Manufacturing (left).

Generally, there is little room for overcautious design in small switches. You can't expect to use a safety factor of 100 to 1000% and still keep the switch small.

Miniature switches require compromise

Often, when occasional surges exist for only a few milliseconds, a small, 1-A rated switch can handle as much as 10 A.

Even with inductive loads, miniature switches must work with small safety factors. Study the load and its Q carefully to determine the true needs. Use suppressors to keep the current surges down.

And, of course, if you must squeeze a lot of capability into a small space, you may have to compromise on life expectancy—which may be a smaller sacrifice than you think. The actuations per hour in your application may be low, so even with a derated life, the hours of operation can outstrip the useful life of the equipment. The switch need not outlast its circuit.

Moreover, a switch rated at, say, 10,000 actuations with a 50% duty cycle, may be able to operate for 50,000 actuations at a 20% duty cycle. Designing the 10,000-actuation switch for a 50,000 actuation life, however, may not only increase its size substantially, but also raise the price 200 to 500%.

What's most important, miniature switches are often used in relatively high-impedance applications such as logic circuits, while end-of-life criteria (when provided) are generally measured in milliohms of contact resistance. Between 0.1 and 1 Ω is realistic for an end-of-life value in such circuits; in some cases even 10 Ω can be tolerated. Such impedance values vastly increase the switch's life expectancy so that is nearly as long as the mechanical life.

A large proportion of miniature-switch applications control currents in the range of only tens of milliamperes with voltages under 28 V. Yet low-cost silver and silver-alloy contacts are most often supplied as standards, despite the tendency of silver to form oxide and sulfide films that require substantial pressure or voltages to punch through the surface contaminants.

Silver—a primrose path?

A clean silver surface is an excellent conductor, has good mechanical qualities and is relatively cheap. However, silver performs best when the electrical energy in the switched current can produce some small amount of arcing (about 0.4 VA) and the available contact forces are 30 g or higher. But since such a combination isn't always available in miniature switches, the switches often perform erratically. Therefore, unless specifically stated, assume the miniature switch is unreliable for voltages below 28 V and 100 mA.

When some arcing is present but without 30 g of contact force, choose palladium and its alloys. Palladium alloyed with up to 40% silver to reduce cost performs reliably in the low-level circuits encountered in the telephone industry.

But where neither arcing nor 30 g of force is present (voltages under 12 V at milliamperic currents), gold becomes the contact material of choice, especially for dry circuits.

Gold is not a panacea

However, gold is by no means a solution to all the problems that can occur at low-level switching. Even the best gold contacts may be useless if lubricant in the switch assembly or a contaminant such as flux gets on the contact surfaces. The low-level energy may not be able to punch

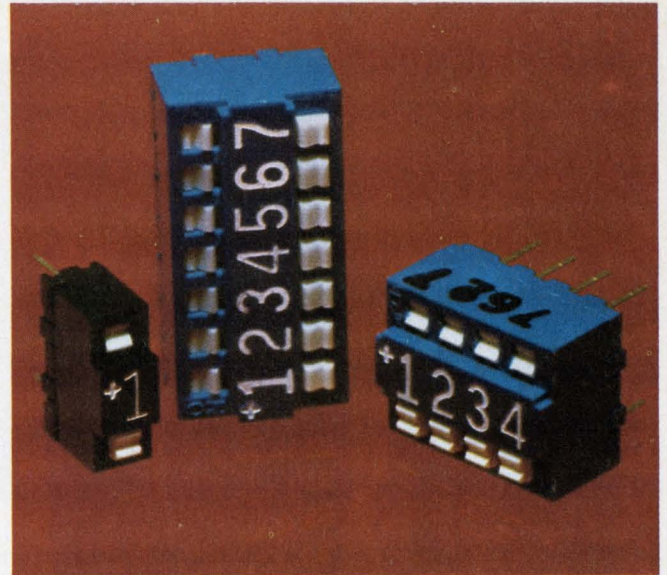
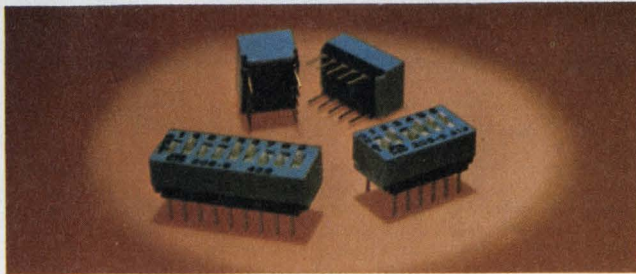
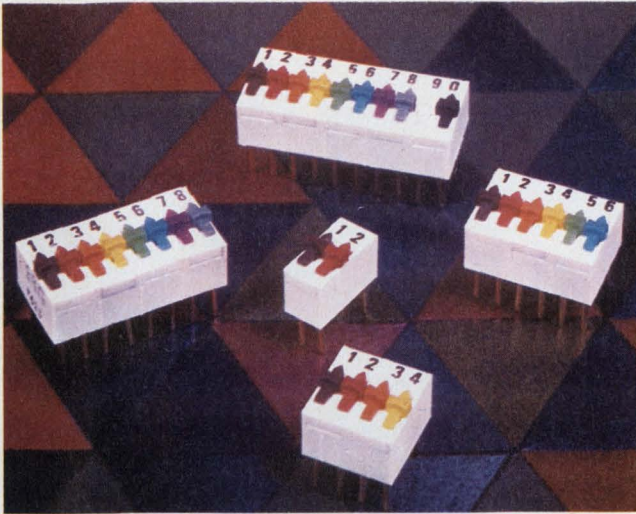

Miniature dual in-line switch assemblies, variously called (from top left counterclockwise) DIL (Spectra series by Erg Industrial), DIP (Series 206 by CTS-Keene) and BIT switches (Standard Applied Engineering) are all designed for PC mounting and need very small fingers, or better, a stylus to actuate them.

through the oil film and the contact pressure may be too weak to push it aside, especially in miniature switches. And above a level of about 0.4 VA and 20 V, gold tends to erode very rapidly.

Some manufacturers bend the specs of their so-called "gold contacts." The high cost of gold is an inducement to cut corners, so a few switch makers try to whistle by with words such as "gold-plated contacts," or even "heavy gold-plated contacts." Actually, the gold contacts may be

merely flashes—between 10 and 15-millionths of an inch thick—virtually useless for long-term reliable operation. Such a thin flashing may be useful, however, to extend the shelf life of silver contacts by keeping oxide and sulfide formation down. But the layer will burn or wear off rapidly in use.

Even "average thickness" is suspect. Variations in thickness can be over 50%. Only a guaranteed minimum thickness fully documented and tested—preferably in-house—can assure that the plating is adequate.

Gold plating should usually be applied over a barrier layer of hard dense material, like nickel, to prevent the gold from migrating into the contact base—silver, copper or brass. However, plating directly onto silver, some experts claim, may sometimes be advantageous,³ while other experts report that silver/gold compounds with poor conductivity can form.

At low-level switching, gold thickness of about 50-millionths of an inch is adequate for switch lives of about 10,000 actuations. Longer-lived units call for greater thickness or inlaid solid-gold inserts. But only the mating parts of a contact set need be gold. Careful contact design puts the gold only where needed and can save a lot of money. But even though the contacts may be most important, the other parts of a miniature switch also must receive careful consideration.

Although all forms of miniature switches—toggle, rotary, pushbutton, slide, snap, and others

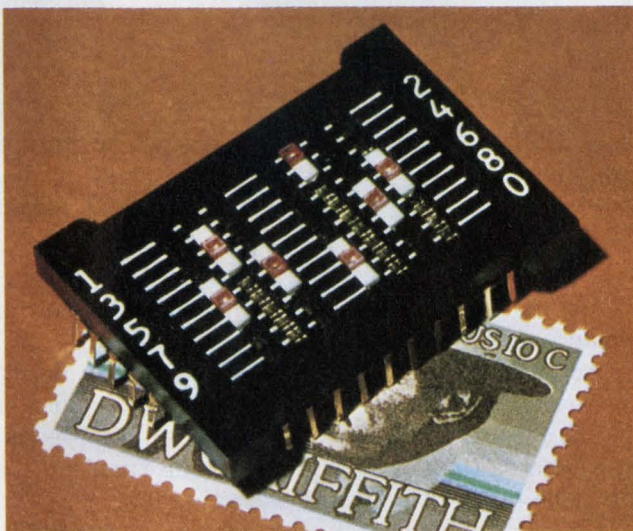

A miniature matrix slide switch made by AMP contains several manually operated, 10-position slide switches in a matrix configuration for PC mounting. Gold-plated crosspoints for logic-level switching (12 V dc 100 mA) offer a dry-circuit contact resistance of less than 1 Ω .

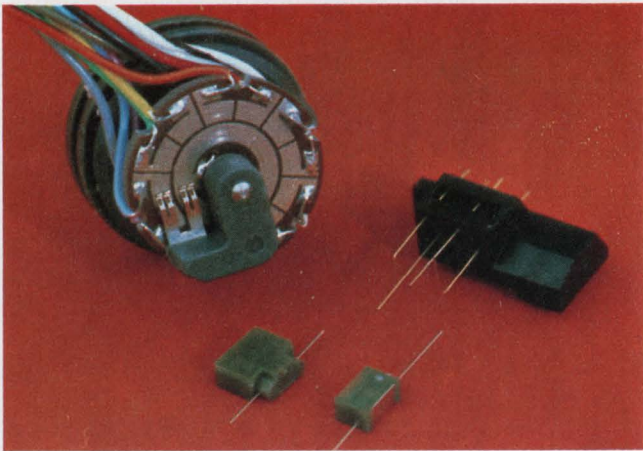

Tiny inertia switches, Models 1575 and 1576 (bottom), used for lighting wristwatch LEDs at the flick of the wrist; a rotary switch, type 1508, used in helicopters; and a delicate 0.007-in.-diameter beryllium-copper unit (upper right) for consumer electronics are all part of the J. M. Ney Company's extensive line of specialized miniature switches.



Miniature switches in all shapes and styles, as in this family portrait from Raytheon, show the diversity of available terminals, actuators, body shapes and mounting methods to fit almost any need.

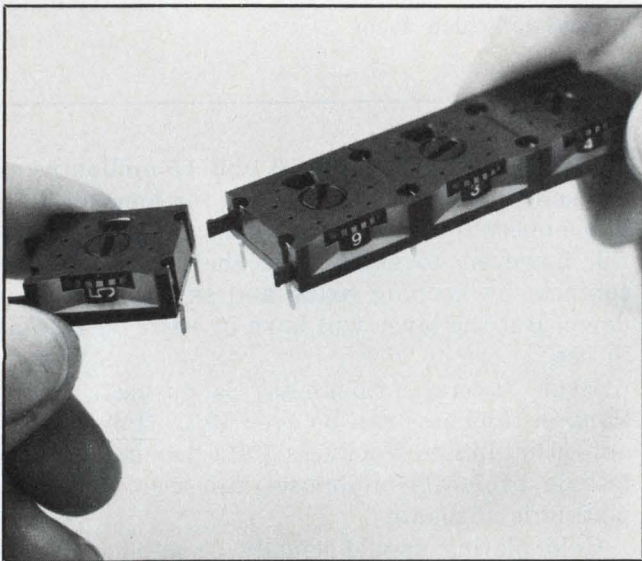

Thumbwheel switches, such as these EECO 2500 series low-profile switches in a strip, feature PC-board mounting by wave, flow or hand soldering. No mounting hardware is needed. Single modules can be snapped together to form a multistation switch assembly of any desired length. Tabs of the end switches snap off easily.

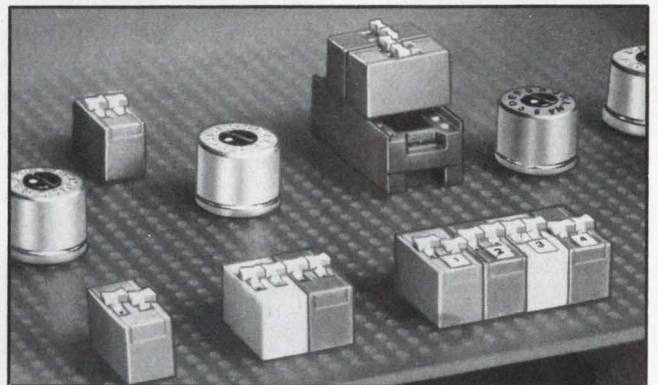

Miniature rotary and slide switches for easy PC mounting are part of Centralab's extensive line of both standard and miniature-sized switches.

—are being used more and more, the slide and pushbutton types seem to be advancing in popularity at a faster rate. Slide switches are particularly desirable for low-level or dry circuits because of their inherent wiping action.

Butting-type contacts often allow deposits to build up rapidly and shorten life prematurely in low-level circuits. Generally, butting contacts should be applied to power circuits (above 0.4 VA) and slide units used for logic levels. One of the most reliable butting-contact arrangements for the pushbutton is the gold-alloy crossbar, which

concentrates the available contact pressure into a small area.

Actuating mechanisms and mechanical contact systems used in many switches are often chosen by manufacturers more to avoid infringing existing patents than to provide a unique function, so don't be taken in by exaggerated claims.

Up to a few years ago, few switches were made specifically for PC mounting. At first, standard-sized switches were adopted for PC use, but they were too large and their terminals were spaced on odd-ball centers. Now, switches specifically de-

signed for PC use, such as the many versions of the so-called DIP switch, have terminals on 0.1-in. centers. Some manufacturers have introduced designs that prevent or alleviate solder and flux wicking. And many slide and pushbutton switches have shrunk so small that they are below human-finger size and must be actuated with a stylus.

Imported switches—blessing or curse?

Ideally, you should be able to select a standard product and save substantially over a custom design. And with some further searching, you may be surprised to find that a significant proportion of the designs you need not only are manufactured overseas but offer further cost savings. Many come from Japan, particularly miniatures. And even some prominent U. S. brands are made

in offshore factories—unfortunately, with widely varying standards of performance.

If the domestically produced miniature switches must be scrutinized, the foreign products must be investigated even more. Start by buying a few. Examine them carefully, tear them apart and compare their structure and techniques with more familiar switch products. Then test them in your circuit. If all goes well, carefully verify delivery, lead time and reliability of the source. ■■

References

1. Grossman, M., "Focus on Reed Relays," *Electronic Design*, July 5, 1972, pp. 50-59.
2. Grossman, M., "Focus on Rotary and Thumbwheel Switches," *Electronic Design*, Sept. 27, 1974, pp. 56-67.
3. Grossman, M., "Focus on Snap-action Switches," *Electronic Design*, Mar. 1, 1975, pp. 44-51.
4. Adkins, R. Max, "Switching Contacts Causing Problems?" *Electronic Design*, Mar. 1, 1975, pp. 60-63.
5. Grossman, M., "Focus on Keyboards," *Electronic Design*, Oct. 25, 1976, pp. 122-133.

Need more information?

For further information on miniature switches, readers may consult the manufacturers listed here by circling the appropriate numbers on the reader service card. More vendors and information may be found in ELECTRONIC DESIGN'S GOLD BOOK.

A. B. Electronic Components Ltd., Abercynon, Glamorgan CF-454SF, Wales, UK. 044-374-0331. **Circle No. 423**

Aeroflex Laboratories Inc., South Service Rd., Plainview, NY 11803. (516) 694-6700. **Circle No. 424**

Airpax Electronics Inc., Cambridge Div., Woods Rd., Cambridge, MD 21613. (301) 228-4600. **Circle No. 425**

Alco Electronic Products Inc., 1551 Osgood St., North Andover, MA 01845. (617) 685-4371. **Circle No. 426**

Aleca SA Electromecanica, Julio Verne 5-7, Barcelona-6, Spain. 212-7104. **Circle No. 427**

Allen-Bradley Co., 1201 S. 2nd St., Milwaukee, WI 53204. (414) 671-2000. **Circle No. 428**

Alma Components Ltd., Park Rd., Diss Norfolk IP223AY, England. 0379-2287. **Circle No. 429**

Alpha Industries, TRG Div., 20 Sylvan Rd., Woburn, MA 01801. (617) 935-5150. **Circle No. 430**

Alps Electric Co. Ltd., 1-7 Yukigaya-Otsuka-Cho Ota-Ku, Tokyo, Japan. (037) 61211. **Circle No. 431**

Ambac Industries Inc., Tele Dynamics Div., 525 Virginia Dr., Fort Washington, PA 19034. (215) 643-3900. **Circle No. 432**

American Switch Corp., 134 Water St., Wakefield, MA 01880. (617) 246-1007. **Circle No. 433**

AMF Inc., UID Electronics, 4105 Pembroke Rd., Hollywood, FL 33021. (305) 981-1211. **Circle No. 434**

AMP Inc., 449 Eisenhower Blvd., Harrisburg, PA 17105. (717) 564-0100. **Circle No. 435**

Applied Resources Corp., 1275 Bloomfield Ave., Fairfield, NJ 07006. (201) 575-0650. **Circle No. 436**

Ark-Les Switch Corp., 51 Water St., Watertown, MA 02172. (617) 924-2330. **Circle No. 437**

Astra Mfturas Radio Electricas, Sugranes 28, Barcelona-14, Spain. 249-8850. **Circle No. 438**

Beckman Instruments Inc., 2500 Harbor Blvd., Fullerton, CA 92634. (714) 871-4848. **Circle No. 439**

Bendix Corp., Electrical Components Div., Sherman Ave., Sidney, NY 13838. (607) 563-9511. **Circle No. 440**

Betatronix Inc., 100 Ricefield Lane, Hauppauge, NY 11787. (516) 543-8780. **Circle No. 441**

Bryant Electric, 1421 State St., Bridgeport, CT 06602. (203) 334-5561. **Circle No. 442**

Bunker Ramo Corp., RF Div., 33 E. Franklin St., Danbury, CT 06810. (203) 743-9272. **Circle No. 443**

Carlingswitch Inc., 505 New Park Ave., West Hartford, CT 06110. (203) 233-5551. **Circle No. 444**

Carson Manufacturing Co., 5451 N. Rural St., Indianapolis, IN 46220. (317) 257-3191. **Circle No. 445**

Cherry Electrical Products Corp., 3600 Sunset, Waukegan, IL 60085. (312) 689-7700. **Circle No. 446**

Chicago Dynamic Inds., Precision Products Div., 1725 W. Diversey, Chicago, IL 60614. (312) 935-4600. **Circle No. 447**

Chicago Switch Inc., 2039 W. Wabansia Ave., Chicago, IL 60647. (312) 489-5500. **Circle No. 448**

Chomerics Inc., 77 Dragon Ct., Woburn, MA 01801. (617) 935-4850. **Circle No. 449**

C & K Components Inc., 103 Morse St., Watertown, MA 02172. (617) 926-0800. **Circle No. 450**

Clare-Pendar Co., Box 785, Post Falls, ID 83854. (208) 773-4541. **Circle No. 451**

Cole-Hersee Co., 20 Old Colony Ave., South Boston, MA 02127. (617) 268-2190. **Circle No. 452**

Cole Instrument Corp., 2034 Placentia Ave., Costa Mesa, CA 92627. (714) 642-8080. **Circle No. 453**

Compu-Lite Corp., 711-F12 W. 17th St., Costa Mesa, CA 92627. (714) 645-1501. **Circle No. 454**

Crouse-Hinds Co., Arrow-Hart Inc., 103 Hawthorn St., Hartford, CT 06101. (203) 249-8471. **Circle No. 455**

CTS Keene Inc., 3230 Riverside Ave., Paso Robles, CA 93446. (805) 238-0350. **Circle No. 456**

Cutler-Hammer Co., Control Switch Div., 1420 Delmar Dr., Folcroft, PA 19032. (215) 586-7500. **Circle No. 457**

C-W Industries, 550 Davisville Rd., Warminster, PA 18974. (215) 355-7080. **Circle No. 458**

Dialight, 203 Harrison Pl., Brooklyn, NY 11237. (212) 497-7600. **Circle No. 459**

Digitran Co., 855 Arroyo Pkwy., Pasadena, CA 91105. (213) 449-3110. **Circle No. 460**

Disc Instruments Inc., 102 E. Baker St., Costa Mesa, CA 92626. (714) 979-5300. **Circle No. 461**

Dresser Inds. Industrial Valve & Instrument Div., 250 E. Main St., Stratford, CT 06497. (203) 378-8281. **Circle No. 462**

Duncan Electronics Inc., 2865 Fairview Rd., Costa Mesa, CA 92626. (714) 545-8261. **Circle No. 463**

Eagle Electronic Manufacturing Co., 45-31 Court Square, Long Island City, NY 11101. (212) 937-8000. **Circle No. 464**

EECO, 1441 E. Chestnut Ave., Santa Ana, CA 92701. (714) 835-6000. **Circle No. 465**

Elcoma/Comm. Dept., Philips, Building BF, Eindhoven, the Netherlands. **Circle No. 466**

Electro Mech Components, 1826 N. Floradale, South El Monte, CA 91733. (213) 442-7180. **Circle No. 467**

Electro-Mec Instrument Corp., 71 S. Tpke Rd., P.O. Box 25, Yalesville, CT 06492. (203) 269-7711. **Circle No. 468**

Electro Switch Corp., 167 King Ave., Weymouth, MA 02188. (617) 335-5200. **Circle No. 469**

Erp Industrial Corp., Ltd., Liton Rd., Sunstable, Bedfordshire LU54LJ, England. 0582 62241. **Circle No. 470**

Fasco Inds. Inc., N. Federal Highway, Boca Raton, FL 33432. (305) 368-0600. **Circle No. 471**

GC Electronics, 400 S. Wyman St., Rockford, IL 61101. (815) 968-9661. **Circle No. 472**

Gemco Electric Co., 1080 N. Crooks Rd., Clawson, MI 48017. (313) 435-0700. **Circle No. 473**

(continued on page 74)

General Control Co., 1200 Soldiers Field Rd., Boston, MA 02134. (617) 782-7440. **Circle No. 474**

Globe Union Inc., Centralab Electronics Div., 5757 N. Green Bay Ave., Milwaukee, WI 53201. (414) 228-1200. **Circle No. 475**

Grayhill Inc., 565 Hillgrove Ave., La Grange, IL 60525. (312) 354-1040. **Circle No. 476**

Haydon Switch & Instrument, 1500 Meriden, Waterbury, CT 06705. (203) 756-7441. **Circle No. 477**

Herald Electronics, 6611 N. Lincoln Ave., Chicago, IL 60645. (312) 675-1100. **Circle No. 478**

Honeywell, Micro Switch Div., 11 W. Spring St., Freeport, IL 61032. (815) 232-1122. **Circle No. 479**

Idec Systems & Controls Corp., 3553 Ryder St., Santa Clara, CA 95051. (408) 738-4332. **Circle No. 480**

IEE/Shadow Inc., 8081 Wallace Rd., Eden Prairie, MN 55343. (612) 944-1820. **Circle No. 481**

Illinois Tool Works Inc., Licon Div., 6615 W. Irving Park Rd., Chicago, IL 60634. (312) 282-4040. **Circle No. 482**

Illuminated Products Inc., P.O. Box 11930, Santa Ana, CA 92711. (714) 540-9471. **Circle No. 483**

Imtronics Industries Ltd., 813 2nd St., Ronkonkoma, NY 11779. (516) 981-3434. **Circle No. 484**

Indak Manufacturing Co., 1915 Techny Rd., Northbrook, IL 60062. (312) 272-0343. **Circle No. 485**

Interswitch, 770 Airport Blvd., Burlingame, CA 94010. (415) 347-8217. **Circle No. 486**

I-T-E Rundel, 950 Charter St., Redwood City, CA 94063. (415) 365-8111. **Circle No. 487**

ITT Components Group, 1551 Osgood St., North Andover, MA 01845. (617) 688-1881. **Circle No. 488**

Jaidinger Manufacturing Co., 1919 W. Hubbard St., Chicago, IL 60622. (312) 421-1090. **Circle No. 489**

Janco Corp., 3111 Winona Ave., Burbank, CA 91504. (213) 845-7473. **Circle No. 490**

Javex Electronics, 9509 Oak Glen Rd., Cherry Valley, CA 92223. (714) 845-3986. **Circle No. 491**

Jay-El Products, 1859 W. 169, Gardena, CA 90247. (213) 321-3260. **Circle No. 492**

Klockner Moeller Corp., Motor Controls Electronics, 4 Strathmore Rd., Natick, MA 01760. (617) 655-1910. **Circle No. 493**

Lake Shore Electric Corp., 205 Willis St., Bedford, OH 44146. (216) 232-0200. **Circle No. 494**

Landis & Gyr, Group Headquarters, Gubelstrasse, 6301 Zug, Switzerland. 042-241-124. **Circle No. 495**

Langevin Precision Switches, 2030 Placentia Ave., Costa Mesa, CA 92627. (714) 642-8083. **Circle No. 496**

Ledex Inc., 123 Webster St., Dayton, OH 45401. (513) 224-9891. **Circle No. 497**

Leecraft Manufacturing Co., Inc., 21-16 44th Rd., Long Island City, NY 11101. (212) 392-8800. **Circle No. 498**

Leviton Manufacturing Co., Inc., 59-25 Little Neck Pkwy., Little Neck, NY 11362. (212) 229-4040. **Circle No. 499**

Littelfuse Inc., 800 E. Northwest Hwy., Des Plaines, IL 60016. (312) 824-1188. **Circle No. 500**

Litton Systems Inc., Poly Scientific Div., 1213 N. Main St., Blacksburg, VA 24060. (703) 552-3014. **Circle No. 501**

LVC Industries Inc., 135-25 37 Ave., Flushing, NY 11354. (212) 939-9777. **Circle No. 502**

Machine Components Corp., 70 Newtown Rd., Plainville, NY 11803. (516) 694-7222. **Circle No. 503**

Mallory Distributing Products Co., 4760 Kentucky Ave., Indianapolis, IN 46241. (317) 856-3731. **Circle No. 504**

Matrix Systems Corp., 9411 Lurline Ave., Chatsworth, CA 91311. (213) 882-2008. **Circle No. 505**

Maurey Instrument, 4559 W. 60 St., Chicago, IL 60629. (312) 581-4555. **Circle No. 506**

McGill Manufacturing Co., N. Campbell St., Valparaiso, IN 46383. (219) 464-4911. **Circle No. 507**

McGraw-Edison Co., Edison Electronics Div. Measurements, GB Grenier Field, Manchester, NH 03103. (603) 669-0940. **Circle No. 508**

James Millen Manufacturing Co., Inc., 150 Exchange St., Malden, MA 02148. (617) 324-4108. **Circle No. 509**

Milli-Switch Corp., P.O. Box 67, Gladwyne, PA 19035. (215) 642-9222. **Circle No. 510**

Mitsumi Electric, 8-2 8 Chome Kokuryo, Chofu-Shi Tokyo 182, Japan. 03 489-5333. **Circle No. 511**

Molex Inc., 2222 Wellington Ct., Lisle, IL 60532. (312) 969-4550. **Circle No. 512**

DP Mossman Inc., Box 265, Brewster, NY 10509. (914) 279-3725. **Circle No. 513**

Mouser Electronics, 11511 Woodside Ave., Lakeside, CA 92040. (714) 449-2220. **Circle No. 514**

Namco Controls Acme-Cleveland, 170 E. 131 St., Cleveland, OH 44108. (216) 268-4200. **Circle No. 515**

Neovol SA, Llsana 22, Barcelona-15, Spain. 224-6031. **Circle No. 516**

Nexus Inc., 50 Sunnyside Ave., Stamford, CT 06902. (203) 327-7300. **Circle No. 517**

JM Nev Co., Electronic Div., Maplewood Ave., Bloomfield, CT 06002. (203) 242-2281. **Circle No. 518**

Noble Electronics, P.O. Box 2536, El Cajon, CA 92021. (714) 449-6650. **Circle No. 519**

NSF Ltd., Switches & Controls Div., Keighley, W Yorks, England BD 21 5EF. 053-526-1144. **Circle No. 520**

Oak Inds Inc., Switch Div., Crystal Lake, IL 60014. (815) 459-5000. **Circle No. 521**

Ohmite Manufacturing, 3601 Howard, Skokie, IL 60075. (312) 675-2600. **Circle No. 522**

Omega Engineering Inc., Box 4047, Stamford, CT 06907. (203) 359-1660. **Circle No. 523**

Omrcon Corp. of America, 1051 State Pkwy., Schaumburg, IL 60172. (312) 885-9500. **Circle No. 524**

Oneida Electronics Manufacturing Co., Inc., P.O. Box 678, Meadville, PA 16335. (814) 336-2125. **Circle No. 525**

Otto Controls Div., 38 Main St., Carpentersville, IL 60110. (312) 428-7171. **Circle No. 526**

Panasonic Co., Industrial Components, 1 Panasonic Way, Secaucus, NJ 07094. (201) 348-7000. **Circle No. 527**

Permofer SA, Niguel s/n&SO-Edificio Cobalto, Hospitalet de Llobregat, Barcelona, Spain. 337-1583. **Circle No. 528**

Philmore Manufacturing Co., Inc., 40 Inip Dr., Inwood, NY 11696. (516) 239-6161. **Circle No. 529**

Potter & Brumfield Inc., 1200 E. Broadway, Princeton, IN 47671. (812) 385-5251. **Circle No. 530**

Qualitrol Corp., 1385 Fairport Rd., Fairport, NY 14450. (716) 586-1515. **Circle No. 531**

Radiall, 101 rue Philibert Hoffman, 93116 Rosny-S/Bois, France. 858-1040. **Circle No. 532**

Radio Switch Corp., P. O. Drawer A, Marlboro, NJ 07746. (201) 462-6100. **Circle No. 533**

Ranco Inc., 601 W. 5 Ave., Columbus, OH 43201. (614) 294-3511. **Circle No. 534**

Raytheon Co., Distributor Products Ops, Fourth Ave., Burlington, MA 01803. (617) 272-6400. **Circle No. 535**

RCL Electronics, Div. of AMF Inc., 700 South St., Irvington, NJ 07111. (201) 374-3311. **Circle No. 536**

Reed Switch Developments Co. Inc., 969 Jefferson, Kerrville, TX 78028. (512) 896-4444. **Circle No. 537**

Relay Specialties Inc., 1300 Plaza Rd., Fair Lawn, NJ 07410. (201) 797-3313. **Circle No. 538**

Robertshaw Controls Co., 2101 Marlane Dr., Grove City, OH 43123. (614) 875-2351. **Circle No. 539**

Milton Ross Co., 511 Second St. Pike, Southampton, PA 18966. (215) 355-0200. **Circle No. 540**

SAIME, San Adrian 78-88, Barcelona-16, Spain. 345-4150. **Circle No. 541**

Sakae Tsushin Kogyo Co. Ltd., 322 Ichinotsubo Nakahara-ku, Kanagawa Pref, Japan MBX. 044-411-5580. **Circle No. 542**

Sakata International Inc., 651 Bonnie Lane, Elk Grove Village, IL 60007. (312) 593-3211. **Circle No. 543**

Samarius Inc., 300 Seymour Ave., Derby, CT 06418. (203) 735-7405. **Circle No. 544**

Sasse KG Dr Eugen, Muhlenstr 4, 8540 Schwabach, Germany. 9122-5015. **Circle No. 545**

Seacor Inc., 598 Broadway, Norwood, NJ 07648. (201) 768-6070. **Circle No. 546**

Shallco Inc., P.O. Box 1089, Smithfield, NC 27577. (919) 934-3135. **Circle No. 547**

Shigoto Industries Ltd., 350 Fifth Ave., New York, NY 10001. (212) 695-0200. **Circle No. 548**

Showa Musen Kogyo Co. Ltd., No 5-5 6-Chome Togoshi, Shinagawa-Ku, Japan. (03) 785-1111. **Circle No. 549**

Siemens Corp., Components Group, 186 Wood Ave. S., Iselin, NJ 08830. (201) 494-1000. **Circle No. 550**

Sola Basic Industries, P.O. Box 753, Milwaukee, WI 53201. (414) 276-1480. **Circle No. 551**

Spectrol Electronics Corp., 17070 E. Gale Ave., City of Industry, CA 91745. (213) 964-6565. **Circle No. 552**

Square D Co., Executive Plaza, Park Ridge, IL 60068. (312) 774-9200. **Circle No. 553**

Stackpole Components Co., P.O. Box 14466, Raleigh, NC 27610. (919) 828-6201. **Circle No. 554**

Standard Grigsby Inc., 920 Rathbone Ave., Aurora, IL 60507. (312) 897-8417. **Circle No. 555**

Stanford Applied Engineering Inc., 340 Martin Ave., Santa Clara, CA 95050. (408) 243-9200. **Circle No. 556**

Stettner-Trush Inc., 67 Albany St., Cazenovia, NY 13035. (315) 655-8141. **Circle No. 557**

Subminiature Instruments Corp., 3147 Durahart St., Riverside, CA 92507. (714) 684-7133. **Circle No. 558**

Switchcraft Inc., 5555 N. Elston Ave., Chicago, IL 60630. (312) 792-2700. **Circle No. 559**

T Bar Inc., 141 Danbury Rd., Wilton, CT 06897. (203) 762-8351. **Circle No. 560**

Technical Labs Inc., Bergen & Edsall Blvds., Palisades Park, NJ 07650. (201) 944-2221. **Circle No. 561**

TEC Inc., Components Div., 2727 N. Fairview Ave., Tucson, AZ 85705. (602) 792-2230. **Circle No. 562**

Teleflex Inc., Church Rd., North Wales, PA 19454. (215) 699-4861. **Circle No. 563**

Telemecanique Inc., 2525 S. Clearbrook Rd., Arlington Heights, IL 60005. (312) 437-1150. **Circle No. 564**

Texas Instruments Inc., 34 Forest St., Attleboro, MA 02703. (617) 222-2800. **Circle No. 565**

Tower Manufacturing Corp., 158 Pine St., Providence, RI 02903. (401) 331-2380. **Circle No. 566**

Unimax Switch Corp., Ives Rd., Wallingford, CT 06492. (203) 269-8701. **Circle No. 567**

Waldom Electronics Inc., 4637 W. 53 St., Chicago, IL 60632. (312) 585-1212. **Circle No. 568**

Westinghouse Electric Corp., Control Products Div., Tuscarawas Rd., Beaver, PA 15009. (412) 775-2000. **Circle No. 569**

Wilbrecht Electronics Inc., 240 Plato Blvd., St. Paul, MN 55107. (612) 222-2791. **Circle No. 570**

Workman Electronics Prods. Inc., P.O. Box 3828, Sarasota, FL 33578. (813) 371-4242. **Circle No. 571**

MICRO-DIP SWITCH

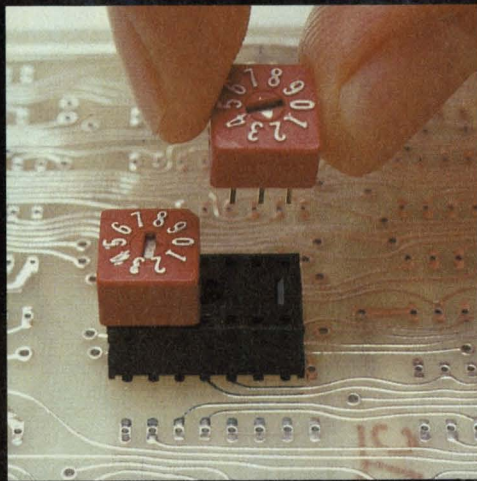

MICRO-DIP...Miniature binary-coded DIP switch designed to be mounted directly to printed circuit boards. Ideal for address encoding, pre-setting, PCB programming...every area using digital electronics.

Packaged in a glass-filled nylon housing with terminals on .100X.300 centers. Occupies only one-half of a standard 14-pin DIP socket.

Screwdriver slot is rotated in either direction to desired setting. Dust-seal concept protects gold contact surfaces. Ease of solderability and cleaning.

Positive detenting 10-position BCD code. Guaranteed life of 10,000 detent operations. Operating temperature range of -10°C to $+60^{\circ}\text{C}$ with contact resistance of 25 milliohms max. initial.

One year warranty.



EECO

1441 East Chestnut Avenue, Santa Ana, California 92701 - Phone 714/835-6000. Distributed in U.S. by G. S. Marshall, Hall-Mark and Schweber. In Canada by R.A.E.

Engineers looking for
new and innovative
switching come to AMP.

Because we keep an
eye on the future.

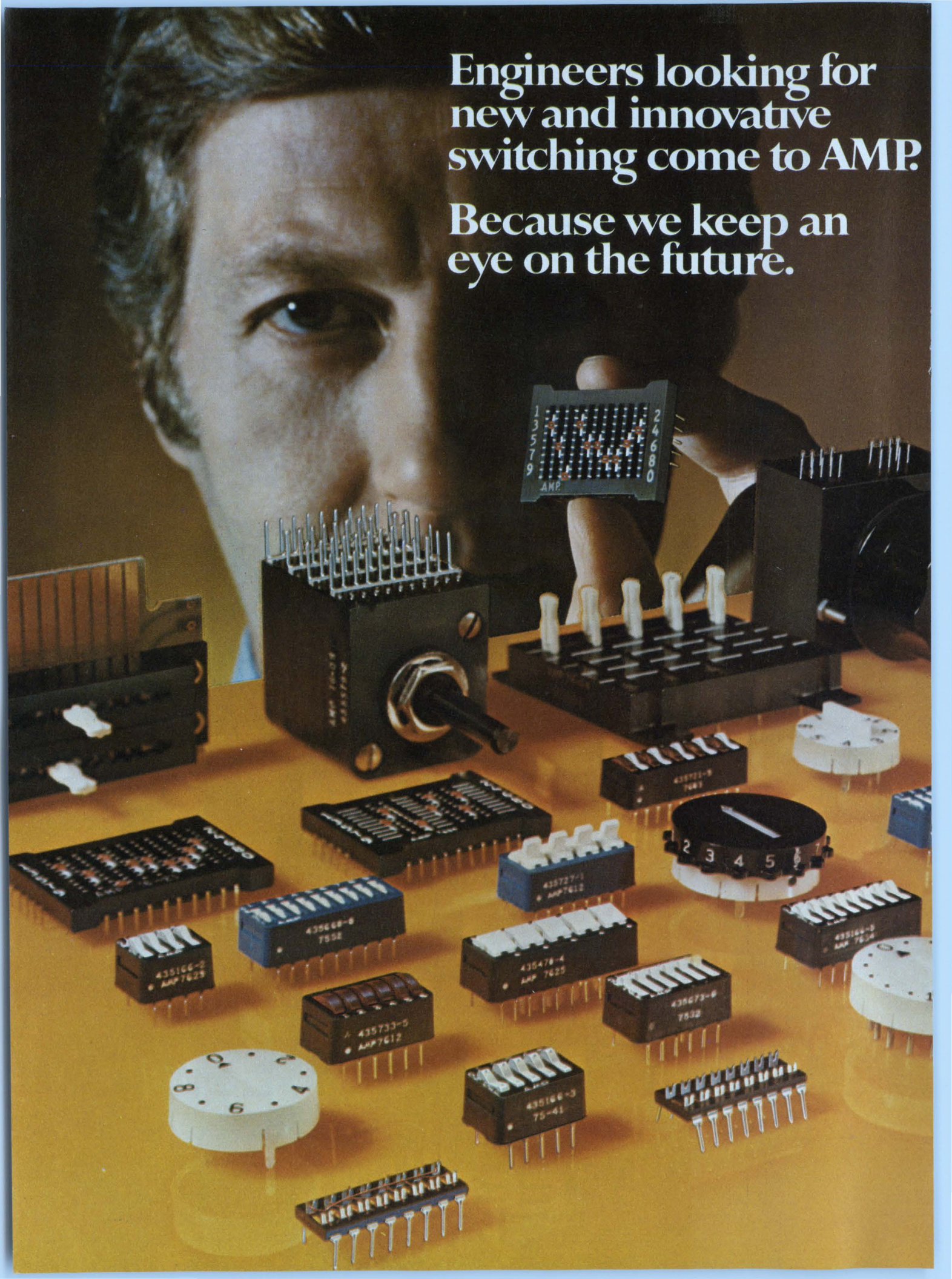

We started with the world's first miniature Dual In-line Package switch and now have types ranging from new mini-matrix slide switches and coded rotary switches to LED and side-actuated DIP types, to name a few.

And as we have from the beginning, we stand behind every one of them, new or old, with an offer of solid, technical support. Not because they need it. But because we believe you as an engineer, are entitled to it when you innovate. It's the kind of full support that says we're ready to work with you not only in product application and production but even earlier, in research and development, if you desire. And we think you'll find it a good way to keep an eye on the future of switching.

Among the most popular of our "future" switching innovations is the unique Mini-Matrix Slide Switch. It's especially useful for logic level matrix, switching applications. And our new programmable DIP Shunts offer another easy way to program manually. By simply opening or closing conductive straps.

But perhaps the most revolutionary switch of all is our unique, patented coded rotary switch. It switches the circuit instead of the contacts. Just as new, is our DIP Network Switch. It's designed for use with thick film capacitor and resistor chips for impedance switching and time delay functions.

As you can see, there are many more switching innovations, like our Standard Rotary switches and Pull-to-set types. For more information, just call AMP Customer Service at (717) 564-0100. Or write AMP Incorporated, Harrisburg, PA 17105.

AMP has a better way.

**"SEE US AT THE INTERNATIONAL
ELECTRONIC COMPONENT
EXHIBITION, PARIS"**

AMP
INCORPORATED
CIRCLE NUMBER 51

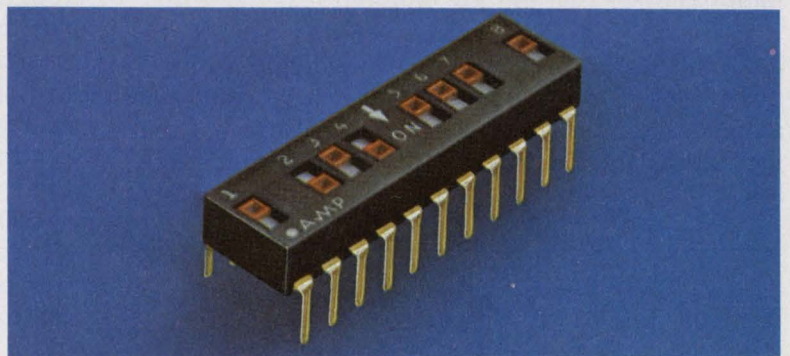
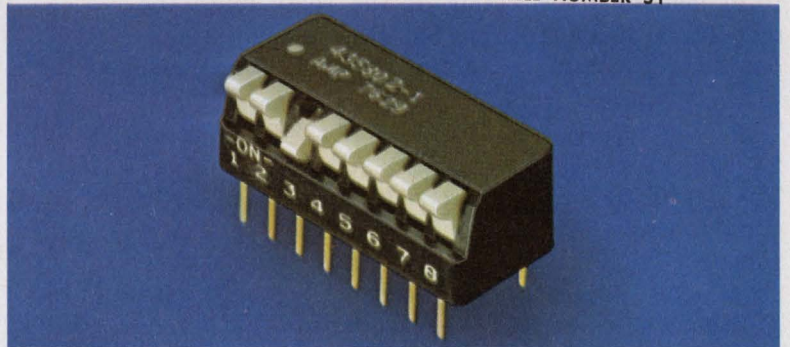
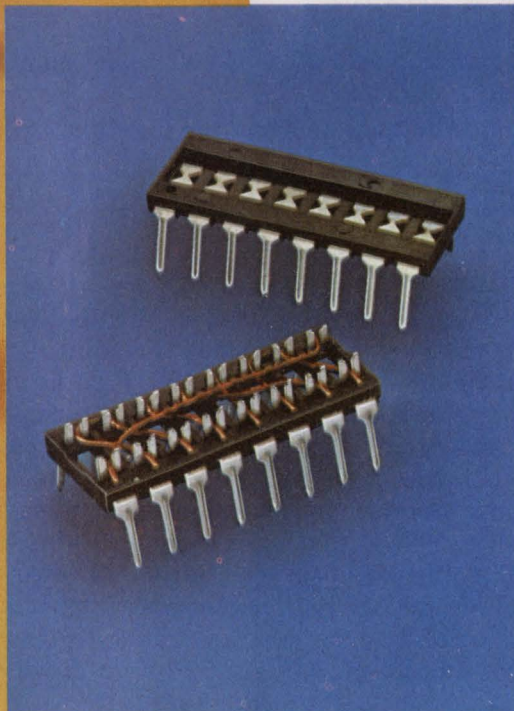

Avoid relay-specification pitfalls.

Don't depend solely on published information. The catalogs leave out too much data essential for proper design.

You can't depend entirely on specification sheets when selecting relays. If you do, you just might give a relay credit for capabilities it doesn't have. So in addition to the manufacturer's published information, keep these considerations in mind:

- Over-all electrical limitations.
- Over and undervoltage characteristics.
- Protection against transients.
- Mechanical and electrical lifetimes.
- Temperature limitations.

Detailed data on these topics are often missing, sketchy or at best buried in footnotes and incomplete charts and tables.

Watch those over-all ratings

Relay specification sheets almost always list the maximum permissible amperage per contact. But they don't always make clear that a multipole relay may be limited further by a maximum total current-carrying capacity. For example, consider a four-pole relay that incorporates contacts rated at 10 A each. Apparently, the total relay capacity is 40 A. But as a matter of fact, the maximum total load on all contacts of the relay might be only 30 A. Such information must either be dug out of footnotes or obtained via a phone call to the manufacturer.

Or say a relay is rated at 10 A at 120 V ac or 24 V dc. What is the current rating at 48 V dc? The catalog probably doesn't say, and you shouldn't guess. Ratings above 24 V dc are a function of contact gap, which can vary widely from one 10-A relay to another. The only safe solution is to explain your needs to the relay manufacturer and get his opinion.

Similarly it's easy to inadvertently exceed the load ratings for reed relays. Usually, the maximum amperage, voltage and wattage (or volt-amperes) are specified separately. However, the wattage is the limiting factor. Even if amperage and voltage are within limits, you should multiply

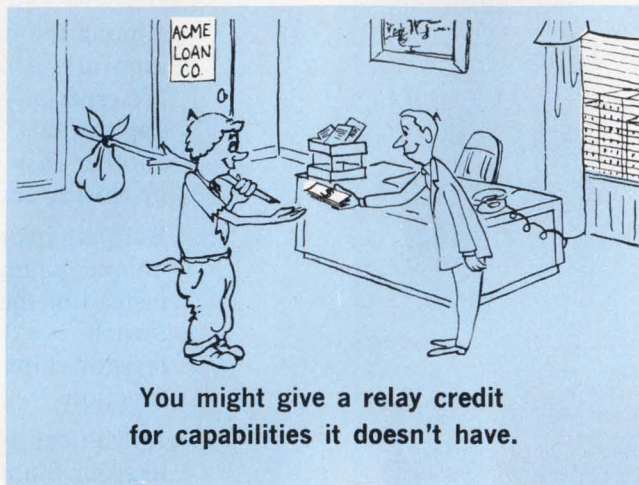

them together to determine if the wattage also is within allowable limits. For example, if a reed relay is rated at a maximum of 250 V and 1 A, then

$$15 \text{ V} \times 1 \text{ A} = 15 \text{ W (maximum rating at 1 A)}$$

or

$$250 \text{ V} \times 0.06 \text{ A} = 15 \text{ W (maximum rating at 250 V)}$$

or

$$24 \text{ V} \times 0.625 \text{ A} = 15 \text{ W (maximum rating at 24 V)}$$

All the maximums can't be used together.

Don't operate relays near voltage limits

Although specification sheets usually provide an allowable under-to-undervoltage tolerance range around a relay coil's nominal-rating range, the effect of continuous use outside the nominal range is rarely mentioned. Such a tolerance range is meant to allow for the occasional fluctuations that occur in nearly all power sources. It doesn't mean you may operate at a continuous over or undervoltage without paying some price. This is seldom explained.

Usually, the specification clearly indicates the allowable range of continuous operating voltage. For example, many relays are rated to operate continuously between 110 and 125 V dc. However,

Clarence Jones, Industrial Products Manager, Struthers-Dunn, Inc., Lambs Rd., Pitman, NJ 08071.

the relays also have an extra tolerance—typically 80 to 110% of nominal at 25 C—for transient fluctuations. This means that the voltage normally available must be between 110 and 125 V dc, but the relay can still operate properly when the voltage temporarily drops to 88 V dc or surges to 137 V dc.

But if the operating voltage remains continuously at, say, 100 V, you can expect problems. The low voltage provides reduced contact pressures, which can cause premature contact failure. On the other hand, a continuous supply of, say, 130 V can overheat and also cut the relay's life. Nevertheless, both the 100 and 130 V are well within the 88-to-137-V spec.

Especially with ac relays, when operating at low voltages (less than 85% of rated nominal), the armature may not close firmly, resulting in a noisy, chattering relay that will fail prematurely. The coil may overheat or the contacts weld.

Select a relay nominally rated as closely as possible to the actual long-term supply voltage. If the normal supply voltage is 100 V, 60 Hz, don't try to use a relay rated at 120 V, 60 Hz—even when the relay's under and overvoltage specs allow such operation. Get a special 100-V coil. The small added cost of the special coil can save you quite a bit of money in the long run, as well as provide more reliable performance.

Dependable relay manufacturers usually have a wealth of information—far more than they can publish in their catalogs. Perhaps you need a relay coil that can pull in at a very low voltage but also can withstand high voltages. It generally won't be in the catalog. Neither will the information you must have about transients.

Transients troublesome to SSRs

Electromechanical relays normally handle most transients in both the coil and contact circuits so well that manufacturers rarely specify or provide transient protection for them. But solid-state (SSR) or hybrid relays can be readily damaged by transients.

For example, a specification sheet may read: "Relay is unaffected by transients of 5-ms duration with an exponential slope from 0 V to a 20- μ s peak of ± 2000 V." But what if the period of peaking is longer? Does the same relay withstand, for instance, a 100- μ s peak, even if the voltage is well below 2000 V?

If you anticipate such long-duration transients, you must ask the relay manufacturer for complete transient-protection statistics; the longer, the more important the information.

And don't overlook the two kinds of transients. Besides the familiar transients that occur every time a circuit closes, there are random, unexpected ones that are difficult to predict and protect

against. There's no excuse for not selecting a relay that can handle the former. But the latter may require some measurements and statistics pertaining to your particular application.

An elementary—but often overlooked—point: Most relays carry two "lifetime" ratings. One is the anticipated electrical lifetime based on operation at the rated load; the other is the mechanical lifetime with no electrical load.

A given relay may have a life of 500,000 cycles at 10 A, but 10-million cycles with no elec-

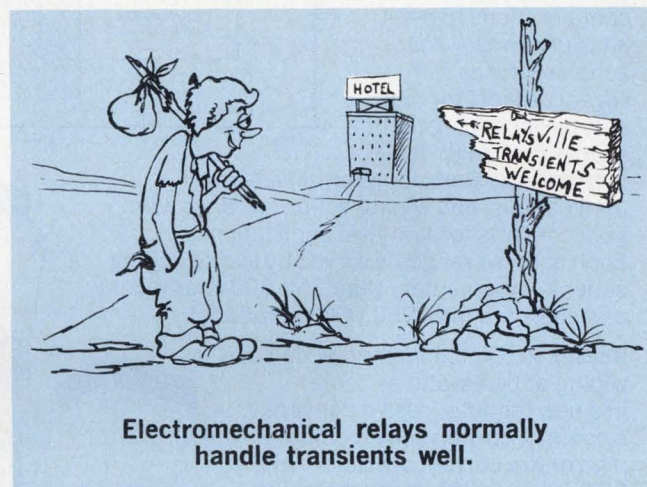

trical load. Data for loads between zero, which is the mechanical life, and rated load are rarely published and usually not linearly proportioned between these points. So again you must ask the manufacturer, and hope he has the data. Some manufacturers may even have life data for load currents above the rated and other variations—such as with transients. For a given relay, you may be willing to trade life for a high load.

A relay's life is also affected by temperature. Relays are usually rated for a "safe" ambient temperature range. But since temperature also affects operating parameters, relays don't necessarily operate equally well at all points within the safe temperature range.

A relay may have an operating range of -10 to 55 C. But the relay's pull-in and drop-out voltages and timing repeatability are almost certain to fall off as either temperature extreme is approached. Especially with time-delay relays, a timing repeatability rating of $\pm 3\%$ in the range of 20 to 25 C can easily deteriorate to $\pm 10\%$ at the extremes of the operating range. Such data are rarely published in the catalog.

And finally, even with all the engineering data in the world, some decisions must still be based upon value judgments. If a relay fails, will the failure cause only a minor inconvenience? Or, can the result be serious? And, of course, what's the manufacturer's reputation? ■■

Dialight Switches

A switch for all reasons.

Reason 1: Dialight offers three switch configurations to meet all your needs—*snap-action switches with silver contacts* for moderate-level applications, *snap-action switches*

with gold contacts for intermediate-level applications, and *wiping-action switches with gold contacts* for low-level applications. Each of these ranges is served by two switching actions—momentary (life: 750,000 operations) and alternate (life: 250,000 operations).

Reason 2: Dialight's snap-action and wiping-action switches come in a new modular design concept . . . a common switch body for either high or low current operation. All 554 series switches and matching indicators have the same rear-panel projection dimensions.

The snap-action switching mechanism guarantees a fast closing and opening rate. This insures that contact force and contact resistance

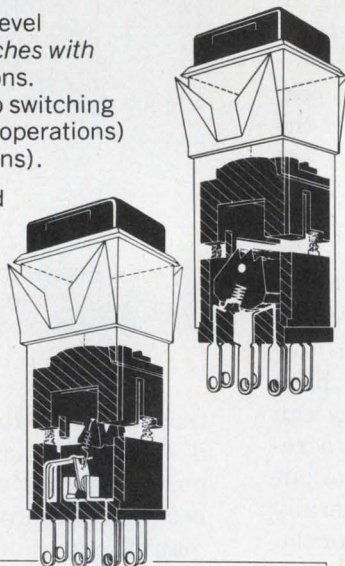
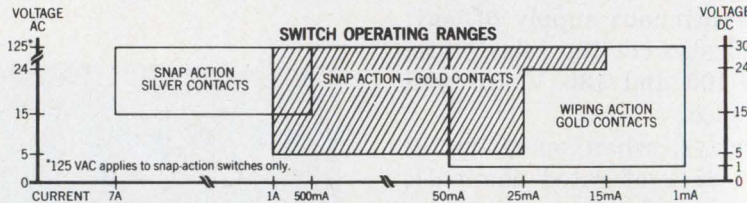

types. There are over 240 switch variations to choose from.

The 554 illuminated switch, designed for front of panel lamp replacement, gives you a choice of five different bezel sizes . . . 3/4" x 1", 5/8" x 3/4", 3/4" square, 5/8" square, and 1/2" square. The first four sizes are also available with barriers. You also get a choice of six cap colors . . . white, blue, amber, red, green, and light yellow . . . four different underlying filter colors . . . red, green, amber, and blue and a variety of engraved or hot-stamped legends . . . over 300 cap styles . . . over 100,000 combinations.

There is also a variety of terminal connections . . . solder blade, quick connect, and for PC board insertions.

Reason 4: Dialight's 554 series is designed as a low cost switch with computer-grade quality.

Reason 3: Dialight offers a wide variety of panel and snap-in bezel mounting switches with momentary and alternate action configurations in SPDT and DPDT

PRODUCT SELECTOR GUIDE

SWITCHING ACTIONS	Snap-Silver contacts		Snap-Gold contacts		Wiping-Gold contacts	
	SPDT	DPDT	SPDT	DPDT	SPDT	DPDT
MOMENTARY	○	○	○	○	○	○
ALTERNATE	○	○	○	○	○	○
OPTIONS						
PUSH BUTTON CAP SIZES						
	1/2" Sq.	5/8" Sq.	5/8" x 3/4"	3/4" Sq.	3/4" x 1"	
BEZEL MOUNTING TO ACCOMMODATE	○	○	○	○	○	
BEZEL MOUNTING WITH BARRIERS TO ACCOMMODATE		○	○	○	○	
PANEL MOUNTING TO ACCOMMODATE	○	○	○	○	○	
MATCHING INDICATORS	○	○	○	○	○	

are independent of the switch's actuation speed.

In the wiping-action switch, the contacts are under constant pressure (A unique Dialight design). This insures long life with a minimum build-up of contact resistance.

Both switch types are tease-proof.

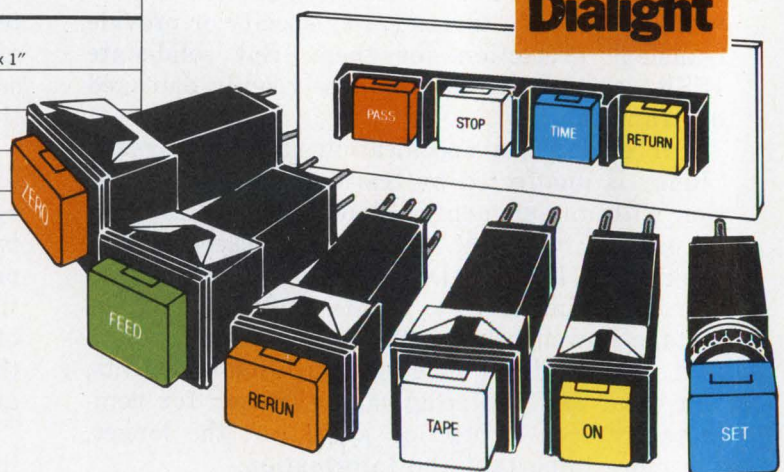

DIALIGHT

A North American Philips Company
203 Harrison Place, Brooklyn, N.Y. 11237
(212) 497-7600



Who
checks you in and out
of the best hotels in New York,
Paris, Honolulu, and Las Vegas?
We.



SYSTEM INSTALLATIONS IN:

Aladdin Hotel & Casino • Cerromar
Beach Hotel • Dorado Beach Hotel •
Hotel Inter-Continental Maui • Hotel
Inter-Continental Paris • Hyatt House Orlando
• Hyatt Regency Waikiki • Innisbrook Resort & Golf
Club • MGM Grand Hotel • Sea Pines Plantation • Sheraton-
Boston Hotel • Sheraton-Four Seasons Hotel • Sheraton
New York Hotel • Sheraton Waikiki • Princess Kaiulani
Hotel • Royal Hawaiian Hotel • Tamarron

The computer system that takes your reservation, registers you, continuously updates your guest folio from hotel points of sale, and prints out your final bill is almost certainly our EECO Hotel System. Because we dominate the field you'll find it unobtrusively doing its job at a growing number of the world's best hotels and resorts.

We're telling you now because we thought it's time you knew we do more than make thumbwheel switches, tape readers, and packaging hardware.

EECO is part of your life.

EECO

1441 E. Chestnut Ave., Santa Ana, California 92701 • Phone 714/835-6000



PLUG

7545

7540F
7540F
7540F

1
2
3
4
5
6
7
8
OPEN

GENERAL AUTOMATIC

DATE

GA counts in microcomputing.

There's not a machine that can touch GA's 220. Not from DEC, Data General, or anywhere else.

- 1. The only μ C with COBOL, FORTRAN and in-depth software support.**
- 2. The only μ C with a full file management system.**
- 3. The only μ C to offer OEMs a wide choice of operating systems:** like FSOS, DBOS, RTX, RTOS.
- 4. The broadest μ C instruction repertoire:** speeds program development, conserves memory, accelerates execution.
- 5. The only μ C that can handle big disks:** I/O rate is 2.0 mB/second.
- 6. The fastest μ C:** LDR/STR (indexed) 2.6 μ s.
- 7. The only μ C with parity built-in:** hardware test, verification, fault isolation, plus write protect.
- 8. The only μ C with a back-up power supply built-in:** protects semiconductor memory from power failures.
- 9. The only μ C with board-level operator controls, switches and displays:** in a microconsole.
- 10. The only μ C with over 100 field-proven I/O controllers.**

GENERAL AUTOMATION

A big break for OEMs: family compatibility, throughout General Automation's extensive micro/mini line, gives GA-16/220 instant access to multiple batch and real-time operating systems, and to software off-the-shelf.

- Rush me full details on GA-16/220 μ C capabilities.
- Contact me for immediate requirements.

Name _____

Title _____

Phone _____ Ext. _____

Clip coupon to company letterhead and send to General Automation, 1055 South East Street, Anaheim, CA 92803. Or call (714) 778-4800.

ED-2

See us at the Computer Caravan.

CIRCLE NUMBER 132

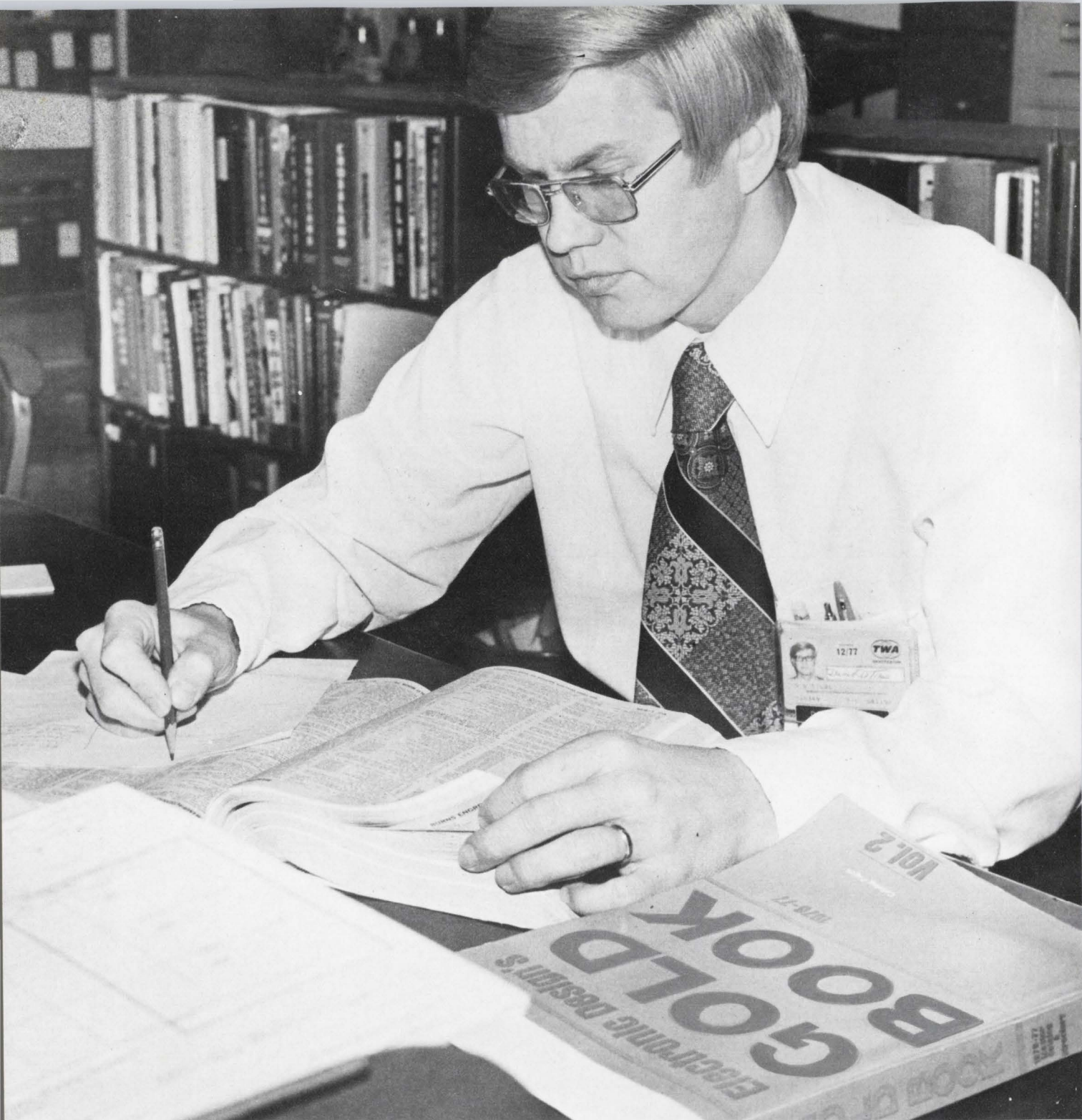

"I BELIEVE THE GOLD BOOK IS ONE OF THE MOST IMPORTANT BOOKS ON MY SHELF."









Darrell D. Tilus is Master Engineer at TWA, Kansas City. He's in charge of design and/or purchase of equipment used to test aircraft "black boxes," and specifies the needed equipment and components. His directory? *Electronic Design's* GOLD BOOK.

Mr. Tilus estimates that he used the GOLD BOOK two or three times a week during the past year, rates it "extremely useful" and has purchased over \$10,000 worth of test equipment, components and devices through its pages.

"I can count on the GOLD BOOK to give me and my fellow engineers the address and phone of all the electronic/electrical companies I need to contact. I think it's far superior to the others (especially the EEM) in the directory pages."

If you're looking for electronic products — do what Mr. Tilus does — look *first* in the GOLD BOOK.

IF IT'S ELECTRONIC...IT'S IN THE GOLD BOOK

 <p>4PDT TS-042-SD-S-LB-S-S</p>	 <p>4PDT TS-042-SD-S-S-S-S</p>	 <p>SPDT TS-012-SD-S-S-S-S</p>
 <p>DPDT TS-022-SD-S-S-S-S</p>	 <p>SPDT TS-012-SD-S-L-S-S</p>	 <p>3PDT TS-032-SD-S-S-S-S</p>
 <p>SPDT TS-012-SD-S-SB-S-S</p>	 <p>DPDT TS-022-SD-S-LI-S-S</p>	 <p>3PDT TS-032-SD-S-P-S-S</p>

The UID collection goes on. And on. Now miniature toggles.

Need a toggle switch? UID offers you a whole collection of high-quality, long-life, miniature toggles.

The easy-mount toggles are completely enclosed to exclude dust and other airborne contaminants. They provide an excellent choice for low-energy circuits or each toggle can be 5 AMP 125 VAC UL-listed to meet your power switching requirements.

If you don't find exactly the switch you want pictured above or in the UID total collection catalog, UID can custom design the perfect switch for your needs.

Write or call Richard L. Winn, UID Electronics Division, AMF Incorporated, 4105 Pembroke Road, Hollywood, Florida 33021.

Telephone (305) 981-1211.



CIRCLE NUMBER 53

Revisiting the cross-field inductor: Ordinary ferrite pot cores improve this useful device, which offers high Q s in tuned circuits and other advantages.

The cross-field inductor not only can do many jobs better than conventional parallel-field reactors, it's also versatile. It can provide remote control, detect picoamps, transform dc, multiply frequencies, trim antennas, couple amplifiers and tune oscillators. But the cross-field inductor is largely ignored because of the mistaken belief that special and costly magnetic cores are required. In fact, you can adapt ordinary ferrite pot cores for cross-field inductors to do otherwise difficult jobs.

Basically, the cross-field inductor is a saturable magnetic device that has two or more windings with orthogonal fields. Mutual inductance coupling—the familiar transformer action—is absent, but a current in one winding affects the inductance of the others. With currents in several windings, energy can be transferred by parametric pumping.

Figure 1 shows a cross-field device and a conventional parallel-field reactor. Both devices exhibit zero mutual inductance, yet in either device, current in one winding affects the inductance of the other winding. The major difference between the two devices is that you don't have to match cores in the cross-field inductor.

In the figure, the two sections of winding 2 are in series opposition to the flux produced by the current in winding 1. Transformer coupling is cancelled if the cores are balanced. The mutual inductance between windings 3 and 4 is zero because of the orthogonal configuration. No balancing of core components is necessary.

Windings 1 and 2 have similar properties, so usually it makes little difference which is used for the control and which for the modulated circuits. The magnetic paths for windings 3 and 4 are quite different, so how the winding roles are assigned is important.

Winding 3 is a conventional bobbin coil whose flux path has a substantially uniform cross-section area over its entire length. If 3 is used as a

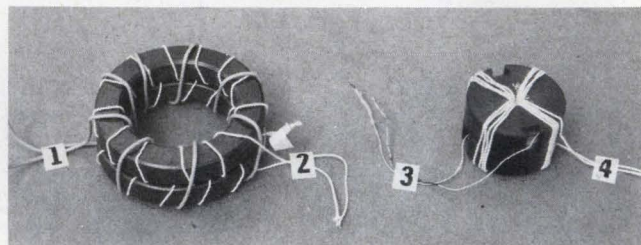

(a)

(b)

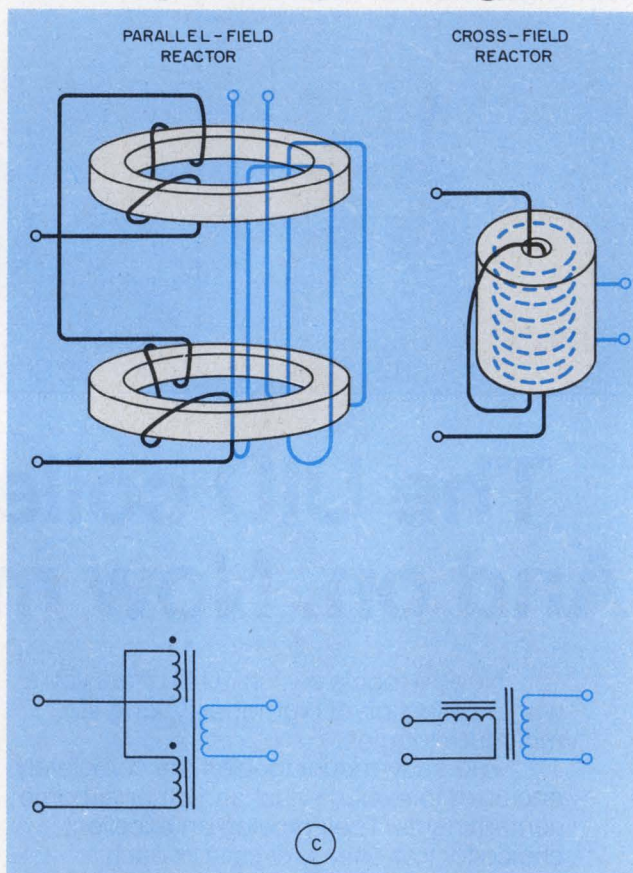

(c)

1. **Contrasting two kinds of saturable reactor:** the parallel-field type (a), widely used in magnetic amplifiers (for clarity, less than the optimum number of turns is shown) and the cross-field counterpart made with a standard ferrite pot core (b). The annular winding (No. 4) consists of 16 turns through the mounting hole and usually acts as the control or modulator. A bobbin coil works best in circuits requiring the highest Q or highest impedance. Winding details are shown in (c).

control winding, all portions of the core will saturate at the same current level.

The effects of core geometry

On the other hand, modulating current in winding 4 first saturates the inner region of the center post. As the current increases, the saturated region spreads to the entire center post. With very large currents, the entire pot core becomes saturated. Thus, the effect of I_4 on L_3 is strongly influenced by the core geometry, whereas the effect of I_3 on L_1 depends largely on the B-H curve of the material.

Standard international pot cores aren't ideal for cross-field use because the center holes are too small, and the slots on the outer diameter increase the MMF needed for saturation. Of the international cores, the 1408, 2213 and 2216 are most suitable for cross-field use. The adverse effect of the core slots can be reduced by rotating the two halves a quarter turn (see Fig. 1b).

The sharp edges of the center hole should be relieved by grinding to avoid damage to the annular-coil insulation. Some devices can be constructed with very large pot cores (the Allen-Bradley C2400, for example) that have been rebored by grinding.

Design considerations of conventional inductors apply to cross-field devices as well. The ferrite should have appropriate properties for the highest expected frequency. For high-frequency coils, use Litz wire; for high-frequency, high-impedance coils, use multisegmented bobbins.

Because of low permeability, high-frequency ferrites are not easily saturated. So, since wide swings in inductance cannot be achieved with modest control-signal power, consider ferrites of higher permeability than you normally would choose to get the maximum Q at the operating frequency.

The cross-field as a chopper

Data for a working cross-field device are shown in Fig. 2. The open-air inductance of the bobbin

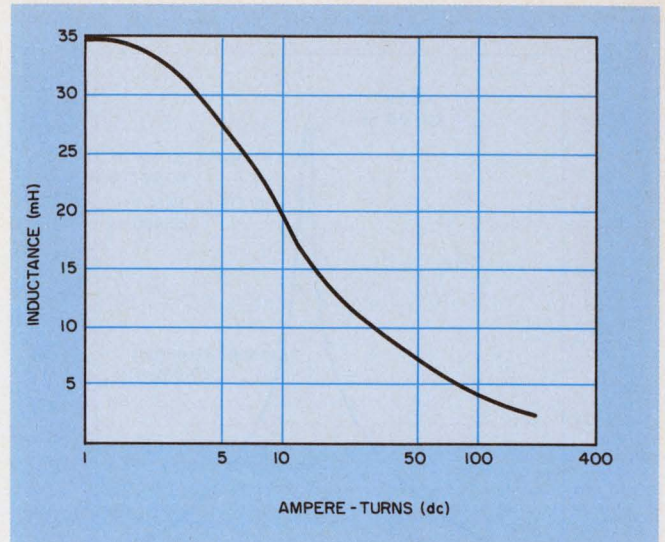

2. The inductance of a cross-field bobbin coil vs its toroidal dc ampere-turns. The bobbin has 68 turns, and its core is Magnetics, Inc., type 43622-UG, a type-D, moderately permeable ferrite that saturates at about 3 oersteds. The steep part of the curve, between 6 and 15 ampere-turns, corresponds to the saturation of the center post. An appreciably greater inductance swing can be obtained with a similar core made from Magnetics type G or Ferroxcube type 3B7 ferrite.

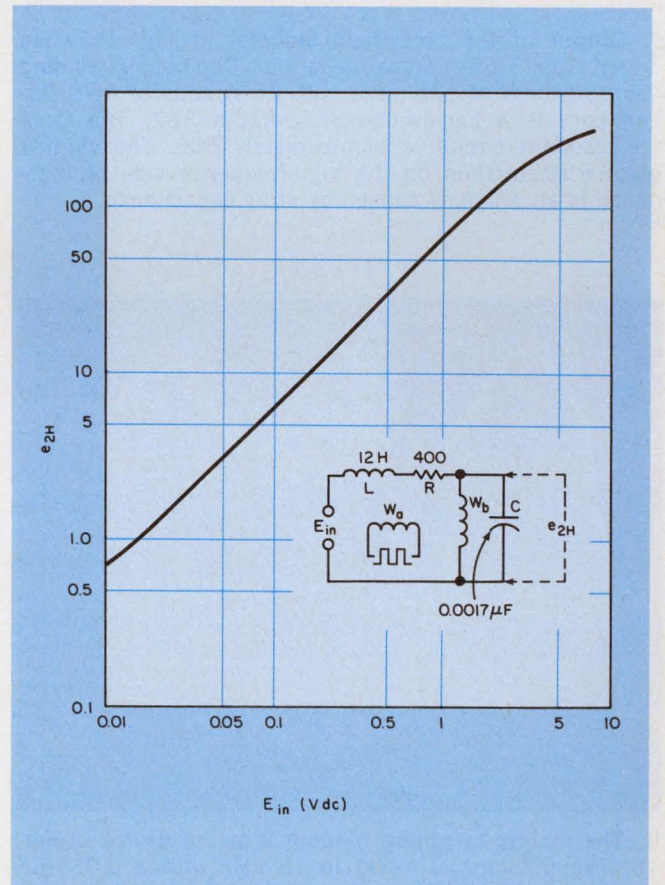

3. Almost three decades of linearity are obtained from a cross-field modulator made with a 1408-A100 miniature pot core. Winding W_a is annular, with 30 turns, W_b is a 750-turn bobbin coil made with 39-gauge wire.

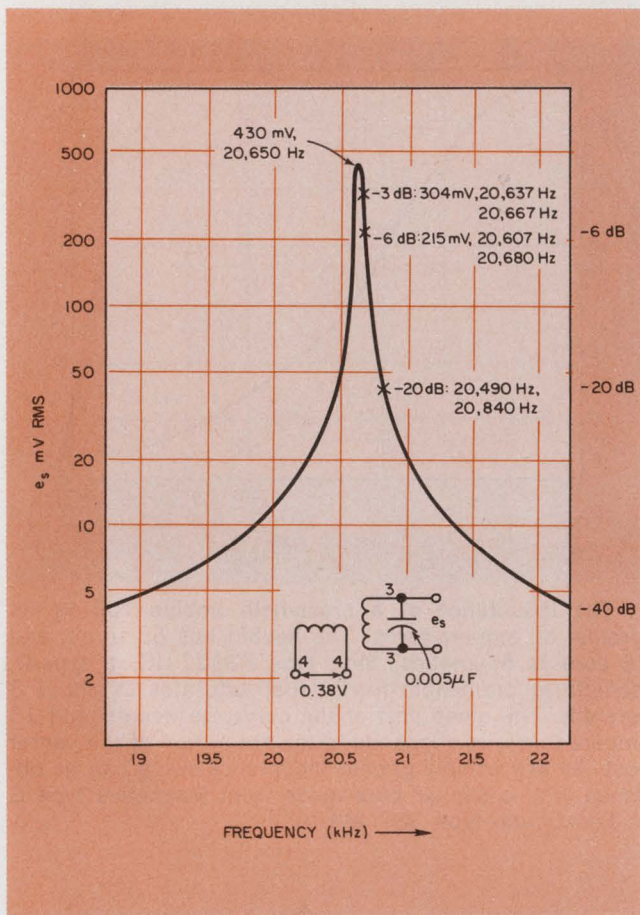

4. Output of the cross-field inductor of Fig. 1b when driven from a 50- Ω signal generator. The bobbin winding has 130 turns of Litz made with 16 strands of AWG 38. The core is a Ferroxcube 3622-A1000-3B7. The Q of the resonant circuit is approximately 600. The slightly greater attenuation on the high-frequency side of resonance is an anomaly caused by stray capacitance.

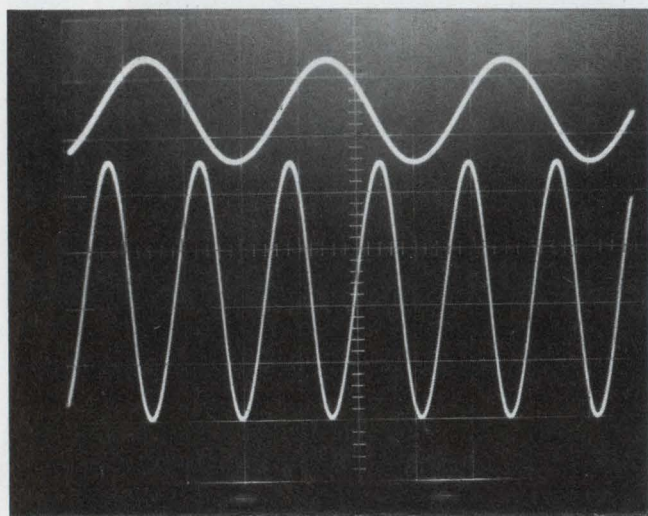

5. The results of tuning winding 3 of the device in Fig. 1b. The inductor is tuned to 13 kHz with a 0.013- μ F capacitor. The vertical sensitivity is 0.1 V/div for both traces, and the horizontal sweep speed is 50 μ s/div. A dc bias of 120 mA in the 16-turn toroidal winding (No. 4) is used to peak the harmonic response. Note the absence of 6.5-kHz drive signal in the top trace.

coil is 84 μ H, a low value that can be approached with a large number of ampere turns in the annular (center-hole) winding if the current is applied in bursts to avoid overheating.

Small dc signals, such as those generated by a thermocouple, can be chopped by a cross-field inductor to produce relatively large ac voltages, which are easier to measure or amplify. The dc signal is applied to the bobbin winding of the pot core, and a strong modulating current appears in the annular winding. At some point following a zero crossing of the modulator current, the core suddenly saturates and the bobbin winding's field collapses.

The energy stored ($1/2LI^2$) in the bobbin winding manifests itself as a voltage spike that occurs after both negative and positive-going zero crossings of the modulator current. Thus, the frequency of spike repetition is twice the modulation frequency, and the device is called, appropriately enough, a second-harmonic magnetic modulator.

The modulator is much cheaper than a conventional magnetic amplifier, has a much longer life than mechanical or photo choppers and, unlike FET choppers, can function in such hostile ambients as a high neutron flux. Moreover, the modulator readily provides galvanic isolation between its input and output circuits. It is ideal for conditioning and transmitting signals in process-control instrumentation.

The cross-field as a modulator

Figure 3 illustrates the performance of a cross-field modulator made with an ordinary miniature pot core. The device operates open-loop and is linear over nearly three decades. Output falls off at the upper end because the signal current causes the core to be partially saturated. The inductance of the bobbin coil thus decreases, and so does the energy stored per I^2 .

At the lower end, a finite signal develops despite a zero-input signal. The reason, in this case, is residual magnetization, which cannot be distinguished from the input signal. This magnetic effect can be eliminated by an appropriate dc bias on either winding. But then other effects begin to be important.

A second harmonic of the modulating frequency is coupled by the small but finite mutual inductance between W_a and W_b . The isolation between W_a and W_b is on the order of 50 dB, and allows some of the modulating signal to feed through. Much of the fundamental component is rejected by the tuned circuit, CW_b , which is resonant to 10 kHz. A second harmonic of the modulator is also coupled but, of course, is not attenuated by the 10-kHz tuned circuit.

Square-wave modulating current is chosen for

two reasons: It is easy to generate, and there's no second harmonic—theoretically, at least.

Galvanic isolation prevails if you provide an additional bobbin winding for the output. To preserve sensitivity, most of the available bobbin space should be allocated to the dc signal circuit. Since this coil will thereby have the higher Q, the capacitor should remain.

Even with a low-source impedance, inductance L and resistance R allow a high-tank Q. If desired, a much smaller L can be used. Temperature changes in the resistance of W_b will introduce errors that can be compensated for by a negative-tempco series resistance.

Preventing saturation

With feedback from an absolute-value amplifier, you needn't use a gapped core to prevent saturation by the signal current. The sensitivity of the device is proportional to the inductance of the bobbin coil which is increased about thirty-fold by replacing the A-100 core with an ungapped 1408-3C8. Whereas the sensitivity of the device in Fig. 3 is approximately $1/4 \mu W$, the ungapped core should work down to $10^{-8} W$.

Most of this energy is dissipated in the resistance of the isolating inductor, L, which contributes 340 Ω to the input circuit's resistance vs 60 Ω for the bobbin winding. Further improvement in sensitivity can be obtained by lowering signal-circuit resistance or by raising the inductance with a larger pot core.

As the sensitivity is pushed above $10^{-10} W$, modulator feedthrough and ferrite anisotropy pose formidable problems. The theoretical limit imposed by ferrite noise is about $10^{-15} W$, a performance ceiling that shouldn't be too confining in process-control, among other applications.

The cross-field inductor in tuned circuits offers many advantages. In conventionally coupled circuits, the Q is limited by the terminating impedances. But cross-field inductors can be driven by low-impedance sources without Q impairment. Figure 4 shows the response of the device of Fig. 1b when resonated with a 0.005- μF capacitor. The achieved Q of 600 is hard to obtain in conventional circuits; the resonant circuit is current-tunable and not affected by either the driver or the tuning-current source.

Cross-field devices are also very efficient at frequency doubling and tripling as shown in Figure 5, top and bottom. Harmonic selection is accomplished simply by tuning the circuit of Figure 4 to the desired harmonic. Best results are obtained when some dc bias, such as provided by a Class-A driving stage, is allowed to flow in either winding. The inherent isolation between the two windings ensures an output that is free of any fundamental frequency component. ■■

New DIP Switch Line from SMK

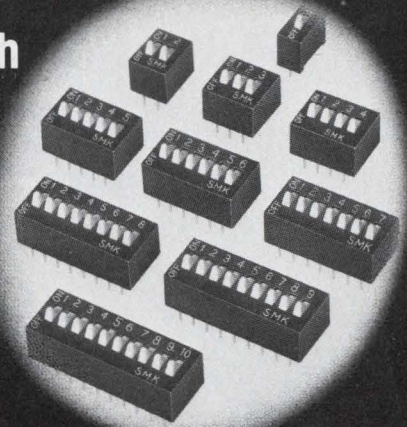

The **JS-8722 Series** is a complete line of DIP Switches, from 1 to 10 positions, featuring sealed construction to prevent flux contamination during wave soldering. A clip-type wiper design assures positive 2-sided contact to provide excellent shock and vibration characteristics.

Available in SPST configuration, the switches are rated at 24V DC at 300mA switching, resistive load, and will operate from $-20^{\circ}C$ to $+60^{\circ}C$.

Typical price for a 4 position DIP Switch in 100 piece quantity would be \$1.71 each.



SMK Electronics Corporation
of America

118 East Savarona Way Carson, California 90746

Tel: (213) 770-8915

CIRCLE NUMBER 54

New Mini-Toggle Switch Line from SMK

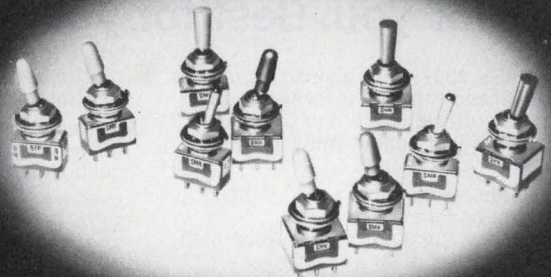

The **JT-3000 Series** complete line of UL Approved mini-toggle switches feature rugged construction with the terminals molded and secured into the housing to provide excellent shock and vibration characteristics.

Available in either SPDT or DPDT, the switches are rated at 6 amps at 125V AC or 12V DC resistive load and will operate from $-10^{\circ}C$ to $+60^{\circ}C$. Mechanical life is 100,000 cycles with no load and 20,000 cycles with rated resistance load.

Priced from \$.90 in 100 piece quantity.



SMK Electronics Corporation
of America

118 East Savarona Way Carson, California 90746

Tel: (213) 770-8915

CIRCLE NUMBER 55



Our 100/200 megabyte OEM disk drives. Best for you. Best for your customers.

The new ISS 733-10/11 disk drives are the most advanced random access storage devices ever designed for the OEM market. With features that benefit you *and* your customers.

For example, exceptional speed in head positioning and start/stop times. Compactness. Quietness. Easy waist-high pack loading.

The big news, however, is their field-upgrade capabilities. The 100-megabyte 733-10 can be easily field-upgraded to 200 megabytes. Or you can have 200 megabytes immediately with ISS 733-11. And both can be ordered with, or field-upgraded to, dual port.

Advanced interface design

Our interface permits functional compatibility between ISS 733-10/11 and most current 40, 80, 100, 150, 200, and 300-megabyte drives. This means minimal controller modifications, if any.

Performance features

Integral power supply. Tolerates wide power variations, reduces susceptibility to cycle sags and brown-outs.

Module select plug. Permits flexibility in disk address assignments in multi-drive systems.

Data separation and write data

precompensation. All data encoding/decoding is performed in the drive.

Absolute cylinder addressing. Disk addressing done in the drive, not the controller. Simplifies programming.

Industry standard media. 3336-1 and 3336-11 or equivalent disk packs.

Programmable sector mark. Allows user to select sector size to fit his application.

Rotational position sensing. Signals the system when the desired sector is approaching the read/write heads. Increases system throughput.

Daisy chaining. Greatly reduces cabling.

Important options

Dual port. ISS 733-10/11 can be upgraded from single to dual port in the field. Or dual port can be installed prior to delivery.

Address mark format. Permits variable record lengths.

Round-the-clock ISS support

ISS maintains a complete support facility. Not just spares, but also technical assistance is available round-the-clock. Just call.

We'll be glad to send more information about the ISS 733-10/11. Write or call ISS Marketing, 10435 N. Tantau Ave., Cupertino, CA 95014, (408) 257-6220. ISS is an operating unit of Sperry Univac.

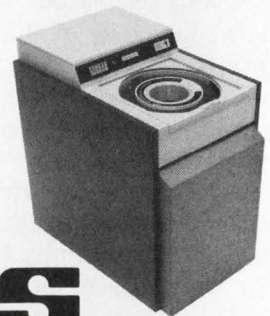

ISS

Technological leadership
for the generations ahead.

Sperry Univac is a division of Sperry Rand Corporation

ACDC's EC Series open-frame power supplies have been designed with the OEM's mind. They're built with ACDC's traditional policy of reliability (25,000 hours MTBF!) and quality, but with a minimum of fancy frills and expensive extras. In short, we designed the new EC Series to be nothing less than solid, dependable power supplies that are mechanically and electrically interchangeable in fit and function with other open-frame units now on the market. And we made choosing one easy - ACDC stocks over 50 different single, dual and triple model types in a variety of voltages and amperages to meet just about any low-cost power supply requirement.

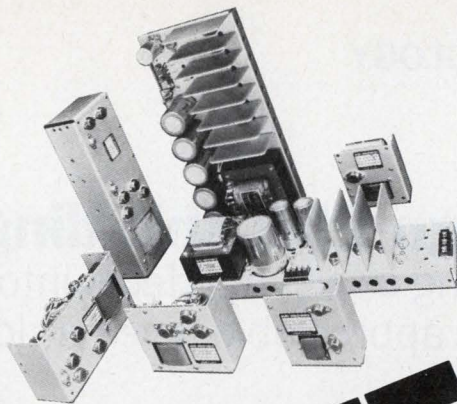

THE EC SERIES ACDC'S NEW LINE OF LOW COST POWER SUPPLIES

- SINGLE, DUAL AND TRIPLE OUTPUT MODELS
- STOCK DELIVERY
- BUILT TO UL STANDARDS
- 2 YEAR GUARANTEE
- 18 WORLD-WIDE SERVICE CENTERS

SINGLE OUTPUT POWER SUPPLIES

Nominal Output Voltage	Max. Current (amps)	Model Number	Price	
			1	250
2V.	3.0	EC2N3	\$ 33.00	\$ 27.00
	6.0	EC2N6	55.00	44.00
	9.5	EC2N9.5	67.00	55.00
	12.0	EC2N12	85.00	70.00
	17.0	EC2N17	108.00	88.00
5V.	3.0	EC5N3	33.00	27.00
	6.0	EC5N6	55.00	44.00
	9.5	EC5N9.5	67.00	55.00
	12.0	EC5N12	85.00	70.00
	17.0	EC5N17	108.00	88.00
6V.	2.6	EC6N2.6	33.00	27.00
	5.4	EC6N5.4	55.00	44.00
	8.5	EC6N8.5	67.00	55.00
	11.0	EC6N11	85.00	70.00
	15.0	EC6N15	108.00	88.00
12V.	2.2	EC12N2.2	33.00	27.00
	3.5	EC12N3.5	55.00	44.00
	6.0	EC12N6	67.50	55.00
	7.5	EC12N7.5	85.00	70.00
	10.0	EC12N10	108.00	88.00
15V.	1.8	EC15N1.8	33.00	27.00
	3.0	EC15N3	55.00	44.00
	5.0	EC15N5	67.00	55.00
	6.5	EC15N6.5	85.00	70.00
	9.5	EC15N9.5	108.00	88.00
20V.	1.5	EC20N1.5	33.00	27.00
	2.5	EC20N2.5	55.00	44.00
	4.2	EC20N4.2	67.00	55.00
	5.3	EC20N5.3	85.00	70.00
	8.0	EC20N8	108.00	88.00

DUAL OUTPUT POWER SUPPLIES

Nominal Output Voltage	Max. Current (amps)	Model Number	Price	
			1	250
±12/15	0.5	EC12D0.5	\$ 45.00	\$ 38.00
	1.5	EC12D1.5	74.00	61.00
	3.0	EC12D3	89.00	72.00
	5.0	EC12D5	130.00	106.00
	5.0	EC12D5	130.00	106.00
±15	0.5	ET301	\$ 82.00	\$ 66.00
	3	ET302	82.00	66.00
	3	ET401	113.00	92.00
	6.0	ET601	168.00	144.00
	12.0	ET602	168.00	144.00

TRIPLE OUTPUT POWER SUPPLIES

Nominal Output Voltage	Max. Current (amps)	Model Number	Price	
			1	250
±12/15	0.5	EC12D0.5	\$ 45.00	\$ 38.00
	1.5	EC12D1.5	74.00	61.00
	3.0	EC12D3	89.00	72.00
	5.0	EC12D5	130.00	106.00
	5.0	EC12D5	130.00	106.00

OVERVOLTAGE PROTECTION OPTION

Rated output current of power supply	Price	
	1	250
0 to 12 Amps	\$ 8.00	\$ 7.50
12 to 24 Amps	12.00	10.50

acdc electronics
 401 Jones Road, Oceanside, California 92054, (714) 757-1880, TWX: 910-322-1470
 524 South Avenue East, Cranford, New Jersey 07016, (201) 272-3377



I would like more information on the low cost EC Series power supplies.
 Send product literature Have your representative call me
 My need is: Immediate Within 30 to 120 days For future reference

Name _____ Company _____ Address _____ City _____ State _____
 Phone _____ Ext. _____
 Dept. _____

Design EMI shielding more accurately

by taking aperture effects into account. They can be appreciable, even at low rf frequencies.

What do microwave ovens, fast computers, wireless intercoms, and the recent flood of CB gear have in common? They all pose a threat to air waves that already are overcrowded. So shielding against unwanted electromagnetic radiation has become extremely important, and you must be able to predict it with higher accuracy than was common in the past.

Traditionally, the shielding effectiveness of metallic barriers has been determined by breaking it down into two components—one accounting for reflections at both surfaces of the shield, and the other describing the attenuation of the wave, as it proceeds through the interior of the metal. Based on transmission line theory, these two effects are well understood, and can be predicted with high accuracy.¹

This method is very useful for the selection of materials and their required thickness for the construction of a particular shield. Material selection is most critical for shielding high power, low frequency sources from predominantly magnetic fields. Otherwise, the structural metal enclosures of electrical equipment usually provide adequate shielding.

There's the hole problem

In practice, over-all shielding efficiency is nearly always determined by openings in the enclosure, often resulting from the construction methods used. What you need is a simple means for estimating their effects.

Since high-frequency leakage involves only the concepts of radiated and received power, you can apply antenna theory directly to solving the problem. Leakage is most serious at microwave frequencies, but extends down to the 100-MHz range. Fig. 1 maps out the strategy for attacking leakage. Antenna 1 with gain G_1 is radiating power P_1 , directly at a slot in an infinite shield. Assume that the polarization of the incident electric field E is perpendicular to the long dimension

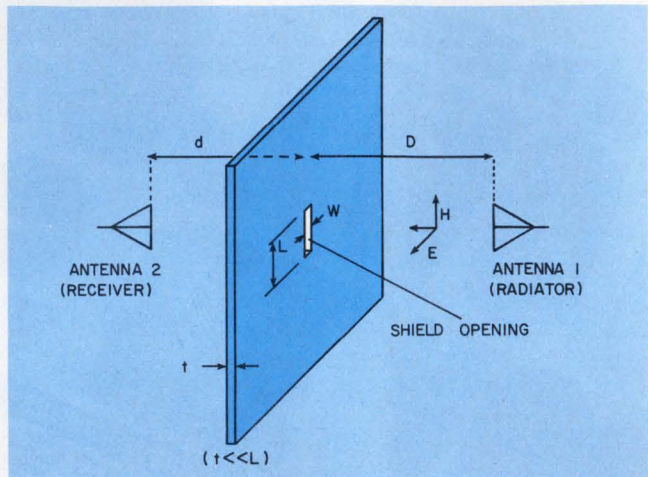

1. To attack the slot-leakage problem, put a radiating and a receiving antenna on opposite sides of an infinitely large metal plate. The slot itself becomes an antenna, receiving power from antenna 1, and reradiating it to the receiving antenna 2.

of the slot, which induces maximum currents perpendicular to the slot and gives minimum shielding effectiveness.

The slot reradiates part of the power to antenna 2, which has a gain G_2 . The difference in dB between the powers received by antenna 2 with and without the shield in place gives an insertion loss called shielding effectiveness SE.

A slot absorbs no power

You can consider the slot as an antenna that, by the principle of duality, has the general characteristics of a similarly shaped metallic antenna in free space. In fact, the field distributions are the same for both antennas, except that the magnetic and electric components are reversed. Since the energy contained in a radiated wave is equally distributed between the electric and magnetic components, the power received by similarly shaped slot and metallic antennas oriented for maximum pick-up is the same.

Equations generally used to calculate antenna power assume that the antenna is terminated in a conjugate-impedance load. The antenna then absorbs the maximum power from a passing

William Jarva, Consultant to ARK Electronics, 624 Davisville Road, Willow Grove, PA 19090.

electromagnetic plane wave of given power density. In the case of the slot, however, the antenna is not terminated, and all of the intercepted power is immediately reradiated into the surrounding space on both sides of the shield. This reradiated power is four times the power received by a matched termination.

Assuming a slot gain G_s , the power received and reradiated by the slot is given by the following equation, in rationalized MKS units:

$$P_2 = \frac{4 P_1 G_1 G_s \lambda^2}{(4 \pi D)^2}$$

where λ is the wavelength. Power received by the receiving antenna is then:

$$P_3 = \frac{P_2 G_2 G_s \lambda^2}{(4 \pi d)^2} = \frac{4 P_1 G_1 G_2 G_s^2 \lambda^4}{(4 \pi d)^2 (4 \pi D)^2}$$

If the shield is removed, the received power becomes:

$$P_4 = \frac{P_1 G_1 G_2 \lambda^2}{[4 \pi (d + D)]^2}$$

The shielding effectiveness is the ratio of P_4 to P_3 , in decibels:

$$SE = 10 \log \frac{P_4}{P_3} = 10 \log \left[\frac{2 \pi d D}{(d + D) G_s \lambda} \right]^2 \quad (1)$$

But Eq. 1 is only accurate at the slot's resonant frequency, which represents the worst case. You thus obtain a simple estimate of the minimum shielding efficiency due to a particular opening in a shield. Eq. 1 also shows:

- Shielding effectiveness is independent of the gain of the test antennas, for the completely aligned condition. If the test antennas are aligned with each other but not with the slot, the measured SE then becomes a function of the directivity of the test antennas, which results in higher SE. Lacking slot orientation is the primary cause for large variations in shielding measurements.

- SE depends on the distance of the receiver from the flaw in a shield. This fact becomes extremely important when safety hazards are involved. For instance, when looking into a microwave oven, you may put your eyes close to a flaw in the oven door. Distance is also important in the protection of equipments from an electromagnetic pulse caused by a nuclear burst (EMP).

- If distances d and D are equal (the usual condition for shielding-test specifications), shielding effectiveness is 6 dB lower than when D is very large compared to d .

- Eq. 1 is symmetrical with respect to d and D ; the principle of reciprocity holds and the transmitting and receiving antennas may be reversed without changing shielding effectiveness.

Don't forget harmonics

Eq. 1 also indicates that SE becomes greater with frequency (decreasing λ). However, you must remember that a linear antenna resonates at

multiples of a half-wave, and the radiation pattern breaks up into a number of high-gain lobes. The test antennas in Fig. 1 are therefore always positioned and directed so as to intercept the main lobes of the slot in the shield. Tests indicate that the shielding effectiveness at successive resonance points (higher frequencies) becomes progressively greater at half-wave resonance.

It has often been assumed that the shielding efficiency of an opening is inversely proportional to the cross sectional area of the opening. Antenna theory, however, shows that a terminated half-wave dipole in space has an effective area equal to $1.64 \lambda^2/4\pi$. This area yields the maximum power that a given plane-wave can deliver to the load. For the half-wave slot the intercepted power is four times as great, but because the power also passes on to the remote side of the barrier, the area (called the "acceptance area") is twice as great, namely $3.28 \lambda^2/4\pi$. In effect, the slot's acceptance area is approximately equal to the slot length squared, and not the slot's cross section.

Table 1 gives SE values for several half-wave slots if the two test antennas of Fig. 1 are each 1 meter away from the shield, and if G_s equals 1.64. The results of Table I are accurate only if the test antennas are far enough from the shield to locate the slot within the far-field, or "Fraunhofer," region of the transmitting antenna. If L is the antenna's largest dimension, this region begins at $2 L^2/\lambda$. When the test antenna's dimensions are similar to slot dimensions, and $d = D = 1$ m, the calculations shouldn't be used for slots much larger than 0.5 m.

Short slots act differently

Slots shorter than half a wavelength have reactive components. Instead of using the effective area, you must consider the electric and magnetic fields, and the effective length of the antenna.

The voltage induced in an electric dipole in free space due to an incident electric field, E_i , is

Table 1. SE of half-wave slots

Frequency (MHz)	Slot length (meters)	Acceptance area (meter ²)	Shielding effectiveness (dB)
300	0.5	0.26	5.65
1000	0.15	0.02	16.12
1500	0.1	0.01	19.64

found as follows:

$$V = E_i \times L_e$$

where L_e is the effective length of the dipole.

For the magnetic dual antenna, an equivalent equation gives the current induced by a magnetic field:

$$I = 2 H_i \times L_e$$

The current (and magnetic field) at the surface of the metal sheet is twice the incident field. The factor of 2 indicates that the dipole in free space is not the exact analog for the slot in a metal sheet. The equivalent would be an electric dipole imbedded in an infinite sheet of very high intrinsic impedance. The electric field would double and the factor 2 appear in the equation for the electric field as well.

The power reradiated by the slot is $I^2 R_s$, where R_s is the slot's radiation resistance:

$$P_s = 4 (H_i L_e)^2 R_s$$

If you use the standard equations for H at the slot due to antenna 1, and follow the same procedure as for the derivation of Eq. 1, you obtain the shielding effectiveness off resonance:

$$SE = 10 \log \left[\left(\frac{d D}{(d + D) L_e} \right)^2 \frac{480 \pi^2}{R_s G_s} \right]$$

The series impedance of the slot is related to the metallic dipole impedance Z_d by:

$$Z_s Z_d = (120 \pi)^2$$

You can then express the radiation resistance of the slot in the more familiar terms of dipole resistance R_d and reactance X_d :

$$R_s = \frac{(120 \pi)^2}{R_d^2 + X_d^2}$$

You obtain the shielding effectiveness for the slot:

$$SE = 10 \log \left[\left(\frac{d D}{(d + D) L_e} \right)^2 \frac{R_d^2 + X_d^2}{30 R_d G_s} \right] \quad (2)$$

where G_s and L_e are the same for both antennas and where R_d and X_d are the characteristics of the equivalent metal dipole.

When the physical length of the antennas increases from very short to a half-wavelength, the length factor varies only from 0.5 to 0.637, and the gain of the antennas varies from 1.5 to 1.64. So, neither factor has much effect on the final result. Indeed, if you assume the extremes in any given calculation, the result changes by a maximum of 5 dB. Thus, if you know only R_d and X_d , you can obtain reasonable estimates of the shielding effectiveness below half-wave resonance.

Table 2 contains representative results assuming a slot length of 10 cm and a width of 0.61 cm. The calculations are based on values for R_d and X_d taken from the literature.² At 1500 MHz, where the slot is half-wave resonant, the values for SE are the same as in Table 1, as you would expect.

Magnetic fields can pose problems

In the vicinity of low-impedance antennas or other low-impedance radiators, magnetic fields prevail over electric field components, often by a large factor. Because testing for magnetic fields is usually done with loops, assume that the antennas of Fig. 1 are now small, coplanar loops with distances d and D measured from the loop centers. The equations for magnetic field emission of small loops then yield:

$$SE = 20 \log \left[\frac{2\pi \omega \mu d^3 D^3}{(d + D)^3 L_e^2 Z_s} \right] \quad (3)$$

where $\omega = 2 \pi f$ and μ is the permeability of free space ($4 \pi \times 10^{-7}$).

Measurements in induction fields require that all distances and antenna sizes be small compared to a wavelength, and are therefore restricted in practice to frequencies of 10 MHz or less. The metal-dipole equivalent of the slot then has an almost purely capacitive impedance:

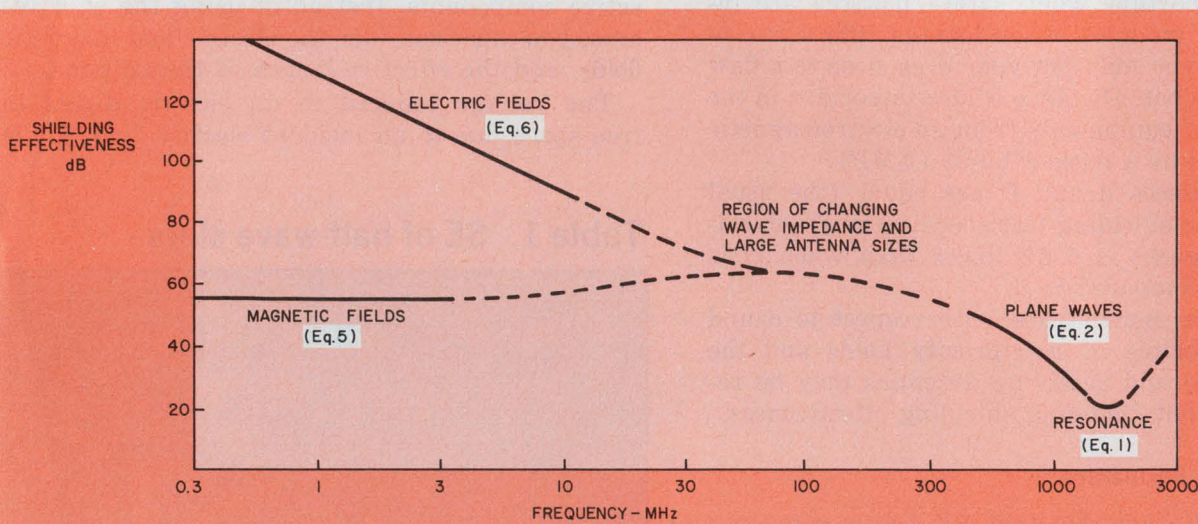

2. Shielding effectiveness in the presence of a 10-cm slot is summarized over a frequency range from the kHz

to the GHz region. Different effects prevail in the different frequency regimes.

$$|Z_s| \approx \frac{(120 \pi)^2}{1/\omega C_d} = (120 \pi)^2 \omega C_d$$

After substitution of Z_s in Eq. 3, the magnetic shielding effectiveness reads as follows:

$$SE = 20 \log \left[\frac{d^3 D^3}{18 (d + D)^3 L_e^2 C_d} \times 10^{-9} \right] \quad (4)$$

where C_d is the capacity of the dipole, approximately given by:

$$C_d \approx \frac{\pi \epsilon L}{\ln (L/a)}$$

where ϵ is the permittivity of free space (8.85×10^{-12}) and L and a are the length and diameter, respectively, of the dipole. Assuming a length of 1 m and a diameter of 0.6 cm, C_d becomes 5.5 pF. The capacitance of a one-meter whip antenna above a ground plane is twice that, or 11 pF. The known value for the 41-in. whip used in military electric field tests is 10 pF, in very good agreement with the calculation.

To apply the capacity of the equivalent dipole to the slotted shield, set the diameter, a , to one-half the width, w , of the slot.³ Then, the shielding effectiveness of the slot due to a magnetic field, expressed in terms of slot parameters alone, is:

$$SE = 20 \log \left[\frac{2 d^3 D^3 \ln (2L/w)}{(d + D)^3 L_e^2 L} \right]$$

Because the effective length, L_e , for short antennas equals one-half the physical length, L , the equation can be simplified to:

$$SE = 20 \log \left[\frac{8 d^3 D^3 \ln (2L/w)}{(d + D)^3 L^3} \right] \quad (5)$$

$$= 60 \log \left[\frac{2 d D}{(d + D) L} \right] + 20 \log [\ln (2L/w)]$$

Under the conditions specified in MIL-STD-285 ($d = D = 0.47$ m, loop dia = 12 in.) the shielding calculation for a 10-cm slot of 1 mm width results in a shielding effectiveness of 55 dB.

Eq. 5 indicates that SE for magnetic fields is independent of frequency, which is confirmed by many tests with small loops, over a wide frequency range. Nor is SE affected much by the slot width, which is also borne out by measurements.

Shielding for electric fields

Fields generated by high-impedance antennas such as short whips or dipoles are predominantly electric, with a very small magnetic component. Assuming that the test dipoles are short, the shielding effectiveness for electric fields is given by:

$$SE = 20 \log \left[\frac{d^2 D^2}{(d + D)^3 L_e^2 Z_s \epsilon f} \right]$$

where ϵ is the permittivity of free space ($10^{-9}/36 \pi$) and f is the frequency in Hz. In terms of the capacity of the equivalent short dipole, the equation becomes:

$$SE = 20 \log \left[\frac{d^2 D^2 1.266 \times 10^5}{(d + D)^3 L_e^2 f^2 C_d} \right]$$

Table 2. SE for a 10 cm meter slot at and below resonance

Freq	Impedance		Length	Gain	SE
(MHz)	R_d	X_d	L_e	G_s	(dB)
500	6	650	0.051	1.5	51.78
1000	20	250	0.055	1.6	37.34
1500	73	0	0.0637	1.64	19.6

Using only the slot dimensions, the shielding effectiveness is:

$$SE = 20 \log \left[\frac{d^2 D^2 \ln (2L/w)}{(d + D)^3 L_e^2 f^2 L} \times 4.65 \times 10^{15} \right] \quad (6)$$

Under MIL-STD-285 test conditions ($d + D = 25$ in.), the electric-field SE for the 10-cm slot with a 1-mm width becomes 132 dB at 1 MHz, and 92 dB at 10 MHz. Both the large values and rapid change with frequency are again confirmed by experience.

Getting it all together

The various calculations for the 10-cm slot under the methods of MIL-STD-285 are plotted in Fig. 2, which provides an over-all view of how shielding varies throughout the usual frequency range.

The region between 10 MHz and a few hundred MHz, indicated by dotted lines, is the range where simple equations for low-frequency conditions are no longer accurate. The wave impedances approach that of free space, and with further increase in frequency the results become equal to those for plane waves.

For magnetic fields, at frequencies lower than about 100 kHz (depending on shield thickness), the metal is penetrated and the shielding effectiveness is no longer a function of the slot characteristic.

In the plane-wave or radiated-power region, antenna sizes become large in comparison with reasonable antenna spacing if the frequency falls below a few hundred MHz. The shield is then well within the Fresnel (or near-field) zone, and the simple equations assumed for radiated and received power no longer apply. ■■

References

- Schelkunoff, S. A. *Electromagnetic Waves*, D. Van Nostrand Co., Princeton, NJ, 1956.
- Schelkunoff, S. A., and Friis, H. T., *Antennas, Theory and Practice*, John Wiley & Sons, New York, NY, p. 438.
- Antenna Theory and Practice*, p. 555



COMING
JUNE 7

Electronic Design's
MAJOR SEMI-ANNUAL
COMPUTER REPORT

The most intensive editorial coverage of computers that *Electronic Design* has ever attempted is scheduled for June 7. The semi-annual COMPUTER REPORT will feature emerging standards for semiconductor memories, standards and protocols for data communications, computer-aided-design software and an in-depth interview with a leading industry authority. It's an issue you'll want to keep for months to come.

PLUS

SPECIAL REPORT: PROM PROGRAMMERS

Since there are a wide variety of PROMS to choose from, there are also many tradeoffs for engineers to consider before selecting a programmer. This report will discuss the new developments in programmers, show the variety of units available, their capabilities, and how to select them wisely.

PLUS

**FOCUS ON CARTRIDGE AND
CASSETTE RECORDERS**

This report in *Electronic Design's* award-winning FOCUS series zeros in on a low-cost medium for storage of digital data — cartridge and cassette recorders. The variations among competing devices in such essential features as drive, guiding mechanism, reliability, data capacity, speed and error rate will be compared and evaluated.

COMPUTER REPORT

ANOTHER REASON **Electronic Design**
IS THE BEST READ ELECTRONICS
PUBLICATION IN THE WORLD!

L. JOHNSON & CO.

CLIPLITE™

COMBINATION LENS AND
MOUNTING DEVICE FOR
T 1³/₄ LED

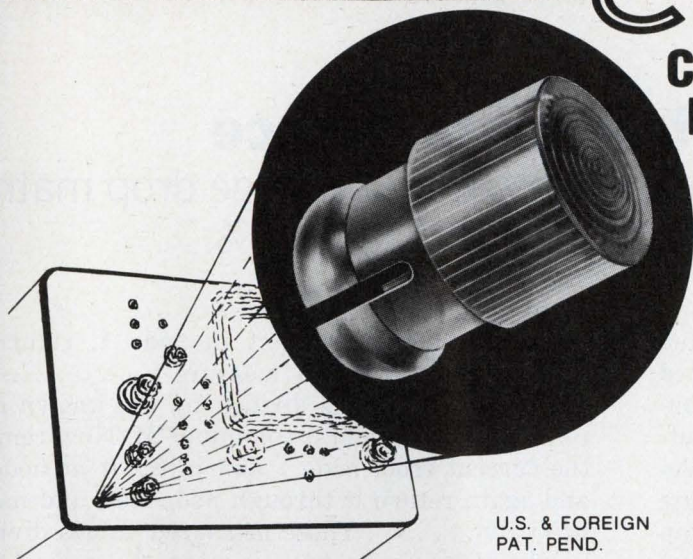

U.S. & FOREIGN
PAT. PEND.

**REQUIRES
NO TOOLS
AND**

INSTALLS IN 6 SECONDS

SIMPLE TWO-STEP INSTALLATION

SNAP CLIPLITE

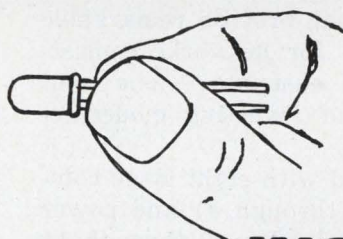
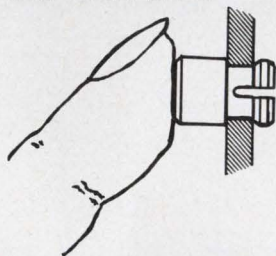

INSERT LED

INSTALLATION The CLIPLITE requires no tools; just snap it into a 1/4" hole and insert the LED.

DESIGN The CLIPLITE design and color have been optimized through the use of selected red, clear, yellow, green, and amber plastics to provide exceptionally high contrast and visibility.

VISIBILITY The CLIPLITE permits up to 180 degrees of viewing angle using any standard T 1³/₄ LED.

AESTHETICS The CLIPLITE gives any display or control panel the finished appearance equal to that of the most expensive indicator light assembly.

BRIGHTNESS The CLIPLITE allows the use of the much brighter narrow beam LED. Example: HP 5082-4657, 12 mcd @ 10ma vs. current popular wide beam LED HP 5082-4650, 2 mcd @ 10ma. Correspondingly, the amber and green narrow beam LEDs typically increase brightness by a factor of 4 over the commonly used wide beam LEDs.

ORDER YOUR TRIAL SAMPLE TODAY

Special Pricing for Trial Order Only

PLEASE SHIP: 100 CLIPLITES \$10.00 LITERATURE

NAME _____ COMPANY _____

ADDRESS _____

CITY _____ STATE _____ ZIP _____



MINIATURE
INDICATORS

VISUAL COMMUNICATIONS COMPANY

P.O. BOX 986

EL SEGUNDO, CALIFORNIA 90245

(213) 822-4727

Predict printed-circuit dc performance

with a circuit-analysis program and a measured voltage drop matrix. You can expect over-all accuracies on the order of 5%.

Multilayer printed-circuit (PC) cards often contain a power distribution plane that is tapped at several points, for instance by DIP power connections. Generally, the power planes contain cut-outs to provide clearance for other circuit elements. Consequently, you can't readily calculate the resistance from the edge connector to the tap points. But you can perform a number of measurements and derive the equivalent network for the power-distribution plane.

If you have access to a computer, these equivalent networks can be used to determine such data as dc drops, voltage differentials and required power supply tolerances for any particular PC card design. Powerful computer circuit analysis programs are available that provide remarkable speed and accuracy, even for networks consisting of many hundreds of elements.^{1,2} The computer should be capable of inverting moderate-size matrices.

Consider the circuit card with eight large components (load locations 1 through 8) and power feed points along the socket edge (9 through 11 and Ref) in Fig. 1. (Numbers 1 through 11 and Ref are assigned arbitrarily.) The following vector matrix equation completely describes the nodal dc behavior of the power plane:

$$v = Mi,$$

where

$i = [i_1, i_2, \dots, i_{11}]$ is a vector made up of elements i_k defined as the current entering the k^{th} node

$v = [v_1, v_2, \dots, v_{11}]$ is a vector with elements v_k defined as the potential measured from node k to node Ref

$M = 11 \times 11$ matrix that describes the resistive nature of the plane.

If M is known, your computer can calculate the solution to any dc problem by conventional methods for solving simultaneous linear equations. The matrix, M , can also be represented by an equivalent circuit such as the one shown in Fig. 2. You can find the values of the resistors in Fig. 2 with the following measurement method.

Inject a known current in node 1, return it through node Ref and measure v_1, v_2, \dots, v_{11} . The measured values divided by the known current represent the first column of M . Now remove the current from node 1 and inject it at node 2, and again return it through node Ref, and measure v_1, v_2, \dots, v_{11} . Those measured values divided by the known current represent the second column of M . Continue through node 11 for a total of 121 measurements to fill in M completely.

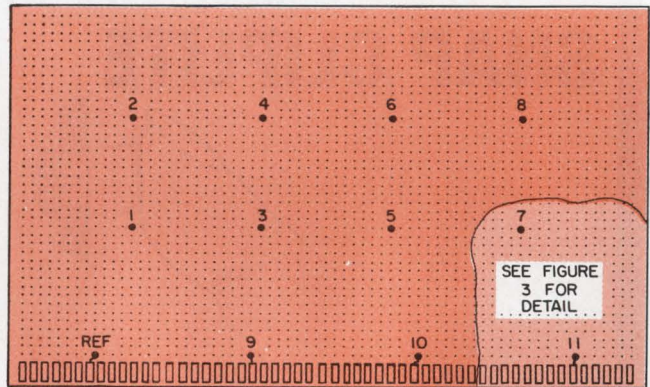

1. This power plane of a printed-circuit card has 8 load connections (1 through 8) and 4 power feed points (9, 10, 11, Ref).

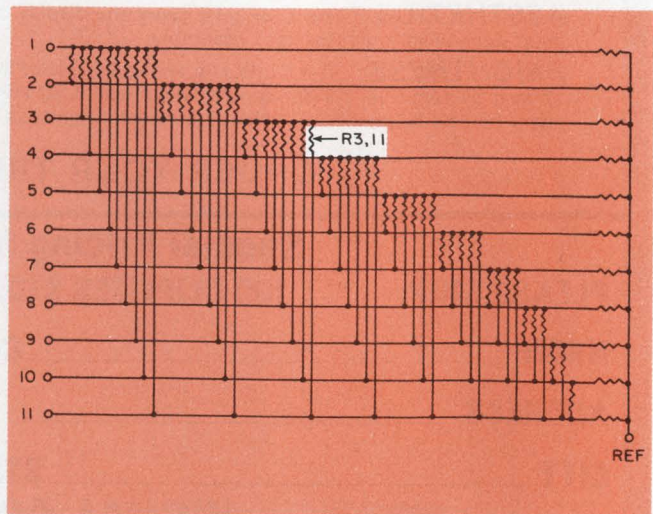

2. The equivalent circuit of the power plane used in the example contains a resistor connecting every node (8 load points and 4 power inputs) to every other node. The resistor connecting nodes 3 and 11 is highlighted.

Dr. J. R. Pivnichny, Development Engineer, and J. Pavlik, Senior Lab Specialist, IBM Corp., System Products Div., Endicott, NY 13760.

The Reciprocity Theorem³ provides a check on the measurements because it requires that $m_{ij} = m_{ji}$, that is, M is a symmetric matrix. Use a computer to subtract M from its transpose, element by element. Any large elements in the difference matrix are suspect, and the corresponding measurements should be repeated.

Note that this procedure does not check the diagonal elements. The accuracy of off-diagonal elements can be improved by calculating a new M equal to half the matrix sum of the measured M and its matrix transpose, thereby effectively using the average of two measurements.

Once you know the M matrix, you can calculate the individual elements in the equivalent circuit of Fig. 2 from conductance matrix $G = M^{-1}$ as follows:⁴

The value of the resistor elements, R_{ii} connecting the reference node to node i is

$$R_{ii} = \frac{1}{\sum_{j=1}^{i=n} g_{ij}} \quad (i = 1, 2, 3 \dots n)$$

The value of resistors R_{ij} connecting nodes i and j is

$$R_{ij} = \frac{1}{-g_{ij}} \quad (i, j = 1, 2, 3, \dots, n \text{ but } i \neq j)$$

How well does it work?

An application example will clarify the measurement technique. Fig. 1 shows a typical PC card. Power enters the card at four tab locations and is connected to an internal power plane by means of a short surface line and plated-through holes. The power plane itself is made from 1 oz/ft² copper with 0.075-in.-diameter clearance holes located on a 0.100-in. grid. The clearance holes provide a path for the signal to pass through the card without contacting the power plane. There are no clearance holes where a component picks up power, as at locations 1 through 8 in Fig. 1.

Resistance measurements on such highly conductive materials as these copper planes require proper 4-terminal connection procedures to eliminate errors due to contact resistance. Fig. 3 shows the typical connecting points used in this example. The contact posts, one of which is shown in Table 1 were measured, and the resistance, which had no clearance holes at these points.

With the numbering scheme of Fig. 1, the data shown in Table 1 were measured, and the resistance values calculated as described. They range from 4.26 m Ω between nodes 2 and 4 to 506 m Ω between nodes Ref and 11.

To establish the over-all accuracy of the calculated equivalent circuit, a particular load pattern

Table 1. Measured-resistance matrix M (milliohms)

3.86	3.25	3.11	3.19	3.11	3.17	3.13	3.15	3.01	3.09	3.12
3.25	4.71	3.38	3.74	3.48	3.63	3.53	3.60	3.21	3.43	3.49
3.10	3.39	4.30	3.54	3.60	3.59	3.59	3.59	3.42	3.56	3.58
3.18	3.75	3.53	4.75	3.71	3.93	3.77	3.86	3.34	3.65	3.73
3.09	3.49	3.60	3.71	4.89	4.01	4.18	4.09	3.51	4.13	4.16
3.13	3.63	3.57	3.91	4.01	5.10	4.14	4.31	3.41	3.92	4.08
3.10	3.54	3.58	3.76	4.18	4.14	5.42	4.44	3.49	4.29	4.68
3.11	3.60	3.57	3.85	4.09	4.31	4.44	5.50	3.45	4.08	4.35
2.98	3.21	3.40	3.32	3.52	3.43	3.51	3.46	6.06	3.56	3.52
3.07	3.46	3.56	3.65	4.13	3.94	4.29	4.09	3.56	7.18	4.40
3.09	3.52	3.57	3.73	4.17	4.09	4.69	4.36	3.51	4.40	7.58

Except for the diagonal elements (deep color), this symmetrical matrix contains all resistance values twice — e.g. $R_{6,3} = R_{3,6}$ (white).

like that shown in Fig. 4 was applied to the actual card. The voltage differentials between all nodes and point Ref were measured. The same voltage differentials were also calculated with the circuit-analysis program ASTAP using the equivalent circuit of Fig. 2. The resistors of Fig. 4 were represented as current loads. The calculated and measured voltage differentials were then compared for three different load patterns to establish over-all accuracy of the equivalent circuit.

The three separate load patterns were:

Case 1: Identical 1- $\Omega \pm 1\%$ loads at all 8 component locations simulated a uniformly loaded card; four nearly identical power feeds were used at the four indicated tab locations, and one ampere was applied to the card through the four wires attached to the power input tabs. The free ends of the eight resistors are connected together

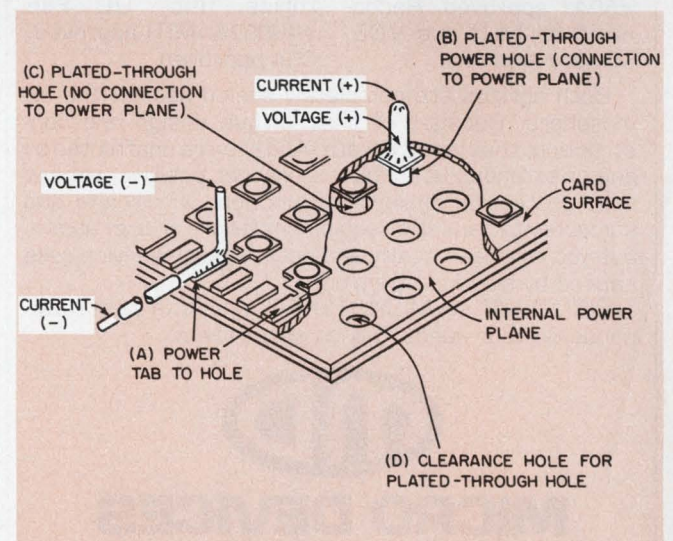

3. Low-resistance measurements require separate feed points for the current and voltage connections of a milliohmmeter.

Want A Safer Product And Lower Manufacturing Costs Too?

On the one hand choose the **MICROTEMP®** thermal cutoff

On the other hand, don't overlook the new **PICOTEMP** thermal cutoff

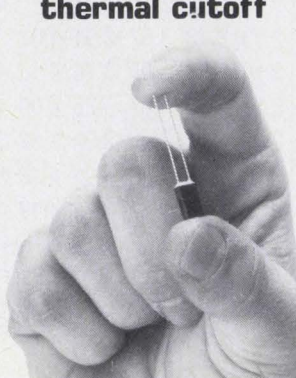
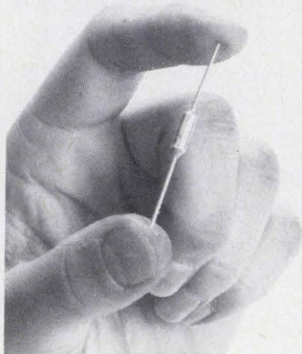

A reliable, accurate easy to install, "one shot" thermal limiter.

- temperature tolerance— $\pm 1.7^{\circ}\text{C}$.
- temperature ratings— 58° to 242°C . (136° to 468°F .)
- current capacity—up to 30 amps at 240 VAC.
- compact—diameter, .157"; length, .457" (exclusive of leads).
- economical
- easy to install—assorted terminations, mounting packages and insulations available.
- Recognized under the Component Program of Underwriters' Laboratories, Inc. UL File #E40667A. CSA approved. BSI Certificate #5041 approved. Recognized by MITI and VDE. Military approval.

Used where installation or space restrictions rule out MICROTEMP® thermal cutoffs.

- temperature tolerance— $+0^{\circ}\text{C}$.— -3.3°C .
- temperature ratings— 63° to 150°C . (146° to 300°F .)
- current capacity—to 5 amps. at 120 VAC. Will hold this rating up to and including 240 VAC.
- compact—.236" x .389" x .087/.104" (exclusive of leads).
- economical
- Package is completely insulated, leads are 26 gauge silver plated wire.
- Recognized under the Component Program of Underwriters' Laboratories, Inc. UL File #40667A. MITI approved. CSA approved.

Both devices are completely sealed against the atmosphere. Because of their unique design and construction, they won't derate. And they're unaffected by age or extended use. You not only get positive, yet low cost protection against malfunctions in circuits and components caused by equipment failure or user abuse, but you eliminate costly and unnecessary service calls caused by nuisance tripping.

PICOTEMP or MICROTEMP? Which is best? Depends on your needs. Tell us about them.



MICRO DEVICES



DIVISION OF EMERSON ELECTRIC CO.
1881 SOUTHTOWN BLVD.
DAYTON OH 45439 513-294-0581

Table 2. Result of verification tests

Node	1	2	3	4	5	6	7	8
Case 1	0.958	1.136	0.958	1.178	0.93	1.111	0.985	1.074
	0.927	1.109	0.926	1.111	0.911	1.1	0.885	1.066
Case 2	0.953	1.098	1.061		0.898	1.19		1.032
	0.936	1.093	1.039		0.898	1.197		1.038
Case 3	1.204	1.373	1.35		1.25	1.504		1.353
	1.159	1.351	1.303		1.239	1.504		1.355

Comparison between measured (white) and calculated (color) voltage differential (mV) from REF to nodes 1 through 8.

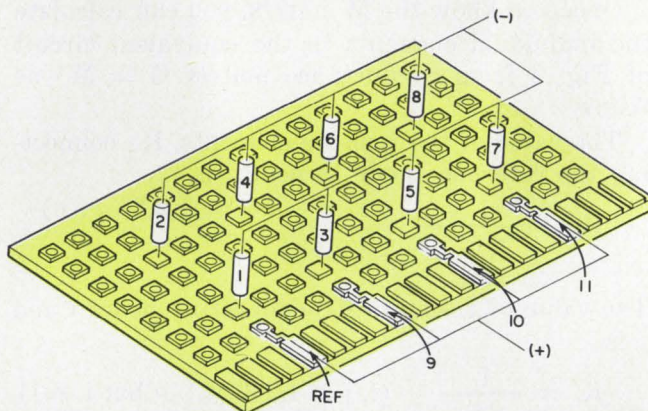

4. For the verification test, eight 1- Ω resistors and four power feed points are used.

and then to the other power-supply terminal.

Case 2: Identical 1- Ω loads were applied at six of the eight module locations; with no loads at the remaining two, four power feeds were used at four tab locations.

Case 3: Identical 1- Ω loads were applied to six of the eight module locations; three power feeds were used at three of the four tab locations.

The results are summarized in Table 2. It compares the calculated with the measured voltage differentials between the reference point (REF) and the load points. Similar tables can be compiled for the power entry points 9, 10 and 11.

The conclusion from the three test cases is that this method of generating resistive equivalent networks for PC card power distribution planes yields a 5% over-all accuracy, with a few 10% worst-case values. Thus, equivalent networks and a circuit-analysis program for the circuit models permit you to predict the over-all dc operation of any PC card. ■■

References

1. *Advanced Statistical Analysis Program (ASTAP)*, IBM Program Reference Manual (SH20-1118-0).
2. Jensen, R. W. and Lieberman, M. D., *IBM Electronic Circuit Analysis Program (ECAP)*, Prentice-Hall, Englewood Cliffs, NJ, 1968.
3. Fink, D. G., *Electronics Engineers Handbook*, McGraw Hill, New York, NY, 1975. (Sections 3-13H, 3-70).
4. Amemiya, H., "Time Domain Analysis of Multiple Parallel Transmission Lines," *RCA Review*, June, 1967, pp. 244-245.

Borrow my coffee cup... but never my C-Meter.

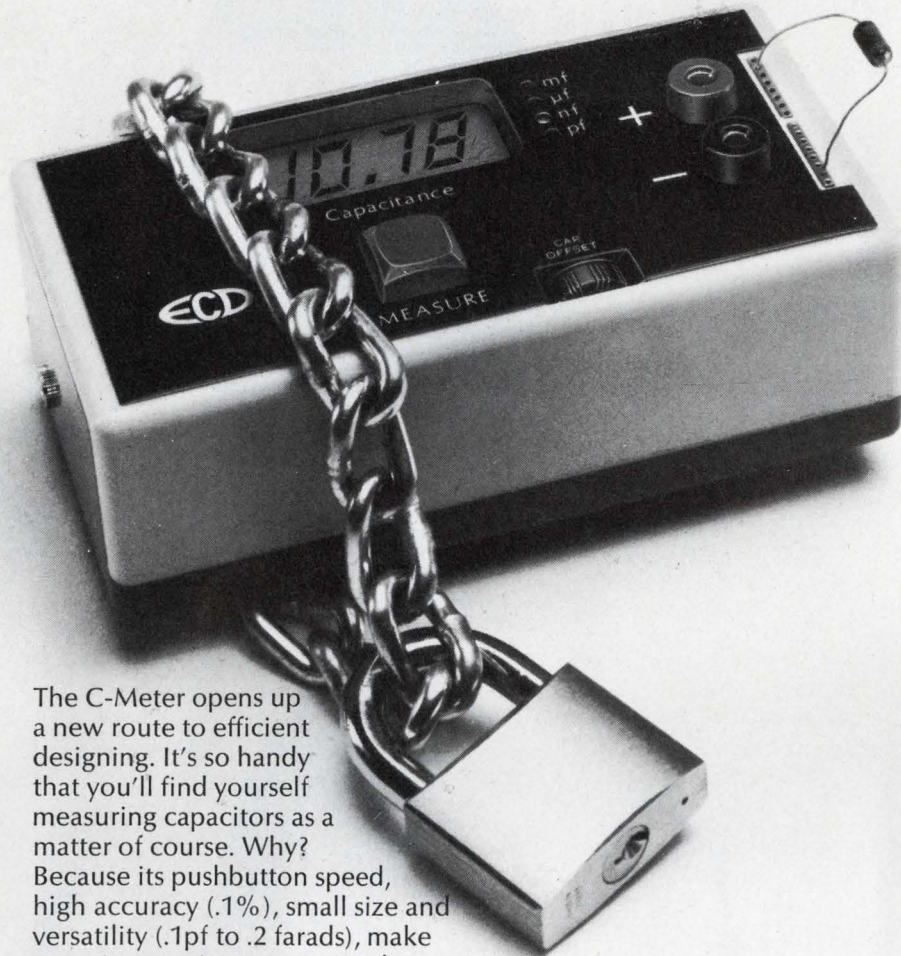

The C-Meter opens up a new route to efficient designing. It's so handy that you'll find yourself measuring capacitors as a matter of course. Why?

Because its pushbutton speed, high accuracy (.1%), small size and versatility (.1pf to .2 farads), make capacitors easier to measure than resistors.

With the C-Meter, you'll waste no time twiddling, and nulling, and you'll cut the need for expensive tight-tolerance capacitors or tweak pots in your circuits. You'll be a much more efficient engineer. And popular too, because people just can't keep their hands off the C-Meter.

You owe it to yourself to try one. Our reps are stocking them at **\$289.**



ECD CORP.

196 BROADWAY, CAMBRIDGE, MASS. 02139
(617) 661-4400

SALES OFFICES: AL, Huntsville (205) 533-5896; AZ, Scottsdale (602) 947-7841; CA, Costa Mesa (714) 540-7160; CA, Sunnyvale (408) 733-8690; CO, Denver (303) 750-1222; FL, Winter Haven (813) 294-5815; GA, Chamblee (404) 457-7117; IL, Elk Grove Vill (312) 593-0282; IN, Indianapolis (317) 293-9827; MD, Silver Spring (301) 622-4200; MA, Burlington (617) 273-0198; MN, Minneapolis (612) 781-1611; NJ, Camden (215) 925-8711; NM, Albuquerque (505) 299-7658; NY, Great Neck (516) 482-3500, (212) 895-7177, Syracuse (315) 446-0220; NC, Raleigh (919) 787-5818; OH, Centerville (513) 433-8171; TX, Houston (713) 688-9971; TX, Richardson (214) 231-2573.

CIRCLE NUMBER 60

Jim Wolfe of Centralab Speaks On Decentralizing Engineering

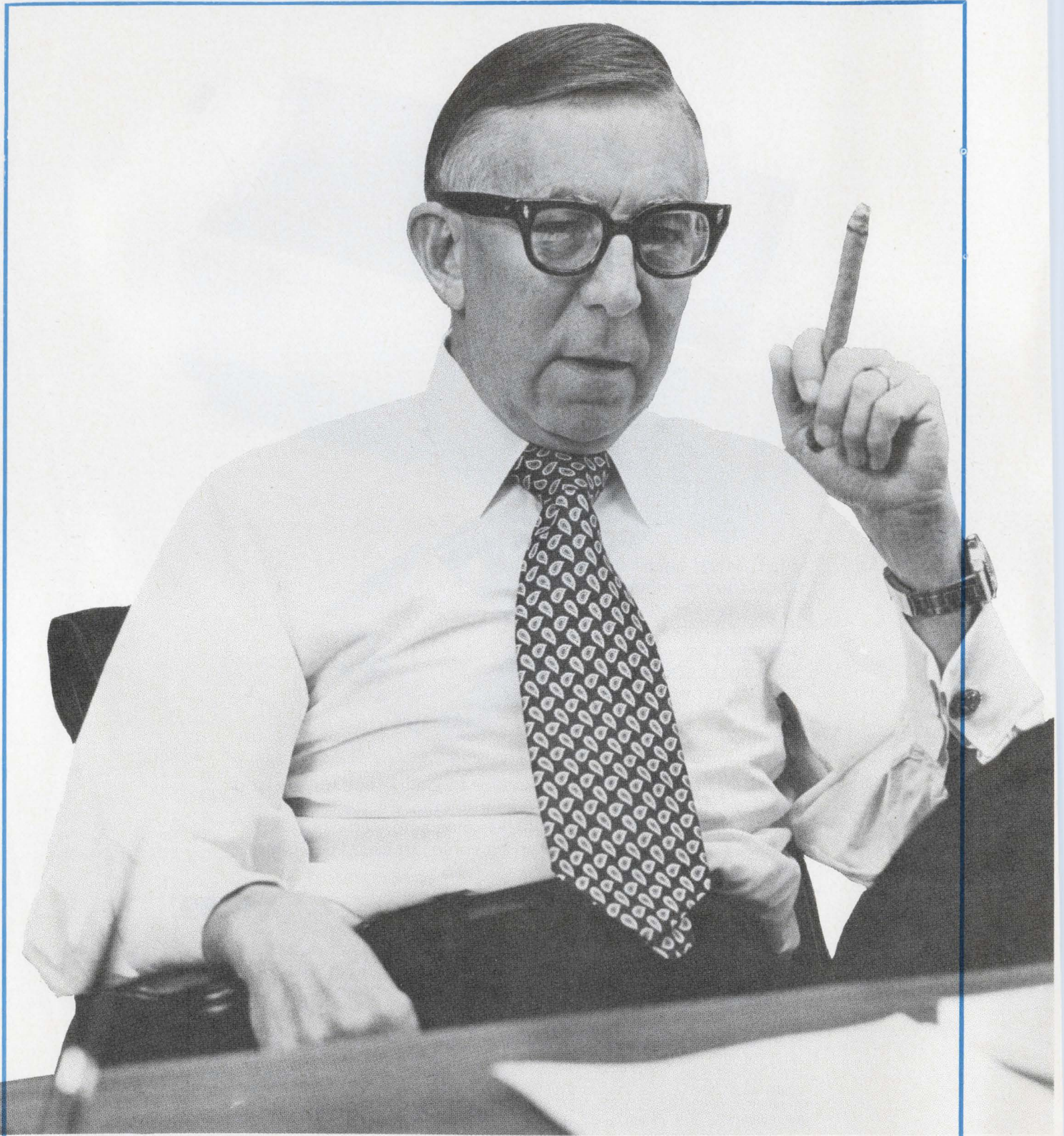

Most companies with many plant facilities do their manufacturing in the various plants, but do their engineering back home. The theory is that this makes for highest efficiency. The manufacturing is done where it's close to raw material, transportation facilities, labor supply or markets. The engineering is done where engineers can talk to each other and learn from each other. And there's economy in the engineering-support services.

Well, we don't think that works well for an electronics business with a diverse product offering in a broad spectrum of markets. And we speak from experience because that's just the way we used to do things up to about seven years ago. We had the typical functional organization, with the main functions here at headquarters in Milwaukee. Here's where our VP Engineering, our VP Marketing and our VP Manufacturing ran things. We used to have almost all manufacturing located here, but now we're spread around the world.

When we first started moving manufacturing facilities to different parts of the country and then, the world, we did it mainly for reasons like labor supply. But what started as an effort to find better labor supply emerged, 10 years later, as a situation where we are now in the markets we want to be in. The labor-base question is still important, but less significant.

The point is that, when we now move out geographically, whatever the impetus for the move, we move our engineers, too—as many as we can justify.

As soon as we can, we try to get our engineers right next to manufacturing. We'd like to get them out there from Day 1. We want to get as much locally designed tooling as possible and as

much local engineering. We want our engineering there because that's how we get the most effective manufacturing and the most effective problem solving. We want our engineering close to the market that's influenced by it.

That's a significant departure from the practice followed by most companies. For example, if they have an operation in Seoul, the only senior person there might be a manufacturing manager. Engineers would commute from the home office whenever there's a problem and, in most cases, the problems would be frequent. Or they would try to fix things by telephone, cable or letter. That doesn't work too smoothly either.

My observation is that, in most places, when somebody at a remote manufacturing organization has a problem and asks for help, he gets a pedantic letter from the home office telling him things he already knew. That wastes time and accomplishes nothing.

We don't think it's practical to manage an operation on a day-to-day basis from a distance. The way to avoid glitches, communications blocks and plain lost time is to have the engineering where the manufacturing action is.

Now the obvious question: Is this efficient? You need separate engineering staffs, separate labs, duplicate equipment, and redundant support services. Every time you have an engineer, you need a secretary, a technician and a draftsman—perhaps not on a one-to-one basis, but in some ratio.

Well, we've found that it's not a problem if you have the courage to make an offsetting change at the home office. Using local engineering, we solve at least 90 percent of the operational problems. For the remainder—and only for the remainder—we can send in talent from the home office.

What led to our reorganization was the understanding that the problems in manufacturing and marketing that were faced by our men in the Far East were completely different from the problems faced by the people in South America or, for that matter, Europe or North America.

We found that we needed intimate communications among the people abroad who were involved in marketing and manufacturing and the people back home who were involved in engineering.

When you have a centralized engineering force, the communications link with far-flung markets becomes too strained. It's just too easy to get things wrong. And it becomes impossible to respond quickly to a change in the marketplace.

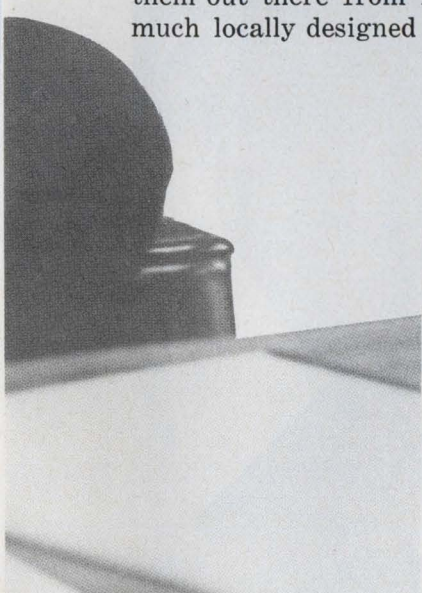

So we now support these organizations locally with the highest level of engineering that those businesses will sustain. Of course, if they have a special problem they may have to reach back here for help. Our engineering staffs in Milwaukee and Los Angeles are available for major trouble-shooting jobs anyplace in the world. But the day-to-day manufacturing-support engineering is done at the local plants. As these businesses grow, we push more and more engineering talent into them.

Now there's a risk in making that kind of transition. When you begin to transfer functions, unless you're alert, you can find that you're doing the same job in two locations. And *that* you don't need.

If you're going to move work to someplace else, you must remove it from the first location. That's traumatic and it takes a certain amount of discipline to make the transition.

But there's a factor that makes the transition easier and less traumatic, and it doesn't show up

on any organization chart. Managers and engineers at all our locations are in close contact with each other. A problem faced by one engineering group could easily involve a solution developed by another.

For example, the people working on monolithic chip capacitors in Los Angeles might well be able to use circuit knowledge from our people in Lafayette, Indiana. And the people in Lafayette, who make thick-film hybrid circuits, are one of the largest customers for the chip capacitors from Los Angeles.

Further, ceramic capacitors for the U.S. market are assembled in Juarez, Mexico. But Juarez gets much of its raw ceramic material from Mexico City. And Mexico City also manufactures complete capacitors and sells them in South America as well as Mexico.

Of course, in a large organization, it may not be possible or wise to decentralize the entire engineering staff.

Who is Jim Wolfe?

After he got his Masters in Business Administration from Harvard in 1948, 25-year-old James W. Wolfe went to work as a financial man in a nut-and-bolt works. "Well," he says, "they weren't nuts and bolts for long. When we went from \$13 million a year to \$25 million, we realized that they were industrial fasteners."

After seven years, Wolfe moved to the consulting firm of Booz-Allen-Hamilton, where he remained for another seven years, then on to A.O. Smith for a seven-year hitch. In 1969, *eight* years ago, Wolfe joined Centralab as general manager and vice president of the parent company, Globe-Union Inc., which enjoys annual sales of about \$290 million.

He finds the components part of the business particularly fascinating because there is a high degree of price elasticity and extreme sensitivity to capacity and demand. "You can have wild price fluctuations over a very short period of time," he points out, "and that's a problem."

Wolfe and the former Marion Hayner were married in 1945—as soon as he got off the boat, he says. Well, he admits, maybe it was a few weeks later. They have three sons, David, Paul and Stewart, and a daughter, Anne. When he wants to relax, Wolfe often races his 23-foot, full-keel sailboat—sometimes with his wife.

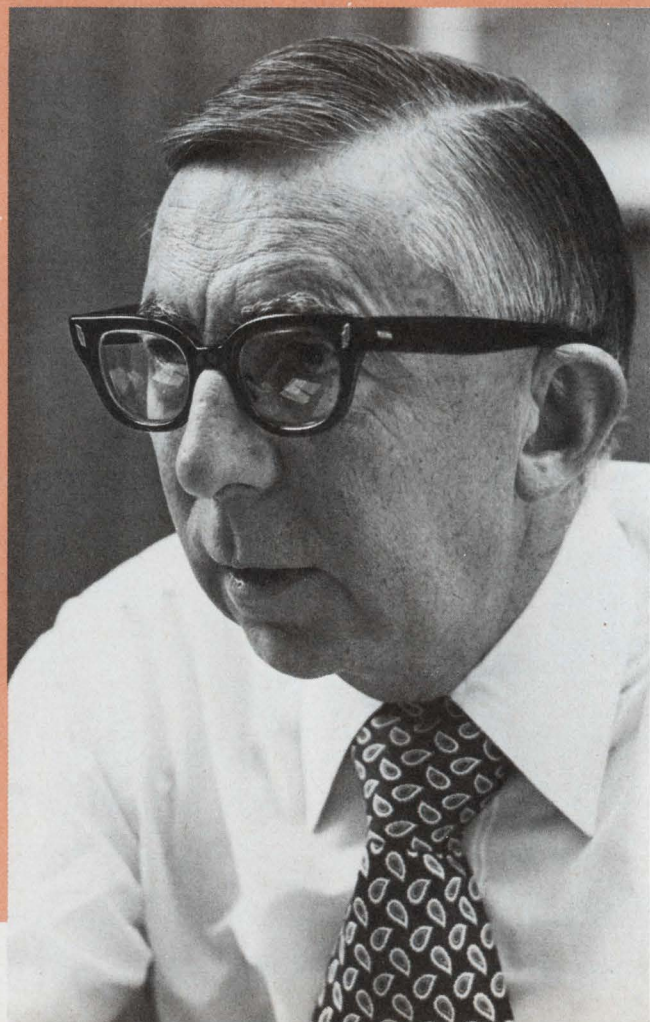

If you decentralized all your engineering, you might find the local engineers devoting their efforts to local and immediate problems. Design of future products and new types of products might be left to chance. The engineers working on trimmers, fixed capacitors or switching arrays would probably spend most of their time designing enhancements of trimmers, fixed capacitors or switch arrays. They wouldn't be working towards a completely new electrode system for capacitors.

That kind of development normally emanates from central product development and research groups whose work is normally aimed at a more distant future. Those central engineers and scientists should not normally be involved in the day-to-day engineering required by on-going businesses. They must be experienced, versatile and have the technical breadth and depth to solve any problem.

We have our central scientists in a group we call Corporate Applied Research. The head of this group is responsive to corporate management, that is, Globe-Union Inc., Centralab's parent company. The activities of this group can stem from requests for help on difficult problems or from projects generated by the division market-research staff.

Let's say, for example, that we were planning a product development and we identified a basic materials problem. Perhaps it was something in the chemistry or physics of a substrate—something needing a breakthrough that we're not equipped to work on at the normal engineering level. Here's where the Corporate Applied Research people come in. They don't develop products, but they can define the material composition that we need, say, for a ceramic capacitor or a resistor.

An example of their effort lies in the Carbon™ system for our resistors. Our new system gives us trimmer resistors with almost the qualities of cermets at a price that's almost as low as conventional carbon compositions.

As another example, the original technology for our Base-Metal-Electrode chip capacitors came from this group. One of the researchers came out of engineering and studied for his doctorate in a rather esoteric branch of ceramics engineering at Marquette University. When he came back, he had some ideas and went into the Corporate Applied Research Group. When BME™ became much more than a laboratory concept and moved into production in Los Angeles, we asked him to transfer so he could contribute broadly in our entire line of monolithics.

And that's the key to our concept. We want our engineers where the manufacturing action is. ■■

QUIK STRIP

SOLDERLESS BUS CONNECTOR

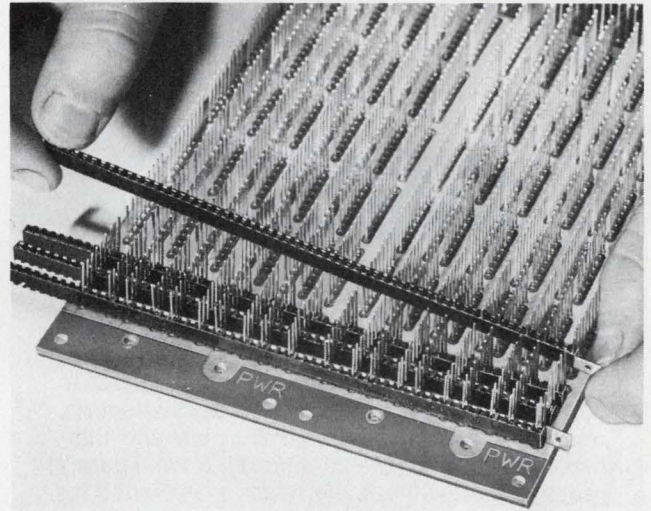

for fast, low cost connection of in-line pins on DIP socket boards and connector arrays.

- low installed cost*
- fully insulated contacts
- extremely reliable — shock and vibration resistant
- 18 gauge current capacity
- strips can be stacked for increased capacity

* Installed cost runs between 2.5¢ and 11¢ per connection.

Write on company letterhead for free sample.
For more information, contact product specialist.



ROGERS CORPORATION

Chandler, AZ 85224

Phone: (602) 963-4584

EUROPE: Mektron NV, Ghent, Belgium. JAPAN: Nippon Mektron, Tokyo.

The M-600 amp works harder at 2.5 ohms

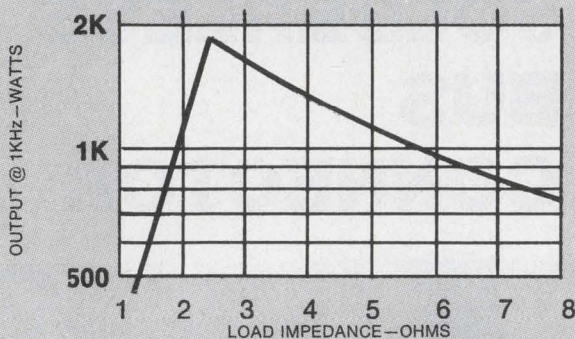

So each watt costs less

You get more watts per dollar from the Crown M-600 power amp if your circuit design lets it look at a 2.5Ω load.

The M-600 provides power from DC to 20KHz with complete protection against shorts, open circuits, mismatch, RF burnout and thermal overload. The M-600 will even drive a purely reactive load without overheating. Designed for continuous operation at full rated power, at any rated frequency.

One M-600 will cost you \$1,795. A copy of the spec sheet is free. Write today.

We'd also like to hear from you if you have any special amplification problems in the DC-20KHz range. We've already solved some tough, unique problems. We'd like to consider yours.

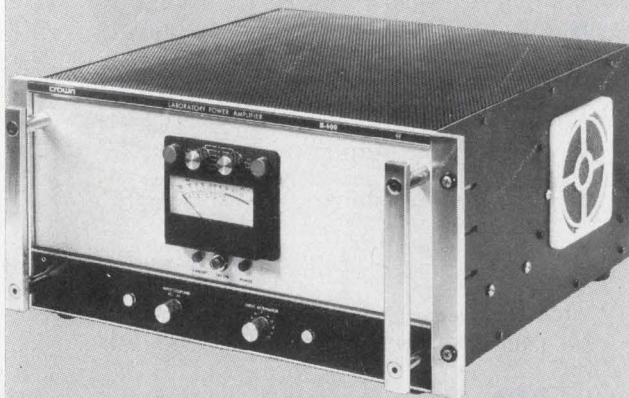

CROWN INDUSTRIAL

1718 W. Mishawaka Road, Elkhart, Indiana 46514
219/294-5571

CIRCLE NUMBER 62

\$1,786,000 IN NEW BUSINESS IN SIX MONTHS

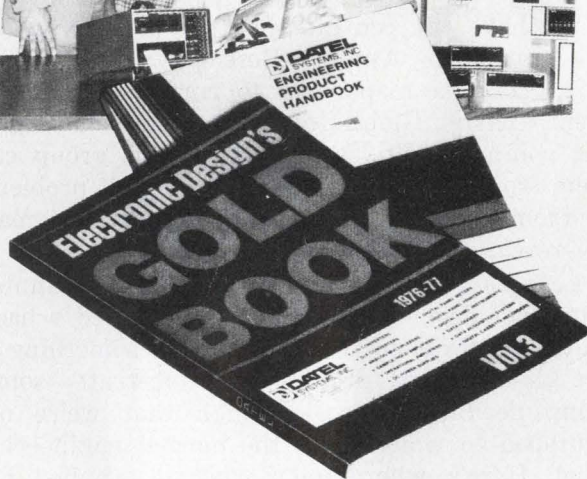

DATEL SYSTEMS' 297 GOLD BOOK PAGES SET AN INDUSTRY ADVERTISING RECORD... SAVED \$200,000 IN PRINTING, OVERRUNS, MAILING AND POSTAGE!

John H. Gallagher, VP of Marketing for Datel Systems, Inc., Canton, Mass., tells the story:

"In 1975, we took 10 pages in the GOLD BOOK and got phenomenal results — more than \$130,000 in orders from engineers all over the world.

"So this year we placed 297 pages — an entire separate volume — the largest single paid advertisement ever carried by an electronics industry directory.

"The result? From July 1976 to Dec. 1976 we've booked more than one and three-quarters million dollars in new orders that have come to us directly from the GOLD BOOK.

"And because of free layouts, production at cost, and massive savings in printing, postage and distribution, we saved \$200,000 in the bargain.

TRY ONE ON GOULD AND YOU DECIDE.

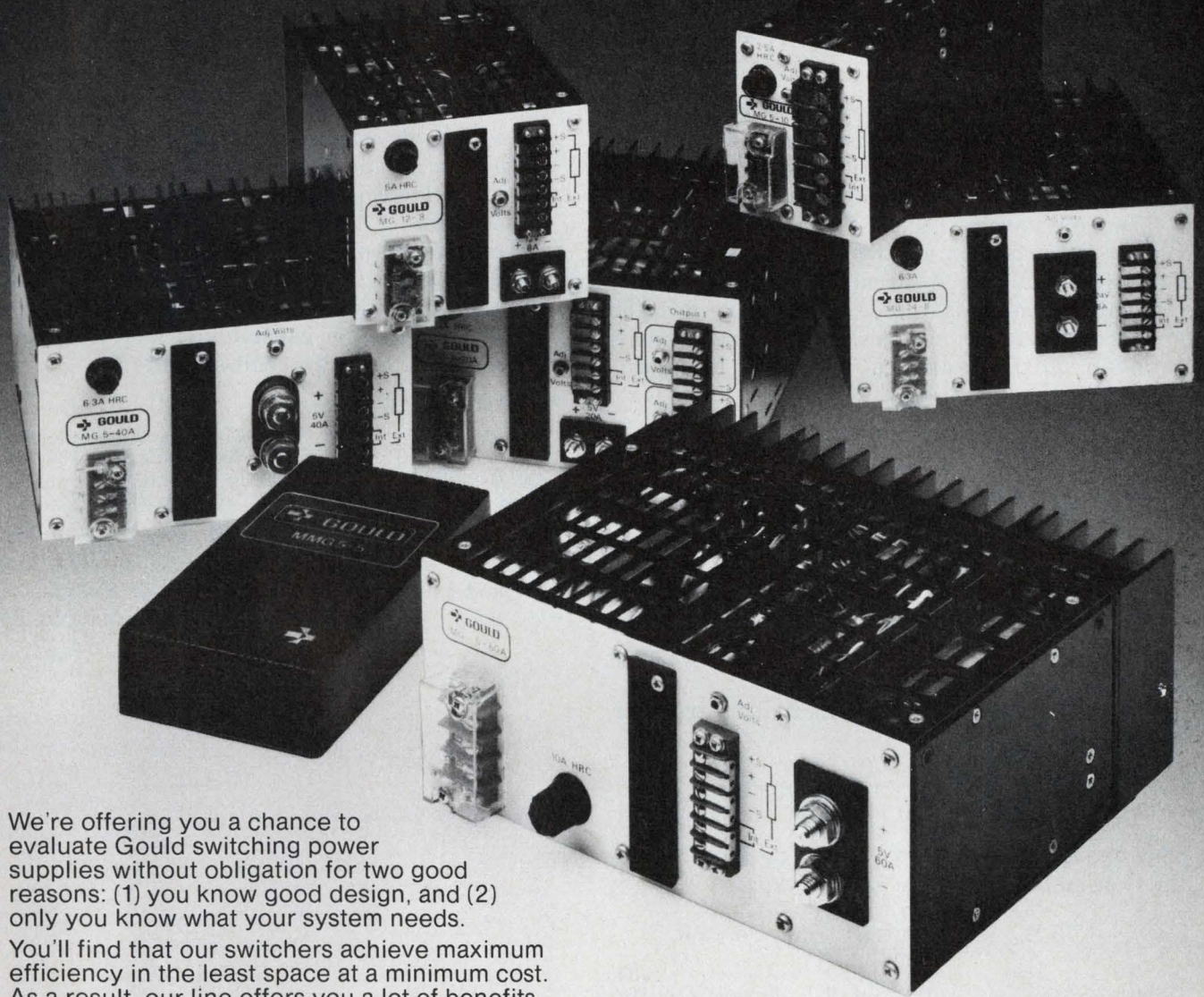

We're offering you a chance to evaluate Gould switching power supplies without obligation for two good reasons: (1) you know good design, and (2) only you know what your system needs.

You'll find that our switchers achieve maximum efficiency in the least space at a minimum cost. As a result, our line offers you a lot of benefits for your system:

- off-the-shelf delivery
- 36,000 hours MTBF
- switching at 33 kHz
- 5 year warranty
- 28 m/sec hold-up time
- 0.1% line/load regulation
- full output at 50°C ambient
- remote sensing and voltage programming
- less than 50 mV peak to peak ripple

But the truth is, you really have to test one of our switching power supplies yourself to appreciate how well our switcher works with your design.

So tell us what you need to fully evaluate our capabilities. Our salesman will deliver the appropriate unit from stock without any obligation to buy.

For information contact Gould Inc., Power Supply Dept., 3631 Perkins Ave., Cleveland, Ohio 44114.

For brochure call toll free at (800) 325-6400 Extension 77

In Missouri: (800) 342-6600

 **GOULD**

CIRCLE NUMBER 63

Circuit provides a Gaussian response with a multifunction converter and op amp

A simple circuit that provides a Gaussian response accurate to within 2.2% of full scale can be built with a multifunction converter, an op amp and a few discrete components (see figure).

The Gaussian, or normal-distribution, function is very important in electronic computations and statistical analysis. A circuit having a Gaussian transfer response is therefore often needed for analog computation systems and in special applications requiring statistical weighting in accordance with the function¹

$$f(x) = \frac{1}{\sqrt{2\pi}} e^{-x^2/2} \quad (1)$$

Such a nonlinear function can be approximated with straight-line segments produced by diodes. Or, a power series with multipliers to generate the power terms could be used. However, using a multifunction converter with op-amp feedback is much simpler. A multifunction converter is a multiplier/divider that has the capability of generating powers and roots.

Analysis of the circuit reveals that its transfer function is

$$e_o = -0.7 \frac{R_2}{R_1} \frac{E_{R2}}{1 + 0.7 \left(\frac{e_i}{E_{R1}} \right)^{2.62}} \quad (2)$$

This expression approximates the positive half of the Gaussian distribution as follows:

$$e_o \approx -1.75 E_{R2} \frac{R_2}{R_1} \cdot \frac{1}{\sqrt{2\pi}} e^{-(e_i/E_{R1})^2/2}, e_i \geq 0 \quad (3)$$

The choice of R_1 , R_2 and E_{R2} determines the circuit's scaling; voltage E_{R1} sets the input range. With the components and voltage levels shown, a 0-to-10-V input swing produces the same output-signal range. An e_i/E_{R1} span of 0 to 1.64 represents the coverage of two standard deviations.

The mathematical approximation between Eqs. 2 and 3 is the primary source of error. For a range of two standard deviations, the approximation error is 2.1% of full scale, which is only 0.8% of the content of the total distribution. When designed for a span of three standard deviations, the approximation deviates by 3.9% of full scale. The multifunction converter con-

tributes an error of only 0.1% of full scale, and the op-amp dc errors are negligible.

To limit circuit errors, the exponent, m , of the multifunction converter and the R_3/R_2 ratio must be set within 1%. At high frequencies, feedback current of the phase-compensation capacitor, C , and bandwidth limitations of the multifunction converter and the op amp introduce more errors. Phase-compensation capacitor C and resistor R_4 are needed to ensure circuit stability.²

References

1. Korn, G. A. and T. M., "Electronic Analog and Hybrid Computers," McGraw-Hill, New York, NY, 1964.
2. Graeme, J., "Applications of Operational Amplifiers-Third Generation Techniques," McGraw-Hill, 1974.

Jerald Graeme, Manager Monolithic Engineering, Burr-Brown Research Corp., International Airport Industrial Park, Tucson, AZ 85734.

CIRCLE No. 311

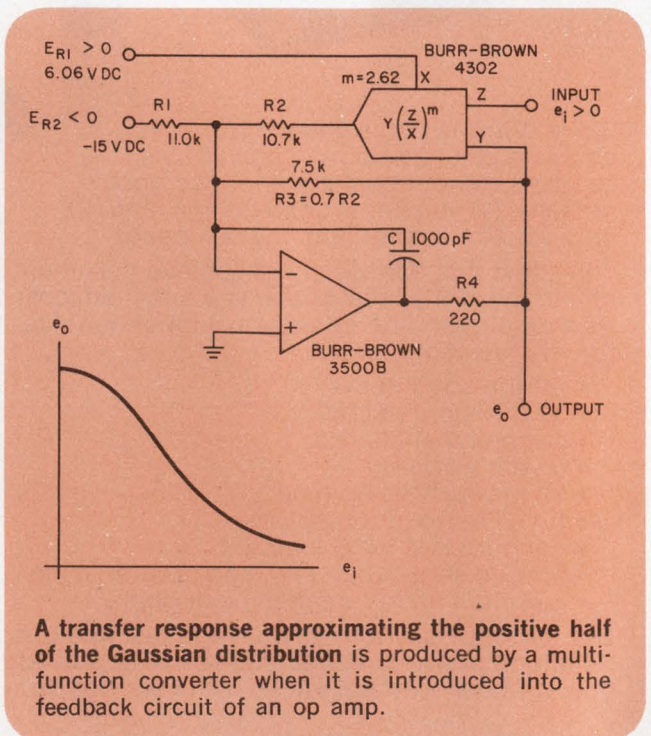

A transfer response approximating the positive half of the Gaussian distribution is produced by a multifunction converter when it is introduced into the feedback circuit of an op amp.

Who needs another source for solenoids?

You do if you want Potter & Brumfield quality, know-how, fast delivery.

Traditional Quality

Imagine! The same great quality you've come to expect in P&B relays is now available in a new line of general purpose solenoids. Although solenoids from P&B may be a new idea to you, they're not exactly new products for us. We've manufactured them for years on a special order basis for specialized applications.

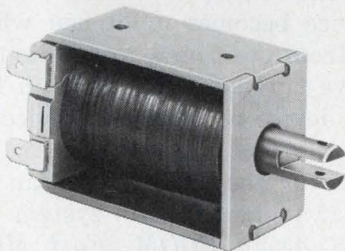

Industry Standards

The Potter & Brumfield name gives new meaning to solenoid quality with our new S11 and S11L series. You can't buy more cost-effective solenoids for demanding photocopy machine, industrial control equipment, tape recorder, or machine tool applications.

The S11 and S11L are industry standard box frame, AC-DC solenoids which meet or exceed the performance of competitive units. We offer pull-on-operate or push-on-operate models with .187" quick connect terminations. Coil voltages are 6 to 24V DC and 24 to 120V AC for the S11, and 6 to 24V DC for the S11L. Coil powers from 8 watts continuous, up to 30 watts (S11L) intermittent duty. Coils rated Class A (105°C).

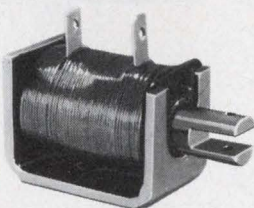

Low Cost Performance

When low cost plus performance is important, our new C-frame S34 series is the only choice. The decision is especially easy when you have a volume application like appliances, vending machines, or valve actuators. If a little more pull is needed, take a look at our S9 series. It, too, features low cost C-

frame construction, but provides a higher range of force characteristics for tougher jobs.

Coil powers are from 5 watts (S9: 6 watts) continuous duty to 10 watts intermittent duty. Standard voltages of 6, 12, 24 DC, and 24 and 120 AC are available. Terminations are standard .187" quick connects. Acetate yarn finished coils meet Class A (105°C) insulation requirements.

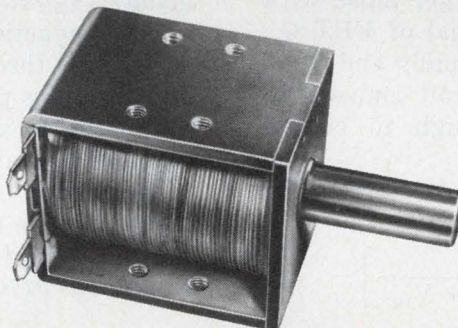

Really Big Jobs

Some jobs call for muscle, and that's when our heavy duty solenoids really perform. Holding forces range up to 170 oz. continuous, and up to 200 oz. intermittent duty. That's power! All you need for a wide range of tough applications. And, it's available in our S4 and S4H series heavy duty solenoids. They pack more power in less space.

Coil voltages for the S4 and S4H are 6 to 24V AC and 6 to 220V DC. Standard terminations are .187" quick connect with optional wire leads or solder terminals. Varnish impregnated coils meet Class A (105°C) and Class B (130°C) insulation requirements.

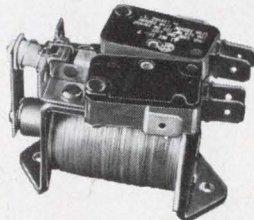

Engineering Help

When a standard won't do, you can rely on us to develop a finished product to solve your specialized application problem. We can call on our relay, switch, time delay relay, or control sub-assembly engineering to help deliver a solution.

Solenoid/switch combinations illustrate our broad capability in but one small way.

Solenoid actuated switch assemblies provide low cost control for garage doors, home appliances, heating and air-conditioning, or automated conveyor systems. Assemblies with one or two "M" style switches are available, with ratings to 10, 15 and 20 amps @ 125/250V AC, 1/2 HP. Solenoid coil voltages are 12 to 240V AC and 6 to 120V DC.

Where corrosive or dirty environments can be anticipated, our encapsulated solenoids really shine. Our Model S99 is designed to operate two-way diaphragm or piston type valves. Corrosion resistant materials handle water and dry or lubricated gases as well as air with ease. Hexagonal plunger design assures proper operation, even when handling water with particulate contaminants up to .02" diameter. Coil voltages are 6 to 120V AC and 6 to 24V DC. Standard mounting is by 3/4" x 20 UNEF 2A nut.

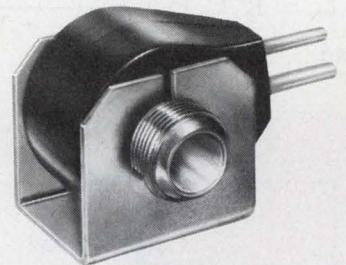

Specials and Variations

Need a special or variation of a standard solenoid? P&B can help! Specify the solenoid you need and we can build it for you—special mountings, optional terminations, intermediate voltages, custom markings, and special plunger-end configurations. All engineered and built with P&B care and attention to quality.

For complete information and specifications, contact your P&B Sales Representative, or write or call Potter & Brumfield Division AMF Incorporated, Princeton, Indiana 47671. 812 386 1000.



Circuit that latches/unlatches magnetic devices uses almost zero standby current

Magnetic-latching devices, such as reed relays and miniature electromechanical indicators, are advantageous in low power applications. They don't need any continuous electrical holding power. But only if their drive circuit requires little power, can this benefit be realized fully.

The circuit of Fig. 1 consumes virtually zero standby power (only nanowatts of leakage). It is used in a small portable micropower electrometer (radiometer) where a latching-reed relay switches the unit's high-impedance ($5 \times 10^{10} \Omega$) ranges within a sealed module (Fig. 2). The circuit can also be used for many other purposes, such as for driving a Minelco-type Bite scale-range or alarm indicator.

Switch S (Fig. 1) is part of the instrument's multiposition range switch (S_{1B} in Fig. 2). When S is switched, toggle action from position 2 to position 1 produces a positive trigger pulse with peak value $2V_s$ in the gate terminal of FET Q_3 . This pulse causes Q_3 to turn on rapidly and Q_4 to saturate. Point P of the device's coil connects to $-V_s$ momentarily but long enough to ensure latching.

The ON period of Q_4 can be calculated from the following relationships:

$$t_{on} = R_3 C_2 \ln \left[\frac{2V_s}{V_{BE(ON)} + V_{GS(th)} + V_{(Q)}} \right] \quad (1)$$

and

$$V_{(Q)} = \left[\frac{2(V_s - V_{CE(sat)})}{h_{FE} \beta R_L} \right]^{1/2}, \quad (2)$$

where

- V_s = Supply voltage.
- $V_{BE(ON)}$ = Voltage drop of forward-biased base-emitter junction of transistor Q_2 or Q_4 .
- $V_{CE(sat)}$ = Voltage drop (collector-emitter) of saturated transistor Q_2 or Q_4 .
- h_{FE} = Forward-current transfer ratio (static-current gain) of transistor Q_2 or Q_4 .
- $V_{GS(th)}$ = Gate-source threshold voltage of (enhancement type) MOSFET Q_1 or Q_3 .
- β = Gain factor (mhos/V) of MOSFET Q_1 or Q_3 .
- R_L = Resistance of magnetic device.

Energy demand during switching is approximately $(V_s^2/R_L) t_{on}$ in joules per pulse.

The magnetic device becomes unlatched when switch S is thrown from position 1 to position 2. The resulting positive current pulse through the coil of the magnetic device restores the device to its original state.

The trigger signal for the circuit also can be a square-wave derived from a control system.

J. C. Nirschl, US Army ECOM, Fort Monmouth, NJ 07703.

CIRCLE NO. 312

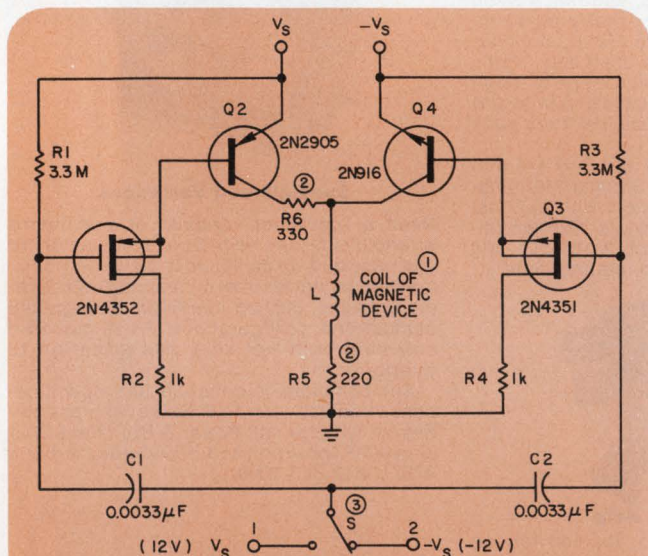

- NOTES:
- ① LATCHING REED RELAY (HAMLIN MDLS-4 WITH COIL ADDED) OR MINELCO MINIATURE INDICATOR TYPE BHG 21 T12
 - ② NOT USED WITH MINELCO INDICATOR
 - ③ MAY BE PART OF MULTIPOSITION RANGE SWITCH

1. A drive circuit for magnetic-latching devices that uses negligible standby power doesn't defeat the original reason for using magnetic latching—to minimize power consumption.

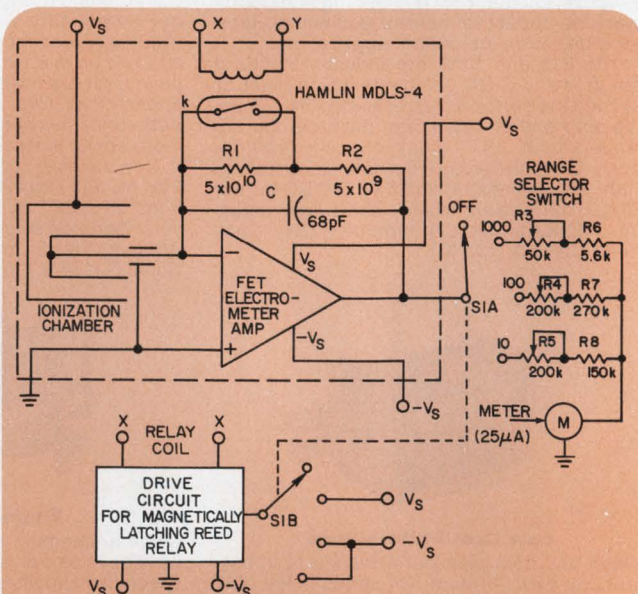

2. In an electrometer application of the drive circuit, a latching reed relay is turned on and off to change the electrometer's range resistor mounted within a sealed high-impedance module. In this way, noncritical external switching can be used.

Guildline Introduces the only 14 Million Count DVM on the Market Today



Guildline's radical 7-1/2 digit precision digital voltmeter, Model 9577 features standards laboratory accuracy and stability. The 9577 is equally at home on the work bench or in a system application via programmable BCD or IEEE Standard 488.

FEATURES:

- Capability — DC volts, AC (rms) volts, ohms, and ratio
- 0.0004% DC accuracy • Resolution — $1 \mu\text{v}$ on 10 volt range
- 20ppm per year stability
- Self-Check via front panel or system mode
- 500 readings per second
- $> 1000\text{G}\Omega$ input resistance • Digital Filtering



Guildline Instruments, Inc.

1997 PALMER AVE., LARCHMONT, NEW YORK 10538 (914) 834-8100

Diode-feedback comparator circuit regulates a LED's drive current

Here's a comparator circuit that can drive a LED display with constant current independently of wide power-supply voltage changes. Add a diode to a standard LM3900 current-differencing amplifier and the circuit can operate with a power-supply range of at least 4 to 30 V (see figure).

An external 1N914 diode, along with the forward-biased diode that is part of the LM3900's internal circuit at the inverting input, blocks current flow from output to input for low output-voltage states. However, when the output voltage swings up and the voltage across R_1 rises to approximately 1 V, a small current (typically less than 30 nA) flows into the inverting input and maintains a constant 1 V across R .

With 10-M Ω resistances for R_{in} , and the inverting input of the comparator grounded, the circuit becomes a LED driver with very high input impedance. Of course, the circuit can figure in many other applications where a controllable constant-current source is needed.

Tom Frederiksen and Martin Giles, Application Engineers, National Semiconductor Corp., 2900 Semiconductor Dr., Santa Clara, CA 95051.

CIRCLE NO. 313

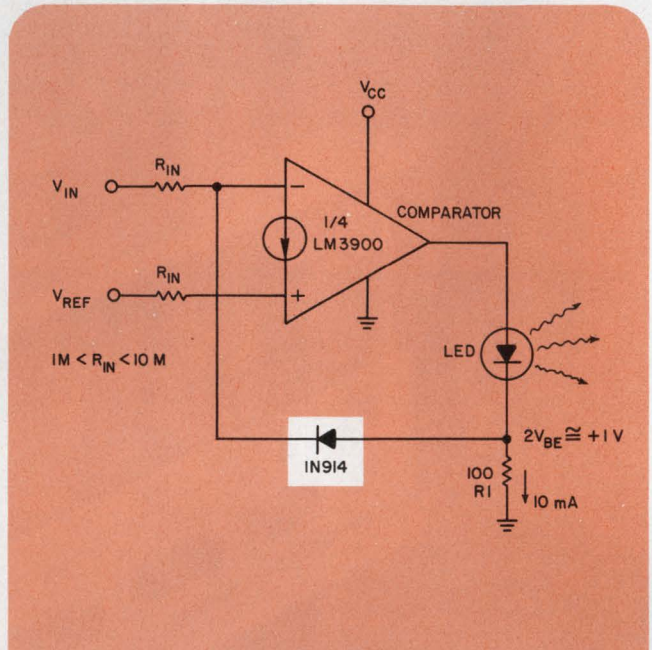

Without the added feedback diode, the comparator would drive the LED with a widely changing current as the power-supply voltage changed. However, the diode acts to keep the LED current nearly constant at about 10 mA.

Time-interval meter reads digitally to 99.9 ms on a DVM IC

Measuring time intervals is a frequent requirement. To meet this need conveniently, the circuits in Figs. 1 and 2 read time in decimal numbers to three places—from 00.0 to 99.9 ms.

The circuit uses a 555 timer in combination with a current source to form a sawtooth generator (Fig. 1). The sawtooth voltage across capacitor C_1 is buffered with a FET input to an L144 op amp. A second op-amp circuit in the L144 scales the ramp and permits the offset to be adjusted. This op-amp's output is a negative-going ramp that periodically resets to zero.

A sample-and-hold circuit stores a voltage sampled from the ramp in capacitor C_2 . Feeding this voltage into the input of a three-digit DVM IC (LD130) produces a digital readout of the time between ramp initiation and sampling

(Fig. 2). Direct interface between the hold capacitor and the DVM IC is possible, because the LD130's input impedance is 1000 M Ω .

A current source charges the 0.1- μ F capacitor, C_1 , to generate a linear ramp. The ramp slope, controlled by the charging current (3.33 μ A), is obtained with two 2N4403s connected as a current source and adjusted by varying the 10-M Ω potentiometer, R_1 . Resistor R_2 controls the discharge time of C_1 , and an output pulse at pin 3 of the 555 of about 1 ms in width is produced.

The ramp amplitude, scaled by 1/3, results in an approximately 1-V ramp height. The ratio R_{S1}/R_{S2} controls the ramp scaling without varying the over-all frequency.

All of the system's offsets can be "tweaked"

(continued on page 110)

TYPICAL "SWAP" ADVANTAGES

Up to 100
SSI's and MSI's



Savings to the customer of 50% or more in IC direct material costs

Significant reduction in IC's required per system... one SWAP circuit replaces 5 to 100 standard devices

Reduced manufacturing costs per customer system... fewer IC insertions... simplified system check-out and repair

Small physical size

into

one SWAP chip

Less Expensive PC boards and hardware

Improved reliability

Smaller and less expensive system power supplies

Reduced inventory control, procurement activity, and simplified documentation

Fully compatible with DTL, TTL, and CMOS IC's and discrete transistors

for maximum cost savings!

SWAP-- Custom-Designed Logic Systems Now Available at Mass Production Prices!

Wouldn't you like your own custom LSI chip that can consolidate up to 50 or 100 of the standard SSI's and MSI's you are using into one circuit? Well, now it's yours with "SWAP" - Stewart-Warner Array Programming - and it will save you lots of money, too!

SWAP is a major price breakthrough in custom logic circuits. Forget about the usual custom-chip penalties, the large tooling costs, the huge entry fees, and the gigantic production order requirements. For as low as \$1800 you can have delivery of your first custom I²L SWAP prototypes in

just 4 weeks, and you will also cut your gate prices by as much as 50% on production orders.

SWAP is ready if you are. Send the coupon now for your SWAP Design Kit (or the "bingo card" for a brochure).

The SWAP Design Kit consists of:

1. the SWAP Design Manual (complete with vellum work sheets);
2. fifteen (15) sample devices illustrating some of the functional blocks that can be used in a SWAP design.

Okay, here's my \$25.00 (or P.O. No. _____) Rush me your I²L SWAP Design Kit.

I need more information, Please have a representative call me.

Tell me about your standard DTL, TTL, and CMOS circuits. (We have products now.)

SYMBOL OF
SW
EXCELLENCE
STEWART-WARNER MICROCIRCUITS DIVISION
STEWART-WARNER CORPORATION
730 E Evelyn Ave • Sunnyvale, Ca 94086 • (408) 245-9200

Name _____

Company _____

Phone _____

Address _____

City _____ State _____ Zip _____

IDEAS FOR DESIGN

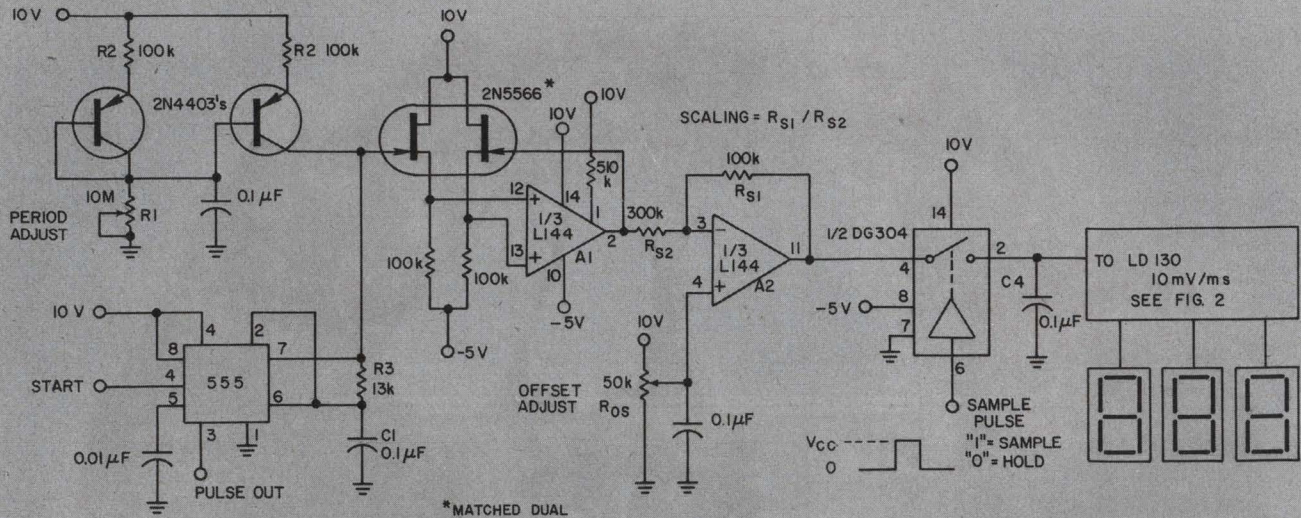

1. A linear ramp voltage generated by a timer IC and constant-current source is sampled and then

measured by a DVM to determine time intervals. All circuit offsets can be zeroed out with R_{0s}.

out and the ramp dc level translated by adjusting the R_{0s} potentiometer. The ramp across C₁ starts at 1/3 V_{CC} and ends at 2/3 V_{CC}, but after scaling its magnitude becomes (1/9) V_{CC} and its polarity, inverted.

The DVM IC measures 000 to 999 mV and consumes little power. Very few additional components are needed to create a complete three-digit DVM.

As an elapsed-time meter for sonar (water or air) and phase and rise or fall-time measurements, the system can be synchronized to external events by controlling pin 4, the 555's reset input.

Thomas J. Mroz, Applications Engineer, Siliconix, Inc., 2201 Laurelwood Rd., Santa Clara, CA 95054.

CIRCLE No. 314

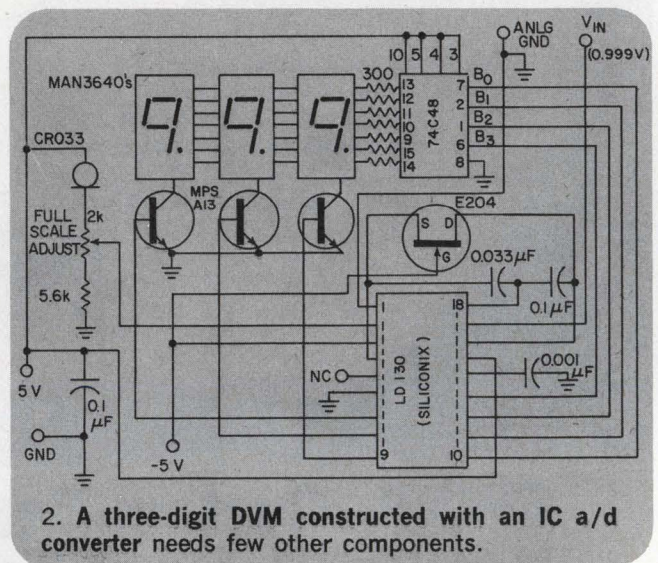

2. A three-digit DVM constructed with an IC a/d converter needs few other components.

IFD Winner of November 8, 1976

Peter A. Ernst, Institut für Regelungstechnik, Universität Erlangen-Nürnberg, Cauerstrasse 7, 8520 Erlangen, Germany. His idea "Remotely Control a Pocket Calculator with a Simple CMOS Interface Circuit" has been voted the Most Valuable of Issue Award.

Vote for the Best Idea in this Issue by circling the number of your selection on the Reader Service Card at the back of this issue.

SEND US YOUR IDEAS FOR DESIGN. You may win a grand total of \$1050 (cash)! Here's how. Submit your IFD describing a new or important circuit or design technique, the clever use of a new component or test equipment, packaging tips, cost-saving ideas to our Ideas for Design editor. Ideas can only be considered for publication if they are submitted exclusively to ELECTRONIC DESIGN. You will receive \$20 for each published idea, \$30 more if it is voted best of issue by our readers. The best-of-issue winners become eligible for the Idea of the Year award of \$1000.

ELECTRONIC DESIGN cannot assume responsibility for circuits shown nor represent freedom from patent infringement.

THERE'S A WHOLE FAMILY OF LOGIC* DESIGNED TO SOLVE YOUR NOISE PROBLEMS.

HERE'S ONE:

THE 367 QUAD SCHMITT TRIGGER

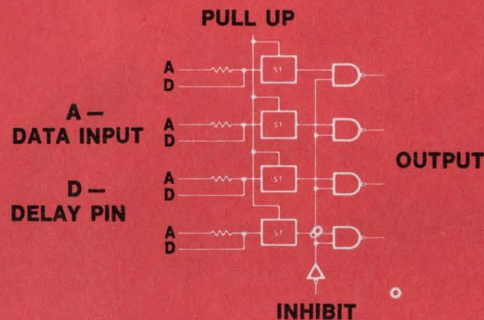

- 4.5V typ hysteresis
- 5.5V typ DC noise immunity
- Delay pin feature
- Dual truth table
- Withstands $\pm 100V$ $1\mu s$ spike

* **HIGH NOISE IMMUNITY LOGIC (HiNIL)** is designed to make logic systems virtually immune to voltage transients and other sources of electrical noise. Typically it provides a noise immunity about 10 times better than conventional logic, such as TTL — even under worst-case conditions. HiNIL is most effective in control applications where high electric currents are present and a severe electro-mechanical interface exists.

With the family of HiNIL devices constantly growing, you can design entirely with HiNIL, or you can use it in place of your conventional I/O logic to protect and interface reliably with CMOS, TTL, or MOS circuits without resorting to special filtering, shielding or power supply regulation.

Get details on the full family of HiNIL logic circuits from your local Teledyne rep or distributor. Or contact us at the address below.

HiNIL CIRCUITS

One Shots/Timers

- 342 Dual Monostable Multivibrator
- 346 Retriggerable Monostable Multivibrator
- 347 Dual Retriggerable Monostable Multivibrator
- 348 Retriggerable Pulse Stretcher
- 349 Dual Retriggerable Pulse Stretcher
- 355 HiNIL Timer

MSI Circuits

- 343 4-bit Digital Comparator
- 361 Dual HiNIL to 5 Volt Interface
- 362 Dual 5 Volt to HiNIL Interface
- 363 Quad 5 Volt to HiNIL Interface
- 367 Quad Schmitt Trigger/Line Receiver
- 368 Quad Schmitt Trigger/Line Receiver (Open Collector)

Interface Buffers

- 390 Dual 4-Input AND
- 391 Dual AND
- 392 Dual NAND
- 393 Dual OR
- 394 Dual NOR
- 395 Dual 4-Input NAND
- 396 Dual Line Driver/Receiver

Gates

- 301 Dual 5-Input Power NAND
- 302 Quad 2-Input Power NAND (Open Collector)
- 303 Quad 2-Input Power NAND (Passive Pullup)
- 304 Triple 4, 3, 4-Input Power NAND (Passive Pullup)
- 306 Quad 2, 2, 2, 3-Input NOR
- 307 Quad 2, 2, 2, 3-Input NOR (Open Collector)
- 321 Quad 2-Input NAND
- 322 Dual 5-Input NAND
- 323 Quad 2-Input NAND (Open Collector)
- 324 Quad 2-Input NAND (Passive Pullup)
- 325 2, 2, 3, 3-Input NAND
- 326 2, 2, 3, 3-Input NAND (Passive Pullup)
- 331 Dual 5-Input Gate Expander
- 332 Hex Inverter (Open Collector)
- 333 Hex Inverter (Passive Pullup)
- 334 Strobed Hex Inverter (Open Collector)
- 335 Strobed Hex Inverter (Passive Pullup)
- 341 Dual 2-Input AND-OR-INVERT
- 344 Dual Expandable AND-NOR

Flip Flops

- 311 Master/Slave RST
- 312 Dual J-K Edge Triggered
- 313 Dual J-K Master/Slave
- 370 Quad D (Passive Pullup)
- 375 4-bit Shift Register

Counters

- 371 Decade (Passive Pullup)
- 372 Hexadecimal (Passive Pullup)
- 373 Up/Down Decade
- 374 Up/Down Hexadecimal

Decoders/Multiplexers

- 350 8-bit Multiplexer
- 351 Dual 4-bit Multiplexer
- 380 BCD to Decade Decoder/Lamp Driver (Open Collector)
- 381 BCD to Decade Decoder/Logic Driver (Open Collector)
- 382 BCD to Decade Decoder/Gas Discharge Driver
- 383 BCD to Seven Segment Decoder/Driver
- 384 BCD to Seven Segment Decoder/Gas Discharge Driver

TELEDYNE SEMICONDUCTOR

1300 Terra Bella Avenue, Mountain View, California 94043 Tel: (415) 968-9241 TWX: 910-379-6494 Telex: 34-8416

SALES OFFICES:

DOMESTIC: Salem, N.H. (603) 893-9551; Stony Brook, N.Y. (516) 751-5640; Des Plaines, IL (312) 299-6196; Los Angeles, CA (213) 826-6639; Mountain View, CA (415) 968-9241 • INTERNATIONAL: Hounslow, Middlesex, England (44) 01-897-2503; Tiengen, West Germany 7741-5066; Kowloon, Hong Kong 3-240122; Tokyo, Japan 03-405-5738.

CIRCLE NUMBER 68

Arrow-M Amber Relays

solve PC board cleaning problems.



Arrow-M's leak-free Amber Relays are N₂ gas-filled and sealed in plastic so they're simple to clean with most de-greasers and detergent cleaners, without affecting the maximum contact reliability of the relays.

And, Arrow-M can help you substantially reduce your labor costs! Just use Arrow-M Amber Relays on your PC board in conjunction with automatic wave soldering, instead of costly hand soldering.

The total savings are even greater when you use Arrow-M Amber Relays. Arrow-M Amber

Relay prices are right in line with standard non-seal types.

Arrow-M Amber Relays. When you want maximum reliability and maximum savings. And only Arrow-M makes them.

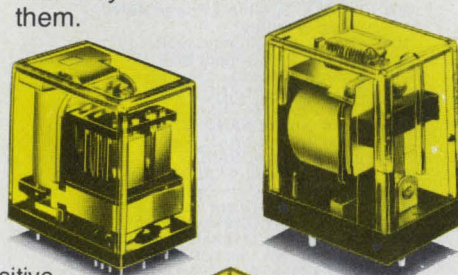

KE—Sensitive—
Long Life—10⁸ mech.

NFE—
New Low Profile—
High Sensitivity

HCE—
Miniature
Power
Type.

**Relays
for advanced
technology.**

For more information on exact specifications, write or call your nearest Arrow-M office.

Arrow-M Corporation
250 Sheffield Street
Mountainside, N.J. 07092
(201) 232-4260

Western Office:
22010 South Wilmington Ave.
Suites 300 & 301
Carson, California 90745
(213) 775-3512

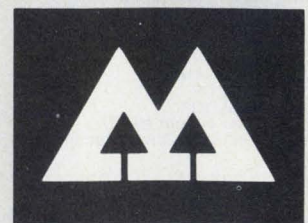

Arrow-M

Member of Matsushita Group

New Products

Industry's first 18-bit modular DAC fits in palm-sized case

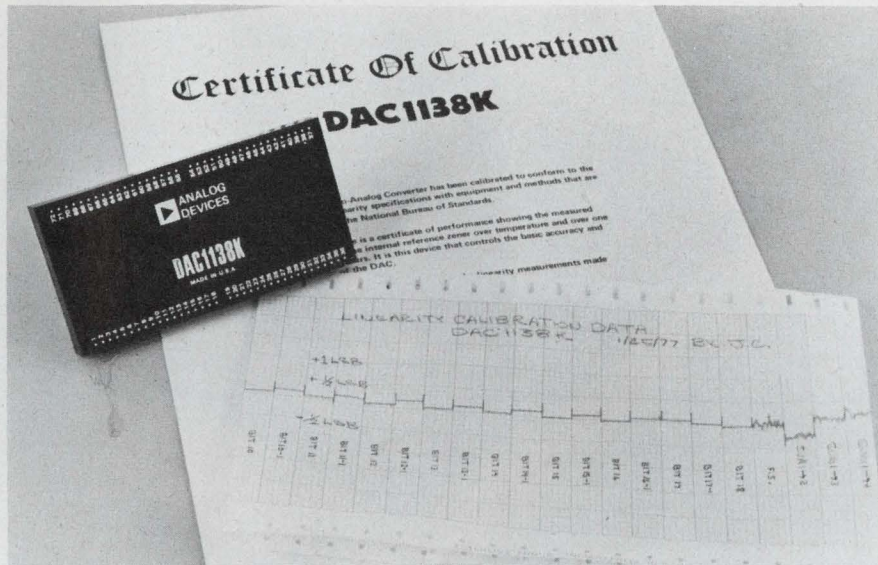

Analog Devices, Rte. 1 Industrial Park, P.O. Box 280, Norwood, MA 02062. Barry Friedman (617) 329-4700. P & A: See text.

Claiming a major first in converter products, Analog Devices has squeezed an 18-bit accurate digital-to-analog converter into a $2 \times 4 \times 0.4$ -in. module. Moreover, in addition to now offering the most accurate modular DACs anywhere—the DAC-1138 series—Analog has also introduced what are reported to be the lowest-cost DACs with 16-bit accuracy—the DAC-1136 series.

The DAC-1138 comes in two versions, one that delivers 18-bit accuracy and resolution (the DAC-1138K), and one that delivers 17-bit accuracy but 18-bit resolution (the DAC-1138J). Neither unit will put much of a strain on your budget: the 1138K costs only \$950 and the 1138J a mere \$750—just slightly more than the cost of previously available top-quality 16-bit converters.

And if you don't need 17 or 18 bits, there are the DAC1136K and DAC1136J, also $2 \times 4 \times 0.4$ in. modular DACs, that offer 16-bit accuracy and resolution or 15-bit accuracy and 16-bit resolution, respectively. Prices for the 1136s are

\$220 for the J and \$260 for the K model.

Both the DAC1136 and 1138-series units come in $2 \times 4 \times 0.4$ -in. modules and are pin-compatible with the company's older QM series of 14 and 16-bit converters. Offset-temperature coefficients for the converters are $0.5 \text{ ppm}/^\circ\text{C}$; differential linearity tempcos are $0.4 \text{ ppm}/^\circ\text{C}$. Except for the 1138K, each d/a converter operates at a specified resolution over a range of 5 to 50 C. The 1138K maintains its accuracy over a ± 10 -C window around any precalibrated point within the 5-to-50-C range. Converter linearity for the 1138K and 1136K is specified at $\pm 0.5 \text{ LSB}$ and $\pm 1 \text{ LSB}$ for the J models.

All converters can be set for either current or voltage outputs, which can be either unipolar or bipolar. Available current outputs are 0 to -2 mA or $\pm 1 \text{ mA}$, and possible voltage ranges include 0 to $+5$, 0 to $+10$, ± 5 and $\pm 10 \text{ V}$.

Settling times to within 0.5 LSB for the current output mode are $10 \mu\text{s}$ for the 1138 series and $8 \mu\text{s}$ for the 1136 units, both for a full-scale step. In the voltage-output mode, full-scale settling times for the 1138 increase to $250 \mu\text{s}$ (unipolar), 3 ms (bipolar), and for

the 1136 to $30 \mu\text{s}$ (unipolar) and $40 \mu\text{s}$ (bipolar), and in all cases the internal amplifiers are used. For a faster voltage settling, an external-output amplifier can be used.

Requirements for the converter's power supply aren't hard to satisfy: only $+5 \text{ V}$ at 9 mA and $\pm 15 \text{ V}$ at 30 mA for any unit—all regulated to within 5%. Power supply rejection in the voltage-output mode is 80 dB for gain error and 75 dB for offset error.

Since both converter series are also available in card-mounted assemblies, you can select options from a "library" of input codes and output amplifiers. Input options include binary, complementary binary, 2's complement, sign-plus-magnitude binary and complementary sign-plus-magnitude binary. The 4.5×6 -in. circuit card also permits you to use three output options: the DAC1138 internal output amplifier, the Model 44 K high-speed modular op amp or the 234L low-noise, low-drift op amp. A four-terminal output connector on the card permits contact-resistance compensation.

No other companies offer an 18-bit d/a converter in modular form, but a few others besides Analog Devices sell 16-bit units: Analogic, Wakefield, MA, offers the MP-1916A; Burr-Brown, Tucson, AZ, the DAC-70; Datel, Canton, MA, the DAC-HR; and Intech, Santa Clara, CA, the 416 BIN and A-867-16.

All of Analog's DAC1136 and 1138 converters are available from stock to 30 days. And the DAC-1138s come with a certificate of performance, including a 1000-hour zener-stability record and a test record of linearity.

For Analog Devices **CIRCLE NO. 302**
For Analogic **CIRCLE NO. 303**
For Burr-Brown **CIRCLE NO. 304**
For Datel **CIRCLE NO. 305**
For Intech **CIRCLE NO. 306**

ALONE AGAIN

in low cost 1-watt
Zener Diodes

SCHAUER

"Z" SERIES ZENERS

DO-41 epoxy
molded case

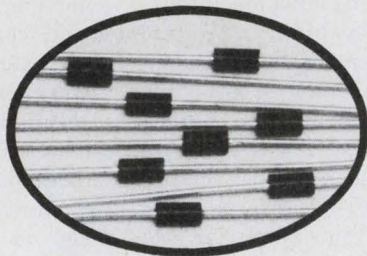

ANY VOLTAGE
2.6 to 34.0

ANY TOLERANCE
1% 2% 5% 10%

At Any Test Current

**Compare These Prices
On 1% Tolerance Diodes**

Quantity	Price each
1-99	91¢
100-499	83¢
500-999	77¢
1000 up	73¢

**LARGE STOCK
GOOD DELIVERIES**

Send for complete rating data
and other tolerance prices.

Semiconductor Division

SCHAUER

MANUFACTURING CORP.

4511 Alpine Ave., Cincinnati, OH 45242
Telephone 513-791-3030 Telex 21-4576

MODULES & SUBASSEMBLIES

Low-noise vhf synthesizer is small and inexpensive

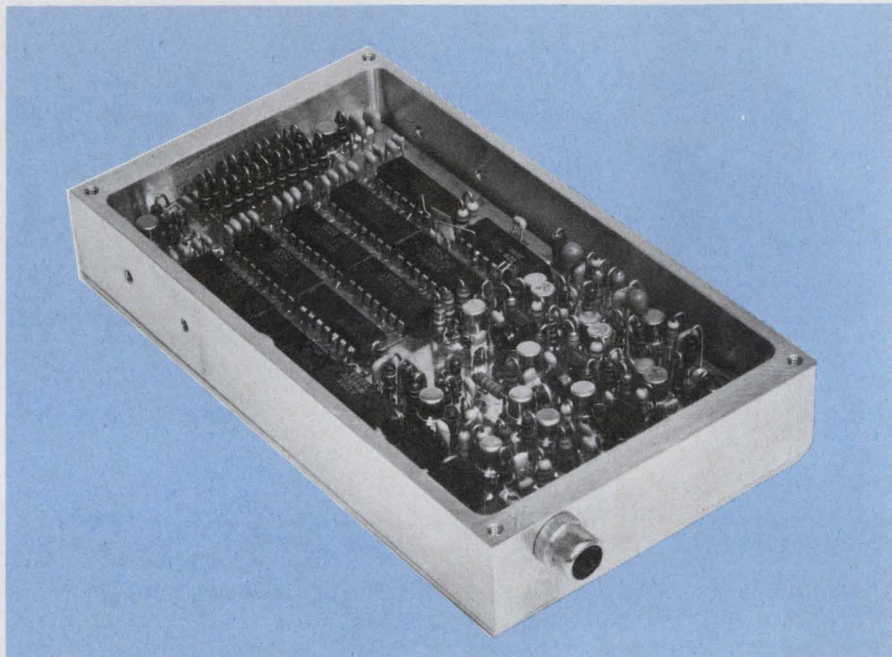

Rohde & Schwarz Sales Co., 14
Gloria Lane, Fairfield, NJ 07006.
Allen Freeland (201) 575-0750.
P&A: see text.

If you're looking for a source of low-noise signals in the 60-to-120-MHz range, check the Model PT-2 from Rohde & Schwarz Sales Co. This compact synthesizer doesn't have all the features of some of its competitors—for example, each PT-2 can only generate frequencies within a narrow part of the band. But, priced at only \$2000 in unit quantities, and \$1400 for 30 or more, the 1-3/8 × 3 × 5-1/4-in. PT-2 costs less than half of what you might otherwise have to pay.

Applications like frequency calibration and satellite communications usually require only a few discrete frequencies. But until now, engineers who needed a programmable low-noise source in the vhf range had to rely on general-purpose synthesizers such as Hewlett-Packard's 8660A or Fluke's 6160B. These instruments can synthesize a wide range of frequencies and have all the controls and features expected in a rack-mount instru-

ment—along with prices upwards of \$6000.

The PT-2's price is much lower because it doesn't have all the frills. It doesn't even include a power supply—you'll have to provide 10 to 13 V at 300 mA. And while the PT-2's design is capable of generating any frequency from 60 to 120 MHz, individual units are tailored to a much narrower spectrum.

To specify a PT-2, start with a single frequency between 60 and 120 MHz. The module then provides up to 20 predetermined synthesized frequencies, starting at the specified frequency and stopping at a frequency 1.4% higher. For example, a single PT-2 might have 20 frequencies between 100 and 101.4 MHz. When it receives a BCD command, the PT-2 delivers the right frequency at a level of zero dBm ±3 dB into 50 Ω.

The output signal is very quiet. In the PT-2, discrete spurious signals within 20 MHz of the output signal are suppressed by 100 dB or more, and all other discrete spurious signals are down 60 dB

or more. Harmonics are at least 60 dB below the output level.

Under worst-case conditions, phase noise in the PT-2 is down 70 dB at 20 Hz from the output. At 2 kHz from the chosen frequency, phase noise is down more than 120 dB.

Two versions of the PT-2 are available. The PT-2A has an internal frequency standard that is voltage-tunable over a range of $\pm 0.01\%$ of the basic frequency. The PT-2B has an output frequency that can be phase-locked to an external 1-MHz standard.

For bench-top applications or manual-frequency selection, the PT-2 can be ordered in an instrument cabinet that measures $3 \times 4 \times 6$ in. The output frequency is selected by front-panel thumbwheel switches instead of BCD signals. In a cabinet, the PT-2 is priced at \$2250 in unit quantities.

CIRCLE NO. 307

Unit measures gas flow from outside the pipe



Teledyne Hastings-Raydist, Hampton, VA 23661. (804) 723-6531. \$490; 3 wks.

All circuitry for the AFSC series of gas-mass flow meters is contained inside the unit's base. There are no sensing elements or projections into the flow stream. The unit operates on a thermal principle that measures true-mass flow. Available in eight ranges from 10 to 50,000 standard cubic cm/min, the devices operate from 24 V dc and produce linear outputs of from 0 to 5 V dc. Normal calibration is for air with conversion factors provided for most gases. Accessories include meters with direct-reading scales, single-and-two-point alarm meters, digital panel meters, totalizers, controllers, and 115-V-ac to 24-V-dc converters.

CIRCLE NO. 308

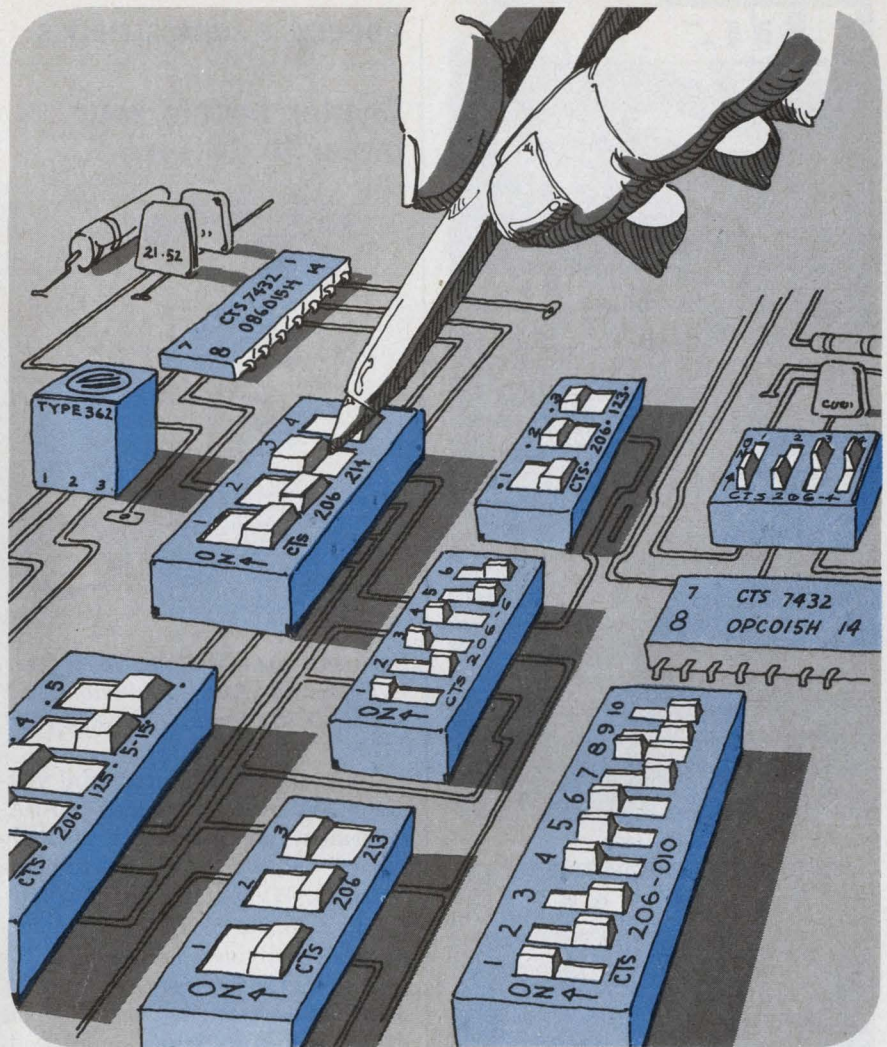

Take your pick... DPST, SPDT or SPST programmable DIP switches

CTS offers them all... with the addition of NEW 2, 3, 4 and 5 section SPDT and DPST switch styles.

A total of 15 Series 206 DIP switch packages are now available from CTS... 7 with SPST actuation, 4 with SPDT actuation and 4 with DPST actuation. All have .100" by .300" centers for PCB or standard DIP socket insertion. Gold plated contacts with nickel barrier assure lowest contact resistance throughout life.

All provide crisp slide actuation and reliable, positive contact wiping

action. Program up to 10 different logic functions with one compact SPST package or up to 5 SPDT or DPST functions with the identical size package.

Use the quality, reliable CTS Series 206 for your next computer, computer peripheral, communication or test equipment switch application. Available from the factory or off the shelf from CTS Distributors. For complete information, write **CTS KEENE, INC.**, 3230 Riverside Avenue, Paso Robles, CA 93446. Phone: (805) 238-0350.

CTS CORPORATION

ELKHART, INDIANA

A world leader in cermet technology

CIRCLE NUMBER 71



ALCOSWITCH
OFFERS

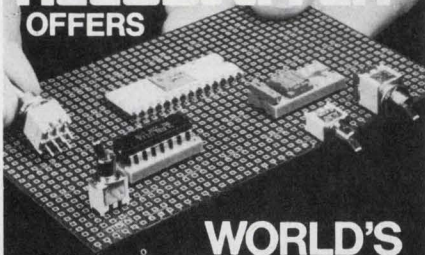

WORLD'S SMALLEST TOGGLE SWITCH

SPECIFICALLY for PC APPLICATIONS

- 60% smaller in volume than existing miniature toggle switches.
- Terminals match standard 1/10" centers on both X-Y axis.
- 3/8" max. height. Compatible with all PC components. Fits 1/2" spacing.
- Gold plated contacts and terminals suitable for low level applications.
- Available in one and two poles; in any switching configuration.
- Free Sample! Specify application, upright or right angle mounting.
- Specify TT Series.

CIRCLE NUMBER 72

ALCOSWITCH
OFFERS



MOST RELIABLE SLIDE SWITCHES

SPECIFICALLY for PC APPLICATIONS

- Same basic construction as our proven TT Toggle switches.
- Upright or right angle PC. Terminals mount on 1/10" centers, X-Y axis.
- One and two poles and also with twin (independent) slide actuators.
- Gold plated contacts and terminals are standard for low level switching.
- Your choice of flush (safe) or .110" protruding actuators. Colors too!
- Free Sample! Specify your needs and we'll comply accordingly.
- Specify TSS Series.

CIRCLE NUMBER 73

Call (617) 685-4371.

ALCO ELECTRONIC PRODUCTS, INC.

1551 Osgood St., No. Andover, Ma. 01845

A Subsidiary of **AUGAT** INC.

MODULES & SUBASSEMBLIES

Divider boosts your meter to 100 kV

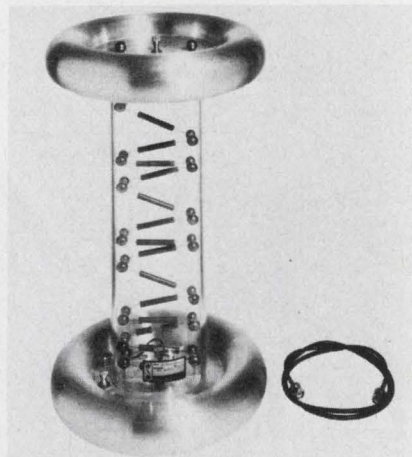

Spellman High Voltage Electronics, 7 Fairchild Ave., Plainview, NY 11803. D. Galluzzo (516) 822-2130. \$595; 8 wks.

Your differential or digital voltmeter and even a standard 100- μ A-movement meter become 0.5%-accuracy high-voltage instruments with the HVD-100 resistive divider. Boasting a 1-G Ω input impedance, the divider is intended for high-voltage low-current sources. Additional specifications for the device include: 100-kV input voltage; 100, 10 and 1-V output taps; 100-ppm/ $^{\circ}$ C tempco and 0.01% 8-h stability. The recommended calibration interval is 90 days.

CIRCLE NO. 309

Digit displays contain multiplexing diodes

Refac Electronics, P.O. Box 809, Winsted, CT 06098. W. Gillis (203) 379-2731. From \$21.95; stock.

Series MDD-430, 440 and 450 are seven-segment directly viewed incandescent digital displays that contain seven isolation diodes for multiplexing. The package measures 0.665 \times 0.275 \times 1.025 in. The displays can be mounted directly to a PC board or plugged into sockets. The units feature light output of 9000 fL with the 0.25-in. character life-rated at 100,000-h per segment. The 4-V and 5-V displays provide a 7:1 contrast ratio in bright sunlight with proper filtering and can be dimmed for night viewing.

CIRCLE NO. 310

The Fastest 8-Bit DIP A/D On 24 Pins

- 100 ns/bit
- $\pm 1/2$ LSB linear over temperature
- 9 input ranges
- Adjustment free
- Serial and parallel outputs
- Extended temperature range available (-55 $^{\circ}$ to 85 $^{\circ}$ C)
- Hermetic 24-pin DIP
- Available with Mil-Std-883 Class B processing



MN 5101
\$234.00

(1 to 24 units)



Micro Networks Corporation
324 Clark Street, Worcester, MA 01606
(617) 852-5400 TWX 710-340-0067

CIRCLE NUMBER 74

ELECTRONIC DESIGN 6, March 15, 1977

Converter zips polar digits to analog X-Y

Interface Engineering, 386 Lindelof Ave., Stoughton, MA 02072. (617) 344-7383. From \$240; stock to 45 days.

The DR320 accepts a 10, 12, or 14-bit natural-binary angle (θ) and a reference (R) and delivers $R \sin \theta$ and $R \cos \theta$ outputs at up to 500-k conversions/s. The trig functions are digitally controlled and the outputs conform individually to the theoretical sine and cosine functions as well as maintaining arctan θ ratio accuracy. The resultant vector, therefore, exhibits an accurate length as well as an accurate pointing angle. You can use the device as a fast multiplier with a trig-function translation and get a conversion lag of less than 1 μ s. The unit accepts a reference (R) input in analog form, from dc to complex waveforms. The module provides d/r and d/s as well as polar-to-rectangular conversions. The converter's speed lets you dynamically control electron-beam deflection in CRT displays. The A model provides $\pm 0.3\%$ vector-amplitude vs angle conformance and $\pm 0.2^\circ$ arctan conformance. The B models provide $\pm 0.1\%$ vector-amplitude conformance and $\pm 0.05^\circ$ arctan conformance.

CIRCLE NO. 320

Multiplexer links 15 ports to a CPU

Digital Systems, Walkersville, MD 21793. J. R. Laughlin (301) 845-4141. From \$5250; 90 days.

The Model 6116 connects to a high-speed bisynchronous communications adapter on a host processor and then fans out that high-speed port to 15 slower speed asynchronous ports. The unit functions either locally or remotely with respect to the host computer. The speed of each terminal device connected to the multiplexer can be preselected at from 110 to 9600 baud, and the speed for each device is independent of the others. The unit is built around a μ P system with 15 separate input buffers. Data are transmitted a character at a time to the device, which then buffers the data until the end of a record is reached.

CIRCLE NO. 321

Solid-state delay switches 4 A

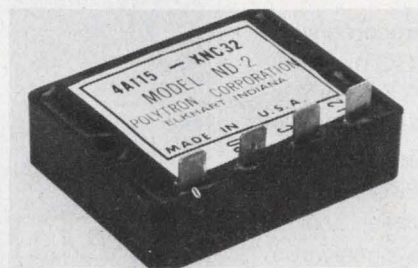

Polytron Corp., P.O. Box 984, Elkhart, IN 46514. Alex Saharian (219) 294-3924. \$6.50 (1000 qty); stock to 2 wks.

The ND-2 line of solid-state time-delay relays is intended for heavy-industrial application. These normally-ON or normally-OFF devices are fully encapsulated and switch loads of up to 4 A at various line voltages. The unit measures $2.5 \times 2 \times 1$ in.

CIRCLE NO. 322



24 GHz

-30 dBm sensitivity, FM tolerance standard

Just those three features alone put Systron-Donner's new Model 6054B Microwave Counter in a class by itself! But there's lots more...

- **Coverage:** 0.02 to 24 GHz in one band with one connector input.
- **Sensitivity:** -30 dBm to 10 GHz; -25 dBm to 18 GHz; -20 dBm to 24 GHz.
- **Dynamic range:** No dead zone! Operative over the complete range up to +30 dBm (1 watt).
- **Protection:** Flashing LED's provide early warning of pending overload.
- **FM tolerance:** Full channel loading and heavily modulated signals with rates up to 10 MHz are measured easily.
- **Models:** If you don't need 24 GHz coverage, S-D also offers 1.25, 4.5, 6.5 and 18 GHz automatic counters.
- **Information:** Call Scientific Devices or contact S-D at 10 Systron Drive, Concord, CA 94518. Phone (415) 676-5000. Overseas, contact Systron-Donner in Munich; Leamington Spa, U.K.; Paris (Le Port Marly); Melbourne.

SYSTRON  DONNER

CIRCLE NUMBER 75

X-Y recorders catalog

FREE book details OEM, industrial, lab recorders

Obtain inexpensive, accurate records of DC or slowly changing AC signals on these user-oriented X-Y recorders. 8-page bulletin includes a low-price OEM X-Y recorder with ultra-fast pen drop, unique pen shuttle, automatic power-down upon overrange. With added controls, recorder ready for the lab. A third model for medical, industrial, and lab applications is capable of recording low level signals from any source, grounded or floating. Fourth model records two independent variables with respect to time or to a third variable. Write for X-Y Bulletin, E500. Esterline Angus Instrument Corporation, Box 24000, Indianapolis, IN 46224. Tel. 317-244-7611.



CIRCLE NUMBER 76



non-standard washers

Our NEW CATALOG lists 3000 non-standard washers and spacers. Circle the number of this ad for your free copy.

SIZE RANGE: Available without die charge from any stampable material.
 OD: .086" to 1.935" Metal washers are tumble deburred.
 ID: .027" to 1.637"
 Thickness: .005" to .125"

For your convenience our complete catalog is now reprinted in ThoMcat. Look under Boker's in Volume 9.

BOKER'S, INC. Stamping Specialists since 1919.

3104 Snelling Avenue South, Minneapolis, Minn. 55406

CIRCLE NUMBER 78

A touch of class

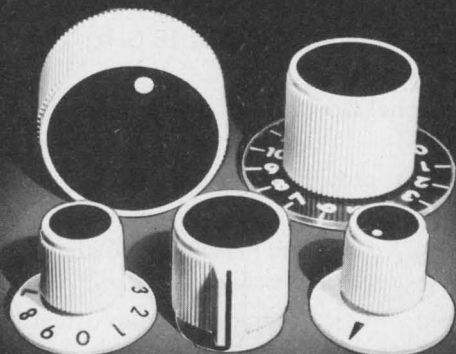

Rogan knobs and custom dials.

Our catalog and samples of particular items will be sent upon request.

ROGAN CORPORATION
 3455 Woodhead Drive
 Northbrook, IL 60062
 Phone (312) 498-2300

CIRCLE NUMBER 77

FREE! THE ALL-NEW NEWARK ELECTRONICS CATALOG 103

688 PAGES!
 100,000 ITEMS.
 ALL PRODUCTS LISTED ARE STOCKED.
 150 TOP BRAND NAME LINES

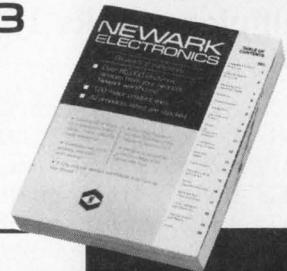

FEATURING

DALE®

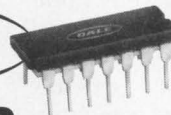

SERIES LDP THICK FILM DIP NETWORK

Up to 17 resistors in a compact network. Suitable for automatic insertion. Available in 14, 16, 18 pin models. Standard circuits interchangeable with Beckman, Bourns, CTS and others.

WRITE OR PHONE TODAY FOR YOUR PERSONAL COPY!



NEWARK ELECTRONICS

500 N. PULASKI • CHICAGO, IL 60624
 PHONE (312) 638-4411 • TELEX 25:3218

CIRCLE NUMBER 79

ELECTRONIC DESIGN 6, March 15, 1977

MODULES & SUBASSEMBLIES

14-bit a/d offers four input ranges



CPS Inc., 722 E. Evelyn Ave., Sunnyvale, CA 94086. (408) 738-0530. \$195 (1-9); 8 wks.

A 14-bit successive-approximation a/d converter, Model CYAD-14 QM, offers pin-selectable analog input ranges of 0 to +5-V, 0 to +10-V unipolar, ± 5 -V and +10-V bipolar. The unit has a conversion time of 100 μ s, and guaranteed monotonicity over 0 to +50 C. The module includes input buffers. Power requirements are +15 V $\pm 5\%$ at 60 mA, -15 V $\pm 5\%$ at 40 mA or +5 V $\pm 5\%$ at 180 mA. The device measures 2 x 4 x 0.4 in.

CIRCLE NO. 323

D/f converter latches onto BCD inputs

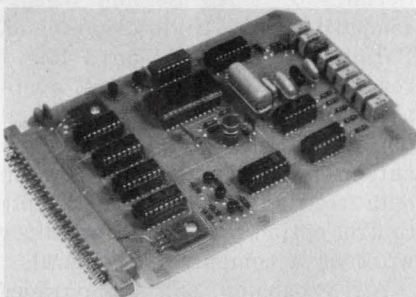

Syntest, 169 Millham St., Marlboro, MA 01752. C. Hoffman (617) 481-7827. \$242 (unit qty); stock.

Featuring direct-BCD programing of both frequency and amplitude range, the SM-106 also gives you on-board logic latches that simplify computer control. Output frequencies between 1 Hz and 160 kHz are available in five ranges. Three digits of BCD frequency-control plus one BCD-digit of range control is provided. The output is a sine wave capable of driving 10 V pk-pk into 600 Ω . Total harmonic distortion of less than 1% is provided over the entire frequency range. Power requirements are +15 V dc at 100 mA and -15 V dc at 50 mA and on-board monolithic voltage regulation is provided.

CIRCLE NO. 324

LSI TECHNICAL SPECIALISTS CIRCUIT DESIGNERS TEST ENGINEERS

Enjoy the good life in Florida ...with a rewarding future at the ITT LSI Systems Support Center

This recently established, corporate-funded organization is located in West Palm Beach, where the year-round living is all you could ask for. The career opportunity is the ideal complement, because this Center is charged with providing the means for optimum use of LSI in wide-ranging ITT telecommunications, space, defense, automotive and industrial product areas. This scope and challenge dictate the building of a highly qualified, technology oriented, system sensitive professional staff. True ground-floor positions with unusual reach into the future, offering excellent prospects for career advancement, are available to those who qualify.

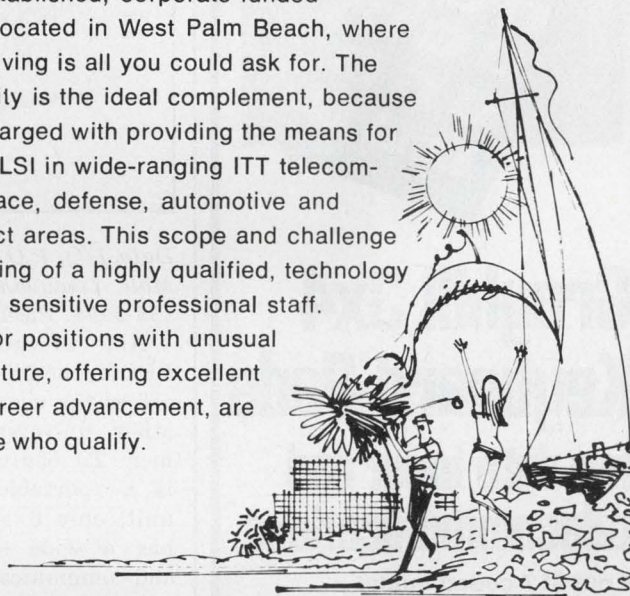

Technical Specialists

Technical expert in advanced large-scale integration. Responsible for interface with ITT equipment and systems divisions in development of new state-of-the-art applications, from LSI studies through chip design to volume manufacturability. Requires MSEE and minimum 4 years LSI design experience.

Circuit Designers

Experienced designer in advanced LSI technologies. Responsible for design of complex LSI circuits in latest bipolar and MOS technologies. Requires BSEE and

2 years design experience using sophisticated computer-aided techniques.

Senior Test Engineers

Interface with ITT equipment and systems divisions in testing philosophy and testability for new applications. Generate and debug test and characterization programs for custom and standard LSI circuits. Requires BSEE and 4 years in product and test engineering. Sentry experience and knowledge of MIL-38510 qualification techniques preferred.

Positions also available at lesser experience levels.

If interested and qualified, please send your resume in confidence to Mr. Robert VerNooy, Personnel Manager, ITT LSI Systems Support Center, 3301 Electronics Way, West Palm Beach, Florida 33407.

ITT LSI SYSTEMS SUPPORT CENTER

An Equal Opportunity Employer, M/F

**A New Standard
of Keyboard Quality**

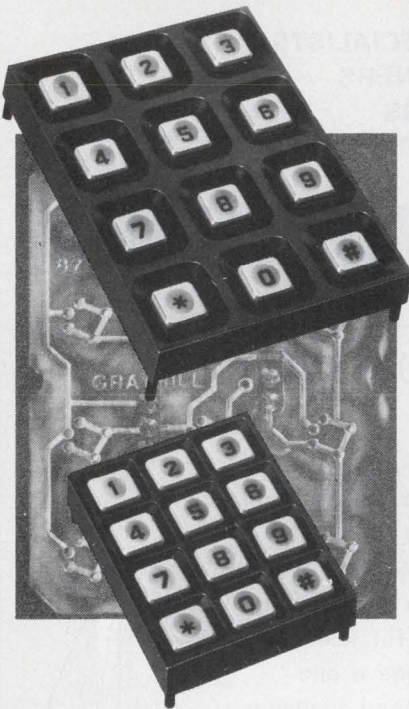

Grayhill 3x4 Keyboard Pads for data input and telecommunications

**2 out of 7 coded output—
tested for millions of operations!**

- 1/2" or 3/4" button centers
- Excellent tactile and audio feedback
- Patented snap-action dome contact provides rugged, durable performance

These new Grayhill low-profile, 12-button keyboard pads feature a 2 out of 7 coded output, standard mounting dimensions, and are ready for top-side or sub-panel mounting. The contact system is life-rated for 3,000,000 operations per button, and is readily interfaced with logic circuitry. The new Grayhill Series 87 modules offer excellent audio and tactile feedback characteristics with total button travel of only .015". These durable keyboards are molded of tough ABS plastic; feature buttons with black on white molded-in legends as standard, and a variety of other legend options including clear snap-on caps for user legending. Complete specifications and truth table are provided in Bulletin #262, available free on request from Grayhill, Inc. 561 Hillgrove, La Grange, Illinois 60525 (312) 354-1040.

CIRCLE NUMBER 82

DATA PROCESSING

Versatile PROM programmer takes on all memories

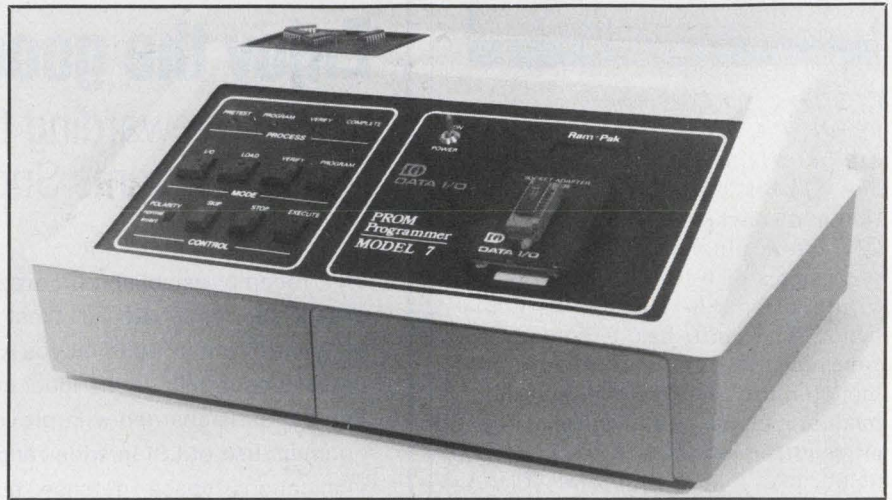

Data I/O, P.O. Box 308, 1297 N.W. Mall, Issaquah, WA 98027. (206) 455-3990. P&A: See text.

Able to program any available PROM, the Model 7 from Data I/O offers the user more than just another universal PROM programmer. To begin with, the Model 7 is a "portable" but line-operated unit, only 6 x 11 x 15 in., and has a wide selection of options and communication capabilities.

In its basic configuration, the Model 7 can program over 200 PROM types. Program-personality modules, which dedicate the programmer to a specific PROM family, plug into an access opening below the front panel. Socket adapters, which match the programmer circuitry to the PROM pinouts, plug directly into the front panel. Thus, generic PROM families from one manufacturer can be programmed with a single personality module and different socket adapters.

This generic programming capability can produce significant savings. For example, the 12 PROMs in the Monolithic Memories generic family can be programmed on the Model 7 at a cost of \$400 for one personality module and \$600 for 12 \$50 socket adapters. Without the Model 7's generic-programming ability, programming the Monolithic Memories family might cost well over \$4800. A separate person-

ality module may be required for each PROM in the family.

A modular design enables the Model 7 to communicate with serial or parallel peripheral devices. Serial I/O is ASR33 and RS232-compatible, at 110 to 2400 baud. Parallel I/O operates on a busy/ready basis. I/O interfaces, available to make the programmer compatible with any data terminal, can automatically check for faults in data transmission. And a remote control option lets the programmer work as a computer peripheral.

An expansion option upgrades the unit to a Model 9 by adding direct entry of keyboard data, address and data display of RAM contents, display of error codes, random-addressing capability, and insertion/deletion RAM editing. Also, a 1-k x 8 bit RAM included in the basic Model 7 to hold programs can be optionally expanded to 4 k x 8 in 1-k increments.

Power required for the programmer can be 100 to 240 V ac, 48 to 66 Hz, at 120 VA. Designed to operate over a 0-to-45-C range, the programmer has an optional, 18.5 x 14 x 8-in. carrying case.

Prices for the Model 7 start at \$1095 and I/O options up the price by \$225. Additional memory costs \$50 to \$200 more, while conversion to the Model 9 costs \$995. Delivery is from stock.

CIRCLE NO. 301

Super floppy claims only 3-ms access time

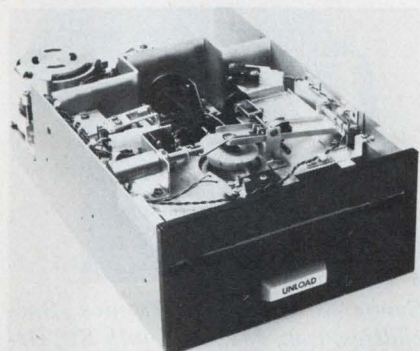

Wangco Inc., 5404 Jandy Pl., Los Angeles, CA 90066. (213) 390-8081. \$500 (small qty); 4 wks.

Said to be twice as fast as any other standard drive, the Model 78 floppy-disc drive boasts a 3-ms track-to-track access time. Other features include optional autoloader, double-density capability to 6.4 M bits, GCR encoding, separation of sector and index pulses, low-power drive and daisy chain capability up to eight drives. Two units fit side-by-side into a 19-in. rack.

CIRCLE NO. 325

Portable terminals have fine resolution



Computer Transceiver Systems, E. 66 Midland Ave., Paramus, NJ 07652. Charles Kaplan (201) 261-6800. From \$3495; 4 to 6 wks.

The Execuport 3000 series are not only the first portable terminals with a 136-column width, but they also have plotting capabilities with a resolution of 240 points per square in. (24 vertical by 10 horizontal). The 1/4-line stepping also permits subscripts, superscripts, and underscoring. The weight (22.5 lb) is the same as for previous models, but the visibility of the print area has been improved. The 3000 series offers built-in couplers, a choice of keyboards, and an RS-232 connection for interfacing with other peripherals.

CIRCLE NO. 326

Emulator board mimics Gould printer/plotter

Varian Graphics Div., 611 Hansen Way, Palo Alto, CA 94303. Robert Altieri (415) 494-3004. \$750.

You can replace a Gould series 5000 printer/plotter with the Varian Statos 4000 series, without having to change software handler, application programs, interface or cables. All you need is the Model

40-340 emulator option to support the full speed capability and high resolution of the Statos printer/plotter in which it is installed. The emulator consists of a single PC board, which mounts in the card cage of the Varian printer/plotter. The cable is I/O plug compatible with the Gould interface. The emulator should be ordered at the same time as the Statos printer/plotter.

CIRCLE NO. 327

Our anatomy is beautiful, too.



If you think you'll need a custom design for your product, here's the rack which proves you don't. And we haven't even shown you all the options. Send for our catalog.

We make you look better

OPTIMA[®]
Scientific-Atlanta

2166 Mountain Industrial Blvd., Tucker, Ga. 30084 • Tel: (404) 939-6340
Europe: Macmerry, East Lothian, Scotland EH33 1EX

CIRCLE NUMBER 83

Fast static memory expands to 512 kbytes

Cromemco, Inc., 2432 Charleston Rd., Mountain View, CA 94043. (415) 964-7400. See text; 1 wk.

The Model 4KZ is a 4-kbyte static RAM card, expandable to eight banks of 64-kbytes each. The memory operates at 4 MHz to match the Cromemco Z-80 CPU card. The 4-MHz speed of the Model 4KZ is achieved by using an address anticipation strategy, in which on-board address counters are incremented at the end of each machine cycle in preparation for the subsequent cycle. The 4KZ can be organized into as many as eight banks of 64 k each. An eight-position switch on the board is used to select the bank, or banks, in which the board resides. The board is available from computer stores or directly from the factory at \$195 for the kit, or \$295 assembled.

CIRCLE NO. 328

Fast-access diskette edits, searches strings



Western Telematic Inc., 3001 Red Hill, Bldg. 5-107, Costa Mesa, CA 92626. (714) 979-0363. \$2750 (1 to 4); 8-10 wks.

DataMaster II is a flexible disc I/O recorder and editing system that plugs between an ASCII terminal and its RS232 modem. Effectively, it adds 311-k characters to your "working storage." Random access to any of 2431 lines of 128 characters each averages 0.3 s, and a complete search for strings up to 128 characters takes 12 s per disc. Edit and file-jump commands are accepted either from the unit's own keyboard, the terminal, or remote processor.

CIRCLE NO. 329

Number always busy? This phone dials itself



Communications Electronics Specialties, Inc., 2311 E. South St., Orlando, FL 32803. (305) 896-0215. \$100; 6-8 wks.

If you suffer from having to redial that same busy number over and over, here is an inexpensive prescription: A telephone that not only gives you pushbutton dialing, but also remembers the last number you called. Just lift the receiver, and there is your party—busy again, most likely. Except for the memory-enable switch, the unit looks like any pushbutton phone, and needs no external power. An optional memory module stores as many as 10 numbers.

CIRCLE NO. 330

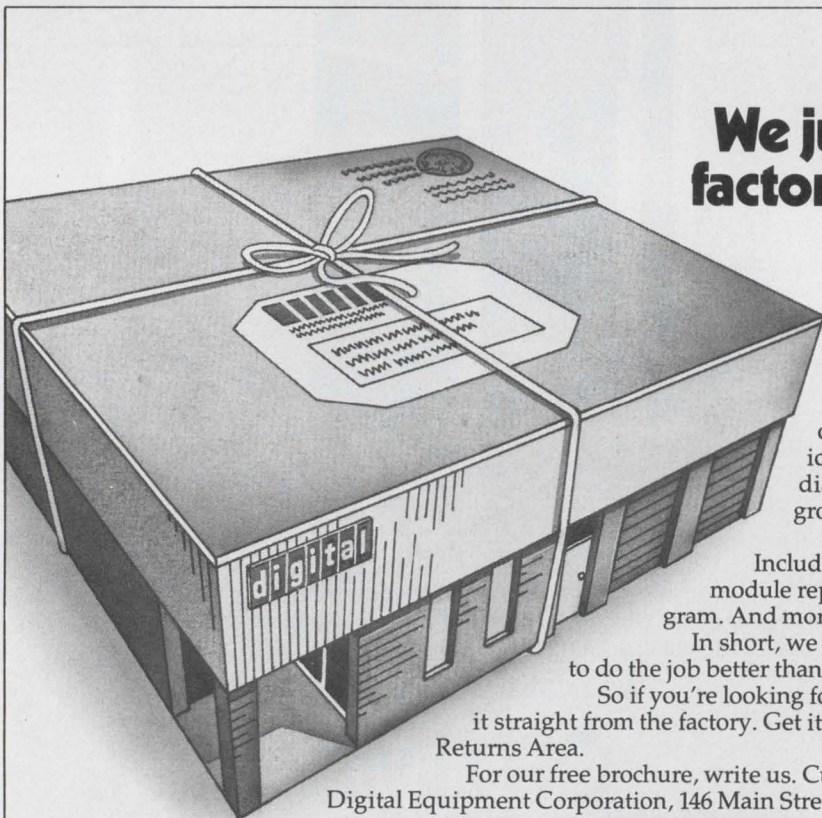

We just brought Digital factory service one step closer to the field.

Announcing the Customer Returns Area. The major off-site repair center for Digital Equipment Corporation.

The Customer Returns Area offers all our customers direct access to factory service. We have our own parts inventory, diagnostic and test center, and engineering group.

We also have a number of service plans.

Including subassembly contracts, individual module repair, our unique Module Mailer™ program. And more.

In short, we have everything it takes to do the job better than anyone else.

So if you're looking for off-site service, get it straight from the factory. Get it from the Customer Returns Area.

For our free brochure, write us. Customer Returns Area, Digital Equipment Corporation, 146 Main Street, Maynard, MA 01754.

digital

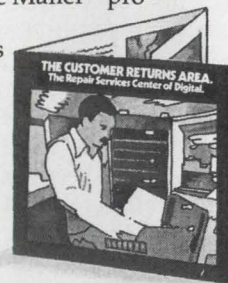

INTEGRATED CIRCUITS

Redesigned op amp replaces LM108 units

Precision Monolithics, 1500 Space Park Dr., Santa Clara, CA 95050. Donn Soderquist (408) 246-9222. From \$4.50 (100-up); stock.

A totally redesigned 108A low-input-current operational amplifier series directly replaces the popular LM108A/308A series. Key maximum specifications include offset current of 200 pA, bias current of 2 nA, offset voltage of 0.5 mV and power consumption of 18 mW (with ± 15 -V power supplies). The offset-voltage drift is $5 \mu\text{V}/^\circ\text{C}$, and offset current drift is $2.5 \text{ pA}/^\circ\text{C}$. The PM108A is specified over -55 to $+125$ C and the PM-308A over 0 to $+70$ C.

CIRCLE NO. 331

Dual op amp has little crossover distortion

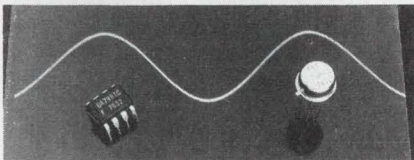

Fairchild Camera and Instrument, Analog Products Div., 464 Ellis St., Mountain View, CA 94042. (415) 962-3816. From \$1.15 (100-up); stock.

Able to operate from a single power supply, the $\mu\text{A}798$ dual op amp virtually eliminates the crossover distortion usually prevalent in single-supply op amps. The $\mu\text{A}798$ maintains the standard pin-out for dual op amps. It is a high-gain, internally compensated device with an input common-mode range, which includes ground during single single-supply operation and V_{-} during dual-supply operation. The device can sink a minimum of 0.35 mA at a 0.2-V output and a 1-V input signal. This is a significant improvement over similar devices that can typically sink approximately 0.01 mA under similar conditions. The $\mu\text{A}798$ comes in three versions: the $\mu\text{A}798\text{HC}$ (commercial grade in a metal can), the $\mu\text{A}798\text{HM}$ (military grade, metal can) and the $\mu\text{A}798\text{TC}$ (commercial grade, molded DIP).

CIRCLE NO. 332

OPTICAL ISOLATORS

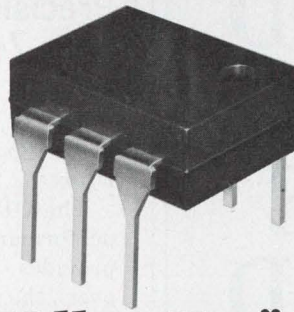

5KV, UL "Yellow Tag" Approved

The same advanced technology used to develop the innovative Spectronics fiber optic product line is incorporated in these 5KV, UL "yellow tag" approved optical isolators. They are directly interchangeable with standard industrial 6-pin isolators. UL approval number E58979.

Contact soon: medium and high-speed isolators in 8-pin DIPs! For more information, contact our corporate office or call the number in your area listed below.

We make optoelectronics work for you with superior quality, competitive pricing, fast deliveries!



Spectronics
INCORPORATED

830 E. Arapaho Rd., Richardson, Texas 75080
(214) 234-4271 Telex 73-0890

(213) 398-6239 (612) 698-3841 (713) 772-0730
(415) 369-4671 (617) 944-8484 Canada: (416) 438-6393

The
Quality
Leader

CIRCLE NUMBER 85

Two weeks delivery

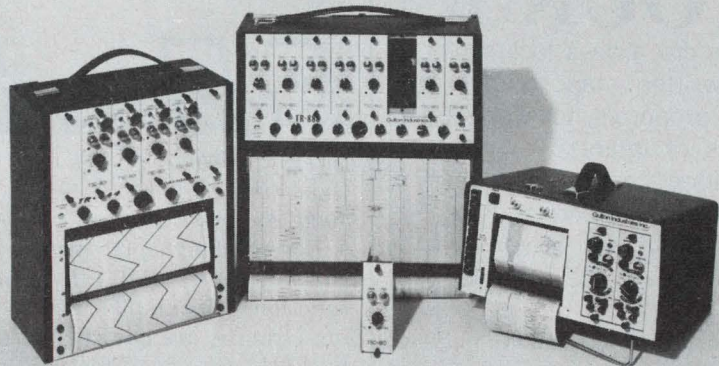

On any Gulton 2, 4, 6 or 8 channel portable with standard signal conditioners. Gulton portables are the lightest, smallest and most versatile medium frequency oscillographic recorders available. A wide range of quick-change plug-in signal conditioners permit recording of volts, amps, temperature, EKG, strain, ac to dc, log to dc, etc. Write or call for 12 page portables catalog.

gulton®

Measurement & Control Systems Division
Gulton Industries Inc., East Greenwich, Rhode Island 02818
401-884-6800 • TWX 710-387-1500

CIRCLE NUMBER 86

**GOOD
BOOKS
ARE
HARD
TO
FIND.**



**WHY
HIDE
YOURS?**

We are always looking for well-written manuscripts, or book proposals, for works on topics of interest to professional engineers that will advance their understanding of the state of their art.

What have you been working on?

What can we do for each other?

Let me know.

S. WILLIAM COOK
EDITORIAL DIRECTOR



Hayden Book Co., Inc.
50 ESSEX STREET
ROCHELLE PARK, N.J. 07662

INTEGRATED CIRCUITS

Precision dual op amp tops 747 performance

Precision Monolithics, 1500 Space Park Dr., Santa Clara, CA 95050. Donn Soderquist (408) 246-9222. From \$3.70 (100-up); stock.

The OP-04, a dual matched high performance operations amplifier, provides improved specifications over the industry standard 747. Input-offset voltage and common-mode rejection ratio of the two op amps in the 04 are matched to within 1 mV (max) and 94 dB (min), respectively. Key maximum specifications for the individual amplifiers include input-offset voltage of 0.75 mV, input-offset current of 2 nA and input bias current of 50 nA for the OP-04A and OP-04E. All models are pin-for-pin improved replacements for 747 types in both the hermetic 14-pin DIPs (Y suffix) and 10-lead TO-100 packages (K suffix).

CIRCLE NO. 333

Watch circuits display time in four languages



Intersil, 10900 N. Tantau Ave., Cupertino, CA 95014. (408) 996-5000. From \$8 (100-up); stock.

Foreign-language display versions of the ICM7214, five and six-function alphanumeric timekeeping circuits, are now available. The ICM7214, a five-function circuit with alphanumeric capability, provides readout of hours, minutes, day, date and seconds. Its perpetual calendar must be reset only once every four years. The ICM7214A is a six-function version, which also provides a readout of the month. Both circuits interface directly with existing nine-segment LED displays. The foreign versions display the day of the week in German, French, or Italian.

CIRCLE NO. 334

Multiplying converters settle in only 85 ns

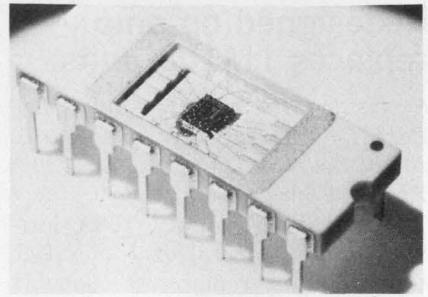

Signetics, 811 E. Arques Ave., Sunnyvale, CA 94086. Peter Guest (408) 739-7700. From \$3.45 (100-up); stock.

Designated NE5007/8 and SE5088, the multiplying d/a converters handle 8-bit inputs and settle in 85 ns. The 5007/8 units are pin and functionally compatible with monoDAC-08 converters originally introduced by Precision Monolithics Inc. Monotonic multiplying performance in the 5007/8 units is attained over a 40-to-1 reference-current range. Full-scale current is prematched to ± 1 LSB. Linearities are as close as 0.19% over the entire operating temperature range, which is -55 to $+125$ C for the SE5008. Operation from ± 4.5 to ± 18 -V supplies is possible and the units are housed in 16-pin plastic DIPs.

CIRCLE NO. 335

Video i-f circuits give discrete performance

N. V. Philips Gloeilampenfabrieken, Elcoma Div., P. O. Box 523, Eindhoven, the Netherlands, J. Geel.

The TDA2540 and 2541 ICs, designed for color and high-quality monochrome television receivers, contain full video i-f circuitry. They offer performance equal to any discrete solution. The only difference between the two circuits lies in the tuner age outputs: the TDA2540 has an output compatible with npn tuners and the TDA2541 with pnp tuners. Contained in the circuits is a noise protected age detector that generates an age voltage for the i-f amplifier and an age current for the tuner. A built-in afc circuit generates a voltage from the reference signal. It has a range of 10 V and is accurate to within 100 kHz.

CIRCLE NO. 336

Dual line driver made for differential lines

Texas Instruments, P.O. Box 5012, Dallas, TX 75222. Dale Pippenger (214) 238-2011. From \$2.12 (100-up); stock.

A dual differential line driver, the SN75158, meets the Electronic Industries Association's RS422 specification. It operates from a 5-V supply, has short-circuit protection and input clamp diodes. Inputs are standard TTL and the outputs provide differential signals with high current capability for driving balanced lines. The output stages are TTL totem-pole types that provide a high impedance state in the power off condition. The SN75158 is characterized for a 0-to-70-C operating range and is offered in either plastic or ceramic 8-pin DIPs.

CIRCLE NO. 337

Image sensors come with 128 to 1728 elements

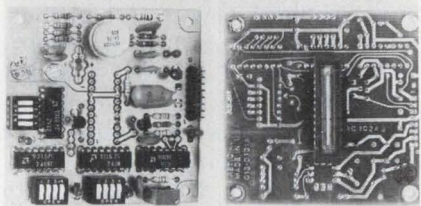

Reticon, 910 Benicia Ave., Sunnyvale, CA 94086. John Rado (408) 738-4266. From \$25 (OEM qty.); stock.

Two families of line scanners, designated the H series and the G series, are available with 15 μm and 25 μm element-to-element spacings. The G series is offered in 128, 256, 512, 768 and 1024-element configurations and contains on chip monolithic drivers and video amplifier circuits. And, instead of critical multiphase clocks, the G series units accept signal phase TTL drive. Device architecture is such that cascaded devices readily drive one another for very high resolution applications. The "H" series units come in 1024 and 1728 element formats for high resolution single-chip facsimile and OCR use. Both units also offer on-chip noise cancellation circuitry, which significantly improves the dynamic range otherwise limited by clock glitches.

CIRCLE NO. 338

Multidecade counter delivers parallel BCD

LSI Computer Systems, 1235 Walt Whitman Rd., Melville, NY 11746. (516) 271-0400. \$7.50 (100-up); stock to 6 wks.

Able to be used as either a dual three-decade or a six-decade up/down counter, the LS7040 delivers BCD data in parallel. This data format enables off-chip comparisons to be made with a minimum

of hardware. The synchronous counter operates from dc to 350 kHz, is equipped with output latches and provides a carry/borrow output for synchronous or asynchronous cascading with another LS7040. The count input may have infinite rise and fall times. All inputs are CMOS, TTL and DTL compatible when the LS7040 operates from 5 V. The circuit operates from a 5-to-15-V-dc supply and comes in a 40-pin DIP.

CIRCLE NO. 339

yes Standard Grigsby's rotary switches have printed circuit and solderless terminals that will not bend or twist

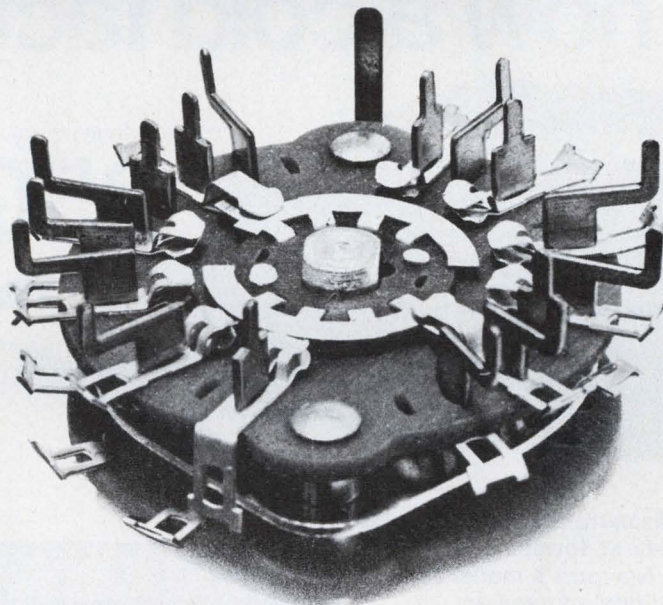

our exclusive rigid construction provides you with savings by eliminating costly assembly operations

"YES" - Save the valuable time wasted on straightening the P.C. terminals of rotary switches!

Our exclusive printed circuit "T" terminals are ruggedly designed to allow EASY insertion of our rotary switches into any P.C. board pattern.

If you wire your rotary switches with wire-wrap or other solderless techniques, try a terminal that won't bend or twist... Standard Grigsby's NEW solderless "T" terminal.

Send for Free "Yes" button and literature.



standard grigsby, inc.

920 Rathbone Avenue • Aurora, Illinois 60507
(312) 844-4300

CIRCLE NUMBER 89

POWER SOURCES

Power-supply series offers 1, 2 or 3 outputs

SGR Corp., Neponset Valley Industrial Park, P.O. Box 391, Canton, MA 02021. (617) 828-7773. \$49 to \$159; stock to 15 days.

Members of the 140 series of power supplies deliver single outputs for logic circuits, dual tracking outputs for power op amps and other function modules, and triple

outputs for a/d and d/a conversion. The series contains two economy models that offer line regulation of 0.01% and load regulation of 0.05%. Premium models provide 0.005%-line and 0.02%-load regulation. The plug-in modules operate from 105 to 125 V ac, 50 to 400 Hz and include overvoltage protection. Other features are a transient response of 1 μ s and a dynamic output impedance of 1 Ω at 100 kHz.

CIRCLE NO. 340

Two-output switcher pours out 750 W



LH Research, 1821 Langley Ave., Irvine, CA 92714. (213) 843-8465. \$685 (10-24); 9 wks.

The Model MMX-420 is a two-output switching-regulated power supply that delivers a total of up to 750 W from a package that measures 5.1 x 7 x 12.75 in. Primary output of the unit is 5 V at 150 A. The second output can be any one of the following: 2 V at 24 A, 5 V at 24 A, 12 V at 20 A, 15 V at 20 A, 18 V at 16 A or 24 V at 10 A. The combined power of both outputs is 750 W max. The up-to-80%-efficient device features 1% or 50-mV pk-pk ripple and noise on the output, 0.4% line regulation over the entire input range, and 0.4% load regulation from no-load to full-load. Response is 200 μ s to 1% after a 25% load change. The supply operates at full rating from 0 to 40 C and derated to 50% at 70 C. The switcher contains an integral fan.

CIRCLE NO. 341

The hottest news in digital pyrometers is now a cold fact.



from only
\$250.

Measure temperature accurately at lowest cost with Newport's model 267A digital pyrometer.

Available in 30 measurement ranges with direct inputs from thermocouples or RTD sensors on bright 1/2" LED's.

Ranges are bipolar with resolution to 0.01° and conformity to $\pm 0.005^\circ\text{C}$ for RTD's and 0.1°C for thermocouples. Changing ranges in the field is made easy with Newport's plug-in polylog linearizer module.

Opto-isolated BCD outputs are standard while buffered, gated and latched outputs are optional.

Other 267A options include a bench mount all metal case with 1



or 12 switched inputs, rechargeable battery operation, linearized analog output, digital setpoint controller, orange LED display . . . and more. The 267A is now available from World Wide distributors, representatives, or factory direct. For immediate response, call (714) 540-4914.

NEWPORT

Newport Labs
630 East Young Street
Santa Ana, California 92705
In Europe-Tele Amsterdam 20-452052

CIRCLE NUMBER 90

Line regulators are efficient at all loads

Topaz Electronics, 3855 Ruffin Rd., San Diego, CA 92123. J. Pedlow (714) 279-0111. From \$265; stock.

Three series of ac line regulators boast efficiencies greater than 98% from no-load to full-load. The 73000, 75000 and 77000 series offer regulations of $\pm 3.3\%$, $\pm 5\%$ and $\pm 7\%$, respectively. These desktop models are primarily intended to protect minicomputers and related equipment from brownouts and other severe voltage fluctuations. Regulators in these series handle power in the 600-to-1600-VA range. Other models are available with ratings through 100 kVA.

CIRCLE NO. 342

3- ϕ line sentinel has UL recognition

Time Mark, P. O. Box 15127, Tulsa, OK 74112. L. Fawcett (918) 939-5811. \$55.87 to \$68.50; stock to 2 wks.

UL recognition has been granted the Model 263 three-phase power monitor. The unit monitors each phase of a three-phase line. Low voltage, loss of phase, or phase reversal causes the device to trip. The trip point is adjustable from the front panel. A trip light is provided. The instrument is stocked in four ranges: 85 to 125 V ac, 160 to 240 V ac, 340 to 480 V ac and 420 to 575 V ac. It is usable on either wye or delta systems.

CIRCLE NO. 343

Unit supplies 14 W and stays cool



Semiconductor Circuits, 306 River St., Haverhill, MA 01830. (617) 373-9104. \$86.95 (singles); stock.

The chassis mountable power supply, Model ES12S1200, features a typical case-temperature rise of 15 C above ambient when delivering its full-rated output of 12 V dc at 1.2 A. No derating is required over the -25 to +71 C range. The input can range from 105 to 125 V at 50 to 440 Hz. Regulation is 0.3% for line and load, and output ripple and noise is 7 mV rms. The output responds smoothly to input-power switching and abrupt changes of load. The output terminals float, and the unit has more than 60 dB of line-transient immunity. The output is short-circuit protected by a power-foldback circuit, and the MTBF exceeds 150,000 hours at 25 C under high-line and full-load conditions. The module is 2.5 x 3.5 x 2 in.

CIRCLE NO. 344

LOW COST ... UL approved, 6 amp, SPDT, Printed Circuit Relay

Model BC69 relay was designed for use in vending machines, air conditioning controls and other lighting and switching applications. It is available in a wide range of coil voltage from 1.5 Vdc to 48 Vdc.

Call Virgil Simpson, Mike Altman or write for a data sheet and free samples.

Available from stock at Hamilton-Avnet.



ACTUAL SIZE

The way to say Quality Relay...BABCOCK

Military/Aerospace/Commercial

BABCOCK RELAYS



ESTERLINE ELECTRONICS

AN ESTERLINE COMPANY

3501 Harbor Blvd., Costa Mesa, California 92626
(714) 540-1234 TWX 910-595-1517

CIRCLE NUMBER 91

Turn On

with Eternacell[®] Lithium Batteries

There's a new technology in primary batteries. It's called the Eternacell Lithium Battery. Or Eternacell for short.

- Operating voltage 2.8 volts per cell
- -65°F to 160°F performance
- Up to 10 years shelf life
- Highest energy and volume density of any battery system
- 1/2 to 30 ampere-hour cell sizes in production quantities
- Stable voltage output

Reliable, proven in memory standby, communications, underwater power, instrumentation, alarm systems ... to name a few. Delivery, stock to 4 weeks.

Eternacell. The highest energy, longest life battery. For information write: Power Conversion, Inc., 70 MacQuesten P'kway South, Mt. Vernon, N.Y. 10550. Or call (914) 699-7333.



Power Conversion

CIRCLE NUMBER 92

Right on the button!

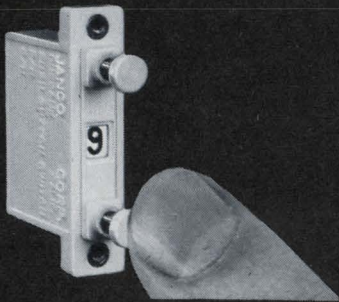

Janco

PUSH BUTTON ROTARY SWITCHES

Unique by virtue of their simplicity, Janco Push Button Rotary Switches function accurately and quickly in the most adverse environmental conditions and are "right on the button" for high density packaging.

Available in Bi-directional and Uni-directional models in 8, 10, 12 and 16 positions in all standard coded outputs with a wide variety of custom features. Qualified to MIL-S-22710.

Janco... the name for quality... since 1947.

Janco
CORPORATION

3111 WINONA AVE., BURBANK, CALIF. 91504
PHONE 213-845-7473 • TWX 910-498-2701

CIRCLE NUMBER 93

FREE CATALOGS on PM and SHUNT-WOUND adjustable speed drive systems



Catalog CDC-PM describes PM systems, 1/12-1/4 Hp. 20 pages, 57 drawings, photos and tables.



CDC-SH describes shunt-wound systems, 1/50-1/4 Hp. 16 pages, 51 photos, drawings and tables.

... from Bodine and Bodine Distributors

Designed and built by Bodine to give you *perfectly matched* speed/torque control characteristics—provide reliability and performance you might expect only from far more costly and complex systems.

BODINE

ELECTRIC

COMPANY

BODINE MOTORS
GEAR MOTORS
SPEED CONTROLS

Send for catalogs today.

Bodine Electric Company, 2500 W. Bradley Place, Chicago, IL 60618

CIRCLE NUMBER 95

Have it your way.

Toggle, pushbutton, rocker handle... snap-in or standard panel mounting... quick-on or screw terminals—you can have our famous Type J breaker any way you please.

It's still the standard hydraulic-magnetic breaker that revolutionized circuit protection for electronic and electrical gear drawing up to 30A ac or dc. And the optional special circuits (relay, shunt, Du-Con™, high-inrush, no-voltage-trip, etc.) extend the Type J's usefulness well beyond its prime function of precision overcurrent protection—*protection that adds value to your product.*

Ask for our newly revised Bulletin J-3333. Heinemann Electric Company, Brunswick Pike, Trenton, NJ 08602.

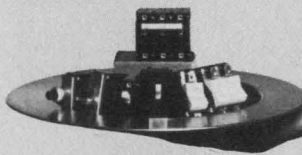

HEINEMANN

We keep you out of trouble.

© Heinemann

6519

CIRCLE NUMBER 94

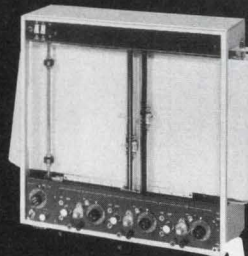

Two pens X-Y, T
Recorder
Model D-72BP

**Multi-pens
X-Y, T Recorder....**

Three pens X-Y, T
Recorder
Model D-73BP

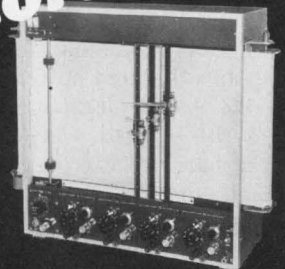

SPECIFICATIONS

Model	D-73BP	D-72BP
Input Sensitivities	X, Y ₁₋₃ 2mV~100V, 11 ranges	X, Y ₁ , Y ₂ 2mV~100V, 11 ranges
Response speed	X...1.2sec. Full span Y ₁₋₃ ...1sec. Full span	X...1sec. Full span Y ₁ , Y ₂ ...0.7sec. Full span
Chart speed	75mm/hr~480mm/min 10 steps	75mm/hr~480mm/min 10 steps

• For further information, please contact:

Riken Denshi Co., Ltd.

5-5-2, Yutenji, Meguro-ku, Tokyo, Japan. TELEX: 0246-8107

CIRCLE NUMBER 96

ELECTRONIC DESIGN 6, March 15, 1977

DISCRETE SEMICONDUCTORS

Zener diodes absorb very fast transients

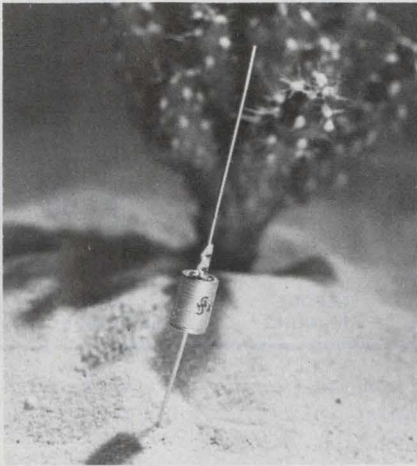

Siemens Corp., 186 Wood Ave. S, Iselin, NJ 08830. (201) 494-1000. \$3.35: 1N5555 (250 up); stock; 4 wks.

A transient-absorption zener diode, the TAZ, has an extremely fast response time of 10^{-12} s and a very high surge-handling capability of 1.5 kW for less than 10^{-12} s. The zener series is available in the hermetically sealed DO-13 case—JEDEC series 1N5555 to 1N5558, 1N5629 to 1N5665A and 1N5907—and covers a range of 6.2 to 200 V. Because of the fast response time, protection characteristics and high discharge capability, the TAZ units have a wide application range.

CIRCLE NO. 345

Power Darlington driven directly from ICs

NEC America, Inc., 3070 Lawrence Expressway, Santa Clara, CA 95051. (408) 738-2180.

NEC's line of 2SD4XX/4YY low-frequency amplifier and low-speed switching transistors are npn silicon power Darlington transistors that can operate directly from IC outputs without predrivers. The Darlington transistors feature high-breakdown voltage and low collector saturation voltage. Common applications include hammer, pulse-motor and relay drivers. The 2SD405/410 series is particularly useful in printers, and the 2SD411/412 series is for automotive ignition and similar high-voltage applications.

CIRCLE NO. 346

Power transistors handle 175 W

International Rectifier, 233 Kansas St., El Segundo, CA 90245. (213) 322-3331. \$7.45: 2N6546, \$10.70: 2N6547 (100-999); stock.

A new series of npn power transistors, 2N6546 and 2N6547, rated for 175-W operation features exceptionally fast inductive switching even at elevated temperatures. The transistors have maximum fall times of 0.71 μ s at 10-A peak col-

lector current and 100-C junction temperature. The units can operate at 850 V (collector to base) with a peak-collector current to 30 A. The transistors are packaged in JEDEC TO-3 metal cases. Dc current gain for the 2N6546 is 12 to 60 at 2 V (collector-emitter) and 5-A collector current. Gain for 2N6547 is 6 to 30 at 2 V and 10 A. Inductive switching times for both types is just 5 μ s at 10-A collector current and 100-C case temperature.

CIRCLE NO. 347

TRY OUR CERAMIC CAPACITORS FOR size . . .

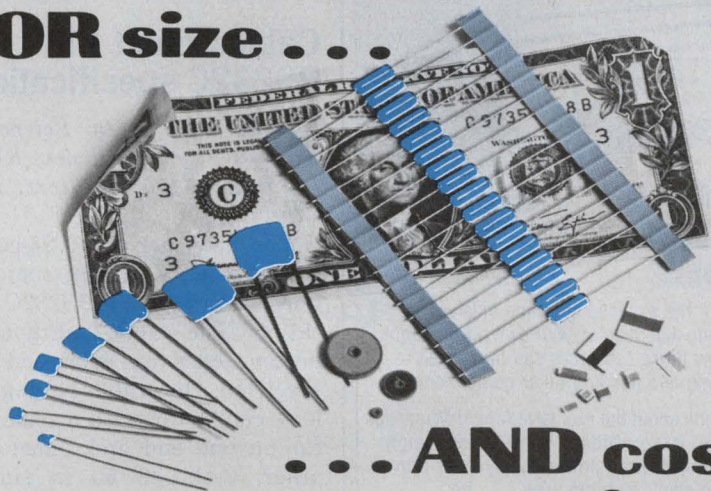

. . . AND cost savings

Need a subminiature or standard ceramic capacitor? Try us for size. With over 40 formulations, we offer the widest range of ceramic capacitors within the industry and off-the-shelf and custom capacitors are available with a capacity range of 1 pf to 10 mfd. Multi-layer, single-layer chip capacitors, conformal-coated leaded devices, glass sealed ceramic capacitors and discoidal

ceramic capacitors are available as small as .050" x .040" or as large as .500" x .500" . . . try us for size.

What about cost savings? Try us for cost. Our modern equipment and technological advances have enabled us to manufacture ceramic capacitors in high volume for low cost applications . . . try us for cost savings.

Write today for our free catalog.



CENTRE ENGINEERING

2820 E. COLLEGE AVE., STATE COLLEGE, PA 16801

814-237-0321 ■ TWX 510-670-3517

BUILDING YOUR OWN POWER SUPPLY?

Think
Twice!

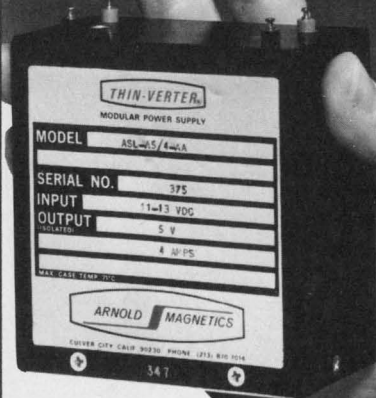

Think "DESIGN-AS-YOU- ORDER"

Think of the expense and time involved in designing and building your own power supply, and how those resources can be applied to designing and building other components.

Now think about the exclusive Arnold Magnetics "Design-As-You-Order" system. You simply order your custom power supply from proven "off-the-shelf" sub-modules . . . no engineering charges, no lost design time. Just fill in our "easy-to-use" specification form, we'll do the rest. Your miniaturized, high efficiency power supply arrives encapsulated and pre-tested.

See if these parameters meet your needs:

- Inputs: Single or dual; 60Hz, 400Hz, 12VDC, 28VDC, 48VDC and 115VDC.
- Regulated Outputs: single or isolated multiple; 5 to 300VDC.
- Line and load regulation to 0.1%.
- Power: 3—160 watts (up to 3.9 watts/in³).
- Other catalog power supplies with outputs to 5000VDC and power to 200 watts.
- Capability to design and build to your special needs.

Send for a free "Design-As-You-Order"
Power Supply Kit today!



ARNOLD MAGNETICS CORPORATION

11520 W. Jefferson Blvd.
Culver City, Ca. 90230 • (213) 870-7014

CIRCLE NUMBER 99

PACKAGING & MATERIALS

Flat-cable connector comes fully assembled

AP Products, 24500 Chagrin Blvd.,
Cleveland, OH 44122. (216) 464-
3636. \$24 (1000); stock.

Cable-connector assemblies with the flat cable of your choice plug directly into 26-pin shielded receptacles made by 3M, Berg, AMP and others. The glass-filled nylon connectors have probe holes, and balanced-force floating contacts. They are compatible with high-speed (1.5 ns/ft) ribbon cables. A two-ended cable assembly runs \$24 plus the cost of the cable, in 1000-quantities.

CIRCLE NO. 348

Cables meet EIA RS232C specifications

International Data Sciences, 100
Nashua St., Providence, RI 02904.
(401) 274-5100. See text; stock-30
days.

The 8520 series of 25-conductor cables meets the Electronic Industries Association's RS232C specification. The cable length and connector sexes on each end can be specified. One cable having a 25-ft long conductor with a male connector on one end and female on the other, costs \$27.50 in single qty (Model No. 3520-25-MF).

CIRCLE NO. 349

These plastic trays give you no static

Wescorp, 1501 Stierlin Rd., Moun-
tain View, CA 94040. (415) 969-
7717. From \$10 (1-24); 3 wks.

Wescorp has added seven new configurations to the award-winning "Scat" line of trays, designed to prevent static failure of microcircuits during manufacture or storage. Anti-static trays range in size from 1-5/8 to 9-in. dimensions, with 3 to 9 compartments per tray. Wall thickness is 40 mils. The transparent polystyrene contains a permanent agent that interacts with atmospheric moisture to produce a conductive surface coating. Therefore no conductive particles can flake off the trays.

CIRCLE NO. 350

Heat-shrunk jackets encapsulate splices

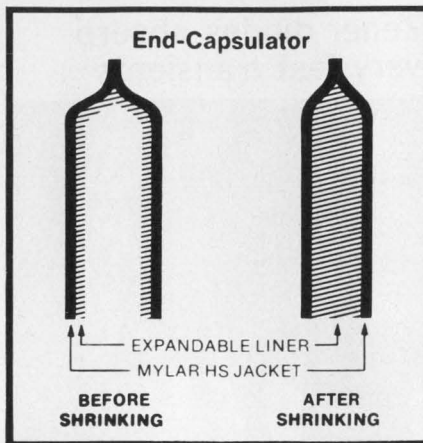

Niemand Co., 45-10 94th St., Elm-
hurst NY 11373. Bob Harris (212)
592-2300. 3-4 wks.

A versatile, convenient cap for moisture-sensitive wire splices consists of a heat-shrinking Mylar jacket with a heat-expanding liner. After a few seconds at 200 to 250 F, the End-Capsulator is completely filled with a thermoplastic polyamide. The forces created by the shrinking cap and expanding liner cause the liner to flow in and around the splices, forming a waterproof seal.

CIRCLE NO. 351

Reliable DIP socket keeps low profile

Textool Products Inc., 1410 W. Pio-
neer Dr., Irving, TX 75061. (214)
259-2676. See text; stock.

The compact "Low Side" DIP socket requires up to 15% less board area than similar sockets, and features low-insertion force contacts for damage-free loading and unloading. Since the contacts do not extend above the top of the socket, they are protected from possible bending or breaking. The low sidewalls leave the device body exposed for better heat dissipation and more uniform airflow, but are high enough to act as a guide for devices with bent or distorted leads. A center slot accepts all current loading and unloading tools. The polysulfone body tolerates up to 300 C. In quantities of 10,000, the sockets costs 74¢ and 81¢ each for 14 and 16-pin versions, respectively.

CIRCLE NO. 352

Screen printer speeds thick-film deposition

C. W. Price Co., Inc., S. Service Rd., Rt. 1-78 at Jutland, R. D. 1, Hampton, NJ 08827. (201) 735-9797. \$4200; 4 wks.

The Model 505 thick-film screen printer provides stable operation with tolerances in all three axes within ± 0.001 in. Conductors, glasses, resists, or epoxies can be applied at a rate of 400 pieces per hour, in semi-automatic operation. When fully automated, production rates can reach 3000 pieces per hour. The Model 505 accommodates a square print area up to 2-7/8 in. It consists of the printer (15 x 30 x 19 in.) and a controller (12 x 18 x 20 in.) that provides pre-programming of power flooding, double printing and squeeze up/down adjustment.

CIRCLE NO. 353

Card cage holds 23 PC boards in 19-in. rack

Garry Manufacturing Co., 1010 Jersey Ave., New Brunswick, NJ 08902. (201) 545-2424. \$1 to \$2 per card position; 2-4 wk.

A rack assembly, called the ECM 72 series, holds up to 23 PC boards measuring 4.375 x 4.862 in. The board center-to-center spacing is 1.2 in. The over-all rack length is 19 in. The rack assembly also holds a 23-connector back panel. Each card connector has 35 contacts with two wire-wrappable posts per contact.

CIRCLE NO. 354

Cases offer custom look at bargain cost

Instant Instruments, 306 River St., Haverhill, MA 01830. E. Eastman (617) 373-9260. From \$12.90 (1-9); stock.

A new series of custom-look instrument cases at bargain prices is available in two configurations. The PV-series has a handle that doubles as a stand, while the NV-series does not. Each case consists of black-textured 0.090-in. aluminum covers with 0.063-in. brush-anodized aluminum front and back panels that are easy to remove and punch. Six sizes are currently available.

CIRCLE NO. 355

ELECTRONIC DESIGN 6, March 15, 1977

M-tron Quartz crystals



AT CUT Crystals 800 KHz to 200 MHz

COMMERCIAL

- Nation's largest capacity for commercial use crystals.
- Frequencies available for:
 - CB, Toy and Scanner Radio applications.
 - Color TV, Video Games and Clock applications.
 - Microprocessor and Mini-computer applications.
- Computer-aided Crystal Design Program assures fast delivery.
- 100% Quality Audit of Critical Parameters.

HIGH RELIABILITY

- QPL approvals to MIL-C-3098.
- Advanced hermetically sealed packaging techniques.
- Frequencies available for Avionic and Marine Radio applications.

PHONE 800-843-6842 • TWX: 910-668-3603

M-tron INDUSTRIES, INC., Box 630, Yankton, S.D. 57078
A Div. of Lynch Corp.

CIRCLE NUMBER 100



Everything in Fail-Proof Drum-Impact Digital Printers.

Used by the world's leaders in cash registers, instrument data loggers, and all print-out applications.

Whatever your hard-copy need—alpha-numeric/digital printout; multi-copy; multi-color; ordinary calculator paper/pressure-sensitive tape; card, label, fan-folded forms, sales slip—printers will suit you perfectly.

Choose up to 21 columns, up to 42 characters/column, 3.4 lines/sec printing speed. Lowest sample prices.

Products of Shinshu-Seiki, world-famous for a decade of reliability. Represented and guaranteed by C. Itoh Electronics—part of the 117-year C. Itoh & Co., Ltd. world-wide trading organization.



C. Itoh Electronics, Inc.

East:
280 Park Ave
New York,
NY 10017

Call 212-682-0420. Telex WUD 12-5059

West:
5301 Beethoven St.
Los Angeles,
CA 90066

Call 213-390-7778. Telex WU 65-2451

C. ITOH & CO.
LTD.

London International Press
Centre
76 Shoe Lane,
London EC4A,
3JB; England

Call Mr. Walker
01-353-6090

C. Itoh means excellence in Digital Printermatics.

CIRCLE NUMBER 101

NEW

ULTRA WIDEBAND AMPLIFIER



Model 1W1000

1 to 1000 MHz 1 Watt Linear

Here's a unique, all-solid-state amplifier that delivers 1 watt of swept power output from 1 to 1000 MHz instantaneously. It's the Model 1W1000 from Amplifier Research. A reliable, unconditionally stable unit, the new Model 1W1000 provides 1 watt of linear power over three decades of bandwidth.

Its performance is matched only by its versatility. For example, Model 1W1000 can be used with high-level sweepers, VSWR measuring systems and network analyzers. It's also used to increase the sensitivity of spectrum analyzers, oscilloscopes and wideband detector systems. It has all the bandwidth you'll ever need. For complete information, write or call:

Amplifier Research
160 School House Road
Souderton, PA 18964
215-723-8181



Your Best source for RF Power Amplifiers

CIRCLE NUMBER 102

INSTRUMENTATION

Function generator comes with output meter

Philips Test & Measuring Instruments, 400 Crossways Park Dr., Woodbury, NY 11797. (516) 921-8880. \$675; 6-8 wks.

A new multifunction generator (sine, triangle and squarewave waveforms), the PM 5108L, offers a frequency range of 1 Hz to 1 MHz, and two outputs of 50 and 600- Ω impedance. A calibrated output meter and fixed attenuators of 20 and 40 dB are also standard. The PM 5108L includes ± 5 -V-dc offset and an external sweep input with which the output signal can be modulated in many ways. The function generator is short-circuit proof. The output meter is calibrated in both volts and decibels. The PM 5108L has six ranges of frequency selection plus a vernier dial.

CIRCLE NO. 356

Bit-error set detects errors at 325 MHz

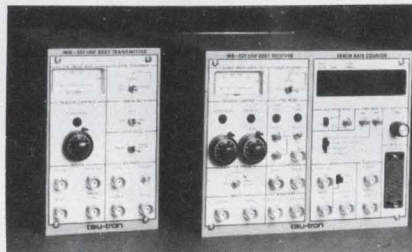

Tau-Tron, 11 Esquire Rd., North Billerica, MA 01862. (617) 667-3874. MB-301, \$6000; MN-301, \$3900; 8-10 wks.

The MN-301 transmitter and MB-301 receiver form a state-of-the-art pseudorandom generator and error-rate detector pair for use from 1 to 325 MHz. The MN-301 provides for two different PN sequence lengths, a fixed test pattern and local or remote error injection. The MB-301 receiver features automatic synchronization, variable threshold adjust and a four-digit counter and display, which allows for totalize, autorange bit-error rate or manual range BER. In addition, the counter features BCD printer output and can be used as an independent frequency or time-rate counter.

CIRCLE NO. 357

Four-digit DVM is computer compatible



McKee-Pedersen Instruments, P.O. Box 322, Danville, CA 94526. (415) 937-3630. \$350.

The MP-1045 four-digit DVM features a 14-bit BCD output and can be remotely controlled with logic levels. All necessary data and control lines are available for interfacing the DVM with a computer or peripherals such as a printer. Data can be transferred in byte-parallel or in serial form. Three calibrated and three variable input ranges go from ± 0.3000 to ± 30.00 V full scale. The variable ranges allow you to adjust meter readings to correspond to pH units, absorbance, etc.

CIRCLE NO. 358

Broadband amplifiers deliver up to 50 W

Ailtech, 19535 E. Walnut Dr., City of Industry, CA 91748. (213) 965-4911. 2020, \$4475; 5020, \$4175; 6 wks.

Two new solid-state wideband amplifiers cover the 1-to-200-MHz frequency range. Model 2020 features a linear output of 20 W with up to 35 W available. Model 5020 features linear output of 50 W with up to 75 W available. The units are usable from 500 kHz to above 225 MHz. Designed to be driven by signal sources such as milliwatt sweepers and frequency synthesizers, Models 2020 and 5020 feature a true directional wattmeter to measure forward and reflected power delivered to the load.

CIRCLE NO. 359

INGENUITY

in creating Stepper Motors.

Like our Model LMS: $7\frac{1}{2}^\circ$ step angle. Torque ranges to 10 oz. in. at 75 P.P.S. Start-stop rates of 450 steps/second. Slew capability to 1100 steps/second.



And that's not all you get at

MOLON

3737 Industrial Ave., Rolling Meadows, Ill. 60008
Phone: (312) 259-8700

CIRCLE NUMBER 103

subminiature trimmer potentiometers

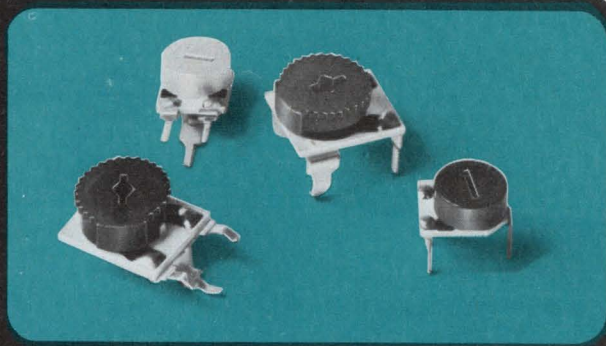

- Miniature size • Competitive prices • Horiz. and vert. mtg. • Alumina-base • Wide range of resistances • $\frac{1}{3}$ and $\frac{1}{5}$ watt • Humidity resistant • Non-combustible design • Long term stability

Designed to meet the requirements of both consumer and industrial applications. Write for complete technical data.

muRata
CORPORATION OF AMERICA

First in ceramics

1148 Franklin Road, S.E.
Marietta, Georgia 30067
Tel: 404-422-9777
Telex: 54-2329
TWX: 810-763-4723

CIRCLE NUMBER 105

FREE
NEW!

CATALOG OF
198 DIGITAL
COUNTERS
(COUNT 'EM!)

Pocket size 48-page catalog includes prices, dimensional drawings, operating specifications and ordering numbers. Also covers wire, tubing, SAE right angle adapters and the Tapeless Measure distance recorder.

GET ONE!

ENM CHICAGO

5340 Northwest Highway, Chicago, Illinois 60630
PHONE: (312) 775-8400 TELEX: 25-4068

CIRCLE NUMBER 104

ELECTRONIC DESIGN 6, March 15, 1977

**ONLY VISHAY GIVES YOU
ALL SIX TOP SPECS
IN RESISTOR PRECISION.**

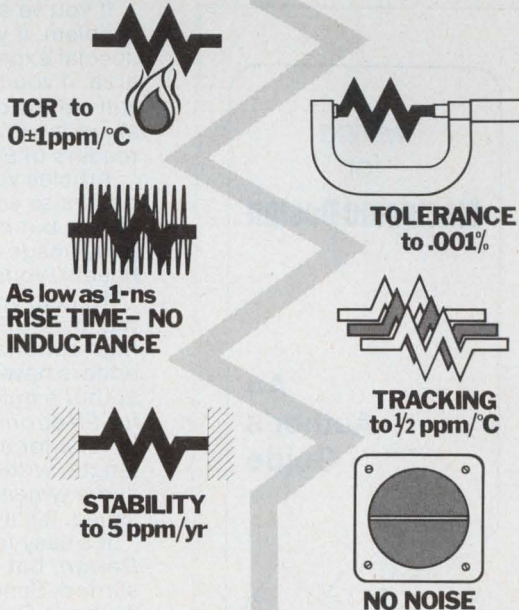

Learn to make custom Vishay resistors in your prototype design lab. Call or write for information on our popular one-day training course. Vishay Resistive Systems Group of Vishay Intertechnology, 63 Lincoln Highway, Malvern, PA 19355; phone (215) 644-1300.



Vishay

CIRCLE NUMBER 106

6465

133

Electronic Cabinets & Cases by PREMIER METAL PRODUCTS CO.

381 Canal Place, Bronx, N.Y. 10451/(212) 993-9200

OVER 1300 ITEMS IN OUR CATALOG



CIRCLE NUMBER 108

AUTHOR'S GUIDE

writing
for
Electronic Design

An
**Author's
Guide**

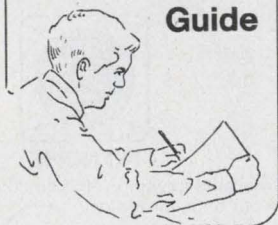

If you've solved a tricky design problem, if you have developed special expertise in a specific area, if you have information that will aid the design process... share it with your fellow engineers—readers of *Electronic Design*.

Articles you have authored not only raise your own professional status, but help build your company image as well. The readers benefit, your company benefits.

To help you prepare material that meets *Electronic Design's* high editorial standards, our editors have prepared a special author's guide entitled "Writing for *Electronic Design*." It covers criteria for acceptability, form, length, writing tips, illustrations, and payment for articles published. It's available without cost.

It's easy to write for *Electronic Design*, but it's often hard to get started. Send for your copy of our Author's Guide today.

**Circle No.
250**

COMPONENTS

Solid-state relay features low cost

International Sensor Systems, P.O. Box 345, Industrial Park, Aurora, NE 68818. (402) 694-6111. \$8.50 (50 up), \$3.50 (10,000 up).

A low-cost optically isolated solid-state relay, Model 750A, features TTL compatible inputs, no contact bounce, DIP packaging, no moving parts and solid-state speed and reliability. Input/output isolation is 1500 V ac over an operating range of -55 to 100 C. The relay will typically handle a 0.5-A-dc load current with a control current of 15 mA at 2.7 V dc. The off-state breakdown voltage across the output is greater than 60 V dc. Hybrid thick-film technology ensures an input-output isolation resistance of greater than $10^{10} \Omega$.

CIRCLE NO. 360

Miniature attenuator pad is multiturn unit

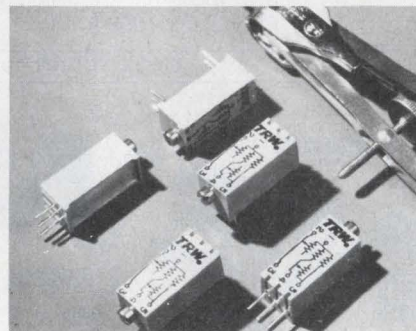

TRW, 2801 72nd St. N., St. Petersburg, FL 33733. (813) 347-2181. \$2.40 (1000 up).

A low-cost miniature multiturn bridge-T pad with $75 \Omega \pm 20\%$ impedance (input and output) featuring five adjustment turns (1800°), provides better resolution than single-turn attenuators. The resistive pattern on the ceramic substrate of the device is a metal glaze that provides four to five times the temperature stability of carbon composition, according to TRW. Type 9950 mounts horizontally; Type 9955 mounts vertically; and each is 11/16-in. rectangular. They provide attenuation from 0.25 to 20 dB over a frequency range from dc to 300 MHz; power rating is 0.125 W at 20 C; and operating temperature range is -55 to 125 C.

CIRCLE NO. 361

12-button keyboard supplies 2-of-7 code

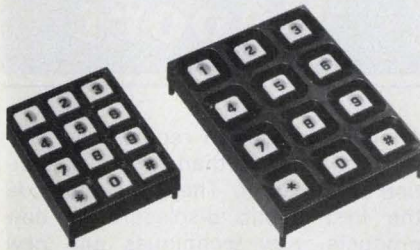

Grayhill, Inc., 561 Hillgrove Ave., La Grange, IL 60525. (312) 354-1040. \$7.07: 0.5 in., \$7.70: 0.75 in. (100 up); 4 to 6 wks.

Low profile, 12-button Series 87 keyboard pads feature a 2-out-of-7 (row/column) coded output. Suited for telecommunication applications, the compact keyboard is arranged in a 3×4 button array and is available with either 0.5 or 0.75-in. button centers. The keyboard's contact system is rated for 3-million operations per button. The contacts have excellent audio and tactile feedback characteristics with a total button travel of only 0.015 in. Molded-in legends are standard for numbers 1 through 9 on the first three rows and *, 0 and # on the bottom row. Switches may be ordered with clear snap-on caps for user legending.

CIRCLE NO. 362

Ultra-stable capacitors meet MIL-C-55514

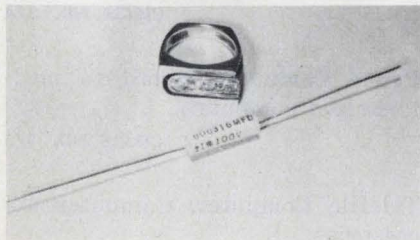

Reliable Capacitors, 7409 Bellaire Ave. N., Hollywood, CA 91605. (213) 983-1970. \$0.79: 316 pF at 1% (1000 up); 4 to 6 wks.

Ultra-stable polystyrene wrap-and-fill capacitors exhibit only a 1% capacitance change at -55 C and 0.5% at 85 C. The dissipation factor varies from 0.05% to 0.06% between -55 and 85 C. Voltage derating is 50% from -65 to 85 C. Insulation resistance is $10^6 \Omega$ at 25 C and $10^4 \Omega$ at 85 C. The capacitors meet MIL-C-55514. Models are available from 100 pF through 2 μ F.

CIRCLE NO. 363

ELECTRONIC DESIGN 6, March 15, 1977

Parallel Entry Printer

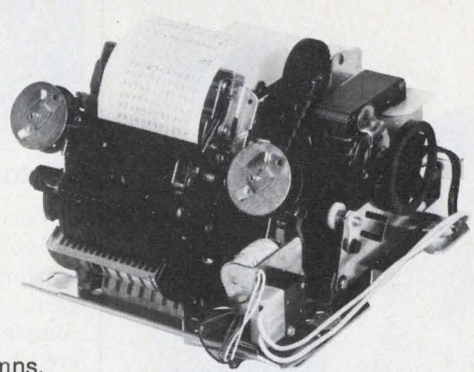

Prints 3 lines per second, 11 character locations per column with a capacity up to 16 columns. Print mechanism is small ($5\frac{1}{4}'' \times 10'' \times 8''$).

Options available: Serial or parallel BDC interface
Power supply Attractive case

With the addition of calculator logic, it becomes our "Intelligent Printer".

Write for catalog of
Addmaster computer peripherals.

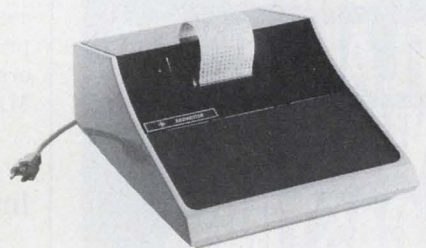

416 Junipero Serra Drive • San Gabriel, California 91776

CIRCLE NUMBER 109

SpaceSaver: New RCA Flameproof Film Resistor Kit

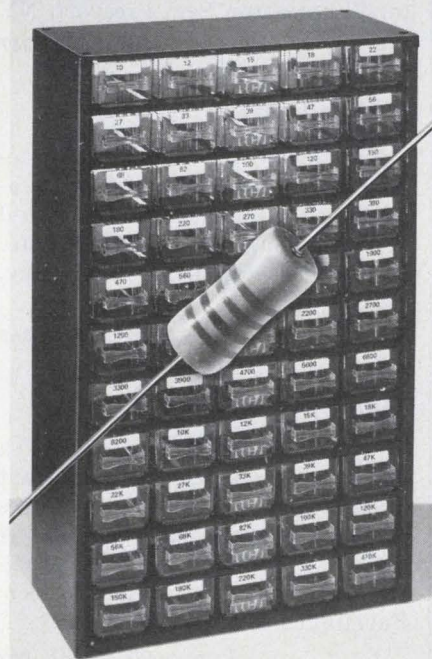

Introducing RCA's convenient, preloaded and prelabeled Flameproof Resistor Kit containing a wide range of the most-needed, standard value resistors in $\frac{1}{2}$, 1 and 2 watt ratings. Two of each rating for a total of 330 resistors; all $\pm 2\%$ tolerance. Packed in a sturdy metal-frame cabinet for easy availability.

Service Technicians prefer RCA Flameproof Film Resistors because of their inherent safety characteristics. Design Engineers prefer them because they won't flame or short even under severe conditions. Look to RCA — your best single source for a complete line of flameproof film resistors.

Contact your authorized RCA Parts Distributor for all the details, or write to RCA Distributor and Special Products Division, 2000 Clements Bridge Road, Deptford, NJ 08096.

RCA Flameproof Film Resistors

CIRCLE NUMBER 110

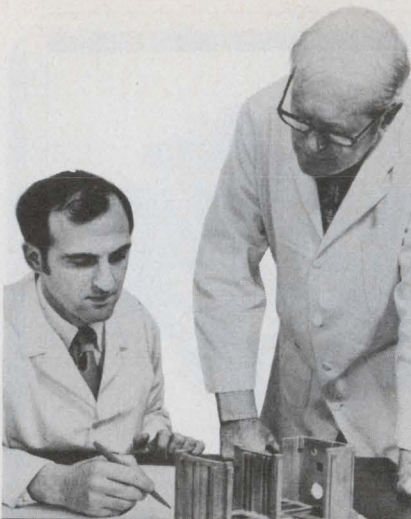

**"CHECK
ATLANTIC FOR
INVESTMENT
CASTINGS
...they deliver
in 3 to 5 weeks"**

Atlantic's patented planar investment casting process provides high production rates and true precision control.

The process combines the best features of Plaster Mold and traditional Investment Casting. Almost any shape or contour is possible.

No order is too big or too small. Delivery in 3 to 5 weeks from Atlantic... the only producer of both investment castings and plaster mold casting serving the industry today.—Literature available.

**Atlantic
Casting**

AND ENGINEERING CORPORATION

Eight - Ten Bloomfield Ave., Clifton, N.J. 07012
(201) 779-2450

CIRCLE NUMBER 112

Application Notes

Vector voltmeters

Various methods in which a vector voltmeter may be used, such as scattering-parameter, phase, amp-gain, harmonic, group-delay and component measurements, are covered in a 12-page paper. PRD Electronics, Syosset, NY

CIRCLE NO. 364

V/f and f/v converters

Applications bulletin AN-20 discusses solving your measurement problems with v/f and f/v converters. Teledyne Philbrick, Dedham, MA

CIRCLE NO. 365

Impatt diodes

Details of the design procedure for waveguide and coaxial amplifiers using HP Impatt diodes are given in an application note. Circuit drawings and design-aid graphs are included. Hewlett-Packard, Palo Alto, CA

CIRCLE NO. 366

Passive filters

Applications information as well as a tutorial look at the design of passive filters and their functions are found in "Using Passive Filters." Comstron Seg, Freeport, NY

CIRCLE NO. 367

Q standards

The theory and technique for design and construction of 1-MHz capacitive Q standards are described in a 10-page application note. Boonton Electronics, Parsippany, NJ

CIRCLE NO. 368

Spectrum analyzers

"Notes on Spectrum Analysis," a 22-pager, discusses the important design and operational features concerning spectrum analyzers. A simple-to-follow question-and-answer format is used. Ailtech, Farmingdale, NY

CIRCLE NO. 369

Vendors Report

Annual and interim reports can provide much more than financial position information. They often include the first public disclosure of new products, new techniques and new directions of our vendors and customers. Further, they often contain superb analyses of segments of industry that a company serves.

Selected companies with recent reports are listed here with their main electronic products or services. For a copy, circle the indicated number.

Solid State Scientific. CMOS, memories, CBs, mobile communication and photo-mask fabrication.

CIRCLE NO. 370

Sykes. Data storage systems.

CIRCLE NO. 371

Wyly Corp. Data communication services.

CIRCLE NO. 372

WUI. International and domestic communications.

CIRCLE NO. 373

Unitrode. Power semiconductors.

CIRCLE NO. 374

Prime Computer. Small to medium-sized computers.

CIRCLE NO. 375

Telefile Computer. Computer accessories.

CIRCLE NO. 376

Anderson Jacobson. Data-communications equipment, keyboard-printer computer terminals and small business computer systems.

CIRCLE NO. 377

Comten. Communications computer systems and computer performance evaluation products.

CIRCLE NO. 378

Data 100. Data processing terminal systems.

CIRCLE NO. 379

New Literature

MMD-1 MINI-MICRO DESIGNER EDUCATION AND DEVELOPMENT MICROCOMPUTER



COMPLETE 8088 MICROPROCESSOR BASIC COMPUTER SUITABLE FOR EDUCATION AS WELL AS SOFTWARE AND SYSTEM DEVELOPMENT

SIMPLE ENOUGH FOR SELF INSTRUCTION AND YET COMPLETE ENOUGH FOR THE PROFESSIONAL SYSTEM DESIGNER AND CLASSROOM TEACHING

BASIC SYSTEM CONTAINS COMPLETE 8088 MPU SET INCLUDING MEMORIES WITH ADD-ON MEMORY AVAILABLE

DIRECT KEYBOARD ENTRY OF DATA AND INSTRUCTIONS (NO DATA ENTRY TERMINAL NECESSARY)

LIGHT EMITTING DIODE STATUS AND DATA INDICATOR

INTERNAL SOLDERLESS BREADBOARDING SOCKET WITH DIRECT BUFFERED ACCESS TO THE MICROPROCESSOR

COMPLETE SELF-CONTAINED POWER SUPPLY

COMPLETE TUTORIAL DOCUMENTATION AND OPERATOR MANUALS

PROVISION FOR DIRECT TELEPRINTER OR CRT TERMINAL AND AUDIO CASSETTE INTERFACES

Microcomputers

An eight-page brochure describes the Mini-Micro Designer, MMD-1 education and development μ C and its optional accessories. E&L Instruments, Derby, CT

CIRCLE NO. 380

Instrumentation recorder

Features and specifications of the Ana-log 714 instrumentation recorder can be found in a 24-page catalog. Philips, Eindhoven, the Netherlands.

CIRCLE NO. 381

Power supplies

Electrical and mechanical parameters on more than 180 power supplies are detailed in a 40-page handbook. Datel Systems, Canton, MA

CIRCLE NO. 382

Arc lamp power supplies

Xenon-and-mercury-arc lamp power supplies are described in a four-page brochure. Specifications are given as well as applications in the following areas: optical instrumentation, image projection, graphic arts and medical. Electronic Measurements, Neptune, NJ

CIRCLE NO. 383

Video equipment

Closed-circuit TV cameras and video products are highlighted in an eight-page brochure. RCA Solid State Div., Somerville, NJ

CIRCLE NO. 384

Rack, panel connectors

Input/output rack and panel connectors are covered in a 32-page catalog. Elco, Huntingdon, PA

CIRCLE NO. 385

Int'l switch approvals

The complexities of national standards covering snap-action switches are dealt with in a 16-page handbook. Procedures for application, specifications, markings, creepage and clearance distances and electrical-life requirements are covered. Copies may be obtained by sending \$2 in cash, check or money order to Cherry Electrical Products, P.O. Box 718, Waukegan, IL 60085

INQUIRE DIRECT

Q: Is there a recorder just for spectrum analyzers?

A:

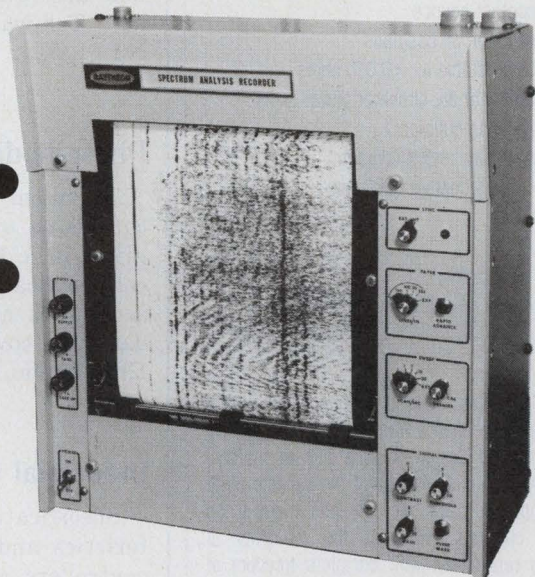

The new 19" rack-mounting SPECTRUM ANALYSIS RECORDER from Raytheon. It's the first dry paper line scanning recorder specifically developed for direct plug-in operation with commercially available spectrum analyzers.

Any new or existing spectrum analyzer equipped with the SAR-097 will have a lot more going for it. Like infinitely variable 100:1 speed range—5 sec/scan to 50 milliscan/scan... stylus position encoder... automatic recorder synchronization... computer/analyzer compatibility... high resolution and dynamic range... all-electronic drive. And more.

If you design and build—or buy and use—spectrum analyzers, you don't have to settle for multi-purpose recorders any more. The SAR-097 is here. For full details write the Marketing Manager, Raytheon Company, Ocean Systems Center, Portsmouth, Rhode Island, 02871. U.S.A. (401) 847-8000.

RAYTHEON

CIRCLE NUMBER 113

1 Relay Miss every 2-Billion Cycles

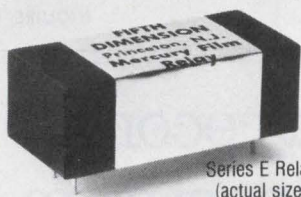

We tested 129 of our new Series E Relays at loads from dry circuits to 3 Amps. After 35-billion operations, only 10 single-cycle misses were monitored.

Series E Relays offer:

- Indefinite life
- No contact bounce
- Operation in all positions
- Contacts stable to ± 0.015 ohms over life
- Reliability at dry circuit or power loads
- Self-healing contacts
- Hermetically sealed contacts
- 1250V rms contact breakdown
- Low cost

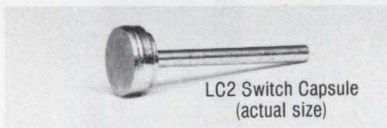

Series E Relay uses a rugged LC2 welded capsule rather than a fragile glass reed switch. This patented design holds a film of mercury securely to the metal walls of the capsule. With every operation, the mercury film renews the switch contacts. You get the reliability of mercury relays, but with complete freedom of mounting orientation. LC2 welded capsule reliability is proven by hundreds-of-thousands of units in the field, as well as billions of cycles under stringent laboratory conditions.

Send for a FREE SAMPLE of the LC2 welded capsule on your letterhead. Circle the reader service card number for Series E Relay information.

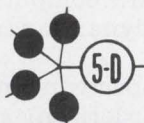

Fifth Dimension, Inc.

P.O. Box 483
Princeton, N.J. 08540
Tel: (609) 452-1200

CIRCLE NUMBER 114

NEW LITERATURE

Semiconductors

A 256-page microwave semiconductor handbook is organized under discrete application areas such as receiving diodes, control diodes and power-generation and application devices. All application sections are tabbed for easy location. Microwave Associates, Burlington, MA

CIRCLE NO. 386

Test equipment

The rental and lease of mobile communications test equipment are covered in a six-page brochure. Metric Resources, Burlingame, CA

CIRCLE NO. 387

MIC components

Technical descriptions, drawings, specifications and major advantages for off-the-shelf MIC products are covered in a 40-page catalog. Tek-wave, New Hyde Park, NY

CIRCLE NO. 388

Photodiodes

Technical and operational specifications on over 40 photodiodes are given in a 12-page catalog. Physical specifications and electrical characteristics along with applications data are covered. Quantrad Corp., El Segundo, CA

CIRCLE NO. 389

Industrial controllers

Specifications, physical characteristics and options of industrial controllers are detailed in a catalog. Theta Instrument, Fairfield, NJ

CIRCLE NO. 390

Sheet stock and foil

Sizes and properties of sheet stock and foil for magnetic shielding are given in a four-page catalog. The catalog gives the physical parameters of Eagle's alloys, the dc and ac magnetic properties of each, machining and drilling speeds and suggestions for welding, soldering and annealing. Eagle Magnetic, Indianapolis, IN

CIRCLE NO. 391

Components

Electronic components, transformers, electronic tools, test equipment, hardware and other related items are featured in a 64-page catalog. Mouser Electronics, Lakeside, CA

CIRCLE NO. 392

Thick-film circuits

The design, application, manufacture and testing of polymer thick-film circuits are detailed in a series of brochures. Methode Development, Chicago, IL

CIRCLE NO. 393

PC connectors

Two-piece metal-to-metal PC connectors are covered in a 52-page catalog. The catalog includes definitions of various connector types, materials and platings. Elco Huntingdon, Huntingdon, PA

CIRCLE NO. 394

Solid-state relays

Block diagrams, schematics, performance graphs, charts and specifications of solid-state relays can be found in a 24-page catalog. Tele-dyne Relays, Hawthorne, CA

CIRCLE NO. 395

Moving-coil meters

Photos, descriptions and specifications of moving-coil meters are shown in a 20-page catalog. British Physical Laboratories, Radlett, Hertfordshire, WD7 7HJ England.

CIRCLE NO. 396

Minicomputer

A 12-page catalog details system use, software and support for the Nova 3 minicomputer family. Data General, Southboro, MA

CIRCLE NO. 397

Multipin connectors

The MMC series of rectangular multipin connectors is featured in a 28-page catalog. The catalog is available in French, English or German. Radiall, 93116 Rosny-sous-Bois, France.

CIRCLE NO. 398

ABSORB FLEX, PULL, PUSH, TWIST...

With Heyco Strain Relief Bushings.

Heyman Strain Relief Bushings are the easy, low-cost way to insulate and protect cable connections. They absorb any push, pull, twist or excessive flex on wire or cable, for full protection. Available in half a hundred sizes for chassis holes from 3/8" thru 1 3/16". U.L. Recognized, C.S.A. approved.

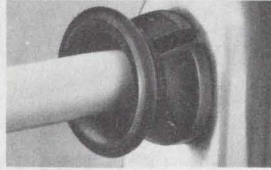

Write for **FREE** sample pack and catalog.

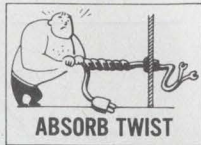
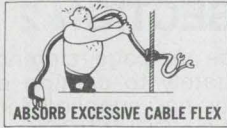

HEYMAN MANUFACTURING COMPANY

KENILWORTH, NEW JERSEY 07033
(201) 245-2345 • TWX: 710-996-5986

WAUKESHA, WISCONSIN 53186
(414) 542-7155 • TWX: 910-265-3668

Call Toll-Free (800) 558-0917 except from Wisconsin.
If calling from Wisconsin use (800) 242-0985



CIRCLE NUMBER 115

WHO MAKES WHAT & WHERE TO FIND IT

Volume 1 of **Electronic Design's** GOLD BOOK tells all. And, when you look up an item in its **PRODUCT DIRECTORY** you'll find each manufacturer listed **COMPLETE WITH STREET ADDRESS, CITY, STATE, ZIP AND PHONE.** Save time. There's no need to refer elsewhere to find missing information.

IT'S ALL THERE
in
Electronic Design
GOLD BOOK

FREE...WALL CHART POWER ROTARY SWITCHES

SELECTOR GUIDE - ROTARY SWITCHES

CHARACTERISTICS	10A-240V	15A-240V	20A-240V	25A-240V	30A-240V	35A-240V	40A-240V	50A-240V	60A-240V	75A-240V	100A-240V	150A-240V	200A-240V	250A-240V	300A-240V	400A-240V	500A-240V	600A-240V
POLES	1-2	1-2	1-2	1-2	1-2	1-2	1-2	1-2	1-2	1-2	1-2	1-2	1-2	1-2	1-2	1-2	1-2	1-2
OPERATING VOLTAGE	240V	240V	240V	240V	240V	240V	240V	240V	240V	240V	240V	240V	240V	240V	240V	240V	240V	240V
OPERATING CURRENT	10A	15A	20A	25A	30A	35A	40A	50A	60A	75A	100A	150A	200A	250A	300A	400A	500A	600A
OPERATING FREQUENCY	60 Hz	60 Hz	60 Hz	60 Hz	60 Hz	60 Hz	60 Hz	60 Hz	60 Hz	60 Hz	60 Hz	60 Hz	60 Hz	60 Hz	60 Hz	60 Hz	60 Hz	60 Hz
OPERATING TEMPERATURE	-40°C to 125°C	-40°C to 125°C	-40°C to 125°C	-40°C to 125°C	-40°C to 125°C	-40°C to 125°C	-40°C to 125°C	-40°C to 125°C	-40°C to 125°C	-40°C to 125°C	-40°C to 125°C	-40°C to 125°C	-40°C to 125°C	-40°C to 125°C	-40°C to 125°C	-40°C to 125°C	-40°C to 125°C	-40°C to 125°C
OPERATING HUMIDITY	5% to 95%	5% to 95%	5% to 95%	5% to 95%	5% to 95%	5% to 95%	5% to 95%	5% to 95%	5% to 95%	5% to 95%	5% to 95%	5% to 95%	5% to 95%	5% to 95%	5% to 95%	5% to 95%	5% to 95%	5% to 95%
OPERATING VIBRATION	0.1g	0.1g	0.1g	0.1g	0.1g	0.1g	0.1g	0.1g	0.1g	0.1g	0.1g	0.1g	0.1g	0.1g	0.1g	0.1g	0.1g	0.1g
OPERATING SHOCK	10g	10g	10g	10g	10g	10g	10g	10g	10g	10g	10g	10g	10g	10g	10g	10g	10g	10g
OPERATING LIFE	100,000	100,000	100,000	100,000	100,000	100,000	100,000	100,000	100,000	100,000	100,000	100,000	100,000	100,000	100,000	100,000	100,000	100,000
OPERATING WEIGHT	10g	15g	20g	25g	30g	35g	40g	50g	60g	75g	100g	150g	200g	250g	300g	400g	500g	600g
OPERATING PRICE	\$0.10	\$0.15	\$0.20	\$0.25	\$0.30	\$0.35	\$0.40	\$0.50	\$0.60	\$0.75	\$1.00	\$1.50	\$2.00	\$2.50	\$3.00	\$4.00	\$5.00	\$6.00

- Snap-action . . . detent . . . and cam switches
- Ratings from 10A-240V to 200A-600V
- Up to 75 poles
- Many standard & custom options
- Fast deliveries

ELECTRO SWITCH
Weymouth, Massachusetts 02188

Telephone: 617/335/5200 • TWX: 710/388/0377

CIRCLE NUMBER 116

Free!

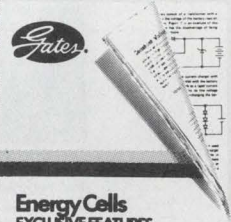

Power advantage . . . economic advantage. Get full details on the energy future . . . new Gates rechargeable, sealed lead-acid batteries. Send today for our free, informative brochure containing exclusive battery features, application information, ratings and specifications. Find out what this new third-generation energy cell could mean to your design work.

Energy Cells
EXCLUSIVE FEATURES
APPLICATION INFORMATION
RATINGS & SPECIFICATIONS

Yes! I would like to know more about these new energy cells. Please send free information.

Name _____

Title _____

Company _____

Address _____

City, State, Zip _____

Mail to: George Sahl,
Gates Energy Products, Inc.
1050 S. Broadway, Denver CO 80217



Where the energy future is now

ED-116

CIRCLE NUMBER 117

makes your life easier

ELECTRONICS PRODUCT DIRECTORY IN THE WORLD!

IS THE COMPANY A SERIOUS MANUFACTURER?

This symbol, "•", separates the serious from the would-be manufacturer. It means the company has submitted literature to us describing the product.

COMPLETE

Company Name, Street Address, City, State, Zip and Phone.

No need to flip pages or look in another directory to contact each supplier.

SPEED YOUR SEARCH FOR SUPPLIERS

Here's what engineers say about the GOLD BOOK:

"GOLD BOOK is my Bible." . . . "The best compilation of electronics information I've seen." . . . "Very good, useful in my work and a time saver." . . . "Easy to use." . . . "Very good to locate manufacturers; I use it several times each day." . . . "Used constantly to identify local reps and distributors." . . . "It's the first place I turn to for suppliers." . . . "The best! My first reference." "My most-used directory."

WANT TO FIND OUT WHO MAKES WHAT?

LOOK FIRST

IN Electronic Design's GOLD BOOK

NAVIGATION EQUIPMENT & INSTRUMENTS

MULTIPLIERS, HIGH VOLTAGE	
•Bentech Corp, Dept G, 652 Mitchell Rd Newbury Park CA 91320 Vol 2/226, 227	(805)498-2111
•Wire Technological Prods, Dept G, 644 W 12 St Erie PA 16512	(814)453-3344
•High Voltage Devices Inc, Dept G, 7485 Av 304 Vista CA 93277	(209)772-2870
•Ion Physics Corp, Dept G, Bedford St Burlington MA 01803	(617)272-2800
•Leesfer Components Corp, 1112G Louisons St Union NJ 07083	(617)687-5410
•Wario Semiconductor Inc, Dept G, 1000 N Shiloh Garland TX 75042	(214)272-4551
•Witva Elec Ltd, Dept G, Bedford Row, Worthing, Sussex, England BN113JW	090-320-8201
•Zenith Rauland Div, Dept G, 2407 W North Av Marrow Park IL 60148	(312)345-4700
MULTIPLIERS, MAGNETIC	
•Transmagetics Inc, 210G Adams Biv Farmingdale NY 11735	(516)293-3100
MULTIPLIERS, MICROWAVE—see FREQUENCY DOUBLERS & MULTIPLIERS:	
MICROWAVE FREQUENCY MULTIPLIERS & UP CONVERTERS	
MULTIPLIERS, SERVO	
•Control Technology, 41-16G 29 St Long Island City NY 11101	(212)361-2133
•Transical Inc, Dept G, Trooper Rd Worcester PA 19490	(215)277-1300
•Transmagetics Inc, 210G Adams Biv Farmingdale NY 11735	(516)293-3100
•Zetlex Inc, 940G Detroit Av Concord CA 94518	(415)686-6660
MULTIPLIER TUBES—see TUBES, MULTIPLIER	
MULTIVIBRATORS—see CARDS, LOGIC, ICs, MULTIVIBRATOR	
NAMEPLATES	
•Acromark Co Dept 727, 60G Locust Av Berkeley Hills NJ 07922	(201)464-6474
•Angell Mfg, 1516G Steyer Dayton OH 45404	(513)461-5800
•Anodyne Inc, Dept G, 1270 NW 165 St N Miami Beach FL 33169	(305)621-3641
•Apothecary Corp Of NE, 101 G Walnut Av Weterston MA 02172	(617)924-1500
•Avery Label Sys, Dept G, 777 E Foothill Avual CA 91702	(213)695-3211
•Bell Co Inc, 106G Morrow Av Trussville AL 35173	(205)655-2135
•Berrus Corp, P/c Design Div, Dept G, Box 335 -Berrus Center Hiderfield CT 06427	(203)431-1500
•Best Mfg Co, 3214G Trout Kaneson City MO 64109	(816)531-6611
•WH Brady Co, Dept G, 727 W Grand Ave Milwaukee WI 53201	(414)264-2100
•Central Plastics Dist, Dept G, 2701 N Pulaski Rd Chicago IL 60639	(312)235-3300
•Coms East Co Inc, Dept G, 6443 Western Ave Glen Arbor MI 49636	(616)534-3081
•Crystronics Inc, Dept G, 11 E 41st St New York NY 10017	(212)661-2277
•Cyclostone Corp, Label Mfg Div, Dept G, 3565 B Victor St Santa Clara CA 95050	(408)984-7077
•Desk Sign Mfg Co, Dept G, 223 S 61 St Philadelphia PA 19139	(215)747-2565
•Devco Engrg Inc, Sys Div, 36G Pier Lane W Fairfield NJ 07006	(201)228-0321
•Drake Co, Dept G, PO Drawer 9110 NW Ste Austin TX 78766	(512)454-3824
•Durath Corp, 325G Orange St Millville NJ 08332	(609)825-8900
•Ebay Corp, 3662G Old Annapolis Rd Columbia MD 21045	(301)730-8450
•Eray Tag & Mfg Inc, 4615G Union Bay Pk NE Seattle WA 98105	(206)524-2700
•GM Nameplate Inc, Dept G, 2040 15 Av W Seattle WA 98119	(206)284-2200
•Graphix Inc, 1G Dell Glen Av Lodi NJ 07644	(201)478-1166
•Hall Co, Dept G, PO Box 38158 Urbana OH 43078	(513)652-1376
•Hermes Plastics Inc, 20G Cooper Sq New York NY 10003	(212)535-5100
•I-E Runtel, 940G Chapter St Redwood City CA 94063	(415)365-8111
•Johnson Controls Inc, Panel Unit, Dept G, Highway 59N Poteau OK 74953	(918)647-2195
•Laminated Fabricators, 1145G San Mateo Av San Bruno CA 94066	(415)583-5092
•Master Engraving Inc, 11G Wallace St Elmwood Pk NY 07407	(201)791-3323
•OH Matthews & Co, Marking Sys Div, 6515G Penn Av Pittsburgh PA 15206	(412)362-6500
•Metalcraft Inc, Dept G, 148 4 St SW Mason City IA 50401	(515)423-9460
•Metal Etching Co Inc, 435G S Main St Freeport NY 11520	(516)868-4500
•Metaphoto Corp, Dept G, 1853 S Miles Rd Cleveland OH 44138	(216)475-0555
•3M Co Headquarters, Prod Information Ctr, Dept G, 3 M Center St Paul MN 55101	(612)733-1110
•Neal Hwy Co, 133G La Parera Av Goleta CA 93017	(805)967-4521
•New Hermes Engraving Machine Corp, 20G Cooper Square New York NY 10003	(212)777-3080
•NPV Co Inc, Dept G, 562G N Rosemead Blvd Tempe City CA 91780	(213)283-8854
•Oklahoma Aeronautics, 632G Penns Av Hartsborne OK 74547	(918)297-2566
•Paralegics Mfg Co Inc, Dept G, 304 N York Rd Bensenville IL 60106	(312)265-7740
•Photo Chemical Prods, 2715G Berkeley St Santa Monica CA 90404	(213)828-9561
•Precision Crafts, 3538G Foothill Biv La Crescenta CA 91214	(213)248-3211
•Seton Name Plate Corp, 1612G Blvd New Haven CT 06505	(203)772-2520
•SGL Graphics, Dept G, John Fitch Indl Park Warriminer PA 18974	(215)672-3600
•SGL Homalite, 11G Brookside Dr Wilmington DE 19804	(302)452-3696
•Shogto Industries Ltd, Dept G, 350G S Av NYC NY 10001	(212)695-0200
•Spektra Lux Corp, 1325G G Northrup Way Bellevue WA 98005	(206)747-0560
•Standex Int'l Corp, Miller Div, Dept G, 4400 N Temple City Bv El Monte CA 91734	(213)444-4555
•Stangor Prods Inc, 366G Main St Pt Washington NY 11050	(516)883-8400
•Tech-Etch Inc, 45G Aldrin Rd Plymouth MA 02360	(617)747-0300
•Vermaline Prods Co, Dept G, 455 W Main St Wyckoff NJ 07481	(201)891-3200
•Waldom Elecs Inc, Dept G, 4637 W 53 St Chicago IL 60632	(312)585-1212
NAVIGATION EQUIPMENT & INSTRUMENTS	
•Epsco Inc, Applied Microwave Div, 411G Providence Hwy Westwood MA 02090 Vol 2/265	(617)329-1500
•Active Control Instrumentation, Dept G, Box 194 East Northport NY 11731	(516)864-2111
•Addington Labs Inc, Solid State Prods, Div, Dept G, 680 N Maude Av Sunnyvale CA 94086	(408)245-6810
•Aerosonic Corp, 3312G Wiley Post Rd Carrollton TX 75006	(214)333-8004
•Aerotron Aircraft Radio Inc, 3322G Industry Dr Signal Hill CA 90806	(213)597-8875
•All Sys, 344G New Albany Rd Moorestown NJ 08057	(609)234-4420
•AMP Inc, Electrical Prod Development Div, Dept G, 1025 N Royal St Alexandria VA 22314	(703)548-7221

strip chart recorders

- OEM MODULES
- LOW PROFILE
- PACKAGED UNITS
- PORTABLE DC

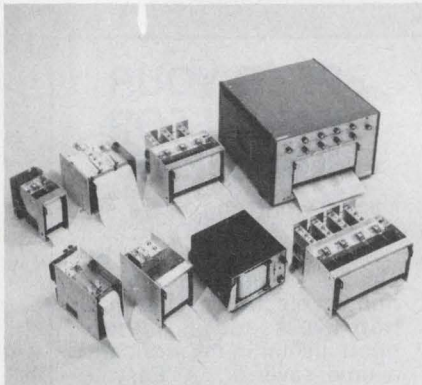

General Scanning thermal writing Strip Chart Recorders are available in a wide range of configurations and performance characteristics to meet virtually every recorder need.

You can select open-loop, velocity feedback or closed-loop operation; continuous roll or fan-feed paper; one to eight channels in channel widths of 20, 40, 50, 80 or 100mm; a variety of chart speeds; and either AC or DC operation.

Recorders can be furnished as modules for use by OEM's or fully packaged.



For complete details, circle readers' service number or write today for our full line Strip Chart Recorder Catalog.

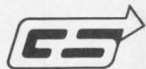

GENERAL SCANNING INC.
150 Coolidge Avenue
Watertown, MA. 02172
TEL: (617) 924-1010

CIRCLE NUMBER 119

Electronic Design

ELECTRONIC DESIGN's function is:

- To aid progress in the electronics manufacturing industry by promoting good design.
- To give the electronic design engineer concepts and ideas that make his job easier and more productive.
- To provide a central source of timely electronics information.
- To promote communication among members of the electronics engineering community.

Want a subscription? ELECTRONIC DESIGN is sent free to qualified engineers and engineering managers doing design work, supervising design or setting standards in the United States and Western Europe. For a free subscription, use the application form bound in the magazine. If none is included, write to us direct for an application form.

If you do not qualify, paid subscription rates are as follows: \$30.00 per year (26 issues) U.S., \$40.00 per year (26 issues) all other countries. Single copies are \$2.00 U.S., \$3.00 all other countries. The Gold Book (27th issue) may be purchased for \$30.00 U.S. and \$40.00 all other countries.

If you change your address, send us an old mailing label and your new address; there is generally a postcard for this bound in the magazine. You will have to requalify to continue receiving ELECTRONIC DESIGN free.

The accuracy policy of ELECTRONIC DESIGN is:

- To make diligent efforts to ensure the accuracy of editorial matter.
- To publish prompt corrections whenever inaccuracies are brought to our attention. Corrections appear in "Across the Desk."
- To encourage our readers as responsible members of our business community to report to us misleading or fraudulent advertising.
- To refuse any advertisement deemed to be misleading or fraudulent.

Microfilm copies are available of complete volumes of ELECTRONIC DESIGN at \$19 per volume, beginning with Volume 1, 1952 through Volume 20. Reprints of individual articles may be obtained for \$3.00 each, prepaid (\$.50 for each additional copy of the same article) no matter how long the article. For further details and to place orders, contact the Customer Services Department, University Microfilms, 300 North Zeeb Road, Ann Arbor, Michigan 48106 telephone (313) 761-4700.

Want to contact us? If you have any comments or wish to submit a manuscript or article outline, address your correspondence to:

Editor
ELECTRONIC DESIGN
50 Essex Street
Rochelle Park, N.J. 07662

**CONNECTORS/
P.C.**

**JACKS &
PINS**

BERYLLIUM
COPPER
CAGES

CONCORD ELECTRONICS CORPORATION

and
**TEFLON*
AND SOLDER
TERMINALS**

*DUPONT T.M.

SEND FOR CATALOG

CIRCLE NUMBER 120

KEEP

Electronic Design's

GOLD BOOK

HANDY

When You Call

Save time when you contact suppliers. Check their catalog pages first in *Electronic Design's* GOLD BOOK. Maybe the information you need is right at your fingertips.

Engineers: Imagine Southern California

Hughes/Missile Systems is looking for a lot of good engineers. With imagination.

Hughes Aircraft Company/Missile Systems Group, Canoga Park, California, is a highly respected, prestigious firm, noted for leadership in technology and for a long-term record of stability and growth. Creative engineering is our business, and we do it in a campus-like facility. You'll have a real chance to apply your skills to major missile programs:

*Circuits Engineers

Experience in design, development of RF/IF, digital, analog circuits for missile-guidance systems. Must know applicable state-of-the-art components.

*Systems Analysts

Tasks involve system function design, solving systems-engineering problems. Experience in signal processing, controls, assembly language, performance analysis, weapon-system integration.

*Electronic Product Engineers

Develop conceptual product designs for state-of-the-art electronic systems, and mechanize designs in low-cost hardware.

*RF Systems Engineers

Experience must include microwave-systems design and test, with emphasis on digital signal processing.

Degree from an accredited institution required. Send resume to: Engineering Employment, Hughes Aircraft, Fallbrook at Roscoe, Canoga Park, CA 91304.

HUGHES
HUGHES AIRCRAFT COMPANY
MISSILE SYSTEMS GROUP

US citizenship required
Equal opportunity M/F/H/C employer

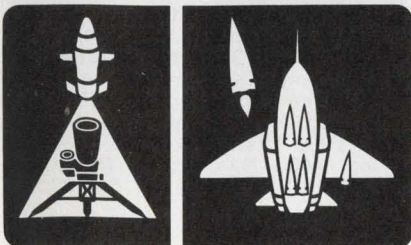

CIRCLE NUMBER 150

ELECTRONIC DESIGN 6, March 15, 1977

Electronic Design

Advertising Sales Staff

Tom W. Carr, Sales Director
Jean Bunfield, Sales Coordinator

Rochelle Park, NJ 07662

Robert W. Gascoigne
Daniel J. Rowland
Thomas P. Barth
50 Essex St.
(201) 843-0550
TWX: 710-990-5071
(HAYDENPUB ROPK)

Philadelphia

Thomas P. Barth
(201) 843-0550

Boston 02178

Gene Pritchard
P.O. Box 379
Belmont, MA 02178
(617) 489-2340

Chicago 60611

Thomas P. Kavooras
Berry Conner, Jr.
200 East Ontario
(312) 337-0588

Cleveland

Thomas P. Kavooras
(312) 337-0588

Los Angeles 90045

Stanley I. Ehrenclou
Burt Underwood
Neil Canavin
8939 Sepulveda Blvd.
(213) 641-6544

Texas

Burt Underwood
(213) 641-6544

San Francisco

Robert A. Lukas
3579 Cambridge Lane
Mountain View, CA 94040
(415) 965-2636

England

Constance McKinley
50 Essex St.
Rochelle Park, NJ 07662
Phone: (201) 843-0550

Europe

Sanders, W. J. M.
Raadhuisstraat 24
Graft-De Ryp, Holland
Phone: 02997-1303
Telegrams: Euradteam-Amsterdam
Telex: 13039-SIPAS

G. Nebut

Promotion Presse Internationale
7 ter Cour des Petites Ecuries
75010 Paris, France
Telephone: 5231917, 1918, 1919
Dieter Wollenberg
8111 Baldham/Muenchen
Erikastrabe 8
Germany
Telephone: 0 8106/4541
Telex: 5215532 auri d

Tokyo

Haruki Hirayama
Electronic Media Service
5th Floor, Lila Bldg.,
4-9-8 Roppongi
Minato-ku, Tokyo, Japan
Phone: 402-4556
Cable: Electronicmedia, Tokyo

NEW! Systems Integration through Switching!

How do you reconfigure four data acquisition channels and 500-600 transducer leads from each of eight test stations — frequently, reliably, quickly, without distorting low level analog signals? Easy. Integrate your system with a matrix switch using 60-circuit T-Bar "Pluggables" that mate directly with wrappable connectors.

T-Bar makes high density multi-pole switches and relays — designs and fabricates special switching systems — reliably and economically. That's all we do. And we've been doing it for 15 years. If you switch a lot of lines — all at once or a few at a time — write or phone today for T-Bar's new Series 6900 Pluggable Switching Catalog.

Tbar[®] INCORPORATED

SWITCHING COMPONENTS DIV.

141 Danbury Road Wilton, CT 06897
Phone: 203/762-8351

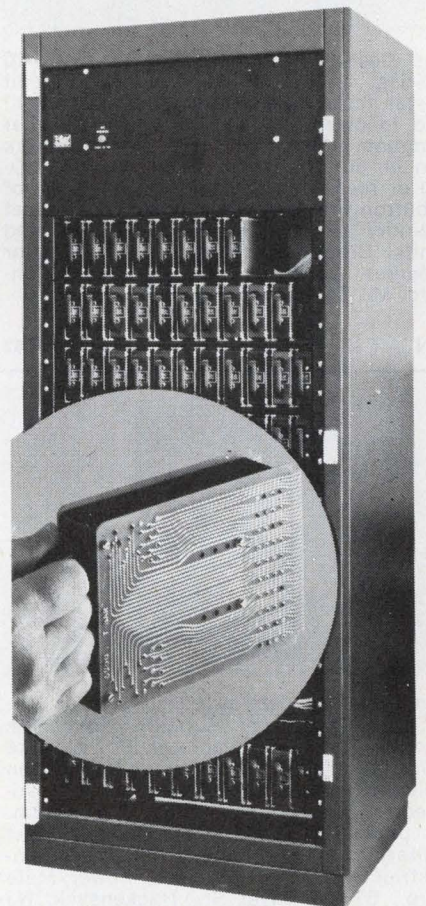

See us at the EDN Caravan in your area.

CIRCLE NUMBER 123

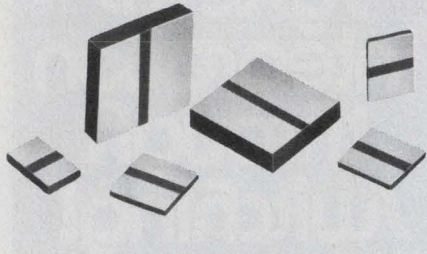

CERAMIC CHIP CAPACITORS. SPLIT-CHIP, is a new concept in ceramic chip capacitor technology. These new units have two broad electrodes on one face and eliminate conventional wrap-around end terminations. This new concept provides lower cost and easier assembly. SPLIT-CHIPS are available in five standard sizes from .040" x .030" to .130" x .090" and .015" thick and in all popular dielectrics and capacitance ranges. JOHANSON DIELECTRICS, INC., Box 6456, Burbank, Ca. 91510 213-848-4465

CERAMIC CHIP CAPACITORS 181

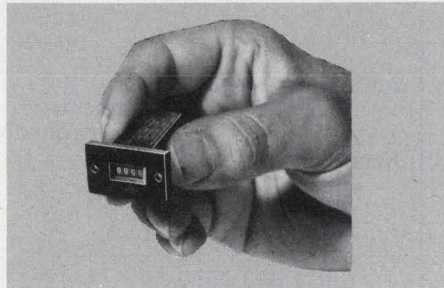

ELAPSED TIME INDICATOR Microminiature. Series 49200. One of smallest direct digital ETI's on the market. Only 37/64" sq by 1-1/2" long. 4-digit hourly readout clearly legible. Uses 1W synchronous motor, 115V ac, 60 Hz. Accuracy $\pm 1\%$ or ± 1 hr., whichever is greater. Where size is important, one of your best buys anywhere. 7 standard mounting styles available. North American Philips Controls Corp., Cheshire, Conn. 06410. (203) 272-0301.

ELAPSED TIME INDICATOR 184

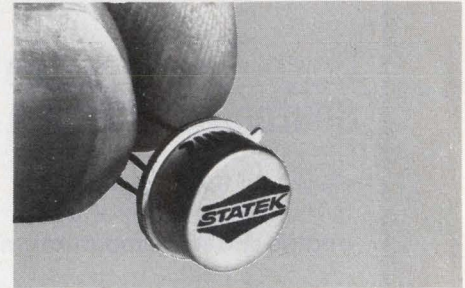

Don't count down. Use SX-1 10 kHz - 300 kHz Quartz Crystals * 18 stock frequencies * 0.185" high TO-5 * 1000g shock * \$2.00 ea. in 1000 qty. ($\pm 0.01\%$ accuracy) * Details in Gold Book & EEM * STATEK CORP. * 1233 Alvarez Ave. * Orange, Calif. 92668 * (714) 639-7810 * Telex 67 8394

QUARTZ CRYSTALS 187

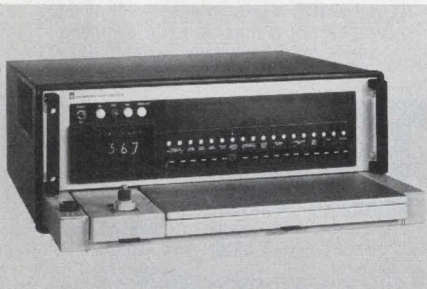

The Cost-Effective Solution to Linear-IC Testing. GenRad's 1730 Linear Circuit Tester tests op amps, comparators, voltage followers and regulators, and other common linear IC's. Up to 18 parameters can be automatically tested in a GO/NO-GO or measurement mode at the push of a button in under 2 seconds. Easily reset memory panel sets test conditions and limits. Broad selection of device-adaptor modules. GenRad, 300 Baker Ave., Concord, MA 01742, (617) 369-8770.

LINEAR IC TESTER 182

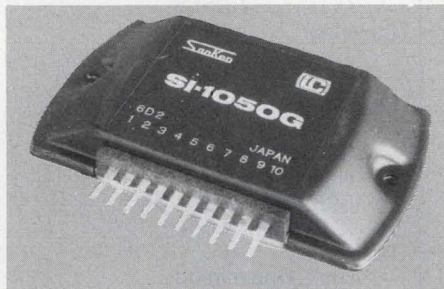

SANKEN 50W AUDIO AMPLIFIER—Multi-purpose self-contained unit for commercial and industrial applications. $< 0.5\%$ harmonic distortion at full power • $1/2$ dB response from 20 to 100,000 Hz • Single or split dual power supply • Built-in current limiting and efficient heat radiating construction • Quasi-complementary class B output • Rugged, compact, lightweight. Model SI-1050G. Price: 1-9 \$26.50; 10-up: \$21.00; 50-up: \$18.00. Energy Electronic Products, 6060 Manchester Ave, Los Angeles, CA 90045 (213) 670-7880.

AUDIO AMPLIFIER 185

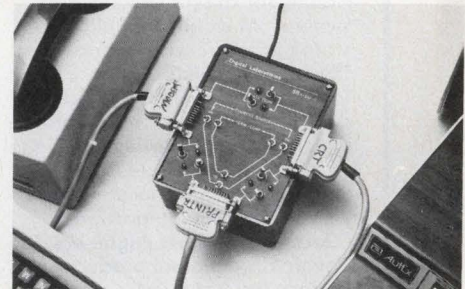

UNIVERSAL JUNCTION UNIT . . . for three devices, RS232C or current loop. . . . Six switches provide all 63 interconnects that are possible between three I-O devices. LED's indicate data flow. . . . Designed to provide circuit compatibility and easy data routing between different manufacturer's devices. . . . \$350 (1-4) from DIGITAL LABORATORIES, 600 Pleasant St., Watertown, MA 02172 (617) 924-1680

3 PORT RS232 & 20 MA LOOP 188

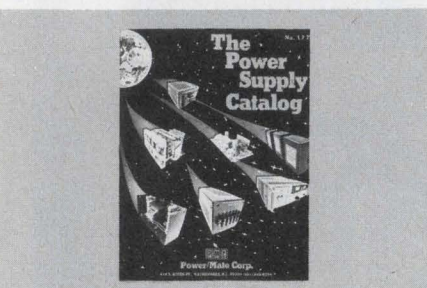

Free New '77 catalog contains over 34,500 quality power supplies from the world's largest manufacturer, Power/Mate Corp. Power Supplies for every application including submodulars, open frame, variated, encapsulated, laboratory & system. All units UL approved and meet most military and commercial specs for industrial and computer uses. Power/Mate Corp., 514 S. River St., Hackensack, NJ 07601 (201) 343-6294

POWER SUPPLIES 183

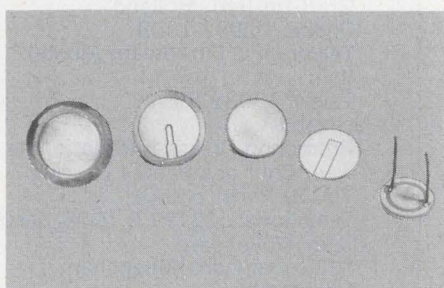

BENDERS FOR AUDIO ALARMS Ideal for low voltage or battery operated applications. Linden's low frequency, highly sensitive benders are available in standard (off-the-shelf) or custom designs to meet your specifications. Write for free catalog. LINDEN LABORATORIES, INC., Box 920, State College, PA 16801, 814-355-5491. A RESOURCE MANAGEMENT CORPORATION SUBSIDIARY.

BENDERS 186

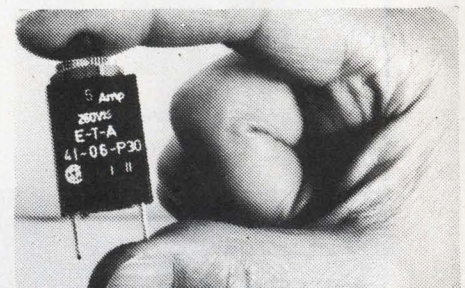

Overcurrent Protector, manual reset eliminates fuse replacement. Convenient panel mounting. 19 fractional ratings from 0.1 to 5 amp. Other models up to 400 amp. Trip-free and fool-proof, UL and CSA approved. High quality, low cost \$1.39 ea. in 1000 lots. E-T-A Products Co. of America, 7400 N. Croname Rd., Chicago, Ill. 60648. Tel: (312) 647-8303. Telex: 253780.

CIRCUIT BREAKER 189



MICRO DIGITAL OHMMETER. The 1700 series digital ohmmeter offers 4½-digit readout and your choice of plugin ohmmeters ranging from 1μΩ through 20 MΩ. Resolution below 20Ω is 1μΩ; above that 10μΩ. Auto-ranging. Automatic comparator and test fixture (both shown) optional. Total price equip. shown (low-ohm plugin): \$2155. Electro Scientific Industries, Portland, Oregon 97229

MICRO DIGITAL OHMMETER 190

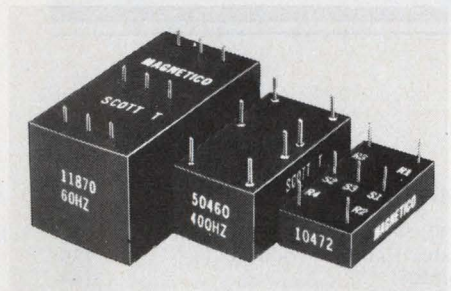

Scott T Transformer. 11870: 60HZ, 90v, L-L in. 1.1x2.1x1.1. 50460: 400 HZ, 90v, L-L in. 7/8x1-5/8x11/16. 50642: 400HZ, 11.8v, L-L in. 7/8x5/8-11/16. 10472: 400-HZ, 11.8v, L-L in. 3/4x1-1/2x3/8. All with 6v RMS sine & cosine output. MAGNETICO, INC., 182 Morris Ave., Holtsville, N.Y. 11742 516-654-1166.

TRANSFORMER 193

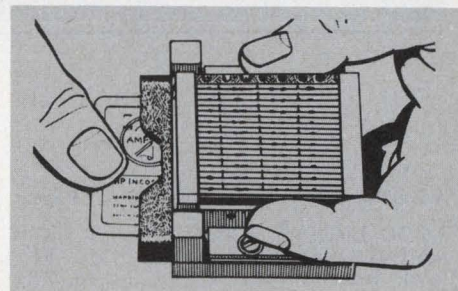

ELECTRONIC SECURITY AT LOCK AND KEY PRICES. The AMP 130 Security Card Reader. Ideal for large-volume access control. No external power. Operates with standard punched identification card. 80-data-bit capacity. Proven high reliability. Compact. Rugged. Withstands temperatures down to -40°F. Needs no adjustment or preventive maintenance. Call (717) 367-1105, or write AMP Incorporated, Capitron Division, Elizabethtown, PA 17022. AMP is a trademark of AMP Incorporated.

SECURITY CARD READER 196

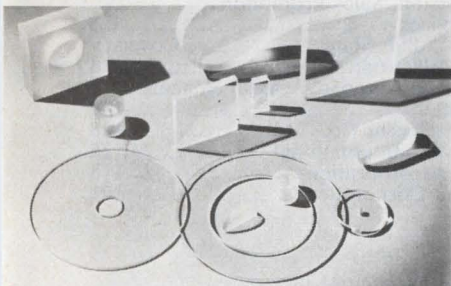

FREE 32 PAGE CATALOG. WINDOWS - PLATES - DISCS - OPTICS. Fused quartz, optical glasses, pyrex Ultra-low expansion materials, highly resistant to thermal shock. High UV and IR transmission. Chemically inert to most corrosive materials. Stocking center for lenses, prisms and laser accessories. Complete fabricating facilities. ESCO PRODUCTS, 181 Oak Ridge Rd., Oak Ridge, N.J. 07438. (201) 697-3700

LENSE, PRISM CATALOG 191



MEMODYNE INCREMENTAL LOW POWER DATA LOGGER Model 2221, is ideal for remote or unattended collection of sporadic measurements. Features 16 channels, 0 to +10 volt analog input, 12 bit resolution, over 2 megabit capacity per 300 foot cassette. Standby current is less than 50 microamps. Available for line or battery operation. Unit price is \$1670.00. Memodyne Corporation, 385 Elliott Street, Newton Upper Falls, Massachusetts, 02164. (617) 527-6600.

LOW POWER DATA LOGGER 194

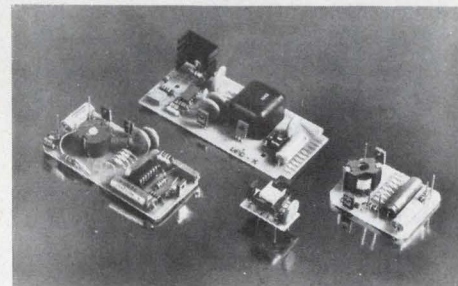

Activate gas discharge readouts! Custom designed and produced DC-to-DC power supplies to activate gas discharge displays, or for other applications. Regulation I/O options, packaging (encapsulated, aluminum shell or open frame), size and configuration, heat dissipation, mounting (PC board pins, edge connectors), etc., can be tailored to meet individual specifications. Price and delivery discussed after specifications are submitted. Endicott Coil Co., Inc., 31 Charlotte Street, Binghamton, N.Y. 13905 (607) 797-1263.

CUSTOM DESIGNED POWER SUPPLIES 197

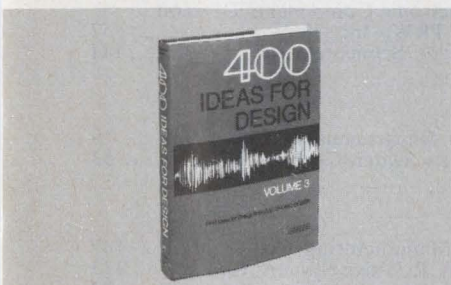

400 IDEAS FOR DESIGN, Volume 3, ed. by Morris Grossman. Brainstorm with the experts! Volume 3 of 400 IDEAS FOR DESIGN contains the best selections from *Electronic Design* that were published between 1971 and 1974. You'll find a wide range of ideas from very complicated to simple, but unique, approaches. #5111-5, 348 pp., \$13.95. Circle the Info Retrieval Number to order your 15-day exam copy. When billed, remit or return book with no obligation. Hayden Book Co., 50 Essex St., Rochelle Park, N.J. 07662.

IDEAS FOR DESIGN 192



NEW MINIATURE LOW COST PILOT LIGHT from Gould is available in full voltage increments from 6 to 120 volts, mounts in a 1" hole. This nonbreakable, noncorrosive unit is oiltight and watertight, comes with red, green or amber lenses, black or grey locking rings. Ideal for industrial electronic panels where quality and appearance are vital. Gould Inc.

MINIATURE PILOT LIGHT 195

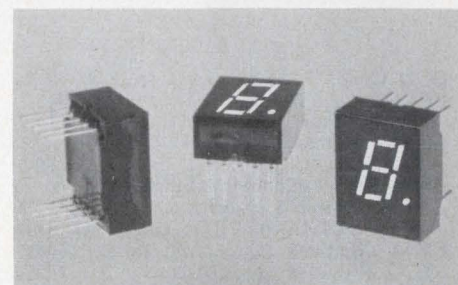

NEW .5" HIGH LED DISPLAYS FROM IEE Series 1786 thru 1789 consist of .5" (12.70mm) high, deep red characters, 0-9 with right hand decimal and ±1; available in common cathode and common anode with typical 600μcd/segment luminous intensity at 20mA/1.7V. Ten horizontal in-line pin connections on .1" spacing; socket or PC board mounting; Interchangeable with Fairchild Models FND500 and FND-507. Price \$1.15 ea in 500. quan. Shelf stocked. IEE, 7740 Lemona Ave., Van Nuys, CA 91405, (213) 787-0311, ext. 268.

.5" LED DISPLAYS 198

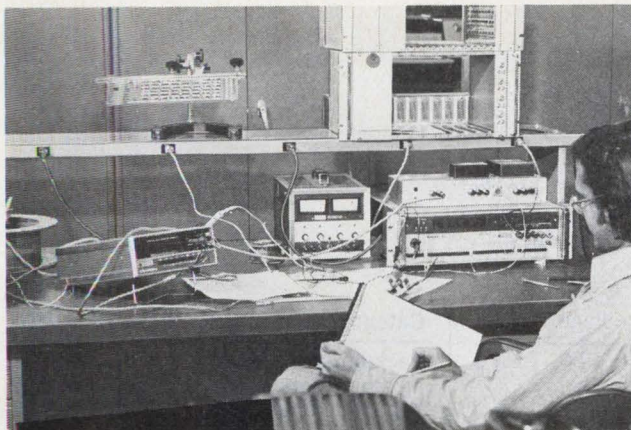

THE QUIET BUNCH

Specify Plugmold® multioutlet strips with noise reducing insulated/isolated grounding receptacles for your lab or test bench and eliminate problems with electromagnetic noise and spurious signals.

Easy to install, easy to use. Available in various lengths and receptacle centers.

For free information contact



THE WIREMOLD COMPANY
West Hartford, Connecticut 06110

CIRCLE NUMBER 124

**This low cost
10 amp relay
conserves
PC board
space**



... and look at all the other design advantages our 28H Series relay offers.

Our 28H Series SPDT relay has so much going for it, it's hard to know where to begin. First, it's mini-sized —occupies only .92 sq. in. board area x 1.188" high. Second, it comes with a dust cover as standard and is available with a choice of enclosure styles and terminals to suit your application. It's also sensitive... 176 mw pick-up. Best of all, its low cost meets or beats competitive prices. U/L recognized. 10 amp 0.8 PF 120V 60Hz or 28V dc resistive. 3 amp models also available.

Write for information today!

NORTH AMERICAN PHILIPS CONTROLS CORP.

Frederick, Md. 21701 • (301) 663-5141

**FOR IMMEDIATE NEED, CIRCLE 126
FOR INFORMATION ONLY, CIRCLE 175**

**FOR ELECTRONIC
EQUIPMENT ENCLOSURES**

**MACHINE TOOLS,
COMPUTERS, ELECTRONICS**

6,000 & 8,000 BTU

McLEAN INDUSTRIAL AIR CONDITIONERS

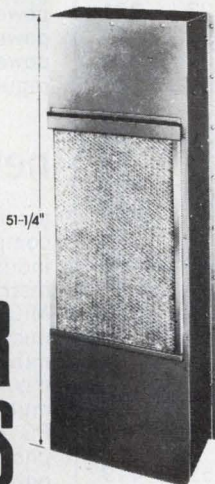

For "closed loop enclosures". Recirculates and cools internal air. Constant clean air in contact with electronics. Highest quality refrigeration and electrical components. 20,000 hours continuous duty in ambients to 125°F. High velocity cooling for maximum heat removal. Std. cabinet mounting. Quick installation. Factory-installed gaskets seal against induction of ambient, contaminated, or polluted air. 115 or 230 volts.

SEND FOR CATALOG

McLEAN McLEAN

ENGINEERING LABORATORIES

ENGINEERING MIDWEST

Princeton Junction, NJ 08550
609-799-0100 • Telex 84-3422

9560 Eighty-Fifth Ave. N.
Maple Grove, MN 55369 • 612-425-4747

CIRCLE NUMBER 125

ELECTRONIC DESIGN 6, March 15, 1977

Big Little DMM

You get bench-size accuracy and performance with our new, hand held, 3½-digit VOM. It's in a class by itself.

- Highly readable, field-effect LCD
- Semi-autoranging
- Fast, accurate response
- Small size, battery operated (ac optional)
- Low power consumption
- Built-in overload protection

See it at your VIZ distributor

VIZ Test Instruments Group of VIZ Mfg. Co.

335 E. Price St.
Phila. PA 19144



**WD-751A
\$179.00**

© VIZ
6721

Formerly
RCA
Instruments

CIRCLE NUMBER 127

147

Product Index

Information Retrieval Service. New Products, Evaluation Samples (ES), Design Aids (DA), Application Notes (AN), and New Literature (NL) in this issue are listed here with page and Reader Service numbers. Reader requests will be promptly processed by computer and mailed to the manufacturer within three days.

Category	Page	RSN	Category	Page	RSN	Category	Page	RSN
Components			zeners	114	70	Packaging & Materials		
attenuator pad	134	361	Instrumentation			air conditioners	147	125
audio indicators	60	44	amplifier, wideband	132	102	bus connector	101	61
capacitors	129	97	amplifiers	132	359	bushings, strain relief	139	115
capacitors	6	4	BERT set	132	357	cabinets and cases	134	108
capacitors	135	363	catalog, digital counter	132	104	cable	130	349
capacitors, chip	55	39	catalog, X-Y recorder	118	76	connectors	11	10
catalog, components	118	79	C-meter	109	67	connectors	42	31
circuit breaker	128	94	DMM	147	127	connectors and contacts	20	18
circuit breakers	39	29	DPMS	27	21	DIP socket	130	352
coils	49	36	DVM	132	358	electronic glass	48	35
controls, PB	53	38	function generator	132	356	enclosures	121	83
film resistor kit	131	101	logic state analyzer	29	22	flat cable assembly	130	348
filters	55	40	microwave counter	117	75	instrument cases	131	355
inductors	57	41	power amplifier	102	62	insulation, heat-shrunk	130	351
keyboard	135	362	pyrometer, digital	126	90	investment casting	136	112
potentiometers	133	105	recorders	128	96	knobs	118	77
quartz crystals	131	100	recorders, oscillographic	123	86	lens and LED mounts	93	58
relay, solid-state	134	360	recorders, strip-chart	12	11	screen printer	131	353
relay, 10-A	147	126	spectrum analyzer	137	113	storage trays	130	350
relays	112	69	timebase display	10	9	strips, multioutlet	147	124
relays	138	114	Integrated Circuits			Power Sources		
resistors	133	106	amp, dual op	124	333	batteries, lead-acid	139	117
solenoids	105	65	amplifier, dual	123	332	power supplies	23	19
stepper motors	133	103	amplifier, operational	123	331	power supplies	87	57
switch, DIP	75	50	chips	31	23	power supply	103	63
switches	7	5	circuit, timekeeping	124	334	power supply, dc	130	99
switches	15	180	converter, a/d	61	46	power supply, dc	126	340
switches	33	24	converters, multiplying	124	335	power supply, dc	126	341
switches	36	26	counter, multidecade	125	339	power supply, dc	127	344
switches	46	33	HiNIL	111	68	regulator, ac line	126	342
switches	80	52	i-f, video	124	336	new literature		
switches	85	54	line driver, dual	125	337	arc lamp power supply	137	383
switches	85	55	memories	17	15	components	138	392
switches, DIP	115	71	op-amps	IV	248	industrial controllers	138	390
switches, PB	13	12	RAMs, static	47	34	instrumentation recorder	137	381
switches, PB	45	32	sensors, image	125	338	MIC components	138	388
switches, PB	128	93	Microprocessor Design			microcomputers	137	380
switches and relays	19	17	assembler, μ P	52	418	minicomputer	138	397
switches and relays	143	122	circuits, 8080 support	56	422	moving-coil meters	138	396
switches, keyboard	60	45	microprocessors	5	8	multipin connectors	138	398
switches, rotary	125	89	multiplexer, 16 channel	52	419	PC connectors	138	394
switches, rotary	139	116	notebook, computer	51	417	photodiodes	138	389
switches, slide	116	73	tool, programming	54	421	power supplies	137	382
switches, thumbwheel	77	51	Modules & Subassemblies			rack, panel connectors	137	385
switches, toggle	81	53	converter, a/d	116	74	semiconductors	138	386
switches, toggle	116	72	converter, a/d	119	323	sheet stock and foil	138	391
thermal cutoff	96	59	converter, d/f	119	324	solid-state relays	138	395
Data Processing			converter, polar X-Y	117	320	test equipment	138	387
customer service			diskette system	122	329	thick-film circuits	138	393
brochure	122	84	display, incandescent	116	310	video equipment	137	384
disc drives	86	56	divider, HV	116	309	application notes		
floppy disc	121	325	meter gas flow	115	308	Impatt diodes	136	366
printer	135	109	multiplexer	117	321	passive filters	136	367
printer/plotter PCB	121	327	programmer, PROM	120	301	Q standards	136	368
RAM card	122	328	rack assembly PC board	131	354	spectrum analyzers	136	369
telephone, memory	122	330	relay, time delay	117	322	v/f and f/v converters	136	365
terminal, portable	121	326	synthesizer, vhf	114	307	vector voltmeters	136	364
Discrete Semiconductors								
Darlington	129	346						
photodetectors and LEDs	123	85						
transistor, power	129	347						
zener protectors	129	345						

THE MOLEX 4850 IS THE MOST VERSATILE FLAT CONDUCTOR CONNECTOR TODAY!

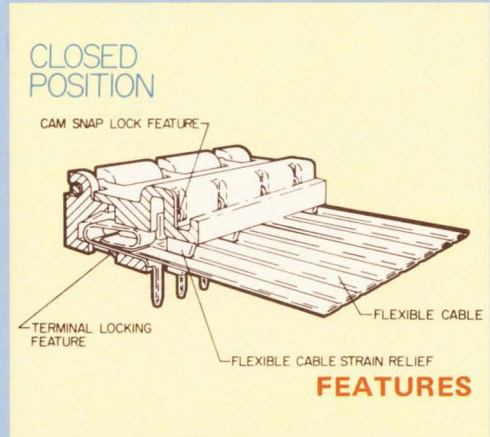
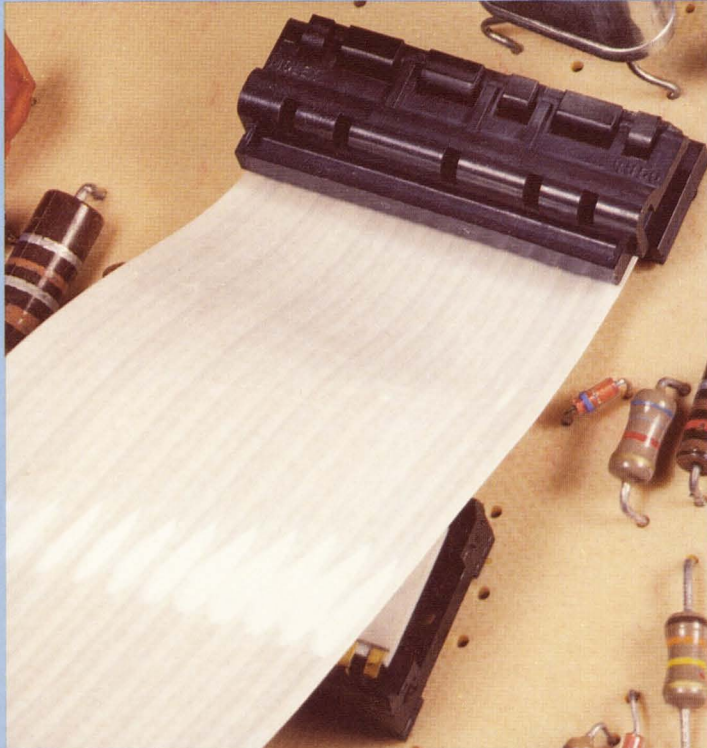

MOLEX 4850 FEATURES

- High reliability.
- Designed for cable or flexible etched circuits.
- Zero insertion/extraction force.
- Unique two-piece housing with a snap-on hinge cam.
- Numerous insertion and withdrawals without damage to plating or flat conductors.
- Strain relief.
- Connector locks to printed board for soldering and use.
- Eliminates soldering to flat conductor cables or circuitry.
- Available in 5 through 25 circuit sizes, inclusive.
- 94V-O, U.L. rated, polyester.
- Simple assembly, no learning curve.
- Tin or gold-plated solder tail terminals.

Another example of Molex "Affordable Technology". For complete details and options available call (312) 969-4550 or write MOLEX INCORPORATED, 2222 Wellington Court, Lisle, Illinois 60532.

molex [®] ... Affordable Technology

New compensated op amp...

BiMOS scores again. Low V_{IO} , low drift, at a low price.



The RCA CA3160: latest proof that BiMOS is today's op amp technology. It has the lowest drift ever available in a low price general purpose op amp: $6 \mu\text{V}/^\circ\text{C}$.

Low enough for 95% of all op amp applications. It has V_{IO} of only 2 mV typical (CA3160A). Ultra-low input current: 2 pA typical. And on-chip compensation.

All this is on top of the other features that have made BiMOS op amps so universally applicable.

Features like very high input impedance: 1.5 T Ω . Rail-to-rail voltage swing. High common-mode

capability: the CA3160 can differentially follow input signals ranging from 3.0 V below the positive supply voltage down to 0.5 V below the negative supply rail. Which can eliminate the need for a dual \pm supply.

Yet the remarkable CA3160 costs a lot less than performance-competitive op amps. Thanks to RCA experience. And the inherently simple manufacturability of BiMOS.

Get the op amp with premium characteristics without paying a premium price. Contact your RCA Solid State distributor.

Or RCA.

Write: RCA Solid State, Box 3200 Somerville, NJ 08876; Sunbury-on-Thames, Middlesex TW16 7HW, England; Ste.-Anne-de-Bellevue, Quebec, Canada; Fuji Bldg., Tokyo, Japan.

**RCA Linear IC
experience is
working for you**

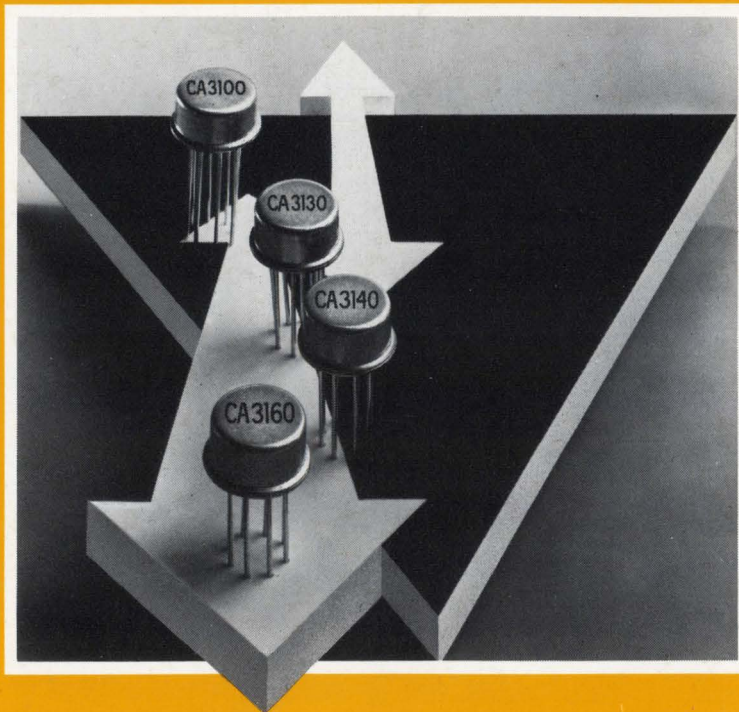

RCA