

# ELECTRONIC DESIGN

APRIL 16, 1992

FOR ENGINEERS AND ENGINEERING MANAGERS—WORLDWIDE

## REGULATOR IC CUTS LAPTOP-BATTERY CURRENT DRAIN

A PENTON PUBLICATION  
U.S. \$10.00

40  
YEARS  
OF EDITORIAL  
EXCELLENCE

- **SPECIAL REPORT:**  
**HIGH-RESOLUTION  
IC DACS**
- **EXPAND VOLTAGE  
REFERENCES BY  
BOOTSTRAPPING**
- **PC DESIGN SECTION**

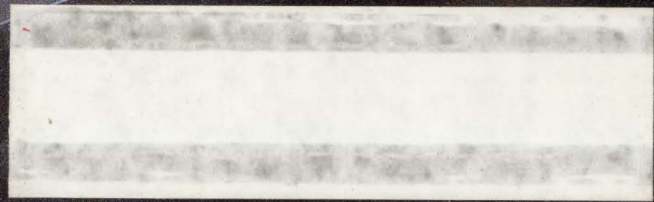

QUICKLOOK

# 1 $\mu$ A SINGLE SUPPLY OP AMPS SWING RAIL-TO-RAIL

## Sources 2mA and Drives Capacitive Loads

Maxim's new MAX406/407/409 are the lowest power op amps available anywhere, requiring a maximum supply current under 1.2 $\mu$ A per amplifier-leakage current in most battery-powered applications. The output swings rail-to-rail while the input voltage range extends to the negative supply rail and only 1.1V from the positive rail.

- ◆ **1.2 $\mu$ A Max Supply Current**
- ◆ **+2.5V to +10V Single Supply Range**
- ◆ **Output Swings Rail-to-Rail**
- ◆ **Input Range Includes Negative Rail**
- ◆ **0.5mV Max Offset Voltage (MAX406A)**
- ◆ **150kHz Gain Bandwidth (MAX409)**
- ◆ **<0.1pA Input Bias Current**
- ◆ **MAX407 (Dual) in 8-Pin DIP/SO**

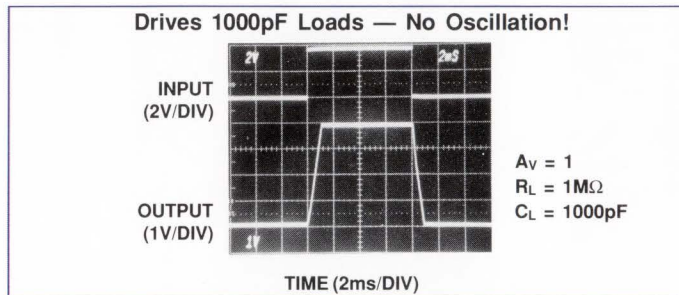

These CMOS op amps are extremely stable without external compensation while driving heavy capacitive loads in excess of 1000pF!

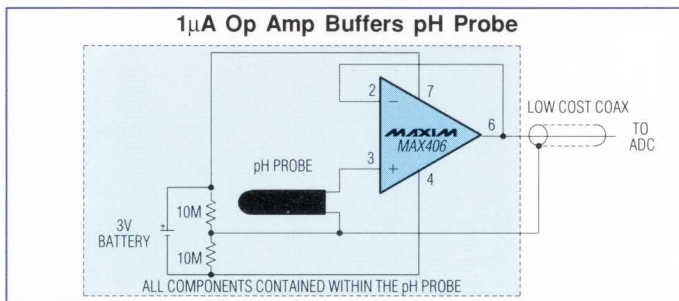

MAX406 as a pH probe buffer eliminates expensive low leakage cable ( $I_B < 0.1pA$ ) while battery life exceeds the probe life (1 $\mu$ A supply current).

## Choose the Lowest Power Op Amps

Device	Op Amps per Pkg	Supply Current per Amp ( $\mu$ A) max	$V_{OS}$ (mV) max	$I_B$ (pA)	Bandwidth (kHz)	Input Voltage Range ( $V_+ = 5V, V_- = GND$ )	Rail-to-Rail Output	Price <sup>†</sup>
MAX406	1	1.2	0.5	<0.1	40	GND to +3.9V	Yes	\$2.50
MAX407	2	1.2	3	<0.1	8	GND to +3.8V	Yes	\$2.95
MAX409*	1	1.2	0.5	<0.1	150	GND to +3.9V	Yes	\$2.50

**OPAMPS** ANALOG DESIGN GUIDE

Circle 160 for U.S. Response

**1 $\mu$ A Op Amp Extends Battery Life 15X**  
Output Swings Rail-to-Rail. Drives 2000 Times Supply Current.

**Lowest Noise & Drift, Highest Gain Op Amps**  
Noise Capping: 300nV/√Hz Noise, 0.005V/°C Drift, 190dB Gain

Circle 161 for U.S. Response

## FREE Op Amp Design Guide

Includes: Application Notes ◆ Data Sheets ◆ Cards For Free Samples  
To receive your design guide, circle the response number, or contact Maxim Integrated Products, 120 San Gabriel Dr., Sunnyvale, CA 94086, (408) 737-7600, FAX (408) 737-7194.

# MAXIM

CIRCLE 160 FOR U.S. RESPONSE

CIRCLE 161 FOR U.S. RESPONSE

Distributed by Arrow, Bell/Graham, Elmo, Hall-Mark, Nu Horizons, Pioneer, and Wyle. Authorized Maxim Representatives: Alabama, (205) 830-0498; Arizona, (602) 730-8093; California, (408) 248-5300, (619) 278-8021, (714) 261-2123; (818) 704-1655; Colorado (303) 779-8060; Connecticut, (203) 384-1112; Delaware, (609) 778-5353; Florida, (305) 426-4601, (407) 830-8444; Georgia, (404) 447-6124; Idaho, (503) 292-8840; Illinois, (708) 358-6622; Indiana, (317) 844-8462; Iowa, (319) 393-2232; Kansas, (816) 436-6445; Louisiana, (214) 234-8438; Maryland, (301) 644-5700; Massachusetts, (617) 329-3454; Michigan, (313) 352-5454; Minnesota, (612) 941-9790; Mississippi, (205) 830-0498; Missouri, (314) 839-0033, (816) 436-6445; Montana, (503) 292-8840; Nebraska, (816) 436-6445; Nevada, (408) 248-5300; New Hampshire, (617) 329-3454; New Jersey, (516) 351-1000, (609) 778-5353; New Mexico, (602) 730-8093; New York, (516) 351-1000, (607) 754-2171; N. Carolina, (919) 851-0010; Ohio, (216) 659-9224, (513) 278-0714, (614) 895-1447; Oklahoma, (214) 234-8438; Oregon, (503) 292-8840; E. Pennsylvania, (609) 778-5353; W. Pennsylvania, (614) 895-1447; S. Carolina, (919) 851-0010; Tennessee, (404) 447-6124; Texas, (214) 234-8438, (713) 782-4144, (512) 346-9186; Utah, (801) 561-5099; Virginia, (301) 644-5700; Washington, (206) 823-9535; W. Virginia, (513) 278-0714; Wisconsin, (414) 476-2790; Canada, (416) 238-0366, (613) 225-5161, (604) 439-1373, (514) 337-7540.

\*Available June 1992. <sup>†</sup>1000-up recommended resale, excludes freight and duty.

Maxim is a registered trademark of Maxim Integrated Products. © 1992 Maxim Integrated Products.



**NEW & NOW**

**SUN SPARCengine™2**  
Embedded SunOS Host  
(in Swing-Away housing)

**IRONICS GALAXY 32+™**  
SunOS and Real-Time  
VMEbus Development/  
Target System

## Real Sun. Real-Time. Real Tough!

The *GALAXY 32+* combines the heart of a Sun Workstation™ with the power of a VMEbus Real-Time Multiprocessing System. You get all the speed of a system where host and target share the same backplane...with none of the headaches.

**A Complete Rugged Workstation —** SunOS, color frame buffer and monitor, keyboard, and mouse PLUS:

**40 MHz SPARCengine 2 —** Sun's own powerplant within the *GALAXY 32+* ensures 100% SunOS compatibility.

**Fast SBus to VMEbus Bridge —** links and safely buffers SunOS from the real-time target debug process.

**Real-Time VMEbus Target Options —** a full line of compute, imaging, and I/O engines.

**VxWorks™ or pSOS+™ Options —** the best SunOS compatible real-time software environments.

**20-Slot ICEBOX™ —** the ultimate VME enclosure optimized for accessibility, power, and cooling.

**Call our VME Product Hotline Today. 1-800-334-4812**



IRONICS Incorporated  
798 Cascadilla Street  
Ithaca, New York 14850 USA

607-277-4060  
Fax 607-272-5787



Value  
Added  
Reseller

All brands or products are trademarks of their respective holders.

CIRCLE 268 FOR U.S. RESPONSE

CIRCLE 269 FOR RESPONSE OUTSIDE THE U.S.

# Low Delays.

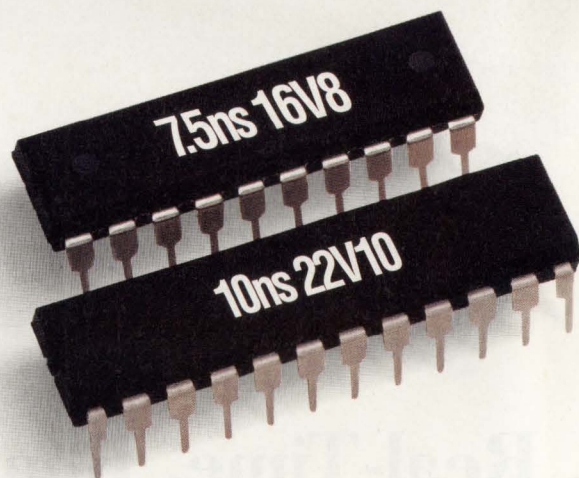

## High-Speed 7.5ns CMOS PAL® Devices.

There's nothing we hate more than delays. That's why we developed high speed CMOS PAL devices that no one can beat—our CMOS 7.5ns 16V8H-7 and 10ns 22V10H-10 PAL devices.

In fact, nobody even comes close to our in-system performance, with the fastest set-up

and clock-to-out times available. Both come in PLCC and DIP varieties. All on state-of-the-art submicron EE CMOS.

## High-Volume, High-Speed Delivery.

Again, there's nothing we hate more than delays. You can get huge volumes of our new CMOS PAL devices now.

And they're on the shelf at your local dis-

# No Delays.



tributor, too. So you can get the quantity and speed you need, whenever you need them.

What more can you expect from the company that sells more programmable logic than all of its competitors combined?

So pick up the phone and place your order today, or call **1-800-222-9323** for more information.

Because at AMD, we don't believe in long delays either.



## Advanced Micro Devices

901 Thompson Place, P.O. Box 3453, Sunnyvale, CA 94088 © 1991 Advanced Micro Devices, Inc. PAL is a registered trademark of Advanced Micro Devices. All brand or product names mentioned are trademarks or registered trademarks of their respective holders.

CIRCLE 84 FOR U.S. RESPONSE

CIRCLE 85 FOR RESPONSE OUTSIDE THE U.S.

# ELECTRONIC DESIGN

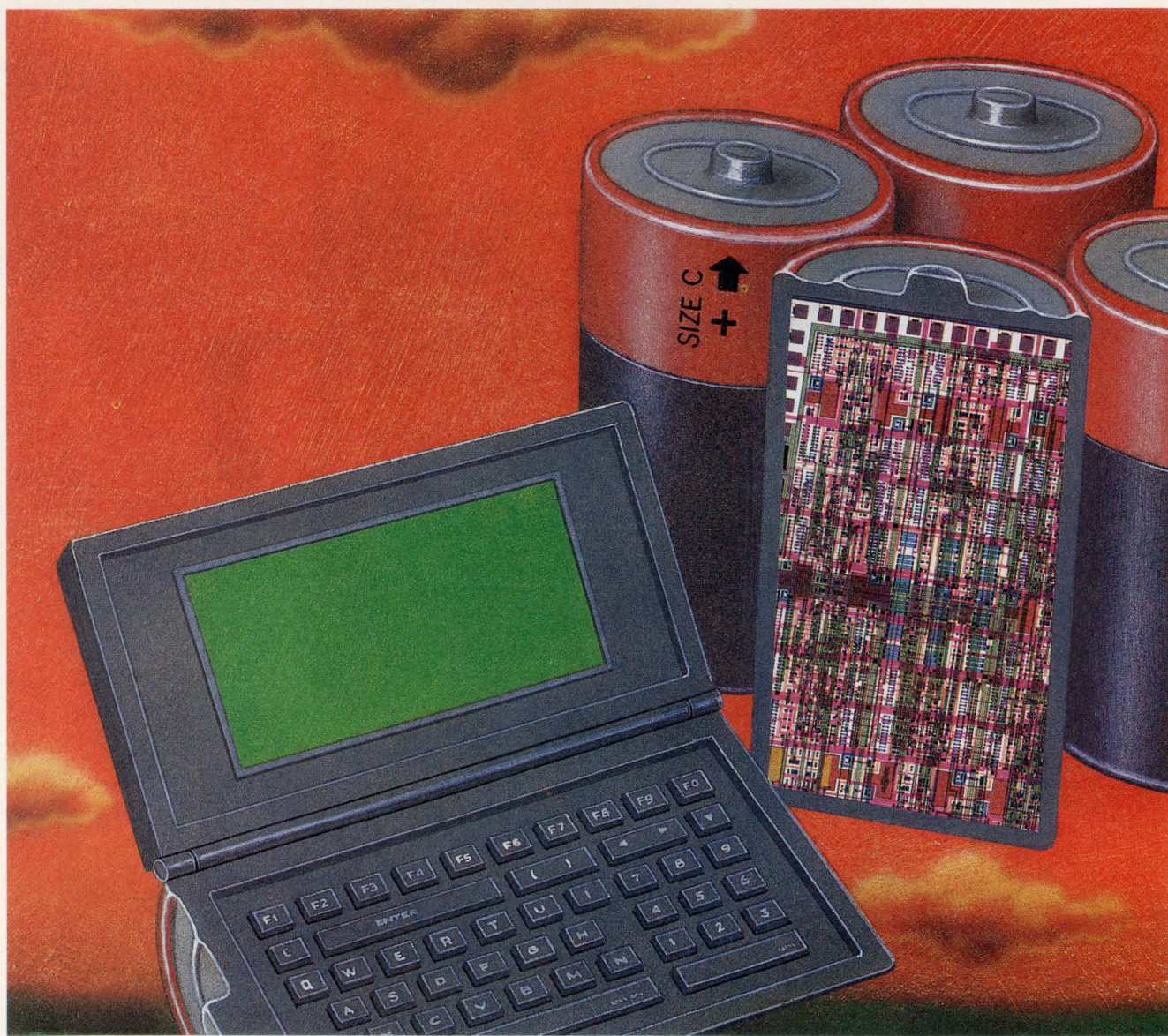

**COVER FEATURE** **47 SYNCHRONOUS RECTIFIER UPS PC BATTERY LIFE**

A tiny IC steps up, steps down, regulates, and controls the battery drain in portable PCs, and laboratory and medical instruments.

**ELECTRONIC DESIGN REPORT** **55 DIGITAL AUDIO DRIVES 14-TO-20-BIT DAC DESIGNS**

Innovative designs for audio hint at future 16-to-20-bit DACs with more than 16-bit dc accuracy.

**DESIGN APPLICATIONS** **75 OP AMPS EXPAND VOLTAGE REFERENCE OPTIONS**

Bootstrap feedback adds polarity and magnitude options to conventional dc-voltage references.

**PRODUCT INNOVATION** **127 RAIL-TO-RAIL OP AMPS USE DEPLETION-MODE PMOSFETS**

CMOS op amps not only swing their outputs to both rails, but also handle + and - common-mode input voltages beyond them.

**14 EDITORIAL**

**18 TECHNOLOGY BRIEFING**

A decade of SCSI

**25 TECHNOLOGY NEWSLETTER**

- First 486-compatible fits 386SX pinout
- Fiber-optic system bridges 200-km distance
- CVD grows BaTiO<sub>3</sub> film on semiconductors
- Single chip compresses data locally
- Consortium backs PA-RISC architecture
- 20-second analog EEPROM finds a home
- Computing agreements to aid DOE research
- Sub-2-in. disk drives pack up to 85 Mbytes

**32 TECHNOLOGY ADVANCES**

- Improved spectrogram algorithm boosts throughput, increases resolution
- FDDI moves to the desktop on twisted-pair lines
- Deep-etch lithography yields 0.5-mm diameter motors
- Simple serial bus eases PC-peripherals interconnect

**93 IDEAS FOR DESIGN**

- Ac-dc converter runs off one supply
- Give TTL gates 3-state outputs
- Make local/remote switching simpler

**96 QUICK LOOK**

- Despite defense cutbacks, night-vision equipment market targets growth
- Skunk works require rigorous trust
- The inherent complexity of developing next-generation products
- Offers you can't refuse

**97 PEASE PORRIDGE**

Bob's Mailbox

**PC DESIGN SPECIAL SECTION**

- 102 PC Design Newsletter
- 103 PC Graphics Watch
- 104 Evaluating the communications performance of your next board design
- 118 PC Design Products

**NEW PRODUCTS**

- 131 Computer-Aided Engineering
- 134 Digital
- 138 Instruments
- 143 Computers & Peripherals
- 145 Communications
- 147 Analog
- 148 Power
- 150 Software

**159 INDEX OF ADVERTISERS**

**161 READER SERVICE CARD**

**COMING NEXT ISSUE**

- **Special Report:** A five-part preview of the Custom Integrated Circuits Conference:
  - CMOS in mixed-signal designs
  - Dense digital ICs
  - Mixed-signal testing
  - EDA software
  - Communications ICs
- Maintain signal fidelity at high digital speeds
- First details on a new architecture for octal DACs
- New mixed-signal cells for ASIC design
- Intelligent software aids pc-board development
- Field-programmable interconnects speed breadboarding
- **PLUS:** Ideas for Design  
Pease Porridge  
Technology Advances  
Quick Look

ELECTRONIC DESIGN (USPS 172-080; ISSN 0013-4872) is published semi monthly except for 3 issues in May and 3 issues in November by Penton Publishing Inc., 1100 Superior Ave., Cleveland, OH 44114-2543. Paid rates for a one year subscription are as follows: \$95 U.S., \$175 Canada, \$255 International. Second-class postage paid at Cleveland, OH, and additional mailing offices. Editorial and advertising addresses: ELECTRONIC DESIGN, 611 Route #46 West, Hasbrouck Heights, NJ 07604. Telephone (201) 393-6060. Facsimile (201) 393-0204.

Printed in U.S.A. Title registered in U.S. Patent Office. Copyright © 1992 by Penton Publishing Inc. All rights reserved. The contents of this publication may not be reproduced in whole or in part without the consent of the copyright owner.

Permission is granted to users registered with the Copyright Clearance Center Inc. (CCC) to photocopy any article, with the exception of those for which separate copyright ownership is indicated on the first page of the article, provided that a base fee of \$1 per copy of the article plus \$.50 per page is paid directly to the CCC, 27 Congress St., Salem, MA 01970 (Code No. 0013-4872/92 \$1.00 + .50). (Can. GST # R126431964) Copying done for other than personal or internal reference use without the express permission of Penton Publishing, Inc. is prohibited. Requests for special permission or bulk orders should be addressed to the editor.

For subscriber change of address and subscription inquiries, call (216) 696-7000.

POSTMASTER: Please send change of address to ELECTRONIC DESIGN, Penton Publishing Inc., 1100 Superior Ave., Cleveland, OH 44114-2543.



Jesse H. Neal Editorial Achievement Awards:  
 1967 First Place Award  
 1968 First Place Award  
 1972 Certificate of Merit  
 1975 Two Certificates of Merit  
 1976 Certificate of Merit  
 1978 Certificate of Merit  
 1980 Certificate of Merit  
 1986 First Place Award  
 1989 Certificate of Merit  
 1992 Certificate of Merit

# While you've been pushing the limits of digital devices,

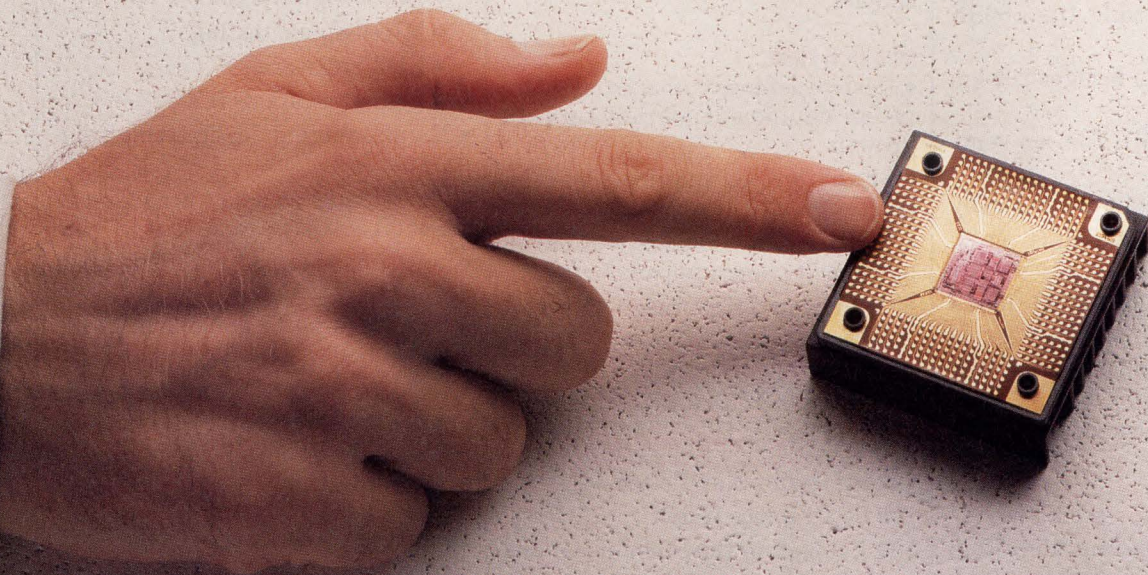

**HP's specially designed per-pin architecture makes high-performance testing an economic reality.**

The HP 83000 Model F660 Digital Test System uses specially designed multi-chip modules to give you the performance you need to fully characterize designs on anything from GaAs to CMOS. With 50 ps accuracy. Speeds to 660 MHz. And up to 1024 chan-



*The HP 83000 Digital Test System for both engineering and production applications.*

nels with true tester-per-pin architecture.

CAE links, automatic test functions, and software tools make test set up fast and characterization thorough. And there's one PMU for every 16 channels, for faster dc testing and greater throughput.

Yet, the HP 83000's highly integrated, modular electronics bring you all this performance at a cost that's less than tradi-



# we've been pushing the limits of testing.

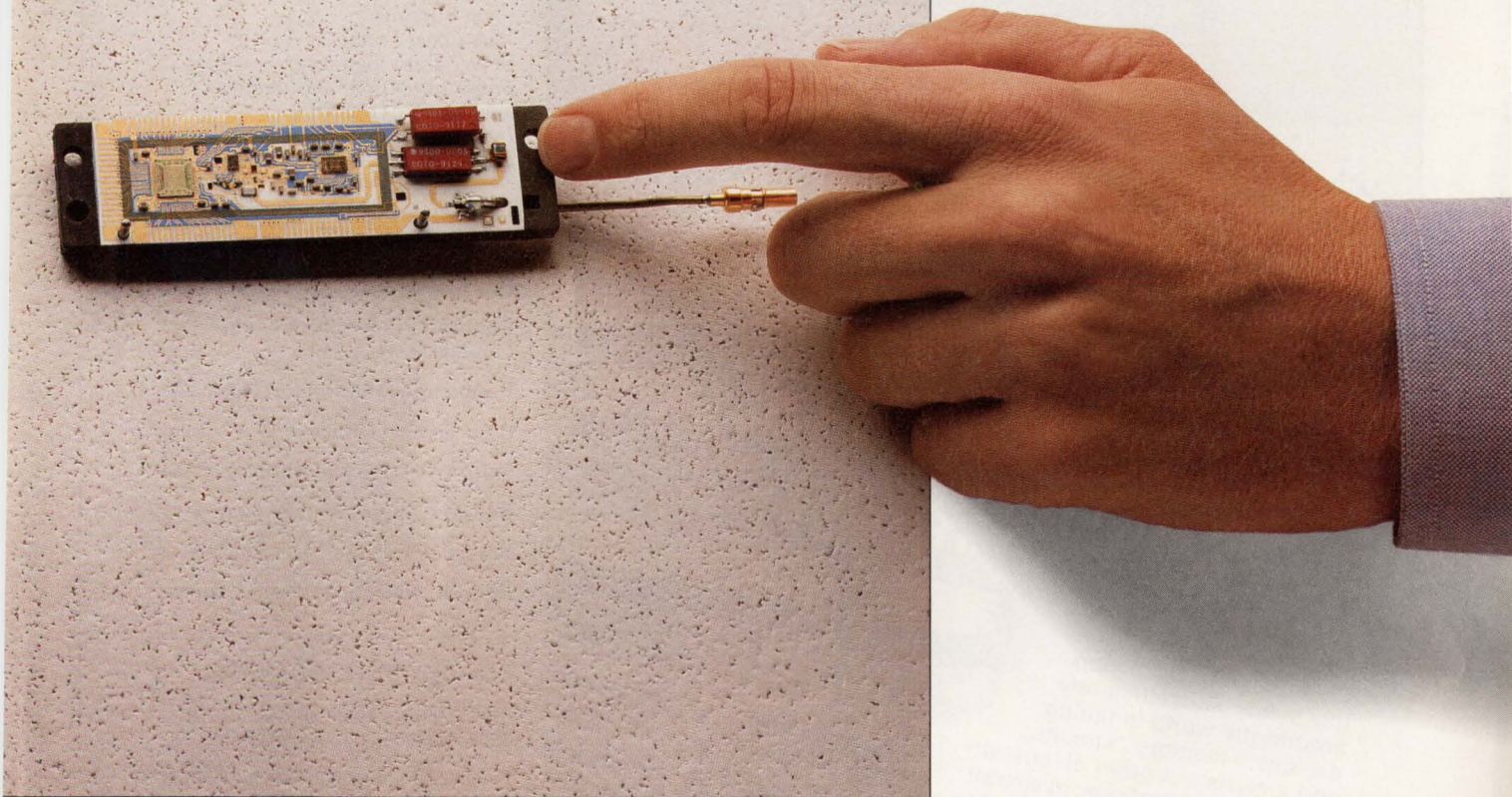

© 1992 Hewlett-Packard Co. TMBID136/ED

tional ATE systems. And since they make the footprint smaller and upgrading easier, cost of ownership is lower, too. In fact, every technical aspect of the HP 83000 system was designed with the best combination of performance and cost efficiency in mind.

So, if you're pushing the performance of digital devices, call **1-800-452-4844\***. Ask for **Ext. 2898**, and we'll send you infor-

mation that explains how the HP 83000 lets you test them to their limits.

There is a better way.



\* In Canada call 1-800-387-3867, Dept. 432.

CIRCLE 136 FOR U.S. RESPONSE

CIRCLE 137 FOR RESPONSE OUTSIDE THE U.S.

# SCSI PORTABLE ANALYZER

- SCSI 1 & 2
- FAST & WIDE
- Single-Ended or Differential (optional)
- Tracing over 10 MHz with 20 nanosec time stamp resolution



Open the case, provide power and it's ready to use!  
Call today for product information

**ANCOT**  
CORPORATION

(415) 322-5322 Fax: (415) 322-0455

115 Constitution Drive, Menlo Park, CA 94025 USA

CIRCLE 98 FOR U.S. RESPONSE

CIRCLE 99 FOR RESPONSE OUTSIDE THE U.S.

## BEI THE LITHIUM POWER SOURCE

When requirements demand high energy density lithium batteries specify BEI

BEI batteries are functioning safely and efficiently around the world in timing devices, memory circuits, and a myriad of other electrical/electronic applications; in aircraft radar and jet engine monitoring equipment; and in devices requiring high energy sources. They remain hermetic and operable at temperatures ranging from  $-55^{\circ}\text{C}$  to  $+200^{\circ}\text{C}$ .

When your application calls for a stable, dependable energy source with predictable performance characteristics, BEI lithium/thionyl chloride batteries are the solution. BEI manufactures standard and custom-designed lithium cells and battery packs for a wide range of applications.

For more information, call/FAX for our FREE brochure.

**BEI BATTERY ENGINEERING, INC.**

1636 Hyde Park Avenue • Hyde Park, Mass. 02136 • 617-361-7555 • FAX: 617-361-1835

• Performance • Safety • Power • Reliability

CIRCLE 104 FOR U.S. RESPONSE

CIRCLE 105 FOR RESPONSE OUTSIDE THE U.S.

## ELECTRONIC DESIGN

Editor-in-Chief: Stephen E. Scrupski

Executive Editor: Roger Allan

Managing Editor: Bob Milne

Senior Editors: Frank Goodenough, Milt Leonard, John Novellino

### Technology Editors:

Analog & Power: Frank Goodenough

Communications & Industrial:

Milt Leonard (San Jose)

Components & Packaging: David Maliniak

Computer-Aided Engineering:

Lisa Maliniak

Computer Systems: Richard Nass

Semiconductors: Dave Bursky (San Jose)

Software: Sherrie Van Tyle

Test & Measurement: John Novellino

### Field Bureaus:

West Coast Executive Editor:

Dave Bursky (San Jose)

Communications & Industrial:

Milt Leonard (San Jose)

Dallas: Jon Campbell

Frankfurt: John Gosch

London: Peter Fletcher

Chief Copy Editor: Roger Engelke, Jr.

### Contributing Editors:

Ron Kmetovicz, Robert A. Pease

### Editorial Production Manager:

Lisa Iarkowski

Production Coordinator: Pat A. Boselli

Associate Art Director: Tony Vitolo

Staff Artist/Designer: Tom Pennella

Editorial Support Supervisor: Mary James

Editorial Assistant: Ann Kunzweiler

Editorial Secretary: Bradie Guerrero

Editorial Offices: (201) 393-6262

### Advertising Production:

(201) 393-6093 or FAX (201) 393-0410

Production Manager: Michael McCabe

Production Assistants:

Donna Marie Bright, Lucrezia Hlavaty,

Eileen Slavinsky

Circulation Manager: Robert Clark

Marketing Communications Manager:

Clifford Meth

Reprints: Helen Ryan 1-800-835-7746

Group Art Director: Peter K. Jeziorski

Published by Penton Publishing

Vice President-Editorial: Perry Pascarella

Publisher: Paul C. Mazzacano

# When Time Is Money ... Tektronix QuickCustom™ ASICs

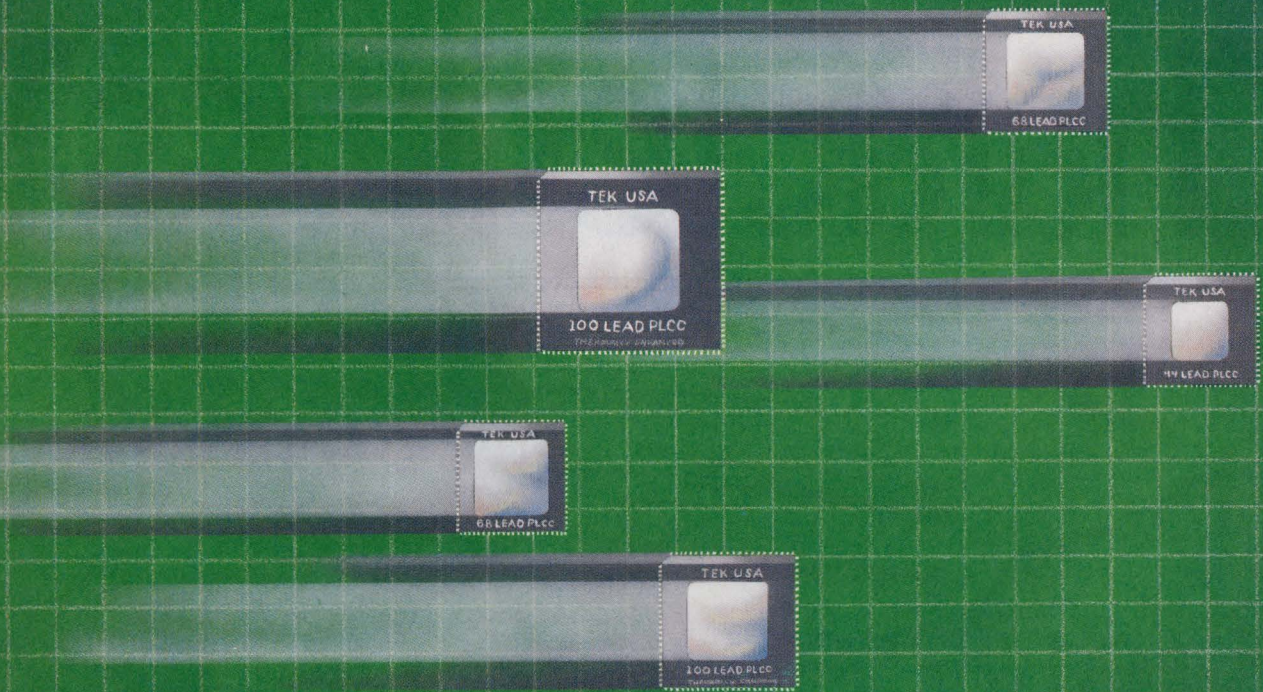

**QuickCustom™** ASIC design methods from Tektronix provide convenient access to high performance bipolar technology. There are three effective design methods offered on the SHPi process with 8.5 GHz NPNs, Schottky diodes, JFETs, thin-film resistors, and PNPs. ♦ **QuickChip™ 6** semicustom analog arrays offer the fastest, lowest risk route between concept and finished product. ♦ Higher performance and greater flexibility are possible using the building block approach of **QuickTiles™**. Integration of mixed signal ASICs is fast using the digital cell library. ♦ **Full custom** design provides optimum performance and minimum die size.

**Tektronix now introduces the QuickChip™ 7 mixed analog-digital array** using a new, higher performance technology, GST-1. This high-density, 12 GHz process is Tektronix'

most advanced bipolar technology. Fiber optic telecommunications transceivers and high-speed mixed-signal applications are quickly implemented on the QuickChip 7 semicustom array.

QuickCustom design methods from Tektronix include the specialized design tools, accurate device modeling and experienced technical support necessary to develop ASICs quickly and without error. Even first time ASIC designers are successful.

When time and performance are critical, choose QuickCustom from Tektronix. For more information, please circle the reader number, call 800-835-9433 extension "100," or FAX your request to 503-627-5560.

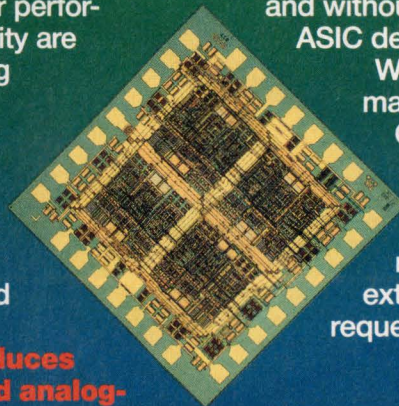

## Tektronix

Test and Measurement  
CIRCLE 230 FOR U.S. RESPONSE

CIRCLE 231 FOR RESPONSE OUTSIDE THE U.S.

# It Takes Some Characteristics To

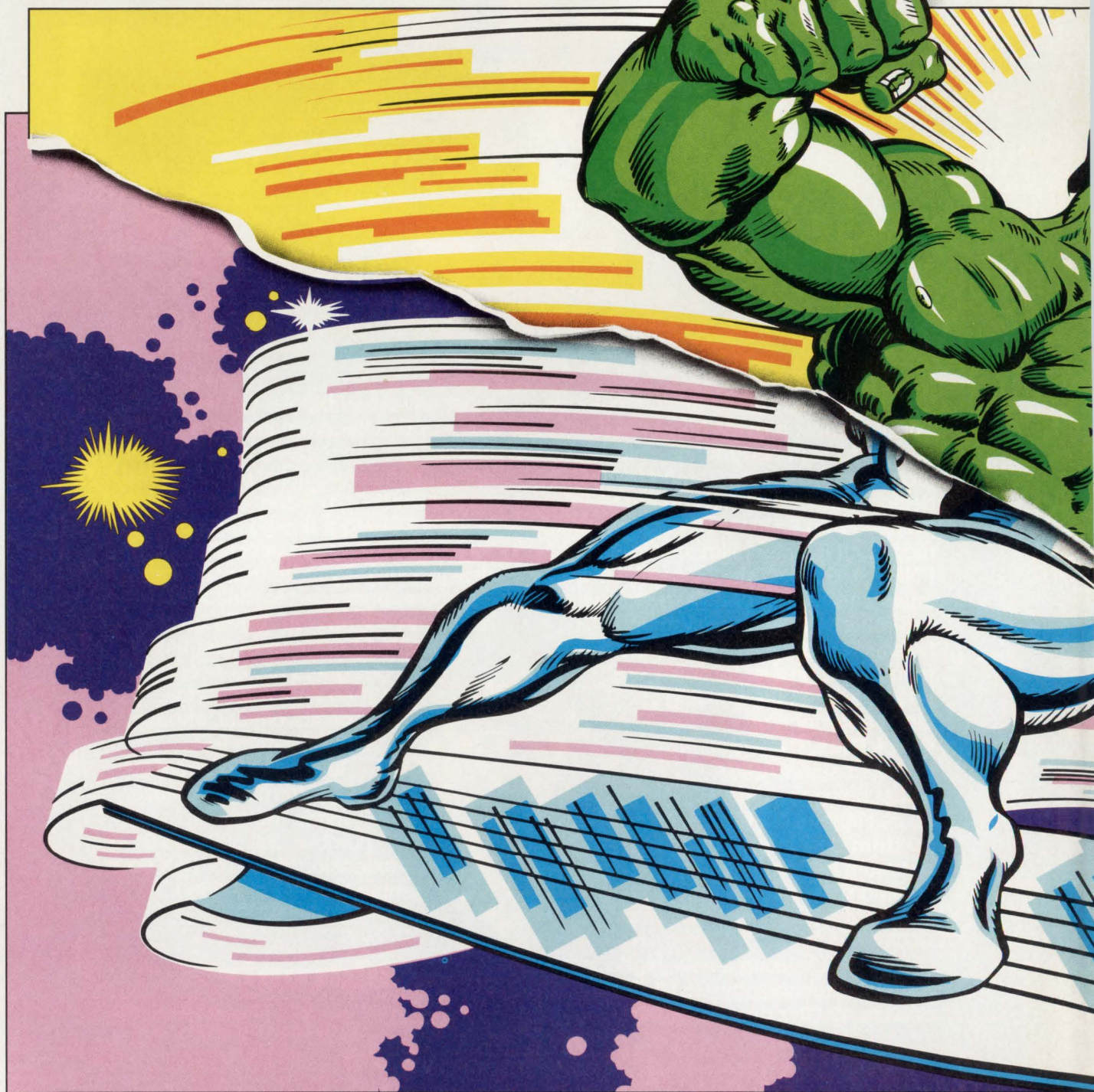

The Silver Surfer and The Incredible Hulk are trademarks of Marvel Entertainment Group, Inc. © 1991. All rights reserved.

# Very Special Be #1 In EPROMs.



AMD EPROMs today are what other mere mortal EPROMs can only aspire to be: high density, of course. But also high speed. Able to store massive amounts of information, with lightning fast access times. All in our superior CMOS technology.

EPROMs have always been our strength—thanks to our unparalleled performance, selection, reliability, and quality.

That's why we sell more EPROMs than any other vendor.\* Period. And we're ready to do the same for years to come. While other vendors have abandoned EPROMs, we're still committed—to making the fastest, highest density EPROMs.

In fact, we've got the most advanced EPROM wafer fab, assembly and test facilities in the world. Which produce the most reliable, highest quality EPROMs available. In everything from surface mount plastic to mil spec compliant packages.

So make yourself a hero. The instant you know your EPROM requirements, get them fast. Get them dense. Get them in volume. And get them right away.

Call AMD at **1-800-222-9323** for more information. Or call your local sales office to place an order.



## Advanced Micro Devices

901 Thompson Place, P.O. Box 3453, Sunnyvale, CA 94088 © 1991 Advanced Micro Devices, Inc.  
All brand or product names mentioned are trademarks or registered trademarks of their respective holders.  
\*Dataquest, March 1991, based on 1990 data.

CIRCLE 88 FOR U.S. RESPONSE

CIRCLE 89 FOR RESPONSE OUTSIDE THE U.S.

“We need you to design, compile, link, load, configure, prototype, debug

**Relax. With a LONBUILDER 2 Developer's Workbench,  
you can do all that and more in record time.**

As competition becomes more intense, pressure to quickly develop new and better products increases. We can help.

With LONWORKS™ control networks for intelligent distributed control applications, and the LONBUILDER™ 2 Developer's Workbench.

LONWORKS control networks make your products “smarter,” able to interoperate with and control other products. Each control network is made up of a series of “nodes” that communicate with each other. At the heart of each node is a NEURON® CHIP, available from Motorola. Nodes also contain a media interface that uses the standard LONTALK™ protocol to communicate with other nodes over a wide range of standard communication media.

And to design those LONWORKS nodes into your products quickly and inexpensively,

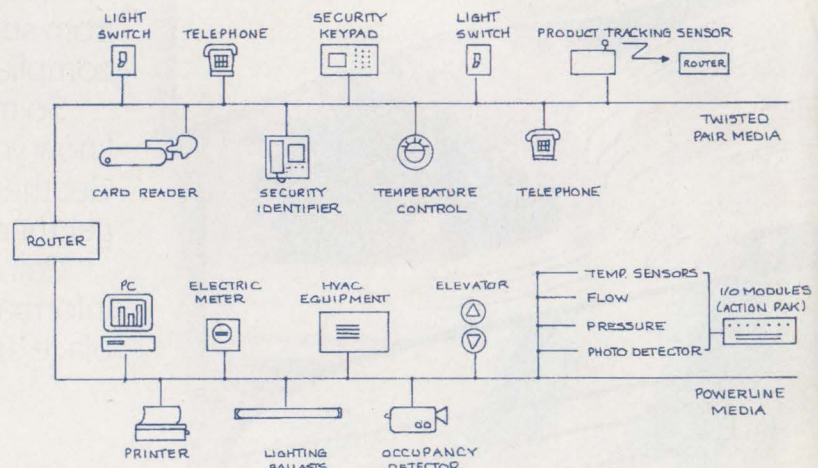

*"You're kidding,  
right?"*

and fabricate a new control network. By yesterday."

there's the PC-based LONBUILDER 2 Developer's Workbench. It's really 3 tools in 1: a multi-node development system for developing and debugging LONWORKS nodes; a network manager for installing and debugging the integrated network; and a protocol analyzer for network monitoring and testing.

A consistent, easy to use interface called LON<sup>®</sup> Navigator guides you through the functions. When you're ready, you can compile, link, load and configure applications with a single command.

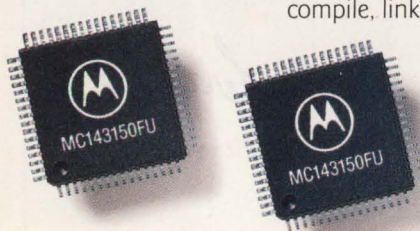

LONWORKS applications are already being introduced. More than 200 companies, many of them on the Fortune 100 list, are using LONBUILDER 2 Developer's Workbenches to design and develop more intelligent, more competitive products. The chances are good some of those companies are your competitors. Which raises the question, "What are you waiting for?"

#### Motorola Demonstration Sites

Come see how revolutionary LONWORKS control network products really are, and how quick and easy it is to design them into your products using a LONBUILDER 2 Developer's Workbench. Get a hands-on demonstration at one of 20 Motorola offices across the country.

Call or fax for more information and the location of the Motorola demonstration office nearest you. **1-800-937-4LON. FAX 1-415-856-6153.**  
Outside the U.S., please fax.



Echelon Corporation, 4015 Miranda Avenue, Palo Alto, CA 94304.

CIRCLE 126 FOR U.S. RESPONSE

CIRCLE 127 FOR RESPONSE OUTSIDE THE U.S.

## LCD Proto Kit

Everything you need to start your LCD application .... create complex screens in just a few hours!

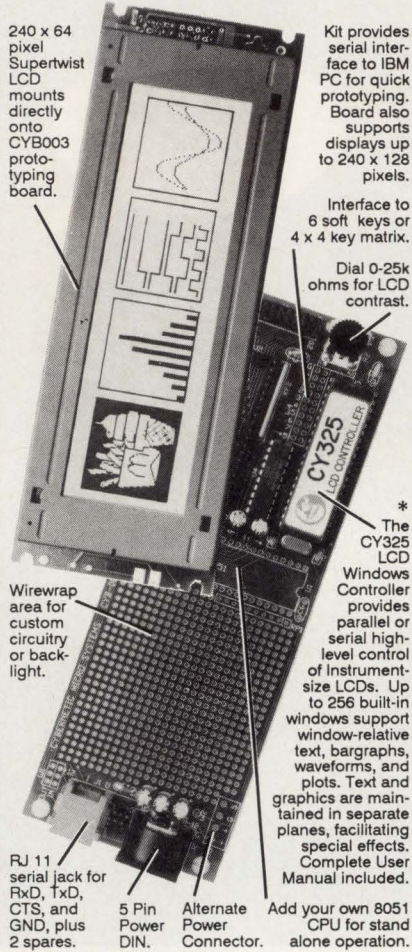

240 x 64 pixel Supertwist LCD mounts directly onto CYB003 prototyping board.

Kit provides serial interface to IBM PC for quick prototyping. Board also supports displays up to 240 x 128 pixels.

Interface to 6 soft keys or 4 x 4 key matrix.

Dial 0-25k ohms for LCD contrast.

Wirewrap area for custom circuitry or back-light.

\* The CY325 LCD Controller provides parallel or serial high-level control of Instrument-size LCDs. Up to 256 built-in windows support window-relative text, bargraphs, waveforms, and plots. Text and graphics are maintained in separate planes, facilitating special effects. Complete User Manual included.

RJ 11 serial jack for Rx/D, Tx/D, CTS, and GND, plus 2 spares.

5 Pin Power DIN. Alternate Power Connector.

Add your own 8051 CPU for stand alone operation.

### Kit also includes:

Power supply provides +5v and Gnd for board, -12v for LCD, and +12v spare.

Sample routines in 8051 Assembler and QuickBasic.

LCD Paint™ for creating your own graphics images.

4-wire RJ11 style cable with DB25F connector for your IBM PC.

Demo routines preprogrammed into 8751 for immediate gratification.

**\$495 - Kit**  
Popular LCD Starter Kit.



(\$595 pre-assembled & tested)

\*The CY325 CMOS 40-pin DIP and 44-pin PLCC LCD Controller IC are available from stock @ \$75/singles, \$20/1000s .

## CyberneticMicroSystems

Box 3000 • San Gregorio CA 94074  
Tel: 415-726-3000 • Fax: 415-726-3003

CIRCLE 116 FOR U.S. RESPONSE

CIRCLE 117 FOR RESPONSE OUTSIDE THE U.S.

## EDITORIAL

# “BUILD THINGS PEOPLE WILL BUY”

Looking out my window down at our building's parking lot, a pile driver continues its relentless pounding of a 60-foot wooden piling into the ground for who-knows-what future construction, nearly bouncing me out of my chair at every impact. It's arresting in its simplicity — just pound the thing into the ground, and then go on to the next one. Designing electronic systems is a lot more complex, of course, but there's something appealing about a team carrying out a tightly focused job to produce something that clearly satisfies a need.

Success in the electronics industry might, but rarely does, stem from a sophisticated, unique philosophy of a company's mission. Most of the time, it results from more basic approaches: hard, steady teamwork turning out products that customers want. A recent article in the Harvard Business Review by Gerard H. Langelier, president of Mentor Graphics' Systems Group, drives this point home. In “The Vision Trap,” Langelier presents an unusually candid review of the evolution of Mentor's philosophy, or “long-term vision,” during the 1980s.

Langelier, one of Mentor's founders, notes that the company's vision early on was simple: “Build things that people will buy.” However, as the company grew through the decade, this vision expanded to levels of greater and greater sophistication and abstraction. These concepts became increasingly difficult to translate into specific marching orders for the engineering staff. Then, Langelier notes, Mentor's management came face-to-face with some unpleasant facts. The release of its 8.0 software was slipping, as was workers' morale, and layoffs and losses were in the offing.

It was time to get down to basics. Stronger scheduling discipline measures were imposed for 8.0, with cutoff dates implemented to prevent perpetual refinement. The product was soon shipped.

Now, says Langelier, the company has come full circle in its thinking. When asked by an employee at a recent company meeting to elucidate the company's vision, he responded simply, “Our current short-, medium-, and long-term vision is to build things people will buy.” This, he says, was greeted with immediate and lengthy applause.

There's something about this story that an engineer has to like. It seems to capture the essence of hard-nosed, real-world engineering: Forget the fancy management theories and just go ahead and build the products that customers will want to buy.



*Steve Scrypski*  
Editor-in-Chief



# incredible!

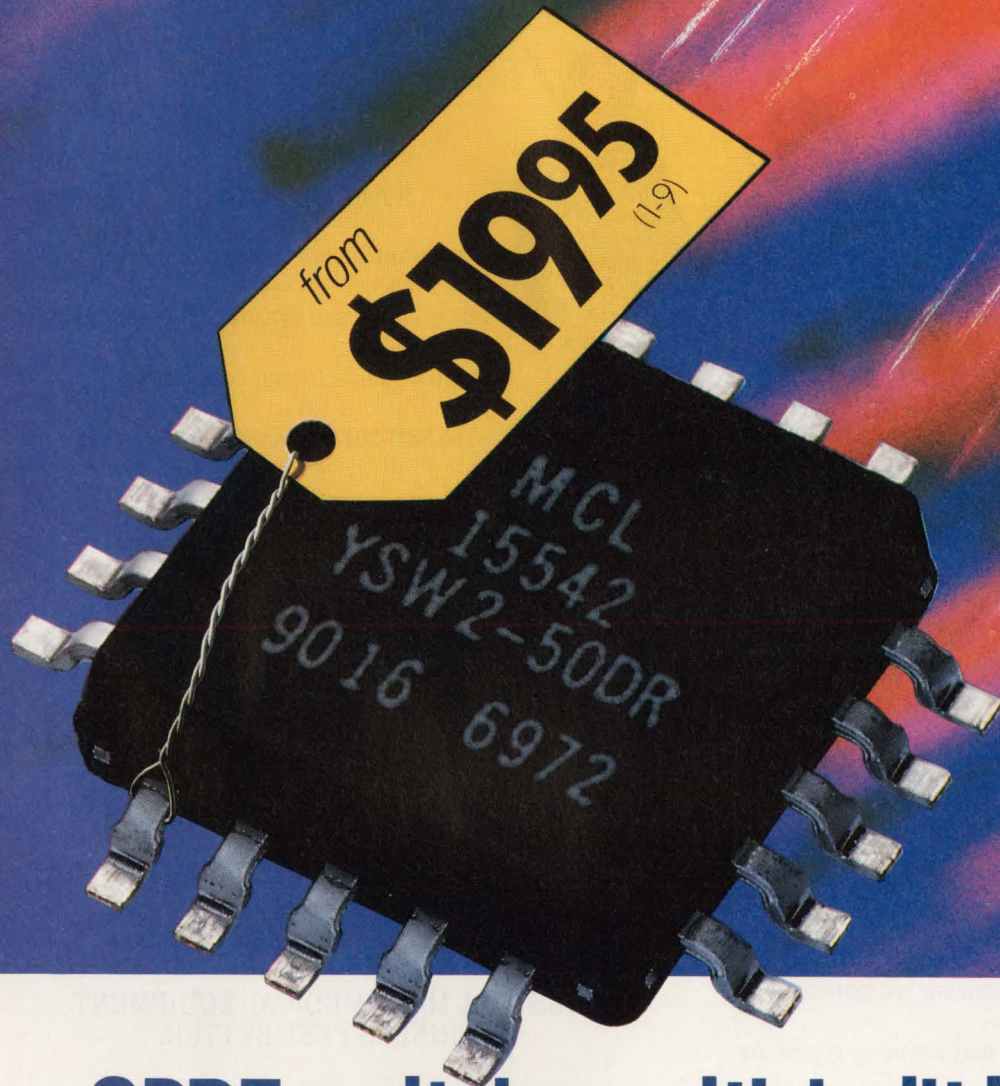

## SPDT switches with built-in driver

### **ABSORPTIVE or REFLECTIVE** dc to 5GHz

Truly incredible...superfast 3nsec GaAs SPDT reflective or absorptive switches with built-in driver, available in pc plug-in or SMA connector models, from only \$19.95. So why bother designing and building a driver interface to further complicate your subsystem and take added space when you can specify Mini-Circuits' latest innovative integrated components?

Check the outstanding performance of these units...high isolation, excellent return loss (even in the "off" state for absorptive models) and 3-sigma guaranteed unit-to-unit repeatability for insertion loss. These rugged devices operate over a -55° to +100°C span. Plug-in models are housed in a tiny plastic case and are available in tape-and-reel format (1500 units max, 24mm). All models are available for immediate delivery with a one-year guarantee.

finding new ways...  
setting higher standards

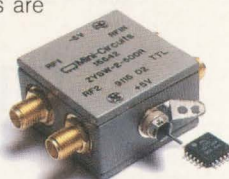

#### SPECIFICATIONS (typ)

	Absorptive SPDT			Reflective SPDT		
	YSWA-2-50DR	YSWA-2-50DR	ZYSWA-2-50DR	YSW-2-50DR	YSW-2-50DR	ZYSW-2-50DR
Frequency (MHz)	dc-500	500-2000	2000-5000	dc-500	500-2000	2000-5000
Ins. Loss (dB)	1.1	1.4	1.9	0.9	1.3	1.4
Isolation (dB)	42	31	20	50	40	28
1dB Comp. (dBm)	18	20	22.5	20	20	24
RF Input (max dBm)	20			22	22	26
VSWR "on"	1.25	1.35	1.5	1.4	1.4	1.4
Video Bkthru (mV,p/p)	30	30	30	30	30	30
Sw. Spd. (nsec)	3	3	3	3	3	3
Price, \$ (1-9 qty)	YSWA-2-50DR (pin) 23.95 ZYSWA-2-50DR (SMA) 69.95			YSW-2-50DR (pin) 19.95 ZYSW-2-50DR (SMA) 59.95		

**Mini-Circuits**

P.O. Box 350166, Brooklyn, New York 11235-0003 (718) 934-4500 Fax (718) 332-4661 Telexes: 6852844 or 620156

CIRCLE 170 FOR U.S. RESPONSE  
CIRCLE 171 FOR RESPONSE OUTSIDE THE U.S.

F141 REV. C

# One loud part can ruin the perf



got the right combination of specifications, performance and price, regardless of your design needs.

## AUDIO DESIGNERS SHOULD LISTEN TO THIS.

If you're designing audio components and want superb transient response, ambience, clarity and dynamic range, our products will be music to your ears.

The SSM-2017 microphone preamp has impressive noise performance ( $950 \text{ pV}/\sqrt{\text{Hz}}$ ) and ultralow THD ( $<0.01\% @ G = 100$ ), while the new dual OP-275 has

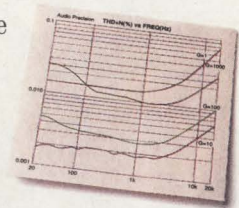

great sonic characteristics, low noise ( $6 \text{ nV}/\sqrt{\text{Hz}}$ ) and low power requirements. And the dual AD712, which has a low offset voltage of  $0.30 \text{ mV}$ , drift of  $7 \mu\text{V}/^\circ\text{C}$  and a  $16 \text{ V}/\mu\text{s}$  min slew rate, delivers high performance at a low price.

## THIS WILL MAKE MEDICAL EQUIPMENT DESIGNERS FEEL BETTER.

Major medical applications, such as CT scanners, digital X-ray and fluid analysis, require low noise and pA bias currents. And we've got just the right prescription.

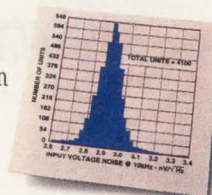

For those who want low voltage noise,

but not at the expense of current noise, the AD743 and the

# The Analog family

A system that isn't working in harmony is a system bound for failure. Particularly if the part acting up is your low noise op amp.

Whether it's current noise or voltage noise you're concerned about, there's a simple way to make sure your system keeps humming along. Get your low noise op amps from Analog Devices.

With the broadest line of low noise op amps around, we've

# Performance of your entire system.

higher speed AD745 offer the best combination of specs — 3.2 nV/√Hz and 6.9 fA/√Hz. If your emphasis is vice versa, then the AD645 has the specs you want — 0.6 fA/√Hz for current noise, and 9 nV/√Hz for voltage noise.

## OP AMPS THAT ARE INSTRUMENTAL FOR INSTRUMENTATION.

If you're working in instrumentation applications, our op amps could prove to be instrumental in your design.

The world's lowest current noise (0.11 fA/√Hz) monolithic op amp, the AD549, has 60 fA of input bias current — which is ideal for interfacing with very high

Model	Voltage Noise nV/√Hz @1 kHz typ	Current Noise fA/√Hz @1 kHz typ	Vos mV max	Supply Current mA typ	Input Bias Current max	SR V/μs typ
AD829	2.0	1.5	0.5	5	7 μA	230
OP27/OP-37	3.0	400	.025	3	40 nA	2.8/17
AD743/745	3.2	6.9	0.5	8	250 pA	2.8/12.5
OP-275 (dual)	6	1500	1	4	350 nA	22
AD645	9	0.6	0.25	3	1.5 pA	2.0
AD712 (dual)	18	0.01	0.7	5	75 pA	20
AD548/648 (dual)	30	1.8	0.25/0.3	.34	10 pA	1.8
AD549	35	0.11	0.5	.60	60 fA	3

impedance sources. The AD548 (single) and AD648 (dual) deliver low bias current (10 pA), extremely low current noise (1.8 fA/√Hz) and low power consumption at a highly attractive price. And the industry-standard OP-27 and OP-37 offer ultralow noise (3 nV/√Hz at 1 kHz) and precision dc performance.

## THE FASTEST LOW NOISE OP AMP AROUND.

If you need low noise but don't want to give up speed, then consider the extremely versatile AD829. It has low voltage and current noise (2 nV/√Hz and 1.5 pA/√Hz, respectively), high speed (230 V/μs slew rate) and excellent video performance (0.02% differential gain and 0.04° differential phase). Making it perfect for a range of applications including office automation, imaging and data acquisition systems.

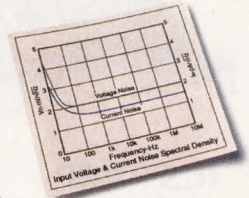

## GIVE US A SHOUT IF YOU NEED HELP.

Since all of these op amps are specifically designed for applications where low noise is critical, you can just drop them into your design and virtually forget about them.

Should you ever have a question, you'll be glad to hear that our products are backed by the most responsive applications support staff in the industry.



How responsive? Give us a shout at 1-800-262-5643 and see for yourself. We'll answer any questions you've got on choosing the right low noise op amp, plus send you a free low noise op amp selection guide and SPICE model library.

Or for more information on our low noise op amps, write to Analog Devices, P.O. Box 9106, Norwood, MA 02062-9106.



# of low noise op amps.

CIRCLE 102 FOR U.S. RESPONSE  
CIRCLE 103 FOR RESPONSE OUTSIDE THE U.S.

# Data Acquisition for the uncompromising.

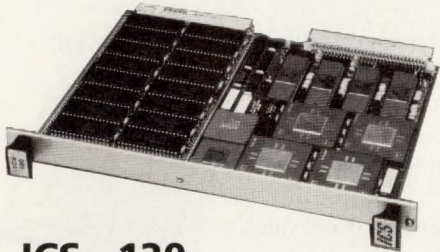

## ICS - 120

- 4-Channel, 12-bit VMEbus Analog Input Board
- Up to 1 MHz/Channel Sampling Rate (Simultaneous Sampling)
- 128 Taps/Channel FIR Filter/Decimator for Output Data Rate Reduction
- 2 Mbytes of On-Board Storage

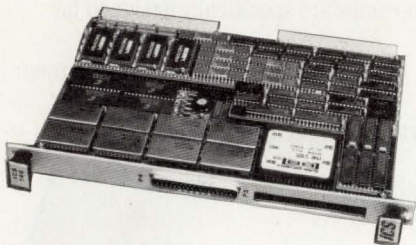

## ICS - 140

- 8-Channel, 16-bit VMEbus Analog Input and Output Board
- Up to 100 KHz/Channel Sampling Rate (Simultaneous Sampling)
- Direct SKYburst Interface to SKYbolt Array Processor
- Direct Serial Interface to Valley Enterprises' VE-32C DSP Board

**For further  
information,  
call us now at:  
1-800-267-9794**

 **INTERACTIVE  
CIRCUITS AND  
SYSTEMS LTD.**

TEL (613) 749-9241 FAX (613) 749-9461

## TECHNOLOGY BRIEFING

### A DECADE OF SCSI

**A** number of major anniversaries seem to be springing up lately. *ELECTRONIC DESIGN* is celebrating its 40th anniversary, and the 10-year anniversaries of the personal computer and the VMEbus have recently passed. This pattern continues with the Small Computer Systems Interface (SCSI), which also observes its 10th year. The goal of SCSI, developed by NCR Corp., Fort Collins, Colo., and Shugart Associates was to improve performance because the existing interfaces, such as RS-232, IEEE-488, MIDI, Centronics, and others, were running out of steam.



RICHARD NASS  
COMPUTER SYSTEMS

SCSI is based on the Shugart Associates System Interface (SASI), which was introduced in an August 20, 1981 cover article in *ELECTRONIC DESIGN*. SASI was comparable to SCSI electrically, but its command set was simpler than that of SCSI. In 1982, NCR worked with Shugart Associates to evolve SASI into SCSI by including differential drivers, a more generic interface, better software, and other features.

Before SCSI, adding a new peripheral to the host meant designing a dedicated hardware and software interface. By the time the host computer "learned" how to communicate with the new peripheral, more advanced peripherals were emerging. This trend held the host one generation behind the current peripheral technology. SCSI's standardization kept the host from learning a new way to communicate with each peripheral, thus reducing integration time. SCSI became an ANSI standard in June 1986.

SCSI was originally conceived to support multiple device types, including sequential- and direct-access devices, printers, and processors. The proposal was extended to include write-once read-many (WORM) drives, CD-ROMs, media-changer devices, scanners, optical-memory drives, and communication hardware. A maximum of eight devices in any mix of hosts and peripherals were permitted in the original specification. The bus contains nine bidirectional data lines plus parity, controlled by nine signals. Data is usually sent in an asynchronous mode, although synchronous operation is an option.

A SCSI controller must have intelligence, and should process one-byte messages (the bus logical interface) and multibyte command-descriptor blocks (the I/O logical interface). Most of the error recovery, data buffering, and other device-specific tasks are handled by the peripheral controller, presenting a device-independent interface to the host. A typical SCSI bus controller translates signals, performs speed matching, and orders bytes between the microprocessor and SCSI buses.

The original SCSI was replaced by the SCSI-II upgrade, which features more speed and increased bandwidth among other enhancements while maintaining backward compatibility with the original SCSI specification. To improve speed, the SCSI bus has options for wider data paths called "wide SCSI" and faster data-transfer rates called "fast SCSI." The wide SCSI bus features synchronous data transfers that are either 16 bits for 10 Mbits/s or 32 bits for 20 Mbits/s. The fast SCSI bus offers synchronous data transfers that are 8 bits for 10 Mbits/s.

NCR based its redundant-array-of-inexpensive-disks (RAID) technology on SCSI-II, introduced on *ELECTRONIC DESIGN*'s March 14, 1991 cover. When combined with fast and wide SCSI controllers, the RAID systems offer higher I/O throughputs to keep up with the parade of faster microprocessors. Data is also protected against drive failures because data from one down drive can be recreated by the other drives within the array. RAID subsystems are being implemented in systems ranging from file servers to mainframes.

Work has just begun on SCSI-III. Some features that may appear in the next generation include a single 16-bit wide SCSI cable, a serial SCSI protocol that can utilize fiber-optic cable, the ability to connect more than eight devices on the SCSI bus, and a more standardized logical interface.

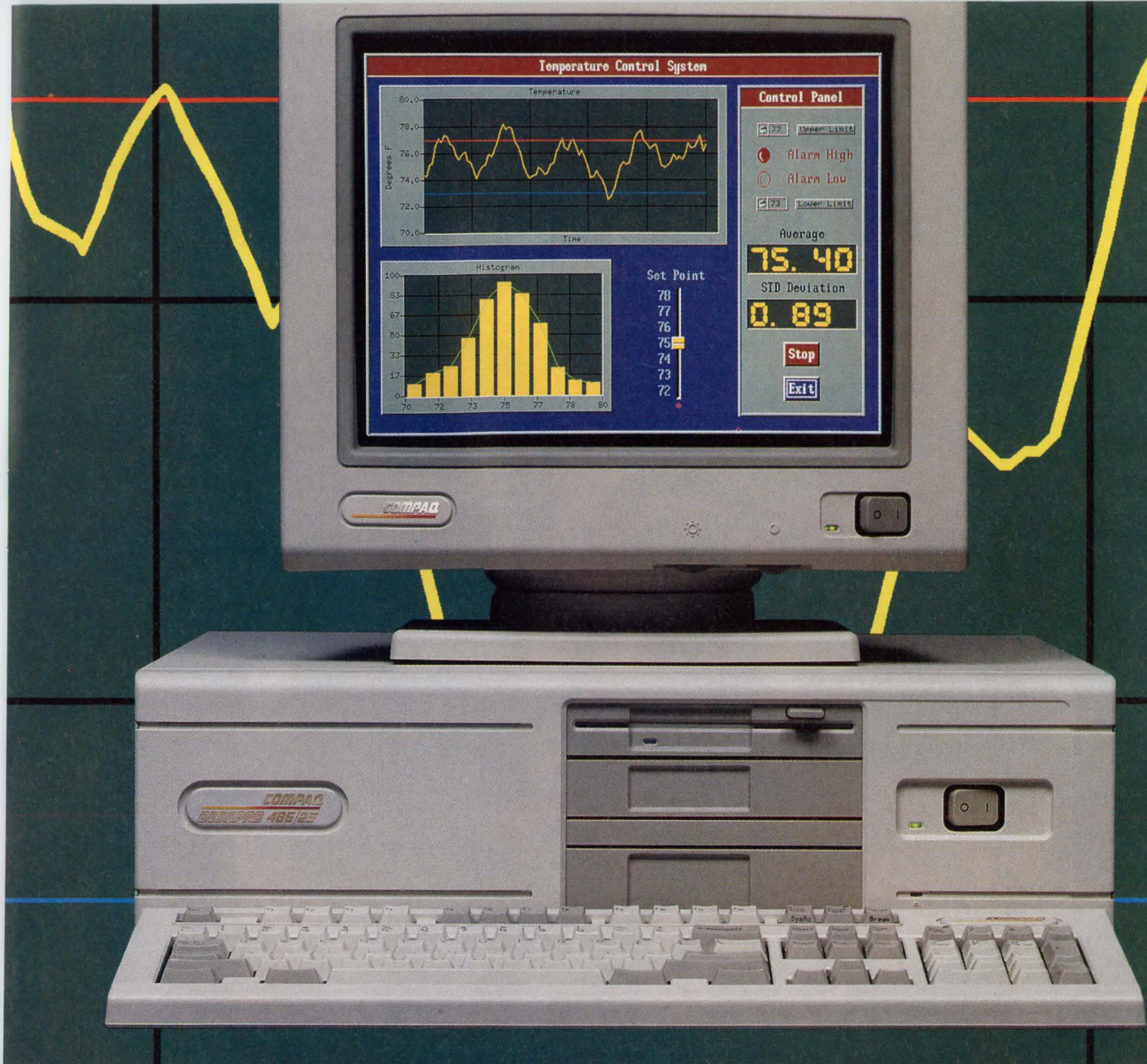

# Take a Look at LabWindows® 2.0

LabWindows 2.0 brings a new look to data acquisition and instrument control. The new look is graphical—a graphical user interface for your acquisition and control system.

## Create a Graphical User Interface

With LabWindows 2.0, you can easily create custom graphics panels to interface with your DOS-based system. Using the graphical editor and standard development tools, you can develop a system that combines data acquisition, data analysis, and data presentation.

## Program with C or BASIC

When you develop a system with LabWindows 2.0, you have the benefit of using standard programming languages with development tools designed specifically for data acquisition and instrument control.

## Use any Acquisition Hardware

LabWindows 2.0 has libraries of functions to control data acquisition hardware ranging from plug-in boards to industry-standard GPIB, VXI, and

RS-232 instruments. You can develop a system with LabWindows to meet all of your measurement and control needs.

Take a look at the new LabWindows 2.0. You'll like what you see.



6504 Bridge Point Parkway  
Austin, TX 78730-5039  
(512) 794-0100  
(800) 433-3488 (U.S. and Canada)

# FILTERS



# dc to 3GHz from \$11.45

## lowpass, highpass, bandpass

- less than 1dB insertion loss
- greater than 40dB stopband rejection
- surface-mount
- BNC, Type N, SMA available
- 5-section, 30dB/octave rolloff
- VSWR less than 1.7 (typ)
- rugged hermetically-sealed pin models
- constant phase
- meets MIL-STD-202 tests
- over 100 off-the-shelf models
- immediate delivery

### low pass, Plug-in, dc to 1200MHz

Model No.	Passband MHz loss < 1dB	Stopband, MHz loss > 20dB	loss > 40dB	Model No.	Passband MHz loss < 1dB	Stopband, MHz loss > 20dB	loss > 40dB
PLP-5	DC-5	8-10	10-200	PLP-250	DC-225	320-400	400-1200
PLP-10.7	DC-11	19-24	24-200	PLP-270	DC-270	410-550	550-1200
PLP-21.4	DC-22	32-41	41-200	PLP-300	DC-300	580-750	750-1800
PLP-30	DC-32	47-61	61-200	PLP-350	DC-350	750-920	920-2000
PLP-50	DC-48	70-90	90-200	PLP-500	DC-500	840-1120	1120-2000
PLP-70	DC-60	90-117	117-300	PLP-600	DC-600	1000-1300	1300-2000
PLP-90	DC-81	121-137	167-400	PLP-750	DC-700	1080-1400	1400-2000
PLP-100	DC-98	146-189	189-400	PLP-800	DC-720	1100-1400	1400-2000
PLP-150	DC-140	210-300	300-600	PLP-850	DC-760	1100-1400	1400-2000
PLP-200	DC-190	290-390	390-800	PLP-1000	DC-900	1340-1750	1750-2000
				PLP-1200	DC-1000	1620-2100	2100-2500

Price, (1-9 qty), all models: plug-in \$14.95, BNC \$32.95, SMA \$34.95, Type N \$35.95

### Surface-mount, dc to 570MHz

Model No.	Passband MHz loss < 1dB	Stopband, MHz loss > 20dB	loss > 40dB	Model No.	Passband MHz loss < 1dB	Stopband, MHz loss > 20dB	loss > 40dB
SCLF-21.4	DC-22	32-41	41-200	SCLF-190	DC-190	290-390	390-800
SCLF-30	DC-30	47-61	61-200	SCLF-380	DC-380	580-750	750-1800
SCLF-45	DC-45	70-90	90-200	SCLF-420	DC-420	750-920	920-2000
SCLF-135	DC-135	210-300	300-600				

Price, (1-9 qty), all models: \$11.45

### Flat Time Delay, dc to 1870MHz

Model No.	Passband MHz loss < 1.2dB	Stopband MHz loss > 10dB	loss > 20dB	VSWR Freq. Range, DC thru 0.2fco X	0.6fco X	Group Delay Variations, ns Freq. Range, DC thru fco X	2fco X	2.67fco X
PBLP-39	DC-23	78-117	117	1.3:1	2.3:1	0.7	4.0	5.0
PBLP-117	DC-65	234-312	312	1.3:1	2.4:1	0.35	1.4	1.9
PBLP-156	DC-94	312-416	416	0.3:1	1.1:1	0.3	1.1	1.5
PBLP-200	DC-120	400-534	534	1.6:1	1.9:1	0.4	1.3	1.6
PBLP-300	DC-180	600-801	801	1.25:1	2.2:1	0.2	0.6	0.8
PBLP-467	DC-280	934-1246	1246	1.25:1	2.2:1	0.15	0.4	0.55
▲BPLP-933	DC-560	1866-2490	2490	1.3:1	2.2:1	0.09	0.2	0.28
▲BPLP-1870	DC-850	3740-6000	5000	1.45:1	2.9:1	0.05	0.1	0.15

Price, (1-9 qty), all models: plug-in \$19.95, BNC \$36.95, SMA \$38.95, Type N \$39.95  
NOTE: ▲ -933 and -1870 only with connectors, at additional \$2 above other connector models.

### high pass, Plug-in, 27.5 to 2200MHz

Model No.	Stopband MHz loss < 40dB	Passband MHz loss < 20dB	VSWR Passband Typ.	Model No.	Stopband MHz loss < 40dB	Passband MHz loss < 20dB	VSWR Passband Typ.		
PHP-25	DC-13	13-19	27.5-200	1.8:1	PHP-400	DC-210	210-290	395-1600	1.7:1
PHP-50	DC-20	20-26	41-200	1.5:1	PHP-500	DC-280	280-365	500-1600	1.8:1
PHP-100	DC-40	40-55	90-400	1.8:1	PHP-600	DC-350	350-440	600-1600	2.0:1
PHP-150	DC-70	70-95	133-600	1.8:1	PHP-700	DC-400	400-520	700-1800	1.6:1
PHP-175	DC-70	70-105	160-800	1.5:1	PHP-800	DC-445	445-570	780-2000	2.1:1
PHP-200	DC-90	90-116	185-800	1.6:1	PHP-900	DC-520	520-660	910-2100	1.8:1
PHP-250	DC-100	100-150	225-1200	1.3:1	PHP-1000	DC-550	550-720	1000-2200	1.9:1
PHP-300	DC-145	145-170	290-1200	1.7:1					

Price, (1-9 qty), all models: plug-in \$14.95, BNC \$36.95, SMA \$38.95, Type N \$39.95

### bandpass, Elliptic Response, 10.7 to 70MHz

Model No.	Center Freq. (MHz)	Passband I.L. 1.5 dB Max. (MHz)	3 dB Bandwidth Typ. (MHz)	I.L. > 20dB at MHz	I.L. > 35dB at MHz
PBP-10.7	10.7	9.6-11.5	8.9-12.7	7.5 & 15	0.6 & 50-1000
PBP-21.4	21.4	19.2-23.6	17.9-25.3	15.5 & 29	3.0 & 80-1000
PBP-30	30.0	27.0-33.0	25-35	22 & 40	3.2 & 99-1000
PBP-60	60.0	55.0-67.0	49.5-70.5	44 & 79	4.6 & 190-1000
PBP-70	70.0	63.0-77.0	68.0-82.0	51 & 94	6.0 & 193-1000

Price, (1-9 qty), all models: plug-in \$18.95, BNC \$40.95, SMA \$42.95, Type N \$43.95

### Constant Impedance, 21.4 to 70MHz

Model No.	Center Freq. MHz	Passband MHz loss < 1dB	Stopband MHz loss > 20dB at MHz	VSWR Total Band MHz
PIF-21.4	21.4	18-25	1.3 & 150	DC-220
PIF-30	30	25-35	1.9 & 210	DC-330
PIF-40	42	35-49	2.6 & 300	DC-400
PIF-50	50	41-58	3.1 & 350	DC-440
PIF-60	60	50-70	3.8 & 400	DC-500
PIF-70	70	58-82	4.4 & 490	DC-550

Price, (1-9 qty), all models: plug-in \$14.95, BNC \$36.95, SMA \$38.95, Type N \$39.95

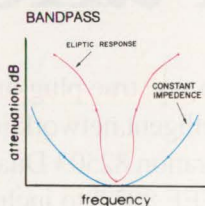
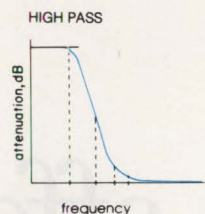
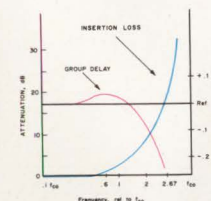
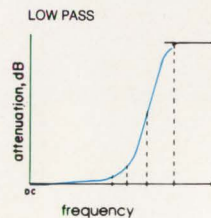

finding new ways ...  
setting higher standards



WE ACCEPT AMERICAN EXPRESS AND VISA

P.O. Box 350166, Brooklyn, New York 11235-0003 (718) 934-4500 Fax (718) 332-4661

Distribution Centers / NORTH AMERICA 800-654-7949 • 417-335-5935 EUROPE 44-252-835094 Fax 44-252-837010

CIRCLE 164 FOR U.S. RESPONSE

CIRCLE 165 FOR RESPONSE OUTSIDE THE U.S.

F132-2 REV. A

# Now you can afford to

Presenting a very small development in Ethernet.\*  
Chipsets that are matched to your system and your budget. In fact, they cost you as little as 5 square inches. Which, by the way, is less total real estate than any competitive solution. But sizable reductions don't stop with board space, because we're also reducing the price up to 30 percent.

Needless to say, true plug-and-play simplicity requires an intelligent network interface. So our new high-integration 82503 Dual Serial Transceiver goes beyond IEEE 802.3 to include automatic port selection, polarity switching and a jumperless interface to AUI or TPE.

For unmatched desktop performance, we offer



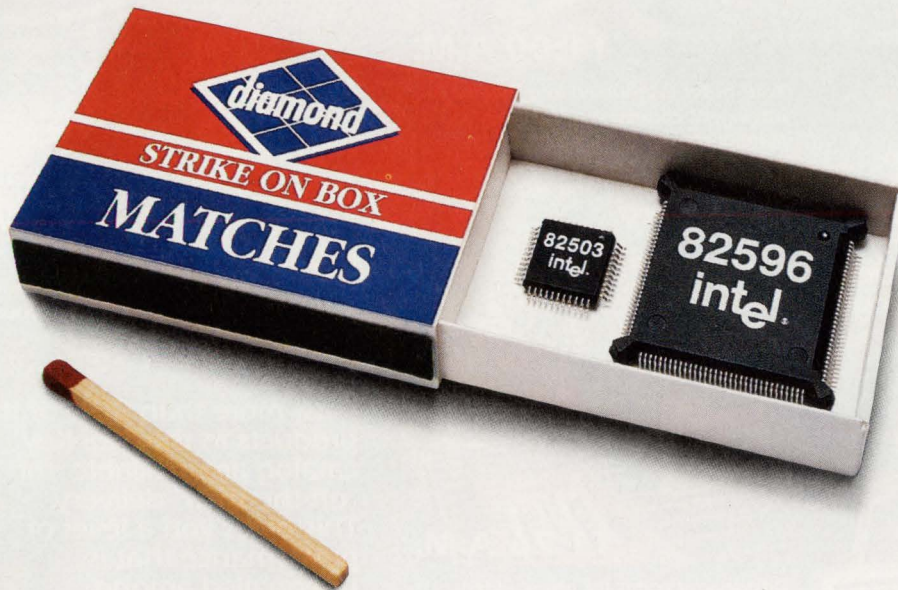

# put Ethernet in any box.

a complete family of 82596 LAN coprocessors, each optimized to a specific Intel486™ CPU for maximum throughput. And our 82593 is the perfect LAN controller for Intel386™ SL notebooks.

Best of all, these true two-chip solutions give you the flexibility to simplify your design and deliver your product to market in the smallest of timeframes.

So look into today's hottest Ethernet chipsets. Call (800) 548-4725 and ask for Lit. Packet #YA23. And learn why we have the perfect match for your next box.

**intel**®

The Computer Inside.™

CIRCLE 142 FOR U.S. RESPONSE

CIRCLE 143 FOR RESPONSE OUTSIDE THE U.S.

# 106 MINUTES!

# ORDER ENTRY TO SHIPPING

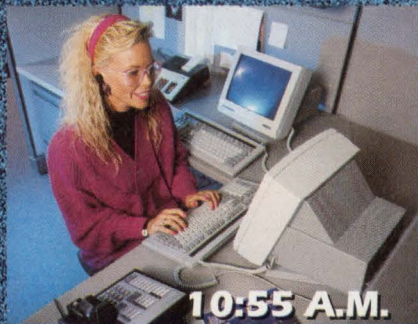

10:55 A.M.

Order entry and customer service is provided by a friendly, competent staff providing real time stock status, on-line order entry and instant information retrieval.

From order entry to shipping, the typical Digi-Key order is processed in just 106 minutes! This is why more than 99% of all orders are shipped within 24 hours.



11:00 A.M.

Your order is inducted into Digi-Key's intelligent conveyor system utilizing state-of-the-art bar-coding and production technologies to achieve unparalleled speed and accuracy in order processing.



11:05 A.M.

Fully supervised by Digi-Key's host computer, the conveyor's programmed logic controllers flawlessly route your order, selectively diverting it to each relevant picking zone.



11:26 A.M.

Designated zones for value-added product and exceptions ensure that even orders with truly unique requirements are handled routinely in Digi-Key's fulfillment process.

Plus, more than 95% of the products in the Digi-Key catalog are available for "off-the-shelf" delivery. This gives you a level of performance that is unequalled among electronic component distributors. Call, write, or fax for your FREE CATALOG today!



11:54 A.M.

Your order has been filled in 59 minutes and is routed to quality assurance where it is checked for accuracy, quantity, quality and proper packaging.



12:06 P.M.

Your order is carefully packaged and prepared for shipment using anti-static, environmentally-safe, CFC-free packaging materials.



12:41 P.M.

Your order is shipped via one of Digi-Key's 43 standard delivery options. Next-day delivery would typically place this order in your hands the next morning.

## Digi-Key<sup>®</sup> CORPORATION

701 Brooks Avenue South  
Thief River Falls, MN 56701  
Toll-Free: 1-800-344-4539  
FAX: 218-681-3380

CIRCLE 124 FOR U.S. RESPONSE

CIRCLE 125 FOR RESPONSE OUTSIDE THE U.S.

## FIRST 486-COMPATIBLE FITS 386SX PINOUT

Long-rumored to be working on a 80386 CPU replacement, designers at Cyrix Corp., Richardson, Texas, surprised the industry by releasing a chip that implements the 80486 instruction set, yet plugs into sockets intended for the 386SX. Even though it has the same 100-lead plastic quad-sided flat package pinout of the 386SX, the chip also offers superset functions controlled by several pins that were no-connects on the 386SX. With a 1-kbyte on-chip merged-instruction and data cache, the fully static CMOS 486SLC can access data two clock periods faster than a zero-wait-state external 16-bit bus access. The words are re-merged in the cache, forming 32-bit words for transfers over the chip's internal data paths to the five-stage pipelined execution unit. The five overlapped stages permit successive instruction overlap to minimize instruction cycle times. By combining the cache and pipeline, as well as some single-cycle instructions, the chip can execute software up to 2.4 times faster than a 386SX or 386SL, and 1.7 times faster than IBM's cache-based 486SLC (if the data or instructions are in the cache). Adding a 16-bit integer multiplier to the CPU's circuitry allows the CPU to perform many graphics- or DSP-related computations in less than one-third the number of cycles required by the 80486 CPU.

The 486SLC CPU will come in 3- and 5-V versions. The 3-V units are ideal for portable systems. With the clock stopped, the chip consumes a mere 100  $\mu$ A; when running at 20 MHz, the power is just 600 mW. Suspend/Resume instructions permit easy chip stoppage, dropping power to the microwatt range, even when running programs like Microsoft Windows. Contact Jim Chapman at (214) 234-8387. *DB*

## FIBER-OPTIC SYSTEM BRIDGES 200-KM DISTANCE

By using an optical power amplifier from Philips, Australia's Telecom PTT was able to send 2.5-Gbit/s signals over a fiber-optic route of more than 200 km (about 120 miles) without the need for an intermediate amplifier. This record distance for a repeater-less link, Philips says, is four times the previous record of 50 km (30 miles). The Australian tests also showed that attenuation is the only factor limiting the potential distance that can be bridged using a fiber-optic cable. The 1550-nm optical power amplifier, the result of a cooperative effort between the Philips Development Labs in Nuremberg, Germany, and the Philips Research Labs in Eindhoven, the Netherlands, has an optical pump laser as its active optical component. It makes available a transmission signal of +12 dBm (about 14 mW). The SDH (synchronous digital hierarchy) transmission system uses a monomode glass fiber with an optical dispersion of 1300 nm. *JG*

## CVD GROWS $BaTiO_3$ FILM ON SEMICONDUCTORS

Advanced Technology Materials Inc., Danbury, Conn., has been awarded a contract by the U.S. Defense Dept.'s Strategic Defense Initiative Office (SDIO) to develop chemical-vapor-deposition (CVD) techniques for fabricating piezoelectric barium titanate ( $BaTiO_3$ ) thin films. The ability to grow such thin films, as well as thin films of other advanced dielectric materials (diamond, silicon carbide), on a semiconductor substrate is critical for the commercialization and high-volume production of next-generation (256-Mbyte) DRAMs.  $BaTiO_3$  films will be used to make devices for high-precision and low-intensity lasers, for CD-ROM and medical applications. When combined with its non-linear optical properties,  $BaTiO_3$  can accelerate the development of high-speed optical computers by allowing integrated optical phase modulators, switches, and couplers to be built. Call Gene Banucci at (203) 794-1100. *FG*

## SUB-2-IN. DISK DRIVES PACK UP TO 85 MBYTES

A trio of 1.8-in. disk-drive families from MiniStor Peripherals Corp., San Jose, Calif.; Aura Associates, Saratoga, Calif.; and NEC Corp., Tokyo, Japan, offer storage capacities ranging from 32 to 85 Mbytes. The drives aim at portable-computer and other battery-powered systems. MiniStor drives with operating and non-operating shock resistances of 20 Gs and 200 Gs, respectively, were designed to withstand high shock. With a shock sensor circuit, the drive can sense jarring movements during write commands, allowing the drive to take data-protection measures. Other features include a ruggedized spindle motor that provides high durability to shock, and a positive mechanical actuator lock that keeps the heads secure when they're parked. MiniStor's drives come in 32- or 64-Mbyte options and in two versions. One version has IDE interfaces for embedded applications, and the other includes the PCMCIA 68-pin memory-card connector, suiting it for removable applications. A 256-kbyte buffer helps eliminate unnecessary disk spin-ups by holding large chunks of data in temporary storage.

Aura Associates together with NEC designed a pair of 1.8-in. drives that employ 32-kbyte buffers, but offer 42.6 or 85.6 Mbytes of storage—about 33% more than the MiniStor drives. Access time is about 19 ms (just slightly slower than MiniStor) and the data-transfer rate is 4.5

# Test Results

R E A L I T Y  
D R I V I N G  
V I S I O N



*GE Plastics*



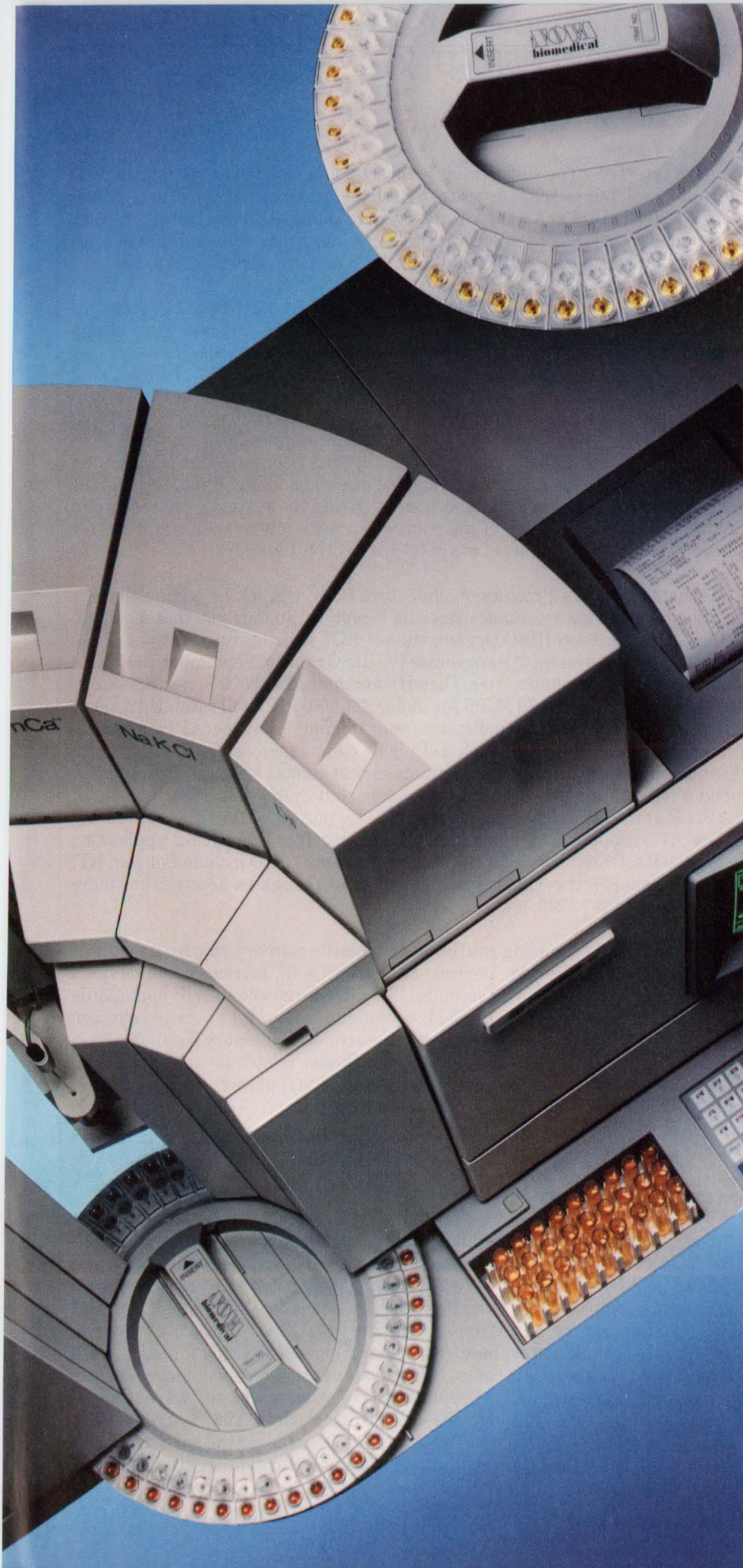

To ensure your company's positive performance in today's keenly competitive marketplace, start with advanced materials and resources available from the engineering plastics leader.

Get the precise combinations of properties you need from the industry's broadest and deepest selection of resin chemistries, copolymers, alloys and composites. Optimize product design and development with hands-on assistance and proprietary programs like our unique Engineering Design Database.

Enhance productivity and cost-efficiency with the significant process advances in progress at our massive Polymer Processing Development Center. Profit by GE Plastics' worldwide presence and market expertise.

NOVA Biomedical did, for their advanced Nucleus™ blood analyzer. **Materials:** Lexan® resin, foamable Prevox® resin, Cycliclac® ABS resin. **Resources:** Design reviews; material, tooling and process selection. **Results:** Creative design with increased functionality and parts consolidation; reduced assembly and finishing for significant savings in cost.

Partnership product development—only from GE. For more information, call: (800) 845-0600.

CIRCLE 130 FOR U.S. RESPONSE

CIRCLE 131 FOR RESPONSE OUTSIDE THE U.S.



**GE Plastics**

® Registered Trademarks of GE.  
™ Trademark of NOVA Biomedical.

Mbytes/s over an IDE interface. The first versions will consume just 880 or 960 mW in their idle modes (platters spinning but no reads or writes). Read and write accesses increase power consumption to 2 to 3 W. Both Aura and NEC will offer nearly identical drives. However, Aura would like to also embed portions of its drive technology into other companies' systems. Contact Jim Miller at MiniStor, (408) 943-0165; and John Scott at Aura (408) 252-2872. *DB*

## SINGLE CHIP COMPRESSES DATA LOCALLY

By placing lossless data compression on the motherboard through a local-bus interface to the CPU, the 9706 chip can perform compression without any negative impact on system performance. The device, a local-bus interface version of a data-compression chip from Stac Electronics Inc., Carlsbad, Calif., handles data transfers at rates exceeding 30 Mbytes/s. All that's needed to incorporate it on PC motherboards are two 32-kbyte static RAMs to hold the coding tables. Average data throughputs during compression of 2.5 Mbytes/s, and 6 Mbytes/s during decompression, enable the IC to operate transparently to the user. The chip also contains a special sleep mode that drops operating-current consumption from about 100 mA to just 0.3 mA when idling. Thus, the chip becomes an attractive option for portable PC motherboards, giving the system manufacturer a wider range of features to offer. Samples of the chip are immediately available and sell for \$19.90 each in lots of 50,000. Contact Robert Lutz at (619) 431-7474. *DB*

## CONSORTIUM BACKS PA-RISC ARCHITECTURE

Hewlett-Packard's Precision-Architecture RISC (PA-RISC) technology has gained worldwide acceptance since its inception. So much so that a consortium, the Precision RISC Organization (PRO), is being formed to back the architecture. The first high-end system to incorporate PA-RISC came in September 1990, with mid-range systems arriving a few months later. Then HP announced its 9000 Series 700 family of desktop workstations, which offers 76 MIPS for under \$21,000. PRO will establish a set of PA-RISC-related standards, including an application programming interface (API) and an application binary interface (ABI). The association will supply compliance verification and certification services, and will license a trademark to products that comply with these standards. PRO has developed a list of standard APIs that are supported by HP-UX, HP's version of Unix, as well as APIs that the organization expects will be supported by the OSF's operating system, OSF/1. The API supplies a common source-code interface, improving application portability from non-PA-RISC architectures. The initial members of PRO include Convex, HP, Hitachi, Hughes, Mitsubishi Electric, Oki, Prime, Sequoia, and Yokogawa Electric. For more information, call PRO at (408) 447-4249. *RN*

## 20-SECOND ANALOG EEPROM FINDS A HOME

By lowering the sampling rate of its nonvolatile memory chip by a factor of 0.8, Information Storage Devices, San Jose, Calif., increased the device's storage time from 16 to 20 seconds. ISD introduced the 64-mil<sup>2</sup> nonvolatile analog memory, which provides better-than-telephone quality audio, just over a year ago (*ELECTRONIC DESIGN*, Jan. 31, 1991, p. 39). By offering 20 seconds of memory for under \$6 in high volume, it becomes economically viable in mass-marketed telephone-answering machines—those that sell to the consumer for under \$100. It will thus replace the tape recorder, which usually provides the owner's outgoing message. The 20-second version of the chip is called the ISD520 TAD (tapeless-answering device). Sanyo will design a line of machines around the IC as well as market the chip in Japan. ISD's goal is a one-minute chip within a year, and ultimately an IC to store at least 30 minutes of speech. For additional information, call Steve Stephansen at (408) 428-1400. *FG*

## COMPUTING AGREEMENTS TO AID DOE RESEARCH

To accelerate cooperative technology development between the Department of Energy (DOE) and the computer industry, three research agreements, called CRADAs (cooperative research and development agreements), were reached. The participating companies are Cray Research Inc., Mendota Heights, Minn., and the Los Alamos National Laboratory, Los Alamos, Calif. The first CRADA calls for the development of a more accurate oceanic-atmospheric (whole-earth) model to study global climate change. The DOE has a unique expertise in computer analysis of complex phenomena, such as large-scale global modeling. The second CRADA aims to develop advanced software to simulate electromagnetic-wave effects in ultra-high-speed electronic devices. That will reduce the cost of designing and developing advanced ICs. The third CRADA calls for the partners to collaborate on improving their capabilities in computational chemistry to support studies on the dynamics of large molecules. *RN*

# It took QuickSim II just 30 minutes to clean Verilog-XL's clock.

In a recent simulation benchmark, our new QuickSim II™ ran 120,000 vectors through a 25,000 gate design in just 30 minutes. The Verilog-XL™ simulator? An hour and a half! Even more amazing, QuickSim II shows comparable gains on designs of up to 100,000 gates. And fully supports sub-micron ASICs.

Powerful tool technology. Proven tool integration.  
To beat the clock, call us. 1(800) 547-3000, Dept. 314.

**Mentor  
Graphics®**

CIRCLE 254 FOR U.S. RESPONSE

CIRCLE 255 FOR RESPONSE OUTSIDE THE U.S.

# RF TRANSFORMERS

Over 50 off-the-shelf models...

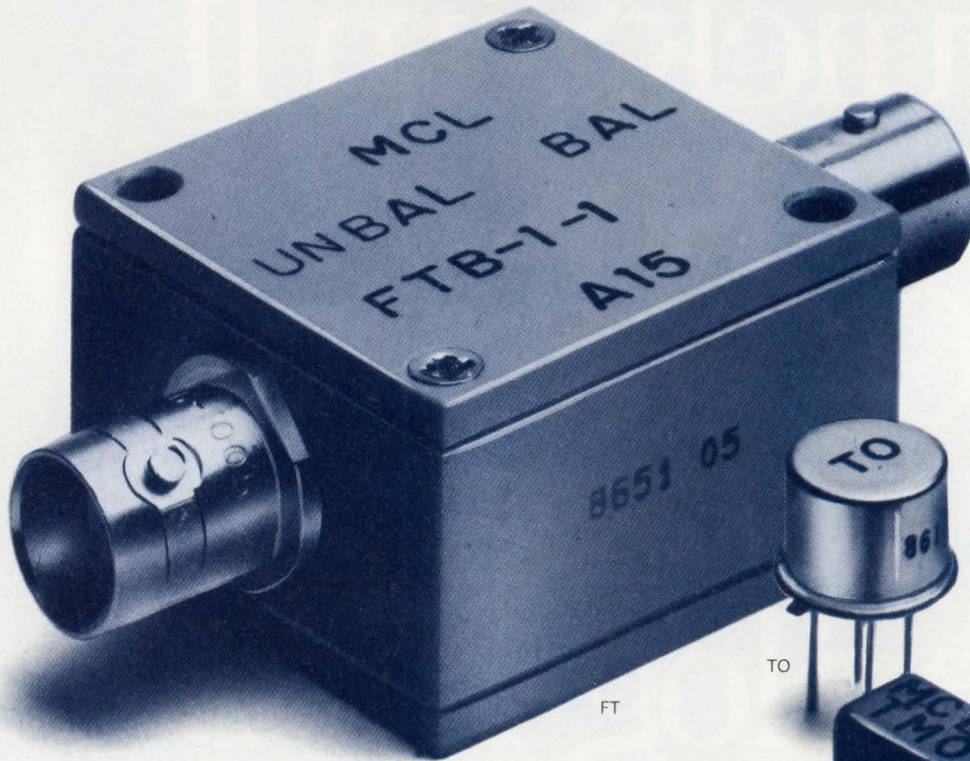

Having difficulty locating RF or pulse transformers with low droop, fast risetime or a particular impedance ratio over a specific frequency range? ... Mini-Circuits offers a solution.

Choose impedance ratios from 1:1 to 36:1, connector or pin versions (plastic or metal case built to meet MIL-T-21038 and MIL-T-55831 requirements\*). Ultra-wideband response achieves low droop and fast risetime for pulse applications. Ratings up to 1000M ohms insulation resistance and up to 1000V dielectric voltage. For wide dynamic range applications involving up to 100 mA DC primary current, use the T-H series. Coaxial connector models are offered with 50 and 75 ohm impedance; BNC standard; request other types. Available for immediate delivery with one-year guarantee.

Call or write for 68-page catalog or see our catalog in EEM, or Microwaves Product Data Directory.

\*units are not QPL listed

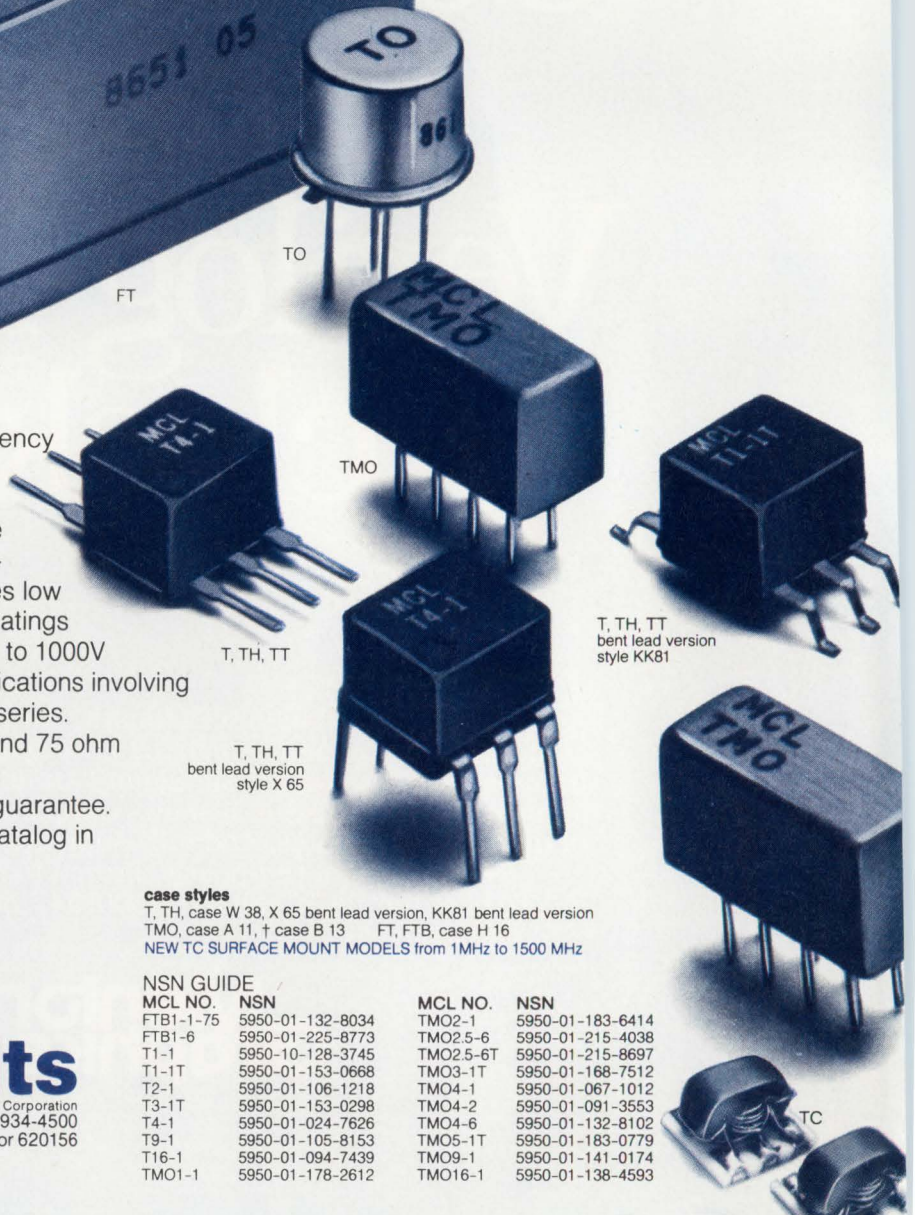

**case styles**

T, TH, case W 38, X 65 bent lead version, KK81 bent lead version  
 TMO, case A 11, † case B 13 FT, FTB, case H 16  
 NEW TC SURFACE MOUNT MODELS from 1MHz to 1500 MHz

**NSN GUIDE**

MCL NO.	NSN	MCL NO.	NSN
FTB1-1-75	5950-01-132-8034	TMO2-1	5950-01-183-6414
FTB1-6	5950-01-225-8773	TMO2.5-6	5950-01-215-4038
T1-1	5950-10-128-3745	TMO2.5-6T	5950-01-215-8697
T1-1T	5950-01-153-0668	TMO3-TT	5950-01-168-7512
T2-1	5950-01-106-1218	TMO4-1	5950-01-067-1012
T3-1T	5950-01-153-0298	TMO4-2	5950-01-091-3553
T4-1	5950-01-024-7626	TMO4-6	5950-01-132-8102
T9-1	5950-01-105-8153	TMO5-1T	5950-01-183-0779
T16-1	5950-01-094-7439	TMO9-1	5950-01-141-0174
TMO1-1	5950-01-178-2612	TMO16-1	5950-01-138-4593

finding new ways ...  
 setting higher standards

**Mini-Circuits**

A Division of Scientific Components Corporation

P.O. Box 350166, Brooklyn, New York 11235-0003 (718) 934-4500

Fax (718) 332-4661 Domestic and International Telexes: 6852844 or 620156



# FORMERS

3KHz-800MHz from \$3<sup>25</sup>

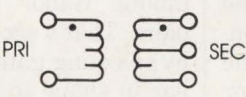
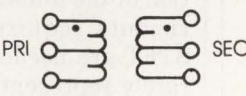
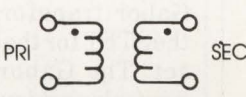
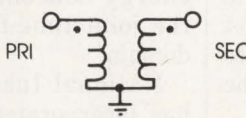
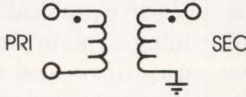
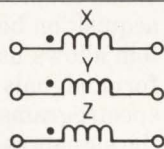
case style number see opposite page	MODEL NO.	$\Omega$ RATIO	FREQUENCY MHz	INSERTION LOSS			PRICE \$ Qty. (1-9)		
				3dB MHz	2dB MHz	1dB MHz			
<b>A*</b> 	T	T11-1T	1	05-200	.05-200	08-150	2-80	4.45	
		T11-6T	1	003-300	.003-300	01-150	02-50	6.95	
		T2-1T	2	07-200	07-200	1-100	5-50	4.95	
		T2.5-6T	2.5	01-100	01-100	02-50	50-20	4.95	
		T3-1T	3	05-250	.05-200	1-200	5-70	4.95	
		T4-1	4	2-350	2-350	35-300	2-100	3.25	
		T4-6T	4	02-250	.02-250	05-150	01-100	4.45	
		T5-1T	5	3-300	3-300	6-200	5-100	4.95	
		T8-1T	8	03-140	.03-140	10-90	1-60	7.95	
		T13-1T	13	3-120	3-120	7-80	5-20	4.95	
		T16-6T	16	.03-75	.03-75	06-30	1-20	5.65	
		T4-1H	4	10-350	10-350	15-300	25-200	5.95	
		TMO	TMO1-1T	1	05-200	05-200	08-150	2-80	7.95
		TMO2-1T	2	07-200	07-200	1-100	5-50	8.45	
		†TMO2.5-6T	2.5	01-100	01-100	02-50	05-20	8.45	
		†TMO3-1T	3	05-250	.05-250	1-200	5-70	7.95	
TMO4-1	4	2-350	2-350	35-300	2-100	6.25			
TMO5-1T	5	3-300	3-300	6-200	5-100	8.45			
TMO13-1T	13	3-120	3-120	7-80	5-20	8.45			
<b>B*</b> 	TT	TT1-6	1	.004-500	.004-500	02-200	1-50	6.95	
		TT1.5-1	1.5	.075-500	.075-500	2-100	1-50	5.95	
		TT2.5-6	2.5	01-50	01-50	025-25	05-10	6.45	
		TT4-1	3	05-200	05-200	2-50	1-30	5.95	
		TT4-1A	4	01-300	01-300	02-250	03-180	6.95	
		TT25-1	25	02-30	02-30	05-20	1-10	9.95	
		TTMO	TTMO25-1	25	02-30	02-30	05-20	1-10	11.95
		TTMO1-1	1	.005-100	.005-100	01-75	05-40	11.45	
		TTMO4-1A	4	0.1-300	0.1-300	0.2-250	0.3-180	13.95	
		<b>C</b> 	T	T11-1	1	.15-400	.15-400	35-200	2-50
T11.8-3	1.18			0.01-250	0.01-250	0.02-200	0.03-50	5.65	
T11-6	1			01-150	01-150	02-100	05-50	5.65	
T11.5-1	1.5			1-300	1-300	2-150	5-80	4.45	
T11.5-6	1.5			02-100	02-100	05-50	01-25	5.65	
T2.5-6	2.5			01-100	01-100	02-50	05-20	4.45	
T4-6	4			02-200	02-200	05-150	1-100	4.45	
T9-1	9			15-200	15-200	3-150	2-40	3.95	
T16-1	16			3-120	3-120	7-80	5-20	4.45	
T36-1	36			03-20	03-20	05-10	1-5	6.95	
TO	TO-75			1	10-500	—	10-500	40-250	6.95
TH	T11-1H			1	8-300	8-300	10-200	25-100	5.95
T9-1H	9			2-90	2-90	3-75	6-50	6.45	
T16-H	16			7-85	7-85	10-65	15-40	6.45	
TMO	TMO1-02			1	1-800	1-800	2-500	—	9.45
TMO1-1	1			15-400	15-400	35-200	2-50	6.25	
TMO1.5-1	1.5			1-300	1-300	2-150	5-8	8.45	
†TMO2.5-6	2.5			01-100	01-100	02-50	05-20	7.95	
†TMO4-6	4	02-200	02-200	05-150	1-100	7.95			
TMO6-1	6	3-200	3-200	5-150	5-50	7.95			
TMO9-1	9	15-200	15-200	3-150	2-40	7.95			
TMO16-1	16	3-120	3-120	7-80	5-20	7.95			
<b>D</b> 	T	T2-1	2	050-600	050-600	1-400	5-200	3.95	
		T3-1	3	5-800	5-800	2-400	—	4.45	
		T4-2	4	2-600	2-600	5-500	2-250	3.95	
		T8-1	8	15-250	15-250	25-200	2-100	3.95	
		T14-1	14	2-150	2-150	5-100	2-50	4.95	
		TMO	TMO2-1	2	050-600	050-600	1-400	5-200	7.95
		TMO3-1	3	5-800	5-800	2-400	—	8.45	
		TMO4-2	4	2-600	2-600	5-500	2-250	7.95	
		TMO8-1	8	15-250	15-250	25-200	2-100	7.95	
		TMO14-1	14	2-150	2-150	5-100	2-50	8.45	
		FT	FT1.22-1	1.22	.005-100	.005-100	01-50	05-25	35.95
		FT1.5-1	1.5	1-400	1-400	5-200	1-100	35.95	
<b>E</b> 	FTB	FTB-1	1	2-500	2-500	5-300	1-100	36.95	
		FTB1-6	1	01-125	01-125	05-50	1-25	36.95	
		■FTB1-75	1	5-500	5-500	5-300	10-100	36.95	
<b>F</b> 	T	T-622	1	0.1-200	0.1-200	0.5-100	5-80	3.25	
		T626	1	0.01-10	0.01-10	0.2-5	0.4-2	3.95	

■ Denotes 75 ohm models

\* FOR A AND B CONFIGURATIONS

Maximum Amplitude Unbalance  
0.1 dB over 1 dB frequency range  
0.5 dB over entire frequency range

Maximum Phase Unbalance  
1.0° over 1 dB frequency range  
5.0° over entire frequency range

CIRCLE 166 FOR U.S. RESPONSE

CIRCLE 167 FOR RESPONSE OUTSIDE THE U.S.

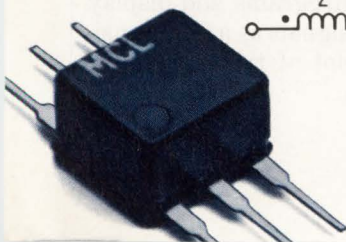

## IMPROVED SPECTROGRAM ALGORITHM BOOSTS THROUGHPUT, INCREASES RESOLUTION

**A** new spectrogram, based on the Gabor transform, overcomes the limitations of spectrograms based on the short-time fast-Fourier transform (STFT). Developed by National Instruments Inc., Austin, Texas, the spectrogram can perform calculations four to six times faster than a sliding FFT. It can also deliver four to eight times better resolution. In traditional frequency analysis used for such applications as speech, sonar, and vibration analysis, information concerning the time at which a sound occurs isn't available. Consequently, joint time-frequency analysis (JTFA) techniques must be used to view the time and frequency information simultaneously.

The STFT spectrogram is the most-commonly used approach to view information when performing JTFA. For each slice of windowed data, the frequency spectrum is computed with FFTs. The time index of the frequency information is assumed to be in the middle of each slice of windowed data. A complete 3D spectrogram can then be established by stepping the window to the right in some regular time interval and recomputing the spectrum.

However, STFT spectrograms do have limitations. For instance, the choice of window type and length can distort the output spectrum. A wide window gives good resolution in the frequency domain but poor resolution in the time domain. Conversely, a nar-

row window gives good time-domain resolution but poor frequency-domain resolution. Furthermore, the STFT requires a considerable set of computational resources—the FFT must be calculated at each point in the input waveform to produce a complete spectrogram. Most STFT systems,

Fourier transform, the Gabor spectrogram avoids the limitations of the STFT spectrogram (Dennis Gabor, the Hungarian-born British physicist, first postulated the transform in an article "Theory of Communication" published in the Journal of the IEE in London in Nov., 1946). The combination of the Gabor

The Gabor transform is defined as:

$$s(i) = \sum_{m=0}^{\infty} \sum_{n=0}^{N-1} C_{m,n} h_{m,n}(i)$$

$$C_{m,n} = \sum_{i=0}^{\infty} s(i) \gamma_{m,n}^*(i)$$

$$h_{m,n}(i) = h(i-m\Delta M)W_L^{n\Delta N i}, \quad \gamma_{m,n}(i) = \gamma(i-m\Delta M)W_L^{n\Delta N i}$$

where:  $s(i)$  is the discrete time-domain signal,  
 $C_{m,n}$  is a Gabor coefficient,  
 $h_{m,n}(i)$  is the basis Gaussian function,  
 $\gamma_{m,n}(i)$  is called the biorthogonal auxiliary function,  
 $\Delta M, \Delta N$  are sampling intervals in the time and frequency domain.

though, use only about half their data points to maintain an acceptable throughput level.

Good joint time-frequency representation is difficult to achieve with STFT. When looking at a spectrogram, the sidelobe leakage from the FFT results in a smearing of the STFT spectrogram. That makes it difficult to detect individual formants. In contrast, the Gabor spectrogram is optimized for both time and frequency resolution. The resulting intensity plot shows very distinct transitions from one sound to another.

By employing a Gabor transform rather than a

transform and another algorithm known as the Pseudo Wigner-Ville Distribution (PWVD) trim the computational time. The incoming signal is first mapped to a set of discrete Gabor coefficients in the time-frequency domain.

The Gabor transform represents the signal as a linear combination of time-and-frequency-shifted Gaussian functions. Once the coefficients are computed, the spectrogram is generated by applying the PWVD to the set of Gaussian functions. One key aspect of the Gabor spectrogram is that the analytical solution of the PWVD of the Gaussian function is

known. Therefore, many computations can be done in advance and placed in a lookup table for use in the future.

The heart of the Gabor spectrogram is the discrete Gabor transform, which is computed using two specific equations (*see the figure*). In the calculations, it's important to obtain unique Gabor transform pairs. That's accomplished by selecting  $\gamma(i)$  similar in shape to  $h(i)$ .  $\gamma_{m,n}(i)$  is a biorthogonal auxiliary function;  $h(i)$  is the basis Gaussian function.

Computing the Gabor coefficients is very efficient because only a fraction of the number of coefficients required by the STFT are needed to accurately represent the original signal. A six-fold throughput improvement can be attained with the Gabor transform versus the STFT for the same data set. The Gabor spectrogram also achieves a better signal-to-noise ratio in the output intensity plot. The higher SNR is obtained because the Gabor coefficients better reflect the local behavior of a signal, resulting in a higher signal-energy concentration in the joint time-frequency domain.

National Instruments has incorporated the Gabor transform as a virtual instrument under its LabView graphical programming system for data acquisition and analysis. When coupled with a data-acquisition board, the system allows users to transform signals into Gabor spectrograms and display the signals as a 2D intensity plot of time-frequency data.

DAVE BURSKY

# LISTEN.

**“P-CAD helps us transform abstract engineering concepts into sound designs.”**

*Jeff Rowland*  
Jeff Rowland, President



## **P-CAD products, unique as your application.**

P-CAD products include all the interactive and automatic tools you need to complete PCBs, from symbol creation through manufacturing.

All made possible by P-CAD's open architecture and its interfaces to a wide range of third party tools such as VIEWlogic®. P-CAD lets you easily exchange PCB files with your favorite

mechanical CAD programs such as CADAM's MICRO CADAM®. And whether it's a DOS or UNIX®-based solution you're looking for, there is a P-CAD product that is engineered to meet your desktop PCB design needs.

## **Now hear this. Here's how to get a free P-CAD demo.\***

When it comes to designing better PCBs faster and more productively, the advantages of P-CAD are definitely worth hearing about. To take advantage of this free offer for a hands-on demonstration, just call us for the name of your nearest CADAM Value Added Reseller. If you think this offer sounds great, simply call today toll-free: **1-800-255-5710**.



**CADAM**  
AN IBM COMPANY

**World Class PCB CAD Productivity**

\*Available from CADAM Value Added Resellers. Contact CADAM for details. IBM is a registered trademark of International Business Machines Corp. CADAM and MICRO CADAM are registered trademarks of CADAM INC. P-CAD is a registered trademark of Personal CAD Systems, Inc. UNIX is a registered trademark of UNIX Systems Labs, Inc. VIEWlogic is a registered trademark of Viewlogic Systems, Inc. CADAM INC., 1935 N. Buena Vista St., Burbank, CA 91504. © 1992 CADAM INC.

CIRCLE 184 FOR U.S. RESPONSE

CIRCLE 185 FOR RESPONSE OUTSIDE THE U.S.

## FDDI MOVES TO THE DESKTOP ON TWISTED-PAIR LINES

**A**lthough the 100-Mbit/s data rate and the  $2.5 \times 10^{-10}$  bit-error rate of the FDDI (Fiber Distributed Data Interface) are desirable for networking desktop computers and peripherals, the high cost of adapter cards is a major stumbling block. Where Ethernet adapter cards are available for under \$200, the \$1500 price tag for an FDDI card is prohibitive for most applications. A large part of this cost comes from the optoelectronic transceiver that connects networked terminals to fiber-optic cables. Another problem stems from present standards that call for fiber-optic cable to be routed from the FDDI backbone to the desktop—a costly outlay for buildings already wired for Ethernet or Token Ring networks.

These problems can be solved when the FDDI standard, which currently specifies only fiber-optic cable, is expanded to include twisted-pair copper wire as the transmission medium. Bringing twisted-pair wire to FDDI cuts the cost of adapter cards by allowing the transceiver to be made with standard silicon processes. This reduces transceiver cost to about \$200. Another benefit is that twisted-pair copper wiring for network connections is already widely installed. However, the transition from fiber to copper wiring reintroduces the problems that caused the industry to select fiber over copper for a 100-Mbit/s network in the first place: copper's high

attenuation, EMI and RFI noise-generation and susceptibility, and its low signal-to-noise ratio.

Searching for a solution to these objections, the ANSI X3T9.5 TP-PMD working group has looked at three types of twisted-pair wiring. Shielded twisted-pair (STP) wiring is a two-pair, 150- $\Omega$  cable consisting of individually shielded pairs contained within a shielded outer jacket. Referred to as IBM Type 1, the wire has a specific number of twists per foot and is used in tokening networks. Data-grade, unshielded twisted pair (DTP) has tight tolerances on crosstalk, attenuation, and impedance characteristics. Referred to as IBM Type 3 or AT&T Category 5, DTP is often used for 10Base-T Ethernet wiring. Distributed inside wire (DIW) is a voice-grade, unshielded twisted-pair cable commonly used for telephone installations. Also referred to as AT&T Category 3, this cable has no guaranteed number of twists per foot and thus no accurately predicted crosstalk, attenuation, and impedance characteristics.

It's easier to meet FCC requirements for electromagnetic interference by using STP. But users generally prefer using the same copper FDDI adapter card with data- or voice-grade unshielded-twisted-pair cable at distances up to 100 meters. Since implementing new silicon for FDDI DIW could take up to three years, the standards committees have considered using separate

standards for data-grade and voice-grade cabling. However, new encoding schemes under evaluation may this solve the problem.

The primary objective of these schemes is to lower the frequency of the transmitted signal without reducing data rates. This would satisfy the data-rate requirements of other parts of the FDDI network while complying with FCC EMI and RFI requirements. The encoding scheme specified by FDDI for fiber transmission is NRZI (nonreturn to zero, inverted), which uses a two-level (logic high and low) waveform to reduce the data-flow frequency from 125 MHz to 62.5 MHz. To provide noise immunity and meet FCC copper requirements, the X3T9.5 working group is evaluating two proposals for modified NRZI encoding.

The first proposal comes from Crescendo Communications, Sunnyvale, Calif., and is co-sponsored by AT&T, British Telecom, Fibronics International, Hewlett-Packard Co., and Ungermann-Bass Inc. Called MLT-3, this scheme uses a scrambled, three-level NRZI-like waveform with three voltage levels. At the receiver end, the voltage difference be-

tween high and low logic levels is 110 mV. This type of coding requires dynamic adaptive equalization to account for different cable lengths. Post-compensation is employed at the receiver end to boost the signal-to-noise ratio.

The second proposal from National Semiconductor, Santa Clara, Calif., and Cabletron Systems Inc., Rochester, N.H., uses a pre-compensated two-level NRZI signal. Called 100Base-T by its proponents, this encoding scheme provides a 180-mV step voltage at the receiver end. Like MLT-3, it requires a scrambling circuit for DTP cable, but doesn't need adaptive equalization. The performances of both approaches are being tested by Hewlett-Packard's communications laboratory in Austin, Texas. Even if one system exhibits a slight advantage over the other, the ultimate choice will hinge on the silicon cost and the cost of system implementation.

These and other FDDI-related issues will be examined in detail at this year's Silicon Valley Networking Conference, to be held at the Santa Clara Convention Center, Santa Clara, Calif., April 27-29.

MILT LEONARD

## DEEP-ETCH LITHOGRAPHY YIELDS 0.5-MM DIAMETER MOTORS

**I**n from the believe it or not department: An electric motor so small that it takes a microscope to recognize its details.

Such a motor is no illusion. It's a down-to-earth device and one of the latest developments in microme-

chanics, the emerging technology for fabricating inexpensive structural elements with dimensions in the millimeter to micrometer range.

The electrostatic stepping motor, resulting from work at the Institute for

# AWESOME

## TEK-AT3 386DX HALF-SIZE PC/AT

We think this is the best way to describe the new TEK-AT3 all CMOS 386DX single board computer. And rightly so. Because the TEK-AT3 comes standard with a powerful 33 Mhz CPU, high performance Cache memory, and a capacity to support up to 16 Megabytes of DRAM.

Plus, you get all the bells and whistles you've come to expect from conventional PCs: hard disk interface, floppy disk controller, serial and parallel ports.

And like all Teknor computer cards, the TEK-AT3 benefits from the latest innovative technologies. Options like 1 Meg of onboard programmable Flash EPROM, 1 Meg of battery-backed SRAM, and the ability to boot from Flash EPROM disk offer possibilities never before conceived on a 7 x 4.7" PC/AT form factor.

In fact, when you consider all the advantages the TEK-AT3 will bring to your system designs... you'll think it's awesome, too!

Call us today at **1-800-387-4222**  
for your free literature package.



CIRCLE 228 FOR U.S. RESPONSE

CIRCLE 229 FOR RESPONSE OUTSIDE THE U.S.

**TEKNOR**  
MICROSYSTEMS INC.

P.O. Box 455, Sainte-Therese (Quebec), Canada J7E 4J8 • Tel: (514) 437-5682 • Fax: (514) 437-8053

# HARRIS GENERATES ASTOUNDING

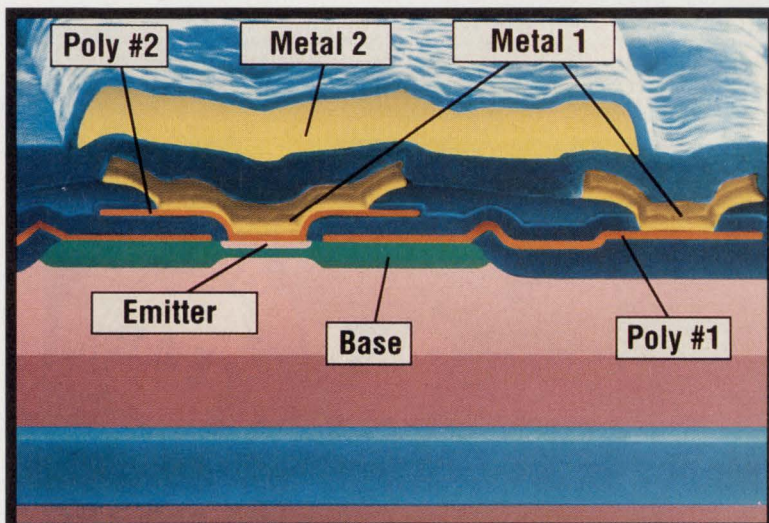

This HFA1100 family's fast performance is made possible by Harris' unique UHF-1 process. The shallow structure of UHF-1 transistors is the result of bonded wafer technology.

## Harris HFA1100

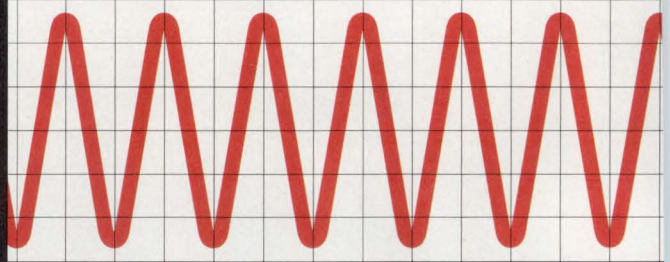

## Ordinary high-speed op amp

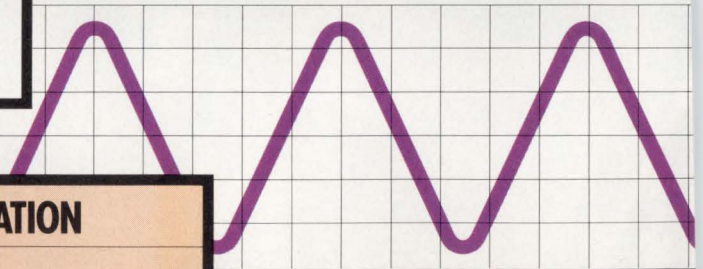

### PRODUCT

### CONFIGURATION

HFA1100 op amp	Standard pinout
HFA1120 op amp	Output offset adjust
HFA1130 clamped op amp	User-defined output clamp
HFA1110 buffer	Standard buffer pinout
HFA1112 buffer	Standard op amp pinout

Once again, the latest breakthrough in ultra-high-speed op amps comes to you from Harris.

This time, it's the HFA1100. Three times as

fast as the old record holder. And just what fast-thinking engineers like you have been waiting for. Quickly imagine what you can do

with a bandwidth so huge. Providing excellent phase linearity and a remarkable gain flatness of 0.14 dB to 100 MHz. And your creativity

# INNOVATIONS WITH FREQUENCY.

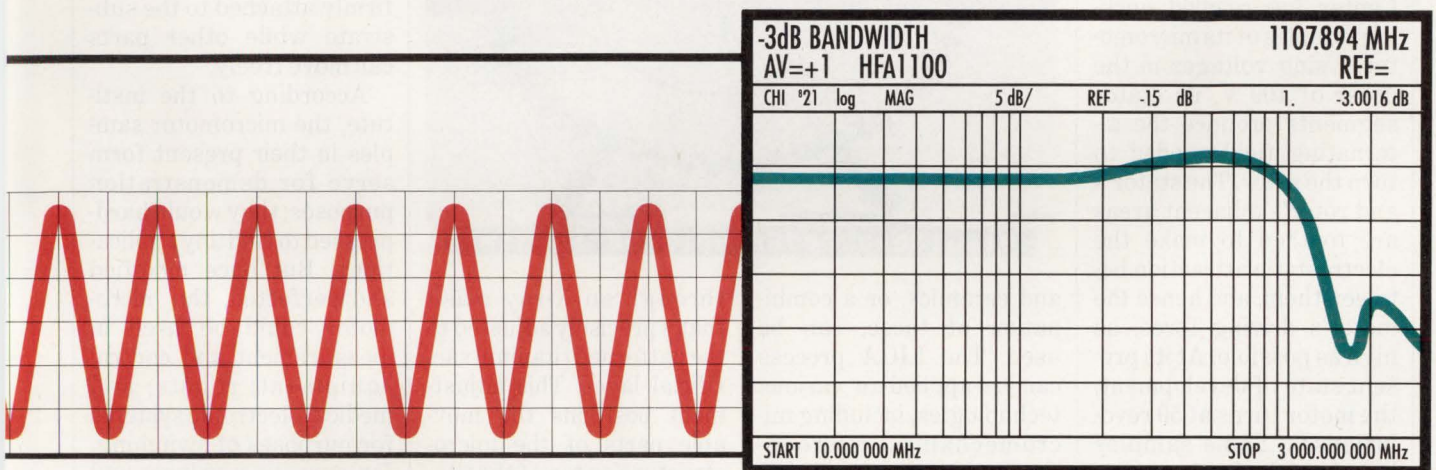

## APPLICATIONS

- High-Resolution Displays
- RF Transmitters/Receivers
- Medical Imaging Systems
- Radar Systems
- Flash A/D Drivers
- Video Switching and Routing/Line Drivers
- Fiber Optics

	HFA1100/20/30	HFA1110/12
-3dB Bandwidth	870 MHz	700MHz
Slew Rate	2500V/ $\mu$ sec	2500V/ $\mu$ sec
Settling Time (0.1%)	11 ns	7 ns
High Current Output	60 mA	60 mA
Temperature Range	-40°C to 85°C	-40°C to 85°C
Packages	8-pin PDIP, CerDIP, SOIC	8-pin PDIP, CerDIP, SOIC
Prices (100s)	\$9.95	\$5.95

needn't stop with standard products. Because the UHF-1 process is available in semicustom, as part of Harris' industry-leading FASTRACK™

design system. So rev up your oscilloscopes. And get your hands on some HFA1100s today. Just call 1-800-4-HARRIS, ext. 1173.



CIRCLE 258 FOR U.S. RESPONSE  
CIRCLE 259 FOR RESPONSE OUTSIDE THE U.S.

Microstructure Technology in Karlsruhe, Germany, has a rotor whose diameter is less than 0.5 mm (*see the photo*). Surrounded by six stator segments, the 100- $\mu\text{m}$ -high rotor turns on an axis with a radius of about 120  $\mu\text{m}$ . The motor is made of galvanized nickel.

The institute, which is part of the Karlsruhe-based Nuclear Research Center, has readied working samples of its micromotor. Using voltages in the order of 100 V, its stator segments produce the alternating field needed to turn the rotor. The stator's and rotor's adjacent areas are toothed to make the electrostatic attraction between them, and hence the motor's driving force, as high as possible. At its present state of development, the motor turns at 50 revolutions/s. Some samples have reached 80 revolutions/s.

Similar micromotors have also been developed elsewhere, at U.S. universities, for example. But these are made of polysilicon and are relatively flat. The Karlsruhe motor, by contrast, can be several hundred micrometers high, and that makes for greater forces.

The institute's process for fabricating arbitrarily-shaped 3D microstructures, such as the stepping motor, is based on deep-etch synchrotron lithography, electroforming, and plastic molding. The LIGA process (its name derives from the German words for lithography, electroforming and molding) allows microstructures of any lateral shape to be made with structural heights of several hundred micrometers, lateral di-

mensions down to 1  $\mu\text{m}$ , and with sub-micrometer accuracy over the structure's total height.

Moreover, different materials like plastics, metals,

the LIGA process steps. A resist layer, several hundred micrometers high, is polymerized directly onto the substrate and exposed to synchrotron radiation



and ceramics, or a combination of these, can be used. The LIGA process can be applied to various technologies, including micromechanics, microoptics, and integrated optics, as well as sensors and actuators. The Karlsruhe institute has extended its process to allow free-moving oscillating or rotating microstructures to be made.

In preparing a substrate for the LIGA process, a thin silver layer for the electrical contacts is deposited onto the insulating substrate, which may be a ceramic or silicon wafer. Next, a titanium layer, a few  $\mu\text{m}$  thick, is sputtered onto the substrate.

This titanium layer serves as the sacrificial layer. It guarantees good adhesion of the X-ray resist to the substrate and constitutes a plating base for the electrodeposited structures. The titanium layer is patterned by conventional photolithography and wet etching.

The substrate so prepared is then subjected to

through an X-ray mask that's precisely adjusted to the patterned titanium sacrificial layer. This adjustment positions the movable parts of the microstructure on top of the titanium layer. The fixed parts are placed on the substrate's metallized areas.

The irradiated resist is subsequently removed and a complementary structure is built up by electrodepositing a metal. After stripping the resist, the titanium sacrificial layer is selectively etched against the overlying and underlying metals using hydrofluoric acid. After this etching process, certain parts of the microstructure remain firmly attached to the substrate while other parts can move freely.

According to the institute, the micromotor samples in their present form serve for demonstration purposes; they would hardly be used to find any applications. But once modified and perfected, the micromotor could be used in measurement and control equipment; robots; and medical electronic systems for purposes of switching, for operating valves, and for adjusting miniature micropumps.

JOHN GOSCH

## SIMPLE SERIAL BUS EASES PC-PERIPHERALS INTERCONNECT

Although most desktop and portable PC-compatible computers pack multiple I/O ports and expansion-card slots, those ports and slots often require long bulky cables or shutting the machine down and opening it up before installing the hardware. Now, however, a moderate-speed serial bus that operates at 100 kbits/s promises to give PC users the same and more flexibility than the Apple desktop bus offers Macintosh system users. Called Access.bus by its developer, Philips-Signetics Corp., Sunnyvale, Calif., the bus was

originally created with Digital Equipment Corp., Maynard, Mass., and is used by DEC on its RISC-based workstations family.

The commercial "open" version of Access.bus differs slightly from the initial DEC version—it uses a 5-V supply and can access 125 peripherals, while the initial version uses a 12-V supply and is limited to 14 peripherals (DEC plans to upgrade its hardware to the open version). Based on the patented Philips inter-IC (I<sup>2</sup>C) bus, the scheme requires just two active signal wires—one for data





# In The World Of Hybrid Microelectronics, Bigger Is Better.

When you're wrestling to find space for a hybrid on a packed board, you want the smallest, lightest product you can find.

But when you're looking for small, lightweight hybrids in large quantities, you need the capabilities of a big, powerful company. A company that can handle

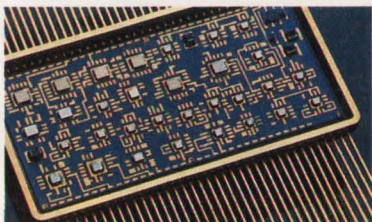

Raytheon currently produces over 400,000 high-reliability hybrid assemblies a year, including MCMs, as well as MIBs (Multilayer Interconnect Boards, SEM-A through E).

high-reliability and high-volume at the same time.

Raytheon is the largest manufacturer of high-reliability hybrids in the world. Our fully-integrated, MIL-STD-1772 certified facility is dedicated to the design, production and testing of hybrid microelectronics, and includes more than 130,000 square feet devoted to fully automated manufacturing, with more than 75% better than Class 100,000.

We use high-precision robotic assembly, automated 100% wire bond pull testing, automatic parametric testing, and automatic vision systems for 100% inspection. As a result, we can handle high-volume production of hybrids that meets virtually any system requirements. We could even double our hybrid production, without sacrificing quality or reliability.

When it comes to hybrids themselves, small is beautiful. But when you're selecting a company you can rely on to supply you with those miniature hybrids and still maintain high-reliability at high-volume, bigger is definitely better.

To learn more about our high-reliability hybrids, call or write for technical support and applications assistance. Raytheon Company, Electronic Components Division, 465 Centre Street, Quincy, MA 02169. (617) 984-8505. FAX: (617) 984-4199.

## Raytheon

*Where Quality Starts With Fundamentals.*

CIRCLE 208 FOR U.S. RESPONSE

CIRCLE 209 FOR RESPONSE OUTSIDE THE U.S.

## TECHNOLOGY ADVANCES

and one for the clock. Two more conductors can be used in the cable for power and ground.

The bus' 100-kbit/s data rate yields an actual information transfer rate of about 80 kbits/s—more than adequate for modems, faxes, keyboards, mice, hand scanners, and low-to-moderate-speed peripherals. If power lines are included in the cable, the bus can also power the peripherals it connects to, up to a maximum current of 500 mA.

Besides offering a simple two- or four-wire connection, the bus allows peripherals to "hot plug" into a system. Each peripheral with the Access.bus port uses a microcontroller that

"announces" its presence on the bus when the unit is plugged in.

The host system's Access.bus port polls the bus regularly. When it detects a peripheral not in its bus map, it updates the bus map, adding the device to the list of available resources and assigning the device an address. The system then sends an acknowledgement signal to the peripheral to turn off the announcement. The entire operation takes just a few milliseconds.

The bus is aimed at three basic types of peripherals commonly used in desktop and portable computing—keyboard-like data-entry systems; positioning systems, such as mice; and

data-stream peripherals, including modems and facsimile units or hand-operated scanners. Unlike Apple's Desktop Bus scheme, which is a somewhat simple network with devices daisy-chained from one peripheral to the next, the Access.bus is a simple two-wire bus: Peripherals simply tap all of the wires just like a connector taps the expansion bus on the PC motherboard. The Access.bus can have a maximum cable length of 8 meters.

Because the Access.bus is a bus-topology network, devices are distinguished by unique identification strings. Strings are defined for protocol and module revision, vendor and module name, and device

number. This data can be integrated into the peripheral and read out by the host during configuration.

Non-handheld peripherals built for the Access.bus should contain two female connectors that internally form the internal "T" connector. Handheld units might typically have a dedicated cable or a single female connector, and they come with a separate "T" connector that attaches to an existing cable. The host system need only have one female connector. Cables would typically be male-to-male. The simple four-contact male and female connectors are available from various suppliers, including Amp and Molex.

The message format

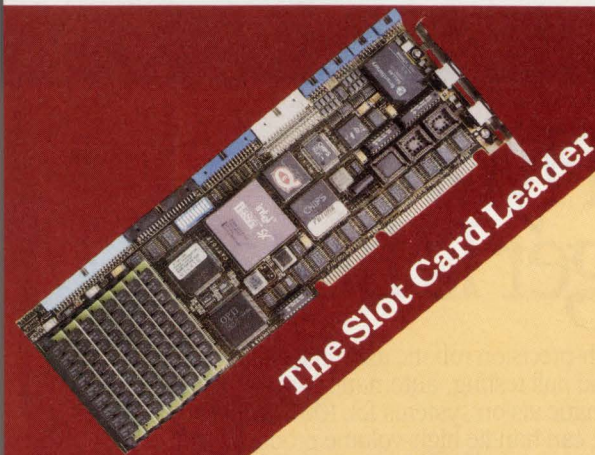

# Diversified

# Reveals Its

If your single board computer contact DTI to solve

GEN. MANAGEMENT	Your Supplier	DTI
Employee turn-over approaches zero		✓
Filled 100,000 plus piece orders for Fortune 500 companies		✓
<b>Slot-card technology pioneer, i.e., excess of 20 yrs.</b>		✓
100% FCC & U.L. certified computer boards		✓
Subjected to Fortune 100 quality audits		✓
Products currently employed in rigid Belcore applications		✓
Provided product into Desert Storm		✓
Implemented a formal customer service organization		✓
Excess of 100,000 product catalogs mailed annually		✓

FINANCE	Your Supplier	DTI
Computerized financial system, from order entry to final invoice		✓
Financial performance rated in upper 10% of Fortune 500 companies		✓
Committed ongoing capital equipment program		✓
Financial independence, i.e., no outside investors		✓
Inventory turns more than 5 times per year		✓
Routine statistical cycle counting of inventory		✓
<b>40 consecutive quarters of profitability</b>		✓

ENGINEERING	Your Supplier	DTI
State-of-the-art development tools		✓
<b>New product development cycles completed in under 60 days</b>		✓
All product designs performed in-house		✓
Routinely develops custom hardware products		✓
Provide custom BIOS		✓
Considered the technology leader in product market place		✓
All products fully validated to insure industry standard compatibility		✓

## TECHNOLOGY ADVANCES

used for communication between the host system and the Access.bus peripheral consists of three opening bytes of header information. They contain the destination address, the source address, a protocol flag bit, and the length of the data transfer (1 to 127 bytes). Following the header are the data bytes, and a checksum byte ends the packet. Messages are either data stream (protocol flag = 0) or control/status information (flag = 1).

The packetized protocol limits each interactive peripheral to occupy the bus for no more than 8 ms at a time. That ensures the other devices have a chance to update the screen every frame time and thus have

**WANT TO GO?**  
**T**he first Access.bus developer's conference will be hosted by Philips-Signetics on April 22 at the Techmart Center in Santa Clara, Calif. There's no registration fee. Call Sharon Baker for details at (408) 991-3518.

the system operate in real time. Non-interactive peripherals can become a bus master for 5 ms at a time, and must allow at least 12 ms from the time they relinquish the bus to the time they can again request to be a bus master.

All of the protocol and data transfers are handled

by a dedicated microcontroller—a version of the 80C51 that includes 16 kbytes of ROM or EPROM, 256 bytes of RAM, two 16-bit timers/counters, four 8-bit I/O ports, a full-duplex UART, and special low-power modes to trim power during idle conditions. The 83C654/87C654 acts as an interface converter and FIFO buffer, eliminating protocol overhead from the device driver and host.

One of the first companies to specialize in Access.bus products, Computer Access Technology Corp., Sunnyvale, Calif., is developing a PC/AT bus-interface adapter that will allow developers or users to add Access.bus capability to an

existing PC. The company will develop standard products as well as offer design consulting services.

Free copies of the Access.bus definition (version 1.1) are available from Philips-Signetics; contact Sharon Baker at (408) 991-3518. A development kit with some MCUs, cables, connectors, source code for typical applications, and a PC adapter card will also be available in the late second or early third quarter. There's no royalty or licensing fee for using the Access.bus standard. The interface board will be available in the third quarter. Contact Dan Wilnai, Computer Access Technology, (408) 732-8910.

*DAVE BURSKY*

# Technology, Inc.

## Secret Of Success...

supplier does not meet these requirements,  
your computer needs.

MANUFACTURING	Your Supplier	DTI
All products manufactured in-house		✓
Strong "Buy America" policy		✓
Perform double sided surface mount technology		✓
All computer products environmentally stressed prior to shipment		✓
State-of-the-art MRP computer system		✓
Rigid configuration control system		✓
All components bought against formal component specifications		✓

QUALITY	Your Supplier	DTI
100% SPC trained staff (Statistical Process Control)		✓
SPC 10-week training classes conducted in-house on continuing basis		✓
Single board computers subjected to 24 2-hour thermal shock cycles (0-70°c) under power		✓
Anti-static devices provided for products in each shipment		✓
Rigid quality tests conducted on all ordered parts received & shipped		✓



Call us toll free for orders and information.

### 1-800-443-2667

U.S.A. - (601) 856-4121

Fax (601) 856-2888

Outside U.S.A. - (201) 891-8718/Fax (201) 891-9629

CIRCLE 240 FOR U.S. RESPONSE

CIRCLE 241 FOR RESPONSE OUTSIDE THE U.S.

Toshiba ships world's first NEURON® CHIPS.

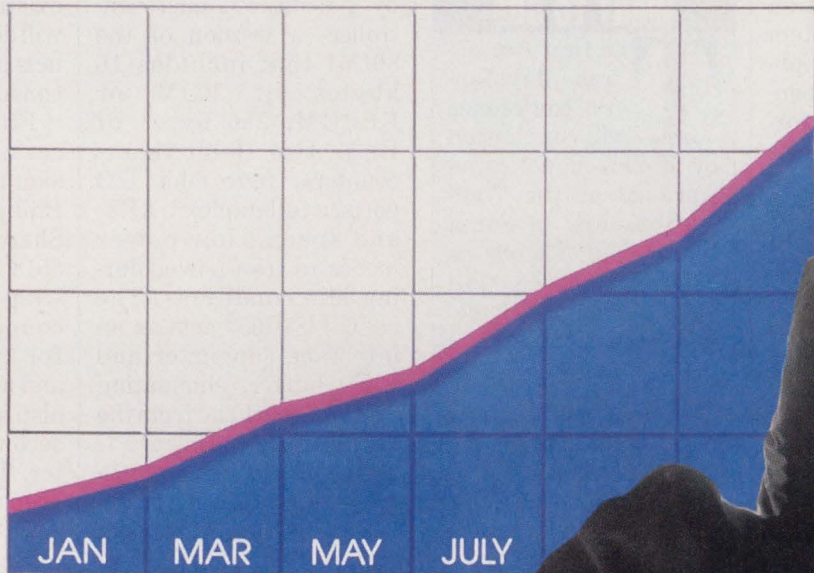

## Good news for companies using LONWORKS technology.

The fact that Toshiba is the first company to ship the NEURON 3150™ CHIP in production quantities means different things to different companies.

For companies already using LONWORKS™ technology and tools from Echelon®, it means they can get their new generation of intelligent products to market very quickly.

And for companies that aren't using LONWORKS technology and tools, it means they're about to face some stiff competition.

LONWORKS technology lets you build control networks into products and environments



for intelligent distributed control applications. Quickly and inexpensively. To produce products that are able to interoperate and perform more functions, more efficiently.

Each LONWORKS control network is made up of a series of "nodes" that communicate with each other. At the core of each node is one of two NEURON CHIPS from Toshiba: the NEURON 3120™ CHIP for applications where size and cost are most critical;

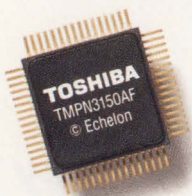

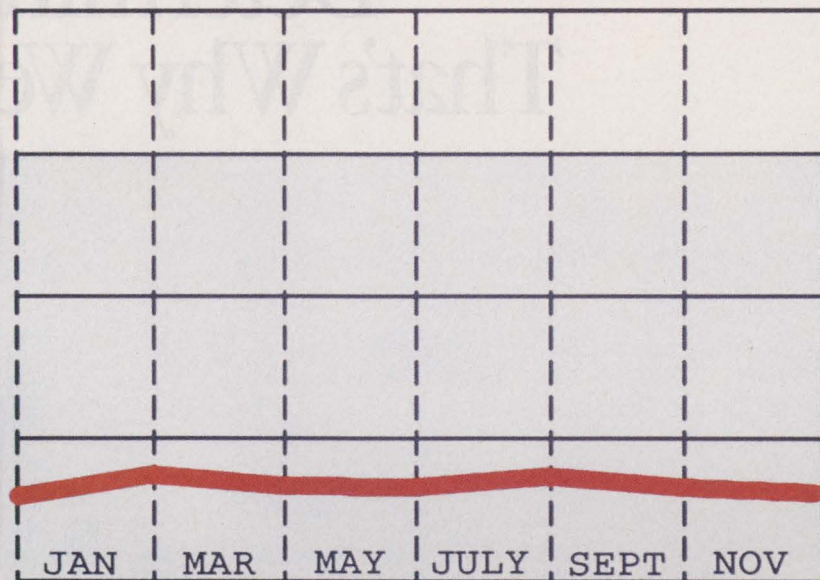

## Bad news for companies that aren't.

and the NEURON 3150 CHIP with external memory support for more complex functions. Each node also contains an interface to communicate with other nodes over a wide range of standard media using the common LONTALK™ protocol. And to design those LONWORKS nodes into your products quickly and inexpensively, there's the PC-based LONBUILDER™ 2 Developer's Workbench.

More than 200 companies, many of them on the Fortune 100 list, are using LONBUILDER 2 Developer's Workbenches right now to design and develop more intelligent, more competitive products.

If you're one of them, congratulations. With Toshiba shipping NEURON CHIPS in quantity, you're that much closer to bringing your new products to market.

And if you're not already using LONWORKS technology and tools, don't give up. Toshiba and Echelon are ready to help you get started. Call the LONWORKS Hotline at **1-800-879-7566**. Fax **1-415-856-6154**. (From outside the U.S., please fax.) Or write Echelon Corporation, 4015 Miranda Ave., Palo Alto, CA 94304.



In Touch with Tomorrow  
**TOSHIBA**

CIRCLE 246 FOR U.S. RESPONSE

CIRCLE 247 FOR RESPONSE OUTSIDE THE U.S.

# Determination To That's Why We Belong



Philips Components Discrete Products Division, 2001 W. Blue Heron Blvd., PO Box 10330, Riviera Beach, FL 33404

**Philips Components**

# Be The Best. On Your Supplier List.

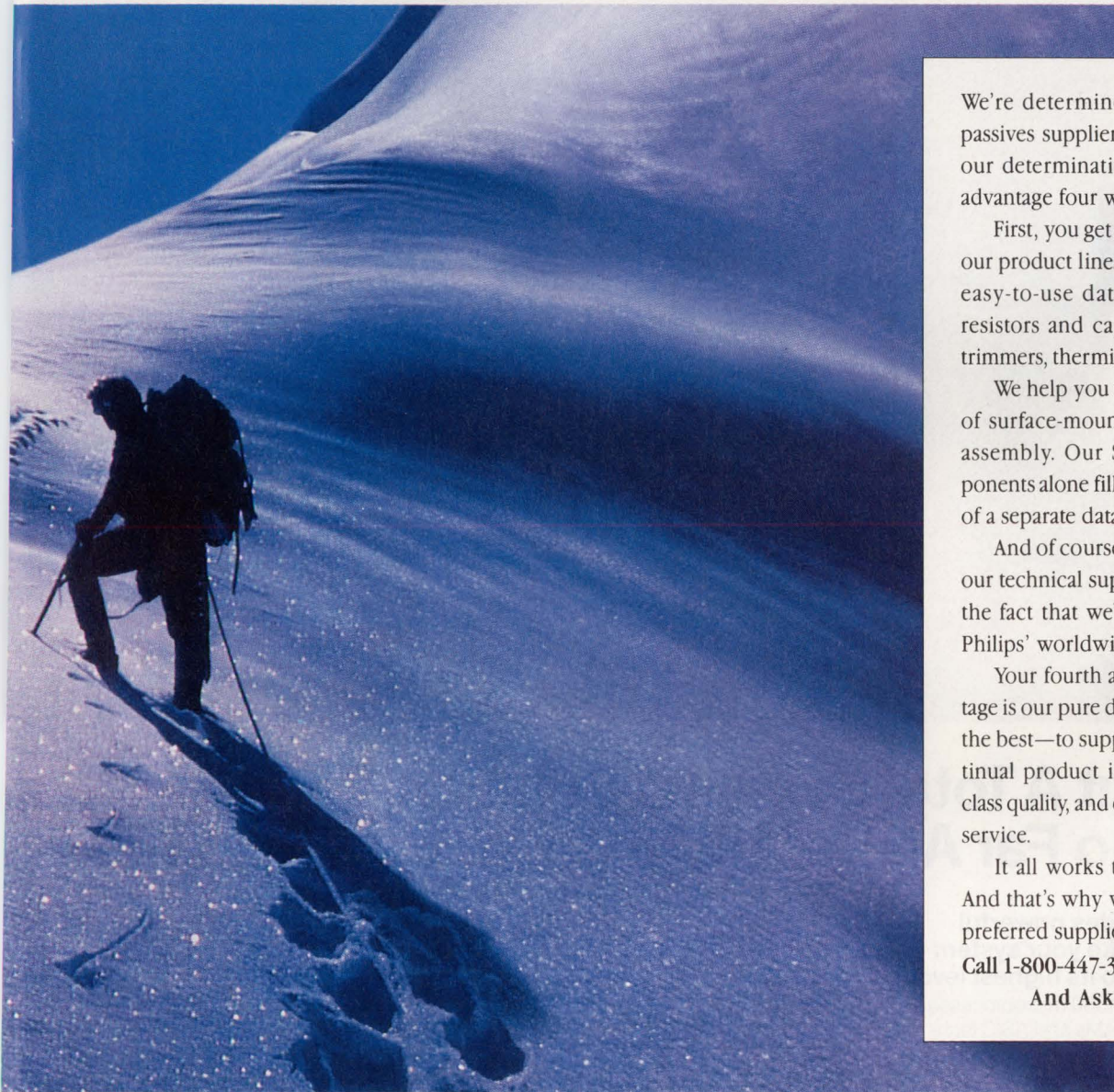

We're determined to be the best passive supplier on your list. And our determination works to your advantage four ways.

First, you get abundant choices: our product lines fill 1,100 pages of easy-to-use data books. Beyond resistors and capacitors, we offer trimmers, thermistors, and varistors.

We help you take full advantage of surface-mount production and assembly. Our SMD® style components alone fill hundreds of pages of a separate data book.

And of course, you benefit from our technical support services, and the fact that we're backed by N.V. Philips' worldwide resources.

Your fourth and greatest advantage is our pure determination to be the best—to support you with continual product innovation, world-class quality, and dedicated customer service.

It all works to your advantage. And that's why we belong on your preferred supplier list.

**Call 1-800-447-3762 For Literature  
And Ask For PCG1.**



# PHILIPS

CIRCLE 301

# SIEMENS



## Without A Total Systems Solution, There's Only So Far An R4000 Supplier Can Take You.

### Siemens provides powerful solutions to take your system performance to its highest level.

By providing the R4000 microprocessor, plus advanced DRAMs and ASIC technology, Siemens has launched a new era in systems capabilities.

### R4000 Power and Performance.

The Siemens R4000—the first true 64-bit processor—provides unequalled throughput in a single chip. As a third-generation product, its scalability allows easy migration to the products of the future, and further shows our commitment to the MIPS RISC family of processors. Plus it comes in three versions, for applications ranging from PCs to sophisticated multiprocessor systems.



Siemens Total Systems Solution

With an estimated 62.5 SPEC rating and full Advanced Computing Environment (ACE) support, our R4000 also provides superior results in a wide range of off-the-shelf applications software. But what's most impressive about our R4000 is that it's only part of our total system solution.

### Superior ASICs and DRAMs.

Siemens is the only European DRAM manufacturer, and one of the leading U.S. suppliers, with high-quality 1-Mb and 4-Mb DRAMs in production today, and 16-Mb and 64-Mb DRAM programs for the near future.

In CMOS ASICs, we offer both Sea-of-Gates and standard-cell product families, featuring sub-micron technology which is completely compatible with Toshiba, even at the GDS2 level, for true



alternate sourcing worldwide. And they're fully supported by Siemens ADVANCAD design system, which is based on industry-standard workstations and simulators.

### Complete System Solution.

Give your system the extra boost we offer with our R4000, DRAMs and ASICs. Our common processes provide you with an extra margin of compatibility, which means the most reliable, highest-quality products in the industry.

See how far Siemens can take your system performance. Call **800-456-9229**, and ask for literature package M20A013.

**Siemens**  
**World Wise, Market Smart**



A TINY IC STEPS UP, STEPS DOWN, REGULATES,  
AND CONTROLS THE BATTERY DRAIN IN PORTABLE  
PCs, AND LABORATORY AND MEDICAL INSTRUMENTS.

# SYNCHRONOUS RECTIFIER UPS PC BATTERY LIFE

FRANK GOODENOUGH

**W**hen power MOSFETs hit the scene over ten years ago, they were hailed as the ultimate device for efficient rectification at the output of low-voltage, high-current switching power supplies.

Operating as synchronous rectifiers, they were expected to replace the diode. But Schottky diodes and other rectifiers that didn't need the "fancy" control circuits of synchronous rectifiers improved, pushing synchronous rectifiers out of the picture. Now, with the emergence of battery-powered PCs plus the need to conserve power, synchronous rectifiers have been given new life.

Today, you've got an edge on the competition if your laptop/notebook PC runs just 5% longer on a battery charge. And exactly the same advantage applies to portable battery-powered instruments or remote (e.g., solar-powered) data-acquisition and/or control systems. Now Micro Linear Corp. has developed the ML4860, a combination of buck-regulator dc-dc converter and power controller aimed at providing that extra 5%.

In the converter, power MOSFET  $Q_2$  operates as a synchronous rectifier, replacing the usual Schottky diode (*Fig. 1*). The forward voltage drop of the rectifier falls from the 500 mV of a typical diode to the 50 mV of a low on-resistance FET. Because both FETs in the ML4860 dissipate virtually zero power, the technique ups the efficiency of the main 5-V supply by more than 5%, dropping battery drain by a similar percentage. With a 6-to-20-V battery, this supply provides 5 to 30 W of

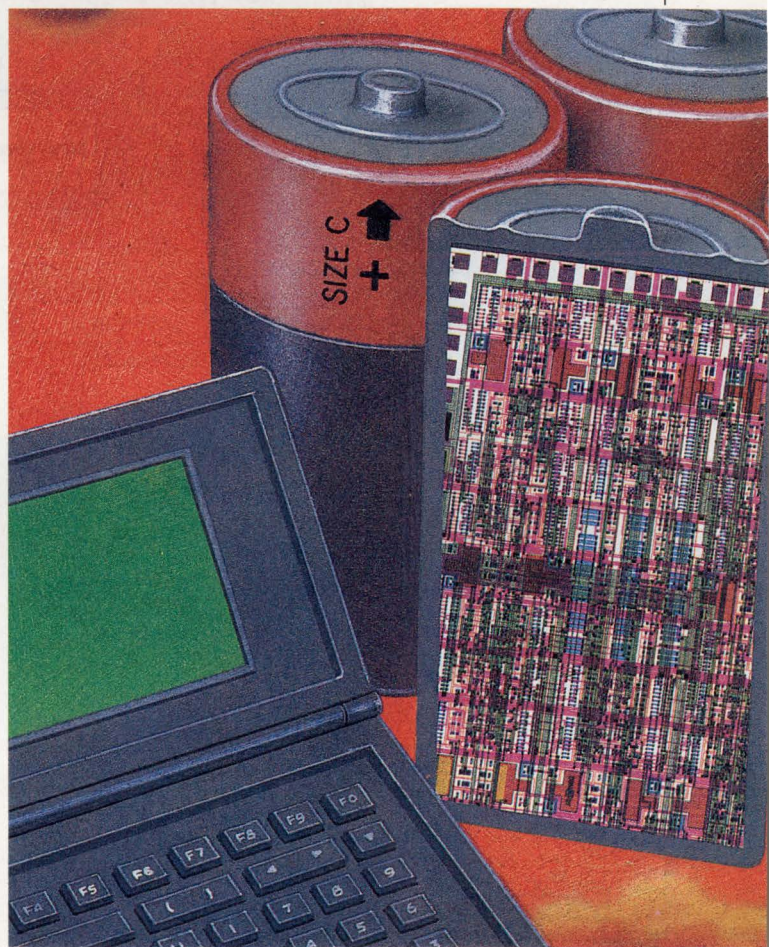

regulated 5-V power for the PC's CPU, memory, and disk drive. (see "A simple synchronous rectifier," p. 49).

As noted, dc-dc conversion isn't the only task performed by this half-inch-on-a-side IC. Its control and regulation functions eliminate six space-hungry ICs typically priced at about \$6 in OEM quantities.

Seven additional tasks performed by the ML4860 are:

# LAPTOP/NOTEBOOK-PC POWER CONTROLLER

- When the laptop is connected to an external power source such as an ac adapter, it disconnects the battery from the input to the converter via external MOSFET switch  $Q_3$ .
- It provides the system's off-chip power-management logic with a regulated 5 V from the battery at all times.
- Its second dc-dc converter (a boost circuit) provides a high-side-gate-drive voltage (11 V above the battery

- voltage) for the system's six, external, n-channel MOSFET switches. They cost about 20% that of the p-channel FETs needed if high-side-drive voltages aren't used.
- It converts three, CMOS-level inputs from the power-management logic to three separate outputs that swing from ground to the high-side drive voltage. Each can drive an external FET switch to control power to a peripheral.

- It supplies a regulated 12 V for programming EEPROMs.
- It has two power-down operating modes offering quiescent currents as low as  $75 \mu\text{A}$ .
- It provides a battery-low signal to the power-management logic.

The chip operates from either an external ac adapter, or from a NiCd or alkaline battery pack. Input supply voltages range from 6 to 20 V. If

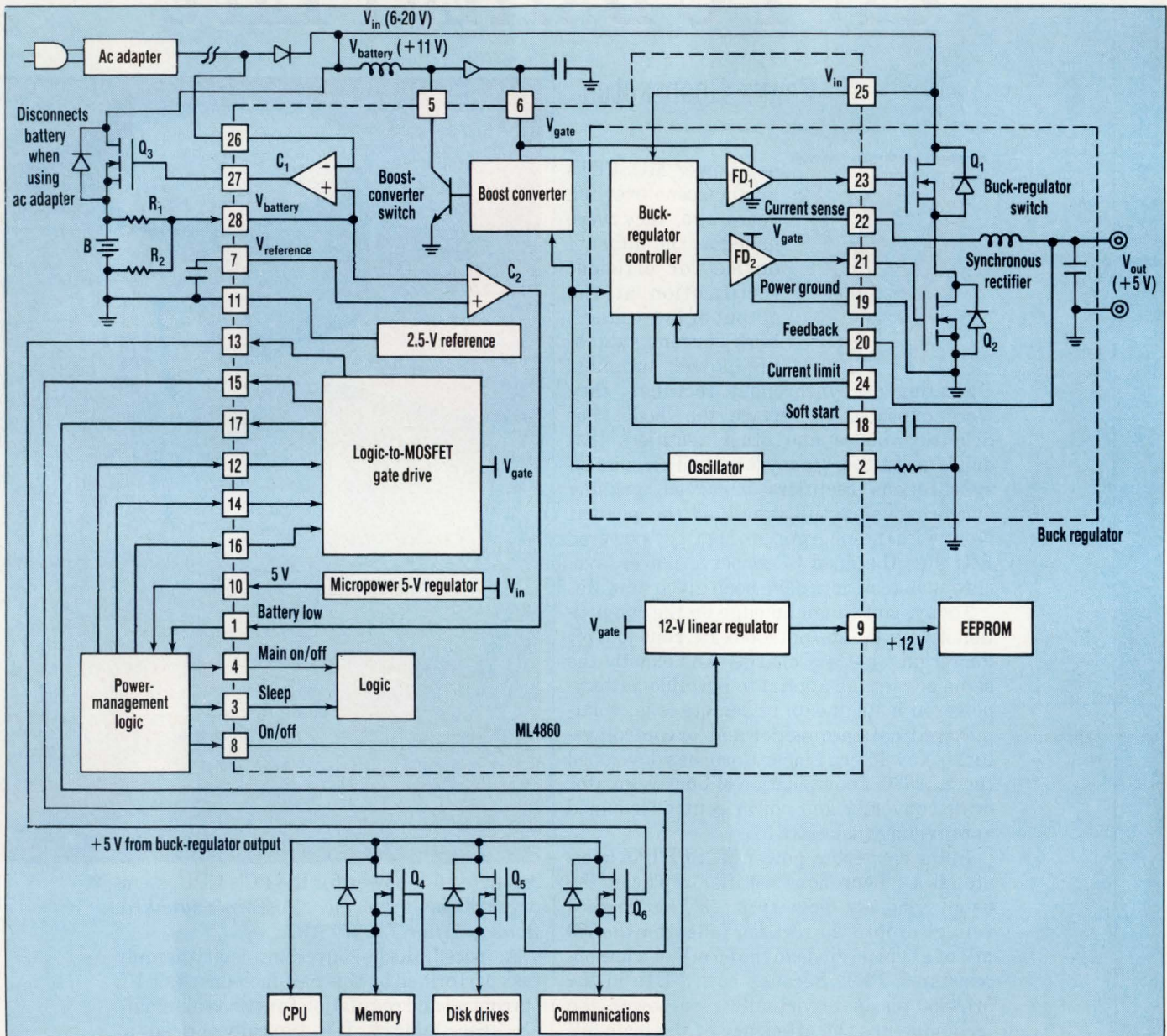

**1. THE ML4860 IC DEVELOPS** and controls the power for battery-powered PCs and instruments. Its buck-type switching regulator employs two off-chip power MOSFETs. The upper one ( $Q_1$ ) is the basic PWM switch. The lower one ( $Q_2$ ) acts as a synchronous rectifier, replacing the typical Schottky diode, and increases the regulator's efficiency by 5%.

# LAPTOP/NOTEBOOK-PC POWER CONTROLLER

the adapter is in use, with or without a battery charger, comparator  $C_1$  senses its output voltage (pin 26) relative to the battery voltage  $V_{\text{battery}}$  (pin 28), and opens the off-chip battery switch MOSFET  $Q_3$ . If the adapter isn't in use, the comparator's output is high, turning on MOSFET  $Q_3$  and connecting the battery to the pair of dc-dc converters and to the chip's  $V_{\text{in}}$  port (pin 25). Internally,  $V_{\text{in}}$  is always connected to the micro-power linear regulator because its 5-V output (pin 10) runs the system's power-management logic, which in turn must have power at all times.

A second comparator,  $C_2$ , provides

a low-battery signal. It compares the battery voltage appearing at pin 28 to the chip's 2.5-V reference. High-resistance external resistors  $R_1$  and  $R_2$  set the voltage at the pin, depending on the battery voltage. The comparator's output goes high when the voltage at pin 28 drops below 2.5 V, providing a low-battery signal at pin 1 to the power-management logic. This logic can provide the user with a warning and/or start to shed the load by disconnecting peripherals via MOSFETs  $Q_3$ ,  $Q_4$ , and  $Q_5$ .

The buck and the boost converters are driven synchronously by the chip's oscillator at 100 kHz. Al-

though optimized to run at 100 kHz, the converters' frequency-setting resistor connected between pin 2 and ground can program them to run at up to 200 kHz. The boost converter creates potential  $V_{\text{gate}}$ , which will always be 11 V more positive than the battery or other input supply voltage. The converter's output (pin 6) is applied internally to four circuits: the two high-side drivers ( $FD_1$  and  $FD_2$ ), the logic-to-MOSFET gate-drive block, and the 12-V regulator.

High-side drivers  $FD_1$  and  $FD_2$  alternately drive (bring high to  $V_{\text{gate}}$ ) the gates of the buck regulator's FET switch  $Q_1$  and the synchronous rectifier  $Q_2$  with pulse-width-modulated pulses from pins 23 and 21, respectively. The logic-to-MOSFET gate-drive circuit takes 5-V logic-level inputs from the power-management-logic circuit (pins 12, 14, and 16) and converts them to a trio of high-side drive-level outputs. The three outputs (pins 13, 15, and 17) are at ground for an input of logic-level zero, and at  $V_{\text{gate}}$  for an input of logic-level one. They turn FET switches  $Q_3$ ,  $Q_4$ , and  $Q_5$  on and off. The 12-V linear regulator's output (pin 9) supplies as much as 100 mA to program EEPROMs. Logic-level signals from the power-management-logic circuit turn it on and off (pin 8).

By way of pins 3 and 4, power-management logic puts the chip/system into one of three operating modes: run, standby, or sleep. Holding pin 4 high puts the chip in the "all-systems-go" run mode, and the IC draws 4 mA of quiescent current. Bringing pin 3 high and pin 4 low puts the IC into standby. Only the low-battery comparator and the 5-V linear regulator for the power-management logic are on and the IC draws just 110  $\mu\text{A}$ . Pulling pins 3 and 4 low puts the chip to sleep. Only the 5-V regulator remains on, and quiescent current drops to 75  $\mu\text{A}$ .

One unique circuit can provide "lossless" current sensing to protect MOSFETs  $Q_1$  and  $Q_2$ . When  $Q_1$  is turned on hard (in saturation), the voltage at  $Q_1$ 's source is measured by the IC (pin 22) relative to  $V_{\text{in}}$ . If that voltage is more than 200 mV, the converter shuts down. Essentially,

## A SIMPLE SYNCHRONOUS RECTIFIER

**I**ncreasing efficiency by implementing a synchronous rectifier in a switch-mode buck-type regulator is quite simple. All that's involved is replacing the typical Schottky diode  $D_1$  with power MOSFET  $Q_2$  (see

the figure). Given that  $V_{\text{out}} = V_{\text{in}} \times D$ , where  $D$  is the duty cycle, the diode will be on for 1/2 of the PWM cycle for a 10-V input (the nominal voltage from a six-cell battery pack). This yields an average conduction loss of about 250 mW, which translates into a 5% efficiency loss in the diode alone, for a 5-W (5 V at 1 A) output.

A forward drop of just 30 mV can be attained by using synchronous rectification and replacing the Schottky diode with an available power MOSFET that provides a mere 30 m $\Omega$  of on-resistance. Average power loss drops to only 15 mW, increasing supply efficiency by almost 5%. Because the duty cycle (on time) of the regulator's switch ( $Q_1$ ) decreases with increasing battery

voltage, the rectifier FET will be on for a greater percentage of the cycle. Thus, at higher battery voltages, the difference in system efficiency between Schottky-diode and FET rectifiers will be even more significant.

the figure). The MOSFET is turned on by the controller while the regulator's switch  $Q_1$  is off, and vice versa. When conducting, the typical Schottky diode has a forward drop of about 500 mV at a current of 1 A.

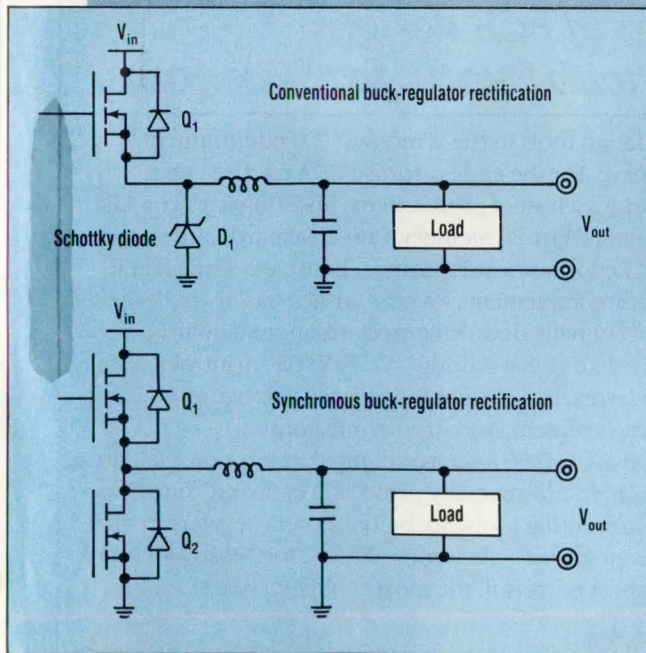

## LAPTOP/NOTEBOOK-PC POWER CONTROLLER

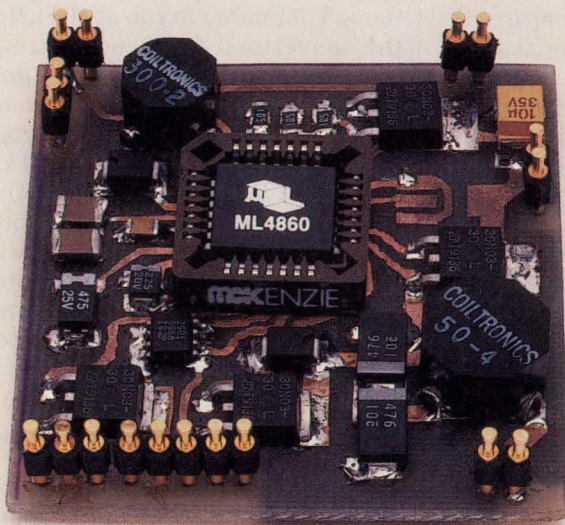

**2. A COMPLETE** power-supply/control subsystem for a battery-powered PC is easy to build on this 2-in.<sup>2</sup> evaluation board from Micro Linear, which uses the company's ML4860 controller IC. The two 100-kHz Coiltronics inductors are quite small when compared with inductors used for higher-power, higher-frequency switching-regulator supplies.

the FET's on-resistance becomes the current-sense resistor. The default threshold of 200 mV represents the drop across a 50-mΩ MOS-FET passing 4 A. If a higher current-limit threshold voltage is required—for example, if a larger current is controlled, or smaller FETs (higher on-resistance) are used—a resistor is connected from pin 24 to ground. The conventional, voltage-mode controller gets its feedback voltage from the output via pin 20. A soft-start capacitor between pin 18 and ground limits the

pulse width at power-up.

As noted earlier, the “jack-of-all-trades” control and regulation features of the ML4860 can save significant pc-board space in a notebook PC, a laptop, or a portable instrument. Though not a true indicator of the minimum circuit size possible from the chip, Micro Linear's evaluation board illustrates what can be accomplished (Fig. 2). The 2-in.<sup>2</sup> board is laid out for ease of use (for probing with an oscilloscope and a meter).

The board's single ML4860 replaces various parts needed in a typical power-management and control system, including: a LinCMOS PWM controller (such as the TLC 4xxx), a micropower linear-regulator IC (such as the MAX667), a dual comparator (like the TLC393), a boost-regulator IC (such as the MAX63x), a multiple n-channel FET driver (like the MAX621), and some glue logic. In OEM quantities, their combined cost would run about \$6.

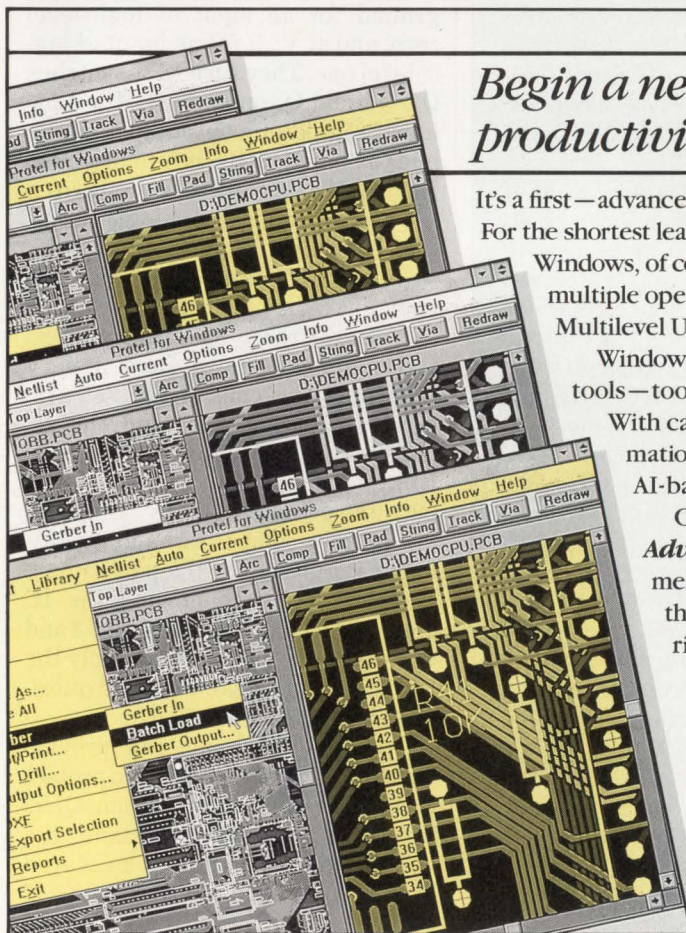

## Begin a new era in PCB design productivity—with Protel for Windows.™

It's a first—advanced PCB design tools in the Windows™ 3.0 environment. For the shortest learning curve. For the easiest-to-use EDA package ever. Windows, of course, brings a host of productivity-boosting features. Like multiple open documents. Virtual memory. Universal hardware support. Multilevel Undo and Redo commands. Comprehensive on-line HELP. Windows perfectly complements Protel's all-new family of design tools—tools that set equally new price/performance standards. With capabilities like global editing. “WYSIWYG” print/plot automation. More layers. Fast Design Rule Check. Global/interactive AI-based autoplacement. And Rip-up Autorouting. Call 1-800-544-4186 for a free demo that lets you evaluate **Advanced Pack**, our specially priced set of layout, autoplacement and autorouting tools. So, before purchase, you'll realize that—except in cost—these new **Protel for Windows** tools rival the most powerful, the most sophisticated, available.



**Protel Technology Inc**  
151 Bernal Road  
San Jose, CA 95119



**Electronic Design Automation Specialists**  
30 day money-back guarantee. Call toll-free 1-800-544-4186

Windows is a registered trademark of Microsoft Inc. © 1992 Protel Technology Inc.

CIRCLE 202 FOR U.S. RESPONSE  
CIRCLE 203 FOR RESPONSE OUTSIDE THE U.S.

# Finally! A true 32V Precision Analog Array —with onboard Digital Logic.



Put all your analog  
and digital control  
functions on a single  
piece of silicon.

**32V** Bipolar gain blocks with signal bandwidths to 4MHz, thin film resistors, and 74LS speed compatible digital gates—all on a single piece of silicon!

That's the new **RLDA80**.

Think of the possibilities.

Programmable timers. PWM controllers.

Motor speed controllers.

Supervisory circuits.

Phase locked loops. Latched analog multiplexers.

RAYTHEON RLDA80 LINEAR/DIGITAL ARRAY	
8	32V PROGRAMMABLE ANALOG MACROCELLS (Op amps, ground sensing amp, low distortion op amps, TTL output comparator, bandgap reference)
36	5V PROGRAMMABLE DIGITAL MACROCELLS
16	5V DEDICATED DIGITAL MACROCELLS (Up to 200 equivalent gates)
16	DIGITAL I/O CELLS
128	200ppm/°C THIN FILM RESISTORS
36	SMALL SIGNAL PNPs and NPNs
4	100mA NPN DRIVE TRANSISTORS

All on a single die.

How many parts would that eliminate in your design? How much space, weight and power would it save? How much easier would assembly be? And how much more rugged would it make your final product?

There's a quick way to find out.

Show us your design—and we'll show you how easily it can be integrated onto a single RLDA80.

It's fast—typically six to eight weeks from design review to prototype.

And flexible—changes to an RLDA80 prototype can be done within four weeks.

We're committed to analog design. And to developing partnerships with our customers to produce the most efficient and cost-effective solutions possible.

So if you've been waiting for a mixed signal array for the "real world," it's here. For specifications on the RLDA80, give us a call at 1-800-722-7074.

**Raytheon Company, Semiconductor Division.**  
350 Ellis St. Mountain View, CA 94039.

CIRCLE 206 FOR U.S. RESPONSE

CIRCLE 207 FOR RESPONSE OUTSIDE THE U.S.

## Raytheon

## LAPTOP/NOTEBOOK-PC POWER CONTROLLER

The three, small square D-PAKs on the evaluation board contain MOSFETs  $Q_1$ ,  $Q_2$ , and  $Q_3$ . A pair of Siliconix "Little foot" devices could easily replace them. Each "Little foot" contains two isolated 50-m $\Omega$  MOSFETs in an 8-pin SOIC. Poten-

tially, in some applications, just three 8-pin SOICs could hold the six external FETs.

The ML4860 isn't limited to smaller PC designs. Like so many new analog ICs originally aimed at narrow niches, the breadth of its applica-

tions are a challenge to any analog designer. For example, it can manage power for a remote, solar/battery-powered data-acquisition system—say for seismic signals ranging from earthquakes and underground nuclear explosions to dynamic stresses in structures, such as vehicular bridges.

In addition to a host microprocessor, this type of system might contain one or more sensors and their excitation and signal-conditioning circuits, a high-resolution (16 or more bits) analog-to-digital converter to sample and quantize data, and a disk drive to store data. It could also be used as a timed system in which data is taken every so often. It would be asleep most of the time, and a CMOS 555 timer operated from the 5-V power-management-logic rail would occasionally wake it up.

The output of the 12-V linear regulator, designed for EEPROMs, can be used to excite the sensors. Up to three individual sensors or three groups of sensors can be excited sequentially using the three external FET switches. In an 8-bit system, the ADC or other system circuits can pull up to 10 mA from the reference. If the system is waiting for a signal, such as an earthquake, most of the system can be asleep most the time, with the micropower regulator providing power when the system is on. An ac adapter can be used for test and maintenance. If the system transmits a message under an alarm condition, the low-battery threshold could be set high. A message could then be sent indicating that help is needed. □

### PRICE AND AVAILABILITY

In its 28-pin PLCC, the ML4860 goes for \$4.95 each in 1000-unit quantities. Small quantities are available from stock. Contact the company for price and delivery of the evaluation board.

Micro Linear Corp., 2092 Concourse Dr., San Jose, CA 95131; Jon Klein, (408) 4332-5200. CIRCLE 511

# No Noise Is Good Noise

## The SR560 Low-Noise Preamplifier

is the ideal voltage amplifier for the most demanding applications. With a low 2 nV/ $\sqrt{\text{Hz}}$  of input noise, even the smallest signals won't get lost. Two adjustable signal filters, each configurable as high or low pass, attenuate unwanted interference. Internal batteries provide operation isolated from the AC line.

And the best news of all, the SR560 is priced at only \$1895, including remote interface. Whether you need lower noise, higher gain, or greater bandwidth, call Stanford Research Systems and take a closer look at the SR560.

**\$1895.00**

2 nV/ $\sqrt{\text{Hz}}$  input noise  
1MHz bandwidth  
Gain variable to 50,000  
AC or DC coupled  
True differential or single-ended input  
2 configurable signal filters  
Selectable gain allocation  
120 dB CMRR  
Line/Internal battery operation  
Remote interface



**Stanford Research Systems**

1290 D Reamwood Avenue, Sunnyvale, CA 94089  
TEL (408) 744-9040 FAX 4087449049 TLX 706891 SRS UD

CIRCLE 226 FOR U.S. RESPONSE

CIRCLE 227 FOR RESPONSE OUTSIDE THE U.S.

### HOW VALUABLE?

HOW VALUABLE?	CIRCLE
HIGHLY	525
MODERATELY	526
SLIGHTLY	527

Read/Write IC Solutions

# No end in sight.

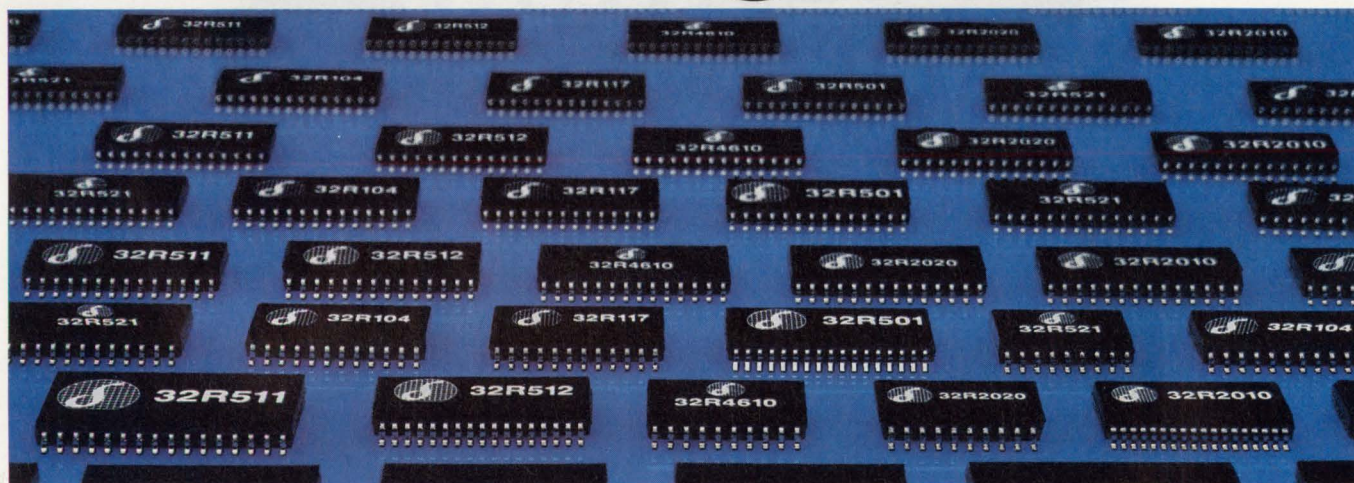

**1978: 32R104**  
Propelled the growth of IBM plug-compatible drives.

**1982: 32R117**  
Designed into 95% of ST506 type drives.

**1984: 32R501**  
Improved things for higher capacity drives.

**1989: 32R521**  
The first +5, +12v thin film read/write.

**1990: 32R511/512R**  
A pin-compatible migration path from three- to two-terminal design.

**1990: 32R4610**  
The first +5v only, two-terminal read/write device.

**1991: 32R2020**  
New. The industry's highest performance +5v only read/write.

**1991: 32R2010**  
New. The industry's highest performance +5, +12v read/write.

With apologies to our competitors, we plan to keep on leading the way in read/write IC technology.

And why not? For nearly two decades Silicon Systems has been increasing performance and reducing power demands in an expanding range of pin-compatible functions. All designed for a world of ever-shrinking form factors.

Current achievements include low-power, +5v only read/write devices that consume under 5mW in idle mode. Our new two-terminal read/write amplifier for thin film and MIG heads. A read/write device for both 3-terminal

ferrite and thin film applications. And devices with up to 16-channel capability.

Hold on tight, though. We're just warming up.

On the drawing board are ICs for MR heads, optical disk drives and a variety of other applications. There's just no end to our involvement.

If you need flexible and far-reaching read/write IC solutions for your next generation of products, call us for literature package SPD-15. We'll send you our new **Read/Write IC Short Form Catalog**, give you the name of your nearest Silicon Systems

representative and update you on our latest developments. **1-800-624-8999, ext. 151**

#### Silicon Systems, Inc.

14351 Myford Road, Tustin, CA 92680  
Ph (714) 573-6000 Fax (714) 573-6906  
European Hdq. U.K. Ph (44) 81-443-7061  
Fax (44) 81-443-7022

*silicon systems*<sup>®</sup>  
A TDK Group Company

Circle 222 for Product Information (U.S. Response)

Circle 223 for Career Information (U.S. Response)

Circle 224 for Product Information (Response Outside U.S.)

Circle 225 for Career Information (Response Outside U.S.)

# The fastest high density PLD.

NOW SHIPPING



System clock rates up to 80 MHz. And a propagation delay of only 15ns pin-to-pin. That's the kind of performance you get with our new pLSI™ family of high density PLDs. Comprised of four devices ranging in density from 2,000 to 8,000 PLD gates, they give you absolute timing predictability, right from the data sheet. Lattice also offers the ispLSI™ family—an in-system programmable (isp) version of the pLSI family that delivers non-volatile, 5-volt only in-system programming capability.

pLSI and ispLSI devices are backed by Lattice's proven E<sup>2</sup>CMOS® technology. With low power,

reprogrammability and 100% DC, AC and functional testing, the pLSI and ispLSI families offer the highest quality available. Not to mention high-speed programming and 100% programming yield. And they are available now in production quantities off-the-shelf.

So pull into the high density PLD fast lane. Call **1-800-327-8425** and ask for information packet #309.



**Leader in E<sup>2</sup>CMOS PLDs.**



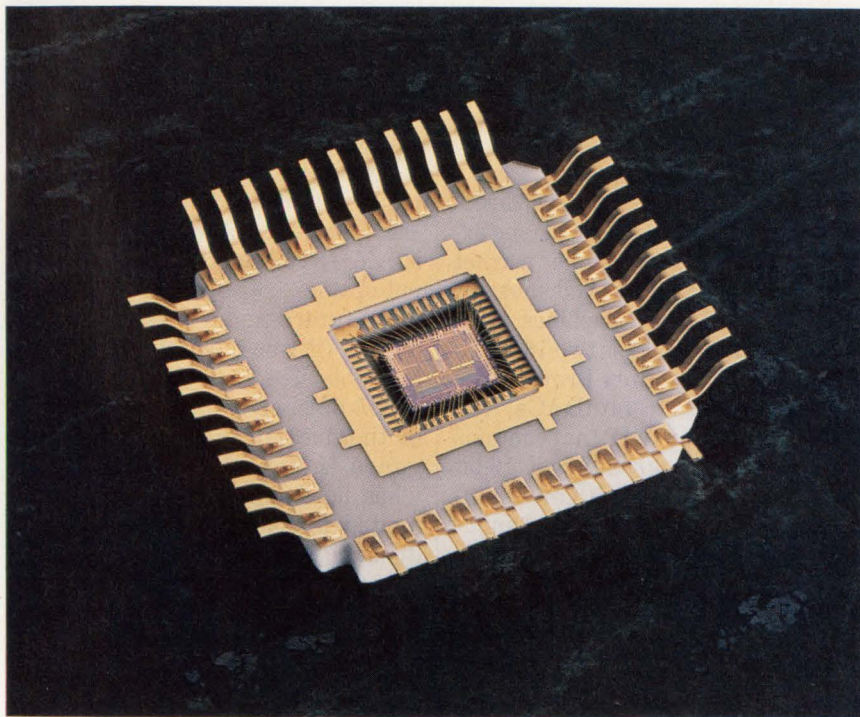

TriQuint Semiconductor Corp.

## DIGITAL AUDIO DRIVES 14-TO-20- BIT DAC DESIGNS

**A**lthough little new appears to be happening in the general-purpose high-resolution (greater than 13 bits) monolithic digital-to-analog converter domain, IC DACs aimed strictly at digital-audio applications are on a roll. And some of this audio-DAC technology—primarily several new DAC architectures—is being transferred to the general-purpose arena. In fact, several of the newest general-purpose DACs are based on audio-DAC technology, with a potential for much more in the future.

Today, you can buy 16-to-20-bit IC

**FRANK GOODENOUGH**

### INNOVATIVE DESIGNS FOR AUDIO HINT AT FUTURE 16-TO- 20-BIT DACs WITH MORE THAN 16-BIT DC ACCURACY.

audio DACs that offer a dynamic range of more than 100 dB and a signal-to-noise ratio of 120 dB (*Table 1*). Also available are 16-to-20-bit general-purpose IC analog-to-digital converters (ADCs) with similar dynamic range that provide accuracy levels of 16 bits or greater at dc and over temperature.

But when it comes to general-purpose monolithic DACs offering dc accuracy over temperature, only a few that are even 16-bit accurate exist (*Table 2*). In fact, like their 14-bit kin, about half are only 14-bit accurate (monotonic) at dc, even at a temperature of just 25°C.

The low level of high-resolution general-purpose DAC development runs directly opposite the 12-bit general-purpose ADC arena, in which a broad range of new-design activity is underway (*ELECTRONIC DESIGN, Sept. 12, 1991, p. 63*). Examples of these new designs range from quad and even octal DACs to RF-generating DACs. This action at 12 bits stands as a precursor of future action at higher resolution.

The most exciting development in the general-purpose field comes from TriQuint Semiconductor Corp., whose 14-bit gallium-arsenide DAC, which has a 2-GHz update rate (at a temperature of 25°C), is close to fru-

ition (see the opening figure). Funded jointly by General Electric, Motorola, Hughes, and Sciteq, it's the only high-resolution DAC aimed at direct digital synthesis (DDS) of high-frequency RF waveforms. This application area has been heating up, as witnessed by the recent announcement of a pair of 12-bit DACs with fast 100- and 500-MHz update rates (ELECTRONIC DESIGN, Feb. 20, pps. 41 and 152).

Multiple DACs per die are now following this trend, with both a little help from digital-audio DAC technology and new architectures. In fact, a pair of 14-bit, octal, voltage-output DACs with a new architecture will appear within the next 30 to 60 days. And these multiple DACs provide a digital I/O more conducive to a microprocessor interface, rather than the typical brute-force approach with latchless 14 to 18 parallel input-data lines.

Though aimed at digital-signal-processing applications instead of waveform synthesis, a few of the lat-

est DACs provide a serial I/O and dynamic (ac) specifications. These specifications include total harmonic distortion and signal-to-noise ratio.

## 20 BITS OR BUST

After more than ten years in development, the compact-disc player exploded on the U.S. consumer market about six years ago. And most of these sophisticated machines from Japan contained one or two 16-bit IC DACs made by Burr-Brown. The first of these 16-bit DACs, the PCM53, is a 24-pin DIP that contains a single, very conventional, 16-bit voltage-output DAC with an unbuffered, 16-line, parallel-digital input (see "Compact-disc players, digital-audio DACs, and oversampling," p. 64). Its architecture forms the basis of most general-purpose monolithic DACs.

A segment decoder in the PCM53 monolithic DAC converts the three most-significant-bit inputs to seven lines that drive seven current switches, which in turn control (switch on

and off) seven equal-current sources. Thirteen additional current switches control the remaining least-significant-bit currents. These LSB currents are developed by a binary-weighted, laser-trimmed, thin-film resistor network.

The PCM53 contains its own buried-Zener voltage reference and output op amp, setting the standard for most future audio DACs. Current-output ( $\pm 1$ -mA) versions are also available. The DAC puts out  $\pm 10$  V at  $\pm 5$  mA and runs off  $\pm 15$ -V rails (both typical of the general-purpose genre then and now). However, while its "audio" specifications are limited to harmonic distortion and dynamic range, virtually all of the specifications expected on the data sheet for a typical general-purpose DAC are included.

Driven by the requirements of CD players for higher performance at lower cost, these once general-purpose DACs quickly evolved through several generations. Early on, digital oversampling filters were added

**TABLE 1: MONOLITHIC 16-, 18-, AND 20-BIT DIGITAL-AUDIO DACs**

Company	Model	Resolution (bits)	Number of DACs	Total harmonic distortion plus noise (dB) at outputs of			Signal-to-noise ratio (dB)	Dynamic range (dB)	Channel separation (dB)	Mid-scale error	Output		Maximum oversampling Factor
				0 (dB)	-20 (dB)	-60 (dB)					V <sub>out</sub> (V/mA)	I <sub>out</sub> (mA)	
Analog Devices	AD1862	20	1	-96	-80	-42	113	102	NA	$\pm 5\mu\text{A}$	NA	$\pm 1$	16
Burr-Brown	PCM63	20	1	-96	-82	-44	116	104	NA	$\pm 10\text{mV}$	NA	$\pm 2$	16
Philips/ Signetics	SAA7340 (alone)	20	2	-93	NS	NS	100	93	100 (t)	NS	1 rms/NS	NA	16
	with TDA1547	20	2	-93	-84	-44	101	> 93	101	NS	NA	NA	16
Analog Devices	AD1865	18	2	-87	-73	-54	107	94	110	$\pm 4$ mV	$\pm 3/\pm 8$	$\pm 1$	16
	AD1868	18	2	-84	-61	-46	95	86	101	$\pm 15\text{mV}$	$\pm 1(t)/\pm 1(t)$	NA	16
	AD1864	18	2	-92	-73	-34	102	94	110	$\pm 4$ mV	$\pm 3/\pm 8$	$\pm 1$	16
	AD1860	18	1	-92	-73	-34	102	94	NA	$\pm 3$ mV	$\pm 3/\pm 8$	$\pm 1$	8
	AD1861	18	1	-87	-75	-36	107	96	NA	$\pm 10\text{mV}$	$\pm 3/\pm 8$	$\pm 1$	16
Burr-Brown	PCM61	18	1	-92	-74	-34	112(t)	108 (t)	NA	$\pm 30$ (t)	$\pm 3(t)/\pm 8$	$\pm 1(t)$	8
	PCM67	18	2	-92	-70	-40	110(t)	108(t)	106(t)	NS	NA	$\pm 1.2(t)$	16
	PCM1700	18	2	-92	-74	-34	96	108(t)	96	$\pm 10\text{mV}$	$\pm 3/\pm 8(t)$	$\pm 0.7(t)$	16
	PCM58	18	1	-96	-80	-40	126(t)	108(t)	NA	$\pm 10\text{mV}$	NA	$\pm 1$	8
Crystal	CS4328	18	2	-90	-73	-33	120	93	100	$\pm 1$ mV	$\pm 1.9/\pm 3$	NA	8
Sony	CXD2558	18	2	-80(t)	NS	NS	90(t)	NS	NS	NS	(1)	NA	16
Analog Devices	AD1851	16	1	-87	-75	-36	107	96	NA	$\pm 10\text{mV}$	$\pm 3/\pm 8$	$\pm 1$	16
	AD1866	16	2	-80	-74	-34	95(t)	90(t)	108	$\pm 30\text{mV}$	$\pm 1/\pm 1$	NA	16
	AD1856	16	1	-92	-74	-34	NS	NS	NA	$\pm 30\text{mV}$	$\pm 3/\pm 8$	$\pm 1$	8
Burr-Brown	PCM60	16	1	-86	68(t)	-28(t)	90(t)	96(t)	NA	$\pm 30\text{mV}$	2.8/0.028	NA	4
	PCM66	16	2 outputs	-86	-68(t)	-28(t)	90(t)	96(t)	NS	$\pm 30\text{mV}$	2.8/0.028	NS	4
	PCM56	16	1	-92	-74(t)	-34(t)	NS	96(t)	NA	$\pm 30\text{mV}$	$\pm 3/\pm 8$	$\pm 1$	8
	PCM55	16	1	-87	-67	-28	NS	96(t)	NA	$\pm 30\text{mV}$	$\pm 3/\pm 2$	$\pm 1$	16
	PCM54	16	1	-92	-74	-34	NS	96(t)	NA	$\pm 30\text{mV}$	$\pm 3/\pm 2$	$\pm 1$	16
	PCM53	16	1	-93	-74	-34	NS	96(t)	NA	$\pm 50\text{mV}$	$\pm 10/\pm 5$	$\pm 1$	16

All specifications are at 25°C and are maximums or minimums unless noted typical (t). NA = not available. NS = not specified. FSR = full-scale range.  
(1) Each of the two differential outputs of the Sony delta-sigma DAC consists of a 5-V train of ones and zeros ready for application to an analog low-pass filter.

ahead of the DAC, and the digital I/O was changed from parallel to serial. To handle the simpler serial I/O, DACs like the Burr-Brown PCM56 added a serial-to-parallel shift register between the serial input and the DAC itself.

General-purpose DAC specifications gradually gave way to audio-DAC specifications (Table 1, again). The supply rails dropped to  $\pm 5$  V, the standard output voltage became  $\pm 3$  V, and SOIC packages appeared. Resolution moved to 18 bits and single 5-V supply devices appeared. Analog Devices joined the fray and two 18-bit DACs were crammed into DIPs and SOICs in 1989. Oversampling factors went from 1 to 16, but basic DAC architectures remained virtually unchanged.

Over the last two years, dramatic changes have evolved in high-resolution IC DACs. New architectures began to emerge, such as those on Crystal Semiconductor's dual 18-bit delta-sigma CS4328 audio DAC (also called a one-bit or bit-stream DAC),

and Burr-Brown's 20-bit PCM63P audio DAC, a single-channel current-output device based on a unique variant of the conventional multibit architecture. More recently, Burr-Brown used an innovative architecture on its 18-bit dual current-output PCM67 DAC, combining one-bit and multibit circuits (see "New DAC architectures and noise shaping," p. 62).

ICs designed specifically for next-generation digital-audio systems are now appearing. Take Crystal's CS4215 and CS4216 dual 16-bit delta-sigma codecs, for example, aimed at multimedia applications (ELECTRONIC DESIGN, Sept. 12, 1991, p. 53). Designed to give PCs the ability to generate and/or process high-quality stereo audio, each IC's core contains a pair of 16-bit delta-sigma ADCs and a pair of 16-bit delta-sigma DACs. By mid-year, a similar device, the AD1849, is expected from Analog Devices.

Because nearly all but the least-expensive compact-disc players

oversample 16 times, five key DAC specifications determine how well they sound:

- **Total harmonic distortion + noise (THD + N)**: Total harmonic distortion + noise is a ratio. The top half of this ratio is the square root of the sum of the squares of the single-frequency signal's harmonic amplitudes, plus the noise (at a system's output). The bottom half is the amplitude of that frequency's fundamental. THD + N is usually expressed in percent or decibel.

- In an audio DAC, THD + N represents a measure of the magnitude and distribution of integral-linearity, differential-linearity, and quantization errors, plus noise introduced during reconstruction and playback. Depending on the signal's amplitude, the errors may be distributed differently. Therefore, the THD + N of audio DACs is specified (and in most cases measured) at three output levels: full output or 0 dB, and two lower levels of -20 and -60 dB. The digital word for a 990.5-Hz sine wave is fed to the DAC and measurements are made on the first 19 harmonics and noise out to 30 kHz.

- **Signal-to-noise ratio (SNR)**: Signal-to-noise ratio is the ratio of the output signal's amplitude when a full-scale code (digital input word) is entered into the DAC, to the output's amplitude when a midscale (bipolar zero) code is entered. It's measured with an A-weight filter (A-weight filters simulate the response of the human ear).

- **Dynamic range**: Dynamic range, sometimes called D-range distortion, is equal to the value of (THD + N) expressed in decibels, plus 60 dB when a signal level of -60 dB is reproduced. Dynamic range is measured with a 1-kHz sine wave using an A-weight filter.

- **Channel separation**: Channel separation is the ratio of a full-scale signal's amplitude on one channel of a two-channel DAC, to the amplitude of that same signal coupled to the other channel.

- **Midscale error**: Midscale, or zero error, is the deviation of a given channel's actual analog output from

Linearity dB	Gain Error (% of FSR)	Match FSR)	Architecture	Power (V/mA)	Power (mW)	Package type	Price (1000s)
$\pm 1$	$\pm 2$	NA	Conventional	$\pm 12/\pm 6$	288(t)	16-pin DIP	\$13.50
$\pm 1$	$\pm 2$	NA	Sign-magnitude	$\pm 5/+15,-45$	300	28-pin DIP	\$11.80
$\pm 1$	NS	0.25	Delta sigma	5/75	375	44-pin QFP	\$26.00
$\pm 0.2$	NS	NS	Delta sigma	$\pm 5/\pm 80$	1300	32-pin DIP	\$17.50
$\pm 2$	$\pm 1$	0.8	Conventional	$\pm 5/\pm 26$	260	24-pin DIP, 28-pin SOIC	\$14.25
$\pm 3$	$\pm 1$	$\pm 1$	Conventional	+5/14	70	16-pin DIP, SOIC	\$9.95
2(t)	$\pm 1$	0.8	Conventional	$\pm 5$ to $\pm 12/\pm 28$	265	24-pin DIP	\$14.25
NS	$\pm 2$	NA	Conventional	$\pm 5$ to $\pm 12/\pm 15$	300	16-pin DIP	\$9.55
NS	$\pm 1$	NA	Conventional	$\pm 5/\pm 15$	100(t)	16-pin DIP, SOIC	\$5.00
NS	$\pm 2$ (t)	NA	Conventional	$\pm 5$ to $\pm 12$ + 17, -35	260	16-pin DIP	\$7.40
$\pm 1$	$\pm 10$	$\pm 5$	One-bit + multibit	5/20	105	16-pin DIP, 20-pin SOIC	\$10.00
$\pm 1$	$\pm 3$	$\pm 3$	Conventional	$\pm 5/+40,-16$	380	28-pin DIP	\$10.95
NS	$\pm 2$	NA	Conventional	5, -12/10, -30	410	28-pin DIP	\$14.55
NS	$\pm 5$	0.1 dB	Delta-sigma	$\pm 5/\pm 55, 5/60$	850	28-pin DIP	\$29.00
NS	NS	NS	Delta-sigma	5/NS	NS	28-pin SOIC	\$12.00
NS	$\pm 1$	NA	Conventional	$\pm 5/\pm 15$	100(t)	16-pin DIP, SOIC	\$4.65
$\pm 3$	$\pm 3$	$\pm 3$	Conventional	5/14	70	16-pin DIP, SOIC	\$8.95
NS	$\pm 2$ (t)	NA	Conventional	$\pm 5$ to $\pm 12$ , +17, -35	260	16-pin DIP	\$9.00
NS	$\pm 10$	$\pm 1$ (t)	Conventional	5/9.5(t)	50	16-pin SOIC	NA
NS	$\pm 10$	$\pm 1$ (t)	Conventional	5/9.5(t)	50	20-pin SOIC	\$7.40
NS	$\pm 2$ (t)	NA	Conventional	$\pm 5$ to +12 +17, -35	260	16-pin DIP	\$6.80
NS	$\pm 2$ (t)	NA	Parallel in, conventional	$\pm 5/+20,-25$	NS	24-pin SOIC	\$9.25
NS	$\pm 2$ (t)	NA	Parallel in, conventional	$\pm 5$ to $\pm 12$ , +20 -25	NS	28-pin DIP	\$9.25
NS	$\pm 1$ (t)	NA	Parallel in, conventional	$\pm 15$ , +5/ $\pm 30$ , +10	NS	24-pin DIP	\$11.80

*.050 centerline stackers.  
Close, closer, closest.*



***THIS IS AMP TODAY.***

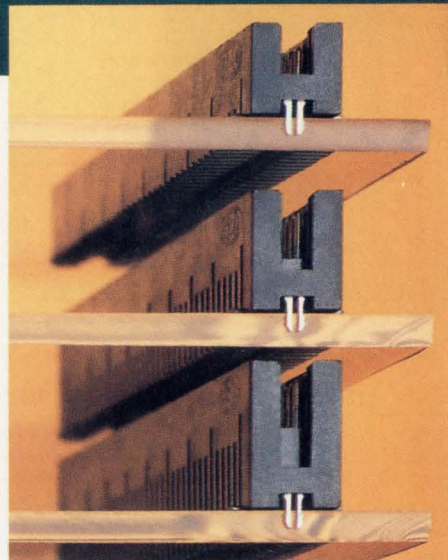

*Surface-mount stack heights: .250" / .320" / .390"*

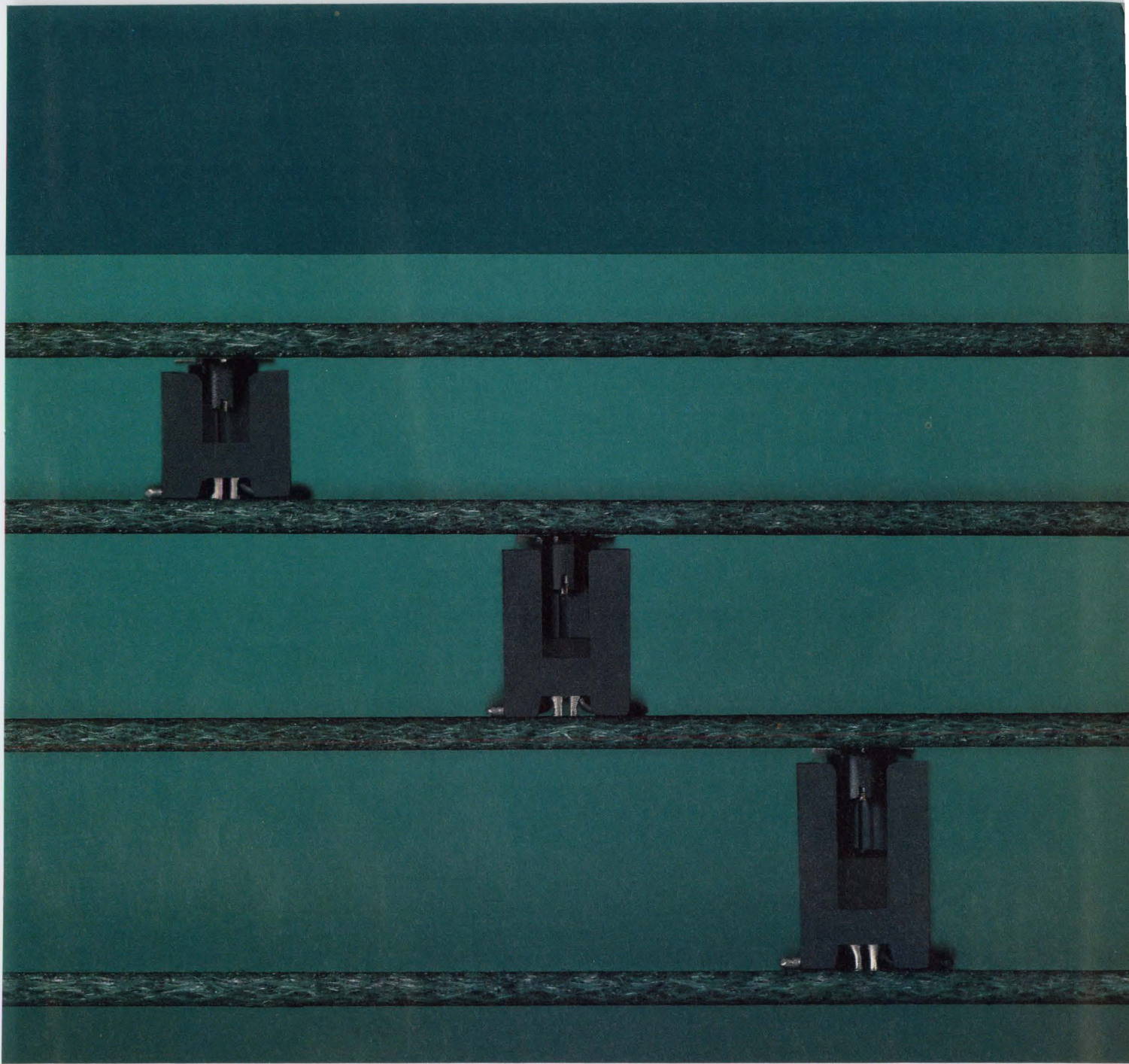

AMPMODU 50/50 Grid Connectors give you a choice of parallel pcb stack heights: .390", .320", and a very close .250" (the tightest in the industry). So you can squeeze everything possible out of (or into) your design.

This surface-mount system utilizes a .050" contact grid in double row, polarized shrouded headers and receptacles, and offers our exclusive plated copper alloy holddowns. On standard .062" thick boards, the

barbed holddowns do their job without protruding through, allowing surface mounting on both sides. And holddowns are soldered during reflow, providing long-term strain relief.

Dual-beam receptacle contacts and duplex gold plating provide high reliability, in selected sizes from 10 to 100 positions. Dimensional tolerances, reference datums, holddown characteristics, and packaging support robotic application; materials are fully

compatible with IR and vapor phase reflow processing.

Ask us for more information on the AMPMODU 50/50 Grid Surface-Mount Connector System. Call the AMP Product Information Center at 1-800-522-6752 (fax 717-986-7575). In Canada call 416-475-6222. AMP Incorporated, Harrisburg, PA 17105-3608.

CIRCLE 90 FOR U.S. RESPONSE

CIRCLE 91 FOR RESPONSE OUTSIDE THE U.S.

**AMP**

## HIGH-RESOLUTION DACs

TABLE 2: MONOLITHIC GENERAL-PURPOSE 14-18 BIT DACs

Company	Model	Resolution (bits)	Output type Voltage	Output Current	Reference		Monotonic Over tem- per- ature		Integral non-linearity (bits)	Full-scale settling time to % of full scale		Features and output range	Digital I/O	Package type	Price (1000s)
					Fixed multiplier	Internal	(bits)	(bits)		( $\pm\%$ )	( $\mu\text{s}$ )				
Analog Devices	AD7534	14	•	•	•	•	14	14	13	0.003	1.5	1, 2	25	40, 41	\$14.00
	AD7535	14	•	•	•	•	14	14	13	0.003	1.5	1, 2	26	40, 41, 42	\$16.00
	AD7536	14	•	•	•	•	14	14	13	0.003	1.5	1, 2, 3	26	42, 43, 44	\$16.00
	AD7538	14	•	•	•	•	14	14	13	0.003	1.5	1, 2	27	45	\$9.00
	AD7840	14	•	•	•	•	14	14	13	1/2 LSB	4	4	28	42, 45	\$9.00
	AD7244(dual)	14	•	•	•	•	14	14	13	1/2 LSB	4	70	63	45, 46	\$15.00
Harris Semiconductor	ICL7134	14	•	•	•	•	14	13	14	1/2 LSB	3	17	26	43	\$14.00
Micro Power Systems	MP7614	14	•	•	•	•	13	13	12	0.01	2 (t)	19	35	40, 51	NA
Sipex	SP7514	14	•	•	•	•	14	14	14	NS	2(t)	1, 12	35	40	\$16.00
Analog Devices	AD569	16	•	•	•	•	16	16	12	0.001	6	5	29	43, 44	\$16.00
	AD669	16	•	•	•	•	16	15	14	0.0008	13	6	30	43, 46	\$14.00
	AD766	16	•	•	•	•	15	15	NS	0.0015	1.5 (t)	7	31	47	\$9.00
	AD7846	16	•	•	•	•	16	16	12	0.003	9	8	30, 37, 38	42, 44, 48	\$16.00
Burr-Brown	DAC700, 01, 02, 03	16	•	•	•	•	14	14	14	0.003	8	9	33	49	\$15 to \$27
	DAC707, 08, 09	16	•	•	•	•	14	14	14	0.003	8	9	33	49	\$17 to \$31
	DAC710	16	•	•	•	•	15	15	14	0.003	8	9, 20	32	49	\$16.00
	DAC725 (dual)	16	•	•	•	•	14	14	14	0.003	8	10	34	48	\$32.00
Datel	DAC-HP163*	16	•	•	•	•	14	14	14	0.005	15(t)	16	32	49	\$67.00
Harris	ICL7121	16	•	•	•	•	16	16	15	1/2 LSB	3	18	29	43	\$18.00
Micro Networks	MN3290*	16	•	•	•	•	14	14	15	0.003	8	9	32	49	\$30 to \$60
Micro Power Systems	MP7616	16	•	•	•	•	13	13	12	0.01	2(t)	19	32	52, 54	NA
	MP7626	16	•	•	•	•	16	15	14	0.1	2(t)	19	36	43, 46, 44	NA
	MP7636	16	•	•	•	•	16	16	14	1/2 LSB	2(t)	19	29	40	NA
SPT	HDAC52160	16	•	•	•	•	15	14	14	0.0015	0.15	15	32	53	NA
Sipex	HS9390*	16	•	•	•	•	14	13	14	0.006	0.15	22	60	56	\$184.00
	SP1148*	16	•	•	•	•	16	15	14	0.00076	20	23	61	56	\$130.00
	SP7516/SP3160	16	•	•	•	•	14	14	14	NS	2(t)	1, 12	35	50/52	\$19/\$22
	HS9371*	16	•	•	•	•	16	16	16	0.0015	5(t)	13	29	48	\$69.00
	SP9316	16	•	•	•	•	15	15	15	0.0015	5(t)	1, 12	30	49	\$30.00
	SP9320(dual)	16	•	•	•	•	16	15	13	NS	3(t)	14	29	43	\$32.00
	SP9321(dual)	16	•	•	•	•	16	15	13	NS	3(t)	14	34, 37, 38	45	\$32.00
Analog Devices	AD1139*	18	•	•	•	•	18	16	18	1/2 LSB	40	24	65	56	\$175.00
Burr-Brown	DSP201/202(dual)	18	•	•	•	•	14	14	14	0.006	2.5(t)	11	64	48	\$21/\$26
	DAC729*	18	•	•	•	•	18	16	17	0.00076	8(t)	20	39	55	\$98.00
Sipex	SP9380*	18	•	•	•	•	18	16	18	1/2 LSB	30(t)	24	62	56	\$160.00

All specifications are maximum or minimums over temperature unless otherwise noted typical (t). Specifications are shown for the model offering monotonicity over temperature for the greatest number of bits. Prices have been rounded off to the nearest dollar. NS = not specified. NA = not available.

\* = Hybrid unit.

**Features and output range:** 1 = micropower, R-2R ladder, reference input of 3.5 to 10 k $\Omega$ . 2 = bringing ground rail to -300 mV minimizes leakage when operating above 70°C. 3 = contains application resistors for four-quadrant multiplication. 4 = output is  $\pm 3$  V at 1.5 mA; ac specifications provided (see text). 5 = output is  $\pm 5$  V at 5 mA; inherently monotonic architecture (see text). 6 = output is  $\pm 10$  V/0-10 V at 5 mA. 7 = output is  $\pm 3$  V at 8 mA or 0-1 mA; designed for DSP applications; ac specifications provided. 8 = output is  $\pm 10$  V,  $\pm 5$  V, 0-10 V, and 0-5 V, all at 5 mA (similar to 5); has Readback and Clear lines. 9 = A family of voltage- and current-output DACs. Voltage-output models provide 5 mA at one or more of the following voltages:  $\pm 5$ ,  $\pm 10$ , 0-5, and 0-10 V. Current-output models provide 0-2 mA and/or  $\pm 1$  mA with a compliance of  $\pm 2.5$  V. 10 = dual voltage-output DAC; each output supplies  $\pm 10$  V at 5 mA. 11 = single (DSP201) and dual (DSP202) voltage-output DACs for digital-signal processing; output is  $\pm 3$  V at 8 mA; ac specifications provided. 12 = reference bandwidth of 1 MHz. 13 = current output of  $\pm 1$  mA or 0-2 mA with application resistors. 14 = dual current-output multiplying DAC; reference input is 1.875 k $\Omega$  ( $\pm 50\%$ ). 15 = high-speed, 5-mA current-output DAC with application resistors to provide voltages of  $\pm 2.5$ ,  $\pm 5$ , 0-5, and 0-10 V; compliance voltage of  $\pm 2.5$  V. 16 = output of  $\pm 5$  V and 0-10 V. 17 = R-2R reference ladder of 7 k $\Omega$  ( $\pm 50\%$ ); uses correction DAC. 18 = R-2R reference ladder of 4.2 k $\Omega$  ( $\pm 50\%$ ); uses correction DAC; total unadjusted error specified at 0.02%. 19 = R-2R reference ladder of 1 k $\Omega$  to 10 k $\Omega$ . 20 = designed for closed-loop servo systems; monotonic to 15

bits around zero. 21 = hybrid, user-trimmable to 18-bit accuracy; output voltages at  $\pm 5$  mA of  $\pm 2.5 \pm 5$ ,  $\pm 10$ , 0-5, and 0-10 V. 22 = high-speed, hybrid, 4- or  $\pm 2$ -mA (t) current-output DAC with application resistors to provide voltages of  $\pm 10$ ,  $\pm 5$ , 0-5, and 0-10 V; compliance voltage of  $\pm 1$  V. 23 = voltage-output ( $\pm 10$ -V) hybrid DAC containing two 8-bit DACs to adjust gain and offset errors to within  $\pm 1/2$  LSB. 24 = voltage-output ( $\pm 5$ -,  $\pm 10$ -,  $+5$ -, and  $+10$ -V) hybrid DAC. 70 = dual outputs each providing nominally  $\pm 3$  V at  $\pm 20$  mA.

**Digital Interface:** 25 = double-buffered, 14 bits, in 2 bytes (8 bits + 6 bits). 26 = double-buffered, 14 bits, parallel, or 2 bytes (8 bits + 6 bits). 27 = double-buffered, 14 bits, parallel. 28 = double-buffered 14 bits, parallel or serial. 29 = double-buffered, 16 bits, parallel, or 2 bytes (8 bits + 8 bits). 30 = double-buffered, 16 bits, parallel. 31 = 16 bits, serial. 32 = unbuffered (no input latches), 16 bits, parallel. 33 = double-buffered, 16 bits in two 8-bit bytes, or serial. 34 = double-buffered to either of two DACs in two 8-bit bytes. 35 = 14 bits, parallel, no latches. 36 = single-buffered, 16 bits, parallel, or two 8-bit bytes. 37 = Clear command sets registers to all zeros. 38 = Readback command permits host to check digital word in registers. 39 = unbuffered, 18 bits, parallel. 60 = single-buffered, 16 bits, parallel. 61 = single-buffered, 16 bits, parallel; 8-bit DACs also single-buffered. 62 = single-buffered, 18 bits, parallel, or in two 9-bit bytes. 63 = separate serial interface for each of two DACs. 64 = 16/18 bits, serial. 65 = single-buffered, 18 bits, parallel.

**Packages:** 40 = 20-pin DIP. 41 = 20-pin PLCC. 42 = 28-pin LCC. 43 = 28-pin DIP. 44 = 28-pin PLCC. 45 = 24-pin DIP. 46 = 28-pin SOIC. 47 = 16-pin DIP. 48 = 28-pin double DIP. 49 = 24-pin double DIP. 50 = 24-pin SOIC. 51 = 20-pin SOIC. 52 = 22-pin DIP. 53 = 32-pin DIP. 54 = 24-pin SOIC. 55 = 40-pin double DIP. 56 = 32-pin triple DIP.

## HIGH-RESOLUTION DACs

the ideal output of 0 V when the input code representing half scale is loaded into the DAC's input register. It's expressed in millivolts and is measured with half-scale output signal levels.

Most humans will be unable to hear any difference between CD players using either 16- or 18-bit DACs (listed in the table) that provide -92 dB of THD + N at full output, an SNR of 100 dB, and a dynamic range of 93 dB, and a CD player using DACs with superior performance. The higher-performance DACs are for the world's "golden ears," and professional studio digital-audio equipment that must always be better than what the CDs will be played on. These DACs also aim at a wide variety of general-purpose applications, particularly in digital-signal processing.

Different high-resolution IC DAC architectures offer different trade-offs. For example, while the THD + N and dynamic-range specifications for Crystal's delta-sigma CS4328 dual DAC aren't quite up to those of most other 18-bit DACs or any of the 20-bit ICs, no other DACs can touch its SNR. And channel separation is low on the CS4328's two DACs. While the conventional DACs also appear to offer an advantage in power requirements, an advantage that's important in portable applications, their power needs don't reflect exactly what's required by the input interpolating filter or the output analog filter.

All other things being equal, the CS4328 offers a distinct advantage when it comes to pc-board space. Complete unto itself, it needs neither a digital oversampling filter on the input nor an analog filter on the output. Its two outputs are ready to put  $\pm 1.9$  V of audio across 600  $\Omega$ .

Other suppliers of one-bit (delta-sigma) DACs include Philips/Signetics and Sony. Sony's two-channel delta-sigma DAC, the CXD2558, has no analog output filter. Each channel provides the train of precision ones and zeros from the one-bit DAC in differential form—that is, two outputs per channel, one going high and the other low. The user-added analog

filter determines ultimate system performance. Crystal will soon announce a similar device (the CS4303), which is essentially the front end of its CS4328. With the proper filter, it expects to raise dynamic range to well over 103 dB. The DACs in the Phillips/Signetics chip set, while containing a switched-capacitor analog filter, still require an external continuous-time filter.

For the most part, overall DAC performance rises with increasing resolution and oversampling (*Table 1, again*). And, of course, so does price. However, there are some exceptions to the rule, like Burr-Brown's 16-bit PCM60 and PCM66 compared with the 18-bit PCM67, and Analog Devices' 16-bit AD1866 compared with the 18-bit AD1868. These devices, aimed at portable, automotive, and CD-player applications, must necessarily use low power by operating from single 5-V supplies and dissipating less than 100 mW, sacrificing some performance. These DACs include circuits that create a zero signal at 2.5 V. In addition, the high oversampling factors move the handling of precision analog signals to several hundred kilohertz, and speed takes power.

### BACK TO BASICS

Not long ago, vector-scan CRT displays, such as those used for air-traffic control, and DACs in high-resolution successive-approximation-register (SAR) hybrid ADCs, represented two of the three major applications for high-resolution DACs. Raster-scan displays using higher-speed 8- or 10-bit video DACs have now virtually replaced high-resolution DACs in CRT displays. And high-speed, high-resolution ADCs, including the DAC if a successive approximation design, have been integrated into one IC. However, the third major application, computer-directed control systems, still exists and is growing. In these systems, the DAC provides the set point for open- and closed-loop control and/or acts as the vital feedback element in a closed-loop system.

Signal synthesis of arbitrary waveforms from ultra-pure sine

# Put All Your Clocks On One Chip



## Replace multiple crystal can oscillators with a single frequency synthesis IC.

In computer graphics and general purpose timing applications, IC DESIGNS' multiple- and variable-frequency devices save board space and money. Which is why some of the industry's largest companies use our components.

**ICD2051 Dual Programmable Oscillator** — Two independent VCO's with multiple low-skew outputs; range from 320KHz - 120MHz.

**ICD2053A Programmable Clock Oscillator** — Industry's smallest footprint 8-pin "Mini-SOIC"; low power consumption; 320KHz - 120MHz clock output.

Contact us for more information about these or other IC DESIGNS frequency synthesis components.



1-800-669-0557

**IC DESIGNS**

12020 113th Ave. N.E. Kirkland, WA 98034

FAX: 1-206-820-8959

CIRCLE 138 FOR U.S. RESPONSE

CIRCLE 139 FOR RESPONSE OUTSIDE THE U.S.

NEW DAC ARCHITECTURES AND NOISE SHAPING

**M**idscale error, the error at or near zero signal level, represents a major cause of distortion in multibit DACs, particularly at low signal levels and in the higher-resolution DACs, where other sources of error have been reduced. It's caused by the most-significant-bit transition that occurs at midscale as the input code switches between a code of 1 and all 0s, and a code of 0 and all 1s. To attack the problem, Analog Devices added a digital offset circuit in its 20-bit AD1862, which shifts creation of the midscale output away from the most significant bit. To minimize until-now-second-order errors, which at 20 bits of resolution become first-order errors at least to the "golden ears" of music, Analog Devices limited the AD1862 to one channel of current output. The user must add an op amp of choice, which can of course be part of the still-mandatory analog filter.

For their 20-bit PCM63P DAC, Burr-Brown created a completely new, multibit DAC architecture to beat the midscale problem (Fig. 1). Dubbed "Colinear," the PCM63P, like the AD1862, contains just a single-channel, cur-

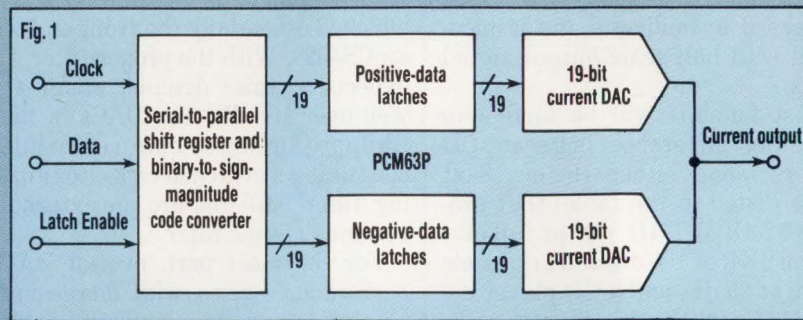

rent-output DAC. The circuit represents a form of sign-magnitude architecture. It uses a pair of 19-bit current DACs, one providing positive currents and the other negative currents. The DACs are summed to form the output current. Only the least-significant-bit current changes at zero. Transparent logic circuitry between the input shift register and the DACs converts the input code to the sign-magnitude code (on-chip reference circuits aren't shown). Future DACs based on this architecture may raise the performance of general-purpose DACs above 14 to 16 bits of resolution at dc and over temperature.

The buzz word today in digital-audio DAC circles is the one-bit DAC, such as Crystal's CS4328

delta-sigma IC (Fig. 2). This two-channel DAC is complete with its own pair of 8X-oversampling input filters, which are followed by 64X-oversampling digital delta-sigma modulators. The modulators drive 1-bit switched-capacitor DACs that are followed by on-chip low-pass filters and output amplifiers. The on-chip 8X input-interpolation filters do the same job as the off-chip filters used with multibit DACs. They remove the images of the input signal that are present at multiples of the input sampling frequency,  $f_s$  (the frequency at which the original music signal was sampled), or 44.1 kHz (Fig. 2a).

The signal at the filters' output has a frequency spectrum with images at multiples of  $8f_s$  (Fig.

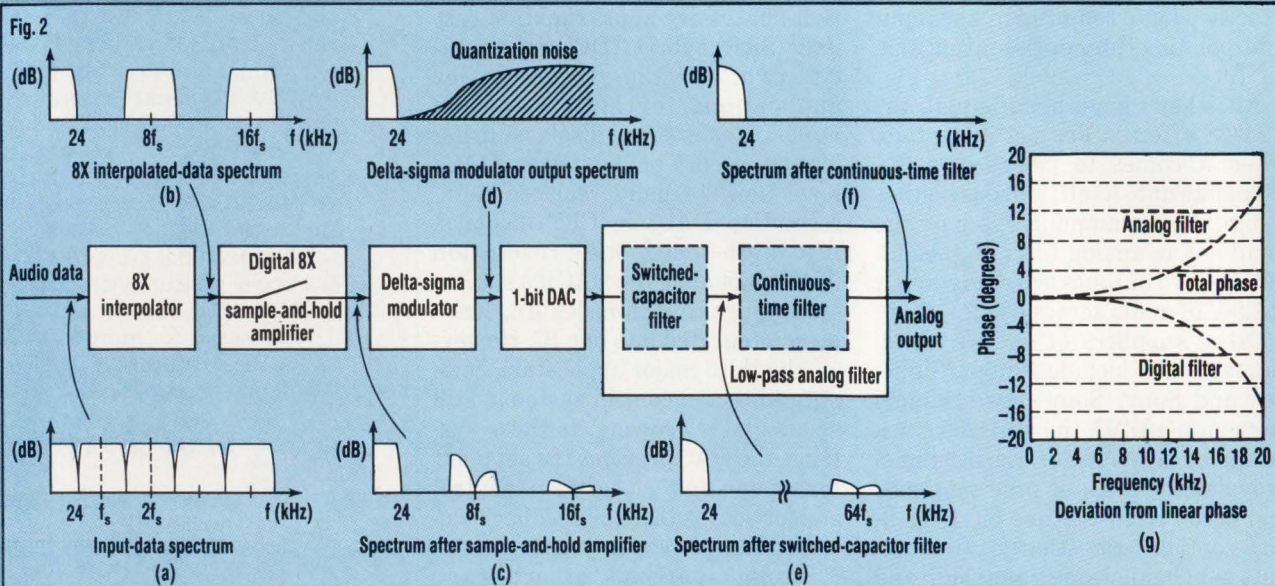



## HIGH-RESOLUTION DACs

2b). The filters drive a digital sample-and-hold stage in which the data points from the interpolator are held for eight clock cycles, creating a  $64f_s$  data stream carrying a  $\sin x/x$  frequency response with zeros at multiples of  $8f_s$ . The  $\sin x/x$  zeros completely attenuate signals at  $8f_s$  and largely suppress the energy remaining in the images (Fig. 2c).

The digital delta-sigma modulator modulates the digital 18-bit audio data, creating a 1-bit  $64f_s$  signal, followed by a 5th-order noise shaper. The shaper moves the quantization noise created in the oversampling process beyond the band of interest (Fig. 2d). The modulator's output drives the 1-bit DAC that translates the bit stream into a series of charge packets.

The magnitude of the charge in each packet is determined by sampling (switching) a precision voltage reference onto a capacitor. The polarity of each packet's charge is controlled by the 1-bit signal, and is a positive charge for a 1, and a negative charge for a 0. A string of alternating 1s and 0s results in 0 V out. Midscale (zero) error is nonexistent or is a function of the circuits that follow the DAC.

The final stage of the DAC consists of a 5th-order switched-capacitor, analog, low-pass filter, followed by a 2nd-order, continuous-time analog low-pass filter. The 5th-order filter eliminates out-of-band signal energy resulting from the noise-shaping process (Fig. 2e).

The filter scales with the master clock driving the digital circuits, permitting operation at different clock rates. The 2nd-order filter eliminates high-frequency energy at multiples of the  $64f_s$  sample rate (Fig. 2f). Together, the digital and analog filters compensate for each other's phase errors, resulting in a phase error (simulated) of zero (Fig. 2g).

waves represents a fourth and growing class of high-resolution DAC applications. Moreover, while control-system bandwidths are relatively low, waveform-generation frequencies can run from dc (programmable power supplies) to whatever maximum update rate is available in a DAC. TriQuint Semiconductor is working on a 14-bit 2-GHz DAC. One new general-purpose DAC application that's coming on-stream is to use the DAC as the output device for a DSP circuit. DSP applications need bandwidths from dc to the maximum signal frequencies the digital-signal processors can handle.

Each of these applications demands maximum performance for several specifications. DACs for control systems must guarantee monotonicity to a certain number of bits over their operating-temperature range. A system (or device) is monotonic if the magnitude of its output remains constant, or increases in value, as the input increases in magnitude. Thus, a DAC is monotonic if its analog output never decreases in value when its digital input code increases in value, and vice versa. To put it another way, a monotonic system's output is always a single-val-

ued function of the input. The derivative of a DAC's transfer function must never change sign.

Monotonicity is mandatory if the DAC is in the feedback loop of a control system. If the error signal from the processor says go left or put on more heat, but the DAC output says go right or cuts the heat, the system becomes unstable.

If you can settle for operation at a temperature of or close to 25°C, you have over a dozen DACs that can provide 16-bit monotonicity. You can even get 18-bit monotonicity, albeit from more-expensive hybrid chip-and-wire types (Table 2, again). And you can get monolithic 16-bit ICs for under \$20. However, if your control system must use the commercial temperature range, your choice of affordable DACs drops in half.

## MIGRATING DACs

There's hope, however, for future migration from the audio-DAC arena. One-bit (delta-sigma) DACs are inherently monotonic, as is Burr-Brown's PCM63 sign-magnitude DAC. Presently available delta-sigma DACs don't lend themselves to anything but the slowest control systems (those with, say, sub-one-hertz

## A SAMPLING OF 14-TO-20-BIT DAC SUPPLIERS

**Analog Devices Inc.**  
Wilmington, Mass.  
(617) 937-1428  
**CIRCLE 571**

**Analogic Corp.**  
Peabody, Mass.  
(508) 977-3000  
**CIRCLE 572**

**Burr-Brown Corp.**  
Tucson, Ariz.  
(800) 548-6132  
**CIRCLE 573**

**Crystal Semiconductor Corp.**  
Austin, Texas  
(512) 445-7222  
**CIRCLE 574**

**Datel Inc.**  
Mansfield, Mass.  
(508) 339-3000  
**CIRCLE 575**

**Harris Semiconductor Corp.**  
Santa Clara, Calif.  
(408) 996-5624  
**CIRCLE 576**

**Maxim Integrated Products Inc.**  
Sunnyvale, Calif.  
(408) 737-7600  
**CIRCLE 577**

**Micro Networks Corp.**  
Worcester, Mass.  
(508) 852-5400  
**CIRCLE 578**

**Micro Power Systems Inc.**  
Santa Clara, Calif.  
(408) 727-5350  
**CIRCLE 579**

**Optimum Semiconductor Inc.**  
Santa Clara, Calif.  
(408) 748-1111  
**CIRCLE 580**

**Philips-Signetics Co.**  
Sunnyvale, Calif.  
(408) 991-4519  
**CIRCLE 581**

**Signal Processing Technologies Inc. (SPT)**  
Colorado Springs, Colo.  
(719) 540-3970  
**CIRCLE 582**

**Sipex Corp.**  
Billerica, Mass.  
(508) 663-9691  
**CIRCLE 584**

**Sony Corp. of America Component Products Co.**  
Cypress, Calif.  
(714) 229-4197  
**CIRCLE 585**

COMPACT-DISC PLAYERS, DIGITAL-AUDIO DACs, AND OVERSAMPLING

At the heart of every compact-disc player lies either one or two 16-bit (or more) digital-to-analog converters (DACs). First-generation systems took a 16-bit parallel word from the digital error-correction circuitry at 44.1 kHz, and applied it to a 16-bit DAC (see the figure, top). The DAC alternately produces samples of analog voltages representing the left- and right-channel audio signal. The analog signals are applied to a pair of sample-and-hold amplifiers (degitchers). While one amplifier samples the left channel, the other applies its previously sampled, now-held, output to an analog, low-pass filter.

The low-pass filter removes all unwanted frequency components (images) caused by the initial sampling of the signal prior to recording, and those caused by the discrete nature of the DAC output. The filter must combine a flat amplitude response with linear phase from dc to 20 kHz. But it must also have deep attenuation (100 dB) above 24 kHz. Such so-called "brick-wall" filters aren't only large and expensive because they require as many as 9 to 13 poles, but their phase response is nonlinear, which can disturb the pulse-like transients in music.

To answer the filter problem, system designers added a digital circuit called an oversampling, or interpolation, filter between the digital signal-processor output and the DAC input. The first filters, which were used with parallel-input DACs like the Burr-Brown PCM53, multiplied the sampling frequency by two (2X oversampling), resulting in an 88.2-kHz data rate. The first images now start to appear at about 68 kHz, but the audio frequencies of interest still stop at 20 kHz. A much simpler filter can now be used in these systems.

It became clear that one serial data line was easier to handle than

16, and 18-bit systems were being developed. So designers asked Burr-Brown to put a serial-to-parallel converter in the DAC, resulting in a third-generation system with an oversampling filter (see the figure, bottom). If 2X oversampling is good at simplifying the analog filter, 4X, 8X, or 16X oversampling is even better. Even just 4X oversampling pushes the first images out to 156 kHz and the sampling rate to 176.4 kHz. Now, filters with just 3 to 5 poles can do the trick.

Why the move to 18- and even 20-bit digital-audio DACs when the basic music is initially sampled and quantized with 16-bit resolution? It's not for CD-player marketing hype. Rather, higher-resolution DACs are needed to re-

duce truncation noise, which is added to the audio passband during the oversampling process by digital filters. Digital filters perform multiply-accumulate operations in which two 16-bit binary numbers are multiplied by each other. The answer can run over 40 bits, which takes lots of silicon. Of more importance, to preserve true signal purity a fast 40-bit DAC is required, which is impossible even to conceive, let alone build. As a result, the latest interpolators round off, or truncate, the accumulation, producing a choice of "practical" 16-, 18-, and 20-bit output words. The system designer can choose which to use, knowing that at least theoretically, the higher the resolution, the better the music will sound.

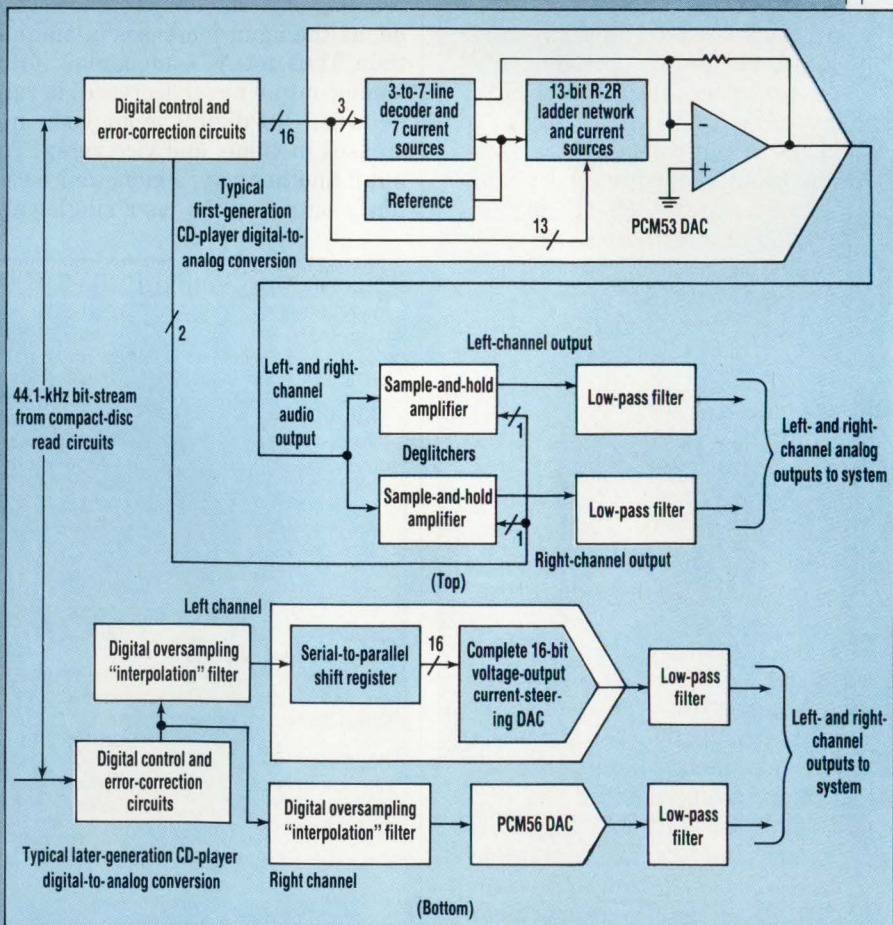

BUSCON  
'91 East  
Product of the Year.

Some people  
think we're power crazy,  
obsessed with quality  
and downright  
cheap.

And it's all true.

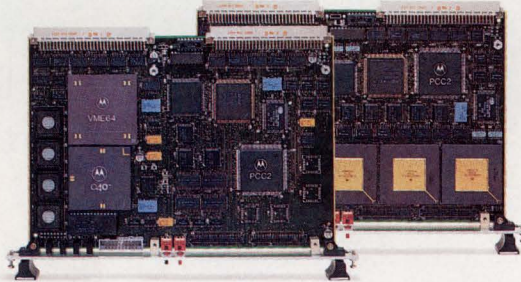

Okay, we admit it. We're hopeless perfectionists. Driven to produce the best boards at the best price.

Take our new MVME187 and MVME167 single board computers, for instance. Best in performance at 38 MIPS\* (RISC) and 26 MIPS\* (CISC), respectively. Best in value at \$105 (RISC) and \$154 (CISC) per MIPS.

Which comes out to just \$3,995 per board. And which compares rather nicely with the \$8,000 to \$12,000 you could pay for the competition's boards. Based on the 88100 and 68040, Motorola's highest performance

32-bit microprocessors, the MVME187 and MVME167 employ VME D64 architecture. Boosting the VMEbus band-

width to a full 40MB/s. And both boards come with four 32-bit timers, as well as SCSI and Ethernet connections.

Naturally, since they're made by Motorola, you can expect the best in quality. The Malcolm Baldrige Award is a powerful testament to that fact.



So call 1-800-234-4VME for a free color brochure. And see why so many people are obsessed with Motorola products.



**MOTOROLA**  
Computer Group

For a free color brochure, call 1-800-234-4VME.

Motorola and the  are registered trademarks of Motorola, Inc. © 1992 Motorola, Inc. All rights reserved. \*MIPS rating based on Dhrystone 1.1 test results where 1757 Dhrystones/s is 1 MIPS (VAX™ 11/780). MIPS performance is based on the Diab 2.36E compiler.

CIRCLE 174 FOR U.S. RESPONSE

CIRCLE 175 FOR RESPONSE OUTSIDE THE U.S.

# How to stay ahead

Start with our high performance standard products. Then add unique functional or performance capabilities with our semi-standard options. To get the ICs you want. And the competitive advantage you need.

Quickly.  
Easily.  
With minimal risk.

## Power factor correction?

Don't just meet the standard. Beat the standard. With a family of standard controllers that offer power factors of .99 in boost or flyback, or combo (boost + PWM). With a choice of average current control for lowest THD or peak control for highest efficiency.

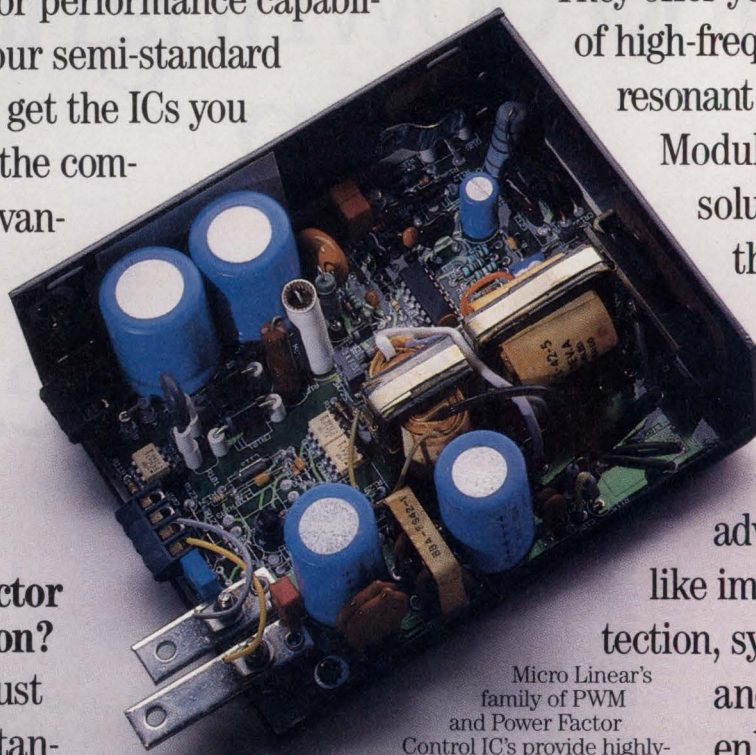

Micro Linear's family of PWM and Power Factor Control IC's provide highly-integrated solutions for a broad range of switching power supplies.

## Or how about our complete family of Off-line controllers?

They offer you a wide range of high-frequency PWM, resonant or the new Phase Modulation single chip solutions for state-of-the-art switching power supplies with operating frequencies over 1 Mhz. With advanced features like improved fault protection, synchronization and stability enhancements.

Product Category	Features
Power Factor Control	Boost or flyback Average Current or Peak Current
PWM Controllers	1Mhz. Improved fault protection synchronization, enhanced stability
Resonant Control	ZVS or ZCS to 3Mhz.
Phase Modulation	Zero Voltage Switching, 1Mhz.
Battery Power Control	Synchronous Rectification

# of the power curve.

## New brushless motor techniques?

Now you have some unique design options. With our ML4410 and ML4411 sensorless motor controllers, the first controllers designed to commutate brushless DC motors without the need for Hall-effect sensors. Using a patented integrating commutation technique, these controllers even allow for PWM speed control and operate in harsh environments.

## Need to extend battery life in portable PCs?

We've just introduced the ML4860, the *first* total system solution to battery power conversion for notebook and laptop computers. With synchronous rectification and a host of power management features, it extends battery life by

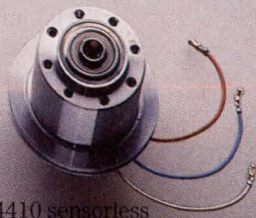

The ML4410 sensorless motor controller can control any wye or delta wound 3-phase brushless DC motor.

over 10% while reducing system cost.

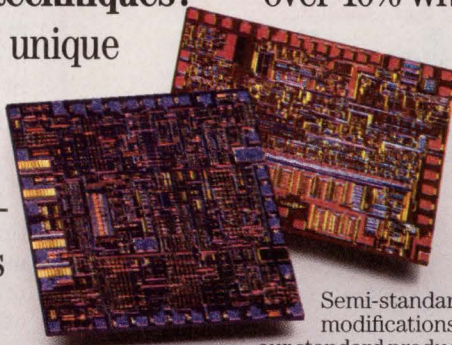

Semi-standard modifications of our standard products offer you better application fit, with lower risk.

## Semi-standard options.

Since all these standard products are based on our semi-standard tile arrays, they can

be easily modified to satisfy specific application requirements. Whether you require proprietary circuit modifications, special screening or packaging.

## Want some straight answers?

Just call Jon Klein at (408) 433-5200 and ask him about our complete line of power control products. And about our semi-standard capabilities. He'll show you that the best way to stay ahead of the power curve is to take a straight line.

**Straight to Micro Linear.**

CIRCLE 244 FOR U.S. RESPONSE  
CIRCLE 245 FOR RESPONSE OUTSIDE THE U.S.

 **Micro Linear**

bandwidths) due to the delay in their filters.

However, future devices may be able to lick this problem by using new filter designs analogous to the way the filters were changed in delta-sigma ADCs to permit multiplex-

ing their inputs. Control systems using conventional DACs add some low-pass filtering to the DAC outputs without affecting system stability. Of course, the first audio DACs were 16-bit general-purpose data converters.

While no longer reflected in audio-DAC specifications, monotonicity, particularly at midscale (zero), impacts audio characteristics. However, gain and offset errors are less important. For example, a typical audio DAC might have a gain error of 0.5 dB (that's 5%), which would be totally unacceptable in most general-purpose applications. However, some brave industrial-system designers are doing their own migration, using present low-cost 16-bit audio DACs in lieu of 12-bit general-purpose types.

## Programmable Linear Phase Filters for A/D Prefiltering Applications

**848DOW Series Combines Constant Delay of a Bessel Filter With The Sharp Attenuation of a Butterworth Filter.**

### Features:

- 8 pole, 6 zero linear phase lowpass filters
- Digitally programmable corner frequency
- 8 bit (256:1) tuning ratio
- Internally latched control lines to store frequency selection data
- Linear phase response to minimize phase distortion
- Sharp roll-off for anti-aliasing
- Plug in, ready to use, fully finished, filter module
- Five frequency ranges to 51.2kHz

### Other Filter Products available:

- Elliptic • Programmable • Fixed Frequency
- Instrumentation • Custom Designs

For more information, please call us at **508-374-0761.**

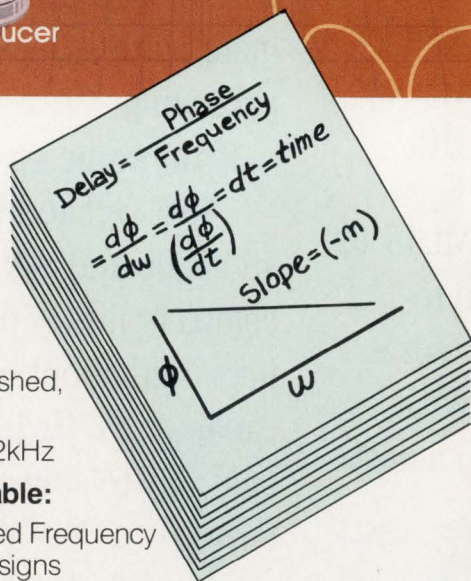
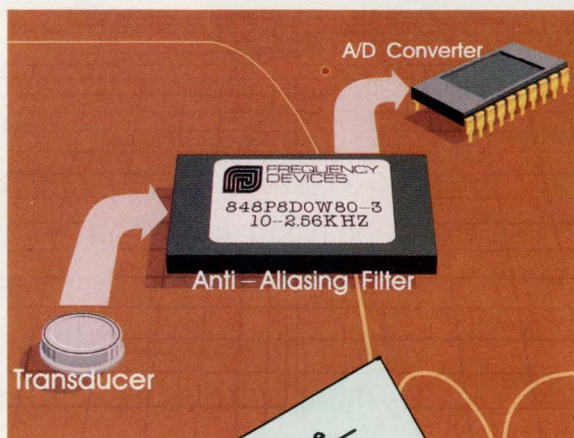

**FREQUENCY DEVICES™**

25 Locust Street  
Haverhill, MA 01832  
(508) 374-0761

### CONTROLLED TEMPERATURES

The audio DAC works best in a temperature-controlled environment, where it's generally higher, unspecified and untested gain and offset drift can be tolerated. And the designer must learn to live with the serial input and  $\pm 3$ -V output. On the other hand, all of the latest audio DACs work off  $\pm 5$ -V rails. And low-power (under 100 mW) devices are available for battery-powered instrumentation. Furthermore, you can get a pair of IC audio DACs in a 16-pin SOIC package for just \$10. But these DACs also need a low-jitter high-frequency clock, something not always available in an instrumentation system.

Several low-cost 16- and 18-bit audio DACs already represent the migration path to industrial applications. Analog Devices' AD669 and AD766, and Burr-Brown's DSP201 and DSP202 are some examples. The last three aim at DSP and frequency-synthesis applications. Their serial inputs and ac specifications show their audio heritage. Even the AD669, which is designed for parallel-input signals, can handle update rates up to 500 kHz and produce low-distortion sine waves well beyond the audio band, according to Analog Devices.

Integral linearity, or relative accuracy, along with gain and offset errors, are of secondary importance in control systems. While they do determine the system's absolute accuracy in set-point applications, errors in both set-point and feedback applications can be calibrated out. Gain and

CIRCLE 242 FOR U.S. RESPONSE  
CIRCLE 243 FOR RESPONSE OUTSIDE THE U.S.

# Let DATEL get you up to speed...

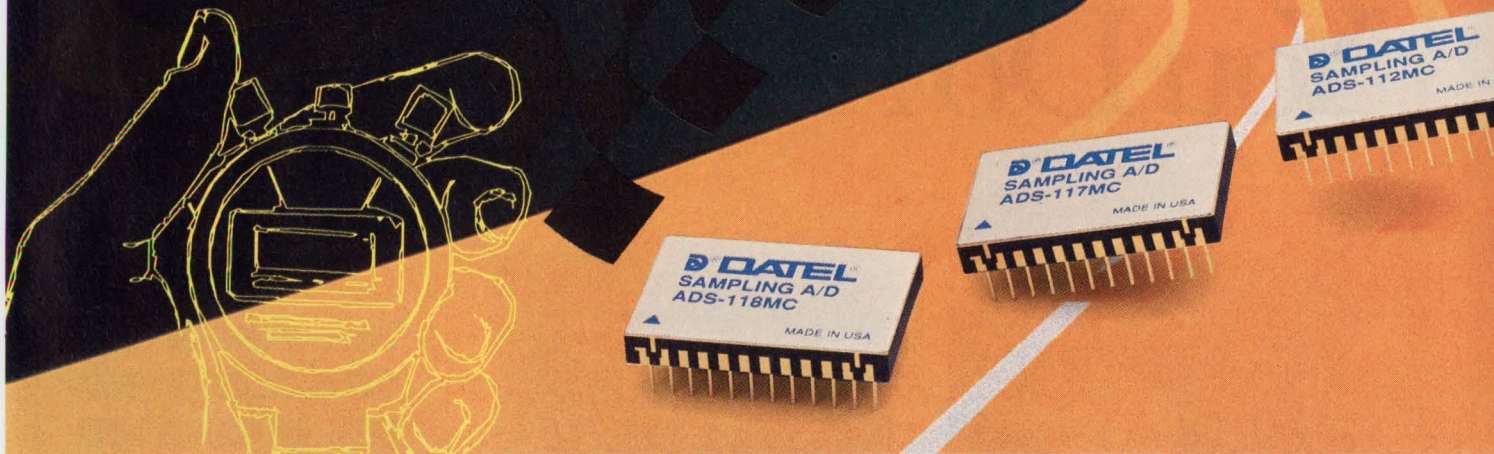

## and down in Power and Size

Get on track with DATEL's expanding line of high speed and high performance Sampling Analog to Digital Converters.

- 12-BIT RESOLUTION • INTERNAL SAMPLE HOLD • FUNCTIONALLY COMPLETE
- SAMPLES TO NYQUIST • NO MISSING CODES • THREE-STATE OUTPUT BUFFERS
- COMMERCIAL AND MILITARY TEMPERATURE RANGE MODELS • PIN COMPATIBLE



### 1MHz

1.3 Watts  
24-pin DIP

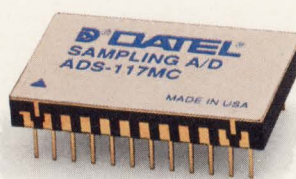

### 2MHz

1.6 Watts  
24-pin DIP

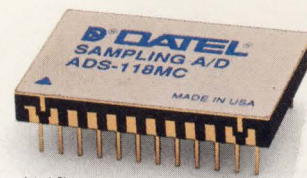

### 5MHz

1.7 Watts  
24-pin DIP

Specification	ADS-112	ADS-117	ADS-118
THD (dB)	-78	-78	-73
SNRD (dB)	70	70	66
Effective Bits	11.4	11.4	10.5
Peak Harmonic (dB)	-81	-81	-75

Contact DATEL for availability of SMT packaging and MIL-STD-883 models

For complete data call or write today. DATEL, Inc., 11 Cabot Boulevard, Mansfield, MA 02048. Telephone: (508)339-3000, FAX: (508)339-6356. For immediate assistance: all USA, EST business hours 1-800-233-2765; Western region only, PST business hours 1-800-452-0719.

CIRCLE 120 FOR U.S. RESPONSE

CIRCLE 121 FOR RESPONSE OUTSIDE THE U.S.

**DATEL**  
INNOVATION and EXCELLENCE

# You Design Actel FPGAs Like You Do A PLD. But That's Where

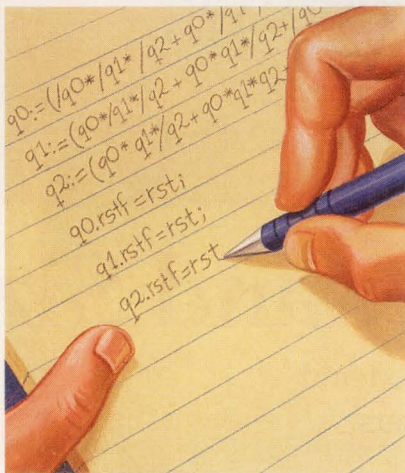

#### Use PLD Tools.

You design Actel FPGAs using the same tools as you would a PLD: ABEL™, CUPL™, LOG/iC™ and PGADesigner™. But that's where the similarity ends.

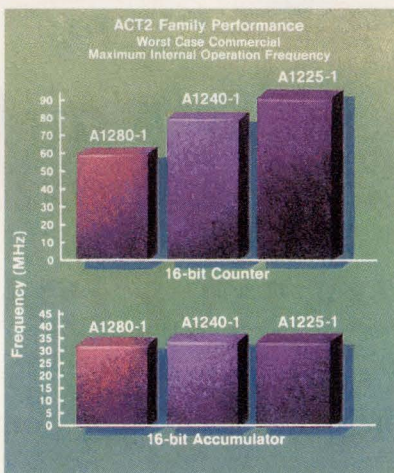

#### Fast. Fast. Fast.

Our FPGAs are real speed demons. Whatever application you may be working on, our parts will give you the kind of performance you're looking for.

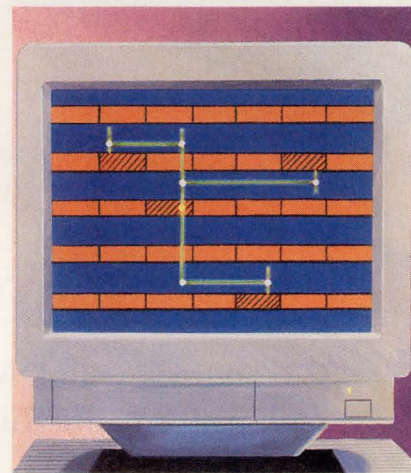

#### 100% Automatic Place And Route.

Coupled with your PLD tools, Actel's Action Logic™ System (ALS) software lets you create your own FPGAs—using a 386 PC or workstation—right at your own desk. With Auto Place and Route that's proven in thousands of applications.

## Announcing A Simple Way To Get From PLDs To FPGAs.

If you're a PLD designer with an interest in fast, flexible FPGAs, but you think you don't have time to learn new design techniques, we'd like to change your mind.

First of all, you don't have to give up your existing PLD design tools or Boolean equations. Actel's ALES™ 1 program translates the output of PLD

tools like CUPL™ and LOG/iC™ into logic optimized for our ACT™ devices. ABEL™ 4.0 includes optimization for Actel devices. Entire FPGA designs can be developed with PGADesigner™.

Actel devices offer everything you want in an FPGA. Like high I/O and flip-flop counts. And 100% automatic place

and route gets you to market fast.

Once your FPGA is designed, our Action Logic™ System (ALS) converts the captured design into a completed device in minutes. To give you true, high-density, field-programmable, channeled gate arrays.

Other FPGA manufacturers fall short on design verification. Our exclusive Actionprobe® diagnostic tools, give you 100%

observability of internal logic signals. So you don't have to give up testability for convenience.

It's never been easier to make your innovative designs a reality. We offer you a complete family of powerful FPGAs, like the A1010 and A1020, available in 44, 68 and 84 pin PLCC versions and implementing up to 273 flip-flops or up to 546 latches. And the first member of our ACT 2 family, the power-



# FPGAs The Same Way The Similarity Ends There.



### More Flexibility And Capacity.

Designing with Actel FPGAs gives you more freedom than you ever imagined. More gates. More flip-flops. More I/O. In fact, our new A1280 is the largest FPGA in the world.

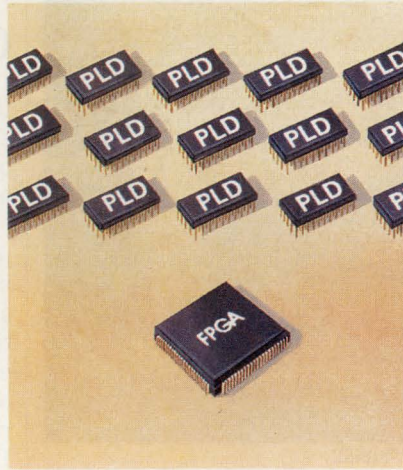

### Small Footprint.

Actel FPGAs give you far more gates per square inch. As much as ten times as many as the densest PLDs. That can save a lot of real estate.



### More Fun.

Designing Actel FPGAs is so simple that you'll have more time to do the things that made you want to become an engineer in the first place. Or just relaxing. You've earned it.

ful A1280. With 8,000 gates, up to 998 flip-flops, and 140 I/O pins, it's the highest capacity FPGA today. And our A1240-1 is the fastest. In the A1240-1, 16-bit counters run at 75 MHz, 16-bit accumulators at 33 MHz. Enough capacity and speed to handle almost any application.

The superior speed,



The FPGA Design Guide

capacity, and auto place and route capabilities of our FPGAs are made possible by Actel's revolutionary PLICE® antifuse programming element. The advanced technology that makes our family of FPGAs an ideal way to unleash your engineering creativity.

Call 1-800-228-3532

for your free FPGA Design Guide.

### Broad Family With High Capacity

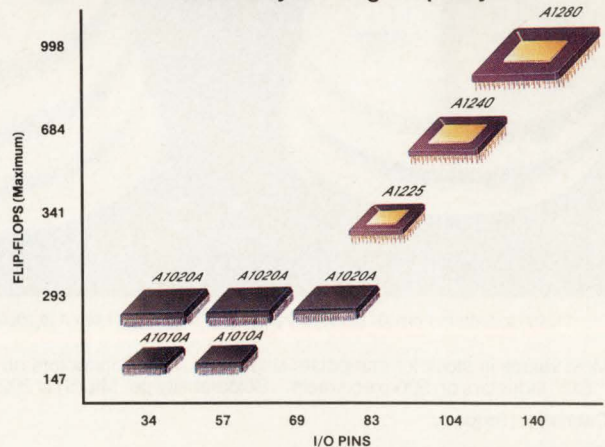

Risk-Free Logic Integration

# INTRODUCING THE SOLDIER SERIES

6" to 25"

## FULLY MILITARIZED OR RUGGEDIZED HIGH RESOLUTION COLOR DISPLAYS

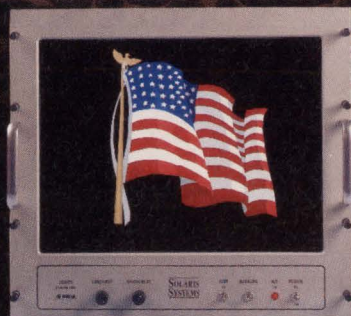

19-INCH "COMMANDER"  
COLOR DISPLAY

★ MADE IN THE USA

**SOLARIS  
SYSTEMS**

A DIVISION OF GTC

SOLARIS SYSTEMS  
1230 S. LEWIS STREET  
ANAHEIM, CA 92805  
TEL (714) 563-3305 FAX (714) 563-4355

- 100% Modular Design  
(Wiring Harnesses Eliminated)
- Advanced Circuit Design
- Digital Electronics
- Cost Competitive

CIRCLE 250 FOR U.S. RESPONSE  
CIRCLE 251 FOR RESPONSE OUTSIDE THE U.S.

## Surface Mount Inductors From Stock

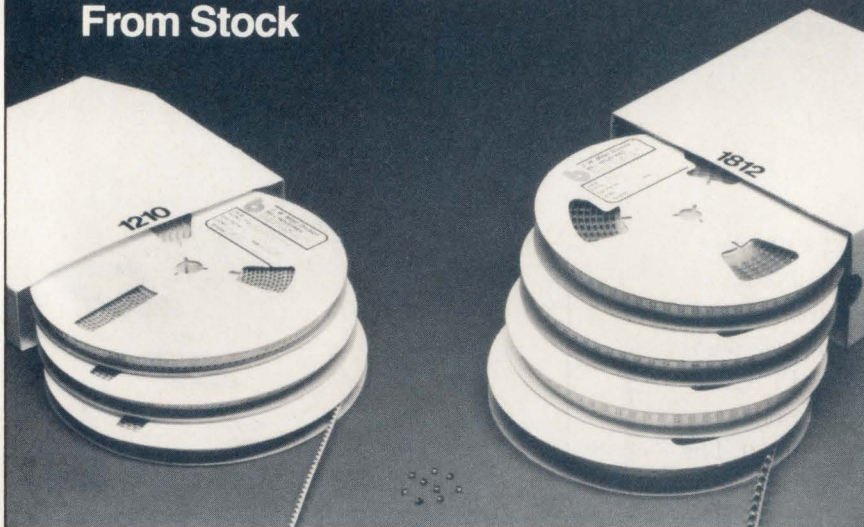

"1210" Inductors from .01 uH to 220 uH; "1812" inductors from .1 to 1000 uH...in 99 values.

Most values in stock for immediate shipment... "1210" inductors on 2000-piece reels and "1812" inductors on 500-piece reels... Solderability per MIL STD 202 Method 208.

Catalog on request.



**J.W. Miller Division  
BELL INDUSTRIES**

306 E. Alondra Blvd., Gardena, CA 90248  
Phone: 310-515-1720 FAX: 310-515-1962  
Since 1924, Leading Manufacturer of Standard and Custom Inductors

CIRCLE 106 FOR U.S. RESPONSE  
CIRCLE 107 FOR RESPONSE OUTSIDE THE U.S.

## HIGH-RESOLUTION DACs

offset can be trimmed as well. Obviously, if system calibration isn't used, these errors must be considered. In feedback loops, gain and integral linearity errors have significantly less effect while resolution and monotonicity are all important, because the system is homing in on a set point.

### GLITCHING GLITCHES

Each of the many waveform-synthesis applications have their own sets of critical specifications. As frequencies rise, glitches become more important.

In the past, sample-and-hold amplifiers on the output, called deglitchers, eliminated the effects of skew on the arrival of data bits, particularly at the major carry. However, today's low-glitch DACs load all of the bits into a register as they arrive, and then strobe them all into the DAC in a few nanoseconds.

As synthesis moves to the generation of RF signals, the spurious-free dynamic range (SFDR) specification becomes the prime parameter. You don't want any spurious frequencies (spurs) generated above some minimum level.

According to TriQuint Semiconductor, their 14-bit GaAs DACs show an SFDR of about 72 dB. If you're looking for high-speed high-resolution voltage- or current-output DACs for any purpose, the pickings are pretty slim. Just three DACs are available: Analog Devices' voltage-output AD766, SPT's current-output HDAC52160, and Sipex's current-output HS9390, a \$184 hybrid.

Multiple DACs per die are also beginning to appear, with 16-bit dual units coming from Burr-Brown and Sipex. However, none are 16-bit monotonic over temperature. On the other hand, Micro Power Systems will soon be offering a pair of octal 14-bit voltage-output DACs, one with a serial I/O and the other with a parallel I/O. □

HOW VALUABLE?	CIRCLE
HIGHLY	528
MODERATELY	529
SLIGHTLY	530

Publication 950 INTERNATIONAL STANDARD 601-1  
Second edition 1988  
INTERNATIONAL ELECTROTECHNICAL COMMISSION  
Publication 950  
Première édition

# Our new GP switchers have everyone's approval!

MISSION ÉLECTROTECHNIQUE INTERNATIONALE  
NORME DE LA CEI  
INTERNATIONAL ELECTROTECHNICAL COMMISSION  
IEC STANDARD  
22.2 No. 234-M90  
Component Power  
and Commercial  
Standard of

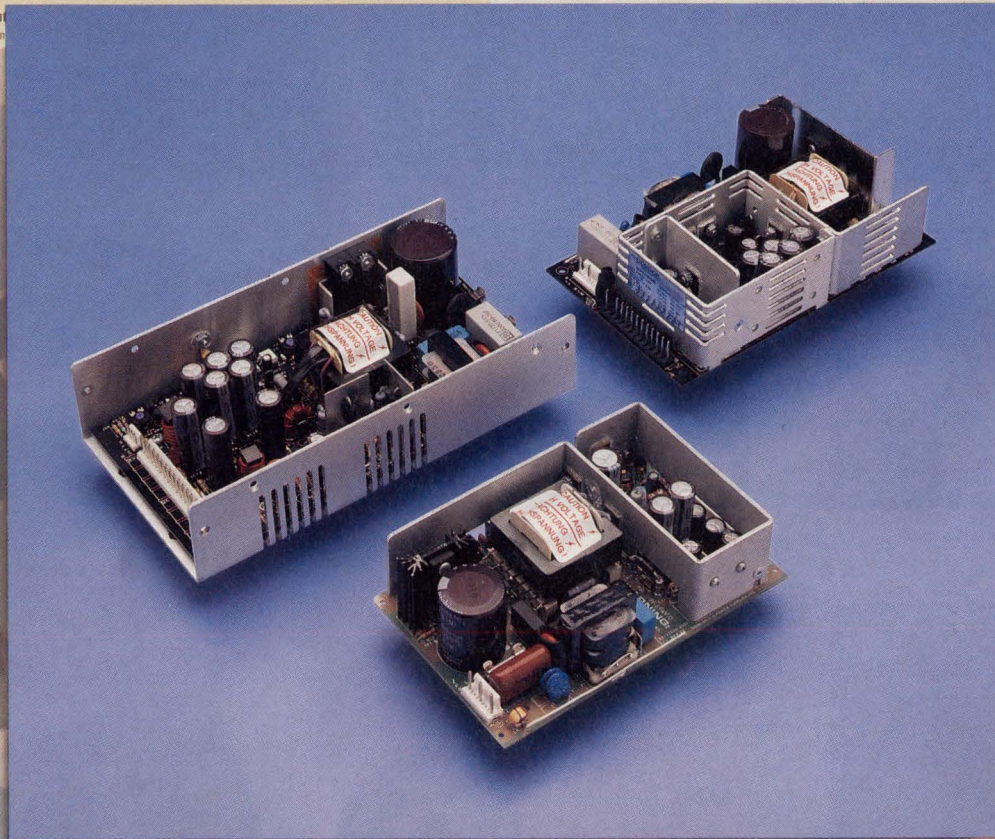

**Condor's Global Performance (GP) switching power supplies offer full agency approvals, continuous range input and more!**

Our newest switchers have the approvals you need (UL 1950, VDE Level B EMI, IEC 950, CSA and TUV) and the features you want, including:

- 71 models (single- and multi-output)
- Industry-standard packages
- 6 power levels (40 to 200W)
- Continuous input voltage (85-264V)
- OVP on all 5V outputs and single-output units

- Fully regulated outputs
- MTBF 100,000+ hours per Mil Hndbk 217E
- 8-hour burn-in with cycling (24 hours on medical versions)
- Computerized testing (data sheets furnished)
- 2-year warranty
- 30-day FREE evaluation (call us for samples)

If you're looking for world class performance, quick turnaround and competitive pricing, try our new GP switchers — the only approval they're missing is yours!

**UL 544/IEC 601 MEDICAL VERSIONS ALSO AVAILABLE**

All Global Performance switchers are available in full medical configurations. Call us for details.

**CALL FOR OUR FREE CATALOG!**

**CONDOR**

Condor D.C. Power Supplies, Inc.  
2311 Statham Parkway  
Oxnard, CA 93033 • (805) 486-4565  
CALL TOLL FREE:  
1-800-235-5929 (outside CA)  
FAX: (805) 487-8911

# THINKING ABOUT HIGH PERFORMANCE DATA ACQUISITION? THINK DATA TRANSLATION.

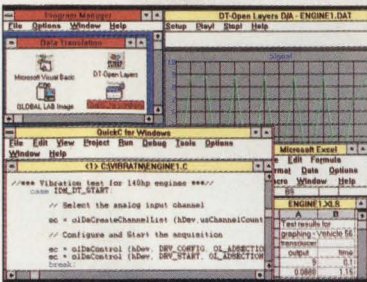

FREE Microsoft® Windows™ Software

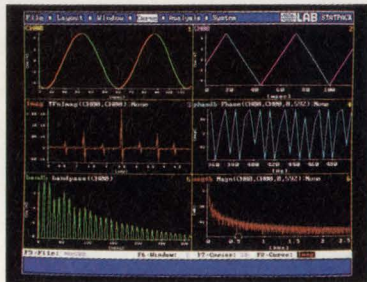

GLOBAL LAB® Application Software



High-Speed, High Channel Count  
Fully Software Configurable



Open Standards to Protect  
Your Investment

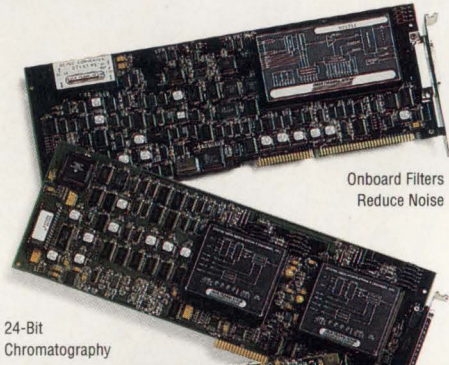

Onboard Filters  
Reduce Noise

24-Bit  
Chromatography

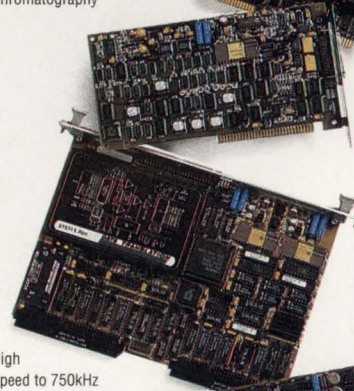

Low  
Cost  
100kHz  
DMA

High  
Speed to 750kHz

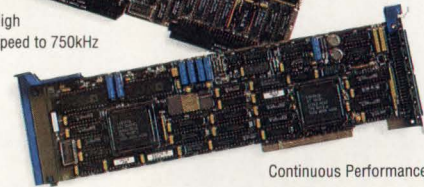

Continuous Performance



*"We can offer you the widest range of data acquisition solutions. Hundreds of products on the most popular buses. Up to: 1 MHz throughput, 24-bit resolution, 256 channels; Windows™ and DOS software. And, when you use our products, you can be assured that your data is as accurate as possible. Our engineers design our products to achieve the highest possible signal integrity."*

—Fred Molinari, President

Call for FREE Handbook  
**(508) 481-3700**

In Canada, call (800) 268-0427

## THE LEADER IN DATA ACQUISITION AND IMAGE PROCESSING **DATA TRANSLATION®**

**World Headquarters:** Data Translation, Inc., 100 Locke Drive, Marlboro, MA 01752-1192 USA, (508) 481-3700, FAX (508) 481-8620, Tlx 951646

**United Kingdom Headquarters:** Data Translation Ltd., The Mulberry Business Park, Wokingham, Berkshire RG11 2QJ, U.K., (734) 793838, FAX (734) 776670, Tlx 94011914

**Germany Headquarters:** Data Translation, GmbH, Im Weilerlen 10, 7120 Beitingheim-Bissingen, Germany, 7142-54025, FAX 7142-64042

**International Sales Offices:** Australia (2) 699-8300; Belgium (2) 466-8199; Brazil (11) 240-0598; Canada (416) 625-1907; Denmark 42 274511; Finland (0) 3511800; France (1) 69077802; Greece (1) 361-4300; Hong Kong (5) 448963; India (22) 23-1040; Israel 52-545685; Italy (2) 82470; Japan (33) 564-6024, (33) 5379-1971; Korea (2) 718-9521; Malaysia 3-248 6786; Mexico (52) 575 6091; Netherlands (70) 399-6360; New Zealand (9) 415-8362; Norway (2) 53 12 50; Pakistan 570 369; Poland (22) 580701; Portugal (1) 7934834; Singapore 338-1300; South Africa (12) 803 7680/93; Spain (1) 555-8112; Sweden (8) 89 38 90; Switzerland (1) 386-8686; Taiwan (2) 3039836

DT-Connect and DT-Open Layers are trademarks and Data Translation and GLOBAL LAB are registered trademarks of Data Translation, Inc. All other trademarks are the property of their respective holders.

CIRCLE 118 FOR U.S. RESPONSE

CIRCLE 119 FOR RESPONSE OUTSIDE THE U.S.

# OP AMPS EXPAND VOLTAGE REFERENCE OPTIONS

**BOOTSTRAP FEEDBACK ADDS POLARITY AND MAGNITUDE OPTIONS TO CONVENTIONAL DC-VOLTAGE REFERENCES.**

**JERALD GRAEME**

Burr-Brown Corp., P. O. Box 11400,  
Tucson, AZ 85734; (602) 746-7412.

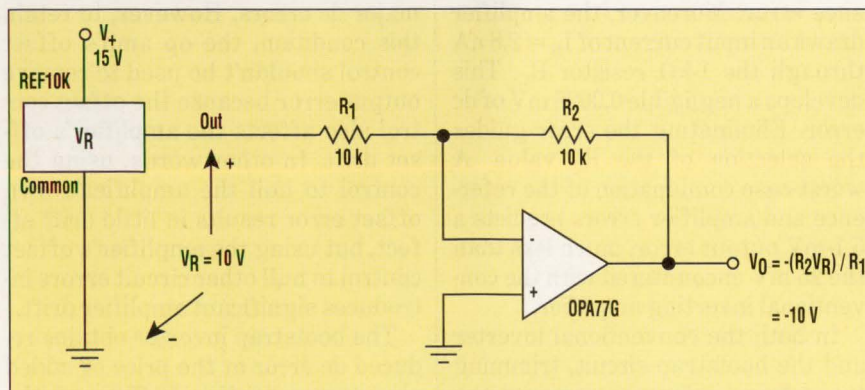

**1. A CONVENTIONAL INVERTING AMPLIFIER** reverses the polarity of a reference voltage, but adds resistor errors to the result.

**B**ecause dc-voltage references predominately supply positive, fixed voltages, engineers must build specialized op-amp circuits to add voltage-polarity and magnitude options beyond those provided by conventional circuits. That's where bootstrap techniques come into play. With bootstrap feedback, designers can create every possible combination of reference-voltage magnitude and polarity. Basically, applying this feedback inverts the reference voltage without introducing errors from any gain-setting resistors.

Generally speaking, the bootstrap technique produces reference circuits with dual voltage outputs. However, in contrast with conventional options, bootstrapping doesn't restrict either output magnitude to that of the original voltage reference. And any polarity combination is available for the two bootstrap outputs. In other words, the two output polarities can be the same or opposite, relative to each other, and the same or opposite relative to the original reference voltage.

Together, the magnitude and polarity degrees of freedom produce various voltage combinations not possible with conventional circuits. Bootstrapping options include an inverted output without resistor errors, inverted polarity for both circuit outputs, and a noninverting output with gain magnitude less than unity. In addition, a variable-output circuit delivers a voltage control that spans all magnitude and polarity combinations.

Consider first the inversion of reference-voltage polarity. Although most available voltage references supply positive voltages, negative references are also widely needed. A simple approach to the problem uses an inverting amplifier to reverse polarity (*Fig. 1*). The inverter converts the  $V_R$  output of the voltage reference to a new reference voltage of  $-R_2V_R/R_1$ . Resistor selection provides magnitude control along with the polarity inversion. However, the inverter adds resistor errors that can degrade the voltage accuracy.

In truth, reference, amplifier, and resistor errors all affect the accuracy of

the inverted voltage. The initial tolerance of reference voltage  $V_R$  transfers directly to the circuit output in a relative sense. The relative or percentage error of voltage  $V_R$  produces the same percentage error in the output of  $-R_2V_R/R_1$ . For the REF10K reference voltage shown, the voltage tolerance error is 5 mV or 0.05% of the nominal 10-V output. Output effects of amplifier input errors depend on the resistor values used. Together, the amplifier input offset voltage,  $V_{OS}$ , and input bias current,  $I_B$ , produce an output error of  $(1 + R_2/R_1)V_{OS} + I_B R_2$ . For the

# VOLTAGE REFERENCE OPTIONS

OPA77G and the resistors shown, this error is  $128 \mu\text{V}$  or about 0.0013% of the  $-10\text{-V}$  output.

Resistor tolerance errors directly affect the output voltage through the  $-R_2/R_1$  circuit gain. Two 0.1% resistors produce as much as 0.2% output error. This overshadows the 0.05% and 0.0013% errors of the reference and the op amp. Worst-case output error totals 0.25% or 25 mV for the 10-V output shown. Obviously, a better approach is needed.

To preserve reference-voltage accuracy, bootstrap feedback inverts the voltage polarity without gain-setting resistors. The basic bootstrap circuit includes phase compensation elements  $R_C$  and  $C_C$  (Fig. 2). However, these elements are ignored for the basic dc function of the circuit: capacitor  $C_C$  has no dc effect and  $R_C$  produces only a small dc voltage with the amplifier input current. Bootstrap feedback drives the common return terminal of the voltage reference. The voltage-reference output follows this drive to control the op amp's inverting input.

The voltage reference's connection places it in the amplifier feedback path where feedback forces the two op-amp inputs to the same voltage. Because the amplifier's noninverting input is connected to common, the feedback drives the voltage reference output to 0 V relative to common. In this process, the amplifier output develops a negative replica of the reference voltage. With the voltage-reference output at 0 V, the op-amp output resides below ground by an amount equal to the reference voltage:  $V_R$  and  $V_O = -V_R$ . This bootstrap produces polarity inversion without gain-setting resistors like those of inverter. Thus, the basic bootstrap circuit eliminates resistor errors from the output.

The circuit in Figure 2 also reduces errors from the amplifier and reference. Here, the amplifier transfers its  $V_{OS}$  error to the new reference

output with unity gain. The previous inverting amplifier multiplies  $V_{OS}$  by a gain of  $1 + R_2/R_1$ . In addition, the bootstrap inverter also removes output loading effects from the voltage-reference output. This output no longer supplies load currents, and its output resistance won't produce a loading-error voltage. Instead, the op amp supplies the load currents from an output resistance reduced by the amplifier's high dc gain.

In practice, the bootstrap amplifier adds some error in the reference-voltage inversion. However, amplifier selection controls this error to be much less than the error of the voltage reference itself. The voltage tolerance error of the REF10K again offsets the ideal  $-10\text{-V}$  output by 5

ultimate trimmed accuracy. Because temperature variations in the normal application environment react with the circuit's drift sources, the trimmed result is only as dependable as its stability in this environment.

Thermal drifts affect the voltage reference, the op amp, and any gain-setting resistors used. The REF10K voltage reference drifts 1 ppm/ $^{\circ}\text{C}$ , or  $10 \mu\text{V}/^{\circ}\text{C}$ . Careful op-amp selection avoids adding to the drift. Drift from the amplifier's dc errors adds directly to the circuit output. For the conventional inverter, the dc error is  $(1 + R_2/R_1)V_{OS} + I_B R_2$ . The components in Figure 1 make the associated output drift  $3 \mu\text{V}/^{\circ}\text{C}$ . For the bootstrap inverter, the drift of error  $V_{OS} + I_B R_C$  is  $1.2 \mu\text{V}/^{\circ}\text{C}$ . No gain-setting resistors add to this inverter's drift, so the worst-case total drift is just  $11.2 \mu\text{V}/^{\circ}\text{C}$ , or 1.12 ppm/ $^{\circ}\text{C}$ .

However, with the conventional inverter, two resistor temperature coefficients add to the output drift. There, two 0.1% wirewound resistors typically dominate drift effects with a combined drift as high as 30 ppm/ $^{\circ}\text{C}$ . Worst-case total drift for this circuit is then 31.3 ppm/ $^{\circ}\text{C}$ . For a  $\pm 5^{\circ}\text{C}$  environment, the bootstrap circuit limits trimmed accuracy to 5.5 ppm, while the convention-

al inverter restricts this accuracy to around 160 ppm.

The amplifier selected in the preceding analysis didn't introduce any major dc errors. However, to retain this condition, the op amp's offset control shouldn't be used to remove output error because the offset control also affects the amplifier's offset drift. In other words, using the control to null the amplifier's own offset error results in little drift effect, but using the amplifier's offset control to null other circuit errors introduces significant amplifier drift.

The bootstrap inverter obtains reduced dc error at the price of added phase compensation. In Figure 2, the voltage reference adds a feedback pole to one that's already present

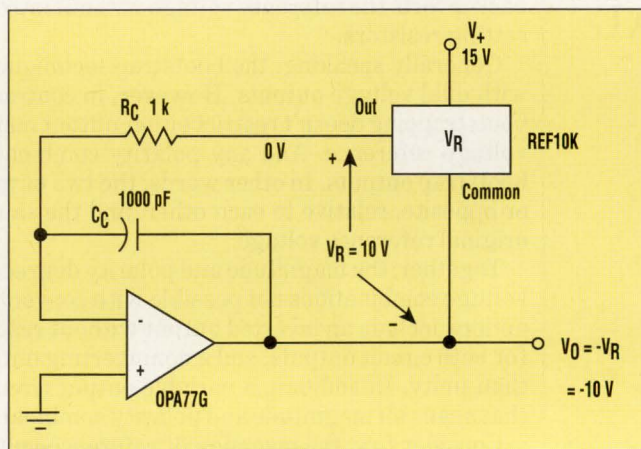

**2. A BOOTSTRAP AMPLIFIER** inverts reference voltage polarity without the error of gain-setting resistors.

mV. Amplifier dc-input errors add to this by an amount  $V_{OS} + I_B R_C$ . With the OPA77G shown in Figure 2,  $V_{OS} = 0.1 \text{ mV}$ , or 1/50 of the initial reference error. Moreover, the amplifier draws an input current of  $I_B = 2.8 \text{ nA}$  through the 1-k $\Omega$  resistor  $R_C$ . This develops a negligible 0.0028 mV of dc error. Eliminating the error guides the selection of the  $R_C$  value. A worst-case combination of the reference and amplifier errors predicts a 5.1-mV output error, much less than the 25 mV encountered with the conventional inverting amplifier.

In both the conventional inverter and the bootstrap circuit, trimming the voltage reference removes the initial error of the polarity inversion. However, thermal drifts define the

# Risky Business



In today's competitive business climate, product development is a perilous journey. One slip can mean lost opportunity... or worse. You've got to plan intelligently, execute on time, and use the best available technology. If you don't, your competitors undoubtedly will.

Why put up with risks and shortcomings associated with obsolete power technologies... bulky, one-of-a-kind designs; program delays; agency approval cycles; last minute surprises; and unproven field reliability. Vicor's power component approach has been proven by thousands of users to be the fastest and most predictable path to successful power system development. And Vicor's complete line of "plug and play" power system building blocks offer unprecedented design flexibility and result in smaller, cooler, more cost-effective products.

Tired of power development cliffhangers? The solution is right at your fingertips... just give us a call.



*Component Solutions For Your Power System*



23 Frontage Road Andover, MA 01810  
TEL: (508) 470-2900 • FAX: (508) 475-6715

CIRCLE 238 FOR U.S. RESPONSE

CIRCLE 239 FOR RESPONSE OUTSIDE THE U.S.

# VOLTAGE REFERENCE OPTIONS

from the op amp. Ideally, the voltage reference  $V_R$  supplies a unity-feedback factor for the op amp and transfers any amplifier-output change directly to the amplifier input. In practice, a phase shift through  $V_R$  delays this transfer at higher frequencies. It also adds to the amplifier's phase shift, increasing net phase shift in the feedback loop that can cause oscillation.

To ensure frequency stability, the phase compensation bypasses the phase shift of  $V_R$  at higher frequencies. Phase-compensation elements  $R_C$  and  $C_C$  shown in Figure 2 decouple the op amp from the feedback of the voltage reference. At higher frequencies, resistor  $R_C$  blocks the voltage-reference output with the bypass effect of capacitor  $C_C$ . The common node of these two elements is the op amp's feedback input. Control of this input shifts with frequency. At low frequencies,  $C_C$  presents a high impedance and offers little feedback signal to the feedback input. Then, feedback through the voltage reference prevails and sets the level of that input. At higher frequencies, the impedance of  $C_C$  becomes less than that of  $R_C$ , and the capacitor assumes control of the op amp's feedback. There,  $C_C$  delivers direct feedback between the amplifier's output and the feedback input. This bypasses the phase shift of the  $V_R$  feedback and the op amp alone controls feedback phase shift.

$R_C$  and  $C_C$  set the transition between the two feedback control paths. Optimum settling time results when the break frequency of these elements is set well below the dominant response pole of the reference. Unfortunately, voltage reference data sheets don't specify this pole frequency, and empirical selection sets the phase compensation break frequency. First,  $R_C$  is chosen to limit the dc error created with the flow of the amplifier's input current. Then,  $C_C$  is selected using a square-wave-output load current. The output voltage response to the load guides the selection of  $C_C$  for optimum settling time.

A second bootstrap circuit provides an inverted reference polarity

and includes a second, noninverting output. The only difference between this circuit and Figure 2 is an added feedback voltage divider (Fig. 3). The op amp's output again drives the common terminal of the voltage reference to shift the reference output relative to ground. Once again, the voltage reference's output drives the op-amp input, but now through a feedback divider.

The additional voltage divider restores the voltage reference output as a useful reference source. The bootstrap amplifier had previously forced the voltage reference output to zero. With the feedback divider, the zero-voltage condition shifts to the voltage-divider junction. To zero this junction, the feedback develops voltages on both of the divider resistors, and the sum of these two voltages equals the original reference voltage  $V_R$ . The voltage divider connects the output and the common terminals of the voltage reference.  $V_R$  divides between the two resistors according to their relative resistances. The equal-valued resistors in Figure 3 support equal voltages of  $V_R/2$ .

Relative to ground, the two resistor voltages present opposite-polarity output voltages in  $V_{O1}$  and  $V_{O2}$ . Zero voltage resides at the junction of the resistors. One resistor's voltage rises above ground, while the other drops below.

This sets the op amp's output at a level of  $V_{O2} = -V_R/2$ . Then, feedback through the voltage reference produces a second voltage-reference output of  $V_{O1} = V_{O2} + V_R = V_R/2$ . Thus, the circuit supplies equal and opposite reference voltages with magnitudes equal to one-half the original reference voltage. Digital-to-analog converters employ this reference-voltage combination by having one polarity

supply the basic reference requirement, and the opposite polarity serve the bipolar-offset function.

Errors in Figure 3's reference outputs follow from Figure 2, and are combined with the additional error effects of the feedback divider. Tolerance error of the initial reference voltage  $V_R$  divides equally between the two circuit outputs through the equal resistors of the divider. Thus, the two outputs tend to track with respect to this error, which benefits the DAC application already mentioned. For the REF101J shown in Figure 3, a 5-mV tolerance error alters the circuit's ideal 10-V output by 0.05%. The same percentage error transfers to  $V_{O1}$  and  $V_{O2}$ , because  $V_R$  is a direct multiplier in the related output expressions.

Amplifier input errors also affect the two circuit outputs equally. Offset voltage  $V_{OS}$  directly shifts the voltage divider junction away from 0 V. No change results in the resistor voltages, but the junction shift moves the two circuit outputs relative to ground. Both outputs move an amount equal to  $V_{OS}$ . Input bias current  $I_B$  shifts the outputs through associated voltage drops on the feedback resistors. With equal-valued resistors, one-half of  $I_B$  flows in each resistor to shift the two outputs by an amount equaling  $I_B R/2$ . The net

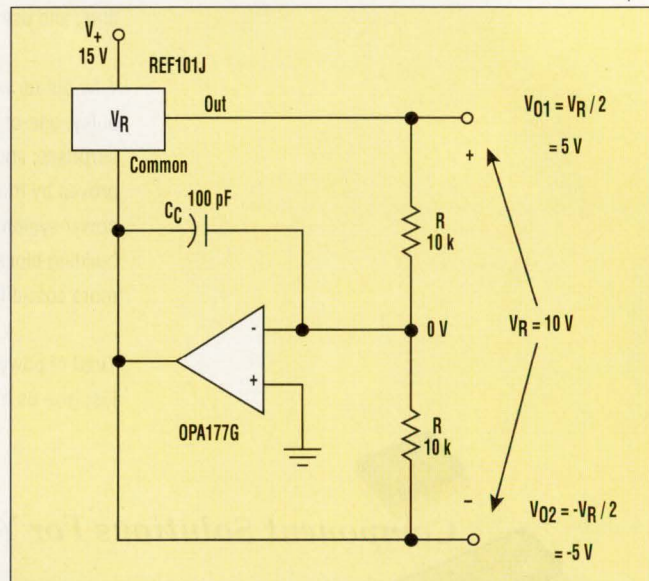

**3. BOOTSTRAPPING AND** a voltage divider split a reference voltage into two output voltages of opposite polarity.



# VOLTAGE REFERENCE OPTIONS

error is then  $V_{OS} + I_B R/2$  for both outputs. With the OPA177G and resistor values given in Figure 3, net error is  $64 \mu\text{V}$ , or about 0.0013% of the 5-V outputs.

The dominant error in Figure 3 results from the resistors added by the feedback divider. The divider resistors introduce errors like those described for the inverter in Figure 1. Wirewound 0.1% resistors increase the initial errors in  $V_{O1}$  and  $V_{O2}$  by as much as 0.2%, or four times the above  $V_R$  tolerance error.

Circuit trim removes the net output errors within the limit imposed by thermal drifts. First, trimming the voltage reference adjusts the difference between  $V_{O1}$  and  $V_{O2}$  so that it's equal to the ideal value of  $V_R$ .

Then, resistor trimming sets a monitored circuit output to its ideal value. Either circuit output can be monitored because the resistor trim actually adjusts both outputs to their ideal values after the first trim adjusts the difference between the two voltages. The second trim, which merely modifies the two voltages so they're relative to ground, compensates for errors due to both the resistors and the amplifier offset. The most convenient resistor trim is obtained with a potentiometer inserted between the two resistors. In this case, the potentiometer wiper rather than the resistor junction connects to the op-amp input.

Trimmed accuracy in Figure 3 depends upon the temperature coefficients of the circuit components. The REF101J's output drifts 3 ppm/°C, and this relative sensitivity transfers directly to the two circuit outputs. Op-amp-induced errors of  $V_{OS} + I_B R/2$  also contribute output drifts. The  $0.7\text{-}\mu\text{V}/^\circ\text{C}$  drift of  $V_{OS}$  and  $60\text{-pA}/^\circ\text{C}$  drift of  $I_B$  produce  $1.3\text{-}\mu\text{V}/^\circ\text{C}$  output drifts for the 10-k $\Omega$  resistors. This drift component translates to a relative sensitivity of 0.26 ppm/°C. Net drift effect of the two circuit outputs is then 3.26 ppm/°C.

Drift effect remains small compared to that produced by typical resistor drift. Resistor drift alters the division of voltage  $V_R$  between the two circuit outputs. Typical 0.1% wirewound resistors drift 15 ppm/°C, or about five times that of the other components previously mentioned. Combined, the worst-case drift error of the components limits trimmed accuracy to around 0.09% in a  $\pm 5^\circ\text{C}$  environment. A resistor network produces greater precision for the voltage divider. Then, the resistors track with temperature so that their temperature coefficients have canceling effects in the division of voltage  $V_R$ .

Phase compensation for Figure 3 follows from the Figure 2 discussion.

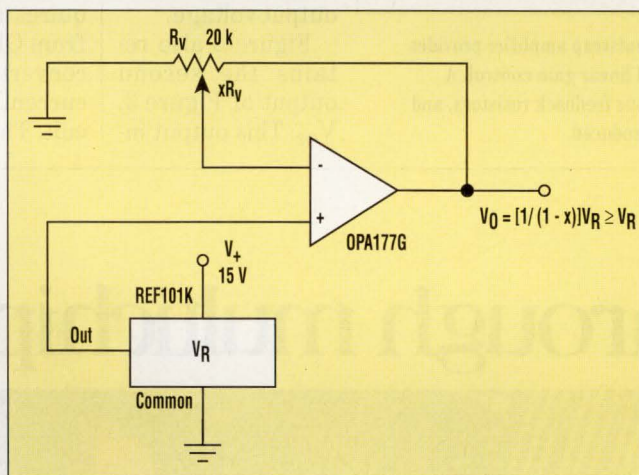

**4. MAGNITUDE CONTROL** without polarity reversal for  $V_0 \geq V_R$  can be supplied by variable-gain noninverting amplifiers.

The compensation decouples the op-amp feedback from the high-frequency phase shift of the voltage reference. As before, capacitor  $C_C$  offers a direct high-frequency feedback path for the op amp. At higher frequencies, the impedance of  $C_C$  becomes low compared to that of the feedback resistance, decoupling the feedback through the voltage reference in favor of the direct feedback through  $C_C$ . Previously, this decoupling required the addition of an isolating resistance,  $R_C$ . However, in this case, the feedback network provides the required resistance.

Selecting the phase-compensation components requires empirical evaluation. First, the value of resistance

$R$  is selected to limit the quiescent current consumed by the feedback network. Then,  $C_C$  is selected for good output settling time under load-current transients. To simulate the effect of these transients, a square-wave current load is applied to the  $V_{O1}$  output. The resulting  $V_{O1}$  settling response guides the capacitor selection.

A unique capability occurs in the noninverting output of the Figure 3 configuration. The  $V_{O1}$  output presents a voltage of the same polarity as the voltage reference, but with a lesser magnitude. Change of voltage magnitude without changing polarity typically involves noninverting amplifier connections of op amps (Fig. 4). The figure illustrates this case with variable gain (a bootstrap alternative will be presented next). The noninverting amplifier in Figure 4 provides a circuit gain of  $1/(1-x)$ , where  $x$  is the potentiometer fractional setting. Because  $0 \leq x \leq 1$ , this gain is never less than unity. Thus, the circuit constrains the output-voltage magnitude to be  $V_0 \geq V_R$ . Moreover, the  $1/(1-x)$  relationship produces nonlinear gain variation as  $x$  varies.

To retain the voltage polarity and reduce magnitude, two inverting amplifiers could be connected in series. However, this straightforward approach introduces the errors of two amplifiers and their feedback resistors. Instead, a variable-magnitude circuit serves the reduced voltage requirements by using the bootstrap in Figure 3 (Fig. 5). A potentiometer replaces the previous feedback resistors, and compensation resistor  $R_C$  is reintroduced. These changes open up a variable-gain option that's also available to the circuits discussed later in the article.

In Figure 5,  $V_R$  remains across the feedback divider now provided by the potentiometer.  $V_R$  divides between the segments of this divider depending on the potentiometer fraction  $x$ . At the noninverting  $V_{O1}$

## VOLTAGE REFERENCE OPTIONS

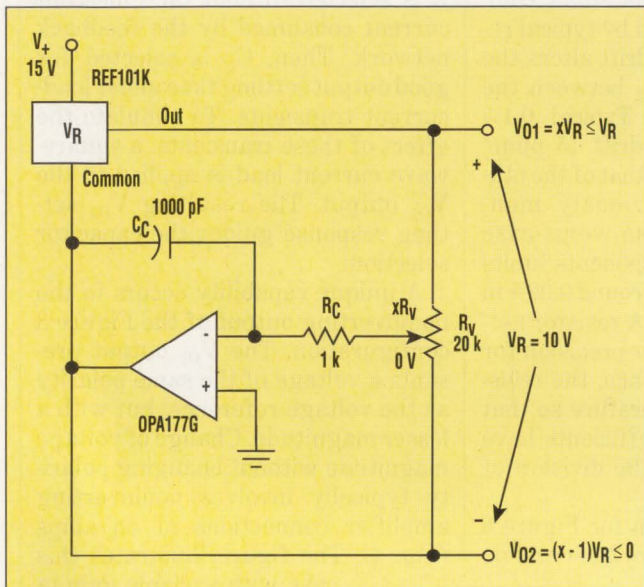

**5. A VARIABLE-GAIN** bootstrap amplifier provides noninverting gain ( $V_o \leq V_R$ ) and linear gain control. A potentiometer replaces the previous feedback resistors, and compensation resistor  $R_c$  is reintroduced.

output, the circuit produces  $V_{O1} = xV_R$ . Here,  $x \leq 1$ , and the desired magnitude reduction occurs while the polarity of  $V_{O1}$  remains the same as that of  $V_R$ . Consequently, the circuit produces  $V_o \leq V_R$  without reversing polarity. As a side benefit, the circuit linearizes the variable gain control. Note that  $V_{O1} = xV_R$  shows a linear relationship between  $x$  and the output voltage.

Figure 5 also retains the second output of Figure 3,  $V_{O2}$ . This output in-

verts polarity and also provides a gain magnitude below unity. At the second output,  $V_{O2} = (x - 1)V_R$ . Because  $0 \leq x \leq 1$ ,  $V_{O2}$  supplies a reduced voltage magnitude and a polarity opposite that of  $V_R$ . A constraint on the magnitude of  $V_{O2}$  results from its relationship to  $V_{O1}$ . The difference between the two output voltages equals  $V_R$  because the original voltage reference connects between the two circuit outputs. Either  $V_{O1}$  or  $V_{O2}$  can be set to any voltage magnitude  $\leq V_R$ , but the other output is then constrained by the requirement  $V_{O1} - V_{O2} = V_R$ .

Many application circuits overcome the output constraint through resistor scaling. Connecting a reference voltage to a resistor input acquires an extra degree of freedom from Ohm's Law. The resistor input converts the reference voltage to a current used by the application circuit. The bipolar offsetting of DACs

# Breakthrough multichip modules



## VOLTAGE REFERENCE OPTIONS

is one such example. In this case,  $V_{O1}$  sets the desired level for the DAC reference voltage, and the opposite polarity  $V_{O2}$  supplies the bipolar offsetting. The offsetting  $V_{O2}$  connects to a resistor for voltage-to-current conversion. Choosing this resistor accommodates the actual voltage of  $V_{O2}$ . Similar freedom prevails when applying a reference voltage to an op-amp summing resistor.

Output errors for the two reference voltages in Figure 5 generally follow from the discussion on Figure 3. Errors from the voltage reference and op amp repeat with allowance for the potentiometer setting  $x$ . The 5-mV tolerance error of the REF101J represents 0.05% of the reference's output. This 5 mV divides between the two circuit outputs in proportion to their output-voltage magnitudes. As a result, the relative error transferred to the outputs remains 0.05%.

The net effect of amplifier errors

varies with the potentiometer setting. Amplifier input-offset voltage again transfers directly to the two circuit outputs. The offset shifts both outputs by the total amount  $V_{OS}$ , independent of the individual output magnitudes. Amplifier input-bias current reacts with the two segments of the potentiometer, and splits between the segments in inverse proportion to their resistances. Resulting error voltages are in direct proportion to the segment resistances, and the inverse and direct proportionalities produce counteracting effects in the error voltages developed. The two output errors produced are again equal. Both outputs shift by an amount  $x(1-x)I_B R_v$ . Thus, the net amplifier error transferred to the two outputs is  $V_{OS} + x(1-x)I_B R_v$ . A potentiometer setting of  $x = 0.5$  maximizes the error. For the OPA177G, the error shifts the outputs by  $95 \mu V$ .

In contrast to the circuit in Figure 3, no resistance tolerance affects the outputs in Figure 5. The initial reference voltage  $V_R$  divides between the two potentiometer segments in accordance with the relative segment resistances. The absolute value of the total potentiometer resistance is unimportant. However, the nonlinearity error of the potentiometer control raises a potential new error source because it causes variation in the relationship between output voltage and potentiometer rotation. In most cases, an output voltage monitor guides the potentiometer adjustment and bypasses this nonlinearity error. If not, precision potentiometers offer control nonlinearities as low as 0.1%.

Thermal drift again limits the final accuracy of the circuit outputs. The reference voltage, amplifier offset, and potentiometer each introduce thermal sensitivities that alter the

## for breakneck speeds.

### That's AT&T "Customerizing."

If beyond 50MHz performance is where you're heading in workstations, AT&T's multi-layer Multichip Module (MCM) solution is the most reliable, viable way to go.

POLYHIC packaging, developed by AT&T Bell Laboratories, combines copper thin film with our patented polymer. It delivers one of the industry's lowest dielectric constants (2.8) to minimize access times between CPU and memory devices. And low-loss POLYHIC technology helps prevent timing problems on critical paths.

Every AT&T MCM is comprehensively tested to meet critical function requirements.

Designs work right the first time because Bell Labs' design expertise assures that your crucial high performance requirements are met. And

POLYHIC MCM modularity helps you get system designs up and running faster.

Should the going get rough, AT&T engineers are on stand-by to advise you. Analyze your circuits. Even recommend a solution to take you

to the next generation of high-end workstation performance. That's "Customerizing."

For more about the POLYHIC power of AT&T's MCMs, call AT&T Microelectronics at 1 800 372-2447, ext. 900.

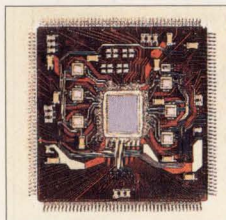

**AT&T**  
Microelectronics

CIRCLE 100 FOR U.S. RESPONSE  
CIRCLE 101 FOR RESPONSE OUTSIDE THE U.S.

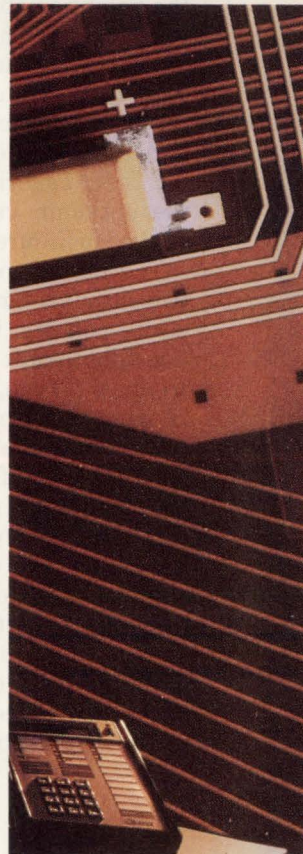

# VOLTAGE REFERENCE OPTIONS

trimmed output values. Reference voltage  $V_R$  from the REF101J introduces a 3-ppm/°C drift to both outputs. Then, the OPA177G's drift alters the  $V_{OS} + x(1-x)I_B R_v$  output errors for additional drifts as large as 1.3  $\mu\text{V}/^\circ\text{C}$ . Potentiometer construction inherently limits the effect of its drift. As stated, the actual value of the potentiometer resistance is unimportant, and drift in this resistance doesn't alter the output voltages. Only the difference in drifts of the  $xR$  and  $(1-x)R$  potentiometer segments affects the circuit outputs. The same material forms both segments, and a 100-ppm/°C potentiometer provides segment drift tracking to within 5 ppm/°C. Combined, the drift sources limit practical trimmed accuracy to around 40 ppm.

Phase compensation for Figure 5's circuit follows the approach used in Figures 2 and 3. As with the circuit in Figure 2,  $R_C$  and  $C_C$  decouple the op-amp feedback from the phase shift of the voltage reference. Figure 3's circuit adds capacitor  $C_C$  for the phase compensation, but the feedback network provides the resistive portion of the decoupling. With potentiometer feedback, the equivalent feedback resistance varies with the potentiometer setting, and even goes to zero. Then, by adding  $R_C$ , a minimum decoupling resistance is set. Once again, choosing a low value for  $R_C$  minimizes the error created with the amplifier-input current. After that, empirical testing defines the optimum value for  $C_C$  as described in Figure 2's discussion.

The circuit in Figure 5 supplies two output reference voltages of opposite polarity. Other polarity relationships result by adding positive feedback. Then, bootstrap circuits supply two outputs of the same polarity, which is either the same as or opposite that of the original reference voltage. In the noninverting version of the positive feedback configuration, the voltage-follower op amp sets the negative feedback of the circuit at unity (Fig. 6). The negative feedback retains circuit stability in the presence of the positive feedback. Positive feedback from the amplifier output travels through the

voltage reference and then through a feedback voltage divider. The divider's output connects to the amplifier noninverting input, defining a positive polarity for the feedback path.

Combined negative and positive feedbacks produce two noninverting reference outputs that overcome two magnitude constraints of conventional solutions. The conventional alternative for a dual-output, noninverting reference simply connects a

noninverting amplifier to the voltage-reference output. However, the first output of this alternative remains that of the reference itself,  $V_R$ . In addition, the second output has the magnitude constraint of  $V_O \geq V_R$ . Bootstrapping removes both magnitude constraints in the circuit shown in Figure 6.

Here, two circuit gains scale the two output voltages. The feedback divider delivers a fraction of  $V_{O1}$  to the op amp's noninverting input. Connected as a voltage follower, the op amp transfers this fraction to the amplifier's output. Therefore,  $V_{O2} = R_2 V_{O1} / (R_1 + R_2)$ . Also, the op amp's output drives the common terminal of the voltage reference to shift its output voltage relative to ground, producing  $V_{O1} = V_{O2} + V_R$ . Combining this result with the previous  $V_{O2}$  expression defines the output voltages in figure 6 as:

$$V_{O1} = (1 + R_2/R_1)V_R$$

$$V_{O2} = (R_2/R_1)V_R$$

Thus, the circuit develops two resistor-controlled gains for two distinct output voltages.

Both  $V_{O1}$  and  $V_{O2}$  retain the same polarity as the original  $V_R$ . Neither output voltage is constrained to equal  $V_R$ , and  $V_{O2}$  can have a magnitude greater than or less than  $V_R$ .

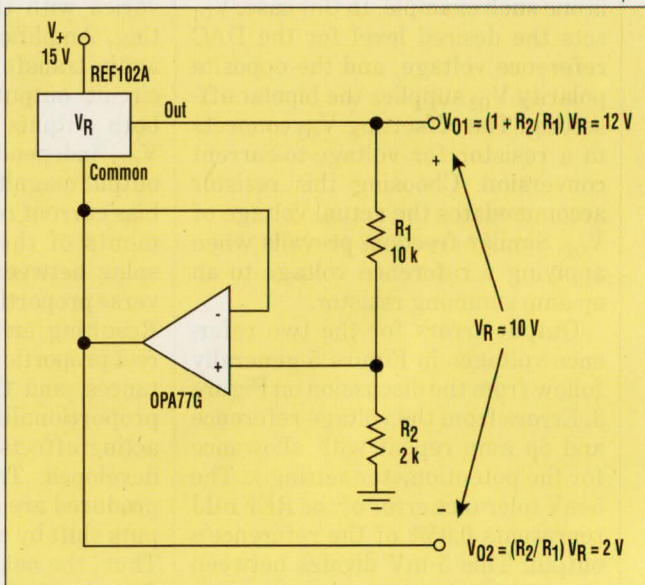

**6. CONNECTING THE** voltage reference in a positive feedback path produces two noninverting outputs.

The only constraint on the output voltages results from the voltage-reference connection between the two circuit outputs. With this connection, the difference between the two output voltages equals  $V_R$ . For the specific resistors shown in Figure 6, the circuit transforms an original 10-V reference into output voltages of 12 V and 2 V.

Accuracy limitations for the circuit in figure 6 parallel those described for previous circuits, but with reduced error from the resistors and increased error from the amplifier offset. The voltage reference introduces static errors and thermal drifts identical to those of the circuit in Figure 5. The associated relative errors directly affect the  $V_R$  terms of the output expressions for Figure 6. For the REF102A, a 10-mV tolerance error in a 10-V output makes the relative tolerance error 0.1%. This 0.1% tolerance affects both  $V_{O1}$  and  $V_{O2}$ . Similarly, the outputs repeat  $V_R$ 's 10-ppm/°C drift.

The op amp's voltage-follower connection reduces resistor-error effect in only one of the output voltages. Resistor errors produce output-voltage deviations through the two gains of the circuit. Although different voltage gains set the circuit's two output voltages, both

# Introducing the AD669, the first complete 16-bit monolithic DAC.

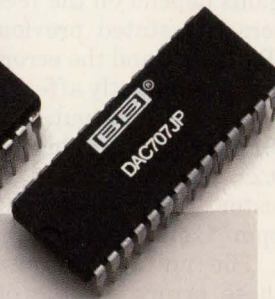
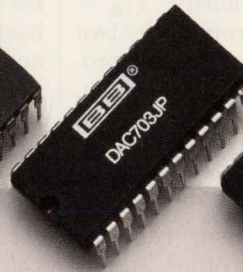
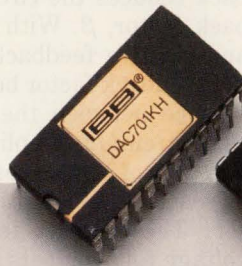

	<b>AD669AN</b>	<b>DAC701KH</b>	<b>DAC703JP</b>	<b>DAC707JP</b>
Linearity	±2 LSB	±2 LSB	±4 LSB	±4 LSB
Differential Linearity	±2 LSB	±4 LSB	±8 LSB	±8 LSB
Gain Error	±0.15%	±0.15%	±0.3%	±0.3%
Unipolar Offset	±5mV	±10mV	N/A	N/A
Bipolar Offset	±15mV	N/A	±20mV	±20mV
Double-buffered Latches	Yes	No	No	Yes
Monolithic	Yes	Yes	Yes	No
PRICE (100s)	<b>\$16.00</b>	<b>\$34.50</b>	<b>\$20.00</b>	<b>\$22.00</b>

## As you can see, the competition underperforms it three-to-one.

Sure the competition can give you a lot of the specs that our new AD669 offers. It'll just take them three parts to do it. But most importantly, in a one-on-one comparison, they can't even come close to touching the most impressive spec of the AD669—its price. At just a buck a bit, the AD669 delivers the highest performance at the lowest price of any 16-bit DAC.

For more information on the monolithic DAC that can take the competition on three-to-one, call Analog Devices at 1-800-262-5643. Or write to us at the address below.



Analog Devices, One Technology Way, P.O. Box 9106, Norwood, MA 02062-9106. Distribution, offices and application support available worldwide.  
 Authorized North American Distributors: Alliance Electronics 505-292-3360 • Allied Electronics 817-595-3500 • Anthem Electronics 408-453-1200 • Bell Industries 213-826-6778  
 • Future Electronics 514-694-7710 • Hall-Mark Electronics 214-343-5000 • Newark Electronics 312-784-5100 • Pioneer-Standard Electronics 800-874-6633  
 • Pioneer Technologies Group 800-227-1693 • Zentronics 416-564-9600 BB is a registered trademark of Burr-Brown.

CIRCLE 94 FOR U.S. RESPONSE

CIRCLE 95 FOR RESPONSE OUTSIDE THE U.S.

## VOLTAGE REFERENCE OPTIONS

gains depend on the feedback resistors. As stated previously,  $V_{O2} = (R_2/R_1)V_R$ , and the errors of the two resistors directly affect the gain producing this output. Consequently, 0.1%-resistors produce as much as a 0.2% error in  $V_{O2}$ , and 15 ppm/°C resistor drifts introduce as much as 30 ppm/°C output drift.

The voltage follower reduces these errors for the other output where  $V_{O1} = (1 + R_2/R_1)V_R$ . The "1" term reduces the gain sensitivity to

amplifier-input errors. Positive feedback reduces the circuit's net feedback factor,  $\beta$ . With both negative and positive feedback, the circuit's net feedback factor becomes the difference between the two factors<sup>1</sup>. Op-amp circuits amplify input errors by a gain of  $1/\beta$ , so positive feedback increases the resulting output error.<sup>2</sup> The negative feedback of the voltage follower sets  $\beta_- = 1$ , and the positive feedback through the resistors sets  $\beta_+ = R_2/(R_1 + R_2)$ . Then, the net feedback factor is  $\beta = \beta_- - \beta_+ = 1 - R_2/(R_1 + R_2) = R_1/(R_1 + R_2)$ .

The input errors amplified by  $1/\beta$  include  $V_{OS}$  and the error-voltage effect of  $I_B$ . Amplifier-input current  $I_B$  reacts with the parallel combination of  $R_1$  and  $R_2$  to develop a second component of input-offset error. Net amplifier input-offset error is then  $V_{OS} + I_B R_1 || R_2$ . Thus, the amplifier input errors produce output offsets of  $(V_{OS} + I_B R_1 || R_2)/\beta = V_{OS}/\beta + I_B R_2$ . This offset shifts both circuit-output voltages by the full offset amount. With the components shown in Figure 6,

$V_{OS} = 50 \mu\text{V}$ ,  $I_B R_2 = 28 \mu\text{V}$ , and  $1/\beta = 6/5$  for output offsets of  $94 \mu\text{V}$ . The same error gain applies to the drift in input-offset error. The components shown in Figure 6 produce drifts of  $1.6 \mu\text{V}/^\circ\text{C}$  in both circuit outputs. For the output voltages, the greater relative error is found on the 2-V output. There, the initial offset represents about 0.005%, and the offset drift represents 80 ppm/°C.

Circuit trimming again removes the output errors to the degree permitted by thermal drifts. For best accuracy, the voltage reference and resistors are both trimmed. First, trim-

ming the voltage reference sets  $V_{O1} - V_{O2}$  at the ideal value of  $V_R$ . Then, resistor trimming sets  $V_{O2}$  at its ideal value relative to ground. Here, the  $V_{O2}$  output serves as the trim monitor because of this output's greater gain sensitivity to resistor value. As mentioned earlier, this sensitivity reduces for  $V_{O1}$ . However, the trim of  $V_{O2}$  automatically adjusts  $V_{O1}$  as well, because the previous trim sets the difference between the two voltages. Following these trims, the thermal drifts set the practical trimmed accuracy in Figure 6 at 0.02% for  $V_{O2}$  and 0.008% for  $V_{O1}$ .

The circuit's positive feedback removes phase-compensation components, while previous circuits require phase compensation to bypass the phase shift of the voltage reference. In previous circuits, a negative-feedback connection of the voltage reference adds the reference's response pole to the negative feedback loop. This added pole degrades stability. However, in Figure 6, the voltage reference's pole rolls off the positive, rather than negative, feedback, which benefits rather than compromises the circuit's stability. As a result, the circuit requires no added phase compensation.

Though previously mentioned positive feedback transforms a reference voltage into two voltages that retain the original polarity, modified positive feedback also makes this transformation for two output voltages with inverted polarities. To invert the result, the voltage reference returns to the negative feedback path (Fig. 7). Feedback through the voltage reference then replaces the follower feedback of the preceding circuit. This feedback switch requires reintroduction of phase-compensation elements  $R_C$  and  $C_C$ . However, these elements don't affect the basic dc function of the circuit.

The circuit in Figure 7 combines Figure 2's bootstrap inverter with the positive-feedback resistors of the last circuit. In Figure 2, the grounded noninverting input of the amplifier forces the voltage-reference output to 0 V relative to ground. To accomplish this feat, the amplifier output moves to  $-V_R$ . The circuit in

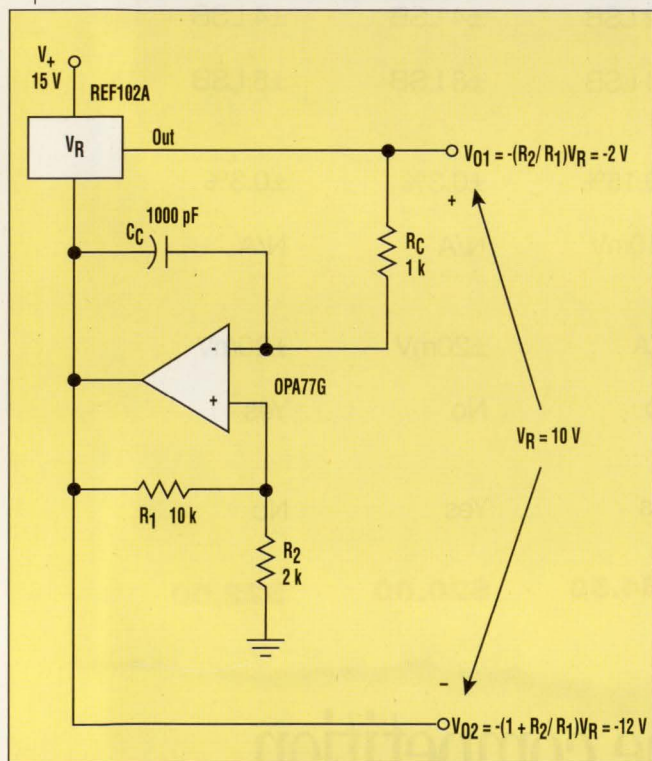

**7. MOVING THE VOLTAGE** reference to the negative feedback path produces two inverting outputs.

$R_1$  and  $R_2$ . Resistor errors only affect the  $R_2/R_1$  portion of the gain, and this portion is the fraction  $R_2/(R_1 + R_2)$  of the total gain. For the specific resistors shown in Figure 6, this fraction is 1/6. A 0.2% total resistor error produces a 0.033% error in  $V_{O1}$ , and a total resistor drift of 30 ppm/°C produces a 5-ppm/°C output drift. The error-reducing "1" term results from bootstrap feedback through a voltage follower. The follower needs no error-producing resistors to set the amplifier's unity gain.

However, the positive feedback of Figure 6 increases the effect of am-

# When space is at a premium, stacking makes a lot of sense.

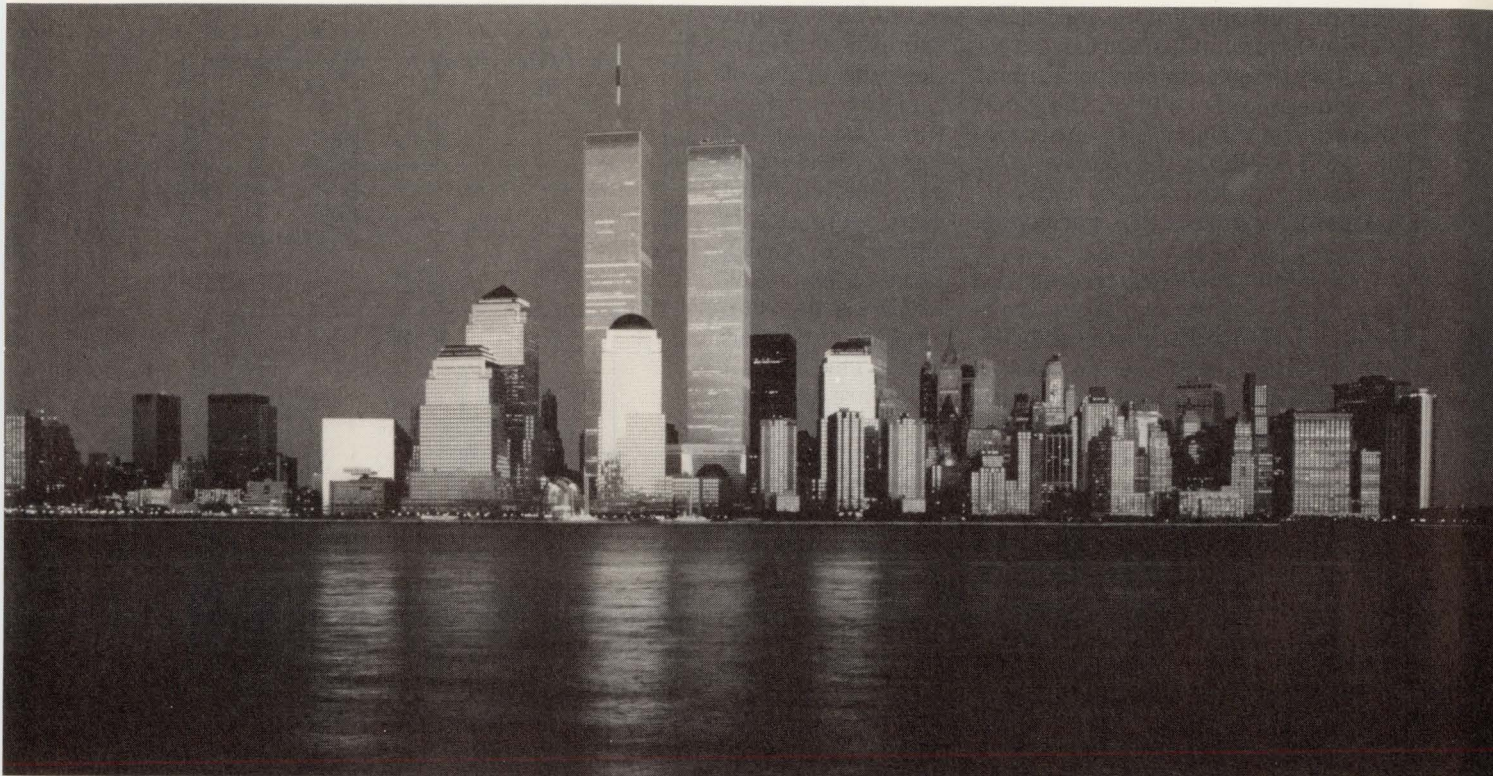

## Micro/Q<sup>®</sup> 3500SM noise decoupling capacitors save valuable board space by surface mounting below PLCC packages.

In today's high-density designs, you need to maximize every square inch of PC board space. The low profile of the Micro/Q 3500SM makes it easy to mount under the PLCC, saving space and improving noise suppression at the same time.

Surface mounting under the PLCC increases board density by eliminating the need for traditional decoupling

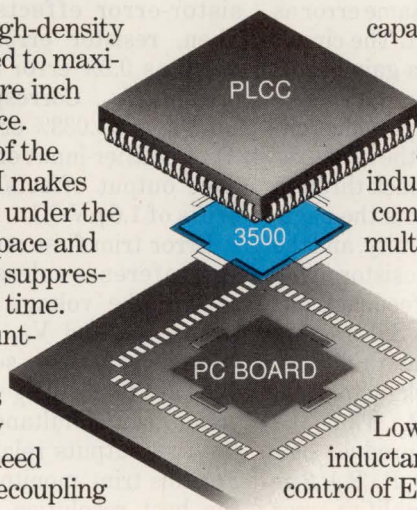

capacitors around the perimeter of the IC package. This "stacking" technique also helps to lower inductance and impedance compared to conventional multi-layer capacitors.

Very thin (0.020" MAX) metallic-parallel plate construction results in less than 1nH of inductance.

Low decoupling loop inductance value improves control of EMI/RFI. Besides

providing superior noise reduction, the Micro/Q 3500SM also absorbs CTE mismatch and prevents electrical failure caused by cracks typical of MLC chips.

The device is ideal for wide frequency bandwidth applications such as 16/32 bit MPUs, DSPs, FPPs, gate arrays, standard cells and custom ASICs. Now available in two sizes: 0.520" to fit below 44 and 52 pin PLCCs, and 0.820" for placement under 68, 84 and higher pin-count PLCCs. Choose either X7R or Z5V dielectric, in tape and reel or bulk formats.

*Technology for tomorrow built on TQC today.*

### Circuit Components

2400 S. Roosevelt Street, Tempe, AZ 85282

A Division of

 **ROGERS**

To see how all the advantages stack up, call a Rogers Product Specialist today at (602) 967-0624. Ask for your free Micro/Q 3500SM specifier's kit. Also available through Mektron Europe, Ghent, Belgium and Rogers Inoac Corp., Nagoya, Japan. Micro/Q is a registered trademark of Rogers Corporation.

CIRCLE 210 FOR U.S. RESPONSE

CIRCLE 211 FOR RESPONSE OUTSIDE THE U.S.

## VOLTAGE REFERENCE OPTIONS

Figure 7 doesn't ground the noninverting input, but instead drives this input with a positive feedback signal from the amplifier output. The added drive shifts the amplifier output below  $-V_R$ , and drags the voltage reference output with it. Then, both output voltages are non-zero and inverted in polarity relative to  $V_R$ .

Net circuit feedback controls the magnitudes of the two output voltages. Simple loop analysis combines the amplifier's negative and positive feedback effects. Ignoring the small effect of  $R_C$ , the output voltage  $V_{O1}$  equals the voltage at the op amp's inverting input. In turn, this voltage equals that at the noninverting input. The common input voltage develops through the positive feedback of  $R_1$  and  $R_2$ . Output voltage  $V_{O2}$  drives these resistors, and the resistor-divider action sets the amplifier's input voltages through  $V_{O1} = R_2 V_{O2} / (R_1 + R_2)$ .  $V_{O1}$  also relates to  $V_{O2}$  through the bootstrap feedback of the voltage reference. This feedback sets  $V_{O1} = V_{O2} + V_R$ . Solving the two  $V_{O1}$  equations simultaneously shows that the outputs in Figure 7 are:

$$V_{O1} = -(R_2/R_1)V_R$$

$$V_{O2} = -(1 + R_2/R_1)V_R$$

These output voltages mirror the last circuit's outputs except for inverted polarity and reversed output terminals. As desired, the circuit in Figure 7 inverts the polarity of both outputs from that of  $V_R$ , and neither output magnitude is constrained to  $V_R$ . However, the voltage  $V_R$  retains control over the difference between the two output voltages. In the figure, the voltage reference again connects directly between the two circuit outputs. For the specific components shown, the original +10-V reference produces output voltages of -2 V and -12 V.

Output errors duplicate those described for the last circuit. The expressions for  $V_{O1}$  and  $V_{O2}$  demonstrate this for output errors that are caused by the voltage reference and resistors. Note that these expressions again reflect direct dependence on  $V_R$ . The relative tolerance error and drift of the voltage reference transfer directly to the circuit out-

puts. The output expressions also reflect the effect of resistor errors through the circuit gains. The two gains defining the outputs are  $-R_2/R_1$  and  $-(1 + R_2/R_1)$ . Resistor errors alter these gains to produce output errors. The circuit gains are identical to those described for the last circuit, and the resistor-error effects determined before apply here as well.

Analysis shows that the output errors caused by the amplifier also repeat in Figure 7's circuit. The op amp's net input error consists of the amplifier input-offset voltage plus the offset voltage created by the amplifier input bias current. This current reacts with the parallel combination of  $R_1$  and  $R_2$ , with the net amplifier input error becoming:  $V_{OS} + I_B R_1 || R_2$ , producing the same error as did the preceding circuit. The circuit amplifies this error by a gain of  $1/\beta$  to produce output errors. While feedback differs from the previous circuit, the net  $1/\beta$  gain is the same.

In Figure 7, the feedback through the voltage reference sets the negative-feedback factor at unity, and the feedback through the resistor divider produces a positive feedback factor of  $R_2/(R_1 + R_2)$ . Subtracting these two feedback factors defines the circuit's net feedback factor as:  $\beta = \beta_- - \beta_+ = R_1/(R_1 + R_2)$ . Thus, the amplifier input errors produce output offsets of  $(V_{OS} + I_B R_1 || R_2)/\beta = V_{OS}/\beta + I_B R_{O2}$ . This amplifier-error expression generates offsets equal to those from the preceding circuit.

Consequently, errors from the reference, resistors, and amplifier all transfer to the circuit outputs in the same way as described for the circuit in Figure 6. In addition, the two circuits have the same specific components, as well as the same numerical-

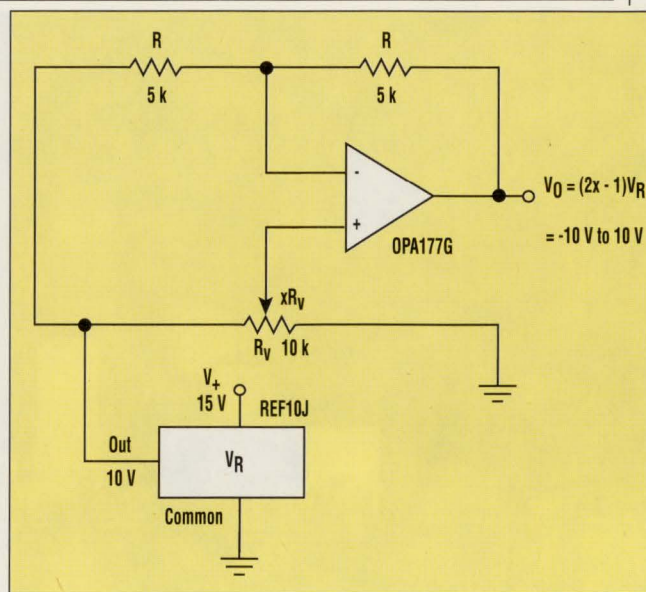

**8. AN OP AMP** with both inverting and noninverting gains delivers a variable reference voltage that spans both polarities.

error results. The voltage reference produces 0.1% initial errors and 10 ppm/ $^{\circ}$ C drifts in the two outputs. As before, resistor errors affect the two outputs differently due to the "1" term in one of the gain equations. Between the two circuits, this term switches from  $V_{O1}$  to  $V_{O2}$ , and the resistor-error effects also switch. Then, resistor errors produce as much as 0.2% error and 30 ppm/ $^{\circ}$ C drift in  $V_{O1}$ . Corresponding errors for  $V_{O2}$  are 0.033% error and 5 ppm/ $^{\circ}$ C. Amplifier-input errors again produce output offsets of 94  $\mu$ V and drifts of 1.6  $\mu$ V/ $^{\circ}$ C.

Error trim first removes the voltage-reference-tolerance effect by setting the voltage difference between  $V_{O1}$  and  $V_{O2}$ . Trimming the voltage reference sets this difference at the ideal  $V_R$  value. Then, resistor trim simultaneously corrects the two outputs relative to ground. For this trim, monitoring  $V_{O1}$  offers the best resolution because of its greater sensitivity to the resistor values. Trimmed accuracy in a laboratory temperature environment is 0.02% for  $V_{O1}$  and 0.008% for  $V_{O2}$ .

Phase compensation for the circuit in Figure 7 follows the approach taken in Figure 2. Compensation elements  $R_C$  and  $C_C$  decouple the circuit feedback from the phase shift intro-



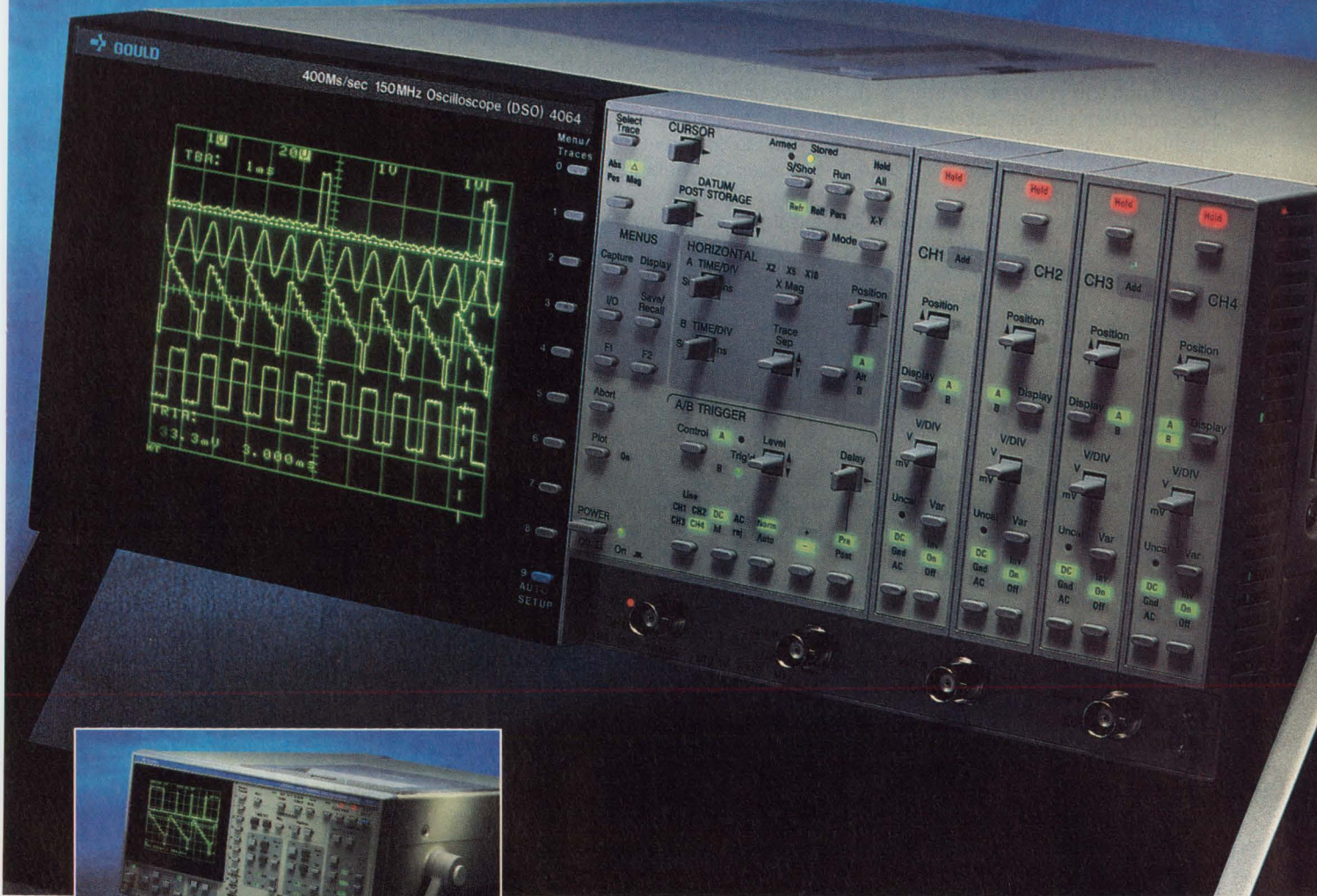

# Get the warranty of a lifetime.

At Gould, we're so sure about the reliability of our newest high-performance digital storage oscilloscopes, we back them with the longest warranty in the industry. You're fully covered for as long as we manufacture the product—or five years—whichever is longer.

CIRCLE 134 FOR U.S. RESPONSE

How can we make that promise? With complete confidence.

Because we control quality every step of the way. Everything from our ASIC and advanced surface-mount technology to our sophisticated burn-in process is designed to provide you with the most reliable DSOs made.

Like the Gould 4060. Available in 2- and 4-channel versions, the 4060 gives you 400MS/sec sampling at a 150MHz bandwidth, 8-bit resolution, on-screen signal measurement and analysis, plus glitch capture and an integral 4-color pen plotter.

Or the Gould 465, with 100MHz bandwidth with a full 200MS/sec sampling on two channels. It's about 20 times faster than similarly priced DSOs. The 465 includes 2GS/sec equivalent time sampling, persistence mode, glitch capture, and a built-in 4-color pen plotter.

CIRCLE 135 FOR RESPONSE OUTSIDE THE U.S.

At the top end, the Gould 4090 offers a superior sample rate performance compared to anything in its class, with 200MHz bandwidth and 800MS/sec sampling per channel.

Each backed by the same unparalleled warranty.

For an on-site demonstration, and details regarding the warranty, call Gould at 1-216-328-7000. You'll be glad you did for years to come.

- Yes!**  Have a Gould representative call to arrange a demonstration  
 Send me the new Gould short form catalog

(Please print, or affix business card)

Name: \_\_\_\_\_  
 Title: \_\_\_\_\_  
 Company: \_\_\_\_\_  
 Street: \_\_\_\_\_  
 City: \_\_\_\_\_ State: \_\_\_\_\_ Zip: \_\_\_\_\_  
 Telephone: \_\_\_\_\_

Send to: Gould Inc., Test and Measurement Group,  
 8333 Rockside Road, Valley View, Ohio 44125.  
 Fax: (216) 328-7400.

## VOLTAGE REFERENCE OPTIONS

duced by the voltage reference. Carefully choosing  $R_C$  limits the dc error that the resistor creates with the amplifier's input current. Then, empirical selection of  $C_C$  optimizes output settling response to a load-current transient.

The final voltage-reference circuit offers variable control of both magnitude and polarity (Fig. 8). It achieves this control through a variable combination of positive and negative gain.<sup>3</sup> Both inverting and non-inverting responses result from the two connections of  $V_R$  to the op amp. Superposition separates the two responses for analysis. First,  $V_R$  connects to the amplifier's inverting input through the feedback network of the two R resistors. This connection sets an inverting gain of  $-1$ , and the first component of output voltage becomes  $-V_R$ .

A second output component results from connecting  $V_R$  to the am-

plifier's noninverting input.  $V_R$  drives this input through the potentiometer  $R_v$ . Potentiometer adjustment varies the noninverting gain from 0 to  $+2$  depending on the potentiometer fractional setting,  $x$ . A setting of  $x = 0$  grounds the noninverting input of the op amp for a noninverting gain of 0. Then, the inverting gain alone controls the circuit output and  $V_O = -V_R$ . At the opposite potentiometer extreme,  $x = 1$  and  $V_R$  connects directly to the amplifier's noninverting input. Under superposition conditions, this connection produces a noninverting-gain component of  $+2$  through the equal-valued R feedback resistors. Superposition combination then results in a net circuit gain of  $-1 + 2 = +1$ , and  $V_O = V_R$ . Thus, the potentiometer varies the circuit output from  $-V_R$  to  $+V_R$ .

In between the potentiometer extremes, the output voltage varies linearly with the setting  $x$ . Potentiome-

ter variation produces a output response of:

$$V_O = (2x - 1)V_R$$

With the REF10 shown in Figure 8,  $V_R = 10$  V. Consequently, the circuit provides a continuously variable reference voltage from  $-10$  V to  $10$  V. Traditional amplifier connections lack this bipolar range because neither the inverting or noninverting amplifier can switch gain polarity. Moreover, the circuit offers the less-than-unity noninverting gains not possible with the traditional noninverting amplifier.

As before, the output voltage deviates from the ideal because of the errors of the voltage reference, the op amp, and the resistances. Relative error in the voltage-reference output translates directly to the circuit output because  $V_R$  is a direct multiplier term in the output equation. With the REF10J, a 5-mV tolerance skews the

FLUKE AND PHILIPS - THE T&M ALLIANCE

## Test results:

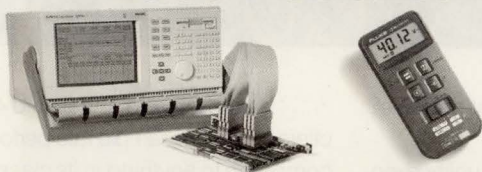

90% of those who try a Philips Logic Analyzer from Fluke buy one.

Just complete Fluke's 30-minute demo and we'll give you a free Fluke 12 DMM when you buy a logic analyzer—whether it's ours or the competition's. (Contact us for complete details.)

See the PM 3580 Logic Analyzer's features first hand:

- Only 30 minutes to set-up and learn.
- Revolutionary architecture that gives you true dual state and timing, simultaneously on every pin, with just one connection. No more dual probing or reconfiguration.

100% get a free DMM.

- Superior  $\mu$ p support, like i486; i386DX; i960CA, 80C186EB, 80286, 68040, 68030, 68HC11, MCS-96, AM29030, 320Cxx.
- Prices about half of comparable analyzers—\$4,495-\$11,450.

For literature, our video or a demonstration, call  
**1-800-44-FLUKE**

John Fluke Mfg. Co., Inc., P.O. Box 9090, M/S 250C,  
Everett, WA 98206-9090 U.S. (206) 356-5400  
Canada (416) 890-7600. Other countries: (206) 356-5500.  
©1992. All rights reserved. Ad No. 00179.

FAST ANSWERS

**FLUKE®**

CIRCLE 148 FOR U.S. RESPONSE

CIRCLE 149 FOR RESPONSE OUTSIDE THE U.S.

## Put Our List On Your List

Our list can help you do the other things you have on your list. Such as buy a car. . . estimate social security. . . start the diet. . . check out investments. . .

Our list is the *Consumer Information Catalog*. It's free and lists more than 200 free and low-cost government booklets on employment, health, safety, nutrition, housing, Federal benefits, and lots of ways you can save money.

So to shorten your list, send for the free *Consumer Information Catalog*. It's the thing to do.

Just send us your name and address. Write:

**Consumer Information Center  
Department LL  
Pueblo, Colorado 81009**

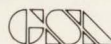

A public service of this publication  
and the Consumer Information Center  
of the U.S. General Services  
Administration

## VOLTAGE REFERENCE OPTIONS

ideal 10-V output by 0.05%. This percentage error transfers directly to the circuit's output, independent of the potentiometer setting. Similarly, the relative 3 ppm/°C drift of the voltage reference shows up in the circuit's output.

Amplifier-input errors add to this output error. The op amp's offset voltage transmits an error to the output through a gain of  $1/\beta$ . Here,  $1/\beta = 2$  because of the equal-valued feedback resistors. The effect of amplifier input current  $I_B$  adds to this offset, and the resulting output offset is  $I_B R$ . Combined, the two amplifier errors produce an output error of  $2V_{OS} + I_B R$ . This error remains independent of the potentiometer setting. Drift in this combined offset further adds to output error. With the precision OPA177G in Figure 8, the amplifier offset and drift effects produce negligible output errors of 134  $\mu$ V and 2.7  $\mu$ V/°C.

The fixed resistors' tolerance errors and drifts influence the output voltage in a variable amount, depending on the potentiometer setting. Resistance errors of the R feedback resistors directly alter the -1 gain component of the circuit's inverting connection. With 0.1% resistors, these tolerance errors introduce as much as 0.2% error in the output voltage. Also, the 15 ppm/°C drift of these resistors produce as much as 30 ppm/°C output drift.

However, the relative significance of these resistor errors varies with the potentiometer setting. When  $x = 1$ , the -1 gain component totally controls the circuit, and the errors of the fixed resistors transfer directly to the circuit output. Yet, when  $x = 0$ , these errors have no effect. Then, the voltage reference connects directly to the op amp's noninverting input, leaving 0 V on the input R resistor. Zero feedback current re-

sults, which also leaves 0 V on the output R resistor. Then, the two fixed resistors exert no influence on the output voltage. In between the potentiometer extremes, the output error due to the fixed resistors varies linearly between the values stated for  $x = 1$  and  $x = 0$ .

Tolerance error in the potentiometer doesn't affect the output because the potentiometer's actual resistance is unimportant. The noninverting gain is affected by the potentiometer through the resistance ratio of the potentiometer segments. This ratio is independent of the total potentiometer resistance. However, the ratio does rely on the potentiometer-control nonlinearity, which affects the potentiometer-resistance division versus control rotation. Still, circuit adjustment with an output-voltage monitor removes adjustment dependence on control rotation.

When combined, Figure 8's error

# TEST

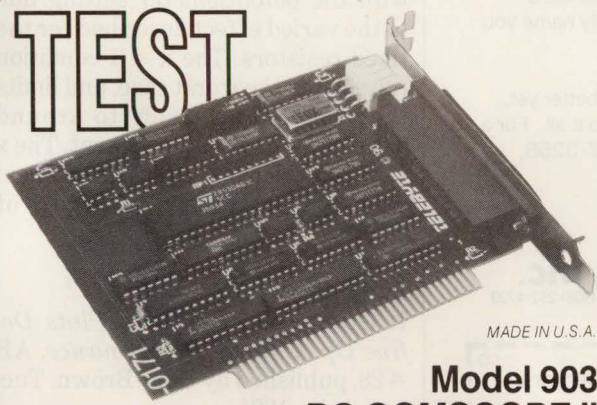

MADE IN U.S.A.

### Model 903 PC COMSCOPE II

Use your **LAPTOP** or **PC** with new power and flexibility in the analysis, emulation and testing of complex serial protocols.

**\$695**

- Operates in LAPTOPS as well as XT/AT/386 compatibles
- Monitors & emulates ASYNC, BISYNC, X.25 and HDLC
- Split screen display for X.25 and SDLC
- BERT—Multi-Functional
- Operator programmable test
- Uses all DOS peripherals

**TELEBYTE**  
TECHNOLOGY, INC.

**CONNECT • COMMUNICATE • SUPPORT**

270 E. Pulaski Road  
Greenlawn, NY 11740  
TEL: (516) 423-3232  
FAX: (516) 385-8184  
1-(800) 835-3298

CIRCLE 234 FOR U.S. RESPONSE  
CIRCLE 235 FOR RESPONSE OUTSIDE THE U.S.

## Your Ally in Precious Metal Alloys

Ney precious metal alloys have been industry standards since the dawn of electronics. Paliney® and Neyoro® are virtually the benchmarks by which others offer "equivalents". Available in ribbon, strip and wire.

Why settle for less? Call Ney today:

**800/282-1141**  
FAX: 203/242-5688

**NEY**

The J.M. Ney Company  
Electronics Division  
Bloomfield, CT 06002  
In CT: 242-2281

Paliney® and Neyoro® are registered trademarks of The J. M. Ney Company

CIRCLE 146 FOR U.S. RESPONSE  
CIRCLE 147 FOR RESPONSE OUTSIDE THE U.S.

# VOLTAGE REFERENCE OPTIONS

## GUESS WHO BRINGS THEM TOGETHER?



You already know Globe as The Bracket Leader, offering the widest range of standard bracket designs for computers, add-on-boards, peripherals, and electronic equipment. With over 1500 standard brackets available, Globe offers you a wider choice of product and award winning quality. Now you can get that same quality, product variety and prompt service for all of your connector needs, too!

### ONLY GLOBE OFFERS YOU BRACKETS AND CONNECTORS FROM A SINGLE SOURCE.

Whatever your connector needs, Globe has them. D-Sub Connectors, I.C. Sockets, Ribbon Cable Connectors, IDC Connectors, Video Connectors, and much more. When you consider that no one offers you as wide a choice of standard brackets and connectors as we do, it's easy to see that Globe is the only name you need for all of your bracket and connector requirements.

One name - Two product lines - One single source. **Globe.**

Call us for all of your brackets. Call us for all of your connectors. Or better yet, call for both. There's no need to do twice the work when one call will do it all. For a free copy of our bracket and connector catalogs, call us at **1-800-227-3258**,

or return the coupon below today.



**Globe Manufacturing Sales, inc.**

1159 Route 22 East, Mountainside, NJ 07092 • (908) 232-7301 • Fax: (908) 232-4729

### Send me the following catalogs:

- Have a Sales Representative contact me.  Connectors  Brackets

Name \_\_\_\_\_ Title \_\_\_\_\_

Company \_\_\_\_\_

Address \_\_\_\_\_

City \_\_\_\_\_ State \_\_\_\_\_ Zip \_\_\_\_\_ Phone \_\_\_\_\_

CD

sources produce an output-error voltage of:

$$V_{O\epsilon} = (2x - 1)\delta V_R + 2V_{OS} + \frac{2(x - 1)V_R\delta R/R}{2(x - 1)V_R\delta R/R}$$

Here,  $\delta V_R$  represents the voltage tolerance of the input reference and  $\delta R/R$  represents the fractional tolerance of the fixed resistors. None of the three error terms in the equation expresses the same dependence on the potentiometer setting  $x$ . Thus, each error must be trimmed independently to achieve error reduction throughout the control range. First,  $V_R$  trim removes the voltage-reference error while observing the reference's output voltage. Then, with  $x = 1$ , amplifier offset adjustment sets  $V_O = V_R$ . Finally, with  $x = 0$ , trim of the fixed resistors sets  $V_O = -V_R$ .

Following the above trim sequence, the circuit accuracy remains a function of thermal-drift sources. As mentioned, reference, amplifier, and resistor drifts each affect this accuracy. Total output drift varies with the potentiometer setting due to the varied effect described for the fixed resistors. The  $x = 1$  condition represents the worst case, and limits the trimmed accuracy to around 0.016% in a  $\pm 5^\circ\text{C}$  environment. The  $x = 0$  condition exemplifies the best case, with a trimmed accuracy of 0.0015%. □

### References:

1. Graeme, J., *Feedback Plots Define Op Amp AC Performance*, AB #28, published by Burr-Brown, Tucson, Ariz., 1991.
2. Ibid., AB #1.
3. Graeme, J., *Designing with Operational Amplifiers*, McGraw-Hill, New York, N.Y., 1977.

*Jerald Graeme, manager of a linear IC development group at Burr-Brown, holds a BSEE from the University of Arizona, Tucson, and an MSEE from Stanford University, Stanford, Calif.*

HOW VALUABLE?	CIRCLE
HIGHLY	531
MODERATELY	532
SLIGHTLY	533

CIRCLE 132 FOR U.S. RESPONSE  
CIRCLE 133 FOR RESPONSE OUTSIDE THE U.S.

# The Truly Portable

## Model 326

- 100-MHz Bandwidth
- Dual Time Base
- 4 Traces with Alternate Sweep
- 12 kV BRIGHT PDA CRT
- Compact Size 9" x 3" x 13"
- 9 lbs. Light Weight

You Are Looking At  
Actual Size



The truly portable oscilloscope Model 326 includes carrying case with probe pouch, front panel cover, CRT hood and 2 probes.

Call toll free  
**1 800 645-5104**

In NY State 516 231-6900

**LEADER**  
FOR PROFESSIONALS WHO KNOW  
THE DIFFERENCE

Leader Instruments Corporation, 380 Oser Avenue, Hauppauge, New York 11788  
Regional Offices: Chicago, Dallas, Los Angeles, Atlanta. In Canada call Omnitrnix Ltd., 416 828-6221

Circle 152 for Product Information Only (U.S. Response)  
Circle 153 Product Information and Demonstration  
are Required (U.S. Response)

Circle 154 for Product Information Only (Response Outside U.S.)  
Circle 155 Product Information and Demonstration  
are Required (Response Outside U.S.)

# 99¢

from

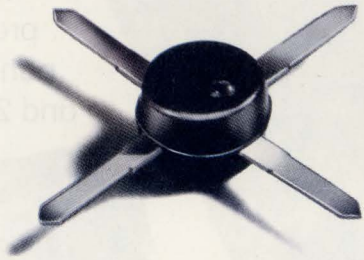

## dc to 2000 MHz amplifier series

### SPECIFICATIONS

MODEL	FREQ. MHz	GAIN, dB			Min. MHz	•MAX. PWR. dBm	NF dB	PRICE \$ Ea.	Qty.
		100 MHz	1000 MHz	2000 MHz					
MAR-1	DC-1000	18.5	15.5	—	13.0	0	5.0	0.99	(100)
MAR-2	DC-2000	13	12.5	11	8.5	+3	6.5	1.35	(25)
MAR-3	DC-2000	13	12.5	10.5	8.0	+8	6.0	1.45	(25)
MAR-4	DC-1000	8.2	8.0	—	7.0	+11	7.0	1.55	(25)
MAR-6	DC-2000	20	16	11	9	0	2.8	1.29	(25)
MAR-7	DC-2000	13.5	12.5	10.5	8.5	+3	5.0	1.75	(25)
MAR-8	DC-1000	33	23	—	19	+10	3.5	1.70	(25)

NOTE: Minimum gain at highest frequency point and over full temperature range.

- 1dB Gain Compression
- +4dBm 1 to 2 GHz

### designers amplifier kit, DAK-2

5 of each model, total 35 amplifiers

only \$59.95

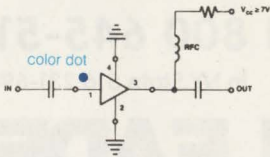

Unbelievable, until now... tiny monolithic wide-band amplifiers for as low as 99 cents. These rugged 0.085 in. diam., plastic-packaged units are 50ohm\* input/output impedance, unconditionally stable regardless of load\*, and easily cascadable. Models in the MAR-series offer up to 33 dB gain, 0 to +11dBm output, noise figure as low as 2.8dB, and up to DC-2000MHz bandwidth.

\*MAR-8, Input/Output Impedance is not 50ohms, see data sheet. Stable for source/load impedance VSWR less than 3:1

Also, for your design convenience, Mini-Circuits offers chip coupling capacitors at 12 cents each.†

Size (mils)	Tolerance	Temperature Characteristic	Value
80 x 50	5%	NPO	10, 22, 47, 68, 100, 220, 470, 680, 1000 pf
80 x 50	10%	X7R	2200, 4700, 6800, 10,000 pf
120 x 60	10%	X7R	.022, .047, .068, .1μf

† Minimum Order 50 per Value

□ Designers kit, KCAP-1, 50 pieces of each capacitor value, only \$99.95

finding new ways ...  
setting higher standards

## Mini-Circuits

A Division of Scientific Components Corporation  
P.O. Box 350166, Brooklyn, New York 11235-0003 (718) 934-4500  
Fax (718) 332-4661 Domestic and International Telexes: 6852844 or 620156

CIRCLE 172 FOR U.S. RESPONSE

CIRCLE 173 FOR RESPONSE OUTSIDE THE U.S.

C113-Rev. D

# CIRCLE 521 AC-DC CONVERTER RUNS OFF ONE SUPPLY

W. STEPHEN WOODWARD

Venable Hall, CB3290, Univ. of North Carolina, Chapel Hill, NC 27599-3290; (919) 966-1358.

**P**recision full-wave conversion of low-level ac signals to dc is a commonly performed function in measurement apparatus. Not surprisingly, therefore, many circuits have been de-

scribed as capable of doing the job. Most of them, however, require bipolar power supplies, and all depend upon precise resistor matching for good rectification symmetry.

In addition, the symmetry of those circuits is limited by the offset voltages of their amplifiers. That is, only ac voltages that are much greater than the amplifier offset voltages can be rectified accurately. As a result, ac-coupled gain stages are often needed, increasing circuit complexity and introducing potential sources of error.

This circuit avoids those shortcomings (see the figure). It accepts the ac input on differential inputs 1 and 2, where capacitors  $C_1$  and  $C_2$  block any dc components of the input and isolate the input signal from the bias generated by resistors  $R_3$  through  $R_6$ .

To see how the rectifier works, suppose that a signal excursion drives input 1 more positive than input 2. Amplifier  $A_1$  responds by driving diode  $D_1$  into conduction, thereby forcing its inverting input to track input 1.

At the same time, amplifier  $A_2$  responds with a negative output excursion. That forces transistor  $Q_2$  to conduct sufficiently to

cause the inverting input of  $A_2$  to track input 2. The  $Q_2$  emitter current that must flow to satisfy this condition is given exactly by:

$$I_e = V_i / Z_{rc}$$

$Z_{rc}$ , the series impedance of  $R_1$  and  $C_3$ , can be replaced by just  $R_1$  if  $C_3$  is large enough to have a very low reactance at the frequencies of interest. In that case, and if  $Q_1$  and  $Q_2$  are very high gain transistors, then the  $Q_2$  collector current will track the emitter current to within better than 0.5%, and will be given by:

$$I_c = V_i / R_1$$

The instantaneous output voltage, therefore, is given by:

$$V_o = R_2 I_c = V_i R_2 / R_1$$

For input excursions of opposite polarity, with  $D_2$  and  $Q_1$  conducting, the roles of the amplifiers reverse. An important characteristic of the circuit is that rectification symmetry does *not* depend upon matching of resistors. Rectification symmetry is limited only by the matching of the transistor alphas, which is better than 1% for high-gain transistors.

Because  $C_3$  prevents amplifier offset voltages from affecting circuit performance, the ratio  $R_2/R_1$  can be made large to provide high gain as well as the conversion function. □

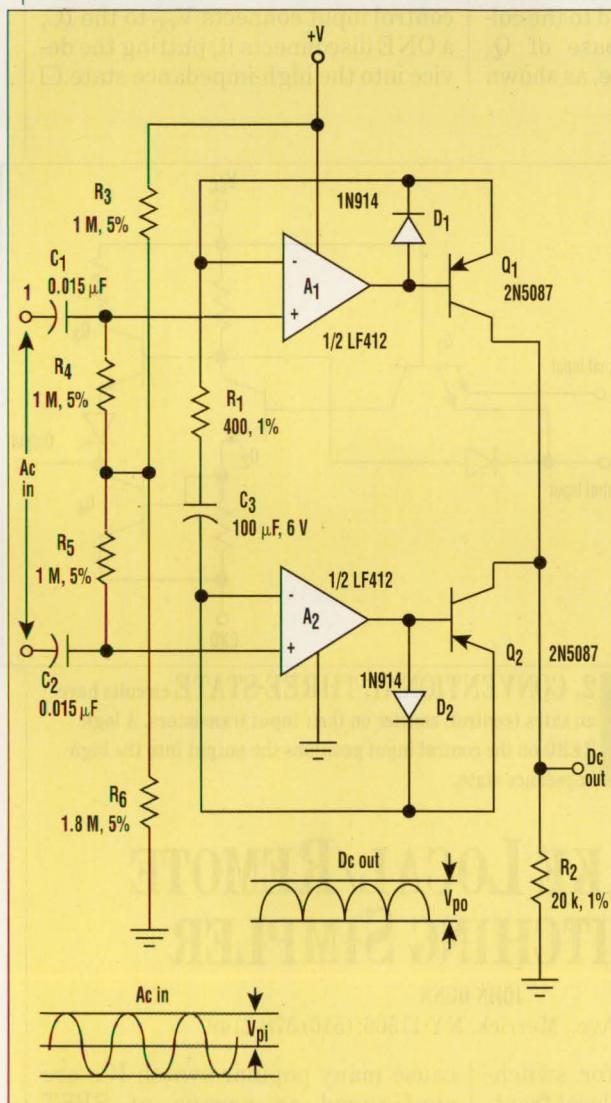

**FOR THE COMPONENT** values shown here, the circuit will convert a 90-mV average absolute (100 mV rms for a sinusoid) ac input into a 5-V dc output. The converter has a 1% frequency response of 50 Hz to 5 kHz. Its differential input impedance is 1 MΩ, and its output impedance is 20 kΩ.

## IFD WINNER

IFD Winner for December 19, 1991

**Charles Ho**, Jet Propulsion Lab, Section 357, 4800 Oak Grove Dr., MS 18-104, Pasadena, CA 91109 (818) 354-7666. His idea: "Simplest Driver Yet For Stepper Motors."

## VOTE!

Read the Ideas for Design in this issue, select your favorite, and circle the appropriate number on the Reader Service Card. The winner receives a \$150 Best-of-Issue award and becomes eligible for a \$1,500 Idea-of-the-Year award.

**CIRCLE**  
**522 GIVE TTL GATES**  
**3-STATE OUTPUTS**

D. BHANUMURTY

Government of India, Ministry of Defence, Defence Research & Development Organisation, Defence Electronics Research Laboratory, Chandrayanagutta, Hyderabad—500 005, India; (0832) 239061.

**A**t times, it's necessary to make an ordinary TTL gate act like a three-state device, such as when a suitable three-state part isn't available. A Siliconix Si9405 load switch can be connected between the power source and the gate to achieve just that function (Fig. 1).

To appreciate how the circuit

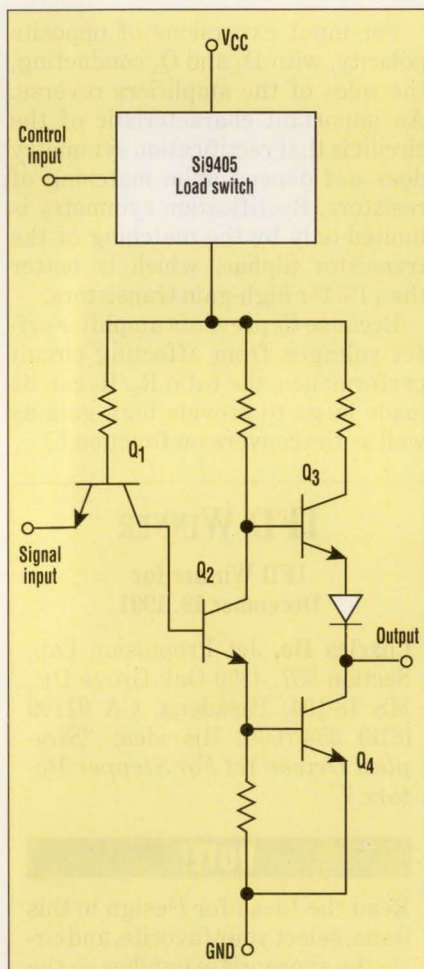

**1. A LOGIC ONE** at the control input of the load switch will cut off the power to the rest of the TTL circuit. Consequently, its output is placed into a high-impedance state.

works, consider the operation of a three-state TTL gate (Fig. 2). In that configuration, the high-impedance condition is incorporated by means of a control input connected to an extra emitter on transistor  $Q_1$ . The control input is also connected to the collector of  $Q_2$  and the base of  $Q_3$  through a (reversed) diode, as shown in Fig. 2.

Applying a logic ZERO to the control input turns off transistors  $Q_2$  and  $Q_3$ . Turning off  $Q_2$  will then turn off  $Q_4$ . So a logic ZERO at the control input turns off  $Q_3$  and  $Q_4$ , isolating the output from both  $V_{CC}$  and ground.

Referring back to Figure 1, it can be seen that a conventional TTL output stage will present a high output impedance when  $V_{CC}$  is disconnected. More specifically, removing  $V_{CC}$  creates a condition

**Send in Your Ideas for Design**

Address your Ideas-for-Design submissions to Richard Nass, Ideas-for-Design Editor, Electronic Design, 611 Route 46 West, Hasbrouck Heights, NJ 07604.

identical to the third state of a three-state device.

The Si9405 provides an excellent means for switching  $V_{CC}$  on and off, albeit with logic opposite to that of a three-state device. A ZERO at its control input connects  $V_{CC}$  to the IC; a ONE disconnects it, putting the device into the high-impedance state. □

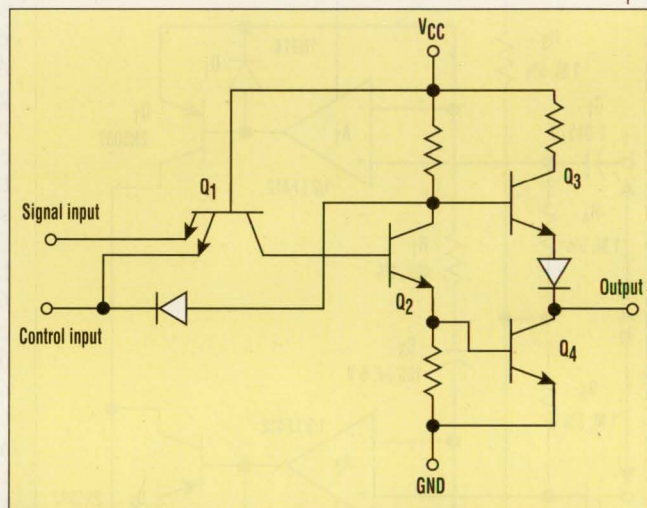

**2. CONVENTIONAL THREE-STATE** circuits have an extra (control) emitter on their input transistors. A logic ZERO on the control input positions the output into the high-impedance state.

**CIRCLE**  
**523 MAKE LOCAL/REMOTE**  
**SWITCHING SIMPLER**

JOHN DUNN

181 Marion Ave., Merrick, NY 11566; (516) 378-2149.

**M**ost schemes for switching between a local front-panel control potentiometer and a remote analog control voltage involve analog SPDT switches. Implementing such schemes becomes complicated be-

cause many popular switch ICs are configured as arrays of SPST switches that have the same switching phase. In other words, all of the switches respond to ones and zeros at their control inputs in the same way (by opening or closing). Thus, to



## IDEAS FOR DESIGN

get the desired SPDT action, it's necessary either to use two ICs of opposite switching phase or to create two logic signals of opposite switching phase. In the former case, a single control signal drives the dissimilar switches; in the latter, the out-of-phase control signals drive two similar switches on the same IC.

A simpler alternative circumvents the problem by using two switch sections of one IC wherein both switches are open for local control and closed for remote (see the figure). As a result, a single logic signal can be used to drive both switch control inputs together. With this scheme, the local input is always connected, but through a resistor ( $R_3$ ); only the remote input is switched in and out. When remote control is desired, the remote signal is switched in. It then swamps the local input and takes over.

The off-impedance of most good

analog switches exceeds the  $10\text{ k}\Omega$  of resistor  $R_3$  by a sufficient margin so as not to affect the linearity of the  $5\text{-k}\Omega$  potentiometer in the local mode. Conversely, the on-impedance of

those switches is low enough so that just a modest amount of amplifier gain allows the remote signal to override the effect of the local potentiometer when desired. □

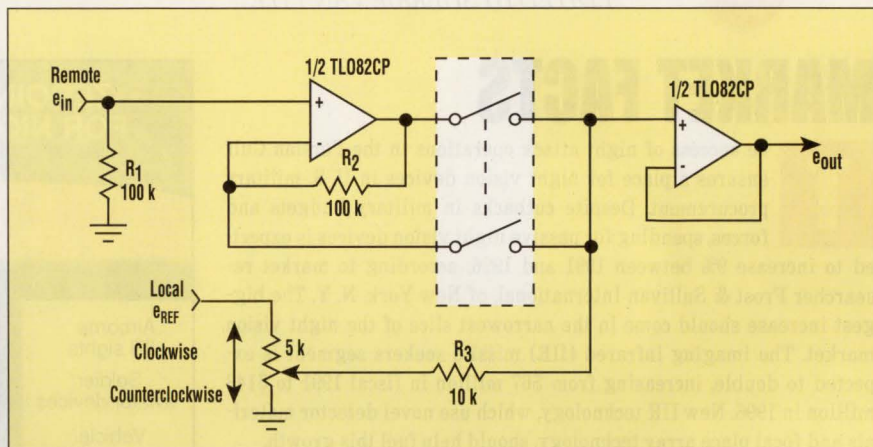

**ONE LOGIC SIGNAL** drives both switches in this simple local/remote selector circuit. The analog switches, which are on the same IC, open up for local operation and close for remote.

## NPC is... High-performance Digital Audio I.C.'s

### Digital Filters - 2 channel/8 times oversampling

Part Number	FIR Filters	Ripple	Stopband Attenuation	Output Format	Format Input	Characteristics
SM5803	153+2 9+17	$\pm 0.00005$	110 db	Serial	Serial	High-performance 8fs filter, multi-function
SM5813	153+2 9+17	$\pm 0.00005$	110 db	Serial	Serial	High-performance 8fs filter
SM5818	61+13 +9	$\pm 0.00005$	110 db	Serial	Serial	8fs filter with 20bit output resolution for low end user
SM5840	61+13 +9	$\pm 0.00005$	55 db	Serial	Serial	For CD, DAT, PCM playback

### D/A Converter

Part Number	Package	Pin NO	Description	Characteristics
SM5860	DIP QFP	40 44	For Digital Audio EQ Delta-Sigma Converter	2 channel D/A converter, match with 4fs or 8fs oversampling digital filter, PWM output, ZSNS
SM5861	DIP QFP	40 44	For Digital Audio EQ Delta-Sigma Converter	2 channel D/A converter, match with 8fs oversampling digital filter, PWM output, ZSNS

### Dolby Prologic Decoder

Part Number	Package	No. of Pins	Description	Characteristics
SM5851	QFP	64	Incorporate all major Dolby Prologic Surround system	<ul style="list-style-type: none"> <li>• 48 kHz, 44.1 kHz or 32 kHz sampling frequencies</li> <li>• Dolby Prologic decoder</li> <li>• Deemphasis filter</li> <li>• Level meter flag</li> </ul>

"Dolby" is a trademark for Dolby Laboratory Licensing Corporation



**NPC U.S. SALES OFFICE c/o**  
**SEPONIX CORPORATION**  
 2151 O'Toole Avenue  
 Suite L San Jose, CA 95131

(408) 922-1033  
 FAX (408) 922-0137  
 1-800-237-4590

## LOOKING FOR A QUALITY BOARDHOUSE?

ALL YOUR CIRCUIT BOARD NEEDS UNDER ONE ROOF

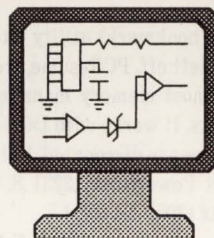

### PCB MANUFACTURING

- 2 Day turn on multi-layers
- Prototype and production
- Gerber Data Review
- Database/Netlist test

### PCB LAYOUTS

- Backplanes
- Impedance control
- Analog and ECL
- SMT both sides

### TECHNICAL ASSISTANCE

- PCB layout tips
- Mfg cost cutting tips
- Artwork standards
- Gerber Data via modem, 24 hours (714) 970-5015

## CALL FOR A QUOTE!

A MANUFACTURING, LAYOUT AND SUPPORT CENTER



**MURRIETTA**  
**CIRCUITS**

4761 E. HUNTER AVE. ANAHEIM, CA. 92807  
 TEL: (714) 970-2430 FAX: (714) 970-2406

CIRCLE 176 FOR U.S. RESPONSE

CIRCLE 177 FOR RESPONSE OUTSIDE THE U.S.

CIRCLE 272 FOR U.S. RESPONSE  
 CIRCLE 273 FOR RESPONSE OUTSIDE THE U.S.

ELECTRONIC DESIGN 95

APRIL 16, 1992

# QUICK LOOK

EDITED BY SHERRIE VAN TYLE

## MARKET FACTS

**T**he success of night attack operations in the Persian Gulf ensures a place for night vision devices in U. S. military procurement. Despite cutbacks in military budgets and forces, spending for passive night vision devices is expected to increase 9% between 1991 and 1996, according to market researcher Frost & Sullivan International, of New York, N. Y. The biggest increase should come in the narrowest slice of the night vision market. The imaging infrared (IIR) missile seekers segment is expected to double, increasing from \$67 million in fiscal 1991 to \$143 million in 1996. New IIR technology, which use novel detector materials and focal plane array technology, should help fuel this growth.

Other sectors won't fare as well in the face of cutbacks in tank, tactical aircraft, and armed helicopter production. Soldier/aviator night vision devices are predicted to drop 33% from 1991's \$189 million to \$128 million in 1996. Airborne IIR sights, worth \$434.5 million last year, are expected to remain about the same in five years, at \$436.4 million. Vehicle/launcher sights, a \$152.9 million market last year, should rise 17% to \$179.4 million in 1996. Not surprisingly, spending for research and development of night vision equipment is expected to rise 53%, going from \$76.1 million to \$116.2 million in 1996.

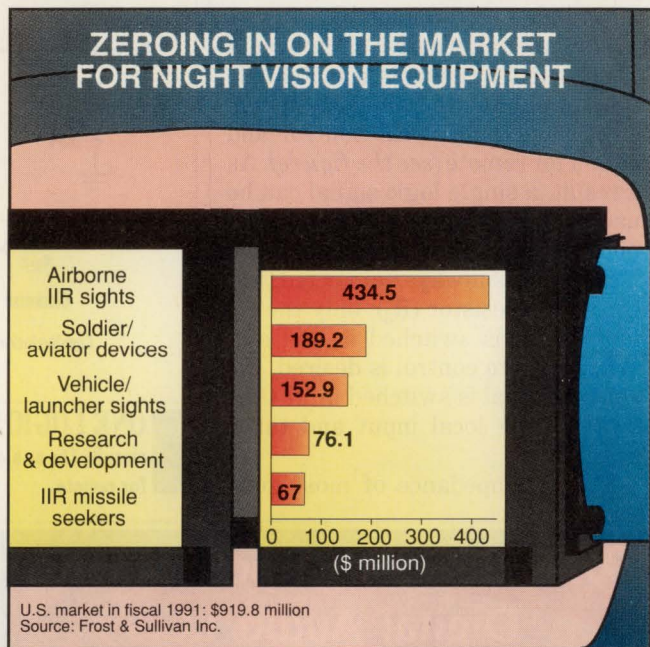

## HOT PC PRODUCTS

**A** low-cost auto resume (electronic bookmark) utility lets a PC user pick up where he or she left off. PCResume, from Powercard, is compatible with most memory managers, Windows 3.0, and Novell networks. It works with DOS 3.0 and higher. List price is \$49 per unit. Quantities are discounted. Delivery time is 60 days after ordering. Contact Powercard, 12231 S. W. 129th Ct., Miami, FL 33186; (305) 251-5855; fax (305) 251-2334.

CIRCLE 453

**T**he SCSI Software Developer's Kit is a complete toolkit for developing Small Computer Systems Interface (SCSI) drivers for PC peripherals. For SCSI peripheral makers and ASPI third-party developers, the Adaptec kit simplifies creating software drivers based on the Advanced SCSI Programming Interface. For makers of SCSI peripherals and ASPI third-party developers, the kit simplifies creating ASPI-based software drivers for any SCSI peripheral.

Each kit contains a copy of the ASPI specification documents and expanded programming guides for DOS, OS/2, and Novell NetWare. A DOS/ASPI interface is provided for developers to test and debug their ASPI device drivers.

Also included in the developer's kit are an ASPI Exerciser Program and a working ASPI disk driver. The kit sells for \$150 from Adaptec Inc., 691 S. Milpitas Blvd., Milpitas, CA 95035; (408) 945-6761.

CIRCLE 454

## QUICK NEWS

**A** recent issue of *American Engineer*, a monthly newsletter from the American Engineering Association, focuses on engineering unemployment, underuse of U. S. engineers, and adverse working conditions. A bleak employment picture is worsened by peace casualties in the wake of defense cutbacks—industries hit hardest during the lingering recession—makers of computers, scientific instruments, and metal and electrical products—rely on defense contracts for much of their business. For a sample copy of the AEA newsletter, write to Richard Tax, AEA, P. O. Box 2012, River Vale, NJ 07675. Membership costs \$20 a year and includes a newsletter subscription.

**A** hazardous waste hotline offers free advice on obtaining EPA identification numbers, handling and disposal of hazardous substances, and complying with local, state, and federal regulations. From RFE Industries, a refiner of precious scrap metal from the electronics industry, the hotline's number is (800) 327-7938. For more information contact RFE Industries, 19 Crows Mill Rd., Keasbey, NJ 08832; (908) 738-5200.

A two-volume directory of Unix hardware and software contains more than 7600 products and services from 2100 vendors. Uniform members get the directory free. Nonmembers can purchase it for \$95. Contact the Uniform order desk at (408) 986-8840, ext. 10.

## OFFERS YOU CAN'T REFUSE

**A** demo program gives an overview of LabWindows 2.0 software development system for data acquisition and instrument control applications. The program, based on a working version of LabWindows 2.0, includes example programs that show how LabWindows is used to develop application programs. Japanese and Spanish versions of the demo are available; a French version is in the works. Contact National Instruments Corp., 6504 Bridge Point Pkwy., Austin, TX 78730-5039; (800) 433-3488 or (512) 794-0100; fax (512) 794-8411. CIRCLE 455

**A** 31-page catalog contains specifications and applications for Star Micronics' audio transducers and buzzers. For the catalog contact Star Micronics America, OEM Division, 70-D Ethel Rd. West, Piscataway, NJ 08854; (908) 572-9512. CIRCLE 456

**M**ultiple DACs save board space, power, insertion costs, and increase reliability owing to fewer ICs. These devices are featured in Analog Devices' *Multiple Digital-to-Analog Converter Integrated Circuit Selection Guide*. A selection table sorts the multiple DACs by resolution and number of DACs. For the guide, contact Analog Devices Literature Center, 70 Shawmut Rd., Canton, MA 02021; fax (617) 821-4273. CIRCLE 457

**T**he NIST Calibration Services Users Guide lists at least 500 calibration services and measurement assurance programs (MAPs) available for industry from the National Institute of Standards. MAPs are quality control programs for calibrating a company's entire measurement system. The catalog also lists NIST technical experts who may be contacted for information on services or measurement problems. For a free guide (SP 250), send a self-addressed mailing label to Calibration Program, Room A104, Building 411, National Institute of Standards and Technology, Gaithersburg, MD 20899; (301) 975-2002.

**A** booklet gives technical assistance in designing aluminum enclosures. From AAvid Engineering, the free material gives design details on drawing layout and points to ways to reduce packaging costs, improve appearance, and extend the system's life. For a copy, contact AAvid Engineering Inc., One Kool Path, Laconia, NH 03247-0400; (603) 528-3400, fax (603) 528-1478. CIRCLE 458

# QUICKLOOK

## K M E T ' S K O R N E R

### ...Perspectives on Time-to-Market

BY RON KMETOVICZ

President, Time to Market Associates Inc.  
Cupertino, Calif.; (408) 446-4458; fax (408) 253-6085



**S**uccess in the next-generation quadrant often kills off an existing product—that's viewed as good if it's your competitor's and bad if it's yours. Incremental product development strategies don't work in this cell: You start by hitting a home run and then begin hitting singles. Product developers make a conscious effort to leapfrog their competition; inspired organizations make a conscious effort to leapfrog themselves. Developers push and focus technology to do familiar things in better and different ways. It takes a lot of money to work in the next-generation cell and time pressure is intense—nothing comes easily.

Data on the realization of predecessor products about to be replaced by the next-generation product helps put a number of items into perspective. Collecting data on two facets, total person months of effort and time to market, of previous efforts can reveal a great deal about the current effort. The data is easy to obtain. First, identify the time to market interval. Remember the stopwatch starts when the product concept has had some review by individuals external to its synthesis, some concept analysis has taken place and the concept is simply documented on a few sheets of paper. It stops when the first dollar of revenue is collected. With the time to market interval defined, then determine how cross-functional, professional staff was applied to realize the product. How were marketing and manufacturing staffed as a function of time? How was R&D staffed over the time to market interval?

Possessing this information makes it possible to make two dramatic predictions about the succeeding next generation effort. One, expect the number of person months of effort that goes into the production of a next generation product to be greater than the number of total person-months it took to get its predecessor to market; and two, time to market of the successor will be longer than that of the predecessor. How can this be? Simply stated, next generation products have to do things better in a big way, and doing things much better takes many people working together for a relatively long time.

Two examples follow to illustrate next generation efforts and their inherent complexity: Storagetek, now at \$1.7 billion in sales, the maker of Jukebox style mass storage systems, is reporting that it will soon offer next generation capability. This time instead of having robots move tape cassettes around, the company plans to package up 128 Hewlett-Packard, 1.600-Gbyte, 5.25 inch, disk drives into a fault-tolerant, rapid I/O system. It does what it replaces plus a whole lot more. Expected price of the product is \$700,000 a deal when viewed from a dollar per megabyte perspective. How long did it take and how many person months of effort were required? The answer is that it took more person-months and more calendar time than the predecessor Jukebox version. Would anyone from Storagetek care to comment?

Coloray Display Corp. is attempting to bring Charles Spindt's field-emitter technology flat panel display to market. In this device, small electron guns shoot at phosphors much as it's done in a conventional CRT. It could be a leapfrog technology from a price and color performance perspective, offering better visibility than active matrix LCDs. Reports out of Japan suggest that it cost billions to get active matrix LCDs to market in high volumes. If Coloray Display can reconstruct the Japanese staffing profile and their time to market, the company can then use this information to scope the organization's development time and development cost barriers. Or may be they already have. Coloray is assembling a group of 20 U.S. companies to discuss the technology, according to a Feb. 3 report in *Business Week*. Could it be looking for lots of money?

*Ron Kmetovicz will lead a Time-to-Market seminar entitled "New Product Development: Doing It Better, Faster, and Cheaper" at Santa Clara University's Executive Development Center, to be held May 9, 1992. For more information on attending the seminar, contact Elmer Luthman, executive center director, at (408) 554-4521; fax (408) 554-4571.*

**WHAT'S NEW**

**NO MATTER HOW YOU LOOK AT IT, SHARP'S NEW PASSIVE COLOR DISPLAY REALLY SHINES.**

Today's exploding growth in notebook computer sales is matched only by the almost dizzying array of improvements in compatible flat panel displays as manufacturers slim down, lighten up and improve the aesthetics of notebook compatible displays, while expanding screen size.

One of the latest breakthroughs from Sharp is a super-

efficient passive matrix color display whose viewing quality leapfrogs anything previously available in its class.

The new LM64C031 passive color LCD provides the compact size, light weight and low power consumption of traditional passive displays — for about half the price of equivalent TFT color models. At the same time, thanks to

Sharp's exclusive three-dimensional film compensation process, the display achieves high brightness, superior color saturation and excellent contrast without the viewing distortion typically associated with

passive color displays. The product offers VGA-quality resolution, a response speed of 450 ms and contrast ratio of 13:1, with mouse-compatible speeds and even

higher contrast ratios to be available soon.



**IMAGINATION AT WORK**

**MAKING IT BIG WITH TFT'S TAKES VISION AND ENORMOUS INVESTMENT.**

Thanks to its early and continual investment in the manufacturing process, Sharp supplies some 70% of the world's thin film transistor (TFT) displays. TFT's compact, light, energy-efficient package provides color, clarity and full-motion video equal to or better than CRTs.

Sharp's new flagship TFT manufacturing plant in Tenri, Japan, incorporates the cutting edge in the "giant scale integration" tools required to produce virtually flawless matrices

of hundreds of thousands of transistors. New advancements in

photolithography, chemical vapor deposition and fusion-drawn glass continue to keep Sharp the quality leader in a market expected to grow to \$3.1 billion by 1995.



**SHARP IN THE U.S.A.**

**SHARP: NOW A MAJOR U.S. MANUFACTURER.**

Sharp has demonstrated an unprecedented

commitment to its U.S. customers by augmenting IC research and development activities at the company's new facility in Camas, Washington, with an

additional \$30 million investment in LCD production.

The first Japanese company with an LCD manufacturing operation in the U.S., Sharp

is now able to assure the fastest response and repair time possible, backed by the largest support team in the country.



**COMING NEXT ISSUE: COLOR FLAT PANEL DISPLAYS. THEY'RE GETTING MORE COMPACT, MORE ENERGY EFFICIENT, WITH LARGER, CLEARER SCREENS. GET THE BIG PICTURE**

**ABOUT WHAT'S NEW IN TFT AND OTHER COLOR DISPLAYS IN THE NEXT ISSUE OF SHARP INSIGHTS.**

**SHARP**  
**FROM SHARP MINDS COME SHARP PRODUCTS™**

**FIRST PERSON**

**THE CHIPS WHOSE TIME HAS COME.**

BY CHUCK HASTINGS  
MARKETING/APPLICATIONS MANAGER  
FIFO AND SPECIALTY MEMORIES  
SHARP MICROELECTRONICS  
TECHNOLOGIES, INC.

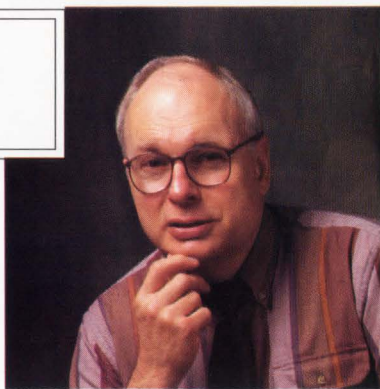

If some of the gold-rush glamour has worn off the electronics field today, as compared to the entrepreneurial '80s, the same can't be said for the First-In, First-Out (FIFO) memories which serve as data buffers between systems operating at different speeds.

Why? Because these never were glamour parts in the first place — never the parts that show up in the block diagram on system designers' blackboards. As often as not, the lines in between these blocks turn into FIFOs.

Nevertheless, the "unglamorous" FIFOs have proven to be the right parts at the right time. In some ways, their evolution is the gating factor in the convergence of higher system performance with greater design efficiency.

The greater availability of "open system" components gives system designers the freedom to draw parts from off the shelf, instead of designing them from scratch. But it's the FIFOs which compensate for mismatches in data rates, word widths and synchronization between those high-profile intelligent engines.

Similarly, FIFOs serve the trend to greater partitioning

of design tasks among people and teams, expediting the eventual interfacing of subsystems and components simply and economically.

Ultimately, the measure of a FIFO like Sharp's new 36-bit bidirectional LH5420 — the first and only true system-level FIFO to date — is how little time, money, board space and special attention it gobbles up during the hardware development process.

As a low-profile supporting player, the feature-packed LH5420 is a huge success — proof that FIFOs are alive and well, and — given the decidedly less glamorous alternatives — just the stuff which the no-nonsense design environment of the '90s is meant to build on.

**THE SHAPE OF THINGS TO COME**

**PRICELESS PREVIEWS.**

The latest issue of Sharp's Memory Data Book includes several "sneak previews" of Sharp memory components now under development: a 32M Mask ROM, for example — the world's largest; a 1024 x 36 unidirectional FIFO with the most fully synchronous

feature set available; and a 20 ns Static RAM in a 64K x 18 configuration. For your free copy of the '91/'92 Memory

Data Book, or for other information about Sharp IC, Opto and LCD components, call your regional Sharp office listed at right.



**N. American Headquarters:**

Camas, WA  
Ph (206) 834-2500, Fax (206) 834-8903

**West**

Northern CA: San Jose, CA  
Ph (408) 436-4900, Fax (408) 436-0924  
Southern CA: Carson, CA  
Ph (213) 637-9488, Fax (213) 631-2945

**Central**

Texas: Irving, TX  
Ph (214) 929-0999, Fax (214) 929-0958  
Texas: Houston, TX  
Ph (713) 955-9909, Fax (713) 955-9910

**Midwestern**

Illinois: Romeoville, IL  
Ph (708) 759-8555, Fax (708) 759-6319

**East**

Northeast: Burlington, MA  
Ph (617) 270-7979, Fax (617) 229-9117  
East Coast: Lawrenceville, GA  
Ph (404) 995-0717, Fax (404) 995-0622  
Canada & Upstate NY: Fairport, NY  
Ph (716) 223-5141, Fax (716) 223-0930



# INSIGHTS

FROM SHARP

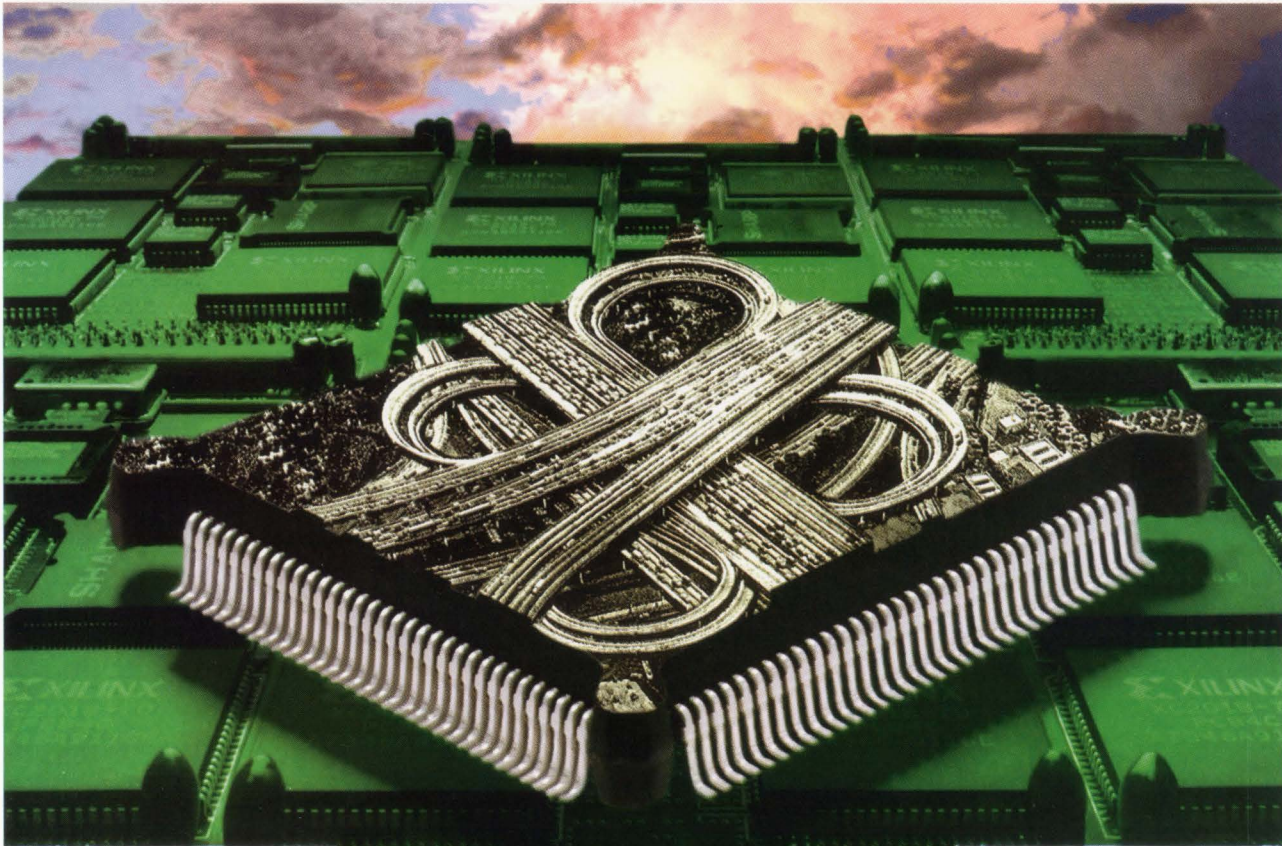

## NEW 36-BIT FIFO MERGES MOST-ASKED-FOR FEATURES.

Variouly described as “data accordions” or “logical rubber bands,” FIFO (First-In, First-Out) memories serve as data buffers between different CPUs running at different speeds, or between controllers and their peripheral equipment. This data-rate-

matching capability provides an ideal thoroughfare between independent, intelligent processors of differing word widths and/or clock speeds.

Now, Sharp's new 36-bit synchronous, bidirectional LH5420

represents the evolution of FIFOs from byte-sized to system-wide solutions. No longer a mere piece part, the LH5420 handles system-level problems, allowing even the most high-performance

systems to be interconnected by efficient data “superhighways.”

Designed to meet the wish lists of top system designers, the LH5420 offers bidirectional, two-way “funneling/defunneling” from a 32-bit bus to a 16-bit or an 8-bit bus, with two-way parity checking built in.

Fully synchronous, the 36-bit LH5420 also is able to provide full-word-width, two-way communications between most 32-bit processors.

By replacing eight or more standard byte-wide FIFOs, the LH5420 saves real estate, simplifies the design process and accelerates system performance.

Its full-word width helps eliminate the problems of race conditions, metastabilities and speed differentials of side-by-side partial-word FIFOs.

The newest addition to Sharp's broad line of FIFOs — including both small-capacity (“shallow”) and large-capacity (“deep”) buffer memories —

### ANSWERING THE WISH LIST.

**THE LH5420 COMES PACKED WITH FEATURES WHICH DESIGNERS TOLD SHARP THEY WANTED IN A FULL-WORD-WIDTH FIFO, INCLUDING ON-THE-FLY PARITY CHECKING, TWO-WAY MAILBOX COMMUNICATIONS, SYNCHRONOUS REQUEST/ACKNOWLEDGE SIGNALS AND PROGRAMMABLE ALMOST-FULL AND ALMOST-EMPTY FLAGS. IT IS AVAILABLE WITH CYCLE TIMES OF 25, 30 AND 35 NS, AND IN BOTH PQFP AND PGA PACKAGES.**

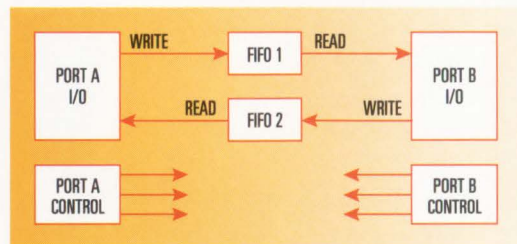

the LH5420 represents the industry's first system-level FIFO, requiring no external glue to integrate. It is available from Sharp for immediate delivery.

**M**ore than half the laptop computers sold in the next decade, rather than rely solely on a keyboard, will be pen-, or stylus-based, or use both a stylus and a keyboard, experts say. To stay abreast of that trend, a conference on pen-based computing will be held in Boston, Mass., May 4-5, 1992 at the Sheraton Boston. Keynote speakers include Ed Yourdon, a pioneer in structured systems analysis, Portia Isaacson, of Dream Machine Inc., and Kirk Cruikshank of Grid Systems Inc. Besides product demos, the conference, sponsored by Digital Consulting Inc., will focus on hardware, user/applications, software, management issues, and communications. For more information, contact DCI, 204 Andover St., Andover, MA 01810; (508) 470-3880. CIRCLE 451

## TALES FROM THE SKUNK WORKS

**T**he subtlety, uncertainty, rapid change, and chaos surrounding a skunk works requires the most fundamental and rigorous trust possible. This is true both between and within teams. In North America, we don't do well at trusting, collaborating, or working together. Our national divorce rate and the success rate of business teamings are tragedies.

The industrial decline in the U. S. further undermines trust. It doesn't help when CEOs pay themselves large salaries while laying off loyal workers. Lean and mean corporations are no substitute for having the right products.

A skunk works requires that we create trust and interdependence. Unfortunately, our home training, schooling, and corporate experience largely neglects these things. Our government is rife with bureaucratic bungling and distrustful, divisive attitudes.

I have discovered through painful life experience that there are three essential components to trust. These are rare, but a skunk works needs all three. The first component of trust is, of course, honesty. A recent national survey showed that 97% of those polled admitted lying. Some 61% admit regularly lying to their bosses.

Another poll showed that while 87% of employees consider management honesty and ethics essential, only 39% believe their management is. And attempts to deceive are increasing, say experts.

An organization that wants a skunk works needs integrity. Punishing deceit is best—or at least let's refrain from rewarding it.

The next component is competency. However honest you may be, I cannot trust you unless you are also competent. We screen and groom well for competency in technical areas. We need to do it better for marketing gurus and small team leaders.

The last component is psychological balance. If you are honest and competent—but emotionally distorted—I must set limits to my trust. Creative people are sometimes eccentric. Some allowances can be made for colorful personalities, yet deadlines must be met. We've all known sincere, creative people who are incapable of ever finishing a product. How about a competent, candid contributor who views the world as out to get her and is always predisposed to fight? What of engineers who take undue credit?

A senior VP I know of in a large corporation overtly and pathologically hated all marketing people. He nearly killed his company. Over a decade it wasted almost a billion dollars of R&D.

The firm often had "killer" technology, but it consistently lost to competitors with better market fit, cycle time, cost, and quality. The company preached empowerment, skunk works, market focus, and multidisciplinary teams, but the VP retained control and destroyed such practices ruthlessly. Before the firm "retired" him, it became notorious for technical arrogance, missed opportunities, annual layoffs, and management turnover.

Winners demand integrity, set limits, tolerate diversity, and compensate for human frailties. If you reward the entire team based on results, the team will help you with trust issues. The team itself knows better than outsiders who is trustworthy and contributing value.

*John D. Trudel lectures and provides business development consulting. Trudel is founder and director of The Trudel Group, 52001 Columbia River Hwy., Scappoose, OR 97056; (503) 690-3300; fax (503) 543-6361. He is also the author of High Tech with Low Risk. To order High Tech, phone Eastern Oregon State College at (503) 962-3755.*

## DID YOU KNOW?

... that the U. S.-Japan semiconductor trade agreement signed last June is on the verge of failure. With nine months left for the U. S. to achieve a 20% foreign market share in Japan, market share stands at 14.3%, where it stood in the first quarter of 1990.

... that a national opinion poll by the Roper Organization shows that 73% of Americans think the government should take a stronger stand against foreign companies that don't open their markets to American goods. Two-thirds of those polled support economic penalties against countries with closed markets, even if it means paying higher prices for consumer goods. Only 23% of those polled are satisfied with the response of the Japanese government to these trade issues.

Semiconductor Industry Association

... that 10 years ago, overseas sales of Taiwan information products amounted to just US\$105 million. By 1990, sales of these products were worth US\$5.25 billion. Today, motherboards made in Taiwan accounted for 66% of world production in 1990. Taiwan is the largest producer of mouse units, snaring 72% of the world market in 1990. Keyboards, color monitors, graphics cards, and scanners from Taiwan each cornered about one-third of sales volume worldwide.

China External Trade Development Council

## ON THE DEFENSE FRONT

**A**ctual design files of military defense system customers are available from Target Marketing, a market research and consulting company. Files identify component parts designed into military equipment by prime and subcontractors as required by the Department of Defense. Component use can be identified by program, part type, part numbers, and contractor.

With the files, users can perform flexible searches of contractor's design files to pinpoint sales opportunities and size up the competition. The service covers more than 2000 active programs. Files come in book, tape, or floppy-disk format. Among other military/defense products, the company has a list of key contacts in defense programs. For more information, contact David Trotz, Target Marketing, 1308 Centennial Ave., Suite 266, Piscataway, NJ 08854; (908) 424-0551; fax 424-0552. CIRCLE 452



# SAFETY IN NUMBERS.

## 150 DESIGN KITS FROM 35 ASIC VENDORS.



If you're an ASIC designer, DAZIX has the numbers you can count on.

Our ASIC design environment lets you choose from over 150 design kits from 35 major ASIC vendors. These kits contain the libraries, models, and interfaces you need for fast, accurate design and simulation of PLDs, FPGAs, gate arrays, cell-based, and full custom ASICs. And by giving you a large number of ASIC vendors to choose from, we expand your design options and help you increase control of your design process.

Within our ASIC design environment, you can select a variety of technologies — including CMOS, HCMOS, bipolar/ECL, and GaAs. Plus, you can



combine different technologies, devices, and vendors. And there's just one design suite and one icon-driven interface to learn, so you won't need to retrain as you migrate from foundry to foundry, project to project, and device to device.

What's more, once your ASIC design is completed, it can be integrated directly into your PCB, hybrid, and MCM designs.

Call for free ASIC catalog. To learn more about how DAZIX can make your ASIC design job easier, call for our newest catalog, *ASIC Design Solutions*.

In the U.S., call 800-239-4111. In Europe, fax 33-1-4537-7135. In the Asia Pacific area, call 852-8661966.



# DAZIX®

An Intergraph Company

DAZIX® and Intergraph® are registered trademarks of Intergraph Corporation. Other brands and product names are trademarks of their respective owners.  
Copyright 1992 Intergraph Corporation. Huntsville, AL 35894-0001. DDAD052A0.

CIRCLE 144 FOR U.S. RESPONSE

CIRCLE 145 FOR RESPONSE OUTSIDE THE U.S.



## PEASE PORRIDGE

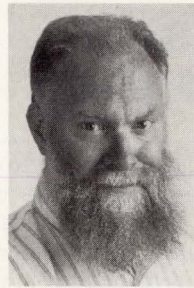

# BOB'S MAILBOX

### Dear Mr. Pease:

I have been able to tolerate your vilification of Spice as that of an uninformed user. However, your publication of a letter from another such user forces me to respond.

Check the words leading to the acronym Spice sometime. A review of the original treatise by Vladimirescu and Liu might be informative. See anything about board design? If you are going to use a tool for a purpose other than what it was intended for, you had better understand how to apply it. The custom *Integrated Circuit* designs that I have done performed as well or better than indicated by Spice simulation.

There is no reason Spice can't be used for board design, if you pay attention to how the program converges, and why it converges to a particular solution. Any professional who uses public domain versions gets what they deserve. The program was developed for those of us that *can't* breadboard a design, not those so foolish not to.

**KEVIN J. McCALL**  
*Custom Analog IC Design Engineer*  
*Leominster, Mass.*

*What irritates me is when people say I am uninformed and Spice has to be telling the truth—when the truth turns out to be vice versa. I'm delighted Spice works for you.—RAP*

### Dear Bob:

I particularly enjoyed your article last year about your calibrated card-board boxes. I work for a well-known temperature-controller company. We were having customer problems with C-type thermocouples and chasing every last tenth of a degree. Needless to say, it wasn't the customer's fault or our fault—the compensation cable didn't match the thermocouple table. It turned out that the errors of an earlier instrument matched the bad cable better than the new one that had smaller errors!

...However, my fingers started to rattle the keys after reading one letter in your mailbag. Namely the guy from

Boeing looking for some strain-gauge power supplies.

Well, "my own bit on the side" just happens to be precisely that. I sell them, at the recommendation of our National Physical Laboratory, to people wanting very high stability for precision force measurement. Now, I took a lot of care to develop a circuit that would give Kelvin buffering to both the positive and negative outputs, and add minimal errors to the basic reference.

I haven't taken that much care over the noise immunity and earthing that Mr. Iverson is looking for. However, I've checked a few details and can quite easily get shielded transformers specially for him. So if anyone else is after stable 10-V power supplies—mine will put out up to an amp, making it a good laboratory reference, too. Please pass them my address.

And now while I'm writing to you, here's a poser that bemuses me. If I, as an engineer, wish to start up my own business at home while working for someone else, it causes all sorts of chaos. "Company loyalty, design rights, conflict of interests"—you name it and it's there. But now, if having left that company, I apply to a new company for a job, and openly declare my own private business, I'll be greeted by enthusiasm. "This man has initiative..."

**JIM EDWARDS**  
*Quiet Electronic Designs*  
*60 Clayton Rd.*  
*Selsey, Sussex PO28 9DF*  
*Tel: (0243) 602132*

*That's a good conundrum. Thanks for the info on good supplies.—RAP*

### Dear Mr. Pease:

I enjoyed the Pease Porridge about splices in speaker wire. It reminded me of the philosopher Paul Thagard's essay about astrology. He says the thing that really marks astrology as a pseudoscience is not that astrologers don't *know* why it should work; it's that they don't care why it should work.

The same could be said for the

speaker-wire cult. If these people had really found an empirical correlation between splices and poor audio quality, they'd be scrambling to find a physical explanation. But no. Like Peter Pan, "ya gotta believe" (and, in this case, pay money).

**MICHAEL A. COVINGTON**  
*Assistant to the Director*  
*The University of Georgia*  
*Artificial Intelligence Programs*  
*Athens, Georgia*

*A good point, nicely worded.—RAP*

### Dear Bob:

Re: What's All This Reflex Response Stuff, Anyhow? ...This is in response to dropping a very small important item (also valuable in terms of inconvenience if lost), such as a 1-mm left-handed screw from a "grungle plunger." Don't try to catch it or deflect it. *Just watch where it goes!*

The reason? Small items often bounce and roll a long way. If you lose sight of it, it can take a frustratingly long time to find because it's small.

**JOHN FLEMING**  
*Research technologist*  
*Department of Midwifery*  
*University of Glasgow*  
*Queen Mother's Hospital*  
*Glasgow, Scotland*

*In your business, when you drop something, you darned well better watch to see where it rolls! —RAP*

### Dear Bob:

Sometimes I have a hard time getting my colleagues to take a simple path to an end. But if I remember correctly, you are currently collecting other people's common-sense stuff for your next book. I know I will have more luck getting my cohorts to try this trick if it appears in your book first. So please accept this widow's mite.

People who design electronic projects often need to be concerned about temperature. Hot spots accelerate degradation of materials and thereby cause premature (whatever that means) failure. So how do we find hot

## PEASE PORRIDGE

spots? If we really care about temperature uniformity, for example in a precision analog instrument, we set up a tangle of thermocouples on a sacrificially modified prototype, and wait. A long measurement period in which we collect lots of data is followed by hours of disagreeable evaluation, culminating in dubious conclusions.

If all we want to do is find hot spots, though, we can use a simpler approach — liberal use of mercury-in-glass fever thermometers. Fever thermometers have a number of favorable characteristics for surveying hot spots in electronic systems.

First, remember how you have to initialize a fever thermometer? It's a

peak recorder. You have to shake it down to the arrow points before you use it. You can shake down a few thermometers and then leave them in the system for as long as you like. You can operate the system in all its various modes, some of which certainly generate different temperature distributions than others.

At the end of the exercise you simply take the thermometers out and look at them, and learn what the worst peak temperatures were in all of the spots you monitored. There is no excess data to discard.

Second, the fever thermometer's temperature range, 94° to 106°F, is near ideal for surveying commercial equipment. By testing your equipment at room temperature ambient, you can learn about an internal 25° to 35° rise. If it turns out to be less than 25°, it's safe and you don't care to know any more about it. If it's more than 35°, you need to understand it better and will want to investigate it in more detail.

Third, a fever thermometer is self-contained, tiny, and (unless you break it) electrically insulative. You can insulate it right where you want it and secure it with sticky tape. Compared to the average thermocouple wire, a glass thermometer is an easily tamed instrument.

Fourth, the mercury bulb of the fever thermometer offers a small, well-focused sensitive target. If located in a convective plume above a heat sink, a fever thermometer will give a surprisingly high (but accurate) reading.

If you think you want a larger target to average over a larger area, wrap the bulb end of the thermometer with several thicknesses of 1-in.-wide aluminum foil, and insulate with clear tape before installing in the system. Or, survey the plume with three or four thermometers all at once.

**DOUG RAYMOND**

*Teradyne ATWC  
Walnut Creek, Calif.*

*The temperature of a hot spot is the room ambient plus its rise above ambient. If you want to resolve large rises, work in a cold room. To resolve small rises, start in a warm room. So, your thermometers are even more useful than at first glance.—RAP*



### Just One Of The 50 Million Americans Who Invests In U.S. Savings Bonds.

More and more Americans are planning for their children's future with U.S. Savings Bonds. This little slugger gets one for each birthday. As he grows older, his Bonds grow in value. So he's not just getting a gift, he's getting an investment. For more information, call 1 800 4 US BOND.



**U.S. Savings Bonds**

Making American Dreams A Reality

A public service of this magazine

## New Dimensions for On-Board Power

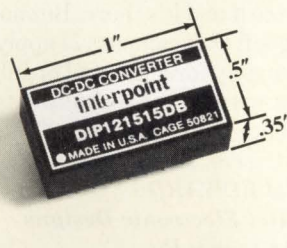
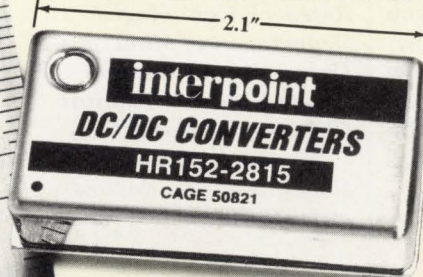

#### HR150 DC-DC Converters

- Up to 20 W output and 82% efficiency
- 18 to 36 or 10 to 16 Vdc input
- 1, 2 or 3 outputs at +5, ±12, or ±15 Vdc
- Regulation: line = 0.1%; load = 0.2%
- Stock, from \$128 (qty. 100)

#### DIP DC-DC Converters

- Up to 1.5 W output and 82% efficiency
- 3 to 7, 9 to 15, or 16 to 32 Vdc input
- 1 or 2 outputs at +5, ±12, or ±15 Vdc
- Regulated, unregulated, or mixed
- Stock, from \$51 (qty. 100)

Save board area! Interpoint's low-profile industrial DC-DC converters use as little as 1/3 the area of the power supplies you're using now. Over 90 models rated at 1 to 30 watts.

**interpoint**

Call to order: 800-822-8782

10301 Willows Rd., Redmond, WA 98073-9705

CIRCLE 256 FOR U.S. RESPONSE  
CIRCLE 257 FOR RESPONSE OUTSIDE THE U.S.



2. Electronic Load



3. Voltage Source



4. Power-Pulse Generator



5. Current Source

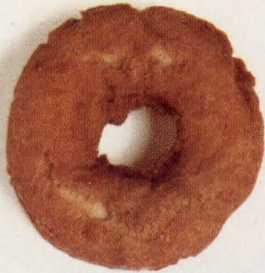

6. Power-Function Generator



7. Direct-Coupled Amplifier



8. Variable-Gain Amplifier



9. Fast-Slewing Power Supply



10. DC Amplifier



11. AC Power Supply



12. Differential Amplifier



13. Signal-Inverting Amplifier

## The BOS/S. A baker's dozen worth of functions in one tasty package.

**The versatile Bi-polar Operational Source/Sink power supply with a full complement of features.**

The BOS/S can satisfy even the most demanding power supply appetites. It delivers four modes of operation: a bi-polar supply, operational supply, sourcing supply and sinking supply. In

addition to delivering DC power, it also gives you the dozen functions you see above. And like any product from Electronic Measurements, the BOS/S is a breeze to use.

The BOS/S. When it comes to versatility any other power supply is just half-baked.

For details, contact:

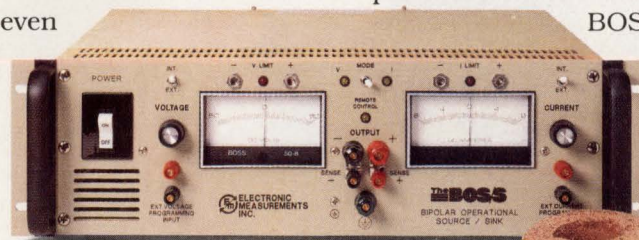

1. DC Power Supply



**ELECTRONIC MEASUREMENTS, INC.**

405 Essex Road, Neptune, NJ 07753 • Telephone: 908-922-9300 • FAX: 908-922-38334

CIRCLE 260 FOR U.S. RESPONSE

CIRCLE 261 FOR RESPONSE OUTSIDE THE U.S.

# EXPRESS YOURSELF!

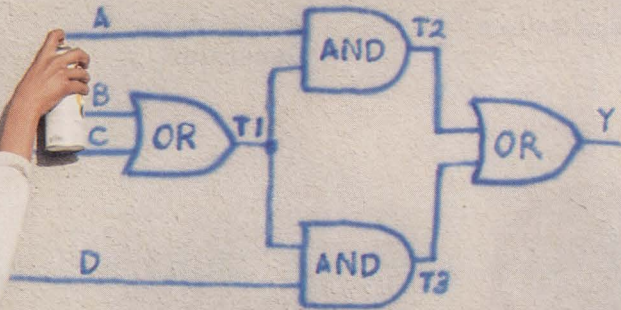

I/O. IO  
ITS OFF TO  
WORK I GO

BOOLE  
RULES

A	B	A AND B
0	0	0
0	1	0
1	0	0
1	1	1

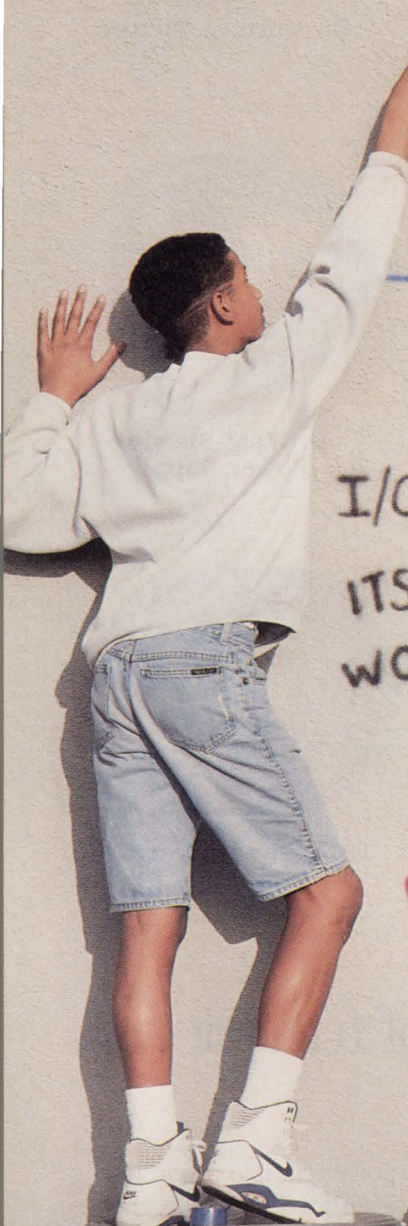

# WITH PROGRAMMABLE LOGIC DESIGN TOOLS

Many people would tell you that expressing logic for a programmable chip is not art. You know better.

Getting the function you need out of the best programmable logic device (usually the cheapest that will do the job) takes craft, skill . . . art.

Just as the painter with the most colors of paint has the most ways of expressing his thoughts, OrCAD's Programmable Logic Design Tools offers more ways for you to express your logic.

Every PLD compiler on the market offers Boolean equations as a form of input. But, OrCAD's offers Boolean algebra with a twist: arithmetic notation (+, -, \*, ÷). Think of the ways you could use them.

And OrCAD Programmable Logic Design Tools offer indexed equations. Imagine taking rows of similar Boolean equations and expressing them all in one or two lines of code.

Some other compilers allow you to express your logic in the forms of truth tables or state machines. We offer both. Plus forms of logic synthesis we call numeric mapping and streams for special cases.

Best of all, you can use more than one type of expression within one design. This gives you a variety of expression impossible before now.

And because its from OrCAD, Programmable Logic Design Tools allows the form of input you would

expect from the maker of the world's most popular EDA tool: schematic entry.

Schematic Design Tools Release IV and Programmable Logic Design Tools were designed to work seamlessly together. The result, unified documentation. The code for your programmable device resides right there on the schematic next to the graphic of the part. Include Digital Simulation Tools and you can perform a timing based simulation of your entire board design including any number of programmed PLDs.

Its the productivity you need at a price you can afford.

*Call or write today for a free demonstration disk and guide. It will only take a few minutes for you to see how easy it is to express yourself.*

**OrCAD**<sup>®</sup> 

*The Better Solution.*

3175 N.W. Alcock Drive  
Hillsboro, Oregon 97124

(503) 690-9881 voice

(503) 690-9891 fax

CIRCLE 182 FOR U.S. RESPONSE

CIRCLE 183 FOR RESPONSE OUTSIDE THE U.S.



# Designing For

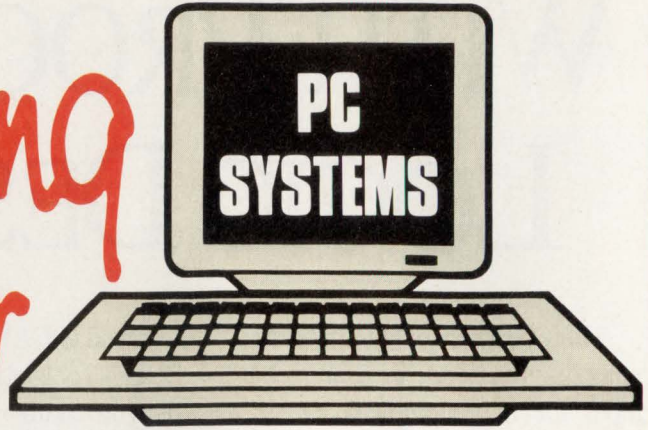

## LOW-VOLTAGE AND FASTER 486s DEBUT

TAKING AIM AT HIGH-performance portable and desktop systems, designers at Intel Corp., Santa Clara, Calif., released the first 3.3-V versions of the i80486DX and SX microprocessors, as well as the long-awaited clock-doubler version. The lower operating voltage trims power consumption by 30 to 40%. And when additional 3.3-V-compatible logic is used, overall system power consumption can be reduced to allow several hours of battery operation. Moreover, Intel designers expect to incorporate improved power management, based on the SL power-management technology, into future implementations of 486 processors. Limited quantities of the 3.3-V 486SX are available in 16-, 20-, and 25-MHz versions, with volume production planned for July. In quantities of 1000 units, the 16-MHz version of the processor sells for \$174 and the 25-MHz unit goes for \$341. DX versions of the processor will be ready for sampling in the second half of this year.

The i486DX2 clock-doubler will be offered initially in a 25-MHz (external) version that operates internally at 50 MHz. The device, which is intended for new systems, fits in the same socket as the 486DX and requires no hardware redesign. However, some BIOS software may have to be adjusted—especially if software timing loops are used. The chip's high internal speed gives the CPU a throughput of about 40 Dhrystones. An even faster version—33-MHz external, 66-MHz internal—will be released later this year. The 50-MHz (internal) version of the DX2 is in production and sells for \$550 each in 1000-unit lots. **CIRCLE 586**

## DOZENS OF SYSTEM MAKERS TO USE DX2

ON THE HEELS OF Intel Corp.'s release of the clock-doubler version of the 80486, almost two dozen system makers have released speed-upgrade versions of their desktop computers. Acer America Corp., San Jose, Calif., for instance, created a novel variable-speed oscillator and autosensing BIOS that will detect which CPU has been installed and adjusts the system to operate at maximum performance levels. With the "ChipUp" scheme, the company can build a common base system and just install the proper CPU module to hit the desired price/performance mark. Systems with "modular" architectures and full motherboard architectures can also

be easily upgraded.

In addition to IBM Corp.'s upgrades to its Models 90 and 95 PS/2 systems, commitments from Advanced Logic Research Inc., Irvine, Calif.; American Megatrends Inc.; Norcross, Ga.; AST Research Inc., Irvine, Calif.; Compaq Computer Corp., Houston, Texas; Dell Computer Corp., Austin, Texas; and many other desktop system makers indicate the wave of interest in offering higher-performance alternatives to cost-conscious power users. The DX2 clock doubler device was also incorporated into departmental systems like file servers—Apricot Computers Ltd., Birmingham, U.K., for example, has released a version of its fault-tolerant FT server with the clock-doubler CPUs. **CIRCLE 587**

## FRAME-BUFFER GRAPHICS COMES TO PCs

TO IMPROVE THE SPEED of graphic displays, Chips and Technologies Inc., San Jose, Calif., turned to the Apple Macintosh and workstations for an architectural solution already in use by those platforms. The company's Wingine chip set implements a frame-buffer interface that delivers several times the speed offered by other VGA accelerators. The 64200 accelerator and the 64201 glue chip (for the Peak/DM motherboard logic chip set) require a "rethinking" of the system architecture because they're intended only for new motherboard designs. They do, though, allow designers to maximize the transfer rate between the microprocessor and the video memory subsystem. By employing a memory architecture in the main memory that divides the storage into standard DRAM and moderate-speed video RAMs, data-transfer rates can hit 20 to 30 Mbytes/s—four to six times those of the AT bus. And because the data-transfer speed is tied directly to the CPU speed, graphics response improves as well when higher-speed CPUs are substituted.

The first Wingine version supports 72-Hz refresh rates and 1024-by-768-pixel by 256-color displays, as well as the emerging 64-kcolor standard. With the two-chip set, designers at Chips and Technologies estimate that building a video control subsystem will cost about the same or less than current accelerator schemes. In large volumes, the 64200 accelerator chip sells for \$18 each, while the 64201 glue chip goes for \$7 each. For more information on the Wingine chip set, Contact Chips and Technologies at (408) 434-0600. **CIRCLE 588**

# LOCAL BUS SPEEDS VIDEO

**L**ocal-bus connections are making waves as a method to increase video performance. By using a local bus rather than the existing ISA, EISA, or Micro Channel Architecture (MCA) system bus, data can be passed at a higher speed without any conflict from other signals being passed on the system bus. The local bus' popularity has raised a few eyebrows among those concerned with system compatibility, because many companies are implementing proprietary local-bus schemes. Hence, the Video Electronics Standards Association (VESA) has formed a committee to standardize a local-bus connector and device interfaces across ISA, EISA, and MCA platforms.

Over the past year, such vendors as CompuAdd, Dell, Micronics, NEC, and Orchid Technologies have released proprietary local-bus motherboards and graphics adapters. Systems implementing a local bus often report a 400% to 600% increase in graphics performance over standard configurations. Local-bus-based systems are receiving more attention because they improve performance in Windows 3.0, AutoCAD, X-Windows, and other graphics-based environments. However, because these systems are proprietary, there's no aftermarket for future expansion and no assurance of overall compatibility. The VESA local bus, dubbed VL-Bus, addresses these issues head on.

Some considerations were made while forming the VL-Bus standard, including ease of implementation, flexibility and reliability, compatibility, mechanical stability, and cost effectiveness. The goal is for end users to be able to buy any VL-Bus adapter board that can plug into their systems without any configuration concerns. VESA directly solicited and invited the participation of CPU, coprocessor, controller, network, and compression chip vendors to ensure compatibility of a wide variety of local-bus peripherals. This resulted in participation of over 40 member companies, including Cirrus Logic, Everex, Micronics, and Tseng Labs.

Currently, up to three devices are supported on the VL-Bus. These devices can reside on an add-in adapter card or directly on the motherboard. Each device or slot is optimized for a 32-bit data path while allowing bus sizing down to 16 bits. This protocol offers an open environment for the most widely available and cost-effective 16-bit devices, and it defines a clear path for future 32-bit devices.

Signals provided on the VL-Bus can implement a local-bus device without accessing the standard I/O bus. However, the option of using standard I/O bus signals is clearly defined. At the device level, this allows for easier, less expensive implementations, because components that don't directly benefit from local accesses can be placed on the I/O bus. For example, rather than use four EPROMs for the BIOS on a purely local device, designers can route BIOS calls through the I/O bus and eliminate two EPROMs. A

second application might employ a conventional 16-bit digital-to-analog converter on the I/O bus while the graphics controller sits on the local bus.

The VL-Bus connector is a standard 112-pin MCA type that lines up directly with the ISA/EISA/MCA slot connectors. Pin One of the VL-Bus slot connector is 1/2 in. from the last pin of the ISA/EISA/MCA slot. This connector supplies the lowest cost and the best electrical characteristics for signals up to 66 MHz. Moreover, local-bus adapter boards can utilize the ISA/EISA/MCA signals as needed while using the extra slot length for greater mechanical strength.

The maximum size of the adapter board is the same as the form factor of the IBM PS/2 Model 30 add-in card. Hence, the VL-Bus adapter fits into slim-line as well as standard-size cases. The three local-bus slots can be aligned with any of the system slots. However, it's recommended that the VL-Bus slots are aligned with the system slots closest to the CPU. At high frequencies, the distance from the slots to the CPU can affect performance. The larger the distance, the greater the degradation in performance.

Up to three bus masters, other than the CPU, can be supported by the VL-Bus. The bus master and the target can both reside on the VL-Bus, or one or more can sit on the I/O bus. A VL-Bus device can communicate with any DMA slave or ISA/EISA/MCA bus master.

The VL-Bus is optimized for 80386 and 80486 CPUs because the signals are closely matched for these processors and their 32-bit data path.

Provisions have been made to expand to a 64-bit data path as those processors become available.

The VL-Bus can operate at speeds up to 66 MHz and supports systems that can dynamically switch CPU speeds. Support is also included in the VL-Bus specification for future CPUs that will operate at higher clock rates.

Although the VL-Bus standard is comparatively robust today, allowances for future expansion have been made. These include expansion to multiple processors, additional interrupts, and widening of the data path. To accommodate future signals, the connector can be extended with a 32-bit MCA connector. Any future VL-Bus extensions must be downward compatible with previous revisions.

The maximum bandwidth of the VL-Bus specification is 133 Mbytes/s at 66 MHz. This contrasts a maximum transfer rate of 5 Mbytes/s on an ISA bus or 33 Mbytes/s on EISA or MCA systems. The bandwidth will supply the horsepower needed today, as well as for tomorrow's high-performance graphical environments.

The VL-Bus specification is complete, and will be formally ratified by the full VESA membership as soon as modeling and verification are done (sometime during the summer). For more information on the VL-Bus or other graphics-related issues, contact VESA at (408) 435-0333.

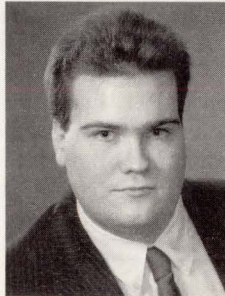

RON McCABE  
TSENG LABS

# Evaluating the Communications Performance of Your Next Board Design

*Limitations from physical media, system bus latency, and software may hinder communications speed.*

BY ROBERT W. O'DELL

Motorola Inc., MS OE216, 6501 William Cannon Dr. West, Austin, TX 78735-8598; (512) 891-2000.

**T**ake a look at your last board design. Was it an island of computation, or did it communicate with the outside world? Whether you designed a PC add-in card or a motherboard, it's likely that some form of data communications had to be dealt with.

Of course, data communications problems aren't limited to PCs. Even if your last board was for embedded control, it probably communicates with other boards, or systems, or has options for doing so. Who would deny that a critical function in a laser printer's design is its need to link to a personal computer or local network, via Ethernet, AppleTalk, Centronics, or UART?

So, given the fact that communications exist on most board designs, the question you must ask yourself on each new project is: Will this solution meet the communication performance goals? The answer can be obtained in terms of three factors—physical media limitations, system bus latency and throughput limitations, and software limitations. This article looks at these limitations to see how they can be used to evaluate a board's communications performance, and differentiates their effectiveness for low- and high-speed communications.

This article uses Motorola's MC68302 Integrated Multiprotocol Processor as an example of low- and medium-speed communications. It contains an MC68000 core, general-purpose peripherals, and three serial communications channels (SCCs). It's currently being employed in PC add-in cards for such applications as V.32 modems, as well as embedded control applications such as laser printers.

Motorola's Fiber Data Distributed Interface (FDDI) chip set is used as an example of high-speed communications. It can connect PCs and workstations to the emerging FDDI local-area networks (LANs), as well as in other embedded applications, such as concentrators and bridges. Regardless of the application, however, the principles are the same.

As a design engineer, you know what it's like to try to meet the performance goals of the board. Often these goals are generated from the marketing group. Everyone is counting on you to create an architecture that meets all of the functional and performance requirements. This would be easy except for that "it's got to be as cheap as possible" item lurking near the top of the list, not to mention that unbelievable schedule required. Most projects start with these things in common, but once beyond this point, the approach from designer to designer and company to company diverges immensely.

For instance, if you're lucky, you might have a performance evaluation model to simulate the devices' behavior. This could take the form of specific component software models that you use to run code on a simulated board made from a library of components. Similarly, hardware models are available that can simulate one or several chips' performance using the actual component. Typically, though, you won't use these models until after you've committed to a given solution and started the actual board design. In fact, these models may never be used.

**O**ther types of behavioral models can also work at a high level to quickly generate analysis. In fact, the brave might even generate their own model in C. Typically, though, it's not possible to do such a thorough analysis before making a decision. There never seems to be enough time to get the board out the door, much less play around with modeling decisions beforehand. It may actually be wisest to take the time beforehand, but convincing your boss of that can be another story altogether.

Therefore, most designers are left to make the decision using their experience, the experience of other company projects, and a healthy safety margin. The marketing group will clamor to your desk if the performance goals aren't met, but will they ever know if you could have met the goals with less

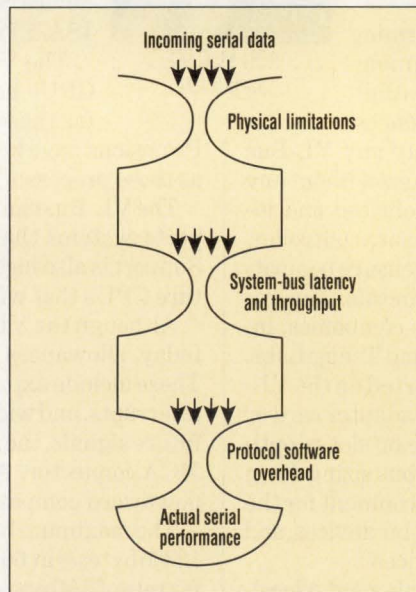

1. Whether the design is for a PC add-in card or for embedded control, the triple-bottleneck model serves as a guide to estimating the serial throughput. The throughput of the board's communications section is gated first by the physical media, second by the system-bus latency and throughput, and third by the software-protocol overhead.



WAS THERE *some special*  
*reason we produced*

*The*

WORLD'S

F I R S T

16 *meg*

D R A M ?

Y E S *there was.*

T O L E T

*you*

C H A N G E

*the*

W O R L D .







Samsung began shipping DRAM chips in the new 16M density—in production volumes—during 1991. Our customers for the product include many of the world's premiere computer and workstation makers.

They tell us we are the first supplier to complete this next generation of memory.

We, in turn, see it as a significant milestone in the global effort toward elegance and power in computing.

Of equal significance, Samsung's completion of the generation marks something of a transformation in the worldwide map of supply. And we believe consumers

of electronic components will benefit from this.

Yet perhaps most important, is the fact that the 16-meg will indeed help the electronics community—in the U.S. and elsewhere—to do nothing less than change the world.

The new-generation DRAMS are a significant boon to the hugely beneficial technology of today's workstations. Machines that allow us to better comprehend the world, and to

advance in areas as different as medicine and transportation, finance and filmmaking.

The new generation will also, in short order, facilitate ever-more-capable notebook and palmtop computers. Computers that will make us more productive—and will also define the workplace in a

whole new way.

In the near future, more will be heard from Samsung.

We are among the major makers of DRAMS in all organizations and densities, and we are an increasingly major supplier of SRAMS. We make a wide line of fast, ultra-fast, and high-density SRAMS, up to 4M in density and 8 ns in speed. Our specialty memories

include ROMs, VRAMS, pseudo and cache SRAMS, EEPROMs, and FIFOs. And we also build superior ASICs, microcontrollers, MOSFETS, and RAM DACs.

And, of course, in DRAMS, there is always the 64-meg.

About which, we hope to be writing soon.

If we may provide further information of any kind,

please contact us via the coupon at left, or by telephone at 1-800-446-2760.

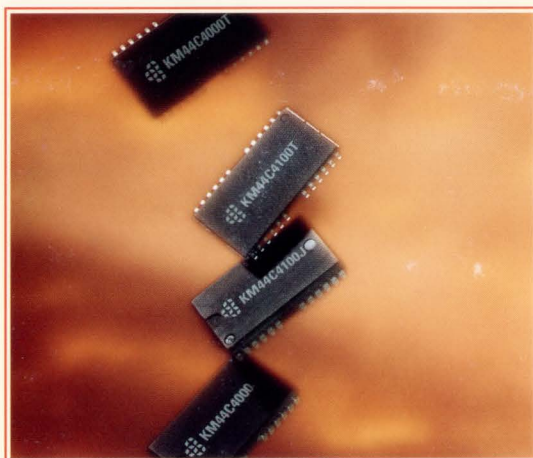

*The world's first 16-meg DRAM.*

Organization	Mode	Speed	Samples	Production
16M X 1	FAST PAGE	60/70/80	NOW	NOW
16M X 1	NIBBLE	60/70/80	NOW	6-92
16M X 1	STATIC COL.	60/70/80	NOW	6-92
4M X 4	FAST PAGE	60/70/80	NOW	NOW
4M X 4	STATIC COL.	60/70/80	5-92	8-92
4M X 4 (WPB)	FAST PAGE	60/70/80	5-92	8-92
4M X 4 (WPB)	STATIC COL.	60/70/80	5-92	8-92

2K and 4K refresh available.

*YES. I want to learn about the next generation of memory. Please send more information.*

Name \_\_\_\_\_ Title \_\_\_\_\_  
 Company \_\_\_\_\_  
 Address \_\_\_\_\_  
 City \_\_\_\_\_ State \_\_\_\_\_ Zip \_\_\_\_\_

Return coupon to Marketing Communications, Samsung Semiconductor, 3725 No. First St., San Jose, CA 95134. Or call:

**1-800-446-2760**



A Generation AHEAD.

# EVALUATING BOARD COMMUNICATIONS PERFORMANCE

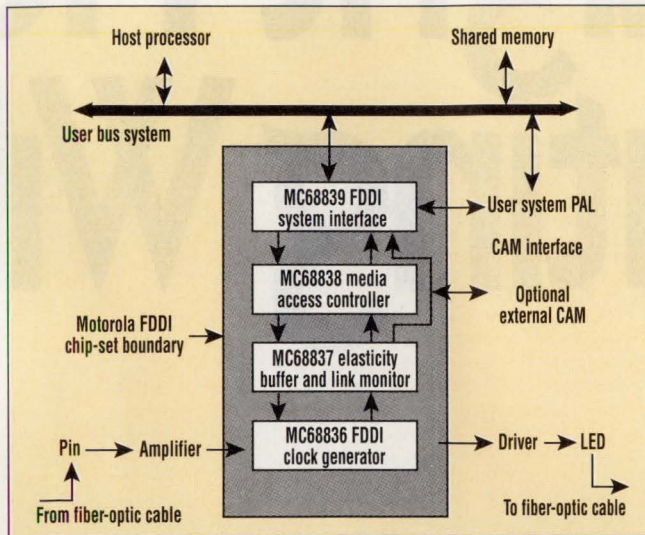

2. The Fiber Distributed Data Interface (FDDI) solution provided by Motorola currently consists of four chips. The MC68836 FDDI clock generator (FCG) connects to the twisted-pair driver or fiber-optic module. The MC68837 elasticity buffer and link monitor (ELM) also performs part of the physical-interface functions. The MC68838 media-access controller (MAC) executes the media access portion of the FDDI standard. Finally, the MC68839 FDDI system interface (FSI) provides the buffering and connection to the system bus.

cost? Probably not. The result is a tendency for you to over-engineer the design, increasing cost to meet the performance goals.

So what steps can be taken to home in more accurately on the performance you can expect? A simple model, called a triple bottleneck model, can help clear up a number of ideas that designers have about the communications performance on their board (Fig. 1). The model illustrates that the throughput of the board's communications section is gated first by the physical media, second by the system bus latency and throughput, and third by the software protocol overhead. What permeates all the way through is the real data communications rate. Actually, the performance of the system is gated by the smallest bottleneck rather than all three. This statement is mathematically expressed as:

System throughput = Minimum (physical, bus, and software performance)

Board designers typically worry too much about physical performance because it's the easiest to deal with. On the other hand, software performance isn't paid much attention because it's not directly related to the hardware. Often, the reverse of these two is a far better scenario.

It should also be pointed out that

these factors aren't truly independent. For instance, increasing the bus performance will usually boost the software performance as well. In another example, increasing the physical performance may cause a faster burst of data to be received, requiring a decrease in the system bus latency. However, let's look at each of the three bottlenecks in more detail before discussing their interdependencies.

The physical performance of the media is the most obvious characteristic of the communications system. It's certainly the most well understood of the three bottlenecks. Depending on your application, the physical performance may not be much of an issue at all. For instance, if you're connecting up to a standard local-area network, such as Fiber Distributed Data Interface (FDDI), you're committed to providing a 100-Mbps connection on your board. In such a case, an FDDI chip set like that from Motorola will be required (Fig. 2).

In the case of a well-defined standard protocol, the only physical performance issue is ensuring that the physical requirements of the connection are satisfied. In a standard LAN environment, the chip vendor will usually supply you with the cookbook solution for making a media connection. If they can't do this, buyer beware—they may not have verified it themselves!

For example, an FDDI solution can be made with the MC68836 FDDI clock generator (FCG) from Motorola (Fig. 3). The FCG is part of the four-chip set for FDDI. The FCG implements the lower portion of the physical layer (PHY) functions of the FDDI standard, including clock recovery, data recovery, and nonreturn-to-zero-inverted (NZRI) conversions. It also does a 5-bit parallel-to-serial conversion during transmission, and a serial-to-5-bit-parallel conversion during reception. The FCG uses the 5-bit parallel interface to communicate with the MC68837 elasticity-buffer-and-link-monitor (ELM) device, and directly connects to fiber-optic modules through differential driver/receiver pins.

If you're making a proprietary connection, however, you may be able to personally choose the data rate of the sys-

TABLE 1: SERIAL PERFORMANCE OF THE MC68302

High-speed channels		Low-speed channels		Comments
Number	Speed	Number	Speed	
1 HDLC	2.8 Mbps	-	-	Buffers in dual-port RAM
1 HDLC	2.2 Mbps	-	-	Buffers in external RAM
2 HDLC	909 kbps	-	-	Buffers in external RAM
3 HDLC	540 kbps	-	-	Buffers in external RAM
1 HDLC	2.2 Mbps	1 UART	62.5 kbps	Buffers in external RAM
1 HDLC	2.2 Mbps	2 UART	3100 baud	Buffers in external RAM
1 HDLC	2.0 Mbps	2 UART	12500 baud	Buffers in external RAM
1 HDLC	2.0 Mbps	1 BISYNC	204 kbps	BISYNC is half-duplex
2 HDLC	869 kbps	1 UART	4100 baud	Buffers in external RAM
3 UART	500 kbaud	-	-	Buffers in external RAM
3 BISYNC	333 kbaud	-	-	Buffers in external RAM
3 DDCMP	266 kbaud	-	-	Buffers in external RAM
1 Transp	2.0 Mbps	-	-	Transparent protocol
2 Transp	869 kbps	-	-	Transparent protocol
3 Transp	571 kbps	-	-	Transparent protocol

# Soon, Eight Ho Computing Will



(actual size)

## AMD Introduces The World's First 386 Microprocessor With 3-Volt Technology.

Two standard dry-cell batteries. There's really nothing special about them. Aside from the fact that they can run a powerful, portable 386 computer for a full eight hours. Provided, of course, that portable is built around a low-voltage Am386™ microprocessor.



The 25MHz DXLV and the 25MHz SXLV are available in POFP packaging.

Thanks to the low-voltage Am386 microprocessors, laptop, palmtop and notebook computer designs will become smaller, lighter, and more powerful than ever before.

With battery life of up to eight hours or more. That's a full day's worth of 386 performance—the per-

# ours Of Portable Look Like This.

formance you need to run sophisticated applications like Windows™ 3.0.

And rest assured, the low-voltage Am386 microprocessors are proven compatible and comply fully with JEDEC standards for low-power, 3-volt computing. We can even supply you with the 3-volt EPROMs your systems will need. Other 3-volt system logic is also readily available.

For more information on the low-voltage

Am386 microprocessors call AMD today at **1-800-222-9323**. You'll never look at dry-cell batteries the same way again.



**Advanced Micro Devices**

*"We're Not Your Competition."™*

# EVALUATING BOARD COMMUNICATIONS PERFORMANCE



tem. For example, in a terminal connection, you may need to provide the option for a connection as low as 300 baud, and as high as 57,600 baud. Moreover, when connecting two systems with a proprietary serial link, a high-level data-link control (HDLC) type of protocol is often used. In such cases, the media speed is arbitrary, and is often chosen by the designer to be between 64 kbps and 10 Mbps.

Higher media speed may accomplish nothing for your connection, and may do more harm than good. If the processor handling the protocol is saturated with work, an increase in the media speed won't help the overall throughput (Fig. 4). In fact, if the protocol doesn't allow for graceful degradation, the actual throughput can actually decrease once a peak is reached. Nevertheless, one may argue that an increase in the media speed may help the response time when one isolated message needs an immediate response. But if software is involved in the response, a point of diminishing returns is reached (Fig. 5). The decision on media speed, therefore, can't be made without consulting the bus and software factors.

Having touched on the physical interface issues, let's move on to the system bus issues—throughput and latency. The bus throughput involves the protocol device moving data to and from memory, still leaving enough time for the software to use the bus in its protocol processing. Bus latency is the delay incurred when the protocol device needs to acquire the bus for a transfer.

Although most of today's new serial devices have built-in direct-memory-access channels, older protocol devices don't, and may not even allow an external direct memory access to be easily used. In such a case, the DMA movement is replaced by software instructions, and the protocol device's bus latency is replaced by the software routines interrupt or polling latency. In any case, the principles are the same.

There are two important goals in bus-performance analysis. The first goal is to analyze the percentage of the bus that will remain for the processor and any other peripherals on the system bus. The second goal is to determine that no underruns or overruns will occur on the protocol devices during operation.

Where do you get such information? Some calculations can be done by yourself, and others may require help from the manufacturer. You can easily calculate the percentage of the bus required by the protocol device during peak periods. This is done as:

$$\frac{[(2 \times \text{Sbps}/8) \div \text{NBPT}] \times \text{NCPT}}{\text{NSBC}}$$

where:

Sbps = serial data rate in bits/s. Sbps is the rate of real data flowing through the serial device to memory. For example, in UART applications, remember that start and stop bits aren't considered real data because they're overhead that's created and stripped by the UART itself. Sbps is then divided by 8 to convert this number into bytes per second. Note that Sbps is multiplied by 2 if the link is full duplex, other-

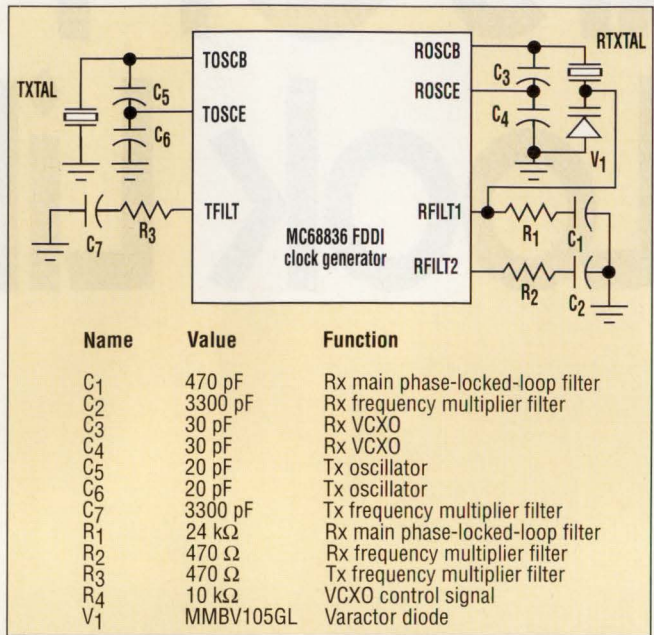

3. This example of a physical-interface cookbook solution for FDDI uses Motorola's FDDI clock generator. Physical-interface issues can be more easily dealt with when a well-known, standard protocol like FDDI is used.

wise it's multiplied by 1.

NBPT = number of bytes per transfer. When data is moved from the protocol device to memory, how many bytes at a time can be moved?

NCPT = number of clocks per transfer. How many clocks does it take to move this data to memory? If no direct memory accesses exist, all software instructions should be counted. If direct memory accesses are used, then the average bus arbitration overhead per transfer should be included in this number.

NSBC = number of system bus clocks that can occur per second.

One typical application for the MC68302 integrated multiprotocol processor might use SCC<sub>1</sub> and SCC<sub>2</sub> to connect to the two B channels at 64 kbps each, with SCC<sub>3</sub> connected to the D channel at 16 kbps (the integrated-service-digital-networks (ISDN) standard defines that B channels be used for voice and data services and that the D channel facilitate the signaling on the ISDN physical interfaces; basic access provides two B channels and a D channel, commonly referred to as 2B + D). This means that Sbps is 64k + 64k + 16k = 144 kbps. Each channel is full duplex.

The MC68302 processor is a 16-bit device, and can move 2 bytes of serial data at a time over the local bus (NBPT = 2). These numbers assume that the add-in card contains a local bus for the MC68302 to operate on, as opposed to the



"When I think about density, a few things come to mind. For example, the Earth is the densest planet in our solar system—5.515 times denser than water. The most densely populated place on the densest planet is Macao, on the coast of China. 479,000 people in an area of 6.5 square miles. Hope they like each other. As for programmable logic, the award for the highest density goes to Altera's MAX 7000. With 1,000 to 20,000 usable gates. And more I/O than any other PLD family. Bye-bye masked gate arrays. That's as dense as it gets. Well, there is Rocko Miller, my old college roommate. 30-inch neck, crushed empty beer cans into his head. You know the type."



They're big. They're fast. They're everything you've asked for. Find out more big news. Call 800-800-7256. **MAX7000**

© 1992, Altera Corporation. MAX is a registered trademark of Altera Corporation.

CIRCLE 82 FOR U.S. RESPONSE

CIRCLE 83 FOR RESPONSE OUTSIDE THE U.S.

# EVALUATING BOARD COMMUNICATIONS PERFORMANCE



system bus of the PC. There are usually three clocks of arbitration for the serial direct memory accesses to acquire the bus, four clocks for a no-wait-state access, and one clock of arbitration following each 16-bit transfer. The direct memory accesses acquire the bus for each 16-bit transfer. This means that  $NCPT = 3 + 4 + 1 = 8$ . With a 20-MHz clock, there are 20M system bus clocks/s available. Thus:

$$\frac{[(2 \times 144 \text{ kbps} \div 8 \text{ bits/byte}) \div 2 \text{ bytes}] \times 8 \text{ clocks}}{20\text{M clocks/s}} = 0.0072$$

Less than 1% of the system bus is required in this situation. Having calculated this for the multiprotocol processor, it makes sense to consider some cost-saving alternatives. First, why not choose cheaper static RAM and add one wait state? Second, the 8-bit bus mode of the processor could be considered. Using this mode means that the 2 bytes of data will have to be moved in two consecutive bus cycles. However, EPROM and RAM width on the board will be saved, potentially saving two chips. With these two changes, the number of clocks per transfer increases from 8 clocks to  $3 + 5 + 5 + 1 = 14$ . The resulting equation gives:

$$\frac{[(2 \times 144 \text{ kbps} \div 8 \text{ bits/byte}) \div 2 \text{ bytes}] \times 14 \text{ clocks}}{20\text{M clocks/s}} = 0.0126$$

Even with the two changes, just barely over one percent of the bus is used.

Modifying the bus will affect processor performance. The 68000 processor on the MC68302 in 8-bit mode is around 60-70% as fast as the regular 68000 under the same conditions, which implies a software performance degradation of around 30-40%. Is that acceptable? Obviously, it depends on the application software that must be run. That will be discussed in detail later.

The above analysis is made assuming there's continuous activity on all three serial channels at the same time. If this isn't true, you can factor these effects into the equation. This isn't really important if the bus utilization is low, as in the previous example. But by using the last equation and running the MC68302 serial channels at maximum speed (an aggregate of around 2.2 Mbps full duplex), the bus utili-

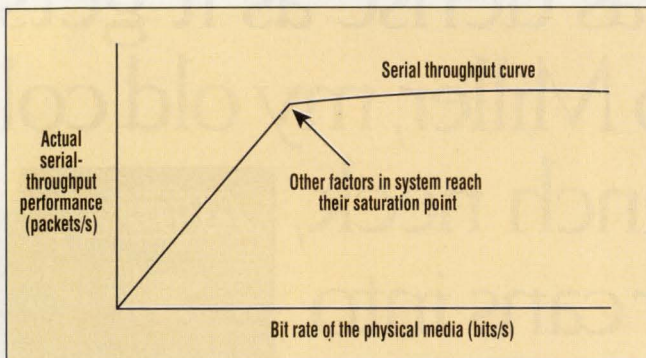

4. Increasing media speed affects overall performance. Regardless of the protocol or system, a saturation point is eventually reached (usually caused by software), after which little or no improvement in serial throughput is obtained.

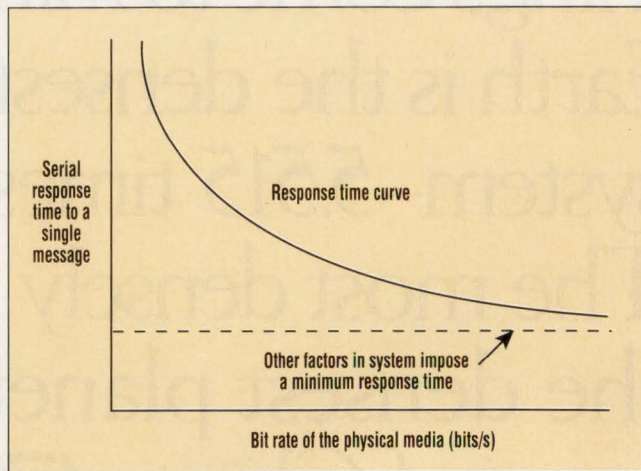

5. An increase in the media speed may help your response time in a situation where one isolated message needs an immediate response. However, the response can involve a number of different steps (like bus cycles, interrupts, and software). If any of those steps have a fixed time associated with them, a minimum response time is the result. Increasing the media speed eventually provides little or no benefit to the system.

zation goes up to 10.5%.

The MC68839 FDDI system interface (FSI) device is designed for much higher speed operation than the MC68302 processor. It moves data to memory either 64 or 32 bits at a time, and can move data in as fast as 1 clock time at 25 MHz (although 2 clocks will be assumed here). The FDDI is a 100-Mbps network, but it's half-duplex because a station can't receive one message and transmit a different message at the same time. Using the previous equation for the FSI in its 32-bit mode, we have:

$$\frac{[(1 \times 100 \text{ Mbps} \div 8 \text{ bits/byte}) \div 4 \text{ bytes}] \times 2 \text{ clocks}}{25\text{M clocks/s}} = 0.25$$

As this equation shows, the FSI will use 25% of the bus during periods of transmission or reception. This is a reasonable figure considering that it only applies when data frames are actually sent to or received from this particular station.

The bus-utilization numbers indicate how much of the bus the processor will have remaining for software tasks. But the second goal in looking at the bus is to determine that no underruns or overruns will occur on the protocol devices during its operation. In most synchronous protocols, once data transmission or reception begins, it's impossible to delay the process. As serial data is received into the protocol device, some sort of buffering is made for the data because there's no guarantee that the system bus will be immediately accessible to the peripheral. On older UART-type devices, this buffer may be just two bytes, known as double buffering. On the MC68839 FSI, supporting 100-Mbps data rates requires more internal buffering. The FSI supports its internal buffering in an 8-kbyte internal RAM shared in various configurations between the receive and transmit machines. On the multiprotocol processor, the buffering depends on the protocol used—either 3 bytes or 3

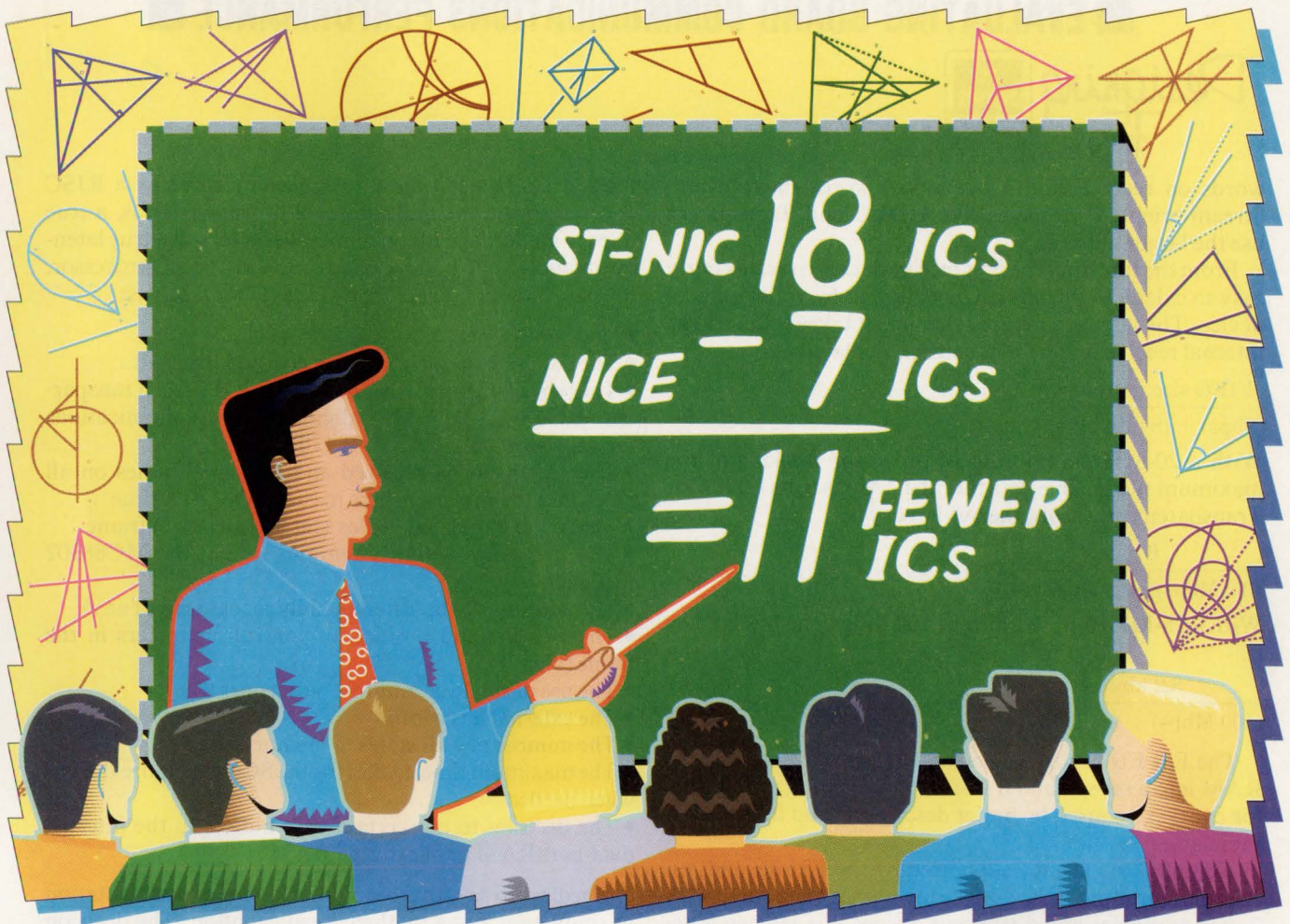

## NICE and simple math exposes the myth of ST-NIC.

It doesn't take a mathematical wizard to see the superiority of the NICE® Ethernet solution from the Advanced Products Division of Fujitsu Microelectronics. We think the numbers speak for themselves.

Our NICE solution, for example, requires far fewer ICs than ST-NIC's so-called single-chip solution — 7 vs. 18\*. And that means fewer passive components as well. Making Ethernet LAN board design easier. Faster. And more cost effective than ever before.

Then, add on another factor — that NICE products are competitively priced — and systems designers clearly have a proven formula.

What's more, the fewer the parts, the smaller the size — and the lower the power consumption. All of paramount importance for motherboard applications.

Plus, because NICE is a highly automated

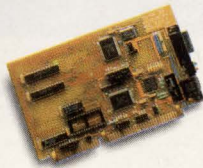

controller, it offers substantially greater system performance for user applications — by freeing CPU and memory bandwidth. Fact is, benchmarks and customers report up to 33% higher performance over competitors' controllers. Quite an edifying statistic, don't you think?

And, unlike other available solutions, NICE has been designed to *fully* comply with Ethernet standards — ensuring international interoperability.

And that's no myth.

For more enlightening facts, here's one more NICE

number: 1-800-866-8608. Or call your local sales office for our NICE Designer Kits. And discover the world's most advanced, highly-integrated, cost-effective Ethernet solution — the NICE family of high-performance products from Fujitsu. Because all it takes to expose a little myth is a little math.

**FUJITSU**

*Delivering the Creative Advantage.*

FUJITSU MICROELECTRONICS, INC., Advanced Products Division, 77 Rio Robles, San Jose, CA 95134-1807. Ph: 408-456-1161 Fax: 408-943-9293. FUJITSU MICROELECTRONICS ASIA PTE LTD. (Head Office, Singapore): Ph: 65-336-1600 Fax: 65-336-1609. HONG KONG SALES OFC: Ph: 852-723-0393 Fax: 852-721-6555. TAIPEI SALES OFC: Ph: 886-2-757-6548 Fax: 886-2-757-6571. JAPAN SALES OFC: Ph: 81-3-3216-3211 Fax: 81-3-3216-9771. KML CORP. (Rep., Korea): Ph: 82-2-588-2011 Fax: 82-2-588-2017. PACIFIC MICROELECTRONICS, PTY. LTD., (Rep., Australia): Ph: 61-2-481-0065 Fax: 61-2-484-4460. FUJITSU MIKROELEKTRONIK GmbH (Dreieich-Buchschlag, Germany): Ph: 06103-6900 Fax: 06103-690122. NICE is a registered trademark of Fujitsu Microelectronics, Inc. ST-NIC is a trademark of National Semiconductor Corporation. \*Reference NSC app note DP839EB-ATT, 1/91.

# EVALUATING BOARD COMMUNICATIONS PERFORMANCE

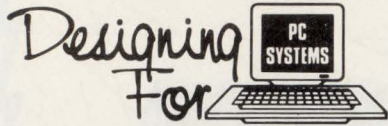

words on receive, and 3 bytes or 4 words on transmit. Stream-oriented protocols like HDLC and Transparent use the larger buffering.

From the time that the first receive data arrives, it's fairly easy to calculate the bus latency allowed by your protocol device. The latency is simply the time it takes to fill up the internal receive buffer. This can be calculated as:

$$\frac{\text{FIFO size in bytes}}{(\text{Sbps}) \div (8 \text{ bits/byte})}$$

With a 20-MHz multiprotocol processor working at the maximum sustainable data rate of 2.2 Mbps in its HDLC or Transparent protocols, the bus latency is:

$$\frac{6 \text{ bytes}}{(2.2 \text{ Mbps}) \div (8 \text{ bits/byte})} = 21.6 \mu\text{s}$$

With a 25-MHz FSI working at 100 Mbps, the bus latency is:

$$\frac{3.2 \text{ kbytes}}{(100 \text{ Mbps}) \div (8 \text{ bits/byte})} = 256 \mu\text{s}$$

The FSI FIFO size is calculated by dividing the 8-kbyte RAM into a receive and transmit portion, after accounting for overhead caused by buffer descriptors and internal parameters.

Actually, the latency supported by the FSI depends on the configuration. If the 8-kbyte memory is configured with 2 receive queues and 4 transmit queues, the latency is reduced to 80  $\mu\text{s}$ —still a reasonable number in most systems.

The problem with those latency calculations is that they don't include the dynamics of every factor that can influence the state of the internal buffers or FIFOs. For instance, on the multiprotocol processor, a complex web of actions can occur between the transmit and receive sections of the three serial channels that it supports. Furthermore, information received at the start of a frame may be checked

for address recognition, a task accomplished by a RISC coprocessor on the multiprotocol processor. Thus, a true latency model depends on numerous factors. If a true latency equation could be developed on the MC68302 processor, it would be a function of many parameters, such as:

- The number of SCCs used
- The data rate on each SCC: receive and transmit
- The type of protocol run on each SCC: HDLC, Transparent, BISYNC, DDCMP (digital data communications message protocol), UART, V.110)
- The length of the received and transmit frames on all SCCs and their relationships to each other over time
- The number of flags or idles sent between each frame
- The frequency of the system-bus side of the MC68302 processor
- The addresses to be automatically recognized (if any)
- The location and position of control characters in the frame (if any)
- The use of single or multiple buffers per frame
- The external bus width
- The number of wait states to memory
- The maximum time it takes for the SCC to acquire the bus when needed
- The decision to put certain data buffers in the internal dual-port RAM or in external RAM

Needless to say, this becomes a job for experimentation or simulation, not a mathematical equation. The decision made for the MC68302 processor was to run a number of experiments in different configurations to get real results on the actual device (*Table 1*). The results show the maximum performance that was obtained with the MC68302 using different protocol combinations on different SCCs. In all cases, full-duplex operation is assumed, unless noted, and the SCCs obtained the bus within 20 system clocks of requesting it. The numbers assume a 20-MHz system clock, and can be scaled linearly for different clock speeds.

These results are superior to latency-calculation results because they show the true maximum performance that was achieved without incurring a FIFO underrun or overrun. Even though the SCC's clocking limit is 8 MHz, the highest long-term sustainable rate is less (2.8 Mbps full duplex), and this value assumes that data buffers are held in the internal dual-port RAM of the chip, as opposed to external memory.

In your project, you probably won't have the luxury of testing a given configuration of your protocol device to see if it will work. For fast results, ask the manufacturer for any available performance data. If you can't get the performance data for the particular configuration you need, ask their applications group about their experience. For instance, although Motorola

**TABLE 2: LAPB OR LAPD SOFTWARE PERFORMANCE ON THE MC68302**

One serial communications channel operating				
Serial bit rate	Frame length	Window size	l frames/s	Theoretical limit
64 kbps	30 bytes	3 frames	412	533
500 kbps	30 bytes	3 frames	470	4167
500 kbps	30 bytes	7 frames	875	4167
500 kbps	30 bytes	9 frames	890	4167

**Notes:**

1. The theoretical limit of the line assumes no overhead (such as flags, CRCs, zero insertion, and receiver-ready frames) and an infinite window size.
2. The window size (also known as k) is the number of frames that may be sent without receiving an acknowledgement (modulo 128). This value can impact performance considerably.
3. Only layer-2 information frames are counted in the total shown. The rate shown is the total full-duplex channel rate. Thus, 890 l frames/s equals 445 transmitted and 445 received l frames/s.
4. The frame length is defined as all bytes between the opening flag and the first CRC byte.
5. Performance numbers for LAPB or LAPD are virtually the same.
6. The following Motorola-developed tasks were running during this experiment:  
 Layer 7—file transfer application  
 Layer 2—LAPB or LAPD (1988 blue-book compatible)  
 Layer 2—MC68302 chip drivers  
 EDX—real-time kernel

**CLOCK GENERATION AND SUPPORT**

# Minimize clock skew.



## With a minimal loss of sanity.

Designing a system clock for a high-performance application can be the ultimate exercise in frustration.

Unless you begin by calling National. Our new family of advanced CGS™ (Clock Generation and Support) products includes

**FEATURES**

- Typical pin-to-pin skew:
  - ECL: 50-150ps
  - CMOS: 100-200ps
  - Bipolar: 200-400ps
- Extensive development tool support
- Future CGS products in development

bipolar, CMOS and ECL clock drivers tested and guaranteed for minimum skew. They meet the requirements of high-end microprocessors: duty cycle, skew, and edge rates.

And they're supported with the development tools you need to simplify your end-system design: SPICE models and a CGS design handbook that includes derating curves.

All of which means you can actually minimize skew while

optimizing system speed and performance. Without losing your wits.



**Protect your sanity.  
Call National today.**

For more information on our CGS2525, CGS2526 and 100115 clock drivers, call 1-800-NAT-SEMI, Ext. 177.



## EVALUATING BOARD COMMUNICATIONS PERFORMANCE

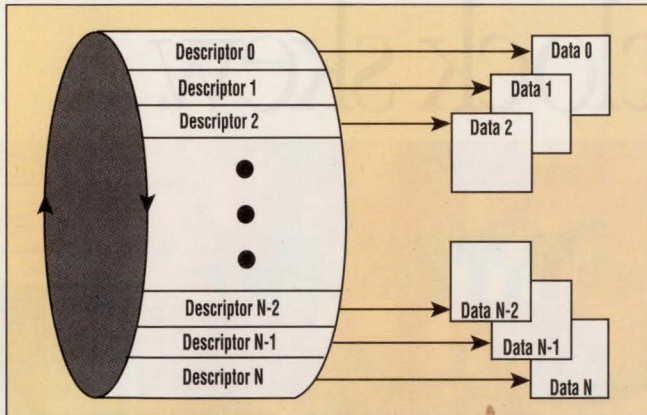

6. The protocol-device driver's performance can be significantly enhanced if the protocol device supports automatic descriptor rings and on-chip direct memory access, like that on the MC68839 FSI and MC68302 multiprotocol processor. The FDDI system interface provides a user-definable number of descriptors, and the multiprotocol processor offers 8 receive and 8 transmit descriptors for each of its three SCC channels.

didn't publish performance data for the MC68302 for any RAM other than zero-wait-state accesses, it was found through experience that each wait state added to the system decreases serial performance by about only 1%.

The last performance-analysis area is the software itself. This is the software-protocol overhead that must execute along with the protocol device to complete the communications desired on the board. The software overhead can be thought of as performing two distinct activities. The first activity is the protocol-device driver, and the second is the upper-layer software execution.

In your application, the device driver in your performance analysis may not be a concern because the driver could be considered as part of the communications software. But, a distinction must be made if the protocol-device driver can be the cause of speed limitations. For instance, the buffer descriptor ring of the multiprotocol processor can receive up to 8 HDLC frames without software intervention. However, consider the effect of a ring only two frames long. HDLC-type frames can be as short as five bytes (1 address; 1 control; 2 cyclic-redundancy-check, or CRC, bytes; and a closing flag that serves as the opening flag of the next frame). Now consider the case of receiving multiple 5-byte HDLC frames back-to-back. After the first frame is received, the software only has five byte times to process the first data buffer before the protocol device reports some kind of "out of buffers" error, and stops receiving. Is the interrupt overhead in the driver low enough to meet this time in all conditions? If not, you have another performance bottleneck to consider.

Obviously, whether or not there's a device-driver bottleneck depends a great deal on the serial data rate (the lower the better), and whether the protocol supports flow control. For instance, link-access protocol, D channel (LAPD) and link-access protocol, balanced (LAPB) support a window function that ensures they will never send more than k

frames (where k is a variable) without receiving an acknowledgement. Similarly, UART protocols may support XON or XOFF characters or out-of-band flow-control signals (such as CTS) to prevent overflowing the receiver.

If the protocol device requires polling or interrupts on a per-byte basis, then the protocol-device driver gets even more important to analyze. The required response time of the driver is one byte. If the protocol device has on-chip direct memory access, yet won't actively switch between data buffers without software control, then your driver must still have a low response time. If your protocol device is like the MC68302, your driver must have a response time of 8 buffers/frame—the number of buffer descriptors the device offers for the receive and transmit sides of each SCC. If your protocol device is like the MC68839 FSI, then it has a user-definable buffer ring capability built into the external RAM, and the driver's response time can be as large as the memory will allow (Fig. 6). Of course, don't overlook the fact that as you wait to process the incoming frames, the amount of work grows.

What do you do if the protocol-device driver in its worst-case situation can't meet the needs of the protocol devices for a particular data rate? You have three possible choices:

1. Do nothing. Based on your analysis, you agree to live with the fact that the out-of-buffers condition will occur once in a while. The only reliable way to decide how often this will happen is to directly measure the system. In any case, your communications protocol has a method of recovering from this error in some manner (for example, this frame and others are possibly retransmitted again later). And the frequency of this occurrence is not great enough to significantly affect the performance.
2. Decrease the software driver latency. This can be done by code optimization, a better software architecture, or a faster main processor (at more cost, of course).
3. Lower the serial data rate. You decide that better total throughput will be obtained by eliminating or decreasing the chance of an out-of-buffers condition.

The upper-layer software includes everything required to make the communications software a full usable package. For instance, in an application that includes an FDDI connection, the FDDI chip set implements the media access control (MAC) and physical (PHY) layers, while the upper-layer software may implement the transfer-control protocol/internet protocol (TCP/IP) layer-3 and -4 functions. In addition, if a home-grown UART-based protocol were used, the MC68302 processor could implement the UART-character formatting, control-character recognition, and part of the flow-control functions, while the upper-layer software does the rest.

As a final example, consider the MC68302 multiprotocol processor used in an application that needs an X.25 connection (consisting of layers 1, 2, and 3). The line driver and the processor would implement layer 1. The processor with its layer-2 support functions and software running on its 68000 core would implement LAPB, which comprises layer 2. The packet-layer protocol (PLP) would be implemented totally by upper-layer software. Even if the physical is-

# Somewhere in the world a Sanyo battery is being "designed-in" to a high performance application.

## Right now.

Industry leaders select industry leaders.

**CADNICA.** In 1964 Sanyo's proprietary technology led to a breakthrough battery that withstands continuous overcharging and overdischarging...the sealed, rechargeable nickel cadmium Cadnica.

**LITHIUM.** Sanyo developed the technology for manganese dioxide compounds to be used in Lithium batteries which produced a cell with high voltage and high energy density characteristics.

**CADNICA EXTRA.** Sanyo's Cadnica E series incorporates high-density electrode plates in a new concept design for 40% greater capacity than conventional batteries and 1-hour charge capability via Sanyo's  $\Delta V$  voltage sensor changing method.

**SOLAR.** Sanyo leads the development of solar cells with the application of amorphous silicon for physical flexibility and the ability to be fabricated into large-area cells.

**NiMH.** Sanyo's proprietary electrode manufacturing process and built-in resealable safety vent lead the development of high capacity, high performance rechargeable, Nickel Metal Hydride batteries.

If you're developing an industry leading product right now, perhaps you should contact Sanyo... right now.

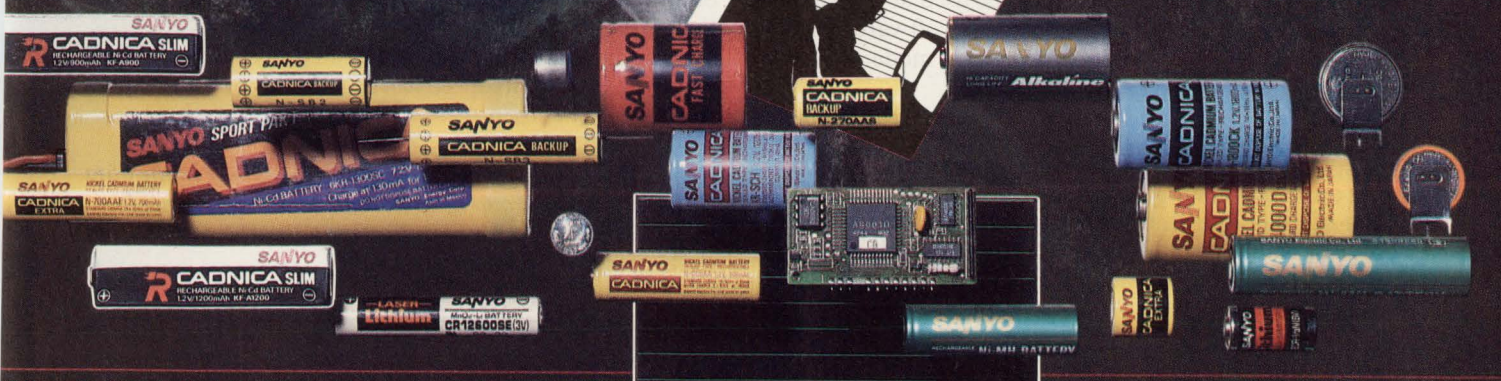

For specification and design assistance please contact your regional Sanyo sales office at the following address:

SANYO Energy (U.S.A.) Corporation  
2001 Sanyo Avenue  
San Diego, California 92173  
(619) 661-6620

In Florida: (904) 376-6711  
In Illinois: (312) 595-5600  
In New Jersey: (201) 641-2333  
In Georgia: (404) 279-7377  
In Dallas: (214) 480-8345

CIRCLE 214 FOR U.S. RESPONSE

CIRCLE 215 FOR RESPONSE OUTSIDE THE U.S.



SANYO Energy (USA) Corporation

## ■ EVALUATING BOARD COMMUNICATIONS PERFORMANCE ■

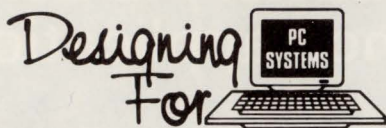

sues, bus-throughput and latency issues, and device-driver issues are dealt with appropriately, the upper-layer software may be the real communications bottleneck in the system. No matter how fast data can be correctly stashed in buffers, it's all wasted capability if the upper-layer software can't keep up.

Consider, for example, an X.25 application running on the MC68302 multiprotocol processor. Experiments were performed using two MC68302 application-development-system (ADS302) boards. Each board contained one MC68302 operating at 16.67 MHz, and 512 kbytes of 1-wait-state DRAM, with all code executed out of 3-wait-state EPROM. The two boards passed frames (created and stored in DRAM) to each other with one SCC operating as a full-duplex HDLC channel.

The software running on each board consisted of different tasks that communicate with message passing, along with the real-time kernel EDX. The results assume 30-byte frames in all cases, and show the data communications rate of the data in frames per second (Table 2).

Under the high serial data rate conditions, adding the PLP layer-3 software decreases the overall throughput by about a factor of 2. This is consistent with results found on other processors in combination with other protocol devices in an X.25 environment.

If the serial data rates are low, the software throughput approaches the physical serial rate. However, when the serial data rate is increased, the software tops out at its own performance limit. The varying results between entries is attributed to whether the software or the physical line is the performance bottleneck. If the result is close to the theoretical limit, the line is clearly the bottleneck. Because the amount of code executed in these experiments is virtually the same regardless of the frame length and the number of serial communications channels used, the software limit is the highest value shown in the results table—about 900 frames/s.

If more software throughput is needed, you must increase the clock speed or change the processor. The MC68302 processor has a feature called slave mode that turns off the CPU and allows it to be used as a peripheral chip to another processor. For instance, software runs four times faster using an MC68302 in slave mode with a 25-MHz 68020 as a master.

There are several alternatives available if there's no software performance on hand, such as:

1. You can compare what you're trying to accomplish with that of other known results. For instance, the LAPD and LAPB results would be generally applicable for any HDLC-type protocol, such as synchronous data-link control (SDLC).
2. If you're changing processors, run some of your old existing communications software, perhaps time-critical routines, on the new processor.
3. Talk to the protocol-device manufacturer to see if they have any unpublished information available.
4. Talk to third-party communications-software-develop-

ment houses about their software performance using the manufacturer's devices.

5. Take a look at the work that must be performed for each frame, add a healthy adder for the unknown, and then scale this up based on the number of frames you expect to receive per second. This should be your last resort.

Now consider an FDDI software application. Although the FDDI chip set can buffer data at 100 Mbps, there's no standard processor that can process FDDI frames at this speed with a full software application running (such as TCP/IP). In fact, even high-end FDDI stations can only process data in the neighborhood of 5 Mbytes/s = 40 Mbps, well under the 100-Mbps limit.

So, why are people designing with FDDI? Basically, they want to obtain better throughput for the LAN as a whole. Even if each FDDI node can only support a low communications rate, an FDDI LAN could support many such stations simultaneously with no real loss in throughput at a given node.

To estimate the maximum performance of a given application, all you need to do is find the bottleneck in the system. As we have seen, it may be found in a number of different places. Once you find the bottleneck, you can take two courses of action—eliminate the bottleneck while being wary of cost; or decide that the performance is satisfactory and look for ways to reduce cost in the design. When looking to reduce cost, you must ask yourself several questions, such as:

1. Do I have the option to reduce the media speed? If so, I may be able to save money on the media, line drivers, and/or protocol device. Note that the protocol device may be available in a lower-cost version when run at a slower speed.
2. Do I have the option to modify the bus characteristics? If so, can I reduce cost by using memory with more wait states? Can I design a narrower bus to eliminate a number of components? Did I add more expensive components or glue in the system to keep the bus latency down to a minimum? If so, perhaps they can be eliminated.
3. Is the software device driver non-critical? If so, then use only high-level languages, such as C, and reduce design time.
4. Is the data rate so slow that the full processor speed isn't required? Perhaps its speed can be reduced, or a less expensive processor chosen.

*Robert W. O'Dell, a senior applications engineer in the data communications group at Motorola, received a BSES from the University of South Florida, Tampa, and a MSCS from the University of Texas, Austin.*

### HOW VALUABLE?

HIGHLY  
MODERATELY  
SLIGHTLY

CIRCLE 541  
CIRCLE 542  
CIRCLE 543



What do LITTLE FOOT p-channel power switches give battery-powered cellular phones?

# LIFE EVERLASTING

**Life everlasting.  
Well, not quite.  
But it may  
seem that  
way to users  
of your battery-  
powered products.**

**Double battery life during normal operation!  
And increase it by 1000% (ten times) in  
standby mode!**

How? With Siliconix LITTLE FOOT™ p-channel power switches. The Si9405, for example, lets you shut down power-consuming analog and digital transmission circuits, as well as display and keyboard electronics, when they are not in use. Then activate them instantly from your standby mode.

These devices can also be used to switch between power inputs such as the battery and the charger.

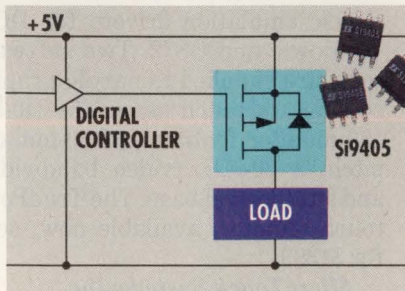

#### Added value.

This improved power management empowers your system with (almost) life everlasting.



It's a compelling competitive advantage that will significantly increase your product's market share and profit margin.

**Running cooler  
and designing smaller.**

The 5-V logic-compatible p-channel

Si9405 has an incredibly low 120-milliohm on-resistance that allows simple switching of high currents. And it comes in a space-saving LITTLE FOOT SOIC 8-pin package to make your portables truly portable.

#### LITTLE FOOT P-Channel Power Switches

<b>Si9400DY</b>	Single P-channel, 250 mΩ
<b>Si9405DY</b>	Single P-channel, 120 mΩ
<b>Si9953DY</b>	Dual P-channel, 2 x 250 mΩ

*These SOIC-8 devices can be driven directly by 5-V logic.*

Everlasting life? Maybe. Ever-increasing sales? Definitely! Call our toll-free hot line now. **1-800-554-5565, ext 561.** Ask for our "LITTLE FOOT Power Management" Design Kit. And remember, at Siliconix we're committed to achieving a seamless interface between the power and digital worlds.

## Siliconix

2201 Laurelwood Rd, Santa Clara, CA 95056

## PC DESIGN PRODUCTS

### ▼ HIGH-SPEED MODEMS SUIT PORTABLE APPLICATIONS

Two single-chip modems offer the features and integration needed for portable applications, including notebook and palmtop PCs and PCMCIA-compatible IC cards. The first, the RC144DPL, is a two-wire 14,400-bit/s device that satisfies the requirements of CCITT V.32bis and

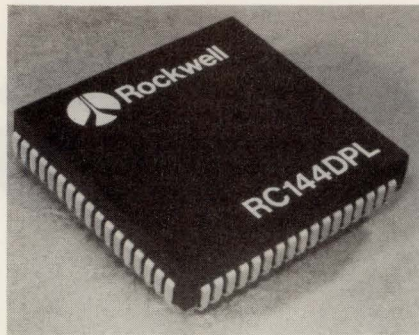

V.17. The full-duplex, synchronous-asynchronous high-speed data-fax modem contains a separate voice pass-through mode that lets the host transmit and receive uncompressed audio signals. The second device, the RC96DPL, operates at 9600 bits/s. The modems are also available without fax capabilities. Power consumption is 400 mW in active mode and just 10 mW in sleep mode.

Each device is compatible with Group 3 fax for high-speed operation. A Group 3-compatible device begins operation at 9600 bits/s, then automatically falls back to V.27 4800-bit/s operation if noise exists in the

line. Users expect a high-speed modem to fall back to a slower mode in case it must communicate with a slower modem. The modems operate over the public switched telephone network through the appropriate line termination. Under control of the host processor, the modems can generate single or dual voice-band tones from 0 to 4800 Hz, with a resolution of 0.15 Hz and an accuracy of  $\pm 0.01\%$ . Tones over 3000 Hz are attenuated. With dual-tone multifrequency (DTMF) tone generation, the devices can work as programmable DTMF dialers.

Two variations are available—the DPL and the ACL series. The ACL product differs from the DPL in that it comes with an interface microcontroller and all of the firmware that's needed to form a complete two-chip V.32 solution. Some designers prefer to just purchase the data pump and develop their own software around the controller of their choice. The DPL series will ship at the end of this month, while the ACL series should ship at the end of next month. The RC96ACL sells for \$98, while its DPL counterpart costs \$83. The RC144DPL is priced at \$98 and the ACL version sells for \$113.

#### **Rockwell International Corp.**

4311 Jamboree Rd.

P. O. Box C

Newport Beach, CA 92658

(714) 833-6849

► CIRCLE 590

### ▼ STORAGE PRODUCTS HOLD MORE, ACCESS FASTER

A slew of storage products that incorporate leading-edge technology, including disk, optical, and tape drives, are being offered to OEMs by IBM. Two 2.5-in. hard drives, at 60- and 120-Mbyte capacities, are just 0.5 and 0.67 in. tall, respectively. An 80-Mbyte model can be used as removable media in a 3.5-in. drive bay.

Using a magneto-resistive (MR) head, the company's 3.5-in. drive can hold 1.2 Gbytes of data. The drive employs independent elements to read and write data—an inductive element to write and an MR element to read. Two 1.2-Gbyte drives fit into a 5.25-in. form factor. This model will be available in the third quarter.

The company has sped up its 120-

Mbyte, 3.5-in. rewritable optical drive and is also offering a 650-Mbyte, 5.25-in. version. The faster 3.5-in. drive has a data-transfer rate of 625 kbytes/s and a rotational speed of 3000 rpm. The data seek time has been lowered to 40 ms.

Three models of a rack-mounted 0.5-in. magnetic tape subsystem use 36-track recording technology. They also incorporate improved data-recording capability and the enhanced capacity cartridge to store up to 2.4 Gbytes per tape. When combined with the automatic cartridge loader, total unattended backup capacity can range from 14.4 to 28.8 Gbytes.

#### **IBM Corp.**

1133 Westchester Ave.

White Plains, NY 10604

► CIRCLE 591

### ▼ UPGRADE 286 SYSTEM TO HIGH-SPEED 386SX

The Fast Cache-SX/Plus memory-expansion card combines 32-bit performance with up to 16 Mbytes of high-speed memory on one full-size ISA board. It uses a 386SX microprocessor to replace the 80286 processor that resides within the system. A flexible circuit-style cable simply plugs into the 286 socket. Installation kits are available for all types of 286 sockets. In addition, a 387SX math coprocessor can be obtained. The board contains an efficient 16-kbyte 486-style internal four-way set-associative cache that results in zero-wait-state fetches of code and data. It also uses a five-deep write buffer to speed data transfers between the processor and system memory. The board starts at \$595.

#### **Microway Inc.**

P. O. Box 79

Kingston, MA 02364

(508) 746-7341

► CIRCLE 592

### ▼ TOUCH-SCREEN MONITOR FITS MULTIMEDIA BILL

Designed for multimedia applications, the TruePoint touch monitor is a low-cost, high-resolution touch-screen display. The package includes a 14-in. VGA display, a capacitive

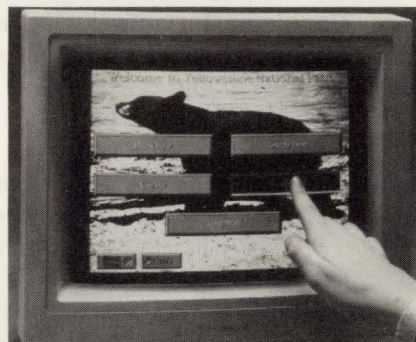

touch screen, a controller, and mouse emulation drivers for DOS, Windows, and OS/2. Two software tools are supplied to handle graphic screens and touch zones. The 640-by-480 monitor features a 0.39-mm dot pitch, a 30-MHz video bandwidth, and a tilt-swivel base. The TruePoint touch monitor, available now, sells for \$1399.

#### **MicroTouch Systems Inc.**

55 Jonspin Rd.

Wilmington, MA 01887

(508) 694-9900

► CIRCLE 593



# SmartFan™

- Senses and regulates cabinet temperature – automatically
- Noise reduction up to 15 db
- 50% greater life
- Built in sensor/speed control
- Closed loop design



# SmartBuy

- Wide variety of popular sizes
- Interchangeable with standard fans with no additional wiring
- Application support
- Patented low noise fan technology
- World leader in fan production



# SmartCall

- Evaluation samples
- Complete specs
- Competitive pricing
- Worldwide distribution
- Call today for fast, knowledgeable action

# 800-662-8321



**NMB** || NMB TECHNOLOGIES  
INCORPORATED

## NMB Technologies Incorporated

Fan Division

9730 Independence Avenue • Chatsworth, CA 91311

Tel: (818) 341-3355 • (800) 662-8321 • Fax: (818) 341-8207

SmartFan™ is a registered trademark of Control Resources, Inc.

## PC DESIGN PRODUCTS

### ▼ ASICs RAISE LOW-END PRINTER PERFORMANCE

A new release of printer-controller ASICs can improve the performance of low-end laser printers while reducing their prices. The first chip is the second generation of the Raster Image Device Accelerator (RIDA) family that was first introduced by Destiny Technology last year (ELECTRONIC DESIGN, Sept. 12, 1991, p. 159). The family increases performance of font-intensive applications, such as desktop publishing. The latest release, the D7002, is an outline font accelerator for VGA or XGA displays that produces scalable outline fonts at hardware-generated speeds under Windows 3.1. The chip is priced at \$20 in production quantities.

Three chips that bring Edge-Enhancement Technology (EET) to laser printers are the D9001L, D9001B, and D9001H. Like the original D9001, the chips detect and smooth jagged edges of printed raster images without any assistance from external software. This results in higher quality and faster output.

The D9001L is a low-cost device housed in a 28-pin DIP. It runs at 50

or 55 MHz. It costs \$10 to \$12 and is available now. The D9001B is designed to accommodate resolutions up to 600 dots/in. and B-size (11-by-17-in.) paper. Samples of the \$18 part will be available in May, with production starting in August. The third member, the D9001H, is designed for printer engines using a video interface operating at greater than 3 MHz. It's available now for \$18.

Also available is an integrated GUI controller called the WinStyler that enables users to get what-you-see-is-what-you-get (WYSIWYG) output on their laser printers. Unlike other GUI-based solutions, it can handle encapsulated PostScript files and Bezier curves. Where other configurations require a card that fits into the printer's I/O slot, another card that goes into the host PC, and a heavy video cable, the WinStyler uses the standard Centronics port and cable. Hence, it's an easy plug-and-play solution.

#### **Destiny Technology Corp.**

300 Montague Expwy.

Suite 150

Milpitas, CA 95035

(408) 262-9400

► CIRCLE 594

### ▼ CONNECT LASER PRINTER ANYWHERE ON NETWORK

Using the JetLAN network print server card, an HP LaserJet printer can be connected anywhere on a twisted-pair (10BaseT) or thin-wire (10Base2, coax) Ethernet local-area network (LAN) running NetWare. This means that a networked printer needn't be connected to the file server—it can be located anywhere along the network. The card also eliminates the dedicated PC that's often connected to the networked laser printer. It simply slides into the Optional I/O (XIO) slot in the back of the printer. The JetLAN can be connected to the existing LAN cable with standard network connections. It's built with LED indicators to supply communication-activity information. The print server board sells for \$595.

#### **ASP Computer Products Inc.**

160 San Gabriel Dr.

Sunnyvale, CA 94086

(408) 746-2965

► CIRCLE 595

### ▼ SUPER VGA CARD ACCELERATES WINDOWS

A Super VGA card, designed to accelerate Windows performance, offers built-in features like hardware-assisted icon transfers and line draws, which is a dramatic improvement over standard VGA. The WIN.VGA card supports flicker-free 72-Hz refresh rates for all resolutions. The heart of the board is the company's HT216 graphics controller. It's designed for graphical-user-interface environments by coding source-destination raster operations in hardware. A memory-caching algorithm lets the CPU continuously process data instead of waiting for the completion of the write operation to display memory. Drivers for the WIN.VGA accelerator board will be included with Microsoft's Windows 3.1.

#### **Headland Technology Inc.**

46221 Landing Pkwy.

Fremont, CA 94538

(415) 623-7857

► CIRCLE 596

## Where you can learn a little black magic.

If you'd like to learn a few new tricks in analog design, check the schedule of the Analog Devices Advanced Linear Design Seminar below and then reserve your space by calling 1-800-ANALOGD (in Canada, call 617-937-1430) today.

### NORTH AMERICA

City	Date
Cleveland, OH	May 5
Detroit, MI	May 6
Santa Clara, CA	May 7
Burlington, MA	May 7
Pleasanton, CA	May 8
Milwaukee, WI	May 11
San Diego, CA	May 11
Chicago, IL	May 12
Irvine, CA	May 12
Houston, TX	May 13
Woodland Hills, CA	May 13
Dallas, TX	May 14
Phoenix, AZ	May 14
Dayton, OH	May 15
Denver, CO	May 15
Minneapolis, MN	May 18
Huntsville, AL	May 18
Waterbury, CT	May 19
Atlanta, GA	May 19
Whippany, NJ	May 20
Tampa, FL	May 20
Smithtown, NY	May 21
Orlando, FL	May 21
Santa Clara, CA	May 27
Rochester, NY	May 27
Beaverton, OR	May 28
Toronto, Can	May 28
Bellevue, WA	May 29
Montreal, Can	May 29
Waltham, MA	June 1
Raleigh, NC	June 2
Ft. Washington, PA	June 3
Baltimore, MD	June 4
McLean, VA	June 5

### EUROPE

City	Date
Copenhagen, Denmark	May 4
Berlin, Germany	May 5
Wiesbaden, Germany	May 6
Hamburg, Germany	May 7
München, Germany	May 8
Vienna, Austria	May 11
Zürich, Switzerland	May 12
Lyon, France	May 13
Paris, France	May 14
London, England	May 15
Edinburgh, Scotland	May 18
Eindhoven, Netherlands	May 19
Stockholm, Sweden	May 20
Rome, Italy	May 21
Milan, Italy	May 22

Far East and Japan seminars to be held in June. Please call 1-617-937-1430 for schedule.



If you've always thought linear design involved a little black magic, here's where you can learn a few of the tricks.

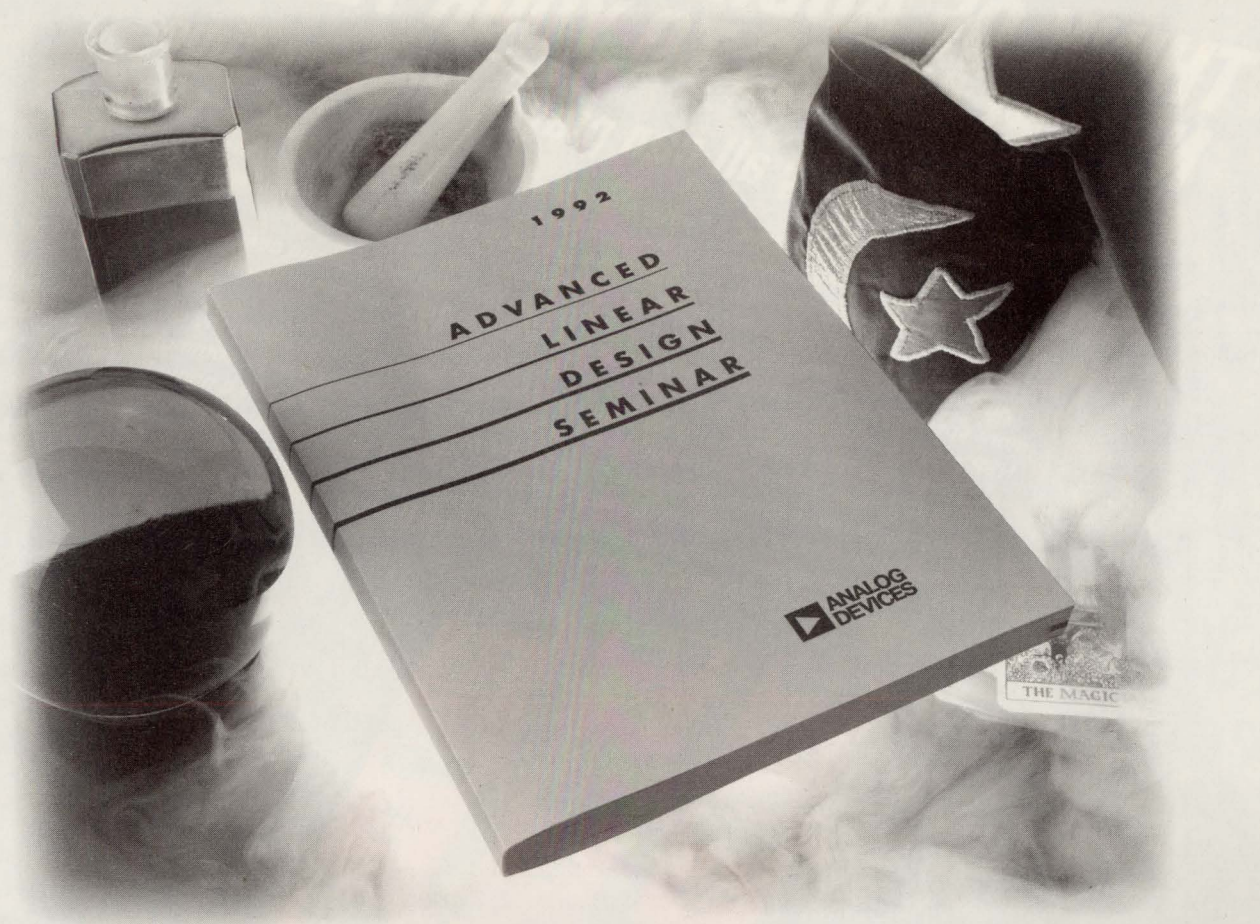

If you're one of the few engineers who realizes the world of analog design isn't all that mysterious, you'll appreciate our Advanced Linear Design Seminar. Because it's the perfect opportunity to pick up a few new tricks.

Hosted by Analog Devices, one of the leading suppliers of analog and mixed-signal ICs, and its distributors, the seminar series will include talks by prominent design wizards such as Derek Bowers, Paul Brokaw, Lou Counts, Barrie Gilbert, Walt Jung, and others.

The full-day tutorials also include solutions-oriented discussions that are geared towards showing you how to increase system performance while actually lowering overall cost. Plus you'll get free product samples, our 700-page *Amplifier Applications Guide*, other technical reference materials, and more.

Admission to the seminar is just \$20, and it includes everything above, lunch, and refreshments.

So if you're a design wizard who wants to add to your repertoire of linear design tricks, it's no secret what you should do — call 1-800-ANALOGD (in Canada, call 617-937-1430) and reserve a seat today. Before they all disappear.



## The Analog Devices Advanced Linear Design Seminar.

Analog Devices, Inc., One Technology Way, P.O. Box 9106, Norwood, MA 02062-9106. Headquarters: (617) 329-4700. Offices, applications support and distribution available worldwide.

CIRCLE 96 FOR U.S. RESPONSE

CIRCLE 97 FOR RESPONSE OUTSIDE THE U.S.

# THINK OF ADDING EIGHT NEW NSP PLAYERS TO YOUR TEAM!

And the rules say all can play at the same time.

Last year the Semiconductor Products Center of Hughes Aircraft Company announced "a whole new ballgame" with an initial lineup of nine multitasking NSP players. (Remember, these are the Nonvolatile Serially Programmable ICs that can work together in any order, won't forget their plays and can take new instructions anytime from homeplate.)

Hughes NSP devices provide a greater variety of functions and extend the capabilities of existing NSP models. They feature micro power, wide operating voltage range, common serial interface, wide temperature range and single power supply. Also, each device has a nonvolatile memory with redundant memory elements to insure reliable storage of settings while power is removed.

For a complete information packet, contact Hughes Semiconductor Products Center, P.O. Box H, Newport Beach, CA 92658; or call the NSP Hotline Number (714) 759-6589 or FAX to (714) 759-2913.

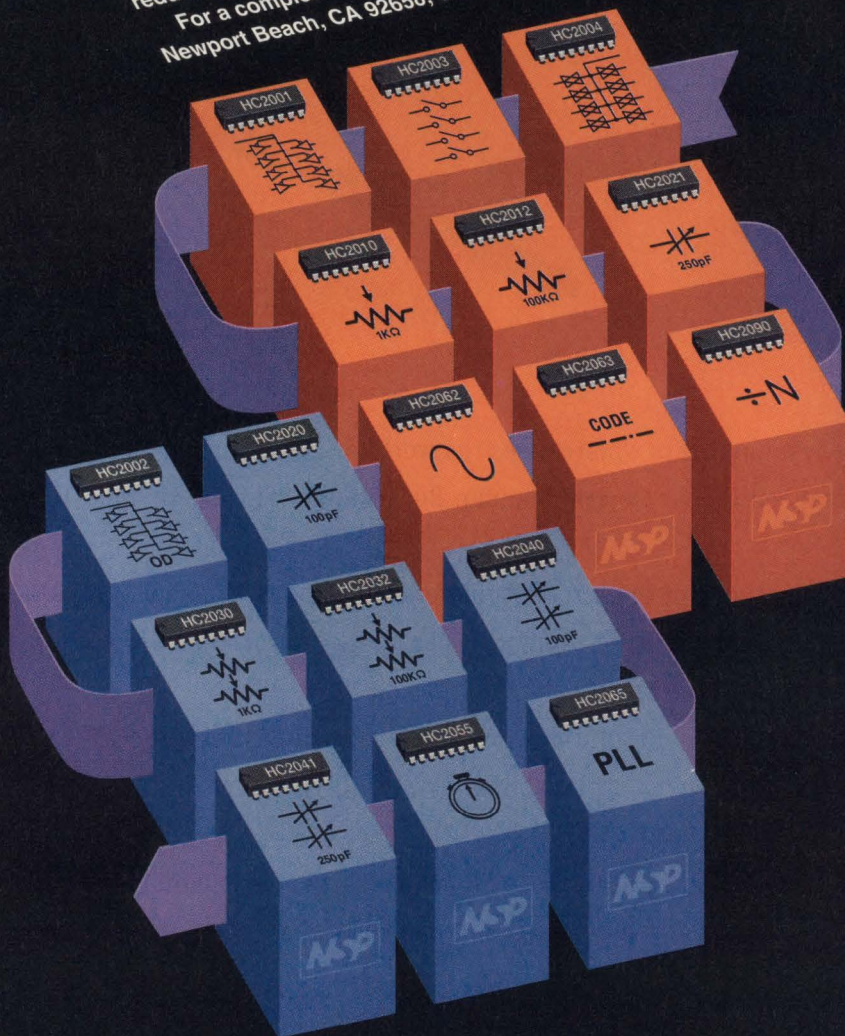

**HUGHES**

SEMICONDUCTOR PRODUCTS CENTER  
Industrial Electronics Group

CIRCLE 262 FOR U.S. RESPONSE

CIRCLE 263 FOR RESPONSE OUTSIDE THE U.S.

## PC DESIGN PRODUCTS

### ▼ SCSI-II RAM DRIVE BOOSTS TRANSFER RATE

Depending on the host SCSI controller and operating system, the SCSI-II Dart delivers sustained data-transfer rates up to a maximum of 12.16 Mbits/s. Access times can be as low as 0.5 ms.



The drive offers 512 Mbytes of virtual memory, enabling DOS- and Windows-based graphics and imaging applications to work with large 24-bit images without any performance degradation. The RAM drive, which is configured with 32 sockets to hold conventional 1-, 4-, and 16-Mbyte SIMMs, will eventually move to 64-Mbyte parts. Two side-by-side modules could even have different capacities.

**Newer Technology**  
7803 E. Osie, Suite 105  
Wichita, KA 62707  
(316) 685-4904  
► CIRCLE 597

### ▼ PROGRAMMING ADAPTER SUPPORTS PCMCIA CARDS

A universal adapter enables existing 32-pin equipment to program flash, EPROM, one-time-programmable, and static-RAM memory cards. The programming adapter supports PCMCIA/JEIDA memory-card formats. The adapter features user-selectable programming of either 128- or 256-kbyte page sizes and LEDs to supply write-protect and battery status.

**MADS Inc.**  
94 Lesnyk Rd.  
Goffstown, NH 03045  
(603) 497-3290  
► CIRCLE 598

### ▼ PCL 5 LASER PRINTER PUMPS OUT 8 PPM

Featuring a 32-bit RISC processor and high-speed output, the CI-8E desktop laser printer is compatible with HP's LaserJet Series III and its PCL 5. The 8-page/min. (ppm), 300 dots/in. speed and quality suit it for most business applications. The printer also comes with edge-enhancement technology (EET) that eliminates jagged edges on text and graphics to create crisp, clear lines and curves. Eight scalable and 14 bit-mapped fonts are built in. Up to 5 Mbytes of memory can be used in 1- or 2-Mbyte increments. The straight-through paper path handles labels, transparencies, and envelopes. The CI-8E is available now for \$1695.

**C-Tech Electronics Inc.**  
2515 McCabe Way  
P. O. Box 19673  
Irvine, CA 92713  
(714) 833-1165  
► CIRCLE 599

### ▼ TRUE-COLOR SUBSYSTEM FITS ISA, EISA, VME

Designed for ISA, EISA, and VME-bus environments, the ITC-1210 true-color display subsystem is built with the Texas Instruments TMS34020 graphics processor. In-

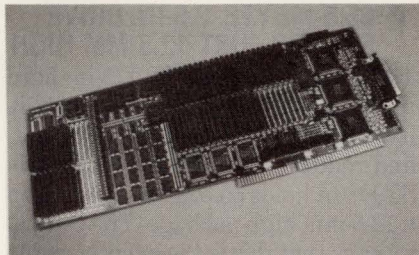

structions are handled by the graphics processor, freeing up the host CPU for other tasks. The 24-bit board comes standard with 6 Mbytes of high-speed, dual-ported VRAM for main image storage and display and 1 Mbyte of overlay memory. It permits simultaneous display of applications, such as Windows, AutoCAD, and other custom applications in the overlay plane. The ITC-1210 is suitable for remote sensing, radar displays, electronic pre-press, and animation. Prices start at \$5995.

**Imagraph Corp.**  
11 Elizabeth Dr.  
Chelmsford, MA 01824  
(508) 256-4624  
► CIRCLE 600

## FAST PCB PROTOTYPES... MADE RIGHT AT YOUR CAD WORKSTATION

Experience the low cost convenience of instantly making your own PCB prototypes. Here's why an LPKF system makes sense:

- Reduces turnaround time from weeks to hours.
- You keep control over the design implementation.
- Environmentally safe - no toxic chemicals.
- Precision German engineering.
- Complete customer support.
- Takes your production ready CAD files and produces circuit board prototypes.
- Supports fine line technology and surface-mounted components.
- Fast payback - typically 3 - 12 months.
- Used worldwide...from small companies to Apple, BMW, Boeing, HP and Tektronix.

FREE PCB INFO PACK...

**CALL TODAY**  
**1-800-345-LPKF**  
(1-800-345-5753)  
or FAX request to:  
1-503-645-0403

**LPKF CAD/CAM SYSTEMS, INC.**  
1800 NW 169TH PLACE, BEAVERTON, OR 97006

CIRCLE 158 FOR U.S. RESPONSE  
CIRCLE 159 FOR RESPONSE OUTSIDE THE U.S.

## PC DESIGN PRODUCTS

### ▼ PORTABLE 2.5-IN. HARD DRIVE HOLDS 360 MBYTES

Users can now take their work with them wherever they go without dragging along a complete system. A 2-1/2-in. portable IDE hard drive can hold up to 360 Mbytes of data and plugs into any PC's parallel port. The

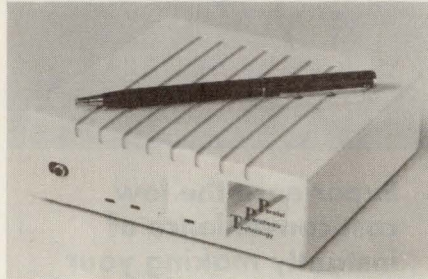

drives weigh just 1-1/2 lbs. and measure 5 by 5 by 1-1/2 in. They feature 22-ms access times and data-transfer times ranging from 4 to 6 Mbytes/min. Prices range from \$499 for a 40-Mbyte model to \$1999 for the 360-Mbyte drive.

#### **Parallel Peripherals Technology Inc.**

260 W. Arrow Hwy.  
San Dimas, CA 91773  
(714) 394-7244

► CIRCLE 601

### ▼ MODEM, FAX INTERFACE FITS IN TINY PACKAGE

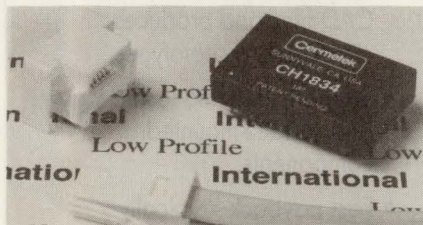

Referred to as a data-access arrangement, the CH1834 is an internationally approved telephone line interface that fits in a 26-by-60-by-9-mm package. The part links modem and facsimile chips to the telephone line to protect the line from unwanted power surges. It employs a proprietary solid-state transformer to reduce size and weight. The CH1834 contains isolation and surge protection, ring detection, and a two-to-four-wire converter. It can be used with modems ranging up to V.32bis and fax applications to V.17.

#### **Cermetek Microelectronics Inc.**

1308 Borregas Ave.  
Sunnyvale, CA 94088  
(408) 752-5000

► CIRCLE 602

### ▼ LOCAL-BUS VGA CHIP SUPPORTS 24-BIT COLOR

By employing a local-bus-type interface to the host CPU, the TVGA8900CX gives designers a fast-responding graphics controller that can support 24-bit true-color modes at 640-by-480-pixels. In addition, the Trident chip can also control 256-color screens at resolutions ranging from 640-by-480 to 1024-by-768 pixels (either interlaced or non-interlaced). A 1280-by-1024 mode with 256 colors using interlaced monitors or 16 colors with noninterlaced monitors provides top resolution. To deliver the pixels, the chip employs a dot-clock of 108 MHz. That rate also supports the VESA (Video Electronics Standards Association) 70-Hz refresh standard.

The chip achieves zero-wait-state performance with the host CPU thanks to an on-chip command FIFO register. That register maximizes the bus transfer speeds for applications like Windows or AutoCAD, because such applications write directly to the video memory. Other enhancements include the using the fast local-bus interface, which employs a 50-MHz DRAM clock, to

pump data from fast-page-mode DRAMs. Furthermore, the controller has a 2-Mbyte linear address space that eliminates overheads imposed by the bank-switching schemes used by most other high-resolution drivers.

The TVGA8900CX can also take advantage of Trident's library of high-resolution drivers that were created for previous graphic controllers (the 8900C and 9000). Drivers support a wide variety of application packages as well as the Analog Devices CEG RAMDAC and the Sierra HiColor RAMDAC.

DRAMs with word widths of 4, 8, or 16 bits can be used by the controller. The device includes programmable timing so that the memory interface can be optimized. Automatic monitor detection, memory detection, and data bus transceivers are also incorporated in the 160-lead PQFP-housed TVGA8900CX. In lots of 1000, the chip sells for \$20 apiece. Samples are available from stock.

#### **Trident Microsystems Inc.**

205 Ravensdale Dr.  
Mountain View, CA 94043  
(415) 691-9211

► CIRCLE 603

### ▼ 65.5-MBYTE, 2.5-IN. DRIVE STANDS JUST 12.5 MM HIGH

The latest in a line of 2-1/2-in. hard drives combines advanced durability, reliability, power management, and reduced form factor. Seagate's ST9080A holds 65.5 Mbytes of data in a 12.5-mm high package. The company says that this is the lowest-profile platform currently available. The 4.8-oz. drive features a 16-ms average seek time, a standard PC/AT interface, an MTBF of 150,000 hours, and can withstand a nonoperating shock of 150 Gs. The power-management features support active, idle, standby, and sleep modes. High data integrity is achieved through 88-bit on-the-fly error-correction code. The ST9080A disk drive is priced at \$395. Evaluation units are available now, with production starting in the third quarter.

#### **Seagate Technology Inc.**

920 Disc Drive  
Scotts Valley, CA 95066  
(408) 438-6550

► CIRCLE 604

### ▼ TINY MODEM FITS PORTABLE APPLICATIONS

A fax-data modem that's designed for portable and pen-based systems can send and receive data at 2400 bits/s and facsimiles at 9600 bits/s. The 2-by-1-in. modem's power-down mode can be implemented to extend a portable system's battery life. The module, which weighs just 1.5-oz., uses surface-mounting technology to increase reliability. It also makes the part easy to integrate onto a motherboard. The modem implements CCITT V.22bis data-correction and V.42 error-correction technology. Housed in a 40-pin DIP, the part operates on a single 5-V supply with less than a 200-mA operating current. In power-down mode, the modem draws just 1 mA.

#### **Micro Integrated Communications Corp.**

3255 Scott Blvd.  
Bldg. #3, Suite 102  
Santa Clara, CA 95054  
(408) 980-9565

► CIRCLE 605



## PC DESIGN PRODUCTS

### ▼ KIT HELPS DESIGN PORTABLE 386SX SYSTEMS

The ESP 386SX development and evaluation kit gives designers the opportunity to develop full PC/AT-compatible systems in packages measuring 5.3 by 4.1 by 2 in. The system's small size tailors it to medical devices, portable communications, and field test equipment. Combining ESP's small form factor with the use of standard ISA bus signals makes it suitable for embedded control and motherboard markets.

ESP was designed for upgradability due to its modularity. The backplane can be modified to conform to the existing space. The kit comes with a 386SX processor running at 16, 20, or 25 MHz; a super-VGA driver that supports liquid-crystal displays and monitors; floppy- and hard-drive controllers; and up to 20 Mbytes of RAM. Optional modules include analog-to-digital and digital-to-analog converters, a network or SCSI interface, and a modem.

#### **Dover Electronics**

P. O. Box 1532  
Longmont, CO 80502  
(303) 772-5933

► CIRCLE 608

### ▼ GRAPHICS CARD DOUBLES PERFORMANCE

Delivering twice the performance as its predecessor at 40% of the price, the Spectrum/24 PDQ Plus graphics card runs on Macintosh NuBus systems. The accelerated, 24-bit card includes SuperVideo, a powerful display-management utility; and SuperMatch, a color-fidelity solution to ensure that on-screen colors match the printer's output. In addition, a digital-frequency synthesizer eliminates the need for oscillators. The card adds functionality for color desktop-publishing, illustration, design, layout, and photo-retouching applications. It supports NTSC RGB and PAL RGB displays and NuBus block-mode transfer in slave mode. Displays up to 21 in. can be accommodated with resolutions to 1152 by 870 pixels. Available now, the Spectrum/24 PDQ Plus sells for \$2399.

#### **SuperMac Technology**

485 Potrero Ave.  
Sunnyvale, CA 94086  
(408) 245-2202

► CIRCLE 609

# FAST TEST

New  
For 1992  
16-bit WIDE

## Low-cost, PC-Based SCSI-2 Testers

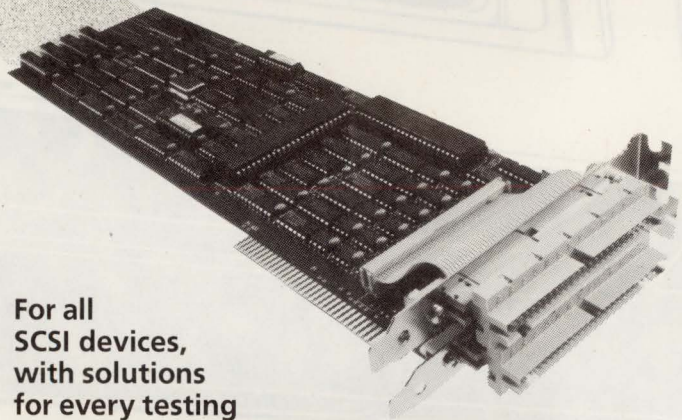

For all  
SCSI devices,  
with solutions  
for every testing  
situation — design  
through manufacturing to field service.

I-TECH'S new **SCSI-2 Fast Testers**, the first of their kind in the marketplace, transfer data at 10 MBytes/second. In addition, they feature:

- **SCSI-2 Command Queuing**
- **SCSI-2 Message System Support**
- **High-level Multi-threading Support**
- **Initiator and Target Emulation**

We offer complete development systems, low-cost manufacturing platforms and portable turn-key systems, all available with integrated bus analysis.

Ask us about **SCSI-2 Solutions**. We'll be happy to give you the details. For Information or prompt quotation call, write or FAX us.

**I-TECH**  
C O R P.

6975 Washington Ave. So. • Suite 220 • Edina, MN 55439  
**612/941-5905 • FAX 612/941-2386**

CIRCLE 274 FOR U.S. RESPONSE  
CIRCLE 275 FOR RESPONSE OUTSIDE THE U.S.

Destination	Flight	Gate	Status
FPGA	28 MHz	5000	DELAYED
GATE ARRAY	40 MHz	10000	DELAYED
FPGA Start-up	28 MHz	5000	CANCELLED
MAX EPLD	40 MHz	7500	BOARDING

## Departures

High Performance Programmable Logic  
Seminars in Your Area. Don't miss them!  
1-800-858-1810\*. Ask for Dept. C32.

# NOW TAKING OFF—MAX EPLD.

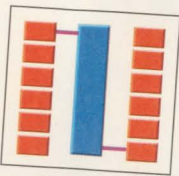

MAX® EPLD  
Architecture allows  
full utilization of  
7,500 gates.

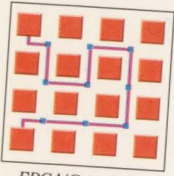

FPGA/Gate Array  
Architecture; prepare  
for lots of delays (speed  
depends on routing).

## The 40 MHz PLD with Gate Array Capacity

If you want PLD design convenience with the density of FPGAs or gate arrays, Cypress has the best way to get you there without delay: our new MAX CY7C341 EPLD.

MAX 341's exclusive Logic Array Block (LAB) architecture always affords you the shortest interconnect path. Data glides between the 12 LABs with a singular, predictable interconnect delay. Count on full, 7,500 gate utilization, with no drop-off from MAX's 40 MHz performance. And MAX 341's nonvolatility and built-in security bit give you extra safety and stability.

Since MAX 341 is a field-programmable EPLD, you cruise above the NREs that can

cloud gate array solutions. You save even more in design-in time with MAX's PC-based development kit, which enables you to have a programmed solution in hours, not months.

Catch the entire MAX family of 28-, 44-, 68- and 84-pin devices in both (erasable) windowed ceramic or plastic packages. Call the Cypress hotline today for your free MAX information, including brochure and Data Book. Our Field Applications Engineers are ready to show you how MAX 341 can make your designs fly.

**FREE MAX INFO HOTLINE:**  
**1-800-858-1810\***  
Ask for Dept C31.



CYPRESS  
SEMICONDUCTOR

\*In Europe, fax your request to the above dept. at (32) 2-652-1504 or call (32) 2-652-0270. In Asia, fax to the above dept. at 1 (415) 961-4201. © 1992 Cypress Semiconductor, 3901 North First Street, San Jose, CA 95134. Phone 1 (408) 943-2600, TELEX: 821032 CYPRESS SNJ UD, TWX: 910-997-0753. MAX is a registered trademark of Altera Corporation.

CMOS OP AMPS NOT ONLY SWING THEIR OUTPUTS TO BOTH RAILS, BUT ALSO HANDLE + AND - COMMON-MODE INPUT VOLTAGES BEYOND THEM.

# RAIL-TO-RAIL OP AMPS USE DEPLETION-MODE PMOSFETS

FRANK GOODENOUGH

**T**he growing demand that analog and mixed-signal systems operate from a single, positive, sub-15-V power-supply rail has brought about a new breed of op amps specifically designed for those conditions. These op amps must handle common-mode voltages (CMVs) at the input that exceed the positive power-supply rail and/or swing below the negative power-supply rail. Just as important, their outputs must be able to swing within a few tens of millivolts of both the ground potential and the positive

power-supply rail while driving a practical load (less than 100 k $\Omega$ ).

System designers need more than a universal device, like the ubiquitous 741 op amp—they want an op amp family that includes general-purpose, micropower, precision, and even precision-micropower and high-speed devices. Pushed for pc-board space, today's designers also demand dual and quad op amp ICs.

To meet these demands, National Semiconductor is adding four new op amps to its family of CMOS op amps: the dual/quad LMC6482/84, the dual LMC6062, and the dual LMC6082. These devices represent the third generation of CMOS op amp circuit

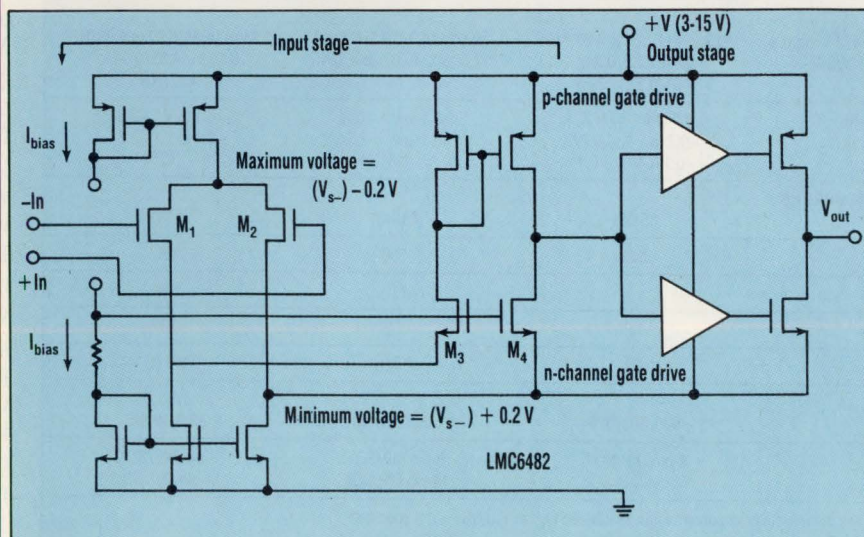

**1. BY USING DEPLETION-MODE** p-channel MOSFETs for the differential-input transistor pair  $M_1$  and  $M_2$  in the LMC6482 CMOS op amp, the op amp can handle input common-mode voltages that exceed both supply rails.

# RAIL-TO-RAIL OP AMPS

designs. The LMC6482/84 addresses both input-CMV range and output-swing demands, while the LMC6062 and 6082 only address output-swing demands. The 6082 adds precision to the mix, while the 6062 combines precision performance with a quiescent current of less than  $19 \mu\text{A}/\text{op amp}$  (see the table).

While over a dozen IC op amps are available with outputs that can swing close to the power-supply rails, the LMC6482/84 is one of the few that can also handle common-mode voltages that exceed both power-supply rails (ELECTRONIC DESIGN, June 13, 1991, p. 135). To do the job, National's IC designers took advantage of a unique, depletion-mode, p-channel MOSFET for the pair of transistors—FETs  $M_1$  and  $M_2$ —forming the differential-pair input circuit (Fig. 1).

To handle input CMVs beyond the power-supply rails, existing op amps have used two differential stages with their inputs connected in parallel and their outputs in a push-pull configuration. One differential pair is built of p-type transistors and the other of n-type transistors (both bipolar and CMOS op amps have used the architecture). This topology suf-

fers from several problems including noise, offset-voltage change with CMV, cross-over distortion and gain variation.

## LOW POWER

The demand for op amps that run off single- and low-voltage power-supply rails was driven by the need for circuit simplicity and the desire to save power. Designers want both the analog and the digital circuits in mixed-signal systems to run off a single 5-V logic supply—an industry standard that's rapidly dropping. And more and more systems are running off batteries. In laptop and notebook PCs, cameras, camcorders, and laboratory and medical instruments, low-voltage power-supply-rail operation is a must to save power and often to permit operation directly from battery-voltage levels

as low as 3 V.

To retain even a smidgen of the 120-or-so-dB dynamic range formerly possible when  $\pm 15\text{-V}$  power-supply rails were once used, analog designers need op amps as such these new National ones with power-supply rail-to-rail input and output circuits. For years, analog designers

grew used to running off  $\pm 15\text{-V}$  power-supply rails, which provided  $\pm 10\text{-V}$  full-scale output signals. Most op amps easily put more than  $\pm 10\text{ V}$  across 2000  $\Omega$ , and typically these bipolar devices offered input-voltage noise below 10 nV per  $\sqrt{\text{Hz}}$ , and many had offset voltages below 500  $\mu\text{V}$ . And in most applications, it was usually easy to keep CMVs inside the power-supply rail—and with  $\pm 10\text{-V}$  signals and  $\pm 15\text{-V}$  power-supply rails, the output signal never had to

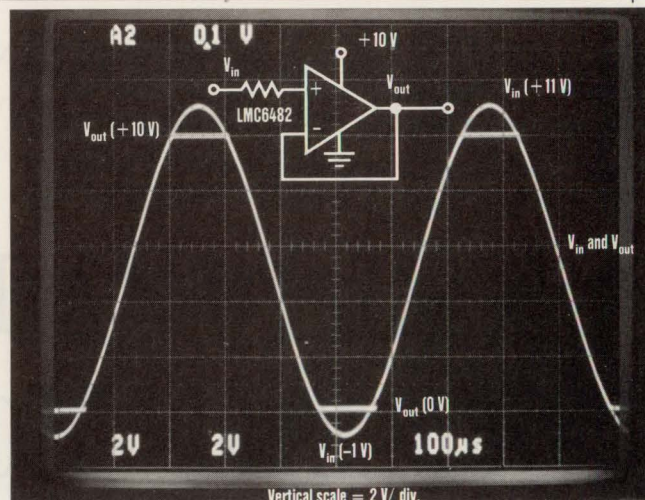

**2. WHEN A 12-V PK-PK SINE WAVE** is applied to the LMC6482 op amp, the output is clipped cleanly at the 0- and +10-V rails. The op amp runs off a single +10-V supply and is connected as a unity-gain follower.

## NATIONAL SEMICONDUCTOR'S CMOS OP AMPS

Specification	LMC6482/84	LMC6082	LMC6062
Output-voltage swing (with load connected to supply voltage $\div 2$ ), V With 2-k $\Omega$ load and 15-V/5-V/3-V supply With 600- $\Omega$ load and 15-V/5-V/3-V supply	0.3 to 14.6/0.1 to 4.87/NS 0.8 to 13.9/0.3 to 4.61/0.32 to 2.65	0.5 to 14.3/0.2 to 4.7/NS 1.3 to 12.9/0.5 to 4.3/NS	0.04 to 14.96/0.02 to 4.98/NS <sup>1</sup> 0.15 to 14.85/0.04 to 4.97/NS <sup>2</sup>
Common-mode-voltage range, dB At 15-V/5-V/3-V supply, for CMRR $\geq 50$ dB	0.2 to $V^+ + 0.2/$ $-0.2$ to $V^+ + 0.2/$ $-0.1$ to $V^+ + 0.1$	$-0.1$ to $V^+ - 2.5/$ $-0.1$ to $V^+ - 2.5/$ NS <sup>3</sup>	$-0.1$ to $V^+ - 2.3/$ $-0.1$ to $V^+ - 2.3/$ NS <sup>3</sup>
Common-mode rejection ratio (CMRR), dB At 15-V/3-V supply	85/NS	75/NS <sup>4</sup>	75/NS <sup>4</sup>
Offset voltage, mV	500	350	350
Offset-voltage drift, $\mu\text{V}/^\circ\text{C}$	2	1 (t)	1 (t)
Slew rate, V/ $\mu\text{s}$	1.2	1.2	0.02
Unity-gain bandwidth, MHz	1.3	1.3 (t)	0.1 (t)
Quiescent current per op amp, $\mu\text{A}$ At 15-V/5-V/3-V supply	625/500/375	850/750/NS	23.5/19/NS
Package type	8-pin DIP/SOIC 14-pin DIP/SOIC	8-pin DIP/SOIC 14-pin DIP/SOIC	8-pin DIP/SOIC 14-pin DIP/SOIC
Specifications are at 25°C and are minimums or maximums unless labeled typical (t). NS = not specified 1 = all voltage swings with 100-k $\Omega$ load 2 = all voltage swings with 25-k $\Omega$ load 3 = CMRR $\geq 60$ dB 4 = $V_{\text{CM}} = 0$ to 12 V			

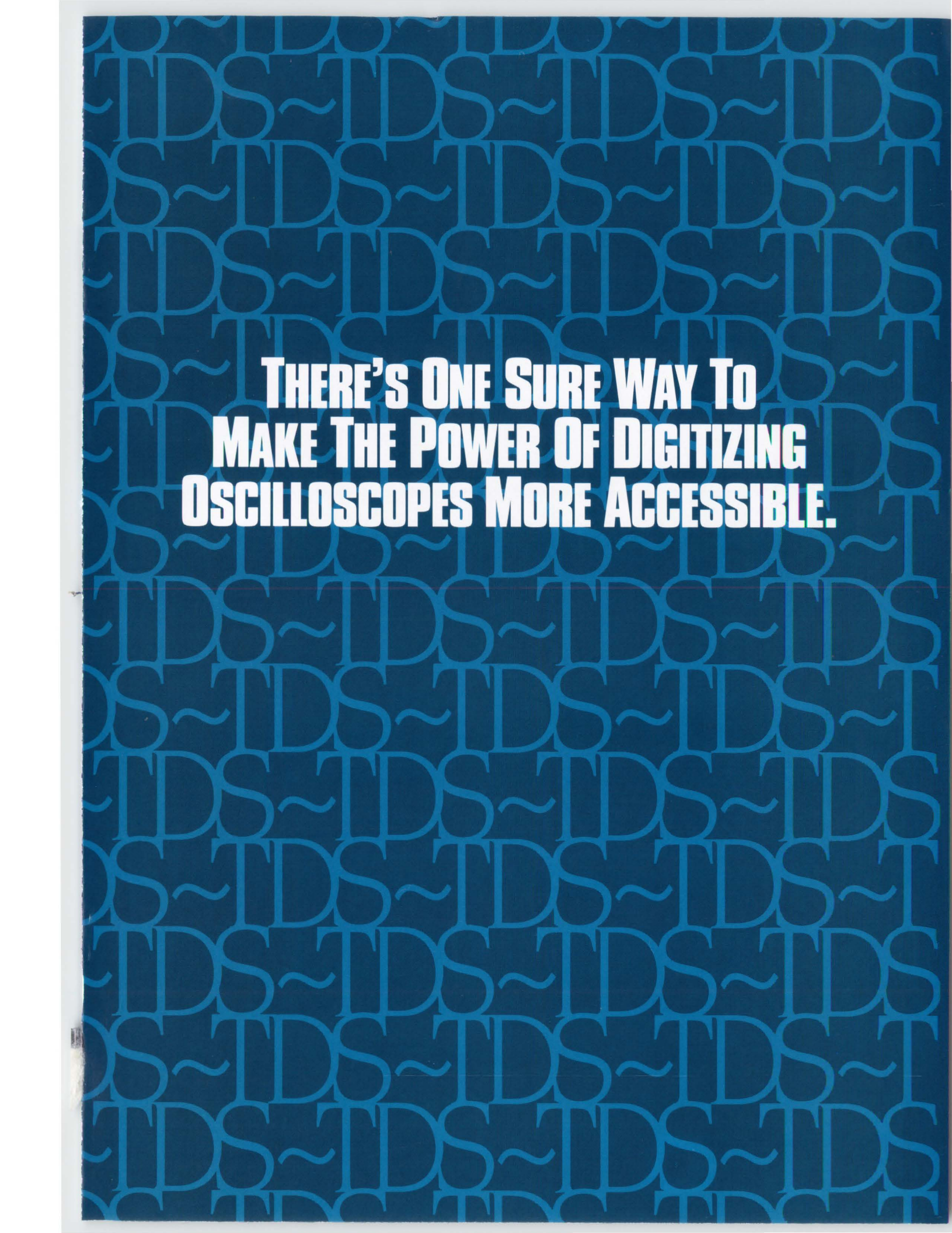

**THERE'S ONE SURE WAY TO  
MAKE THE POWER OF DIGITIZING  
OSCILLOSCOPES MORE ACCESSIBLE.**

# GET IN OUR

**Tektronix**

**TDS 640**

FOUR CHANNEL  
DIGITIZING OSCILLOSCOPE

200  
500

Tek Stopped: Single Seq

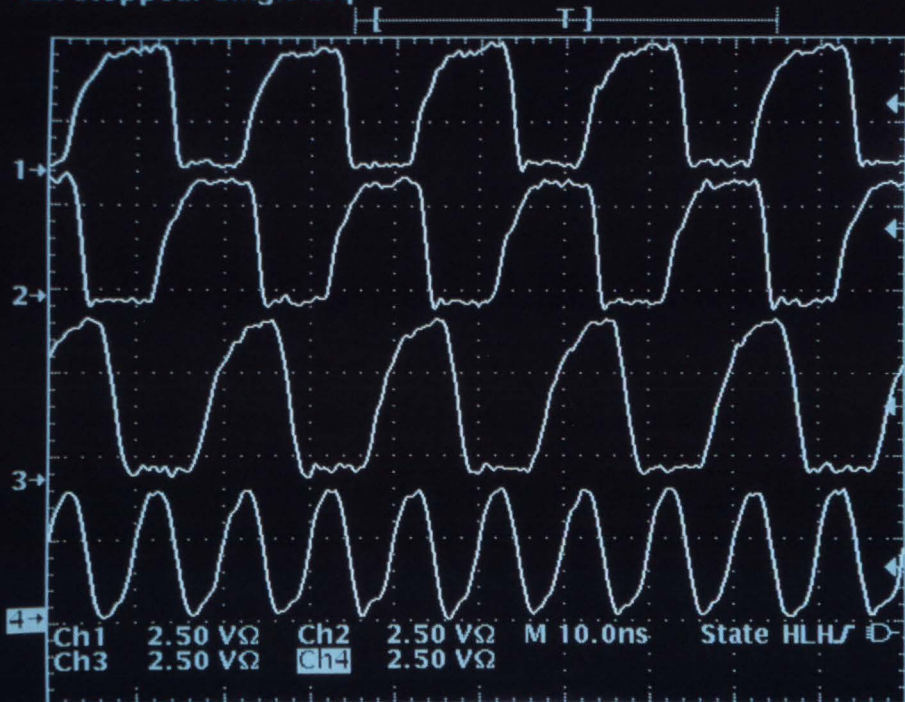

Logic State  
Function

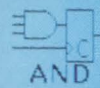

AND

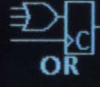

OR



NAND



NOR

Type <Logic>	Class <State>	Define Inputs	Define Logic AND	Trigger when Goes TRUE	Set Thresholds	Mode & Holdoff
-----------------	------------------	------------------	------------------------	------------------------------	-------------------	----------------------

ON/  
STBY

# FACE.

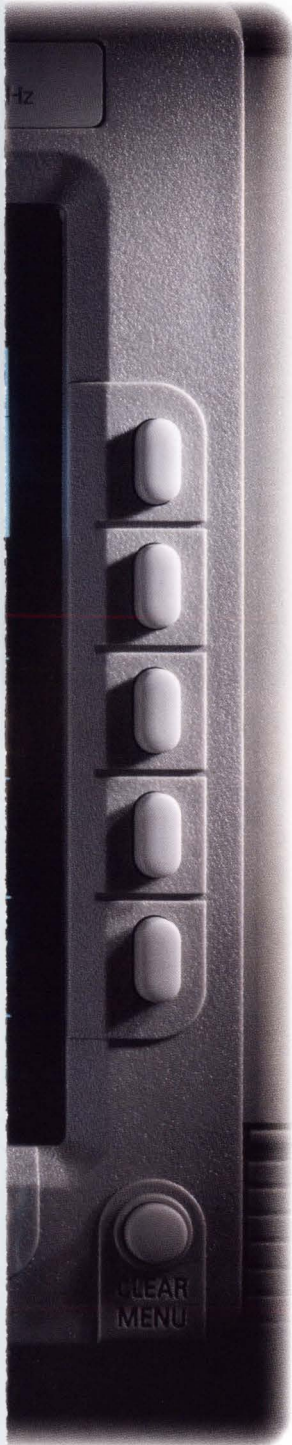

A great face can open a lot of doors. Ours will take you into a world of digital oscilloscope technology that until now has existed only in the maddening pages of some instruction manual. You'll find this face on every **TDS** scope we make. Intuitive, affordable scopes so easy to use, you'll feel like a digital expert whatever your background. Tektronix. When it comes to digital scopes, we've put on a whole new face. Now all you have to do is get in it.

**Tektronix**  
Test and Measurement

**GO AHEAD. PULL THE TRIGGER ON**

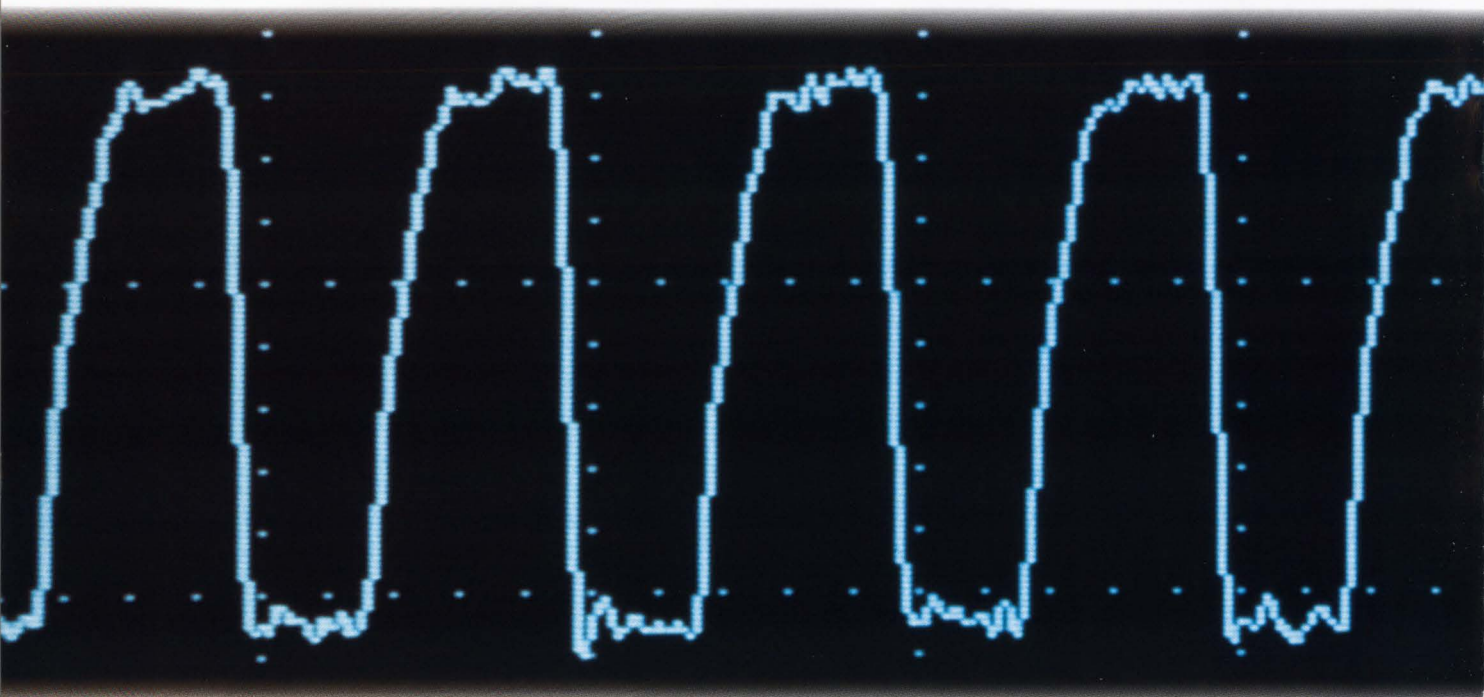



# THE LITTLE RUNT.

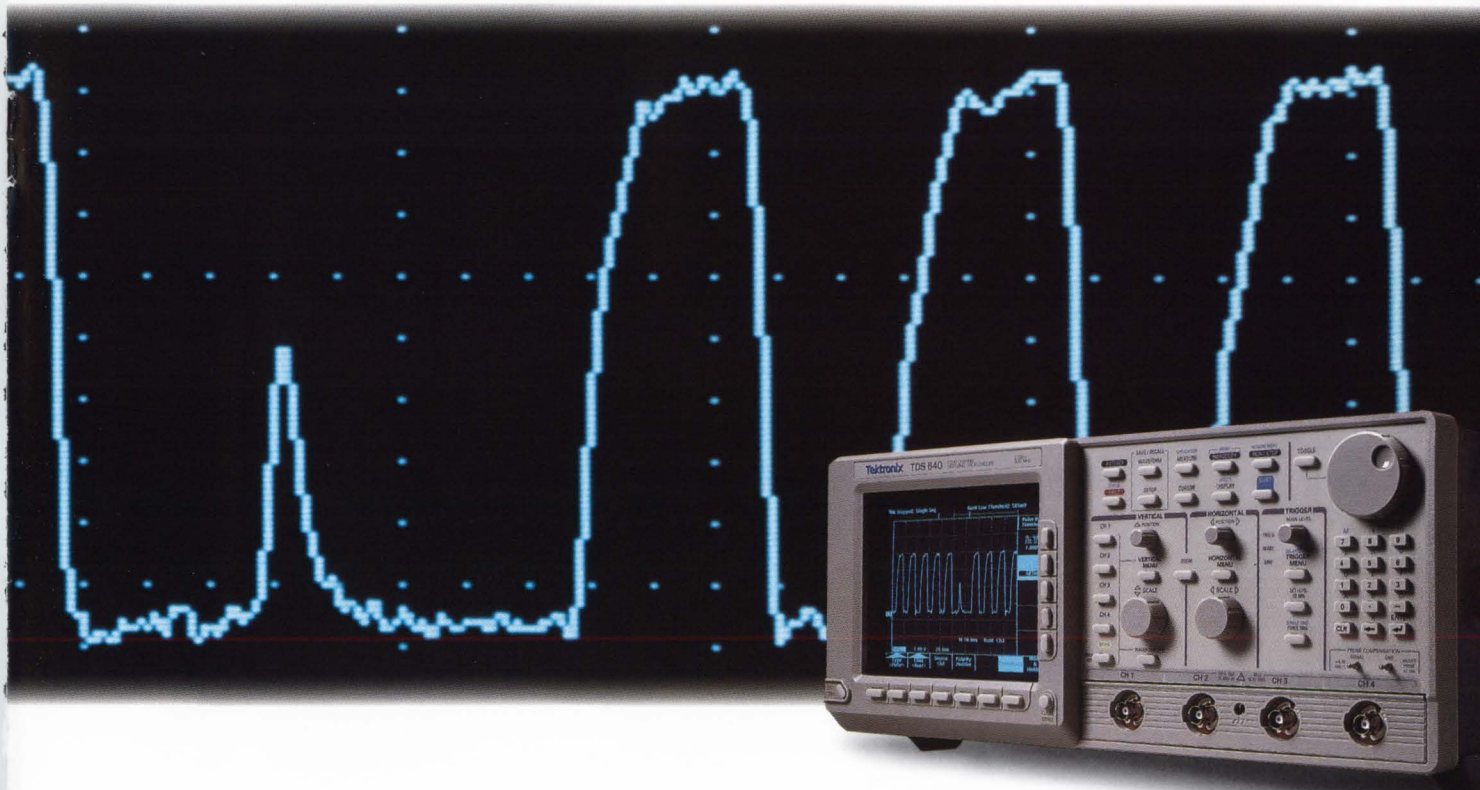

Our new TDS 620 and TDS 640 digital oscilloscopes make triggering so easy, it's just like target practice.

See, with an extraordinary sampling rate of **2 GS** per second on all 4 channels at once, you can get a precisely detailed look at what you're aiming at. And with the ingenious TDS user interface and application-specific icons, you can now quickly access nearly a dozen extended trigger functions, including runt, logic and glitch. Better still, either model is available for a price noticeably lower than any competitive scope.

The undeniably accurate, remarkably affordable, intuitively trigger-happy **TDS 600** Series digital scopes from Tektronix. Without a doubt, they'll make your day. **TALK TO TEK/1-800-426-2200 EXT. TDS7**

**Tektronix**  
Test and Measurement

**FACE IT. WITH TODAY'S FASTER SYSTEMS, YOU'VE GOT A**

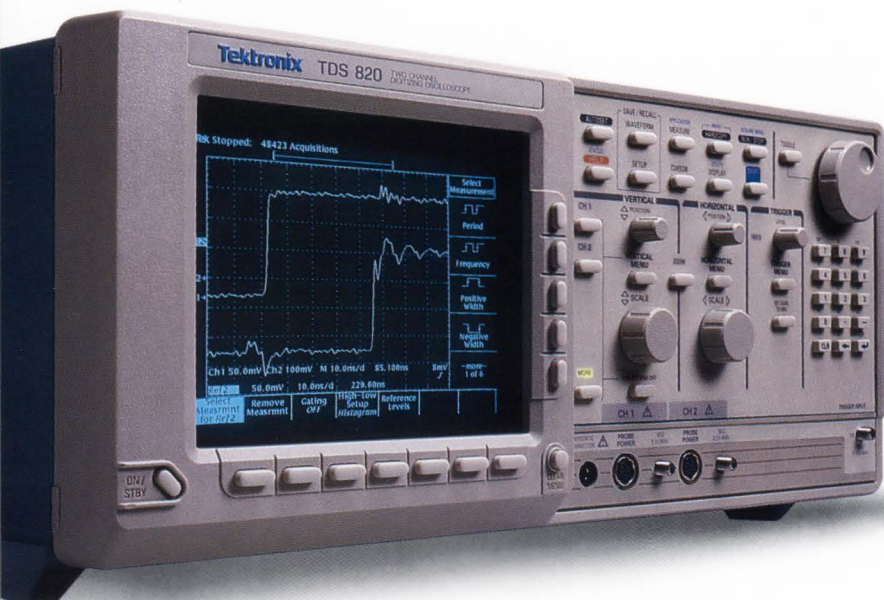



**LOT LESS**

**MARGIN**

**FOR ERROR.** And that's exactly why we built the TDS

820. The digital oscilloscope that's accurate to within **2 ps**

and provides time resolution in femtoseconds. In fact, at 0.40ps

with a **6 GHz** bandwidth, now even the narrowest timing

margin is nothing to be afraid of. Combine that with the intuitive

TDS user interface, and applications like device characterization

require nothing more than the push of a button. Better still, there

is another aspect of the **TDS 820** that, upon compari-

son with any so-called competitive scope, will ease your toughest

margin of all: The price tag. **TALK TO TEK/1-800-426-2200 EXT. TDS7**

**Tektronix**

Test and Measurement

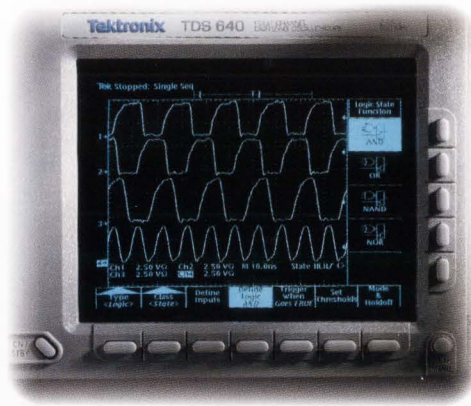

# BESIDES EASE OF USE, WE ALSO CONSIDERED SUITABLE FRAMING.

At Tektronix, we designed our TDS Series user interface to be the picture of simplicity. Then, because everybody's needs are different, we framed it seven different ways. For instance, besides the TDS 620, 640 and 820, we also build the TDS 420, 460, 520 and 540.

On the 2 channel **TDS 520** and 4 channel 540, you



get 500 MHz bandwidth and up to 50k record lengths. A single-channel sampling rate of 1 GS/sec on the **TDS 540** and 500 MS/sec on the 520—combined with edge, pattern, state, glitch, runt & pulse width triggering—greatly simplifies debugging and fault isolation. What's more, both feature built-in

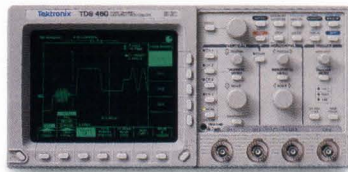

FFT analysis. Or, for a more economical solution, take a look at the **TDS 420** and **TDS 460**. First off, they provide up to

350 MHz across 4 channels, at a cost usually found on 2 channel scopes. They provide video triggering, a 30,000 record length, and a sampling rate of 100 MS/sec. And both feature 5 different acquisition modes: sample, peak detect, high-resolution, envelope, and average. All of which you'll find amazingly accessible thanks to the ingenious TDS user interface. The TDS Series of digital oscilloscopes from Tektronix. For more information, don't hesitate. Get in our face. **TALK TO TEK/1-800-426-2200 EXT. TDS7**

**Tektronix**  
Test and Measurement

## RAIL-TO-RAIL OP AMPS

swing even close to either power-supply rail.

However, most of today's single-power-supply op amps are different animals. Many, like National's, are CMOS. Although they simplify power-supply rail-to-rail output swings, they can't touch bipolar devices on input-voltage noise. In addition, performance—particularly speed/bandwidth and common-mode rejection ratio (CMRR)—drops with supply voltage. Thus, to maximize dynamic range (the difference between the maximum signal and the noise floor) and signal-to-noise ratio (SNR), IC designers are developing op amps to swing as close to the power-supply rail as possible. Moreover, data sheets are specifying multiple power-supply voltages.

For example, the basic specifications for all four new op amps are written around a +5-V power-supply rail. In addition, CMRR, CMV range, output swing, and quiescent current of the LMC6482/84, are also specified running off a +3-V power-supply rail (*see the table, again*)—some data is also given running off 15 V.

An unbelievably low typical bias current of 10 fA represents one feature common to all members of the new CMOS op-amp family: It is a typical specification because it can't be measured "economically" in production quantities. Guaranteed specifications drop as low as 4 pA, however that's at a temperature of 85°C. Because bias current is halved for every 10°C drop in temperature, bias current should be less than 0.07 pA at 25°C. And current noise becomes truly unmeasurable, albeit a typical value of  $0.0002 \text{ pA}/\sqrt{\text{Hz}}$ .

All four of these ICs offer low quiescent currents. Quiescent current of the dual LMC6062 is a maximum of just 19  $\mu\text{A}$  per op amp running on a +5-V power-rail, and is less than 24  $\mu\text{A}$  per op amp on a +15-V power-supply rail. Running off either +5- or +15-V power-supply rails, the LMC6082 needs less than 850  $\mu\text{A}$ /op amp. Running off +3-, +5-, and +15-V power-supply rails, the LMC6482/84 typically needs 416, 500, and 625  $\mu\text{A}$  per op amp, respectively. Also note that these are true op amps with

typical open-loop gains of more than 100 dB while driving loads of 2000  $\Omega$ , and somewhat less while driving loads of 600  $\Omega$ . And all but the LMC6062 can drive loads of 2 k $\Omega$  to within a few 100 mV of both power-supply rails while running off a +5-V power supply, and within about a volt of both power-supply rails when using a +15-V power supply. In addition, the LMC6482/84 can all drive 500-pF loads, at a closed-loop gain of unity, without oscillating.

A good low-voltage single-power-supply application for the LMC6484 might be to form the heart of a micro-power data-acquisition system running off a +3-V battery. Two of the LMC6484's four op amps can form a very high-input-impedance instrumentation amplifier to monitor a low-level sensor such as a strain gage excited by the power supply. The instrumentation-amplifier's output drives a third op amp, which acts as the input stage of a sample-and-hold amplifier, whose output can easily charge a hold capacitor with a value of up to 100 pF. The IC's fourth op amp buffers the charge on the hold capacitor, taking full advantage of the device's low bias current. Each op amp's low output impedance is ideal for driving an analog-to-digital converter.

The silicon-MOSFET world is largely dominated by enhancement-mode transistors, devices whose gates must be brought positive with respect to the source to turn them on. However, depletion-mode n-channel devices whose gates, like the grids of vacuum tubes, must be brought to a potential negative with respect to their sources to turn them off, can be used to do some interesting tricks, like the depletion-mode devices in the LMC6482/84 (*Fig. 1, again*). The pair operates as depletion-mode FETs for signals close to the plus power-supply rail, and as enhancement-mode FETs for signals close to the minus power-supply rail. This so-called soft-depletion, p-channel FET was developed by National Semiconductor's process engineers especially for the company's double-polysilicon analog CMOS process, on which all their CMOS op amps are made.

A folded-cascode circuit consisting of FETs  $M_3$  and  $M_4$  was chosen for the second section of the input stage (*Fig. 1, again*). It provides simple level shifting and the near power-supply rail-to-rail biasing required by the first section of the circuit. The output stage consists of two large complementary, common-source connected, n- and p-channel FETs driven in a push-pull manner. Output swing is limited by the transistor's transconductance and the minimum load resistance.

An oscilloscope trace represents the best indication of the ability of the LMC6482/6484 to handle CMVs beyond the op-amp's power-supply rails (*Fig. 2*). The op amp is connected as a unity-gain follower and runs off a single +10-V power supply. A sine wave whose peaks swing from -1 to +11 V is applied to the input and the output clips cleanly at 0 and +10 V. The smooth transitions in the output, shown coming off the power-supply rails, indicate that when overdriven, the op amp recovers quickly without any aberrations in the waveform. That is, the output waveform can be laid over the input waveform, both of which coincide over the complete linear operating range of the device from ground to the +10-V power-supply rail.

### PRICE AND AVAILABILITY

The LMC6062, LMC6082, LMC6482, and LMC6484 are rated for operation from -40°C to +85°C and for the military-temperature range. In quantities of 100, pricing ranges from \$1.70 to \$7.60 each for the LMC6062, and \$1.60 to \$7.50 each for the LMC6082, depending on temperature version and package type. In the same quantities, the LMC6482 is priced at \$1.65 and \$3.30 each for industrial- and military-temperature-range versions, respectively; the LMC6484 is priced at \$2.40 and \$4.94 each for industrial- and military-temperature-range versions, respectively. Samples of the LMC6482/84 are available now and full production will start by June.

National Semiconductor Corp., 2900 Semiconductor Dr., Santa Clara, CA 95052-8090; Bettina Briz, (408) 721-2274.

CIRCLE 544

HOW VALUABLE?	CIRCLE
HIGHLY	568
MODERATELY	569
SLIGHTLY	570

# USER-FRIENDLY ASIC SUPPORT AT YOUR FINGERTIPS

## Local Resources Speed ASIC Design Cycle

**E**asy access to ASIC support means fast design cycles—and fast time to market. Oki's East and West Coast design centers offer the local, comprehensive ASIC resources you need for quick turnaround times.

With Oki, you work in a user-friendly environment equipped with state-of-the-art workstations, industry-standard CAD tools, advanced software support, and an experienced staff. We provide leading-edge 0.8 $\mu$ m sea-of-gate, standard cell, and 3-volt technology. Plus we assign a task team to your project, ensuring a steady communications link and a speedy, successful design flow.

For easy access to complete, local ASIC design support, call 1-800-OKI-6388 today. To receive Oki's ASIC Capabilities Brochure, ask for Package 057.



### Oki ASIC Design Tool Support for 0.8 $\mu$ m, 1.0 $\mu$ m, & 1.2 $\mu$ m

Vendor	Platform	Operating System/Application
Cadence	Sun/Solbourne	Verilog: Simulation, fault grading, design verification
DAZIX	Sun	Design capture, simulation
IKOS	IKOS	Simulation, fault grading
Mentor Graphics	HP/Apollo	Design capture, simulation
	Sun/Solbourne	Parade: Layout, clock and timing structures
Synopsys	Sun-4	Design synthesis, test synthesis
	Interface to Mentor, Valid, Viewlogic	
Valid	Sun/Solbourne	Design capture, simulation
	DECstation 3100	Design check
	IBM RS6000	GED, ValidSIM, RapidSIM
VIEWlogic	Sun-4	Design capture, simulation
	PC386	Design check

All brands, product names, and company names are trademarks or registered trademarks of their respective owners.



**OKI**  
Semiconductor

785 North Mary Avenue  
Sunnyvale, CA 94086-2909  
800-OKI-6388

TRANSFORMING TECHNOLOGY INTO CUSTOMER SOLUTIONS

## HARDWARE EMULATOR SUPPORTS ALL TYPES OF DESIGN STYLES

**S**ynchronous, nonsynchronous, and asynchronous designs are all supported in RPMplus, Quickturn's fourth-generation hardware-emulation system. The product is based on a technology the company calls Precision Emulation, which helps automate design-mapping. Precision Emulation technology works through the Precision-Prototype-Synthesis and Timing-Sensitive-Partitioning algorithms. These algorithms enable users to precisely control emulation timing to deal with the asynchronous portions of designs.

Engineers can use RPMplus to emulate designs of up to 50,000 gates. If more gates are needed, RPMplus is compatible with Quickturn's mRPM products that emulate up to 1 million gates. In addition, new CAE interfaces let users automatically transfer data from Mentor Graphics and Verilog databases to the RPMplus emulator. This eliminates the need to use ASIC-vendors tools to generate an emulation net

list for each design change.

The tight integration with the Mentor and Verilog simulation environments makes it easier to use hardware emulation for accelerating functional verification before in-circuit emulation. Users can apply simulation test vectors and compare results without leaving their familiar simulation environment. In the Verilog environment, the portion of the design configured in the RPMplus can be cosimulated with the rest of the design being simulated in software. Consequently, system validation can take place at the software level before users create a hardware prototype for in-circuit emulation.

RPMplus runs under X-Windows and can be used in existing HP/Apollo, IBM, and Sun environments. Production shipments begin this month. The base price for the RPMplus 50,000-gate system is \$175,000.

**Quickturn Systems Inc., 325 E. Middlefield Rd., Mountain View, CA 94043; (415) 967-3300. CIRCLE 460**  
 ■ LISA MALINIAC

## VHDL SIMULATOR RUNS FASTER WITH LESS MEMORY

**F**eatures of Version 4.0 of the VantageSpreadsheet VHDL simulation system include faster compiler speed, a 50% reduction in memory requirements, and a C interface to other design tools. Also new is a code-coverage tool that grades test stimulus, the Concurrent Compiler for distributed VHDL-code compilation, and a new back-annotation tool called the Generic Loader.

Version 4.0 is twice as fast as the previous version of Vantage's simulation tools for simulating and compiling at the gate level. For complex behavioral models, simulation and compilation are improved by up to a factor of five.

A new code-coverage tool is essentially a VHDL equivalent of the toggle-test found in older simulators, which helps engineers grade test stimulus by checking that each source path in the code was exercised. It improves model testing by counting the number of times each line of code is executed, and also counting the number of events on each signal.

A major enhancement for VantageSpreadsheet is the Concurrent Compiler, a parallel version of Vantage's VHDL compiler that distributes compilation tasks across an HP or Sun network using an intelligent partitioning system. The compiler system has robust error-recovery capabilities, including the ability to retarget faults automatically if a network or machine problem occurs. Compiling portions of a job in parallel can reduce overall project compilation time by a factor of ten or more.

The Generic Loader loads generic timing information from a test file at a rate of 100,000 parameters/min. In addition, the simulators don't have to stop to complete the loading of a new generic set, which allows users to quickly switch from best, worst, or nominal conditions. Pricing for VantageSpreadsheet 4.0, which runs on Unix workstations, starts at \$44,000 per copy.

**Vantage Analysis Systems Inc., 42808 Christy St., Suite 200, Fremont, CA 94538; (510) 659-0901. CIRCLE 461**  
 ■ LISA MALINIAC

## PCB TOOL CALCULATES MANUFACTURABILITY

PCB Design for Assembly, a PC-based software tool, analyzes the cost of pc-board component assembly, and provides indices reflecting the manufacturability of the board. The tool reduces design-cycle time and cost-to-manufacture by enabling users to

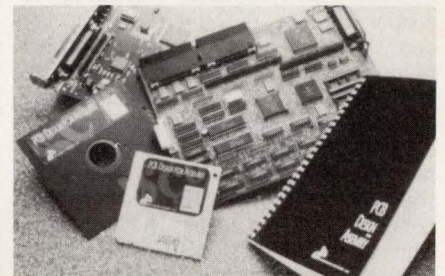

generate manufacturable design alternatives in minutes. Jointly developed by Texas Instruments and Boothroyd Dewhurst, PCB Design for Assembly assists users in five critical board-design areas: placement and density analysis, height analysis, auto-insertion analysis, quality and labor analysis, and cost analysis. In addition, a library-management feature filled with industry-proven components helps users identify part types. PCB Design for Assembly is shipping now. Site licenses start at \$9500.

**Boothroyd Dewhurst Inc., 138 Main St., Wakefield, RI 02879; (401) 783-5840. CIRCLE 462**

## BUILDING-BLOCK LIBRARY INCLUDES LARGE CORES

Version 1.2 of the Soft-Design library of synthesizable architectures includes versions of the 8051 microcontroller, the 2900 series of bit-sliced microcontrollers, and a multiplier macro-function group. The architectures are actually Verilog or VHDL representations of complex parts used by ASIC and system designers as core building blocks in their high-level design descriptions. After the high-level design is verified, these building blocks are synthesized using industry-standard synthesis tools. The Soft-Design toolkit is offered in Verilog or VHDL for use with Cadence, Mentor, Synopsys, or Vantage simulation and synthesis tools. The architectures are provided in source code, along with a test validation suite, synthesis scripts, data sheets, and documentation. Call the company for pricing and availability.

**HDL Systems Corp., 2150 N. First St., Suite 670, San Jose, CA 95131; (408) 428-1000. CIRCLE 463**

## DESIGN MIXED-SIGNAL ASICS WITH ONE TOOL

Engineers can use Path Programmable Logic (PPL) version 5.0 to design both the analog and digital portions of a circuit. PPL's physical context-switching capabilities allow it to change rules, libraries, and constraints based on area definitions. In addition, version 5.0 incorporates the WYSIWYG (what you see is what you get) operation that has made desktop publishing easy to use. Users define a physical boundary between analog and digital sections of a circuit that causes the tool to switch to new libraries and rules for the respective areas. Then the software can interconnect elements across the boundary. The standard PPL ASIC package includes design entry, extraction, mixed-signal simulation, layout generation, schematic generation, and libraries for Mosis or Foresight shared-silicon services. PPL version 5.0 runs on PCs, and is shipping now for \$14,500. A Sun-workstation version is also available.

**Bonneville Microelectronics Inc., 1399 S. 700 E, Suite 10, Salt Lake City, UT 84105; (801) 467-4698. CIRCLE 464**

## 44 NEW MODELS EXPAND SIMULATION LIBRARY

Analogy has added 44 popular a-d converters to its simulation model library. These behavioral models, which include the AD 574A, have been fully characterized by the company for use with Saber, its mixed-signal simulation tool. Analogy worked from complete component specifications from Analog Devices and Burr-Brown, so the models are accurately characterized for performance parameters. In addition, because the models are behavioral, simulation times are greatly improved over transistor-level models. Analogy is now shipping the a-d converter models as part of its library of more than 4500 analog and mixed-signal parts.

**Analogy Inc., 9205 S.W. Gemini Dr., Beaverton, OR 97075; (503) 626-9700. CIRCLE 465**

## ASIC DELAY CALCULATOR DRIVES MANY SIMULATORS

An enhanced version of Mentor Graphics' TimeBase ASIC delay calculator now supports third-party logic simulators. TimeBase calculates design-specific timing delays based on design topology and layout parasitics. In the past engineers have had to develop and maintain a separate calculator for each

simulator they used. With TimeBase, however, they can support a diverse set of simulators, proprietary or third party, with one ASIC library. This allows tighter integration of third-party simulators with Mentor's Falcon Framework for concurrent design. The enhanced version of TimeBase will begin shipping by the second half of this year for \$4900. In addition, it will be included at no charge with purchases of Mentor's logic simulator, QuickSim II.

**Mentor Graphics Corp., 8005 S.W. Boeckman Rd., Wilsonville, OR 97070-7777. CIRCLE 466**

## UTILITIES SOFTWARE EDITS ORCAD SCHEMATICS

The SDT Utilities 1.0 software performs automated schematic editing and annotation of OrCAD SDT schematics. Engineers can locate signals

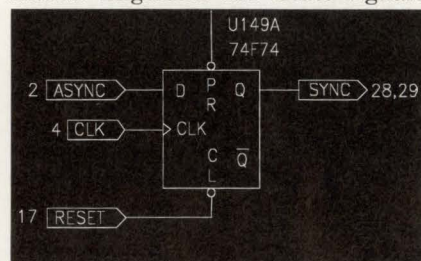

quickly with a function that annotates the schematic with the source- and destination-sheet numbers of all off-sheet signals. In addition, they can use the program's language to build commands that perform editing operations on any sheets in a schematic design. These commands may include title-block changes, reference-designator changes, part-field entry, and deleting objects. SDT Utilities 1.0 runs on PCs. It's shipping now for \$99.

**Robertson Engineering, 3721 Arlen Ct., San Jose, CA 95132; (408) 946-1200. CIRCLE 467**

## CREATE LOGIC MODELS FROM SPICE NET LISTS

Engineers can automatically generate ASIC-cell functional models from Spice net lists with the spice2logic software. Model creation starts with a Spice net list of a CMOS cell, a side file describing model attributes, and a golden simulation environment, such as Verilog. Spice2logic transforms the Spice file into a switch-level representation that's exhaustively simulated. The simulation results are then used to synthesize the functional behavior of the CMOS cell, which is stored in an intermediate description file called Cell Description Format (CDF). The tool uses the CDF

to fabricate functional simulation, synthesis, and timing-analysis models that represent the exact behavior of the Spice net list. Users can create Ikos, Mentor, OrCAD, Synopsys, Verilog, and Viewlogic models. The spice2logic software runs on Unix workstations. Pricing starts at \$17,500 for the core product with one model generator. Additional generators cost \$10,000.

**SimQuest Corp., 3235 Kifer Rd., Suite 300, Santa Clara, CA 95051; (408) 739-7582. CIRCLE 468**

## FPGA LAYOUT TOOLS COMPLETE MOST DESIGNS

An improved version of the NeoRoute tools for the physical layout of Xilinx FPGAs increases design-completion rates and reduces net delays. In addition, NeoRoute is three to five times faster than Xilinx routines, requires fewer place-and-route iterations, and almost eliminates clock-skew problems in Xilinx 3000 devices. The Xilinx-version of NeoRoute is a subset of FPGA Foundry, a device-independent CAD toolset for FPGAs. NeoRoute is available now. It runs on 80386- and 80486-based PCs under MS Windows, and on Unix-based workstations running X-Windows and Motif. The PC and workstations versions cost \$7500 and \$12,000, respectively.

**NeoCAD Inc., 2585 Central Ave., Boulder, CO 80301; (303) 442-9121.**

**CIRCLE 469**

## VHDL PRICE TAG REDUCED FOR FIRST-TIME USERS

The VHDL Consulting Group has significantly reduced the price of its Std\_DevelopersKit software package so that any VHDL-model builder can afford it, even for demonstration projects. Because first-time users need a low-cost entry point to VHDL, the company offers the package at \$9200 for a site-wide source-code license that includes more than 40,000 lines of VHDL code and extensive documentation. The Std\_DevelopersKit is made up of five VHDL subroutine packages that supply a foundation to build simulator-independent models. In addition, the kit includes Std\_ModelSpec, a VHDL model-development guidebook packed with the years of model-writing experience. The Std\_DevelopersKit is shipping now. Licenses are also available on a division- or corporate-wide basis for \$25,000 and \$50,000, respectively.

**VHDL Consulting Group, 974 Marcon Blvd., Suite 260, Allentown, PA 18103; (215) 266-9791. CIRCLE 470**



# Batteries not included.

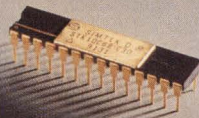

Nonvolatile random access memory doesn't need batteries anymore. It doesn't need an extra chip either. All it needs is this. The nvSRAM from Simtek.

At 64K, the nvSRAM offers the density to handle virtually anything you can come up with. It's extremely fast, with access speeds ranging from 30ns-55ns. It doesn't depend on a battery for nonvolatility, so reliability is unsurpassed. And because it's a one-chip solution, precious little board space is required.

We think you'll find our nvSRAM is well suited to applications ranging from cellular phones to the most advanced military hardware. To prove it, we'll send you a free design kit. And we guarantee you'll get it within 48 hours of your request. So call Simtek at 1-800-637-1667 right now for your free design kit (For production quantities, call your local Arrow/Schweber Electronics branch). And find out why, when it comes to nonvolatile RAM, batteries are dead.



719-531-9444 Fax 719-531-9481

CIRCLE 248 FOR U.S. RESPONSE  
CIRCLE 249 FOR RESPONSE OUTSIDE THE U.S.

## CHIP INTEGRATES FOUR DIGITALLY CONTROLLED POTENTIOMETERS

The X9241 Quad E<sup>2</sup>POT from Xicor contains four digitally controlled resistor arrays, each composed of 63 resistive elements connected in series. Sixty-four taps located between each element and at the ends of each array are accessible to the wiper elements, whose position is controlled by the user through a two-wire serial-bus interface. Each resistor array has an associated wiper counter register and four 8-bit data registers that can be directly written and read by the user. In addition, the contents of the data registers can be transferred to the wiper counter register to position the wiper. The current wiper position can be transferred to any one of its associated data registers.

Mask-programmable resistance values range from 2 to 20 k $\Omega$ . The resistor arrays can be cascaded to form resistive elements with 127, 190, or 253 taps,

for a total resistance value of 500  $\Omega$  to 200 k $\Omega$ , depending on the mask-programmed resistance values. The X9241 supports a bidirectional bus-oriented protocol that defines the origin and destination of any traffic on the bus. Each direct-write cell consists of 16 bytes of E<sup>2</sup>PROM memory, and each register has an endurance of 100,000 write cycles and 100-year data retention.

In thousands, the 20-pin plastic DIP version costs \$4.00, \$4.40, \$7.00, and \$15.12 for the commercial, industrial, military, and MIL-STD-883 temperature ranges, respectively. Pricing for the 20-pin SOIC package is \$4.80 and \$5.25 for the commercial and industrial temperature range, respectively. The chip is sampling now with production quantities available in the second quarter.

*Xicor Inc., 851 Buckeye Ct., Milpitas, CA 95135-7493; (408) 432-8888.*

**CIRCLE 471**

■ MILT LEONARD

## EEPROM-BASED LOGIC ICs DELIVER FPGA DENSITIES

The first in a family of electrically erasable programmable logic chips, the pLSI 1032-80 supplies the highest gate count—6000 gates—of any EE-based field-programmable gate array. Lattice, which introduced the chips last year (ELECTRONIC DESIGN, June 27, 1991, p. 137), has improved the chips' performance.

Now the EEPROM logic chips can run with 80-MHz clocks, rather than with 70-MHz ones. The 1032 chip—originally the ispLSI32—will have three other family members—the 1016, 1024, and 1048, which pack 2000, 4000, and 8000 gates, respectively. All four ICs come as either the pLSI-series and require a high-voltage external programming signal, or as the in-system programmable (ispLSI) series that can be configured (or reconfigured) with the 5-V power supply.

When running with system clocks of 80 MHz, the pLSI 1032 has an input-to-output delay of just 15 ns. The logic consists of 32 generic logic blocks (GLB) in the 1032 (and 16, 24 or 48 blocks in the other chips). Each GLB has 18 logic inputs that drive a product-term array that, in turn, sends four outputs to the output macrocell. The macrocell contains a D flip-flop that has an Exclusive-OR input gate, and combinatorial logic. Additionally, the 1032 includes 192 registers, 64 I/O pins, 8 dedicated inputs, 4 dedicated clock inputs, and a global routing pool for interconnections.

The family will be supported by pDS, Lattice's development system for IBM 386/486-based PCs and compatibles in a Microsoft Windows environment. Also available is the isp engineering kit, which includes a chip, a programming module, cable, and power adapter. The pDS software and kit sell for \$995 and \$395, respectively. The 84-pin pLSI 1032 comes in both 50- and 80-MHz versions, and sells for \$49 and \$81 apiece, respectively, in thousands. Either speed grade of the chips is immediately available.

*Lattice Semiconductor Corp., 5555 Northeast Moore Ct., Hillsboro, OR 97124-6421; (503) 681-0118.*

**CIRCLE 472**

■ DAVE BURSKY



**29th  
ACM/IEEE  
Design  
Automation  
Conference<sup>®</sup>**

sponsored by    in cooperation with 

**Anaheim Convention Center • Anaheim, CA • June 8-12, 1992**

- Over 115 exhibitors of CAD hardware and software products
- 20 & 40 minute Exhibitor Presentations all day Monday, June 8, 1992
- Expanded emphasis on **DA USER Topics** featuring panels, papers, and tutorials
- Presentation of over 140 papers, tutorials and panel sessions
- **Nine full-day tutorials** offered Friday, June 12, 1992

- **Free Monday** exhibit-only passes available from vendors or call toll-free (800) 321-4573 (**offer valid before May 15, 1992 Only!**) After the May 15 cutoff date, exhibit-only passes (valid June 8 - 11, 1992) are available for \$35.00

For more information and registration materials contact:  
**Design Automation Conference**  
 7490 Clubhouse Rd., Suite 102  
 Boulder, CO 80301  
 U.S.A.  
 (303) 530-4333  
 email: [dacinfo@dac.com](mailto:dacinfo@dac.com) **ED**

CIRCLE 122 FOR U.S. RESPONSE

CIRCLE 123 FOR RESPONSE OUTSIDE THE U.S.

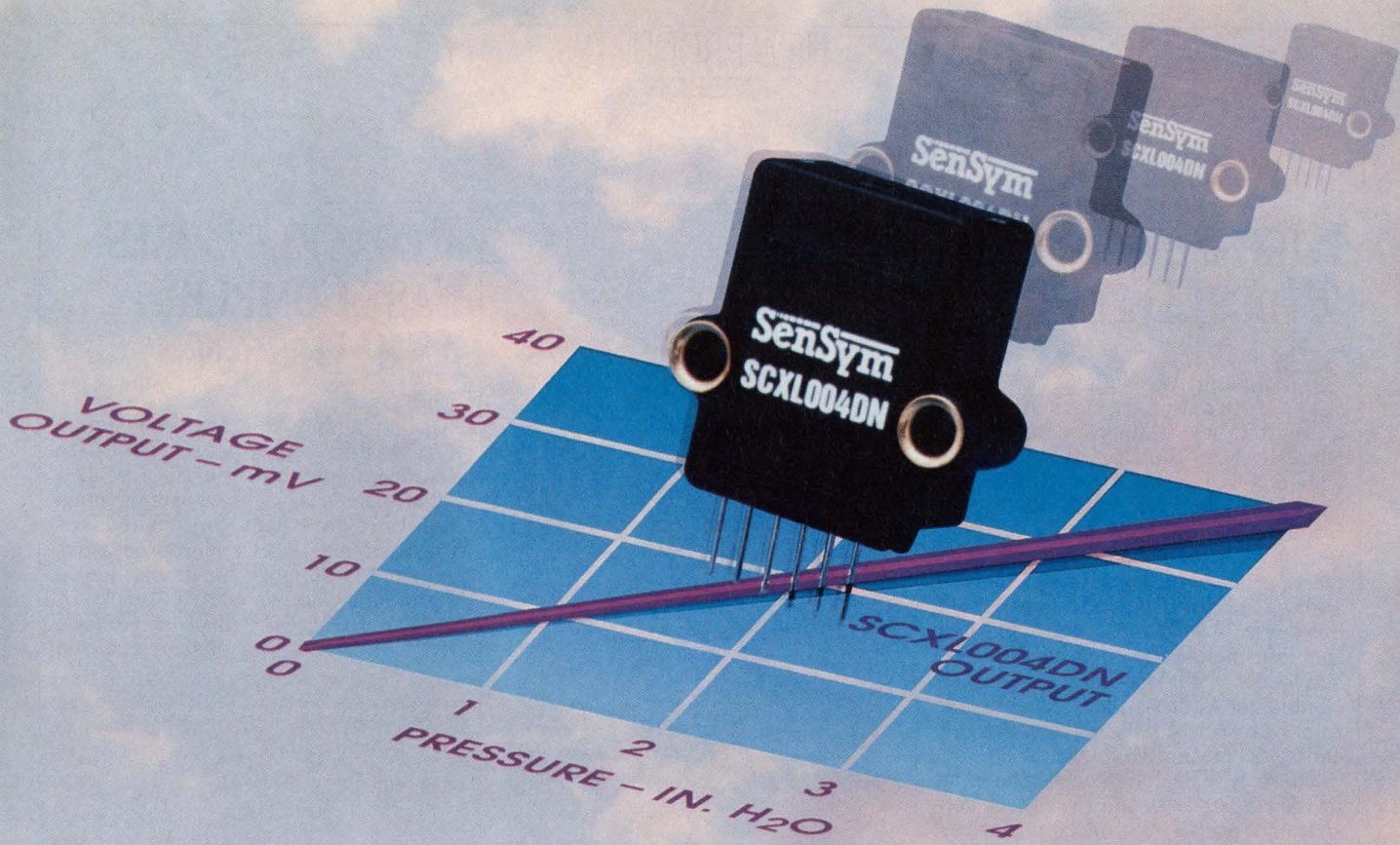

# NEW LOW PRESSURE SENSOR

## (0 to 4 inches of H<sub>2</sub>O Full Scale)

### ANNOUNCING THE NEW SCXL004DN PRESSURE SENSOR!

This new SCXL004DN sensor offers up to 10x the sensitivity of previously available solid-state sensors.

#### Features Include:

- 40mV Span (@ 4" H<sub>2</sub>O)
- Laser Trimmed for Cal. and Temperature Compensation
- Linearity and Hysteresis:  $\pm 1\%$

All this available now for **under \$50** in 100 piece quantities.

#### Typical applications include:

- Respirators and Ventilators
- HVAC Air Flow
- Gas Flows

Complete application assistance and evaluation boards are available. Call or FAX us today.

**For Immediate Assistance Call: 1-800-45SENSYM**

CIRCLE 216 FOR U.S. RESPONSE

CIRCLE 217 FOR RESPONSE OUTSIDE THE U.S.

- Please call me, I'd like SCXL004DN samples for evaluation.
- Please rush me the *FREE* 1991 SenSym Handbook. (*This Handbook contains over 250 pages of application information and product specifications.*)

Name \_\_\_\_\_  
 Title \_\_\_\_\_  
 Phone # \_\_\_\_\_  
 Company Name \_\_\_\_\_  
 Address \_\_\_\_\_  
 City \_\_\_\_\_  
 State \_\_\_\_\_ Zip \_\_\_\_\_



Return to:

**SenSym, Inc.** • 1244 Reamwood Avenue • Sunnyvale, CA 94089 • FAX (408) 734-0407

## HIGH-SPEED SRAM OFFERS WIDEST DATA PATH

Packing the industry's widest data path for a static RAM—32 bits wide—the SDT8640 CMOS static RAM is the first of a family of wide-bus memories from Silicon Design Technology. The initial RAM, offered in a 32-kword by 32-bit organization, is an asynchronous memory with transparent address latches and the ability to operate with either 3-V or 5-V bus logic. Additional control lines on the chip include both active-high and active-low Chip-Enables, an Output-Enable, an Address-Latch Enable, and four Byte-Select lines so that the chip can perform single-byte writes.

There will be four speed grades of the SDT8640, with the first three consisting of the 15-, 17-, and 20-ns devices. A 12-ns version is also in development. Slightly wider RAMs with 36-bit buses (32 bits plus byte parity) are also in development, as are smaller-bus-width SRAMs with 18- and 16-bit buses, still other commodity fast SRAMs, and some CPU-specific SRAMs.

Housed in an 80-lead plastic quad-sided flat package with 0.8-mm lead spacings, the SRAMs have common data input and output lines. The package also has many power and ground pins (two for every byte) and a separate output buffer power supply pin to minimize power-line noise. The chip can serve as a single-chip cache for processors in the

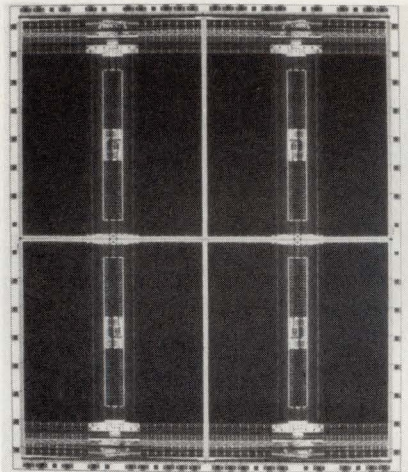

Intel X86 family. Its wide word size also suits the IC for RISC systems and communication controllers. When operating at maximum speed, the SRAMs draw from 240 to 400 mA (20 to 12 ns, respectively) from a 5-V supply. Samples of the chips will be available in May; production is slated for August. The 15-ns version sells for \$50 apiece in thousands; the 17-ns chip is \$40 in similar quantities.

**Silicon Design Technology, 39899 Balentine Dr., Ste. 200, Newark, CA 94560; Jeff Hall, (510) 651-9343. **CIRCLE 474****

■ DAVE BURSKY

## SBUS DMA CONTROLLER DOES 32-BIT ADDRESSING

Extending the addressing capability to the full 32-bit range of the SBus interface, the NIM618 DMA controller chip from Nimbus Technology can access any part of the 32-bit address space. In contrast, the original L68453 SBus DMA control chip from LSI Logic has only limited 24-bit addressing. The NIM618 is completely pin- and software compatible with LSI Logic's chip and can interface any type of peripheral that requires bus master DMA data transfers to the SBus—intelligent network and disk controllers, for example. Its \$35 price—apiece, in hundreds—suits it for slave-only peripherals. Samples are available.

**Nimbus Technology, 2900 Lakeside Dr., Ste. 205, Santa Clara, CA 95054; Spencer Greene, (408) 727-5445.**

**CIRCLE 475**

## USE 64 BITS TO DOUBLE VME PERFORMANCE

By using 64- rather than 32-bit transfers, VMEbus board makers can double performance without making changes to the backplane hardware. This can be done using the VIC64 VMEbus interface controller, a VME64-compatible bus interface chip. By using the VMEbus' 32-bit address bus for data during its frequent idle periods, designers can increase system performance by implementing 64-bit transfers at 70 Mbytes/s. The chip, from Cypress Semiconductor, is compatible with the company's VIC068 pin-out and with software for the VIC068. In hundreds the chip sells for \$140 each; 144-lead PGAs and 160-lead plastic quad flat packs are available.

**Cypress Semiconductor Corp., 3901 North First St., San Jose, CA 95134; (408) 943-2600. **CIRCLE 476****

## MEGACELL CORES EASE COMPLEX ASIC DESIGN

By adding complex predesigned functions—"CoreWare"—to its standard-cell library, LSI Logic eases designing systems on a chip. CoreWare cells consist of large functions like RISC microprocessors and related support functions like direct-memory-access control, blocks of RAM or ROM, SCSI disk controllers, DSP functions, and custom-created

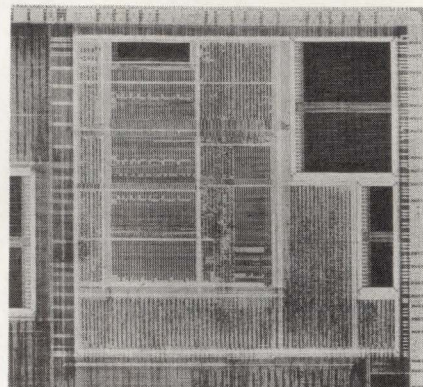

blocks. Predesigned and pretested blocks means designs can be completed faster and with fewer errors.

Some of the major cores that are currently available include the CW33000 RISC CPU core based on the R3000 microprocessor from Mips Computer Inc., the companion CW3230 read/write buffer, the CW900 embedded SPARC processor, the CW853A SBus DMA controller, along with a multiprocessor bus interface. High-speed math blocks such as pipelined and non-pipelined 32-bit ALUs, multipliers, and dividers, as well as non-pipelined 64-bit ALUs and multipliers. For military projects, LSI also offers the CW1750A 16-bit CPU.

All CoreWare cells are fully compatible with the company's MDE design environment and submicron CMOS processes. The large cells are supplemented with a library of over 1000 macrocells and other large building blocks. Pricing is based on an access fee to the CoreWare blocks (minimum of \$25,000) plus an engineering charge (minimum of \$30,000), production costs and package requirements.

**LSI Logic Corp., 1551 McCarthy Blvd., Milpitas, CA 95035; Thomas Harington, (408) 954-4875.**

**CIRCLE 477**

■ DAVE BURSKY

Performance Integrated MIPS Module

# 40-MHz PIMM

The easiest & lowest cost path  
to 33 MIPS and 6.5 MFlops\*  
with 5,000,000 Transistors  
inside a Single VLSI Package

\*Double Precision LINPACK

Actual Size  
144-pin PGA  
1.96x1.96"



Contains MIPS RISC CPU, Floating Point Accelerator, Write, Read & Parity Buffer, 32KB Instruction & 32KB Data Caches

#### Easy to Design-In

Designers no longer have to contend with the high-speed cache bus or other high-frequency signals because they are integrated in PIMM's VLSI package.

PIMM also provides a fully flexible and simple interface that helps designers to build high performance workstations, servers, and embedded systems.

#### Single Package with Minimum Board Space

PIMM integrates a CPU, FPA, 32KB I & 32KB D caches, 8-word-deep write buffer, and a 32-word programmable read buffer in a 2-inch square package — thereby reducing board space and cost *dramatically*.

#### Full MIPS Software Support

Mature compilers and operating systems exercised on hundreds of thousands of production systems by dozens of manufacturers over three years.

*For more information call*

U.S.A. (408) 734-9000

Europe 44-256-59585

CIRCLE 194 FOR U.S. RESPONSE  
CIRCLE 195 FOR RESPONSE OUTSIDE THE U.S.

**PERFORMANCE**  
SEMICONDUCTOR CORPORATION  
610 East Weddell Drive, Sunnyvale, California 94089

# ULTRA-MINIATURE SURFACE MOUNT



Actual Size

## DC-DC Converter Transformers and Power Inductors

All PICO surface mount units utilize materials and methods to withstand extreme temperature (220°C) of vapor phase, IR, and other reflow procedures without degradation of electrical or mechanical characteristics.

These units have gull wing construction and are packaged in shipping tubes, which is compatible with tube fed automatic placement equipment or pick and place manufacturing techniques. Transformers can be used for self-saturating or linear switching applications. The Inductors are ideal for noise, spike and power filtering applications in Power Supplies, DC-DC Converters and Switching Regulators.

- Transformers have input voltages of 5V, 12V, 24V and 48V. Output voltages to 300V.
- Transformers can be used for self-saturating or linear switching applications
- Schematics and parts list provided with transformers
- Inductors to 20mH with DC currents to 23 amps
- Inductors have split windings

Delivery—  
stock to one week

See EEM  
or send direct for  
FREE PICO Catalog

# PICO Electronics, Inc.

453 N. MacQuesten Pkwy. Mt. Vernon, N.Y. 10552

Call Toll Free 800-431-1064

IN NEW YORK CALL 914-699-5514

FAX 914-699-5565

CIRCLE 196 FOR U.S. RESPONSE

CIRCLE 197 FOR RESPONSE OUTSIDE THE U.S.

## NEW PRODUCTS

INSTRUMENTS

### 4-GSAMPLE/S SCOPE BOASTS 1.5 MHz BANDWIDTH

Designers of systems with clock rates to 100 MHz and edge speeds below a nanosecond will find the HP 54720A 4-Gsample/s, 2-channel oscilloscope to be a valuable debugging tool. The scope accurately reconstructs signals with 1-GHz of real-time bandwidth and 1.5-GHz of equivalent-time bandwidth, which is enough to examine the overshoot and ringing found in fast digital circuits.

The unit supplies 8-bit vertical resolution and 1% vertical gain accuracy. Time-interval accuracy is better than 30 ps, and memory depth is 32 ksamples on 2 channels and 16 ksamples on 4 channels. The scope can trigger on logic bits, timed logic patterns, or glitches as narrow as 500 ps.

The scope's modular signal-conditioning section allows users maximum flexibility and, together with a built-in disk drive and flash ROM, permit future upgrades with new hardware or application-specific software. For example, users can configure the quad 2-Gsample/s analog-to-digital converters for 2 channels at 4 Gsamples/s or 4 channels at 2 Gsamples/s.

An optional active probe, the HP 54701A, features 1% flatness over 2.5

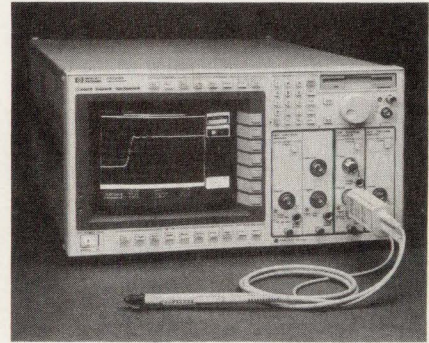

GHz. The probe's input capacitance is only 0.6 pF and its input resistance is 100 kΩ. The HP 54701A draws its power from the scope but can also be used with the HP 1143A power supply.

The 4-Gsample/s, 2-channel HP 54720A mainframe costs \$42,900, and a 2-Gsample/s, 2-channel version, the HP 54710A, costs \$29,900. Modules range in price from \$2400 to \$4700 for the 4-Gsample/s, 1-GHz amplifier. The HP 54701A 2.5-GHz active probe costs \$2300. Delivery is estimated at 16 weeks.

Hewlett-Packard Co., 19310 Pruneridge Ave., Cupertino, CA 95014; (800) 752-0900. **CIRCLE 478**

■ JOHN NOVELLINO

### VXI MODULE MEASURES POWER TO 100 GHz

A one-slot C-size VXIbus module measures power levels from 100 pW (-70 dBm) to 7 W. Sensors are available to make measurements from 100 kHz to 100 GHz. The Model 4052 power meter may be ordered with from one to four channels, all housed in the same size module. Calibration requires only one bus command, which stores the results in an on-card battery-backed memory. To ensure measurement integrity, the module features additional stabilization and noise-rejection circuitry in a fully shielded housing. The meter can be used with microwave sweepers, a frequency counter, and appropriate directional couplers to form a low-cost scalar network analyzer. With additional sensors the setup can make simultaneous return loss measurements. The Model 4052 costs \$3750 and is available with delivery in 6 weeks.

Racal-Dana Instruments Inc., 4 Good-year St., Irvine, CA 92718; (800) 722-3262. **CIRCLE 479**

### POWER METER MAKES MULTIPLE MEASUREMENTS

An easy-to-use precision, single-phase power analyzer makes many power-related measurements including true power, harmonics, power factor, and voltage and current crest factors. The PM1200 performs autoranging peak voltage and current measurements from 2 to 1000 V and 10 mA to 175 A. The meter also makes direct readout measurements of harmonics (phase and angle) and total harmonic distortion to the 50th harmonic and crest factor to 19.9. Basic accuracy is 0.25%, even for distorted waveforms. Readings are made over a range of dc to 50 kHz. The PM1200 comes in benchtop or half-rack versions, and includes IEEE-488, RS-232C, Centronics printer, and analog chart recorder interfaces. The bench version costs \$5950 and the rack-mount version \$6170. Delivery is from stock to 4 weeks.

Voltech Inc., 200 Butterfield Dr., Ashland, MA 01721; (508) 881-7329.

**CIRCLE 480**

# POWER-ONE Offers 2 Million Voltage/Current Combinations Within 2 Weeks.



## Modular High Power Up To 2000 Watts

You're in the initial stages of design. You need a prototype and you're facing a deadline. You also need a power supply with specific voltage/current outputs. And you need it fast!

That's where POWER-ONE's fully modular SPM High Power Series comes in. Single, dual, or triple output modules enable you to specify up to 15 DC outputs...from stock. With delivery time as little as two weeks.

And there's more. The incredibly versatile SPM represents the industry's highest power density—up to 2000 watts of multiple output power in the most compact package available today. There's even an optional on-board UPS capability. And no matter what configuration you require, be assured this internationally recognized power supply will meet the toughest safety regulations, worldwide.

So remember....whatever your requirements, we're keeping our shelves stocked for those urgent, limited-quantity deliveries. You'll get the exact voltage/current combination you need, on time. Every time.

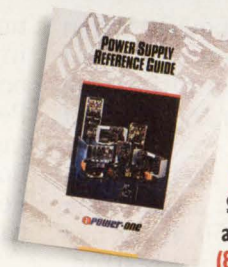

Get Complete Details Today. Call our Toll Free LITERATURE HOT-LINE for our Sensational New Tutorial and Product Catalog! (800) 678-9445

"Innovators in Power Supply Technology"  
**POWER-ONE**  
 D.C. POWER SUPPLIES

POWER-ONE, INC.  
 740 Calle Plano • Camarillo, CA 93012-8583  
 Phone: (805) 987-8741 • FAX: (805) 388-0476



CIRCLE 200 FOR U.S. RESPONSE

CIRCLE 201 FOR RESPONSE OUTSIDE THE U.S.

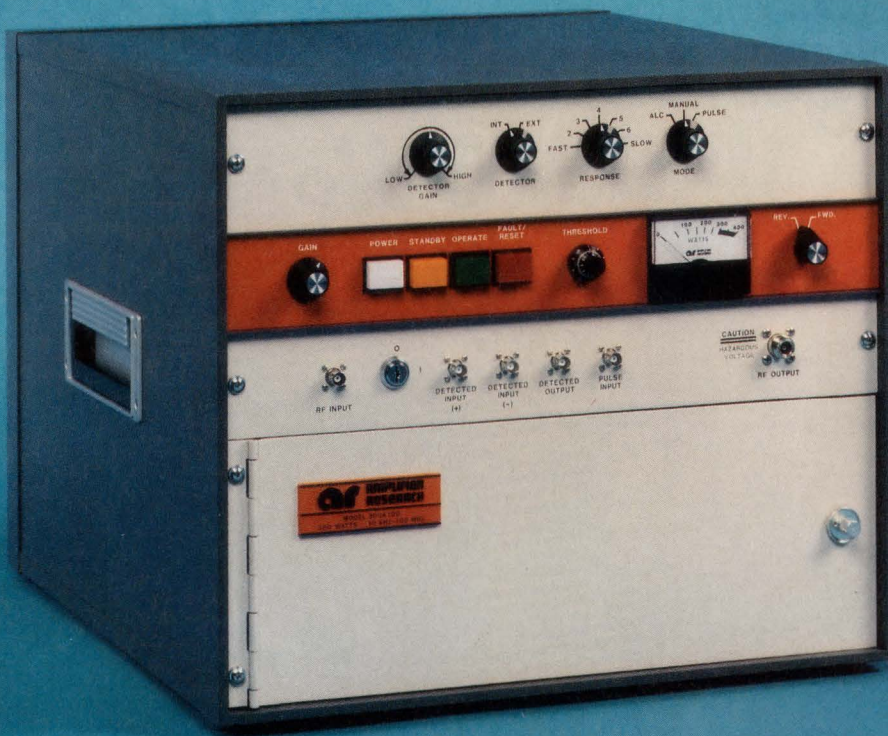

# Staying power.

Reliable solid-state power. When we designed our new 300-watt Model 300A100 rf amplifier, we knew it would answer the needs of many kinds of people.

People seeking a stable, economical way to drive an antenna to deliver at least 50 volts per meter for susceptibility testing. People who *must* trust an amplifier's ability to keep operating into a severe load mismatch—even shorted or open output terminals—without damage, oscillation, or foldback. People who expect the full bandwidth—10 kHz to 100 MHz—to be there instantly for sweep testing, with

no need for tuning or bandswitching. People who have to monitor both forward and reflected power. People who want automatic leveling. People who regularly perform both pulsed and cw procedures. People who demand remote-control interfacing.

The 300A100 is the latest all-solid-state member of a family of AR amplifiers covering a power range from one watt up to 10 kilowatts, and the rf range from 10 kHz up to 1 GHz. Their staying power is rated very conservatively—output stated as minimum, not nominal or peak. Chat with one of our applications engineers, who'll



pick up the phone himself when you call, toll-free,

## 1-800-933-8181



**AMPLIFIER  
RESEARCH**

160 School House Road  
Souderton, PA 18964-9990 USA  
215-723-8181 • Fax 215-723-5688

For engineering assistance and service throughout Europe, call

EMV GmbH • Munich • 89-612-8054  
EMV Ltd. • London • 908-566-556  
EMV S.A.R.L. • Paris • 1-64-61-63-29

CIRCLE 92 FOR U.S. RESPONSE

CIRCLE 93 FOR RESPONSE OUTSIDE THE U.S.

1677



## NEW PRODUCTS

INSTRUMENTS

### ANALOG/DIGITAL SCOPES OFFER SPEED, CHANNEL CHOICES

A family of oscilloscopes offers users a wide range of choices for varying applications. The scopes operate in analog and digital modes and come in 100-MHz and 200-MHz versions with a choice of full 4-channel or 2+2-channel operation.

The two pairs of scopes, the PM 3382/84 and PM 3392/94, combine the ease of operation and real-time 100- or 200-MHz bandwidth of an analog instrument with a digital sampling rate of 200 Msamples/s. Users can take advantage of the "live" signal representation and infinite resolution of the analog mode for applications that require such capability. Or they can quickly switch to the digital mode, which offers an extensive set of built-in automated voltage and timing measurements. Direct access control eliminates the need for menus.

Triggering modes include logic-state and pattern triggering, and glitch triggering down to 2 ns. Besides pre- and post-trigger display, the instruments allow event delay and time-after-event

delay. The acquisition memory can store 32 ksamples. A unique Touch Hold and Measure feature lets users initiate a measurement by pushing a probe-mounted button.

The PM 3384 and PM 3394 are true 4-channel scopes. That is, all four channels provide full sensitivity with complete attenuation ranges on each channel. The 2+2 versions have limited sensitivity on the two additional channels.

A comprehensive Math+ option performs more complex calculations, like integration, differentiation, template testing, and FFTs. An optional IEEE-488.2 (GPIB) interface permits full remote programmability using the Standard Commands for Programmable Instruments. A serial printer-plotter interface is standard.

The 100-MHz PM 3382 and PM 3384 cost \$4490 and \$5490, respectively. The 200-MHz PM 3392 and PM 3394 are priced at \$5990 and \$6490, respectively.

*John Fluke Mfg. Co. Inc. P. O. Box 9090, Everett, WA 98206; (800) 443-5853. **CIRCLE 481***

■ JOHN NOVELLINO

### FAST TESTERS HANDLE UP TO 64 DRAMS IN PARALLEL

A pair of memory testers with excellent speed and accuracy capabilities are the first members of the J990 series of memory test systems. The systems also offer a high degree of parallel test capability.

The J997 is a general-purpose high-performance memory tester well-suited for engineering and wafer test. Maximum operating frequency is 200 MHz, and overall timing accuracy is 300 ps. The J997 can test 32 DRAMs in parallel on two test stations. The J994 is optimized for final test of packaged devices, with a capacity of 64 DRAMs in parallel. The system's maximum operating frequency is 120 MHz, and overall timing accuracy is 500 ps.

The new testers are the first to use Tester-per-Site, a proprietary architecture evolved from the pin-slice concept used in Teradyne's VLSI test systems. This architecture gives the J990 series the flexibility and speed needed to test multiple wide-width DRAMs and specialty memory devices in parallel. Con-

ventional shared-architecture testers cannot deliver the accuracy and site-to-site correlation that IC manufacturers need.

The Tester-per-Site architecture applies a complete set of parallel electronics to each pin of the devices to be tested in parallel. For example, one set of pin electronics is assigned to pin 1 of each device, and another set is dedicated to pin 2. The systems include Teradyne's patented E/MOS design, which takes advantage of the high-performance of ECL technology in the critical timing circuitry and employs the economy and reliability of CMOS in other, less sensitive areas.

Prices for a J997 single-station system configured for engineering start at about \$1 million. A J994 system for production costs from \$1 million to \$1.5 million, depending on configuration.

*Teradyne Inc. Semiconductor Test Div., 30801 Agoura Rd., Agoura Hills, CA 91301; (818) 991-2900.*

**CIRCLE 482**

■ JOHN NOVELLINO

# WHO DELIVERS THE SMALLEST

# HYBRID CIRCUIT,

T H E

# GREATEST

# DENSITIES,

# THE FASTEST

# SPEED?

At Pacific Hybrid, we do it all — and then some. Truth is, we can meet virtually all of your hybrid product needs, packing maximum performance into the smallest possible package — up to 10 times smaller than other technologies.

Faster turnaround.  
Lower overall costs.

Who could ask for anything more?  
Feel free: just call us at  
**1-800-622-5574** Dept. ED2.



**PACIFIC HYBRID**  
MICROELECTRONICS  
We do small miracles™

10575 SW Cascade Blvd. Portland, OR 97223  
(503) 684-5657 FAX (503) 620-8051

**CIRCLE 186 FOR U.S. RESPONSE**

**CIRCLE 187 FOR RESPONSE OUTSIDE THE U.S.**

# NEW!

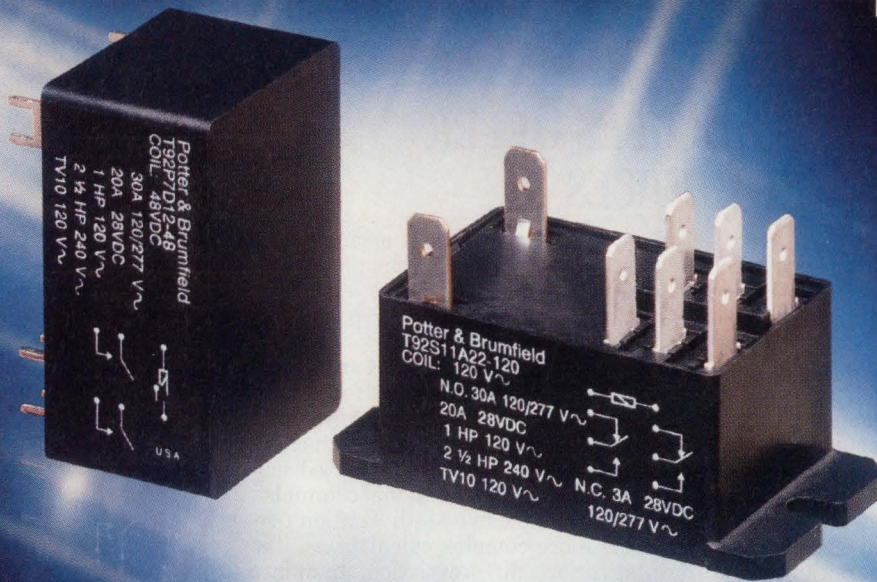

## The smallest, double-pole, 30A relay you can buy for either printed circuit board or panel mounting!

### Space-efficient design...

Our new T92 relay saves valuable space in your power switching application. It lets you do more with less whether you're switching HVAC compressors, appliance pump motors or ballasts in energy management applications.

### Switches 0.5 to 30A loads...

Double pole T92 can switch two, 30A loads in either its panel-mount or PC board configuration. And for many loads its life is comparable to that of more costly definite purpose contactors. Both a dust cover and a sealed, immersion-cleanable enclosure are available.

### Contact Ratings & Electrical Life (Normally Open Contacts, DC Coil)

Load	Expected Life
30A @ 240VAC	300K operations
1.0 HP @ 120VAC	100K operations
2.5 HP @ 240VAC	100K operations
25.3 FLA, 110 LRA	100K operations
TV10 @ 120VAC	100K operations
20A @ 28VDC	100K operations

### Low coil power requirement...

The T92's efficient coil requires less than 1.7W of power for DC types; 4.0VA for AC models. Coil voltages are offered from 6 through 110VDC and from 24 through 277VAC.

### Meets standards worldwide...

Designed to meet VDE isolation requirements, T92 provides internal spacings of 8 mm through air and 9.5 mm over surface. Dielectric strength is 4kV between contacts and coil, 1.5kV between open contacts and 2kV between poles.

### The quality you demand...

Of course, T92 relays are built to the same stringent standards that have allowed many of our general purpose and power relays to become the standards of the industry. No brag, just fact!

### Find out more...

Contact us today to learn more about how you can use the T92 to solve your toughest power switching problems.

### Board Layout for PC Mounting

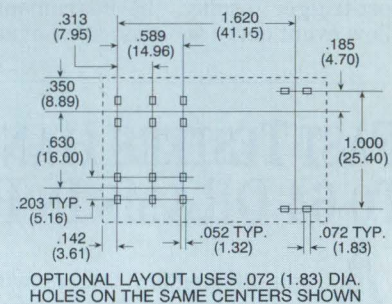

### Panel Mounting Dimensions

Two .125 (3.175) mounting slots are provided on 2.351 (59.71) centers.

### Solving switching problems is what we're all about...

Potter & Brumfield  
200 S. Richland Creek Dr.  
Princeton, IN 47671-0001  
Fax: (812) 386-2335

Call toll-free **1-800-255-2550** for the P&B authorized distributor, sales representative or regional sales office serving your area.

# Potter & Brumfield A Siemens Company

## NEW PRODUCTS

COMPUTERS & PERIPHERALS

### RISC-BASED PLOTTER PRODUCES C-SIZE DRAWINGS IN UNDER 5 MIN.

To get high-quality C-size plots, users typically had to spend \$7000 to \$15,000 for a laser or thermal printer. Now, with the ProTracer, from Pacific Data Products, they can get those plots for just \$1499. The ProTracer combines an Intel i960 embedded RISC processor and a high-performance Canon ink-jet engine to produce final-quality drawings in less than 5 min.

The ProTracer offers 360- by 360-dots/in. output to print crisp lines and

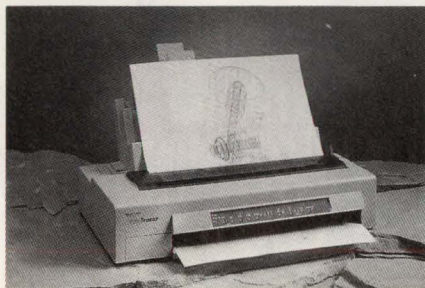

smooth curves. Area fills are solid with no bonding or streaking. For check plots, the plotter can be placed in a high-speed, low-resolution mode. It supports commonly used media such as plain and bond paper, plotter paper, and vellum. Two optional sheet feeders can feed A-and B-size cut-sheet paper or business-size envelopes automatically. The plotter can also be used for laser-quality office documents on standard paper. It easily fits on any desktop because of its small footprint.

By adding HP-GL and PostScript emulation cards, users can customize the printer to match a specific software application. Adding 2 Mbytes of memory and an HP-GL cartridge costs an extra \$500. A PostScript card and 8 Mbytes of memory costs \$1398. The ProTracer and its accessories will be available in April.

*Pacific Data Products, 9125 Rehco Rd., San Diego, CA 92121; (619) 552-0880. CIRCLE 483*

■ RICHARD NASS

### DESKSIDE FAMILY IS BASED ON MIPS R4000

The Iris Crimson family of desk-side computer systems from Silicon Graphics is based on the Mips R4000 64-bit RISC microprocessor. Starting below \$28,000, the family includes seven models that span a full range of graphics capabilities.

Binary compatible with the company's line of Iris 4D workstations and servers, the family incorporates the 50-MHz R4000SC, delivering 70 SPECmarks of performance. The R4000SC, the fastest version of the R4000, offers balanced floating-point and integer performance and tightly integrated support for a large secondary cache, a critical element of the systems' performance. The processor contains an internal clock rate of 100 MHz, achieved through superpipelining. This technique breaks each instruction into tasks, allowing several tasks to be handled by one clock cycle.

By maximizing ASIC technology, the Crimson family can achieve memory transfer rates of 400 Mbytes/s. This tight coupling of the compute and memory subsystems, combined with a sophisticated two-level caching scheme, reduces the long wait states typically

associated with CPU access to main memory.

The seven models of the family include the S, the Entry, the XS, the XS24, the Elan, the VGX, and the VGXT. The S is the base system, while the Entry adds some entry-level graphics capabilities, suitable for X-Windows and 2D or 3D vector applications. The XS supplies an optional hardware Z-buffer and a Geometry Engine graphics processor to increase polygon performance and the XS24 adds 24-bit plane color. The Elan includes the hardware Z-buffer and Geometry Engine.

The VGA includes the Silicon Graphics' PowerVision graphics to deliver the fast polygon performance, hardware-assisted antialiasing, and texture-mapping capabilities. The VGXT delivers the company's top-of-the-line graphics performance.

All the systems include up to 256 Mbytes of memory, 3.6 Gbytes of internal disk storage, two SCSI channels, and four VME slots.

*Silicon Graphics Inc., 2011 N. Shoreline Blvd., P. O. Box 7311, Mountain View, CA 94039; (415) 960-1980. CIRCLE 484*

■ RICHARD NASS

# WHO GETS YOU THE DENSEST

# MULTICHIP MODULE AT THE SMARTEST PRICE?

There's just one place to go for next-generation hybrid performance that's priced right, right now: Pacific Hybrid. Because now we offer unbeatable 2-mil line, 3-mil space ceramic multichip module performance, thanks to a unique transfer tape technology that also improves reliability, turnaround time and overall costs.

So when you're looking for an MCM that's really dense, get smart. Call us at **1-800-622-5574** Dept. ED1.

 **PACIFIC HYBRID**  
MICROELECTRONICS  
We do small miracles.™

10575 SW Cascade Blvd. Portland, OR 97223  
(503) 684-5657 FAX (503) 620-8051

CIRCLE 188 FOR U.S. RESPONSE

CIRCLE 189 FOR RESPONSE OUTSIDE THE U.S.

# New 14-Bit, 5.12MHz Sampling ADC Delivers -88dB SFDR

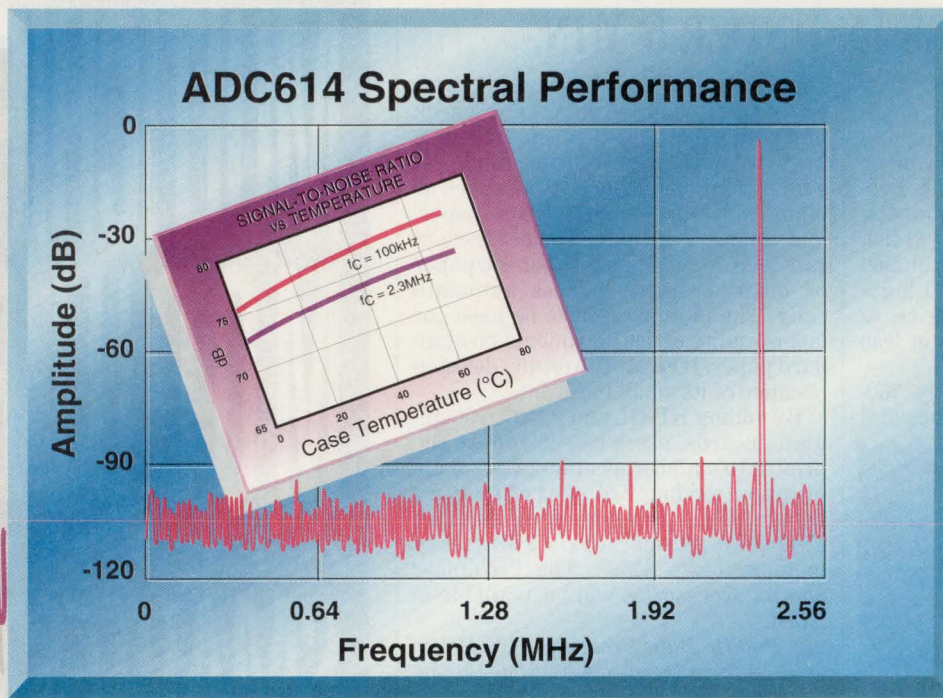

## Clearer, Cleaner Signals

ADC614 is a complete two-step subranging subsystem containing an ADC, sample/hold, voltage reference, timing and error correction circuitry. Packaged in a compact 46-pin DIP, the hybrid's excellent wideband linearity allows 14-bit performance with a Nyquist spurious-free dynamic range of -88dB (typ). It's an excellent choice for spectral analysis in radar, medical, and digital receiver applications. The device dissipates just 6.1W and is specified for 0/+70°C. Logic is TTL.

CIRCLE 252 FOR U.S. RESPONSE

ADC614 is pin-consistent with Burr-Brown's 12-bit ADC603 family. Speed and dynamic range trade-offs can be made by simply plugging in an ADC614, ADC603 or ADC604. Insuring the highest performance, "KH" units are not only thoroughly DC and AC tested, but they're also shipped with free test data summaries.



CIRCLE 253 FOR RESPONSE OUTSIDE THE U.S.

## Key ADC614 Specifications

- Resolution 14-bits
- Sample rate DC to 5.12MHz
- -88dBFS SFDR
- Two-Tone IMD -87dBFS
- 77dB SNR
- No missing codes

## Free Selection Guide

Our new *High Speed Linear Products* guide describes our complete line and contains valuable test and application tips. Ask your local sales rep for a free copy or call **1-800-548-6132** for immediate assistance.

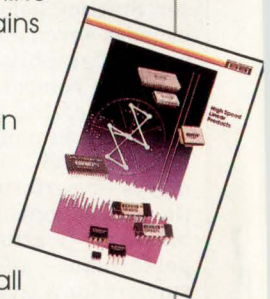

**Burr-Brown Corp.**  
P.O. Box 11400  
Tucson, AZ 85734

**BURR - BROWN®**  
**BB**

## NEW PRODUCTS

COMMUNICATIONS

### LASER-DIODE MODULES PUMP DATA THROUGH FIBER PIPES

**T**wo types of laser-diode modules from Mitsubishi Electronics America are designed for long-distance data-transmission systems. The 1480-nm FU-622SLD-1 pump-laser-diode module is for use in long-haul, erbium-doped fiber amplification (EDFA) systems. The module provides continuous output for optical pumping in undersea and terrestrial long-distant EDFA transmission. Typical output power is 45 mW with an rms spectral width of 10 nm. The module includes a built-in thermoelectric cooler. Samples are available for \$10,000 each.

For Sonet and other high bit-rate applications, Mitsubishi's FU-68SDF-2 multiple-quantum-well laser-diode module transmits data at a rate of 2.5 Gbits/s over distances greater than 70

km without a bit-error-rate floor. The spectral width is typically 0.2 nm, and typical side-mode suppression is 40.0 dB. The input of the single-mode fiber-pigtail module is impedance-matched to 25  $\Omega$ . The device has a built-in thermoelectric cooler, and an optical isolator limits noise to -155 dB/Hz.

The laser diodes' minimum output power is 2 mW; minimum cutoff frequency is 3.5 GHz, and maximum rise and fall times are 150 ps. Typical light-emission central wavelength is 1550 nm. Packaged in a standard butterfly housing, the laser diode module sells for \$9000 each.

*Mitsubishi Electronics America, Ltd., 1050 E. Arques Ave., Sunnyvale, CA 94086; (408) 730-5900*

**CIRCLE 485**

■ MILT LEONARD

### SLIC CUTS STANDBY POWER, DEVICE COUNT

A two-chip subscriber line interface circuit (SLIC) kit offers low dissipation in the standby mode and high integration. Aimed at applications in central offices, PABXs, digital key systems, terminals and multiplexers, this kit from SGS-Thomson Microelectronics consists of the new L3092 SLIC control unit and the company's existing L3000 high-voltage SLIC line interface IC.

The two ICs integrate all functions of a subscriber line interface, including ringing signal rejection, a function typically performed by external circuits. This contributes to a low component count.

Another important benefit is the greatly reduced dissipation in standby—less than 50 mW with signaling functions active. This is important in central office and PABX applications where lines are in the standby state most of the time.

The L3092/L3000 SLIC can also measure the length and conditions of the line so that the card can choose an appropriate feeding scheme. For example, in the case of short loops, the battery feed can be reduced to limit dissipation, and the coefficients can be modified to optimize matching. Comprehensive development support is provided by evaluation boards, software, Spice models and detailed application notes to make application development fast and simple.

Available now, the two-chip SLIC kit sells for about \$14 apiece in quantities of 100.

*SGS-Thomson Microelectronics, I-20041 Agrate Brianza, Via C. Olivetti 2, Italy. Contact: Maria Grazia Presolini; phone (00) 39 39 6035 597.*

**CIRCLE 486**

### SI MODULUS DEVICES OUTPERFORM GAAS

A line of silicon modulus divider ICs can outperform gallium arsenide devices in communication and instrumentation applications. The five devices in the SP8900 series have ratios of 2, 4, 8, 10, or 16. An "A" grade option guarantees 5.5-GHz operation at -40° to +85°C and 5.0 GHz over -55° to +125°C, while the B grade option guarantees 5.0 GHz at -40° to +85°C, the company says. The devices fabricated on the company's 14-GHz F<sub>1</sub> HE bipolar process.

Input sensitivity is -2dBm and does not require pre-amplification for typical GaAs parts, the company says. GPS also claims they use less power than gallium arsenide devices, at 350 mW from a single 5-V supply. Noise floor for the dividers is typically -144dBc/Hz at 5GHz. The 1000-unit price for the B grade dividers is \$33 in eight-pin ceramic, dual in-line packages. A grade price is \$57.

*GEC Plessey Semiconductors, Cheney Manor, Swindon, Wiltshire, SN2 2QW, UK; +44 (0)793 518411. CIRCLE 487*

# WHO MEETS ALL YOUR

# SMT

# DESIGN

# & COST

# DEMANDS BY

# THINKING

# SMALL?

It's no big surprise: at Pacific Hybrid, we offer all the latest fine pitch surface-mount technologies you need to squeeze more performance out of less board space. Along with world-class manufacturing, we also offer the turnkey solutions and JIT economies needed to meet your tightest scheduling and budget demands.

Bottom line: it pays to get us on the line, so call.

**1-800-622-5574** Dept. ED3.

 **PACIFIC HYBRID**  
MICROELECTRONICS  
**We do small miracles.™**

10575 SW Cascade Blvd. Portland, OR 97223  
(503) 684-5657 FAX (503) 620-8051

CIRCLE 190 FOR U.S. RESPONSE

CIRCLE 191 FOR RESPONSE OUTSIDE THE U.S.



- 45. Inter...
- 46. Sends command...
- 47. Computer-automated test (acronym).
- 49. Gathering data.
- 56. Hyperbolic sin.
- 58. Breaks the 640K \_\_\_\_\_ barrier.
- 59. **The perfect language fit for technical users.**
- 61. IBM PS2 bus (abbrev.)
- 71. Automation technique for test & measurement.
- 77. Online keyword documentation.

- Across**
- 1. Rocky Mountain Basic compat
  - 3. Fast Fourier Transform (acro
  - 5. HTBasic 386 Compiler.
  - 6. Complex numbers.
  - 7. HTBasic's price is \_\_\_\_\_

# HTBasic Is the Perfect Fit

TransEra's HTBasic combines the effortless programming of HP-style BASIC with advanced application development system features such as scientific instrument control, data analysis, and graphic presentation.

Powerful facilities for data acquisition and IEEE-488.2/RS-232 instrument control, COMPLEX arithmetic, CSUB capabilities, matrix mathematics, and complete HP-style graphics make HTBasic the answer for all levels of users.

TransEra's 32-bit Compiler for HTBasic routines gives access to significant performance increases in high-speed math calculations. And a full library of pre-compiled subroutines for FFT's, curve-fitting, waveform analysis, and digital filtering/windowing

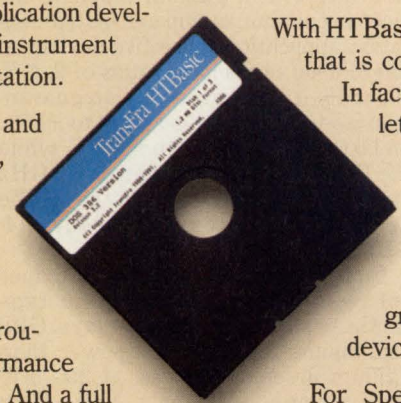

can make developing your application much less puzzling.

With HTBasic, your PC becomes a scientific workstation that is compatible with the HP9000 Series 200/300.

In fact, the transfer utility included with HTBasic lets you port your current HP Basic programs to the PC and run them with little or no modification while adding all of the functionality of industry standard PC hardware and software. You can share data with spreadsheet and database programs, use standard graphics displays, output devices, even networks.

For Speed, Power, Flexibility, and Functionality, HTBasic for the PC is the perfect fit.

Call or write today.

CIRCLE 236 FOR U.S. RESPONSE

CIRCLE 237 FOR RESPONSE OUTSIDE THE U.S.

**TransEra**

Engineering Excellence for 15 Years™

3707 N. Canyon Road, Provo, UT 84604 • (801) 224-6550, FAX (801) 224-0355

## NEW PRODUCTS

ANALOG

### DUAL, CONTINUOUS LOW-PASS FILTER IS PROGRAMMED DIGITALLY

Switched-capacitor filters that are digitally programmable are noisy while time continuous (CT) filters are quiet, yet not easily programmed by a microprocessor. Now Maxim's MAX270 IC contains a pair of CT low-pass filters on a single chip—and their cutoff frequencies are digitally programmable. Writing a 7-bit word to each of the MAX270's two memory addresses sets the cut-off frequency ( $C_f$ ) of each of its second order Sallen-Key, Chebyshev filters to one of 128 frequencies between 1 kHz and 25 kHz.

Alternatively, for fixed  $C_f$  operation, pin-strapping can replace the programming.  $C_f$  resolution is best shown by giving examples of sets of adjacent  $C_f$ s: 1 kHz, 1.011 kHz; 1.605 kHz, 1.635 kHz; 3.620, 3.671; 6.481, 6.645; and 22.826 kHz, 25 kHz.

Programmed  $C_f$  accuracy typically runs  $\pm 2.9\%$  with  $C_f$  set at 2.536 kHz;  $\pm 9.5\%$  with  $C_f$  set at 25 kHz. Gain within the pass band runs between  $-0.5$  and  $-6$  dB. These filters, plus their output

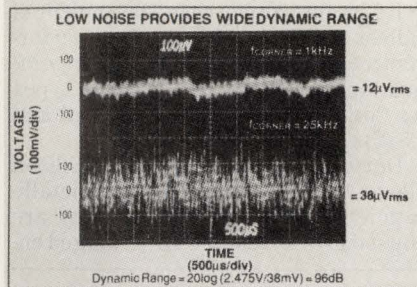

operational amplifiers, achieve a maximum total harmonic distortion (THD) of  $-70$  dB while putting a 3.5-V pk-pk 390-Hz sine wave across  $5$  k $\Omega$  with  $C_f$  set at 2.01 kHz. Similarly, spurious-free dynamic range (SFDR) runs a minimum of 70 dB. In its 20-pin plastic DIP the MAX270 low-pass filter chip sells for \$7.72 in 1000-unit quantities.

**Maxim Integrated Products Inc., 120 San Gabriel Dr., Sunnyvale, CA 94086; Steven Leandro, (408) 737-7600. **CIRCLE 488****

■ FRANK GOODENOUGH

### SHAS GRAB FOUR FAST SIGNALS SIMULTANEOUSLY, IN 900 NS MAX

Capable of simultaneously sampling four analog voltages, Dattel's MSH-840 is aimed at applications in which the amplitude of multiple analog signals must be measured and measurements made virtually si-

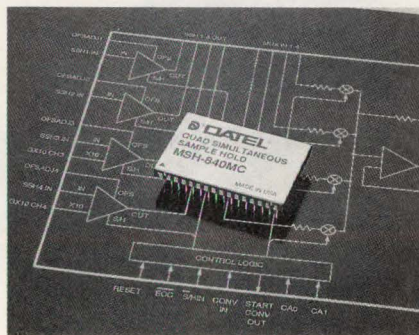

multaneously. Measuring simultaneously is mandatory if the time or phase relationship between them is important. The four sample-and-hold amplifiers (SHAs) in the MSH-840 can each independently, and if directed simultaneously, acquire a 10-V voltage

step to 0.01% accuracy in a maximum of 900 ns.

Once the voltage is acquired, if in turn the SHAs are simultaneously commanded into HOLD, the aperture delay for each is 60 ns maximum, and the aperture uncertainty 50 ns maximum. Thus all four samples will have been taken within less than 100 ns of each other. The MSH-840 also contains an output multiplexer followed by a buffer amplifier. Acquisition time for the SHAs includes that for the multiplexer. Minimum small-signal bandwidth runs 8 MHz, minimum full-power bandwidth, 300 kHz.

Two of the four channels can be given a gain of ten by the user. This unique feature adapts the MSH-840 for sampling the same voltage before and after analog signal processing, which may include gain. In OEM quantities the commercial grade MSH-840 goes for \$224 each; its military counterpart sells for \$244 each.

**Dattel Inc., 11 Cabot Blvd., Mansfield, MA 02048; Bob Leonard (508) 339-3000. **CIRCLE 489****

■ FRANK GOODENOUGH

# WHO

TAKES ALL YOUR

# CONTRACT ASSEMBLY

# NEEDS AND KNOCKS 'EM DOWN TO SIZE

# FASTER, FOR LESS?

The answer's simple: Pacific Hybrid. The fact is, right now, we can take you into the future with fine pitch SMDs, custom hybrids and high-performance multichip modules — whatever it takes to meet your design needs or fabrication demands.

Need a prototype fast? Faced with a bare-bones budget? There's no question who to call: Pacific Hybrid.  
**1-800-622-5574** Dept. ED4.

**PH** PACIFIC HYBRID  
**HM** MICROELECTRONICS  
We do small miracles.™

10575 SW Cascade Blvd. Portland, OR 97223  
(503) 684-5657 FAX (503) 620-8051

CIRCLE 192 FOR U.S. RESPONSE

CIRCLE 193 FOR RESPONSE OUTSIDE THE U.S.

## NEW PRODUCTS

POWER

### IEEE-488



Control any IEEE-488 (HP-IB, GP-IB) device with our cards, cables, and software for the PC/AT/386, EISA, MicroChannel, and NuBus.

### SINGLE CHIP DRIVES BIPOLAR STEPPER MOTOR

Containing on one chip all the circuitry needed to control and drive a two-phase bipolar stepper motor, the L6219 smart power IC from SGS-Thomson Microelectronics replaces two-chip solutions, making a compact motor drive.

The IC incorporates two bridge power stages rated at 750 mA plus two current control chopper circuits. The latter are of the fixed OFF time type, which minimizes current ripple and makes it possible to drive motors with low resistance.

Two logic inputs allow the output current to be programmed in four levels, permitting motor operation in the full-step and half-step modes. Moreover, by using an external D/A converter to vary the voltage applied to a reference voltage input, it's possible to micro step the motor.

The L6219 is housed in a 24-lead DIP package, which is both compact and convenient for automatic assembly. Four leads conduct heat from the die to circuit board tracts; no other heat sinking is necessary. A PLCC-44 plastic chip carrier version will be introduced later in the year. Available now, the L6219 sells for \$1.70 apiece in quantities of 25,000 units.

SGS-Thomson Microelectronics, 100 East Bell Rd., Phoenix, AZ 85022; J.P. Rossomme: (602) 867-6228. **CIRCLE 490**

### TRANSISTORS BOOST BASE STATION EFFICIENCY

Featuring input and output-matching networks optimized for 800 to 900 MHz and 900 to 960 MHz operation, respectively, the BLV101A and BLV101B RF power transistors are suitable for the driver and output stages of cellular radio base-station transmitters. Both transistors are high-gain, npn types de-

livering output power of up to 50 W at operating efficiencies exceeding 50%.

The double-input and output matching networks integrated into the devices make designing the transistors in to RF circuits fairly easy. An implanted ballast resistor stabilizes their performance over a wide operating temperature range. Power gain for both types is a minimum of 8.5 dB for the 101A and 7.5 dB for the 101B.

Devices are fabricated in a silicon planar epitaxial process. Gold metallization improves reliability. They are housed in a six-lead SOT273 flanged en-

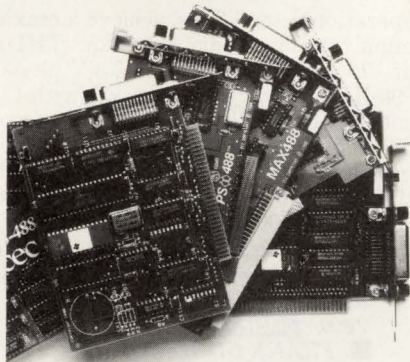

You get fast hardware and software support for all the popular languages. A software library and time saving utilities are included that make instrument control easier than ever before. Ask about our no risk guarantee.

capsulation with a ceramic cap. Samples of the BLV101A and BLV101B are available for about \$70 each. Production volumes can be delivered six weeks after receipt of order.

Philips Semiconductors, 2001 West Blue Heron Blvd., Riviera Beach, FL 33404-5099; Miriam Coleman: (407) 881-3257. **CIRCLE 491**

### CIRCUITS OFFER HIGH-SPEED SWITCHING

The closely controlled gain and switching specifications of a new line of 1500-V bipolar transistors allows designers to minimize the size and cost of heat sinks without compromising device reliability. Designed for horizontal line-deflection circuits for TV sets and CRT monitors, the BU2508A, BU2520A, and BU2525A transistors are intended for operation in applications with nominal collector current requirements of up to 4.5 A, 6.0 A, and 8.0 A, respectively. The

larger devices are suitable for use in line-deflection circuits operating at line frequencies as high as 64 kHz and are available with or without an integral damper diode.

Fabricated in an advanced triple-diffused, mega-glass passivated process, the transistors have closely controlled switching parameters. The BU2508A, BU2520A, and BU2525A transistors are available in SOT199 and SOT93 plastic power packages. Delivery is six weeks after receipt of order. Prices are given on request.

Philips Semiconductors, 2001 West Blue Heron Blvd., Riviera Beach, FL 33404-5099; Miriam Coleman: (407) 881-3257. **CIRCLE 492**

### 75-W BENCH SUPPLY HAS KEYPAD CONTROL

Conventional control knobs are nowhere to be found on the DPS Series of 75-W bench power supplies. Four ranges are available from zero to 12.5 V to zero to 125 V. A keypad commands a built-in microprocessor that sets voltage, current limit, range, overvoltage protection, displays, and overcurrent protection. Remote talk-listen control is exercised by means of a simple RS-232C connection that may be addressed in Basic or most common languages. List price is \$429 in single quantities. Call for delivery.

Keeco Inc., 131-38 Sanford Ave., Flushing, NY 11352; (718) 461-7000. **CIRCLE 493**



Free: Informative catalog 800-234-4232  
Applications help (617) 273-1818



Capital Equipment Corp.  
Burlington, MA. 01803

CIRCLE 110 FOR U.S. RESPONSE

CIRCLE 111 FOR RESPONSE OUTSIDE THE U.S.



# For demanding designs, FPGA is no longer a four-letter word.

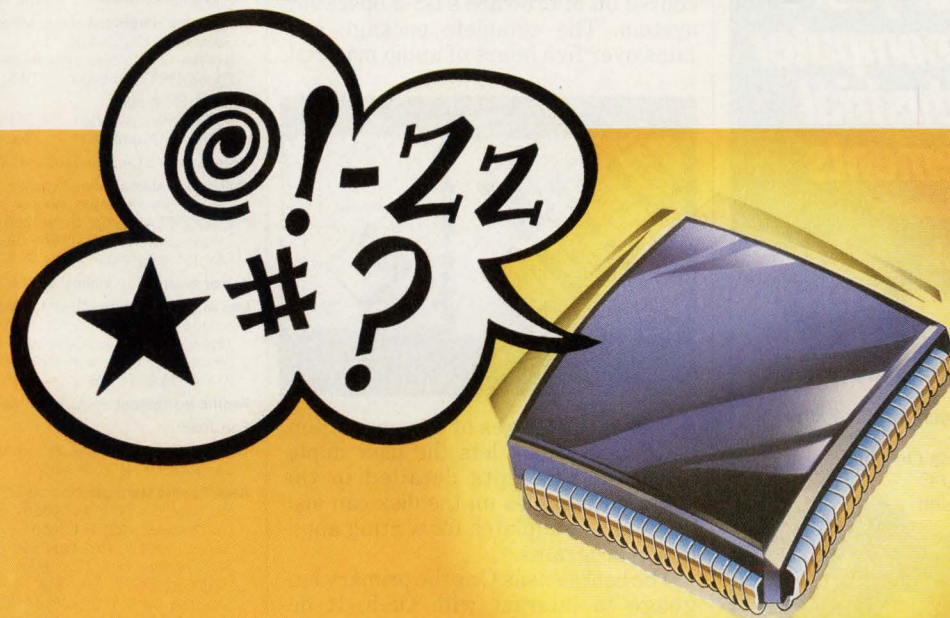

**T**o push performance and logic density to obscene limits, you need an FPGA architecture you can fine tune. With the CLi6000 Series, you get the fastest, most symmetrical array structure available today. It's easy to understand and manipulate. With no complex cell logic puzzles to solve.

This advanced architecture takes the curse off of conventional FPGAs. Now you can create pipelined, register-rich designs in much smaller arrays, because CLi6000 Series devices feature *thousands of registers*—many times the number of any comparable FPGA.



This architecture supports system speeds of up to 70MHz—the *fastest in-system performance* of any SRAM-based FPGA today. And it delivers *lots of I/O* too, even with low-density devices. So your high-I/O designs fit into smaller, less expensive arrays. Plus you get the *highest silicon efficiency*, with lots of small, powerful cells that pack plenty of logic into very little space.

When design talk gets tough, the tough talk to Concurrent Logic. To order your CLi6000 Series Information Packet, call (408) 522-8703 or fax (408) 732-2765 today. Or write Concurrent Logic, Inc. 1290 Oakmead Parkway, Sunnyvale, CA 94086.

All product and company names are trademarks of their respective holders.

**Concurrent Logic, Inc.**

CIRCLE 130 FOR U.S. RESPONSE

CIRCLE 131 FOR RESPONSE OUTSIDE THE U.S.

# PICO AC-DC POWER SUPPLIES

meet all your  
military, computer  
and industrial  
requirements

INDUSTRIAL

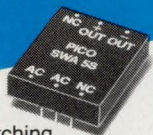

- Both Linear and Switching Models available New Switching Series .500" Tall
- Linear available with terminal strip or PC mount
- Single, Dual, Triple Outputs
- No Derating to 70°C
- Regulated—Isolated

OPEN-FRAME

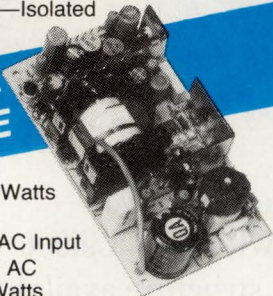

- Up to 200 Watts available
- Universal AC Input 85—264V AC up to 65 Watts
- Jumper Selectable Inputs up to 200 Watts
- Short Circuit Protection
- UL-CSA-TUV Compliant
- Regulated-Isolated
- Multiple Outputs

HI-RELIABILITY and  
MILITARY Applications



- Low Profile .500" Height
- Meet MIL-STD-704D Input Requirements
- Optional -55°C to +85°C Operating Temperature
- Selected Environmental Screening per MIL-STD-883 available

**PICO**  
**Electronics, Inc.**

453 N. MacQuesten Pkwy. Mt. Vernon, N.Y. 10552

Call Toll Free **800-431-1064**

IN NEW YORK CALL **914-699-5514**

FAX **914-699-5565**

See EEM  
or send direct for  
FREE PICO Catalog

## NEW PRODUCTS

SOFTWARE

### AUDIO COURSE TEACHES OS-9 REAL-TIME OS

To help engineers become familiar with real-time multitasking programming, Gespac has produced a self-study audio course on Microware's OS-9 operating system. The complete package contains over five hours of audio material,

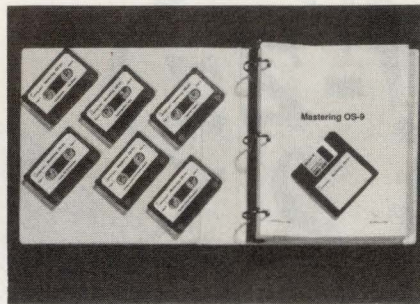

as well as 270 pages of documentation. An exercise disk lets the user implement the concepts detailed in the course. Examples on the disk can also be used as templates for writing application programs.

The course uses C as the primary language to interact with OS-9. It describes the operating system's basic operation, the structure of modules, and how to use signals, events, pipes, and data and subroutine modules. The material is hardware independent and is applicable to any OS-9 680X0-based platform. The course is available now for \$595.

*Gespac Inc., 50 W. Hoover Ave., Mesa, AZ 85210; (602) 962-5559. CIRCLE 494*

### TRANSACTION SOFTWARE DOUBLES IN SPEED

Release 3.0 of Burr-Brown's TMV9000 transaction-processing software doubles the speed of earlier versions. The software performs real-time networked data-collection on Digital Equipment Corp.'s VAS/VMS-based computer systems. Users also get access to Rdb/VMS databases and ISAM files, which enhances the read, write, and append functions in earlier releases. An external programmer's interface affords access to system routines written in standard programming languages. TMV9000 release 3.0 offers connection through such interfaces as direct RS-423, DEC servers, LAT, and polled RS-422; as a result, existing wiring can be used. Contact the company for price information.

*Burr-Brown Corp., P. O. Box 11400, Tucson, AZ 85734; (602) 746-1111; fax (602) 889-1510. CIRCLE 495*

## ELECTRONIC DESIGN

**Chairman and CEO:** Sal F. Marino  
**President and COO:** Daniel J. Ramella  
**President, Electronics Group:** James D. Atherton

**Advertising Sales Staff**

**Publisher:** Paul C. Mazzacano  
Hasbrouck Heights, NJ; (201) 393-6060

**National Sales Manager:** Russ Gerches  
Hasbrouck Heights, NJ; (201) 393-6045

**General Manager, European Operations:** John Allen  
Four Seasons House  
102B Woodstock Rd., Witney, Oxford OX8 6DY England  
Phone: 0993-778-077 FAX: 44-993-778-246

**Hasbrouck Heights:** Judith L. Miller, Robert Zaremba  
*Sales Asst.:* Debbie Eng  
611 Route #46 West, Hasbrouck Heights, NJ 07604;  
Phone: (201) 393-6060 TWX: 710-990-5071

**Boston:** Ric Wasley  
400 Fifth Ave., Waltham, MA 02154;  
Phone: (617) 890-0891 FAX: (617) 890-6131

**Colorado:** Lou Demeter (408) 441-0550

**Chicago/Midwest:** Mark Kearney  
*Sales Assistant:* Susan Johnson  
2 Illinois Center Bldg., Suite 1300  
Chicago, IL 60601; (312) 861-0880  
FAX: (312) 861-0874

**Arizona:** James Theriault (408) 441-0550

**Los Angeles/Orange County/San Diego:** Ian Hill  
*Sales Coordinator:* Philisha Henry  
16255 Ventura Blvd., Suite 300  
Encino, CA 91436; (818) 990-9000  
FAX: (818) 905-1206

**Pacific Northwest:** Bill Giller (408) 441-0550

**San Jose:**

**Western Sales Manager:** William M. Giller  
San Jose, CA; (408) 441-0550

**Asia/Pacific Manager:** Andrew M. Dellins  
San Jose, CA; (408) 441-0550

Lou Demeter (408) 441-0550  
James Theriault (408) 441-0550  
*Sales Administrator:* Kim Codron  
2025 Gateway Pl., Suite 354  
San Jose, CA 95110; (408) 441-0550  
FAX: (408) 441-6052 or (408) 441-7336

**Texas/Southeast:** Bill Yarborough  
12201 Merritt Dr., Suite 220, Dallas, TX 75251;  
(214) 661-5576 FAX: (214) 661-5573

**Direct Connection Ad & DAC Sales Representative:**  
Jeanie Griffin (201) 393-6080

**Canada:** Tony Chisholm  
Action Communications  
135 Spy Court, Markham, Ontario L3R 5H6  
Phone: 416-477-3222 FAX: 416-477-4320

**Netherlands, Belgium:** W.J.M. Sanders, S.I.P.A.S.  
Oosterpark 6-P.O. Box 25  
1483 DeRyp, Holland Phone: 02997-1303  
Telex: 13039 SIPAS NL Telefax: (02997)-1500

**France, Spain:** Claude Brill  
IMS Paris, c/o IDG Communications France  
Cedex 65, 92051 Paris la Defense—France  
Phone: 33 149 047 900 FAX: 33 149 047 878

**Germany, Austria, Switzerland:** Friedrich Anacker  
InterMedia Partners GmbH  
Katzenberger Strasse 247, 5600 Wuppertal 1  
West Germany Phone: 02-02-711-091/92

**Hong Kong:** Tom Gorman, China Consultant Intl.  
Guardian Hse, Ste 905  
32 Oi Kwan Road, Happy Valley, Hong Kong  
Phone: 852 833 2181 FAX: 852 834 5620

**Israel:** Igal Eilan, Elan Marketing Group  
22 Daphna St., Tel Aviv, Israel  
Phone: 972-3-6952967 FAX: 972-3-268020  
Toll Free in Israel only: 177-022-1331

**Italy:** Cesare Casiraghi, Casiraghi Cesare, S.A.S.  
Via Cardano 81 1, 22100 Como, Italy  
Phone: 39 31 536 003 FAX: 39 31 536 007

**Japan:** Hirokazu Morita, Japan Advertising Communications  
New Gunza Buiding 3-13  
Gunza 7-chome, Chuo-Ku, Tokyo 104 Japan  
Phone: 011-81-3-3571-8748 FAX: 011-81-3-511-8710

**Korea:** Young Sang Jo, Business Communications Inc.  
K.P.O. Box 1916, Midopa Building 146,  
Dangju-Dong, Chongju-Ku, Seoul, Korea  
Phone: 011-82-2-739-7840 FAX: 011-82-2-732-3662

**Taiwan:** Daniel Cheng, United Pacific International  
No. 311 Nanking E. Rd., Sec. 3  
Taipei, Taiwan R.O.C. Phone: 011-886-27-150-751  
FAX: 011-886-27-169-493

**United Kingdom:** John Maycock  
Huttons Buildings, 146 West St.  
Sheffield, England S1 4ES Phone: 742-759186

CIRCLE 196 FOR U.S. RESPONSE

CIRCLE 197 FOR RESPONSE OUTSIDE THE U.S.

Because you're  
thinking fast...

# Comlinear's new video amp and mux...

Here are two new high-performance  
components from Comlinear to keep  
you on the cutting edge of high-  
definition video.

## Fastest $\pm 15V$ video op amp you'll find.

With a 200 MHz bandwidth and 2300V $\mu$ sec slew rate, the CLC411 is the highest-speed, widest bandwidth  $\pm 15V$  monolithic video op amp on the market. Equally important, the CLC411 delivers an exceptional  $\pm 0.05$  dB gain flatness to 30 MHz. Plus 0.02%/0.003 $^\circ$  diff. gain/phase. That's an unparalleled combination of speed and performance in a monolithic  $\pm 15V$  video op amp.

CIRCLE 112

## And the best high-speed multiplexer.

For your many switching tasks, the CLC532 is a 2:1 multiplexer that combines the speed, isolation and low distortion that's critical in high-definition video. Settling time is a fast 17 ns to 0.01%. Its channel-to-channel isolation is better than 80 dB, and harmonic distortion is a low -80 dBc.

Call today and we'll send all the details to help you keep up with the fast-changing world of high-definition video.

CIRCLE 113

 Comlinear  
Corporation

*Solutions with speed*

4800 Wheaton Drive  
Fort Collins, CO 80525  
(303) 226-0500  
1-800-776-0500 (USA)



**Test & Design Expo**  
**May 12-14, 1992**  
**(Conference begins May 11)**  
**Garden State Convention Center**  
**Somerset, New Jersey**

YES! I am interested in exhibiting at Test & Design Expo. Please send me an Exhibitor Prospectus.

YES! I am interested in attending. Please send me more information.

Name \_\_\_\_\_

Title \_\_\_\_\_

Company \_\_\_\_\_

Address \_\_\_\_\_

City \_\_\_\_\_ State \_\_\_\_\_ Zip \_\_\_\_\_

Phone \_\_\_\_\_ Fax \_\_\_\_\_

Mail or fax to Miller Freeman, Inc.  
 13760 Noel Road, Suite 500  
 Dallas, TX 75240  
 Phone: 800/223-7126 • Fax: 214/419-7915

ED

# It's a Jungle Out There.

## Test & Design Expo

Test & Design Expo is a new exposition and conference that speaks directly to design and test engineers and managers – professionals who are working closer together in the manufacturing operation. Test & Design Expo maps out all the latest products and leading-edge technology available in the industry today – from CAD/CAE/CAM, to design for testability, to ATE, to VXIbus systems.

### It's Survival of the Fittest.

Test & Design Expo is the first forum to put design and test together on one floor, in one conference. Our Technical Program will help designers and test professionals communicate better and work smarter – with sessions, tutorials, minicourses, and forums emphasizing concurrent engineering, boundary scan, and VXI/systems integration.

### It's Time-to-Market.

Concurrent engineering has evolved into the driving force in electronics manufacturing. It's what quality and profitability are all about – and it's what Test & Design Expo is all about. Concurrent Engineering can shorten time-to-market by 30% to 40%, improve product quality, reduce the number of design iterations, and lower manufacturing and test costs by 20% to 50%.\* Users aren't ignoring its importance for survival in the '90s. And neither should you.

Exhibit your products, equipment, and services to buying teams of designers and test professionals at Test & Design Expo.

## Test & Design Expo A New Exposition and Conference for Test & Design Professionals

To reserve your exhibit space, complete and mail or fax the form or call 800/223-7126.

Owned and produced by Miller Freeman, Inc.

\* Source: Electronic Trend Publications' *ATE Market Trends, Applications, and Strategies*.

CIRCLE 162 FOR U.S. RESPONSE

CIRCLE 163 FOR RESPONSE OUTSIDE THE U.S.

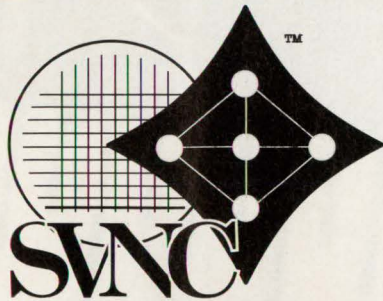

# THE SILICON VALLEY NETWORKING CONFERENCE

Location : The Santa Clara Convention Center, Santa Clara, California and the adjacent Westin Hotel

**APRIL 27 - 29, 1992**

## KEYNOTE SPEAKERS:

Eric Benhamou, Chief Executive Officer, 3Com Corp.  
 Dr. Colin Mick, Technical Director, Network Products, Comdisco Systems Inc.

### SVNC'92 TECHNICAL PROGRAM OVERVIEW\*

Monday, April 27

Tutorial Subjects  
 (full day seminars)

(T1) FDDI

(T2) INTERNETWORKING

(T3) NETWORK MANAGEMENT

Tuesday, April 28

Keynote Presentation  
 (morning subjects)  
 FDDI

Distributed Systems  
 LAN Foundations  
 Future Technology Issues  
 Panel: Technology's Impact on  
 Networking

PRODUCT EXHIBITS\*\* & Lunch

(afternoon subjects)  
 Internetworking  
 ISDN and SONET Design  
 Distributed Systems  
 LAN Applications and Protocols  
 LAN Technology Issues  
 Network Implementation Approaches  
 Panel: Implementation Issues

PRODUCT EXHIBITS\*\*

Wednesday, April 29

Keynote Presentation  
 (morning subjects)  
 Physical Layer Design  
 Network Management

Internetworking  
 Wide-Area Networking  
 Panel: Internetworking Issues

PRODUCT EXHIBITS\*\* & Lunch

(afternoon subjects)  
 Physical Layer Design  
 New Architectures and Functions  
 High-Speed Networking  
 Network Implementation Approaches  
 Panel: A Status Report on Global  
 Networking

\*tentative; subject to change

\*\* Product exhibits are open from Noon to 2 pm and from 5:30 to 7:30 pm on Tuesday, April 28, and from Noon to 2 pm on Wednesday, April 29.

Note: Registration fees for the conference include coffee-break refreshments, lunch, one set of tutorial notes and/or conference proceedings, and one exhibits admission. A \$100 handling fee will be charged for registrations cancelled before March 30, 1992; no refunds after March 30.

Make your room reservations directly with the Westin Hotel, 5101 Great America Parkway, Santa Clara, Calif. (408) 986-0700; Ask for the special SVNC room rate.

The Silicon Valley Networking Conference is the only networking conference that focuses on the DESIGN side of network-related hardware down to the chip level as well as the development and use of network management and testing software. In addition to technical papers that focus on design issues there will be panel sessions and papers for system planners and strategic MIS executives that focus on future technology trends and network implementation issues.

The SVNC program venue consists of three full-day tutorials on the opening day (Monday, April 27) and more than 70 technical and management-oriented paper and panel presentations arranged in three parallel sessions on the second and third days (Tuesday and Wednesday, April 28 and 29). Table-top product exhibits and demonstrations will supplement the technical paper program on Tuesday and Wednesday. Limited exhibit space is still available; contact Ken Majithia at SysTech Research - (408) 924-3930 - for exhibition details.

The Silicon Valley Networking Conference is a creation of SysTech Research. SVNC is co-sponsored by 3Com Corp., National Semiconductor Corp., and Electronic Design and Electronics Magazines (Penton Publications).

### SVNC'92 REGISTRATION FORM

Please mail in this form with your payment. Make checks payable to SysTech Research and mail to: SysTech Research, 1248 Olive Branch Lane, San Jose, CA 95120. FAX inquiries to (408) 997-8265.

	Payment * postmarked by 3/30/92	Payment * postmarked after 3/30/92	Payment at the door
(A) Tutorial only (one tutorial on 4/27) Select one: T1 --- T2 --- T3 . . . . .	\$250	\$295	\$350
(B) Papers only (includes exhibits entry) (Technical paper sessions on 4/28, 29). . . . .	\$350	\$395	\$450
(C) Full conference (includes 1 tutorial, all papers and exhibits); mark tutorial in (A). . .	\$450	\$495	\$550
(D) Exhibits-only admission (Table top exhibits only on 4/28 or 4/29). . .	\$ 25	\$ 25	\$ 25
(E) Extra proceedings (For pick-up at the conference); If not attending, add \$20/domestic, \$40/intnl, for shipping. . . . .	\$ 85	\$ 85	\$100

\* New extended deadline dates; after 4/16 do not mail, bring for at-door registration Tax ID #77-025-4502

Name \_\_\_\_\_ Title \_\_\_\_\_

Company \_\_\_\_\_ Mail Stop \_\_\_\_\_

Address \_\_\_\_\_ City \_\_\_\_\_ State \_\_\_\_\_ Zip \_\_\_\_\_

Telephone \_\_\_\_\_ FAX \_\_\_\_\_ Email \_\_\_\_\_

Charge to my MASTERCARD \_\_\_\_\_ VISA \_\_\_\_\_ account. EXP. DATE \_\_\_\_\_

Account Number \_\_\_\_\_ Signature \_\_\_\_\_

# QSI's Rule of Thumb

## SMALLER IS BETTER!

### Smaller is Better!

Our package is the smallest!

Using our Quarter Size Outline Package (QSOP) of parts opens the door to a new world of design for you. Quality's QSOP line of logic parts will save you up to 75% of useable board space over SOIC parts. Really, 75%! Just think of the possibilities. With **Quality** you design smaller, cleaner, and faster products, no question!

### Now Smaller is Faster and Cleaner!

Now available in "D" Speed our QSOP package gives you the fastest logic parts available. QSOP's shorter inter and intra-chip distances reduce trace delays, that means a lower lead inductance, which means more speed! By using the QSOP package in the FCT 2000 series with internal 25 ohm resistor you have signals so clean that ground bounce, reflection, and cross talk are not a factor. This is the fastest family of logic chips available. QSI lets you design smaller, faster, better!

### Smaller Is Easier!

The real magic in our quarter size product is the ease in which our logic line can be incorporated into your designs while achieving substantial savings in board space. Our industry standard 25.0 mil lead spaced QSOP chip is half the length, and half the width of a 24-pin, 300 mil SOIC, but by using JEDEC standard 150 mil wide bodies and the same outline of a 14-pin SOIC it requires no new SMT tooling. You get all the benefits and none of the headaches!

### Your Full-line Logic Supplier With Innovation!

Quality Semiconductor's full-line of logic parts are shipping now! With our ultra-small QSOP, ZIP, PDIP, and SOIC packages available in A,B,C, and D speeds as well as the FCT 2000 series with on-chip resistors, you have the fastest, cleanest and smallest line of logic parts available! Call **Quality Semiconductor** at **(408) 450-8027** today for more information on our outstanding line-up of logic parts.

## Quality Semiconductor, Inc.



851 Martin Avenue ■ Santa Clara, CA 95050  
Tel: (408) 450-8027 ■ Fax: (408) 496-0773

CIRCLE 204 FOR U.S. RESPONSE CIRCLE 205 FOR RESPONSE OUTSIDE THE U.S.

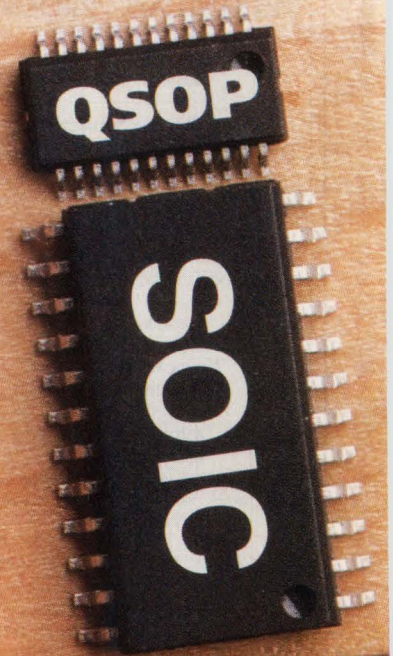

### Quality Products in QSOP

74 FCT 2000 SERIES				74 FCT SERIES			
2151	2251	2543	2827	151	251	543	827
2153	2257	2544	2828	153	257	544	828
2157	2258	2573	2833	157	258	573	833
2158	2273	2574	2834	158	273	574	834
2161	2299	2640	2841	161	299	640	841
2163	2373	2646	2843	163	373	646	843
2191	2374	2648	2845	191	374	648	845
2193	2377	2651	2854	193	377	651	854
2240	2533	2652	2861	240	533	652	861
2241	2534	2821	2862	241	534	821	862
2244	2540	2823	2863	244	540	823	863
2245	2541	2825	2864	245	541	825	864
29FCT 2000 SERIES				29FCT SERIES			
2052	2053	2520	2521	052	053	520	521
<small>Available in A, B, C and D speeds</small>							
QUICKSWITCH SERIES							
74QST3383				74QST3384			

QSI, QCMOS, QSOP, QST and QuickSwitch are registered trademarks of Quality Semiconductor, Inc.

# ELECTRONIC DESIGN

**DIRECT CONNECTION ADS**  
 New Products/Services Presented By The Manufacturer.  
 To Advertise, Call JEANIE GRIFFIN At 201/393-6080

## The Only Low Cost/High Performance Arbitrary Waveform Generator

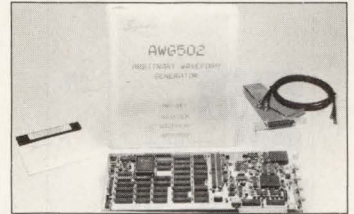

**AWG502**

- A must for Engineering Development or Production Test.
  - ★ IBM AT compatible board
  - ★ Two analog output channels + 24 digital outputs
  - ★ Up to 50 Megapoints/sec output each channel
  - ★ 12 bit resolution
  - ★ 10 output filters per channel
  - ★ Frequency synthesizer
  - ★ 64k words RAM per channel with segment looping
  - ★ The best software support on the market
- Full price is \$3500. Phone Today for immediate information.

**Signatec**  
 Signatec, Inc.  
 357 N. Sheridan St., Suite 119  
 Corona, California 91720  
 (714) 734-3001  
 FAX: (714) 734-4356

SIGNATEC INC.

CIRCLE 425



**FREE!**  
**120**  
**Page**  
**Catalog**  
 -----  
**"Optics**  
**for**  
**Industry"**

**ROLYN OPTICS** supplies all types of "Off-the-Shelf" optical components. Lenses, prisms, mirrors, irises, microscope objectives & eyepieces plus hundreds of others. All from stock. Roly also supplies custom products & coatings in prototype or production quantities. Write or call for our free 120 page catalog describing products & listing off-the-shelf prices. **ROLYN OPTICS CO.**, 706 Arrowgrand Circle, Covina, CA 91722, (818) 915-5707 & (818) 915-5717. TELEX: 67-0380. FAX: (818) 915-1379.

ROLYN OPTICS

CIRCLE 413

## 68HC11

PC-based emulator for 68HC11

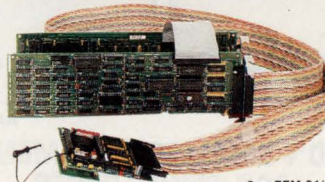

See EEM 91/92  
 Pages D 1300-1303

- PC plug-in or RS-232 box.
- Pull-down menus with full window support, combined with command-driven User Interface.
- Up to 16 MHz real time emulation.
- No intrusions to the 68HC11's resources.
- 64 bit wide 16K deep trace. All functions usable without disturbing emulation. Time stamping. Two level trigger.
- Symbolic and C Source Level Debugging, including in-line assembler and disassembler.
- Supports A, D, E, F, G, J, K and L parts

**CALL OR WRITE FOR FREE DEMO DISK!**

Ask about our demo video

**NOHAU**  
 CORPORATION (408) 866-1820

Call 408-378-2912  
 Nohau's 24-hour  
 information center to  
 receive info via your FAX

NOHAU CORP.

CIRCLE 409

## Tango

The Complete Electronic Design Solution.

For **FREE** evaluation software and product specs, call **800 488-0680**



Tango, the leader in PC-based tools for:

- Schematic entry
- PCB layout and autorouting
- PLD design
- Simulation, timing verification and thermal reliability

ACCEL Technologies, Inc.  
 6825 Flanders Drive  
 San Diego, CA 92121-2986  
 Service 619 554-1000  
 Fax 619 554-1019

ACCEL TECHNOLOGY

CIRCLE 400

## Interactive/Real-Time

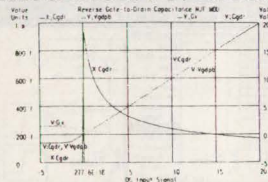

**ECA-2**  
 Engineering a Better Way

### Analog Circuit Simulation

- AC, DC, Transient, Fourier, Temperature, MonteCarlo and/or Worst-Case Analysis • Interactive or batch modes
- Full nonlinear simulation • On-line real time graphics
- Multiple plots • 2 to 50 times faster than SPICE
- Component optimization sweeping • New 424 pg. manual

All the Features, Twice the Speed  
 at Half the Cost

Call for **FREE DEMO!**

**Tatum Labs, Inc.**  
 P.O. Box 1263, Ann Arbor, MI 48106-1263  
 313-663-8810

TATUM LABS, INC.

CIRCLE 418

## Instant Microcontroller



### Instant C Programming

Don't use a microprocessor, use a **SmartBlock™** microcontroller module to build your custom controller. Our \$195 interactive **Dynamic C™** development system makes programming easy. 3.5 x 2.5 inch module includes microprocessor, memory, time/date clock, eeprom, watchdog, serial ports and more. As low as \$59 in quantity. The efficiency of a custom design without the headaches.

#### Z-World Engineering

1724 Picasso Ave., Davis, CA 95616 USA

Tel: (916) 757-3737

Regular Fax: (916) 753-5141

Automatic Fax: (916)-753-0618

(Call from your fax, request data sheet #14.)

Z-WORLD

CIRCLE 421

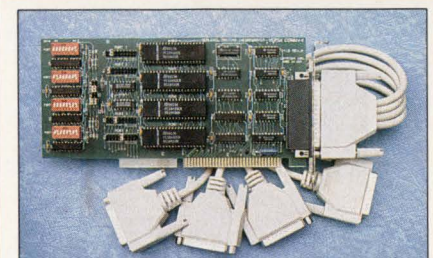

### ADVANCED COMMUNICATIONS PRODUCTS

- 1-, 2-, or 4-port RS-232 and RS-422/485 Boards
- Current Loop, RS-530, and V.35 Interface Boards
- High Speed Sync (HDLC, SDLC) and Async with DMA
- Digital and Relay I/O Boards
- Diskless EPROM Board with Promkit Software by Annabooks
- New Micro Channel Boards
- New Laptop Add Ons
- Excellent Technical Support



**SEALEVEL SYSTEMS, INC.**  
 PO Box 830  
 Liberty, SC 29657  
 803-843-4343

SEALEVEL SYSTEMS

CIRCLE 415

**Total Solutions for PC-based Industrial Automation and Control**



**Industrial PC Solutions**

20-page, solution oriented reference guide detailing a complete line of PC-based industrial automation and control products: industrial PCs, 486/386/286 CPU Cards, RAM/ROM disks, rack mount keyboards and monitor enclosures. All of the latest technology at budget-conscious prices. Call for FREE reference guide (408) 293-6786.

**American Advantech**

ADVANTECH

CIRCLE 401

**UNIVERSAL DATA ACQUISITION SYSTEM**

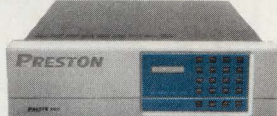

**PRESYS 1000**

New microprocessor-based system offers thousands of functional combinations for up to six concurrent users:

- 15 all-purpose card slots
- Analog and digital I/Os
- A/D & D/A conversion
- 13-16 bit resolution
- 300 KHz-1 MHz data rate
- 32 MB FIFO memory
- Multiple computer interfaces.

For full-color brochure contact



1180 N. Blue Gum St., Anaheim, CA 92806  
(714) 632-3700, Fax (714) 632-7355

PRESTON

CIRCLE 412

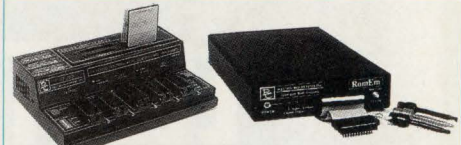

**RS232 EE/EPROM, MICRO & MEMORY CARD PROGRAMMER \$345/495**

- Programs EE/EProms, Flash EProms, ZPRams, Intel Micros, Memory Cards.
- Stand-Alone Mode for EE/EProms and Memory Card Duplication / Verify.
- All 24/28/32 pin EE/EProms to 8 Mbits (upgradable to 32 Megabits).
- Micros: 8741(A, 2), A-4, 4-9, 51, CS1, CS1FA/B, 52, 53, 55, CS21, CS41, 9761.
- Accepts dedicated modules: Memory Card Programming Module (Seiko/Epson) - \$145, Eraser/Timer Module - \$50, Gang Module (4 sockets) - \$145. Simultaneously duplicates up to 5 devices in stand-alone mode (with Gang).
- Can be operated with any computer containing an RS-232 serial port.
- User friendly Menu-Driven Interface Program for IBM-PC or compatible.
- Full 1 year warranty. Customer support via voice line, fax or dedicated BBS.

**INTELLIGENT ROM EMULATOR \$445**

- Emulates 2716 through 27512 EProms with a single unit. Access time 120ns.
- Connects to the standard parallel printer port via a standard printer cable.
- User friendly software. Command set includes: Load(data), Write(data), Display(memory), Type(of EProm), Edit(memory), Fill(memory), Calculator, Reset(target system), Activate(debugging feature), Monitor(selected feature).
- Address Compare with Halt output, Address Snapshot, Trigger input.
- Fast data loading via parallel printer port (64k bytes in less than 10 sec).
- Cascadable up to 8 units. Includes target cable with Trigger/Reset/Halt clips.
- CMOS RAM chips with rechargeable NiCad battery backup.

MC / VISA / AMEX All prices are U.S. list only.



B&C MICROSYSTEMS

CIRCLE 403

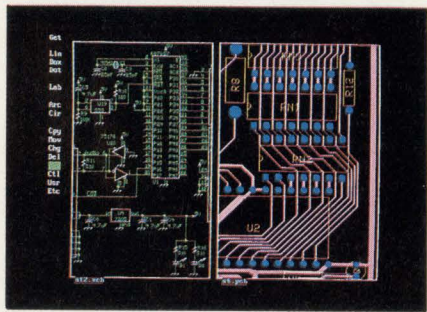

**NEW SCHEMATIC AND PCB SOFTWARE**

With support for extended and expanded memory, HiWIRE II can handle your most demanding schematic and PCB designs quickly and easily. The unique HiWIRE editor allows you to display and edit schematics and PCBs simultaneously, using the same commands for each. HiWIRE II is \$995, and is guaranteed.

**WINTEK CORPORATION,**

1801 South Street, Lafayette, IN 47904  
(800) 742-6809 or (317) 448-1903

WINTEK

CIRCLE 420

**DREAM METER**

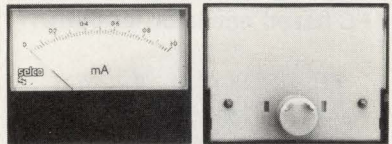

FRONT BACK

**80% SMALLER MOVEMENT, 66% FEWER PARTS.**

- Core magnet design
- Dramatically reduced total volume
- Taut band suspension
- Accuracy to  $\pm 1.5\%$  of full scale
- Four sizes
- AC and DC versions
- Standards conformance
- Custom Marking Services

**selco PRODUCTS CO.**

7580 Stage Road, Buena Park, CA 90621  
(213) 921-0681 • (800) 229-2332  
FAX (714) 739-1507

SELCO PRODUCTS

CIRCLE 416

**Free Circular Connector Catalog from LEMO**

LEMO's new circular connector catalog highlights expanded shell and insert designs. Insert configurations are available in single, multi or mixed designs including signal, coaxial, triaxial, high voltage, fiber optic and fluidic/pneumatic. Shell styles are available in standard chrome plated brass, anodized aluminum, plastic or stainless steel.

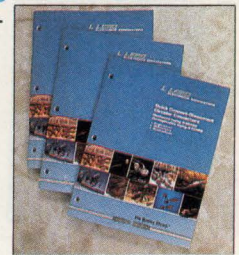

P.O. Box 11488, Santa Rosa, CA 95406  
Phone (800) 444-LEMO Fax (707) 578-0869

LEMO USA

CIRCLE 407

**Oxley SMOX Surface Mount Test Points and Test Pads**

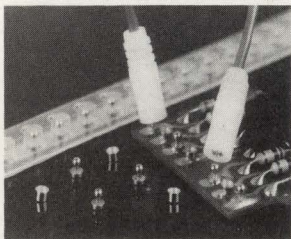

- \*SMOX Test points and Test pads are designed to ensure fast consistent and trouble-free testing without damaging the pcb.
- \*SMOX Test points and sockets—ball and socket arrangement provides quick and damage free connections.
- \*SMOX Test pads—ideal for loosely toleranced bed of nail connections.
- \*Gold-plated for minimal contact resistance.

**OXLEY INC.**  
25 Business Park Drive  
PO Box 814 Branford  
Connecticut 06405 USA  
Tel: 0101 203 488 1033  
Fax: 0101 203 481 6971



OXLEY, INC.

CIRCLE 411

**Telecom Solutions from Teltone**

**R1 and R2 MF Transceivers**

M-986 transmits and receives CCITT R1 or R2 forward and backward multifrequency signals. For trunk adapters, test equipment, etc.



- Single or dual channel versions available
- For N. Am. (R1) or Int'l. (R2) toll signals
- Binary or 2 of 6 input/output format
- Complete microprocessor interface
- 40-pin IC, 5-volt power, crystal time base

**1-800-426-3926**

Or: 206-487-1515 Fax: 206-487-2288



Teltone Corporation, 22121-20th Avenue SE, Bothell, WA 98021

TELTONE

CIRCLE 419

**Analog Circuit Simulation SPICE FOR THE PC**

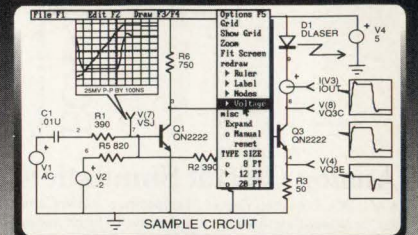

- Schematic Entry • SPICE Simulation
- Model Libraries • Waveform Graphics

**Intusoft has it all at an Affordable Price!**

INTEGRATED, EASY TO USE SIMULATION ENVIRONMENT, FEATURING: A powerful SPICE (IsSpice) simulator performing AC, DC, Transient, Noise, Fourier, Distortion, Sensitivity, Monte Carlo, and Temperature analyses. Extensive model libraries, Schematic entry, and Waveform processing. Starting at \$95 for IsSpice, complete systems are available for \$815.

Call Or Write For Your Free Demo and Information Kit!



P.O. Box 710 San Pedro, CA 90733-0710

Tel. 213-833-0710

Fax 213-833-9658

INTUSOFT

CIRCLE 405



16 MHz CPU  
DRAM to 512K  
20 MHz DSP  
SRAM to 96K  
DAPL™ Operating System  
100+ standard commands  
Custom commands in C

**The Intelligent Solution For Data Acquisition**

CALL and talk to us about your project.  
(206) 453-2345

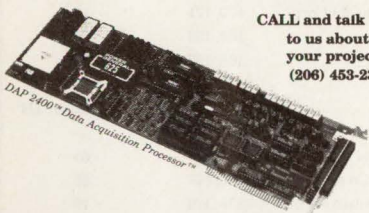

DAP 2400™ Data Acquisition Processor™

ANALOG I/O  
DIGITAL I/O  
Inputs to 235K samples per second  
Outputs to 250K samples per second

Or call for FREE demo diskette.

MICROSTAR LABORATORIES 7  
2265 116th Avenue NE  
Bellevue, WA 98004  
FAX (206) 463-3199

MICROSTAR LABORATORIES CIRCLE 408

**GraphiC-6.0™**

SW I-I CHART

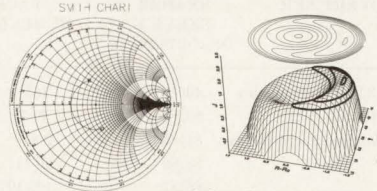

$I = 1 - (r-1)^2 + \epsilon \cos(\theta)$

"All of the C language routines you need to write an impressive scientific graphing program of your own. Highly Recommended."  
—PC Magazine

- Linear, log, polar plots
- 3-D curves & surfaces
- Shaded contour plots
- Smith and 3-D bar Charts
- '286-extender version
- Output Tek 4105, HPGL/2, color PostScript, PIC, GEM
- TIGA, DGIS, 8514, VGA
- Source code for full control
- Licensed for personal use

**Scientific Endeavors**  
508 North Kentucky St., Kingston, TN 37763  
(615) 376-4146 FAX: (615) 376-1571

SCIENTIFIC ENDEAVORS CIRCLE 414



**Free Catalog**  
The World's Largest Collection of Adapters & Accessories for VLSI/Surface Mount Devices

- Emulator Pods & Adapters
- Debugging Accessories
- Debug Tools
- Prototyping Adapters
- Programming Adapters
- Custom Engineering
- Socket Converters

Emulation Technology, Inc.  
2344 Walsh Ave. Santa Clara, CA 95051  
Phone: 408-982-0660 FAX: 408-982-0664

EMULATION TECHNOLOGY CIRCLE 404

**Fuzzy Logic Training Kit!**



Introduce yourself to the hot technology of the '90s! The ADS230 Fuzzy Logic Applications Development Kit gives you hands-on exposure. The PC-compatible card includes an NLX230 MircoController — allowing you to develop and test applications for hardware-based fuzzy logic. The kit includes all necessary controlling software and documentation. From America's fuzzy logic leader!

**\$395**

**NeuraLogix** 411 Central Park Dr.  
Sanford, FL 32771  
407-322-5608 FAX 407-322-5609

AMERICAN NEURALOGIX CIRCLE 402

**IEEE 488.2**

Hardware for IBM PC/AT, Micro Channel, Sun, Macintosh, DEC, and NeXT.



Software for DOS, UNIX, VMS, menu-driven and icon-driven environments.

IEEE 488 extenders, analyzers, converters, analog I/O, and digital I/O.

Call for your free IEEE catalog

**LOtech**

LOtech, Inc. • 25971 Cannon Road  
Cleveland, Ohio 44146 • (216) 439-4091

IO TECH CIRCLE 406

**NoiseKen**

**Noise simulators help find perils in power-line defects**

IMPULSE NOISE SIMULATOR



**MODEL INS-410**

U.S.A. WATAHAN NOHARA INTERNATIONAL, INC.  
TEL (800)366-3515

NOISE LABORATORY CIRCLE 410

**END WARPAGE WITH BOARD STIFFENERS**



- Rigidize boards during and after assembly
- Prevent vibration and shock damage
- One-step installation requires no hardware
- Use as a ground, or to carry up to 64 amps

Send for Rogers Board Stiffeners Application Bulletin.

Rogers Corp., 2400 S. Roosevelt St.  
Tempe, AZ 85282 602/967-0624  
ROGERS CORP. CIRCLE 422

**RELIABILITY PREDICTION SOFTWARE**

**ARE YOUR PRODUCTS RELIABLE?**

The RelCalc 2 Software Package automates the reliability prediction procedure of MIL-HDBK-217, or Bellcore, allowing quick and easy reliability analysis of electronic products on your PC. Say goodbye to tedious, time consuming, and error prone manual methods!

- NEW UPDATE! VERSION 3.1 now available.
- User friendly: pop-up menus, hypertext help.
- Very easy to learn and use; quick data entry.
- Part library for rapid recall of part data.
- Global editing functions for what-if? trials.
- Reports which clearly organize results.
- Save time & money as you design for quality.
- Try our Demo Package today for \$25.

T-Cubed Systems, 31220 La Baya Drive, Suite 110, Westlake Village, CA 91362  
CALL: (818) 991-0057 FAX: (818) 991-1281

T-CUBE SYSTEMS CIRCLE 417

**Gate Curve Characteristic Tester**  
PC Based Nodal Analyzer for IBM PCXT/AT Compatibles  
Component Level Troubleshooting Aid

When Active Testing Fails to Produce the Defective Component  
The GCCT Module can Light the Way

Passive Testing  
Freq Selective 60Hz, 400Hz, 2KHz  
Voltage Selective  
+40V +30V +20V +10V  
Testing to 40 Pins  
Multiple Sample Summation  
Menu Driven C Program

Equal	Different	Different	Equal
Pin 1	Pin 2	Pin 3	Pin 4
Different	Equal	Equal	Different
Pin 5	Pin 6	Pin 7	Pin 8

Professional Digital Components

Making Electronics Friendly For You  
2213 N Reynolds Rd Suite 7 Bryant, AR 72022  
(501) 847-2557 Call for FREE DEMO DISKETTE

PROFESSIONAL DIGITAL COMPONENTS CIRCLE 424

# CLASSIFIEDS

## EMPLOYMENT OPPORTUNITIES

### SENIOR DESIGN ENGINEER

Responsible for research and development of advanced models for temperature variation, high frequency parasitics, current-flow dependent behavior, and scaling effect of both bipolar and CMOS devices. Successful candidate will also research and develop computation efficient models to improve circuit simulation time, process and device characterization, extraction methodology for sub-micron integrated circuit fabrication processes, analyze statistical data of best/typical/worst case models, develop correlation theory of device parametric interdependency for various process technologies, develop and enhance measurement capability and HP programs, improve accuracy for dc, ac, transient, C-V profiling and S-parameter characterization of semiconductor devices from -55C to 175C with wafer probing station, HP network analyzer, HP LCRZ meter, HP semiconductor parameter analyzer, HP computer, etc.

Requirements: Ph.D. in Electrical Engineering with more than 5 years laboratory experience in design, fabrication, and electrical characterization of solid state and thin film devices, experience in microelectronics, semiconductor device physics, solid-state physics, and integrated circuit modeling and simulation, knowledge of integrated circuit design, fabrication process, and SPICE simulation. Must also possess extensive measurement technique at low temperature and microwave frequency and have a strong background in electromagnetic wave, microwave circuit and device, statistical analysis, thermal physics, numerical analysis, and experience of HP instrumentation and programming on HP computer.

Send resume to P.O. Box 1509, Kennebunkport, ME 04046 no later than April 29, 1992. Must show proof of legal authority to work in U.S. EOE M/F/V/H.

## CONSULTANTS

### MICROPROCESSOR CONTROLS Customized To Your Application

#### Our Complete Package Includes:

- A hardware interface, designed specifically to your needs, utilizing the latest Motorola HCMOS technology and other state-of-the-art chips.
- Complete programming to your specifications.
- Delivery in 4-6 weeks from receipt of your P.O.
- Board prices begin at \$165.00 in lots of 10.
- Our one-time engineering charges begin at \$500.00.

#### NORAD ELECTRONICS

102 Railroad Ave., Bridgeport, CT 06604  
Tel. 203/339-3600 FAX. 203/339-3604

## BUSINESS SERVICES

### HARDWARE AND SOFTWARE DEVELOPMENT SERVICES

- We specialize in developing microprocessor/FPGA based products/systems and embedded software development.
- Custom Windows V3.0 and networking software development.
- Can help with part of or handle the entire project.
- Full Microprocessor Development Systems, iPCIE, CAD/CAM, and PCB layout system.
- Development for LAN, Multibus, VME, PC, MCA, and STD.

**Applied Computer Techniques, Inc.**  
Tel. (407) 851-2525 Incorporated 1978

# INDEX OF ADVERTISERS

ADVERTISER	READER SERVICE	PAGE NUMBER	ADVERTISER	READER SERVICE	PAGE NUMBER
	U.S./OUTSIDE U.S.			U.S./OUTSIDE U.S.	
ACCEL Technologies	400	155	Mini-Circuits Laboratory, a Div. of Scientific Components Corp.	170, 171	15
Aetel	80, 81	70-71		164, 165	20-21
Advanced Micro Devices	84, 85	2-3		166, 167	30-31
	88, 89	10-11		172, 173	92
	86, 87	106-107		168, 169	Cover III
Altera	82, 83	109	Motorola Semiconductor Products	174, 175	65
American Advantech	401	157	Murietta Circuits	176, 177	95
AMP	90, 91	58-59	National Instruments	178, 179	19
Amplifier Research	92, 93	140	National Semiconductor	180, 181	113
Analog Devices	102, 103	16-17	NeuraLogix	402	156
	94, 95	83	NMB Technologies	232, 233	119
	96, 97	120-121	Nohau	409	155
Ancot	98, 99	8	Noise Laboratories	410	156
AT&T	100, 101	80-81	OKI Semiconductor	0	130
B&C Microsystems	403	157	Orcad	182, 183	100-101
Battery Engineering	104, 105	8	Oxley, Inc.	411	157
Bud Industries	108, 109	159	P-Cad	184, 185	33
Burr-Brown	252, 253	144	Pacific Hybrid	186, 187	141
Capital Equipment Corp.	110, 111	148		188, 189	143
Comlinear	112, 113	151		190, 191	145
Concurrent Logic	270, 271	149		192, 193	147
Condor	114, 115	73	Performance Semiconductor	194, 195	137
Cybernetic Micro Systems	116, 117	14	Philips Discrete Products	301	44-45
Cypress Semiconductor	0	126	Pico Electronics, Inc.	196, 197	138, 150
Data Translation	118, 119	74	Potter & Brumfield	198, 199	142
Datel	120, 121	69	Power-One	200, 201	139
Dazix, an Intergraph Co.	144, 145	96F	Preston	412	157
Design Automation	122, 123	134	Professional Digital Components	424	156
Digi-Key	124, 125	24	Protel Technology	202, 203	50
Diversified Technology	240, 241	40-41	Quality Semiconductor	204, 205	154
Echelon	126, 127	12-13	Raytheon	208, 209	39
	246, 247	42-43		206, 207	51
Electronic Measurements	260, 261	99	Rogers Corp.	210, 211	85
Emulation Technology	404	156		422	156
Frequency Devices	242, 243	68	Rolyn Optics	413	155
Fujitsu	128, 129	111	Samsung Semiconductor	212, 213	104A-104D
GE Plastics	130, 131	26-27	Sanyo Energy	214, 215	115
Globe Manufacturing Sales, Inc.	132, 133	90	Scientific Endeavours	414	156
Gould Test & Measurement	134, 135	87	Sealevel Systems	415	155
Harris Semiconductor	258, 259	36-37	Selco Products	416	157
Hewlett-Packard Co.	136, 137	6-7	SenSym	216, 217	135
Hughes Semiconductor	262, 263	122	Seponix	272, 273	95
IC Design	138, 139	61	Sharp Microelectronics	218, 219	96B-96D
ICS Computer	140, 141	18	Siemens Components	220, 221	46
IOtech	406	156	Signatec	425	155
Intel	142, 143	22-23	Siliconix	0	117
Interpoint	256, 257	98	Silicon Systems	222-223, 224-225	53
Intusoft	405	157	Simtek	248, 249	133
Ironics	268, 269	1	Solaris Systems	250, 251	72
I-TECH Corp.	274, 275	125	Stanford Research	226, 227	52
J.M. Ney	146, 147	89	Systech Research	0	153
J.W. Miller	106, 107	72	T-Cubed Systems	417	156
John Fluke Mfg.	148, 149	88	Tatum Labs	418	155
Lambda Electronics	150, 151	48A-48H	Teknor Microsystems	228, 229	35
Lattice Semiconductor	276, 277	54	Tektronix	230, 231	9
Leader Instruments	152-153, 154-155	91		300	128A-128H
LEMOUSA	407	157	Telebyte Technology	234, 235	89
Linear Technology	156, 157	Cover IV	Teltone	419	157
LPKF CAD/CAM Systems	158, 159	123	TransEra	236, 237	144
Maxim Integrated Products	160, 161	Cover II	Vicor	238, 239	77
Mentor Graphics	254, 255	29	Wintek	420	157
MicroLinear	244, 245	66-67	Yamaha LSI	266, 267	160
Microstar Laboratories	408	156	Z-World Engineering	421	155
Miller-Freeman	162, 163	152			

The advertisers index is prepared as an extra service.  
Electronic Design does not assume any liability for omis-

# JAGUAR™

The ultimate enclosure with sleek, sophisticated styling,  
computer-aided, high-tech design and functionality  
and Bud's legendary built-in quality.

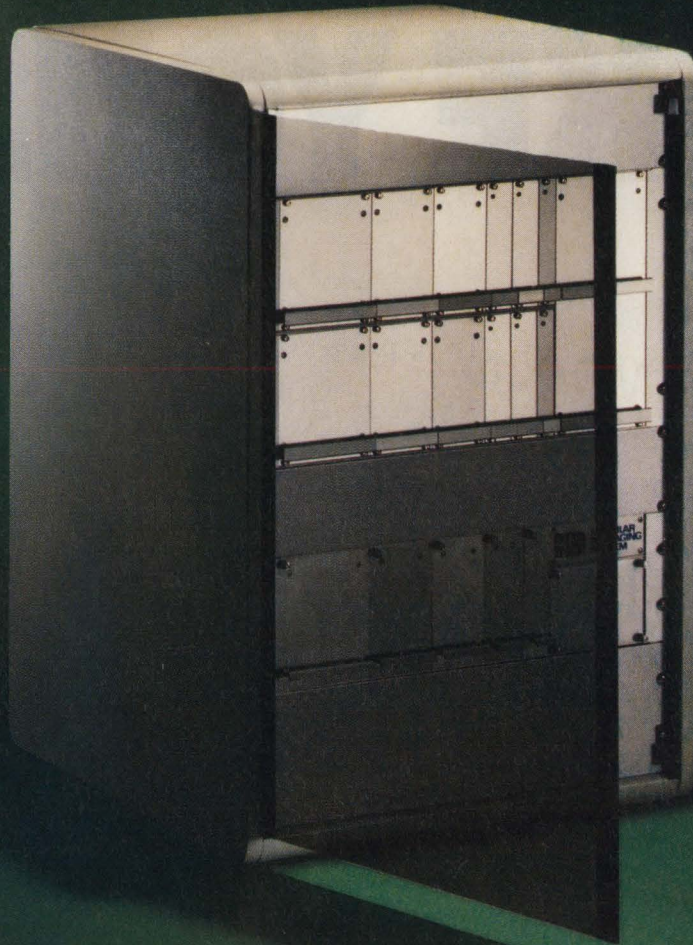

The new Jaguar Cabinet offers the contoured elegance of a modern classic in perfect harmony with advanced engineering and inspired technical innovation. Beneath the graceful curves of its removable top cover, you'll discover a rugged steel frame engineered to be incredibly strong and stable. The sophisticated, functional design provides a precise environment for today's, and tomorrow's, high-tech equipment.

Utilizing Bud's standard option packages and our engineer-assisted custom capabilities, we can create a unique Jaguar Cabinet to meet your specific technical requirements.

Bud East, Inc.  
4605 East 355th Street  
P.O. Box 431  
Willoughby, Ohio 44094  
(216) 946-3200  
FAX: 216-951-4015

**BUD**  
Bud Industries, Inc.

Bud West, Inc.  
7733 West Olive Avenue  
P.O. Box 1029  
Peoria, Arizona 85345-0350  
(602) 979-0300  
FAX: 602-878-5371

**BUD...Your Single Source Enclosure Company.**  
CIRCLE 108 FOR U.S. RESPONSE      CIRCLE 109 FOR RESPONSE OUTSIDE THE U.S.

# WE'VE GOT TWO WORDS FOR PEOPLE LIKE YOU.

**FAX Vodem™** \ faks-vo-dem \ n  
[ origin: Yamaha LSI ] 1: world's first single-chip  
multimedia communications device 2: Fax/data/  
ADPCM voice and caller I.D. 3: transfers data,  
fax and voice via a single line

If you're one of those people who goes around integrating communications devices into PCs, laptops and other hardware, we've got two words for you — FAX Vodem™.

What do they mean? In a word, plenty. Yamaha defined FAX Vodem on September 26, 1991, as a major breakthrough in multimedia communications. And now it's going to change the way you communicate. Because with FAX Vodem, you'll be able to integrate Fax. Data. ADPCM voice communications. And caller I.D. All on a single line. And all with a single-chip LSI that'll give your products multimedia communications capabilities you never thought possible.

Sound too good to be true? It's not. And we'd like to prove it to you. Just call us at 1-800-543-7457 or write and we'll send you all the nitty gritty technical details that wouldn't fit in this ad.

So start integrating FAX Vodem into your new products. And when your colleagues notice what a great communicator you've become, just tell them you've got two words for people like them.

## YAMAHA<sup>®</sup> LSI

Yamaha Corporation of America  
Systems Technology Division  
981 Ridder Park Drive, San Jose, CA 95131  
(408) 437-3133 FAX (408) 437-8791

© 1992, Yamaha Corporation of America, Systems Technology Division, Yamaha LSI, Systems Technology Division and the Yamaha logo are registered trademarks and FAX Vodem is a trademark of Yamaha Corporation of America.

CIRCLE 266 FOR U.S. RESPONSE

CIRCLE 267 FOR RESPONSE OUTSIDE THE U.S.

# POWER SPLITTERS/ COMBINERS

the world's largest selection  
2KHz to 8GHz from \$4<sup>95</sup>

With over 300 models, from 2-way to 48-way, 0°, 90° and 180°, a variety of pin and connector packages, 50 and 75 ohm, covering 2KHz to 8000MHz, Mini-Circuits offers the world's largest selection of off-the-shelf power splitter/combiners. So why compromise your systems design when you can select the power splitter/combiner that closely matches your specific package and frequency band requirements at lowest cost and with immediate delivery.

And we will handle your "special" needs, such as wider bandwidth, higher isolation, intermixed connectors, etc. courteously with rapid turnaround time.

Of course, all units come with our one-year guarantee. Unprecedented 4.5 sigma unit-to-unit repeatability also guaranteed, meaning units ordered today or next year will provide performance identical to those delivered last year.

For detailed specs and performance data, refer to the MicroWaves Product Directory, EEM or Mini-Circuits RF/IF Signal Processing Handbook, Vol. II. Or contact us for our free 68-page RF/IF Signal Processing Guide.

CIRCLE 168 FOR U.S. RESPONSE CIRCLE 169 FOR RESPONSE OUTSIDE THE U.S.

finding new ways ...  
setting higher standards

## Mini-Circuits

A Division of Scientific Components Corporation  
P.O. Box 350166, Brooklyn, New York 11235-0003 (718) 934-4500  
Fax (718) 332-4661 Domestic and International Telexes: 6852844 or 620156

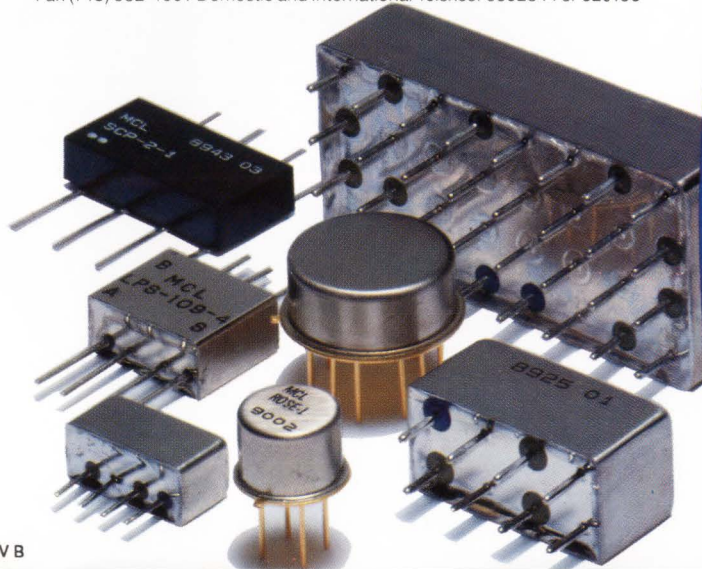

# Get Your Sample In 3 $\mu$ Sec.

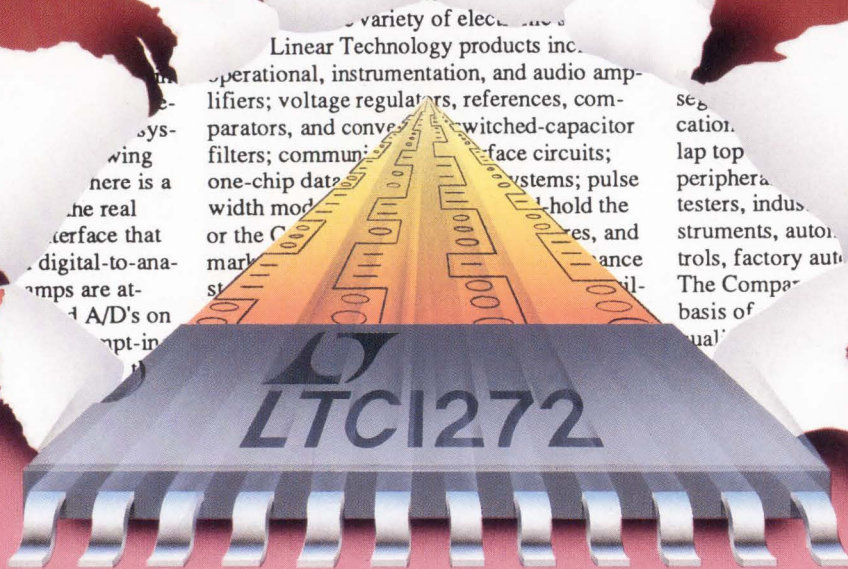

## Single Supply, 5V, 12 Bit, Sampling ADCs From \$16.90.

Linear Technology delivers 12 bit samples faster and cheaper using less power and less board space.

The new LTC1272 is a 3 $\mu$ sec, 12 bit sampling ADC that blows the doors off non-sampling 7572 and 574 type parts and their sampling upgrades. In the 7572 pinout, it samples at 250kHz and typically draws only 75mW from a single 5V supply.

And you don't need the extra errors, board space, power and cost of an external sample and hold! With on-chip sample and hold, the LTC1272 delivers

	LTC1272	AD7572	AD574	AD1674	MAX162
INTERNAL REFERENCE	✓	✓	✓	✓	✓
7572 PINOUT	✓	✓			✓
3 $\mu$ sec CONVERSION TIME	✓				✓
S & H INCLUDED	✓			✓	
LOW POWER CONSUMPTION	✓				
250 kHz SAMPLE RATE	✓				
SINGLE 5V SUPPLY OPERATION	✓				

a typical 450nsec acquisition time and 72dB typical signal to noise + distortion. The linearity, including the sample and hold errors, is  $\pm 0.5$  LSB.

With on-board voltage reference, the LTC1272 is a complete, sampling ADC solution. Get it now in your choice of 3, 5, and 8 $\mu$ sec speeds for military and commercial temperature grade applications. Packaging is plastic DIP, SO and hermetic. For details contact Linear Technology Corporation, 1630 McCarthy Blvd., Milpitas, CA 95035. Or call 800-637-5545.



TOUGH PRODUCTS  
FOR TOUGH APPLICATIONS.

CIRCLE 156 FOR U.S. RESPONSE

CIRCLE 157 FOR RESPONSE OUTSIDE THE U.S.