

electronics

A McGraw-Hill Publication 75 Cents

TELSTAR SATELLITE

*First by private
industry, p 26*

(Photo below)

EL-PC SWITCH

*A solid-state
commutator, p 38*

LEAKY-WAVE ANTENNAS

*Beam scans with
frequency, p 35*



R. D. SKINNER
1020 GOVINGTON RD
LOS ALTOS CALIF
L C

S	M	T	W	T	F	S
				1	2	3
4	5	6	7	8	9	10
11	12	13	14	15	16	17
18	19	20	21	22	23	24
25	26	27	28	29	30	31

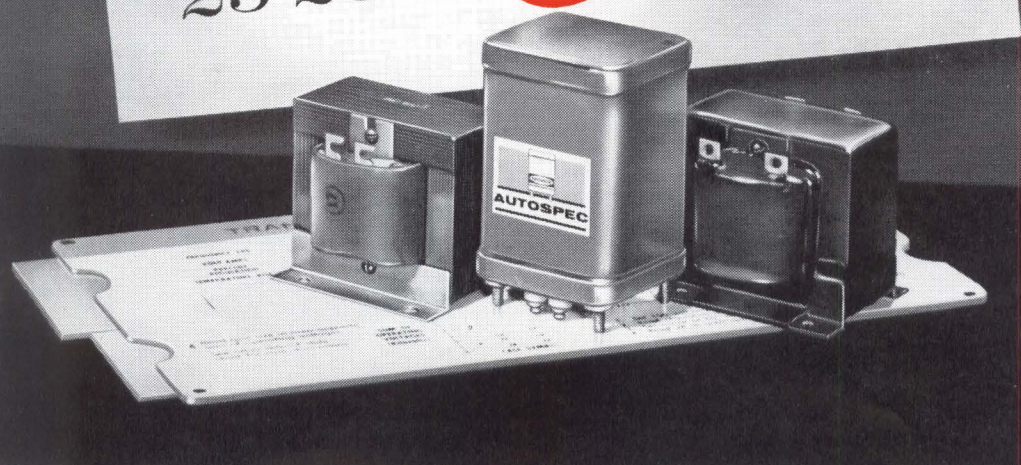

VITAL NEWS FOR ALL USERS OF TRANSFORMERS

AUTOSPEC from Raytheon... Transformers quoted in 3 days Delivered in 3 weeks

Raytheon announces the fastest, most efficient system yet devised for specifying, ordering and delivering power transformers and filter inductors to your requirements

From now on, every engineer can have at his fingertips a set of tools that will enable him to *automatically specify* the size of the transformer that exactly meets his electrical requirements. Mounting, terminal location and style are quickly and easily determined from convenient charts. The new Raytheon "AUTOSPEC" system delivers high quality "specials" in quantities from 1 to 15 within 3 weeks. With AUTOSPEC, Raytheon has discarded

the classic trial-and-error approach to transformer design and has developed the first fully coordinated transformer data system for all required power, temperature rise, regulation and dimensional calculations. A comprehensive brochure explains how you can employ AUTOSPEC to simplify your transformer design work and reduce component costs while cutting delivery time to the 2 to 3 weeks now associated with off-the-shelf items.

HOW AUTOSPEC WORKS

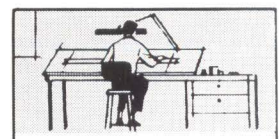

1. YOU DETERMINE SPECS, estimate size new easy way



2. QUOTE AND DRAWING confirms request in 3 days



3. PRODUCTION STARTS using new Raytheon technique

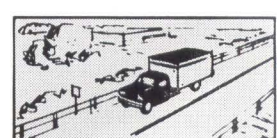

4. YOUR TRANSFORMERS are delivered within 3 weeks

FREE SLIDE RULE

SEND COUPON
 ON PAGE 91 →

Unique transformer selector (shown in illustration above left) plus descriptive brochure and comprehensive technical manual will be sent by return mail on receipt of your coupon.



RAYTHEON COMPANY

MAGNETICS OPERATION

CIRCLE 251 ON READER SERVICE CARD

electronics

A McGraw-Hill Publication 75 Cents



W. W. MacDONALD, Editor

J. M. CARROLL, Managing Editor

SENIOR EDITORS: Samuel Weber, George W. Sideris. SENIOR ASSOCIATE EDITORS: William E. Bushor, Michael F. Wolff. ASSOCIATE EDITORS: Michael F. Tomaino, Sylvester P. Carter, William P. O'Brien, John F. Mason, Thomas Emma, Sy Vogel, Leslie Solomon, M. M. Perugini, George J. Flynn, Laurence D. Shergalis. ASSISTANT EDITORS: Nilo Lindgren, Stanley Froud, Stephen B. Gray, Roy J. Bruun, George V. Novotny, Leon H. Dulberger. REGIONAL EDITORS: Harold C. Hood (Pacific Coast, Los Angeles), Thomas Maguire (New England, Boston), Cletus M. Wiley (Midwest, Chicago). ART DIRECTOR: Harry Phillips; Howard R. Berry. PRODUCTION EDITOR: John C. Wright, Jr. EDITORIAL ASSISTANTS: Gloria J. Meurer, Bernice Duffy, Lorraine Rossi, Virginia T. Bastian, Lynn Emery, Laura W. Smith, Bette H. Snyder, Rosemary Abbruzzese, Judy Haskins, Ann Mella. FOREIGN NEWS BUREAU: Director, John Wilhelm, Alyne Elias. London—John Shinn, Derek Barlow, Nicholas London. Bonn—Peter Forbath, James Morrison, Silke McQueen. Paris—Robert Farrell, Arthur Erikson. Milan—Gene DiRaimondo. Mexico City—Bruce Bendow. Rio de Janeiro—Leslie Warren. Moscow—Stewart Ramsey. Tokyo—Richard Halloran, Charles Cohen, John Yamaguchi.

JAMES GIRDWOOD, Publisher

TESTING THE TELSTAR. First communications satellite built by private industry undergoes test in a thermal vacuum chamber at Bell Labs Hillside facility. Medium-level active repeater will work at microwave frequencies. *This may be a step towards intercontinental live television.* See p 26 COVER

NUCLEAR AND SUPERCONDUCTING GYROS. Research efforts of the past several years are bearing fruit. Cryogenic gyro models have been built, a nuclear device is expected this fall. *Nuclear gyros would have no moving parts* 20

PRIVATE SATELLITE Goes Up This Spring at Cape Canaveral. Telstar will test worldwide communications techniques with a broadband repeater satellite. *It will also check performance of components in radiation environment* 26

TERACYCLE DEVICES COMING. Panel at AIEE Winter General Meeting reviews techniques for millimeter wave generators. *Key seems to be application of phenomena like cyclotron resonance* 27

SOLID-STATE MICROWAVE. Utility men see demonstration of tubeless system for commercial relay service. *Stations could be operated by 48-volt batteries* 28

RADIO ASTRONOMY to Get More Room in the Spectrum. FCC is proposing international allocations of higher frequency bands. *Changes in domestic allocations would reduce interference from other radio services* 30

LEAKY-WAVE ANTENNA DESIGNS. Basically, a leaky-wave antenna is a waveguide with one wall perforated. *These antennas are useful in communications and countermeasures because varying the transmitted frequency causes the beam to scan.* W. J. Getsinger 35

SOLID-STATE OPTOELECTRONIC COMMUTATOR. It is actually an array of electroluminescent-photoconductive switches suitably interconnected. *The commutator has isolated input and output, high power gain, low noise and good linearity.* R. D. Stewart 38

BIONICS: Animal Sensors and Electronic Analogs. Part II of a four-part series. Microelectrode studies reveal functioning of the retina of the eye; the ear comes next. *This work may be important in design of communications systems and image-processing schemes.* N. Lindgren 40

Contents continued

Published weekly, with Electronics Buyers' Guide and Reference issue, as part of the subscription, by McGraw-Hill Publishing Company, Inc. Founder: James H. McGraw (1860-1948).

Indexed Annually in Buyers' Guide and Reference issue.

Title ® registered U.S. Patent Office; © Copyright 1962 by McGraw-Hill Publishing Co., Inc. All rights reserved, including the right to reproduce the contents of this publication, in whole or in part.

Executive, editorial, circulation and advertising offices McGraw-Hill Building, 330 West 42nd Street, New York 36, N. Y. Telephone Longacre 4-3000. Teletype TWX N.Y. 1-1636. Cable McGrawhill, N. Y. PRINTED IN ALBANY, N. Y.; second class postage paid at Albany, N. Y.

OFFICERS OF THE PUBLICATIONS DIVISION: Nelson L. Bond, President; Shelton Fisher, Wallace F. Traendly, Senior Vice Presidents; John R. Callahan, Vice President and Editorial Director; Joseph H. Allen, Vice President and Director of Advertising Sales; A. R. Venezian, Vice President and Circulation Coordinator; Daniel F. Crowley, Vice President and Controller.

OFFICERS OF THE CORPORATION: Donald C. McGraw, President; Hugh J. Kelly, Harry L. Waddell, Executive Vice Presidents; L. Keith Goodrich, Executive Vice President and Treasurer; John J. Cooke, Vice President and Secretary.

Subscriptions are solicited only from those actively engaged in the field of the publication. Position and company connection must be indicated on orders. Subscription rates: United States and Possessions, \$6.00 one year; \$9.00 two years; \$12.00 three years. Canada, \$10.00 one year. All other countries \$20.00 one year. Single Copies, United States and Possessions and Canada 75¢. Single copies all other countries \$1.50.

THE PUBLISHER, UPON WRITTEN REQUEST FROM ANY SUBSCRIBER TO OUR NEW YORK OFFICE, AGREES TO REFUND THAT PART OF THE SUBSCRIPTION PRICE APPLYING TO COPIES NOT YET MAILED.

Subscribers: Please address all correspondence, change of address notices, subscription orders or complaints to Fulfillment Manager, Electronics, at above address. Change of address notices should provide old as well as new address, including postal zone number if any. If possible, attach address label from recent issue. Allow one month for change to become effective.

Postmaster: Please send Form 3579 to Fulfillment Manager, Electronics, 330 West 42nd Street, New York 36, New York.



Audited Paid Circulation

CONTENTS continued

NEW MILLIMETER DETECTORS AND HIGH-POWER TUBES. British Institute of Physics and Physical Society convention also highlights semiconductor devices and computer circuits. *Indium antimonide in magnetic field shows photoconductivity at millimeter wavelengths.* D. H. Barlow 44

COMPOSITE TUNNEL-DIODE CHARACTERISTICS: How to Use Them in Digital Circuits. Connecting tunnel diodes in series results in a multistable composite characteristic. *Circuits can perform binary addition, scaling and encoding.* B. Rabinovici and J. Klapper 46

REFERENCE SHEET: Electron-Beam Design Chart. Helps calculate electron-beam voltage, current and dimensions. *Use this in designing oscilloscopes and microwave tubes.* D. L. Holloway 49

DEPARTMENTS

Crosstalk. *Physicists and Engineers. Fisherman's Punch* 3

Comment. *Annual Market Survey* 4

Electronics Newsletter. *Armed Services Procurement Regulations* 7

Washington Outlook. *Commercial Satellite Company Proposed* 12

Meetings Ahead. *Medical and Biological Data Acquisition and Processing Conference* 32

Research and Development. *Indicator Warns of Excessive Rise Rates* 54

Components and Materials. *Flat Wires and Cables* 60

Production Techniques. *Infrared Ovens Permanently Mark Teflon Wire* 68

New Products Design and Application. *Semiconductor Relay, Inertia-Less Contacts* 74

Literature of the Week 82

Plants and People. *Endevco Announces Plant Purchase* 88

Index to Advertisers 97

CROSSTALK

ESOTERICA. A few months ago we reported a comment, by a respected scientist, that major advances in electronics are now being made by physicists rather than engineers. The report aroused criticism that it downgraded electronic engineering.

That certainly wasn't the idea. Engineering is as much our bread and butter as our readers'. The speaker's purpose was to alert engineers to the necessity of keeping abreast of what physicists are doing, unless they wish to abdicate creativity to the physicists.

Keeping abreast is our job, too. There is much evidence that electronics is tending toward a materials-oriented technology. Significant equipment advances seem to depend more and more on development of devices whose operation hangs on phenomena which concerned nobody but physicists a relatively few years ago.

Two cases in point are news articles on pages 20 and 27: nuclear gyro possibilities and how to use cyclotron resonance in millimeter wave generators. Both were written by Senior Associate Editor Wolff. Incidentally, the latter article gives us a chance to give Tc a good workout. It's the abbreviation for teracycle— 10^{12} cps—and is much less cumbersome than 1,000,000 Mc or, as some people prefer, 1,000 Kmc. We gave up Kmc in favor of Gc, for gigacycle, some time ago.

FISHERMAN'S PUNCH. The cocktail party effect is an unlikely title for a scientific study. Nevertheless, the phrase has been cropping up more and more often in scientific papers. Like electronics, the cocktail party effect covers several different but related studies. We can screen out unwanted conversation and concentrate on interesting talk. We can also decide from what direction a given sound comes. So we combine these two effects and use them to great advantage at cocktail parties to listen to a remote conversation when the one near us is dull.

Another cocktail party effect is the almost bistable change in ambient noise level occasioned by speakers from several groups trying to talk above the general din. The louder one person talks the higher the others tend to raise their voices to combat him. The result is a cumulative

increase in noise level until everybody is shouting to make himself heard.

In his second article on bionics, in this issue (p 40), Assistant Editor Lindgren discusses some facets of the cocktail party effect. Among living creatures,

bats have the most advanced hearing mechanism, sufficiently developed in fact for them to use it for sonar navigation. Fish are at the other end of the scale. It is not yet established whether fish actually hear at all in the conventional sense, or whether they have a more rudimentary mechanism that merely detects disturbances in the water.

The photograph shows Bell Telephone Laboratories researcher Gene Michaels training a killifish to operate a "fish automat" that automatically delivers a juicy worm whenever a fish responds correctly to vibrational disturbances in the tank. After training, the fish undergo experiments to map their over-all hearing ability.

The Bell Labs work on fish is part of a program with the immediate aim of learning more about fish sound detection processes. The long-term goal is to delve into the fundamentals of biological hearing and to see if any of the principles used in nature can be adapted to man-made machines.

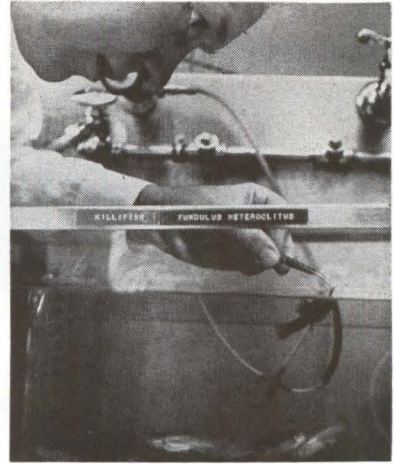

Coming in Our February 23 Issue

INFRARED GENERATOR. Getting infrared radiation is simple. Strike a match or turn on a lamp. Making an infrared signal generator is not so easy. Arthur Glaser, of Telewave Labs, tells how infrared can be obtained in accurately known wavelengths between one and 14 microns. When the lamp is turned on, the different wavelengths are sorted by a prism and picked off. To calibrate, a chopper disk and bolometer are used. The generator is continuously variable.

From **WEINSCHEL**

EXTENDED RANGE More Accurate Calibration

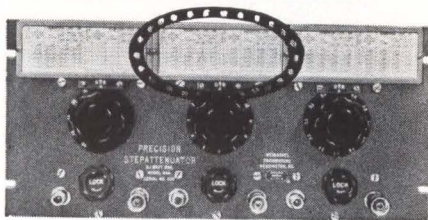

Model 64A

PRECISION STEPATTENUATOR

D.B. DIVISION	D.C. VOLTAGES				D.C. VOLTAGES			
	1000 MC	100 MC	10 MC	1 MC	1000 MC	100 MC	10 MC	1 MC
0	1.00	1.00	1.00	1.00	2.45	2.45	2.45	2.45
1	1.00	1.00	1.00	1.00	2.45	2.45	2.45	2.45
2	1.00	1.00	1.00	1.00	2.45	2.45	2.45	2.45
3	1.00	1.00	1.00	1.00	2.45	2.45	2.45	2.45
4	1.00	1.00	1.00	1.00	2.45	2.45	2.45	2.45
5	1.00	1.00	1.00	1.00	2.45	2.45	2.45	2.45
6	1.00	1.00	1.00	1.00	2.45	2.45	2.45	2.45
7	1.00	1.00	1.00	1.00	2.45	2.45	2.45	2.45
8	1.00	1.00	1.00	1.00	2.45	2.45	2.45	2.45
9	1.00	1.00	1.00	1.00	2.45	2.45	2.45	2.45
10	1.00	1.00	1.00	1.00	2.45	2.45	2.45	2.45

Specifically designed to meet your most exacting requirements for accuracy and reliability, the Model 64A Stepattenuator, covering the range from 0 to 64 db in 0.1 db steps, includes these exclusive Weinschel features:

NEW Calibration data of the highest commercially available accuracy—0.02 db per 10 db—permanently mounted on the front panel for fast, easy reference

NEW Actual operable frequency range—DC to 2 KMC

NEW Simplified readout

NEW One male and one female Type N connector for each drum to reduce the need for adapters

For complete specifications on the Model 64A Precision Stepattenuator, or for information on special models to meet other requirements, contact our Application Engineering Department.

WEINSCHEL
ENGINEERING



10503 METROPOLITAN AVENUE
KENSINGTON, MARYLAND
Tel.: 949-0141 (Area Code 301)
TWX: KENS 446
In California: 631 Wilshire Blvd.
Santa Monica
TWX: SMON 7185

COMMENT

Annual Market Survey

Congratulations on an extremely well done and comprehensive survey of the electronics market [Our Growing Markets, p 35, Jan. 5]. Suffice to say that we here at Sperry are using it as our standard reference on electronics markets.

I note that your assessment of the 1961 market and your predictions for the coming year are optimistic. Since optimism is an important part of marketing, we are going along with ELECTRONICS in our outlook for '62.

In general, your listing of items for tomorrow's market seems to be a good one and finds us solidly in many of the categories mentioned. A comforting thought!

WILLIAM G. MOUNT
Sperry Gyroscope Company
Great Neck, New York

Proprietary Piracy

Regarding your excellent *Cross-talk* in the Dec. 22 issue: I think it is one of the finest bits of coverage concerning proprietary piracy that I have ever encountered. I am responsible for the publication of a small monthly newspaper which is distributed on a worldwide basis to field engineers in every part of the free world. It would be greatly appreciated if you would grant permission to reproduce this article with full credit to your fine magazine.

W. A. FEEHLEY, EDITOR
Field Engineering Reporter
Bendix Radio Division
Owings Mills, Md.

Noise Generator

Re: White Noise Signals Aid Systems Analysis (p 86, Jan. 5).

If one insists on using potentiometers to generate noise, I would like to suggest the alternative approach shown in my diagram (see below). Although it lacks sophistication, systems-wise, it has much to

offer reliability-wise and simplicity-wise.

M. W. EGERTON, JR.
Towson Laboratories, Inc.
Towson, Maryland

By removing the shaft stops from the tv volume control, Reader Egerton has created an infra-sophisticated source of noisy sawteeth, with an audio taper if you like. Or should that be sawtooths, noise-wise?

Hazards of Beryllia Ceramics

An outstanding authority on the toxic effects of beryllium has called our attention to the possibility of a misunderstanding on two points in our article, How Dangerous are Beryllia Ceramics?, in the Oct. 13 issue (p 78). We would therefore like to make the following clarification:

In referring to "beryllia" in the article, we meant in every case a fully-sintered ceramic body of beryllium oxide. It should be clearly understood that the powder raw material, which is also known as "beryllia" in our industry, cannot be freely handled without hazard.

Also, we want to make clear that whenever any machining (grinding) or metallizing of beryllia is done, primary protection, consisting of enclosures under negative pressure with filtered exhaust, must be provided. We did not intend to imply that "merely doing a little machining or metallizing" would be acceptable without this positive primary protection. Our point here was that with such primary protection provided, no secondary protection nor environmental provision, such as special clothing or strippable wall coatings, need be made, especially where only a little machining or metallizing is being done. It was such secondary protection that we meant when referring to "production impediments."

C. E. WINDECKER
Vice President
National Beryllia Corp.
Haskell, New Jersey

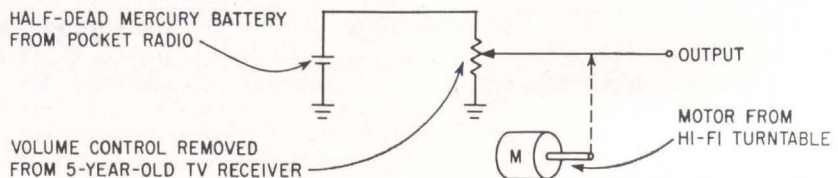

LAMBDA

Convection Cooled Transistorized Regulated Power Supplies

AVAILABLE FROM STOCK

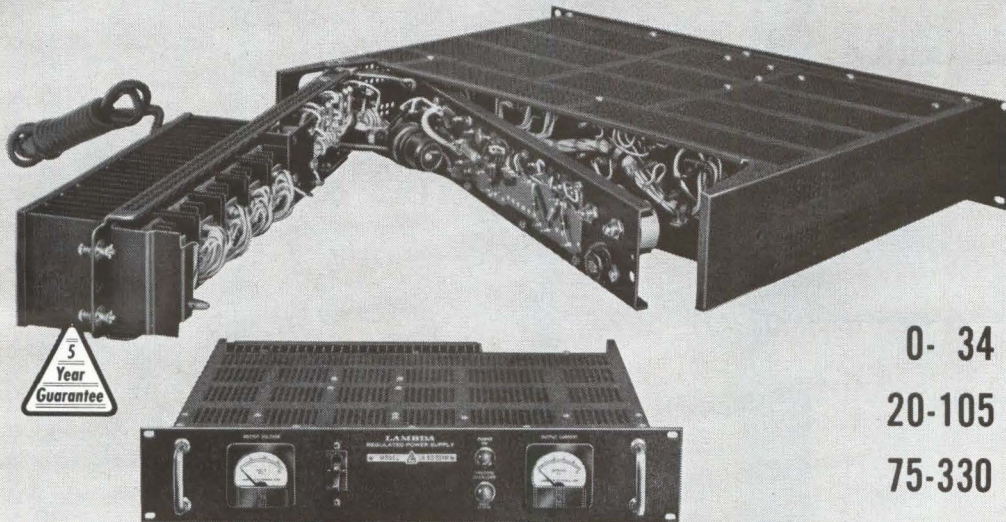

LA SERIES

0- 34 VDC 5, 10, 20 AMP
 20-105 VDC 2, 4, 8 AMP
 75-330 VDC 0.8, 1.5, 3 AMP

SPECIAL FEATURES

- Convection Cooled—No internal blowers or filters—maintenance free
- Ambient 50°C
- No Voltage Spikes or overshoot on "turn on, turn off," or power failure
- Guaranteed 5 years
- Remote programming over Vernier band
- Hermetically-sealed transformer designed to MIL-T-27A
- Easy Service Access
- Short Circuit Proof
- Constant Current Operation—Consult Factory

ALL MODELS 105-140 VAC INPUT

CONDENSED DATA—LA SERIES

DC OUTPUT (Regulated for line and load)

Model	Voltage Range (1)	Vernier Band (2)	Current Range (3)	Price (4)
LA 50-03B	0- 34 VDC	4 V	0- 5 AMP	\$ 395
LA100-03B	0- 34 VDC	4 V	0-10 AMP	510
LA200-03B	0- 34 VDC	4 V	0-20 AMP	795
LA 20-05B	20-105 VDC	10 V	0- 2 AMP	350
LA 40-05B	20-105 VDC	10 V	0- 4 AMP	495
LA 80-05B	20-105 VDC	10 V	0- 8 AMP	780
LA 8-08B	75-330 VDC	30 V	0- 0.8 AMP	395
LA 15-08B	75-330 VDC	30 V	0- 1.5 AMP	560
LA 30-08B	75-330 VDC	30 V	0- 3 AMP	860

Regulation (line) Less than 0.05 per cent or 8 millivolts (whichever is greater). For input variations from 105-140 VAC.

Regulation (load) Less than 0.10 per cent or 15 millivolts (whichever is greater). For load variations from 0 to full load.

Ripple and Noise Less than 1 millivolt rms with either terminal grounded.

Temperature Coefficient Less than 0.025%/°C.

(1) The DC output voltage for each model is completely covered by four selector switches plus vernier range.

(2) Center of vernier band may be set at any of 16 points throughout voltage range.

(3) Current rating applies over entire voltage range.

(4) Prices are for un-metered models. For metered models add the suffix "M" and add \$30.00 to the price.

AC INPUT 105-140 VAC, 60 ± 0.3 cycle (5)

(5) This frequency band amply covers standard commercial power line tolerances in the United States and Canada. For operation over wider frequency band, consult factory.

Size

LA 50-03B, LA20-05B, LA 8-08B 3½" H x 19" W x 14⅞" D
 LA100-03B, LA40-05B, LA15-08B 7" H x 19" W x 14⅞" D
 LA200-03B, LA80-05B, LA30-08B 10½" H x 19" W x 16½" D

SEND FOR COMPLETE LAMBDA CATALOG.



LAMBDA ELECTRONICS CORP.

515 BROAD HOLLOW ROAD • HUNTINGTON, L. I., NEW YORK • 516 MYRTLE 4-4200

Western Regional Office: 230 North Lake Avenue, Pasadena, California • Phone: Code 213, MURRAY 1-2544

New England Regional Office: 275 Boston Post Road, Marlboro, Massachusetts • Phone: Code 617, HUNTLEY 5-7122

Middle Atlantic District Office: 515 Broad Hollow Road, Huntington, L. I., New York • Phone: Code 516, MYRTLE 4-4200

**Power 250 different
klystrons with this
new, high performance,
ultra-dependable
hp 716A Power Supply**



Not only does this new hp instrument give you unique versatility for powering 250 different types of klystrons . . . but its unusually low ripple and high regulation mean almost total absence of FM and AM from high-performance klystrons.

The 716A has a high resolution reflector voltage control that eliminates the possibility of misadjustment. Reflector voltage may be set to within $\pm 1/2\%$ on the direct-reading, 3-foot voltage scale. Similarly, beam voltage may be set to within $\pm 2\%$. Other features include a sawtooth supply for FM, a square wave supply for on-off operation, and a 6.3 volt regulated dc klystron filament supply for maximum tube stability.

The hp 716A is designed as the most useful, most valuable general purpose klystron supply yet offered. Ask your hp representative for a demonstration now.

SPECIFICATIONS

REFLECTOR SUPPLY:

Voltage: 0 to 800 volts neg. with respect to beam supply
Voltage Accuracy: $\pm 0.5\%$ of dial reading
Current: High impedance output
Ripple: Less than 500 microvolts
Line Regulation: Better than 0.05%

BEAM SUPPLY:

Voltage: 250 to 800 volts neg. with respect to ground
Voltage Accuracy: $\pm 2\%$ of dial reading
Current: 0 to 100 ma
Ripple: Less than 1 mv
Line Regulation: Better than 0.1%
Load Regulation: Better than 0.05%

REGULATED DC FILAMENT SUPPLY:

Voltage: 6.3 volts dc, adjustable internally, isolated from ground
Current: 0 to 2.0 amperes
Ripple: Less than 15 mv
Line Regulation: Better than 1%

INTERNAL SQUARE WAVE MODULATION:

Frequency: 400 cps to 2.5 KC
Amplitude: 10 to 200 volts, peak-to-peak, positive excursion clamped to reflector voltage
Rise Time: < 5 microseconds
Frequency Stability: 0.1% short term

INTERNAL SAWTOOTH MODULATION:

Frequency: 60 cps
Amplitude: 0 to 200 volts peak-to-peak, ac coupled to reflector

EXTERNAL MODULATION:

Maximum Input: 200 volts peak-to-peak
Input Impedance: 500 K, 100 pf, nominal

EXTERNAL SYNCHRONIZATION OF INTERNAL SQUARE WAVE:

Input Voltage: 2 volts peak
Input Impedance: 500 K nominal

SCOPE SYNC:

When using internal square wave modulation: Output impedance, 50 ohms; voltage, 10 volts, peak-to-peak, for scope sync
When using internal sawtooth modulation: Output impedance, 50 K; voltage, 2 volts, peak-to-peak, for scope sweep

GENERAL:

Meter: 0 to 100 ma meter monitors beam current
Power: 115/230 volts $\pm 10\%$, 50/60 cps, approx. 200/350 watts depending on line voltage and load
Weight: Net 45 lbs.
Dimensions: 16 $3/4$ " wide, 7" high, 18 $3/8$ " deep overall (cabinet), hardware furnished converts cabinet to 7" x 19" for rack mounting
Price: \$675.00

Data subject to change without notice

HEWLETT-PACKARD COMPANY

1501 Page Mill Road
 Cable "HEWPACK"

Palo Alto, California, U.S.A.
 DAVenport 6-7000

Sales representatives in all principal areas

HEWLETT-PACKARD S. A.

Rue du Vieux Billard No. 1
 Geneva, Switzerland
 Tel. No. (022) 26. 43. 36
 Cable "HEWPACKSA"



7370

ELECTRONICS NEWSLETTER

Mixed Reaction to Procurement Changes

WASHINGTON—Spokesmen for defense manufacturers have voiced mixed reactions to the proposed changes in the Armed Services Procurement Regulations. The changes are aimed at spurring contractors into assumption of higher risks in return for greater profits. Representatives of defense industries like the idea, but have serious reservations on the language.

EIA, for example, says there should be less stress on "penalty aspects to the exclusion of adequate incentive aspects." It also wants more emphasis on price evaluation and less on cost estimates.

Aerospace Industries Association wants stronger assurances of greater "retained earnings" for high-performance contractors. This would protect them from loss of incentive profits through renegotiation and price redetermination proceedings.

The proposed changes call for greater use of cost-plus incentive fee contracts and fewer cost-plus fixed-fee awards; wider dependence on fixed-price incentive contracts; allowing contractors to earn a larger share of savings on incentive contracts, and a wider range of fees in cost-reimbursement contracts.

High-Speed Logic and Diodes Are Reported

LOGIC CIRCUIT using tunnel diode switching and transistor isolation to achieve 500-Mc bit rates was reported by W. E. Peil and R. A. Marolf, of GE, at the Solid-State Circuits Conference in Philadelphia yesterday.

Called Pumped Tunnel Diode-Transistor Logic (PTDTL), the system reportedly adds four times faster with one-tenth the number of modules in other systems. Three basic modules are used: a negative input-positive output (NIPO), a complementary element (PINO) and a 1:1 inverting transformer. Four logical functions can be performed in 2 nsec, resulting in a logic rate of 2 Gc.

In Syracuse, GE also announced availability to laboratories of ger-

manium tunnel diodes with switching time less than 5 psec. Other tunnel diodes with intrinsic switching time of 0.5 psec have been made but are not yet available, GE said. The diodes are believed to make feasible computers with clock rates up to 10 Gc. Tunnel diodes with intrinsic cutoff frequencies of 25 Gc have been developed for microwave applications, GE said.

Adams Succeeds Krafve As Raytheon President

RAYTHEON'S board of directors announced last week that it has accepted with regret the resignation of Richard E. Krafve as president. Krafve said he was resigning because of differences of opinion on management policies. The board elected Charles F. Adams, board chairman, who was president from 1948 to 1960.

Krafve, a former Ford vice president, joined Raytheon in 1959 and became executive vice president that September. He was elected president in April, 1960. There are unconfirmed reports that Krafve

Is Nothing Sacred?

LAST MONTH, Lockheed reported plans to make sperm whales carry sonar transmitters for antisubmarine warfare experiments (p 7, Jan. 12).

Now, they're "eavesdropping on the maternity ward chatter" of a gam (herd) of Pacific gray whales. A ship was sent to barricade one of the calving ground channels and listen with hydrophones.

Lockheed is collecting a library of sea animal and fish sounds so true and false targets can be differentiated on asw gear

may return to Ford as the head of its newly-acquired Philco division.

Raytheon spokesmen indicate that Adams is not simply filling in as a pro tem president, but has resumed full rein. Thomas L. Phillips, technically active in the missile-space field, recently became executive vice president.

Film Memory Switches in 5 Nsec, Cycles in 100

IBM'S RESEARCH lab in Switzerland has built a thin film memory which switches in 5 nsec and has a read-write cycle of 100 nsec. Drive pulses are produced by transistor circuits. Current applied to word and bit lines is 400 ma.

The word-oriented memory holds 256 72-bit words in a 4-by-8-inch planar array. Bits are Permalloy deposited on silver coated with silicon oxide. On top of the array is etched copper strip line wiring, fine-slotted to avoid eddy currents.

Two California Companies Announce Plans to Merge

STOCKHOLDER approval will be sought this spring for the merger of Lear, Inc., of Santa Monica, into the Siegler Corp. Boards of directors of the two firms approved the plan last week.

The merger would give Siegler annual sales of more than \$200 million and assets of more than \$100,000. Siegler operates plants in six states, Lear in three states, West Germany and Switzerland.

Siegler has acquired 650,000 shares of Lear stock, including all the personal holdings of William P. Lear, Sr. Lear said he wished to devote his major attention to private business ventures, including a seven-passenger corporate jet aircraft being built by his Swiss American Aviation Co.

Varying Pitch of Helix Boosts TWT Efficiency

INCREASING the number of turns at the end of a traveling-wave tube's helix raises tube efficiency. The sig-

nal wave takes longer to traverse the helix, allowing the electron beam—which slows down—to catch up and remain in phase with the signal.

Joseph E. Rowe, director of Michigan University's Electron Physics Lab, and John Meeker, now with Bendix, have worked out a theory for varying the pitch. They say tube efficiency can be raised by 40 to 100 percent and length can be reduced 20 to 30 percent. Work on finding the most efficient pitch is continuing.

In a 3-Gc twt model, pitch was varied from 18.5 turns per inch in the uniform section to 37 in the variable section. Efficiency was increased 35 percent and gain by 2 db over the entire frequency range of 2-3.8 Gc, it was reported. The investigation was sponsored by Air Forces Rome Air Development Center.

Custom-Can Transistors To Avoid Obsolescence

HUGHES SEMICONDUCTOR plans to produce all its basic transistors in the presealed, Microseal configuration. They'll be stocked uncanned and canned to customer order. Up to 10 of the tiny (0.03 by 0.08-0.088-inch) units can be packed into a can. Hermetic sealing of cans will be eliminated.

Hughes says this marketing concept will allow it to get into volume production of Microseal units and cut costs. Obsolescence, caused by stocking basic units in a variety of cans, will be lessened as will the amount of inventory carried.

Transistor Is Made for Optical-Path Computers

LANSDALE DIVISION of Philco reports it is making electro-optical transistors which will enable light paths to be used instead of wiring in future computers. The epitaxial planar transistors are designed to respond to both light and electrical signals at nanosecond speeds.

Use of optical and electrical drives permits an overall propagation time of less than 0.1 microsecond, according to C. G. Thornton, director of semiconductor R&D. He

said the transistors are unusually sensitive to light, with a dark current ratio of 10,000:1 at 100 ft candles. They may also be used in laser communications systems, Thornton said.

Multilayer Technique Fuses Circuits in Ceramic Block

RCA LAST WEEK announced it would begin pilot production this year of pill-sized circuit blocks that can be mass-produced cheaper than conventional circuits. A typical unit with four resistors, a capacitor, diode and transistor is 0.3 inch square and 30 mils thick.

Resistor, capacitor and connector patterns are printed in metalizing ink on thin ceramic sheets. Sheets are cut, punched, stacked and fired so components are sealed in the fused ceramic. At present, active devices are mounted in a well atop the stack. Blocks are compatible with micromodules.

High-Energy Lasers Cut Stainless Steel

LASER HEAD that will burn through $\frac{1}{8}$ -inch stainless steel sheet in 0.5 msec has been added by Raytheon to its line. With a 2,000-joule input to a flash tube in an elliptical cavity, output is 7 to 10 joules uncooled and 15 to 20 joules with cooling to liquid nitrogen temperature. A second head, built for crystal size flexibility, gives an output of 1 joule uncooled or 3 joules cooled, for an input of 500 joules.

Moon Radar Camera to Be Tried Out Soon

WITHIN the next few months, Jet Propulsion Laboratory will attempt to take radar pictures of earth at distances comparable to those used in future lunar and planetary probes. Radar pictures and photographs will be taken with equipment launched at White Sands Proving Ground in an Aerobee rocket, then compared. JPL hopes to establish useful correlations between the two surveillance techniques.

In Brief . . .

NASA REPORTS that weather photos televised by Tiros IV—the fourth straight success in the program—are of exceptionally high quality. The satellite carries an improved camera lens.

DESPITE lack of an orbiting dipole belt, coast-to-coast digital communications with Project West Ford equipment was successfully tested by bouncing teletypewriter messages off the moon.

COLLINS RADIO has a \$10 million Marine Corps contract for AN/TRC-75 long-range mobile radios, \$5 million contract for AN/TSC-15 transportable communications centers, \$1.7 million contract for a multiplex system for Taiwan.

VARIAN ASSOCIATES is building a megawatt radio transmitter for deep-space communications experiments by NASA. It will use two new klystrons, delivering 25 Kw and 100 Kw.

SPERRY PHOENIX and Douglas Aircraft report modifications of the automatic flight system for the DC-8 that will bring the plane down close to the ground when landing in bad weather.

DOUBLE-SIDEBAND doppler vor system will be built by Hazeltine. FAA will use it to evaluate advantages of double over single-sideband vor.

GE IS MAKING microminiature ceramic triodes and diodes for TIMM circuits (p 82, June 10, 1960). They weigh 0.27 to 0.57 gram.

NASA has invited proposals from General Dynamics, Lockheed and Martin Marietta for a rocket to test a nuclear engine. Aerojet General and Westinghouse Electric are building the engine, called Nerva.

AERONUTRONIC has received another \$10.5 million from Army for continued development of the AN/MSQ-19 battlefield operations center.

NOW
AVAILABLE
WITH WELDABLE
LEADS

**RUGGED END-CAP
CONSTRUCTION FOR
LONG TERM STABILITY**

**EXCEPTIONAL RESISTANCE
TO MOISTURE
AND MECHANICAL
DAMAGE**

**SURPASS MIL-R-10509
PERFORMANCE
REQUIREMENTS**

AVAILABLE IN
REEL PACKING
FOR AUTOMATED
PWB INSERTION

FILMISTOR[®] METAL FILM RESISTORS

**OFFER 5 DISTINCT
TEMPERATURE
COEFFICIENTS TO
MEET ALL CIRCUIT
REQUIREMENTS**

Providing close accuracy, reliability and stability with low controlled temperature coefficients, these molded case metal-film resistors outperform precision wirewound and carbon film resistors. Prime characteristics include minimum inherent noise level, negligible voltage coefficient of resistance and excellent long-time stability under rated load as well as under severe conditions of humidity.

Close tracking of resistance values of 2 or more resistors over a wide temperature range is another key performance characteristic of molded-case Filmistor Metal Film Resistors. This is especially important where they are used to make highly accurate ratio dividers.

Filmistor Metal Film Resistors, in 1/8, 1/4, 1/2 and 1 watt ratings, surpass stringent performance requirements of MIL-R-10509D, Characteristics C and E. Write for Engineering Bulletin No. 7025 to: Technical Literature Section, Sprague Electric Co., 35 Marshall Street, North Adams, Mass.

*For application engineering assistance write:
Resistor Division, Sprague Electric Co., Nashua, New Hampshire.*
SPRAGUE COMPONENTS

RESISTORS
CAPACITORS
MAGNETIC COMPONENTS
TRANSISTORS

INTERFERENCE FILTERS
PULSE TRANSFORMERS
PIEZOELECTRIC CERAMICS
PULSE-FORMING NETWORKS

HIGH TEMPERATURE MAGNET WIRE
CERAMIC-BASE PRINTED NETWORKS
PACKAGED COMPONENT ASSEMBLIES
FUNCTIONAL DIGITAL CIRCUITS



'Sprague' and '®' are registered trademarks of the Sprague Electric Co.

Special Pliers for the Highly Specialized Electronics Field

When the early transmission lines were strung in this country a century ago, it was Klein Pliers in the hands of linemen that helped do the job.

Klein has kept pace with the development of the electrical field, meeting each new challenge with tools specially designed to do the wiring job better . . . more economically.

Shown here are a few of the many highly specialized Klein Pliers carried in stock to meet the needs of electrical and electronics manufacturers.

You will find your assemblies go together more smoothly and wiring is done more rapidly when the right Klein Plier is used.

SEE YOUR DISTRIBUTOR



D211-6C—Cutters at tip set at 45° angle.

D208-6C—A shear cutting plier designed to cut dead soft or extremely hard wire.

D208-6PC—Shear cutting blade at tip. Holds clipped end.

D318-5½—Long needle nose for reaching confined space.

204-6—Cutters at tip. Ideal for electronic wiring.

D229-4C—Springs between jaws hold clipped end of wire.

D052-C—Specially designed for wiring printed circuits.

D207-5C—Replaceable blade shear cutter. Will cut dead soft wire or extremely hard wire.



Mathias KLEIN & Sons
Established 1857 Chicago, Ill., U.S.A.

INCORPORATED
7200 McCORMICK ROAD, CHICAGO 45, ILL.



Mathias Klein & Sons, Inc. 7200 McCormick Road, Chicago 45, Ill.
Please send me the Klein Plier Catalog and information.

Name _____
Title _____
Company _____
Address _____
City _____ State _____

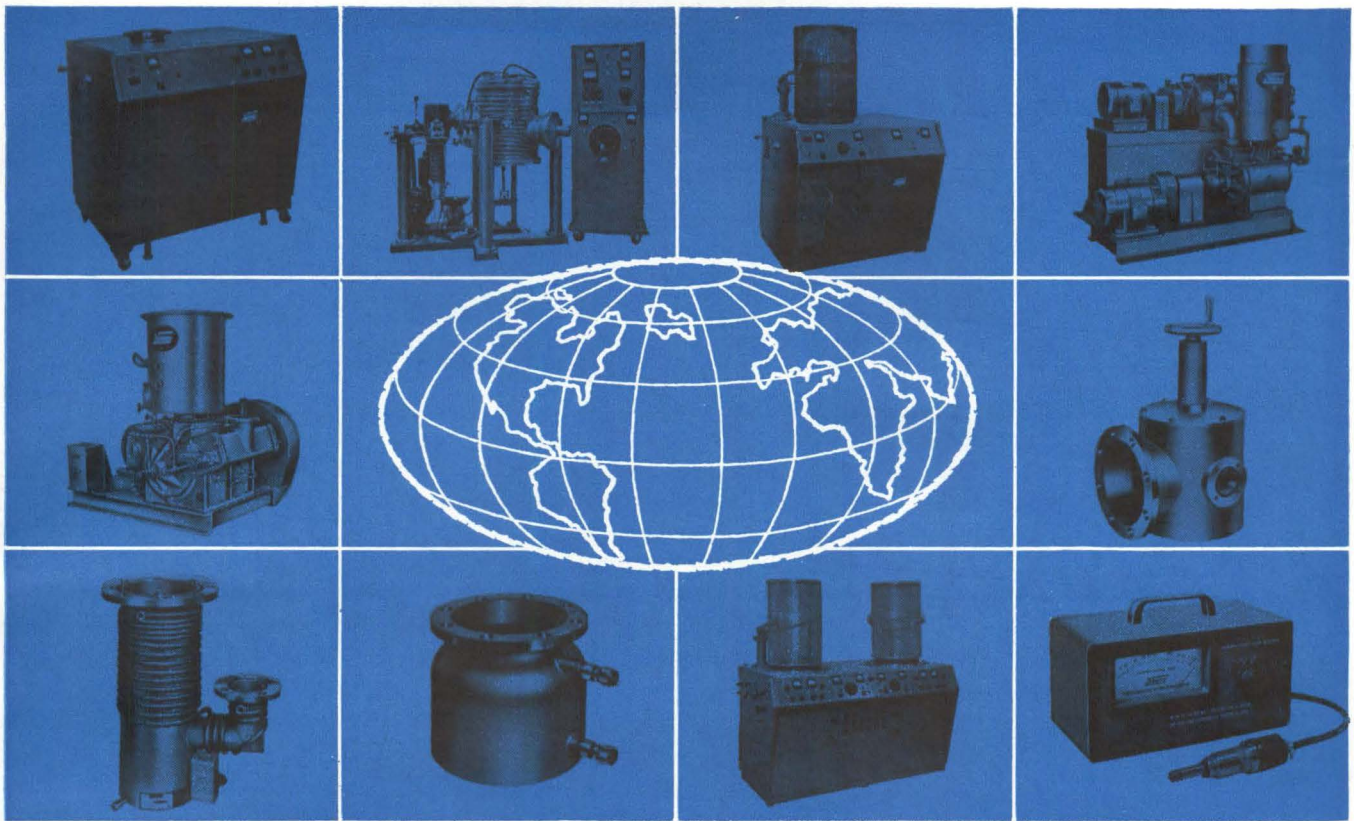

LEADERSHIP

with a forward look in the field
of high vacuum equipment . . .

Kinney Vacuum, the accepted leader in the manufacture of vacuum pumps is acknowledged foremost in research and development in the high vacuum industry.

This leadership is carefully guarded by constant and extensive research and development that produces the ultimate in mechanical pumps, diffusion pumps, valves, baffles, gauges, vacuum furnaces, space chambers, and complete vacuum systems. The resources of the New York Air Brake Company and all of its divisions guarantee every Kinney Vacuum product to be efficient in operation, most modern in design, and constructed to give the maximum in service.

- PROVEN STABILITY
- EXTENSIVE RESOURCES
- DYNAMIC DEVELOPMENT

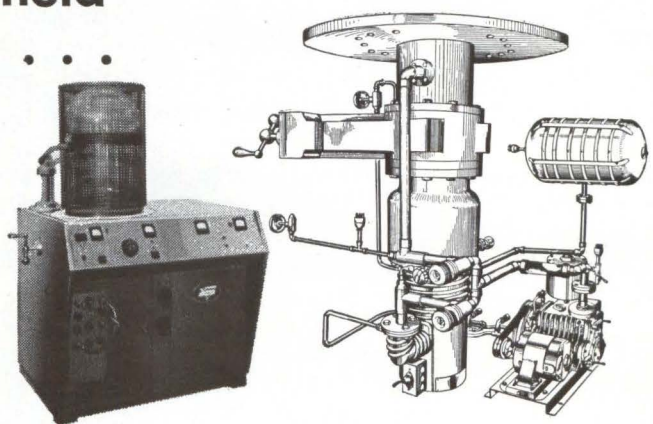

HIGH VACUUM EVAPORATORS . . . KSE-6, KSE-6H

This attractively packaged system delivers maximum performance, requires minimum floor space. Formica work surfaces, integral control panels with grouped controls for operating convenience. These units are built around flange connected components including new high speed oil diffusion pumps, water cooled baffle (also available with liquid nitrogen cooled baffle). Hydraulic bell jar hoist. Rapid evacuation to below 1×10^{-6} torr., ultimate pressure less than 5×10^{-7} torr. KSE-6H offers a pot-type base plate (Haas Chamber) to allow more freedom for location of monitoring devices and additional feed-throughs.

KINNEY VACUUM DIVISION THE NEW YORK AIR BRAKE COMPANY
3529 WASHINGTON STREET • BOSTON 30, MASS.

WASHINGTON OUTLOOK

THE ADMINISTRATION'S plan for ownership of the proposed commercial communications satellite is reminiscent of the companies of gentlemen adventurers that opened the frontiers of the New World in the early seventeenth century.

Congress now has the plan. It is likely to touch off a full round of stormy debates and possible changes. But both Congress and the administration are anxious to get the show into space. In the end, Congress will probably adopt a plan patterned along the lines of the administration bill.

The White House plan calls for a broad-based private corporation, in effect a federally chartered monopoly, with a capitalization of \$1 billion. Money would come from sale to the public of a million shares of class A stock at not less than \$1,000 a share. No one investor could hold more than 15 percent of the total. Class A stock would have voting rights and be eligible for dividends—dividends that may well be a long time in coming.

Some 10,000 shares of class B stock without voting or dividend rights are to be offered to communication carriers approved by the FCC. Price is not specified. Federal control over the new corporation would set rates and ensure competition in equipment purchase practices.

Industry and government both have been split over the satellite system. The FCC leans to ownership by international carriers; the Department of Justice would like ownership spread wide to include domestic carriers and equipment makers. Industry groups are allied on either side.

A HARD-FISTED attitude by FCC Chairman Newton N. Minow may finally score an economic breakthrough for ultrahigh-frequency television. Basically he puts this choice squarely up to the three big networks: get behind uhf tv or face more federal regulation. Right now, getting behind uhf means coming out for the proposed law requiring all tv receivers to be able to pick up all 70 uhf channels as well as the 12 vhf channels.

Minow's approach is getting results. Columbia Broadcasting System and American Broadcasting Company both came through with endorsements of the all-channel receiver plan. Even NBC came through, although its parent RCA has, as a tv setmaker, previously opposed the plan. Zenith Radio got on the bandwagon too. Zenith and RCA together account for more than one third of tv sets made in U. S.

Hearings on the all-channel receiver bill will be held in Congress this year for the first time. If the legislation goes through, FCC won't go through with its deintermixture program of removing vhf stations.

OPEN HEARINGS will start soon on allegedly excessive profits on defense contracts. The inquiry will be conducted by the Senate Investigations Subcommittee headed by Sen. John McClellan (D. Ark.), as part of his probe into the lag in construction of missile sites.

The committee is zeroing in on the Air Force's weapons system management system for missile R&D and production. They call it "profit pyramiding". Under the system, which has been considerably watered down in the past couple of years, prime system contractors held wide-ranging authority to award subcontractors covering major components directly.

The committee will look into charges that in many cases "profits were compounded" as primes and major subcontractors took cuts out of profit allowances or fees of lower-tier subcontractors.

PRIVATE SATELLITE COMPANY PROPOSED

BIG PUSH FOR UHF-TV

CONGRESS TO PROBE MISSILE PROFITS

33 REASONS WHY SHALLCROSS MINIATURE SERIES SWITCHES OFFER SUPERIOR PERFORMANCE

UNEQUALED VERSATILITY

1. 24 OR 36 POSITION WAFERS
1 TO 32 POSITIONS SHORTING (SINGLE POLE)
1 TO 16 POSITIONS NON-SHORTING (SINGLE POLE)
2. 4 INDEXING ANGLES SHORTING ($11\frac{1}{4}^\circ$, 15° , $22\frac{1}{2}^\circ$ OR 30°) AND 2 INDEXING ANGLES NON-SHORTING ($22\frac{1}{2}^\circ$ OR 30°)
3. 1, 2, 3 OR 4 POLES PER DECK
4. ADJUSTABLE STOPS
5. UP TO 24 DECKS OR 70 POLES PER SWITCH
6. BUSHING AND TANG (3 BUSHING LENGTHS AVAILABLE) OR TWO HOLE MOUNTING
7. CLUSTER ARM ROTORS FOR PROGRESSIVELY SHORTING OR OPENING ELECTRICAL CIRCUITS WHEN REQUIRED
8. SPRING RETURN ACTION FOR ROTATION IN EITHER OR BOTH DIRECTIONS FROM REST POSITION (UP TO FOUR POLES)
9. DUAL CONCENTRIC SHAFT VERSIONS FOR INDEPENDENT SWITCHING OF 2 SWITCH GROUPS ON ONE SHAFT
10. PRINTED CIRCUIT MOUNTING AVAILABLE FOR LAST DECK
11. REMOVABLE DETENT FOR MOTOR DRIVEN OPERATION
12. AVAILABLE PREWIRED TO REDUCE FINAL ASSEMBLY TIME AND COSTS
13. AVAILABLE WITH GOLD PLATED CURRENT CARRYING PARTS TO REDUCE CONTACT RESISTANCE AND CORROSION EFFECTS
14. AVAILABLE WITH SHAFT SEALS FOR HERMATIC SEAL APPLICATIONS
15. LOCKING MECHANISMS TO PREVENT ACCIDENTAL SWITCH ROTATION (OPTIONAL ACCESSORY)
16. ADAPTABLE TO SOLENOID OPERATION
17. COMPLETE ACCESSORIES (DIALS, KNOBS, REAR MOUNTING BRACKETS AND MISCELLANEOUS HARDWARE)

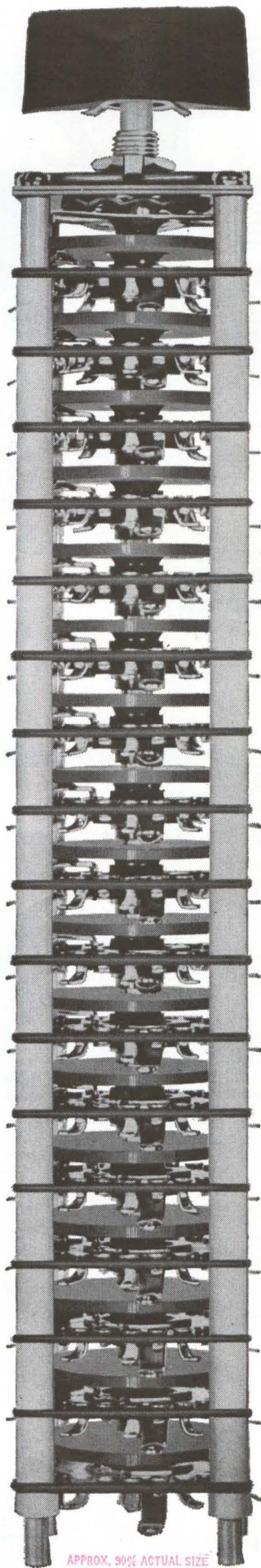

APPROX. 90% ACTUAL SIZE

HIGH QUALITY ELECTRICAL FEATURES

1. INITIAL CONTACT RESISTANCE 2 MILLIOHMS OR LESS
2. CONTACT RESISTANCE STABILITY 1 MILLIOHM FOR 20,000 OPERATIONS
3. INSULATION RESISTANCE OVER 1000 MEGOHMS BETWEEN CONTACTS
4. NEGLIGIBLE THERMAL EMF (SIMILAR METALS FOR ALL CURRENT CARRYING PARTS)
5. COMPLETELY ISOLATED SHAFT

HIGH QUALITY MECHANICAL FEATURES

1. POSITIVE INDEXING
2. UNCOMPROMISED MATERIAL QUALITY (COIN SILVER TERMINALS AND CONTACTS, SILVER ALLOY ARMS AND COLLECTOR RINGS, GLASS FIBRE EPOXY LAMINATE WAFERS, PASSIVATED STAINLESS STEEL SHAFTS MOUNTING PLATES AND DETENT ASSEMBLIES (MILITARY APPROVED))
3. SELF CLEANING WIPING ACTION
4. MULTIPLE LEAF WIPER ARMS WITH "FLOAT" TYPE WIPING ACTION FOR MAXIMUM CONTACT RESISTANCE STABILITY
5. INTEGRAL CONTACTS AND TERMINALS TO ELIMINATE MECHANICAL JOINTS

COMPACTNESS

1. 1.015" BACK PANEL DEPTH FOR SINGLE DECK SWITCH AND ONLY $\frac{1}{16}$ " FOR EACH ADDITIONAL DECK
2. OVER 650 CIRCUITS CAN BE SWITCHED IN ONLY 38 CUBIC INCHES
3. LIGHT-WEIGHT CONSTRUCTION (79 GRAMS SINGLE DECK SWITCH AND 30 GRAMS EACH ADDITIONAL DECK)

ATTRACTIVE CONVENIENCE FEATURES

1. EXTENDED TERMINAL LUGS FOR EASY WIRING
2. IDENTIFICATION MARKINGS FOR COMMON TERMINALS AND NUMBER ONE CONTACTS
3. INDIVIDUAL "AIR TIGHT" VINYL PACKAGES FOR DUST AND CORROSION FREE STORAGE

PROTO-TYPE SERVICE 1-5 DAYS
PRODUCTION QUANTITIES 1-2 WEEKS

FOR COMPLETE SPECIFICATIONS ON THIS SWITCH SERIES, MARK READER SERVICE CARD OR REQUEST SHALLCROSS L45-A-1 L45-B

Shallcross

INSTRUMENTS • RESISTORS • SWITCHES • ATTENUATORS • DELAY LINES

MELPAR CAPABILITIES

RANGE FROM **a** TO **Z**

And we are looking for scientists and engineers to help us expand these capabilities and to grow with us.

A as in ANT...



or A as in ARTRON... At Melpar scientists study animal life to apply its functions to the machine. Result: A machine with "instincts" and "intelligence," one that can "think" its own way through problems.

Z as in ZEROING IN...



After research comes development and production of hardware—from the smallest components to entire system complexes. Melpar has made, and continues to make, vital contributions to the nation's space and missile programs.

AN OPEN LETTER . . . To those who would help forge the future, Melpar offers unusual growth potential as it expands its exciting work. Outstanding opportunities are now available in our **AEROSPACE, MINUTEMAN, RESEARCH, ENGINEERING, AND APPLIED SCIENCE** Divisions. We invite engineers and scientists on all levels to participate in projects involving: • **RADIATION FIELD THEORY • SYSTEMS ANALYSIS • SPACE COMMUNICATIONS SYSTEMS • RADAR SIGNAL PROCESSING • INFORMATION THEORY • THERMODYNAMICS • ACOUSTICS • TRANSISTOR CIRCUITRY • AERONAUTICS • MICROELECTRONICS • INFRARED HOMING • DIFFERENTIAL GAS ABSORPTION SPECTROSCOPY • HORIZONTAL PATH ATMOSPHERIC SCINTILLATION • E.H.F. • ADVANCED DETECTION PRINCIPLES AND SYSTEMS • MULTILAYER INTERFERENCE FILTERS • SHOCK AND VIBRATION ANALYSIS • ELECTRO OPTICAL INFORMATION COLLECTION.** If you want to be part of our dynamic team, write to me direct for personal interview.

J. T. Lafrank
Director of Personnel

MELPAR INC

A SUBSIDIARY OF WESTINGHOUSE AIR BRAKE CO.
3000 ARLINGTON BLVD., FALLS CHURCH, VA.

An equal-opportunity employer.

CIRCLE 200 ON READER SERVICE CARD

EIC



115/60-BER-12/600, in case

**50 amp power supplies
0.1% regulation**

Model	Output Voltage*	Ripple	Delivery	Price
115/60-BER-12/600	12	1 mv, rms	From stock	\$ 945
230/60-BER-28/1400	28	2 mv, rms	Less than 30 days	\$1750

*Output voltage adjustable over $\pm 17\%$ range.

These supplies have magnetic circuit breakers for overload protection, metered outputs, and remote sensing capability. Optional features include modifications for parallel operation and remote programming. Available for 19-inch racks or in case mountings.

Write for complete specifications on these and many other EIC power supplies.

ELECTRODYNAMIC INSTRUMENT CORPORATION

Subsidiary of Reed Roller Bit Company

JA 6-3761 • 1841 Old Spanish Trail • Houston 25, Texas

CIRCLE 14 ON READER SERVICE CARD

When you need **POWER...**

choose **NICAD**[®]

**NEW
Nickel Cadmium
Rechargeable
Batteries**

SEALED CELLS

Hermetically sealed and rechargeable, Nicad batteries are small in size, require no maintenance, operate in any position. They make practical the battery operation of many types of equipment not previously suited to dry, mercury, or lead acid types.

SEALED CELLS

VENTED CELLS

High surge power cells, in sintered or pocket plate types, are capable of sustained voltage at high discharge rates over a wide temperature range. They have extremely long life... little or no maintenance. For more of the POWER story, write

VENTED CELLS



NICAD BATTERY DIVISION

GOULD-NATIONAL BATTERIES, INC. E-1411 First National Bank Bldg., St. Paul 1, Minn.

CIRCLE 201 ON READER SERVICE CARD
electronics

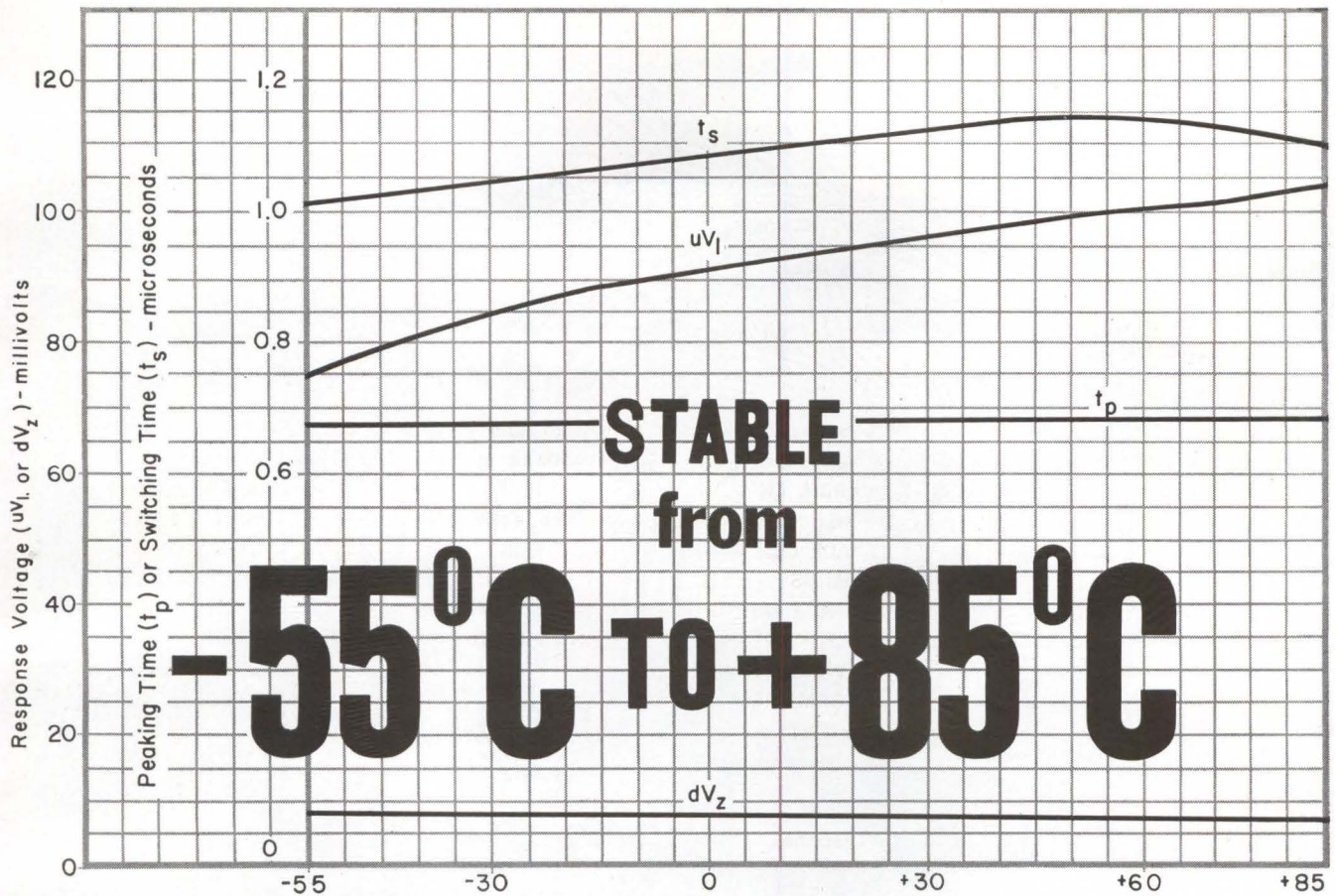

NEW RCA MEMORY CORE MAINTAINS STABILITY WITHOUT CURRENT COMPENSATION OR TEMPERATURE CONTROL

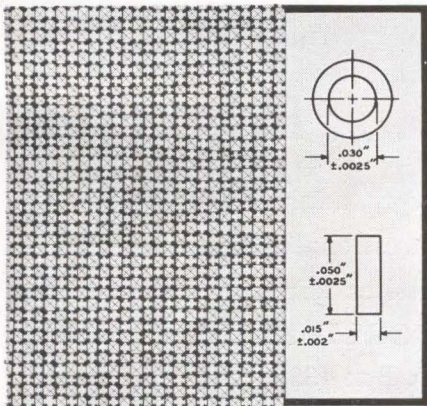

Through new developments in ferrite technology, RCA announces the 233M1, a new ferrite memory core that operates without current compensation over a temperature range four times greater than that permissible for conventional cores.

RCA introduces a new high-temperature ferrite memory core, type 233M1, having an output variation less than 0.25 millivolt per °C from -55°C to +85°C. This operating stability eliminates the need for much of the peripheral temperature control and conditioning equipment now necessary in many computer designs. This new high level of stability opens the way to greater design freedom in applications where space and weight are prime considerations.

The new RCA 233M1 is especially useful in coincident-current magnetic memory devices. At a full driving current of 900 ma, it has a switching time of 1.1 μ sec, making it suitable for use in magnetic memories having operating cycles in the 5 μ sec region.

RCA now offers one of the industry's most comprehensive lines of memory cores. For your custom requirements, RCA ferrite-core specialists are ready to design virtually any core you require.

Call your RCA Semiconductor and Materials Division Field Representative for a completely coordinated applications service covering transistors, tunnel diodes, multiple semiconductor switching diodes, ferrite components, and memory systems. For further technical information, write RCA Semiconductor and Materials Division, Commercial Engineering, Section B-19-NF-2, Somerville, N. J.

TYPICAL CHARACTERISTICS OF TYPE 233M1 DRIVING CURRENT CONDITIONS

Full Driving Current (I_m)	900 ma
Partial Write Current (I_{pw})	450 ma
Pulse Rise Time (t_r)	0.5 μ sec.
Pulse Duration (t_d)	4.0 μ sec.
Core Size: .050" x .030" x .015"	



The Most Trusted Name in Electronics

RCA SEMICONDUCTOR & MATERIALS DIVISION FIELD OFFICES... EAST: Newark, N. J., 744 Broad St., HU 5-3900 • (Camden-Philadelphia Area) Erlton, N. J., 605 Marlton Pike, HA 8-4802 • Syracuse, N. Y., 731 James St., Rm. 402, GR 4-5591 • Baltimore, Md., EN 9-1850 • NORTHEAST: Needham Heights 94, Mass., 64 "A" St., HI 4-7200 • SOUTHEAST: Orlando, Fla., 1520 Edgewater Dr., Suite #1, GA 4-4768 • EAST CENTRAL: Detroit 2, Mich., 714 New Center Bldg., TR 5-5600 • CENTRAL: Chicago, Ill., Suite 1154, Merchandise Mart Plaza, WH 4-2900 • Indianapolis 5, Ind., 2132 East 52nd St., CL 1-1405 • Minneapolis 16, Minn., 5805 Excelsior Blvd., WE 9-0676 • WEST: Los Angeles 22, Cal., 6801 E. Washington Blvd., RA 3-8361 • (San Francisco area) Burlingame, Cal., 1838 El Camino Real, OX 7-1620 • Seattle 4, Washington, 2250 First Ave. S., MA 2-8350 • SOUTHWEST: Dallas 7, Tex., 7905 Carpenter Freeway, ME 1-9720 • GOV'T: Dayton, O., 224 N. Wilkinson St., BA 6-2366 • Washington, D. C., 1725 "K" St., N.W., FE 7-8500.

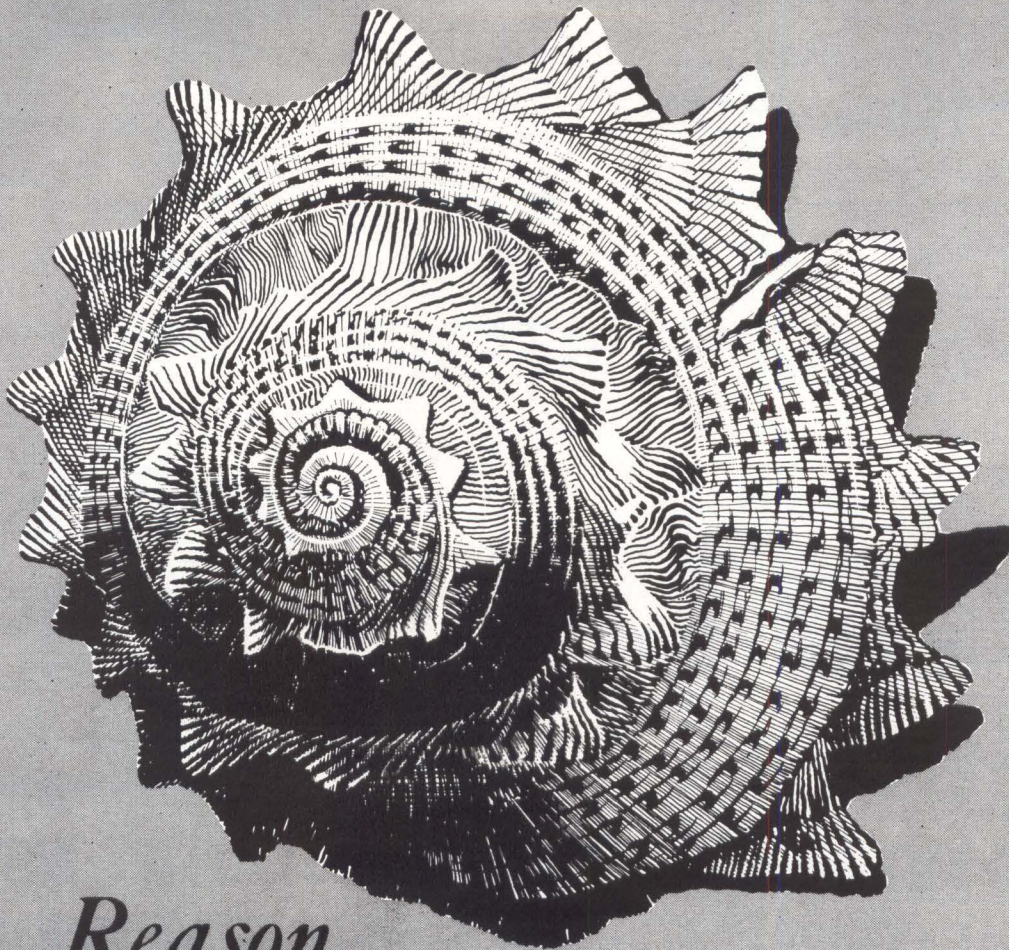

Reason

Reason regulates all things... Epictetus

Guided Missiles Range Division of Pan American World Airways, Inc., as prime contractor to the U. S. Air Force at Cape Canaveral, is increasing technical staffs in Planning, Engineering and Operations of the Atlantic Missile Range.

Technically respected people with leadership ability are needed to fill these new career positions.

Current requirements are for physicists, engineers and mathematicians with B.S., M.S., and Ph.D. degrees.

For a prompt reply, address your inquiry in confidence to: Professional Employment Manager, Guided Missiles Range Division, PAN AMERICAN WORLD AIRWAYS, INC., Dept. W-4, P. O. Box 4336, MU 113, Patrick Air Force Base, Florida.

All qualified applicants will be considered for employment without regard to race, creed, color or national origin.



GUIDED MISSILES RANGE DIVISION

PATRICK AIR FORCE BASE, FLORIDA

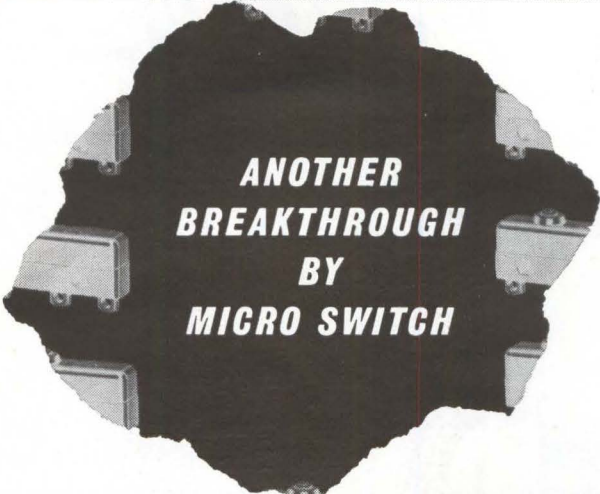

ANOTHER
BREAKTHROUGH
BY
MICRO SWITCH

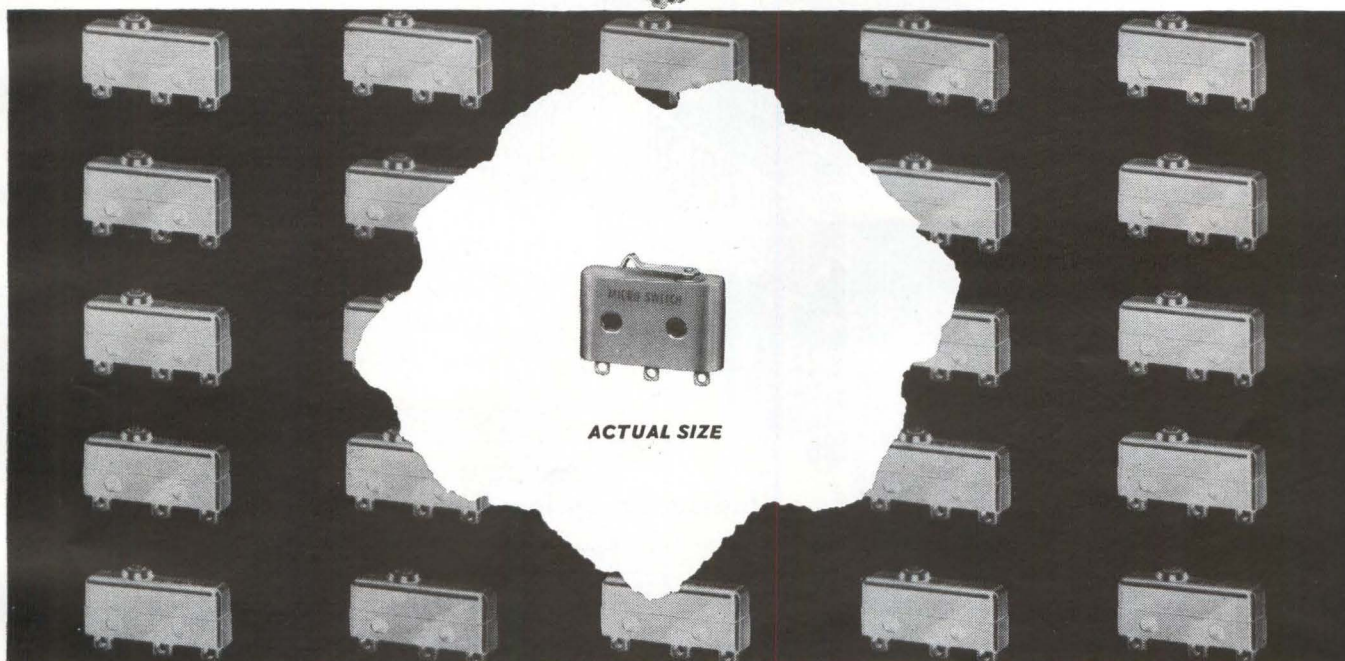

ACTUAL SIZE

HERMETICALLY-SEALED SUBMINIATURE SWITCH INTERCHANGEABLE WITH EXISTING SUBMINIATURE SWITCHES (MS 25085-1)

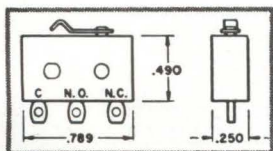

The new MICRO SWITCH "HM" Series was developed primarily for military applications, such as missiles, rockets, spacecraft and electronic equipment. It is interchangeable with existing (MS 25085-1) subminiature switches in size, mounting, and characteristics. Designed for use with standard auxiliary actuators and in push-button, toggle and rotary-actuated switch assemblies. Meets explosion-proof requirements of MIL-E-5272.

Temperature Range: The case is welded or high-temperature brazed to assure reliability and long life of the switch in temperature ranges from -300°F to $+250^{\circ}\text{F}$.

Hermetic Seal: The seal at the actuator diaphragm and

around the mounting holes is by metal-to-metal fusion. The terminals seal is glass-to-metal. This provides a true hermetic seal. The switching element chamber is evacuated, filled with inert gas, sealed, then checked by a mass spectrometer.

Corrosion Resistant: Stainless steel construction of all exposed parts meets corrosion resistant requirements of MIL-S-6743.

Circuit: Contact arrangement is single-pole double-throw.

Rating: Electrical rating is 3 amps inductive and 5 amps resistive at 28 vdc. Especially suitable for low-energy circuits and for long shelf-life requirements. Minimum mechanical life is 25,000 operations.

MICRO SWITCH manufactures a complete line of sealed switches. For details, call your nearby MICRO SWITCH Branch Office. Or write for Catalogs 77 and 78 and Data Sheet 192.

MICRO SWITCH, FREEPORT, ILLINOIS

A Division of Honeywell

In Canada: Honeywell Controls, Limited, Toronto 17, Ontario



Honeywell

MICRO SWITCH Precision Switches

NEW! BUSS

Signal Indicating • Alarm Activating GMT Fuse & HLT Fuseholder

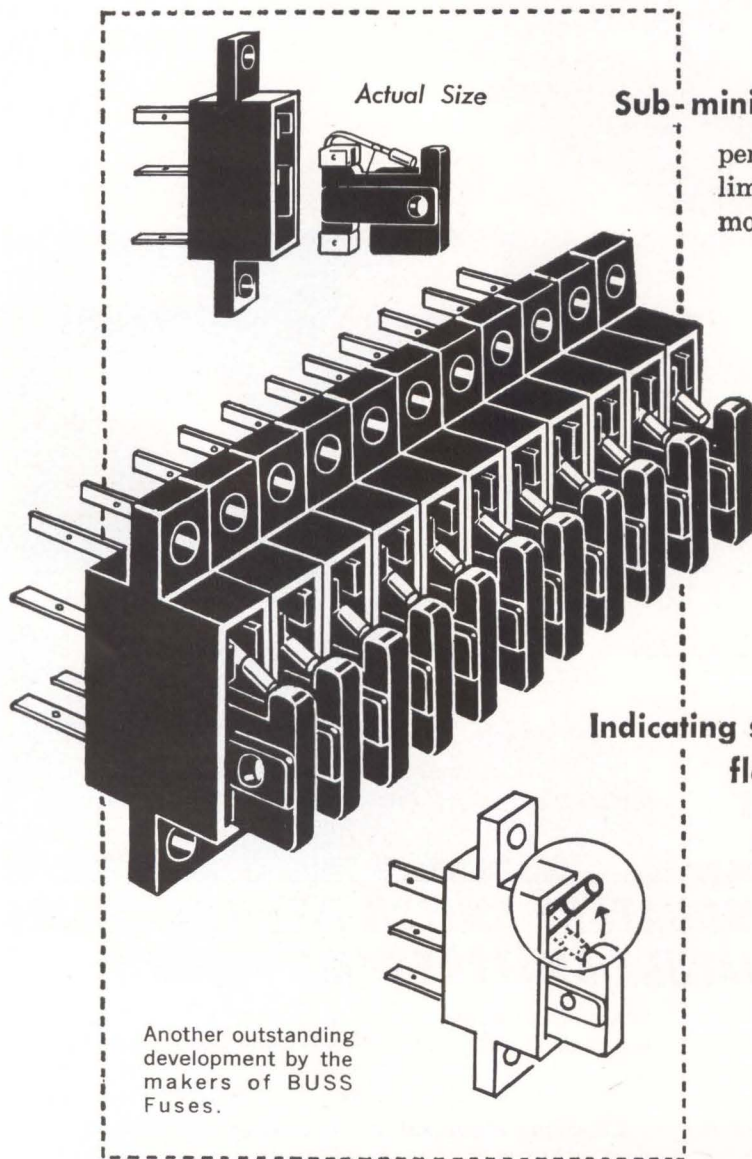

Sub-miniature design

permits multiple mounting of fuses in limited space. Fuseholders can be mounted on $\frac{1}{4}$ inch horizontal centers.

Fuse and holder combination readily adaptable for use in equipment operating at 300 volts or less, such as: communication equipment, business machines, computers, control equipment or other multiple circuit apparatus where space is at a premium.

Indicating spring flashes color-coded flag when fuse opens

to give quick, positive identification of faulty circuit.

Indicator spring also makes contact with an alarm circuit so, it can be used to flash a light—or sound audible signal on fuse panel or at a remote location.

Ask for bulletin GMCS on BUSS GMT fuses and HLT holders.

Another outstanding development by the makers of BUSS Fuses.

In the BUSS line,

you'll find the type and size fuse to fit your every need
... plus a companion line of clips, blocks and holders.

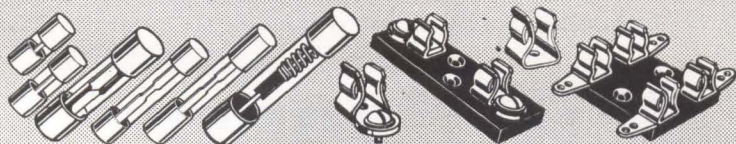

BUSSMANN MFG. DIVISION, McGraw-Edison Co., UNIVERSITY AT JEFFERSON, ST. LOUIS 7, MO.



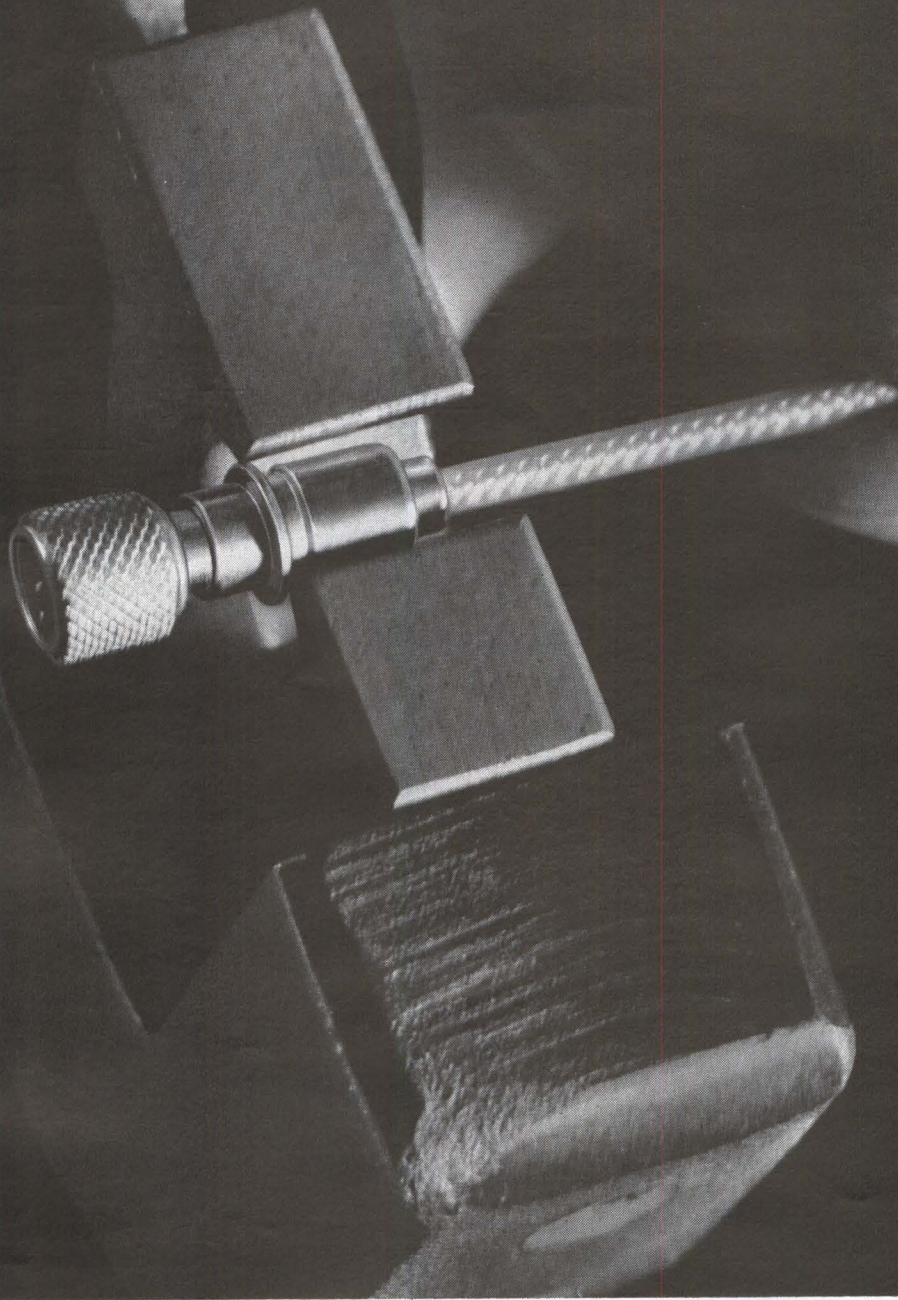

**Brand new Subminax®
coaxial connector series,
plus standard crimping tool,
cuts costs—fast!**

FXR's new Subminax Series 5116 quick-crimp micro-miniatures make faster, more reliable, less costly cable assemblies. And you don't have to re-design your product to use them, because Series 5116 micro-miniatures are interchangeable with competitive counterparts. In fact, the addition of this new Series to the Subminax line means that you can now specify a Subminax connector that mates with or is interchangeable with any known

sub-miniature or micro-miniature coaxial connector on the market today.

The new Subminax Series 5116 has at least three major advantages over other micro-miniatures:

Faster Assembly—Quick-crimping feature, plus standard crimping tool, makes child's play of cable assembly. For example, Series 5116 plugs and jacks have only three parts, including body assembly. Easier, less critical cable stripping. No braid soldering.

Dependable Delivery—new FXR micro-miniatures are immediately

available from factory stocks or your Amphenol distributor.

Lower Price—Series 5116 coaxial connectors are priced substantially below current prices for competitive "equivalents."

Technical Facts: 500 VRMS; impedance: 50, 75 or 95 ohms; gold-plated captivated contacts (solder type); Teflon® insulation; silver-plated body; screw-on or push-on coupling; color coding boots—optional. For use with coaxial cables in the .075 to .115 OD range. Write, call for more information.

*Registered trademark of DuPont

FXR™

33 EAST FRANKLIN STREET, DANBURY, CONNECTICUT
FXR IS THE RF PRODUCTS AND MICROWAVE DIVISION OF AMPHENOL-BORG ELECTRONICS CORPORATION

CIRCLE 19 ON READER SERVICE CARD

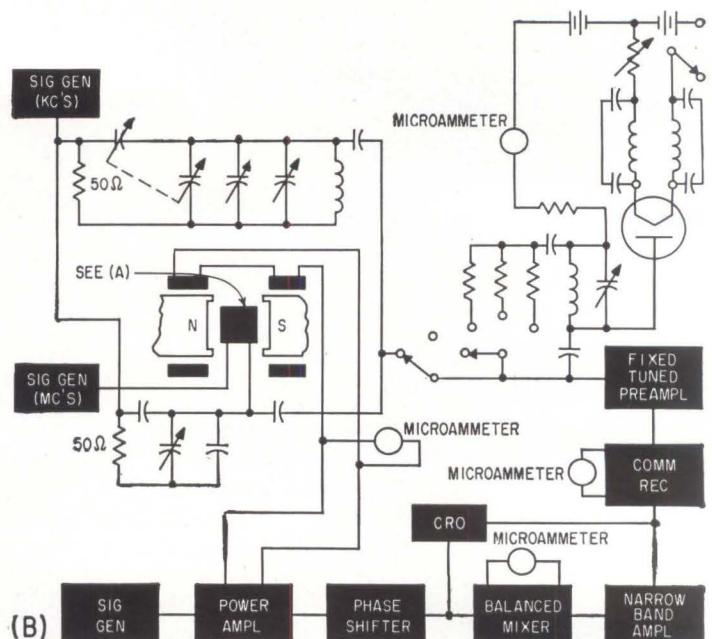
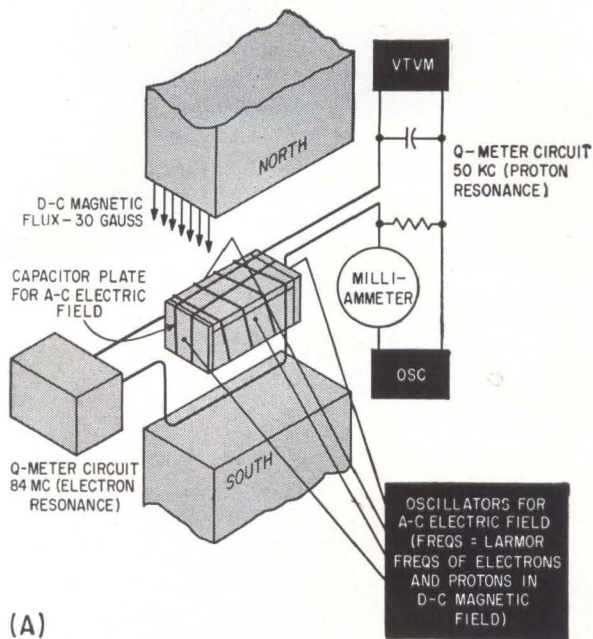

Simplified schematic of Overhauser method (A) and nuclear magnetic resonance circuits (B) being explored by Arma's basic research department

Nuclear and Superconducting Gyro Research Begins to Pay Off

By MICHAEL F. WOLFF
Senior Associate Editor

IT SHOULDN'T BE LONG before gyros of the elementary particle and superconducting types become a reality. Studies during the past several years are beginning to pay off.

Scientists at General Precision's GPL division expect to have an experimental model of a nuclear gyro working by next fall. GE has built a superconducting gyro and is testing a two-degree-of-freedom gyro with a design improved over early models (ELECTRONICS, p 32, Feb. 5, 1960). Several other firms are also active in research and development.

GPL's nuclear gyro is of the class that would use the angular momentum of atomic nuclei and electrons, rather than conventional rotor momentum, as a directional reference. These gyros would have no moving parts, so should be durable and produce minimum inertial reaction on

a spacecraft. Provided size is not a limitation, they theoretically should duplicate and perhaps exceed performance of conventional gyros.

Practical methods of orienting particles and sensing this orientation are needed to construct an operational particle gyro. Several experimental orientation techniques have been studied.

One is to allow nuclei to come to thermal equilibrium at low temperatures in large magnetic fields. Interaction between the external magnetic field and the magnetic moments associated with angular momentum of each nucleus is utilized to align the nuclei.

The cryogenic nuclear gyro is an example of this type. As studied at Rand Corp. and Sperry Microwave Electronics Co., it would enclose aligned nuclei of gaseous helium 3 in a superconducting sphere. This would exclude all varying external magnetic fields that would disturb

nuclear orientation.

The technique is called static because it relies on orienting nuclei and isolating them from external fields so the net magnetization vector remains constant.

Other static techniques include orienting the electric dipole moment produced by interaction of a large electrostatic field and electrons, and using higher-order electrostatic fields to align nuclei (quadrupole interactions). Some use internal lattice fields for orientation, aided by weak external fields.

Static techniques generally require cryogenic temperatures, or strong external fields, or both. This would not necessarily be the case with dynamic techniques.

In dynamic techniques, the particles are considered to be constantly precessing. It is the change in this precessional motion that is measured. Optical pumping is considered, at present, the most practical

dynamic technique. A d-c magnetic field is used with infrared or visible light to orient the particles.

Two dynamic techniques that orient as well as sense orientation are nuclear magnetic resonance (NMR) and electron paramagnetic resonance (EPR). Particles are made to precess by applying a d-c magnetic field and a perpendicular r-f field. In NMR, r-f field frequency equals precession frequency of the nuclei in the d-c field. In EPR, r-f frequency equals precession frequency of the electrons.

A combination of NMR and EPR—using the Overhauser effect—is reported about 1,000 times more precise than NMR or EPR.

Overhauser Effect

The Overhauser effect is a quantum shift effect that redistributes energy levels due to simultaneous alignment of electrons and protons. A d-c magnetic field is followed by the simultaneous application of r-f fields whose precessional frequencies equal that of the nuclei and electrons (see sketch).

Net result is an orientation of nuclei and electrons that is more than simply additive. The electrons cause a greater number of nuclei to be oriented and vice-versa.

Arma is exploring this technique, optical pumping and another method of quantum-dynamic orientation. GPL is pursuing the dynamic approach.

GPL has been researching nuclear gyros for the Air Force since 1958. Early experiments used conventional magnetic resonance techniques. Nuclei in distilled water were oriented at right angles to the earth's magnetic field by applying a d-c magnetic field of a few hundred gauss. When the field is removed suddenly, the net magnetization vector precesses about the earth field direction, inducing voltage in a pickup coil. Subsequent platform rotation causes a change in output frequency indicative of motion relative to inertial space.

Potential readout techniques include light transmission and variations of NMR and EPR methods. In one, plane or circularly polarized light would be passed through the material and absorption measured. Absorption is related to the angle between the polarization plane and direction of spin orientation. NMR

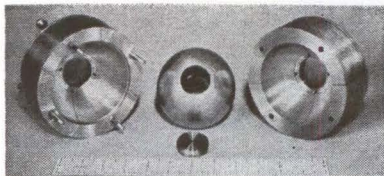

Parts of cryogenic gyro with niobium rotor, developed by GE for NASA

and EPR measurements sense orientation because it can be correlated with the amount of energy absorbed from the r-f field. Energy is determined by measuring voltage drop or Q with a pickup coil.

There is some argument whether high precession rates will allow sufficiently accurate dynamic sensing. However, formidable readout problems face static techniques because of low signal-to-noise ratio at cryogenic temperatures.

Another problem important in particle gyros is that in all known materials aligned nuclei or electrons rapidly decay into randomness. This relaxation time varies from milliseconds to around two hours in the case of helium 3. A particle gyro might serve as a directional gyro for only a short time, but it could be used as a rate gyro by making consecutive readings of particle orientation relative to inertial space and recording any change.

Superconducting gyros are further along in development. GE's Ordnance department is testing a three-piece assembly designed for maximum structural rigidity and ease of manufacturing.

The rotor support system is ex-

cited through superconducting transformers that eliminate vacuum seals. Optical readout is used. The gyro has been run at rotor speeds between 12,000 and 15,000 rpm. Performance characteristics to be evaluated in the next several months include effect of rotor asphericity on accuracy.

GE has also been studying possible use of the gyro in an azimuth reference system. The system may have greater accuracy and memory than presently known devices. Cryogenic gyros are inherently stable because, unlike electrically-suspended gyros, the bearing support is not attractive.

Cryogenic Accelerometer

Principles established in GE's program have been applied to a cryogenic accelerometer (ELECTRONICS, p 87, Nov. 17, 1961). Feasibility of an analog device with capacitive pickoff has been shown and GE is working on circuits to convert it to a digital accelerometer for greater accuracy. The analog accelerometer has had limited testing up to a few g's, demonstrating linear output characteristics over this range.

Other groups studying cryogenic gyros include Cal Tech's Jet Propulsion Lab, Minneapolis-Honeywell and Arma. Arma researchers are investigating ceramic rotors coated with a thin superconducting film. Since a film can sustain a higher magnetic field than a bulk superconductor, it should support a heavier sphere. Performance would be improved and machining made easier.

Microwave Linac X-Rays 20-Inch Steel

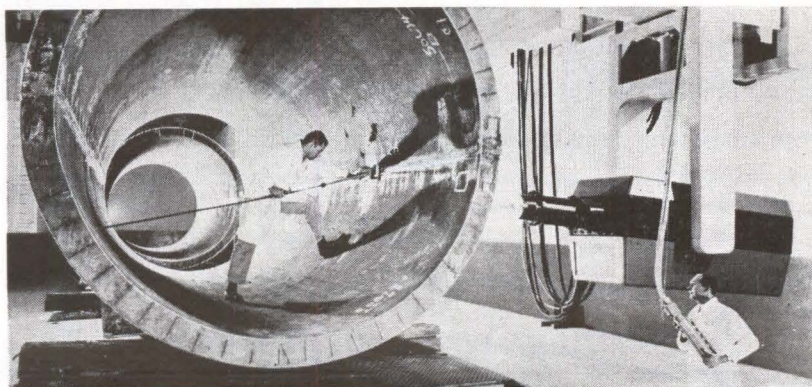

A. O. Smith Corp., Milwaukee, is checking welds in heavy pressure vessels with this 8-Mev linear accelerator made by High Voltage Engineering. Beam can penetrate 20-in. steel, radiograph 8 inches in a minute. Pulse modulator drives Amplitrons at frequencies of 1-3 Gc



PRICE BREAKTHROUGH !!!

EECo T-SERIES DIGITAL CIRCUITS ON CARDS

...Yes, now you can have our new CT-Series family of circuit cards at prices even lower than the new low prices on T-Series modules.

■ The most popular of the more than 150 time-proven EECo T-Series digital circuits are now available from stock on epoxy circuit cards. These are proven circuits, electrically identical with the T-Series. And, of course, you can count on EECo's usual true "off-the-shelf" delivery.

Send today for information and price list. You'll find 250-kc flip-flops for about \$8.50 each in quantities.



ENGINEERED ELECTRONICS Company

1441 EAST CHESTNUT AVENUE • SANTA ANA, CALIFORNIA
TELEPHONE Kimberly 7-5651 • CABLE ADDRESS: ENGELEX

*for maximum
reliability*
**SPECIFY BIRTCHER
3-B SERIES
HEAT RADIATORS**

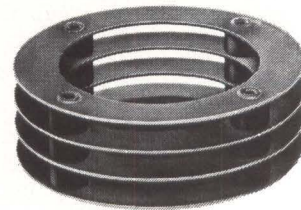

PREVENT THERMAL RUNAWAY— GET MAXIMUM SEMICONDUCTOR PERFORMANCE

Semiconductor devices derate rapidly when operated at temperatures above those recommended by the manufacturer. Destructive heat rise can be controlled, even when solid state devices are operated at maximum rated load, by using Birtcher 3-B Series Heat Radiators. The exclusive, compact, patented stacked fin design provides up to 12 square inches of radiating surface... permits maximum density packaging. Sizes IN STOCK for every popular semiconductor device.

*Available from authorized
distributors coast-to-coast*



Write for catalog and
test reports on
world's largest line of
semiconductor cooling
and retention devices

THE BIRTCHER CORPORATION

INDUSTRIAL DIVISION
745 S. Monterey Pass Road, Monterey Park, Calif.

**TUBE/TRANSISTOR/COMPONENT
RETENTION AND COOLING DEVICES
CIRCLE 202 ON READER SERVICE CARD**

electronics

ALITE[®]

HIGH-ALUMINA

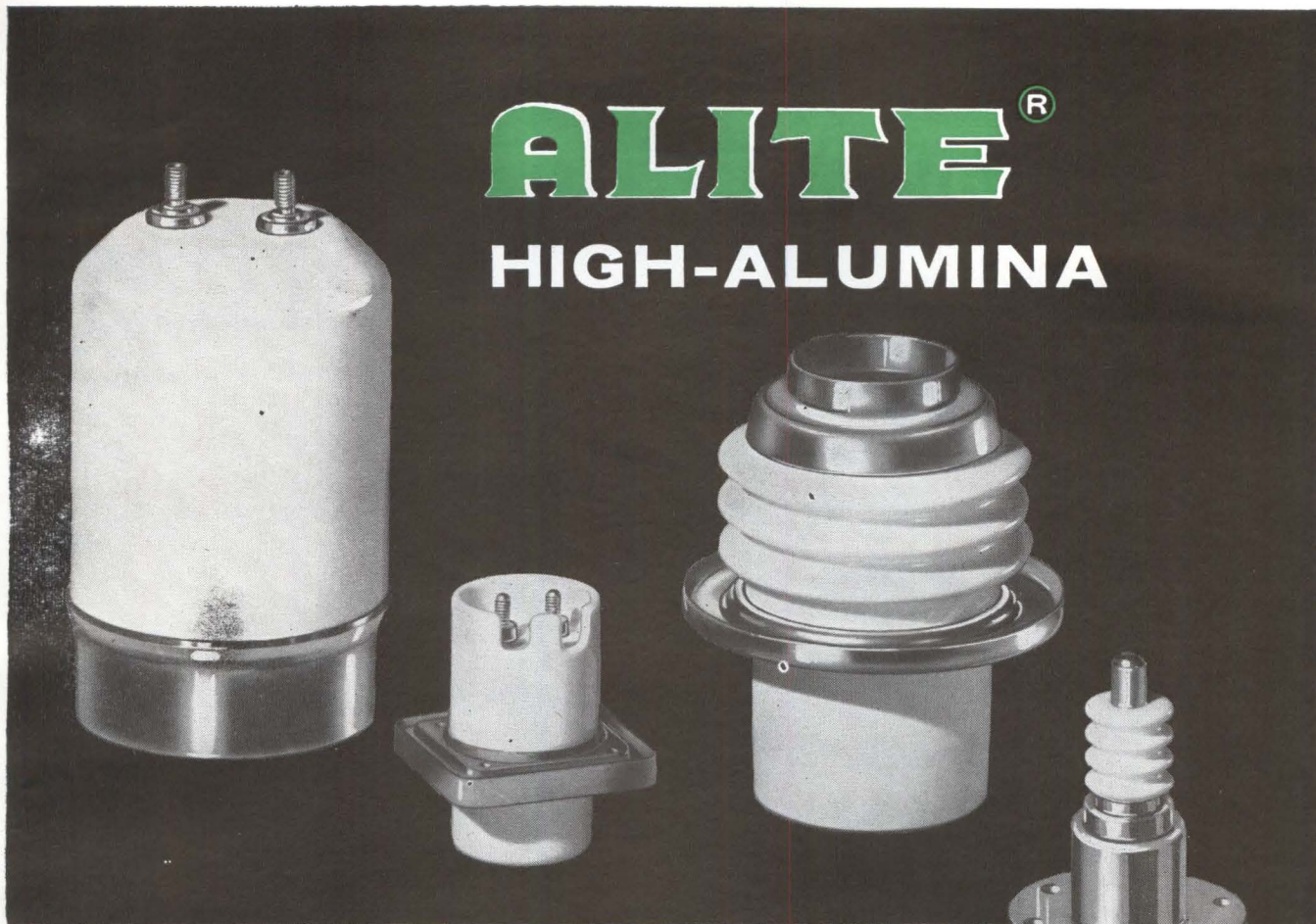

Ceramic-to-metal seals from one integrated source

ALITE — with its completely equipped facilities for producing high quality, vacuum-tight, ceramic-to-metal seals — is geared to meet all your requirements for high alumina ceramic-metal components. From design to finished assembly, every manufacturing step — including formulating, firing, metalizing and testing—is carefully supervised in our own plant. Result: effective quality control and utmost reliability.

Hermetic seals and bushings made of high alumina Alite are recommended for electromechanical applications where service conditions are extremely severe or critical. Alite has high mechanical strength and thermal shock resistance. It maintains low-loss characteristics through a wide frequency and temperature range. It resists corrosion, abrasion and nuclear radiation. Its extra-smooth, hard, high-fired glaze assures high surface resistivity.

To simplify design problems and speed delivery, Alite high voltage terminals, feed-throughs and cable end seals are available in over 100 standard sizes. However, when specifications call for special units for unusual applications, you can rely on expert assistance from Alite engineers to help you take full advantage of Alite's superior properties.

Write us about your specific requirements today.

WRITE FOR HELPFUL FREE BULLETINS

Bulletin A-8 gives useful comparative data. Bulletin A-40-R describes Alite facilities and complete line of Alite Standard Bushings.



ALITE DIVISION

U. S. STONEWARE

BOX 119

ORRVILLE, OHIO

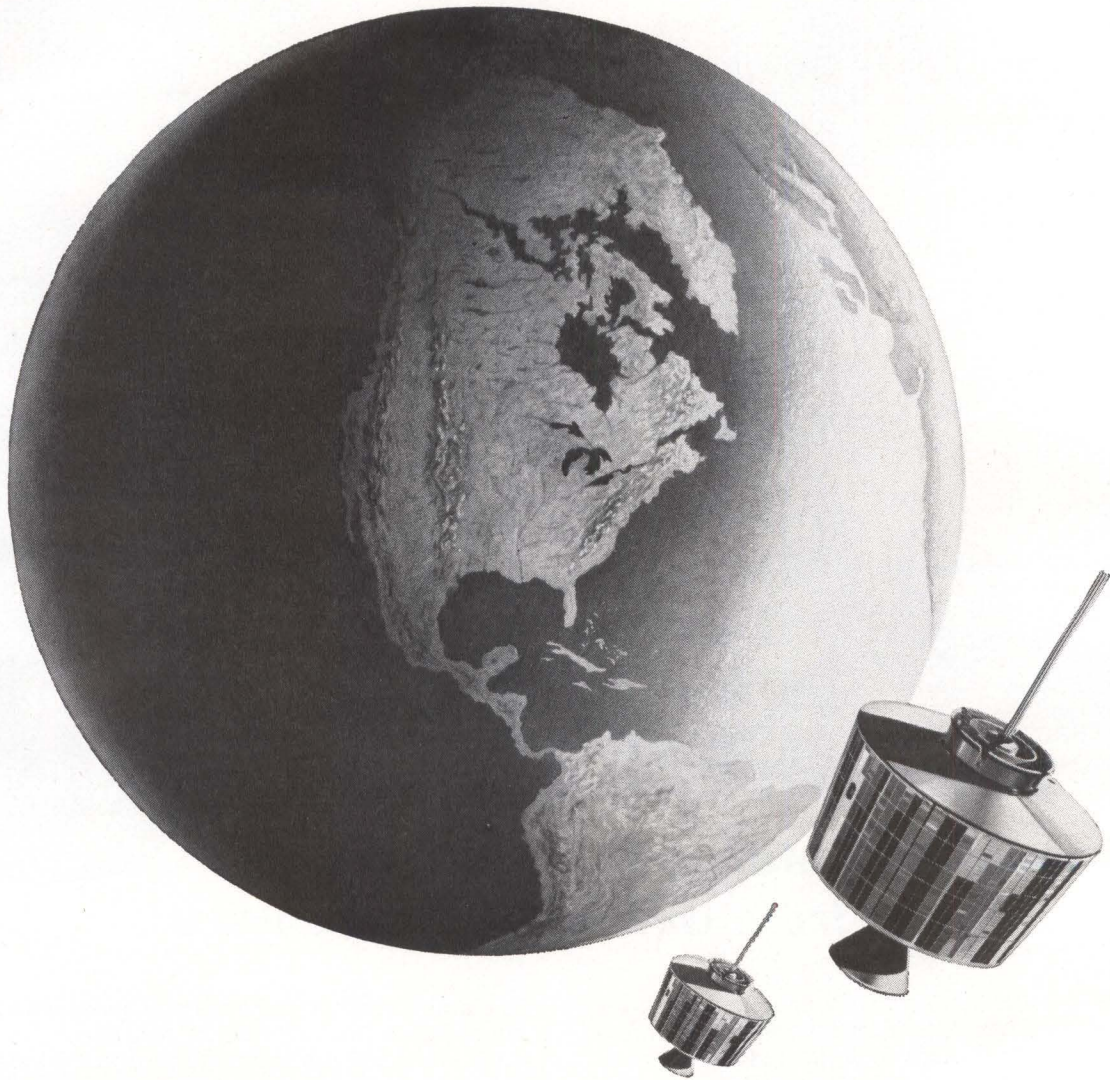

circuit designers...is your appointment in space with Hughes?

Today at Hughes you will find one of the country's most active space-electronics organizations. Important new and continuing projects, including SURVEYOR, SYNCOM, ARPAT, BAMBI and POLARIS guidance systems are growing at unprecedented rates.

This vigor promises the qualified engineer or scientist more and bigger opportunities for both professional and personal growth.

Many immediate openings exist. The engineers selected for these positions will be assigned to the following design tasks: the development of high power airborne radar transmitters, the design of which involves use

of the most advanced components; the design of low noise radar receivers using parametric amplifiers; solid state masers and other advanced microwave components; radar data processing circuit design, including range and speed trackers, crystal filter circuitry and a variety of display circuits; high efficiency power supplies for airborne and space electronic systems; telemetering and command circuits for space vehicles, timing, control and display circuits for the Hughes COLIDAR* (Coherent Light Detection and Ranging).

If you are interested and believe that you can contribute, make your appointment today.

Please airmail your resume to:
Mr. Robert A. Martin
Supervisor of Scientific Employment
Hughes Aerospace Divisions
11940 W. Jefferson Blvd.
Culver City 46, California
 We promise you a reply within one week.

Creating a new world with ELECTRONICS

HUGHES

HUGHES AIRCRAFT COMPANY
AEROSPACE DIVISIONS

An equal opportunity employer.

New "Missilmite" mica offers 10 times
the capacitance  in 1/25 the size!

Inside General Instrument Mica Capacitors is a significant history of capacitor development. The present "Missilmite" molded mica is a case in point: it packs 320 mmfd. — 10 times the capacitance of its 36-year-old predecessor (white area)—in 1/25 the size. ■ "Missilmite" is unusual in other respects. Its unique radial configuration (only General Instrument supplies these molded micas in both radial and axial types) satisfies the requirements of special printed circuitry. And its ability to operate continuously at temperatures up to 150°C meets MIL specs for stability and heat dissipation. ■ Find out more about General Instrument Capacitor Division's micas (in standard sizes or micromodules); tantalums, electrolytics and film capacitors too. Write for booklet "Inside General Instrument Capacitor," Dept. 200B, General Instrument Corporation, Darlington, S.C.

GENERAL INSTRUMENT CAPACITORS

CIRCLE 25 ON READER SERVICE CARD

Private Repeater Satellite

Bell Telephone Laboratories will use Telstar to test world-wide communications with satellites



Antennas at main ground station at Andover were erected this winter under a huge inflated dome

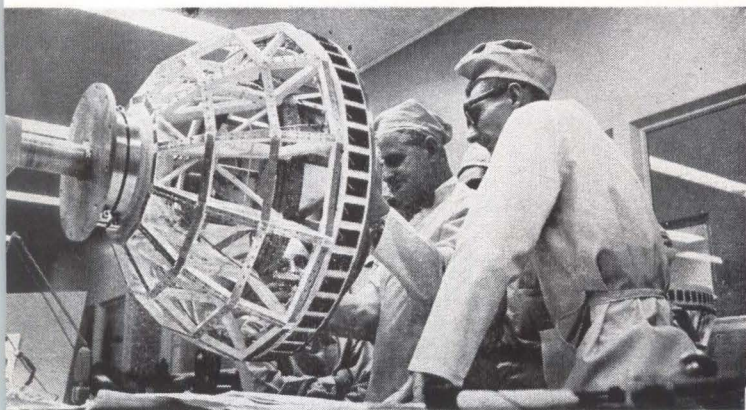

Canister containing electronic systems will be suspended in center of magnesium frame by shock-absorbing nylon cords

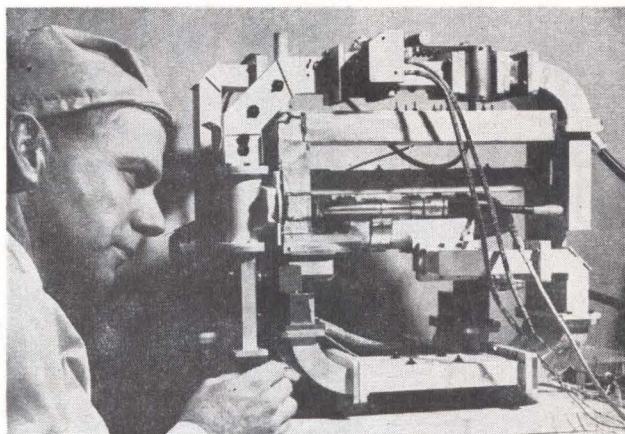

Traveling-wave tube is tested in its magnetic circuit. It will be the only tube carried in the satellite



These transistors are made with wide, radiation-sensitive base regions, for experiments in space radiation damage

IF ALL GOES WELL this Spring, Telstar—the first private communications satellite—will be launched from Cape Canaveral by NASA for Bell Telephone Laboratories.

During the two years before its telemetry transmitter is silenced, Telstar will test the use of broadband repeater satellites for world-wide communications, and check out tracking techniques and ground equipment.

By telemetry, data will also be gathered on satellite equipment performance and how the space environment affects components. In all, 115 conditions will be measured. These projects involve some 400 Bell Labs personnel and 800 subcontractors.

If the launch is unsuccessful, a backup satellite will be ready for a possible second try two months later. Another launching is tentatively scheduled for the Fall. Bell Labs will pay NASA \$3 million for each launch, successful or not.

Telstar and its ground station can transmit 600 conversations or a single tv channel—one way. While not designed for two-way telephony, they can handle 12 conversations and perhaps 60.

Broadband communications signals will be transmitted to Telstar at 6.39 Gc. They'll be received, converted to 90-Mc i-f, amplified, reconverted and retransmitted to earth at a center frequency of 4.17 Gc. Amplifier circuits will use 14 diffused base germanium transistors. Automatic gain control will keep signals constant despite varying input signal strength and transistor aging.

Command signals at 120 Mc will be received by pairs of receivers and decoders. Primary command function is to conserve power by turning the communications transmitter on and off.

A tracking beacon signal will be

Goes Up This Spring at Cape Canaveral

transmitted at 4.08 Gc. The 136-Mc telemetry system will use pcm/f-m/a-m coding to maintain constant output power and phase. This quarter-watt transmitter will radiate constantly, as an auxiliary tracking beacon. (For details on command tracking and telemetry, see *ELECTRONICS*, p 23, Dec. 22, 1961.)

Telstar's only tube is a foot-long twt. A broadband amplifier (5,000 times amplification), it will put out both the 4.17-Gc and 4.08-Gc signals. Other active components are 1,024 transistors and 1,301 diodes.

The satellite (see cover) is 34 inches in diameter and weighs 170 lbs. Antennas are the belt. Electronic systems are housed in a foam-filled canister suspended in the frame by shock-absorbing nylon cords. Canister temperature will be adjusted by thermal controls that open and close the lid.

Surface facets carry 3,600 solar cells, protected by clear sapphire, to recharge nickel-cadmium batteries. As one experiment, output of six cells with varying shielding will be compared with output of a pre-radiated cell to determine degradation under space radiation. Other cells used as sunlight detectors will indicate the angle of Telstar's spin axis.

Four special silicon diodes will measure energy and density of particles in the Van Allen radiation belt. Electrical response will vary with the energy lost by particles striking the diodes or passing through them. Brookhaven National Laboratory assisted in designing the instrumentation.

Two diodes are almost unshielded. One with fixed bias measures electron density and energy from 0.25-1 Mev. The other has varying bias and measures protons in five energy regions between 2-25 Mev. Two have thicker shielding and will measure protons, one in the range above 25 Mev and the other above 40 Mev.

Radiation damage to transistors will be measured by six silicon transistors made with wide base

regions so they are unusually sensitive to radiation. They will be mounted in pairs with varying shielding. Output will be compared with that of a preradiated transistor.

A microwave relay system has been built by AT&T to link the

main ground station at Andover, Maine, to the Bell System. The station at Holmdel, N. J., used in Echo passive relay experiments, will be modified to receive Telstar's beacon signals. Both stations will also participate in NASA's Relay satellite experiment later this year.

Teracycle Devices Coming

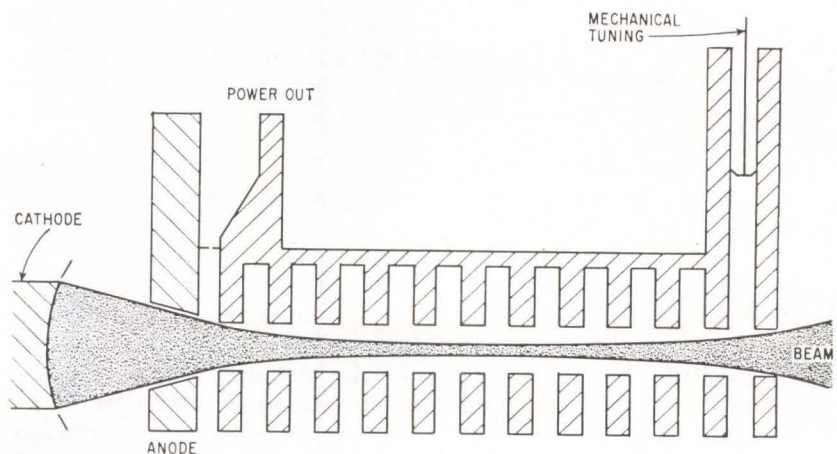

Litton's 4-mm extended interaction circuit oscillator without magnetic focusing field

NEW YORK—Techniques for building coherent millimeter-wave generators in the 300-Gc to 300-Tc (300×10^{12} cps) region were scrutinized at the recent AIEE Winter General Meeting. One of the key themes at a panel discussion was that more attention be paid to cyclotron resonance phenomena.

It was predicted that at 300 Gc to 3 Tc, O-type electron beam devices would become dominant soon. Some support for this prediction came from CSF which reported work aimed at an 0.5-mm Carcinotron (*ELECTRONICS*, p 7, Feb. 9).

With lasers expected to dominate at 300 Tc and higher, attention focused on ways of closing the infrared gap between 3 Tc and 300 Tc. Herbert Kroemer, of Varian,

pointed out that this is in the range of crystal lattice vibrations. But an efficient device would have to use phenomena reasonably well decoupled from lattice vibrations.

He felt more work should be done on cyclotron resonance schemes like those associated with negative-mass carriers and semiconductor masers. A semiconductor maser, as proposed at MIT Lincoln Lab, would use a material such as indium antimonide. Its coupling is weak because the electron mean free path can be many wavelengths of the lattice vibration. The device would use a laser for a pump source and an external kilogauss magnetic field to break up the conduction and valence bands into discrete energy levels.

(continued on p 28)

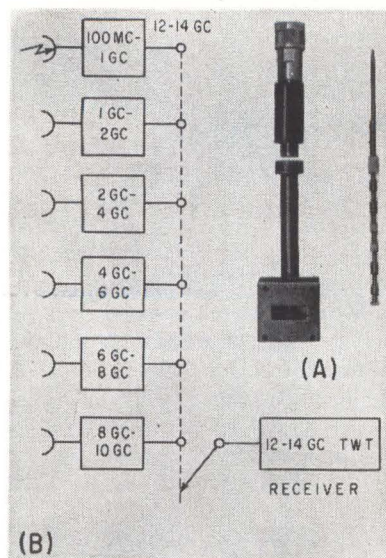

How RCA would use broadband parametric amplifier (A) in counter-measures detector (B)

Resulting electron motion is then cyclotron-type motion with intervening collisions.

In a survey of mm-wave research, Glen Wade, of Raytheon, commented that we are on the verge of important advances in coherent generation. In addition to the mm-wave masers, several approaches might lead to practical devices. Among these are:

- A crossed-field, axial-gain tube with fast-wave circuits being built for X-band at Raytheon. Extension of techniques may ultimately achieve megawatts of average power at mm wavelengths. Work is also underway on submillimeter devices.

- Using radiation from an orbiting electron cloud as in General Telephone and Electronics' Tor-

nadotron. Output frequency of 1,800 Gc and kilowatt peak pulsed power with an applied magnetic field of 600 Kg are anticipated. So far, with 25 Kg, milliwatts of power have been obtained at 70 Gc.

- A solid-state analog of the Tornadotron. Radiation is obtained from precessing electron spins in ferrites. Work at Stanford University on this approach may lead to 300-Gc outputs with peak pulse power of tens of watts for magnetic fields of 100 Kg.

- Cerenkov radiators. Future experiments at University of Illinois, using plasma couplers, are expected to raise outputs to the watt level.

- Nonlinear effects for multiplying and mixing. An example is a difference frequency mixer proposed by a British researcher, K. Froome. Two lasers would be fired at a glancing angle at a drop of liquid cesium which would then emit difference frequency radiation in all directions. Such a device might have one percent efficiency.

Exitron and Ubitron

Some generators that show promise of producing high power at mm wavelengths are the Exitron and GE's Ubitron. In a talk on slow-wave circuits, C. K. Birdsall, of University of California, pointed out that the Ubitron, a device in which the beam rather than the structure is periodic, could produce 1 Mw at 2 cm.

A. J. Prommer, of Litton Industries, reported that Exitron peak-power outputs in the tens of kilowatts range should be achievable at 4 mm with efficiencies comparing favorably with magnetrons at the same frequency. The Exitron is a form of Monotron. The interaction

cavity is replaced by a section of slow-wave structure terminated so it forms a resonant circuit. The device features a low starting current and conversion efficiency of 33 to 34 percent.

In response to a question about the outlook for plasma devices, Birdsall commented he did not know of any successful attempt so far to produce coherent outputs at mm wavelengths. He also pointed out that plasma is noisy and that it is not certain whether plasma can be made as uniform and smooth as a slow-wave structure.

Parametric Amplifiers

In other reports, B. B. Bossard, of RCA, described a new design technique that has resulted in a family of extremely broadband parametric amplifiers (ELECTRONICS, p 7, Feb. 9). He said these amplifiers would be useful in countermeasures, phase arrays and pulse compression radars. It could be used for a microwave spectrum countermeasures detector by sequentially coupling the common outputs of a series of parametric up-converters to a receiver in the 12 to 14-Gc range, as illustrated. Pump sources can be individual klystrons or solid-state sources, harmonically related.

A hybrid-coupled parametric amplifier with 200-Mc bandwidth centered at 3 Gc, 12-db gain, and double-channel noise figure of 1.8 db was reported by David Sabih, of Hughes Aircraft. Input signal (see sketch) divides between arms 1 and 2 with the field at the latter lagging by 90 deg. The amplified signals in each arm are reflected so that their sum appears in the output arm.

An electronically tuned tunnel diode oscillator for 600 to 900 Mc was described by F. G. Haneman and G. W. Thomson, of Airborne Instruments Lab. The oscillator delivers 0.5 mw into 50 ohms. It uses a voltage variable capacitor operated above its self-resonant frequency as the tuning element.

An integral-cavity triode amplifier tube termed the Coaxitron was discussed in a paper by F. S. Keith, W. N. Parker and C. L. Rintz, of RCA. A prototype device is reported to have been operated at peak power outputs exceeding 5 Mw over a 50-Mc bandwidth without any mechanical tuning adjustment.

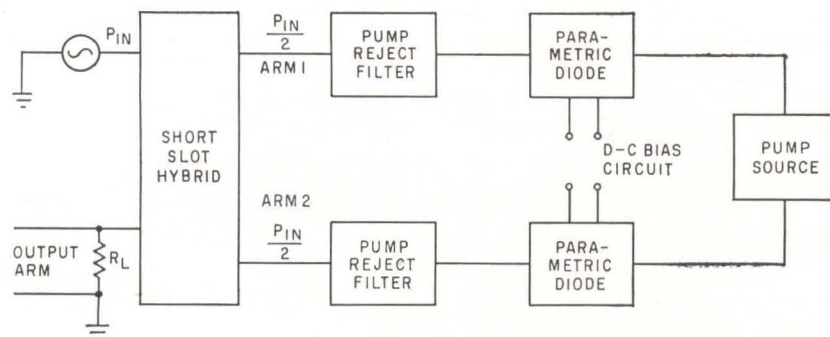

Hughes' hybrid-coupled parametric amplifier has input and output separated so structure is matched at input and output terminals

Commercial Microwave System Has No Tubes

RCA THIS MONTH demonstrated a solid-state microwave transmitter-receiver, operating at 6 Gc, to Pennsylvania Electric Association members. It was reported to give "excellent" voice service in a laboratory equivalent of a 60-mile system. The model was made up basic elements of terminal, repeater and junction stations.

The equipment is crystal-controlled and uses transistors and varactor diodes. RCA said that new circuit designs eliminate complex automatic frequency control loops, mode balance tuning and high-voltage regulated power supplies. Distortion and level variations are minimized by heterodyning at repeater stations, according to E. J. Hart, manager of RCA's microwave department. Stations, he said, could be operated from 48-v batteries.

Combat Weather Radar Detects A-Bomb Clouds

ARMY is conducting operational tests on an improved, mobile weather radar. It can monitor movements of clouds resulting from nuclear explosions, as well as weather in a 400-mile range.

Developed by the Signal Corps and Raytheon, the set is housed in a 26-ft van and has a power-erected antenna which rises through the van roof.

Tactical 3-D Radar

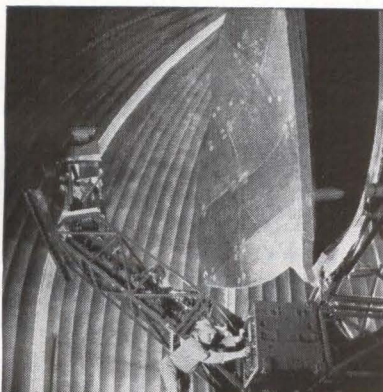

Sperry Gyroscope is producing for Marine Corps use a radar system with one rotating antenna for range, azimuth and elevation data. The antenna is dually polarized for individual transmitters and receivers, puts out a V beam

MARC Time Division Multiplex

alarm, remote control, and data transmission systems

MARC systems automatically monitor the status of any number of remote points, and transmit on/off control, alarm, or data information to a central station over any communication link — physical pair, carrier, radio, VHF, or microwave.

MARC CODER AND DECODER UNITS DESIGNED FOR STANDARD RACK MOUNTING

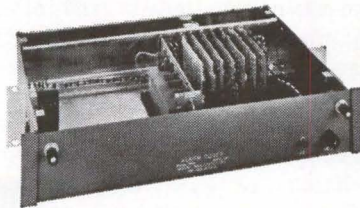

The MARC Coder continuously generates serial time coded signals in accordance with the input signals monitored. Each pulse in the serial code train is weighted short or long, in appropriate sequential order, according to the condition of the input information to be transmitted. Information sent in this time-sharing mode is called time division multiplex (TDM).

Marc TDM signals can be transmitted, much like teletype, over DC physical pairs, or voice frequency tone channels, to modulate carrier, wire, or microwave links. Marc can also be used to key the baseband of a VHF or microwave transmitter directly. Speed of transmission of control information is adjusted to system requirements, within the communication link bandwidth.

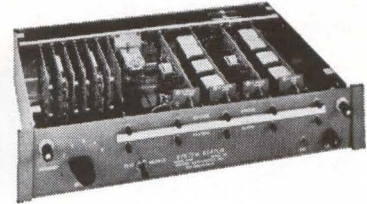

The MARC Decoder is synchronized with the coder by means of a synchronizing pulse at the end of each serial pulse train. By use of logic circuitry, the system affords extremely high immunity to noise and spurious signals, virtually excluding improper control function selection.

The information output of the decoder is the presence or absence of a voltage, corresponding to the information received from the coder. This voltage can be used to operate inductive loads, such as relays, or resistive loads, such as indicator lamps.

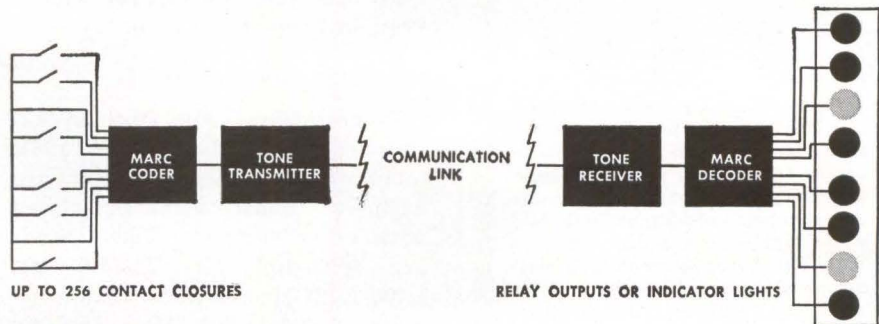

MARC equipment is all-solid-state, providing extremely reliable operation with virtually no maintenance. Modular components — code-notched printed circuit cards — can be combined in many different configurations to meet the operating requirements of virtually any application. Systems can be simple or highly sophisticated, depending upon the mode of operation, reliability parameters, and time available for transmission. For details, write:



MOORE ASSOCIATES INC.

893 American Street, San Carlos, California

SPRAGUE PIEZO- ELECTRIC CERAMIC ELEMENTS



**ELEMENTS
FOR ALL
APPLICATIONS
AS WELL AS
COMPLETE**

**TRANSDUCER ASSEMBLIES
FOR MOST APPLICATIONS,
SUCH AS UNDERWATER
SOUND AND
VARIOUS ORDNANCE AND
MISSILE DEVICES.**



Sprague-developed mass production and quality-control techniques assure lowest possible cost consistent with utmost quality and reliability. Here too, complete fabrication facilities permit prompt production in a full, wide range of sizes and shapes.

Look to Sprague for today's most advanced ceramic elements—where continuing intensive research promises new material with many properties extended beyond present limits.



**YOUR INQUIRIES
ARE INVITED**

**WRITE FOR
LITERATURE**

SPRAGUE ELECTRIC COMPANY
35 Marshall Street, North Adams, Mass.

SPRAGUE[®]
THE MARK OF RELIABILITY

Astronomers to Get More Room

By THOMAS EMMA

Associate Editor

FEDERAL COMMUNICATIONS COMMISSION wants to give radio astronomers more space in the spectrum in both domestic and international allocations.

Plans are not firm yet. Comments have been solicited in the U. S. and international comments are to be received at an international conference tentatively scheduled for next year. At present, international tables mainly show radio astronomy provisions as footnote references. FCC would make these actual allocations.

FCC says its international plans would result in little dislocation of other services around the world. International provisions (see table) would be unchanged below 25 Mc. Most allocations at higher frequencies would be exclusive.

One of FCC's aims in making the proposals is to stimulate international discussion. It hopes that with more attention on radio astronomy there would be more exchange of information. Part of the plan is that observatories report twice a year on frequencies used.

Domestic Plans and Shifts

Domestically, only stations authorized on or before Dec. 1, 1961, could operate in nine bands that are exclusive to astronomy or shared with other services. These bands are 40.66-40.7 Mc, 73-74.6 Mc, 1,400-1,427 Mc and the six bands between 2,690-31,500 Mc. The six lowest frequency bands (see table)

PROPOSED ALLOCATIONS

Freq. in Mc	404.0-406.0 ^f
2,495-2,505 ^a	1,400-1,427
4,995-5,005 ^a	1,664.4-1,668.4
9,995-10,005 ^b	2,690-2,700 ^d
14,99-15,01 ^a	4,990-5,000 ^d
19,99-20,01 ^c	10,680-10,700 ^d
24,99-25,01 ^a	15,350-15,400 ^d
40.66-40.7	19,300-19,400 ^d
73.00-74.6 ^d	31,300-31,500 ^d
328.6-335.4 ^e	88,000-90,000

(a) Secondary service status (b) Share with Standard Frequency Reference services (c) Share with SFR and space communications (d) Footnote status on present international spectrum table (e) Share with radio navigation (f) delete from radio astronomy service

would be allocated astronomers on a secondary basis.

Radio astronomers do not need FCC licenses. FCC points out that if a secondary service, astronomy cannot claim protection from interference from primary or permitted services in the same band. Astronomers, however, can claim protection from other secondary services.

FCC plans to have radio astronomers operate at frequencies where busy earth traffic is less likely to complicate the difficult job of picking up and analyzing weak, random astronomical signals.

The space communications service allocation at 10.003-10.005 Mc, for example, will be withdrawn. This will give astronomers a clearer field in the 9.995-10.005 band, which will be shared only with Standard Frequency Reference services. The 404-406 Mc band now allocated to astronomers would go instead to space communications.

Allocation of 40.68 Mc to industrial, scientific and medical services, little used for this purpose, says FCC, would be withdrawn to give a clear field to astronomy at 40.66-40.7 Mc.

Artificial Hand Reacts Automatically to Pressure

BELGRADE—The Yugoslav government has announced plans to manufacture artificial hands for invalids. The hands reportedly respond automatically to pressure and to the weight and form of objects picked up.

A hand contains "small fields of fine coal dust" in palm, fingertips and other vital parts. Pressure on these creates impulses which trigger an electronic system to react with equal pressure.

A practical prototype is to be made by the Institute for Automation and Telecommunication. Quantity production is to begin in 18 months. Rajko Tomovic, head of the electronics laboratory at the nuclear institute in Vincha is credited with development.

when airborne radar requires the very best:
BOMAC K_U BAND MAGNETRONS

Designers of radar equipment will find Bomac Laboratories' new BLM-071 K_U-band pulse magnetron meets exacting requirements for airborne systems: lightweight, rugged, powerful. This newest contribution from Bomac is a fixed-frequency tube (15.9-16.1 kMc) rated at 100 kW peak, at 0.001 duty cycle.

Cathode structure is greatly improved over similar magnetrons. Operable at high ambient temperatures, with input/output terminals permitting pressurization to 30 psia. Special construction minimizes leakage current. High power output and low operating voltage are combined in a compact, ruggedized unit. Long life. Weight: less than 8½ lbs.

The many advantages to Bomac's BLM-071 magnetron make it readily adaptable to navigation, high-altitude mapping, airport surveillance, and similar applications. Write for full technical details.

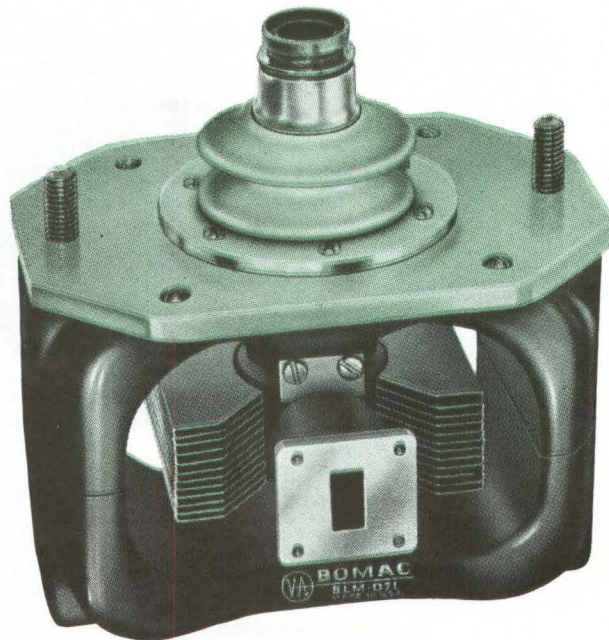

FEATURES: Frequency 15.9-16.1 kMc.
Peak Power 100 kW.
Normal efficiency 30%.
Duty cycle 0.001 Max.
Pulse width 0.06 to 1.2 usec.

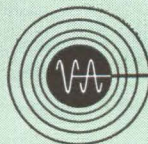

BOMAC laboratories, inc.

BEVERLY 1, MASSACHUSETTS
A Varian Subsidiary

Other Subsidiaries of Varian Associates:

S-F-D LABORATORIES, INC.
VARIAN ASSOCIATES OF CANADA, LTD.
SEMICON ASSOCIATES, INC.
SEMICON OF CALIFORNIA, INC.
VARIAN A.G. (SWITZERLAND)

CATASTROPHIC FAILURE? NOT THIS POT!

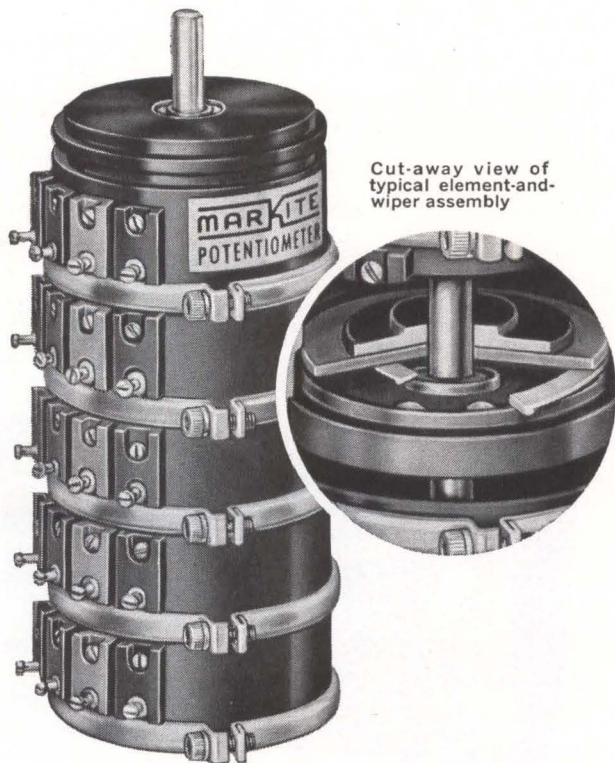

Cut-away view of typical element-and-wiper assembly

Protection against sudden, unpredictable open-circuiting is built into the Markite precision potentiometer. No delicate resistance element here. Instead—a sturdy one-piece element embodying a solid, raised resistive track of Markite conductive plastic co-molded to insulator base with insert-molded taps and terminals.

This unique resistive track insures service continuity because of:

- large cross-section
- hard, smooth surface
- elimination of wiper galling
- elimination of wiper bounce

Potentiometer construction matches inherent reliability of its resistance element—2 precision ball bearings • anodized aluminum or stainless steel case • noble metal contacts. With Markite pots. . . long wear-life and performance predictability — even under environmental extremes—are assured! Life results, in many applications: at least 50 million revolutions!

Available in rotary and rectilinear configurations, these units offer infinite resolution and other outstanding electrical characteristics.

Write for Bulletin 216 or send in your specifications.

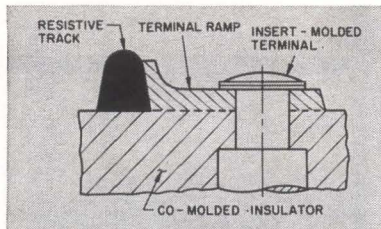

MARKITE

Markite Corporation, 155 Waverly Place
New York 14, New York—ORegion 5-1384

MEETINGS AHEAD

TRACKING & COMMAND OF AEROSPACE VEHICLES Symposium, IAS; Jack Tar Hotel, San Francisco, Feb. 19-21.

ELECTRICAL INSULATION CONFERENCE NEMA; Shoreham Hotel, Wash., D. C., Feb. 19-22.

APPLICATION OF SWITCHING THEORY TO SPACE TECHNOLOGY Symposium, USAF, Lockheed Missiles and Space; at Lockheed, Sunnyvale, Calif., Feb. 27-Mar. 1.

SCINTILLATION AND SEMICONDUCTOR COUNTER Symp., PGNS of IRE, AIEE, AEC, NBS; Shoreham Hotel, Washington, D. C., Mar. 1-3.

VACUUM COATING Conference, Soc. of Vacuum Coaters; Sheraton-Cleveland Hotel Cleveland, Ohio, Mar. 6-7.

MISSILES & ROCKET TESTING Symp., Armed Forces Communications & Electronics Association Coca Beach, Fla., Mar. 6-8.

EXTRA-HIGH VOLTAGE COMMUNICATION, CONTROL & RELAYING, AIEE; Baker Hotel, Dallas, Tex., Mar. 14-16.

IRE INTERNATIONAL CONVENTION, Coliseum & Waldorf Astoria Hotel, New York City, Mar. 26-29.

QUALITY CONTROL Clinic, Rochester Soc. for Q.C.; U. of Rochester, Rochester, N. Y., Mar. 27.

ENGINEERING ASPECTS OF MAGNETO-HYDRODYNAMICS, AIEE, IAS, IRE, University of Rochester, Rochester, N. Y., Mar. 28-29.

SOUTHWEST IRE CONFERENCE AND SHOW; Rich Hotel, Houston, Texas, April 11-13.

JOINT COMPUTER CONFERENCE, PGEC of IRE, AIEE, ACM; Fairmont Hotel, San Francisco, Calif., May 1-3.

HUMAN FACTORS in Electronics, PGHFE of IRE; Los Angeles, Calif., May 3-4.

ELECTRONIC COMPONENTS CONFERENCE, PGCP of IRE, AIEE, EIA; Marriott Twin Bridges Hotel, Washington, D. C., May 8-10.

NATIONAL AEROSPACE Electronics Conference, PGANE of IRE; Biltmore Hotel, Dayton, Ohio, May 22-24.

SELF-ORGANIZING INFORMATION SYSTEMS Conference, ONR, Armour Research Fd.; Museum of Sci., and Ind., Chicago, May 22-24.

ADVANCE REPORT

MEDICAL & BIOLOGICAL DATA ACQUISITION AND PROCESSING Conference: at University of Rochester Medical Center, Rochester, N. Y., July 17-18. Papers should stress diagnostic methods, data enhancing methods and clinical applications rather than development of devices. Instrumentation, feasibility studies, actual computations and philosophical approaches will be of interest. Abstracts should be submitted by Mar. 1 to the U. of Rochester Office of Public Information, River Campus Station, Rochester 20, N. Y.

BRAND-REX CABLEMANSHIP*

BOEING'S Communications Link between Minuteman Systems!

America's first "push-button" missile system, the Minuteman is predicated upon high reliability, maximum simplicity and greatly improved cost effectiveness. Supporting the effective missilemanship of Boeing, the Minuteman systems integrator, is the Cablemanship of Brand-Rex.

Linking the vast complex of Minuteman Communications systems are a broad range of Brand-Rex multi-conductor cables. By combining the most suited plastics for the specific purpose, they insure functional and environmental integrity. Polyethylene, with its excellent electrical characteristics, is used as primary insulation; nylon jackets impart dimensional stability to single conductors as temperature increases; and over-all neoprene jackets provide low tem-

perature flexibility, abrasion resistance and resiliency. The processing problems inherent in such material combinations have been successfully solved by Brand-Rex technicians.

If your requirements for wire, cable and insulating materials demand the reliability, uniformity, and adherence to specifications of the Communications system of the Minuteman project, call on the Cablemanship of Brand-Rex!

*Brand-Rex Cablemanship — a combination of technology, skill, design engineering, 3-plant production capability and technical service provided by a tightly knit organization of cable specialists . . . all backed by the vast resources of American Enka Corporation.

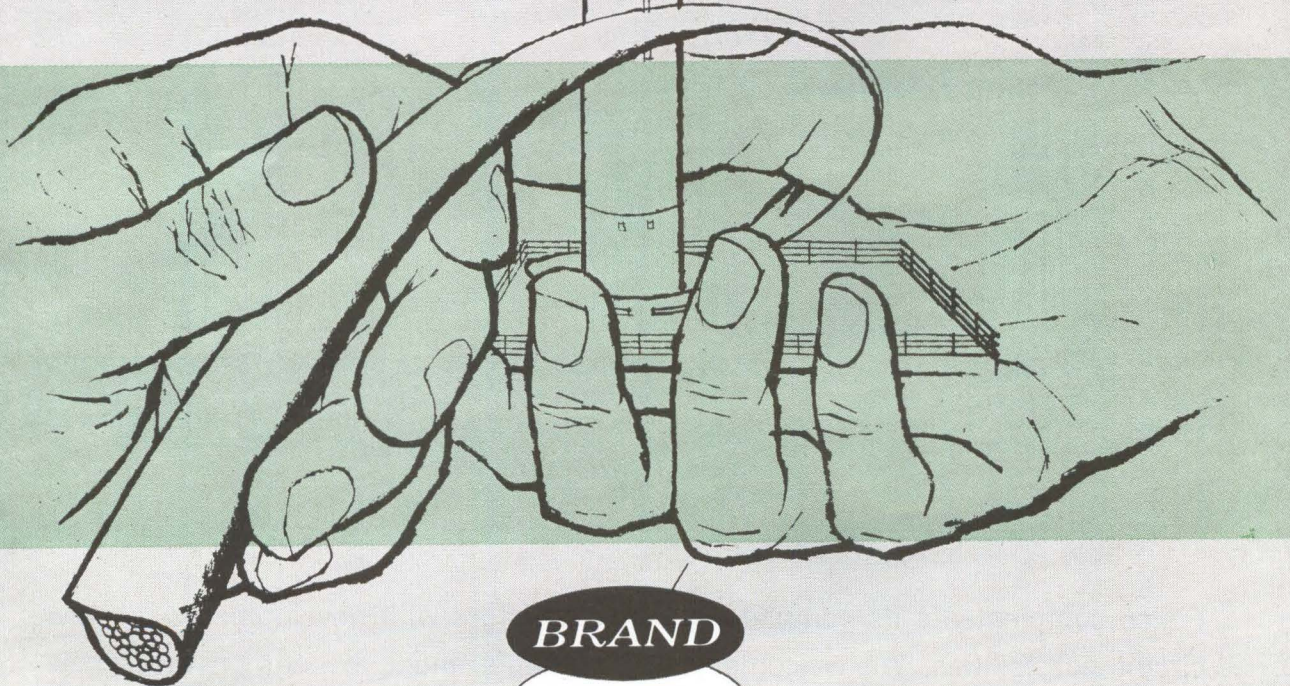
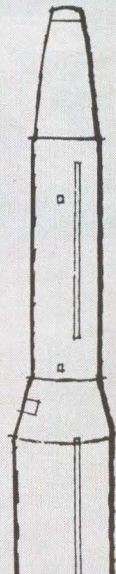

DIVISION OF  American **ENKA** Corporation
DEPT. NC, 39 SUDBURY ROAD, CONCORD, MASSACHUSETTS
TELEPHONE: EMERSON 9-9630

VINYL, TEFLON, POLYETHYLENE, NYLON WIRE AND CABLES, ELECTRICAL TUBING AND SLEEVING — UHF CAST PLASTICS

6 NEW PHILCO DEVELOPMENTS BROADEN THE DESIGNER'S

HORIZONS



1 AMP. TUNNEL DIODE

For Tunnel Diode motors, power converters, and current surge limiters. TO-18 package. Tight peak current control.



EPOXY-PACKAGED TUNNEL DIODE

New low cost, 5 ma high speed tunnel diode for logic and memory applications. Subminiature package mounts like a resistor.



OPTICAL EPITAXIAL SILICON PLANAR TRANSISTOR

Responds to both electrical and light signals. High switching speed ($t_{OH} = 25$ nsec max.). High photosensitivity ($1 \mu\text{a}/\text{ftC}$).



2 Kmc MADT*

Amplifier, oscillator and mixer for UHF and microwave. Available in both TO-18 and coaxial packages.



400 mc POWER AMPLIFIERS AND OSCILLATORS

Guaranteed power outputs: 0.5 w at 160 mc (min. eff. 42%); 0.2 w at 240 mc (min. eff. 29%); 0.055 w at 400 mc (min. eff. 10%).



VIDEO AMPLIFIER TRANSISTORS

For driving CRT's and other high level ($V_{OUT} \geq 120$ V) wideband (to 5 mc) video requirements.

Philco complements its complete line of transistors with developments for new circuit possibilities. We welcome your comments and questions on these new Philco devices. Design samples and data are available now. Write Dept. E21662.

LANSDALE DIVISION
PHILCO
 A SUBSIDIARY OF *Ford Motor Company*
 LANSDALE, PENNSYLVANIA

*Micro Alloy Diffused-base Transistor



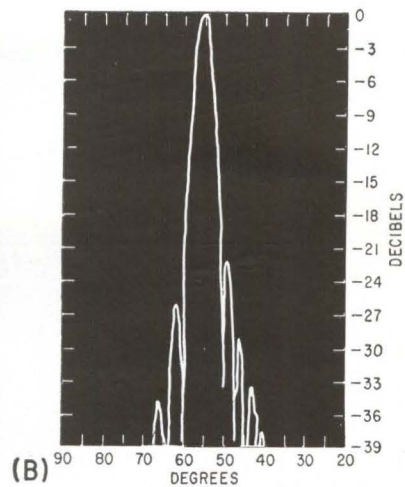
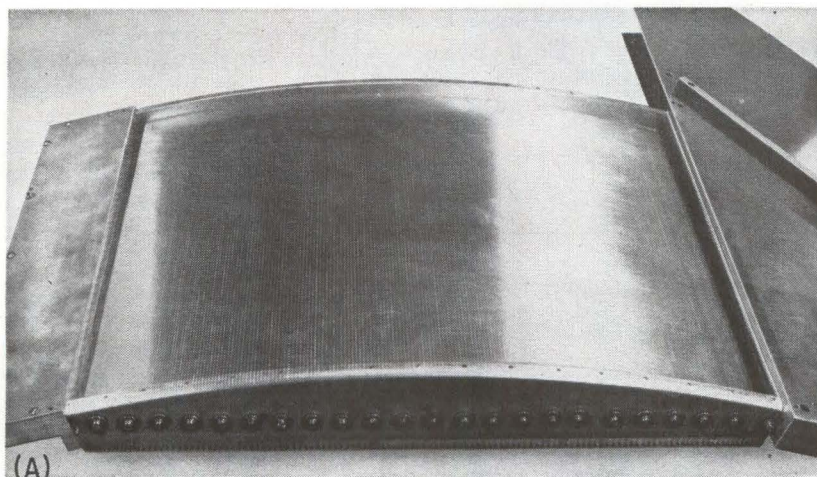

FIG. 1—Cylindrically contoured leaky-wave antenna (A) and its experimental H-plane pattern (B), measured at 11.42 Gc

New Leaky-Wave Antenna Designs

Basically a perforated waveguide, this type of antenna scans as its frequency is varied. This article describes several imaginative designs

By W. J. GETSINGER

Senior Research Engineer,
Electromagnetics Laboratory,
Stanford Research Inst.,
Menlo Park, Cal.

LEAKY-WAVE antennas are wide-band, wide-aperture devices radiating a narrow beam that scans with frequency. Because leaky-wave antennas are large in wavelength, they are most useful at microwave frequencies. Their thinness, small volume, and suitability for flush mounting makes them interesting for aircraft and missile radar, and communications applications, especially where rapid scanning or adjustment of beam direction is de-

sirable. Beam direction of these broad-bandwidth antennas depends on frequency; thus, a leaky-wave antenna can handle a number of frequencies simultaneously, routing or receiving different information in different directions.

The leaky-wave structure is a fast-wave transmission line, such as a waveguide. The construction of the line is altered in gradations, usually by perforating one wall of the waveguide; this causes a traveling wave on the line to leak its power to free space, gradually over the length of the aperture, without reflection. At the end of the aperture, the small power left in

the guide is absorbed in a load. This concept has proven useful because the accuracy of the analytical method used in design is less a limiting factor than the mechanical precision with which such an antenna can be built. This has been demonstrated by R. C. Honey of SRI, who provided much of the theoretical work basic to the leaky-wave realizations to be described.¹

The antenna shown in Fig. 1A has a curved radiating surface² but otherwise is similar to planar ones previously made by Honey. The wire grid, which forms the leaky wall, is stretched above a recessed metal wall. A TE_{01} wave, with the

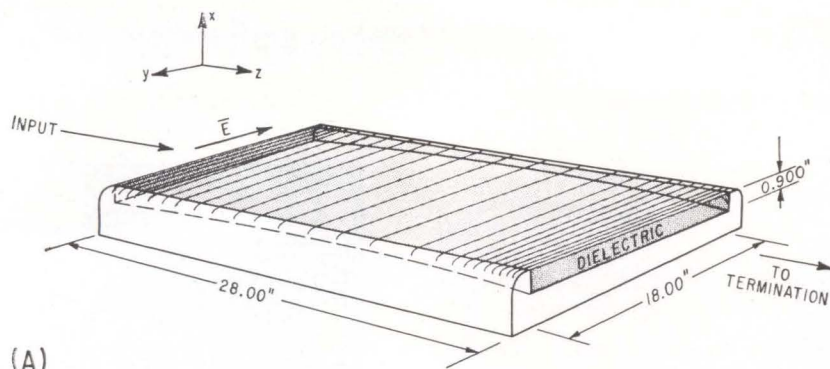

(A)

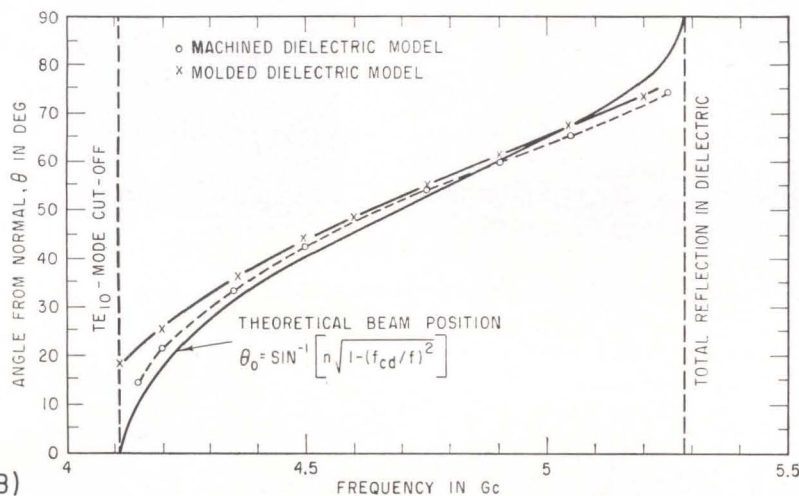

(B)

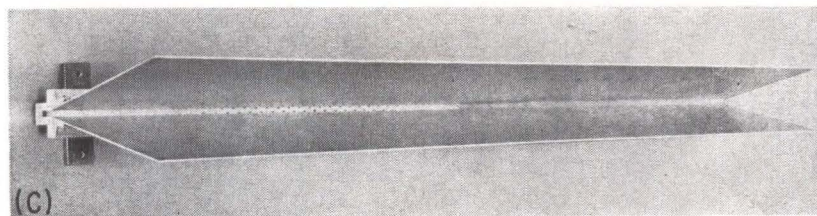

(C)

FIG. 2—Dielectric-loaded antenna (A) and effect of frequency on its beam position (B). Dielectric-loaded antenna of (C) operates in the X-band

E vector parallel to the wires, enters the structure from the right, gradually leaking power through the grid into free space as it passes to the left. Radius of curvature of the surface is about 46 inches, or 44 wave-lengths at the design frequency. Antenna aperture is 18 inches in the E-plane with an arc length of 24 inches in the H-plane. At the design frequency, 11.42 Gc, the experimental results (Fig. 1B) check well with theoretical predictions. The pencil beam is 3.8 deg wide in the H plane and 3 deg wide in the E plane; at 11.42 Gc, it is tilted 55 deg from the normal to the surface at the feed end. Leaky-wave antennas of this type can be designed to fit flush with singly curved surfaces, such as the skin of an aircraft or space vehicle.

The scan-with-frequency characteristic of the antenna shown in

Fig. 2A is enhanced by dielectric loading.³ The structure is like a dielectric-loaded rectangular waveguide. This antenna consists of a 28 × 18-inch trough filled with a dielectric material over which parallel wires are strung. At the design frequency, 4.75 Gc, the an-

tenna radiates a pencil beam 9.4 × 8.3 deg wide at an angle of 54 deg, measured from the normal to the input surface. Refraction at the dielectric-air interface causes the antenna to scan over a wide angle for only a small change of frequency. The antenna beam can be scanned from approximately 75 deg to 12 deg, measured from the normal to the aperture, by changing the frequency from 5.25 Gc to 4.20 Gc (Fig. 2B). Beyond both limits the radiation pattern deteriorates sharply.

The dielectric-loaded leaky-wave antenna shown in Fig. 2C operates at X band.⁴ Its leaky wall is a thin copper sheet with small rectangular holes placed periodically along the length of the aperture.

Figure 3A shows another leaky-wave antenna that uses periodically spaced small-amplitude radiators.^{4, 5} This antenna, which radiates a narrow, circularly polarized beam, consists of an array of waveguides laid side by side, radiating through crossed slots in their broad walls. The aperture is 20 inches long. It scans a five-degree beam through about 22 deg, with ellipticity less than six db, over a 25 percent frequency band centered about 9.0 Gc (Fig. 3B to 3D). Beam width and beam angle are practically the same along either principal axis of the polarization ellipse. Sidelobe structure is different along the principal axes and the first sidelobes are higher than calculated, for two reasons. First, a number of approximations were made in determining design equations for this antenna; second, there are physical difficulties in making the antenna structure precisely as designed. The design approximations, which cause the high first sidelobes, can be

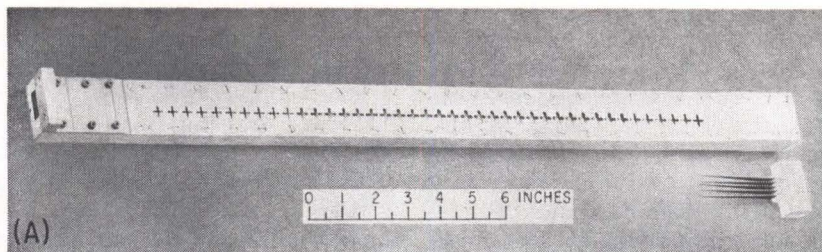

(A)

FIG. 3—Antenna (A) consists of an array of waveguides that radiate through their slots. Curves in (B), (C) and (D) at right, on next page, show effect of frequency on characteristics of the antenna's main beam

overcome by empirical adjustment of physical parameters. The constructional inaccuracies, which prevent accurate prediction of the details of the sidelobes at levels far below the level of the main beam, are usually not important, and for this type of antenna nothing would be done about them. However, there are other constructions that can be analyzed accurately and built with precision. An example of this is wire-grid construction, for which the predicted pattern can be achieved, up to the limits of accuracy of the measuring equipment (except for dielectric loaded antennas, whose performance is limited by nonuniformity of the dielectric).

Not as predictable as the wire-grid antenna, but more so than perforated-wall antennas, is the sturdy, mechanically reproducible transverse-slot leaky-wave antenna^{6,7} shown in Fig. 4. This antenna consists of an array of nine X-band waveguides placed side by side. Their broad walls are replaced on one side by metal bars, a quarter-wave thick, spaced to allow the energy in the waveguides to leak out so as to give the desired aperture distribution. The antenna is 9 inches wide and 20 inches long. It is fed from the hog horn (left side of photo) which produces approximately sinusoidal H-plane illumination over the 9-inch aperture width. At the design frequency of 11 Gc, beamwidths are 5.4 deg (E-plane) and 7.3 deg (H-plane) while the first-side-lobe levels were -24.7 db (E-plane) and -24.2 db (H-plane) (in close agreement with theoretical expectations of 25 db). Good radiation patterns were obtained from 7.0 Gc—slightly above the cut-off frequency of the guides

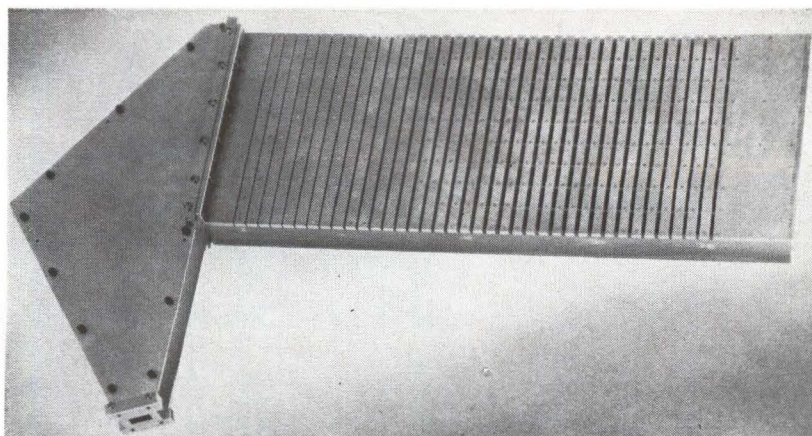

FIG. 4—Leaky-wave antenna comprises an array of nine waveguides

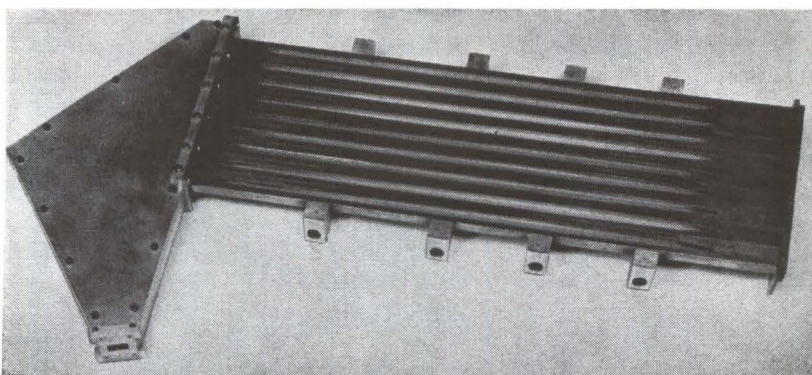

FIG. 5—This antenna comprises an array of waveguides and a dielectric cover, not shown here, over the waveguide slots

—to 11.5 Gc, slightly below the frequency at which spurious lobes are generated by the widely spaced slots. Over the range from 7 to 11.5 Gc, the position of the beam scans about a 35-degree interval. At 11 Gc, the position of the beam is within 0.35 deg of the design value of 36.6 deg above the plane of the array. This antenna can be flush mounted in the skin of an aircraft or space vehicle and requires only about one wavelength of depth.

The antenna in Fig. 5 is a planar array that requires a dielectric

covering (not shown).^{8,9} Thus, it has its own built-in radome.

The references give design equations and other detailed technical information. This work has been sponsored by the Air Force Cambridge Research Laboratories.

REFERENCES

- (1) R. C. Honey, A Flush-Mounted Leaky-Wave Antenna with Predictable Patterns, *IRE Trans PGAP-7*, 4, Oct. 1959.
- (2) R. C. Honey and J. K. Shimizu, "A Leaky-Wave Antenna with a Curved Aperture," Sci. Rpt. 5, Contract AF 19(604)-3502, S.R.I., Menlo Park, Cal., Feb. 1960.
- (3) J. Aasted and R. C. Honey, "A Dielectric-Loaded Leaky-Wave Antenna," Sci. Rpt. 8, Contract AF 19(604)-3502, S.R.I., Menlo Park, Cal., Mar. 1961.
- (4) W. J. Getsinger, "Leaky-Wave Antennas Using Periodically Spaced Small Apertures," Sci. Rpt. 10, Contract AF 19(604)-3502, S.R.I., Menlo Park, Cal., Mar. 1961.
- (5) W. J. Getsinger, "An Elliptically Polarized Leaky Wave Array," *IRE Trans PGAP-10*, to be pub. Mar. 1962.
- (6) E. M. T. Jones and J. K. Shimizu, "A Wide-Band Transverse-Slot Flush-Mounted Array," Sci. Rpt. 3, Contract AF 19(604)-3502, S.R.I., Menlo Park, Cal., Sept. 1959.
- (7) E. M. T. Jones and J. K. Shimizu, "A Wide-Band Transverse-Slot Flush-Mounted Array," *IRE Trans. PGAP-8*, July 1960.
- (8) E. D. Sharp and E. M. T. Jones, "An Antenna Array of Longitudinally-Slotted Dielectric-Loaded Waveguides," Sci. Rpt. 6, Contract AF 19(604)-3502, S.R.I., Menlo Park, Cal., Mar. 1961.
- (9) E. D. Sharp and E. M. T. Jones, "An Antenna Array of Longitudinally-Slotted Dielectric Loaded Waveguides," *IRE Trans. PGAP-10*, to be pub. Mar. 1962.

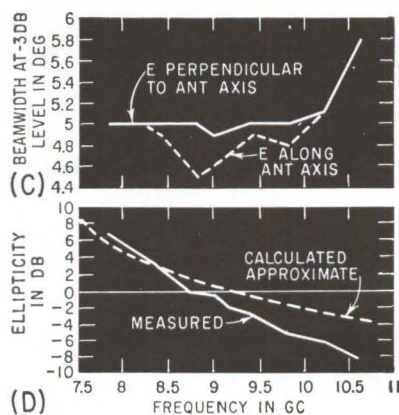
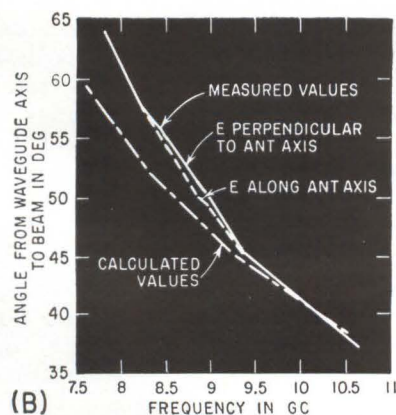

Solid-State Optoelectronic Commutator

Electroluminescent-photoconductive switching elements are combined into low-noise, high-gain switching arrays with high packing density

By R. D. STEWART

General Electric Co.,
Schenectady, N. Y.

VARIATION OF IMPEDANCE as a function of illumination makes the photoconductor suitable for use in solid-state commutators. The photoconductor (PC) has several advantages over other solid-state devices:

The PC and its actuating light source form a four-terminal device, with electrically isolated signal and control circuits.

The matching EL-PC (electroluminescent-photoconductor) arrays can be packed to less than 0.01 cubic inch per EL-PC pair.

Power gain, the ratio of maximum transferred signal power to switching power, is greater than 40 db for an EL-PC pair.¹

Minimum observed noise level of photoconductors is determined primarily by the Johnson noise of its equivalent resistance, permitting

detection of signals in the low microvolt region.

The photoconductor is linear over a wide range of signal levels.

The optoelectronic commutator can be defined as a suitably connected array of photoconductive switches. The simplest form is the single series PC, shown in Fig. 1A, where channel selection is by illumination of photoconductors. Here R_g and R_o are the generator and output impedances respectively, and the photoconductor has a resistance of R when lit, and KR when dark. Values of K of the order of 10^3 can be obtained with low-level, 1 ft-lambert excitation.

Expansion of this circuit to large numbers of channels is limited by the maximum obtainable on/off output ratio. The maximum number of channels is that which would cause the total contribution from the off channels to equal one ON channel signal.

A second type of photoconductive

switch is the T-section circuit of Fig. 1B. Again R_g and R_o are the generator and output impedance, and the photoconductor has a resistance of R when lit and KR when dark. The ON state corresponds to illumination of photoconductors 1 and 3, with cell 2 in a dark state, while the OFF state corresponds to a reversal of these conditions. In effect, PC's 1 and 2 form a voltage dividing circuit equivalent to a limited-range potentiometer, since both sides of the divider change resistance. Cell PC-3 does not enter into the switching function; however, if the switch is to be effective as a bidirectional device, it must also prevent signals from passing in the reverse direction.

Analysis of Fig. 1A indicates that independent of input or output impedances, the T-section has an on/off output ratio in excess of K . This permits cascading the T-sections, so that if n sections are cascaded, the total on/off output ratio is equal to or greater than K^n .

Substituting a single or cascaded T-section network for the single photoconductor of Fig. 1A produces a commutator with an improved on/off output ratio. However, the number of components and attenuation are increased.

The attenuation of a single T-section may be readily calculated. For cascaded T-sections it is first necessary to compute the total ABCD parameter matrix and then the attenuation as a function of the terminating impedance. A simplified procedure results from the use of a characteristic impedance termination, for then the total attenuation is the product of individual T-section attenuations. Thus for n identical cascaded T-sections, the total attenuation is the attenuation of a single section taken n times.

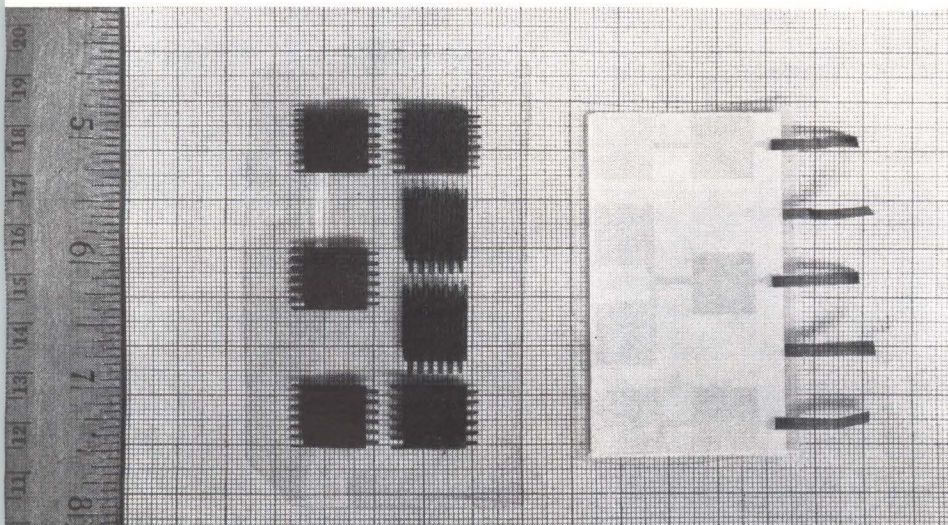

Matching electroluminescent-photoelectric arrays manufactured for high density packing

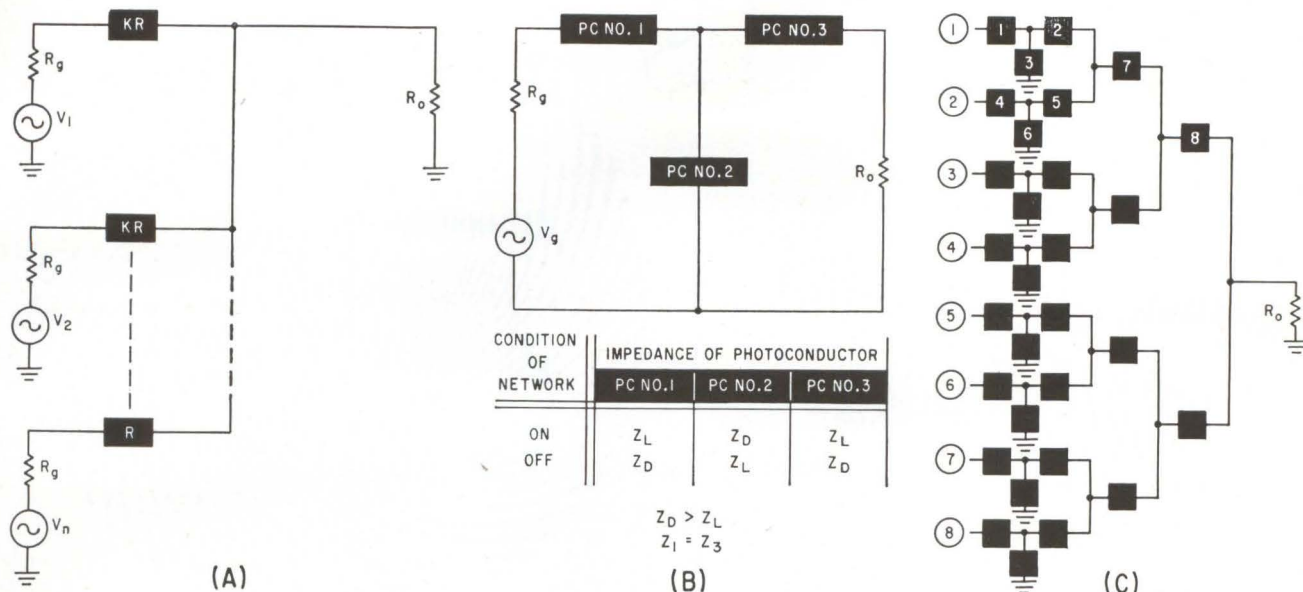

FIG. 1—Parallel operation of single photoconductive commutator sections, (A); photoconductor T-section configuration, (B); eight-channel binary output commutator, (C)

An improved method of interconnection is shown in Fig. 1C. This 8-channel commutator consists of a single T-section switch connected to a conventional binary tree. The channel of interest is activated by illuminating the T-section switch as previously described, and then illuminating the branches.

A reduction of the circuit of Fig. 1C is shown in Fig. 2, where the T-section is cascaded with the T-sections of the binary tree. The illuminated branches appear as the series arms of the T-sections, while each successive group of 2^q ($q = 0, 1, 2, \dots$) channels form the shunt arms. The combined series-parallel photoconductor combinations of the shunt arms may be approximated by a single photoconductor whose value is always less than $2KR$.

The final half-section filter, providing that $R_o > KR$, approximates the characteristic impedance of the preceding T-section. This approximation permits calculation of the total attenuation of the n -section channel as the n^{th} power of the attenuation of a single T-section.

An eight-channel commutator, corresponding to the circuit of Fig. 1C, was built and evaluated, using ohmic contact CdS photoconductors and orange electroluminescent cells. The lit resistance of the photoconductors was 800 ohms and the dark resistance 300 kilohms.

A test of attenuation (or gain) and on/off ratio was performed on each channel for frequencies from

1 Kc to 10 Mc. Since the photoconductor is an equivalent shunt R-C circuit, K decreases with higher frequencies, as shown in Fig. 3.

For the T-section switch of the commutator, the no-load output signal will reach 50 percent of its final value when the series and shunt resistances are equal; thus the time constant for the commutator is the time taken for two photoconductors, one initially lit and the other initially dark, to reach equal values of resistance, assuming that illumination conditions are reversed at time zero. Switching times were in the range of 50 to 200 milliseconds.

Since the d-c bias level of the photoconductor is reduced to zero, its noise level was equal to the Johnson or thermal noise of its equivalent resistance. Thus the noise associated with the four series-illuminated photoconductors of Fig. 3 is less than 12 microvolts for a 2-Megacycle bandwidth, representing the minimum possible signal level. The upper signal limit for most commercial photoconductors is at least 60 volts.

While the commutator was made with individual components, smaller, more economical photoconductive devices are available using array fabrication shown in the photograph. Coupled with the low power consumption of the EL cells—less than one quarter of a milliwatt real power per matching EL cell—the EL-PC commutator offers small

size, wide bandwidth, and low signal level capabilities.

This work was performed under contract AF30(602)-2164 with Rome Air Development Center.

REFERENCE

- (1) T. E. Bray, "Gain and Geometrical Considerations in Planar Optoelectronic Circuits"; 1961 International Solid State Circuits Conference.

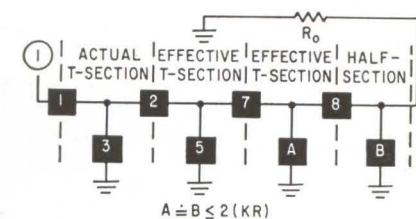

FIG. 2—Reduction of binary output commutator to actual and effective T-sections

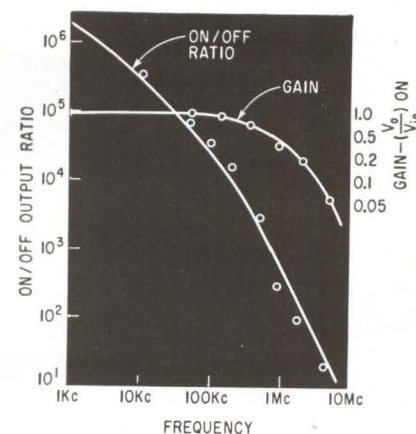

FIG. 3—Gain and on-off ratio for an eight-channel binary output commutator plotted against frequency

BIONICS

Part II: Animal Sensors and Electronic Analogs

Recent studies of the eye by microelectrode methods have led to design of sophisticated electronic and optoelectronic models of retinal functions. Similar studies of the ear are underway. Communications and data-processing fields may benefit from this work

AMONG biological transducers are the eyes, ears, olfactory senses, taste buds and touch sense. It is possible to include the senses of temperature, pain, vibration and equilibrium. Anatomists have also described in some creatures organs for which no function has yet been discovered.

Of the sensors, the eyes and ears have been of greatest interest. Over 90 percent of all information to the human brain comes through the eyes¹—each eye has 10^8 receptor cells that are stimulated by a photochemical process to produce trains of electrical pulses. These receptors feed into an optic tract of 10^6 ganglion nerve fibers. Thus there is a 100 to 1 redundancy between receptors and ganglion cells.

The ear has only about 30,000 nerve fibers in the auditory channel. All the other senses occupy only a few percent of the total channels feeding the brain.¹

The recent tendency of electronic engineering to reconsider complex parallel schemes in image-processing equipment has made the understanding of eye mechanisms important.² The activity of the eye

includes passing light to the retinal surface, the photochemical process at the retina, and the transformation of these processes into the coded signals that proceed up the optic channel to the visual areas of the brain.

The first of these three mechanisms has been covered chiefly in optics studies. Recent work at MIT's Neurology Group, Research Lab. of Electronics, under Dr. L. Stark, has been directed towards understanding the pupil servo-mechanism, which regulates the light falling on the retina, the sensitive region at the back of the eye. Working experimentally with a pupillometer and including human subjects in servo loops, Stark and his group are developing transfer functions for the pupil and retinal system to set up an analog model as a program for a digital computer.³ Eye servomechanisms are also under study at Cornell Aeronautical Labs in Buffalo, N. Y.

The entire eye itself engages continuously in small excursions even when the eye is fixed on a stationary object. When these excursions are stabilized in

an experimental setup, the image seen by the subject fades and disappears, showing that the eye motion plays a role in the sensory

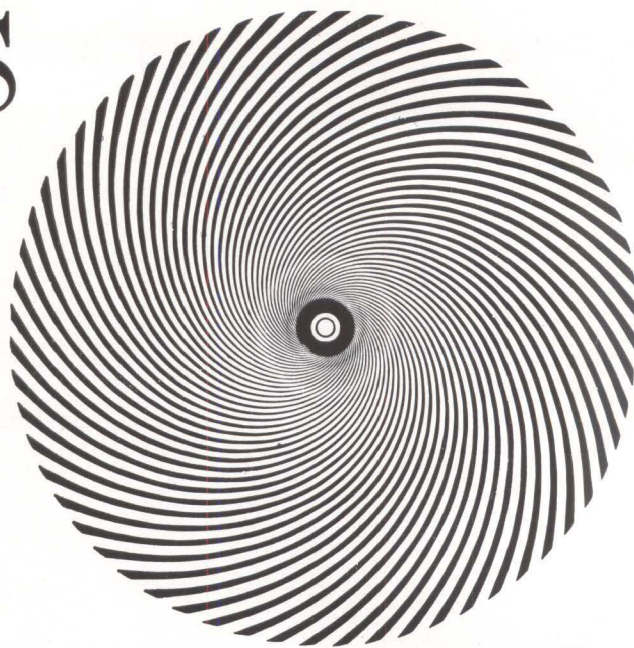

FIG. 1—Target figure produces complementary after-images used in psychological studies of visual processes

By NILO LINDGREN, Assistant Editor

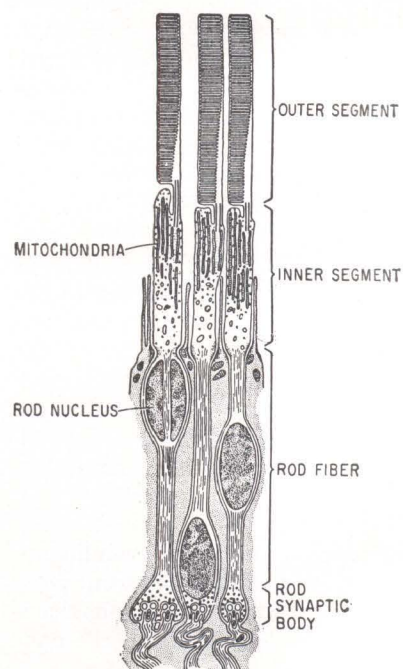

FIG. 2—Schematic of retinal rods in guinea pig eye (Rev. Mod. Physics)

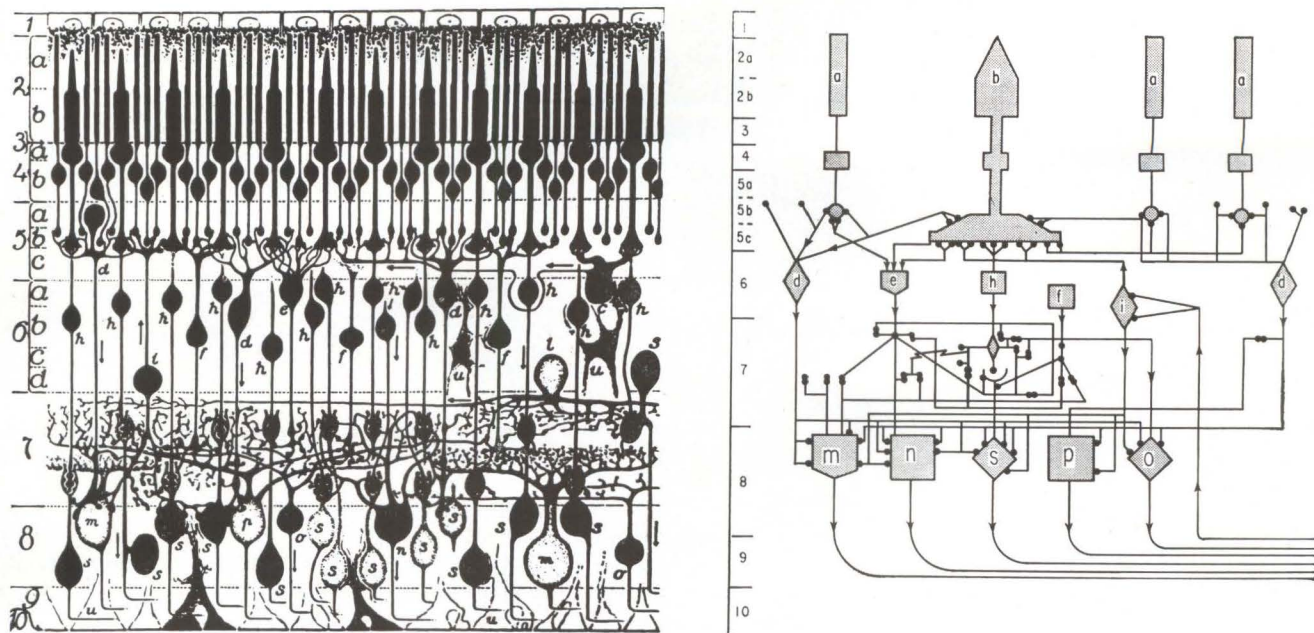

FIG. 3—Section of the primate retinal network (left) made by staining (Univ. of Chicago Press). And right, a clarification of some of the transverse wiring connections between the retinal components

function of the eye. Work on this is going on at McGill University under D. O. Hebb.⁴

Another phase of eye investigation deals with the correlation of unusual visual stimuli (such as those that evoke optical illusions) and overt responses. Donald MacKay, at the University College of N. Staffordshire in England, has done work on interactive processes in vision and their role in perception by constructing patterns such as Fig. 1. These produce complementary after-images suggesting the possibility of standing-wave phenomena.⁵ Coupled with new stroboscopic studies, such effects indicate that retinal velocity of the visual field is coded separately from changes in position.⁵

Another vision study using external stimuli is that of Bela Julesz at Bell Labs.⁶ In a series of experiments using stereo lenses with computer-generated artificial stereo patterns, and eliminating ordinary monocular depth cues such as linear perspective and apparent change in size of known objects, he demonstrated that depth perception is closely related to pattern recognition in the binocular field. Without monocular cues, depth can still be perceived with simple properties such as one-dimensional connectivity. The importance of his

findings is that such properties may be simulated by present computer technology, so that devices can be developed to determine depth automatically. These might be used to study aerial photographs or to draw three-dimensional relief maps automatically. Another application might be automatically perceiving a complex function in a three-dimensional arrangement of seemingly random signals.

Anatomically, the retina of the eye consists of multiple layers of cells, among whose branching dendrites there is much overlapping and interconnection. The transduction of light takes place in the receptor rods and cones that are arrayed by the millions, packed together like a phalanx, under the pigment layer. Figure 2 shows the structure of these retinal rods in a guinea pig.⁷ The outer segment converts light to chemical energy; the inner segment is an energy generating center. The entire rod body conducts stimuli along its length and at its bottom end these synapse or connect to the next level of cells.⁸ Figure 3 (left) shows the complex layers of cells that lie behind the level of the rod and cone receptors. This diagram⁷ is of the primate retina which includes man.

The nerve cells are called: (a) rods; (b) cones; (c) horizontal

cells; (d, e, f, h) bipolar cells; (i, l) amacrine cells; (m, n, o, p, s) ganglion cells; and (u) radial fibers. The ganglion cells branch out in treelike forms. The axons of these ganglion cells make up the optic nerve going to the brain. Through their dendritic branching and through the bipolar cells, the ganglion cells connect with many of the photoreceptor rods and cones. Thus they survey visual events over an area of several degrees on the retina.

Although the anatomical disposition of elements in the eye has been known for some time, definite knowledge about the roles of the different elements was gained only recently. By working with the frog, whose retinal structure is simpler than man's, and by using electrophysiological techniques, Lettvin, Maturana, Pitts and McCulloch, all at MIT, discovered many features of the frog's visual system, showing that the ganglion cells perform complex operations on the visual image.^{9, 10, 11}

Using microelectrodes, these researchers wire-tapped the connections from the frog's retina, through the twisted bundles of nerve fibers in the optic tract, up to the level of the tectum or visual area of the frog's brain. By moving objects of different sizes,

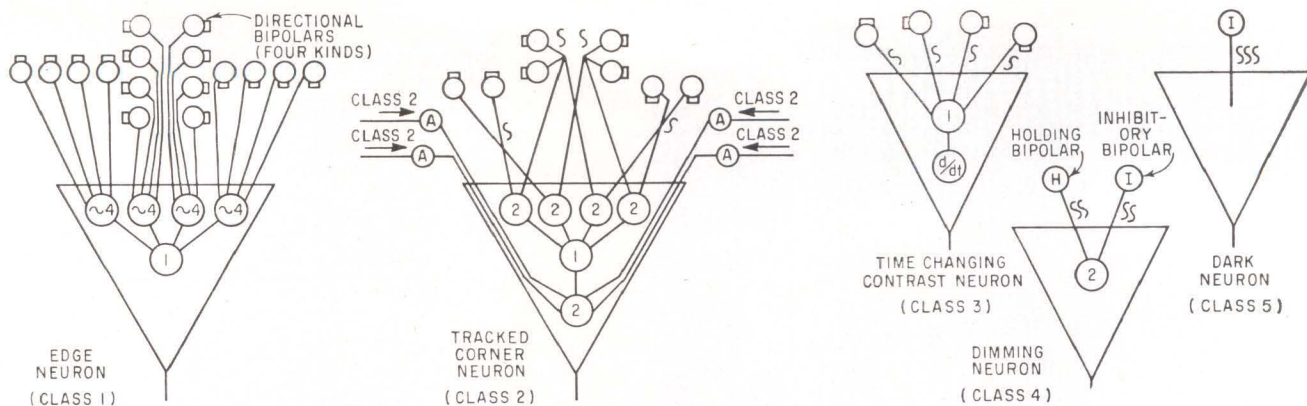

FIG. 4—Five types of ganglion cells that are part of a sophisticated synthetic frog retina being developed at the Radio Corp. of America's Princeton research laboratories

shapes and contrasts at differing speeds across the frog's visual field, by stopping them and moving them jerkily, by changing the illumination, and so forth, they traced the functions of the frog's eye.

In the frog's eye there are five types of ganglion cells, distinguishable by the shape and size of their dendritic branching. Lettvin and his colleagues associated five feature-extraction functions of the eye with these cell types—boundary detection, dimming detection, contrast movement and change detection, movement-gated dark convex boundary detection, and average light-level measurement.¹¹ Each class of cell also has a different sized responsive receptive field and different speed of signal conduction up the axons. The slowest signals arrive at the surface layers of the tectum, the fastest at the deepest.

Information passing up the axons of the ganglia emerges at the tectum in four separate layers, each layer receiving the axon terminations of a single function. All layers are in registration, and preserve a rough one-to-one mapping of the visual field. The fifth function, dark detection, terminates in the third layer, which is the changing-contrast detection.

Optimum responses for each ganglion type or function were found. Thus, the convexity detectors responded maximally when a dark object between 1 and 3 deg in diameter and having a sharp edge, moved in from the periphery of the visual field, something having the characteristics of a fly or bug. Changes of illumination have no effect, so long as the object is visible. The frog's visual apparatus

is thus admirably suited as an all-weather bug detector. Support for the frog's eye work was provided in part by the Signal Corps, Air Force, ONR and Bell Labs.

Recently, Lettvin has made similar studies of the eye of the octopus.¹² Other basic studies of octopus vision have been made by N. S. Sutherland, Oxford, and J. Z. Young and others at University College, London.

A. D. Little reports that in doing work in automatic pattern recognition, they have developed a Gestalt-type method of recognition that classifies patterns independently of position, orientation, size or perspective from which patterns are viewed, and that the method is similar to the methods used within the eye of the octopus.¹³

E. E. Loebner at RCA in Princeton, N. J. has designed a synthetic retina that duplicates the known functions of the frog's eye. The first design² has been generalized and improved to include time dependencies originally not taken into account.¹⁴ This work, under contract from the Bionics and Computer Branch of ASD, is to be completed by January 1963.¹⁵

The completed retina will measure about 35 × 35 inches,¹⁵ and will be built up in three layers of neurons—receptors, bipolars and ganglion cells. Solid-state optoelectronic active devices will be used, since such devices are amenable to inexpensive microminiaturization, and can serve also as logic elements.

The first layer will consist of 1,300 receptor units,¹⁵ connected locally to bipolar units in the second layer. The bipolar units are directional contrast neurons (oriented

to four directions), receiving facilitatory and inhibitory signals from receptors in the first layer. Two other types of bipolar units are the inhibitory and holding neurons, the latter having a slow memory decay. The holding neurons remember that an object has entered the field of view even though it may have stopped moving, just as the frog does. The third layer consists of 650 ganglion cells¹⁵ of all five types. Figure 4 shows something of the internal logic of the ganglion cells and their connections to the bipolar cells.

In addition to the frog's retina work, Loebner has also dealt analytically with the primate retina. Figure 3 (right) illustrates the transverse retinal signal network that provides direct pathways for electrical impulses from the receptor cells to the brain.² Not shown are the lateral or horizontal signal handling networks that exist in great abundance and complexity in the primate retina. Lettering corresponds to that in Fig. 3 (left). All types of diffuse bipolar neurons make contact with all types of ganglion cells. The midget bipolar (h), found only in human and simian retinas, has an input from one cone only (monosynaptic connection) and an output only to dendrites of ganglion cells; midget ganglion cells (s) are also monosynaptic, so that in these two cases signal transmission from receptor to brain occurs without processing.

The net-convexity detector function found in the frog's eye has also been roughly simulated with a model by Harmon at Bell Labs,¹⁰ using seven photoreceptors and only one electronic artificial neu-

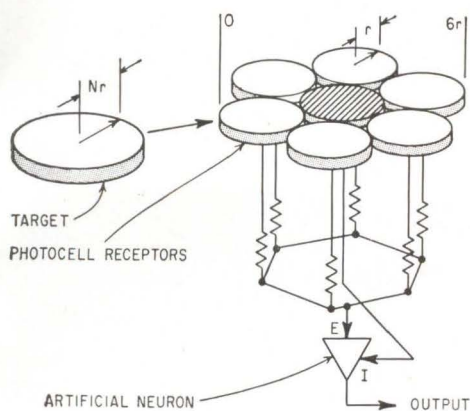

FIG. 5—Simple bug detector using one electronic neuron

ron that has many of the digital and analog properties of biological neurons. Figure 5 shows the "bug detector", consisting of a receptive field of seven photocells, the central shaded one supplying the inhibition function for the neuromime. Excitation comes from a weighted summation of the six surrounding photocells. Initially, the model is set up so that uniform illumination over the array causes excitation and inhibition outputs to cancel, and there is no output signal. If the central photoreceptor is completely covered, its output (inhibition to the neuromime) is maximally eliminated resulting in maximum excitation of the neuron. This represents the critical size, the size of the bug. More recent work, with more complex models built up with neuromimes, has led to the development of other visual functions.

A new understanding of color perception has also come about as a result of recent studies. In 1959, Edwin Land showed experimentally that colored scenes could be pro-

duced that contained all colors by mixing only two colors rather than the classical three. Following this, Huseyin Yilmaz at Sylvania developed a mathematical formulation of color vision based on two different color-sensitive elements. This theory may have an effect on color-system applications.

Fundamental physiological studies of animal seeing and hearing are going on in many laboratories and universities. For example: neuroelectric responses to sounds are being studied by T. Sandel, C. Molnar and others at the Communications Biophysics Group at MIT, under Walter Rosenblith. Feedback attenuation of aural signals is being studied by Gene Bernard at GE's Advanced Electronics Center. In the Visual and Acoustical Research department, at Bell Labs, studies by Larry Frishkopf have shown that there is an interaction between the auditory and vibration sense in the frog. The frog's vibration sense can be inhibited by higher frequency sounds between 300 and 1,000 cps.¹⁷ Also at Bell, William van Bergeijk has been studying binaural hearing in fish. At IBM and at the Neurology Group of RLE at MIT, the photosensitive "eye" in the tail of the crayfish has been under investigation.

Because the field of possibilities is so vast, the Air Force contracted Armour Research Foundation to survey the biological literature for ideas, components and systems applicable to communications. This contract resulted in an account, representing over 400 references, including nearly 160 papers and books on animal transducers alone.⁸ In addition, ASD has contracted a

team, representing medicine, zoology, and physics, at Adaptronics, Annandale, Va., to make a compilation of biological laws, effects and phenomena, with associated physical analogs.¹⁸

At Wright Field, in-house work goes on in the Bionics and Neurophysiology Section under the direction of Dr. J. R. Mundie. Two major areas are under investigation:¹⁹ (1) aural information processing—all levels of information processing within the auditory system; and (2) animal servomechanisms. The group is studying the design of the transducers in the ear, which are receivers that partially process information as well as code it. And they are studying the coding in the transmission of information in the communication channels between the ear and the aural region of the cerebral cortex. Here it is known there exists frequency localization. Working chiefly with guinea pigs, Mundie's group is trying to do for the ear what Lettvin did for the frog's eye, that is, determine the number of functional classes of channels that deliver information from the ear to the brain. Work on the mechanical action of the ear has shown that the ear acts like a band-pass filter that converts time domain information into space domain information in a manner close to a Fourier transform. Thus the group is attempting to find how much data analysis is done by the mechanical portion of the ear and how much is done by the neural elements, with emphasis on the neural elements. Besides basic aural research, the Air Force is sponsoring the development of ear analogs.

REFERENCES

- (1) L. D. Harmon, Analogs and Models of the Human Visual System, *Am Jl Optometry & Arch Am Acad Opto*, June 1959.
- (2) E. E. Loebner, Image Processing and Functional Retina Synthesis, RCA Labs, Princeton, in *Bionics Symp.*, WADD 60-600, Sept. 1960.
- (3) L. Stark, Stability, Oscillations, and Noise in the Human Pupil Servomechanism, *Proc IRE*, 47, No. 11, Nov. 1959.
- (4) R. M. Pritchard, Stabilized Images on the Retina, McGill Univ., *Sc. Am.*, June 1961.
- (5) D. M. MacKay, Interactive Processes in Visual Perception, p. 339 in "Sensory Communication", ed. by W. A. Rosenblith, MIT Press and Wiley & Sons, 1961; and D. M. MacKay, Behind the Eye, Fleming Memorial Lecture, given at Royal Institution, England, Jan. 26, 1961.
- (6) Bela Julesz, Binocular Depth Perception of Computer-Generated Patterns, *Bell Sys Tech Jour*, 39, Sept. 1960.
- (7) Retinal rods from F. S. Sjostrand, Fine Structure of Cytoplasm, *Rev. Mod. Physics*, April 1959. Primate retina from S. Polyak, "The Retina", 1942, copyright The Univ. of Chicago Press.
- (8) E. F. Uretz, et al. Creature Communication. Literature Review, Armour Research Foundation, III. Inst. of Tech., July 31, 1961.
- (9) J. Y. Lettvin, H. R. Maturana, W. S. McCulloch and W. H. Pitts, "What the Frog's Eye Tells the Frog's Brain," *Proc IRE*, p. 1,940, Nov. 1959.
- (10) H. R. Maturana, et al. Anatomy and Physiology of Vision in the Frog, *Jour Gen Physiol*, p. 129, 43, July 1960.
- (11) J. Y. Lettvin, et al. Two Remarks on the Visual System of the Frog, p. 757 in "Sensory Communication", ed. W. A. Rosenblith, MIT Press and Wiley & Sons, 1961.
- (12) J. Y. Lettvin and H. R. Maturana, Octopus Vision, Neurophysiology Section of Quarterly Progress Report, No. 61, MIT, RLE, April 15, 1961.
- (13) V. E. Giuliano, A. D. Little, Inc., Cambridge, Mass., Private Communication, Nov. 27, 1961.
- (14) E. E. Loebner and T. Henneberger, Image Processing in Synthetic Visual Organs, RCA Research Tech. Report, July 21, 1961.
- (15) Conversation with Dr. E. E. Loebner, RCA Research Labs, Princeton.
- (16) L. D. Harmon, Studies with Artificial Neurons, Part I, and W. A. van Bergeijk, Part II, Bell Labs Reports, Murray Hill, N. J.
- (17) Conversation with Dr. Larry Frishkopf, Bell Tel. Labs., Murray Hill.
- (18) Conversation with Col. Butsch, Capt. Knapp and Mr. Gwinn, Bionics and Computer Branch, ETL, ASD, at Wright Field.
- (19) Conversation with Dr. Mundie, Chief of Bionics and Neurophysiology Section, ASD, Wright Field.

DEVELOPMENTS IN BRITAIN: Millimeter

Trends toward more development of millimeter systems and components is indicated at physics show. Developments in transistors and computers also highlighted

By DEREK H. BARLOW, McGraw-Hill World News

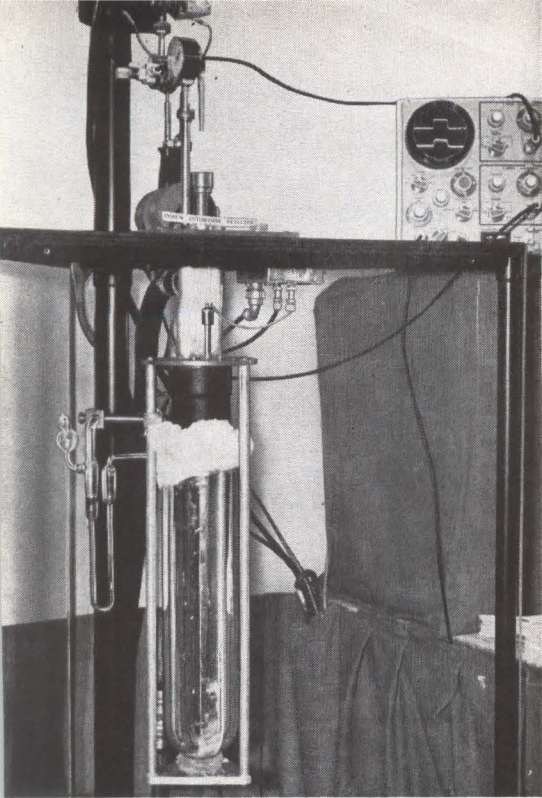

FIG. 1—Crystal detector for millimeter wavelengths is cooled to 1.5 K

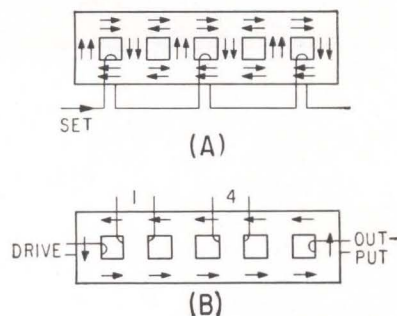

FIG. 2—Multiaperture square-loop ferrite logic combines set windings (A), and drive and four hold windings (B)

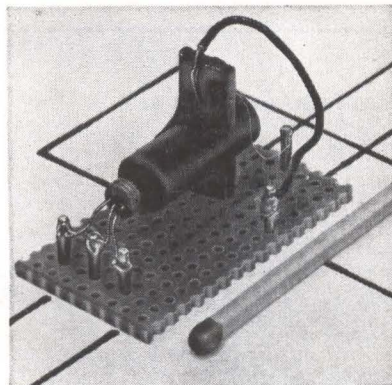

FIG. 3—Miniature analog memory can retain its memory even if power is turned off

HIGHLIGHTS of the Institute of Physics and Physical Society annual exhibition last month included 1,000 Mc transistors, new millimetric radiation detectors, analog memories, multiaperture ferrite logic, silicon carbide semiconductors operating at 500 C and large thyratrons and traveling wave tubes.

Exciting news at the show was the development of fast response photodetection of submillimeter radiation by the Ministry of Aviation's Royal Radar Establishment, which now enables measurements to be made in the 0.2-8.6 millimeter band. At these wavelengths, to produce photoconductive effects by exciting electrons into the conduction band of the semiconductor, demands impurity concentrations in an *n*-type indium antimonide material of less than $10^{14}/\text{cm}^3$. The RRE overcame this by applying a 6,000 gauss magnetic field across the material. This reduces interaction between neighboring impurities to sufficiently low levels to permit photoconductivity at millimeter wavelengths. Thermal ionization is eliminated by cryostat operation of the detector below 2 K. In the practical detector shown in Fig. 1, used for plasma investigations, the detector is mounted in a liquid helium cryostat pumped to 1.5 K. A superconducting niobium solenoid provides a magnetic field up to 8,000 gauss across the detector comprising an InSb *n*-type plate with dimensions of $5 \times 5 \times 1$ mm and a free carrier concentration of $5 \times 10^{18}/\text{cm}^3$. Incoming radiation is con-

densed onto the crystal by a tapered light-pipe. The crystal output feeds, via a pair of indium solder contacts, low-noise amplifier whose equivalent noise resistance is 14,100 ohms at 1.5 K. Initial experiments at RRE indicate the detector time constant as less than one microsecond.

In a single sideband generation system developed by Associated Electrical Industries, a single Hall effect vector multiplier will replace the two balanced modulators and addition networks required in conventional ssb generation methods.

The new system generates only the required single sideband, instead of producing both sidebands and suppressing one. Basis of the system is the concept of a frequency translated signal as the vector product of two rotating coplanar vectors representing the carrier and modulation signal. Rotating vectors at the Hall multiplier are produced by applying quadrature signals to quadrature spaced terminals, one vector being fed to the Hall plate itself, the other as a quadrature field across the plate. Multiplier output then gives direct frequency translation. The transmitted signal is received by a multiplier operating in reverse. The sideband signal is applied as the input current vector normal to the plane of rotation of the carrier so that the Hall output voltage rotates in the same plane. The voltages measured at the two positions in spatial quadrature are fed to phase-shift networks from which the original signal is recovered.

Detectors and High-Power Tubes

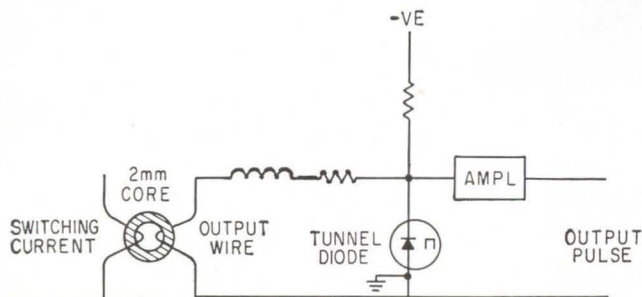

FIG. 4—Tunnel diode amplifies and stabilizes gain

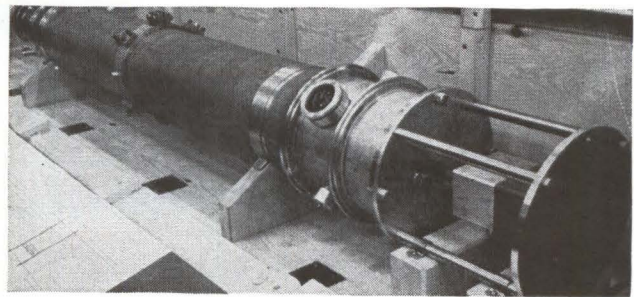

FIG. 5—400-Mc traveling-wave tube produces 100 Kw

New component techniques that British engineers are looking at include multiaperture square-loop ferrite logic, and novel memory systems. The multiaperture system shown in Fig. 2 was developed by Mullard Research Laboratories. It is a nine section ladder form with apertures $\frac{3}{8}$ inch square. By using a combination of four hold windings together with a set and drive input, AND, OR and NOT functions are generated. An additional feature especially useful in railroad signaling is the inhibit circuit achieved by a winding opposing the input drive pulse. The drive and set pulses are interlaced with the set pulse saturating the material. The subsequent drive pulse reverses the flux direction in the first two rungs. A hold pulse at the first hold winding prevents this flux change and switches the flux change into the fourth rung of the ladder. The output at the end of the ladder only occurs when all hold windings are energized, the system then acting as an AND unit. The OR function is generated by providing several windings on the particular rungs of the ladder so that any one of them (if energized) allows the transmission of the flux change past that rung.

Two approaches to analog memory systems look promising. One of these (Fig. 3) under development at the Bio-Engineering Department of the National Institute for Medical Research stores information without a continuous power drain and retains the stored state in the event of a power failure. It con-

sists of a transparent base filter covered with a conducting film to which copper can be plated. The optical density of the filter is reversibly changed by plating and unplating the film in accordance with the analog input. A light source and semiconductive detector measure the film density as a function of the analog quantity stored. Storage periods achieved to date are several weeks.

Second analog memory system under development at United Kingdom Atomic Energy Authority uses a barrier-grid storage tube together with a ferrite core store. The tube records analog voltages while digital information relating to the analog signal source is entered on the core. Both sets of information are read into a magnetic tape permanent store in digital form, the analog-digital conversion occurring in the barrier tube itself.

Specific circuit designs from research institutes and universities were new at the exhibition. One circuit (Fig. 4) overcomes problems associated with gain-stabilized, high-frequency response read-out amplifiers by using a tunnel diode to give both amplification and level discrimination on the output of a 2 mm core store. In the circuit developed by International Computers and Tabulators Ltd., the diode is biased below the peak point by a resistor. An inductor integrates the peak output from the store and applies it to the diode in the same sense as the bias voltage. Switching occurs when the sum exceeds the peak point, the system provid-

ing stable and accurately determined discriminating levels for signals below 100 mv.

Reversing normal capacitor-diode storage design at the Research Labs of Associated Electrical Industries (Woolwich) Ltd. resulted in a dynamic diode-capacitor store consuming zero power while storing information. Designed for storing telephone dialing information, the system uses capacitors to store the information, yes-no conditions being indicated by their charge.

At Mullard Ltd., experimental alloy diffused transistors are being produced with an f_t greater than 1,000 Mc and a base resistance of 20 ohms. Gains of 10 db are possible with 6-8 db noise figures. Silicon carbide is the new material being used for high temperature semiconductors by the British General Electric Co. Due to the material's high gap energy of 2.86 eV, GEC already has semiconductors operating satisfactorily up to 500 C. Another company, Joseph Lucas Ltd., is concentrating on high-voltage transistors and have developed an experimental silicon diffused npn power transistor having collector characteristics rated at 500 volts, 5 amps. Continuous power handling capacity of these transistors is 50 watts.

In more conventional tubes, GEC revealed two of the world's largest, a deuterium-filled, copper-envelope, water-cooled thyratron with a peak power of 175 megawatts and a 400 Mc travelling wave tube 9 feet long and 18 inches in diameter with 100 Kw pulse power Fig. 5.

Designing Tunnel-Diode Circuits

Tunnel diodes connected in series generate a multistable current-voltage characteristic that can be applied to design of high-speed digital circuits

By B. RABINOVICI and J. KLAPPER

Defense Electronic Products, Radio Corporation of America, New York, N. Y.

CONTROLLED DEVICES, such as tunnel diodes can be connected in series and a multistable composite characteristic obtained. If n tunnel diodes connected in series satisfy certain relationships between their peak and valley currents and their final voltages, the composite curve has $2^n - 1$ peaks, $2^n - 1$ valleys and 2^n stable positive regions. Composite characteristics of this type can be used to perform a number of functions such as binary addition, scaling and encoding.

Consider two tunnel diodes, D_1 and D_2 , connected in series and biased from a low impedance source. Let $I_{p1} < I_{p2}$, $I_{v1} > I_{v2}$ and $V_{f2} \cong 2V_{f1}$ where I_p is peak current, I_v is valley current and V_f is final voltage, Fig. 1. The combined characteristic is now obtained by

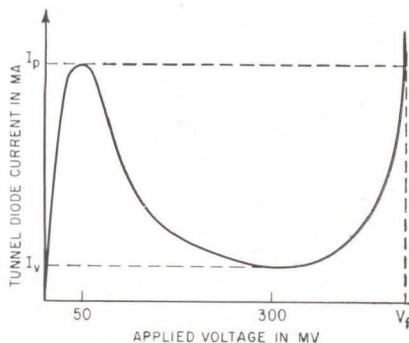

FIG. 1—Typical negative resistance characteristic of a single tunnel diode showing peak and valley currents and final voltage

noting that the current is identical in both tunnel diodes, while the combined voltage is the sum of the voltages across each.

As the applied voltage is increased from zero, the current through the tunnel diodes increases and the voltage across each tunnel diode is about the same, until the current reaches the value of I_{p1} . This is the first peak of the combined characteristic. If the voltage is raised beyond this point, the current in D_1 must decrease, forcing the current in D_2 also to decrease. Now, as the applied voltage increases, the voltage across D_1 increases, but that across D_2 decreases. This is so until I_{v1} is reached where the first valley of the combined characteristic is generated. If the voltage is increased further, the current and the voltage in both tunnel diodes increase, until I_{p2} is reached where the second peak of the combined characteristic is created. Beyond this point, increasing the voltage must result in a decrease of the current through the tunnel diodes. In this region, the voltage across D_2 increases but that across D_1 decreases. This is so until the current reaches the value of I_{v2} . Since the current must diminish further to reach the value I_{v2} and since D_1 permits this low current only when it is near the zero voltage level, D_1 is switched back by a further increase in voltage. The second valley of the combined char-

acteristic is obtained when the current decreases to I_{v2} . A further increase in the applied voltage sees both the current and the voltages across each tunnel diode increase until the current reaches the value I_{p1} , where the third peak of the combined characteristic is brought forth.

An applied voltage beyond this, means a smaller current due to D_1 , until the current has the value of I_{v1} , when the third valley of the combined characteristic is obtained. Further increases in the applied voltage result in an increase in current and the voltages of both tunnel diodes.

For n tunnel diodes in series meeting the specifications $I_{p1} < I_{p2} < \dots < I_{pn}$, $I_{v1} > I_{v2} > \dots > I_{vn}$; $V_{f1} \leq \frac{1}{2} V_{f2} \leq \dots \leq \frac{1}{2} V_{fn}$, $2^n - 1$ peaks, $2^n - 1$ valleys and 2^n positive resistance regions are obtained. A theoretical plot of three tunnel diodes in series satisfying these conditions is shown in Fig. 2A. The dotted portions are inaccessible in practice. An oscillogram of the characteristic of three commercial tunnel diodes in series is presented in Fig. 2B.

If the series connected tunnel diodes satisfying the conditions are biased from a constant-current source of value I_0 between the lowest peak and the highest valley, $I_{v1} < I_0 < I_{p1}$, 2^n stable operating points are obtained. This is illustrated for three tunnel diodes in

Using Composite Characteristics

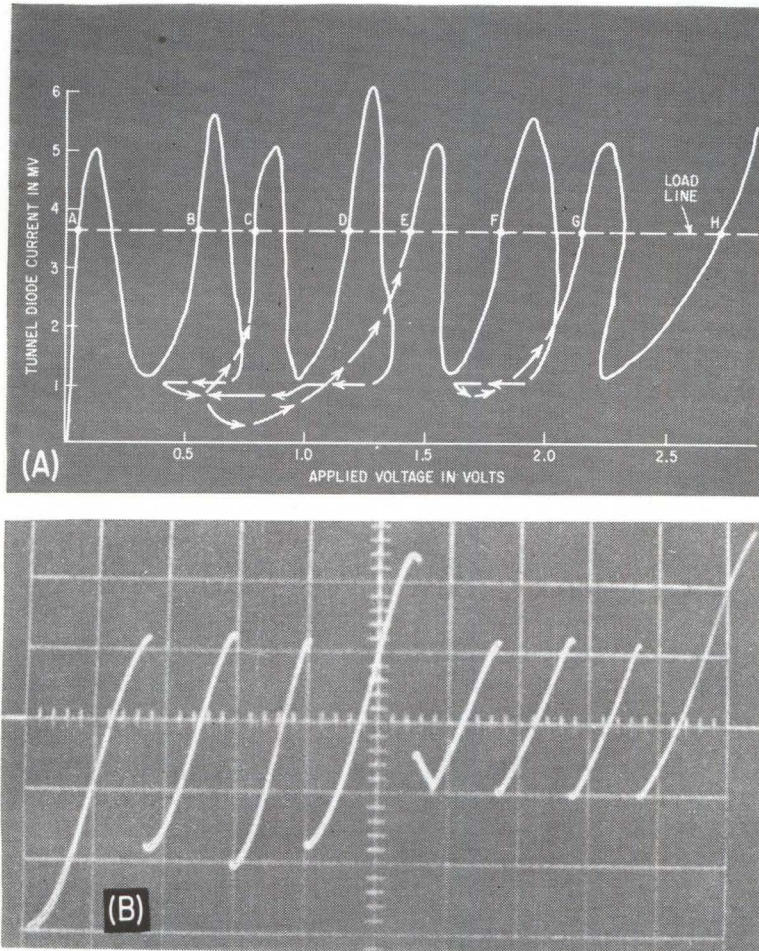

FIG. 2—Composite characteristic of three tunnel diodes connected in series (A) as plotted from theoretical values, and (B) an oscillogram of three commercial tunnel diodes in series

Fig. 2A, where the dashed line is the load line and points A through H are stable operating points. Thus three tunnel diodes can give eight stable states.

In order that the stable operating points be accessible, it is necessary to trigger from a low-impedance source. When triggered by pulses, the voltage across the series connected tunnel diodes is in the form of a staircase, giving $2^n - 1$ stairs for n tunnel diodes. For these stairs to be of equal height and all peaks be distinct, it is required that the V_i 's of the tunnel diodes from the series: 0.1, 0.3, 0.6, 1.1, 2.2, etc.

For ease of triggering, it is desirable that the pulse source impedance be as low as possible.

An operation performed by the arithmetic unit of a digital computer is the addition of two numbers, X, Y and a lower order carry C' to yield a sum and a carry in accordance with the truth table for full binary addition. A circuit capable of performing this addition is called a full binary adder. A full adder receives signals representing a 1 or 0 from three different sources, and adds them to give a 00, 01, 10, or 11, depending whether none, one, two or all three input

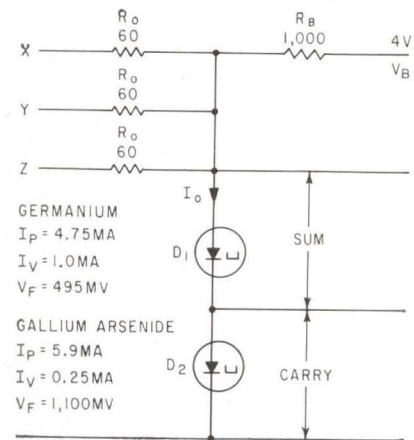

FIG. 3—Full binary adder uses two tunnel diodes in series

signals are 1. The carry obtained is fed to the next higher order. A conventional way of constructing a binary adder requires a large number of diodes or transistors arranged in four levels of logic driven serially, which greatly reduces the speed at which the circuit can be operated. A circuit having two tunnel diodes in series that performs the arithmetic function of full addition is shown in Fig. 3.

The two tunnel diodes D_1 and D_2 are made of Ge and GaAs, respectively. The effective load on the composite curve is $R_L = R_o/3$ and the quiescent d-c current flowing

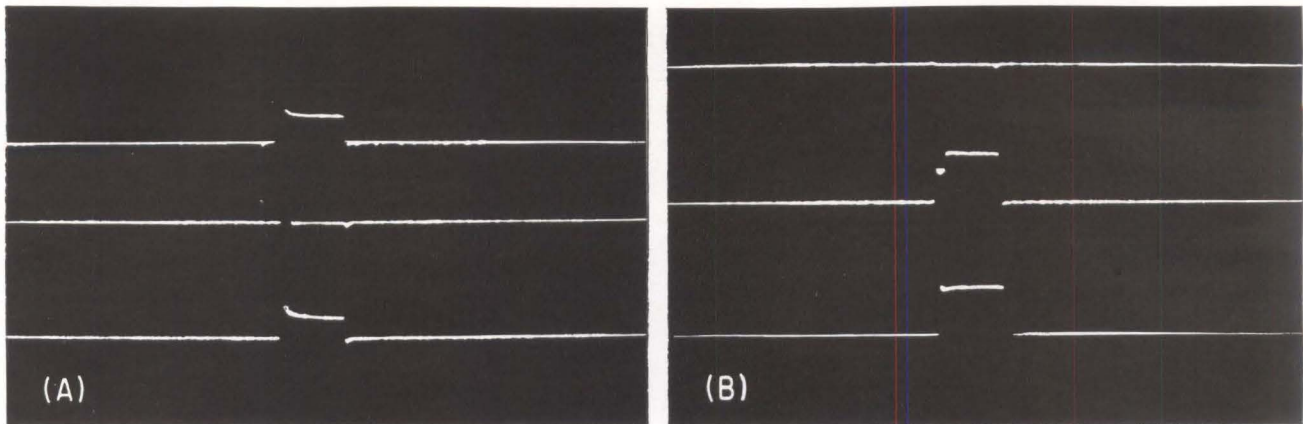

FIG. 4—Waveforms of sum (A) and carry (B) outputs of the full binary adder

through the diodes is I_v , where $I_v < I_p$. With one input receiving voltage signal V_v representing a 1, tunnel diode D_1 will switch to its high state whereas tunnel diode D_2 remains in the low state, and a 01 reading is registered across the diodes. With any two inputs receiving a 1, D_2 will switch over to its high state and D_1 will stay in its low state. The reading recorded across the diodes will now be 10. When all three inputs receive a 1 both tunnel diodes switch over to their high state and yield a reading of 11 across the diodes.

It should be observed that the digital circuit shown in Fig. 3 could be made to perform various logical functions by externally biasing on or off one of the inputs. From the truth table for full binary addition, if one input is biased, the sum has an output just for the case when

both inputs receive like assignments of 1 or 0. Thus the operation "if and only if" is accomplished. The carry is 0 just when both inputs have 0, thus an inclusive OR. On the other hand if one input is biased off, the sum has a 1 if and only if a 1 is assigned to either Y or Z, but not to both. This is the logical operation of exclusive OR. The carry has a 1 only if both inputs have 1 thus performing the logical operation of a connective AND. The experimental results of this adder are given in Fig. 4.

A circuit that performs the function of encoding data from analog form directly into binary digits is shown in Fig. 5. This circuit consists of three tunnel diodes in series providing eight discrete stable states. The individual tunnel diodes are: one Ge, one Si, and one GaAs. The load resistance is chosen

graphically to obtain a switching of state whenever the magnitude of the input voltage changes by a fixed amount.

Bias voltage V_v is applied to the circuit. The d-c current flowing through the diodes is I_v . The continuous voltage $v(t)$ representing an analog of some physical quantity being measured is applied to the input. When this voltage reaches v_1 , D_1 switches to its high state (this is arbitrarily chosen to represent a 1). The readings across the tunnel diodes are 001. When the input voltage reaches the value of $2v_1$, D_1 switches back to low state, D_2 switches on to high state and D_3 stays in the low state. The readings across the diodes will be 010. For an input voltage equal to $3v_1$, D_1 and D_2 will be in high state and D_3 in low state. The reading across the diodes will be 011, and so on. For $v(t)$ equal to $7v_1$ all tunnel diodes will be in the high state and readings across them will be 111.

To increase the resolution of the encoder to four or five bits would be difficult with present types of tunnel diodes. These circuits possess inherent capabilities of high operating speed. A time response analysis performed on the above circuits has indicated inherent capabilities of operating speeds of less than 10 nanoseconds. Measurements with a sampling oscilloscope show good agreement with the analytical results.

The author wishes to acknowledge the contributions of J. Sie to this work.

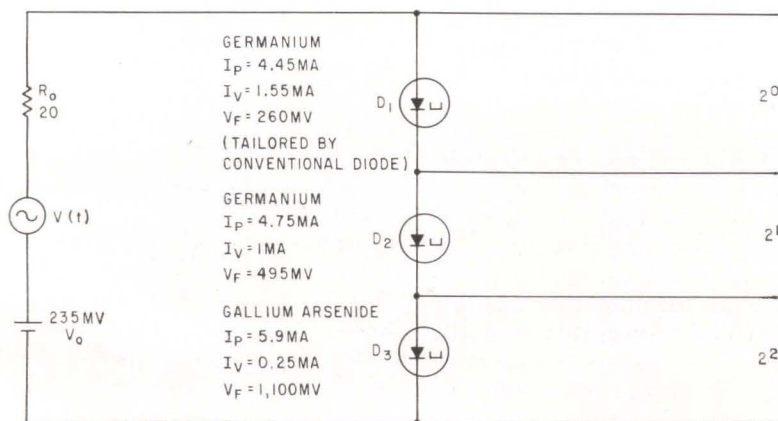

FIG. 5—Analog to digital converter using three tunnel diodes in series. Analog input is $V(t)$

Kodak reports on:

what the flying-spot scanner will tell the biochemist... PbSe detectors, stable in high vacuum...

Ektaline, sweet Ektaline

Disc electrophoresis

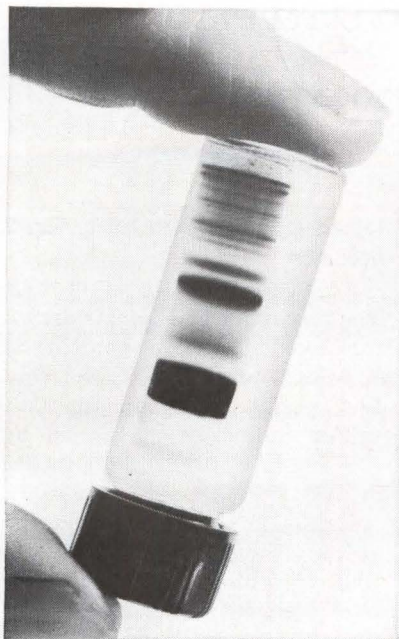

Each of the dark discs in this little tube of gel represents a different protein in a 3-microliter sample of normal human serum. The separation was effected in 30 minutes. The pattern tells a detailed story to the practiced eye. The equipment can be jerry-built in the laboratory for a materials outlay of about \$12.* The chemicals we recommend are *N,N*-Methylenbisacrylamide (Eastman 8383, meticulously recrystallized, gratefully praised for the purpose by those who know), *Acrylamide* (Eastman 5521), *2-Amino-2-(hydroxymethyl)-1,3-propanediol* (Eastman 4833), and *N,N,N',N'*-Tetramethylethylenediamine (Eastman 8178). To reduce dependence on perceptual machinery in the skull of the operator, a program is under development wherein protein concentrations represented by the discs are to be determined by a flying-spot scanner and the signals fed to a digital computer programmed to identify patterns at the rate of 10^4 per week.

Peripheral as may be our connection with the new disc electrophoresis, we can do our part by drum-beating in print for people to learn how Drs. B. J. Davis and Leonard Ornstein of The Mount Sinai Hospital Cell Research Laboratory in New York City have extended electrophoresis in the directions of 1) more simplified equipment

*Or it can be purchased in a variety of models from CANALCO, 4935 Cordell Ave., Bethesda 14, Md.

This is another advertisement where Eastman Kodak Company probes at random for mutual interests and occasionally a little revenue from those whose work has something to do with science

For sale practically off the shelf:

(unless response to this advertisement swamps us)

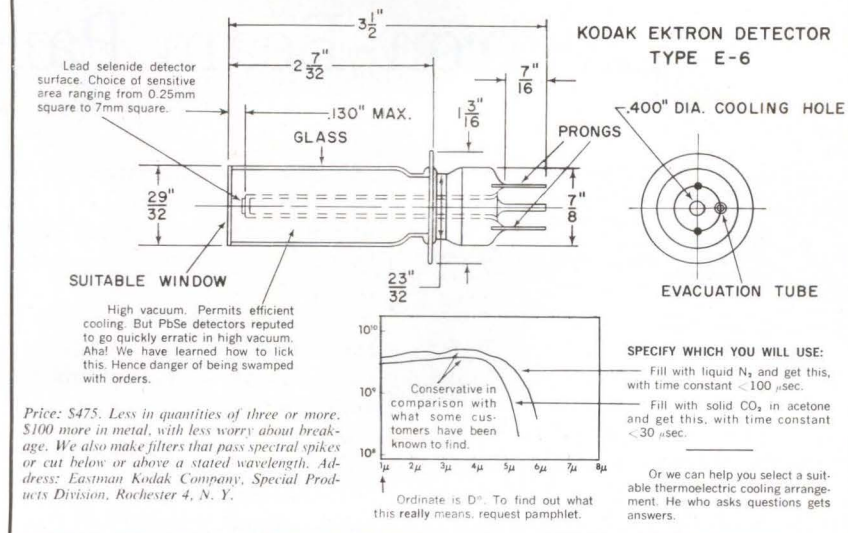

that gets you into the technique easily; 2) more sophisticated equipment that speeds and refines results once you have found the technique indispensable; 3) a clear (albeit concentrated and mathematical) exposition of the physical chemistry at work.

We propose a little experiment in casting bread upon the waters. We shall count how many will accept an offer hereby made by Distillation Products Industries, Rochester 3, N. Y. (Division of Eastman Kodak Company) to send a free preprint of a paper by Dr. Ornstein on the theory and a fully illustrated set of directions by Dr. Davis on how to proceed. Then we shall wait and count how many orders come in for the above-named Eastman Organic Chemicals. The results of this experiment you will never know.

THIS paper

"My husband sells oscillograph paper. Competition is fierce. He comes home beat every night."

Few overhearing her would know what the poor soul is talking about, yet she speaks the truth. With research and development activity now constituting such a respectable fraction of the Gross National Product, oscillographs probably outnumber pickle barrels in this country at the present time. Oscillographers are correspondingly numerous. Methods that one sect of oscillographers prefers above all else another sect can't see for dirt. One sect prefers automatic oscillogram processors. Paper manufacturers like us find their favor worth competing for.

Therefore we announce a new advance in media for their use.

An advance in the old art of paper-making came first. Then new emulsions were devised to work properly with the new base. Then proper processing chemicals were devised for the new emulsions. Then the combination was extensively proved out under practical conditions of use by parties interested only in end results and hardly at all in the how and why. They found that

1. THIS paper dries thoroughly at high processor speeds without creases. 180 in./min. is not too fast.
2. THIS paper gives trace lines that stand out as black as the ace of spades. Background is nice and clean.
3. THIS paper isn't fussy about how long it sits around before use. O.K. to keep plenty on hand.
4. THIS paper is rugged. No cracking, no crumbling.
5. THIS paper holds its dimensions. Justifies careful measurement.

"THIS" won't do for a trademark. (The code name for the field trials was "Kind 1534.") Let's call it Kodak Ektaline paper. It comes in the two usual speeds for oscillographs, Kodak Ektaline 16 paper and Kodak Ektaline 18 paper. Kodak Ektaline chemicals come as liquids. The stabilization principle used in the automatic oscillogram processors came from Kodak, too. An inquiry to Eastman Kodak Company, Photorecording Methods Division, Rochester 4, N. Y., puts everything in place right up to the moment.

Prices are subject to change without notice.

Kodak
TRADE MARK

Design Chart for Calculating Electron-Beam Parameters

By D. L. HOLLWAY

Division of Electrotechnology,
National Standards Laboratory,
Commonwealth Scientific and
Industrial Research Organization,
Chippendale, N. S. W., Australia

IN DESIGNING electron-beam devices, such as oscilloscope and microwave tubes, the problem is that of finding numerical values satisfying design requirements for the mutually interacting variables: V = beam voltage, I = beam current, Z_s = distance between the electron gun (or objective lens) and screen, r_i = initial radius of the electron beam and r_s = the radius of the smallest spot that can be focused at the distance z_s .

In addition to aberrations of the focusing system, two fundamental effects limit the spot current density: beam defocusing by space-charge repulsion and beam spreading caused by random thermal velocities of the emitted electrons.

To obtain the smallest possible spot at a given distance it is necessary to set the initial convergence to a greater value than is needed to bring the beam to a

point focus at the screen in the absence of space-charge. The beam contour then passes through a minimum before reaching the screen, Fig. 1, the minimum plane being close to the screen when the effect of space-charge is small and moving back towards the gun as it is increased.

The following approximation is more convenient when the spot radius falls between 1/20 and twice the initial beam radius

$$r_s r_c / r_i = 5.9 \times 10^4 [(Z_s / r_i) (I / V^{3/2})^{1/2}]^{5/2} \quad (1)$$

where I = beam current in amp.

It is possible to present exact solutions in a chart (Fig. 2) and to include a scale giving spot size determined by thermal velocity spreading. This is based upon Langmuir's equation

$$\rho_o = \rho_c [(eV/KT) + 1] \sin^2 \alpha \quad (2)$$

where ρ_o and ρ_c are the spot and cathode current densities, T is the cathode temperature and α is half the angle of convergence of the beam. To find ρ_c let r_c denote the radius of a cathode emitting the beam current I at a uniform density $\rho_c = I / (\pi r_c^2)$. As r_i / z_s

$\approx \sin \alpha$ and $V \gg kT/e$, Eq. 2 becomes

$$r_s / r_c = (Z_s / r_i) (KT/eV)^{1/2} \quad (3)$$

The r_s / r_c scale of Fig. 2 is drawn for an oxide cathode operating at 1,160 K, thus $kT/eV = 0.1$ volt. For thoriated tungsten the r_s / r_c values should be multiplied by 1.3 and for tungsten cathodes by 1.5.

In Eq. 2, ρ_o is the peak value of a Gaussian distribution, whereas a uniform beam density was assumed in the analysis of space charge defocusing. According to Moss, it is convenient to define r_s as the radius at $1/\epsilon$ amplitude, so that $I = \rho_o \pi r_s^2$.

Use of the chart is shown by this example:

An oscilloscope tube operating at 1,000 v has an initial beam radius of 1 mm and a screen distance of 14 cm. Find the radius of the smallest spot that may be focused at a beam current of 50 μ amp.

The line joining $V = 1,000$ at point A and $I = 50 \mu$ amp at B cuts the perveance scale at point C, $I/V^{3/2} = 1.58 \times 10^{-9}$. Join point C to D, at $z_s/r_i = 140$, and continue across to the r_s/r_i scale at E, $r_s/r_i = 0.14$. Minimum spot size determined by space-charge repulsion is 0.14 mm.

To find the value of ρ_c at which thermal velocities also raise the minimum spot size to $r_s = 0.14$ mm, join the voltage and screen distance scales at A and D and project the line to F, cutting the r_s/r_c scale at 1.4. Thus for $r_s = 0.14$ mm, r_c may not exceed 0.1 mm and $\rho_c = I / (\pi r_c^2) = 0.16$ amp cm^{-2} . In practice the cathode density must be somewhat greater, as ρ_c does not include emission intercepted by stops in the electron gun.

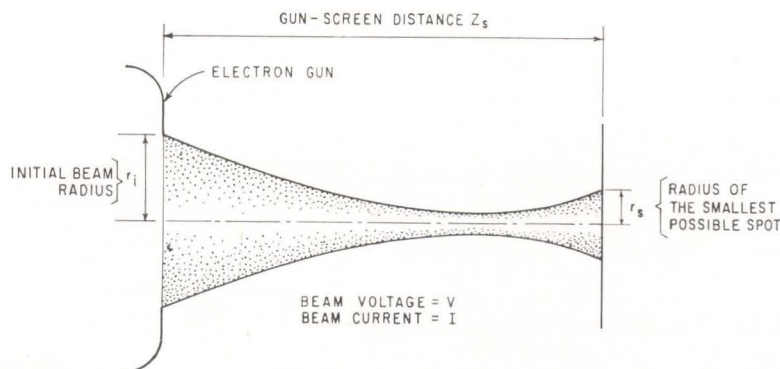
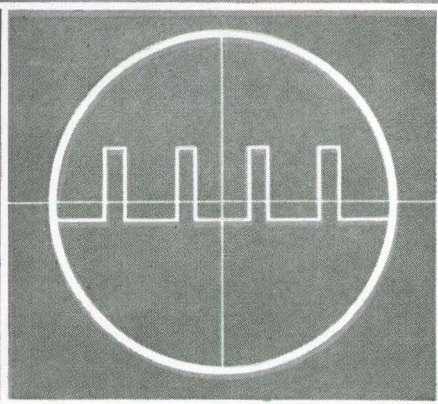

FIG. 1—Dimensions and contour of a typical electron beam having circular symmetry when focused for the smallest spot

ALL-NEW...

TRUE RMS VOLTMETER

now . . . measure
true RMS value
of virtually all
waveforms



MODEL 910A

For the *first time* one instrument provides 1% midband accuracy, 10 cps to 7mc bandwidth, plus 100 u v sensitivity. For added versatility an amplifier output is provided for simultaneous oscilloscope or recorder monitoring.

Model 910A employs a thermocouple located in the feedback loop of a sensitive DC amplifier to measure the actual heating effect of the input waveform. This circuit arrangement is the key to the rapid response and high calibration accuracy of the Model 910A and also prevents any error in reading due to ambient temperature variation. Isolation of the thermocouple from the input terminals by a high gain, ultra stable AC amplifier provides high input impedance and completely protects the thermocouple from burnout under any condition of overload.

Model 910A is ideal for measuring AC currents in non linear devices, total harmonic content of distorted waveforms, noise, average power of pulse trains, and other measurements that involve waveforms which are not necessarily pure sinusoids.

Prices and data subject to change without notice.

A more complete description
will be sent to you upon request.

JOHN FLUKE MFG. CO., INC.
P. O. Box 7428 Seattle 33, Washington

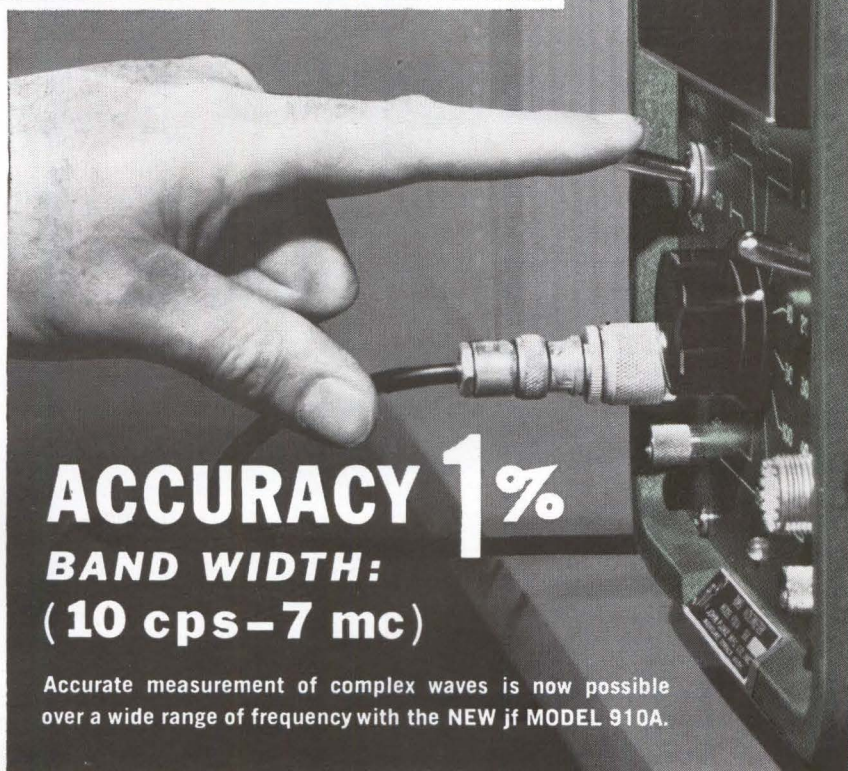

ACCURACY 1%
BAND WIDTH:
(10 cps - 7 mc)

Accurate measurement of complex waves is now possible
over a wide range of frequency with the NEW jf MODEL 910A.

Partial Specifications—jf MODEL 910A

Voltage Range:	1 MV to 300V (full scale readings)
Decibel Range:	-72 to +52 dbm
Frequency Response:	10 cps to 7Mc
Accuracy:	± 1% of full scale 50 cps to 800 KC ± 2% of full scale 20 cps to 2Mc ± 3% of full scale 20 cps to 3.5 Mc ± 5% of full scale 10 cps to 7 Mc
Input Impedance:	10 megohms shunted by 30 pf for 0.3 volt range and below, 10 megohms shunted by 15 pf for 1.0 volt range and above.
Crest Factor:	3 at full scale, proportionately higher for readings less than full scale.
Price:	Cabinet Model—\$545.00 Rack Model—\$565.00 Prices f.o.b. factory.

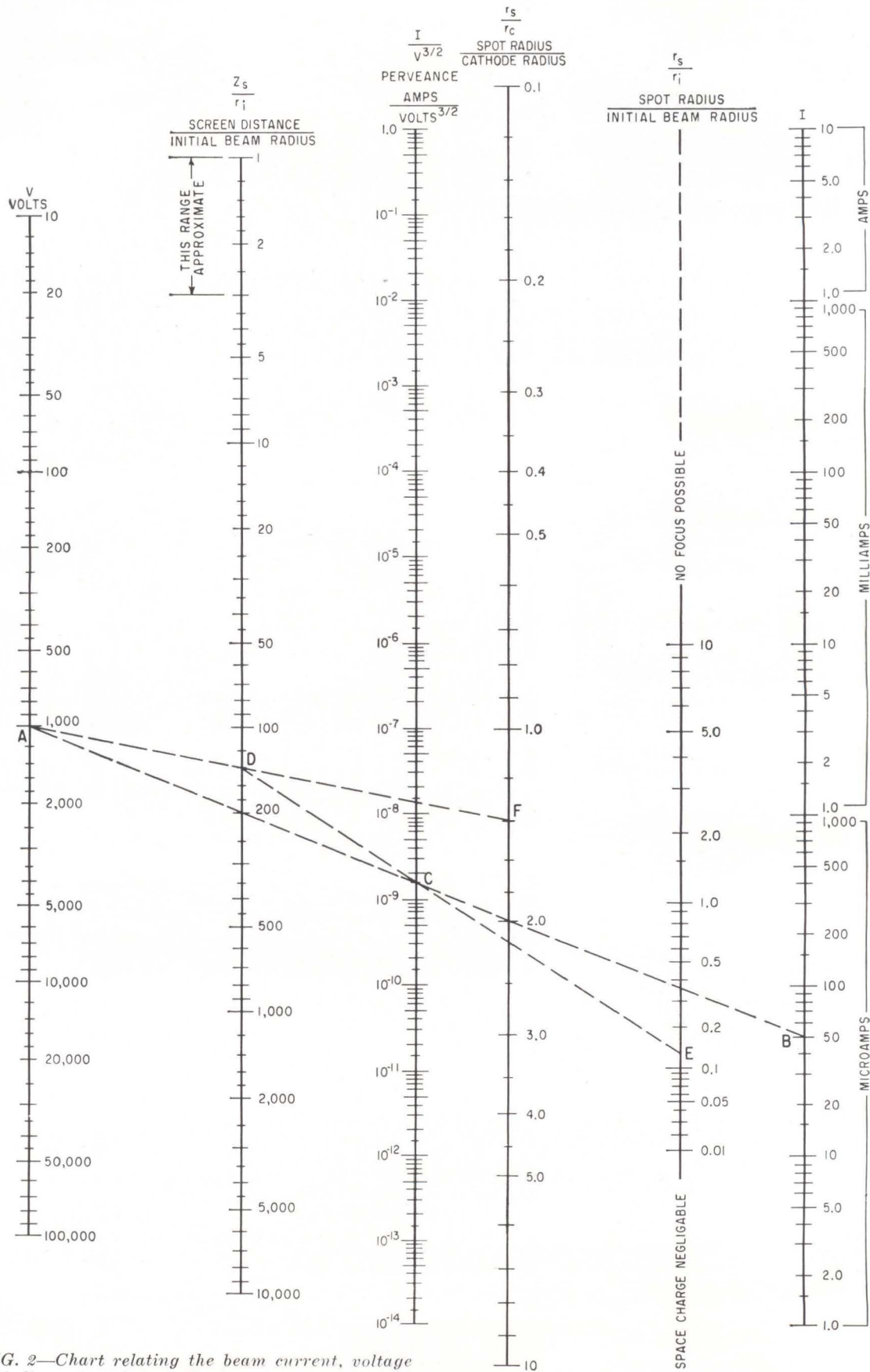
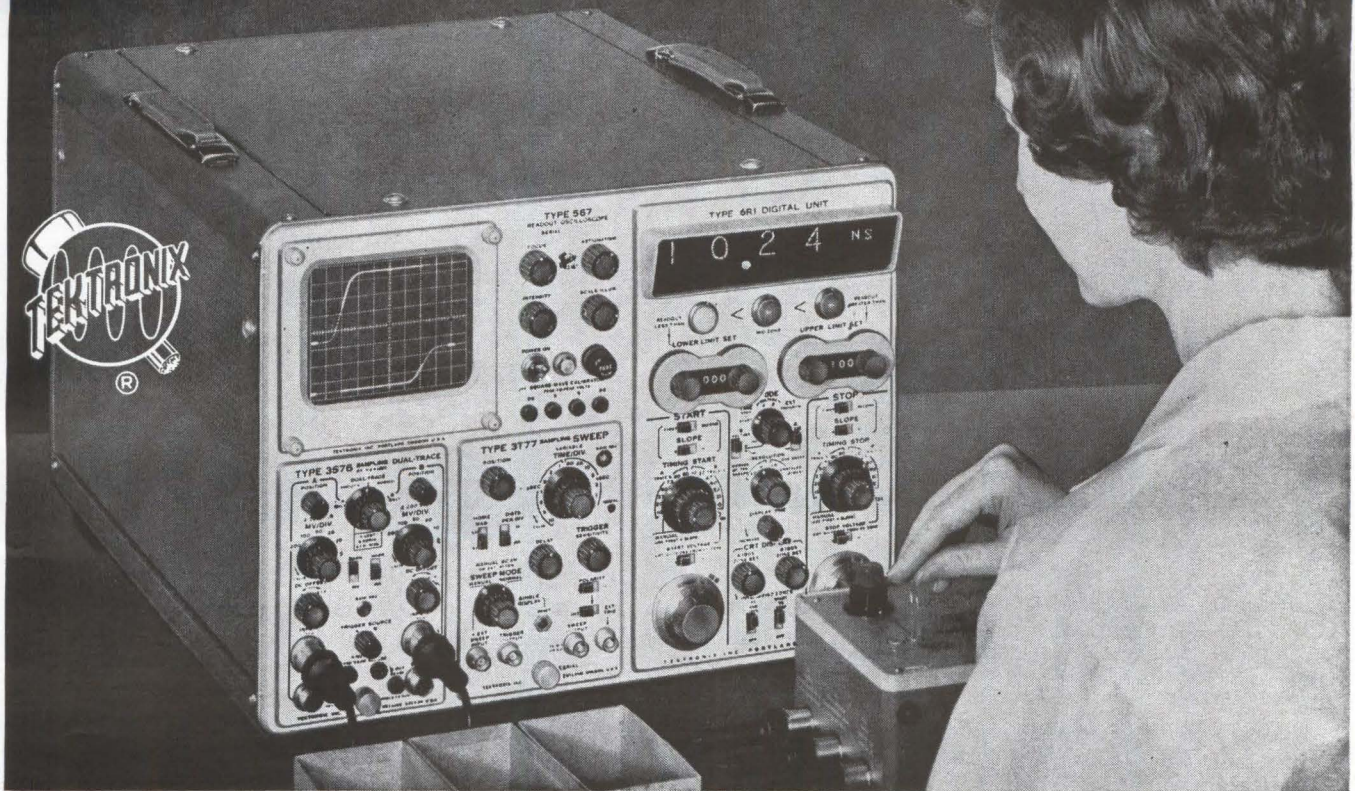

FIG. 2—Chart relating the beam current, voltage and dimensions for condition of optimum focus

FASTER AND SIMPLER PRODUCTION-RUN TESTS WITH NEW DIGITAL READOUT OSCILLOSCOPE



DIGITAL READOUT of time differences as short as 50 picoseconds.

DIGITAL READOUT of pulse risetimes as fast as one-half nanosecond.

DIGITAL READOUT of pulse amplitudes as small as 2 millivolts peak-to-peak.

With a Tektronix Readout Oscilloscope you can check production-run units faster and easier—for simultaneously with the analog display on the 5-inch crt, you have a digital presentation on the automatic computing programmer.

You set the program *once* for all successive similar measurements.

For each quality-control check, you merely read the up-to-4-digit decimal units of actual measurement.

Indicators light to designate the readout status—whether *in* the preset-limit range, *below* it, or *above* it.

In a typical application such as transistor-switching-time measurements, you can read directly such characteristics as the delay, rise, storage, and fall times; the total turn-on and turn-off times; the width of pulse A and pulse B; and time and amplitude between two selected points on either or both waveforms. You know immediately by the digital presentation and indicator lights whether or not the item tested has met specifications.

On a production line, in a laboratory, or for sustained testing programs, the digital readout convenience of a Type 567 can speed-up and simplify measurement of pulse amplitudes and time increments between percentages of selected amplitude levels *on an absolute or relative basis*. In addition, you can also measure pulse amplitudes and time increments on differential signals between A and B inputs.

To achieve this faster and simpler approach to precision measurement, the Type 567 incorporates many features *new* to an oscilloscope. In the automatic computing programmer, for example, some of these new features include: positionable measurement-reference zones, automatic normalization, zone-intensity markers, automatic and manual start-timing and stop-timing systems, preset-limit selector and indicators, provision for external programming. These features—and others in the two sampling plug-in units and the oscilloscope itself—enable the new Type 567 to greatly increase your measurement proficiency.

Type 567 Readout Oscilloscope (without plug-ins) \$ 700

Plug-In Units include:

Type 6R1 Digital Unit (Automatic Computing Programmer) \$2500

Type 3S76 Sampling Dual-Trace Unit \$1100

Type 3T77 Sampling Sweep Unit \$ 650

U.S. Sales Prices, f.o.b. Beaverton, Oregon

For complete information about the characteristics and capabilities of this new Digital Readout Oscilloscope, please call your Tektronix Field Engineer.

Tektronix, Inc. P. O. BOX 500 • BEAVERTON, OREGON / Mitchell 4-0161 • TWX—BEAV 311 • Cable: TEKTRONIX

TEKTRONIX FIELD OFFICES: Albuquerque, N. Mex. • Atlanta, Ga. • Baltimore (Towson) Md. • Boston (Lexington) Mass. • Buffalo, N.Y. • Chicago (Park Ridge) Ill. • Cleveland, Ohio • Dallas, Texas • Dayton, Ohio • Denver, Colo. • Detroit (Lathrup Village) Mich. • Endicott (Endwell) N.Y. • Greensboro, N.C. • Houston, Texas • Indianapolis, Ind. • Kansas City (Mission) Kan. • Los Angeles, Calif. Area (East Los Angeles Encino • West Los Angeles) • Minneapolis, Minn. • Montreal, Quebec, Canada • New York City Area (Albertson, L.I., N.Y. • Stamford, Conn. • Union, N.J.) • Orlando, Fla. • Philadelphia, Pa. • Phoenix (Scottsdale) Ariz. • Portland, Oreg. • Poughkeepsie, N.Y. • San Diego, Calif. • San Francisco, Calif. Area (Lafayette, Palo Alto) • Seattle, Wash. • Syracuse, N.Y. • Toronto (Willowdale) Ont., Canada • Washington, D.C. (Annandale, Va.),

ENGINEERING REPRESENTATIVES: Ketrion Hawaii Ltd., Honolulu, Hawaii. Tektronix is represented in twenty-five overseas countries by qualified engineering organizations.

European and African countries, the countries of Lebanon and Turkey, please contact **TEKTRONIX INTERNATIONAL A.G.**, Terrassenweg 1A, Zug, Switzerland, for the name of your local engineering representative. Other Overseas areas, please write or cable directly to Tektronix, Inc., International Marketing Department, P. O. Box 500, Beaverton, Oregon, U.S.A. Cable: TEKTRONIX.

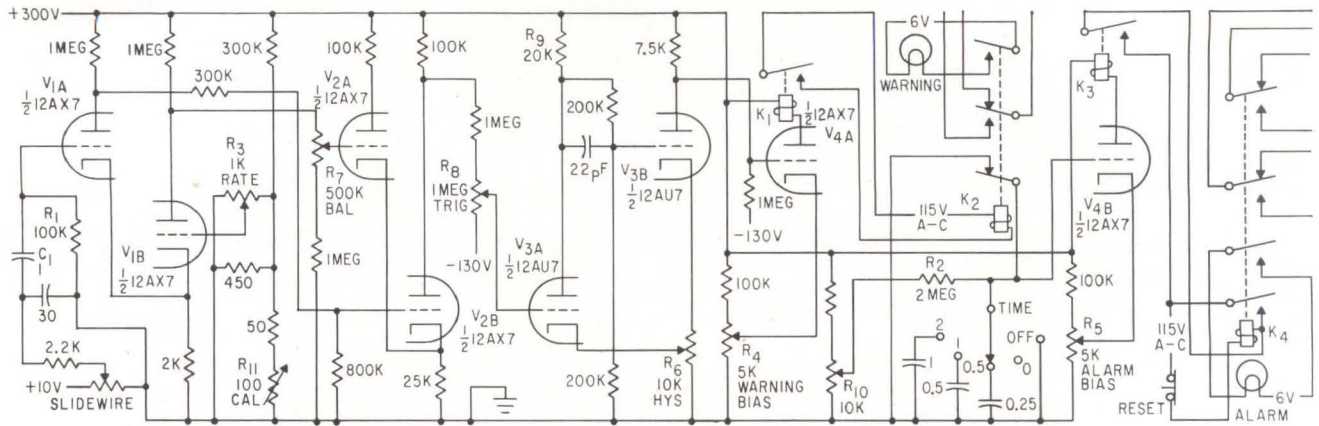

FIG. 1—Circuit lights warning lamp if rise rate exceeds preset limit and alarm lamp if excessive rise rate persists beyond preselected time delay

Indicator Warns of Excessive Rise Rates

By T. L. GREENWOOD

Member of Staff, Marshall Space Flight Center, NASA Huntsville, Ala.

INDICATOR can detect fire in enclosures or monitor bearing temperatures in machinery. The rise rate indicator warns of abnormal rise rates, or fall rates, in thermocouple outputs. It can be used to detect any positive or negative rates of change beyond an adjustable minimum in the millivolt range.

Thermocouple output is fed to a servo null-balance type strip chart recorder having a repeater slidewire with an output range of 0 to 10 volts d-c. The recorder serves as monitor, amplifier and low-pass filter. Slidewire output to the indicator is differentiated and compared to an adjustable voltage representing a constant rise rate.

When selected rise rate is exceeded, a warning lamp lights. When the excessive rate persists beyond an adjustable time, an alarm lamp lights. Relays are energized when the lamps light to operate external indicating and control devices, such as fuel supply line valves.

Input to the circuit in Fig. 1 is differentiated by C_1R_1 . About one-tenth of the change in input voltage appears across R_1 with the component values used. Grid voltage of V_{1A} is compared with a reference

rise rate voltage at the grid of V_{1B} . Stable amplifier V_1 - V_2 amplifies the difference. If the differentiated input exceeds the reference, the amplified difference switches Schmitt trigger V_3 . As V_{3B} is cut off, the rise in plate voltage cause V_{4A} to conduct, energizing K_1 .

Relay K_1 operates K_2 , opening a parallel path in the grid circuit of V_{4B} and grid voltage rises at a rate determined by R_2 and a switch-selected capacitor. When conduction in V_{4B} develops sufficient voltage across the coil of K_3 , the relay is energized. Relay K_3 operates K_4 , which is latched by one of its contacts until it is reset.

After a 30-minute warmup, the indicator is adjusted with the time switch at off and R_3 set for maximum plate voltage in V_{1B} . Controls

R_4 and R_5 are set for maximum negative cathode voltage, and R_6 is set for minimum resistance between the cathodes of V_3 . Control R_7 is then set for 230 volts at the plate of V_{2B} .

If the warning lamp cannot be switched on by rotating R_8 through the operating point, resistance between the cathodes of V_3 is increased by R_9 until it can. If the lamp does not light with 235 volts at the plate of V_{2B} , R_7 and R_8 are readjusted.

Trigger hysteresis is satisfactory if voltage across R_6 switches smoothly between about 50 and 150 volts as R_7 is rotated slightly to light the warning light. Hysteresis is reduced using R_{10} to lower resistance between the cathodes of V_3 . With the warning lamp off, R_4 and R_5 are set for 1 volt across the coils of K_1 and K_3 . To establish a standard time delay, the time switch is set at 0, R_7 is used to light the warning lamp, and R_{10} is used to obtain 30 volts across the coil of K_3 . With the voltmeter removed from the plate of V_{2B} , if necessary R_7 is readjusted so the warning lamp is just switched off.

The ramp signal generator in Fig. 2 is used to test the indicator and check calibration of the dial of rate control R_3 , where readings equal divisions per second on the

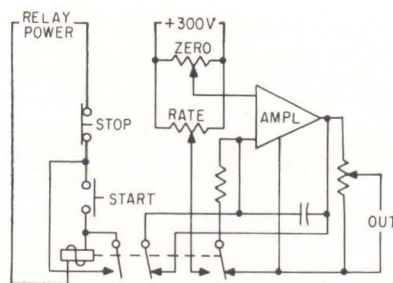

FIG. 2—Ramp function generator for testing indicator uses dual-input operational amplifier connected as integrator

NEW—AND
MOST VERSATILE

TRIPLET

**MODEL 850
ELECTRONIC
VOLT-OHMMETER
IS BEST FOR YOU**

MODEL 850 \$79.50



FEATURES:

1 Now you can test low voltage applications. .5 VOLT full scale range on D.C. Extremely useful in low voltage transistor circuits.

2 BETTER STABILITY through improved current design.

3 LONG FULL VIEW SCALES. Scales 7" long at top arc for easy reading.

High Input Impedance (11 MEGOHMS) and wide Frequency Ranges give this extremely versatile Electronic Volt-Ohmmeter considerable advantage in the measurement of DC voltages, AC RMS and Peak-to-Peak voltages. It measures directly the Peak-to-Peak values of high-frequency complex wave forms and RMS values of sine waves on separate scales.

ADDED PROTECTION. Meter is shorted out in OFF position for greater damping, meter safety during transit, electrically protected against accidental overload. ZERO CENTER mark for FM discriminator alignment, plus other galvanometer measurements.

New pencil thin test probe used for all functions: DC, AC, and ohms. No need to change cables. Beautifully styled case for professional appearance and functional utility, 7 $\frac{1}{8}$ " x 6 $\frac{1}{16}$ " x 3 $\frac{3}{4}$ ".

Carrying handle can be used as a tester stand to place the tester at 25° angle for ease in reading.

Frequencies to 250 MC may be measured with auxiliary Diode Probe, \$7.50 extra. DC voltages to 60 KV may be measured with auxiliary High Voltage Probe. \$20.50 extra.

CARRYING CASE

Case 859—OP—Black leather Padded Carrying Case. \$19.50 Net



RANGES

8 DC VOLTS RANGES	0-.5-1.5-5-15-50-150-500-1500
7 AC RMS VOLTS RANGES	0-1.5-5-15-50-150-500-1500
7 PEAK-TO-PEAK VOLTS RANGES	0-4-14-40-140-400-1400-4000
7 RESISTANCE RANGES	0-1000-10,000-100,000 OHMS; 1-10-100-1000 MEGOHMS.

FREQUENCY RANGE 15 CPS to 3MC; (Up to 250 MC with accessory diode probe available extra.)

INPUT IMPEDANCE DC Volts 11 Megohms; AC Volts minimum of .83 Megohms.

TRIPLET ELECTRICAL INSTRUMENT COMPANY, BLUFFTON, OHIO

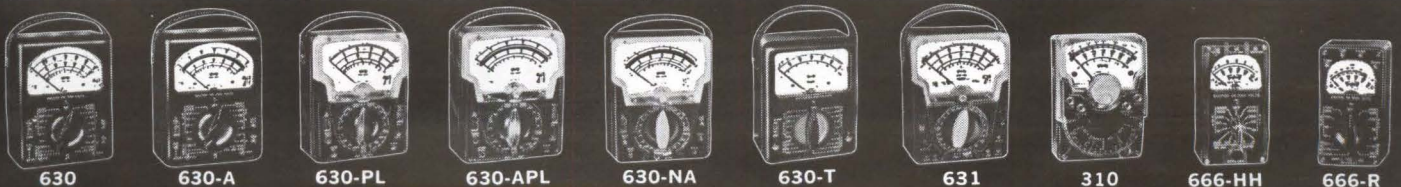

THE WORLD'S MOST COMPLETE LINE OF V-O-Ms, AVAILABLE FROM YOUR TRIPLET DISTRIBUTOR'S STOCK

**POWER,
CONTROL,
SIGNAL
CIRCUITS...**

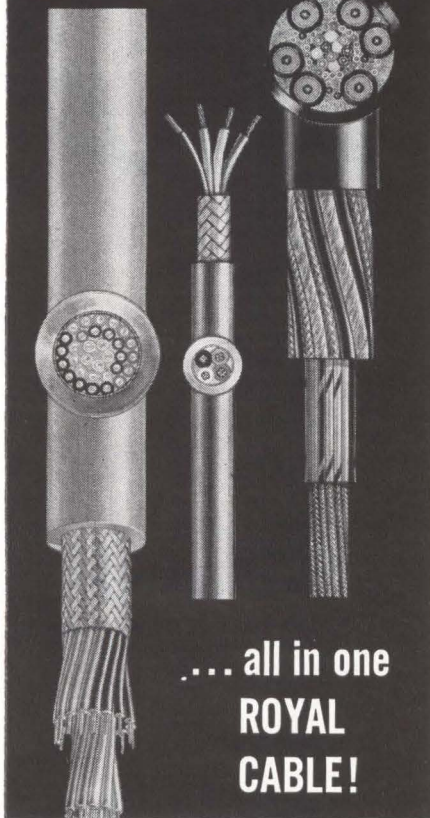

**... all in one
ROYAL
CABLE!**

ROYAL MULTI-CONDUCTOR CABLES are designed, manufactured and quality-controlled to your exact specifications . . . for a myriad of uses . . . for simple or complex applications. Cable elements and materials may be combined to include signal, control and power circuits into one construction and within one jacket. Royal is equipped and experienced to provide a finished cable that will assure predictable, dependable on-the-job performance. And remember, Royal is ready . . . to quote . . . to supply . . . to satisfy.

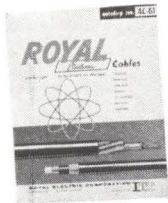

Write for new Catalog No. 4C-61 . . . (includes charts on Royal RG and special application cables, physical characteristics, test procedures, engineering tables, etc.)

ROYAL ELECTRIC CORPORATION
301 Saratoga Ave., Pawtucket, R. I.
In Canada: Royal Electric Company
(Quebec) Ltd., Pointe Claire, Quebec

ROYAL
ELECTRIC 
... an associate of

recorder chart. The operational amplifier is connected as an integrator with output rise rate proportional to input voltage. Adjustable input voltage is obtained from the d-c supply and a multiturn divider is used to adjust output voltage.

The start switch energizes the relay, removing the short around the capacitor and applying a low voltage to the second input of the dual-input amplifier. The low voltage is adjusted for zero output be-

fore the start of the ramp. Constant output of the saturated amplifier is adjusted at the end of the ramp. The stop switch returns the circuit to its original condition. The rate dial indicates percent of maximum output voltage per sec and the output dial is in millivolts.

The indicator is checked with the generator connected to the recorder. If the rate control dial indication is not correct during trial runs, it is adjusted by R_{11} .

C-W Solid-State Optical Maser

CONTINUOUS output has been obtained from a solid-state optical maser. This achievement indicates the possibility of combining the prolonged operation previously associated only with the gaseous optical maser and the high output power more easily attainable with solids.

The continuous operation, which was attained at Bell Labs, is in the infrared region at 10,650 angstroms. Present output is in the milliwatt range but substantially higher power is anticipated.

The active medium in the device is a single crystal rod of calcium tungstate containing trivalent neodymium ($\text{CaWO}_4:\text{Nd}^{3+}$). The highly polished, slightly convex ends of the rod are silvered. When the rod is excited by a bright pumping light, a coherent optical wave oscillates in it with some light escaping from the partly reflective ends. Flash lamps have been required to provide the high power pumping light, and solid-state optical masers could oscillate only a few milliseconds.

Oscillation can be maintained indefinitely in the new solid-state maser. It resulted from discovery of a strong fluorescence in certain crystals containing neodymium. Calcium tungstate crystals were grown containing neodymium of high optical quality and pulse optical maser action was achieved with them. The low power threshold, where optical maser action begins, indicated that this type crystal is suitable for continuous operation.

In the c-w maser experiments, a special housing was used for the maser crystal rod consisting of an elliptical cylinder with highly pol-

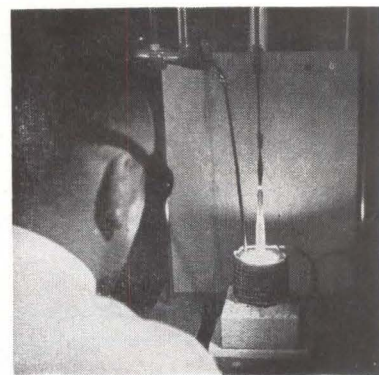

Neodymium in calcium tungstate used in c-w optical maser is pulled from melt

ished, silver-plated walls. A high-power d-c lamp at one focus of the cavity concentrates pumping light on the crystal at the other focus.

The apparatus also contains provisions for removing heat from the crystal and an optical filter to remove ultraviolet light, which tends to degrade the maser crystal. Maser action is achieved when power to the d-c lamp exceeds 900 watts. Continuous oscillation was observed for five minutes in the experiment with no detectable decrease in amplitude. It is believed that operation could have been continued for substantially longer.

Other crystals containing neodymium show promise for continuous operation. Strontium molybdate containing trivalent neodymium has been used to construct an optical maser that operates with a 30 percent duty cycle indefinitely when pumped by a lamp powered at sixty cycles. Oscillation wavelength is 10,634 angstroms. Physical measurements suggest that this material can also operate continuously.

2N1714/1718

Circuit Characteristics at 7.5 w Power Output:

Power Gain — 45 db min
 Voltage Amplification — 44 ± 2 db
 Input Resistance — $1.9 \text{ K} \Omega$ min
 Total Harmonic Distortion — 5% max
 Ambient Temperature Range — -55°C to $+125^\circ\text{C}$

Component Values:

R_1 — 800Ω
 R_2 — 6.19 K
 R_3 — 6.81 K
 R_4 — 3.32 K
 R_5 — 46.4Ω
 R_6 — 2.15 K
 R_7 and R_8 — 7.5Ω
 R_9 — 3.32 K
 C_1 — $40 \mu\text{f}$, 50 v
 C_2 — 2000 pf , 50 v
 C_3 — $500 \mu\text{f}$, 50 v
 C_4 — $0.1 \mu\text{f}$, 150 v
 D_1 — TI 1N538
 Q_1 — TI 2N1721
 Q_2 and Q_3 — TI 2N1715 or TI 2N1719

Q_2 and Q_3 Mounted on $3'' \times 3'' \times \frac{1}{4}''$ Copper Heat Sink.

7.5 watt, 400 cps, 125°C servo amplifier circuit*

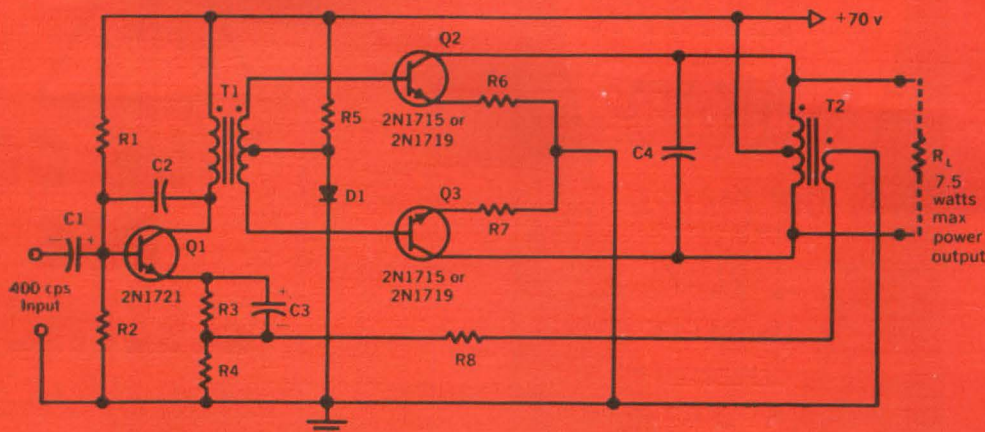

Increase Amplifier Performance at High Temperatures

WITH TI 2N1714/1718 MEDIUM POWER TRANSISTORS

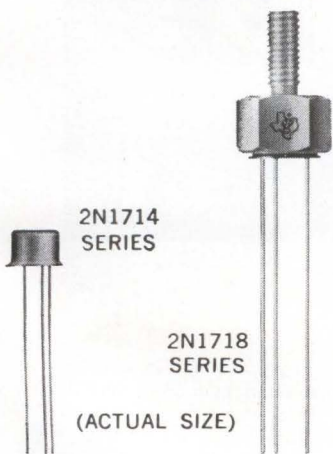

This 7.5 watt amplifier circuit shows you how to get 45 db gain from -55°C to 125°C by using Texas Instruments 2N1714/1718 series silicon transistors. These medium power, N-P-N devices feature exceptionally low thermal resistance ($7.5^\circ\text{C}/\text{watt}$ derating from 100°C case) to give you more useful power at high temperatures. Electrically identical, the TI 2N1714 series and 2N1718 series provide the high temperature advantages of TI's exclusive *Thermoslug* construction. The 2N1714 package is a conventional TO-5, while the 2N1718 features the double-ended stud package for convenient heat-sink mounting. For better high-voltage amplifier performance at high temperatures, design with TI 2N1714 and 2N1718 series instead of such series as the following: 2N657, 2N657A, 2N545, 2N1054, 2N1116, and 2N1479.

*write for TI application note SC-2065

TYPE	BV _{CEO} min	I _{CEs} max	BV _{EBO} min	h _{FE}		V _{BE} max	V _{CE(sat)} max
	I _C = 30 ma	90 v V _{CE} 150 v	I _C = 10 μa	I _C = 200 ma	I _C = 200 ma	I _C = 200 ma	I _C = 200 ma
2N1714, 2N1718	60 v	50 μa	6 v	20 min	60 max	1.6 v	2 v
2N1715, 2N1719	100 v	50 μa	6 v	20 min	60 max	1.6 v	2 v
2N1716, 2N1720	60 v	50 μa	6 v	40 min	120 max	1.6 v	2 v
2N1717, 2N1721	100 v	50 μa	6 v	40 min	120 max	1.6 v	2 v

f_T min = 16 mc at V_{CE} = 10 v, I_C = 100 ma

TRANSISTOR PRODUCTS DIVISION



TEXAS INSTRUMENTS INCORPORATED
 13500 N. CENTRAL EXPRESSWAY
 P. O. BOX 5012 • DALLAS 22, TEXAS

DEFLECTRONS

BY CELCO FOR
PRECISION
DISPLAYS
SMALLEST
DEFLECTED
SPOTS

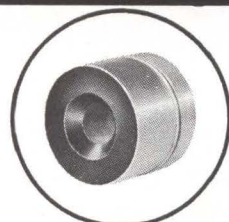
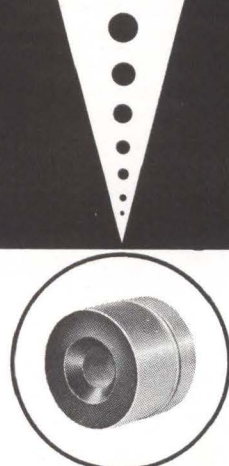

Deflectrons

for critical applications
where ordinary YOKES fail

REPEATABILITY to 0.1%!

SPOT GROWTH 1:1.3 max!

RECOVERY to 0.1%!

Just off the press "Linearity Notes"
by John M. Constantine—Request
your copy today.

Celco

*Constantine Engineering
Laboratories Co.*

Main Plant: MAHWAH, N. J. DAVis 7-1123
PACIFIC DIV.—UPLAND, CALIF. YUkon 2-0215
CENTRAL DIV.—LANESBORO, PA. ULYsSES 3-3500

IRE SHOW



presenting

"THE GOLDEN AGE OF ELECTRONICS"

March 26-29, 1962

The New York Coliseum

... part of the

International Convention of the IRE

The Institute of Radio Engineers
1 East 79th Street • New York 21

Members \$1.00. Non-members \$3.00. Age limit: over 18
CIRCLE 203 ON READER SERVICE CARD

MUST YOU MEET

SHORT-RUN LABELING?

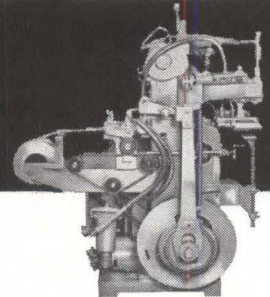

If short runs and a wide variety of labels are part of your labeling problem, this machine can help you. Industry has found that *roll labeling without glue* offers matchless control, efficiency and convenience • New Jersey Machine Corp. offers the economies of roll labels, the ability to imprint valuable data within a master label, and a quick-start no-glue labeling operation. Write today for full information.



Labeling, Cartoning, Paper Box Machinery

NEW JERSEY MACHINE CORPORATION

MAIN OFFICE AND PLANT • 16TH ST. AND WILLOW AVENUE, HOBOKEN, N. J. • OLDFIELD 9-0483
FACTORY SALES AND SERVICE BRANCHES; 325 W. HURON ST., CHICAGO 10, ILLINOIS, 2500 W. 8TH ST., LOS ANGELES 57, CALIFORNIA

CIRCLE 204 ON READER SERVICE CARD
electronics

GENERAL ELECTRIC PLANAR EPITAXIAL PASSIVATED DIODES

Fused hemisphere front contact in the glass subminiature package provides unusually good mechanical protection against shock and vibration. There are no loose parts to cause intermittent operation.

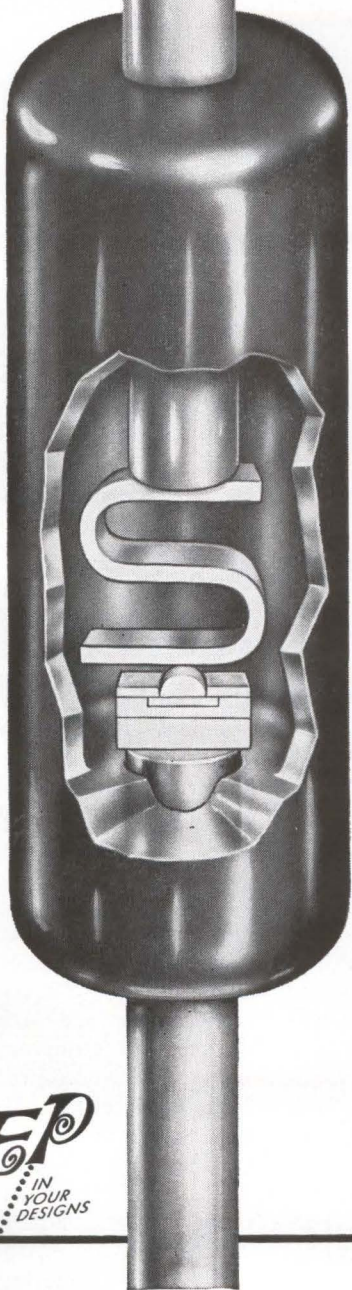

FEATURE CONTROLLED CONDUCTANCE

General Electric PEP silicon diodes bring you a unique design combination that allows ultra-fast switching speed combined with extremely tightly controlled conductance over a wide current range.

Gaseous *planar* diffused junction means high breakdown voltage with low capacitance.

Thin *epitaxial* layer on low resistivity substrate gives negligible body drop and increased uniformity from diode to diode.

Surface *passivation* is applied before the junction is formed for maximum protection against contamination.

FORWARD VOLTAGE CHARACTERISTICS				
1N3605 1N3606	1N3608 1N3609		1N3605 1N3608	1N3606 1N3609
I_f (ma)	V_f (millivolts) Min. Max.	Breakdown Voltage ($I_R=5 \mu\text{amps}$)	40 V min.	75 V min.
0.1	485 555	Leakage Current (25°C)	50 μamps max. @ $V_R=30V$	50 μamps max. @ $V_R=50V$
0.250	525 595	Leakage Current (150°C)	50 μamps max. @ $V_R=30V$	50 μamps max. @ $V_R=50V$
1.0	580 680			
2.0	625 725			
10.0	710 840			
20.0	750 900			

1N3605 AND 1N3606 ARE IN THE GLASS SUBMINIATURE PACKAGE ILLUSTRATED. 1N3608 AND 1N3609 ARE IN A MICROMINIATURE PACKAGE.

If your application does not require controlled conductance and exceptionally tight specifications, G-E also has available 1N3063. For complete details, call your Semiconductor District Sales Manager. Or write Semiconductor Products Department, Section 16B118, General Electric Company, Electronics Park, Syracuse, N.Y. In Canada: Canadian General Electric, 189 Dufferin St., Toronto, Ont. Export: International General Electric, 159 Madison Ave., New York, N.Y.

STOCKED BY YOUR G-E SEMICONDUCTOR DISTRIBUTOR

GENERAL  ELECTRIC



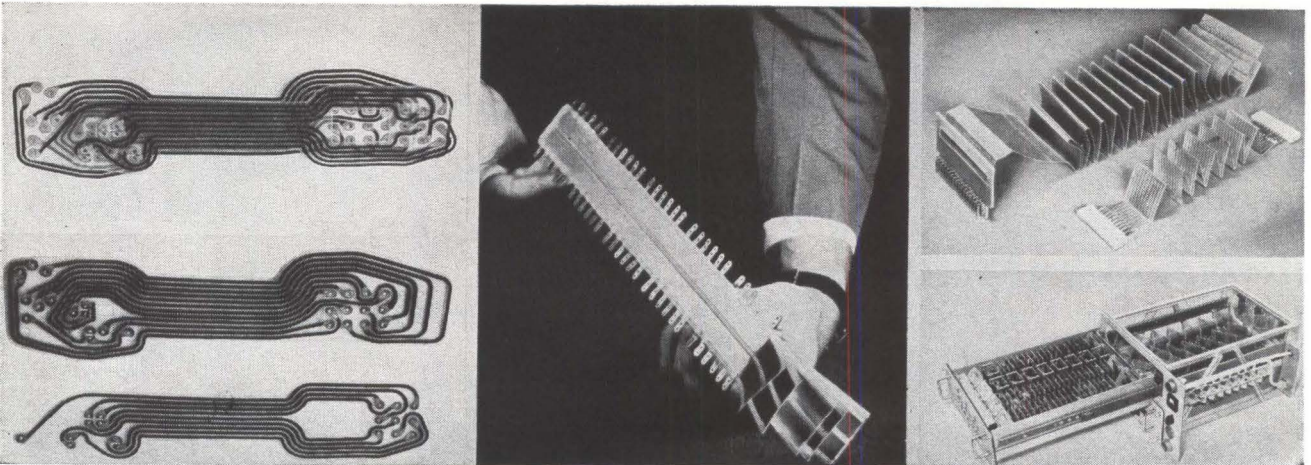

Two flat etched cables, superimposed (left, top), permit significant size reduction where space is a premium. Multi-layered power distribution cable (center) has exactly reproducible electrical characteristics. Flat accordion-fold cable (right) has a permanent heat-set spring for stretch-retract situation.

Applying Flat Wires and Cables

DESIGN ADVANTAGES AND CONFIGURATIONS

By **GEORGE E. METTER**
 Senior Application Engineer,
 International Resistance Co.,
 Philadelphia

FLAT CONDUCTOR CABLE assemblies are receiving a big up-swing in usage. Although present designs and concepts are about six years old, better materials and methods, and lower cost manufacturing techniques have effected large markets in flat wiring. Recently flat cables have been put to use in transmission lines, and the thin flat conductors now offer an advance in the science and art of electronic wiring for interconnections.

Noticeable features of flat wires are the same for most forms. The conductor is encapsulated between two films of tough plastic, usually transparent or translucent, see Fig. 1. The layers are thin, 0.0027 to 0.012-in awg/layer. The cables utilize many insulation systems: polyester film and thermoplastic, polyester film and adhesive, Kel-F or equal which is nonflammable, Teflon FEP or TFE, glass-supported Teflon, or the recently developed silicone rubber-glass which can take 250 C. Glass cloth can be

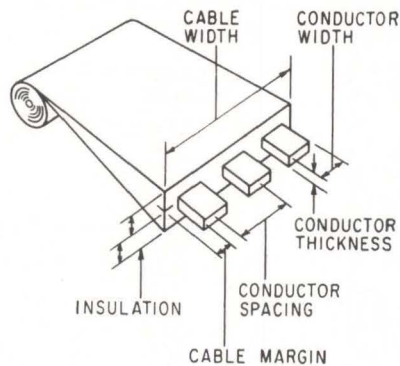

FIG. 1—Prefabricated conductors are arrayed in parallel and laminated between plastic insulation

laminated in for stability on any system.

Plastic insulation protects the cable from chemicals, humidity, conductive dust, abrasion, and other environmental conditions. Light weight and firm positioning of conductors permit the cable to withstand severe shock, vibration, and acceleration. Extremely flexible films with supporting conductors are available in rolls, accordion folds, and flexible etched forms which are used similarly to printed-circuit boards.

Parallel cables can be cut to length, or received in bulk. Mounting the flat cables is usually necessary in the interest of exact electrical characteristic reproducibility, constant interference patterns and to decrease the possibility of entanglement with moving parts. Clamps, cable ties or pressure-sensitive adhesives are used for interconnections.

The use of flat wiring offers the solution to many high density, complex wiring and component interconnection problems. Predetermined conductor size and economical applications result from designing with standard sizes, widths, and spacing.

Multilayer power distribution cable is built up from flat cable and has reproducible electrical characteristics in production quantities. Conductors are usually oxidized copper, but other conductors have been used successfully. Manufacturing processes have been developed which prevent shift of conductor location during lamination.

The bond obtained between oxidized copper conductors and fluoro-carbon plastic is equivalent to a Class A hermetic seal. Bond



Phantom II... the fastest, highest-flying fighting aircraft.

Firepower CONTROL

In defense or attack . . . in any weather . . . the Navy's new McDonnell F4H is a mighty potent fighting aircraft. It carries a variety of weapons . . . and relies on one of the most advanced and accurate airborne missile control radars ever built, the APQ-72 by Westinghouse.

Now operational, the APQ-72 is a proved radar. Long range. All-weather. Designed and packaged for high reliability and ease of maintenance, with "built-in" test features.

This modern, airborne radar is the latest in a succession of outstanding applications, which include the Bomarc target seeker and the Aero-13 system for the F4D "Skyray". It is another example of Westinghouse leadership in aerospace electronics.—Defense Products Group, 1000 Connecticut Avenue, N.W., Washington 6, D. C.

You can be sure . . . if it's Westinghouse. 4-2310



Westinghouse

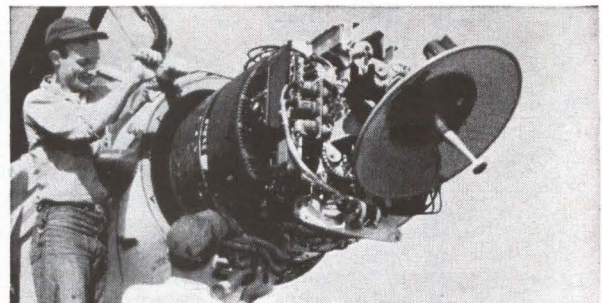

Years of airborne electronics experience at Westinghouse with such radars as the Aero-13 system in the Douglas F4D, and the Boeing Bomarc have produced many state-of-the-art advances. These are incorporated in the all-new APQ-72 system.



Accuracy and long range of the APQ-72 system were demonstrated during the 1961 record-setting Bendix Trophy race. It located tanker aircraft long before they were in sight, helping cut aerial refueling times in half.

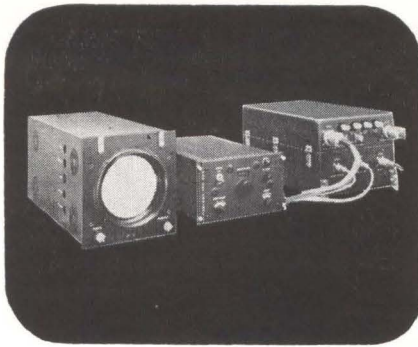

This ELECTRICALLY TUNED RECEIVER that fits in any odd space on planes or on ships that lets you look at a signal you hear on a companion receiver that should be kept near that has no moving parts that sweeps the full band or shows on expanded mode a signal just scanned comes from the house that TRAK built

TRAK PANORAMIC RECEIVER TYPE PAN 1-F Frequency range: 100-150 MC. Dynamic range: 60 db. Scan rate: 22 sweeps/second. Measures frequency to 0.2%. Tangential sensitivity .25 micro-volt.

TRAK AUTOMATIC ACTIVE COUNTER-MEASURES SYSTEM Electronically tuned receiver searches, stops, listens, evaluates. Transmitter automatically tunes to target frequency and jams for predetermined interval.

TRAK MODEL 2887 ANTENNA SWITCH Allows signals from two, three, or four antennas to be displayed simultaneously on a single panoramic receiver. Electrically switched. No moving parts. 90-160 MC.

Simply write 59 Danbury Rd. or phone PO 2-5521.



COMMUNICATIONS AND RECONNAISSANCE DEPT.
TRAK ELECTRONICS CO., INC., WILTON, CONN.

ADVANTAGES OF FLAT CABLES AND FLEXIBLE ETCHED CIRCUITS

Weight reduction	Up to 10:1 for a given cable. Needed in airborne designs. AWG 28 equivalent = 0.81 lb/1,000 cond ft
Space savings	Up to 7:1. Fits in restricted or unused chassis areas. Eliminates false floor between cabinets. Allows high density packages
Cost savings	As much as 2:1. Inspection reduced
Current capacity	Increased up to 200 per cent for a given temperature rise and conductor cross section
Electrical characteristics	Consistent. Built-in reliability, environment resistant, sealed conductors, humidity has little effect. Pre-positioned conductors, no cross overs
Ease of handling	Flexible. Readily folds or bends to mounting area, simple to interconnect

strengths in excess of seven pounds per inch of width are usual, and bonds between other plastics and copper are about the same.

Designers can save money by choosing a manufacturer's standard insulations and insulation thicknesses, as well as standard conductor materials, sizes and spacings. Typical of standard flat cables now on the market are International Resistance Company's Polystrip, flexible multiconductor cable; and Lamoflex, the thin custom-etched wiring. Cable connections can be made by applying hand or dip soldering methods, welding conductors or by use of flat cable connectors. Etched forms usually fit over component pins and are used as received from the manufacturer.

Parallel multiconductor cable is usually used to join segments of an overall system. Standardization eliminates problems of wire selection, cable construction, lacing and tortuous training in limited space. Accuracy of connections is certain, coding of conductors is automatic, and inspections are simplified. The wiring becomes a prefabricated subassembly which can be dropped into place and connected by an inexperienced worker.

Flat wires and cables are available in almost any configuration a designer may require. Conductors may be round (very small sizes) as well as flat. The accordion fold cable allows moving segments of a circuit to be joined electrically. A well-constructed accordion fold cable performs reliably in a stretch-react situation. In one test, a 21-strip accordion fold with eleven 2¼-in folds was flexed from 3 in to 13 in at a rate of 99 cpm. Conduc-

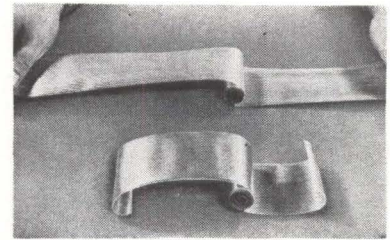

Roller form cable is light weight, small in volume, and self-supporting when extended. The spring produced in the plastic by heating is retained indefinitely

tors were connected in series and loaded with 250 milliamperes. More than 25 million cycles were recorded before failure of the first conductor. Accordion folds can be built up in layers to provide additional circuits without material loss in flexibility.

A roller form cable is available to maintain circuit connections to an open door or chassis, or between drawers and fixed elements of relay-rack mounts. Conventional round wire would involve so much weight and bulk as to seriously hinder movement. The spring produced in the cable is retained indefinitely.

Another form of flat cable consists of an etched circuit laminated between layers of plastic insulation which is impervious to nearly any environment.

Government programs are evaluating the desirability of using two-layer, four-layer and six-layer forms of layered printed wiring boards consistent with the requirements of auto-assembly techniques. The original aim was to increase the printed conductor density by a factor of three, and the part termination density to 100 per sq in.



Bendix Craftsmanship at work for you

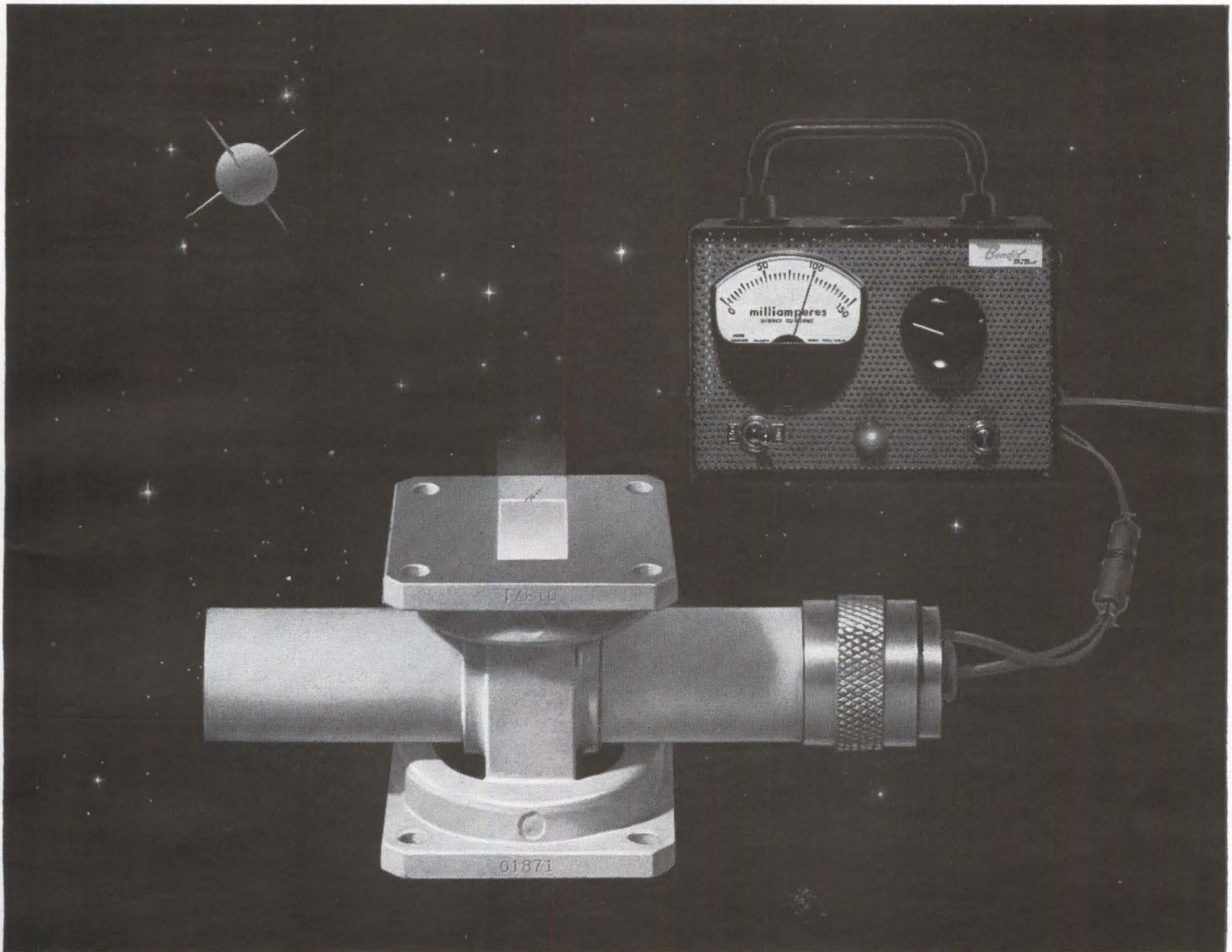

NEW BENDIX® 6-OUNCE NOISE GENERATOR meets need for fast, accurate noise measurement in miniaturized package. It has special value on noise monitoring applications—such as microwave and radar receivers—where size, weight, and power drain rank equally important with band width. This Bendix model TN-1 is only 2.00" x 4.25" over-all, weighs a mere six ounces, features low power drain, and is ruggedly built for long, trouble-free service. Designed for transmission-type use over frequency range of 8500 to 9600 mc. For further information, write Electron Tube Products, The Bendix Corporation, Eatontown, New Jersey.

Red Bank Division



Searching for a "Crash Program" SPECIALIST?

Try
Methode

Two vital factors determine the success of a crash program — **SPEED + CAPABILITY!** That's where Methode shines. Some are fast — some are capable — Methode is both.

Proof?
OUR RECENTLY INTRODUCED
SMI-600 series CONNECTORS

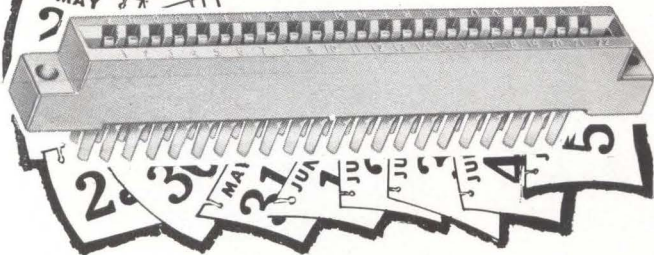

... developed and delivered from start to finish in 6 weeks!

These rugged high-retention connectors which were produced to meet the time and specification requirements, stringent as they were, are but one in a series of devices from Methode, specially designed for crash program needs. Evidence, indeed, that when the chips are down, Methode comes through for you. Now, or in the future, when "Crash Programs" appear on your production schedules, come to Methode — the specialists in crash tooling of custom connectors — for the product performance and delivery you want!

Visit Booth #2741 at the I.R.E. Show.



Methode Electronics, Inc.

7447 West Wilson Avenue
Chicago 31, Illinois

SAMPLES and detailed literature are available.

Eisler

A NAME TO REMEMBER IN MACHINERY FOR ELECTRONICS

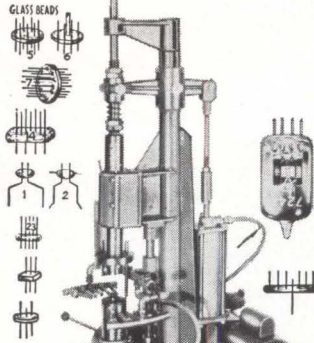

At left: No. 105-BSTI Single position Button Stem and Wafer making machine — Designed for small production runs on special tube parts, or for laboratory use. Produces button stems up to 1 1/4" diameter.

Illustrated below: An Eisler precision Vertical Spot Welder designed exclusively for welding of electronic components. Available in sizes from 1/2 to 7 1/2 KVA.



Write us today for full particulars!



EISLER ENGINEERING CO., INC.

Charles Eisler Jr., President

751 So. 13th St., Newark 3, N.J.

CIRCLE 205 ON READER SERVICE CARD



THE SHARPEST CUT IS IN LACING CORD COSTS!



X-TYPE NYLON LACING CORDS

Look to the Linen Thread Company for the most complete line and latest types of lacing tapes and cords for electronics — including X-Type Nylon Cords, which meet Specification Mil-T-713A, cost far less, give superior performance in indicated applications.

Other Specification Lacing Cords, Tapes and Braids in Nylon, Linen, Teflon, Cotton, Dacron.



Est. 1784

Write for new illustrated catalog, "Lacing Cords and Tapes for Electronics."

THE LINEN THREAD CO., INC.

Dept. 16B

BLUE MOUNTAIN, ALABAMA

CIRCLE 206 ON READER SERVICE CARD

electronics

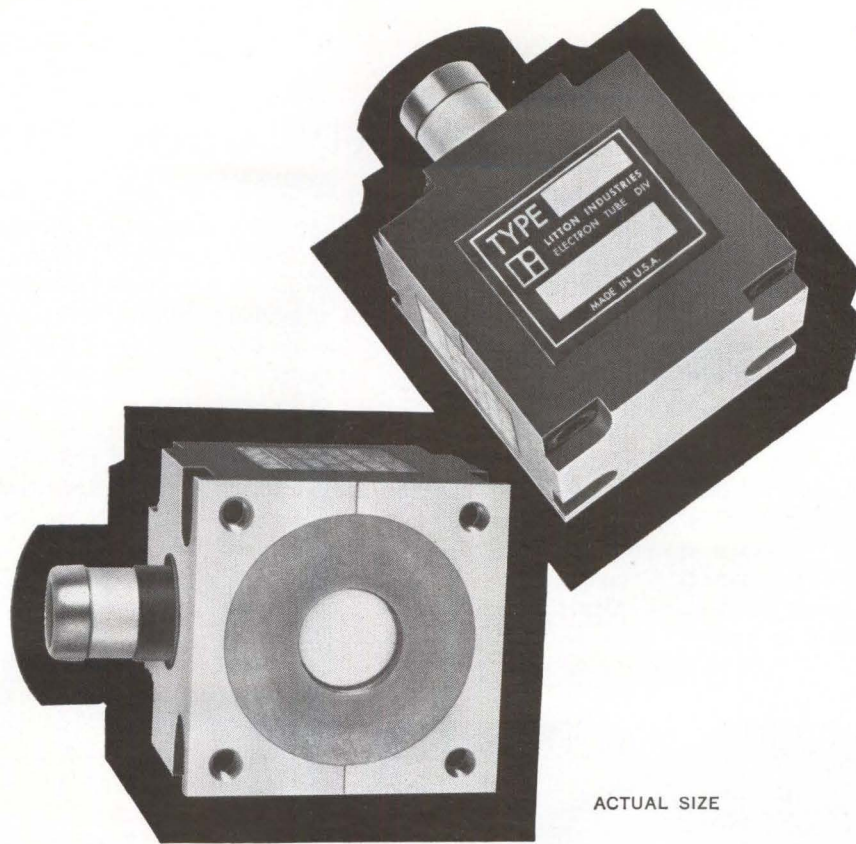

ACTUAL SIZE

SMALLER, LIGHTER, LITTON MINIATURE MAGNETRONS for beacons, IFF, interrogators, portable radars

- Lightweight — 8 oz. at X-Band, 16 oz. at Ku-Band
- Small, permanent magnet package — X-Band models shown actual size above
- Ruggedized — meets missile vibration, shock and acceleration requirements. X-Band tube developed under Diamond Ordnance Fuze Laboratory Sponsorship
- High duty rating — 1% at X- and Ku-Bands
- Low Voltage — designed for semiconductor power supplies
- Conduction cooled for Class II environment
- Quick 13-second warmup
- High efficiency — nominally 35% at X-Band
- Highest magnetron frequency stability (<100 Kc/°C Coefficient at X-Band)

Litton also designs and manufactures a large variety of other magnetrons for many applications with output powers as high as 2 megawatts.

CUBE MINIATURE MAGNETRONS • NOMINAL CHARACTERISTICS

	Type L-3430	Type L-3606	Type L-3719
Minimum Peak Power	1000 watt	500 watts	750 watts
Frequency	9,300 \pm 30 Mc	9,300 \pm 30 Mc	15,000 \pm 100 Mc
Filament Voltage	6.3 volts	6.3 volts	6.3 volts
Filament Current	.9 amps	.9 amps	.9 amps
Anode Voltage	1400 volts	1300 volts	1750 volts
Peak Anode Current	2.2 amps	1.3 amps	1.5 amps
Maximum Duty	.005	.01	.01
Pulse Length	.02 to 3 μ sec	.02 to 3 μ sec	.02 to 3 μ sec
Size	1 $\frac{1}{8}$ " cube	1 $\frac{1}{8}$ " cube	2" cube
Weight	8 ounces	8 ounces	16 ounces

Contact us at San Carlos, California, for complete information.



LITTON INDUSTRIES
Electron Tube Division

MICROWAVE TUBES AND DISPLAY DEVICES

Infrared Ovens Permanently Mark Teflon Wire

By GEORGE E. FRANZ

Electronics Systems and Products Div.,
Martin Marietta Corp., Baltimore, Md.

TEFLON is used in missile and rocket wiring because it is one of the least easily damaged materials known. However, if a wire is to retain its particular identity in the environment of inclement weather, heat, vibration and the exotic fuels associated with space vehicles, it must have some kind of permanent mark. A permanent mark for wire insulation can be defined as a mark

that cannot be removed without destroying the insulation. Color-coded wire can be considered as being permanently marked provided the colors do not fade. In missile wiring, however, it typically is necessary to mark wire with an alpha-numeric code. Thus Teflon insulated wire, selected because it is highly resistance to deterioration and defacement, must be permanently defaced by identification marks.

Martin engineers have developed a successful method of sintering

teflon foil marking onto Teflon insulated wires and sleeving. The process requires the right application of the right kind of heat and control of material sublimation during the pyrolytic process. Exhaustive research eliminated all the conventional approaches to controlled heating applications. Gas, heated dies, strip or cartridge heaters, coils etc., were considered but the final decision was to use quartz infrared lamps. The infrared lamps are placed in parabolic stainless steel reflectors that focus the infrared rays toward the centroidal axis of the wire being processed. The heart of the oven thus consists of a double walled cylinder containing four 19-inch, 20 amp, 1,600 watt, quartz infrared tubes. These are mounted axially in four polished stainless reflectors, as shown in the sketch. Although the linear central sections of the tubes develop temperatures in excess of 2,000 F, the ends of the tubes require cooling to about 600 F, which is accomplished with small fans.

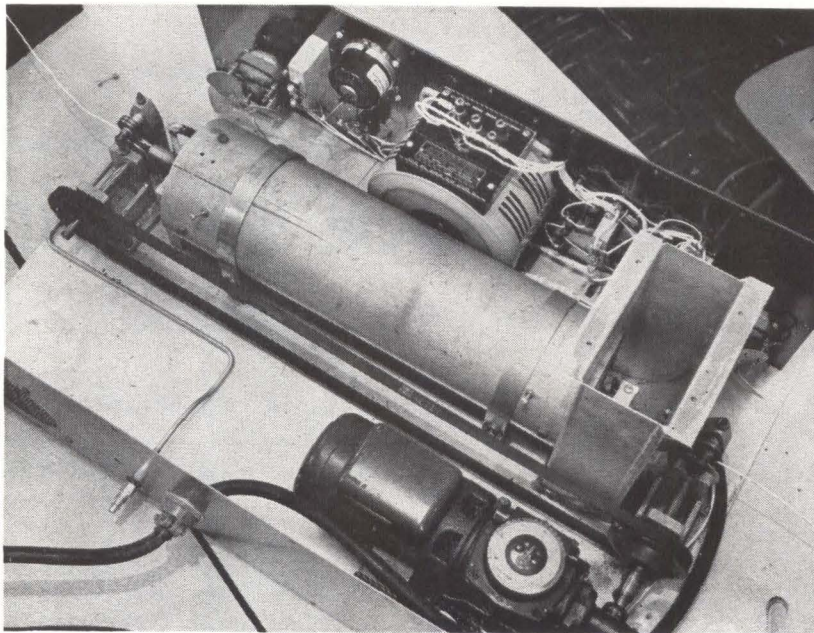

Prototype oven has unmarked wire entering at left and permanently marked wire leaving at right

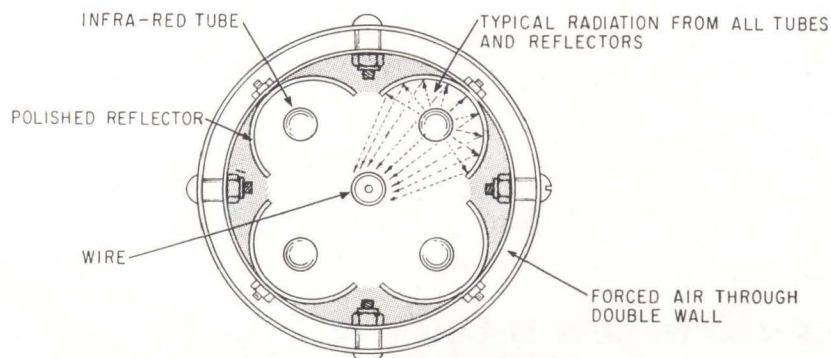

Teflon wire passing through the center of the oven is heated enough to make a permanent fusion between insulation and Teflon markers

Processing Technique

In processing, Teflon insulated wire is first stamped with Teflon foil marking tape. Wire thus marked is drawn through the heating chamber by rollers driven by a variable speed drive. Oven temperature is controlled essentially by the Variac power transformer feeding the lamps and the flow of air forced between the walls of the heating chamber. For the conditions involved, this provides better control than on-off thermostatic devices, which would cause a fluctuation in temperature. As the wire passes thru the chamber, radiant heat is quickly absorbed by the dark markings on the lighter insulation. The area under the dark markings heats faster than the surrounding area but the result is a satisfactory distribution of heat between wire and label. The variable speed drive is adjusted to suit wire size and class of insulation. Air circulated in the oven during operation be-



NEW

FM STEREO MODULATOR

TYPE 219-A

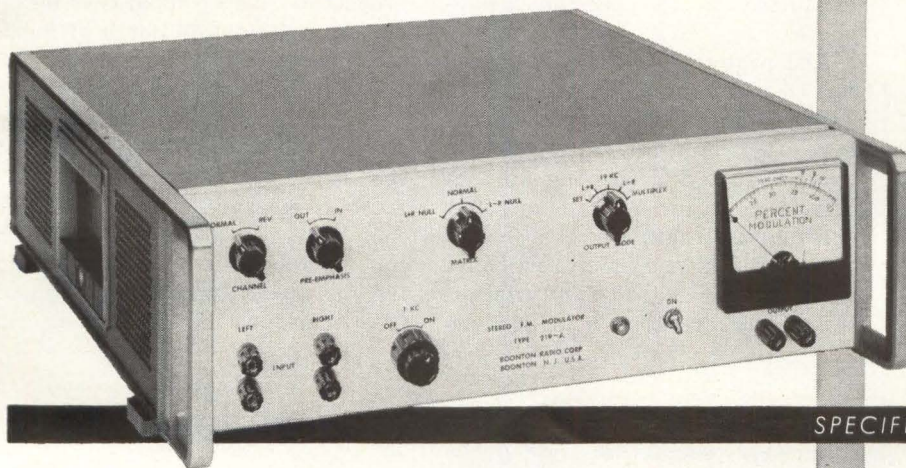

- Direct (L) & (R) Inputs
- SCA Input
- Internal Preemphasis
- Internal 1 KC Modulating Oscillator
- Peak Reading Output Meter
- Self-Checking Switchable Matrix

INPUT CHARACTERISTICS

LEFT (L) & RIGHT (R) INPUTS

Frequency Range: 50 cps - 15 KC

Level: 1.7 ± 0.3 volts rms*

*For 45% peak multiplex output; simultaneous (L) and (R) inputs yield 90% peak multiplex output

Preemphasis: 75 μ sec preemphasis switchable in or out of circuit

SUBSIDIARY COMMUNICATIONS (SCA) INPUT

Frequency range: 20 - 75 KC

Level: 1.0 volt rms*

*For approx. 10% peak multiplex output

MODULATING OSCILLATOR CHARACTERISTICS

Osc Frequency: 1 KC

Osc Output: Switchable into either (L) or (R) input

SPECIFICATIONS:

The FM Stereo Modulator Type 219-A is designed to provide a multiplex output signal in accordance with FCC Docket 13506 when fed with Left (L) and Right (R) audio stereo channel inputs and/or subsidiary communications FM sub-carriers (SCA). The output of the modulator may be switched to provide either (L + R), (L - R), 19 KC pilot carrier, 38 KC residual carrier or the complete multiplex signal which can then be used to modulate a suitable FM Signal Generator. When used with the BRC Type 202-E, no external audio oscillator or other equipment is required.

A peak reading metering system, calibrated in % of system deviation, is provided for setting and monitoring the levels of the individual sub-carriers. The internal matrix may be switched from the normal condition to provide either (L + R) or (L - R) null for checking the matrix in the receiver under test. The modulator is completely self-contained and housed in a single cabinet which may be adapted for standard rack mounting.

BOONTON RADIO CORPORATION

A Subsidiary of Hewlett-Packard Company 

P. O. Box 390, BOONTON, NEW JERSEY • Tel: OAKwood 7-6400

TWX-BOONTON, NEW JERSEY 866 • CABLE ADDRESS: BOONRACO

OUTPUT CHARACTERISTICS

Level: 0 - 7.5 volts peak*

*Multiplex output

Residual Hum & Noise: > 60 db below 100% output

Crosstalk*: > 40 db below 100% output

*(L - R) into (L + R)

METERING

Range: 0 - 10%* (19 KC and 38 KC only); 0 - 100%*

*Multiplex output; output adjustable 0 - 7.5 volts peak for 100%

Output Modes: Switchable for (L + R), (L - R), 19 KC pilot carrier, 38 KC residual carrier, or multiplex signal

PILOT CARRIER

Frequency: 19 KC

Accuracy: $\pm 0.01\%$

MONAURAL (L + R)

Fidelity: 50 cps - 15 KC ± 1 db*

* ± 0.2 db and $\pm 1.5^\circ$ relative to (L - R)

DOUBLE SIDEBAND SUPPRESSED CARRIER (L - R)

Frequency: 38 KC

Fidelity: 50 cps - 15 KC ± 1 db*

* ± 0.2 db and $\pm 1.5^\circ$ relative to (L + R)

SUBSIDIARY COMMUNICATIONS (SCA)

Fidelity: 20 - 75 KC ± 0.5 db

OSCILLOSCOPE SYNC SIGNAL

Frequency: 19 KC

Output Level: 0.5 volts rms

1 kc to 500 mc Stable Noise Output is variable in 1 db steps to 20 db

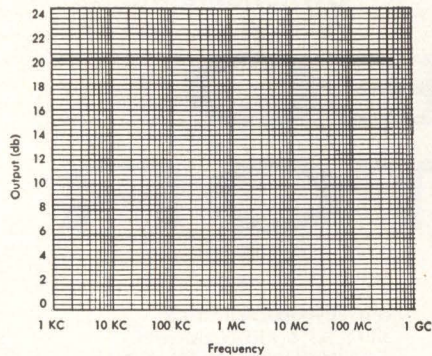

This chart demonstrates the constant noise output, from 1 kc to 500 mc, of Polarad's Precision Noise Generator—Model N-1. Its direct reading, accurately calibrated dial simplifies direct noise figure measurements. □ The noise output is kept at the set level by a feedback circuit so that output noise calibration is independent of terminating resistance. A maximum of 20 db into 50 ohms is available. □ Vernier adjustment is provided enabling 0 to 1 db interpolation for measurements in vacuum tube and transistor amplifiers, receivers and oscillators. Accuracy is ± 0.25 db. □

Write Polarad or call your local Polarad representative (listed in the Yellow Pages) for complete specifications and a demonstration.

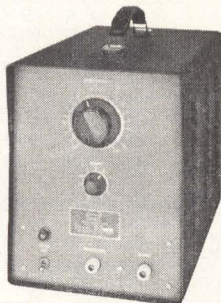

Model N-1
Precision Noise Generator

POLARAD
ELECTRONICS CORPORATION
43-20 34th Street, Long Island City 1, N.Y.



Sintering oven for Teflon sleeving incorporates some modifications to feed mechanism

comes contaminated to some extent with the pyrolytic sublimates from the heated Teflon. These fumes are exhausted to the outside atmosphere.

The prototype oven is still used for 16 to 22 gage, class A and C, Teflon insulated wires. Other ovens have been built for sintering wire up to 2 gage and sleeving up to 1 inch in diameter. Additional gages and diameters are being processed for qualification. Controls have been simplified so that average skilled workers, after brief instruc-

tions, can operate the ovens. Charts for oven control settings for heat, speed of wire movement, air pressure, etc. are furnished to manufacturing personnel.

Electromagnetic Test Tells Steel Hardness

LONDON—Electromagnetic non-destructive method of measuring depth of surface hardness in steel is showing distinctly favorable results, reports Nottingham University.

Electrical and magnetic properties of flame-hardened steel are functions of the prequenching temperature which determines hardness depth. Surface electromagnetic properties give a comparative measure of variations in depth of hardness, over a whole surface.

Electromagnetic surface factor (product of resistivity and permeability which changes abruptly at the hardened, unhardened interface) is measured in terms of the complex impedance of an a-c search coil magnetically close-coupled to the surface. A ferrite cup core and frequencies around 15 Kc are used.

Harnesses Held by Small Nylon Hooks



Velcro is the trade name of a fastening technique that uses small nylon hooks that interlock with other nylon hooks or with a special pile material. Hughes Aircraft Co., Fullerton Calif., is using a self-locking tape version of the material (above) for spot-tying wire harnesses and wire preps before final assembly. Advantages of the technique, according to Hughes, are several: it is not sticky, it can be used repeatedly, it can be color coded, and the production people use it readily. (Distributor of the material is The Hartwell Corp., 9035 Venice Blvd., Los Angeles 34, Calif.)

NOW!
A SIZE 11
integrator
compensated
FOR
temperature
AND
frequency change

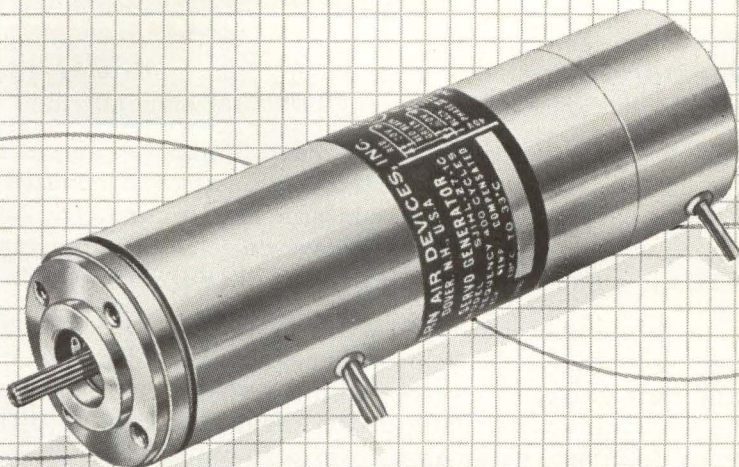

**THE LATEST ADDITION TO EAD'S
 PROVEN LINE OF INTEGRATING TACHOMETERS**

Advanced compensation of output voltage and phase angle over wide temperature ranges in this new size 11 tachometer assures accuracy equalling or exceeding that of standard size 15 tachometers...and over any temperature range. Unique compensating circuits make this unit particularly insensitive to fluctuations in input frequency and voltage thus increasing the accuracy of the most complex systems...even those operating from poorly regulated power supplies. Variations in motor winding voltage ratings, custom scale factors, and special temperature compensation ranges can be supplied to meet application requirements.

TACHOMETER

Excitation Voltage115 volts 400 cps	Gradient tolerance at 25°C.±.25%
Current075 amperes	Phase Shift tolerance at 25°C.±30'
Power 5.5 watts	Axis error, in-phase 3.5 mv.
Power factor65	quadrature 7.0 mv.
Impedance1530 (990 + j 1160) ohms	Cup position error, in-phase 7 mv.
Output gradient 2.75 volts/1000 rpm	quadrature15 mv.
Output phase shift, nominal 0°	Harmonics at 0 rpm20 mv. max.
Output load 150 K ±1% ohms Resistive	Linearity 0 to ±3600 rpm07%
Calibration speed 3600 rpm	Output impedance 6900 ohms

Variation in gradient and phase shift vs. temperature

Temp. range, -55°C. to +85°C.	gradient ±.4%	phase shift ±45'
-------------------------------	-------------------------	----------------------------

Variation in gradient and phase shift from 400 cps values @ 25°C.

frequency	gradient	phase shift
380 cps	-.35 ±.15%	2.0 ±0.5° leading
420 cps	+.2 ±.15%	2.0 ±.5° lagging

MOTOR MECHANICAL DATA

No load speed 5500 rpm	Motor time constant115 sec.
Stall torque55 oz-in.	Theoretical stall acc5040 rad/sec ²
Moment of inertia 7.7 gm-cm ² (motor & tach.)	Length 3.438"
	Weight 9 oz.

For additional data, call your nearest EAD representative or write about your specific needs.



Rotation Is A Science At

EASTERN AIR DEVICES, Inc.

A Subsidiary of Norbut Corporation

397 CENTRAL AVENUE • DOVER, NEW HAMPSHIRE

Conventional test systems tend to be time-consuming to design, build, and debug, and unhappily restricted in range and function. **TRI/LIM** ends all that!

This new and revolutionary approach to limit-testing lets you design your own test systems in a matter of minutes. It assembles as fast as a few intermodule jumpers can be wired, and it measures virtually every electrical parameter with the reliability characteristic of all **trio/lab** products.

Seventeen engineering man-years went into the selection and design of **TRI/LIM** modules and circuitry. The result is a truly universal electronic limit-test system that can be programmed manually or digitally, measures 23 different electrical parameters, over a 10 million-to-1 range, with up to 4-digit resolution and compatible accuracy. Readout appears in simple go/no-go format, or as contact closures for sorting or marking. Printout accessories are easily accommodated.

As little as \$500.00 delivers a single-limit **TRI/LIM** system, a fully-programmable version of it is only \$650.00. We warn you that you'll sell yourself on getting even fancier.

Learn all about **TRI/LIM** from **trio/lab**'s new "Handbook of Limit Instrumentation". It includes a definitive limit-of-error analysis, and it's yours for the asking.

Introducing **TRI/LIM**

*A Fresh Approach to
Precision Limit Instrumentation*



trio/lab

Original Concepts in Instrumentation

**TRIO LABORATORIES, INC., PLAINVIEW, L. I. NEW YORK
OVERBROOK 1-0400, AREA CODE 516, TWX HKVL 1166**

Use the
POLAROID®
10,000 SPEED
Land Film

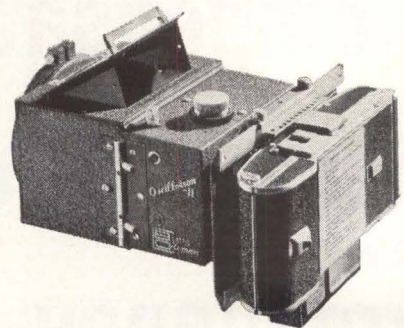

in the new
**BEATTIE-COLEMAN
MARK II
OSCILLOTRON**

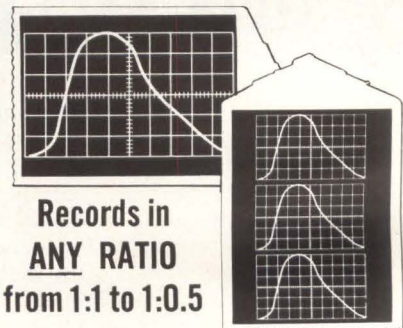

Records in
ANY RATIO
from 1:1 to 1:0.5

Here's the most versatile oscilloscope camera ever made. Especially designed for new 10,000 speed Polaroid Land Type 410 film that records pulses of extremely short duration. Prints in 10 secs. Easily change ratios from 1:1 to 1:0.5 without extra lenses. External focusing. Flat field lens. Electric shutter eliminates cable release. Direct viewing port or hood. Records up to 13 traces on one frame. Dark slide on Polaroid Land Camera back. Records written data on film. Fits any 5" scope. Attractively priced. Send for catalogs on all B-C Oscillotron models now.

"Polaroid"® by Polaroid Corporation



**BEATTIE-
COLEMAN
INC.**

1004 N. OLIVE ST., ANAHEIM, CALIFORNIA
CIRCLE 207 ON READER SERVICE CARD
electronics

fci

the stabilized
precision capacitor
for critical applications

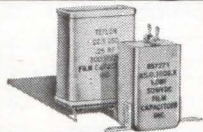

POLYSTYRENE and TEFLON CAPACITORS

- Highest I.R. — Lowest Dielectric Absorption and Power Factor — Low T.C.
- Highest Capacitance Stability
- Stable operation up to 85° C (Polystyrene) and 200° C (Teflon)



H.V. CAPACITORS

- High reliability paper — mylar® dielectric
- Small size — light weight
- Operation up to 125 C
- Voltage up to 60,000 V



TYPE D CAPACITORS (MYLAR)®

- High insulation resistance — low dielectric absorption
- Small in size — available in styles CP04, CP53, and CP70



SUBMINIATURE SELF-HEALING METALLIZED MYLAR CAPACITORS

- Available in all standard housings



Hermetically-sealed Self-Contained Solid State POWER SUPPLIES

Specially designed by FCI for high voltage, low current DC applications from 2 to 50 KV

fci

Send for complete catalog
FILM CAPACITORS, INC.

3400 PARK AVE., New York 56, N. Y., CY 2-5180

CIRCLE 208 ON READER SERVICE CARD
February 16, 1962

A MIGHTY STABLE POWER SUPPLY

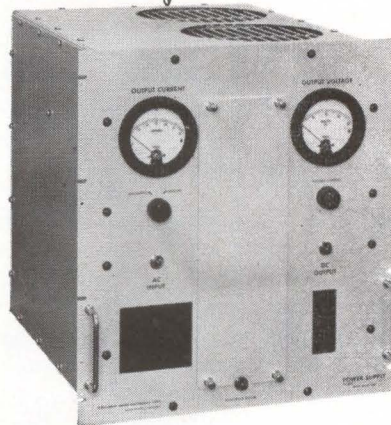

The STP-100 is a heavy-duty, all-transistorized d-c power source. It features exceptional line and load regulation of better than 10mv. The extremely low load transients and the complete absence of line transients make this supply ideal for powering semiconductors that are sensitive to voltage spikes.

The unit has all-electronic short-circuit protection and regulator failure protection. Additional features include:

- Thermal protective circuit
- Local or remote sensing
- Transistor monitoring circuit

The STP-100 is ideal for ground support equipment and high current applications. It provides from 22 to 32 volts d-c power at 100 amperes and to 125 amperes short term. It will deliver full power even with up to 25% of the regulator transistors non-operating. The unit is constructed primarily of MIL hardware and incorporates MIL-T-27 transformers and ruggedized meters. It is qualified to meet MIL-I-6181. The supply is designed to fit standard racks, 19" x 21" x 21".

PRICE—\$3,850. F.O.B. Santa Monica, California.

Behlman-Invar manufactures a broad line of both a-c and d-c laboratory power supplies as well as modular power supplies for rack mounting. For detailed information, write to:

BEHLMAN-INVAR ELECTRONICS CORP.

1723 CLOVERFIELD BOULEVARD—SANTA MONICA, CALIFORNIA

Behlman-Invar representatives are: T. Louis Snitzer Company—Los Angeles, La Jolla and Sunnyvale, California. • Cain and Company—Albuquerque; Great Neck, N.Y.; Boston; Orlando, Fla.; Philadelphia; Chicago; Dallas; Washington, D.C.



CIRCLE 73 ON READER SERVICE CARD 73

DESIGN AND APPLICATION

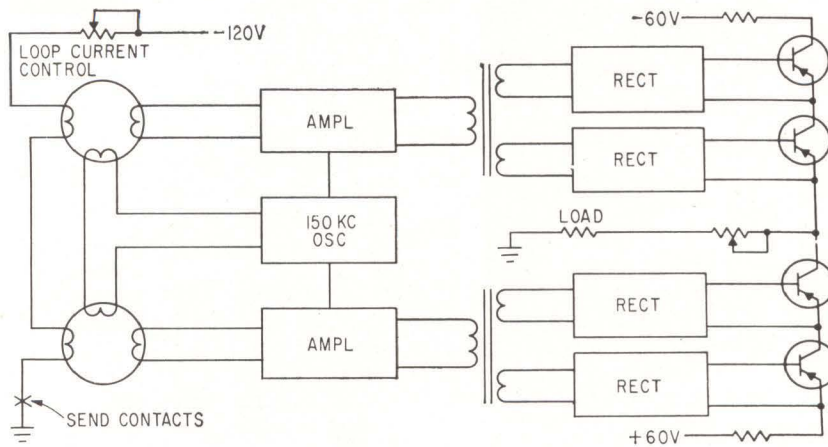

Semiconductor Relay

INERTIA-LESS CONTACTS

A NEW APPROACH to semiconductor relay design is claimed by Rixon Electronics Corp., 2121 Industrial Parkway, Montgomery Industrial Park, Silver Spring, Maryland. The two-terminal coil input is free of ground and has impedance and operating current characteristics equivalent to its mechanical counterparts. Input may be polar or neutral with operating sensitivity from 5 to 60 ma. As shown in the basic sketch, a rectangular hysteresis loop core at the input of each channel is continuously driven by a 150 Kc pulse generator. The drive signal is a series of single

polarity current pulses that drive the cores to saturation. If no input or bias current is provided, the cores will remain saturated and the oscillator pulses will produce no flux change and therefore no signal on the output winding. When a current of suitable magnitude and polarity flows in an input or bias winding, the core is reset during the interval between oscillator pulses so that the output winding produces a series of pulses at the oscillator frequency as long as the resetting d-c input is present.

CIRCLE 301 ON READER SERVICE CARD

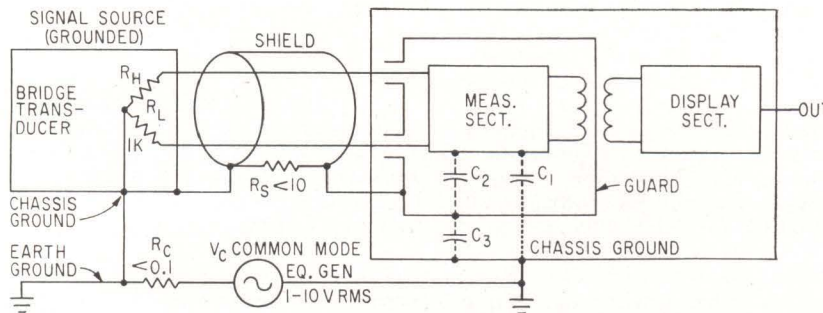

Integrating Digital Voltmeter

MEASURES THROUGH HEAVY NOISE

RECENTLY announced by the Dymec 395 Page Mill Road, Palo Alto, Division of Hewlett-Packard Co., California, is the model DY-2401A

integrating digital voltmeter. The most frequent noise source is power line pickup or hum (called common mode) which results from having two grounds in the system—one at the signal source and the other at the voltmeter. Other possible sources might include pickup from stray magnetic fields (usually power line frequency) and transducer vibrations. Here, the signal pair shield is connected to the guard shield. Except for slight voltage drop in R_s , the guard operates at signal source potential. The measuring circuit and the guard are at the same potential resulting in negligible current through C_2 and consequently a negligible current through R_L . Circulating ground current forced by V_c is effectively shunted away from the measuring circuit, now flowing through the signal pair shield and C_3 . Imperfection of the guard is shown by C_1 (mainly around power transformer and input terminals). Both C_2 and C_3 have negligible effect on common-mode rejection. Typical values are $0.002 \mu\text{f}$. If $R_s = 10$ ohms, $V_c = 10$ v at 60 cps and $R_c = 0$, current through C_3 will develop 75×10^{-6} v across R_s . A current of less than 10^{-10} amperes will flow through C_2 and less than 10^{-7} v will be developed across an R_L of 1,000 ohms. Rejection ratio would be approximately 160 db. With $C_1 = 2.5$ pf, rejection ratio will be 120 db. In reality, C_1 , C_2 and C_3 should each be shunted by a leakage conductance which will take over at d-c and determine a d-c common-mode rejection specification. Further rejection of superimposed a-c noise is accomplished by averaging or integration within the device.

CIRCLE 302 ON READER SERVICE CARD

Tiny Capacitors

EPOXY COATED

A LINE of tiny capacitors, claimed by their manufacturer to be one-third the size of other available

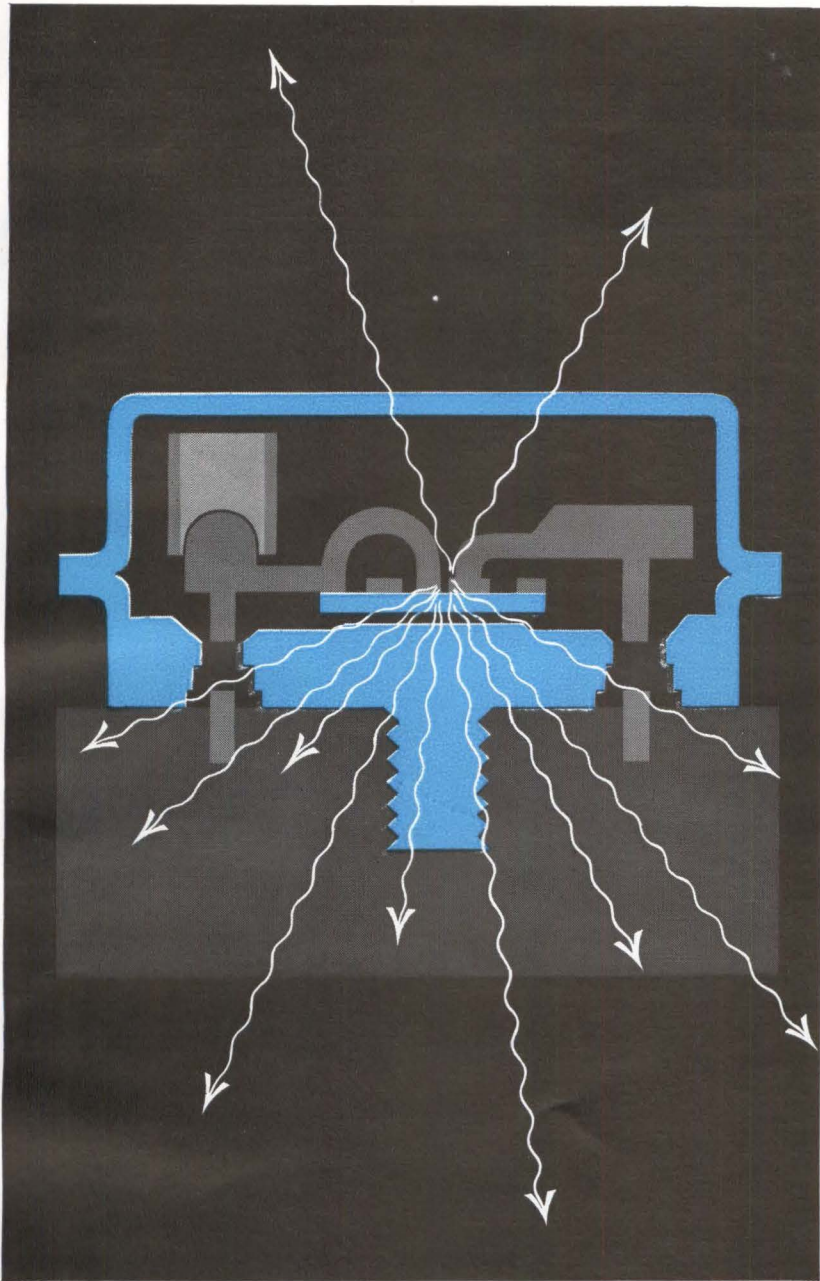

TUNG-SOL CONTROLS 'K' FACTOR

TO PRODUCE POWER TRANSISTORS
THAT DELIVER FULL POWER

Icbo is first measured at an elevated temperature. The transistor is then coupled, with silicone oil contact, to a copper block water-cooled to 25°C to provide an infinite heat sink. Power input is raised until Icbo equals high temperature Icbo. The temperature difference, divided by power, yields K in °C/watt.

This measure of a transistor's ability to remove heat from the junction is one of several significant criteria of Tung-Sol transistor quality and reliability.

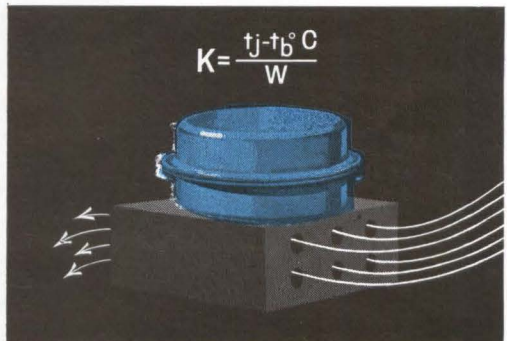

Maximum junction temperatures of 110°C, plus low K factors, enable Tung-Sol germanium power transistors to deliver full rated power under even the most adverse conditions. Design engineers can rely on full power performance because of the Tung-Sol policy of basing transistor design and specifications upon the most meaningful combinations of environmental and electrical tests.

K factor, or thermal resistance, is typical. Deceptively low K factors can be obtained by improper positioning of the external case temperature measuring device. Tung-Sol specifies junction-to-case—a more valid measure.

In monitoring junction temperature, Tung-Sol uses reverse leakage current (Icbo), a parameter more meaningful to the design engineer than forward voltage drop, because it tends

to reveal the effects of junction hot spots.

Maintaining low K factors (.5° C/watt maximum for the TO-36 configuration and .8° C/watt for the TO-3) is one of many ways Tung-Sol engineering builds an extra margin of power into transistors. In addition to 110°C junction temperatures, Tung-Sol power transistors have lower saturation voltage and higher breakdown voltages than ordinary transistors. Power transistor cases have copper-to-copper Cold Welds to prevent heat-caused contamination and damage and to assure maximum heat dissipation. Mounting surfaces are flat-ground to assure full heat sink contact.

All these quality features are available in both TO-3 and TO-36 configurations. Write for design information. Tung-Sol Electric Inc., Newark 4, New Jersey. TWX: NK193



TUNG-SOL® FULL POWER
POWER TRANSISTORS

WESTINGHOUSE ULTRASONICS

A reliable production tool . . . cleans almost anything better.

Do you need absolute cleaning of metal, glass, ceramic or plastic parts or assemblies? Westinghouse ultrasonic cleaning can do it. It's fast. Production-line dependable, too: generators are solid-state, transducers are long-life Magnapak and—for insurance—Westinghouse supplies local maintenance and service. Write: Westinghouse Electronic Equipment Department, 2519 Wilkens Ave., Baltimore 3, Md. You can be sure...if it's

Westinghouse

J-35520

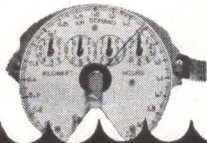
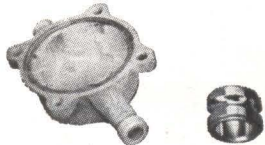
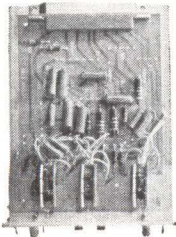
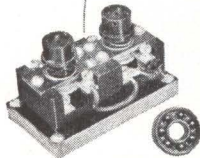
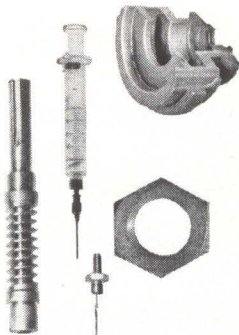

units of comparable specs, has been introduced by Chem-electro Research Inc., of Van Nuys, Calif. Specifically designed for a West Coast firm which wished to reduce the size of its modular circuits from ½-in. cube to ¼-in. cube. The new devices measure 0.060 by 0.060 inch and vary in length from 0.075 to 0.2-in. Capacitors range from 47 to 1000 μ f, and d-c voltage is rated at 100 v.

Barium titanate, used as the dielectric, is vacuum deposited on both sides with silver and leads are of gold-plated Kovar for either welding or soldering. Epoxy coating is used rather than the usual encapsulation.

CIRCLE 303 ON READER SERVICE CARD

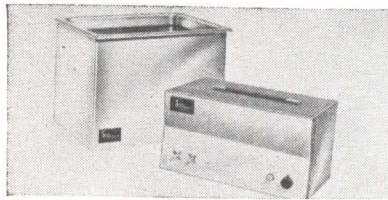

Ultrasonic Cleaner

SELF-TUNED

SONIC SYSTEMS, INC., 1250 Shames Drive, Westbury, N.Y. Model MSS-1500 series three gallon ultrasonic cleaner combines self-tuning, automatic operation, high reliability and ruggedness at the cost of many one gallon systems. Generator has 150 w average power, 600 w peak. Transducer tank with i-d of 10½ by 12¼ by 6 in. deep can operate at temperatures of 230 F.

CIRCLE 304 ON READER SERVICE CARD

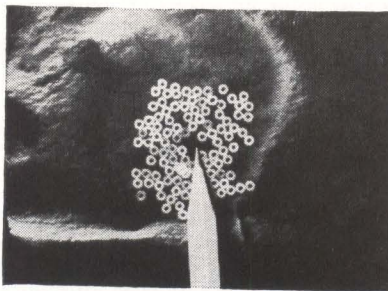

Clad Metal Washers

FOR SEMICONDUCTORS

SEMI-ALLOYS, INC., 20 N. MacQuesten Parkway, Mount Vernon, N.Y., offers metal washers for use as base tabs or rings in semiconductor manufacture. They have a combined flatness and burr of less than 0.0005 in. in sizes ranging from an inner

diameter of 0.030 in. up. Washers are available in molybdenum, nickel-iron, or Kovar cores with gold, silver and indium alloys or solders. They can be clad on one or both sides with either single or double claddings.

CIRCLE 305 ON READER SERVICE CARD

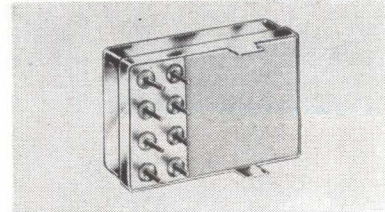

Miniature Reed Relays

CRYSTAL CAN

STRUTHERS-DUNN, INC., Pitman, N.J. Only 1.25 by 0.80 by 0.40 in. in size and combining 2 Form A and 2 Form B break-before-make contacts, the MRR2A2B magnetically shielded miniature reed relays replace crystal can types in many applications requiring long life and extreme contact reliability on dry circuit and light load switching. Insulated, nonmagnetic terminals aligned on 0.2 in. grid centers on the enclosure bases assure fast, convenient p-c mounting.

CIRCLE 306 ON READER SERVICE CARD

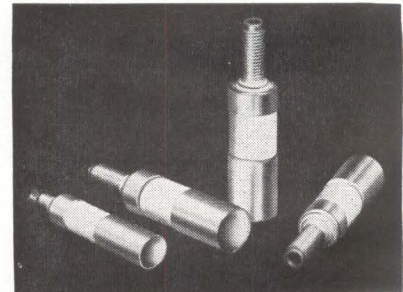

Cable End Seals

VARIETY OF SIZES

CERAMICS INTERNATIONAL CORP., 39 Siding Place, Mahwah, N.J., is mass producing cable end seals varying in sizes from 0.250 i-d to 0.625 i-d. They are made of an alumina insulator jointed by a pure silver or copper braze to a pure nickel tube on one end, and a nickel cap and steel or monel stud on the other end. They are used primarily as terminations for single conductor heater cables. Their reliability makes them suitable in many other hermetic feed through applications where a

stud is needed for tightening on an external lead.

CIRCLE 307 ON READER SERVICE CARD

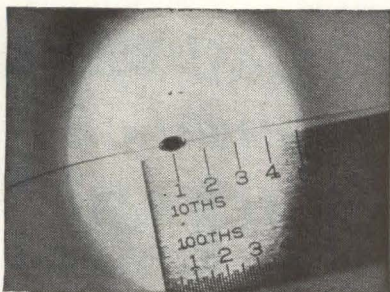

Temperature Sensor SOLID STATE

MICRO SYSTEMS, INC., 319 Agostino Road, San Gabriel, Calif. The T111-1000 solid state silicon temperature sensor has a repeatable operating range from approximately -400 F to $+400$ F. Over this linear range resistance changes 50 percent per 100F, thus making the unit suitable for temperature applications where 5 v per 500 F temperature change can be provided with a Wheatstone bridge circuit.

CIRCLE 308 ON READER SERVICE CARD

A/D Converter

DYNAMIC SYSTEMS ELECTRONICS, 2001 N. Scottsdale Rd., Scottsdale, Arizona, has available the ADC-2, a high-speed, high-accuracy, economically priced analog-to-digital converter.

CIRCLE 309 ON READER SERVICE CARD

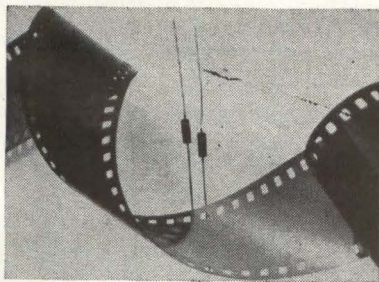

Switching Diodes VERY HIGH SPEED

GENERAL ELECTRIC CO., Syracuse, N.Y., announces two controlled conductance, very high speed silicon switching diodes for computer circuits and general purpose use. The SD-160 and SD-160A are planar, epitaxial, passivated devices. They have their maximum and minimum forward voltages specified within

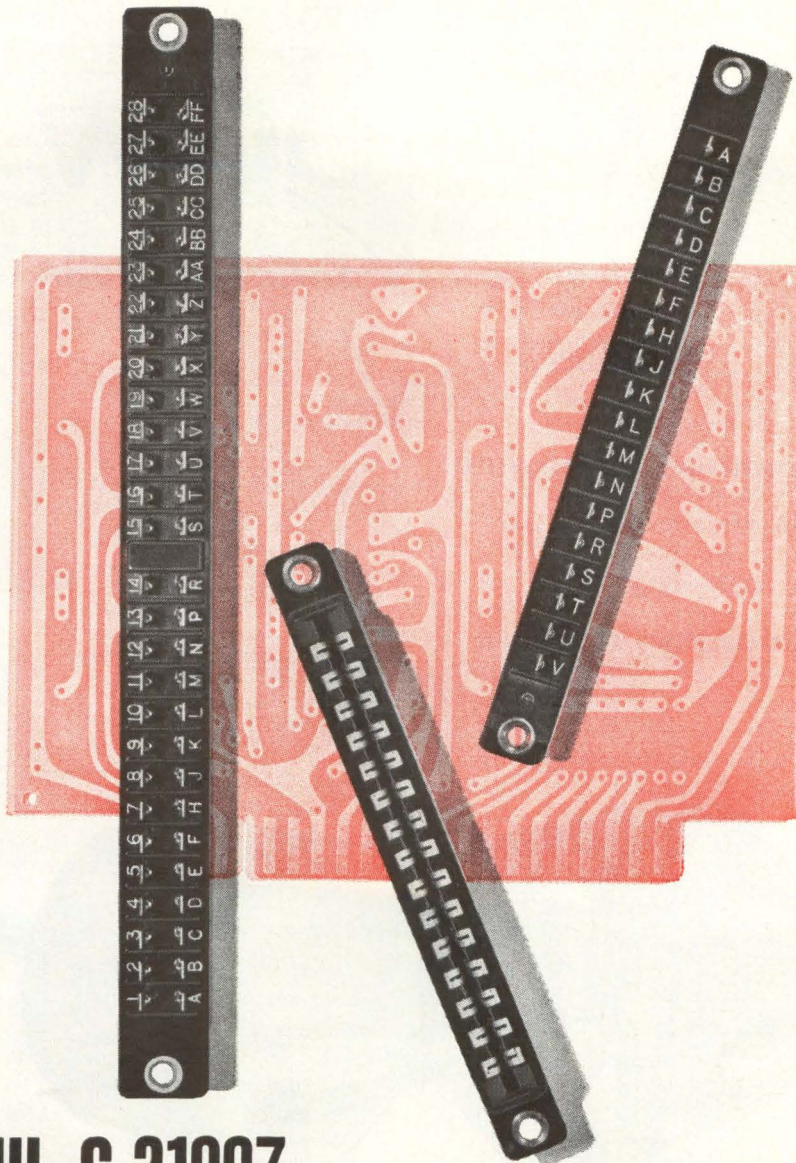

MIL C-21097 PBA PRINTED CIRCUIT PLUG NOW AVAILABLE FOR IMMEDIATE DELIVERY

- Designed To Mil C-21097
- Contrasting Extra Large Letters For Easy Wiring Identification
- Contacts Specially Designed For High Durability And Low Board Wear

The Cannon PBA Series of printed circuit plugs are ready for immediate delivery! GREEN OR BROWN DIALL FLAME RESISTANT INSULATORS ■ BIFURCATED BELLOWS CONTACTS ■ AVAILABLE IN SINGLE READOUT OF 15, 18, 22 CONTACTS—DOUBLE READOUT OF 30, 44, 56 CONTACTS ■ ACCOMMODATES PRINTED CIRCUIT BOARDS FROM 0.054 TO 0.071 INCHES ■ MOUNTING AVAILABLE IN THROUGH-HOLE, THREADED INSERT, OR FLOAT BUSHING ■ TWO METHODS OF POLARIZATION—CUSTOMER INSERTED PLASTIC KEYS, FACTORY INSERTED METAL KEYS. For complete information write for the PB catalog.

**CANNON
PLUGS**



CANNON ELECTRIC COMPANY, 3208 Humboldt Street, Los Angeles 31, California

REAR WINDOW CRT... optically clear

combines electronic
& photographic
display and
recording medias

Both electronic and photographic displays can be used simultaneously in this new ETC Type M1048—a high resolution, high brightness cathode ray tube for radar traffic control applications. Two distortionless and stria-free “rear windows”—allow grids, maps or other displays to be projected on the screen together with the PPI display. If preferred, a camera may be mounted to one rear window to record the composite display appearing in the tube’s 10” screen.

For details, write for ETC Bulletin M1048.

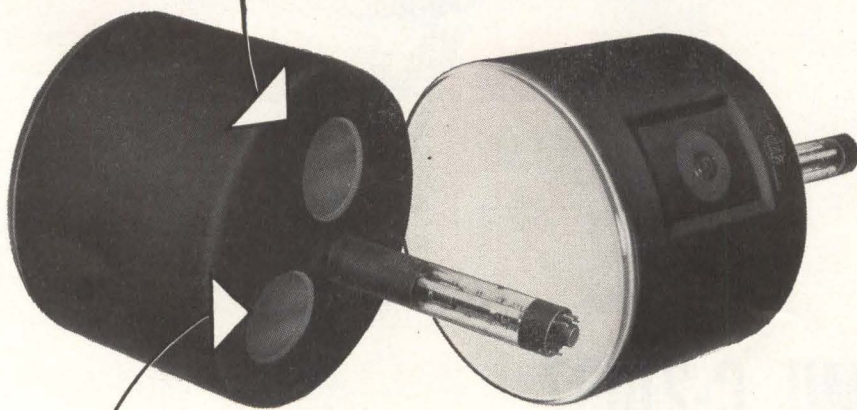

paceing trends IN CATHODE RAY TUBE DESIGN ...since 1937

The M1048 is one of many special purpose ETC tubes developed during recent months to provide new concepts in radar tracking and fire control indication efficiency. Types include single and dual-trace tubes with greatly enhanced defocussing and tracking accuracy. All can be designed with more than two guns for special uses. Inquiries for specific requirements will receive prompt attention.



electronic tube & instrument division

of General Atronics Corporation

1200 E. MERMAID LANE, PHILADELPHIA 18, PENNA.

(formerly Electronic Tube Corporation)

See us at the IRE Show—Booths 3315-3317

first
choice
FOR
critical
applications



ADJUSTABLE PRECISION POLYSTYRENE CAPACITORS

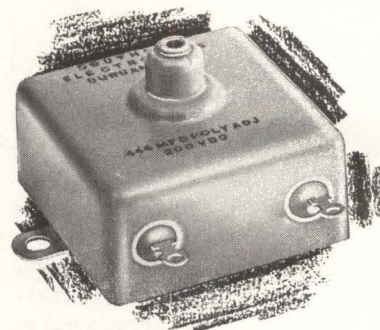

**.01% accuracy
hermetically sealed**

SOUTHERN ELECTRONICS hermetically sealed precision adjustable capacitors are finding many applications in analog computers, network tuning circuits, differential analyzers and similar electronic circuitry that requires the utmost in accuracy and reliability.

SEC has pioneered in the design and manufacture of hermetically sealed adjustable capacitors, and this experience has resulted in a .01% accuracy standard, and a degree of in-circuit-reliability not previously available at any price. SEC adjustable capacitors incorporate features proven to be years ahead of any comparable product now available.

GENERAL SPECIFICATIONS

Available from .01 mfd. to 10 mfd.

Accuracy: .01%

Long Term Stability: 0.03%

Temperature Coefficient: -100 PPM per °C

Temperature Range: -40°F to +140°F

Write today for complete specifications and general catalog.



See us at I.R.E. March 21-25.
Booth #2925 N.Y. Coliseum

**SOUTHERN
ELECTRONICS**
Corporation

150 WEST CYPRESS AVENUE
BURBANK, CALIFORNIA

CIRCLE 209 ON READER SERVICE CARD
electronics

70 mv at 100 μ a and within 150 mv at 20 ma. Maximum reverse recovery time at a forward current of 10 ma and a reverse voltage of -6 v with a load resistance of 100 ohms is 2 nsec.

CIRCLE 310 ON READER SERVICE CARD

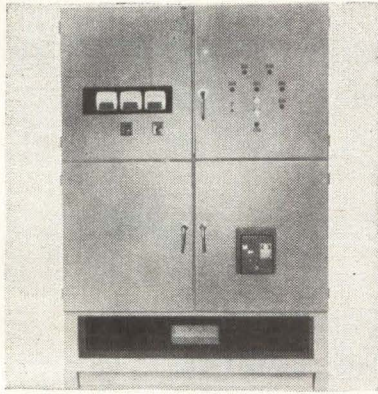

Power Supply

FOR PLASMA RESEARCH

PERKIN ELECTRONICS CORP., 345 Kansas St., El Segundo, Calif., has developed a 500 Kw-d-c power cubicle with saturable reactor control for plasma research. It will have applications in wind tunnel investigation of metals for space travel. Capable of operating at 150 percent of load for two hours continuously, the power supply is rated 1,000 v at 500 amp, 500 v at 1,000 amp, or 250 v at 2,000 amp.

CIRCLE 311 ON READER SERVICE CARD

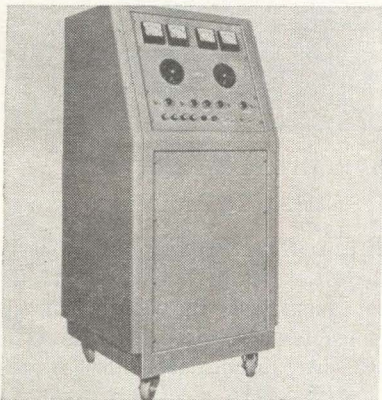

Hard Tube Modulators

FOUR MODELS

NARDA MICROWAVE CORP., Plainview, N. Y. Four standard models of hard tube modulators provide peak pulse power outputs from 0 to -16 Kv at 16 amp max. Pulse widths are continuously variable from 0.25 to 5.0 μ sec. Complete metering and viewing circuits are included for con-

THINK... High Density

242,000 to
450,000 BCD Digits/Sec

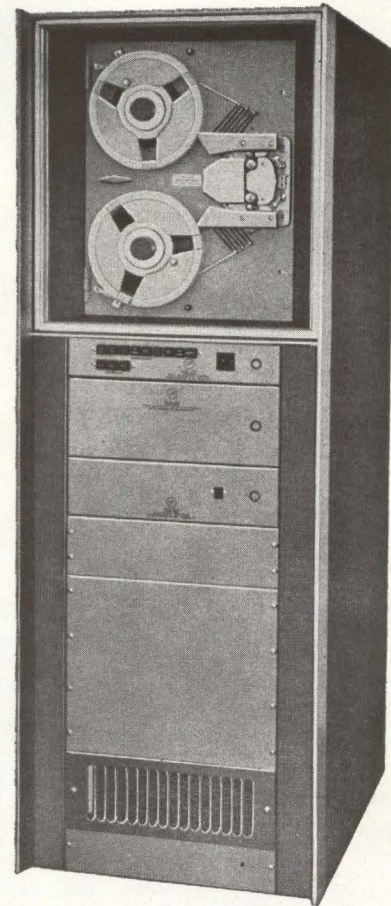

Available from
POTTER
Today!

Potter High Density Tape Systems provide reliable performance for any computer system...and at bit packing densities higher than any other digital magnetic tape system available now. Each reel of 1-inch tape recorded using the Potter High Density technique holds as much data as eleven reels recorded by the most common systems. This break-through in the art provides data transfer rates of 242,000 to 450,000 BCD digits per second...with a guaranteed recovery of at least 99,999,999 out of 100,000,000 bits recorded at the higher transfer rate.

There's much more to our story. So much more that we've produced a fact-filled brochure called "The Topic is...HIGH DENSITY." It's designed to answer your questions regarding this advanced recording technique...why not send for your copy today?



POTTER INSTRUMENT CO., INC.
Sunnyside Boulevard • Plainview, New York

T.M.

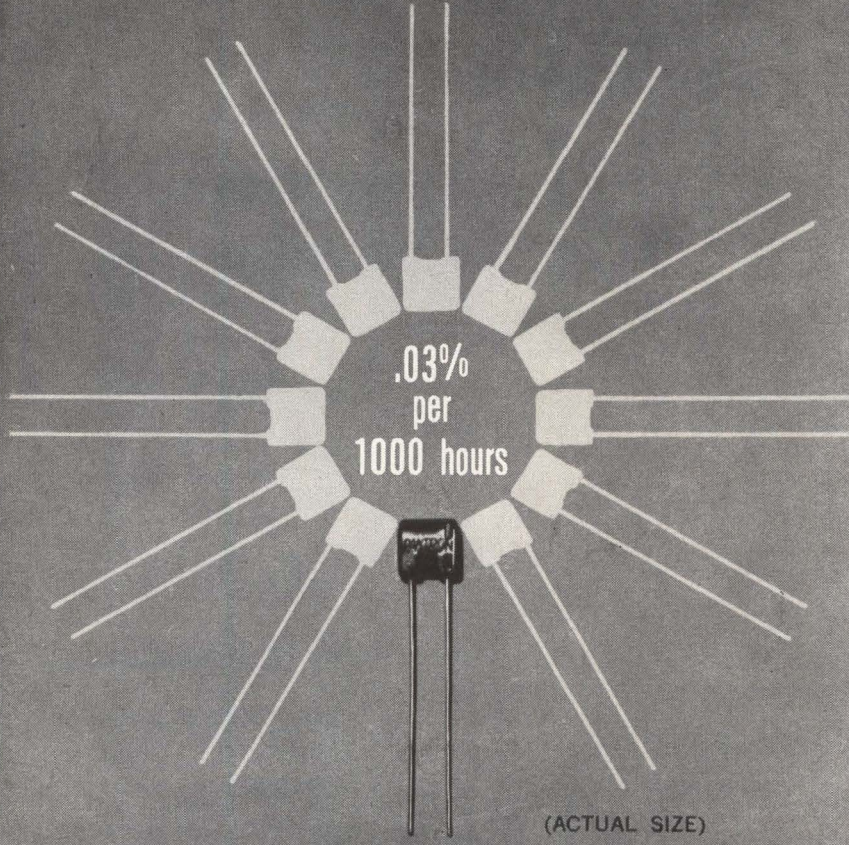

completely reliable

That's the MR 330 Paktron Mylar* Capacitor. Specifically—0.3% per 1,000 hours. If such outstanding features as high capacitance, small size, outstanding stability, low dissipation and low cost will solve your problems, then write today. We'll get complete information to you at once.

i t PAKTRON
PACKAGED ELECTRONICS
DIVISION OF ILLINOIS TOOL WORKS
 1321 LESLIE AVENUE • ALEXANDRIA, VIRGINIA

AREA CODE 703 King 8-4400

** DUPONT

tinuous monitoring of all principal parameters during operation, and all of the units provide automatic overload protection. All are bench-top equipment except model 10010 (illustrated). Prices range from \$2,450 to \$5,875.

CIRCLE 312 ON READER SERVICE CARD



Variable Attenuator 100-700 MEGACYCLES

RADAR DESIGN CORP., Pickard Drive, Syracuse 11, N.Y. Model D-1428 has less than 0.5 db insertion loss and a non-frequency sensitive adjustment range of 15 db. Connectors are BNC. Price and delivery \$230 each, 3 weeks.

CIRCLE 313 ON READER SERVICE CARD



Synchro Test Set SEMIAUTOMATIC

THETA INSTRUMENT CORP., 520 Victor St., Saddle Brook, N. J. Test set measures the major synchro characteristics described in MIL-S-20708A. Model MST-5SSA tests electrical zero, electrical error, fundamental null and total null. Synchros may be measured at a rate of 1,000 per month by unskilled operators. Specifications: electrical error range, 0 deg through 360 deg in 5 deg steps; null range, 0 deg through 360 deg in 60 deg steps; self-contained phase sensitive voltmeters and phase reference. Price, \$4,500.

CIRCLE 314 ON READER SERVICE CARD

PRODUCT BRIEFS

SCANNER 100 position-4 pole. Auto Data, 943 Turquoise, San Diego, Calif. (315)

D-C RATIOMETER five-digit resolution. Non-Linear Systems, Inc., Del Mar, Calif. (316)

T-Y RECORDERS low-priced. Houston Instrument Corp., P.O. Box 22234, Houston 27, Texas. (317)

SILICON RECTIFIERS clip-in. Solitron Devices, Inc., 500 Livingston St., Norwood, N. J. (318)

TUNING FORK meets MIL frequency standards. Time & Frequency, Batavia, Ill. (319)

LINE VOLTAGE MONITOR for quality control. MSI Electronics Inc., 116-06 Myrtle Ave., Richmond Hill 18, N. Y. (320)

MOLDED CHOKE COILS subminiature. Delevan Electronics Corp., 77 Olean Rd., East Aurora, N. Y. (321)

ELECTROSTATIC CRT is 1½ in. in diameter. Electronic Tube and Instrument Div. of General Atronics Corp., 1200 E. Mermaid Lane, Philadelphia 18, Pa. (322)

SINE-COSINE POT accuracies to 0.1 percent. Computer Instruments Corp., 92 Madison Ave., Hempstead, L. I., N. Y. (323)

P-C TOROIDS 0.1 inch grid. Hisonic, Inc., Shawnee, Kan. (324)

ELECTRONIC PROGRAMMER five-channel. Abrams Instrument Corp., Lansing, Mich. (325)

PULSE HEIGHT ANALYZER transistorized, multichannel. Technical Measurement Corp., 441 Washington Ave., North Haven, Conn. (326)

K_n-BAND WAVEGUIDE SWITCH space saving. Airtron, a Division of Litton Industries, 200 E. Hanover Ave., Morris Plains, N. J. (327)

TIME DELAY RELAYS a-c and d-c versions. Hi-G, Inc., Bradley Field, Windsor Locks, Conn. (328)

PRESET COUNTERS high-speed. Micro Measurements Corp., 2412 Norwood, Melrose Park, Ill. (329)

STATIC INVERTER high voltage. Grafix Co., P.O. Box 3296, Albuquerque, N. M. (330)

P. I. recorder stars in command performance aboard Discoverer/Agema

Upon command, an instrumentation tape recorder goes into instant action aboard the Agema satellite used in the Air Force's Discoverer program. After recording way-out scientific data, the 100-ounce recorder brings it down to earth in a hurry by playing back eight times as fast as it records. And by recording in one direction, playing back in the other, the recorder bypasses the usual rewind function . . . not only saving time and payload weight, but also permitting a simplicity in design which insures extreme reliability. ■ This remarkable instrument, the 3-channel Precision PS-303L, is a veteran performer on the orbital circuit and has contributed significantly to the Discoverer program.

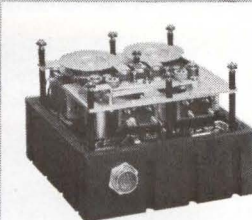

PS 303L Recorder

Despite the fact that it was designed* to function under extreme environmental conditions, it offers performance capabilities comparable with those of much larger, earth-bound recorders. Frequency response, for example, is 5 kc at a recording frequency of only 1½ ips. ■ When your next project involving data acquisition is ready for orbit, we suggest you investi-

gate the P.I. approach to the problems involved. The P.I. concept of full-size performance in a fraction of the space is already saving important dollars in hundreds of applications, from monitoring missiles to recording infra-red, from gathering geophysical shock data to simulating radar signals. Write today for the current P.I. brochure.



PRECISION INSTRUMENT

1011 Commercial St., San Carlos, Calif. LYtel 1-4441 TWX: SCAR BEL 30

Representatives in principal cities throughout the world

*for Lockheed Missiles & Space Company, Sunnyvale, California

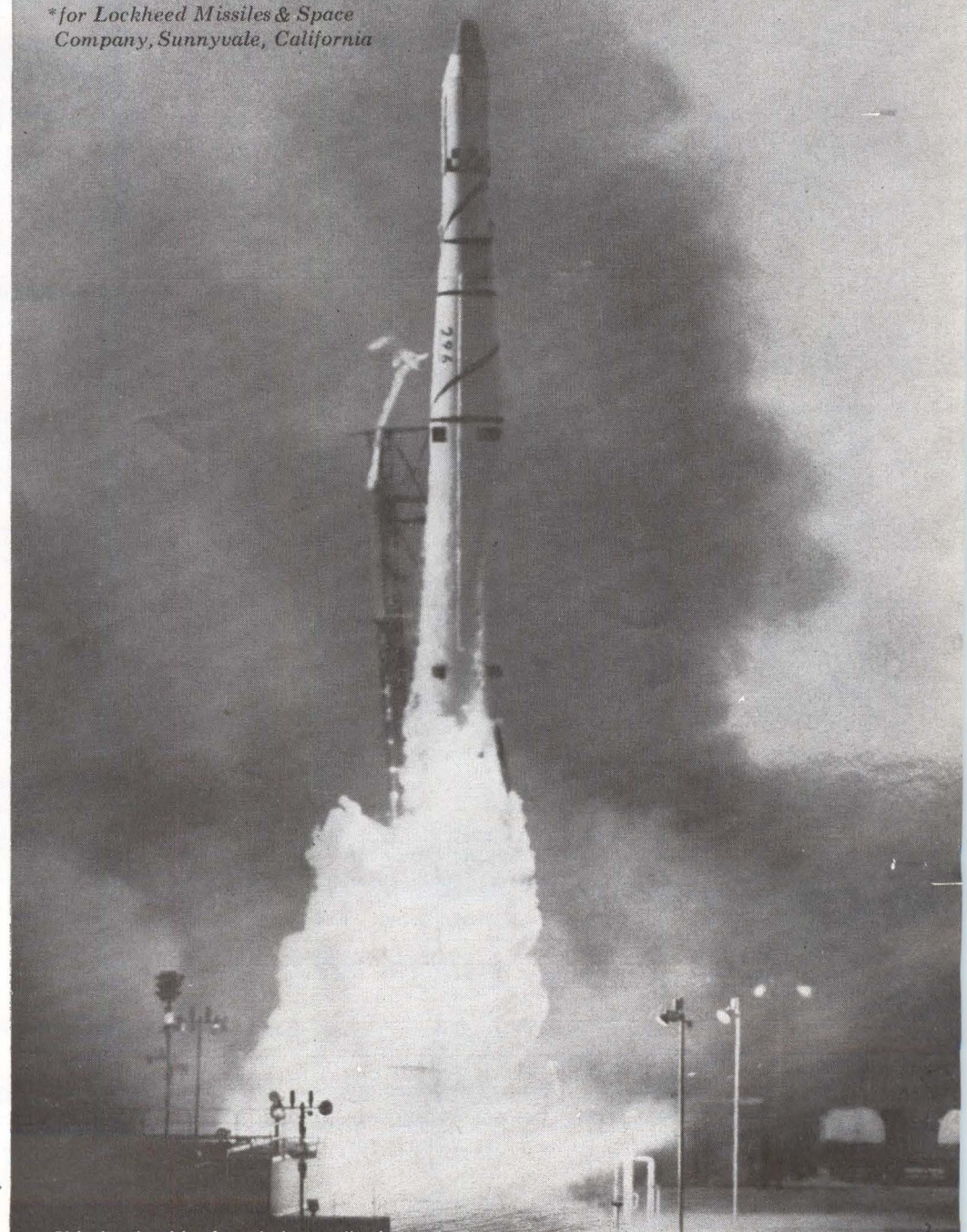

CIRCLE 81 ON READER SERVICE CARD →

PI invites inquiries from design, application, and sales engineers.

ENGINEERING CASE HISTORY LOG-LIN AMPLIFIER

PROBLEM: Customer* required a special-purpose amplifier, part of a receiver for use in Navy weather radar equipment (AN FPS-68). Working from a microwave mixer, the low-noise system must accommodate an input dynamic range of 70 db without overload. An additional 60 db of STC control was required to provide range normalization during the receive period. Units must conform to MIL-E-16400. Full spec prototype system required 45 days ARO.

SOLUTION: RHG designed and built a two-unit system and achieved an IF noise figure of 1.5 db. STC control is provided in the input unit and the gain in db is reduced linearly with control voltage. Output unit is designed to be a log-linear amplifier using silicon diodes in temperature-stabilized successive detection networks to provide highly accurate logarithmic compression without overload. Gating circuitry permits selection of log or linear outputs and provision for continuous monitoring of noise figure is provided. Delivered to customer 45 days ARO.

*Cardion Electronics, Westbury, N.Y.

Send for Catalog 1010B covering standard amplifiers and instruments. RHG custom engineers solutions to your special problem. May we help you?



RHG ELECTRONICS LABORATORY, INC.

94 Milbar Blvd., Farmingdale, N.Y., NY 4-3100

CIRCLE 210 ON READER SERVICE CARD

Literature of the Week

SYNCHRO TEST SET Theta Instrument Corp., 520 Victor St., Saddle Brook, N.J. Four-page technical bulletin contains complete description of model MST-5SSA synchro test set. (331)

GAMMA COUNTING SYSTEM Delta Instrument Corp., 250 Delaware Ave., Clifton, N.J., offers a bulletin on a low level gamma counting system for measuring radioactivity in bulk samples. (332)

PLANAR EPITAXIALS General Instrument Corp., 65 Gouverneur St., Newark 4, N.J., has available an 8-page brochure on silicon planar epitaxial transistors. (333)

RECORDER/REPRODUCER Consolidated Electrodynamics Corp., 360 Sierra Madre Villa, Pasadena, Calif. A 4-page bulletin describes the outstanding characteristics of the GR-2800 magnetic tape recorder/reproducer. (334)

PRODUCT BROCHURE General Electronic Laboratories, Inc., 18 Ames St., Cambridge 42, Mass. Brochure describes products for communications, radio telemetry, electronic countermeasures, antennas and antenna systems, microwave equipment, parametric and solid state devices. (335)

CAPACITOR CHART Cornell-Dubilier Electronics, 50 Paris St., Newark, N.J., has developed a detailed Periodic Table of selection and application data on all 18 major types of capacitors. (336)

TRANSISTOR BULLETIN Sperry Semiconductor, Norwalk, Conn., offers bulletin SS-300 on silicon alloy pnp transistors. (337)

ELECTRONIC CHOPPER Solid State Electronics Co., 15321 Rayen St., Sepulveda, Calif., has published a bulletin describing model 70 silicon transistor electronic chopper with operating temperature range -55 C to +130 C. (338)

ENCAPSULATING SHELLS Epoxy Products Div., Joseph Waldman & Sons, 137 Coit St., Irvington 11, N. J., has available an information bulletin describing the use of encapsulating shells for environmental protection of electronic components. (339)

For Production

Line Testing...



EICO SCOPES

give you:

- professional performance
- reliability
- ruggedness
- versatility

... at moderate cost

EICO's high quality standards and low initial cost add up to true economy: EICO units outperform scopes selling for two or three times EICO's prices.

With kits, the initial cost is even lower. And the experience each operator gains in building his own, increases his efficiency, and enables him to keep his scope in better condition, with less "down" time.

	prices		freq. resp. (sinusoidal)		sensitivity (rms)	
	kit	wired	vert.	horiz.	vert.	horiz.
5" Push-Pull Scope #425	\$44.95	\$79.95	5 cps to 400 kc	5 cps to 400 kc	75 mv/in	0.1V/in
5" DC-4.5 MC Scope #460	79.95	129.95	DC-4.5 mc/flat	1 cps to 400 kc flat	25 mv/in	0.6V/in



See the 41 additional EICO test instruments helpful for your lab and production work. Write for free Catalog & name of neighborhood Distributor.

3300 NORTHERN BOULEVARD, Dept. E-2B, L. I. C., 1, N. Y.

See us at IRE Booth #3701

add 5% in the West

IRE SHOW



presenting

"THE GOLDEN AGE OF ELECTRONICS"

March 26-29, 1962

The New York Coliseum

... part of the

International Convention of the IRE

The Institute of Radio Engineers
1 East 79th Street • New York 21

Members \$1.00. Non-members \$3.00. Age limit: over 18
CIRCLE 211 ON READER SERVICE CARD

NEW Stromberg-Carlson® lightweight telephone handsets



... for a wide range of applications such as dictating systems, mobile radio, carrier and microwave.

These new lightweight Stromberg-Carlson handsets, No. 33 and No. 35, incorporate push-to-talk switches, broadening the range of their applications. Both feature high-gain, high-efficiency transmitter and receiver.

The No. 33 model is furnished with a bar-type switch, located on the underside of the handle.

The No. 35 handset is furnished with a button switch on the side of the handle near the receiver end. Also available with both button and bar switches.

For technical details and ordering information, contact any of these sales offices: Atlanta—750 Ponce de Leon Place, N.E.; Chicago—564 W. Adams Street; Kansas City (Mo.)—2017 Grand Avenue; Rochester—1040 University Ave.; San Francisco—1805 Rollins Rd.

**GENERAL DYNAMICS
TELECOMMUNICATION**

CIRCLE 83 ON READER SERVICE CARD 83

FASTENERS FROM

GRC

DIE CAST ZINC ALLOY



Wing Nuts



Cap Nuts



Thumb Nuts



Thumb & Wing Screws



Screws



Hex Nuts



Washers



Screw Insulators



MOLDED NYLON SCREW INSULATORS and WASHERS

Insulators completely insulate metal screws from mounting... used as light load bearings and bushings. Washers used in a wide variety of insulating applications. Both are stocked in sizes to fit #4 to 1/4" screws.

Elastic and resilient, they conform to irregular surfaces, seal, dampen vibration... are economical. GRC's special automatic molding techniques assure high quality at lowest possible cost—let you make the most of nylon's high strength-to-weight ratio, electrical insulating and other qualities.

Write, wire, phone TODAY for samples, prices, literature on GRC's unique molding techniques.



GRIES REPRODUCER CORP.
World's Foremost Producer of Small Die Castings
151 Beechwood Ave. • New Rochelle, N.Y.
Phone: (914) NEW Rochelle 3-8600
BE SURE TO SEE US AT THE IRE: BOOTH 4054

CIRCLE 222 ON READER SERVICE CARD

February 16, 1962

Heyco Nylon BUSHINGS



STRAIN RELIEFS
The insulating bushing that anchors a cord set to an electrically operated machine or appliance.

JUNCTION-TERMINAL BUSHINGS

Eliminate "pig-tails" — Miniature size, Snap-in assembly, color or number coded. Can be used as plug-in receptacle. Simple quick disconnect.

ACCORDIAN TYPE
Fit curved surfaces
Nylon bushing — brass tab

HEYCO NYLON Snap Bushings

10 Sizes for holes from 3/8" to 1 3/4" dia.—various inside diameters. Snap locks into panels up to 3/8" thick.



FREE SAMPLES! BUSHINGS OF YOUR CHOICE

**HEYMAN
MANUFACTURING COMPANY**
KENILWORTH 2, NEW JERSEY

CIRCLE 223 ON READER SERVICE CARD

NOW A family of Precise Thermistors

YSI produces a family of precise thermistors which match standard Resistance-temperature curves within $\pm 1\%$.

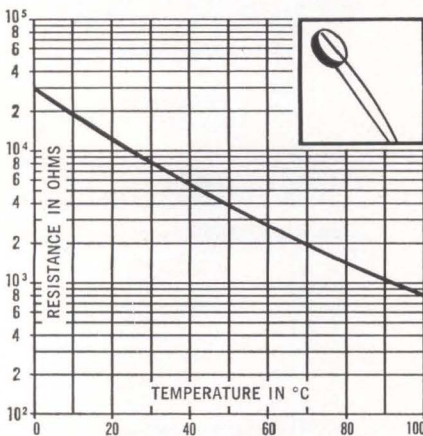

Resistance Temperature Characteristics - Partial Range-YSI #44006 Thermistors (10K).

You can now use stock YSI thermistors interchangeably as components in any temperature transducer or compensator circuit without individual padding or balancing.

DATA

Base resistances at 25° C. of:

100 Ω	1 K	10 K
300 Ω	3 K	30 K
		100 K

- Each family follows the same RT curve within $\pm 1\%$ accuracy from -40° to $+150^\circ$ C.
- Cost under \$5.00 each, with substantial discounts on quantity orders.
- Quantities under 100 available from stock at YSI now.
- YSI can produce precise thermistors with different base resistances and beta's where design requirements and quantities warrant.

For complete specifications and details write:



for improved MULTIPLE-FILTER SPECTRUM ANALYZERS

it's **SPECTRAN**
ELECTRONICS

For substantially instantaneous, high resolution of spectra as wide as 50 kc/s, two standard spectrum analyzers employ arrays of 480 and 40 very narrow-band-pass magnetostrictive filters — other arrays on special order. Important electronic features include solid-state drive circuitry capable of 20 watts output to drive an entire 480-filter array simultaneously.

Write for technical data sheets.

SPECTRAN
ELECTRONICS

146 Main Street
Maynard, Massachusetts

CIRCLE 212 ON READER SERVICE CARD

DRIFT-FREE CHOPPER STABILIZED DC AMPLIFIER

Accuracy — $\frac{1}{2}\%$
Ideal for use with
O-IMA Recorders

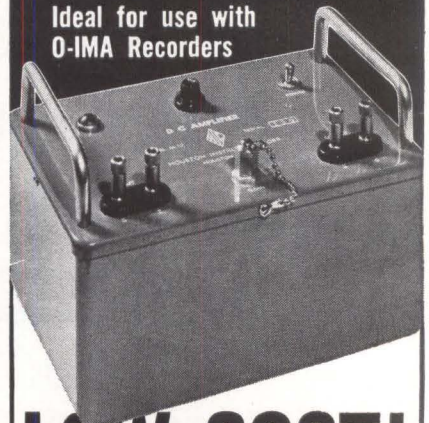

LOW COST!

\$135 IMMEDIATE DELIVERY! WRITE FOR BULLETIN



**houston
instrument**
corporation

Box 22234 Houston 27, Texas MO 7-7403

CIRCLE 213 ON READER SERVICE CARD

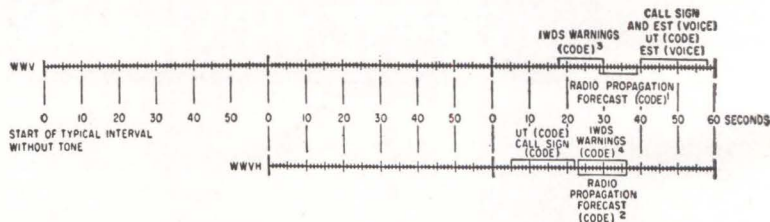

PRIMARY STANDARDS

Whether you want to pace a city's clocks or time the transit of an artificial satellite, you'll find the standard time intervals and frequencies broadcast by the National Bureau of Standards of vital assistance.

You'll find a complete run-down on this NBS service in your 1961 **electronics Buyers' Guide** and Reference Issue, plus information on how you can obtain NBS calibration of practically any secondary standard, from resistance to the complex elements of the tensor permeability matrix.

Wealth of information like this makes your 1961 EBG a primary reference volume in the electronics field. You'll find new uses for it every day.

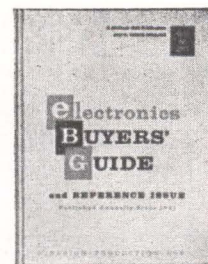

electronics BUYERS' GUIDE and Reference Issue

The Basic Buying Guide in Electronics since 1941



93% of the answers stressed *Opportunity* for Professional Advancement *We Have It —* and here's how it works . . .

(1) Twenty Seven Management Selection Committees function, in a completely unbiased and calculated system to find the best qualified individuals to fill openings which occur.

In the year 1961 they spent over twenty-two hundred manhours evaluating qualifications of employees.

For every opening which occurs these responsible committees do a thorough job of screening and may come up with one outstanding prospect, but if more than one are equal in qualifications, the involved Department Head has the final choice.

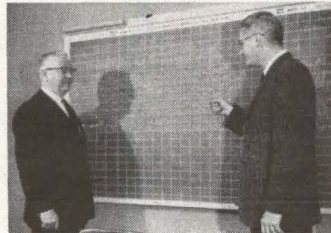
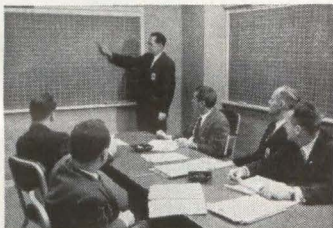
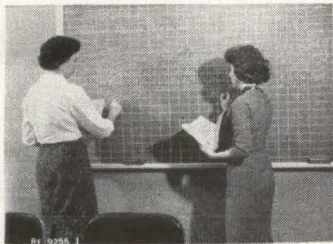

(2) Management Development, on the other hand, functions to encourage and aid those employees who wish to further develop their capabilities and talents.

If this system appeals to YOU in offering opportunity for YOUR further development and advancement—write us today!

THE ENGINEERING CENTER
LOCKHEED-GEORGIA COMPANY
A DIVISION OF LOCKHEED AIRCRAFT CORPORATION
AN EQUAL OPPORTUNITY EMPLOYER



Where, we find,
there's **MORE** of what **MORE** Engineers want **MORE** of

OK...
LOCKHEED
Here's
what
I
want

- Opportunity for professional advancement
- Opportunity to work on challenging projects
- Long range job security
- Full opportunity to capitalize on my education
- Full opportunity to utilize my experience
- Year-round recreational facilities
- Income
- Professionally advantageous associations
- Freedom to work with less red tape
- Desirable fringe benefits
- Company stability and prestige
- Pleasant living conditions
- Opportunities for further education
- Recognition of personal contributions

NAME _____
ADDRESS _____
PHONE _____

ENGINEERS

Have YOU Answered
This Invitation Yet?

It appeared in the January issues of Scientific American, Aviation Week, Aerospace Engineering, Aerospace Management, Space Aeronautics and a number of other publications. Answers received so far indicate that we already offer a remarkably high percentage of the advantages desired by the majority of Engineers AND THAT WE CAN PROBABLY TAILOR A POSITION TO FIT THE REQUIREMENTS OF THE EXCEPTIONS. You'll never know how well your own desires and requirements can be satisfied unless you challenge us to meet them by telling us WHAT YOU WANT!

We challenge YOU TO DO IT NOW!

*Tell us what
you want*

MAIL TO:

Hugh L. Gordon
Professional Employment Manager
Lockheed-Georgia Company
834 West Peachtree Street
Atlanta 8, Georgia Dept. TT-88

VITREOSIL®

PURE FUSED QUARTZ

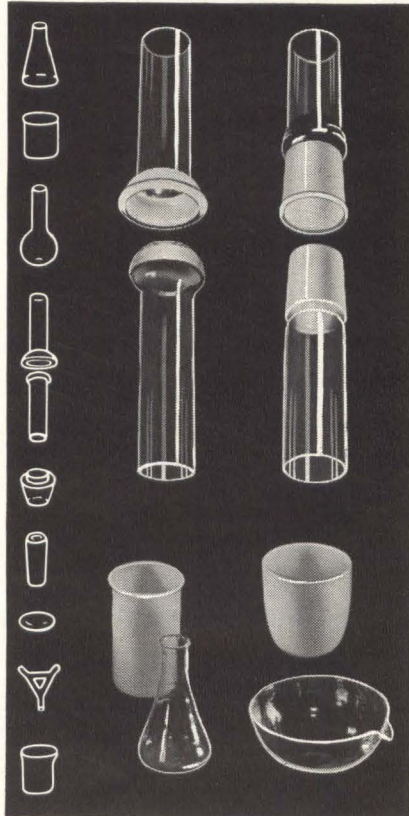

For use in Production of Semi-Conductor Metals

VITREOSIL pure fused quartz can take temperatures in excess of 1000°C and is unaffected by more acids than glass, platinum, or porcelain. Comes in tubes, rods, sheets, and blocks for lenses, laboratory and industrial ware, special fabrication etc. Our know how enables us to hold close tolerances; and metal to quartz seals are a production item.

SPECTROSIL®, the purest form of quartz known, is recommended where the optimum is required in semi-conductor work. Spectrosil has unique qualities in purity, transparency and homogeneity — fabrication the same as Vitreosil — in clear only.

For more details see Chemical Engineering Catalog, Electronic Engineers Master, or write for our 32 page catalog.

3

THERMAL AMERICAN FUSED QUARTZ CO.



RT. 202 & CHANGE BRIDGE RD.
MONTVILLE, NEW JERSEY

Electrically and Electronically Ceramics Is Our Middle Name

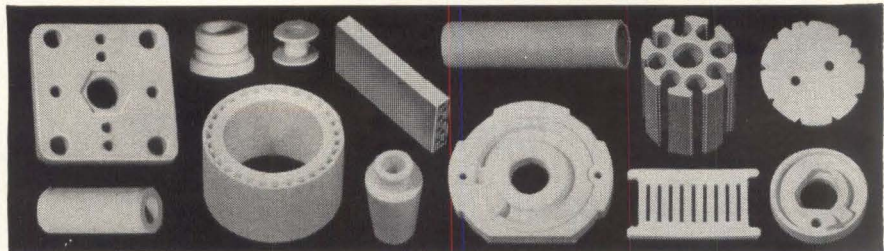

in precision-engineered parts for critical demands

- STEATITE
- ALUMINA
- DC-265 96% ALUMINA
- ZIRCON
- MAGNESIUM OXIDE
- FORSTERITE
- SPECIAL COMPOSITIONS



DU-CO CERAMICS CO.

202 Main Street

Saxonburg, Pa.

CIRCLE 214 ON READER SERVICE CARD

• Whether you call for a hard, shock-resistant material with emphasis on design, or a special composition that is vacuum tight and possessing high thermal conductivity, you can be sure that Du-Co standards of quality, workmanship and scheduled delivery are zeroed-in to your rigid specifications.

• Du-Co's ability to produce in large quantities at lowest prices, and to maintain facilities and equipment for the most exacting machining operation makes it unique as a ceramic supplier to the electrical and electronic industries.

• Regardless of the ceramic problem, let Du-Co quote from your prints and submit samples first!

"Proud to Serve You"

Coils for Contact Capsules

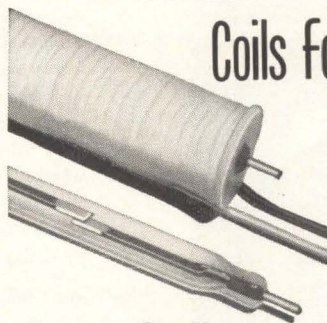

TYPE	DC-V	Ohms	Nom. Watts	Nom. Amp/Turns
S	6	100	.40	250
	12	360		
	24	1400		
M	6	50	.70	250
	12	175		
	24	820		
T	6	100	.35	125
	12	400		
	24	1600		
	32	2800		
	48	4600		

Coto-Coils

Write for Bulletin and Prices

COTO-COIL CO., INC. 65 Pavilion Avenue, Providence 5, R. I.

CIRCLE 215 ON READER SERVICE CARD

Coil Windings

WIRE SIZES
#6 to #56
CLASSES A, B, F and H

Since 1917 Coto-Coil has wound all types of coils for every application. Complete design and engineering service is available.

Is your advertising selling the same four key buyers your salesmen call on? Competition demands it! Only advertising in electronics reaches and sells the electronics man wherever he is: in Research,

TODAY YOU MUST SELL ALL FOUR!

Design, Production, and Management. Put your advertising where it works hardest...

in **electronics**

electronics

TURBOTEMP
 TURBOTEMP
 TURBOTEMP
 TURBOTEMP®

Teflon-Insulated Wire & Cable

- The widest line of Teflon-insulated wires and cables available.
- U.L. Approved in both TFE and FEP types — meeting military specifications wherever applicable.
- Fast deliveries from the biggest inventory and the broadest Teflon wire and cable manufacturing capability in the nation.
- Quality assured All Turbo-temp wires and cables are manufactured in Brand-Rex plants under strict quality control.

Do you have a special Teflon-insulated wire or cable problem? Brand-Rex cable engineers will work cooperatively with you without obligation.

JUST PUBLISHED! 10-page, fact-filled brochure. "TURBOTEMP TEFLON WIRE AND CABLE". Write for your copy today.



DIVISION OF
 American ENKA Corporation
 SUDBURY ROAD, CONCORD, MASSACHUSETTS
 TELEPHONE: EMERSON 9-9630

CIRCLE 216 ON READER SERVICE CARD
 February 16, 1962

NEW KEITHLEY MILLIOHMMETER

*fast,
 accurate,
 direct-reading*



—permits low resistance measurements from 10 micro-ohms!

Accurate low resistance measurements can now be read directly with a maximum sample dissipation of only 10 microwatts. Exceptionally stable, the Keithley Model 503 requires no balancing—as encountered in Kelvin Bridges—and is designed for rapid measurements. The line-operated 503 supplies an output voltage usable either for chart recording or control functions.

The measurement technique involves an ammeter-voltmeter method using an ac test current. Four terminals are employed, two furnishing a known test current to the sample and two measuring the resultant voltage drop. The voltage is measured by a synchronous ac voltmeter sensitive only to the test current frequency.

The Model 503 lends itself to a wide variety of applications by combining laboratory precision with production line ruggedness. Typical uses include measurements of internal resistance of dry cells, resistivity profiles of thermoelectric materials and low value resistors; measurement of temperatures with thermistors and resistance changes in conductors due to temperature and humidity effects; as well as dry-circuit testing of relay contacts, semi-conductor resistivity measurements, contact resistance of vibrators, relays and choppers, and safe measurement of fuses and squibs.

RANGE: 0.001 to 1000 ohms full scale. The test current, the input voltage drop, and sample power dissipation for full scale readings are given below.

Range Ohms	Applied Current ma, rms	Voltage Drop μ v, rms	Maximum Power in Sample Microwatts
0.001	100	100	10
0.003	33	100	3.3
0.010	10	100	1.0
0.030	3.3	100	0.33
0.10	1.0	100	0.10
0.30	0.33	100	0.033
1.0	0.30	3000	9
3.0	1.0	3000	3
10	0.3	3000	0.9
30	0.10	3000	0.3
100	0.03	3000	0.09
300	0.01	3000	0.03
1000	0.003	3000	0.009

OUTPUT CHARACTERISTICS: +100 millivolts dc at full scale, output impedance 800 ohms.

CALIBRATION: Provision for verification and adjustment on front panel.

POWER REQUIREMENT: 105-125 volts, 50-1000 cps, 30 watts. May be wired for 210-250 volt line.

TWO-IN-ONE CONSTRUCTION — A new package design permits choice of bench or rack mounting by means of a conversion kit supplied with each unit at no extra cost.



ACCURACY: 1% of full scale on all ranges for meter indications. 0.5% of full scale on all ranges at output voltage terminals.

SPEED OF RESPONSE: 0.25 second to 90% full scale on all ranges.

STABILITY: No visible drift after 15 minute warmup.

REPEATABILITY: Within 0.25% of full scale range setting.

PRICE:
 Model 503 \$675.00
 Model 503C (Contact Meter Model) 825.00

send for complete specifications in latest engineering note...



KEITHLEY INSTRUMENTS
 12415 EUCLID AVENUE CLEVELAND 6, OHIO

electrometers • micro-microammeters • microvoltmeters • power supplies • ac amplifiers

CIRCLE 87 ON READER SERVICE CARD 87



Endevco Announces Plant Purchase

ENDEVCO CORP., Pasadena, Calif., has purchased a 70,000-sq-ft manufacturing plant from the Holly-General division of the Siegler Corp., also of Pasadena. The property totals approximately four acres.

Endevco plans to occupy the new property in early 1962, reported Wilson Bradley, Jr., executive vice president. This will consolidate seven separate operating facilities under one roof. Plans to remodel the facade and redesign the interior are now under way. Purchase of the building, Bradley said, will enable the company to remain in Pasadena with an eye toward double its present capabilities.



Vard Division Names McGraw V-P

APPOINTMENT of John T. McGraw as vice president of the Vard Division of Royal Industries, Inc., Pasadena, Calif., is announced.

McGraw joined Vard in 1960 as

Endevco, founded in 1949 by H. D. Wright, president, has shown a consistent yearly growth. The company designs, produces and sells microminiature piezoelectric transducers, subminiature amplifiers and related instrumentation for the measurement of shock, vibration, pressure, turbulence and force signals.

It also owns and operates The Digitran Co., Pasadena; a separate manufacturing company, in Puerto Rico; and a foreign headquarters, Endevco (U.K.) Limited, in England. The corporation is represented by its own staff of field engineers in seven U. S. cities.

director of engineering and will continue in that responsibility.

Vard designs and manufactures precision equipment for the nuclear and aerospace industries.

Daystrom Promotes Four Engineers

E. J. OTIS, formerly manager of engineering of Daystrom, Inc., Control Systems division, La Jolla, Calif., has been promoted to director of operations.

Other promotions announced include that of Bevitt J. Norris to manager of engineering, Richard R. Bartelme to manager of technical services (both reporting to Otis),

and Jack K. Zimmerman to chief research and development engineer, reporting to Norris.

DCA Forms Third British Subsidiary

EXPANDING its activities in the European electronics market, Dynamics Corp. of America has formed its third British subsidiary, Digital Measurements, Ltd., Mytchett, England, to design and produce factory automation and data processing equipment and systems for industrial plants in Britain and the rest of Western Europe.

Through its other British subsidiaries, Winston Electronics, Ltd., and Norbury Instruments, Ltd., DCA also produces for European markets a wide range of scientific, medical, nucleonic, industrial and military equipment and components.



Librascope Appoints Research Scientist

EDWIN R. LEWIS has joined General Precision's Librascope Division as a research scientist in the advanced research department. He will conduct basic research on the simulation of nervous systems and other projects leading to the development of advanced computer systems.

Lewis was formerly associated with Texas Instruments, Inc., as an applications engineer, and with the Autonetics Division of North American Aviation, Inc., as a junior research engineer.

The Grow Corp. Elects Two Executives

THE GROW CORP., electronics and chemical firm of Plainview, N. Y., and Detroit, Mich., has elected

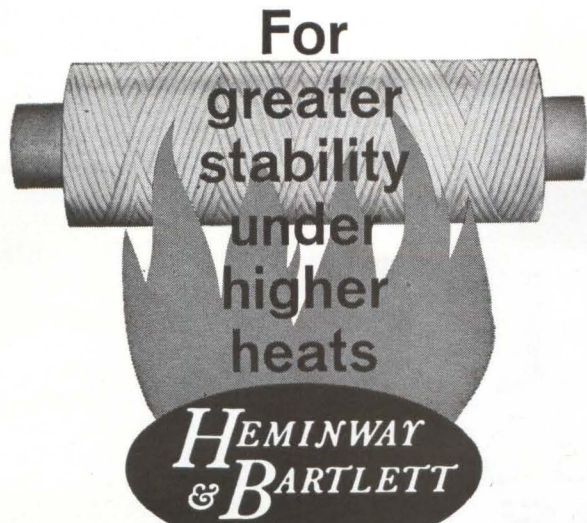

DACRON LACING CORDS AND TAPES

These flat-braided Dacron lacing tapes and cords are specially processed for stability under higher heats. Fungus-proof, non-slip finish ties faster, easier, tighter.

Available wax-coated, wax-free or with G. E. Finish. Write today for free samples.

THE HEMINWAY & BARTLETT MFG. CO.

Electronics Division: 500 Fifth Avenue, New York 36, N.Y.
Distributor—Alpha Wire, New York

CIRCLE 217 ON READER SERVICE CARD

AMERICAN ZENER DIODES

USN 1N3020B	USN 1N3036B
USN 1N3021B	USN 1N3037B
USN 1N3022B	USN 1N3038B
USN 1N3023B	USN 1N3039B
USN 1N3024B	USN 1N3040B
USN 1N3025B	USN 1N3041B
USN 1N3026B	USN 1N3042B
USN 1N3027B	USN 1N3043B
USN 1N3028B	USN 1N3044B
USN 1N3029B	USN 1N3045B
USN 1N3030B	USN 1N3046B
USN 1N3031B	USN 1N3047B
USN 1N3032B	USN 1N3048B
USN 1N3033B	USN 1N3049B
USN 1N3034B	USN 1N3050B
USN 1N3035B	USN 1N3051B

All thirty-two of the listed American Zener Diodes meet the requirements of MIL-S-19500/115A (Navy).

And the new AMERSEAL process—a unique bonding and sealing technique—provides Silicon Zener Diodes with voltage tolerances of $\pm 2\%$ or lower which are maintained in actual operation or extended periods of "shelf time". Reliability, too, results from AMERSEALING with its elimination of lead or gold bonding at connections. Diodes are fail-proof under extremes of shock. And because AMERSEAL permits near-perfect heat dissipation across the entire diode, dissipators can be smaller, lighter, or even eliminated. Write for technical data.



AMERICAN
SEMICONDUCTOR CORPORATION
3940 N. Kilpatrick Ave., Chicago 41, Illinois

CIRCLE 218 ON READER SERVICE CARD

February 16, 1962

SAGE SCORES A MAJOR BREAK-THROUGH

New Chassis Mount Resistor
Design Now Provides:

- ★ higher wattage ratings with no increase in size.
- ★ improved heat transfer to chassis.
- ★ improved structural simplicity.
- ★ a new high in reliability.

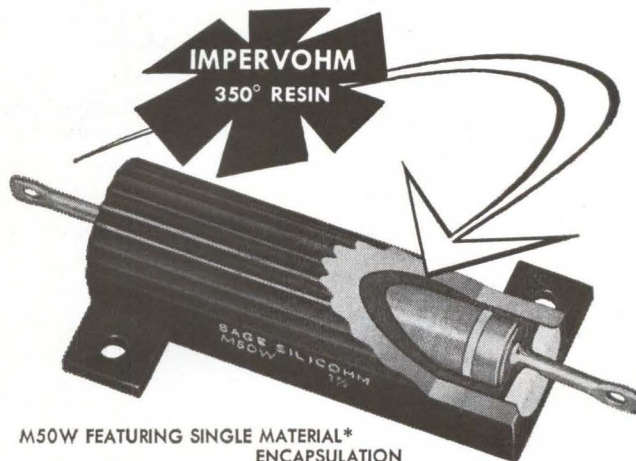

M50W FEATURING SINGLE MATERIAL*
ENCAPSULATION

The new SAGE Type "M" design represents the first major advance in the history of chassis-mount resistors. With no dimensional changes, SAGE M10W, M25W and M50W Resistors now offer:

1 HIGHER WATTAGE RATING

	SAGE Old	SAGE New	MIL-R-18546C	
			Watts	Style
M10W	10	14	10	RE65
M25W	20	25	15	RE70
M50W	40	50	20	RE75

2 GREATER RELIABILITY

Compared to competitive designs, SAGE parts function at significantly lower inside hot spot temperature.

3 IMPROVED STABILITY

Typical .3% resistance change after 1000 hour rated load life.

4 UNEQUALED IMPERVOHM® SEAL AGAINST MOISTURE AND THERMAL SHOCK.

Test samples available on request



SAGE

SAGE ELECTRONICS CORP.
Country Club Road • East Rochester, N. Y.

CIRCLE 89 ON READER SERVICE CARD 89

18 CHANNEL TELEMETRY MONITOR

SOLID STATE
for high reliability,
service free life, and
low power dissipation.

COMPACT SIZE
Eighteen units mount in a
standard 19" rack panel,
8-3/4" high.

STANDARD I R I G
center frequencies,
percentage deviation and
intelligence bandwidths.

PLUG-IN COMPONENTS
Units convert to
other bands by changing
plug-in frequency
determining components.

INPUT SENSITIVITY
and **DYNAMIC RANGE**
10 mv RMS min.; 60 db.

LINEARITY
Deviation 0.15%
of bandwidth or better.

STABILITY
Drift will not exceed
0.25% of bandwidth
over 36 hour period.

The unique use of a MAGMETER® saturating magnetic core frequency detector permits stable, accurate performance at a minimum cost in these completely solid state units. Power requirement is relatively small and the low internal dissipation eliminates rack cooling problems.

Airpax discriminators can be supplied for any channel in the range of 100 cps to 120 kc. Standard I R I G $\pm 7.5\%$ or $\pm 15\%$ frequency deviations are provided. Other deviations, such as 40%, are available on request.



SEMINOLE DIVISION • FT. LAUDERDALE, FLA.

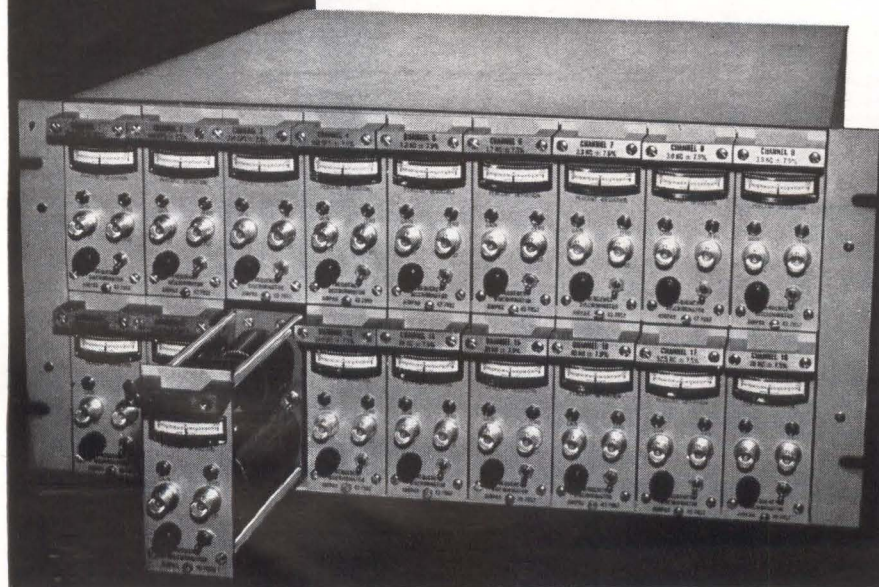

Sheppard Beidler as chairman of the board, and Russell Banks as president.

The company recently changed its name from Metropolitan Telecommunications Corp. after acquiring Grow Solvent Co., of Detroit. Beidler was president of Metropolitan and Banks was its executive vice president.

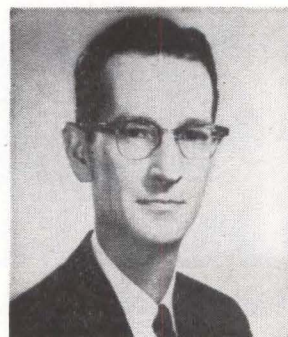

IEI Appoints Alley To Fill New Post

PAUL D. ALLEY has joined International Electronics Industries Division of Standard Pressed Steel Co. as technical director. In his newly created position, he will assume complete charge of production engineering and broad administrative duties for the Nashville, Tenn., capacitor plant.

Alley has most recently served, and will continue to serve, as a director of Vogue Instrument Co., Brooklyn, N.Y. Prior to his association with IEI, he was president and chairman of Efcron, Inc., Garden City, N.Y. Upon Efcron's merger with General Instrument Corp., Alley was named general manager.



MCS Corp. Promotes Albert Coverley

ALBERT COVERLEY moves up from production manager to vice president-general manager of Microwave

**Acoustical Components
of Superior Quality**

JAPAN PIEZO supplies 80% of Japan's crystal product requirements.

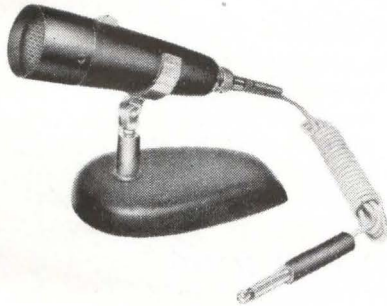
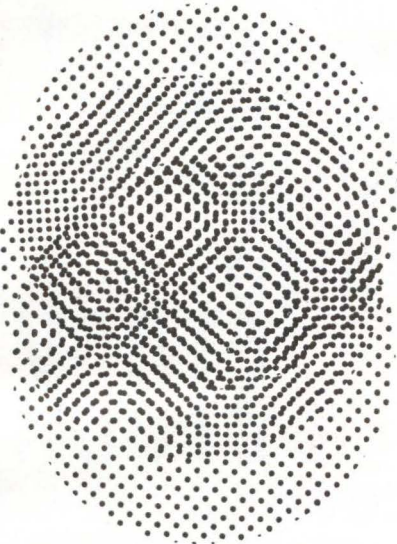

MICROPHONE
Crystal — X-29

At 20°C, 1 KC/s, Sensitivity is -58 ± 5 db. Impedance: 100 K Ω . Capacitance: 1,500 pF.

Write for detailed catalog on our complete line of acoustical products including pickups, cartridges, record players, phonograph motors and many associated products.



**JAPAN PIEZO
ELECTRIC CO., LTD.**

Kami-renjaku, Mitaka, Tokyo, Japan

CIRCLE 219 ON READER SERVICE CARD

February 16, 1962

IRE SHOW



presenting

"THE GOLDEN AGE OF ELECTRONICS"

March 26-29, 1962

The New York Coliseum

... part of the

International Convention of the IRE

The Institute of Radio Engineers
1 East 79th Street • New York 21

Members \$1.00. Non-members \$3.00. Age limit: over 18
CIRCLE 220 ON READER SERVICE CARD



**ELECTROLYTIC
AND
PAPER TUBULAR
CONDENSERS**

"35 YEARS OF PROVEN
DEPENDABILITY"

COSMIC CONDENSER CO.

853 WHITTIER STREET, BRONX, N. Y.
LUdlow 9-3360

CIRCLE 221 ON READER SERVICE CARD

FREE TRANSFORMER SLIDE RULE SELECTOR



New convenient way
to determine trans-
former parameters.

SEE INSIDE FRONT COVER

RAYTHEON

**RAYTHEON
COMPANY**

RAYTHEON COMPANY

Magnetics Operation
Waltham 54, Massachusetts

Gentlemen:

() Please send me my "AUTOSPEC"
transformer slide rule selector, des-
criptive brochure and technical man-
ual by return mail.

I am interested in this material:

() In connection with an immediate
project.

() For future reference.

NAME _____
TITLE _____
COMPANY _____
ADDRESS _____
CITY _____ STATE _____

MIDGET TAP SWITCH

has
giant
range

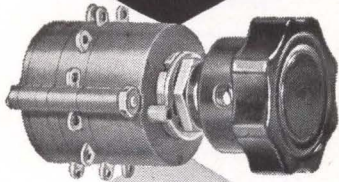

TYPE 3A

Only 1" in diameter . . . weighs 30 grams . . . as many as 8 decks and up to 12 positions per deck. These are among the features of Tech Labs' new all-molded miniature Type 3A tap switch.

Designed for a wide range of military and commercial applications, this single-hole mounted switch has adjustable stops if fewer than 12 positions, single pole, or 6 positions, double pole, are required. "Shorting" and "non-shorting" types are available and the switch can be furnished solenoid-operated and hermetically sealed.

SPECIFICATIONS

Size: 1" diameter, 1 1/4" with terminals. First deck, 1-1/16" long. Each additional deck, 1/2" long.

Weight: First deck, 30 grams. 10 grams for each additional deck.

Rating: 1200 volts rms, 2000 VDC, 5 amps (carrying) 115V.

Insulating resistance: 100 megohms minimum at 500 volts DC.

Life: 1.5 — 2 million revolutions.

Contact resistance:

(standard) 6-10 milliohms.

(silver) 3-5 milliohms.

Temperature range: -65°C to 100°C.

Mounting: Single-hole.

Meets MIL-S-3786 and MIL-E-5272C



Write for details
and prices.

PALISADES PARK, NEW JERSEY

Components & Systems Corp., Monrovia, Calif.

In his new post, Coverley will assume responsibility for coordinating the manufacturing operations of the company's various departments. They include engineering, electrical test, production, purchasing and assembly.

Babcock Relays Hires Maples

APPOINTMENT of Howard L. Maples as manufacturing engineer of Babcock Relays division, Babcock Electronics Corp., Costa Mesa, Calif., is announced. He joins Babcock Relays from Hoffman Electronics Co., Los Angeles, Calif., where he served as production engineer.

PEOPLE IN BRIEF

George E. Wendell leaves Trak, Inc., to become head of the electronics program at Magnion, Inc. The Electrical Products div. of Corning Glass Works promotes **John W. Hoos** to mgr. of quality control. Motorola Semiconductor Products advances **James S. LaRue** to program mgr. for the Motorola/Autonetics Minuteman Reliability Program. **Alfred P. Barton**, formerly with Elgin National Watch Co., is named v-p and g-m of American Gyro, a div. of Tamar Electronics Industries, Inc. **Leslie Merrill** moves up at Daystrom, Inc., Control Systems div., to the position of staff engineer. **Alfred M. Martin**, previously with PCA Electronics, Inc., appointed g-m of Washington Scientific, Inc. **Dugald Black** of The Bendix Corp. elected v-p for international operations by the board of directors. **Dexter E. MacMillan** leaves Torwico Electronics, Inc., to form Electro Windings and Components, Inc. Other officers of the new company are: **William J. Cyrana**, v-p in charge of mfg. and **Melvin J. MacMillan**, v-p in charge of engineering—both ex-Torwico. **Jerold B. Wellen**, from Douglas Aircraft Co. to Mesa Scientific Corp., computer consultants. **Thomas G. Utley**, formerly with Metrolonics, Inc., named executive v-p and g-m of Merlin Industries, Inc.

Precision to:

+ .0002

- .0000



Stainless Steel

PINS in STOCK

DOWEL & TAPER IMMEDIATE SHIPMENT

DOWEL PINS

(precision tolerance)

- Stainless steel 18-8, type 303
- Diams: .0312 through .500
- Lengths: 3/32" through 2 1/2"
- Chamfered ends
- "Specials" manufactured promptly
- Full range raw material on hand

TAPER PINS

(commercial, precision, AN)

- Stainless 18-8, type 303. Also many in type 316 (Commercial tolerance)
- Size: 9/0 through 10 in stock
- Lengths: 3/16" through 8" (not all lengths in all sizes.)
- "Specials" manufactured promptly, any material

PLUS all types and sizes of screws (slotted, Phillips—both magnetic and non-magnetic—hex, socket), bolts, nuts, washers, rivets, nails, keys, etc.

PHONE OR WRITE for prompt quotation or shipment. Ask for catalog.



ALLMETAL®

SCREW PRODUCTS COMPANY, INC.

Manufacturers of Stainless Fasteners Since 1929

821 Stewart Avenue, Garden City, L.I., N.Y.

Phone: Pioneer 1-1200

TWX GCY 603

Midwest Division

6424 W. Belmont Avenue, Chicago 34, Illinois

Phone: AVenue 2-3232

TWX CG 3185

West Coast Division — Office and Warehouse

5822 West Washington Blvd., Culver City, Calif.

Phone: WEBster 3-9595

TWX LA 1472

CIRCLE 224 ON READER SERVICE CARD
electronics

electronics

WEEKLY QUALIFICATION FORM FOR POSITIONS AVAILABLE

ATTENTION: ENGINEERS, SCIENTISTS, PHYSICISTS

This Qualification Form is designed to help you advance in the electronics industry. It is unique and compact. Designed with the assistance of professional personnel management, it isolates specific experience in electronics and deals only in essential background information.

The advertisers listed here are seeking professional experience. Fill in the Qualification Form below.

STRICTLY CONFIDENTIAL

Your Qualification form will be handled as "Strictly Confidential" by ELECTRONICS. Our processing system is such that your form will be forwarded within 24 hours to the proper executives in the companies you select. You will be contacted at your home by the interested companies.

WHAT TO DO

1. Review the positions in the advertisements.
2. Select those for which you qualify.
3. Notice the key numbers.
4. Circle the corresponding key number below the Qualification Form.
5. Fill out the form completely. *Please print clearly.*
6. Mail to: D. Hawksby, Classified Advertising Div., ELECTRONICS, Box 12, New York 36, N. Y. (No charge, of course).

COMPANY	SEE PAGE	KEY #
ATOMIC PERSONNEL INC. Philadelphia, Pennsylvania	132°	1
COLUMBIA UNIVERSITY Nevis Laboratories Irvington, New York	94	2
DELCO RADIO DIV. GENERAL MOTORS Kokomo, Indiana	123°	3
ELECTRO-MECHANICAL RESEARCH INC. Sarasota, Florida	132°	4
ESQUIRE PERSONNEL SERVICE INC. Chicago, Illinois	130°	5
GENERAL DYNAMICS/POMONA Pomona, California	103°	6
GILLETTE SAFETY RAZOR CO. Boston, Massachusetts	96	7
GRUMMAN AIRCRAFT ENGINEERING CORP. Bethpage, L. I., New York	129°	8
INTERNATIONAL BUSINESS MACHINES CORP. New York, New York	131°	9
INTERNATIONAL BUSINESS MACHINES CORP. Supplies Division Vestal, New York	96	10
LOCKHEED CALIFORNIA CO. Div. of Lockheed Aircraft Corp. Burbank, California	115°	11
LOCKHEED-GEORGIA CO. Div. of Lockheed Aircraft Corp. Atlanta, Georgia	85	12
LORAL ELECTRONICS CORPORATION Bronx, New York	95	13
MARTIN MARIETTA Aerospace Division Orlando, Florida	94	14
MICROWAVE SERVICES INTERNATIONAL, INC. Denville, New Jersey	130°	15
MOTOROLA, INC. Chicago, Illinois	130°	16
NATIONAL CASH REGISTER CO. Dayton, Ohio	132°	17

CONTINUED ON PAGE 96

(cut here)

(cut here)

electronics WEEKLY QUALIFICATION FORM FOR POSITIONS AVAILABLE

Personal Background

NAME
 HOME ADDRESS
 CITY ZONE STATE
 HOME TELEPHONE

Education

PROFESSIONAL DEGREE(S)
 MAJOR(S)
 UNIVERSITY
 DATE(S)

FIELDS OF EXPERIENCE (Please Check)

2162

- | | | |
|--|--|---------------------------------------|
| <input type="checkbox"/> Aerospace | <input type="checkbox"/> Fire Control | <input type="checkbox"/> Radar |
| <input type="checkbox"/> Antennas | <input type="checkbox"/> Human Factors | <input type="checkbox"/> Radio—TV |
| <input type="checkbox"/> ASW | <input type="checkbox"/> Infrared | <input type="checkbox"/> Simulators |
| <input type="checkbox"/> Circuits | <input type="checkbox"/> Instrumentation | <input type="checkbox"/> Solid State |
| <input type="checkbox"/> Communications | <input type="checkbox"/> Medicine | <input type="checkbox"/> Telemetry |
| <input type="checkbox"/> Components | <input type="checkbox"/> Microwave | <input type="checkbox"/> Transformers |
| <input type="checkbox"/> Computers | <input type="checkbox"/> Navigation | <input type="checkbox"/> Other |
| <input type="checkbox"/> ECM | <input type="checkbox"/> Operations Research | <input type="checkbox"/> |
| <input type="checkbox"/> Electron Tubes | <input type="checkbox"/> Optics | <input type="checkbox"/> |
| <input type="checkbox"/> Engineering Writing | <input type="checkbox"/> Packaging | <input type="checkbox"/> |

CATEGORY OF SPECIALIZATION

Please indicate number of months experience on proper lines.

	Technical Experience (Months)	Supervisory Experience (Months)
RESEARCH (pure, fundamental, basic)
RESEARCH (Applied)
SYSTEMS (New Concepts)
DEVELOPMENT (Model)
DESIGN (Product)
MANUFACTURING (Product)
FIELD (Service)
SALES (Proposals & Products)

CIRCLE KEY NUMBERS OF ABOVE COMPANIES' POSITIONS THAT INTEREST YOU

1 2 3 4 5 6 7 8 9 10 11 12 13 14 15 16 17 18 19 20 21 22 23 24 25

EMPLOYMENT OPPORTUNITIES

The Advertisements in this section include all employment opportunities—executive, management, technical, selling, office, skilled, manual, etc. Look in the forward section of the magazine for additional Employment Opportunities advertising



Positions Vacant
Positions Wanted
Part Time Work

Civil Service Opportunities
Selling Opportunities Wanted
Selling Opportunities Offered

Employment Agencies
Employment Services
Labor Bureaus

DISPLAYED

The advertising rate is \$40.17 per inch for all advertising appearing on other than a contract basis. Contract rates quoted on request.

An advertising inch is measured 3/8" vertically on a column—3 columns—30 inches to a page.

Subject to Agency Commission.

---RATES---

\$2.70 per line, minimum 3 lines. To figure advance payment count 5 average words as a line.

Box Numbers—counts as 1 line.

Position Wanted ads are 1/2 of above rate.

Discount of 10% if full payment is made in advance for 4 consecutive insertions.

Not subject to Agency Commission.

UNDISPLAYED

Send NEW ADS or Inquiries to Classified Advertising Division of ELECTRONICS, P. O. Box 12, N. Y. 36, N. Y.

RADAR

Systems Scientists For Advanced Programs Staff

Staff level openings in Orlando, Florida, are available for outstanding technical contributors in radar systems technology.

Assignments will involve conception, direction, and participation in radar systems studies. Additional emphasis will be placed on associated research and development in the evolution of space-based, airborne, and ground-based radar.

These positions offer salary and responsibility commensurate with top-level scientific ability. Investigate them by sending your resume, in confidence, to Mr. H. L. Phillips, Sec. 262.

AEROSPACE DIVISION—ORLANDO, FLORIDA

MARTIN MARIETTA

(an equal opportunity employer)

ELECTRONIC ENGINEER OR PHYSICIST

We need a young, bright or an old experienced man to help our physicist invent and develop nanosecond pulse circuitry for basic nuclear physics research use.

We offer an opportunity to grow in a lively, informal, academic atmosphere with competitive salary.

TUITION EXEMPTION AVAILABLE

A wide range of other electronic and electro-mechanical problems are also available for an interested man. No citizenship or clearance requirements.

Please Call or Send Resume to:

DR. W. F. GOODELL

COLUMBIA UNIVERSITY

NEVIS LABORATORIES

PO Box 137, Irvington, New York 914 LY 1-8100

An Equal Opportunity Employer

MICROWAVE COMMUNICATIONS ENGINEERS

Ankara - Teheran - Karachi
Bangkok - U. S.

Work involves engineering, supervision of installation, operation and maintenance of microwave communications systems.

College Degree Mandatory

MICROWAVE COMMUNICATIONS TECHNICIANS

Must be qualified by education and experience to inspect installation, operate and maintain microwave communications systems to insure quality and performance standards.

Technical or trade school training mandatory.

Families May Accompany

Usual Overseas Benefits

Send detailed resumes to:

P-7950, Electronics

645 N. Michigan Avenue, Chicago 11, Ill.

SCIENTISTS/ENGINEERS

Career opportunities in:

- DESIGN
- RESEARCH
- DEVELOPMENT
- SALES
- MARKETING
- APPLICATION

Submit resume in confidence to:

- Alan Glou Technical/Scientific
- Sid Hopner Sales/Marketing

Specialists in the personalized placement of Electronic Engineers and Scientists, on a national basis, who have a BS or advanced degree. Client companies assume fee and relocation costs.



SCOPE

PROFESSIONAL PLACEMENT CENTER
1277 MAIN ST. WALTHAM, MASS.

EMPLOYMENT PROBLEM?

When you are in need of specialized men for specialized jobs, contact them through an employment ad in this publication.

ELECTRONICS

CHIEF ENGINEER

Must be strong in the areas of acoustics, communication equipment and instrumentation for both civilian and military requirements. Ability to generate new product concepts and applications is essential. Minimum of a B.S. in Engineering required.

ENGINEERS

Must be experienced in communications, instrumentation and acoustics. Must be highly creative. Degree in E.E. required.

PRODUCTION SUPERVISOR

Minimum of 5 years experience in the assembly of production and R & D items. Degree in E.E. desirable but not necessary.

ELECTRONICS TEST TECHNICIANS

Should be familiar with all aspects of testing electronic devices including environmental testing. Must know mil. specs.

These openings are for a new operation at our Bristol, Penna., facility and offer a chance to join THIOKOL at the beginning of a program that promises to expand rapidly.

Send résumé to

Thiokol®

CHEMICAL CORPORATION
P. O. Box 27
Bristol, Pa.

AN EQUAL OPPORTUNITY EMPLOYER

February 16, 1962

If you had \$25,000 in cold cash, how would you invest it? If you're like most people you'd seek an investment situation that would offer maximum return with minimum risk. What's this got to do with an engineer and his job? Allowing for time, tuition, maintenance, books, travel, and board, every engineer possessing a B. S. degree has considerably more than

\$25,000 invested in his profession. When an engineer joins a company he is literally investing this money with that organization. ■ We feel that many engineers are today making career investments that are expensive and unwise. For example, when was the last time you asked yourself these questions about your investment: 1. Is my company growing in proportion to the rest of the electronics industry? 2. Is its product line broad enough to insure stability? 3. Are its research programs focused on areas of long-term importance? 4. Is management aggressive as well as progressive? 5. Am I doing work that will enhance my professional stature and worth? 6. Am I working with colleagues from whom I can learn? ■ If, after answering these questions, you may have some doubts about the prudence of your present investment, we would welcome the opportunity to tell you about the dividends you will find at LORAL ELECTRONICS CORPORATION.

■ Reinvestment opportunities are currently available for:

Senior Electronic Systems Engineers

Digital Systems
Radar Systems
ECM Systems

Senior Electronic Engineers

Transistorized Power Supply Design
RF Design
IF Design
Pulse & Digital Circuitry Design
Antenna Design
Microwave Design

Electronic Engineers

Video Pulse Circuitry Design
RFI

Reliability Engineers

Senior Technical Writer

Contact Mr. John Norwood, Technical Employment Manager, **LORAL ELECTRONICS CORPORATION**, 825 Bronx River Ave., New York 72, N. Y. (Tivoli 2-9500)

An Equal Opportunity Employer



Imprint of Integrity

CAREER OPPORTUNITY AT IBM

ELECTRICAL ENGINEER PHYSICIST

Magnetic Recording Media

The IBM Supplies Division Magnetic Products Laboratory located in upper New York State has positions available for an electrical engineer or physicist to apply theory to practice in problem solving in the field of magnetic recording media.

Challenging assignments will include (1) Developing new and improved methods for determining magnetic characteristics of magnetic recording surfaces and materials (2) Developing new concepts in the field of information recording in other than digital form.

An advanced degree is preferred. Three to eight years' engineering background is necessary. Magnetic experience is desirable. There are some opportunities available for well-qualified people interested in magnetics, but having only related experience.

IBM is an Equal Opportunity Employer.

Please write, outlining your background and experience, to . . .

Roger Williams, Dept. 554-03
IBM Corporation
Supplies Division
Vestal, New York

INTERNATIONAL BUSINESS MACHINES CORPORATION

RESEARCH OPPORTUNITY

Expanded Research Needs
Create New Position.

APPLIED RESEARCH

ENGINEERING PHYSICIST

B.S. or M.S. with experience in electronic instrumentation and process control; induction heating, electro-mechanical and electro-optical circuitry and applications.

Comprehensive employee benefit program.

Send detailed resume including salary information in strict confidence to Walter F. Evans.

GILLETTE SAFETY RAZOR CO.



Gillette Park Boston 6, Mass.
An equal opportunity employer

electronics

WEEKLY QUALIFICATIONS FORM FOR POSITIONS AVAILABLE

(Continued from page 93)

COMPANY	SEE PAGE	KEY #
PAN AMERICAN WORLD AIRWAYS INC. Guided Missiles Range Div. Patrick AFB, Florida	16	18
PHILCO WESTERN DEVELOPMENT LABORATORIES Palo Alto, California	133*	19
SCOPE PROFESSIONAL PLACEMENT CENTER Waltham, Massachusetts	94	20
THIOKOL CHEMICAL CORPORATION Bristol, Pennsylvania	95	21
UNION CARBIDE NUCLEAR CO. Oak Ridge, Tennessee	132*	22
P-7950	94	23
P-8238	132*	24

* These advertisements appeared in the 2/9/62 issue.

SEARCHLIGHT SECTION

(Classified Advertising)

BUSINESS OPPORTUNITIES

EQUIPMENT - USED or RESALE

WANTED

Wanted—Weston Model 155 portable 8-range moving iron voltmeter in good order or suitable for repair. The Robert Kruse Laboratory, Madison, Connecticut.

NEW INDUSTRY WANTED

Community Has Cash To Help locate industry in western Kentucky lake area. No gimmick! Plenty of water, labor, sites, gas, power, 100% plant financing. For more details call or write, West Hopkins Industries, Box 245, Dawson Springs, Ky.

FOR INFORMATION

About Classified Advertising

Contact The McGraw-Hill
Office Nearest You

ATLANTA, 9 1375 Peachtree St. N. E. TRinity 5-0523 D. HICKS
BOSTON, 16 Copley Square CONgress 2-1160 M. SHOUVLIN
CHICAGO, 11 645 No. Michigan Ave. MOhawk 4-5800 W. J. HIGGINS
CLEVELAND, 13 1164 Illuminating Bldg. SUperior 1-7000 I. C. HILL
DALLAS, 2 1712 Commerce St., Vaughn Bldg. Riverside 7-9721 J. GRANT
DENVER, 2 1700 Broadway, Tower Bldg. ALpine 5-2981 J. PATTEN
DETROIT, 26 856 Penobscot Bldg. WOodward 2-1793 WM. H. GINDER, JR.
HOUSTON, 25 Prudential Bldg., Room W-724 Holcombe Blvd. JAckson 6-1281 J. PAGE
LOS ANGELES, 17 1125 W. 6th St. HUntley 2-5450 W. C. GRIES
NEW YORK, 36 500 Fifth Ave. OXford 5-5959 H. T. BUCHANAN - T. W. BENDER
PHILADELPHIA, 3 Six Penn Center Plaza LOcust 8-4330 W. B. SULLIVAN - F. W. MCCARTHY
PITTSBURGH, 22 4 Gateway Center EXpress 1-1314
ST. LOUIS, 3 7751 Carondelet Ave. PArkview 5-7285
SAN FRANCISCO, 11 255 California St. DOuglas 2-4600 J. A. HARTLEY

INDEX TO ADVERTISERS



Audited Paid Circulation

• Airpax Electronics, Inc.	90	Paktron, Div. of Illinois Tool Works..	80
• Allmetal Screw Products Co., Inc.	92	Pan American Airways.....	16
American Semiconductor Corp.....	89	• Philco Corporation	34
Beattie-Coleman Inc.....	72	• Polarad Electronics Corporation	70
Behlman-Invar Electronics Corp.....	73	• Potter Instrument Co., Inc.	79
• Bendix Corporation		Precision Instrument Co.....	81
Red Bank Division.....	63	• Radio Corporation of America	4th Cover, 15
• Bircher Corporation, The	22	RHG Electronics Laboratory, Inc.....	82
Bomac Laboratories, Inc.....	31	• Raytheon Company	2nd Cover, 91
• Boonton Radio Corp.	69	• Royal Electric Corp.	56
Brand-Rex Division of American Enka Corp.....	33, 87	• Sage Electronics Corp.	89
• Brush Instruments, Div. of Clevite Corp.	3rd Cover	Shalleross Mfg. Co.....	13
• Bussmann Mfg. Co.	18	• Southern Electronics Corp.	78
• Cannon Electric Co.	77	Spectran Electronics.....	84
• Celco-Constantine Engineering Laboratories	58	Sprague Electric Co.....	9, 30
• Constantine Engineering Laboratories	58	• Tech Laboratories, Inc.	92
• Cosmic Condenser Co.	91	Tektronix, Inc.....	53
• Coto-Coil Co., Inc.	86	Texas Instruments Incorporated	
• Du-Co Ceramics Co.	86	Transistor Products Division.....	57
Dynacor, Inc., A Sub. of Sprague Electric Co.....	97	Thermal American Fused Quartz Co., Inc.....	86
• Eastern Air Devices, Inc.	71	• Trak Electronics Co., Inc.	62
Eastman Kodak Co.....	49	• Trio Laboratories, Inc.	72
Eisler Engineering Co., Inc.....	64	Triplett Electrical Instrument Co.....	55
Electrodynamic Instrument Corporation	14	• Tung-Sol Electric, Inc.	75
• Electronic Instrument Co., Inc. (EICO)	82	U. S. Stoneware.....	23
Electronic Tube Instrument Div. of General Atomics Corp.....	78	• Weinschel Engineering	4
• Engineered Electronics Co.	22	Westinghouse Electric Corp.	
• FXR, A Div. of Amphenol-Borg Electronics Corp.	19	Defense Products Group.....	61
• Film Capacitors, Inc.	73	Electronic Equipment Dept.....	76
Fluke Mfg. Co., Inc., John.....	51	Yellow Springs Instrument Co., Inc....	84
General Dynamics Telecommunication	83		
General Electric Co.			
Semi-Conductors Products Dept.....	59		
• General Instrument Corp.			
Capacitor Div.....	25		
• Gould National Batteries Inc.	14		
Gries Reproducer Corp.....	83		
Heminway & Bartlett Mfg. Co., The...	89		
• Hewlett-Packard Company	6		
• Heyman Manufacturing Co.	83		
• Houston Instrument Corp.	84		
Hughes Aircraft Co.			
Aerospace Divisions.....	24		
Institute of Radio Engineers.....	58, 83, 91		
• Japan Piezo Electric Co., Ltd.	91		
Keithley Instruments, Inc.....	87		
Kinney Vacuum, Div. of New York Air Brake Co.....	11		
Klein & Sons, Mathias.....	10		
• Lambda Electronics Corp.	5		
Linen Thread Co., Inc., The.....	64		
• Litton Industries			
Electron Tube Division.....	67		
Lockheed-Georgia Co.....	85		
• Marconi Instruments	98		
Markite Corp.....	32		
Melpar Inc.....	14		
• Method Electronics, Inc.	64		
• Microswitch, Div. of Honeywell	17		
Moore Associates Inc.....	29		
New Jersey Machine Corp.....	58		

February 16, 1962

TOUGH

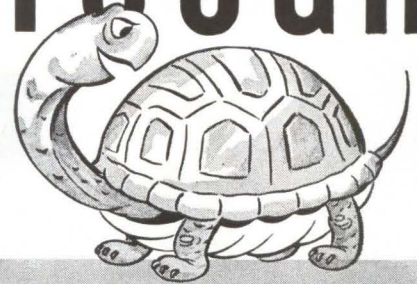

... AS A TURTLE'S BACK

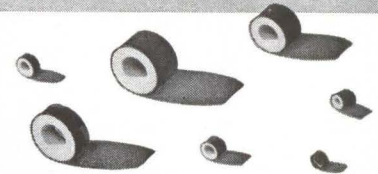

**ARMAG*-PROTECTED
DYNACOR®
BOBBIN CORES
AT NO EXTRA COST!**

Tough-as-tortoise-shell Armag armor is an exclusive Dynacor development. It is a thin, non-metallic laminated jacket for bobbin cores that replaces the defects of nylon materials and polyester tape with *very definite advantages*—and, you pay no premium for Armag extra protection.

Tough Armag is suitable for use with normal encapsulation techniques on both ceramic and stainless steel bobbins. It withstands 180°C without deterioration—is completely compatible with poured potted compounds—has no abrasive effect on copper wire during winding—fabricates easily to close-tolerance dimensions—inner layer is compressible to assure tight fit on bobbin—does not shrink, age or discolor.

Write for Engineering Bulletins DN 1500, DN 1000A, DN 1003 for complete performance and specification data covering the wide range of Dynacor low cost Standard, Special and Custom Bobbin Cores—all available with Armag non-metallic armor.

*TRADEMARK

DYNACOR®

DYNACOR, INC.
A SUBSIDIARY OF SPRAGUE ELECTRIC CO.

35 Marshall St. • North Adams, Mass.

CIRCLE 97 ON READER SERVICE CARD 97

NOW

A SINGLE Q METER

COVERS 1 kc to 300 mc . . .

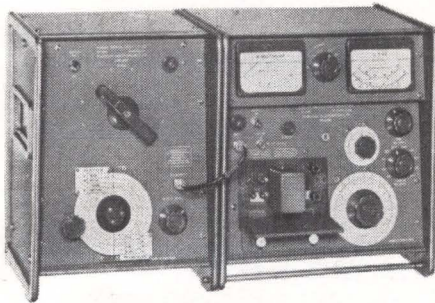

. . . with dual measuring circuits and plug-in oscillators for flexibility and reduced cost. Marconi Model 1245 has stability, high accuracy and silky smooth controls without backlash which make it a pleasure to use. Demonstration in your plant is easily arranged and can be convincing.

Q Range5 to 1000
Delta-Q25-0-25
Tuning C7.5 to 500pF
Price\$600
(Oscillators extra)

Ask for 31-page brochure —
"Measurements by Q Meter"

MARCONI

INSTRUMENTS

DIVISION OF ENGLISH ELECTRIC CORPORATION
111 CEDAR LANE, ENGLEWOOD, NEW JERSEY
MAIN PLANT: ST. ALBANS, ENGLAND

electronics



Audit Bureau
of Circulations

Associated Business
Publications

Audited Paid Circulation

JAMES T. HAUPTLI

Advertising Sales Manager

R. S. QUINT:
Assistant Publisher Buyers'
Guide and Business Manager
FRED STEWART:
Promotion Manager
B. ANELLO:
Marketing Service Manager

RICHARD J. TOMLINSON:
Production Manager
GEORGE E. POMEROY:
Classified Manager
HUGH J. QUINN:
Circulation Manager

ADVERTISING REPRESENTATIVES

NEW YORK (36):

Donald H. Miller, Henry M. Shaw,
George F. Werner
500 Fifth Avenue, Oxford 5-5959

BOSTON (16):

William S. Hodgkinson, Donald R. Furth
McGraw-Hill Building, Copley Square,
Congress 2-1160

PITTSBURGH (22):

Paul T. Fegley
Four Gateway Center, Express 1-1314

PHILADELPHIA (3):

Warren H. Gardner, William J. Boyle
6 Penn Center Plaza, LOcust 8-4330

CHICAGO (11):

Harvey W. Wernecke, Robert M. Denmead
645 North Michigan Avenue, Mohawk 4-5800

CLEVELAND (13):

Paul T. Fegley
55 Public Square, Superior 1-7000

SAN FRANCISCO (11):

R. C. Alcorn
255 California Street, Douglas 2-4600

LOS ANGELES (17):

Peter S. Carberry, Ashley P. Hartman
1125 W. 6th St., Huntley 2-5450

DENVER (2):

J. W. Patten
Tower Bldg., 1700 Broadway,
Alpine 5-2981

ATLANTA (9):

Michael H. Miller, Robert C. Johnson
1375 Peachtree St. N.E., Trinity 5-0523

HOUSTON (25):

Joseph C. Page, Jr.
Prudential Bldg., Holcomb Blvd.,
Jackson 6-1281

DALLAS (1):

Frank Le Beau
The Vaughn Bldg., 1712 Commerce St.
Riverside 7-9721

LONDON W1:

Dennis McDonald
34 Dover St.

FRANKFURT/Main:

Stanley R. Kimes
85 Westendstrasse

GENEVA:

Michael R. Zeynel
2 Place du Port

"Headquarters for Business Information"

McGraw-Hill Technical and Business Publications

American Machinist/Metal-
working Manufacturing
Aviation Week and Space
Technology
Business Week
Chemical Engineering
Chemical Week
Coal Age
Construction Methods and
Equipment
Construction Daily
Control Engineering
Electrical Construction
and Maintenance
Electrical Merchandising Week
Electrical Newsletter
Electrical West

Electrical Wholesaling
Electrical World
Electronics
Engineering Digest
Engineering and Mining Journal
E & MJ Metal and Mineral
Markets
Engineering News-Record
Factory
Fleet Owner
Industrial Distribution
National Petroleum News
Nucleonics
Nucleonics Week
Platt's Oilgram News
Platt's Oilgram Price Service
Power

Product Engineering
Purchasing Week
Science Week
Textile World

Overseas only:
Automobile International
(English, Spanish)
Ingenieria Internacional
Construccion (Spanish)
International Management
(English, Spanish
Portuguese editions)
Metalworking Production
(Great Britain)

Available by subscription only — to qualified persons actively engaged in the field of the publication. For subscription rates and information describing the editorial coverage of any of the above publications, write to: *Subscription Manager, Circulation Department, McGraw-Hill Publishing Company, 330 West 42nd Street, New York 36, N. Y.*

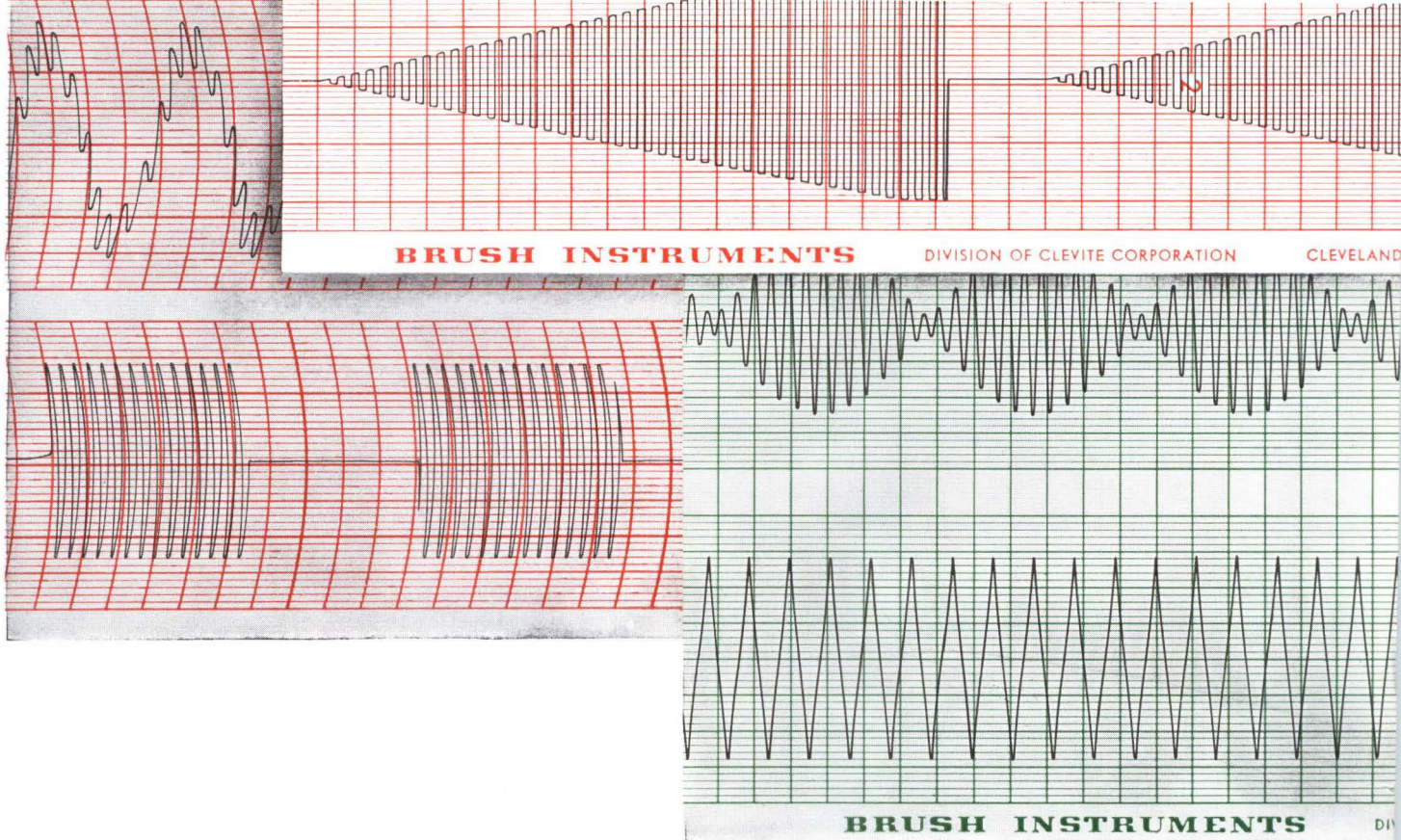

it pays
to use
Engineered
chart paper

Engineered details make the difference in chart paper. And only Brush chart paper is engineered as an integral part of the rigid specifications for today's Recording Systems. Imitation papers cannot match the special processing of paper surface to minimize pen friction; the unusual dimensional stability and tensile strength; the perfect alignment attained by winding and then rewinding the rolls; the carefully controlled printing conditions. Eliminate chance—specify *Brush* and you'll know your records will be accurate, permanent, easily read and reproduced. Stocks available from branches and sales representatives throughout the U. S. and Canada. Write for samples of actual tracings on Brush Chart Paper. Ask for "Brush Engineered Recording Supplies".

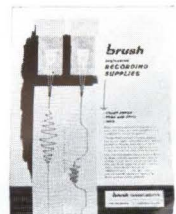

brush INSTRUMENTS
DIVISION OF CLEVITE 37TH AND PERKINS, CLEVELAND 14, OHIO



choose the one that is exactly right for you

The Industry's broadest line of Vidicons—from RCA—offers high resolution capability for broadcast-quality pictures in any television pickup function: live, closed-circuit, or film. In each RCA type the unmatched tube-after-tube uniformity and quality is built-in by RCA's unique photosurface processes.

Tested to assure long-life reliability, these RCA Vidicon Camera Tubes are strengthened with all-glass beaded mounts. They are the Industry's leaders, offering highest sensitivity—lowest lag. And with these benefits each RCA type provides for its intended application an outstanding balance in performance characteristics.

RCA Vidicons are a superior answer to designer specifications in new compact camera designs. For special applications, RCA Vidicons can be adapted to your needs in other portions of the spectrum. They can also be custom-designed with fiber optic or radiation resistant faceplates. In addition to its wide choice of Vidicons, of course, RCA offers a complete line of Image Orthicons and Display Tubes.

For information on RCA Vidicons and other camera tubes, write: Section B-19-Q-2, Commercial Engineering, RCA Electron Tube Division, Harrison, N. J.

RCA Vidicons—for any Television Function

Type	Photosurface	Recommended Usage	Max. Length	Approx. Diameter	Focus	Deflection
8051	Good Sensitivity High Resolution Low Lag	Film Pickup Data Transmission	8"	1½"	Magnetic	Magnetic
7038	Ultra-Uniform Photoconductor	Film Pickup	6½"	1"	Magnetic	Magnetic
7735A	High Sensitivity Low Lag	Industrial	6½"	1"	Magnetic	Magnetic
7262A	High Sensitivity Low Heater Power Low Lag	Industrial	5½"	1"	Magnetic	Magnetic
7263A	High Sensitivity Low Heater Power Low Lag	(Ruggedized) Military	5½"	1"	Magnetic	Magnetic
4427	High Sensitivity Low Lag	Industrial	3¾"	½"	Magnetic	Magnetic
C74015	High Sensitivity Low Lag	Industrial	6½"	1"	Electrostatic	Magnetic
C74016	High Sensitivity Low Lag	Industrial	6½"	1"	Electrostatic	Electrostatic

INDUSTRIAL TUBE PRODUCTS FIELD OFFICES... OEM SALES: Newark 2, N. J., 744 Broad St., HU 5-3900 • Chicago 54, Ill., Suite 1154, Merchandise Mart Plaza, WH 4-2900 • Los Angeles 22, Calif., 6801 E. Washington Blvd., RA 3-8161 • Burlingame, Calif., 1838 El Camino Real, OX 7-1620. **GOVERNMENT LIAISON:** Harrison, N. J., 415 South Fifth Street, HU 5-3900 • Dayton 2, Ohio, 224 N. Wilkinson Street, BA 6-2366 • Washington 7, D. C., 1725 "K" Street, N.W., FE 7-8500



The Most Trusted Name in Television