

# electronics®

For Space:

## A GIANT MONITOR

*Arecibo antenna  
nears completion, p 18  
(photo below)*

## REFERENCE AMPLIFIER

*New integrated device  
for power supplies, p 39*

## NO LAYOUT, NO DRAFTING

*Computers to design  
tomorrow's circuits, p 16*

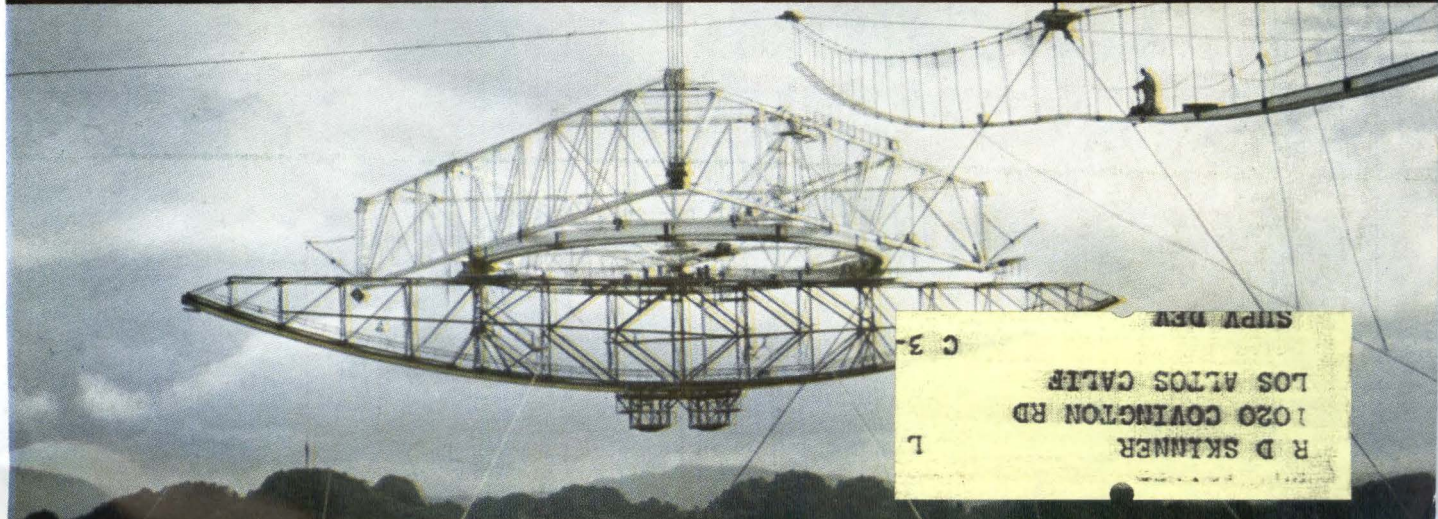

R D SKINNER  
 1020 COVINGTON RD  
 LOS ALTOS CALIF  
 C-3-  
 SUPV DEPT  
 L

Distribuiti in tutto il mondo

Distribución mundial

للتوزيع في جميع أنحاء العالم

Valable dans le monde entier

Weltweite Verteilung

Tillgänglig över hela världen

世界的に普及した

**WORLD-WIDE  
COVERAGE**



**Regardless of your needs in electronic instrumentation**, regardless of where you need it, Hewlett-Packard Company and its affiliates\* are prepared to give you fast service through more than 30 sales and application engineering offices throughout the world. Many of these offices are also service centers, staffed by factory-trained specialists

ready to help maintain your Hewlett-Packard instruments in top operating condition.

In addition to complete coverage of the entire continental United States and Canada, these sales facilities are present to serve you in many other countries:

**Argentina**, Mauricio A. Suarez, Telecomunicaciones, Carlos Calvo 224, Buenos Aires, Tel: 30-6312; **Australia**, Sample Electronics Pty. Ltd., 9-11 Cremorne Street, Richmond, E. 1, Victoria, Phones: 42-4757 (3 lines); 48 Chippen Street, Sydney, New South Wales, Tel: 69-6338 (6 lines); **Belgium**, Electronic Marketing Co., S.A., 20-24 Rue de l'Hopital, Brussels, Tel: 11.22.20; **Denmark**, Tage Olsen A/S, Centrumgården, 6D Vesterbrogade, Copenhagen V, Tel: Minerva 6838; **Finland**, INTO O/Y, 11 Meritullinkatu, Helsinki, Tel: 66.39.09 and 35.125; **France**, Radio Equipments, 65 rue de Richelieu, Paris 2ème, Tel: RIChelieu 49-88, 95-41; **Germany**, Hewlett-Packard Vertriebsgesellschaft m.b.H., Sophienstrasse 8, Frankfurt am Main, Tel: 77-31-75 and 77-94-25; Steindamm 35, Hamburg, Tel: 24-05-51; Severinstrasse 5, München, Tel: 49-51-21; **Greece**, K. Karayannis, Klaptonos Square, Athens, Tel: 230.301 (5 lines); **India**, The Scientific Instrument Company, Ltd., 6, Tej Bahadur Sapru Road, Allahabad 1, Tel: 2451; 240 Dr. Dadabhai Naoroji Road, Bombay 1, Tel: 26-2642; 11, Esplanade East, Calcutta 1; 30, Mount Road, Madras 2; B-7, Ajmeri Gate Extn., New Delhi 1, Tel: 26053; **Israel**, Electronics & Engineering Ltd., 16 Kremenetski St., Tel-Aviv, Tel: 35021 (3 lines); **Italy**, Dott. Ing. Mario Vianello, Via L. Anelli 13, Milano, Tel: 553-081 and 553-811; Via S Croce in Gerusalemme 97, Rome, Tel: 756-7250 and 756-7941; **Japan**, Seki & Company, Ltd., Chushoku Building, 9 2-chome, Nihonbashi Koami-cho, Chuo-ku, Tokyo, Tel: (860) 4121-5; Sumi Bldg., 106 Umegae-cho, Kita-ku, Osaka, Tel: (362) 8151-5; **Korea**, American Trading Company, Korea, Ltd., 112-35 Sokong-Dong, Seoul, Tel: 3-7613, 3-7049; **Netherlands**, Electronic Marketing Co., N. V., 23, Burg. Roellstraat, Amsterdam W., Tel: 13.28.98; **New Zealand**, Geo. H. Sample & Son (N. Z.) Ltd., 431 Mount Albert Road, Mount Roskill, Auckland, S3, Tel: 898-439; **Norway**, Morgenstjerne & Co., Wessels Gate 6, Oslo, Tel: 42.99.93; **South Africa**, F. H. Flanter & Co., (Pty.), Ltd., Rosella House, Buitencingle Street, Cape Town, Tel: 3-3817; **Spain**, ATAIO, Ingerieros, A. Aguilera, No. 8, Madrid 15, Tel: 223-27-42, 254-53-80; **Sweden**, H-P Instrument AB, Centrälvagen 28, Solna (Stockholm), Tel: 83-08-30; **Switzerland**, Max Paul Frey, Wankdorffeldstrasse 66, Bern, Tel: (031) 42.00.78; **Taiwan (Formosa)**, Hwa Sheng Electronic Co., Ltd., 21 Nanking West Road, Taipei, Tel: 4-6076; **United Kingdom**, Hewlett-Packard Ltd., Dallas Road, Bedford, England, Tel: BEDford 68052; Livingston Laboratories Ltd., 31 Camden Road, London N.W. 1, Tel: GULLiver 4191; **Yugoslavia**, Belram Electronics, 83 Av. Des Mimosas, Brussels 15, Belgium, Tel: 35.29.58.

\*Boonton Radio Company, Dymec Div., F. L. Moseley Co., Harrison Laboratories, Sanborn Industrial Division.

## HEWLETT-PACKARD COMPANY



1501 Page Mill Road, Palo Alto, California, (415) 326-7000. Sales and service representatives in all principal areas; Europe, Hewlett-Packard, S.A., 54 Route des Acacias, Geneva, Switzerland; Canada, Hewlett-Packard (Canada) Ltd., 8270 Mayrand Street, Montreal, Quebec.

CIRCLE 900 ON READER SERVICE CARD

# electronics

A McGraw-Hill Weekly 75 Cents



**W. W. MacDONALD, Editor**

**J. M. CARROLL, Managing Editor**

**SENIOR EDITORS**

Samuel Weber, George W. Sideris

**SENIOR ASSOCIATE EDITORS**

Michael F. Wolff, John F. Mason

**ASSOCIATE EDITORS**

Michael F. Tomaino, William P. O'Brien, Sy Vogel, George J. Flynn, Laurence D. Shergalis, George V. Novotny, Leon H. Dulberger.

**ASSISTANT EDITORS**

Stanley Froud, Stephen B. Gray, Roy J. Bruun, Barry A. Briskman, Dan Smith, Joel A. Strasser

**REGIONAL EDITORS**

Harold C. Hood (Pacific Coast, Los Angeles), Thomas Maguire (New England, Boston), Cletus M. Wiley (Midwest, Chicago)

**ART DIRECTOR**

Howard R. Berry

**ASSISTANT ART DIRECTOR**

John C. Wright, Jr

**EDITORIAL ASSISTANTS**

Lorraine Rossi, Virginia T. Bastian, Lynn Emery, Ann Mella, Lorraine Werner, Alice M. O'Brien, Sharon Parks, Patricia Mitchell, Claire Benell

**FOREIGN NEWS BUREAU**

DIRECTOR, John Wilhelm;  
Alyne Elias, Charles Obertance

LONDON—John Shinn, Derek Barlow, Nicholas Landon

BONN—Bruce Bendow,  
Richard Mikton, Silke McQueen

BRUSSELS—Peter Forbath

PARIS—Robert Farrell,  
Arthur Erikson

MILAN—Marc A. Messina

MEXICO CITY—Wesley Perry, Jr

RIO DE JANEIRO—Leslie Warren

MOSCOW—Stewart Ramsey

TOKYO—Richard Halloran,  
Charles Cohen, John Yamaguchi

**CIRCULATION MANAGER**

Hugh J. Quinn

**W. W. GAREY, Publisher**

**NATURAL BOWL** near Arecibo, Puerto Rico, has been converted into an extremely sensitive, radio-radar telescope. Cables from 400-foot towers suspend the scan and feed elements 435 feet above the mesh reflector. *The instrument is the biggest of its kind in the world. See p 18* COVER

**THE COMPUTER:** Design Assistant Extraordinary. Program aims at getting computers to design electronic circuits, not just analyze them. *This circuit-design concept sees the man-machine team as a direct link between engineering and production* 16

**U.S. ADOPTS** British ILS. Instrument landing system will have glide slope, radio altimeter and automatic throttle control. *But FAA will go slow on making the system fully automatic* 17

**ARECIBO:** World's Biggest Ear. When it is completed this summer, the 18½-acre radio-radar telescope will give scientists the most sensitive instrument yet built for ionospheric and space investigations. *The size of the electronics components would do justice to bridge builders* 18

**TECNETRON FAMILY EXPANDS.** French develop bistable and high-power versions of the high-frequency, field-effect transistor. *Silicon planar techniques are expected to give higher frequencies than germanium etching, the technique now used* 18

**MERGERS IN SOLID-STATE TECHNIQUES:** Key to New Breakthroughs. Thin-film, integrated-circuit, dot and chip techniques will be united. *Goal is to multiply frequency performance 10 times* 24

**DOUBLE-COLLECTOR TRANSISTORS** Raise Logic Speed. New configuration for integrated circuits is reported to raise speed an average of 30 percent. *Fan-out and fan-in figures run higher than 10* 30

**FROM SPACE TO INDUSTRY.** Diffusion of NASA R&D information aids industrial and consumer electronics designers. *Here are some of the new products that have resulted* 30

**INTEGRATED REFERENCE:** New Device Simplifies Power Supply Design. Transistor-zener diode integrated structure is both voltage reference and error voltage amplifier in single package. *New definition of temperature coefficient for reference devices is given and test circuits enable accurate measurement.*  
By T. P. Sylvan, General Electric 39

**INFRARED DIODE:** Novel Application in Tape Reader. Use of GaAs diodes as a source of illumination increases the reliability of optoelectronic tape readers for computers. The diode replaces the conventional tungsten lamp, has greater efficiency and longer life. *Potentially, higher speeds are possible too.*  
By R. F. Broom and C. Hilsum,  
Services Electronics Research Lab 44

Published weekly, with Electronics Buyers' Guide as part of the subscription, by McGraw-Hill Publishing Company, Inc. Founder: James H. McGraw (1860-1948).

Title ® registered U.S. Patent Office; © copyright 1963 by McGraw-Hill Publishing Co., Inc. All rights reserved, including the right to reproduce the contents of this publication, in whole or in part.

Executive, editorial, circulation and advertising offices: McGraw-Hill Building, 330 West 42nd Street, New York 36, N. Y. Telephone Longacre 4-3000. Teletype TWX N.Y. 212-640-4646. Cable McGrawhill, N. Y. PRINTED IN ALBANY, N. Y.; second class postage paid at Albany, N. Y.

OFFICERS OF THE PUBLICATIONS DIVISION: Shelton Fisher, President; Vice Presidents: Joseph H. Allen, Operations; John R. Callahan, Editorial; Ervin E. DeGraff, Circulation; Donald C. McGraw, Jr., Advertising Sales; Angelo R. Venezian, Marketing.

OFFICERS OF THE CORPORATION: Donald C. McGraw, President; Hugh J. Kelly, Harry L. Waddell, Executive Vice Presidents; L. Keith Goodrich, Executive Vice President and Treasurer; John J. Cooke, Vice President and Secretary.

Subscriptions are solicited only from those actively engaged in the field of the publication. Position and company connection must be indicated on orders. Subscription rates: United States and Possessions, \$6.00 one year, \$9.00 two years, \$12.00 three years. Canada: \$10.00 one year. All other countries \$20.00 one year. Single copies, United States and Possessions and Canada 75¢. Single copies all other countries \$1.50.

THE PUBLISHER, UPON WRITTEN REQUEST FROM ANY SUBSCRIBER TO OUR NEW YORK OFFICE AGREES TO REFUND THAT PART OF THE SUBSCRIPTION PRICE APPLYING TO COPIES NOT YET MAILED.

Subscribers: Please send change of address notices, subscription orders or complaints to Fulfillment Manager, Electronics, at the address below. Change of address notices should provide old as well as new address, including postal zone number if any. If possible, attach address label from recent issue. Allow one month for change to become effective.

Postmaster: Please send Form 3579 to Fulfillment Manager, Electronics, P. O. Box 430, Hightstown, New Jersey.



Audited Paid Circulation

CONTENTS continued

**CONSUMER ELECTRONICS:** Appliances & Housewares. Last of a Series. Latest trends in electronic ranges, thermoelectric cooling, ultrasonic dishwashers, telephone dialers and toys. *But it will be a while before electronics moves out of the living room into the kitchen and laundry.* By S. B. Gray 46

**RADAR JAMMING:** Designing Receivers to Eliminate It. In radar systems design, careful attention to certain details can eliminate rfi and alleviate susceptibility to various forms of jamming. *This article shows the forms such interference can assume and provides a checklist of steps necessary to combat them.* By J. C. Galenian, USAERDL 51

DEPARTMENTS

Crosstalk. <i>Continuing Education</i>	3
Comment. <i>Imported Components. Square-Wave Generator</i>	4
Electronics Newsletter. <i>Air Force Dampens Hopes for Below-Ground Radio</i>	7
Washington This Week. <i>Pentagon to Set Profits by Formula, Revamp Contractor Selection Procedure</i>	12
Meetings Ahead. <i>Physics of Failure in Electronics Symposium</i>	36
Research and Development. <i>National Magnet Lab Pushes for 250 Kilogauss</i>	56
Components and Materials. <i>NEMA Lab Updates Tests for Laminates</i>	62
Production Techniques. <i>Fabrication Aids Cut Submodule Rejection Rate</i>	68
New Products. <i>Efficient GaAs Light Source in Glass Package</i>	74
Literature of the Week	82
People and Plants. <i>Avakian—Wizard In A Wheelchair</i>	84
Index to Advertisers	88

# Continuing Education

**AS ENGINEERS** we are concerned with the lifetime of electronic equipment and components. We should also be concerned with the lifetime of our engineering educations.

How long is a BS in engineering good for? Many "help wanted" ads specify a degree less than ten years old. In some fields, an engineer with a degree five years old has already grown a beard unless he has taken steps to keep up with his field.

How to keep up? You are doing it right now reading *ELECTRONICS*. You help yourself keep up every time you attend a conference, listen to a lecture or just engage in a technical bull session with the other boys in the car pool or luncheon group.

But our rapidly changing technology requires more than this informal keeping up. Sometimes it is necessary to go back to school. Special two-week crash courses are useful. Many engineers go for their Master's degree. This keeps them in touch with the more theoretical aspects of their field—also gets them out of a certain amount of window washing, diaper changing, leaf raking and the like.

But after the Master's degree, then what? The PhD? Some engineers have done it while holding a full-time job, but more often the dissertation requirement stops them and they go on for years thinking about doing the research and writing the paper while their courses grow stale and their hair falls out. By this time they are often too far along in industry and family responsibilities to resume the *Vie Boheme* for the one or two years it takes to do the dissertation. Moreover, the engineering work in which they are engaged is often just refinement of technology, and seldom the work of one man, and therefore fails to meet academic requirements.

Universities might consider another kind of degree, a sort of super master's degree, or junior PhD. This could bear the same relationship to the PhD as the Doctor of Education bears to a PhD in educational psychology, or a Doctor of



*CONTRIBUTIONS to technology, made in plants like this, should count towards higher academic degrees*

Medicine bears to a PhD in microbiology. Such a degree could be granted for completing an advanced series of courses with high grades. The thesis could be a survey in the engineer's major field of interest, or a report on his contributions to technology rather than original research strictly construed.

After a doctorate what? In the medical profession we have Fellows of societies who attain their standing by post-doctoral studies. Perhaps the professional societies could establish a title of Fellow-Engineer, not just for a specific contribution to the profession but for a comprehensive course of studies beyond the doctorate level.

Then there could be the title Scholar-Engineer, conferred on one who has attained the master's, doctorate and fellow in his specialty, who continues to take a minimum of, say, six hours of college credit each year. He might hold this title only as long as he continued his work.

A system of this nature would distinguish those engineers who continue to keep up with their field and provide clearly understood incentives for all engineers to keep up.

# SPRAGUE®

## MODEL 500 INTERFERENCE LOCATOR

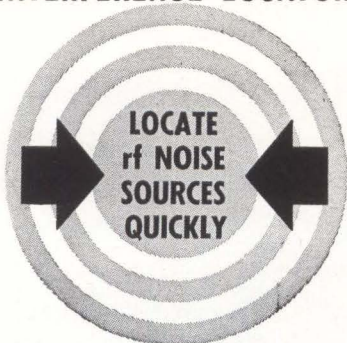

This versatile instrument is a highly sensitive interference locator—with the widest frequency range of any standard available unit! Model 500 tunes across the entire standard and FM broadcast, shortwave, and VHF-TV spectrums from 550 kc. to 220 mc. in 6 bands.

It's a compact, portable, rugged, versatile instrument—engineered and designed for most efficient operation in practical field use. It features a transistorized power supply, meter indications proportional to carrier strength as well as sensitivity of 5 microvolts minimum for 5% meter deflection over entire tuning range.

For full details, send for brochure IL-106.

**SPRAGUE ELECTRIC COMPANY**  
35 Marshall Street, North Adams, Mass.

**SPRAGUE®**  
THE MARK OF RELIABILITY

## COMMENT

### Imported Components

"Believe it or not, it's not the low price of Japanese imported electronic components that is hurting American electronic component manufacturers," said a design engineer friend of mine recently, after he had visited a large American manufacturer of small radios. There he saw boxes of Japanese components dumped onto the assembly-line tables. "How come?" he asked the manufacturer. "Why do you use these?" The answer: "Because I have absolutely no rejects."

In an experimental laboratory, the owner held up a miniature resistor. "See this," he said, "It's  $\frac{1}{2}$  watt and was made in Japan. We just tested this box full and every one was 'on the nose.'"

Mr. Component Manufacturer in the U.S.A. If your customers are buying Japanese merchandise, the reasons are obviously not entirely based on price alone.

GEORGE G. FELT

Reast & Connolly  
South Orange, New Jersey

### TV Projection Tubes and X-Rays

We note with interest, letters from Mr. A. R. Rogers and Mr. J. H. Owens Harries (*Comment*, p 4, March 15), regarding X-rays from television projection tubes.

This company has been producing projection tv receivers since 1948, utilizing a 2 $\frac{1}{2}$ -inch tube operating at 25 Kv and a beam current of up to 400 microamperes. Operating under these conditions in an optical system of Schmidt design, X-ray radiation is well below the level of the average 23-inch tube at 20 Kv.

In a practical design of a front-projection receiver displaying a 34-inch picture, the crt is about 12 inches from the floor and its screen pointing away from the viewer. It has been proved that a projection receiver operating at 25 Kv is infinitely safer from X-rays than almost any type of direct-viewing receiver, whether colour or black and white.

V. VALCHERA

Valradio Limited  
Feltham, Middlesex, England

### Square-Wave Generator

We note with interest the improved transistor square-wave generator described by R. O. Gregory and J. C. Bowers on p 47 of your issue of Dec. 21, 1962.

The use of diodes in the manner there described, to relieve the transistors of loading by the cross-coupling capacitors, was developed in this company by F. Rozner (British Patent No. 790,941, Application date 29.9.1955); such diodes are known to many of us as "Rozner's stand-off diodes." The arrangement was shown by him in a letter published in *Electronic Engineering*, Sept. 1957, p 455, and has been used for some years in our transistor television waveform generators. We recommend it thoroughly.

J. V. CORNEY

Ferguson Radio Corporation Ltd.  
Enfield, Middlesex  
England

### Crystal-Controlled Multivibrator

I was very pleased with the publication of my article, Crystal-Controlled Multivibrator Has Better Stability (p 60, April 12). Upon reviewing the captions, however, I feel that two of the descriptions are misleading. The first of these occurs in the foreword preceding the article title, namely that portion stating "this circuit uses crystal control to achieve higher stability and improve rise and fall times." The addition of a crystal does not improve rise and fall times, only stability.

The description under Fig. 1 states that crystals with a CT cut were used but, "Crystals with an AT cut are also suitable." It would be more accurate to say that AT cut crystals are preferable rather than suitable, due to their higher activity and lower temperature drift.

In addition, the vertical axis on the scope photos in Fig. 2 are inverted; this would make what is actually the rise time on the waveform appear to be the fall time.

Incidentally, there was also one typographical error. On p 61, col. 3, line 20, "look" should correctly have been printed "lock."

HARRY R. NEWHOFF

Litton Systems, Inc.  
Woodland Hills, California

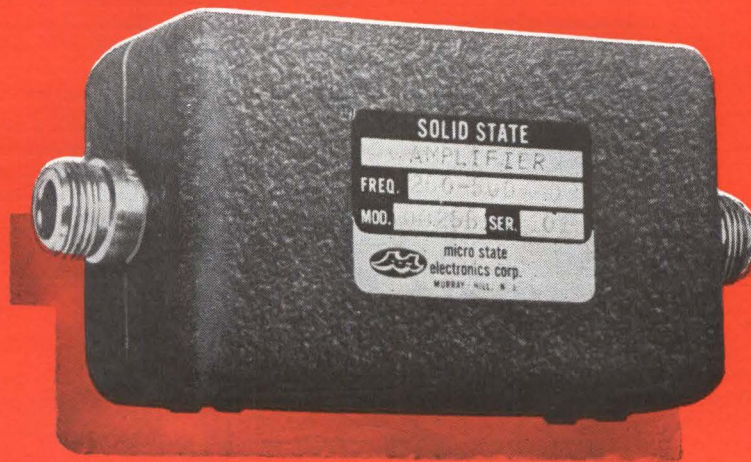

# *advanced techniques lower transistor amplifier prices*

The rapid acceptance of the TQ series amplifiers now permits Micro State to offer low production prices on small quantities of both standard and custom designed units. This series of transistor amplifiers includes over 35 standard designs from IF to UHF.

Features include:

- All solid state reliability
- Low noise figure
- High gain
- Small size — light weight
- Low power consumption
- Ruggedized for military application
- Broadband operation

For detailed information, contact Micro State Electronics Corporation.

## REPRESENTATIVE SPECIFICATIONS

MODEL	BANDPASS (mc)	GAIN (db)	NOISE FIGURE (db)	SIZE (in.)
<b>OCTAVE BANDWIDTH</b>				
TQO 1603	160-320	32	5	6 x 2 x 2
TQO 2503	250-500	25	7	5 3/4 x 2 x 2
TQO 5003	500-1000	25	9	6 x 2 x 2
<b>ULTRA WIDE BANDWIDTH</b>				
TQW 2571	250-750	15	7	3 3/4 x 2 x 2
<b>NARROW BANDWIDTH</b>				
TQN 2151	215-260	20	4.5	4 x 2 x 2
Temperature Range		-40°C to +70°C		
Input VSWR		TQO, TQW, < 1.75; TQN, < 1.3 (50 ohms)		
Bandpass Ripple		< ± 1.5 db		



**micro state electronics corporation**

152 FLORAL AVENUE, MURRAY HILL, NEW JERSEY 201-464-3000  
AN EQUAL OPPORTUNITY EMPLOYER

CIRCLE 5 ON READER SERVICE CARD

By Unanimous Endorsement of the U.S. Industrial Payroll Savings Committee  
for the Treasury Department of the United States of America

## DECLARATION of INTER-DEPENDENCE

We, the undersigned—recognizing the responsibilities charged to us as citizens of the United States and stewards of free American enterprises—declare: In order to pursue the greater security of our country, and of our fellow-citizens in the ranks of business and industry, we shall vigorously promote broad ownership of United States Savings Bonds, and the benefits of acquiring these instruments of security through systematic Payroll Savings. By so doing, we hope to strengthen the inter-dependent resources of our people, our industry, our nation.

We recognize, further, that increased public ownership of the national debt—through United States Savings Bonds—is essential to the sound management of our government's finances, to the stability of our currency, and—consequently—to our continued ability to meet our responsibilities in the defense of the free world. This voluntary exercise of thrift secures both individual and nation against adversity and emergency, and earns the participant a greater share in the abundance of America.

We urge all employers to co-operate with their government for the common good—by providing leadership in the systematic Payroll Savings Plan, and promoting among their people investment in their country's future—

*Douglas Dillon*

*H. S. Genee*

<i>Conrad Baker</i>	<i>Samuel H. Kamevala</i>	<i>Thomas H.</i>
<i>[Signature]</i>	<i>John R. Gushman</i>	<i>J. Martino</i>
<i>[Signature]</i>	<i>[Signature]</i>	<i>Frank K. Mullen</i>
<i>Raymond D. Burger</i>	<i>[Signature]</i>	<i>Shirley F. Ferguson</i>
<i>M. R. Chambers</i>	<i>[Signature]</i>	<i>[Signature]</i>
<i>[Signature]</i>	<i>Thomas V. Jones</i>	<i>[Signature]</i>
<i>[Signature]</i>	<i>Clarence A. Kelley</i>	<i>Hal. Pommer</i>
<i>[Signature]</i>	<i>[Signature]</i>	<i>A. K. Williams</i>
<i>[Signature]</i>	<i>[Signature]</i>	<i>[Signature]</i>
<i>[Signature]</i>		

Endorsed and Subscribed to

*[Signature]*

name \_\_\_\_\_

company \_\_\_\_\_

### Why every electronics firm should endorse this document

The 29 signatures on this "Declaration" were inscribed by the Secretary of the Treasury and executives of major companies in many different areas of American business. I am proud to represent the electronics industry on this distinguished committee, for I am convinced that no industry has a greater stake in the 1963 Payroll Savings Drive than ours.

Our hundreds of companies and more than a million workers have in a very short time put out roots and grown to great heights—heights attainable only under our economic system. We must recognize the real need for increased enrollment in the Payroll Savings

Plan—increased public ownership of the national debt—as a vital support for this system and as a stabilizing factor in the financing of our national defense and space effort.

We also cannot overlook the personal benefits this systematic savings program offers the individual employee by helping him to provide for his future. From the standpoint of personnel relations alone, Payroll Savings makes sense to us.

We ask you to consider the merits of a vigorous Bond program throughout your organization and invite you to join in this patriotic and practical plan for a strengthened U.S. economy.

*[Signature]*

H. S. Genee, President  
International Telephone and Telegraph Corporation  
Chairman, U. S. Industrial Payroll Savings Committee



# AF Dampens Hopes for Below-Ground Radio

BEDFORD, MASS.—Air Force has sounded a sour note in the chorus of optimism about sub-surface transmission of radio waves (p 7, March 29). Propagation of radio signals through rock and earth strata has been boomed for several years as capable of providing military communications with low vulnerability to bomb damage, high security and low ambient noise level.

However, a study conducted at AF Cambridge Research Laboratories here indicates that 100-mile-or-more underground paths are not feasible. The study concerns only underground transmissions, not up-over-down methods, from one buried antenna to another over the earth's surface.

At bedrock is bedrock. It's just about impossible to find long stretches of it without large faults, AFCRL scientists say. And low attenuation of the propagated signal requires high resistivity, meaning the rock must be free of moisture. This is easy to measure in the lab, but it has been found extremely difficult to determine moisture content with certainty in field experiments, according to AFCRL.

AFCRL says though that the sub-surface technique still holds promise for extremely hardened communications through rock strata over short paths—10 miles or so. AFCRL will continue its study, hoping to define the boundary conditions for the communications possibilities—principally by concentrating on the geological, geophysical and electrical properties of the rock structures.

## Army Will Test Laser Range Finders

THIS SUMMER, the Army will take delivery of several ruby-laser range finders, built by RCA, for evaluation at Army's Electronics Research and Development Lab. The instrument, which looks like a large double telescope, is based on a Fort Monmouth design. It re-

portedly operates at 6,943 Å and employs Q spoiling for high peak power. It is expected to penetrate smoke and fog better than conventional optical range finders and presumably would supplement radar and optical range finders used for artillery and rocket control.

## Automatic Drawing Feasible for Pert

NORTH AMERICAN Aviation has successfully demonstrated automatic drawing of the charts which form the basis of Program Evaluation and Review Technique (Pert). Present techniques require the re-drawing by hand of part or all of the Pert network, making it difficult to keep the system up to date when a complex program is involved. Automatic plotting will make it possible to feed changes into a computer on one day and have updated networks back the next morning, North American says.

## Mexico Limits Uhf Tv to Color

MEXICO CITY—The Mexican government has announced that uhf tv broadcasting here must be color

## Keeping Place in Space

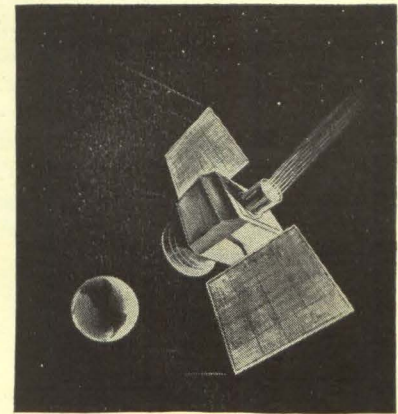

ION PROPULSION engine, pushing down against earth's rotational force would keep synchronous communications satellite in orbital position, says Electro-Optical Systems

only. The first uhf channel has been assigned to XHTO-TV.

Transmitting equipment and receivers would be imported from Japan or the U.S. until they can be manufactured or assembled in Mexico. The owners of the station also claim they will be allowed to import receivers, which would mean a reversal of the government's policy of protecting Mexico's small electronics industry.

Two-color broadcasting system being demonstrated by a vhf station, XHGO-TV, is believed to have

## DOD Seen Shifting to Project Managers

WASHINGTON—The project-manager setup will be used in every future DOD program of any size, predicts James H. Gardner, retiring deputy director of Defense Research and Engineering.

Gardner, who delivered the keynote address at the Electronic Components Conference here last week, said the competence of government technical managers is presently uneven and far from adequate. The project-manager structure, used in the Polaris program, would help overcome this by providing the opportunity for managerial accomplishment, he said. Under this arrangement, a single project manager has both the technical and financial responsibility for a program.

Gardner said the line managers who now make decisions and run programs in defense development are not giving the required emphasis to utility and reliability. Incentive contracting and program definition though are improving the relationship between government and contractors, he said

the inside track for a Mexican system (p 42, May 3).

## LEM Electronics Subcontractor Chosen

RCA WILL SUPPLY much of the electronics equipment for the Lunar Excursion Module (LEM) in the Apollo program, the company says. Included will be elements of the attitude and stabilization system and tv and communications equipment. A spokesman for Grumman, prime contractor for LEM, said a detailed announcement will be made soon.

## Seek Steerable Array For 6-MM Communications

BOSTON—TRG Inc. here is conducting a feasibility study to determine if phased-array techniques can be used to make an electronically steerable array for a 6-mm communications system. Ferrite phase shifters are being developed for an array of 16 antennas to swing a circularly polarized beam  $\pm 30$  deg.

Work is being performed under subcontract to Republic Aviation, prime contractor to the Air Force for a millimeter communications system to be used between satellites. Extremely narrow beamwidths at millimeter frequencies make it necessary for some type of search system to seek out the other terminal in the communications link.

## Component Firms Oust Middle Man

WASHINGTON — Electronics companies were plugging into each other's components last week in a joint sales effort. Rixon, Sangamo and Alden Electronics each contributed components to a complex voice-facsimile communications system, AlPurCom, in a search for corporate and government markets for components.

The system was on display during the AlPurCom conference here sponsored by Automation Management, Inc., which is attempting to launch a new trend in small-firm cooperation in systems design and

sale. AMI, according to president William Alden, is designing needed systems and then seeking component manufacturers willing to ride them to market. The arrangement eliminates the usual middle man.

## Pass Band Filters Help Telstar II

LOSS OF SIGNAL strength in Telstar II's telemetry has apparently been compensated for with the addition of filters to narrow the pass band on the receiving equipment at the Andover, Me., ground station, AT&T says. The filters increased the signal-to-noise ratio by 4 or 5 db and color-tv tests run during the second evening came off without the problems experienced the first night. The satellite's beacon antenna pointed away from the earth creating marginal telemetry signals during the first few passes.

## Laser Beams Voice 118 Miles in Desert

PASADENA, CALIF.—A distance record of 118 miles for laser voice communication is claimed by the Amateur Radio Club of Electro-Optical Systems, Inc. Signals for the 300-word message were pumped at r-f through a helium-neon laser with confocal mirrors, beamed across the California desert by a 10-power telescope, and demodulated with an S-20 multiplier phototube. The transmitter operated at 6,328 Å with 125  $\mu$ w output.

## Single Sideband Eyed For Maritime Services

FCC PROPOSES that all marine radiotelephone emissions in the 4 to 27.5-Mc band be limited to single-sideband starting in 1970. With the exception of certain frequencies required for safety communications, all carrier frequencies now available for radiotelephony below 27.5 Mc would be available for SSB using upper sideband with either compatible full carrier (A3H), reduced carrier (A3A), or suppressed carrier (A3J) emissions.

## In Brief . . .

BETTING early this week favored an MA-10 launch to fill in the 15- to 18-month gap between the Cooper attempt and Gemini. NASA has released about \$1 million for study of MA-10 flight.

PROJECT WEST FORD has begun, the Air Force says (p 7, Feb. 1, p 7, April 26 and p 7, May 10).

ULTRASONIC treatment of mental patients can accomplish the aims of prefrontal lobotomy without permanently impairing functions, reports the University of Utah.

NASA HAS BEEN ASKED by Illinois' Governor Otto Kerner to set up an electronic research center adjacent to Argonne National Lab.

RADIATION, INC. will build two automated telemetry data processing systems, for Apollo and Saturn. Contracts total \$3.5 million.

BENDIX has been given a \$990,000 contract for air-data computer systems to be installed in the Air Force and Navy versions of the F-111 (TFX) fighter plane.

HEART BEATS of a pregnant woman and her unborn child were transmitted last week from Mount Sinai Hospital in Milwaukee to Paris, France by cable. Magnavox developed the f-m equipment.

REENTRY VEHICLES will be instrumented with arrays of Langmuir probes (p 18, May 25, 1962) to measure electron density and temperatures at various locations in the flow field. Geophysics Corp. of America developed the equipment for the Air Force.

USSR SAYS it will test improved variations of carrier rockets for "cosmic objects" in Pacific between May 15 and July 15.

RCA IS PHASING out its electronic manufacturing operations in Mexico. It plans to expand its production of records.

NAVY WILL OPEN bids in Los Angeles, June 11, for the first increment of the 65-million vlf radio station on North West Cape, Australia (p 20, Jan 4).

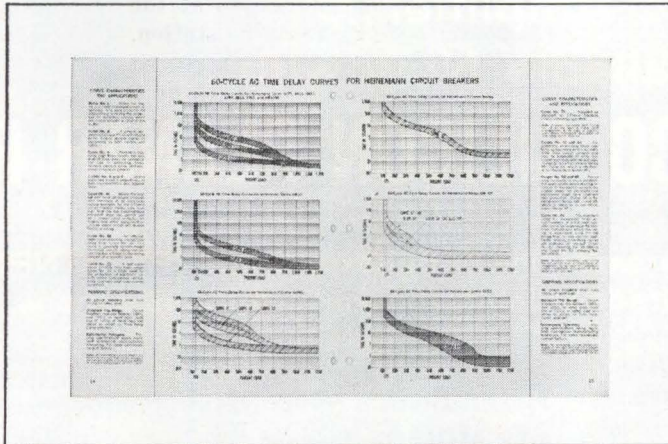
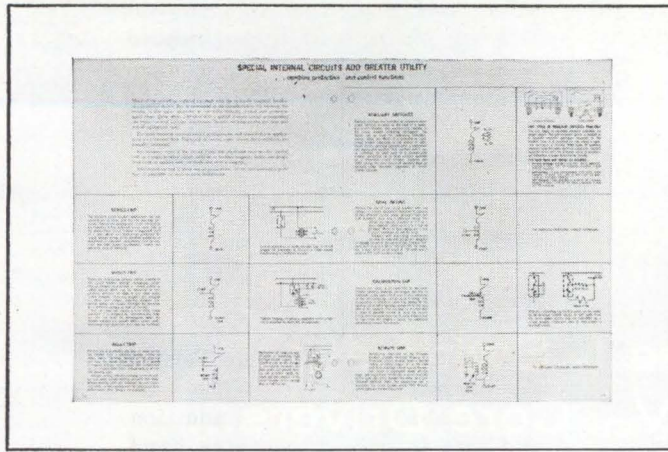

## SOURCE BOOK FOR DESIGN IDEAS

*The Heinemann Engineering Guide: thirty-two pages of circuit breaker application data for the OEM engineer.*

If you are in any way concerned with the design of electrical or electronic equipment, you probably ought to have a copy of our new Engineering Guide. Particularly if you haven't yet acquainted yourself with the capabilities of the Heinemann hydraulic-magnetic circuit breaker.

Did you know, for example, that you can spec the current rating of a Heinemann breaker down to two decimal places, if need be? That you can choose from several different time-delay characteristics? That you can get the

breaker with such multi-purpose constructions as relay-trip, shunt-trip, auxiliary contacts, etc.?

The Engineering Guide, Bulletin 202, tells you all about these parameters and, in addition, gives detailed data on voltage drop, impedance values, and other essential performance characteristics of our entire line of breakers. It also suggests a number of interesting applicational possibilities. All in all, it's a handy book for the circuit designer. The coupon will bring you a copy.

**HEINEMANN ELECTRIC COMPANY 2600 BRUNSWICK DRIVE, TRENTON 2, NEW JERSEY**

Heinemann Electric Company  
Trenton 2, New Jersey

Please send me a copy of your new Circuit Breaker Engineering Guide.

Name \_\_\_\_\_ Title \_\_\_\_\_

Company \_\_\_\_\_

Address \_\_\_\_\_

\_\_\_\_\_

SA2774

600 mc  $f_T$  Switches...  
 120V  $V_{CB}$  Core Drivers...  
 100 mc Amplifier...  
 All Available Now with...

# PHILCO SILICON PLANAR RELIABILITY

Philco's versatile line of Epitaxial Silicon Planar NPN Transistors enables you to upgrade reliability in transistor applications.

## ULTRA HIGH SPEED SWITCHES

TYPE*	Maximum Ratings			Characteristics							
	$T_S$ °C.	$V_{CB}$ volts	$P_T$ @25°C. mw	$I_{CBO}$ max. $\mu$ a	$h_{FE}$ min.	$V_{CE(SAT)}$ max. volts	$f_T$ min. mc	$C_{ob}$ max. pf	$t_s$ max. nsec	$t_{on}$ max. nsec	$t_{off}$ max. nsec
2N709	300	15	300	0.05	20	0.30	600	3	6	15	15
T-2877	300	15	300	0.05	20	0.30	500	3	8	17	17

\*TO-18 case—collector internally connected to case.

## CORE DRIVERS/PULSE AMPLIFIERS

TYPE*	$V_{CB}$ max. volts	$f_T$ @ 50 ma mc	$h_{FE}$ @ 150 ma
2N1893	120	50	40
2N1613	75	60	40

\*TO-5 case—collector internally connected to case.

## 100 mc LOW-NOISE AMPLIFIER

Industry's Newest Silicon Amplifier Standard

TYPE	Power Gain	Maximum Noise Figure	Minimum $BV_{CEO}$
T-2857*	15-22db@100 mc	5db@100 mc	20 volts

The new Philco T-2857 is industry's first silicon amplifier transistor to be functionally tested at 100 mc for fixed-matched, fixed neutralized, and fixed-bias performance. This insures interchangeability in practical communications circuits.

\*TO-18 case with 4 leads—collector isolated from case.

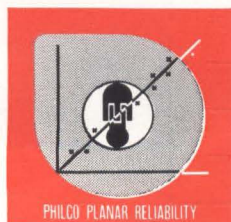

Whatever your silicon transistor application, evaluate Philco Planar Transistors.

For complete data, and new Reliability report, write Dept. E51763.

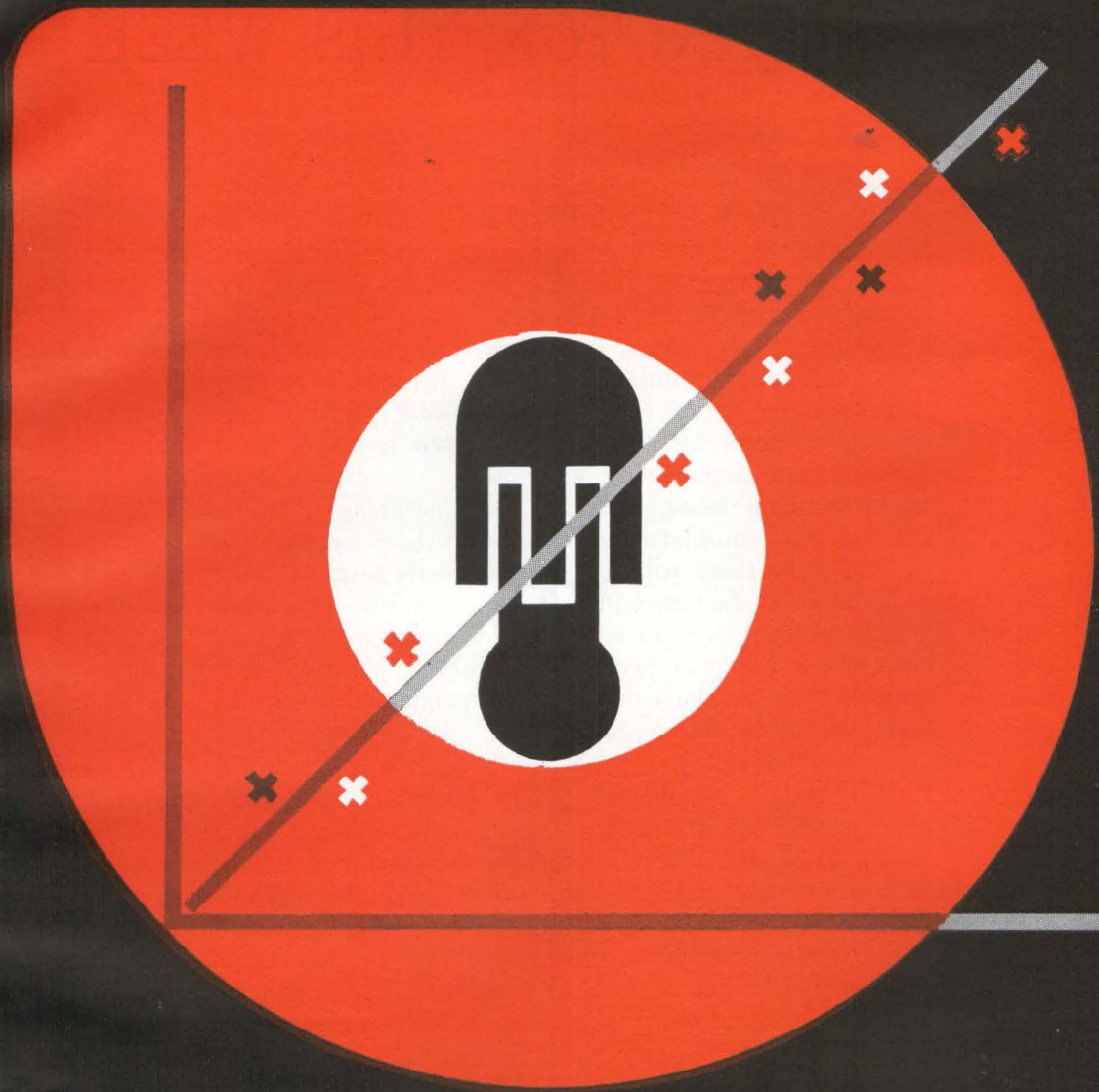

### VERY HIGH SPEED SWITCHES

These Philco Types Feature Industry's Best Combination of Voltage, Switching Speed, and Beta.

TYPE†	Maximum Ratings					Characteristics							
	T <sub>s</sub> °C.	V <sub>CB0</sub> volts	V <sub>CE0</sub> volts	P <sub>T</sub> @ 25° C. mw	I <sub>c</sub> ma	I <sub>CB0</sub> max. μA	h <sub>FE</sub> min.	V <sub>CE</sub> (SAT) max. volts	f <sub>T</sub> min. mc	C <sub>ob</sub> max. pf	t <sub>s</sub> max. nsec	t <sub>on</sub> max. nsec	t <sub>off</sub> max. nsec
2N2710	300	40	20	360	500	0.03	40	0.25	500	4	15	20	35
2N2651	300	40	20	360	500	0.03	25	0.25	350	4	25	35	75
2N914	300	40	15	360	500	0.025	30	0.25	300	6	20	40 @ 200 ma	40 @ 200 ma
2N834	175	40	30**	300	200	0.50	25	0.25	350	4	25	35	75
2N784A	300	40	15	350	200	0.025	25	0.19	300	3.5	15	20	40
2N708	300	40	15	360		0.025	30	0.40	300	6	25		
2N706	175	25	20*	300	50	0.5	20	0.60	200	6	60		

\*V<sub>CEr</sub>

\*\*V<sub>CEs</sub>

† TO-18 case—collector internally connected to case.

# PHILCO®

A SUBSIDIARY OF *Ford Motor Company*

LANSDALE DIVISION, LANSDALE, PA.  
CIRCLE 11 ON READER SERVICE CARD



# WASHINGTON THIS WEEK

## PENTAGON TO SET PROFITS BY FORMULA

HERE'S HOW PROCUREMENT officials will, in a few months, be figuring target profits or fees on noncompetitive negotiated contracts, under the "weighted guideline approach" drafted for the Pentagon (ELECTRONICS, p 12, Feb. 12, 1963, and p 12, Dec. 14, 1962). Object is to set uniform profit standards, reflecting contractor performance.

In evaluating a contract proposal, the official will apply percentage values to the "contractor's input to total performance." Percentages are: direct material, 2 to 4; purchased parts, 2 to 4; subcontracted items, 1 to 5; engineering labor, 9 to 15; engineering overhead, 6 to 9; manufacturing labor, 5 to 9; manufacturing overhead, 4 to 7, and general and administrative expense, 6 to 8 percent. Multiplying cost categories by these will give the composite target profit.

Then, other factors will raise or lower the composite. For example, 0 to 5 percent can be added for the contractor's cost risk, and  $\pm 2$  percent for his past performance record. A similar range is set for such factors as the contractor's dependence on government financial, material and technical resources.

## REVAMPING CONTRACTOR SELECTION

PENTAGON IS ALSO going ahead with the plan to revamp contractor selection through a dual bidding method (ELECTRONICS, p 10, March 1). Aim is to limit final competition on R&D projects to the best technically qualified firms. A brief first proposal would be used to screen potential contractors. Firms meeting requirements could then submit detailed technical and cost proposals. Deputy Defense Secretary Gilpatric says the new plan will "not change the distribution of authority," nor set up new criteria for contract awards.

## COMPUTERS— LESS LEASING MORE SHARING

IN A FEW YEARS computers bought by the government will outnumber those leased, Budget Bureau officials predict. The government now owns 15 percent, but the General Accounting Office wants buying accelerated.

Meanwhile, to reduce the \$20-million-a-year data processing bill, plans are to increase computer sharing among agencies. A study of Philadelphia's 50 computers showed unused computer time could be reduced one-third by more sharing. The experiment will be duplicated at other computer centers. The government's 200 owned and 1,200 leased computers now work an average of 267 hours a month each.

In Washington, which has the most computers, Department of Commerce will organize a computer servicing program and area sharing.

## WHITE HOUSE WANTS FEWER NEW R&D LABS

FISCAL 1965 BUDGET estimators are being pressured to trim R&D budgets by cutting back on multiplication of new facilities. The emphasis is on increased sharing of in-house R&D facilities among government agencies. In the last three years, facilities budgets have jumped from \$500 million to more than \$1 billion.

Greater sharing is sparked by two developments: AEC has made Oak Ridge National Laboratory available for nonnuclear contract work; the computer-sharing experiments have been successful.

It is too early to predict whether the ultimate result will be a new shape for government labs, perhaps one like the British National Laboratories. But the subject is getting more attention at White House bogsat (bunch of guys sitting around a table) meetings.

# for SHOCK and VIBRATION

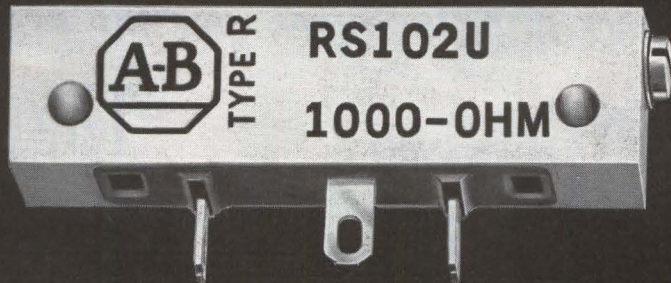

*this  
resistor  
is unmatched*



Where risk of failure cannot be tolerated, Allen-Bradley adjustable fixed resistors bring an extra wide margin of safety to your circuit performance. Through a unique process—developed and used only by A-B—the solid resistance elements, terminals, and insulating body of the Type R are hot molded into a single, rugged structure that's virtually indestructible—no instance of “catastrophic failure” has ever been brought to our attention. With adjustment approaching “infinite” resolution, abrupt changes in resistance cannot occur. The moving element is self-locking to hold absolutely stable settings under severe shock and vibration.

The molded case of the Type R adjustable fixed resistor is both dust-tight and watertight—it can be used where entire circuits are encapsulated. The Type R control is rated  $\frac{1}{4}$  watt at  $70^{\circ}\text{C}$  and available in total resistance values from 100 ohms to 2.5 megohms. Please send for Technical Bulletin 5205. Allen-Bradley Co., 110 W. Greenfield Avenue, Milwaukee 4, Wisconsin. In Canada: Allen-Bradley Canada Ltd., Galt, Ontario.

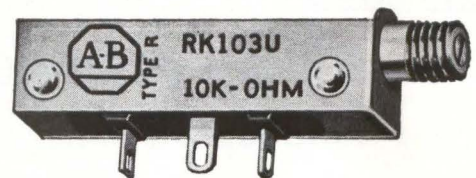

PANEL MOUNTING permits front of panel adjustment

Units shown approx. 1.5 times actual size



CUP GUARD permits adjustment after encapsulation



## ALLEN-BRADLEY

QUALITY ELECTRONIC COMPONENTS

# Specifying discriminators? Do you know...

*Which discriminator gives you the greatest reliability?*



## The GFD-3

(5000 hours MTBF...and we can prove it!)

*Which discriminator is the most compact?*

## The GFD-5

(Seven occupy just 3½ inches of panel height)

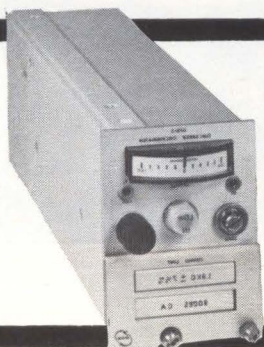

*Which discriminator works at the highest frequency?*

## The GFD-8

(Up to 5 Mc...high enough?)

*Which switchable discriminator gives you phase-locked-loop operation?*

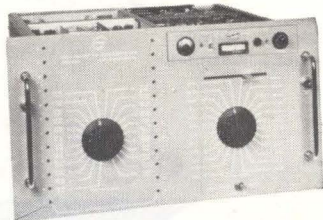

## The GSD-3

(23 channels; provision for remote control)

# Who makes them?



A few more important facts about the complete family of DCS Discriminators: They're all solid state. They're all available on rapid delivery. And, there's a full line of accessories and mounting hardware. For more information, including data sheets containing complete specifications, write today to: Dept. E-11

Write for the name of your nearest representative. Address: Dept. E-11

**DATA-CONTROL SYSTEMS, INC.**  
*Instrumentation for Research*

Los Angeles • Santa Clara • Wash., D. C. • Cape Canaveral

Home Office: E. Liberty St., Danbury, Conn. • Pioneer 3-9241





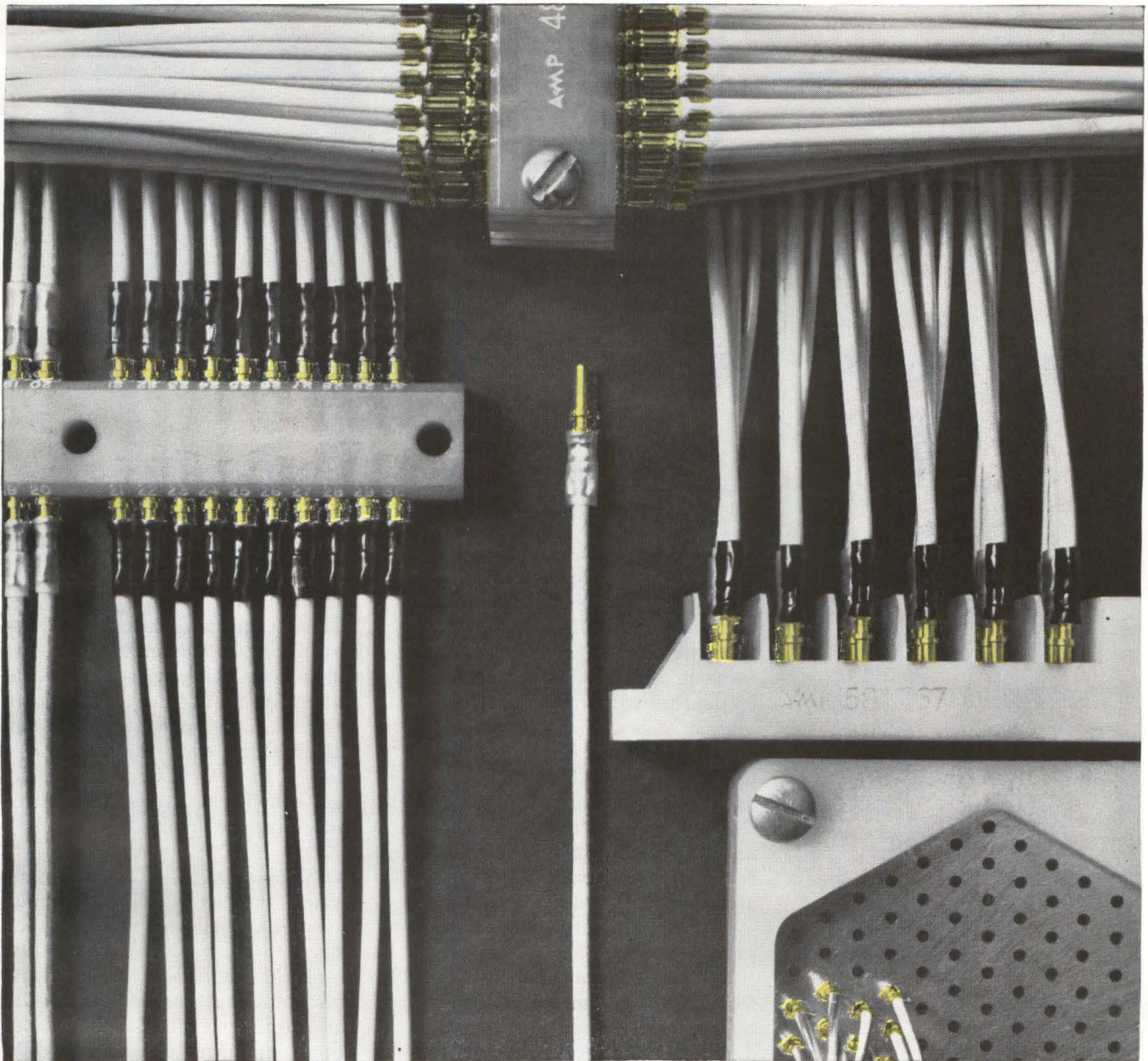

## 1,000,000,000 Why's

In data processing machines, in radar installations, in missile guidance systems—in well over 1 billion electrical-electronic circuits, A-MP\* Taper products rate first choice. And with good reason.

**Maximum Density**—An A-MP termination, just slightly thicker than the wire insulation diameter, permits maximum circuit concentration. Provides greater space freedom for design requirements of other vital components.

**Front-end Fitness**—AMP's precision taper creates peak mechanical and electrical characteristics. It makes the pins self-cleaning and self-locking. Makes sure they stay put under the most grueling operating conditions.

**Compression-crimp Consistency**—Quick, precise attachment by matching crimping tools eliminates oxide creep, burnt and brittle insulation, cold solder joints. Assures uniformity throughout the connections, and at a lower total installed cost than any other method.

**Broadest Selection**—With AMP you choose from the most complete line of taper products in the industry. All types of pins—stamped and formed, uninsulated and insulation piercing types, screw machine with insulation support and pre-insulated Diamond Grip. One and two piece stackable taper blocks in standard configurations of 10, 20 and 30 cavities. Plus a long list of companion items, such as vertical entrance blocks, taper bus bar and taper tab blocks.

For all maximum density, high reliability circuits, choose A-MP Taper products. Complete information available on request. \*Trademark of AMP INCORPORATED.

**AMP**  
INCORPORATED  
Harrisburg, Pennsylvania



AMP products and engineering assistance are available through subsidiary companies in: Australia • Canada • England • France • Holland • Italy • Japan • Mexico • West Germany

By THOMAS MAGUIRE  
New England Editor

*Circuit-design concept  
sees man-machine team as  
direct link to production*

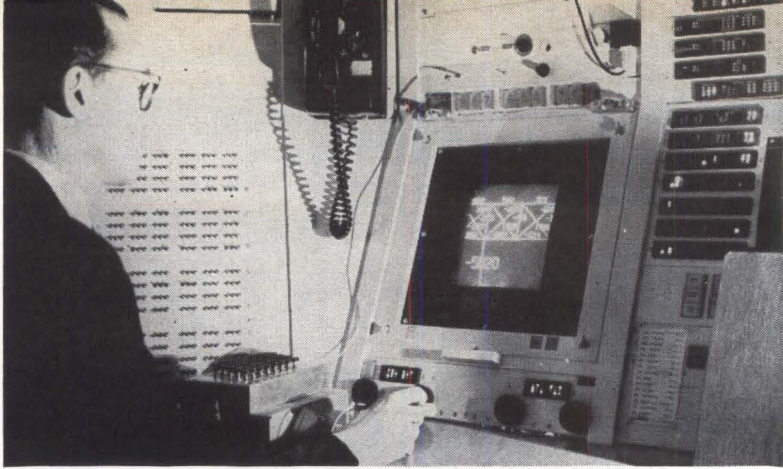

TX-2 LIGHT PEN generates arch bridge. Computer immediately shows strain on elements, analyzes and displays effect of load changes

## The Computer: Design Assistant

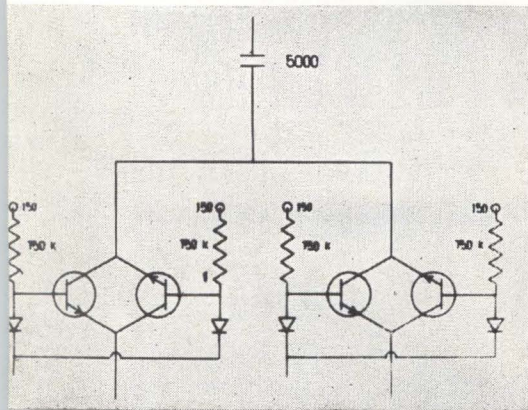

CIRCUIT produced on TX-2 computer at MIT

**BOSTON**—The man-machine circuit design team—a logical outgrowth of numerical control in manufacturing — may be still several years away, but substantial chunks of the theoretical and experimental foundation are now being laid.

Integration of computers into the design process can eventually eliminate layout, detail drafting and part-programming and place design and manufacturing back-to-back.

The circuit shown was produced on the scope of the TX-2 computer at MIT Lincoln Laboratory, in a program called Sketchpad. It is not yet economical to produce complicated drawings or detailed engineering drawings, but a few have been made to try out the system.

At the Spring Joint Computer Conference next week, the MIT

approach will be outlined at a special session. Numerical control was pioneered at MIT, and further work on data processing methods evolved in 1958 into the Automatically Programmed Tool (APT) system, now widely used.

**CONCEPT**—The concept is that engineer and computer associate as designing partners with information flowing freely back and forth between man and machine at high speed and in human terms—in graphical and symbolic language.

The engineer may have an idea for the parameters of a circuit. By freehand sketch and word, he describes it loosely to the computer. He can ask the machine to make specific analyses—say of impedance matching. He may alter the circuit as desired, or return to further generalized descriptions—all the time communicating with the computer. Ultimately man

and computer achieve an acceptable design.

In the case of a mechanical design, it can be transmitted directly to the calculating part of the APT program and numerical tapes for machine tools prepared without the design ever having been drafted by pen and paper. Reference drawings can be made automatically.

**SYSTEM GOALS**—The MIT approach envisions the designer sitting at a console with one or more output oscilloscopes or other graphical input-output devices, light pens, buttons, switches, etc., and a typewriter-like keyboard. These constitute a highly flexible and expressive communication medium between designer and computer.

Backed up by a highly sophisticated programming system, the console will provide the designer with a powerful assistant work-

---

### DESIGNING, NOT JUST ANALYZING

Computer-aided design has been mostly concerned with mechanical design, or stress analysis of space frames. But the math and symbolic language lend themselves to electronic circuit design and calculation of electrical and magnetic fields, heat transfer and aerodynamics.

Special programs for network and system analysis have been used for years, but the field of computer-aided design combines the human designer and the machine into a design team, working on-line and in real time

---

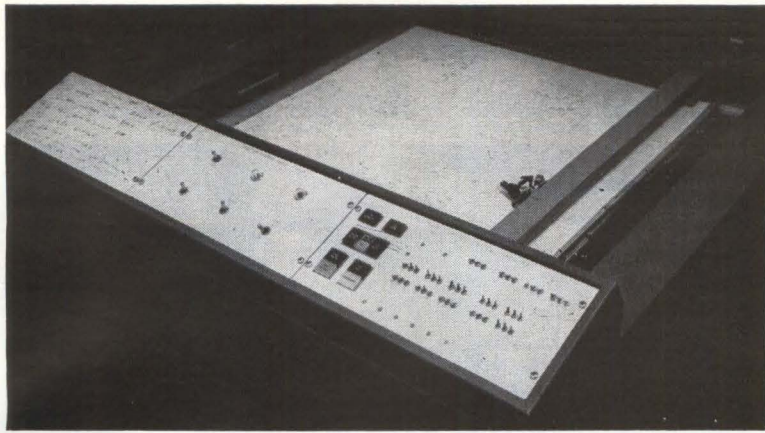

COMPUTER-GENERATED circuits are recorded on automatic plotter

## Extraordinary

ing with him—on line, in real time—at every stage of the design process. The designer will be able to instruct the system in new modes of behavior so that the system becomes more and more powerful. While no one now postulates creativity for the machine, the designer's creativity will be greatly amplified.

In electronic circuit design, common symbols can be called up from the computer memory, enlarged or reduced, moved and re-

oriented, duplicated, and used in building blocks in more elaborate configurations that can in turn be stored for recall and manipulation until a complex electronic circuit is constructed.

When a circuit diagram is set up, the computer could simulate the performance of the actual circuit. Components could be added, omitted or reconnected at will with the light pen, and the designers could observe the effect on circuit performance.

## U.S., British Debate ILS

**GENEVA**—British and U.S. delegates to the International Air Transport Association meeting agreed and disagreed on how to lower ceiling and visibility minimum requirements for landing.

British and European airlines and the U.S. Federal Aviation Agency agree that techniques used in the British system will be used. These consist of the standard instrument landing system (ILS), glide slope, radio altimeter, and automatic throttle control (ELECTRONICS, p 46, Dec. 14, 1962).

There was disagreement, however, on the extent to which the system can be utilized at the present time. Britain's airlines are planning to plunge directly into Phase III operations (zero-zero

visibility) using the automatic landing system. They will eliminate Phase II (100-ft ceiling and ¼-mile visibility). Britain now has two aircraft, the Trident and the VC-10, undergoing flying tests. Both are fitted with fully automatic landing systems suitable for commercial service.

FAA does not plan to go fully automatic, preferring to implement Phase II and assess the advantages of this before moving into fully automatic operation. FAA plans to install one fully automatic system aboard an aircraft backed up by a dual installation of flight director instrumentation and visual displays. The pilot will monitor the system and can take over manually in the event of equipment failure.

## ELECTRONIC COUNTERS, INC. MODEL 960 DIGITAL RECORDER

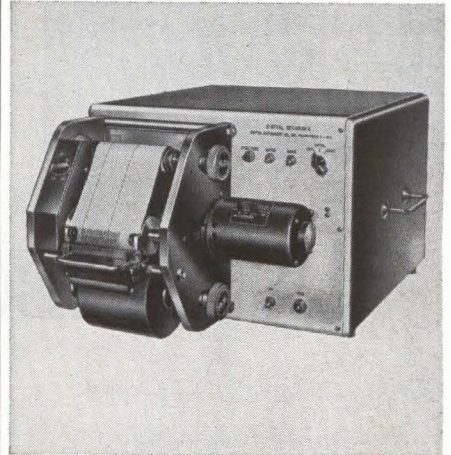

**provides permanent  
measurement records  
... INSTANTLY!**

Do you require high speed permanent recording of binary coded information? Do you require both intermittent and continuous operation capabilities? If these are your requirements, the Potter Model 960 Digital Recorder is your answer.

This highly reliable instrument uses the Potter developed 1-2-4-8 coding format to provide an easily read permanent record of measurement data involving micro-second phenomena. Up to 150 eight-digit numbers per second can be permanently recorded—and the visible record is available instantly. No processing is required.

For additional information and detailed specifications write today ...



**ELECTRONIC  
COUNTERS, INC.**

Subsidiary of

**POTTER INSTRUMENT CO., INC.**  
151 Sunnyside Boulevard • Plainview, New York



BEFORE CONSTRUCTION seen in cover photos, site in Puerto Rico looked like this

LINE FEED looks more like bridge member than precision component

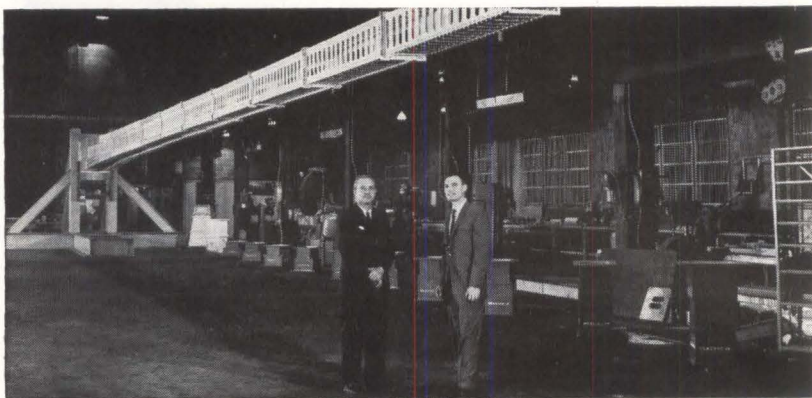

## ARECIBO: World's Biggest Ear

*This summer, 18½-acre radio-radar telescope will be completed*

ONE OF THE MOST gigantic engineering-construction projects ever tackled in electronics will come to a close this summer when the Arecibo Ionospheric Observatory

(ELECTRONICS, p 20, Jan. 27, 1961) is completed in Puerto Rico.

The \$8-million observatory will have the world's largest radio-radar telescope. It covers 18½ acres. Mesh is now being installed for the 1,000-ft-wide spherical reflector.

The observatory will provide the most sensitive instrument yet built for investigating ionospheric and space phenomena, and for other scientific uses.

It is also expected to prove a valuable tool for detecting ionospheric perturbations caused by detonations, missiles and satellites. Advanced Research Projects Agency is underwriting the cost.

CONSTRUCTION—A movable 5-ton, 96-ft-long line feed will correct for spherical aberrations in the reflector. Built by TRG Inc. (ELECTRONICS, p 46, July 7, 1961) the

## Tecnetron Family Expands

*French develop two new versions of h-f field-effect transistor*

By ARTHUR ERIKSON  
McGraw-Hill World News

PARIS—With field-effect transistors starting to catch hold these days, prospects never looked brighter for the French member of the family, the Tecnetron.

True, the 200 to 220 Mc of germanium units now on the market fall far short of frequency obtained in the lab, but a switch to silicon planar techniques should raise it.

Even at 200 Mc, the germanium Tecnetron is a front-runner for am-

plifiers demanding high input impedance. So much so that the device, and the electrolytic jet technique to produce it, has gone overseas. In the U.S., Atlantic Instruments and Electronics, Inc., of Boston, plans to produce and market them under the tradename Fieldtron (ELECTRONICS, p 7, March 29).

Two new versions will get the device into other applications. Prototypes of a bistable unit that acts as a triode or high-speed flip-flop will be available in a few months. A high-power version for industrial controls will come out next fall.

The Tecnetron (Te for its inventor Stanislas Teszner, cnet for the Centre National d'Etudes des Telecommunications where it was devel-

oped, plus ron) first became prominent five years ago when Teszner disclosed it amplified at 400 Mc.

FABRICATION—The device is essentially a short cylinder of *n*-type germanium, necked down near the center. An indium ring deposited around the neck forms the gate and permits applying a centripetal electric field. That gives an I-V curve like a pentode's. A nickel wire is the electrode for the cathode (source); at the anode (drain), it is a nickel ribbon. Both are soldered to the germanium with a tin-base solder. The drain-joint solder has a majority-carrier impurity like that doping the germanium.

Compagnie Francaise Thomson-Houston industrialized the electro-

feed will scan the reflector from a height of 435 ft.

From one end to the middle of the feed-arm truss, the carriage house will ride along with a probe, taking power off a slotted waveguide and giving this power to the line feed. A turnstile at the carriage house will change polarity.

A counterweighting carriage house on the other side of the feed-arm truss may, in the future, carry another feed. Tentative plans are to install a broadband Gregorian-type feed (ELECTRONICS, p 43, Sept. 7, 1962) to extend telescope operation from the nominal 430 Mc out to the hydrogen-line at 1,420 Mc.

Line feed motion provides elevation scan up to 20 deg from zenith at a speed of 5 deg per minute. For azimuth scan, the entire feed-arm truss rotates 360 degrees at 50 deg per minute.

**MANAGEMENT**—Project Director is Philip Blacksmith, of Air Force Cambridge Research Laboratories. Under AFCRL supervision, Cornell University is prime contractor—Prof. William E. Gordon conceived the project. The observatory will be operated for ARPA by the Air Force Office of Scientific Research. Gordon will be director and Gordon Pettengill, of MIT Lincoln Laboratory, assistant director.

lytic jet technique that produces the Tecnetron. The neck is roughed out with an abrasive jet, prefinished with an electrolytic jet, then finished with a second electrolytic jet that also deposits the indium.

**PARAMETERS**—First production units oscillated at 110 Mc, with 90 mw dissipation and slope of 90  $\mu\text{a}/\text{volt}$ . Later units had 200 Mc, 200 mw, and 120  $\mu\text{a}/\text{volt}$ . Input resistance is 20 to 50 megohms at 1 Kc, remains above 20,000 ohms at 200 Mc. But more important, input and output capacitances are below 1 pf, keeping input impedance very high at a-f. For production units, with source of 10 megohms and 1 pf, equivalent input noise level typically runs between -110 and -120

# THIN-FILM MICROCIRCUITS NOW AVAILABLE FROM SPRAGUE!

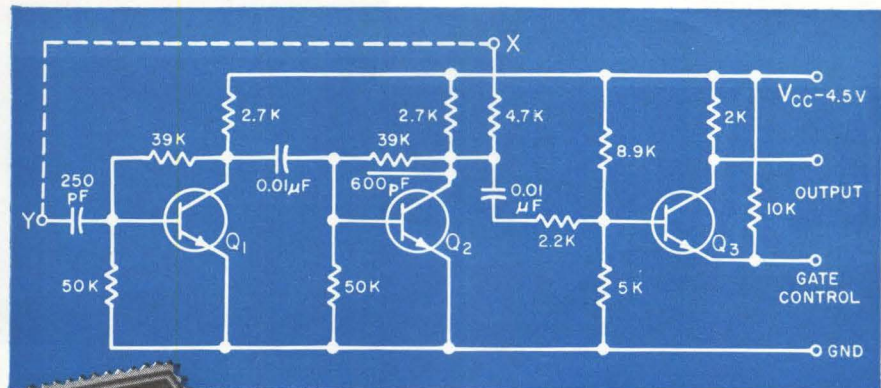

Smaller than a postage stamp, this typical CERACIRCUIT is a two-stage oscillator and gated amplifier, used as a clock-pulse source in digital systems.

## LINEAR and DIGITAL CERACIRCUITS\*

For Greater Design Flexibility... Increased Reliability... Circuit Economy!

Thin-film CERACIRCUITS allow great flexibility in the choice of components and types of circuits. Chopping size, weight, and cost, while boosting reliability and power utilization, these revolutionary microcircuits are being used by alert design engineers in ever-increasing numbers. Their ease of usability is remarkable. Containing familiar circuit elements such as capacitors, inductors, resistors, diodes, and transistors, CERACIRCUITS offer precision components with a wider choice of tighter parameters, assuring greater design freedom.

★Trademark

### SPRAGUE COMPONENTS

MICROCIRCUITS  
CAPACITORS  
RESISTORS  
TRANSISTORS  
INTERFERENCE FILTERS  
PIEZOELECTRIC CERAMICS

PACKAGED COMPONENT ASSEMBLIES  
FUNCTIONAL DIGITAL CIRCUITS  
MAGNETIC COMPONENTS  
PULSE TRANSFORMERS  
CERAMIC-BASE PRINTED NETWORKS  
PULSE-FORMING NETWORKS

491M-113-63/

Custom thin-film CERACIRCUITS are here... Now! A Sprague microcircuit specialist will be glad to discuss the transition of *your* circuits to the thin-film. He can also supply CERACIRCUITS such as linear amplifiers, oscillators, NOR gates and drivers, indicators, binary counters, and clocks for evaluation of Ceramic-base CERACIRCUITS in *your* equipment. For complete information, write to Technical Literature Service, Sprague Electric Company, 35 Marshall Street, North Adams, Massachusetts.



# reliability

...based  
on  
experience



## ultra-high precision capacitors

Southern Electronics high-precision capacitors are demonstrating their proven reliability today in twelve different missiles, analog computers, and many radar and communications applications.

SEC high-precision capacitors utilize polystyrene, providing .01% tolerances, and mylar and teflon to meet .5% requirements. They show excellent stability characteristics over an extended temperature range, and tolerances are unaffected even at extreme high altitudes.

The unusual accuracy, stability and reliability of SEC capacitors are the result of engineering experience concentrated on the design and manufacture of precision capacitors only, plus rigid quality control standards subjecting each capacitor to seven inspections during manufacture, plus final inspection.

Our engineering experience enables us to meet your size requirements, while holding to exact capacitance and tolerance specifications.

SEC capacitors are manufactured in a wide range of capacitance to meet your needs from 100 mmfd. to any higher value, and meet or exceed the most rigid MIL-SPECS.

Write today for detailed technical data and general catalog.



**SOUTHERN ELECTRONICS Corporation**

150 WEST CYPRESS AVENUE  
BURBANK, CALIFORNIA

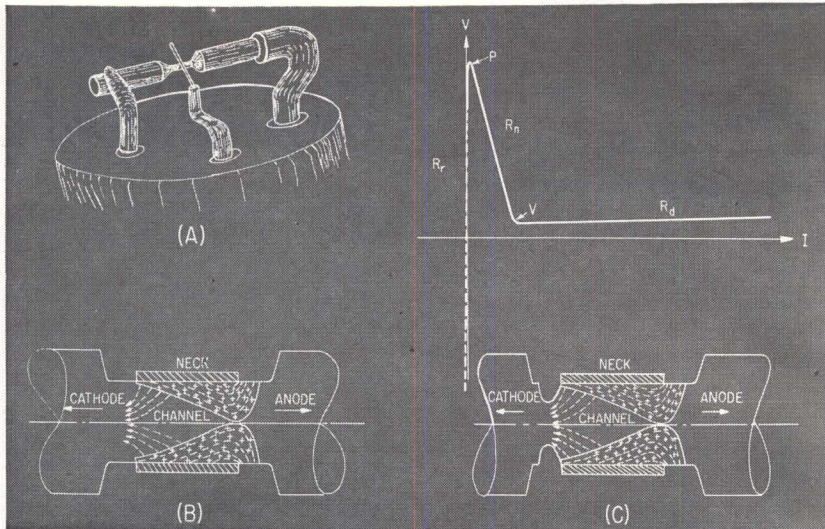

FIELDTRON (Tecnatron) field effect transistor. Grooved active assembly is shown in mounting position in (A). Electron flow at neckdown section is indicated in (B). Electron flow at the subgroove section of the bistable switching type and I-V plot are diagrammed in (C)

db below 1 v for a bandwidth of 1 cps.

**IMPROVEMENTS**—In the 200-Mc units, cylinder diameter was boosted from 0.5 mm to 1 mm, length cut from 2 mm to 1.3 mm, and neck dimensions slashed to 50 microns length and diameter, compared to 90 microns length and 50 microns diameter for the 110-Mc units. Top frequency increases as the neck shortens. Slope was slightly increased by cutting down parasitic resistances.

Société Européenne des Semiconducteurs, the CFTH semiconductor subsidiary, sees little chance of getting much higher than 220 Mc with germanium Tecnetrans. They expect a silicon planar technique to provide high frequency, excellent transconductance characteristics like those of bipolar transistors and high transconductance/drain current ratio. SESCO plans to unveil planars at the Paris Electronics Components Show next February.

**BISTABLE TYPE**—The new bistable version SESCO is readying for production has an added 20-micron necked-down section alongside the main one. This subgroove on the source (or cathode) side of the gate, establishes a very concentrated resistance, with carriers limiting drift velocity. It introduces a gate-source resistance with a static value well above 10,000 ohms and megohm dynamic values.

The high static value provides for relatively high trigger voltages with small power loss in the blocking state. Since the groove is near the gate, in the conducting state resistance drops to zero quickly because of mass-injection of minority carriers. Total on-off switch time runs about 25 to 30 nanoseconds, making it a candidate for computer applications. It works as a bipolar device in the conducting stage. The high dynamic resistance forms a high input impedance when it operates as a triode; the control electrode is the drain electrode.

**HIGH-POWER DEVICE**—Bipolar also is the high-power Tecnatron that Tetzner developed in cooperation with Forges et Ateliers de Constructions Electriques de Jeumont and Ateliers de Constructions Electriques de Charleroi. For this version, a grid of stubby n-type germanium cylinders is sandwiched between anode and cathode plates. It acts as a diode with no blocking voltage on the grid, but as a pentode with blocking voltage for current control and on-off use.

Preliminary work indicates ratings of at least 10 amp, with much higher current-breaking capacity, forward drop less than 2 v, and piv of 300 to 400 v. Power-handling potential is eye-popping; no special matching is necessary for parallel connection so groups in parallel could in theory handle unlimited power.

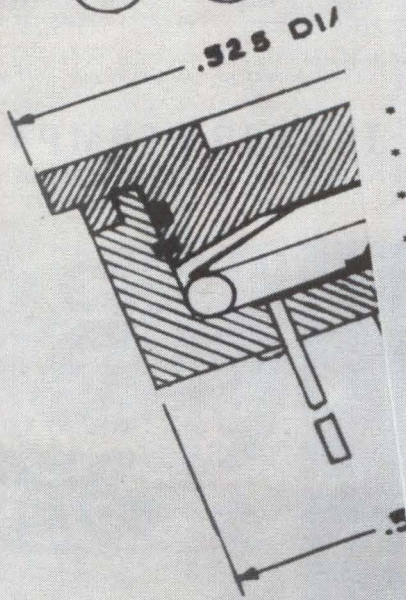
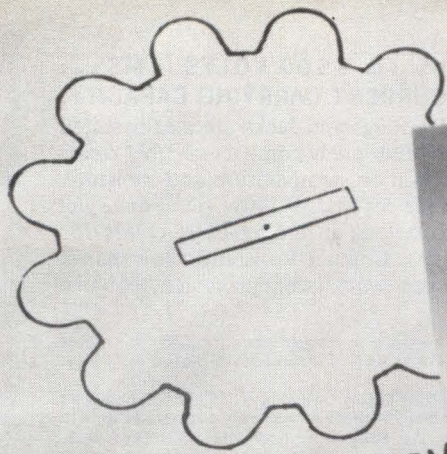

- \* SQUARETRIM RESIST. ELEMENT
- \* SPECIAL ALLOY WIPER
- \* GOLD-PLATED DUMET LEADS
- \* STAINLESS RETAINING RING
- \* KEL-F ADJUST. KNOB
- \* BUNA RUBBER O-RING
- \* DIALLYL PHTHALATE HOUSING

• TOTAL

7 PARTS = 1 POT  
DAYSTROM MODEL 515  
COMMERCIAL TRIMMER



**NEW LOW-COST COMMERCIAL TRIMMER:** Simplicity and ease of fabrication now make possible this high-reliability Daystrom potentiometer at low cost. ■ It dissipates 1 full watt in still air @ 55°C., measures only 0.317" x 0.525" (shown actual size), and is offered in resistance ranges from 10Ω to 50K. ■ Operating temperatures are -55°C to +150°C. ■ The reliability stems from the use of the same basic resistance element as the famous MIL Squaretrims®, with the "wire-in-groove" winding technique. ■ A unique Buna rubber O-ring between the housing and the adjustment knob seals the unit against humidity, and also prevents wiper shift during shock and vibration. ■ The Daystrom Model 515 is a single-turn potentiometer with stops, and can be adjusted either with screwdriver or fingertips. ■ Investigate this new addition to the Daystrom line for computers, EDP systems, power supplies, or other commercial applications. ■ Write for full specifications!

DAYSTROM POTENTIOMETERS ARE ANOTHER PRODUCT OF



**WESTON**

**Instruments & Electronics**

*Division of Daystrom, Incorporated*

614 FRELINGHUYSEN AVENUE, NEWARK 14, NEW JERSEY

**STANDARD  
NYLON CONNECTORS**

Molded of tough, low-loss, shock-proof nylon—will not chip or crack, even when subjected to extreme temperature changes or severe mechanical stress. Voltage breakdowns to 12,500 volts DC. Wide line: Tip Plugs and Jacks; Metal Clad and Rapid Mount Jacks; Banana Plugs and Jacks; Binding Post. Designed for fast, easy mounting—available in 13 colors for coded applications.

**Other Connectors—**

Johnson also manufactures a complete line of standard connectors in addition to the nylon types. For complete information write for our newest components catalog.

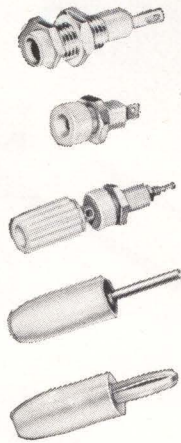

**OPERATING VOLTAGES TO 1500 VOLTS RMS...  
5 AMPERES MAXIMUM CURRENT CARRYING CAPACITY!**

These tiny Johnson Nylon Tip Plugs and Jacks are ideally suited for limited space applications! Extremely compact—highly resistant to extremes of shock, vibration, temperature and moisture. Body, tough low-loss polyamide per MIL-P-17091 (Du Pont Zytel 101 nylon.) Available in 13 colors, including basis colors for MS16108C coding applications. Contact Resistance: less than 2 milliohms. Capacitance between two adjacent jacks: less than one mmf. at 1MC.

**Series 105-751 Horizontal Jack**—Unique design accepts .080" diameter tip plug in either end, or from top or bottom. Formed silver-plated beryllium copper contact. Two terminals.

**Series 105-851 Vertical Jack**—Mounts through single .052" hole, requires minimum mounting area. Formed silver-plated beryllium copper contact.

**Series 105-771 Sub-Miniature Tip Plug**—For use with miniature jack, only .080" diameter. One-piece nickel-plated, machined brass tip. Solder type lead connection.

**Series 105-881 Long Sub-Miniature Tip Plug**—Identical to tip plug above, but with 4" nylon body to permit access to "hard to reach" test points.



**E. F. JOHNSON COMPANY**

3002 TENTH AVENUE S.W. • WASECA, MINNESOTA

**MINIATURE  
Nylon Plugs and Jacks**

**DESIGNED FOR PRINTED CIRCUIT USE!**

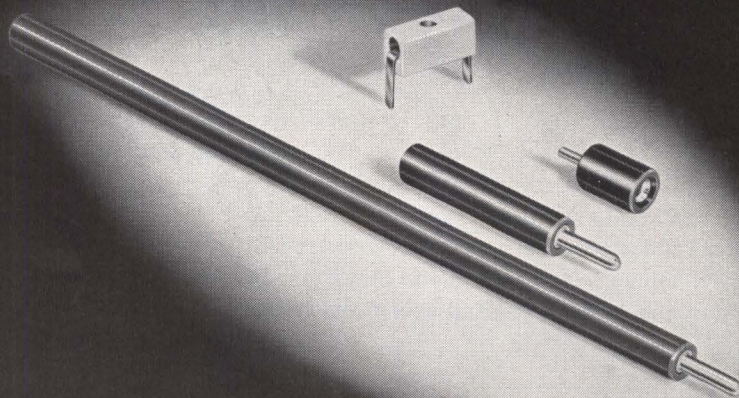

ACTUAL  
SIZE

DETAILED COMPONENTS CATALOG AVAILABLE—Write today on company letterhead

• CAPACITORS • TUBE SOCKETS • CONNECTORS • PILOT LIGHTS • INSULATORS • KNOBS AND DIALS • INDUCTORS • HARDWARE

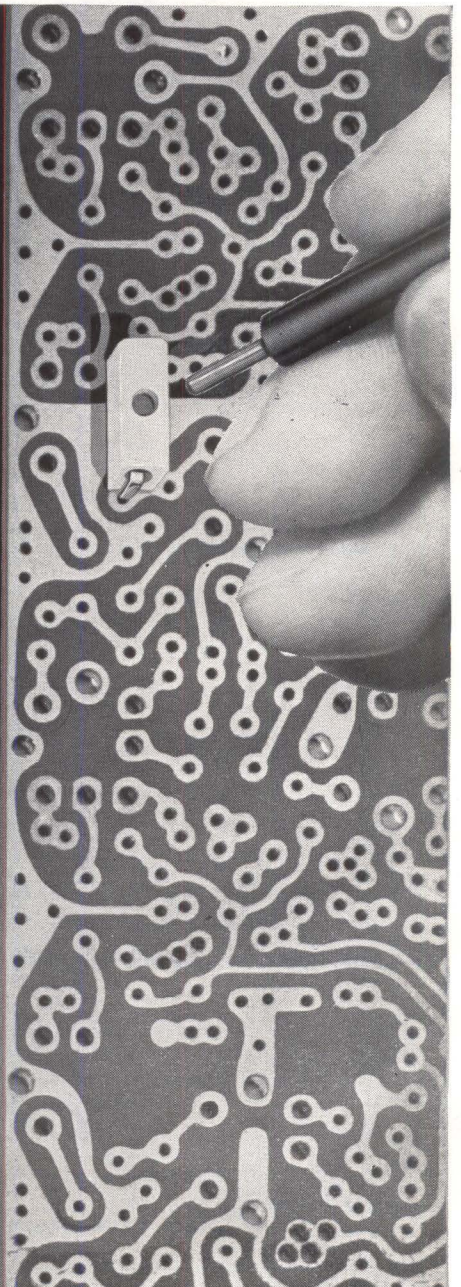



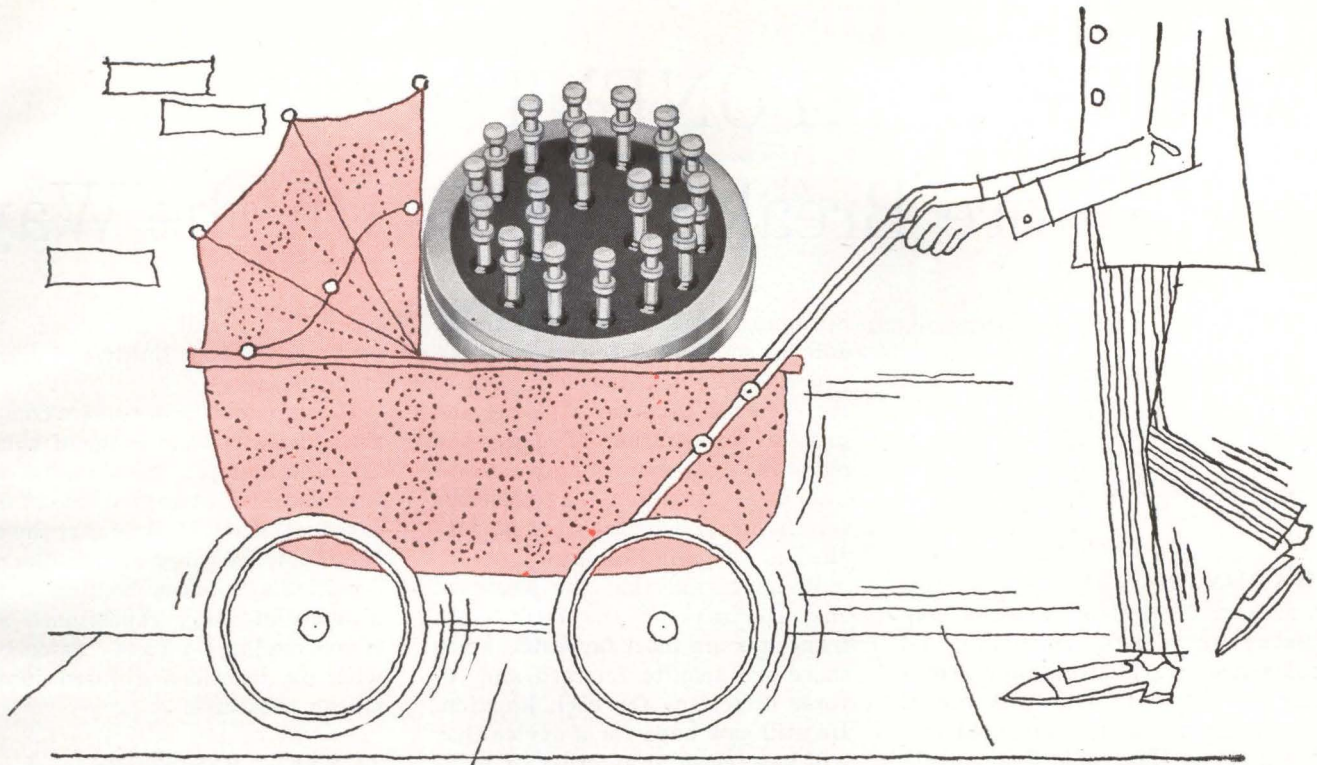

## *Please don't "BABY" Fusite Terminals*

In our standard quality control testing procedures we twist, bend, pull and vibrate the electrodes in their glass base. We put them from dry ice to boiling water and we subject them to tremendous pressures. After a trip through this torture chamber, Fusite Terminals still check leak-proof to  $1 \times 10^{-10}$  std. cc/sec on a Veeco Leak Detector.

### *Two Reasons this is Important to You*

1. Whatever your manufacturing or assembly operation, be it welding, soldering or mechanical, you need not make special concessions to Fusite Glass-to-Steel Terminals.
2. Even more importantly—no matter the conditions under which your products operate, your field failures caused by any rupture of seal between glass and metal of your hermetic terminal will be close to nil.

Why not test Fusite Terminals for yourself? Write for a sample and catalog. Dept. J-1.



## **THE FUSITE CORPORATION**

**6000 FERNVIEW AVENUE • CINCINNATI 12, OHIO**

Fusite Corporation, Cincinnati, O.

Woodford Mfg. Co., Versailles, Ky.

Fusite N. V., Konigweg 16, Almelo, Holland

Fusite GmbH, Dieselstrasse 5 Karlsruhe, W. Germany

Fusite-Japan, Gotemba, Japan

# ACTIVE COMPONENTS:

## More Breakthroughs On the Way

*Combining of techniques sets stage for jump in device performance*

By MICHAEL F. TOMAINO  
Associate Editor

WASHINGTON, D. C.—Cross-fertilization of electronics technology among physicists, chemists, and materials specialists is now breeding new devices. This was one of the dominant trends indicated last week at the Electronic Components Conference.

Important advantages of thin-films, solid-state silicon systems and dot or chip components will be combined until breakthroughs occur in active devices that can be constructed with 10 times the frequency performance of conventional junction transistors.

ACTIVE FILMS—C. Wrigley, of

Sprague, discussed work done to date on active devices that take the general form of a triode structure. He reviewed structures giving the greatest expectation of gain—the metal base transistor and the metal interface amplifier. Applications for the latter will probably be confined to switching circuits.

Wrigley said that the electrical characteristics of the metal base transistor are most favorable, since there are definite forward and reverse directions for each junction. He still saw hope for a device that will have close to an order of magnitude better frequency performance than junction transistors.

TWO SYSTEMS—M. Casey, of Philco, reviewed new techniques for integrating tantalum and silicon in microcircuits. He said that it was highly desirable to develop a microcircuit system which unites the important advantages of the two systems into a single compatible

technology, and presented approaches for both linear and digital applications.

Casey noted that passive-component tolerances and range of values for thin-film passive elements are superior, at present, to those of diffused elements. He said that the upper frequency range of thin-film microcircuits is better because of the absence of stray capacitance and cross-coupling effects associated with *pn* junctions diffused into a silicon substrate.

TUNNEL RESISTORS — J. T. Wallmark, of RCA, discussed company work on tunnel resistors. These combine the characteristics of a tunnel diode and resistor. Unit will be useful as a load resistor for high-speed digital tunnel-diode circuits. The resistor consists of a tunneling junction with a thin layer of metal plated across it. The devices have been fabricated from nickel and several other metals, and from gallium arsenide and gallium antimonide.

Investigation into materials like niobium, for resistors, was outlined by F. E. Cariou, of Kemet. Company program, sponsored by Bu-Ships, is now at the halfway mark. Niobium is in abundant supply, will be more suitable for nuclear reactor applications, and has a higher dielectric constant than tantalum, he said.

Further advances in precision potentiometer technology may be possible, with metal-glaze materials, according to H. Casey, of International Resistance. Casey said that a material has now been found to supply a broad base for resistive applications. A power resistor is now in production using alumina substrates.

OXIDE FILMS—Dave Peterson, of Motorola, evaluated vapor-plated oxide films for capacitor dielectrics. These are films of silicon dioxide, titanium dioxide, and aluminum di-

### Thin-Films for Navy's Typhon Missile

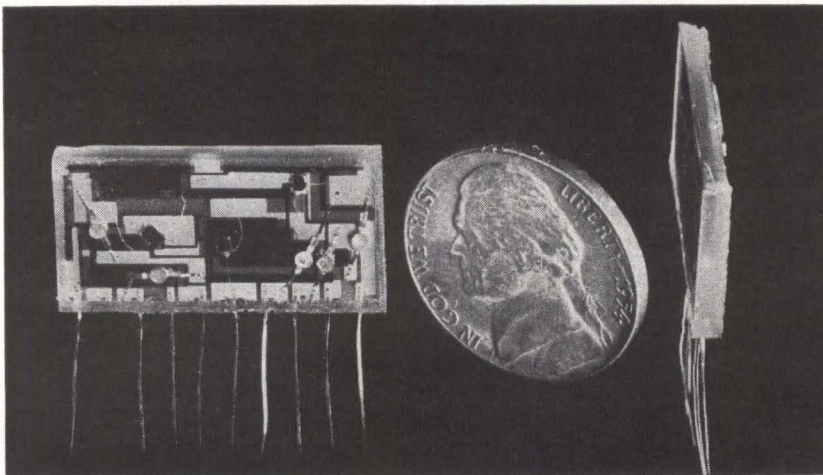

FLIP-FLOP is one of 34 types of thin-film circuit modules in low-power digital decoder with 1,500 components. GE will deliver 3 decoders to Johns Hopkins Applied Physics Lab in about 3 months under a \$140,000 contract. Nickel-chromium resistors, silicon-monoxide insulators, aluminum connectors, and microtransistors and microdiodes are potted in glass sandwich. Program goal is determining suitability of thin-film military systems; so far they show cost comparable to welded circuits, possibly greater reliability, 50-percent size reduction, and no difficult fabrication problems

oxide, and mixtures of these oxides. He said that preliminary results indicate that vapor-plated oxides have good potentials for capacitor applications. Plans are underway at Motorola to construct functioning circuits using these materials.

Capacitor designers are looking into new materials other than tantalum, and tantalum is being pushed into higher voltages.

## NASA Needs Better Power Components

CHICAGO—Improved solar cells are one big requirement for the space program, Walter T. Olson, of NASA's Lewis Research Center, told manufacturers attending the third National Conference on Peaceful Uses of Space last week.

New cells should operate at higher temperatures and should offer more radiation resistance in belts where last year's nuclear explosion effects may persist for the next century.

Thin-film solar cells made of selenium, silicon, cadmium sulfide, cadmium telluride or gallium arsenide promise greater radiation resistances, along with greater power per unit of weight.

Scarcely any technology yet exists for reliable generators, alternators, inverters, transformers or switch gear, capable of handling high current densities and incorporating the considerable cooling probably required for space stations, Olson said.

## Improved Syncom Set For Mid-Summer Launch

MAXIMUM redundancy is being incorporated into Syncom communications satellite to be launched this summer, to head off a repeat of the power supply failure that resulted in the loss of the first Syncom shortly after launch.

All wires to power-consuming subsystems are being fully duplicated and an extra set of batteries in the beacon will provide 10 or 15

...up to 160  
channels in a  
5 $\frac{1}{4}$ " panel!

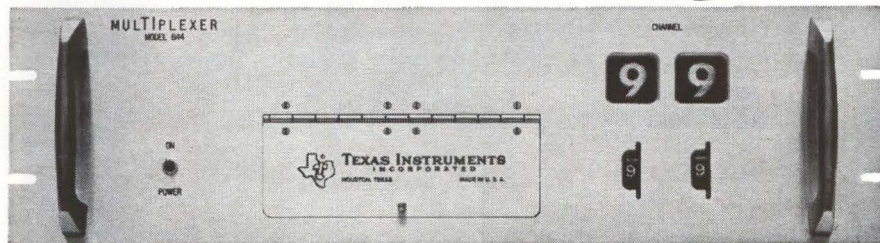
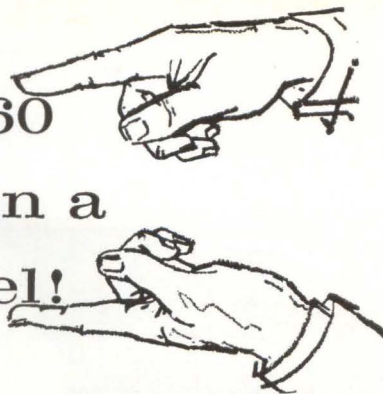

## versatile addressable or sequential Multiplexers

### features

- Sampling rate to 50,000 channels/sec
- Variable frame length
- Accuracy  $\pm 0.02\%$  full scale
- Input levels to  $\pm 10$  V

Texas Instruments Multiplexers are all solid state units providing accurate, high-speed bipolar operation with low dynamic crossfeed, fast settling time, and variable strobe. Manual channel select switches facilitate system set-up and check-out. Frame length is selectable from front panel. Expandable to 160 channels by means of plug-in printed circuit cards. Case size 5 $\frac{1}{4}$  by 19 by 18 inches for standard relay rack mounting.

TI's high speed Model 834 Analog-Digital Converter, ideal companion instrument to the TI Multiplexer.

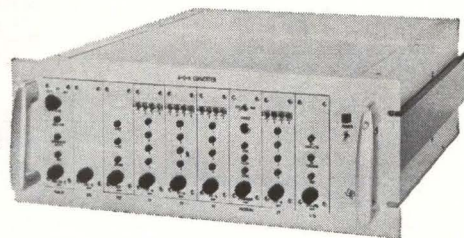

High speed: 1.5  $\mu$ sec per bit  
Built-in sample and hold

Accuracy:  $\pm 0.05\%$  full scale  
Automatic zero stabilization

Ask a TI Application Engineer for further information on digital data handling equipment for your specific needs.

INDUSTRIAL  
PRODUCTS  
GROUP



**TEXAS INSTRUMENTS**  
INCORPORATED  
P. O. BOX 66027 HOUSTON 6, TEXAS

SENSING • RECORDING • TESTING • DIGITIZING INSTRUMENTS  
THE INSTRUMENTS OF TEXAS INSTRUMENTS

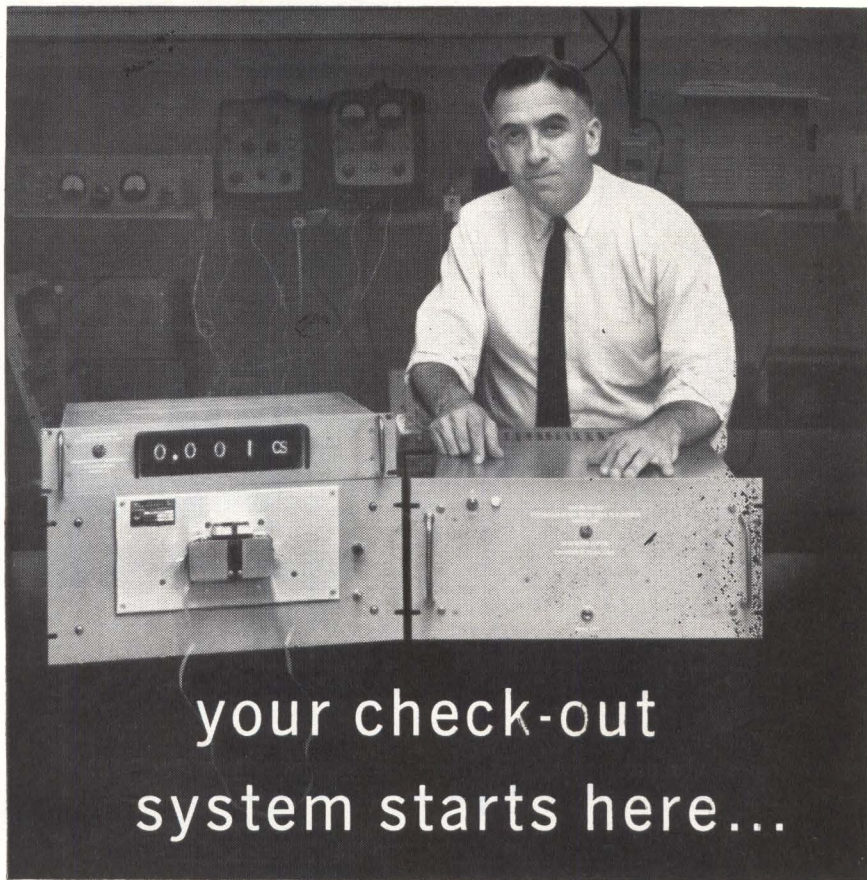

your check-out  
system starts here...

### with this Model 442 programmable oscillator

Here's the ideal source of ac stimulus, in a wide-range, low-distortion oscillator. Ideal for automatic testing of components, assemblies, systems — any equipment requiring ac performance evaluation.

The Krohn-Hite Model 442 offers unique coverage at the low end . . . provides remote or automatically controlled ac signals from 0.001 cps to 99.99 kc. Distortion is 0.1% or less throughout the mid range. Output is both sine and square wave simultaneously.

This programmable oscillator has found wide acceptance in component checkout systems, because of its excellent stability (0.05%) and its precise resetability. It is readily adaptable to a wide variety of input program and indicating devices, as well as many output amplitude control combinations.

Other Krohn-Hite programmable oscillators are also available for specialized testing requirements. For example, Model 447 is a stable-amplitude (0.01%), very low-distortion (0.02%) programmable oscillator, covering a frequency range of 1 cps to 100 kc. For automatic oscillator applications requiring superior frequency accuracy, Krohn-Hite's Model 451 offers 0.05% accuracy and covers a range from 1 cps to 20 kc. The Model 453 combines superior frequency accuracy, and amplitude stability, and very low distortion over a range from 1 cps to 20 kc.

So, if you're looking for a reliable, programmable source of ac for automatic or remotely controlled testing — check out these Krohn-Hite wide-range programmable oscillators! Write for full details.

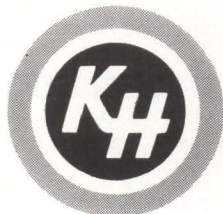

**KROHN-HITE CORPORATION**  
580 Massachusetts Avenue • Cambridge 39, Mass.  
Pioneering in Quality Electronic Instruments

### Communists Buy Counters

TOKYO—Takeda Riken Industry reports it is exporting 25 10-cps to 10.5-Mc electronic counters to Communist China, and 10 10-cps to 600 Kc counters to the Soviet Union. These are said to be the first such exports to those countries from Japan

extra minutes of telemetry for location purposes, should the same problem occur. The improved Syncom will soon begin extensive shake-down tests, according to Russ Burke, Syncom's project manager at NASA.

### U. S. Trade Show Sells Instruments to Japan

TOKYO—More than \$300,000 in sales were made during the Industrial Instruments and Laboratory Apparatus Show at the U.S. Trade Center. Another \$450,000 worth of orders directly attributable to the show are expected. Displays at the show consisted mainly of advanced electronics apparatus needed by Japanese industry but not produced in Japan. Some 11,218 persons, of the 25,000 invited, visited the show.

### Miniature Space Gyro

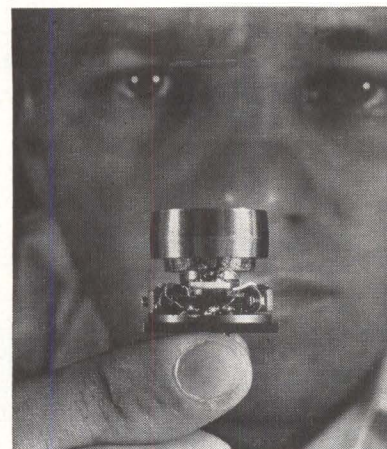

*FINGERTIP holds rate gyro demonstrated this week by Special Devices Laboratories, Inc. It weighs 1½ oz, occupies less than 1 cu in. Design, which eliminates conventional gimbaling, is said to provide sensitivity of larger units*

# **LEVIN** HIGH PRECISION CABINET MOUNTED INSTRUMENT LATHES

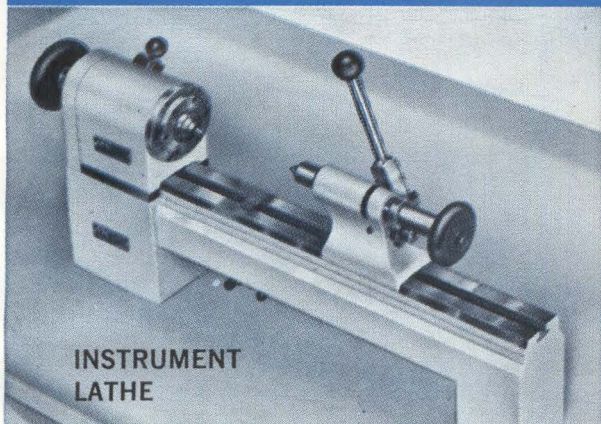

INSTRUMENT  
LATHE

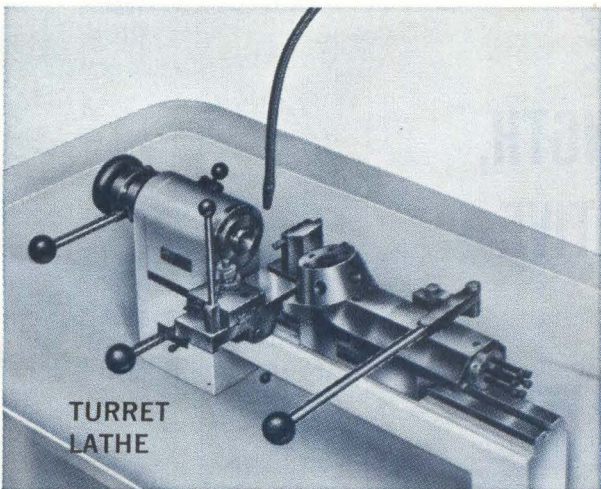

TURRET  
LATHE



MICRO-DRILLING  
MACHINE

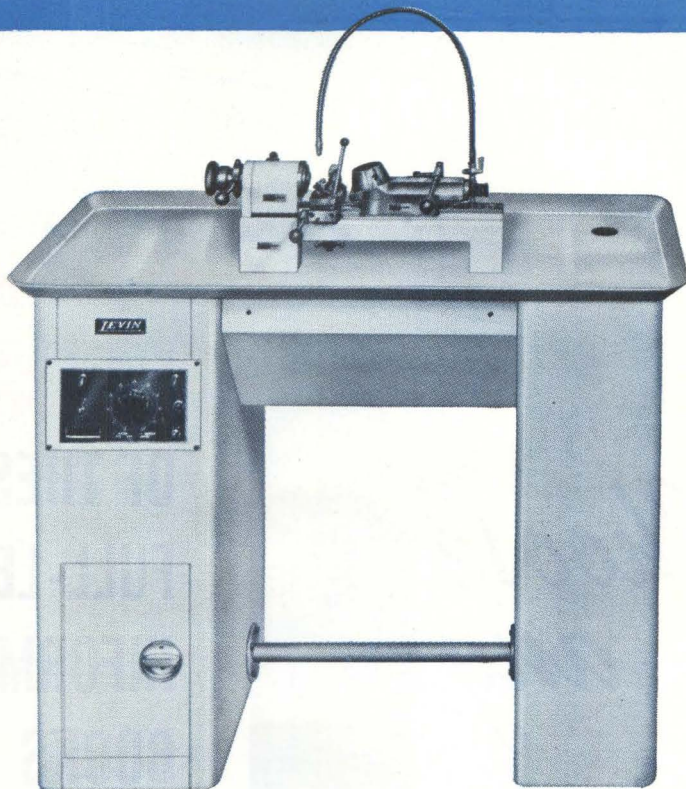

LEVIN now offers a complete line of Instrument Lathes mounted on a welded steel cabinet. These machines have the advantages of greater rigidity, higher spindle speeds, increased operator efficiency due to cabinet design, multi-vee belt drive, and for the first time, operating and alignment tolerances heretofore available only on specially built lathes.

Your LEVIN dealer or the factory will be glad to furnish complete details. These machines are on display in dealer showrooms in New York and Los Angeles. Send for complete catalog.

LOUIS LEVIN & SON, INC., 3573 HAYDEN AVENUE  
CULVER CITY, CALIFORNIA

DEALERS:

RUSSELL HOLBROOK & HENDERSON, INC.  
NEW YORK and LOS ANGELES  
INDUSTRIAL TOOL & SUPPLY COMPANY — SAN JOSE  
MARSHALL TOOL & SUPPLY CORPORATION — LOS ANGELES  
ROYAL-TSCHANTRE — BALTIMORE

# **LEVIN**<sup>®</sup>

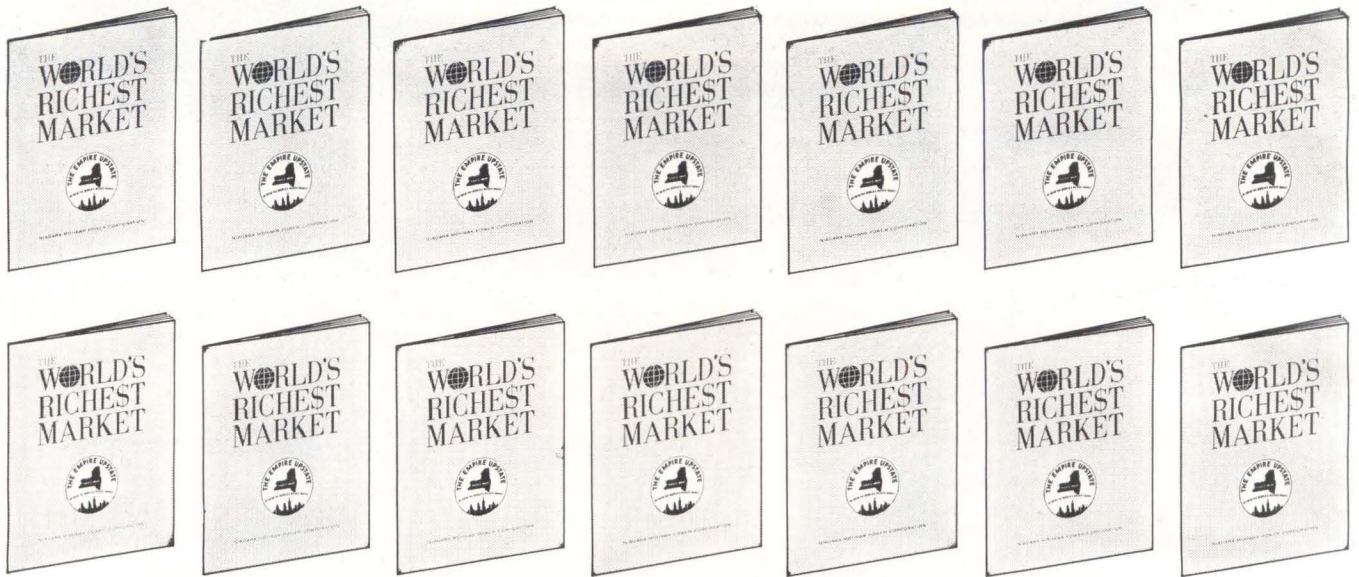

*Choose any* **1** OF THESE FULL-LENGTH, INFORMATIVE BOOKS FREE

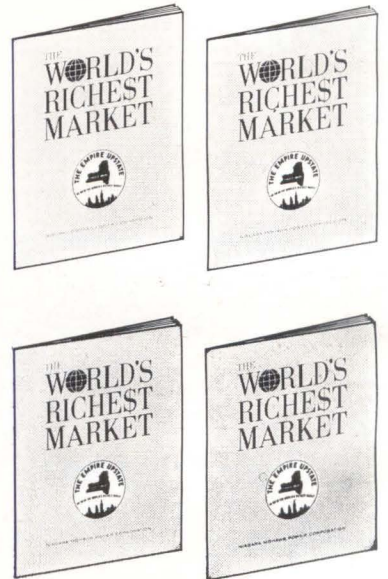

**YOU'RE ON TOP OF THE WORLD'S RICHEST MARKET** in the Empire Upstate. And this free new book proves it. Consider these startling facts:

- 45 million people live within 250 miles of Upstate, N. Y. (Put your plant where the customers are!)
- These people earn 28.3% of the nation's income. (There's more profit per square mile in the Empire Upstate!)
- The Northeastern market area leads the nation in

population density growth. (A bright future!)

These are just a few of the profitable facts about Upstate, N. Y. uncovered in a recent survey conducted by Market Statistics Inc. We've brought the complete story together in one comprehensive book entitled "World's Richest Market". Write for your FREE copy on your company letterhead to Richard F. Torrey, Director of Area Development, Dept. E-5, Niagara Mohawk Power Corp., 300 Erie Blvd. West, Syracuse 2, N. Y. Phone 474-1511 (Area Code 315).



INVESTOR OWNED • TAXPAYING

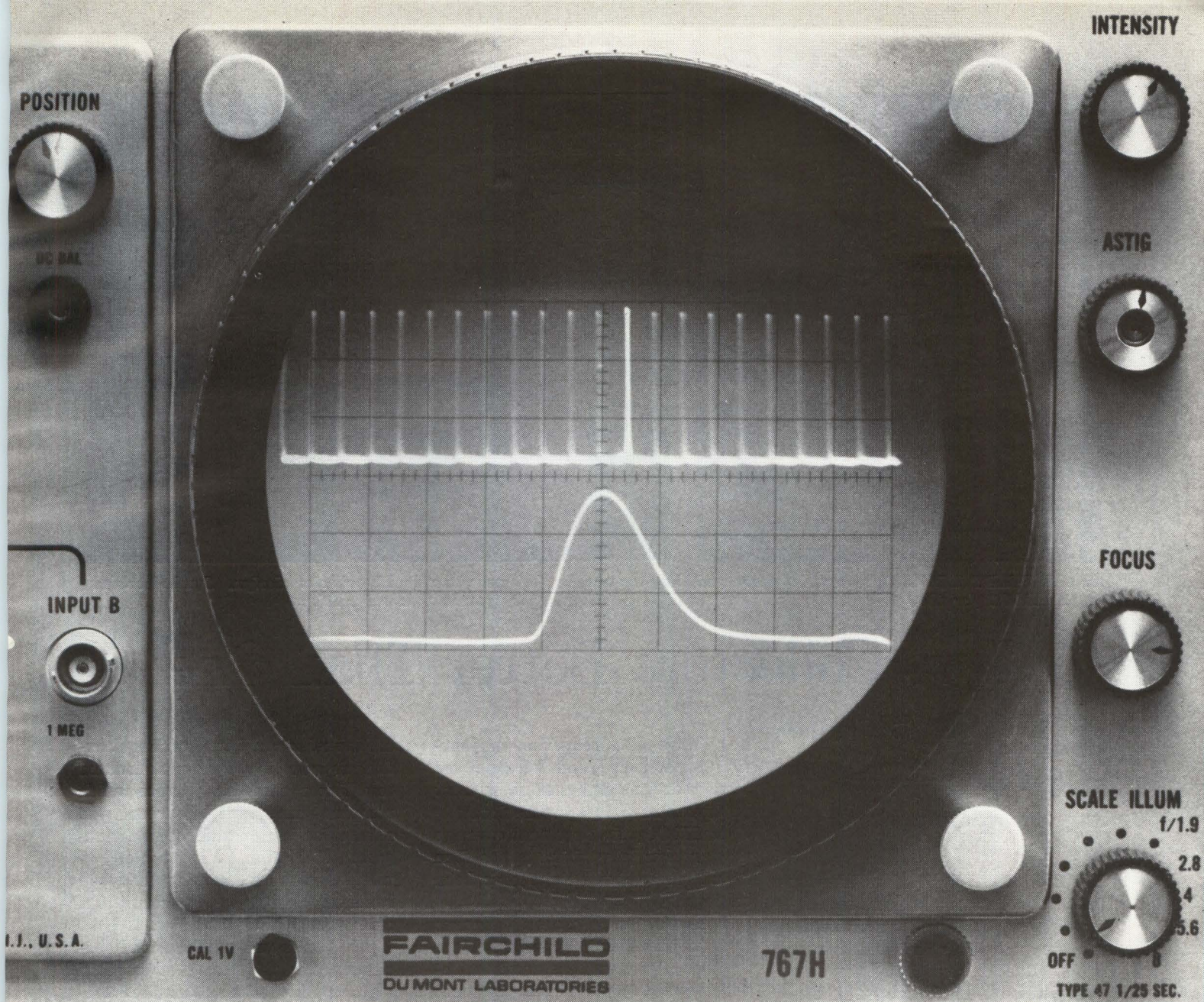

## What's the delay here?

The delay here is what happened to a 10-nano-second radar pulse on its way through a Fairchild Type 767H Oscilloscope. The trace is a multiple exposure of a strobed delaying sweep and the magnified delayed sweep. Its clear, "locked in" display was made with the Delaying Sweep Plug-In unit of this new Fairchild solid state scope.



The 50 mc Plug-In used to make this trace has a rise time of 7.5 nsec, sensitivity of 50 mv/cm. Other available plug-ins provide many other capabilities — enough to replace half a dozen or more special purpose scopes.

Investigate the new Fairchild line before you invest in another scope. Write for our Instruments Catalog. Better yet, call in a field sales engineer (offices in

39 principal cities) for a demonstration. Fairchild Scientific Instruments, 750 Bloomfield Avenue, Clifton, N. J.

# FAIRCHILD

## DU MONT LABORATORIES

DIVISIONS OF FAIRCHILD CAMERA AND INSTRUMENT CORPORATION  
750 BLOOMFIELD AVENUE, CLIFTON, NEW JERSEY

CIRCLE 29 ON READER SERVICE CARD

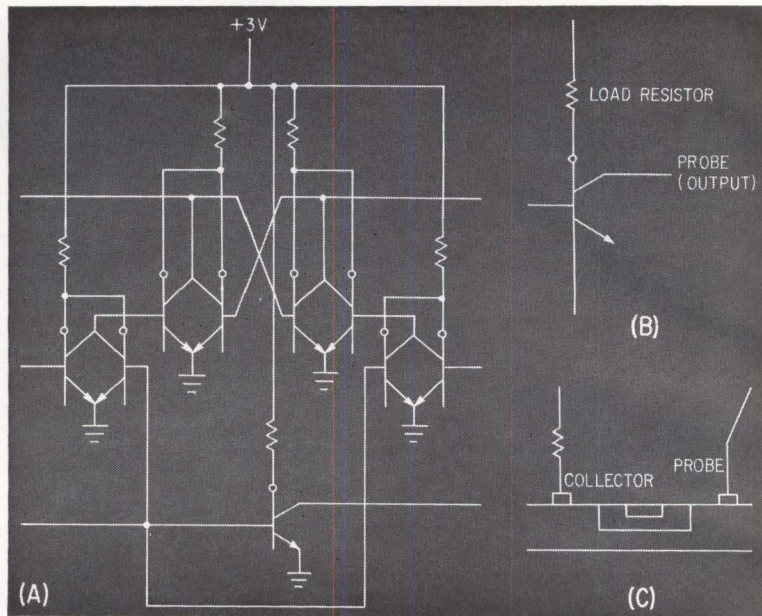
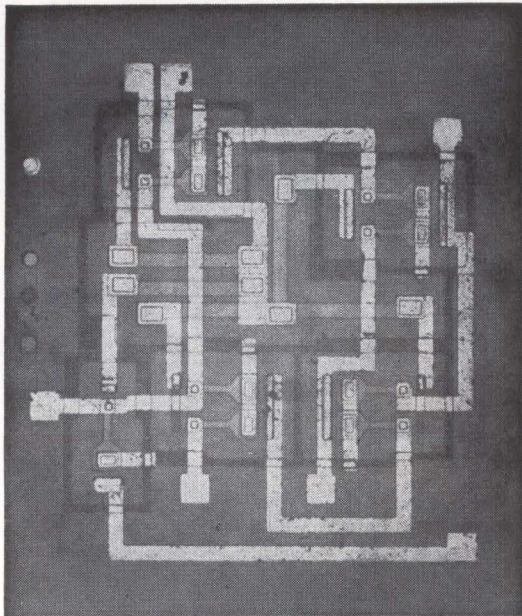

HALF SHIFT REGISTER seen in photo and diagrammed in (A) uses the double-collector design. Symbol coined by AMELCO for the two-collector transistor is (B) and (C) is the transistor cross section.

## Two Collectors Better Than One

*Additional collector raises transistor speed in integrated circuits*

**MOUNTAIN VIEW, CALIF.**—By using conventional diffusion techniques, but adding a second collector to transistor configurations, AMELCO Inc., says it has come up with a new family of integrated circuits of special significance for switching applications.

The two collector contacts are symmetrically or diagonally opposite. One, called the collector (see diagram) is on the base contact side. The other, called the probe, is on the emitter contact side.

The second collector contact permits a decrease in  $V_{ce(sat)}$  to the theoretical limit as determined by the forward bias of the emitter base, the company says.  $V_{ce(sat)}$  is on the order of 0.1 v.

**SPEED INCREASE**—Average increase in switching speeds of gates, flip-flops, buffers, and other circuits reportedly is 30 percent, and in some cases is better by a factor of two over the same circuits integrated with conventional techniques.

A company spokesman says this

is because of a reduction in junction capacitance and because the transistor was designed so it can't be driven hard into saturation.

AMELCO also says that average propagation delay times better than 25 nanoseconds per stage have been achieved.

Fan-out and fan-in figures greater than ten, allowing a large number of stages to be driven without amplifiers, and the development of larger noise immunity in switching circuitry are also reported.

**DESIGN DIFFERENCE** — The higher figure results from design of

the transistor and its boundary conditions so that the input is limited to a linear ohmic impedance which remains invariant between the saturation region and the linear region. This eliminates problem of uneven current sharing between bases of transistors in saturation and those to be turned on.

The technique was developed specifically for the DCTL NOR type of logic configuration. But the company says there are promising applications as well in diode logic, and any type of logic where current drawn from the collector in the ON state is small.

## R&D Goes Back to Earth

By CLETUS M. WILEY  
Midwest Editor

**CHICAGO** — Industrial and consumer electronics can benefit greatly from space R&D—if they define their requirements and work out most of the application details themselves — NASA said last week at the Third National Conference on Peaceful Uses of Space.

Among NASA's newest plans for diffusing its R&D are:

- An experimental research applications center at Indiana University is developing a cataloguing, computer storage and retrieval system. Flash sheets will review new developments. Seminars will advise specific industries.

- Westinghouse is studying best techniques for motivating NASA contractors to report promptly





# MICRO SWITCH Precision Switches

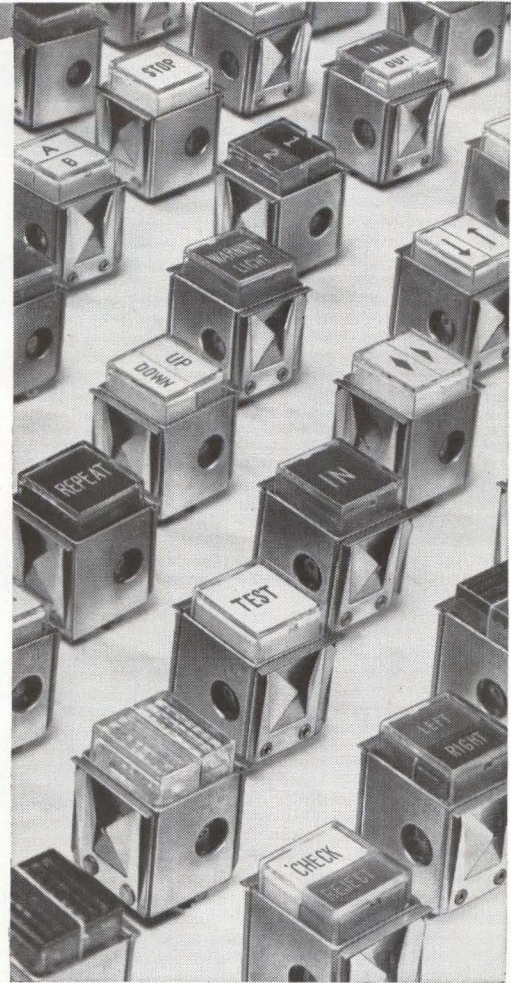
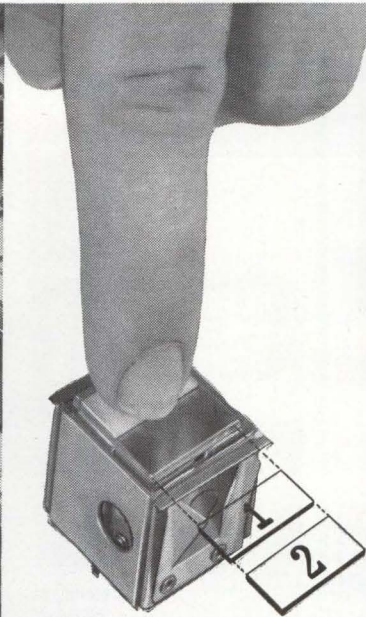
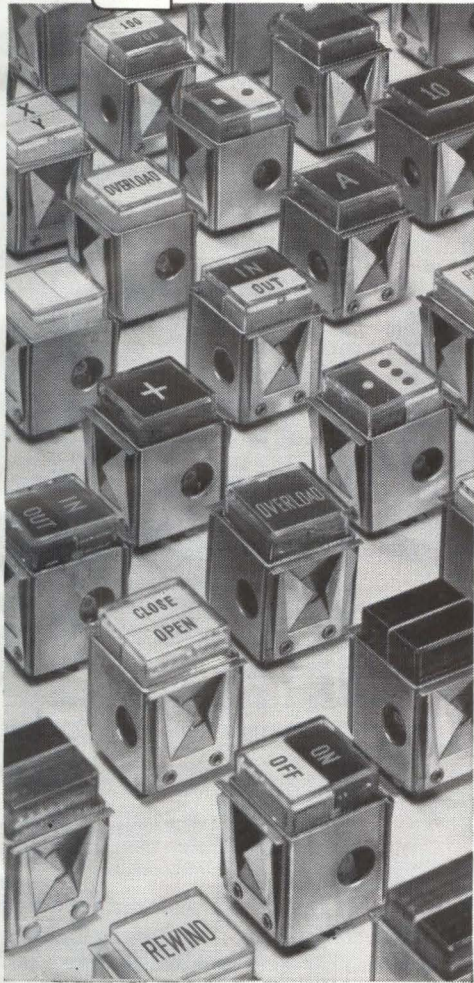

Wide variety of colors.  
 Unlimited labeling capability.  
 Savings in panel space:  
 Complete unit less than  
 1 cubic inch.

## NEW VARIETY OF MINIATURE PUSHBUTTONS WITH LIGHTED LEGENDS UNLIMITED

Now you can put your finger on miniature lighted pushbutton indicator-switches and indicator units that are *tailored* to your specific requirements—tailored color displays, tailored snap-in legends.

**New 302 Series** gives you a selection of 70 indicator-switches with double-pole double-throw circuits, and either momentary or maintained switching action—plus 35 matching indicator units. You select from a wide variety of one- and two-color individually lighted display combinations. Select one-legend or two-legend inserts—label them any way to suit your need.

**Requiring less than one cubic inch of panel space**, these versatile miniatures are ideal for a wide range of applications where space is critical. The complete unit is less than one cubic inch. **Lamp life is virtually unlimited.** Switches rated at 7 amps, 115-230 vac or 28 vdc.

For information, call our Branch Office (see Yellow Pages), or write for Data Sheet 182.

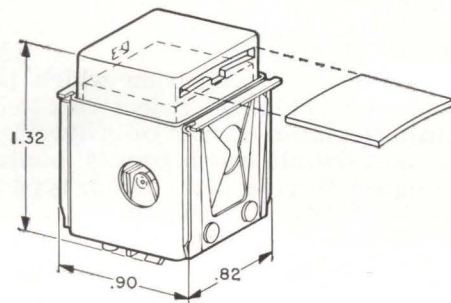

### MICRO SWITCH

FREEPORT, ILLINOIS

A DIVISION OF HONEYWELL

IN CANADA: HONEYWELL CONTROLS LIMITED, TORONTO 17, ONTARIO

HONEYWELL INTERNATIONAL—SALES AND SERVICE OFFICES IN ALL PRINCIPAL CITIES OF THE WORLD. MANUFACTURING IN UNITED STATES, UNITED KINGDOM, CANADA, NETHERLANDS, GERMANY, FRANCE, JAPAN.



## EMCOR II

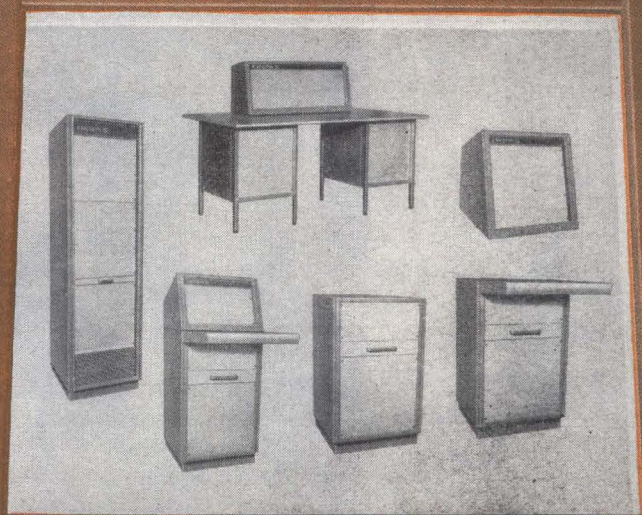

# EMCOR® II Modular Enclosures hold the answer to your enclosure problems

Your imagination creates the custom look for your equipment with EMCOR II Modular Enclosures. EMCOR II Enclosures have basic points of modification which provide each customer with product individuality. Select recessed, flush or extended panel mountings; choice of trim or grillwork extrusions; nameplate style variations, double width frames, pontoon bases and side panels—all designed to give you custom type enclosures without the cost of custom fabrication. A few of the many EMCOR II Enclosure configurations are shown above. Contact your local Ingersoll Products Sales Engineering Representative or write for full details.

REQUEST NEW  
EMCOR II  
LITERATURE



Ingersoll Products Sales Engineers also represent McLean Blowers for enclosures  
VISIT US AT NEP/CON BOOTH 3108-3208

EMCOR—The Original Modular Enclosure System By  
**INGERSOLL PRODUCTS**  
Division of Borg-Warner Corporation  
1000 W. 120th ST. • DEPT. 1242 • CHICAGO 43, ILL.

their technical innovations. Contractors, according to Louis Fong, director of the NASA Office of Technology Utilization, should provide a substantial source of ideas.

• Semimonthly reports are going out to more than 12,000 reference centers and contractors from NASA's Office of Scientific and Technical Information.

**APPLICATIONS**—Most space-to-industry transfers have come from firms already active in aerospace programs, said Howard Gadberry, reporting on Midwest Research Institute's pilot effort to speed up commercial applications of space-related technical developments.

Hoffman's highway emergency call box for example, uses solar cells, nickel-cadmium batteries and digital pcm signalling. Flat, flexible multiconductors have been adapted by Methode to dashboard wiring for Buick.

Among indirect applications of space techniques developed through MRI:

• Substitution of sintered-oxide rods helped a wire-wound resistor manufacturer eliminate steatite rod breakage during production.

• Magnetic pulse-forming technique developed for Saturn fastens terminals and connectors onto low-impedance coaxial cable without damaging a thin insulating sheath.

**SPEAKER LIGHT**—A retrometer developed for communication through satellite reentry sheaths has been adapted for short-range visual communications device, reported Fong.

Replacing one mirrored surface of a corner reflector with a taut sheet of aluminized Mylar (used in Echo) allows speech, moving the diaphragm, to modulate a light beam. A detector system reproduces the speech. This can be used as a cordless microphone in noisy areas and where radio interference is high, or for military and ship-to-ship and ship-to-shore communications.

An infrared micrometer for red-hot steel, radiation thermometers and infrared camera applications in nondestructive testing and medical diagnosis, including cancer-detection possibilities, were reported on by R. B. Barnes, of Barnes Engineering.

7½ TEST YEARS

CUT TO 18 MONTHS FOR

60 MILLION DATA TEST HOURS!

BETTER  
MEASURING  
FROM



In determinations of acceleration factors for metal and carbon film resistors for the high reliability MINUTEMAN Program, Electra Manufacturing Company uses an Automatic Resistor Data Logging System designed and built by Electro Instruments.

This system, in conjunction with other test equipment, has accumulated over 60 million resistor hours of data in the last 18 months. *Without this accelerated testing system, 7½ years of test time would have been required!* Most important, the EI system gives Electra the confidence that their products meet stringent government specifications.

As in this EI system created for Electra, EI *all solid state* Digital Multimeters are the basis for *better measuring* at greater speed, higher reliability, significant cost savings and a much lower investment.

Whether your interest lies in spacecraft, electronic components or industrial processes, we can demonstrate to you the advantages of EI digital instruments in measuring DC volts, AC volts, DC ratios, resistance, capacitance, inductance and impedance. Let EI *all solid state* Digital Multimeters or Complete Systems provide swift, accurate, low cost solutions to your measurement and display problems!

*For full details on EI's individual digital instruments, or our complete capabilities in the field of measurement, display and recording—write direct to Electro Instruments, Inc.*

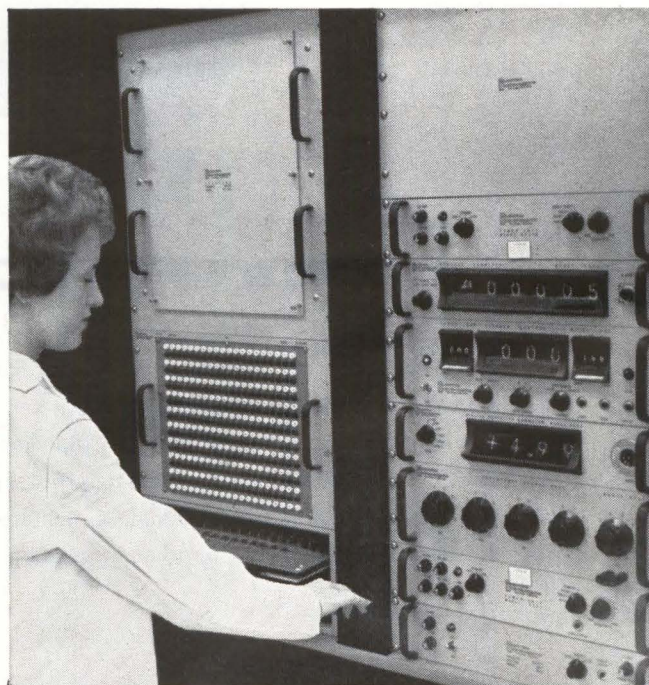

Technician at Electra Manufacturing Company inserts test resistors in the Automatic Resistor Data Logging System designed and built by Electro Instruments. Over 60 million resistor hours of data were accumulated in 18 months.



**Electro Instruments, Inc.**  
8611 Balboa Avenue, San Diego 12, California

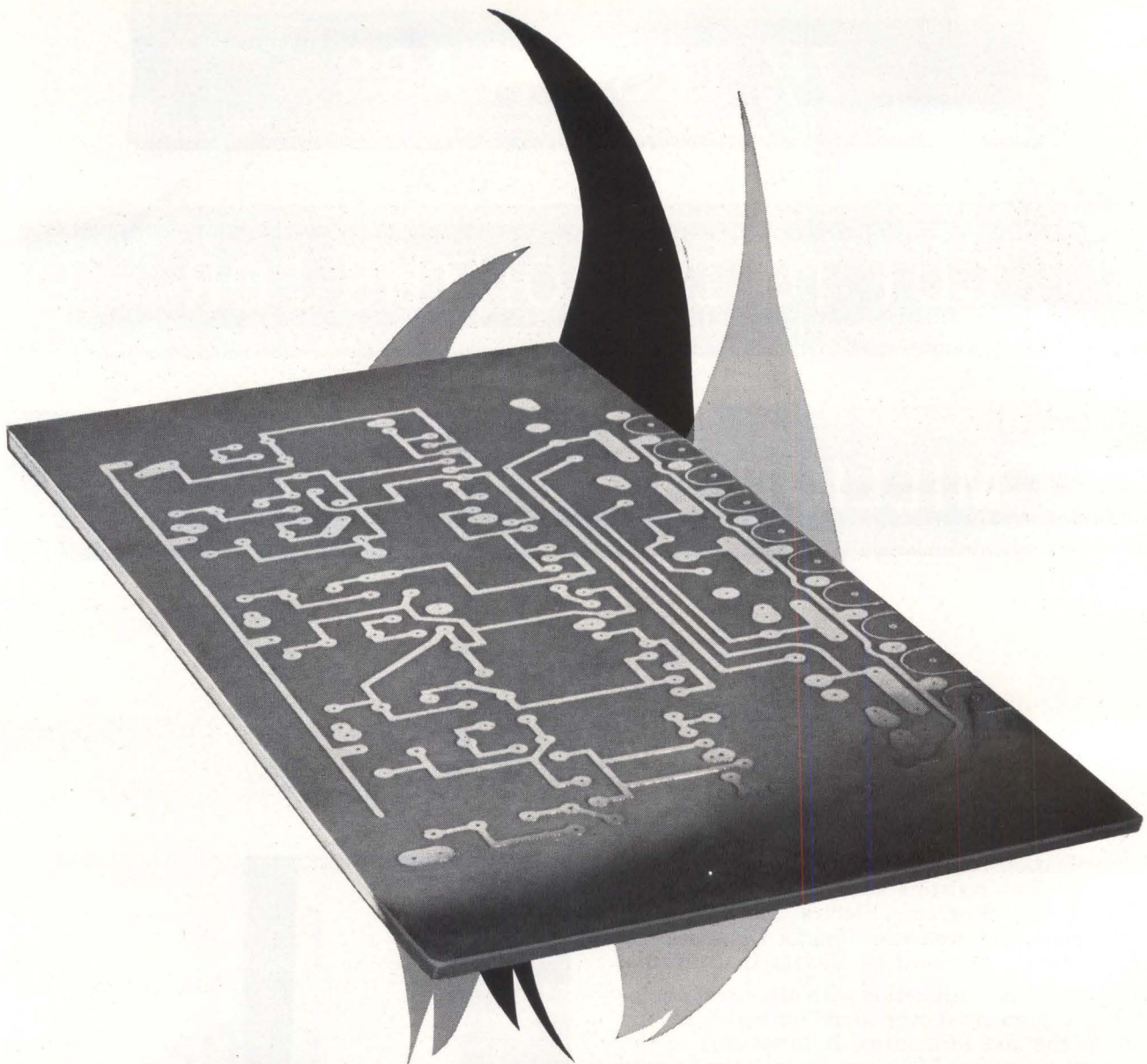

## New Formica® FR-200: Flame retardant

Formica FR-200 paper-phenolic laminate . . . for flame retardant printed circuitry. NEMA grade FR-2. Meets properties of MIL-P-3115C. Burn time: 4 sec. (ASTM D635-65 test modified to show burn time after 1st ignition.) High flexural strength (flatwise average value: 21,500 psi lengthwise, 17,500 psi crosswise.) Excellent insulation resistance. High solder blister resistance . . . in excess of 15 sec. at 500°F. Good solvent resistance: 10 min. in trichloroethylene. Can be punched cold up to and including  $\frac{1}{16}$ " , warm (140° to 180°F) up to and including  $\frac{3}{32}$ ". Available copper clad or unclad.

WRITE FOR DATA ON:

- Electrical /electronic grades
- Copper clad laminates
- Mechanical grades
- Engraving stock

FORMICA CORPORATION  
DEPARTMENT CS-621, CINCINNATI 32, OHIO  
subsidiary of 



industrial plastics

# Hoffman, house of Mil-Type Zeners, keeps adding "M"s!

Every day, Hoffman—pioneer and leader in zener diode technology—offers more devices meeting the tough new reliability requirements of the latest, most demanding mil specs. Now, with more than 94 mil-type zeners already

available in-depth and off-the-shelf, we're applying our technical resources and industry-leading quality assurance program to the job of qualifying more zeners to these most rigorous ever MIL-S-19500 standards.

**USAF1N429** 200 mW reference diode, 6.2 volts    **USN1N430** 250 mW reference unit, 8.4 volts    **USA1N709** 250 mW, 6.2 volts    **USA1N716** 250 mW, 12 volts    **USA1N718** 250 mW, 15 volts    **USA1N720** 250 mW, 18 volts    **USA1N722** 250 mW, 22 volts    **USA1N2970B** through **USA1N3004B** 10 watt, 6.8 through 91 volts    **USA1N2970RB** through **USA1N3004RB** 10 watt, 6.8 through 91 volts    **USN1N821** and **USN1N823** 400 mW, 6.2 volts

plus oxide-passivated (and tested to deliver 1/5 mil-spec leakage)

**USN1N962B**

through

**USN1N973B**

400 mW, 11 through 33 volts (actually operates to 600 mW)...and

**USN1N3016B**

through

**USN1N3032B**

1 watt, 6.8 through 33 volts

So, when you need mil-type zeners—with or without the "M"—call on your nearest Hoffman distributor or sales office first...for immediate delivery from stock or for more information on soon-to-be-available types.

**Hoffman** / **ELECTRONICS CORPORATION**  
Semiconductor Division

4501 N. Arden Dr., El Monte, Calif. • CUMBERLAND 3-7191 • TWX: 213-442-5633

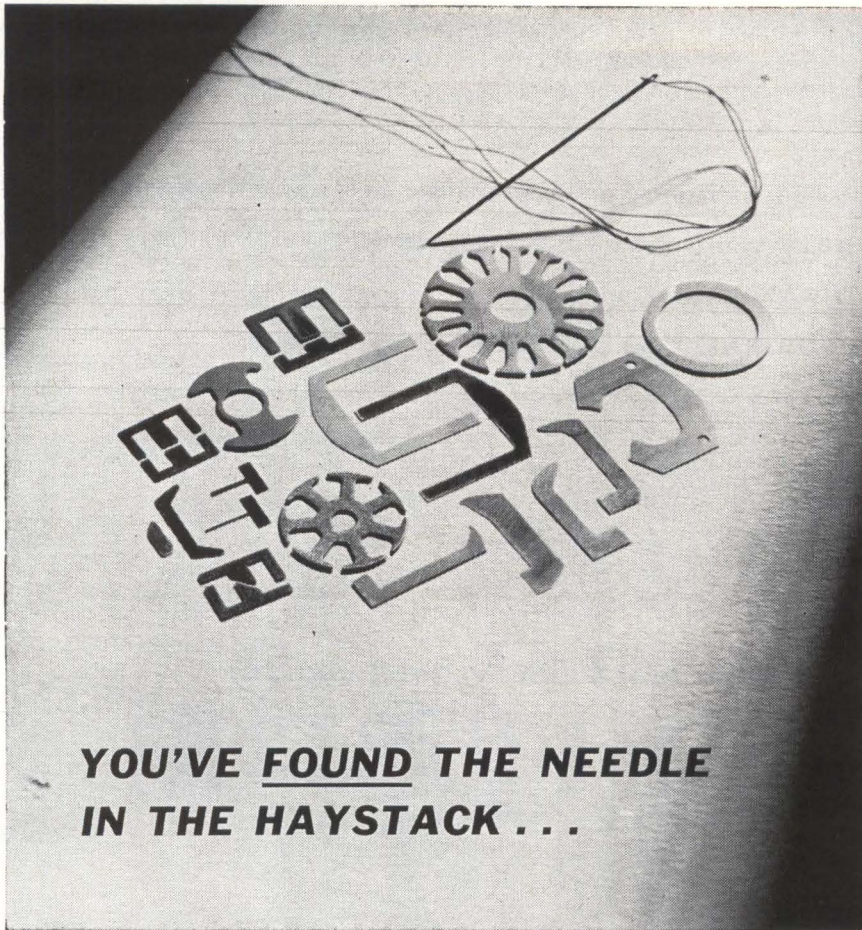

**YOU'VE FOUND THE NEEDLE  
IN THE HAYSTACK . . .**

## TOP QUALITY THIN-GAUGE NICKEL IRON LAMINATIONS FOR YOUR MINIATURIZATIONS

Special die-making processes and press equipment are available at Arnold's Pacific Division in Fullerton, California, to produce the tiniest of parts in production quantities for your designs. Material thicknesses of .001", .002", .003" and .004", etc. are available in 4-79 Permalloy, Mumetal, 4750 and other high permeability nickel-iron alloys—as well as a range of silicon steels—from which these parts may be produced to meet your magnetic requirements.

Special hydrogen-annealing furnaces are also available for optimum heat treatment after anneal.

The complete Arnold processing techniques used are capable of producing thin-gauge laminations to exacting dimensional tolerances. Their perfection of size and surface finish can be strong factors in protecting the uniformity and quality of your equipment.

Specify Arnold thin-gauge miniature parts for your requirements in magnetic recording and pickup heads, etc.; and for tiny motor and transformer laminations. We invite your inquiries for the tooling and production of special shapes. *Technical data on request.*

4673RIA

ADDRESS DEPT. E-5

**PACIFIC DIVISION**  
  
**ARNOLD**  
 SPECIALISTS in MAGNETIC MATERIALS

THE ARNOLD ENGINEERING COMPANY, Main Office: MARENGO, ILL.  
 PACIFIC DIVISION: 1551 E. Orangethorpe Ave., Fullerton, Calif. • TRojan 1-1560

## MEETINGS AHEAD

NORTHEASTERN DISTRICT MEETING, IEEE; Wentworth By-The-Sea, Portsmouth, N. H., May 20-22.

ELECTRONIC PARTS DISTRIBUTORS SHOW, Electronic Industry Show Corporation; Conrad Hilton Hotel, Chicago, May 20-22.

AMERICAN SOCIETY FOR QUALITY CONTROL ANNUAL CONVENTION; ASQC; Sherman House, Chicago, May 20-22.

MICROWAVE THEORY & TECHNIQUES NATIONAL SYMPOSIUM, IEEE-PTGTT; Miramar Hotel, Santa Monica, Calif., May 20-22.

NATIONAL TELEMETERING CONFERENCE, IEEE, AIAA, ISA; Hilton Hotel, Albuquerque, N. M., May 20-23.

INTERNATIONAL TELEVISION SYMPOSIUM, IEEE, et al; Montreaux, Switzerland, May 20-25.

SPRING JOINT COMPUTER CONFERENCE, IEEE and ACM; Cobo Hall, Detroit, Mich., May 21-23.

PRODUCT ENGINEERING & PRODUCTION NATIONAL CONFERENCE, IEEE-PTGPEP; Continental Hotel, Cambridge, Mass., May 27-28.

ARMED FORCES COMMUNICATIONS & ELECTRONICS ASSOCIATION CONVENTION, AFCEA; Sheraton-Park Hotel, Washington, D. C., June 4-6.

BIO-ENGINEERING SYMPOSIUM, ISA; Union Oil Co. Bldg., Los Angeles, June 14-16.

X-RAY AND ELECTRON PROBE ANALYSIS SYMPOSIUM, American Society for Testing and Materials; Chalfonte-Haddon Hall, Atlantic City, N. J., June 23-28.

IMPACT OF MICROELECTRONICS CONFERENCE, Armour Research Foundation and ELECTRONICS Magazine; Illinois Institute of Technology, Chicago, Ill., June 26-27.

WESTERN ELECTRONIC SHOW AND CONFERENCE, WEMA, IEEE; Cow Palace, San Francisco, Calif., Aug. 20-23.

## ADVANCE REPORT

PHYSICS OF FAILURE IN ELECTRONICS SYMPOSIUM, Rome Air Development Center and Armour Research Foundation; at ARF, Chicago, Sept. 25-26. June 7 is the deadline for submitting three copies of an abstract and author's biography to: Morton Goldberg, Symposium Co-chairman, Armour Research Foundation, Technology Center, Chicago 16, Illinois, or Joseph Vaccaro, Symposium Co-chairman, Applied Research Laboratory, Rome Air Development Center, Rome, N. Y.

Suggested subject matter includes: identification of particular failure mechanisms; reliability improvements through elimination of failure mechanisms; effects of stress factors upon device performance; device improvement cost factors; physics of failure principles applied to microelectronic circuits; long range implications of failure approach; etc.

## NEW DEEP-SEA AMPLIFIER TRANSMITS 128 TELEPHONE CONVERSATIONS

Our engineers have developed a new amplifier which simultaneously transmits 128 telephone conversations in both directions over a single cable. It is designed to operate without repair or maintenance on the ocean floor for 20 years.

The new amplifier (illustration below) is an important advance in deep-sea communications technology.

To make a single amplifier operate in two directions, it was necessary to provide a precise, complex filter system to separate the signals. Signals traveling in one direction occupy a frequency band from 116 to 512 kc., and those traveling in the other direction, from 652 to 1052 kc.

The gain of each amplifier must accurately compensate for its share of cable loss. The total loss varies over the frequency band and, in a transatlantic system, reaches a maximum of 9000 decibels. Since there is no way to adjust an amplifier on the ocean floor, the per-

formance of each one must be pre-established with extreme precision.

A 3600-mile cable link, with its 180 amplifiers, includes 36,000 electronic components. Each component has to be endowed with a reliability far in excess of the requirements of conventional land systems.

The casing and its seal to the cable must prevent minute water seepage at ocean bottom pressures. This could accumulate fatally over the years, and so production tests employing radioactive isotopes are used to search for any such microscopic leakage.

In bringing the new underseas system to production we worked closely with Western Electric, the manufacturing unit of the Bell System. Our joint objective was to create a system of high reliability that could be manufactured economically. The new amplifiers are being used first in the new deep-sea telephone link from Florida to Jamaica and Panama.



### BELL TELEPHONE LABORATORIES

World center of communications research and development



View of deep-sea amplifier with casing cut away. The casing is of noncorrosive beryllium copper, tested to withstand pressures up to 11,000 psi.

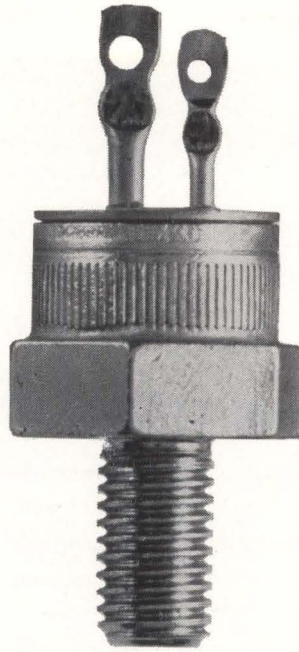

**THE C20 IS THE FIRST \$2.00 SCR SPECIFICALLY DESIGNED FOR LOW-COST, HIGH-VOLUME APPLICATIONS . . .**

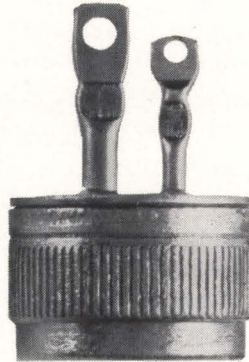

**DITTO ON THE C22**

(note the press fit feature . . . SCR versatility at an even lower cost to you)

**RATINGS AND CHARACTERISTICS**

RMS Forward Current,  
On state .....  
7.4 amperes (all conduction angles)

Average Forward Current,  
On state .....  
3.0 amperes at 80°C case (half wave rectified sine wave)  
6.0 amperes at 80°C case (full wave rectified sine wave)

Peak One Cycle Surge Forward Current,  $I_{FM}$  (surge) .....  
80 amperes

Operating Junction Temperature .....  
-25°C to +100°C

Gate Trigger Current .....  
25.0 mAdc max.

A few years ago you couldn't design a Silicon Controlled Rectifier into your circuit for less than \$25. But now General Electric has specially designed a highly reliable, extremely efficient SCR for low-cost, high-volume applications such as light dimmers, power supplies, inverters, motor speed and temperature controls, static switches, automotive ignition and regulator systems and electronic crowbars for circuit protection. And now it's economical too—for the new 200V G-E C20B costs less than \$2.00 in production quantities, and the C22B even less than that.

The C22 is packaged in the popular cup housing for easy press fit, solder down or glue down installation. The C20 is the same SCR with integral stud connection for "nut and bolt" type assembly. Both types have solid, one-piece terminals for gate and cathode, and both are available in repetitive PRV ratings from 25 to 400 volts, transient PRV ratings from 35 to 500 volts.

Rectifier Components Department,  
Section 16E110  
General Electric Company  
Auburn, New York

Please send me complete specifications on the new, low-cost C20 and C22 Silicon Controlled Rectifiers.

Name \_\_\_\_\_  
Job Title \_\_\_\_\_  
Company Name \_\_\_\_\_  
Address \_\_\_\_\_  
City \_\_\_\_\_ Zone \_\_\_\_\_ State \_\_\_\_\_

Available through your G-E  
semiconductor distributor

**GENERAL  ELECTRIC**



CIRCUIT board for precision 12-volt regulated power supply is shown without rectifiers and filter capacitors

## New Device Simplifies Power Supply Design

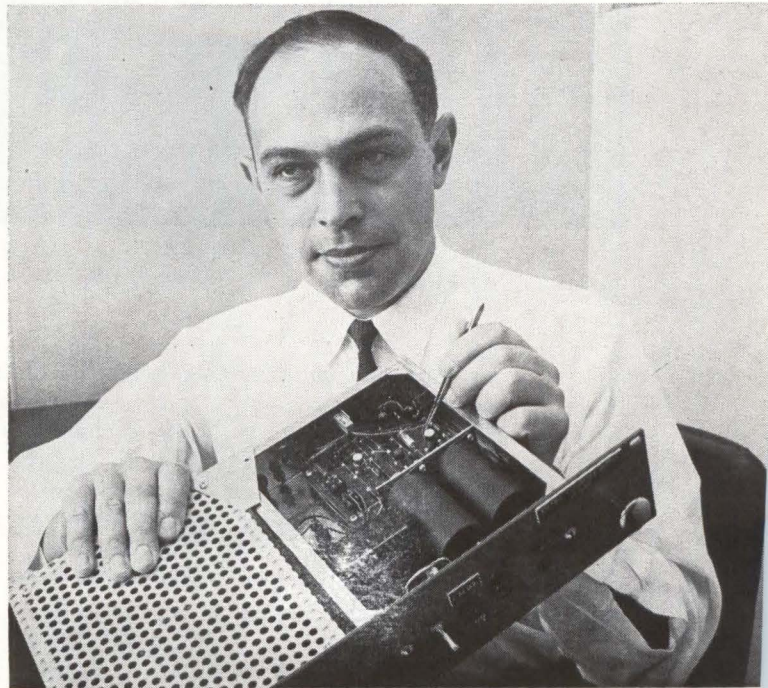

*Transistor and zener diode in integrated structure is both voltage reference and error voltage amplifier in highly stable regulated power supplies. New definition specifies integrated amplifier temperature coefficient throughout temperature range, and test circuits enable its measurement*

By T. P. SYLVAN General Electric Company Semiconductor Products Department, Syracuse, New York

**INTEGRATED** reference amplifier is comprised of a silicon *npn* transistor and a zener diode in a single pellet. The new device offers design simplification, low cost and high stability in regulated power supplies. The structure reduces the temperature differential between

the zener diode and the transistors and also isolates critical regions of the device from the outside environment.

**DESIGN REQUIREMENTS** — A regulated power supply can be considered as being comprised of four

functional blocks: power converter, reference element, error voltage amplifier and output power amplifier. The power converter might be a d-c to a-c converter, a d-c to d-c converter, an a-c to a-c converter (frequency changer) or an a-c to d-c converter. The most common type of power supply uses an a-c to d-c converter comprised of a transformer, rectifier and filter.

The reference element is generally one type of constant-voltage device, such as a gas-tube regulator, zener diode, mercury cell or reach-through transistor. However, any device with a nonlinear characteristic, such as a tunnel diode, field-effect transistor, incandescent lamp or nonlinear resistor can also be used as a reference element. The zener diode has been widely ac-

---

### EASIER CIRCUIT DESIGN

Design simplification is one of the primary objectives of engineering. Among the many benefits that can result from simplifying circuits are lower development and production costs, greater reliability, improved performance, weight and size reductions, and lower power consumption. This integrated zener diode-transistor unit permits regulated power supply design to be simplified with the consequent reward. Also, some additional benefits are inherent in structure of the device

---

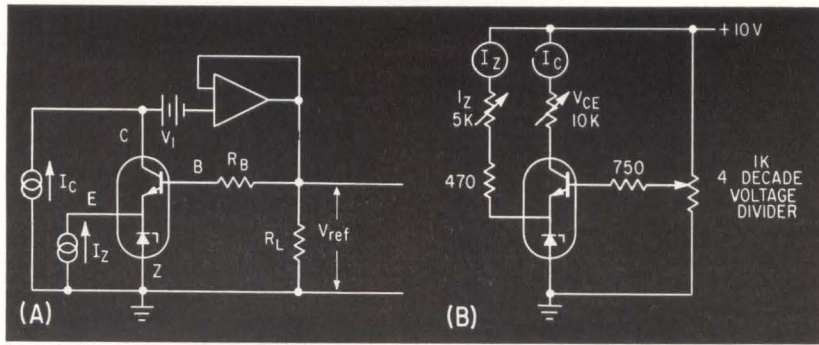

REFERENCE amplifier can be tested using basic circuit (A) or alternate circuit (B)—Fig. 1

cepted as a reference element because of its small size, low temperature coefficient, fast response and ability to withstand shock and vibration. Improvements in the structure and processing of zener diodes have made possible voltage stability better than 10 parts per million per year, which approaches a standard cell.

The error-voltage amplifier is used to compare output of the reference element with power supply output voltage, current or power and to provide an amplified error signal to the output amplifier.

Regulation, output impedance and ripple of a d-c regulated voltage supply depend primarily on the gains of the error-voltage amplifier and the output amplifier. Power supply temperature coefficient and long-term stability are set primarily by the temperature coefficient and stabilities of the reference element and the input stage of the error-voltage amplifier.

To achieve the best possible long and short-term stability in a power supply, temperature must be compensated individually in the reference element and the input stage of the error-voltage amplifier. If it is not, noncompensating voltage shifts can occur as a result of temperature differentials or changes in power dissipation. These requirements are generally met by using a temperature-compensated zener diode as the reference element and an integrated transistor differential amplifier or a chopper-stabilized amplifier as the input stage of the error-voltage amplifier.

**INTEGRATED AMPLIFIER**—The integrated reference amplifier is

fabricated using a combination of grown-diffused and alloy techniques for optimum characteristics of both transistor and zener diode and post-passivation processes for long-term stability. A four-leaded TO-5 package is used. Electrical isolation from the case is achieved by mounting the pellet on a ceramic disk.

Temperature coefficient of the zener diode is a function of the zener voltage, becoming more positive as zener voltage increases. By controlling zener voltage in the reference amplifier, it is thus possible to achieve exact compensation for temperature variations in both base-emitter diode voltage and transistor current gain. At a collector current of 0.5 ma, compensation requires a zener temperature coefficient of about +2.5 mv per deg C, which in turn requires a zener voltage of about 6.3 volts.

A major advantage of the integrated structure is the reduction

of the temperature differential between the zener diode and the transistor, with a consequent reduction in the long and short-term drift of the reference voltage. The estimated thermal resistance between the junction of the zener diode and the base-emitter junction of the transistor is 0.05 deg C per milliwatt, compared to a thermal resistance to air of 0.3 deg C per mw for each device. The overall structure thus provides an efficient thermal filter between the environment and the critical regions of the device, which minimizes the effects of sudden changes in ambient temperature on reference voltage.

**TEST CIRCUITS**—The most important characteristic of the reference amplifier is the temperature coefficient of the reference voltage. Temperature coefficient must be specified and measured with specific values of collector-to-base voltage, collector current, zener current and base source resistance.

A general test circuit is shown in Fig. 1A. Collector current and zener current are controlled by current generators  $I_c$  and  $I_z$ . Zener current is defined as the current flowing into the common terminal formed by the transistor emitter and the zener cathode, whereas the actual current flowing through the zener diode is the sum of  $I_z$ ,  $I_c$  and transistor base current.

An operational amplifier used as a follower is connected between the collector of the reference amplifier

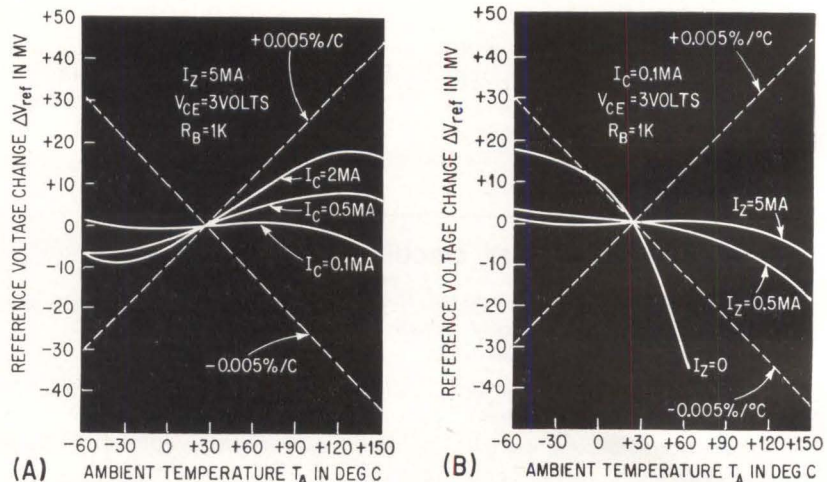

VARIATION of reference voltage with temperature is shown for three values of collector current (A) and zener bias current (B)—Fig. 2

and the output. Bias voltage  $V_1$  provides a means for adjusting collector-to-base voltage of the transistor.

The circuit in Fig. 1A is in effect a regulated voltage supply that maintains constant bias on the reference amplifier. Reference voltage  $V_{ref}$  can be measured on an accurate differential voltmeter or digital voltmeter as temperature of the reference amplifier is varied. The percentage change in reference voltage for a given temperature change corresponds to the percentage change of output voltage that can be expected in a well designed power supply over the same temperature range.

Bias source resistance  $R_B$  is included in the specification of the reference voltage temperature coefficient to duplicate the effect of the resistance divider used in most power supplies to set output voltage. Divider resistance should be as low as possible for maximum gain of the reference amplifier and to reduce the effects of  $I_{CO}$  and  $h_{FE}$  on reference voltage. However, such factors as power dissipation in the divider and current drain set a lower limit on divider resistance. Considering these requirements, a compromise value of 1,000 ohms was chosen for  $R_B$ .

An alternate test circuit that avoids use of differential voltmeters and operational amplifiers is shown in Fig. 1B. This circuit uses a 10-volt supply having a short-term stability of 2 millivolts or better and a four-decade voltage divider. The 5,000-ohm potentiometer is adjusted for desired zener bias current; the decade resistor is adjusted for collector current; and the 10,000-ohm pot is adjusted for desired collector-to-base voltage.

The reference amplifier is then heated or cooled, and the voltage divider is adjusted to maintain the initial collector current. The variation in reference voltage can then be read to within 1 millivolt directly from the voltage divider. A 750-ohm resistor is added in series with the arm of the voltage divider to give a base source resistance of about 1,000 ohms.

#### TEMPERATURE COEFFICIENT

—Using the circuit in Fig. 1A, the

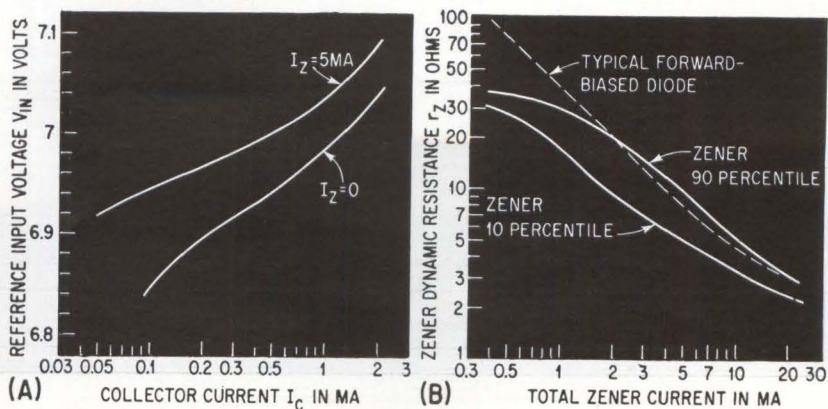

TYPICAL transfer characteristic of reference amplifier (A) is shown for two values of zener bias current. Dynamic resistance of zener diode in reference amplifier (B) as a function of bias current is compared to dynamic resistance of forward-biased silicon diode—Fig. 3

variation in reference voltage has been plotted against temperature on an x-y recorder using the base-emitter diode of the transistor as a thermometer. Voltage of the base-emitter diode is a linear function of temperature and is uniform among the devices. Because of the integrated structure of the reference amplifier, the device can be heated and cooled rapidly with no appreciable error in the voltage-temperature characteristic. Thus a complete x-y recording can be made over a temperature range of  $-55$  to  $150$  deg C in less than 30 seconds with negligible hysteresis between the trace and retrace.

Curves obtained on an x-y recorder are shown in Fig. 2A for a typical unit operating at three different values of collector current. The upward bending of the curves at low temperatures results primarily from falloff of  $h_{FE}$  as is evident from the increased curvature at higher collector currents. The downward bending of the curve at high temperatures results primarily from the rapid increase of  $I_{CO}$  and the resultant voltage drop across the base source resistor.

The curves for all reference amplifiers are similarly shaped. The curvature can be reduced by using transistors with higher values of  $h_{FE}$  and lower values of  $I_{CO}$  or by decreasing the value of the base source resistor.

The similar set of curves in Fig. 2B were obtained on the same unit operating at three values of zener current. These curves show that it

is not advisable to operate with both low collector current and low zener current. Also, the temperature coefficient of the reference voltage becomes more positive as either zener current or collector current is increased, as shown in Fig. 2A and B. With some reference amplifiers, the temperature coefficient can be set exactly equal to zero at a specific temperature by adjusting the bias currents. Because of the relatively good linearity of the curves, extremely low temperature coefficients can be achieved over a moderate temperature range. For example, temperature coefficients as low as  $\pm 0.0001$  percent per deg C or  $\pm 1$  part per million per deg C have been observed over a temperature range from zero to  $70$  deg. C.

**TRANSCONDUCTANCE**—The transfer characteristic of the reference amplifier, as shown in Fig. 3A, determines the change in collector current resulting from a small change in the reference voltage at the base. Circuit transconductance, defined as the ratio of collector current change to reference voltage change, is equivalent to the slope of the curve in Fig. 4 or

$$g_{mc} = dI_c/dV_{ref} \quad (1)$$

where  $V_c$  and  $I_z$  are constant.

Circuit transconductance includes the effects of base source resistance and dynamic zener impedance. Hence, it is lower than the transconductance of a transistor common-emitter amplifier ( $1/h_{ib}$ ). Cir-

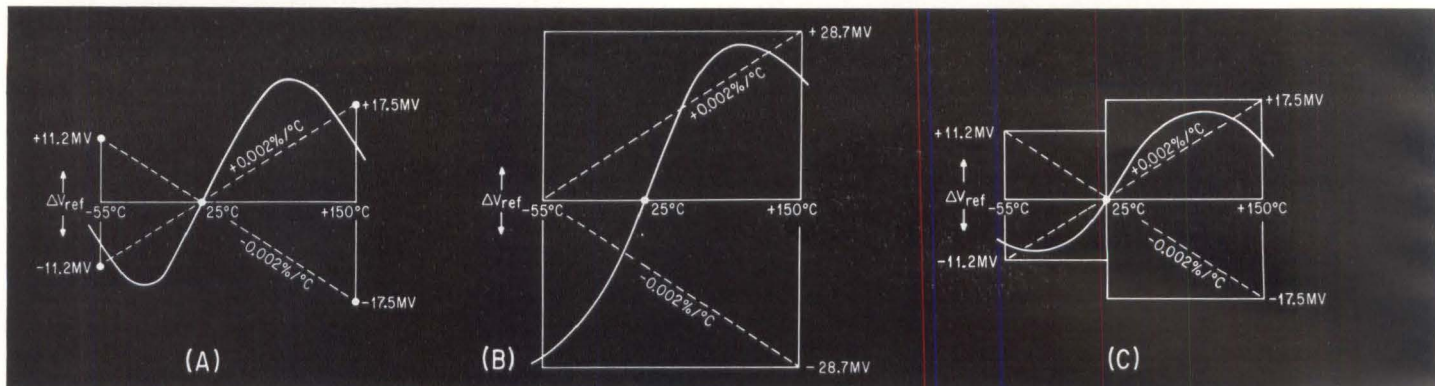

circuit transconductance is approximately

$$g_{mc} = 1/[h_{ib} + R_B/(1 + h_{fe}) + r_z], \quad (2)$$

where  $r_z$  is dynamic zener resistance and all parameters are measured at the specified bias conditions.

For maximum transconductance, a device should have high  $h_{fe}$  and low  $r_z$  and should operate at high collector current and zener current to minimize  $h_{ib}$  and  $r_z$ . In practice, an upper limit to collector current is determined by the linearity of the reference voltage curve at low temperatures, as indicated in Fig. 2A.

Dynamic resistance of the zener diode in the reference amplifier is relatively low, as indicated by Fig. 3B, which shows that at low current levels  $r_z$  is lower than dynamic resistance of a forward-biased silicon diode. The low value of  $r_z$  permits the reference amplifier to be operated at values of collector current as low as 0.5 ma without additional biasing current for the zener diode, permitting simplification in regulated power supply design without compromising performance.

Circuit transconductance can be conveniently measured using the circuit in Fig. 1B. After adjusting the circuit for nominal bias, the decade voltage divider is set 5 millivolts below the nominal value. The corresponding change in collector current is noted, and the value of  $g_{mc}$  is computed from Eq. 1.

**SPECIFICATIONS**—Three different methods are presently used for

defining temperature coefficient of voltage reference devices. A particular device may have considerably different temperature coefficients, depending on which definition is used. Hence, in evaluating a specification, the exact definition of temperature coefficient must be known.

The methods of defining temperature coefficient are illustrated in Fig. 4 for a voltage reference device having a nominal voltage of 7 volts and a maximum temperature coefficient of  $\pm 0.002$  percent per deg C over a temperature range of  $-55$  to  $150$  deg C. The definition illustrated in Fig. 4A guarantees the variation in voltage at the temperature extremes but not at intermediate temperatures. The definition in Fig. 4B determines the allowable voltage variation on the basis of the total temperature range, whereas in Fig. 4C the allowable voltage variation is determined separately between  $25$  deg C and each temperature extreme. In both cases, a maximum voltage variation is guaranteed over the entire temperature range, but temperature coefficient over a smaller range can be considerably higher

than the specified range.

A new and more exacting definition of temperature coefficient has been developed for the reference amplifier and is shown in Fig. 4D. This definition ensures that the temperature coefficient over any temperature range within the extreme limits will be less than the specified maximum temperature coefficient. An x-y recording of the voltage versus temperature characteristic can be provided with each unit to assure compliance with the specified temperature coefficient over the entire applicable temperature range.

Specifications for the reference amplifier include reference voltage, circuit transconductance and temperature coefficient. These parameters are generally all that are required to design a regulated power supply, although other parameters should also be specified for special applications.

Typical specifications for a reference amplifier were compiled under test conditions of 0.5 ma collector current, zero zener current, 3 volts collector-to-base voltage and 1,000 ohms base source resistance. The

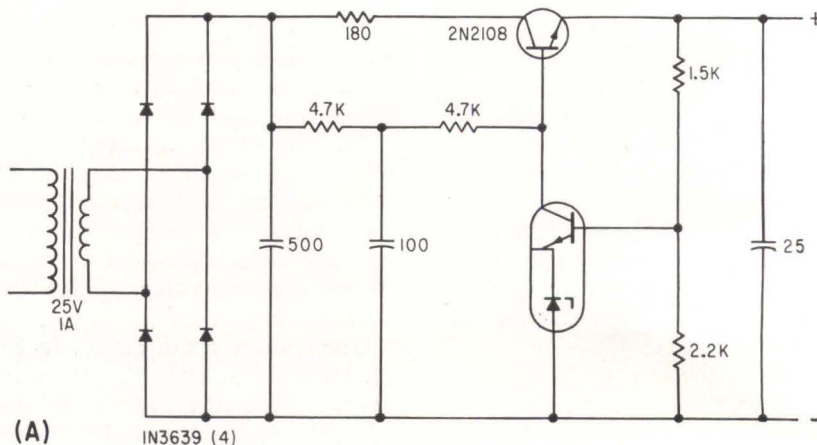

SIMPLE 12-volt regulated supply (A) uses reference amplifier, and alternate precision 12-volt supply (B) uses current limiting—Fig. 5

TEMPERATURE coefficient of a voltage reference device can be compared as it is defined by four different methods—Fig. 4

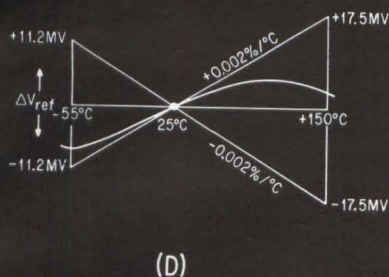

specifications are 7 volts  $\pm 5$  percent reference voltage, 6,000 micromhos minimum circuit transconductance,  $\pm 0.002$  percent per deg C temperature coefficient between  $-55$  and  $150$  deg C, 40 to 120 current gain and 45 volts collector voltage rating.

**POWER SUPPLIES**—Two alternative power supply circuits are illustrated in Fig. 5: the simple 12-volt regulated supply that uses a reference amplifier, and an alternate power supply circuit of higher precision output voltage, using a current-limiting scheme. Both circuits can be easily laid out on a printed circuit board, as shown later. The simplest regulated power supply using the reference amplifier is shown in Fig. 5A. It is designed for an output of 12 volts at currents up to 100 ma. The 180-ohm resistor provides short circuit protection, limiting output current to less than 200 ma. The 100-microfarad capacitor and the 4,700-ohm resistors provide an effective filter for the base current of the 2N2108 transistor, reducing output voltage ripple to less than

80 microvolts under full load. Output impedance of the supply is about 0.65 ohms. For line voltage variations of  $\pm 10$  percent, output voltage regulation is better than  $\pm 0.3$  percent.

Use of the reference amplifier in a precision 12-volt, 50-ma regulated voltage supply is shown in Fig. 5B. The 2N1131 *pn*p silicon transistor is used to regulate collector current in the reference amplifier. Output current of the 2N1131 varies with line voltage because of the finite output resistance of the transistor and the voltage divider formed by  $R_2$  and the dynamic resistance of  $D_1$  and  $D_2$ . Resistor  $R_3$ , added to compensate these effects, makes output current of the 2N1131 almost completely independent of line voltage changes. For a line voltage change of  $\pm 10$  percent, the variation in output voltage is typically less than  $\pm 0.001$  percent and can be reduced to less than  $\pm 0.0001$  percent by adjusting  $R_3$ .

Diode  $D_2$  provides temperature compensation for the base-emitter diode of the 2N1131 transistor. This compensation is not critical, since, owing to the reference amplifier gain, a 1-percent change in the collector current of the 2N1131 has the effect of only a 0.01-percent change in reference voltage.

A 2N2785 Darlington transistor is used for the series regulator. Current gain of this transistor is typically 5,000 at 100 ma, so the normal variation of collector cur-

rent in the reference amplifier over the full range of output current is 20 microamperes or only 4 percent of nominal collector current.

In a constant-voltage power supply, regulation of collector current in the reference amplifier allows collector-to-base voltage to be adjusted to any desired operating value by adding a resistor between the base of the series regulator and the collector of the reference amplifier.

Sharp current limiting is provided in this circuit by  $R_1$  and  $D_3$ . When the  $IR$  drop across  $R_1$  exceeds 6 volts, diode  $D_3$  conducts, decreasing emitter current to the 2N1131 transistor and thus reducing base current to the 2N2785. Dynamic resistance of the current-limiting characteristic is about 2,200 ohms.

Output impedance of the power supply is about 0.03 ohm, and output ripples and noise at full load is less than 10 microvolts. Output impedance can be reduced to about 1 milliohm by adding another emitter follower stage to the series regulator and rearranging the circuit for voltage sensing across the load. Higher output current and power can be obtained by substituting a power transistor such as the 2N2197, mounted on an appropriate heat sink, for the series regulator. Temperature stability of the supply is mainly dependent on the temperature coefficient of the reference amplifier. An overall temperature coefficient of  $\pm 0.002$  percent per deg C can easily be achieved.

The printed-circuit board layout of the power supply in Fig. 5B is shown in the photograph excluding the rectifiers and filter capacitors.

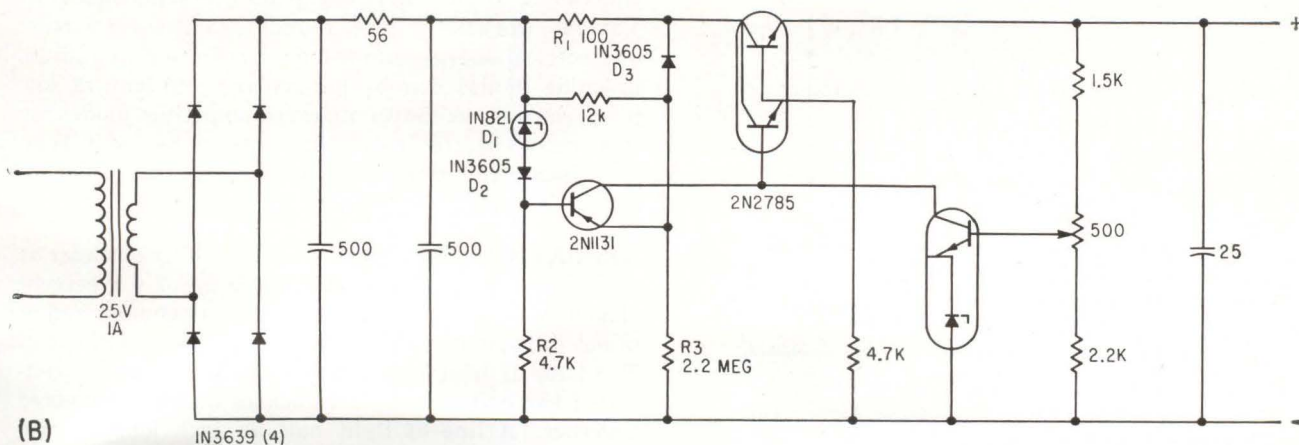

# DIODE LAMP

## Makes Tape Readers Faster

*Optoelectronic tape readers are often used to supply binary data to a computer. Here is one device with improved reliability that takes advantage of the infrared emission of gallium-arsenide diodes*

By R. F. BROOM and C. HILSUM, Services Electronics Research Lab, Baldock, Herts., England.

IN EARLY tape readers, holes were detected by imperforated paper breaking an electrical contact. More modern instruments use optical sensing; a tungsten filament lamp is placed on one side of the tape, and an array of silicon photocells with one cell for each channel, on the other. If a hole stops in front of a photocell, a signal is generated that can be amplified and processed. This method overcomes many of the disadvantages of mechanical systems, but introduces a number of others due to deficiencies in the tungsten lamp.

Lamp reliability is much lower than that of the rest of the instrument. The lamp cannot be modulated, so that d-c amplifiers are commonly used. Moreover, as the lamp ages, the filament sags and optical misalignment occurs. It is difficult to make this type of tape reader work for long periods over a large ambient temperature range. Standard paper tape is

not opaque; discrimination between hole and paper is due to the difference between the light transmitted through the hole and that scattered by the paper, and this will be high only if an accurately collimated light beam is used. However, permanent accurate collimation is possible only if the light source does not move. With tungsten lamps, some compromise is required. The lamp can either be slightly defocused or a diffuser can be interposed between the lamp and the paper. In either case, the discrimination between hole and paper is rarely greater than 20:1 under favorable conditions. At high ambient temperatures, the drift in the d-c amplifier can cause serious reduction in this discrimination. If the tape is greasy or moist and the scattered light is increased, the system will stop working.

The principle of photoelectric tape readers is sound, but a satisfactory instrument can be made only by using a lamp that is rugged, reliable, and long-lived. The output of the lamp must be at a wavelength suitable for detection by silicon or germanium photocells, and simple a-c or pulse-code modulation should be possible. Finally, the source of light must remain in a fixed position.

**GaAs LAMP**—A semiconductor *p-n* junction biased in the forward direction emits radiation of energy equivalent to the energy gap of the semiconductor. Various workers<sup>1,2</sup> have found that the conversion of electrical energy into infrared radiation in gallium arsenide diodes can be particularly efficient at low temperatures. A GaAs infrared emitting diode for tape reader use at room temperature has now been developed<sup>3</sup>; the relevant properties of this semiconductor lamp are summarized in the box.

**OPERATION**—The block diagram of the reader is shown in Fig. 1. A single GaAs lamp of 0.5 percent efficiency can operate five photocell channels, and it is not difficult to make lamps five times this efficient. The lamp is held 1-inch above a lens system consisting of two cylindrical plastic lenses that are cemented together. A line of light half an inch long is pro-

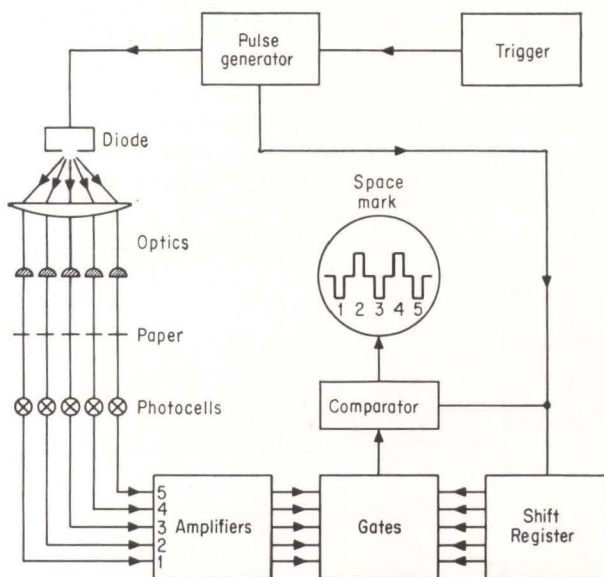

SINGLE GaAs diode lamp with an efficiency of 0.5-percent operates 5 channels. Lamps with much higher efficiencies are possible—Fig. 1

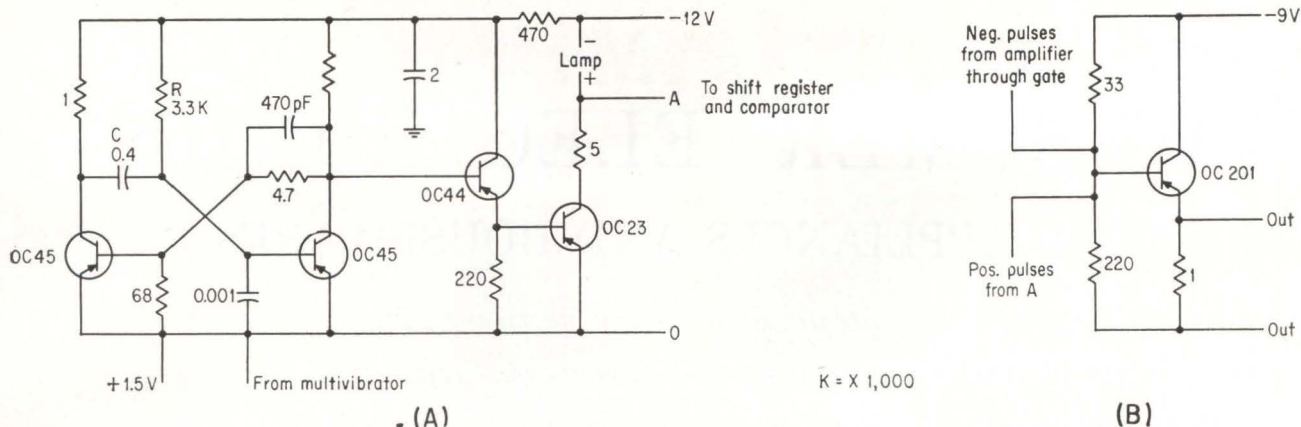

LAMP DRIVE system (A) and comparator circuit (B)—Fig. 2

jected onto the paper  $\frac{1}{4}$ -inch below the lens. This beam is focused at the Ferranti MS9AE silicon photodiode detectors that are positioned slightly further away. When the optics are carefully aligned, a discrimination between hole and paper that is greater than 500:1 for standard tape is obtained.

The output from GaAs lamps is not proportional to the current, being low at currents less than 200 ma for diodes 1 mm<sup>2</sup> in area. It is therefore advisable to operate the lamp at a current of 1 amp or more, supplied in pulses to simplify amplification. Pulses are generated by a multivibrator that triggers a flip-flop, as shown in Fig. 2A, and are then fed through an emitter-follower to a power transistor. A 5-ohm resistor in series with the semiconductor lamp restricts the current to 2 amp. In this tape reader, the repetition frequency was 10 cps, and the pulse length was 150 microseconds. A simple change in *R* and *C* of Fig. 2A raises the repetition frequency to 1 Kc. The same circuit can operate at higher frequencies if the pulse length is reduced. The maximum modulation frequency for the lamp is above 100 Mc if a more sophisticated driver and amplifier circuit are used.

**AMPLIFIERS**—The photocell amplifiers each include two transistors. The first has a common-emitter gain greater than 50 to ensure that a current pulse of 0.2  $\mu$ a from the photocell is amplified sufficiently to bottom the second transistor. Under normal operating conditions, these pulses are actually greater than 1  $\mu$ a, and the pulses from the amplifier are therefore independent of lamp output, photocell sensitivity or amplifier gain.

It is possible to process the information in the same form that leaves the amplifiers, with pulses arriving when there is a hole in front of the photocell, and zero input when the paper is not perforated. It is more convenient to have the information as a continuous stream of pulses, with, for example, negative pulses for holes and positive pulses for no holes. This is accomplished by feeding the amplifier output into a comparator as shown in Fig. 2B. Here, the amplified photocell signals are compared with pulses of opposite sign coming directly from the lamp driving circuit. The amplifier output pulses are arranged to be about twice as large as the drive pulses. When

no signal is developed by the photocell, the drive pulse generates a positive pulse at the output of the comparator. If there is a hole in front of the photocell, a negative pulse comes from the amplifier, and since this is larger than the drive pulse, the comparator emits a negative pulse.

When it is not convenient to have all photocell outputs processed simultaneously, they can be selected in turn using normal computer circuits. Each amplifier is followed by a gate operated by a shift register. A shift is made each time a pulse is generated by the lamp driving circuit.

**PERFORMANCE**—The optoelectronic tape reader seems superior in nearly every respect to a system using a tungsten lamp. Discrimination is adequate using the lowest grades of paper over a temperature range of 0-50 C, and it is probable that satisfactory performance can be obtained over a much larger range. The tungsten lamp used in the original reader consumed 6 watts and had a life expectancy between 30 and 100 hours. The semiconductor lamp requires 5 mw, and will function for more than 1,000 hours. Maximum frequency of operation is now determined by the paper drive mechanism, and is probably above 2 Kc. Much higher speeds are possible using smaller holes in the tape. If photographic recording on fine grain film is used, speeds in the megacycle range become feasible.

This instrument represents one of a series of practical optoelectronic systems that can now be designed, for the gallium arsenide lamp is ideally suited for use with silicon photocells.

The tape reader was developed in collaboration with N. D. Bayley and J. D. Ralphs of the Diplomatic Wireless Service, and we are grateful to them for their co-operation. We are also glad to acknowledge the help of B. R. Holeman and A. T. James in the development and supply of the semiconductor lamps used. Permission to publish has been given by the Admiralty.

REFERENCES

- (1) R.J. Keyes and T.M. Quist, *Proc IRE* 50, 1822, 1962.
- (2) J.I. Pankove and M. Massouli *Bull. Am. Phys. Soc.*, 7, 88, 1962.
- (3) C. Hilsum and B.R. Holeman. To be published.

# CONSUMER ELECTRONICS

## PART III: APPLIANCES AND HOUSEWARES

*Last of a series describes late developments in electronic ranges, thermoelectric cooling ultrasonic dishwashers, telephone dialers, security alarms, sound movie cameras and hearing aids*

By STEPHEN B. GRAY, Assistant Editor

**ELECTRONIC RANGE**—Microwave cooking in the home is now reportedly faster than ever with the Tappan Company's R-4 electronic range (see p 49). Using the Litton Industries L-3189 quick-heating magnetron, the range heats in six seconds. The previous tube required 75 seconds. Because the heat is generated within the food, the cooking utensils remain comparatively cool.

The magnetron operates as a grounded-plate, self-rectifying oscillator with about 6,600 volts at 300 ma. The microwave energy developed by the magnetron is coupled to the top opening of the oven cavity

by a short rectangular waveguide. A motor-driven stirrer beneath the mouth of the waveguide distributes the microwave energy evenly in the oven to avoid hot spots, by changing the cavity dimensions, which breaks up the standing-wave pattern.

**THERMOELECTRIC COOLING** — Thermoelectric freezers and refrigerators have a novelty appeal. Their coefficient of performance is low, about 0.2, so that to get one watt out, five watts must be used to drive the device, and then six watts must be dissipated. The power supply is another problem: the 115 volts of house current must be transformed to low-voltage d-c, around two or three volts, which requires an expensive transformer. A third problem is the cost of materials. A thermoelectric element is a pair of *p*-type and *n*-type metallic blocks of bismuth telluride joined by a conducting bridge.

According to an industry source, thermoelectric devices will not displace freon systems in large refrigerators or in air-conditioners. For large differences in temperature, large heat-pumps are necessary. And the amount of space cooled per consumer dollar is much less for thermoelectric refrigerators.

Many of the present uses of thermoelectric cooling is for novelty, such as the ice-cube freezers in the Chicago Sheraton. These are made by Norge with Melcor thermoelectric elements, and consist of two trays under the bathroom sink. At last report, it took seven hours to freeze the cubes. Thermoelectric cooling finds more practical use in commercial applications such as stabilizing the operation of resistors, amplifiers and laboratory baths.

Many of the thermoelectric elements used in this country are made in Canada by Needco, or in Japan by such companies as Sanyo. Two Sanyo thermoelectric devices are currently being marketed experimentally by RCA-Whirlpool to professional outlets such as physicians and hospitals. One is a freezer, originally designed for making icecubes; the other is a refrigerator. These two items are made entirely in Japan except for fan, motor, rectifiers and transformer, which, according to Sanyo, were found to be

### ELECTRONICS IN WHITE GOODS

When will the transistor and vacuum tube move out of the living room and den and into the kitchen and laundry?

It will be some time by all accounts. Although there are thermoelectric refrigerators and experimental ultrasonic dishwashers, such products are still a long way from competing in price with conventional electromechanical equipment

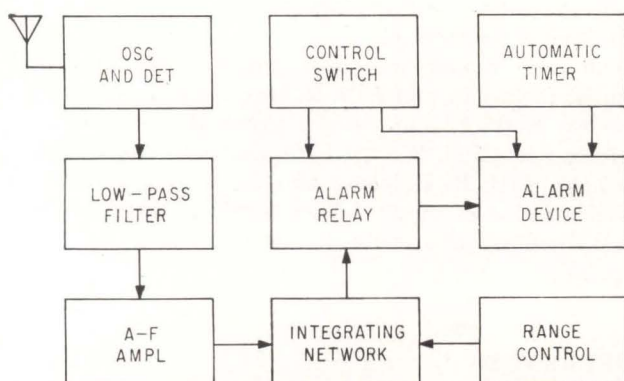

SECURITY ALARM with adjustable range, by Pinkerton Electro-Security—Fig. 1



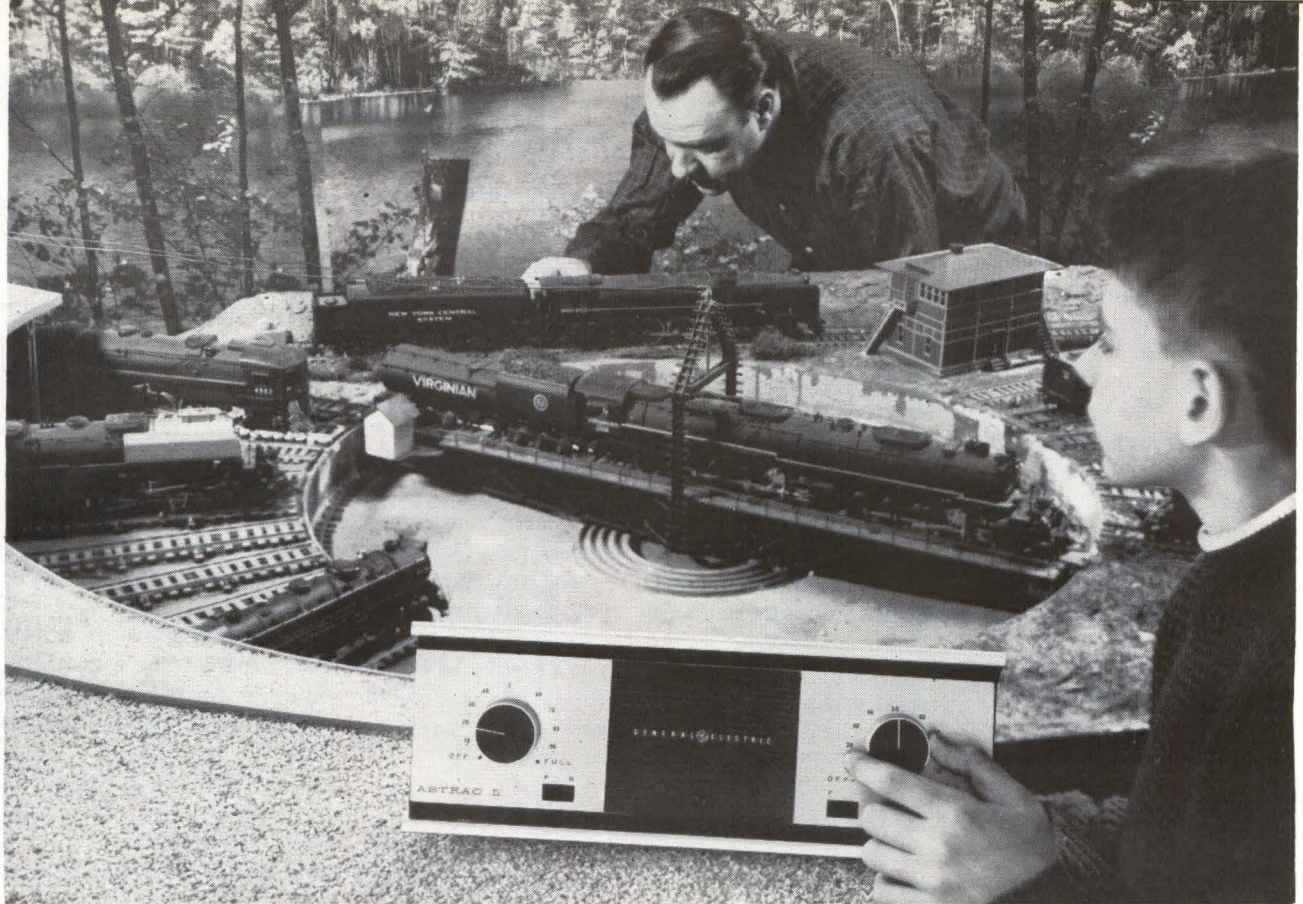

SIMULTANEOUS CONTROL of two trains on the same track is possible with this dual transmitter by General Electric. Receiver units are inside engines or tenders

available more cheaply here. Other Sanyo thermoelectric items, such as their watercooler, are undergoing further development in an effort to lower the prices, which are still too high for the U. S.

About the only thermoelectric device currently on the consumer market, beside the Norge ice-cube freezer, is a portable refrigerator made by the Wright Manufacturing division of Midland-Ross, and which is listed in the current Montgomery Ward catalog for

\$120. This 22-pound refrigerator has a capacity of 0.53 cubic foot, and operates on 115 volt a-c, or on 12-volt d-c from auto or boat battery or from a power-pack accessory. The thermoelectric elements are made by Jepson Thermoelectrics with material supplied by Materials Electronic Products Corporation (Melcor).

**ULTRASONIC DISHWASHER**—Although ultra-

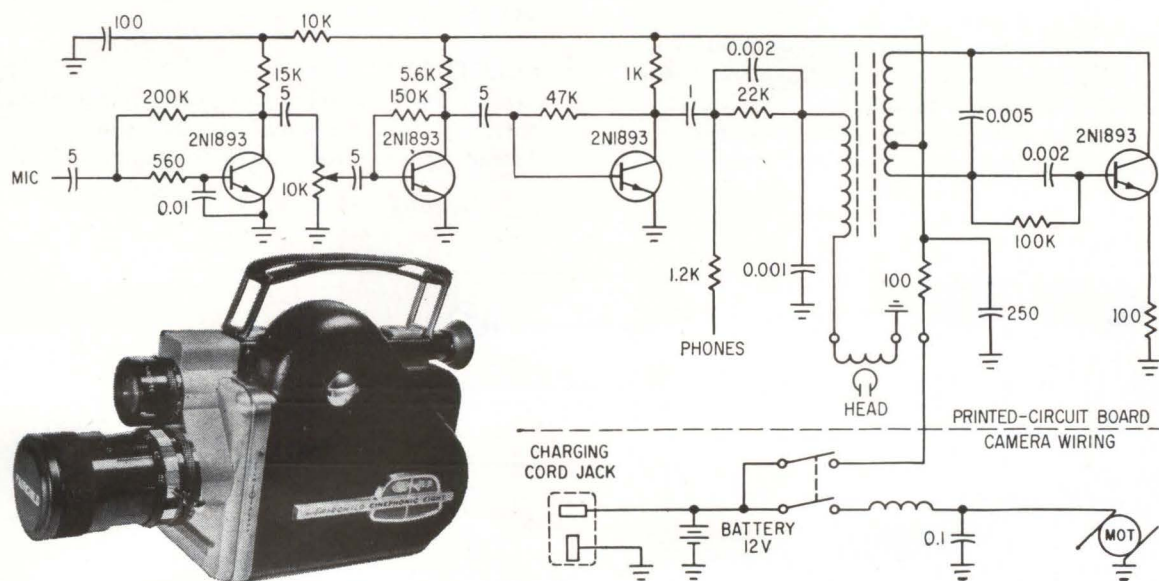

SOUND MOVIE CAMERA for home use, and amplifier circuit, by Fairchild—Fig. 2

sonic dishwashers are made for commercial use, a consumer model would be too expensive to market at the moment. The price would be around \$2,000, and a 24-inch-base cabinet would be required to hold the mechanism and the dish container. Westinghouse had a demonstrator of a consumer-type ultrasonic dishwasher about three years ago, but "it cost a small fortune to build." Although there are other manufacturers who have working models, there is as yet no breakthrough that would permit a \$300 model, or even a \$1,000 model.

There exists another problem beside cost: an ultrasonic dishwasher needs much more water to work than a conventional washer. The rinsing requires another large amount of water. And often, during rinsing, the dirt that comes off the dishes will adhere to them again.

**ELECTRONIC DIALER**—For automatic dialing of telephone numbers, Perini Electronic Corporation markets an electronic dialer to independent phone companies through the Stromberg-Carlson division of General Dynamics. The dialer will soon be market tested by AT&T.

The dialer (see p 49) has a motor-driven magnetic tape, available in three lengths, for 400, 650 or 950 listings. The number is typed or written on the front of the tape for visual indexing; the number is recorded in the form of dial pulses on the magnetic-oxide back.

To record numbers, a special dial box plugs into the rear of the dialer. A 60-cycle synchronous motor controls both this dial and the magnetic head that moves across the width of the tape.

To use the dialer, tape-drive buttons locate the alphabetic group at a speed of  $1\frac{1}{4}$  seconds per hundred lines, and a selector wheel places the desired name between guidelines. After lifting the receiver for the dial tone, the user presses the DIAL button, and the call is placed in about half the time required for manual dialing.

**SECURITY ALARMS**—A portable doppler-type alarm was introduced last month by Pinkerton Electro-Security Corporation, a subsidiary of Pinkerton's National Detective Agency. The alarm (see Fig. 1) consists of a 13 $\frac{1}{4}$ -pound detector-emitter unit about

the size of a table radio with a short vertical antenna mounted top center, an alarm unit of the same size and a key-operated control unit. The maximum range of detection is a circle 30 feet in diameter; the doughnut-shaped field pattern has a maximum vertical thickness of about 10 feet. A potentiometer in the detector unit adjusts the range. The waves will penetrate nonmetallic walls and floors, permitting protection of more than one room.

The "Radar-Eye Minuteman" alarm transmits a 401-Mc signal. A moving object returns the waves at a different frequency, activating the alarm bell. The alarm continues to sound for one minute after motion has ceased, then resets itself automatically for the next intrusion. An adjustment permits a continuous alarm until shut off.

An auxiliary battery sounds the alarm if power fails or wire is cut or disconnected. The alarm also sounds if the detector or alarm units are lifted or their covers tampered with, or if the control is tampered with.

Intrusion into an area covered by this alarm can be detected at a remote location through a beep signal. After the alarm sounds, the operator switches the receiving unit over to tracking. The character of the beeps gives some indication of the degree of activity at the scene, and can also indicate if there is more than one intruder, according to Pinkerton.

**SOUND MOVIE CAMERA**—The latest Fairchild 8-mm home sound movie camera (Fig. 2) has an f/1.8 zoom lens (10 to 30 mm) and a coupled light-meter. The power supply is a self-contained 12-volt nickel cadmium battery, recharged with a special cord that contains a transformer, rectifier and current-limiting resistor. The battery capacity, on full charge, is sufficient to pull eight 50-foot reels through the camera.

The silicon transistor amplifier is near the drive motor, so the components had to be laid out for minimum effect from magnetic radiation. Frequency response is 100 to 6,000 cps.

**ELECTRONIC TOYS**—An interesting electronic item in the toy market this year is General Electric's Astrac (automatic simultaneous train control). The Astrac system uses a high-frequency signal to con-

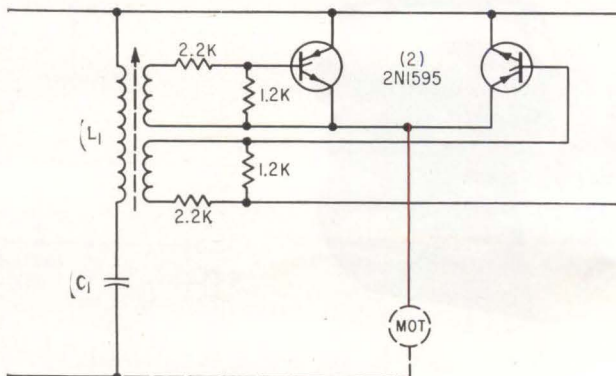
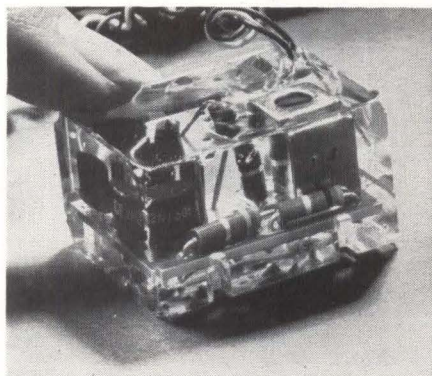

TRAIN CONTROL module and circuit, by General Electric—Fig. 3

trol train operation, and a-c track voltage to supply the power. Up to five trains can be controlled separately on one track by using receivers at different frequencies.

The receivers, encased in GE silicone rubber (see Fig. 3, left), measures  $1\frac{1}{2}$  by  $1\frac{1}{8}$  by  $\frac{3}{4}$  inch. The circuit (Fig. 3, right) features two silicon controlled rectifiers. The scr's change the a-c track voltage to d-c to power the motor. The receiver is usually installed in the tenders of steam engines, and directly in diesels. The input wires are connected to the left and right pickup wheels.

Coil  $L_1$  and capacitor  $C_1$  form a tuned circuit that separates the high-frequency signals from the a-c track voltage. The signal is fed to the gate cathode of the scr to turn it on. The polarity of the r-f signal determines which scr will conduct, and whether the train will go forward or reverse.

The r-f signal is not sent out continuously, but in a pulsed code, on only the positive or the negative half-cycle of the wave, so that only a half-cycle of current will be conducted by the scr into the motor. The forward-reverse switch in the transmitter determines which half of the a-c cycle the r-f will be put on.

There is a receiver for each of the five channels, at 100, 140, 180, 220 and 255 Kc. The receivers can handle up to 1.6 amperes, 15 amperes one cycle surge, and a 48-watt load at 30 volts. They operate at from 6 to 30 volts a-c, 25 to 60 cycles.

The transmitter is wired to the track in parallel with the transformer. The dual-control transmitter (see p 47) is available in two models: one for channels 1 and 5, the other for channels 2 and 4, with separate forward-reverse switches. A five-channel transmitter permits control of any one of five trains. For simultaneous control of five trains, two dual-control transmitters would be required, plus a five-channel model for controlling channel 3.

The Astrac system eliminates jackrabbit starts and provides realistic starting and creeping, according to GE. The power available at low speeds permits pulling two stalled engines up a 5-percent grade at creep speed.

**HEARING AIDS**—A transistor hearing aid small enough to fit in less than half an aspirin tin (see photo) was recently announced by the Acousticon division of Dictograph. The amplifier assembly, containing 13 components, is shown on top of an aspirin tablet. The silver-oxide battery, developed for Acousticon by Eveready, powers the  $\frac{1}{8}$ -ounce hearing aid for over 40 hours.

The amplifier consists of three transistors, a thermistor and several capacitors mounted on a ceramic substrate, upon which resistors and conductive elements have been vacuum-deposited. The amplifier, completely encased in silicon rubber, has an average gain of 93 db.

The volume control can be seen in the upper right corner of the aspirin tin, and below it the hinged door of the battery compartment, which, when opened slightly, turns off the hearing aid.

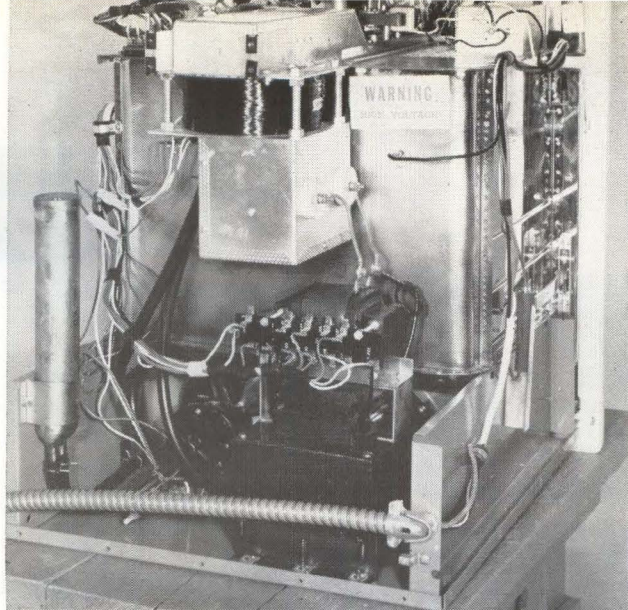

ELECTRONIC RANGE, rear view with covers removed, by Tappan. Top rear units are waveguide, field coil and r-f filter housing



ELECTRONIC DIALER, with dial box for recording numbers on magnetic dialer tape, by Perini Electronic Corporation



HEARING AID with an amplifier smaller than an aspirin tablet, by Acousticon

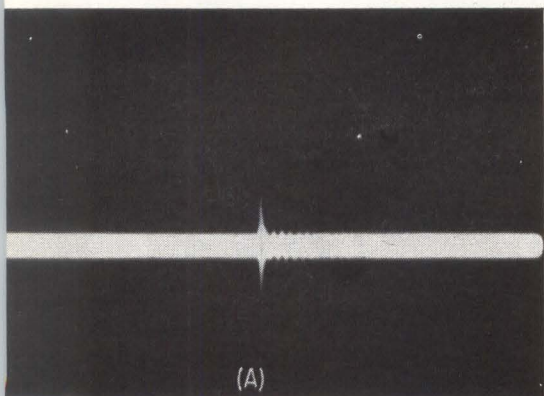

(A)

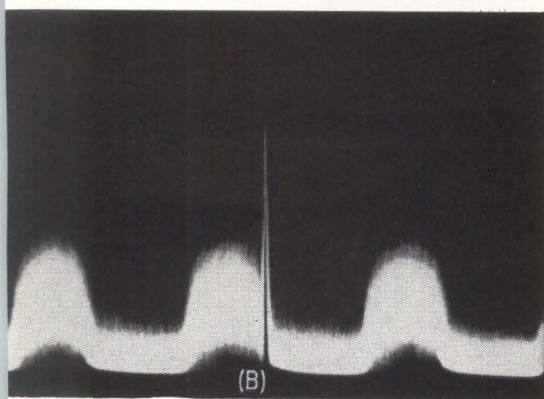

(B)

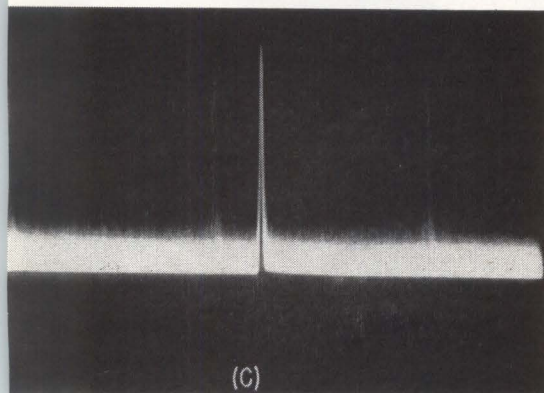

(C)

**RADAR INTERFERENCE** as it appears on an A-scope presentation. Effect of a c-w signal (A), effect of swept-frequency jamming (B), and the effect of nonsynchronous pulse interference (C)—Fig. 1

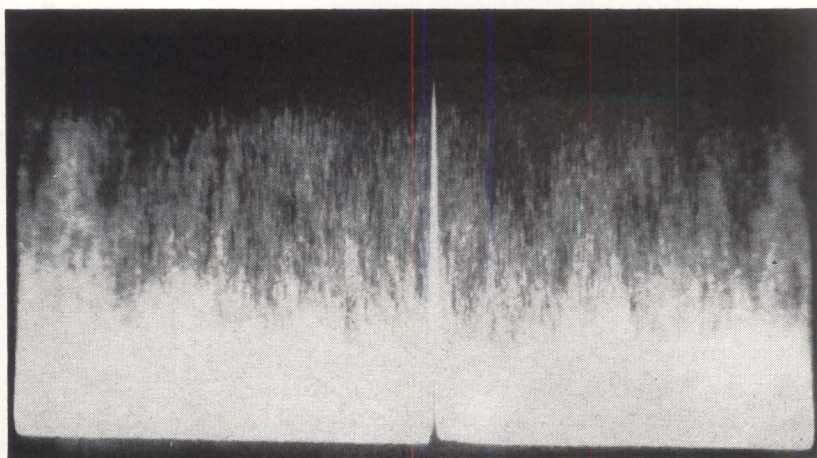

**NOISE JAMMING** may saturate the video portion of the receiver making the desired signal barely discernible—Fig. 2

## Designing Radar

*Same aspects of receiver design, often*

By JOHN C. GALENIAN, U. S. Army Electronic

**RADAR TRANSMITTERS** radiate energy over a wide range of frequencies, above and below the nominal operating frequency. This energy may be received by an adjacent radar set because of the large power output of the transmitter and the sensitivity of the victim receiver. Adjacent radar sets interfere with each other even though they operate on different frequency bands. This interference, often called "rabbits", appears as random pulses moving across an A-scope or as a series of moving bright dots on a ppi or B-scope. The tendency of the rabbits to move will depend on the degree to which the pulse repetition frequency (prf) of the interfering radar is similar to that of the victim radar. If the two prf's are identical, then the interfering pulse will remain stationary on the indicator and may have the appearance of a legitimate target echo. This type of interference is not too troublesome to an A-scope indicator but may cause a confusing display on a ppi or B-scope display.

In addition to interference caused by the radar transmitter, the modulator generates large amounts of radiated energy over a wide range of frequencies. This also may cause interference to nearby radar and communications equipment.

Intentional interference or jamming may take many widely differing forms. The simplest form of jamming consists of an unmodulated carrier wave at the operating frequency of the radar set. This is continuous-wave (c-w) jamming as shown in Fig. 1A. The carrier may be amplitude modulated with random noise, or other waveforms. This is termed

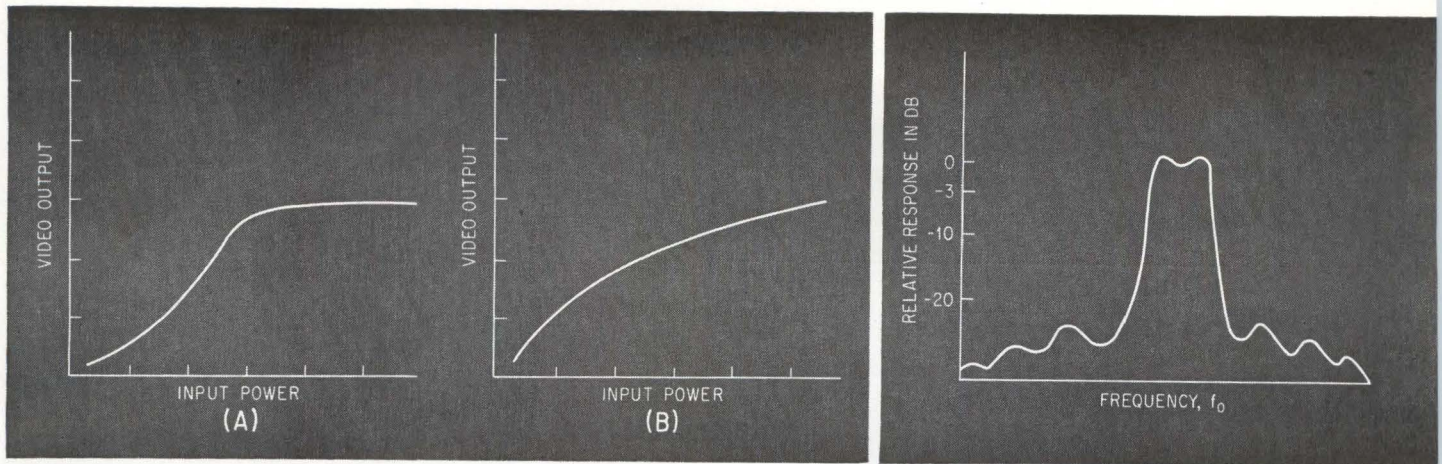

INPUT versus output characteristic of normal receiver (A) and receiver using a log *i-f* amplifier (B) show how a large dynamic range may be obtained—Fig. 3

RESPONSE curve of a typical receiver in which undesired responses are down 20 to 40 db—Fig. 4

# Receivers To Overcome Jamming

*overlooked, that will reduce susceptibility to jamming and other interference*

Research and Development Laboratory, Fort Monmouth, New Jersey

amplitude-modulated c-w (amcw) jamming.

The carrier frequency may be varied in step with a sawtooth or other waveform. This is f-m or swept-frequency jamming, Fig. 1B. The carrier may be pulsed on and off with pulses that may be either synchronized or not synchronized with the radar prf. This is known as pulse jamming. Nonsynchronous pulse interference is shown in Fig. 1C.

A jammer may receive the radar's transmitted pulse and re-transmit one or more replicas of it back to the radar. The jamming pulses may appear to be legitimate target echoes on the radar indicators and may cause confusion as to the number and location of true targets. This is known as repeater jamming. Passive reflectors, such as strips of aluminum foil or chaff, may also cause spurious targets to appear on the radar indicators.

Atmospheric phenomena, such as lightning and aurora borealis, spark type interference from nearby rotating machinery, engines, generators, neon signs and the like may also enter the radar receiver.

**RECEIVER CHARACTERISTICS**—Undesired signals may affect the radar receiver in several respects. The undesired signal may cause saturation or overload of the receiver, masking or hiding of desired signals or blocking of the receiver. The undesired signal may, effectively, be lengthened in its time dimension by the impulse response of the receiver. Spurious signals may appear in the output of the receiver.

In general, the ability of the undesired signal to

cause saturation will be determined by the pulse gain characteristics of the receiver. Its ability to mask the desired signal will be determined by the selectivity of the receiver, its impulse response, linearity, stability and the presence of any special video processing circuits or filters. The tendency of the undesired signal to cause blocking of the receiver will be determined by the recovery time characteristic of the receiver. The tendency of the receiver to lengthen the time duration of the interfering signal will be determined by the impulse response and recovery time of the receiver. The tendency of the interfering signals to cause spurious signals to appear in the output of the receiver will be determined by the selectivity of the receiver and the presence of special video-processing circuits in the receiver.

**PULSE GAIN**—The pulse gain, or input versus output, characteristics of a receiver have a major effect on its susceptibility to interference. Generally, a large dynamic range and good linearity of response tend to reduce this susceptibility.

The *i-f* and video dynamic ranges of a receiver may be different and will have different effects on susceptibility. For example, the c-w or carrier component of jamming signals may cause saturation or overload of the *i-f* amplifier. This will result in the suppression of desired target echoes and receiver noise. The c-w signal itself will cause a d-c voltage to appear at the output of the receiver's second detector. This d-c voltage will be blocked by the usual coupling capacitor between the second detector and the video

amplifier. Thus, a large c-w signal can cause a decrease in the video output of the receiver and a suppression of desired signals.

Output video dynamic range is usually restricted to 10 or 15 db so as to accommodate the characteristics of the radar indicators. Noise, Fig. 2, or other

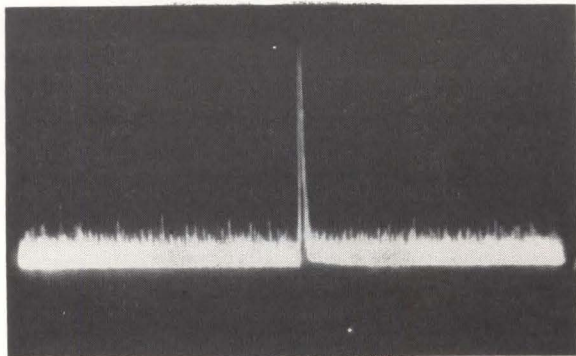

### THE JAMMING PROBLEM AND WHAT TO DO ABOUT IT

This is a normal radar video presentation on an A-scope. The object of the following check list is to enable you to get a picture that looks like this as often as possible and under most conditions

#### Antenna

Side and back lobes should be 25-40 db down from main lobe

#### R-F Section

Image rejection should be 20 db or more

#### I-F Amplifier

Input dynamic range is 40 to 80 db

Bandwidth is 1.2 to 2.0 times the reciprocal of pulse width

Spurious responses should be more than 40 db down

Recovery time is less than the pulse width

Free from oscillation in the presence of both pulse and c-w signals

Capable of accommodating input signals with a 100 percent duty cycle without damage to components

#### Automatic Gain Control

Free from oscillation in the presence of signals, with frequencies of d-c up to  $\frac{1}{2}$  the i-f bandwidth, at the input to the agc loop

Agc voltage is proportional to both pulsed and c-w r-f signal amplitude

#### System Trigger Generator

Variation in inter-pulse interval (jitter) should not increase with high-level c-w and noise signals present at the receiver input terminals

jamming modulation, may saturate the video portion of the receiver if the received jamming power is as little as 10 or 15 db above the minimum discernible signal level. Desired signals may not be discernible even though they may be greater in amplitude than the jamming signal and may be present in the output of the receiver's i-f amplifier.

Cross-modulation products may be generated in the receiver by interaction of the jamming signal with the desired signal and the receiver local oscillator. These cross-modulation products will tend to mask the desired signal. The formation of the cross-modulation products will be minimized by a linear pulse gain characteristic.

A large dynamic range may be desirable from a performance viewpoint as well as from a susceptibility viewpoint. Several methods are commonly employed, and these tend to improve the susceptibility of the receiver as well as its normal operating characteristics, although there are several pitfalls.

Automatic gain control (agc) is sometimes employed to adjust receiver gain and avoid saturation by strong signals. The receiver dynamic range may be extended from a typical value of 20 db without agc to 60 to 100 db with agc. Unfortunately, most agc circuits are a-c coupled and will not pass d-c produced by a c-w signal at the output of the second detector. The amplitude of the c-w signal will, then, be ineffective in controlling the receiver gain, and the agc will not prevent saturation. In fact, the agc may make matters worse. The c-w will cause suppression, or a decrease in amplitude, of the desired signal. This decrease will be sensed by the agc circuit which will then increase the receiver gain in an attempt to maintain the signal at a constant level. The increase in receiver gain will hasten saturation, but a reduction in gain would have avoided saturation. Direct coupling should be used throughout the agc loop so that jamming signals as well as the desired signal will control receiver gain and saturation will be avoided.

Another difficulty with agc is oscillation of the agc loop. Jamming modulation or cross-modulation products formed in the receiver may occur at frequencies where oscillation will be supported by the agc loop. The agc voltage will fluctuate and cause receiver gain to change in a random manner. These loops should be designed to be stable in the presence of a wide range of signal frequencies.

A second method of obtaining a large dynamic range is by the use of a logarithmic or linear-logarithmic i-f amplifier, where output is proportional to the logarithm of the input as shown in Fig. 3. These amplifiers allow a large input dynamic range to be compressed to a small dynamic range compatible with the requirements of the radar indicators. The difficulties that may be encountered in the design of agc circuits are avoided, since gain is maintained constant.

From a susceptibility viewpoint, the large dynamic range of the log i-f amplifier is desirable, but the decrease in incremental gain at the higher input power levels may cause desired signals to be suppressed to below the usable amplitude by c-w jam-

ming even though complete saturation is avoided. The nonlinear pulse gain characteristic may also increase generation of cross-modulation products in the presence of jamming.

A third method, and perhaps the most desirable from a susceptibility viewpoint, is the use of a second detector capable of operating at a low i-f voltage, and high-power output tubes or transistors as i-f amplifiers. This combination of a low minimum detectable signal voltage and a large output voltage capability results in a large input and output dynamic range. This is desirable because a linear response may be attained with the large dynamic range, and possible difficulties with age circuits avoided.

**SELECTIVITY**—Noise, or other undesired signal modulation may cause masking or hiding of desired signals. As a general rule, random noise is more effective than other waveforms in masking the desired signal.

The most efficient means of avoiding the masking of desired signals by undesired ones is to keep the two signals separated in the receiving process. In other words, good receiver selectivity is desirable. Receiver selectivity may be divided into three categories, frequency selectivity, spatial selectivity and time-domain selectivity.

**FREQUENCY SELECTIVITY**—Frequency selectivity of a receiver determines the extent to which it will respond to signals at frequencies other than the radar system's operating frequency. Ideally, the radar receiver's response curve should exactly match the spectrum of the radar's transmitted pulse.

Care should be taken to insure that undesired responses at the lower portion of the receiver's frequency response curve (20 to 40 db down points) are not present as in Fig 4. These unwanted responses or spurious responses will allow off-frequency undesired signals to enter the receiver. These responses may be more troublesome than expected because one-way transmission of undesired signals give them an advantage over desired signals which must follow a two-way path. High levels of undesired signals may still be received. Spurious responses will also cause wider video pulses to result from the passage of a swept-frequency jammer through the receiver pass-band. The receiver video output will increase and decrease in step with the frequency of the jammer. A replica of the receiver response curve (a pulse-like signal) will appear in the video output of the receiver. The width of the video pulse will be  $T = B/S$ , where  $T$  = width of video output pulse in  $\mu\text{sec}$ ;  $S$  = jammer sweep speed in Mc per  $\mu\text{sec}$ ;  $B$  = receiver bandwidth in Mc. Thus, the width of the induced jamming pulse is proportional to receiver bandwidth and inversely proportional to jammer sweep speed. If receiver bandwidth is unnecessarily wide, then the effective duty cycle of the jammer will be increased and the jamming signal will be more effective in masking desired signals. The duty cycle of the jammer is the time the jammer is in the receiver pass-band divided by the jammer's repetition

period, or the ratio of the receiver bandwidth to the jammer's sweep width.

The minimum width of the induced jamming pulse is approximately equal to the inverse of the receiver bandwidth. This minimum width is the impulse response time of the receiver.

The receiver may respond to undesired signals at the receiver's image frequency. The image frequency allows undesired signals from two parts of the frequency spectrum to enter the receiver, thereby increasing the amplitude of undesired signals. Image frequency response also causes twice as many induced pulses to be generated by swept-frequency jamming signals than would be the case if image response were not present.

A good image-rejection ratio is desirable to minimize the amount of interference that enters the receiver. Image-rejection ratios of 20 to 40 db may be obtained by the use of r-f filters or preselectors in the r-f portion of the radar receiver.

**SPATIAL SELECTIVITY**—Ideally, a radar system transmits and receives energy only along the axis

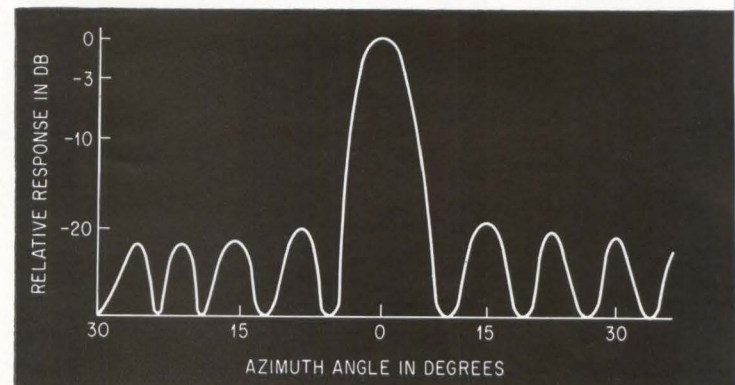

ANTENNA pattern with minor lobes that may result in reception of undesired signals off the main antenna—Fig. 5

of the radar antenna's main-beam response. Unfortunately, all antennas have a number of minor lobes in their beam patterns, Fig. 5.

The minor lobes allow undesired signals from sources at directions other than the direction of the main lobe to enter the receiver. Minor lobe responses are usually about 20 db down from main-lobe response. However, due to one-way transmission of the undesired signals, there may be sufficient amplitude to affect the reception of desired signals.

A minor-lobe response of 20 db down is adequate for normal radar operation. Energy from targets in the direction of the minor lobe will be 40 db down from the main-lobe response, since both the transmitted energy and the received energy will be attenuated by 20 db. Each reduction in side-lobe amplitude of 3 db will have the same effect as halving the jammer's transmitter power.

**TIME-DOMAIN SELECTIVITY**—The ability of the receiver to discriminate against signals having pulse

lengths and prf's different from those of the radar transmitter will decrease its susceptibility to undesired signals.

Filters, including the matched-filter radar systems, will reject signals of longer duration than the desired signal. An example is the highpass filter or the fast time constant (ftc) circuit. A simple version of this circuit is an  $R-C$  coupling network with a time-constant slightly greater than that of the transmitter pulse. Signals of longer duration, such as ground clutter or low-frequency jamming modulation components, will be attenuated by the ftc circuit. Video processing circuits, such as video integrators or interference blankers will reject signals whose repetition frequency is not identical to that of the radar transmitter.

**RECOVERY TIME**—The time required for the receiver to regain normal sensitivity following the re-

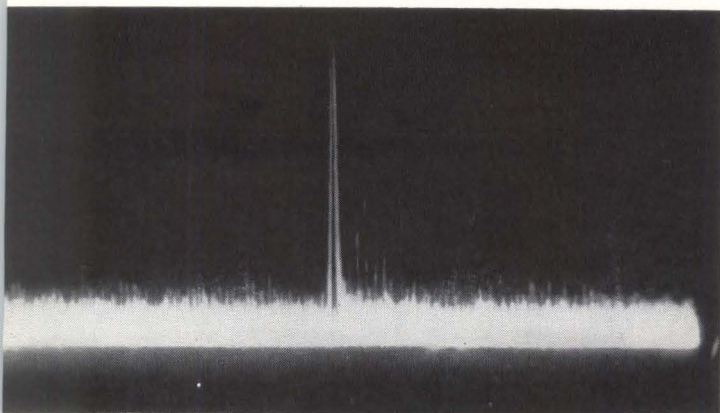

UNSTABLE operation caused by unstable trigger—*Fig. 6*

ception of a long-duration signal of high amplitude, recovery time, is proportional to the time constants in the receiver. For example, coupling capacitors in the i-f or video amplifiers may be charged, during the reception of a strong signal, by the grid (or base) current of the associated amplifier stage. When the signal has ceased, the capacitors will remain charged until they have had time to discharge through the grid (or base) network to ground. During the discharge period, a negative voltage will appear at the grid of a tube-type amplifier. This reduces stage gain until the capacitor has discharged.

A rapid discharge path should be provided for coupling capacitors. The inductive portion of the interstage coupling network should be placed on the grid (or base) side of the coupling capacitor to provide a low d-c resistance path for the discharge. High-resistance bias networks should be avoided. The tendency to use very large coupling capacitors in transistor i-f and video amplifiers should be minimized. Storage-time characteristics should be considered in the selection of transistor i-f amplifiers.

**STABILITY**—A receiver may tend to oscillate in the presence of undesired signals, even though the

i-f is free from oscillation with no jamming present. Oscillation may occur because the c-w signal is of longer duration than the desired signals, and normal damping of oscillations is prevented. The c-w signal may also move the operating point of the i-f amplifier to a region of inherent instability where oscillation may occur. The receiver should be tested for the presence of undesired oscillation both with and without c-w jamming present.

Possible corrective measures include selecting dimensions of the i-f amplifier chassis so that waveguide propagation of signal energy from the output of the amplifier to its input cannot occur, interstage decoupling, power supply filtering, shielding and stable agc circuits.

Among other factors that may affect the susceptibility of the receiver, is the presence of long-duration signals such as c-w jamming. These may exceed the designed duty factor of the receiver. Larger-than-normal values of power will be dissipated in the amplifier stages.

Power ratings of some of the tubes, transistors or resistors in the i-f amplifier may be exceeded and component failure may occur. Components in i-f amplifiers should be rated for a 100 percent duty cycle.

Crystal diodes in the receiver mixer are also subject to burnout by strong signals. Crystals should have the highest burnout power rating obtainable and should be protected by limiters or other means. The usual TR tube provides no protection to the crystals except during the firing time of the transmitter.

The minimum time duration of the output signal of the receiver, with a signal of shorter duration than the transmitter pulse present at its input, is approximately equal to the reciprocal of the 3 db bandwidth of the receiver. This is also known as the impulse response time of the receiver. For example, the shortest pulse that can be reproduced by a receiver with a bandwidth of 1 Mc is a 1  $\mu$ sec pulse. Pulses shorter than 1  $\mu$ sec at the receiver's input will appear as 1  $\mu$ sec pulses, reduced in amplitude, at the output. Thus, the effective time-duration of short-duration undesired signals will be increased as will their effectiveness in masking desired signals from being adequately received.

As a result, impulse response time, including transient responses, of the receiver should be as short as possible.

Undesired signals may be coupled, by the power supply, stray coupling paths or a number of other means, to the trigger pulse generator of the radar system. The trigger generator may then be triggered by the undesired signals and unstable operation of the complete system as shown in Fig. 6, or even non-operation, may result. This effect is most likely to occur in moving-target indication (MTI) systems, where a recirculating trigger is employed. The effect may not occur under normal operating conditions, but may occur in the presence of interference because of the higher-than-normal signal levels that are involved.



# MAXIMUM RELIABILITY



Provided by photochopper in this completely solid state  
**DC AMPLIFIER**  
for only \$395!

**Photoconductive chopper, all-transistor circuitry permit reliable low-level measurements with the wide-band, high-gain DY-2460A.**

Here's a completely solid state high-gain DC amplifier for only \$395. Exceptional reliability is achieved on low-level measurements with a specially designed photoconductive chopper and all-transistor circuitry.

The DY-2460A will supply an output of  $\pm 10$  v peak at 10 ma. Zero drift is less than  $1 \mu\text{v}$  per week, noise less than  $4 \mu\text{v}$  peak to peak. Fast settling time (as little as  $25 \mu\text{s}$  to 0.01%) and rapid overload recovery (only  $20 \mu\text{s}$ , plus settling time) make the amplifier ideal for systems use.

Long life is assured for the DY-2460A because of advanced solid state design. The photo chopper is unaffected by external vibration and is inherently a long-life device. Power consumption is only 4 watts, so that heat problems are non-existent.

Plug-in versatility is offered in the DY-2460A, with interchangeable plug-ins available for systems use (5 fixed gains, 10 to 1000); bench use (fixed gain in decade steps 1 through 1000); for special individual situations (patch panel brings input, output, summing point and feedback circuit to the front panel), and plus-one amplifier uses (input resistance greater than  $10^{10}$  ohm, high gain accuracy).

**PRICE:** DY-2460A Amplifier, \$395.00. DY-2461A-M1 Data Systems Plug-in, \$85.00. DY-2461A-M2 Bench-use Plug-in, \$125.00. DY-2461A-M3 Patch Unit Plug-in, \$75.00. DY-2461A-M4 Plus-one Gain Plug-in, \$35.00.

Write or call today for complete details and specifications.

*Data subject to change without notice. Prices f.o.b. factory.*



Major circuits of the DY-2460A are mounted on three plug-in etched circuit boards, which swing out for easy access. Sides, top and bottom are easily removed for servicing.

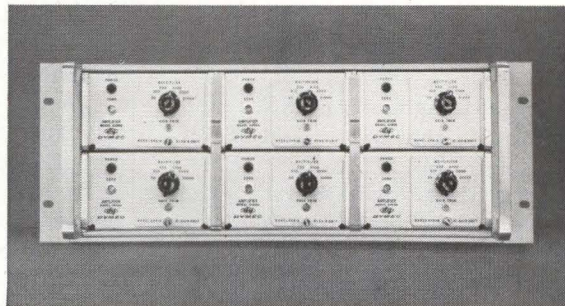

A combining case accommodates up to six amplifiers, can be used on the bench or mounted in standard rack with adapters furnished. Combining case C-146B-2, \$200.00.

## DYMEC

A Division of Hewlett-Packard Company

Dept. E-517 395 Page Mill Road, Palo Alto, Calif. Tel. (415) 326-1755 • TWX, 415-492-9363



# National Magnet Lab Pushes for 250 Kgauss

*MIT researchers pinpoint diode laser mechanism in solid-state experiment*

By THOMAS MAGUIRE  
New England Editor

**CAMBRIDGE, MASS.**—Solid state researchers acquired a powerful new citadel here with the dedication of the Air Force-sponsored National Magnet Laboratory.

Although located adjacent to MIT, the laboratory is a national center for research in high magnetic fields and their effects on materials—the only laboratory of its kind in the world.

The \$6 million to build and equip the center was provided by the AF Office of Scientific Research, which will also make available about \$2 million per year to support research at NML by scientists from this country and abroad.

NML's crowning glory yet to be reached is the attainment of a record-breaking field of 250,000 gauss. MIT scientists who manage the laboratory expect to achieve this field in the next couple of months with a specially designed solenoid (ELECTRONICS, p. 24, Dec. 1, 1961).

Henry H. Kolm of the NML staff generated a continuous field of 126 kilogauss two years ago (ELECTRONICS, p. 24, April 28, 1961), but subsequently a field of 160 kilogauss was reached at the Radar Research Establishment in England.

**CONTINUOUS 200 KGAUSS**—To generate the target field of 250 kilogauss, NML has at hand two motor-generator units to produce 10 megawatts of d-c power, all of which will be channeled to the one specially designed magnet. This could produce 250 Kg for about one minute, or 200 Kg "really continuous." By tapping power stored in two 85-ton steel flywheels (one coupled to each motor generator unit), it will be able to

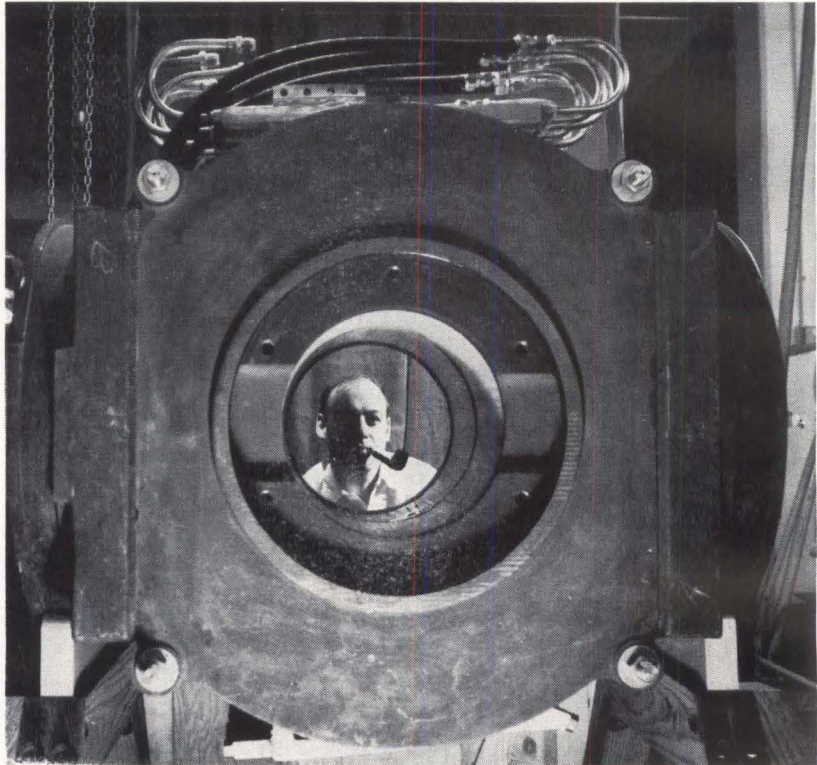

WORLD'S MOST POWERFUL magnet will be the 3-ton, 250,000-gauss unit shown here being inspected by D. Bruce Montgomery of Air Force's new National Magnet Laboratory

supply 32 megawatts of d-c for a few seconds. This full surge passed through a single magnet now being designed could produce a pulsed magnetic field of more than 400 kilogauss for a duration of the order of 2 seconds.

To dissipate the tremendous heat involved in power of this magnitude, the NML has a water-cooling system that can pull as much as 15,000 gallons of water per minute out of the nearby Charles River.

**SOLID-STATE WORK** — Heavy emphasis at NML will be on solid-state experiments, some of which have been waiting for the availability of just the type of capability in magnetic field intensity that this center has.

First experiment in what promises to be a long line of history-making tests was a study of the

emission from a gallium arsenide laser diode to help determine the mechanism of radiation. The diode was placed in the core of a Bitter solenoid and subjected to infrared probes while the magnetic field was varied from zero to 108 kilogauss. Changes were measured in the reflectivity of ir on the sample as the magnetic field changed. According to NML scientists, results so far indicate that the radiation comes from impurity atoms which allow transitions normally forbidden in their absence.

The solid state physics program at NML will also include studies of Faraday rotation in semiconductors, magneto-plasma effects, Zeeman effects in solids, magnetic properties of antiferromagnetics, Mossbauer effect, superconductivity, atomic spectroscopy, mm and sub-mm wave generation, and

can you use the advantages of Kepco's  
**AUTOMATIC VOLTAGE-CURRENT CROSSOVER**

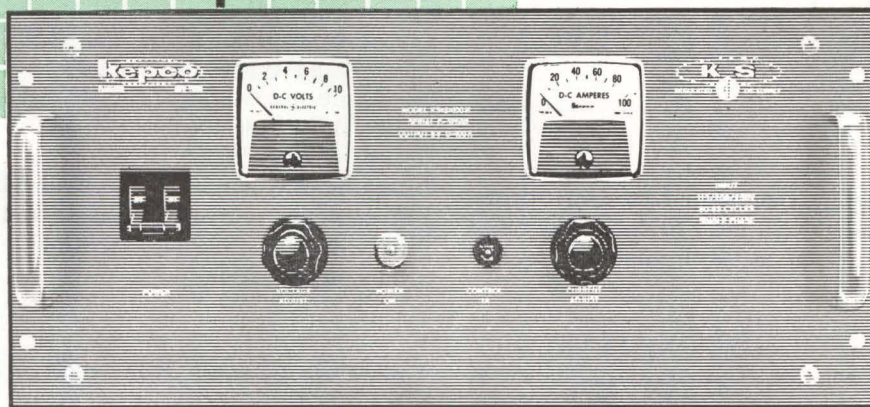
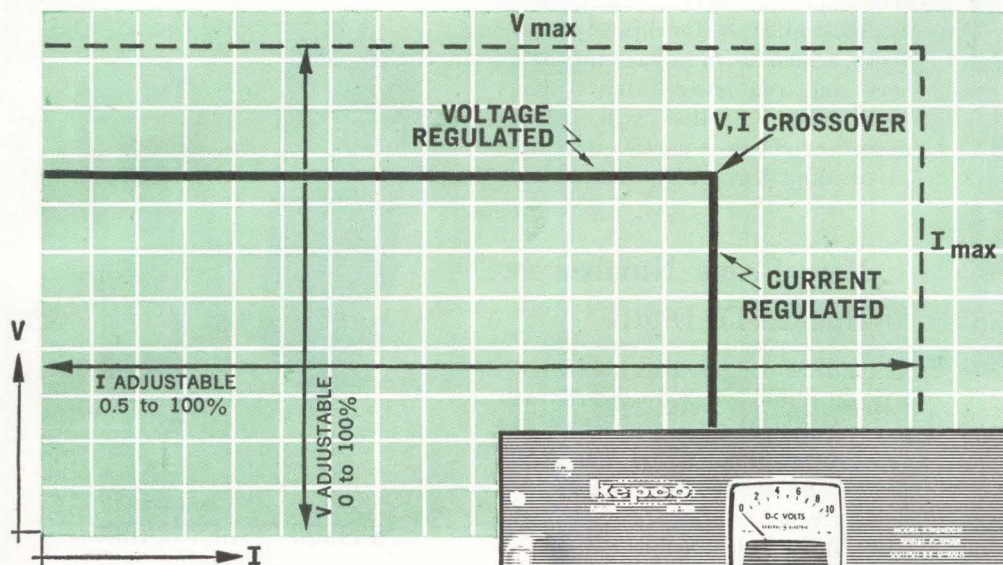

**KEPCO**  **POWER SUPPLIES**

**Automatic Voltage-Current Crossover** is the characteristic of a power supply that automatically changes the method of regulation from *constant-voltage* to *constant-current* (or vice-versa), as dictated by varying load conditions. The constant-voltage and constant-current levels can be independently adjusted within their specified voltage and current limits. The intersection of the constant-voltage and constant-current lines is called the crossover point (V,I, as shown in the graph above), and may be located anywhere within the volt-ampere range.

Kepco's KS Group of HIGH-POWER, highly regulated DC power supplies provides two panel control

knobs that allow *automatic crossover* to be set from less than 0.5% to 100% of rated current and 0 to 100% of rated voltage.

- Programming of output voltage
- Programming of output current
- Remote error signal sensing
- High resolution adjustment
- No voltage overshoot

0.01% REGULATION and STABILITY	MODEL	DC OUTPUT RANGE		PRICE
		VOLTS	AMPS	
	KS 8—100M	0—8	100	\$1,395
	KS 18—50M	0—18	50	\$1,295
	KS 36—30M	0—36	30	\$1,195
	KS 60—20M	0—60	20	\$1,295

for complete specifications on more than 250 standard models, write for NEW Catalog B-631



131-38 SANFORD AVENUE • FLUSHING 52, N.Y., U.S.A.  
 N.Y. Phone (212) IN 1-7000 • TWX# (212) 539-6623  
 Cable Address: KEPPOWER NEWYORK

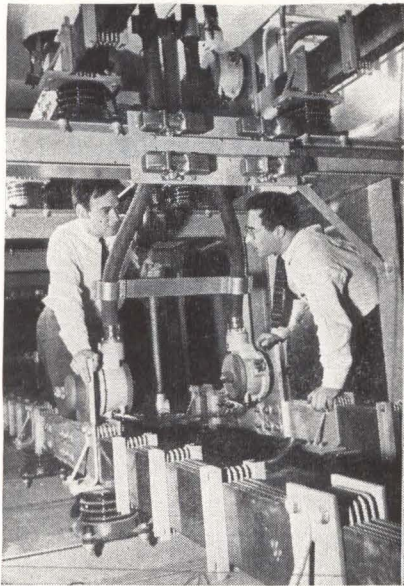

MAGNETIC EXPERIMENTS will be conducted at the National Magnet Laboratory; shown here are busses and switching equipment for energizing the huge solenoids, with staff members H. H. Kolm and D. B. Montgomery

MHD. Benjamin Lax, NML director, is also head of the Solid State Division at MIT Lincoln Laboratory.

**NOT SUPERCONDUCTING** — When the NML was established in temporary quarters at MIT in 1960, it was decided that a water-cooled, room-temperature system would be superior to superconducting magnets for the purposes in mind. Since then, progress in achieving high fields from superconducting magnets has slowed down, with the present limit at about 80 kilogauss. "Another breakthrough is needed in the superconducting magnet field, but it is not in sight," says Donald T. Stevenson, NML assistant director. At NML, superconducting magnets will be used to smooth out spatial characteristics of some of the larger magnets, and work will be continued on studies of superconductivity, but none of the 10 magnet locations or experiment stations in the NML will be set aside for work with superconducting magnets.

Cooperative programs with other laboratories and agencies will include work in the effects of high magnetic fields on living systems. This is of special interest to NASA, which is studying the value of magnetic fields in shielding space ex-

plorers and their vehicles from cosmic radiation by deflecting charged particles.

The NML will also be used for geophysical studies. Prof. Francis Bitter, pioneer in magnet research and design and now professor of geophysics at MIT, will conduct model studies of the upper atmosphere, scaled down in vacuum chambers and requiring intense magnetic fields. Studies will include models of charged particle streams, aurora and Van Allen radiation.

### New Prime Number Has 2,917 Digits

ILLIAC II, a computer at the University of Illinois, has discovered and proved a new prime number, the largest yet known. It has 2,917 digits and typewritten solidly fills a single-spaced page. Mathematically it is described as "2, multiplied by itself 9,689 times, less 1." Proving the number took Illiac II 85 minutes, during which it did three-quarter billion multiplications and additions.

### Organic Laser Research Project at Brooklyn Poly

RESEARCH INTO organic materials for optical continuous masers will be conducted at Brooklyn Polytechnic Institute under a one-year, \$70,967 contract awarded by the Office of Naval Research.

Goal of the project is to develop continuous-wave room-temperature lasers with low pumping power. Prof. G. Oster of the Institute's Chemistry Department told ELECTRONICS that this may lead to fabrication of organic lasers tailored for any desired wavelength.

In particular, research will be concentrated on luminescent dyes and other aromatic organic luminescent materials dissolved in a wide variety of matrices, including organic glasses and plastics, and inorganic glasses. Especially promising, according to Professor Oster, are aromatic fused-ring polycarbonates, because of their hardness and optical clarity.

The investigation will be concerned essentially with the determination of the luminescence char-

## Have you evaluated OHMITE? DIODES?

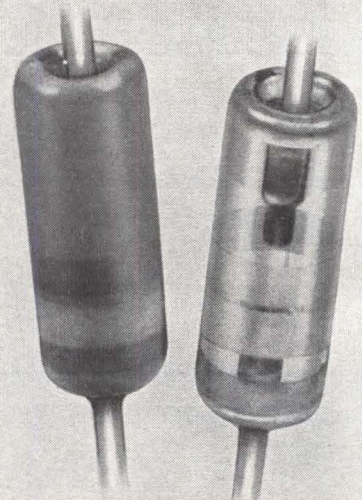

SILICON      Gold Bonded  
GERMANIUM  
(Subminiature Glass Envelopes Enlarged)

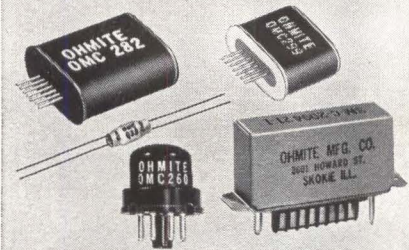

**You may be in for a surprise!**  
**Users report considerably lower reject rates. The reason? Close control over manufacturing, typical of all Ohmite components. Price and delivery? Competitive! Why not try these superior diodes? Available from factory stock and electronic distributors.**

#### BRING YOUR DIODE DATA UP TO DATE

Germanium:  
Catalog (No. 801)  
Stock Price List (No. SR819)  
Interchangeability Tables  
(No. 803)

Silicon:  
Catalog (No. 804)



**OHMITE**  
MANUFACTURING COMPANY  
3610 Howard Street, Skokie, Illinois  
Phone: (312) ORchard 5-2600

# World's Largest Selection

SIZES • VALUES • STOCK UNITS • SPECIAL FEATURES

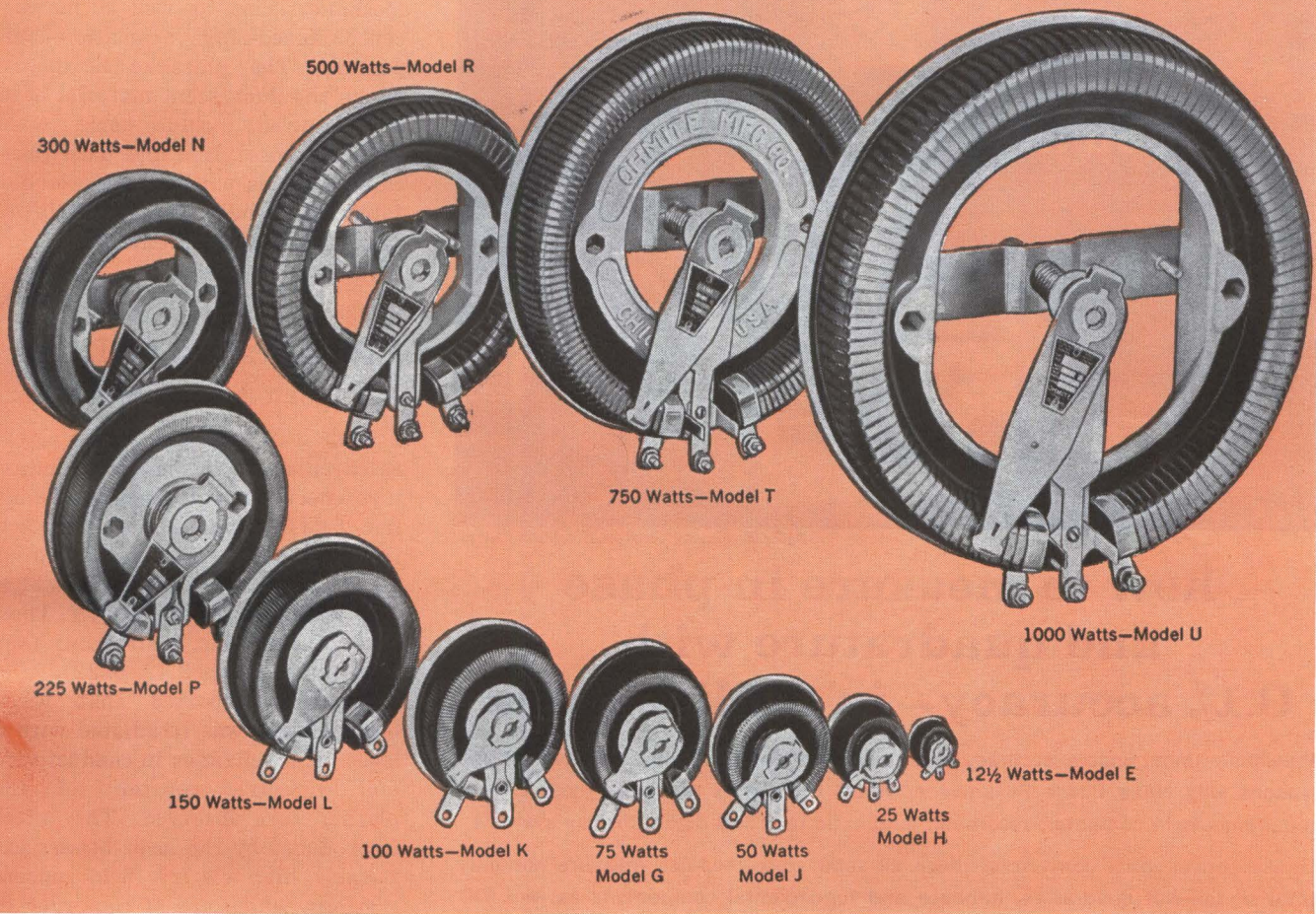

**OHMITE** offers the largest and most varied assortment of power rheostats ever developed.

You can choose from 413 stock commercial sizes and types ranging from 12½ to 1000 watts . . . or from over 400 stock MIL-R-22A sizes and values, with "special fast delivery" on all other MIL units. You can find, for example, scores of different shaft styles, sizes, configurations—already engineered and waiting. Literally, hundreds of other special features take care of any rheostat application envisioned today.

But Ohmite rheostats give you more than just "largest selection." Ohmite wire-wound units of all ceramic and metal construction represent the highest degree of operational reliability ever attained in rheostats. They bring you the backup of industry's greatest reservoir of engineering talent in rheostat design and application.

Because of this, you find more Ohmite units in use than all other makes combined. On your next project calling for rheostats, make your selection from the smooth, close control units preferred throughout industry.

Stocked by the Factory and Electronic Distributors Everywhere

## OHMITE RHEOSTATS

**OHMITE MANUFACTURING COMPANY**  
3610 Howard Street, Skokie, Illinois



Rheostats  
Power Resistors  
Precision Resistors  
Variable Transformers  
Tantalum Capacitors  
Tap Switches  
Relays  
R.F. Chokes  
Semiconductor Diodes

**Ron  
Schubert  
can  
show  
you ...**

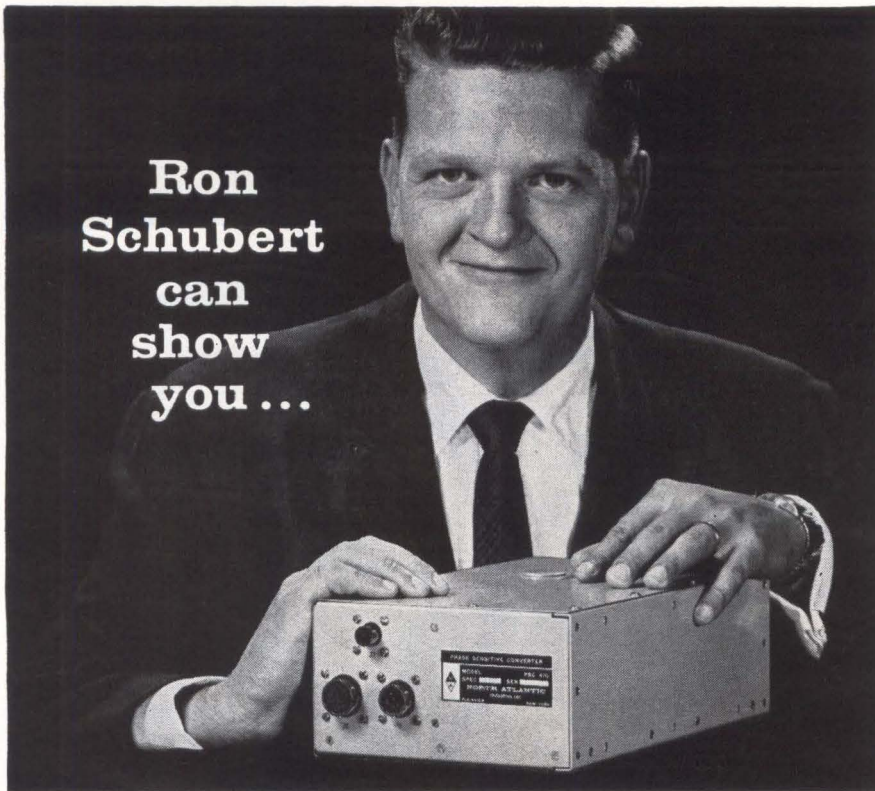

*Sales Engineer, Carlson Electronic Sales*

## how to measure in-phase and quadrature with 0.1% accuracy—in milliseconds

Previously unobtainable accuracy and millisecond response are only two of the reasons why NAI's Phase Sensitive AC-to-DC Converters meet the most critical requirements in computer, recording, automatic test and digital display systems.

Unlike conventional converters, these all solid state modules measure **not only total signal—but quadrature, in-phase and fundamental components as well.** DC output is proportional to selected input component, yet unaffected by harmonics. A wide range of manual and relay-actuated models permits selection and programming of function, range and frequency to suit test or system requirements.

Specifications of relay-programmed models are given in the table. Data on manually switched models PSC-415 and -416 upon request.

	PSC-410/411	PSC-420/421
Voltage Range	(410 & 420) (411 & 421)	1 v f.s. to 300 v f.s., 4 ranges 10 mv f.s. to 300 v f.s., 6 ranges
Frequency Range	(phase sens.) (total volts)	1 frequency* 3 frequencies*
Linearity	60 cps—20 kc	60 cps—20 kc
Functions	0.1% f.s.	0.1% f.s.
Output Voltage	E+, E f, Ein and Eq	
Input Impedance	0-10 v dc, into 10 k load, for all functions	
Response Time	1 megohm	1 megohm
	0.1 sec	

*\*any frequency between 60cps and 10kc.*

The North Atlantic man in your area can quickly show you how the PSC-410 and -420 simplify AC measurement jobs from GSE to production test of transducers, networks and amplifiers. Call today for his name, or request Bulletin PSC-1.



**NORTH ATLANTIC industries, inc.**  
TERMINAL DRIVE, PLAINVIEW, L. I., NEW YORK • OVerbrook 1-8600

acteristics, such as quantum efficiency, spectra, and lifetime of phosphorescence. Also to be determined are the absorption spectra under strong illumination.

Substances to be examined include many fluorescent dyes, members of the xanthene and triphenyl methane series, as well as fluorescence fused-ring aromatic compounds. The glasslike media in which the fluorescent material is to be dissolved include boric oxide glass, glucose glass and hard plastics. Methods will be developed for fabricating the glasses for incorporation in an interferometer.

## Biological Use for Lasers Reported at Meeting

LASERS MAY FIND USE in biological research or in the chemical industry where their high-energy electric fields would be used for such things as polymerization, according to a paper delivered at the Brooklyn Poly laser symposium by V. T. Tomberg of Kollsman Instrument (see ELECTRONICS, April 12, p. 22).

Tomberg reported that when blood plasma was irradiated with a laser beam, changes in conductivity and dielectric constant of the plasma were observed. This effect is produced by the laser beam's extremely high electric field concentrations, which are of the order of 600 million volts per meter. Previous medical-biological laser applications have for the most part depended on the thermal and specific-thermal effects of the beam. The high voltage field is capable of producing chemical effects such as polymerization, bond weakening, process catalyzing, even producing free radicals, and also polar and electrolytic changes. They can orient anisotropic molecules, which implies a change of the dielectric constant, the degree of depolarization, change of conductivity etc. In the future lasers may be used to produce chemical changes in complex substances such as vaccines.

There is also interest in the so called behavioral changes due to lasers. A speaker from the U. S. Naval Training Center said that a large change in the recovery time of ocular tissue had been noted in animals after laser irradiation.

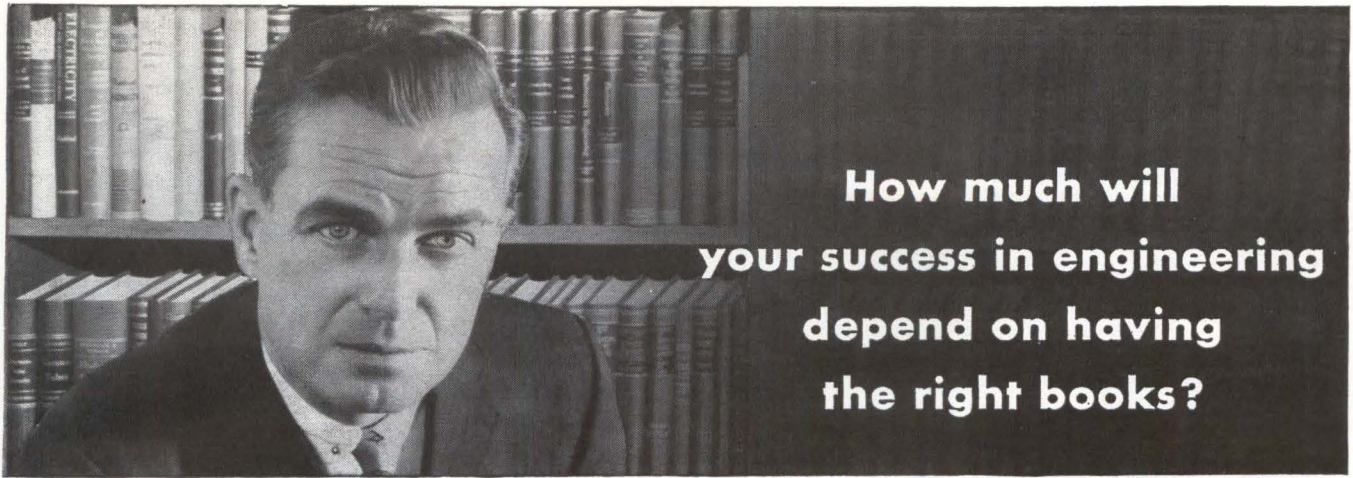

How much will  
your success in engineering  
depend on having  
the right books?

## The Electronics and Control Engineers' Book Club helps you keep ahead in your field . . . at a savings

Start your membership with any of these selections:



Electronic Switching, Timing, and Pulse Circuits by J. M. Pettit. Provides a practical understanding of operation of complex circuits.

Publisher's Price, \$8.50  
Club Price, \$7.25



Information Transmission, Modulation, and Noise by M. Schwartz. A unified approach to communication systems.

Publisher's Price, \$11.75  
Club Price, \$9.95



Mathematics for Electronics with Applications by H. M. Nodelman and F. W. Smith, Jr. Methods for solving practical problems.

Publisher's Price, \$7.00  
Club Price, \$5.95



Digital Computer and Control Engineering by R. S. Ledley. Full coverage from basic electronic design to advanced programming techniques.

Publisher's Price, \$14.50  
Club Price, \$12.35



Modern Transistor Circuits by J. Carroll. Presents almost 200 modern transistor circuits in 101 separate articles.

Publisher's Price, \$9.00  
Club Price, \$7.65



Magnetic Recording Techniques by W. E. Stewart. Full description of magnetic recording methods and devices.

Publisher's Price, \$9.00  
Club Price, \$7.65



Wave Generation and Shaping by L. Strauss. Essential features and techniques of practical wave-generating and -shaping circuits.

Publisher's Price, \$12.50  
Club Price, \$10.65

Your engineering career owes a great deal to books. Why not take advantage of this convenient, economical way to have the best professional books available when you need them? THE ELECTRONICS AND CONTROL ENGINEERS' BOOK CLUB brings you the essential technical literature in your field. It also helps you overcome today's high cost of building a professional library by saving you an average of 15% from publisher's prices.

**How the Club Operates.** You regularly receive free of charge *The Electronics and Control Engineers' Book Bulletin*. This gives complete advance notice of the next selection-of-the-month, as well as many alternate selections. If you want the main selection you do nothing; the book will be mailed to you. If you want an alternate selection—or no book at all—you can notify the Club by returning the convenient card enclosed with each *Bulletin*.

**Saves You Time and Money.** You agree only to the purchase of three books in a year. Certainly out of the large number of books in your field offered in any twelve months there are at least three you would buy anyway. By joining the Club you save both money and the trouble of searching.

**Send No Money Now.** Just check the book you want as your first selection on the coupon below. With it you will be sent *Transistor Circuit Design* for only one dollar. Take advantage of this offer and receive two books for less than the regular price of one. (If coupon is detached, write to The Electronics and Control Engineers' Book Club, Dept. L-5-17, 330 W. 42nd St., New York 36, N. Y.



ACCEPT THIS  
BRAND NEW  
\$15.00 BOOK

FOR ONLY \$1.00

with membership in  
The Electronics and  
Control Engineers'  
Book Club

### TRANSISTOR CIRCUIT DESIGN

Prepared by the Engineering Staff  
of Texas Instruments Incorporated

Here's a practical reference that can ease your transistor circuit design work. It brings you a wealth of data and facts prepared by the engineering staff of Texas Instruments, Inc. Reflecting the combined knowledge and experience of 32 expert circuit design engineers, this book makes conveniently available the actual design procedures and circuits most often requested from Texas Instruments.

*Transistor Circuit Design* is typical of the selections of THE ELECTRONICS AND CONTROL ENGINEERS' BOOK CLUB. All books are chosen by qualified editors and consultants. Their thoroughgoing understanding of the standards and values of the literature in your field guarantees the authoritativeness of the selections.

(NOTE: If you already own this volume, you may substitute any other book on this page as your DOLLAR book. Check two books below and you will receive the higher priced selection for only \$1.00.)

## CLIP AND MAIL THIS COUPON TODAY

The Electronics and Control Engineers' Book Club, Dept. L-5-17  
330 West 42nd Street, New York 36, N. Y.

Please enroll me as a member of The Electronics and Control Engineers' Book Club. You will bill me for my first selection indicated at right at the special club price and \$1 for *Transistor Circuit Design* (or alternate choice), plus few cents delivery costs. (The Club assumes this charge on prepaid orders.) Forthcoming selections will be described in advance and I may decline any book. I need take only 3 selections or alternates in 12 months of membership. (This offer good in U. S. only.)

### PLEASE PRINT

Name .....

Address .....

City..... Zone..... State.....

Company .....

**NO RISK GUARANTEE:** If not completely satisfied, you may return your first shipment within 10 days and your membership will be canceled.

Send as my first selection: (If more than one book is checked we will send the higher priced selection as your \$1.00 book.)

- Electronic Switching, Timing, and Pulse Circuits, \$7.25
- Information Transmission, Modulation, and Noise, \$9.95
- Mathematics for Electronics with Applications, \$5.95
- Digital Computer and Control Engineering, \$12.35
- Modern Transistor Circuits, \$7.65
- Magnetic Recording Techniques, \$7.65
- Wave Generation and Shaping, \$10.65

return your first shipment within 10 days  
L-5-17

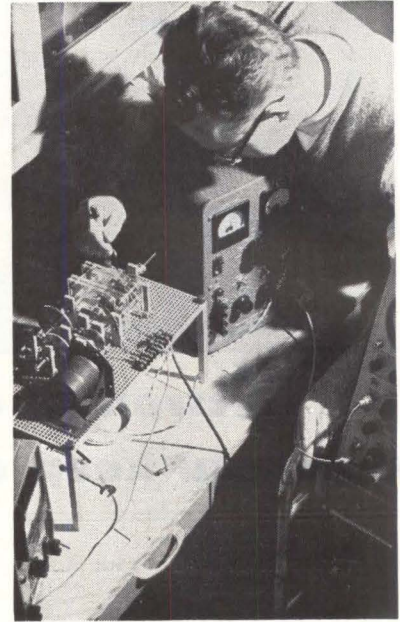
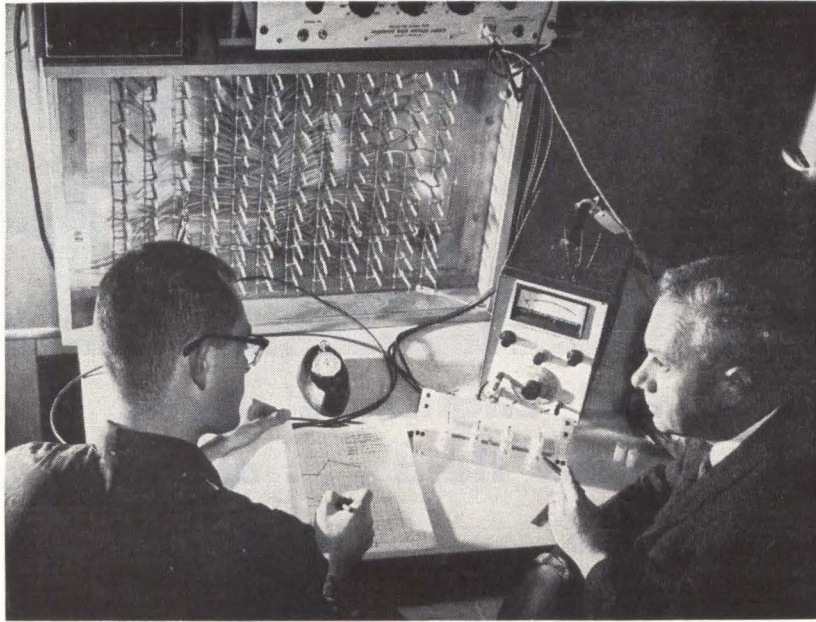

NEW industry standards for the basic measurement of insulation resistance of materials, perhaps 100 times more precise than any before, may result from new test methods developed at NEMA Laminated Plastics Laboratory, University of Delaware (left). Equipment (right) is used to determine dielectric polarization of laminates

## NEMA Lab Updates Tests for Laminates

*Expanded program will establish test methods for improved laminates*

**NEWARK, DEL.** — New information about laminated plastics will come out of NEMA sponsored Laminated Plastics Laboratory established at the University of Delaware. Laboratory will help establish new standards and obtain information about properties of materials not commonly available.

The plastics laboratory is directed by Milton G. Young, who is also chairman of the Department of Electrical Engineering at the University.

Financial support and program guidance for the laboratory are provided by 19 industrial concerns, all members of the Laminate sections of NEMA's Insulating Materials Division.

NEMA is the National Electric

Manufacturers Association. More than 500 members of this trade organization produce most of the electrical equipment sold in the United States, or exported from the country.

The following investigations, presently underway on the study of laminates, are typical of the work being performed at the University of Delaware Laboratory.

**RESISTIVITY**—A study of the present test methods for determining electrical resistivity of copper-clad laminates is being conducted by the NEMA group in cooperation with the Electronic Industries Association and the American Society for Testing Materials.

Test methods used to date are not reproducible from one laboratory to another, and the Delaware facility will develop better tests.

To date, the facility has improved reproducibility of test by 70 percent. Test results that formerly varied as much as one order of magnitude are now being held

to two-fold or three-fold differences. The Laboratory has determined that materials may vary in insulation resistance with humidity change, and has revised the method of achieving intimate contact with the test specimen to eliminate local resistance around connections. A new test specimen has been developed for this purpose. Improved test methods will help manufacturers control leakage which causes unstable electric circuits; will permit writing of realistic specifications for this testing.

Another test for more uniform punching of laminates in production will help assure quality and reliability of finished products, and reduce cost. Simpler, more applicable test methods would permit more accurate test and control of materials irrespective of harder-to-control environmental variables.

**RADIATION**—Another project at the Plastics Laboratory will de-



**cppe**

— Your Specialist for

# CASCADED AMPLIFIERLESS RESOLVER CHAINS

SIZE 8



SIZE 10  
MATCHED  
SET



SIZE 11



SIZE 15

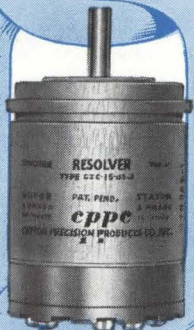

PANCAKE



Why not take advantage of the years of pioneering experience which Clifton Precision has gained in cascaded resolvers?

Not only have we designed and developed the widest variety of these resolvers, but we have also become extremely well versed in the attendant systems engineering.

Thus you can have two important advantages by dealing with Clifton: top quality components and wide systems experience.

For price and delivery, contact: Sales Dept. 5050 State Rd., Drexel Hill, Pa. Area 215 MADison 2-1000 • TWX 215 623-6068—our Representatives.

### Simple Follow-Up Chains—No Compensation

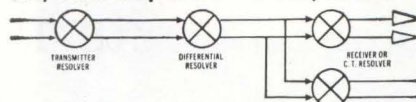

The above chain uses simple production tolerances on the components and represents a four wire data transmission system used in servo work. Variations of the above system can utilize several receivers if necessary by proper impedance matching.

### Simple Amplifierless Chains With Matched Sets of Live and Dummy Resolvers

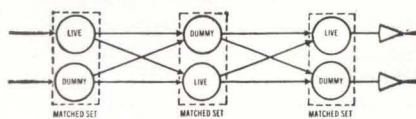

The above concept can be supplied as matched sets of live and dummy resolvers either as independent components or built into a single integral case. Matched sets can be constructed that will be all the same for a system or matched sets for different impedance levels (e. g. matched set #1, set #2, set #3, etc.). No compensation resistor, thermistor or capacitor is used in the above concept.

### Intermediate Chains With Interchangeable Components—Some Compensation

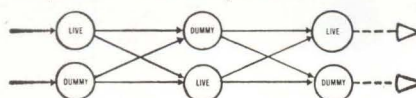

In the system above only one electrical type is utilized for both dummy and live resolver. All live resolvers are interchangeable with any other live resolver and any dummy resolver is interchangeable with any other dummy resolver. Units are compensated for constancy of transformation ratio and phase shift over temperature as well as unit to unit. No capacitors are used in the above system to reduce phase shifts.

### Completely Compensated Interchangeable Amplifierless Chains With Thermal Stability

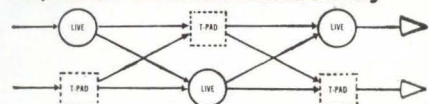

The illustrated system employs the use of completely compensated resolvers. These units are compensated for T.R. and phase shift over temperature with a characteristic impedance concept. T-Pads are shown which are utilized with this system but dummy type transformer units completely compensated will yield better system accuracy and symmetry. The above system is frequency sensitive due to the use of timing capacitors.

### Chains For Different Frequencies, Voltages and Environmental Conditions

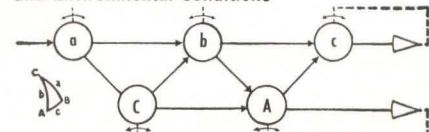

CPPE has developed cascaded chains for different voltages and different frequencies (e.g. 400 ~, 800 ~, 900 ~, 1600 ~, 3200 ~, 5000 ~, 10V., 15V., 26V., 50V., 115V..) employing the use of standard components, pancakes (with and without gymbal bearings), as well as components in aluminum, stainless steel and beryllium. Some chains have been developed which must be calibrated at three different temperature levels.

**cppe**

**CLIFTON PRECISION PRODUCTS CO., INC.**  
Clifton Heights, Pa. • Colorado Springs, Colo.



FOR SUPER-FINE  
CUTTING OF HARD,  
BRITTLE MATERIALS...

## THE *S.S. White* Airbrasive® Unit

The Airbrasive is *not* the way to open your breakfast egg. But it is often the *only* way to cut many extremely hard, fragile materials.

It would pay you to look around your production line or laboratory to see where you can use the Airbrasive. Any tool that can make tricky cuts like these in such a fragile object as an empty egg-shell can surely do jobs for you that you previously thought were impossible.

The secret of its unique ability lies in a finely controlled stream of microscopic abrasive particles gas-propelled through a precise nozzle. This stream cuts or abrades or cleans *without shock, heat, or vibration*.

Use it to make cuts as fine as 0.005" . . . remove surface coatings . . . adjust microminiature circuits . . . debur tiny parts . . . and many more delicate tasks. The cost is low. For under \$1,000 you can set up your own Airbrasive cutting unit.

Send us samples of your "impossible" jobs and let us test them for you at no cost.

WRITE FOR  
BULLETIN  
6006.



1963  
DESIGN  
ENGINEERING  
SHOW  
Booth #2108-11

S. S. WHITE INDUSTRIAL DIVISION

Dept. EU, 10 East 40th St., New York 16, N. Y. • Telephone 212 MU 3-3015 collect.

*S.S. White* INDUSTRIAL  
AIRBRASIVE®

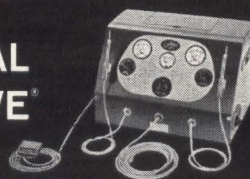

termine effects of nuclear radiation on properties of laminates and provide information needed by laminators which is not presently available. Materials under consideration for test include cellulose, glass, asbestos, and nylon fillers and synthetic phenolic, melamine, epoxy, and silicone resins. These would be tested for dielectric constant, dissipation factor, surface and volume resistivity, dielectric strength, and flexural strength. Knowledge of radiation effects will allow government and industry to improve materials used in aerospace and defense projects.

**PEEL STRENGTH**—The University of Delaware has developed and modified a test apparatus, known as the Luster-Jordan equipment, for measuring bond strength of copper to laminate and to determine blister times for copper laminates. The NEMA hot-peel test will aid in developing metal-clad laminates which will not fail under severe operating conditions.

**SALES UP**—The role of the National Electrical Manufacturers Association was outlined by NEMA President E. R. Perry who pointed out that industry sales of electrical insulating materials are expected to follow the anticipated rise in the general economy this year and are forecast at over \$307 million dollars "While Gross National Product rose six times since 1939, the insulating materials business increased seven and a half times in the past 24 years", he said.

"Industrial laminates have accounted for about a half of total sales of the electrical insulating materials industry (excluding decorative laminates) from 1939 to 1961. Sales in 1939 amounted to \$17 million, increasing to \$71 million in 1950 and continuing to rise to over \$157 million in 1962", according to Perry.

### Thin Films Deposited On Fluid Surface

DEPOSITION of silicon onto polycrystalline alumina substrates coated with a glassy layer which is liquid at the decomposition temperature is

being investigated by Sylvania's Microelectronics Laboratory.

These silicon films have been used to form operating diodes and transistors, according to Sylvania's Egone Rasmanis.

Films deposited on glazed polycrystalline alumina substrates are reported to have electrical properties required for silicon thin film device formation. Films deposited on fluid surfaces were then used to form *pn* junction diodes and transistors by epitaxial growth of *p*-type and *n*-type layers.

Experimental characteristics of transistors formed by this process were:  $I_{CBO}$  equal to 10 to 20  $\mu$ amp at 2v;  $I_{EBO}$  of 2 to 5  $\mu$ amp at 2v;  $h_{FE}$ , 10 to 200 at  $I_c$  was equal to one ma; and  $V_{CE}$  was one volt.

Substrate used in these investigations was a polycrystalline alumina wafer coated with a layer of glass. This specially prepared glass consisted of oxides of sodium, magnesium and silicon. Proportions were chosen to obtain a thermal expansion coefficient of the resulting glass that matches the expansion coefficient of alumina and silicon sufficiently closely to avoid cracking or peeling of the silicon film after it is cooled to room temperature.

Process was described at Electrochemical Society meeting last month by Egone Rasmanis.

### Phototransistor Device Aids Blind Operators

NEW DEVELOPMENT by the Bell Telephone System will make it easier for blind people to operate telephone switchboards. The device uses a probe equipped with small phototransistor, converts light signals to audible indications in the operator's headset. Narrow panel of special pilot lamps mounted on face of switchboard supplements the scheme, which guides the blind operator to the correct jack.

### D-C Current Steps-up Zone Refining

AXIAL application of direct current during zone refining of first-reduction germanium increases rate of impurity segregation according to a

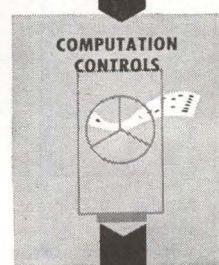
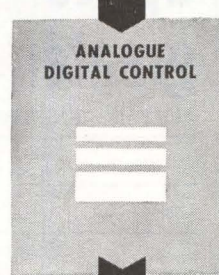
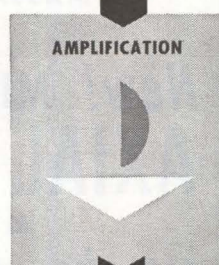
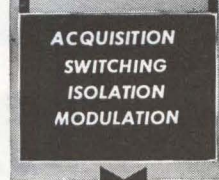
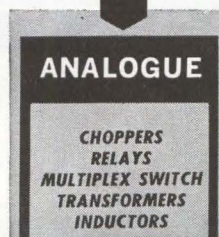
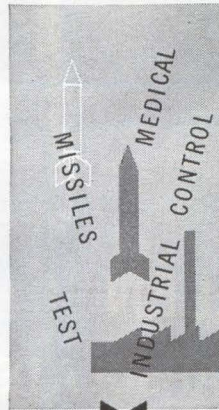

KEY SUPPLIER OF PRECISION COMPUTERS & COMPUTER CONTROLS

# 140 db Common Mode Rejection

through balance and electrostatic shielding

with **JAMES**

## INSTRUMENT TRANSFORMERS

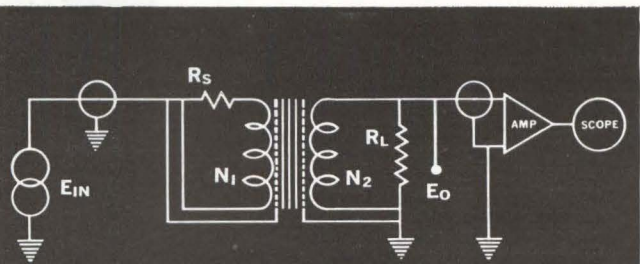

$$N_1 = N_2 = 6080 \text{ TURNS}$$

$$E_{IN} = 50 \text{ VRMS COMMON MODE SIGNAL INPUT}$$

$$E_O = 5 \mu \text{ VRMS COMMON MODE SIGNAL OUTPUT}$$

$$\text{CMR (COMMON MODE REJECTION)} = 20 \text{ Log} \left( \frac{N_1}{N_2} \times \frac{E_{IN}}{E_O} \right)$$

$$\text{CMR} = 140 \text{ DB}$$

#### MAGNETIC SHIELDING

Up to 120 db. of magnetic shielding offered. Multiple mu-metal and copper shields give the designer a wide choice of models for each application.

#### LOW THERMAL CONSTRUCTION

All junctions of windings to leads are made with a special solder that minimizes thermal voltage generation at the junctions. Bare copper leads from each winding are carried to the exterior for further low thermal application.

#### BALANCED WINDINGS

Each side of these transformers has balanced windings. They are prematched to the exact turn with D.C. resistance unbalance less than .05%.

#### APPLICATIONS

Especially suited to A.C. Bridge and Differential D.C. and A.C. Amplifier applications.

Write for complete technical details and specifications.

**JAMES** ELECTRONICS, INC.

Chicago 18, Illinois

Phone: Area Code 312 463-6500

Designed for



Application

**MILLEN**  
**ENCAPSULATED INDUCTANCES**  
 FOR PRINTED WIRING APPLICATIONS

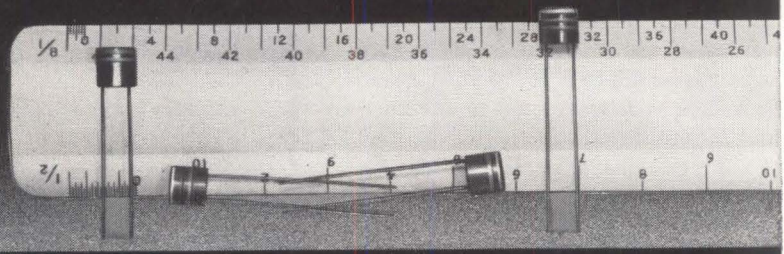

**MINIATURE INDUCTANCES  
 FOR PRINTED WIRING**

22 to 10,000 microhenries  $\pm$  5%. Maximum d.c. current rating 1210 to 60 milliamperes. Low d.c. resistance. Wound with high temperature wire and encapsulated in epoxy for  $-55^{\circ}\text{C}$  to  $+125^{\circ}\text{C}$  ambient temperature. Approximately the size of a transistor. Leads spaced 0.2 inch.

**JAMES MILLEN MFG. CO., INC.**  
**MALDEN**  
**MASSACHUSETTS**

CIRCLE 200 ON READER SERVICE CARD

**Test  
 Equipment  
 Cart  
 Model 30-1**

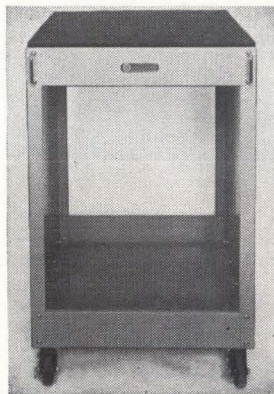

The Model 30-1 Basic Cart was designed for easy handling of counters. It is large enough to handle single large or several small test units. The base provides storage for test leads and auxiliary equipment. To provide maximum utility, various alternative modifications have been developed. Shipped knocked down.

BASIC MODEL \$59.50

**Specifications**

- Color ..... Dark Brown
- Handles ..... Nickel Plated
- Hardware ..... Nickel Plated
- Cushion .....  $\frac{1}{16}$ " Felt
- Construction ..... Heavy Gauge
- Size ..... 23" x 23" x 36 $\frac{1}{2}$ "
- Weight ..... 90 Pounds (basic cart)
- Deluxe Model (with drawers) ..... \$131.50

**NORTHEASTERN  
 ENGINEERING INCORPORATED**  
 A SUBSIDIARY OF ATLANTIC RESEARCH CORPORATION  
 DEPARTMENT 7-A. MANCHESTER, NEW HAMPSHIRE

Employment Opportunities Open At All Levels

**New! MINIATURE  
 AXIAL FANS**  
 with  
 up to 4 times  
 greater cooling efficiency!

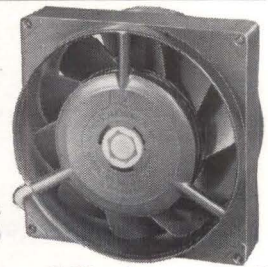

FULLY GUARANTEED FOR 10,000 HRS. UNDER NORMAL OPERATING CONDITIONS

Characteristic	PAMOTOR Model 1000	Conventional Fan
Type of Motor	induction (capacitor-type squirrel cage)	shaded-pole
Housing	die cast warp-free Zymec	plastic
Output @ 60 cps (0 back pressure) (.25" back pressure) (.3" back pressure)	125 cfm 75 cfm 50 cfm	100 cfm 20 cfm 0
Output @ 50 cps (0 back pressure) (.25" back pressure)	100 cfm 62.5 cfm	75 cfm 5 cfm
Operating Temp. Range	$-55^{\circ}\text{C}$ to $+85^{\circ}\text{C}$	$-18^{\circ}\text{C}$ to $+44^{\circ}\text{C}$

The PAMOTOR Model 1000 Miniature Fan is completely interchangeable with conventional units now in use (4 $\frac{1}{8}$ " center-to-center mounting holes). But the similarity ends there.

check this comparison chart!

Model 1000 meets MIL-T-5422E (Class 2), and MIL-STD-202 Environmental specs. Inside-outside rotating motor design gives fly-wheel effect, resulting in constant, quiet fan speed. Large surface sleeve bearings mean minimum maintenance, maximum reliability.

For complete specifications and name of nearest stocking distributor, write to:

**PAMOTOR, Inc.**  
 312 Seventh Street • San Francisco 3, Calif.

CIRCLE 201 ON READER SERVICE CARD

May 17, 1963 • electronics

study conducted by Air Force and performed by L. L. Thomas of the Nuclear Corporation of America. Segregation rate is increased when the current flows opposite to the direction of zone travel. It decreases when current is reversed. Optimum current density, says a study report, depends on geometry and thermal conditions of the ingot—under experimental conditions it was found to be between 100 and 150 amp./sq. cm. and was limited by stability of the freezing interface.

### Bonding Technique Extrudes Insulators

**BONDING TECHNIQUE** for extruding uniform, thin, pin hole free insulating materials onto conductors has been developed by Berkshire Technical Products, Reading, Pa. Continuous, splice free lengths greater than 100,000 feet have been manufactured to specifications.

With the process, as little as three mils of insulation can be extruded reliably.

### Flux-Grown Ruby Has Low Radiation Loss

A RUBY crystal has been operated as an optical maser using a pair of perfect natural faces of the ruby as the feedback surface.

Flux-growth process involves crystal formation from a solvent. Aluminum oxide with chromium is dissolved in a flux of lead oxide and boron oxide. Crystals are formed slowly at temperatures far below the melting point of ruby. Crystal growth results in rubies with naturally flat and parallel surfaces.

Resulting crystals have a homogeneity of the index of refraction, an absence of scattering centers, and faces whose flatness and parallel structure are not obtained by other known methods, according to Bell Telephone Laboratories.

Interferometry measurements have shown the optical path lengths through the crystal vary only about one-tenth of a wavelength of red light over the entire reflecting face.

The flux-growth technique was developed at Bell Laboratories by Joseph P. Remeika. Donald Nelson performed laser studies.

## Attention Module Makers! **INCREASE WELD CONSISTENCY, RELIABILITY**

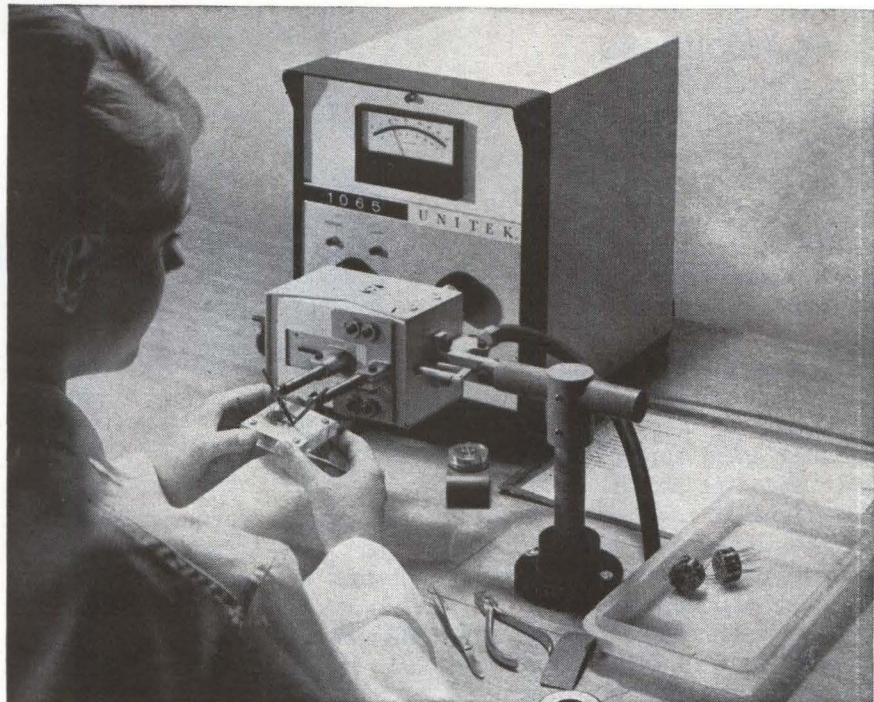

### THIS NEW **WELDMATIC 1065 DUAL PULSE POWER SUPPLY**



Want more Facts? Write Weldmatic Division/Unitek, 950 Royal Oaks Drive, Monrovia, California. Request Bulletin PB-26.

#### Has Two Optimum Pulse Shapes

Long—for high conductivity metals like Tinned Copper

Normal—for high resistivity metal like Kovar, Dumet

#### FOR SUPERIOR QUALITY CONTROL—

Precise pulse of heat energy is accurately matched to metal's weld characteristics. Hence, a wider latitude of weld reliability on every joint you weld.

Each pulse has an ultra high stability. It is exactly repeatable, weld after weld.

Energy pulse generated by two separate circuits. Optimum shape of each pulse based on 18 months of intensive field research.

Dual range (20/100WS) power supply is further matched to follow up characteristics of Weldmatic 1032 head promoting even greater weld accuracy.

**WELDMATIC DIVISION / UNITEK**

# Fabrication Aids Cut Submodule Rejection Rate

*Very small cordwood units require high skill to produce*

By H. G. FRANKLAND  
M. FREITAG

Ryan Aeronautical Company  
San Diego, Calif.

**CORDWOOD** packages that are most standardized and popular today have configurations in which components are suspended between two etched boards by their axial leads. This arrangement is imparted with the necessary rigidity and mechanical support by being either coated or potted.

Packaging production thus sounds quite simple, but extreme small size produces many headaches respecting assembly and electrical interconnection. These include:

- Holes in sandwich boards misaligned causing canting of components, component-positioning difficulty and violation of spatial distance between components
- Thermal over-stressing of components during interconnection
- Pad peeling caused by mechanical overstress
- Sandwich boards not parallel or flexed due to poor coating or potting operation
- Solder-joint failure at lead connection to component body
- Ragged - edged boards not trimmed true after assembly
- Human errors: use of wrong-valued parts, reversed polarity of parts, wrong materials, poor curing practices.

**MISALIGNED HOLES**—By making the circuit board master at least 5 times normal size, hole positioning can be held to the close tolerances required to prevent mis-

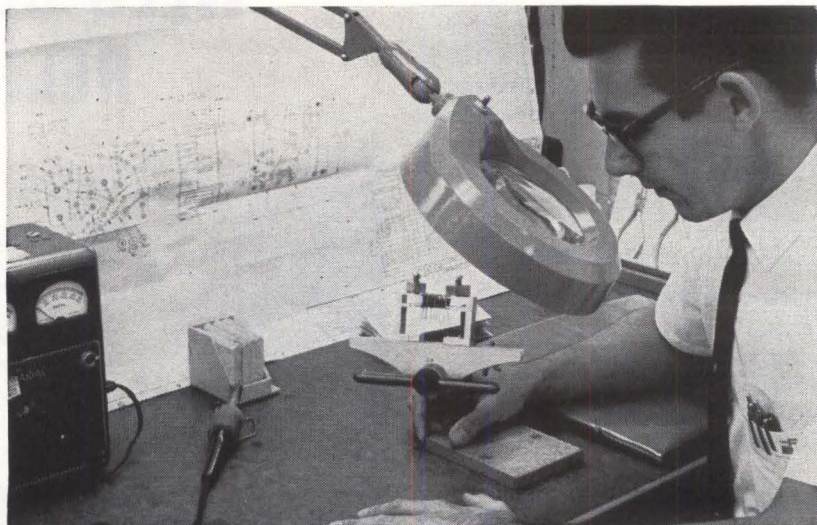

*MAGNIFIER is used to carefully examine each solder connection. Close proximity of components in cordwood packages makes cold solder joints one of major problems*

alignment. During finalization upper and lower circuit board masters are superimposed to ascertain correct alignment. Correct alignment in submodule assembly, however, depends also upon degree of board trimming accuracy (to be discussed) and on correct holding-fixture design.

**THERMAL OVERSTRESSING** — Submodules may be rejected when sandwiching circuit boards are burned or damaged by repeated soldering or unsoldering: connection pads may be lifted by the excess heat. Heat damage to parts in inaccessible locations makes correc-

tive disassembly impracticable in advance fabrication stages. Hence, the use of welding, with nickel ribbon replacing circuit boards in making interconnections, might be feasible, but this requires provision for supplying structural rigidity during interconnect operation and gives problems respecting proper placement of electrodes.

If soldering is used in making interconnections, the correct use of heat sinks to prevent component damage is critical. Fig. 1 indicates a recommended heat-sink technique. Here, as shown, components are attached using enlarged pads. In addition to proper production technique, proper design of cordwood modules will place critical or heat sensitive components on the outside perimeter of unit to minimize corrective disassembly and reassembly procedures.

Short lead lengths used in 3-dimensional packaging of this sort drastically increases heat conduction. Hence, a component location technique such as that shown in Fig. 2 should be used so that component bodies are located as far from solder joints as space permits. Fig.

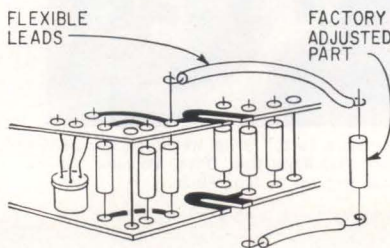

*RECOMMENDED heat sink technique is used especially when soldering is performed—Fig. 1*

# How Barden gained a 50% increase in cleaning capacity for precision bearings!

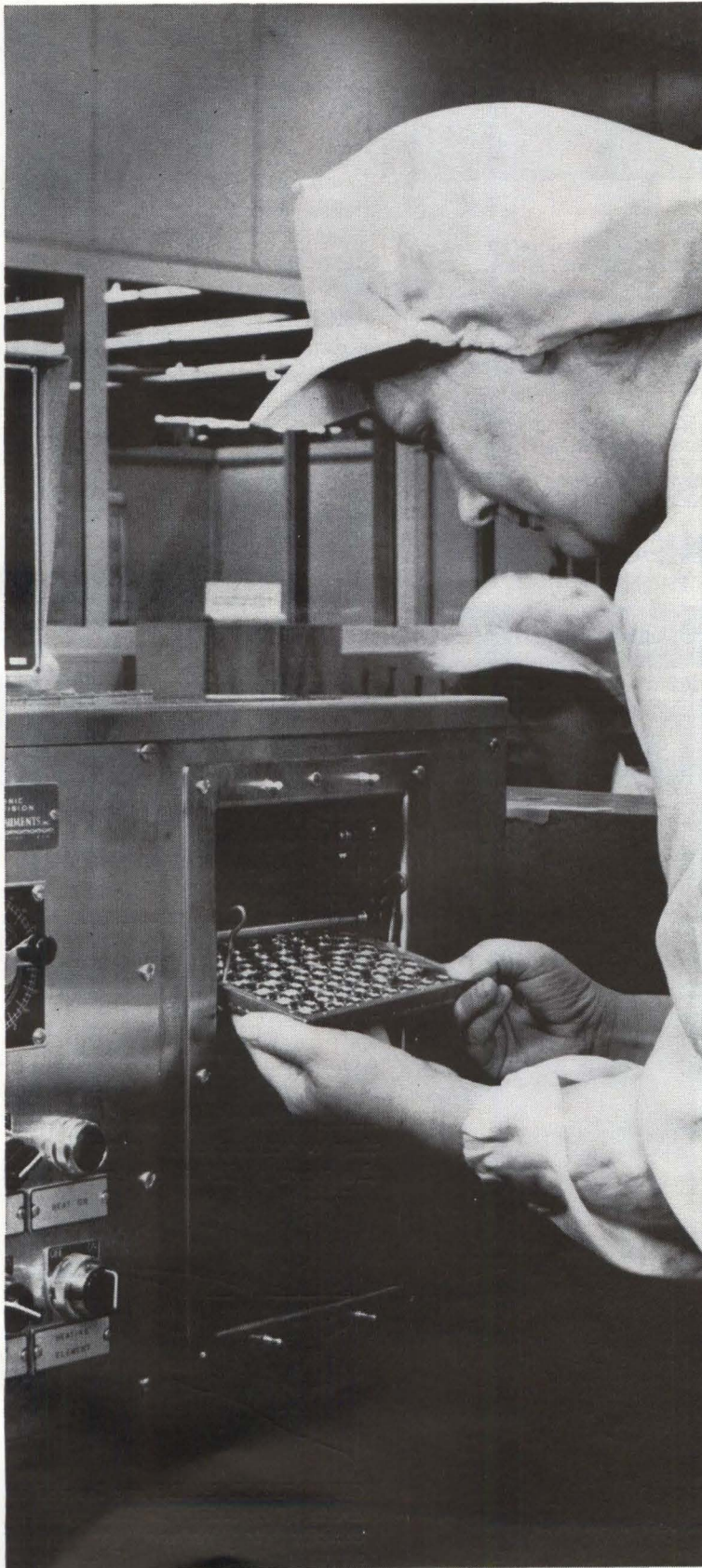

**PROBLEM:** Precision cleaning of assembled ball bearings for instruments used to be a time-consuming operation for the Barden Corporation, Danbury, Connecticut. Bearings up to 1" diameter went through a spray-cleaning machine at a relatively low production rate. Larger bearings were individually spray-cleaned.

**SOLUTION:** A new cleaning system based on an ultrasonic bath of FREON fluorocarbon solvent coupled with spray cleaning. FREON is a *selective* solvent in that it effectively removes dirt, yet has no effect on critical steel, bronze, plastic and fiber components of these bearings. Ultrasonic action combined with the extremely low surface tension of FREON digs contaminants out of the tiniest crevices. Result: Barden now cleans completely assembled bearings *in batches of hundreds*. Over-all cleaning capacity is up 50%!

And Barden reports that FREON solvents give them *better cleaning quality*. Particle count is 15% lower than before, which is a significant drop because the count was very low to start with.

Barden also points out that FREON dries quickly and leaves no residue, and that its very low toxicity and nonflammability let them operate without expensive ventilating equipment. They've found the new system economical to use, because FREON can be recovered in simple equipment—for reuse over and over again.

We'll be glad to show you how FREON solvents can improve your own cleaning operation. First, *send the coupon or Reader Service Card* for our new booklet on cleaning!

**FREON<sup>®</sup>**  
solvents



BETTER THINGS FOR BETTER LIVING . . . THROUGH CHEMISTRY

## MAIL COUPON FOR NEW BOOKLET ON CLEANING

E. I. du Pont de Nemours & Co. (Inc.)  
FREON Products Division  
N-2420-E-5, Wilmington 98, Delaware

Name \_\_\_\_\_ Title \_\_\_\_\_

Company \_\_\_\_\_

Address \_\_\_\_\_

Please send new booklet on FREON solvents for precision cleaning.

I am interested in cleaning \_\_\_\_\_

I would like to talk to a cleaning specialist.

# for ANTENNABILITY



LOOK  
TO  
**TRYLON**

**TRYLON offers  
outstanding Antenna  
and Tower capability**

Use this knowledgeable, experienced source that offers:

1. Worldwide experience in military, civilian and government applications.
2. Full service and responsibility

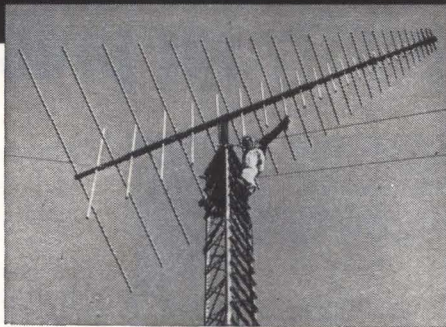

Antennas for all services from VLF to UHF including Log Periodics, Rhombics, Corner Reflector, etc.

including: research, development, manufacture and installation.

3. Resourceful, experienced personnel with outstanding records of achievement.
4. Worth-while economies because we do our own manufacturing.

Full line of accessories. Full capability and facilities for testing, research and development.

Write, wire, or phone and let us help you on your requirements.

## WIND TURBINE COMPANY

ELVERSON, PA.

PHONE: WHITNEY 2-2981

**TRYLON TOWER AND ANTENNA SYSTEMS**  
RESEARCH • DEVELOPMENT • MANUFACTURE • INSTALLATION

CIRCLE 202 ON READER SERVICE CARD

### DO YOU HAVE ANTENNABILITY?

There's a promising future here for antenna engineers who enjoy the stimulus of challenging research and development projects with an expanding company. There are good opportunities too for mechanical, structural and civil engineers on tower work.



## MIL TYPE CRYSTALS

**Now Available:** New James Knights brochure listing MIL Type Crystals in common use today—for both military and non-military equipment designs. James Knights also manufactures comparable type crystals having increased quality and performance characteristics. Tell us your requirements. Write for latest brochure.

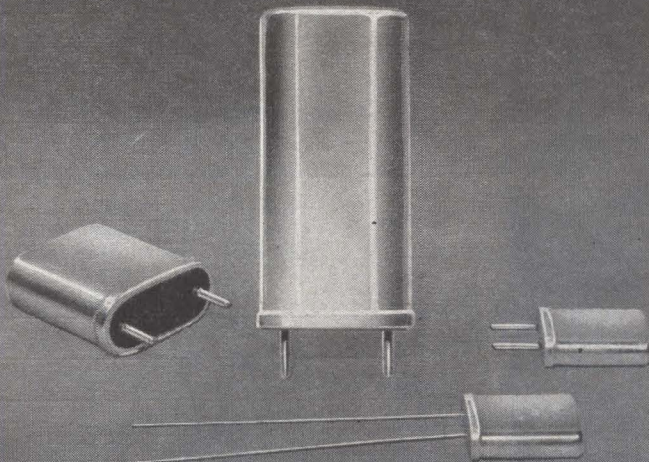

THE JAMES KNIGHTS COMPANY • Sandwich, Illinois

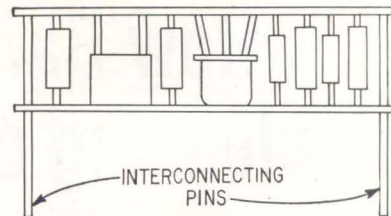

COMPONENT location technique drastically increases heat conduction to protect parts against overheating—Fig. 2

2 applies to assembly of transistors, diodes, capacitors and other components where multiple leads are involved.

**MECHANICAL OVERSTRESS** — Pad peeling caused by mechanical overstress occurs as follows: When assembling tightly packed sub-modules, it is sometimes convenient to solder the lead first and then ease the component into place. In doing this, adjacent parts may be juxtapositioned to place stress on leads and component bodies. Since components are suspended by their leads, this stress is communicated to connecting pads on boards. Thus, pad strength is reduced resulting in immediate or eventual peeling of pad board material.

This failure mode can be reduced by using plated-through connector holes and oversized pads in certain areas where component density makes installation difficult. Fig. 3 shows how this can be done with components mounted on outer perimeter of submodule where this failure mode has occurred most frequently.

**NON-PARALLEL BOARDS** — Sandwich boards not parallel or flexed after plastic coating or potting operation usually result from the wrong choice of coating ma-

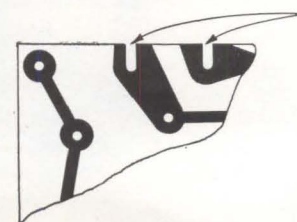

ELONGATED HOLES FOR FACTORY ADJUST PARTS

OVERSIZED PADS are located in areas of especially high component density to reduce mechanical stresses during assembly—Fig. 3



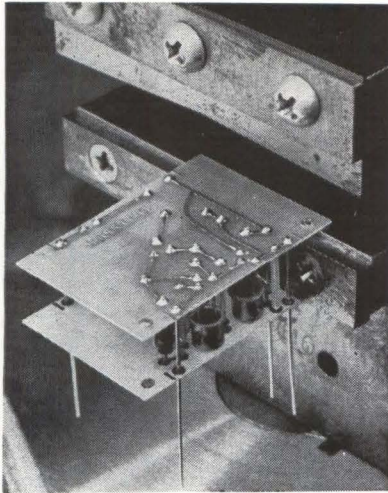

DOUBLE-BLADED machine slices board cleanly while minimizing shock to assembled unit—Fig. 4

terial or of poor process control. This condition usually results in a height dimension being out of tolerance. To correct it, a compliant epoxy coating should be applied first that will allow for thermal expansion and contraction at the rate imparted by combined thermal expansion of parts. A top coat of stiffer potting material can then be applied for greater shock-and-vibration protection and to provide the required mechanical support.

Kinking of leads to provide the necessary compliance for thermal contraction and expansion is another method for preventing this type of failure.

**SOLDER-JOINT FAILURE** — Assuming that solder connection of leads to component body have been checked prior to potting, failure of such joints after potting or during the curing operation is probably due to thermal-expansion incompatibility in lead-body and lead-epoxy board relationship or to insufficient compliance being allowed for in this relationship. The lead kinking and epoxy thermal expansion corrective measures described above should eliminate this mode of failure.

**RAGGED BOARDS** — Ragged-edged or out-of-trim boards can result if careful post-assembly trimming is not followed: method used should not only place no undue stress on circuit board but must also prevent stress being communicated to electronic components by

## EXPANDO DOES IT!

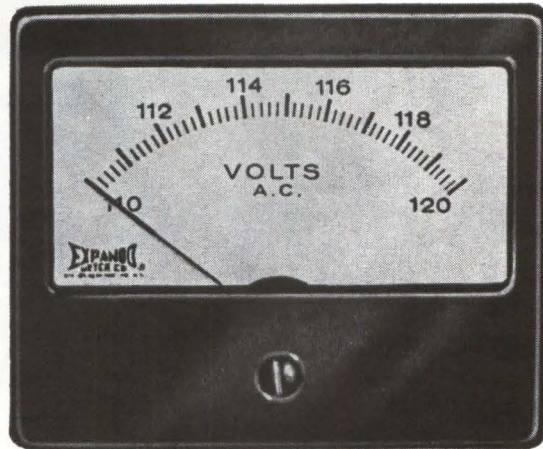

TYPICAL MANUFACTURER'S MODEL WITH EXPANDED SCALE

**The scale is expanded . . .**

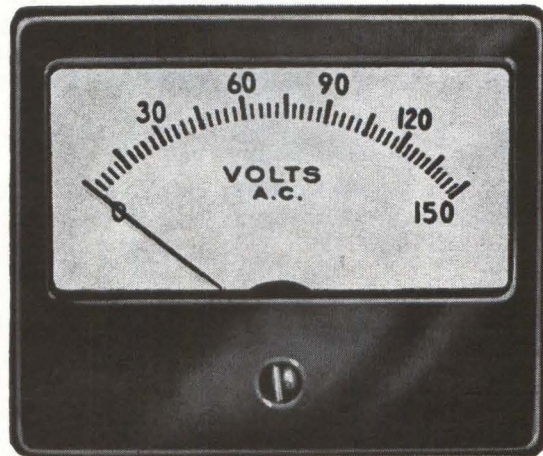

SAME MODEL WITH FULL SCALE

**but it's still the same case**

**HIGHER SENSITIVITIES** — Expando's unique linear bridge circuit achieves sensitivities in the order of 500, 1000, 2000 . . . up to 10,000 ohms per volt without costly, bulky, external power units.

**NO ENLARGEMENT OF CASE DEPTH** — Extremely sensitive, compact Expando network attains high impedances within standard meter dimensions, and needs no external power source to achieve accuracies as high as 0.1%.

**METER MATCHING** — Any manufacturer's meters can have a part of the range expanded to full scale width for greatly increased accuracy, resolution, and readability.

*Write for specifications on expanded scale AC or DC voltmeters, ammeters, milliammeters, true RMS, frequency meters and meter relays.*

# EXPANDO®

A & M INSTRUMENT, INC. / SUBSIDIARY OF LORAL ELECTRONICS, INC.  
48-01 31ST AVE., LONG ISLAND CITY 3, NEW YORK / TWX NY 4-323

# -260°C. to +500°C. Industrial temperature sensors

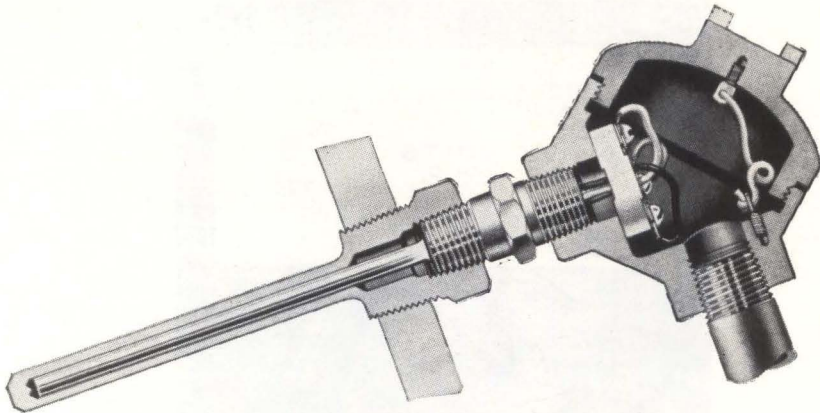

## REC's 104 series platinum resistance temperature sensors

Models for direct immersion, thermowell, or surface applications. Designed for high pressure and a wide temperature range, this new line of rugged, platinum resistance temperature sensors is competitively priced. Check these features of the Model 104 series:

- Wide range: -260° C. to +500° C.
- Stability: repeats within 0.05° C. at 0° C. when used over above range.
- Fast Response: Models available with time constant less than one second.
- Interchangeability: within 0.1% of master resistance curve at 0° C (or within 0.250° C.)
- Versatility: Mount in thermowells, directly into pipes or pressure vessels, or on surfaces.
- High Pressure Rating: 3000 psi on all models.

The REC Model 104 element is made of highly pure platinum wire mounted strain-free in a ceramic rod, and hermetically sealed into a stainless steel sheath. Sensors are available with diameters as small as .084". Many options in mountings, lead wires, and connectors.

### A complete line

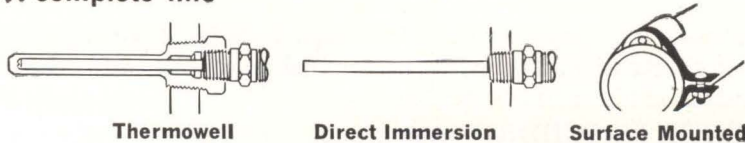

For further details on how the new REC Model 104 sensors will fit your application, write for Bulletin 8622 on Industrial Applications of platinum resistance temperature sensors. This 32-page bulletin gives a variety of fundamental engineering data on platinum thermometry and provides detailed performance specifications.



**ROSEMOUNT  
ENGINEERING  
COMPANY**

4900 West 78th Street • Minneapolis 24, Minn.

**SPECIALISTS IN TEMPERATURE & PRESSURE MEASUREMENT**

shock or vibration. Fig. 4 indicates workable technique: a two-bladed tool slices from both sides of board simultaneously to provide the necessary support and shock isolation.

**HUMAN FACTORS**—Human error resulting in problems mentioned at beginning of article can only be offset by optimum selection and training of personnel together with good process and material control. Training, however, should include both engineering and production personnel. Designers, for example, can thus get the feel of producibility factors to improve their component layouts.

**VISUAL AIDS**—Small size of submodules force production engineers to determine each step in assembly process, documenting then in detailed instructions through audio visual aids: slide projectors, flip charts. Hughes Aircraft Company (among others) has developed an audio-visual system for programming complex electronic assembly:

Colored slides show the location of each color-coded part and how to correctly position it in submodule. Also shown are placement of soldering iron or welding electrodes together with power settings.

## Dry Process Makes Contoured Circuit Board

PRINTED circuit board that would remain permanently contoured in accordance to Texas Instruments requirements for transistor testing has been produced by a dry (non-etchant) printing process. Board had to have a curved shape unattainable with conventional board materials. Process coats a dry adhesive on a flexible 1/8-inch triple X-P quality phenolic board. Board and adhesive then receive a light layer of silver-plated copper powder. Next, board is placed in a die-set and subjected to hydraulic pressure to produce circuit pattern on board and to shape board. One-half hour heat cure completes process. Dies used for pattern are electrically etched in less than 2 hours. Process was developed by Yolatron, Inc. of Dallas, Texas.

*Countdown for moon shot: 1890*

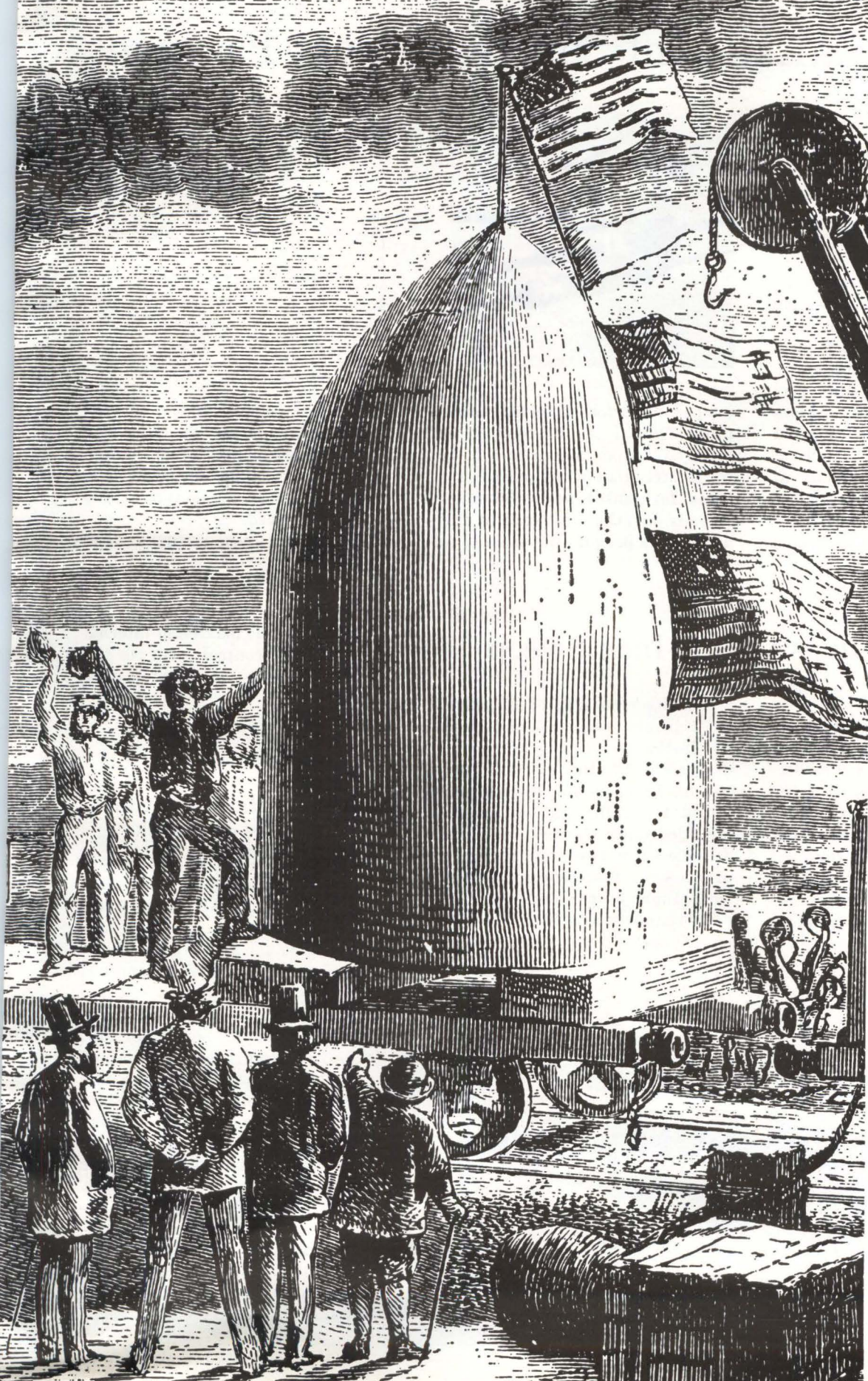

## Finish the moon shot Jules Verne began 73 years ago!

Science fiction pioneer Jules Verne foresaw problems in hitting the moon. His fictional moonship missed its mark, after nearly colliding with a meteor.\* Now, 73 years later, Hughes offers you the opportunity to be part of a real moon project.

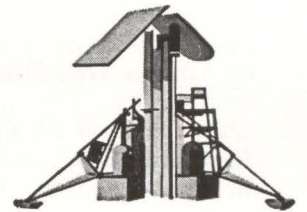

Help us soft-land the SURVEYOR on the moon. Or work with us on other advanced projects such as: MMRBM Integration, Assembly & Checkout, TOW Anti-Tank Missile, TFX(N) Guided Missile System, SYNCOM (Synchronous-Orbit Communications Satellite), VATE, ARPAT, Advanced POLARIS Guidance... and many others. Positions are open for senior and junior control engineers, circuit designers, electronic weapon systems analysts, mechanical engineers and infrared specialists, with degrees from an accredited university.

Please airmail your resume today to:

**Mr. Robert A. Martin**  
Head of Employment  
Hughes Aerospace Divisions  
11940 W. Jefferson Blvd.  
Culver City 8, California

*Creating a new world with electronics*

**HUGHES**

HUGHES AIRCRAFT COMPANY  
AEROSPACE DIVISIONS  
An equal opportunity employer.

\*In Verne's 1890 novel, "From the Earth to the Moon," his spaceship, "Columbiad," was launched from Tampa, Florida—just 120 miles from Cape Canaveral! After missing the moon, the craft returned to earth at 115,200 miles an hour. It plunged into the sea, popped to the surface—and the three men inside were found "playing at dominoes."

Bettman Archive

## Efficient GaAs Light Source in Glass Package

*Radiation wavelength is centered at 0.95 micron, bandwidth is 0.04 micron*

**PACKAGED** in a conventional diode envelope, this gallium arsenide light-emitting diode comes in models ranging from 0.04 to 0.35 percent efficient at room temperature, and capable of 30 times this performance when cooled to 77 degrees Kelvin. The diodes, from Infrared Industries, Inc., Santa Barbara, California, are rated nominally at 180 ma average current, with operating potential of 1.2 volts.

Radiation intensities at room

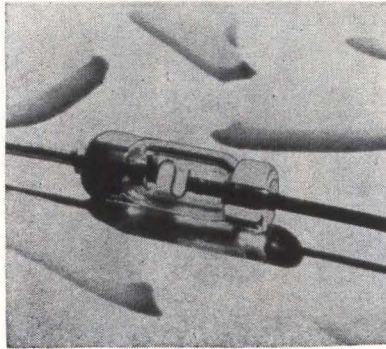

temperature for different models range from  $1 \times 10^{-5}$  to  $7 \times 10^{-5}$  watts/steradian, rising to  $5 \times 10^{-3}$  watts/steradian when pulsed at 12 amps for pulses below 10 microseconds duration. Absence of thermal inertia permits the diode to fol-

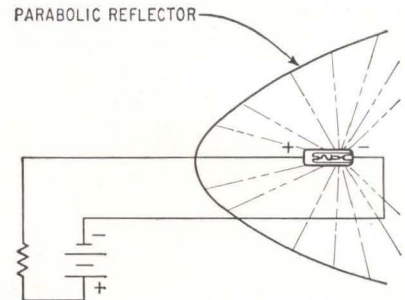

low pulsed inputs, where conventional light sources would merely radiate in proportion to the average energy. Cooling the device to 77 K permits current pulses up to 100 amps to be used.

CIRCLE 301, READER SERVICE CARD

## 25 Volts Gives CRT 2-Inch Sweep

**MAJOR FEATURE** of this new cathode-ray tube is its high deflection sensitivity, making the tube compatible with transistor deflection circuits. Four models of the tube are available with sensitivities ranging from 12.5 to 30 volts per inch. Designed specifically for solid state oscilloscopes and for monitoring-applications in fully transistorized equipment, the tube provides

a useful screen area of roughly 2½ by 3 inches, and does not exceed 13½ inches overall length. The tube designers: Electronic Tube Corporation, Philadelphia 18, Pa., have aimed for high light output with low deflection factors, and have achieved this result partly by use of 3,000 volt post-deflector acceleration. Light output at 10 microampere beam-current is 5 foot lam-

berts minimum; maximum internal capacitance (control grid to all other electrodes) is below 7 picofarads. (302)

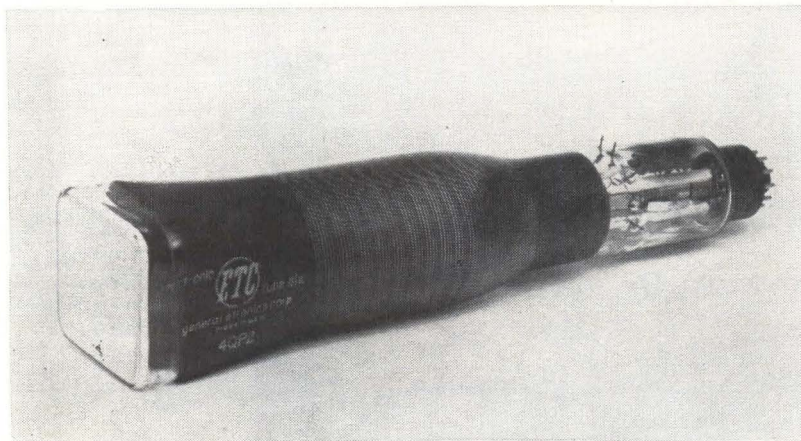

## Thin-Film Hall Generator Is Only 0.004-In. Thick

**LINE OF HALL** effect generators with active area only 0.004-in. thick are marketed by American Aerospace Controls, Inc., Farmingdale, N. Y. Principal advantages of the new units, stemming from improved manufacturing techniques, are absence of flux concentrators (permitting operation to 30,000 gauss), flexibility, permitting the Hall unit to conform to curved surfaces of ½ inch radius or more, extreme thinness, permitting insertion in very narrow air gaps, and manufacture with reproducible galvanometric characteristics.

Hall voltages of up to 100 millivolts are obtained with an open circuit sensitivity of 40 millivolts per ampere-kilogauss. Input resistance is in the 5 to 10 ohms range; output resistance is half this figure. Appli-

# Will the real Stackpole resistor stand up?

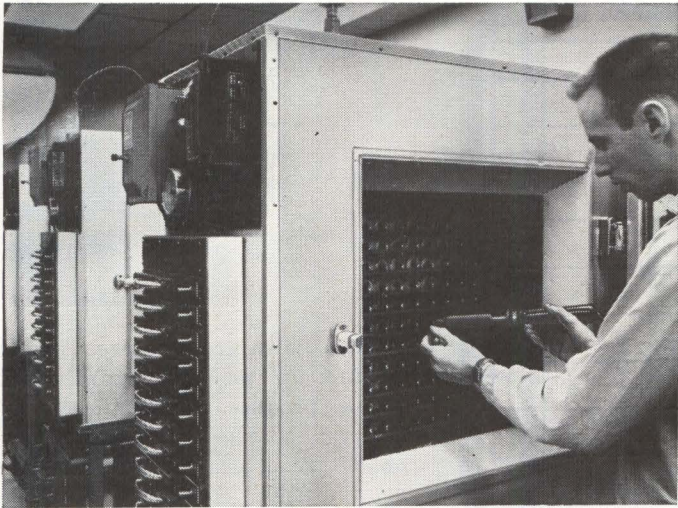

**70°C load life test.** Stackpole COLDITE 70+ Resistors are soldered into ovens and temperature is raised to 70°C. Resistance is read after 0, 50, 100, 250, 500, 750 and 1000 hours under full load. MIL-R-11 allowable change:  $\pm 10\%$  maximum,  $\pm 6\%$  average. Stackpole maximum expected changes:  $+2.5\%$  to  $-5.0\%$  for all types!

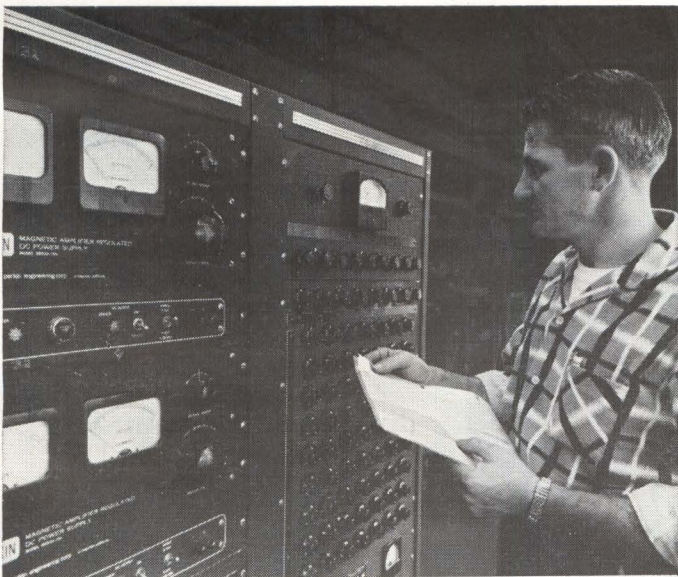

**Production line sorting.** The next to the last quality control check made before shipment. All COLDITE 70+ Resistors coming down production lines pass this machine which automatically measures resistance values. Machine unerringly classifies resistors according to specified tolerances.

Will it meet, or exceed, your MIL-R-11 requirements? Will it stand up to the load life . . . have the humidity and temperature characteristics and the solderability . . . you require?

You bet! And at left are some of the reasons you can be so sure. They are just two of the many ways in which every Stackpole COLDITE 70+® Fixed Composition Resistor is checked and double-checked in one of the toughest quality control programs in the industry.

When a Stackpole resistor leaves our plant, you are getting the real thing! Even the color coding bands are critically inspected to make certain that a Stackpole resistor looks like the quality component it is.

Stackpole COLDITE 70+ Fixed Composition Resistors are available in all popular resistance values and sizes. And they are competitively priced! There is no extra charge for the extra measure of quality you are getting!

You can get immediate delivery of Stackpole COLDITE 70+ Fixed Composition Resistors from leading electronic parts distributors across the country. For information on large runs, write: Electronic Components Division, Stackpole Carbon Company, St. Marys, Pennsylvania.

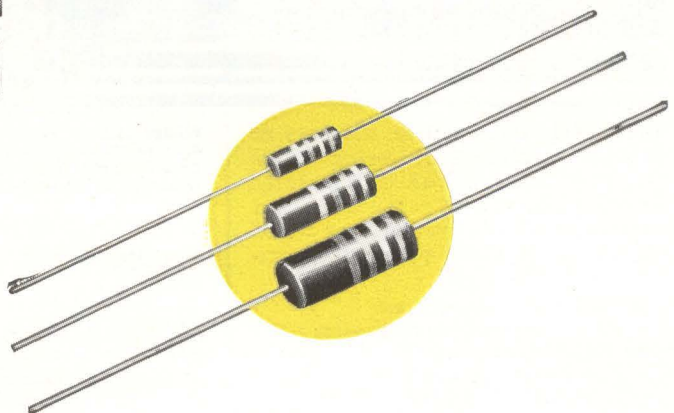

# STACKPOLE

CARBON COMPANY, *Electronic Components Division*  
St. Marys, Pennsylvania

# COMINCO

HIGH PURITY METALS  
AVAILABLE FORMS

*clip and save*

Product	ALUMINUM	ANTIMONY	ARSENIC	BISMUTH	CADMIUM	GOLD	INDIUM	LEAD	SILVER	TIN	ZINC
BARS	✓	✓	✓	✓	✓	✓	✓	✓	✓	✓	✓
SHEETS	✓				✓	✓	✓	✓	✓	✓	✓
WIRE	✓				✓		✓	✓		✓	✓
POWDER		✓	✓	✓	✓	✓	✓	✓	✓	✓	✓
SHOT		✓		✓	✓	✓	✓	✓	✓	✓	✓
ROD	✓			✓	✓		✓	✓	✓	✓	✓
RIBBON							✓	✓			
PRE-FORMS	✓				✓	✓	✓	✓	✓	✓	✓
SALTS					✓		✓				

## COMINCO PRODUCTS, INC.

electronic materials division

933 West Third Avenue, Spokane 4, Washington  
Phone Area Code 509 RI 7-7103 • TWX 509 328-1207

3602

CIRCLE 203 ON READER SERVICE CARD

# DYNAMICS

## INSTRUMENTATION AMPLIFIERS

— with *complete*  
galvanometer  
conditioning  
controls



**Model 6411**—transistorized, wideband dc amplifier capable of delivering  $\pm 10V$  and  $\pm 100$  ma to the load. Unit features continuously variable gain control and variable dc offset adjustment of  $\pm 10V$  output range. Front panel galvanometer controls include:

- galvanometer damping switch
- galvanometer simulated load switch
- dc output current meter
- output polarity-reversing switch
- internal/external load switch

**Voltage Gain:** 0.1 through 1000 in 9 steps, continuously variable between steps.

**Linearity:** Better than 0.05%

**Frequency response:**  $\pm 2.0\%$  to 10 kc; down 3.0 db at 30 kc

**Drift:**  $\pm 2.0 \mu V$  in 40 hours operation after warm-up, referred to input

**Power line isolation:** shielded transformer produces less than 5.0 mmf of direct power line capacity to amplifier ground.

The galvanometer conditioning controls are also available on Dynamics gain 10 or gain 100 dc amplifiers. These units feature instantaneous overload recovery time (within rise time of the amplifier).

Write for complete literature on Model 6411, or the entire line.

**DYNAMICS INSTRUMENTATION COMPANY**

583 Monterey Pass Rd., Monterey Park, Calif. • Phone: CU. 3-7773

76 CIRCLE 76 ON READER SERVICE CARD

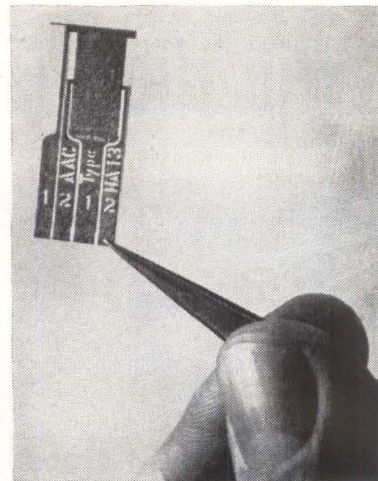

cations lie in areas where a vector product of two input quantities is to be produced: including wattmeters, analog multipliers, synchros, resolvers, fluxmeters, and related uses.

CIRCLE 303, READER SERVICE CARD

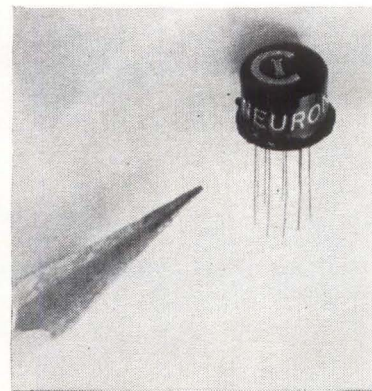

### Single-Chip Neuron For Sophisticated Logic Use

UNIVERSAL digital logic device capable of performing practically all of the basic logic functions, is made possible by advanced field effect manufacturing processes at Crystallonics Inc., 147 Sherman Street, Cambridge, Mass. Unlike most logic units, this neuron is not an assembly of individual active and inactive elements; instead, its ability to perform many logic functions arises from a novel method of controlling electron flow within a single monolithic block of silicon.

A salient feature of the device is its high input impedance of 10 megohms minimum, permitting many such units to be driven from one earlier stage. Output impedance is below 200 ohms, propagation delay

May 17, 1963 • electronics

is around 40 nsec, and the unit will operate up to 1 Mc over temperature range -55 to 125 C. Logic levels up to 13 are available. (304)

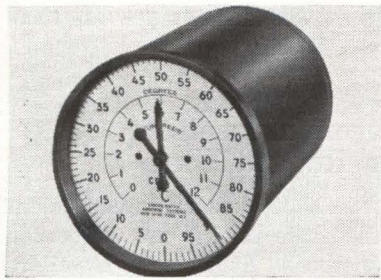

### Servo Indicator Has 3-In. Diameter

ON THE MARKET is a 3-in. diameter exhaust gas thermometer servo indicator. The hermetically sealed unit is used in conjunction with a chromel-alumel thermocouple to present a 0-1200 C dial display. Two concentric pointers are used on the output shafts, a small pointer turning about 270 deg angular and indicating hundreds of degrees, and a larger pointer rotating one revolution every 100 C and indicating temperature in individual degrees C. This easily allows for a readability of temperature to  $\frac{1}{4}$  C. The internal servo indicator consists of a cold junction compensator, mechanical chopper, solid state servo amplifier, low inertia servo motor, gear train, and characterized re-balance pot. Consolidated Airborne Systems, Inc., 900 Third Ave., New Hyde Park, N. Y. (305)



### Delay Line for Computer Application

DELAY LINE type 1954 has been introduced. The case is hermetically sealed and has a multi-terminal outlet. Designed as a plug-in unit for easy access, the line has wide range use since the electrical and physical specifications can be adapted for many applications. Total delay, shorted output is  $4.880 \mu\text{sec} \pm 0.1 \mu\text{sec}$ . Delay-rise time ratio is 50 to

## In CAPACITANCE MEASUREMENTS

Bridges from Boonton Electronics give you

- Semiconductor junction measurements
- Usable test signal levels down to 1 mv
- DC bias provisions up to 400 v
- Two-terminal and three-terminal measurements
- Test frequencies to 50 megacycles
- Self contained oscillator and detector units
- Capacitance accuracy to 0.25%
- Capacitance readings: 20  $\mu\text{pf}$  to 11,000 pf
- Conductance readings: 0.001 to 23,000  $\mu\text{mhos}$

See condensed specification chart below. For complete data contact Boonton Electronics Corporation or our local representative.

MODEL	TEST FREQUENCY	CAPACITANCE RANGE	CONDUCTANCE RANGE	BASIC ACCURACY	DC BIAS CAPABILITY	PRICE
75A-S8	1 Mc	200 $\mu\text{pf}$ to 1000 pf	0.01 to 1000 $\mu\text{mhos}$	Capacitance 0.25% Conductance 10% (+ range factors)	Internal -5 v to +125 v External up to 400 v	\$1200.
75B-S8	1 Mc	20 $\mu\text{pf}$ to 1000 pf	0.01 to 1000 $\mu\text{mhos}$	Capacitance 0.25% Conductance 10% (+ range factors)	Internal -5 v to +125 v External up to 400 v	\$1450.
75C	5 Kc-500 Kc (Variable)	200 $\mu\text{pf}$ to 1000 pf	0.001 to 1000 $\mu\text{mhos}$	Capacitance 0.25% Conductance 10% (+ range factors)	Internal only -5 v to +125 v	\$1900.
74C-S8	100 Kc	200 $\mu\text{pf}$ to 11,000 pf	0.001 to 1000 $\mu\text{mhos}$	Capacitance 0.25% Conductance 10% (+ range factors)	Internal only -5 v to +125 v	\$1125.
33A	1-50 Mc (7 steps) Xtal osc.	0.05 pf to 150 pf	0.5 to 23,000 $\mu\text{mhos}$ ( $\infty - 43 \Omega$ )	Capacitance 1% Conductance 2% (+ range factors)	Internal -5 to 100 v External 250 v	\$2000.

12 other models available including those without DC bias

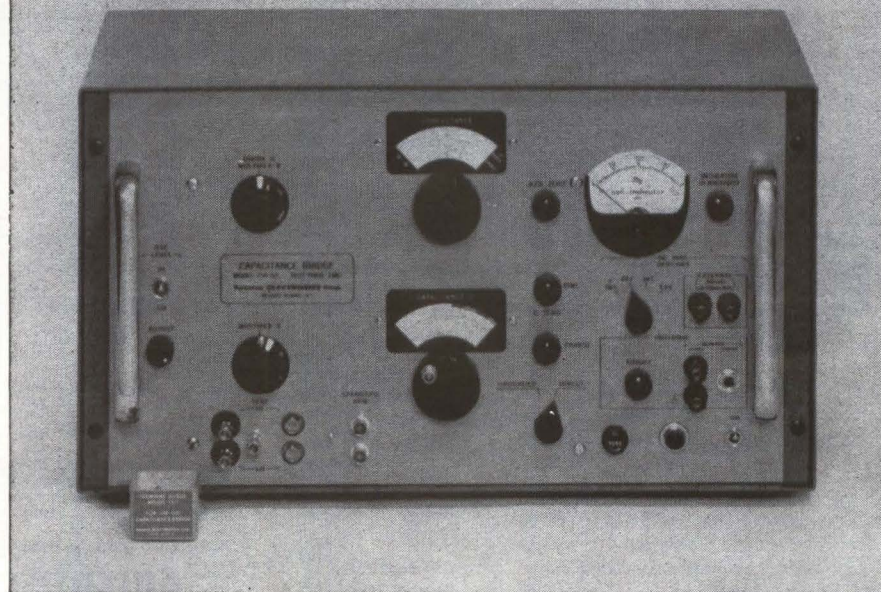

**BOONTON  
ELECTRONICS**  
CORPORATION

RF VOLTMETERS • CAPACITANCE  
BRIDGES • INDUCTANCE BRIDGES  
RF ADMITTANCE BRIDGES • DC  
METERS • RF DISTORTION METERS  
MORRIS PLAINS, N. J.

# 30,000 V 8 MA ±.05% REGULATION OFF-THE-SHELF POWER SUPPLIES

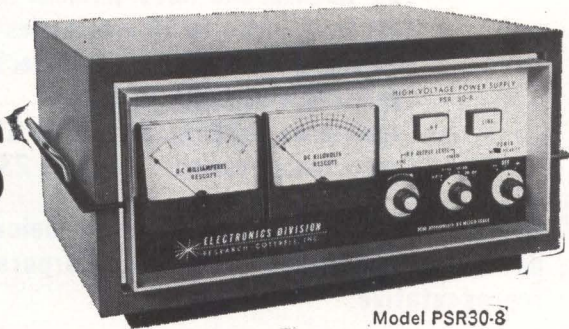

Model PSR30-8

PSR Series offers these important features: 11 Models available • Range 5 to 30 KV, 2 to 30 MA • Regulation ±.05% • Ripple .1% RMS • Completely Solid State Circuitry • Light Weight • Rack Height 8¾" maximum • Dry Insulation • Overload Protection • Reversible Polarity • Simplified Controls; coarse and fine voltage, ON-OFF meter reversing switch • Triple-Range Kilovoltmeter and Milliammeter. Write for New 1963 High Voltage Bulletin.

**ELECTRONICS DIVISION**



**RESEARCH-COTTRELL, INC.,** BOUND BROOK, NEW JERSEY

CIRCLE 204 ON READER SERVICE CARD

RC-284E

1. Taps and trimming sections are available. Impedance, 200 ohms —5 percent. Temperature coefficient, 50 ppm per deg C. Size, 5½ by 4½ by 1 in. Columbia Technical Corp., Woodside 77, N. Y.

CIRCLE 306, READER SERVICE CARD

## Beacon Magnetron For Rugged Use

THE SYM-4350 is an advancement in the state of the art of beacon magnetrons. It is a lightweight, compact millimeter tube, at 34 Gc, with power output peak of 2 Kw. It is designed for rugged use at high altitudes. Sylvania Electric Products Inc., 1100 Main St., Buffalo 9, N. Y. (307)

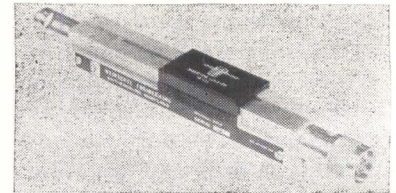

## Coaxial Attenuator Features Long Life

MODEL 953 is a 10 db direct reading, variable coaxial attenuator. Over the range from 2.5 to 12.0 Gc there is little change in attenuation with frequency. Because the variable element is capacitively coupled, there is no wear on the resistive elements. Unit can be used in systems requiring the exacting service of a rugged, stable attenuator—as a trimmer to balance power levels, for extending the range of power measurements, or as a simple level set. Weinschel Engineering, Gaithersburg, Md. (308)

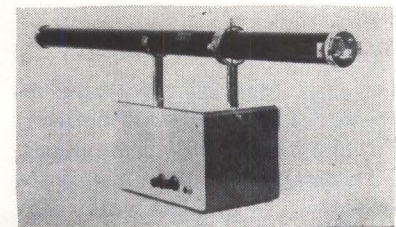

## Gaseous State Laser Has Variety of Uses

GASEOUS state laser OMG10, operating in the visible region, is being

*A sweet little Amplifier*

*(and tough as nails)*

NEXUS TYPE CDA-1 ALL SILICON SOLID STATE OPERATIONAL AMPLIFIER MEETS OR EXCEEDS SHOCK, VIBRATION, ETC. AS PER MIL-E-5272C. For further information on this superb analog module and other quality types write, wire or phone.

**NEXUS**  
RESEARCH LABORATORY, INC.  
19 Needham St., Dedham, Mass. 617-326-8414

## GRCtiny parts

See us at the Design Show—  
Booth #624 and 626

die cast  
**ZINC ALLOY**

molded  
**PLASTICS**



Coil Bobbins  
Gears & Pinions

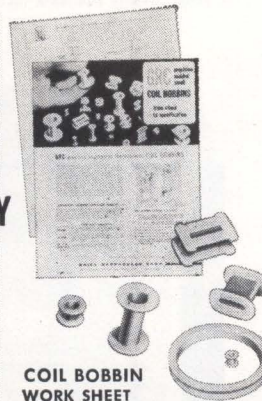

COIL BOBBIN  
WORK SHEET

Get this valuable data on GRC's wide range of small bobbin sizes, shapes and designs. GRC's methods give you quality and accuracy in small parts of die cast zinc alloy, Nylon, Delrin and other engineering thermoplastics. Exclusive single cavity, automatic techniques allow new designs, new production and assembly shortcuts. Write, wire, phone for samples and bulletins. Send prints for quotations.

No Minimum Size! Maximum sizes:  
Zinc Alloy—  
2" long,  
½ oz.  
Plastic—  
1¾" long,  
.05 oz.

**GRIES**

**GRIES REPRODUCER CORP.**  
World's Foremost Producer of Small Die Castings  
151 Beechwood Ave., New Rochelle, N. Y.  
Phone: (914) NEw Rochelle 3-8600

CIRCLE 205 ON READER SERVICE CARD



HIGHEST  
SPEED AND  
*Quietest*

## DURANT

Model "D" with  
HIGH SPEED INDEXING

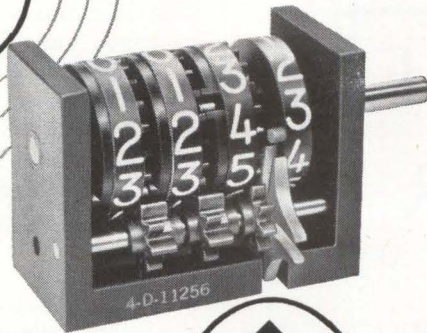

Model 4-D-11256

Think of it . . . high speed mechanical digital readout . . . 3500 RPM intermittent, 2000 RPM continuous, yet with longer life and up to 50% less noise level. Built with standard mounting and drive dimensions of Durant "D" instrument counters.

*Designed to meet military specifications*

▲ This specially designed **GENEVA INDEX** made of high impact thermo-plastic makes the **BIG DIFFERENCE!**

# DURANT®

MANUFACTURING COMPANY

1912 N. Buffum St.  
Milwaukee 1, Wis.

12 Thurbers Ave.  
Providence 5, R. I

SALES ENGINEERS IN PRINCIPAL CITIES  
SEE US BOOTH 1418, DESIGN ENGINEERING SHOW  
CIRCLE 206 ON READER SERVICE CARD

## AROUND THE WORLD IT'S KEW

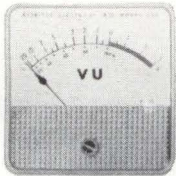

MODEL P-25

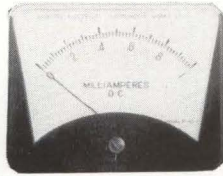

MODEL P-40

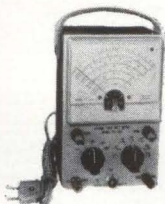

MODEL PV-202



MODEL TK-90A



MODEL KHE-505



MODEL EW-8



MODEL EW-16

### KYORITSU ELECTRICAL INST. WORKS, LTD.

NO. 120, NAKANE-CHO, MEGURO-KU, TOKYO, JAPAN  
CABLE ADDRESS: "KYORITSUKEIKI TOKYO"  
TEL: (717) 0131-5 • 0151-3

CIRCLE 207 ON READER SERVICE CARD

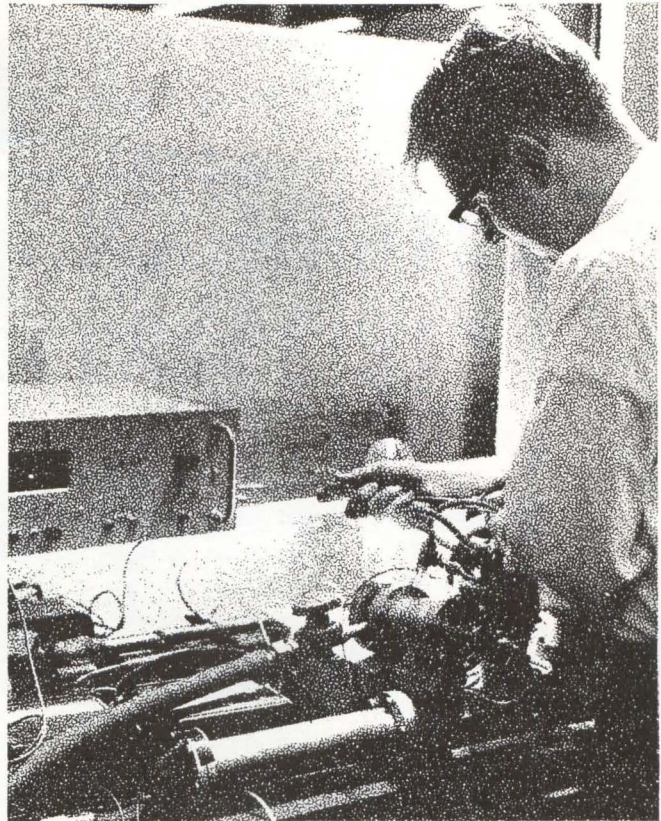

### HIGH VOLTAGE ENGINEERING

The above experiment is associated with a program to develop radiator cooled components for use in high energy electron beam handling equipment. The apparatus shown is a mock up of a system which utilizes photoconductive cells to measure the temperature of a wheel rotating in a vacuum.

The engineer is testing a calibrating light source which will enable the performance of a photoconductive cell to be monitored periodically from a control console located a considerable distance from equipment subject to extremely intense ionizing radiation.

This experiment is just one of the many challenging problems under investigation at High Voltage Engineering Corporation. Engineers and Scientists are invited to investigate career opportunities.

**RF CIRCUITRY**  
**INSTRUMENTATION**  
**MAGNETIC FIELD-MEASURING DEVICES**  
**MAGNET OPTICS**

*Please contact Mr. Louis P. Ennis  
P. O. Box 98, Burlington, Mass.*

### HIGH VOLTAGE ENGINEERING CORP.



BURLINGTON, MASSACHUSETTS  
(12 Miles North of Boston)

An equal opportunity employer

# NEW GERTSCH PHASE ANGLE VOLTMETER



**—measures in-phase voltages, quadrature voltages, and phase angles**

This versatile instrument accommodates up to 3 frequencies, employing plug-in filters and networks to 10 KC. You can order a single-frequency unit—then add or change frequencies as they are needed.

**Variable gain control** permits full-scale setting of any voltage from 1 mv to 300V, allowing equivalent angular error to be read directly in degrees and minutes. Ideal for synchro and resolver testing.

**Band-pass filtering** of both the signal and reference voltages minimizes effects of harmonic distortion, and noise.

Instrument can also be used as a standard VTVM (50 cps to 50 KC), and a phase-sensitive null indicator ( $5\mu\text{v}$  sensitivity).

**Available with isolation transformers** for both signal and reference channels.

**“Go” — “no-go” testing**—enabled by optional full-scale meter relay.

**Complete information** on all Gertsch synchro/resolver test instruments in catalog #11—40 pages of technical information, specifications, theory, application data and engineering bulletins. A valuable reference source for design and test engineers.



**Gertsch**

GERTSCH PRODUCTS, INC.

3211 S. La Cienega Blvd., Los Angeles 16, Calif. • UPTon 0-2761 • VERmont 9-2201

produced for general laboratory experimental and educational use. Unit has a variety of applications where coherent light beams are required. This sophisticated c-w device is available in one complete packaged unit, performance tested and ready for use. Total weight is 18 lb, including the r-f power supply. This laser can also be operated in the infrared region by the use of an optional set of mirrors. Controls are provided for mode adjustment and power input. Mechanical adjustments allow for accurate pointing of the laser beam. Litton Industries, Electron Tube division, San Carlos, Calif.

CIRCLE 309, READER SERVICE CARD

## Trimmer Pots Feature Small Size

FOR USE in electrical circuits as a single turn screw actuated two or three terminal variable resistance network, the  $\frac{1}{4}$  in. round precision Mechatrim trimmer potentiometers offer infinite resolution, 200 C high temperature performance, 100 Mc frequency range and low temperature coefficient of resistance. Resistance element is deposited metal film. Mechatrol, a division of Servomechanisms, Inc., 1200 Prospect Ave., Westbury, L. I., N. Y. (310)

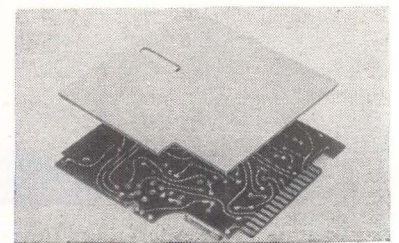

## Circuit-Board Damper Adds Little Weight

CIRCUIT-BOARD damper is a combination of a viscoelastic material and a Fiberglas constraining layer. It is designed to reduce vibration in circuit boards and similar plate-type structures. It permits damping of a circuit board after complete assembly. The entire board can be dipped or encapsulated prior to affixing circuit-board damper, without affecting the damping characteristics. It weighs 0.07 oz per square inch, is simple to install, low in cost. Barry Controls division of Barry Wright Corp., 700 Pleasant St., Watertown 72, Mass. (311)

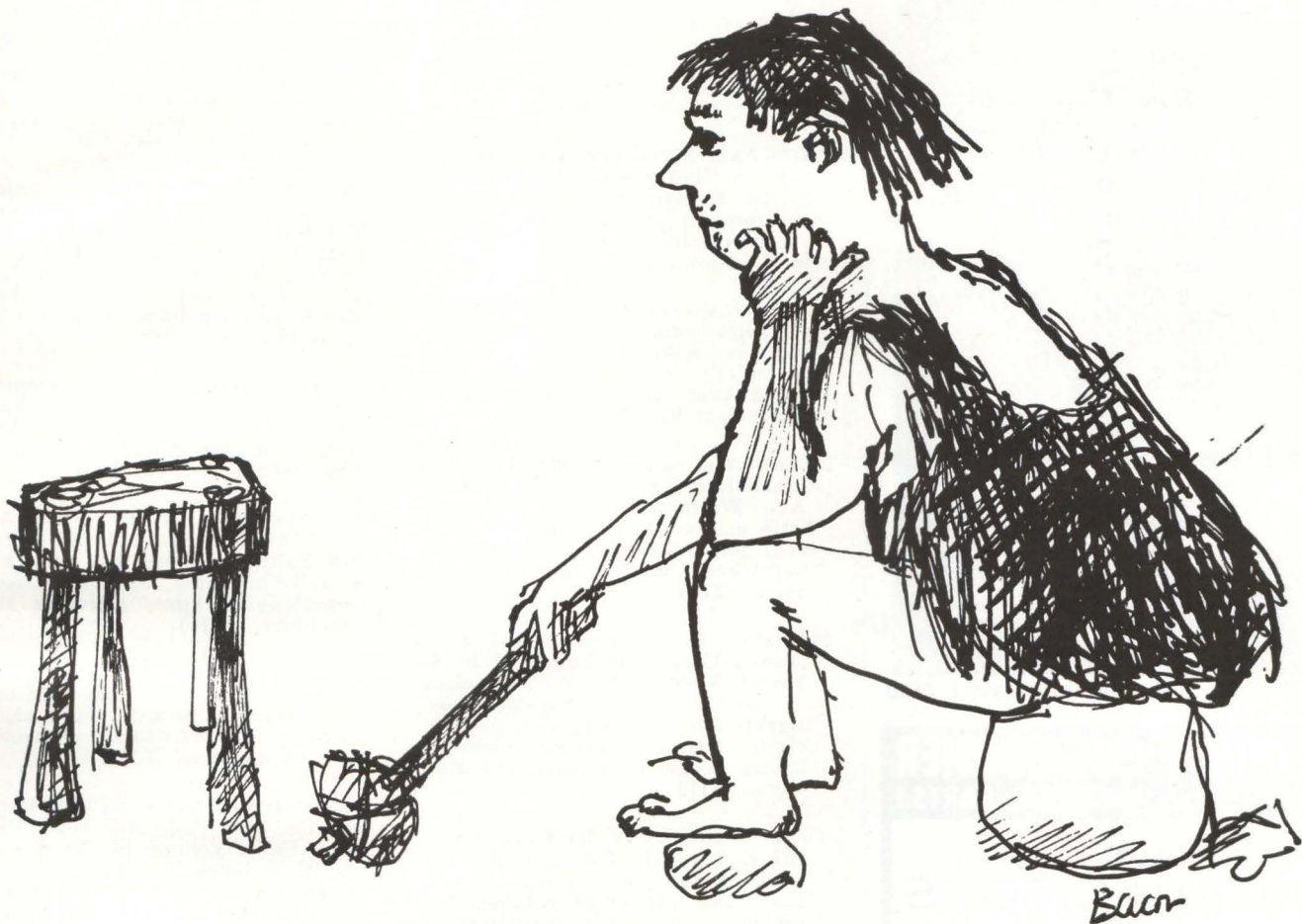

The day when the designer selected his materials all by his lonesome is past—especially in electronics. Lots of engineers, from many departments, get into the electronics buying act with the design engineer today. Production engineers, for example, feel free to bare their fangs at any specified product they feel would snafu the production line. Procurement people growl for their freedom to respecify for the sake of better prices or delivery. Service engineers, once burned by a faulty component or subassembly, are twice shy and thrice loud about its inclusion in future equipment. And management's oxen are notoriously goreable. That's what makes electronics marketers turn gray. The advertiser today must

reach the design engineer *and* everyone else in electronics engineering. He can do so either through a passel of splinter publications, or through electronics.

Well, that's the price of progress.

electronics is the weekly, contemporary engineering publication of the modern electronics industry. It integrates the interests of 57,000 engineers in all phases and functions of electronics—the people who pass on your products before they are bought. In a field abounding with free publications, these 57,000 engineers pay up to \$6 a year to subscribe to electronics. They need electronics. You need them. Advertise in electronics.

**electronics:** *your basic buy for electronics advertising* | A McGRAW-HILL PUBLICATION

330 West 42nd St., New York 36, N. Y.



For Big Guying Jobs  
on Towers and Antennas

*Preformed*  
**BIG-GRIP**

**DEAD-ENDS**  
Hold Guy Strand  
up to 1" Dia.  
(100% RBS — 104,500 lbs.)

BIG-GRIP Dead-Ends secure galvanized and Alumoweld guys for various types of antennas and towers (some over 600 ft. in height). These dead-ends are hand applied in seconds; never require maintenance; completely safe. Write for bulletins SP-2041 and SP-2002.



**PREFORMED  
LINE PRODUCTS  
COMPANY**

5349 St. Clair Avenue  
Cleveland 3, Ohio  
681-4900 (DDD 216)  
600 Hansen Way  
Palo Alto, California  
327-0170 (DDD 415)

Made in accordance with  
or for use under U. S.  
Patent Nos. 2,691,865  
and 2,761,273

**CIRCLE 208 ON READER SERVICE CARD**

**DON'T CUT CORNER  
ON VITAL PARTS!**

**SHIZUKI  
CAPACITORS**

Using metallized paper and metallized mylar film produced by itself.

- \* Lacquer Film Capacitors
- \* Polystyrene Capacitors
- \* Mylar Capacitors
- \* Metallized Paper Capacitors for motor running, fluorescent ballasts
- \* Noise Suppression Capacitors
- \* Ignition Capacitors

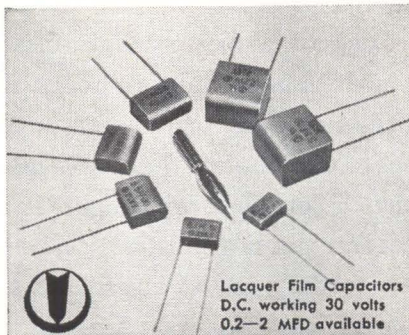

Lacquer Film Capacitors  
D.C. working 30 volts  
0.2—2 MFD available

**SHIZUKI ELECTRIC WORKS CO., LTD.**

HEAD OFFICE: 1, TAISHA-CHO, NISHINOMIYA, JAPAN  
CABLE ADDRESS: "CAPACITOR" NISHINOMIYA  
TOKYO FACTORY: 10-7, ARAJIYUKU, OTA-KU, TOKYO

**82 CIRCLE 82 ON READER SERVICE CARD**

## Literature of the Week

**DIGITAL MODULES** Digital Equipment Corp., 146 Main St., Maynard, Mass. A 4-page brochure covers 5 new, low cost 1 Mc modules.  
**CIRCLE 312, READER SERVICE CARD**

**PLANAR RELIABILITY** Philco, a subsidiary of Ford Motor Co., Lansdale, Pa., has published a report on the ultra reliability of its *n-p-n* silicon planar transistors. (313)

**STRIP-CHART RECORDERS** LaPine Scientific Co., 6001 S Knox Ave., Chicago 29, Ill. Bulletin describes a linear/log recorder and a high-sensitivity recorder with a sensitivity of 1 $\mu$ v in the 1/2-mv range. (314)

**SILICON FLANGELESS RECTIFIERS** Atlantic Semiconductor, Inc., 905 Mattison Ave., Asbury Park, N. J., offers a bulletin entitled "Double Diffused Avalanche Regulated Silicon Flangeless Rectifiers." (315)

**DIFFERENTIAL PRESSURE CELLS** Baldwin-Lima-Hamilton Corp., 42 Fourth Ave., Waltham 54, Mass. Data bulletin discusses differential pressure cells recommended particularly for aerospace wind-tunnel research work. (316)

**PRECISION ANGLE SENSORS** Del Electronics Corp., 250 Sandford Blvd., Mount Vernon, N. Y., has made available a manual to acquaint designers and engineers with the precision position sensing elements known as the Inductosyn and Multisyn. (317)

**ANTENNA TOWERS** Tri-Ex Tower Corp., 127 E. Inyo St., Tulare, Calif., has available an antenna tower wall chart and condensed catalog that provides basic data necessary to select a tower properly to fit antenna load requirements. (318)

**STEP SERVOS** IMC Magnetics Corp., 6058 Walker Ave., Maywood, Calif., has available a complete literature kit on step-servo systems and motors. (319)

**MICA CAPACITORS** Cornell Dubilier Electronics division of Federal Pacific Electric Co., 50 Paris St., Newark 1, N. J., offers the Mica Minder, a 17 in. by 22 in. wall chart compiled to aid circuit designers select mica capacitors for military, industrial and commercial applications. (320)

**MILITARY COMPONENTS** Clarostat Mfg. Co., Inc., Dover, N. H. A complete catalog of military type fixed and variable resistors is available. (321)

**TELESCOPING MASTS** Andrew Corp., P. O. Box 807, Chicago 42, Ill. Catalog P covers pneumatically operated masts and accessories for transportable communication systems. (322)

**DIGITAL COMPUTER** Computer Control Co., Inc., Old Connecticut Path,

Framingham, Mass., has published a comprehensive package of literature detailing the new high speed DDP-24 general purpose digital computer. Letterhead response requested.

**H-F ANTENNAS** Granger Associates, 1601 California St., Stanford Industrial Park, Palo Alto, Calif. Bulletin outlines antenna needs for h-f communications and surveys types of antennas available. (323)

**SYSTEM FUNCTION MODULES** Navigation Computer Corp., Rittenhouse and Van Buren St., Valley Forge Industrial Park, Norristown, Pa. Brochure presents the 400 series line of computer system function modules in terms a logic designer normally utilizes. (324)

**D-C PLUG-IN POWER SUPPLIES** Acopian Technical Co., 927 Spruce St., Easton, Pa. New d-c plug-in power supply catalog describes in detail over 700 models. (325)

**SPACE ACTIVITIES** Westinghouse Air Arm Division, Box 746, Mail Stop 210, Baltimore 3, Md., has published a well-illustrated, 28-page booklet describing its space activities and capability. (326)

**ELECTRONIC SIGNAL SIMULATORS** Telometrics, Inc., 12927 So. Budlong Ave., Gardena, Calif. Data sheet 45 covers the 301 and 303 electronic signal simulators. (327)

**MICROWAVE MODULATOR** Hewlett-Packard Co., 1501 Page Mill Road, Palo Alto, Calif. Volume 14, No. 7-8 of the H-P Journal contains a well-illustrated article on the model 8714A microwave modulator. (328)

**CAPABILITIES BROCHURE** Larr Optics and Electronics Co., 4901 Ward Road, Wheatridge, Colo., has available a capabilities brochure on specialized optics systems and infrared applications. (329)

**SILICON DIODES** Ohmite Mfg. Co., 3655 Howard St., Skokie, Ill. Catalog 804 announces a new line of silicon diodes for general purpose or low power rectifier use. (330)

**OPERATIONAL AMPLIFIER** Nexus Research Laboratory, Inc., Dedham, Mass., has published bulletin ATB-3 on its all silicon solid-state operational amplifier. (331)

**VARIABLE ATTENUATORS** Microwave Development Laboratories, Inc., 87 Crescent Road, Needham Heights 94, Mass. Bulletin AT-1 illustrates and describes single topwall variable attenuators. (332)

**D-C POWER SUPPLIES** Electronic Measurements Co., Eatontown, N. J. Catalog 63 features index-tab selection of power supplies by mode of regulation—constant-voltage, constant-current, or dual. (333)

May 17, 1963 • electronics



## remote sensing . . .

**THE NEW ART IN MEASUREMENT OF  
VIBRATION FREQUENCY  
OR ROTATIONAL SPEED**

OPTOmechanisms' Transistorized Optical Tachometer, Model 219A, provides a portable velocity measuring capability when used in conjunction with OPTOmechanisms' Frequency Meter.

The Frequency Meter Model 220FM is specifically designed to visually indicate in cycles per second the results sensed by the Optical Tachometer. The transistorized frequency meter is self contained, complete with power source for portable field use, shop, or test laboratory. Power is supplied by four type D flashlight cells.

The Tachometer is also available as a separate unit for use with basic laboratory equipment.

For detailed specifications write:

# OPTOmechanisms Inc.

ENGINEERS HILL, PLAINVIEW, L. I., NEW YORK GE 3-8100  
TWX: CODE 516 433 9690

CIRCLE 209 ON READER SERVICE CARD



**Are you a  
COMPLETELY  
INFORMED  
electronics  
engineer?**

Today you may be working in microwaves. But on what project will you be working tomorrow? You could have read electronics this past year

and kept abreast of, say, microwave technology. There were 96 individual microwave articles between July, 1961 and June, 1962!

But suppose tomorrow you work in some area of standard electronic components, in semiconductors, in systems? Would you be up-to-date in these technologies? Did you read the more than 3,000 editorial pages that electronics' 28-man editorial staff prepared last year?

electronics is edited to keep you current wherever you work in the industry, whatever your job function(s). If you do not have your own copy of electronics, subscribe today via the Reader Service Card in this issue. Only 7½ cents a copy at the 3 year rate.

# electronics

electronics • May 17, 1963

Because you've got to SEE it to BELIEVE it

...we will send you a FREE sample!!!!

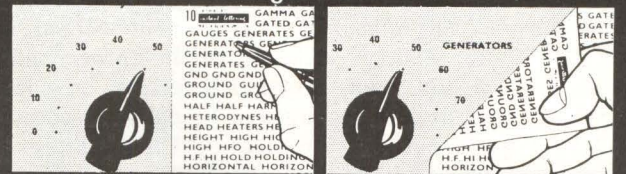

*instant lettering*

## DRY TRANSFER TITLES

FOR PROTOTYPES AND ELECTRONIC PANELS

**NOT A DECAL — NO WATER — NO TAPES — NO SCREENS  
GOES ON INSTANTLY — JUST PRESS AND IT'S THERE  
MAKES PROTOTYPES LOOK LIKE FINISHED EQUIPMENT!**

"Instant Lettering" Electronic Titles transfer DRY to almost any surface—metal, glass, wood, plastic—with just a quick light pressure. Simply try the sample. You'll agree "Instant Lettering" is the easiest quickest way to get professional lettering you've ever seen.

Complete "Instant Lettering" Title Sets contain 24 sheets with thousands of preset words and phrases researched to give you the greatest variety and flexibility.

No. 958 — Black ..... \$4.95  
No. 959 — White ..... 4.95

The complete line of standard "Instant Lettering" sheets is also available. Type sizes range from 8 point to 1½ inch display letters in a wide selection of type faces.

WRITE — WIRE — PHONE FOR FREE SAMPLE!

### THE DATAK CORPORATION

63 71st STREET  
N. J. 201—UN 4-6555

GUTTENBERG, N. J.  
N. Y. 212—LA 4-0346

CIRCLE 83 ON READER SERVICE CARD

83

## Avakian—Wizard in a Wheelchair

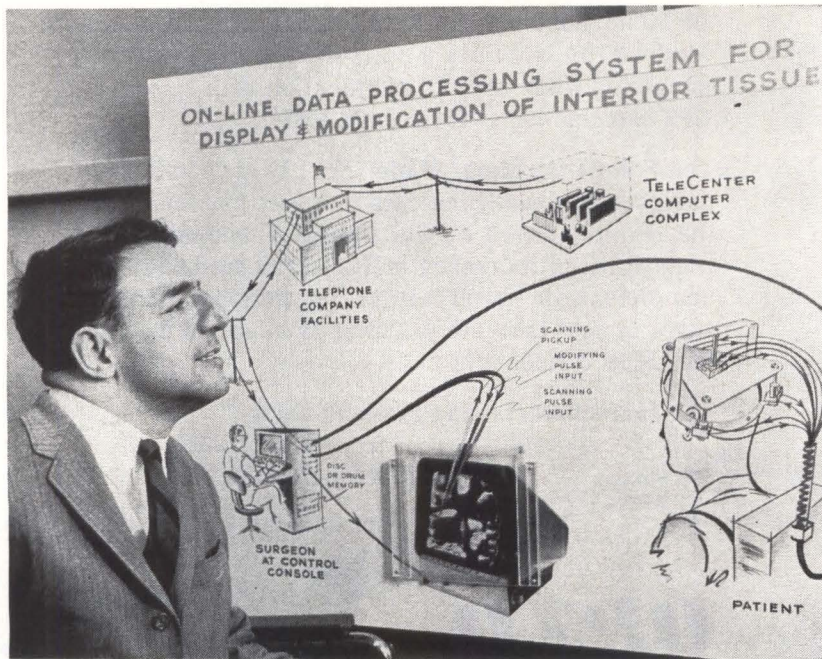

**EMIK A. AVAKIAN** is a 39 year old scientist who has spent his life in a wheel chair. He is a successful engineer and inventor; many of his ideas have been developed into highly useful products.

It is ironic that one who is a victim of the nearly complete breakdown of his own internal nerve communication system should be an expert in the field of communication between men and machines. In his full time job as a supervisory engineer at The Teleregister Corporation, he is responsible for developing devices for getting information into and out of electronic data processors.

Born of Armenian descent in Teheran, Avakian has been denied virtually every human physical faculty. He is unable to walk, and his arms, hands, and fingers are useless to him. He speaks very slowly with what is apparently a tremendous physical effort. While it is difficult at first to understand him, listeners become used to his manner of speech within a few minutes. His cheerful personality makes it easy for secretaries, draftsmen and lab technicians to execute his ideas and instructions.

In spite of his limitations, he

has accomplished far more than most gifted persons with normal physical ability. He is endowed with remarkable mental powers including a sense of humor. His accomplishments as a student, a professional man, an author, an inventor, and a good American citizen are the credentials which caused the President of The United States to name him Handicapped American of the Year 1961. This April the Shah of Iran conferred on him the Crown Medal, highest honor bestowed by the land of his birth.

**INVENTIONS**—He is co-inventor of a signature scrambler which enables banks to encode depositor's signatures in passbooks so tellers can decode them, but would-be forgers cannot, and of a unique digital data-to-voice conversion system which is to be used for announcing stock quotations.

In recognition of work in his avocational field of neurological motor mechanisms and their disorders, he was named to the American Academy of Neurology.

Avakian says of his parents, with whom he lives, "They have been the chief instrument of any

successes that have come to me during my life." Mr. and Mrs. Alexander Avakian are quietly proud of their son, who has proven their faith by earning a B.A. degree from Eureka College, and an M.A. from Columbia University in math and physics, and by his later professional accomplishments.

**HELPING OTHERS** — He finds time in his busy life to promote the idea that handicapped persons make good employees. His latest effort to help this group is perhaps his greatest: putting electronic computers to work on defective human nervous systems. Simply stated, a computer would be used to visualize interior tissue and to control beams of radiation which would in turn modify the inaccessible afflicted brain areas that cause palsy and other human disorders.

Avakian's success with other engineering projects heretofore bodes well for his efforts in the neurological field. It is conceivable that cancer and other diseases may eventually be treated successfully with the techniques he has evolved.



### Mallory Appoints Ben Anello

**P. R. MALLORY & CO., INC.**, Indianapolis, Ind., has appointed Ben Anello as manager of marketing services.

Anello joins the staff of the manufacturer of electronic components, battery systems and metallurgical products—moving from the post of manager, market services, at **ELECTRONICS** magazine.

The new Mallory executive has been active in developing applica-

A.C. & D.C.  
MOTORS, GEARMOTORS  
BLOWERS .001 HP to .1 HP  
24-HOUR DELIVERY  
OFF OUR SHELF

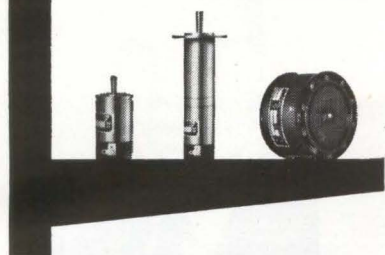

**Telephone Us!** Why fiddle around waiting weeks or months for prototype motors, gearmotors, or blowers? Pick up the phone and call Globe instead. We stock hundreds of standard units just for the man in a bind who needs a unit fast. If you design with precision motors and blowers up to 1/10 HP, request Bulletin 24 describing this swift service. Better yet, phone us at Area Code 513 222-3741. **Globe Industries, Inc., 1784 Stanley Ave., Dayton 4, Ohio.**

GLOBE

CIRCLE 210 ON READER SERVICE CARD

**1**  
Tie faster,  
easier,  
tighter!

**2**  
Form knots  
that  
don't slip!

**3**  
Greater  
stability  
under  
high heat!

WHAT DO YOU WANT  
LACING CORDS and TAPES  
TO DO FOR YOU?

HEMINWAY  
& BARTLETT

NYLON and DACRON CORDS  
FLAT BRAIDED TAPES  
and TEFLON COATED  
FIBERGLAS TAPES

GIVE YOU  
ALL THESE ADVANTAGES

Available in wax-coated, wax-free or "G.E." finish  
Write for free samples and specification book.

**THE HEMINWAY & BARTLETT MFG. CO.**  
Electronics Division: 500 Fifth Avenue, New York 36, N.Y.

CIRCLE 211 ON READER SERVICE CARD

electronics • May 17, 1963

## KINNEY PUMPS AND COMPONENTS REDUCE HIGH VACUUM PROBLEMS TO A MINIMUM



### VACUUM GAUGES

A variety of Kinney vacuum gauges includes the KTG Thermocouple Gauge (3000 to 1 micron range), the KDG Discharge Gauge (10 microns to  $2 \times 10^{-7}$  torr range), and the TD-1 McLeod Gauge (150 torr to 1 micron range).

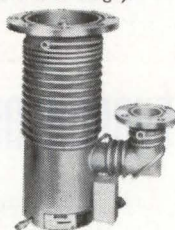

### DIFFUSION PUMPS

Kinney Series KDP Diffusion Pumps provide maximum pumping speeds in 2", 4", and 6" sizes. They obtain pressures of  $4 \times 10^{-7}$  torr un-baffled, and  $1 \times 10^{-8}$  torr when combined with the Model KDB baffle using liquid nitrogen.

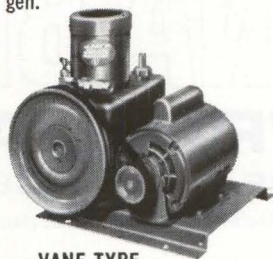

### VANE-TYPE MECHANICAL PUMPS

The Series KCV Vane Pumps are provided in 2, 3, 5, and 7 cfm sizes and are manufactured to the same high quality standards as Kinney cam-and-piston pumps. Quiet, vibrationless, and smoke-free, they are ideal for laboratory use.



### CAM AND PISTON MECHANICAL PUMPS

Kinney produces the highest quality in mechanical pumps ranging in size from 2 to 850 cfm. Series KS and KD Single Stage Pumps attain pressures below 10 microns; Series KC Compound Pumps deliver pressures below 0.2 micron.



### HIGH VACUUM VALVES

Kinney's complete line of vacuum valves includes series DC Diaphragm Valves, Series BB and OB Bellows sealed Valves, Series KRV Right Angle Valves, and Series G Gate Valves. They are provided for soldered, threaded, or flanged connection and for manual or air operation.



### BAFFLES AND COLD TRAPS

A unique design gives Kinney Baffles high conductance and maximum effectiveness. The Series KDB is intended for water or liquid nitrogen cooling; the Series KWB is used with water or freon. Supplied in 2", 4", 6" and 10" sizes.



**KINNEY VACUUM DIVISION**

THE NEW YORK AIR BRAKE COMPANY  
3529 WASHINGTON STREET • BOSTON 30, MASS.

**KINNEY . . . EVERYTHING IN VACUUM**

CIRCLE 85 ON READER SERVICE CARD 85

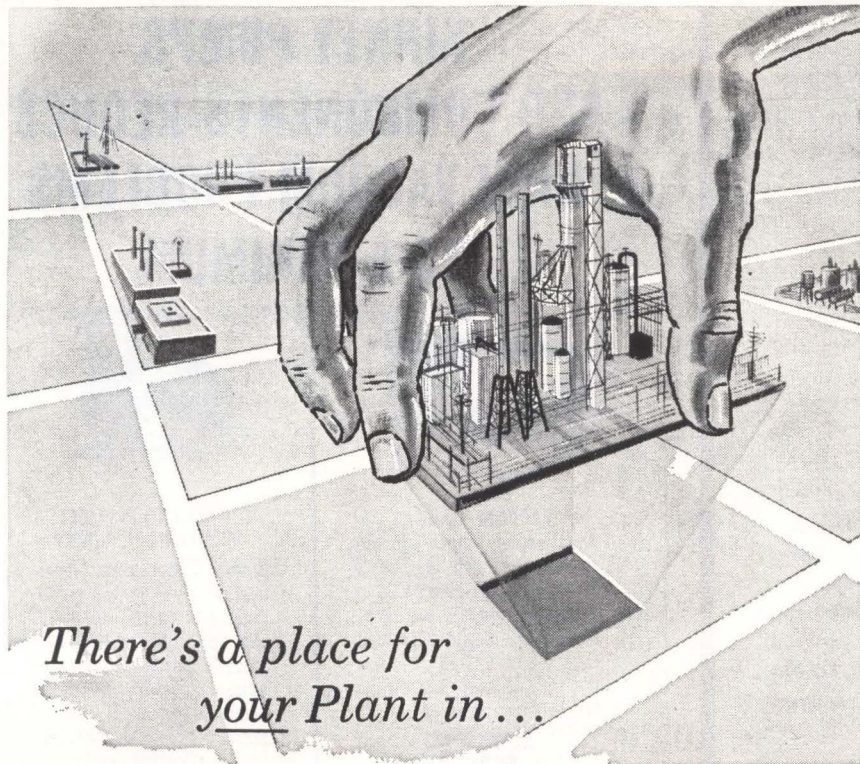

## Florida's newest metropolitan industrial areas

General Electric chose Daytona Beach...The same advantages that impressed them when seeking a location for the Headquarters of their Command Systems Division are also available to you. FLORIDA'S EXPANDING MARKET, MILD YEAR-ROUND CLIMATE, AMPLE MANPOWER, LOW COST INDUSTRIAL SITES, FAVORABLE TAXES, AMPLE POWER, WATER AND FUEL, EXCELLENT TRANSPORTATION, AN INDUSTRY-MINDED COMMUNITY — ALL YOURS IN...

# DAYTONA BEACH INDUSTRIAL AREAS THRESHOLD OF THE RACE TO SPACE

Ormond Beach • Holly Hill • Daytona Beach • South Daytona • Daytona Beach Shores • Port Orange

THE DAYTONA BEACH AREA COMMITTEE OF 100 pledges its complete cooperation in helping you find a profitable industrial site. Direct your inquiry to J. Saxton Lloyd, Chairman, who will hold all such inquiries in his personal file in the very strictest confidence.

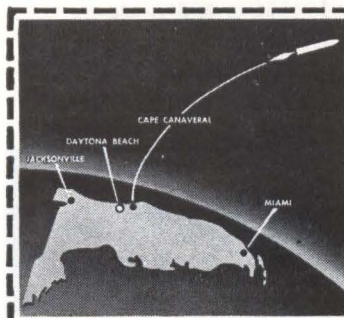

Mr. J. Saxton Lloyd, Chairman  
Committee of 100  
Daytona Beach Industrial Areas  
Dept. A12, Daytona Beach, Fla.  
Please send detailed information on the  
Daytona Beach Industrial Areas.

NAME.....TITLE.....  
COMPANY.....  
ADDRESS.....  
CITY.....ZONE...STATE.....

*All inquiries held in strict confidence*

tions and markets for electronic products. He will report to James Girdwood, director of marketing.



Designatronics  
Names Hoffman

MARTIN HOFFMAN has been named vice president in charge of sales of Designatronics Inc., Mineola, N. Y. He will continue to be responsible for the management of the firm's Sterling Instrument division.

Hoffman was formerly assistant to the president.



Entekin Advances to  
Vice Presidency

GUY B. ENTREKIN, JR., Instrument Division general manager of Bourns, Inc., has been appointed a vice president by the company's board of directors. He will continue to be responsible for the complete operations of the Instrument Division facility in Riverside, Calif.

Entekin joined Bourns early this year from Collins Radio where he was general manager of the Components division, Newport Beach, Calif.

## Vitramon Creates Research Department

VITRAMON, INC., Monroe, Conn., manufacturer of high reliability





## Are you a COMPLETELY INFORMED electronics engineer?

Today you may be working in microwaves. But on what project will you be working tomorrow? You *could* have read **electronics** this past year and kept abreast of, say, microwave technology. *There were 96 individual microwave articles between July, 1961 and June, 1962!*

But suppose tomorrow you work in some area of standard electronic components, in semiconductors, in systems? Would you be up-to-date in these technologies? Did you read the more than 3,000 editorial pages that **electronics'** 28-man editorial staff prepared last year?

**electronics** is edited to keep you current *wherever* you work in the industry, *whatever* your job function(s). If you do not have your own copy of **electronics**, subscribe today via the Reader Service Card in this issue. Only 7½ cents a copy at the 3 year rate.

# electronics

electronics • May 17, 1963

electronic components, has announced the formation of a new department of research which will become operative on July 1.

According to Barton L. Weller, Vitramon president, the new department will concentrate on pure scientific inquiry covering the total electronics world, and will augment Vitramon's present program of long-range practical application research.

The department will be housed in the Monroe plant for the remainder of 1963, after which it will relocate.

## PEOPLE IN BRIEF

James F. Harrigan moves up to v-p at Hazeltine Corp. Bernard R. Martus promoted to chief engineer by Zero Mfg. Co. Kenneth Archbold, formerly with McCoy Electronics Co., appointed director of engineering at Delta-f, Inc. A. S. Chivers advances at Barry Wright Corp. to v-p of new business development. Gardner-Denver Co. ups Cedric H. Rieman to president and chief exec officer replacing Gifford V. Leece who was elected chairman of the board and of the exec committee. Milton Magid leaves Loral Electronics Corp. to join Singer Metrics div. of The Singer Mfg. Co. as chief engineer for microwave products. Vito L. Carbonaro, previously asst. works mgr., named director of engineering at Roanwell Corp. John M. Teem, technical director of Electro-Optical Systems, Inc., also elected a corporate v-p. Jerome W. Babb, ex-Sangamo Electric Co., appointed supervisor electronics engineer in charge of the Hydro-Space section of Electro International, Inc. Edward L. Smiley promoted to mgr., electronic production at The Sippican Corp. John J. Myers advances to v-p, surface based electronic systems, and James F. Reagan to v-p, missiles, at North American Aviation's Columbus div. Edward Kuebert elevated to value engineering mgr. at Fairchild Space and Defense Systems. E. Dean Border, formerly with Lido Mfg. Co., named asst. to the mgr. of R&D and head of electronics engineering at Servonic Instruments, Inc.

## EMPLOYMENT OPPORTUNITIES



**E. E.'s**  
for FEE-PAID Positions  
**WRITE US FIRST!**  
Use our confidential application for professional, individualized service . . . a complete national technical employment agency.  
**ATOMIC PERSONNEL, INC.**  
Suite 1207L, 1518 Walnut St., Phila. 2, Pa.

## SEARCHLIGHT SECTION

(Classified Advertising)  
BUSINESS OPPORTUNITIES  
EQUIPMENT - USED or RESALE

### WANTED:

### AN/TRC-24 RADIO SET COMPONENTS

AM-912/TRC  
AM-913/TRC  
AM-914/TRC  
AM-915/TRC  
PP-685/TRC  
R-417/TRC  
T-302/TRC

W-2147, Electronics  
Class. Adv. Div., P.O. Box 12, N.Y. 36, N.Y.

### CIRCLE 950 ON READER SERVICE CARD



### U.S. ARMY EE-8

Telephone fully reconditioned at 2 for \$35.00. Any number can be used on same line. Wire 1¢ per ft. or \$35.00 per mile. Write for complete telephone list.

TELEPHONE ENGINEERING CO.  
Dept. E-5173 Simpson, Pa.

### CIRCLE 951 ON READER SERVICE CARD

### WANTED

Two Used No. 331 Dumont  
**CATHODE RAY OSCILLOGRAPHS**  
In Good Condition

W. DENTON  
P. O. Box 293, Church Street Station  
New York 7, New York

### CIRCLE 952 ON READER SERVICE CARD

### RADIO RESEARCH INSTRUMENT CO.

AUTO-TRACK & TELEMETRY ANTENNA PEDESTALS  
3 & 10 CM. SCR. 584 AUTOTRACK RADARS.  
AN/TPS-1D SEARCH. AN/TPS-10 HT. FINDERS.  
AN/FPN-32GCA. AN/APS-10 NAVIG. & WEATHER.  
AN/APS-15B PRECISION. AN/APQ-35B PRECISION.  
AN/APS-31A SEARCH. DOZENS MORE.  
5-1-2 MEGAWATT HIGH POWER PULSERS.

RADIO RESEARCH INSTRUMENT CO.  
550 Fifth Ave., New York Judson 6-4691

RADAR SYSTEMS & COMPONENTS / IMMEDIATE DELIVERY

### CIRCLE 953 ON READER SERVICE CARD

## FOR SALE

Standard 3-channel open-wire Carrier  
Terminals and Repeaters.

Standard v-f carrier-telegraph terminals.

Standard v-f ringers, v-f repeaters,  
repeating coils, condensers, filters, re-  
tard coils, polar relays.

Complete list on request

FS-2148, Electronics  
Class. Adv. Div., P.O. Box 12, N.Y. 36, N.Y.

### CIRCLE 954 ON READER SERVICE CARD

# INDEX TO ADVERTISERS

A & M Instrument, Inc. ....	71	James Electronics Inc. ....	65	Texas Instruments Incorporated	
• AMP Incorporated .....	15	Johnson Company, E. F. ....	22	Industrial Products Group .....	25
Allen-Bradley Co. ....	13				
Arnold Engineering Co., The .....	36				
		• Kepeco, Inc. ....	57	Weldmatic Division/Unitek .....	67
Bell Telephone Laboratories .....	37	Kinney Vacuum		Weston Instruments	
Boonton Electronics Corp. ....	77	Div. of New York Air Brake Co. ....	85	A Division of Daystrom Inc. ....	21
		• Knights Company, James .....	70	White S. S. ....	64
		Krohn-Hite Corp. ....	26	• Wind Turbine Company .....	70
		• Kyoritsu Electrical Instruments			
• Clifton Precision Products Co., Inc. ....	63	Works, Ltd. ....	79		
Cominco Products, Inc. ....	76				
		Levin and Son, Inc., Louis. ....	27		
Data-Control Systems, Inc. ....	14				
Datak Corp. ....	83	• McGraw-Hill Book Co. ....	61		
Daytona Beach .....	86	Micro State Electronics Corp. ....	5		
Dumont Laboratories		• Microswitch			
Div. of Fairchild Camera &		Division of Honeywell .....	31		
Instrument Corp. ....	29	Millen Mfg. Co., Inc., James .....	66		
duPont de Nemours & Co., Inc. E. I. ....	69				
• Durant Manufacturing Co. ....	79				
Dymec					
A Division of Hewlett Packard Co. ....	55				
Dynamics Instrumentation Co. ....	76				
Electro Instruments Inc. ....	33				
Formica Corp. ....	34				
• Fusite Corp., The .....	23				
• General Electric Co.					
Rectifier Components Dept. ....	38				
Gertsch Products, Inc. ....	80				
Globe Industries, Inc. ....	85				
Gries Reproducer Corp. ....	78				
Heinemann Electric Co. ....	9				
Heminway & Bartlett Mfg. Co., The .....	85				
• Hewlett-Packard Company .. 2nd cover					
High Voltage Engineering Co. ....	79				
Hoffmann Electronics Corp. ....	35				
Hughes Aircraft Co.					
Aerospace Divisions .....	73				
Ingersoll Products					
Division of Borg-Warner Corp. ....	32				

## CLASSIFIED ADVERTISING

F. J. Eberle, Business Mgr.

## EMPLOYMENT OPPORTUNITIES ... 87

## EQUIPMENT

Used or Surplus New)  
For Sale ..... 87

## ADVERTISERS INDEX

Atomic Personnel Inc. ....	87
Denton, W. ....	87
• Radio Research Instrument Co. ....	87
• Telephone Engineering Co. ....	87

• See advertisement in the July 25, 1962 issue of Electronics Buyers' Guide for complete line of products or services.

This Index and our Reader Service Numbers are published as a service. Every precaution is taken to make them accurate, but **electronics** assumes no responsibilities for errors or omissions.

## electronics



Audit Bureau  
of Circulation



Associated Business  
Publications

Audited Paid Circulation

**JAMES T. HAUPTLI**

Advertising Sales Manager

**DAVID CUNNIFF**

Promotion Manager

**Electronics Buyers' Guide**

**R. S. QUINT**  
General Manager

**RICHARD J. TOMLINSON**  
Business Manager

**THEODORE R. GEIPEL**  
Production Manager

## ADVERTISING REPRESENTATIVES

### ATLANTA (9):

Michael H. Miller, Robert C. Johnson  
1375 Peachtree St. N.E., Trinity 5-0523  
(area code 404)

### BOSTON (16):

William S. Hodgkinson, Donald R. Furth  
McGraw-Hill Building, Copley Square,  
Congress 2-1160 (area code 617)

### CHICAGO (11):

Harvey W. Wernecke, Robert M. Denmead  
645 North Michigan Avenue, Mohawk 4-5800  
(area code 312)

### CLEVELAND (13):

Paul T. Fegley  
55 Public Square, Superior 1-7000  
(area code 216)

### DALLAS (1):

Frank Le Beau  
The Vaughn Bldg., 1712 Commerce St.  
Riverside 7-9721 (area code 214)

### DENVER (2):

John W. Patten  
Tower Bldg., 1700 Broadway,  
Alpine 5-2981 (area code 303)

### HOUSTON (25):

Joseph C. Page, Jr.  
Prudential Bldg., Halcombe Blvd.,  
Riverside 8-1280 (area code 713)

### LOS ANGELES (17):

Ashley P. Hartman, John G. Zisch,  
William C. Gries  
1125 W. 6th St., Huntley 2-5450  
(area code 213)

### NEW YORK (36):

Donald H. Miller, Henry M. Shaw,  
George F. Werner  
500 Fifth Avenue, LO-4-3000  
(area code 212)

### PHILADELPHIA (3):

Warren H. Gardner, William J. Boyle  
6 Penn Center Plaza, LOcust 8-4330  
(area code 215)

### SAN FRANCISCO (11):

Richard C. Alcorn  
255 California Street, Douglas 2-4600  
(area code 415)

### LONDON W1:

Edwin S. Murphy Jr.  
34 Dover St.

### FRANKFURT/Main:

Matthée Herfurth  
85 Westendstrasse

### GENEVA:

Michael R. Zeynel  
2 Place du Port

### TOKYO:

George Olcott,  
1, Kotohiracho, Shiba, Minato-ku



## To reduce the size of a TWT...just squeeze it!

To keep Sperry TWT's sized for today's aerospace systems, we apply a little pressure . . . on the stainless steel shell of the tube. This lets us insert the helix and its support rods into the shell without using the conventional straps and springs. We can use smaller support rods. Smaller magnets too. The whole tube becomes smaller, lighter, stronger.

When the pressure is released, the shell springs back into shape, clamping the whole helix assembly firmly in its proper place.

Sperry's squeeze technique has already reduced the size of advanced new TWT's like the STL-280, STC-180B, and STX-310, and it is being used in several current TWT development programs. Other successful techniques add to our pride in our size and weight reduction program. These include higher perveance guns, improved magnets, and shorter attenuators.

**A NEW TECHNICAL PAPER** gives scientific and engineering details on the highly successful Sperry effort to reduce size and weight across the entire TWT line. For your free copy, write Sperry, Gainesville, Florida, or contact your Cain & Co. representative.



SPERRY RAND CORPORATION  
GAINESVILLE, FLA. / GREAT NECK, N. Y.

CIRCLE 901 ON READER SERVICE CARD

# EXTRA NEW "UNIVERSAL" TRANSISTOR

RCA  
CAN

RCA

CA

UP TO

# SILICON TRANSISTORS NOW ON THE MARKET



## HERE NOW IN QUANTITY!

HIGH-PERFORMANCE, RELIABILITY-PROVED, TRIPLE DIFFUSED SILICON  
2N2102 AND 2N2270 NOW AVAILABLE AT ECONOMY PRICES

RCA now announces new economy prices on the 2N2102, the "universal" triple-diffused planar silicon transistor designed for widest possible application in military and industrial equipment. It can replace up to 40% of all silicon transistors now on the market and will cover a vast majority of your Small-Signal and Medium-Power Applications.

The RCA 2N2102 features high switching speed, high pulsed beta ( $h_{FE}$ ) at  $I_C = 1$  amp, and controlled beta from  $I_C = 10\mu\text{a}$  to 1 ampere. It has high breakdown-voltage ratings, high dissipation ratings, low saturation voltages and low output capacitances.

RCA 2N2270, economy version of the RCA 2N2102, offers many of the features of the 2N2102 at substantial savings.

Call your RCA Representative today or write RCA Semiconductor and Materials Division, Commercial Engineering, Section IN5-3, Somerville, N.J.

**For Application information on RCA 2N2102,** write for Application Note SMA-14, "The Design of Low-Level and RF Circuits Utilizing the RCA 2N2102".

**For Reliability data on RCA 2N2102,** call your local RCA Semiconductor Field Office. Your RCA Representative will discuss the latest reliability information with you.

AVAILABLE THROUGH  
YOUR RCA DISTRIBUTOR



THE MOST TRUSTED NAME IN ELECTRONICS  
CIRCLE 902 ON READER SERVICE CARD