

electronics®



WHAT'S NEW IN MATERIALS?

Laser and semiconductor crystals command attention

RELIABILITY SLIDERULE

Cut out and paste this versatile design aid

TUNNEL DIODES READOUT CORES

These circuits mean better analog-digital converters

SPECIAL

TELEMETRY TODAY

Here's a chance to catch up with a fast-moving art that spells big business in our industry and there's no cutback in sight



R D SKINNER
1020 GOVINGTON RD
LOS ALTOS CALIF
C 3-5

CLAMP AROUND THE LEAD:

and measure dc current 0.1 ma to 10 amps, without breaking circuit leads, without loading the circuit.

Pull back the probe flange, the probe opens. Aim it at a lead and let loose. The probe closes. Now you can measure dc current, on a bare or insulated wire . . . and you can read it directly, even in the presence of equally strong ac on the same wire, without breaking a lead and without loading the circuit.

The hp 428B Clip-on DC Ammeter reads dc current directly in 9 ranges by sensing the magnetic flux induced by the dc current. To measure the sum or difference of currents flowing through two separate wires, you simply clamp the probe around them both . . . and read. The standard 428B has a range of 0.1 ma to 10 amps and lets you read dc currents on wires up to $\frac{5}{32}$ " in diameter. A recorder, oscilloscope output is provided on the 428B.

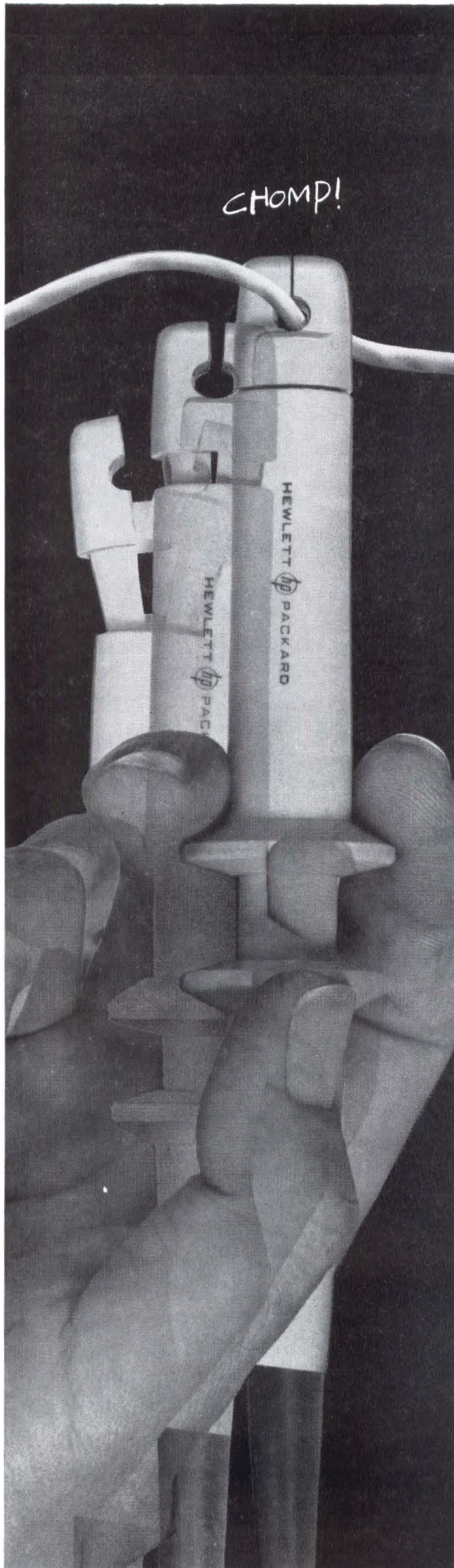

hp 3528A Current Probe

hp 3529A Magnetometer Probe

The hp 3528A Current Probe (\$450 with degausser) lets you measure dc current in conductors up to $2\frac{1}{2}$ " in their maximum dimensions . . . even pipes, multiconductor cables, lead-sheathed cables, micro-wave waveguide.

The hp 3529A Magnetometer Probe (\$75) is useful in applications ranging from acoustical transducer design to study of the Zeeman effect; it measures the direction or magnitude of any magnetic field with 1 milligauss sensitivity.

Look at the 428B specs, then call your hp field engineer or write direct for a single data sheet which describes all its capabilities.

428B SPECIFICATIONS

- Current Range:** 1 ma to 10 a full scale in 9 ranges
 - Accuracy:** $\pm 3\%$, ± 0.1 ma
 - Probe Inductance:** $< 0.5 \mu\text{h}$ introduced into measured circuit
 - Probe Induced-Voltage:** < 15 mv peak into measured circuit
 - AC Rejection:** ac with peak value less than full scale affects meter accuracy less than 2% at frequencies above 5 cps and different from carrier (40 kc) and its harmonics; (on 10 range, ac is limited to 4 a peak)
 - Recorder/Oscilloscope Output:** app. 1.4 v across 1400 ohms full scale; frequency response dc to 400 cps
 - Probe Insulation:** 300 v maximum
 - Price:** hp 428B, \$600 (cabinet); hp 428BR, \$605 (rack mount) (428A also available; same as 428B except range: 3 ma to 1 ampere full scale; no recorder output, \$500)
- Data subject to change without notice. Prices f.o.b. factory.

8595

**HEWLETT
PACKARD
COMPANY**



1501 Page Mill Rd., Palo Alto, Calif., (415) 326-7000. Sales and service representatives in principal areas. Europe, Hewlett-Packard S.A., 54 Route des Acacias, Geneva, Switzerland; Canada, Hewlett-Packard (Canada) Ltd., 8270 Mayrand St., Montreal, Que.

electronics

A MCGRAW-HILL WEEKLY 75 CENTS

W. W. MacDONALD, Editor (2645)

J. M. CARROLL, Managing Editor (2293)

SENIOR EDITORS

Samuel Weber (2371)
George W. Sideris (3444)

SENIOR ASSOCIATE EDITORS

Michael F. Wolff (2600)
John F. Mason (2666)

ASSOCIATE EDITORS

Michael F. Tomaino (2071)
William P. O'Brien (2297)
Sy Vogel (2467)
George J. Flynn (2188)
George V. Novotny (3151)
Leon H. Dulberger (3446)
Alexander A. McKenzie (2685)

ASSISTANT EDITORS

Stephen B. Gray (2245)
Barry A. Briskman (2306)
Dan Smith (2472)
Joel A. Strasser (2127)

REGIONAL EDITORS

Harold C. Hood,
1125 W. 6th St., Los Angeles 90017, Calif.
(213-482-5450)
Laurence D. Shergalis,
John Hancock Bldg., 255 California St.,
San Francisco 94111, Calif. (415-362-4600)
Thomas Maquire,
McGraw-Hill Bldg., 607 Boylston St.,
Boston 02116, Mass. (617-262-1160)
Cletus M. Wiley,
Blair Bldg., 645 N. Michigan Ave.,
Chicago 60611, Ill. (312-664-5800)

ART DIRECTOR

Howard R. Berry (2430)

ASSISTANT ART DIRECTOR

John C. Wright, Jr. (3430)

EDITORIAL ASSISTANTS

Lorraine Rossi, Virginia T. Bastian,
Lynn Emery, Ann Mella, Lorraine Werner,
Alice M. O'Brien, Sharon Parks, Patricia
Mitchell, Claire Benell, Kay Fontana

FOREIGN NEWS BUREAU

DIRECTOR, John Wilhelm, (2532);
Lawrence Mihlon (2997), Alyne Elias
(2998)
LONDON—John Shinn, Derek Barlow,
Nicholas Landon, 34 Dover St., London
W.1, England
BONN—Bruce Bendow, Richard Mikton,
Silke McQueen, Mittelstrasse 39, Bad
Godesberg, Germany
BRUSSELS—27 Rue Ducarle, Brussels,
Belgium
PARIS—Robert Farrell, Arthur Erikson,
17 Ave. Matignon, 3rd Fl., Paris 8,
France
MILAN—Marc A. Messina, Via Manzoni
No. 12, Milan, Italy
MEXICO CITY—Wesley Perry, Jr.,
Lafragua 4-314, Mexico 1 D.F. Mexico
RIO DE JANEIRO—Leslie Warren, Rua
Mexico 3-S/1507 1509, Rio de Janeiro,
Brazil
MOSCOW—Stewart Ramsey,
Kutuzovsky Prospekt 19, Apt. 28-29,
Moscow, USSR
TOKYO—Richard Halloran, Charles Cohen,
John Yamaguchi, Toranomom Sangyo
Bldg., 1 Kotohiracho Shiba, Minato-Ku

CIRCULATION MANAGER

Hugh J. Quinn (2310)

W. W. GAREY, Publisher (2016)

NEW YORK TELEPHONE:

Dial Direct: 971 plus extensions shown
above in parentheses. Area Code 212

THE WORLD OF TELEMETRY—Superimposed on our artist's conception of a modern telemetering antenna, Bell Labs' Telstar II blasts skyward from Cape Canaveral in the nose of a NASA Thor-Delta rocket while a Bell Labs engineer at Andover, Maine, manipulates the telemetry panels of the Telstar control console. *For a fast rundown on what else is new in telemetry today, see p 31*

COVER

ASW SURVEILLANCE GAINS Threaten Submarine Invulnerability. Multiplication of sensor techniques may leave subs no place to hide. *Potentially important techniques: infrared, nuclear, temperature-difference, galvanic, biological, optical*

10

AFTER ECHO II: What and Why? Passive communications satellites offer multiple access, are jam-proof and durable. *Echo II is a balloon, but more exotic designs are proposed*

24

SPECIAL—TELEMETRY TODAY. An essential part of every space exploration project, telemetering is also enjoying unprecedented expansion in down-to-earth industrial applications. This report covers proposed IRIG subcarrier frequencies, compares modulation methods including new hybrid pulse schemes and orthogonal coding to correct errors. *Many new techniques aim at increasing bandwidth: vestigial sideband modulation, predetection recording and off-line data processing as well as the coming shift of telemetry channels to uhf.* By B. A. Briskman

31

TUNNEL DIODES SAVE PARTS: Continuous Readout of Magnetic Cores. A tunnel diode biased in its bistable mode can give continuous indication of the flux-state of any closed magnetic path. Circuits like this have been used in an analog-to-digital converter using five-aperture cores. *The application resulted in a saving of 80 percent in parts and 40 percent in solder joints.*

By W. G. Trabold, GM Research Labs

38

NEW TELECASTING TECHNIQUE—Special-Effect Amplifier Combines Scenes Without Sharp Transition Edge. This tv dissolve wiper shapes the transition-region video scenes and overlaps them to give an indistinct border needed in drama and musical shows. *The key factor is a gating signal consisting of a ramp connecting two constant voltages. It is obtained by clipping the top and bottom of a sawtooth waveform.*

By K. Kazama, T. Ishino, K. Shudo and K. Kumakura,
Japan Broadcasting Corp., Tokyo

40

Contents continued

Published weekly, with Electronics Buyers' Guide as part of the subscription, by McGraw-Hill Publishing Company, Inc. Founder: James H. McGraw (1860-1948).

Title ® registered U.S. Patent Office; © copyright 1963 by McGraw-Hill Publishing Co., Inc. All rights reserved, including the right to reproduce the contents of this publication, in whole or in part.

Executive, editorial, circulation and advertising offices: McGraw-Hill Building, 330 West 42nd Street, New York, N. Y., 10036. Telephone Area Code 212 971-3333. Teletype TWX N. Y. 212-640-4646. Cable McGrawhill, N. Y. PRINTED IN ALBANY, N. Y.; second class postage paid at Albany, N. Y.

OFFICERS OF THE PUBLICATIONS DIVISION: Shelton Fisher, President; Vice Presidents: Joseph H. Allen, Operations; John R. Callahan, Editorial; Ervin E. DeGraff, Circulation; Donald C. McGraw, Jr., Advertising Sales; Angelo R. Venezian, Marketing.

OFFICERS OF THE CORPORATION: Donald C. McGraw, President; Hugh J. Kelly, Harry L. Waddell, L. Keith Goodrich, Executive Vice Presidents; John L. McGraw, Treasurer; John J. Cooke, Vice President and Secretary.

Subscriptions are solicited only from those actively engaged in the field of the publication. Position and company connection must be indicated on orders. Subscription rates: United States and Possessions and Canada, \$6.00 one year, \$9.00 two years, \$12.00 three years. All other countries \$20.00 one year. Single copies, United States and Possessions and Canada 75¢. Single copies all other countries \$1.50.

THE PUBLISHER, UPON WRITTEN REQUEST TO OUR NEW YORK OFFICE FROM ANY SUBSCRIBER AGREES TO REFUND THAT PART OF THE SUBSCRIPTION PRICE APPLYING TO COPIES NOT YET MAILED.

Subscribers: Please send change of address notices, subscription orders or complaints to Fulfillment Manager, Electronics, at the address below. Change of address notices should provide old as well as new address, including postal zone number if any. If possible, attach address label from recent issue. Allow one month for change to become effective.

Postmaster: Please send Form 3579 to Fulfillment Manager, Electronics, P. O. Box 430, Hightstown, New Jersey, 08520.



Audited Paid Circulation

CONTENTS continued

REFERENCE SHEET: Cut Out Your Own Reliability Slide Rule. If you know the required system reliability and percent of total system failures assigned to a subsystem, this rule will give required subsystem reliability directly. Also, knowing the total number of failures, tests and the required confidence, you can find system reliability. *Just cut out p 46 for body of rule and p 48 for the slide then mount on stiff cardboard and assemble.* By G. F. Allen, General Dynamics/Pomona 44

DISARMAMENT—What Chance? What Impact? Washington sees no realistic timetable for disarmament. *But if it should come, arms-control, space, civilian electronics would help offset defense electronics cuts* 56

TV BRIEFS Air Force. Pentagon spends \$½ million on closed-circuit system. *World-wide network may be next* 58

MATERIALS CONTROL Key to New Devices. That was the dominant theme at last week's conference on advanced electronic materials. *Among the advances: epitaxial lasers, semiconductor ultrasonic amplifiers* 66

NEW TECNETRONS Switch 15 Amp. Today, a high-power version of the French field-effect device was introduced for a-c and d-c switching. *Devices to switch 50 amp are being planned* 75

HELICOPTERS Try L-F Navigator. FAA certification for instrument flight sought. *Decca is used to avoid line-of-sight problems* 77

DEPARTMENTS

Crosstalk. *Telemetry Tomorrow. Our New Look* 5

Comment. *Keeping Abreast. Transistor Symbol* 6

Electronics Newsletter. *Overseas Investment by Electrical-Electronics Companies Rises* 17

Meetings Ahead. *Electronics Components Conference* 19

Washington This Week. *Congress Trims NASA's New Budget* 20

Research and Development. *New Cooler Uses Thermoelectric Effect* 84

Components and Materials. *Thin-Film Photocells Get Brighter Faster* 99

Production Techniques. *Etched Molds Form P-C Boards* 108

New Products. *High-Speed Solid-State Printer* 119

Literature of the Week 143

People and Plants. *Sanders Enters New Facility* 144

Index to Advertisers 153

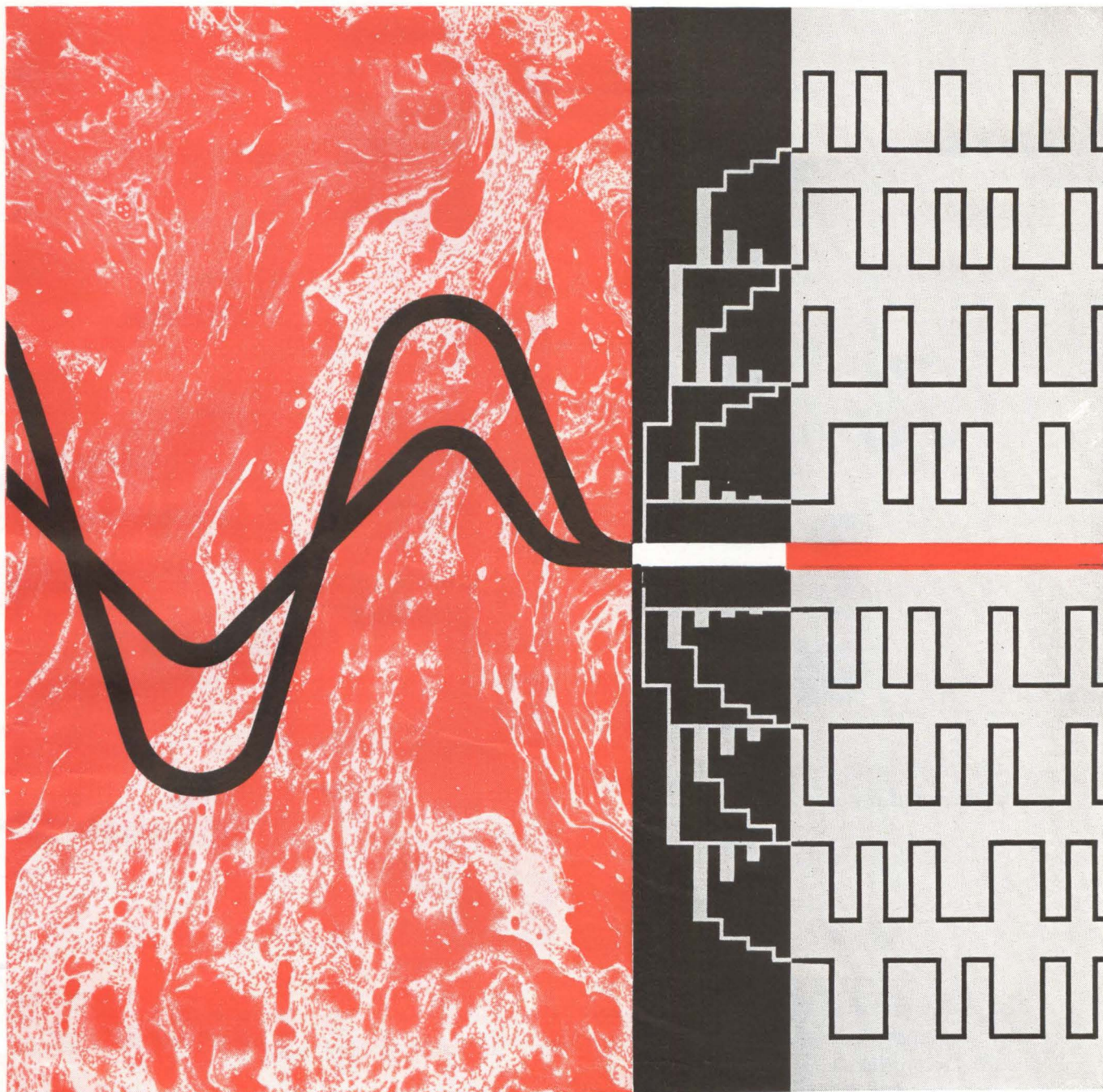

HIGH-SPEED ANALOG TO DIGITAL AND DIGITAL TO ANALOG CONVERTERS

5 million bits per second
1 watt power consumption

High-speed Telemetry Signals
High-speed Data Processing
High-speed Signal Digitizing
Digital Television
Speech Digitizing/Voice Communications
Computerizing Wide-Band Data

SPECIFICATIONS / SERIES 1042-1046

- From 4 to 8 bits including parity
- Sampling aperture 300 nanoseconds
- Serial and Parallel outputs
- NRZ, M and C code formats
- Even or odd parity-bit
- Size—5 x 4 x 4 inches
- Weight—less than 3 lbs.



Vector Manufacturing Company, Inc., Southampton, Pa.

Telemetry Components & Systems / ELmwood 7-7600 TWX 215 357 1276

Vg SWITCHING MODULE

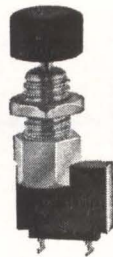

this tiny "bounce-free" switch eliminated the need for

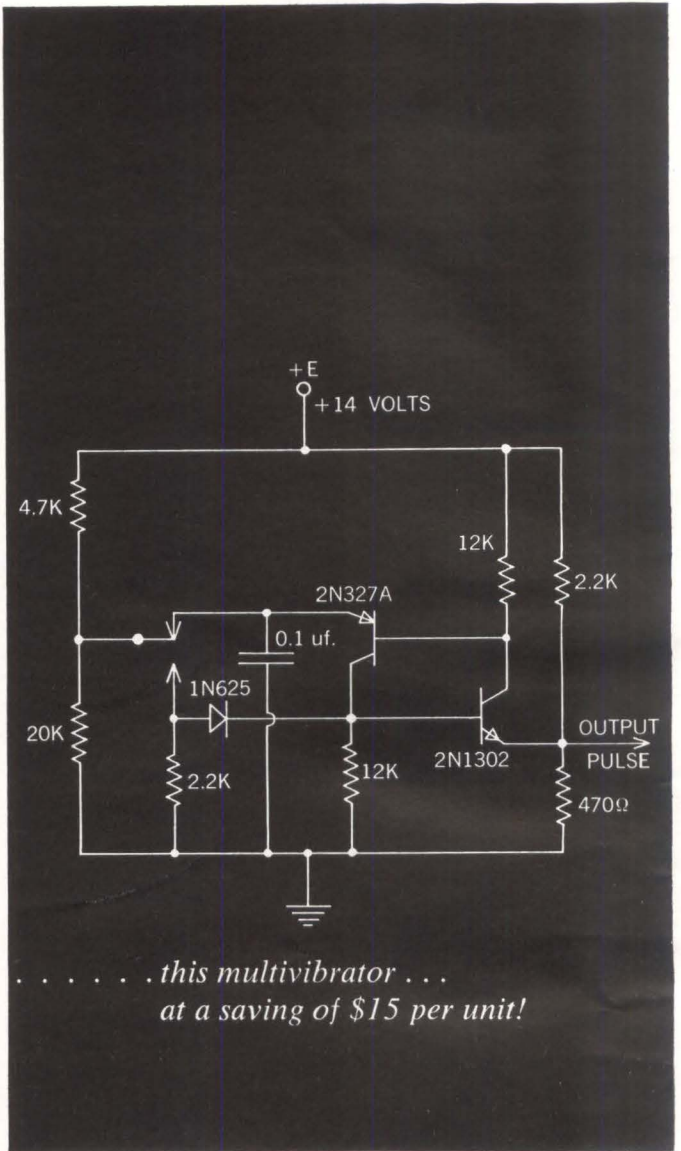

*. this multivibrator . . .
at a saving of \$15 per unit!*

The multivibrator was used to obtain a square pulse from a pushbutton switch installed in digital equipment developed by a leading systems manufacturer. *Note that "Form C" had to be used to produce a satisfactory signal.*

Substituting a "VG" Pushbutton Switch, the design engineer obtained the clean signal he needed — *without the multivibrator* — and saved the company \$15 on every unit produced! The no-bounce, no-noise operation of "VG" Switches, coupled with extreme reliability in the "micro-dry" circuit switching region (and even as high as 1/4 ampere), have made possible dramatic simplification of circuitry, including the elimination of filters and associated components.

Write for complete information on the "VG" Pushbutton Switch, and the mechanically actuated "VG" Switching Module designed for precision contacting at rates up to 1000 closure cycles per second.

© Vitramon, Inc. 1963

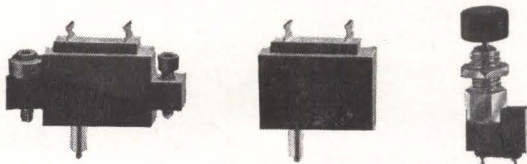

Vitramon

INCORPORATED

VITRAMON, INC. • BOX 544 • BRIDGEPORT 1, CONNECTICUT

Telemetry Tomorrow

THIS WEEK'S feature on telemetry (p 31) points up advances the art has made in meeting today's complex aerospace and civilian demands. A good portion of present techniques, however, will become history by 1970, the year when most telemetry users will have had to swing over from the present 215 to 260-Mc vhf band to new uhf assignments between 1.435 and 1.535 Gc or 2.2 to 2.3 Gc.

The coming of the uhf telemetry allocations has important technical and financial implications.

One aim of the switchover, ordered by FCC and the Interdepartmental Radio Advisory Committee (IRAC) of the Office of Emergency Planning, is to improve telemetry. For example, a broader telemetry spectrum will permit a greater number of experiments in a given space shot, since more data channels can be employed. This adds up to more data with fewer space vehicles, plus an added bonus of increased reliability. Moreover, such requirements as obtaining positional data will become easier to meet. At uhf, tracking data may be obtained from telemetry alone, reducing the need for radar beacons.

Uhf equipment is markedly different than vhf gear. In transmitters, for example, output circuits will employ cavities rather than simple LC circuits or tuned lines. Receivers will require lower-noise front ends, additional frequency conversion and perhaps remote preamplification to do away with losses incurred between the antenna and receiver. The r-f

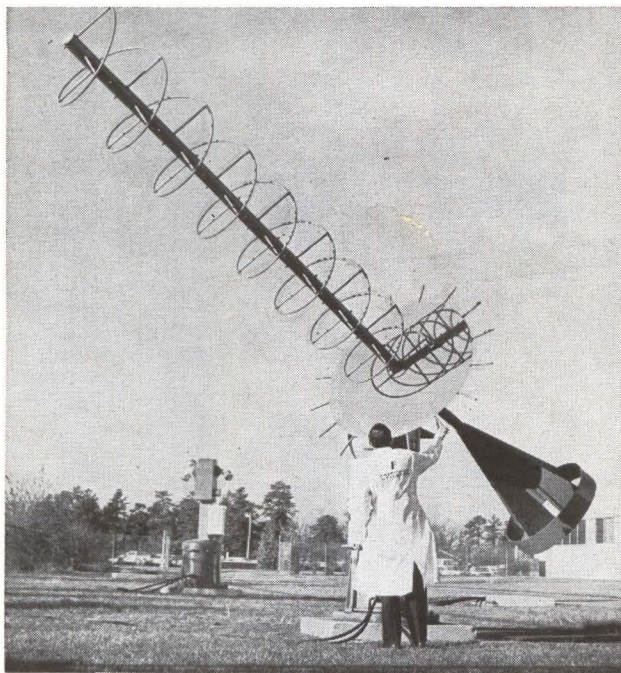

portions of the telemetry link will require the greatest amounts of new thinking and redesign since they exhibit little similarity at 200 Mc and at 2 Gc.

Reinstrumentation of r-f equipment will undoubtedly require modification or replacement of large amounts of vhf equipment. Doing the technical job is not a major stumbling block since the problems from both operational and equipment viewpoints are well understood. Ingenuity and practical operational analysis will probably dictate the changeover designs.

While many in the telemetry business agree that the frequency shift will be a good one, there is some concern as to where the money is coming from and when. If, as some suggest, funding does not appear until 1969 or 1970, a crash program may be forced upon both suppliers and users.

This prospect is one that should be countered, while there is still plenty of time, by more substantial government funding of redevelopment in the next few years. The government military and space programs are, after all, the largest users of radio telemetry, and have the most vital interest in making the changeover with a minimum of debugging at the last moment.

QUESTIONNAIRE—On page 89 of this issue of **electronics**, you will find a form similar to our reader service card. We ask you to fill in the form and mail it to us. The more we know about your needs the better we can serve you.

OUR NEW LOOK

We've restyled **electronics** and hope you like it.

Don't want to bore you with shoptalk, but here are the most important changes:

- New type is larger and easier to read; because of its design we get the same number of words on a page
- Our Newsletter has been increased by one page and, together with the Washington report, is printed in an easy-to-find insert
- Meetings will be regularly listed within the insert
- Important technical articles have been moved well forward
- Important news is carried throughout the magazine

Other improvements will, we hope, be apparent to you

SPRAGUE[®]

MODEL 500

INTERFERENCE LOCATOR

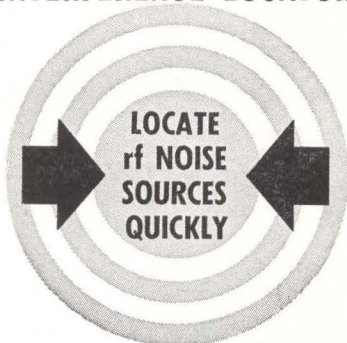

This versatile instrument is a highly sensitive interference locator—with the widest frequency range of any standard available unit! Model 500 tunes across the entire standard and FM broadcast, shortwave, and VHF-TV spectrums from 550 kc. to 220 mc. in 6 bands.

It's a compact, portable, rugged, versatile instrument—engineered and designed for most efficient operation in practical field use. It features a transistorized power supply, meter indications proportional to carrier strength as well as sensitivity of 5 microvolts minimum for 5% meter deflection over entire tuning range.

For full details, send for brochure IL-106.

SPRAGUE ELECTRIC COMPANY
35 Marshall Street, North Adams, Mass.

SPRAGUE[®]
THE MARK OF RELIABILITY

COMMENT

KEEPING ABREAST

The May 24 issue contained an article, Can Synthetic Sleep Save Time? (p 20), which aroused my interest...

As a Canadian Air Defense Command Advisor, I find your magazine to be the only way to keep abreast of new developments and techniques. I've been a subscriber for almost two years now, and I look forward to each week's issue.

LOUIS G. ESPOSITO

Ville LeMoynes, Quebec
Canada

TRANSISTOR SYMBOL

The recent Crosstalk article entitled Defeat in Venice (p 3, July 12), expressed an interesting, but distressing viewpoint. The symbol controversy should be given thought by all electrical engineers, not just by our committee members.

The Swedish symbol seemed to be a radical idea when I was introduced to it several years ago. It has proven itself to me in practice, and I now use it almost exclusively.

The Swedish symbol is not, as you have stated, "a giant step backwards" to a symbol resembling a vacuum tube, but a step forward. The classical symbol was derived from the physical configuration of the now obsolete point-contact transistor, whereas the Swedish symbol does in fact more closely resemble the modern junction transistor.

This alone would be far from sufficient to justify the new Swedish symbol. The circuit diagram itself is the best justification. Below I have drawn two diagrams of a simple flip-flop, one with the conventional symbol, and the other with the Swedish symbol. Which diagram appears neater, easier to draw and easier to read?

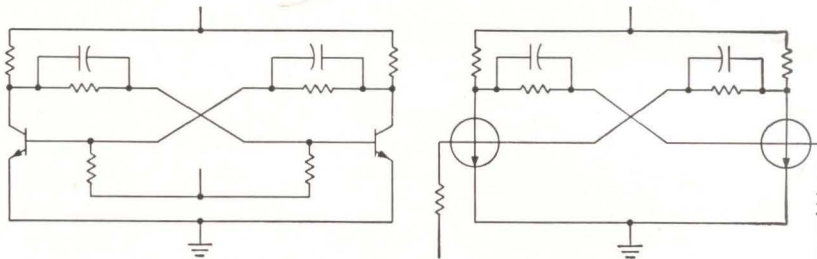

I encourage you to try this test on any circuit you wish.

I fear that much of the support the classical symbol receives is due to lack of knowledge of the new symbol, rather than a true preference. I was surprised to find that a majority of the engineers I have shown the symbol to, had never seen it before.

Are we right and are all the Europeans who have jumped on the bandwagon wrong? Are they merely being impulsive? Perhaps the European trend should be given more serious thought, not only by our committees, but by each and every engineer who will be using the symbols.

ROBERT L. HERRMANN

West Lafayette, Indiana

NEGATIVE RESISTANCE VIII

Since the interpretation of the expression "negative resistance" is a repeatedly discussed subject in Comment, I want to point out that the negative resistance is not a recently introduced concept. To prove this point, I enclose photocopy extracts from my patent 1,920,569, filed in the United States on November 11, 1929.

L. L. KOROS

Cherry Hill, New Jersey

• The patent is on a "Device for Keeping Constant the Terminal Voltage of Sources of Current," and reads, in part:

If in a coordinate system the terminal voltage e is changed in dependency on the intensity of current i , there follows for a glow cathode discharging tube the inclining curve E negative, a characteristic which is known as negative resistance characteristic.

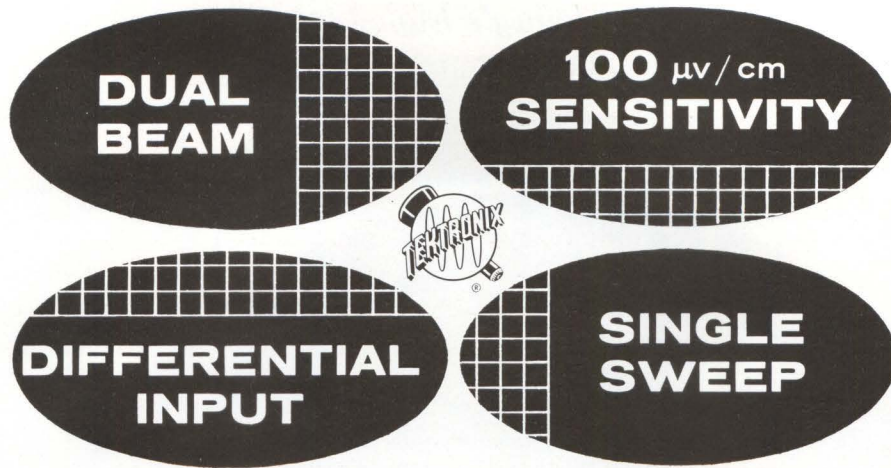

to simplify waveform-comparison applications . . . Type 502A

- . . . To measure stimulus and reaction on the same time base.
- . . . To measure transducer outputs, such as pressure vs. volume.
- . . . To measure phase angles and frequency differences.
- . . . To measure plots of X-Y curve-tracing presentations.
- . . . To measure other characteristics of low-level displays.

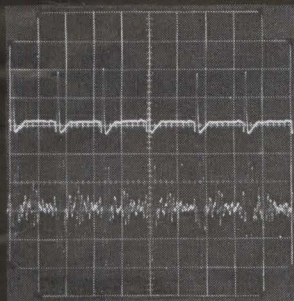

BIO-MEDICAL APPLICATION

Typical dual-beam display shows presentation of ECG (upper beam) vs. heart sounds (lower beam) of patient.

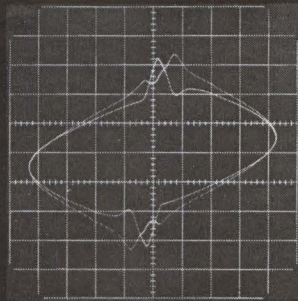

QUALITY-CONTROL APPLICATION

Typical dual-beam X-Y display shows comparison of E/I loops of two transformers in a production run.

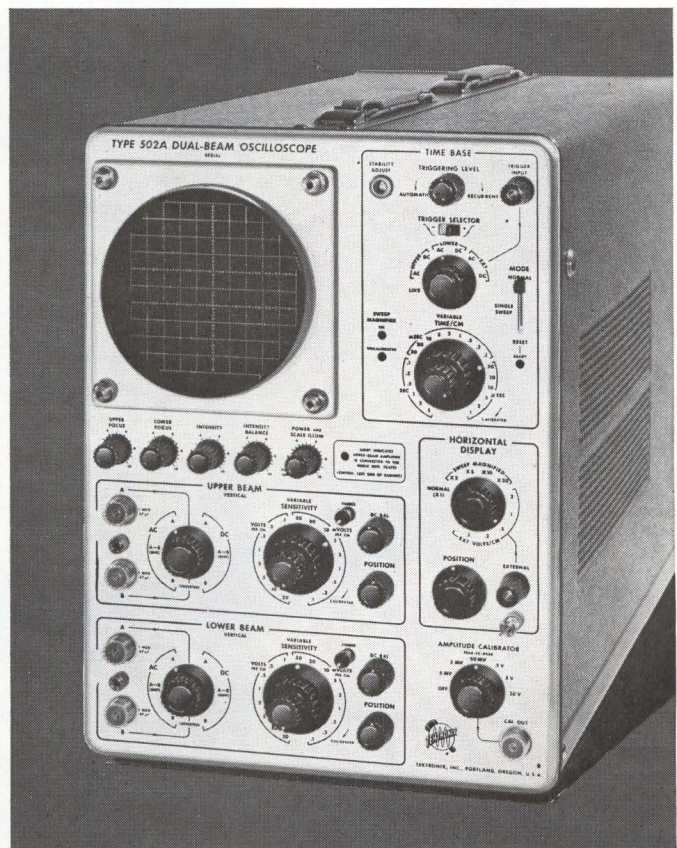

FEATURES

- 2 identical vertical amplifiers
- 17 calibrated steps of sensitivity
- 21 calibrated sweep rates
- 4 steps of sweep magnification
- Continuously adjustable sweep and sensitivity controls
- Push-button beam finders
- Intensity-balance control

FOR A DEMONSTRATION, PLEASE CALL YOUR TEKTRONIX FIELD ENGINEER

MAIN PERFORMANCE CHARACTERISTICS

- Passbands from dc-to-50 kc, minimum, to dc-to-1 Mc maximum
- Calibrated Vertical Sensitivity in 17 steps from 100 $\mu\text{v}/\text{cm}$ to 20 v/cm, both amplifiers
- Calibrated Sweep Range in 21 rates from 1 $\mu\text{sec}/\text{cm}$ to 5 sec/cm
- Variable, Uncalibrated, Sensitivity and Sweep Range Controls
- 2X, 5X, 10X, or 20X Sweep Magnification
- Flexible Trigger Facilities
- Amplitude Calibrator
- Electronically-Regulated Power Supplies

Type 502A Oscilloscope \$1050
U. S. Sales Price f.o.b. Beaverton, Oregon

Tektronix, Inc. / P. O. BOX 500 • BEAVERTON, OREGON 97005 / Phone (Area Code 503) Mitchell 4-0161 • Telex: 036-691 • TWX: 503-291-6805 • Cable: TEKTRONIX • OVERSEAS DISTRIBUTORS IN 27 COUNTRIES

Tektronix Field Offices: in principal cities in the United States. Consult Telephone Directory • Tektronix Limited, Guernsey, Channel Islands
Tektronix Canada Ltd.: Montreal, Quebec • Toronto (Willowdale), Ontario • Tektronix Australia Pty. Limited, Sydney, New South Wales

How much do you know about today's high-frequency scopes?

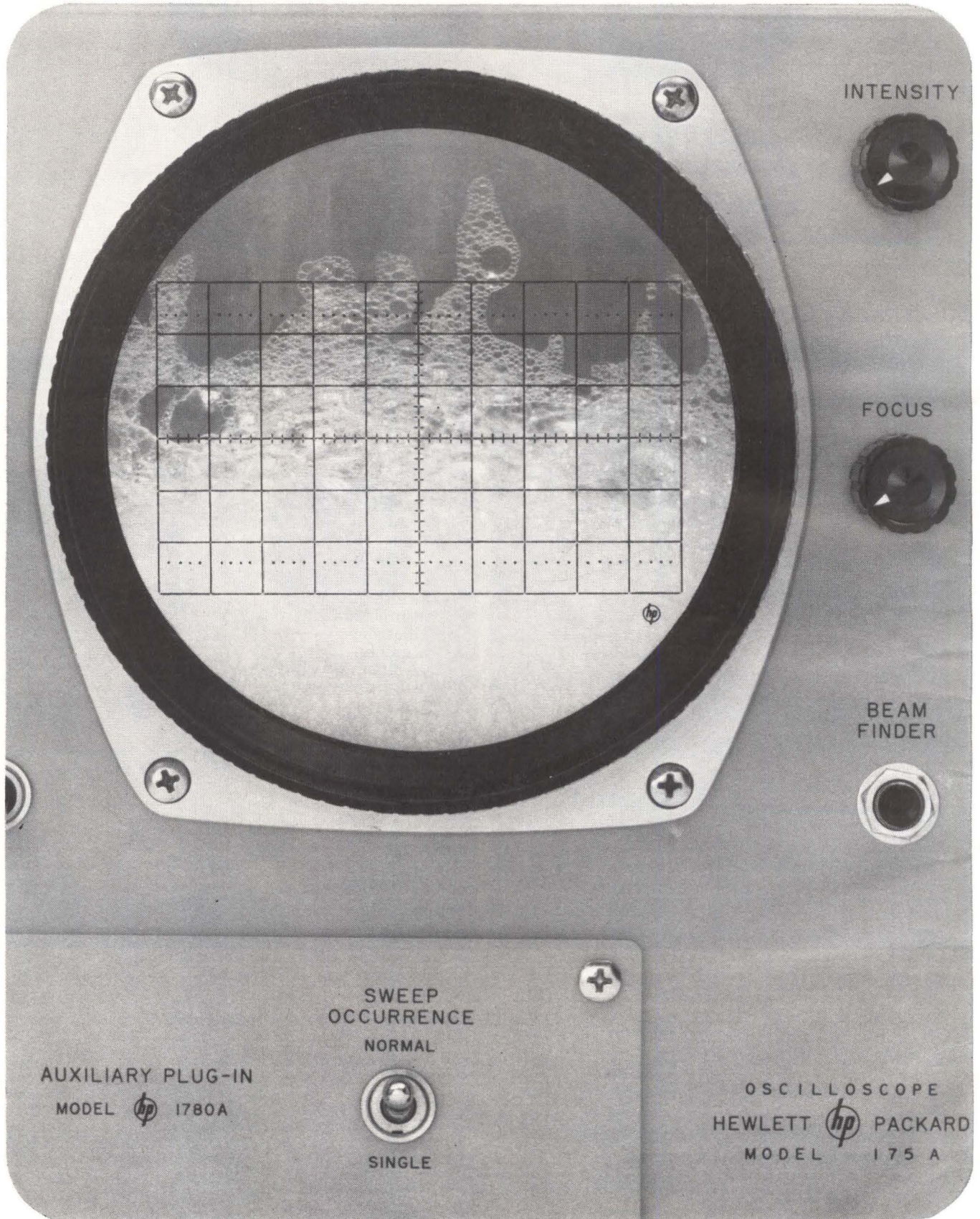

Easy as ABC

Easy as ABC

Clean operation... As familiar as you are with your present high-frequency scope, it doesn't seem like much of a chore to operate it. But then the wife didn't think she was working too hard on Mondays before the washer-drier came into being. But here's a real test on just how easy your scope operation is:

Take a novice, someone who hasn't used your kind of high-frequency scope. Give him the instruction manual and ask him to get a signal on the crt. Time him. Then do the same with the hp 175A Oscilloscope. (You can try the 175A *first*, if you like... the results will be the same.)

Try getting a spot. With many scopes you have to put one hand on the horizontal position control, the other on the vertical position control... and play. If the intensity control happens to be turned down, you won't find anything. On the 175A you push a button... the beam finder... and there's the spot. You can see where it comes from; you know immediately which way to turn the position controls—no fiddling here.

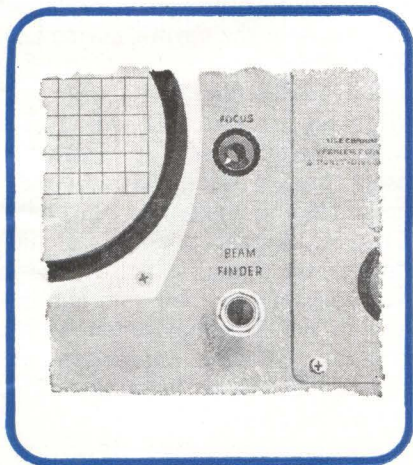

So you have a spot. Try focusing. With the conventional scope you focus, you set intensity and then, when you try a sweep, you find that astigmatism hinders the measurement. You adjust the astigmatism control, then focus, then astigmatism, then...

Not so with the 175A, which has no front-panel astigmatism knob — because it doesn't need one. (Our 12 kv crt is so sensitive that deflection defocusing is history — no more jockeying between focus and astigmatism control to get a meaningful picture of the important trace.)

Now the controls. The 175A uses concentric controls... fewer, at that, than the conventional scope. They're concentric for a *reason* (they relate to related functions), and they are color-coded to front panel legends, so you can't miss. What's more, they're logically arranged—you don't spend half the time looking for an engraved or silk-screened legend that isn't where it *really* belongs.

Next (and you don't have to check your novice for this one), look at the triggering controls. How many modes are indicated on the triggering switch of your present high-frequency scope? Then check this:

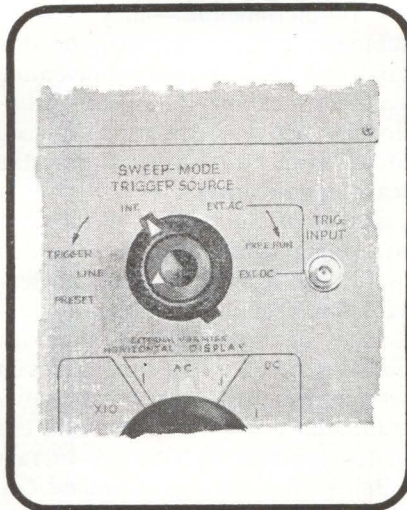

We've incorporated tunnel diode triggering circuitry, more sensitive, vastly easier to set — and the 175A is the only scope in its price range to offer this feature. We have fewer triggering modes, none of them bandwidth-limited, and trigger slope and level are a snap to set. Your check-out will prove it.

And speaking of bandwidth limited, surely one of your problems when you buy a 50 mc oscilloscope is to find that it will operate only to, say, 30 mc on the precise function you need. With the 175A, using a particular trigger mode or other function control doesn't limit the specified performance of the scope. It's a 50 mc scope that does what it says it will—in every way you want it to.

Add to all this the fact that the 175A gives you a 6x10 cm picture (as opposed to the 4x10 cm picture you're used to), a crt that eliminates parallax error with an internal graticule and a non-glare faceplate, the greatest viewing accuracy *ever*.

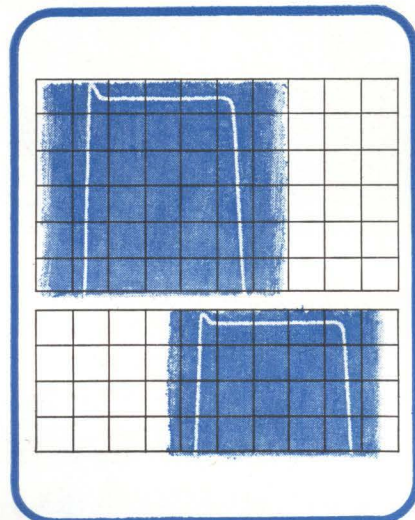

With the 175A, too, we deliver the utmost in both horizontal and vertical plug-in flexibility — dual- and four-trace and high sensitivity vertical viewing, sweep delay and x-y recording capabilities... when, but not unless you need them. They're all available as 175A plug-ins.

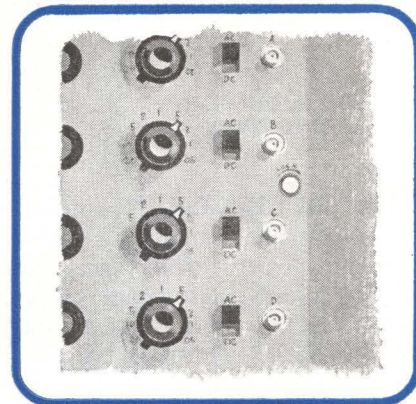

Easy maintenance, too. No distributed amplifiers to adjust (the sensitive 12 kv crt doesn't need them); no delay adjustments (a built-in cable delay line requires no adjustment); the fewest possible number of adjustments (i.e., only five simple, independent adjustments for the main vertical amplifier); use of only 7 tube types and 5 transistor types (none of them "selected"), to reduce your spare parts inventory and make component replacement easier.

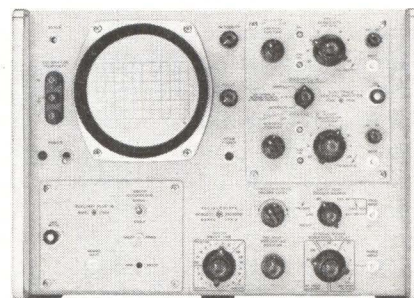

The 175A is big in performance with a big story that we can tell you on your bench. One thing small about it is the price. If two words can describe the 175A, they're "performance" and "value." It takes *three* words to describe other high-frequency scopes alongside the 175A: "Not nearly comparable." hp 175A, \$1325 (without plug-ins).

Data subject to change without notice. Price f.o.b. factory.

**HEWLETT
PACKARD
COMPANY**



1501 Page Mill Rd., Palo Alto, Calif., (415) 326-7000. Sales and service representatives in principal areas. Europe, Hewlett-Packard S.A., 54 Route des Acacias, Geneva, Switzerland; Canada, Hewlett-Packard (Canada) Ltd., 8270 Mayrand St., Montreal, Quebec.

Gains in ASW Surveillance

Multiplication of sensor techniques may leave subs no place to hide

By **LEON H. DULBERGER**
Associate Editor

THE MUCH-SOUGHT antisubmarine-warfare (ASW) sensor breakthrough is still unrealized. Until it is, surveillance undersea will not be as easy as radar penetration of the skies. However, gains in sonar and magnetic anomaly detectors (MAD) plus promising new sensing methods are making it increasingly difficult for enemy submarines to remain undetected.

Latest sensor techniques in use or possibly under study include: detection of heat in a submarine's wake with airborne infrared scanners, ultraviolet inspection of dead microbiological life trailing a sub, inspection of snorkel exhaust traces in the atmosphere with a nuclei detector, check of nuclear radiation imparted to water by passage of an atomic submarine, possible use of detection gear to measure voltage caused by dissimilar metals in water, and possible exploitation of lightning-generated radio waves that penetrate water.

SONAR'S LIABILITIES—So far, sonar remains the chief technique for long-range penetration of water because sound travels readily through the medium. But bending of sonar

rays at temperature interfaces in water—thermoclines—may shield submarines from detection or distort surveillance patterns preventing accurate location of targets. Additionally, active sonar, which is used to fix target location gives away the searcher's location.

Radar, useful against surfaced or snorkeling submarines, has limited usefulness against modern nuclear subs that remain submerged for extended periods. The Communist bloc has roughly 450 submarines in service, some of them atomic-powered. Our military experts point out that the submarine's ability to rain missiles on American mainland targets while submerged, or when surfacing briefly off our coast lines, represents one of the gravest threats to our security.

Sonar advances include ability to operate beneath thermoclines through use of deep-dipping sonar operated from helicopters or surface ships. Also called variable-depth sonar, it is finding extensive ASW application.

Project Artemis, an extremely high-power, long-range active sonar system under test in the Atlantic uses a transducer ship, and hydrophones to pick up echoes that are sent to data-processing gear on an island laboratory. The system may lead to an active sonar early warning net. Project Caesar, now being expanded, uses many hydrophones in a listening network off America's shores.

Sonobouys, deployed from air-

craft or ships, are a mainstay of Navy's ASW and are being improved.

Presently they lower a transducer beneath thermoclines and radio back data by a transmitter operating on the surface. A chemical explosive charge set off underwater near a pattern of several passive sonobouys provides location information on submarines hidden in the area. Development work on a sonodiver which records sound, temperature and other data while hovering beneath the surface may possibly find ASW applications.

MAD ADVANCES — Magnetic anomaly detectors used for years by the Navy, are undergoing improvements to increase range. MAD is helpful in identifying targets discovered by sonar through recording of variations in the earth's magnetism. Submarines and sea creatures are readily differentiated. It also provides an accurate fix on targets. MAD systems may presently be using proton free-precession magnetometers for increased sensitivity. This is thought possible as such devices are finding extensive use in oceanography and treasure hunting, and in the *Thresher* search in the Atlantic. Proton magnetometers respond to minute distortions in the earth's magnetic field.

INFRARED—Temperature measurement of water by airborne IR scanners, and also by *in situ* sensors drawn through the water, may be

DESTROYERS drop depth charges during ASW exercises



Threaten Subs' Invulnerability

designed to reveal the 0.5 to 1-degree change in temperature caused by a submarine's passage. Airborne equipment using infrared radiometers, some with low-noise maser amplifier inputs, are finding growing application in hydrographic work. Infrared scanners able to measure sea surface temperature with an accuracy of ± 0.2 degree C over a range of -2 to $+35$ degrees C are being tested in hydrographic research from airborne platforms and may find ASW applications. Thermistors spaced along chains towed behind surface vessels have been used in oceanographic work for charting thermal currents with high accuracy. If used in ASW surveillance, thermistor chains may allow penetration to depths where today's deep-running submarines lurk.

SIDE-LOOKING RADAR—Radar using high resolution side-looking techniques could be operated from aircraft to detect submarine snorkels from the background clutter of waves with a minimum of signal-processing circuits. Side-looking airborne radar produces a readily definable target against random motion waves and spray when recording the steady motion of submarine snorkels. It may also prove possible to detect the rise in the ocean's surface caused by passage of a submarine beneath it, using radar techniques.

Condensation nuclei detectors are used to track conventional snorkeling or surfaced submarines

from the air by inspecting the nuclear structure of the atmosphere, which is affected by engine exhaust.

Radioactivity imparted to water by the passage of a nuclear-powered submarine presents another possible means of locating submerged submarines.

MARINE ORGANISMS—Microbiological life present in water is affected by the movement of submarines, and techniques to discover the dead organisms are under study. These may possibly include ultraviolet inspection of the water with airborne sensors to detect the bioluminescence of marine organisms, and also *in situ* tests by taking samples in bottles at extended depths for study.

Dissimilar metals immersed in seawater produce a voltage, and may possibly form the basis for an ASW sensor. The technique is being used in the search for the sunken *Thresher* lost in the Atlantic. It may prove important in locating enemy subs at rest.

LASERS—Optical techniques underwater continue to receive attention. They include the possibility of a laser-operated, three-dimensional scanning system for positive target identification at short ranges. A 3-D system might use a scanning technique, and an intense blue-green coherent, narrow-band laser as a light source, when it is developed. Synchronized scanning of the target would reduce backscatter due to

suspended particle matter in the water. Only a small portion of the target and water adjacent to the beam would be illuminated, with the optical receiver designed for narrow band pickup.

Low-frequency radio signals are known to be transmittable through water and presently provide communication to submerged submarines on ulf bands. Because worldwide, lightning-generated, long-wave signals occur many times a second, it may be that they will form the basis for an ASW surveillance technique in the future.

Other surveillance techniques under consideration include a magnetically operated device that locks onto passing submarines and transmits a beacon signal to implement tracking.

SEA FORECASTING—The high complex. Signal processing and data processing systems are being developed to process and display sensor information in a manner that permits rapid target identification and deployment of attack weapons.

Another factor in the use of future ASW surveillance systems is the operation of an oceanographic, sea-condition forecasting net, Asweps, to tell ASW commanders what to expect from their equipment at a given time, in various theaters of operation. It would also allow routing convoys around areas of bad ASW-operating conditions, to allow best ocean environment for defense and attack by ASW commanders.



ASW PATROL PLANE, Orion, helped Navy track and flush Soviet submarines during the Cuban crisis. Extending from tail is magnetic anomaly detector

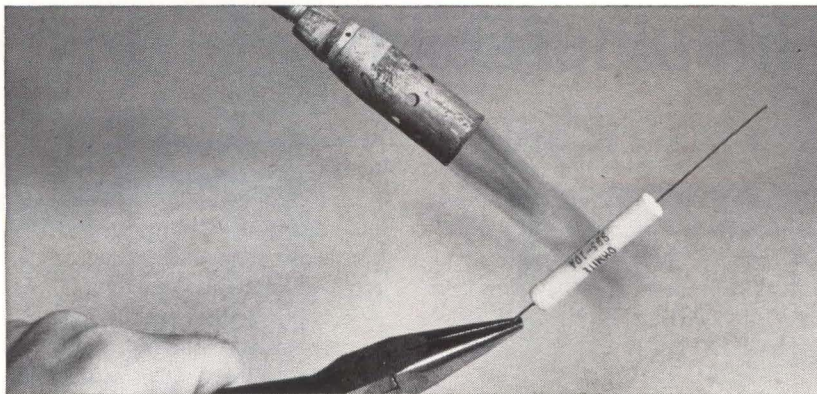

TORCH IT! Withstands temperatures of 1500°F without a sign of deformation. No other vitreous-enamelled resistor will stand 1500°F without burning, softening, or dripping away. There's absolutely no effect on markings either . . . they are vitreous in nature . . . a ceramic marking fired right into the coating. Markings on all other resistors burn off immediately, or rapidly become illegible.

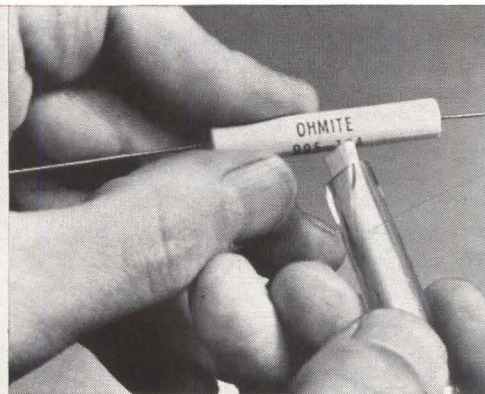

ABRADE IT! Try it yourself. Use a glass fiber eraser, for example, on the markings. Rub them hard. Nothing happens. Do it again. Still the markings don't come off, because they are vitreous ceramic, *fired into* the molded vitreous coating. You can't remove them except with a grinding wheel. With any other resistor, the markings disappear with the first couple of rubs.

DON'T try all these tests

OHMITE Series 99 Wire-Wound Resistor

"molded" in vitreous enamel
...for highest quality protection!

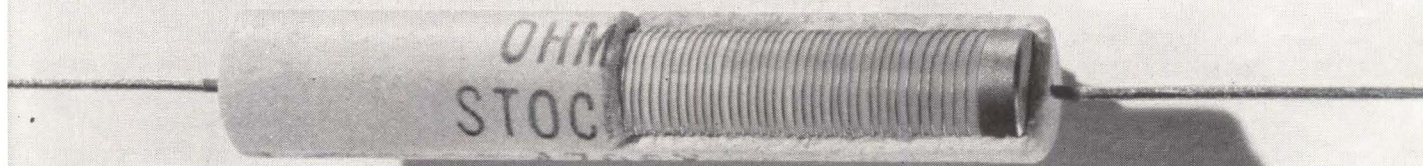

Enlarged 2½ times

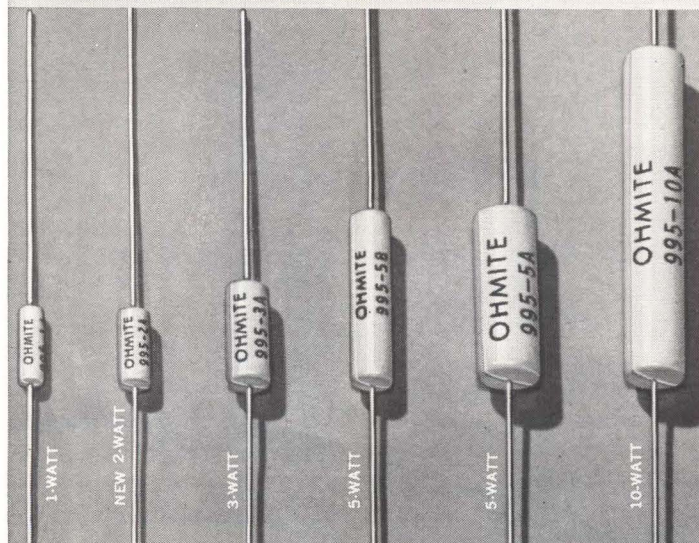

Series 99 resistors represent a completely new approach—a breakthrough in the science of protective coatings. The result is an *insulated* (1000 V to ground) axial-lead resistor of the highest quality.

The molded vitreous coating of Series 99 resistors involves an entirely new process of vitreous enameling (patent applied for) which creates an entirely new product (patent applied for). It endures the red heat of manufacture, yet retains its precise molded shape and dimensions with a uniformity that varies only in thousandths of an inch. This new process locks the uniformly wound resistance wire in place which eliminates hotspots during operation.

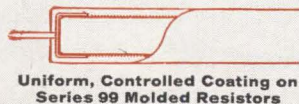

Uniform, Controlled Coating on Series 99 Molded Resistors

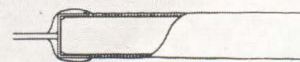

Variable Coating on Conventional Dipped Resistors

Series 99 resistors, constructed in accordance with the requirements of MIL-R-26C will pass the famous and

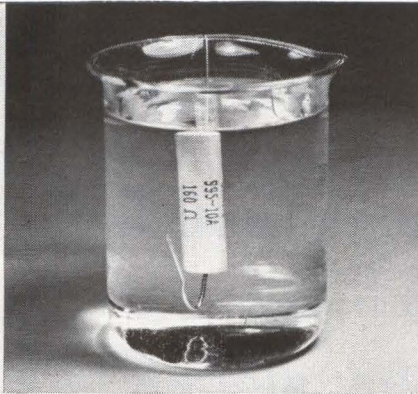

SOAK IT IN SOLVENT! Here's another test you can run quickly. Fill a beaker with the most active of organic solvents used in degreasing and flux removal. Drop in a Series 99 molded resistor. Let it soak. Then try to rub off the markings. They're bright as new, because they're part of the ceramic coating. Try this on any other resistor . . . the markings dissolve and can be rubbed off.

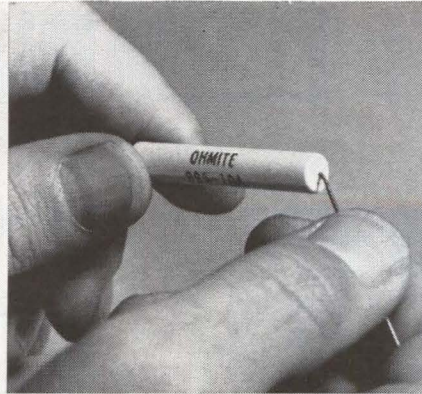

BEND THE LEAD where it emerges from the resistor body! You can bend the lead repeatedly at this point without damage. Conventional axial-lead, vitreous-enamelled resistors have a dipped coating which forms a meniscus around the lead where it joins the body of the resistor. Bending the lead ruptures the meniscus and damages the coating. Series 99 resistors are molded and there is no meniscus.

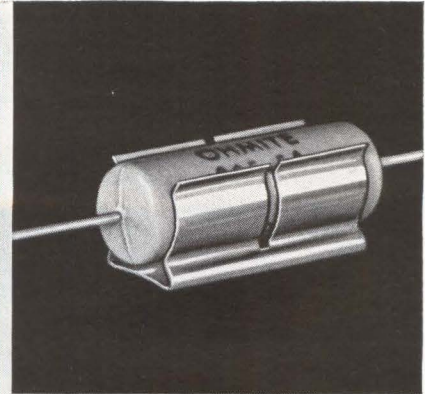

CLIP IT! Insert a molded Series 99 resistor into a metal clip. Don't baby it; ram it in. There's no danger of cutting, chipping, or scratching the hard coating which provides 1000 VAC insulation. Notice the snug fit, too. The clip mounting shown is resistant to high shock and vibration. When mounted on a metal chassis, it provides a heat sink which may increase the wattage rating as much as 100%.

on any other resistor!

10,964,000 UNIT-HOURS OF TESTING! This new molded construction has been proven in extensive load-life tests shown in the accompanying table.

These test results have been obtained from many experimental lots of resistors representing different constructional materials and manufacturing processes. These resistors were produced, tested, and evaluated for developmental purposes which ultimately determined our present production practices. Hence, the % Δ R values given should not be specified as design or performance limits.

More typical Δ R data is presently being collected as part of another test program in which samples are being taken from standard production lots. Data will be available after sufficient time has elapsed.

CYCLIC LOAD-LIFE TEST SUMMARY ON TYPE 995 RESISTORS AT RATED WATTAGE (GROUPS STARTED AT DIFFERENT TIMES)

TYPE	TOTAL NUMBER OF UNITS	TOTAL UNIT-HOURS "ON-TIME" AS OF 6/4/63	ALL GROUPS 2000 HRS. "ON-TIME"		ATTAINED "ON-TIME" OF DIFFERENT SUBGROUPS AS OF JUNE 4, 1963					
					3000 HRS.		4000 HRS.		5000 HRS.	
			NO. OF UNITS	AV. % Δ R	NO. OF UNITS	AV. % Δ R	NO. OF UNITS	AV. % Δ R	NO. OF UNITS	AV. % Δ R
995-1A	409	1,304,000	409	0.447	284	0.536	101	1.051		
995-3A	768	3,055,000	768	0.868	155	0.999	373	1.397	206	0.876
995-5A	346	1,131,000	346	0.633	89	0.687	175	0.662		
995-5B	281	1,124,000	281	2.109			281	2.740		
995-10A	438	1,609,000	438	0.733	146	0.780	238	0.891	37	0.974
ALL	2242	8,223,000*	2242	0.712	674	0.715	1168	1.455	243	0.891

*Equal to 10,964,000 total unit-hours of test (cyclic: 1½ hours on, ½ hour off).

"fatal" characteristic F (salt water immersion test) of former MIL-R-26B.

SPECIFICATIONS

Series 99 molded vitreous resistors meet all requirements of MIL-R-26C for insulated units RW69, RW67, and RW68, characteristics V (350° C max hotspot) or G (275° C).

They can also be supplied as RW59, RW57, and RW58 resistors, characteristics G or V.

Standard tolerance is $\pm 5\%$. Tolerances down to $\pm 0.25\%$ supplied to order.

Low temperature-coefficient requirements of 0 ± 30 ppm/°C for resistances of 10 ohms and greater, and 0 ± 50 ppm/°C for resistances under 10 ohms (up to 350°C) are available on order.

Standard leads are solder-dip coated for soldering; furnished bare for welding, or gold plated on order.

OHMITE STYLE	RATED WATTS AT 25° C	DIMENSIONS (INCHES)		OHMS RANGE (COMM'L)
		DIAM. $\pm .031$ - .000	LENGTH $\pm .015$	
995-1A	1	0.125†	0.422‡	1 to 3,000
995-2A	2	0.188	0.375	1 to 3,000
995-3A*	3	0.203	0.547	1 to 10,000
995-5A§	5	0.313	0.922	1 to 30,000
995-5B	5	0.203	0.938	1 to 25,000
995-10A†	10	0.313	1.781	1 to 51,000

NOTE: Standard lead length is 1½". *Also in MIL style RW69V (991-3). §Also in MIL style RW67V (991-6.5). †Also in MIL style RW68V (991-11). ‡Tolerance, $\pm .015$ - .005.

Write for Bulletin 103



OHMITE
MANUFACTURING COMPANY
3610 Howard Street, Skokie, Illinois
Phone: (312) ORchard 5-2600

RHEOSTATS • POWER RESISTORS • PRECISION RESISTORS • VARIABLE TRANSFORMERS
TANTALUM CAPACITORS • TAP SWITCHES • RELAYS • R. F. CHOKES • SEMICONDUCTOR DIODES

MIL-T-55164 TERMINAL BOARDS

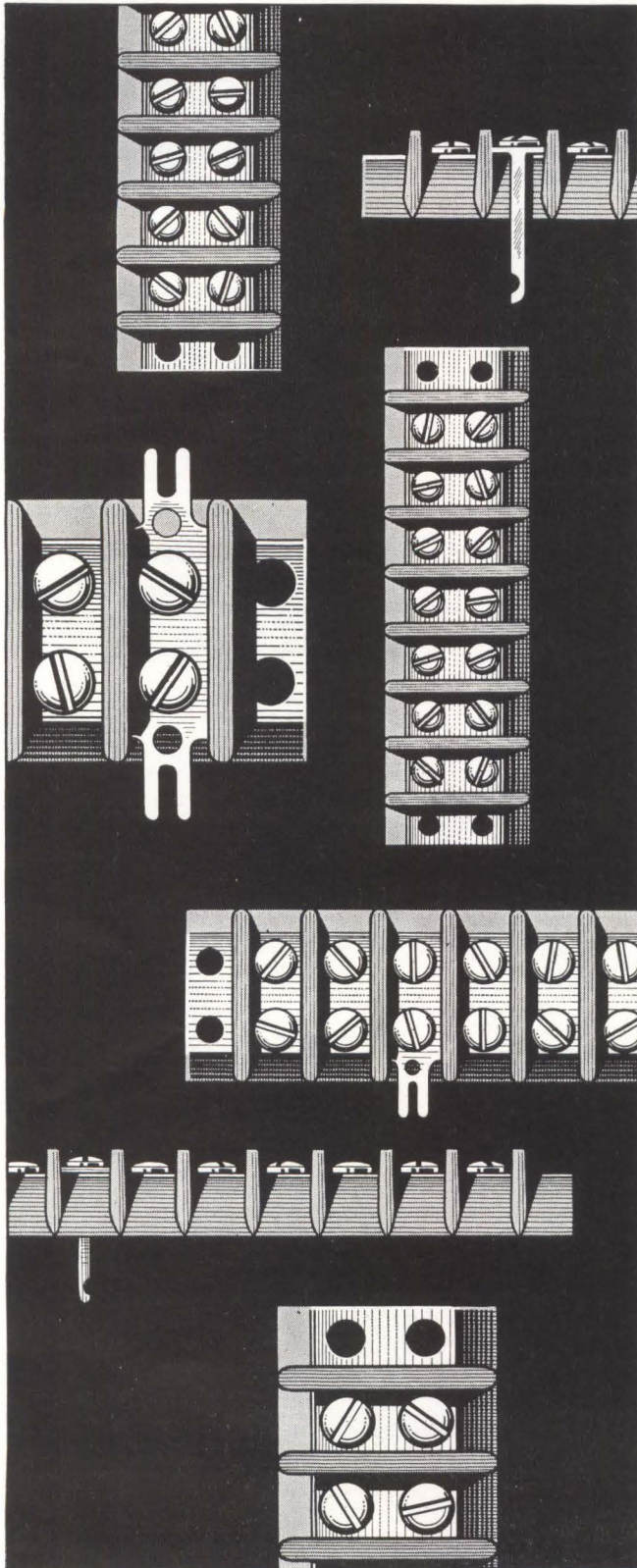

**Immediate delivery
from industry's
largest stocks**

The first coordinated military specification on terminal boards for use in all electrical and electronic equipment manufactured for the Department of Defense, Gen-Pro boards are produced in full accordance with MIL-T-55164 and are available for immediate delivery.

The Gen-Pro military blocks feature solid, insulated backs with completely smooth surface; molded-in conductors to assure positive, contamination-proof terminals; molded-in saddle plates around mounting holes for greater strength and easier handling. They are molded of Compound GDI-30F per MIL-M-19833.

Gen-Pro maintains full inventories at all times. TBLS and TBLD hardware is also available for immediate delivery. Gen-Pro, the originator of solid-back blocks, can meet your production schedules with complete service . . . no need to worry about slow shipments or back orders.

**For descriptive literature, write to
Military Products Manager**



**GENERAL PRODUCTS CORPORATION
UNION SPRINGS, N.Y.**

Phone: (area code 315) TT9-7367 • TWX: 315-999-1455

The Nation's Leading Producer of Military Terminal Boards

FLUKE

offers the most complete line of differential voltmeters on the market

Features common to all models are infinite input resistance at null; in-line readout with automatic lighted decimal; front panel DC polarity switch; standard cell reference (zener diode optional); taut band suspension meter and flow-soldered glass epoxy printed circuit boards.



Choose the degree of accuracy that meets your need...

Models	DC ACCURACY ±% of input voltage		AC ACCURACY ±% of input voltage	
	DC	AC	DC	AC
801B	0.05%			
825A	0.02%			
821A	0.01%			
803B	0.05%	0.2%		
803D	0.02%	0.1%	0.01%	0.1%
823A			0.1%	0.1%

Models	801B	825A	821A	803B	803D	823A
INPUT RANGE	0-500V	0-500V	0-500V	0-500V	0-500V	0-500V
FREQUENCY RANGE	20 cps-10 kc	5 cps-100 kc	5 cps-100 kc
MAXIMUM FULL SCALE SENSITIVITY	10 mv	1 mv	1 mv	10 mv DC 1 mv AC	1 mv	1 mv
MAXIMUM METER RESOLUTION	50 uv	5 uv	5 uv	50 uv DC 5 uv AC	5 uv	5 uv
REFERENCE	Std. cell (zener diode optional)	Std. cell (zener diode optional)	Standard cell	Std. cell (zener diode optional)	Std. cell (zener diode optional)	Standard cell
PRICE Cabinet model	\$485.00	\$590.00	\$795.00	\$875.00	\$1,100.00	\$1,300.00
Rack model	\$505.00	\$610.00	\$815.00	\$895.00	\$1,120.00	\$1,320.00

Prices and data subject to change without notice. Prices f.o.b. factory.

MILITARIZED — DC DIFF. VOLTMETER



Meets all environmental requirements of Mil-T-945A. Provides accurate voltage measurements (0 to 500V) under adverse environmental conditions.

MODEL 8011A
PRICE: \$1745.00
Complete technical data on all FLUKE voltmeters available upon request.

PARTIAL 8011A SPECIFICATIONS

ACCURACY: ±0.05% of input from 0.1 to 500V
±0.1% of input or 0.5 mv, whichever is greater, below 0.1V
NULL RANGES: ±10, ±1, ±0.1, ±0.01V
INPUT IMPEDANCE: Infinite at null from 0 to 500V
MAXIMUM METER RESOLUTION: 50 uv
REFERENCE: Temperature controlled Zener diode

John Fluke Mfg.
Co., Inc., Box 7428
Seattle 33, Wash.



PR 6-1171 TWX 206-879-1864 TLX 852 Cable: FLUKE

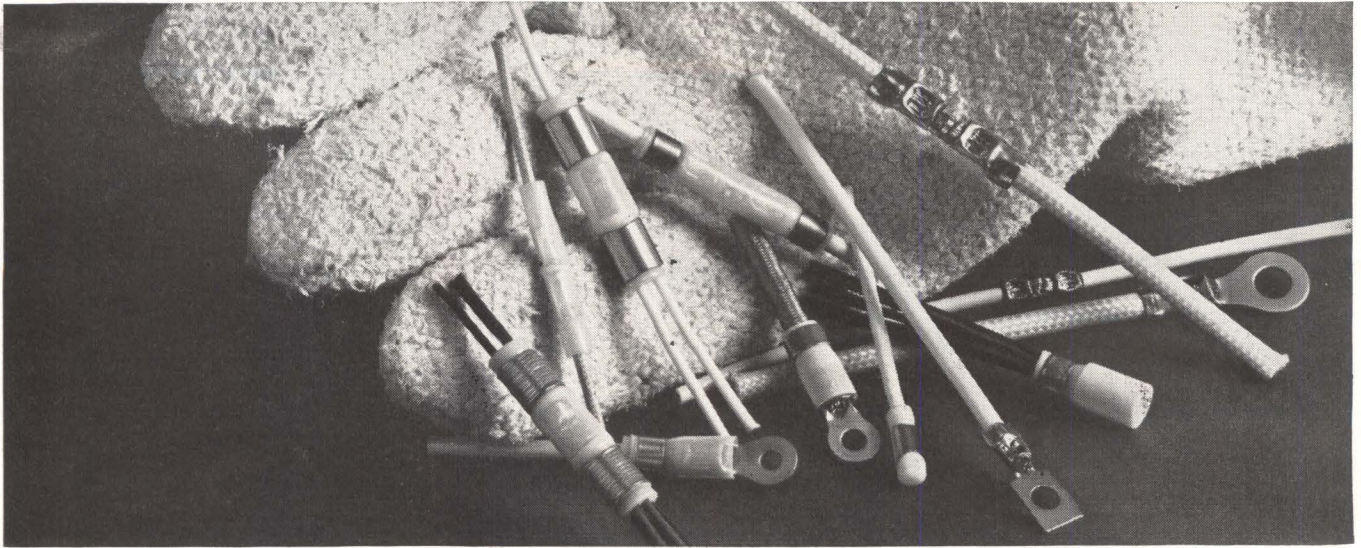

Some . . .

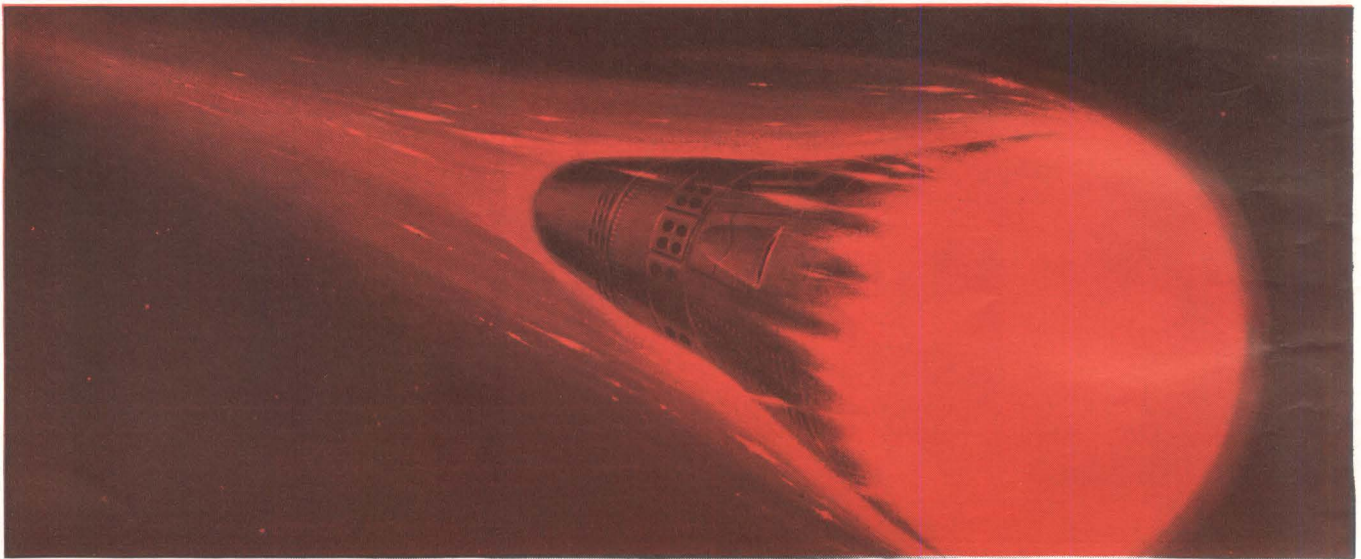

like it hot!

Go as high as you want and as hot as 1200° F. and our STRATOTHERM* terminals and splices perform with utmost reliability . . . all the way! In a vapor-trailed jet at 35,000 feet or a cherry-nosed missile braked by earth's atmosphere, STRATOTHERM brand products easily ride out vibration, corrosion, heat, cold and other extremes that go with pushing beyond sound or into space.

You can choose from three basic, temperature-oriented types: uninsulated (650° F. or 1200° F.), pre-insulated (550°F.) and post-insulated (500° F.). Splices (sealed or unsealed) for single or multiple wire applications. Caps for pigtail splices and spare wire caps . . . all part of the largest line of high-temperature, high-altitude connection devices available anywhere.

Quite by design, our STRATOTHERM terminal and splice line offers many other advantages including:

- choice of plating predicated on temperature requirements
- color coding of sleeve or crimping rings
- precision controlled crimping with matching A-MP* tools—hand or automatic
- wire size range—AWG 26-2/0
- TEFLON® insulation used throughout

There's more to tell; all of it convincing, if your needs are in high-temperature, high-altitude connections. So, send now for complete information on AMP STRATOTHERM terminals and splices.

*Trademark of AMP INCORPORATED.

TEFLON® Trademark of E. I. Du Pont



AMP products and engineering assistance are available through subsidiary companies in: Australia • Canada • England • France • Holland • Italy • Japan • Mexico • West Germany

Investment Abroad Rising

NEW YORK—Electrical-electronics firms plan to invest \$60.9 million this year to begin operations in Europe's Common Market—about \$9 million more than last year and \$57 million more than five years ago. To that they'll add \$39 million for plants, property equipment elsewhere in Europe, reports McGraw-Hill's fifth annual survey of overseas capital investment.

In two years, electrical and electronic companies expect to spend \$76.8 million just in the Common Market.

In other European nations the 1962 figure was \$44.1 million, the poll says, and this year's seems \$39.1 million. Next year they anticipate pumping in \$30.7 million; in 1965, \$23 million. Will it diminish? Eighty percent of firms responding said "no." Those saying "yes," like other businesses, gave one major reason: projects abroad are now or would soon be completed.

The report also disclosed that gains felt in Europe take their toll elsewhere—mainly Latin America, until now a prime area for outside-U.S. investing. Countries there garnered a quarter of all overseas outlays five years ago. This year, electrical-electronics people are sinking only \$2.9 million into Latin America, forecast only \$6.4 million in 1965.

Finally, the survey predicts that subsidiary sales will continue outstripping exports, at least for two years, as firms forecasted in all four earlier studies. While electrical-electronics exports might rise 5 percent during 1963-64, subsidiary sales should show a gain three times that.

Japanese Tv-Price Floor Near Approval

TOKYO—Last week the Japanese Television Exporters Council officially applied to the Ministry of International Trade and Industry (MITI) for approval of their agreement to fix floor prices for tv sets destined for U.S. markets (p 8, Aug. 30; p 7, Aug. 2).

Nippon Electric Company is the only major manufacturer abstraining. A spokesman stated the company's first task was to settle the lawsuit brought by Symphonic Electronic Corp.

(Symphonic contracted to buy receivers from NEC. A Symphonic

customer, the Spieged mail-order house, advertised the sets at \$30 below the going market. Upon request, Spieged agreed to readjust prices in their next catalog. According to the lawsuit, NEC and the Japanese tv industry then refused to sell tv sets to Symphonic.)

There has been some concern that the price-fixing agreement is illegal under the U.S. antitrust law. Both the council of tv manufacturers and MITI pointed out, however, that if tv price agreement violates U.S. laws, so do 126 other similar agreements now in existence.

Silicon-Carbide Laser Emits Blue Light

LOW-POWER c-w injection laser that emits blue light at room temperature has been developed by Tyco Laboratories in Waltham, Mass. The device is a silicon-carbide structure with molybdenum electrodes; it is fabricated by a crystal-growing technique known as the traveling solvent method.

Use of silicon carbide has allowed achieving very low threshold current densities (120 amp per sq cm) at room temperature. Thus, the device is considered particularly promising for applications requiring ruggedness.

Emission is at 4,560 angstroms—in the visible blue-region of the spectrum. Tyco Laboratories' president Arthur J. Rosenberg told ELECTRONICS that this emission exhibits constructive interference and that the spacing of the interference lines implies that the emitted radiation comes from an aperture that agrees precisely with the actual physical dimensions of the diode *t-n* junction.

Coinventors are L. B. Griffiths and A. I. Mlavsky. They were assisted by G. Rupprecht, P. H. Smakula and M. A. Wright. The Norton Co. is licensed to manufacture and sell the device.

Big Advances Predicted in Computer Technology

FUTURE ADVANCES in computers as significant as the transition from the vacuum-tube to the solid-state type were predicted last week by William C. Norris, president of Control Data Corp. They would include new concepts of machine organization and new wiring and packaging schemes. Norris was keynote speaker at the 18th annual conference of the Association for Computing Machinery in Denver.

Norris predicted development of a "second generation of input-output equipment" within the next 10 years. These would include cathode ray tube "visual techniques" for real-time problems, wider use of film to store information and the develop-

IN BRIEF

JAPANESE plan two industrial trade fairs in Communist China this fall. Some \$400,000 in equipment, including electronics, will be shown in Peiping during October and Shanghai in December. The British are also planning an industrial show in Peiping, in November.

ECONOMICAL production capability for cesium-beam tubes (time and frequency standard) is goal of \$262,500 Army contract awarded National Company.

MICROWAVE altimeter for unmanned helicopters has been developed for Navy by Sylvania. It will permit helicopters like the Dash ASW system (p 18, April 19) to maintain present altitudes to 1,000 ft.

VIDEO tape recorders, made by Precision Instrument, will be sold as accessories to Westinghouse x-ray and fluoroscope systems. Recordings will provide alternative to x-ray movies.

JOSEPH H. McCONNELL, of Reynolds metal, formerly with RCA and NBC, will head U. S. delegation to Extraordinary Administrative Radio Conference of ITU Oct. 7 to Nov. 8. He will have the rank of ambassador.

UNDERSEA CABLE link between Guam and Philippines will permit all-cable communications between U. S. and Philippines in late 1964. AT&T will lay the cable, a joint project with overseas companies.

SWEDISH Army demonstrated a new 15-lb manpack transistor radio transceiver with range of 15 miles. It will replace sets now used.

GENERAL PRECISION is denying reports it will merge with Magnavox. Reports were heard last week after Frank Freimann, Magnavox president, said his company was considering a "sizable" acquisition.

CLEVITE and Kokusan-Denki, of Japan, are jointly developing a piezoelectric ignition system for internal combustion engines.

NASA is now hoping to flight-test in late 1965 or early 1966 a passively oriented, passive-communications satellite (for earlier story, see p 24).

MAGNAVOX's \$12.4-million award for solid-state, f-m, vehicular communications systems brings total to \$34.4-million.

BACHE & CO. has installed first of Ultronic Systems' Lectrascan system. It displays stock ticker tape reports on alphanumeric tubes.

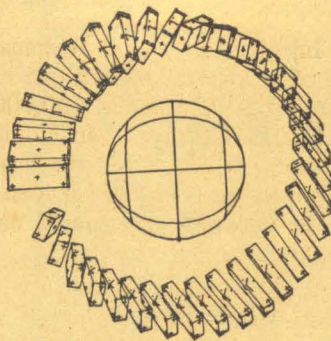

TECHNIQUE for drawing perspective movies frame-by-frame on a crt was among several programming methods described last week at the ACM meeting. Example above, from Bell Telephone Labs, simulates motion of satellite orbiting earth

ment of audio communication equipment for both input and output. He also called the use of standard languages such as Cobol, Algol and Fortran as "absolute necessity."

At the conference, ACM announced a special education program to train the blind as computer programmers. ACM said computers can be programmed to print out data in a special kind of braille.

Negative-Resistance May Improve Lasers

DAYTON, OHIO—Upgraded lasers may result from negative-resistance experiments with cadmium sulfide reported last Wednesday by Donald Reynolds, aerospace research labs, Wright Patterson Air Force Base.

Negative resistance in semiconductors is important because of its apparent connection with junction-laser action, Reynolds said. He also suggested applications to light integration and other monitoring or measuring devices of light quanta and particle emission.

Resistivity of CdS crystals has been changed up to 10 orders of magnitude and kept at any level within a chosen range, after crystals were cooled to liquid nitrogen temperatures.

Red light beyond the 6,900 —A wavelength or 1.75-ev photon threshold appears to excite electrons up to a conduction band, while trapping holes.

Negative resistance seems to result from double-carrier injection of electrons at an indium electrode and of holes at a silver electrode, Reynolds reported. Crystals apparently pump themselves up to a higher level of stimulation by absorption of their own recombination radiation.

Infrared radiation destimulates the crystal, by exciting trapped holes to valence bands, where recombination with trapped electrons radiates green light.

Quantum Transitions Multiply Frequencies

SAN FRANCISCO—Kane Engineering Labs (KEL) are using multiple quantum transition techniques in frequency-conversion devices to multiply X-band frequencies to obtain K-band frequencies. Outputs up to 80 watts have been obtained with 250-kilowatt inputs. KEL has also achieved fifth harmonic conversion—from C-band to K-band frequencies. They are also researching the adaptation of optical techniques for creating millimeter and submillimeter waves via multiple quantum transitions. KEL is looking for suitable materials to provide the proper atomic or molecular conversion system.

Are the Russians Using Laser Space Speedometer?

VIENNA—Design for a laser doppler system that can measure relative velocities of two rendezvousing spacecraft is described in the Russian journal, *Znaniesila*, according to the Czech publication, *Priroda a Spolocnost*.

(The report did not make clear whether the system is actually being used. Similar systems have been proposed in the U. S.)

Output from the transmitting laser is split into two beams by a semitransparent mirror. One beam is projected onto a photocell in the

first spacecraft and serves as a frequency reference. The other beam is reflected from a mirror on the second spacecraft.

Doppler shift in the returning beam is directly indicated as relative velocity of the two craft, according to the report. The system is said to be able to measure velocities of 8 km/sec to 0.03 mm/sec (4.97 mi/sec to 0.0118 in./sec).

UK Urged to Adopt NTSC Color-Tv System

LONDON—In choosing a common color system for European tv, it would be "folly" if any other than the U. S. National Television System Committee (NTSC) method were adopted—according to Dudley Saward, managing director of the Rank-Bush Murphy Group. He went on to urge that Britain should take the lead in color tv as it did in black-and-white since one person in four in the UK has a tv set as compared to one in ten in the Common Market countries. He pointed out that the NTSC method has been operating in the U. S. for 10 years and for 8 years in Britain, while transmitting and receiving experience with the French SECAM and the West German PAL (p 22, Aug. 2) is less than a year.

AFCRL Drops IR Detectors Through Titan II Plumes

CAMBRIDGE, MASS.—Two separate infrared instrument packages were dropped through ballistic missile tail plumes on August 21 in an experiment by Air Force Cambridge Research Laboratory. The experiment, revealed last week, is reportedly the first of its kind. It was designed to examine missile thrust and fuel efficiency and to study the characteristic signature of exhaust plumes as an aid to missile identification.

The instruments, designed and built by Block Engineering, Inc.,

were injected into the exhaust stream of a Titan II rocket; one at 300,000 feet, the other at 600,000 feet. The 13 instruments, including complementary devices on the missile, reportedly all operated successfully. The packages telemetered the data to earth.

Magnetic Tape Market Gets Two New Entries

PHILADELPHIA—Eastman Kodak's Durol magnetic sound-recording tape will be marketed by International Resistance Co. starting this month. The cellulose triacetate tape is reported to have—in addition to professional quality—low-stretch characteristics that prevent curling if the tape is broken. There are to

be two types of tapes, a low-print tape with an output comparable to a good general-purpose tape, and a high-output tape with low print-through characteristics.

How Do You Find Water on the Moon?

DALLAS—Texas Instruments will evaluate geophysical methods for finding water on the moon under a \$105,926 Air Force Cambridge Research Laboratories contract. Theoretical studies to identify the best techniques and equipment will be made. Techniques which, at present, appear to hold particular promise include infrared measurement, electrical resistivity methods, nuclear logging, and seismic profiling.

MEETINGS AHEAD

MILITARY ELECTRONICS NATIONAL CONFERENCE, IEEE-PTGMIL; Shoreham Hotel, Washington, D. C., Sept. 9-11.

ANNUAL ISA INSTRUMENT-AUTOMATION CONFERENCE-EXHIBIT, ISA; McCormick Place, Chicago, Ill., Sept. 9-12.

ELECTRICAL INSULATION CONFERENCE, IEEE, NEMA; Conrad-Hilton Hotel, Chicago, Sept. 10-14.

JOINT ENGINEERING MANAGEMENT CONFERENCE, IEEE, ASME; Biltmore Hotel, Los Angeles, Sept. 12-13.

INTERNATIONAL ASSOCIATION FOR ANALOG COMPUTING, AICA; Brighton College of Technology, Lewes Rd., Brighton, England, Sept. 14-18.

INDUSTRIAL ELECTRONICS ANNUAL CONFERENCE, IEEE, ISA; Michigan State University, East Lansing, Mich., Sept. 18-19.

NATIONAL POWER CONFERENCE, IEEE, ASME; Netherland-Hilton Hotel, Cincinnati, Ohio, Sept. 22-25.

INTERNATIONAL TELEMETERING CONFERENCE, IEE, IEEE, ISA, ARS, IAS; London, England, Sept. 24-27.

PHYSICS OF FAILURE IN ELECTRONICS SYMPOSIUM, Armour Research Foundation and Rome Air Development Center, Illinois Institute of Technology, Chicago, Sept. 25-26.

ELECTROCHEMICAL SOCIETY FALL MEETING, ECS; New Yorker Hotel, New York, Sept. 29-Oct. 30.

CANADIAN ELECTRONICS CONFERENCE, IEE REGION 7; Automotive Bldg., Toronto, Ont., Canada, Sept. 30-Oct. 2.

SPACE ELECTRONICS NATIONAL SYMPOSIUM, IEEE-PTG-SET; Fontainebleu Hotel, Miami Beach, Fla., Oct. 1-3.

ELECTROMAGNETIC RELAYS INTERNATIONAL CONFERENCE, IEEE, ICER, IEE, Tohoku University, Science Council of Japan; Sendai, Japan, Oct. 8-11.

ELECTRICAL-ELECTRONICS CONFERENCE, Aerospace Electrical Society; Pan Pacific Auditorium, Los Angeles, Calif., Oct. 9-11.

NATIONAL AEROSPACE CONFERENCE, National Society of Professional Engineers; Lafayette Hotel, Long Beach, Calif., Oct. 10-11.

ADVANCE REPORT

ELECTRONICS COMPONENTS CONFERENCE, EIA, IEEE; Marriott Twin Bridges Motor Hotel, Washington, D. C., May 5-7, 1964; Nov. 1 is deadline for submitting 500-word abstract, 3 copies, to Dr. John J. Bohrer, Technical Program Chairman, International Resistance Co., 401 North Broad St., Philadelphia 8, Pa. Some invited topics: fixed and variable resistors, capacitors, printed wiring, thin film devices, micro-miniaturization (excluding silicon integrated devices), reliability and testing techniques, conductors and cables.

Congress Cuts NASA Budget \$362 Million

CONGRESS has slashed \$362 million from NASA's \$5,712-million authorization request for fiscal 1964—a compromise between a \$509-million cut by the House and a \$201-million cut by the Senate. The trimming amounts more to a congressional admonishment to the space agency to present better-justified budgets in the future than a roll back of the space program. By and large, reductions made are for long-lead-time items and for requests not adequately supported with details on just how and when money would be spent.

There were few specific cuts in electronics. Those made include: \$13.2 million from the \$231.5-million request for tracking and data acquisition; \$6.7 million from a \$90-million request to equip three new instrumentation ships; and \$28 million out of \$153 million requested for integration and checkout programs. Congress pared \$1.1 million from the \$5 million for a new electronics center in Boston. NASA must submit new site selection surveys to Congress before it can proceed with the facility. Virtually no one expects NASA to shift the center's location.

Tariff Break Sought by EIA

ROBERT C. SPRAGUE, chairman of the Electronic Industries Association's Electronic Imports Committee, has asked the President's special representative, Christian A. Herter, to separate electronic equipment from electrical machinery in lists prepared for 1964 tariff negotiations under the Trade Expansion Act. Electronic products are distinguished from electrical machinery by high skilled-labor content—and, therefore, high value-to-mass ratio, Sprague said. He added that the rise in electronic imports indicates an accelerating invasion of the domestic electronic product market.

Probe to Weigh Buying Changes

ECONOMIC implications of shifts in defense spending are being studied in Washington these days with unusual seriousness. There is considerable disagreement among government and other economists over the urgency of the problem, reflecting opposing opinions on the effects of military spending on the economy: whether it is a "drag" or a stimulus.

The focal point of this controversy will probably be a series of hearings by the Senate Subcommittee on Manpower and Employment, scheduled for October or November. The inquiry, headed by Sen. Joseph Clark (D.-Pa.) will be a far-reaching look at what would happen to the economy if defense spending is reduced and at proposals for easing the adjustment.

TFX Electronics Off-the-Shelf

AIR FORCE will supply the IFF transponder, instrument landing system, uhf radio, intercommunication system, TACAN and omni-range navigation equipment as "government-furnished" equipment to the prime contractor on the F-111 (TFX) tactical fighter aircraft. Air Force Secretary Zuckert says, "to a large extent, these will be off-the-shelf items". First flight test for the F-111 has been scheduled for January, 1965.

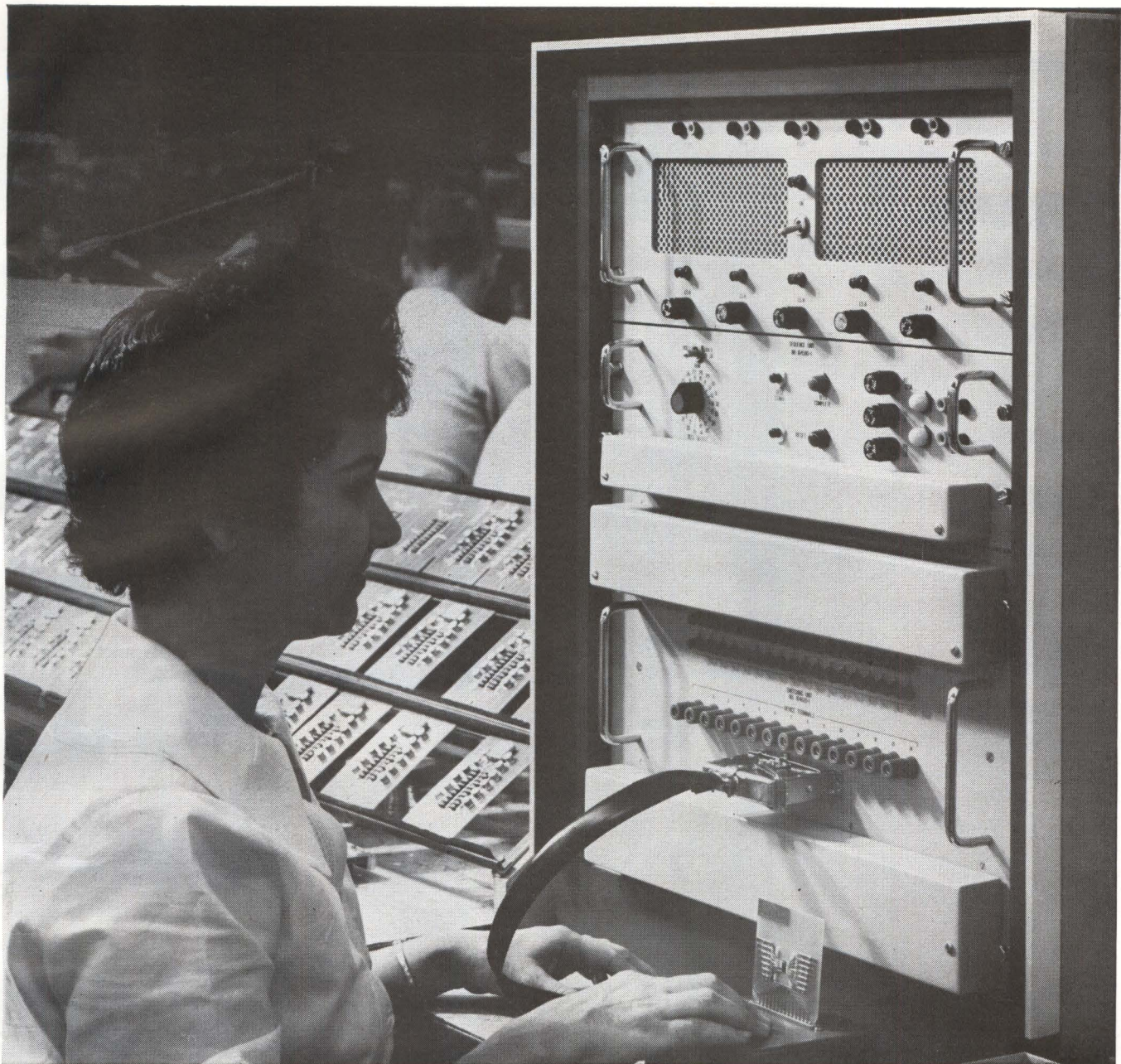

Testing Integrated Circuits? reduce test time and cost

With TI's new Integrated Circuit Tester, the 659A, you can make 36 d-c or logic function tests on integral circuit packages in less than 2 seconds. Two-terminal (Kelvin) connections are made to 14 active leads. You can stack two units—operate them in series—for a 72 test sequence. You can program the 659A easily using printed circuit boards for bias conditions, tim-

ing, limits, and sorting logic. Integral circuit packages, no matter their size or shape, mount on device holders which plug into the test socket. To operate, simply press the start button. Four solid-state power supplies provide test bias voltages. Internal logic determines classification to 15 categories for use with a companion sorter. Failures are indicated on front

panel lights. The 659A is compact, yet designed for ease of maintenance. Test points are accessible on the front panel, printed circuit boards are easily removable . . . and the basic unit is priced at \$16,500 f.o.b. plant. Let a TI representative show you the advantages of 659A integrated circuit testing.

Write for complete information.

INDUSTRIAL
PRODUCTS
GROUP



TEXAS INSTRUMENTS
INCORPORATED
P. O. BOX 66027 HOUSTON 6, TEXAS

606

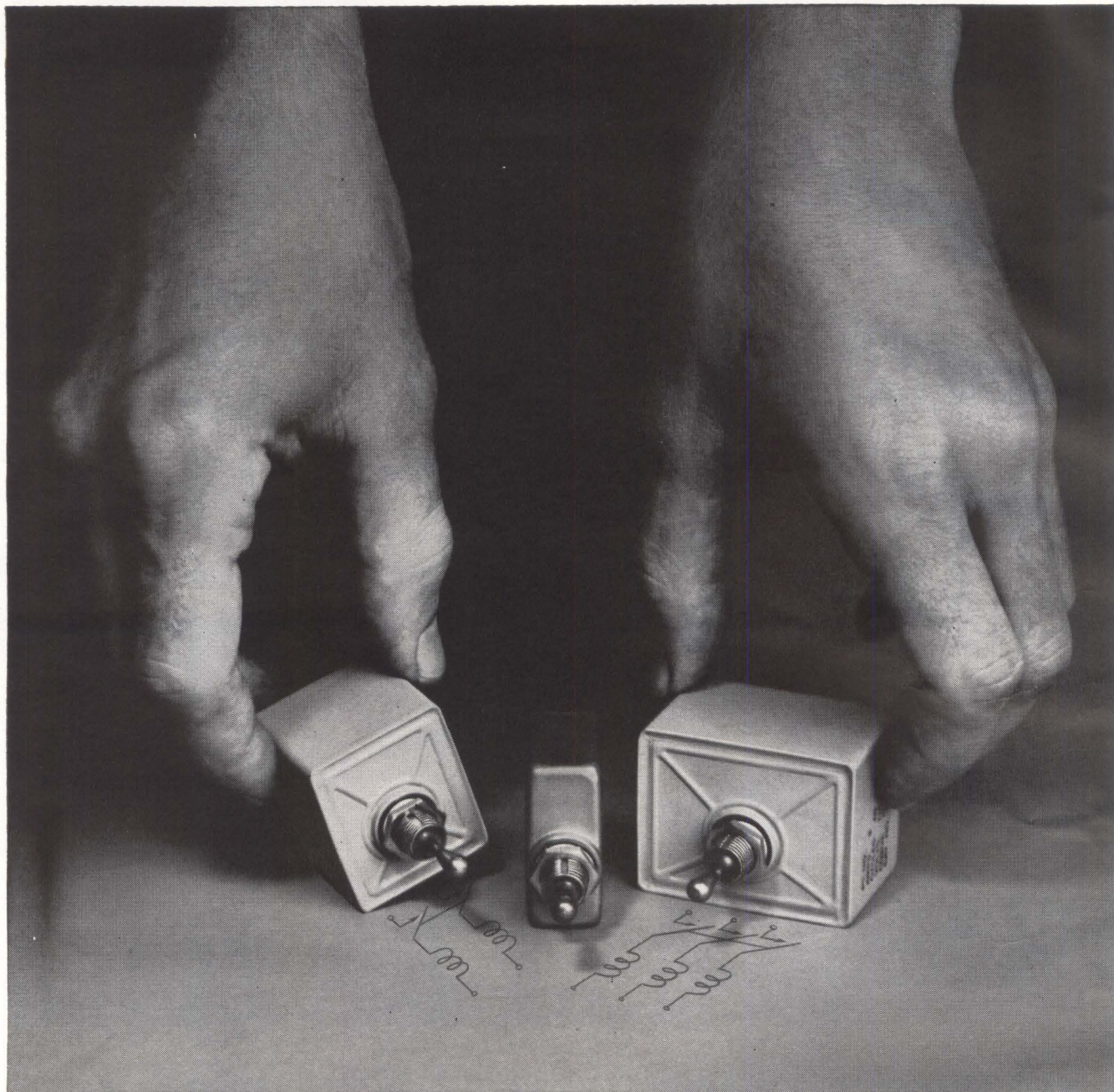

If you are designing for severe-environment service and need polyphase or multiple-circuit protection, these new subminiature two- and three-pole SM breakers can probably help you out.

Built to take rough going, they are designed to meet stringent specs for operation under conditions of shock, vibration, high humidity, sand and dust atmosphere, and salt-sea atmosphere. In addition, they will comply with requirements for explosion-proofing, fungus resistance, and high-altitude operation.

That's not all. The breakers are also temperature-stable (thanks to hydraulic-magnetic actuation). You don't have to derate them for high-ambient service. They will maintain nominal load capacity and calibrated trip points

**Now available
in multi-pole models:
Heinemann's
rugged, Mil-type
SM circuit breaker**

at any temperature from -40° to 100°C .

And, nicely enough, you don't have to pay a weight or space penalty to get these capabilities. The two-pole SM weighs only $3\frac{1}{4}$ ounces, and measures just $1.5 \times 1.25 \times 1.9$ inches (excluding handle). The three-pole model weighs $4\frac{1}{2}$ ounces, measures $1.5 \times 1.9 \times 1.9$ inches.

You can have both models in any integral or fractional current rating you need, from 0.050 to 20 amps, with either a "fast" or "slow" inverse time delay, or instantaneous trip. Both can be furnished in voltage ratings of 230V AC (max.), 60 or 400 cycles, or 50V DC (max.).

Our Bulletins 3502 and 3503 will give you complete technical information. A word from you will put them in the mail.

HEINEMANN ELECTRIC COMPANY  **2600 BRUNSWICK PIKE, TRENTON 2, N. J.**

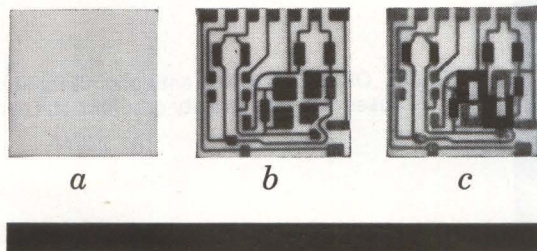

If you could
make your own,
wouldn't you make
microcircuits like this?

a We start with an alumina ceramic that we make ourselves, that we know is free of impurities. It's glazed with glass that we make ourselves and that we formulate so that its electrical properties match precisely those of the films we add later. Surface smoothness is controlled to less than one micro-inch.

b We add the basic circuit pattern with our own tin-oxide film which bonds *molecularly*—not just mechanically—with the substrate. This is the same film used in our high-reliability discrete resistors which have run more than 135,000,000 mostly *overstressed* unit test hours without a single failure. You can forget environmental prob-

lems because the film is already an oxide. Our tin-oxide patterning process lets us match your proprietary designs with surprising economy.

c Depending on your requirements, we add copper, gold, or aluminum circuitry where needed. Here we have silicon monoxide capacitors coupled with resistors and conductors. Mount your transistors and diodes—the holes are there—and you've got a flip-flop circuit.

All this adds up to the *total control* that we exercise over all the materials and processes that go into the making of CORNING microcircuits.

To total control, you can add the proven reliability of tin-oxide resistive

film, the proven technology of our long experience with substrates and metallizing, and the economical flexibility we can bring to bear on *your* custom design.

One more point: every custom microcircuit we've made so far has outperformed our promises for it.

For more information on our capabilities in superior microcircuitry, write Corning Glass Works, 3901 Electronics Drive, Raleigh, N. C.

**CORNING
ELECTRONICS**

A DIVISION OF CORNING GLASS WORKS

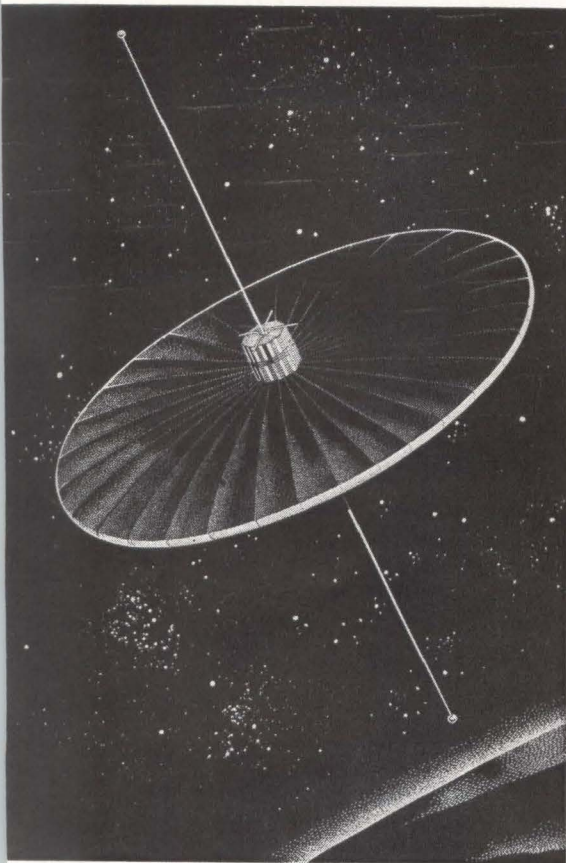

Passive comsats offer multiple access, are jam-proof and durable

By JOEL STRASSER, Assistant Editor

WASHINGTON—Although active communications satellites are in the limelight now, much thought is being devoted to advanced types of passive satellites, Donald P. Rogers, Echo project director for NASA, told *ELECTRONICS* last week.

Passive satellites can have advantages over active; they are not frequency sensitive, are ideally adaptable for multiple access by using different frequencies and can have extremely long lifetimes. Significantly, the fact that they are difficult to jam makes them particularly attractive to the military.

Passive comsats can be made to do almost anything their active counterparts can do. Depending on the balloon diameter, antenna diameters, altitude and power required, passive satellites can even transmit television. For example,

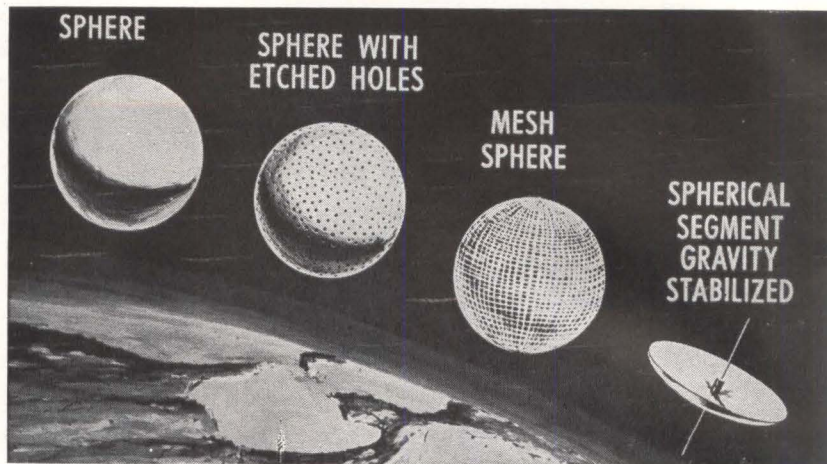

VARIETY OF CONFIGURATIONS of passive communications satellites have been proposed. Goal is larger reflective surface, lighter weight

PASSIVE ORIENTATION Lenticular Satellite (Poles) designed by General Electric uses two-axis gravity-gradient stabilization

After Echo II: What

one tv channel can be accommodated on a passive satellite balloon 427 feet in diameter at a 2,000-mile altitude using 100-kw ground transmitter with an 85-foot diameter antenna. Frequency would be 6 Gc and receiver noise temperature, 100 K. Ground stations would need twenty times more power than if a comparable active satellite were used, but it can be done.

NEW CONFIGURATIONS—Beyond Echo II, the two most attractive configurations being examined by NASA are a larger, lightweight spherical balloon, and a lenticular (lentil-shaped) type using gravity-gradient stabilization (*ELECTRONICS*, p 16, Aug. 23). Both types would provide a larger diameter, thus greater r-f reflectivity.

Passive satellites made of wire mesh have been proposed to reduce the force of solar radiation pressure upon them. The spacings of the mesh are directly proportional to the wavelength. For a smaller wavelength, the mesh wires are closer together; a coarse mesh is used for long wavelengths. Fine mesh would be used for high frequencies. For the passive wire mesh satellite, re-

flection factor equals

$$\frac{1}{1 + 4s^2/\lambda^2 \log^2(s/\pi a)}$$

where a is diameter of the wire in the mesh, s is spacing of the wires and λ is wavelength.

To make a wire mesh satellite erectable in space, the balloon is made gas-tight with a plastic film. Special plastic film, called a photolizable film, has been proposed which would disintegrate and evaporate under the influence of radiation leaving only the wire mesh.

Another proposal is to construct the mesh of plastic fibers coated with vapor-deposited metal to make them radio reflective. The fibers would have a "memory effect" so that mechanical energy stored in them would be released by the heat of the sun after injection into orbit, thus erecting the satellite.

Spherical segments, apart from complete spheres, are also receiving considerable attention. These range from an orbiting reflector plate to a lenticular satellite. In both cases, they would have to be stabilized to keep the reflecting surface facing the earth.

Did you know Sprague makes...?

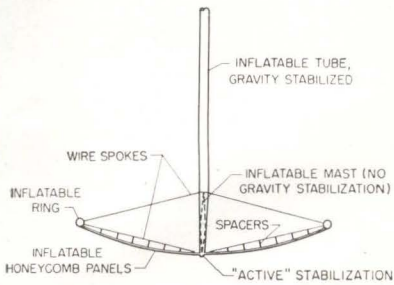

ORIENTED REFLECTOR could use either active or passive stabilization. William J. O'Sullivan, Jr. described this and other configurations at the Conference on Artificial Satellites at Blacksburg, Va. in August

and Why?

TWO PROPOSALS—According to Rogers, a flight program for passive satellites will begin when planners develop a configuration that is better than Echo II by a factor of 10. To do this, designers are seeking either a spherical design 427 feet in diameter weighing the same as Echo II, or a good design for a gravity-stabilized lenticular satellite.

In the late sixties, NASA plans to test a 1,000-foot balloon at the first manned orbiting space laboratory.

Goodyear Aircraft now has a study contract for the lenticular satellite. They are working with Philco to develop a gravity-gradient stabilization system to orient the satellite toward earth.

In a parallel study, General Electric's Passive Attitude Control Group headed by Richard J. Kattucki, has a \$29,000 study contract with Goddard Space Flight Center due next week for a three-axis completely passive damper approach. It would be used in the two-axis Passive Orientation Lenticular Satellite (Poles).

A final decision on which system NASA will use is expected this month.

MAGNETIC LOGIC DEVICES



Core-diode and core transistor magnetic shift registers and magnetic counters for switching and storage applications in computer and logic circuitry.

CIRCLE 277 ON READER SERVICE CARD

MOLDED PULSE TRANSFORMERS

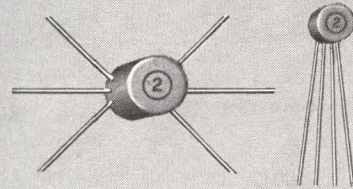

Miniature Pulse Transformers with tough molded cases for increased protection against physical damage and severe atmospheric conditions.

CIRCLE 278 ON READER SERVICE CARD

NANOSECOND PULSE TRANSFORMERS IN TO-5 TRANSISTOR CASES

Special design offers distinct advantages: (1) Mini-fied size. (2) Welded hermetic seal. (3) Increased reliability. (4) Compatibility with transistor mounting techniques.



CIRCLE 279 ON READER SERVICE CARD

SOMETHING NEW IN COUNTING TECHNIQUES

Simple yet versatile, low-cost yet reliable counters available for predetermined (2 to 11) or selectable (5 through 10) counting cycles.



CIRCLE 280 ON READER SERVICE CARD

DYNACOR® BOBBIN CORES



Series "300" Cores with logical flux values in popular physical sizes are stocked in production quantities for fast delivery. They're value engineered for quality with economy!

CIRCLE 282 ON READER SERVICE CARD

HERMETICALLY-SEALED TO-5 ENCASED SWITCH CORES

Designed especially for high-speed, low-power switching up to 100 kc, adaptability with conventional transistor packaging techniques, and performance under MIL-S-21038 environmental conditions.



CIRCLE 281 ON READER SERVICE CARD

ELECTRONIC MODULES TO CUSTOMER REQUIREMENTS

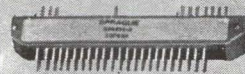

Custom packaging is no novelty at Sprague's Special Products Division, where "specials" are continually being developed and produced with countless variations in electrical characteristics and mechanical configurations.

CIRCLE 283 ON READER SERVICE CARD

For application engineering assistance (without obligation, of course) on any of the above products, write or call the Special Products Division, Sprague Electric Company, 35 Union Street, North Adams, Massachusetts.

455P-111-63 R4

SPRAGUE®
THE MARK OF RELIABILITY

*Sprague' and '®' are registered trademarks of the Sprague Electric Co.

Honeywell data acquisition system records stresses on ships at sea

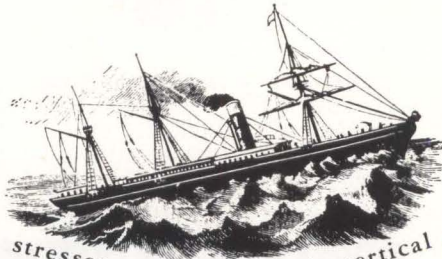

The extremely low recording speed capability of a Honeywell Magnetic Tape System and the versatility of a Honeywell Visicorder Oscillograph have teamed up to report a new story of the punishment ships take at sea. Lessells and Associates, Inc., Boston, used the Honeywell system to measure the vertical longitudinal stresses induced in the hull each time a ship is pounded by a wave.

A Honeywell LAR 7460 Magnetic Tape Recording system was installed aboard the S.S. Hoosier State, and later aboard a sister ship, the S.S. Wolverine State. Both are 520-foot, 15,000 ton freighters operated by States Marine Lines of New York. Strain gages were attached to the port and starboard gunwales amidships to sense stresses produced by waves encountered over the turbulent trade routes of the North Atlantic.

The outputs of the gages were combined in a manner which would cancel the horizontal and transverse

stresses and permit only vertical bending stresses to be measured.

Data from the strain gages were then recorded at .3 inches per second on the 14-track LAR 7460 tape system. The extremely low speed capability of the recorder permitted 40 hours of data to be recorded on a single pass of a 10½-inch reel of tape. During the voyage, the ship's officers rewound the tape every 40 hours, permitting 160 hours of data to be recorded on a single reel of tape.

After the voyage, the tape was taken to Lessells' laboratory and played back from a Honeywell reproducing and amplifying system at 60 inches per second, or a speed ratio of 200 to 1. From the playback system, the data were recorded on a Honeywell Model 906 Visicorder oscillograph, operating at a paper speed of one inch per second.

The data were also fed through a probability distribution analyzer and this processed output was fed into the

Visicorder to permit simultaneous observation of original and processed data. By being able to control both the recording speed and the playback speed, as well as the paper speed of the Visicorder, Lessells could obtain a permanent record of the data with any desired trace resolution.

Whatever your data acquisition requirements may be, Honeywell systems can meet your needs. Visicorder oscillographs are available with channel capacities from 1 to 36 and paper speeds from 1 inch per hour to 160 inches per second. Honeywell Magnetic Tape Systems range from the economical Honeywell 8100 portable recorder/reproducer to complete laboratory systems, with capabilities including FM, direct, digital, and incremental recording.

For complete information, call your local Honeywell representative. Or write or call Honeywell, Denver Division, Industrial Products Group, Denver 10, Colo. (303-794-4311)

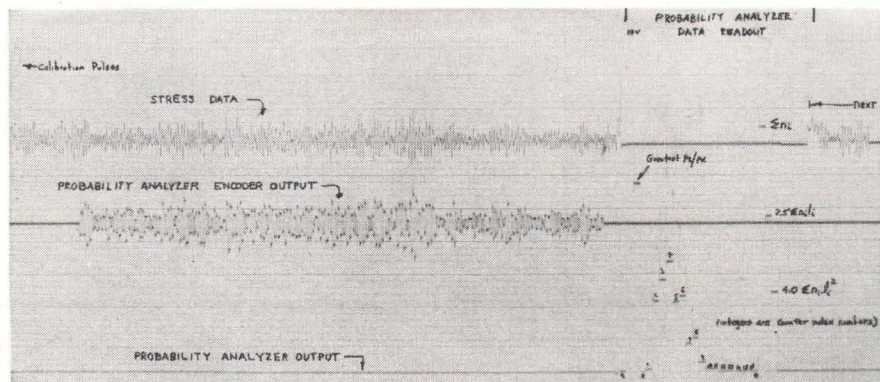

Top trace: Stress data as recorded on ship. Middle trace: Probability distribution analyzer encoder output. Bottom trace: Probability distribution analyzer output. Work performed under NOBS Contracts: #88349, Ships Structures Committee; #88451, Office Chief of Transportation, Dept. of Army.

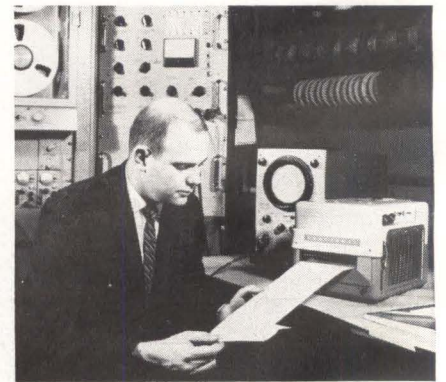

The Honeywell reproducing and amplifying tape system and the Model 906 Visicorder Oscillograph in Lessells' Boston laboratory.

DATA HANDLING SYSTEMS

Honeywell

HONEYWELL INTERNATIONAL Sales and Service offices in all principal cities of the world. Manufacturing in United States, United Kingdom, Canada, Netherlands, Germany, France, Japan.

What's new
behind the
compact-TV
camera lens?

3 New G-E Vidicons

High sensitivity, low lag, and more uniform photoconductive surfaces give broadcast-quality pictures in *any* television pickup function. New "Snow White" manufacturing facilities assure uniformity.



The GL-7038 vidicon is designed for televising live scenes and film pickup applications. Highly uniform photoconductive surface provides a uniform, high-quality picture across the scanned area. The GL-7038 will replace the 6198 and 6198A vidicons. Over-all length: 6¼".



The GL-7325's high sensitivity is ideal for televising live scenes, at lower light levels. The photoconductive surface provides low lag (20-30%) at these light levels. Over-all length: 6¼".



The GL-7226 is designed for transistorized camera chains. Featuring a low heater power cathode which operates at 90 ma, performance characteristics of the tube are the same as the GL-7325. Over-all length: 5½".

For specifications and data on the complete line of G-E vidicons and image orthicons, write to: General Electric Company, Room 8006A, Owensboro, Kentucky, or call your nearest G-E Industrial Tube Distributor, today!

Dedicated to Broadcast Quality in Industrial Applications

Progress Is Our Most Important Product

GENERAL  ELECTRIC

CIRCLE 27 ON READER SERVICE CARD

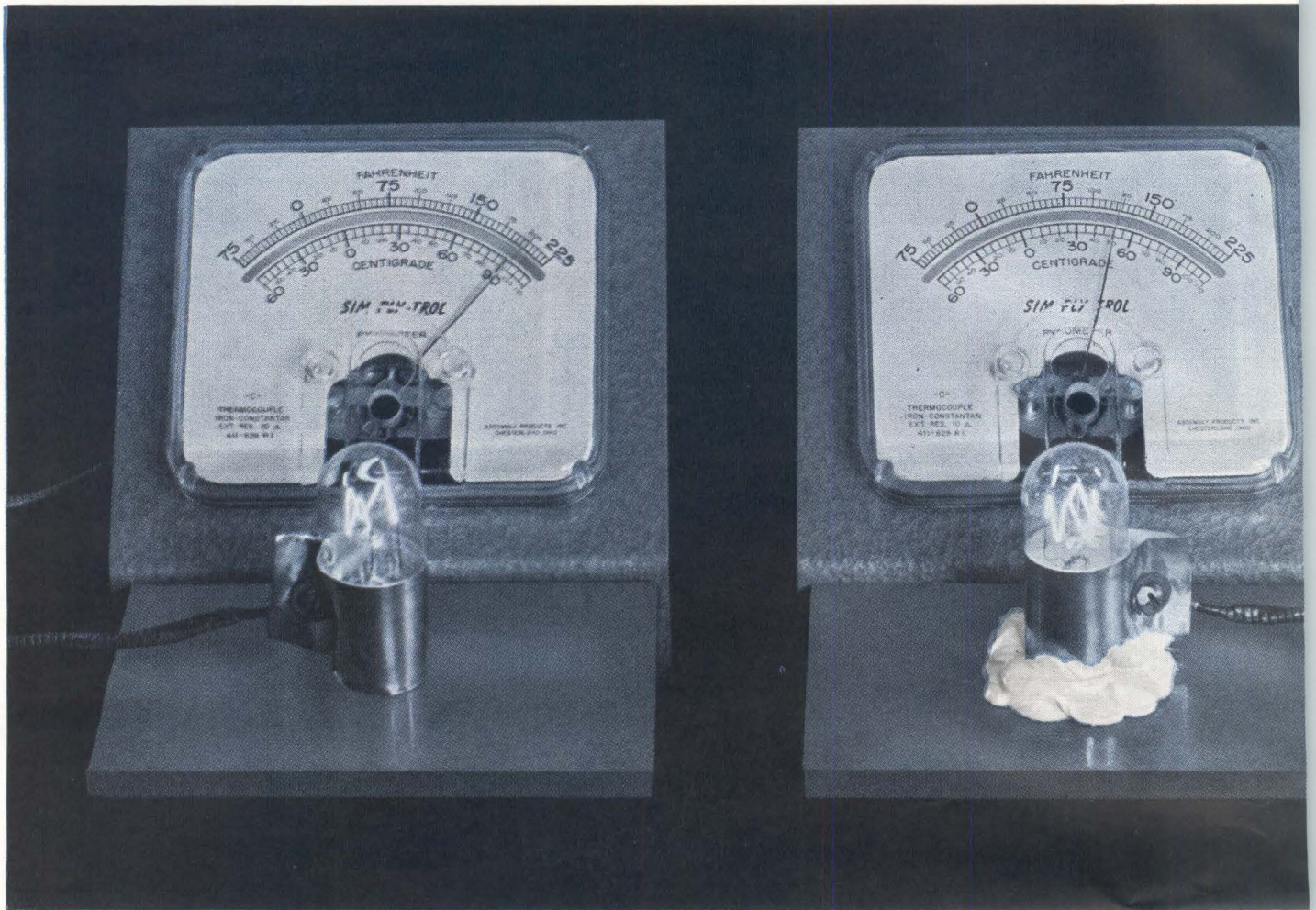

News Briefs



New compound for transistor potting
 Dow Corning® 18 semiconductor potting compound keeps junction temperatures at a minimum, cushions against shock, acts as a moisture getter to absorb moisture from within the cap. These advantages — plus high centrifuge stability — assure uniform properties and reliability of transistors, diodes . . . other solid state devices.

CIRCLE 290 ON READER-SERVICE CARD

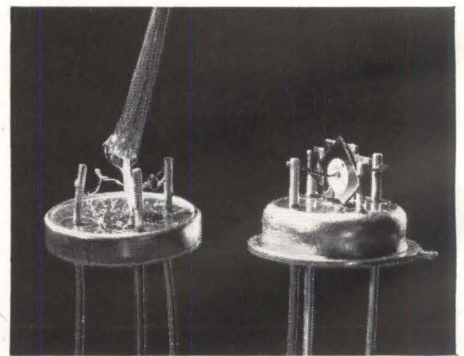

New resins protect device junctions
 Exceptionally high purity standards characterize three new Dow Corning transistor junction coating resins. Applied with a dropper or brush, these resins cure to form a tough protective film that seals out contaminants; assures junction integrity. Cure time is adjustable from 30 minutes at 250 C to 16 hours at 150 C.

CIRCLE 291 ON READER-SERVICE CARD

Speed heat dissipation, extend device life with new compound

Why is one bulb base 75 degrees cooler than its mate? Simply because this new Dow Corning® 340 silicone heat sink compound is carrying heat to the heat sink faster. Having three times the thermal conductivity of other materials, this new compound assures cooler operation, longer life and greater reliability for diodes, transistors, rectifiers and other devices.

Dow Corning 340 silicone heat sink compound fills all air spaces; maintains a positive seal between component and heat sink or chassis; provides a uniform heat transfer path. It will not dry out, harden, gum or melt, even after prolonged exposure to

200 C. Dow Corning 340 is chemically inert, has low loss factor, low power factor, excellent arc resistance.

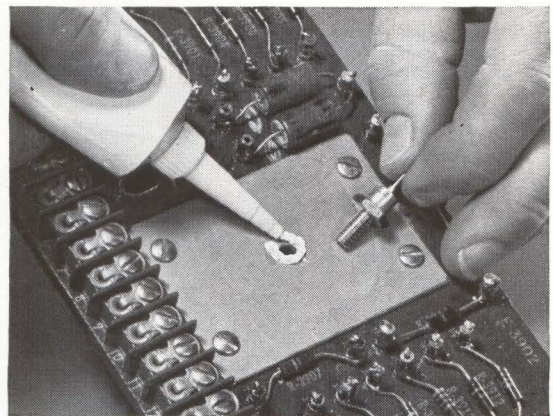

CIRCLE 289 ON READER-SERVICE CARD

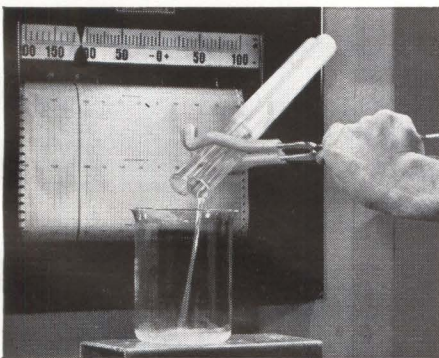

New fluid non-congealing at -110 F

Higher pumping rates, rapid heat transfer, and smaller, lighter weight pumps are among the design advantages made practical with Dow Corning® 331 fluid coolant. This low viscosity silicone fluid flows freely when other coolants are frozen solid, features high flash point and an operating temperature range from -130 F to 400 F, -90 C to 204 C.

We'll be pleased to forward full information on these and other materials that aid reliability and performance. Just write Dept. 3921, Electronic Products Division, Dow Corning, Midland, Michigan.

Dow Corning

CIRCLE 292 ON READER-SERVICE CARD

NEWS from DEI

SHOWCASE FOR PRE-DETECTION TELEMETRY AT ATLANTIC MISSILE RANGE

At the Atlantic Missile Range, the U.S. Air Force will install over the next several years the most advanced telemetry complex yet available . . . employing throughout pre-detection receiving and recording systems designed and built by Defense Electronics, Inc.

This SHOWCASE OF PRE-DETECTION TELEMETRY will be used to monitor, record and playback all telemetry data from existing as well as all future missile and space programs . . . with assured reliability, flexibility and economy . . . and with minimum effort.

It will be the first large-scale application of the "pre-d" concept, for which DEI is the recognized industry leader.

The many telemetry pre-detection receiver/recorder systems to be installed by DEI will allow the Atlantic Missile Range complex to record the original space data before it is detected and demodulated. Later, other sophisticated electronic components can make **repeated** use of the "assured data" for varied scientific applications.

Defense Electronics, Inc., one of the largest producers of ground station telemetry receiving equipment in the country, has enjoyed unprecedented growth in the past three years. As a result, there is a broad range of opportunity and responsibility for qualified electronic engineers who are seeking career positions in the dynamic field of telemetry/space communications equipment and systems.

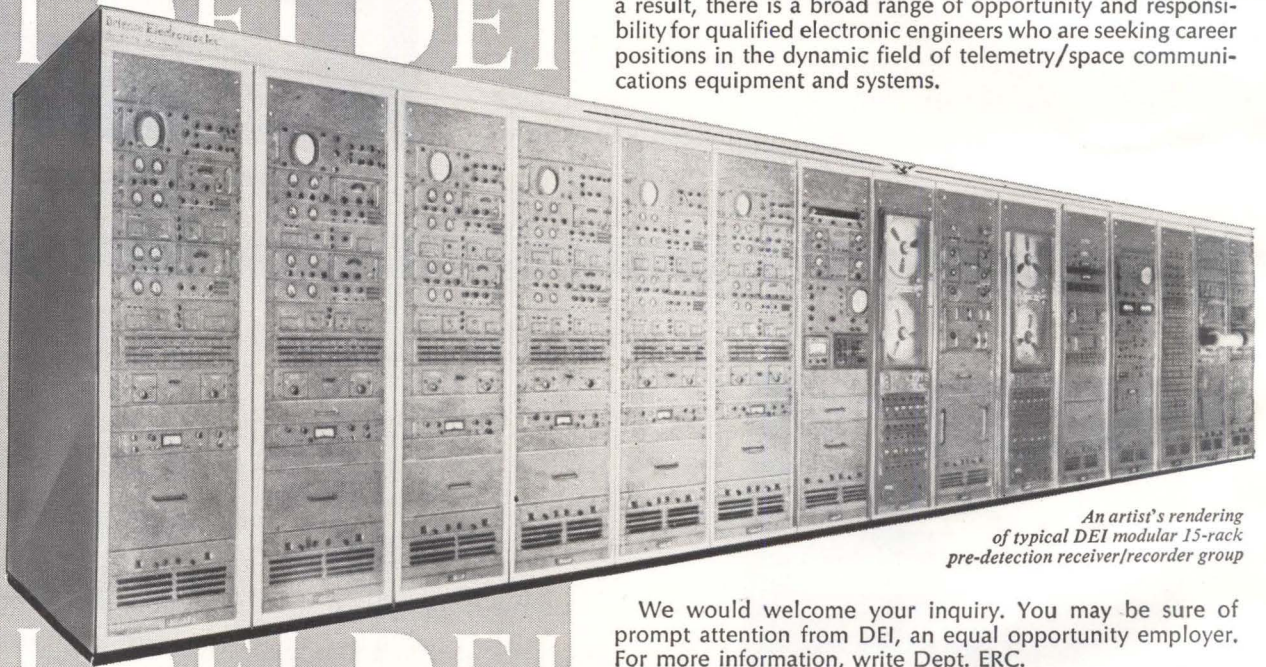

*An artist's rendering
of typical DEI modular 15-rack
pre-detection receiver/recorder group*

We would welcome your inquiry. You may be sure of prompt attention from DEI, an equal opportunity employer. For more information, write Dept. ERC.



DEI
SERVING
GOVERNMENT
AND INDUSTRY

Defense Electronics, Inc.

Rockville, Maryland

TWX: 301-949-6788 Phone: 301-946-2600

Sherman Oaks, California, Phone: 873-4322

CIRCLE 30 ON READER SERVICE CARD

TELEMETRY TODAY

More and better methods have been developed to permit faster handling and processing of telemetry data. Here is how tried-and-true techniques and late ideas meet modern demands

By **BARRY A. BRISKMAN**, Assistant Editor

TELEMETRY fulfills one of man's basic scientific needs by transmitting information derived in a hostile environment or remote location. Dating back to the late 1800s in concept, practical use of telemetering techniques appeared in elementary form in public utilities around 1912. While growth of the field had been slow until about 1950, the advent of space vehicles, satellites and high-altitude manned flights has moved telemetry forward at a rate comparable to most aerospace endeavors.

Today, telemetry is considered a prime, if not the only means of returning scientific information from distances that range from near to astronomical. It has found wide use in commerce and industry for performing remote power measurements, securing data on weather conditions and water pressure, keeping tabs on off-shore oil facilities

MOUSE MOBILE is actually an attempt to telemeter medical data. This experiment and others have led the way to expanding biomedical telemetry applications

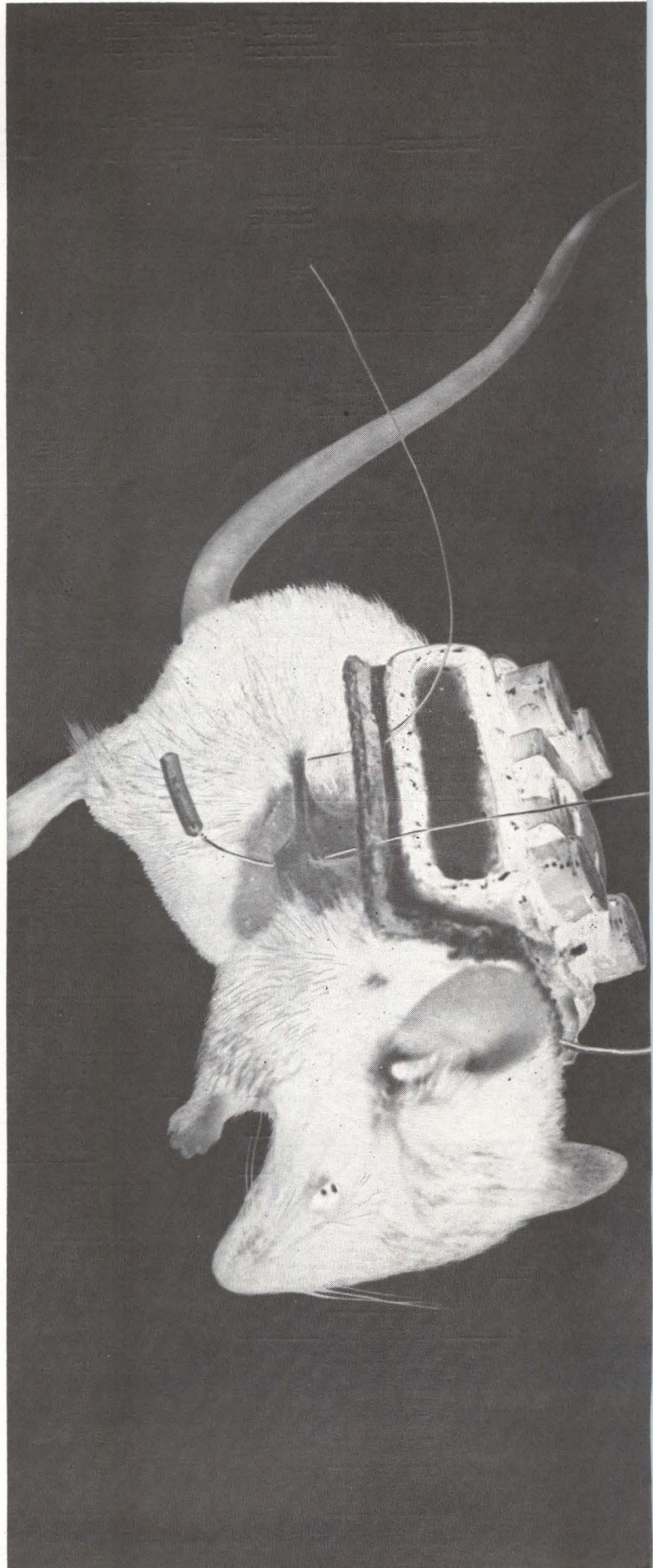

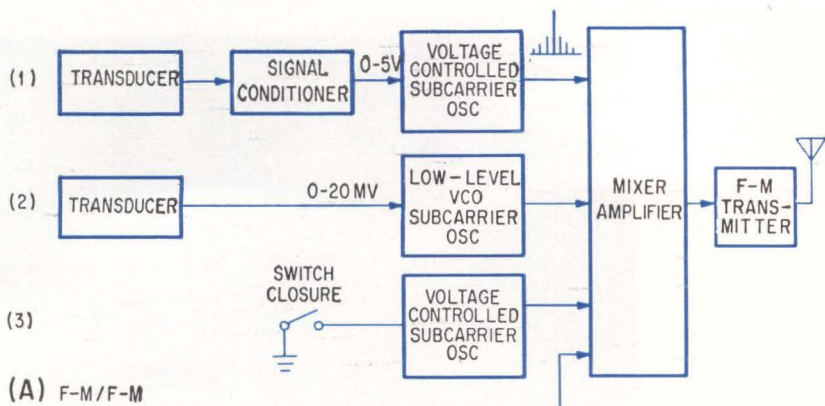

(A) F-M/F-M

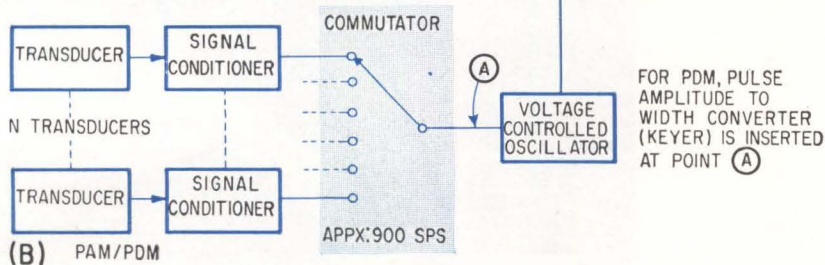

(B) PAM/PDM

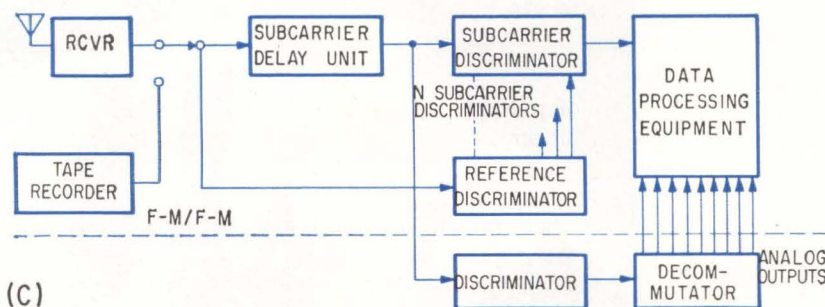

(C)

F-M/F-M SYSTEMS are still widely used as they are simple and reliable (A); pam and pdm, however, permit larger amounts of data to be transmitted (B). Similar basic ground equipment is used with all three techniques (C)—Fig. 1

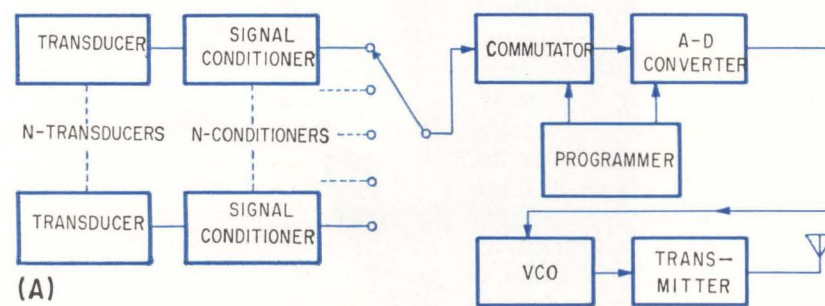

(A)

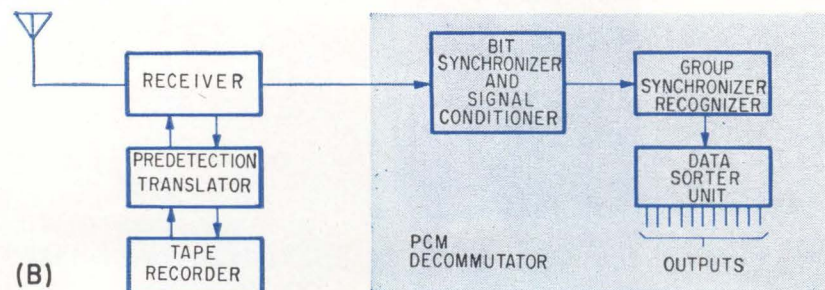

(B)

FLEXIBILITY and high-data capacity are achieved with pcm airborne equipment (A). Fixed facilities often include predetection recording for data storage (B)—Fig. 2

and a host of other interests. Moreover, our Mariner II Venus probe has proven that the secrets of other planets may be unlocked and the data successfully returned to earth through multimeasurement telemetering systems.

Being primarily electronic, telemetry has been responsible for considerable expansion in our industry as evidenced by the increasing number of companies in the telemetry field and growing research and development funding. While aerospace telemetry represents the major portion of the industry, non-space applications have also seen unprecedented expansion.

One survey predicts that as much as \$65 million a year will be spent for industrial telemetering by the end of 1963. Last year's figure exceeded \$55 million.

METHODS—The basic differences between aerospace telemetry systems lie mainly in data capacity, range of transmission and the environments in which they operate. Of these differences, capacity presents the greatest problem. The large number of measurements required and extremely high cost of r&d for high-altitude and space flight, demands that telemetry systems be capable of handling as much data as possible to obtain the greatest value from each flight. High accuracy, reduced spectrum usage, decreased weight and size and increased capacity have been the basis of intensified research.

The main telemetry techniques now in use include f-m/f-m (frequency modulation on frequency modulation), pam (pulse amplitude modulation), pdm (pulse duration modulation) and pcm (pulse code modulation). There are also numerous other schemes such as pfm, (pulse frequency modulation), ppm (pulse position modulation) and psk (phase-shift keying).

F-M/F-M—In f-m/f-m telemetry, a transmitter is frequency modulated by the output of one or more subcarrier, voltage-controlled oscillators that have been frequency modulated by data signals from a transducer and signal conditioner as shown in Fig. 1A. The number of subcarrier oscillators used is dependent upon the desired data-handling capacity of the system. Subcarrier frequen-

cies¹ have been adopted for standardized use by the Inter-Range Instrumentation Group of the Range Commanders' Conference (IRIG). Proposed expansions to the present standards are shown in Table I. Figure 1C illustrates the ground equipment required to receive and process f-m/f-m telemetry signals.

Of all telemetry systems, f-m/f-m enjoys widest use. Called the workhorse of the field, it can provide accuracies of 2 to 3 percent and handle as many as 18 IRIG channels.

PULSE AMPLITUDE—Data handling capacity is increased by pam. Here, a commutator (switch) can rapidly sample portions of the outputs of a large number of additional transducers delivering quasistatic (slowly-varying) data. Since quasistatic signals usually vary at less than 1 cps, continuous transmission is not necessary. Hence, portions of each cycle may be selected to adequately supply data-signal definition. A multitude of sequentially sampled channels can be used with one commutator and only one sub-carrier oscillator.

PULSE DURATION—This technique is similar to pam except that a keyer (pulse-amplitude-to-width converter) is inserted between the commutator and the vco as shown in Fig. 1B. Amplitude-to-width conversion results in a substantial improvement in noise figure and better accuracy of received data. The commutator required for pdm differs slightly from that used in pam systems because it must provide trigger pulses to both start the keyer and provide synchronization and timing.² Both pam and pdm techniques are widely used where multichannel time sharing is desirable. Moreover, they can provide an increase or decrease in data-frequency response by super or sub-commutation.

PULSE CODE—Pulse code modulation has gained wide recognition. Though under consideration for many years, reliable and practical pcm equipment has been in existence for only a short time. In pcm, a series of coded pulses is transmitted that represents a finite number of possible values of the desired data. The code may be transmitted as the presence or absence

of a pulse, or a sequence of pulses. The output of the multiplexer or high-speed commutator is a series of pulses that is sent to a high-speed analog-to-digital converter where the pulses are changed to binary digits representing the magnitude of the data from which the pulse is derived. Encoding or conversion is accomplished by comparing the magnitude of the input pulse with a number of accurate reference voltages within the A-D converter and sending a group of coded pulses representing the input pulse magnitude.²

The serial train of output pulses is fed to a radio transmitter where a ONE causes the center frequency to shift in a positive direction and a ZERO causes a negative shift. With this type of transmission, near perfect reproduction of the signal is maintained as long as the amplitude of the code group is greater than the noise. When received on the ground, digital words are tape-recorded or changed in format and fed into digital computers in real time.³ Block diagrams of a typical pcm airborne and ground facility appear in Fig. 2A and 2B. The bit synchronizer and signal conditioner shown in the pcm decommutator group in Fig. 2B acquires bit synchronization, generates a clock signal and determines

whether a bit is a ONE or a ZERO. One modern pcm system is shown in Fig. 9.

Other digital and analog telemetry systems have also found use. The binary pulse code modulation waveform for example, may be used to amplitude or phase modulate a primary carrier rather than to frequency modulate it. A system of this type might be designated pcm/a-m or pcm/p-m. A pcm waveform can also be used to modulate a sub-carrier that will in turn modulate a primary carrier.

In pulse frequency modulation or pfm, information is contained within the frequency of a sequential series of pulses or bursts separated by blanks or intervals. Data is electronically commutated and encoded into a series of time-multiplexed pfm bursts and blanks where the burst frequency contains the intelligence of one analog parameter or three binary bits; and the location of the burst within the telemetry sequence identifies the parameter being measured. This type of system is suited for small satellite systems because it makes efficient use of transmitter power as a function of bit rate. A practical form of a pfm system was used in the Explorer XII satellite.

Pulse position modulation, ppm,

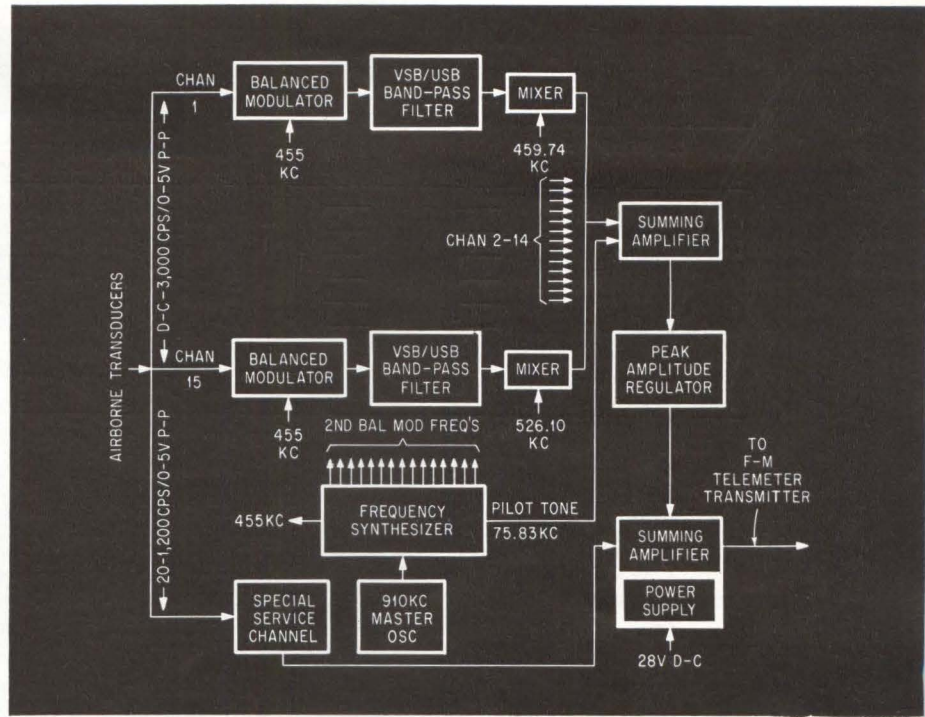

VESTIGIAL sideband telemetry is a recent technique that shows promise. This system also can be used for voice communications—Fig. 3.

Proposed Additions To Inter-Range Instrumentation Group (IRIG) Subcarrier Bands—TABLE I

BAND	CENTER FREQ (cps)	LOWER LIMIT (cps)	UPPER LIMIT (cps)	MAX. DEVIATION (percent)	FREQUENCY RESP. (cps)
19	93,000	—	—	7.5	1,400
20	124,000	—	—	7.5	1,900
21	165,000	—	—	7.5	2,500
F	93,000	—	—	15	2,800
G	124,000	—	—	15	3,700
H	165,000	—	—	15	5,000

NOTE: The entire IRIG chart as revised in 1962 can be found in IRIG Document No. 106-60

though similar to pdm, is not widely used. With ppm, the desired information is contained in the time separation between successive pulse pairs. The initial pulse in each pair corresponds to sampling time and the separation between pulses varies with modulation amplitude. Position pulses directly modulate the transmitter by amplitude modulating the r-f carrier.

Phase shift keying or psk techniques have been used in space probes such as Mariner II and Explorer VI. Permitting only all-or-none modulation of the carrier, psk is compatible with digitized data and permits continuous peak power. With psk, the carrier is shifted between 0 and 180 degrees depending upon binary data.

There are many different codes other than the binary code that may be used to describe data and transmit it by radio. One popular technique is called orthogonal. Here,

data is encoded so that only a few out of many possible codes are used and many errors, not just one, must occur before one of the applied values is changed to another value. In this way, errors due to the transmission process can often be corrected.

Orthogonal systems require wider r-f spectrums than conventional pcm but will operate satisfactorily with a lower-level signal.

VESTIGIAL SIDEBAND—One recent ssb system is shown in Fig. 3. Called vestigial sideband frequency modulation instrumentation, it is an outgrowth of a technique in use on the Saturn program. It has 16 input channels of which 15 handle data with input frequencies ranging from d-c to 3,000 cps plus one special channel that accommodates frequencies from 50 to 3,000 cps. The sixteen data inputs are combined into one complex signal by frequency multiplexing that modulates a fre-

quency modulation transmitter.

In operation, any type of data can be fed to the airborne vestigial ssb multiplexer. After reception on the ground by conventional f-m receivers, the output can be recorded or fed directly to a demodulator. The transmission of almost 48 kc of data in 75 kc of baseband spectrum on one r-f link makes this system about 13 times as efficient as f-m systems that usually handle 4 kc of data in a 75 kc baseband.

TRANSDUCERS—Quantities such as gas pressure, acceleration, temperature, vibration, fuel flow, and many others may be measured by transducers and applied to the telemetry system for transmission from a vehicle fixed remote location.

A large number of transducers have outputs that range between 0 and 50 mv.⁴ In addition, transducer outputs can take many different forms such as low-level d-c signals from thermocouples, pulses from flowmeters, low-level low-frequency signals from strain gages, and low-level a-c signals from vibration pickups.

For aerospace applications, transducer size, weight and reliability are of major importance. Latest developments include a growing family of solid-state transducers that meet these specifications and have reduced power consumption.

COMMUTATORS—A commutator sequentially samples a number of different data sources and generates

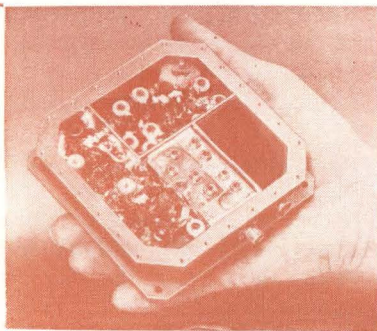

TYPICAL of trends toward compact transmitters, this unit manufactured by Conic produces 5 watts between 215 and 260 Mc—Fig. 4

MODERN telemetry receivers are a system in themselves. Modular construction as in this solid-state unit by Vitro is typical—Fig. 5

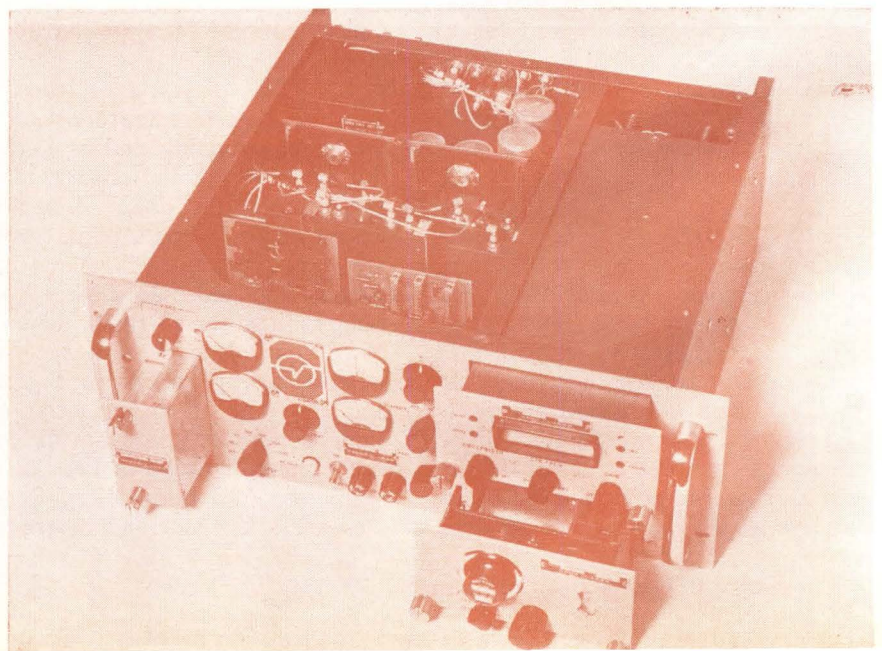

a serial train of amplitude-modulated pulses at its output. The amplitude of each pulse is equal to the amplitude of the signal on its respective data source. This process is known as time multiplexing. The advantage of time multiplexing is that it provides the capability of evenly distributing the bandwidth of the communication medium throughout a large number of data channels.

Commutators are generally classed by the level of signals they are designed to accommodate and the design differences between low and high-level devices can vary substantially. Also, low-level units² are generally more difficult to construct.

TRANSMITTERS—A telemetry transmitter is responsible for transmitting the data from the remote location or vehicle. Frequencies employed by U. S. aerospace facilities fall between 216 and 260 Mc; however, additional telemetry bands and frequencies are available as illustrated in Table II.

A major design problem is securing greatest output power with minimum weight and size and high reliability. Both vacuum tubes and semiconductors have been used in units with power outputs varying between 5 milliwatts and 150 watts.

Heat dissipation also poses a substantial problem to designers of telemetry r-f links. As transmitter output power goes higher, final stages with efficiencies between 35 and 75 percent generate additional heat that must be removed to protect circuits

Aerospace Telemetry Bands—TABLE II	
FREQUENCY (Mc)	USAGE
20*	U. S. and USSR ionospheric experimentation
40	USSR satellites
108	IGY satellites; minitrack beacons through 1960
136-137*	U. S. minitrack beacons since 1960
183	USSR satellites and space probes
216-260	U. S. flight tests, missiles
378	U. S. satellites and space probes
960	U. S. satellites and space probes
1,435-1,535	U. S. govt & civilian flight test & space
2,200-2,300*	U. S. flight tests & space vehicles

* Asterisks denote frequencies allocated by ITU on July 1, 1961

within the r-f equipment package.

A typical 5-watt transmitter using solid-state techniques is shown in Fig. 4. Having high reliability, this unit can be used anywhere in the 215 to 260 Mc range. Units of this type are typical of latest solid-state designs and are small and lightweight. Manufacturer also produces models with 2 and 10-watt outputs.

Present telemetry systems use many different power sources. Among these, solar cells, chemical batteries and mechanical generators powered by hydrogen-peroxide turbines or other prime sources find wide use. Atomic energy conversion devices will very likely be the power sources of the future.

RECEIVERS—The flexibility of telemetry receivers has been vastly increased to meet the growing complexity and sophistication of telemetry signals. For example, receivers now have plug-in r-f tuners to ac-

commodate the seven authorized frequency ranges. In addition, front panel plug-in modules readily provide the various bandwidths required for differing modulation formats. Bandwidths are determined by filter configurations and receivers include demodulators with matched characteristics to optimize linearity, sensitivity and capture capabilities. Demodulators are available incorporating latest demodulation techniques including phase lock, frequency feedback and synchronous a-m and p-m. True phase demodulators can be obtained that linearly accommodate phase deviations approaching ± 180 degrees. These synchronous techniques eliminate the threshold phenomena normally associated with wide-band demodulators.

Receivers such as the solid-state unit shown in Fig. 5 minimize size, weight and power consumption while simultaneously offering improved re-

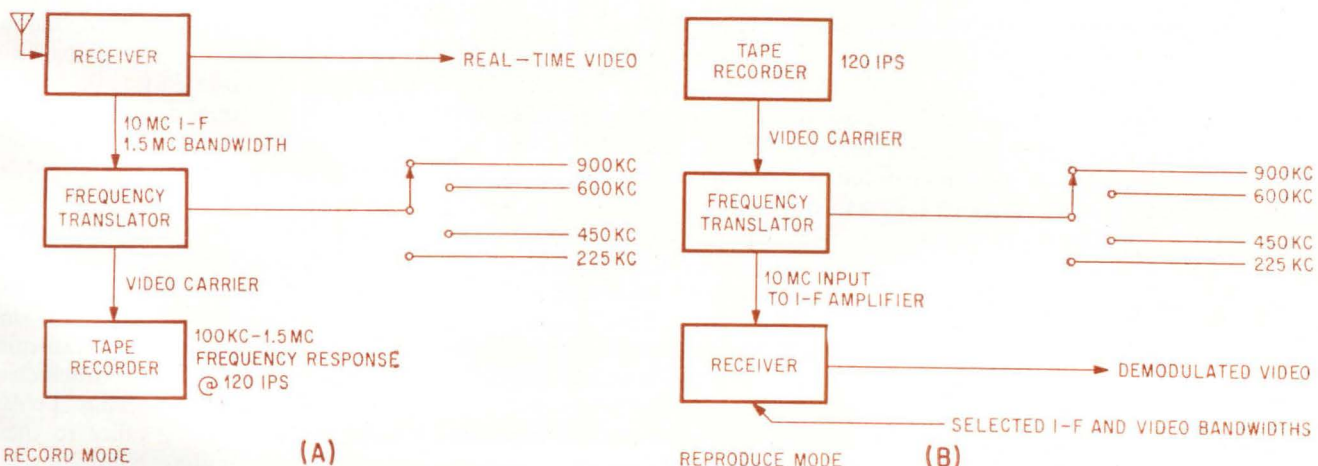

PREDETECTION systems are being used more and more since wide-bandwidth tape recording became practical. Record mode is shown in (A), and reproduce mode in (B)—Fig. 6

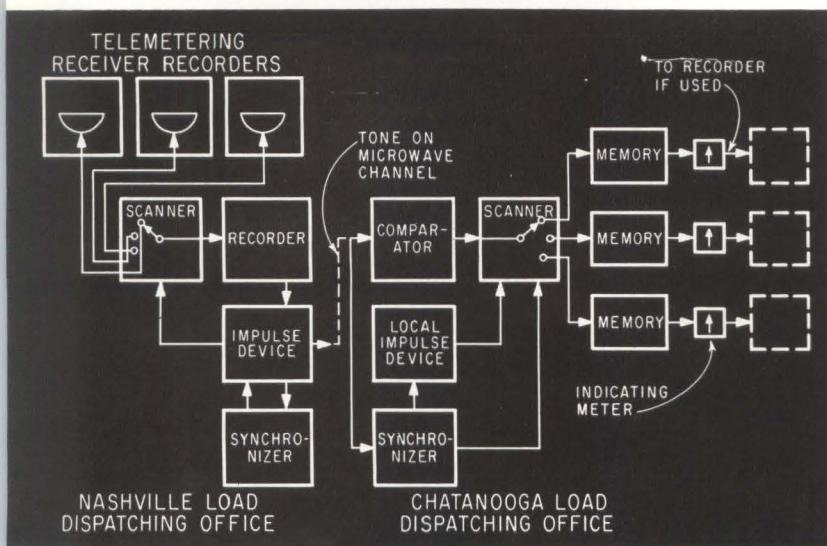

TENNESSEE VALLEY AUTHORITY uses this system for teletesting electrical-load data from facility to facility and central office—Fig. 7

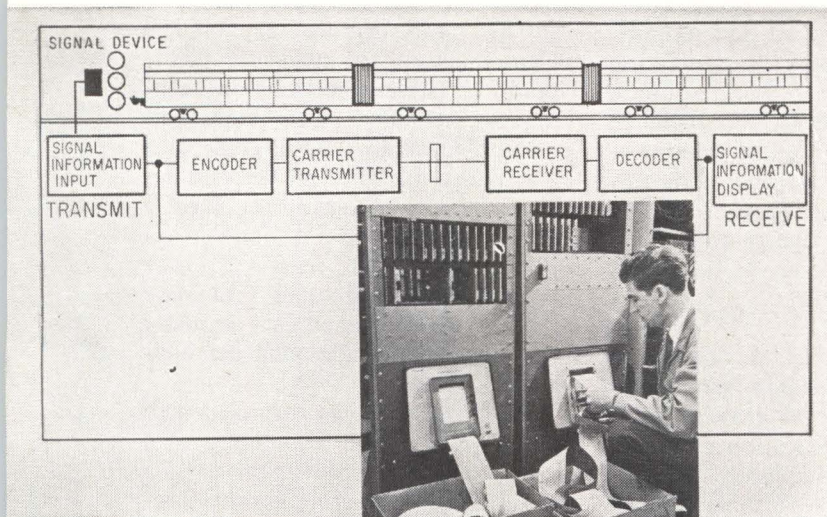

TRANSPORTATION was one of the first industries to employ teletesting back in 1912. This modern system has been successfully tested in New York subways—Fig. 8

liability. Flexibility is achieved through complete modular construction of etched, solid-state circuits. Due to reduction in size and power consumption, additional features such as spectrum-display units or predetection up and down converters are now available as integral portions of a receiver.

RECORDERS-COMPUTERS—

Until recently, most telemetry data was recorded on either a galvanometer or cathode-ray oscilloscope. With the advent of magnetic tape in the early 50s, this data could be

tape recorded to preserve the signal in an electrical form that could be fed to various reduction processes and computers.

With the advent of digital systems, recorders were developed for saturation-pulse recording where serial bits from a pcm system were converted into parallel format, with each bit of a coded group recorded on a different head.

Latest and most flexible methods of telemetry recording make use of the intermediate frequency of the receiver prior to detection. Called predetection recording (preD), this

technique is possible because recent advances have expanded the bandwidth of tape units. PreD has highest value since it may be used with almost all types of incoming telemetry data without banks of separate equipment for each change of incoming format.

Both record and reproduce modes of predetection recording are shown in Fig. 6A and 6B. In the record mode, the widest predetection-bandwidth capability of the system is used so that optimum bandwidth selection is accomplished during reproduction. During playback, the recorded spectrum is reconverted or translated back up to the original i-f frequency and reinserted into the receiver i-f amplifier where it is demodulated as if it were the original r-f signal.

Computers speed up evaluation of data and simplify analysis. However, various types of interface equipment must be employed to convert received data into a form suitable for computer insertion and handling.

With recent successes in videotape recording and the development of automatic data-processing equipment, data processing now includes the handling of all data after it leaves the receiver. Thus, data processing may often be considered automatic data reduction and it is the speedy performing of this and other functions that makes the use of computers so vital to modern telemetry.

INDUSTRIAL TELEMETRY—

There are numerous teletesting methods used today by industry that are concerned with converting information into suitable form for data-link transmission, receiving at supervisory points and converting data into a usable form. Basic systems may be either analog or digital and may use f-m/f-m, pdm, pam, or pcm techniques; each has specific advantages for a given job.

A time-division multiplex system in use by the Tennessee Valley Authority provides power-system dispatchers with data formerly obtainable only by telephone. It transmits load readings of five hydroelectric plants and their total from TVA's Nashville dispatching office to their Chattanooga facility. Numerous in-channels. The load readings of interconnecting companies are totaled in Chattanooga and compared with

a schedule; any deviation from the schedule is transmitted to the appropriate generating station, which automatically adjusts its output to compensate. Figure 7 shows a block diagram of the TVA system.

A solid-state digital telemetry link has been successfully used by the New York City Transit Authority in its subway system. Using wire-link coding with high-speed binary logic, it is used for both switch and signal controls and also to indicate high-density data such as track indications, switch positions and signal aspects to a central control point. The technique used appears in Fig. 8.

In medicine, and particularly aerospace medicine, the telemetry field has seen great expansion. One paper⁵ recently described a microwatt telemetry system for implantation in small animals. Operating around 130 Mc, the transmitter package for animal use contained an f-m oscillator, a battery and a small magnetic microphone, and was excellent for the transmit end of a simple animal-borne f-m/f-m telemetry system. The complete unit mounted on a mouse is shown in the lead photograph.

PROGNOSTICATION—Probably the most significant change coming is the shift to the uhf range between 1.435 to 1.535 and 2.2 to 2.3 Gc. Directives have been issued that will require most telemetry application to be so instrumented by 1970. The change will undoubtedly render obsolete large amounts of present-day equipment that will require modification or replacement. Problems from both operational and equipment viewpoints are well understood. While present-day equipment evolved with experience, present knowledge will provide a basis for a more systematic development program for the future.

There are many technological problems associated with the shift to uhf. In transmitters, for example, design criteria vary drastically between 200 Mc and 2,000 Mc. Final tanks for the higher range will probably be cavities similar to those shown in the photo on the right. The capabilities and limitations of new equipment must be well understood. Ingenuity and practical operational analysis will dictate designs to provide versatility in most areas. More-

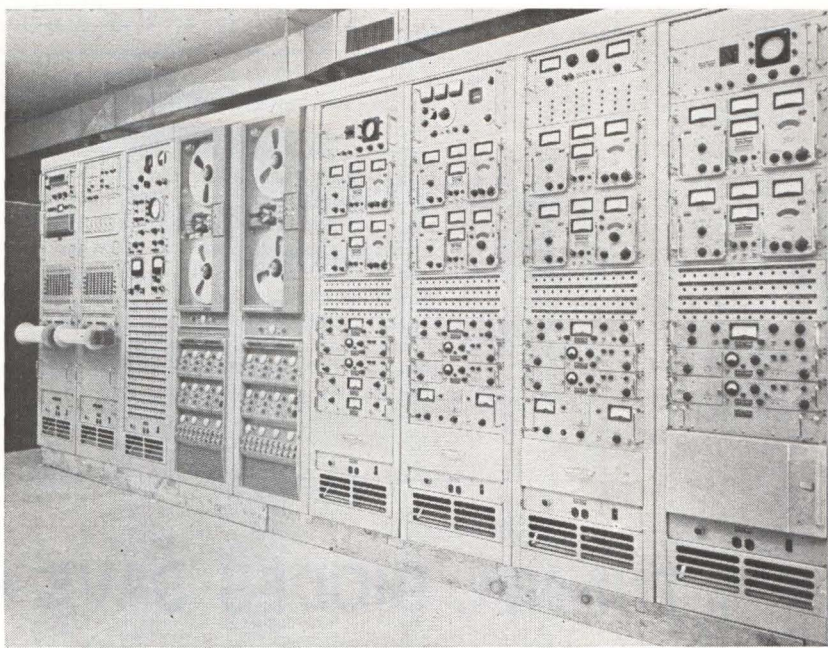

GROUND equipment can handle a variety of formats with increased speed and reliability. Systems like this TPRS-5 manufactured by Defense Electronics exemplify today's trends—Fig. 9

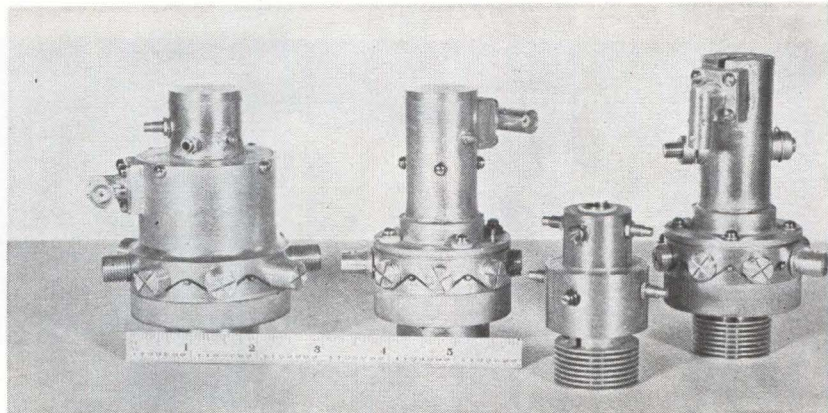

IMPENDING switch to the uhf range has given rise to new techniques. The cavities above are earmarked for use in new transmitters

over, the requirement for obtaining positional information from tracking systems will become easier to meet.

The author thanks Victor Ratner, Bob Blanchard, Elton Sherman and

Mort Cohen of Defense Electronics, Don Allison, Jr. and Mort Salkind of Vitro Corp. of American and Ted Rybicki of Ortronix for their cooperation in the preparation of this article.

REFERENCES

- (1) IRIG Telemetry Standards, Armed Services Technical Information Agency, Arlington Hall Station, Va., Document No. 106-60 Revised June 1962.
- (2) Stiltz, H. L., "Aerospace Telemetry", Prentice-Hall Inc., Englewood, N. J., 1961.
- (3) Gardenhire, L. W., Internal Paper, Radiation, Inc., Melbourne, Fla., 1962.
- (4) Moody, W. N., A Comparison of Low-Level Commutators, p 2-4, *Proc 1963*

National Telemetry Conference, Washington, D. C.

- (5) Adams, R. M., Fromme, G. L., Dizon, D., and Anstadt, C. L., A Microwatt VHF Telemetry System For Implantation In Small Animals, p 52, *Proc 1963 National Telemetry Conference*, Washington, D. C.

- (6) Dickstein, H. D., The New UHF Telemetry Bands: Systems Considerations and Hardware Solutions, p 112, *Proc 1963 National Telemetry Conference*, Washington, D. C.

WHY THIS CIRCUIT?

Application of magnetic switching circuits has been deterred by the problem of obtaining continuous indication of the flux state in the magnetic path. Since the path is closed, a flux meter or Hall effect device is unusable. An additional winding around the magnetic path yields only transient information that must be fed through a bistable device like a flip-flop to obtain continuous indication of flux state. R-f transformers can be used to sense flux state in minor apertures of a multiaperture device. If the aperture is in the blocked state, the transformer is effectively decoupled from the primary. But other ancillary equipment is required. The tunnel-diode circuit is simple and it saves parts

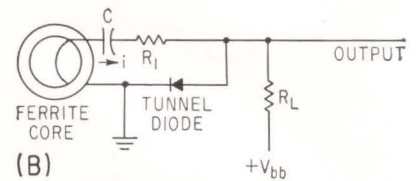
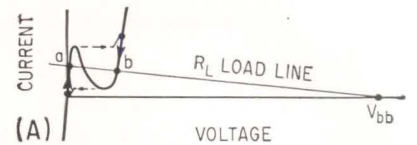

TUNNEL DIODE operating in its bistable mode (A) is shunt fed by a ferrite core (B) to give continuous indication of flux state—Fig. 1

TUNNEL DIODES SAVE PARTS Continuous

Devices operating in the bistable mode save 80 percent on components and 40 percent on soldering in an analog-digital converter

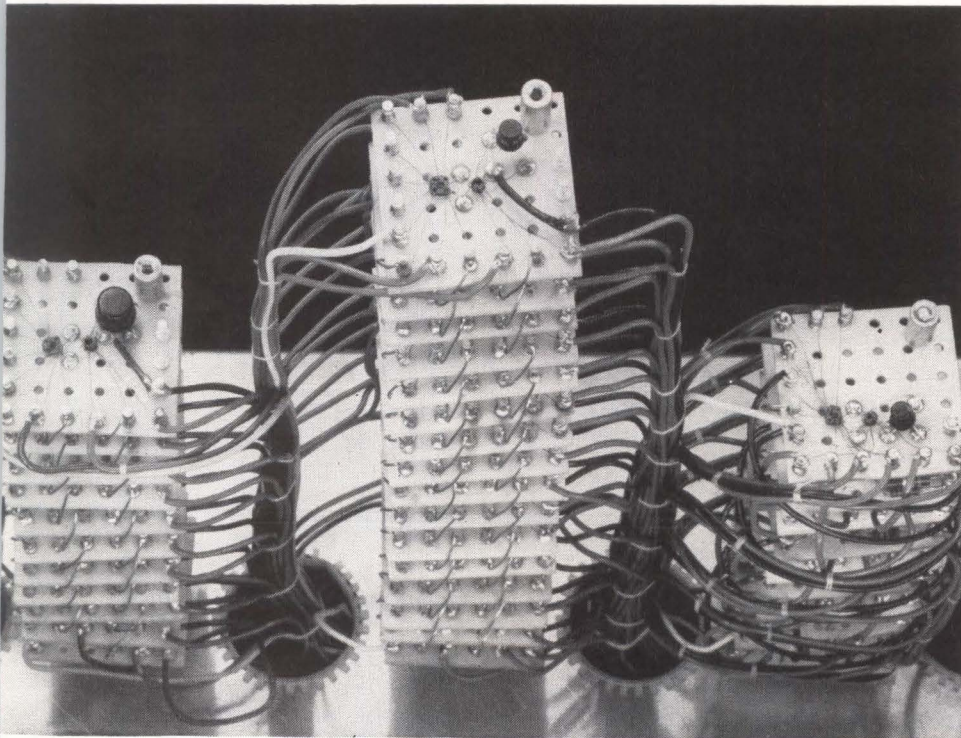

LOGIC STACKS that perform the analog-digital conversion in equipment employing tunnel diodes for continuous flux sensing

CONTINUOUS indication of the flux-state of any closed reversible magnetic path can be shown by a tunnel diode biased in its bistable mode. Both shunt fed and series fed circuits are described.

The shunt fed circuit is given in Fig. 1. Figure 1A shows the tunnel diode voltage-current characteristic and the load line forming two stable intercepts. The load line is chosen so the low-voltage state *a* and the high-voltage state *b* are removed as far as practical from the tunnel diode peak and valley current points. This condition yields the maximum circuit stability and noise tolerance.

Figure 1B indicates the method of shunt feeding the core signal into the tunnel diode. Initially the core is in its ccw flux state and the tunnel diode is in its low-voltage state. When the core switches to cw flux state, a positive voltage with respect to ground is induced in the core winding. The induced voltage causes a transient current *i* to flow through capacitor *C* and series resistor *R*₁ into the tunnel diode. This current pulse is sufficient to raise the tunnel diode current from the low-voltage point beyond its peak current value, thereby switching the tunnel diode to the high-voltage state. Since the high-voltage point is stable, the tunnel diode will remain in that state

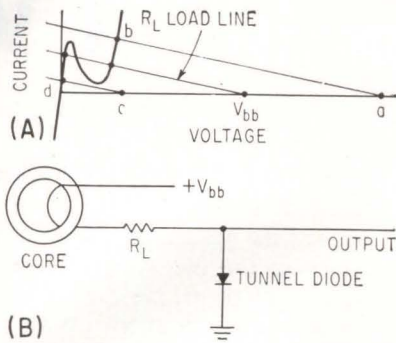

LOAD LINE of tunnel diode (A) is shifted by a series feed from ferrite core (B) to give continuous flux-status indication—Fig. 2

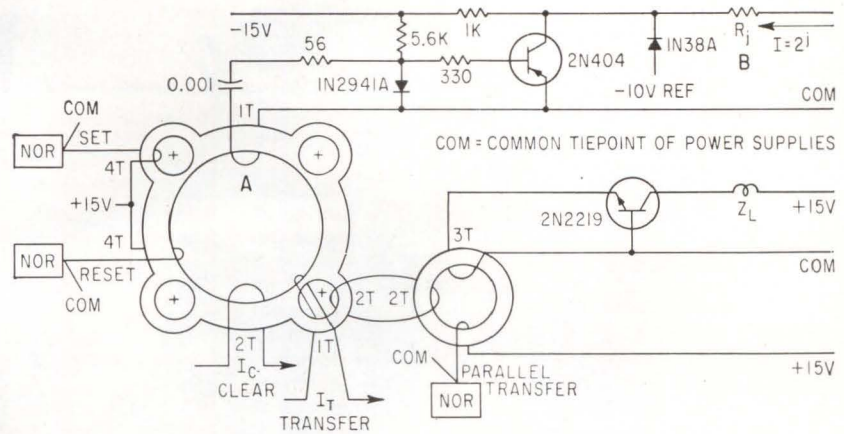

ANALOG-DIGITAL converter module employs tunnel diode to sense change in state of core (point A) and switch binary weighted current generator on and off (point B)—Fig. 3

Readout of Magnetic Cores

By WILLIAM G. TRABOLD, Electronics and Instrumentation Dept., G.M. Research Laboratories, Warren, Michigan

pending the core-flux reversal.

NEGATIVE SWITCH — When flux is switched from the cw to the ccw direction in the core, a negative voltage is induced in the winding. This voltage causes the tunnel diode current to decrease from the high-voltage point to a value less than its valley current and the tunnel diode switches to the low-voltage state. It remains in that state until the flux is again switched to a clockwise direction.

The tunnel diode may also be series fed by the magnetic path. If the circuit shown in Fig. 2 is used, the series capacitor and resistor can be eliminated. However, this circuit has the disadvantage of requiring a larger number of turns on the core, or the use of a lower bias voltage V_{bb} or both. The use of a lower bias voltage will generally yield a lower circuit stability.

In the series fed circuit the core is initially in the ccw flux state and the tunnel diode in the low-voltage state. When the core is switched to its cw flux state, a transient voltage induced in the core winding adds to the bias voltage V_{bb} . The induced voltage pulse shifts the load line from V_{bb} to a , thereby shifting the tunnel diode current to point b . As the induced voltage decays to zero

the load line returns to V_{bb} and the tunnel diode is left in its stable high-voltage state.

When the core is switched to its ccw flux state, a transient voltage is induced in the winding such as to subtract from the bias voltage V_{bb} . This voltage pulse shifts the load line to point c and the tunnel diode current is shifted to point d . As the induced voltage decays to zero, the load line returns to V_{bb} and the tunnel diode is left in its stable low-voltage state.

OUTPUT POLARITY — Any polarity combination of core winding and tunnel diode and bias polarity may be used to obtain the output signal polarity and state desired. For example, the cw flux state can produce a positive or negative output signal with the tunnel diode in either the high or low voltage state as required by other circuit considerations.

If a germanium tunnel diode is used, it may be coupled directly to the base of a germanium transistor. When the tunnel diode is driven to the low-voltage state, the transistor is cut off. When it is in the high-voltage state, the transistor is saturated.

The core-tunnel diode circuit has been used successfully in the design

of an analog-to-digital converter. All switching functions of the a-d converter are implemented using NOR, OR logic functions. The NOR, OR logic functions were generated using multiaperture ferrite devices. Transistors are used on the output of the modules to facilitate fan-out and conventional wiring harness.

The core-tunnel diode circuit was used to read out the flux state of a five aperture core and control the switching of binary weighted current generators, shown in Fig. 3. Multiaperture ferrite logic effected a parts saving of 80 percent and a solder-joint saving of 40 percent over conventional diode-transistor logic circuitry.

Resistor R_j is a binary weighted resistor used to generate a reference current. Five such current generators are used in the circuit:

$$\begin{aligned} I_1 &= 1 \text{ ma; } R_{j1} = 10K \\ I_2 &= 1/2 \text{ ma; } R_{j2} = 20K \\ I_3 &= 1/4 \text{ ma; } R_{j3} = 40K \\ I_4 &= 1/8 \text{ ma; } R_{j4} = 80K \\ I_5 &= 1/16 \text{ ma; } R_{j5} = 160K \end{aligned}$$

BIBLIOGRAPHY

- H. D. Crane and E. K. Van De Riet, Design of an All-Magnetic Computing System, Part I—Circuit Design, *IRE Transactions on Electronic Computers*, p. 207, June, 1960.
 "General Electric Tunnel Diode Manual", 1st ed., General Electric Co., p. 44, 1961.

TV

Special-effect



TV PROGRAM photographed from monitor screen showing result of dissolve wipe used with an iris shape. Transition from camera output showing girl to floral background from another video source is gradual and more artistic than sharp-edge newscast type of box wipe

By **KOMEI KAZAMA, TAKAYOSHI ISHINO, KATSURO SHUDO,** and **KUNIKATSU KUMAKURA,** Japan Broadcasting Corp. (NHK), Tokyo, Japan

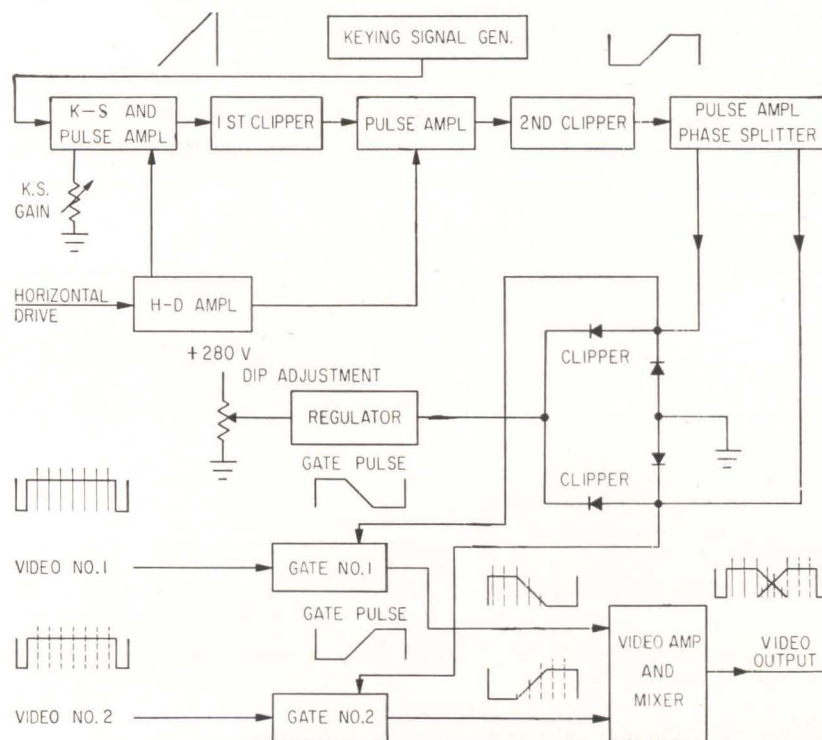

GATING PULSES, necessary for controlling video sources before they enter mixer, are derived from keying signal generator and processed through clippers and pulse amplifiers. Waveforms shown are for simple horizontal dissolve wipe—Fig. 1

GRADUAL TRANSITION is produced in the tv dissolve wiper by shaping the transition region video signals of the two scenes and then overlapping them. No camera modifications are required. With the exception of operating controls on the studio console it is completely housed in a rack panel. Both the width and brightness of the transition region can be adjusted as directed by the producer.

CIRCUITS—The block diagram in Fig. 1 shows how the two video signals are shaped and mixed. Only a simple wipe across the scene is described for simplicity.

Heart of the tv dissolve wiper is the keying signal generator. It is similar to that of the RCA montage amplifier. The timing of the sawtooth waves from this source determines the pattern of the dissolve. For simple horizontal dissolves the output of the keying signal generator comprises sawtooth waves that start at the beginning of each horizontal sweep and rise linearly to the end of the horizontal line.

The sawtooth voltage from the keying signal generator passes through two amplifiers and two clippers that shape it into a gating signal. The first clipper removes the upper portion of the sawtooth, the second clipper the lower portion. The resultant gating signal consists of two constant voltages at different levels connected by a ramp voltage.

The circuits are so designed that the difference between the voltages at which the two clippers operate is a constant. Thus the height of the signal ramp remains constant. But the absolute value of both clipper voltages can be changed in equal increments simultaneously. As the clipper voltages are varied the ramp portion of the gating signal appears earlier or later in the horizontal line.

The gating signal is passed through a phase splitter to obtain two signals opposite in phase. The upper levels of these two signals are clipped again by transition region brightness clippers. The sig-

DISSOLVE WIPER

amplifier combines scenes without sharp transition edge

A WIPE IS RASTER DIVISION

In television broadcasting terminology, the word wipe defines the next production step beyond fading one camera off and fading a second camera on. In elementary form, as one picture was wiped sharply off the screen, another followed immediately after it. A split screen is a stationary wipe. The wipes described in this article involve even more complex forms, such as the diamond, diagonal, wedge and iris. But far from being sharp-edged, they are deliberately blurred for artistic effect. The technique is relatively simple and can be applied to any system

nals are then coupled into the gate circuits, which they control. Video signals from the two scenes are shaped in the gate circuits, as shown in Fig. 2, mixed and amplified.

The video dissolve occurs during the interval Δt in Fig. 2. The dissolve interval is variable from zero to H , the horizontal period, by controlling the gain of the keying signal amplifier. The higher the gain the steeper the slope of the ramp portion of the keying voltage and the shorter the dissolve interval.

Control of the transition region brightness clipper is adjustable over the dissolve interval Δt . It can be adjusted at will for a dissolve that is the same or either darker or lighter than the two scenes it divides.

Brightness in the dissolved portion of the picture is proportional to the sum of the two video signals. By varying the overlap of the two signals it is possible to make total video signal amplitude in the transition region greater or less than in the undissolved portions.

Gating voltage for each video channel in the prototype equipment is a-c coupled through a capacitor to the gate circuit. A germanium diode clamp prevents the voltage at the gating circuit from rising above zero volts. Gain of the gate circuit varies almost linearly with gating voltage between zero at its cutoff voltage and maximum at zero volts. Available gating voltage is larger than necessary to cut off the

gate. Under these conditions, overlap of the two video signals is small, as shown in Fig. 3A.

The transition region brightness clippers eliminate the positive portions of the two gating voltages from the phase inverter. After passing through the coupling capacitors to the gate circuits the positive levels are clamped at zero volts.

As gating signal clipping is increased, overlap of the two signals and thus total video signal amplitude in the transition region is increased. As shown in Fig. 3B and 3C brightness in the transition region can be increased until it is equal to, or greater than, brightness in the undissolved portions.

Waveforms of total video signal in Fig. 3 are only approximate. Nonlinearities in gate-circuit characteristics will cause slight variations. Variation of the transition region brightness may cause a small change in the transition region width, but not the reverse effect.

D-C LEVEL—Capacitor coupling is also used between stages of the tv dissolve wiper in which the gating signal is generated to insure

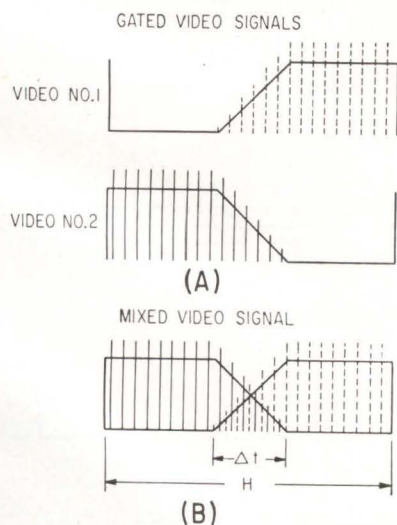

WAVEFORMS of gated video signals from first and second video sources (A) and the composite mixed video signal (B)—Fig. 2

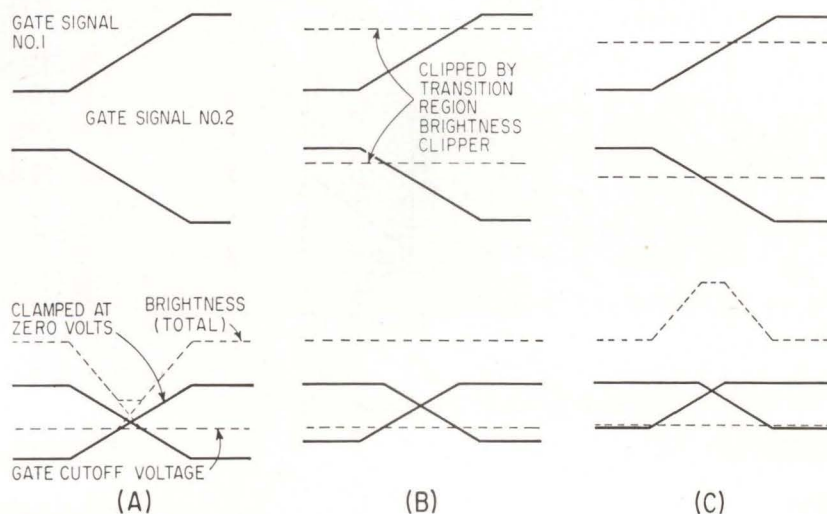

TRANSITION REGION brightness clipper, with full amplitude gating (A) moderately clipped gating signal (B), further clipped gating signal when overlap is increased and brightness in the transition region is greater than in undissolved regions—Fig. 3

simplicity and increased stability. Diode clamps provide reinsertion, where necessary, of the d-c level lost through capacitor a-c coupling.

No problems are caused by the use of a-c coupling except when the transition region is at the extreme left or right. This situation occurs when it is necessary to have one of the two scenes occupy the entire screen. If the producer desires to have the scene from video 1 occupy the entire screen, then the aperture between the clippers, shown in Fig. 4, will be below the negative tips.

This defect is remedied, while retaining the advantages of a-c coupling, by adding pulses from the horizontal driving pulse generator to the horizontal sawtooth from the keying signal generator. The horizontal driving pulses are the source from which the horizontal sawtooth is derived. They occur during the retrace period. Horizontal driving pulses are added to the sawtooth wave as shown in Fig. 1. When the transition region falls in the center of the screen these added pulses fall outside of the range passed by the two clippers and do not affect operation. The waveforms illustrating this action are shown in Fig. 5.

The horizontal driving pulses added in the second pulse amplifier

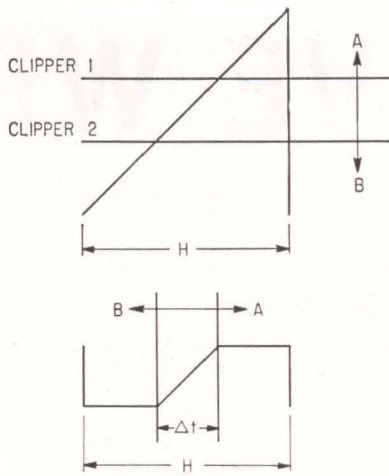

RAMP PORTION of the gating signal shifts to right or left with variation in height of aperture between two clipping levels—Fig. 4

cause rectangular pips during the retract period that extend below the negative tips of the sawtooth. Thus, when the transition region is at the extreme left, the output of the two clippers is a series of rectangular pulses. These pulses, together with their inverse generated in the phase splitter, keep video 1 on and video 2 off during the entire field. This generation of the rectangular pulses is shown in Fig. 5B.

The horizontal driving pulses applied to the first pulse amplifier

cause rectangular pips during the retrace period that extend above the positive tips of the sawtooth. These serve to produce a series of rectangular pulses when the transition period is at the extreme right or left.

With the aperture below the tips of the sawtooth, no portion of the sawtooth will appear at the output of the second clipper. No gating signal will be generated and both gates will be biased for maximum gain. Signal to both gates, video 1 and video 2, will overlap across the entire width of the screen.

It might be thought that the horizontal driving pulses applied to the first two pulse amplifiers would cancel each other out. They do not. When the transition region is at the extreme left the horizontal driving pulse inserted in the first pulse amplifier, together with the entire sawtooth, is removed by the first clipper.

When the transition region is at the extreme right cancellation is prevented by properly proportioning gain and inserted pulse amplitude. Horizontal driving pulse inserted into the second pulse amplifier is much smaller than the opposite polarity pulse from the preceding stage. Slight cancellation occurs but pulse height still remains adequate.

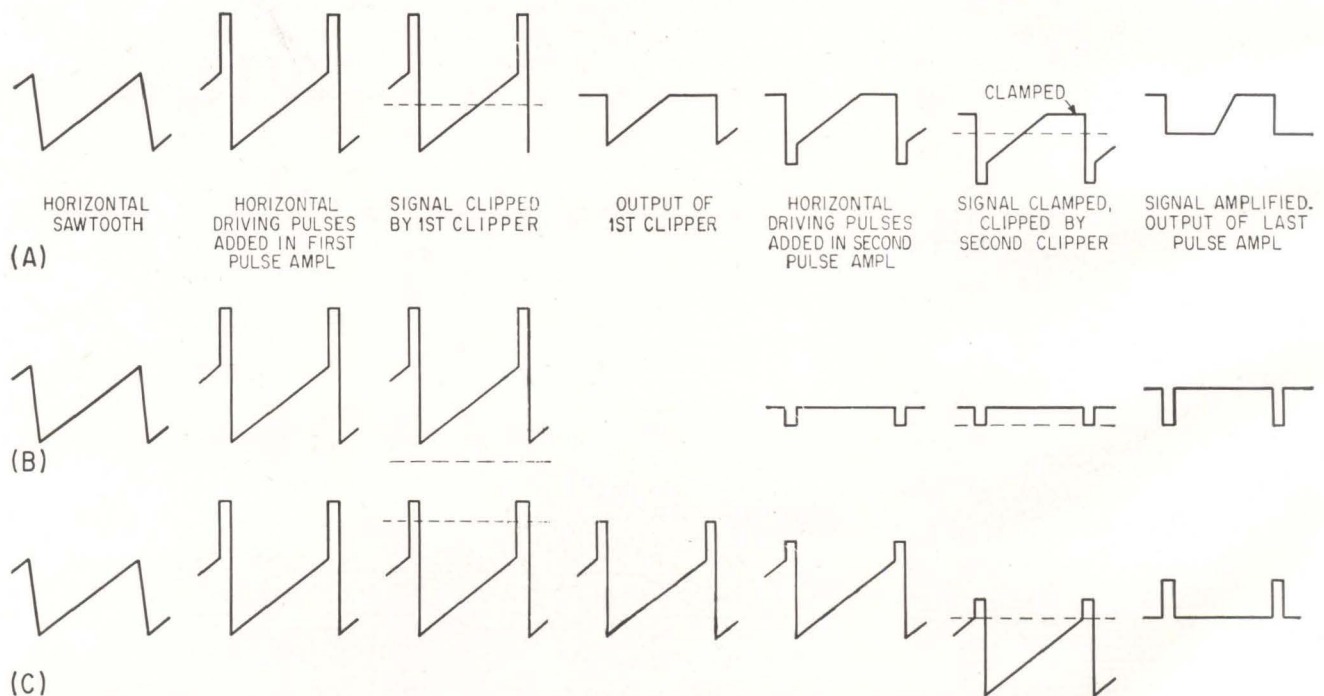

HORIZONTAL driving pulse added to horizontal sawtooth with transition region in center of screen, addition of horizontal driving pulse has no effect on gating waveform (A). At extreme left transition there would be no gating waveform without horizontal driving pulses (B). Same condition when the transition region is at the extreme right (C). Gating waveform is a series of rectangular pulses—Fig. 5

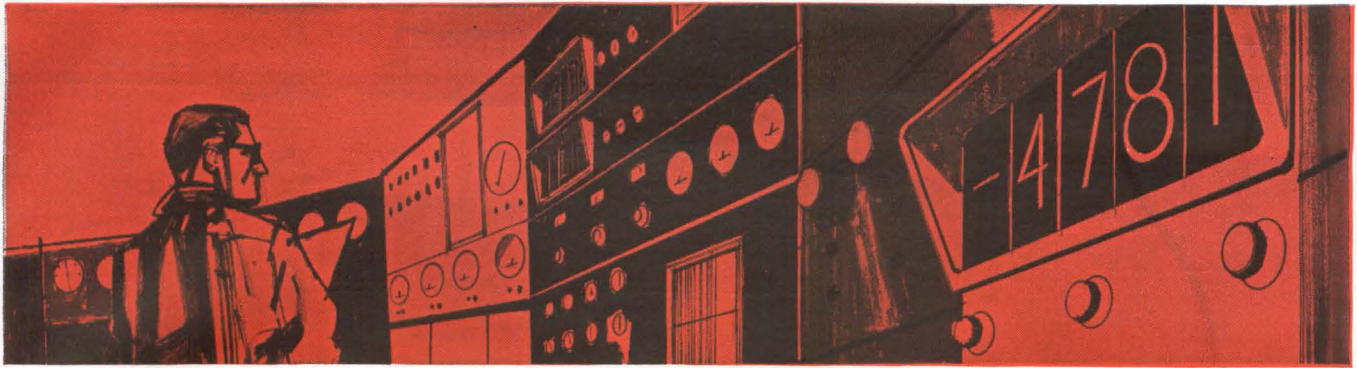

Burroughs Corporation uses Allen-Bradley hot molded resistors in their Beam-X counter modules because... **time and experience have eliminated all questions about their reliability***

■ Burroughs* simplified counter modules feature greatly increased reliability. Where individual component reliability is paramount—as in this application—Allen-Bradley hot molded resistors are a “natural” choice . . . and for the best of reasons.





Allen-Bradley’s exclusive hot molding process results in such amazingly uniform properties from resistor to resistor—and from year to year—that they have become the only “choice” in critical circuits, where strictly commercial resistors can be used. The billions of A-B resistors produced over the years have proven that in the combination of conservative ratings and consistently stable

characteristics, these resistors have no equal. It also makes possible the accurate prediction of the resistor performance in apparatus in which the A-B resistors are used. It is also well to remember that there is no instance on record where an A-B hot molded resistor has failed catastrophically.

So far as resistors are concerned, only by specifying Allen-Bradley hot molded resistors can you be certain you’re building the full measure of reliability into your electronic equipment. For complete resistor data, please send for Technical Bulletin 5050: Allen-Bradley Co., 110 W. Greenfield Ave., Milwaukee 4, Wis. In Canada: Allen-Bradley Canada Ltd., Galt, Ont.

**Trademark of Burroughs Corporation*

ALLEN-BRADLEY HOT MOLDED FIXED RESISTORS are available in all standard EIA and MIL-R-11 resistance values and tolerances.

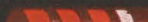
TYPE TR 1/10 WATT		MIL TYPE RC 06
TYPE CB 1/4 WATT		MIL TYPE RC 07
TYPE EB 1/2 WATT		MIL TYPE RC 20
TYPE GB 1 WATT		MIL TYPE RC 32
TYPE HB 2 WATTS		MIL TYPE RC 42

Burroughs Corporation's Model DC-114 transistorized decade counter with Nixie* tube readout, showing use of Allen-Bradley hot molded resistors.



ALLEN-BRADLEY
QUALITY ELECTRONIC COMPONENTS

CUT OUT
YOUR OWN

Reliability Slide Rule

By GERALD F. ALLEN, General Dynamics/Pomona, Pomona, California

RELIABILITY calculations for both systems and subsystems can be made quickly with the slide rule to be assembled from the accompanying illustrations. The number of tests that must be made to prove out a system or component to a given confidence and reliability is found from one set of scales. Failure rates allowable to subsystems to meet system specifications are determined from a second set of scales.

With the data obtained, estimates of project costs and ultimate capabilities can be made more realistically.¹ Before reading the following discussion, it may be desirable to assemble the rule (see Slide Rule Assembly). Detailed analysis of the slide rule mathematics will not be made.

BACKGROUND—An accepted working definition of reliability is the probability that a device will perform as intended under design conditions for a specified period of time.² After all design work is completed and prototypes of an item are produced, then—and not before—reliability must be proved. The only legitimate question becomes—how many items will work under the specified conditions?

The only applicable variables are the number of tests and the number of failures. In preliminary planning stages, the question takes another form—how many items will have to be allocated for tests to demonstrate required reliability? A basic application of the so-called binominal distribution gives the required answers. Although frequently overlooked, the theorem yields demonstrated reliability in exact accord with the preceding definition.

Scales *D*, *E*, *F* and *G* on the slide rule are based on this distribution. The statistical formulations governing these scales stem from probability laws concerning the occurrence of one of any two possible outcomes. The outcome of any event (or test) is constrained to one of two values: acceptable or unacceptable. Once the boundary segregating these alternatives has been established, there can be no question about the outcome of any test; whatever its value, it falls in one of two discrete categories. The outcomes of such realistic tests follow the binominal distribution. (The popular normal, or Gaussian distribution, incidentally, serves as an approximation to the binominal for a large number of tests or items.)

To demonstrate the use of the reliability slide rule, consider a large bag with an unknown mixture of black and white marbles. From a handful of marbles, the mixture within the bag is to be inferred.

Intuitively, if we draw only two marbles from the bag and both turn out to be white, we would not be

justified in saying that 100 percent of the marbles in the bag are white; but if we drew 100 marbles and all were white, we would feel more certain that there were at least a large percentage of white marbles.

What, then, is the probability that the examined handful of marbles is representative of the remainder in the bag? The larger the handful the surer we can be that it is a meaningful indicator. The term confidence is used to indicate the rigorous arithmetic analysis of the size of the handful or sample on the ability to predict the characteristics of the remainder. From the handful of 100 white marbles we can predict that any group of marbles removed from the bag will be at least 98 percent white. We can have 90 percent confidence that the prediction is correct; stated another way, the prediction will be correct at least 90 times out of 100.

Using the slide rule, the number of black marbles drawn is zero and is set up in the window of scale *F* for the desired confidence of scale *G*. In this case 90 percent; under the total number of marbles drawn, 100, on scale *E*, we read a reliability of about 0.977 on scale *D*. This means that based on our sample set of 100 tests (marbles), there would be a 90 percent chance of drawing a handful of 100 marbles with 98 or more white marbles in it. To put it another way, if we replaced each handful after it was drawn and counted, so as not to upset the ratio, 90 percent of an infinite number of handfuls should contain 98 or more white marbles.

Note that each white marble has been considered a success and each black marble a failure. Since reliability is the probability of success, we can read the white-marble probability on the reliability scale.

Logically, the likelihood of drawing 99 or more white marbles in any one handful is less than the likelihood of drawing 98, while the likelihood of drawing 96 or more is greater. A reliability schedule can readily be developed using the slide rule. Using the example of a 100-marble handful containing no black marbles, we can infer the following.

The lower-limit white-marble probability is	With this confidence (in percent)
0.991	60
0.977	90
0.957	99

The same reasoning applies to missile testing and other events. First a performance boundary (such as miss distance for missiles) is established. When tested, missiles falling within the boundary are counted as successes, those outside as failures. Suppose 17

continued on p 48

FOR HIGH RF POWER OUTPUT IN TRANSISTORIZED TRANSMITTER EQUIPMENT

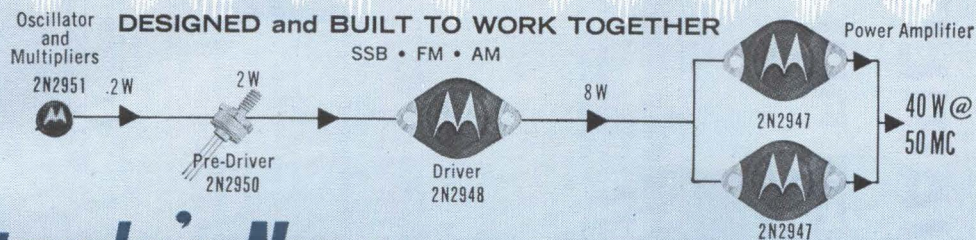
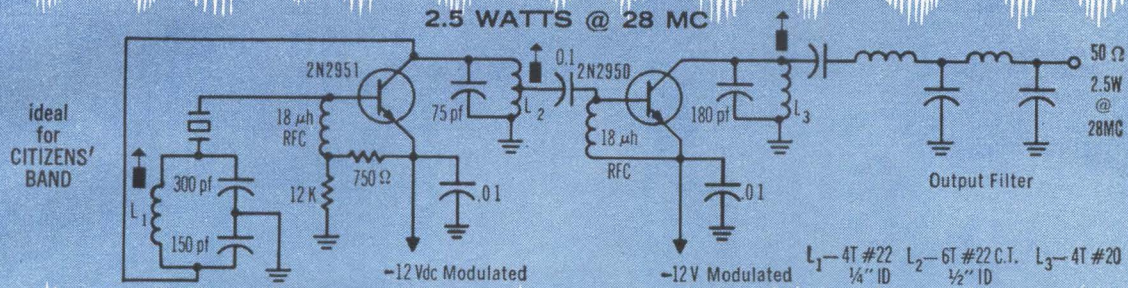
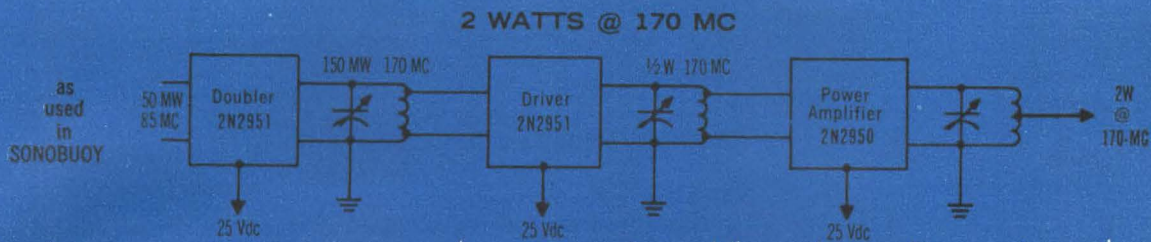

Motorola's New Silicon RF Power Transistors Offer up to 20 Watts Output @ 50mc

Motorola's new team of silicon high-power, high-frequency RF power transistors are immediately available from your local Motorola District Office or Distributor... available at production prices.

Designed to operate at low supply voltages (12 to 25 volts), these devices are ideal for portable equipment in spacecraft... in the military... in the field.

For additional application or pricing information on these new Motorola RF Amplifier transistors, contact your Motorola Semiconductor Distributor or District Office or write: Technical Information Center, Motorola Semiconductor Products Inc., Box 955, Phoenix 1, Arizona.

the RF Amplifier Line

Type	Package	TYPICAL PERFORMANCE DATA ($V_{CC} = 25 V @ 50 mc$)			MAXIMUM RATINGS @ 25°C ($T_{j, max} = 175°C$)			
		Power Output in Watts (cw)	Power Gain @ Power Output (db)	Collector Efficiency (%)	Pulse Breakdown* $V_{CES} (V)$	$V_{CB} (Vdc)$	$I_{C, max} (Adc)$	P_D 25°C Case
2N2947	TO-3	17	8.5	70	90	60	1.5	25
2N2948	TO-3	10	7	60	80	40	1.5	25
2N2950	STUD	3.5	12	50	85	60	0.75	6.0
2N2951	TO-5	0.7	7.5	40	—	60	0.50	2.0

*Minimum specification limit measured in pulse condition at 250 mA.



"new leader in Total Silicon Technology"

MOTOROLA Semiconductor Products Inc.

BOX 955 • PHOENIX 1, ARIZONA • A SUBSIDIARY OF MOTOROLA INC.

D-63-046

SLIDE RULE ASSEMBLY

Before committing the templates to use, experiment with available backing material, glue, and parts of pages from this issue.

1. Cut out templates and paste or glue to thin cardboard or plastic.
2. Cut out areas marked **XX**. If

transparent plastic is used as stiffener, cutouts need be made only through the templates and not through stiffener.

3. Cut two long thin strips (approximately $7\frac{1}{4} \times 3/16$ in.) of backing or thin metal to use as spacers.
4. Match slide to one face of rule and put spacers in place. Lock spacers in place with glue or paste.

5. Set other face in place and bind to spacers.

6. Once rule is aligned, small rivets can be added to increase strength.

A clear plastic spray over the templates will help preserve readability. Since the scales do not fold over from front to back, alignment in this respect is not critical

(Continued)

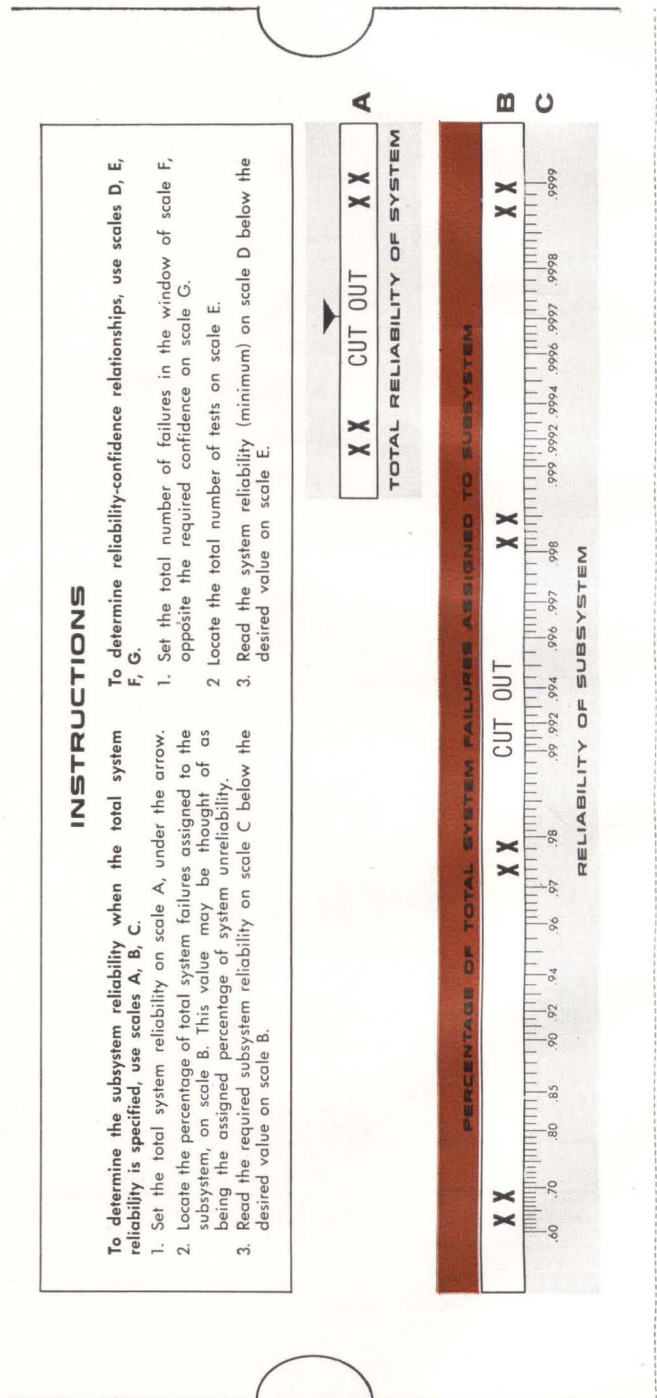
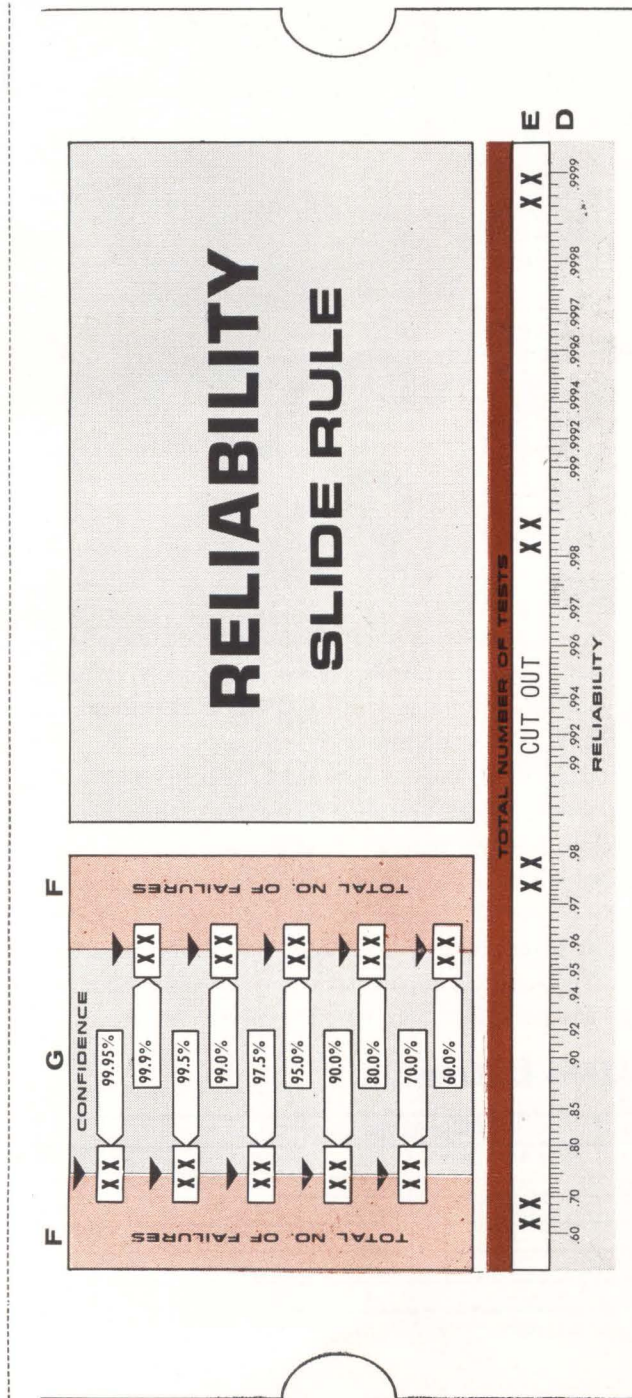

TEMPLATE for body of rule should be cut along indicated line. Cutouts can be made with razor blade

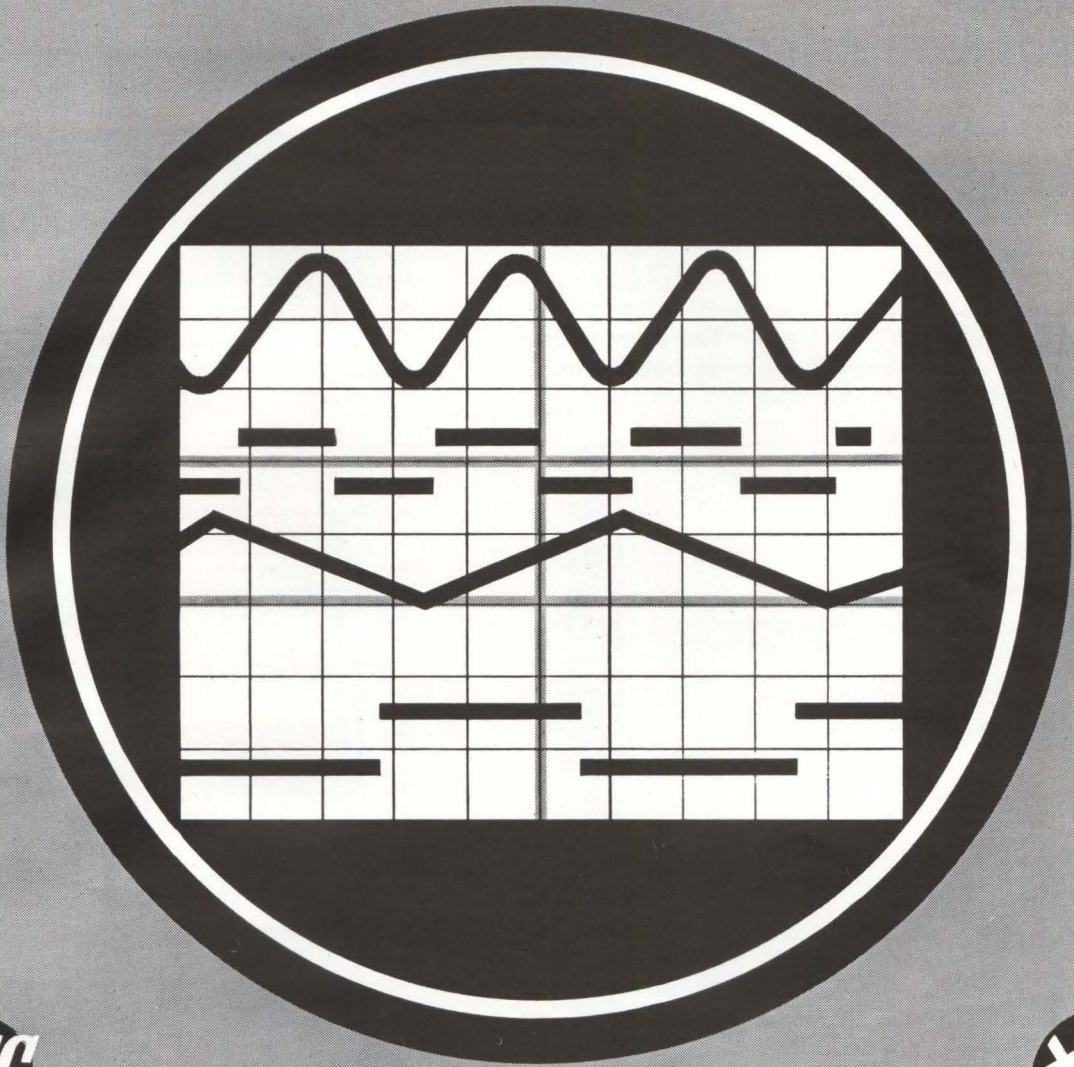

ANOTHER FIRST FROM GENERAL ATRONICS...

TRANSISTORIZED DUAL-BEAM OSCILLOSCOPE



The new General Atronics model GA-255 oscilloscope puts dual-beam versatility and 15 mc bandwidth in a compact 48-pound package. Transistorization, the secret of its relatively small size, also yields cool operation, ruggedness, and a low power requirement—only 165 watts. Its total dimensions: 12" height, 16" width, 19 $\frac{3}{4}$ " depth.

You'll like its high light output (with 10 KV accelerating potential). You'll like its big dual-beam display (5" round CRT has a flat face that eliminates parallax). And you'll like General Atronics' plug-in preamplifiers and sweep generator accessories — including a dual trace plug-in for 4-trace capability. Send for complete data on model GA-255. Write Dept. E9963.



GENERAL ATRONICS

ELECTRONIC TUBE AND INSTRUMENT DIVISION, PHILA. 18, PA.

CATHODE RAY TUBES • OSCILLOSCOPES • OSCILLOSCOPE RECORDING CAMERAS

CIRCLE 47 ON READER SERVICE CARD

REFERENCE SHEET

missiles are fired and 14 hits are recorded: 3 failures out of 17 tests. These tests demonstrate for 90 percent confidence, that the reliability of the missiles in the batch from which the 17 were fired is at least 0.60.

The binominal distribution reliability is not limited to one-shot items; it is equally applicable to long-term durable equipment. Consider a sampling of radar sets tested for 200 hours. The number of sets that failed during this 200-hour interval, in conjunction with the total number of sets tested, leads

directly to a reliability-confidence figure. For example, 15 radars were turned on (after adequate burn-in time as determined by failure rate analysis). Fourteen were still operating at the end of the 200-hour period. Thus, for 95 percent confidence, one failure in 15 tests indicates a reliability of 0.68 for the remainder.

According to the error chart on the slide portion of the slide rule, however, 95 percent confidence figures overstate the total number of tests by two.

(Continued)

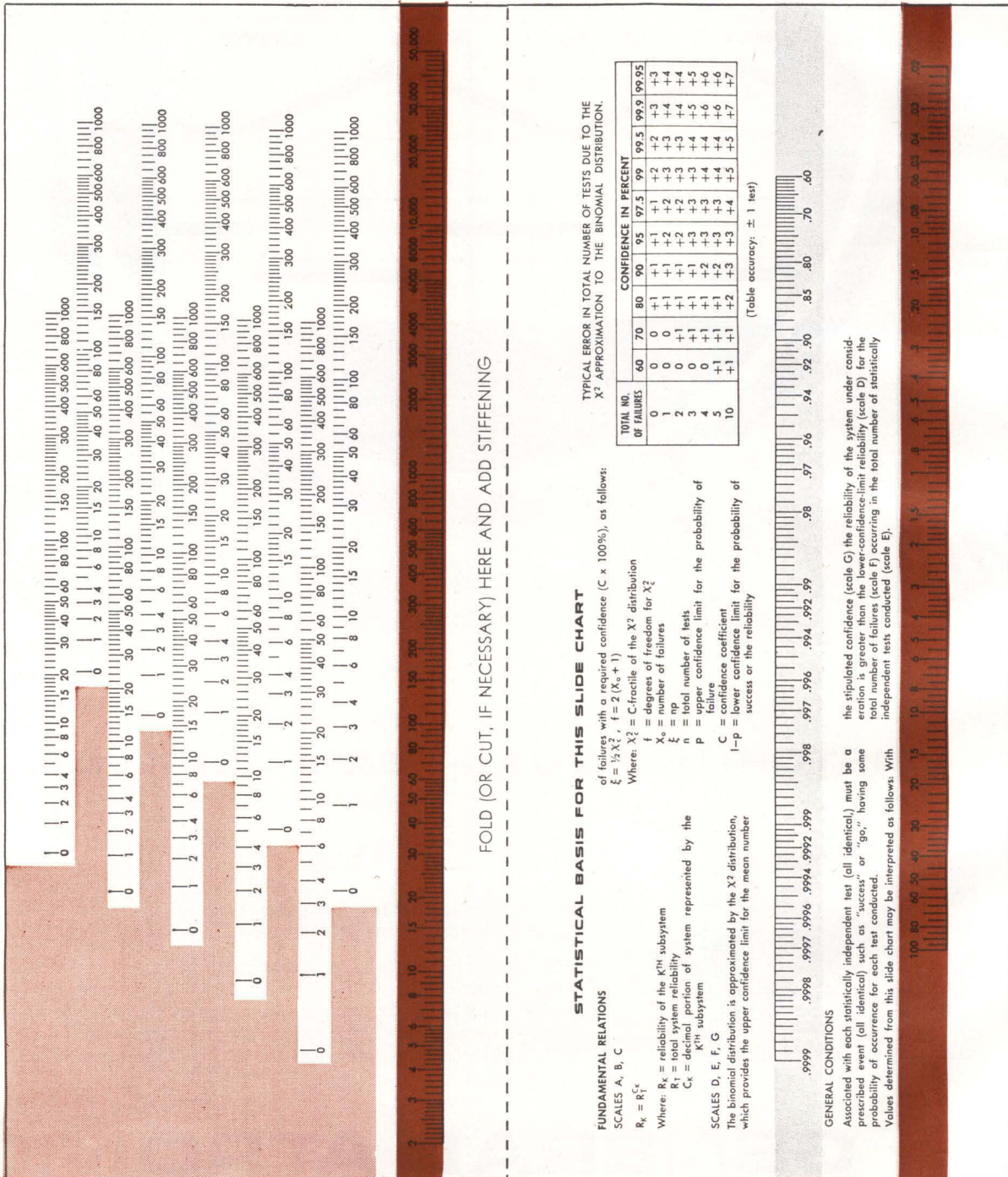

TEMPLATE for slide can be folded or cut along dashed line. Table on slide provides correction factor for figuring number of tests required

Now - TRIMPOT® Miniature Adjustable Time Delays for Critical Applications

NUMBER 29 - NEW PRODUCT SERIES

Need to stall for time? These two miniature modules offer delays with a repeatable accuracy of $\pm 5\%$ from -55°C to $+120^{\circ}\text{C}$. They are the Bourns Model 3900 Time Delay Relay and Model 3907 Time Delay Module. Both units give you the versatility of either the DPDT high-current-carrying capabilities of an integral relay or the long operating life of a solid state timing switch.

Both modules are capable of providing a time delay range of 0.1 to 200 seconds by the external addition of a readily available resistor or a capacitor-resistor combination. More important, these miniature time delays have a self-contained adjustment feature by means of a Bourns TRIMPOT® potentiometer allowing precise selection of the desired delay time through a 1.5 sec. range.

Model 3900 employs a DPDT relay capable of one ampere at 26.5 VDC, while Model 3907 features an internal SPST NO solid state device rated at 250 milliamperes at 26.5 VDC.

An internal diode protects the units against accidental polarity reversal, and protection is provided against transients up to 100% of the operating voltage with pulse widths of 50 microseconds. Both models have all welded circuitry, are vacuum-

potted and meet the environmental requirements of MIL-R-5757D. They readily withstand 20G, 2000 CPS vibration and 75G shock.

Models 3900 and 3907 are available from stock. Write today for complete technical data.

	MODEL 3900	MODEL 3907
Time delay range:	0.1 to 200 Seconds	0.1 to 200 Seconds
Nominal voltage:	20 to 30 VDC	20 to 30 VDC
Life (min):	10^6 cycles	10^6 cycles
Output:	DPDT Relay	SPST NO - Solid State
Contact rating:	1 ampere resistive at 26.5 VDC, 120°C	0.05 amperes resistive at 26.5 VDC, 120°C ; 0.250 amps at 25°C
Ambient temp. range:	-55 to $+120^{\circ}\text{C}$	-55 to $+120^{\circ}\text{C}$
Size:	.4" x .8" x 1.31"	.4" x .8" x 1.0"

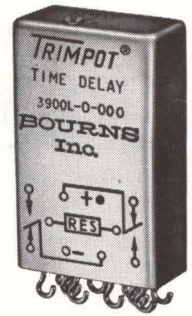

ACTUAL SIZE



BOURNS

BOURNS, INC., TRIMPOT DIVISION
1200 COLUMBIA AVE., RIVERSIDE, CALIF.
PHONE 684-1700 · TWX: 714-682 9582
CABLE: BOURNSINC.

MANUFACTURER: TRIMPOT® & PRECISION POTENTIOMETERS, RELAYS; TRANSDUCERS FOR PRESSURE, POSITION, ACCELERATION. PLANTS: RIVERSIDE, CALIFORNIA; AMES, IOWA; TORONTO, CANADA

Therefore, $15 + 2 = 17$ is the scale E value under which the reliability is found; opposite 17 is found 0.72. The slide rule is conservative if the error chart is ignored. Error chart use when the total number of tests is desired is illustrated in a following example.

SUBSYSTEM RELIABILITY—Scales A , B , and C apply to the failures likely to occur in the over-all system, and how these failures are to be apportioned among series connected subdivisions which are defined as subsystems. The failure of any one of these subsystems is assumed to disable or no-go the entire system.

Suppose, for example, a particular subsystem is allowed by design to contribute only a small percentage of the failures occurring in the entire system. For this to happen, the reliability of the particular subsystem must be higher than that of other subsystems that are allowed a greater portion of likely system failures. Based on the relative complexity of the subsystems, or on any other design basis or decision, the percentage of overall system failures likely to occur in any subsystem may be assigned.

The reliability of any one subsystem (scale C) is related to the over-all system reliability (scale A) by the percentage of failures assigned the subsystem under question (scale B) according to the equation

$$R_k = R_T^{C_k}$$

presented on the sliding portion of the slide rule. The derivation of this simple closed form expression is given at the end of this article, since it has not been found in previous literature.

EXAMPLE—The following problem is relatively complex, but it illustrates a variety of applications.

A missile is proposed. When a series of this missile is manufactured, a sample portion must demonstrate a reliability of at least 0.92, with 99 percent confidence for the remainder of the series. The reliability of certain missile sections have already been established, as follows

Warhead and fuze	0.992
Rocket motor	0.995
Airframe and power supply	0.993

The parts to be produced are the autopilot and guidance sections, so the first problem is to determine the reliability requirements for these sections.

(1) Set 0.92 on scale A under the arrow.

(2) Read off the percentages on scale B over the appropriate values on scale C for the established portions of the system. For the warhead fuse, with a reliability of 0.992, the allowed failures are 9.5 percent; for rocket motor, 6 percent; for airframe and power supply, 8.5 percent; total, 24 percent.

(3) Subtracting the sum of other section percentages from 100, leaves 76 percent. This is the portion of likely failures that will be allocated to both the autopilot and guidance sections. Suppose the guidance system is three times as complex as the autopilot, based on the number and nature of the components

used. Apportioning the 76 percent accordingly ($Z + 3Z = 76$; $Z = 19$), we choose 19 percent for the portion of likely failures allowed the autopilot and 57 percent allowed the guidance section.

(4) With 0.92 on scale A under the arrow, read off opposite 19 percent failures a reliability of 0.984; opposite 57 percent read 0.954.

(5) Thus 0.984 and 0.954 are, respectively, the reliabilities required of the autopilot and guidance sections.

The second problem is to determine the minimum number of tests required to demonstrate the stipulated 0.92 reliability with 99 percent confidence.

(1) Set 0 (zero) on scale F in the 99 percent window of scale G .

(2) Read on scale E , opposite to 0.92 on scale D , the minimum number of tests required: 59.

(3) According to the error chart on the back of the movable slide, the answer in the step above is in error by + 2 tests (0 failure, 99 percent confidence); therefore, 57 tests are required—assuming no failures—to demonstrate a reliability of at least 0.92 with 99 percent confidence.

APPENDIX—The expression for the reliability associated with a specified portion of the total is easily derived.

Let C_k = decimal portion of the overall system failures allowed the k th subsystem

n = total number of subsystems considered

R_T = reliability of overall system

R = reliability of k th subsystem

The system chain reliability expression is

$$R_T = \prod_{k=1}^n R_k$$

Then $R_k = r^{n C_k}$ because, in accord with the definition above

$$\sum_{k=1}^n C_k = 1$$

Therefore

$$R_T = r^n = \prod_{k=1}^n r^{n C_k} = r^{n(C_1 + \dots + C_k + \dots + C_n)}$$

and

$$R_k = \frac{r^n}{r^{n(C_1 + \dots + C_k + \dots + C_n - C_k)}} = r^{n[1 - (C_1 + \dots + C_k + \dots + C_n - C_k)]} = r^{n C_k}$$

Finally

$$R_k = R_T^{C_k}$$

REFERENCES

(1) Slide charts have been produced by the Perrygraf Corp., for General Dynamics/Pomona, a Division of General Dynamics Corporation. They are available on a controlled basis from company representatives.

(2) J. M. Carroll, Reliability: 1962, *Electronics*, p 55, Nov. 30, 1962.

BIBLIOGRAPHY

Harald Cramer, "Mathematical Methods of Statistics," Princeton University Press, Princeton, N. J., 1946.

A. Hald, "Statistical Theory With Engineering Applications," John Wiley & Sons, Inc., New York, N. Y., 1952.

From 6 volts to 100 volts— get Mallory quality in all solid tantalum capacitors

Available ratings
for Mallory type
TAS solid
tantalum capacitors

With the addition of new 75 and 100 volt ratings, the Mallory TAS line of solid tantalum capacitors now gives you a complete range of ratings . . . including all standard MIL ratings. The new 75 volt units come in values from 0.47 to 3.3 mfd. The 100

volt series ranges from .47 to 2.7 mfd. Temperature rating is -80°C to $+125^{\circ}\text{C}$. Both are in two case sizes: MIL size A, .125" dia. by .250"; and size B, .175" dia. by .438". Tinned nickel leads are standard; untinned or Dumet leads on special order.

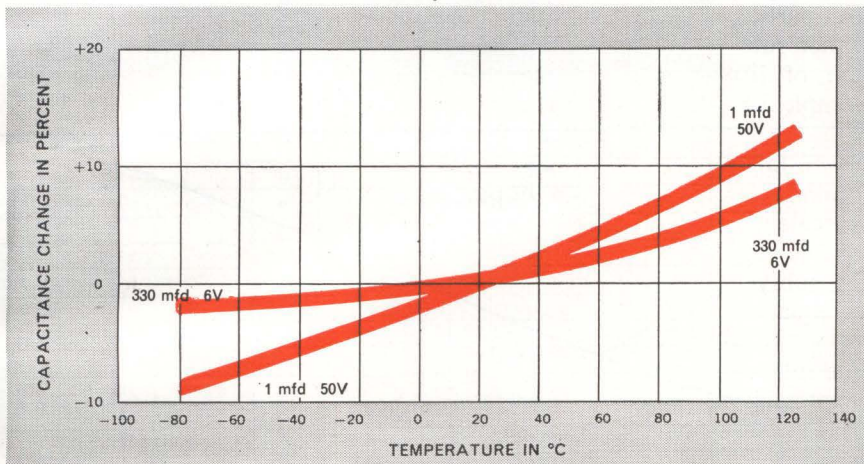

Typical temperature stability curve for type TAS; other ratings show comparable performance.

Proved by over 14 million piece-hours of reliability testing, with only 4 catastrophic failures in all this period, Mallory TAS capacitors are made with the consistently high quality that comes from over 12 years of experience in tantalum capacitor manufacturing. Many ratings are

available on immediate delivery. All are designed and tested to meet or exceed requirements of MIL-C-26655A and MIL-C-26655/2C. For a copy of our new Bulletin 4-40J, write to Mallory Capacitor Company, Indianapolis 6, Indiana, a division of P. R. Mallory & Co. Inc.

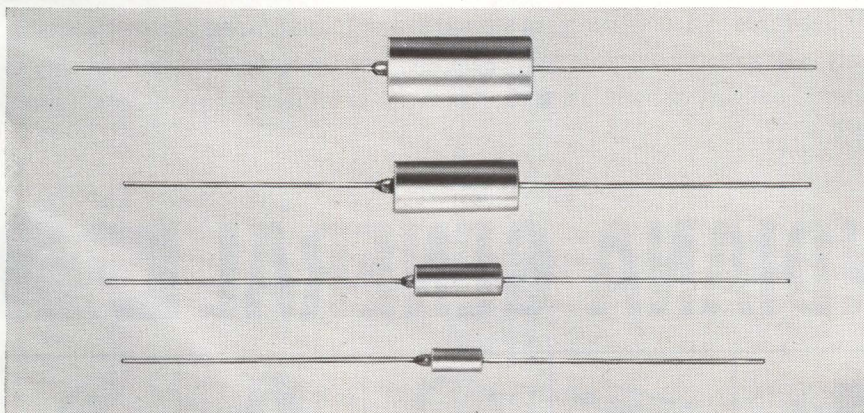

WET SLUG, FOIL AND SOLID TANTALUM CAPACITORS

VOLTAGE	MAXIMUM MFD.	MINIMUM MFD.
100	2.7	.47
75	3.3	.47
50	22	.47
35	47	.0047
20	100	.0047
15	150	.0047
10	220	.0047
6	330	.0047



NEW FERRAMIC® TC-4 MATERIAL LINEAR OVER -65° TO 145°C RANGE

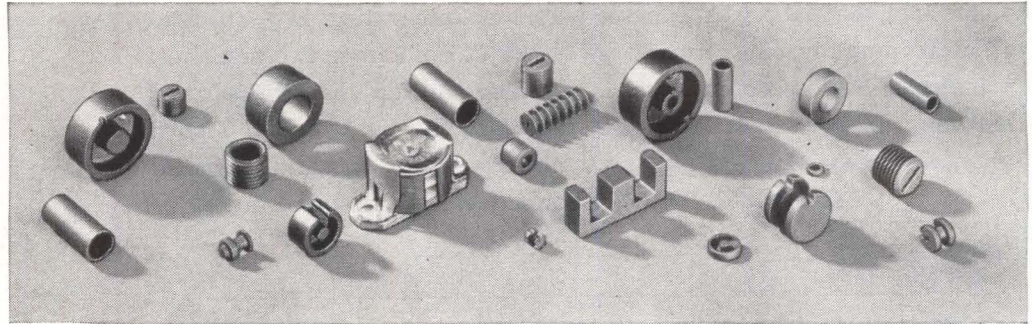

TOROIDAL VALUES	TC-4
Initial Permeability — μ_0	95
Q @ 5 MC	180
Temperature Coefficient ppm/°C	500
Temperature Range "°C"	-65 to +145
Application Frequency Range	1Kc to 15 Mc

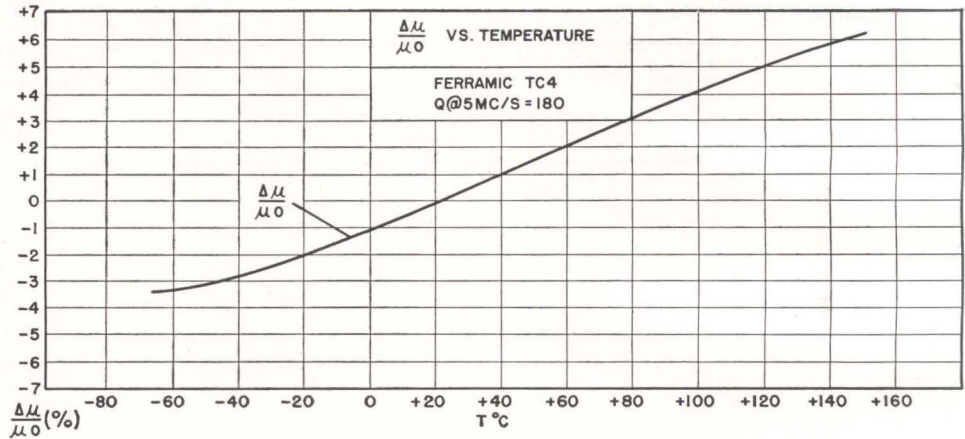

Indiana General's new ferrite material meets the need for miniaturized fixed and adjustable inductors operating over a wide temperature range. ■ **Wide Temperature Range** TC-4 inductors exhibit a linear predictable change of inductance over a temperature range of from -65°C to +145°C. Combination of small size and temperature coefficient advantages make inductors of the new TC-4 material the logical choice for numerous filter, communication and micro-miniature applications, both military and commercial. ■ **Miniaturization** TC-4 adjustable and fixed inductors offer you high initial permeability with low losses for optimum performance in minimum sizes. ■ **Wide Range of Parts** New TC-4 Material is available in a wide range of standard and miniaturized parts — bobbins, sleeves, toroids, E, I and U cores. ■ **Quality** IGC's modern production facilities assure you of consistent quality to meet your most rigid requirements—with short delivery schedules. ■ Call or write to Indiana General Corporation, Electronics Division, Keasbey, New Jersey.

INDIANA GENERAL

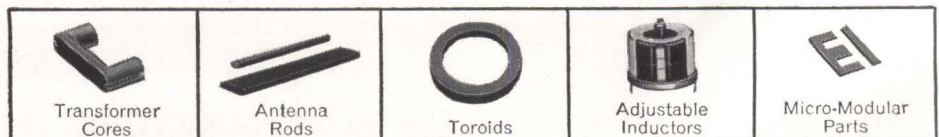

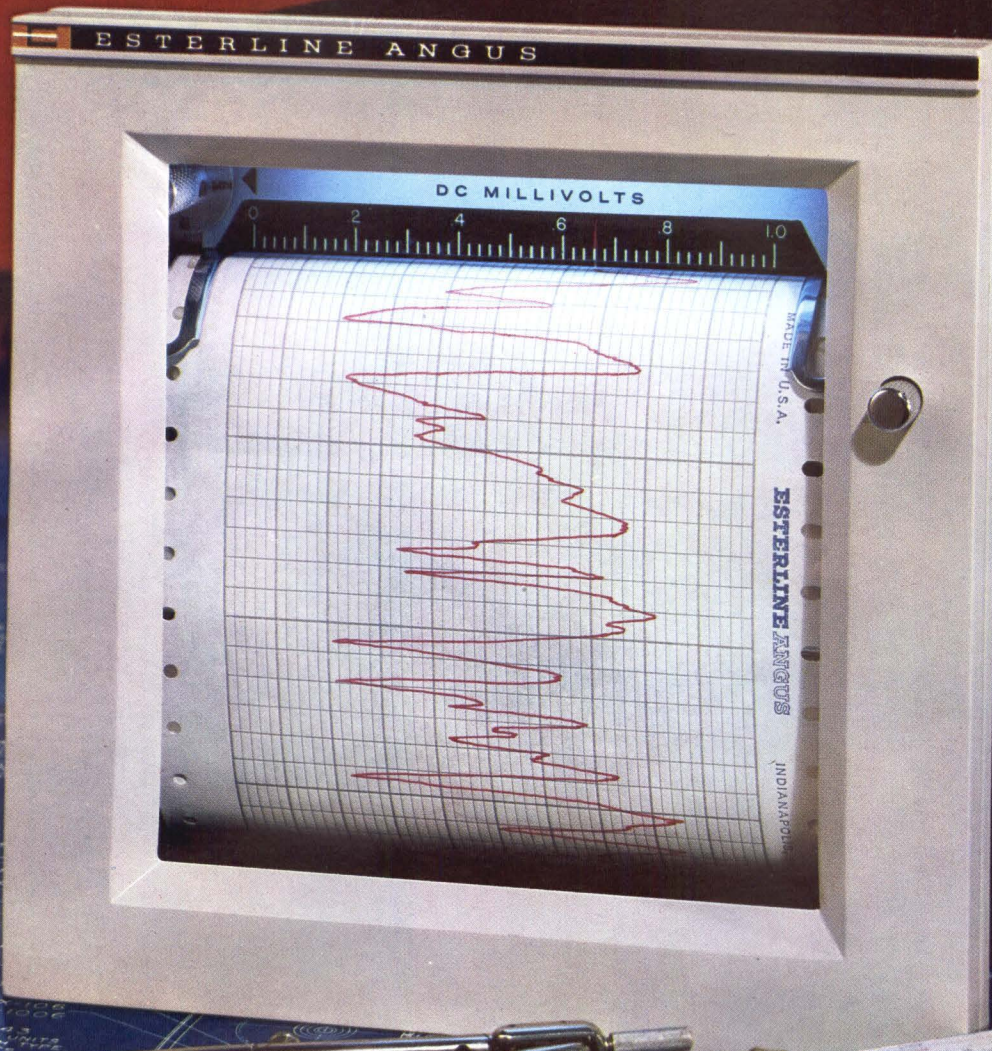

(Illustrated: Flush recorder with 8" x 8" front. Portable "Labgraph" also available.)

New Speedservo . . . swift, sure, simple, small!

High Speed: $\frac{1}{8}$ second full scale response. Records 4 cycle signals without significant attenuation. • **Versatile:** Accommodates DC circuits with output impedance 100,000 ohms or less. • **Sensitive:** 0-1 MV DC without jitter. Many higher ranges. Accuracy $\frac{1}{2}\%$. • **Efficient:** Raymond Loewy styled 8" x 8" case front conserves valuable panel space. Full 6" wide 100' long chart. • **Convenient:** Dial 14 chart speeds from $\frac{3}{4}$ " per hour to 6" per second. "Drop in" chart loading. Disconnect and pull chassis from case in seconds. Chart supply indicator. • **Less Maintenance:** Simple linear motion pen motor, no strings, no pulleys. Zener reference voltage.

Infinite resolution glass hard potentiometer prevents the major cause of hunting.

In addition to "Speedservo," the radically new EA "Graph" Line of rectilinear recorders includes both single and two-channel DC Microammeters, DC Milliammeters, AC or DC Ammeters or Voltmeters, plus inkless and ink type event recorders.



For complete information, write for "Graph" Line Brochure

ESTERLINE ANGUS INSTRUMENT COMPANY,
Inc., Box 596E,
Indianapolis 6, Indiana

Portable "Labgraph" with sloped writing surface also available! Esterline Angus will gladly adapt standard instruments to your needs, or develop new ones for you. Your inquiry is invited.



Excellence in instrumentation for over 60 years **ESTERLINE ANGUS**



Single Place Gyrocopter by Bensen Aircraft Corp.

From industry's viewpoint,
men become modern
manpower fast in
Northeastern North Carolina.

You'll find an abundance of top grade human material to staff your plant in Northeastern North Carolina. It's new material—but not raw material. For this state provides an outstanding Industrial Education Program that turns out modern manpower with skills tailored to your needs.

Ask VEPCO about the proven high productivity of this expanding, home-grown work force. Ask VEPCO as well for available plant site data, and economic studies in depth on this land of



pleasant living, fine beaches, and low-production costs . . . all within overnight range of multi-billion-dollar northern and mid-western markets. VEPCO's confidential site finding help is yours without obligation. Write, wire or phone.

VIRGINIA ELECTRIC and POWER COMPANY 
J. Randolph Perrow, Manager—Area Development
Electric Building, Richmond 9, Virginia • Milton 9-1411
Serving the Top-of-the-South with 2,540,000 kilowatts—due to reach 3,500,000 kilowatts by 1965.

small
change



FOUR-LAYER INTEGRATED CIRCUIT AND LOGIC MODULE CARRIER

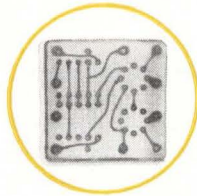

Small change? Yes—but it guarantees big performance. This little board is one sample of our leadership in the field of precision multilayer circuitry. It costs just about what you see here. Why not send us **your** requirements?

CINCH-GRAPHIK

DIVISION OF UNITED-CARR FASTENER CORPORATION



200 South Turnbull Canyon Road, City of Industry (Los Angeles), California • Phone (Area Code 213) 333-1201
Offices in 22 Principal Cities throughout United States, Canada, England and Australia listed under Cinch Mfg. Co.
or United-Carr Fastener Corporation • Cinch • Ucinite • Monadnock Mills • Howard B. Jones • Palnut

DISARMAMENT

WHAT CHANCE? WHAT IMPACT?

If it comes, arms-control sales could not offset loss of defense contracts

By **WARREN KORNBERG**
McGraw-Hill World News

WASHINGTON—Chances of real disarmament are very slim. No informed Washingtonian expects it. Yet disarmament is being discussed increasingly because of the test-ban treaty (*ELECTRONICS*, p 18, Aug. 2) and other signs of a cold-war thaw.

One of the many facets of the disarmament question is the potential economic impact on electronics and

other industries heavily dependent on defense contracts, and whether disarmament control and monitoring equipment sales could offset reductions in defense production.

Since no realistic timetable for disarmament exists, the question is hypothetical. But the best available answers at present are negative—disarmament controls alone would not take up the slack.

CAN WE DISARM?—State Department and Disarmament Agency officials are becoming more and more concerned about the U. S. position if the Soviets agree to general and complete disarmament on our terms. The President, at a recent press conference, put it succinctly

when he named China as the major overseas threat in the foreseeable future. The power growth anticipated from a militant China could mean a more or less permanent cold war.

At any rate, besides being a long way off, disarmament when and if it comes would be a long-term process. Percentage cuts would be spread out over months and years to insure against economic disruption and serious one-shot weakening of the national security.

MONITORS—Any firm expecting to cash in on arms-control needs is in for a rude shock. The \$12-billion annual figure reported elsewhere as the disarmament surveillance equipment need is broadly discredited in the Arms Control and Disarmament Agency, Defense Department and Electronics Industries Association.

Surveillance would depend on the kind of disarmament agreement. Considering present Soviet intransigence on inspections by teams in Russia, surveillance is expected to lean toward the more expensive, mechanized, heavily electronic devices. But even these would not cost more than \$5 billion to \$7 billion over a period of several years.

Remote sensors being considered include satellite-borne photographic, electronic and infrared scanners; rail and road traffic monitors; remote temperature, chemosensitive and radiosensitive water monitors for evaluating industrial processes by their waste products, similar air-pollution monitors, and the like.

Some impetus—still small—has already been given electronics development by existing diplomatic efforts to relax tensions. The search for devices to detect and identify underground nuclear explosions geared up geophysical companies. Now the search is on for more sophisticated equipment to monitor space, air and ocean—the environments prohibited under the proposed test-ban treaty.

LOTS OF SLACK—Monitoring sales would be small compared to

Disarmament Studies Growing

SINCE the U. S. Arms Control and Disarmament Agency was established in September, 1961, it has awarded 25 contracts and 8 grants for various study projects. Many more studies are planned by the agency and the size and number of contracts will undoubtedly grow if Congress approves the \$15 million budget the agency has asked for the 1964 fiscal year. Until now, the agency has been operating under a \$10-million ceiling.

Here are the major contracts previously awarded by the agency:

Bendix, \$159,900, techniques for monitoring the production of strategic delivery vehicles; Raytheon, \$125,000, progressive zonal inspection for verifying arms control agreements; Market Research Corp. of America, \$47,461, application of statistical methodology to inspection systems; Institute for Defense Analyses, \$120,000, inspection and control of disarmament agreements; Bendix, \$95,000, verification requirements for agreements; Hudson Institute, \$147,000, political and strategic implications of civil defense programs; Sylvania, \$354,000, verification arrangements on bans for placing weapons of mass destruction in orbit and restricting or halting missile flight tests.

Aerospace Corp., \$217,000, ballistic missile and military space systems developments; Bendix, \$218,500, additional studies on monitoring production of delivery vehicles; Historical Evaluation and Research Organization, \$162,000, analysis of the historical patterns of treaty violations; Washington Center

of Foreign Policy Research, \$87,308, measures to strengthen the means of keeping the peace; Sylvania, \$202,000, limiting conventional arms and forces; Stanford Research Institute, \$267,688, effect of disarmament on the military balance in Europe; Massachusetts Institute of Technology, \$65,000, Soviet motivations and interest in arms control; MIT, \$145,000, regional arms control.

Research Analysis Corp., \$177,300, impact of arms control measures on Western and Communist Bloc ground forces; North American Aviation, \$136,600, data collection equipment; Burroughs, \$203,999, automated data processing methods; Columbia University, \$91,000, factors affecting Soviet attitudes on disarmament; Arthur D. Little, Inc., \$159,000, ground inspectable features of Soviet armaments production; Washington Center of Foreign Policy Research, \$139,000, future role of UN peace observation arrangements; Yale University, \$90,000, political trends in Western Europe.

QUICK, SLICK WAY TO PROTECT PRODUCTS



MADE OF TOUGH, FLEXIBLE POLYETHYLENE
WON'T CHIP, BREAK, SHRED OR COLLAPSE
SAFEGUARD PRODUCTS IN PROCESS, STORAGE
AND TRANSIT
OVER 700 SIZES IN NUMEROUS STYLES AND
COLORS NOW IN STOCK

Caplugs

GET FREE SAMPLE KIT IN EXCHANGE FOR THIS COUPON

**CAPPLUGS DIVISION
PROTECTIVE CLOSURES CO., INC.**
2205-11 ELMWOOD AVE., BUFFALO 23, N. Y.

MAIL a free assortment of Caplugs, literature and prices to us, without obligation.

name _____
title _____
firm _____
address _____
city _____ zone _____ state _____





avoid guesswork

... when you're specifying important high-vacuum components. Put two decades of VEECO experience and reputation to work for you; discover the advantages of the highly successful VEECO value formula:

- **QUALITY** — specify VEECO for components which are thoroughly checked in the plant before being shipped to you.
- **RELIABILITY** — specify VEECO for components which have been engineered by high vacuum specialists, and used in proven systems for years.
- **DURABILITY** — specify VEECO for components designed for long use.
- **REPUTATION** — specify VEECO for components whose workmanship is backed by one of the most trusted names in high vacuum technology.

Send for our Condensed Catalog and learn more about VEECO's complete line of systems and components including our new TC-DG-9 High Vacuum Controller, our Ionization Gauge and Tubes, our new line of Forged Brass Valves, our Diffusion Pumps, Low-Loss Cold Traps, and BAF Baffles . . . components which will make your systems work better and longer. Write for your copy today and see for yourself how the guesswork disappears.

**VACUUM-
ELECTRONICS
CORP.** *Veeco*[®]

TERMINAL DRIVE,
PLAINVIEW,
LONG ISLAND, N. Y.



May we
send
you our
catalog?

present defense electronics sales. The \$50-billion fiscal 1964 defense budget contains some \$8.3 billion for electronics, mainly: RDT&E, \$2.1 billion; aircraft, \$1.4 billion; missiles, \$1.5 billion, and electronics-communications, \$1.1 billion.

Disarmament-control requirements may hold the electronics-communications spending up, but aircraft, missiles and ship construction, and RDT&E accordingly, would be cut back sharply during disarmament stages.

Of the \$10.2 billion or so in electronics sales to the government, \$1.6 billion goes to NASA for the space program. The NASA budget should continue to climb in the next few years, even if the defense budget levels off or drops. The space budget will probably double again in 10 years. Of NASA's major items, tracking and communications are 90 percent electronics, vehicles are 50 percent electronic and spacecraft are 70 percent electronic. Anticipated growth in these areas will help take up the slack.

CIVILIAN ELECTRONICS—The areas reportedly being explored as additional alternate markets include surface transportation, biomedical electronics, communications and the like. Arms-control specialists, in

considering economic impact of disarmament, cite the shock-cushioning effects of industrial-commercial electronics. The release of skilled manpower, imagination and facilities, they say, will create undreamed-of transformations in the economy.

Industry specialists, however, are less sanguine. They don't expect automation to become the bread-and-butter market that defense is. Some new area of consumer needs, running off into the science fiction of a decade ago, is probably the ultimate answer. Nobody, however, will speculate on it.

Though the electronics industry is expected to survive any armaments cutback better than airframe and ordnance industries, government and industry observers think there would be a substantial shake-out of electronics firms, without—over a period of time—substantial loss to the industry as a whole. The firms in best position to survive are seen as the old-line radio-electronics outfits which do 25 to 40 percent, or less, of their business with the government.

Several major military electronics firms are already reported as reexamining major available markets with an eye toward shifting their dependence away from government work.

Tv Now Briefs Air Force

NEW MANAGEMENT AID to one of the biggest organizational complexes in the world—the U. S. Air Force—is disseminating “in-house” information faster, more effectively, and cheaper than before.

The new facility consists of a closed-circuit television studio with 11 viewing locations—all equipped with 21-inch compatible television re-

AIR FORCE SECRETARY Eugene M. Zukert can speak “live” to 11 private conference rooms in the Pentagon, and later, by video tape, to major commands throughout the world. Ultimately, the system will transmit direct to other commands



Meanwhile, in Peking



CHINESE communists claim 15,000 students are enrolled in Peking university tv courses. Programs like the one shown are reportedly viewed in "hundreds of centers" in the city, suburbs and factories

receivers for color or black-and-white viewing.

The biggest room also contains a tv projector which displays a 6×8-foot color or black and white picture.

Besides the conference rooms in the Pentagon, where both live and taped briefings are presented, U. S. bases throughout the world also get in on the network by videotapes sent through the mail or by courier.

In time, Air Force hopes to pro-

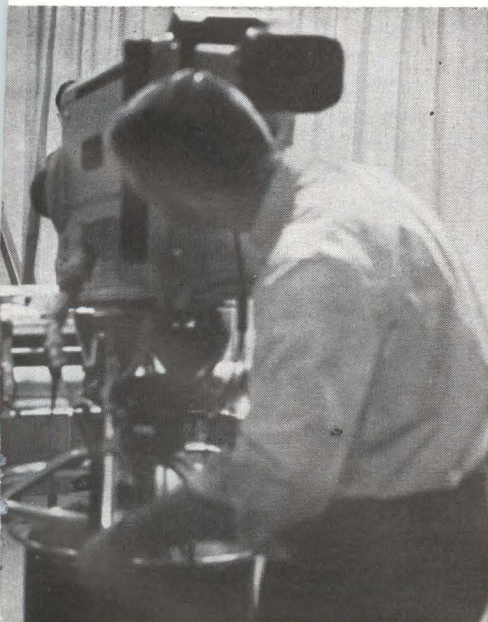

OFFERS THE WIDEST RANGE OF RESISTANCE VALUES

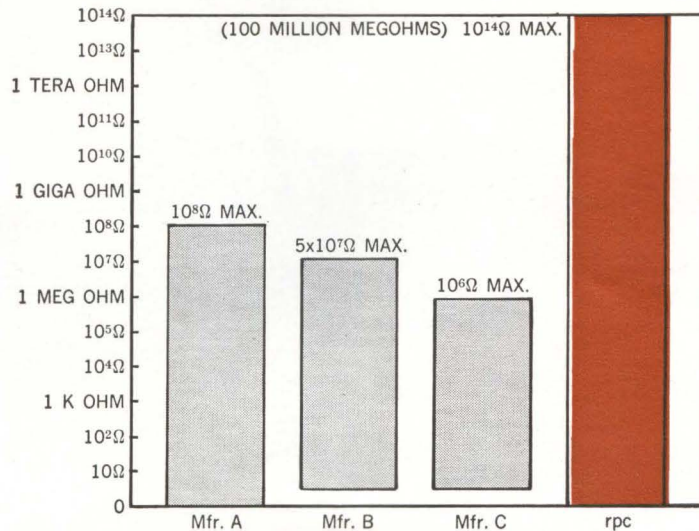

Manufacturers' ohmic ranges based on highest and lowest ohm single resistor.



WIREWOUND RESISTORS DRIFT ONLY 25 PPM IN 3 YEARS

(If applicable to your needs)

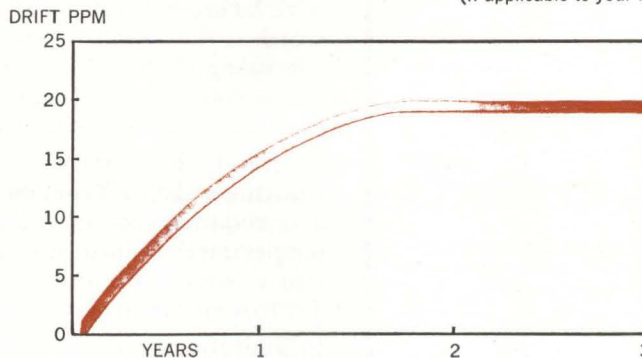

Drift in PPM. Resistors stored and measured at room temperature without the use of controlled atmosphere.

In addition to brilliant performance and outstanding reliability, RPC offers you a wide choice of quality resistors and a highly competent engineering department that can help you solve sticky problems involving resistance.

- PRECISION WIRE WOUND
- PRECISION METAL FILM,
- CARBON FILM
- RESISTANCE NETWORKS



Resistance Products Co.

914 S. 13th Street, Harrisburg, Pa.

HOW MUCH MORE WILL THE COST BE IF YOU SPECIFY GUDEBROD LACING TAPE?



GUDEBROD FLAT BRAIDED LACING TAPES FOR EVERY NEED

Strict manufacturing control guarantees the quality of Gudebrod Tapes. There are many different types meeting wide range of needs, including:

GUDELACE®-non-slip—Nylon with microcrystalline wax finish—complies with MIL-T-713A.

GUDELACE-H®—Nylon with special coating of fungistatic synthetic rubber.

STUR-D-LACE-FLH®—Dacron* fibers impregnated with fungistatic, burn proof finish. Tem. -100°F. to 350°F.

TEMP-LACE PRE-SHRUNK®—Teflon*—virtually unaffected by temperatures from -100°F to 425°F.

GUDE-Q®—Extreme Temperature—excellent tying qualities. Essentially stable in excess of 1500°F.

The Gudebrod Cable-Lacer speeds and eases the Harness tying operation. Inquire about it.

Lacing tape might represent as little as 1/100,000th part of the total cost for producing a standard electronic unit. The labor cost for tying the harness with this tape could be as much as 500 times greater than the material cost. Where then, can the economy of saving a few cents on wire lacing be profitable? Of much more worth is the confident knowledge that in specifying Gudebrod Flat Braided Lacing Tapes you are providing the very best for your wire harness lacing work.

Specifically made for wire harness lacing, Gudebrod Lacing Tapes meet many particular requirements for fungus resistance, temperature fluctuations, chemical content, as well as meeting or exceeding MIL-T-713A specifications.

In addition Gudebrod Lacing Tapes are soft and flat. Stress is distributed over the full width without cut-through or harshness to injure insulation or fingers. Knots stay tied. The good handle of Gudebrod Tapes pleases harness room workers—assures production improvement.

For samples, for further information, for the Technical Data Book, get in touch with your local Gudebrod representative, or write to the Electronics Division.

*Du Pont registered trademarks



GUDEBROD BROS. SILK CO., INC.

FOUNDED IN 1870

Electronics Division

12 SOUTH 12TH STREET, PHILADELPHIA, PENNSYLVANIA 19107



PENTAGON SYSTEM can distribute four different programs simultaneously to different viewing areas

vide live transmission to commands by cable, troposcatter, or even satellite relay. The problem will be in assuring secure communications. The system now in the Pentagon is secure.

At present two 4½-inch black-and-white image-orthicon cameras, and two standard image-orthicon color cameras are used. Cost of the entire system is about \$½ million.

Swedes Building Big Radiotelescope

STOCKHOLM—Scandinavia's largest radio telescope is at present under erection at Rao near Gothenburg on the Swedish west coast. Intended for galactic research and for tracing space signals, the telescope will be equipped with a light-metal reflector close to 26 meters in diameter.

Under construction work is a five-story conical tower. One story will house the electronic equipment of the Scandinavian Telesatellite Committee, another will house equipment for measuring the volume and speed of hydrogen clouds in the milky way, while still another will contain equipment to receive data from space rockets.

The parabolic reflector is to be mounted in September. Made of 56 sections of perforated light metal, it is provided with a hyperboloid subreflector. When signals from space hit the big reflector they are deflected towards the subreflector and then focused towards the center of the reflector where there is a one-man receiving laboratory.

There is no access to the lab from the reflector tower. The man in charge will be lifted into it from the outside by a mobile cherry-picker crane.



What do big carriers charge for little packages?

Answer: 25 lbs. Los Angeles to New York

Airline X	\$18.50
Airline Y	\$18.50
Airline Z	\$17.00
Flying Tigers	\$ 9.25

Your minimum shipment via Tigers costs about half of what most other airfreight carriers charge. Most carriers figure a

minimum shipment at 50 lbs. Tigers' minimum is 25 lbs. multiplied by the established commodity rate, or \$4.00 for the shipment . . . whichever is greater.

How can Flying Tigers do it? Simple. They're the Airfreight Specialists. Big shipment or minimum shipment, always specify Flying Tigers—world's largest all-cargo airline.

first in airfreight with airfreight first **FLYING TIGER LINE**



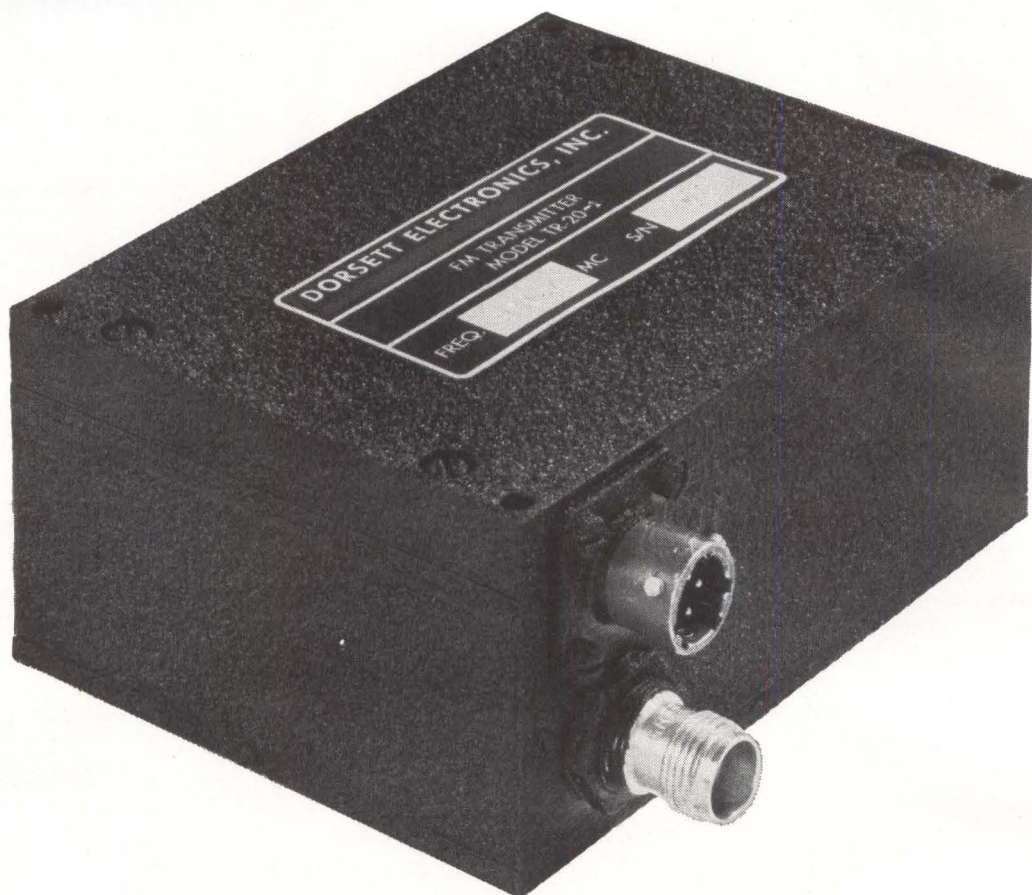

It's only a five watt, solid state, FM telemetry transmitter

We started development on this one four years ago. Last January we put it into production, and have made regular shipments since. In the past four years we breadboarded about a thousand different circuits. We found one that really works. We also found 999 others that almost did. When you're designing for high reliability space communications almost is not good enough.

We call it the TR-20. It transmits a five-watt true FM signal in the standard telemetry band, 225-260 mc. The power consumption is low — one ampere from a 28 volt input. Our lab tests shows that rfi and spurious radiation levels are well below current specs for missile range use.

The photo above is full size. The package is small. It measures 1.75 x 3.0 x 4.0 inches. It weighs 14 ounces.

Electronically it's what you'd expect from a very good telemetry transmitter: Modulation range, 20 to 100,000 CPS \pm 1 db. Deviation, \pm 125 KC. Input sensitivity, one volt RMS for full deviation. Frequency stability, 0.01% (-20° to + 90° C). Distortion, less than 1%. Power supply stability, 0.01% or better for \pm 15% change in supply voltage. Output impedance, 50 ohms. Input impedance 100,000 ohms.

Environmental specs are good too: Shock, 100 G for 11 milliseconds in any plane. Acceleration, 100 G. Vibration, .4 inches D. A. displacement 5 to 50 cps and 20 G from

50 cps to 2 KC in each major axis. Temperature, operational from -40°C to + 100°C.

The TR-20 is compatible with any modulation system . . . PCM, PDM, PAM, FM or any combination thereof. It's also compatible with the full line of telemetry components built by Dorsett Electronics including: Subcarrier oscillators, millivolt oscillators, mixer amplifiers, and PDM keyers. And it's compatible with components and systems built by other manufacturers.

Will it meet reliability requirements for long term space flight? To our knowledge, it hasn't been flown into space yet. Has anyone's? Our customers, the list reads like a Who's Who in the aerospace industry, seem pleased and reports from the field are most favorable.

The TR-20 is a good telemetry transmitter, in fact we think it's the best available today. It should be, the engineers who designed and developed it have as much experience in designing telemetry equipment for space application as anyone in the industry, and more than most. You can order it today for delivery in evaluation quantities in 30 days. Large orders will take a little longer. Want more information? Write us. We'll send a sales engineer if you request. Our address is P. O. Box 36, Tulsa 1, Okla.

Dorsett Electronics, Inc.



BELDFOIL

BREAKS THE NOISE BARRIER!

APPLICATIONS: Beldfoil is effective over the entire audio frequency range. Typical applications include instrumentation, data processing, and telemetering equipment, and any information and measurement circuits.

QUIET PERFORMANCE!

Yes, Beldfoil* shielding definitely breaks the noise barrier. It breaks the noise barrier by *being* a noise barrier. Beldfoil gives *total* shielding . . . 100% isolation between adjacent pairs. For audio and radio frequency, it completely eliminates cross talk, spurious signal impulses . . . and it's ideal for stationary or limited flexing. Beldfoil is lighter in weight, requires less space, and is usually lower in cost.

MINIATURIZES!

Beldfoil shielding reduces the diameter of multi-conductor cables . . . by as much as 66 $\frac{2}{3}$ %. It gives design engineers extra space . . . extra conduit space, extra raceway space, extra console and rack space. Beldfoil shielding means that you can "think small."

ASK FOR DATA SHEET. Get your copy of newly published bulletin 8-63-A and technical data sheet. They give complete information on Beldfoil shielding. Write Belden Manufacturing Company, 415 South Kilpatrick Avenue, Chicago 44, Illinois.

WHAT IS BELDFOIL? It's a lamination of aluminum foil with Mylar** that provides a high dielectric insulation. A patented Belden method of folding*** gives definite benefits. An inner fold creates a continuous metallic path around the surface of the cable. This eliminates any possible inductive effects. An outer fold tucks the cut edge of the aluminum under the Mylar. This gives complete isolation from other adjacent shielded cables.



Typical cross section looks like this.

*Belden Trademark Reg. U. S. Patent Office
du Pont Trademark *U. S. Patent 3,032,604

Belden
WIREMAKER FOR INDUSTRY
SINCE 1902 - CHICAGO

8-1-3

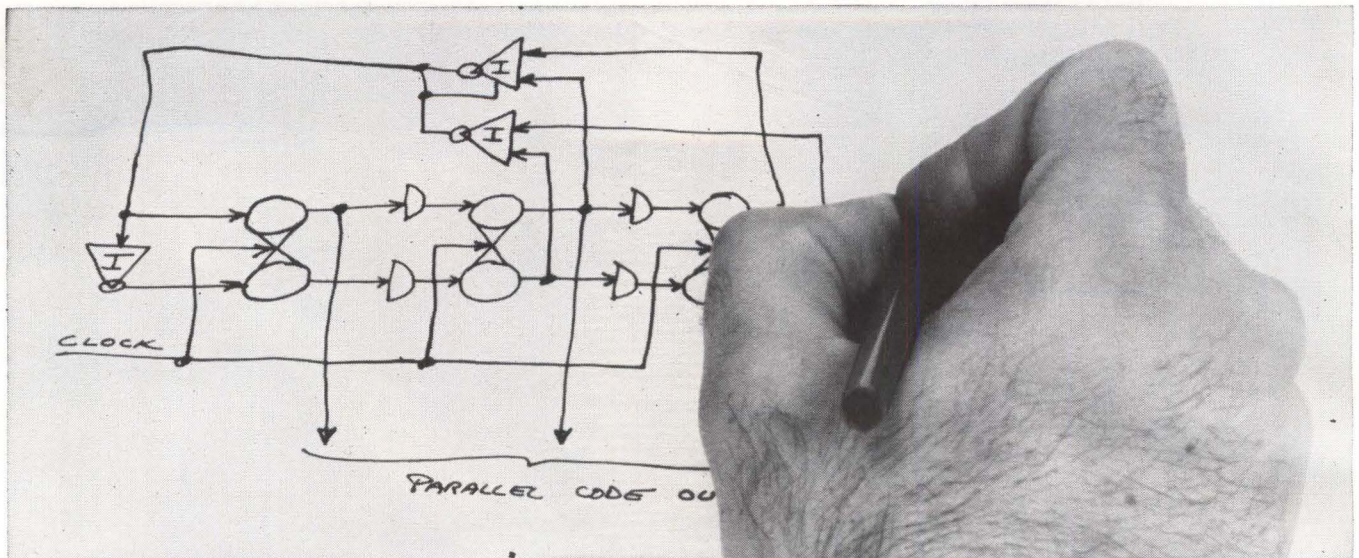

WILL IT WORK AT 10 MC?

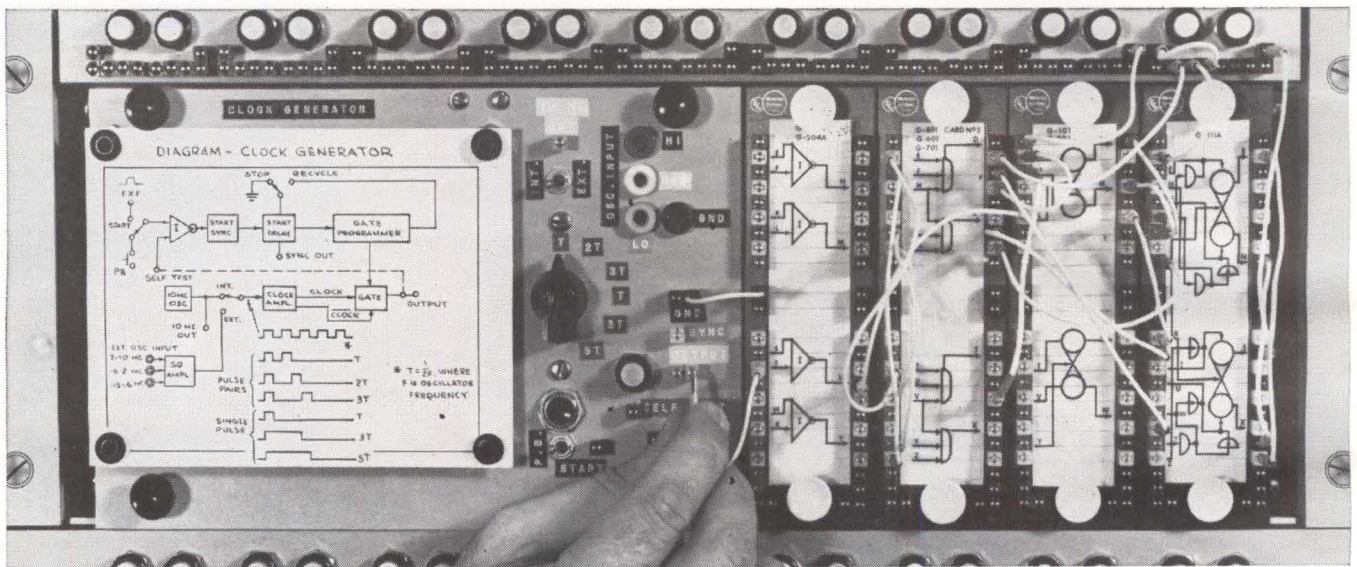

FIND OUT FAST WITH AN EEC_o HIGH-SPEED DIGITAL SYSTEM BREADBOARD

It looks good on paper. Now—what will be the effect of clock duty cycle? Wiring? Propagation delay?

You can get the answers *fast* with EEC_o system breadboard equipment—an exceptionally simple means of formulating and testing digital electronic circuits at clock speeds to 10 Mpps.

This versatile transistor equipment lets you patch up trial circuit combinations with the same catalog modules that go into the final system, perform tests at operating frequencies by pushing a button on the control panel, and get a “stop-action” look at the over-all logic flow.

The built-in clock generator permits fast set-up of a wide range of test conditions, and indicators give you an immediate reading on any part of the circuit. Plastic symbol cards

further speed your work by giving you a road map of the system as you put it together.

You may operate the system slowly to check individual operations or at end-system speeds, introducing high-speed pulses either singly or in pairs. If you want to try an alternative design idea, a few minutes of patching will make your brainstorm a reality.

Discover for yourself this speedy route from paper to prototype. Write for our new breadboard brochure today.

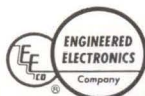

ENGINEERED ELECTRONICS Company

1441 East Chestnut Avenue, Santa Ana, California
Telephone: 547-5651 Cable Address: ENGELEX

STORED PROGRAM PCM GROUND STATION

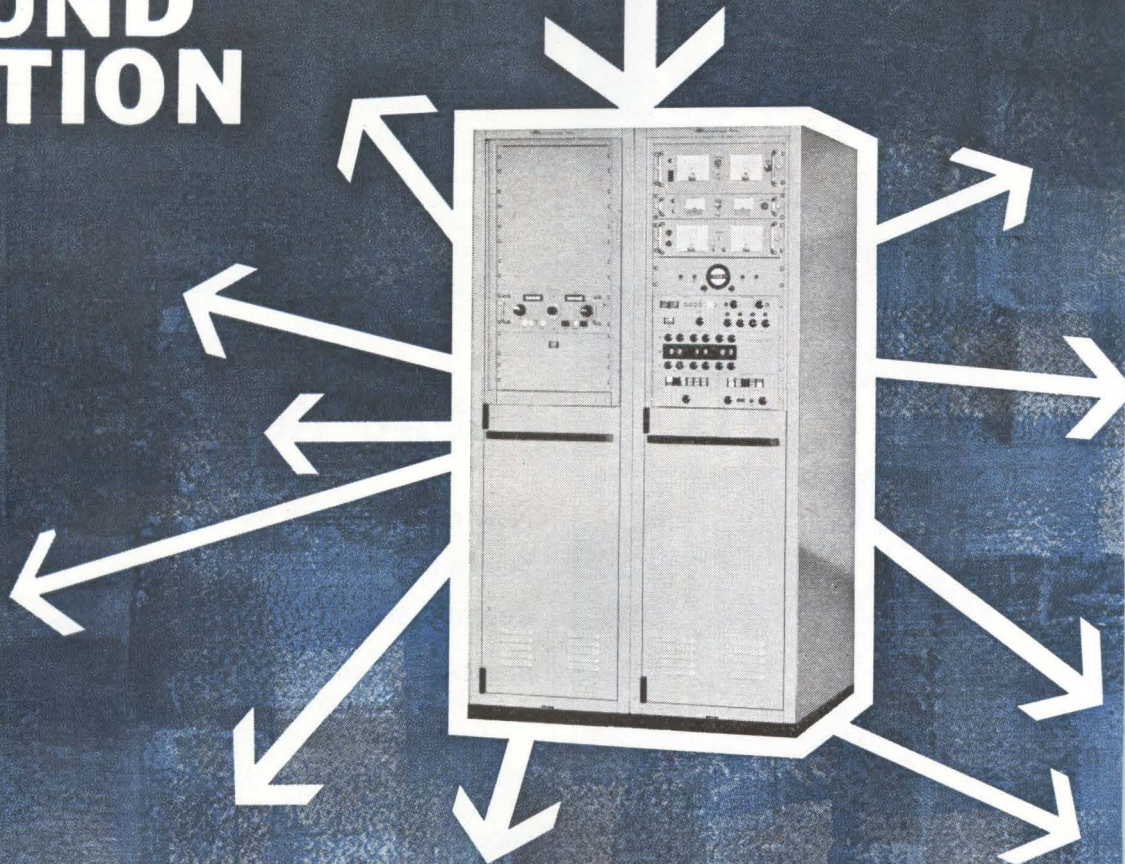

Now a new system by Dynatronics offers automatic control of format selection and distribution of PCM data!

The Dynatronics Stored Program PCM Decommutator is designed to provide a real-time data reduction facility and to permit rapid changes to data distribution as required during a particular mission. This unique system employs magnetic core storage and computer control principles to realize the high flexibility and convenience necessary in high capacity telemetry processing requirements.

■ Universal format capability ■ Rapid format switching ■ Distribution switching on command ■ Bit rates to 1 megacycle ■ Word rates to 125 kc—with simultaneous format changes ■ Variable word length capability—any channel.

WRITE FOR A TECHNICAL BULLETIN that describes how this system can speed your PCM data handling.

**Dynatronics, Inc.**
AEROSPACE ELECTRONICS

Box 2566, Orlando, Florida

OFFICES: COCOA BEACH / HOUSTON / LOS ANGELES / SAN FRANCISCO / WASHINGTON
CIRCLE 65 ON READER SERVICE CARD

and
now...
**MASER
TUBES**

in

VITREOSIL[®]

PURE

FUSED

QUARTZ

For experimental gaseous optical maser (laser) applications. Precision bore stock size tubes are ready for filling complete with graded seals to Pyrex or Kovar and quartz windows in half, quarter and tenth wave flatness — transmission from U.V. through I.R. Vitreosil permits high bake-out temperatures, does not contaminate gases and maintains dimensional stability over a wide temperature range. Write for details.

13



THERMAL AMERICAN
FUSED QUARTZ CO.
RT. 202 & CHANGE BRIDGE RD.
MONTVILLE, NEW JERSEY

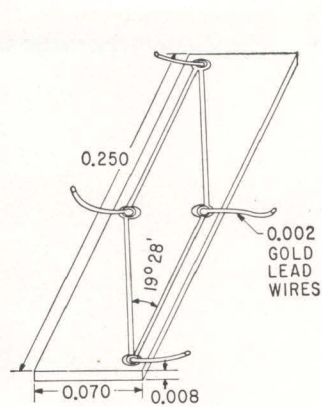

ALL DIMENSIONS ARE IN INCHES

EPITAXIAL piezoresistive devices are claimed to have the advantages of diffused strain gages plus greater process reproducibility. Skew-bridge sensor (left) and sheet-shear sensor are two of the silicon epitaxial devices described by E. G. Carson, of GE Semiconductor Products dept

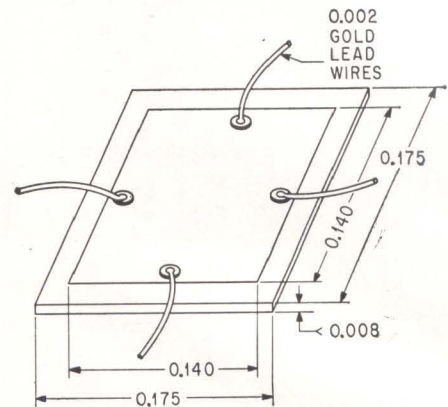

Future Keyed to MATERIALS

New devices such as lasers and semiconductors demand closer control

By **MICHAEL F. WOLFF**
Senior Associate Editor

BOSTON—Successful development of the host of new devices now undergoing exploratory research will depend largely upon understanding and controlling materials properties considerably more subtle than those dealt with in the transistor era.

Concern with this problem and its possible solutions dominated the conference on advanced electronic materials, sponsored here last week by the Metallurgical Society of AIME. It was generally agreed that besides requiring more work in such basic areas as crystal growing and impurity control, institutions will have to provide an environment where the materials scientist and electronic device and circuit designer can work together almost as one man.

FUTURE TRENDS—A panel discussion on trends in electronic materials agreed that this interdisciplinary coupling was essential to future progress and would be lead-

ing to even more team effort. Motorola vice president C. L. Hogan pointed out that in semiconductor microelectronics you can't design a circuit anymore without going back to the basic limitations of the material, since the circuit properties are determined in the materials fabrication step.

"We need people who know materials and can specify materials," Hogan said, adding that while these people will have to invent new circuits compatible with the microelectronics technology, such circuits will, in the foreseeable future, remain based upon silicon and the processes of diffusion and epitaxy.

Materials available for such new devices as the injection laser and ultrasonic amplifier are primitive compared to what will be needed for useful applications, according to Morris Tanenbaum, director of Bell Labs' solid-state laboratory. He cited several areas that require work, including:

- Laser crystals, where optical quality is a major problem. Here it may be necessary to impose specifications on the uniformity of impurity doping several orders of magnitude more demanding than in current semiconductor technology

- Piezo-optic materials, where a similar situation exists — optical properties are sensitive to strain and

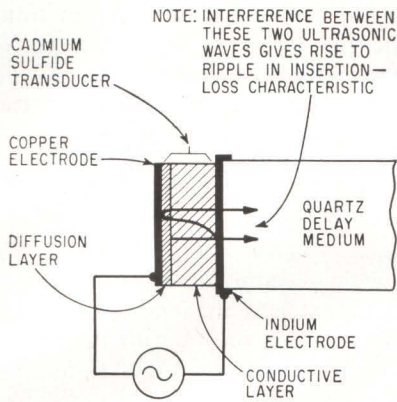

DIFFUSION-LAYER ultrasonic transducer has thin, highly resistive layer formed by diffusing copper into CdS (Bell Labs)

PROPERTIES

losses occur from trace impurities

- Magnetoelastic resonators and delay lines, where single crystals of ferromagnetic garnets are needed that are of high quality and several times larger than are now available.

- Piezoelectric ultrasonic amplifiers, which will require fabrication techniques more sophisticated than those used in present germanium and silicon devices.

The rate at which experimental devices are converted to useful devices will depend upon the skill of the materials man in solving such problems and also in his gaining an understanding of such subtle materials properties as electron lattice interactions, Tanenbaum concluded.

Technical reports at the three-day meeting emphasized materials problems related to lasers, ultrasonic devices and thermoelectrics. Here are the highlights:

LASERS—Epitaxially grown GaAs laser diodes were described by Herbert Nelson, of RCA. Preliminary tests indicate these may be better than the conventional diodes using zinc diffused into *n*-type GaAs. Technique allows: 1) more freedom in choosing the dopants, 2) fabricating diodes whose *n* and *p*-type impurity distributions vary considerably from those possible with diffusion, and 3) achieving

"A GUY COULD GET KILLED IN HERE"...

... this place is like a roller-skating rink! What's all the traffic? I had to *fight* my way into the instrument room!

Oh, hello, Rip! Yes, we're doing a rush business here today! Every instrument in the joint's been in and out of here at least twice. Particularly amplifiers — just can't get 'em back here fast enough to meet all the requests!



Amplifiers? Any special types really hot right now?

Dunno. All my data-acquisition types have been out for about a week now. And all my audio amplifiers are down the hall in Dept. 23. Video amplifiers have been on the most-wanted list, too. And here are three requests for RF amplifiers I can't even fill until tomorrow at the earliest!

What you need are more amplifiers like Krohn-Hite's DCA-10 — a stable ten watts, tenth-percent distortion, wide band!

We're always using the DCA-10's you sold us — as audio amplifiers, mainly. But how about the other applications I've got to fill?

But nothing! You're short on data-acquisition types? Look — the DCA-10's direct-coupled, goes all the way down to dc. Only 0.2% distortion at .01 cps. Perfect on data circuitry. And talk about video amplifiers — the DCA-10 is one in disguise! No droop on a step function from a DCA-10, as you'd get from a capacitor-coupled amplifier! And with a megacycle bandwidth, you get a rise time in the order of 0.1 microseconds.

Yeah, the top end of a megacycle would serve the needs of many of the requests for RF amplifiers.

Now you're thinking Krohn-Hite! Actually, there's really nothing like it for the money — frequency response flat within a db all the way up, stable dc level, too, and low hum and noise.

You certainly don't have low hum and noise!

What do you expect — *I'm a rep!* Just one more thing — when you need 20 watts push-pull — two DCA-10's cascaded, one in the unity gain position, will give it to you. For *more* power, its big brother, the DCA-50 gives 50 watts single-ended or 100 watts push-pull, up to 500kc, with the *same* clean specs of the DCA-10. Now, anything else I can tell you about the DCA-10?

Yeah — price and delivery on twenty!



**KROHN-HITE
CORPORATION**

580 Massachusetts Avenue, Cambridge 39, Mass.
Area Code 617 491-3211

Pioneering in Quality Electronic Instruments

IDS PROGRESS REPORT

252 CHANNEL AIRBORNE PCM TELEMETRY

Model 12-10 was developed and delivered in 90 days. This 420 cubic inch solid-state system features $\pm .2\%$ accuracy from -20°C to $+85^{\circ}\text{C}$ and $\pm .1\%$ accuracy from $+10^{\circ}\text{C}$ to $+50^{\circ}\text{C}$.

The package includes a 90-channel primary multiplexer, a 135-channel subcommutator and a 45-channel subcommutator. Of the total 252 channels, 245 are data channels and 7 are used for frame

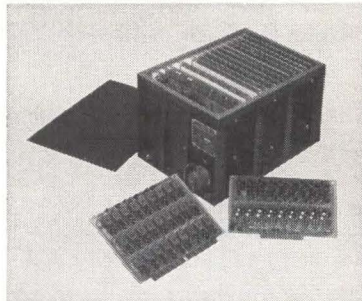

synchronization. Sample-and-hold is provided for accurate measurement of ac signal voltages, and remote low-level subcommutation can be added with minor modifications.

The digital data output — obtained from a compact A-D converter — is a 10-bit serial binary code which includes a nine-bit data sample plus a single bit for odd parity. The system weighs just 15 lbs. and consumes only 7 watts power. An optional r-f package designed specifically for Model 12-10 is available on request.



An IDS Technician checks out the PCM package using specially designed IDS test equipment. Each unit is individually checked for performance and workmanship and copies of test data are submitted with delivery.

COMPATIBLE GROUND PCM STATION

Design considerations for a modular, solid-state PCM ground decommutation station compatible with the Model 12-10 airborne equipment and other IRIG systems have been completed. The station accepts serial, PCM/FM telemetry data and furnishes digital, analog and quick-look readouts. It is capable of operation in subcommutation or super commutation modes and each major assembly is designed for mounting in standard 19-inch relay racks.

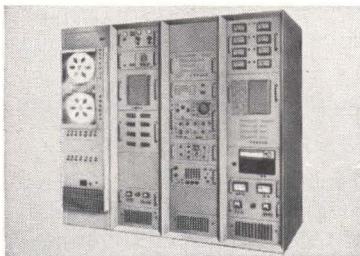

These examples have been selected from a broad capability. For further information, please write or contact our Marketing Manager.



INTERNATIONAL DATA SYSTEMS, INC. • 2925 MERRELL ROAD
DALLAS 29, TEXAS • TELEPHONE 214 FL 7-6271 • DESK-FAX NVG

more perfect junctions, Nelson said.

Method is epitaxial growth from the liquid phase. A *p*-type GaAs wafer whose major surfaces are (100) planes is placed at one end of a graphite boat and a tin-GaAs melt at the other. The boat is in a quartz tube furnace tipped so as to keep the melt and wafer separate. Temperature is raised until the tin is saturated with GaAs and the furnace is then tipped to bring the melt in contact with the wafer. The tin dissolves a slight amount of the wafer to leave a mirror-like (100) plane.

As temperature drops epitaxial regrowth sets in and a tin-doped *n* region is formed on the *p*-type GaAs substrate. This is then cleaved into laser diodes whose junctions will be perpendicular to the (110) cleavage planes. Junctions formed in this manner are expected to have less imperfections and therefore lower thresholds for laser action.

An example of how laser operation depends on perfect crystals was provided in a paper by M. H. Pilkuhn and H. Rupprecht, of IBM. They reported c-w operation at only 8.2 ma from an unsilvered GaAs diode with four sides cleaved and a perfectly planar junction. This was at 77 deg K in a diode whose junction area was on the order of only 10^{-5} sq cm.

ULTRASONIC AMPLIFIERS—

Equations to evaluate performance of piezoelectric semiconductors in ultrasonic amplifiers were presented by W. E. Newell, of Westinghouse Electric. At a power density of 10 w per cu cm the equations give maximum gains for CdS and ZnO of approximately 70 db per cm at around 50 Mc.

In a statement from the floor, G. C. Gerhard, of GE, said he felt geometry could be designed for better heat transfer so that at, say, 100 w per cu cm it might be possible to reach 155 db per cm at 150 Mc.

Latest data for a new ultrasonic transducer was reported by N. F. Foster, of Bell Labs. He said 200-Mc bandwidths at 300 Mc, and 47-db insertion loss had been measured in a CdS diffusion layer transducer (see figure). Foster is presently investigating ways to remove ripple so the device can be used as a delay line with quartz as the delay medium.

NEWS

Boron nitride: the better solution to high-temperature dielectric problems

If you need just one of the exceptional properties of our boron nitride, chances are you'd be better off with another material. BN isn't cheap.

But when you need a material that gives you two or more exceptional properties like these—a 4+ dielectric constant and high dielectric strength and high thermal capability and excellent thermal shock resistance and easy machinability into the shape you want—then boron nitride becomes a bargain.

Some pertinent data:

A 1" diameter disc of our BN, 10 mils thick, gives you dielectric strength up to 1450 volts/mil.

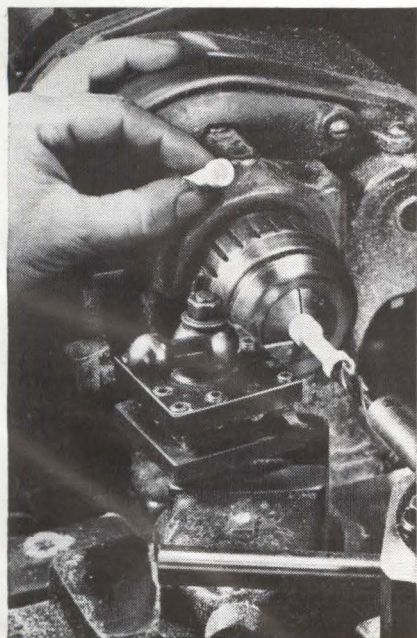

You can easily machine boron nitride into intricate shapes with standard tools.

In a non-oxidizing atmosphere, you can use our solid BN forms at temperatures as high as 5000 F. That's because it's a refractory. In an oxidizing atmosphere, the forms will work for you up to 1800 F.

You can just about forget thermal shock, because boron nitride has exceptionally low thermal expansion perpendicular to molding direction and exceptionally high heat conductivity and mechanical strength.

Match all these properties against what you'd ask for in a high-temperature dielectric and you'll see why boron nitride is at work now in tough applications—like these:

- **magneto hydrodynamic generator**—a BN tube encloses a beryllium oxide tube to insulate against 20,000-30,000 volts. Our material withstands the high temperatures generated through the beryllium oxide tube by jet engine thrust, and its lubricity permits slipping of the tubes as they expand and contract.

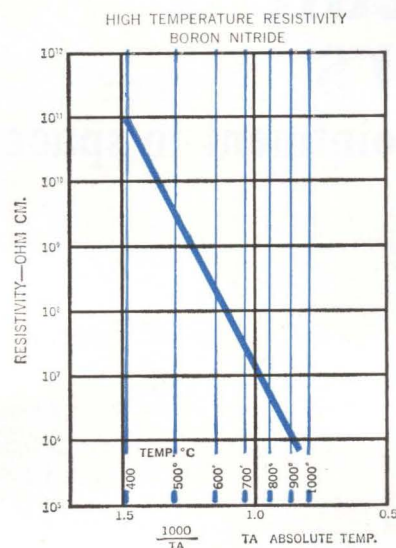

- **arc jet engines**—boron nitride finds varied uses in ion engine chambers, most of them involving its dielectric strength and its ability to stand up in the 3000 F range.

- **hydrogen gas heater**—boron nitride sections support and contain a tungsten element which heats the hydrogen to about 5000 F in an apparatus to test what happens to other materials at elevated temperatures. Portions of the boron nitride pieces reach 5000 F while other portions are at only 2000 F. No thermal failures.

- **electron beam gun spacers**—boron nitride spacers are used because of their thermal shock resistance, their electrical insulating properties, and because they're non-reactive with most vaporized metals.

- **coil form**—its electrical resistivity and thermal shock resistance made BN the choice for a wire-wound form that measures jet and rocket engine housing temperatures.

Can boron nitride solve a high-temperature dielectric problem for you? Does the fact you can machine it yourself into the part you want have interest? Write for our boron nitride technical bulletin to Electronics Division, Dept. E-09, The Carborundum Company, Latrobe, Pa.

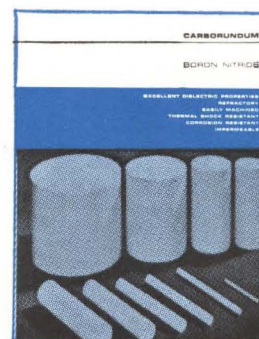

CARBORUNDUM



circuit designers...is your appointment in space with Hughes?

Today, Hughes is one of the nation's most active aerospace/electronics firms. Projects include: F-111B PHOENIX Guided Missile System, TOW Anti-Tank Missile, SURVEYOR Lunar Spacecraft, SYNCOM, VATE, ARPAT, POLARIS, Hard Point Defense and others.

This vigor promises the qualified engineer or scientist more and bigger opportunities for both professional and personal growth.

Many immediate openings exist. The engineers selected for these positions will be assigned to the following design tasks: the development of high power airborne radar transmitters, the design of which involves use

of the most advanced components; the design of low noise radar receivers using parametric amplifiers; solid state masers and other advanced microwave components; radar data processing circuit design, including range and speed trackers, crystal filter circuitry and a variety of display circuits; high efficiency power supplies for airborne and space electronic systems; telemetering and command circuits for space vehicles, timing, control and display circuits for the Hughes COLIDAR (Coherent Light Detection and Ranging).

If you are interested and believe that you can contribute, make your appointment today.

Please airmail your resume to:
Mr. Robert A. Martin
Head of Employment
Hughes Aerospace Divisions
11940 W. Jefferson Blvd.
Culver City 16, California

We promise you a reply within one week.

Creating a new world with electronics

HUGHES

HUGHES AIRCRAFT COMPANY
AEROSPACE DIVISIONS
An equal opportunity employer.

IF YOU NEED

ENERGY

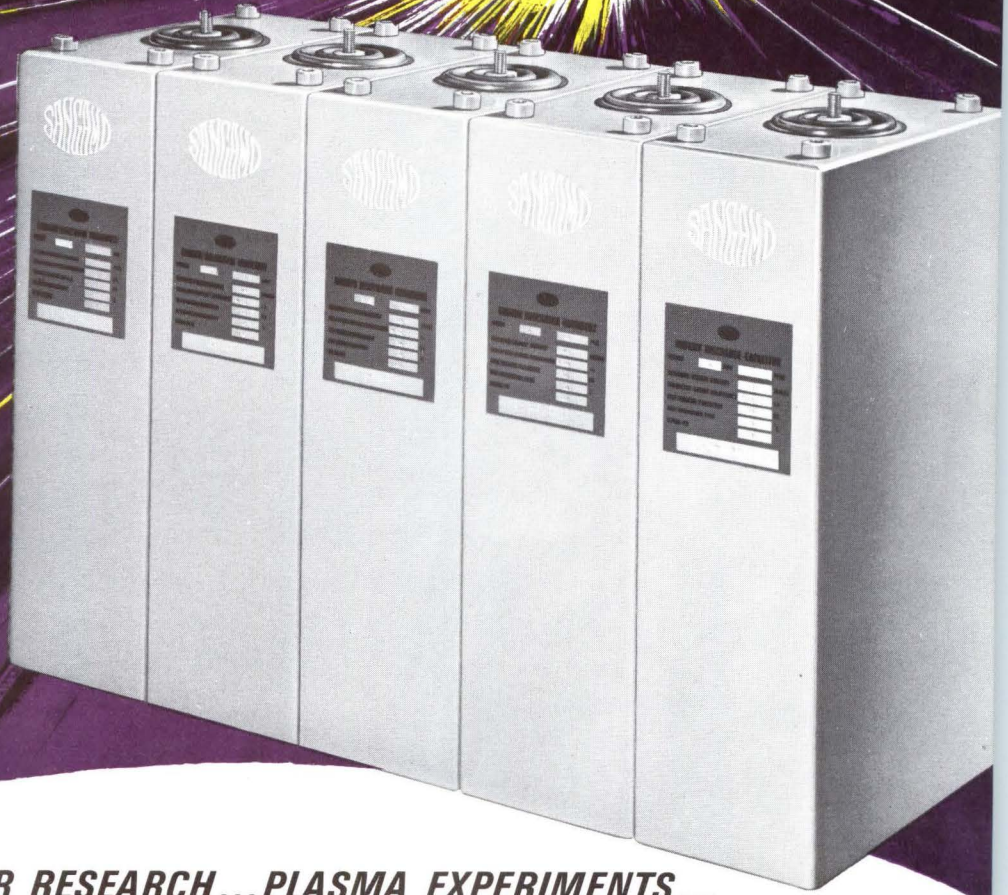

***FOR LASER RESEARCH...PLASMA EXPERIMENTS...
METAL FORMING...IMPULSE GENERATORS***

Whenever large amounts of energy are required to be delivered in microseconds... Sangamo can supply the ENERGY DISCHARGE CAPACITORS that meet your specifications. As the leader in the development of Energy Capacitors, Sangamo has designed and manufactured special low inductance, high voltage units for the most rigid applications. A complete line of type EDC Energy Discharge Capacitors and a complete line of type LDC Laser Discharge Capacitors are *available for immediate delivery from stock*. ■ Sangamo type EDC Energy Discharge Capacitors have very low inductance, high voltage, and long life expectancy characteristics. ■ Sangamo type LDC Laser Discharge Capacitors are designed for the advanced XENON tube voltages and the discharge current requirements necessary for laser pumping. ■ We welcome the opportunity to assist you with your energy capacitor applications. Send for Bulletin 2610.

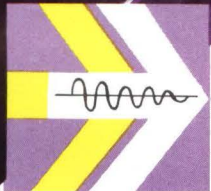

SANGAMO
SANGAMO
SANGAMO
SANGAMO
SANGAMO
SANGAMO
SANGAMO
SANGAMO
SANGAMO
SANGAMO
SANGAMO
SANGAMO
SANGAMO
SANGAMO
SANGAMO
SANGAMO
SANGAMO
SANGAMO
SANGAMO
SANGAMO
SANGAMO
SANGAMO
SANGAMO
SANGAMO
SANGAMO
SANGAMO



SANGAMO ELECTRIC COMPANY
SPRINGFIELD, ILLINOIS

EC63-6

versatile

RECORDER/REPRODUCER.

Sangamo 4700 Series...unparalleled (flexibility and convenience in data acquisition and reduction. Eight speeds are instantly available with the turn of a switch. Get reel-to-reel or continuous tape loop by turning another. Four automatically selected speeds of FM (dc to 20 kc) and Direct (300 cycles to 300 kc) record/reproduce electronics are in a single module. Adjust a knob for variable search from

40 ips to 150 ips. And these controls are right before your eyes, on the *front* of the cabinet. Tape width?... $\frac{1}{4}$ " to 2". With all this convenient versatility, Sangamo's unique light-mass speed-control system provides undistorted data reduction... unsurpassed recording/reproducing accuracy. And, the 4700's ability to handle *your* instrumentation data is backed by the industry's first one-year warranty.

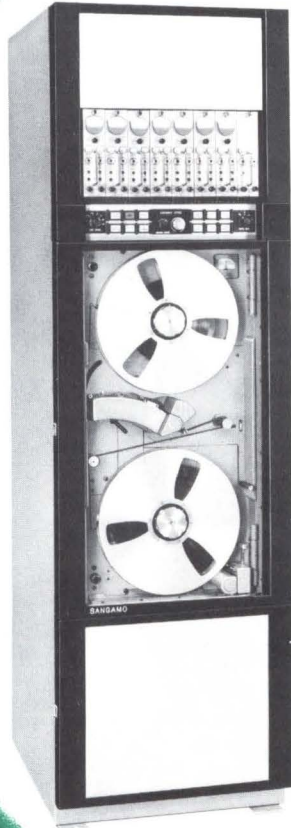

SANGAMO ELECTRIC COMPANY
SPRINGFIELD, ILLINOIS



SANGAMO
SANGAMO
SANGAMO
SANGAMO
SANGAMO

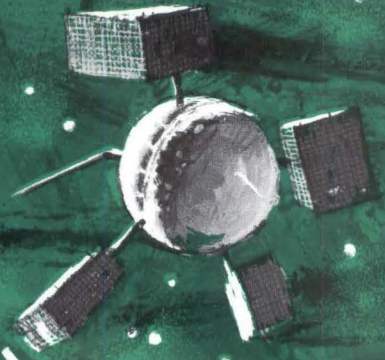

R-F Systems, Instruments and Components

Today, as always, the knowledgeable buyer knows there are both tangible and intangible values in every product purchased. ■ At Telerad, we believe in stressing those factors that will establish us in your mind as a truly dependable source. A dependability that's built on creative research . . . on rigid electrical and mechanical testing as the standard for quality control . . . on our being customer-minded so that you get precisely what you require and on time, too. ■ Whatever your field of interest — systems or component engineering, research and development or straight purchasing of standard components — don't you think it would be a good idea to try us at Telerad next time?

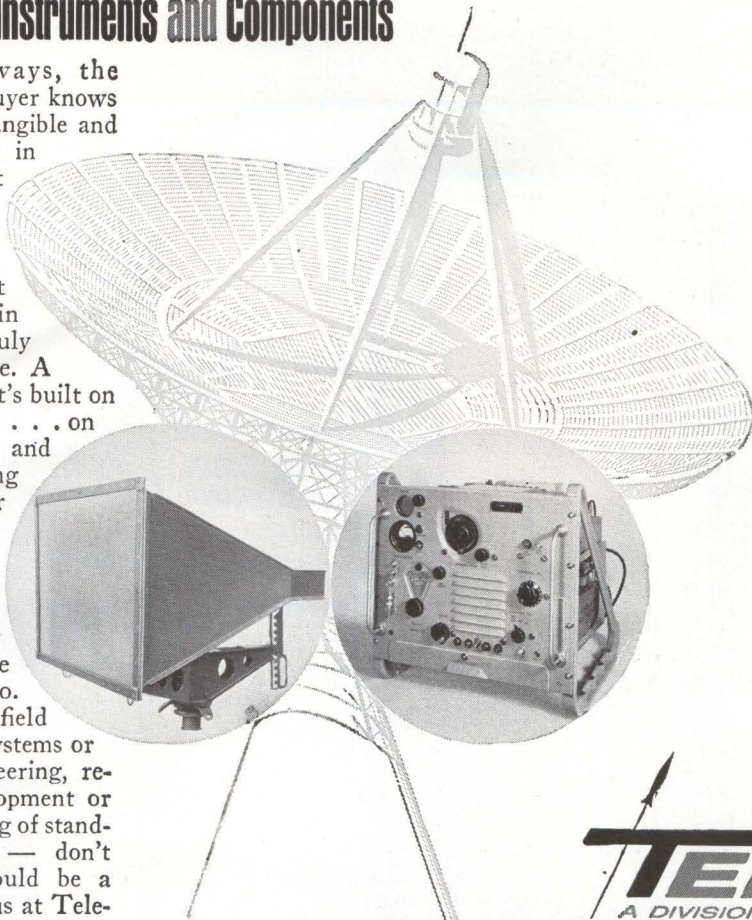

FROM AN ESTABLISHED SOURCE

TELERAD
A DIVISION OF LIONEL CORPORATION

Route 69-202 (South), Flemington, N. J. Phone: STate 2-2011, Area Code 201
CIRCLE 202 ON READER SERVICE CARD

Origin

SILICON SMALL TECHNOLOGY ASSURES MAXIMUM STACK RELIABILITY IN SEMICONDUCTORS SP MODEL

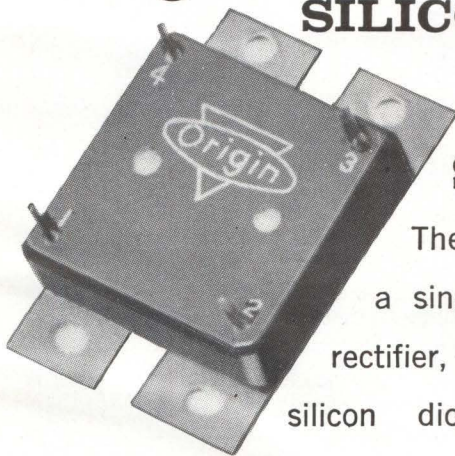

The Silicon small stack, a single phase, full-wave rectifier, is composed of four silicon diodes, Model SE-05,

sealed into synthetic resin case as a unit for use in a single phase, full-wave rectifying system.

Outstanding features:

1. Wide temperature tolerance -55°C ~ +130°C
2. High peak inverse voltage Maximum 1,000V
3. High inverse resistance Several hundred megohms
4. High efficiency Continuous 1 A
(1.5 A when mounted on chassis)

Main Products:

Semi-conductors, condenser type spot welder, synthetic enamel and miniature ball bearing.

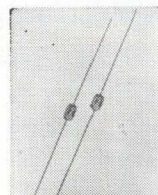

SM-150: Available in 4 physical configurations. PIV: 400-1000 Volts. Max. AC input voltages (RMS) of 280, 420, 560 and 700 Volts. Max. Reverse Leakage Current (PIV) 10A. Max. Average Rectified Current (Single-phase, half-wave) 150 mA. Surge Current (for 1 cycle) 10A.

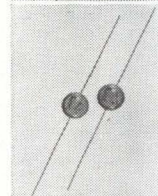

SW-05(SE-05): Available in 4 physical configurations. PIV: 400-1000 Volts. Max. AC input voltages (RMS) of 280, 420, 560 and 700 Volts. Max. Average Rectified Current (Single-phase, half-wave) 500mA. Surge Current (for 1 cycle) 16A.

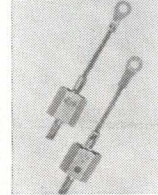

S-3: Available in 5 physical configurations. PIV: 300-1000 volts. Max. AC input voltages (RMS) of 210, 280, 420, 560 and 700 Volts. Max. Average Rectified Current (Single-phase, half-wave) 3A. Surge Current (for a half cycle) 300A. Ambient temperature: -55 to +130°C for all types.



ORIGIN ELECTRIC COMPANY LTD.

1-195 Takadaminami-cho, Toshima-ku,
Tokyo, Japan
Cable Address: "ORIGINELE TOKYO"

PCM

TELEMETRY GROUND STATION

A BENDIX/CORRELATED DATA PRODUCT

*from
Bendix-Pacific*

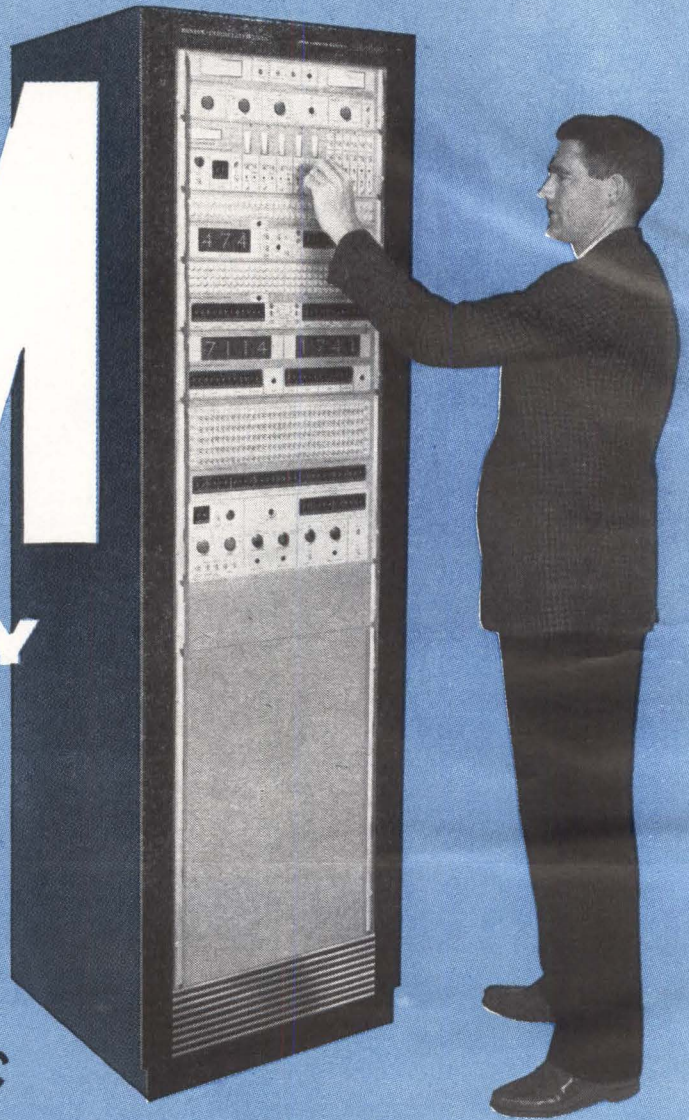

The latest from Bendix-Pacific — Model DDS-1000 solid-state Pulse Code Modulation ground station. This is a digital decommutation station capable of demodulating and processing all serial digital information. Outputs are available in a wide variety of serial or parallel digital formats, as well as analog signals for real time visual analysis of data. Flexibility is implemented with self-powered modular sub-assemblies for universal applications, as well as mechanization for special requirements. Silicon semiconductor devices are used throughout the system for high reliability and optimum performance over a wide temperature range. The DDS-1000 is adaptable to all bit, word, frame, and code formats now in use or planned for the future. The station incorporates an advanced bit synchronizer and signal conditioner for processing serial PCM video signals, as well as a signal simulator for complete self-check. The complete station occupies only a single seven-foot instrumentation rack.

Model DDS-1000 is a development of Correlated Data Systems Corporation and available exclusively from Bendix-Pacific. Contact Bendix-Pacific, North Hollywood, for complete information.

Bendix-Pacific Division



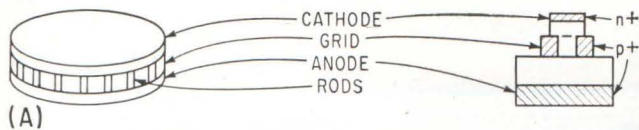

(A)

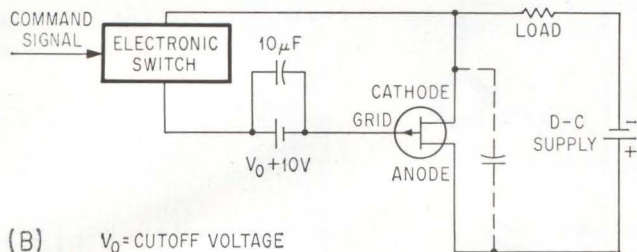
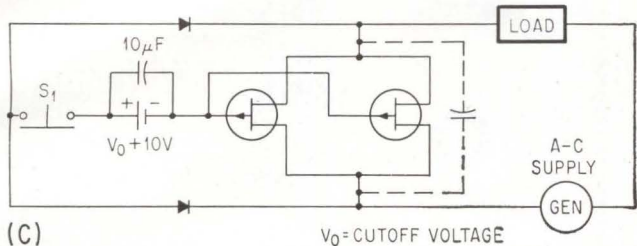
(B) $V_0 =$ CUTOFF VOLTAGE(C) $V_0 =$ CUTOFF VOLTAGE

ROD ARRANGEMENT and cross-section through rod (A). Basic circuits for d-c switching (B) and a-c switching (C)

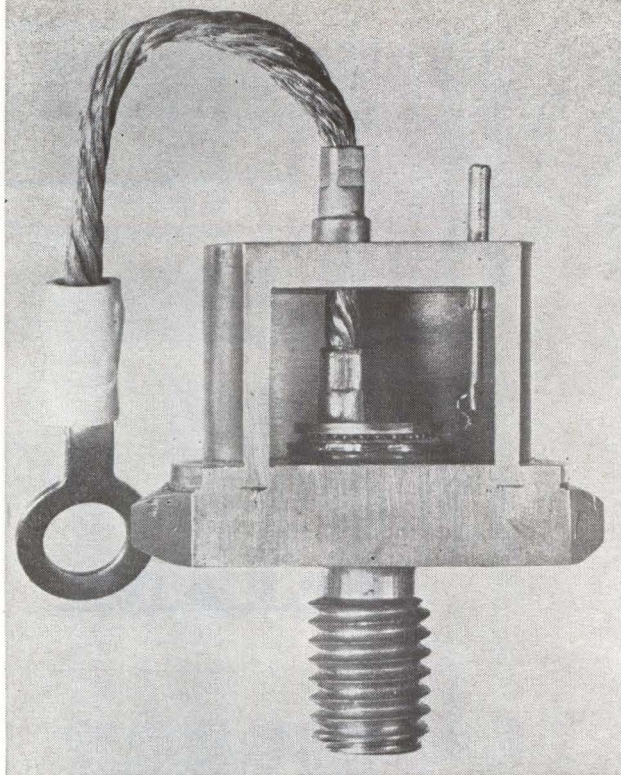

CUTAWAY view of new high-power Tecnetron. Note gear-like rod arrangement

New Tecnetrons Switch 15 Amp

French now planning field-effect devices to switch 50 amp

By **ARTHUR ERIKSON**
McGraw-Hill World News

PARIS—A French-developed field-effect semiconductor device that can switch high d-c currents made its official debut today at the International Exhibition of Industrial Electronics held at Basle, Switzerland.

Prototype versions of the device, called the high power Tecnetron, have nominal continuous ratings of 10 amp and break capability higher than 15 amp. They handle a-c or d-c to 150 v, with forward drop less than 2 v and residual current of 20 ma or less. Peak-inverse voltage rating is 300 to 400 v.

The device switches fast, too; on time is in the order of 1 μ sec and off time is 10 times faster. And since it acts as a diode in the conducting

state but as a cutoff pentode in the pinched condition, the high-power Tecnetron can be used for proportional control as well as on-off applications.

Slated to follow the 10-amp versions that will be in pilot production by early next year are 50-amp units both in germanium and silicon. The silicon units will have voltage ratings to 500 v and piv of 1,000 to 1,200 v (see table). But most important, the power-handling potential of this family of devices is practically unlimited—units can be connected in parallel directly with no special matching.

DESIGN—The high-power Tecnetron differs from the high-frequency communications version (ELECTRONICS, p 18 May 17) in structure and operation. Instead of a single *n*-type germanium rod, it has many rods sandwiched between a common base or anode plate and a cathode plate. The rods are *n*-type germanium of relatively high resistivity with a *p*+ layer at one end and an *n*+ layer at the other. A grid of *p*+ material surrounds the *n*-type rods over part of the height between the plates.

With a forward voltage applied between the anode and cathode plates, but no voltage applied to the grid, the device acts as a diode with carrier injection at both electrodes. But when a negative cutoff voltage is applied to the grid, it extracts minority carriers and a donor space charge develops to block carrier flow between anode and cathode.

For complete cutoff, grid bias ranges from -60 to -90 v. Up to cutoff, the I-V curve flattens out as bias increases so the family of curves resembles that of a pentode. With no grid bias, however, the curve has a diode-like look. Bias for complete cut-off will be reduced to -30 to -60 volts for the future 50-amp versions.

SWITCHING CIRCUITS — Basic circuit for using the high-power Tecnetron as a d-c switch is shown. The electronic switch in the grid circuit can be built around a fast low-power silicon controlled rectifier, or

FM

PDM

DIRECT

PCM

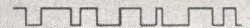
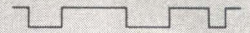
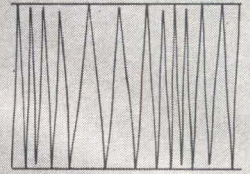
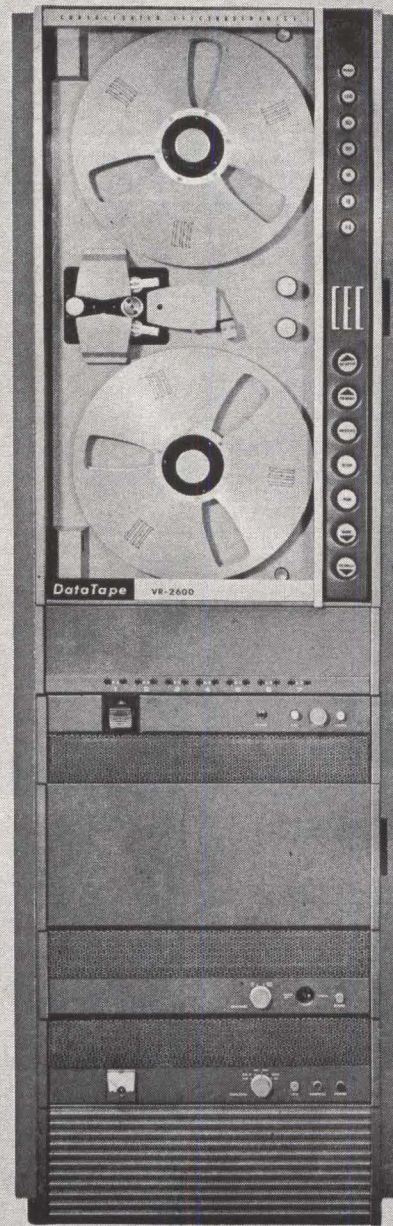

Standard of excellence in four languages

When it comes to versatility, there isn't a better recorder/reproducer in its class than CEC's VR-2600. This six speed, push-button-controlled multi-channel wide band data system handles d-c to 40 kc and d-c to 80 kc FM, 400 cps to 600 kc Direct, IRIG PDM and 1000 bit/inch parallel PCM recording/reproducing...the four languages of magnetic tape storage.

Embodying unique concepts of accuracy, simplicity and reliability, the VR-2600 is excellent for environmental testing, structural or transient studies, radar recording or telemetry. It's at home in laboratory, mobile, shipboard, trailer or blockhouse environments.

Designed using all solid state electronics for low power consumption, the VR-2600 is actuated by color coded, back-lighted pushbuttons. A complete 7-or 14-channel record and playback system is housed in a single or dual cabinet (optional) with conditioning amplifiers available for Direct, FM, PDM and PCM techniques. Exceptionally

low skew allows parallel PCM recordings of 1000 bits per inch. Six speeds in two ranges ($1\frac{1}{8}$ -60 ips; $3\frac{3}{4}$ -120 ips) are available as standard equipment.

Need further information about the VR-2600? Call or write for Bulletin CEC 2600-X21.

CEC

Data Recorders Division

CONSOLIDATED ELECTRODYNAMICS

A Subsidiary of Bell & Howell • Pasadena, Calif. 91109

ERASE RE-USE TAPE

it's easy with



CEC's high performance Automatic Tape Degausser

Easy to operate, CEC's TD-2903 Automatic Tape Degausser de-gausses magnetic tapes to a nominal 90 db below saturation level in only 120 seconds. The TD-2903 accepts all reel sizes, can be used with CEC, EIA or MIL-R-22842 reel-hubs utilizing 5/16 inch or 3 inch center holes. Over-all reel diameter can be from 3 inches to 14 inches. Tape widths from 1/4 to 2 inches (including television tapes) are accommodated. Weighing only 90 lbs. (15"x16"x23") the TD-2903 can be operated on a bench top, in a RETMA rack or cabinet. Need more information? Call or write your CEC office for Bulletin 2903-X4.

CEC

Data Recorders Division

CONSOLIDATED ELECTRODYNAMICS

A Subsidiary of Bell & Howell • Pasadena, Calif.

CIRCLE 77 ON READER SERVICE CARD

electronics • SEPTEMBER 6, 1963

CHARACTERISTICS OF BIPOLAR HIGH-POWER TECNETRON

	Available Now Germanium	Projected Germanium	Projected Silicon
Continuous current rating (I_n)	10 amp	> 50 amp	> 50 amp
Circuit break rating	≥ 15 amp	> 100 amp	> 100 amp
Forward voltage drop (at I_n)	≤ 2 v	≤ 2 v	≤ 2 v
Residual current	$0.002 I_n$	$0.001 I_n$	$< 0.0001 I_n$
Grid bias (V_{go}) for complete pinch-off	60-90 v	30-60 v	30-60 v
Peak energy drawn by grid (transient)	$\approx I_n V_{go} 10^{-6} j$	$0.5 I_n V_{go} 10^{-6} j$	$0.5 I_n V_{go} 10^{-6} j$
Average power drawn by grid	$2 I_n V_{go} 10^{-3} w$	$I_n V_{go} 10^{-3} w$	$< I_n V_{go} 10^{-4} w$
Peak inverse voltage	300-400 v	400 v	1,000-1,200 v
Duty voltage rating	≈ 150 v	150-200 v	400-500 v
Intrinsic OFF switch time	$\approx 0.1 \mu sec$	$\approx 0.1 \mu sec$	$\approx 0.1 \mu sec$
Intrinsic ON switch time	$\approx 1 \mu sec$	$\approx 1 \mu sec$	$\approx 1 \mu sec$

a power transistor, switched by a low-power bistable Tecnetron or a unijunction transistor.

To function properly in the grid switch, the scr must be able to pass in the conducting state during an interval of 2 to 3 μsec a peak current equal to one-third of the load current. In the blocking state, the scr must withstand the Tecnetron's cutoff grid voltage. An scr rated for 0.5 amp and 100 v, for example, could handle a Tecnetron with 30-amp breaking capacity.

Requirements are the same for a power transistor used to switch the cutoff voltage onto the Tecnetron grid. A Texas Instruments' 2N1046, for example, would suffice for Tecnetrons with breaking capacity up to at least 30 amp.

For highly inductive loads, an R-C network is added in the grid circuit to control the speed of applying cutoff voltage to the grid. Otherwise, the inherent 0.1- μsec off time of the Tecnetron is so fast overvoltages may develop across the load. At the same time, so that injection of minority carriers at the anode won't upset cutoff, the speed of voltage buildup across the anode and cathode must be matched to the slower breaking time by a capacitance shunt (indicated by dotted lines in the basic schematic).

A-C SWITCH—To switch a-c, the basic circuit is two Tecnetrons inverted in parallel with a common grid circuit. The grid source is connected through two diodes so that the voltage between the grid and the cathode-anode connection at each end is always at least equal to the cutoff voltage. The two diodes also isolate the grid and power circuits. No special circuit tricks are neces-

sary for a-c switching, but the Tecnetrons must be mounted on separate heat sinks insulated from each other. An electronic switching circuit would in actual practice replace the mechanical switch shown for simplicity's sake in the grid circuit.

The high-power Tecnetron (*Te* for its inventor Dr. Stanislas Teszner, *cnet* for Centre National d'Etudes des Telecommunications where Teszner developed his original high-frequency communications field-effect devices, plus *ron*) was developed by a Franco-Belgian pair of electrical equipment manufacturers—Forges et Ateliers de Constructions Electriques de Jeumont and Ateliers de Constructions Electriques de Charleroi. In the United States, Atlantic Instruments and Electronics Inc. of Boston will produce and market the device under the tradename Fieldtron.

'Copters Try L-F Navigator

NEW YORK—New York Airways (NYA) is banking on becoming the first commercial helicopter service certified by FAA for instrument flight.

The airline, which runs ferry flights to airports around New York City, plans to use the short-range, British-built Decca navigation system instead of higher-frequency, line-of-sight equipment commonly used by airliners (for a comparison of systems, see *ELECTRONICS*, p 112, Aug. 7, 1959).

Decca operates at frequencies around 100 kc. NYA found that

DOWN: 1000 Fathoms

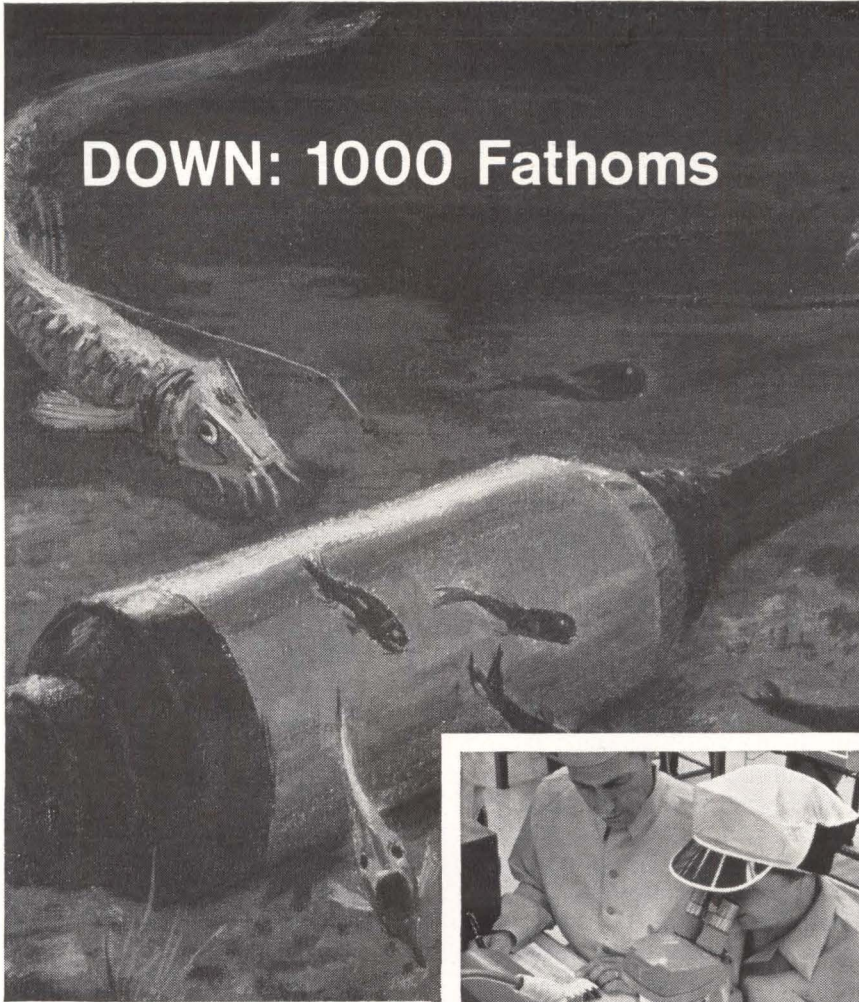

StereoZoom[®] helps build 20-year reliability in this Western Electric undersea rigid repeater

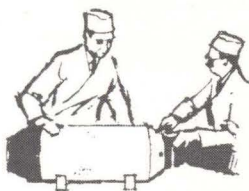

Talk about reliability! Each of these 36" x 13" diameter repeater amplifiers contains more than 5000 precision parts . . . and each is rated for a minimum of 20 maintenance-free years on the ocean floor. Spaced every 20 miles in Bell Telephone's new single-cable transoceanic system, these repeaters

help transmit 128 two-way messages simultaneously.

To make sure, Bell System's Western Electric Company uses StereoZoom Microscopes for the assembly and inspection of the high-voltage capacitors. StereoZoom's big, bright, natural, 3-dimensional views make sure of alignment, bond, and freedom from flaws or foreign particles. Its shockproof, dustproof optical system shrugs off punishing industrial use.

Have you got big problems with tiny parts? Call your dealer, or write for an on-the-job demonstration of StereoZoom Microscopes. Bausch & Lomb Incorporated, 61445 Bausch Street, Rochester 2, New York.

BAUSCH & LOMB 

the higher-frequency systems give erratic results at the low altitudes used for helicopter flights, particularly around the tall buildings near its Wall Street heliport.

In each helicopter, NYA uses twin Decca Mark 8 Navigators. The additional set increases reliability through redundancy. This model



TWIN installation in helicopter adds to reliability

also has an all-transistor computer that is less susceptible to vibration. Two of the computers have 500 hours flight time with only one malfunction—a broken wire.

The ground stations, operated by an NYA division, consist of a master and three slave stations.

FAA will start flight-testing the navigation system soon. Flight evaluation of the Boeing-Vertol 107 helicopters has been completed. An FAA spokesman says he sees no insurmountable obstacles to certification of the equipment and pilots, and he thinks that instrument flights will be possible next year.

Infrared Sensors Map Underground Water Sources

Washington — Airborne infrared scanners are being used by the U. S. Geological Survey to survey the flow of ground water into surface streams. Underground water temperatures are more uniform than surface water temperatures. Scanners made by Lear-Siegler detect differences in temperature.



PHOTO COURTESY NASA

Five years in outer space prove reliability of **TEFLON**[®] under radiation ...hard vacuum

March 17, 1958: Vanguard I is placed into orbit. All insulators in the coaxial fittings are made of a Du Pont TEFLON TFE-fluorocarbon resin. So is the satellite's transmitter field-coil core, and insulation on internal hookup wire.

Today, more than five years after launch, Vanguard I is still transmitting intelligible signals.

This is just another example of the *reliability in use* demonstrated by TEFLON under the most demanding space-environment conditions. It confirms exacting laboratory evaluations of TEFLON as regards outgassing and radiation resistance in hard vacuum.

If high reliability in space environments is demanded of your product, consider the proven advantages of TEFLON resins. For more information, write to: E. I. du Pont de Nemours & Co.(Inc.), Div. ELEC-6-63TE, Room 2526, Nemours Building, Wilmington 98, Delaware.

In Canada: Du Pont of Canada Ltd., P.O. Box 660, Montreal, Quebec.

TEFLON[®]

FLUOROCARBON RESINS

TEFLON is Du Pont's registered trademark for its family of fluorocarbon resins, fibers and film, including TFE (tetrafluoroethylene) resins and FEP (fluorinated ethylene propylene) resins.



BETTER THINGS FOR BETTER LIVING . . . THROUGH CHEMISTRY

CIRCLE 79 ON READER SERVICE CARD 79

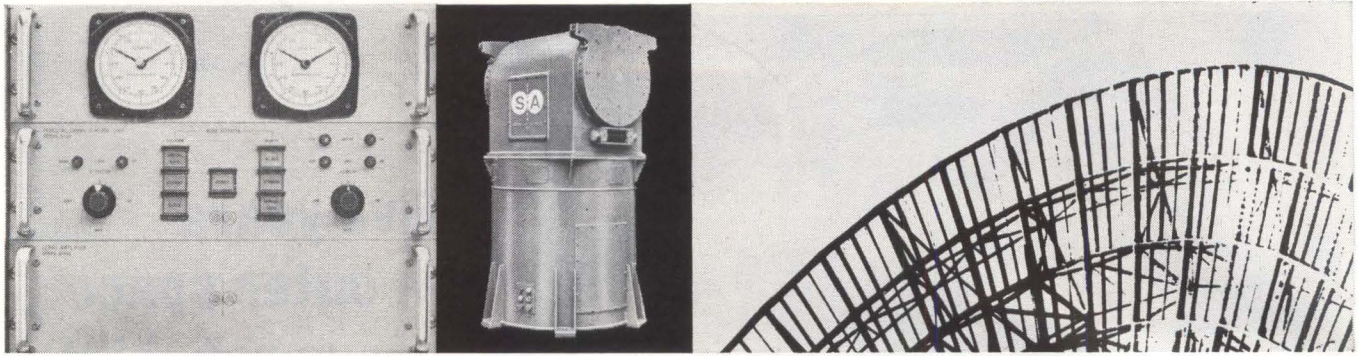

Front line duty!

Scientific-Atlanta's Servo-Controlled Tracking Pedestal Systems

In Europe . . . in Australia . . . in many locations at home and over the world, Scientific-Atlanta's tracking systems are hard at work under operating conditions that are demanding and difficult. Proved and proved again, these systems offer advantages not found anywhere else in the industry . . . production-line assembly from standardized modules offer substantial off-the-shelf economy and adaptability . . . designed to meet MIL SPEC environmental and RFI conditions . . . solid state servos for maximum dependability . . . fail-safe brakes with electrical and mechanical stops assure safety and reliability . . . takes antennas up to 30 feet diameter with output torques from 250 to 15,000 lbs./ft., velocities to 30°/sec., accelerations to 30°/sec.², and accuracies to 0.05°/rpm dynamic. Multiple mode operation, automatic, slave, manual, or preprogrammed tracking, and a full range of options and accessories make a system package able to meet any requirement. Write today for full data. ■ Scientific-Atlanta, Inc., P.O. Box 13654, Atlanta 24, Georgia Phone: 404-938-2930. TWX: 404-938-1322. Zip: 30324

Scientific-Atlanta, Inc. SA

CIRCLE 203 ON READER SERVICE CARD

LEL Performs Good Like a Mixer Preamp Should

LEL's wide range of matched microwave mixer-preamplifiers in varying combinations of bandwidth, center frequency and output impedance work good...like they should. Pioneered by LEL...accepted by industry, these rugged, compact units feature low noise figure and add proven performance to all your microwave receiving equipment.

Send for 72-page catalog 63



LEL Model UDS-2 . . . Strip Type Mixer Preamplifier one of more than 1000 models available in strip transistor, tube and nuvistor types.

LEL INC.

75 AKRON STREET,
COPIAGUE, L. I., N. Y.

(516) PYramid 9-8200

(516) AMityville 4-2200

DRG-DTH

HAMLIN
magnetic reed
SWITCHES

the largest selection ever offered . . .

The use of magnetic reed switches has been increasing by leaps and bounds, and Hamlin engineers have set the pace with the greatest selection. All standard varieties, of course, plus . . .

- DRM-001 High Voltages (up to 5000 v)
- DRG-DTH Double Throw (Form C)
- DRR-5 Heavy Duty (up to 50 v amp.)
- DRS-5 Heavy Thrust (in-rush to 15 amp.)
- HRC-1 No-Bounce (Mercury wetted)

and many more designed for special requirements . . . **YOUR** specifications. Send for literature.

SEE IT! HEAR IT!

FREE CARD
with magnet
and switch

HAMLIN INC.
Dept. EL • LAKE AND GROVE STREETS • LAKE MILLS, WISCONSIN

C.R.T. PROBLEMS? THIS NEW FERRANTI CATHODE RAY TUBE HANDBOOK WILL HELP YOU SOLVE THEM



The exacting requirements of present day system design make the correct selection of components essential. Ferranti has available a variety of precision Cathode Ray Tubes in its MICROSPOT series. Many accessories, including a stabilized power supply, focus and scan coils are also available.

This handbook, (of more than 60 pages) covers this range of Ferranti products. This is the most comprehensive data-packed, C.R.T. manual ever published. It has been compiled by our staff of engineers to provide both design experts and engineers who have no experience in this field, with valuable assistance.

How do we accomplish this? In these four ways:

1. For the expert there are data sheets covering the exclusive Ferranti range of phosphors, coils and C.R.T.'s. These data sheets contain full details of operating parameters, outline drawings, response curves and other essential technical data.
2. For the 'not quite so expert' we have included notes on selecting a cathode ray tube and on the factors affecting the performance of the C.R.T. and its accessories.
3. For both groups details are given of Spatial Frequency Measurement — the recognized scientific and objective

method of measuring resolution. The 'setting up' procedures will enable the best performance to be obtained from these products.

4. Finally, Ferranti will issue up-dating pages, and complete chapters as the state of the art advances. This up-dating service is available, at no extra cost, simply by completing and mailing the registration card at the front of the book.

This handbook is contained in a durable ring binder and will rapidly become the industry's accepted authority on cathode ray tubes.

For your copy (post paid) remit \$2.50 to: Dept. ED

Ferranti
FERRANTI ELECTRIC, INC.

Industrial Park No. 1
PLAINVIEW, Long Island, N. Y.
Tel. WElls 8-7500 • TWX 516-433-9160

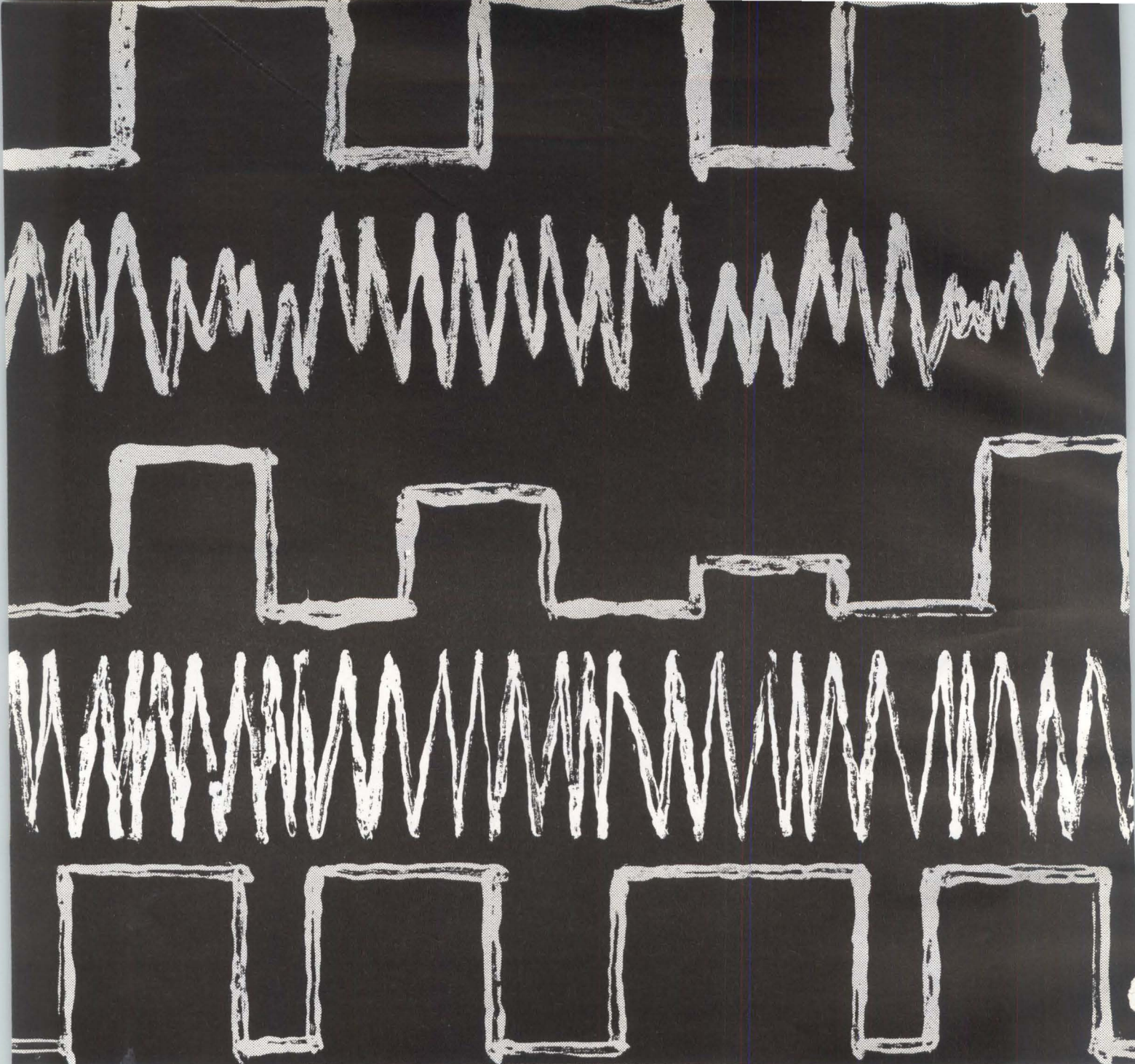

telemetry systems!

Brown Engineering Company, Inc., telemetry systems manufacturers, and specialists in Reliability and Quality Control, employs methods of soldering connections that result in the ultimate degree of dependability.

In systems utilizing welded modules, fabrication techniques are simplified and reliability is assured. A continuous program of system and component testing is in effect.

The high reliability of Brown-manufactured telemetry systems stems from three factors: high quality materials, expert workmanship, and rigorous inspection.

These systems include PCM, SS/FM, PAM, FM/FM, PDM, FM/FM/FM, time-sharing multiplexers, digital data processing systems, transmitter systems, decoders, calibrators, noise generators, and signal conditioners.

For further information contact Aerospace Programs Department, Brown Engineering Co., Inc., Industrial Research Park, Huntsville, Alabama.

BROWN ENGINEERING COMPANY, INC.

Report from

**BELL
LABORATORIES**

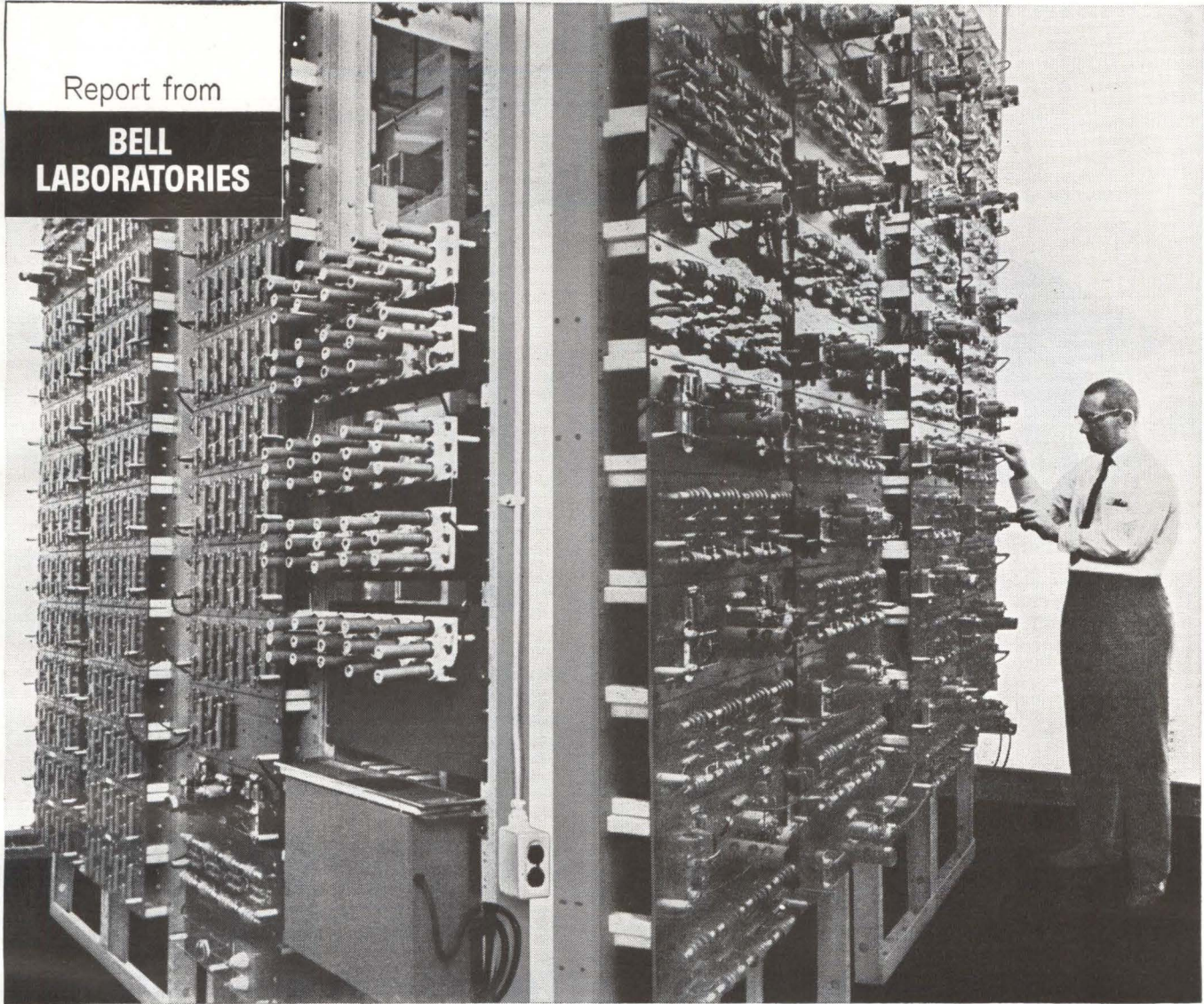

Engineer A. H. Evans measures the effect of voltage surges on Bell Laboratories' simulated undersea telephone cable. Simulating 180 amplifiers and 181 cable sections, with a total length of 3600 miles, the arrangement includes over 1100 electrical components. Photo merges two sides of the simulated cable so that both can be viewed at once.

THE UNDERSEA "CABLE" THAT NEVER GOES TO SEA

In undersea cable systems, electric power for the amplifiers is transmitted along the cable itself. To make this possible, precisely engineered circuits and devices must be designed into the system for protecting electron tubes and other components from sudden voltage surges which may result from accidental damage to the cable.

In systems such as these, the computation of the effects of such surges to establish the needed design parameters is extremely complex. Here, as in many other areas of our work, a solution to the problem has been found through electrical simulation.

Full-scale simulation is achieved by means of networks of electrical components. For the new 128-channel cable scheduled for transatlantic service this year, a network (above) was built to simulate the power path of a 3600-mile cable with its 180 amplifiers.

With the aid of this simulator, engineers can study the effects of voltage surges, the operation of electron tube protectors, and the performance of the power supply in the various contingencies that may occur in active service.

This study of unknown factors by means of electrical simulation is an example of how engineers at Bell Laboratories work to assure the performance and reliability of new communications systems before they are committed to service.



Bell Telephone Laboratories

World center of communications research and development

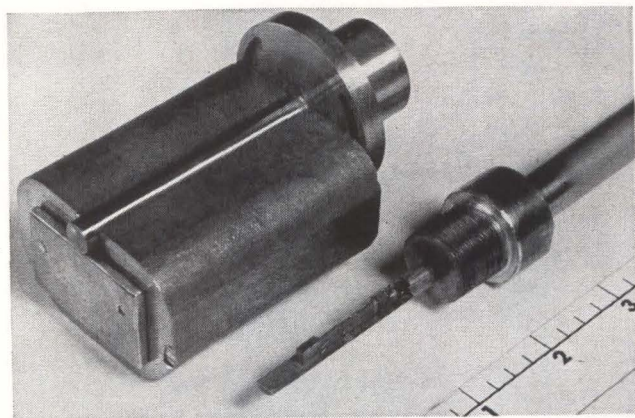

COOLING UNIT assembly, showing the permanent magnet, top, and the bismuth-antimony element, bottom, and copper sink. Current passing through element produces cooling effect—Fig. 1

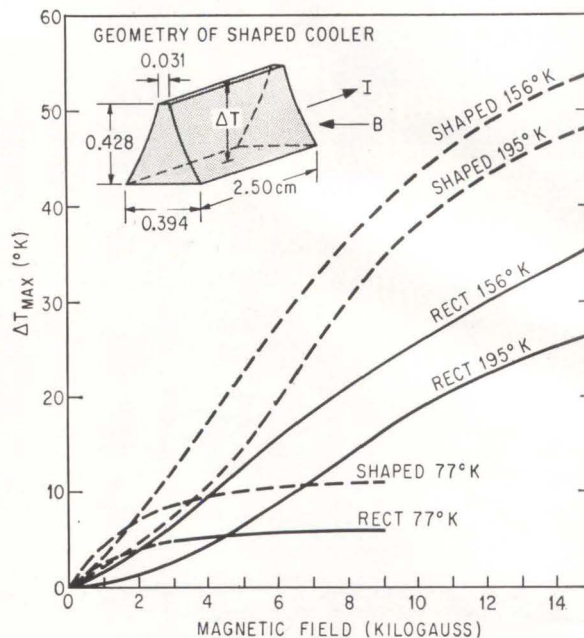

MAXIMUM TEMPERATURE differential, plotted against magnetic field for rectangular and exponentially shaped Bi (97) Sb (3) Ettingshausen coolers, at heat sink temperatures of 77, 156 and 195 deg K—Fig. 2

New Cooler Uses Thermomagnetic Effect

Bismuth-antimony crystal with exponential shape efficiently cools at 77°K

ETTINGSHAUSEN EFFECT, a galvano-magnetic effect that has traditionally been obscure and considered very small, has been proved to be large in certain compounds, and points the way toward a new type of thermomagnetic solid-state cooler, one which is particularly efficient in the 77 to 200 deg K temperature range.

An experimental cooler based on the Ettingshausen effect has been built by the Research and Development Division, Lockheed Missiles and Space Co., Palo Alto, Calif. Shown in Fig. 1, the cooler uses a bismuth-antimony alloy crystal (97

and 3 percent, respectively). Current enters the device through the bus wire, flows through the cooling element and leaves through the copper heat sink. The hot side of the cooling element is electrically insulated from the heat sink by silicone grease. The performance, measured by a differential thermocouple for a number of different magnetic field values, is shown in Fig. 2. The Lockheed researchers, S. R. Hawkins, C. F. Kooi, K. F. Cuff, J. L. Weaver, R. B. Horst and G. M. Enslow achieved as much as 54 deg K of cooling with a heat sink temperature of 156 deg K and a field of 15 kilogauss.

PRINCIPLE—In order to use the Ettingshausen effect in a practical cooling device, it is necessary only to provide a heat sink to keep the

hot side of the element at a fixed reference temperature. This is shown schematically in Fig. 3. Since the electrodes and current leads in the picture must be good electrical conductors, they will in general have a much higher thermal conductivity than the thermomagnetic material. There are therefore two thermal losses caused by the electrode and current leads: one due to the thermal shorting through the electrode of the desired temperature gradient, the other the heat leak along the current leads.

For this reason the cooler element is made long compared to its height and width, and its principal cooling area is taken near the center, where it can be considered essentially isothermal in the direction of current flow.

Much work has been done recently on the determination of a figure of merit for thermomagnetic materials. It is now generally agreed that the material in which the Ettingshausen and Nernst effects are the largest are those with equal numbers of holes and electrons.

Refer to Fig. 4 (A), which illustrates the Ettingshausen effect in a

12 'ABC' POWER SUPPLIES

FLEXIBILITY • HIGH QUALITY • LOW COST

**CHECK
KEPCO**



REGULATED DC SUPPLY

GROUP

from 0-2V/1A to
0-2500V/2ma

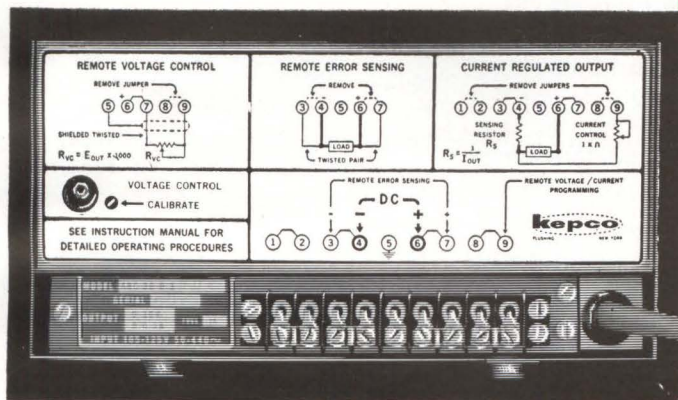
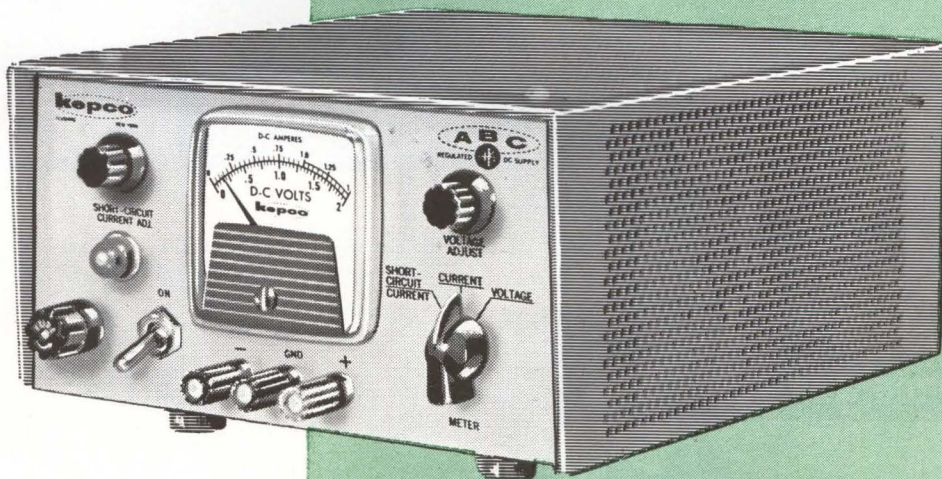

VOLTAGE/CURRENT REGULATED

Connections provide for:

- REMOTE PROGRAMMING OF VOLTAGE OR CURRENT BY RESISTANCE OR VOLTAGE
- REMOTE ERROR SENSING
- PARALLEL AND SERIES CONNECTION

**PROMPT DELIVERY
MOST MODELS FROM STOCK**

0.05% REGULATION and STABILITY

ALL-TRANSISTOR MODELS

DC OUTPUT VOLTS	DC OUTPUT AMPS	RIPLLE RMS MV	PRICE	*METERED MODEL
0-2	0-1	0.25	\$179.00	ABC 2-1M
0-7.5	0-2	0.25	159.00	ABC 7.5-2M
0-10	0-0.75	0.25	119.00	ABC 10-0.75M
0-15	0-1	0.25	159.00	ABC 15-1M
0-18	0-0.5	0.25	119.00	ABC 18-0.5M
0-30	0-0.3	0.25	119.00	ABC 30-0.3M
0-40	0-0.5	0.25	159.00	ABC 40-0.5M

HYBRID MODELS

0-200	0-0.1	0.5	199.00	ABC 200M
0-425	0-0.05	0.5	199.00	ABC 425M
0-1000	0-0.02	1.0	274.00	ABC 1000M
0-1500	0-0.005	1.0	274.00	ABC 1500M
0-2500	0-0.002	1.0	334.00	ABC 2500M

INPUT REQUIREMENTS: 105-125V AC, 50-440 cycles.

All-Transistor Circuit is illustrated below. The Hybrid Circuit is a unique design which achieves high efficiency and reliability through the use of Transistorized Reference and Amplifiers combined with a Vacuum Tube series pass element for reliable high voltage operation.

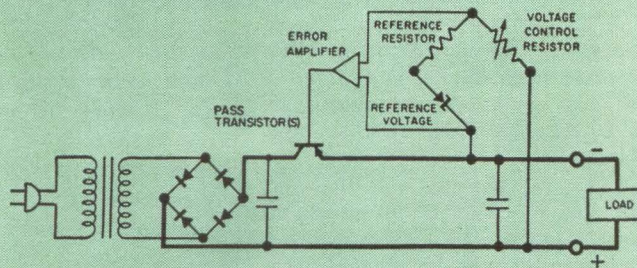

All models are designed for continuous operation without de-rating under all specified line, load and temperature conditions.

* UNITS are available without volt/amp meter; delete suffix "M" from model number and deduct \$20.00 from price (ABC 2500M, ABC 1500M, ABC 1000M voltmeter only; deduct \$15.00).

RACK MOUNTING ADAPTER (5-1/4" H x 19" W):

Model RA-4: for mounting 2 units\$15.00
Model RA-5: for single unit\$15.00



For complete specifications on more than 230 standard model Power Supplies, send for NEW Catalog B-631.

131-38 SANFORD AVENUE • FLUSHING 52, N.Y., U.S.A. • Phone (212) IN 1-7000 • TWX# (212) 539-6623 • Cable Address: KEPCOPOWER, NEW YORK

7 Seconds to

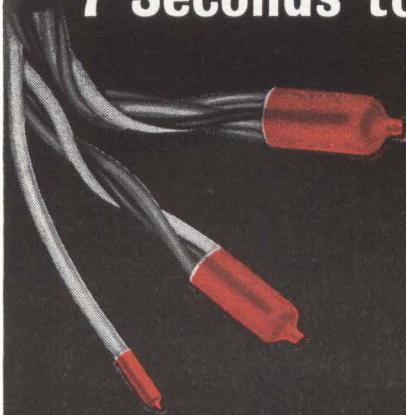

CAP IT!
once and for all...

with

NEW
ALPHLEX®



SHRINKABLE
FIT-Caps

New, easy-to-use Alphlex FIT-Caps are short lengths of semi-rigid shrinkable polyolefin tubing sealed on one end and specifically designed to permanently seal and insulate wire, cable and splices. FIT-Caps form a skin-tight, moisture-proof encapsulation that clings firmly to the ends of one or more wires, even when subject to extreme stress, vibration or abrasion. Simply slip on the cap, apply heat (275°F) with the Alpha Heat Gun or other heat source, and within 7 seconds the FIT-Cap shrinks down to 1/2 its original diameter . . . and stops.

Supplied in expanded form to slip on easily, Alphlex FIT-Caps are available in 4 sizes. See them at your local electronics distributor.

Write for FREE catalog describing the industry's most complete tubing line.



ALPHA WIRE CORPORATION

Subsidiary of LORAL Electronics Corporation
200 Varick Street, New York 14, N. Y.
PACIFIC DIVISION:
11844 Mississippi Ave., Los Angeles 25, Calif.

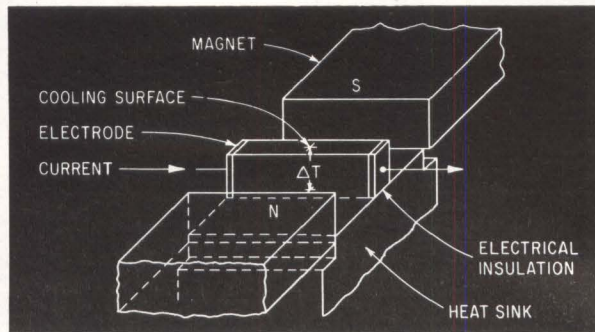

SCHEMATIC DRAWING of Ettingshausen cooler shows mechanical configuration—Fig. 3

ETTINGSHAUSEN EFFECT in single and two-carrier systems showing a single-carrier system (A) and a two-carrier system (B)—Fig. 4

single-carrier system (electrons in this case). Due to the magnetic field, there is a net force on any electron given by $\vec{F}(\epsilon) = -e[\vec{v}(\epsilon) \times \vec{B} - \vec{E}_H]$ where e is the electronic charge, \vec{v} is the velocity, \vec{E}_H is the opposing Hall field and ϵ is the energy. For steady-state conditions, the net current flow in the x-direction vanishes and for some suitable energy ϵ necessarily $\vec{F}(\epsilon) = 0$. Thus electrons for which $\epsilon < \epsilon_c$ will drift in one direction and those for which $\epsilon > \epsilon_c$ will drift in the other, resulting in a net heat flow in the negative x-direction; the opposing Hall effect tends to limit this flow.

For the two-carrier system in Fig. 4 (B), thermal energy is transported by both holes and electrons, and the Ettingshausen effect is caused mainly by generation of hole-electron pairs at one side of the sample and by their recombination at the other side. In addition, transport theory indicates that if the number densities and mobilities of both holes and electrons are equal, the Hall effect and the opposing Hall field vanish; in this case the Ettingshausen effect can be expected to be large.

Thus, for maximum Ettingshausen

effect, the material should have a two-carrier system with equal numbers of holes and electrons (that is, it should be intrinsic or have a small overlap between the valence and conduction bands). The hole and electron mobilities should be equal; the larger their values the higher the figure of merit and the smaller the magnetic field required for operation. Also, the material should have low lattice thermal conductivity.

MATERIALS—The best material presently available is the bismuth-antimony crystal system. Pure bismuth has a slight overlap between the conduction and valence bands, and in proper orientation both carriers have similar mobilities. Adding a small amount of antimony greatly reduces the lattice thermal conductivity, although it also decreases the energy-band overlap; the optimum antimony content is about 3 percent.

In designing a practical Ettingshausen cooler element, as with Peltier coolers, the overall coefficient of performance and T_{max} can be greatly improved by staging or cascading a number of individual units. Each successive stage must pump

HOW THIS EFFECT WORKS

Ettingshausen effect, one of the four galvano- and thermomagnetic effects (the others are the Hall, Nernst and Righi-Leduc effects) is the temperature difference that appears in a direction perpendicular to both the longitudinal electric current and the applied magnetic field. Up to now it was thought too small an effect for practical applications; research has shown otherwise

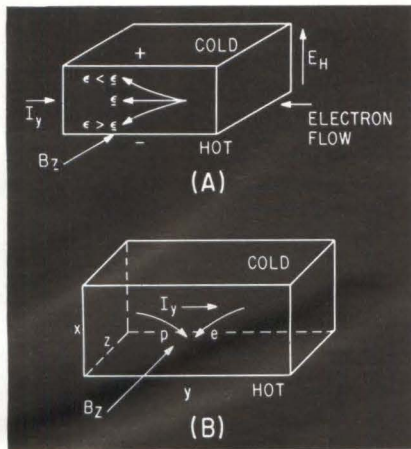

an amount of heat equivalent to the input heat plus the input power to all of the colder stages, and so the size and heat pumping capacity of the individual stages must increase correspondingly toward the heat sink.

This can be done by increasing the cross-section area of each element, in the direction of heat flow. If the same electrical field is supplied to each stage of the cascade, no electrical insulation is needed between stages, since the electric field is constant in each rectangular stage. Thus the cooler can be made out of a single block of material. Since there is no limit to the number of stages that can be built of a single block, it is possible to achieve, in effect, infinite staging. The optimum shaping should be close to exponential. The Ettingshausen coolers, like Peltier effect coolers, have no moving parts and a high degree of reliability. They are ideally suited for cooling very small areas, without loss of overall efficiency.

APPLICATIONS — One obvious application is the cooling of infrared detectors. Another is temperature control of small components, relative to a low-temperature bath. Although the Ettingshausen cooler requires a magnetic field for its operation, at 77 deg K, using Bi(97)Sb(3), maximum cooling can be achieved at magnetic field strengths that are easily obtained with small permanent magnets.

The Ettingshausen cooler has several advantages over the Peltier cooler: It consists of only one type of material, while each Peltier junction requires an *n*-type and a *p*-type leg, with metal-to-semiconductor

**Brian
Clare
can
show
you...**





Sales Engineer, North Atlantic Industries

how North Atlantic's instrument servos fill the five major systems jobs... exactly.

Measurement, remote display, data conversion, control, computation... Name the task and it's probable that the North Atlantic man can show you how to meet it precisely from NAI's comprehensive line of 3" and 2" vacuum tube and all solid state instrument servos.

Production models are available for high- and low-level ac, dc, synchro, strain gage, thermocouple, resistance bulb and other inputs. Most can be supplied with choice of pointer, counter, torque shaft or digitizer outputs. All utilize flexible design that permits any combination of input-output features to be supplied rapidly to user requirements, for both ground and airborne applications. Some are described below.

SBI-7000 Single Pointer DC Ratiometer	SBI-7090 A-to D Converter	SBI-8010 Shaft Position Repeater	SBI-8020 Three-Digit Counter Readout	SBI-8050 Dual Scale Readout
				
Input Denom. 5-50v Num. 10 mv-100v Accuracy $\pm .2$ to $\pm .5\%$ fs Resolution .1 to .2% Response .25 sec. fs	Input 10 mv to 100v dc Accuracy $\pm .1\%$ fs Resolution from 0.05%* Response from 2 sec fs* *depending on encoder used	Input ac, dc or synchro Accuracy $\pm .1$ to $\pm .5\%$ fs Resolution .05 to .25% Response 7 sec. @ 15 oz-in	Input ac, dc, or synchro Accuracy $\pm .5$ to .1% fs Resolution .02 to .05% Response 15 sec. fs	Input ac, dc, or synchro Accuracy .05 to .1% fs Resolution .02 to .05% Response 6 sec. fs

If there's a critical job for an instrument servo in your system design, it will be worth your while to talk to your North Atlantic engineering representative. For his name, call or write today. Or request Catalog SFC-1 for complete data.



NORTH ATLANTIC industries, inc.
TERMINAL DRIVE, PLAINVIEW, L. I., NEW YORK • Overbrook 1-8600

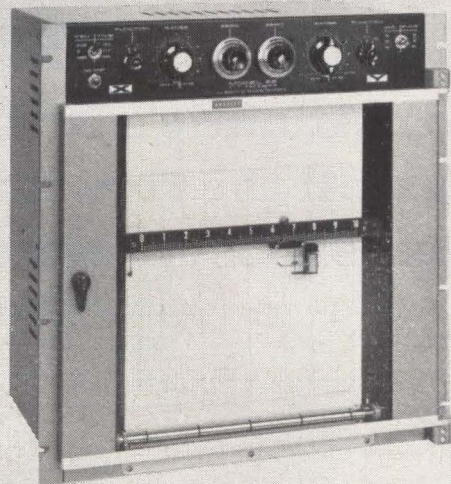
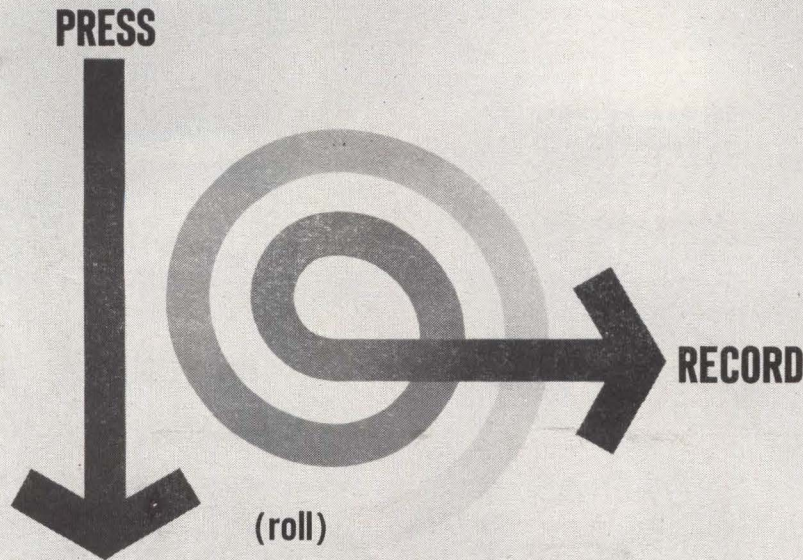

Automatic chart advance: This new Moseley 6S X-Y Recorder, 19½" high in rack, offers automatic frame advance of a continuous roll of complete charts, manual- or remote-controlled, 120 charts/roll, the 10" x 10" recording area in full view during operation. When one chart is completed, you simply press a lever or remotely actuate a switch and the next 10" chart rolls smoothly into place. Used charts fed out, may be detached or stored on takeup roll. Built-in time sweep, selectable by front-panel control, 0.5-50 sec/in. Input 0.5 mv-50 v/in., 16 ranges. Full range zero set and one full scale of zero suppression on each axis. \$3,150.

F. L. MOSELEY CO.
 409 N. Fair Oaks Ave., Pasadena, Calif.
 an affiliate of Hewlett-Packard

8149

contacts. The effect of infinite cascading can be achieved by merely shaping the cooling element appropriately, while cascaded Peltier coolers are complex multielement structures. The Ettingshausen cooler is most efficient below 200 deg K, while the Peltier cooler becomes inefficient below 200 K.

In cases where cooling to cryogenic temperatures from room temperature or temperature considerably above 200 K is desired, the combination of Ettingshausen-Peltier cooler is a good prospect. With the present state of art, cooling to temperatures below 150 K from room temperature should be possible by this method.

Prospects exist for the further development of Ettingshausen devices, and for new materials suitable for such coolers.

New Film Developed for CRO and Research Use

WIDE-RANGE film that can photograph the sun and the moon with the identical shutter speed and aperture setting without loss of detail or overexposure has been announced by Edgerton, Germeshausen and Grier in Boston.

The new XR (extended range) film, with a sensitivity range of one to a hundred million, is designed for extensive applications in the scientific and industrial recording of rocket exhaust phenomena, plasma and heat ablation investigations, and aerial and satellite photography.

XR film can take photographs of

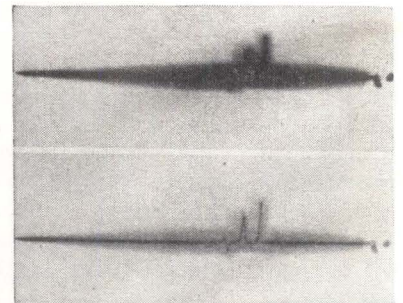

OSCILLOGRAM print, above, made with only the fast-emulsion layer of EG&G XR film, obscures detail by overexposure. Below, the same trace printed from both the fast and slow layer images, reveals detail of entire trace

an oscillograph tracing having a high risetime, retaining detail in all portions of the trace and the base line. It can also photograph a rocket exhaust and reveal detail of heat and material ablation that are unseen by conventional film. An example of an oscillograph tracing of a fast-risetime pulse made on the new film is shown in the photograph.

THREE LAYERS—Three photographic emulsions, having three different light sensitivity levels, are superimposed in layers on a conventional film base. The uppermost layer is most sensitive, with an ASA exposure index of 400, and registers the faintest light intensities. The bottom layer is the slowest, with an exposure index of 0.004, for photographing light of the greatest intensity. The middle layer has a sensitivity between the other two values. All three layers are exposed simultaneously.

Applying XR film to photographing a burst of light, such as an explosion, the researcher would obtain three images on the film. The faintest light resulting from the explosion would be recorded on the first, most sensitive emulsion layer. The light of medium intensity would be captured by the middle layer,

IR Scan Finds Forest Fire Through Smoke Cloud

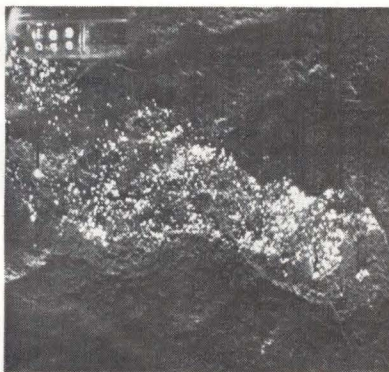

HOT SPOTS of a forest fire are clearly visible in an airborne infrared scan, made through smoke cover by U. S. foresters during evaluation experiments of the technique of using infrared aerial mapping for control of forest fires (ELECTRONICS, p 8, Aug 23)

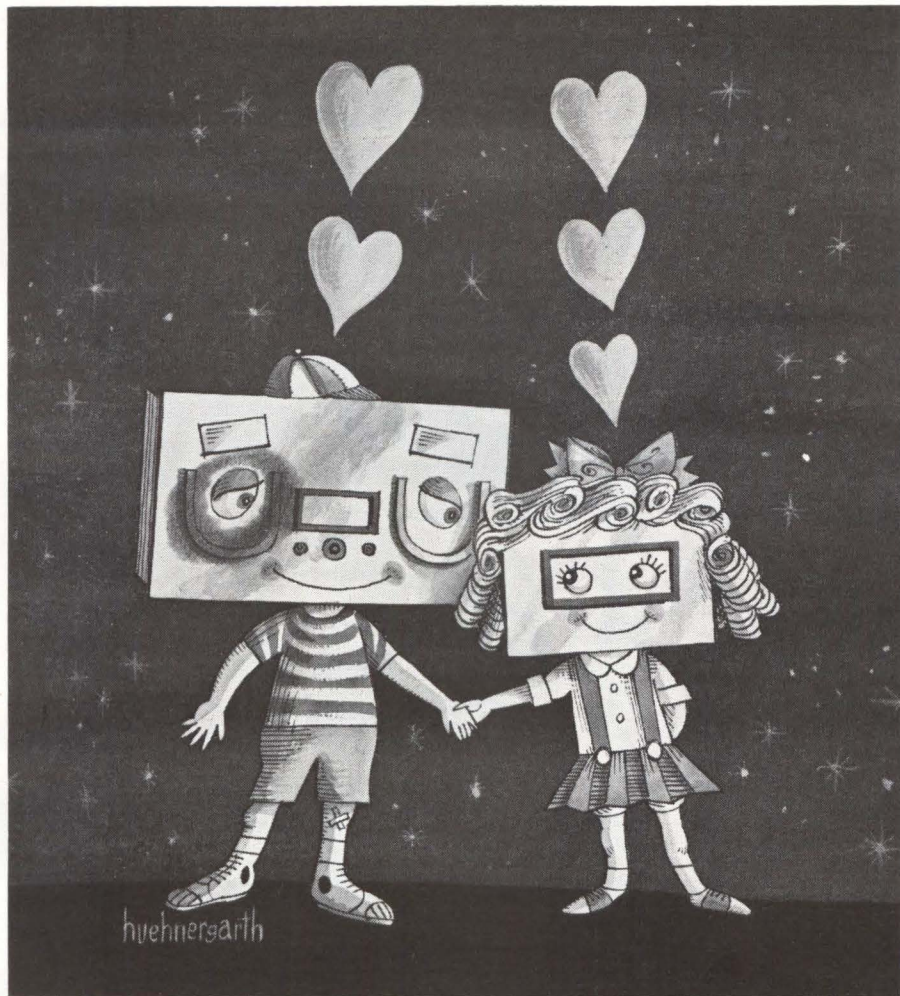

NEMS-CLARKE Spectrum Display Unit is Happy with ANY Receiver

Here is a Universal Solid State Spectrum Display Unit that can be used with *any* conventional tube type 21.4 or 30 mc IF telemetry or surveillance receiver. Nems-Clarke R & D in modularized solid state telemetry and surveillance receivers has produced this SDU in a fraction the size of standard units.

The 360 Series SDU provides a visual indication of frequency versus relative amplitude and aids in location of interference sources. Unique features include: 1) crystal-controlled marker pips for accurate calibration of frequency display, 2) two-to-one resolution improvement over conventional units without reduction in display area, 3) self-contained power supply permitting plug-in operation of 1, 2 or 3 units in single 3½" rack tray. Each unit monitors up to 4 receivers with accessory 4 position coax switch panel.



For brochure, write:
Vitro Electronics, 919 Jesup-Blair Drive,
Silver Spring, Maryland.
A Division of Vitro Corporation of America

Vitro ELECTRONICS

SPECIFICATIONS

Input Center Frequency
(corresponds to first IF of receiver) Type SDU 361—21.4 mc
Type SDU 362—30.0 mc
Maximum Sweep Width 4.0 mc
Sweep Rate 20 cps
Signal Resolution 10 kc
Control Markers . 21.4 mc with side-band markers at 500 kc intervals. Other frequencies available from 300 kc to 1.5mc upon request.
Power Input . . . 115/200 vac, 50/400 cps, 12 watts
Unit Size 3½" x 6½" x 13½"
(hxwx d)

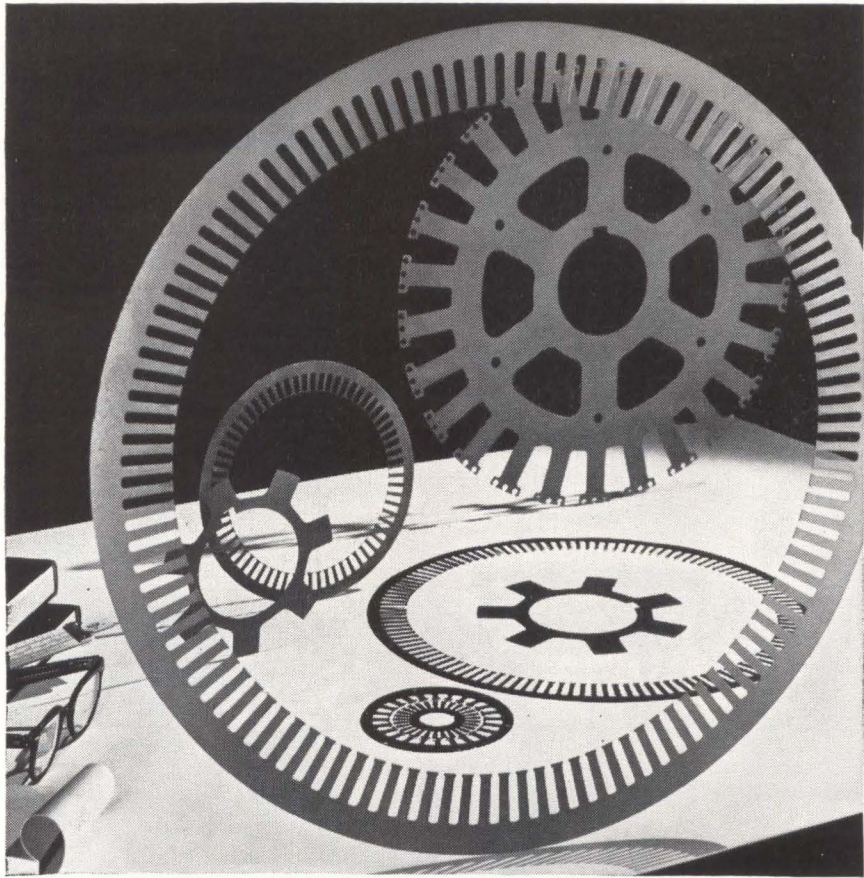

ROTOR and STATOR LAMINATIONS FROM THESE SIZES DOWN TO A DIME

Arnold's Pacific Division produces motor laminations to meet a wide range of requirements. Materials include a broad selection of silicon steel and nickel-iron alloys to achieve the characteristics desired. Sizes range from the tiniest thin-gauge laminations to diameters of 20" and more.

Special note: Many rotary shapes for motors and generators must be produced in somewhat limited quantities—often so low that the cost of a multi-station die would be prohibitive. Arnold has available notching presses for producing rotor and

stator laminations to meet these limited order requirements at low-cost tooling.

To help you further minimize tooling costs and improve delivery time on such parts, a number of ring dies owned by Arnold are available for use where applicable. Our engineers will help you work out special designs by this method.

- Other Arnold Pacific Division products include a complete line of transformer laminations, cans and mounting hardware, and magnetic shields. *Let us work with you.*

4686 RIA

PACIFIC DIVISION
ARNOLD
SPECIALISTS in MAGNETIC MATERIALS

THE ARNOLD ENGINEERING COMPANY, Main Office: MARENGO, ILL.
PACIFIC DIVISION: 1551 E. Orangethorpe Ave., Fullerton, Calif. • TRojan 1-1560

and the most intense light occurring would register on the bottom layer. Thus the scientist would be able to look into the explosion, see the different light intensities that resulted, and find details that would normally be hidden by overexposure of ordinary film.

The three different images in the three layers are kept separated by the use of different colored coupler layers. This makes it possible to examine all three images at once or to print only one or two of them, using different color filters. No matter what the intensity of the event to be recorded, the extended-range film will register an image in at least one of its layers, obviating the necessity for photographing with multiple cameras using different films and exposure settings.

Edgerton, Germeshausen and Grier, Inc., make available to qualified research users 35-mm test rolls, as well as cut-sheet and aerial film sizes. The company also provides a processing service for the film.

Air Force Gets Display Console for Radar Work

DISPLAY CONSOLE that translates computer output into words, numbers, graphics and symbols at a rate of up to 30,000 characters a second and displays them on a 19-inch special shaped-beam tube has been purchased by Air Force's Rome Air Development Center at Griffiss Air Force Base, Rome, N. Y., from General Dynamics/Electronics-San Diego.

Designed for use by the military as the vital man-machine link for presenting information from such sources as radar equipment to human operators, the new console makes use of a special tube with a small picture window in the rear. A projector placed at the window projects onto the tube face slides containing static information such as grids or maps, thus saving cathode-ray time. The electron beam is then used to superimpose the non-static information on the back-projected grid.

The rear window can also be used as access for a recording camera to take data off tube face without interfering with visual observation.

FROM CANNON

NUMBER ONE IN ELECTRICAL CONNECTORS...



TWO NEW DESIGNS TO INTERMATE WITH MIL-C-26500 and MIL-C-26482 CONNECTORS

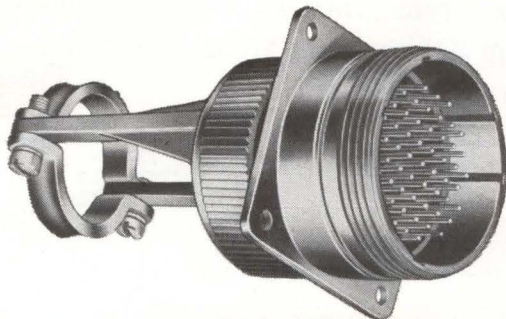

THREADED COUPLING

KV

MATES WITH
MIL-C-26500
CONNECTORS



COMMON INSERTION/EXTRACTION TOOL—COMMON CONTACTS

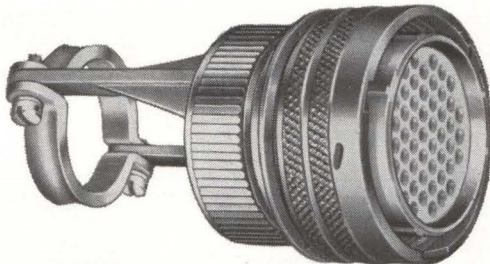

BAYONET COUPLING

PV

MATES WITH
MIL-C-26482
CONNECTORS

- ASSURED INTERMATEABILITY—ELECTRICALLY AND MECHANICALLY
- PROVEN "LITTLE CAESAR" REAR RELEASE SYSTEM
- INTERCHANGEABLE CONTACTS FOR BOTH KV AND PV
- ONE INSERTION/EXTRACTION TOOL FOR BOTH CONNECTORS

Problems of recessed pins, broken pins, mismatching, and connector failure are minimized by the hard-front, closed-entry socket insulators and simplified contact design utilized in the KV and PV! Outstanding new design features incorporate identical contacts and backshells for both connectors...one common, plastic expendable tool provides safe insertion and extrac-

tion—no chance of damage to insulators, contacts, or sealing members. The KV and PV series substantially reduce assembly errors and provide greater standardization and reliability...another reason why you should specify CANNON,[®] the world's largest and most experienced manufacturer of electrical connectors. Write to:

CANNON ELECTRIC COMPANY

3208 Humboldt Street, Los Angeles 31, California

ADDITIONAL PLANTS IN: SANTA ANA & ANAHEIM, CALIF. • PHOENIX, ARIZ. • SALEM, MASS. • TORONTO • LONDON • PARIS • BORNEM, BELGIUM • TOKYO • MELBOURNE

Sales offices and representatives in principal cities of the world

© "CANNON" IS A TRADEMARK REGISTERED IN U.S. PATENT OFFICE AND IN OTHER COUNTRIES BY CANNON ELECTRIC COMPANY

©1963 CANNON ELECTRIC COMPANY



HITACHI TRANSISTORS

SPECIFY "MESA" TYPE TRANSISTORS FOR HIGH FREQUENCY USE

2SA233, 2SA234, 2SA235

Hitachi PNP germanium diffused "Mesa" type transistors provide outstanding high frequency characteristics compared with conventional alloy junction or drift transistors.

Exclusive "Mesa" type transistors are indispensable for FM receivers used in tuner circuits and intermediate frequency amplifiers and also in TV receivers in intermediate

frequency amplifiers. They can be used effectively in short-wave converters, medium wave converters and all high frequency applications.

For superior performance, specify Hitachi "Mesa" type transistors . . . another engineering achievement from one of the world leaders in electronics.

Maximum Ratings ($T_a = 25^\circ\text{C}$)

Items	Symbol	Unit	2SA233	2SA234	2SA235
Collector Voltage	V_{CBO}	V	-20	-20	-20
Emitter Voltage	V_{EBO}	V	-0.5	-0.5	-0.5
Collector Current	I_C	mA	-10	-10	-10
Emitter Current	I_E	mA	10	10	10
Junction Temperature	T_j	$^\circ\text{C}$	85	85	85
Collector Dissipation	P_C	mW	80	80	80
Ambient Temperature	T_A	$^\circ\text{C}$	60	60	60

Characteristics ($T_a = 25^\circ\text{C}$)

Items	Symbol	Conditions for measurement	Unit	2SA233	2SA234	2SA235
Max. Collector Cut-off-Current	I_{CBO}	$V_C = -20\text{V}$ $I_E = 0$	μA	-30	-30	-30
Max. Emitter Cut-off-Current	I_{EBO}	$V_E = -0.5\text{V}$ $I_C = 0$	μA	-50	-50	-50
Current Amplification Factor	h_{fe}	$V_C = -6\text{V}$ $I_E = 1\text{mA}$		50	60	80
Alpha Cut-off Frequency	f_{α_b}	$V_C = -6\text{V}$ $I_E = 1\text{mA}$	Mc	90	110	125

Typical Operation ($T_a = 25^\circ\text{C}$)

Items	Conditions for Measurement	Unit	2SA233	2SA234	2SA235
Power Gain at FM Radio Frequency	$V_C = -6\text{V}$ $I_E = 1\text{mA}$	db	—	—	12
	$f_s = 100\text{Mc/s}$				
	$R_g = 75\Omega$ $R_L = 2\text{k}\Omega$				
Mixer Gain at FM Radio Frequency	$V_C = -6\text{V}$ $I_E = 1\text{mA}$	db	—	—	13
	$f_s = 100\text{Mc/s}$ $f_{osc} = 110.7\text{Mc}$				
	$R_g = 3\text{k}\Omega$ $R_L = 15\text{k}\Omega$				

10.7 Mc Intermediate Frequency Amplifier Circuit

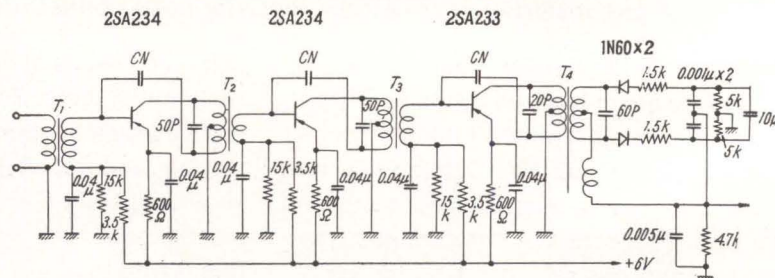

Hitachi, Ltd., Chicago Office
333 N. Michigan Ave., Chicago 1, Ill. Tel: 726-4572/4
Hitachi New York, Ltd.
666, Fifth Ave., New York 19, N.Y. Tel: JUdson 6-4757
Hitachi, Ltd., San Francisco Office
100 California St., San Francisco 11, Calif. Tel. YUkon 1-7871

 **Hitachi, Ltd.**
Tokyo Japan

SEE US AT JAPAN ELECTRONICS SHOW 1963, OSAKA, OCTOBER 2-8

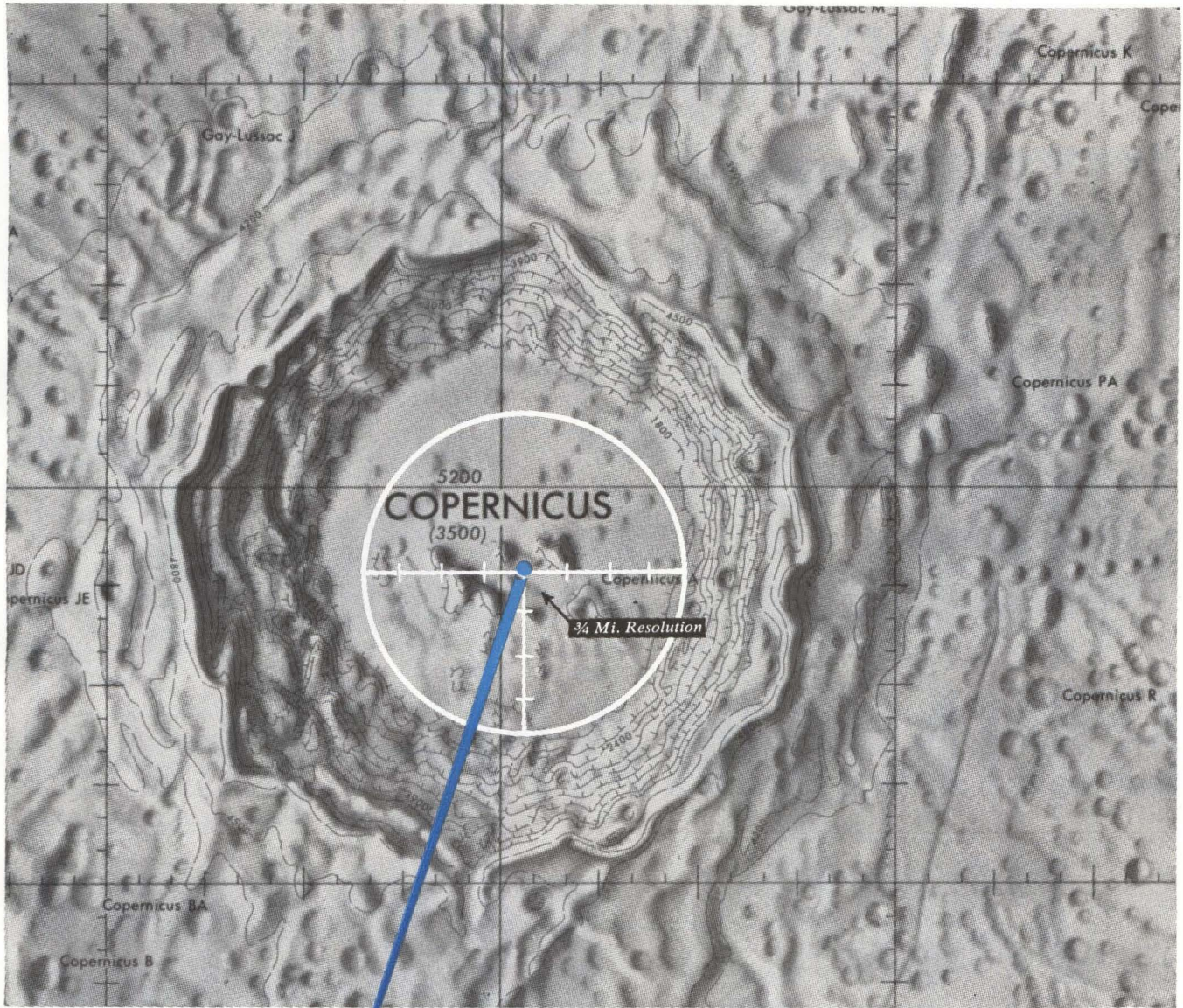

Lunar Chart Published by Aeronautical Chart and Information Center, United States Air Force.

**THIS
ACCURATE**

For the first time, an angle encoding system—the Colorado Research Microgon®—provides accuracies compatible with beam widths afforded by laser communication and tracking systems.

Microgon® features a single turn non-optical transducer, a 1σ accuracy of 0.618 seconds of arc, and an extremely reliable all solid state electronic processing unit incorporating continuous visual read-out with simultaneous serial or parallel outputs in a variety of standard code formats.

Currently, the systems are employed for missile and satellite tracking, missile launch control, rate gyro test stands, inertial test tables, and precision laboratory angle measurements. Typical installations are on the ARIS Downrange Tracking Ships, and at White Sands Missile Range where Microgons® provide real time position recording for photo theodolite tracking systems.

Other applications and advantages are outlined in our brochure, available on request.

Staff positions are open for engineering and scientific personnel.



COLORADO RESEARCH Company

BROOMFIELD, COLORADO

The Electronics Division of Bell & Gossett Company

MICRO MANIPULATORS

MANY NEW MODELS FOR RESEARCH AND DEVELOPMENT

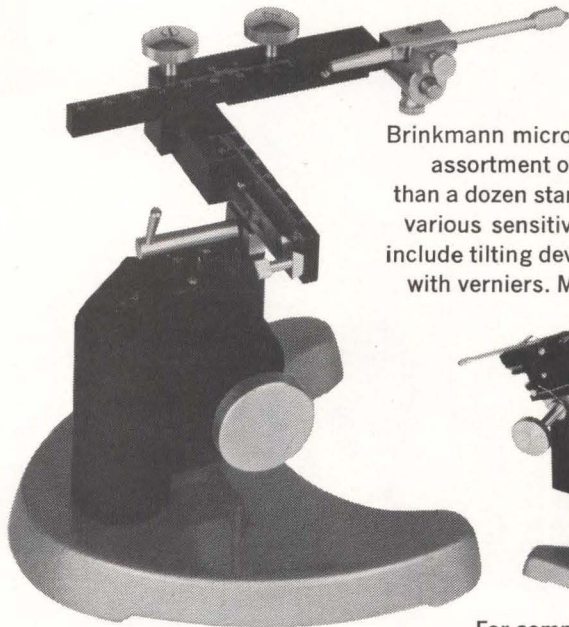

Brinkmann micro manipulators offer the most complete and most versatile assortment of mechanical micro positioners—now available in more than a dozen standard versions. All feature three-dimensional movements in various sensitivities, and all are available with optional facilities which include tilting devices, rotating devices, special instrument holders and scales with verniers. Micrometer systems are calibrated in inches or millimeters.

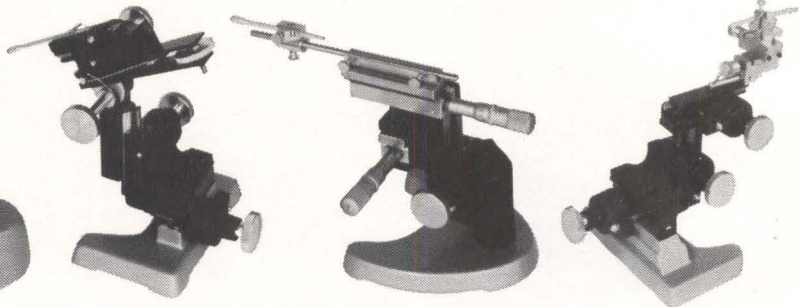

For complete descriptive literature, please contact:

BRINKMANN

(NEW ADDRESS)
BRINKMANN INSTRUMENTS INC.,
CANTIAGUE ROAD,
WESTBURY, L. I., NEW YORK
PHILADELPHIA - CLEVELAND - HOUSTON - MIAMI
MENLO PARK, CAL. - ST. LOUIS

CIRCLE 205 ON READER SERVICE CARD

FAST
DELIVERY
ANYWHERE

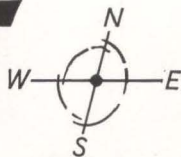

MIDWEC INSTRUMENT GRADE MYLAR* DIELECTRIC

Ca-pac-i-tors

Best Shipping Interval In The Industry—3 Weeks Standard
High Reliability and Quality
Competitively Priced

Specialists In Low Tolerance Units

Approved for use in Talos, Minute Man, Titan, Typhon,
Telephone Companies ■ 100% Test for dielectric strength,
capacitance, insulation resistance and dissipation factor

See the
EBG
Page 55

MIDWEC
OSHKOSH, NEBRASKA

write for
data sheets
and prices

SALES OFFICE: 601 So. Jason St., Denver 23, Colo.
TWX: 292-3891—Telephone SH 4-3481—DDD 303

*DuPont TM for Polyester Film.

the finest precision
coaxial connectors*

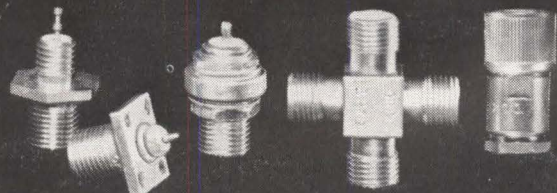

* TM[®]
(miniaturized TNC)

General RF Fittings, Inc.

702 BEACON STREET, BOSTON 15, MASSACHUSETTS
Telephone: 617 267-5120

CIRCLE 206 ON READER SERVICE CARD

SEPTEMBER 6, 1963 • electronics

Special Introductory Offer

To new members of the
ELECTRONICS and CONTROL ENGINEERS' Book Club

ANY ONE

FOR ONLY

\$1.00

YOURS WITH A CHARTER MEMBERSHIP
AND SENT WITH YOUR FIRST SELECTION

VALUES FROM \$7.00 TO \$22.50

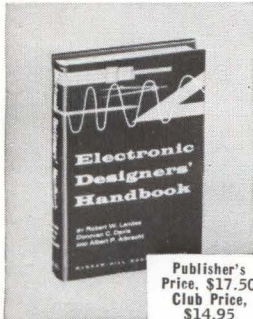

Publisher's Price, \$17.50
Club Price, \$14.95

Electronic Designers' Handbook, Edited by R. W. Landee, D. C. Davis, and A. P. Albrecht. Presents detailed, practical design data.

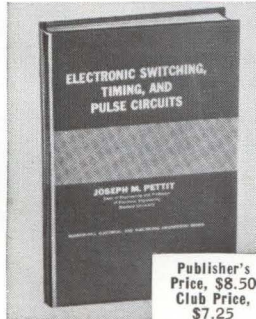

Publisher's Price, \$8.50
Club Price, \$7.25

Electronic Switching, Timing, and Pulse Circuits by J. M. Pettit. Provides a practical understanding of complex circuits.

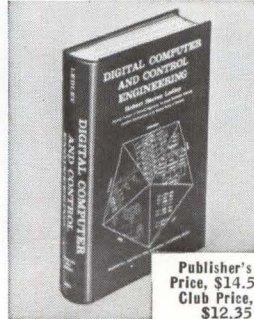

Publisher's Price, \$14.50
Club Price, \$12.35

Digital Computer and Control Engineering by R. S. Ledley. Full coverage from basic design to, advanced programming techniques.

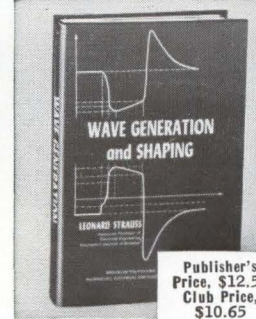

Publisher's Price, \$12.50
Club Price, \$10.65

Wave Generation and Shaping by L. Strauss. Essential features and techniques of practical wave-generating and -shaping circuits.

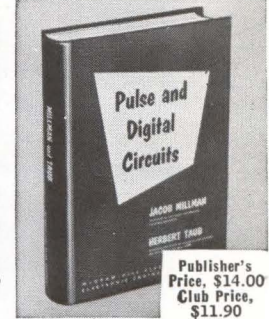

Publisher's Price, \$14.00
Club Price, \$11.90

Pulse and Digital Circuits, by J. Millman and H. Taub. Fully explains pulse and digital circuit operation for electronic systems design.

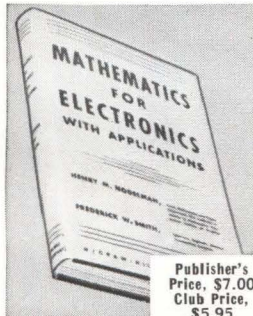

Publisher's Price, \$7.00
Club Price, \$5.95

Mathematics for Electronics with Applications by H. M. Nodelman and F. W. Smith, Jr. Methods for solving practical problems.

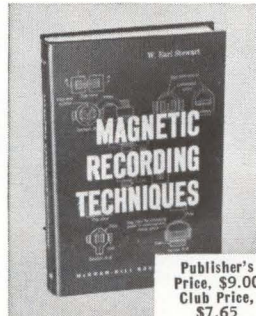

Publisher's Price, \$9.00
Club Price, \$7.65

Magnetic Recording Techniques by W. E. Stewart. Full description of magnetic recording methods and devices.

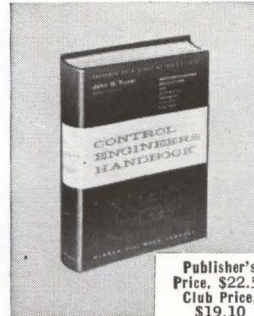

Publisher's Price, \$22.50
Club Price, \$19.10

Control Engineers' Handbook by J. C. Truxal. A wealth of practical help on automatic feedback control systems.

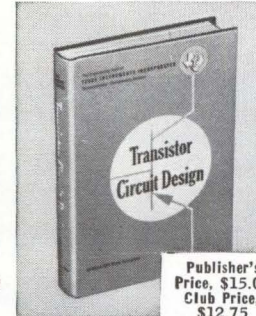

Publisher's Price, \$15.00
Club Price, \$12.75

Transistor Circuit Design, prepared by the Engineering Staff of Texas Instruments Inc. Reduces theory to actual practice.

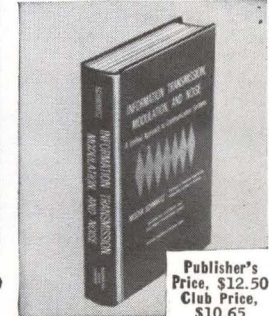

Publisher's Price, \$12.50
Club Price, \$10.65

Information Transmission, Modulation, and Noise by M. Schwartz. A unified approach to communication systems.

How many of the books shown here do you wish you had immediately at hand?

Select one for JUST A DOLLAR! Choose from *Electronic Designers' Handbook*, *Magnetic Recording Techniques*, *Wave Generation and Shaping*, and seven other valuable books . . . your introduction to membership in *The Electronic and Control Engineers' Book Club*.

If you're missing out on important technical literature—if today's high cost of reading curbs the growth of your library—here's the solution to your problem. *The Electronic and Control Engineers' Book Club* was organized for you, to provide an economical technical reading program that cannot fail to be of value to you.

All books are chosen by qualified editors and consultants. Their thoroughgoing understanding of the standards and values of the literature in your field guarantees the authoritativeness of the selections.

How the Club operates. Periodically you receive free of charge *The Electronic and Control Engineers' Book Bulletin* (issued eight times a year). This gives complete advance notice of the next main selection, as well as a number of alternate selections. If you want the main selection you do nothing; the book will be mailed to you. If you want an alternate selection . . . or if you want no book at all for that particular period . . . notify the Club by returning the convenient card enclosed with each *Bulletin*.

We ask you to agree only to the purchase of three books in a year. Certainly out of the

large number of books in your field offered in any twelve months there will be at least three you would buy anyway. By joining the Club you save yourself the bother of searching and shopping, and save in cost about 15 per cent from publishers' prices.

Send no money now. Just check any two books you want—one for only \$1.00 and one as your first Club selection—in the coupon below. Take advantage of this offer now, and get two books for less than the regular price of one.

THIS COUPON IS WORTH UP TO \$21.50

The Electronic and Control Engineers' Book Club, Dept. L-9-6
330 West 42nd Street, New York 36, N. Y.

Please enroll me as a member of the Electronic and Control Engineers' Book Club. I am to receive the two books I have indicated at the right. You will bill me for my first selection at the special club price and \$1 for my new membership book, plus a few additional cents for delivery costs. (The Club assumes this charge on prepaid orders.) Forthcoming selections will be described to me in advance and I may decline any book. I need take only 3 selections or alternates in 12 months of membership. (This offer good in U.S. only.)

PLEASE PRINT

Name

Address

City..... Zone..... State.....

Company

NO RISK GUARANTEE If not completely satisfied, you may return your first shipment within 10 days and your membership will be canceled.

Check 2 Books: We will send the higher priced book for only \$1.00, and the other as your Club Selection:

- Electronic Designers' Handbook**, \$14.95
- Electronic Switching, Timing, and Pulse Circuits**, \$7.25
- Digital Computer and Control Engineering**, \$12.35
- Wave Generation and Shaping**, \$10.65
- Pulse and Digital Circuits**, \$11.90
- Mathematics for Electronics with Applications**, \$5.95
- Magnetic Recording Techniques**, \$7.65
- Control Engineers' Handbook**, \$19.10
- Transistor Circuit Design**, \$12.75
- Information Transmission, Modulation and Noise**, \$10.65 L-8-23

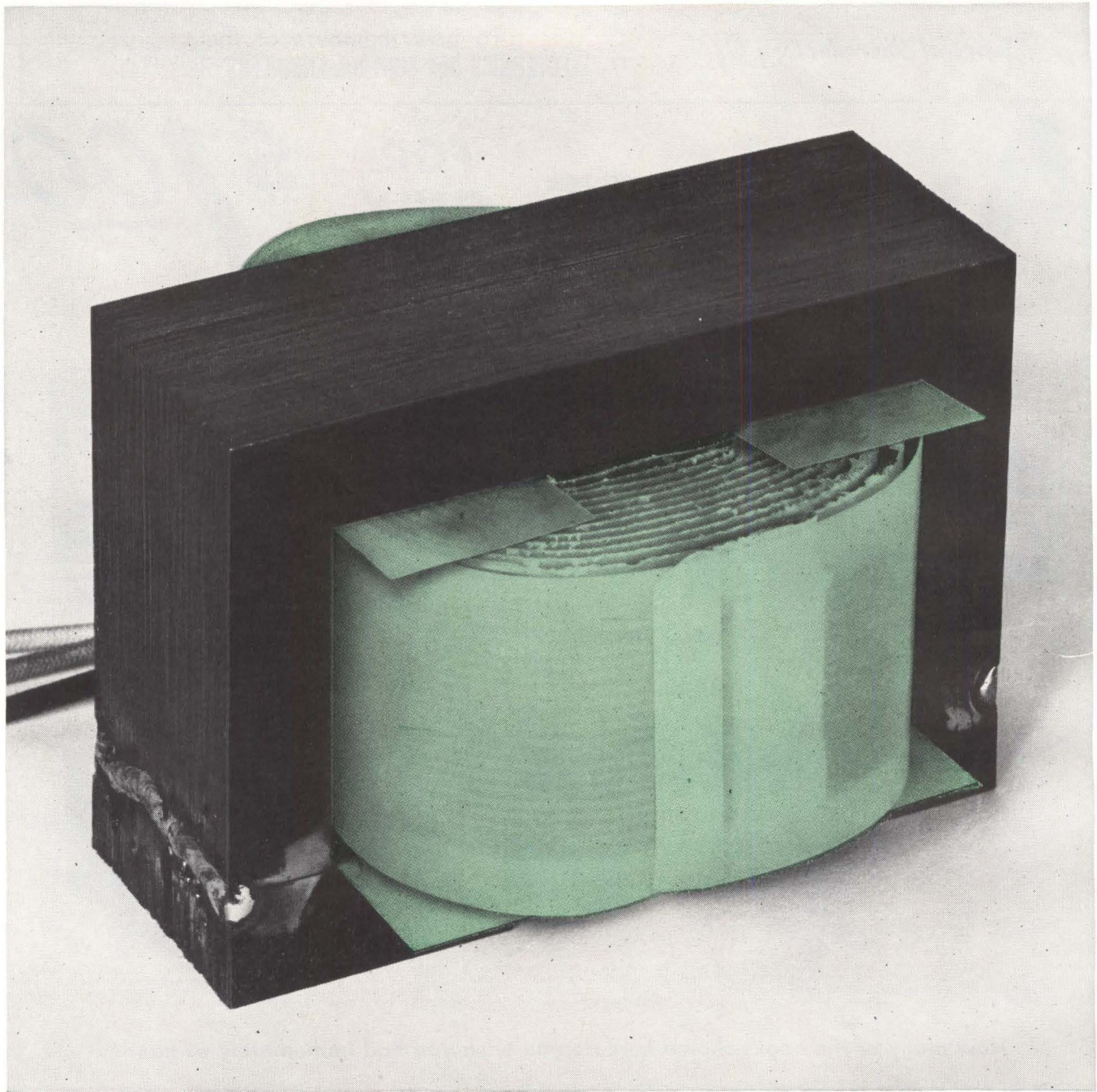

MYLAR® tripled the guarantee on this ballast transformer!

It's Wide-Lite Corporation's new 1,000-watt ballast transformer. It offers an exclusive 3-year guarantee against failure, compared with the usual 1-year guarantee! Wide-Lite was able to do this by using insulation of "Mylar"* polyester film on the windings. "Mylar" is far more heat-resistant than conventional insulation, and it retains its extremely high dielectric strength even when damp. These properties also gave the ballast an official approval for Class B temperature conditions (130°C).

With longer guarantees and Class B approval possible, think what insulation of "Mylar"

could do in your own designs! Besides its thermal, dielectric and moisture-resistant properties, insulation of "Mylar" is strong and durable. Also, "Mylar" is of high-volume resistivity, resistant to solvents and easy to work with, compared with other insulation materials.

Find out the full story by writing Du Pont Company, Film Dept., Box 22F—Rm. N10452, Wilmington 98, Delaware. *Du Pont's registered trademark.



Better Things for Better Living
...through Chemistry

HEXAGONAL structure of photoconductor material deposited on alumina. Cell contains cadmium, silicon carbide and sulphide compounds. Magnification is 1,800 times

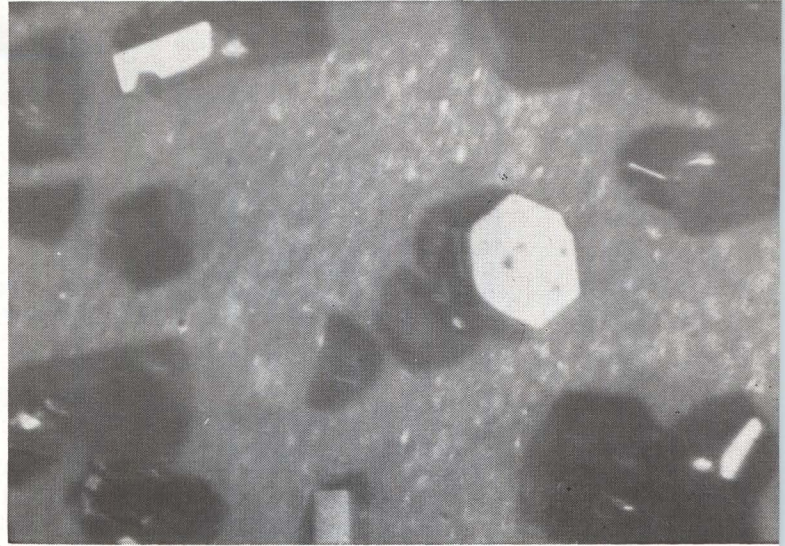

Thin-Film

Photocells Get Brighter Faster

High density cells have
rise-decay under 50 μ sec.
Deposits are uniform



IMPROVED light characteristics are claimed for photoconductive thin films, developed for optical displays.

The material and techniques for deposition on substrates were developed by Photometrics Corporation, Walker Valley, New York. Performance and applications were described by Roland C. B. Beeh, company president.

The material will open up new

avenues for optoelectronic devices and electroluminescent solid-state display panels, Beeh says.

A mosaic of photoconductive cells is formed on a substrate by vacuum deposition. Cells are said to exhibit fast recurrent or nonrecurrent illumination. Rise and decay time of less than 50 μ sec is claimed. The photosensitive areas operate under light modulation up to 100 kc, according to reports.

Characteristics of the material can be applied to visual displays for command control centers, and large panel displays for air-traffic.

A high density of photoconductive regions can be attained. Performance is uniform and the material can be deposited over large areas with uniformity of deposition within 5 percent, Beeh added.

LATTICE—The photoconductor has a polycrystalline structure. Cadmium, silicon carbide and sulphide compounds are tightly bonded in a hexagonal lattice. Dimension of the lattice is given as less than 5 angstroms.

The materials are vacuum deposited, purified compounds are selected by molecular beam. Ion pumping is used, instead of oil diffusion, to avoid formation of hydrocarbons. Seven elements can be evaporated at the same time. Activators are introduced by ionization at high temperature, under high

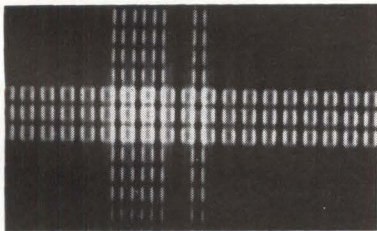

GHOST effect is shown on 100 element/inch solid-state electroluminescent panel. Approaches are now being considered to circumvent cross illumination

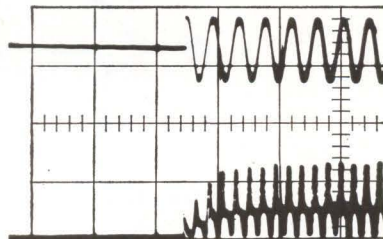

SPEED of response of material is shown in lower trace. Upper trace shows 10,000 cycle input. Material obtains full brightness within 2 cycles

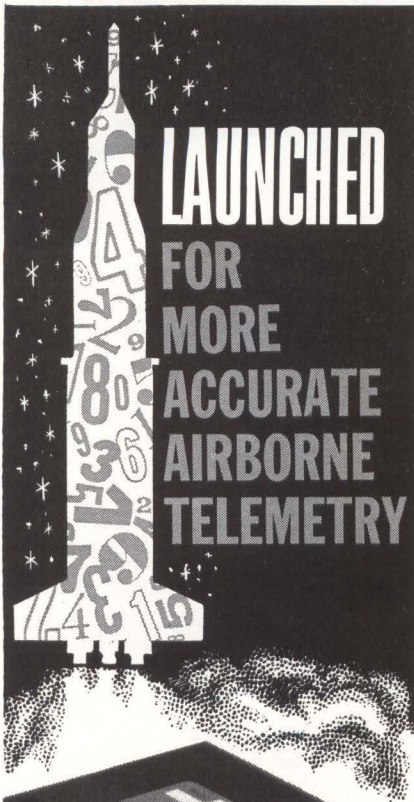

New solid state, completely transistorized airborne VHF/FM telemetry transmitter

There's safety in numbers — especially those transposed from the exceptionally reliable TS-2 telemetry transmitter, designed and produced by Advanced Electronics. Proven performance has earned it a prime spot in telemetry systems for a major space vehicle... with many other important applications imminent to meet its advanced technology. This new solid state, completely transistorized unit delivers 2.0 watts minimum into a 50 ohm load... an exciting achievement for such a compact package.

There are other FM and AM telemetry transmitters and amplifiers in the line. Their fine record of space age attainments is indicative of Advanced Electronics' unique capabilities. We invite you to consult with our specialized engineering staff to help expedite your telemetry program.

Write or call for details and literature.

SEE OUR TELEMETRY CATALOG AD:

eem File System Sec.
electronic engineers master 5200

ADVANCED ELECTRONICS CORPORATION
2 Commercial St., Hicksville, L. I., N. Y. • OV 1-6400
TELEMETRY TRANSMITTERS & AMPLIFIERS •
POWER SUPPLIES • R.F. FILTERS

DISPLAYS NOW, TELEVISION WILL FOLLOW

Emphasis is placed on improving solid-state electroluminescent panels. The government needs them for visual displays—panels for aircraft cockpits, for radar, and large display boards for military situations.

Ultimately this approach may be used for television sets with a flat, solid picture screen. But it may take five years to get needed megacycle range of speed response, an image that is bright enough, and a life that is long enough.

Photoconductive cells, deposited on substrates, now have speed of response in microsecond range. Mosaic of photocells can be deposited over large areas. Photoconductive regions can be isolated, high-density deposition is now possible.

New deposition techniques and improved materials promise longer life, higher brightness. Protective envelopes are no longer necessary. Storage is provided on the screen itself. Present work now attacks cross suppression of light between lines, eliminating cross talk, and uneven illumination.

vacuum. Quartz, aluminum or sapphire substrates may be used. Presently, the method does not apply to glass, because of contamination from the glass, and its low melting point.

Dr. Beeh told *ELECTRONICS* that the maximum spectral response of the photoconductor lies at 4100 angstroms. The wavelength may be shifted up to 6500 angstroms, depending on the activator used. Photoconductors operate with blue, yellow, and white phosphors.

Voltage applied across the cells may range from a few microvolts up to 3,000 volts d-c, or from the 10 cycles up to 100 kc. The cells dissipate from a few milliwatts, up to 0.3 watts. Current may range from a few up to 200 milliamperes.

WRITE-IN—The high speed of response of the material is useful when photoconductors are combined with electroluminescent cells which are turned on and off according to a binary code generated by computers.

This feature, in a display panel, allows for write-in speeds of 200 microseconds or less, per picture element. Display panels, provided with these photoconductors, can operate at frame rates of less than one-half a second, Beeh said.

The number of photoconductors that can be incorporated per square inch depends upon the power dissipation per photoconductor.

Practical electroluminescent-photoconductor panels can be constructed that contain 4 million

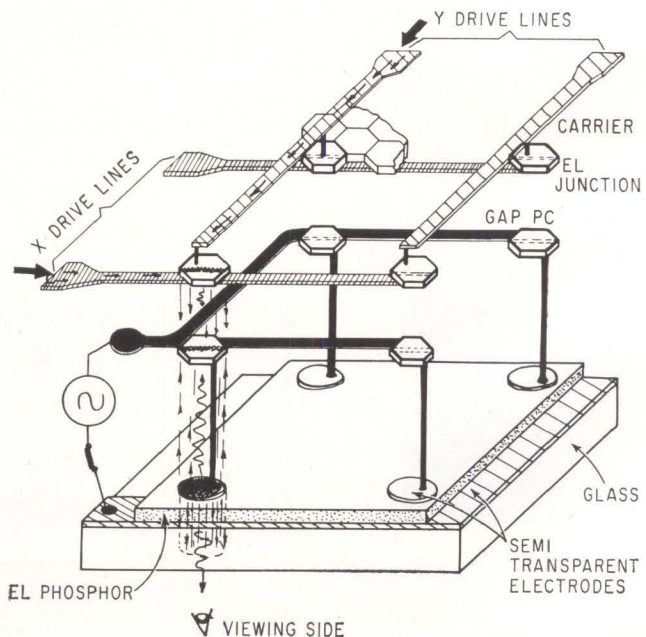

FOUR element low drive voltage display panel



What you can do with General Electric's RTV silicone compounds

to insulate, seal and mold from -150°F to 500°F

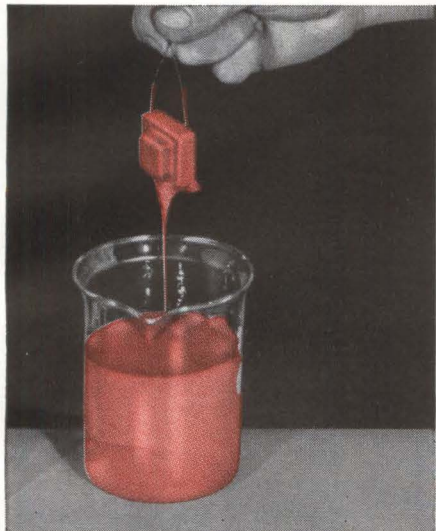

Encapsulate it. Fluid RTV silicone rubber penetrates deep into transformer coils. RTV has excellent dielectric strength and practically no shrinkage. Cure time at room temperature can be varied from minutes to hours.



Pot it. Transparent or opaque, G-E silicones provide a resilient protection against moisture, ozone, thermal and mechanical shock. Flows freely around complicated parts, can be cut away to replace internal components.

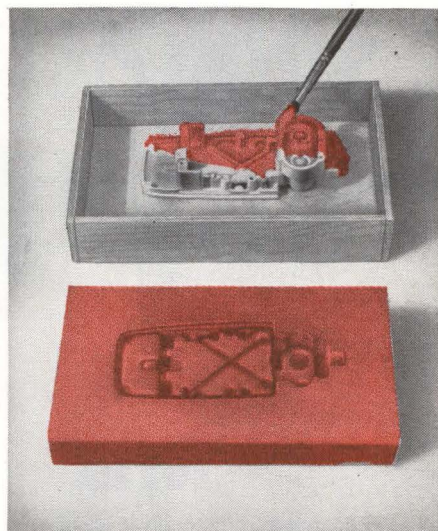

Duplicate it. Flexible RTV is often used to make molds for prototypes and short run production. This part requires deep undercutting, but duplicate parts flex free easily. RTV's tensile strength is as high as 850 psi.

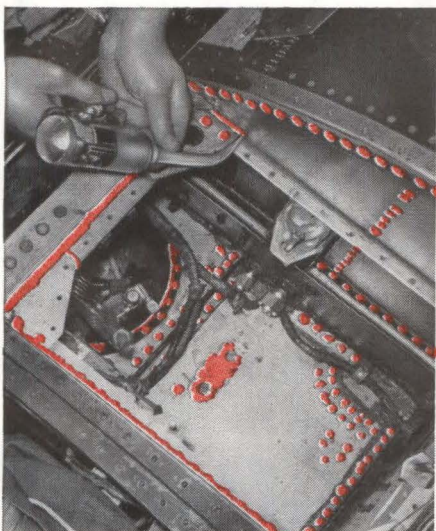

Seal it. Bondable RTV (when surface is properly primed) seals against moisture and vibration, ozone and chemicals. Can be used for sheet metal fabrication, shock mounts, gasketing. Viscosities range from pourable to paste.



Insulate it. Adhesive/sealant RTV-102 requires no mixing of catalyst, can be used to insulate open wiring, for on-the-spot caulking, gluing and soldering. RTVs are virtually ageless, will not stress-crack or weather.



Manufacture it. RTV adhesive/sealants are fast working assembly tools, eliminate prefabricated parts or more costly, time consuming techniques. Here an RTV adhesive laminates flexible mica strips to form cylindrical ducts.

If you would like a free sample of one of the nine General Electric RTV silicones for evaluation, write on your letterhead, describing your application. For additional information, check reader service card. Section N995, Silicone Products Dept., General Electric Company, Waterford, New York.

GENERAL  ELECTRIC

BONDABLE TEFLON*



FLEXLEAD MB is Markel's answer to your bonding problems for applications requiring encapsulation of wires insulated with Teflon. Factory-applied to any of the FLEXLEAD Teflon Wires, extruded or tape-wrapped, the MB process renders the surface bondable with the commonly used elastomeric and epoxy-base potting and encapsulating compounds. Without affecting the color or electrical properties of the insulation, the MB treatment provides a bond with up to 150 psi pull-out strength, and a surface receptive to marking and printing.



TWISTED PAIRS

The new FLEXLEAD Fused Twisted Pair construction of Teflon insulated wire provides all the characteristics of a balanced twisted pair, with the added advantage that it will not unravel during installation or after repeated flexing.

Ask for Samples, Data, and Prices

L. FRANK **MARKEL** & SONS
SINCE 1922
NORRISTOWN, PA.



SOURCE FOR EXCELLENCE

Insulating Tubings and Sleeveings
High Temperature Wire and Cable

*Du Pont Trademark

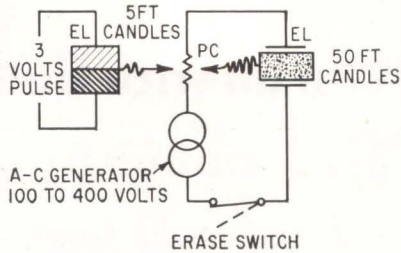

SINGLE element display with storage

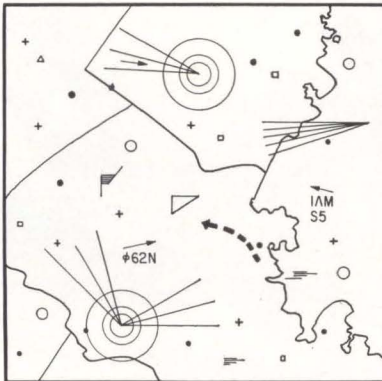

TYPICAL situation display shows coastline, radar stations, airfields, and armament centers. Vectors represent moving aircraft or missiles

picture elements and 40,000 photoconductors per sq in.

The sensitivity of the photoconductors averages 6,000 microamperes per foot-candle. Polarizing voltage of 50 v d-c with an illumination of 1 foot-candle from a tungsten filament source, operates at 2,853 deg K.

The photoconductors may also be photoetched directly on the substrate to provide isolated junctions. Once deposited, the cells are not hygroscopic, and are said to have good surface hardness. Protective envelopes are not needed. This cuts the cost of fabricating a mosaic of cells. There is no need for hermetically sealing feedthrough for the lead wires.

One method looks promising for el displays. A storage would be provided on the display panel itself. A mosaic of photoconductors on the back of the panel would provide an el-pc latch. The photoconductor lowers its internal resistance when the picture element is excited by the x and y voltages. Current flows through the picture element, even though the selected electrical pulses have been removed.

The dark current characteristic

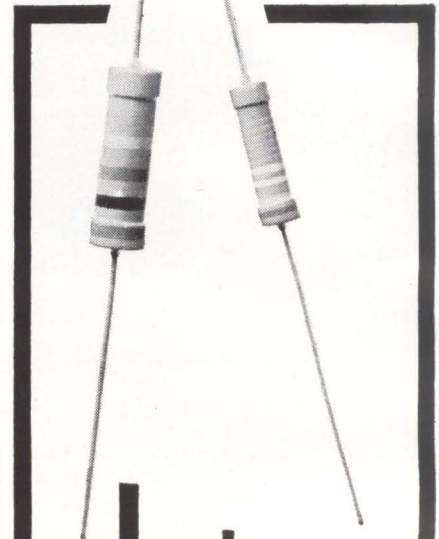
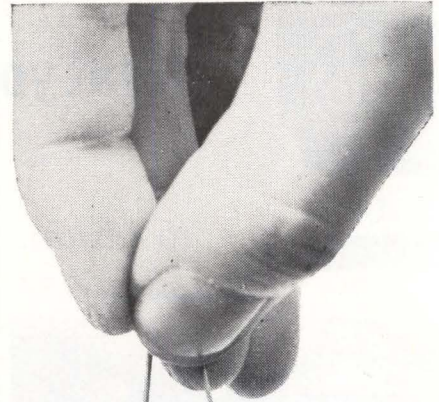

Let us help you cut costs!

CARBON FILM RESISTOR

Rohm

**TOYO
ELECTRONICS
INDUSTRY
CORPORATION**

P. O. BOX 103 CENTRAL
KYOTO JAPAN

CIRCLE 207 ON READER SERVICE CARD
SEPTEMBER 6, 1963 • electronics

EL86

6CW5

Mullard Tubes for Television



LOW IMPEDANCE OUTPUT PENTODE

For audio, video amplifier and field output stages there is no better tube than the Mullard EL86. This 12 Watt output pentode gives advantages of high slope, low impedance and high efficiency. A single EL86 will give an audio output of 5.3 Watts.

CHARACTERISTICS EL86

g_m	11	mA/V
r_p	26	k Ω
P_p	12	W
E_b	170	V
E_c	-12.5	V
I_b	70	mA

Full details on the Mullard range of tubes for television, stereo and high-fidelity available from:
INTERNATIONAL ELECTRONICS CORPORATION,
81 SPRING STREET, NEW YORK 12, N.Y.
Worth 6-0790



Mullard

ELECTRONIC TUBES
MULLARD OVERSEAS LTD., LONDON, ENGLAND.

MIL-C-19978B
MIL-C-19978B
MIL-C-19978B
MIL-C-19978B
MIL-C-19978B
MIL-C-19978B
MIL-C-19978B
MIL-C-19978B
MIL-C-19978B
MIL-C-19978B
MIL-C-19978B
MIL-C-19978B

MIL-C-19978B
Certifying data with respect to test qualifications available. All data compiled by a government approved testing laboratory.

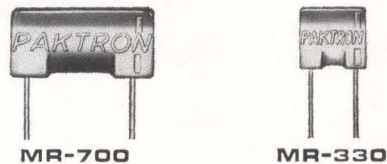

Paktron **MOLDED MINIATURE MYLAR* CAPACITORS—MR330 and MR700**—provide the widest possible capacitance range and most useful voltage ratings in the smallest physical size consistent with **HIGH PERFORMANCE AND RELIABILITY.**

For specific information regarding performance characteristics, write today.

*Dupont Polyester Film

i t PAKTRON
W DIVISION ILLINOIS TOOL WORKS INC.
1321 LESLIE AVENUE • ALEXANDRIA, VIRGINIA

of the cell is less than 0.0015 ma after removal, within 50 μ sec, of an illumination of 100 foot candles. Dark noise is less than 10^{-11} amperes. Beeh says that this is important in making decoding circuits using many cells.

The photoconductors operate within a range between -60 C and 150 C. Dark resistance is in the order of 800 megohms. Resistance under illumination can be as low as 4,000 ohms, depending upon application and intensity of illumination.

GHOST EFFECT — Suppression of illumination between the x and y drive lines has been a problem in el displays. Six x drive lines and eight y drive lines were selected in a 100-element-per-inch panel to show this effect, see photo. The ghost effect can be reduced using nonlinear resistive elements.

Layers of silicon carbide, cadmium sulphide, imbedded in epoxy, can be placed between the x and y electrodes. However, this approach increases voltage requirements. In higher-resolution panels, this can result in cross talk and uneven illumination.

Several other approaches are being considered at Photonetics to circumvent this problem.

The company is making available to industry, under development contracts, mosaics of photoconductors and electroluminescent panels. These are supplied with photoconductive wafers on isolated substrates to suit a variety of electrode geometrics.

**Flexible Wire
Takes 1,200 F**

NUMBER 22 AWG wire, insulated with reconstituted muscovite mica, can take 1,200 F continuously. Exposed to 2,000 F for 15 minutes, wire withstands electrical tests at 600-v d-c.

Present demand is for miniaturized instrumentation and motor assemblies in space electronics. The wire is made by Rockbestos Wire and Cable Co., New Haven, Conn. Company says reinforced insulation gives complete flexibility, heat and radiation resistance, and no smoke during high current loads.

This new catalog
can change
the way you buy
Mercury-wetted
relays

send for it

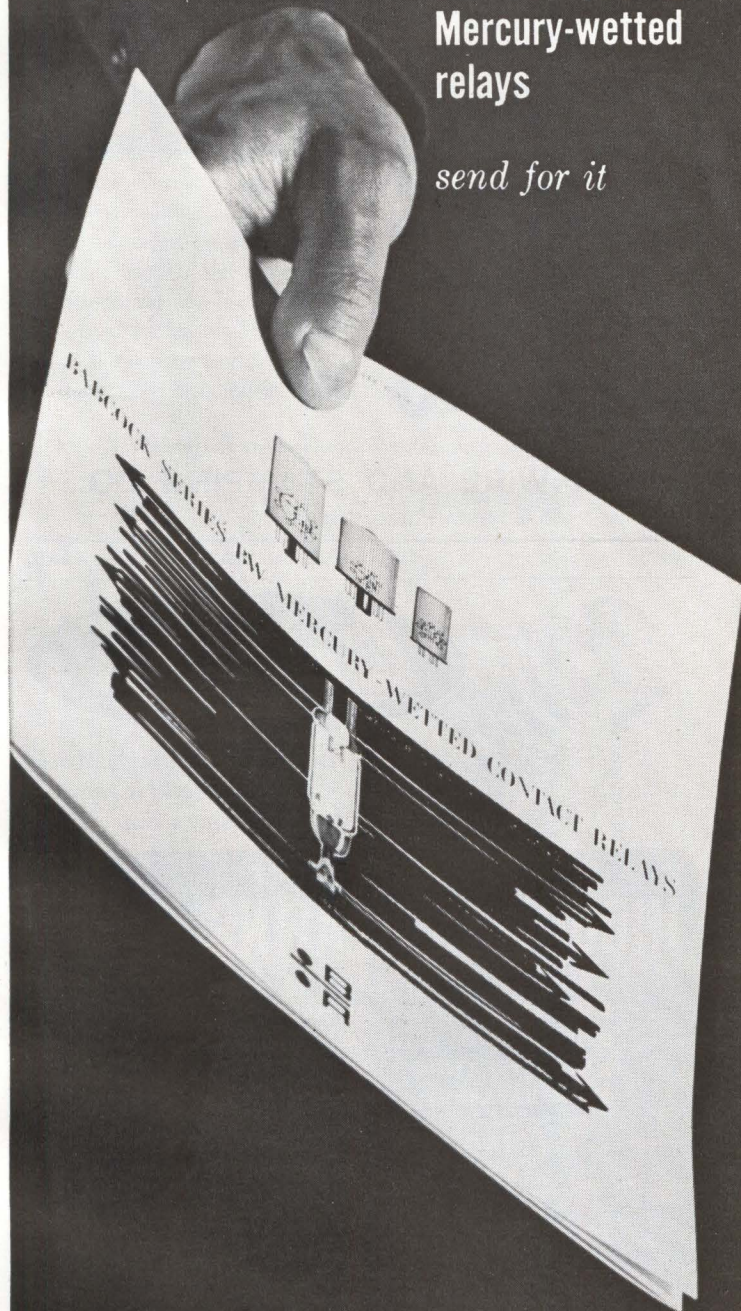

A new standard of excellence in mercury-wetted relays

Babcock's new non-bridging, mercury-wetted contact relays are designed for the high speed switching requirements of computer, control, and data processing applications. Operating at speeds as high as 1 millisecond or on power as low as 1.2 milliwatts, these high performance relays have a contact breaking acceleration of 1500 Gs.

Featuring Babcock's new form C mercury switch element, Series BW relays provide billions of trouble-free operations, constant contact characteristics and permanent low contact resistance without erosion, bounce or chatter.

An exclusive Babcock feature offers a wide variety of special adjustments.

Five models are available, each designed to meet specific applications.



Model BW-2: A single switch unit housed in a 1.234" steel container. Available in a wide range of single-side stable, bi-stable and chopper adjustments.



Model BW-3: Similar to the BW-2, but housed in a shorter steel container. Designed for use where mounting space is limited.



Model BW-4: A seven pin, miniature plug-in relay measuring only .625" (dia.) x 1.891". Recommended for use in military and commercial applications where small size is a critical factor.



Model BW-5: Module form designed for printed circuit board applications. Plated steel enclosure can be grounded to provide both mechanical protection and magnetic shielding.



Model BW-6: Similar to the BW-5 but housed in an epoxy-filled molded nylon enclosure for cooler operation. Recommended for applications where caustics and solvents are involved.

Send for complete details.

BABCOCK RELAYS

A DIVISION OF BABCOCK ELECTRONICS CORPORATION
3501 HARBOR BLVD., COSTA MESA, CALIF. • 546-2711



For Average or Critical insulation, you need QUALITY-CONTROLLED Synthane laminates

It costs you little or nothing more to have Synthane quality laminated plastics for any application, the same quality you would demand for critical circuits. Synthane quality is built into every Synthane grade—every Synthane sheet, rod, tube or fabricated part—from the time the resins and fillers are received through manufacture and machining of the laminates. Every step is tightly controlled to insure uniform and high quality. You can easily afford Synthane for your normal requirements; use it by all means on your most exacting applications.

SYNTHANE

CORPORATION **S** OAKS, PENNA.

Glendale 2-2211 (Area Code 215) TWX 215-666-0589
Synthane-Pacific, 518 W. Garfield Ave., Glendale 4, Calif. TWX 213-240-2104U

Synthane Corporation, 36 River Rd., Oaks, Pa.

Gentlemen:

Please send me complete catalog of Synthane laminated plastics.

Name _____

Address _____

City _____ Zone _____ State _____

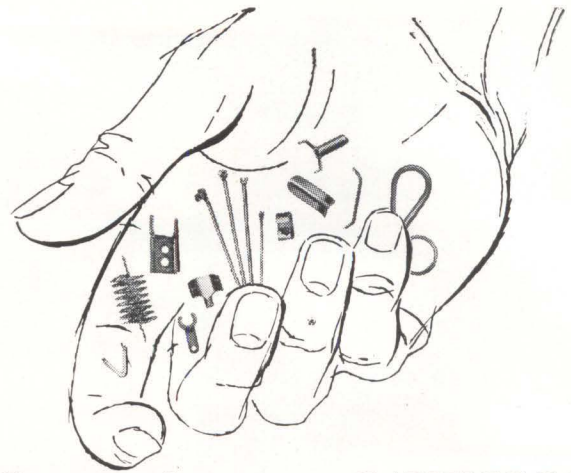

We can show you **SAVINGS!**

PRECISION WIRE FORMS

Art Wire's high speed, automatic machines and production economies mean **BIG SAVINGS** for you ... with guaranteed precision from the first to the millionth unit. Widest variety of wire components, made for today's automatic production, delivered on schedule to assure uninterrupted work flow.

Send a Sample or Blueprint for Estimates

ART WIRE AND STAMPING CO.

18 Boyden Place, Newark 2, N.J.

CIRCLE 208 ON READER SERVICE CARD



Induction Heating's Most
Trusted and Creative
Craftsmen Since 1926

High Frequency INDUCTION HEATING UNITS

for

- BRAZING
- MELTING
- SOLDERING
- ZONE REFINING
- HEAT TREATING
- CRYSTAL GROWING
- BOMBARDING
- PLASMA TORCH

ELECTRONIC TUBE GENERATORS

Kilocycle Frequency Units

Megacycle Frequency Units

Dual Frequency Units

- SPARK GAP CONVERTERS
- ACCESSORY EQUIPMENT

FREE APPLICATION ENGINEERING SERVICE — Our engineers will process your work samples and submit recommendations.

WRITE FOR NEW LEPEL CATALOG
Lepel HIGH FREQUENCY LABORATORIES, INC.

55th St. & 37th Ave., Woodside 77, N.Y.C.

Chicago Office for Sales & Service: 6246 W. NORTH AVE.

CIRCLE 209 ON READER SERVICE CARD

SEPTEMBER 6, 1963 • electronics

**MAXIMUM
RELIABILITY**

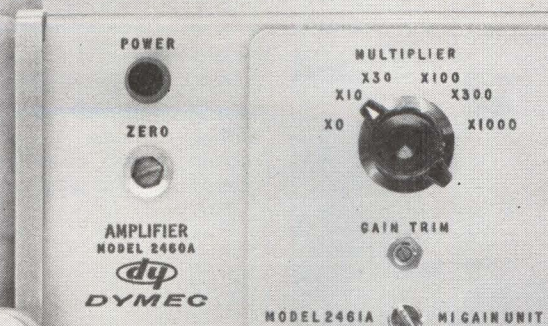

Provided by photochopper in this completely solid state
DC AMPLIFIER
for only \$395!

Photoconductive chopper, all-transistor circuitry permit reliable low-level measurements with the wide-band, high-gain DY-2460A.

Here's a completely solid state high-gain DC amplifier for only \$395. Exceptional reliability is achieved on low-level measurements with a specially designed photoconductive chopper and all-transistor circuitry.

The DY-2460A will supply an output of ± 10 v peak at 10 ma. Zero drift is less than $1 \mu\text{v}$ per week, noise less than $4 \mu\text{v}$ peak to peak. Fast settling time (as little as $25 \mu\text{s}$ to 0.01%) and rapid overload recovery (only $20 \mu\text{s}$, plus settling time) make the amplifier ideal for systems use.

Long life is assured for the DY-2460A because of advanced solid state design. The photo chopper is unaffected by external vibration and is inherently a long-life device. Power consumption is only 4 watts, so that heat problems are non-existent.

Plug-in versatility is offered in the DY-2460A, with interchangeable plug-ins available for systems use (5 fixed gains, 10 to 1000); bench use (fixed gain in decade steps 1 through 1000); for special individual situations (patch panel brings input, output, summing point and feedback circuit to the front panel), and plus-one amplifier uses (input resistance greater than 10^{10} ohm, high gain accuracy).

PRICE: DY-2460A Amplifier, \$395.00. DY-2461A-M1 Data Systems Plug-in, \$85.00. DY-2461A-M2 Bench-use Plug-in, \$125.00. DY-2461A-M3 Patch Unit Plug-in, \$75.00. DY-2461A-M4 Plus-one Gain Plug-in, \$35.00.

Write or call today for complete details and specifications.

Data subject to change without notice. Prices f.o.b. factory.

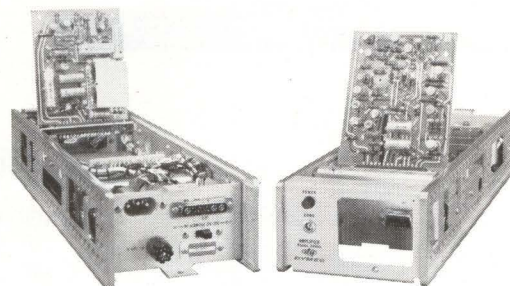

Major circuits of the DY-2460A are mounted on three plug-in etched circuit boards, which swing out for easy access. Sides, top and bottom are easily removed for servicing.

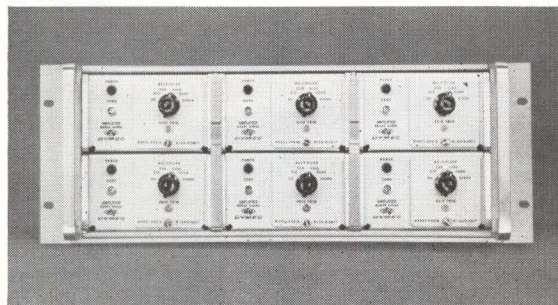

A combining case accommodates up to six amplifiers, can be used on the bench or mounted in standard rack with adapters furnished. Combining case C-146B-2, \$200.00.

DYMEC

A Division of Hewlett-Packard Company



Dept. E-9 395 Page Mill Road, Palo Alto, Calif. Tel. (415) 326-1755 • TWX, 415-492-9363

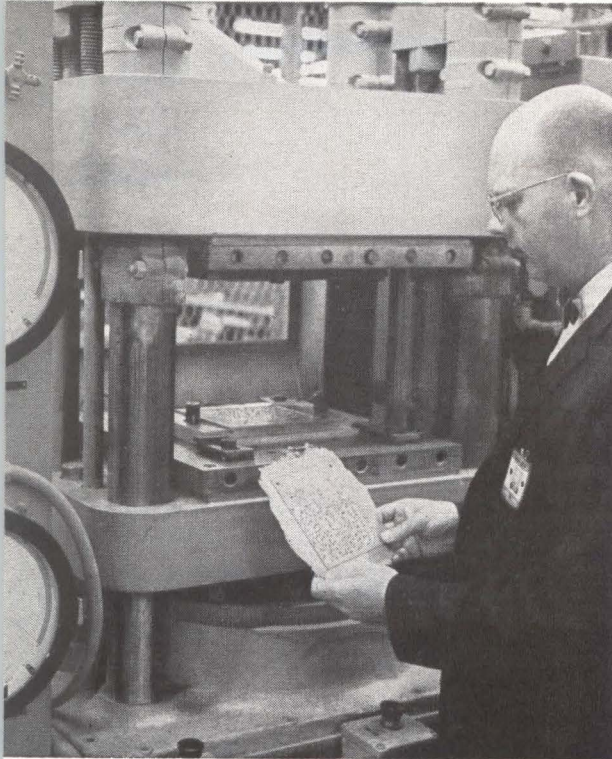

MOLDED BOARD is inspected by author Cichocki as it comes off molding press. Boards are made of glass-fiber-filled plastic

ETCHED MOLDS Form P-C Boards

By C. CICHOCKI and J. DILLON

Light Military Electronics Dept., G.E. Company, Utica, N.Y.

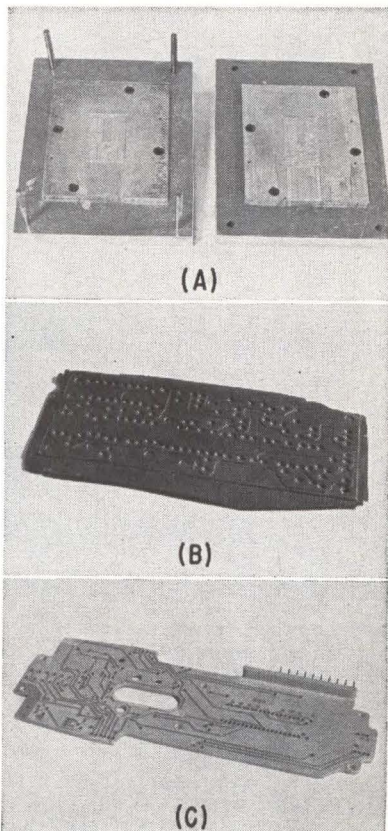

TYPICAL free flash mold commonly used for molded p-c boards (A). Molded board is shown before flash is removed (B). Note vertical riser produced by this process (C)

Cavities made by photoengraving cut costs and lead time

RELIABILITY and utility have spurred the use of molded printed-circuit boards. But a few years ago GE's Light Military Electronics Department had to face two major production drawbacks: potentially high tooling costs and long delivery cycles caused by the making of molds. Both of these were aggravated by the basic nature of the military market where small quantities and short delivery cycles prevail. Conventional mold-making techniques required a shop lead time of 2 or 3 months and a tool investment of \$3,000 to \$6,000 a mold.

LMED engineers have now developed a technique that quickly fabricates mold cavities by photo-printing and etching. This new mold-making process has reduced both mold cost and lead time enough to make molded circuit-board production economically feasible.

Compensation for board shrinkage

is easily made in setting up production. Reliability of connections through the board is improved because holes can be shaped by molding to improve the integrity and performance of electrical connections. The holes are electroplated.

MOLDS—Most often molds are of the free-flash design with a simple cavity configuration. Also used is the semi-positive mold, which restrains the flash by flow through a vertical channel before allowing it to flow horizontally. Multicavity molds 14 × 14 inches are now being used. Boards produced have thicknesses of 30 to 125 mils.

PROCEDURE—The DAIP (diallyl-iso-phthalate) molding material—a thermosetting alkyd resin plastic with a 40-percent filler of long glass fibers—is placed in the heated mold. After curing under pressure, the molded board is removed, de-flashed and oven-cured. This is followed by drilling to remove molding flash from holes, surface preparation and electroless deposition of thin copper. This deposition of electroless copper controls location of final

How Barden gained a 50% increase in cleaning capacity for precision bearings!



PROBLEM: Precision cleaning of assembled ball bearings for instruments used to be a time-consuming operation for the Barden Corporation, Danbury, Connecticut. Bearings up to 1" diameter went through a spray-cleaning machine at a relatively low production rate. Larger bearings were individually spray-cleaned.

SOLUTION: A new cleaning system based on an ultrasonic bath of FREON fluorocarbon solvent coupled with spray cleaning. FREON is a *selective* solvent in that it effectively removes dirt, yet has no effect on critical steel, bronze, plastic and fiber components of these bearings. Ultrasonic action combined with the extremely low surface tension of FREON digs contaminants out of the tiniest crevices. Result: Barden now cleans completely assembled bearings *in batches of hundreds*. Over-all cleaning capacity is up 50%!

And Barden reports that FREON solvents give them *better cleaning quality*. Particle count is 15% lower than before, which is a significant drop because the count was very low to start with.

Barden also points out that FREON dries quickly and leaves no residue, and that its very low toxicity and nonflammability let them operate without expensive ventilating equipment. They've found the new system economical to use, because FREON can be recovered in simple equipment—for reuse over and over again.

We'll be glad to show you how FREON solvents can improve your own cleaning operation. First, *send the coupon or Reader Service Card* for our new booklet on cleaning!

FREON[®]
solvents



BETTER THINGS FOR BETTER LIVING . . . THROUGH CHEMISTRY

MAIL COUPON FOR NEW BOOKLET ON CLEANING

E. I. du Pont de Nemours & Co. (Inc.)
FREON Products Division
N-2420-E-9, Wilmington 98, Delaware

Name _____ Title _____

Company _____

Address _____

Please send new booklet on FREON solvents for precision cleaning.

I am interested in cleaning _____

I would like to talk to a cleaning specialist.

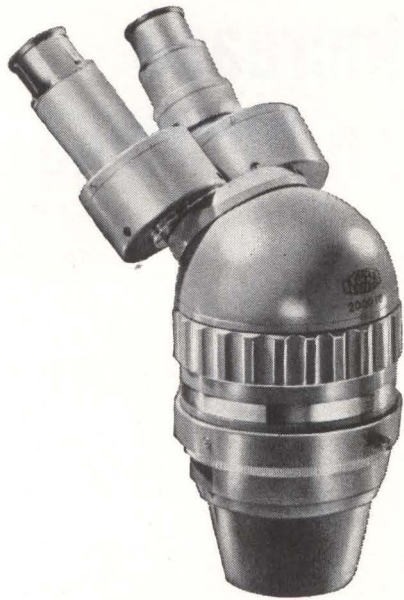

NOW! 1 GREAT ELGEET-OLYMPUS ZOOM STEREO MICROSCOPE IN 3 GREAT VERSIONS!

ELGEET'S FAMED STANDARD MODEL

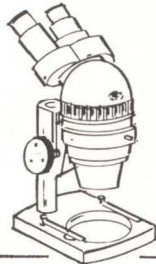

Zooms through a range from 1:4...while offering 7.5 to 30X magnification! Internal prism system provides sharp images through all stages! With 10X wide field paired eyepieces (with 20X wide field optional). \$382.00 with hardwood carry case, lock and key.

NEW! ON ELEVATED BASE!



Ideal laboratory or education model (with mirror beneath the glass stage). Bases may be purchased individually. On base with mirror, \$418.00.

NEW! ON UNIVERSAL STAND!

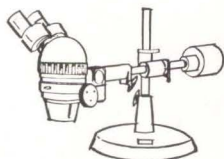

For inspection station and production line installations — counter-balanced universal stand! For electronic assembly, other micro-miniature problems. Microscope and universal stand ... \$411.50. Stand separately — \$79.50. Write for detailed literature SZ-163.

Elgeet OPTICAL
COMPANY, INC.,
303 Child Street, Rochester 11, N. Y.

plating by electrolysis.

Rapid curing property of DAIP caused board-warping problems as variations above 0.015 inch per running inch are not tolerated. Chill blocks, heavy metal plates above and below molded boards, are used for cooling the hot board during the molding operation and is followed by post curing in ovens to stabilize board flatness. Cure completion is controlled by board surface hardness measurement after baking. However, this test is dependent on the constancy of molding plasticizer used in DAIP by vendors.

To counteract shrinkage, compensation is made in artwork used for the photoengraving process. This compensation is regulated so that after the board is removed from the mold, it shrinks to design dimensions.

A 50-percent overcharge of DAIP material in the mold is used to assure proper plastic flow to accommodate changes in circuit configurations and densities. This assures adequate quantity of DAIP for a given mold, despite normal process and material variations. Rec-

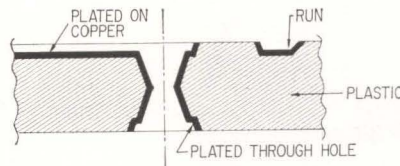

CROSS SECTION of the hour-glass shaped molded hole. Electroless deposition of thin layer of copper makes possible final electroplating of conductive surfaces

tangular bar preforms of DAIP have substantially reduced problems due to storage and lot-to-lot variability.

To eliminate small voids or porosities found occasionally in boards, minor adjustments are made in molding pressures and temperature.

KEY—DAIP material has been a key to process success. It is high-performance material with an impact strength of 9 ft lbs per inch notch, important in withstanding shocks. Heat distortion point of 490 F is good for limited dissipation available in process. It is resistant to organic solvents used during electroless copper deposition. Its arc resistance is 180 seconds.

Abrasive Powder Improves Tuning Fork Tuning

TUNING FORKS are now adjusted and balanced at Melpar's Special Products division by abrading the fork tines with gas-propelled alumina powder. The forks are tuned to accuracies of ± 10 parts per million while the operator monitors

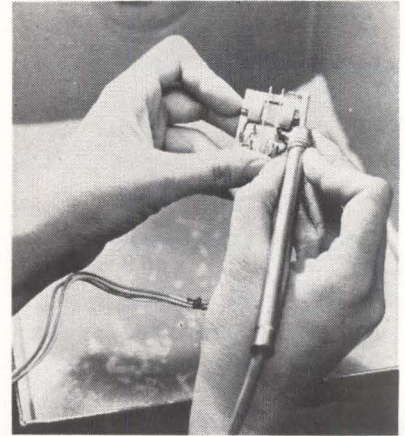

NOZZLE directs fine abrasive at workpiece. Dust is removed from work area by custom-designed dust collector

fork performance with an oscilloscope and counter.

The tuning tool is an S.S. White Industrial Airbrasive unit. The nozzle projects the abrasive (S.S. White #1 aluminum-oxide powder at a flow of 10 gpm) from a distance of about 1 inch from the fork tines.

Among the reported advantages are: because of the fine cutting action of the powder, tines are rarely overcut (overcutting requires balancing of the other tine, which changes fork frequency and slows the process); the tool is not electrical, so cannot generate interference that would affect the monitoring instruments; since the tool does not contact the tine, stresses which could distort frequency are not set up in the fork's nickel-steel alloy; heat is removed by the gas stream.

Melpar had been using an electric grinder to trim the tines.

Cryopump Is Small But Evacuates Quickly

CRYOGENIC PUMP, capable of running 10,000 years at 10^{-8} torr before it would have to be purged of



For Signal Conditioning

AC or DC Transducer outputs

... look at the "custom" answers among the wide variety of standard Sanborn amplifiers. For one channel — or a hundred — of reliable, accurate transducer signal-conditioning, Sanborn probably makes the instrumentation you need. *Types of units* include amplifiers for virtually all AC and DC transducer outputs, excitation sources, and numerous readout and recording instruments. *Packaging* ranges from single-channel portable and plug-in units to multi-channel amplifier modules for system rack mounting. In *performance capabilities*, choices run from simple, low-cost DC signal conditioning circuitry to highly versatile equipment providing maximum input/output adjustment and control.

FOR AC-EXCITED TRANSDUCERS such as DT's, strain gage bridges and variable reluctance units, Sanborn offers single- to 8-channel Carrier Amplifiers for rack, cabinet or portable case mounting; Phase-Sensitive Demodulator Amplifiers, Accelerometer and Integrating Amplifiers; compact, low-cost 28 VDC or 115 VAC Transducer Converters for carrier excitation and signal demodulation of DT-type transducers; and 115 VAC or battery-operated portable Transducer Amplifier/Indicators providing transducer excitation, signal amplification and panel meter readout.

FOR DC-EXCITED TRANSDUCERS such as thermocouples, DC strain gages, DC tachometers, Sanborn "LVsyn" linear velocity and Series 7 DCDT linear displacement units, Sanborn makes 15 different signal-conditioning amplifiers. Straight DC, DC Coupling, Low Level and Stabilized DC types are each available in three *different* amplifier Series. For DC-10 KC and DC-100 cps differential amplification with floating input isolated from floating output, or DC-50 KC, 3-terminal floating amplification, the new solid-state, miniaturized "860" Series provides high performance in a compact highly reliable package. *Talk over your AC or DC transducer instrumentation problems now with your Sanborn Sales-Engineering Representative. He can supply valuable experience, complete information and the reliable equipment you need. Or write*

SANBORN COMPANY, 175 Wyman Street, Waltham 54, Mass.

INDUSTRIAL DIVISION

(A Subsidiary of Hewlett-Packard Company)

CIRCLE 111 ON READER SERVICE CARD

NEW! BALLANTINE SENSITIVE TRUE-RMS RF MILLIVOLTMETER

*Measures 300 μ V to 3 V
from 0.1 Mc to 1,000 Mc*

**Measures True-RMS
regardless of
Waveform
and Voltage**

**High, Uniform
Accuracy and
Resolution over
entire 5-inch scale**



Ballantine's new Model 340 is an extremely sensitive RF millivoltmeter designed for accurate True-RMS measurements with high resolution. Its 5-inch voltage scale spreads out the readings logarithmically so that you can make measurements to the same high resolution and accuracy at the bottom as at full scale. This advantage means that you can not only measure voltages accurately, regardless of waveform, but also calibrate the 340 using a signal source that may be far from sinusoidal. The new 340 is now available in both portable and rack versions.

SPECIFICATIONS

Voltage Range 300 μ V to 3 V	Crest Factor 100 to 3 depending on voltage range
Frequency Range 0.1 Mc to >1,000 Mc; calibrated to 700 Mc	Scales Two logarithmic voltage scales, 0.95 to 3.3 and 3.0 to 10.6. One decibel scale, 0 to 10
Indication True-RMS on all ranges, all voltages	Mean Square DC Output ... 0.1 V to 1.0 V dc. Internal resistance 20 kilohms. (For connection to recorder.)
Accuracy ...% of Reading	
0.1 Mc — 100 Mc, 4%;	
100 Mc — 700 Mc, 10%;	
above 700 Mc as sensitive indicator	

*Accessories include a probe tip for in-circuit measurements, an adapter for connection to N or BNC, a T adapter for connection to a 50 ohm line, and a 40 db attenuator

Write for brochure giving many more details

— Since 1932 —

B BALLANTINE LABORATORIES INC.
Boonton, New Jersey

CHECK WITH BALLANTINE FIRST FOR LABORATORY VACUUM TUBE VOLTMETERS, REGARDLESS OF YOUR REQUIREMENTS FOR AMPLITUDE, FREQUENCY, OR WAVEFORM. WE HAVE A LARGE LINE, WITH ADDITIONS EACH YEAR. ALSO AC/DC LINEAR CONVERTERS, CALIBRATORS, WIDE BAND AMPLIFIERS, DIRECT-READING CAPACITANCE METERS, AND A LINE OF LABORATORY VOLTAGE STANDARDS 0 TO 1,000 MC.

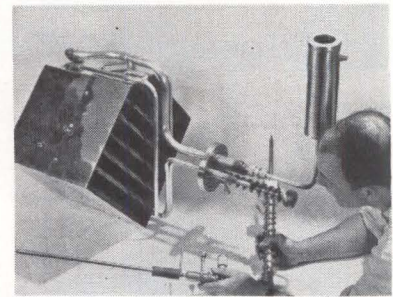

CRYOGENIC PUMP removes gases by condensation on cryogenic surfaces

absorbed gases has been developed for space simulation, thin film applications and fundamental research according to the National Research Corporation, Newton, Massachusetts.

Pumping speed of this unit is 8,000 to 17,000 liters per second for nitrogen and oxygen, 6,000 to 15,000 liters per second for argon and 100,000 liters per second for water vapor.

Operating costs are approximately \$4 to \$5 per hour for use with a liquid helium dewar.

OPERATION—Basically this cryopump is a box measuring 12 × 15 × 15 inches with helium cooled surfaces. The pumping action is due to the fact that cryogenic surfaces remove gases by condensation. Operation is at temperatures below 25 degrees K. These helium-cooled surfaces are shrouded with liquid nitrogen-cooled chevrons that shield the main pumping area from the warmer surrounding atmosphere. Two flanges are provided so the pump may be used when helium is supplied from a storage dewar or to allow the pump to be coupled to a closed cycle refrigerator.

New Tool Solves Cable Lacing Problems

UNIQUE hand held cable-lacer is being used at Seeburg Corporation, Chicago, to resolve production problems in lacing cable harnesses. This inexpensive device supplied by Gudebrod Brothers Silk Company is completely mechanical and requires no electrical power.

Functioning as a simple extension of the worker's hands, it performs all the intricate steps of the

Turning Mountains Into Molehills

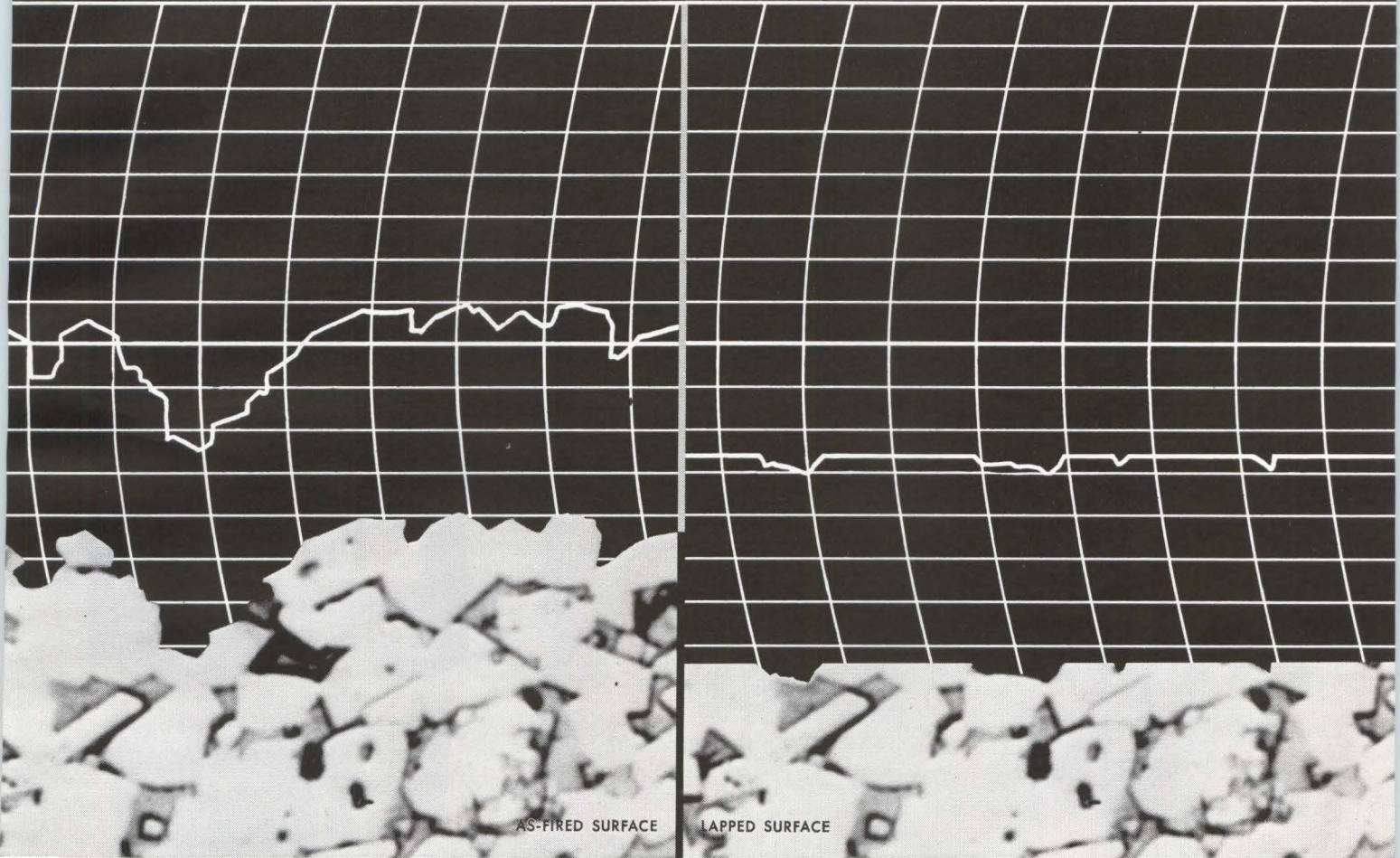

Photomicrographs: 3000x

The "as-fired" surface of a ceramic, under high magnification, looks like a series of mountain peaks. This is because of its crystalline structure. Surface finishing turns these mountains into molehills—or more correctly into plateaus—resulting in smooth, precise surfaces. Your specification of surface finishes is directly related to the economics of your design. To help you get the correct finish, without overdesign—Coors has published a complete set of surface texture traces for Coors AD-85, AD-94, AD-99—and, for comparison, metal. Available are flatness ranges to one and two light bands, surfaces to three microinch, AA. Write for "Surface Characteristics of Coors Ceramics," Data Sheet 3061, or call your nearest Coors Regional Sales Manager: SOUTHERN CALIFORNIA, *Kenneth Lloyd, 847-6812, Huntington Beach*; BAY AREA AND NORTHWEST, *John E. Marozeck, EM 6-8129, Redwood City*; MIDWEST, *Tom Daly, 529-2510, Chicago*; CENTRAL, *Donald Dobbins, GL 4-9638, Canton, O.*; EAST COAST, *John J. McManus, MA 7-3996, Manhasset, N. Y.*; *Herbert W. Larisch, 563-4487, Philadelphia*; NEW ENGLAND, *Warren G. McDonald, FR 4-0663, Schenectady, N. Y.*; SOUTHWEST, *William H. Ramsey, UN 4-6369, Houston.*

Coors

ALUMINA CERAMICS

Coors Porcelain Co., Golden, Colo.

CIRCLE 113 ON READER SERVICE CARD

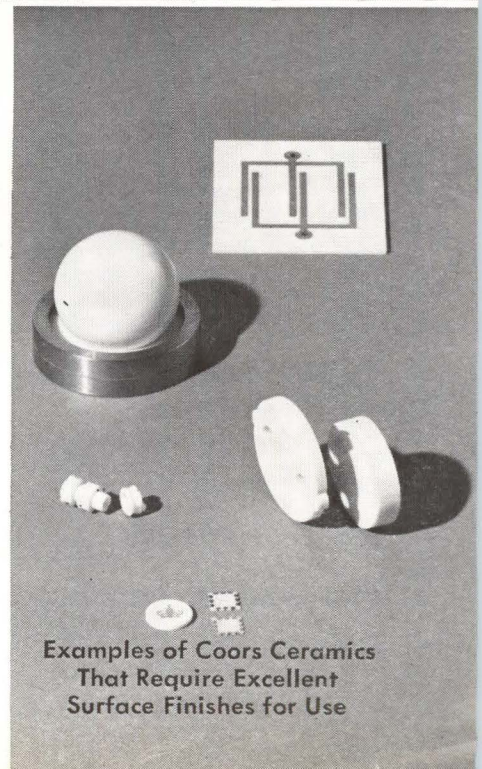

Examples of Coors Ceramics That Require Excellent Surface Finishes for Use

SPECIFY Stromberg-Carlson TELEPHONE-TYPE RELAYS

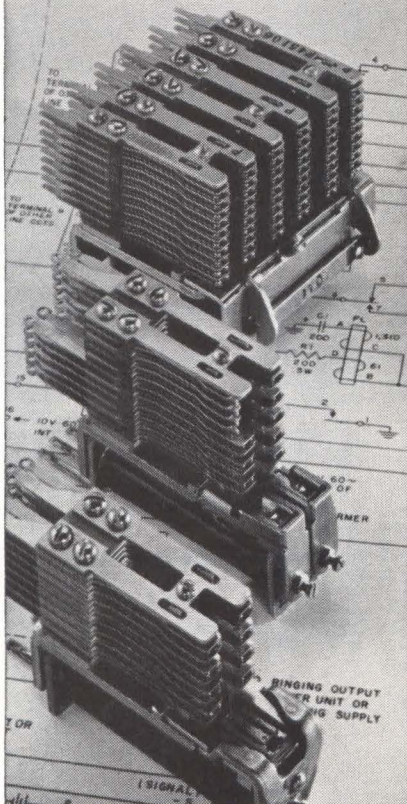

The sound design and long, reliable life of these Stromberg-Carlson relays have been proved by many years of successful use in the exacting field of telecommunication:

Type A: general-purpose relay. Up to 20 Form "A" spring combinations.

Type B: multi-contact relay. Up to 60 Form "A" spring combinations.

Type BB: multi-contact relay. Up to 100 Form "A" springs.

Type C: two relays on one frame; mounts in same space as one Type A.

Type E: general-purpose relay; universal mounting; interchangeable with relays of other manufacturers.

All standard spring combinations are available in these telephone-quality relays. For complete technical data and details on special features, write to Industrial Sales Department.

STROMBERG-CARLSON
A DIVISION OF **GENERAL DYNAMICS**
114 CARLSON ROAD • ROCHESTER 3, N. Y.

knotting operation with consistent speed and efficiency. Physical abuse to the hands of the worker is absorbed by the lacer. Operators have exhibited measurably greater skill and higher morale, says Gudebrod.

DESCRIPTION—Lacer is of all-metal construction and has a torpedo-shaped body six inches in length. An extended lacing hook is from 2 to 4 inches long. This hook is formed to suit specialized harnessing needs. A guide shaft is provided within the cylindrical body for loading of a 60-ft. spool of nylon tape. The free end of the tape is fed up and out through a slot in the outer shell, then down through a guide hole provided in a cap in the base. Flow of the tape, as it unwinds from the spool, is regulated by a simple lever, parallel to and running the length of the lacer cylinder. This lever, called a cord grip handle, is easily compressed by light hand pressure and provides an instantaneous automatic stop for the tape whenever required.

OPERATION—In the lacing operation the cord is first tied to the cable. The left hand is used to form a loop with the tape above the cable and is held there while the lower dangling part of the loop is engaged with the lacer's extended hook. With the tape being fed continuously from the bottom of the lacer, a second loop is formed on the side of the cable opposite the first, hand-held loop. Once this new loop has been made, the hook of the lacer is disengaged from it, and it is allowed to slide downward over the hook toward the lacer body. Then, with the handle compressed so no additional tape can be fed, the lacer is passed, by means of an upward motion, completely through both loops to form the knot. Final position and tightness of the knot can be regulated to any desired degree through simple manipulation of the lacer. The tie cord handle is compressed in every case to insure tautness.

It is in the actual tying and tightening of the knot that the lacer has proven of most benefit, Gudebrod says. With the protection and control offered by the lacer body and its stop, knots of extreme firmness, and tightness can be tied.

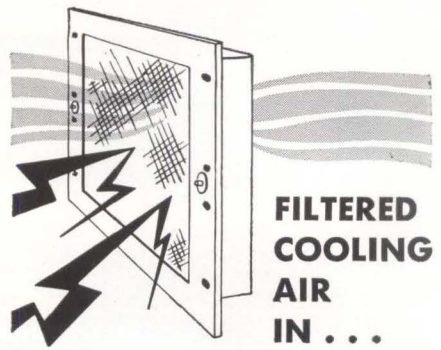

RFI OUT!

WITH NEW
McLEAN
RFI
SHIELDED
BLOWERS
and Filter-Grille Assemblies



Now you can pressurize radio-shielded electronic cabinets with cool, filtered air without opening the "envelope" to RF interference.

McLean RFI-shielded blowers and filter-grille assemblies have been designed and built for RFI performance in accordance with MIL-1-6181D — meeting or exceeding all requirements including susceptibility, generation and shieldability. WRITE TODAY for details.

SEND FOR
NEW 44-PAGE
CATALOG



McLEAN ENGINEERING LABORATORIES
World Leader in Packaged Cooling
P.O. Box 228, Princeton, New Jersey
Phone Area Code 609 WALnut 4-4440
TWX 609-799-0245

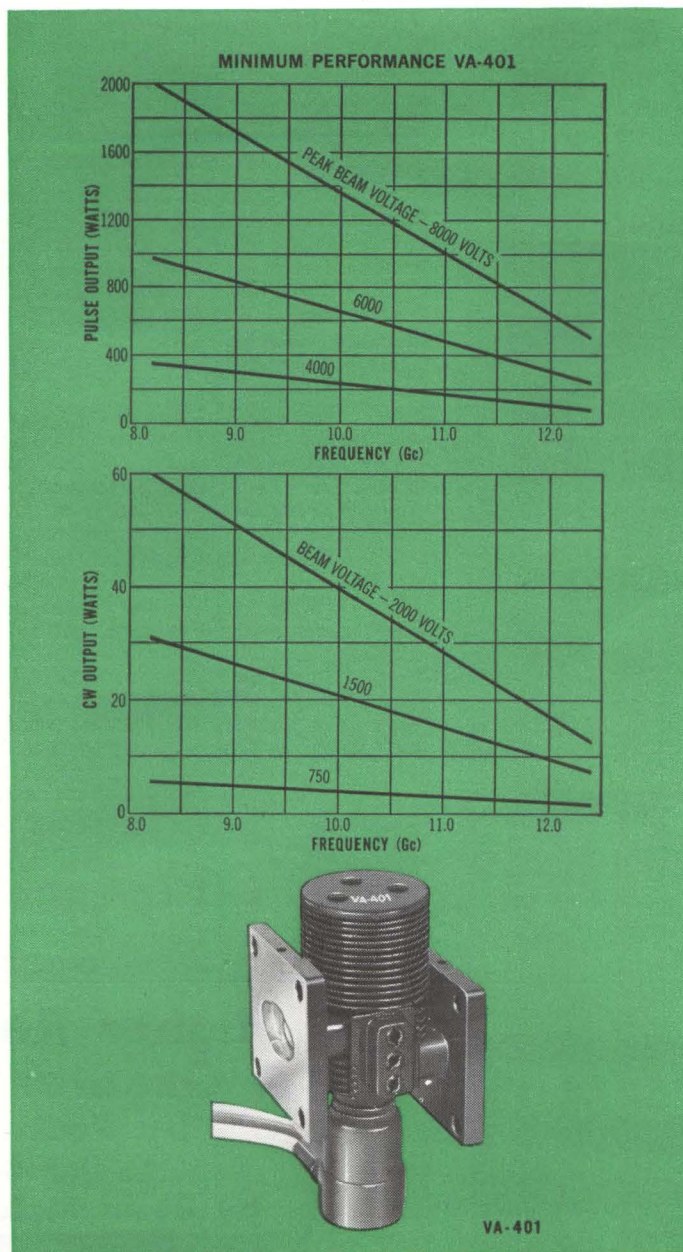

LIGHTWEIGHT X-BAND TUBE OPERATES PULSE OR CW ... NEW FROM VARIAN

Varian's new VA-401 klystron can operate either as a pulse or CW amplifier at any fixed frequency selected between 8.2 and 12.4 Gc. Exceptional design permits this tube to be operated at various power levels by using the appropriate beam voltage. ■ This electrostatically-focused three-cavity tube will deliver at least 500 watts in pulse service and 10 watts CW at the high-frequency end of the operating range. As shown in the graphs above, the output at the low-frequency end of the range is several times greater. This tube is an excellent choice for airborne CW radar, doppler navigation, multichannel parametric amplifier pumping, or synchrodyne systems. Typical gain, 30 db. Weight, 13 ozs. Write for more information.



VARIAN
TUBE DIVISION
Palo Alto 1, Calif.

MICROWAVE TUBE GROUP: PALO ALTO TUBE DIVISION • BOMAC
DIVISION • S-F-D LABORATORIES, INC. • SEMICON OF CALIFORNIA, INC.
VARIAN ASSOCIATES OF CANADA, LTD. • SEMICON ASSOCIATES, INC.

EUROPEAN SALES HEADQUARTERS: VARIAN A.G., ZUG, SWITZERLAND

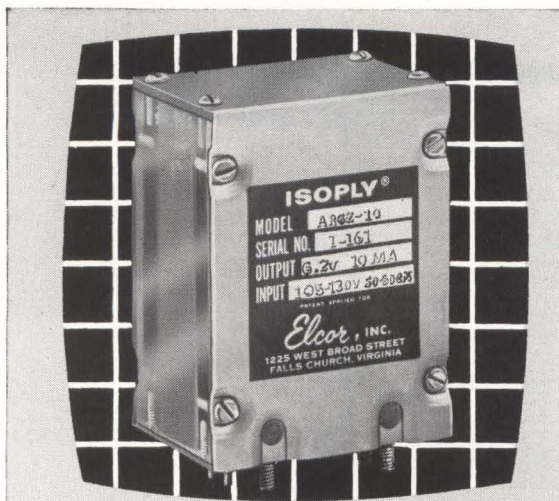

**TYPICAL A4R SERIES ISOPLY
SPECIFICATIONS—MODEL AR62-10**

Input.....	105-130 vac 50-60 cps
Output.....	6.2 vdc \pm 5% fixed at 10 ma constant load
Output ripple.....	1 mv p-p
Stability.....	.01% over 105-130 vac input (less than .001% per volt of input change)
a Line stability.....	
b Load stability.....	.01% per-ohm of load change
c Temperature coefficient.....	.01% /C° from 0°C to 60°C
d Long term stability after 15 minutes warm-up.....	.01% per day (with line load and ambient temperature held constant)
Isolation.....	
a Intercircuit capacitance from dc output to primary winding.....	.1 pf
b Shunt capacitance from dc output to ground.....	20 pf
c Insulation voltage.....	1000 vdc
d Leakage resistance to ground.....	greater than 100,000 megohms
*Hum and noise induced in external circuit with power supply ungrounded.....	less than 10 uv p-p per kilohm (neither output terminal grounded)
Dimensions.....	1 1/4" x 2 1/4" x 3-1/16"
Weight.....	.75 lb.

Elcor IsoPLY Circuitry Handbook (60 pages) Available. Price \$1.00

What can a power supply contribute to circuit design?

PLENTY... if it's an *ISOPLY®

SPECIFY ELCOR FOR:

- Servo design** . . . ISOPLY substantially eliminates ground loop problems and zero errors.
- Bridge design** . . . ISOPLY eliminates common-mode signal . . . no differential amplifier needed. Ground referenced Bridge output available.
- Digital design** . . . ISOPLY allows DE-coupled DIRECT coupled circuits.
- Amplifier design** . . . ISOPLY is ideal for bootstrap cathode or emitter follower and related circuits.
- Nuclear design** . . . ISOPLY changes polarity from the detectors to suit the instrument.
- RFI design** . . . ISOPLY can meet MIL-I-16910 or other appropriate specifications.
- Bio-medical design** . . . ISOPLY provides the isolation required for neuro-physiological stimulation experiments.
- Special designs** . . . ISOPLY construction lends itself to design flexibility and variation capable of meeting many special requirements.
- Multiple output design** . . . ISOPLYS with as many as four outputs are available.
- *Highly isolated power sources** . . . ISOPLYS . . . offer a completely new dimension in circuit design flexibility by removing the constraint imposed by dependence upon ground referenced power.
- Other Elcor Products** . . . ISOFORMERS® (Isolated Transformers) up to 1 KW . . . ISOREX® (Isolated Transformer-Rectifier) units and unregulated but isolated power packs . . . Current Indicators and Integrators and related measurement instruments . . . specify Elcor.

for further information, write, wire or phone:



ELCOR, Incorporated
Subsidiary of Welx Electronics Corporation
1225 West Broad Street, Falls Church, Va.
Telephone Code 703—JE 2-8850
(FAX No.-RFJ, Falls Church, Va.)
Some areas still open for representation

CIRCLE 211 ON READER SERVICE CARD

exclusively
for
industry

free

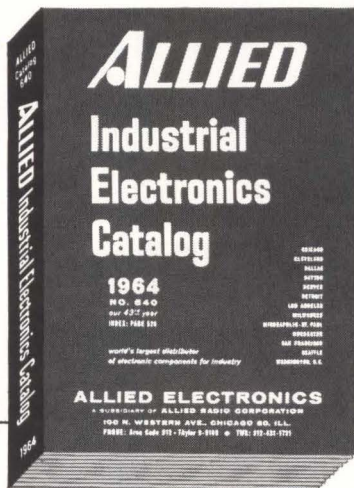

ask for
your

1964 **ALLIED INDUSTRIAL CATALOG 640**

540 PAGES • COMPLETE INDUSTRIAL ELECTRONICS CATALOG FOR THE SPECIAL USE OF PURCHASING AGENTS AND ENGINEERS

- World's Largest Stocks of Electronic Components
- Same Day Shipment • Factory OEM Prices

for FREE copy, check reader service card or write direct

ALLIED ELECTRONICS

subsidiary of ALLIED RADIO CORPORATION

100 N. Western Ave., Dept. 80-J, Chicago 80, Ill.

For separate Catalog No. 230 featuring hi-fi, build-your-own kits, home tape recording, ham gear, etc., write directly to Allied Radio, Dept. AX, 100 N. Western Ave., Chicago 80, Ill.

**Higher Reliability
& Greater Stability
by Passivation.
Lower Price
by Resin Molding Process**

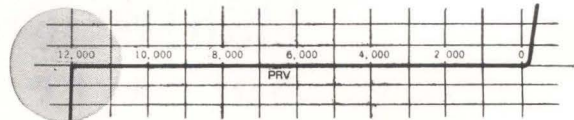

Sharp Reverse Breakdown,
Unchangeable by Time
or Environment.

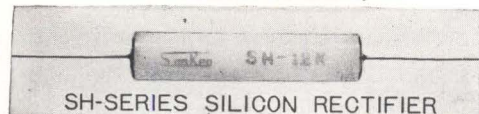

SH-SERIES SILICON RECTIFIER

For Low Power Supplies SD-1 Series For High Power Supplies SH-Series

SD-1	400PRV	500mA	SH-6K	6000 PRV	30mA
SD-1A	600PRV	500mA	SH-8K	8000 PRV	30mA
SD-1B	800PRV	500mA	SH-10K	10000PRV	30mA
SD-1C	1000PRV	500mA	SH-12K	12000PRV	30mA

Sanken SANKEN ELECTRIC CO., LTD.

Daiwa Bldg., 1-11, Ikebukuro-Higashi, Toshima-ku, Tokyo

Cable: SANKEN TOKYO

CIRCLE 212 ON READER SERVICE CARD

SEPTEMBER 6, 1963 • electronics

NEW COAX!



MINIATURE THIN WALL 100% SHIELDED TEFLON COAXIAL CABLE

Inner-space, outer-space, or lack of space — wherever size, weight, and shielding of coax is a criteria, Hitemp's new cables provide design advantages not previously available!

Engineering, production, and Q.C. techniques advanced by Hitemp make it possible to hold shielding to a wall thickness of 1.5 mils, or less. For example, on a RG-196A/U teflon insulated coax cable, Hitemp holds the O.D. to .040" or half the O.D. of conventional wire braid construction (.080"). Subsequently, there's a weight savings of 21%. And this miniaturized cable can be wrapped around a $\frac{3}{8}$ " mandrel.

Naturally, the 100% shielded construction improves attenuation characteristics, reduces cross-talk to a minimum, stabilizes capacitance, and lowers VSWR.

100% shielding offers you assembly economies, too. It eliminates many termination problems associated with braided shields, and increases the reliability of the terminations, themselves.

Wherever your circuitry requires lower attenuation, improved VSWR, and so forth — wherever shielding, weight, size, flexibility, and reliability are critical, that's where it will pay you to use Hitemp's new miniature 100% shielded.

SEND FOR A SAMPLE if you'd like to run some checks on it yourself. Or, send us a piece of what you're currently using. We'll evaluate it and advise you of the savings you can make with Hitemp's new miniature coax. Why not take advantage of *either* offer today!

HITEMP WIRES CO.

a Division of Simplex Wire & Cable Co.

1200 SHAMES DRIVE, WESTBURY, NEW YORK
1532 S. CALIFORNIA AVE., MONROVIA, CALIF.



< **HOW CAN I CUT
 TRIMMER
 CAPACITOR COSTS
 IN MY EQUIPMENT
 WITHOUT
 LOSING
 RELIABILITY?**

USE >
 THE
 NEW
**JFD
 HI-LIFE
 "Y"
 PISTON
 TRIMMER.**

JFD piston capacitor know-how now gives you a competitive edge in performance and price.

New technological advances together with automatic production facilities make it possible for you to buy new JFD "Y" trimmers at approximately 30 per cent below the cost of other comparable capacitors.

Model VC9GWY 0.8 to 8.5 pf. panel mount (one of over 24 "Y" trimmers now available). Actual size.



Compare the other advantages, too: ■ Precision Hi-Life adjust mechanism guarantees adjustment life of 500 cycles — more than 600 per cent greater than requirements of Mil-C-14409A ■ Special process glass dielectric for high stability over a wide range of operating temperatures (−55°C to 125°C)

■ High Q factor — 500 measured at 1 MC ■ Ultra linear tuning with no reversals ■ Fine vernier multi-turn adjustment for increased sensitivity and excellent resolution. ■ Space-saving telescopic tuning assembly with little, if any protrusion of adjustment screw for compactness. ■ Anti-backlash design maintains its setting through shock and vibration and gives smooth uniform tuning adjustment. JFD "Y" trimmers are available in panel mount and printed circuit types—as well as Sealcap, Max-C, split stator, or differential, glass or quartz construction. Special "Y" trimmers can also be designed to meet your performance requirements. Ask your distributor or write us for Bulletin "Y".

**JFD ELECTRONICS
 CORPORATION**
 THE  AMERICA KNOWS BEST!

Components Division

JFD ELECTRONICS CORPORATION, 15th Ave. at 62nd St., Brooklyn 19, N. Y. • DEWey 1-1000 • TWX: 212-833-7001
 JFD NORTHEASTERN, Ruth Drive, P.O. Box 228, Marlboro, Mass. • HUntley 5-7311
 JFD MID-ATLANTIC, 313 E. Broad St., Palmyra, N. J. • 609-665-0788
 JFD MIDWESTERN, 6330 Hermione St., Chicago 46, Illinois • 775-5424, 5425
 JFD MIDWESTERN-OHIO, 7415 Montgomery Road, Cincinnati 36, Ohio • 513-421-1166
 JFD WESTERN, 9 Morlan Place, Arcadia, California • 213 HI 6-0312
 JFD CANADA, LTD., 51 McCormack Street, Toronto, Ontario, Canada • ROger 2-7571
 STANDARD TELEPHONE & CABLES LTD., Components Group, Capacitor Sales Dept., Footscray, Sidcup, Kent, England
 LCC STEAFIX, 128 Rue de Paris, Boite Postale 51, Montreuil-sous-Bois, Seine, France
 JFD ISRAEL, LTD., Bldg. 23, Industrial Area B, Azur, Israel
 DUCON CONDENSER PTY. LTD., Christina Road, Villawood, N.S.W., Australia

Variable Trimmer Piston Capacitors ■ Metalized Inductors ■ LC Tuners ■ Fixed Capacitors ■ Fixed and Variable Distributed and Lumped Constant Delay Lines ■ Pulse Forming Networks

High-Speed Solid-State Printer

Unit can provide
10,000 word-per-minute
line at a time printing

INTRODUCED by Kleinschmidt Div., Smith-Corona Marchant Inc., Deerfield, Illinois, Model 311 high-speed electronic data printer is designed for operation in communication or data processing systems and permits transmission and reception of 5, 6, 7 or 8 level codes. The printer operates at speeds of 40 character-per-second using sequential or parallel signaling and contains a type drum with 64 characters around its periphery. The unit's all-transistor electronic logic module provides for 14 plug-in boards, though most conventional applications require only 9. The additional 5 boards can provide operation or control features such as character selection and answer back. The en-

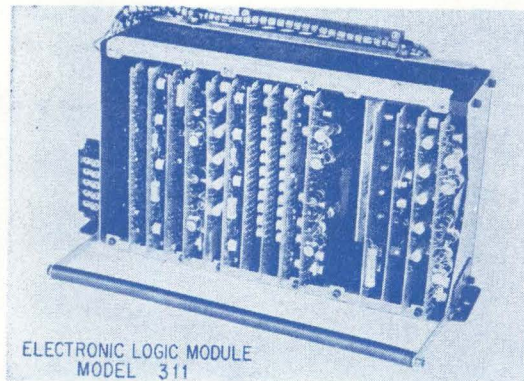

tire logic module, which normally mounts on the rear of the printer, may be positioned remotely to permit a variety of installations.

According to the manufacturer, the model 311 is the first teleprinter capable of handling both standard 60 to 100 word per minute direct-wire communications as well as input and output for computers requiring high-speed (10,000 wpm) line-at-a-time printing. Moreover,

the device requires only 25 percent of the moving parts found in conventional electromechanical printers without solid-state electronics and modular construction. Use of electronic rather than mechanical character selection permits receipt of incoming signals with as much as 45-percent distortion without error. Model 311 is self contained and weighs only 55 pounds.

CIRCLE 301, READER SERVICE CARD

Recorder Withstands 100-G Acceleration

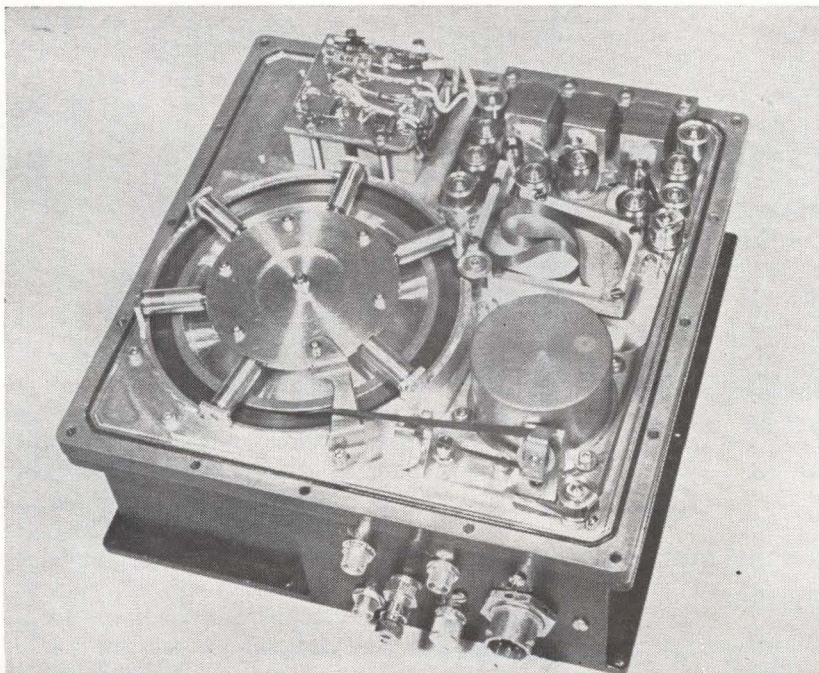

DESIGNED specifically to obtain accurate data during missile re-entry, launch and other difficult environments, model R-304 recorder has proved capable of operation with low wow and flutter during tests at a sustained acceleration of 100 G. According to the manufacturer, Borg-Warner Controls, Santa Ana, Calif., the device is a continuous-loop unit with a capacity of 300 feet of 1/4-inch magnetic tape. Moreover, the use of a Moebius loop permits a recording length of 600 feet with up to four data channels. Three magnetic heads provide record, reproduce and erase functions.

Model R-304 has tape speeds of 7.5 and 30 inches per second and can be provided with other speeds with minor modifications. Control of tape speed is within 0.1 percent.

Cornered

by
PW Assembly
Problems?

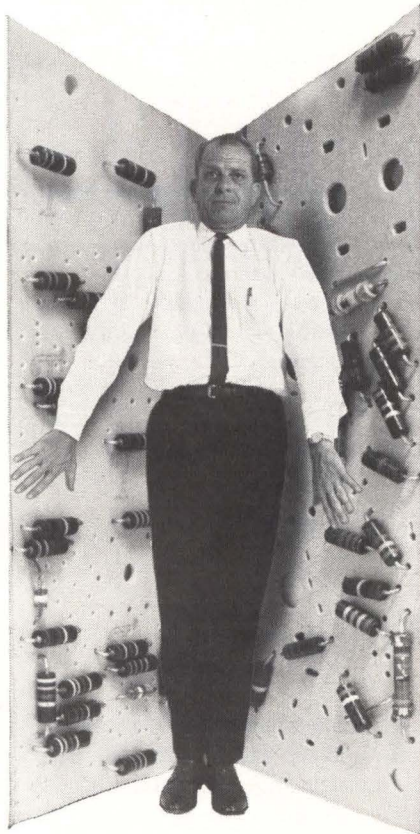

DYNASERT®

Discover how automatic inserting equipment can open new ways to profit for you. This is modern, automated component insertion. Even if your production is as little as a few hundred insertions a week, Dynasert delivers a multitude of advantages. It's high-speed: up to ten times faster than costly hand methods. It delivers uniformly high product quality. It automatically feeds, cuts, and bends leads, inserts and clinches all types of axial lead components. Requires little operator training. Changes made from one board or component type in seconds. Money saved in direct labor costs and production time can pay for a Dynasert installation in less than a year. Get complete facts. Write for a free copy of: Dynasert — Production Equipment for Electronics. Dynasert Dept. 3, United Shoe Machinery Corp., Boston, Massachusetts.



United Shoe Machinery
BOSTON, MASSACHUSETTS

at any given temperature and within 0.5 percent over a wide temperature range. Speed control is achieved by means of an electronic servo system, while Mylar drive and pinch belts assure long transport life. The recorder has wow and flutter below 0.5 percent rms under severe operational conditions and consumes between 4 and 20 watts of power at an operating voltage of 28 volts d-c ± 4 volts. Furthermore, it meets RFI specs of MIL-I-26600 and weighs between 7 and 9 lb depending upon service requirements. CIRCLE 302, READER SERVICE CARD

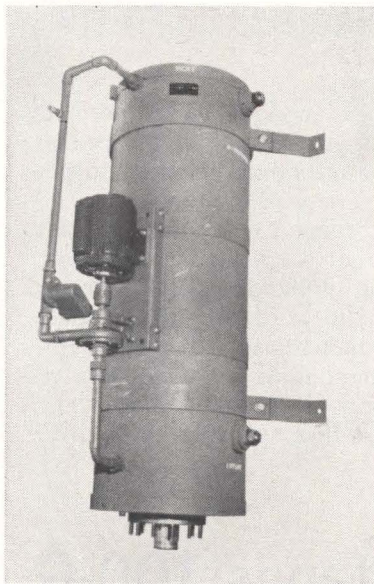

Dummy Load Dissipates 100 KW

ANNOUNCED by Electro Impulse Laboratory, 208 River Street, Red Bank, New Jersey, r-f termination will dissipate 100,000 watts between d-c and 1,000 Mc. Unit consists of an oil-filled resistor and an oil to water heat exchanger. Oil is circulated between the dummy load and the exchanger by a circulating pump and tap or sea water running through the exchanger carries away the heat. Since water is used only in the secondary cooling system, any type of water may be used in the load. Price is \$4,500. (303)

Phase-Shift Modules Are Lossless

MANUFACTURED by Nilsen Manufacturing Co., P. O. Box 127,

Haines City, Fla., new series of phase-shifting modules can be used for continuously shifting the phase angle of an r-f signal between 0 and 360 degrees without insertion loss. Called the Varigon series V-56A, units contain electrostatic phase

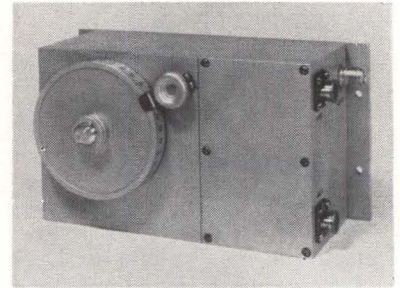

shifters with phase-splitting networks and transistor circuits that isolate and amplify phase-shifted signals. A special capacitor makes shifting possible without brushes and the units can be produced for any specified frequency and dialed manually or driven at speeds to 5,500 rpm. Moreover, they can be used to produce continuous time delays or phase variation directly proportional to dial rotation. Functional characteristics of a typical module at a frequency of 500 kc are: insertion loss of zero, 50-ohm input and output impedance, 1.1:1 typical vswr, infinite resolution and 0.5-volt rms input amplitude. Units have application in radar ranging, sine and cosine generators, frequency modulators, frequency changers, rotary-position indicators and phase-meter instruments. Series V-56A modules weigh about 4¾ pounds and are priced at \$822.90 each. (304)

Instrument Measures Leakage to 1 Nanoamp

MARKETED by Texas Instruments, Inc., 3609 Buffalo Speedway, Houston, Texas, low-current unit for use with the company's transistor and component tester (TACT) makes rapid, fully-automatic current measurements from 0.999 ma through 999 picoamperes. Device provides full-scale accuracy of 0.5 percent with picoampere resolution. Total ranging speed for 6 decades is less than 2 seconds. Low-current testing

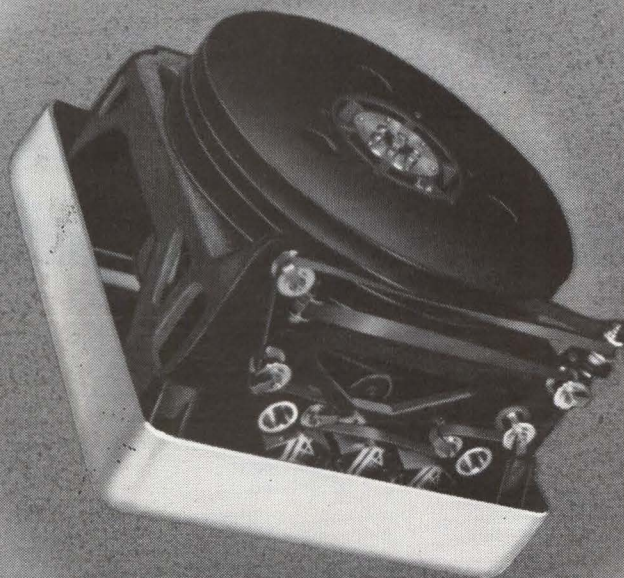

Toughened to live with a nuclear neighbor

This is Leach's newest Satellite Tape Recorder. It is built to resist the radiation from SNAP-10A (System for Nuclear Auxiliary Power).

A two channel, miniature, hermetically sealed recorder, Model 2200 was tested this year during the development program at the Nuclear Aerospace Reactor Facility in Forth Worth. The final results tell the story — the complete recorder was successfully irradiated to the ultimate design goals — a radiation dose of 1×10^{13} neutrons/cm² and 1×10^8 carbon rads.

Capable of recording up to 136.2 minutes of DC to 128 cps square wave data, this nuclear-hardened satellite tape recorder weighs a mere 10.5 pounds and takes up only 304 cubic inches of space.

Other Leach Satellite Recorder/Reproducers, hardened for operation in the Van Allen Belt, are now in orbit.

They're storing quantities of data and playing that data back when and where it's needed. Soon this newest member of the Leach recorder family will also be in space...operating in a radiation environment near a nuclear reactor!

Leach is a leader in developing nuclear-resistant telemetry equipment and relays of all sorts. We'll be glad to share our findings with you. A collect call or letter to Leach is a good place to start.

LEACH
CORPORATION

CONTROLS DIVISION

717 N. Coney Ave.
Azusa, California • Phone 334-8211
Export: Leach International S. A.

LAPP HEAVY-DUTY ENTRANCE INSULATORS

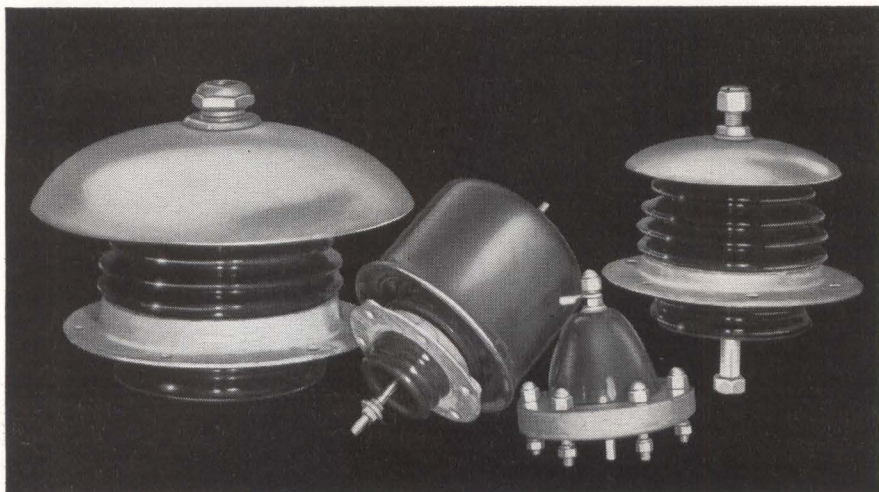

...in all these standard sizes
to save you time
and money

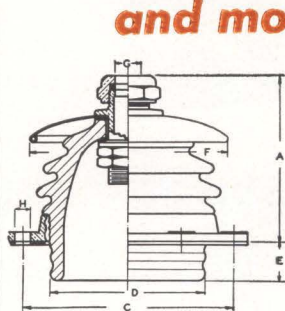

TYPE A
Permits use of continuous pipe conductor through the insulator.

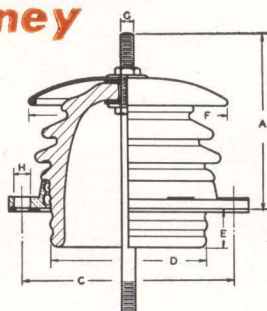

TYPE B
Stud secured to porcelain bowl.

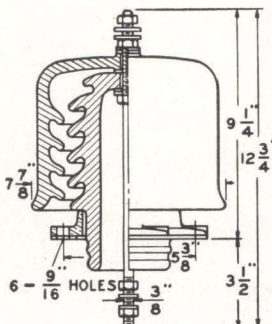

TYPE C—NO. 11896
Similar to Type B, but with porcelain hood added.

DIMENSIONS IN INCHES—FLASHOVER AND RADIO RATINGS

Catalog Number	Type	A	C	D*	E	F	G	H	DRY FO 60% kv eff.	Radio Rating kv eff.
10030	A	12 $\frac{3}{4}$	14 $\frac{3}{8}$	12 $\frac{1}{2}$	1	16	2 Max.**	$\frac{5}{16}$	80	16
9553	A	10 $\frac{1}{2}$	12	9 $\frac{3}{4}$	2 $\frac{1}{2}$	16	1 $\frac{1}{2}$ Max.**	$\frac{5}{16}$	70	12
9554	A	7 $\frac{1}{16}$	9	7 $\frac{1}{2}$	2	9 $\frac{1}{4}$	1 $\frac{1}{2}$ Max.**	$\frac{5}{16}$	55	8
22913	A	6 $\frac{1}{8}$	7 $\frac{3}{4}$	6 $\frac{1}{2}$	1 $\frac{1}{2}$	7 $\frac{1}{4}$	1 Max.**	$\frac{5}{16}$	45	9 $\frac{1}{2}$
7321	B	12 $\frac{1}{2}$	14 $\frac{3}{8}$	12 $\frac{1}{2}$	1 $\frac{1}{2}$	13 $\frac{3}{8}$	$\frac{3}{4}$	$\frac{1}{16}$	80	16
5363	B	10 $\frac{3}{8}$	12	9 $\frac{3}{4}$	2 $\frac{1}{2}$	16	$\frac{3}{4}$	$\frac{5}{16}$	70	12
8141	B	6 $\frac{1}{2}$	7 $\frac{3}{4}$	6 $\frac{1}{2}$	1 $\frac{1}{2}$	7 $\frac{1}{4}$	$\frac{1}{2}$	$\frac{5}{16}$	45	9 $\frac{1}{2}$
22611	B	8 $\frac{3}{4}$	5 $\frac{3}{8}$	4 $\frac{1}{4}$	1 $\frac{1}{2}$	8 $\frac{1}{2}$	$\frac{3}{8}$	$\frac{5}{16}$	55	9 $\frac{1}{2}$
10300	B	6 $\frac{1}{2}$	5 $\frac{3}{8}$	4 $\frac{1}{4}$	1 $\frac{1}{2}$	5 $\frac{1}{4}$	$\frac{3}{8}$	$\frac{5}{16}$	45	8

*D is mounting hole diameter.

**Always specify outside diameter of conductor.

Lapp

WRITE for Bulletin 301-R.
Lapp Insulator Co., Inc.,
208 Sumner Street, LeRoy, N. Y.



is automatically performed when called for by prepunched card programming used to assure absolute repeatability. Readout for all tests is either by an in-line visual unit and one of several printers or card-punch devices.

The low-current unit has seven full-scale ranges from 10^{-3} amps to 10^{-9} amps, accuracy of ± 1 percent or ± 0.5 percent of full scale depending upon which is greater, speed for automatic ranging and stabilization to the most sensitive range of 1.5 seconds, fixed range stabilization speed of 380 millisecc and output of ± 1 volt d-c for full-scale reading, or panel-meter indication. The device is basically a capacitance - modulated summing amplifier with ranges selected by connecting feedback resistors between 1,000 ohms and 1,000 megohms between the amplifier output and the summing point. Resistors are switched by means of low-leakage reed relays that can be operated manually, remotely or automatically.

CIRCLE 305, READER SERVICE CARD

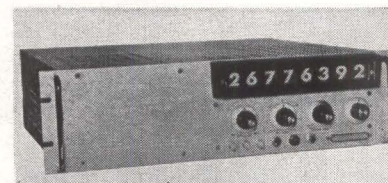

Decimal Computer Displays 8-Place Data

MODEL 123 decimal display computer provides decimal format conversion of 10 to 24 bit serial or parallel binary data. Eight-place decimal data is visually displayed and BCD and decimal outputs are provided for external recording. Unit accepts either positive or negative logic, variable-amplitude inputs and is capable of being programmed to permit automatic scaling of fractional, integer, or linear scale fac-

WORKHORSE



Downtime's nemesis, rugged and reliable as a purebred workhorse — that's Mincom. Common denominator of dependability in all four basic Mincom Recorder/Reproducers is the exclusive Mincom DC Top Plate. Here's a tape transport built with beautiful simplicity: Only 12 moving parts with four easy adjustments, full dynamic braking, instant six-speed pushbutton control, seven or fourteen tracks — plus tape speed accuracy within $\pm 0.005\%$ using Mincom's Cyclelock®. Whether your specifications call for wideband predetection at 1.5 mc, or a comfortable 120 kc at 60 ips, there's a reliable Mincom workhorse to meet your facility's needs. Write today for details.

Mincom Division **3M**
COMPANY

2049 South Barrington Avenue, Los Angeles 25
425 13th Street N.W., Washington 4, D. C.

**Stable to 0.01%
... Indefinitely**

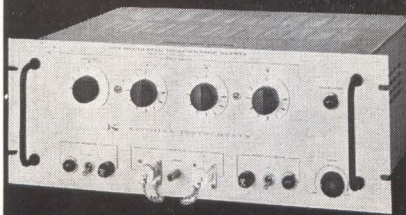

**NEW KEITHLEY
3500V D.C. SUPPLY**

The extreme stability of the Model 242 is not specified in hours. Now—over several months—you can perform extended duration measurements. Cumulative drift of this regulated supply is prevented by a self-correcting feedback loop featuring a temperature compensated zener diode reference, photo-chopper comparator and wire wound sampling resistors. 300 V to 3500 V are delivered at 25 ma, with less than 1 mv combined ripple and noise— ideal for photo tube, photo multiplier and electron multiplier applications. Other specifications contributing to the outstanding value of the Keithley 242 are shown below.

- **output:** 300 to 3,500 V at 25 ma in 1 volt steps—plus, minus, or floating to 4500 V
- **stability:** 0.01% indefinitely, after 30 minute warm-up
- **accuracy:** $\pm 0.1\%$
- **ripple and noise:** Less than 1.0 millivolt rms
- **line regulation:** 0.005% for 10% change in line voltage
- **load regulation:** 0.005% from zero to full load
- **overload protection:** Automatic disconnect if current exceeds 27 ma
- **price:** \$850

Other Regulated DC Supplies

Model 241, 0-1000 V, 0.05% accuracy \$800
Model 240, 0-1000 V, 1.0% accuracy \$345

Send for Latest Catalog



**KEITHLEY
INSTRUMENTS**

12415 Euclid Avenue • Cleveland 6, Ohio

tors. Missouri Research Laboratories, Inc., 2109 Locust Street, St. Louis 3, Missouri.

CIRCLE 306, READER SERVICE CARD

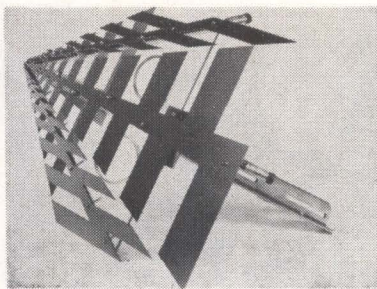

**Log Periodic Feeds
Have Dual Polarization**

DUAL polarized log periodic feeds have vswr of 2:1 maximum and minimum crosstalk of 20 db. The units employ broadband, trapezoidal-tooth, log periodic elements and can be used with a variety of paraboloidal reflectors to achieve excellent gain, beamwidth and side-lobe performance. Model 95690 operates in the 800 Mc to 2.2 Gc range while model 96410 operates between 400 Mc and 2.0 Gc. Other models are available for operation down to 80 Mc and up to 4.0 Gc. Kennedy Antenna Division, 155 King Street, Cohasset, Massachusetts. (307)

**Wirewound Potentiometer
Is Radiation Resistant**

MINIATURE wirewound potentiometer, which operates efficiently at extremely high temperatures and in radiation environments, has been developed. Bourns model 3040 is encased in the established TRIMPOT® Rectangular configuration and operates to 350 C with a power rating of 5 watts at 70 C. Unit will function satisfactorily in radiation environments of high flux dosage—150 megarad total gamma radiation and fast neutron radiation of $5 \times 10^{15} \text{n/cm}^2$. Model 3040 will successfully withstand bombardments of high-energy particles from nuclear explosions or from outer-space environments such as the Van Allen belt. Specifications include: resistance range of 500 to 20K ohms; resistance tolerance of $\pm 10\%$; operating temperature range from -65 to $+350$ C; shock

**With Hart Series W:
More Relay**



... 25 amps!

CONTACT RATINGS

25 A resistive	120 V a-c or 240 V a-c
25 A inductive	(75% power factor) 120 V a-c
12½ A inductive	(75% power factor) 240 V a-c
1 HP	120 V a-c (96A locked rotor)
2 HP	240 V a-c (72A locked rotor)
25 A resistive	24 V d-c

Low Cost, Easy to Mount



For more information on these compact, dependable, general-purpose relays, write for Bulletin WU-09 which gives complete data, specifications, applications and illustrations.

HART
MANUFACTURING CO.
202 BARTHOLOMEW AVENUE
HARTFORD 1, CONNECTICUT
Telephone: Area Code 203: 525-3491
A SUBSIDIARY OF OAK MANUFACTURING CO.

Model
7 DCDT-050
transducer



**MEASURE
DISPLACEMENTS**
of $\pm 0.050''$ to $\pm 3''$ with
**6 VDC EXCITATION,
DC OUTPUT**

Now you can have all differential transformer transducer advantages in linear displacement measurements — without external carrier systems or phase shift and balancing problems. Sanborn 7 DCDT Series are miniature, hermetically sealed units with carrier systems built-in. Features include unlimited resolution, high accuracy and high sensitivity. Delivery from stock. Modifications available on special order.

MODEL	FULL SCALE STROKE (inches)	FULL SCALE OUTPUT (VDC)	OUTPUT IMPED. (K ohms)	FREQ. RESP. (3 db down at cps)	PRICE (FOB Waltham, Mass.)
7 DCDT-050	± 0.050	± 1.5	2.2	350	\$ 99
-100	± 0.100	± 2.8	3.0	170	104
-250	± 0.250	± 1.5	5.0	120	119
-500	± 0.500	± 3.3	5.3	135	132
-1000	± 1.000	± 4.8	5.5	114	141
-2000	± 2.000	± 4.6	5.2	128	155
-3000	± 3.000	± 5.0	5.0	100	162

TRANSducer DIVISION
SANBORN COMPANY
175 Wyman St., Waltham 54, Mass.

CIRCLE 214 ON READER SERVICE CARD

**LEL-LINE Components Take
The Worry Out Of Being Close**

Here is a sure way to eliminate waste space in electronic packaging... LEL-LINE Strip Type components are compatible, lightweight and compact... just right for reliable performance in close quarters. Hybrids, dividers, comparators, modulators, mixers, switches, attenuators or matched assemblies.

Need 'em fast? Quick Reaction Capability delivers one or all in jig time to do the job... they're LEL designed and manufactured too.



LEL-LINE Strip Type Low Pass Filters
FREQUENCY RANGE: 1000 to 5000 Mc

Send for 72-page catalog 63

LEL INC. / 75 AKRON STREET,
COPIAGUE, L. I., N. Y.
(516) PYramid 9-8200 (516) AMityville 4-2200

CIRCLE 215 ON READER SERVICE CARD

NOW

Inventoried Package Waveguide Systems

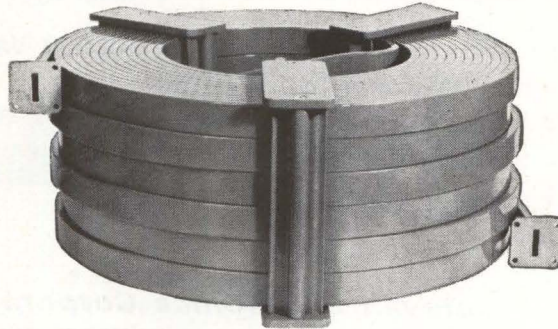

7.0 to 18.0 G.C. Odd or even packages. Circular or rectangular.

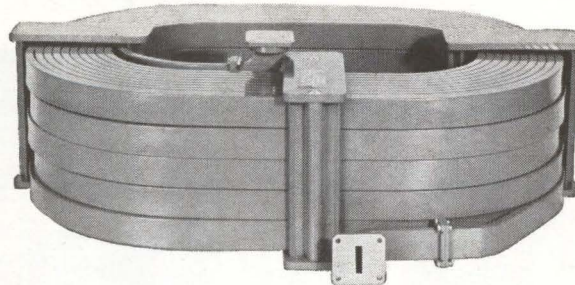

- Up to 1300 ft. free space equivalent carried in stock. Larger free space equivalents furnished promptly on request.
- Cut testing time with minimum distortion, and reduction of discontinuities.
- For time delay comparison, range calibration, laboratory delay measurements, pulse parameter tests, channel equalization.

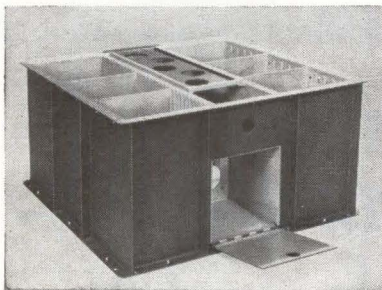

**DIP-BRAZING
OF ELECTRONIC
ASSEMBLIES**

You can hold close tolerances, and meet design requirements with electronic assemblies dip-brazed by Turbo. Electronic chassis, illustrated, has 67 interlocked parts. Send print for quotation.

TURBO

Ordnance and Electronic Department

TURBO MACHINE CO., LANSDALE, PA.
Phone: Area Code 215, Ulysses 5-5131

CIRCLE 125 ON READER SERVICE CARD 125

ELECTRONICS ENGINEERS...EVALUATE THIS COIL... DELEVAN'S MOLDING TECHNIQUES OPEN NEW HORIZONS FOR **VARIABLE COILS**

Discover new reliability in molded variable coils. Eliminate the "weak link" in your system. Most variable coils (and transformers) are designed and built today exactly as they were 10 years ago. With the Delevan Molded "Variable," the state-of-the-art for variables is advanced to equality with all other reliable components. Available with either powdered iron or ferrite cores, each coil is designed for minimum capacity and optimum Q. Delevan is proud of this achievement in high-reliability programming.

SPECIFICATIONS: **SERIES 4000 MOLDED VARIABLE COILS**

- Size: 0.40" Diameter; 0.93" Molded Length
- Mounting: Chassis or Printed Circuit
- Inductance: .18 uh to 70,000 uh
- Environment: Grade 1, Class B, MIL-C-15305



Delevan Electronics Corporation

A SUBSIDIARY OF AMERICAN PRECISION INDUSTRIES INC.
270 QUAKER ROAD EAST AURORA, NEW YORK 14052



HERE ARE 2 NEW COIL ENGINEERING KITS THAT EQUIP YOU WITH THE RIGHT COIL FOR ANY DESIGN APPLICATION.

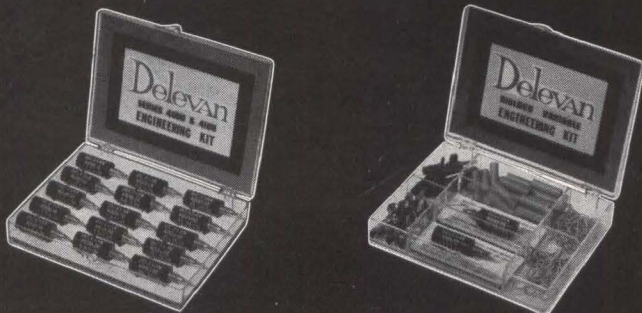

KIT No. 1 supplies 15 Series 4000 molded variable coils.

KIT No. 2 provides components to design your own variable coils.

Write for further information on these engineering kits today.

CIRCLE 126 ON READER SERVICE CARD

WANT TO DO BUSINESS WITH THE GOVERNMENT ????????

Then check the Military and Government Procurement Guide in the orange section of your **ELECTRONICS BUYERS' GUIDE**.

of 50 G and vibration of 20 G between 30-2000 cps. The unit weighs 0.25 ounce. Bourns, Inc., 1200 Columbia Ave., Riverside, Calif. CIRCLE 308, READER SERVICE CARD

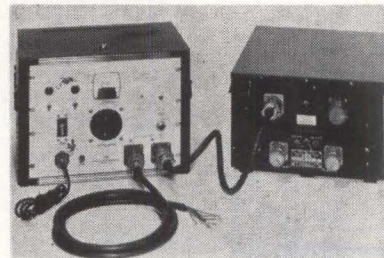

Pulse Energy Source Yields 10,000 Joules

SERIES 520 Joule Pac stores 1250 or 2500 joules of electrical energy and is continuously variable from 0 to 4 kv. Series 522 power supply can be used with any combination of up to four series 523 energy banks to produce a full 10,000 joules of stored energy. Originally designed as a pulsed energy source for the company's extensive range of high-power laser flash tubes, series 520 Joule Pac is a modular system that can be used in virtually any application where large pulses of energy are required. Safety interlocks are provided and the unit is also protected by a circuit breaker. The power supply module includes a jack for synchronous output and provision is made for manual or remote firing. Edgerton, Germeshausen and Grier, Inc., 170 Brookline Ave., Boston, Mass. (309)

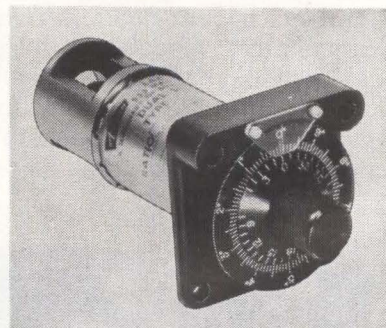

Precision Drive Stresses Accuracy

SUBMINIATURE precision dual-speed drive occupies less than a 2-inch square of panel space and weighs 4 ounces complete with mounting hardware and servo component

WHAT MAKES AN INSTRUMENTATION CABLE FAIL?

It can pass inspection perfectly one minute and fail miserably the next. Simply manufacturing it to spec isn't good enough. Insurance against failure must be built into the cable at every step from diagram to installation.

Where can it go wrong? At almost any point not adequately safeguarded. Here are four of the most common trouble spots:

- (1) Incompatible Plasticizers
- (2) Filler Material
- (3) Component lay-factors
- (4) Shielding

INCOMPATIBLE PLASTICIZERS A unique form of chemical warfare within cable materials has fouled more than one missile program. Plasticizer materials have to be added to compounds to obtain the required flexibility. These additives are seldom compatible with each other. Incompatible plasticizers used in systems in contact with each other without control may attack each other with disastrous effects. (As a prime example, additives in low temperature neoprene jackets are not always compatible with the insulating materials.)

Manufacturers can control plasticizer migration problems by selecting proper materials and by using suitable barriers between components. Many specifications make the use of barrier material optional and a manufacturer whose only concern is price will leave it out.

Rome-Alcoa, as a result of its wide experience with materials, always uses barriers where migration could be a problem.

FILLER MATERIALS When spurious signals arrive at your display, recording or control panel, the fault could be in the improper selection of filler material. Compatibility between insulations and filler materials is of prime importance.

In the case of some plastics or rubbers, the material's "memory" can cause it to shrink disproportionately, creating undue stresses internally in the cable. This can cause kinking of the insulated conductors; electrical failures follow.

Only experience can tell a cable manufacturer how to compensate for "memory" and how to control compatibility in filler materials. Experience in areas such as this has given Rome-Alcoa its remarkable record of instrumentation cable reliability.

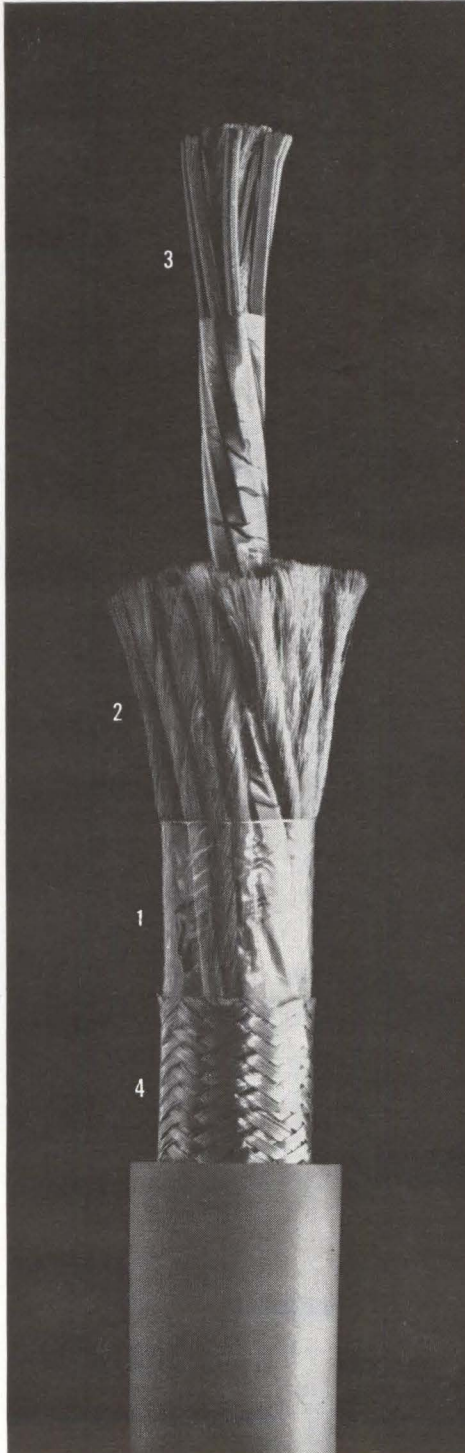

COMPONENT LAY-FACTORS Conductor kinking can also be a result of mistakes in the twisting of component conductors. Inconsistent tensions and improper sequence of lay-up can create uneven tensions in the assembled conductors.

In such cases, individual conductors may actually push through their insulations, causing electrical failures.

Obviously, these mistakes should be avoided during cabling. At this stage in cable construction careful, experienced workmanship can provide safeguards against possible trouble later on. Such careful craftsmanship sometimes costs a little more, but it can make the difference between success and failure.

SHIELDING Constructed of many ends of fine strands, shielding braids are prone to having broken and loose ends. These can break through insulations and short out component conductors. Improperly treated, they are the most common cause of shielding failures.

It's cheaper to let such loose ends remain in the braid—but it can also be disastrous. Experience on thousands of such shieldings has taught Rome-Alcoa the exact tensions which must be maintained, as well as methods of protecting and treating loose ends.

HOW TO AVOID FAILURES No manufacturer can promise you 100% reliability at every development stage. But it's only logical that the one way to be sure of maximum reliability is to have your cable planned and manufactured by a company with depth of experience and a record of reliability in the field.

Rome-Alcoa is, frankly, one of the few companies that qualify. We've been designing and constructing these cables since their first conception—long enough to know what can cause a cable failure, and how to avoid it. If you're planning to design or install instrumentation cable soon, call us.

As a starter, send for our 24-page booklet titled "Instrumentation Cables, Cable Assemblies and Hook-up Wires." In it, we describe instrumentation cable constructions, production, military specifications and our qualifications. For your copy, write Rome Cable Division of Alcoa, Dept. 27-93, Rome, N.Y.



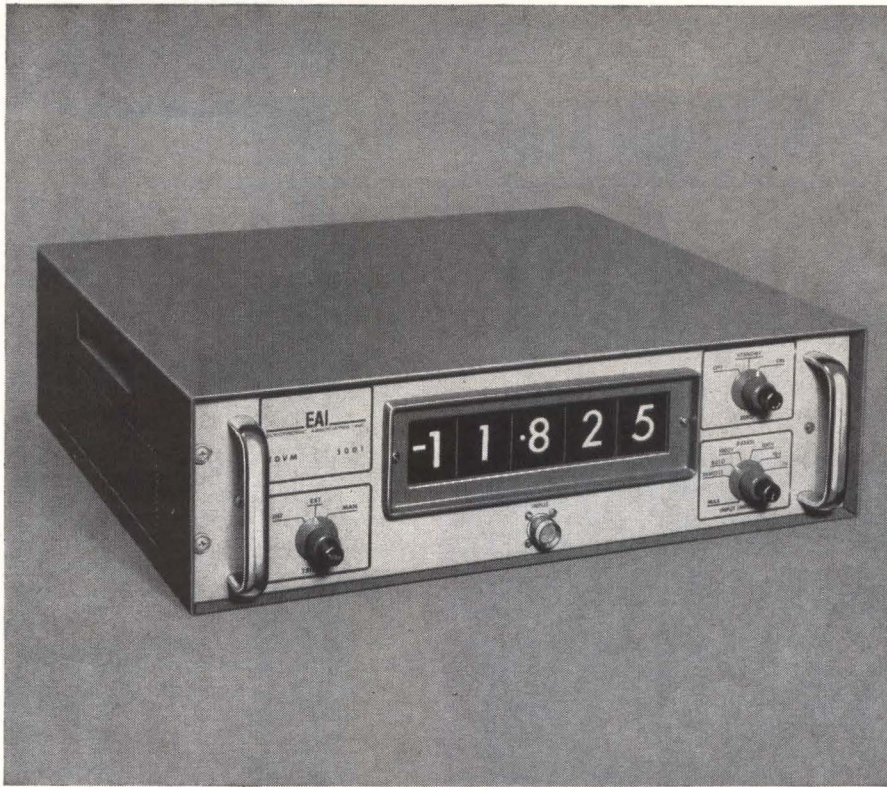

THIS IS THE DVM THAT REVOLUTIONIZED DIGITAL INSTRUMENTATION

Introduced in 1961, the all solid-state, automatic ranging Series 5001 has in the past two years become accepted as the standard for laboratory and digital systems instrumentation. □ Keystone of the EAI line of all solid-state digital voltmeter instruments, the Series 5001 is priced at only \$3,950 and features:

- ±.01% + 1 digit absolute accuracy
- 100 microvolt resolution
- 4 ranges to 1199.9 volts dc.
- 200 readings/second
- guaranteed 6 months stability
- all solid-state reliability
- completely automatic and programmable
- complete system flexibility

Companion instruments to the 5001 also feature 6 months stability, all solid-state reliability and complete system flexibility. They include:

- AC/DC and AC/DC/OHMS digital multimeters
- Digital volt-ohmmeters
- AC-DC Converters
- Input Scanners
- Output printers and serializers
- Remote display units

Write for details today. Prices apply in U.S.A. Only

EAI ELECTRONIC ASSOCIATES, INC. Long Branch, New Jersey

ADVANCED SYSTEMS ANALYSIS AND COMPUTATION SERVICES/ANALOG COMPUTERS/HYBRID ANALOG-DIGITAL COMPUTATION EQUIPMENT/SIMULATION SYSTEMS/SCIENTIFIC AND LABORATORY INSTRUMENTS/INDUSTRIAL PROCESS CONTROL SYSTEMS/PHOTOGRAMMETRIC EQUIPMENT/RANGE INSTRUMENTATION SYSTEMS/TEST AND CHECK-OUT SYSTEMS/MILITARY AND INDUSTRIAL RESEARCH AND DEVELOPMENT SERVICES/FIELD ENGINEERING AND EQUIPMENT MAINTENANCE SERVICES.

adapter. Called the DSD-6, the unit is a plug-in module designed for assembly and checking with Size 5 through 11 servo mounting components before installation, as a complete precision positioning assembly. Unit has zero backlash at torques up to 3 ounce inches and provides readings of angular setting to 0.1 degree for resolvers, synchros, tuning devices, potentiometers and other servo components. A coarse inner scale provides readings from 0 to 360 degrees in 10 degree increments. It is precision gear coupled in a ratio of 36:1 to an outer fine scale providing readings from 0 to 10 degrees in 0.1 degree increments. Both scales read out on a single vertical hairline. Rigidity and loading of all bearings and internal operating components is said to facilitate accurate 3-minute positional estimates. Scales finer than the 0.1-degree divisions can be supplied. The drive can be installed or removed as a unit for access to other system components without disturbing the dials or necessitating revisions to precision logging charts. Acton Laboratories, Inc., subsidiary of Bowmar Instrument Corp., 533 Main Street, Acton, Massachusetts. CIRCLE 310, READER SERVICE CARD

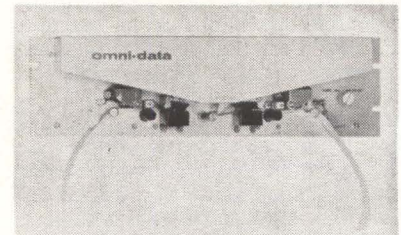

Tape Readers Operate At 1,000 Characters Per Sec

VERY-high-speed photoelectric tape readers, designated models PTR-90 and PTR-91, are designed for reading all types and colors of paper and plastic tape at speeds up to 1,000 characters per second. An exclusive principle of reflected light is employed to enable interchangeable reading of opaque or transparent, punched or printed, light or dark-colored tapes without need for amplifier adjustment. No variable electrical components are used. Model PTR-90 is a unidirectional reader, priced at \$1745, or at \$3430 in combination with a model

FOUR NEW *Preformed* GRID WIRE CONNECTORS...

AND... TWO HANDS

1

T-CONNECTORS*— Designed for terminating a wire at a cross-wire or catenary, they prevent premature fatigue damage often caused by high-stress fittings... Available in both standard and reducing configurations.

2

CROSS-TIES*— Interlock design holds grid wires securely yet permits adjustment to various angles. Available in standard or reducing configurations, as well as spacer types, which join intersecting but noncontacting wires.

3

L-CONNECTORS*— An excellent electrical and mechanical connector; made of compatible materials... available in standard or reducing types, for wires of equal or different diameters.

4

Nothing more needed to make connections on Grid Type Arrays

PREFORMED helically-formed Grid-Wire Connectors are wrapped on by hand; no tools are needed. They provide safe uniform holding; prevent stress points.

No parts can loosen to create noise. High mechanical strength and electrical conductivity are assured

Preformed **DEAD-ENDS**** are used to terminate all grid wires. These dead-ends hold securely, eliminate clamping devices, bolts, and socketed fittings. They are applied without tools.



PREFORMED LINE PRODUCTS COMPANY

5349 St. Clair Avenue • Cleveland 3, Ohio • UT 1-4900 (DDD 216)
600 Hansen Way • Palo Alto, California • 327-0170 (DDD 415)

Use the reader service card to request complete information, or write for Bulletin SP-2041.

*Made in accordance with U. S. Patent No. 2,681,865.

**Made in accordance with or for use under U. S. Patents 2,691,865 and 2,761,273.

CIRCLE 216 ON READER SERVICE CARD

TO ORDER REPRINTS

Fill in, cut out coupon below
insert in envelope and mail to:

electronics Reprint Dept.
330 W. 42nd Street, New York, N. Y. 10036

REPRINT ORDER FORM

(To help expedite mailing of your reprints please send cash, check or money order with your order.)

For Listing of Reprints Available see the Reader Service Card.

For Reprints of the latest Special Report:
Radio Frequency Interference

Send me.....Reprints of Key No. **R-39** 1-10 copies 75¢ each, 11-24 copies 60¢ each, 25 or more 50¢ each.

For Reprints of previous **Special Reports** or **Feature Articles** fill in below:

Send me.....Reprints of Key No.(s).....@.....¢ each.
(For prices, see Reader Service Card.)

*For orders of **Bulk Reprints** of other editorial articles in this issue or past issues:

Send me....Reprints of page No.(s)....of issue date....
of article entitled.....

*Minimum bulk order 100 copies. You will be advised of costs by return mail.

Name

Number of Street

City, Zone No., State.....

Now Specified Frequently by OEM

8 1/2" x 11"

X-Y RECORDER

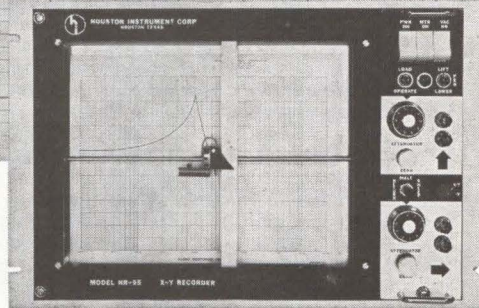

HR-95-TO

\$1250*

1 mv/in basic sensitivity, 15 in/sec pen speed, 0.25% overall accuracy, 600 in/sec peak acceleration, 0.1% resetability. Available in 11" x 17" chart size for additional \$100.

*\$100 additional for time base

Send for free catalog illustrating full line of laboratory test instruments



houston instrument corporation

4950 Terminal Avenue/Bellaire 101, Texas
Mohawk 7-7403/Cable: HOINCO TWX 713-571-2063

CIRCLE 129 ON READER SERVICE CARD

6

GUIDANCE STUDIES

REQUIRING ADVANCED THINKING
AT HONEYWELL IN FLORIDA!

- Application of terrestrial and astronomical fundamentals to practical navigation of manned and unmanned vehicles.
- Derivation and application of aircraft and missile guidance techniques.
- Analysis of control systems, including stochastic processes.
- Simulation of real-time devices.
- Application of aerospace digital computers to real-time control and data processing.
- Statistical analysis of expected performance of guidance systems.

TALENT AND EXPERIENCE IN ANY OF THESE AREAS CAN MEAN IMMEDIATE AND REWARDING CAREER ADVANCEMENT AT HONEYWELL'S STEADILY EXPANDING FLORIDA FACILITY.

We are actively engaged in the design and development of airborne and spaceborne navigation systems for such programs as X-20A, Centaur, Gemini and others of even greater complexity. Our continuing expansion means fresh opportunity in several engineering disciplines AT EVERY LEVEL OF EXPERIENCE. Honeywell offers the inquisitive, imaginative engineer the growth and responsibility possible only within an aggressive engineering-oriented firm.

We urge you to investigate further. Qualified applicants are invited to visit our facilities, meet our people and discover for themselves the many added advantages of working and living here on Florida's Suncoast. Simply send a brief note describing your education, experience and specific job interest to **N. L. Keese, Honeywell, 13350, U. S. Highway 19, St. Petersburg, Florida.** We promise a prompt, confidential reply.

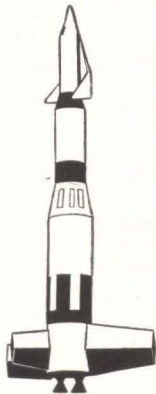

Honeywell

An Equal Opportunity Employer

"A Good Place to Work . . . A Good Place to Live"

To investigate professional openings in other Honeywell facilities, send resume to F. F. Laing, Honeywell, Minneapolis 8, Minnesota.

HONEYWELL ENGINEERS ARE DOING THINGS IN FLORIDA

RS-500 reeler operating at speeds up to 100 inches per second. The bidirectional model, PTR-91 is priced at \$1,995, or at \$3,780 in combination with a model RS-600 bidirectional reeler, also 100 inches per second. Omnitronics, Inc., 511 N. Broad St., Philadelphia 23, Pa. CIRCLE 311, READER SERVICE CARD

Digital Readouts Handle Many Codes

COMPLETELY self-contained transistorized digital readout mounts on one-inch centers. Called the TEC-LITE TNR-30 series, it is available in eight models to handle 8-wire or 4-wire BCD input in 1, 2, 4, 8 code. Other input codes as well as a wide variety of signal voltages, can be accommodated on special order. Supply voltage of 180 v d-c ± 10 v d-c at 2 to 6 ma is confined to the panel area, and elements of the rectangular neon readout tube are controlled by internal all-tran-

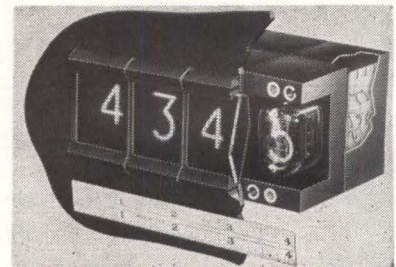

sistor decoder-driven circuitry that eliminates diode decoders and reduces the number of semiconductor components by 60 percent. All tube elements may be turned off when no indication is required. Readout utilizes rectangular, ultra-long-life NIXIE tube with a flat face which brings numerals closer to front for excellent wide-angle viewing. Numerals are 0.610-inch high. Life expectancy is 100,000 to 200,000 hours. TNR-30 series meets all applicable MIL or Federal Specifications and can be custom designed to meet unusual mechanical requirements and special electrical functions such as coded input to octal readout, counters and memories. Transistor Electronics, Box 6191, Minneapolis 24, Minnesota. (312)



Scanner Gives 4,200-Point Skips

MODEL 3205, 200 Position Scanner can scan sequentially, be internally programmed for 4 separate 200 point skip programs, or remotely programmed by tape or card readers. The internal skip programming facility consists of 4 plug-in cards, each providing a 200 point skip program. The active points in a program are determined by inserting ordinary carbon resistors into the corresponding matrix positions on the card. The four programs are selected by a front panel switch. The start and stop scan positions are determined by front-panel, thumb-wheel switches. Isolated decimal contact closures are provided by reed relays for printout. The device uses tamper-proof dry reeds for switching, and all reed contacts are isolated by epoxy glass blocks for minimum leakage and are direct wired to external connectors for minimum series resistance. Contact resistance of each reed switch is less than 40 milliohms. Price: \$3,475. Houston Instrument Corp., 4950 Terminal Ave., Bellaire, Texas. (313)

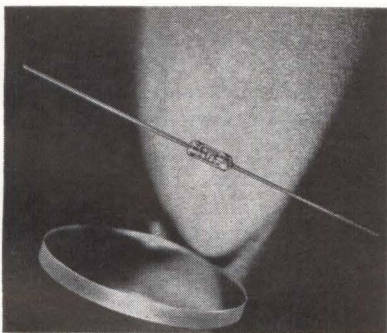

4-Layer Switches Extend Sensitivity

TWO-terminal subminiature light activated silicon switches extend light sensitivity to fire range to 3,000 footcandles. Designated types FL3S1 through FL3S25, the silicon

PUSH TO TEST

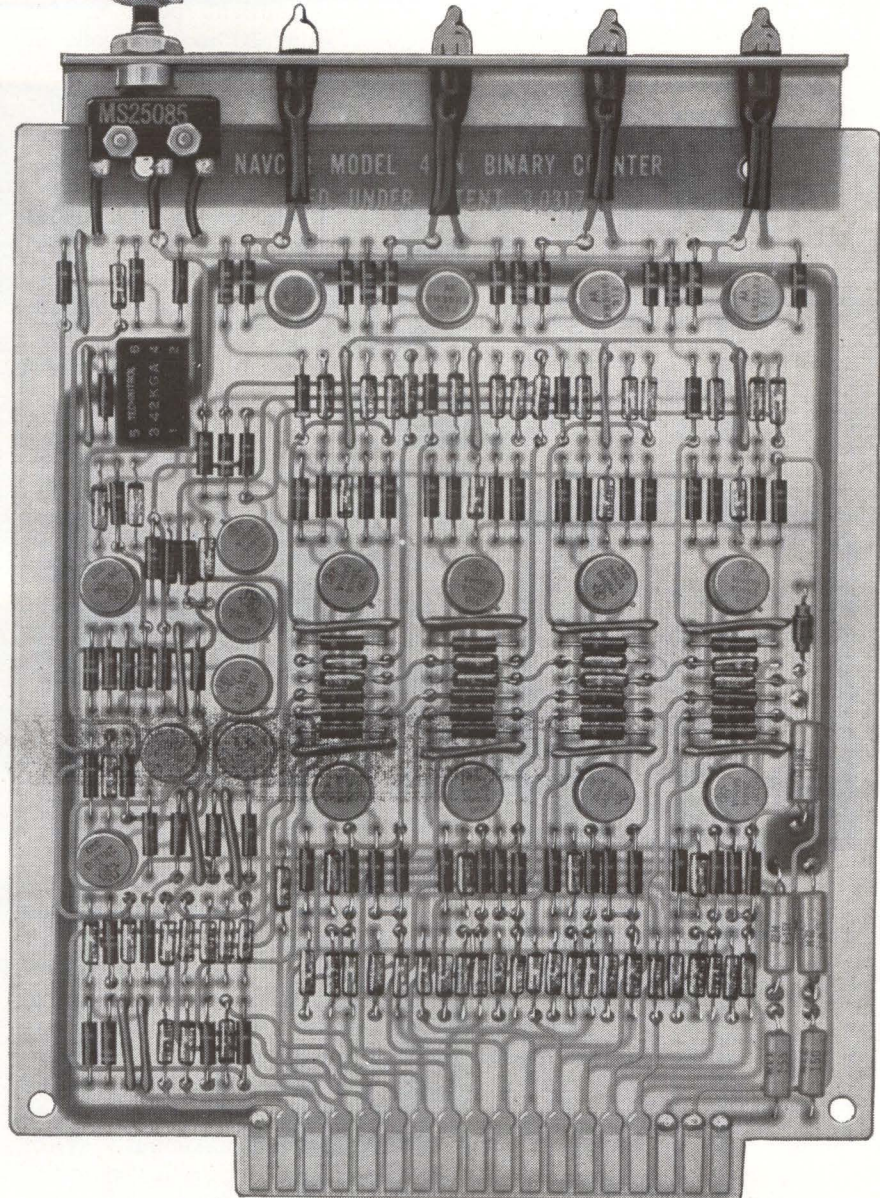

Push a button . . . follow the operation of a Navcor 400 Series system function module one logical step at a time on the neon indicator lights. Each module is a complete system function, grouping many logic elements. Push button and lights permit positive checkout in a fraction of the time required with less sophisticated flip-flops. Write for data on complete MIL Standard line of

Transistorized Digital System Function Modules

NAVCOR

VALLEY FORGE INDUSTRIAL PARK

930 RITTENHOUSE ROAD, NORRISTOWN, PA. • GL 2-6531

Straits Tin Report

New superconductive wire is formed with a columbium-tin core. According to its developer, Superior Tube Co., Norristown, Pa., it offers designers significant advantages in the development and fabrication of supercooled magnetic coils.

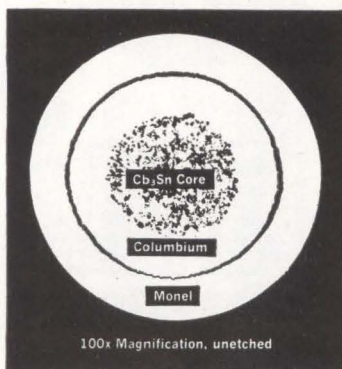

Only 1/20 the diameter of 200-amp solid wire, yet it offers up to 2½ times greater field strength, 3-4 times greater critical temperature, and the same current-carrying capacity.

The superconductive powder core is 75% columbium, 25% tin. The core is encased in a barrier tube of high-purity columbium and an outer insulating sheath of Monel metal.

This new tin-containing wire affords field strengths of 80-200 kilogauss compared with 50-80 for solid zirconium-columbium alloy wire (15-30% zirconium). Maximum operating temperature is 18.5°K compared with a maximum temperature between 4 and 6°K. Current-carrying capacity is the same as 200 amp rubber-covered copper wire, although the diameter is only .015 in. compared with .325 in. Field experience indicates that supercooled magnets of 100 kilogauss can be made for a fraction of the cost of the old style.

This is one more example of the ever-new uses for tin in today's technology. Consider Straits Tin from Malaya—world standard for quality, purity, reliability.

FREE BROCHURE

Write today for new, free colorfully illustrated brochure on mining, smelting and uses of Straits Tin from Malaya.

The Malayan Tin Bureau
Dept. B-25-J, 2000 K St., N.W., Washington, D.C. 20006

switch series offers maximum forward and reverse blocking voltages from 12 to 250 volts at 75 C, and maximum transient peak reverse voltages from 20 to 350 volts at 75 C. The pnpn light switches have particular application in data processing readout systems, direct switching of controlled rectifiers, relays and solenoids, and light logic. Units are priced between \$2.20 and \$12.50 in quantities between 1 and 99. International Rectifier Corp., 233 Kansas St., El Segundo, California.

CIRCLE 314, READER SERVICE CARD

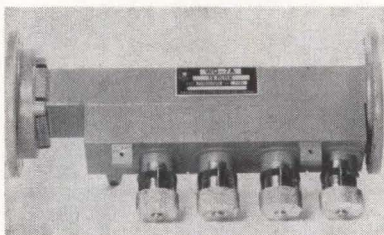

C-Band Filter Handles 6 kw

FILTER WQ7A is a tunable high-power unit designed for c-w operation in the 4.4 to 5.0 Gc band. It is designed to provide greater than 40 db rejection to frequencies spaced 200 Mc from the tuned center frequency. Tuning is achieved by means of calibrated micrometers for maximally-flat response. Insertion loss varies between 0.3 and 0.5 db from the high to the low end of the band and maximum vswr for a 25-Mc bandwidth is 1.2 when terminated in a 1.02 load. The WQ7A handles 6 kw of c-w power over the entire frequency band when water cooled; rating with air cooling varies from 2 kw at the low end of the band to 5 kw at the high end. Electronics Division, Canadian Westinghouse Company, Ltd., Hamilton, Ontario, Canada. (315)

Silicone Resins Cure at Room Temperature

two flexible silicone resins, one transparent and one opaque, cure at room temperature. The transparent product, Sylgard 184, is the first flexible, room-temperature-curing, transparent silicone potting material ever developed. Its com-

Acoustical Components of Superior Quality

JAPAN PIEZO supplies 80% of Japan's crystal product requirements.

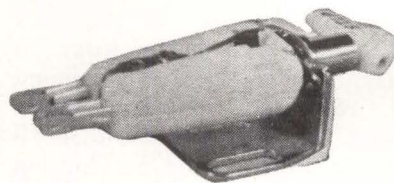
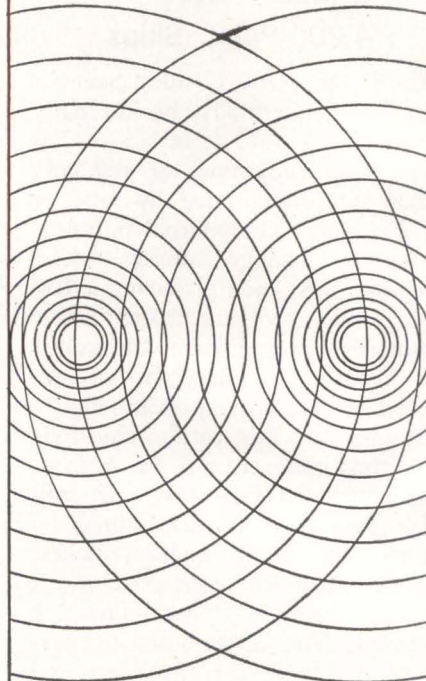

STEREO CARTRIDGE Crystal — "PIEZO" Y-130 X'TAL STEREO CARTRIDGE

At 20°C, response: 50 to 10,000 c/s with a separation of 16.5 db. 0.6 V output at 50 mm/sec. Tracking force: 6±1 gm. Compliance: 1.5 × 10⁻⁶ cm/dyne. Termination: 1MΩ + 150 pF.

Write for detailed catalog on our complete line of acoustical products including pickups, microphones, record players, phonograph motors and many associated products.



**JAPAN PIEZO
ELECTRIC CO., LTD.**

Kami-renjaku, Mitaka, Tokyo, Japan

CIRCLE 217 ON READER SERVICE CARD
SEPTEMBER 6, 1963 • electronics



panion product, Sylgard 185 is a black, opaque material with identical handling characteristics. Each of the materials cures in 24 hours without exotherm, after a curing agent is mixed with the resin. Curing time can be shortened by heating the mixture. Conventional flexible packaging resins and encapsulants require heat to cure. Both products provide protection for electronic circuitry against moisture, mechanical shock and vibration, thermal shock, heat, ozone, chemicals and voltage stress. Moreover, both retain good physical and electrical properties from -65 to 200 C and show little change in electrical characteristics over a wide range of frequencies. Dow Corning Corp., Midland, Mich. (316)

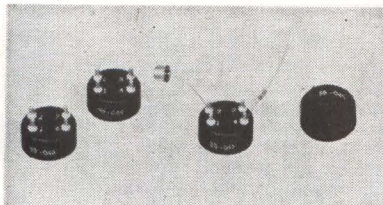

Toroidal Transformers for A-M Detectors

TRANSFORMERS S5-046 through S5-049 are toroidal units designed specifically for use with diode a-m detectors. Units have a 1:12.5 turns ratio which permits operation of the detector diode in its linear region, when driven from a low-voltage transistor. The four units are similar except for the carrier frequency bands that vary between 20 to 90 kc for model S5-046 to 400 kc to 1 Mc for model S5-049. Upper frequencies are limited by winding resonance. The low limits correspond to a 1000-ohm resonant primary impedance which is adequate for the 2N2217 or other transistors with similar saturation con-

NEW

VERSATILITY IN LIGHT MEASUREMENT

lite-mike

measures:

MEASUREMENT	MONOCHROMATIC SPECTRUM		CHROMATIC SPECTRUM
	LASER	GALLIUM ARSENIDE	
WAVESHAPE Rise time Fall time Duration Amplitude	Yes	Yes	Yes
Average Power (watts)	Yes	Yes	*
Energy (joules)	Yes	Yes	*

*Can be calculated within spectral response capabilities.

		RESPONSE RANGE										
		1.13 μ				0.35 μ						
ANGSTROMS		NEAR IR	10 ⁴	9,000	8,000	7,000	6,000	VISIBLE	5,000	4,000	NEAR UV	3,000
MICRONS		1	0.9	0.8	0.7	0.6	0.5	0.4	0.3			

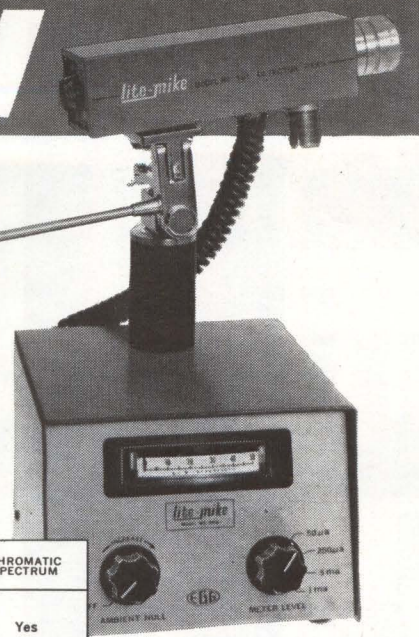

Compact (10" high) and lightweight, the EG&G LITE-MIKE has built-in controls for sensitivity and balancing of ambient light. Head is swivel-mounted for ease of alignment with source.

NEW

SD-100 SILICON PHOTO-DIODE offers this unique combination of advantages

- (1) **FAST RESPONSE** / Rise time: 4×10^{-9} sec. @ 90v
Fall time: 15×10^{-9} sec. @ 90v
- (2) **WIDE SPECTRUM** 0.35 to 1.13 microns (10% points)
- (3) **HIGH SENSITIVITY** 0.25 microamps per microwatt
- (4) **LOW NOISE** 1×10^{-12} watts \cdot (cps) $^{-1/2}$
- (5) **WIDE DYNAMIC RANGE** 0.1 amp to approx. 10^{-8} amp

Applications: receiving equipment for lasers and injection laser systems; measurements on modulator and pulsed light sources; measurements of light intensity and wave forms, detection of color changes.

For full information on LITE-MIKES and SD-100 photo-diodes, contact: Marketing Dept., EG&G, 176 Brookline Ave., Boston 15, Mass.



EDGERTON, GERMESHAUSEN & GRIER, INC.
1007 BOSTON • LAS VEGAS • SANTA BARBARA

CHESTER

MULTI- CONDUCTOR CABLES

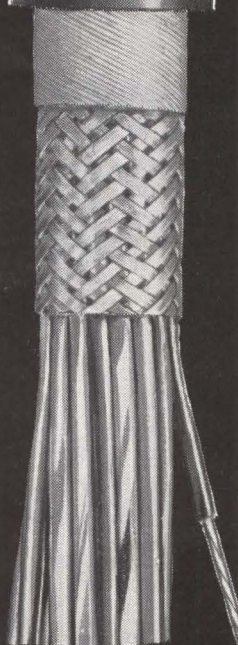

Custom constructions to meet your exact requirements. Any combination of conductors, Plastico® insulations, shields, jackets, color coding, etc. Send for brochure, today!

**CHESTER
CABLE CORP.**
CHESTER, NEW YORK
a subsidiary of
TENNESSEE CORPORATION



ductance. Units are priced at \$21 in quantities between 1 and 9. Spectran Electronics, 146 Main St., Maynard, Mass.
CIRCLE 317, READER SERVICE CARD

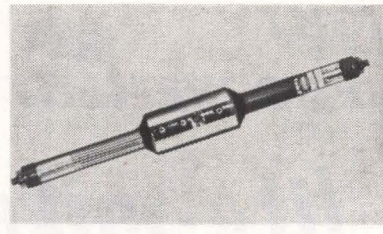

Storage Tube Uses Dual-Gun Scan

DUAL-GUN scan-converting storage tube has been developed for use in all transistor bright-display systems of the FAA. Called the CK1383, storage tube features electronic input and output for use in equipments requiring simultaneous reading and writing. Resolution exceeds 1200 TV lines-per-diameter. This, a high output signal, and ability to gradually erase previously-recorded information, qualify the device as an efficient scan converter of circularly-scanned radar data into horizontally-scanned television form for multiple display and transmission. Automatic and gradual erasure of old information is adjustable and provides a method for generating target trails indicating course and speed of aircraft or vessels detected by the radar. The tube employs magnetic deflection and focusing on both electron guns. Raytheon Co., 58 Chapel St., Newton, Mass. (318)

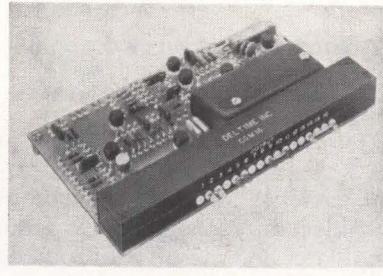

Unity Gain Line Provides Delays to 18.5 μSec

VARIABLE, unity-gain delay line, designated the CGM-16 provides delays from approximately 2.5 to 18.5 μsec. Device has no switches, knobs, or buttons. Delays are se-



How high is your goal?

Ours are out of sight—in the labyrinth of space. But your opportunities are a tangible reality, here and now at North American's Space and Information Systems Division.

Trained, creative engineering minds, attuned to the research, development and production of manned spacecraft, large booster systems, inflatable winged recovery systems and missile weapon systems will find fertile fields to grow in at S&ID.

COMPUTER SIMULATION

To analyze needs and requirements for simulated spacecraft trajectory and relation mechanics and simulated spacecraft systems. To evolve diagnostic and check out methods for simulation and trainer complexes (equations and programs). To design automatic process systems for operation and control of trainer and simulation complexes.

LOGIC DESIGNERS

To perform conceptual analysis and trade-off studies resulting in logic designs of command data systems.

ELECTRONICS CIRCUIT DESIGN

To carry out design and development of digital interface equipment required for controls and display compatibility.

Interested? Please Contact:
MR. P. J. MONAR
ENGINEERING AND SCIENTIFIC EMPLOYMENT
12214 LAKEWOOD BLVD.
DOWNEY, CALIFORNIA

All qualified applicants will receive consideration for employment without regard to race, creed, color, or national origin.

SPACE AND INFORMATION SYSTEMS DIVISION

NORTH AMERICAN AVIATION 

High CAPACITY VACUUM

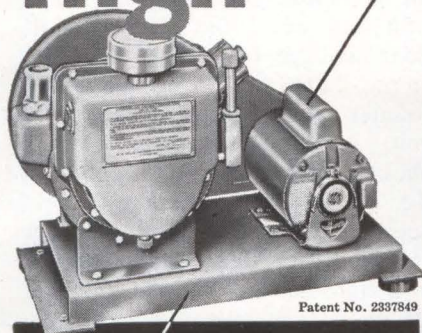

Patent No. 2337849

WELCH
DUO-SEAL VACUUM PUMP
WITH VENTED EXHAUST

Welch "Duo-Seal" No. 1397 is a two-stage, oil sealed, rotary vacuum pump with a free air capacity of 425 liters per minute and a guaranteed vacuum performance of 0.1 micron or better with the vented exhaust closed . . . 1.0 micron with vent open. The performance is uniformly high over a range to 1×10^{-4} mm Hg (Torr). It is especially suited for application to large systems involving substantial vapor removal.

The 1397's are equipped with vented exhausts to eliminate condensation of vapors which raise the vapor pressure of the sealing oil, contaminate and break down the oil, and corrode the metal parts.

IMPORTANT FEATURES:

- High pumping speed—425 liters per minute
- Low ultimate pressure— 1×10^{-4} mm Hg (Torr)
- Quiet, vibration-free operation
- Compact, rugged design
- Air-cooled
- Vented Exhaust—eliminates condensed vapors, oil filters and separators
- Belt guard
- Trouble-free, low maintenance

Over the years, Welch "Duo-Seal" Vacuum Pumps have gained a world-wide reputation for best performance, greatest reliability and quietest operation. They are available in a wide selection of capacities and ultimate vacuum characteristics, ranging in capacities from 21 to 1400 liters/minute and ultimates from 2×10^{-2} mm Hg (Torr) down to 1×10^{-4} mm Hg (Torr).

WHEN YOU USE A WELCH "DUO-SEAL" VACUUM PUMP, YOU'RE USING THE FINEST!

For complete descriptions, specifications and prices, write for Welch "Duo-Seal" catalog.

WELCH
SINCE 1880 THE WELCH SCIENTIFIC COMPANY
Foremost manufacturers of scientific equipment

1515 Sedgwick St. Dept. 906
Chicago 10, Ill.

CIRCLE 218 ON READER SERVICE CARD
electronics • SEPTEMBER 6, 1963

lected from the front panel in 1.0 μ sec steps by inserting miniature jumpers into Teflon-insulated jacks. The only inputs required are d-c power and an input trigger. The unit contains 10 transistors, a multi-tapped magnetostrictive delay line and associated circuitry. Weighing only 8 ounces, the CGM-16 requires a panel access slot of $9/32 \times 4$ -inches. Module operates in a return-to-zero mode and provides up to 16 output pulses with an amplitude of -6.60 volts, a width of 0.5 μ sec and having rise and fall times of less than 0.1 μ sec. Nominal input trigger requirements are: -6 volts amplitude, 0.3 μ sec width, and rise and fall times of less than 0.08 μ sec. Power requirements are ± 6 v d-c. DelTime, Inc., 608 Fayette Ave., Mamaroneck, N. Y. (319)

Pencil Triode Operates to 3 Gc

MEDIUM- μ (20) triode capable of operating at full input ratings at frequencies up to 1.7Gc and at reduced input rating up to 3.0Gc is announced. Called type 5675, the tube is intended primarily for service as a local oscillator and will provide a useful power output of approximately 475 mw and 50 mw at 1.7 Gc and 3.0 Gc respectively, when used in a suitable cavity in a cathode-driven circuit. For use in a typical cathode-driven oscillator at 1.7 Gc, the 5675 requires plate voltage of 128, plate current of 25 ma, grid current of 4 ma and delivers useful power output of about 475 mw. Sylvania Electric Products Inc., 1100 Main Street, Buffalo 9, New York. (320)

Microwave Power Supply Is Universal

MODEL Z817B universal microwave power supply drives all microwave triodes, tetrodes, klystrons, twts, bwos, voltage tunable magnetrons, or any of their variants. Six individual floating power supplies may be interconnected in various combinations to extend flexibility of the instrument for laboratory and pro-

COAXIAL CABLES

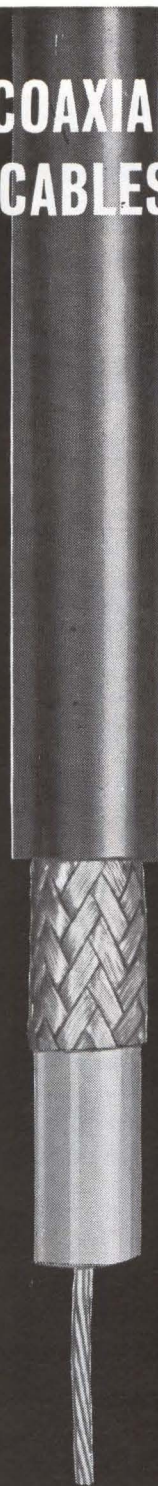

Accepted by industry as the quality line of Coaxial cables.

Conform to Military Specifications including MIL-C-17C—or your own special requirements.

Send for complete Coaxial Cable catalog.

**CHESTER
CABLE CORP.,
CHESTER, NEW YORK**
a subsidiary of
TENNESSEE CORPORATION

CHESTER

Magneline®
THE INDICATOR WITH INHERENT MEMORY

Two new series for digital readout,
ideal for multiplex applications

SERIES 14000—FOR SOLID STATE LOGIC
Character Size..... $\frac{9}{32}$ " x $\frac{1}{4}$ "
No. of Characters.....Up to 11
Leads.....11 plus a common
Watts.....2.4

SERIES 15000—FOR RELAY LOGIC
Character Size..... $\frac{5}{16}$ " x $\frac{1}{4}$ "
No. of Characters.....Up to 10
Leads.....5 plus a common*
Watts.....1.3-1.7

*Requires switching of lead in combination with reversal of polarity to change indicator.

Units hold last reading without power. Totally enclosed, self-stacking housing for front or rear mounting. Jewel bearings, only one moving part. Standard voltages 6, 12, 24, or 28 V.D.C. Readability 12 feet at normal room lighting. Options include special voltage, special characters, and internal lighting for dark room applications.

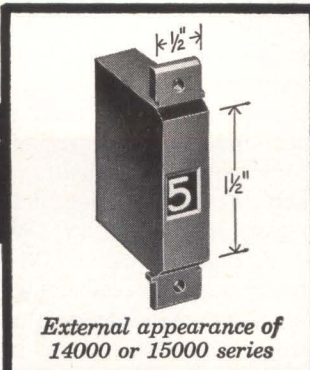

External appearance of 14000 or 15000 series

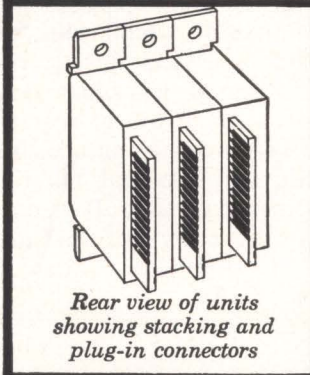

Rear view of units showing stacking and plug-in connectors

Write or teletype
(203-753-9341)
for free literature

PATWIN® ELECTRONICS
A DIVISION OF THE PATENT BUTTON COMPANY
WATERBURY 20, CONNECTICUT
CIRCLE 219 ON READER SERVICE CARD

duction applications. All voltages can be pre-set, and both voltage and current can be checked on front panel meters. Provisions are made for both automatic frequency control and automatic gain control. Beam voltage (0-4000 v d-c) may be pre-set to $\pm 0.1\%$ using a 4-digit counter with a least division of 1 volt. All other major power supplies have dial readouts accurate to 0.5% or digital readouts to 0.25%. Seven panel meters register voltage and current of the various supplies to a full-scale accuracy of $\pm 2.0\%$. Beam current meter has a non-

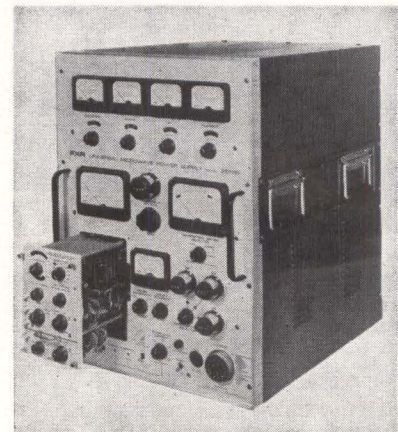

linear movement that expands the low-current region of the scale. A calibrating meter for all major supplies is accurate to $\pm 0.25\%$ at the zero and full-scale points. Four types of modulation are provided: sine wave, square wave, pulse wave and sawtooth wave. Modulation can be applied to the four grid supplies and the anode supply. Other features include overload relays on d-c supplies and cabinet, and output-connector personnel safety interlocks. The Z817B has been completely modularized for convenient maintenance, and the unit is available in both rack mount and cabinet styles. Price of cabinet model is \$2,950. FXR, 25-26 50th Street, Woodside 77, N. Y.

CIRCLE 321, READER SERVICE CARD

Wave Analyzer
Offers Three Bandwidths

SWITCH SELECTION of 3, 10, or 50 cps bandwidth is one of the many features of type 1900-A wave analyzer, a precise heterodyne voltmeter covering the frequency range

Rely on **ROHN**

for TOWERS, TOWER SYSTEMS, MICROWAVE PASSIVE REFLECTORS, LIGHTING EQUIPMENT and ACCESSORIES

ROHN is the largest company of its kind exclusively manufacturing communication towers and allied equipment. They can supply a wide range of both guyed and self-supporting towers from all heights up to 800'. They have available engineering and manufacturing facilities for special tower systems and complete engineering and design services. Also ROHN makes microwave passive reflectors and complete tower lighting equipment. So whether it's a single tower or a complete communications system, contact ROHN for dependable and reliable equipment and service.

ROHN Manufacturing Company

Box 2000, Peoria, Illinois • Phone 309-637-8416

"Pioneer Manufacturers of towers of all kinds—Representatives world-wide"

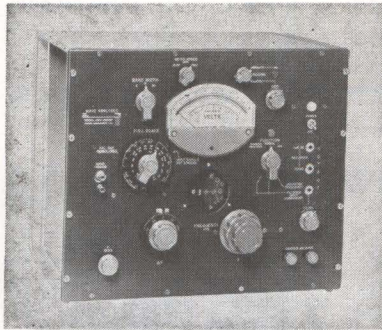

from 20 cps to 50 kc. Full-scale voltage range is 30 μ v to 300 v, with 1-megohm input impedance on all ranges. Several outputs are provided: 100-kc and 1 ma d-c outputs for recording, a restored-signal output at the frequency of the input signal, and a tracking-analyzer sine-wave output at the indicated center frequency. Availability of these outputs makes the unit a complete system for response measurements on a wide variety of networks and devices. Other features include a built-in voltage-calibrating system, a precise, linear frequency scale, and afc. Type 1900-A wave analyzer is priced at \$2150.00 and is available in both rack and bench versions. General Radio Co., West Concord, Mass. (322)

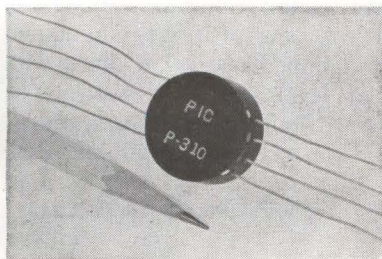

Transformer Gives Square Pulses to 250 Watts

FLAT-top pulses for pulse powers up to 250 watts are now attainable from a transistorized blocking-oscillator circuit. Designed for use in a two-transistor BO circuit, P-300 series BO transformers deliver pulse outputs from 50 to 600 volts and $\frac{1}{2}$ to 5 amp. Output pulses are unaffected by changes in load impedance. Nominal pulse widths of 1, 2, 3, 5, 10 and 20 microseconds are provided by separate units in the P-300 series. The size of the 10 microsecond-pulse width unit is 1-inch dia. \times 0.6-inch high. Rise times down to 0.1 microsecond may

HOW TO USE YOUR ELECTRONICS BUYERS' GUIDE

Advertising Product Sections

Advertisements in the ELECTRONICS BUYERS' GUIDE are grouped together according to the kind of product advertised. All Power Supply advertisements, for example, will be found in the same section of the book. Thus it is made convenient for you to "shop" through the specifications presented to you by advertisers, without having to flip pages back and forth constantly.

Keep your ELECTRONICS BUYERS' GUIDE close to your work area at all times.

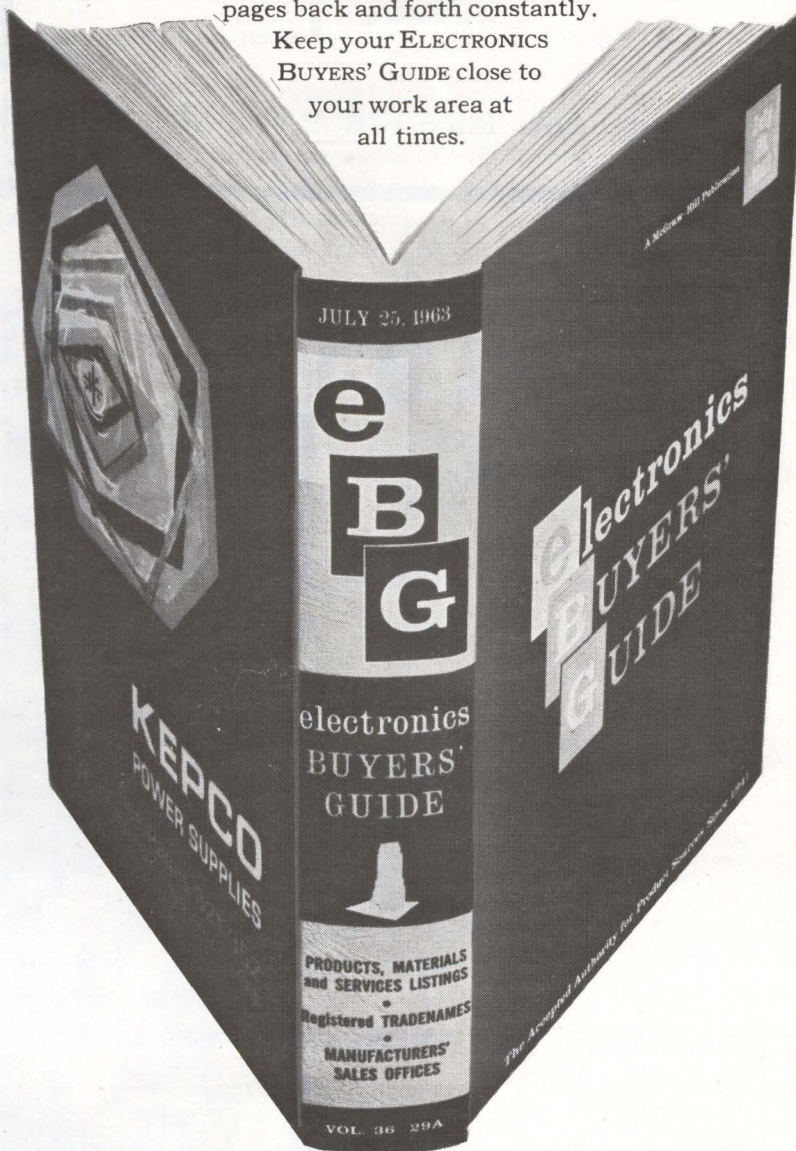

FIRST TIME

A VHF-UHF RECEIVING SYSTEM THAT PROVIDES AM-FM-CW RECEPTION OVER 30 - 1000 mc FREQUENCY RANGE IN ONE RECEIVER

A visual display of signals in a band around the received signal is provided. This complete frequency coverage and visual display is packaged into a 5 1/4 inch high unit designed for rack mounting. Audio and video outputs are provided from a 2mc IF strip and a selectable 20kc/75kc/300kc IF strip simultaneously. Nuvisitors and transistors are used throughout to reduce weight and power consumption.



CEI TYPE RS-111-1

Frequency range.....	30-1000mc.	Type of reception.....	AM, FM, CW
Band A: 30-60mc	Band B: 60-300mc.	Power input.....	115.230vac, 50-60/cps
Band C: 235-500mc	Band D: 490-1000mc.	Power consumption.....	50 watts, approx.
Noise figure		Weight.....	35 lbs. approx.
Band A: 4db max.	Band B: 6.5 max.	Size.....	5 1/4" H x 19" W x 15 1/2" D
Band C: 10db max.	Band D: 12db max.		

If Bandwidths (4)..... 2 operate simultaneously: 2mc and either 20kc 75kc or 300 kc selectable from front panel

Frequency display sweep width..... Continuously adjustable 0 to 3mc.

Communication Electronics Incorporated
4908 HAMPDEN LANE, BETHESDA 14, MARYLAND

CIRCLE 220 ON READER SERVICE CARD

be obtained. Units have applications in trigger circuits for thyratrons and microwave diodes, modulators for r-f tubes, and test circuits for pulse transformers. Polyphase Instrument Co., Bridgeport, Pa.

CIRCLE 323, READER SERVICE CARD

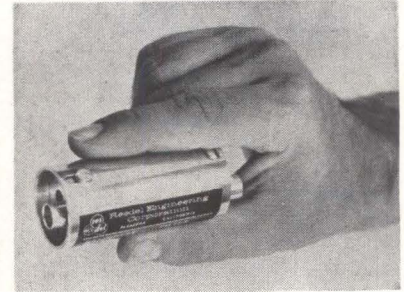

Bandpass Filters Are Adjustable

DEVELOPMENT of four new models of adjustable bandpass filters for general lab and breadboard testing is announced. The four models cover the frequency ranges: 50 Mc to 125 Mc; 125 Mc to 250 Mc; 250 Mc to 500 Mc; and 500 Mc to 1.0 Gc. Filters are manually adjustable, and bandwidth range is 2.5% to 25%. Insertion loss is 2 db at 2 1/2% bandwidth; 1db at 4% bandwidth; and is reduced to only 1/2 db at maximum bandwidth. Units feature full-octave tunability and low vswr of 1.5:1. Input and output impedance is 50 ohms with power levels up to 5 watts. The standard unit has BNC connectors, other connectors are optional. Resdel Engineering Co., 990 S. Fair Oaks Ave., Pasadena, Calif. (324)

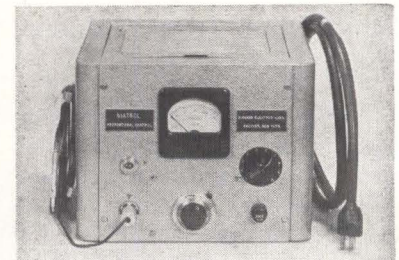

Proportional Controller Has Many Applications

THE NIATROL, rated at 10 amperes a-c output, but usable to 15 amperes at a 120 volt reference, is designed chiefly for precise temperature control (-60 to +280 C) with thermistors. It is also useful

FOR CLOSE TOLERANCE FLUSH CUTS of Electronic Wires

1. Cut extruding leads flush to an un-encapsulated module.
2. Snip off excess semi-conductor whisker wire without jarring the delicate solder bond.
3. Cut and strip stranded or solid Hook-Up wire in miniature electronic equipment.
4. Remove excess hard filament wire in electron tube and lamp assembly.

The HR PEER Nipper is a light-weight precision tool, hand made in Switzerland, with long-wearing, honed cutting edges, that easily outlasts the ordinary nipper. Send for catalog on light-weight nippers and cutting tweezers today!



HR HAMMEL, RIGLANDER & CO., INC.
401 Park Avenue South, N. Y. 16, N. Y.
Phone: LEExington 2-2530, Area Code 212

Distributors in most principal cities.



NIPPERS

OBLIQUE CUTTERS

Order No.	Approx. Length	Handles
36-617	4 1/4"	Straight
36-617C	4"	Straight
36-619	4 1/4"	Curved

END CUTTERS

Order No.	Approx. Length	Handles
36-616	4 1/2"	Straight
36-618	4 1/2"	Curved
36-620	4 1/2"	Straight (both ends of cutter pointed)

No. 36-617
\$9.00

actual size

with other transducers controlling from light, humidity, etc. Unit produces proportional outputs from other instruments and is also useful as a finely-adjustable power source, with or without self-regulation. A semiconductor device, the Niatrol has no moving parts, requires no maintenance and is quiet in operation. Niagara Electron Laboratories, Andover, New York. (325)

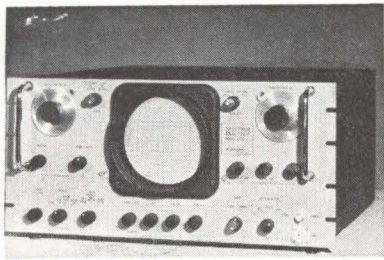

Spectrum Analyzer Features Log-Lin Display

SPECTRUM analyzer model LCA-1 is an extremely sensitive scanning-heterodyne receiver that automatically displays the frequency and amplitude of signals from 50 cps to 600 kc. Its output can be linearly or logarithmically displayed on a calibrated cathode ray tube. Unit features 60 db displayed log range, independent or automatic optimum resolution, balanced or single-ended input, variable sweep rate of 30 sec/sweep to 60 sweeps/sec, calibrated frequency and sweep width dials and 10 kc and 100 kc markers good to 600 kc. Applications include check-out of Loran C and communications transmitters, harmonic-medical-ultrasonic spectrum-frequency band and cross-modulation studies, ultrasonic vibration measurements, filter and transmission line checks and telemetering. Probescope Co., Inc., 211 Robbins La., Syosset, N. Y. (326)



Stereo Recorder Has 14 Moving Parts

SIMPLIFIED and ruggedized mechanical construction features tooled

"CLAIREXCOR NYC — TELEGRAM

"AT 1201 PST TODAY DEC 14 1962 THE MARINER 11 SPACECRAFT MADE ITS CLOSEST APPROACH TO THE PLANET VENUS WITHIN THE PLANNED MISS CORRIDOR THIS INTERPLANETARY FLIGHT HAS SET MANY WORLD RECORDS INCLUDING COMMUNICATIONS DISTANCE QUANTITY AND SIGNIFICANCE OF DATA RECEIVED THREE AXIS ATTITUDE CONTROL AND INTERPLANETARY SPACE MANEUVER.

"WE ARE PLEASED TO REPORT THAT YOUR CADMIUM SULFIDE PHOTOCONDUCTOR DETECTORS USED IN THE MARINER 11 SUN SENSORS AND SUN ATE HAVE OPERATED SUCCESSFULLY THROUGHOUT THE COMPLETE 109 DAY FLIGHT YOUR DETECTORS HAVE PLAYED A KEY PART IN THE SUCCESS OF THIS HIGHLY SUCCESSFUL MISSION. JET PROP LAB G W MEISENHOLDER SCHMIDT R G FONEY J M WHALEN"

THE EYES OF A MODERN MARINER



CLAIREX PHOTOCONDUCTIVE CELLS recently served as the detectors in the sun-sensing "eyes" of Mariner II, our Venus space vehicle, controlling reference attitude prior to the critical mid-course correction maneuver which reduced the "miss" from 233,000 to 21,000 miles! The sun sensors also served as panel-orientors throughout the flight for maximum power output of the solar cell panels, signalling position errors to the pitch and yaw stabilization jets.

The Clairex cells in Mariner II were the standard CL-605 type now in use in hundreds of other more earth-bound applications. Special single-crystal Clairex components, however, have been utilized in Ranger and other space probe projects as radiation detectors.

MID-COURSE CORRECTION AFFECTS FLIGHT PATH

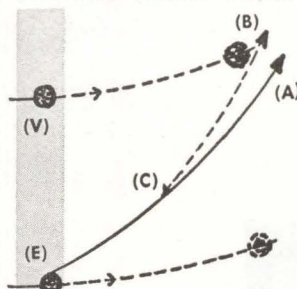

Redirecting vehicle from destination (A) to (B) in vicinity of Venus required flight correction at point (C) by applied jet propulsion of short duration. The vehicle's maneuvers prior to corrective propulsion were based on initial proper sun reference via the photoconductive sun sensors.

SUN SENSING ARRAY ON MARINER VEHICLE

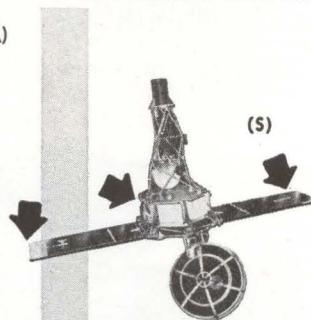

Throughout the life of the craft, prior and subsequent to mid-course correction, the sun sensors (S) signalled error-correcting commands to the stabilization jets for pitch and yaw control, thus keeping the solar cell banks properly oriented for maximum power output.

PHOTOCONDUCTIVE CELL COMPONENTS

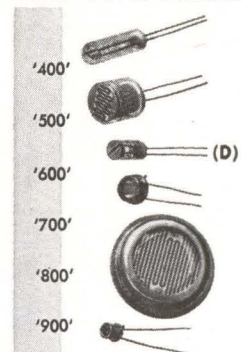

Six Standard Series of photoconductive cells, including the Mariner II type, (D), are manufactured by Clairex Corporation. Illustrated are units of both Cadmium Sulfide and Cadmium Selenide, in glass or metal containers, offering a wide range of response characteristics.

Technical design data available on request.

"The light touch in automation and control"

CLAIREX CORPORATION

8 West 30th Street, New York 1, New York

THE OLDEST MANUFACTURER OF CADMIUM SULPHIDE AND CADMIUM SELENIDE PHOTOCONDUCTIVE CELLS

NEW 16 PAGE PHOTOCONDUCTIVE CELL DESIGN MANUAL FREE ON REQUEST

HOW TO USE YOUR ELECTRONICS BUYERS' GUIDE *

Advertising Product Sections

Advertisements in the **ELECTRONICS BUYERS' GUIDE** are grouped together according to the kind of product advertised. All Power Supply advertisements, for example, will be found in the same section of the book. Thus it is made convenient for you to "shop" through the specifications presented to you by advertisers, without having to flip pages back and forth constantly. Keep your **ELECTRONICS BUYERS' GUIDE** close to your work area.

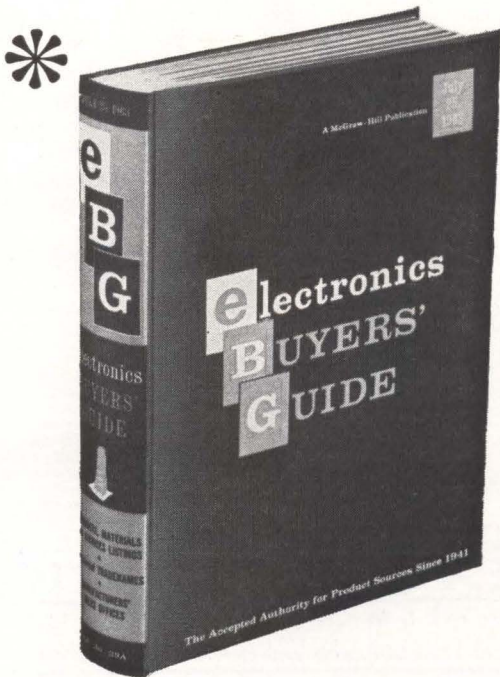

parts, heavy-gage materials, automotive-type brake shoes and unitized staking of parts in this professional type stereo tape recorder. The model 70 unit provides four-track monaural recording that enables two separate programs to be combined on a third track. Illuminated recording level meters, 20-watt output per channel, detachable wing speakers and external connections for public address use are available. Locking devices on wind-rewind and recording controls prevent tape breakage and accidental erasure. When desired, up to eight recordings can be placed on a single monaural track. Estey Electronics, Inc., 201 West John St., Hicksville, N. Y.
CIRCLE 327, READER SERVICE CARD

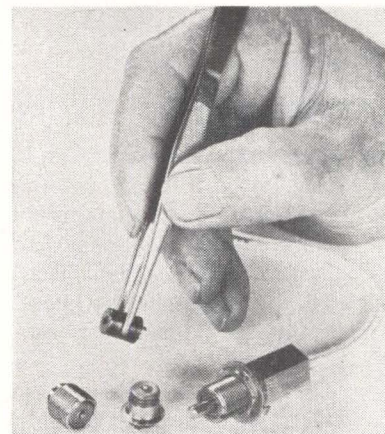

Snap-Acting Switch Is All-Welded

SUBMINIATURE (0.045 cu in.), snap-acting, all-welded, Class A hermetically-sealed sensitive switch operates in ambient temperature from -65 F to 650 F, weighs less than 1 gram and features vibration resistance over 75 g. Ratings of the Klixon 3AT are 2 amp resistive at 28 v d-c for 10,000 cycles minimum, or 1 amp resistive at 28 v d-c for 15,000 cycles minimum. Metals & Controls Inc., a corporate division of Texas Instruments Incorporated, Attleboro, Mass. (328)

Switching Diode For Logic Circuits

DIFFUSED silicon switching diode for logic circuits and h-f modulation circuits has been developed. Maximum ratings of type 1S306 are: peak inverse current, 35 v; d-c inverse voltage, 30 v; peak forward

current, 180 ma; average rectified current, 60 ma. Nippon Electric Co., Ltd., Box 1, Takanawa, Tokyo, Japan. (329)

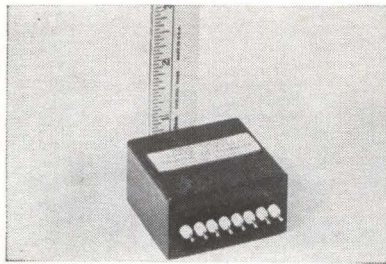

Dual Power Supply Has High Regulation

ALL-SILICON-TRANSISTOR, highly regulated dual power supply is announced. A 400-cps a-c input with fixed d-c outputs from 5 to 50 v at 50 ma each, are available in a package size $\frac{3}{4}$ in. by 2 in. by 2 in. Line regulation is 1.5 mv for 10-percent line change, load regulation is less than 2 mv from no-load to full-load. Ripple is less than 800 μ v rms. Compact size and stability of the power supply make it an ideal substitute for mercury cells, or any situation where the power unit can be placed at the load to eliminate a sensing loop. Universal Electronics Co., 1720 Twenty-Second St., Santa Monica, Calif. (330)

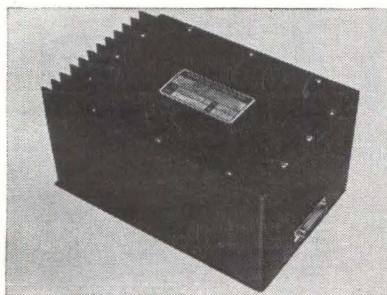

Core Memory Contains 4,096 Words

MILITARIZED, high-density, random access core memory, SEMS-1R has a 4.0 μ sec read/write time and will operate over a range of -55 C to $+100$ C without current compensation. The memory contains 4,096 words, up to 32 bits in length. It is available in two package configurations—the larger has removable circuits to allow maximum field maintenance and repairs; the smaller has all subassemblies packaged in

The man who works with his mind
also lives with it

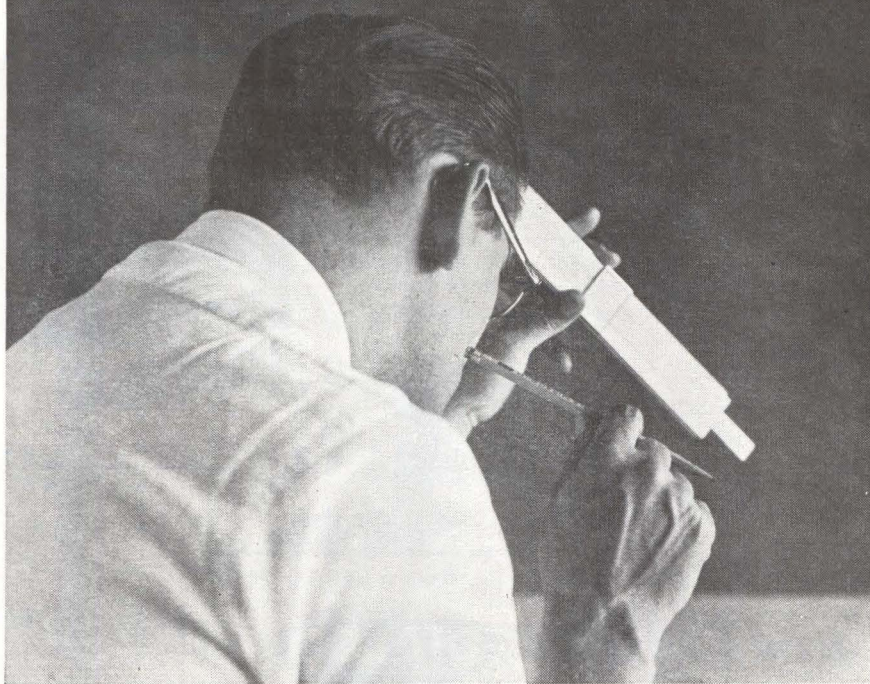

...that is why hard-to-get technical help prefers to live in Washington state, where the recreational, cultural and educational advantages are outstanding!



Washington's many facilities for culture, education and research all appeal to highly skilled or technical personnel.

IF YOUR BUSINESS utilizes highly technical or skilled personnel, you know they're often hard to find, and sometimes harder to hold. But in Washington State, there is an abundance of skilled and technical workers. Why? For one thing, this is a center of space-age technology, such as atomic energy, aerospace and electronics.

Too, year around recreational facilities in Washington State are fabulous. The mild, easy-going climate, summer and winter, appeals to everyone. Educational and cultural centers are at every hand. Highly skilled workers live here by choice, are reluctant to leave.

If you're planning a business expansion or move, consider Washington State, where space-age technology has come into its own, along with a better life.

For more information on *The Surprising State*, Washington, write on your letterhead today, to Washington State Department of Commerce and Economic Development—Industrial Division, General Administration Building, Olympia, Washington.

Rob't. E. Rose

Rob't. E. Rose, Director

Albert D. Rosellini

Albert D. Rosellini, Governor

THE
Surprising
STATE



WASHINGTON

Assure High Reliability and Effective Display

with DIALCO Twin Lamp

PLACARD LIGHTS

Maximum reliability and safety are achieved by DIALCO'S twin lamp and Press-to-Test construction: Burnout of one lamp will not result in failure of the indication. The Press-to-Test feature enables instant checking of both lamps without removing them from the Placard Light assembly.

Flexibility in application is provided by: Choice of single units or stacks of 2 to 10 indicators; maximum area for legend display and wide variety of legend colors and styles; 4 mounting methods—with an escutcheon plate, or flush-to-panel with end-mounting, side-mounting, or "L" angle brackets...DIALCO Placard Lights conform to applicable Military Standards.

THE LIGHT SOURCE: ▷

Two T-1¼ Incandescent Bulbs (with midget flanged base); available in voltages from 1.3 to 28 V. Lamps are easily replaced from the front—without removing the assembly.

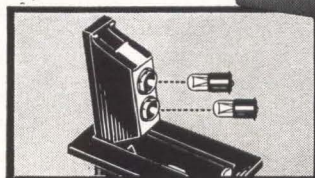

A typical stack of 10 Placard Light assemblies with an escutcheon plate. (approx. 3/5 size)



For complete data, request Catalog L-170

Foremost Manufacturer of Pilot Lights

DIALIGHT
CORPORATION

DIALCO

60 STEWART AVENUE
BROOKLYN 37, N.Y.
(212) HYacinth 7-7600

CIRCLE 221 ON READER SERVICE CARD

Gold Plated Copper Wire .020" diam.



Gold Plated per MIL-G-45204 Type 1, Class 3

Photomicrograph 133x

Uniform . . . Well-bonded . . . Quality with Economy . . .

SIGMUND COHN CORP. 121 So. Columbus Ave., Mount Vernon, New York

SIGMUND COHN CORP. OF CALIFORNIA, 151 C. NORTH MAPLE STR., BURBANK, CAL.

142 CIRCLE 142 ON READER SERVICE CARD

welded modules for maximum reliability. Both utilize standard components in special, high-density welded circuit designs. Electronic Memories, Inc., 12621 Chadron Ave., Hawthorne, Calif.

CIRCLE 331, READER SERVICE CARD

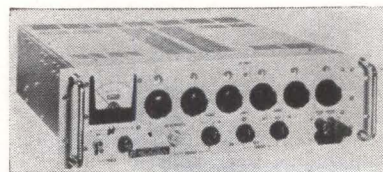

Solid-State Supply Has High Stability

SOLID-STATE d-c power supply, model 313A, is capable of supplying up to 2 amp from 0 to 50 v with a calibration accuracy of 0.01 percent of its six-digit in-line read-out. It has a resolution of 10 μ v (5 v range) and 100 μ v (50 v range) with a stability of 0.002 percent per hour and 0.005 percent per month. Line and load regulation are 0.0005 percent with less than 100 μ v rms ripple. Remote programming, remote sensing, and continuously adjustable current limiting are provided. John Fluke Mfg. Co., Inc., P. O. Box 7428, Seattle 33, Wash. (332)

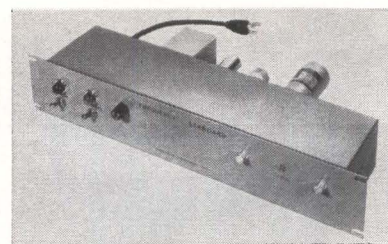

Frequency Standards Are Solid-State Units

FREQUENCY standards, models 67100 (fixed frequency) and 67200 (voltage controlled), are available at any output frequency between 60 cps and 100 Mc, with 0.001-percent to 0.000001-percent stability. Input: 120 v a-c, 60 cps \pm 10 percent. Output: 1 v rms minimum. Load impedance: any load from 100 ohms to 1 megohm. Output wave form: sine, 2 percent max harmonic distortion. Output regulation: \pm 2 percent. Greenray Industries, Inc., East Simpson Road, Mechanicsburg, Pa. (333)

SEPTEMBER 6, 1963 • electronics

LITERATURE OF THE WEEK

EPOXY RESIN HARDENER Smooth-On Mfg. Co., 572 Communipaw Ave., Jersey City 4, N. J. Properties of Sonite No. 41 hardener for epoxy resins and its use in making castings and laminates are described in three technical bulletins. (334)

SWEEPING OSCILLATOR Kay Electric Co., Maple Ave., Pine Brook, N. J. Mailing piece illustrates and describes Multi-Sweep 159-A, a 1- to 300-Mc sweeping oscillator. (335)

SOLDER STRIPPER MacDermid Inc., Waterbury, Conn. Technical data sheet contains complete information on a new solder stripper for p-c boards and other electronic components and hardware. (336)

VHF VOLTMETER Ballantine Laboratories, Boonton, N. J. Looseleaf-perforated bulletin illustrates and describes model 340 true-rms r-f millivoltmeter. (337)

D-C RECORDERS Amprobe Instrument Corp., 630 Merrick Road, Lynbrook, N. Y. Catalog/specification sheet covers a line of d-c 50-mv recorders. (338)

CIRCUIT-BUILDING TECHNIQUE AeroCircuits Co., Box 209, Fairfield, Conn. Four-page folder describes CirPlan circuit boards, which are designed to provide a quality and effective method of packaging a complete high- or low-frequency circuit. (339)

TUBE SHIELDING Cool-Fin Electronics Corp., 1717 No. Potrero, South El Monte, Calif. Folder of catalog sheets covers high-efficiency fin-type heat dissipating and r-f shielding for electronic tubes. (340)

SCR FIRING CIRCUIT Lectrologic Corp., P. O. Box 4857, Fort Lauderdale, Fla. Four-page folder describes model 101 firing circuit. (341)

UHF TRIODE POWER AMPLIFIER Amtron Corp., 17 Felton St., Waltham, Mass. Catalog sheet describes model 125 uhf scr firing circuit. (341)

P-C BOARD ASSEMBLY MACHINES Universal Instruments Corp., Binghamton, N. Y. Four-page brochure describes new automatic high-speed inserting and clinching machines for printed-circuit board assembly. (343)

SLIDE RULE Electra Scientific Corp., Electra Way, Fullerton, Calif., offers at no charge a slide rule intended primarily for engineers involved in piezoelectric transducer design and similar applications. (344)

TAPE TRANSPORT S-I Electronics, Inc., 103 Park Ave., Nutley 10, N. J. Data sheet describes a precision digital magnetic tape transport designed for airborne, shipboard and vehicular system applications. (345)

MYLAR DIELECTRIC CAPACITORS The Gude-man Co., 340 W. Huron St., Chicago 10, Ill., has available a bulletin describing a new line of miniature flat and tubular Mylar dielectric capacitors. (346)

CLUSTERED MAGNETIC SHIELDS Magnetic Shield Division Perfection Mica Co., 1322 No. Elston Ave., Chicago 22, Ill. Data sheet 163 deals with space-saving clustered Netic and Co-Netic magnetic shields for multiple photomultiplier tube applications. (347)

AUTOMATIC CIRCUIT CHECKOUT Digital Equipment Corp., 146 Main St., Maynard, Mass. Brochure covers a system for automatic production-line checkout of electronic circuits, controlled by the Programmed Data Processor-4 computer. (348)

POWER SUPPLY MODULES Valor Instruments, Inc., 13214 Crenshaw Blvd., Gardena, Calif. Bulletin PS663 covers MilliPak miniature d-c power supply modules. (349)

METALIZED TEFLON CAPACITORS Dearborn Electronic Laboratories, Inc., P. O. Box 3431, Orlando, Fla. Engineering data 4-TB-63 contains complete information on a line of metalized Teflon capacitors that offer volumetric reduction to as much as four-to-one. (350)

NPN TRANSISTORS Bendix Semiconductor Division, Holmdel, N. J. An engineering data sheet discusses silicon Leaf planar epitaxial npn transistors. (351)

BIPOLAR ANALOG COMPUTATION Applied Dynamics, Inc., 2275 Platt Rd., Ann Arbor, Mich. A 16-page pamphlet describes a significant improvement in analog-computer programming through the use of bipolar operational amplifiers. (352)

ELECTROLYTIC CAPACITORS Aerovox Corp., New Bedford, Mass. Catalog 203B1 describes type QE aluminum electrolytic capacitors designed for high reliability and long life. (353)

INTERCHANGEABLE WAFER THERMISTORS Gulton Industries, Inc., 212 Durham Ave., Metuchen, N. J. Bulletin describes interchangeable wafer thermistors for temperature measurement, control and compensation. (345)

DIGITAL OPERATIONS SYSTEM Electronic Associates, Inc., Long Branch, N. J. Bulletin AC-6297 describes the series 350 hybrid computer digital operations system. (355)

MULTI-APPLICATION CAPACITOR CTS Corp., Elkhart, Ind. Advance data sheet 8500 covers a multi-application thin-film screened capacitor which features high reliability due to the inherent stability of its inorganic construction. (356)

DUAL TRANSISTORS Hughes Semiconductor Division, 500 Superior Ave., Newport Beach, Calif. Bulletin DX52 describes the 2N2871 and 2N2872 pnp silicon alloy dual transistors. (357)

RECORDING SYSTEMS Brush Instruments, division of Clevite Corp., 37th and Perkins, Cleveland, O. A 20-page condensed catalog describes a line of recording systems for industrial, military and scientific applications. (358)

How high is your goal?

Ours are out of sight—in the labyrinth of space. But your opportunities are a tangible reality, here and now at North American's Space and Information Systems Division.

LOGIC DESIGN

Perform conceptual analysis and trade-off studies resulting in logic design of command and data systems. Optimize logic networks for minimum complexity and maximum reliability; prepare design specifications; and conduct laboratory evaluations of developmental systems.

PCM TELEMETRY

Develop a PCM System utilized in checkout of the spacecraft systems. Includes data acquisition, multiplexing and long distance transmission. All phases of development are involved, from conceptual analysis and trade-off studies to hardware design and evaluation studies.

R. F. ELECTRONICS & ANTENNAS

Design and analysis of space communication equipment including VHF, voice and telemetry transmitters and receivers, C-band beacons, coherent S-band transponders, space rendezvous radar and ground radar systems and associated antenna systems covering the 10 MC to 13 KMC frequency band.

CONTROL SYSTEM DESIGN

To analyze, design, and develop high performance digital and analog multi-loop feedback systems required to provide vehicle dynamic responses. Automatic flight-controls experience helpful. Interested? Please contact:

Mr. P. J. MANINO, ENGINEERING AND SCIENTIFIC EMPLOYMENT, 12214 LAKEWOOD BLVD., DOWNEY, CALIFORNIA

All qualified applicants will receive consideration for employment without regard to race, creed, color, or national origin.

SPACE AND INFORMATION SYSTEMS DIVISION
NORTH AMERICAN AVIATION





Sanders Enters New Facility

SANDERS ASSOCIATES, INC. has occupied a new 50,000-square foot facility on "electronics row" in Bedford, Mass. The new Bedford division will house the Corporate Advanced Program Development Group and the Advanced Systems Laboratories previously located in a leased building in Burlington, Mass.

The versatile, two-story Bedford facility is a self-sustained division of Sanders Associates, Inc., with both a capacity and capability to support company research, development and production programs.

A flexible plant layout allows for fast economical expansion by adding modular sections of up to 150,000 square feet to the new facility.

The Corporate Advanced Program Development Group is directed by corporate vice president Martin R. Richmond. It is responsible for the coordination and expansion of total company capabilities in all facilities for new programs of major potential in several fields of advanced weapon systems.

The Advanced Systems Laboratories is directed by vice president David D. Coffin, and is engaged in the development of advanced radar pulse doppler systems, space communications, missile systems analysis, product design and computer synthesis.

The Bedford division is the third new plant constructed by the company in the past three years in a program of rapid expansion. During the three-year period the sales volume has climbed from about \$17 million in 1960 to a present annual rate of about \$55 million.

Sanders Associates, Inc. has its headquarters in Nashua, N.H., with other facilities in Plainview, L.I., N.Y., and Manchester, N.H.



Univac Elevates Retterer

RAY W. RETTERER has been appointed senior vice president, marketing, of the Univac division of Sperry Rand Corporation, New York City. In this newly established position, he will be responsible for all commercial, Federal Government, and defense marketing activities for the division in the continental United States.

Retterer joined Univac in 1961 as executive assistant to the vice president and general manager. Since December, 1961, he has been director of marketing.



Radiation at Stanford Appoints Leifer

RADIATION AT STANFORD, Palo Alto, Calif., has appointed Meyer Leifer as vice president-operations. In this position he will be in charge of the company's operating divisions, which include the R-F Systems division, Optical Systems division, Products division, Magnetic Components division, and the Production division.

Prior to joining Radiation at Stanford, Leifer was director of Sylvania's Systems Engineering and Management Organization (SEMO) in Waltham, Mass.



Culver Takes Over Top Company Post

EUGENE S. CULVER has been elected president of Washington Technological Associates, Rockville, Md. He succeeds Harold M. Briggs who has resigned.

Culver has been serving as executive vice president and director of technical operations of WTA since 1960.

Washington Technological Associates, Inc. is an engineering research/development and manufacturing firm specializing in missile handling equipment, prototype fabrication, satellites and electrome-

2N439

Print top and side together at 3200/hour

187

NS 16870-U21

Identify products with inks that meet government specs

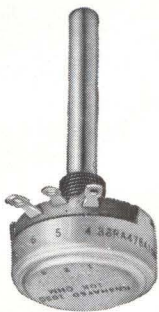

Print 1500 hard-to-hold items per hour with complete uniformity — change to new imprint in seconds

cut your identification costs with modern methods like these

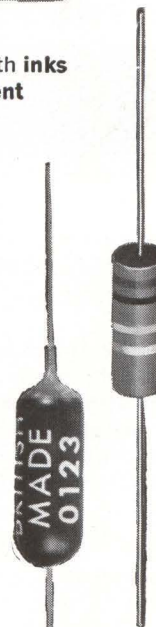

Color-band and/or print economically by machine — in sample lots or up to 6000/hour



Save purchase, inventory and obsolescence costs by making your own labels exactly as needed



Get sharp, durable imprints on extremely irregular shapes or rough surfaces

Looking for faster identification . . . imprints that meet government specs . . . flexibility to meet changing requirements . . . a practical way to mark prototype or sample lots? Would direct printing or making your own labels cut costs, give higher print quality? Ask Markem to analyze your identifica-

tion needs now — without obligation — and show you *how* and *where* you can save money. Frequently, a Markem in-plant identification system pays for itself in a few months. Contact the Markem Technical Representative near you, or write Markem Machine Co., Keene 5, New Hampshire.

New 12-page Catalog describes Electrical/Electronic Identification Methods and Equipment. Copy on request.



MARKEM

TECHNICAL ASSISTANCE AND INDUSTRY-PROVEN EQUIPMENT WORLDWIDE . . . TO HELP YOUR PRODUCT SPEAK FOR ITSELF

CODE/SCAN[®]

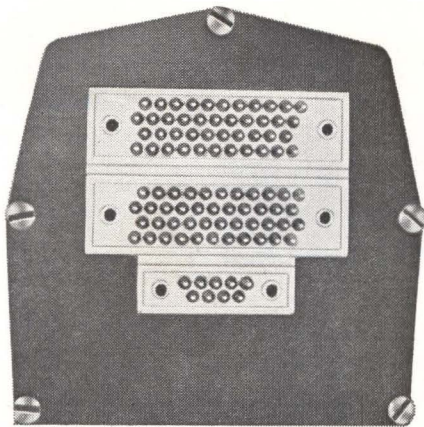

You are looking into the business end of today's most reliable multiple low level signal conditioner.

It time shares one amplifier with up to 128 different data points in perfect pulse-lock with your channel and frame program. It is agreeable to signal levels as low as 10 mv full scale. Its scanning format can be cross strapped or rearranged in the field for flexible application.

It gives you better than 1/2% accuracy whether you heat it, freeze it or bang it around. It completely ignores common mode voltages and with automatic drift correction quietly changes your 10 mv signal into a husky 5 volt output for direct insertion into your data system. You provide only raw power and a place to sit (the other interfaces have already been attended to).

It doesn't use matched components, doesn't require special personnel and you don't have to fiddle with it or tweak it. Over its extended life-time it requires **no adjustments or calibrations** and in fact has no provision to do so. If you need data you can trust, you can get **CODE/SCAN**, mated to your particular requirement in less than 60 days and with kind attention to your budget. Order the same kind NASA uses and save yourself the qualification effort.



FIFTH DIMENSION INC.
P.O. BOX 483 • PRINCETON, N. J.
WALNUT 4-5990

*Your company letterhead is enough to get a live demonstration of **CODE/SCAN** in your laboratory, or see it at the London ITC.*

mechanical-electronic instrumentation and development.



Augenblick Assumes Bogart Presidency

HARRY A. AUGENBLICK has assumed the presidency of Bogart Manufacturing Corp. of Brooklyn, N.Y. Bogart, recently acquired by Microlab, manufactures waveguides and high power microwave components.

Augenblick, who will continue in his capacity as president of Microlab, will actively coordinate and direct the various activities of Bogart.



Howard Accepts New Position

APPOINTMENT of George F. Howard as manager of Blackstone Ultrasonics, Inc., Sheffield, Pa., is announced. Blackstone Ultrasonics, which was formed early this year, is a wholly-owned subsidiary of Blackstone Corp., Jamestown, N.Y.

In his new position, Howard will be responsible for complete management of the company, including production and sales.

Most recently, Howard served as sales manager for General Instrument Corp., Harris A.S.W. division.

EOS Appoints Two Senior Scientists

EDMUND M. DIGIULIO and Ivan E. Walenta have joined Electro-Optical Systems, Inc., Pasadena, Calif., as senior scientists engaged in advanced systems development operations and advanced systems engineering, respectively.

Digiulio was previously vice president of engineering and manufacturing at Craig Research, Inc., Los Angeles.

Walenta was formerly with Caltech's Jet Propulsion Laboratory, Pasadena, as chief of the space instrument systems section of the Space Sciences division.

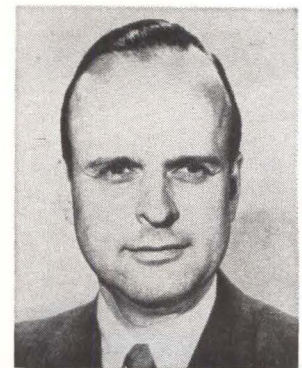

Bridge Incorporated Elects Leas

J. WESLEY LEAS, formerly general manager for the data communications and custom projects department of the EDP division at RCA, has been elected vice president of Bridge Inc., Philadelphia, Pa.

Bridge designs and manufactures high-speed card readers and punches, as well as specialized peripheral equipment for the electronic data processing industry.

Orr Joins Tracerlab As Division Manager

JAMES F. ORR has been named manager, Industrial division, for Tracerlab, a division of Laboratory For Electronics, Inc., Waltham, Mass. His responsibilities in this new post include engineering, manufacturing and marketing of Tracerlab's industrial beta gage process

LAST CALL!!

for Electronic Engineers
to manage the
Installation, Maintenance
& Reliability Programs
for Naval
Shipboard Systems

Because the many electronic devices and systems on board the Navy's new surface and sub-surface vessels must operate with near-perfect reliability—despite rugged environmental conditions and inherent complexity—installation and maintenance engineering are more important than ever before. Specifically to meet this challenge, the Bureau of Ships has established the ELECTRONICS MAINTENANCE CENTER in Norfolk, Virginia . . . to take over the management of, and the responsibility for, shipboard INSTALLATION, RELIABILITY, MAINTENANCE and PRODUCT IMPROVEMENT requirements for

- ECM and RADAR • COMMUNICATIONS
- SONAR • COMPUTERS
- SUPPORT SYSTEMS

If you are a graduate EE with 3 to 5 years' experience—or a top-grade graduate without experience—you may qualify for one of the few remaining key positions in which you can gain an insight and influence in military electronics matters far beyond your years and experience. And, since you will be responsible for liaison with design and development people at Bureau headquarters, with industrial contractors, with operating units and support activities, and with your counterparts in other Navy Bureaus, you will have ample opportunity to *know and become known*.

As a Project Engineer at the Center you will start as high as \$9,475 (\$9,980 after January 1st), with the many benefits of Career Civil Service. For those without sufficient experience, there are Junior Engineering positions open from \$6,650 to \$7,125 (also subject to automatic increase on January 1st), plus Civil Service benefits. Advancement to Senior Project Engineering positions—to \$13,615 and beyond—is well within reach for both engineering categories.

Get in on the ground floor of this new forward-looking organization by contacting the Director—Industrial Relations and Manpower, Code 722A.

bureau of ships

Department of the Navy
Washington 25, D.C.
An Equal Opportunity Employer

KINNEY PUMPS AND COMPONENTS REDUCE HIGH VACUUM PROBLEMS TO A MINIMUM



VACUUM GAUGES

A variety of Kinney vacuum gauges includes the KTG Thermocouple Gauge (3000 to 1 micron range), the KDG Discharge Gauge (10 microns to 2×10^{-7} torr range), and the TD-1 McLeod Gauge (150 torr to 1 micron range).

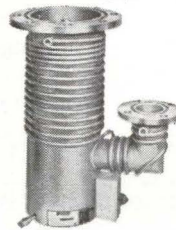

DIFFUSION PUMPS

Kinney Series KDP Diffusion Pumps provide maximum pumping speeds in 2", 4", and 6" sizes. They obtain pressures of 4×10^{-7} torr un-baffled, and 1×10^{-8} torr when combined with the Model KDB baffle using liquid nitrogen.



VANE-TYPE MECHANICAL PUMPS

The Series KCV Vane Pumps are provided in 2, 3, 5, and 7 cfm sizes and are manufactured to the same high quality standards as Kinney cam-and-piston pumps. Quiet, vibrationless, and smoke-free, they are ideal for laboratory use.

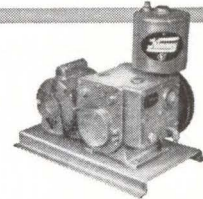

CAM AND PISTON MECHANICAL PUMPS

Kinney produces the highest quality in mechanical pumps ranging in size from 2 to 850 cfm. Series KS and KD Single Stage Pumps attain pressures below 10 microns; Series KC Compound Pumps deliver pressures below 0.2 micron.



HIGH VACUUM VALVES

Kinney's complete line of vacuum valves includes series DC Diaphragm Valves, Series BB and OB Bellows sealed Valves, Series KRV Right Angle Valves, and Series G Gate Valves. They are provided for soldered, threaded, or flanged connection and for manual or air operation.



BAFFLES AND COLD TRAPS

A unique design gives Kinney Baffles high conductance and maximum effectiveness. The Series KDB is intended for water or liquid nitrogen cooling; the Series KWB is used with water or freon. Supplied in 2", 4", 6" and 10" sizes.



KINNEY VACUUM DIVISION

THE NEW YORK AIR BRAKE COMPANY
3529 WASHINGTON STREET • BOSTON 30, MASS.

KINNEY . . . EVERYTHING IN VACUUM

**FREQUENCY
STANDARD
PERFORMANCE**
in
**Packaged
Oscillator
Size**



For additional technical data, WRITE:



PRODUCTS

**THE
JAMES
KNIGHTS
COMPANY**

SANDWICH, ILLINOIS

JKTS-1000: A completely packaged oscillator-oven unit. Performance equal-to or better-than many laboratory frequency standards designed for system and equipment use. SPECIFICATIONS: large diameter, 1 mc, glass-enclosed crystal, together with oscillator-buffer circuitry, voltage regulation and temperature control completely housed in a double proportionally-controlled oven. External and remote trimming. Stability and calibration 1×10^{-9} per day at time of shipment.

CIRCLE 222 ON READER SERVICE CARD

AM-FM Tuner Unit

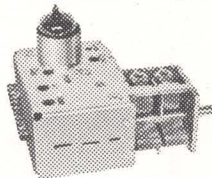

AM SEC. CAPACITY: MAX. 377PF
: MIN. 12PF
TUBE: 6AQ8, 12DT8, 17EW8

PLASTIC
VARIABLE CONDENSER

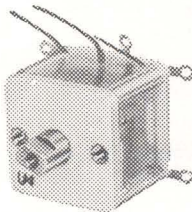

Square Size:
15mm., 17mm.,
20mm., 21mm.,
Single band:
2 band, 3 band
and for FM only.



SANKAISHA CO., LTD.

Cable address: SANESVARICON TOKYO
1425, 4-chome, Higashinakanobu,
Shinagawa-ku, Tokyo, Japan.

**DON'T CUT CORNER
ON VITAL PARTS!**

**SHIZUKI
CAPACITORS**

Using metallized paper and metallized mylar film produced by itself.

- * Lacquer Film Capacitors
- * Polystyrene Capacitors
- * Mylar Capacitors
- * Metallized Paper Capacitors for motor running, fluorescent ballasts
- * Noise Suppression Capacitors
- * Ignition Capacitors

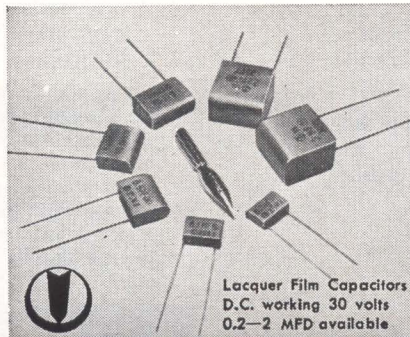

Lacquer Film Capacitors
D.C. working 30 volts
0.2-2 MFD available

SHIZUKI ELECTRIC WORKS CO., LTD.

HEAD OFFICE: 1, TAISHA-CHO, NISHINOMIYA, JAPAN
CABLE ADDRESS: "CAPACITOR" NISHINOMIYA
TOKYO FACTORY: 10-7, ARAIYUKU, OTA-KU, TOKYO

CIRCLE 223 ON READER SERVICE CARD

control systems. Orr joins Tracerlab from the servo Corporation of America, Hicksville, N.Y.

PEOPLE IN BRIEF

Stanley J. Kukawka moves up to quality control director of Bourns Trimpot div. **William E. Williams**, formerly with Missimers, Inc., named chief engineer of the Western div. of Tenney Engineering, Inc. **Robert R. Sparacino** promoted to R&D director for General Motors AC Spark Plug div.'s missile and space activities. **Frederick W. Treue** advances to mfg. mgr. for Frequency Engineering Laboratories. **William H. Christoffers** and **John T. Mendel** are raised to mgr. and associate mgr., respectively, of the microwave tube div. of Hughes Aircraft Co. **Charles J. Koch**, with Martin Co. since 1941, appointed exec director of space programs. **Peter F. LeFort** leaves Microwave Associates to join Amperex Electronic Corp. as product mgr., microwave tubes and components. **Stanley E. Rauch**, ex-U. of Calif. professor, named head of the Electronics Research dept. of the Research div. of Melpar, Inc. **Tak Yamashita**, from Bendix Computer div. to TRW Computer div. as mgr., Programming Sciences dept. **Wendell D. Trudgen** promoted to mgr. of application engineering for GE's Process Computer Section. Litton Industries elevates **Bernard Rider** to director of the Advanced Technology operation of the RADCOM div. **Harry F. Albert**, formerly with the Teledynamics div. of American Bosch Arma Corp., appointed g-m of Sonex, Inc. **Thomas R. McGinley, Jr.**, previously with Kollsman Instruments Corp., now mgr. of operations for the Physics Research div. of Geophysics Corp. of America. **Fred E. Stote**, ex-Texas Instruments, named g-m of the new Semiconductor div. of Clevite Corp. **M. Donald Blue**, ex-Westinghouse and Bell Labs, appointed section head of solid-state physics research at Honeywell Research Center. **Oscar Valdez**, previously with Arnoux Corp., named operations engineering mgr. for Telemetrics, Inc.

electronics

WEEKLY QUALIFICATION FORM FOR POSITIONS AVAILABLE

ATTENTION: ENGINEERS, SCIENTISTS, PHYSICISTS

This Qualification Form is designed to help you advance in the electronics industry. It is unique and compact. Designed with the assistance of professional personnel management, it isolates specific experience in electronics and deals only in essential background information.

The advertisers listed here are seeking professional experience. Fill in the Qualification Form below.

STRICTLY CONFIDENTIAL

Your Qualification form will be handled as "Strictly Confidential" by ELECTRONICS. Our processing system is such that your form will be forwarded within 24 hours to the proper executives in the companies you select. You will be contacted at your home by the interested companies.

WHAT TO DO

1. Review the positions in the advertisements.
2. Select those for which you qualify.
3. Notice the key numbers.
4. Circle the corresponding key number below the Qualification Form.
5. Fill out the form completely. Please print clearly.
6. Mail to: Classified Advertising Div., ELECTRONICS, Box 12, New York, N. Y. 10036. (No charge, of course).

COMPANY	SEE PAGE	KEY #
ATOMIC PERSONNEL INC. Philadelphia, Penna.	152	1
BELL AEROSYSTEMS CO. Div. of Bell Aerospace Corporation A Textron Company Buffalo, New York	152	2
BUREAU OF SHIPS Electronics Maintenance Center U. S. Navy Department Washington, D. C.	147	3
HONEYWELL St. Petersburg, Fla.	130	4
INTERNATIONAL BUSINESS MACHINES CORP. Owego, New York	151	5
NORTH AMERICAN AVIATION INC. Space & Information Systems Div. Downey, Calif.	134, 143	6
PAN AMERICAN WORLD AIRWAYS, INC. Guided Missiles Range Division Patrick Air Force Base, Fla.	55*	7
SPACE—GENERAL CORP. A Subsidiary of Aerojet-General Corp. El Monte, Calif.	52*	8
UNION CARBIDE NUCLEAR COMPANY A Division of Union Carbide Corp. Oak Ridge, Tenn.	54*	9
UNIVAC Div. of Sperry Rand Corp. St. Paul, Minn.	150	10

* These advertisements appeared in the August 30th issue.

(cut here)

electronics WEEKLY QUALIFICATION FORM FOR POSITIONS AVAILABLE

(cut here)

(Please type or print clearly. Necessary for reproduction.)

Personal Background

NAME

HOME ADDRESS

CITY ZONE STATE

HOME TELEPHONE

Education

PROFESSIONAL DEGREE(S)

MAJOR(S)

UNIVERSITY

DATE(S)

FIELDS OF EXPERIENCE (Please Check)

9663

- | | | |
|--|--|---------------------------------------|
| <input type="checkbox"/> Aerospace | <input type="checkbox"/> Fire Control | <input type="checkbox"/> Radar |
| <input type="checkbox"/> Antennas | <input type="checkbox"/> Human Factors | <input type="checkbox"/> Radio—TV |
| <input type="checkbox"/> ASW | <input type="checkbox"/> Infrared | <input type="checkbox"/> Simulators |
| <input type="checkbox"/> Circuits | <input type="checkbox"/> Instrumentation | <input type="checkbox"/> Solid State |
| <input type="checkbox"/> Communications | <input type="checkbox"/> Medicine | <input type="checkbox"/> Telemetry |
| <input type="checkbox"/> Components | <input type="checkbox"/> Microwave | <input type="checkbox"/> Transformers |
| <input type="checkbox"/> Computers | <input type="checkbox"/> Navigation | <input type="checkbox"/> Other |
| <input type="checkbox"/> ECM | <input type="checkbox"/> Operations Research | <input type="checkbox"/> |
| <input type="checkbox"/> Electron Tubes | <input type="checkbox"/> Optics | <input type="checkbox"/> |
| <input type="checkbox"/> Engineering Writing | <input type="checkbox"/> Packaging | <input type="checkbox"/> |

CATEGORY OF SPECIALIZATION

Please indicate number of months experience on proper lines.

	Technical Experience (Months)	Supervisory Experience (Months)
RESEARCH (pure, fundamental, basic)
RESEARCH (Applied)
SYSTEMS (New Concepts)
DEVELOPMENT (Model)
DESIGN (Product)
MANUFACTURING (Product)
FIELD (Service)
SALES (Proposals & Products)

CIRCLE KEY NUMBERS OF ABOVE COMPANIES' POSITIONS THAT INTEREST YOU

1 2 3 4 5 6 7 8 9 10 11 12 13 14 15



A-NEW

■ One of the U.S. Navy's most pressing problems is anti-submarine warfare. An important step toward the solution to this problem is the A-NEW concept to provide the fleet with an integrated airborne ASW system able to cope with potential submarine threats.

A basic airborne ASW problem centers around the necessity for rapid and precise information processing. Therefore, the A-NEW system is integrated by the application of digital and analogue techniques designed by an Industry/U.S. Navy team. A most important element of the A-NEW system is ADD (Aerospace Digital Development), a UNIVAC airborne computer.

The UNIVAC computer will assist in the determination and display of such things as optimum tactical employment of sensors, sonobuoy and armament, thereby providing a tracking and attack capability against multiple targets.

The A-NEW program is just one of the challenges available at UNIVAC to qualified scientific personnel.

Immediate Openings. Engineering or Scientific Degree plus experience in one of the following disciplines is required.

Aero Space Systems Engineers • System Design Engineers • Production Research Printed Circuit Engineers • Micro-Module Design Engineers • Scientific Programmers • Military Operations Analysts

Address inquiries with a resume of your education and experience to:

R. K. PATTERSON
UNIVAC
Univac Park
St. Paul 16, Minnesota

OR

W. K. LOWE
UNIVAC
P.O. Box 6248
San Diego 6, California

UNIVAC

DIVISION OF SPERRY RAND CORPORATION

Sperry Rand Building, New York 19, N. Y.
(An Equal Opportunity Employer)

FOR INFORMATION

about Classified Advertising

contact the McGraw-Hill
office nearest you

ATLANTA, 30309

I. HILL—R. JOHNSON
1375 Peachtree St., N.E.
875-0523 (Area Code 404)

BOSTON, 02116

J. WREDE
McGraw-Hill Bldg., Copley Square
COngress 2-1160 (Area Code 617)

CHICAGO, 60611

WM. HIGGENS—G. AMBROZE
645 No. Michigan Avenue
MOhawk 4-5800 (Area Code 313)

CLEVELAND, 44113

R. HARTER
55 Public Square
SUperior 1-7000 (Area Code 216)

DALLAS, 75201

F. LeBEAU
1712 Commerce St., Vaughn Bldg.
Riverside 7-9721 (Area Code 214)

DENVER, 80202

J. PATTEN
1700 Broadway, Tower Bldg.
255-2981 (Area Code 303)

DETROIT, 48226

T. JAMES
856 Penobscot Building
962-1793 (Area Code 313)

HOUSTON, 77025

K. GEORGE
Prudential Bldg., Holcombe Blvd.
Riverside 8-1280 (Area Code 713)

LOS ANGELES, 90017

R. McGINNIS
1125 West Sixth Street
HUntley 2-5450 (Area Code 213)

NEW YORK, 10036

D. HAWKSBY—H. BUCHANAN
500 Fifth Avenue
971-3596 (Area Code 212)

PHILADELPHIA, 19103

WM. SULLIVAN—R. LEWIS
Six Penn Center Plaza
LOcust 8-4330 (Area Code 215)

PITTSBURGH, 15222

4 Gateway Center
391-1314 (Area Code 412)

ST. LOUIS, 63105

J. CROWE
7751 Carondelet Avenue
PArkview 5-7285 (Area Code 314)

SAN FRANCISCO, 94111

J. A. HARTLEY
255 California Street
DOuglas 2-4600 (Area Code 415)

Modulating the laser light beam is a key to using the vast data-transmission capability of lasers.

IBM scientists achieved a significant advance when they created the injection laser. With other types of lasers, it is necessary to modulate the output light beam itself. This is relatively inefficient. In contrast, since the injection laser is stimulated by electrical energy, it can be modulated simply by varying the stimulating current. Six months after IBM announced the first injection laser—made of gallium arsenide—engineers were able to demonstrate the first successful transmission of voice signals over an injection laser beam. In addition, IBM scientists have pursued the exploitation of new materials for injection lasers and recently fabricated an indium phosphide device.

The injection laser is excited by passing a current above

a certain threshold through a p-n junction. Electrons produce photons by falling from the conduction band to the valence band and stimulate regenerative oscillations between sharply cleaved ends of the crystal in the region adjacent to the junction. The reinforced oscillations emerge from a 0.01 square millimeter cross-sectional face as an infrared beam having a spectral width of less than 0.5 Angstrom and an angle of spread of 2.5 degrees. Modulation of the output light can be accomplished by varying the current across the junction.

If you are interested in making contributions in lasers or other areas in which IBM scientists and engineers look for answers to basic questions, write: Mgr. of Employment, IBM Corp., Dept. 554J1, 590 Madison Ave., N. Y. 22, N. Y. IBM is an Equal Opportunity Employer.

IBM asks basic questions in lasers

How can we modulate light?

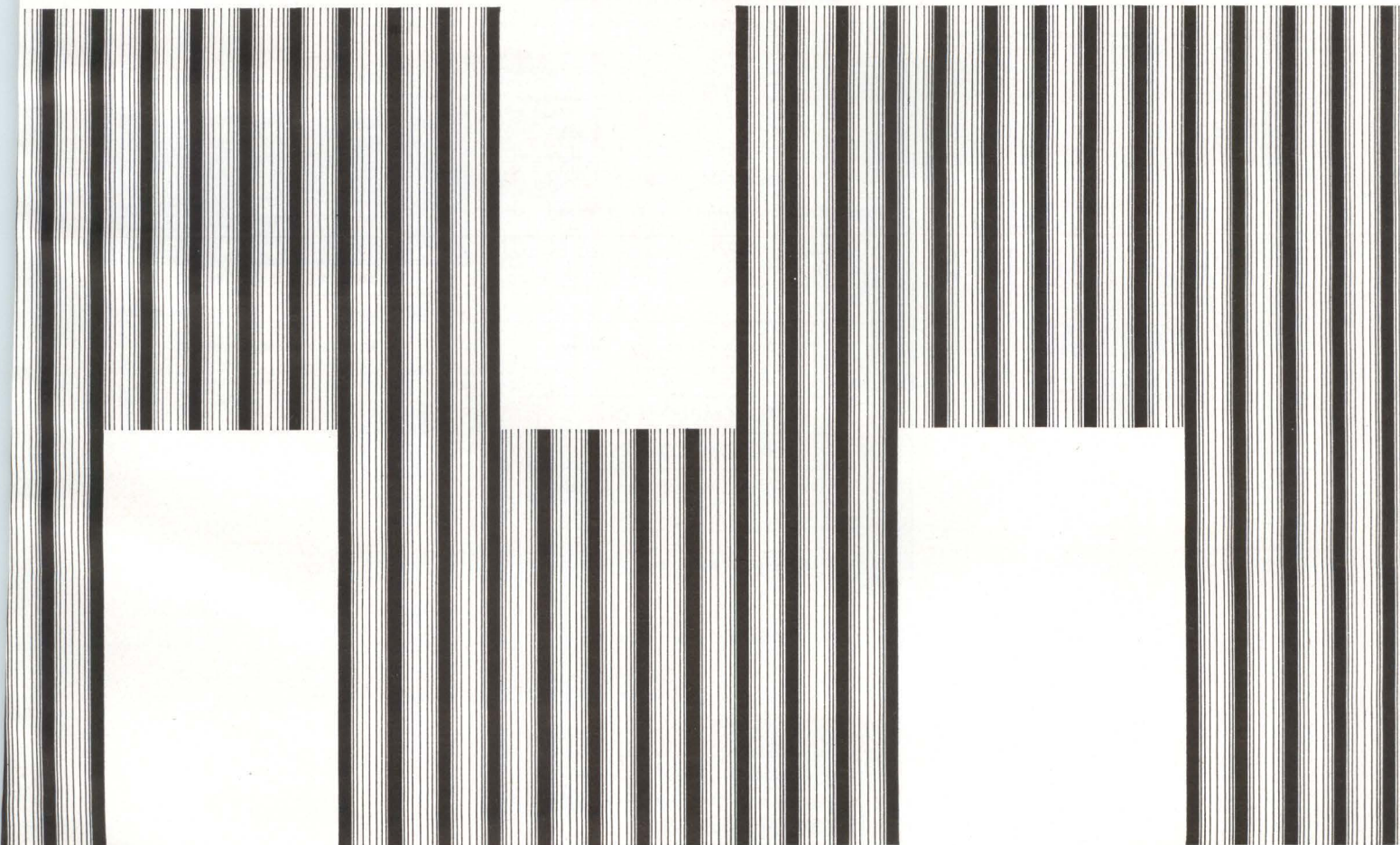

ADVANCED COMMAND & CONTROL SYSTEMS DESIGN ENGINEER

A high level position is now available with Bell Aerosystems Co., a company holding a variety of advanced contracts including a lunar landing research vehicle, exotic instruments, battlefield air traffic controls, mapping systems and learning machines.

The man selected will be responsible for analytical and preliminary design studies of command and control systems for terrestrial and orbital vehicles, accurately defining system requirements and limitations. Specific areas of investigation include position determination, vehicle control, data processing and transmission, and information display.

The demands of the job to be done require an advanced degree in Physics or EE with minimum 8 years related experience, plus knowledge of military system design requirements. Salary to \$18,000.



Please send resumes, in confidence, to
Mr. Thomas Fritschi, Dept. G-32

BELL AEROSYSTEMS CO.

DIVISION OF BELL AEROSPACE CORPORATION - A **Textron** COMPANY

P.O. BOX # 1, BUFFALO 5, NEW YORK

An Equal Opportunity Employer



E. E.'s

for FEE-PAID Positions
WRITE US FIRST!

Use our confidential application for professional, individualized service . . . a complete national technical employment agency.

ATOMIC PERSONNEL, INC.
Suite 1207L, 1518 Walnut St., Phila. 2, Pa.

EMPLOYMENT OPPORTUNITIES



The advertisements in this section include all employment opportunities—executive, management, technical, selling, office, skilled, manual, etc.

Look in the forward section of the magazine for additional Employment Opportunities advertising.

— RATES —

DISPLAYED: The advertising rate is \$40.17 per inch for all advertising appearing on other than a contract basis. Contract rates quoted on request.

An advertising inch is measured 7/8" vertically on a column—3 columns—30 inches to a page.

Subject to Agency Commission.

UNDISPLAYED: \$2.70 per line, minimum 3 lines. To figure advance payment count 5 average words as a line.

Box numbers—count as 1 line.

Discount of 10% if full payment is made in advance for 4 consecutive insertions. Not subject to Agency Commission.

SELLING OPPORTUNITY AVAILABLE

"ALFA" Radio Testers (VOM)—Made in Belgium. We should like to appoint Distributors in USA for the famous ALFA Radio Testers (VOM), competitive in the International Market—beautiful and precise instruments. For conditions and quotations please write to: Societe Industrielle Alfa, S.A., 80, rue de la Senne, Brussels-Belgium. Tel.: 12-67-30 (5 lines). Telex: 2-21844.

POSITION WANTED

Swiss Engineer (Diploma Technician), age 25, presently working on electronic microscopes, seeks position with American firm, preferably research or laboratory work. Available Spring 1964. Apply Box OFA 4761 CH, Orell Fussli-Annonces, Zurich 22/Switzerland.

"Put Yourself in the Other
Fellow's Place"

TO EMPLOYERS
TO EMPLOYEES

Letters written offering Employment or applying for same are written with the hope of satisfying a current need. An answer, regardless of whether it is favorable or not, is usually expected.

MR. EMPLOYER, won't you remove the mystery about the status of an employee's application by acknowledging all applicants and not just the promising candidates.

MR. EMPLOYEE you, too, can help by acknowledging applications and job offers. This would encourage more companies to answer position wanted ads in this section. We make this suggestion in a spirit of helpful cooperation between employers and employees.

This section will be the more useful to all as a result of this consideration.

Classified Advertising Division

McGraw-Hill Publishing Co., Inc.

330 West 42nd St., New York, N. Y. 10036

SEARCHLIGHT SECTION

(Classified Advertising)

BUSINESS OPPORTUNITIES

EQUIPMENT - USED or RESALE

DISPLAYED RATE

The advertising rate is \$27.25 per inch for all advertising appearing on other than a contract basis. Contract rates quoted on request. AN ADVERTISING INCH is measured 7/8 inch vertically on one column, 3 columns—30 inches—to a page. EQUIPMENT WANTED or FOR SALE ADVERTISEMENTS acceptable only in Displayed Style.

UNDISPLAYED RATE

\$2.70 a line, minimum 3 lines. To figure advance payment count 5 average words as a line.

PROPOSALS, \$2.70 a line an insertion.

BOX NUMBERS count as one line additional in undisplayed ads.

DISCOUNT OF 10% if full payment is made in advance for four consecutive insertions of undisplayed ads (not including proposals).

GEORGE:

D.A.T.A. Tabulations keep you current

on all Transistors • Semicon. Diodes

• Microwave Tubes in the world.

Characteristics, type numbers, manu-

facturers. For free literature write:

D.A.T.A., INC., 43-15 S. Day St.,

Orange, N. J. 07050

CIRCLE 951 ON READER SERVICE CARD

RADIO RESEARCH INSTRUMENT CO.

AUTO-TRACK & TELEMETRY ANTENNA PEDESTALS 3 & 10 CM. SCR. 584 AUTOTRACK RADARS. AN/TPS-10 SEARCH. AN/TPS-10 HT. FINDERS. AN/FPS-32CCA. AN/APS-10 NAVIG. & WEATHER. AN/APS-15B PRECISION. AN/APQ-35B PRECISION. AN/APS-31A SEARCH. DOZENS MORE. 5-1-2 MEGAWATT HIGH POWER PULSERS.

RADIO RESEARCH INSTRUMENT CO.
550 Fifth Ave., New York Judson 6-4691

RADAR SYSTEMS & COMPONENTS/ IMMEDIATE DELIVERY

CIRCLE 952 ON READER SERVICE CARD

SEARCHLIGHT EQUIPMENT LOCATING SERVICE

No Cost or Obligation

This service is designed to help you, the reader of SEARCHLIGHT SECTION, to locate used or rebuilt equipment not currently advertised. HOW TO USE: Check the ads in this SEARCHLIGHT SECTION to see if what you want is advertised. If not, print clearly the specifications of the equipment and/or components wanted on the coupon below, or on your own letterhead.

THIS IS A SERVICE TO OUR READERS. THIS PUBLICATION DOES NOT BUY, SELL OR STOCK EQUIPMENT OR MATERIALS OF ANY TYPE. Your requirements will be brought promptly to the attention of the used equipment dealers advertising in this section. You will receive replies directly from them. Obviously, the list of such advertisers is limited by comparison with the over 57,000 subscribers to ELECTRONICS, all directly engaged in the electronics industry. A small EQUIPMENT WANTED advertisement in the SEARCHLIGHT SECTION will bring your needs to the attention of ALL who read ELECTRONICS. The cost is low . . . just \$27.25 per advertising inch—7/8" x 2-3/16".

Searchlight Equipment Locating Service
CLASSIFIED ADVERTISING

c/o Electronics P. O. Box 12, New York, N. Y. 10036

Please help us to locate the following used equipment:

NAME
TITLE
COMPANY
STREET
CITY ZONE
STATE 9/6/63

INDEX TO ADVERTISERS

- AMP Incorporated 16
- Advanced Electronics Corp. 100
- Allen-Bradley Co. 43
- Allied Electronics 116
- Alpha Wire Corp. 86
- Arnold Engineering Co., The 92
- Art Wire & Stamping Co. 106

- Babcock Relays, Inc. 105
- Ballantine Laboratories, Inc. 112
- Bausch & Lomb, Inc. 78
- Belden Manufacturing Co. 63
- Bell Telephone Laboratories 83
- Bendix Corporation
Bendix Pacific Division 74
- Bourns Inc. 49
- Brinkmann Instruments Inc. 96
- Brown Engineering Co., Inc. 82
- Bureau of Ships 147

- Cannon Electric Co. 93
- Carborundum Company, The 69
- Chester Cable Corp. 134, 135
- Cinch Graphik Div. of
United Carr Fastener Corp. 55
- Clairex Corp. 139
- Cohn Corp., Sigmund 142
- Colorado Research Co. 95
- Communication Electronics Inc. 138
- Consolidated Electrodynamics
Corp. 76, 77
- Coors Porcelain Co. 113
- Corning Electronics
A Div. of Corning Glass Works 23

- Defense Electronics, Inc. 30
- Delevan Electronics Corp. 126
- Dialight Corporation 142
- Dorsett Electronics, Inc. 62
- Dow Corning Corp. 28, 29
- duPont de Nemours & Co., Inc.,
E. I. 79, 98, 109
- Dymec
A Division of Hewlett Packard
Co. 107
- Dynatronics Inc. 65

- Edgerton, Germeshausen & Grier
Inc. 133
- Elcor, Inc. 116
- Electronic Associates, Inc. 128
- Elgeet Optical Co., Inc. 110
- Engineered Electronics Co. 64
- Esterline-Angus-Instrument Co.,
Inc. 53

- Ferranti Electric, Inc. 81
- Fifth Dimension, Inc. 146
- Fluke Mfg. Co., Inc., John 15
- Flying Tiger Line 61

- General Atronics 47
- General Electric Co.
Industrial Tube Div. 27
Silicone Products Dept. 101
- General Products Corp. 14
- General RF Fittings, Inc. 96
- Gudebrod Bros. Silk Co., Inc. 60

- Hamlin, Inc. 80
- Hammel, Riglander & Co. Inc. 138
- Hart Manufacturing Co. 124
- Heinemann Electric Co. 22
- Hewlett-Packard Company 2nd cover
8, 9
- Hitachi, Ltd. 94
- Hitemp Wires Inc. 117
- Honeywell 130
- Honeywell Denver Division 26
- Houston Instrument Corp. 129
- Hughes Aircraft Co.
Aerospace Divisions 70

- Indiana General Corp. 52
- International Data Systems, Inc. 68

- J F D Electronics Corp. 118
- Japan Piezo Electric Co., Ltd. 132

- Keithley Instruments, Inc. 124
- Kepco, Inc. 85
- Kinney Vacuum
Div. of New York Air Brake Co. 147
- Knights Company, James 148
- Krohn-Hite Corp. 67

- Lapp Insulator Co., Inc. 122
- Leach Corporation 121
- LEL, Inc. 80, 125
- Lepel High Frequency Laboratories,
Inc. 106

- Malayan Tin Bureau 132
- Mallory and Co., Inc., P. R. 51
- Markel & Sons, L. Frank 102
- Markem Machine Co. 145
- McGraw-Hill Book Co. 97
- McLean Engineering
Laboratories 114
- Midwec 96
- Minnesota Mining & Mfg. Co.
Mincom Division 123
- Moseley Co., F. L. 88
- Motorola Semiconductor Products
Inc. 45
- Mullard Ltd. 103

- NAVCOR 131
- North Atlantic Industries, Inc. 87

- Ohmite Mfg. Co. 12, 13
- Origin Electric Co., Ltd. 73

- Paktron
Div. of Illinois Tool Works 104
- Patwin Electronics 136
- Preformed Line Products Co. 129
- Protectvie Closures Co., Inc. 57

Radio Corporation of America	4th cover
Resistance Products Co.	59
• Rohn Mfg. Co.	136
Rome Cable Div. of Alcoa	127
• Sanborn Company	111, 125
• Sangamo Electric Co.	71, 72
Sankaisha Co., Ltd.	148
Sanken Electric Co., Ltd.	116
Scientific Atlanta, Inc.	80
Shizuki Electric Works Co., Ltd.	148
Space & Information Systems, Div. North American Aviation	134, 143
Sperry Electronic Tube Div. Sperry Rand Corp. ...	3rd cover
Sprague Electric Co.	6, 25
Stromberg-Carlson A Div. of General Dynamics ...	114
• Synthane Corp.	106
• Tektronix, Inc.	7
• Telerad Div. of Lionel Corp.	73

Texas Instruments Incorporated Industrial Products Group	21
Thermal American Fused Quartz Co., Inc.	66
• Toyo Electronics Ind., Corp. ...	102
Turbo Machine Co.	125
• United Shoe Machinery Corp. ...	120
Vacuum-Electronics Corp.	58
Varian Associates	115
Vector Mfg. Co., Inc.	3
Virginia Electric & Power Co. ...	54
• Vitramon, Inc.	4
• Vitro Electronics	91
Washington State	141
Welch-Scientific Co., The	135

CLASSIFIED ADVERTISING
F. J. Eberle, Business Mgr. (2557)

EMPLOYMENT OPPORTUNITIES 150-152

EQUIPMENT
(Used or Surplus New)
For Sale 152

CLASSIFIED ADVERTISERS INDEX

Atomic Personnel Inc. 152

Bell Aerosystems Co
Div. of Bell Aerospace Corp. 152

D.A.T.A. Inc. 152

International Business Machines 151

• Radio Research Instrument Co. 152

Univac
Div. of Sperry Rand Corp. ... 150

• See advertisement in the July 25, 1963 issue of Electronics Buyers' Guide for complete line of products or services.

This Index and our Reader Service Numbers are published as a service. Every precaution is taken to make them accurate, but **electronics** assumes no responsibilities for errors or omissions.

electronics



AUDITED PAID CIRCULATION

JAMES T. HAUPTLI (2210)
Advertising Sales Manager

DAVID CUNNIFF (3139)
Promotion Manager

HENRY M. SHAW (3485)
Market Research Manager

electronics Buyers' Guide

R. S. QUINT (2335)
General Manager

RICHARD J. TOMLINSON (3191)
Business Manager

THEODORE R. GEIPEL (2044)
Production Manager

NEW YORK TELEPHONE: Dial Direct:
971 plus number in parenthesis,
Area Code 212

ADVERTISING REPRESENTATIVES

ATLANTA, GA. 30009
Michael H. Miller, Robert C. Johnson
1375 Peachtree St. N.E.,
Trinity 5-0523 (area code 404)

BOSTON, MASS. 02116
William S. Hodgkinson
McGraw-Hill Building, Copley Square,
Congress 2-1160 (area code 617)

CHICAGO, ILL. 60611
Harvey W. Wernecke,
Robert M. Denmead
645 North Michigan Avenue,
Mohawk 4-5800 (area code 312)

CLEVELAND, OHIO 44113
Paul T. Fegley
55 Public Square, Superior 1-7000
(area code 216)

DALLAS, TEXAS 75201
Frank Le Beau
The Vaughn Bldg.,
1712 Commerce St.
Riverside 7-9721 (area code 214)

DENVER, COLO. 80202
John W. Patten
Tower Bldg., 1700 Broadway,
Alpine 5-2981 (area code 303)

HOUSTON, TEXAS 77025
Kenneth George
Prudential Bldg., Halcombe Blvd.,
Riverside 8-1280 (area code 713)

LOS ANGELES, CALIF. 90017
Ashley P. Hartman, John G. Zisch,
1125 W. 6th St., Huntley 2-5450
(area code 213)

NEW YORK, N. Y. 10036
Donald H. Miller (212) 971 3615
George F. Werner (212) 971 3617
Donald R. Furth (212) 971 3616
500 Fifth Avenue

PHILADELPHIA, PA. 19103
Warren H. Gardner, William J. Boyle
6 Penn Center Plaza,
LOcust 8-4330 (area code 215)

SAN FRANCISCO, CALIF. 94111
Richard C. Alcorn
255 California Street,
Douglas 2-4600 (area code 415)

LONDON W1:
Edwin S. Murphy Jr.
34 Dover St.

FRANKFURT/Main:
Matthee Herfurth
85 Westendstrasse

GENEVA:
Michael R. Zeynel
2 Place du Port

TOKYO:
George Olcott,
1, Kotohiracho, Shiba, Minato-ku

JOHN R. WHITFORD

Division Manager

**Performance
(not promises)
is what Sperry
delivers in
high-power
CW klystrons**



"The high-power CW klystrons on this table are already in production! They are our SAC-406, SAX-4181 and SAX-418. They cover frequencies from 4.4 to 11 Gc.

"Our unique new 'modular manufacturing' concept has allowed us to customize these production tubes to many different frequencies. At the same time, we have achieved gain as high as 70 db, efficiency as high as 42%, and CW power levels up to 50 kW.

"Delivery? No problem. We'll deliver a high-power CW klystron to your specifications in 120 days, but often we have beaten that. We recently shipped a SAX-418 for plasma investigations in just 10 days, ARO. And a 10 kW, CW broadband klystron for a satellite communications system was completed in just 16 days after receipt of order.

"Do you need high performance from CW klystrons and fast performance from their manufacturer? Then get full details on the hardware in being at Sperry.

"Write Sperry, Gainesville, Florida, or contact your nearby Cain & Co. representative. In Europe, contact Sperry Europe Continental, Paris."



CIRCLE 901 ON READER SERVICE CARD

Never Before A Commercially Available Silicon Transistor
With The Low-Noise Performance of RCA 2N2857

4 db NOISE FIGURE AT 450 Mc

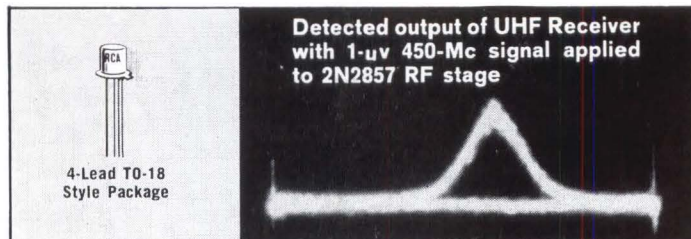

DESIGNED FOR UHF • SPECIFIED FOR UHF • 100% TESTED FOR UHF

The low-noise npn 2N2857 uses a new miniature structure to achieve these outstanding characteristics:

- Extremely low noise... 4 db typical in 450 Mc common-emitter RF amplifier
- High Gain... 14 db typical at 450 Mc in neutralized 20 Mc bandwidth amplifier
- Excellent 450-Mc Mixer Performance... NF=7 db, Gain=15 db (typical)
- Excellent UHF Oscillator Performance... Power Output=40 mw typical at 500 Mc, 20 mw typical at 1 Gc (unit will oscillate at frequencies to 2 Gc)
- Maximum Ratings... $V_{CBO}=30V$, $V_{CEO}=15V$, $P_t=200$ mw at 25°C free-air
- Gain-Bandwidth Product=1200 Mc Typical

Each RCA 2N2857 is tested for maximum noise figure and minimum power gain @ 450 Mc as a standard factory procedure. Specified 2N2857 values are based on 1/2-inch leads. With shorter leads gain can be improved as much as 1.5 db gain and noise figure as much as 0.5 db.

RCA also offers New Silicon NPN Transistor 2N2708 designed specifically for VHF Applications. The new RCA 2N2708 planar epitaxial transistor is specifically designed for VHF applications to 500 Mc. Here are some of the features of this new transistor:

- 200 Mc wideband RF amplifier... 15 db min. gain (neutralized common-emitter)
- Maximum ratings... $V_{CBO}=35V$, $V_{CEO}=20V$, $V_{EBO}=3V$
- Gain-Bandwidth Product... 700 Mc min.
- NF=8.5 db max. at 200 Mc, $I_C=2$ ma

Each RCA 2N2708 is tested for maximum noise figure and minimum power gain @ 200 Mc as a standard factory procedure.

Call your RCA Representative today for complete information on these outstanding RCA transistors. For further technical data, write Commercial Engineering, Section CN10-1, RCA Electronic Components and Devices, Harrison, N. J.

AVAILABLE THROUGH YOUR RCA DISTRIBUTOR



The Most Trusted Name in Electronics

CIRCLE 902 ON READER SERVICE CARD