

# Electronics®

A cure for transistor breakdown: page 66

Solid state modernizes boiler control: page 85

Cutting costs of thin-film manufacture: page 94

June 15, 1964

75 cents

A McGraw-Hill Publication

Below: how devices perform at low temperature, page 75



# For Impedance Measurements over a 400-kc to 60-Mc range

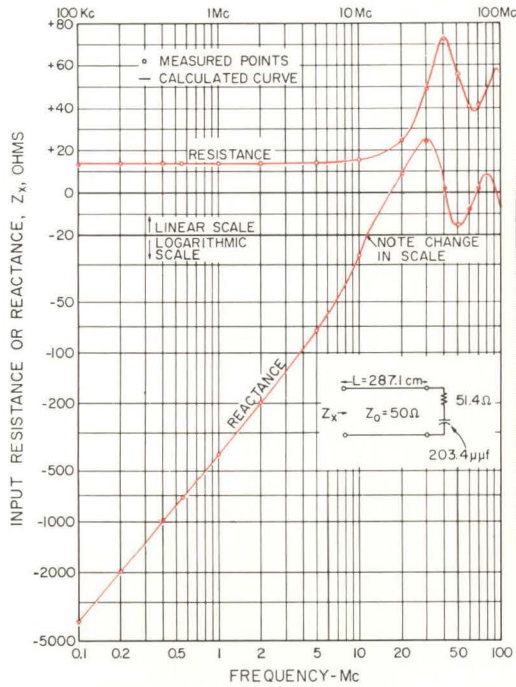

Resistance and reactance of a loaded transmission line as measured with a 1606-A R-F Bridge.

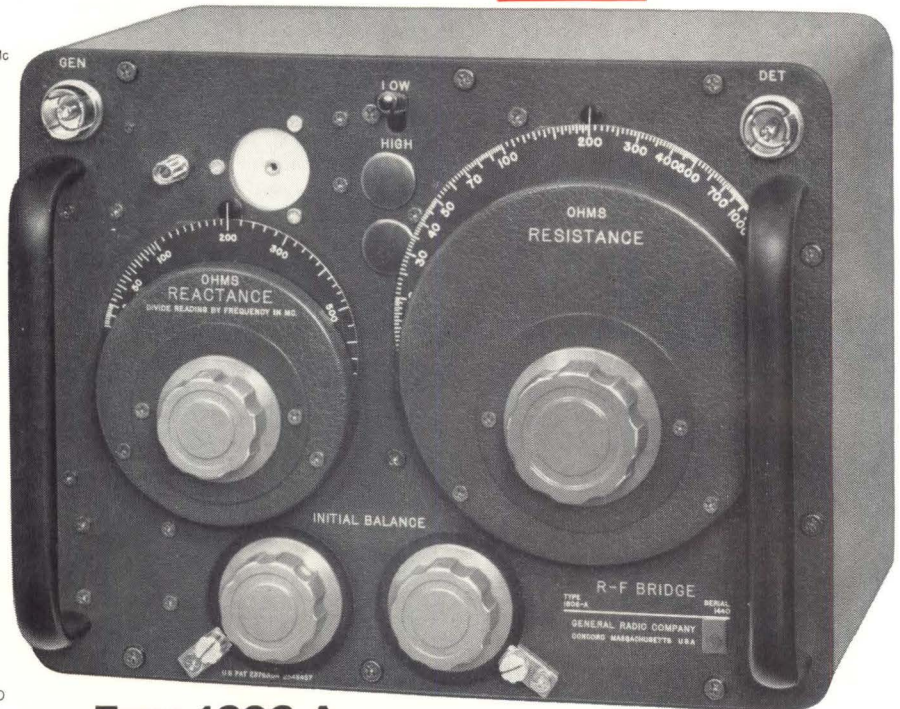

**Type 1606-A  
Radio-Frequency Bridge . . . \$750**

This R-F Bridge measures resistance and reactance of antennas, transmission lines and networks over a 150:1 frequency range. It is easy to use; measuring technique is by the series-substitution method. The bridge is first balanced with a short-circuit across the unknown terminals. The short is removed, the unknown connected, and the bridge rebalanced. Resistance and reactance of the unknown are then read directly on the bridge's dials (reactance dial reads directly at 1 Mc; at other frequencies the reading must be divided by frequency in Mc).

This instrument has the physical ruggedness necessary to withstand severe operating conditions — it is as useful in the field as it is in the laboratory. A complete line of generators and null detectors are available. Write for complete information.

## G-R Designed Components Help Make This R-F Impedance Bridge A Broad-Band, Highly Stable Instrument

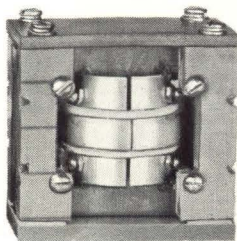

Both rotor and stator sections of this unique balancing capacitor are milled from solid blocks of aluminum. This technique eliminates losses that occur at joints between spacers and plates found in conventional designs.

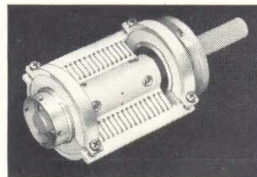

This transformer is used to couple an external generator to the bridge. It covers the instrument's entire 150:1 frequency range and is triple shielded to keep undesirable coupling to an insignificant level.

### SPECIFICATIONS

**Frequency Range:** 400 kc to 60 Mc

**Resistance Range:** 0 to 1000 ohms

**Reactance Range:**  $\pm 5000$  ohms direct reading at 1 Mc — range varies inversely with frequency

**Basic Accuracy:**  $\pm(1\% + 0.1\Omega)$  for resistance and  $\pm(2\% + 1\Omega)$  for reactance; slightly less accurate at higher frequencies — corrections supplied.

## GENERAL RADIO COMPANY

WEST CONCORD, MASSACHUSETTS

IN CANADA: Toronto 247-2171, Montreal (Mt. Royal) 737-3673  
IN EUROPE: General Radio Overseas, Zurich, Switzerland

NEW YORK, N. Y., 964-2722  
(Ridgefield, N. J.) 943-3140

CHICAGO  
(Oak Park) 848-9400

PHILADELPHIA, 424-7419  
(Abington) 887-8486

WASHINGTON, D. C.  
(Rockville, Md.) 946-1600

SYRACUSE  
454-9323

DALLAS  
FL 7-4031

SAN FRANCISCO  
(Los Altos) 948-8233

LOS ANGELES  
469-6201

ORLANDO, FLA.  
425-4671

CLEVELAND  
886-0150

Circle 900 on reader service card



THIS NEW X-Y RECORDER  
CONTRIBUTES SIX  
MAJOR IMPROVEMENTS  
TO THE STATE-OF-THE-ART

**MOSELEY**   
an affiliate of Hewlett-Packard

\*Trade Mark Pat. pend.

9429

- New, exclusive AUTOGRIP® hold-down for any size paper to 11"x17"
- 100 microvolts/inch sensitivity at one megohm input resistance
- AC input ranges to 5 millivolts/inch
- 120 db common mode rejection at line frequency
- Multi-contact flat mandrel potentiometers for unprecedented reliability
- Time sweeps for either axis with automatic reset and adjustable sweep length

These improvements, coupled with proven Moseley quality and precision, make the Model 7000A the most advanced X-Y recorder available today. Available, too, is the companion model 7030A, same as 7000A but accepts paper to 8½" x 11", without ac inputs. Model 7000A, \$2575; Model 7030A, \$1795. Call your Moseley/Hewlett-Packard field engineer or write: F. L. MOSELEY CO., 433 N. Fair Oaks Ave., Pasadena, Calif. 91102.

Circle 1 on reader service card

# MEASURE VOLTAGE, FREQUENCY, RESISTANCE

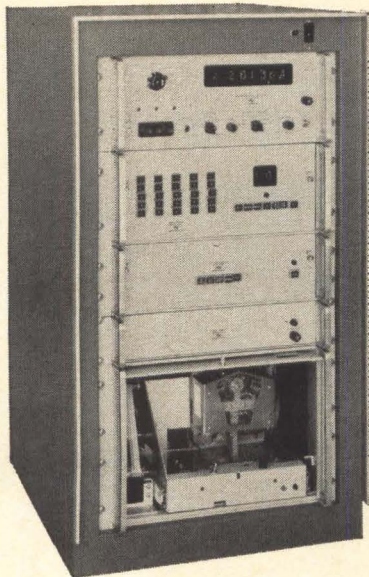

DY-2010B  
Data Acquisition System

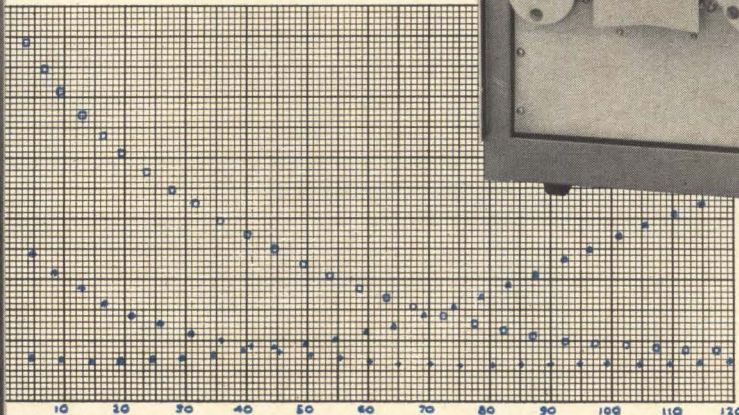

## THEN DIRECTLY MAKE X-Y PLOTS

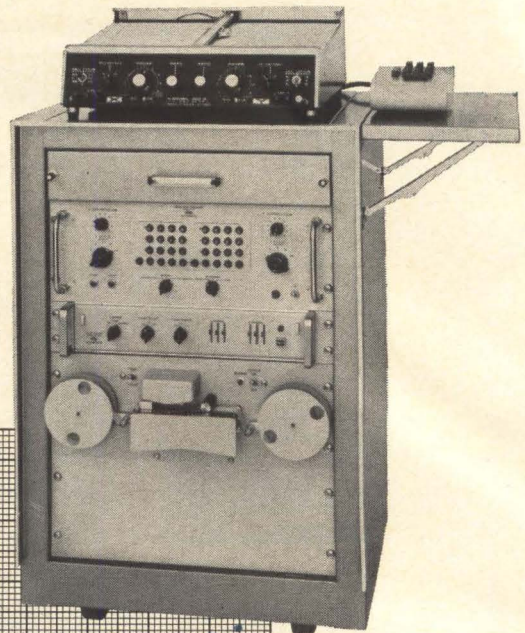

DY-2030B  
Data Plotting System

### When digital data is more meaningful in graphical form:

You can get an accurate x-y recording of the data you measure in the time it takes to unload a tape from one system and on to another. Measure with a Dymec 2010 Series Data Acquisition System, and just add the DY-2030 Data Plotting System and DY-2734A Punched Paper Tape Editor. No other equipment, no intermediate steps required, and the total capability costs less than \$22,000.

With any of three DY-2010 systems providing a recorded output on punched paper tape (but differing in input capabilities) you can measure data from up to 200 three-wire sources. Measurements of dc volts, low-level dc, ac volts, resistance and frequency are made by the floated and guarded DY-2401B Integrating Digital Voltmeter, heart of each versatile 2010

system. Then the data can be played back immediately on the DY-2030 Plotting System.

The tape editor in the system lets you (1) plot any channel on punched paper tape against real time recorded on the tape, (2) plot any channel on the tape against any other channel on the same tape, (3) plot any recorded channel against an internally generated step. Variables can be plotted in either x or y coordinate, with scale factor set for each, and independent of each other.

All of these Dymec systems are fully specified and priced, and may be ordered from the catalog. And never before have comparable capabilities been available at the price. \$10,800 for the DY-2010B, for example, plus as little as \$10,875 for the 2030B with 2734A Editor.

*Data subject to change without notice. Prices f.o.b. factory.*

Call your Dymec/Hewlett-Packard field engineer for more information or for a demonstration of a standard digital data acquisition system.

# DYMEC

A DIVISION OF HEWLETT-PACKARD COMPANY



DEPT. E-6, 395 PAGE MILL ROAD, PALO ALTO, CALIF. • PHONE (415) 326-1755 TWX 415-492-9363

9406

# Electronics

Page 4	Readers comment
8	People
10	Meetings ahead
15	Editorial
17	Electronics newsletter
59	Washington newsletter
133	New products
153	New literature
154	New books
157	Technical abstracts

## In this issue

<b>Industrial electronics</b>	85
<b>Manufacturing</b>	94
<b>Military electronics</b>	99

## Electronics review

Page 25	Computer understudy	28	Slow change
25	GM's wheelless wonder	30	Nigeria calling
26	F-111 equipment	30	Seagoing electronics
26	Industrial 3-D X-rays	32	Weather eye in sky
27	Another big dish?	32	Saturn saved
27	Multijunction converter	34	To track EGO
27	Second sound	34	Final round
28	The long tunnel		

## Probing the news

113	The tough transition
115	Scanning the mails
120	The connector controversy
124	Making money in space

## Technical articles

### I. Design

#### **Solid state** 66 **Preventing second breakdown in transistor circuits**

A repeatable, nondestructive test helps design around a power-transistor limitation  
Peter Schiff, Radio Corp. of America

#### **Components** 75 **The cool world of components**

More and more applications demand components run at low temperatures. Here's how they perform  
R.J. Allen and E. Niehenke, Bunker-Ramo Corp.

#### **Circuit design** 80 **Designer's casebook**

Field-effect transistor controls pulse oscillator; 4-terminal controlled switch divides frequencies by 10; generating two rectangular waves; network filters stabilize d-c supply over wide range

### II. Application

#### **Industrial electronics** 85 **The anatomy of boiler control**

1. Tighter rein with a-c servo systems

88 2. Simple controller for a complex job  
H. Smoot and F.J. Karlov, Rockwell Mfg. Co.

#### **Manufacturing** 94 **Photoetching thin-film circuits**

Selective chemical etching is better, faster and cheaper than deposition through mechanical masks  
C.W. Skaggs, Bunker-Ramo Corp.

#### **Military electronics** 99 **Portrait of a killer**

Electronics makes potent weapons of new atomic submarines

John M. Carroll, managing editor

# Electronics

**Editor:** Lewis H. Young

**Managing editor:** John M. Carroll

**Senior editors**

**Technical:** Samuel Weber

**News:** George Sideris

**Senior associate editors:** Michael F. Wolff, John F. Mason

**Department editors**

**Advanced technology:** George V. Novotny

**Avionics:** William Evezia

**Circuit design:** Jerome Eimbinder

**Communications:** Alexander A. McKenzie

**Components:** Michael F. Tomaino

**Computers:** Stephen B. Gray

**Consumer electronics:** V.S. Acunto

**Industrial electronics:** Louis S. Gomolak

**Instrumentation:** George J. Flynn

**Military electronics:** John F. Mason

**New products:** William P. O'Brien

**Solid state:** Michael F. Wolff, G.G. Tirellis

**Space electronics:** Joel A. Strasser

**Staff writers:** Leon H. Dulberger, Peggy Jackson

**Regional editors**

**Boston:** Thomas Maguire, editor; Susan Turner

**Chicago:** Cletus M. Wiley, editor; Virginia T. Bastian

**Los Angeles:** Harold C. Hood, editor

**San Francisco:** Laurence D. Shergalis, editor; Mary Jo Jadin

**London:** Derek Barlow, editor

**Copy editors**

Howard Rausch, Sally Powell

**Illustration**

**Art director:** Howard R. Berry

**Assistant art director:** John C. Wright, Jr.

**Editorial production:** Ann Mella, Sandra A. LeMond

**Editorial secretaries:** Claire Benell, Lynn Emery,  
Kay Fontana, Lorraine Rossi, Lorraine Werner

**McGraw-Hill news service**

**Director:** John Wilhelm; **Atlanta:** Fran Ridgeway; **Chicago:** Bruce Cross;

**Cleveland:** Arthur Zimmerman; **Dallas:** Marvin Reid;

**Detroit:** Donald MacDonald; **Los Angeles:** Kemp Anderson, Michael Murphy,

Ron Lovell; **San Francisco:** Margaret Ralston, Ed. Addeo;

**Seattle:** Ray Bloomberg; **Washington:** George Bryant Jr., Glen Bayless,  
Charles Gardner

**McGraw-Hill world news service**

**Bonn:** Richard Mikton; **Brussels:** Arthur Erikson; **London:** John Shinn;

**Mexico City:** Wesley Perry; **Milan:** Bruce Bendow;

**Moscow:** Donald Winston; **Paris:** Dan Smith;

**Rio de Janeiro:** Leslie Warren; **Tokyo:** Richard Halloran, Charles Cohen

**Circulation manager:** Hugh Quinn

**Reprints:** T.M. Egan

**Publisher:** C.C. Randolph

**Electronics:** June 15, 1964, Vol. 37, No. 18

Printed at 99 North Broadway, Albany, N.Y.  
Second class postage paid at Albany, N.Y.

Subscriptions are solicited only from those actively engaged in the field of the publication. Position and company connection must be indicated on orders. Subscription prices: United States and Possessions and Canada, \$6.00 one year, \$9.00 two years, \$12.00 three years. All other countries \$20.00 one year. Single copies, United States and Possessions and Canada 75¢. Single copies all other countries \$1.50.

Published every other Monday by McGraw-Hill Inc. 330 West 42nd Street, New York, N.Y. 10036. Founder: James H. McGraw, 1860-1948.

**Subscribers:** The Publisher, upon written request to our New York office from any subscriber, agrees to refund that part of the subscription price applying to copies not yet mailed. Please send change of address notices, subscription orders or complaints to Fulfillment Manager, Electronics, at the address below. Change of address notices should provide old as well as new address, including postal zone number if any. If possible, attach address label from recent issue. Allow one month for change to become effective.

Postmaster: Please send Form 3579 to Fulfillment Manager, Electronics, P.O. Box 430, Hightstown, New Jersey 08520

## Readers Comment

### Electrooptics

Regarding Mrs. Thomas W. Newmyer's letter [Apr. 20, p. 6], I would like to state that the name "Optron" has been in use for 10 years as a company name.

I would like to suggest Electro Optics as the abbreviation for the optoelectronics technology. This terminology has been used for several years by all the companies in this particular field, including government agencies.

Karl F. Zimmer

Optron Corp.  
Santa Barbara, Calif.

### Firebee target drones

The military forces operating the Firebee target drones out of Tyndall have done a much better job than inferred by the article on page 31 of your May 4 issue. They have reported 577 ground or air launches of Firebees from July 1960 through April 1964. Of these, 247 were returned by satisfactory salt water retrieval and 203 satisfactory land retrievals. Of the recovered targets, 28 had partial damage from missile firing hits but were still recovered. At least 11 of the Tyndall Firebees have flown 10 or more missions each. Drone target losses are due primarily to missile kills or damage. Some 6 losses have been from known high risk missions because of high seas, approaching foul weather, etc., where the operation requirement warrants. Of the 10 lost at sea, only 3 were reported lost because they were not located.

Locating targets for retrieval in the Tyndall range is difficult if the target is not returned to the normal recovery area. However, the use of a 200 to 400-Kc beacon as suggested for retrieval is impractical technically, since antennas of physical lengths compatible with a 23-ft. drone have a radiation resistance of approximately 0.01 ohms and very low efficiency. A more practical approach used by VU-5B in Okinawa is to add a relay, operated by the salt water switch, which reapplies telemetry power. The vhf telemetry signal will be

# New from Sprague!

## A MOLDED SOLID TANTALUM CAPACITOR THAT MAKES SENSE

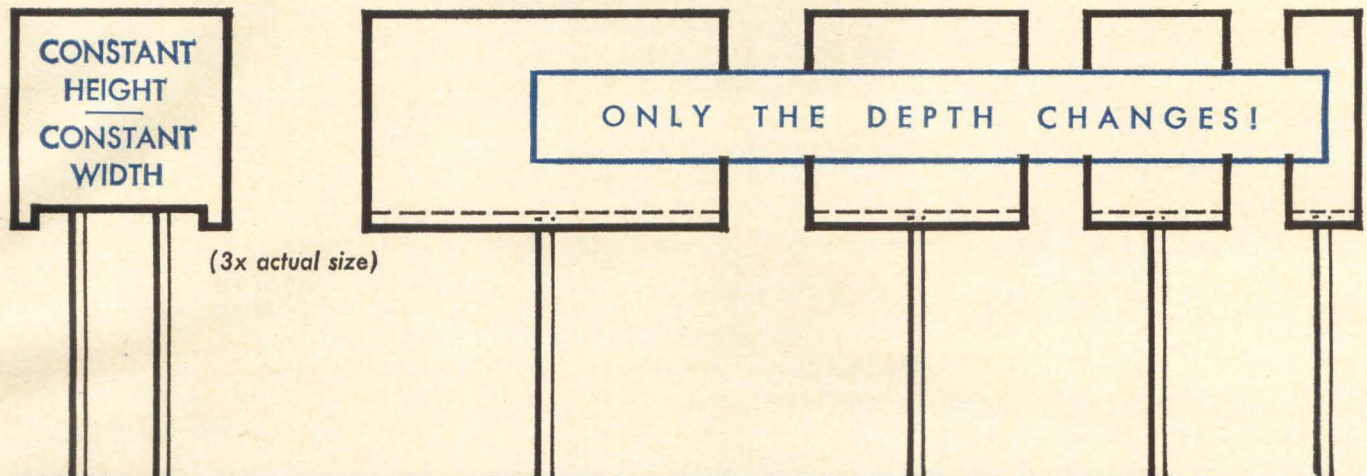

### TYPE 190D RECTANGULAR TANTALEX<sup>®</sup> CAPACITORS

**Especially qualified for applications such as printed circuits, where board space is at a premium and must be fully utilized.**

- Only the depth changes from case to case—face area remains constant, making Type 190D Capacitors extremely well-suited for automatic insertion.
- Carefully selected height (0.350") corresponds with most acceptable maximum height in normal printed board spacing.
- Uniform width (0.375") permits neat, space-saving alignment on wiring board.
- Present lead spacing based on popular 0.100" printed board grid. In anticipation of the 0.125" grid, Type 190D Capacitors will also be available with new lead spacing when required by future circuit designs.
- Encapsulated in tough molded case with excel-

lent dielectric properties, Type 190D Capacitors fully meet environmental test requirements of Specification MIL-C-26655A.

- Capacitance values from .01 $\mu$ F to 330 $\mu$ F—voltage range, 6 to 50 vdc.
- Stand-off feet at base of capacitors permit complete circulation of air, preventing moisture and solvent traps.
- Unlike many solid tantalums, these new capacitors exhibit the low impedance at high frequencies desired for high-speed computer applications.
- Low dissipation factor (high  $Q$ ) permits higher ripple currents.



*For complete technical data write for Engineering Bulletin 3531 to Technical Literature Service, Sprague Electric Company, 35 Marshall Street, North Adams, Massachusetts.*

#### SPRAGUE COMPONENTS

CAPACITORS  
TRANSISTORS  
RESISTORS  
MICRO CIRCUITS  
INTERFERENCE FILTERS

PULSE TRANSFORMERS  
PIEZOELECTRIC CERAMICS  
PULSE-FORMING NETWORKS  
TOROIDAL INDUCTORS  
ELECTRIC WAVE FILTERS

CERAMIC-BASE PRINTED NETWORKS  
PACKAGED COMPONENT ASSEMBLIES  
BOBBIN and TAPE WOUND MAGNETIC CORES  
SILICON RECTIFIER GATE CONTROLS  
FUNCTIONAL DIGITAL CIRCUITS

**SPRAGUE<sup>®</sup>**  
THE MARK OF RELIABILITY

\*Sprague' and '®' are registered trademarks of the Sprague Electric Co.

## Obviously from Sprague!

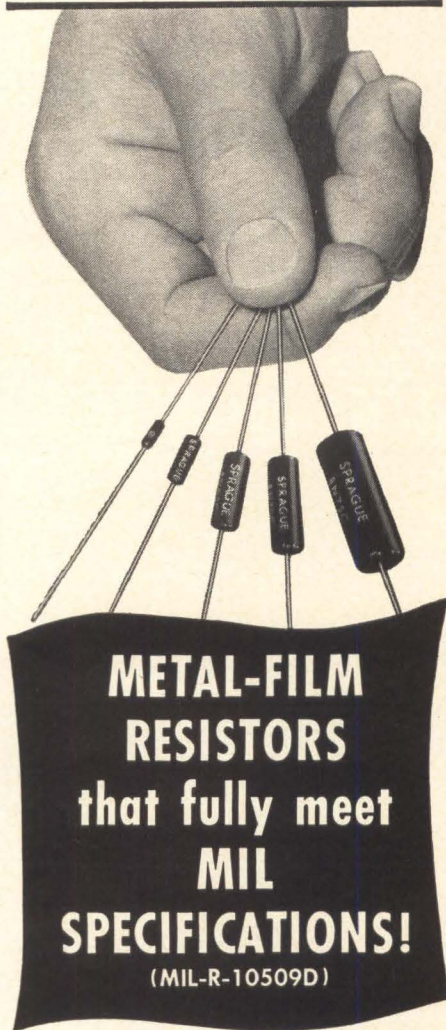

**Sprague Filmistor® Resistors equal or surpass precision wirewounds in accuracy...stability...reliability... yet they're smaller in size!**

Other key features include:

- Low, controlled temperature coefficients.
- Low inherent noise level.
- Negligible voltage coefficient of resistance.
- Tough molded shell for positive protection against mechanical damage and humidity.
- Available in 5 wattage ratings— $1/10$ ,  $1/8$ ,  $1/4$ ,  $1/2$ , and 1 watt.

For complete technical data, write for Engineering Bulletin 7025B to Technical Literature Service, Sprague Electric Co., 35 Marshall St., North Adams, Mass.



'Sprague' and '®' are registered trademarks of the Sprague Electric Co.

emitted for an hour or more before the Firebee battery is discharged. The use of the vhf telemetry signal provides an effective retrieval beacon, inexpensive and with minimum modification to the drone. The utilization of the existing equipment, where applicable, is in keeping with the procurement controls retained by the Services.

Allen T. Steinkamp

Ryan Aeronautical Co.  
San Diego, Calif.

▪ Electronics got its figures from Tyndall Air Force Base.

### Light demodulators

In your article, Evaluating light demodulators [Apr. 6, p. 54], one important error occurred in the statement and application of the shot-noise formula for an electron multiplier. Rather than  $2eMI_{TReq}$  per unit bandwidth, it should have been written

$$2 e I_T R_{eq} \frac{M_0^n (M_0^{n+1} - 1)}{M_0 - 1}$$

where  $M_0$  is the current multiplication factor per dynode and  $n$  is the number of diodes. For practical values of  $M_0$  and  $n$ , this expression reduces to within a factor of two or less to the simpler expression,  $2eM^2I_{TReq}$ , where  $M$  is again the overall current multiplication factor.

The major result of this correction is to modify the conclusion obtained for the shot-noise-limited figure-of-merit (or the heterodyne figure of merit), which should be simply  $\eta$  rather than  $\eta M$  as stated. That is, in optical heterodyne detection, sensitivity is determined solely by quantum efficiency.

Also, on p. 55, first column, the  $\mu$  in line seven should be a  $\nu$ , and in the second column, the  $h$  in line 12 should be a  $k$ . On p. 57, first column, fifth paragraph, line 3, it should be S-band. On p. 59, first column, third paragraph, line 2, the exponent of the second 10 should be simply  $-5$ . And on p. 60, second column, second line,  $R_{eq}$  is nearly equal to 100 ohms.

D.E. Caddes

B.J. McMurtry

Sylvania Electronic Systems  
Mountain View, Calif.

### Colored-light organ

A recent Electronics Newsletter [Feb. 21, p. 18] had an item (Colored Display Lets Deaf See Symphonies) describing a "new" apparatus.

This apparatus, "worked out recently by Soviet cyberneticists," is similar to one invented and constructed about 25 years ago. The modest inventor and elaborator of the idea and the equipment itself is the signer of this letter. I hold Brazilian patent No. 54332/1950 for it.

My sound - into - colored - light transformer, also called an organ of colored light, works on the following principles:

1. The apparatus captures music by microphone or any type of pick-up and transforms it into an electric (a-f) signal. It increases the signals by a broadband (hi-fi) amplifier.

2. It then analyzes the sound with selective filters. My invention also has an "arbitrarily chosen transformation key," as does the Soviet device. But in my system the frequencies of the colored light correspond proportionally to the frequencies of the sound; these are very important.

The lower frequencies of the sound, 16 to 200 cps, will be transformed into lower colored-light frequencies (430 to  $500 \times 10^{12}$  cps), or red and orange. The middle sound frequencies, 200 to 600 cps, will appear as yellow and green ( $500$  to  $600 \times 10^{12}$  cps) and the high frequencies, 600 to 10,000 cps, as blue-green and blue ( $600$  to  $750 \times 10^{12}$  cps).

My apparatus then translates the different a-f electric pulses into different (but logically corresponding) colors with variable brilliance on a screen, or uses other optical means such as spotlights.

My patent mentions these possible uses of my invention: in the theater, opera-house or music-hall, mostly to accompany the ballet, and in the future to fully coordinate music, movement and colored light; to help understand and popularize heavy classical music; to analyze new music; in psychotherapy; to analyze a-f amplifiers simply and cheaply; and to help the deaf to know and understand music.

Lajos de Bodroghy  
Belo Horizonte, Brazil





**Psss**

Psss-fffft—that's the sound of our automachine crimping AMP-INCERT★ pin and socket contacts. It's that fast! And that's why we offer the lowest total applied cost in the industry.

You get maximum production levels without sacrificing quality. And you get maximum reliability, too. Because contacts are crimped with consistent pressures, terminations are always the same. Gold over nickel plating provides top resistance to corrosion. External retention springs facilitate quick assembly and firm seating in the connector block. Cantilever-beam engagement springs minimize surface wear.

Just figure out your production requirements. There are a number of automatic application machines that provide high speed terminations all ready for snap-in assembly. And their speed permits extreme flexibility in production matters . . . contacts can be crimped to leads or harnesses any time, anywhere. And actual

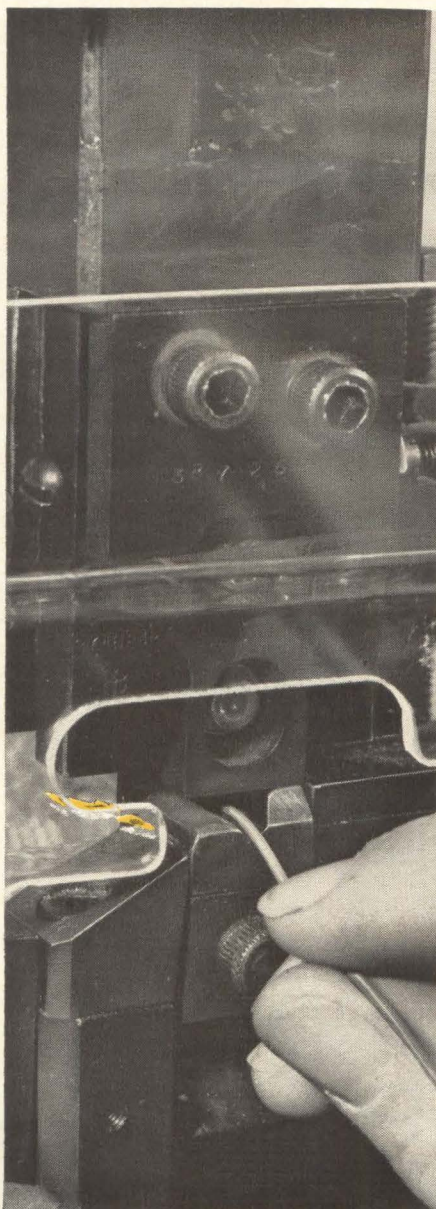

**fffft**

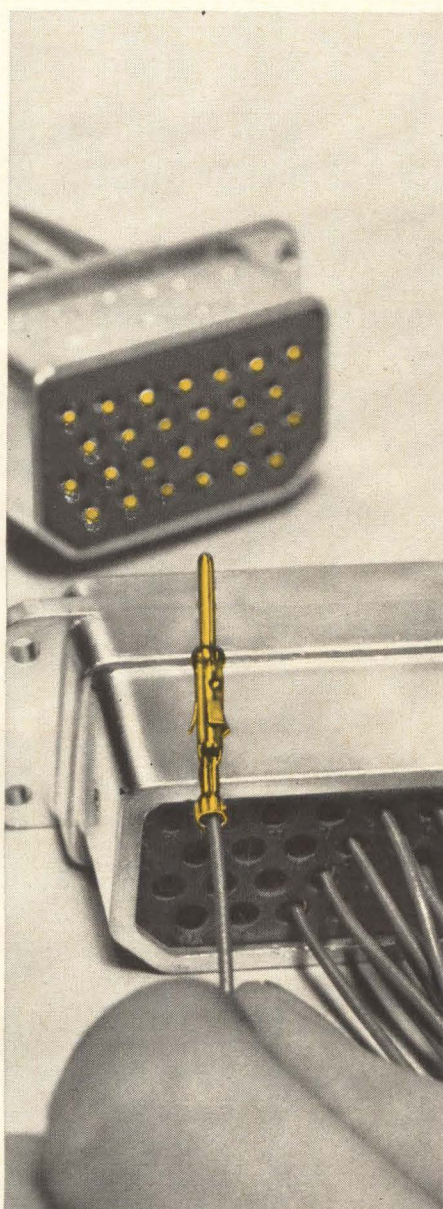

**fini**

insertion can be done in any volume or sequence you desire.

Automatic machines are available in portable and bench mounted types. Power is pneumatic or fully electric. They terminate formed contacts fed in strip form, or tape mounted screw-machined contacts. Either way you get maximum reliability for a wide range of wire sizes.

Increased production. Lower cost. Maximum reliability. That's what you get. If you want further proof, write us today for complete information and test data.

★Trademark of AMP INCORPORATED



A-MP★ products and engineering assistance are available through subsidiary companies in: Australia • Canada • England • France • Holland • Italy • Japan • Mexico • West Germany

**NEW MINIATURE PLANAR TRIODES...  
FREQUENCY STABLE...HIGH CATHODE CURRENT**

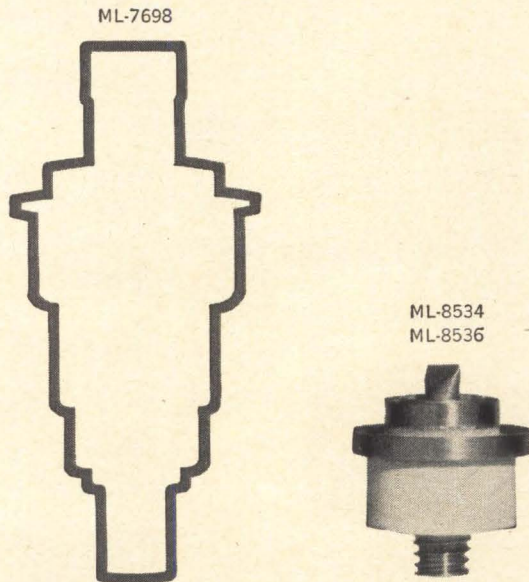

**Same ratings...1/3 size**

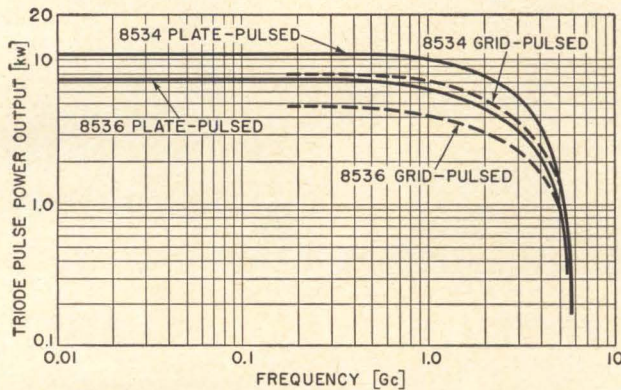

**As UHF plate or grid pulsed amplifier**

The same fast frequency stable performance—100 times faster than normal—is obtained with both the miniature ML-8534 and ML-8536 planar triodes. Both tubes employ the Phormat (matrix) cathode. Both allow use of variable duty cycle operation without noticeable frequency shift. But the ML-8534 and ML-8536 miniature planars are only 1/3 the size of the ML-7698 and permit significant reductions in cavity and equipment size. Ratings: ML-8534, plate pulsed, 3500v, 5.0a; grid pulsed, 2500v, 5.0a. ML-8536, plate pulsed, 3500v, 3.0a; grid pulsed, 2500v, 3.0a. For complete data on miniature planar triodes, write: The Machlett Laboratories, Inc., Springdale, Connecticut. An affiliate of Raytheon Company.



**People**

Ronald Horne is sparking a drive by the Chemstrand division of Monsanto Co. to remedy what he considers a notorious lack of research and development in the textile industry. Under his auspices, the four-year-old electronic instrument department has increased from two to 16 men. It concentrates on developing and producing sophisticated electronic instrumentation both for Chemstrand and for outside customers. Horne, born in New Zealand 41 years ago, says he moved to the United States in gratitude at being liberated by the U. S. Seventh Army after four years as a German prisoner-of-war.



After the war, he worked for the J. Arthur Rank Corp. in England and did much of the sound work for the film "The Red Shoes." He joined Chemstrand in 1960. Among the products developed under his direction have been a solid-state tachometer that measures spindle speeds of up to 1.2 million rpms, and a short-range (50 feet or so) telemetry system for tire testing. The product development operation started, he says, because the company "started funneling their hairy problems to us in the hopes that we could solve them."

Cynthia Haiiao-Ping Kozin last month became the second woman in the history of Purdue University to receive a Ph. D. in engineering. Born in Nanking, China, 29 years ago, she moved with her family to Formosa when she was 13. She received her master's degree from MIT. Married and the mother of a 3 1/2-year-old son who was born between semesters, Dr. Kozin received her doctorate for research in statistical communications.



# Fill the Industrial 10-Turn Potentiometer Gap for Under \$5

This new, low-cost  $\frac{7}{8}$ "-diameter potentiometer is the latest addition to the famous Bourns potentiometer family — and less than \$5 puts it into your applications.

Almost  $\frac{1}{2}$ " shorter than competitive units, it helps you keep over-all system size down. Despite its compactness, it has resistances from 100 ohms to 100,000 ohms, together with standard linearity of  $\pm 0.5\%$  and resolution to 0.01%. Part of the secret behind this achievement is a unique design that allows us to put a 10% longer resistance element in the shorter package.

In industrial application environments, the Model 3507 offers you the superior reliability you expect. You can operate it at

105° C, in steady-state humidity, and under conditions of 10 G vibration and 50 G shock. Like other Bourns precision potentiometers, it incorporates the exclusive, indestructible SILVERWELD® termination and is subjected to rigorous tests to assure full compliance with specifications.

Don't settle for a compromise in your industrial or commercial system — specify the Bourns Model 3507! It's available now! Write today for free technical information.

Temperature range	-55° to +105° C
Rotation life	200,000 cycles
Independent linearity, max.	$\pm 5\%$
Power dissipation	2 watts @ 25° C
Noise, max.	100 $\Omega$ ENR



ONE-HALF ACTUAL SIZE



Mil Type  
Multi-Turn Precision  
Potentiometer

Low-Cost  
Industrial Multi-Turn  
Potentiometer

Commercial  
Multi-Turn Potentiometer



**BOURNS**

BOURNS, INC., TRIMPOT DIVISION  
1200 COLUMBIA AVE., RIVERSIDE, CALIF.  
PHONE 684-1700 • TWX: 714-682 9582  
CABLE: BOURNSINC.

**NOW . . .**

**THE FAMOUS  
JERROLD  
900-B  
SWEEP SIGNAL  
GENERATOR**

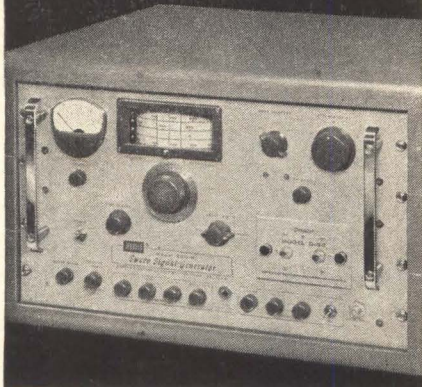

**OFFERS CENTER  
FREQUENCIES FROM  
500 kc to 2,400 mc  
without plug-ins**

The versatile Jerrold Model 900-B Sweep Signal Generator now extends its useful frequency range all the way up to 2,400 mc, with sweep widths ranging from 10 kc to 800 mc. A diode frequency doubler, priced at only \$115, increases the usefulness of the 900-B without the need for plug-ins.

**Frequency Doubler Specifications**

Input Frequency..... 500-1,200 mc  
Output Frequency..... 1,000-2,400 mc  
Conversion loss at 0.5 volt RMS  
... less than 12 db to 2,000 mc  
... less than 13 db to 2,400 mc

Output component, other  
than harmonic  
of input..... .20 db or more below  
Maximum Input..... 1 volt RMS  
Connectors..... .50 ohm, BNC

The diode frequency doubler can also be used with the economical Jerrold 900-A Sweep Generator.

Model 900-B..... \$1,980  
Model 900-A..... \$1,260  
Frequency Doubler..... \$ 115

Write for complete technical data.  
Jerrold Electronics Corporation, 15th  
& Lehigh Ave., Philadelphia 32, Pa.



A subsidiary of THE JERROLD CORPORATION

## Meetings

**Nuclear Radiation Effects Conference**, PTG-NS IEEE, University of Washington; University of Washington, Seattle, Washington, **June 20-24.**

**Conference on Precision Electromagnetic Measurements**, NBS, Radio Stds. Lab., IEEE PTG-IM, Inter. Scientific Radio Union, US Commission on Radio Measurements and Standards; NBS Boulder Laboratories, Boulder, Colo., **June 23-25.**

**Computers and Data Processing Annual Symposium**, University of Denver's Research Institute; Elkhorn Lodge, Estes Park, Colo., **June 24-25**

**Joint Automatic Control Conference**, ASME, AICE, ISA, IEEE, AIAA; Stanford University, Stanford Cal., **June 24-26.**

**Conference of Vacuum Metallurgy**, Vacuum Metallurgy Div., American Vacuum Society; Barbazon Plaza Hotel, New York City, **June 29-30.**

**Aerospace Reliability and Maintainability Annual Conference**, SAE, ASME, AIAA; Statler Hilton Hotel, Washington, D.C., **June 29-July 1.**

**Rochester Conference on Data Acquisition and Processing in Medicine and Biology**, U. of Rochester; U of R Whipple Auditorium, Rochester, N.Y., **July 13-15.**

**Analog Simulation and Engineering Analysis Course**, EAI; University of Tennessee, Knoxville, Tenn., **July 20-24.**

**Special Technical Conference on Nuclear Radiation Effects**, IEEE PTG-NS, Radiation Effects Committee; University of Washington, Seattle, Wash., **July 20-24.**

**Research Conference on Instrumentation Science**, ISA; William Smith College, Geneva, N. Y., **Aug. 3-7.**

**Special Program on Language Data Processing**, Harvard, Div. of Engineering and Applied Physics; Harvard Summer School, Cambridge, Mass., **Aug. 10-21.**

**UAIDE Annual Meetings**, Users of Information Display Equipment; International Hotel, Sepulveda and Century Blvds, Los Angeles, Cal., **Aug. 12-14.**

**Symposium on Ultra Low Frequency Electromagnetic Fields**, NBS Central Radio Propagation Lab. and National Center of Atmospheric Research; Boulder Laboratories, Boulder, Colo., **Aug. 17-20.**

**Distributor-Manufacturer-Representative**

**Conference**, WESCON; Ambassador Hotel, Los Angeles, Cal., **Aug. 24.**

**WESCON 1964**, 6 Region IEEE and Western Electronic Manufacturers Asso.; Los Angeles Sports Arena and Hollywood Park, Los Angeles, Cal., **Aug. 25-28.**

**International Conference on Microwaves, Circuit Theory and Information Theory**, Inst. Electrical Comm. Engrs. of Japan, Science Council of Japan and International Scientific Radio Union; Alaska Prince Hotel, Tokyo, **Sept. 7-11.**

**International Convention on Military Electronics (MIL-E-CON 8)**, IEEE; Shoreham Hotel, Washington, D. C., **Sept. 14-16.**

**Ceramic-To-Metal Session**, American Ceramic Society; Philadelphia, **Sept. 17.**

**Annual Northwest Computing Conference**, Northwest Computing Association, University of Washington Computing Center; University of Washington, Seattle, Washington, **Sept. 17-18.**

**Engineering Management Annual Conference**, IEEE-ASME; Pick-Carter Hotel, Cleveland, Ohio, **Sept. 17-18.**

## Call for papers

**Mid-America Electronics Conference (MAECON)**, Kansas State University; Hotel Continental, Kansas City, Missouri, November 23-24. **July 15** is deadline for submitting abstracts to Edwin J. Martin, Jr., Midwest Research Institute, 425 Volker Boulevard, Kansas City, Missouri 64110. Papers are invited in the general area of measurements and instrumentation as applied to the broad areas of cryogenics, power generation and distribution, navigation, electronics and communications, decision devices, telemetering, data processing and conversion, management controls, etc.

**United States National Committee Fall Meeting**, IEEE PTG; University of Illinois, Urbana, Illinois, October 11-14. **August 1** is deadline for submitting a 200 word abstract in duplicate to Fall URSI Arrangements Committee, Dept. of Electrical Engineering, University of Illinois, Urbana, Illinois 61803.

# F.A.A. Lens-Like Antenna Grid\* Connected, Spaced, and Supported by more than 73,000 *Preformed* Fittings

TRADEMARK

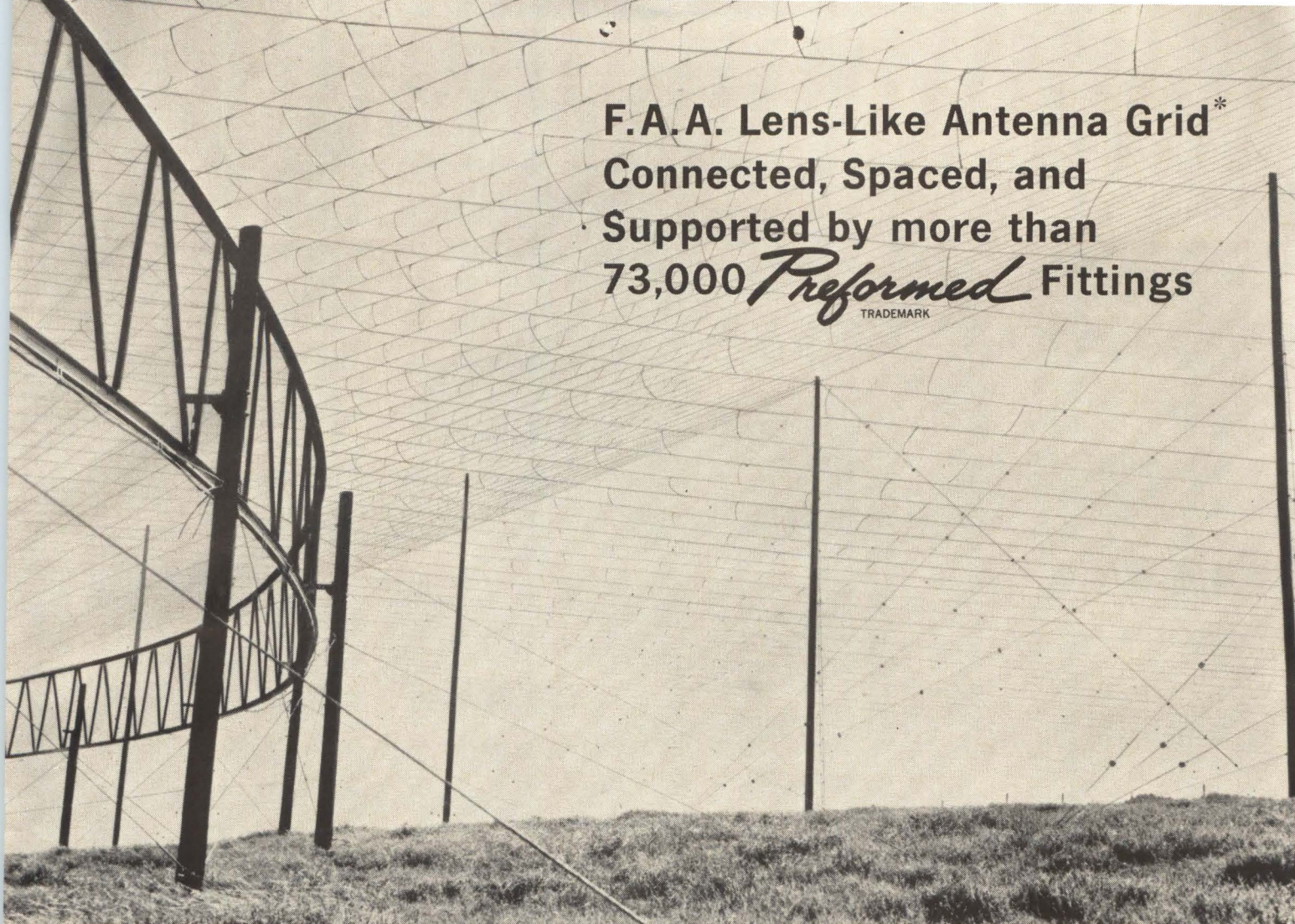

The unique helically-shaped wire fittings illustrated were used extensively in the construction of this revolutionary high-frequency antenna.

Through their use, rigid connectors and hand-wired joints are completely eliminated. Excellent electrical conductivity and superior mechanical strength are maintained.

PREFORMED fittings are simple to apply and adjust. Once attached, they cannot shift or loosen. They are light in weight, low in cost.

Current applications of PREFORMED products of the types shown here include RHOMBIC and LOG PERIODIC ANTENNAS, CONICAL MONOPOLES, MICROWAVE COMMUNICATION TOWERS, HORN ANTENNAS and other GRID-TYPE TRANSMITTING AND RECEIVING ARRAYS. PREFORMED Connectors are in use on many U. S. Government and commercial installations throughout the world.

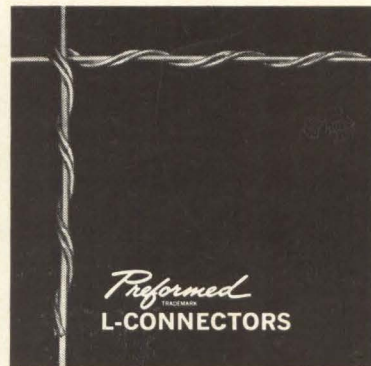
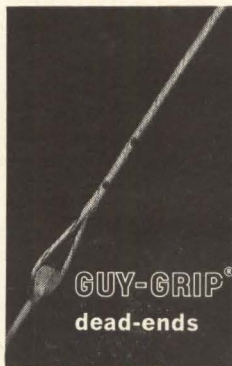

Details of the antenna are contained in the February 28, 1964 issue of ELECTRONICS. A reprint is included in the Tower & Antenna Products Data Folio. You may obtain this folio by requesting it from:



**PREFORMED LINE  
PRODUCTS COMPANY**

5349 St. Clair Avenue • Cleveland, Ohio 44103  
Utah 1-4900 (DDD 216)

600 Hansen Way • Palo Alto, California 94306  
327-0170 (DDD 415)

\* Segment of the F.A.A. "Luneberg" Lens antenna designed by Dr. R. L. Tanner of TRG-West and installed at the International Flight Service Receiver Station, Molokai, Hawaii.

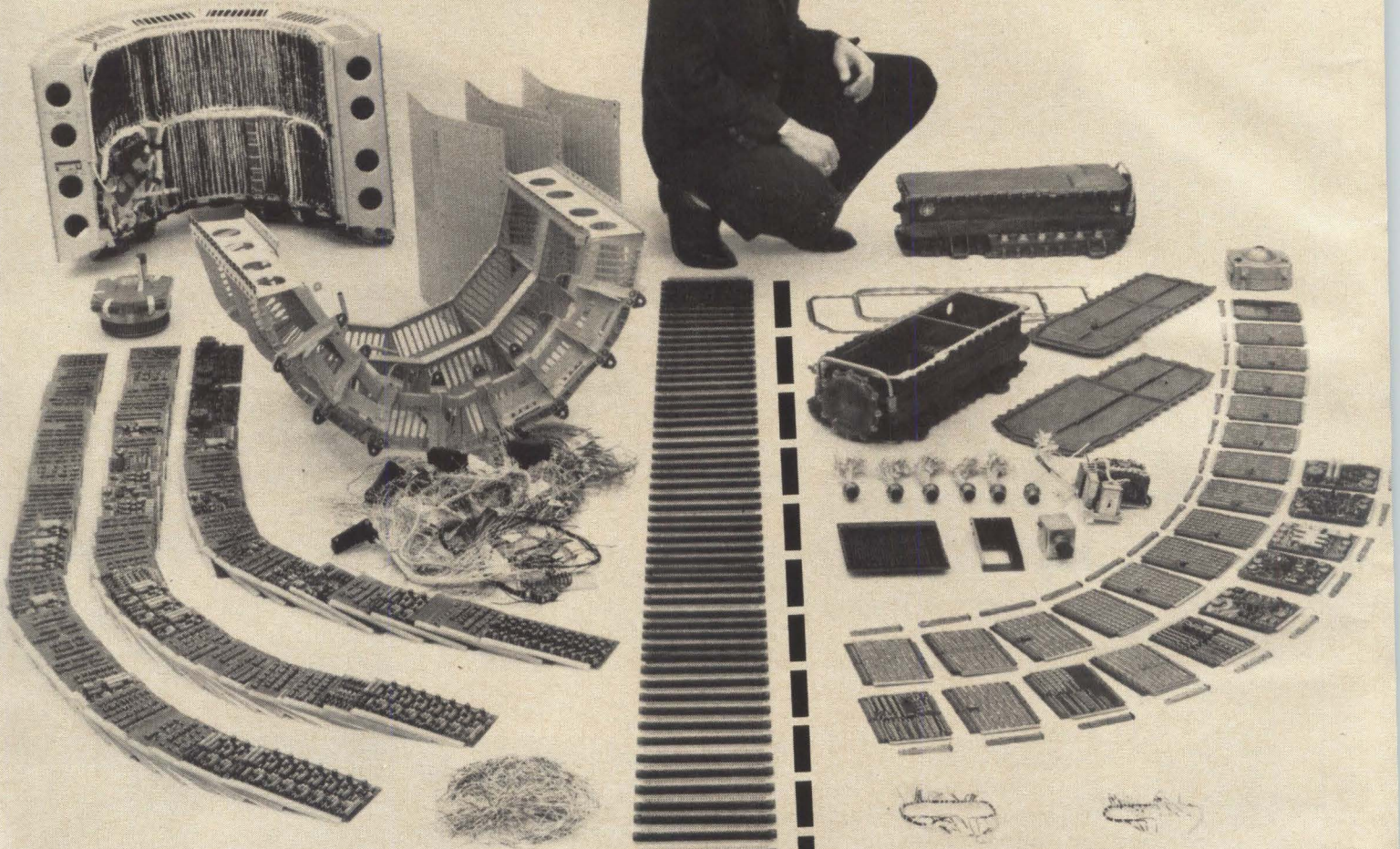

**Minuteman I computer  
uses discrete components**

weight -- 62 pounds

volume -- 1.5 cu ft

No. of circuit boards -- 75

No. of components -- 14,711

Memory -- 2,944 words

**Minuteman II computer  
uses TI integrated circuits**

weight -- 32 pounds

volume -- 0.4 cu ft

No. of circuit boards -- 25

No. of components -- 5,126

Memory -- 6,966 words

# See the difference in Minuteman computers

**TI integrated circuits help make Autonetics' D37B computer for the Air Force Minuteman II smaller, lighter and more reliable . . . with more than twice the operational capacity of its predecessor. These "Minuteman series" integrated circuits are now available for your designs.**

You can see many differences between the two computers at left, but the biggest difference — reliability — doesn't show in the photograph. Autonetics division of North American Aviation, Inc., the Air Force's prime contractor for Minuteman II's guidance and control system, estimates that the new computer will be several times more reliable than that for Minuteman I.

TI's experience with integrated circuits since 1958 has developed the special technologies, the advanced packaging concepts, and the volume production capabilities which made this new D37B computer possible. Working with Autonetics' designers, TI produced custom **SOLID CIRCUIT**<sup>®</sup> semiconductor networks for logic, input/output and memory functions which account for 90 per cent of the computer's electronics. The new computer has more than double the capacity of its predecessor . . . yet is considerably smaller and lighter in weight than the computer for Minuteman I.

Also, despite its larger operational capacity, the Minuteman II computer's assembly is simpler. It contains only about a third as many components and soldered connections are significantly reduced compared to the earlier model. Since connections are the least reliable parts of most equipments, reliability increases greatly when connections are reduced.

TI "Minuteman series" integrated circuits provide additional reliability benefits, since they incorporate two or more circuits in a single silicon block for *further* reduction of components and connections.

Greater system simplicity also opens the way to cost reduction. Material, inventory and assembly costs can be drastically reduced. Here again, "Minuteman series" semiconductor networks from TI offer special advantages over conventional integrated circuits: First, multi-circuit networks minimize parts requirements. Second, since most of the TI circuits are designed for several different applications in Minuteman II, the variety of circuits which must be inventoried can be substantially reduced.

For your new systems, TI offers the experience and capabilities which helped make possible the Minuteman II computer . . . as well as the inertial platform and flight control electronics, that also include large numbers of TI integrated circuits. TI engineers are ready today to help you apply specially designed integrated circuits to your unique problems.

Also, for your immediate applications, TI has made available a large number of standard catalog circuits which are production-proved and ready for use. The new "Minuteman series," for example, is now widely available to industry and includes 18 networks — logic, memory, input/output, and linear — which are functionally compatible and can perform 75 to 95 per cent of the circuit functions in a military general-purpose computer.

Ask your TI sales engineer or your authorized TI distributor for data sheets, or write to Integrated Circuits department (443), Dallas.

SEMICONDUCTOR PLANTS IN  
BEDFORD, ENGLAND • NICE, FRANCE  
DALLAS, TEXAS



**TEXAS INSTRUMENTS  
INCORPORATED**  
13500 N. CENTRAL EXPRESSWAY  
P. O. BOX 5012 • DALLAS 22, TEXAS

# INTRODUCING the New, Versatile Thin-Line **VY**® Porcelain Capacitors

- \* 0.5 pf to .01 mf
- \* -55°C to +125°C operation
- \* Ratings to 500 vdc

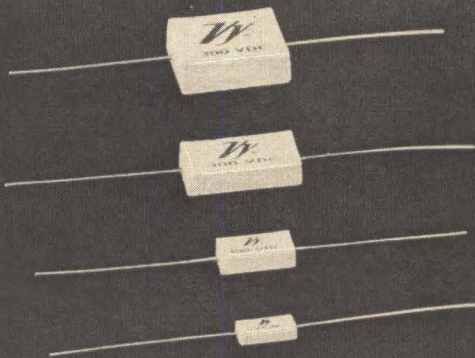

AXIAL



FACE RADIAL

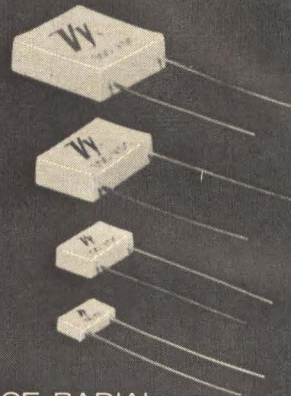

EDGE RADIAL

*... with outstanding electrical and physical characteristics to meet all your requirements for design and performance!*

- \* **CHOICE OF TEMPERATURE COEFFICIENTS**  
+105±25 ppm/°C and 0±25 ppm/°C. (From +105±25 ppm/°C to -100±25 ppm/°C available.)
- \* **CHOICE OF LEAD MATERIALS**  
Solder Coated Copper, Dumet, Nickel A, etc.
- \* **CHOICE OF LEAD CONFIGURATIONS**  
Axial, Face Radial, Edge Radial
- \* **THIN-LINE DESIGN**
- \* **MONOLITHIC CONSTRUCTION**
- \* **HIGH RF CURRENT CARRYING CAPABILITY**
- \* **LOW DISSIPATION FACTOR**
- \* **HIGH INSULATION RESISTANCE**
- \* **WITHSTANDS SEVERE ENVIRONMENTAL CONDITIONS**
- \* **TEMPERATURE STABILITY**
- \* **FREQUENCY STABILITY**
- \* **DEMONSTRATED RELIABILITY**

Specify these features in any combination to meet your requirements

New space-saving feature

Quality features in all "VY" Capacitors

© Vitramon, Inc. 1964

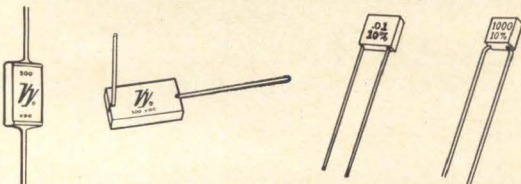

**Vitramon**  
INCORPORATED

BOX 544 • BRIDGEPORT 1,  
CONNECTICUT, U.S.A.

In United Kingdom contact:  
Vitramon Laboratories  
Limited  
45 Holloway Lane  
Harmondsworth, Middlesex  
England



# The challenge of change

On almost every side, we see signs that the electronics industry is about to undergo another major change. And this may be the most complicated change yet.

Microelectronics is rushing into widespread application far ahead of the schedules proffered by the most enthusiastic advocates.

The reduction of military spending has pushed many specialists in military electronics into exploring consumer, medical, industrial and military areas.

Suppliers of industrial electronics, who had been turned away repeatedly by nonelectronics customers for years, are finding a welcome mat at last.

And consumer electronics may well be on the threshold of a revolution of its own: transistorized tv will be here in the autumn, and microelectronic controls for home appliances aren't very far off.

Although job opportunities in engineering have slimmed down, the challenge for engineers was never greater. Now the big payoff will come to the man who can devise the inexpensive, ingenious product for a big-volume market that is independent of giant government projects.

On page 113, we describe how some companies are rising to this challenge. Their efforts range from developing artificial limbs to devising drunkometers and parcel-sorting systems.

Still not enough defense companies are doing anything yet about the hard times that have fallen upon them. Too many firms only bemoan their fate and spend all their time trying to find somebody on whom they can place the blame.

In Boston late last month, the problem of conversion was supposed to be discussed at the third annual Management Conference on Marketing in the Defense Industries. But the speakers spent most of their time commiserating with each other and passing the crying towel like runners in a relay race.

Getting electronics defense contractors moving again will take more than sympathy. It will take hard, careful planning; it will take a radical change by management; it will take thorough studies of engineering, production and marketing; it will take ingenuity; it will take hard work; and it will take aggressiveness.

What are the affected companies waiting for?

It takes time for a military-oriented company to expand into other technical pursuits. It can't happen overnight. In fact, the time needed may even frighten some people.

Under good conditions, a company can make a solid start in as little as two years. On the average, however, it takes about five years to develop the product, organize production and establish a capable marketing organization. In some cases it can even take 7 to 10 years.

The sooner the companies get started, the closer they'll be to diversification. We and others have said all of this before.

**IN MODULAR POWER SUPPLIES**

# KEPCO APPLICATION VERSATILITY MAKES THE DIFFERENCE!

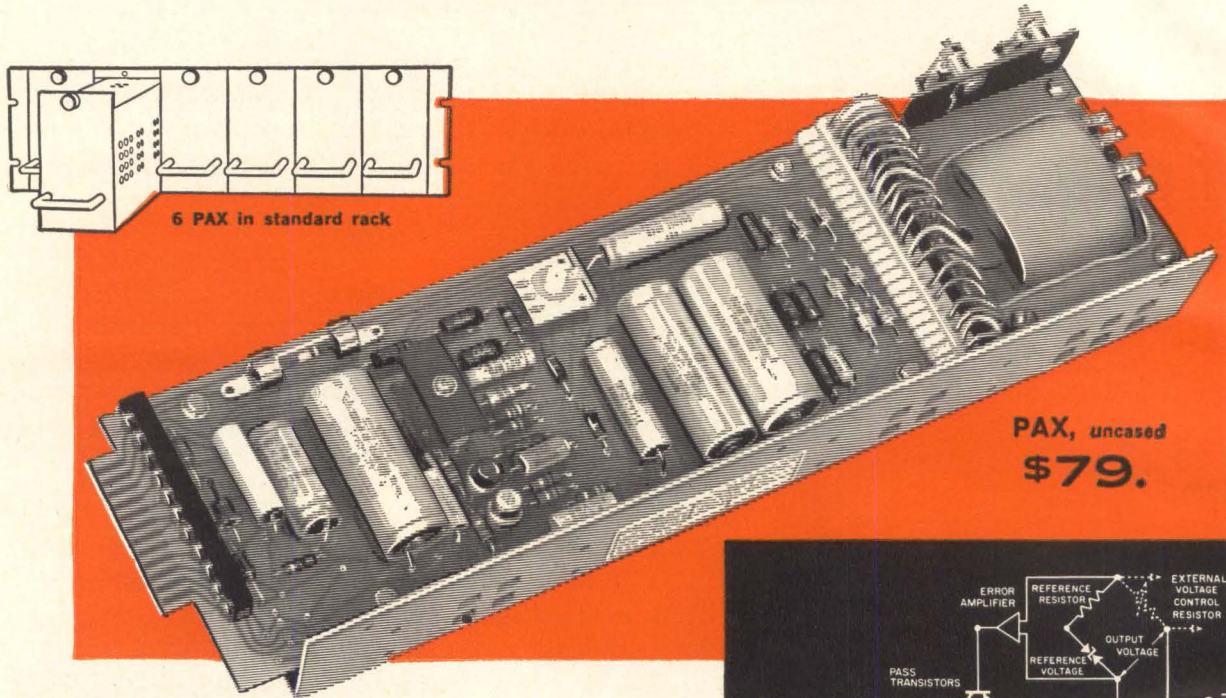

6 PAX in standard rack

PAX, uncased  
**\$79.**



**MODULES**

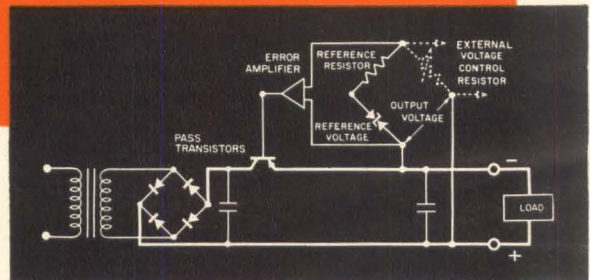

## A KEPCO ADVANCE IN MODULAR POWER SUPPLIES

Versatile electrical and mechanical characteristics of the Kepco PAX Design Group represent a distinctive advance in modular power supplies. Rated for continuous duty, wide range operation, resistance or voltage programming, voltage or current regulation and a choice of mounting methods, PAX modules offer the designer unusual flexibility in his system design. Value engineering has been applied to achieve high performance at competitive prices.

- 0.05% regulation and stability
- Resistance/voltage programmable
- Ripple <0.25 millivolt rms
- Short circuit protected, current limiting
- 50 microsecond recovery time
- No voltage overshoot, turn-on, off
- 115/230V 50-440 cps input
- Convection cooling
- Voltage or current regulation
- Laboratory or systems use
- Patented Kepco Bridge Circuit†
- Open/cased/rack mounting choice

†Applicable Patent Nos. furnished on request

MODEL	DC OUTPUT RANGE		MAX. INPUT AMPS At 125 V AC
	VOLTS	AMPS	
PAX 7-1	0-7	0-1	0.3
PAX 14-0.75	0-14	0-0.75	0.3
PAX 21-0.5	0-21	0-0.5	0.3
PAX 36-0.3	0-36	0-0.3	0.3
PAX 72-0.15	0-72	0-0.15	0.3

See our complete Catalog in **eem** 321-352 **eBG**



For complete specifications write for Brochure #146-1053

131-38 SANFORD AVENUE, FLUSHING, N.Y. 11352 • Phone: (212) IN 1-7000 • TWX #212-539-6623 • Cable: KEPCOPOWER NEWYORK

---

# Electronics Newsletter

---

June 15, 1964

## Surveillance role for orbiting lab

The Air Force's Manned Orbiting Laboratory will be designed to spot ballistic missile launches as they leave Soviet launching pads. It will also detect and interrogate orbiting satellites.

Detectors will be a group of ultraviolet and infrared systems. Industry proposals for their development were submitted to the Air Force Systems Command on June 3.

The manned satellite will, in effect, take over the functions of two unmanned satellite projects: the heat-seeking Midas that spots an intercontinental ballistic missile 60 seconds after launch, and Satellite Inspector, another unmanned, maneuverable satellite that got to the prototype stage and was then cut back to a study.

## Anglo-American waffle irons

Two new developments that have taken place simultaneously on both sides of the Atlantic have sparked greater interest in the possibilities of using a combination of ferrite and metal in memory construction. The current practice is to use one or the other.

Both memories use waffle-iron construction, and both extend the state-of-the-art in one dimension.

One memory, built by Standard Telephones and Cables, Ltd. of England, is four times faster than previously-built memories of this type. It has an access time of 100 nanoseconds and a capacity of 6,000 bits.

In the United States the memory built by Bell Telephone Laboratories is not as fast (it has an access time of 400 nanoseconds) but its 30,000 bit capacity is much greater. This is a big jump over the 8,000-bit, 400-nanosecond memory Bell is also developing.

## Two-year search for life on Mars

The National Aeronautics and Space Administration has issued 16 requests for proposals to design an automatic biological laboratory to search for life on Mars. The laboratory idea represents a switch from earlier plans to have separate landings of payloads with a few life-detection experiments on each.

The devices designed for use under the previous concept [Electronics, Jan. 3, 1964, p. 17] may or may not be used. If they are, they would be automated in a laboratory designed to operate on Mars for two years. Automation will cover sequencing, programing, sample acquisition, data handling, and recycling the experiments to initial conditions.

The one-year contract will call for defining the spacecraft and launch vehicle. Centaur and Saturn are seen as leading launch vehicle candidates for the mission, which would take place in the early 1970's.

## New phosphor brightens tv color

Development of a new red rare-earth phosphor, europium, will permit 40% greater brightness in color-tv tubes. Until now the brightness of green and blue sulphide phosphors had to be held back in order that the inherently less bright red sulphide, used in earlier tubes, would not be overpowered.

The europium phosphor was developed by General Telephone and Electronics Laboratory, Inc., the research subsidiary of General Telephone and Electronics. Sylvania Electric Products Inc., also a sub-

---

# Electronics Newsletter

---

sidiary of GT&E, will use the new material in its 1965 color sets slated to come off the production line in August.

The company says that viewers will immediately notice the increased brightness of the new tubes and the naturalness of the red tones—even in a lighted room. In addition to more vivid color projection, the new tubes are expected to provide better black and white reception.

## Hig-speed logic is on the way

A new family of high-speed digital integrated circuits is being developed by Fairchild Camera and Instrument Corp.'s semiconductor division. It is called complementary transistor logic (CTL) because it uses pnp and npn transistor in the same silicon chip. Individual logic gains are expected to have propagation delays as low as 1 nanosecond. The average propagation delay per gating function in a logic chain is about 5 nanoseconds. Power dissipation is between 20 and 40 milliwatts per gating function.

## Sea launch improves signals

A means of obtaining more reliable over-water radio communication at relatively low frequencies (about 5 megacycles) will soon be demonstrated. E. O. Willoughby of the University of Adelaide, Australia, wants to move inland transmitters (used for international communications) to sites near the shore. These seaside transmitters would bounce vertically polarized waves off the surface of the ocean.

The over-all gain of ocean-bounced radio signals is 14 decibels, or a voltage gain of five, over that of a system using half-wave dipole antennas in free space. The ocean-bounce system employs an angle of fire depressed two to three degrees below the horizontal. Its antenna masts need not exceed 120 ft.

There will be a demonstration of the higher reliability of the ocean-bounce technique during the present period of low sunspot activity and low critical frequency; a time when the slightly higher frequency signals bounce off the sea, pass through the ionosphere and are lost.

## Low-cost system to trace calls

Bell Telephone Laboratories has found a way to produce economically a memory system that traces telephone calls instantly. The system also identifies fingerprints in a split second, and instantly retrieves the remaining part of stored information when supplied with the known portion.

Balanced bipolar circuitry—circuitry composed entirely of relatively low-cost magnetic material and wire—under study at Bell is expected to bring down the cost of building content-addressable memory systems. Costs now for building content-addressable systems with previously developed semiconductor-device circuitry are nearly prohibitive.

## More colors for radar screens

A technique that could permit radar or sonar screens to display hundreds of different colors has been developed by Sylvania Electronic Systems division of Sylvania Electric Products, Inc. The technique makes use of the three properties of color—hue, brightness and saturation—to permit rapid visual identification of a greater number of images than is possible with color differentiation alone. The company says that radar screens for the military have been developed to display varying brightness (pink or fuschia, for example) or varying saturation (bright pink or dull pink). No technique to combine the two had previously been developed.

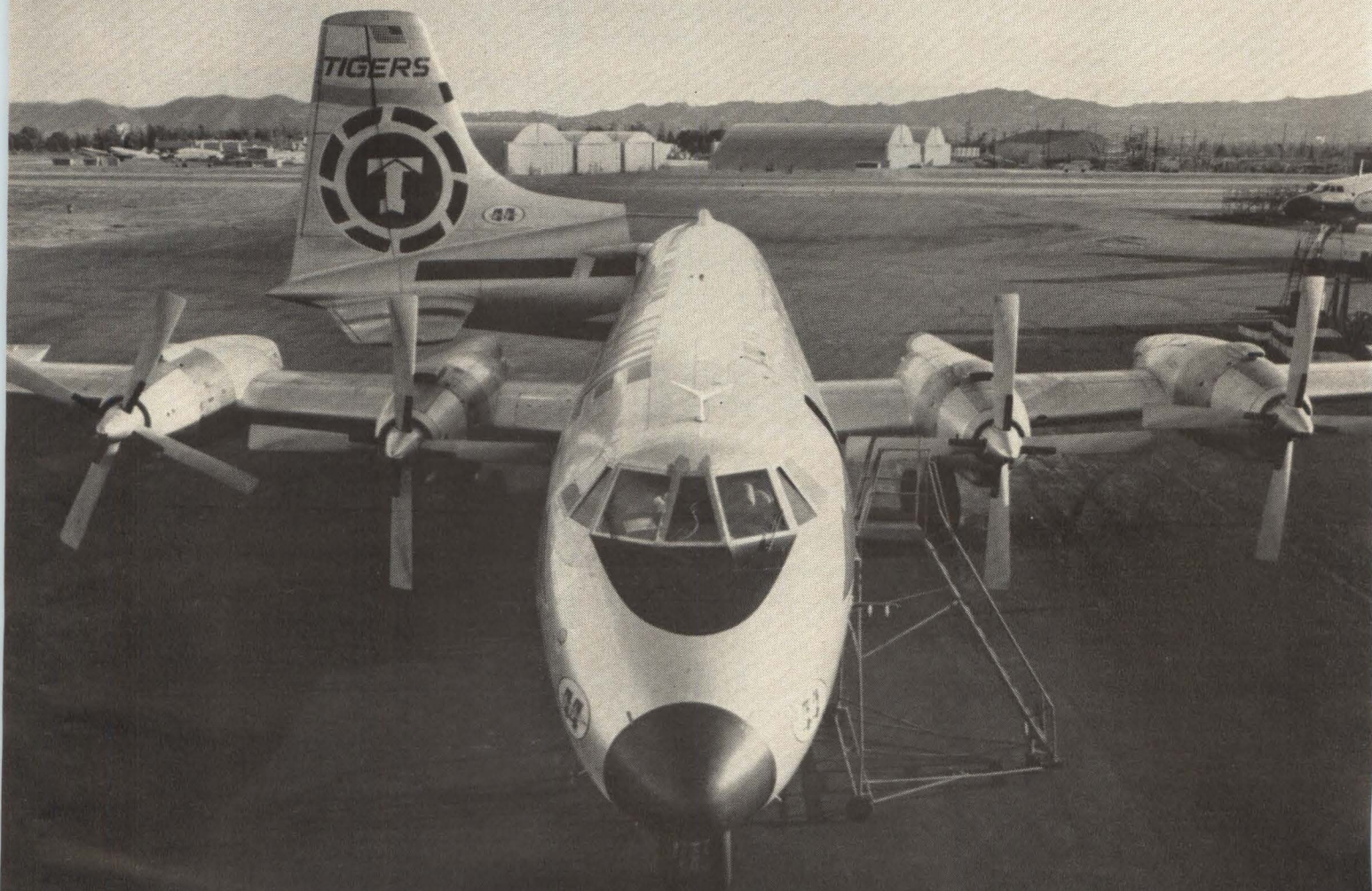

## We'll break our back for you

That's how accommodating the Flying Tiger Swingtail-44 is. The tail assembly literally breaks away from the rest of the plane. Swings out wide, giving you a real advantage in straight-in loading for big shipments. The result is Tigers' Swingtail-44s regularly take on outsize cargo that side-loaders don't dare try. And Flying Tigers doesn't ask you to palletize your shipment, either.

There are many ways our airfreight specialists will knock themselves out for

you, too. Like offering you "Skyroad" service, Tigers' combined air, rail and truck system that can open up more than 2,500 U.S. markets to you. One bill covers the whole "Skyroad" operation. And Tiger will keep tabs on your shipment from your door to your destination, thanks to 2-way radios in Tiger trucks and Tigers' special teletype monitoring system.

Next time you have a shipment, large or small, anywhere in the world, call Tigers. We'll break our backs for you.

*first in airfreight with airfreight first*

**FLYING TIGER LINE**





## NEW hp MICROWAVE SIGNAL GENERATORS furnish stable signals, with leveled output

Important UHF applications ranging from DME and air traffic control to multichannel relay systems and radar altimeters are served by the hp 8614A and 8616A Signal Generators. These new instruments combine previously unavailable frequency range, stability, modulation capability and accuracy. They differ primarily in frequency range, 800 to 2400 mc for the 8614A and 1800 to 4500 for the 8616A.

Hewlett-Packard also offers a group of accessory instruments ideal for combining into signal generation test systems for modulation versatility, maximum stability, high power output and remote programming.

The two microwave signal generators offer many features actually requested by prospective users. Leveled output to  $\pm 0.5$  db eliminates need for time-consuming adjustments and increases accuracy.

A unique PIN diode modulator allows amplitude modulation from dc to 1 mc without frequency pulling or jitter. Frequency or square wave modulation, with or without leveling, may be accomplished concurrently. For less sophisticated applications the hp 8614B and 8616B Signal Sources retain the frequency stability, high level output, accurate attenuation and square wave modulation of the "A" models; they are ideal for slotted line, bridging and similar applications.

Operation is simple and less subject to error, with frequency and attenuation set on direct-reading digital dial and with generator function selected by error-safe front-panel pushbuttons. Call your hp Field Engineer for full particulars and a demonstration. You'll learn of totally new capabilities in the field of microwave signal generation for testing. Or write Hewlett-Packard Company, Palo Alto, California 94304, Telephone (415) 326-7000; Europe: 54 Route des Acacias, Geneva; Canada: 8270 Mayrand Street, Montreal.

## SPECIFICATIONS

### 8614A, 8616A Signal Generators

<b>Frequency range:</b>	8614A, 800 to 2400 mc; 8616A, 1800 to 4500 mc
<b>Frequency calibration accuracy:</b>	8614A, $\pm 5$ mc; 8616A, $\pm 10$ mc
<b>Frequency stability:</b>	approximately 0.005%/°C change in ambient temperature, less than 2500 cps peak incidental FM, less than 0.003% change for line voltage variation of $\pm 10\%$
<b>RF output power:</b>	+10 dbm (10 mw) to -127 dbm into 50-ohm load; direct reading digital attenuator control calibrated 0 to -127 dbm; 2nd uncalibrated rf output at front panel, at least 1 mw
<b>Automatic power output control:</b>	holds output constant within $\pm 0.5$ db at attenuator settings 0 to -127 dbm across entire frequency range; adjustable -4 db to +4 db of normal calibrated level
<b>Attenuator accuracy:</b>	$\pm 0.75$ db from -7 to -127 dbm; direct reading linear dial to 0.2 dbm; dial uncalibrated 0 dbm to +10 dbm
<b>Modulation:</b>	internal square wave, 950 to 1050 cps, 2 $\mu$ sec rise time; external pulse, 50 cps to 50 kc; external AM, dc to 1 mc; external FM
<b>Price:</b>	8614A, \$2100; 8616A, \$2100; "B" models retain frequency and attenuator characteristics but do not have rf monitoring or leveling; external AM; 8614B, \$1450; 8616B, \$1450

# 800 to 4500 mc!

## SIGNAL GENERATION SYSTEMS

Accessory hp and Dymec instruments permit you to put together a completely programmable signal generation system (with either the 8614A or the 8616A), offering broad modulation capabilities, absolute control of frequency and up to 1 watt power output.

The hp 8714A and 8716A Modulators permit direct AM of signal generator output, deliver rf pulses with 0.03  $\mu$ sec rise and fall times, 0.1  $\mu$ sec minimum duration and less than 1 nsec jitter. Fast square wave modulation and sinusoidal modulation also are possible, dc to 10 mc. 8714A, 800 to 2400 mc, \$1300; 8716A, 1800 to 4500 mc, \$1300.

The hp 480-490 Microwave Amplifiers deliver at least 1 watt for a milliwatt input, 1 to 12.4 gc. AM, remote programming, power leveling possible. 489A, 1 to 2 gc, and 491C, 2 to 4 gc, \$2300; 493A, 4 to 8 gc, and 495A, 7 to 12 gc, \$2900.

The Dymec 2650A Oscillator Synchronizer provides absolute control of frequency by phase-locking the signal generator

output to an extremely stable internal crystal oscillator. DY 2650A, 1 to 12.4 gc, \$1450 (with 100 mc fr reference, \$1480 with special-order crystal).

The DY 2307A Servo Programmer provides mechanical programming of frequency and/or output level of your signal generator. Permits choice of 10 preset frequency or attenuation settings, may itself be programmed externally, with the programmer up to 1000 feet from the drive unit mounted on the generator. DY 2307A, \$1100.

*Data subject to change without notice. Prices f. o. b. factory.*

**HEWLETT  
PACKARD**  *An extra measure of quality*

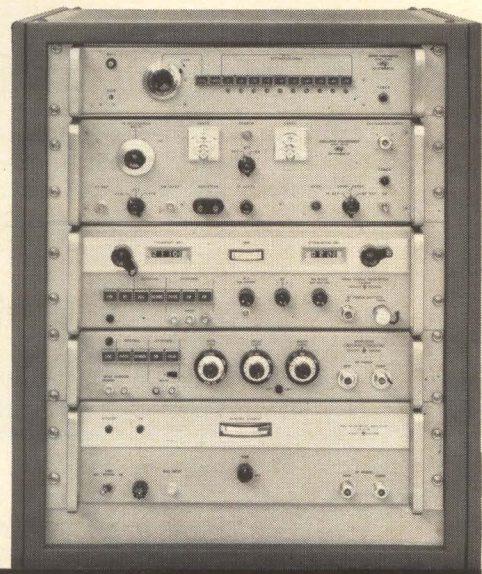

# MALLORY

P. R. MALLORY & CO. INC., INDIANAPOLIS 6, INDIANA

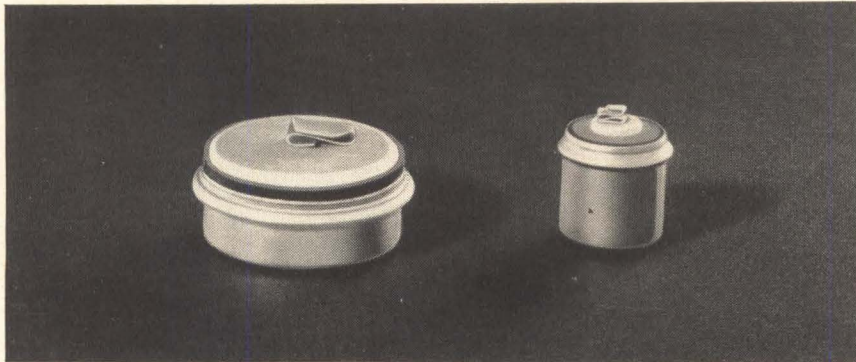
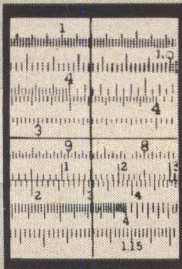

4R and 1R Non-magnetic cells

## High-energy batteries in non-magnetic cases

For applications where batteries must be free from magnetic properties, we make a series of models in stainless steel cases. The internal chemistry of the battery is not altered, and the electrical characteristics of the cell are identical with standard Mallory models.

Stainless steel cases that go into these special batteries are demagnetized by our technicians to remove the traces of magnetism which may develop even in full austenitic steels due to mechanical action during shipment. Our techniques reduce residual magnetism to values required by military specifications.

Non-magnetic mercury batteries for military use are supplied in two sizes: the 1R Non-magnetic, with 1000 milliampere-hours capacity, and the 4R Non-magnetic, with 3400 milliampere-hours. When these are made into multi-cell power packs, non-magnetic tabs and connectors are used, and the complete assembly is usually potted.

In the commercial field, miniature cells for electric and electronic watches are now being standardized in non-magnetic construction. We supply these regularly in silver oxide, mercuric dioxysulfate and mercury systems, in the standard watch cell sizes.

CIRCLE 240 ON READER SERVICE CARD

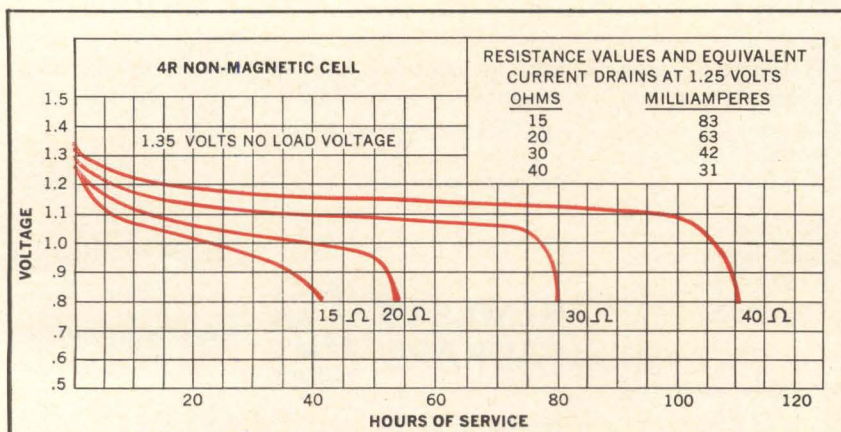

## Mallory Film Resistors stay stable in high humidity

A recent series of humidity exposure tests demonstrate the ability of Mallory Type MOL metal oxide film resistors to hold stable values of resistance when subjected to extreme moisture.

The tests were run on a group of 33,000-ohm, 3-watt MOL resistors with nominal 10% tolerance. First, the resistors were exposed to 95% relative humidity at 40°C for 100 hours at no load. Result: average change in resistance was +0.37% ... maximum change was +0.51%.

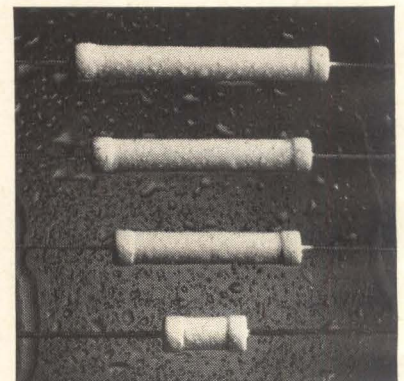

Next, the resistors were held for 1000 hours in this same atmosphere, with full rated wattage applied. Result: average change in resistance was in the band from -0.7% to +0.62%; maximum changes were -1.2% and +1.6%.

Through all this high humidity test Mallory MOL resistors remained at resistance values well within their stated tolerances. On long-term load life tests—10,000 hours—they show equally fine stability, with resistance holding within 1% of initial values.

The MOL series comes in 2, 3, 4, 5 and 7 watt ratings, with resistance values ranging from 30 ohms minimum on the 2 watt to a maximum of 125K ohms for the 7 watt unit. Standard tolerance is 10%; other tolerances can be supplied.

CIRCLE 241 ON READER SERVICE CARD



# DESIGNER'S FILE

## Micro-Size Modular Resistors

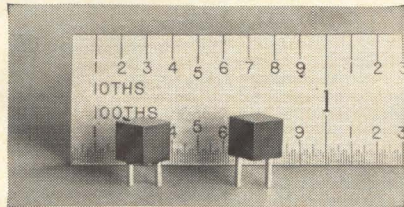

Mallory pellet film resistors are now available in a tiny encapsulated package ready for circuit connection. Its cubic shape allows easy assembly to a printed wiring board without lead bending. Size is 0.150" on a side with terminals on one face.

Characteristics:

1. Low inductance.
2. Resistance—1 ohm to 2.5 megohm.
3. Resistance tolerances to 1%.
4. Power rating— $\frac{1}{4}$  watt at 125°C.
5. Terminals— $\frac{5}{32}$ " long on staggered 75 mil grid.
6. Over 420,000 pellet-hours without failure @  $\frac{1}{4}$  watt @ 125°C.

This high density assembly is ideal where space reduction, high reliability and stability are required.  
**CIRCLE 242 ON READER SERVICE CARD**

## Adjustable multi-cam industrial timer

A new Mallory sequence timer offers exceptional flexibility due to a design feature which permits time cycles to be adjusted without the use of tools. Cycles can be changed in increments as small as two degrees of cam shaft rotation. This timer has many applications in vending machines, in photocopy equipment, and in laboratory setups and production line controls.

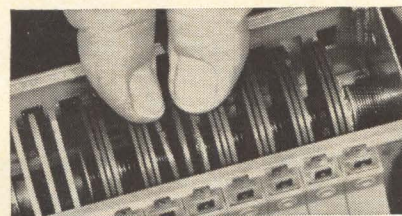
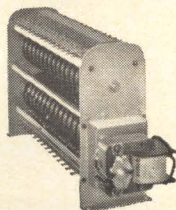

Time cycles can be changed without tools. New settings won't slip out of adjustment.

It is ruggedly built to deliver highly reliable service under constant usage. Custom-engineered models, with from 1 to 30 cams, and with cycles anywhere from 2 seconds to several hours per cam shaft revolution are available from Mallory Timers Company.

**CIRCLE 243 ON READER SERVICE CARD**

## Radiation resistance of XTG capacitors demonstrated by nuclear testing

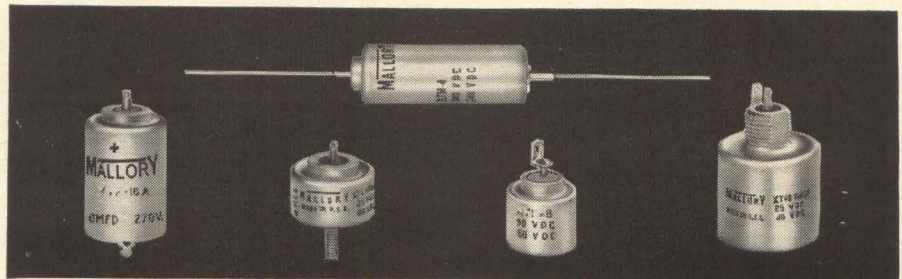

The ability of XTG radiation-resistance wet slug tantalum capacitors has been evaluated in a series of radiation exposure tests. This new line of Mallory capacitors is designed for use in radiation environments where massive shielding is impractical.

The data curves shown here report the results of testing. Test conditions were such that the following dosage levels were accumulated:

*Fast neutron bombardment:*  $6.583 \times 10^{13}$  neutrons/cm<sup>2</sup> at energy level greater than 0.1 Mev.

*Gamma ray exposure:*  $79.60 \times 10^6$  Rad (carbon).

Both capacitance and dissipation factor held quite constant to initial values during exposure, and returned virtually to initial measurements when capacitors were withdrawn from radiation environment. DC leakage increased to a plateau value during bombardment, and also returned to initial value after radiation ceased.

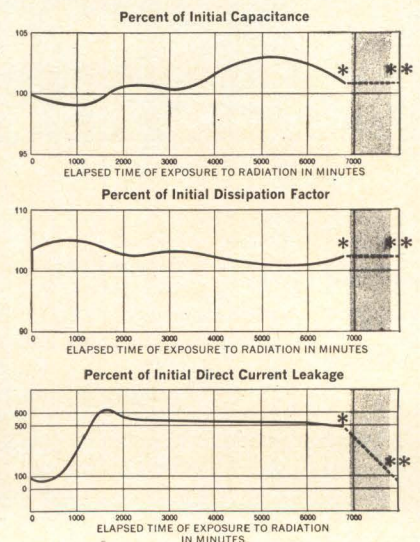

\*6745 hours—end of test  
 \*\*Measurements after withdrawal from radiation

The XTG series is available in the same ratings as standard Mallory XTL, XTH, XTV, XTK and XTM wet slug tantalum capacitors, in all MIL terminal configurations. Temperature range is  $-55^{\circ}$  to  $+85^{\circ}$ C.

**CIRCLE 244 ON READER SERVICE CARD**

**NOW YOU SEE IT...**

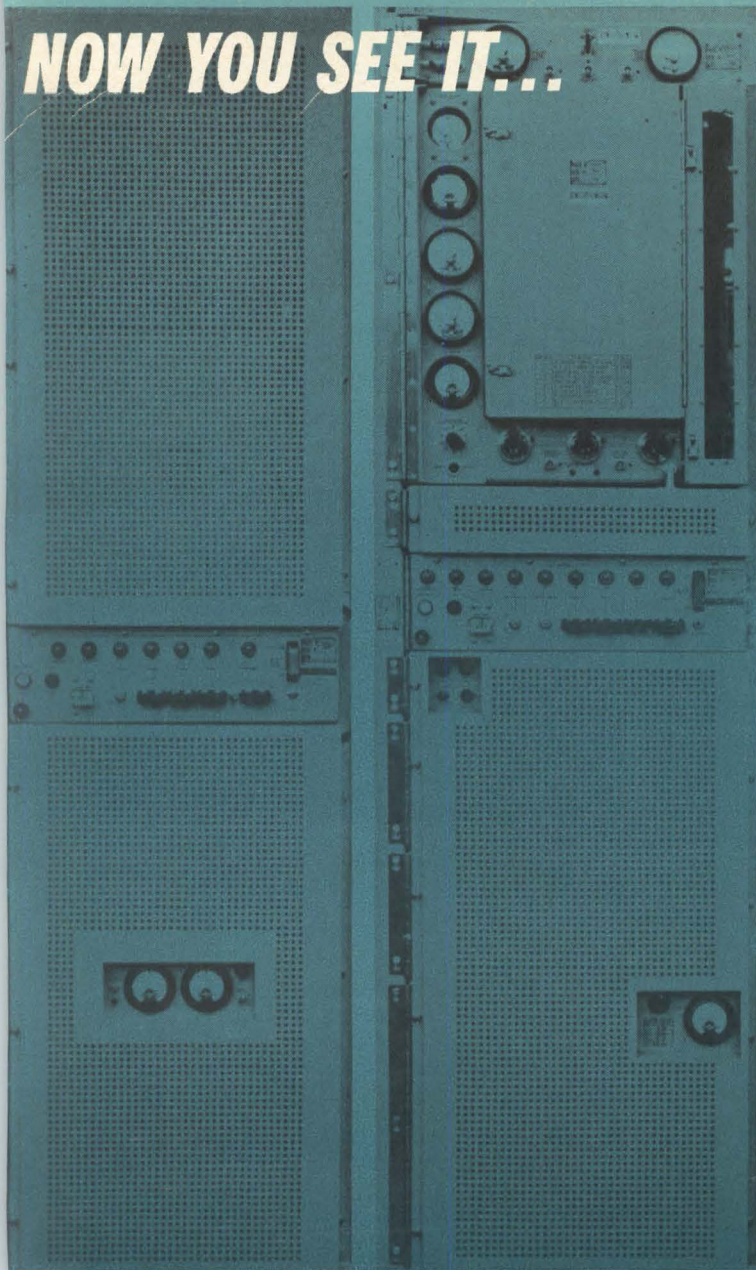

**NOW YOU SEE IT AGAIN  
REDUCED TO  
SOLID-STATE  
BY REL**

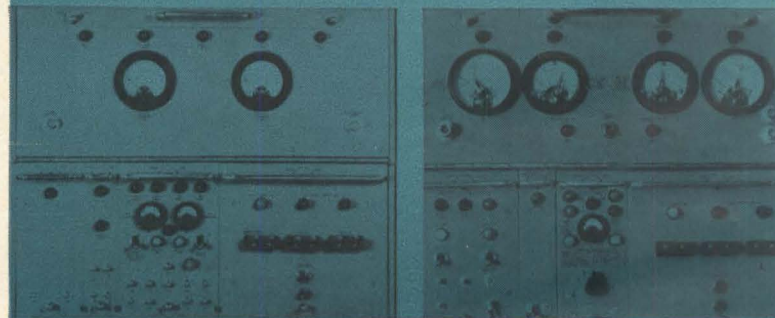

New 2600 Series by REL represents completely solid-state tropo scatter radio equipment.

Advanced solid-state design by REL—pioneering leader in tropo scatter communications—provides a rugged and reliable system that meets tactical communications requirements for both tropo and line-of-sight applications.

Meeting and exceeding performance standards of REL's famed AN/FRC-39-A(V) radio system, the 2600 Series truly represents the latest development of solid-state, modular-constructed tropo scatter radio hardware.

Reduced to one-fifth the size, weight, and power drain of conventional tube equipment, the new 2600 Series proves out for tactical use as well as for transportable and fixed-plant installations in wide-ranging commercial and military applications.

For the future, as in the past, this same REL engineering and performance leadership stands ready to help solve your military or commercial telecommunications problems.

For additional information on 2600 Series, write for Brochure SE-1.



24-channel, dual-diversity, 1 kw tactical tropo terminal in S-144 shelter—total weight only 1500 lbs.

Circle 24 on reader service card



**RADIO ENGINEERING LABORATORIES**  
A division of Dynamics Corporation of America  
Long Island City 1, New York

# Electronics Review

Volume 37  
Number 18

## Computers

### Computer understudy

A second computer will back up the one in the guidance-navigation system of the Apollo spacecraft. Because flatpack microcircuitry will be used instead of hermetically sealed cans, the two complete computers will weigh less than the one originally specified.

The original computer was to have had spare module trays [Electronics, Oct. 4, 1963, p. 14]. But that would have added field maintenance to the astronauts' other tasks in space. The new design permits astronauts to switch from one complete computer system to the other.

The two-computer system, called Block II, also eliminates the dangers of being unable to determine which module is at fault and of mixing good and bad modules during a flight.

**Rectangular flatpacks.** The dual system, being developed at the Massachusetts Institute of Technology, calls for rectangular flatpacks 0.15 inch thick, with leads coming out of the thin faces. The original system, called Block I, was to have used TO-47 transistor cans.

A Block I system is currently being tested at MIT. It will later be used to help check out the Apollo ground-support system at an MIT laboratory being built in Downey, Calif.

Besides the backup computer, Block II will have a miniaturized inertial measurement unit, a miniaturized navigation base and a common mount for the stable platform and optics.

George E. Mueller, associate administrator of the National Aeronautics and Space Administration, says the changes in the guidance-navigation system will save about

75 pounds. That's not much in a 9,000-pound command module, he admits, but it reverses the usual trend of weight increases while a program moves forward.

### GM's wheelless wonder

Visitors to the lobby of the General Motors Corp. headquarters in Detroit can see the country's most modern industrial communications center. It's a computer-based switching unit that is expected to handle 100 million characters—the equivalent of about 16 million words—a day by 1969. It will serve all 1,133 GM plants and offices in North America and in 15 countries abroad.

The basic system is the 8050 computer of the Control Data Corp.

**Savings expected.** GM hopes the on-line inquiry system will drastically reduce inventories. By tying the sales offices directly to the assembly plants, the system is also expected to cut the 12 days now required between writing an order and beginning production. GM is also considering facsimile equipment for handling engineering communications.

The hardware for the 8050 is duplicated throughout the system. It consists of two 8050 switching units comprising two 8952 magnetic-drum memory units, five 603 tape transports, two 162 tape synchronizers, two 169 auxiliary memory units, five 8165 multiplexers, two 160A computers, one control console and one 8050 text board, plus printers and card readers. A battery of eight call-director telephones receives messages originating in headquarters, which are passed by an automatic conveyor to any of the ten M28 Teletypewriter stations that are open for sending.

The switching center is programmed to receive and transmit



From the street, the control console of the General Motors "nerve center" looks like this. The system will eventually handle 100 million characters a day.

messages by any conventional method, from paper tape to drum or core computers. It can handle any of seven machine languages, translating automatically through cores.

John A. Carpenter, GM's director of communications, figures that communications now cost the company one cent a word, based on an average of six characters a word. He expects that cost to be reduced significantly.

**Lost: 24 pounds.** The chief programmer John Tancredi, claims to have lost 24 pounds during the three man-years required for programming. He aimed for dynamic storage of only 120,000 characters at a time, and figures a disk system would have cost an additional \$8,000 to \$9,000 a month for operation.

The system is on real time, and traffic cannot be stopped. It will handle 40 to 50 lines at once, with "busy signals" handled in order. Storage period is a maximum of 2½ seconds, in and out.

A history tape of all messages is kept for 24 hours after handling, but thought is being given to creating a permanent file on tape for corporate records.

Control Data, which had never

built a dynamic storage system, won the contract over 12 other companies.

### Avionics

#### Equipment for the F-111

State-of-the-art avionics subsystems for the F-111 (TFX) are now being received for test and evaluation by the Air Force. Later, advanced circuitry, particularly microcircuitry, will probably be used by both the Air Force and Navy.

Breadboard models of the avionics equipment will be tested and qualified in F-106 and T-29 flying test beds. Early models of the F-111 will be used for more tests.

The Air Force is tightening its requirements on components. General Dynamics, the prime contractor, will have to make good on specific standards of mean time to failure, and maintenance man-hours per hour of operating time.

The main avionics subcontractors are Bendix Corp. for the air data computer; Avco Corp., countermeasures receiver set; General Electric Corp., flight control optical sight and missile launch computers and attack radar; Westinghouse Electric Corp., a-c power systems; Dalmo-Victor, Inc., radar homing and warning; Litton Systems, Inc., navigation and attack; Collins Radio Co., h-f radio set; and Texas Instruments, Inc., terrain-following radar.

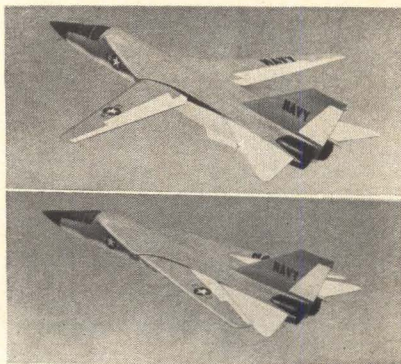

First photographs of F-111 model show variable swept-wing configuration.

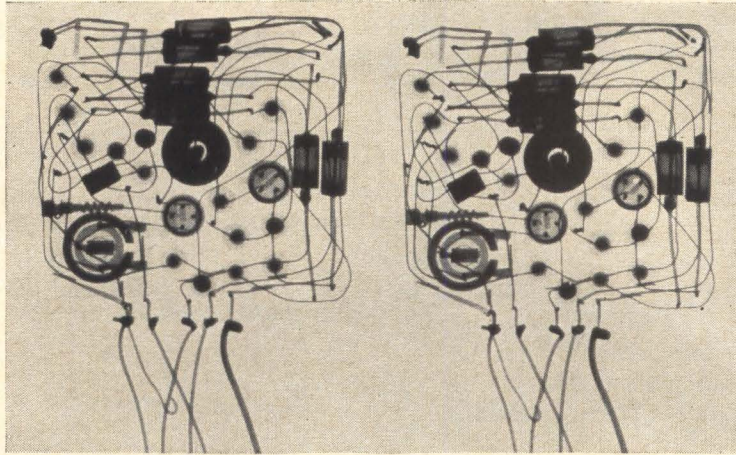

**Stereoscopic X-ray** of encapsulated preamplifier module, part of the zero-gravity fuel-gauging equipment for a spacecraft. To see this photo in 3-D without a viewer, ignore the double image print for the moment and focus your eyes on a point 10 feet away. Then bring the double image print up slowly into the line of sight, maintaining the same focus with your eyes. Three images will appear side by side. The center one will be a stereo composite of the two photos. You may need practice. If you're impatient you can clip out the photo and use a 3-D viewer.

### Manufacturing

#### Industrial 3-D X-rays

Three dimensional X-ray photographs are being produced that visually separate components of potted modules according to their depth within the potted block. Heretofore, these components have appeared as an irregularly shaped blob.

With a quality-control technique developed by the Giannini Controls Corp., it's possible to see the distance between component leads in a potted module, or whether they pass too close to a metallic heat sink.

A technician, digging into a mass of opaque epoxy to replace or test a component, knows how far to penetrate.

**Depth detector.** The principle of three-dimensional X-ray photography also has medical applications. For example, it has been used to determine the depth of a bone infection.

In the Giannini technique, for a 3-D look inside a potted module, the module is mounted in front of a general-purpose LC-90 X-ray machine made by the General Electric Co. The photograph is taken

with a conventional oscilloscope-type Polaroid camera. A sheet of lead  $\frac{1}{16}$  inch thick is used with the camera to block off half of one frame, and the first photo is taken.

Next, the camera is shifted laterally one-half the width of the film frame, and the lead sheet is moved to the other side of the frame. The module being photographed is rotated  $3^\circ$  to  $5^\circ$  and the second picture is taken. The result, seen through a stereoscopic viewer, is a three-dimensional X-ray photo.

**5-minute prints.** A service group is being set up at Giannini, employing the technique in various manufacturing and inspection operations. The group can deliver a stereo print for 3-D evaluation five minutes after receiving a module.

The technique also has been used in checking transformer characteristics. By taking X-ray pictures in 3-D, it is possible to determine exactly how much the wire leads within the transformer case have been pushed out of shape during potting.

In its components division, Giannini has taken 3-D shots inside pressure transducers while in operation, to study mechanical action of the internal elements.

With a little practice, the average person can get the 3-D effect

without the aid of a stereoscopic viewer. The "wide-eyed" technique for doing this is outlined beneath the photograph at the top of the facing page.

## Advanced Technology

### Another 'biggest' dish?

A 600-foot steerable antenna is being considered again, this time by a team from Harvard University and the Massachusetts Institute of Technology. The giant dish—like the one at Sugar Grove, W. Va., that the Navy abandoned in 1962—would be the major facility in what may be the most advanced radio astronomy observatory in the world.

Harvard and MIT sources say they have not yet pinpointed the location, size, reflector configuration or type of mount. A source of funds also is yet to be determined.

New England is considered the most likely location for the observatory. Harvard and MIT have an impressive combination of talent in radio astronomy and systems engineering and, as one scientist says, "A 600-foot dish is a systems engineering job, pure and simple." If construction is undertaken, the observatory probably would be completed within the next decade.

**Which frequencies?** One antenna expert, commenting on the possibilities of success where the Navy failed, said this would depend upon the frequencies used. "For higher frequencies, the tolerances must be tighter. If they were going to use it at the lower frequencies it wouldn't be too hard a job," he said. He added that resonance, caused by servomechanisms, was the major problem with the Sugar Grove antenna, and "at the lower frequencies you can build it without servos."

The embryonic Harvard-MIT project is not yet far enough along to consider frequencies. Confidence in Harvard-MIT ability to engineer a 600-foot steerable dish is undoubtedly enhanced by the 120-foot Haystack antenna, now near-

ing completion [Electronics, Nov. 9, 1962, p. 49]. Live tests on Haystack are scheduled to start this fall.

### Multijunction converter

A British development in thermojunction current meters offers promise for accurate measurements of audio- and radio-frequency current.

Like conventional thermal converters, it detects the temperature rise caused in a heater wire by the measured current, and produces a thermocouple voltage output whose magnitude is a measure of the current's amplitude. Unlike the usual unijunction converter, it has 160 plated copper-constantan junctions that give a voltage output up to half a volt. The voltage can be fed directly into a digital meter without intermediate amplification. Conventional converters put out signals on the order of millivolts.

**Plating technique.** Developed at the National Physical Laboratory at Teddington, the thermal converter was made possible by the use of a plating technique to form the 160 junctions. A one-inch-long heater wire is surrounded by a constantan spiral. Part of the spiral is embedded in a copper block, forming the cold junctions, and part is plated with copper, forming the hot junctions at the heater.

The voltage output has been measured at 5.5 millivolts per degree centigrade of temperature rise, compared with about 5 millivolts for a 200-degree rise for single-thermocouple converters.

Accuracy of measurements using the multijunction converter has been achieved to one part in  $10^5$ , with a predicted one part in  $10^6$ . The linearity of the instrument is better than 0.01% over a 7-to-1 current range, while the temperature coefficient can be made zero by varying the plating thickness.

Initial application is for digital measurement of steel-strip power loss. Two converters are used in a current-voltage sum-and-difference circuit that measures power directly.

### Second sound

Second sound, a rare phenomenon previously thought to occur only in liquid helium, has been observed in photoconducting crystals of cadmium sulfide. This discovery, made by scientists at the Sperry Rand Corp. Research Center in Sudbury, Mass., may find applications in amplifying delay lines, in solid-state oscillators and in a harmonic generator providing gain at a desired harmonic frequency.

Second sound is believed to be a type of heat wave that combines useful properties of both heat and sound. Like heat, it carries energy; but it moves at nearly the speed of sound. Richard W. Damon of Sperry says this phenomenon may help to point out some basic frequency limitations in active thin-film devices currently under development in many laboratories. Its current-saturation characteristics suggest possible use as a current limiter, and its nonlinear effects also open the possibility of using the mechanism for frequency-doubling devices.

The new mode of energy transport was observed at Sperry by Harry Kroger, Earl W. Prohofsky and Richard Damon during experiments on direct amplification of sound waves. The arrangement used is shown in the diagram. Shear waves from 10 to 60 Mc, polarized along the C axis of the cadmium sulfide crystal, were propagated through the crystal at room temperature, with the aid of indium bond layers connected to a voltage source, and a small lamp illuminating the sulfide crystal. With the input sound pulse on, light aimed at the crystal produced random free electrons, and the re-

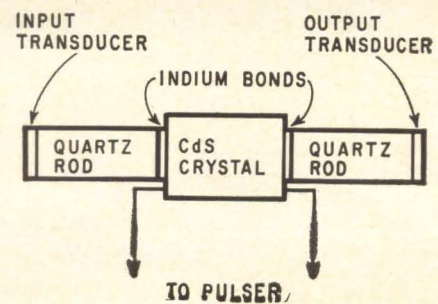

sulting phonon-electron interactions attenuated the sound. When the voltage source was switched on, the electrical field forced the drifting electrons to move down the crystal and interact with the sound waves to produce amplification. The resulting sound waveforms were followed by a second, lower-amplitude waveform — second sound—which was visible as long as the electric field was present.

The Sperry researchers said they would search for the same effect in other compounds, including gallium arsenide, zinc oxide and zinc telluride.

### The long tunnel

A gas laser will be used to achieve precise alignment of the 10,000-foot-long waveguide that makes up the world's largest linear accelerator. The Stanford Linear Accelerator Center in Palo Alto, Calif. is building the 20- to 40-billion electron-volt accelerator, made up of 960 separate ten-foot sections of disc-loaded circular waveguides.

Alignment of the near two-mile-long instrument must be accomplished to an accuracy of plus or minus one millimeter of a true straight line, without disturbing the path of accelerated electrons. The optical alignment method will use a gas laser as a coherent light source. The light beam is sent down the large diameter pipe

which runs parallel to the waveguide and also forms its mechanical support. A diffraction grating is placed in the pipe at fixed intervals to produce the interference phenomena patterns used for alignment.

**Techniques are tested.** The underground accelerator tube, and the above-ground housing which contains up to 960 klystrons to power the accelerator, should be completed in 1966. Right now, in an abandoned railroad tunnel, tests of the optical alignment techniques are being run on a mockup of the linear accelerator. Final construction calls for a 24-inch diameter pipe that will rest on supports attached to the tunnel floor and wall. It will be adjustable for mechanical alignment.

The copper waveguide tube itself has a four-inch outside diameter, and an inside diameter of  $\frac{7}{8}$  inch. Microwave power, at a frequency of 2,856 Mc, drives the electron beam. The supporting 24-inch pipe has built-in observation target housings located every 40 feet along the 10,000-foot length. They allow retractable Fresnel targets to be inserted into the light path for interference pattern checks. Remote electronic controls will operate jacks to achieve perfect alignment of the waveguide pipe. Plans now call for control rooms every 330 feet along the length of the linear accelerator, manned by op-

erators who will probably use remote scanning devices to check the alignment of the waveguide system.

**Traveling light.** The laser light beam travels down the support pipe to target housings located along the light path. The housings are coarse two-dimensional square gratings, of the Fresnel zone type. An observation system is located at the far end of the tunnel.

The c-w gas laser operates at 6,328 angstroms. It is supplied by Spectra Physics, Inc., Mountain View, Calif. Bandwidth of the laser is 0.02 angstrom. Beam divergence is 0.2 milliradian.

The Stanford scientists are doubling the natural divergence of the laser to produce a divergence of about six inches in 40 feet. The laser is excited by r-f at 40.68 Mc. Average power available from the laser is three milliwatts, and efficiency is 0.1 percent.

The beam image, produced by the Fresnel screens, is scanned by a coherent detector and a differentiating circuit that analyzes its intensity. Flarman Laboratories, Waltham, Mass. is doing preliminary testing on the Fresnel screens even though the Stanford Linear Accelerator Center hasn't yet picked the screen supplier.

---

## Communications

---

### Slow change

Missile ranges are preparing to switch from the crowded vhf telemetry band (225 to 260 megacycles) to the two higher frequency bands that were allocated for that purpose several years ago. But companies and most government agencies are slow to make the complicated conversion.

All telemetry antennas being installed at Cape Kennedy will be able to operate on the two new bands—1,435 to 1,535 Mc (L band) and 2,200 to 2,300 Mc (S band). Antenna mesh has to be finer to receive the higher frequencies, and the steering gear and pedestals must be stronger to resist the

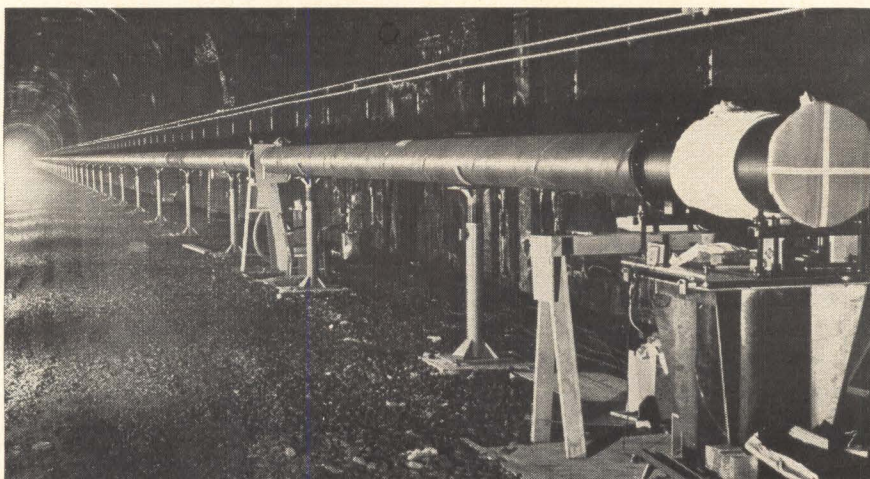

**Mockup of linear accelerator** housed in an abandoned railroad tunnel. A gas laser will provide a light source for optical alignment in the 10,000-foot-long accelerator.

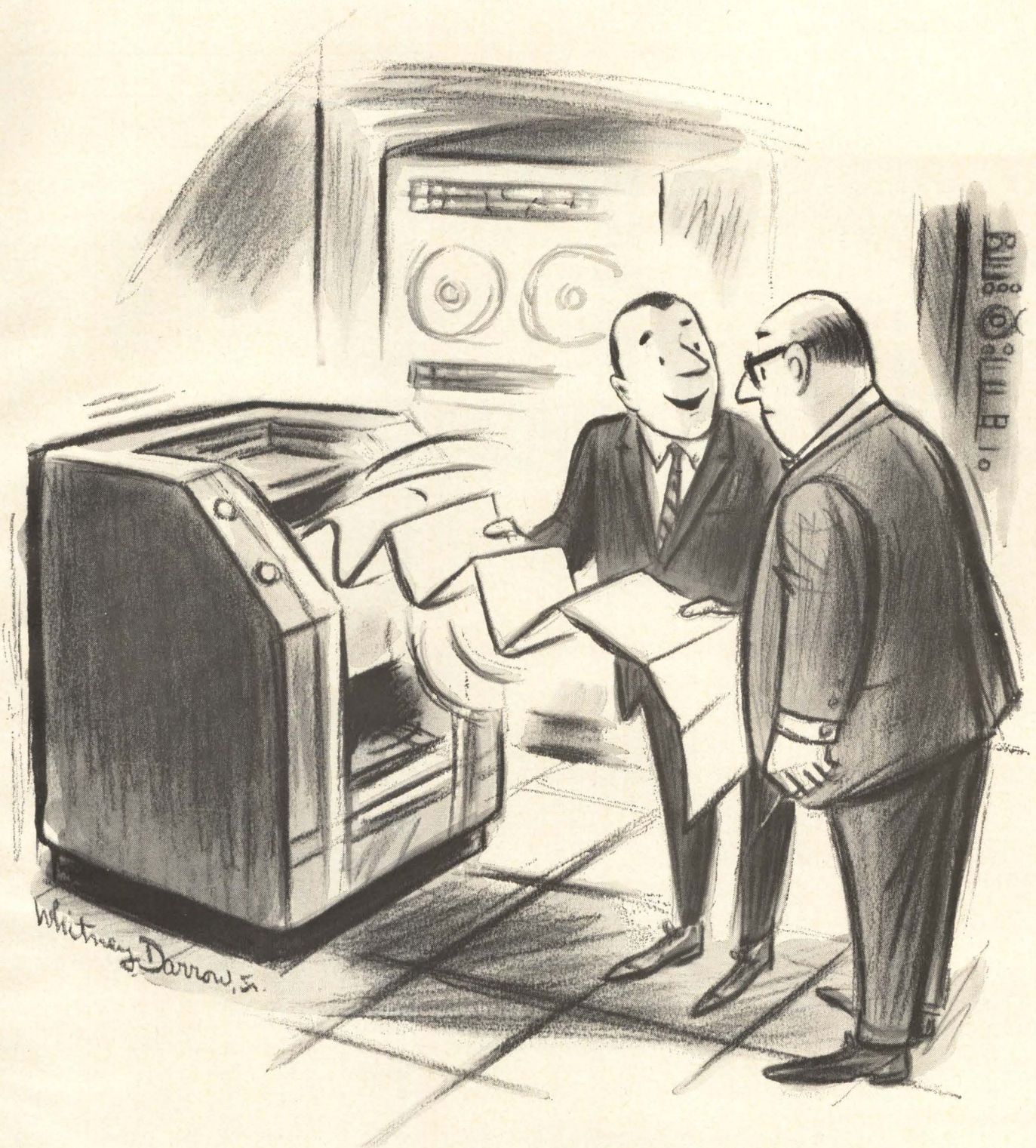

*"It says it's exactly one year old and wants a new supply of tapes of MYLAR® for its birthday."*

What a coincidence . . . "Mylar"\* is having a birthday, too. It's ten years old. In the decade since it was first introduced as a base for recording tape, "Mylar" has consistently been the most used, most trusted tape base for all EDP applications. And why not? "Mylar"

is strong (a tensile strength of 20,000 psi), stable (unaffected by temperature or humidity changes) and durable (can't dry out or become brittle with age). Celebrate the birthday of "Mylar" by giving yourself the gift of reliability. When reliability counts, count on "Mylar".



Better Things for Better Living  
... through Chemistry

only DU PONT makes

**MYLAR®**  
POLYESTER FILM

\*Du Pont's registered trademark for its polyester film.

added wind load caused by the finer mesh.

The S band will be tested intensively in mid-1965, and will be used for the Mariner planetary probes and the Surveyor flight to the moon. There are no requirements yet for telemetry in the L band.

**Supply low, price high.** Industry and agency delays are due to the scarcity and high cost of new equipment. No airborne gear has been built for S band, and little exists for L band. The equipment developed so far is still too big for an airborne package.

**Deadline.** Regardless of delays, the missile ranges will have to get out of the congested vhf band by Jan. 1970. There's too much competition from voice communications and navigation equipment.

New equipment for the missile ranges will include antennas with a broadband-feed covering frequencies from 130 to 2,300 Mc; pre-amplifiers to cover portions of these frequencies; multicouplers and receivers. All frequencies above 1,000 Mc will be down-converted to the 300- to 400-Mc band and entered directly into the telemetry receivers.

Later, the ranges will need data recording and separation equipment of greater capability to handle the wider bandwidth and high information rates expected.

### Nigeria calling

Early this month the Western Electric Co. sent out 28 requests for proposals for the first stage of a \$55 million microwave telecommunications system for Nigeria. The requests went to 14 American and 14 foreign companies.

Western Electric is advising the Nigerians on the telecommunications system under an \$860,000 contract with the U.S. Agency for International Development. Company engineers will be in Nigeria over the next few years to supervise installation and train local personnel. The company undertook a similar — but smaller — job for Thailand, for which Collins Radio

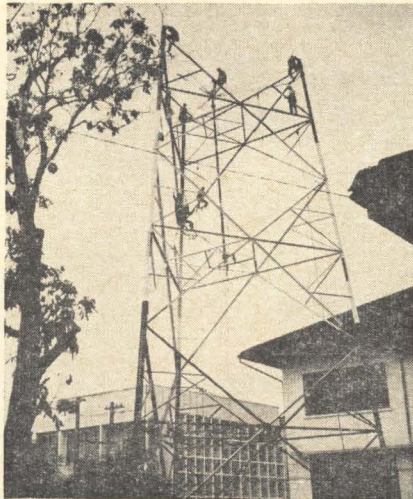

The radio tower for Thailand's communications network was built under Western Electric Co.'s supervision. A similar, but larger, job is about to start in Nigeria.

Co. is prime contractor.

**Five-year job.** The system will be contracted in four stages. The first will include all the radio transmission equipment—about \$8 million worth—and is expected to be completed in September, 1964. The contract will be let September 15. The second, to be completed in September, 1966, will include some of the telephone switching equipment. The third and largest stage—about \$28 million—will be a combination of radio transmission and telephone switching equipment and will be completed in 1967. The final phase, slated for completion in 1969, will comprise the rest of the telephone switching equipment.

There could be as many as four prime contractors—one for each phase. Scores of subcontractors are expected to get a piece of the \$55 million job.

**Double the number.** Nigeria now has about 54,000 telephones. By 1969, when the new microwave system is completed, this figure will more than double.

Joseph Gardner, manager of the Nigerian project for Western Electric, said that the only problems successful bidders may encounter are heat and humidity—and the fact that housing conditions, outside of the capital, Lagos, are rustic, to say the least.

## Industrial electronics

### Seagoing electronics

All of the major shipping lines in the United States have now entered the automation race. The companies are spending an estimated \$400 million on about 30 electronically controlled ships. The shippers were given a push last fall by the Federal Maritime Subsidy Board when, in effect, they were told that all new cargo ships had to have some form of remote-control of the main engine from the bridge to qualify for operating subsidies.

The American Racer, launched last month by the United States Lines, will be the most automated cargo liner in the world—but not the first. The Colombians, Italians, British, Norwegians, Japanese, West Germans and Dutch are already sailing with at least partially automated ships and there are reports that the Soviet Union has a "fully-automated" tanker on the Caspian Sea.

**Smaller crews.** All of these ships have some kind of centralized engine room control. Most of the duties previously performed by crewmen—engine operation, data logging, cargo handling—will be electronically controlled. Crew sizes will be reduced from about 50 to 30 men.

The General Electric Co. and the Westinghouse Electric Corp. are the major suppliers of the automatic control equipment, with GE reportedly having the lion's share of both U.S. and foreign sales.

**Shifting the burden.** The two major factors that have scuttled conventional ship control and boosted centralized electronic systems are fierce international competition for high-seas cargo, and government reluctance to continue the huge operating subsidies that have become so important to the merchant marine.

Clarence D. Martin, Jr. the Under Secretary for Transportation of the Department of Commerce told a Senate subcommittee, "To



# New Ink Rectilinear Recorder for analog computer or telemetry write-out

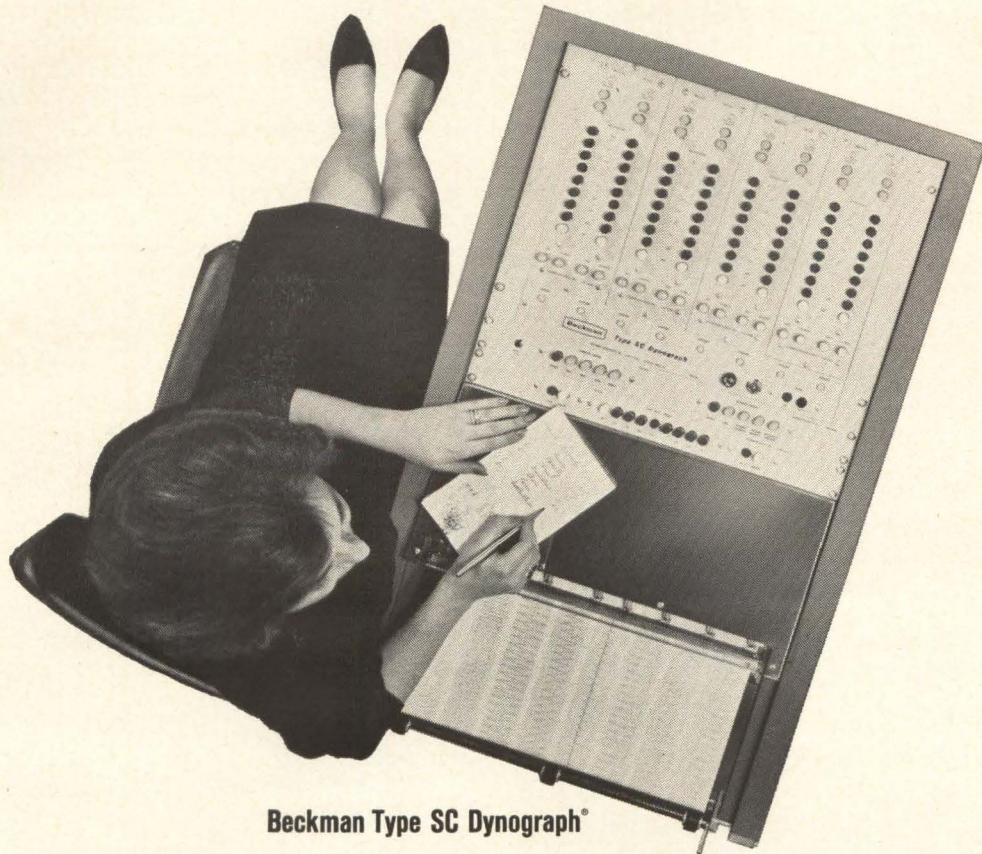

Beckman Type SC Dynograph®

## All the desirability of the Dynograph ink-rectilinear recorder, in a design for complete compatibility with analog computers

*Famous Locked-In Accuracy* at the tracing! Servo system constantly compares pen tip and input signal for maximum accuracy and linearity.

*Reliable Solid-State Circuitry* eliminates drift, component aging. No warm-up time; low total power consumption (230 w. max., for 8 channels).

- Channels: 8 analog plus event marker (standard)
- Width: 40 mm (50 divisions) /channel
- Sensitivity Range: 2.5–250 volts full scale
- Input Impedance: 1 megohm, single-ended or differential
- Linearity:  $\pm 0.25\%$
- Frequency Response: DC-150 cps
- Zero Suppression: 3 times full scale
- Computer Controls: "Operate," "Hold," "Reset"
- Polarity Reversal: for each channel
- Local-remote Controls: "Chart Speed," "Event Marker"
- Centralized Push Button Controls: "Sensitivity," "Paper Speed," "Calibrate," "Polarity," "Local-Remote"
- Pressurized inking system
- Paper Capacity: 1,000 ft. high gloss maximum contrast
- Paper Take-up: Reel standard, optional take-up assembly available
- Paper Drive: Zero weave, 8 or 16 speeds
- Calibration: Operate, zero, calibrate, attenuator
- Overload Indicator: each channel
- Timing Marker: one/sec or remote; second marker optional

Write, or see your local Offner Representative,  
for Bulletin O64-1039 on the Type SC Dynograph®

**Beckman®**

INSTRUMENTS, INC.

OFFNER DIVISION

SCHILLER PARK, ILLINOIS • 60176

INTERNATIONAL SUBSIDIARIES: GENEVA, SWITZERLAND; MUNICH, GERMANY; GLENROTHES, SCOTLAND; PARIS, FRANCE; TOKYO, JAPAN; CAPE TOWN, SOUTH AFRICA

provide subsidy so that water carriers can reduce their rates or improve their competitive position simply shifts part of the burden for recovering the full cost of transportation services from the user to the general taxpayer, a shift we do not believe is justified."

**Dwindling fleet.** The ailing U. S. merchant marine needs help if it's to compete with foreign carriers. Electronic control might be part of the answer. The U. S. merchant fleet has dropped from 5,000 cargo ships in 1945 to 983 in 1964, and now ranks number four in world shipping. The Soviet Union, which is presently building some 370 cargo carriers, is reportedly plying the more profitable trade routes at abnormally low rates to keep the market depressed. The Japanese, with the world's biggest cargo ships, run at rates American lines can't match but that the Dutch, Norwegians, West Germans, Colombians and Italians do.

**Ship-to-computer.** There is one other interesting seagoing tie-in for electronics. Lloyd's of London is going to use a computer for statistical studies of the world's shipping. It now has an IBM 1620 that analyzes data radioed from ships in trouble at sea and then radios the correct technical solution back to the ship.

## Space electronics

### Weather eye in the sky

The Weather Bureau plans to pay \$9 million to the Radio Corp. of America for five operational wheel-configuration weather satellites even though an experimental Tiros of this type has never been flown.

The first experimental launch is scheduled for October. The Weather Bureau's confidence is based on experiments conducted with the earlier Tiros 5, in which the spacecraft was turned to the position it would assume if it were flown as a wheel.

**Complete coverage.** In the new Tiros configuration, the spacecraft rolls on its side like a large wheel.

Earlier Tiros satellites were injected into an orbit that was inclined 58° to the equator, with cameras pointing down, providing 15% to 20% coverage of the earth's surface. The wheel satellite is placed into a near-polar orbit, with its two cameras perpendicular to the sides of the spacecraft. Since at least one camera is constantly facing the earth, the satellite can provide almost 100% coverage.

Digital circuits will be used on board the wheel Tiros because more computations are needed now than before, and integrated circuits are being contemplated to reduce weight and volume.

The experimental wheel has a flexible clock to permit 32, 64 or 128-second intervals between frames of weather pictures, and variable photo-storage capacities of 16, 32 and 48 pictures. The analog circuits used in the earlier Tiros satellites permitted only a fixed clock set at 32-second intervals between frames.

**Controlling spin.** A magnetic spin-control will speed up or slow down the spin rate to the programmed 10 revolutions per minute. The earlier Tiros had spin-up rockets that could only increase the rate.

The experimental wheel Tiros uses ½-inch vidicon camera tubes with 500-line resolution. The operational wheel will carry one-inch vidicons with 800-line resolution. Of the five operational wheels, three will carry redundant advanced vidicon camera systems

and the other two will have redundant automatic picture transmission systems that will provide cloud-cover pictures to ground stations throughout the world.

Telemetry transmitters aboard Tiros 9 and subsequent Tiros satellites will be solid state. RCA recently contracted with the Leach Corp. for new, more efficient solid-state telemetry transmitters that will operate from 215 to 260 Mc at 5 watts, vhf and fm. The previous eight Tiros spacecraft carried tube versions manufactured by Radiation, Inc.

### Guidance saves Saturn

A Saturn I rocket launching a boilerplate Apollo on May 28, was saved from failure by an active guidance system that was used for the first time.

For 40-seconds the missile had no eighth engine and no path-adaptive guidance. One of the eight engines in the first stage of the Saturn I failed to operate for its final 24 seconds, but the digital computer guidance system that was activated 16 seconds after second-stage ignition placed the giant booster back on course. The booster is designed to operate successfully with one engine out by lengthening the boost times of the other engines.

The launch became the first of the Saturn series to actively use a digital computer and an advanced, stabilized platform to guide it into orbit. The computer is a modifica-

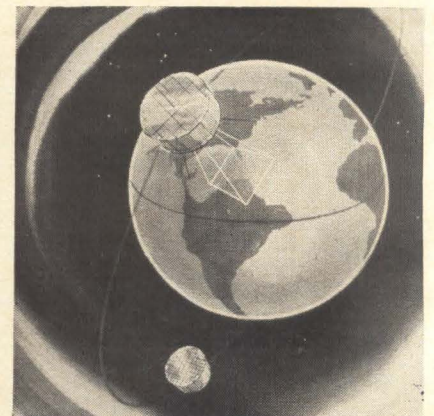
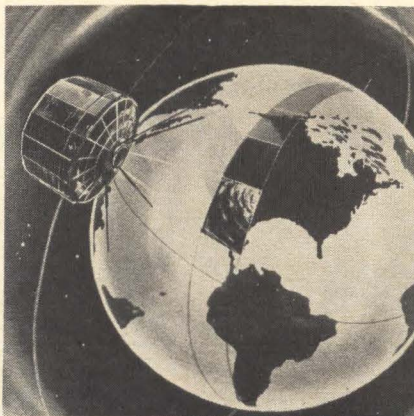

Tiros wheel satellite (left) allows one of its two cameras to constantly face the earth in near-polar orbit. Earlier Tiros cameras were useful for only half an orbit.

**"THE LIVES OF TWO MEN  
DEPEND ON THIS PART"**

says  
**Douglas Massey,**  
vice-president of  
**Beta Engineering,**  
Los Angeles, in  
explaining why they use  
**Levin high-precision lathes.**

Specific use of 1½ x ¾-in. forging (top) is classified, but men's lives depend on its precision. Companion part (bottom) requires counterbored hole.

Each of the miniature stainless-steel forgings, 1½ x ¾ inch in size, produced for use by a government agency requires a 0.04-inch-diameter hole drilled to highly precise tolerances. Inasmuch as the lives of two men depend on this part, consistent quality and precision are absolutely essential. After eight other companies had tried unsuccessfully to do the job, Beta Engineering solved the problem by using a Levin high-precision lathe with a deep-hole drilling attachment.

A companion part, produced on the same lathe, poses a different type of problem—a counterbored hole with a diameter of 0.125 inch for one inch and 0.060 inch for 1½ inch. Chief difficulty is that the 0.060-inch diameter is through an undercut only 0.125 inch in diameter.

Levin high-precision lathes are specifically designed for precise small-lot production of work too small for the usual engine or toolmaker lathe. Spindle speeds are continuously variable up to 4000 rpm. Precision collets of two types are available—5/16 inch (8mm) and 3/16-inch (5mm) maximum clear-through capacities. Levin also supplies a complete line of auxiliary attachments for use on Levin lathes and other machine tools. Contact the Levin dealer in your area or write for a complete catalog.

Levin lathes and auxiliary attachments have the built-in precision required to meet the exacting demands of the space age

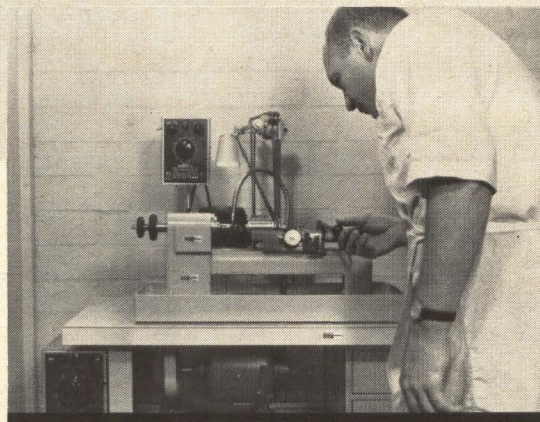
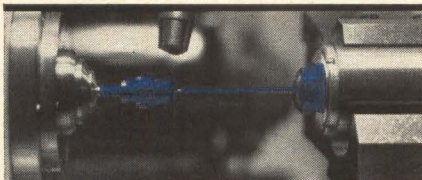

Easy to set up, easy to operate, Levin lathes are particularly useful in economical short-run production of high-precision parts.

# LEVIN<sup>®</sup>

**LOUIS LEVIN & SON, INC.,** 3573 Hayden Avenue, Culver City, California, (213) UP 0-9555.

Exclusive Dealers: **Russell-Holbrook & Henderson, Inc.,** New York and Los Angeles / **Industrial Tool & Supply Co.,** San Jose / **Marshall Tool & Supply Corp.,** Los Angeles / **Royal-Tschantre,** Baltimore / **Morton L. Friedman Co.,** Chicago / Plus dealers in all important Industrial Centers

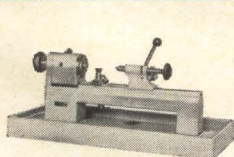

INSTRUMENT LATHE

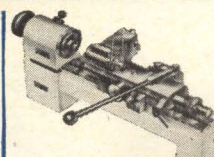

MICRO-DRILL

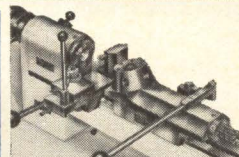

TURRET LATHE

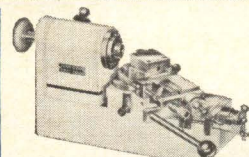

RADIUS TURNING

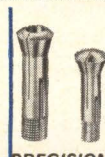

PRECISION COLLETS

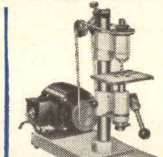

PRECISION DRILL

tion of the unit in the Titan II.

Earlier Saturn I flights used an autopilot system and carried an open-loop guidance system for flight-test evaluation. The major components of the active guidance system on the latest flight included an ST-124 stabilized platform and its electronics, a guidance signal processor and a digital computer.

The digital computer was an IBM ASC-15, which uses a 4.5-inch, 81-head magnetic-drum memory. The memory revolves 6,000 times a minute and has 47 semiconductor logic modules, each comprised of four welded encapsulated modules mounted on a common interconnecting base. Four panels hold the logic modules on one side, and the connecting wiring on the other. Together, the panels form the basic box shape of the computer with the memory in the center of the box. The error information from the analog instrumentation was fed to a signal processor that converted it to digital signals for the Saturn computer.

### Keeping track of EGO

The National Aeronautics and Space Administration has opened up three new tracking and data acquisition stations in the southern hemisphere. They are being readied for the launch of EGO, the Eccentric Geophysical Observatory, now set for July or August.

All three stations will use an old antenna that has been redesigned to do a new job. Located at Johannesburg, South Africa; Quito, Ecuador and Santiago, Chile, the new stations employ a 40-foot Philco Corp. dish similar to the one installed at the Mojave Station.

At the new sites, each antenna has three feed systems. Each station is equipped to receive 136 Mc with a 1-Mc bandwidth for general housekeeping and tracking, 400 Mc with a 1-Mc bandwidth to receive data telemetered from the observatory satellites and 1,700 Mc with a 10-Mc bandwidth to receive Nimbus' weather picture transmissions at S band. The stations are also equipped to handle X band. In addition to the three new stations,

85-foot dish stations at Rosman, N. C. and Fairbanks, Alaska will monitor EGO.

### Final round

Competition for a contract to build a unified S-band system for the Apollo space project has gone into the finals. The National Aeronautics and Space Administration has narrowed the field for the award—estimated at \$18-million—to the Collins Radio Co. of Dallas and the Philco Corp.'s Western Development Laboratory in Palo Alto, Calif.

Observers give Collins a slight edge for two nontechnical reasons. First, loss of the contract would require the company to lay off more than 100 engineers who are geared up to do the work. Also, Collins' location in Texas, rather than California, is considered a political advantage.

NASA would spend \$5 million for two complete tracking and data-acquisition systems, including 30-foot dishes and three electronic subsystems. Options for up to 10 additional complete systems and for up to 23 more electronic subsystems could add up to \$13 million more.

**Combining frequencies.** The project calls for placing on a single band all television, voice communications, command, tracking, and telemetry for the spacecraft.

In operation, the separate frequencies are combined into a coded carrier frequency and transmitted by a single antenna. The carrier is received by one antenna system and decoded into its individual signals. This is similar to the technique used on Mariner flights, but with the addition of voice and data channels Apollo needs.

The first two systems would be installed at the manned spacecraft tracking stations in Bermuda and Carnarvon, Australia. The electronic subsystems would go into the deep-space instrumentation facility at Goldstone, Calif., operated by the Jet Propulsion Laboratories of the California Institute of Technology, and to the monitoring and checkout station at Cape Kennedy. The third would be used to train.

# If you don't see this...

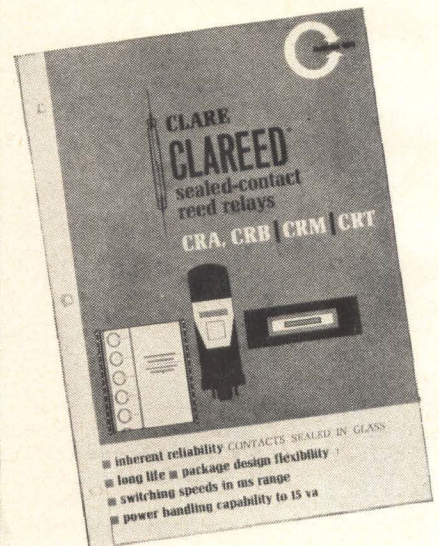

*Somebody's beat you to an informative 8-page bulletin on CLAREED Sealed-Contact Relays*

# but

## DON'T GIVE UP--WE'LL SEND YOU ANOTHER

*Just circle Reader Service Number below*



Circle 34 on reader service card

Report from

**BELL  
LABORATORIES**



The new TOUCH-TONE® telephone designed by Bell Laboratories. Instead of direct-current pulses from a rotary dial, alternating-current tones are generated by a transistor oscillator within the set and sent, over the voice channel, to the central telephone office.

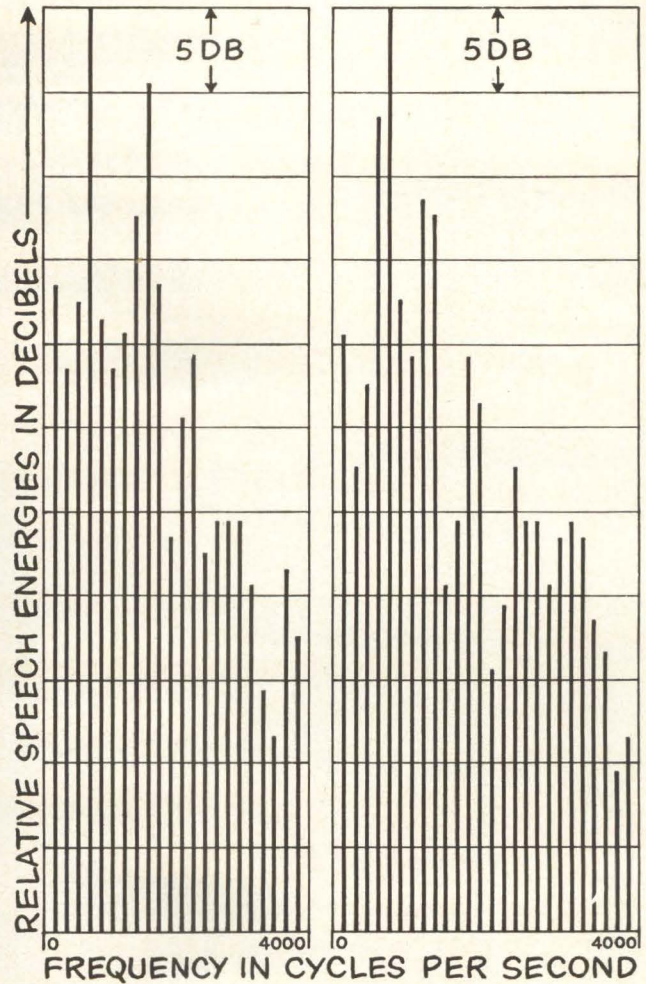

Fourier analyses of two 6-millisecond segments of male speech vowel sounds. Vertical bars show relative energies of successive harmonics of fundamental speech tones over approximate telephone transmission frequency band.

## TONES FOR A TELEPHONE WITHOUT A DIAL

In developing the new TOUCH-TONE® pushbutton telephone (above, left), engineers at Bell Telephone Laboratories faced a challenging problem.

The pushbuttons on the new telephone trigger audio-frequency signals, or audible "musical tones," that register telephone-number digits in the central office. But human voices produce highly complex patterns of speech energy throughout this same range of frequencies (above, right). The problem was to arrange the pushbutton frequencies and design the central office receiver in such a way that

automatic equipment would not misinterpret voices or room noises as digits.

Bell Laboratories people, drawing upon a fund of acoustical knowledge built up over years of research and development and upon the results of new experiments, found the solution in the use of multifrequency signaling tones for each digit.

The tones, selected from high and low frequency bands, are used in combinations that seldom occur in speech. In addition, compared to the tones, particular components of speech energy are usually much

less stable in frequency and much less uniform in amplitude. Also, speech energy is always made up of many frequency components, whereas the tones used in the TOUCH-TONE® telephone set are substantially pure.

By taking advantage of these characteristics of speech, Bell Laboratories engineers were able to design the signaling system to meet Bell System standards of accuracy and reliability. BELL TELEPHONE LABORATORIES. World center of communications research and development.



*If one of these 2  
GAF Ozalid Reproduction  
machines isn't perfect  
for your company...*

*one of these is!*



**PRINTMASTER® 810**...accommodates materials up to 42" wide. Printing and developing speeds up to 40 ft. per minute.



**PRINTMASTER 900**...accommodates materials up to 42" wide. Printing and developing speeds up to 75 ft. per minute. Just right for organizations requiring high quality copies at high production speed.



**STREAMLINER® 200**...accommodates materials up to 42" wide. Printing and developing speeds up to 14 ft. per minute. Perfect for companies with limited volume needs, or for those needing short runs processed without interrupting work on high-speed machines.



**STREAMLINER 400**...accommodates materials up to 42" wide. Printing and developing speeds up to 24 ft. per minute. Engineered for drafting rooms, architectural offices and agencies requiring large work sheets or massive charts.

Whatever the volume of your company's reproduction requirements, there's a GAF Ozalid whiteprinting machine to bring you all the economy of diazo copying—and all the quality, too. And all at a price to fit your budget.

Your GAF Ozalid Representative will gladly recommend the one that suits your needs. Write: General Aniline & Film Corp., Dept. DQ-8, Binghamton, N. Y.

**gaf** **OZALID**  
REPRO PRODUCTS  
GENERAL ANILINE & FILM CORPORATION  
BINGHAMTON, NEW YORK

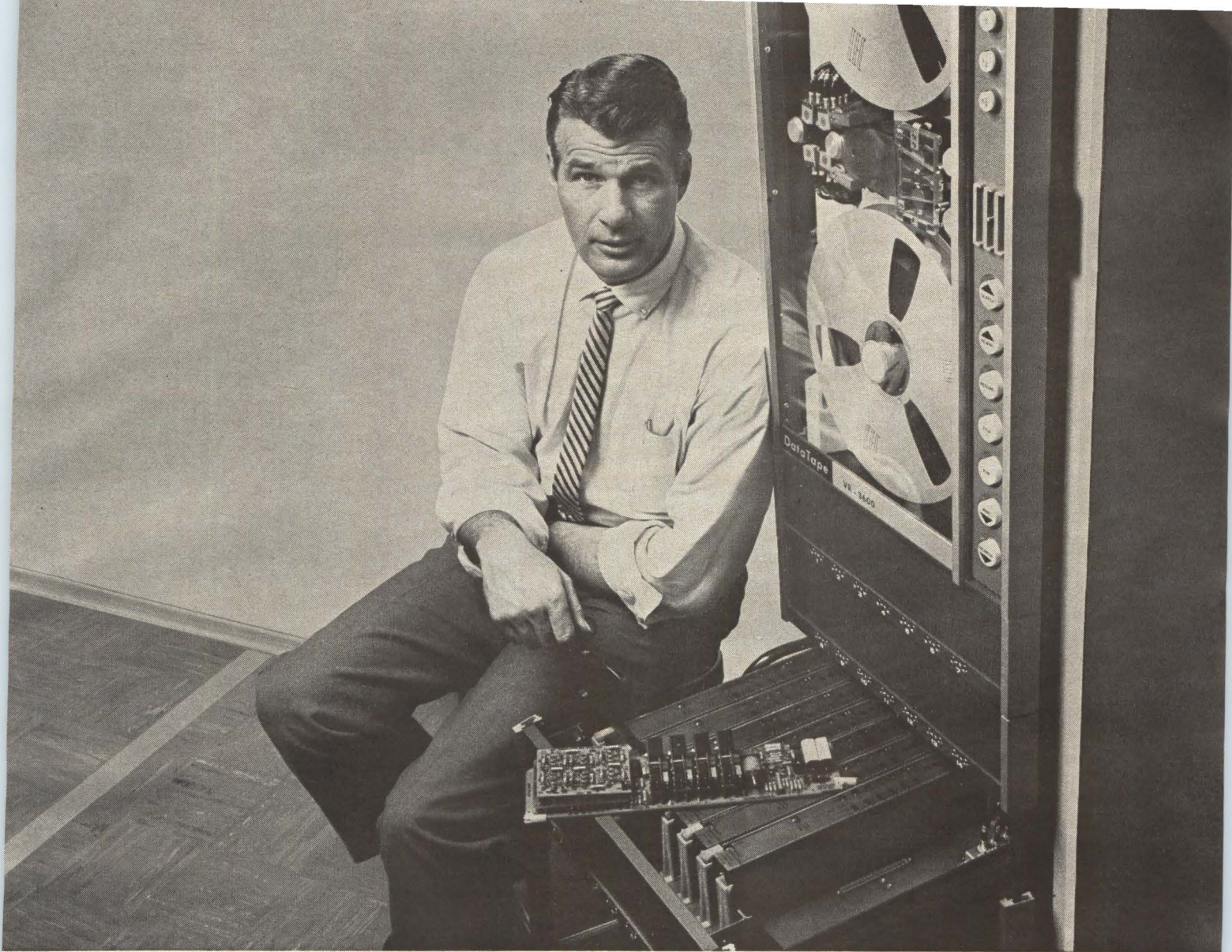

## Our customers asked for the best

### So we gave them the VR-3600

There is no other recorder/reproducer available today equal to the VR-3600. Its extremely wide bandwidth multi-channel system is superior in performance to any comparable instrumentation. In addition, the VR-3600 has the capacity to store vast amounts of data on a minimum amount of tape.

Consequently, the VR-3600 is now considered the ideal "universal" recorder—for the most demanding laboratory use or the storing of pre-and post-detection telemetry information. The following advantages will explain why.

- Each of its 7 or 14 record/reproduce channels can be used for data storage in the 400 cps to 1.5 mc frequency range.
- Signal-to-noise ratio is the highest; distortion the lowest.
- Record and reproduce amplifiers are

solid state; the direct system fully amplitude and phase equalized.

- Pushbutton selection of six transport speeds along with associated electronics.
- All-metal-front-surface magnetic heads are self-cleaning and exceptionally long-lived.
- Tape is constantly cleaned by vacuum/ionization; tension constantly maintained by closed-loop servo control.
- Tape transport skew is less than 0.5 usec; flutter less than 0.30% p-p at 120 ips.
- Automatic end-of-reel sensing stops tape without leaders; transfer switch provides start command for nearby recorder.
- Individual plug-in-equalizers (6 per amplifier) meet all specifications

simultaneously. Buy only those required, then set and forget.

- The system may be supplied in single or dual rack configurations, with or without a dolly.

For all the outstanding facts about the VR-3600, call CEC or write for Bulletin 3600-X6.



# CEC

Data Recorders Division

**CONSOLIDATED ELECTRODYNAMICS**

A SUBSIDIARY OF BELL & HOWELL/PASADENA, CALIF. 91109  
INTERNATIONAL SUBSIDIARIES: WOKING, SURREY, ENGLAND  
AND FRANKFURT/MAIN, GERMANY

Circle 45 on reader service card

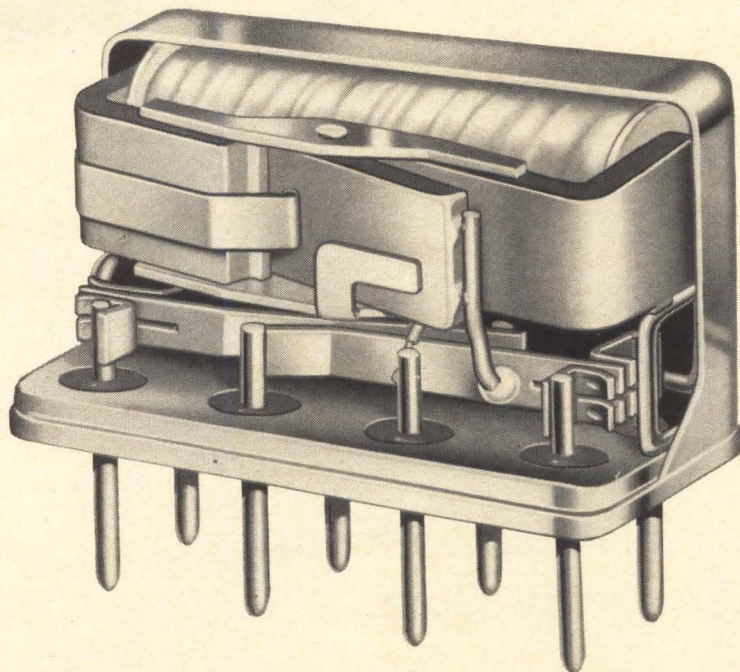

Location of Leach Electron Beam Weld is shown in this greatly enlarged cutaway illustration. Relays at the right are shown actual size.

**LEACH  
NOW  
WELDS  
HERE....**

**TO MAKE  
THESE**

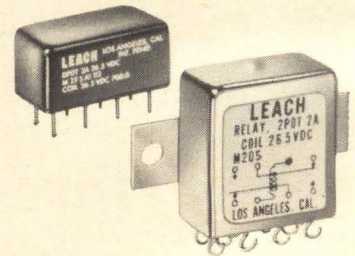

**BETTER**

Now all headers and cans on Leach crystal can relays are welded with the new Leach Electron Beam Welder. This advanced welding technique supplements other welding methods previously used in the manufacture of our miniature and subminiature relays. Now, with this new fabricating advantage, all of the smaller Leach relays become completely welded components.

This forward step offers many advantages. One of the most important is the elimination of the possibility of solder flux contamination.

The metals are fused together by a focusing electron beam with a power density of 38 million watts per sq. in. This forms a stronger joint, elimi-

nates hydrocarbons that could cause high resistance and malfunction of the actuating mechanism.

The higher melting point of a welded joint means you have a relay that works better at high temperatures. And studies prove that the new Leach Electron Beam Welder makes joints that hold up better under shock and vibration. So what? So you get a better relay. And that's what Leach is all about.

**LEACH**  
CORPORATION  
**RELAY DIVISION**

5915 Avalon Blvd., Los Angeles 3, Calif.  
Export: LEACH INTERNATIONAL S. A.



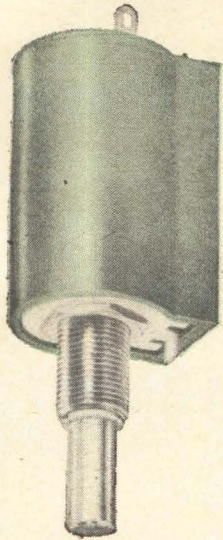

3

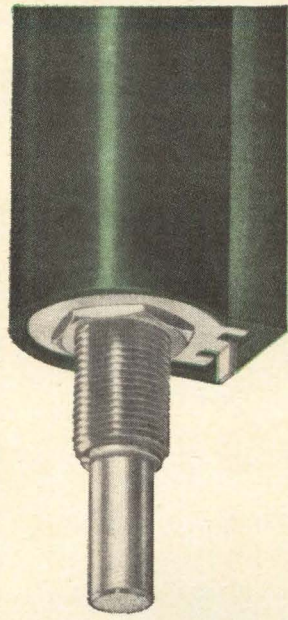

5

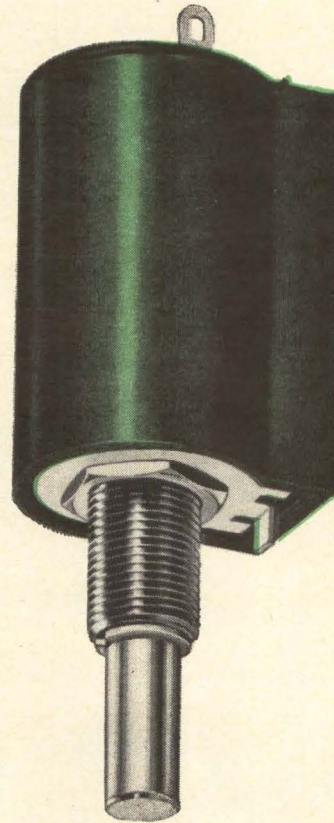

OR **10** TURN

PRECISION POTENTIOMETERS  
FOR AS LITTLE AS \$500 EACH

**series 62** multi-turn precision potentiometers will fill the bill for all your requirements in industrial and instrument applications . . . and the price is right! Check these outstanding features for a typical 10-turn model: ■ Absolute linearity —  $\pm 0.25\%$  ■ Resistance Tolerance —  $\pm 5\%$  ■ Power Rating — 2 watts @ 25°C ■ Dielectric Strength — 1000 V. rms for 1 minute at atmospheric pressure. Add to this, your choice of number of turns up to 10 and you've truly got top performance at lowest cost. Send today for complete details. . . .



**CLAROSTAT**

MFG. CO., INC. DOVER, NEW HAMPSHIRE

# high-speed

**Tektronix Oscilloscope with general-purpose convenience**

## Type 585A / 82 unit features

■ **Dual-Trace Operation** with 4 operating modes and independent controls for each channel—for individual attenuation, positioning, inversion, and ac or dc coupling as desired.

■ **Passband typically DC-TO-85 MC** (3-db down) at 100 mv/cm (12-db down at 150 Mc), and typically DC-TO-80 MC (3-db down) at 10 mv/cm.

■ **Calibrated Sensitivity in 9 steps** from 100 mv/cm to 50 v/cm, and in *10X Amplifier Mode*, from 10 mv/cm to 5 v/cm, variable between steps.

■ **Internal and External Triggering** to 150 Mc.

■ **Sweep Range from 10 nsec/cm** to 2 sec/cm.

■ **Single-Sweep Photography** at 10 nsec/cm.

■ **Calibrated Sweep Delay** from 2 microseconds to 10 seconds.

■ **Bright, High-Resolution Display** with small spot size.

■ **Conventional Passive Probes** for convenience.

**plus**

■ **Compatibility with 17 Letter-Series Plug-Ins** to permit differential, multi-trace, sampling, other laboratory applications—when used with Type 81 adapter.

Type 585A Oscilloscope . . . . . \$1725

Type RM585A Oscilloscope . . . . . \$1825

Type 581A Oscilloscope . . . . . \$1425

No sweep-delay capabilities, but other features similar to Type 585A.

Type 82 Dual-Trace Unit . . . . . \$ 650

Type 86 Single-Trace Unit . . . . . \$ 350

Type 81 Plug-In Adapter . . . . . \$ 135

Allows insertion of 17 Tektronix letter-series plug-ins. Band-width (up to 30 Mc) and Sensitivity depend upon plug-in used.

U.S. Sales Prices, f.o.b. Beaverton, Oregon

**For a demonstration, call your Tektronix Field Engineer.**

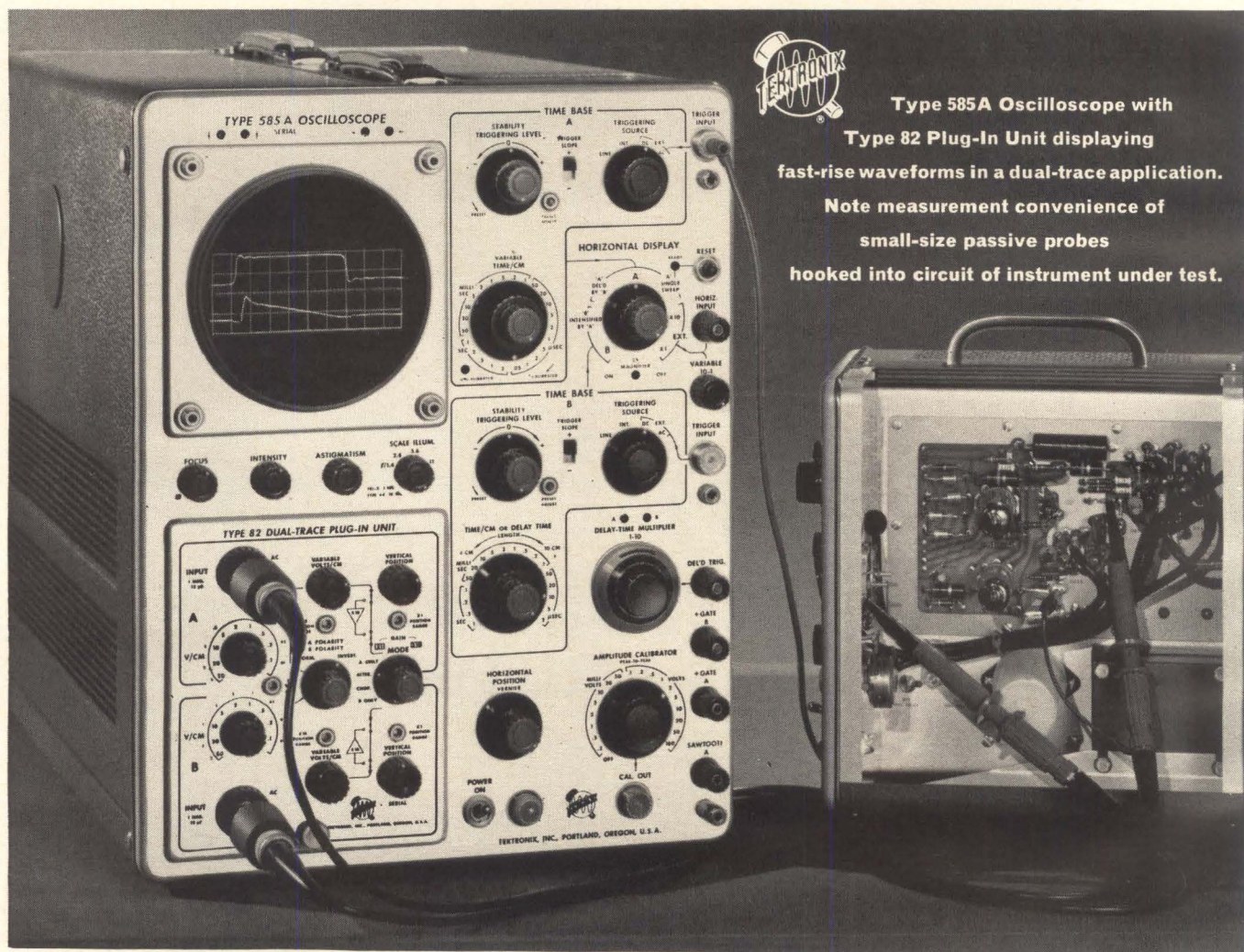

**Type 585A Oscilloscope with Type 82 Plug-In Unit displaying fast-rise waveforms in a dual-trace application. Note measurement convenience of small-size passive probes hooked into circuit of instrument under test.**

**Tektronix, Inc.**

P.O. BOX 500 • BEAVERTON, OREGON 97005 • Phone: (Area Code 503) Mitchell 4-0161 • Telex: 036-691  
 TWX: 503-291-6805 • Cable: TEKTRONIX • OVERSEAS DISTRIBUTORS IN 25 COUNTRIES  
 TEKTRONIX FIELD OFFICES in principal cities in United States. Consult Telephone Directory

Tektronix Australia Pty., Ltd., Melbourne; Sydney • Tektronix Canada Ltd., Montreal; Toronto

Tektronix International A.G., Zug, Switzerland • Tektronix Ltd., Guernsey, C. I. • Tektronix U. K. Ltd., Harpenden, Herts

FORMICA® is our trademark for various products,  
including our brand of industrial plastics.

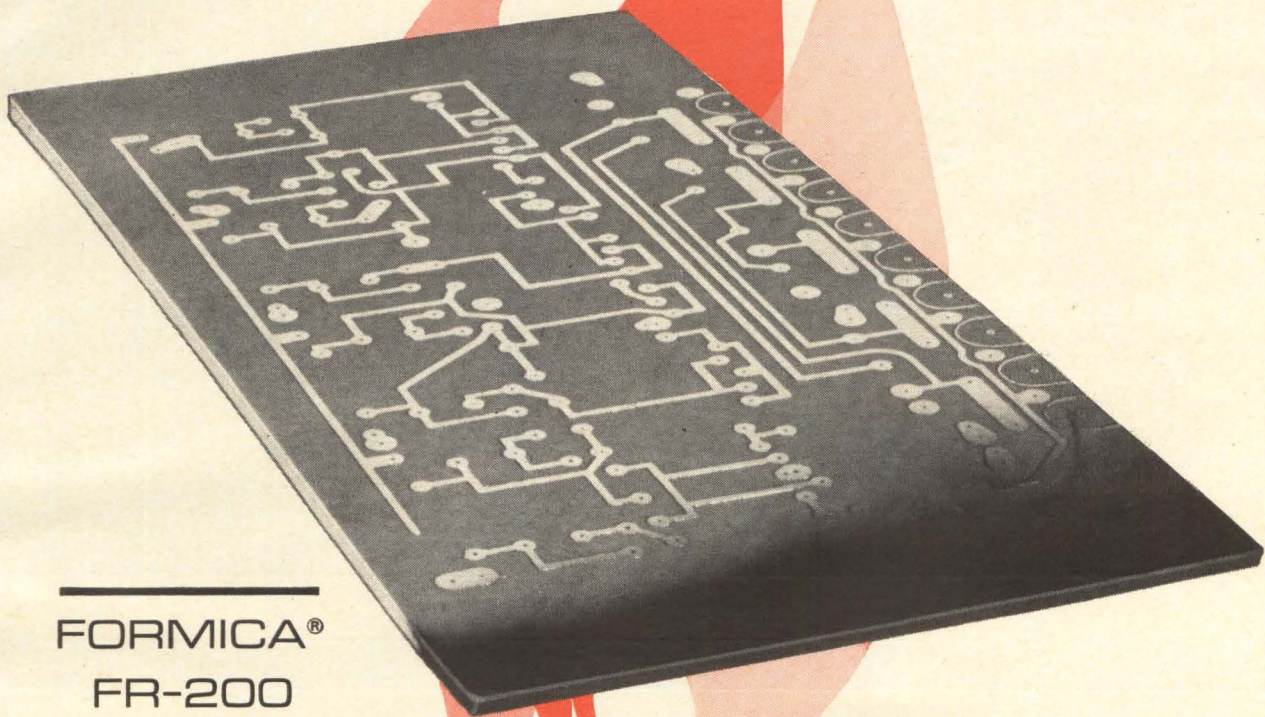

---

FORMICA®  
FR-200

---

• **Flame retardant • High strength • No premium price**

FORMICA FR-200 paper-phenolic laminate . . . for flame retardant printed circuitry. NEMA grade FR-2. Meets properties of MIL-P-3115C. Burn time: 4 sec. (ASTM D635-65 test modified to show burn time after 1st ignition.) High flexural strength (flatwise average value: 21,500 psi lengthwise, 17,500 psi crosswise.) Excellent insulation resistance. High solder blister resistance . . . in excess of 15 sec. at 500 °F. Good solvent resistance: 10 min. in trichloroethylene. Can be punched cold up to and including  $\frac{1}{16}$ " , warm (140° to 180 °F) up to and including  $\frac{3}{32}$ ". Available copper clad or unclad. And you pay no more for FORMICA FR-200 than you would for a top-quality XXXP grade.

WRITE FOR DATA ON:

- Electrical /electronic grades
- Copper clad laminates
- Mechanical grades
- Engraving stock

FORMICA CORPORATION  
DEPARTMENT I-423, CINCINNATI 32, OHIO  
subsidiary of 



**FORMICA®**  
industrial plastics

See The Formica World's Fair House at New York for the newest and best in carefree contemporary living.

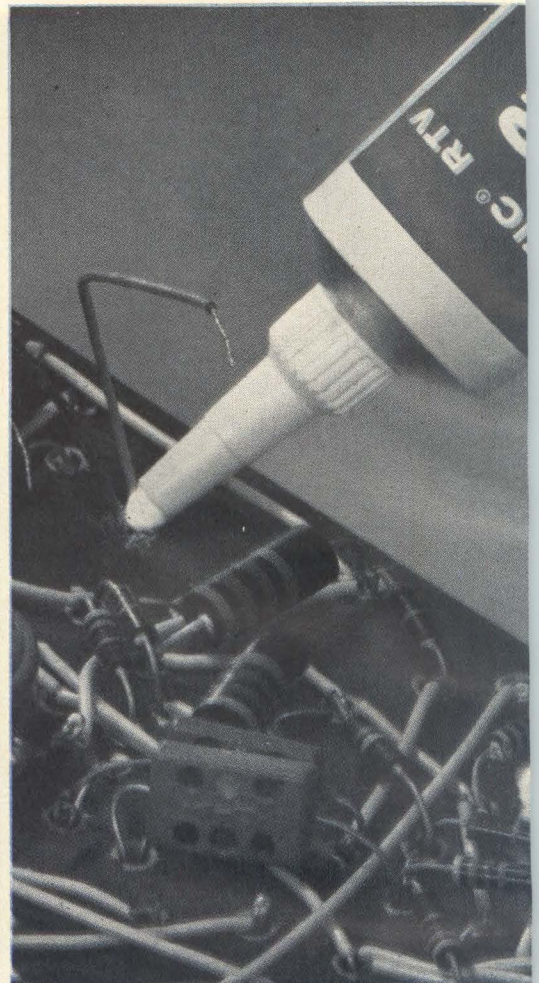
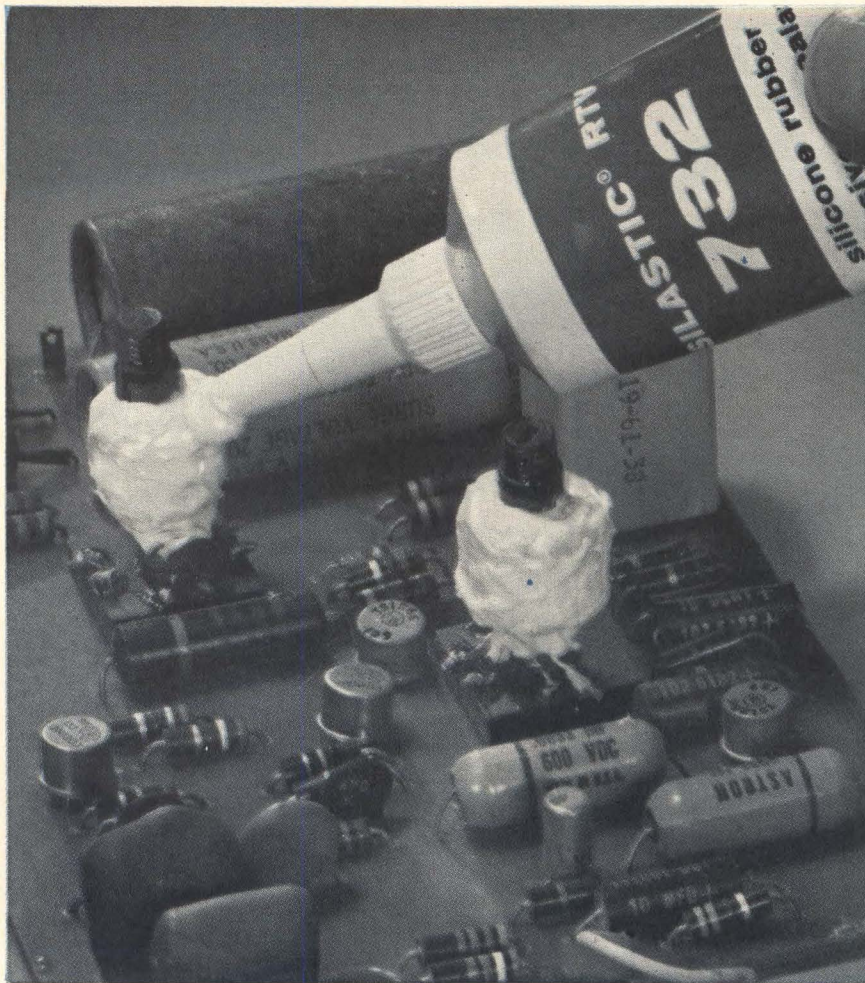

## News Briefs

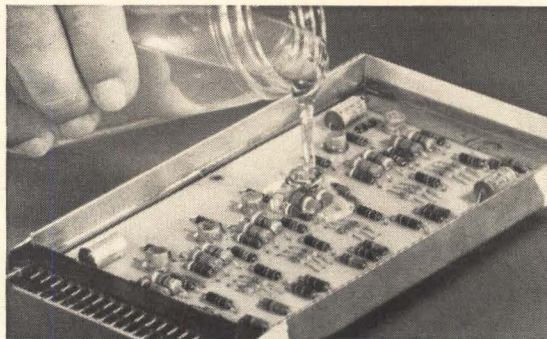

**To package and protect** heat-sensitive components, specify Sylgard® 184 resin, a colorless, solventless silicone. Designed for potting, filling, embedding and encapsulating electronic circuits, it is applied as a low viscosity fluid . . . cures at room temperature without exotherm . . . forms a transparent, resilient embedment that permits visual inspection of components and circuits. When necessary to repair or replace defective components, Sylgard 184 resin can be cut away, then replaced with new material. Tensile strength from 800 to 1000 psi and long service life at operating temperatures of -65 to 200 C assure circuit integrity.

CIRCLE 290 ON READER-SERVICE CARD



**Designed specifically** to meet the requirements of MIL-I-8660A, Dow Corning® 4 compound retains its grease-like consistency and electrical properties over the broad temperature range of -60 to 205 C (-70 to 400 F) . . . won't dry out or harden. Used as a moisture-proof dielectric seal for connectors, terminations, toroids, many other components. Dow Corning 4 compound features low loss factor; seals out corrosion and corona, increases surface resistivity of plastic parts. Can be applied to dry metals, ceramics, rubber, other insulating materials.

CIRCLE 291 ON READER-SERVICE CARD

## Ready-to-use silicone rubber encapsulates, seals, bonds . . .

Silastic® 732 RTV silicone rubber is a tough, squeeze-on adhesive/sealant that stays where you put it — on metal, glass, plastics, rubber and many other materials. It bonds, waterproofs and insulates . . . cures at room temperature in 24 hours to a solid rubber.

Silastic 732 RTV rubber stays flexible at temperatures from  $-60$  to  $260$  C ( $-85$  to  $500$  F), has excellent electrical insulating properties and resists weathering, moisture, corona.

Use this easy-to-apply non-shrink adhesive/sealant to bond wires, seal connectors, splice and repair cable and lead wires, to seal radome and antenna enclosures, to dust-proof cabinets and housings. Where vibration, flexing or differential expansion between parts is breaking bonds or opening seals, specify Silastic 732 RTV silicone rubber. If color coding is a consider-

ation, Silastic 732 RTV rubber is available as a translucent material as well as in black or white.

For a free sample of this material write on your letterhead indicating intended use.

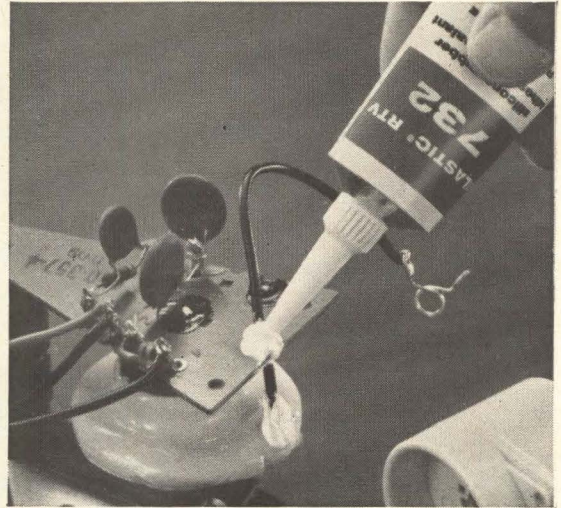

CIRCLE 289 ON READER-SERVICE CARD

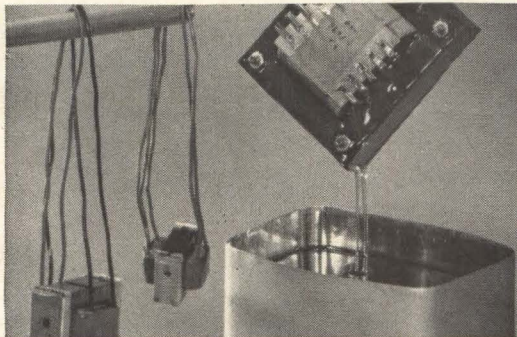

Sylgard® 1377 varnish is an easy-to-process thermally stable impregnant designed specifically for electronic applications. Applied by dipping, flooding or vacuum impregnation, it assures added reliability for devices such as transformers and reactors, control actuators, servo mechanisms, gyro motors. When specified for equipment designed to operate at temperatures to  $200$  C, it assures high bond strength, resistance to chemicals and repellency to moisture. Sylgard 1377 varnish offers the optimum balance of properties, simplified processing and flexible cure schedules.

CIRCLE 292 ON READER-SERVICE CARD

We'll be pleased to forward full information on these and other materials that aid reliability and performance. Just write Dept. 3906, Electronic Products Division, Dow Corning, Midland, Michigan.

## Dow Corning

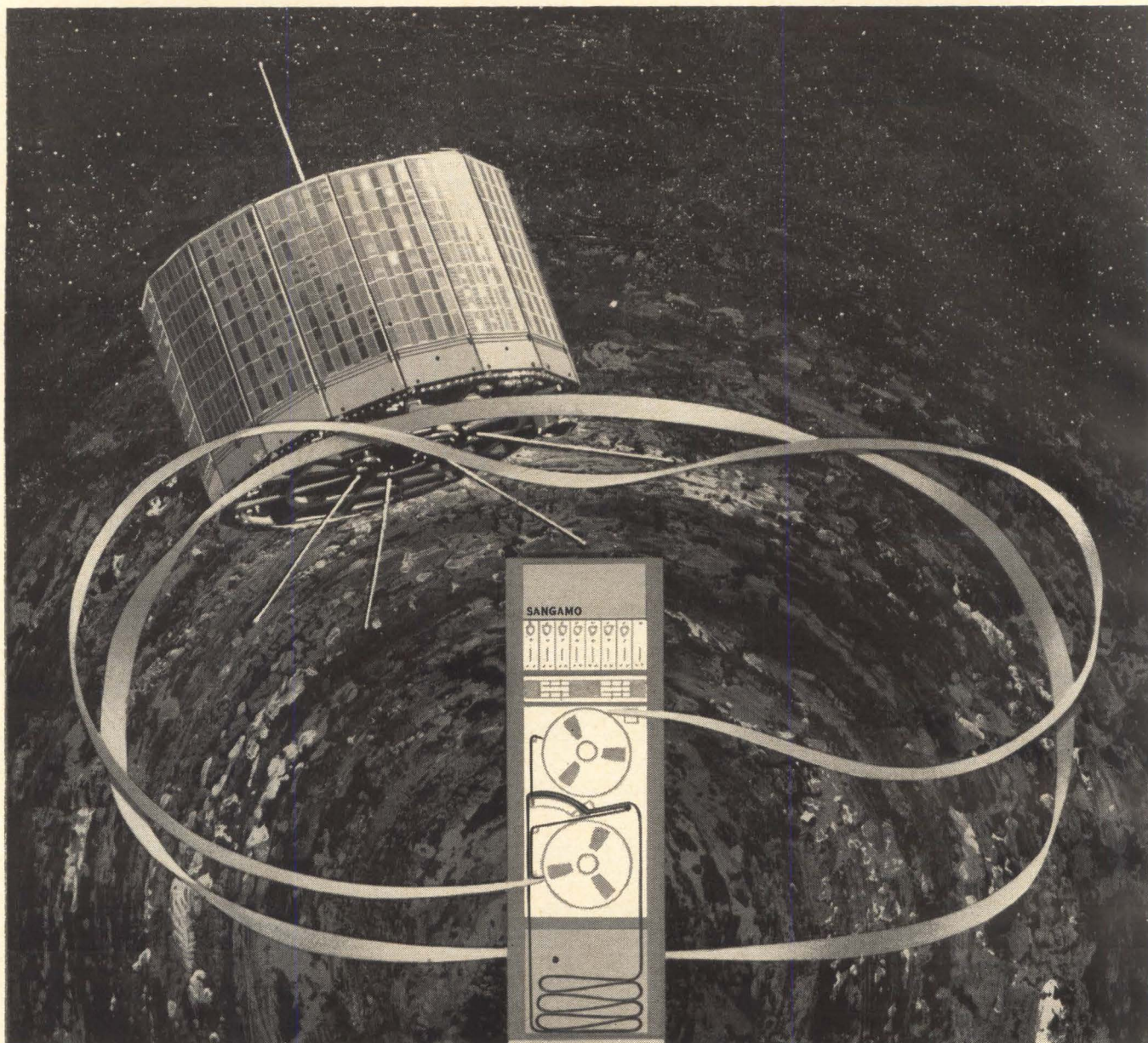

Another Sangamo first in Magnetic Tape Flexibility

## NOW THE SANGAMO 4700 HANDLES BOTH 1" AND 1/2" TAPE SIMULTANEOUSLY

**Record or Reproduce either width without mechanical or electrical changes.**

Make continuous loop dubs from original tapes on one recorder. Operating at your choice of 8 electrically-selected tape speeds, Sangamo 4700 now has an optional feature which allows you to handle two different tape widths at the same time. One width operates in reel-to-reel mode . . . the other width operates as a continuous loop.

Flexibility is unparalleled. Without time-consuming mechanical or electrical changes—without even changing heads or guides—the 4700 will handle 1/2" or 1" tape, either on reels or in a loop.

The Sangamo 4700 is unique in analog tape instrumentation. Its light mass capstan drive and unmatched servo speed control provide unsurpassed data accuracy in FM (DC to 20 KC) and Direct (300 to 300,000 cps) ranges.

Be sure to investigate the 4700 for general recording applications and the 480 time delay magnetic tape recorder/reproducer for auto- and cross-correlation applications.

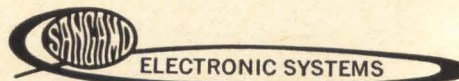

ES64-1

**SANGAMO ELECTRIC COMPANY**  
SPRINGFIELD, ILLINOIS

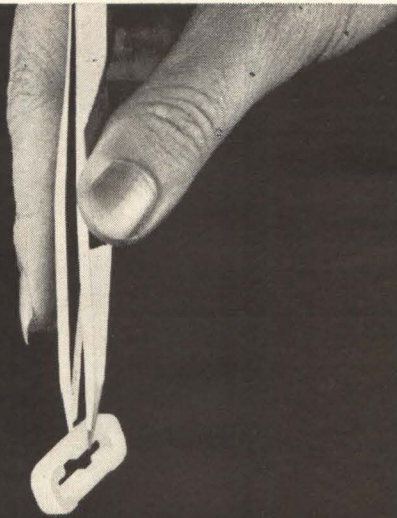

## What good is a getter?

*Babcock uses them to increase relay reliability.*

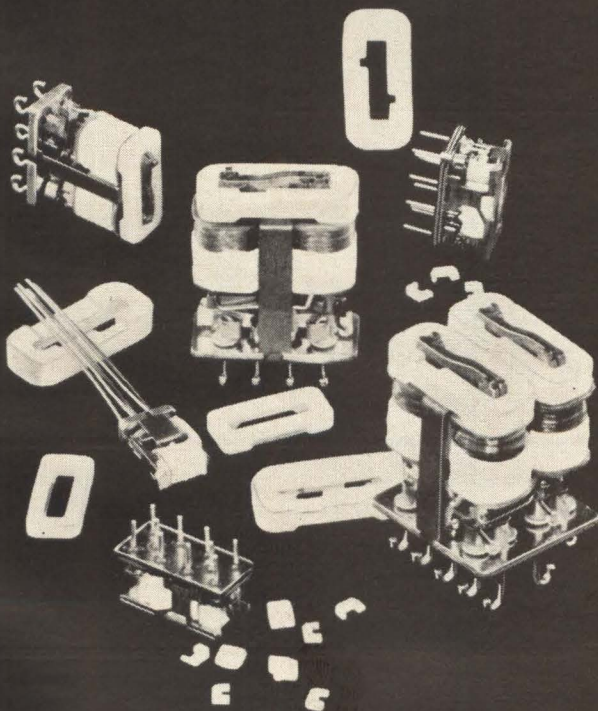

### Exclusive Babcock Design Feature Provides Lower Contact Resistance & Longer Relay Life

Contact contamination from vaporization is one of the major causes of erratic performance and eventual failure of hermetically sealed relays. After extensive investigation Babcock Relays, in conjunction with Corning Glass Works, has developed an activated getter from Corning's Vycor brand porous glass. During operation, the activated getters prevent relay contacts from being fouled by contaminants emitted at elevated temperatures. Babcock has subjected relays using Vycor getters to hundreds of thousands of operations at loads varying in excess of 200G's for 11 milliseconds and vibration at 35G's, 3-5,000 cps. It has been determined that up to 99% of organic contaminants remaining after production degassing are adsorbed by the dessicant. Conclusive life testing at 125°C has proven that contact erosion and contamination accumulation on all vital areas within hermetically sealed relays has been substantially reduced. Consistently lower contact resistance is also exhibited due to the reduction in contamination.

The end result provides Babcock relays with increased performance and efficiency, higher temperature application, and longer, more reliable life.

Babcock reliability rated relays featuring Vycor getters include:



BR-5—Transistor-sized dry circuit to one amp



BR-13—Microminiature, all-welded for dry circuit to 3 amp



BR-17—Half-size magnetic latching for dry circuit to 2 amp operation. Also available as non-latching model.



BR-14—Subminiature 4 PDT available in 10, 7.5 and 5 amp



BR-19—Subminiature all-welded 10 amp relay. BR-20 magnetic latching version also available.

Booth 2808—IEEE

# BABCOCK RELAYS

A DIVISION OF BABCOCK ELECTRONICS CORPORATION  
3501 HARBOR BLVD., COSTA MESA, CALIF. • 546-2711

# PAR excellence in a digital voltmeter

## *It's small*

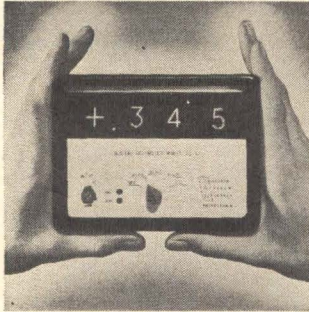

The new PAR Model CS-3.1 represents a breakthrough in reducing the size of digital voltmeters. The size reduction has been achieved without compromising the outstanding operating characteristics of this unit.

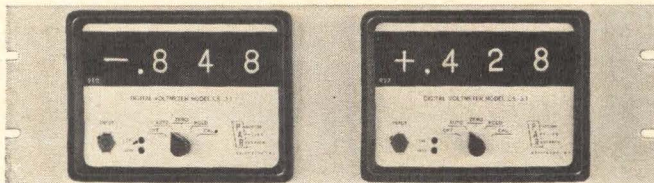

It is only 6½" wide, 5" high and 8¾" deep. Weighs but 9 lbs. Two units can be mounted in a 5¼" rack panel without any modification or special mounting hardware. Individual units can be used as digital panel meters.

## *It's reliable*

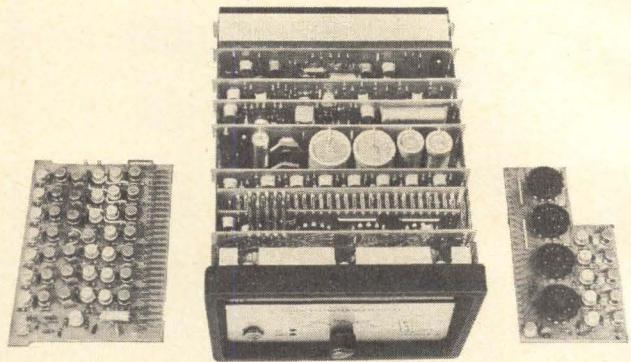

Completely solid state electronic circuitry except for two miniature nuvistor tubes at the input stage of the comparator to obtain high impedance input. High reliability dry-reed relays are used to switch the attenuators, for automatic ranging, automatic polarity, and amplifier stabilization. Long service free life is assured by use of glass epoxy boards, aged zener references, rugged plug-in printed circuit construction, and long life nixie tubes.

## *It's versatile*

The CS-3.1 digital voltmeter can be used in many applications. Ranging is automatic. Polarity indication is automatic. It is available with ten line decimal coded output for digital print-out. It may be used with an associated remote readout. Balancing time is from 0.15 to 3.15 seconds, depending on the change of range. Sensitivity is 1 millivolt. Accuracy is  $\pm 0.1\%$   $\pm 1$  count.

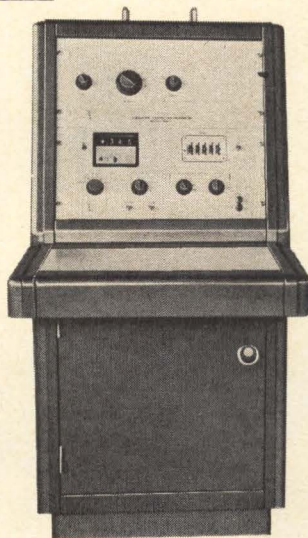

## *It's loaded*

Truly floating and guarded differential input circuit permit differential voltage measurements with guard floating up to  $\pm 500$  volts DC with respect to chassis, which is at power line ground.

Common mode rejection is greater than 100 d.b. Input impedance is a minimum of 10 megohms at all times.

Openings exist for permanent positions in our R. and D. Dept. Write to the attention of the personnel director.



Write for bulletin no. 107D to:

**PRINCETON APPLIED RESEARCH CORP., Box 565, Princeton, N. J., Tel: 799-1222, Code 609**



# new developments in "GPR" relays

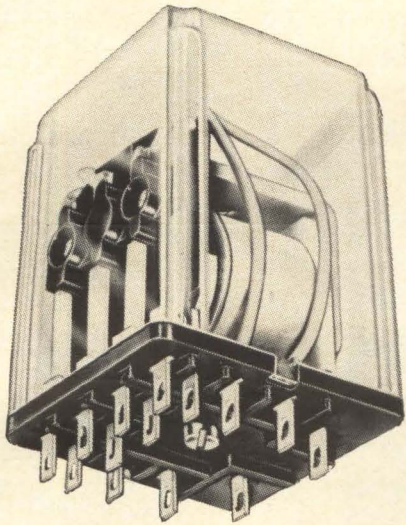

## The only available 4-pole unit in this type of relay

For the first time, you can get the *extra circuit-handling* capability of a 4PDT combination in a good quality, economical, compact relay of this type. This is made possible by the unique design of Ohmite GPR relays which locates *all terminals* (including coil terminal) on *one panel*. Terminal panel meets UL spacing requirements for 150 volts.

The 4PDT model is currently *stocked for immediate delivery* as open or enclosed units with 5-amp or 10-amp contacts—regular models, plate circuit types, and for thyatron (2050, 2D21) plate circuits. Coil operating voltages range from 6 to 230 VAC and 6 to 110 VDC. (BULLETIN 707)

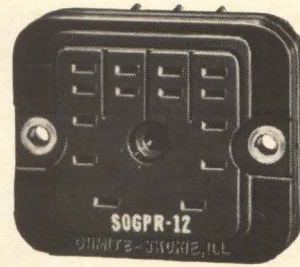

SOCKETS UP TO 4-POLE MEET UL TERMINAL SPACING REQUIREMENTS FOR 150 VOLTS.

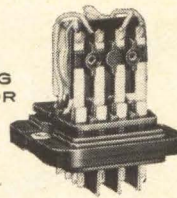

## Low cost, plug-in sockets

Here's the welcome convenience of a plug-in connection for the Ohmite line of GPR relays. SOGPR sockets accommodate all standard 4PDT models, and UL approved models up to 3PDT—both the open and enclosed types.

Firm, snug mounting is assured even under conditions of vibration and shock by means of a hold-down spring, which can be used at your option, or as the application demands.

The solder terminals on the new sockets are the Ohmite multi-use type, and will accept AMP110 quick-connect (push-on) connectors. SOGPR sockets are carried in stock for *immediate delivery*.

(BULLETINS 706 and 707)

## OHMITE "GPR" RELAYS ARE LOADED WITH PROBLEM-SOLVING FEATURES

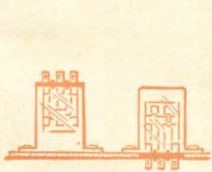

**CHOICE** of below-chassis or above-chassis connecting in plastic enclosures.

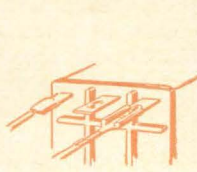

**MULTI USE** terminals allow soldering, insertion in printed circuit board, and use of AMP Style 110 push-on terminals.

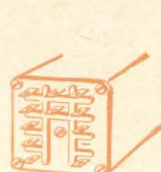

**ALL TERMINALS** on one panel . . . permits insertion in printed circuit board.



**OCTAL PLUG** relays up to DPDT have recessed pin bases . . . meet UL spacing requirements to 150 V.



**ALL ENCLOSED** relays mount solidly on base . . . not on covers.



**INTEGRAL** plug-in base up to DPDT avoids wiring between contact terminals and pins.

Call Your Distributor or Write for Complete Relay Catalog 700



RHEOSTATS • POWER RESISTORS • PRECISION RESISTORS • VARIABLE TRANSFORMERS  
TANTALUM CAPACITORS • TAP SWITCHES • RELAYS • R.F. CHOKES • SEMICONDUCTOR DIODES



**OHMITE**  
MANUFACTURING COMPANY  
3610 Howard Street, Skokie, Illinois 60076  
Phone: (312) ORchard 5-2600



TIPS (Technical Information & Product Service)

## FIVE NEW DEVELOPMENTS

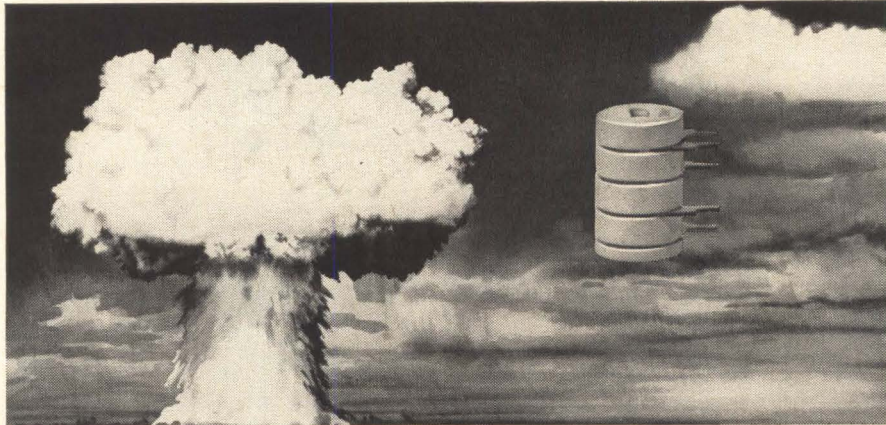

### CERAMIC TUBES OPERATE AT $3 \times 10^{18}$ NVT; UPPER TOLERANCE LIMIT STILL UNKNOWN

Ceramic tubes have a demonstrated capability of withstanding at least  $3 \times 10^{18}$  nvt, and the upper limit of this capability is still not known.

Ceramic tubes' high tolerance to nuclear radiation makes them highly attractive to the aerospace system designer. Electronic portions of these systems are susceptible to damage both from high ambient temperature associated with the vehicle mission profile and from radiation effects associated with the space environment, on-board reactors, or weapons effects. In a nuclear explosion, the transient—pulse—effect of gamma rays or neutrons is troublesome to many electronic systems.

The ability of ceramic tubes to withstand the high nuclear radiation levels to which aerospace systems will be subjected has been demonstrated with factual data taken during the many radiation tests to which these tubes have been subjected. For example, General Electric 7296 triodes were irradiated during May of 1961 and subjected to 140 hours of nuclear radiation exposure with the reactor operating at 2 megawatts. The General Electric ceramic tube circuits were functioning properly at the termination of the test. The average thermal neutron flux during the run was  $6.4 \times 10^{12}$  neutrons/cm<sup>2</sup>/sec. and the integrated

flux was  $3.2 \times 10^{18}$  neutrons/cm<sup>2</sup>. The integrated fast neutron flux ( $E > 2.5$  Mev) was  $2.0 \times 10^{18}$  neutrons/cm<sup>2</sup>.

In October, 1962, fifteen General Electric ceramic triodes were irradiated in the Air Force Ground Test Reactor. The ceramic tubes showed no measurable changes in operation or characteristics during and after receiving a total integrated flux of more than  $1 \times 10^{17}$  nvt. The reactor was operated for 128 hours, achieving a 3-megawatt level at 20 hours. TIMM (Thermionic Integrated Micromodule) tubes, constructed from the same basic materials used in G-E ceramic tubes, were irradiated under a joint GE-USAF program. During the 190 hours of operation the tubes were subjected to a total integrated dose in excess of  $3 \times 10^{18}$  nvt and the tube characteristics showed no appreciable change.

We believe that G-E ceramic tubes are capable of operation to  $10^{20}$  nvt or more, and know from past experience that they need not be shielded from either fast or thermal neutrons nor do they deteriorate when high-level gamma heating is present, provided that cathode temperature is held within reasonable ratings. These tubes are the most radiation-tolerant electron devices known to the electronic components field.

### 38 G-E Tubes Now Have Long-Life Rhenium Heaters

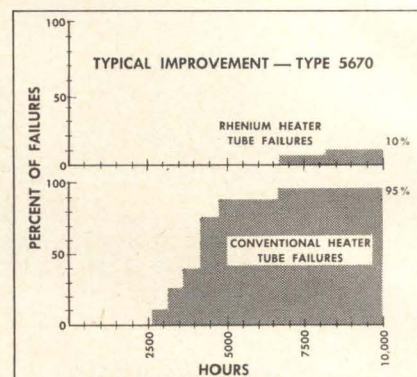

Life tests of 10,000 hours under difficult conditions—in high ambient temperature and with the heaters negative with respect to the cathodes—gave the typical results shown above. The first open heater occurred in the tubes with conventional heaters at 2700 hours, and in the tubes with rhenium-tungsten heaters at 6300 hours. At 10,000 hours this grueling test had destroyed 95 percent of the conventional tubes, but only 10 percent of the rhenium-tungsten heater tubes.

Another test showed that rhenium-tungsten heaters in the type 5696-A small thyratron, used in a difficult, computer switching-circuit, more than tripled tube life.

The reason behind these outstanding test results is that rhenium-tungsten wire has less tendency to break or twist over a period of time under stresses of alternate expansion and contraction from thermal cycling as power is turned on and off. The alloy wire also has a higher electrical resistivity than the wire customarily used in tubes. Its use permits either a larger filament wire size or a shorter filament length—whichever may be the most advantageous.

In addition to the types mentioned above, rhenium now is used in the 1B3-GT, 1A2D, 1A2L, 1G3-GT, 1J3, 1K3, 2DF4, 6AK5, 6AK5WB, 6D10, 6DT8, 6EZ8, 6GY8, 12AT7, 12AT7WA, 12DT8, 19EZ8, 30AG11, 5654, 5725, 5751, 5814A, 6072-A, 6111, 6112, 6201, 6386, 6679/12AT7, 6829, 7077, 7462, 7486, 7720, 7910, 8082, and 8083.

# IN ELECTRONIC TUBE APPLICATION

## G.E. Conquers UHF Snivets With 38HE7

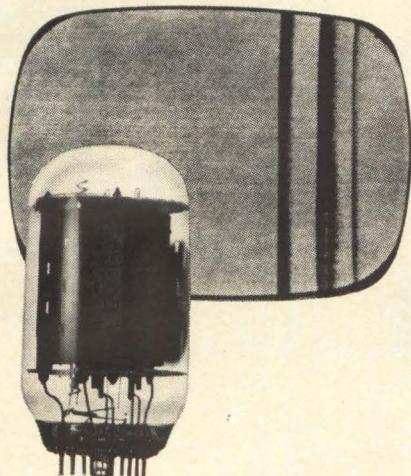

The wobbling, blurry, vertical trail of a snivet on the face of a picture tube usually indicates Barkhausen oscillation in the horizontal output tube. It results from a certain combination of voltage relationships within the tube.

UHF snivets reared their ugly heads "en masse" when two things came to pass in the last year: (1) the low B+ in television sets—140 volts instead of 270—and (2) the rule that all television sets must include UHF tuners, thus offering a "doorway" to Barkhausen oscillations.

With the older, higher B+ sets, a circuit designer could get all of the performance he needed without driving down into the voltage conditions conducive to snivets. However, with only 140 volts, the tube must be driven lower in anode voltage for comparable performance.

The General Electric Tube Department designed the 38HE7 specifically to minimize UHF snivets without the expense of providing unusual voltages to the beam plates. You'll be seeing a lot of these tubes in the new all-UHF television receivers.

An added value in the 38HE7 is that it includes the damper diode as well as the horizontal output pentode—thus combining two tough functions in one envelope, saving space and reducing costs.

## Versatile Ceramic Tubes Offer High Performance In Small, Regulated Power Supplies

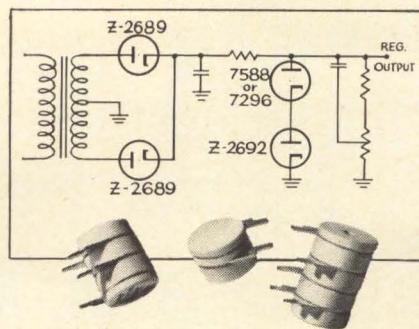

Small, versatile, ceramic receiving tubes offer unique characteristics not only at C and X bands, but also for direct current and audio applications. With transconductances up to 50,000 micromhos, these tubes are excellently suited for regulated power supplies.

Small ceramic tubes can handle voltages in the area up to 1000 volts or so. They're ideal for difficult environments and for applications such as traveling wave tubes, backward wave oscillators, klystrons and voltage tunable magnetrons. High transconductance and high voltage make the small planar triodes particularly useful where DC drift and ripple can cause serious frequency drift and/or modulation. Developmental samples have been operated satisfactorily up to about 600°C., with suitable reductions in heater power.

Types are available for every regulated power supply function (including a ceramic voltage reference tube). At 250 and 350 volt levels, high-level regulation has been obtained with high current loads. Ceramic tubes offer exceptional advantages in regulated power supplies for the higher voltage applications requiring only a few milliamperes of current. Small size of the tubes and their tolerance to heat contribute to permitting extremely small, ruggedized, lightweight power supplies as contrasted with the bulkiness of most supplies now in use for such purposes.

## Conduction Heated Cathodes Show Many Advantages

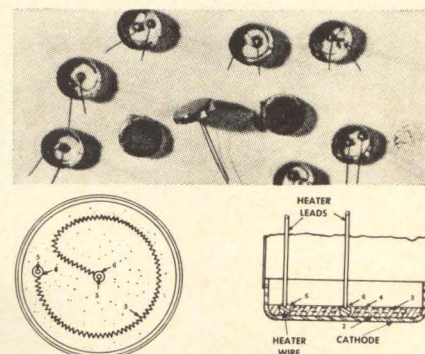

The cathodes of most receiving tubes are heated by radiation from a red-hot heater. General Electric tube engineers have done considerable development work on a new approach to the problem of heating cathodes. They are trying out "conduction heated cathodes" in the small ceramic tubes—wherein the heater wire is bonded directly to the cathode with a ceramic coating.

Apparent advantages:

1. Fast warm-up—as low as 2.1 seconds has been achieved.
2. High current density attained in the cathode.
3. Less power used to heat the cathode—thus greater efficiency in overall tube operation.
4. Less chance for contamination which could lead to heater failure—because heater and cathode are sealed together in the ceramic coating.
5. Heater and tube operate at a lower temperature (approx. 800°C. vs. 1400°C., for the heater).
6. Higher tolerance to vibration because the heater wire is sealed tightly and cannot vibrate by itself.

*Progress Is Our Most Important Product*

**GENERAL ELECTRIC**

For more information, write G-E Tube Department, TIPS, Room 7008, Owensboro, Ky. Be sure to specify product(s).



**SIZE 15**

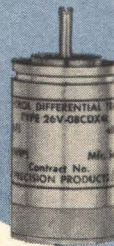

**SIZE 8**



**SIZE 15**



**SIZE 8**

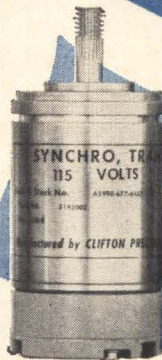

**SIZE 11**



**SIZE 11**

# *cppc* II for BuWeps Synchros



Clifton Precision is building a wider and wider line of BuWeps synchros. Size 8 CX's, CT's, and CD's are the latest. 115 volt and 26 volt size 11's were introduced some time ago. The 15's we have been building for years. Clifton has BuWeps synchros operational in the important Terrier and Talos shipboard missiles. Think of Clifton for BuWeps synchros. Think of Clifton for *quality* rotating components! For further information, contact: Sales Dept. 215 MADison 2-1000, TWX 215 623-6068— or our Representatives.

**CLIFTON PRECISION PRODUCTS**

*Division of Litton Precision Products, Inc.*

*cppc*  
II

Clifton Heights, Pa.  
Colorado Springs, Colo.

---

# Washington Newsletter

---

June 15, 1964

## Satellite studies asked by Comsat

The Communications Satellite Corp. has asked the Federal Communications Commission for permission to contract for six-month engineering design studies on a basic global communications satellite system.

One study is to be made by the American Telephone and Telegraph Co. and the Radio Corp. of America, as a team, on a 530-channel, medium-altitude 6,000 mile random satellite system. AT&T would receive \$1,079,600 for its work, and RCA \$1,300,000. The two companies have offered to guarantee their satellite system for a five-year lifetime even though the system will be designed for a 10-year lifetime.

**Experience gained from the Telstar and Relay communications satellites makes this long lifetime possible according to the companies.**

The other six-month study for \$1,265,000 will go to the Space Technology Laboratories, Inc. with International Telephone and Telegraph Corp. as an associate contractor. It will cover a medium-altitude controlled satellite system using gravity-gradient [Electronics, May 18, 1964, p. 112] to keep the satellites properly oriented toward the earth.

In addition to the medium-altitude satellite studies, COMSAT will place a \$100,000 contract with the Hughes Aircraft Co. for continued work on a 600-channel synchronous communications satellite.

## Air Force eases watch on firms

The Air Force's experiment with reduced government supervision of defense contracts is being broadened to include an electronics firm. A contract, covering production of the 486L tropospheric scatter communications system has been awarded to the Federal Electric Corp. With the shift to incentive and fixed-price contracting [p. 124] the Pentagon is trying to find out how far it can go in relaxing controls. Previously awarded under the plan were a General Electric Co. engine contract, a Northrop Corp. plane contract and an Avco Corp. reentry system contract.

## Pentagon assays its technical data

Having strengthened and clarified its rights to technical data under military contracts [Electronics, June 1, p. 36], the Defense Department is now trying to make sure that it doesn't acquire excessive amounts and that what it receives is used wisely.

**A new directive sets forth guidelines to help defense personnel determine what data needs to be obtained from contractors and to make sure that neither too much nor too little data is acquired.** The department also is interviewing a 4% cross-section of its 35,000 employees in research and development test-and-evaluation to determine how they obtain and use scientific and technical information.

The Pentagon spends about \$2 billion a year in acquiring technical information. It is concerned with the increasing amount of effort spent in searching through mountains of existing data.

The Defense Department hopes its contractors will determine how technical information is acquired and the extent to which it is used in their own plants. The Electronic Industries Association, the Aerospace Industries Association and the National Security Industrial Association have been asked to consider recommending similar surveys to their

---

# Washington Newsletter

---

members. Copies of the R&D questionnaire and a handbook on its use can be obtained from Fred A. Kother, Director of Technical Information, Advanced Research Projects Agency, the Pentagon, Washington.

## New weapons and arms control

The Arms Control and Disarmament Agency is trying to carve out a major role for itself in the decision on whether to produce the Nike X and any other major new or improved weapon. The agency wants to be sure that arms-control implications are fully considered in such decisions.

To bolster its case, the agency has awarded a \$204,000 contract to the Hudson Institute to study the relationship of future weapons technology to arms control and disarmament. The study will investigate how the development and spread of future weapons could change concepts of war, deterrence, defense and strategy. It will examine international, political and strategic trends that might encourage deployment of new weapons, the range of feasible arms-control measures, and factors that favor and work against such measures.

## SBA sets up idea sessions

Irving Maness, deputy administrator of the Small Business Administration, is soliciting ideas on how to keep small firms from being hurt by defense procurement cutbacks. Dates and locations for a series of government-industry conferences on the problem, to include representatives of both large and small firms, will be announced soon.

## Nationwide library proposed

A nationwide network of computerized library centers is being considered by the Federal Council on Science and Technology. The project would cost a total of about \$300 million over a six-year period. If President Johnson agrees, legislation will be proposed early next year.

Dr. Stafford Warren, a special assistant to the President, has proposed a main library center in Washington, with regional centers in other major cities. The libraries would code, tape-index and reproduce scientific and technical publications. Duplicates would be stored in Washington, at the regional centers and at large libraries.

Warren has based part of his proposal on the National Library of Medicine's experimental MEDLARS network, the Medical Literature Analysis and Retrieval Systems.

## Global meetings on communications

A possible Soviet role in a global space communications system will be discussed in Switzerland on June 15 and 16 when Soviet officials meet with Comsat officials.

An accord is already being worked out with European, Canadian, Australian and Japanese representatives. After the Geneva meetings, the Comsat negotiators are scheduled to go to London on Thursday for more talks with the Europeans. On June 29 and 30, Comsat has talks slated with officials from seven Latin American countries: Argentina, Brazil, Chile, Peru, Colombia, Mexico and Venezuela.

The Russians were invited to a meeting 18 months ago, but it wasn't until 15 months later that they showed any interest in the international project. It's still not clear whether they want to join the global organizations or merely are seeking technical information for their own communications system.



PHILCO MICROLOGIC AND MILLIWATT MICROLOGIC  
**now in a flat pack**



ENLARGED TOP VIEW



ENLARGED SIDE VIEW



ACTUAL SIZE (1/4" x 1/8" nom.)

**Industry's most-widely-used Microelectronic Circuit Family  
 is now available in the industry's most-wanted package!**

■ Now, designers have the option to specify any of sixteen Philco integrated circuits in a new, all-glass flat package as well as in TO-5.

■ This new glass "Flat Pack" provides designers all the convenience and reliability of Philco integrated circuitry plus the flexibility of a greatly reduced package mass. The new, high-density Flat Pack facilitates use with multi-layer circuit boards.

■ The new Philco all-glass Flat Pack features a true hermetic glass-to-glass fused seal, oven-fused by a controlled time-temperature process to eliminate all undue thermal stresses. Leads are gold-clad alloy 52.

■ Design quantities of the following Philco Micrologic and Milliwatt Micrologic\* circuits

are now available in the new glass Flat Pack from your nearest Philco Microelectronics Distributor:

**MICROLOGIC**

PL 900 Buffer  
 PL 901 Counter Adapter  
 PL 904 Half Adder  
 PL 905 Half-Shift Register  
 PL 906 Half-Shift Register  
 without inverter  
 PL 914 Dual Two-Input  
 Gate  
 PL 915 Dual Three-Input  
 Gate  
 PL 916 J-K Flip-Flop

**MILLIWATT MICROLOGIC**

PL 908 Modulo 2 Adder  
 PL 909 Gated Buffer  
 PL 910 Dual Two-Input Gate  
 PL 911 4-Input Gate  
 PL 912 Half Adder  
 PL 913 Type D Flip-Flop  
 PL 921 Gate Expander  
 PL 939 Dual Three-Input  
 Gate

\*Philco Micrologic and Milliwatt Micrologic circuits are manufactured using the Planar Epitaxial Process through a cross-licensing agreement with Fairchild Camera and Instrument Corporation.

■ For more information write Dept. E61564



MICROELECTRONICS OPERATION

**PHILCO**<sup>®</sup>

A SUBSIDIARY OF *Ford Motor Company*

LANSDALE DIVISION, LANSDALE, PA.  
 In Canada: Don Mills Road, Don Mills, Ontario, Canada

Circle 61 on reader service card



# fans and blowers for cooling

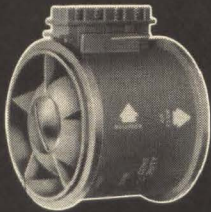

## AXIMAX® 1

Ideal for small, tightly packed airborne equipments. Delivers 23 CFM free delivery. Diameter 1.5" by 1.4" length. Weight 4 ounces. Choose from constant or varying speed designs. Airflow instantly reversible. Servo rim mounting, electrical connections to compact terminal block. Operates on 115 or 200 VAC, 400 CPS, 1 or 3 phase. Meets applicable military specifications. 60 CPS version available.

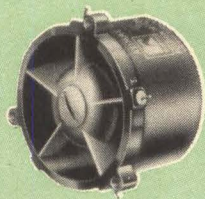
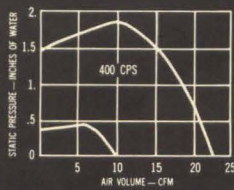

## AXIMAX® 2

Air delivery of 60 CFM free delivery from fan 2" diameter by 1.5" axial length. Weighs 4½ ounces. Designed for maximum cooling against high static pressures with minimum space and weight loss. Available in choice of constant speed or variable speed Altivar® motor designs. Power requirements 115 or 200 VAC, 400 CPS, 1 or 3 phase. Meets applicable military specifications. 60 CPS version available.

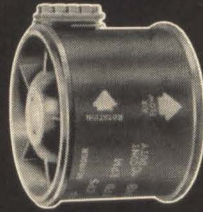
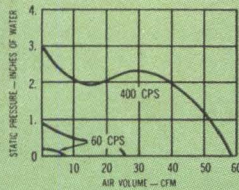

## AXIMAX® 3

Air delivery of 165 CFM free delivery. Fan only 3" in diameter by 2.3" in length. Weighs only 14 ounces. Selection from constant or varying speed motors. Reversible airflow. Servo rim mounting. Meets applicable military specifications. Power requirements 115 or 200 VAC, 400 CPS, 1 or 3 phase. Rapid electrical connections to compact terminal block. 60 CPS version available.

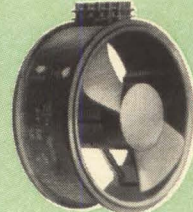
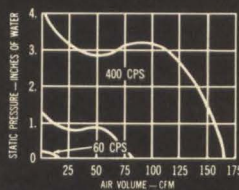

## PROPIMAX® 2

Air delivery of 120 CFM from fan only 3" in diameter by 1.5" axial length. Fan weighs only 6½ ounces. Selection from constant or varying speed motors. Ideal for missile and airborne applications. Reversible airflow. Servo rims at either end for quick mounting. Power requirements 115 or 200 VAC, 400 CPS, 1 or 3 phase. Meets applicable military specifications. Electrical connections made to terminal block. 60 CPS version available.

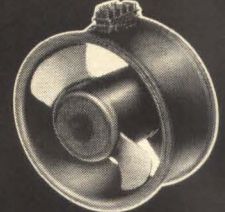
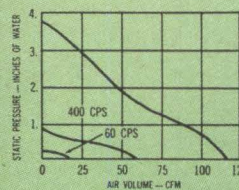

## PROPIMAX® 3

For ground or airborne military applications where line frequencies are high; size, weight and reliability critical; and where high heat loads must be dissipated. Delivers 220 CFM at 22,000 RPM. Size 3¾" in diameter by 2" in depth. Airflow reversible. Servo rim mounting. High altitude designs available. 115 or 200 VAC, 400 CPS, 1 or 3 phase. Available as Propimax 3B for 200 CFM at 11,000 RPM, 400 CPS and also 60 CFM at 3,300 RPM, 60 CPS operation.

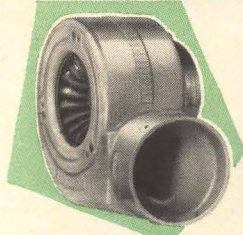
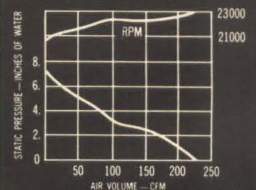

## nugget blower™

For spot cooling requirements in commercial electronic equipment. Features 15 CFM at free delivery. Lightweight — only .6 lbs. Compact design — 3½" x 4½" x 2¼". 115 VAC, 60 CPS, 1 phase, 3200 RPM. Draws only 7

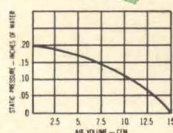

watts. Extremely quiet operation. Low cost. "Centr axial" wheel for greater volume-to-pressure characteristics. Air impeller and blower housing molded of high impact strength polycarbonate plastic. Unit can be mounted from inlet side, from motor side, or from a flange (optional) located on outlet side.

## TWINPAX-2™

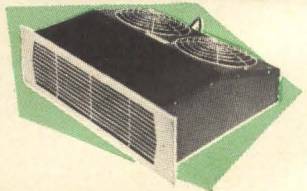
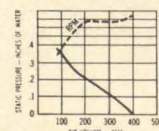

Efficient cabinet cooling at noise level of only 55 db. Delivers up to 400 CFM of clean, filtered air from twin "Feather Fans." Mounts easily to any standard 19" relay rack and requires only 5¼" of panel height. Directs air to minimize dead-spots or eddying. Long-life motors complete with capacitors. Pre-lubricated bearings for maintenance-free operation. Twinpax 1 available for 60 and 400 CPS military requirements.



# electronic equipment by

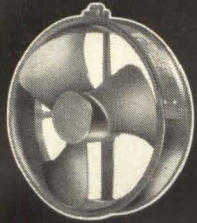

## SAUCER® FAN

Perfect for flushing tightly packed electronic cabinets requiring filtered cooling air. Delivers up to 280 CFM. Driving motor entirely contained in propeller hub. Measures 7" in diameter by 1.7" in axial depth. Weighs 1 lb. 9 ounces. Airflow reversible. Servo rims for easy mounting. Electrical connections to compact terminal block. 115 VAC, 50-60 CPS, 1 phase. 400 CPS version available. Meets applicable military specifications.

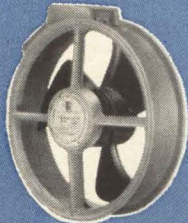
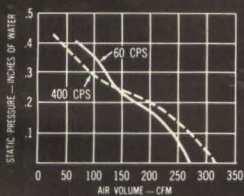

## FEATHER® FAN

Delivers 270 CFM of air at free delivery. 7" in diameter by 2 1/4" in axial depth. Weighs only 1.5 pounds. Rated for continuous duty from -55°C to +65°C. Draws only 22 watts. 3380 RPM, 115 VAC, 50-60 CPS, single phase. High quality commercial unit with military type performance. Made from high strength polycarbonate plastic. Filter assembly available. Ideal for cooling computer consoles, relay racks, power supplies and semiconductor packages.

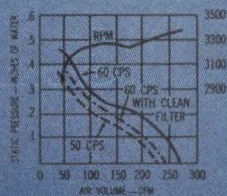

## Whisper® Fan

Specifically designed to deliver a substantial quantity of cooling with maximum reliability and minimum acoustical disturbance. Delivers 60 CFM. Size 4 1/4" square by only 1 1/2" deep. Lightweight — only 1.2 pounds. Long life, advanced bearing system. 1800 RPM, 115 VAC, 60 CPS, 1 phase. Dimensionally interchangeable with "Sentinel" Fan. Maintenance-free design. Installs in seconds. Airflow instantly reversible. Available with washable dust filter.

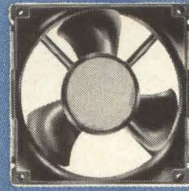
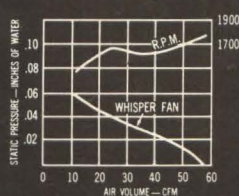

## Sentinel™ FAN

Trouble-free cooling in a compact package. Measures 4 1/4" square by only 1 1/2" in depth. Rugged and reliable. Features stainless-steel ball-bearings. Lubricated for long life. Suitable for 160°F applications. 115 VAC, 50-60 CPS, 1 phase. Weighs just 1 pound. Venturi and spider molded of high impact strength phenolic. Propeller molded of polyolefin. Grill molded of polycarbonate. Quiet operation. Available in "Skeleton," "Venturi," "Grille" and "Filter" versions.

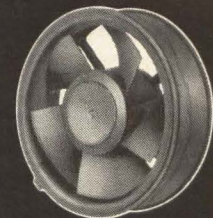
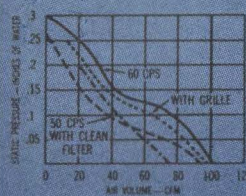

## SPARTAN™ FAN

Power packed performer for military applications. Delivers 100 CFM at free delivery. Available with square flanges to mount to 4 holes spaced 4 1/8" apart, interchangeable with "Sentinel" Fan mounting dimensions. Only 1 1/2" axial depth. Clamping rings available for mounting with standard motor clamps. 115 VAC, 50-60 CPS, 1 phase. Airflow reversible. Stainless-steel ball-bearings. Built to military specifications (MIL-E-5272C).

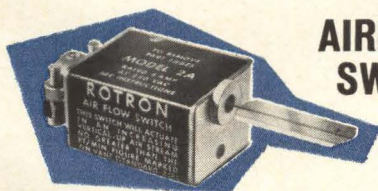
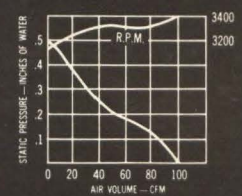

## AIRFLOW SWITCH

Interlocks equipment operation with cooling airflow. Actuates on velocity change. Detects air stoppages up and down. Eight air velocity ratings — mil-

lions of operations life expectancy. Determinator Kit available consisting of air flow switch and 8 actuating vanes for selecting correct vane size.

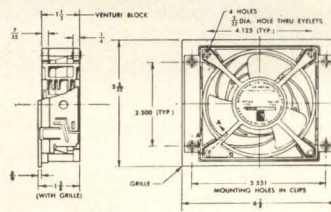

## ROTRON mfg. co., inc.

WOODSTOCK, NEW YORK • ORiole 9-2401  
West Coast: Rotron/Pacific, Glendale, Calif.  
Canada: The Hoover Co., Ltd., Hamilton, Ont.

## **ES** Product of the month: GUARANTEED INSTRUMENT MOTORS

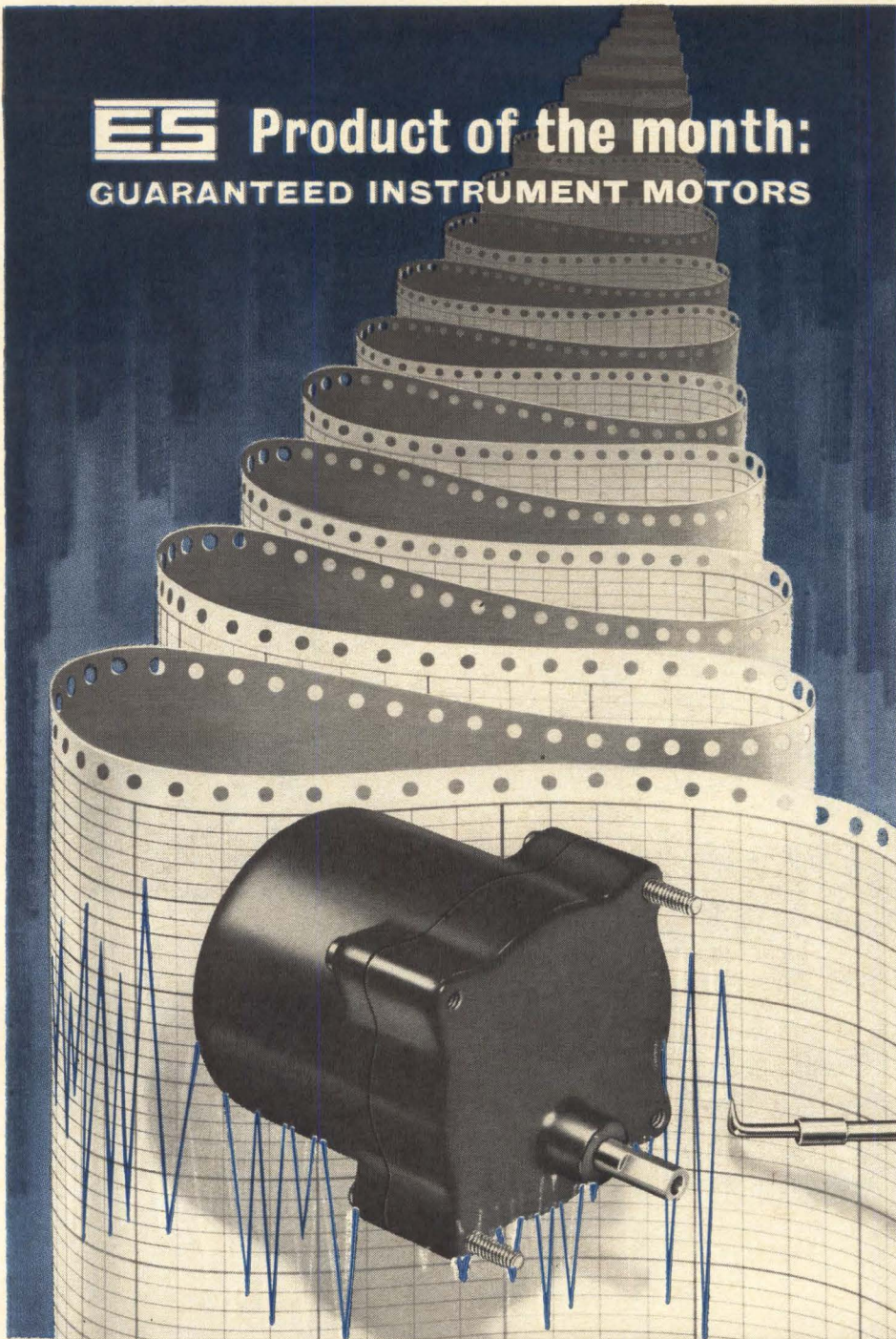

As a direct result of its experience in designing and producing electric motors and power systems for military applications, Electronic Specialty has developed a complete line of high quality, reliable sub-fractional horsepower motors—Series 0211—for industrial instruments such as strip chart recorders. All units carry a two year guarantee on the motor and the gear train. These competitively priced motors meet or exceed NEMA specifications and include normal and high slip induction, reluctance synchronous, hysteresis synchronous, and low inertia servo designs, with and without gearheads.

**The 0211 Series incorporates:** encapsulated windings; close tolerance through-bore construction; low noise Delrin gears in primary stages; heavy duty, standard-pitch gears in secondary stages for reliability; hardened steel motor pinions; stainless steel shafts; die cast rotors; interchangeability with existing designs; standard NEMA class 2-11 frame sizes and ratings. Thirty standard gear ratios are available off-the-shelf; other gear ratios can be provided upon request.

For further information write to William Marcy, Director of Marketing, address below.

**ES** is a diversified, dynamic, multi-divisional organization serving defense and industry over a broad range of vital areas with advanced systems, sub-systems, and state-of-the-art components. Major contributions are currently being made in the following:

### **ELECTRONIC AND ELECTROMECHANICAL CONTROLS:**

gyroscopes, relays, static switching devices, sensors, flashers, regulators, converters, rotary and linear actuators, motors, generators, weapon and camera controls, electromechanical assemblies for aerospace applications.

### **COMMUNICATIONS:**

antennas, flexible and rigid waveguides, coaxial switches, diplexers, power dividers, filters, radio telescopes, solar furnaces, matching networks, antenna drive motors and controls.

### **POWER:**

precise power systems, dynamotors, computer power sources, motor-generators, actuators, starter generators, power conversion systems, transmission towers for public utilities.

### **SPACE CONDITIONING:**

electronically programmed environmental controls and systems for industrial, commercial, and military applications.

### **SYSTEMS:**

Systems Laboratories conduct research, development and study programs in reconnaissance, electronic countermeasures, interferometer phased array systems, and total energy packages; integrating divisional components, sub-systems, and specialized technical skills.

*For information concerning the corporate systems capability, product line, or research and development programs, write to the Director of Marketing, address below.*



**ELECTRONIC SPECIALTY CO.**

5121 SAN FERNANDO ROAD, LOS ANGELES, CALIFORNIA 90039

# Electronics technical articles

## Highlights



### Preventing second breakdown in transistor circuits: page 66

In certain circuits, transistors fail from second breakdown—the impedance drops from a high value to a low one. A new, repeatable, nondestructive test set helps design safe, reliable inductive circuits, using high-speed silicon transistors.

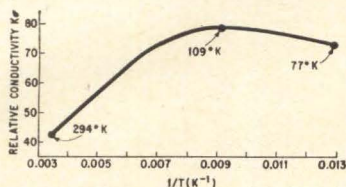

### Component performance at low temperatures: page 75

In superconducting work and in some space applications, components have to perform at very low temperatures. Here's a look at how resistors, capacitors, diodes and transistors react at temperatures near absolute zero.

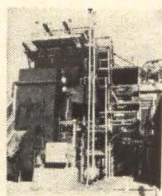

### Solid state modernizes boiler control: page 85

An examination in two parts of new electronic devices incorporated into a system to control boilers. Part one: signals, signal sources and positioners. Part two: electronic controllers.



### Phototechniques for thin-film manufacture: page 94

A step-by-step description of how to make thin-film components by photoetching instead of more expensive mechanical masks.

---

## Coming June 29

---

### Special report: Magnetics

- I. Applications in electronics
  - II. Computer magnetics
  - III. Magnetics for power and control circuits
  - IV. Magnetics for microwave applications
  - V. New devices from magnetic effects
  - VI. Generating high-magnetic fields
- Thyristors run paper mills
  - New microwave interferometer
  - System analysis by sweeping a scope

# Preventing second breakdown in transistor circuits

A repeatable, nondestructive test set helps design safe, reliable inductive circuits using high-speed silicon power transistors

By Peter Schiff

Radio Corp. of America, Electronics Components and Devices Division, Somerville, N.J.

**A major problem** plaguing designers of high-speed switching circuits is transistor failure due to second breakdown—a condition where the output impedance of a transistor changes almost instantaneously from a large value to a small limiting value.

Second breakdown is encountered most often in circuits where the base-emitter junction of the transistor is reverse biased and an appreciable collector current flows. This condition occurs in circuits with inductive loads, such as inverters, switching regulators, magnetic deflection amplifiers, solenoid drivers, ignition systems and computer core drivers. The effect is accompanied by a sharp drop in collector-to-emitter voltage ( $V_{CE}$ ) as shown on p. 67.

The difficulty has been to determine the exact conditions under which reverse-biased second breakdown occurs in a particular transistor without destroying the unit. Now a method of preventing reverse-biased second breakdown in transistor circuits that operate with inductive loads is presented and a test set for making repeatable and nondestructive tests for second breakdown is described. Because of the great variation of second breakdown in each type of transistor with little relationship to other electrical characteristics, this test set is a valuable tool for circuit design as well as transistor evaluation.

## Design curves

A transistor usually is not damaged when subjected to an inductive kickback until second breakdown occurs and a definite amount of energy is dissipated in the sustaining mode of the device. The circuit designer's objective is to operate below this point, yet close enough to it to gain circuit efficiency and eliminate unnecessary circuit components.

Data needed to find the safe operating region for

four types of transistors is shown on p. 67. The curves are used for any transistor whose physical structure (mesa or planar) is the same and whose electrical parameters are within  $\pm 30$  percent of the values tabulated. These four transistor types cover most of the available high-speed npn silicon power transistors (see table on p. 70). The curves are similar for pnp transistors.

The curves show the collector current at second breakdown ( $I_{S/B}$ ) for varying inductance. Results are given for the 10th and 50th percentile groups of a selection of transistors tested at the Radio Corp. of America for second breakdown. This selection was made from relatively large samples of units taken from several production runs. Some samples contained more than 40 units (most data published up to now is based on three or four units). Since these samples were selected to represent an average distribution of the product, the data is considered reliable.

The use of the design curves depends on the transistor having a minimum value of second breakdown for one combination of  $R_{BE}$ ,  $V_{BE}$  and  $L$ , specified due to the large energy variations present for each transistor type. This point would lie immediately below the 10th percentile curve. If such a minimum value of second breakdown is not specified on the data sheet, the 10th percentile curve is not reliable for a worst-case analysis, and the use of the test described later is recommended to determine the second-breakdown conditions.

In the curves,  $R_{BE}$  is maintained constant while a separate curve is shown for each percentile for different base-to-emitter reverse bias voltages ( $V_{BE}$ ). The 10th percentile data is used as a design limit for a worst-case analysis, while the 50th percentile represents selected devices. Similar curves for units in the 90th percentile would be spaced

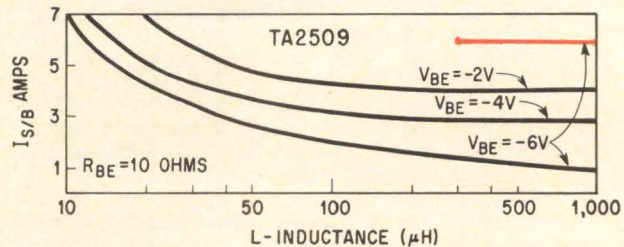
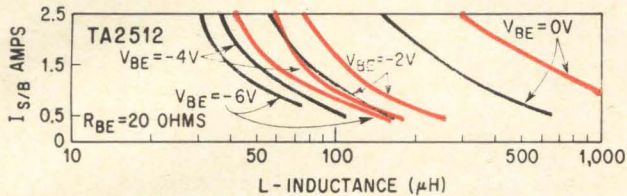
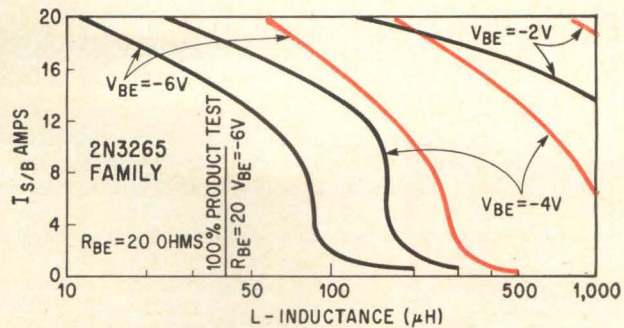
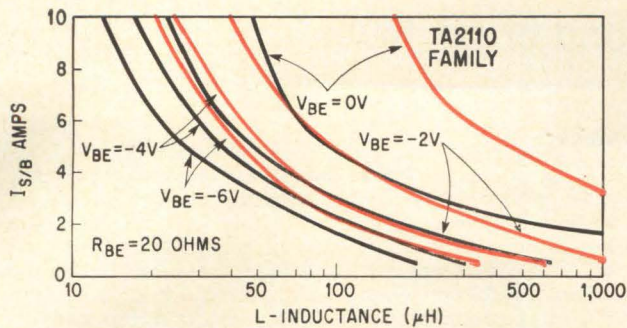

Family design curves for four types of transistors, show the collector current at second breakdown ( $I_{S/B}$ ) for a varying inductance. The 90th percentile curves (not shown) are far to the right of the 50th percentile (color) as is the 50th from the 10th. The safe operating region, for example, for conditions of  $V_{BE} = -6V$  and  $R_{BE} = 20 \text{ ohms}$  is the area under the curve labeled  $V_{BE} = -6V$  for a particular transistor.

approximately as far from the 50th percentile curves as are the 10th percentile curves.

The effect of changes in  $I_{S/B}$  due to the resistance that is in series with the reverse-bias voltage is shown on p. 70. In these curves  $\Delta I_{S/B}$  is the change in collector current necessary to produce second breakdown due to changes in  $R_{BE}$ . The curves are applicable for all percentiles and  $V_{BE}$  conditions for the particular types of transistors. As shown later in the design procedure the appropriate  $I_{S/B}$  is obtained from the  $I_{S/B}$  versus  $L$  curves, and is added to  $\Delta I_{S/B}$  to compute the energy at which second breakdown occurs.

The prevention procedure is divided into applications of a transistor with and without the parallel capacitor  $C_1$ .

### Design without a parallel capacitor

Consider a transistor without a parallel capacitor first: once a transistor is selected, the circuit parameters,  $V_{BE}$ ,  $R_{BE}$  and  $I_C$ , and  $L$  are adjusted so that the maximum energy dissipated in the reverse-biased mode is below that value necessary to cause second-breakdown failure. This level is obtained as follows:

1. For the particular type of transistor  $R_{BE}$  is neglected and  $I_{S/B}$  is obtained from the design curves above for a particular  $V_{BE}$  and  $L$  using the 10th percentile curves for worst case design.
  2. The value of  $\Delta I_{S/B}$  for the given value of  $R_{BE}$  is obtained from the design curves on p. 70.
  3.  $I_{S/B}$  is added to  $\Delta I_{S/B}$  thereby getting the  $I$  of eq. 1 (p. 68) which now represents  $I_{S/B}$  corrected for changes in  $R_{BE}$ . Substituting  $L$  and this corrected value of  $I_{S/B}$  in equation 1 gives  $E_{S/B}$  for a circuit in which minimum losses are assumed.
  4. Neglecting the  $R_L I_p/2$  term,  $E_{S/B}$  is set equal
- Continued on p. 70

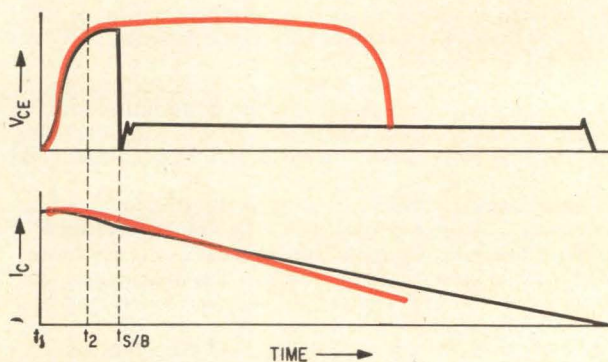

Collector-to-emitter voltage vs time of a transistor that switches an inductive load with second-breakdown occurrence (black) and without second-breakdown occurrence (color). The end of the saturation mode occurs at  $t_1$  and the sustaining mode is reached at  $t_2$ .



Collector current control is increased until second-breakdown oscillations are detected by reverse-biased second-breakdown test set.

# Background: reverse-biased second breakdown

Primary breakdown (avalanche breakdown) is usually referred to as the sustaining mode of the transistor and unlike second breakdown is not a failure mode. Here the transistor collector-to-emitter voltage ( $V_{CE}$ ) is relatively constant for different collector supply voltages ( $V_{CC}$ 's).

Second breakdown is distinguished from normal transistor operation by the fact that once it occurs, the base no longer controls normal collector characteristics. In addition there is a sharp drop in  $V_{CE}$  accompanied by an oscillation of several volts across the base-emitter terminals at the beginning of reverse-biased second breakdown.

Second breakdown is associated with imperfections in the device structure. It is usually more severe in multiple-diffused, high-speed devices where close spacing of the active base region is characteristic.

Physically, second breakdown is caused by localized current concentrations within the active collector regions, resulting in the uncontrollable generation and multiplication of current carriers, with a sudden reduction of the collector impedance. Because the duration of this phenomenon exceeds the thermal time constant of this minute area, the transistor is irreversibly damaged.

The distributions of base-to-emitter bias level and the emitter-current injection for a npn transistor during both forward and reverse-biased operations on page 69. The polarities are reversed for pnp transistors. These plots are the same for planar transistors and show that the emitter current is more evenly distributed through the base during forward-biased operation than during reverse-biased operation. This is explained by the potential differences in the base caused by transverse base currents and the resistivity of the base material.

Since second breakdown is dependent upon a concentration of injected current carriers (holes or electrons), it is more likely to occur during reverse-biased conditions. Also, higher collector-to-emitter sustaining voltages tend to increase the importance of device imperfections, due to the higher electric fields associated with them—causing more current concentrations and second-breakdown occurrence.

The sustaining voltage of a transistor  $V_{CE(sus)}$  is the collector-to-emitter breakdown voltage while the emitter is conducting (injecting current carriers). Under this condition,  $V_{CE}$  remains relatively constant with collector current changes.  $V_{CEX(sus)}$  is the collector-to-emitter sustaining voltage with the base reverse-biased.  $V_{CEO(sus)}$  is the collector-to-emitter sustaining voltage with the base open.

Reverse-biased second-breakdown results obtained with multiple-diffused silicon npn transistors are applicable also to the small number of pnp silicon power transistors used in r-f and high-speed switching applications.

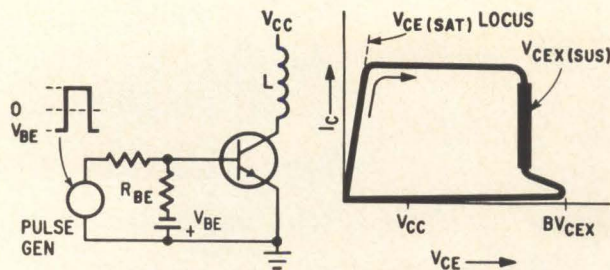

Reverse-biased transistor switches an inductive load resulting in the I-V load line.

## Theory

Reverse-biased second breakdown is associated generally with circuits having inductive loads, such as inverters, switching regulators. In this type of circuit, the transistor is first driven into saturation. When the transistor is cut off abruptly, a voltage is induced across the inductor with a magnitude and direction tending to keep the collector current flowing. This results in the load-line shown below:

The voltage induced across the inductor when the transistor is turned off is given by  $V = L (di/dt)$  where  $(di/dt)$  represents the decay of collector current per unit of time. In high-speed transistors, the fall time  $(dt)$  is relatively small, thus permitting high voltages to be induced across the transistor for suitable inductances and collector currents. Fall time is the time it takes the transistor collector-emitter voltage to sweep from the saturation to the sustaining mode.

When these voltages produce the critical field of the semiconductor material in the transistor, the collector-base junction avalanches, clamping the output voltage of the inductor. Plots of  $V_{CE}$  and  $I_C$  versus time for a transistor free from second breakdown and in second breakdown are shown on p 67. At second breakdown,  $V_{CE}$  drops sharply but  $I_C$  continues its almost linear decay.

Before a transistor goes into reverse-biased second breakdown, a definite quantity of energy is dissipated in its sustaining region. This energy is calculated for a non-saturated (or air-core) inductor by the equation:

$$E = \frac{1}{2}LI^2 \quad (1)$$

where  $E$  is the energy in joules or watt-seconds and  $I$  is the maximum collector current at the end of the transistor saturation cycle. For second breakdown,  $E$  becomes  $E_{S/B}$  and  $I$  becomes  $I_{S/B}$ .

If circuit parameters such as  $V_{CC}$  and  $R_L$  are considered, the following formula applies (the equivalent circuit is shown below).

$$E_L = \frac{1}{2}LI_p^2(1 + (V_{CC} - \frac{1}{2}R_L I_p)/V_{CEX(sus)}), \text{ if } C_1 = 0 \quad (2)$$

where  $E_L$  is the energy in the inductor as seen by the transistor;  $I_p$  is the maximum collector current at the end of the saturation cycle taking into account  $R_L$ , the transistor breakdown characteristics  $V_{CEX(sus)}$  and the supply voltage  $V_{CC}$ .

Any external capacity ( $C_1$ ) affects the transistor in the following way: suppose the inductor charges  $C_1$  to  $V_{CEX(sus)}$  in less time than the fall time ( $t_f$ ) of the transistor, such that

$$C_1 \leq C_{ob} \text{ at } \frac{1}{2}(V_{CEX(sus)}) \quad (3)$$

where  $C_{ob}$  is the collector-to-base capacitance at a given

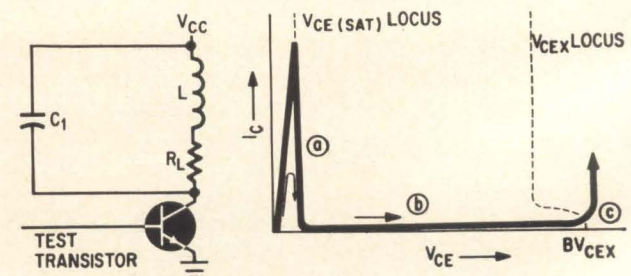

The equivalent circuit of an inductive load has an ideal inductor,  $L$ , a d-c resistance of the inductor,  $R_L$ , a stray or external capacitance,  $C_1$  and a transistor under test. The inductive load line of the equivalent circuit applies for large  $C_1$ .

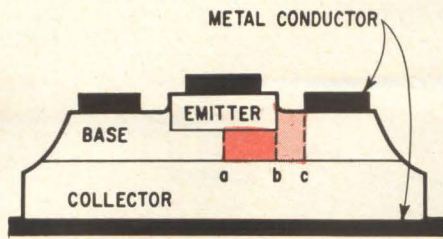

A

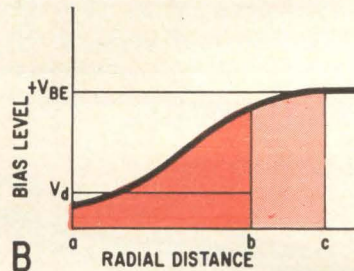

B

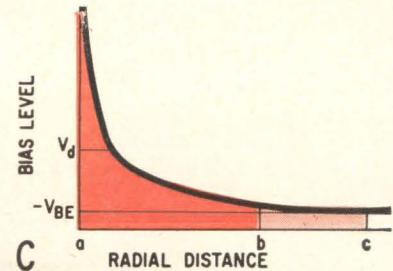

C

NPN mesa-type transistor (A) has a base-to-emitter bias level for forward-biased operation (B) and reverse-biased operation (C). The shaded area represents the emitter current injection.  $V_d$  is the base-to-emitter diode threshold voltage. The radial distance in (B) and (C) is measured from the point a in (A).

voltage. Then the energy dissipated in the transistor is:

$$E = E_L - E_C = E_L - \frac{1}{2}C(V_{CEX(sus)})^2 \quad (4)$$

where  $E_C$  is the energy in  $C_1$ .

If  $C_1$  is greater than  $C_{ob}$ , practically all of the energy in the inductor is absorbed by  $C_1$ . The VI plot of the transistor (p. 68) shows that  $I_C$  collapses at point A before the sustaining region of the transistor is reached. This is due to the slow rate of rise of  $V_{CE}$ . At point B,  $V_{CE}$  tends to increase until  $E = E_C$ . When  $BV_{CEX}$  is reached at point C, the transistor attempts to "snap back" into the sustaining region. Since  $C_1$  is discharged for a decrease in  $V_{CE}$ , there is an abrupt increase in  $I_C$ . This current increase causes second breakdown failure. Therefore, if capacitors absorb the energy in the inductor coil such that

$$E = E_C = \frac{1}{2}CV^2 \quad (5)$$

where  $V$  must be less than  $BV_{CEX}$ . Before the transistor is turned on again,  $V_{CE}$  must be less than  $V_{CEO(sus)}$  to avoid a similar increase in  $I_C$  and second-breakdown failure. Due to a large value of  $C_1$ , the transistor may be in the forward-biased region for a considerable length of time when it is turned on by another pulse. Thus forward-biased second breakdown may occur.<sup>2</sup>

The effect of the fall time ( $t_f$ ) of the transistor on second breakdown is shown by the following equations. In terms of energy dissipated in the transistor for the sustaining mode

$$E_{(sus)} = E_L - \frac{t_f V_{CEX(sus)}}{2} \left( I_P - \frac{t_f V_{CEX(sus)}}{4L} \right) \quad (6)$$

Reverse-biased second breakdown often occurs at the first instant of the  $V_{CEX(sus)}$  mode when the most power is being dissipated in the device. The effect of  $t_f$  on peak dissipated power in the following expression consists of the negative term which is the dissipated power when the transistor goes from the saturation mode to the sustaining mode.

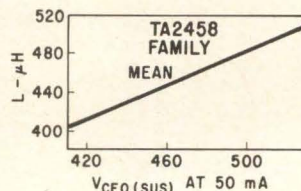
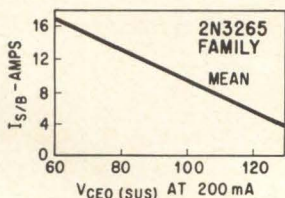

The 2N3265 family of high-current, low-voltage transistors has a  $I_{S/B}$  vs  $V_{CEO(sus)}$  (at 200 mA) at the conditions  $L = 200\mu H$ ,  $V_{BE} = -6V$  and  $R_{BE} = 20$  ohms (A). The TA2458 family of high-voltage, low-current transistors has  $L$  vs  $V_{CEO(sus)}$  (at 50 mA) for the conditions  $I_{S/B} = 0.5A$ ,  $R_{BE} = 50$  ohms and  $V_{BE} = -6$  volts.

$$P_p = V_{CEX(sus)} I'$$

$$= V_{CEX(sus)} \left( I_p - \frac{t_f V_{CEX(sus)}}{2L} \right) \quad (7)$$

Contrary to most published data, reverse-biased second-breakdown is not a function of reverse-bias current alone but is affected by both the  $R_{BE}$  and  $V_{BE}$  components. This is due to the internal impedance of the transistor, especially the base-spreading resistance,  $R_{bb'}$ . Breakdown characteristics, such as  $V_{CEO(sus)}$  also affect reverse-biased second breakdown.

In high current and/or low voltage types the energy necessary for second breakdown ( $E_{S/B}$ ) decreases with increasing  $V_{CEO(sus)}$ . This is explained by the higher voltage gradients that result in more pronounced current concentrations at imperfections in the device. A typical example of  $I_{S/B}$  versus  $V_{CEO(sus)}$  for the 2N3265 family is below.

Devices exhibiting both high-voltage and low-current characteristics often display second-breakdown failure as soon as the  $V_{CEX(sus)}$  mode is reached. In this case, a higher breakdown voltage results in an increased  $t_r$  (time to reach this voltage) and thus a higher  $E_{S/B}$ . A typical example is the RCA developmental type TA2458 with a  $V_{CEO(sus)}$  minimum of 350 volts and a maximum  $I_C$  of 0.5 amp. Thus, a high-voltage, low-current transistor shows a higher value of  $E_{S/B}$  than a low-voltage transistor of the same type.

A graph of  $L$  versus  $V_{CEO(sus)}$  for the TA2458 with  $I_{S/B}$  constant at 0.5 amp is shown below. Since  $E = \frac{1}{2} L I^2$  and  $I$  is constant,  $E$  (or  $E_{S/B}$ ) is proportional to  $L$ .

The effect of temperature on  $I_{S/B}$ , measured for two devices, is shown below. Here the increase in  $I_{S/B}$  with higher junction temperatures is due to an apparent fan-out of the current concentrations at elevated temperatures because of the accompanying increase in resistivity of the silicon material. This increase is caused by a decrease in current carrier mobility at higher junction temperatures and is more apparent in lightly doped, high-voltage transistors.

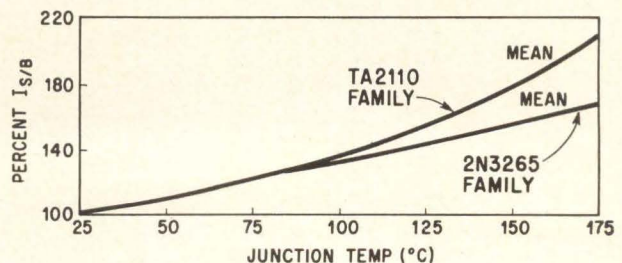

The effect of junction temperature on  $I_{S/B}$  normalized to 25°C. TA2110 family data is applicable for all  $I_C$  from 0.5 to 10 amps, while 2N3265 family data applies only from 5.0 to 20 amp, displaying greater variations below 5 amps.

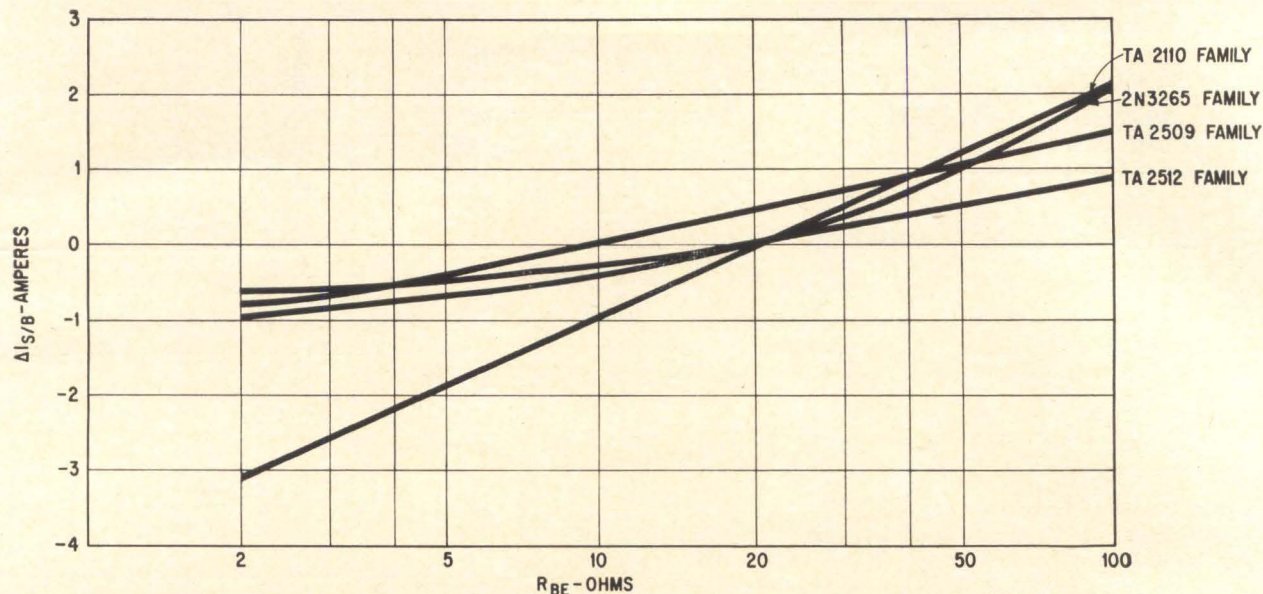

Design curves normalized to 20 ohms give the relationship of  $I_{S/B}$  with changes of the resistances in series with the reverse-bias voltage. These are applicable for all percentiles and  $V_{BE}$  conditions.

### Four types of multiple-diffused silicon npn transistors

Type Series	Package	Construction	Max Collector Current	Min $V_{CEO(sus)}$	$f_t$
TA2110 FAMILY	Stud	Mesa	10 A	250-300 V	15 Mc
TA2512 FAMILY	Modified TO-8	Mesa	5 A	175-300 V	15 Mc
2N3265 FAMILY	Stud	Mesa	20 A	60-90 V	25-30 Mc
TA2509	Modified TO-8	Planar	7 A	80 V	70 Mc

Note—TA refers to RCA developmental numbers. The above four groups contain moderate and high current devices for both high and intermediate breakdown voltages.

to the righthand side of eq. 2 on p. 68, which is solved for  $I_p$ , the current at which second breakdown occurs in the actual application. The aim of the design procedure is to keep the maximum collector current below this figure.

The  $R_L I_p / 2$  term is neglected because it does not always affect the peak power dissipated in the transistor in its sustaining mode of operation, a major factor in second-breakdown occurrence. The reason is that for large enough inductors  $di/dt$  is negligible despite higher induced voltages necessary to overcome  $R_L$ .

#### Design with parallel capacitor

If small capacitors are encountered across the transistor, such that equation 3 holds, the same procedure is followed as for a transistor without a parallel capacitor, with the following exception: when calculating  $I_p$  with equation 2,

$$E = E_L - E_C = E_L - \frac{1}{2} C (V_{CEX(sus)})^2$$

where  $E$  is the energy dissipated in the transistor and is derived by the use of equation 1 as before.

When large capacitors ( $C_1 > C_{ob}$ ) are used to shunt the inductively loaded transistor (either because this transistor itself cannot withstand the large energy component of the load or because of

circuit requirements) the following second-breakdown prevention procedure applies.

The transistor does not dissipate a considerable amount of energy because of the changed load line as shown on p. 68. Thus,  $E$  equals  $E_C$  where  $E_C$  is derived by equation 5. The procedure here is to calculate  $E$  from equation 1 and set it equal to  $\frac{1}{2} (CV^2)$ , where  $V$  is less than  $BV_{CEX}$ . This gives the value of the capacitor  $C_1$ .

Since  $V_{CEX(sus)}$  is often unobtainable,  $V_{CEO(sus)}$  may be obtained from the transistor data sheet and used instead. This will lead to conservative results regarding second-breakdown limitations.

#### Design example

The magnetic deflection amplifier shown on p. 71 is used as a design example. Since  $L$  is assumed fixed at 100  $\mu H$ , reverse-biased second breakdown is controlled by either varying the input condition or the maximum collector current. If the input characteristics are also fixed, the collector current is controlled in two ways. Suppose  $V_{BE}$  is 2 volts and  $R_{BE}$  is 50 ohms.

Case 1—The maximum  $I_c$  is determined by calculating  $R_L$  as follows: At  $L = 100 \mu H$  and  $V_{BE} = -2V$ , the TA2512 family curves shown on p. 67,



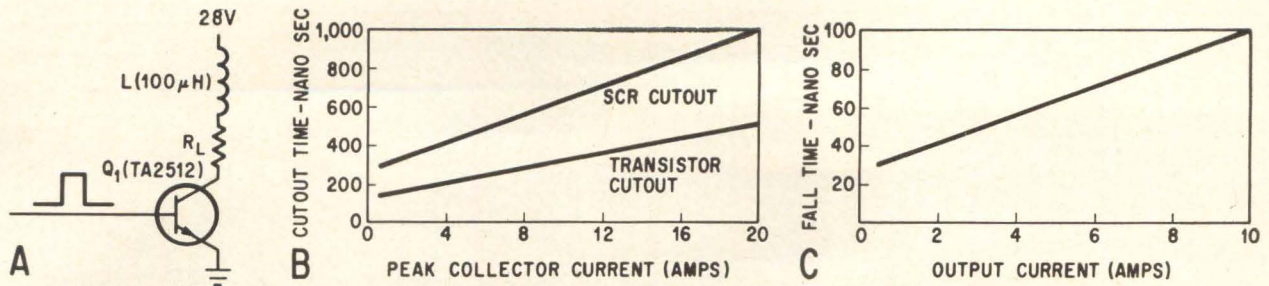

For the inductive load (A) of the magnetic deflection amplifier the assumption is that L never saturates. A performance comparison (B) between the SCR (high voltage) and the transistor cutout circuits of the test set is given. The pulse generator is capable of high output currents with short fall times (C).

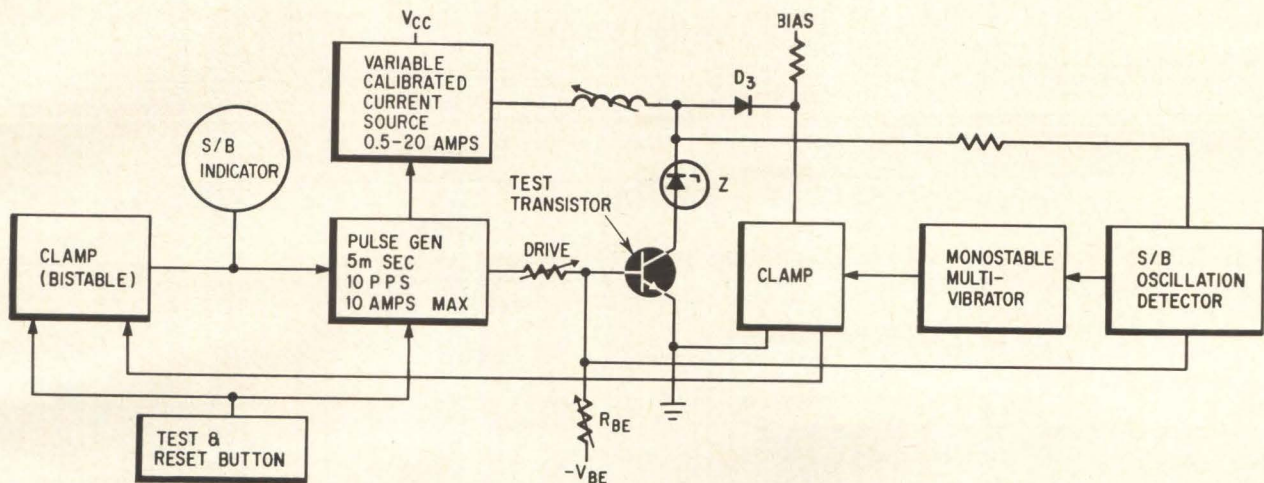

The test button of the test set releases the clamp on the pulse generator which generates a 5 millisecond pulse at the rate of 10 pulses per second. The test set is capable of repeatable and non-destructive tests for reverse-biased second breakdown.

give  $I_{S/B} = 1.1$  amperes for the 10th percentile at  $R_{BE} = 20$  ohms. For  $R_{BE} = 50$  ohms,  $\Delta I_{S/B}$  is  $+0.5$  ampere. Therefore the exact  $I_{S/B}$  is 1.6 amperes at  $L = 100 \mu H$ ,  $V_{BE} = -2$  volts and  $R_{BE} = 50$  ohms.

Next  $I_{S/B}$  and  $L$  are substituted into equation 1 to get (taking the next lower value when rounding off)  $E_{S/B} = \frac{1}{2} LI^2 = (10^{-4})(1.6)^2/2 = 1.2 (10^{-4})$  joules. This energy is substituted into equation 2, ignoring  $R_L I_p$ , to get  $E_{S/B} = \frac{1}{2} LI_p^2 (1 + V_{CC}/V_{CEX(sus)})$ .

The assumption,  $V_{CEO(sus)min} = V_{CEX(sus)}$  is made if  $V_{CEX(sus)}$  is not available from the data sheet. This produces conservative results since  $V_{CEO(sus)min}$  is less than  $V_{CEX(sus)}$ . Then,  $(1.2) 10^{-4} = \frac{1}{2} (10^{-4}) I_p^2 (1 + 28/300)$  or  $I_p = 1.5$  amps for a 28-volt supply. If this collector current is below that required by the circuit, it can be increased by varying  $R_{BE}$  and  $V_{BE}$ .  $R_{L(min)}$  is determined by Ohm's law such that:  
 $R_{L(min)} = (V_{CC} - V_{CE(sat)})/I_p = (28 - 0.5)/1.5 = 18.3$  ohms.

Case 2—The maximum current can also be limited by controlling the saturation time  $Q_1$ . If  $R_L = 0$ , the maximum saturation time of  $Q_1$  is derived from  $V = L (di/dt)$ :

$$V = L (di/dt) = V_{CC} - V_{CE(sat)} = L I_p / T_{(sat)}$$

For an  $I_p$  of 1.5 amperes (derived in case 1) the maximum saturation time is:  
 $28 - 0.5 = (10^{-4})(1.5)/T_{(sat)}$  or 5.5 microseconds.

### Test set for second breakdown

A test set has been designed for transistor manufacturers and circuit designers to test any npn power transistor nondestructively for second breakdown. This test set gives the circuit designer a direct reading of  $I_{S/B}$  which is used in the preceding design procedure to determine the safe operating region of the transistor.

The two major problems in testing for reverse-biased second breakdown are the lack of a repeatable means of second-breakdown detection and the requirement for a high-speed cutout circuit to protect the transistor under test. (Cutout is the time in the test circuit between second breakdown and where the transistor is no longer dissipating the energy in the inductor.)

While monitoring the collector of the transistor under test, it is difficult to design a second-breakdown detection circuit to distinguish a second-breakdown  $V_{CE}$  collapse from a normal return of  $V_{CE}$  to the supply voltage.

It was discovered that all transistors exhibited

### Capacitors

Three-piece parallel arrangements consisting of 0.47  $\mu\text{f}$  ceramic, 1.0  $\mu\text{f}$  mica, and the third is:

C<sub>1</sub>, C<sub>6</sub> 500  $\mu\text{f}$  at 12V  
 C<sub>2</sub>, C<sub>3</sub>, C<sub>7</sub> 100  $\mu\text{f}$  at 12 V  
 C<sub>4</sub> 2000  $\mu\text{f}$  at 12V  
 C<sub>5</sub> 1000  $\mu\text{f}$  at 6V

Variable air inductor (10–800  $\mu\text{H}$ )  
 (#14 wire closely wound. Form-circumference of 10 inches and length of 15 inches)  
 RY — Potter and Brumfield KM 11-D(12V)

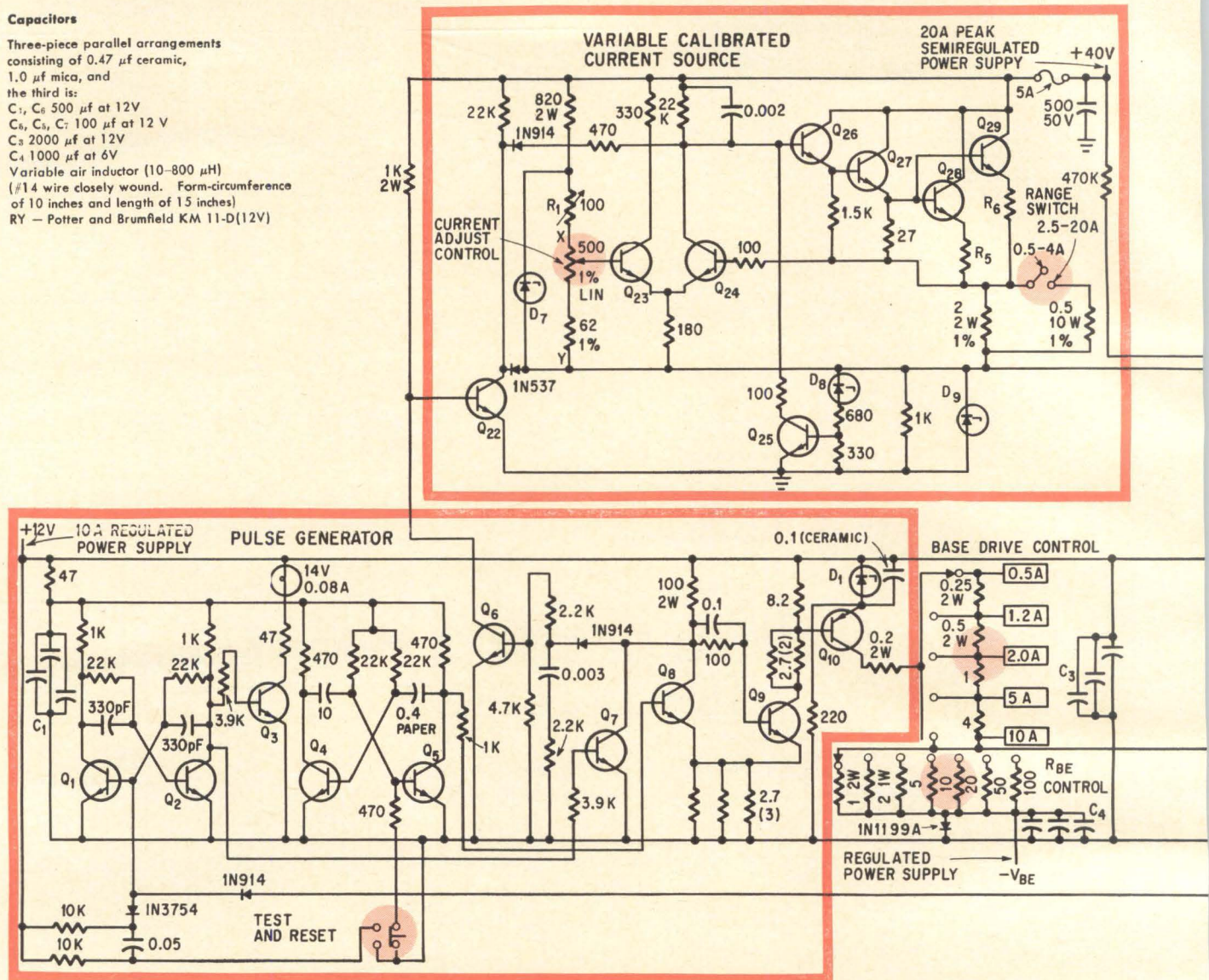

a large-amplitude  $V_{BE}$  oscillation in the r-f region, above 5 megacycles, at the initiation of second breakdown. This provides an effective and repeatable means of second-breakdown detection, completely independent of any transistor parameters.

A unique detector was built which differentiates the steep-slope second-breakdown oscillations from circuit noise and ringing. Thus, it is possible to detect second breakdown under any circuit conditions. This detector is essentially a common-collector circuit with a wide-band tuned input and feedback. It rejects all signals in the base of the test transistor other than second-breakdown oscillations. Any signal that resonates the wide-band tuned circuit in the base of the detector transistor appears in the emitter, after being current-amplified by the beta of the transistor. Here it is fed back into the base and produces an integrating action and voltage gain by adding each positive pulse in the base to the emitter-to-ground potential produced by the preceding pulse.

The second-breakdown detector triggers a mono-

stable multivibrator which in turn drives a high-speed clamp. The clamp shorts the transistor under test from collector to emitter, when second breakdown occurs, rather than disconnecting it. This eliminates the storage time which a saturated transistor switch in series with the test transistor introduces, thus assuring the fastest cutout now possible. Shorting the test transistor with a parallel element when second breakdown occurs makes the use of a silicon controlled rectifier possible, since such devices cannot be turned off without removing the load. Because high voltage SCRs are available, the highest voltage transistors on the market may be tested with this cutout circuit. A performance curve of the SCR and transistor cutouts is shown on p. 71.

As illustrated in the theory on p. 68, an external capacitance that shunts the transistor has a definite effect on second breakdown. Therefore, the clamp is isolated with a diode ( $D_3$  on the block diagram), which is reverse-biased with a voltage higher than the greatest  $V_{CEX(sus)}$  of the test tran-

### Transistors

Q9 - TA2509 (RCA)  
 Q10 - 2N2912 (Motorola)  
 Q11 - 2N689 (RCA) ( $V_{F_{BOM}} > 800V$ )  
 Q12, Q13, Q14 - TA2110 (RCA)  
 Q16 - 2N3266 (RCA)  
 Q17, Q18, Q19, Q20, Q21 - 2N2476 (RCA)  
 Q22, Q27 - 2N1486 (RCA)  
 Q28, Q29 - 2N3265 (RCA)  
 All others 2N2102 (RCA)

### Diodes

D1 - 6.8V 10W zener (IR 1N2970A)  
 D2 - 3.9V 10W zener (IR 1N1599)  
 D3, D4 - 1N1206A (RCA) ( $P_{FV} = 1KV$ )  
 D5 - 320V zener (2XIR + 1N3049)  
 D6 - 22V zener (IR 1N1527)  
 D7 - 8.2V zener (IR 1N1522) ( $V_Z > 8V$ )  
 D8 - 15V zener (IR 1N1525)  
 D9 - 22V 10W zener (IR 1N1608)

### Resistors

All resistors are 1/2 watt unless specified  
 $R_1$  is adjusted for 8 volts between x and y  
 $R_{2-4}$  are 0.1 ohm non-inductive  
 (Wire from 25W 1 ohm resistor non-inductively wound on 1W 10 ohm resistor)  
 $R_1$  is adjusted for 8V between X and Y

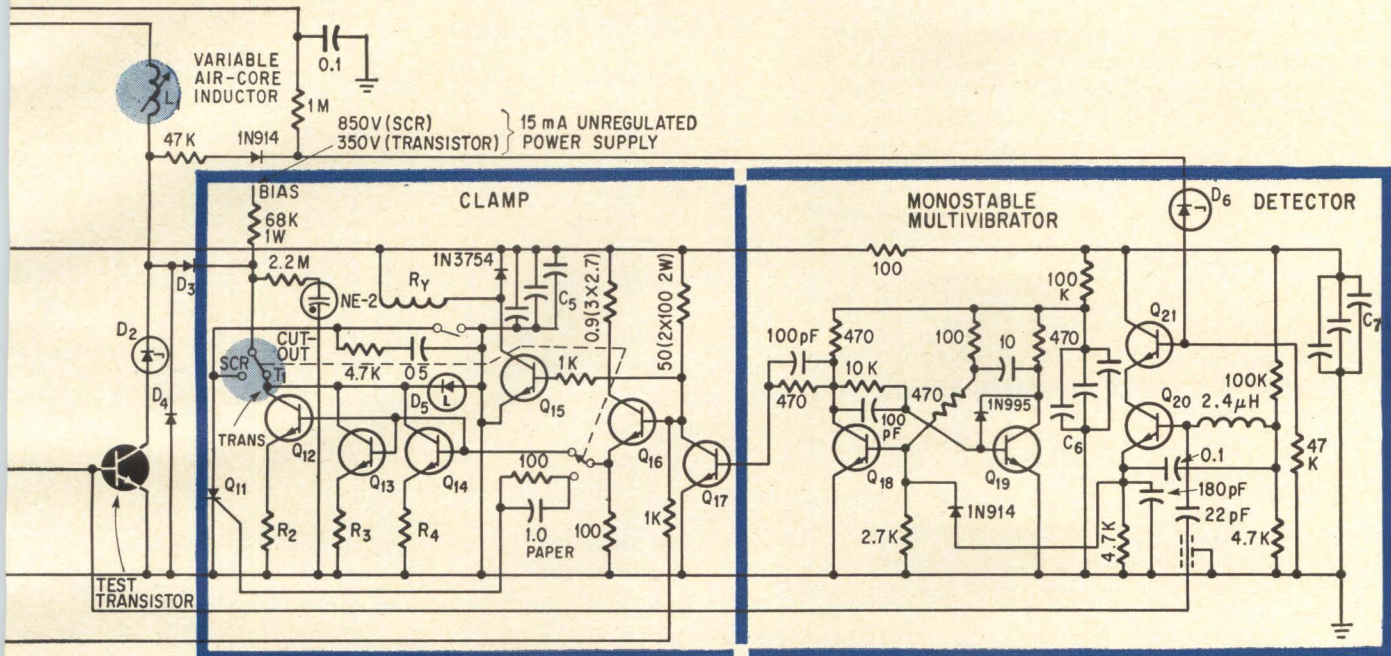

External controls on the second-breakdown test set (shown in color) are: test and reset button; the range switch and current-adjustment control for collector currents from 0.5 to 20 amp in the transistor under test (T.U.T.); the variable air-core inductor,  $L$ ; the cutout switch (SCR or transistor clamp); the resistance  $R_{BE}$  control in series with the negative bias; the base drive control for adjusting base current to the T.U.T. and overcoming reverse-bias current.

sistor. Then the transistor cutout circuit is used for induced voltages up to 300 volts (350 volt bias). The SCR cutout circuit is used for induced voltages up to 800 volts (850 volt bias).

To extend the usefulness of the test set, the need for any readout device, such as a scope, is eliminated by the use of a calibrated current source, which is turned on only while the test transistor is in saturation. Because leakage keeps the SCR turned on once it is triggered, the addition of a relay is required.

The pulse generator of the test set is capable of high output currents which overcome the reverse-bias conditions and drive the test transistor into saturation with a short fall time as shown on p. 71. The duty cycle is maintained at 5% to minimize the rise of junction temperature of the transistor under test above ambient temperature.

### Operation of test set

The operation of the test set is best explained in terms of the block diagram shown on p. 71. Press-

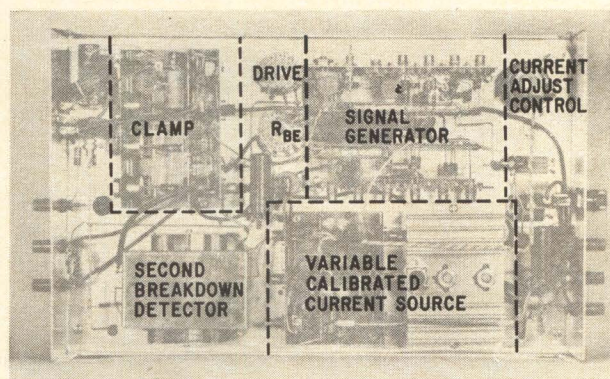

Shielding of the second-breakdown detector and monostable multivibrator (included in the same can) is essential in order to avoid mistripping on stray signals.

ing the test button releases the clamp on the pulse generator, which generates a 5 millisecond pulse at a rate of 10 pulses per second. The pulse generator also turns on the calibrated current source for each

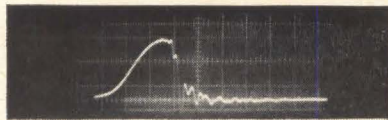

TIME →  
VERTICAL - 200 V/DIV  
HORIZONTAL - 100 n SEC/DIV

A

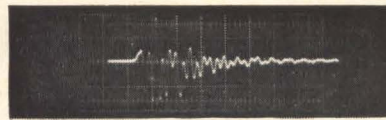

TIME →  
VERTICAL - 5 V/DIV  
HORIZONTAL - 100 n SEC/DIV

B

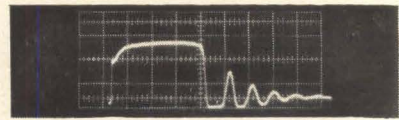

TIME →  
VERTICAL - 50 V/DIV  
HORIZONTAL - 1 μ SEC/DIV

C

In second breakdown the  $V_{CE}$  collapse (A) of a TA2110 occurs in less than 10 nanoseconds considering the 20 nanoseconds rise time of the oscilloscope. The  $V_{BE}$  oscillation (B) of a 2N3265 occurs at the initiation of second breakdown—conditions of  $V_{BE} = -6$  V and  $R_{BE} = 20$  ohms. The  $V_{CE}$  trace of a 2N3265, subjected to a 2 millijoule inductive kickback is free from second breakdown for conditions of  $I_C = 10$  A and  $L = 40$  μH. All of the traces were pulsed 40 times each, illustrating their complete repeatability.

pulse. To eliminate mistriggering, the second-breakdown oscillation detector is energized only when the transistor under test displays a high collector-to-emitter voltage. The calibrated current-source control and/or the variable inductor are progressively increased until second-breakdown oscillations are detected. The detector then triggers the monostable multivibrator which shorts the transistor under test and the pulse generator, besides illuminating the second-breakdown indicator. The zener diode in the collector of the test transistor cancels the resistance of  $D_3$  and the clamp.

To avoid mistriggering on stray signals, the second-breakdown detector and monostable multivibrator are shielded. Although the variable inductor increases the flexibility of the test set, any other inductor may be substituted, provided it has a resistance equal to or less than 0.5 ohm. If unusually large inductors are used, the pulse length of the pulse generator may have to be increased to develop high enough collector currents in the test transistor. This is accomplished also by increasing the capacitor in the collector of  $Q_5$ .

When both cutout circuits are not required and the larger cutout time of the SCR can be tolerated,  $Q_{12}$ ,  $Q_{13}$ ,  $Q_{14}$ , and  $D_5$  are eliminated. This amounts to a considerable saving. If the maximum breakdown voltage of transistors does not exceed 300 volts, yet a fast cutout circuit is required for maximum transistor protection,  $Q_{11}$ ,  $Q_{15}$ , the relay may be eliminated. Then the minimum peak inverse voltage of  $D_3$  and  $D_4$  is only 400 volts.

If reverse-biased second breakdown is to be tested in pnp transistors, the basic test set circuit may be used. However, all diodes are reversed and all npn transistors are replaced with similar pnp types and vice versa.

#### The author

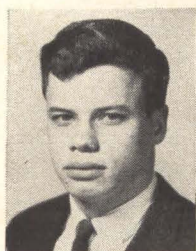

Peter Schiff is a member of the Industrial Applications Department at RCA's Somerville facility. He joined RCA last year after doing basic research on silicon epitaxy at the Philco Corp. He is enrolled in the electrical engineering program at the Drexel Institute of Technology.

#### Test set operating procedure

1. The desired value of  $V_{BE}$  is divided by  $R_{BE}$  to obtain the current required to overcome the reverse-bias conditions of  $R_{BE}$  and  $V_{BE}$ , thereby putting the test transistor in a forward-bias mode.
2. The base current required to saturate the transistor at the maximum collector current is obtained from the transistor data sheet.
3. The two values of current are added and the base drive selector is set to at least twice this value. This doubling ensures getting a true value of  $I_{S/B}$  at the selected reverse-bias conditions by making the fall time of the pulse generator output less than the storage time of the test transistor.
4. The  $R_{BE}$  selector is set to the desired value.
5.  $V_{BE}$  is adjusted to the desired value by changing the power supply voltage accordingly.
6.  $I_C$  is increased by varying the current adjust control and/or the large inductor,  $L$ , is also increased until second breakdown occurs. This is indicated by the lamp glowing and the clicking of relay RY. The setting of the  $I_C$  dial is the value of  $I_{S/B}$  which is used in the design procedure.

The susceptibility of transistors to second-breakdown damage in the test set is related to particular types of transistors displaying high collector-to-base capacitance, ( $C_{ob}$ ). Of all the units considered in this article, only the 2N3265 displays this tendency.  $C_{ob}$  has to be discharged at S/B.

When transistors are subjected to reverse-biased second breakdown, permanent damage to the transistor results in a collector-to-emitter short while the base-emitter diode characteristics are retained, provided the transistor is not damaged by long periods of current flow from the power supply after second-breakdown failure has occurred. If the damage is less severe, the greatest change results in a degradation of  $V_{CBO}$  and  $I_{S/B}$ .

To resolve any doubt about mistriggering of the second-breakdown detector, the base of the test transistor is monitored with an oscilloscope for second-breakdown oscillations.

#### References

1. C.R. Turner, Interpretation of Voltage Ratings for Transistors, RCA Application Note SMA-2
2. Z.F. Chang and C.R. Turner, Characterization of Second Breakdown in Silicon Power Transistors, RCA Application Note SMA-21

# The cool world of components

Modern circuit design demands an understanding of the behavior of existing devices at low temperatures. Specific performance data is given for components at 77°K.

By R.J. Allen and E. Niehenke\*

Eastern Technological Center,  
Bunker-Ramo Corp., Silver Spring, Md.

If current trends continue, the system and circuit designer will have to solve many new problems associated with an extremely low-temperature environment. This environment occurs in space but there are many terrestrial applications for devices requiring low temperatures—masers, lasers, parametric amplifiers and infrared detection devices.

Electronic components can meet the demands of extreme temperatures but the conventional approach calls for complex temperature-compensating circuits, coupled with bulky and expensive packaging schemes. Now the aim is to design electronic equipment with components that operate satisfactorily at low temperatures without such costly and space-consuming protective methods. The goal can be achieved through a better understanding of the behavior of components at low temperature.

\* Now with Aerospace Division,  
Westinghouse Electric Corp., Baltimore

## Resistor behavior at liquid nitrogen temperature

Resistor type	Nominal value room temp.	% Change at 77 deg K	Power breakdown at 77 deg K
Carbon film, 1%—1/10 watt (Mepco)	1 K	8	little change
	10 K	8	
Nickel alloy film, (Martin)	varied values	+2	doubles
Tin oxide, (Intellux)		-1.35	
Carbon comp. 5%—1/2 watt (Ohmite)	100	+32	little change
	1 K	+51	little change
	2 K	+80	
Carbon comp. 10%—1/2 watt	10 K	+68	little change
Wire wound type WW4J	2 K	-1	

The literature on low-temperature performance of conventional circuits and components is meager and widely scattered but there is data available on various types of components that may be considered for use in temperatures in the liquid-nitrogen range (77°Kelvin). Most investigations of component behavior at low temperature have taken place in this range. The main object of the research which is described here has been to understand the behavior of various classes of devices, rather than to conduct exhaustive evaluations on the variations between individual components.

## Resistors

The performance at 77°K of a wide range of resistor types is summarized in the table, left<sup>1, 2</sup>. The data shows that all types perform satisfactorily at low temperature, and most types actually show improved characteristics. The carbon-composition resistor exhibits the widest change in resistance value, while carbon-film types show only a small amount of change. Both exhibit a small increase in power-handling capability, probably attributable to poor heat-transfer characteristics of the composition material in which they are packaged. Performance of thin-film, evaporated metal resistors is particularly promising for designers. By the use of various additives during the evaporation process, the temperature coefficient of resistance of the resistors can be controlled during manufacture to yield a variation of resistance less than 2% between 77° and 300°K. In addition, the table shows that power-handling capacity increases significantly.

There were no mechanical failures of commercial resistors either while running at rated power and 77°K, or during thermal shock. The test periods were not long enough to determine long-term effects of 77°K operation. In general, resistance

values at both room and liquid nitrogen temperature increased slightly (under 1%) after thermal-cycling and rated-power tests.

### Capacitors

In obtaining data on a wide variety of capacitor types, emphasis has been placed on evaluating a wide range of components with accuracy sufficient for engineering purposes (see table below).

Measurements were taken at 60 cps and 1 Kc. Wet electrolytic capacitors, both tantalum and paper, failed completely at liquid-nitrogen temperature, while most other types performed reasonably well. Teflon and polystyrene-foil capacitors give the best performance in the wound (paper) class, by maintaining high breakdown-voltage and low loss-tangent. At lower temperature Teflon dielectric probably would give the best results—it remains flexible even at liquid helium temperature (4°K). Polystyrene becomes brittle at temperatures somewhat above that of liquid nitrogen.

Ceramic capacitors show the widest variation in characteristics. This was expected since the dielectric constant of such capacitors depends on the crystalline properties of the ferroelectric used and it, in turn is dependent on temperature. At room temperature additives are used to minimize this thermal dependency.

The effect of additives on the host material at low temperatures provides another variable factor. In general, it was noted that the capacitance of the

ceramic units first increased as the temperature was lowered, peaked, then dropped to values below those at room temperature when 77°K was reached.

Loss tangent of capacitors increases slightly. The Aerovox ceramic capacitors show a much smaller change in capacitance and smaller spread in values than the Erie types, but the former exhibits a slightly larger dissipation factor.

Dry tantalum capacitors retain a major part of their capacitance at low temperatures. They appear to be the only type that provides large capacitance values, since the wet electrolytic fails completely. The capacitance stability of dry tantalum capacitors is offset for some applications by a large increase in dissipation factor in the larger capacitance units (> 1.0  $\mu$ f). However, in the smaller values, the dissipation factor decreased considerably. This suggests that the increase may be due to a variation in manufacturing methods, and is not inherent in the capacitor types.

As in the case of resistors, there is a surprisingly low incidence of permanent failure of units at low temperature. No mechanical or electrical failure was noted except for the cracking of the phenolic case on large wet electrolytics. The wet electrolytic paper and tantalum types, which were completely inoperable at low temperature, recovered fully when brought back to room temperature.

### Diodes

Performance data has also been obtained on

### Capacitor behavior at liquid nitrogen temperatures

Type	Value	Manufacturer	Part number	% Change in Capacitance	Conclusions
Mica	470 pf	Micamold Mfg. Co.	CM15D471J03	-1.25	Satisfactory
Paper	0.047 $\mu$ f	San Fernando Elect. Co.	CP08A1KE473K3 100 vvdc	-21.4	Usable. Predictable derating of capacitance. Considerable improvement in dissipation
Paper	0.47 $\mu$ f	San Fernando Elect. Co.	CP08A1KE474K3 100 vvdc	-25.9	Capacitance derating predictable. Breakdown voltage greatly reduced
Polystyrene	0.047 $\mu$ f	General Products Corp.	CQ04A1PF473J	+2	Appears satisfactory but only one sample tested
Teflon	0.01 $\mu$ f	General Products Corp.	CQ04A1TC103K	+0.86	Satisfactory
Tantalum (wet electrolyte)	1.5 $\mu$ f 10 $\mu$ f	Ohmite Mfg. Co.	CL448P1R7TP3 10-6B12	-100 -100	Unsatisfactory
Tantalum (dry dielectric)	0.01 $\mu$ f 1.0 $\mu$ f 150 $\mu$ f	Sprague	150D103X9035A0 150D105X9035A0 150D157X001550	-8.3 -9.7 -28.8	Satisfactory; dissip factor improves Satisfactory if dissip factor can be tolerated
Ceramic	0.005 $\mu$ f	Aerovox	90A2-2	-22	Usable with capacitance derating and dissipation increasing
	0.020		90A2-4	-10	
	0.050		90A2-5	-25	
	470pf	Erie Resistor Corp.	ED-470	-40	Usable (as above)
	0.001 $\mu$ f		ED-1000	-60	Usable (as above)
	0.0047		ED-0.0047	-91	Unsatisfactory
	0.010		ED-0.01	-50	Usable with capacitance derating and dissipation increasing
Thin film	440 pf	Martin Marietta	Experimental samples	-25	Satisfactory. Small sample size. Room temperature defects
Electrolytic (paper)	40 $\mu$ f 2000 $\mu$ f etc.	(Several Mfg.)		-100	Unsatisfactory

high-speed diodes, tunnel diodes, zener diodes, storage diodes and rectifier diodes.

P-n junctions exhibit an increase in barrier potential with low-temperature operation. At 77°K, the open-circuit barrier potential is approximately doubled for both silicon and germanium units. This increase is a direct consequence of the change of the fermi levels of both the p and n semiconductor. Under these conditions, the reverse current of the diodes is practically undetectable. The junction capacitance also decreases as the junction potential increases, in accordance with the following relationship,

$$C = \frac{C_0}{\left(1 - \frac{v}{\phi}\right)^\gamma}$$

where  $C_0$  is zero-bias capacitance,  $v$  is voltage and  $\phi$  is the contact potential. For an abrupt junction  $\delta$  is equal to  $\frac{1}{2}$ , and  $\frac{1}{3}$  for a diffused junction.

As temperature goes down,  $C_0$  decreases and  $\phi$  increases resulting in a net loss of capacitance. Reduced capacitance allows the diode to perform at higher operating speeds and greater bandwidth. Zero-bias capacitance is reduced by approximately 80%. The series resistance of germanium diodes decreases considerably while the resistance of silicon units doubles at 77°K.

In high-speed applications, diode back-recovery time is an important factor. This is the time required for the removal of carriers (electrons or holes) from the diode, after the applied pulse has been removed. For silicon high-speed diodes, recovery time decreases 20- to 50%, at 77°K, while the breakdown voltage of semiconductor junctions increases slightly. One zener diode showed a 0.1-volt increase in the breakdown level when voltage was applied in one direction and only a 0.02-volt increase in the other direction. This unit has a 5-volt breakdown in both directions at room temperature.

Tunnel diodes exhibit an increase in peak current, a decrease in valley current, an increase in valley voltage and a decrease in dynamic resistance at liquid nitrogen temperatures. These effects result in increased switching speed of the diode as well

as increasing the available output voltage level for pulse applications. The curve (shown below) gives the volt-ampere characteristics of the General Electric Co.'s TD-103 tunnel diode.

When storage diodes are used in diode amplifier circuits, the charge is injected slowly into the device at low voltage and, at a later time, retrieved rapidly at higher voltage. Such a device showed improved efficiency as a charge transformer in a nanosecond logic circuit at 77°K.

## Transistors

In a semiconductor, transistor action is related to a number of factors, all of which have varying thermal dependencies. At 77°K, the voltage gain of alloy junction transistors, such as the 2N34, remains fairly constant. Other transistors (2N39 and 2N2034) are characterized by a small reduction in voltage and current gain. In general, it was found that almost all conventional transistors are not usable at liquid nitrogen temperatures.

Special transistors exhibiting low-energy gaps have been found to operate successfully at 77°K. For example, the National Semiconductor Corp. has developed a transistor, their CG-1, that will operate efficiently from 175°C to -200°C [Electronics, Feb. 21, 1964, p. 44]. Texas Instruments Inc. has utilized the high mobility of indium antimonide in a transistor with the hope of achieving fast switching time at low temperature.<sup>3</sup> It is said that this transistor, operating at 77°K, had characteristics comparable to transistors that worked at room temperatures. Texas Instruments has suspended its research in the field of indium-antimonide transistors, but the work already done shows that special transistors can and will have to be built for low-temperature circuit operation.

While the gain of a conventional transistor decreases, that of a field-effect transistor increases substantially in liquid nitrogen. Its transconductance is directly proportional to channel conductivity. Conductivity  $\sigma$  is related to  $n$ , the number of electrons available for conduction, and their mobility  $\mu_n$  by the relation  $\sigma = ne\mu_n$  where  $e$  = the charge on an electron.

The channel conductivity versus temperature has been plotted for a Crystallonics C-620 field-effect

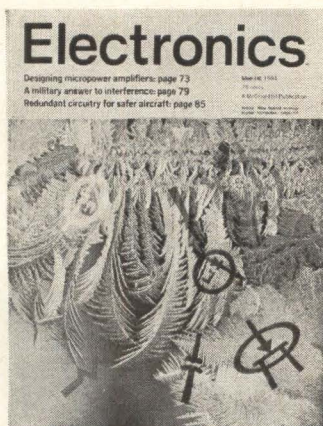

### The cover

Electronic components at low temperatures are represented by component symbols immersed in ice crystals on a window. Working on this cool cover helped Art Director Howard Berry keep comfortable during a recent hot spell.

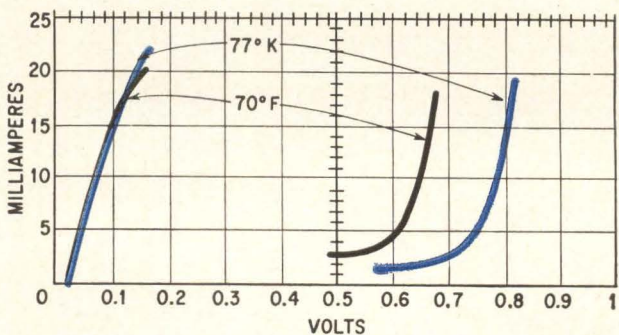

Volt-ampere characteristic of GE type TD-103 tunnel diode shows an increase of peak current when immersed in liquid nitrogen.

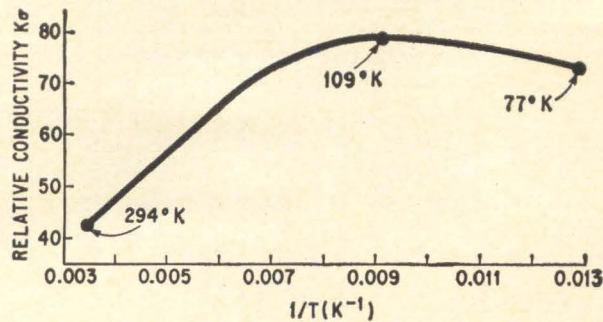

Conductivity of field-effect transistor, proportional to transconductance, peaks at 109° Kelvin, the point at which all donors are ionized.

FIELD EFFECT TRANSISTOR (C-624)						
CURVE	TEMP	R <sub>L</sub>	f (CUTOFF)	f (3DB)	GAIN BANDWIDTH	INPUT IMPEDANCE (1Kc) (15 Kc)
—	70 F	38.3 KΩ	150 Kc	50 Kc	196 Kc	5MΩ 0.125 MΩ
- - -	77 K	10 KΩ	1150 Kc	340 Kc	1260 Kc	6.7MΩ 0.129 MΩ
- - -	77 K	38.3 KΩ	760 Kc	78 Kc	846 Kc	

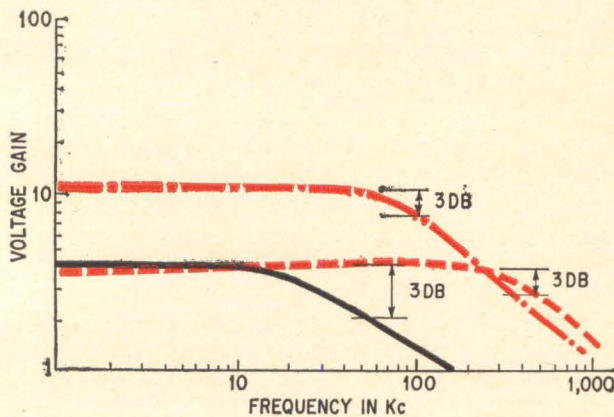

Response curves for a field-effect transistor amplifier are compared at room temperature and at liquid nitrogen temperature.

#### The authors



Richard J. Allen has been with the Martin Co. since 1955, most recently in the research and advanced technology department of the Electronics Systems and Products division. There he has been responsible for the development of super conducting delay lines, and the investigation of the effects of nuclear radiation on components.



Edward C. Niehenke joined the Westinghouse Electric Corp. after two years at the Martin Co. where, as an associate engineer in the research and advanced technology department, he worked on X-band cryogenic delay lines, and investigated the properties of solid-state devices at 77°K. He is a candidate for the master's degree at the Drexel Institute of Technology.

transistor (shown left). At low temperature, the conductivity is low because of incomplete ionization of the donors. At 109°K, all donors are ionized, resulting in maximum conductivity. Further increase of temperature is characterized by decreasing conductivity as the result of a reduction of carrier mobility. Low temperature volt-ampere characteristics were taken for field-effect transistors made by Crystalonics, Inc., Fairchild Semiconductor and Texas Instruments, Inc. The equivalent circuit capacitance was measured for a Crystalonics C-624 unit, over the entire operating region. The gate-to-source capacitance decreased 20% for normal operating regions, due to an increase of the depletion region width. Little change was observed in the gate-to-drain capacitance.

#### Circuits

Field-effect transistor circuits and diode or tunnel-diode circuits show improved operation at low temperature. While the gain bandwidth product of a field-effect transistor circuit was found to improve by almost an order of magnitude, use of the circuit is still limited to frequencies under one megacycle. The diode and tunnel-diode exhibited faster logic capability at reduced temperature.

The higher frequency response of a field-effect amplifier at 77°K. is shown (shown left). The gain bandwidth product of the C-624 unit was extended from 196 Kc to 846 Kc, the load resistor, (R<sub>L</sub> = 38.3-k ohms). The gain-bandwidth product was increased to 1,260 Kc by using a load resistor to 10-k ohms. The input impedance was increased from 5 Megohms to 6.7 Megohms at 1 Kc for identical gains at 70°F and 77°K. A lower pinchoff voltage was also noted.

A monostable tunnel-diode circuit operated satisfactorily at liquid-nitrogen temperatures. This cir-

#### Editors note

Although no one presently specifies field-effect transistors or, for that matter, any semiconductor device specifically for operation at low temperatures, field-effect transistors have been recognized for some time for their ability to function under such conditions.

The C-620 and C-624, discussed (p. 77 and 78) are early alloy versions of Crystalonics' low-noise field-effect transistor. These have since been supplanted by the 2N3088 in the case of the C-620, and the 3088A in the case of the C-624. The more recent devices are similar in noise characteristics but exhibit much higher G<sub>m</sub> and lower input capacitance along with the stability and low leakage inherent in the planar process, a part of the epitaxial junction process. The lower input capacity greatly extends their frequency response, especially when being driven from high source resistances.

In the field-effect transistor there is a magic operating point where the pinchoff voltage is approximately 0.7 of a volt. This operating point is usually achieved with reverse bias. At this point the gain characteristic of the field-effect transistor does not change significantly with temperature. This is due to a balance in the two inherent temperature coefficients—the increase in bulk resistivity with temperature causes the current to decrease, and the decrease in junction potential with temperature causes



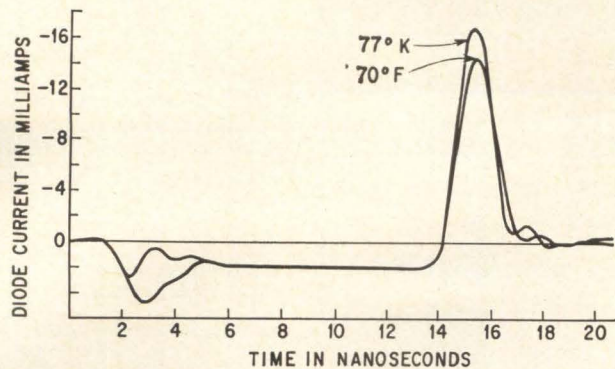

Gain of diode amplifier at 77°K, is enhanced over that at room temperature. Curve shows diode amplifier output for 2-ma forward current.

cuit consisted of a General Electric TD-103 20-ma tunnel diode in series with a  $0.3 \mu\text{h}$  inductor, all shunted with a  $3.3\text{-}\Omega$  resistor. Relaxation oscillation is obtained by supplying current in excess of the peak current of the tunnel diode. Similarly, monostable operation may be obtained by a reduction of the current supplied and application of a trigger pulse through a gating diode supplying the required current.

At reduced temperatures, both the charge and discharge time-constants of the circuit were reduced, resulting in increased repetition rate and reduced pulse width. Also, the pulse height increased due to larger valley voltage at 77°K.

Diode amplifiers are used in nanosecond logic circuits. These devices store a charge by application of current in the forward direction. The stored charge is then released upon reception of a negative pulse whose rise time is less than the carrier lifetime of the diode. The output current waveform is a pulse with an amplitude many times that of

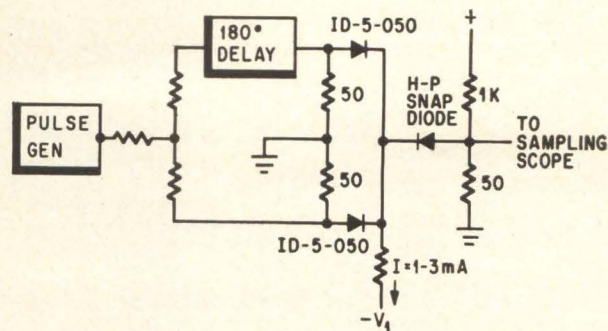

This amplifier circuit was used to evaluate the performance of charge storage diodes, as typified by the experimental Hewlett-Packard unit. Curve at left

the input, with a rise time of a nanosecond. The curve (shown above) gives the characteristics of the diode amplifier circuit shown. It uses an experimental graded-base snap-off diode made by the Hewlett-Packard Co. At 77°K, for an identical input, the output pulse is eight times the amplitude of the input pulse, compared with a ratio of seven at room temperature.

Investigations have shown how components designed for less stringent environment behave at liquid nitrogen temperature. Some conventional circuits operate satisfactorily at 77°K. Resistors and diodes offer no problems and in many cases, their performance improves at low temperatures.

## References

1. Allen, R.J. et al, Final Report—Investigation of Electronic Instrumentation at Liquid Nitrogen Temperature, RADCD-63-20 December, 1962.
2. Hickmott, J.T., Notes on Transistor Circuits for Lowered Temperatures, ASTIA-AD211818, February, 1959.
3. Henneke, H.L., Indium-Antimonide Transistors, Solid State Electronics, Pergamon Press, 1961, Vol. 3, pp. 159-161.

the channel to widen because of a decrease in the width of the depletion region.

Another method of compensation is to use the field-effect transistor with a significantly high pinchoff along with the standard bipolar transistor in a configuration similar to Crystalonics' composite series of C-640 field-effect transistors. With these, the University of Southern California ran tests from  $-200^{\circ}\text{C}$ , to  $+100^{\circ}\text{C}$ , and found typical gain variations of less than 25% over its entire temperature range. Although gain does increase with the decrease in temperature in a field-effect transistor whose pinchoff is above 0.7 of a volt, the noise also increases slightly. This makes packaging the only true advantage in using a field-effect transistor at cryogenic temperatures in cool detector applications.<sup>1</sup>

At the Bell Telephone Laboratory, investigations of the junction capacitance of gallium-arsenide diodes (conducted by H.J. Fink, D.C. Hanson and M. Uenohara) have shown that the change in junction capacitance from liquid-nitrogen temperature to liquid-helium temperature is much smaller than that from room temperature to liquid-nitrogen temperature. Similar results have also been obtained with some epitaxial silicon diodes. It has also been found that the dynamic quality factor Q of gallium-arsenide diodes improves continuously down to liquid helium temperature. Blake and others at the Massachusetts Institute of Technology's Lincoln

Laboratory have recently measured  $10^{\circ}\text{K}$ . excess noise temperature for an L-band parametric amplifier operated at liquid-helium temperature. This correspondence presents the experimental data of a 4-Gc parametric amplifier obtained at liquid-helium temperature.

H.J. Fink and his colleagues measured the input impedance loci of the 4-Gc amplifier with a gallium-arsenide diode at three different temperatures, i.e.  $298^{\circ}\text{K}$ ,  $77^{\circ}\text{K}$  and  $4.2^{\circ}\text{K}$ , as a function of bias voltage. All three impedance loci were measured at 4.17 Gc, with all circuit conditions maintained constant for the entire experiment. The resonant bias voltage shifted from  $-125 \text{ v}$ . at  $298^{\circ}\text{K}$ . to  $-0.94 \text{ v}$ . at  $77^{\circ}\text{K}$ . and to  $-0.85 \text{ v}$ . at  $4.2^{\circ}\text{K}$ . From the capacitance measured at room temperature, the Bell Lab workers determined the effective diode capacitance at each temperature. The series resistance  $R_s$  also decreased as the temperature was lowered to liquid-helium temperature. This was shown by the increase in the vswr at the resonant point as the temperature was reduced.<sup>2</sup>

## References

1. Private communication from Joel M. Cohen, Applications Engineer, Crystalonics, Inc., Cambridge, Mass.
2. H.J. Fink, D.C. Hanson and M. Uenohara, Bell Telephone Labs., Proceedings of the IEEE, Vol. 51, No. 1, Jan. 1963.

# Designer's casebook

Designer's casebook is a regular feature in Electronics. Readers are invited to submit novel circuit ideas, packaging schemes, or other unusual solutions to design problems. Descriptions should be short. We'll pay \$50 for each item published.

## Field-effect transistor controls pulse oscillator

By T. C. Ross

Infrared Industries, Inc., Santa Barbara, Calif.

A field-effect transistor can be used as a voltage-controlled nonlinear resistor [Electronics, Feb. 21, 1964, p. 36]. When used in the pulse oscillator shown, it provided in some applications a circuit with greater reliability than a conventional multivibrator. The circuit was operated at frequencies to one kilocycle when used as an exponentially variable clock to provide smooth acceleration for high-speed stepping motors. Output frequencies of several megacycles per second were also obtained with this circuit after minor modification and using high-speed transistors.

The basic configuration of the pulse oscillator is shown in (A). The modification of the basic circuit to allow voltage control over the output pulse repetition rate is shown in (B). In (B), the field-effect transistor  $Q_3$  replaces the fixed resistor  $R_5$  of (A), and is used as a voltage-controlled resistor to vary the oscillator time constant. The large input resistance of the field-effect transistor provides the circuit with an excellent input characteristic, which allows voltage control by signal sources of very high internal impedance.

The operation of the circuit in (B) is more easily explained by first referring to the circuit in (A). When the power is connected, capacitor  $C_1$  begins charging through  $R_1$  and the base of  $Q_2$ .  $Q_2$  conducts. The charging time constant is  $C_1R_1$ . Transistor  $Q_2$  saturates and keeps  $Q_1$  nonconducting. Time constant  $R_1C_1$  determines how long  $Q_2$  conducts. As  $C_1$  builds up charge, the current charging  $C_1$  drops below the value needed to keep  $Q_2$  in saturation. Transistor  $Q_1$  now conducts;  $Q_1$  base current begins to flow through  $R_3$ ; and  $Q_1$  collector current starts to flow through  $R_1$ . The  $Q_1$  collector current displaces the residual capacitor charging current in  $R_1$  and causes  $Q_2$  to be cut off. This further increases  $Q_1$  base current through  $R_3$ , and the positive-going voltage at the collector of  $Q_1$  is coupled through  $C_1$  back to the base of  $Q_2$ , reverse-biasing the  $Q_2$  base-to-emitter junction.

Capacitor  $C_1$  now discharges through  $R_5$  and the fully conducting  $Q_1$ . The discharge current keeps  $Q_2$  cut off as long as the voltage developed across  $R_5$  remains greater than the voltage drop supported by  $Q_1$  across  $R_2$ .

As soon as the discharge current falls below the value needed to maintain a voltage drop across  $R_5$  which keeps the base of  $Q_2$  positive,  $Q_2$  base current will begin to flow in  $R_5$ . The resumption of conduction by  $Q_2$  starts the regenerative process, which decreases the conduction of  $Q_1$  and again leads to the saturation of  $Q_2$  and the cutoff of  $Q_1$ , and the cycle is repeated.

Capacitor  $C_1$  appears in two separate time constants,  $R_1C_1$  (charging) and  $R_5C_1$  (discharging). By varying the value of  $R_1$  or  $R_5$ , the pulse repetition rate is changed without affecting the pulse width.

In (B),  $R_5$  is replaced by a field-effect transistor and  $R_6$ , an isolation resistor, is added. Time constant  $R_1C_1$  is typically made short to produce narrow output pulses. The spacing between successive pulses and therefore the repetition rate is controlled by  $C_1$  and the equivalent resistance of the field-effect transistor.

Capacitor  $C_1$  appears in two separate time constants,  $R_1C_1$  (charging) and  $R_5C_1$  (discharging). By varying the value of  $R_1$  or  $R_5$ , the pulse repetition rate is changed without affecting the pulse width.

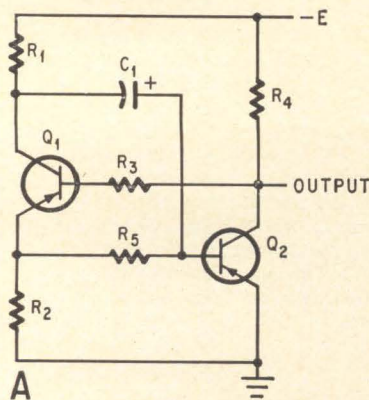

Basic configuration of pulse oscillator

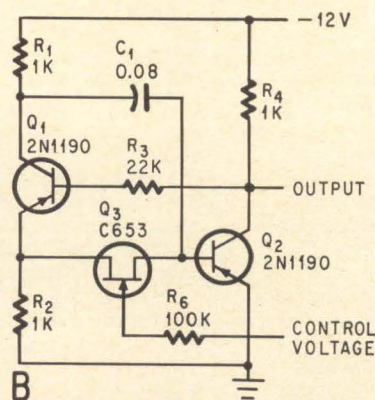

Voltage-controlled pulse oscillator circuit with field-effect transistor in place of  $R_5$

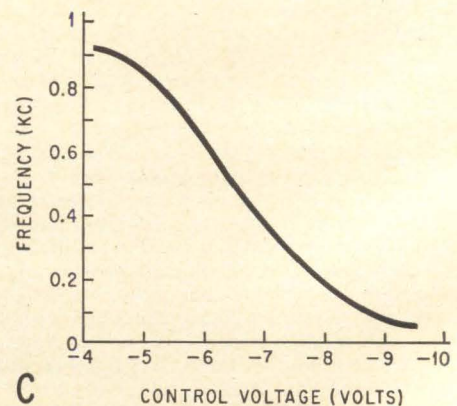

Pulse repetition rate (frequency) vs. control voltage

Resistor  $R_6$  is used to protect  $Q_3$  from damage by accidental connection of excessively large control voltages. The value of  $R_6$  has no important significance to circuit operation because of the high input resistance of  $Q_3$ , and is chosen for convenience in the 100,000-ohm range.

The high input resistance of the field-effect transistor places nearly no load on the controlling volt-

age. This allows the use of simple filter elements to shape the controlling voltage to produce the desired modulation of the output frequency. The variation in output frequency produced by changing the control voltage is shown in (C).

The field-effect transistor used was an n-channel type C653, manufactured by Crystalonics, Inc., Cambridge, Mass.

## 4-terminal controlled switch divides frequencies by 10

By Richard J. Wold

Geophysical and Polar Research Center,  
University of Wisconsin, Madison, Wisc.

An accurate relaxation-oscillator frequency divider was needed to divide a 1,000-cps signal down to 10-cps in a chronometer. Two stages of division were employed with each stage basically consisting of a four-terminal silicon-controlled switch, a resistor and a capacitor.

In the basic frequency-divider stage (above), positive voltages are supplied at points  $V_B$  and  $G_A$  ( $V_B > V_{GA}$ ). Capacitor C starts to charge according to the RC time constant. When C has charged sufficiently, the silicon-controlled switch is turned on. Capacitor C then discharges through the silicon-controlled switch. When the discharge current falls below the holding current—the minimum current required to maintain current—of the silicon-controlled switch, the device is turned off. Capacitor C starts to charge again and the cycle is repeated.

Synchronization of the relaxation oscillator is achieved by applying a positive pulse to point  $G_C$ . The synchronization pulses raise the operating frequency to a synchronous frequency that is higher than the oscillator's natural frequency.

The output waveform produced is a sawtooth, which also allows the use of the circuit as a sawtooth generator. With a high voltage at point B (about 100 volts) and a low bias at point  $G_A$  (about five volts), a fairly linear sawtooth waveform may be developed with periods up to one minute.

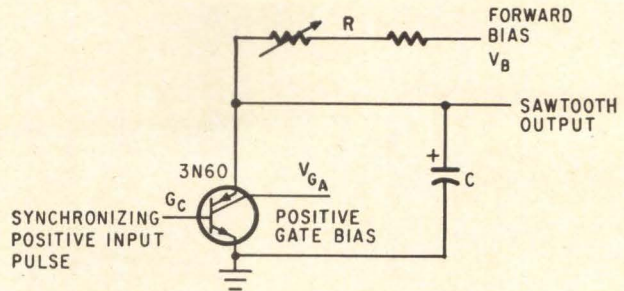

Basic relaxation-oscillator frequency divider

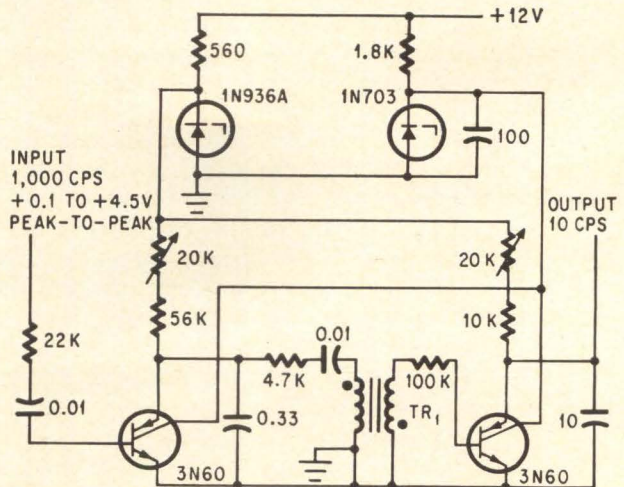

Two 4-terminal silicon-controlled switches divide input signal frequency by 100.

The circuit is capable of division by 10 for any input signal from 0.1 to 4.5 volts peak-to-peak, ranging in frequency from 250 kilocycles down to frequencies with periods as long as one minute.

The two-stage circuit used to accomplish the frequency division by 100 is given in the figure

### Frequency-divider stage typical operating data

Controlled switch	$E_B$ (volts)	$I_B$ ( $\mu a$ )	$E_{GA}$ (volts)	$I_{GA}$ ( $\mu a$ )	R (megohms)	C ( $\mu f$ )	$E_{GC}$ (volts)	Frequency Input	Output
3N60	120	120	6.2	20	1	.068	1.0	2,800 cps	280 cps
3N60	120	110	6.2	5	1.1	.00012	*	*	40 kc**
3N60	11.8	70	6.2	5	0.1	.068	1.0	1,800 cps	180 cps
3N60	11.8	20	6.2	180	0.3	.0018	*	*	2.5 kc
3N58	120	120	6.2	70	1	.068	1.0	2,800 cps	280 cps
3N58	11.8	23	6.2	3	0.34	.068	*	*	40 cps

\* Free-Running; \*\* Maximum output frequency for any combination of  $E_B$ ,  $E_{GA}$ , R or C

## Designers casebook

shown. Silicon-controlled switch type 3N60, manufactured by the General Electric Co., was used in each stage, Type 3N58 may also be used as shown in the accompanying chart of typical operating data. United Transformer Co.'s type DI-T25 is used between stages as the coupling transformer.

## Generating two rectangular waves

By Robert W. Maine

Dynalectron Corp., Gardena, Calif.

**Calibration of a system** for flare ejection required accurate generation of two separate rectangular waveforms—a 50-millisecond positive pulse and a 125-millisecond positive pulse both occurring at a frequency of .5 cps. Because the system was intended for use on aircraft, the weight and space requirements demanded a minimum number of components.

It was also necessary for the circuit to operate from a single power source and for each pulse to have rise and fall times under 2 microseconds

with a minimum pulse amplitude of 12 volts.

Initially, when the power is applied, transistors  $Q_4$  and  $Q_5$  conduct and become saturated. The resulting negative-going voltage at the base of  $Q_6$  forward biases  $Q_6$  while the positive-going voltage at the base of  $Q_7$  reverse biases  $Q_7$ . Point A is placed at ground potential and point B at approximately +16 volts.

Meanwhile capacitor  $C_1$  starts to charge through  $R_1$ . When  $C_1$  has charged sufficiently, the emitter of  $Q_1$ , a unijunction transistor, reaches the breakover potential. Positive and negative pulses appear simultaneously at base 1 and base 2 of the unijunction transistor (inherently synchronized positive and negative signals may be obtained from a unijunction transistor). These signals are coupled through  $C_2$  and  $C_3$  to the collectors of  $Q_2$  and  $Q_3$ , turning both  $Q_2$  and  $Q_3$  on. The negative-going voltage at the collector of  $Q_2$  is applied through  $C_4$  to the base of  $Q_4$  and the positive-going voltage at the collector of  $Q_3$  is applied through  $C_5$  to the base of  $Q_5$ . Both  $Q_4$  and  $Q_5$  are brought out of saturation turning  $Q_6$  off and  $Q_7$  on. The potential at point A is now approximately +16 volts and point B is at ground potential.

Time constants  $R_6C_4$  and  $R_8C_5$  determine when  $Q_4$  and  $Q_5$  revert to their original saturated condition. Then  $Q_6$  turns on,  $Q_7$  turns off, point A returns to ground potential, and point B to +16 volts.

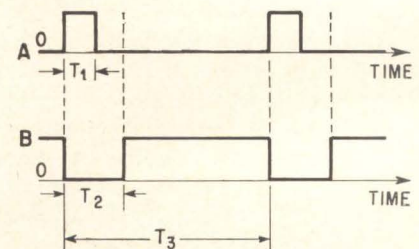
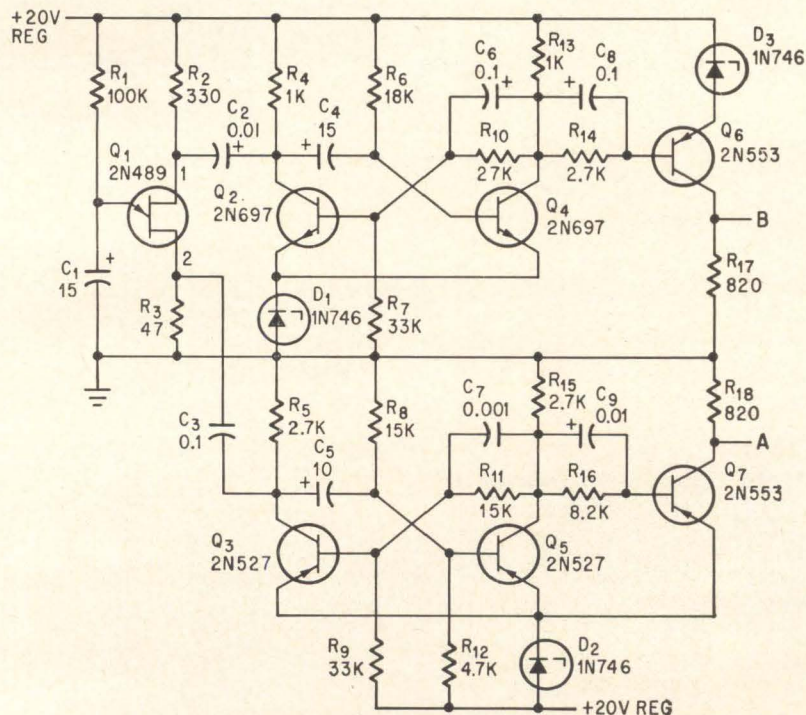

Voltage output waveforms at points A and B

A p-emitter unijunction transistor, two n-p-n transistors and four p-n-p transistors were used to provide the required output pulses with a minimum number of components.

Time period  $T_1$  depends on  $R_5C_5$  and  $R_6C_4$  determines  $T_2$ . The repetition rate is set by  $R_1C_1$ .

With the component values shown, the rise and fall times were under one microsecond. The am-

plitude of the output voltage was from 14 to 17 volts. Stability for the time periods was  $\pm 5$  milliseconds. The equipment was operated over a temperature range from  $0^\circ\text{C}$  to  $55^\circ\text{C}$ .

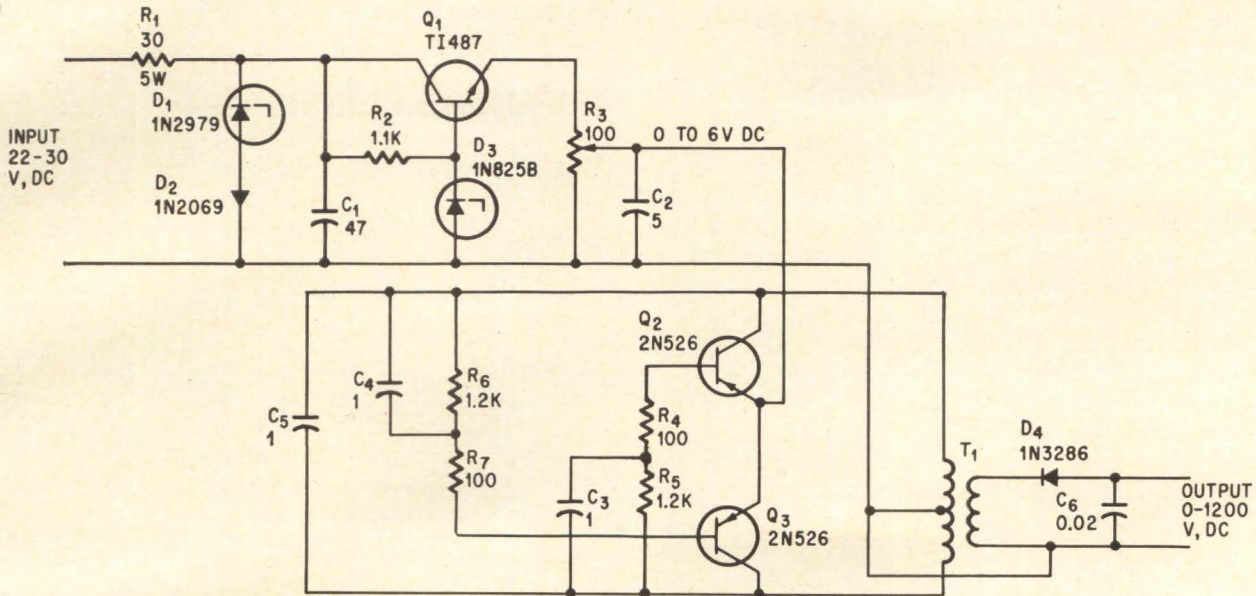

Regulation of output voltage was within  $\pm 0.5$  over the entire operating-voltage range.

## Network filters stabilize d-c supply over wide range

By John G. Peddie

Aero Service Corp., Philadelphia

**A compact** and highly stable d-c supply was needed to provide power to a photomultiplier stage of an aerial surveillance system. It was necessary for the supply to be variable from 0 to 1200 volts and to have good regulation, once set at a particular voltage, despite modulation by the aircraft's generators. Since the supply was to be used in airborne equipment, stability over a wide operating-temperature range was also important. In addition, only eight cubic inches of space were available to contain it.

The filter network used consists of  $R_1$ ,  $D_1$ ,  $D_2$ , and  $C_1$ . Silicon diodes  $D_1$  and  $D_2$  have matched temperature coefficients. However the temperature coefficient of  $D_1$  is negative (its resistance decreases with temperature) while the temperature coefficient of  $D_2$  is positive (its resistance increases with temperature). As a result, a change in temperature results in equal but opposite changes in voltage

across each diode and the drop across both diodes remains nearly unchanged. Both  $D_1$ ,  $D_2$  and the stud-mounted  $Q_1$  are placed in heat sinks to assist heat dissipation.

Diode  $D_3$ , an avalanche-breakdown diode with a zener-voltage rating of 6.2 volts, holds the base of transistor  $Q_1$  at 6.2 volts. Resistor  $R_3$  varies the voltage to the inverting oscillator and, therefore, determines the amplitude of the output voltage.

The input voltage supply may vary from 22 to 30 volts with up to 5% ripple. The output data obtained with the supply follows:

Output voltage... 0-1200 volts d-c, Ripple-2% max.

Regulation...  $\pm 0.5\%$

Output power... 200 mw max.

Output isolation 30 db min.

Temperature coefficient... 0.1% of output voltage per  $^\circ\text{C}$  from  $-15^\circ\text{C}$  to  $+15^\circ\text{C}$ .

Transistor type TI487 is manufactured by Texas Instruments, Inc. The diodes and transistor type 2N526 are available from a wide number of manufacturers. Microtran type M8072 was used for transformer  $T_1$ .

For additional temperature stability,  $R_5$  and  $R_6$  may be replaced by Texas Instrument Sensistors. Higher output voltages may be obtained by using a full-wave bridge or voltage doubling circuits.

## Designer's casebook

# Low-cost time delay controls recorder

By Thomas H. Charters

Tektronix, Inc., Beaverton, Oregon

To avoid using a larger, more expensive, electro-mechanical timer to turn on recording instruments for a 15-minute reading period, a low-cost time delay circuit was designed. The circuit, shown below, uses a relay and three semiconductor devices—one of which is a silicon controlled switch.

The relay is activated at the beginning of the timing cycle and deactivated 15 minutes later.

When switch  $S_1$  is closed, both the +9 volts and the -9 volts are simultaneously applied. Transistor  $Q_1$  is immediately turned on by the biasing network and driven into saturation, activating relay  $K_1$ .

Meanwhile, following the closing of  $S_1$ ,  $C_1$  begins to charge slowly towards +18 volts. The charging path for  $C_1$  is from +9 volts through  $R_3$  and  $C_1$  to -9 volts.  $C_1$  continues to charge until its voltage reaches the magnitude necessary to forward-bias the cathode gate of the silicon controlled switch. This voltage ( $V_0$ ) is approximately  $[E_2 R_1/R_1 + R_2] + 1$  volts. For the component values shown, this value is about 8 volts.

The time required for  $C_1$  to charge to a sufficiently positive voltage to turn on the silicon controlled switch is expressed by:

$$t = R_3 C_1 \ln [(E_1 - E_2)/(E_1 - E_2 - V_0)]$$

Substituting the component values shown in the figure, the time required is 900 seconds.

When  $D_1$  is turned on, the voltage at the base of  $Q_1$  drops to about -1 volt,  $Q_1$  turns off, and the relay is deactivated. The circuit remains in this state, drawing only about 0.5 milliamperes from the power supplies until  $S_1$  is opened. When  $S_1$  is

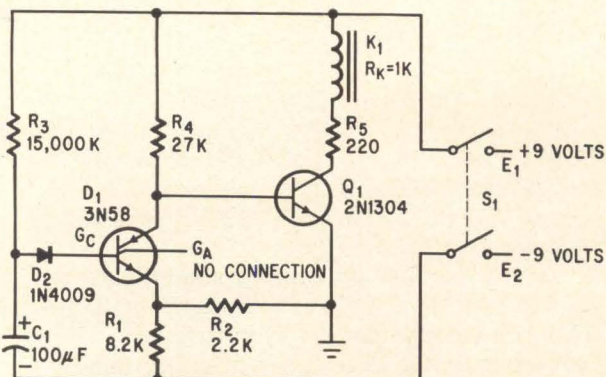

Closing switch  $S_1$  activates the relay for 15 minutes.

opened,  $C_1$  discharges rapidly through  $D_2$ ,  $R_1$ , and the forward biased gate-to-cathode junction of  $D_1$ .

A 100- $\mu$ f tantalum capacitor made by Sprague was used for  $C_1$ . The 3N58 has four leads but one of them, the anode gate lead, is not used in this circuit. The relay used was Sigma type 11F-1000G/SIL. Its coil has 1000 ohms resistance and requires a 7-milliamperes operating current.

## Laminated dissipator improves heat transfer

By Edward Trunk

Staver Co., Bay Shore, N.Y.

Conventional heat sinks intended for use with high-power transistors are often spotfaced (machined off) at the area of contact between the transistor collector and the heat sink surface. This allows maximum transfer of heat from the transistor to heat sink, but it also places the heat sink at the same potential as the collector, posing a safety hazard.

The conventional way to isolate the heat sink from the collector voltage is to place a washer or standoff insulator made of mica, Mylar, Teflon, fiberglass or similar insulating material between the transistor collector and the heat sink. However, this increases the total thermal resistance of the sink and reduces the efficiency of the heat transfer.

By using a laminated heat sink consisting of two sections joined by bonding cement, maximum thermal transfer is obtained and the high operating potential is removed from the main body of the heat sink. Either standard radiating fins or miniature rectangular cans with openings at both ends should be added to the heat-sink sections for greater heat dissipation.

When a laminated heat sink (3 inches wide, 4 $\frac{3}{4}$  inches long and 1 $\frac{1}{4}$  inches high) replaces a combination of a conventional heat sink (same size) and a mica washer, the thermal resistance is reduced from 3.2° to 2.4° C per watt.

The laminated heat sink uses an aluminum top plate, 3/32 inch thick, spotfaced to accommodate mounting the transistor. Except for the machined area, the top plate is hard-anodized coated; the anodizing is done in a refrigerated bath for extra-dense coating. The remainder of the heat sink is aluminum with a black anodized coating—a standard heat-sink finish applied at room temperature.

A layer of bonding cement with high thermal conductivity is used to join the two heat-sink sections. The layer is about 0.002 to 0.005 inch thick. The hard anodized coating on the top plate prevents electrical conduction from the top plate to the main body of the heat sink.

industrial electronics

# Boiler control: 1 Tighter rein with a-c servo systems

Transistorized versions increase advantages over conventional analog control systems

By Charles H. Smoot and Frank J. Karlov

Rockwell Manufacturing Co., Chicago



**In the process industries**—chemicals, petroleum, metals—conventional analog control systems, using d-c operational amplifiers and the usual feedback methods, are in widespread use. For the boilers that power those plants, however, conventional control isn't tight enough.

Conventional control solves processing problems with relatively independent control loops. But a boiler's complex, interrelated parameters are best held in rein by alternating-current servo control techniques.

A-c servo control has been in commercial use for 15 years. Some systems have been used with digital computers. Now transistorized versions are adding further advantages.

A major problem in boiler control is the fact that a boiler's output cannot be stored. While a process plant operates continuously at, or near, its maximum, a boiler must produce steam instantly, on demand.

Operating under fairly constant conditions, a plant can use unmodified differential-pressure measurements of flow. But a boiler's output fluctuates sharply and over a wide range. Flow measurements must be linear to perform the computations required for wide-range control, fool-proof manual control, and bumpless transitions between automatic, semiautomatic and manual control.

## Direct signals

Alternating current as the signal and control medium eliminates the need for conversion to d-c

and permits the use of electromagnetic devices that are inherently reliable and have no exact counterpart in d-c.

Usable high-level measurement and control signals are generated by differential transformers without any need for amplification. A differential transformer is one in which the core of the excitation winding can be moved. The core's position affects the output signals of two secondary windings that are wired to oppose each other. The motions required to produce outputs from controllers and other computational devices are achieved through the use of squirrel-cage a-c induction motors, which are reliable and require no maintenance.

Using a-c signals permits adding and subtracting with transformers, whose losses are trivial compared with the signal levels. Timing functions required for optimum boiler control, such as integration and differentiation, are easily produced by using induction generators within the servo mechanisms. These derivative signals are included in the feedback-loop for integration.

The servo system uses a small number of relatively simple devices. In addition to the differential transformer, induction motor and generator, the building blocks of this system include a noncritical servo amplifier, a simple proportional amplifier, transformers, slidewires and a few other passive electrical components. These building blocks can be put together in a large number of combinations, providing the measurement, computation, automatic and manual control, and valve-positioning

functions needed to control large industrial boilers accurately and reliably.

### Signal sources

The differential transformer is the signal source in a servo control system, providing a signal proportional to its core position. This is similar to the signal at the wiper of a slidewire with a voltage impressed across it. Transmitters consist of differential transformers whose cores are positioned by process forces operating Bourdon tubes, differential bellows, diaphragms and similar primary sensing elements.

The drawings (below, this column) show two typical transmitters. In A, the differential transformer driven by pressure from a Bourdon tube (flexible diaphragm) produces a signal proportional to that pressure. In B, a differential pressure bellows drives the differential transformer through a mechanical square-rooting linkage, so that the transmitter provides a direct flow-measurement signal. The rate of fluid flow in a conduit is proportional to the square root of the pressure drop across a restriction on the conduit. With linear mechanical linkage, the transmitter provides a linear signal and can be used to detect liquid level

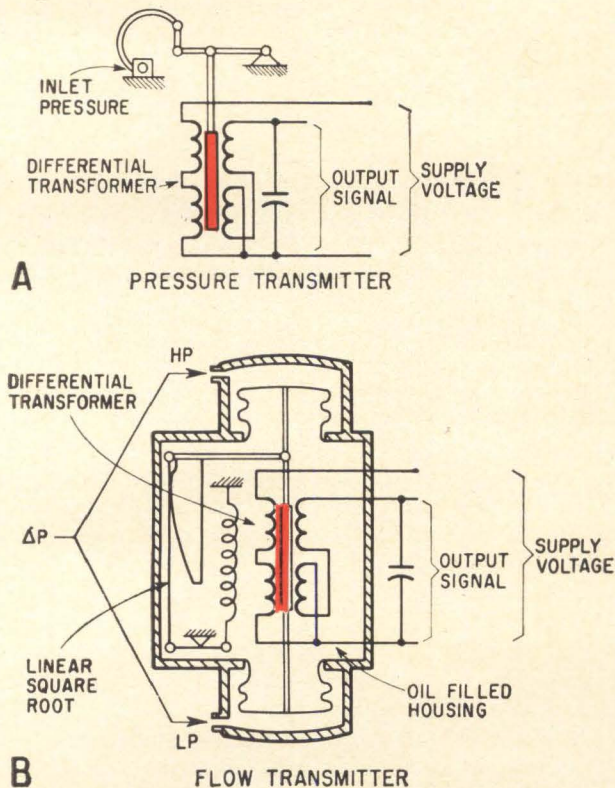

High-level signals of about one watt are produced by the Bourdon-tube pressure transmitter (top). The differential bellows (bottom) drives a differential transformer through a square-root linkage for a direct flow-measurement signal.

and other similar parameters. The moving members of these transmitters are mounted with flexural pivots to eliminate friction and the accompanying dead spot.

These transmitters provide a high-level a-c voltage signal, of the order of one watt power, so that signal transmission over long distances avoid stray pick up. The high signal-power level, and the ability to characterize the signal (direct flow, or signal proportional to measurement) at the transmitter, eliminates the need for amplifiers. This allows the transmitters to furnish directly usable signals to controllers, indicators and recorders, totalizers, integrators and other computation modules in the control system.

### Servo vs conventional

An example of the simple hardware that can perform fairly complex computations is shown below, this column. The method used within the a-c servo system to total three flow measurements at top is compared with the more conventional method below, which uses typical process-control devices. The use of series-connected transformer secondaries, at the top, with primaries connected directly across the square-rooted sig-

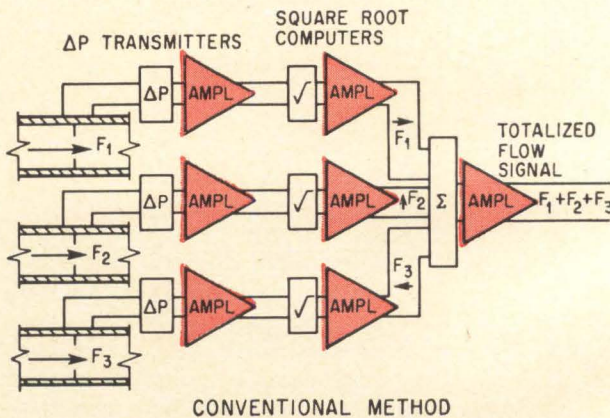
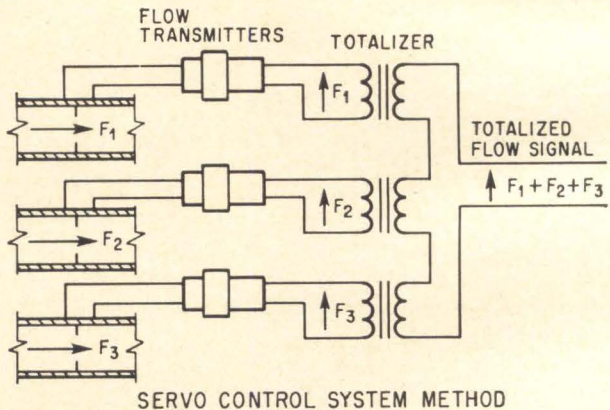

Simplicity breeds reliability as shown in this comparison of the a-c servo control method and the conventional method using d-c operational amplifiers. The conventional system needs seven separate amplifiers, shown in color. The servo system needs none using a-c as the signal and control medium.



nals from the transmitters, maintains the high power level of the transmitted signals throughout the computation.

The totaled output signal can drive the various receivers in the system requiring this signal, without the need for amplification of any kind.

The conventional operational amplifier approach may require as many as seven amplifiers, each of which must be precise and reliable. The amplifiers restore the signals to useful power levels after their attenuation in the computation circuitry. Since the accuracy of any control system can be no better than its measurement signals, the ability of the servo control system to generate, transport and use its signals, without passing them through amplifiers, is a significant factor contributing to over-all system accuracy and reliability.

### Positioners

At the bottom of this page is the servo mechanism whose output is the mechanical motion of a drive-unit positioner. The electrical components are identical with those used for the integrating controller discussed on page 88. Here, the set point is typically the command signed from a controller, and is combined with its own output position signal to provide the error voltage for the servo amplifier that drives the servo motor until coincidence is reached. The signal from the rate generator causes the servo amplifier to anticipate the servo's arrival at its final balance position. This provides first-derivative damping to prevent servo hunting.

Since the mechanical output of the device drives a pilot valve, the assembly is much less subject to sticking than a conventional force-balance mechanism. Force-balance mechanisms develop small dead spots for small sticking, and correspondingly larger dead spots as the sticking increases. The servo mechanism approach develops practically no dead spot unless the sticking of the pilot valve approaches the full-stall torque of the servo motor. This advantage plus the ability of the positioner to remain in its last controlled position in case of electrical power failure, are major factors in its consistent performance and reliability.

### Simplifying the system

The similarity of components of the integrating controller and positioner allow for further simplification of the system.

By eliminating the feedback differential transformer of the positioner and its signal, and using instead a similar signal from the process transmitter, both the controller and positioning functions can be achieved simultaneously from a single set of servo components. Here the servo gear train and error scaling are selected to provide the required timing function for stable loop performance. This simplified scheme can be used in control loops in which the process responds almost instantaneously to changes in valve position, such as in many flow loops. In such loops, the differential transformer can be considered to be driven through the valve-

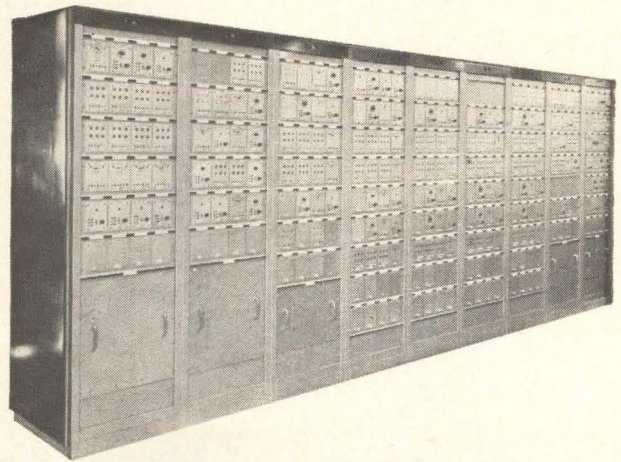
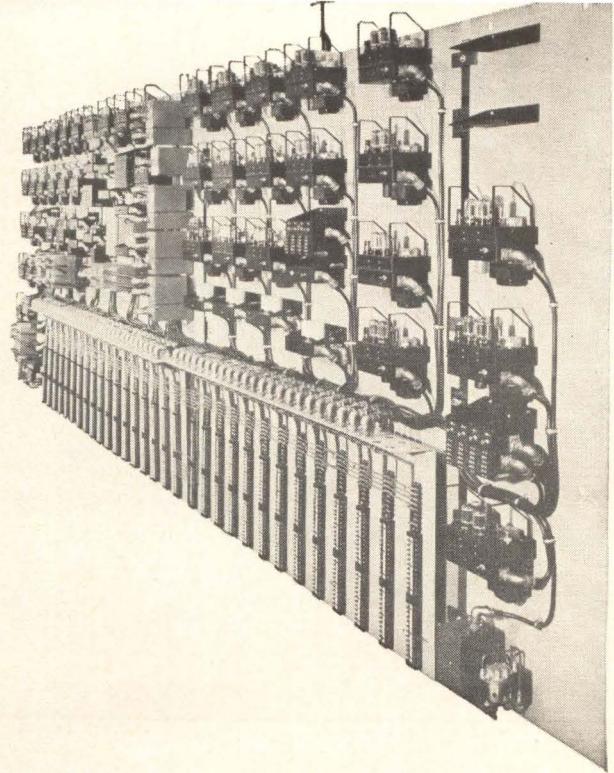

Half the space and three times the control are offered by the servo system, bottom photo. Its predecessor, the tube version, top photo, was the normal setup until transistors were introduced.

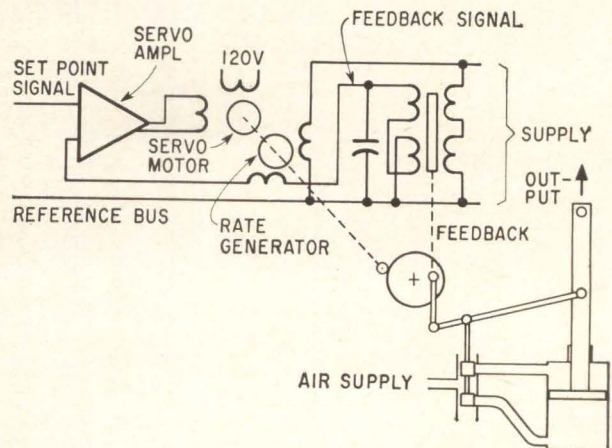

Servo positioner uses the same basic components as the integrating controller on page 88, reducing number of spare parts required. Rate generator feeds back signal to servo amplifier to reduce servo hunting.

process-transmitter chain, instead of through the motor gear train. This economy of components is not possible with the "universal" type of control format.

### Equipment rack

In addition to increased reliability due to solid-state electronic devices, their reduced size and heat dissipation permit the design of relatively small control-component modules that may be compactly arranged to build up a complex control system. On p. 87, middle, is a typical system equipment rack, containing all of the functional components of the control system, except the transmitters and drive units located throughout the plant and the operator's control console. These equipment racks are connected to the necessary external equipment

by multiconductor plug-in cables. This allows the control system to be operated as a closed-loop simulated plant before shipment, and eliminates many installation and initial start-up problems.

The control modules in the equipment rack are all plug-in units. Although the rack may contain a large number of modules, the variety of modules is quite small, since most control functions are achieved with few basic devices. Modules of the same type can be readily interchanged for fast diagnosis of suspected malfunctions in equipment. Each module includes enough test points so that system and plant performance may be analyzed quickly.

At the top of p. 87, for comparison, is a system-equipment panel fitted with vacuum-tube electronics that preceded the solid-state modules. Al-

## Boiler control: 2 Simple controller for a complex job

A few components in simple circuits give reliable performance; here's how its done

**Considering the complex**, interrelated forces that the system handles in boiler control, the basic controller in an a-c servo system is simple. Its simplicity, compared with conventional controllers, makes an interesting study.

The servo controller consists of a squirrel-cage induction motor, a non-critical nulling amplifier, an a-c induction generator and a device that generates output signals. The generator could be a differential transformer coupled to the motor-generator shaft through a gear train. The schematic of the integrating controller (right) shows the hookup of these components.

The controller output is typically a position-command signal to a final drive unit, which positions a valve or damper that corrects the pressure, flow or some other variable in the process. This output signal is derived from a differential transformer whose core is positioned through a gear train by the servo motor. The brushless, two-phase motor is of the squirrel-cage induction type requiring a 90° phase-angle difference between its stator windings to create its rotating field. This difference induces currents in the armature, resulting in torque. With the reference winding con-

stantly energized by the line, the direction and magnitude of the armature torque is a function of the phase—whether leading or lagging by 90°—and the magnitude of the voltage applied to the control winding.

On a common shaft with the induction motor is a similarly constructed induction rate-generator whose reference winding is also line energized. Its second winding produces a voltage, at line

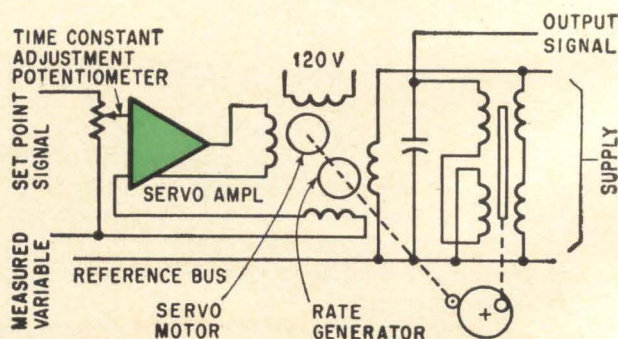

**Basic module** is this integrating controller. Many of the computing and control modules are modifications of this circuit.

though this panel covers more than twice the area of the equipment on the left, it supports only about one-third of the control equipment. Many successful boiler-control systems using this older design, however, have been installed and continue to provide efficient and reliable service. Boilers ranging in size from the most modest industrial units to the largest utility units have been controlled effectively. Today, similar installations use the solid state modules for greater serviceability, reliability and space economy.

The need for steam at several pressures simultaneously, and at widely varying loads is only one consideration affecting the control system's ability to perform effectively and reliably. Some other considerations are the economic requirement to burn fuels that may be waste-byproducts of the plant,

the many start-ups and the parallel operation of several boilers into a single header. The performance records of the 150 installed systems have proved the capability and reliability of the a-c servo control system concept.

One such installation includes the control for the Masonite Corp. boiler shown on the opening page. This boiler is one of eight working into six separate, but interconnected, headers with steam pressures ranging from 30 to 1,300 pounds per square inch. It has a maximum capacity of 200,000 pounds of superheated steam per hour and can operate on waste products or can burn natural gas as an automatic make-up fuel, to satisfy boiler fuel demand when waste products are in short supply. This control system has been in continuous operation for two years, and has already paid for itself.

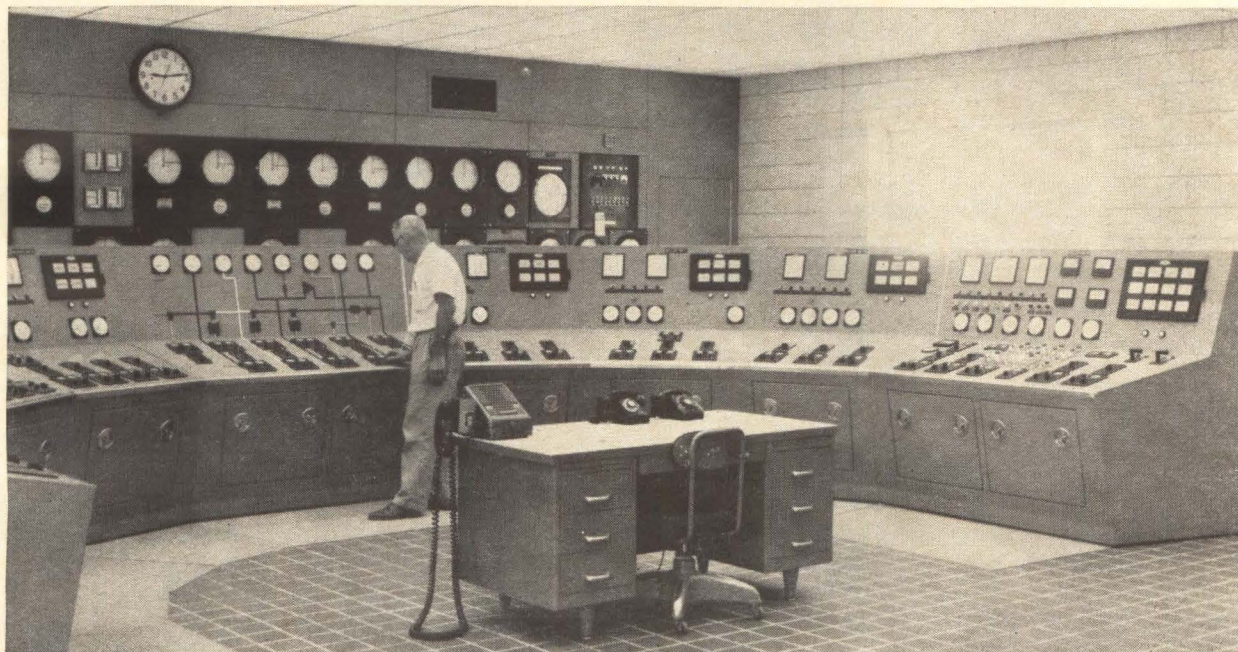

Extreme right end of console contains the controls for a-c servo system of the boiler shown at the beginning of this article. The remaining 87% of the console consists of controls for seven smaller boilers.

frequency, proportional in amplitude and phase to the speed and direction of rotation of its armature. The generator's output is proportional to the rate of change of controller output since it is mechanically-coupled to the differential transformer.

In the automatic control mode, the motor's control winding is fed by the servo amplifier. Because of its very high gain, the amplifier's output drives the motor to a speed that causes the generator to produce a voltage that almost completely cancels out the error voltage—the difference between the set point and measured variable signals, as scaled by the time-constant adjustment potentiometer. The speed with which the controller

reduces the error is proportional to the magnitude of the error voltage. This mode of controller action is proportional-speed floating control, or pure integrating control, and continually acts to make the measured variable coincide with the set point.

#### Gear trains vs rc circuits

The speed of integration of the controller is determined by the gear-train selection. The degree of error-voltage scaling by the time-constant adjustment potentiometer provides for continuous vernier setting.

The wide choice of gear trains allows for the generation of virtually any timing function to pro-

vide optimum control. Time constants ranging from five seconds to five hours have been produced.

Many of the conventional controllers that use resistance-capacitance networks to determine timing functions suffer severe degradation of performance in attempting time-constants in excess of a few minutes. High capacitances, with sufficiently low leakages, are physically large and economically prohibitive. Large resistance values reduce the signal power to the point where environmental conditions such as temperature, humidity and stray pickup can dominate controller performance.

On the other hand, the generation of long time-constants with speed-reducing gears in the servo system is neither costly nor physically large, nor is there any degradation of signal level.

### Bumpless transfer

The preceding description was concerned solely with the "automatic" control mode of controller operation. In this mode, the integrating action of the controller continually modulates the controlled variable to minimize the error and maintain the controlled variable at its desired value. For manual control, the controller is switched to "manual," and the motor is disconnected from its amplifier and is thereby de-energized, maintaining the last position of the automatic mode until one of two directional switches is depressed to drive the servo to some new position.

During manual positioning, the motor receives its control-winding power directly from the power line, through one of the momentary directional switches and through a phase-shift capacitor in series with the winding for required two-phase operation.

This controller gives bumpless transfer between the automatic and manual modes in both directions. This is because the manual control consists of jogging action on the same servo that performs the integration function while on automatic control. The servo remains in its last position when transferred from automatic to manual, and starts from the manual position when transferred back to automatic.

The servo controller's ability of bumpless transfer results from its stationary memory. The significant signals are not required to be maintained by any amplifier, but are stored as positions of the servo mechanism that can be changed only by applying power to the motor. This feature also gives the servo control system a fail-safe capability, since loss of an amplifier, or even total loss of line power, permits the status quo to be maintained indefinitely without triggering a chain reaction to cause general system failure. This memory capability is a major factor for operating reliability of the servo control system, and is a principal area of contrast to conventional approaches to control.

### The servo nulling amplifier

The amplifier used to power the controller's servo

motor during automatic operation is a nulling amplifier, which is required to build a very small error signal, of a few millivolts, into a level sufficient to power the control winding of the motor. The amplifier's voltage gain is not critical, but should exceed 1,000. Its output power, needed to drive the control winding of the motor, is approximately five watts. And it must introduce a 90° phase shift, since the two-phase motor has its reference winding connected to the power line and the amplifier's input signals are in phase with the line voltage. The amplifier always has a 60-cycle-per-second motor as its load and is always used in a nulling circuit. Therefore, linearity, distortion and band-width no longer pose any problems.

The amplifier consists of five silicon transistor stages; two voltage amplifiers, a driver amplifier, and a push-pull power output stage, see the schematic at right. The input is isolated and impedance matched by the input transformer. Diodes  $D_1$  and  $D_2$  limit the input voltage to the amplifier when large error voltages exist that would otherwise over-drive and block the amplifier. Resistor  $R_1$  prevents the diodes from loading the signal sources.

The two voltage amplifier stages, and the driver stage, are operated in the common-emitter, Class A mode, and are direct-coupled through forward-biased diodes. No interstage coupling or signal by-pass capacitors are used.

### Stability

Gain stability and d-c bias stability of the first three stages are achieved by feedback from the collector of the driver, through  $R_7$  and  $R_6$  to the base of the input transistor. The positive bias of the input stage imposed by this feedback is reduced by summing the feedback current and a current from the negative voltage bus of the power supply through  $R_8$ . The negative voltage bus also provides the forward bias current for the coupling diodes through  $R_9$  and  $R_{10}$ . Diode  $D_3$  protects the emitter diode of the input transistor from being punctured by large negative voltage transients such as may occur during turn-on. Local degeneration of the individual stages is by collector-to-base capacitors, with further degeneration of the driver stage provided by its unbypassed emitter resistor.

The power output stage uses two power transistors connected in a grounded-emitter configuration for push-pull, Class B operation. The bases are driven through a phase-splitting transformer that matches the impedance of the driver collector. The output transformer matches the output transistor collectors to the amplifier load—a servo motor control winding—and is fixed-tuned by capacitor  $C_7$  for maximum power gain at line (signal) frequency. Feedback around the driver and output stages is from the output transformer's secondary through  $R_{13}$  to the emitter of the driver. This reduces the amplifier's output impedance,



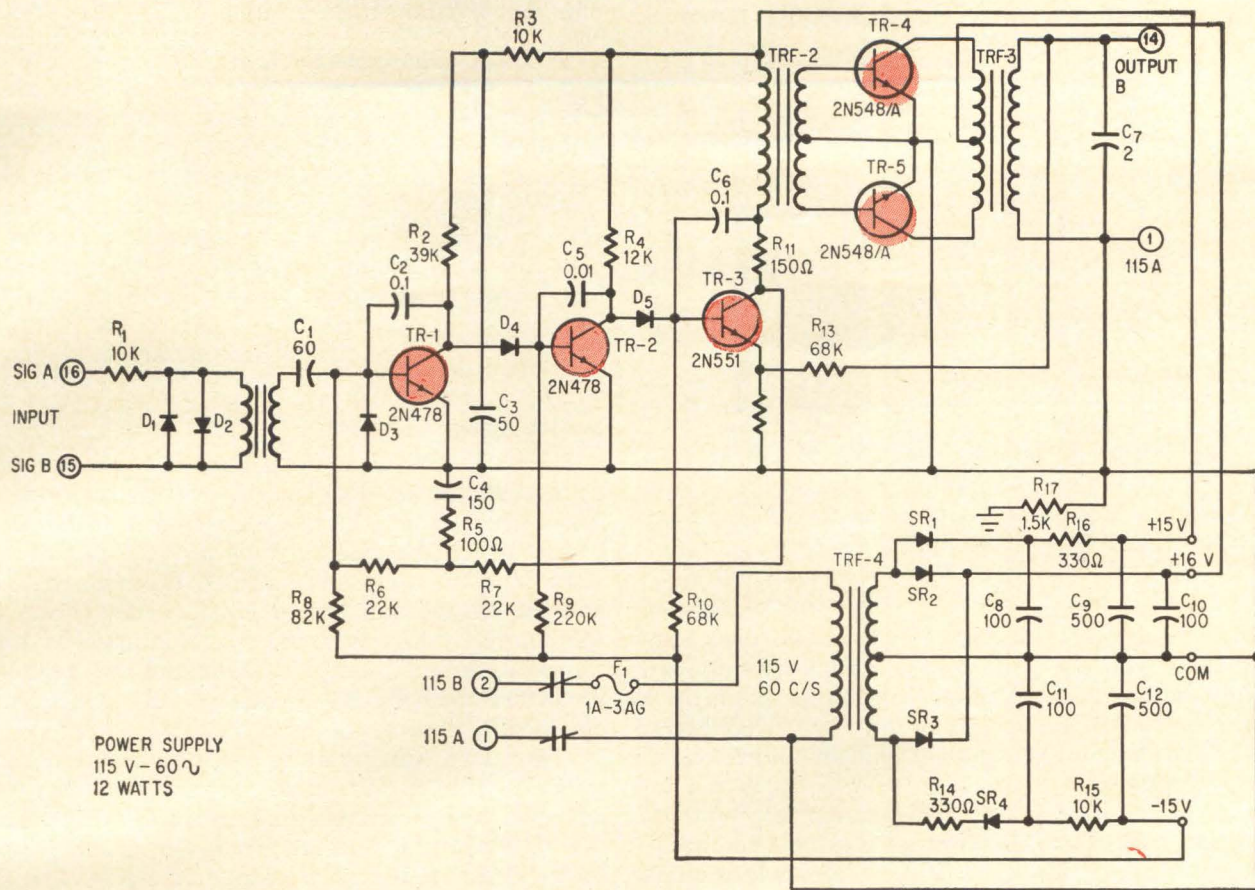

**Servo amplifier** uses five silicon transistors, two as voltage amplifiers and one as a driver; also two in the push-pull power-output stage. Power-supply design techniques minimize problems usually found in decoupling within the amplifier's circuitry, where multiple feedback is used to control amplifier performance.

reduces crossover distortion of the output stage, and minimizes the dependence of amplifier performance upon transistor characteristics.

A total phase lead of approximately 90° is attained through the amplifier, which is the result of lead and lag contributions from the various reactive elements. The main contributions are from the input and driver transformers and from capacitor C<sub>4</sub>, which filters a portion of the low-level feedback signal around the first three stages.

The power supply provides excellent decoupling for the amplifier by separately rectifying and filtering the voltages for the output stage and the low-level stages. Full-wave rectification is used for the output-stage supply. Simultaneously conducting half-wave rectifiers supply the positive and negative voltages for the low-level stages.

These techniques minimize the difficulties often encountered in decoupling within the amplifier circuitry, especially where multiple feedback is used to control amplifier performance.

### Performance

The servo amplifier builds up a 15-millivolt signal (loading the source by 30,000 ohms) to 110 volts at 5 watts. The amplifier is not significantly affected by power-line variations from 100 to 130 volts, or by ambient temperatures from 0 to 140° F.

All circuit components except the driver, output and power transformers are mounted on glass-epoxy printed circuit boards. Heat sinks for the stud-mounted output transistors conduct directly to the heavy aluminum chassis of the amplifier. All components are operated well within their ratings to insure long and reliable performance in extreme industrial environments.

The amplifier is packaged in a 3¾ by 5 by 12-inch aluminum case, and is fitted with a plug-in connector for mounting on a relay rack. The front panel contains the power switch, fuse and numerous test points for easy control-system adjustment and trouble-shooting. The size and general appearance of the servo amplifier module are typical of most of the modules in the system.

### Proportional plus integral controller

The pure integrating controller can be used for relatively fast, low-storage processes. But slower, higher-storage processes require proportional plus integral control action for optimum response. This is done by adding a proportional amplifier to the integrating controller at top of p. 92. Here the error voltage is boosted directly by the proportional amplifier, whose output is serially added to the integral controller's output to provide the position signal for the drive unit. Even though this is

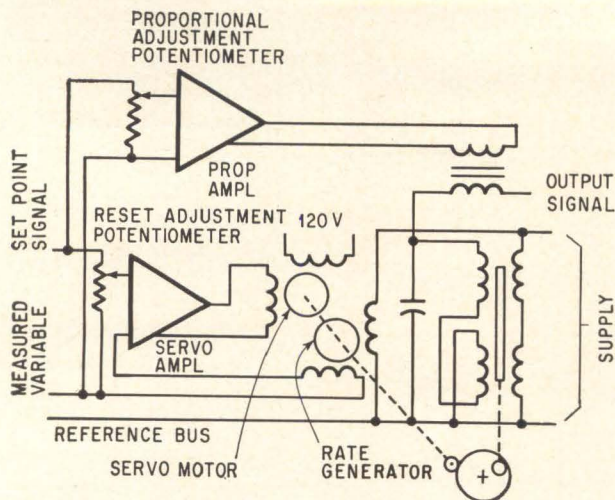

Simply adding a proportional amplifier to the integrating controller gives proportional plus integral control action.

a more complex arrangement than the pure integrating controller, the added complexity—by virtue of the mode of interconnecting—results in a degree of redundancy providing more reliability.

Failure of either amplifier, and therefore loss of its control contribution, does not cripple the remaining control mode. This is in sharp contrast to the typical process controller, whose composite control signal relies on the precise and continuing operation of a single amplifier.

### Proportional amplifier

For satisfactory performance, the proportional amplifier's output signal must be proportional to and in phase with its input, and it must have adjustable fixed gain, a low output impedance and isolation between its input and output terminals. Its output is a control signal, not merely a raw power signal to drive a motor, as is the signal from the servo amplifier. The output may be used as input signals by other controllers and computers in the system; therefore, its distortion and phase-shift requirements are somewhat more stringent than for the servo amplifier.

On p. 93 is a schematic of the proportional amplifier, which consists of three silicon transistor stages—preamplifier, driver and push-pull power-output. The input signal is isolated and impedance-matched by the input transformer, scaled by the gain-adjusting potentiometer and fed to the base of

the preamplifier. This is a common-emitter stage, and highly degenerated by the unbypassed emitter resistor  $R_2$ . The collector is direct-coupled to the base of the driver stage that is loaded by the primary of the driver transformer. The transistor's emitter is bypassed to ground.

Direct-current bias stability of the first two stages is by feeding the voltage, developed at the emitter of the second stage, through  $R_3$  and the gain-adjusting potentiometer to the base of the first stage. Capacitor  $C_1$  tunes the driver transformer to maximize the stage gain at the control frequency and provide phase correction to the signal.

### Bootstrapping

The push-pull power-output stage is driven from split secondary windings on the driver transformer. The circuit at first glance may appear to be the common-collector (emitter-follower) configuration, since the driven elements are the transistor bases and the output transformer is connected between the emitters. However, the split windings do not return to ground, but to points on the voltage dividers formed by  $R_8$ ,  $R_{10}$  and  $R_7$ ,  $R_9$ , which are electrically close to the emitters.

This hybrid configuration, a form of bootstrapping, provides the voltage and power gain usually achieved with a common-emitter circuit except that the output-transformer return is to ground, not to  $B+$ . This allows the output voltage—as seen by the output transformer primary—to be used as an overall feedback signal, without including in that signal the power-supply ripple that is normally present at the collectors.

Highly reduced filtering and decoupling requirements are the main advantages of employing this power amplifier technique. The output transistors are biased slightly above class B to minimize distortion effects of crossover. Resistors  $R_5$  and  $R_6$ , connected to the 14-volt bus, provide the bias current.

### Dual feedback

Over-all feedback (exclusive of the isolating windings of the input and output transformers) around the amplifier is used to provide stable gain over wide variations of line voltage, ambient temperatures and transistor characteristics, as well as high input impedance, low output and controlled minimum-phase shift. Dual balanced feedback is used—one path is from one side of the output

### The authors



Charles H. Smoot is manager of engineering of the Republic division of the Rockwell Manufacturing Co., where he has concentrated on electronic control and instrumentation for boilers. He holds 16 patents in his field. He likes to sail, ski and fly.



Frank J. Karlov is engineering supervisor at the Republic division, in charge of developing and designing industrial electronic instruments and control components. He's a model railroad buff.

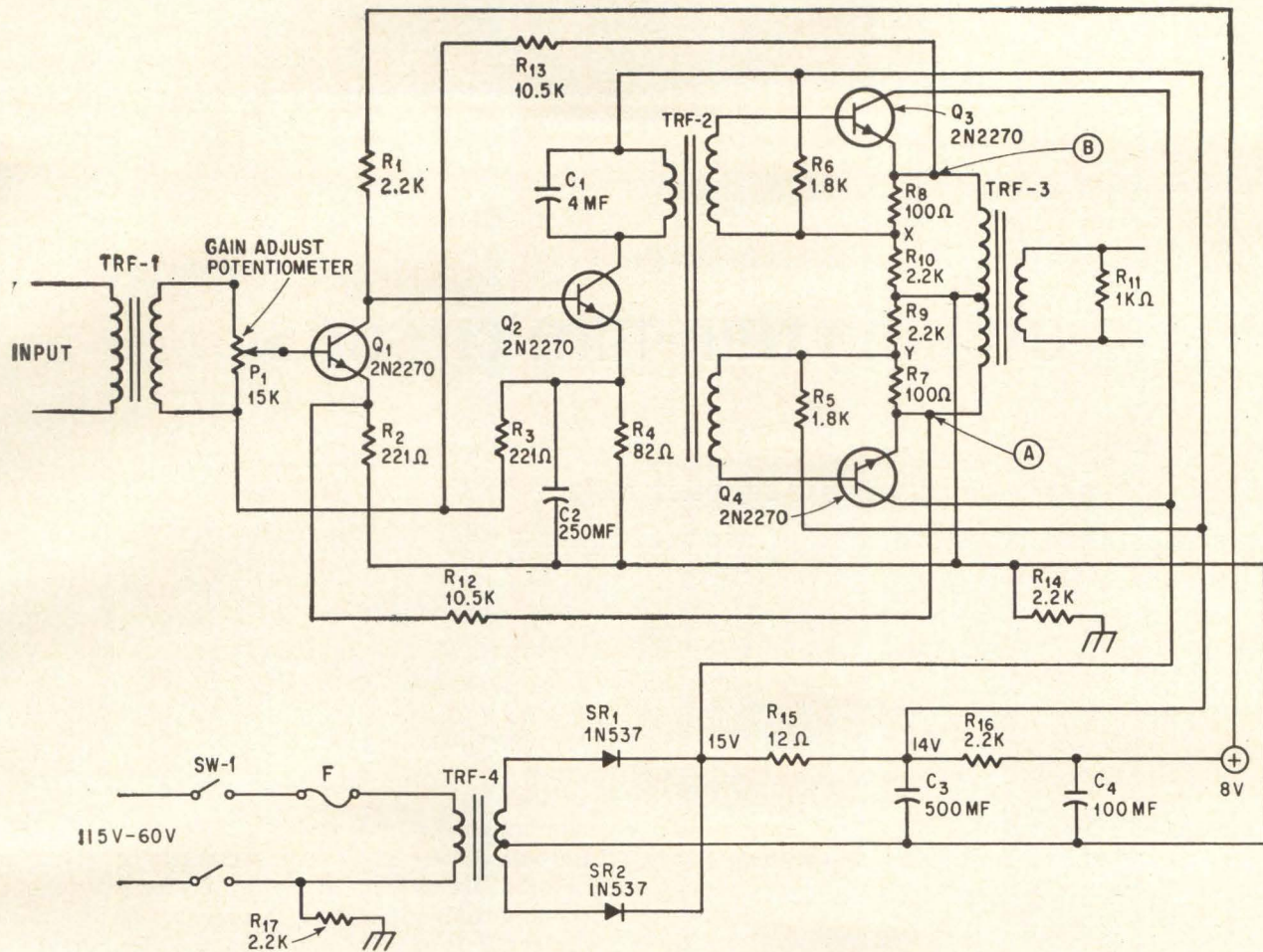

**Not what it seems to be.** The push-pull power-output stage is not a common-collector (emitter-follower) design. The split windings of the output transformer don't return to ground, but to points on the voltage dividers formed by  $R_5$  and  $R_{10}$  and  $R_7$  and  $R_9$ , which are electrically close to the emitters. This hybrid design is a form of bootstrapping.

transformer primary at A to the emitter of the input transistor through  $R_{12}$ ; the second path is from the other side of the output transformer primary at B to the base of the same input transistor through  $R_{13}$  and the gain-adjusting potentiometer.

This dual feedback eliminates the effects of transformer-winding-imbalance and leakage inductance between primary halves, that could result in excessive distortion and/or high frequency oscillations within the amplifier loop. The total overall feedback from both feedback paths is about 30 decibels.

#### Unfiltered power supply

The proportional amplifier power supply consists of a single full-wave rectifier, furnishing three voltages by successive filtering, one to power each of the three stages. The power for the output collectors is taken directly from the rectifiers without being filtered in the usual fashion. Since the amplifier's input signal, and therefore the amplified signal in the output stage, is always in phase with the line voltage, the output transistors are called upon to conduct only in step with the instantaneous line voltage.

There is no need, therefore, to furnish these transistors with a constant d-c voltage; that would merely result in a greater voltage drop across these transistors during the partial conduction intervals which, in turn, would mean additional dissipation of transistor power. Capacitor  $C_3$  and resistor  $R_{15}$  are rated to provide mild filtering to the 15-volt power bus in order to fill in the valleys of the raw rectified voltage. This averts starvation of the output stage when the line voltage is going through zero.

The use of this technique sharply reduces the power dissipation in the output transistors. This allows the output of the amplifier to be permanently short-circuited under full-signal conditions without approaching the thermal limits of the transistors and other components.

Performance specifications of the proportional amplifier are: voltage gain adjustable from 0 to 30; input impedance 100,000 ohms; output impedance 100 ohms; output 35 volts into 500 ohms; less than 1% gain change with line voltage variations from 100 to 130 volts; ambient temperature variations from 0 to 140° F; and phase shift within  $\pm 3^\circ$ . The physical construction of the proportional amplifier is similar to that of the servo amplifier.

# Photo-etching thin-film circuits

Selective chemical etching seems to be better, faster and cheaper than deposition through mechanical masks

By C.W. Skaggs

Bunker-Ramo Corp., Canoga Park, Calif.

**A method** of preparing thin-film circuits through photo-etching promises to achieve higher quality and yields at lower cost than conventional mechanical masking methods.

Instead of laying down thin-film patterns, one material at a time through expensive mechanical masks, on an insulating substrate, a layer of resistive material is first deposited over the entire substrate, then a layer of conducting material is deposited over the resistive layer. The conducting lands and resistive paths of the thin-film circuit pattern are made by selective chemical etching, using Kodak Photo-Resist and photographic techniques. Furthermore, large numbers of substrates can be prepared in each batch without breaking vacuum in the deposition apparatus.

Chromium or cermet is used as the resistive material, and compounds of chromium and gold, cermet and gold, chromium and copper, or cermet and copper are used as the conductive material. The cermet is—by volume—four parts 325-mesh electrolytic chromium powder and one part select-grade powdered silicon. The chromium is purified carbon-free metal; the gold is 40-mil wire that is 99.99% pure; and the copper is in shot form and also 99.99% pure.

So far, 0211 glass, 7059 glass, and glazed aluminum oxide ( $Al_2O_3$ ) have been used as substrates. The substrates are prepared by an ultrasonic cleaning in a 40-60 mixture of alcohol and toluene, and then by a similar cleaning in a detergent bath. They are then rinsed, first in hot, running tap water and then ultrasonically three times in distilled water. They are finally dipped in alcohol and vapor-degreased. The substrates are stored in a vacuum dessicator until they are used.

## Vacuum system

An oil-diffusion-pump vacuum system deposits the thin-film layers on the substrate. Initial pressure is  $1 \times 10^{-6}$  millimeters of mercury or lower. Substrates are mounted within a spherical dome that is radiantly heated to 120°C. While the thin-film layers are being deposited, the substrates are spun at 50 revolutions per minute, which insures even distribution of the thin-film material.

The cleaned substrates are loaded into the dome [photo] and the system is evacuated. The dome is spun. The substrates are heated to 120°C. The thin-film and conductive layers are deposited sequentially. A manually controlled mechanical feed-through positions any of six sources of thin-film material directly under the dome so the material can be deposited. The resistive and conductive materials are deposited until a precalibrated resistance monitor indicates that the desired values of resistance have been attained.

Chromium and cermet are evaporated from aluminum oxide crucibles with spiral stranded tungsten filaments used as radiant heaters. The gold and copper are evaporated from resistance-heated molybdenum boats.

The average rate of deposition of the resistive material is 12.5 ohms per square per second based on a deposition rate of 200 ohms per square. The conductor thickness is approximately 0.2 mil, having a resistance of 0.05 ohm per square or lower. The resistive material, besides being used to form the resistors, is also used to form a tenacious bond between the top conductor layer and the substrate.

After the materials are deposited in complete layers on the entire surface of the substrate, they are dip coated with undiluted Kodak Photo-Resist





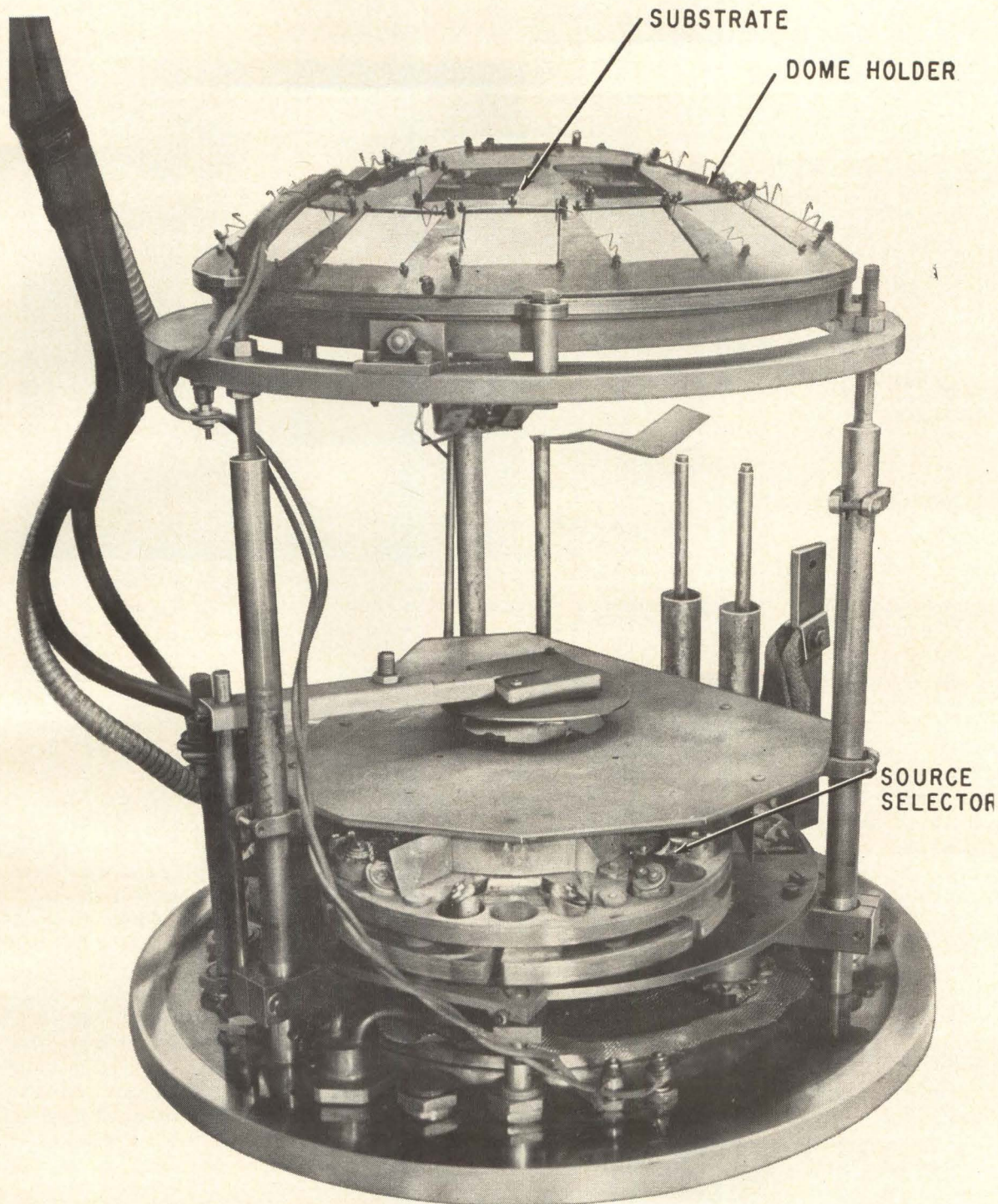

**Source selector** permits selection of any one of six sources of thin-film material with a manually controlled mechanical feed-through. Substrates are rotated automatically at 50 revolutions a minute.

(KPR), air-dried for 15 minutes and oven-dried at 120°C for five minutes. Then these three steps are repeated.

Dipping and drying has to be done in a dust-free area using filtered KPR, since dust particles in or on the KPR can cause pinholes in resistors and conductors when the samples are later processed through the etchants. The care taken in the application of the KPR determines, to a great extent, the yield of acceptable units by the process.

The KPR-coated substrates are then exposed with an ultraviolet light through a sharp photographic negative of the complete circuit. The negatives are one-twentieth scale reductions of the original pressure-tape pasteups of the circuit. Any ultraviolet light source may be used with the appropriate distance and exposure time; 275-watt sun lamps at a distance of one foot and an exposure time of 3.5 minutes work satisfactorily.

In addition to the composite negative, a separate

## Composite and conductor etching . . .

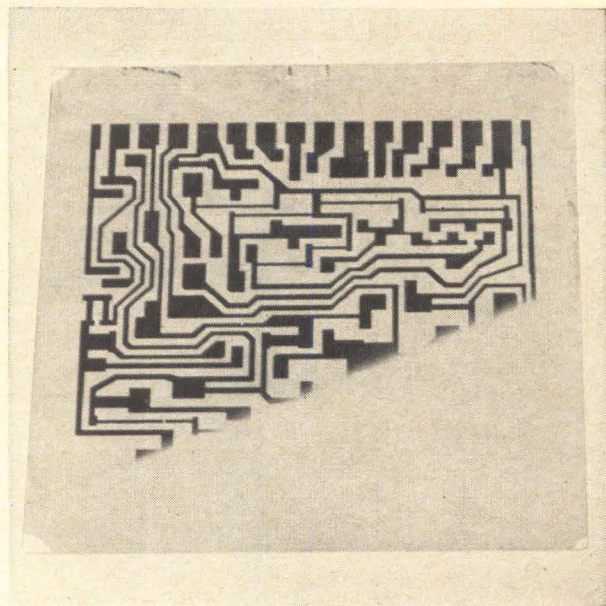

Substrate after first etching process. Under the dark areas, the resistive and conductive layers are unharmed.

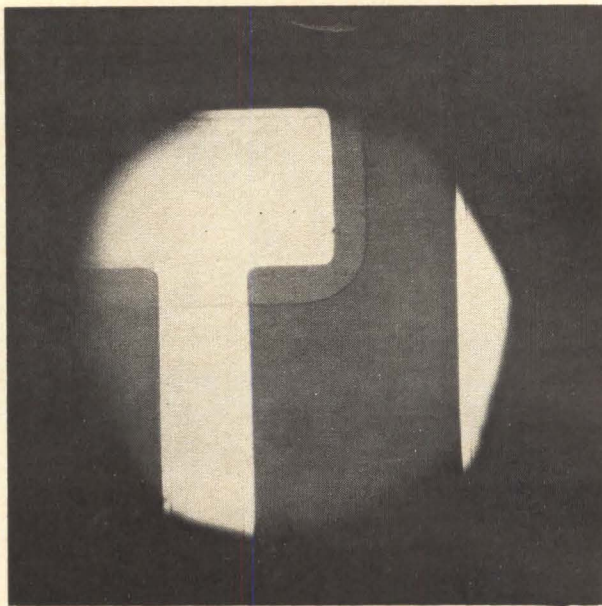

Five-mil spread on conductive pattern is evident in close-up of substrate

negative showing only the conductive paths is prepared. It has a spread of five mils per edge. The spreading is accomplished by illuminating photographic film through the negative by means of a rotating collimated light through an appropriate angle and placing a transparent spacer of appropriate thickness between the negative and the photographic film. The speed positive obtained from this operation is then used to prepare the spread negative by contact printing.

### Composite etching

First, the composite negative is used to expose the KPR-coated substrates. The exposed substrates are then developed in KPR developer for five minutes and rinsed in aerated running tap water for one minute.

After exposure and development, the samples are etched. Gold is removed with a commercial gold stripper, copper is removed with ferric chloride, and chromium or cermet is removed with hydrochloric acid. A temperature of 60° to 80° is maintained in the gold stripper and the ferric chloride solution. Chromium or cermet is etched with hydrochloric acid by placing the substrate into the acid

and introducing an aluminum wire. Since aluminum is above chromium in the electromotive series and both aluminum and chromium are soluble in hydrochloric acid, the aluminum ions replace the chromium ions in solution, stripping the chromium from the substrate in the unprotected areas.

The etching times are 15 seconds in the gold stripper, 20 seconds in the ferric chloride and 5 seconds in the hydrochloride acid. These times are for the material thickness described previously, and may vary if the thicknesses are different.

Following the etching process, the KPR is removed by a two-minute ultrasonic rinse in photoresist stripper, followed by a one-minute rinse in a strong spray of tap water. The substrates are then dipped in methyl alcohol (methanol) and degreased in trichlorethylene. The substrates are dipped in KPR a second time and dried as they were after the first application. This second coating of KPR is exposed to the ultraviolet light source through the five-mil spread conductor negative.

### Conductor etching

The five-mil-per-edge spread is used to simplify alignment of the conductor negative and composite pattern, and protects the conductor lands while defining the resistor length. The specimens are developed and rinsed as before. The second resist pattern protects the conductors and defines the length of the resistors during the second etching.

In the second etching, only the gold- and copper-removing solutions—the gold stripper and ferric chloride—are used. The KPR is removed in the same manner as before, and the specimens are again dipped in methanol and degreased. The circuits are completed after the second etching and after the KPR is removed.

### The author



Clyde W. Skaggs is a senior engineer at the Bunker-Ramo Corp., engaged in research and development of new processes for making thin-film components and circuits. Bunker-Ramo was owned jointly by the Martin-Marietta Corp. and Thompson Ramo Wooldridge, Inc. Last month, it was purchased by the Teleregister Corp.

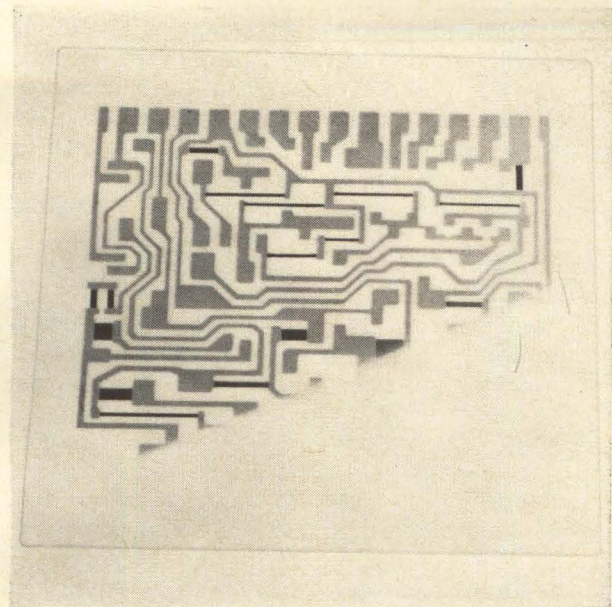

Completely etched substrate has been cleaned; darker areas are resistors and gray areas are conducting pads.

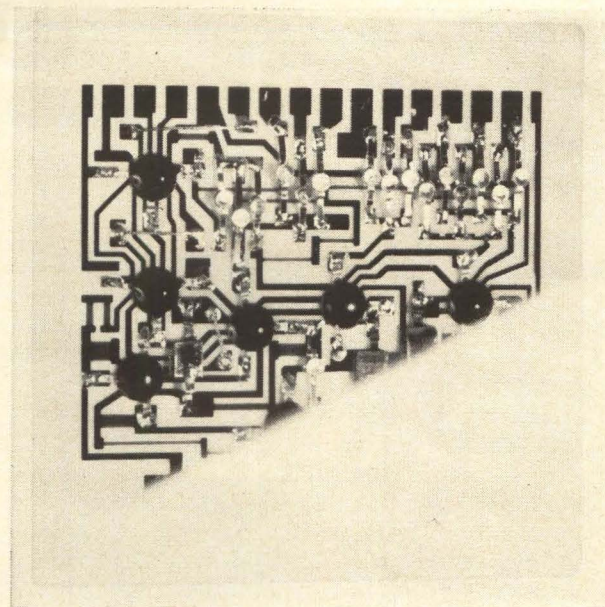

Completed circuit has transistors and chip-capacitors. These were soldered on, but could have been welded.

## Bonding

Active components are subsequently attached by thermocompression bonding, chip bonding and soldering. This operation determines the choice of conductor materials. For thermocompression bonding or chip bonding, chromium-gold or cermet-gold conductors are used, depending on the type of resistive material. Chromium-copper-gold or cermet-copper-gold conductors are recommended for soldering, again depending on the type of resistor used. The gold is used over the copper to minimize oxidation of the copper.

Although active components initially were attached by hand, the photo etch process resulted in reduced costs and improved yields over conventional processes, and it became apparent that the attachment of semiconductors entirely by hand was not practical. To satisfy present demands and those of the immediate future, it was necessary to design an assembly system to meet the following conditions:

- Nonrecurring tooling must be low enough in cost so that it can be fully amortized on small production runs even when orders are for as few as 70 to 100 identical circuits.
- The assembly system must be operable by low to moderately skilled personnel.
- If possible, it is advantageous to do away with, or minimize, use of conventional assembly apparatus such as microscopes and micropositioners.

After analyzing several possible assembly systems and considering their costs, it seems that a system capable of assembling a circuit in five minutes would satisfy production requirements and cost considerations as well as the other conditions of manufacture.

## Assembly

The resultant system is basically manual. However, when job requirements warrant, many functions can be automated.

The heart of the system is an aluminum die made in the image of the circuit to be assembled. The registration, which is critical, is achieved with a negative that is made from the master tapes. The negative is used to photocopy the circuit image onto a blank coated with photo resist. The die is then fabricated by a combination of chemical milling and drilling. This die accepts the transistors and diodes and—if applicable—capacitors into machined cavities that register them to the circuit and simultaneously provide a heat sink. When the transistors and diodes are placed into their respective cavities, their leads fall into recesses.

A device such as a transistor is held in the cavity by a vacuum. The lead is spring-loaded tightly to the interconnecting pad area as soon as the die is placed over the circuit substrate. Since all component leads are of standard geometry, it is possible to use tooling that crimps and cuts the leads to a standard configuration. The apex of the crimp bears tightly against the aluminum die, which effectively sinks the heat traveling from the end of the leads being soldered. In addition, the crimp in the lead applies spring pressure and provides relief from shear stresses on the solder joint. The solder joint is made by inserting a heated probe through the holes in the die at the extremities of the leads.

## Sweating

To obtain uniform interconnections, an extension or modification of the system has been designed in which the die remains basically unchanged, but

heated probes are not used to achieve the soldered interconnection. Instead, a solder ball is dropped into the hole at the end of each lead; then the entire assembly is heated to 250°C. To minimize oxidation of the conductors, and to keep the semiconductors at a safe temperature, the vacuum used during component insertion is relieved, and hydrogen is forced through the vacuum holes to act as a coolant and oxidation inhibitor.

Although most circuits made to date use chip capacitors soldered in place, this will not necessarily be the best approach in every instance. There are many situations where the capability of vacuum depositing the capacitors can cut costs even more. The major problem of combining vacuum-deposited capacitors with photo-etched conductors and resistors is maintaining continuity across the step that is created when the conductor pattern is etched. Unless the large step at the conductor edges is graded or rounded by chemical etching or some other process, it prevents deposition of capacitors after photo-etching of resistors and conductors.

One way to overcome this problem is to vacuum-

deposit the capacitor first, then overcoat it with a layer of silicon monoxide 10,000 angstroms or more thick deposited through a second mask. The second mask is designed to leave a portion of the capacitor electrodes exposed. The substrates are then completely coated with the appropriate resistive and conductive materials, which make contact with the exposed portions of the capacitor electrodes where they should. The general conductor-resistor pattern can now be formed with the photo-etch process without affecting the capacitor, since the silicon oxide is impervious to the etchants.

The photo-etch process allows circuits to be made in which the resistors have tolerances of  $\pm 5\%$  as they are removed from the vacuum system—that is, without further trimming. The temperature coefficients of resistance of the chromium resistors is  $-200$  to  $0$  parts per million per degree centigrade for the pressure, at the substrate temperature and deposition rate cited above. Uncoated cermet resistors fabricated with this process exhibit temperature coefficients of  $-500$  to  $-50$  parts per million per degree centigrade.

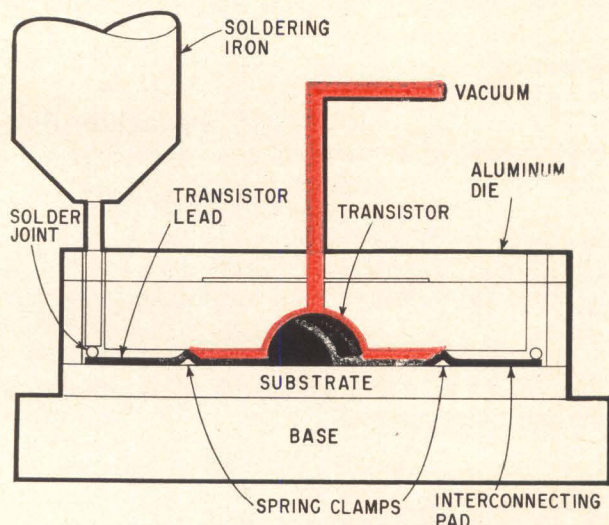

Vacuum (color) holds components, such as this transistor, in the die until they are attached to the substrate.

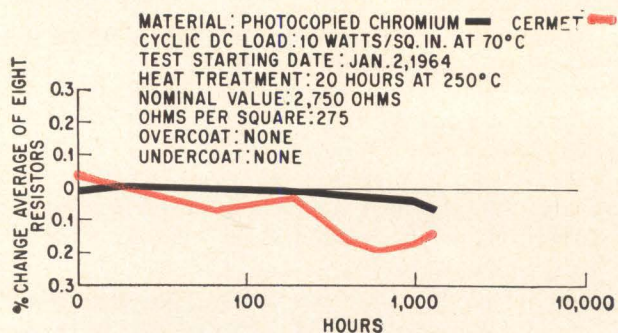

Typical load life data curves for eight 275-ohms-per-square chromium resistors and eight 275-ohms-per-square cermet resistors (in color) made by this process. These resistors are uncoated and carry a power load of 10 watts/in<sup>2</sup> in an ambient temperature of 70°C. Neither type of resistor exhibits a very large change after 1,000 hours of cyclic dc loading.

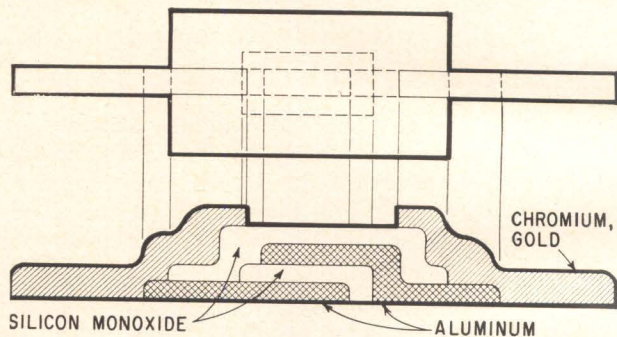

Capacitors can also be formed, as shown in cross-section.

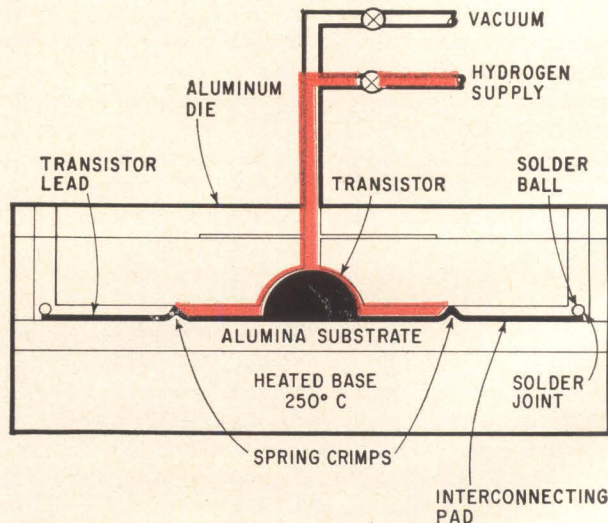

Advanced version of assembly apparatus uses a back fill of hydrogen (color) to keep the devices cool while the substrate temperature is raised to 250°C for soldering. Heat from the base melts solder and forms a joint.

Sail of the USS Dace knives through the water. When surfaced like this the sub can make a top speed of 17 knots; submerged her speed is well in excess of 20 knots.



Military electronics

## USS Dace: portrait of a killer

Nuclear attack submarines run deeper, quieter, faster than anything under the water. Electronic equipment provides their eyes and ears—and makes up nearly half their cost of \$60 million

By John M. Carroll

Managing Editor

**Almost a year** to the day since the nuclear attack submarine Thresher dived to her doom off the New England coast, her sister ship, the USS Dace (SSN-607)—fifth of the Thresher class and the Navy's 19th nuclear hunter-killer sub—left her berth at the Ingalls Shipbuilding Co. (a division of Litton Industries, Inc.) in Pascagoula, Miss. It was

the fifth time out for the crew; their 13th day at sea. Eventually the Dace will have 26 sister ships.

### Electronics aboard

A nuclear attack submarine like the Dace costs about \$60 million of which only \$28 million represents basic hull cost. The biggest slice of what's

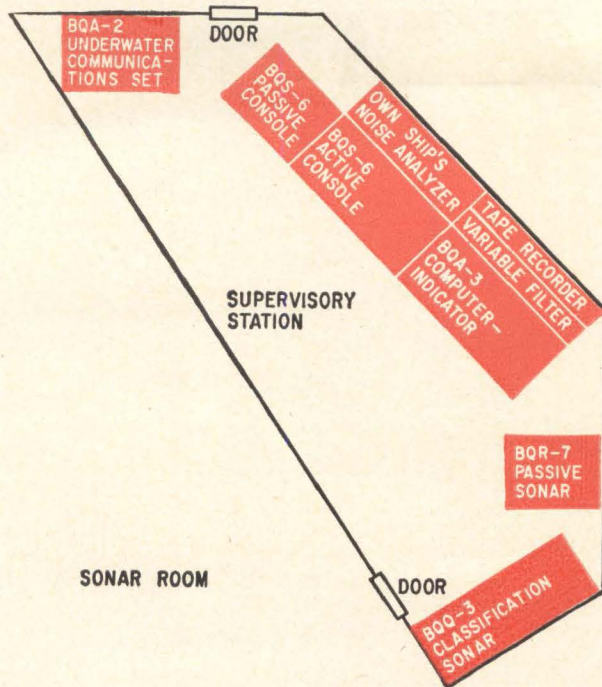

Ears of sub: equipment layout in the sonar room of an attack submarine.



Control center of submarine. Sailor in foreground is helmsman or inboard planesman. He controls course, speed and angle of sail planes. Beside him sits the outboard planesman who controls the angle of the stern or main diving planes. The diving officer stands behind the planesman. Panel in background is ballast control, diving station of the Chief of the Watch.

left goes for electronics.

The most expensive single item is sonar. These subs are blind without it. There are two systems, one of which is an integrated system that consists of four units. The sonar equipment incorporates the latest developments in underwater acoustics—many of which are still shrouded in secrecy.

The submarine's armament consists of torpedoes, many types of which are electronically guided. All are fired by an electronic weapons monitor system and aimed and set by a fire-control computer.

Since she is nuclear powered, the Dace requires electronics for reactor control and radiation monitoring. The latter function has been developed to a fine art aboard vessels such as this.

Other electronic equipment aboard includes the Ships' Inertial Navigation System and more conventional marine electronics gear such as radar, radio, countermeasures equipment, depth finders and other navigational aids.

### Taking the sub down

At 0120, the engineering officer withdraws the reactor control rods and at 0620 the sub gets under way. A 325-horsepower electric outboard engine eases the stern away from the pier and the 278-foot craft backs slowly out of the dock at full port rudder driven by her main propulsion engines. Commander Jack Walsh orders two thirds speed ahead and full starboard rudder. The 4,000-ton sub starts to glide silently down the Pascagoula River to Mississippi Sound.

Soon she is making 17 knots bow down, decks awash and a broad frothy train stretching far behind. At 1100 she reaches the 50-fathom contour. The traditional klaxon sounds a warning "ready to dive" signal. The conning officer orders a 5° dive and passes course, speed and depth to the diving officer. The diving officer repeats course and speed to the inboard planesman who controls the rudder and sail planes. The inboard planesman also rings down the speed to the throttlemaster in the maneuvering room who sets the throttle and rings back.

The diving officer repeats depth and dive angle to the outboard planesman who controls the stern or main diving planes. As the sub levels off at 80 feet, the Chief of the Watch at the ballast control panel, trims her up.

The sub then executes a series of dives until she is down below 400 feet, traveling faster than 20 knots, diving and climbing at angles up to 35°, turning and banking just like an airplane.

### Mission of the Dace

The Dace is the Navy's fastest, quietest and deepest-running submarine. Her mission is to stalk marauding submarines in the stillness of great depths and strike them down with deadly accuracy. The Dace, like the Polaris Fleet Ballistic Missile submarines, is a true submersible. She is provisioned for 90 days and when on patrol her hatches are sealed with wax to make her contours smooth. Her reactor fuel lasts three years and the reactor

itself will run 20 years without maintenance.

In her completely equipped machine shop is an information retrieval system that can recall on microfilm aperture cards the blueprint of any component part in the ship and print out an electrostatic copy. She need never put in for maintenance; she can manufacture her own spare parts.

### Lessons from Thresher

The Dace was already in wet dock when the Thresher broke up: her keel was laid June 6, 1960; she was launched Aug. 18, 1962, and commissioned Apr. 4, 1964. But the Navy was able to incorporate some of the lessons learned from the Thresher disaster: the Dace carries 16 bottles of compressed air with which to blow her ballast, instead of eight on the Thresher. Also mechanical interconnections have been upgraded: from fittings to silver brazed joints (Silbraze), from Silbraze to welded joints.

All welded joints are inspected radiographically. Silbraze joints are inspected by ultrasonics. Incidentally, electronics enters into more than just inspection. Instead of using the traditional full-scale templates, shipbuilders now optically project microfilms of drawings to correct size while electronic analog-controlled followers burn steel plates in the desired shape.

### The sonar suite

The single most expensive electronic system is the sonar "suite." It is called a suite because it consists of several sets.

The ears of the ship are the BQQ-2 integrated sonar consisting of a large ranging-and-listening set, a listen-only set, a computer-indicator and an underwater communications system.

The Raytheon BQS-6 ranging-and-listening set is low in frequency and so high in power that when it pings (transmits) at the dock it makes a visible wave in the quiet water. Its antenna is a great sphere, 10 to 12 feet in diameter, located in a free-flooding area outside the pressure hull in the bow of the sub—far from the noise of the torpedo room. The surface of the sphere is a patchwork quilt of 1,245 barium titanate transducers. The transducers can ping and listen or just listen. They can work all together to make up an omnidirectional sonar "antenna" or selected transducers can be phased together and sequentially switched to make up a scanning beam. The beam affords extremely precise discrimination.

The beam can be scanned in azimuth and in elevation. The latter mode is especially useful for getting the most out of bottom-bounce sonar. The BQS-6 has ranged successfully up to the maximum range of the SUBROC missile using bottom-bounce techniques.

### Listening at great depths

The active or ranging console of the set has a big plan position indicator with one cursor or trace showing the heading of the beam and another showing the stern line of the sub. There is also sector-

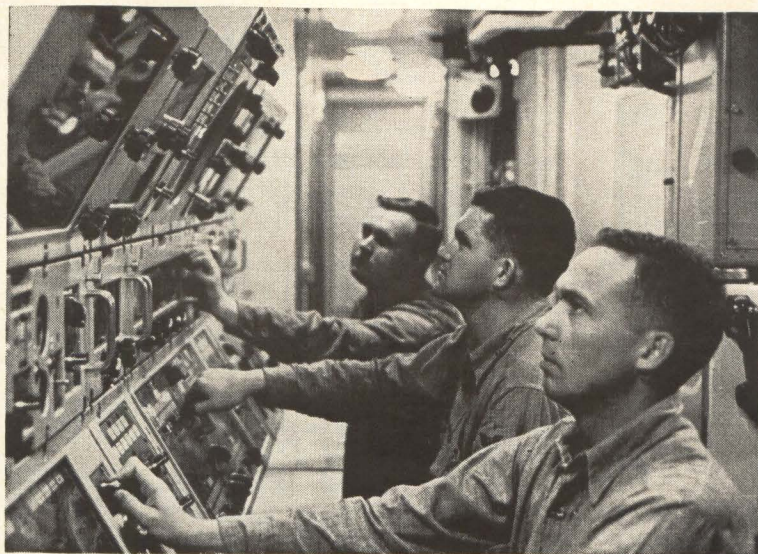

**Attack center in control room.** There are two complete fire-control panels. Each accepts range and bearing data from sonar, radar or visual sightings. For training purposes, one panel can furnish simulated targets to the other panel.

scan indication centered around the beam.

The passive or listening console permits the listening beam to be moved manually. It has an electrographic recorder that plots target signatures on a linear time-versus-bearing display in which strength of shading represents signal intensity.

The Edo BQR-7 listen-only sonar works off a conformal (roughly semi-ellipsoidal) array of 156 hydrophones mounted in three rows in the bow (and extending roughly 50 feet aft). A recorder-analyzer for this set is located in the control room.

The BQA-3 computer-indicator that works with the BQS-6 active console records range and bearing to target. It contains a digital computer that determines rate of change of range and rate of change of bearing relative to the sub's own course then feeds this data directly to the fire-control computer in the control room.

The remaining part of the BQQ-2 system is the Raytheon BQA-2 underwater communications system that incorporates speech-privacy equipment.

### Other sonar gear

Another sonar system on the sub is a classification sonar made by the Western Electric Co.

An audio recorder may be used to capture target signatures on magnetic tape for later sound-spectrum analysis using a variable audio-frequency filter. But usually the Navy depends on the practiced ears and eyes of experienced sonarmen.

To monitor the distance from her keel to the bottom, the sub employs the Edo UQN-1B depth finder and a Sperry digital depth recorder. To monitor the distance from her sail to the surface or the underside of an ice pack she uses the Edo BON-4A depth sounder.

Since the Dace's method of stalking is to listen for her prey, she is pretty self-conscious about mak-

ing noise herself. The OSN or own ship's noise analyzer picks up noises through hydrophones on the hull and indicates noise level by a flashing neon light in the sonar room; it works like the over-modulation monitor used in audio recording work. There is also a sound-and-vibration analyzer located in the auxiliary machinery space.

### Torpedoes

The weapons of a modern attack submarine are her torpedoes—the only guns on the Dace are 45-caliber automatics for the quartermaster of the watch and officer of the deck and 30-caliber rifles for shark watch when the crew swims off the deck.

She carries some conventional steam torpedoes whose gyroscopes are set for a collision course with the target. Newer hydrogen-peroxide torpedoes are faster. They leave no wake and can be controlled throughout their course by command signals sent over a wire. The Mark 37 sonic torpedo homes on its target by means of self-contained passive sonar.

The two-ton SUBROC (submarine rocket) will be taken aboard in the near future. Captains of the Navy's attack submarines are enthusiastic about this new weapon. It is ejected by water pressure, as are all of Dace's torpedoes. Once in the water its booster rocket ignites and the inertially guided SUBROC hurtles upward, breaks the surface and streaks to its target which, reportedly, may be 20 to 30 miles away. It reenters the water as a depth bomb.

In the torpedo room, well aft of the sonar sphere

in the bow, four torpedo tubes angle 10 degrees off the sub's center line—this configuration reduces noise in the sonar.

### Torpedo attack

The sonarman at the BQS-6 passive console hears the sound of propellers in his headphones. Manually he sweeps a sector with his listening beam—"Target off the port bow, probably a freighter".

His counterpart operator on the active console sets up a sector sweep and ranges on the target: "Range 12300, bearing 060."

The BQA-3 computes rate of change of range and bearing and feeds data to one of two Librascope Mark 113 fire-control panels in the control room. This equipment incorporates a digital computer using magnetic-core storage. It solves the attack problem and makes up the gyroscope setting for a torpedo to intercept the target at a selected point. The computer could accept range and bearing also from radar or visual contact reports.

In the torpedo room, two Librascope Mark 18 weapons monitors control the firing of the tubes. The port torpedoman pushes button 1 and the breech of number one torpedo tube swings open. In a real attack a hydraulic ram would now drive home a torpedo from a loading skid. The torpedo would be held in chocks set at the length appropriate for that size "fish." Now button 2 is depressed and the breech swings shut. Pressing button 3 floods the tube with water, and button four opens the muzzle door. If any buttons were pushed

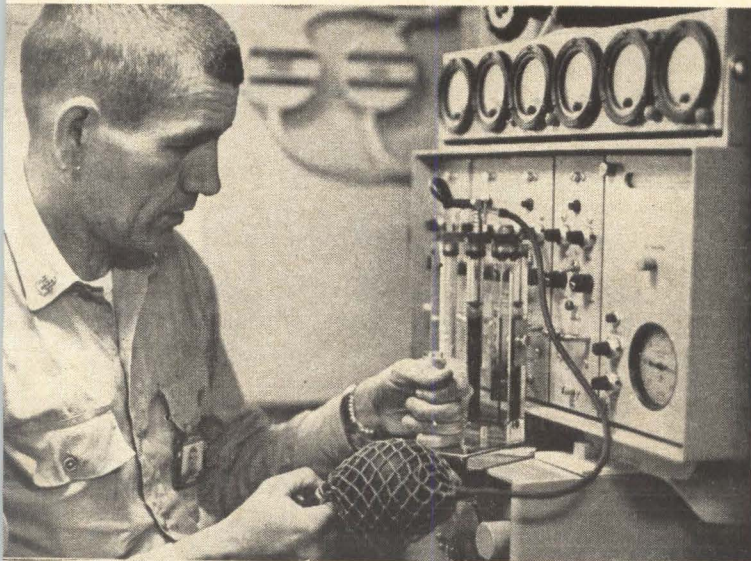

**Hospital corpsman** checks composition of atmosphere. Mark 4 atmosphere analyzer (background) measures eight components at 12 locations in the submarine. It incorporates infrared and ultraviolet comparators, conductivity bridge and paramagnetic analyzer.

**Sonarman on watch** attends to signals picked up by BQS-6 sonar in passive or listen-only mode. His experience and training enables him to distinguish between different sea sounds; he has an electrographic bearing-vs.-time presentation to assist him.





prematurely or out of proper sequence, the weapons monitor would lock out the rest of the firing cycle.

Now the leading torpedoman, on signal, depresses the firing switch. Wham, wham, hiss, thud and the torpedo would have been away—a grating opens between the impulse tube and the torpedo tube, the chocks release, and an air-driven ram forces water from the impulse tube into the torpedo tube driving the big fish out. Then the grating to the impulse tube closes. After the firing the port torpedoman presses button 5 to close the muzzle and button 6 to drain water from the tube.

### Radar and countermeasures

When operating at periscope depth the sub uses the Western Electric BPS-9 surface-search radar (also called the SS-2). This equipment operates at X-band. But these subs would always rather listen than talk. For them electronic countermeasures can be a more effective detection device than radar. The Dace is equipped with a Western Electric electronic countermeasure set.

### Nucleonics monitoring

Safety of the crew and of the people in ports visited by nuclear ships are a prime consideration. In fact, were the Navy or any other user of nuclear energy to become careless about safety it would invite the Atomic Energy Commission to put its own men in charge of the reactor.

The Navy health-physics team consists of a medical officer and two chief hospital corpsmen. They check the reactor for leaks by analyzing cooling water and surveying the ship for loose contamination. Every 30 days they check the badges of photographic film that darken to show how much radiation each crewman has received. Men working close to the reactor wear pocket dosimeters as well as film badges. Safety pays off. As a result of safety measures and effective reactor shielding that makes use of lead, steel and polyethylene, sailors aboard a nuclear sub get less radiation than the general population since they are shielded from ambient cosmic radiations and emanations from the earth.

A Beckman pH meter, a conductivity bridge and two Nuclear Electronics Corp. integrating counters are used to test reactor cooling water. This water is so pure the crew calls it "holy water".

The corpsmen use two radiac (radiation survey) instruments incorporating geiger muller tubes to check for loose contamination. In addition, geiger counters for air sampling are located in the engine room, reactor compartment and auxiliary machinery space. A Weston densitometer reads the crew's film badges. Selective masking allows the badges to determine separately the wearer's exposure to alpha, beta or gamma radiation.

The air itself is regularly analyzed. There is a Beckman oxygen analyzer in the nucleonics lab. But the Beckman Mark 4 atmosphere analyzer is a more complete unit. It can check the air at 12 places in the ship simultaneously. The analyzer



Weapons control panel in torpedo room. Each outboard torpedoman pushes buttons to prepare two torpedo tubes for firing. Torpedoman in middle fires the "fish." Weapons monitor locks out rest of firing cycle if prior events are not completed or occur out of sequence.

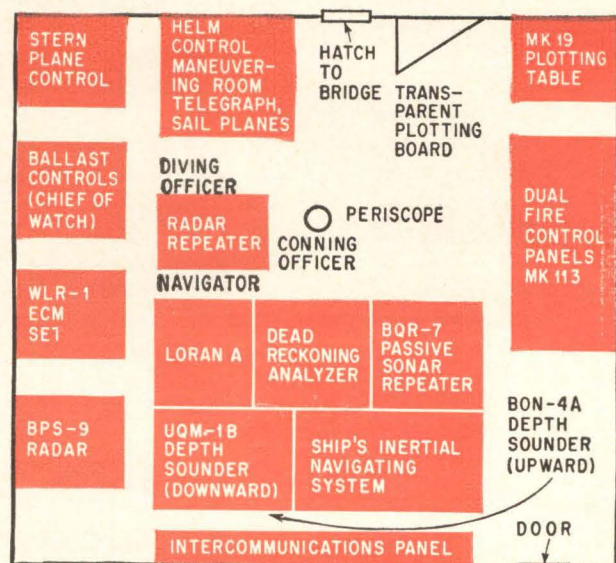

Nerve center: equipment layout in the control room of an attack submarine.

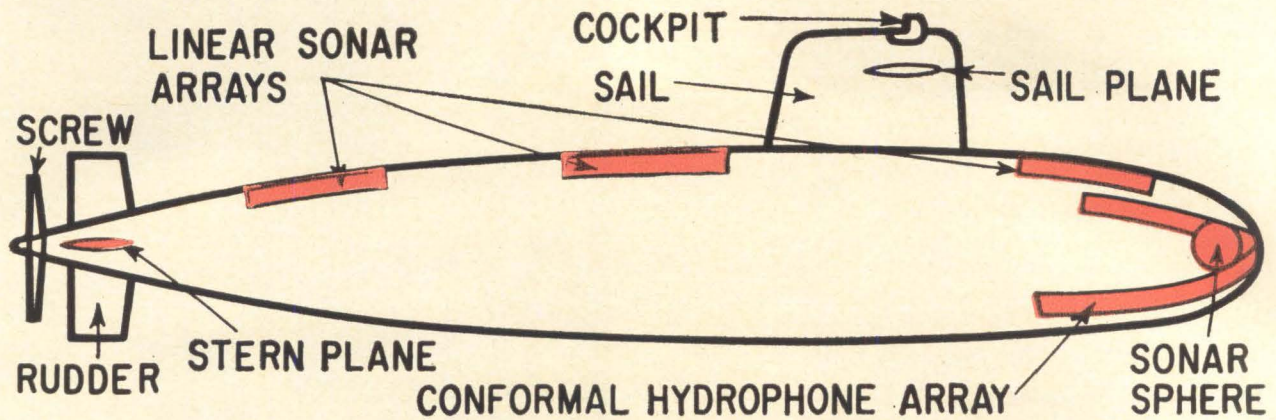

Hull of nuclear attack submarine showing location of sonic transducers. Antennas on top of sail retract when sub dives.

employs four modes of operation and measures eight atmospheric constituents. Infrared comparators are utilized to determine percent of carbon monoxide, carbon dioxide and Freon 12. An ultraviolet comparator measures percent of mercury vapor, total hydrocarbons and ozone. A conductivity bridge measures percent hydrogen. And a paramagnetic analyzer determines partial pressure of oxygen.

There are five electrostatic precipitators aboard to clean the air: one each in the fan room, galley and auxiliary machinery space and two in the engine room.

#### Navigational aids

Electronics not only helps the ship to fight and protect her from radiation hazards, it also helps her get where she has to go. Conventional navigational equipment includes a loran A or medium-frequency loran set by the Polarad Electronics Corp., two dead reckoning analyzers by the S. S. Hunter Corp., a Sperry Mark 19 gyroscope and a Litton Mark 19 plotting board.

The SINS (Ships' Inertial Navigational System) by the Autonetics division of North American Aviation Inc. makes use of the VERDAN (versatile digital analyzer) computer. This computer can be used for supplementary off-line computing. It incorporates a magnetic-disk memory. The SINS is corrected for error more than once a day.

A novel device is the McKiernan-Terry electromagnetic logmeter. This logmeter is fixed to the hull of the ship and is not extractable as in other ships. It reads out ship's velocity directly to navigational equipment, the fire-control equipment and the engine room. The rodmeter has a shaft that protrudes into the water where an electromagnet generates a field. Motion of this field through sea water creates a voltage. This voltage is picked up by buttons at the tip of the rodmeter and displayed both as velocity and electronically integrated to indicate distance traveled.

A Sperry Automatic Course Control Unit keeps

the ship on course after it deviates only one quarter of one degree.

#### Communications

The ship's radio room is under tight security because messages are encrypted and decrypted there. The sail of the sub carries several retractable antennas.

The UUR receiver and loudspeaker system furnishes entertainment for the crew. It is installed with magnetic-tape recorders for use when the submarine is submerged.

#### Nuclear deterrent

The modern nuclear attack submarine is at once comforting and frightening. It is almost immune to detection because it operates silently, is able to dive deep and stay down for long periods. It is deadly against both submarines and surface craft.

These subs are comforting since they may provide an answer to the threat posed by the Soviet Union's great fleet of conventional submarines and her developmental nuclear ones.

They are frightening when we consider our reliance on the invulnerability of the Fleet Ballistic Missile submarine as a nuclear deterrent and then concede that in time Russia can solve the problems posed by noisy and radioactively hot nuclear subs and perhaps develop attack submarines as good or even better than the Dace.



Commander Jack Walsh, skipper of the Dace, climbs to the bridge of his submarine.

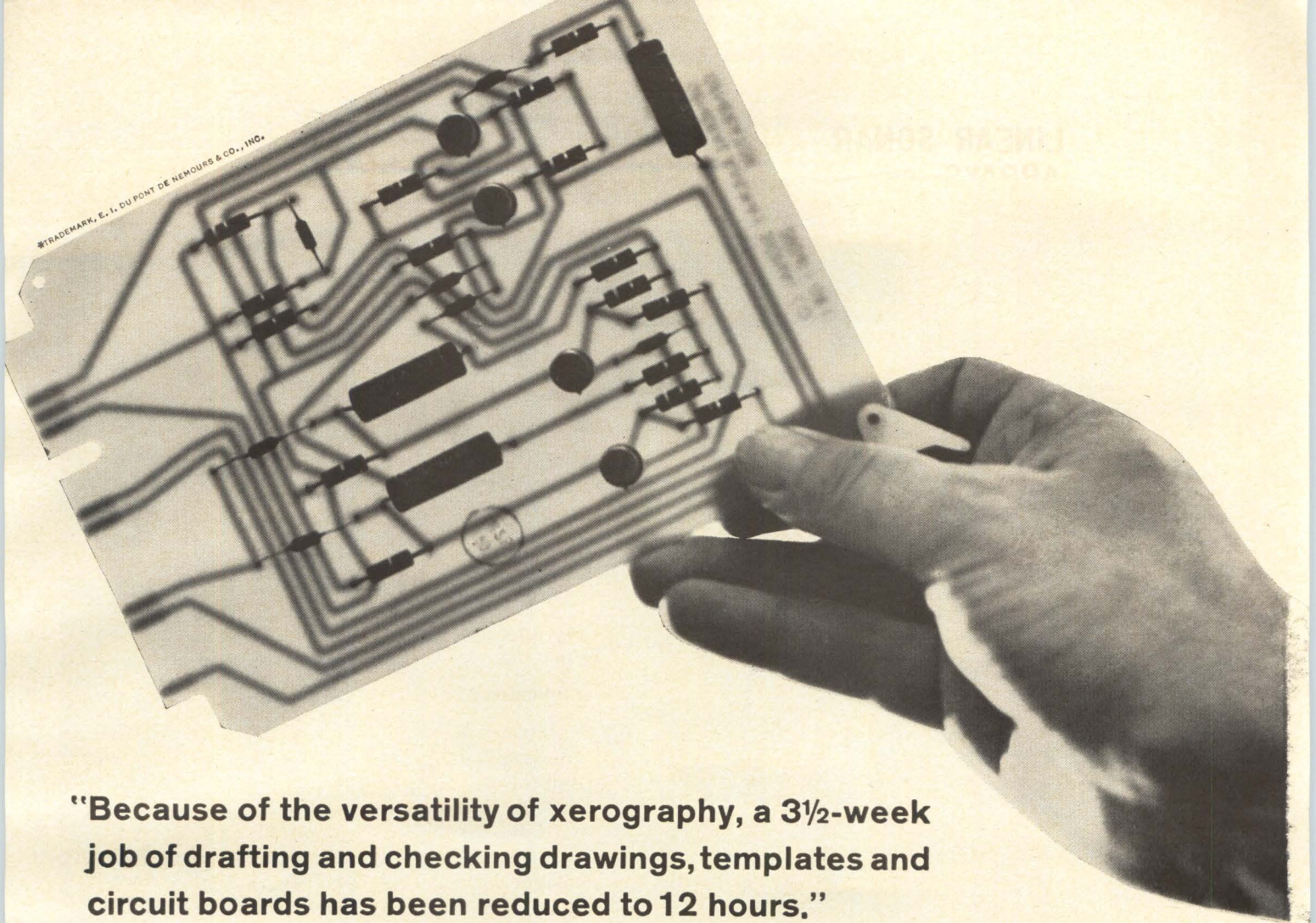

**"Because of the versatility of xerography, a 3½-week job of drafting and checking drawings, templates and circuit boards has been reduced to 12 hours."**

**W. F. "Pete" Harman, Chief Draftsman,  
General Railway Signal Company**

They used to make three separate drawings for each new printed circuit board. Each of the drawings was checked against the others. Then a template was made. This was checked against the circuit board detail drawing and the circuit art work. Then the circuit board was made and checked again.

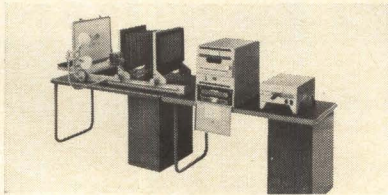

Now they make just one drawing. That's all. Once it's checked, they produce everything else, even the printed circuit boards, from this single drawing. Xerox Standard Equipment does it. Simple. Fast.

And guaranteed accurate.

The drawing is made twice-size on a dimensionally stable Mylar\* sheet. Circuit lines are drawn in ink or by placing strips of black tape on the layout. Holes and terminal points are inked in.

Then the Xerox Standard Equipment is used to copy the drawing, reduced to the exact size required, onto the copper surface of a circuit board. Because Xerox Standard Equipment makes perfect copies, no more drawing or checking of dimensions is needed. All they have to do is put the board in the etching bath.

Total time: 12 hours.

Xerox Standard Equipment is the most versatile way to copy on just about anything that will hold still. Wiring diagrams on circuit boards. Photographs on offset masters. Draw-

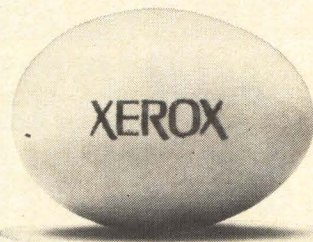

ings on acetate for projection. Even an image on an egg.

Find out how many ways xerography can save you time and money. We'll lend you the equipment for 30 days. No charge. Supplies, too.

Call your Xerox representative. Xerox Corporation, Rochester, N.Y. 14603. Offices in U.S. cities.

CANADA: XEROX OF CANADA LIMITED, TORONTO. OVERSEAS: RANK XEROX LTD., LONDON; FUJI-XEROX CO., LTD., TOKYO, BOTH JOINTLY OWNED WITH RANK ORGANISATION, LTD.

*Xerox Standard Equipment  
the most versatile way to copy.*

*See General Eisenhower, Senators Humphrey & Ervin on ABC-TV and XEROX convention and election night coverage.*

Circle 105 on reader service card

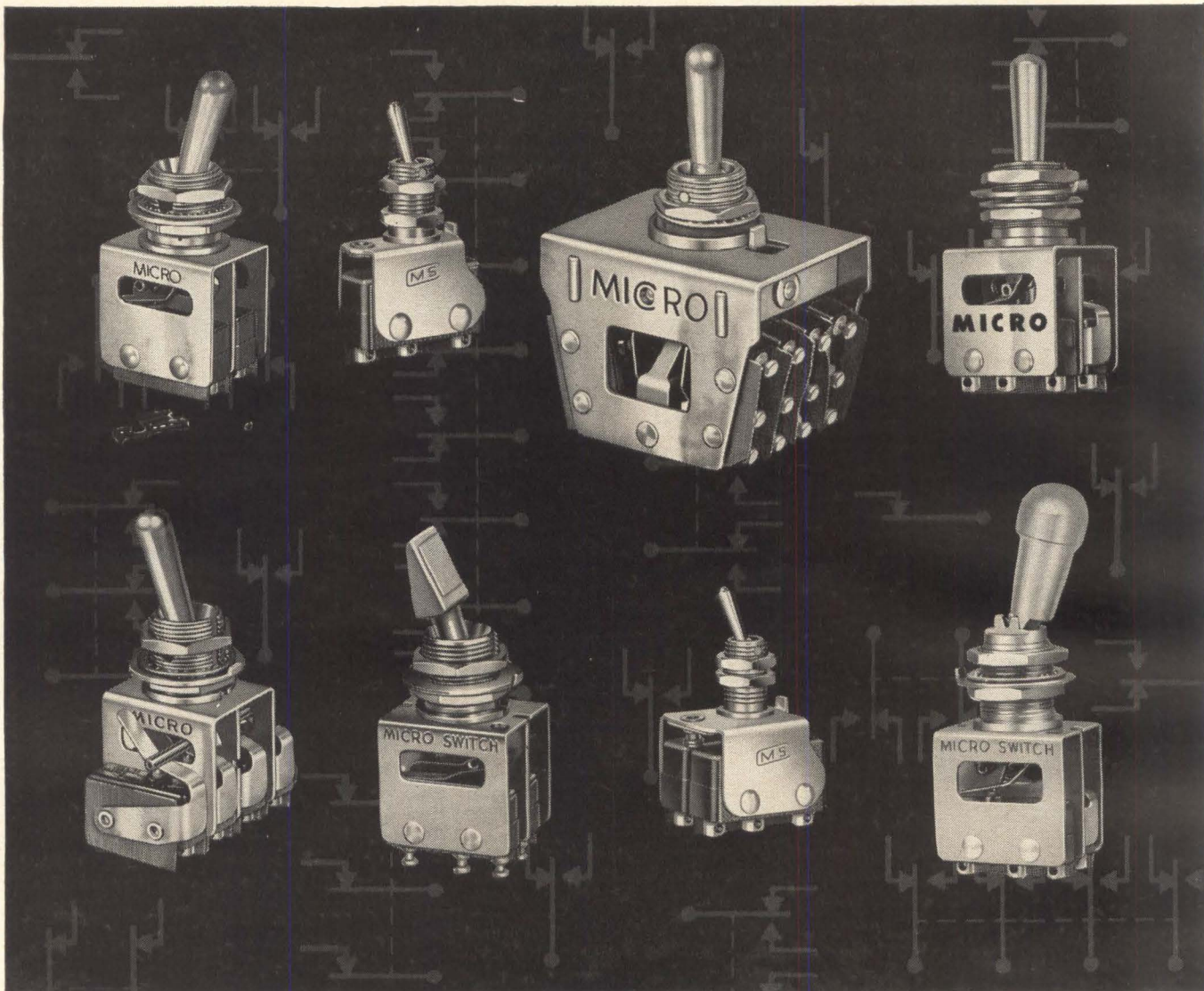

## HUNDREDS OF TOGGLE SWITCH ASSEMBLIES FOR GREATER DESIGN FLEXIBILITY

Tailored answers to a wide variety of control problems—countless ways to simplify circuit design, increase reliability and save space—all are available in the broad MICRO SWITCH line of "AT" Toggle Switch Assemblies. These dependable units are used extensively in electronic, aircraft, mobile and marine applications.

They provide ways to actuate up to a dozen miniature precision snap-action switches—all in one compact toggle assembly. Line offers complete design versatility with a broad range of circuit combinations; 2 and 3 position toggles; maintained and momentary lever positions; pull-to-unlock levers; sealed levers;

and special features such as "electric memory" and "dry circuit" capabilities.

Write for catalog 73, or call our Branch Office (see Yellow Pages).



### MICRO SWITCH

FREEPORT, ILLINOIS

A DIVISION OF HONEYWELL

IN CANADA: HONEYWELL CONTROLS LIMITED, TORONTO 17, ONTARIO

HONEYWELL INTERNATIONAL SALES AND SERVICE OFFICES IN ALL PRINCIPAL CITIES OF THE WORLD. MANUFACTURING IN UNITED STATES, UNITED KINGDOM, CANADA, NETHERLANDS, GERMANY, FRANCE, JAPAN.

TIME BASE CORRECTION

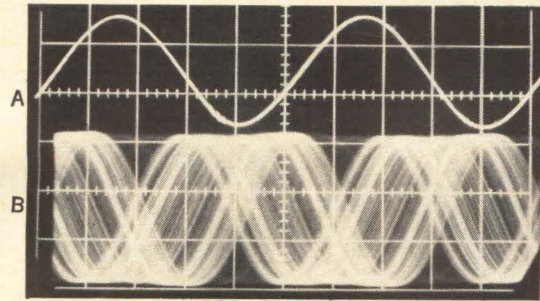

CONVENTIONAL

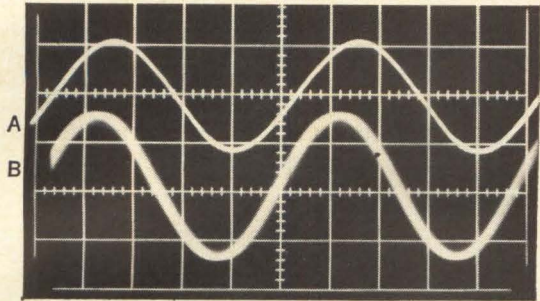

TICOR II

TRACE A: 100-kc oscillator reference signal  
 TRACE B: 100-kc line driver output, track 13  
 One-inch tape, speed 60 ips. Sweep rate: 2.0  $\mu$ sec/cm.  
 Photo exposure: 1/25 sec.



**EXCLUSIVE STORY ON MINCOM'S NEW 1.5-mc TICOR II**

On playback, lock in your tape reference track to TICOR II's reference oscillator signal—the traces above demonstrate a time-base correlation between events holding well within  $\pm 0.5 \mu$ sec, continuously anywhere on the tape. This unique and exclusive Mincom 1.5-mc recorder/reproducer immediately updates any existing data reduction center. It opens new doors to data analysis in radar recording, single sideband, serial PCM and other systems dependent on precise time-base stability. Flutter components below 200 cps are essentially removed. Rapidly convertible from 1/2-inch to 1-inch tape, all solid state, one equipment rack, RFI-shielded. Write for specifications.

**Mincom Division** **3M**  
COMPANY

300 South Lewis Road, Camarillo, California • 320 Shaw Road, South San Francisco, California • 529 Pennsylvania Building, 425 13th Street, N.W., Washington, D.C. • 135 West 50th Street, New York, New York • Post Office Box 272, Fairborn, Ohio • 1230 Orange Avenue, Winter Park, Florida • 2121 Santa Anna Avenue, Dallas, Texas • Eltron Engineering Sales, Inc., 246 Walnut Street, Newtonville, Massachusetts

# DENSITY...

*Up to 137 Radiation Digital Logic Modules can be mounted per inch of panel height!*

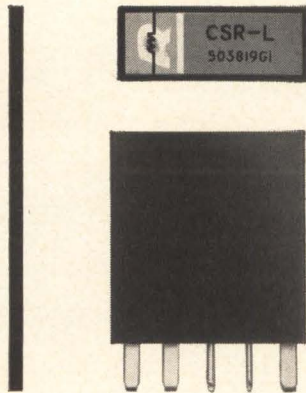
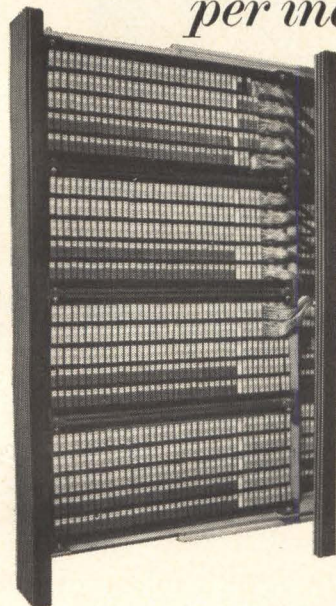

**DIGITAL MODULES** are available from stock in two sets of fully compatible resistor-transistor logic circuitry— for bit rates up to 200 kc; for bit rates to 1 Mc. More than a dozen types include: 4-input NOR • Counter Shift Register • Power Inverter • Emitter Follower • Complementary Driver • Differential • Filter (Decoupler)



**RADIATION**  
INCORPORATED

Radiation Logic Modules can be used in any configuration, type or number compatible with your digital system requirements. They can be mounted in vertical or horizontal drawers, in standard 19" racks, or on breadboards... fixed or removable. Compact modular construction permits packaging densities up to 137 modules per inch of panel height in standard racks. There's no need for design compromise.

## RELIABILITY

Superior engineering and rigid component selection assure highest reliability; based on extensive tests, MTBF for low-speed NOR Modules exceeds 2,940,000 hours! The units are also packaged for rugged use. Construction consists of welded circuitry molded in epoxy and mounted with high-density module connectors on cast aluminum frames. The resulting positive-contact units measure only 0.4" x 1" x 1.1", with a 0.25" pin protrusion.

## ECONOMY

Each module represents a fraction of the entire digital system. Each is designed for easy interrogation. Change or replacement is as simple as plugging in another unit. Thus, expensive downtime is reduced, costly benchwork eliminated.

## APPLICATIONS ASSISTANCE

Radiation offers the services of its engineering staff in the application of digital logic modules or in helping solve your unique data problems. Write or phone for technical data sheets. Radiation Incorporated, Products Division, Department EL-06, Melbourne, Florida. Telephone: (305) 723-1511.

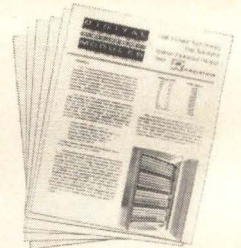

## PRICE LIST—DIGITAL MODULES

Part Number	Description	Unit Price
503815G1	NOR—Medium Speed	\$ 10.38
503816G1	NOR—Low Speed	6.40
503818G1	Power Inverter—Low Speed	5.95
503818G2	Power Inverter—Medium Speed	10.69
503819G1	CSR—Low Speed	8.82
503819G2	CSR—Medium Speed	11.66
503819G3	CSR—Medium Speed	37.65
503820G1	MSMV "B" Side	7.74
503821G1	Diff (MSMV "A" Side)	9.68
503834G1	Filter (Decoupler)	7.55
503860G1	Compl. Driver—Low Speed	12.55
505694G1	Diode Gate	11.40
505703G1	D/A Converter	14.20
505704G1	Indicator Driver	14.15
506030G1	CSR-M1	21.20
507318G1	Emitter Follower—Low Speed	7.29
507318G2	Emitter Follower—Medium Speed	12.11
508334G1-G8	Octal Patch	4.20
508335G1-G2	Jumper Patch	4.84
508367G1	5 Volt Reference	196.20
508517G1	Module, Special Component	13.62
509050G1	Indicator Driver (Negative Coincident Input)	15.15

Specifications and prices subject to change without notice due to technological advances. Delivery, discount schedules and additional pricing information available upon request.

# LAMBDA MULTI-CURRENT-RATED®

power supplies offer maximum flexibility for any application at any ambient to 71°C

NOW 0-60, 0-40, 0-20 VDC IN ¼ and ½ RACK MODELS

ALL  
SILICON  
LH  
SERIES



Lab  
Ambient  
30°C

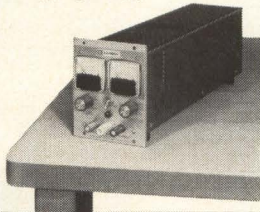

Industrial  
Ambient  
50°C

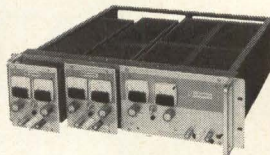

Elevated  
Ambients  
60°C 71°C

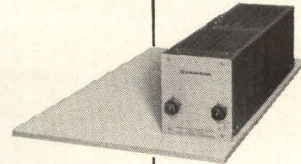

CURRENT RANGE AT AMBIENT OF: (1)

Model	Voltage Range	30°C	50°C	60°C	71°C	Price (2)
LH 121	0-20VDC	0-2.4A	0-2.2A	0-1.8A	0-1.5A	\$159.00
LH 122	0-20VDC	0-5.7A	0-4.7A	0-4.0A	0-3.3A	\$260.00
LH 124	0-40VDC	0-1.3A	0-1.1A	0-0.9A	0-0.7A	\$154.00
LH 125	0-40VDC	0-3.0A	0-2.7A	0-2.3A	0-1.9A	\$269.00
LH 127	0-60VDC	0-0.9A	0-0.7A	0-0.6A	0-0.5A	\$184.00
LH 128	0-60VDC	0-2.4A	0-2.1A	0-1.8A	0-1.5A	\$315.00

(1) Current rating applies over entire voltage range. DC OUTPUT Voltage regulated for line and load

(2) Prices are for non-metered models. For metered models and front panel controls, add suffix (FM) to model number and add \$25.00 to the price. For non-metered chassis mounting models, add suffix (S) to model number and subtract \$5.00 from the non-metered price.

- AC INPUT—105-135 VAC, 45-480 cps
- REGULATION—Line or Load—.015% or 1 MV
- RIPPLE—less than 250 microvolts rms and 1 millivolt P-P
- TEMPERATURE COEFFICIENT—.015%/°C
- MEETS RFI SPECIFICATIONS—MIL-I-26600, Class 3
- CONSTANT CURRENT/CONSTANT VOLTAGE
- REMOTELY PROGRAMMABLE AND CONTINUOUSLY VARIABLE
- SIZE: LH 121, 124, 127 5<sup>3</sup>/<sub>16</sub>" x 4<sup>3</sup>/<sub>16</sub>" x 15<sup>3</sup>/<sub>16</sub>"  
LH 122, 125, 128 5<sup>3</sup>/<sub>16</sub>" x 8<sup>3</sup>/<sub>16</sub>" x 15<sup>3</sup>/<sub>16</sub>"
- RACK ADAPTERS  
Model RA-1 for ruggedized mounting—Price \$60.00  
Model RA-2 for conventional mounting—Price \$25.00

SEND FOR COMPLETE LAMBDA CATALOG.



**LAMBDA ELECTRONICS CORP.**

515 BROAD HOLLOW ROAD • MELVILLE, L. I., NEW YORK • 516 MYRTLE 4-4200

SALES OFFICES AND REPRESENTATIVES CONVENIENTLY LOCATED IN MAJOR CITIES

### **Waveguide Components**

Attenuators, Loads, Waveguide & Coax Switches. Pressure Windows. Waveguide Accessories. Power Dividers — many types, Detector Mounts. Tuners. Waveguide Castings — hybrids, tees, bends. Stripline Components. Orthotree™ & standard Mixers. Sideband Generators. Shutters.

### **Solid State**

Low power, narrow band Power Sources. Broadband frequency amplifier/multiplier Harmonic Generators. High & low power Ferrite Circulators, Isolators & Circulator Switches. Waveguide & coax Semiconductor Switches & Limiters. Semiconductor & Ferrite Duplexers. IF Amplifiers.

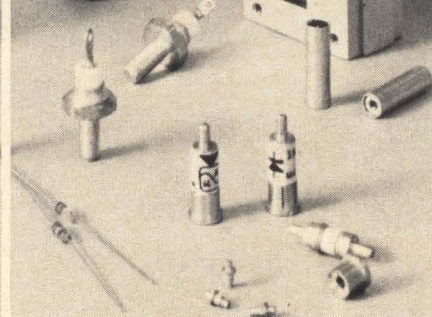
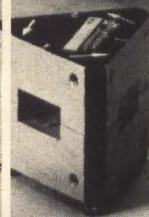
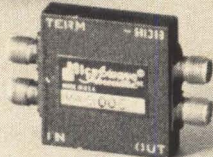
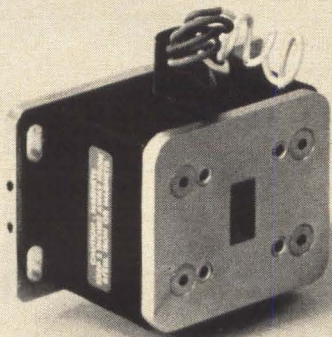

# **Microwave Associates at $K_u$ & $K_e$ BANDS**

*a  
complete  
capability*

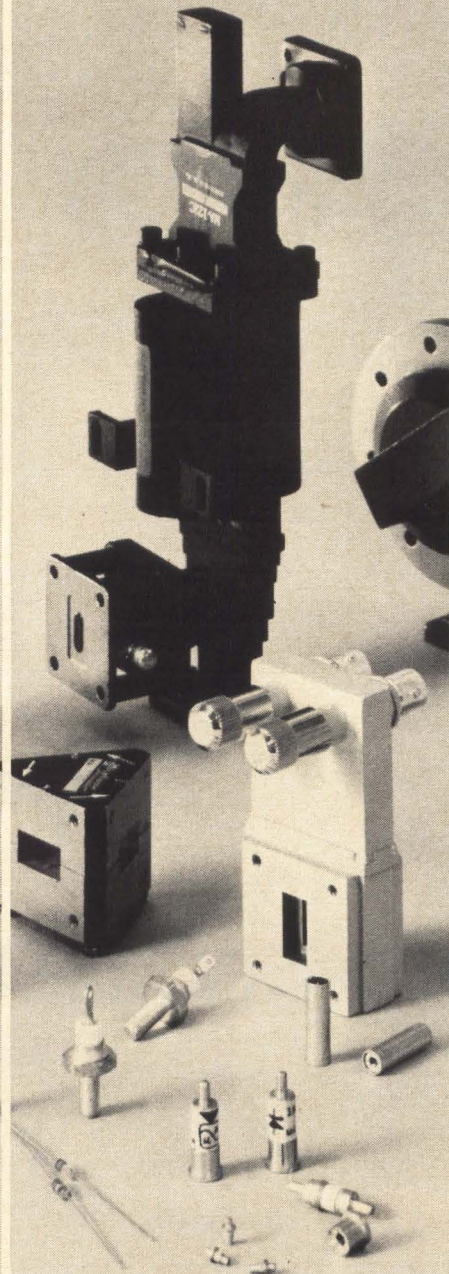

### **Tubes and Duplexers**

TR Tubes for all power and environmental conditions. CW & pulsed Beacon Magnetrons. Ferrite & Gas Duplexers.

### **Semiconductors**

Microwave silicon Mixer & Video Detector Diodes. Varactor Diodes. Tunnel Diodes. Switching Diodes. Special Purpose Diodes. Computer Diodes.

### **Instruments & Assemblies**

Waveguide Assemblies & Subsystems fully proven in our own high power test facilities. Microwave Test Equipment. Super High Power Components. Research & Development.

Products are also available at VHF, UHF, C, S, L, X and Ka bands.

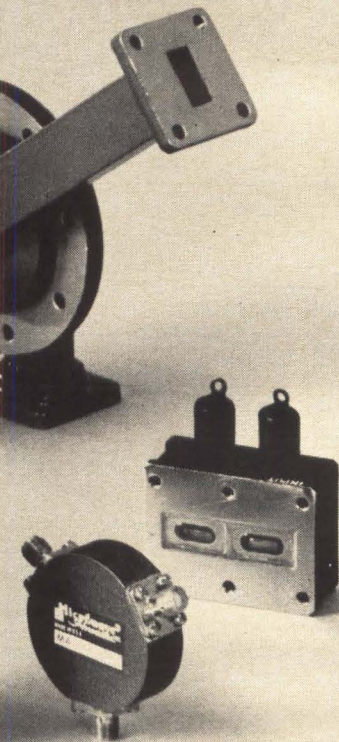

**MICROWAVE ASSOCIATES, INC.**

BURLINGTON, MASS. • WESTERN UNION FAX  
TWX: 617-272-1492 • TEL: 617-272-3000

Overseas Sales: Microwave Associates International, Inc.  
Burlington, Massachusetts

United Kingdom Sales: Microwave Associates, Ltd.  
Cradock Road, Luton, Beds, England



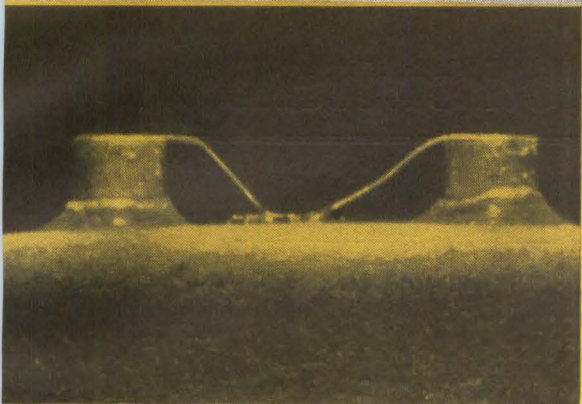
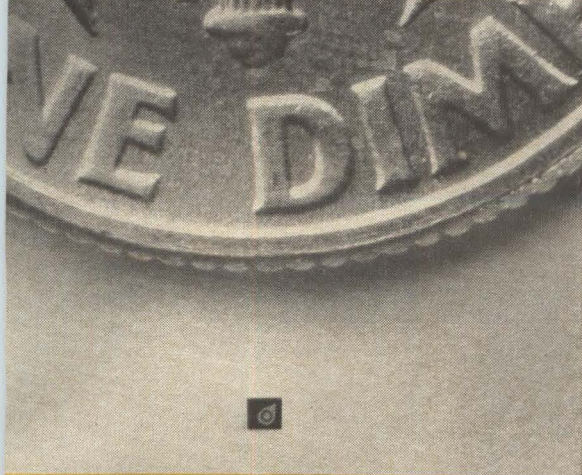

#### Typical characteristics

- leakage under  $1 \mu\text{A}$  @  $170^\circ\text{C}$ ,  $45\text{V}$
- $B_{\text{VCE0}}$   $65\text{V}$  @  $10\text{mA}$
- noise under  $1.5 \text{db}$  @  $25^\circ\text{C}$
- noise under  $3\text{db}$  @  $-55^\circ\text{C}$
- $h_{\text{FE}}$  ( $10\mu\text{A}$ ) of  $45$  @  $-55^\circ\text{C}$
- aluminum construction permits  $300^\circ\text{C}$  storage without purple plague (or black death) at the chip



TO-18

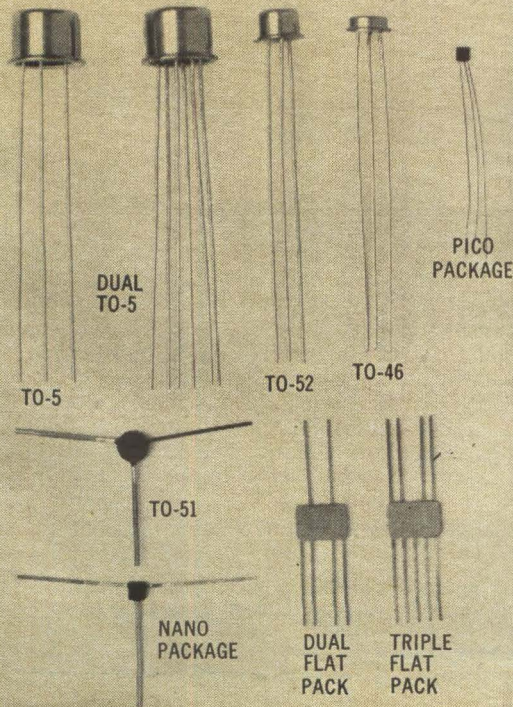

# this chip

LOW NOISE, LOW LEVEL NPN SILICON PLANAR TRANSISTOR

# with this construction

ALUMINUM LEAD-WIRE AND METALLIZATION

# delivers this PERFORMANCE as the 2N930

# and in all these packages too

Transitron brings you a new dimension in low noise, low level transistor performance in the 2N929-30 family . . . and a new dimension in packaging versatility. The new device combines high temperature reliability and low temperature performance with low noise and high beta at  $-55^\circ\text{C}$ . All aluminum lead-wire and metallization construction eliminates purple plague (or black death) at the chip. Package versatility is unlimited. The following popular registered types are readily available: 2N929-30, 2N929A-30A, 2N2483-4, 2N2509-11, 2N3077-8, 2N3045, 2N3048, 2N2641, 2N2644. (Transitron also makes this transistor family in dual form as matched or unmatched pairs.) All now available through your Transitron Distributor. For further information, write Transitron, Wakefield, Mass.

## Transitron

electronic corporation  
wakefield, melrose, boston, mass.

SALES OFFICES IN PRINCIPAL CITIES THROUGHOUT THE U.S.A. AND EUROPE • CABLE ADDRESS: TRELCO

# Q • Circuit design versatility?

# A • Silicon controlled switch!

... for example:

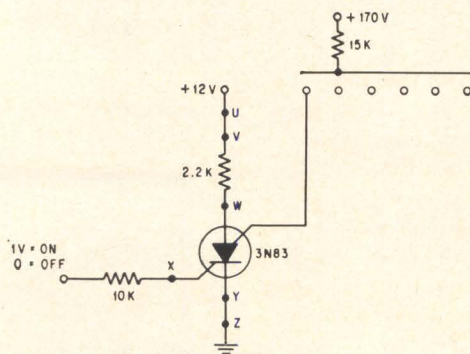

NIXIE\* TUBE DRIVER

\* NIXIE: Trademark of Burroughs Corporation

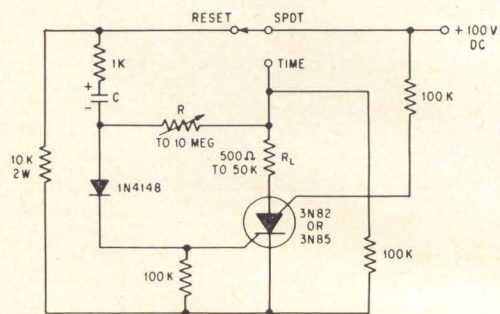

Load current starts approx. 0.5 RC after switch is thrown.  
TIMING CIRCUIT

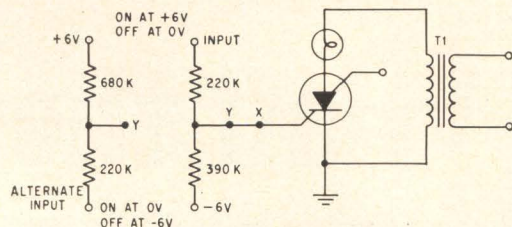

LAMP	RATING VOLTS	AMPS	SCS	SEC. VOLTS RMS T1*
24	24	.035	3N81	34

\* Increased voltage gives normal brightness in half-wave circuit.

INCANDESCENT LAMP DRIVER

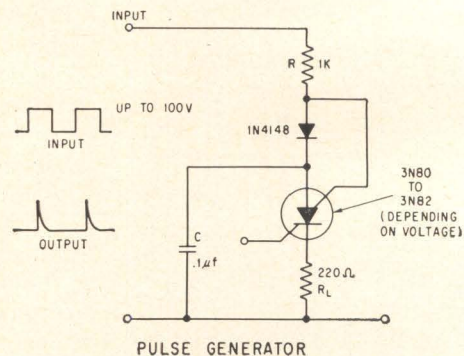

PULSE GENERATOR

the Silicon Controlled Switch (SCS) is a PNP structure with all four semiconductor regions accessible, and this greatly expands circuit possibilities beyond those of conventional transistors or SCRs. The circuits shown are only a few typical examples.

- ... to some, the SCS is an integrated circuit consisting of a PNP and an NPN transistor in a positive feedback configuration, offering fewer connections and parts, lower cost and better characterization than is available from two separate transistors.
- ... to others, it is an SCR with "an extra lead" which can completely eliminate rate effect problems.
- ... some prefer to use it as a complementary SCR being triggered by negative going pulses.
- ... many find the high triggering sensitivity ideal for timing and level sensing applications.

... looking at the SCS as a transistor with an additional "latching" junction, some have developed very useful bistable circuits with high turn-on and turn-off gains.

Find out more about the SCS and how it can improve your circuits. See your General Electric District Sales Manager. Or write for SCS Application note. Pub-90.16 to Section 16F167R, Semiconductor Products Department, General Electric Company, Electronics Park, Syracuse, New York. In Canada: Canadian General Electric, 189 Dufferin Street, Toronto, Ont. Export: International General Electric, 159 Madison Ave., New York 16, N. Y.

Available through your G-E semiconductor distributor

GENERAL  ELECTRIC

# Probing the News

## Industry

### The tough transition

How some companies are finding solutions to problems posed by the cutback in defense spending

**The Aerojet General Corp.**, which sells \$500 million worth of rockets every year, recently began to promote such civilian products as an automated parcel-sorting system for post offices and warehouses, a brushless alternator for automobiles, a drunkometer, a brain probe and a glass pressure tank that is as rugged as Aerojet's filament-wound containers for rockets.

All these items are outgrowths of the company's defense work, which comprised about 98% of Aerojet's sales of \$703 million last year. Besides rockets, Aerojet makes infrared tracking and guidance devices, and airborne and underwater instruments.

Aerojet has a big advantage over some other companies trying to diversify to survive the anticipated \$11.5 billion cut in defense spending between now and 1969. As a subsidiary of the giant General Tire & Rubber Co., it can tap resources and experience that aren't available to independent concerns.

#### Transition trouble

Yet even Aerojet finds the transition to commercial products a difficult one. Some industry officials estimate it will be seven years before advanced military technology can really make itself felt in civilian fields.

At the Republic Aviation Co., whose 1963 sales were exclusively to the government, an executive explains: "The imagination that has been utilized by the technical needs of defense will be freed to think up a better mousetrap. But it takes a while to stop the military wheels turning and to start up the industrial or consumer wheels."

Citing the need for nationwide marketing organizations and experience, Republic estimates that the transition from 100% to 50% military output would take 10 years. Some firms consider that projection optimistic.

An official of another company, discussing mass transportation, complains: "How do you deal with transport authorities that have bought locomotives from one company and cars from another firm since they started in business? They ask, 'Who are you? How good is your in with our purchasing agent?' It takes money and perseverance to crack these new markets."

**Hope from failures.** Nevertheless, countless companies are trying to apply military know-how to civilian markets. Sometimes even unsuccessful defense projects hold out bright hopes for civilian applications.

Aerojet was outbid on a gas chromatograph for analyzing gases on the moon. But the company has incorporated the principle into a compact device that warns when toxic gases are present in a factory or when too much alcohol is present in a motorist's breath.

An Aerojet subsidiary, the Space General Corp., failed to sell a lunar walker to the National Aeronautics and Space Administration. The device, designed to carry out unmanned, roving expeditions on the moon, caught the attention of medical researchers at the University of California at Los Angeles. The doctors think the development may be adapted to serve as an arm or leg for a limbless child.

**Technical transfer.** NASA is fully

aware that its continued affluence may depend on commercial applications for its space technology. The agency generally refrains from obtaining patents except on classified devices, and regularly publishes at least four newsletters designed to acquaint industries with technological advances in the space program. All of these activities are handled by NASA's Office of Technology Utilization.

NASA's best seller to date is a booklet on selective welding techniques. More than 13,000 copies have been mailed in response to requests.

**Too many 'customers.'** The program's very size and scope, however, may be its biggest drawback. Even if a company does consider a NASA-developed device useful, it knows that hundreds of other concerns have received the same bulletin from the agency. The company is reluctant to commit manufacturing dollars to a device that a competitor might also produce.

Some critics have suggested that



Microwelder is another outgrowth of Aerojet's defense technology.

NASA should be more selective in sending out technical information. But other observers reply that such selectivity might open the agency to charges of favoritism.

In addition, the technology utilization office seems to be having trouble determining potential industrial applications for NASA's products and techniques.

### Commercial byproducts

The agency is optimistic about commercial applications for products developed for the space program. It has emphasized findings on the optical and electronic properties of solid matter, and predicted that this research would lead to improved medical diagnostic tools. NASA also expects commercial advantages from developments in semiconductors for optical detectors, for miniaturization of tape recorders for use in space, as well as solar cells, an infrared horizon sensor and many other technological advances.

George L. Simpson Jr., the agency's assistant administrator for technology utilization, has called special attention to an aluminum phosphate composition that isolates electric components from the high level of vibration that is generated by a launch vehicle. The material, developed at the Goddard Space Flight Center in Greenbelt, Md., is said to possess excellent heat-insulating and sound-absorbing properties. Simpson says it is economical and cures at temperatures less than 100° C. He concludes that these characteristics "may make it commercially attractive."

**Help from chimps.** Several space developments have educational implications. An example is the agency's experience in training animals to perform complex tasks in early space programs. The chimps and mice are no longer used, but the Institute of Behavioral Research is continuing research on the training techniques under a NASA grant. One result of the program, a new way to teach languages to children, is being tested by psychologists at Georgetown University.

Another study stemming from space animals involves interpreting brain waves in animals and hu-

mans. Small, highly reliable, portable equipment can now be used in mobile hospitals to detect brain damage. A NASA grant to the Baylor University College of Medicine in Houston, Tex., has financed the first electroencephalogram library in the country, containing thousands of examples of normal and abnormal brain-wave patterns.

**Cardiac monitor.** The United Aircraft Corp. has received a NASA contract to develop a device to stimulate a monkey's central nervous system electrically by wireless telemetry. The space agency says this device can be used in medicine to enable one person to monitor a large number of cardiac cases.

Another byproduct of Project Mercury's animal studies is a baby feeder. Originally designed to deliver measured amounts of water to animals under weightless conditions, the device—which includes an electronic programmer—has been found suitable for use with infants.

### Data library

To cope with the information explosion, NASA has arranged to send all of its unclassified literature to the Aerospace Research Applications Center (ARAC) of Indiana University. The center receives contractor and other technical reports, computer tapes, microforms, and all publications on technology utilization. The number of NASA titles filed at Indiana is rapidly approaching 100,000.

The center's job is to organize this mass of information so that a participating industrial company can quickly obtain pertinent data. Last year 29 companies paid \$5,000 apiece to receive these services. They embrace a spectrum that includes the International Telephone and Telegraph Corp., Texas Gas Transmission Corp. and Eli Lilly & Co.

Many companies have declared the Indiana services to be worthwhile. The Socony Mobile Oil Co. wrote, "We believe the ARAC experiment is a prototype of the future information systems." A spokesman for the Ball Bros. Co. said, "One NASA innovation may lead to a major change in the circuitry of one of our inspection instruments and greatly enhance its value."

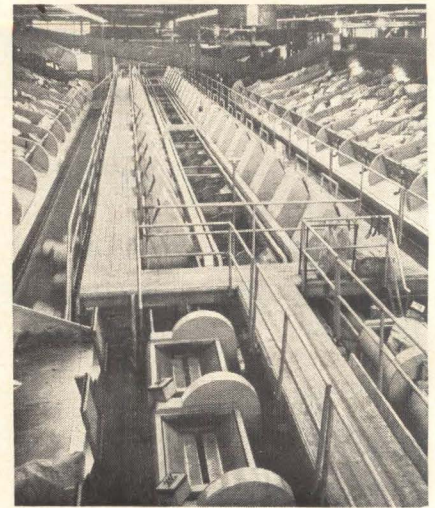

Parcel sorting system, developed by Aerojet General Corp., flips packages into the proper bins.

**Work in Washington.** Efforts to help industry convert from military to civilian products have originated at the highest government level. Last year, President Johnson created a Committee on the Economic Impact of Defense and Disarmament. Its job is to coordinate federal activities in this field.

The Senate is considering a bill introduced by Philip A. Hart (D., Mich.) that would establish a national commission on automation and technological progress. The commission would study technological developments, define areas in which the new technologies might do the most good, and suggest ways to match the technologies with the needs. The commission would report to the President and Congress by Jan. 1, 1966.

The bill also would require defense companies to set up active programs, underwritten by the government, to plan for civilian work in case of military cutbacks. Conversion plans are now voluntary.

The Senate Manpower subcommittee has completed hearings on the Hart Bill and is expected to approve it when the civil-rights battle ends. The bill also is expected to clear the House Labor Committee after that body completes hearings on the President's poverty program.

**Job proposals.** In a report on employment policy, the Senate subcommittee made these major recommendations:

- Order a thorough review of pat-

ent policies to assure that government-financed technology is used to encourage new firms and jobs.

- Require future contractors for defense work to make plans for conversion to civilian work if the contract should be canceled or curtailed.

- Create a defense adjustment fund, comprised of small sums proportional to the size of each defense contract. This fund would be used to help communities and individuals attract new jobs when existing industries are hurt by defense cutbacks.

**Pentagon's policies.** The present law gives the Defense Department the right, in awarding contracts, to grant limited preference to areas of chronic depression and labor surplus.

But the Defense Secretary, Robert S. McNamara, warns: "The Defense Department cannot and should not assume responsibility for creating a level of demand adequate to keep the economy healthy and growing. Nor should it, in developing its programs, depart from the strictest standards of military need and operating efficiency in order to aid an economically distressed company or community."

**Dollars disappear.** One problem with the Pentagon's effort to help depressed areas is the fact that it's difficult to measure the economic effects of a specific contract. Government officials point out that as much as 80% of the contract may be let out to a subcontractor anywhere in the country. The Pentagon has no clear picture of where its money ultimately goes.

To correct this situation, the Census Bureau is making a survey of government work as a supplement to its annual survey of manufacturers. When this data is available, the Pentagon expects to be better able to determine both the industrial and regional impact of the defense program. The Defense Department already projects its needs five years ahead. By measuring this projection against the census data, it hopes to provide an effective early-warning system to alert companies and communities of impending changes.

### Study on electronics

The electronics industry is the

subject of a study ordered by the Arms Control and Disarmament Agency. The Battelle Memorial Institute, an industrial research organization, has received \$107,000 to survey "the implications of reduced defense demand for the electronics industry." The report is due by July, 1965.

The agency asked Battelle to "examine the extent and nature of the dependence of the electronics industry upon demand arising from national defense requirements" with special attention "to the identification of the industry's output by major types of market (military, industrial, consumer, space) and the employment generated by such output."

The study will examine industry's efforts to reduce its dependence on defense contracts, and the effects on the industry of major reductions in military demand. Battelle also will look at problems encountered in adjusting electronics industry resources to different patterns of production and marketing.

**Buying diversification.** In addition to renewed emphasis on civilian products, some companies are taking the fast route to diversification by buying other concerns.

Late last month, Aerojet bought Gibbs Shipyards, Inc., in Jacksonville, Fla. Gibbs is making two automated survey ships for the Coastal and Geodetic Survey, and a seagoing platform for acoustic research by the Navy.

Republic Aviation bought a 30% interest in the Fokker Aircraft Co. of the Netherlands several years ago, and expects to sell the new F-28 short-haul transport plane that Fokker plans to produce by 1967.

Another big producer of electronic equipment for defense, the Raytheon Corp., has bought Penta Laboratories in Santa Barbara, Calif., a maker of pentode tubes. A Raytheon spokesman says the acquisition "complements an existing line." The purchase was arranged by a new "acquisition group" at Raytheon, whose 1963 business was 75% military.

How effective are these efforts toward diversification?

Most companies emphasize that they're only starting. An official of Aerojet doubts that the company's civilian sales will increase much from the 2% of last year, despite defense cutbacks. "But," he adds, "We're setting up the foundation for the future."

## Industrial electronics

# Scanning the mails

Zip codes speed service. Next: electronic readers, automated data-processing centers

By Warren Kornberg

McGraw-Hill World News

**The flickering eye** of an electro-optical scanning machine could be the beacon guiding the Post Office's sorting procedures into the 20th Century. Without modern reading techniques, the post office is chained to a sorting routine as old as mail itself—letter by letter.

The sorting process has been somewhat mechanized recently. Operators now punch a console-

keyboard to sort letters into bins faster than a man used to push them into cubbyholes. Elaborate setups are also used to scan and flip envelopes so they all face the same way, with electric eyes reading phosphor-tagged stamps to sort air-mail from other letters.

But until the first electronic reader is actually in an office, no envelope can be delivered without

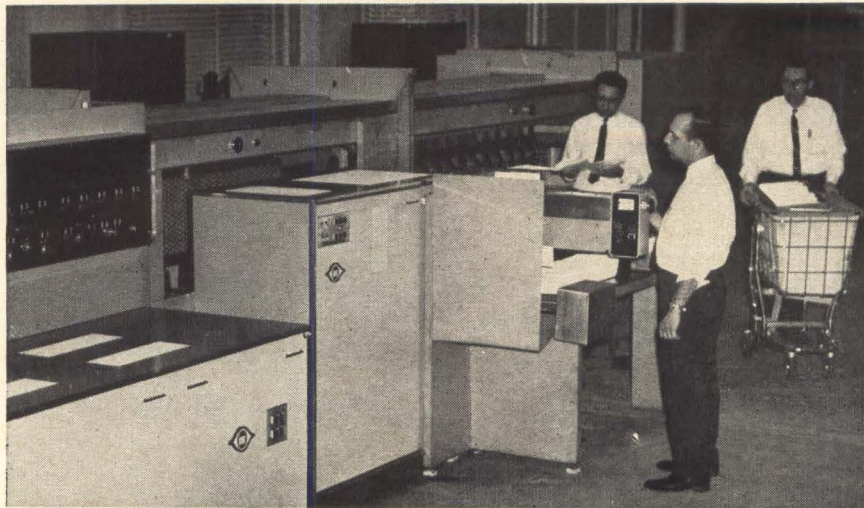

First address reader to be field-tested later this year in Detroit will be a larger version of this Farrington machine.

first being stopped and read by a man whose maximum speed, even with mechanization, never exceeds one letter a second. Even the first scanners, tested almost 10 years ago, quadruple this speed to four letters a second.

#### Technology trailing

With mail volume increasing by two billion pieces a year, postal needs have always kept far ahead of technology. The answer, previously low-priority, is now jammed at the head of the improvements list.

Postal officials are seriously considering electronic reading machines for 200 major post offices across the country. These would be linked in a leased-line network to six central automatic data-processing centers to be completed within 10 years.

Only the largest post offices, if any, would have independent automatic data-processing equipment. Under the present proposal, most post offices would be tied to the data-processing centers.

**Five producers.** There are five major competitors for a basic scanner business that is estimated at \$100 million. The companies are the Burroughs Corp., Farrington Electronics, Inc., National Cash Register Co., Philco Corp. and the Rabinow Engineering Co. Farrington is the oldest company in the field.

Starting with a slit-scanner disk technique that is still in use, Farrington proved a machine could

recognize the character-group "Washington, D. C." By 1958, a Farrington machine was picking out about 20 city-state combinations, all spelled out.

This year an advanced machine will be tested in Detroit. It will be plugged into a mechanical system, replacing the console-keyboard. The test will be to sort mail by states—recognizing abbreviations, capital and small letters, and even a couple of city names. Later tests would increase the number of cities to 50, at a sorting rate of 27,000 pieces an hour.

**Second generation.** Being based on character-group identification limits the machine's scope to the groups programed into it. Thus these machines only sort outgoing mail. Incoming mail, destined for many different areas within one city, is another problem. Sorting of incoming mail is forcing the Post Office to find and use more advanced equipment—a second generation in research and development.

In 1960 the Philco Corp. received a contract for an alpha-numeric machine based on a flying-spot scanner that can match Farrington's record of being able to handle 70% of all business mail with only a 2% error. Philco's machine will also be checked out under operating conditions in August.

#### Enter zip codes

With the development of zip codes, the Post Office realized it would need highly developed nu-

meric readers to complement its sophisticated address scanners.

Proposals were sought from the electronics industry, thirty firms were interested, nine bid and three got development contracts, with the understanding that they were still in a competition. The companies were the Burroughs Corp., National Cash Register Co. and Rabinow Engineering.

**Test planned.** All three machines will be tested this Fall for ability to feed, transport and scan envelopes, locate and read the five-digit zip code, recognize the code, compare it with a stored address-directory, and give instructions to the letter-sorter. After an evaluation of efficiency against cost, maintenance ease and other factors one machine will be selected.

Each zip reader has its own approach.

Burroughs uses a five-shift-register and the "best match" code-comparison method, with a flying-spot scanner. The electronically deflected light spot sweeps the envelope, locates the address, is positioned near the end of the address line and scans the code. The pattern is picked up by a phototube, stored in a 150-bit shift-register matrix and analyzed. The code is identified and compared with the stored address-directory and a signal is fed to the sorter. The approach disregards the size of letters and digits.

National Cash Register also uses a flying-spot scanner, but substitutes a set of photographic "feature" templates as the analyzing device. This approach requires standardization of the characters. The machine has a 2,000-bit optical shift-register and a 19-lens beam splitter. Separate cathode-ray tubes are used to find the address lines and scan them. The read scan-signals are fed to a storage tube that displays each character sequentially. The character image is superimposed on a group of photographic templates, each template looking at a small segment of the character. Each character is recognized by a combination of specific segments.

Rabinow's machine is the only one that does not use a flying-spot scanner. Light pipes, in an image converter tube, pick up the moving

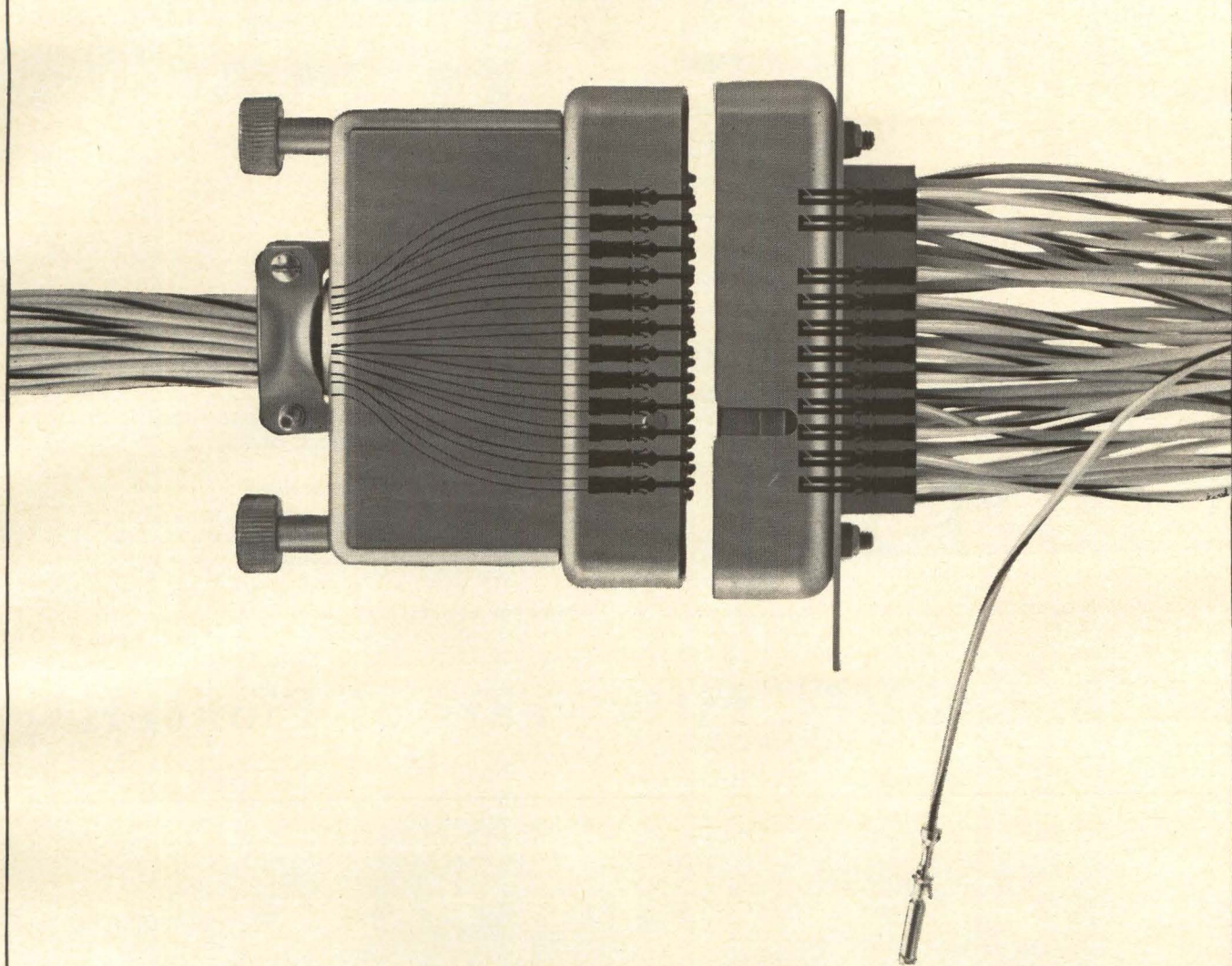

## LET WINCHESTER ELECTRONICS HELP YOU CRIMP HIGH CONNECTOR COSTS

Lowest production and replacement costs, greatest design flexibility, increased reliability... these are the all-important benefits of incorporating removable, crimp contact connectors into your system. And industry-pacing Winchester Electronics supplies the whole package—inserts, shells, contacts, hoods, mounting plates, jackscrews and jacksockets, insertion and removal tools, and automated, portable pneumatic and manual crimping tools.

Our removable, crimp contact connector package means faster assembly of wires during any phase of the production cycle; circuit changes or replacement of individual contacts without destroying the connector; and positive crimped connections with contacts that can accommodate a wide range of wire sizes. Stock is readily available in numerous

miniature and subminiature rack and panel, and printed circuit types.

We also offer complete lines of hermetically-sealed, miniature and subminiature rectangular, round, printed circuit, quick-disconnect/heavy-duty, environmental and special-application connectors. Prompt delivery and engineering assistance are assured by a nationwide network of distributors, regional offices and representatives. For a complete description of our connectors, accessories and tools, write for a copy of Catalog No. 364: Winchester Electronics, 19 Willard Road, Norwalk, Connecticut.

**WINCHESTER ELECTRONICS**   
A DIVISION OF LITTON INDUSTRIES

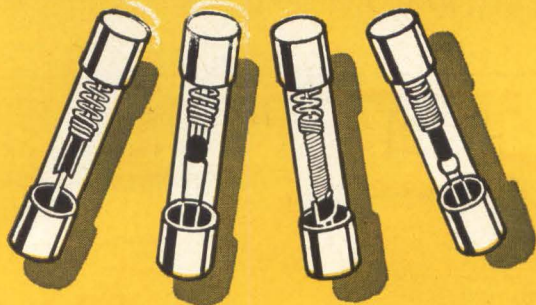

## FUSETRON

dual-element Fuses

*time-delay type*

“Slow blowing” fuses that prevent needless outages by not opening on motor starting currents or other harmless overloads—yet provide safe protection against short-circuits or dangerous overloads.

# BUSS

Write for BUSS  
Bulletin SFB

BUSSMANN MFG. DIVISON, McGraw-Edison Co., St. Louis, Mo. 63107

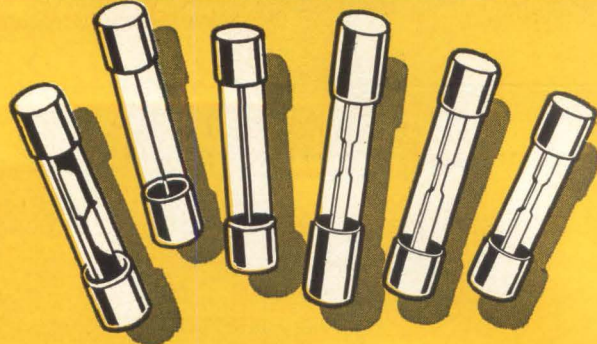

## BUSS

*quick-acting Fuses*

“Fast Acting” fuses for protection of sensitive instruments or delicate apparatus;—or normal acting fuses for protection where circuit is not subject to starting currents or surges.

# BUSS

Write for BUSS  
Bulletin SFB

BUSSMANN MFG. DIVISON, McGraw-Edison Co., St. Louis, Mo. 63107

# BUSS: 1914-1964, Fifty years of Pioneering...

Circle 119 on reader service card

Circle 119 on reader service card

## PICK YOUR PUMP

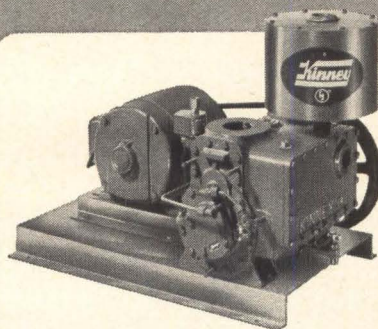

### SINGLE STAGE ROTARY PISTON

Ultimate pressure: 10 microns. Rugged workhorse of the high vacuum field.

KS-13 (13 cfm)  
KS-27 (27 cfm)

KD-30 (30 cfm)  
KS-47 (47 cfm)

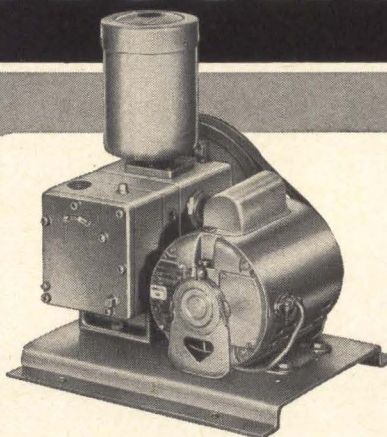

### COMPOUND VANE

Ultimate pressure: 0.2 micron. For laboratory work where lowest noise level and freedom from vibration are essential.

KCV-2 (2 cfm)  
KCV-3 (3 cfm)

KCV-5 (5 cfm)  
KCV-7 (7 cfm)

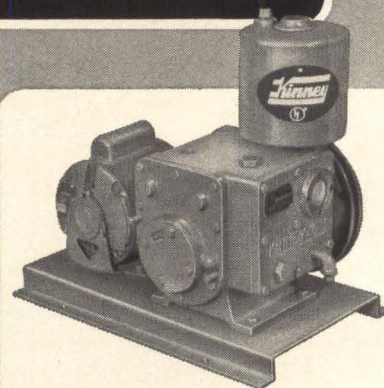

### COMPOUND ROTARY PISTON

Ultimate pressure: 0.2 micron. Ideal production tool that performs tirelessly in the high vacuum range.

KC-2 (2 cfm)  
KC-3 (3 cfm)  
KC-5 (5 cfm)

KC-8 (8 cfm)  
KC-15 (15 cfm)  
KC-46 (46 cfm)

Each Kinney high vacuum pump has been developed to produce specific vacuum conditions for specific purposes. Pick the Kinney Pump that suits your need; gas ballast standard on all Kinney Mechanical Pumps.

## KINNEY VACUUM



DIVISION THE NEW YORK AIR BRAKE COMPANY  
3529 WASHINGTON STREET, BOSTON 30, MASS.

# K

“EVERYTHING IN VACUUM”



address, reproduce it on the back surface of the tube and shift it up and down at high speed.

The characters are scanned by a light-sensitive cell behind a pin-hole. The cell generates electronic signal patterns corresponding to the specific character on the envelope. These are recognized and compared with the address-directory on a "best match" basis.

### The best of both

The post office expects ultimately to use a combination of address and zip-code readers. The more the zip code is used—and mailers of about 80% of the nation's mail have already agreed to use it—the smaller will be the number of address readers needed by the post office. "Just the location of the characters on the letter eats up a lot of electronics," says Richard

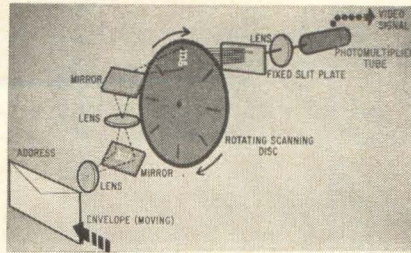

Slit-scanning dates back to 1958 but is still in use. A character in the address is read onto a scanning disk and is broken into solid streams of light. The fixed slit plate breaks the stream into discrete signals that are converted in the photomultiplier, from light into electrical energy. The video signal, in binary form, then goes to interpreter circuitry.

Hessinger, the Post Office's director of research. He estimates that if just the location of the address on the envelope could be standardized, as much as 25% to 50% of the research and development costs

could be eliminated.

"We expect these machines to pay for themselves within 10 years," says Edward E. Harriman, director of the postal department's office of research and engineering. "If they can't give a 10% annual return on investment, they won't do."

Harriman estimates the ultimate cost of each electronic reader at \$100,000. At least two readers, with three read-heads each, should be installed in each of the 200 major post offices where the cost can be justified, according to Harriman. This equipment, plus sorting and other machines, would put the price at about \$500,000 per office.

"The first address reader will be operating in Detroit next year," says Harriman. "The rest of the program should be in full operation in 5 to 10 years."

## ...New Developments in Electrical Protection

### New! BUSS SPACE SAVER PANEL MOUNTED FUSEHOLDER

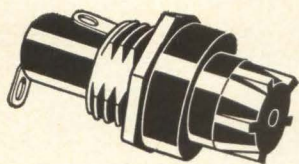

Actual Size  
Only  $1\frac{1}{8}$  inches long . . .  
Extends just  $\frac{29}{32}$  inch  
behind front of panel

- Fuseholder takes  $\frac{1}{4} \times 1\frac{1}{4}$  inch fuses. Converts to  $\frac{9}{32} \times 1\frac{1}{4}$  inch fuses simply by changing screw type knob. Holder is rated at 30 ampere for any voltage up to 250.
- Also available in military type which meets all requirements of MIL-F-19207A.

# BUSS

Write for BUSS  
Bulletin SFH-10

BUSSMANN MFG. DIVISION, McGraw-Edison Co., St. Louis 7, Mo.

### Save Assembly Time with Quick-Connect Terminals on BUSS Fuseholders

Eliminates soldering. Permits  
use of pre-assembled harness.  
Reduces assembly time.

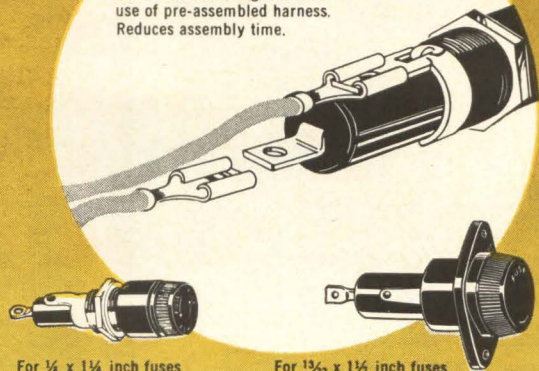

For  $\frac{1}{4} \times 1\frac{1}{4}$  inch fuses  
Series HJ, HK, and HLD

For  $\frac{9}{32} \times 1\frac{1}{2}$  inch fuses  
Series HPC

# BUSS

Write for BUSS  
Bulletin SFB.

BUSSMANN MFG. DIVISION, McGraw-Edison Co., St. Louis 7, Mo.

# EACH TOOL CRIMPS MOST CONTACT TYPES

**Cycle-Controlled  
No Operator Adjustments**

**MINIATURE HAND TOOL** only 6¾" long —For crimping miniature contacts in small, hard-to-reach spaces. One tool plus low-cost positioners crimp proprietary and MIL-Spec contact #20 and smaller—wire sizes #20 thru #30. Weighs only 10 ounces.

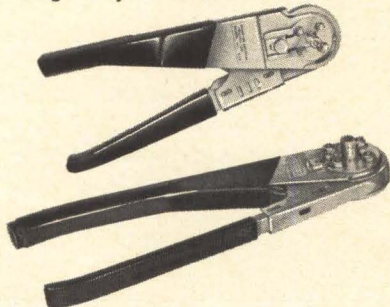

**STANDARD HAND TOOL — MIL-T-22520 Class I.** Crimps contact sizes #12 thru #20. Positive control of crimp depth, crimp location, point of ratchet release.

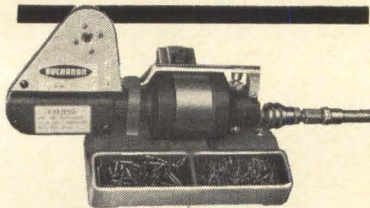

**MANUAL FEED TOOL —** For moderate volume production. Pneumatic. Portable or bench mounted. For wire sizes #8 thru #30. Weighs less than 5 lbs. Meets performance specs of MIL-T-22520.

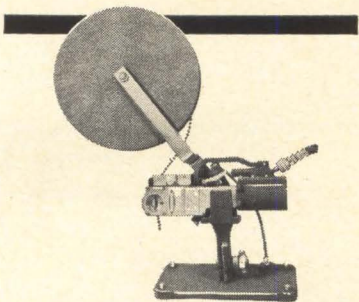

**AUTOMATIC FEED TOOL —** Portable or bench mounted. For high volume production. Pneumatic, versatile. Crimps contacts for wire sizes #12 thru #30. 2,000 or more contacts per loading when bench mounted. Meets performance specs of MIL-T-22520.

**WRITE TODAY FOR** complete library of crimping data and **NEW** catalog.



216-615 Route #22  
HILLSIDE, NEW JERSEY • (201) WA 3-7474  
a subsidiary of Elastic Stop Nut Corporation of America

## Components

# Connector controversy

Fierce competition, and a flaw in a Minuteman component, stir a war among electronics firms

By Ron Lovell

McGraw-Hill World News

**The Defense Department**, already under attack for concentrating the nation's deterrence on missiles, now faces critical questions about the dependability of its most powerful missile, the Minuteman.

Although considered a reliable weapon, the Minuteman has had some recent test failures. And half of those failures have been blamed on the missile's main electronic connector—the MIL-C-26500. This charge was made by Paul Swisher, TRW Space Technology Laboratories, a subsidiary of Thompson Ramo Wooldridge, Inc. Swisher is a project manager on the Minuteman program.

The chief difficulty is mismatching, caused by a soft dielectric into which male pins are forced and bent.

### Maker admits flaw

The flaw is admitted by the Amphenol-Borg Electronics Corp., one of two major suppliers of the 26500. To rectify it, the company last year developed a closed-entry hard-dielectric connector, the 38300. Nevertheless, Amphenol considers recent criticism of the 26500 as greatly exaggerated.

Meanwhile, the Defense Department continues, almost automatically, to requalify the 26500 for use in the Minuteman.

**Designer pulls out.** One of the connector's most outspoken critics is a company that helped to design it—the Cannon Electric Co., now a division of the International Telephone and Telegraph Corp. Cannon says it noted flaws in 1960, early in the component's evolution, but was told by the Air Force that there was no problem.

The program continued to roll on "like an express train going down the road too late to be stopped," one Cannon official says. So Cannon withdrew as a supplier of the 26500, issued a scathing "white paper" on the continued use of the 26500, and proceeded to help design another connector, the NAS-1599.

The 1599 has the backing of a group of connector firms working through the National Aerospace Standards Committee, an organization of 40 members, most of them representing large aerospace companies and manufacturers of air frames.

**Rival design.** The group worked for two years and came up with specifications for the rear-release 1599, in contrast to the front-release 26500. Four companies have committed themselves to supply 1599s if the design is approved by the Pentagon. Two of the prospective suppliers were original suppliers

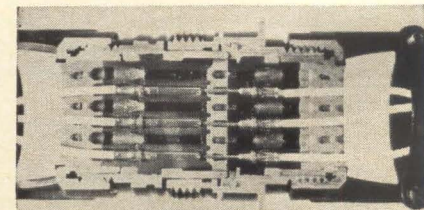
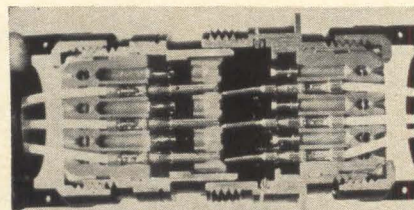

Rival designs are the front-release MIL-C-26500 connector, left, and rear-release NAS-1599. Defect that caused male pins in the 26500 to be bent has been rectified in the 38300 model, the manufacturer says.

At last...

**an SCR line that meets cost,  
size, and performance requirements  
for high volume applications**

Creative design engineers get a special sense of accomplishment out of finding a device that not only saves money for their company but also helps them design new levels of performance and reliability into their equipment. In a nutshell, that's what Motorola's Economy Line has to offer — *it literally crashes size, price and performance barriers which previously have limited the use of SCR's in high volume applications.*

The units shown at right are ideal for power, motor speed and process control devices in all types of commercial and industrial equipment, including portable tools and appliances, as well as in light dimming and heating control units. Complete circuit assemblies are also available. In large production quantities, prices are as low as a dime per amp — and even evaluation quantities for prototype programs will cost out at extremely practical prices (a 200 volt, 8-amp unit is only \$1.60, 100-up).

In terms of low-cost, small-size, first-rate performance, low power consumption and consistently high quality, these devices represent the best SCR "find" on the market — an advantage which adds up to greater operating economy, lower warranty costs, and greater customer satisfaction with your equipment. It can also add up to competitive leadership in your field!

Evaluation quantities may be ordered off-the-shelf from your local Motorola semiconductor distributor at OEM factory prices. For more information, write: Motorola Semiconductor Products Inc., Dept. TIC-ELF, Box 955, Phoenix, Arizona 85001

\*Trademark of Motorola Inc.



**MOTOROLA**  
**Semiconductor Products Inc.**  
BOX 955 • PHOENIX, ARIZONA 85001 618E6

**MCR1304 ELF\* SERIES**

- Smallest 8-ampere SCR available
- 25 to 400 volts
- Can switch up to 3.2 KW
- Can control a full 8-amp d-c output; operating temperature range = -40 to +100°C



**MCR1604 SERIES**

- Electrically same as MCR1304 series, including uniform low level gate characteristics
- Anode lead is on same end as gate and cathode leads for special mounting convenience



**MCR1605 SERIES**

- 8 amperes, 25 to 400 volts
- Anode lead on opposite end of unit from gate and cathode leads
- Like all Elf units, features a surge rating of 100 amperes

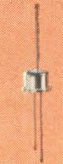

**MCR1305 SERIES**

- 7/16" hex, 10-32 stud version of MCR1304
- 8 amperes, 25 to 400 volts
- Ideal for lamp dimmers, battery chargers, flashers, low-cost power supplies, and appliance motor controls



**MCR808 SERIES**

- The lowest cost-per-amp SCR available at this current level
- 18 amperes, 25 to 400 V
- Available in reverse polarity
- High surge current rating (225A); Low forward voltage drop (1.1 volt typical at 18A d-c, T<sub>J</sub> = 100°C)



**MCR1308 SERIES**

- 11/16" hex, 1/4-28 stud package for mounting versatility
- Same ratings as MCR808, including high-gain gate characteristics
- Available in reverse polarity



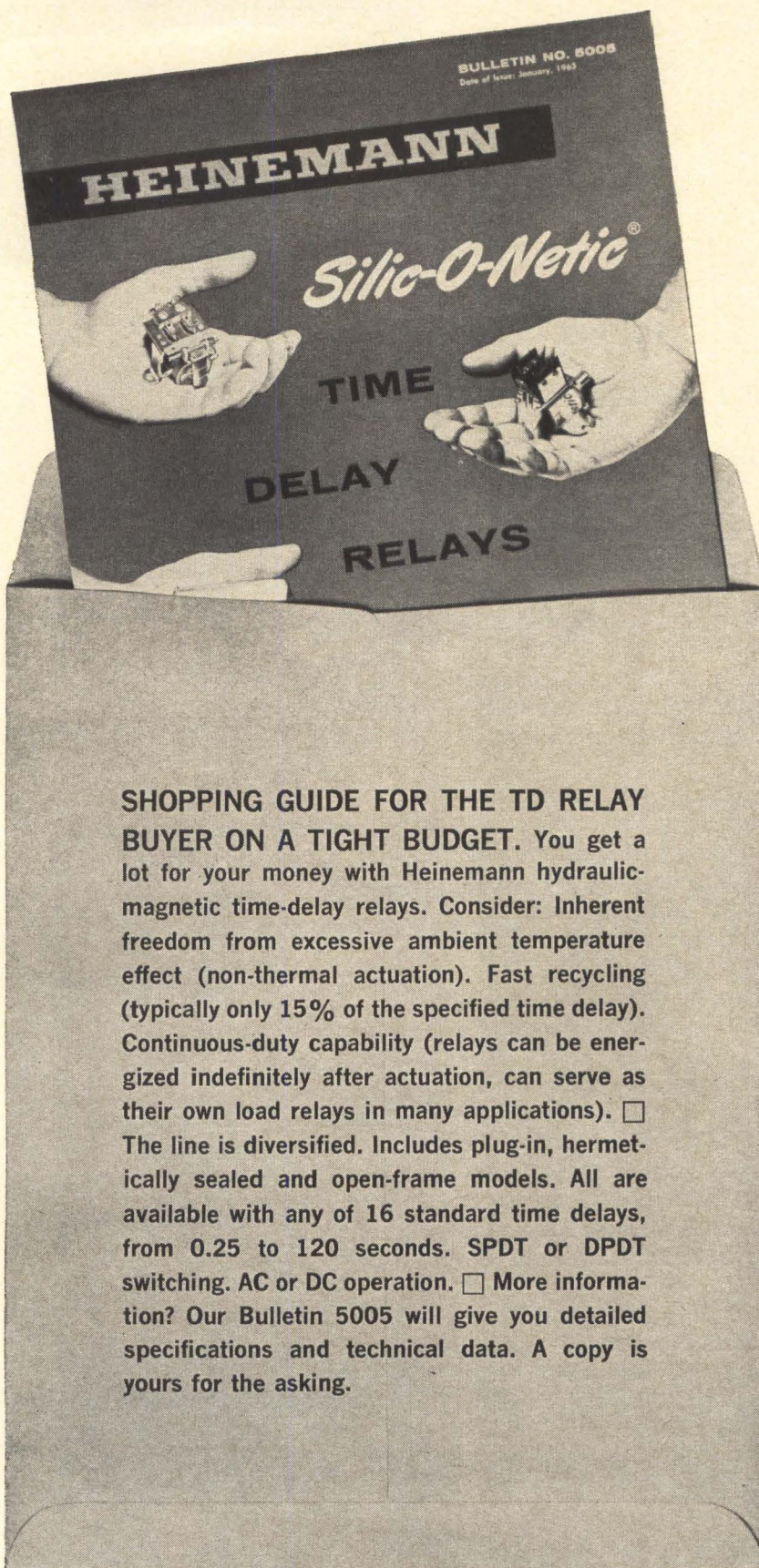

**SHOPPING GUIDE FOR THE TD RELAY BUYER ON A TIGHT BUDGET.** You get a lot for your money with Heinemann hydraulic-magnetic time-delay relays. Consider: Inherent freedom from excessive ambient temperature effect (non-thermal actuation). Fast recycling (typically only 15% of the specified time delay). Continuous-duty capability (relays can be energized indefinitely after actuation, can serve as their own load relays in many applications). □ The line is diversified. Includes plug-in, hermetically sealed and open-frame models. All are available with any of 16 standard time delays, from 0.25 to 120 seconds. SPDT or DPDT switching. AC or DC operation. □ More information? Our Bulletin 5005 will give you detailed specifications and technical data. A copy is yours for the asking.

**HEINEMANN ELECTRIC COMPANY**  
2600 Brunswick Pike • Trenton, N. J. 08602

of the 26500: Cannon and the Pyle-National Co., which still shares the Minuteman connector field with Amphenol. The other companies are the Deutsch Co. and the Bendix Corp.

The four companies admit they cooperated in designing the 1599, but maintain that this was solely for standardization. If the Pentagon accepts it, they promise that the field will be highly competitive.

#### **In defense of the 26500**

While producing the socket-insert 38300 connector, Amphenol continues to defend the 26500. The company says it never had a chance to rebut complaints made against the 26500 at open meetings such as the symposium conducted last February by the Space Technology Labs. It also has been barred from seeing specific data substantiating the complaints. Furthermore, it charges, the connectors declared faulty at the meeting were not its own, but made by the Consolidated Electrodynamics Corp.

Robert F. Dorrell, Amphenol's vice president for engineering, puts it this way: "Our basic position is that there is no need for the NAS 1599 specification. When the specification was announced last year, its avowed purpose was to solve the problems arising from the use of the MIL-C-26500 connectors.

"This implied that there were insurmountable problems concerning the use of MIL-C-26500 connectors," he continues. "We don't believe this is true."

**Cautions against confusion.** Dorrell believes that Amphenol's new 38300 connector, with its hard dielectric insert, does away with the need for NAS 1599 and the confusion that might result from adding another main connector.

In a slap at the four producers of the 1599, he adds: "We find it interesting that there are many other members of the National Aerospace Standards group, all prime contractors on other aircraft, missile and space programs using 26500 connectors, who do not feel the need to get involved in writing a new, commercially controlled spec."

He mentions the TFX and Boeing 727 aircraft, the Sergeant and Lance missile, the Gemini space project and the Titan II and III missiles.

SA 2899



**McLEAN** *Presents*  
**THE ULTIMATE IN  
 PACKAGED COOLING**  
*Styled for the COMPUTER AGE*  
 RFI SHIELDED • MIL-SPEC • COMMERCIAL

**'Vocal minority.'** "We view the NAS 1599 specifications as the attempt of a vocal minority to serve its proprietary interests," he charges, stepping up his attack with the observation, "It is interesting that it is not the Air Force that has attacked 26500, but commercial organizations. The Air Force has reaffirmed its belief in the value of the 26500 connector by perpetuating its concepts in improved forms by issuing MIL-C-38300."

Why has the Air Force stuck by the connector so persistently? Economics certainly plays a big role in the decisions; the Air Force spent a lot of money with Amphenol in developing the contract.

**The cost of change**

Another reason may be logistics. Even if a new connector were adopted, it would require new test and training procedures. Such a change would also render existing contacts useless.

Also involved is a basic difference between the Air Force and the Navy over connector policy. The Navy has stuck to its MIL-C-26482 connector, questioning whether the 26500's high-performance design is really necessary and worth the expense.

**Who'll be the judge?**

The outcome may depend largely on who is to judge the controversy.

A spokesman for the Space Technology Labs says Autonetics, the guidance contractor, will decide on whether to change the Minuteman's connector designs. If that is true, makers of the 1599 think their connector has the best chance of being adopted. They note that the 1599 already has the support of Autonetics and of the Air Force Ballistics Systems Division, the military-approving authority.

But Amphenol says the Air Force, not Autonetics, will make the final decision because the Boeing Co.'s aerospace unit, as contractor for the weapons system, outranks Autonetics on the Minuteman project. Amphenol is confident that Air Force support will swing Boeing's verdict to the 26500 or the new 38300.

If Amphenol designs should lose out, the company says it would be more of a blow to its prestige than to its pocketbook.

New "digital design" gives clean horizontal accents.

Accidental bumping or penetration can't damage this grille, or filter.

Panel sizes 5 1/4" high to 10 3/4" high x 19" wide. Half size and special widths also available.

Brushed aluminum surface adds note of polished elegance.

Filter completely invisible.

Over 100 models . . . air deliveries from 150 to 1,000 CFM.

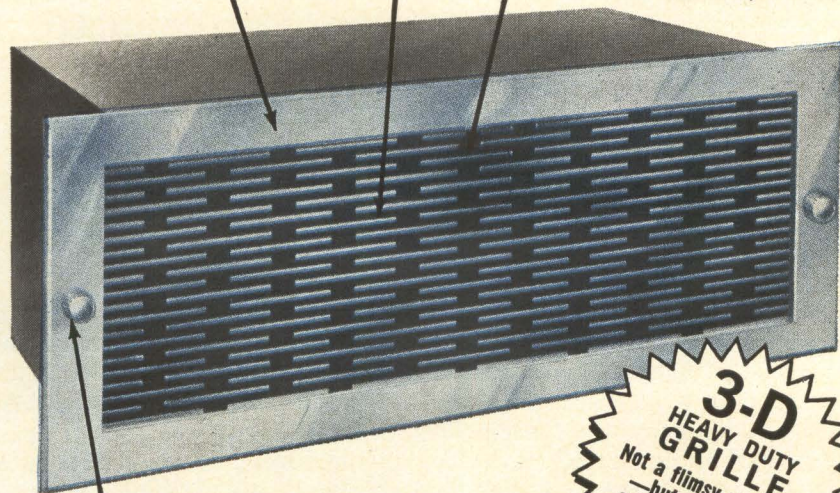

Permanent washable filter easily removed without tools. Fingertip accessibility.

**3-D HEAVY DUTY GRILLE**  
 Not a flimsy stamping —but a sturdy grille of beautiful extruded aluminum

McLean does it again with a handsome new line of packaged blowers . . . complete with the long-proved McLean reliability! Sound engineering and high performance is blended with a high styling that imparts lasting good looks. All this is combined with a practical ruggedness, long life and . . . *they're service-free!* McLean blowers are "whisper quiet" and tops in reliability and economy.

**McLEAN ENGINEERING LABORATORIES**

P.O. Box 228, Princeton, New Jersey

Phone 609-799-0100 • TWX 609-799-0245



Send For NEW Illustrated Brochure

THE ORIGINATOR AND LEADER IN PACKAGED COOLING

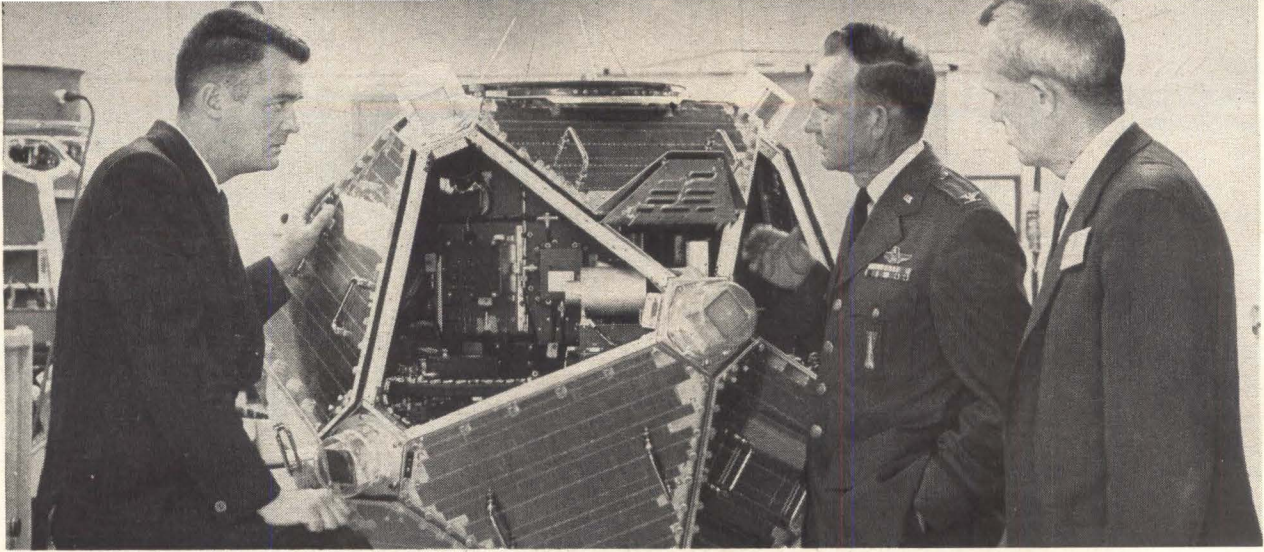

Nuclear detection satellite was built under a double-or-nothing incentive contract. TRW Space Technology Labs will get \$14 million and gamble on making \$2 million more.

## Space electronics

# Making money in space

The incentive contract, based on satellite performance in orbit, offers contractors an opportunity to make a profit

By Joel A. Strasser

Space Electronics Editor

One of the most agreeable sounds heard recently at the TRW Space Technology Laboratories was the steady ticking of the money machine. It came from a space-mileage meter—a digital readout device—that emitted a satisfied click for every mile covered, at a penny a mile, by each of the two nuclear detection satellites the company built for the Defense Department.

This, in essence, is the idea behind a new kind of incentive contract, born of the space age. Incentive contracts, based on performance in orbit as well as costs and ability to meet production schedules, are changing buying policies on space probes, manned spacecraft and boosters.

**Trend toward incentive.** According to George Vecchietti, the National Aeronautics and Space Administration's deputy director of procurement, there were no incentive contracts in 1961. But by Feb-

ruary 1964, there were 23 such contracts valued at \$313 million. Eighteen more are being negotiated now with about \$5 million at stake. In the next two years, the Department of Defense wants 80% of its contracts to include incentive clauses.

All new space contracts will have incentive arrangements. Many existing contracts, not near termination, are being converted from fixed fee to incentive. Among those being examined for such conversion are: Gemini (McDonnell Aircraft), Apollo's Lunar Excursion Module (Grumman Aircraft Engineering Corp.), Apollo Command and Service Modules (North American Aviation), Saturn S-1 stage (Chrysler Corp.), Saturn S-2 stage (North American Aviation), Saturn S-1B stage (Boeing Co.), Saturn S-IV and S-IVB stages (Douglas Aircraft) and the Saturn J-2, H-1 and F-1 engines (North American Avia-

tion). Space Technology Labs' Orbiting Geophysical Observatory and Pioneer satellite, and General Electric Co.'s Biosatellite are also expected to have incentives built in.

An incentive specialist, Warren Linnerooth, has been summoned from Wright-Patterson Air Force Base to run the NASA program. Vecchietti calls him "Mr. Incentive."

The space agency sees many advantages both to itself and industry from incentive-on-performance-in-orbit contracting—lower costs, better performance and on-schedule delivery.

The new policy is designed to discourage overbidding of performance and delivery as well as underbidding of costs. It would encourage better preplanning and program definition—NASA will be able to define missions earlier.

**Profits and pitfalls.** There is more profit in incentive than in fixed-fee contracts, NASA says, and one contractor agrees. Space Technology Labs sees the new contracting technique as "a way to solve industry's dilemma of how to make money in defense and space." But the new policy can have its pitfalls too.

The first nuclear detection satellites seem to have been so well made that they have accomplished the objectives of the next four launches. As a result, the Air Force

is considering modifying the contract with the possibility of eliminating some of the later satellites in the series.

**Payoff for performance.** The Department of Defense, NASA and the Communications Satellite Corp. each has at least one important incentive contract in force. In March, the Communications Satellite Corp. awarded a \$7.5 million contract to the Hughes Aircraft Co. for two synchronous "early bird" operational communications satellites. The incentives are determined by how long and how many communications channels operate. Here's how it works:

For each of the two spacecraft that orbits and operates satisfactorily, Hughes gets \$3 million plus \$125,000 for each operating month, with total incentive payments not exceeding \$2,250,000. If a satellite launch is not successful, Hughes receives \$3,750,000. If the launch is successful, and the satellite fails to operate, the fee is \$3 million, subject to adjustment by the delivery incentive. If the satellite is only partially operable, the \$125,000 monthly rate is multiplied by the ratio of the number of actual operating channels over the total number of channels the spacecraft was initially designed to handle. Hughes can receive anywhere from \$6,335,000 to \$10,835,000 depending completely on the performance of the satellites.

**Bonus for Boeing.** Last month, NASA awarded an \$80 million contract to Boeing Co. for the construction of five Lunar Orbiter spacecraft to take close-up photos of the lunar surface. These will help locate a suitable landing site for the Apollo spacecraft. If all Lunar Orbiter missions are successful, Boeing can receive another \$5.3 million.

Because the earlier flights are more important as well as more difficult to achieve, the fee increases will be graduated per flight from 2.67% of the target cost for the first flight to 0.33% for the fifth flight "based on the degree of usefulness of photographic data as determined by a NASA review board."

Other NASA contracts are going in this direction. The contract for Pioneer, for example, will base its

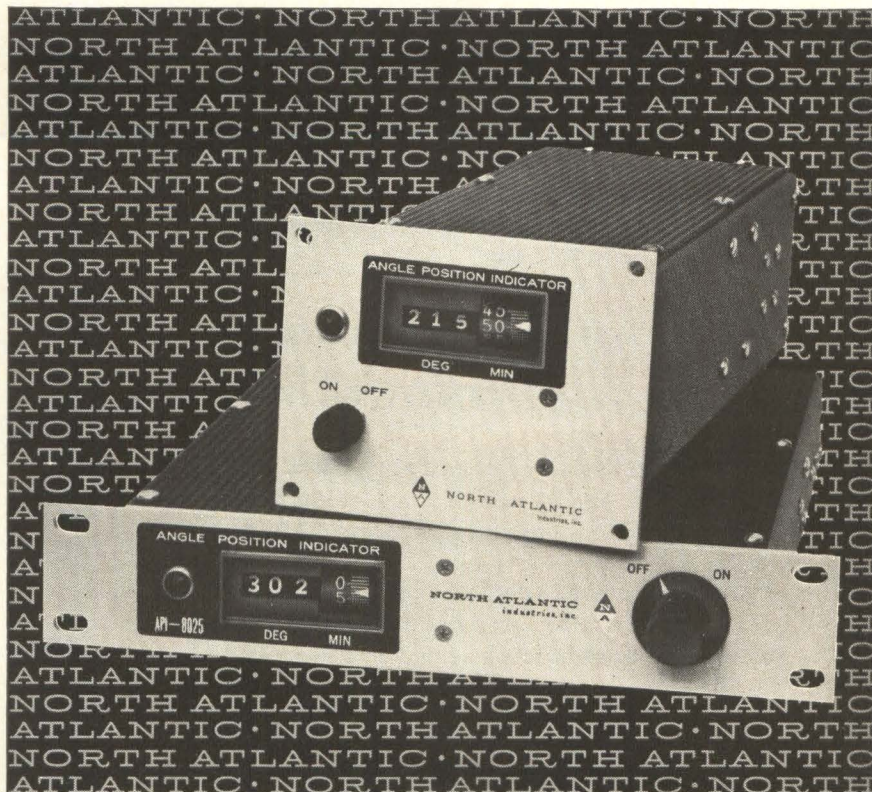

## how to measure resolver or synchro position with 30 second repeatability

In both production test and ground checkout systems, North Atlantic's high performance Angle Position Indicators provide exceptional operator ease and precision in the measurement of synchro and resolver position. Features include digital readout in degrees and minutes, 30 second resolution, continuous rotation, plug-in solid-state amplifier and power supply modules. Due to the design flexibility of these units, they can be readily provided with a variety of features for specific requirements. Typical units in this line incorporate combinations of the following features:

- Single Synchro or Resolver Input
- Dual Synchro or Resolver Inputs
- Retransmit Synchro, Resolver, Potentiometer, or Encoder
- 2-Speed Synchro Input
- Multi-frequency Inputs
- DC Input
- 0-999 Counter

### BASIC SPECIFICATIONS

Range.....	0°-360° continuous rotation
Accuracy.....	...6 minutes (standard)
Repeatability.....	...30 seconds
Slew Speed.....	...25°/second
Power.....	...115 volts, 400 cps
Size.....	API-8025.....13 1/4" h x 9 1/2" w x 9" d
	API-8027.....3 1/2" h x 4 7/16" w x 9 3/4" d



Your local North Atlantic representative has complete data on the API line. Call him today or write direct for technical literature.

**NORTH ATLANTIC industries, inc.**  
TERMINAL DRIVE, PLAINVIEW, L. I., NEW YORK • Overbrook 1-8600

# YOU MAY NEVER NEED THIS KIND OF REGULATION ...but YOU'LL BE GLAD YOU HAVE IT .....

Maybe we build our power supplies too good. But, by anticipating the unusual conditions of some installations, we provide a margin of performance that may be necessary to overcome problems in isolated cases. This then assures precise operation in the ordinary installation. Precision control is the key to a high level of performance over a wide range of installation conditions.

If you need power supplies, that are designed and built with a high degree of regulation, like the units shown below — then get in touch with Acme Electric.

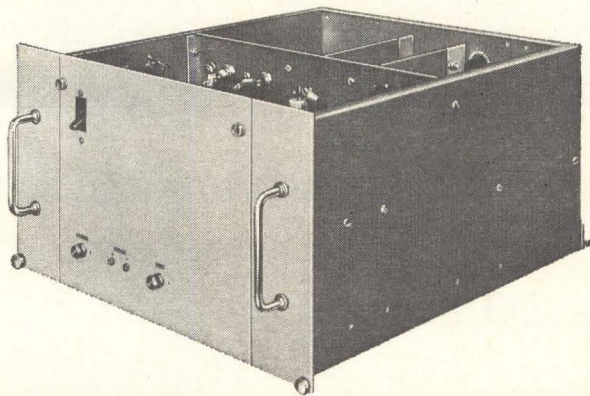

AC Input Volts: 190, 198, 206, 214, 222, 230, 238, 246, 254, 277,  $\pm 15\%$   
 Frequency: 48-62 cps  
 DC Output: 60 volts @ 20 amperes  $\pm 2\%$

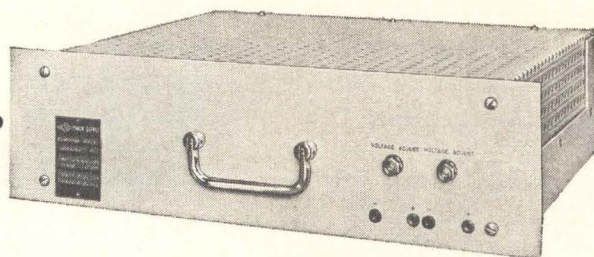

Input: 208V  $\pm 15\%$ ; 60 cps  $\pm \frac{1}{2}$  cps; 3 phase Y  
 240V  $\pm 15\%$  60 cps  $\pm \frac{1}{2}$  cps; 1 phase  
 220V  $\pm 15\%$ ; 50 cps  $\pm 1$  cps; 1 phase  
 Output: 99.98 - 100.02 V. @ .25 amperes,  $\pm .03\%$   
 Ripple: .002%  
 Line Regulation: .001%  
 Load Regulation: .002% (50 - 100%)  
 Drift: .04%

## Acme Electric

Engineers and Builders of...

316 WATER STREET, CUBA, NEW YORK

In Canada: Acme Electric Corp. Ltd.  
 50 Northline Rd., Toronto, Ont.

REGULATED POWER SUPPLIES  
 STATIC POWER RECTIFIERS  
 VOLTAGE STABILIZERS  
 VOLTAGE REGULATORS

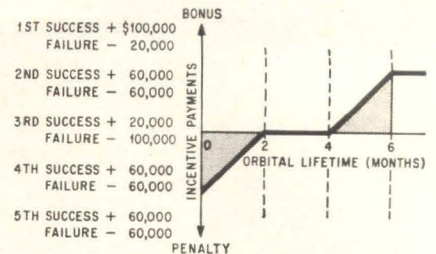

Penalties and rewards were built into TRW Space Technology Laboratories incentive contract for five nuclear detection satellite launches.

incentives on keeping spacecraft weight down, making power available for all experiments, communication capacity, magnetic-field strength and lifetime in orbit. Biosatellite's incentive provisions will be based on launch rates of the six satellites, environmental control and de-orbit and recovery.

**The big gamble.** The first of the new breed of incentive contracts went to Space Technology Labs when the Defense Department wanted ten nuclear detection satellites to monitor any Soviet violation of the nuclear test ban treaty. The contract is a double-or-nothing arrangement where the company gets \$14 million and gambles on doubling or completely losing another \$1 million.

By putting two satellites into orbit on the first try last October, Space Technology Labs won \$125,000 over the \$1 million. If the first launch had failed, a successful second try would have brought the company \$98,000. On the third try it wouldn't have won or lost anything. But for failure on the fourth and fifth attempts, \$98,000 and \$125,000, respectively, would have been subtracted from the \$1 million.

**Keeping it up.** Once the satellites are in orbit there's still more money to be made or lost. Every day short of two months in orbit would have cost the company \$1600 per day.

There is no reward or penalty during the period of two to four months after orbit; the longevity incentive affects the four to six month period. Space Technology Laboratories received \$100,000, the maximum amount, for keeping the two satellites in orbit for six months. The company will make about 10% profit, compared to 7% with a fixed fee plan.



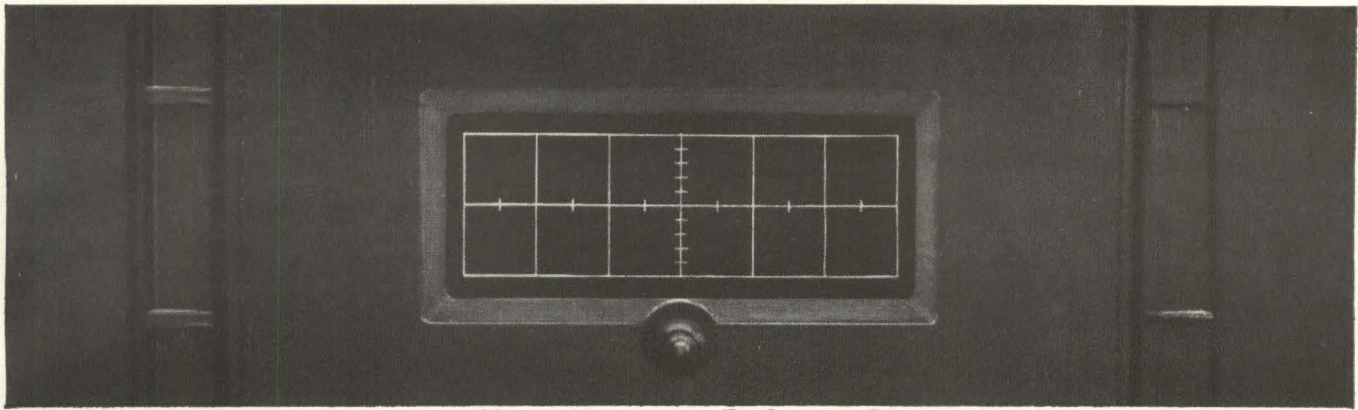

**See anything?**

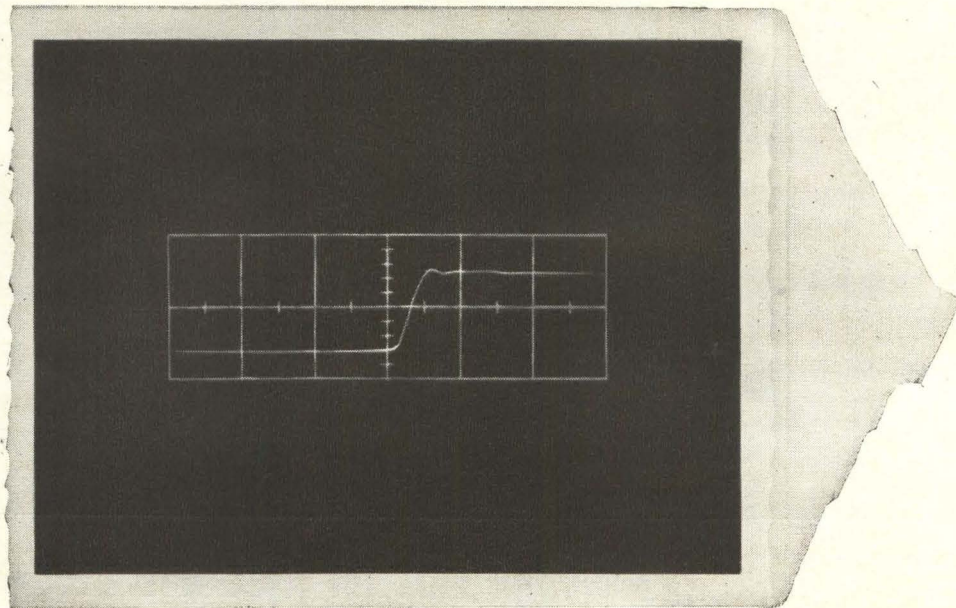

**This new film did.**

This new film saw something the eye couldn't: the rise time of a single pulse on a Tektronix 519 scope at a sweep rate of 2 nanoseconds/cm. The new film, Polaroid PolaScope Land Film, actually extends the usefulness of existing oscilloscopes by supplying "brightness" that the scope hasn't got!

The reason is that this PolaScope film has an ASA equivalent rating of 10,000, which means it can see things your eye cannot. It has about twice the writing rate of the Polaroid 3000-speed film, currently the standard for

high speed oscilloscope photography. (No other commercially available films come anywhere near the speed of PolaScope film.) And because it's made by Polaroid you get a finished usable print—see above—ten seconds after exposure.

PolaScope film will also give you better shots of slower pulses and stationary waveforms. So little light is required, camera aperture and scope intensity can be reduced considerably, and that's how to get really sharp oscilloscope pictures.

And wherever else light is at a premium — such as photomicrography and Kerr Cell photography — PolaScope film will make new applications possible, old applications more useful.

PolaScope Type 410 Film is packed 12 rolls to the carton. The price is about the same as the Polaroid 3000-speed film. For the name of the industrial photographic dealer nearest you, write to Technical Sales Department, Polaroid Corporation, Cambridge 39, Massachusetts.

POLAROID®

**New Polaroid Land 10,000-speed film for oscillography**

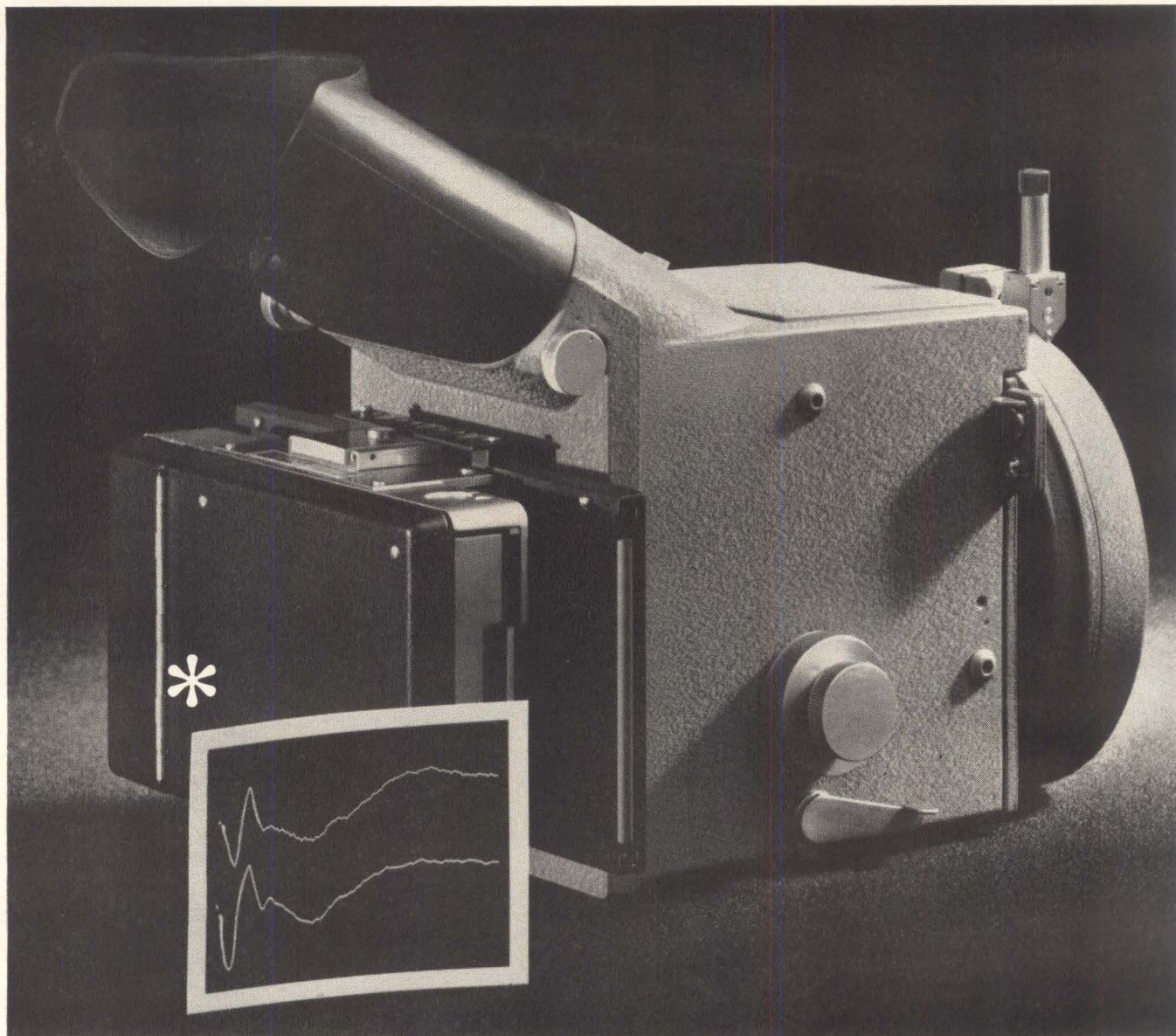

## FAIRCHILD SCOPE CAMERA AIDS EYE RESEARCH

*Use as clinical tool illustrates versatility of Type 450-A camera; Polaroid Land Back and Film provide immediate record*

Electroretinography is but one of the scientific frontiers where Fairchild Oscilloscope Cameras are providing high precision recording of displayed phenomena. Among the features which contribute to this high performance are: • helical rack and pinion mechanism for pinpoint focusing and image reduction • heavy duty synchro-shutters • jam-proof lever for positive tripping of shutter. • Object-to-image ratio is continuously adjustable from 1:1 to 1:0.85, permitting recording of full 6 x 10 cm field on Polaroid Land film in 0.9 actual size. With the new Polaroid Land Film Pack Adapter prints — developed outside the camera — are available in 10 seconds. • Accessories include data chamber for writing in test identification for recording simultaneously with CRT display. If your work requires precision recording of oscilloscope displays, call your local Fairchild Field Engineer or write for complete data on the Type 450-A and other Fairchild Oscilloscope Cameras. Fairchild Scientific Instrument Dept., 750 Bloomfield Ave., Clifton, N.J. ("Polaroid"® by Polaroid Corp.)

\* Traces show reaction of human eyes to a short light stimulus. The retinae electric potential is picked up with contact lens electrodes, fed to scope and recorded by Fairchild Oscilloscope camera fitted with Polaroid Back. Sequence is initiated by synchro-shutter of camera. Polaroid print is reproduction of one of thousands made at New York Medical College by G. Peter Halberg, M.D., Associate Clinical Professor of Ophthalmology.

---

**FAIRCHILD**

---

DU MONT LABORATORIES  
SCIENTIFIC INSTRUMENT DEPARTMENT



What does it take to make a transmitter 10 times more reliable?

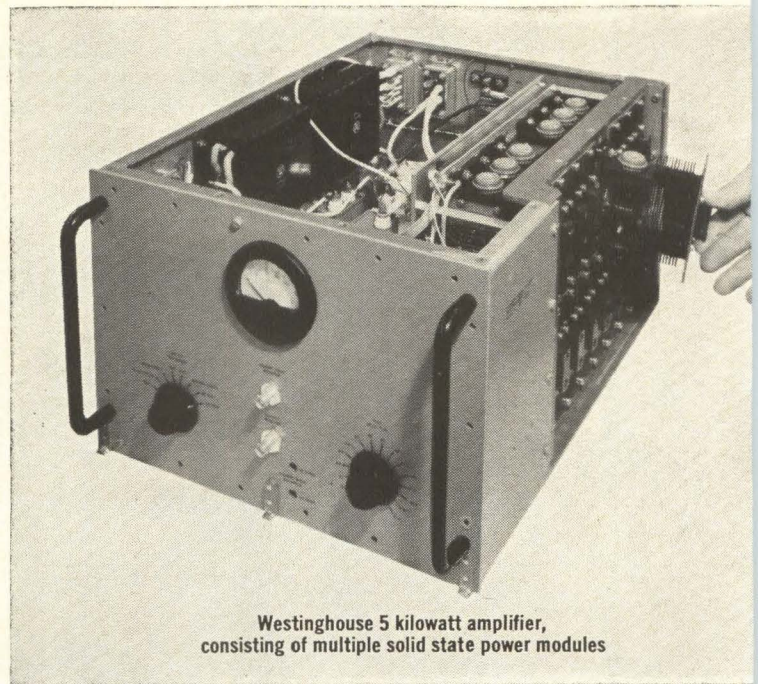
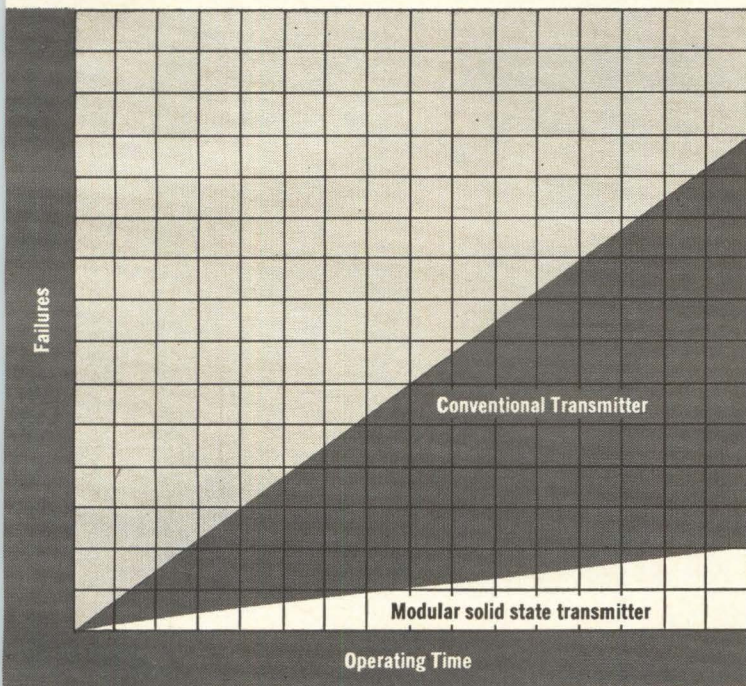

### Westinghouse solid state circuits

Reliability is a prime requirement for effective communications links in unattended situations. This is why Westinghouse solid state circuitry and devices have proved ideal for such applications. Series ST solid state transmitters, for example, have achieved *10 to 1 increase in mean time between failures* over conventional, filament-type designs.

High efficiency and reliability of Westinghouse solid state transmitters permit their use in remote, unattended communications or sonar terminals. Modular design and redundancy techniques assure continued operation, at reduced power output, even if a malfunction should occur in one or more modules.

Small size, light weight, low heat dissipa-

tion and inherent ruggedness make solid state transmitters ideal for airborne, shipboard and vehicular applications. Westinghouse is producing these versatile transmitters in a variety of configurations for all the major military services. Write for brochure ED-4-6-3: Westinghouse Electric Corporation, P.O. Box 868, Pittsburgh 30, Pennsylvania.

J-02356

You can be sure if it's Westinghouse



Circle 129 on reader service card

# NEW 30,000,000 WATT RADAR SYSTEM!

L/UHF dual-frequency, pencil-beam radars pioneer new concepts in super power research systems

LTV Continental Electronics Division is systems contractor for two unique radar systems now in operation at White Sands Missile Range: the AN/FPA-22 and the AN/FPA-23. Each system is powered by two Continental 30 megawatt transmitters: one L-band, one UHF. Peak transmitter power is 30 megawatts; average power is 30 kilowatts. Pulse width for both systems is  $1\mu\text{s}$  and  $10\mu\text{s}$ . Pulse forming lines are triggered by ignitrons; timing pulses come from an exciter/synchronizer. Both techniques are outgrowths of other LTV Continental Electronics contracts.

Electronics for the two systems are almost identical: the AN/FPA-22 uses an 84-foot dish antenna, the AN/FPA-23 uses a 30-foot dish.

The AN/FPA-22 UHF system has a range of 1100 nautical miles: the AN/FPA-22 L-Band system, 2000 nautical miles. The AN/FPA-23 UHF system has a range of 440 nautical miles: the AN/FPA-23 L-Band system, 710 nautical miles.

Other Continental radar transmitters have been used at Trinidad, Prince Albert, all transmitters at all three BMEWS sites, MIT El Campo Laboratory, Stanford University and Nike-Zeus R & D sites. Earlier radar work led to the development of the AN/FPT-5 transmitter for MIT Millstone Hill Laboratory. Among many other notable achievements, this transmitter bounced signals off Venus in 1958.

for information on this and similar super power radar/radio system experience, write dept. 25:

**LTV Continental Electronics Division**   
CONTINENTAL ELECTRONICS MANUFACTURING CO.  
MAILING ADDRESS: BOX 17040 / DALLAS, TEXAS 75217 / TELEX CEPSCO  
THE SPECIALISTS IN SUPER POWER RADAR & RADIO TRANSMITTERS

UHF waveguide, filter,  
transmission line and  
mode suppressors

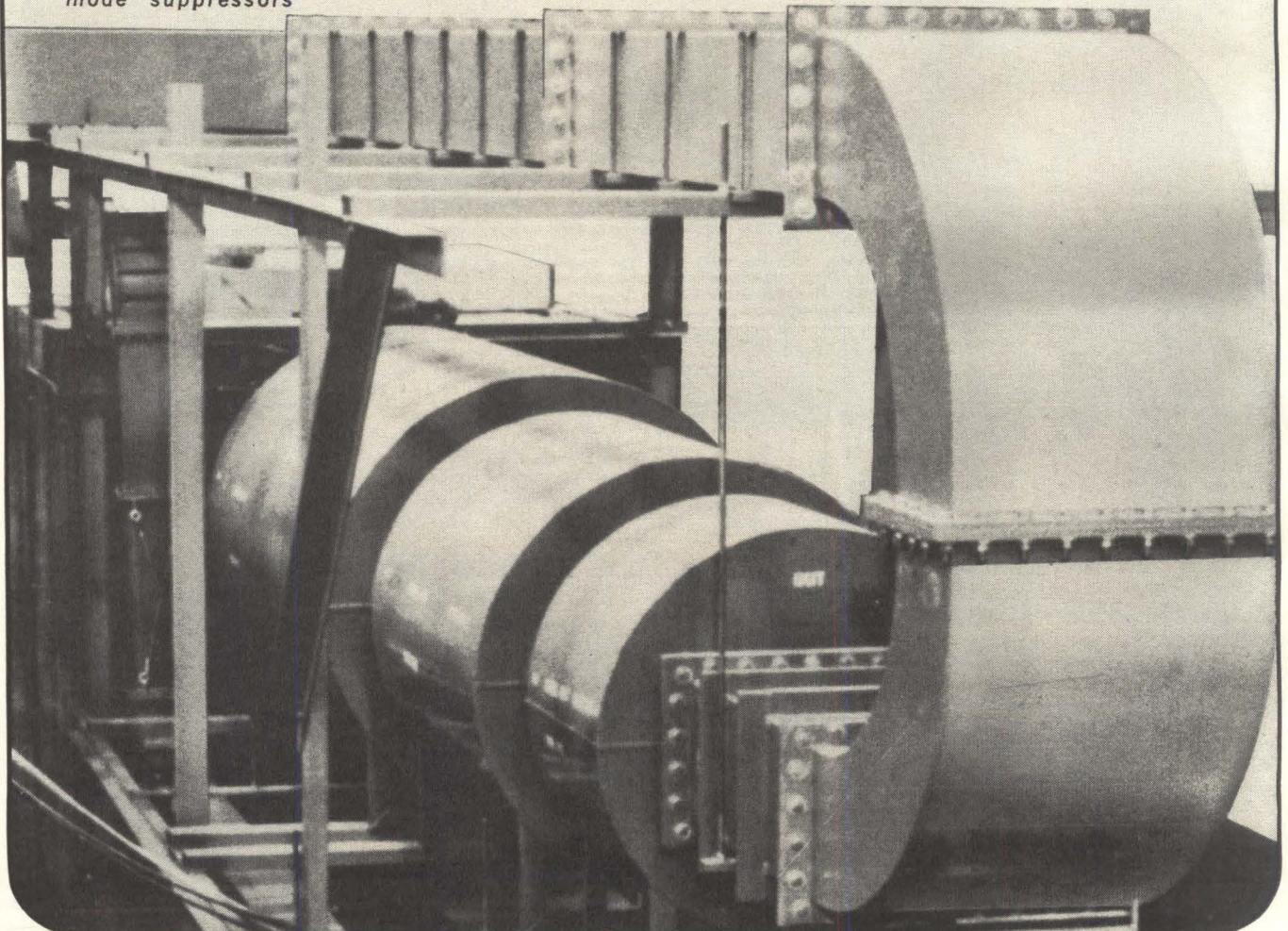

# familiar faces from the world's broadest line of indicating relays

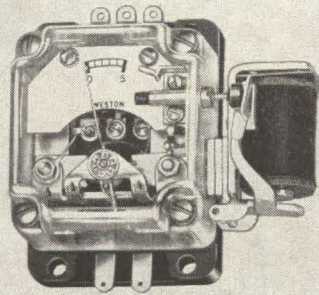

*Model 813 Miniature* — compact and lightweight; sensitive and Sensitrol (magnetic) contacts; single or double contact; ranges as low as 2-0-2  $\mu$ a.

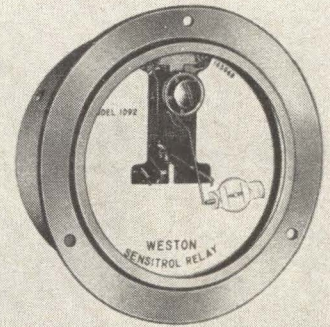

*Model 1092 Sensitrol*—low cost; all purpose; magnetically shielded; wide range adjustability; ideal for use in engineering breadboard circuits.

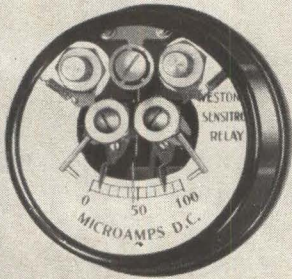

*Model 705 Sensitrol*—highly sensitive; surface or flush mounted; single or double, fixed or adjustable contact; ranges as low as 0.5-0-0.5  $\mu$ a.

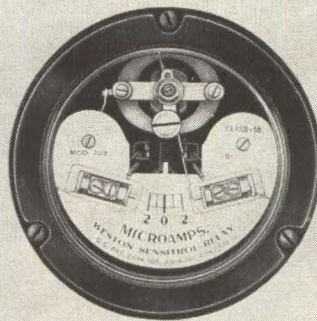

*Model 723 Sensitrol*—sealed; shielded; internal reset; solder terminals; single or double magnetic contact; ranges as low as 1-0-1  $\mu$ a.

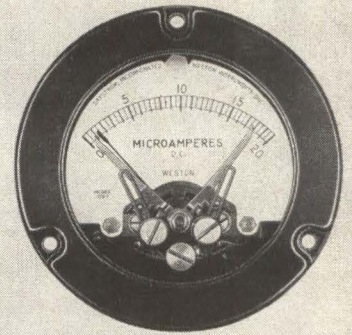

*Model 1097 Ruggedized 3 1/2" Relay*—LCCA type fully meets applicable portions of military ruggedized spec; sealed; long scale; shielded; solder terminals; single or double adjustable contacts.

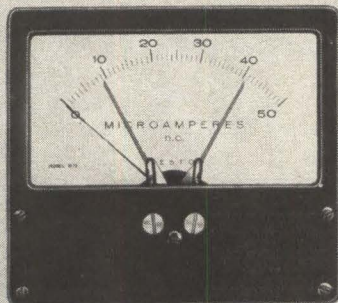

*Model 1075 Photronic*—operates without physical contact; single or double adjustable set points; continuous reading beyond set point; taut band frictionless mechanism; solid state switching circuit; ranges from 10  $\mu$ a.

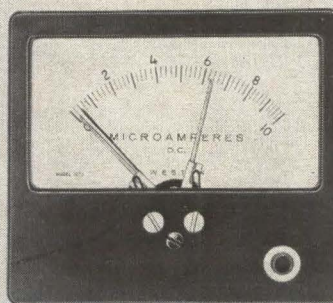

*Model 1073 Mag Trak*—long scale; shielded; positive contact; combines LCAA with magnetic attraction; self-contained reset; single or double adjustable contacts; ranges from 10  $\mu$ a.

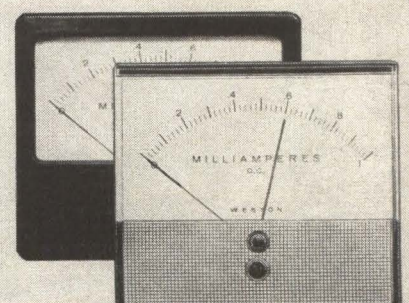

*Model 1930/1940 Photronic*—3 1/2" and 4 1/2" in either bakelite or plastic front; low cost; add-on power supply and solid state switching circuit; shielded; non-physical, adjustable contact.

world's standard in measurement and display

**WESTON**  
INSTRUMENTS & ELECTRONICS

614 Frelinghuysen Ave.,  
Newark 14, New Jersey  
Division of  
Daystrom, Incorporated

Circle 131 on reader service card

# with Integrated Circuits the big problem <sup>was</sup> is testing

## here are the BIG problem solvers

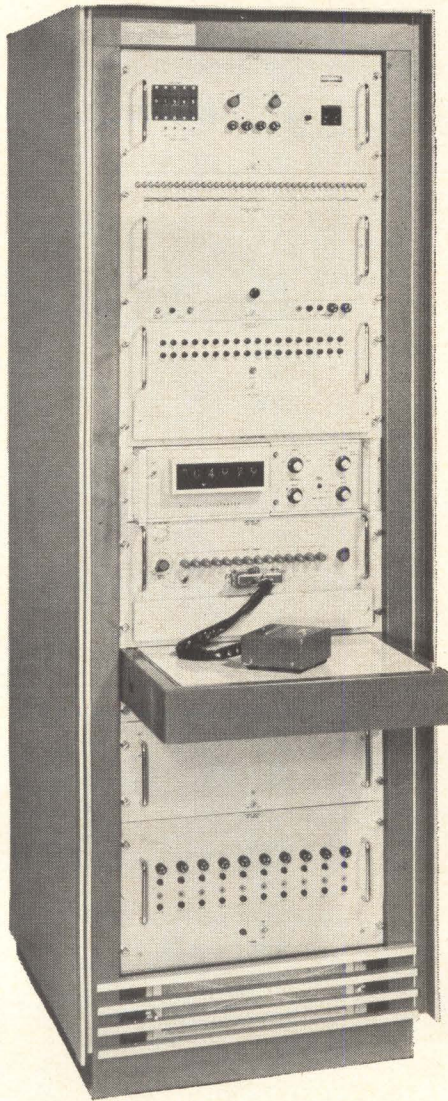

- 36 d-c tests
- 14 active leads
- Kelvin connections
- "Do it yourself" programming
- .05% power regulation
- Less than 1-mv long-term drift
- All logic types

### MODEL 662

Digital readout for quality control and incoming inspection testing. Optional digital comparator provides accurate, repeatable trip points. Can be quickly programmed for both high *and* low limits on each of the 36 tests. Recording output for a tape punch, typewriter, card punch or digital printer. Both automatic and manual handling equipment can be furnished for a variety of devices.

### MODEL 659A

A fast go/no-go instrument designed for high-volume production and incoming testing. Short test times permit a complete 36-test sequence in less than 2 seconds. Four programmable power supplies provided.

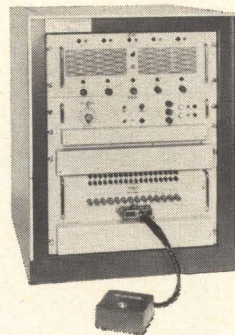

### MODEL 659B

Similar to the 659A with space and connections for digital voltmeter. Includes two fixed power supplies and eight programmable power supplies.

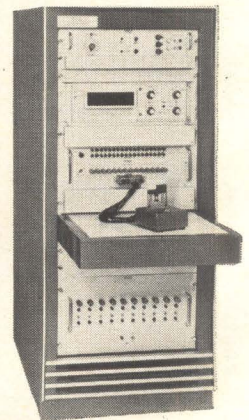

INDUSTRIAL  
PRODUCTS  
GROUP



**TEXAS INSTRUMENTS**  
INCORPORATED  
P. O. BOX 66027 HOUSTON 6, TEXAS

645R

# Generator provides complex pulse sequences

As many as 16 program steps may be repeated up to a million times depending on the frequency of an internal periodic clock

**Analyses and tests** of a wide range of digital devices, circuits and complete systems can be obtained by a new programmed current pulse generator. Advanced-design linear current-drivers and a universal 16-step pulse program capability, enable the model 1600, according to the manufacturer, to handle a large number of requirements for complex sequences of high-current pulses with fast, controllable, linear rise-and-fall characteristics.

The 1600 is also said to be the first programmed current pulse generator available that offers a step-quad repeat mode, which allows a four-step pulse sequence to be repeated as many as 250,000 times before the program goes on to the next step. This design feature, the manufacturer claims, makes it one of the most powerful digital test systems available.

**Where it's used.** Applications of the model 1600 include both laboratory analysis and production testing of magnetic cores and core

arrays, thin-film circuits and memories, plated wire and glass magnetics, linear select memories, circuits involving multi-apertured devices—such as transfluxors, apertured ferrite sheets and bi-ax elements—and other advanced solid-state components and circuits. In these applications, high performance of the current drivers is essential because testing of the advanced devices mentioned requires precise control over the input signal; that is, current pulses up to 1 amp must be provided with no overshoot, ringing or droop. The output stages of the model 1600 employ, for this purpose, the models 1453/1454 linear current pulse drivers that are high-speed positive and negative.

These drivers produce pulses with linear rise-and-fall time as fast as 50 nsec. Fall time of the pulses is unaffected by the rise-time adjustment and vice versa. To deliver bipolar current pulses into a common load, outputs are d-c referenced to ground, and a number of

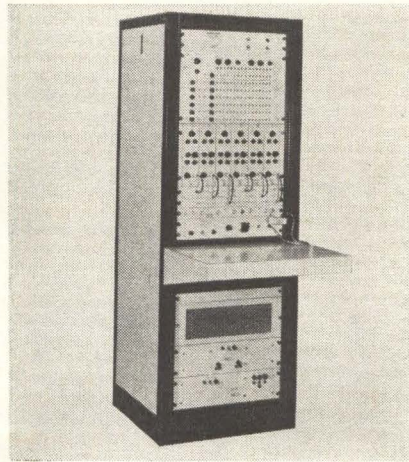

drivers may be operated in parallel. An output coupling panel facilitates the selective paralleling of the drivers into any of three different loads such as block/set, prime and read inputs to a transfluxor. The drivers deliver current pulses from 50 ma to 1 amp, and have a maximum back electromotive force capability of 50 v. Rise and fall times are continuously adjustable from 2  $\mu$ sec to 50 nsec. The full 50-v output of these drivers makes it easy to drive remote loads at full load current through 50-ohm coaxial cable termination.

Model 1600 operates at stepping rates from 1 kc to 1 Mc, with clock frequencies continuously adjustable through 10 calibrated overlapping ranges. Any of the 16 program steps may be repeated up to one million times, depending on clock frequency. Each pulse-current driver in the generator may be independently programmed to operate at any of the 16 program steps, at any position within the step, up to 10  $\mu$ sec after the start of the step and at any preset width from 100 nsec to 10  $\mu$ sec.

Computer Test Corp., Rt.38 and Longwood Ave., Cherry Hill, N.J.  
Circle 301 reader service card

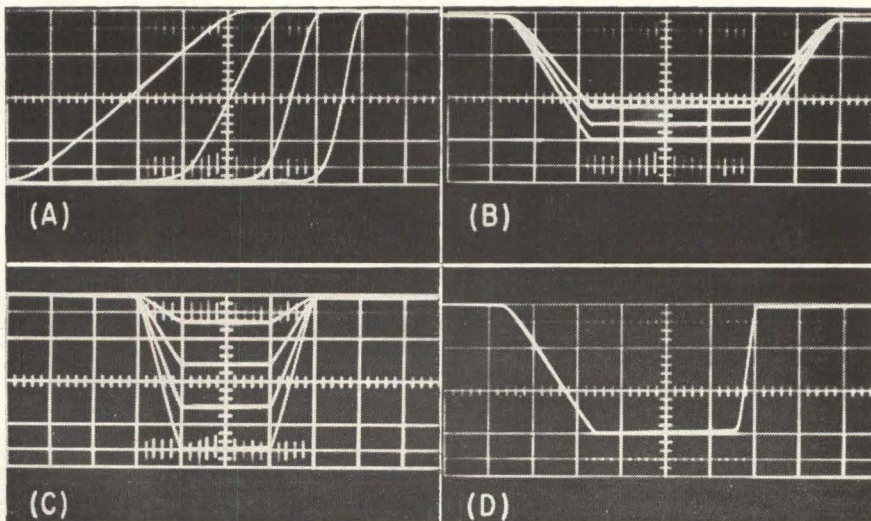

**Output waveforms** from the models 1453/1454 current drivers show: (A) fast, linear rise and fall . . . vertical scale, 200 ma/cm; horizontal scale 50 nsec/cm; (B) preset plus-and-minus amplitude deviation controls; (C) rise and fall times independent of amplitude; and (D) independently variable rise-and-fall times.

# NEW

FROM **AEL**

## PARABOLIC REFLECTORS WITH FREQUENCY INDEPENDENT FEEDS

COVER the RANGE 0.3 to 11 Gc

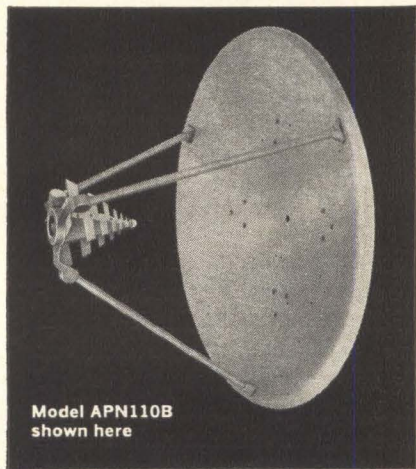

Model APN110B shown here

### FEATURES . . .

- Broadband, high gain performance over multi-octave bands
- Linear polarization — with the pyramidal log periodic feed
- Circular polarization — with the conical helix feed
- Impedance-matched to 50 ohms
- Eight standard models . . .
- OFF-THE-SHELF AVAILABILITY

Model No.		Frequency (Gc)	Reflector size (ft.)	Gain, $f_{lo}$ to $f_{hi}$			
Circularly polarized	Linearly polarized			db @ Gc	to db @ Gc	to db @ Gc	
ALN123B	APN112B	0.3-3.0	6	10	0.3	30	3.0
ALN122B	APN111B	1.0-11.0	6	20	1.0	39	11
ALN121B	APN110B	1.0-11.0	3	14	1.0	33	11
ALN111C	APN102C	1.0-11.0	1.5	8	1.0	27	11

Request Bulletin No. 20-8 for complete details



**American Electronic Laboratories, Inc.**

P. O. BOX 552M, LANSDALE, PA.  
(215) 822-2929 • TWX 510-661-4976

suburban Philadelphia

## New Components and Hardware

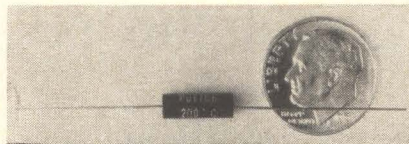

### Ceramic capacitors can be stored at $-210^{\circ}\text{C}$

Ceramic capacitors are available in values from 10 pf to 120,000 pf at 100 v d-c. They meet or exceed the  $150^{\circ}\text{C}$  requirements of MIL-C-11015 C when operating at  $+200^{\circ}\text{C}$  and are capable of withstanding storage temperatures of  $-210^{\circ}\text{C}$ . The 2072 series capacitors are available in three case sizes: 0.093 by 0.250 in. long, 0.125 by 0.250 long and 0.125 by 0.425 long. Weldable and solderable nickel A leads are used. Price range is from 95 cents to \$2.75 in quantity. The Potter Co., 1424 South Allec St., Anaheim, Calif. [311]

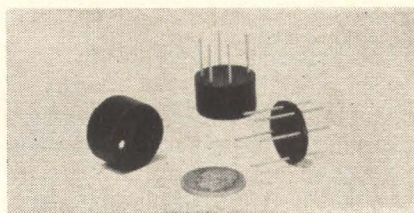

### Shells and headers standardize tooling

Two new shell-and-header combinations allow greater tooling standardization in pulse transformer assemblies for circuit boards. Header model 60155 (right) can be molded with up to eight pins. Pin locations conform to grid points, so that no extra tooling is required to match the conventional circular layout. To help position the wound core, this header's lead wires extend well into the case. These allow internal soldering away from the base, which prevents "unsoldering" when an assembly is finally soldered to a p-c board. A choice of new thermoset encapsulating shells are offered for combining with the header. Shell model 12007 (center) has a plain

top and model 50018 (left) has fill and vent holes. Each shell-and-header combination has a total package height of 0.437 in. and a diameter of 0.750 in. All models are molded in glass-filled diallyl phthalate, meeting MIL-M-14F type SDG specifications. Milton Ross Co., Southampton, Pa. [312]

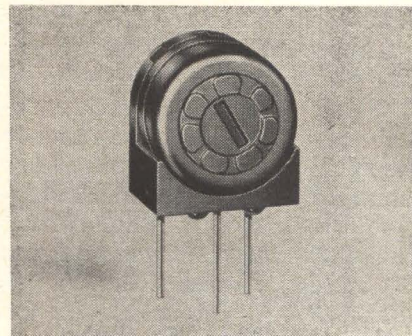

### Subminiature pot rated 0.5 w at $70^{\circ}\text{C}$

Low-cost, single-turn potentiometer is smaller than a TO-5 transistor can. Wirewound model 3307 measures  $\frac{5}{16}$  in. in diameter by  $\frac{3}{16}$  in.; is available with gold-plated nickel p-c pins, top or side screw-driver adjustment, and the Silverweld termination. Resistance range is 50 to 20,000 ohms; power rating, 0.5 w at  $70^{\circ}\text{C}$ ; operating temperature,  $-65$  to  $+150^{\circ}\text{C}$ ; vibration, 20 g; shock, 50 g. Unit is priced at \$2.80 in lots of 100.

Bourns, Inc., 1200 Columbia Ave., Riverside, Calif. [313]

### Hydrogen thyratrons fit small space

Two new English Electric Co. hydrogen thyratrons, the 6587 and the 6777, are designed for use in compact equipment where space is at a premium. The tubes are intended for pulse operation at high repetition rates and both incorporate hydrogen reservoirs for long and reliable life. Peak forward voltage of the 6587 is 16 kv, and peak anode current is 325 amp. The 6777 has a maximum peak forward volt-



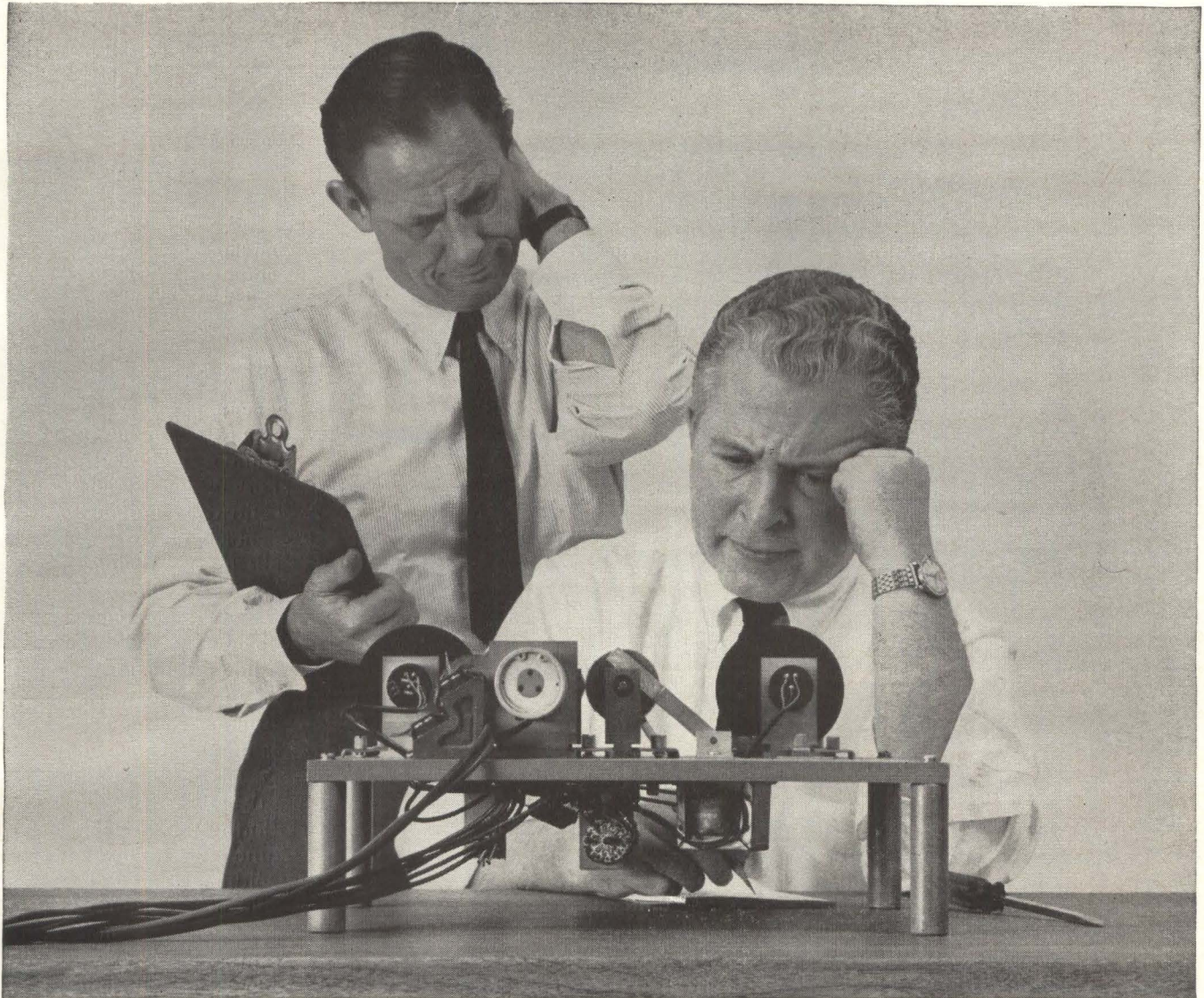

If your \$20,000 engineer spends hours de-bugging an automatic control system, get him a SERVOMATIC servo system analyzer.

Then he'll do the job in minutes.

Any engineer will focus in minutes on the trouble-spot in any feedback control with the help of a SERVOMATIC® analyzer. It enables him to determine the ability of his system to meet specifications by analyzing the changes in phase, gain, and transient response.

**What happened when the paint dried**

Almost before the paint dried on the first SERVOSCOPE® analyzer ten years ago, industry recognized and adopted the instrument as an accurate standard for the testing of the simplest to the most complex electronic, electro-hydraulic, electro-mechanical, and electro-pneumatic control systems. Ten years later, the SERVOSCOPE and SERVOMATIC

analyzers' list of applications is still lengthening. You can add another application to the endless list—*yours*. And pocket some worthwhile savings in engineer hours.

**2 ways to find out about the SERVOMATIC analyzer**

1. The slow way: write today to the Analog/Digital Products Division, 111 New South Road, Hicksville, N.Y., and request detailed information on the SERVOMATIC analyzer.

2. The fast way: phone us at 516 WE 8-9700 and set up a free SERVOMATIC analyzer demonstration right in your own plant. Before it has gone through all its paces, you'll see at least one SERVOMATIC analyzer application that will save you big-dollar engineering hours.



ANALOG/DIGITAL PRODUCTS DIVISION  
**SERVO CORPORATION OF AMERICA**

111 New South Road, Hicksville, N.Y. 11801

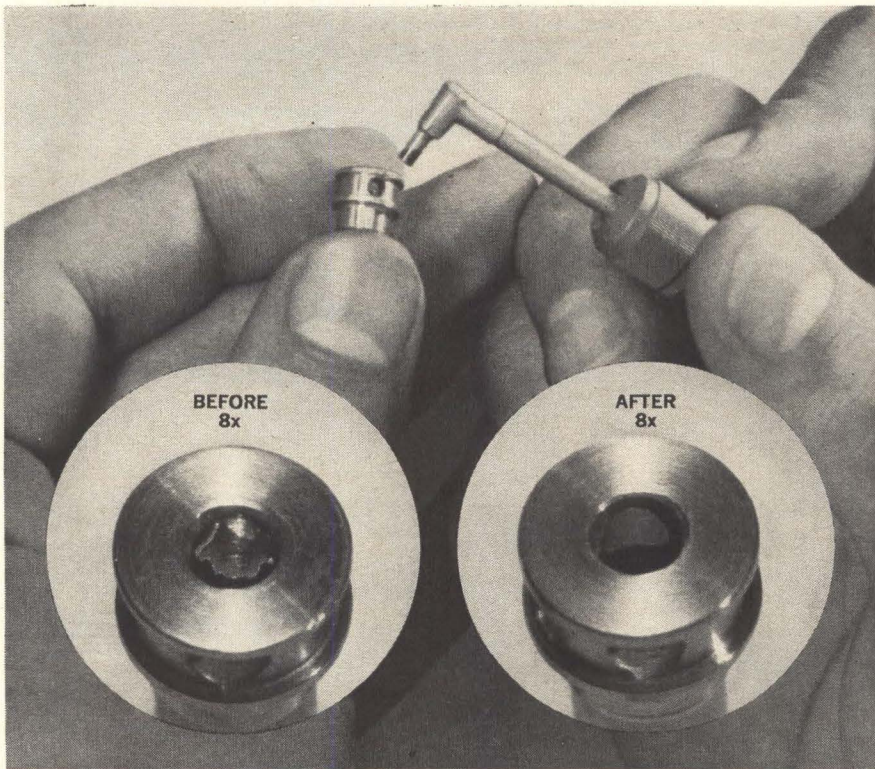

## Airbrasive® cuts deburring time 80% for tiny missile part

Those stubborn, microscopic burrs tucked away in inaccessible places are a snap for the Airbrasive.

Take, for example, the burrs at intersections in a 3/32" hole in a high-performance hydraulic filter made by the Dynamic Filters Division of Michigan-Dynamics, Inc. The filter is designed to prevent particles as small as 10 microns from entering missile servos and actuators. A burr migrating from the filter could be catastrophic.

**The company tried everything** — all kinds of slurries and tumbling, scraping, electropolishing—still, the best removal time was 20 minutes per part.

**The Airbrasive's precision jet of abrasive** blasted the burrs away in five minutes or less, with no damage to the part. Less skill was required...less operator fatigue. Best of all, fewer rejects.

**This unique tool** can do hundreds of seemingly "impossible" jobs. All kinds of hard, brittle materials can be deburred, cut, shaped, and cleaned. Cost is low, too. For under \$1000 you can set up your own Airbrasive cutting unit.

*Let us make a free trial for you.*

*Send samples for test or telephone collect  
for a demonstration.*

SEND FOR  
BULLETIN 6006  
...complete information



S. S. WHITE INDUSTRIAL DIVISION

DEPT. EU, 10 East 40th St., N. Y. 16, N. Y. Telephone MU 3-3015 collect

for superfine cutting • deburring • cleaning

hard brittle materials

**S.S. White INDUSTRIAL AIRBRASIVE®**

## New Components

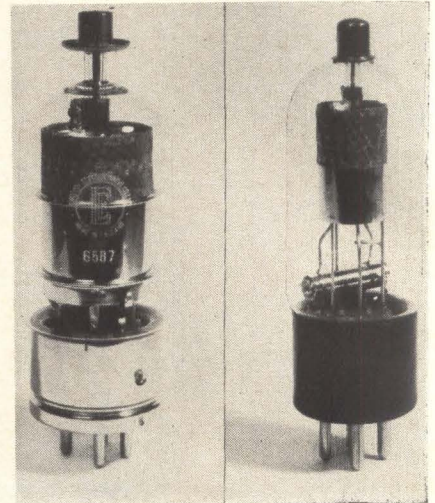

age of 8.0 kv and a peak anode current of 35 amp. Quantities of 15 or more cost \$56.40 each.

Calvert Electronics, Inc., 220 E. 23rd St., New York 10. [314]

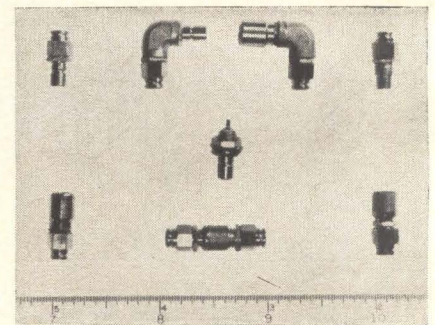

## Tiny coaxial connector has only three parts

A new miniature coaxial r-f connector features a simple three-part design for straight cable applications. Conventional designs have five or more parts. Called Mi-Kro Grip, the new connectors are said to assemble faster and require no special tools. Available in three different mating forms—screw-on, push-on and slide-on—they are tee adapters, bulkhead connectors and dummy loads. A specially designed series for striplines are available in four different types: male straight, male right angle, female straight and female right angle. These four types are designed as screw-on or push-on connectors. Mi-Kro Connector Corp., 40-09 21st St., Long Island City, N.Y. [315]



**“Mylar” makes a smaller capacitor than paper**

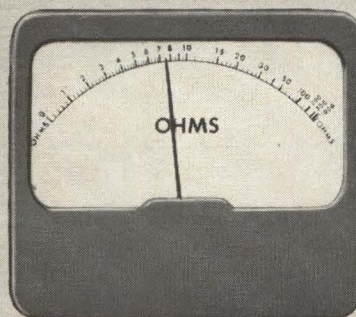
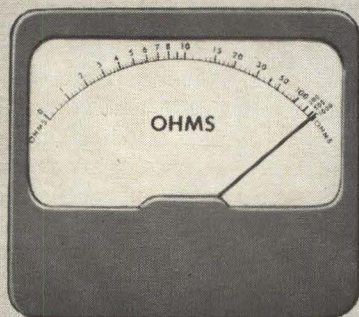

**“Mylar” absorbs less moisture than paper**

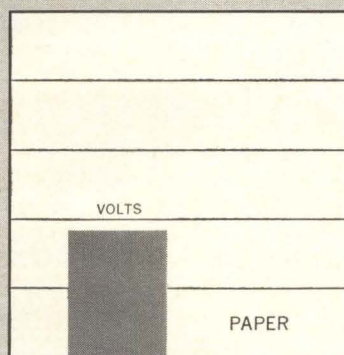
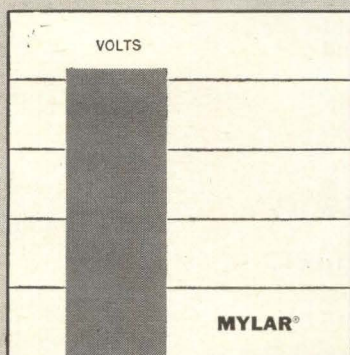

**“Mylar” operates at higher voltage stress than paper<sup>†</sup>**

**and capacitors of “Mylar”<sup>\*</sup> cost about the same as paper**

Within the range of .001 to 1. MFD under 600 volts, you get the added dielectric strength, reduced leakage and greater stability of “Mylar” at equivalent cost to paper on a set-complement basis. Specify “Mylar”.



BETTER THINGS FOR BETTER LIVING . . . THROUGH CHEMISTRY

<sup>†</sup>At higher voltage stress “Mylar” operates with equal or better reliability than paper. <sup>\*</sup>Du Pont registered trademark.

How many ways  
can the all-electric  
**ELECTROTABLE**  
increase your  
production?

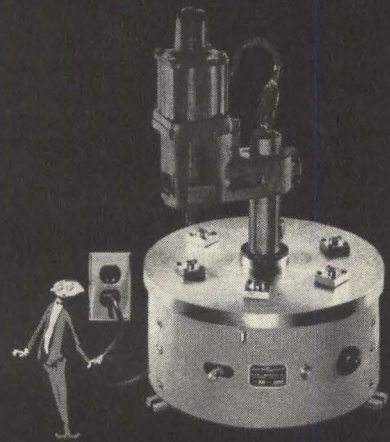

**BLACK &  
WEBSTER**  
INC.  
570 PLEASANT STREET,  
WATERTOWN 72, MASS.

Gentlemen:

Please send me information about the Series 3  
Black & Webster all-electric indexing table which:

1. automatically positions work within  $\pm .001$ "
2. triggers other tools to swage, stake, rivet, punch, etc. as desired
3. accommodates as many as 12 stations at speeds to 48 indices per minute
4. plugs into any 115V outlet
5. has no complicated connections or piping of any kind
6. adapts easily to automatic feeds
7. cuts costs, time, and labor

NAME \_\_\_\_\_

COMPANY \_\_\_\_\_

STREET \_\_\_\_\_

CITY \_\_\_\_\_

ZONE \_\_\_\_\_

STATE \_\_\_\_\_

DEPT. E \_\_\_\_\_

## New Instruments

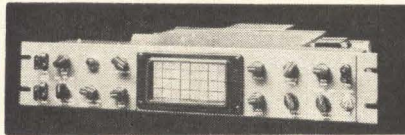

### Rectangular scope has linear sweep

A rack-mounted oscilloscope on a 3½-in. panel has been introduced. It uses a 4⅝-in. by 2⅝-in. rectangular 5BXP1 cathode-ray tube. Both amplifiers cover d-c to 550 kc. Vertical sensitivity is 0.16 v peak-to-peak per cm deflection. Horizontal sensitivity is 0.3 v peak-to-peak per cm deflection. Model 90925 offers exceptionally linear sweep of 1 sweep per sec to 30 kc. Price is \$300 less crt.

James Millen Mfg. Co., 150 Exchange St., Malden 48, Mass. [351]

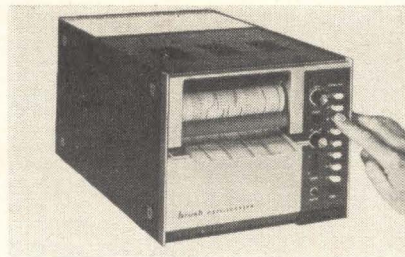

### Oscillograph accessory adds 10 event channels

A line of multichannel light-beam oscillographs features a new method for obtaining 10 channels of event recordings without disturbing the existing analog recording channels. The 2300 series is available with either 8 or 16 channels for high-speed analog recording. Light sources for both analog and event recording are incandescent filament lamps. The 10-channel event lamp accessory can be quickly added or removed from the basic oscillograph. This accessory consists of a small panel with 10 pinhead-size lamps mounted on it. The panel is aligned with the edge of the chart paper and is situated so that the lamps practically butt up against the paper. All 10 chan-

nels of event recording are contained within ½ in. along the edge of the chart paper. In conventional oscillographs the standard procedure for obtaining event recording is to use a galvanometer, reducing the number of channels available for analog recording. The new method provides 10 channels of on-off recording without eliminating any galvos. When an event occurs, a lamp is energized and a trace appears on the edge of the chart paper. Action of event lamps is independent of galvanometer operation. Response time for a lamp to register "on" is 10 millisees. By adding event amplifiers, response for on can be reduced to less than 1 milliseec.

Brush Instruments, division of Clevite Corp., 37th and Perkins, Cleveland 14. [352]

### Kerr cell positioned at Brewster angle

Now available is a Brewster-angle Kerr cell specifically designed for ultrahigh-power Q-switching and modulation of ruby lasers. It differs from standard shutter devices in that it sets at the classic Brewster angle rather than a normal 90°. Called a Branglcell, it is made of optical-quality, strain-free glass, ground flat to a ¼ wavelength of sodium D light. Units can be ground to 1/10 wavelength on request. Branglcells contain ultrahigh-purity nitrobenzene necessary to meet d-c bias mode requirements associated with laser Q-switching. They eliminate reflective losses, permitting much higher power levels. The Brewster-angle Kerr cell is available in a variety of apertures for use with laser rods of all sizes. Price is \$1,250.

Electro-Optical Instruments, Inc., 922 S. Myrtle Ave., Monrovia, Calif. 91016. [353]

### Digital voltmeter with high d-c accuracy

D-c, ratio, and a-c measurements, plus 5-digit readout and provision for estimating a sixth digit by

means of an analog meter, are afforded in the 2350 series digital voltmeters. The most salient feature of the new instrument is its 0.005% d-c accuracy, over a 40 to 100° F range, with 10- $\mu$ V resolution. The manufacturer claims that counterparts have, at best, accuracies of 0.01% with resolution of 100  $\mu$ V. The instrument has no reference drift. Range and polarity selection are automatic with 200 milliseconds average balancing time. Common-mode rejection is 120 db with full overload protection on all ranges. The basic d-c/ratio instrument can be expanded internally at any time by field personnel to include a-c measurement, decimal printout and remote programming. The completely floating instrument utilizes tamper-proof reed switches in a new bridge circuit which greatly extends life and eliminates any possible inaccuracies.

Houston Instrument Corp., 4950 Terminal Ave., Bellaire, Texas. [354]

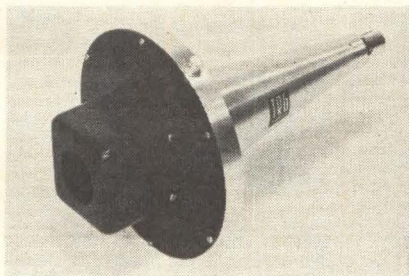

## Detector measures laser pulses

A fast detector (rise time less than 0.3 nsec) directly measures the wave shape of laser outputs. The TRG-105 photodetector consists of a vacuum photodiode in a specially designed wide-band microwave structure. The spectral response of the instrument is 3,000 to 12,000 angstroms in three steps. The cathode lead of the photodiode is connected to a coaxial line with an impedance of 50 or 125 ohms. The lead can also be connected to a coaxial transformer whose impedance varies exponentially with distance from 20 ohms at the photodiode to 125 ohms at the scope end. This feature gives the instrument its wide-band response: d-c to 125 Gc. The output voltage is high enough



She's welding wires  
1/6<sup>th</sup> the size of a human hair...

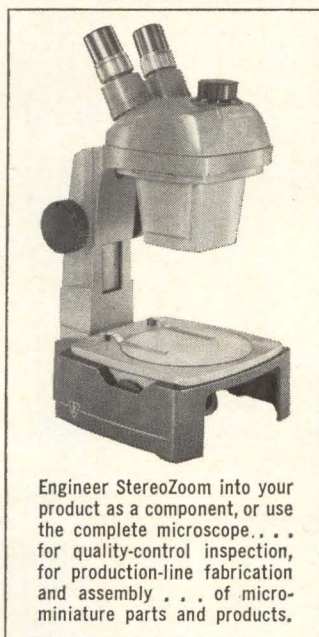

Engineer StereoZoom into your product as a component, or use the complete microscope... for quality-control inspection, for production-line fabrication and assembly... of micro-miniature parts and products.

## ... using Aerojet-General's MICROWELDER Mark II, teamed with Bausch & Lomb's StereoZoom® Microscope

With very little training, this girl learned to weld wires that are almost too small to see. The Bausch & Lomb StereoZoom Microscope incorporated in the Mark II helps her perform the delicate operation easily and precisely. StereoZoom gives her big, sharp *three-dimensional* images of the subminiature parts and microwelder tip.

The Commercial Products Division of Aerojet-General Corporation, Azusa, California, developed and is marketing the Mark II for welding wires as small as .0005 inch in diameter for microelectronic

application. To provide operators with bright 3-D magnification of the minute work, Aerojet chose the Bausch & Lomb StereoZoom... an optically-superb instrument, ruggedly built for hard industrial use.

If you have a small-parts assembly or inspection problem, there's a Bausch & Lomb StereoZoom to fit your requirements—24 models with magnification ranges from 3.5X to 120X. Call your dealer, or write Bausch & Lomb Incorporated, 61406 Bausch St., Rochester, N. Y. 14602

**BAUSCH & LOMB** 

In Canada, write Bausch & Lomb Optical Co., Ltd., Dept. 614, Scientific Instrument Division, 16 Grosvenor St., Toronto 5, Ont.

# NEW

## VERSATILITY IN LIGHT MEASUREMENT

### lite-mike

measures:

MEASUREMENT	MONOCHROMATIC SPECTRUM		CHROMATIC SPECTRUM
	LASER	GALLIUM ARSENIDE	
WAVESHAPE			
Rise time	Yes	Yes	Yes
Fall Time			
Duration			
Amplitude			
Average Power (watts)	Yes	Yes	*
Energy (joules)	Yes	Yes	*

\*Can be calculated within spectral response capabilities.

		RESPONSE RANGE									
		1.13 $\mu$					0.35 $\mu$				
ANGSTROMS		10 <sup>4</sup>	9,000	8,000	7,000	6,000	5,000	4,000	3,000	2,000	1,000
	NEAR IR						VISIBLE				NEAR UV
		1	0.9	0.8	0.7	0.6	0.5	0.4	0.3		
	MICRONS										



Compact (10" high) and lightweight, the EG&G LITE-MIKE has built-in controls for sensitivity and balancing of ambient light. Head is swivel-mounted for ease of alignment with source.

## New Instruments

to permit the direct observation of axial mode beating in Q-switched lasers with a traveling-wave oscilloscope. No coupling capacitor is required since the output, which is positive going, is taken from the cathode circuit. Although the unit is designed to measure fast-rise-time Q-switched laser pulses, it can be applied just as easily to monitor c-w light sources.

TRG, Inc., Route 110, Melville, N.Y. 11749. [355]

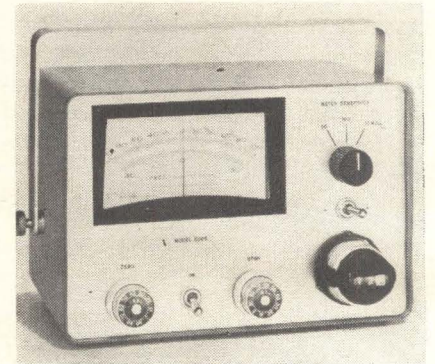

## Transducer indicator offers dual readout

A transducer indicator is available that provides direct-reading measurement when operated with variable reluctance transducers. Both analog and digital readout capabilities are included in the one instrument. The reading appears as a deflection on a 1%-accuracy taut-band meter, or as a 3-digit dial setting with  $\pm 0.1\%$  full-scale accuracy, using the meter as a null detector. A separate  $\pm 10$ -v d-c full-scale output is also provided for indication and recording of dynamic as well as static phenomena over 0 to 1,000 cps. Model CD25 incorporates an all-solid-state carrier-demodulator system and operates on 115 v 60 cps at 1 w. Features include 0.1% regulation against line-voltage variation, 0.5% long-term stability, polarity reversal for bidirection transducer measurement, and calibrated 10-turn zero and span controls for convenience in resetting.

Pace Engineering Co., 13035 Saticoy St., N. Hollywood, Calif. [356]

# NEW

## SD-100 SILICON

### PHOTODIODE offers this unique combination of advantages

- (1) FAST RESPONSE** / Rise time:  $4 \times 10^{-9}$  sec. @ 90v  
Fall time:  $15 \times 10^{-9}$  sec. @ 90v
- (2) WIDE SPECTRUM** 0.35 to 1.13 microns (10% points)
- (3) HIGH SENSITIVITY** 0.25 microamps per microwatt
- (4) LOW NOISE**  $1 \times 10^{-12}$  watts  $\cdot$  (cps)<sup>-1/2</sup>
- (5) WIDE DYNAMIC RANGE** 0.1 amp to approx.  $10^{-8}$  amp

Applications: receiving equipment for lasers and injection laser systems; measurements on modulator and pulsed light sources; measurements of light intensity and wave forms, detection of color changes.

For full information on LITE-MIKES and SD-100 photo-diodes, contact: Marketing Dept., EG&G, 176 Brookline Ave., Boston 15, Mass.



### EDGERTON, GERMESHAUSEN & GRIER, INC.

BOSTON • LAS VEGAS • SANTA BARBARA

1007

## New Semiconductors

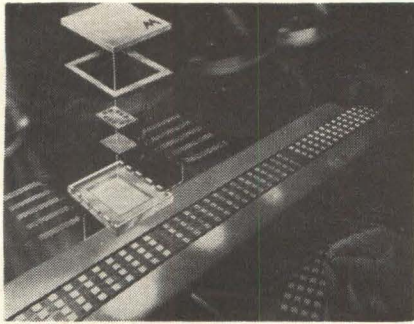

### Integrated circuits in ceramic flat pack

Featured in Motorola's MECL line of integrated circuits is a heat-dissipating ceramic flat package. The reduced-size (0.250 by 0.250 by 0.060 in.) flat package offers a substantial reduction in space and weight from the standard TO-5 can, and an over-under high-density packing capability offers further space-saving possibilities. The ceramic material used retains the insulating properties of glass and exhibits superior structural and mechanical characteristics. Package walls are thinner but stronger; thermal expansion is matched to Kovar leads; and heat dissipation is three to five times greater than that of glass. MECL logic circuits offer these advantages: large fan-in and fan-out capability (up to 25), high logic capability (the direct signal and its complement are available from the same gate), simple connection systems, good noise immunity (up to 50% of logic swing), and high-speed operation (propagation delay times average 6 nsec).

Motorola Semiconductor Products, Inc., P.O. Box 955, Phoenix 85001. [331]

### Scr features high surge rating

An 18-amp silicon controlled rectifier with a surge-current rating of 250 amp is in production. It represents an improvement in surge-current rating of 67% over standard devices, according to the manufac-

turer. The new series spans the peak-reverse-voltage range from 25 to 500 v and has a minimum critical rate of rise of forward voltage of 200 v per  $\mu\text{sec}$  for the 25 through 300-v devices, and 100 v for the 400 and 500-v types. Reverse leakage of the devices, designated 2N681A through 2N689A, is also lower, with a maximum of 1 ma full cycle average leakage current across the entire range of voltage ratings.

International Rectifier Corp., 233 Kansas St., El Segundo, Calif. [332]

### Silicon transistors for 12-v applications

Two new silicon npn power transistors, priced to compete with germanium types, operate efficiently with very high case temperatures, drastically reducing heat-sink sizes and improving thermal stability of circuits. Type 40250, specifically designed for 12-v. class A audio applications, can provide 4 w. power output and a power gain up to 30 db. When used in 12-v push-pull inverter applications, these devices will deliver 24 w of output power at switching rates up to 15 kc. For higher power applications, the 40251 can provide 15 w of audio power output in 12-v class A operation. It is ideally suited for 12-v push-pull inverter power supply applications where up to 100 w. output power is required at frequencies up to 10 kc.

Radio Corp. of America, Somerville, N.J. [333]

### Power transistors cut saturation voltage

Four 20-amp, silicon planar power transistors, the MHT8012, -13, 15 and -16, reduce maximum base-emitter saturation voltage to 1.5 v at 10 amp, and collector-emitter saturation voltage to 0.6 v at 10 amp. They cut leakage current to 10  $\mu\text{a}$  at  $V_{CB} = 60$  v. Other specifications include 100-w power dissipation at 100°C,  $BV_{CBO} = 80/100$

*You expect it first from API*

## 1% tracking is now standard for API taut-bands —at no extra cost!

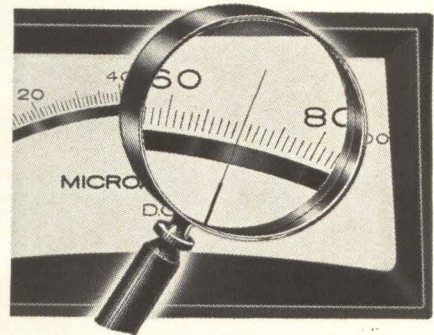

You get an inherently better meter—and it costs us less to make it. Hence it'll cost you less too.

That's the net result of exciting design and production improvements in taut-band panel meters now being offered by Assembly Products. Effective April 1,

**When you order  
an API taut-band meter,  
you automatically get  
 $\pm 1\%$  tracking**

The only exceptions will be extremely sensitive and extremely small meters. Please ask about these.

**1% tracking gives you  
better measurement**

1. You can measure very precisely the fractions of a full-scale signal.
2. Therefore, as long as you know (and can control) the current that makes the meter read full-scale, you will read very accurate absolute values anywhere on the scale.

*Ask for Bulletin 38*



**Assembly Products, Inc.**  
CHESTERLAND, OHIO • AREA CODE 216 HA 3-3131

**NOW! a NEW Shielded  
High Q Variable Inductor  
with exceptional stability!**

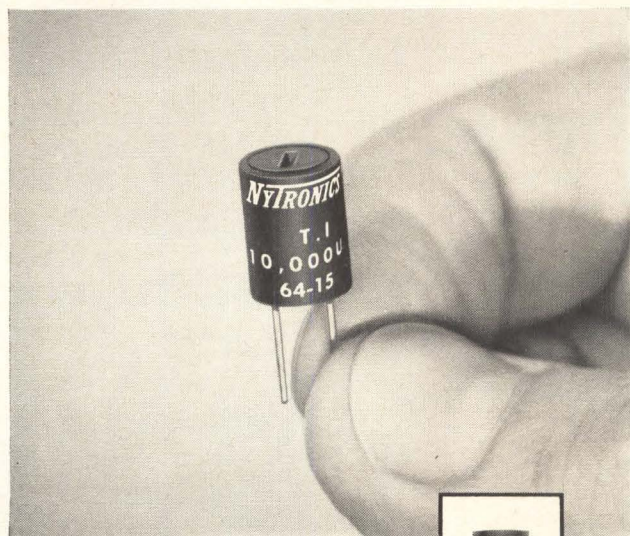

*The NEW  
Wee V-L*



ACTUAL SIZE

Adjustable Inductance range 0.10 $\mu$ h to 100,000 $\mu$ h in 0.300" by 0.400" molded case with 0.200" grid spacing.

**24 HOUR DELIVERY!**

The new Wee V-L now offers the design engineer these important advantages: Meets requirements of MIL-C-15305C; unitized epoxy molded construction; 73 stock values; and shielded for minimum coupling.

The Wee V-L is the newest product to join the Nytronics subminiature family of inductors, ceramic capacitors, precision wire wound resistors, thin film resistors and delay lines. Use coupon for engineering data!

**NYTRONICS**

Design leaders  
STANDARD components to meet  
CUSTOM requirements

550 Springfield Ave., Berkeley Heights, N. J.

**MAIL COUPON TODAY FOR COMPLETE  
ENGINEERING DATA ON THE NEW WEE V-L**

TO: NYTRONICS, INC. Dept. C  
550 Springfield Avenue, Berkeley Heights, N. J.  
Please send complete engineering data on the Wee V-L

NAME \_\_\_\_\_

TITLE \_\_\_\_\_

FIRM \_\_\_\_\_

ADDRESS \_\_\_\_\_

CITY \_\_\_\_\_ STATE \_\_\_\_\_ ZIP \_\_\_\_\_

**Don't let the price tag fool you!**

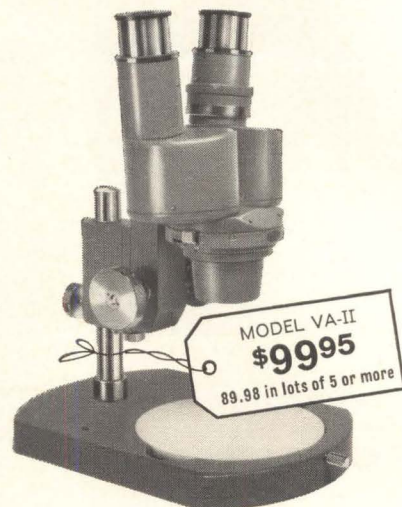

**This is a genuine, full-quality  
Elgeet-Olympus STEREO microscope**

Distortion-free optics, brilliant imagery. Ideal for quality control, inspection and assembly of miniature parts and circuits. Magnification: 8X to 40X. A complete range of coated achromatic optics is available. For details, write Elgeet Optical Co., Inc., 303 Child Street, Rochester, New York 14611.



Circle 209 on reader service card

**How to use catalog 700  
FOR ALL IT'S WORTH!**



**Product  
Details  
End  
Guesswork**

Find at a glance all the data you need for specifying electronic parts and hardware. Comprehensive drawings provide full dimensional details (for example, see pp. 8, 28, 49, 84, 121, 124, 131, 154). Tables for each component list all materials plus standard finishes available. Compliance with applicable Mil Specs shown in each product section. Just some of the aids to help you choose among the more than 15,000 *guaranteed* CAMBION® components included in this one-of-a-kind engineering catalog. For local availability, contact your Authorized CAMBION Distributors. For particular samples, sales engineering or additional free copies of full-line Catalog 700, write Cambridge Thermionic Corporation, 206 Concord Ave., Cambridge, Mass. 02138.



Standardize on CAMBION... The Guaranteed Electronic Components



## New Semiconductors

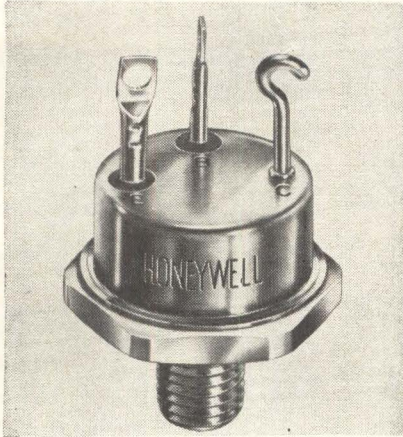

v;  $BV_{CEO} = 60/80$  v;  $BV_{EBO} = 8$  v;  $h_{FE} = 40-120$  and 100 minimum;  $f_T = 25$  Mc minimum. Designed for military applications, the units are priced from \$60 to \$82 in 100-lot quantities.

Honeywell Semiconductor Products division, 2747 Fourth Ave. South, Minneapolis 55409. [334]

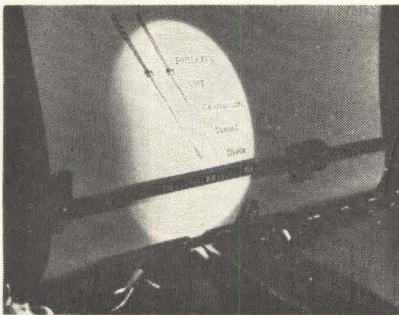

## Tunnel diodes switch fast at low levels

Uhf germanium tunnel diodes were designed for high-speed, low-level switching and small-signal applications. Types 1N3712, -14, -16 and -18 are housed in axial lead DO-17 packages. Typical case capacitance is 0.5 pf and typical lead inductance is 0.5 nh. The DO-17 package, being minuscule and easy to mount, is ideal for applications requiring a high density of units. Peak currents from 1 to 10 ma are offered, with switching speeds of less than 2 nsec. Also available are maximum oscillation frequencies of more than 3.3 Gc.

Philco Corp., Lansdale division, Lansdale, Pa. [335]

## Trouble-free Performance

# RMC DISCAPS

TEMPERATURE COMPENSATING

TYPE C

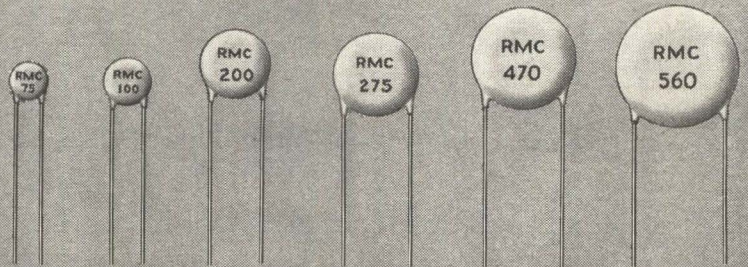

TC	.290	.400	.570	.660	.790	.890
P-100	1- 5 MMF	6- 10 MMF	11- 20 MMF	—	—	—
NPO	1-15	16- 33	34- 69	70- 85 MMF	86-115 MMF	116-175 MMF
N- 33	1-15	16- 33	34- 69	70- 85	86-115	116-175
N- 75	2-15	16- 33	34- 69	70- 95	96-130	131-190
N- 150	2-15	16- 36	37- 67	68- 95	96-130	131-230
N- 220	2-15	16- 36	37- 75	76-100	101-160	161-230
N- 330	2-20	21- 51	52- 75	76-115	116-190	191-270
N- 470	2-20	21- 51	52- 80	81-120	121-200	201-275
N- 750	2-32	33- 75	76-155	156-220	221-300	301-470
N-1500	10-74	75-140	141-220	221-399	400-550	551-800
N-2200	20-75	76-150	151-299	300-450	451-680	681-900

Temperature Coefficients up to N5200 Available on Special Order  
Disc sizes under 1/2" diameter have lead spacing of .250. Discs 1/2" diameter and over have .375 spacing.

RMC Type C DISCAPS meet or exceed all specifications of the EIA standard RS-198. Rated at 1000 working volts, Type C DISCAPS provide a higher safety factor than other paper or mica capacitors.

Constant production checks assure that all specifications and temperature characteristics are met. Another phase of complete quality control consists of 100% testing of capacities.

Throughout the years leading manufacturers have relied on RMC for quality of product and maintenance of delivery schedules. Write on your company letterhead for additional information on DISCAPS.

## SPECIFICATIONS

**POWER FACTOR:** Over 10 MMF less than .1% at 1 megacycle. Under 10 MMF less than .2% at 1 megacycle

**WORKING VOLTAGE:** 1000 V.D.C.

**TEST VOLTAGE (FLASH):** 2000 V.D.C.

**LIFE TEST:** 1500 volts for 1000 hrs. at 85°C ±3°C

**CODING:** Capacity, tolerance and TC stamped on disc

**INSULATION:** Durez phenolic—vacuum waxed

**INITIAL LEAKAGE RESISTANCE:** Guaranteed higher than 7500 megohms

**AFTER HUMIDITY LEAKAGE RESISTANCE:** Guaranteed higher than 1000 megohms

**LEADS:** No. 22 tinned copper (.026 dia.)

**TOLERANCES:** ±5% ±10% ±20%

DISCAP  
CERAMIC  
CAPACITORS

RMC

RADIO MATERIALS COMPANY

A DIVISION OF P. R. MALLORY & CO., INC.

GENERAL OFFICE: 4242 W. Bryn Mawr Ave., Chicago 46, Ill.

Two RMC Plants Devoted Exclusively to Ceramic Capacitors

FACTORIES AT CHICAGO, ILL. AND ATTICA, IND.

# New Trygon Modular DC Supplies!

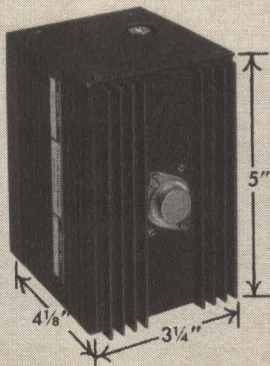

## Plug them in anywhere— then forget them!

This is literally true. You merely select the proper Trygon module and then mount it wherever you like, in any position—horizontally or vertically. All solid state components are silicon, and a generous heat sink is built-in—which means you can operate in ambients up to 71°C with no problems. The built-in current limited short circuit protection automatically resets when the fault is removed—so again, you don't have to worry where you place a Trygon module in a system.

Remote sensing? Provision is built-in. Remote programming, too. And premium components plus derated circuits yield MTBF figures in excess of 30,000 hours. (Yet, if service is ever required, all components are readily accessible.) For additional flexibility, input/output connections are available with either terminal strips, solder lugs or octal sockets.

Check the table below for the models you need. For prompt delivery, contact your local Trygon rep. Or, write for complete specifications and catalog, to: Dept. E-10.

### ELECTRICAL SPECIFICATIONS

Regulation: 0.02% load, 0.01% line  
Ripple: 0.5 mv RMS max.  
Recovery Time: Less than 25 microseconds  
Remote Programming: Provided on all units over output range

MODEL	VOLTS	AMPS	PRICE
PS20-400	0-20	0-0.4	\$140
PS32-250	0-32	0-0.250	\$140
PS50-150	0-50	0-0.150	\$155
PS3-1.5F	2.5-3.5	0-1.5	\$130
PS6-1F	4-8	0-1	\$120
PS12-900F	10-14	0-0.9	\$115
PS18-800F	16-20	0-0.8	\$120
PS24-700F	22-26	0-0.7	\$120
PS28-600F	26-30	0-0.6	\$120
PS48-400F	46-50	0-0.4	\$130

NOTE: All models designated "F" are also available with reduced current output at lower prices.

# TRYGON

**ELECTRONICS, INC.**  
111 Pleasant Ave. Roosevelt, L. I., N. Y.  
(516) FR 8-2800 TWX (516) 868-7508



actual size

## ULTRA MINIATURE MOTOR

Globe's Type VT permanent magnet d.c. motor is the smallest **standardized** power motor we know about. Fourteen standard armature windings are available for 3 to 50 v.d.c., with no-load speeds from 5,000 to 22,000 rpm. You can apply this miniaturized unit for continuous duty ratings up to 1-1/2 watts, and for starting torques up to 1.0 oz. in. Unit is 5/8" in diameter by 1-5/8" long; weight is 1.5 ounces. Brakes, governors, gear heads, and radio noise filters can be supplied.

Type VT is only one of many d.c. and a.c. motors built to high standards of quality by the largest manufacturer of precision miniature motors. Request Bulletin VT-2.

Globe Industries, Inc., 1784 Stanley Avenue, Dayton 4, Ohio.

GLOBE

Circle 211 on reader service card

## THUMBWHEEL SWITCHES

TABET U.S. Patent 2,841,660

**Binary & Digital. Meet MIL-S-22710**



- For Critical Reliability Applications.
- Available with internal lighting MIL-L-25467A.



Permanent wafer type, Series TSD-P. Only 1/2" panel space needed per module. Also available in multi-deck series TM.

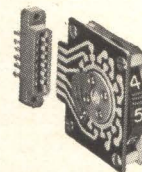

Removable wafer type, Series TSD-R. For continuous operation applications where interruptions must be held to an absolute minimum.

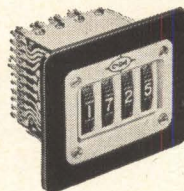

Permanent wafer type, Series TSB-P. Available in 8, 10, 12 or 16 positions, up to 36 switches per assembly.

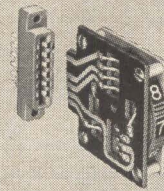

Removable wafer type, Series TSB-R. For applications where maintenance time is valuable and rapid servicing a necessity.

**CHICAGO DYNAMIC INDUSTRIES, Inc.**



PRECISION PRODUCTS DIVISION  
1725 Diversey Blvd., Chicago 14, Illinois  
Phone: WElington 5-4600

Circle 212 on reader service card  
Electronics | June 15, 1964

## New Subassemblies and Systems

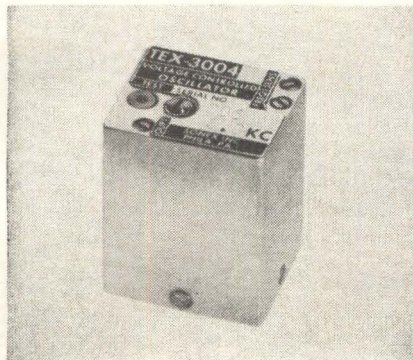

### Solid-state oscillator requires low power

A miniature solid-state subcarrier oscillator has been developed for use where space and power requirements are critical factors. Model TEX-3004 meets air borne mechanical requirements such as acceleration, shock and vibration. It features power consumption of less than 6 mw and operates at a nominal 6 v, 1 ma. Modulation sensitivity is 0 to 5 v  $\pm 2.5$  v. Input impedance is 500,000 minimum, and output voltage is 0.5 v rms into a 10,000-ohm load. Distortion is reported to be less than 0.75%, while amplitude modulation is less than 10% and temperature stability less than 1% design band width over the range of 0° to 85°C. Weight of the oscillator is 1.8 oz., and the unit measures 1.4 in. by 1.1 in. by 0.92 in.

Sonex, Inc., 20 E. Herman St., Philadelphia. 19144 [371]

### Dispersive delay lines are small and light

A series of 30-Mc dispersive delay lines for use in pulse compression systems vary at the rate of 0.1333  $\mu$ sec per Mc for each  $\mu$ sec of delay at 30 Mc. The region in which the delay varies linearly with frequency is approximately 3 Mc. The linearity in this band-pass is 1%. Variations in delay up to 80  $\mu$ sec are possible. The insertion losses of these devices vary with length and range between 30 and 50 db. Well suited for airborne

applications, a line with a 100-to-1 pulse compression ratio can be packaged in a volume 10 in. by  $\frac{3}{4}$  in. by  $\frac{3}{8}$  in. and will weigh only a few ounces.

Andersen Laboratories, Inc., 501 New Park Ave., West Hartford 10, Conn. [372]

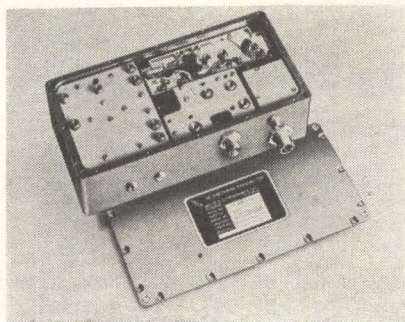

### Vhf transmitters are solid-state

A family of solid-state transmitters provide 3, 7.5 and 15 w nominal r-f power in the 215- to 260-Mc vhf telemetry band. Designated TR-26, TR-27, and TR-28, the units feature true frequency modulation and analog frequency response of  $\pm 1$  db from d-c to 300 kc, or digital data to 600 kilobits. Frequency stability to  $\pm 0.005\%$  and input impedance of 1,000 to 100,000 ohms are available. Rf characteristics meet mil-spec requirements. Deviation sensitivity of from 2 mv/kc to 10 mv/kc is offered, as well as digital inputs of 0 to 5 v. Operating temperature range is  $-20^{\circ}\text{C}$  to  $+85^{\circ}\text{C}$ .

United ElectroDynamics, Inc., Aerospace Division, 675 E. Bonita St., Pomona, Calif. [373]

### Core memory system for severe environment

The core memory system illustrated (p. 146) has an output of up to 4,096 words of 28 bits, handling up to 220,000 random memory cycles per sec. The compact 175-cu-in. unit includes memory stack plus driving, sensing and control circuits. It operates under shock, vi-

**0.01%**  
stability  
indefinitely

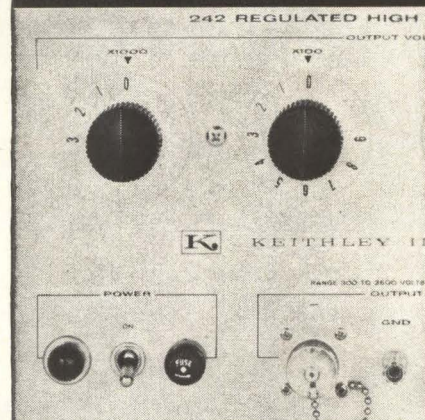

### KEITHLEY 3500V dc SUPPLY

The Model 242 is ideal for long term measurements. This regulated supply prevents cumulative drift by use of a chopper circuit, featuring a temperature-compensated zener diode reference, a photomodulator comparator and wire wound resistors. Applications include use as a calibrator, comparator, and excitation potential source for photo multipliers and ion chambers.

- **output:** 300 to 3500V at 25 ma in 1 volt steps—plus, minus or floating up to 1000V off ground
- **stability:** 0.01% indefinitely, after 30-minute warm-up
- **accuracy:**  $\pm 0.1\%$
- **line and load regulation:**  $\pm 0.005\%$
- **automatic overload protection**
- **price:** \$850

#### other HIGH VOLTAGE SUPPLIES

Model 241: 0-1000V, 0.05% accuracy \$800  
Model 240: 0-1000V, 1.0% accuracy \$345



**KEITHLEY  
INSTRUMENTS**

12415 Euclid Avenue • Cleveland 6, Ohio

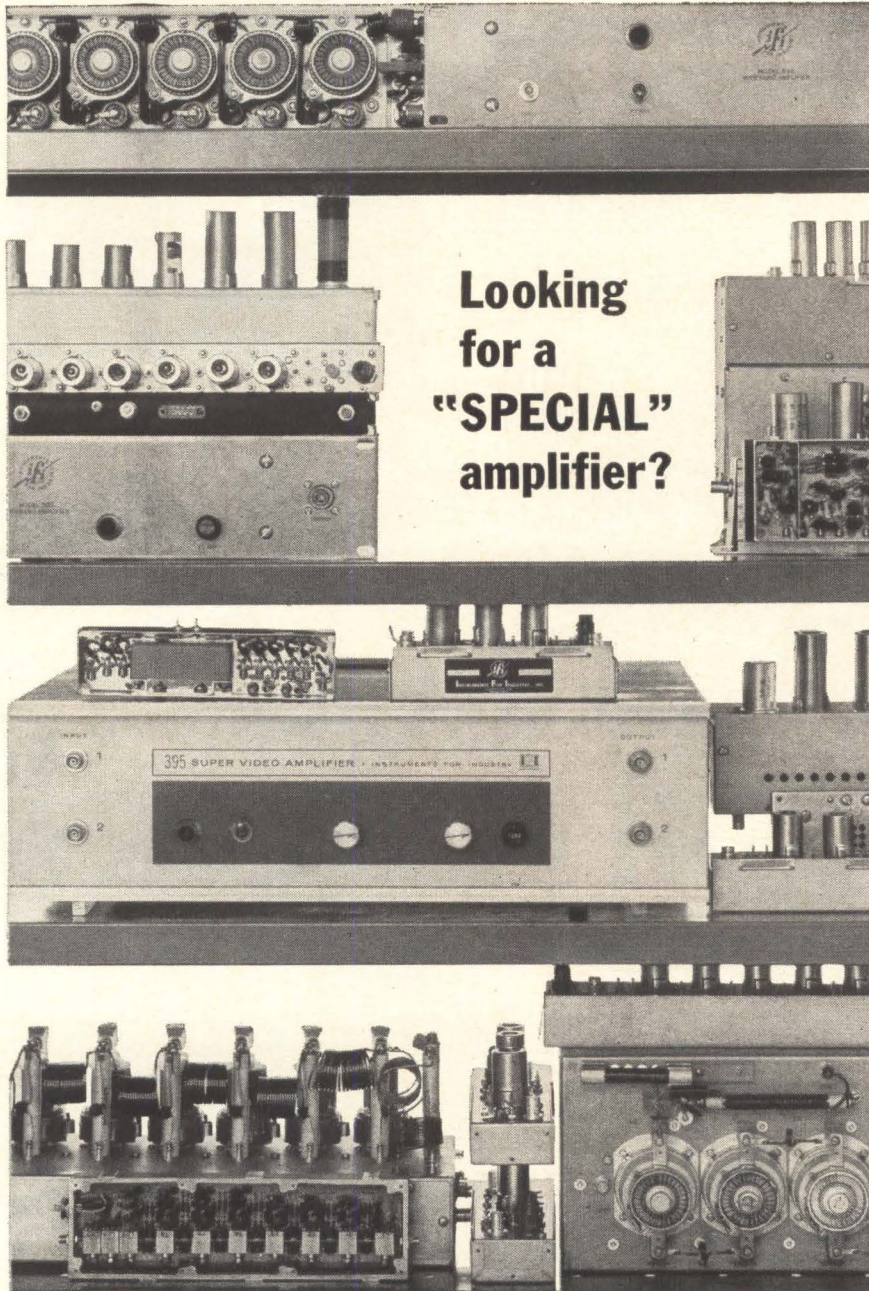

Looking  
for a  
**"SPECIAL"**  
amplifier?

## CHANCES ARE WE'VE BUILT IT

Nobody builds **more** amplifiers, or **more types** of amplifiers: IF, RF, Broadband, High Power, Video, Low Noise, Nuvistor, Transistorized, Distributed, VHF, UHF . . . you name it.

It will pay you to check with IFI, **headquarters** for amplifiers, RF, ECM, ECCM, training and automatic checkout systems.

Ask for latest spec bulletins, or better yet, 'phone our Customer Service Engineer: OV 1-7100 (Code 516).



**INSTRUMENTS FOR INDUSTRY, INC.**

101 NEW SOUTH ROAD,  
HICKSVILLE, L.I., N.Y.

### New Subassemblies

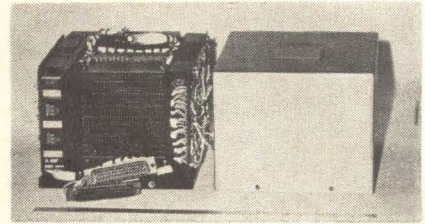

bration, humidity and wide temperature excursions to military specs. Two ranges are available:  $-55^{\circ}\text{C}$  to  $+100^{\circ}\text{C}$  and  $-25^{\circ}\text{C}$  to  $+75^{\circ}\text{C}$ .

Electronic Memories, Inc., 12621 Chadron Ave., Hawthorne, Calif. [374]

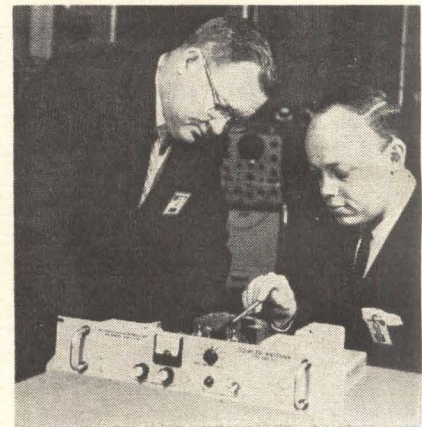

### Antenna multicoupler has solid-state design

A solid-state high-frequency antenna coupler connects up to eight receivers directly to one antenna—more than eight if the coupler is cascaded. It meets requirements of MIL-E-16400 and MIL-E-4185. Frequency range is 2 to 32 Mc. The coupler's superior signal linearity is illustrated by a maximum of 3 db small-signal gain reduction with average large signal interference of 3 to 6 v rms. Phase-tracking accuracy is  $\pm 2$  degrees between all outputs. Gains tracking is to within a maximum of 0.2 db between outputs of one coupler, and a maximum of 1 db between different couplers. Insertion gain is 0 to +3 db. Typical noise figure for the KMS-101 coupler is 8 db. Input vswr is less than 2:1 including r-f bandpass input filter and less than

1.6:1 with high-pass filter only.  
Westinghouse Electric Corp., Box 2278,  
Pittsburgh 30. [375]

## Computer tape reader operates at slow speed

A slow-speed tape reader, for numerically controlled machine tools, plotters, printers, punches and data communications equipment, reads computer output tapes at up to 800 character per in. at speeds down to zero in. per sec. Using IBM-format magnetic tape as an input and a teletypewriter as an output, the printer operates at a maximum of 600 words per min. with a tape movement of only 1/80 in. per sec. Under these conditions, a standard 2,400-ft computer reel provides output for 640 hr. through the reader, resulting in a saving of buffer storage capacity. The key feature that permits the slow-speed reading is a flux-responsive head. This allows tape reading at any speed because it responds to the tape flux instead of the voltage induced by tape motion. For operating off-time peripheral equipment, the reader will allow large reductions in computer time.

General Kinetics, Inc., 2611 Shirlington Rd., Arlington, Va. [376]

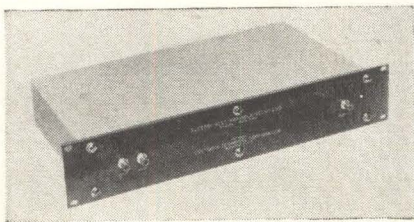

## Delay line provides $\pm 10\text{-}\mu\text{sec}$ variation

An electrically variable delay line, CTC-2462, provides a large nominal delay and variation of delay in terms of the small bias voltages involved, approaching zero power. Specifications are: nominal delay, 50  $\mu\text{sec}$ ; variation of delay,  $\pm 10\ \mu\text{sec}$ ; nominal impedance 3,000 ohms; maximum bandwidth, 400 kc; size, standard rack-mount type, 3½ in.; price, \$1,250.

Columbia Technical Corp., 24-30 Brooklyn-Queens Expressway W., Woodside 77, N.Y. [377]

# IT'S ONLY LACING TAPE— WHY ALL THIS GUDEBROD QUALITY CONTROL?



## WHAT'S THE ADVANTAGE OF GUDEBROD FLAT BRAIDED LACING TAPE?

When tying round lacing cord there is a tendency for the cord to create a sharp cutting edge which may knife through the insulation, the cord itself or the worker's hands.

With Gudebrod Flat Braided Lacing Tape the stress is distributed over the flat surface. Firm, flat contact is made, cold flow is eliminated, hands are safe.

Even a minor detail such as lacing tape becomes important when your electronic equipment must meet exacting specifications. So that you can specify Gudebrod Flat Braided Lacing Tapes with complete confidence Gudebrod goes to great lengths to back up its guarantee of quality. The lot number on every package of Gudebrod Tape assures that it has been made under strict control. Close tolerances have been met on such characteristics as slip resistance, fray resistance, tensile strength, finish, fungus resistance, and many others. Where MIL-T-713A Specifications apply, Gudebrod Tape meets or exceeds the requirements.

Whatever your lacing needs—Teflon\*, Dacron\*, nylon, glass—for general use, for burn proof requirements, for high temperature, for fungus resistance, Gudebrod makes a tape or will produce one. And you'll know that knots will not slip, harnesses will stay tied and assemblies remain firm. Workers prefer Gudebrod Tape, too, because it does not cut either insulation or hands.

If you want to inspect a sample, want more information, get in touch with your Gudebrod representative, or write to the Electronics Division.

\*Du Pont registered trademarks

**GUDEBROD BROS. SILK CO., INC.**  
FOUNDED IN 1870



*Electronics Division*

12 SOUTH 12TH STREET, PHILADELPHIA, PENNSYLVANIA 19107

*Couch*

ROTARY  
RELAYS

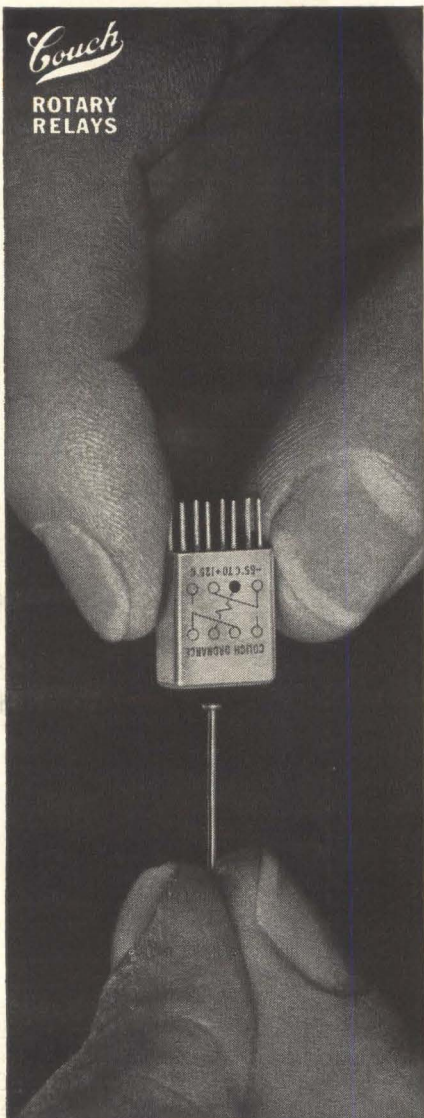

## good and small

This new Couch rotary relay is surprisingly microminiature when you consider the rugged construction inside and the specifications

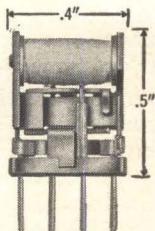

SIZE .....	.2" x .4" x .5"
TERMINAL SPACING .....	1/10" grid
RATING .....	.5 amp @ 30 VDC
COIL OPERATING POWER .....	150 mw
COIL RESISTANCE .....	60 ohms to 1,000 ohms
TEMPERATURE .....	-65°C to +125°C
VIBRATION .....	20 G
SHOCK .....	75 G

Write for Data Sheet No. 9

RUGGED ROTARY RELAYS  Dynamically and Statically Balanced

**COUCH ORDNANCE INC.**

3 Arlington Street, North Quincy 71, Mass., Area Code 617,  
Cypress 8-4147 • A subsidiary of S. H. COUCH COMPANY, INC.

## New Microwave

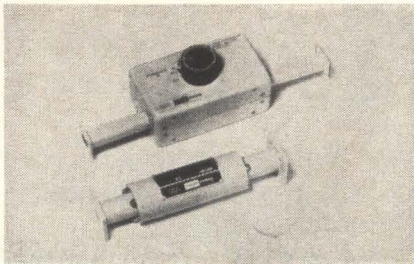

### Waveguide attenuators cover 10 to 15 Gc

Precision waveguide attenuators are available in two models. Model AW-751 fixed attenuator covers 10 to 15 Gc, with attenuation values of 3, 6, 10, 20, 30, 40 db. Vswr is 1.15 max, with bilateral matching. The AW-755, with maximum vswr of 1.20 and bilateral matching, also covers 10 to 15 Gc. It is a step attenuator for 0, 20, 40 and 60 maximum db. Both attenuators dissipate at least 1w, and fit WR-75 waveguide. They utilize the rotary vane principle for superior flatness of attenuation vs frequency. Singer Co., Metrics Division, 915 Pembroke St., Bridgeport, Conn. [391]

high-voltage ionizing pulses until the gas tube fires. Upon firing, the pulses cease, and the power supply maintains proper operating current through the tube. The unit provides a wide operating range—40 to 200 ma—in two models. Remote-control operation is available on special order.

Microwave Components & Systems Corp., 1001 S. Mountain Ave., Monrovia, Calif. [392]

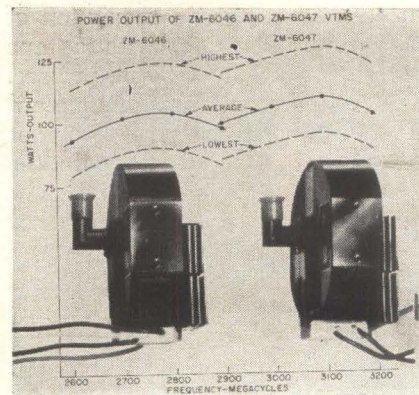

### High-power magnetrons are voltage-tunable

Two voltage-tunable magnetrons offer nearly three times the power output and 50% greater efficiency than previously available vtm's, according to the maker. Types ZM-6046 and ZM-6047 have average power outputs exceeding 90 w across the bandwidths from 2,600 to 2,900 Mc and from 2,900 to 3,200 Mc, respectively. Although rated power is 75 w, company engineers say that 90 w. is a conservative average at the band edges and that most tubes exceed 100 w. in the center of the band. The tubes produce 75 w. for 50 Mc beyond the band edges. Conversion efficiency averages over 65% in the lower band and more than 55% in the upper band, with only  $\pm 2\%$  variation across the band. Standard deviation from tube to tube is less than 3%, indicating a high degree of uniformity. Laboratory samples of the tube types have demonstrated efficiencies exceeding 75% with bandwidths of 800 Mc. The new vtm's measure ap-

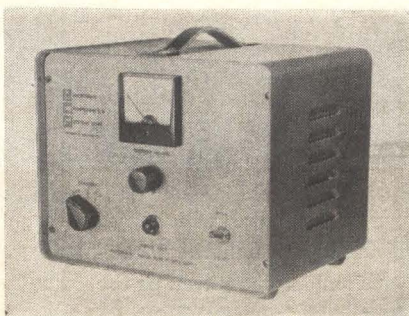

### Power supply fires gas tubes

A gas-tube power supply for testing microwave equipment has been developed to fire and maintain noise sources automatically, eliminating the need for time-consuming manual firing. The unit permits unattended operation at programmed or preset time intervals, using an integral timer or customer's timer. In operation, the firing circuit automatically initiates repetitive

proximately 4.5 by 5.5 by 4 in. and weigh 7.5 lb. They qualify for high-power oscillator applications, such as might be used in electronic countermeasures equipment. General Electric Co., Owensboro, Ky. [393]

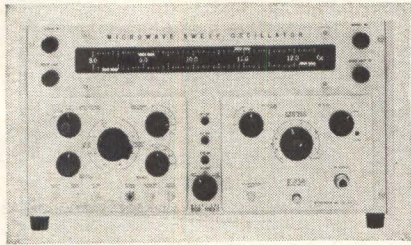

### Sweep oscillator spans 500 Mc to 40 Gc

Featured in the model 220 modular microwave sweep oscillator are a series of 8 front panel plug-in oscillator units covering the frequency range of 500 Mc to 40 Gc. The r-f output can be controlled, swept or preset in 9 distinct and different modes: adjustable and limit sweep; expanded end limit sweep; symmetrical sweep from 0 to 100% about an adjustable center frequency; manual sweep of the r-f by a continuously variable front-panel control; four presettable c-w frequencies; external d-c or sweep signal controlling r-f; external resistance programming of r-f; external trigger or manual trigger initiating internal sweep generator. An internal feedback amplifier maintains output power variation to within  $\pm 0.1$  db plus coupler and detector variation. Price of the basic model 220 is \$1,650. A typical plug-in oscillator unit costs \$2,000. Micro-Power, Inc., 20-21 Steinway St., Long Island City 5, N.Y. [394]

### K-band magnetron has compact design

Designed for missile use, the rugged QKH1124 K-band magnetron is conduction-cooled and weighs less than 4 lb. It is fixed-tuned to 24,000 Mc ( $\pm 200$  Mc). Peak power output is 30 kw. Pulse width is 0.08  $\mu$ sec with a 0.00032 duty cycle. Unit measures 4 in. by 5 in. by 2 in. Raytheon Co., Wayside Ave., Burlington, Mass. 01804. [395]

# Newest Ballantine R-A-P VTVM!

(true-Rms) (Average) (Peak)

## Measures Wide Range of Voltages, Frequencies, and Waveforms

Three instruments in one:  
Measures True-RMS,  
Average, or Peak Voltage

Same Accuracy and  
Resolution over entire  
Five-Inch Log Scales

Accuracy of 2% of  
Indication is far better  
over the lower half of  
the scale than for a  
linear scale instrument  
rated at 1% F.S.D.

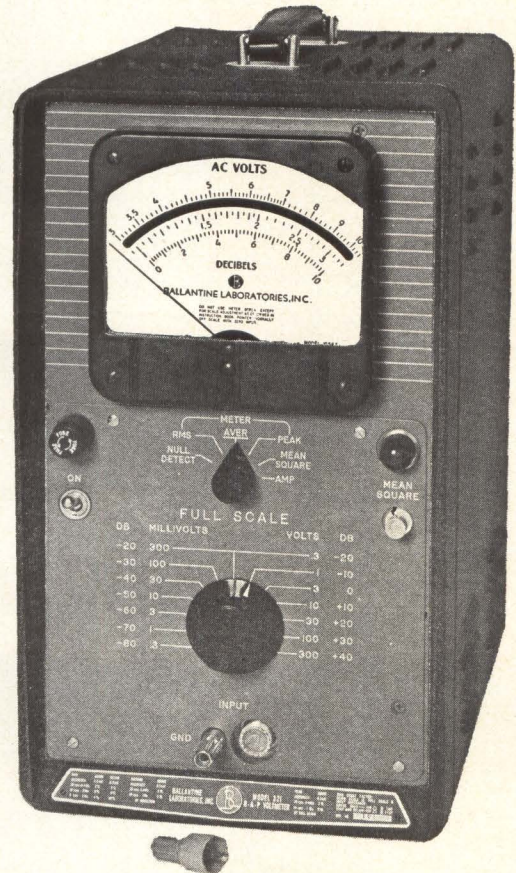

Model 321 Price: \$560

Ballantine's Model 321 is an electronic voltmeter designed for accurate measurements of the true-rms, average, or peak values of a wide range of voltages and waveforms. It is *not* limited to measurement of pure sine waves to obtain the specified accuracy, but will measure sine, distorted sine, complex, pulse, or random signals whose frequency components lie within the designated frequency range.

The instrument's five-inch voltage scales make it possible for you to specify uniform resolution and accuracy in % of indication over the entire scale length. This feature is not possible with a linear scale meter.

#### PARTIAL SPECIFICATIONS

<b>VOLTAGE RANGE</b>	<b>FREQUENCY RANGE</b>
RMS .....100 $\mu$ V - 330 V	RMS .....5 cps - 4 Mc
Average & Peak .....300 $\mu$ V - 330 V	3 db bandwidth .....2 cps - 7 Mc
As null detector .....to 10 $\mu$ V	
<b>WAVEFORMS</b>	<b>ACCURACY, ABOVE 300 <math>\mu</math>V, MID-BAND</b>
Sine, distorted sine, complex, pulse, random	RMS & Average .....2% of indication
	Peak .....3% f.s.
<b>Power Requirements:</b> 115/230 V, 50 - 420 cps, 90 W	<b>Amplifier:</b> 90 db
	<b>Mean Square Output (dc):</b> 1 V

Available in portable or rack versions

Write for brochure giving many more details



— Since 1932 —  
**BALLANTINE LABORATORIES INC.**  
Boonton, New Jersey

CHECK WITH BALLANTINE FIRST FOR LABORATORY VACUUM TUBE VOLTMETERS, REGARDLESS OF YOUR REQUIREMENTS FOR AMPLITUDE, FREQUENCY, OR WAVEFORM. WE HAVE A LARGE LINE, WITH ADDITIONS EACH YEAR. ALSO AC/DC LINEAR CONVERTERS, CALIBRATORS, WIDE BAND AMPLIFIERS, DIRECT-READING CAPACITANCE METERS, AND A LINE OF LABORATORY VOLTAGE STANDARDS 0 TO 1,000 MC.

# THE MOST RELIABLE MODULES ARE POTTED IN *TIMONIUM*

2 Mcps

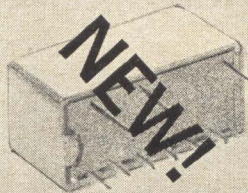

SILICON

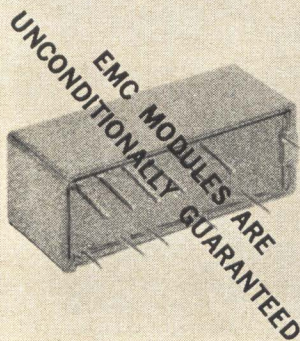
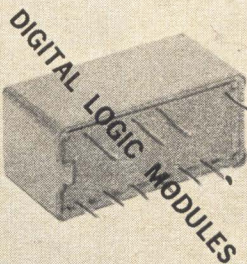

250 Kcps & 2 Mcps

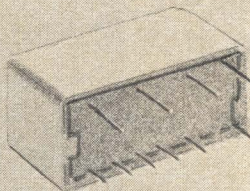

GERMANIUM

D.O.D. LOW SPEED  
DIGITAL MODULES

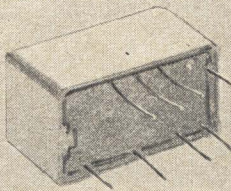

FLYBALL FAMILY

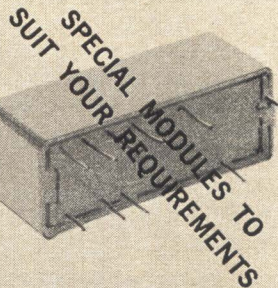

SPECIAL CIRCUIT AND PACKAGE DESIGN FROM INCEPTION TO A PRODUCTION UNIT IN THE SHORTEST TIME AND AT THE LOWEST COST

**ELECTRONIC  
MODULES  
CORPORATION EMC**

1949 GREENSPRING DRIVE • TIMONIUM, MD. 21093  
301 - Clearbrook 2-2900 • TWX - 301-252-0723

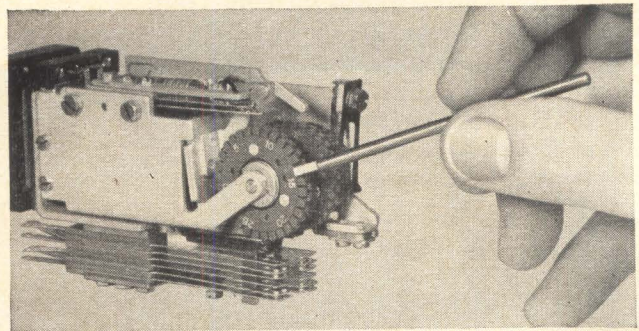

## NEW GENALEX

### RATCHET-RELAY STEPPING SWITCH WITH UNIVERSAL CAM

Universal cam with 30 or 36 removable teeth provides any cam action desired.

For Automatic Switching,  
Circuit Selection  
and Timing Control

- Occupies small mounting space
- Does not overheat
- Accurate, dependable, sturdy

#### FEATURING

36 steps per second on self-interruption  
20 steps per second from external pulses  
Operation on 75% nominal voltage  
Life of 50,000,000 steps or better

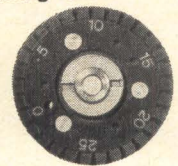

For complete information on the new ratchet-relay stepping switch and other Genalex precision products, write:



11 UNIVERSITY ROAD, CAMBRIDGE 38, MASS.

Sole U. S. Distributors for the General Electric Co., LTD. of England

Circle 213 on reader service card

## THERMO-VAC SPACE ENVIRONMENT SIMULATOR

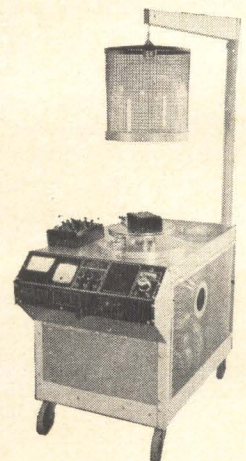

$5 \times 10^{-6}$  TORR  
 $-50^{\circ}\text{C}$  to  $+100^{\circ}\text{C}$

- Bell jar vacuum chamber, derrick hoist
- Pumps to  $5 \times 10^{-6}$  Torr in 5 minutes
- High, low voltage connections fed through fittings to convenient terminal board
- Thermal plate cycles from  $-50^{\circ}\text{C}$  to  $+100^{\circ}\text{C}$  in 5 minutes
- Mobile, all controls on single front panel
- Model ARI 2023 Space Simulator



P.O. Drawer B Nashua, N.H.  
Telephone 603-882-8166

**ASTRONETIC RESEARCH, INC.**



## New Production Equipment

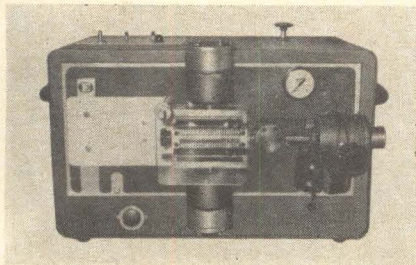

### Semiautomatic machine strips coaxial cable

The wire and cable stripper shown above, model 85, is a semiautomatic machine that strips coaxial cable at one, two or three points (jacket, shield, dielectric) in a single operation. The operator inserts the end of the cable into the cutter-head and presses a switch button. Compressed air drives the blades together and a clamp pulls the wire to break the cut insulation and shielding. An unskilled operator can strip 600 cable ends per hour with this machine. The portable machine will accommodate cable sizes from 0.060 in. to 0.490 in. o-d. Price is approximately \$875.

Eubanks Engineering Co., 225 W. Duarte Rd., Monrovia, Calif. [421]

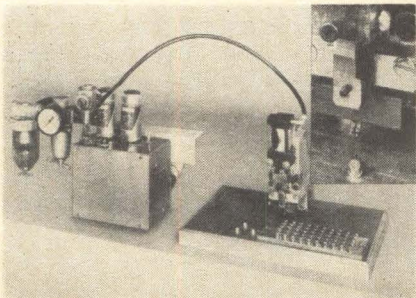

### Small stamping press codes transistor cans

A bench-model pneumatic stamping press indent-marks the tops of transistor cans or other similar small components before assembly, with highly readable impressions as small as 0.032 in. Built of stainless steel and aluminum for heavy-duty use, the unit is 12 in. by 8½ in. by 6½ in. Additional table space required for its air and elec-

trical controls is 12 in. by 8 in. In production, 50 transistor cans are vibrated at a time into a loading plate (not shown), then inverted over a specially designed peg board composed of steel pegs imbedded in a plate. The operator positions each can in turn between two 6-v. contact points which actuate the highly reliable press, thus striking the code mark within its tiny periphery. Actuation is accomplished from these two points through an electronic control box to a 110-v. three-way solenoid valve, which commands one power and one return stroke of the cylinder to complete the cycle.

Sossner Steel Stamps, Inc., 39-39 29th St., Long Island City 1, N.Y. [422]

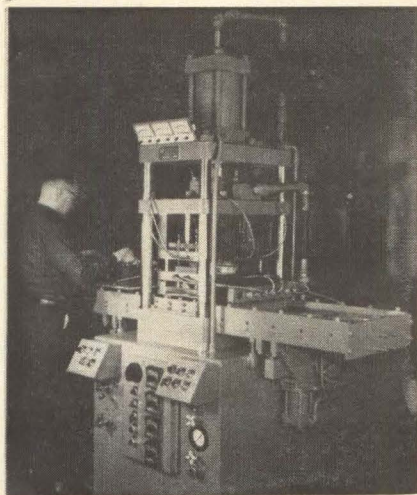

### High-speed press molds components

A 50-ton shuttle-type compression and transfer molding press has been developed. Designed especially for insert molding and encapsulation, the high-speed press (over 400 operations per minute) features downward clamping, downward transfer plus a hydraulically actuated shuttle mechanism that moves the bottom halves of the mold in and out of the molding area for hydraulic ejection of the molded parts and loading of the insert. It is claimed to be ideal for connectors, coils, relays and motors.

Hull Corp., Hatboro, Pa. [423]

## NO MORE POWER FAILURES!

Not even a flicker of the lights as an **ELECTRO-PAC "A"** Standby Power Supply maintains uninterrupted power to the load

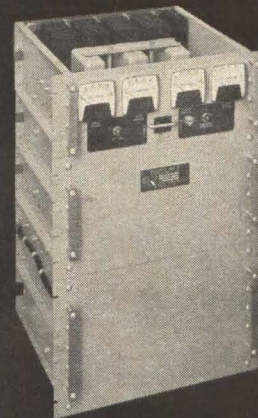

The ELECTRO-PAC "A" is more than an emergency inverter which changes a reserve power battery source to ac... it is a full-time voltage regulator, maintaining the ac line within  $\pm 5\%$  of 120 volts.

For emergency power when a few cycles interruption can be tolerated, the economical ELECTRO-PAC "B" is available... to "invert" dc to sinusoidal ac... for use with dc generators... to provide an ac source while "floating" on a battery.

ELECTRO-PAC "A" or "B" units are available for outputs of 0.5 to 5 KVA and for use with inputs of 22-28 v., 42-56 v., and 100-140 v., dc. Efficiencies up to 80%.

Write for application bulletins on standard "A" and "B" units. Complete standby power systems also available.

**ELECTRO-SEAL  
CORPORATION**

946-C North Avenue  
Des Plaines, Illinois



# Buy This Spectrum Analyzer...

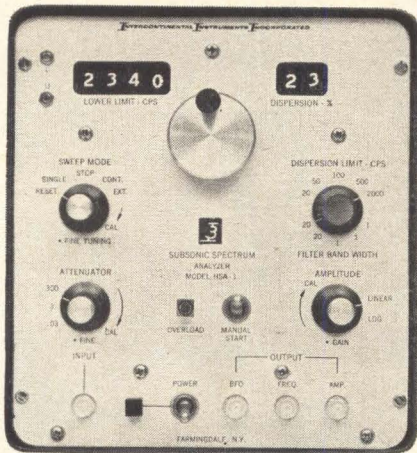

# Get This Wave Analyzer Free...



Intercontinental's HSA-1 gives you **both** spectrum analyzer and wave analyzer in one 8½ by 9 by 14½" package. Just turn a switch to select the mode you want. Designed for measurement of subsonic signals, the HSA-1 covers 1 cps to 4 kc, with one cps resolution over the entire range. Other features include 60 db single scale dynamic range, odometer indication with 1% accuracy, linear and log amplitude scales, BFO and linear sweep outputs, remote sweep control, readout on any standard plotter or recorder. The HSA-1 is priced at \$2500. At any price you'll find its specs hard to beat. Proof? Ask for Bulletin 105.



**INTERCONTINENTAL  
INSTRUMENTS INC.**  
123 Gaza Blvd., Farmingdale, N.Y.  
Phone: (516) MYrtle 4-6060

## New Materials

### Solution protects p-c card contacts

A low-cost circuit-card protector solution is said to eliminate damage to p-c card contacts (fingers or inserts) during production. Solution No. 620 can be applied to any printed-circuit card in 5 to 15 seconds. It provides a tough, durable, protective plastic film which can remain on the unit through processing, applying of components, dip soldering and shipping. When the printed circuit is ready to be inserted into a connector, the film easily peels off in one piece. No sticking to the board will occur if the solution is properly applied, the company states. Prices start at \$1.98 per lb. for 1 to 10 lb., with large quantity discounts offered. Circuit Structures Lab., 1667 Placentia Ave., Costa Mesa, Calif. [411]



### Pourable polymer cures without heat

A pourable 100% solids compound that cures to a flexible rubber at room temperature offers product improvement and cost reduction potentials in many electrical potting applications. These include transformers, switches, relays, connectors and other components and assemblies. The easy-to-use, two-part sulphurless compound creates a potting material with the electrical properties of natural rubber at a cost under 56 cents per lb. or 3 cents a cubic inch. It features

a usable temperature of -40°F to 180°F; negligible exotherm and shrinkage; 85% cure in 24 hours at 72°F; 100% cure after 48 hours to Shore A 35.

DPR, Inc., a subsidiary of H.V. Hardman Co., 571 Cortlandt St., Belleville, N.J. 07109. [412]

### Quick-curing adhesive has long pot life

A series of modified epoxy adhesives combines fast curing with long pot life. Designated Adopox, these two-component adhesives differ from other epoxy adhesives in that when the two parts are mixed together, the pot life will range from 12 hours to 5 days, depending on formulation used. This makes it possible to mix the necessary batch required for an entire working day or for several days with no sacrifice of the quick-curing cycle. Adopox is excellent for bonding glass, metal, stone, wood, concrete, plastic, masonite, polyester, epoxy and sponge rubber. It is available in various viscosities ranging from thin syrup to heavy paste, is water white in color and low in toxicity. Once cured, it has excellent resistance to heat, water and solvents. Adhesive Products Corp., 1660 Boone Ave., Bronx, N.Y. 10460. [413]

### Paper-phenolic laminate fabricates easily

A paper-phenolic-grade Textolite industrial laminate shears and punches cleanly and easily at room temperature. The cold-punch properties of grade 11660 paper-phenolic, combined with high strength and low moisture absorption, make it ideal for terminal boards, radio tube sockets, subassembly panels, insulating washers and other similar items where ease of fabrication and low cost are essential. It is available in thicknesses from 1/32 to 1/8 in. in standard sheets. General Electric Co., Laminated Products Dept., Coshocton, Ohio. [414]

## New Literature

**Core memory.** Ampex Corp., 401 Broadway, Redwood City, Calif. Model RZ high-speed core memory is described and illustrated in a 6-page bulletin. Circle 451 reader service card

**Snap-action switches.** Cherry Electrical Products Corp., 1650 Old Deerfield Road, Highland Park, Ill., offers a short-form catalog showing 24 standard snap-action switches of the 7 basic switch types in its complete line. [452]

**Time domain reflectometry.** Hewlett-Packard Co., 1501 Page Mill Road, Palo Alto, Calif. 94304. Application Note 62 describes time domain reflectometry, a new technique for isolating and identifying the character of transmission line disturbances. [453]

**Military fan.** Rotron Mfg. Co., Inc., Woodstock, N.Y. Bulletin E-2802 covers the Spartan fan, which measures 1½ in. deep by 4 11/16 in. in diameter and delivers 100 cfm. [454]

**Military switches.** Oak Mfg. Co., division of Oak Electro/Netics Corp., Crystal Lake, Ill., has available a technical bulletin listing its switches that meet MIL-S-3786A, along with their characteristics. [455]

**Temperature control.** Assembly Products, Inc., 7100 Wilson Mills Rd., Chesterland, O. Bulletin 37-A covers a low-cost, solid-state automatic temperature control. [456]

**Tantalum capacitors.** Tansitor Electronics, Inc., West Road, Bennington, Vt. A short form catalog presents condensed information on a line of tantalum capacitors comprising 14 different series with over 2,500 separate standard units. [457]

**Measuring potentiometer systems noise.** Markite Corp., 155 Waverly Place, New York, N.Y. 10014, offers a 12-page technical data bulletin containing recent studies in potentiometer output smoothness. [458]

**Microminiature choppers.** Solid State Electronics Co., 15321 Rayen St., Sepulveda, Calif. A catalog sheet describes models 40 and 40P silicon transistor choppers with operating temperature range from -55° to +150° C. [459]

**Packaged blowers.** McLean Engineering Laboratories, P.O. Box 228, Princeton, N.J. A 24-page condensed catalog presents over 150 models of packaged cooling equipment that meet a wide cross-section of engineering requirements. [460]

**Lighted pushbutton switches.** Micro Switch, Freeport, Ill. Data sheet 224 describes the new 2N series of lighted pushbutton switches that feature relamping without tools. [461]

# LAPP ANTENNA INSULATORS

...in all these standard sizes to save you time and money

## RECTANGULAR STRAIN INSULATORS

Porcelain or steatite, in standard "P" dimensions of 4, 6, 8, 10, and 12 in.—other spacings available.

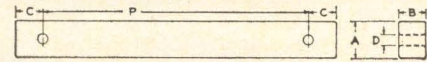

TYPE A

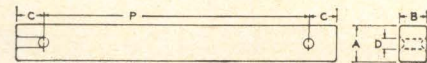

TYPE B

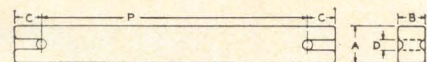

TYPE C

### DIMENSIONS IN INCHES

Catalog Number	Material	Type	A	B	C	D	Strength Lbs.
9178	Porcelain	A	1½	1	⅞	1⅜	1500
25381	Steatite	A	1½	1	⅞	1⅜	1800
23959	Porcelain	B	1½	1	1	⅞	1500
25380	Steatite	B	1½	1	1	⅞	1800
26766	Porcelain	C	1½	1	1	⅞	1500
25374	Steatite	C	1½	1	1	⅞	1800

## ROUND STRAINS

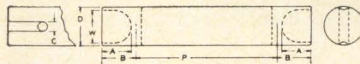

Porcelain units available in "P" dimensions of 12, 16 and 20 inches. Steatite, in "P" dimensions of 12 and 16 inches.

### DIMENSIONS IN INCHES

Catalog Number	Material	A	B	C	D	Strength Lbs.
9175	Porcelain	1⅞	1⅞	⅞	1½	2000
26239	Steatite	1⅞	1⅞	⅞	1½	2300

## SPREADERS

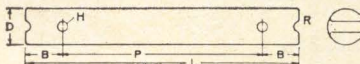

No. 26036 and No. 26223 available in lengths of 4, 6, 8, 10 and 12 inches. No. 9181 and No. 24811 available in lengths of 6, 10 and 12 inches. Other lengths available on special order.

### DIMENSIONS IN INCHES

Catalog Number	Material	B	D	H	R
26036	Porcelain	¾	¾	⅞	⅞
26223	Steatite	¾	¾	⅞	⅞
9181	Porcelain	1	1	⅞	⅞
24811	Steatite	1	1	⅞	⅞

## SHAPED ANTENNA INSULATORS

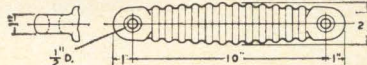

No. 5993, porcelain, 1750 lb. strength; radio rating 25 kv eff.; 60 $\omega$  wet flash-over 65 kv eff.

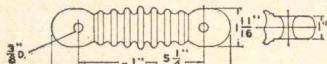

No. 23800, porcelain, 1250 lb. strength; radio rating 18 kv eff.; 60 $\omega$  wet flash-over 52 kv eff.

### RATINGS FOR RECTANGULAR, ROUND AND SPREADER INSULATORS

"P" Inches	WET FLASHOVER 60 $\omega$ kv eff.	RADIO RATING kv eff.	
		Porcelain	Steatite
4	26	18	36
6	36	22	44
8	45	24	48
10	55	25	50
16	80	25	50
30	125	25	50

# Lapp

WRITE for Bulletin 301-R  
Lapp Insulator Co., Inc.,  
219 Sumner Street, LeRoy, N. Y.

# WHAT'S THE LATEST IN DISC CATHODES? ASK SUPERIOR.

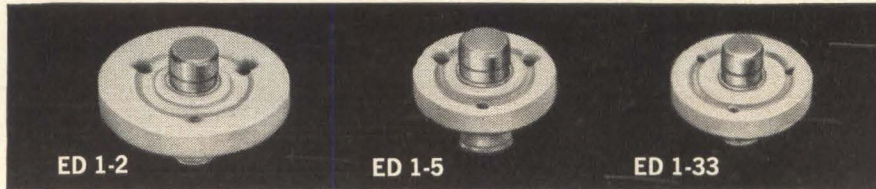

**Standard ED 1-2.** (.121" OD shank, .490" ceramic). Most widely used cathode. Standard length, .312".

**Narrow neck ED 1-5.** (.121" OD shank, .365" ceramic). For 110° deflection tubes. Standard length, .312".

**Miniature ED 1-33.** (.100" OD shank, .365" ceramic). For 110° deflection tubes. Standard length, .280".



**Miniature ED 1-11.** (.090" OD shank, .365" ceramic). Save up to 50% heater power. Standard length, .280".

**Shielded EX 271.** Permits better temperature uniformity and control of grid-cathode spacing.

**Shielded EX 270.** Permits operation with small power consumption and hence low heat generation.

## Widest choice of disc cathode designs

There are three basic types of Superior disc cathodes. Each has its own advantages. All feature close control of the E-dimension (distance between top of cap and top of ceramic), flare at the shank opening to facilitate assembly, shadow groove in the ceramic to inhibit electrical leakage and are available in wide choice of both cap and shank materials. Available in 0.121", 0.100" and 0.090" outside diameter shanks. Ceramic diameters can be either 0.490" or 0.365", with either round or triangular center hole.

## New shielded disc cathodes—EX 271 and EX 270

In the EX 271 design, the emitter is shielded from the ceramic and isolated by an exceptionally long heat-conducting path. In the EX 270 design, the slender shank, thermal shield and thin ceramic permit low heater power consumption. The shield also acts to eliminate leakage if sublimation takes place.

## Widest choice of disc cathode materials

Superior's disc cathodes feature separate nickel cap and shank alloys. Hence you may choose the most suitable material for each. The Cathaloy® series, developed and controlled by Superior Tube Co., offers alloys with high strength, high activity, low sublimation, freedom from interface impedance, or any desired combination.

**Cathaloy A-31.** Approximately twice as strong as tungsten-free alloys at high temperatures.

**Cathaloy A-33.** Combines the high emission of active alloys with freedom from sublimation and interface impedance.

**Cathaloy P-51.** More than 100% stronger than X-3014 at high temperatures.

**X-3014.** Powder metallurgy pure nickel for resistance to sublimation. Suggested for shanks.

**X-3015.** Special shank alloy for strength with resistance to sublimation and for non-emitting characteristics.

**Nickel 220, Nickel 225, Nickel 230 and Nickel 233.** Suggested for caps requiring normal emission with rapid activation.

**Driver Harris 599 and 799.** Provide rapid activation plus high level d-c emission. For caps only.

For your copy of our Catalog 51, write Superior Tube Company, 2500 Germantown Ave., Norristown, Pa.

**Superior Tube** 

The big name in small tubing  
NORRISTOWN, PA. 19404

West Coast: Pacific Tube Company, Los Angeles, California

Johnson & Hoffman Mfg. Corp., Carle Place, N.Y.—an affiliated company making precision metal stampings and deep-drawn parts

## New Books

### Navy Circuits

Handbook Preferred Circuits, Navy Aeronautical Electronic Equipment, Vol. I, Electron Tube Circuits, NAVWEPS 16-1-519-1; prepared by the National Bureau of Standards, U.S. Dept. of Commerce, available from Government Printing Office, Washington 20402, 325 pp., \$2.75.

This new edition of the Navy's preferred circuits manual includes all the preferred vacuum-tube circuits and the notes to the preferred Circuits Handbook, which were published in 1956 in the original Handbook Preferred Circuits, Navy Aeronautical Equipment, NAVWEPS 16-1-519, and in the four supplements that were issued between 1958 and 1961.

In this new edition, the circuits have been updated and most have also been expanded to include data for their use with subminiature tubes. Altogether, 46 circuits are treated in detail, each including a circuit diagram, component values and tolerance specifications, operating characteristics and a discussion of the applications, design considerations and performance of the circuit. The circuits given range from d-c power-supply regulators and simple amplifiers to video drivers, multivibrators and servo preamplifiers.

Part two of the handbook is a collection of notes describing the manner of operation of each class of circuit, giving reasons for the selection of specific preferred circuits and detailed application instructions.

As a popular treasury of practical circuits that have stood the test of time, the Navy collection should prove even more useful in its new expanded form. While this volume deals exclusively with electron-tube circuits, a companion volume, the Handbook Preferred Circuits, Vol. II, Semiconductor Device Circuits, NAVWEPS 16-1-159-2, contains the transistor circuits. Published in 1962, it is still available from the Government Printing Office (address above) for \$1.75. Both volumes are in loose-leaf form for convenient use.

The book will find a ready place

in technical libraries and with the engineer or scientist who wants an authoritative treatment in different technical areas. Excellent references are given at the end of each article.

C. Janoff  
Avionics Division  
Bell Aerospace Systems Co.  
Buffalo, New York

### Space Instrumentation

Air, Space and Instruments, edited by Sidney Lees, McGraw-Hill Book Co., New York, 516 pp., \$15.

This book, dedicated to Dr. Charles S. Draper, is a collection of 37 original papers by Dr. Draper's colleagues, friends and former students.

It contains a variety of topics with the single thread of Draper's wide-ranging activities to connect them.

There are several articles showing the significance of Draper's work from a military standpoint. These cover the military history of his work as well as the evolution of various systems and instruments.

An excellent series of papers on gyroscopes, instruments and inertial guidance systems will be useful to both the experienced person and the novice in the field.

A series of papers on the performance aspects of air transport development review aerodynamic performance, propulsion and gust-load consideration.

The papers not only illustrate successful designs and scientific background but, more important, the papers show how the basic principles can be used in future designs.

The wide range of subjects can be further seen from the articles on space rendezvous, trajectory studies, pyrometry and forest fires. The last article discusses a mathematical model of a fire-front movement to help solve the important problem of fire spread.

The book's major limitation is that it is Draper-MIT-oriented. It would have been useful to the reader to know how systems or instruments selected by the authors compared with others. This could be shown for adaptive controls, single-degree-of-freedom gyro and accelerator testing.

**COMPLETE LINE OF HIGHLY RELIABLE  
CTS CORPORATION SELECTOR SWITCHES**  
for military and industrial applications.  
Unprecedented switch uniformity—due  
to error-free automated manufacture.

16 pages of  
specifications  
on thousands of  
switch variations:  
Request Catalog  
4000 today.



**CTS CORPORATION • ELKHART, INDIANA**

WEST COAST: Also produced by Chicago Telephone of California, Inc., 1010 Sycamore Avenue, South Pasadena, California

Circle 215 on reader service card

# Telrex

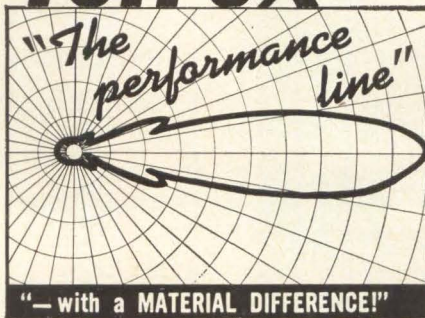

The Choice of the Discriminating  
Communication Engineer... the  
Man who Never Settles for Anything  
Less than THE-VERY-BEST!

**telrex "BEAMED-POWER"  
ANTENNAS and ANTENNA SYSTEMS**

Provide optimum performance and  
reliability per element, per dollar.  
Antennas from 500 Kc to 1500 Mc.  
Free PL88 condensed data and pricing  
catalog, describes military and commercial  
antennas, systems, accessories,  
Towers, Masts, Rotators, "Baluns"  
and transmission line data.

ANTENNAS **telrex** Communication  
SINCE 1921 **LABORATORIES** and TV Antennas

Asbury Park 41, New Jersey, U.S.A.

Circle 216 on reader service card

## Distinctively Styled

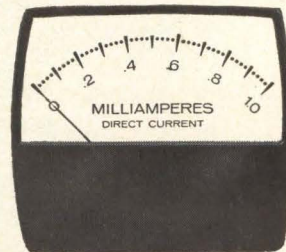

1½ in. AM-1 Model

**high torque, self-shielded  
panel meters**

Clean, modern styling... easy readability of long scales,  
and a complete choice of sizes, 1½ to 4½ inches. Full  
size, high torque mechanisms give all meters standard 1%  
deflection linearity, a consistent 2% pointer accuracy and  
sensitivity to 20 microamperes. Magnetic system com-  
pletely shields meters from external field influences, per-  
mitting cluster mounting bezel-to-bezel on any panel  
material without interaction or effect on calibration.

Complete choice of colors or finishes, and custom dials to  
suit the most modern panels. ASA/MIL 4-stud mounting.  
Complete data on request.

# AMMON

AMMON INSTRUMENTS, INC.  
345 Kelley Street, Manchester, N. H. 03105

**new**  
**FM SIGNAL GENERATOR**

**WIDE DEVIATION  
HIGH MODULATION FREQUENCY**



MODEL 1066B/6

Frequency range:  
10 to 470 mc on fundamentals  
Built-in crystal calibrator:  
10 mc and 1 mc  
FM Deviation: up to  $\pm 400$  kc  
Modulation Range: 30 cps to 100 kc

The new 1066B/6 complements Model 1066B (6625-815-2194) which has the same features but offers deviations to  $\pm 100$  kc, mod. to 15 kc and is without crystal calibrator. (Model 1066B \$1495).

**MODEL 1066B/6**  
**\$1650**

Write  
for detailed  
catalog sheet.

**MARCONI**  
**INSTRUMENTS**

DIVISION OF ENGLISH ELECTRIC CORPORATION  
111 CEDAR LANE • ENGLEWOOD, NEW JERSEY  
Main Plant: St. Albans, England

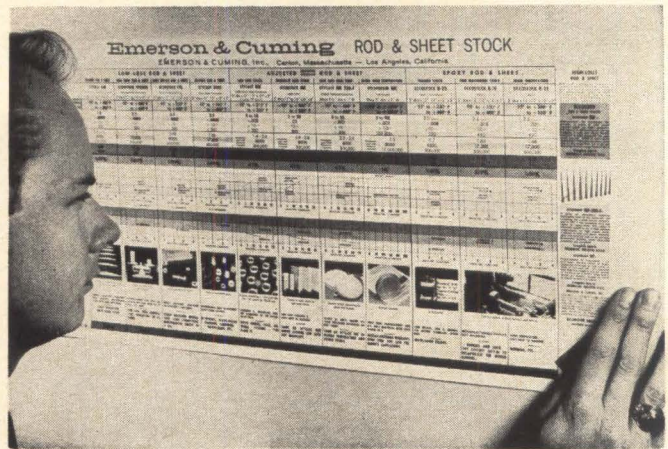

**NEW** **ECCOSTOCK®** **FREE**  
**STYCAST®**

**Rod and Sheet Stock Wall Chart**

Complete physical and electrical data are displayed for eleven materials.

**Plastics/Ceramics**  
low loss, high temperature, adjusted dielectric constant, epoxies, etc.



This full color fold-out chart for notebook or wall mounting is yours. Write or Circle Reader Service Card.

**EMERSON & CUMING, INC.**  
Canton, 9667 Allen Ave. 604 W. 182 St.  
Mass. Rosemont, Ill. Gardena, Calif.

CIRCLE 217 ON READER SERVICE CARD

To order reprints:  
fill in, cut out coupon below,  
insert in envelope and mail to:  
**Electronics Reprint Dept.**  
**330 W. 42nd Street**  
**New York, N. Y. 10036**

**Reprint order form**

To help expedite mailing of your reprints please send cash, check or money order with your order

For listing of reprints available see  
**Reader Service Card**  
For reprints of the latest Special Report

Digital Instrumentation  
Send me . . . . . reprints of Key No. R-53 at 50¢ each.  
For reprints of previous reports or articles fill in below:  
Send me . . . . . reprints of Key No[s] . . . . .  
@ . . . . . ¢ each.

[For prices see Reader Service Card]

Name . . . . .

Number of Street . . . . .

City, State, Zip Code . . . . .

## Technical Abstracts

### Parasitic capacitance

The use of preferential etching and preferential epitaxy in microelectronics. Andrew F. McKelvey, Philco Corporation, Lansdale division, Lansdale, Pa.

Two limitations of reverse-biased pn junctions are parasitic capacitance and relatively low breakdown voltage. This paper describes Philco's new process for fabricating microcircuits to overcome these limitations.

Preferential techniques are described in which active silicon regions are separated (isolated) by a layer of semi-insulating silicon. This is done by preferentially growing a high resistivity silicon layer into which an impurity is diffused. The impurity has deep-lying levels to compensate all of the existing dopant in the high resistivity epitaxial layer thus producing an even higher resistivity region. When the isolation diodes of the resulting structure are reverse-biased, a depletion layer is produced which is an order of magnitude wider than that existing in conventional isolation junctions of solid silicon circuits.

The Philco preferential epitaxy method brings the n+ collector region directly to the surface where metal contact is made. This is in contrast to the commonly used process wherein the n+ layer is buried completely and requires a separate diffusion from the surface to make contact.

Presented at the annual microelectronic symposium of the St. Louis section of the IEEE, April 13-15, 1964, St. Louis, Mo.

### Space mapping system

A star field mapping system for determining the attitude of a spinning probe.\* Robert L. Kenimer and Thomas M. Walsh. Control Information and Display Section, Instrument Research Division, NASA Langley Research Center, Hampton, Va.

Certain space experiments require precise knowledge of the attitude orientation of a spin-stabilized probe and a technique of star mapping has resulted.

Star mapping is accomplished by optically scanning a band of the star field about the vehicle's equator. Determination of the orienta-

tion of the vehicle's spin axis and roll angle to the celestial sphere is accomplished by cross correlation of the scanned star map with a known reference map of the celestial sphere.

The spinning motion of the vehicle causes star images to pass over a combined optical-reticle-sensor which permits two groups of coded pulses to be generated at the output of the sensor. The signal amplitudes out of the optical sensor will be proportional to the spectral radiance of the scanned stars since the action of the reticle is to modulate the radiation received by the optical sensor. Thus, classification of stars according to their visual magnitude is possible. The time of the occurrence of the two pulse groups is related to the azimuth angle to the star and the time separation of the pulse groups is related to the star's elevation angle.

This paper describes the system configuration and system environment. Parameters which limit performance characteristics of the system are discussed. A typical design is considered and estimated performance characteristics are presented.

### Computer in space

Computer operational systems engineering for an orbiting satellite and its command and telemetry data acquisition station.\* J.S. Bailey, D. R. Johnson, C.C. Lawson and R. Luck, General Electric Co. Spacecraft Department, Philadelphia, Pa.

The system discussed in this paper is for a typical data-gathering, earth-orbiting satellite that passes over a command and data-acquisition station.

The system employs computer equipment both on-line in near real-time, and off-line to assess satellite performance for operational purposes.

The commands transmitted to the satellite are derived and printed out by the computer and its peripheral equipment from a diagnostic processing of the satellite's recorded telemetry data. While the spacecraft is still within communication range, commands

# LASER GASES

**MIXED TO ANY SPECIFICATION  
XENON • NEON  
HELIUM • ARGON  
OXYGEN**

- Scientifically blended and tested mixtures for critical needs.
- Guaranteed ultra-high purity.
- Fast nationwide delivery in bulbs or cylinders.
- Quality based on more than 50 years of rare gas know-how.
- Complete technical service.

**SEND FOR NEW 24-PAGE  
ONE-SOURCE RARE GAS BOOKLET**

First comprehensive price and specification list for most gases and mixtures.

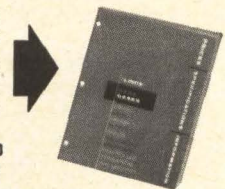

**CLIP COUPON ATTACH TO  
BUSINESS LETTERHEAD**

Union Carbide Corporation  
Linde Division, Dept. E-62  
270 Park Avenue, N. Y., N. Y. 10017

- Please send a copy of your booklet listing prices, specifications, and information on LINDE Atmospheric Gases.
- Have a representative contact me.

**UNION  
CARBIDE**

**LINDE  
DIVISION**

"Linde" and "Union Carbide" are registered trade marks of Union Carbide Corporation.

# this Catalog is not for everybody...



It has been prepared for those who require technical information, mechanical and electrical specifications about precision-film potentiometers, pressure transducers, commutators and switches.

This sturdy loose leaf binder comes complete with 16 and 20 page catalogs, in separate categories for your convenience. Additional sections covering technical information, environment specs and applications, as well as newer products will be distributed as soon as they are ready. If you are one for whom this volume has been prepared — senior designer, engineer, technician or purchasing agent — just fill out the coupon below, please.

## **C.I.C.** COMPUTER INSTRUMENTS CORPORATION 68 MADISON AVENUE, HEMPSTEAD, L.I., N.Y. / 516 IV 3-8200

COMPUTER INSTRUMENTS CORPORATION  
68 Madison Avenue, Hempstead, N.Y.

Please send me, without obligation, the C.I.C. catalog, and include my name on your list for additional pages.

(All information must be filled in below.)

Name \_\_\_\_\_  
Position \_\_\_\_\_  
Company \_\_\_\_\_  
Address \_\_\_\_\_

are transmitted from the ground station either for immediate or later use.

\*Presented at the international conference and exhibit on aerospace electro-technology, Apr. 19-25, Phoenix.

### Thin-film structure

Negative resistance and electron emission in thin insulating sandwiches. R.A. Cola, J.G. Simmons and R.R. Verderber. Burroughs Corp. Paoli Research Laboratory, Paoli, Pa.

This paper describes the fabrication, electrical characteristics, and transport mechanism of a new, simple, vacuum-evaporated, thin-film structure consisting of layers of aluminum, aluminum oxide, magnesium fluoride and gold. The present interest in this structure is due to a negative resistance region exhibited in the I-V characteristic of the structure. This region allows two stable states to be established, which may be designated as a low-impedance state and a high-impedance state. The device can be switched from one state to the other, and, if certain rules for removing the voltage bias are obeyed, it has the ability to remember the last state it has been in. Another feature of great practical interest is the emission of electrons from the device in the high-impedance state; excitation of a phosphor screen is clearly visible in a normally lighted room.

Quantitative measurement of the electrical characteristics and the temperature dependence of the I-V characteristics have made it possible to verify a new theory, based upon tunnel-hopping through traps, which explains the transport mechanism of the device in the low-impedance state. Using this tunneling transport theory, some of the observed electrical characteristics can be reasonably explained.

Some important applications are: a nondestructive read memory element requiring only pulse power during read and write operation; a resistor-coupled threshold-type logic element; shift registers, scalars, squaring circuits, and hybrid circuits; and flat cathode-ray tube displays utilizing metal-insulator-metal cold-electron emitters having memory or hold facilities.

Presented at the national aerospace electronics conference, May 11, 1964, Dayton, Ohio



## Triggered spark gap

A d-c triggered high-speed high-power microwave spark gap switch.

H. Farber, M. Klinger, M. Sucher and E. Malloy, Polytechnic Institute of Brooklyn, Long Island Graduate Center, Farmingdale, N.Y.

Rapid switching of high-peak pulsed microwave power is a problem of widespread interest, for instance in high power pulse-compression radar. For this purpose, variations of a spark gap arrangement have been utilized. One technique that uses a pulse of intense ultra-violet light to trigger the gap has achieved nanosecond switching times, but the range of pulse width was limited to 0.25-0.50 microseconds, and the r-f power levels capable of being switched were limited to values approximating the breakdown value of the gap itself.

In contrast with this method, rapid switching has been achieved by the authors by the sudden application across the gap of a pulsed high-voltage d-c field of 10-15 nanoseconds duration, parallel to the direction of the r-f field. With this arrangement, the r-f switching time was less than 10 nanoseconds using a half-sinusoid trigger pulse with a rise time of about 5 ns.

The switch, which was designed for use in the 5.2 to 5.8 Gc range consists of two opposed hemispherical domes attached to the broad walls of a section of waveguide. The trigger electrode, a stainless steel rod capped by a sphere is inserted into the guide through a dielectric bushing in one of the side walls so that its tip is centered in the gap. The switch is pressurized at three atmospheres, raising the peak power holdoff to about 2 Mw.

Several modes of switch operation are possible, depending on the level of applied microwave power. At relatively low r-f levels, the discharge is maintained solely by the d-c trigger, at higher power by the d-c and microwave fields jointly, and at sufficiently high microwave levels by the microwave field alone. In the last case, only a short-duration trigger voltage pulse from a relatively low-power d-c source is required.

The device is simple to construct and relatively inexpensive, while it can be made physically rugged.

Presented at the 1964 PTG-MTT international symposium, May 19-21, 1964, New York.

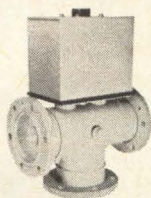

RC21F

### VACUUM COAXIAL RELAYS OFFER HIGHEST RELIABILITY

Type RC21F-SPDT Impedance—50 ohms.  
Frequency range—0 to 600 mc.  
VSWR—1.03 at 200 mc and 1.09 at 600 mc.  
Power rating—3 megawatt peak, 20 kw average at 500 mc.  
Insertion loss—0.01 db max.

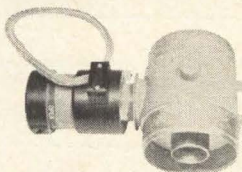

RC10

### FOR HIGHER PULSE POWER AT HIGH FREQUENCIES

Type RC10-SPST Impedance—50 ohms.  
Frequency range—0 to 100 mc.  
Power rating—50 kw average to 60 mc.  
VSWR—1.02 max. at 30 mc, 1.05 max. at 60 mc.

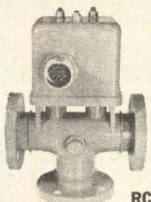

RC6

### LOW CONTACT RESISTANCE STAYS PERMANENTLY LOW

Type RC6-SPDT Impedance—50 ohms.  
Frequency range—0 to 150 mc.  
Power rating—25 kw cw average, 30 mc. @ 1:1 VSWR.  
Insertion loss—0.01 db max.

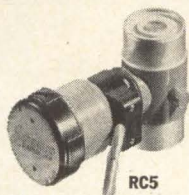

RC5

### LOW INHERENT NOISE LEVEL AND LOW LOSS OPERATION

Type RC5-SPST Impedance—50 ohms.  
Frequency range—0 to 100 mc.  
Power rating—25 kw cw average at 30 mc.  
VSWR—1.02 max. at 30 mc.

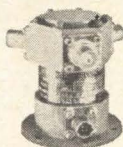

RC41

### AVAILABLE IN A WIDE VARIETY OF SIZES AND CONNECTIONS

Type RC41-SPDT Impedance—50 ohms.  
Frequency range—0 to 600 mc.  
Power rating—2 kw average at 30 mc. for type C connectors, 7.5 kw for type MC.  
VSWR—1.05:1 max.

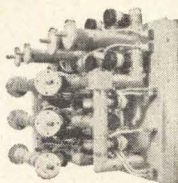

### SIMPLE FITTINGS PERMIT EASY ASSEMBLY OF VACUUM RELAYS IN CROSSBAR NETWORKS

Vacuum coaxial crossbar switching systems, due to the inherent advantages of vacuum, offer the ultimate in reliability and speed. The components have been designed for modular expansion. This also allows switch replacement in seconds if necessary.

Jennings vacuum coaxial relays were specially designed to solve the problems of remote switching of coaxial lines of all standard sizes for television, communications, and radar transmitters at high frequencies and high power levels. We will be pleased to send more detailed literature on Jennings complete line of vacuum coaxial relays at your request.

RELIABILITY MEANS VACUUM / VACUUM MEANS *Jennings*

JENNINGS RADIO MFG. CORP., 970 McLAUGHLIN AVE., SAN JOSE 8, CALIF., PHONE CYpress 2-4025

QUALIFICATION FORM  
FOR POSITIONS AVAILABLE

ATTENTION: Engineers, Scientists, Physicists

This Qualification Form is designed to help you advance in the electronics industry. It is unique and compact. Designed with the assistance of professional personnel management, it isolates specific experience in electronics and deals only in essential background information.

The advertisers listed here are seeking professional experience. Fill in the Qualification Form below.

Strictly Confidential

Your Qualification Form will be handled as "Strictly Confidential" by Electronics. Our processing system is such that your form will be forwarded within 24 hours to the proper executives in the companies you select. You will be contacted at your home by the interested companies.

What To Do

1. Review the positions in the advertisements.
2. Select those for which you qualify.
3. Notice the key numbers.
4. Circle the corresponding key number below the Qualification Form.
5. Fill out the form completely. Please print clearly.
6. Mail to: Classified Advertising Div., Electronics, Box 12, New York, N. Y. 10036.

COMPANY	SEE PAGE	KEY #
AEROSPACE PLACEMENT CORP. Phila., Pa.	114*	1
ATOMIC PERSONNEL INC. Phila., Pa.	160	2
GENERAL ELECTRIC CO. Apollo Support Dept. Daytona Beach, Fla.	115*	3
MOTOROLA Military Electronics Div. Scottsdale, Arizona	161	4
NATIONAL SECURITY AGENCY Fort George G. Meade, Md.	12*	5
POTOMAC RIVER NAVAL COMMAND US Naval Station Annex Washington, D.C.	20*	6

\* These advertisements appeared in the June 1 issue.

(cut here) ----- (cut here)

Electronics Qualification Form For Positions Available

(Please type or print clearly. Necessary for reproduction.)

Personal Background

Name .....  
Home Address .....  
City ..... Zone ..... State .....

Home Telephone .....

Education

Professional Degree(s) .....  
Major(s) .....  
University .....  
Date(s) .....

Fields of Experience (Please Check)

61564

- |  |  |                                       |
|--|--|---------------------------------------|
| <input type="checkbox"/> Aerospace           | <input type="checkbox"/> Fire Control        | <input type="checkbox"/> Radar        |
| <input type="checkbox"/> Antennas            | <input type="checkbox"/> Human Factors       | <input type="checkbox"/> Radio-TV     |
| <input type="checkbox"/> ASW                 | <input type="checkbox"/> Infrared            | <input type="checkbox"/> Simulators   |
| <input type="checkbox"/> Circuits            | <input type="checkbox"/> Instrumentation     | <input type="checkbox"/> Solid State  |
| <input type="checkbox"/> Communications      | <input type="checkbox"/> Medicine            | <input type="checkbox"/> Telemetry    |
| <input type="checkbox"/> Components          | <input type="checkbox"/> Microwave           | <input type="checkbox"/> Transformers |
| <input type="checkbox"/> Computers           | <input type="checkbox"/> Navigation          | <input type="checkbox"/> Other .....  |
| <input type="checkbox"/> ECM                 | <input type="checkbox"/> Operations Research | <input type="checkbox"/> .....        |
| <input type="checkbox"/> Electron Tubes      | <input type="checkbox"/> Optics              | <input type="checkbox"/> .....        |
| <input type="checkbox"/> Engineering Writing | <input type="checkbox"/> Packaging           | <input type="checkbox"/> .....        |

Category of Specialization

Please indicate number of months experience on proper lines.

	Technical Experience (Months)	Supervisory Experience (Months)
Research (pure, fundamental, basic)	.....	.....
Research (Applied)	.....	.....
Systems (New Concepts)	.....	.....
Development (Model)	.....	.....
Design (Product)	.....	.....
Manufacturing (Product)	.....	.....
Field (Service)	.....	.....
Sales (Proposals & Products)	.....	.....

Circle Key Numbers of Above Companies' Positions That Interest You

1 2 3 4 5 6 7 8 9 10 11 12 13 14 15

EMPLOYMENT OPPORTUNITIES



The advertisements in this section include all employment opportunities — executive, management, technical, selling, office, skilled, manual, etc.

Look in the forward section of the magazine for additional Employment Opportunities advertising.

— RATES —

DISPLAYED: The advertising rate is \$52.00 per inch for all advertising appearing on other than a contract basis. Contract rates quoted on request.

An advertising inch is measured 7/8" vertically on a column—3 columns—30 inches to a page.

Subject to Agency Commission.

UNDISPLAYED: \$2.70 per line, minimum 3 lines. To figure advance payment count 5 average words as a line.

Box numbers—count as 1 line.

Discount of 10% if full payment is made in advance for 4 consecutive insertions.

Not subject to Agency Commission.



E. E.'s

for FEE-PAID Positions  
WRITE US FIRST!

Use our confidential application for professional, individualized service... a complete national technical employment agency.

ATOMIC PERSONNEL, INC.  
Suite 1207L, 1518 Walnut St., Phila. 2, Pa.

EMPLOYMENT

for all employment advertising including Positions Vacant or Wanted and Selling Opportunities Offered or Wanted.

SEARCHLIGHT

A national medium for Surplus New or Used Equipment and other Business Opportunities

PROFESSIONAL SERVICES

A dignified method for Specialized skills and services

Benefit yourself

by using these sections

Most useful to the advertiser

Most useful to the reader

For Rates and Information Write:

ELECTRONICS

Class. Adv. Div.,

P. O. Box 12, N. Y., N. Y. 10036

## SEARCHLIGHT SECTION

(Classified Advertising)

BUSINESS OPPORTUNITIES

EQUIPMENT - USED or RESALE

### DISPLAYED RATE

The advertising rate is \$27.25 per inch for all advertising appearing on other than a contract basis. Contract rates quoted on request. AN ADVERTISING INCH is measured  $\frac{3}{8}$  inch vertically on one column, 3 columns—30 inches—to a page. EQUIPMENT WANTED or FOR SALE ADVERTISEMENTS acceptable only in Displayed Style.

### UNDISPLAYED RATE

\$2.70 a line, minimum 3 lines. To figure advance payment count 5 average words as a line.

PROPOSALS, \$2.70 a line an insertion.

BOX NUMBERS count as one line additional in undisplayed ads.

DISCOUNT OF 10% if full payment is made in advance for four consecutive insertions of undisplayed ads (not including proposals).

GENERAL RADIO Bridge Oscillator, Model 1330 A..... **350.00**

HEWLETT PACKARD Noise Figure Meter, Model 340 A..... **350.00**

ALFRED Backward Wave Oscillator, Model BWO-X..... **250.00**

BERKELEY SCIENTIFIC CO. Eput Meter Model 7160 B..... **650.00**

DAVEN CO. Antenna for Model VT 795 G..... **125.00**

ENGINEERING & EQUIPMENT CO. Sweepmaster, Model SW-1..... **495.00**

E-H RESEARCH LABS. MILLIMICRO Second Pulse Generator, Model 120 B... **350.00**

FXR INC. Klystron Power Supply Model 28116-A..... **125.00**

HEWLETT PACKARD Power Supply, Model 710 B..... **65.00**

HEWLETT PACKARD Klystron Power Supply, Model 715 A..... **125.00**

HEWLETT PACKARD Regulated Power Supply, Model 712 B..... **195.00**

JENNINGS CORP., Kilovolt Vacuum Tube Voltmeter, Model J-1002..... **275.00**

MENLO PARK ENGINEERING Traveling Wave Tube, Power Supply Model TS-6 with solenoid supply Model SS-6..... **450.00**

POLARAD CORP. Signal Generator Frequency Range, Model GB-2, 4450 to 8000 MC..... **995.00**

POLARAD CORP. Signal Generator, Frequency Range, Model GB-2, 6950 to 11000 MC..... **995.00**

TECHNICAL MATERIAL CORP. All Band Test Receiver, Model FFR-3 with five tuning units covering Freq. Range of 100-200 KC and 2 MC to 32 MC..... **395.00**

See previous issues for more equipment. Send for Flyers.

All material in excellent condition. All prices F.O.B., San Francisco, Cal., subject to prior sale. Send for Listing and Flyers.

## Marty's Mart

1236 Market St., San Francisco 3, California  
Phone: UNderhill 3-1215

CIRCLE 950 ON READER SERVICE CARD

## Antique

TELEPHONES

As is complete, decorative purpose \$17.50. Working order, inter-comm. \$19.50. Ext. on dial \$24.50. talking circuit only. Write for complete list. All shipments FOB, Simpson, Pa.

TELEPHONE ENGINEERING CO.  
Dept. 61564, Simpson, Pa.



CIRCLE 951 ON READER SERVICE CARD

TUBES & COMPONENT  
**FREE...CATALOG**  
**BARRY ELECTRONICS**

512 BROADWAY 212-WALKER 5-7000  
NEW YORK 12, N.Y. TWX-571-0484

CIRCLE 952 ON READER SERVICE CARD

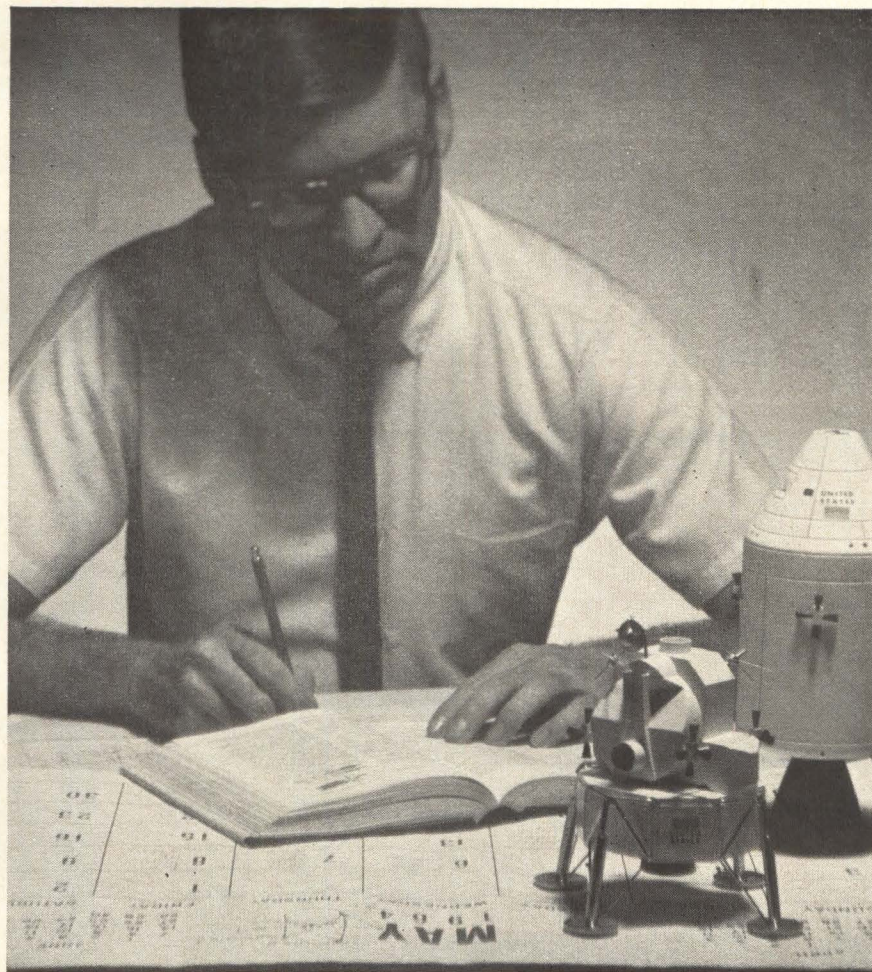

## CALENDAR COUNT-DOWN

Every working day at the Western Center of Motorola's Military Electronics Division advances the state-of-the-art in our nation's aerospace telecommunications. One of many exciting breakthroughs achieved by Motorola engineers is the Unified S-Band System — which uses a single transmitter/receiver and carrier frequency for tracking, rendezvous, command, data transfer, telemetry, and voice link. Result: a reduction of one half in size, two thirds in weight, and three fourths in power required — a technological advancement which will play a key role in bringing NASA's Apollo program to successful fulfillment at the earliest possible date.

Motorola offers excellent opportunities to engineers and space scientists of demonstrated capability. *Specific opportunities are:*

Antennas & Propagation  
Solid State R.F.  
Microwave Techniques  
Missile & Space  
Instrumentation  
Operational Support Equipment  
Integrated Circuitry

Reliability Analysis  
Parts Reliability  
Reliability Program Coordination  
Data Acquisition, Processing &  
Display  
CW Transponders  
Radar and Radar Transponders

Guidance & Navigation  
Command & Control  
Space Communications  
Signal Processing  
ECM, CCM &  
Surveillance  
Tracking & Telemetry

Contact Phil Nienstedt, Manager of Recruitment, Department 656



Military Electronics Division • Western Center • P.O. Box 1417, Scottsdale, Arizona  
MOTOROLA ALSO OFFERS OPPORTUNITIES AT CHICAGO, ILLINOIS — AN EQUAL OPPORTUNITY EMPLOYER

## AUTOTRACK ANTENNA MOUNT

360 degree azimuth, 210 degree elevation sweep with better than 1 mil. accuracy. Missile velocity acceleration and slewing rates. Amplitude and servo control. Will handle up to 20 ft. dish. Supplied complete with control chassis. In stock—immediate delivery. Used world over by NASA, USAF. TYPE MP-61-B. SCR-584.

## SCR 584 RADARS AUTOMATIC TRACKING 3 CM & 10 CM

Our 584s in like new condition, ready to go, and in stock for immediate delivery. Ideal for telemetry research and development, missile tracking, satellite tracking, balloon tracking, weather forecasting, anti-aircraft defense tactical air support. Used on Atlantic Missile Range, Pacific Missile Range, N.A.S.A. Wallops Island, A.B.M.A. Write us. Fully Desc. MIT Rad. Lab. Series, Vol. 1, pps. 207-210, 228, 284-286.

## NIKE "AJAX" MOUNTS

Complete antenna mounts, as new, in stock for immediate delivery.

## PULSE MODULATORS

### MIT MODEL 9 PULSER

#### 1 MEGAWATT—HARD TUBE

Output 25 kv 40 amp. Duty cycle .002. Pulse lengths .25 to 2 microsec. Also .5 to 5 microsec, and 1 to 5 microsec. Uses 6C21. Input 115v 60 cycle AC. Mfr. GE. Complete with driver and high voltage power supply. Ref: MIT Rad. Lab. Series, Vol. 5, pps. 152-160.

### 500KW THYRATRON PULSER

Output 22kv at 28 amp. Rep. rates: 2.25 microsec. 300 pps. 1.75 msec 550 pps. 4 msec 2500 pps. Uses 5C22 hydrogen thyatron. Complete with driver and high voltage power supply. Input 115v 60 cy AC.

### 2 MEGAWATT PULSER

Output 30 kv at 70 amp. Duty cycle .001. Rep rates: 1 microsec 600 pps. 1 or 2 msec 300 pps. Uses 5948 hydrogen thyatron. Input 120/208 VAC 60 cycle. Mfr. GE. Complete with high voltage power supply.

### 15KW PULSER—DRIVER

Biased multivibrator type pulse generator using 3E29. Output 3kv at 5 amp. Pulse lgths .5 to 5 microsec, easily adj. to 1 to 5 msec. Input 115v 60 cy AC. \$475. Ref: MIT Rad. Lab. Series, Vol. 5, pps. 157-160.

### MIT MODEL 3 PULSER

Output: 144 kw (12 kv at 12 amp.) Duty ratio: .001 max. Pulse duration: .5, 1 and 2 microsec. Input: 115 v 400 to 2000 cps and 24 vdc. \$325 ea. Full desc. Vol. 5, MIT Rad. Lab. series, pg. 140.

## MICROWAVE SYSTEMS

### C-BAND RADAR

250 KW output, C-band, PPI indicator, 5C22 thyatron modulator. Antenna hi gain parabolic section. Input 115 volts 60 cycle AC, complete \$2750.00.

### 300 TO 2400MC RF PKG.

300 to 2400 MC CW. Tuneable. Transmitter 10 to 30 Watts. Output. As new \$475.

### X BAND DOPPLER SYSTEM

AN/APN-102 G.P.L. ANT/RCVR/XMTR PKG. 4 Beam Pulsed Janus Planar Array—New \$1,600 ea.

### AN/TPS-ID RADAR

500 kw 1220-1359 mcs. 160 nautical mile search range P.P.I. and A Scopes. MTI. thyatron mod. 5J26 magnetron. Complete system.

### 10 CM. WEATHER RADAR SYSTEM

Raytheon. 275 KW output S Band. Rotating yoke P.P.I. Weather Band. 4, 20 and 80 mile range. 360 degree azimuth scan. Price \$975 complete.

### AN/APS-15B 3 CM RADAR

Airborne radar. 40 kw output using 725A magnetron. Model 3 pulser. 30-in. parabolic stabilized antenna. PPI scope. Complete system. \$1200 each. New.

### 10KW 3 CM. X BAND RADAR

Complete RF head including transmitter, receiver, modulator. Uses 2F42 magnetron. Fully described in MIT Rad. Lab. Series Vol. I, pps 616-625 and Vol. II, pps. 171-185. \$375. Complete System \$750.

### AN/APS-27 X BAND RADAR

Complete 100 kw output airborne system with AMTI, 5C22 thr. mod. 4J52 magnetron, PPI. 360 deg az sweep, 60 deg. elev. sweep, gyro stabilizer, hi-gain revr. Complete with all plugs and cables \$2800.

### M-33 AUTO-TRACT RADAR SYSTEM

X band with plotting board, automatic range tracking, etc. Complete with 1 megawatt acquisition radar.

### AN/APS-45 HEIGHT FINDER

Airborne system, 40,000 ft. altitude display on PPI & RHL. 9375 mcs. 400kw output using QK-172 megatron. 5622 thyatron.

### L BAND RF PKG.

20 KW peak 900 to 1040 MC. Pulse width .7 to 1.2 microsec. Rep rate 180 to 420 pps. Input 115 vac. Incl. Receiver \$1200.

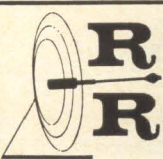

**Radio-Research Instrument Co.**  
560 5th Ave. New York 36, N.Y.  
Tel. JUdson 6-4691

CIRCLE 953 ON READER SERVICE CARD

# SEARCHLIGHT SECTION

(Classified Advertising)

BUSINESS OPPORTUNITIES

EQUIPMENT - USED or RESALE

STEPPING SIGMA HERMETICALLY  
SWITCHES KURMAN SEALED  
SENSITROLS WARD LEONARD  
STRUTHERS M... AUTOMATIC  
DUNN... ELECTRIC  
ROTARY RACHET... LEACH  
CLARE... CLARE  
ALLIED... EVENS  
LEDEX... NOLD  
CLARE... ANCE  
LEACH... ALLIED  
MINIA... CRAFT  
SIGMA... LEDEX  
NORTH... KEYING  
ELECTRIC... PHILLIPS  
DORMEYER... CONTROLS  
TELEPHONE... AMPERITE  
TYPE... PRODUCTION WESTERN  
KURMAN... QUANTITIES ELECTRIC  
STEVENS... MOST MAKES CUTLER  
ARNOLD... IN STOCK HAMMER  
CONTACT... Send for GENERAL  
MERCURY... Latest ELECTRIC  
SOLENOIDS... Catalog GUARDIAN  
ADVANCE... E CONTACTORS  
ALLEN BRADLEY PRICE ELECTRIC  
POTTER SQUARE D WESTON  
BRUMFIELD MINIATURE AIRCRAFT

**LARGEST STOCK OF RELAYS IN THE WORLD**

## Universal RELAY CORP.

42 WHITE ST. NEW YORK 13, N. Y. Walker 5-6900

CIRCLE 954 ON READER SERVICE CARD

## PUBLIC AUCTION

By order of ALWAC  
a DIVISION OF EL-TRONICS

Moved for convenience of sale to:  
304 So. CENTRAL AVE., LOS ANGELES, CALIF.

FRIDAY, JUNE 19th 10:30 A.M.

ELECTRONIC TEST EQUIP.—COMPUTERS  
PARTS

5—ALWAC IIIIE DATA PROCESSING SYSTEMS consisting of Program, Data Storage—Arithmetic & Logic—Power Supply—Hi Speed Paper Tape Consoles—Teletype Machines

Oscilloscopes — Winders — Power Supplies — Drill Presses — Metal Working Tools — Benches — Gauges — Components — Parts — Wire — Tools — Electronic Test Instruments

For information & brochure contact

**OSTRIN & OSTRIN**  
AUCTIONEERS

304 S. Central Ave., L. A. 90013  
MA 4-7431

CIRCLE 955 ON READER SERVICE CARD

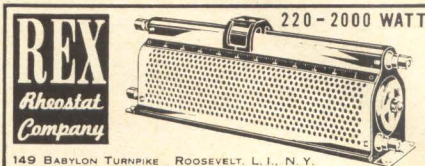

CIRCLE 956 ON READER SERVICE CARD

## TRANSISTORS • DIODES

Miniature Components  
Is Our Business. New Surplus Only.  
Small or Large Quantities Available  
**TRANSISTORS UNLIMITED COMPANY**  
462 JERICHO TURNPIKE, MINEOLA, N. Y.  
516-P17-7221

CIRCLE 957 ON READER SERVICE CARD

Exceptional offer for POTENTIOMETERS  
We have shipped erroneously one month ago to the Free ZONE of COLON—S.A., 5,000 potentiometers dia. of the case 25mm. 50,000 ohms with switch shafts 1/4" dia.—3" long. We offer the exceptional price of \$140—per thousand C.I.F., any port in the world, and guarantee the highest quality available. These potentiometers are of current production.

SOCIETE INDUSTRIELLE ALFA, S.A.  
80, rue de la Senne, BRUSSELS—Belgium.  
Phone: 12-67-30 (5 lines). Telex: 02/21.844  
Cable Address RALFA—Brussels.

CIRCLE 958 ON READER SERVICE CARD

## NEW DISC CAPACITORS

OVER 3 1/2 MILLION IN STOCK  
ALL SIZES—BELOW FACTORY PRICES

Call or Write for Quotes  
**SAMUEL GLICK & SONS**  
313 Broadway, Dept. C, New York 7, N. Y.  
Phone: 212 WO 4-5162

CIRCLE 959 ON READER SERVICE CARD

## WANTED

Opportunity to bid on quantities of used commercial two-way radios.

Richard Baker, Pres.

Airesman-Baker  
56 West Main St., Newark, Ohio 43055

CIRCLE 960 ON READER SERVICE CARD

WRITE FOR NEW **KEYSTONE** free catalog

BATTERY HOLDERS, TERMINALS,  
TERMINAL BOARDS & HARDWARE

KEYSTONE ELECTRONICS CORP.  
49 BLEECKER ST., NEW YORK 12, N. Y.

CIRCLE 961 ON READER SERVICE CARD

## An Investment!

Productive advertising is an INVESTMENT rather than an EXPENDITURE.

"Searchlight" advertisers invariably report prompt and satisfactory results.

BE CONVINCED — send us your advertisement TODAY.

Address  
Classified Advertising Division

## ELECTRONICS

P. O. BOX 12, N. Y., N. Y. 10036

# Electronics advertisers

June 15, 1964

■ AMP Inc.	7	General Radio Co.	2ndCover	Radiation Inc.	108
Garceau, Hargrave & McCullough Inc.		K.E. Morang Co.		G.M. Basford Company	
■ Acme Electric Corp.	126	■ Globe Industries Inc.	144	Radio Corporation of America	4th Cover
Scheel Adv. Agency		Odiorne Industrial Adv. Inc.		Al Paul Lefton Co.	
American Electronic Laboratories, Inc.	134	Gries Reproducer Corp.	164	Radio Engineering Laboratories,	
Benn Associates		Harold Marshall Adv. Co.		Div. of Dynamics Corp. of America	24
Ammon Instruments Inc.	155	Gudebrod Bros. Silk Co. Inc.	147	Arthur Falconer Associates Corp.	
Culver Advertising Inc.		Heinemann Electric Co.	122	■ Radio Materials Co.,	
Assembly Products	141	Thomas R. Sundheim Inc.		Div. of P.R. Mallory Co.	143
George Z. Griswold Adv.		■ Hewlett Packard Co.	20, 21	Rosenbloom, Elias & Associates	
Astronetic Research Inc.	150	L.C. Cole Company Inc.		■ Rotron Mfg. Co.	62, 63
Babcock Relays	53	■ Imtra Corporation	150	Lescarboursa Advertising Inc.	
Jay Chiat and Associates		S. Gunnar Myrbeck & Company		■ Sangamo Electric Company	52
■ Ballantine Labs.	149	Instruments For Industry, Inc.	146	Winius-Brandon Company	
Lang-Lawrence Adv. Inc.		Duncan-Brooks, Inc.		Servo Corporation of America	135
Bausch & Lomb, Inc.	139	Intercontinental Instruments Inc.	152	Mabuchi, Kameny & Smith, Inc.	
Wolff Associates, Inc.		Dunwoodie Associates Inc.		Shizuki Electrical Mfg Co.	164
Beckman Instruments Inc.,	31	■ Jennings Radio Mfg. Corp.	159	New Asia Trading News Agency Ltd.	
Offner Division		L.H. Waldron		Sprague Electric Co.	5, 6
Erwin Wasey, Ruthrauff & Ryan Inc.		Jerrold Corp.	10	The Harry P. Bridge Co.	
Bell Telephone Laboratories	43	Irving Gould Adv. Inc.		■ Superior Tube Co.	154
N.W. Ayer & Son Inc.		■ Keithley Instruments Inc.	145	Gray & Rogers, Inc.	
Black & Webster Inc.	138	Bayless-Kerr Company		■ Tektronix Inc.	48
Larcom Randall Adv., Inc.		■ Kepco, Inc.	16	Hugh Dwight Adv. Inc.	
■ Bourns Inc., Trimpot Div.	9	Weiss Advertising		Telrex Laboratories	155
Allen, Dorsey & Hatfield Inc.		Kinny Vacuum Div. of New York		George Homer Martin Associates	
Brush Instruments,	3rd Cover	Air Brake Company	118	Texas Instruments Incorporated	
Div. of Clevite		Jerome OLeary & Company Inc.		Industrial Products Group	132
Carr Liggett Adv., Inc.		■ Lambda Electronics Corp.	109	Robinson-Gerrard, Inc.	
Buchanan Electrical Products Corp.	120	Michel Cather, Inc.		Texas Instruments Incorporated	
Keyes, Martin & Company		■ Lapp Insulator Co., Inc.	153	Division	12, 13
■ Bussmann Mfg. Co.,		Wolf Associates, Inc.		Don L. Baxter	
Div. of McGraw Edison Co.	118, 119	Leach Corp.	46	Transitron Electronic Corp.	111
Henderson Advertising Company		Hixson & Jorgensen, Inc.		The Bresnick Co. Inc.	
■ CTS Corporation	155	Levin & Son, Inc., Louis	33	■ Trygon Electronics	144
Burton Browne Adv.		M.R. Crossman Co.		Carpenter, Matthews & Stewart, Inc.	
Cambridge Thermionic Corp.	142	Linde Division of Union Carbide Corp.	157	U.S. Stoneware	164
Chirurg & Cairns, Inc.		J.M. Mathes Incorporated		Ralph Gross Adv. Inc.	
■ Chicago Dynamic Industries Inc.	144	Machlett Laboratories Inc., The	8	■ Vitramon Inc.	14
Burton Browne Advertising		Fuller & Smith & Ross		Ted Sommers, Inc.	
Clare & Company, C.P.	34, 35-42	Mallory & Co. Inc. P.R.	22, 23	Westinghouse Electric Corp.	
Reincke, Meyer & Finn Adv.		The Aitkin-Kynett Co.		Defense Pdts.	129
■ Clarostat Mfg. Co.	47	Marconi Instruments	156	Ketchum, MacLeod & Grove Inc.	
Lescarboursa Advertising Inc.		Armand Richards Adv. Agency		■ Weston Instruments & Electronics	131
■ Clifton Precision Products	58	■ McLean Engineering Laboratories	123	G.M. Basford Company	
Ivey Adv. Inc.		Healy Adv. Agency		White, S.S.	136
■ Computer Instruments Corp.	158	■ Micro Switch Div. of Honeywell	106	W.L. Towne Co. Inc.	
Dickerman Adv.		Batten, Barton, Durstine & Osborn Inc.		Winchester Electronics	117
Consolidated Electrodynamics Corp.	45	Microwave Associates	110	Div. of Litton Industries	
Hixson & Jorgensen, Inc.		Kalb & Schneider Inc.		West, Weir & Bartel Inc.	
Continental Electronics		Minnesota Mining & Mfg. Co.	107	Xerox Corporation	105
Sub. of Ling Temco Vought	130	Mincom Division		Papert, Koenig, Lois, Inc.	
Evans, Young, Wyatt Advertising		Reach, McClinton & Co., Inc.		Classified Advertising	
■ Couch Ordnance, Inc.	148	■ Moseley, F.L.	1	F. J. Eberle, Business Mgr.	
Culver Advertising Inc.		L.C. Cole Company, Inc.		[212]-971-2557	
Dow Corning Corp.	50, 51	Motorola Semiconductor Products Inc.	121	Employment Opportunities	160-161
Church and Guisewite Adv., Inc.		Lane and Bird Advertising Inc.		Equipment	
DuPont de Nemours & Co. Inc.E.I.	29, 137	■ North Atlantic Industries, Inc.	125	(Used or Surplus New)	
Batten, Barton, Durstine & Osborn		Dunwoodie Associates, Inc.		For Sale	162
Dymec Div. of Hewlett Packard Co.	2	Nytronics Inc.	142	Classified Advertisers Index	
L.C. Cole Company Inc.		Stukalin Advertising Agency Inc.		Airesman-Baker	162
Edgerton, Germeshausen & Grier, Inc.	140	Ohmite Mfg. Co.	55	Atomic Personnel Inc.	160
Reach, McClinton & Humphrey, Inc.		Fensholt Adv. Agency		■ Barry Electronics	161
Electro-Seal Corporation	151	Ozalid A Div. of General Aniline &	44	Glick & Sons, Samuel	162
Merchandising Advertisers, Inc.		Film Corp.		Keystone Electronics Corp.	162
Electronic Modules Corp.	150	Lennen & Newell Inc.		Martys Mart	161
Ray Thompson & Associates Inc.		■ Philco, A Sub. of Ford Motor Co.	61	Motorola	161
Electronic Specialty Co.	64	Maxwell Associates, Inc.		Ostrin & Ostrin	162
Grant Adv., Inc.		Polaroid Corporation	127	Radio Research Instrument Co.	162
Elgett Optical Co., Inc.	142	Doyle, Dane, Bernbach Inc.		Rex Rheostat Co.	162
Hutchins Adv. Co., Inc.		Preformed Line Products Company	11	Societe Industrielle Alfa, S.A.	162
Emerson & Cuming Inc.	156	The Bayless-Kerr Company		Transistors Unlimited Co.	162
Fairchild Dumont Laboratories	128	Princeton Applied Research Corp.	54	Universal Relay Corp.	162
The Roger and Wilbur Co. Inc.		Mort Barish Associates			
Flying Tiger Line	19				
Hixson & Jorgensen, Inc.					
Formica Corp.	49				
Perry-Brown Inc.					
■ General Electric Company					
Equipment Sales	56, 57				
Gardner Advertising Company					
■ General Electric Co.,					
Semiconductor Products Dept.	112				
Ross Roy Inc.					

■ For more information on complete product line see advertisement in the latest Electronics Buyers' Guide

Executive, editorial, circulation and advertising offices: McGraw-Hill Building, 330 West 42nd Street, New York, N.Y., 10036. Telephone Area Code 212-971-3333. Teletype TWX N.Y. 212-640-4646. Cable McGrawhill, N.Y. Officers of the Publications Division: Shelton Fisher, President; Vice Presidents: Joseph H. Allen, Operations; John R. Callahan, Editorial; Ervin E. DeGraff, Circulation; Donald C. McGraw, Jr., Advertising Sales; Angelo R. Venezian, Marketing, Officers of the Corporation: Donald C. McGraw, President; Hugh J. Kelly, Harry L. Waddell, L. Keith Goodrich, Executive Vice Presidents; John L. McGraw, Treasurer; John J. Cooke, Vice President and Secretary. Title R registered U.S. Patent Office; © copyright 1964 by McGraw-Hill, Inc. All rights reserved, including the right to reproduce the contents of this publication, in whole or in part.

**IMMEDIATE DELIVERY!**

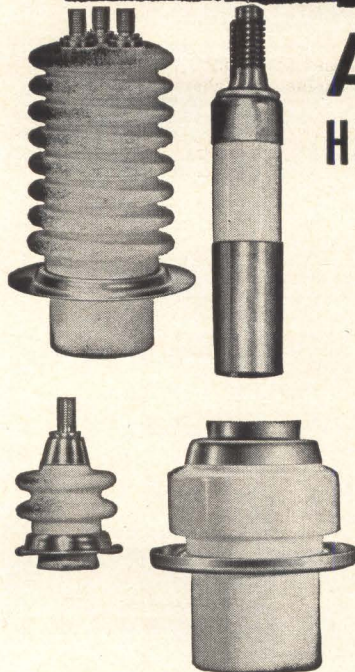

**ALITE<sup>®</sup> STANDARD  
HIGH ALUMINA BUSHINGS**

**OVER 100 TYPES AND SIZES!**

Save time . . . cut costs . . . simplify design problems with Alite standard high alumina high voltage terminals, feed-throughs, cable end seals and high amperage bushings — all stocked for "off-the-shelf" delivery. Vacuum-tight, rugged and heat-shock resistant, Alite Bushings maintain their dielectric properties at elevated temperatures. Virtually any assembly procedure, such as welding, brazing or soldering, may be used.

Send today for free catalog showing types and sizes.



57-J

ALITE

DIVISION

**U. S. STONEWARE**

BOX 119

ORRVILLE, OHIO

Circle 218 on reader service card

**SHIZUKI  
CAPACITORS**

**Injection Polypropylene Resin  
Molded Metallized Lacquer Film  
Capacitors ( -30°C +85°C)**

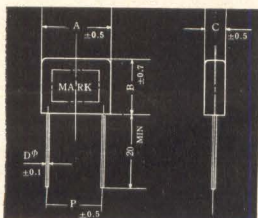

50 volts D.C. Working unit: mm

TYPE	CAP	A	B	C	D	P
PML-0.47/50	*0.47 μF	14.0	14.0	5.0	0.6	10.0
PML-0.5 /50	0.5 μF	14.0	14.0	5.0	0.6	10.0
PML-0.68/50	*0.68 μF	19.5	16.0	5.5	0.6	15.0
PML-1.0 /50	*1.0 μF	19.5	16.0	5.5	0.6	15.0
PML-1.5 /50	*1.5 μF	24.0	19.0	6.5	0.7	19.0
PML-2.0 /50	2.0 μF	24.0	19.0	6.5	0.7	19.0
PML-2.2 /50	*2.2 μF	24.0	19.0	6.5	0.7	19.0
PML-3.3 /50	*3.3 μF	30.0	20.0	7.0	0.7	25.0
PML-6.8 /50	*6.8 μF	31.0	23.0	10.0	0.8	25.0

\*STANDARD

- ◇ Lacquer Film Capacitors ◇ Mylar Capacitors
- ◇ Metallized Paper Capacitors for Motor running, fluorescent ballasts ◇ Noise Suppression Capacitors ◇ Ignition Capacitors ◇ Miniature Electrolytic Capacitors



**SHIZUKI ELECTRICAL MFG. CO., LTD.**

HEAD OFFICE: TAISHA-CHO, NISHINOMIYA, JAPAN  
CABLE ADDRESS: "CAPACITOR" NISHINOMIYA  
TOKYO FACTORY: 10-7, ARAIYUKU, OTA-KU, TOKYO

**GRC tiny parts**

die cast  
**ZINC ALLOY**

molded  
**PLASTICS**

Coil Bobbins  
Gears & Pinions

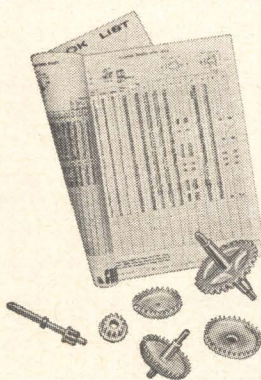

**GEAR & PINION GUIDE BOOK**

Gives full specs for hundreds of stock combinations of small 1-pc. die cast zinc alloy gears integral with pinions, shafts, spacers, etc. . . . also combination to specs. GRC's exclusive techniques give you high quality in small parts of die cast zinc alloy, and engineering thermo-plastics at **low cost!** Write for samples and literature. Send prints for quotation.

**No Minimum Size!** Max: Zinc Alloy-2" long 1/2 oz. Plastic-1 1/2" long, .05 oz.

**GRIES**

**GRIES REPRODUCER CORP.**

World's Foremost Producer of Small Die Castings  
151 Beechwood Ave. • New Rochelle, N. Y.  
phone: (914) NEw Rochelle 3-8600

Circle 219 on reader service card 219



**Electronics**

June 15, 1964

**Advertising sales staff**

**James T. Hauptli:** [212] 971-2210  
Advertising sales manager

**Atlanta, Ga. 30309:** Gus H. Krimsier,  
Michael H. Miller, 1375 Peachtree St. N.E.,  
[404] TR 5-0523

**Boston, Mass. 02116:** William S. Hodgkinson,  
McGraw-Hill Building, Copley Square,  
[617] CO 2-1160

**Chicago, Ill. 60611:** Robert M. Denmead,  
Daniel E. Shea, Jr., 645 North Michigan  
Avenue, [312] MO 4-5800

**Cleveland, Ohio 44113:** Paul T. Fegley, 55  
Public Square, [216] SU 1-7000

**Dallas, Texas 75201:** Frank Le Beau, The  
Vaughn Building, 1712 Commerce Street,  
[214] RI 7-9721

**Denver, Colo. 80202:** John W. Patten, David  
M. Watson, Tower Bldg., 1700 Broadway,  
[303] AL 5-2981

**Houston, Texas 77025:** Kenneth George,  
Prudential Bldg., Halcombe Blvd.,  
[713] RI 8-1280

**Los Angeles, Calif. 90017:** Ashley P.  
Hartman, John G. Zisch, 1125 W. 6th St.,  
[213] HU 2-5450

**New York, N.Y. 10036:**  
Donald R. Furth [212] 971-3616  
Donald H. Miller [212] 971-3615  
George F. Werner [212] 971-3617  
500 Fifth Avenue

**Philadelphia, Pa. 19103:** William J. Boyle,  
Warren H. Gardner, 6 Penn Center Plaza,  
[215] LO 8-6161

**San Francisco, Calif. 94111:**  
255 California Street,  
[415] DO 2-4600

**London W1:** Edwin S. Murphy Jr., 34 Dover  
Street

**Frankfurt/Main:** Matthee Herfurth, 85  
Westendstrasse Phone: 77 26 65 and  
77 30 59

**Geneva:** Michael R. Zeynel,  
2 Place du Port 244275

**Paris VIII:** Denis Jacob, 17 Avenue  
Matignon ALMA-0452

**Tokyo:** Shigeo Chiba, 1, Kotohiracho,  
Shiba, Minato-ku (502) 0656

**Osaka:** Kazutaka Miura, 163, Umegae-cho,  
Kita-ku [362] 8771

**Nagoya:** International Media  
Representatives, Yamagishi Bldg.,  
13,2-Chome, Oike-cho Naga-ku

**R.S. Quint:** [212] 971-2335  
General manager  
Electronics Buyers' Guide

**David M. Tempest:** [212] 971-3139  
Promotion manager

**Henry M. Shaw:** [212] 971-3485  
Market research manager

**Richard J. Tomlinson:** [212] 971-3191  
Business manager

**Theodore R. Geipel:** [212] 971-2044  
Production manager

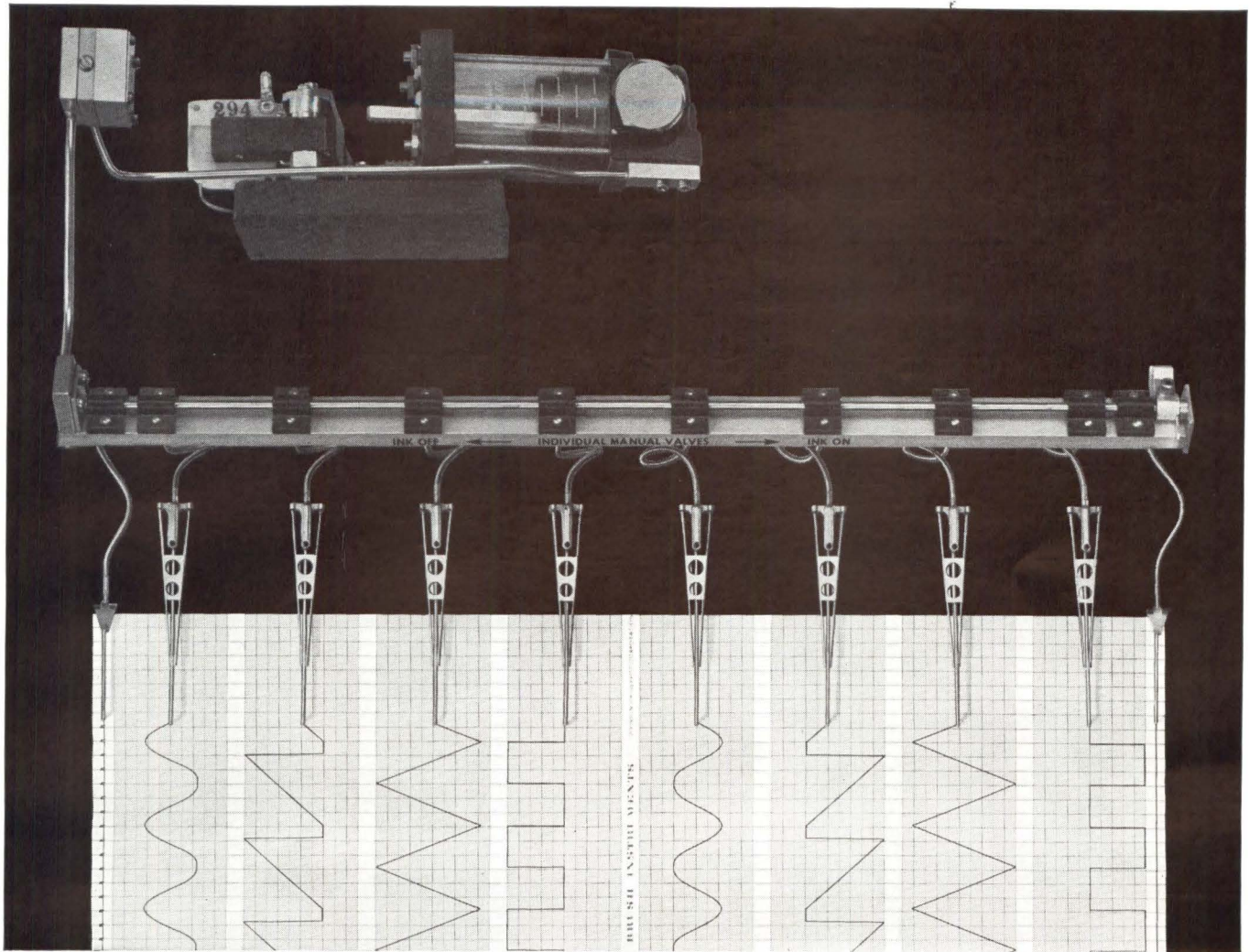

## This is the Brush Mark 200 system of writing – patented as a “Balanced Hydrostatic Inking System”

(modern oscillography will never be the same)

More than 10,000 channels have been recorded by this completely closed, pressurized inking system . . . with accuracy and reliability that cannot be duplicated by any other direct writing recorder. Traces dry instantly because fluid is forced *into* the paper. Traces are so accurate and crisp that you can't misread the signal. *True* rectilinear motion results from a unique linkage that creates a straight line 99.9% accurate. Penmotors contain a super-sensor called the Metrisite® which “polices” the pen position and provides instant self-correction without mechanical restraints. Truly, modern oscillography will *never* be the same. Today's requirements demand these new Brush Mark 200 writing standards. Your letterhead request will bring the complete story.

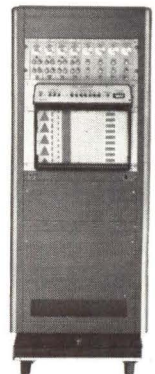

**brush** INSTRUMENTS  
DIVISION OF CLEVITE 37TH AND PERKINS, CLEVELAND 14, OHIO

Circle 901 on reader service card

# NOW!

# RCA BRINGS THE INDUSTRY

# NEW ECONOMY IN

# HIGH-PERFORMANCE

# SILICON POWER FOR

# 12-VOLT APPLICATIONS

## 4 Watts Output (Class A)

RCA-40250—Silicon Performance plus real Economy for 12-volt Audio Amplifiers such as Mobile, Portable, and Marine Radios

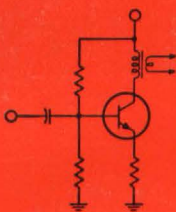

### CLASS A AUDIO CIRCUIT

$V_{CEV} = 50V$   
 $V_{CE}(\text{sat}) = 1.5V$  at 1.5 amp  
 $h_{FE}$  at 1.5 amp = 25-100  
 $f_T = 1 \text{ Mc (typ)}$

## 100 Watts Output (Class A)

RCA-40251—Silicon Performance plus Real Economy for 12-volt High-Output Audio Systems or Inverter and Regulator Applications such as Portable Power Supplies.

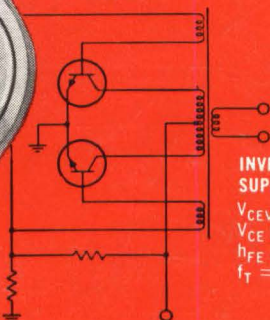

### INVERTER POWER SUPPLY CIRCUIT

$V_{CEV} = 50V$   
 $V_{CE}(\text{sat}) = 1.5V$  at 8 amp  
 $h_{FE}$  at 8 amp = 15-60  
 $f_T = 500 \text{ Kc}$

Here are two more RCA high-performance economy silicon power transistors: RCA-40250—for audio power to 4 watts—and RCA-40251—for inverter power to 100 watts.

Offering you the big performance advantages of silicon at low prices, these two new RCA transistors are hermetically sealed in TO-3 and "small TO-3" packages. They are designed for volume production and complete freedom from second breakdown.

For extra operating cushion, both RCA-40250 and RCA-40251 offer 200°C max junction temperature.

No matter what stage your design is in now, it will pay you to investigate the advantages—and economy—of RCA-40250 and RCA-40251. Ask your RCA Representative for complete information. For technical data, write: Commercial Engineering, Section IN-6-3, RCA Electronic Components and Devices, Harrison, N. J.

### CHECK RCA'S GROWING FAMILY OF ECONOMY SILICON TYPES

	RCA Type	$V_{CBO}$	$I_C$	$P_T$	$f_T$	$h_{FE} @ I_C$
12-volt Types	40250	50V	4A	29W	1Mc	25-100 @ 1.5A
	40251	50V	15A	115W	500Kc	15-60 @ 8A
Higher-Voltage Types	2N3054	90V	4A	25W	1Mc	25-100 @ 0.5A
	2N3055	100V	15A	115W	500Kc	20-70 @ 4A

### AVAILABLE THROUGH YOUR RCA DISTRIBUTOR

**RCA FIELD OFFICES:** 32 Green St., Newark 2, N. J., 485-3900 • 731 James St., Room 402, Syracuse 3, N. Y., GR 4-5591 • 605 Mariton Pike, Haddonfield, N. J. (08034), HA 8-4802 • 64 "A" St., Needham Heights 94, Mass., HI 4-7200 • 200 East Marks St., Orlando, Fla., 425-5563 • Suite 1154, Merchandise Mart Plaza, Chicago 54, Ill., 527-2900 • 2511 East 46th St., Suite Q2, Atkinson Sq., Indianapolis, Ind., (46205), 546-4001 • 5805 Excelsior Blvd., Minneapolis 15, Minn., WE 9-0676 • 714 New Center Bldg., Detroit 2, Mich., TR 5-5600 • 6363 Sunset Blvd., Hollywood, Calif., (90028), 461-9171 • 4546 El Camino Real, Suite P, Los Altos, Calif., (94022), 948-8996 • 2250 First Ave., South, Seattle 4, Wash., MA 2-8816 • 224 N. Wilkinson St., Dayton 2, Ohio, BA 6-2366 • 1725 "K" St., N.W., Washington 6, D. C., FE 7-8500 • RCA INTERNATIONAL DIV., 30 Rockefeller Plaza, N. Y. 20, N. Y. • Cable Address: RADIOINTER, N. Y.



The Most Trusted Name in Electronics