

Electronics®

Designing for space radiation—part 2: page 70

Very low frequency makes a comeback: page 80

Special report: 1965 Electronics markets: page 87

January 11, 1965

75 cents

A McGraw-Hill Publication

Below: new applications for microelectronics in 1965, page 87





**PIONEERS IN
MINIATURIZATION**

TM

NEW PIP SERIES

ULTRAMINIATURE TRANSISTOR PULSE TRANSFORMERS

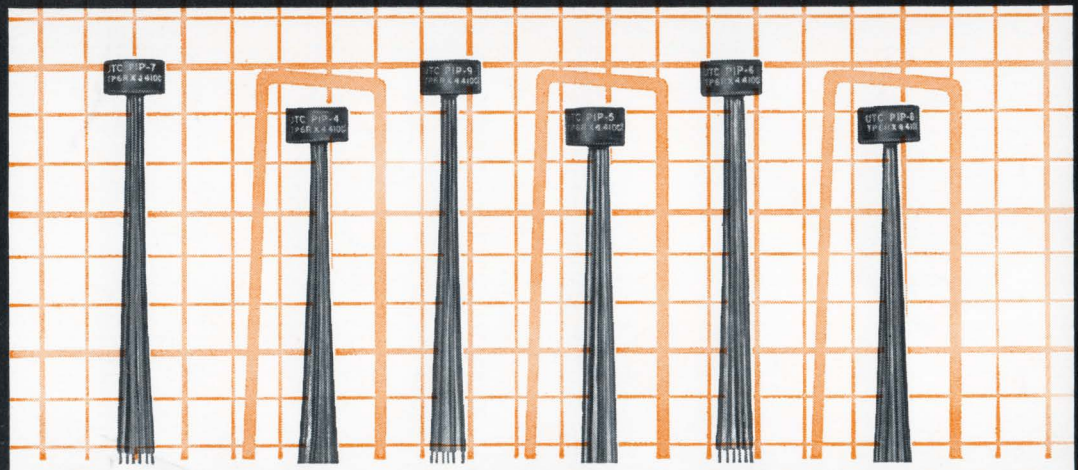

UNITS SHOWN ACTUAL SIZE—IMMEDIATE DELIVERY FROM STOCK

TRANSISTOR TEST CIRCUIT

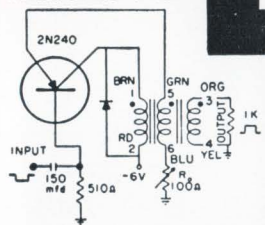

All units individually checked and adjusted, in transistor circuit illustrated, to parameters in table.

DEFINITIONS

Amplitude: Intersection of leading pulse edge with smooth curve approximating top of pulse.
Pulse width: Microseconds between 50% amplitude points on leading and trailing pulse edges.
Rise Time: Microseconds required to increase from 10% to 90% amplitude.
Overshoot: Percentage by which first excursion of pulse exceeds 100% amplitude.
Droop: Percentage reduction from 100% amplitude a specified time after 100% amplitude point.
Backswing: Negative swing after trailing edge as percentage of 100% amplitude.

- **RUGGED—COMPLETELY METAL CASED**
- **Manufactured & Guaranteed to MIL-T-21038B**
- **5/16" Dia. x 3/16" Ht.; Wt. 1/20 oz.**
- **Ratios—4:4:1 and 5:3:1**
- **Anchored leads, withstands 10 lb. pull test**
- **Printed circuit use, plastic insulated leads**
- **Can be suspended by leads or clip mounted**

Type No.	APPROX. DCR, OHMS			BLOCKING OSCILLATOR PULSE					COUPLING CIRCUIT CHARACTERISTICS						
	1-Brn 2-Rd	3-Org 4-Yel	5-Grn 6-Blu	Width μ Sec.	Rise Time	% Over Shoot	Droop %	% Back Swing	P Width μ Sec.	Volt Out	Rise Time	% Over Shoot	Droop %	Back Swing	Imp. in/out*
RATIO 4:4:1 MIL TYPE TP6RX4410CZ															
PIP-1	.18	.20	.07	.05	.02	0	0	37	.05	9	.018	0	0	12	50
PIP-2	.47	.56	.17	.1	.025	0	0	25	.1	8	.02	0	0	5	50
PIP-3	1.01	1.25	.37	.2	.03	2	0	15	.2	7	.035	0	0	5	100
PIP-4	1.5	1.85	.54	.5	.05	0	0	15	.5	7	.06	0	0	0	100
PIP-5	2.45	3.1	.9	1	.08	0	0	14	1	6.8	.15	0	0	5	100
PIP-6	3.0	3.7	1.1	2	.10	0	0	15	2	6.6	.18	0	2	10	100
PIP-7	4.9	6.05	1.8	3	.20	0	0	14	3	6.8	.20	0	2	10	100
PIP-8	8.0	9.7	2.9	5	.30	0	0	3	5	7.9	.22	0	13	25	200
PIP-9	13.1	15.9	4.7	10	.35	0	5	12	10	6.5	.4	0	15	20	200
PIP-100	Transistor pulse transformer kit, consisting of PIP-1 thru PIP-9 in plastic case.														
RATIO 5:3:1 MIL TYPE TP6RX5310CZ															
PIP-10	.55	.41	.15	.1	.01	0	0	20	.1	8	.01	0	0	5	140/50
PIP-11	2.9	2.2	.82	1	.02	4	4	6	1	6.6	.05	0	6	12	280/100
PIP-12	9.4	7.1	2.6	5	.05	0	12	12	5	8	.09	2	12	25	560/200

* Input winding leads Brn-Rd (1-2); output winding leads Org-Yel (3-4); leads Grn-Blu (5-6) open.

**AND CUSTOM BUILT
UNITS TO YOUR SPECS.**

Write for catalog for full details on these and 1000 other stock items



UNITED TRANSFORMER CORP.

150 VARICK STREET, NEW YORK 13, N. Y.

PACIFIC MFG. DIVISION: 3630 EASTHAM DRIVE, CULVER CITY, CALIF.
 EXPORT DIVISION: 13 EAST 40th STREET, NEW YORK 16, N. Y. CABLES: "ARLAB"

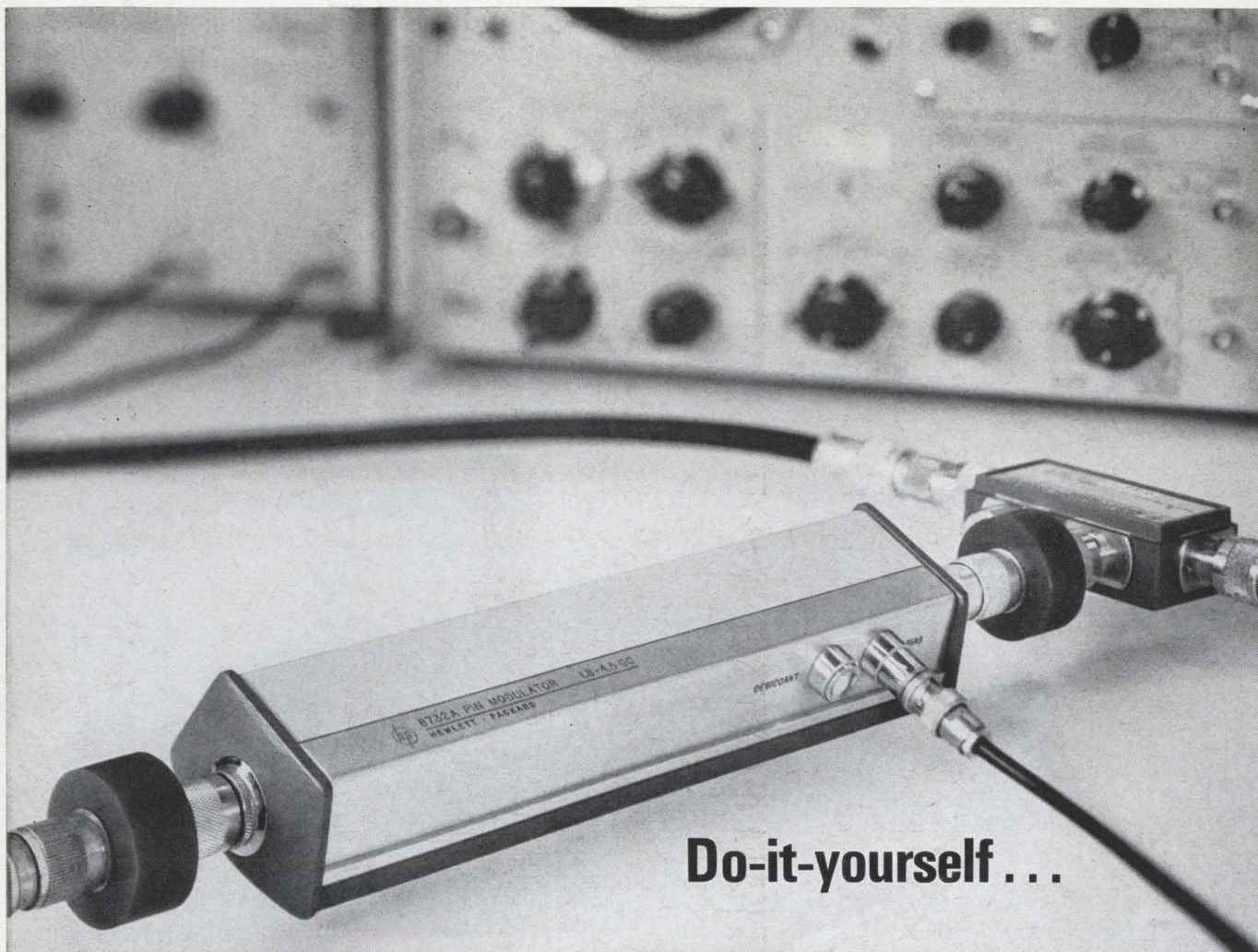

Do-it-yourself . . .

. . . MICROWAVE MODULATION

Flexibility is yours with Hewlett-Packard PIN diode modulators, absorption-type devices that eliminate incidental FM and frequency-pulling, permit leveling, amplitude modulation, noise modulation, pulse modulation, and perform with low jitter and high speed.

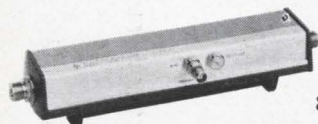

8732A

hp 8730 PIN Modulators: "A" models for 30 db attenuation—for leveling, AM and noise modulation—"B" models for 80 db attenuation—for pulse modulation. Just add them to your system. Constant input and output match from these voltage-controlled devices, whose

PIN diodes absorb rf power, and offer extremely fast rise times, typically 30 nsec. Four overlapping bands, 0.8 to 12.4 gc, plus X-band waveguide models. "A" models \$300, "B" models \$500.



8403A

hp 8403 Modulator: Provides complete control for 8730 Modulators, including appropriate wave shapes and bias levels for fast rise times, rated on/off ratios and AM. Internal square-wave and pulse

modulator, which can be synchronized with external signals, has a free-running prf 50 cps to 50 kc. Adjustable width and delay in pulse modulation mode. External AM input. hp 8403, \$700; add \$50 to have 8730 Modulator installed.

Whether your need is for modulation components or a complete system, this group of Hewlett-Packard products offers the answer. Call your hp field engineer for complete data or write Hewlett-Packard, Palo Alto, California 94304, Telephone (415) 326-7000; Europe: 54 Route des Acacias, Geneva; Canada: 8270 Mayrand Street, Montreal.

*Data subject to change without notice.
Prices f.o.b. factory.*

HEWLETT  **PACKARD**
An extra measure of quality

New Sanborn Tape System

- 7 CHANNELS plus monitoring track**
- 6 ELECTRICAL SPEEDS without capstan change**
- 40 db or better SIGNAL/NOISE RATIO**
- 0.2% P-P FLUTTER**
- IRIG compatibility**

for under \$9,000

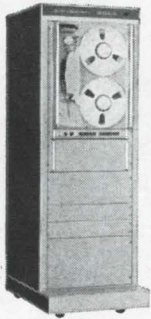

Now you can have precision instrumentation tape system performance at *substantially lower cost than ever before*, with this completely new Sanborn 3900 Series incorporating a specially-designed Hewlett-Packard transport. The primary objective was to provide a highly flexible, reliably useful system with *stable* tape motion, *simple* operation and *no* maintenance — at a significantly *lower cost*. These objectives have

been successfully accomplished, in a system which has:

- Greatly reduced interchannel crosstalk with a new magnetic head assembly design using improved shielding.
- High signal/noise ratio, gentle tape handling and reduced tape wear, through precisely controlled tape tension, driving and braking torques, and guide element designs.
- Plug-in solid-state electronics with record/reproduce amplifiers on the same cards, and equalization plug-ins necessary only for speeds to be used.
- No need for maintenance or lubrication, except for cleaning tape path.
- Built-in footage counter accurate to 99.95%.
- Quick, easy snap-on tape reel loading.
- Cabinet, rack or portable case mounting.

Check the key specifications here, then call your local H-P Field Engineering Office for complete details and prices. Or write Sanborn Company, Industrial Division, 175 Wyman Street, Waltham, Massachusetts 02154.

SERIES 3907A (7-channel), 3914A (14-channel)

SPEEDS	6, electrically controlled, pushbutton selected, 1 7/8 to 60 ips; other speed ranges optional. Max. start 2 sec., max. stop 1 sec.; $\pm 0.25\%$ max. variation in tape speed at nominal line frequency.
TAPE	7-channel 1/2"; 14-channel 1"; 2400 feet 1.5 mil, 3600 feet 1.0 mil; 4800 feet 0.65 mil; 10 1/2" reels.
RECORDING MODES	Direct, FM or Pulse Record/Reproduce via interchangeable solid state plug-in electronics; 7-channels in 7 1/2" panel space. Single-ended inputs, push-pull with optional coupler. Adjustable input/output levels.

Circle 2 on reader service card

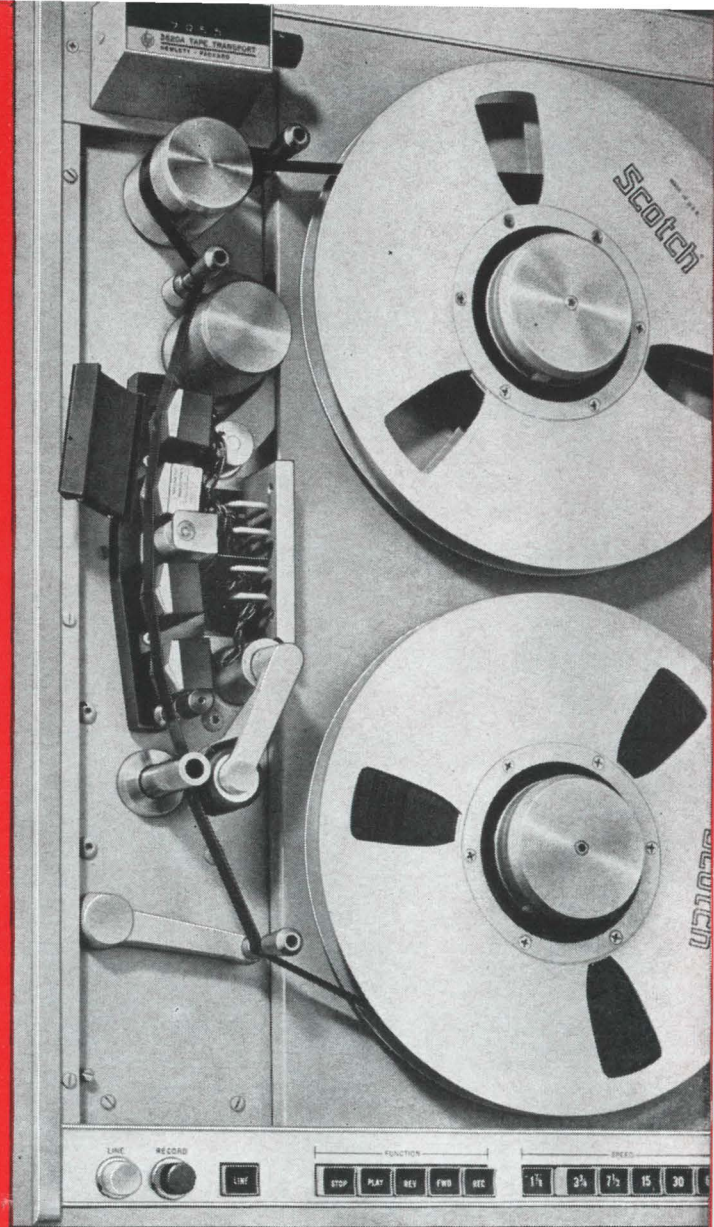

BANDWIDTH	RESPONSE	SIGNAL/NOISE RATIO (RMS)
Direct (60 ips) 100-100,000 cps	≈ 3 db	40 db
FM (60 ips) 0-10,000 cps (Wideband systems available soon — 250 KC direct, 20 KC FM)	$\approx 0, -1$ db	44 db without flutter compensation 48 db with flutter compensation
P-P FLUTTER (30 & 60 ips)	0-1 KC, 0.2% max. 0-5 KC, 0.5% max.	

CONTROLS Power, Stop, Play, Reverse, Fast Forward, Record; all can be remotely controlled

PRICES (f.o.b. Waltham, Mass.) (Systems represent two of many choices available. Prices are correspondingly lower for fewer speed filters, or where direct record/reproduce electronics are specified, and higher when filters for all six speeds are ordered.)

Complete 7-channel system for FM recording and reproducing, with filters for 3 speeds, extra (8th) channel for monitoring, and console cabinet: **\$8900**

Same system, for 14-channels: **\$13,370**

SANBORN 
A DIVISION OF HEWLETT-PACKARD

Electronics

January 11, 1965
Volume 38, Number 1

Page	4	Readers Comment
	8	People
	10	Meetings
	15	Editorial
	17	Electronics Newsletter
	61	Washington Newsletter
	143	New Products
	188	New Books
	190	Technical Abstracts
	198	New Literature

Electronics Review

Page	35	Ion plating	38	Telecast insurance
	36	A brighter view	40	Gamma scale
	36	'Dehired,' not fired	40	Missile detection
	37	Sighting the enemy	40	Tracking down CAT
	37	Radar and relativity	42	Laser's second chance
	38	Sorting space signals		

Electronics Abroad

209	Mapping Liberia	211	Jet-noise monitor
209	Price of apartheid	211	Electronics market
210	Display in 3-D	212	Colorful new year
210	Spy scare		

Probing the News

123	The fight for integrated-circuit markets
126	Millimeter-wave research is back in style
130	Putting zip into mail-sorting

Technical Articles

Space electronics	70	Designing against radiation: Part 2 Selecting components and design techniques for radiation-proof circuits Henning H. Lind Olesen, General Electric Co.
Circuit design	77	Designer's casebook Antenna's reflecting surfaces increase beacon bandwidth; transistor switch passes current both ways
Communications	80	Very low frequency antennas are going back to work Abandoned since the 30's, vlf has new promise for worldwide navigation systems John C. Walter, U.S. Navy
Special report	87	Electronics markets 1965 An analysis of 17 major areas of electronics activity, spotlighting trends in markets, products and engineering L. H. Dulberger and J. A. Strasser
	111	Statistical gatefold Tabulation and graphs of data collected in Electronics annual survey of the industry

Title R registered
U.S. Patent Office;
© copyright 1965
by McGraw-Hill, Inc.
All right reserved,
including the right to
reproduce the contents
of this publication,
in whole or in part.

Electronics

Editor: Lewis H. Young

Senior editors

Technical: Samuel Weber

News: Kemp Anderson, Jr.

Senior associate editors: John F. Mason, George Sideris

Department editors

Advanced technology: George V. Novotny

Avionics: W.J. Evanzia

Circuit design: Michael Elia

Communications: Alexander A. McKenzie

Components: Michael F. Tomaino

Industrial electronics: Louis S. Gomolak

Instrumentation: Carl Moskowitz

Manufacturing: George Sideris

Military electronics: John F. Mason

New products: William P. O'Brien

Solid state: Jerome Eimbinder, G.G. Tirellis

Space electronics: Joel A. Strasser

Staff writer: Leon H. Dulberger

Regional editors

Boston: Thomas Maguire, editor; Robin Carlson

Chicago: Cletus M. Wiley, editor; Leslie Krimston

Los Angeles: William Wallace, editor; June Long

San Francisco: Laurence D. Shergalis, editor; Mary Jo Jadin

London: Derek Barlow, editor

Copy editors

Howard Rausch, Sally Powell, Stanley Zarowin

Graphic design

Art director: Saul Sussman

Assistant art director: John C. Wright, Jr.

Editorial production: Ann Mella

Production editor: Arthur C. Miller

Editorial secretaries: Claire Benell, Mary D'Angelo, Lynn Emery, Kay Fontana, Carolyn Michnowicz, Lorraine Rossi, Lorraine Werner

McGraw-Hill news service

Director: John Wilhelm; Atlanta: Fran Ridgeway; Chicago: Bruce Cross;

Cleveland: Arthur Zimmerman; Dallas: Marvin Reid;

Detroit: Donald MacDonald; Los Angeles: Michael Murphy,

Ron Lovell; San Francisco: Margaret Ralston, Ed. Addeo;

Seattle: Ray Bloomberg; Washington: George Bryant Jr., Glen Bayless, Charles Gardner

McGraw-Hill world news service

Bonn: Richard Mikton; Brussels: Arthur Erikson; London: John Shinn;

Mexico City: Wesley Perry; Milan: Bruce Bendow;

Moscow: Donald Winston; Paris: Dan Smith;

Rio de Janeiro: Leslie Warren; Tokyo: Marvin Petal, Charles Cohen

Circulation manager: Hugh J. Quinn

Reprints: T.M. Egan

Publisher: C.C. Randolph

Electronics: January 11, 1965, Vol. 38, No. 1

Printed at 99 North Broadway, Albany, N.Y.

Second class postage paid at Albany, N.Y.

Subscriptions are solicited only from those actively engaged in the field of the publication. Position and company connection must be indicated on orders. Subscription prices: United States¹ and Possessions and Canada, \$6.00 one year, \$9.00 two years, \$12.00 three years. All other countries \$20.00 one year. Single copies, United States and Possessions and Canada 75¢. Single copies all other countries \$1.50.

Published every other Monday by McGraw-Hill Inc. 330 West 42nd Street, New York, N.Y. 10036. Founder: James H. McGraw, 1860-1948.

Subscribers: The Publisher, upon written request to our New York office from any subscriber, agrees to refund that part of the subscription price applying to copies not yet mailed. Please send change of address notices, subscription orders or complaints to Fulfillment Manager, Electronics, at the address below. Change of address notices should provide old as well as new address, including postal zone number if any. If possible, attach address label from recent issue. Allow one month for change to become effective.

Postmaster: Please send Form 3579 to Fulfillment Manager, Electronics, P.O. Box 430, Hightstown New Jersey 08520

Readers Comment

Nothing new under the sun

To the Editor:

In reading the story "Setting up radar behind enemy lines" [Electronics, Nov. 30, p. 85], one is tempted to cite World War II radars such as SCR 602-T1-T3 as well as the British Ames Type 5 and 6. I wonder if Joseph Enrino [who designed the system at the Air Force's Rome Air Development Center] doesn't get a chuckle out of being associated with similar beasts again! Shades of Pelican Island, circa 1941 and 1942! So what else is new in the field?

R.H. Boutillette

Huntsville, Ala.

Laser photography

To the Editor:

After reading your report on holography in "The little train that wasn't" [Electronics, Nov. 30, p. 86], I became quite interested in the optical technique used to produce the images. At the MIT Stroboscopic Light Laboratory, we have sufficient equipment to duplicate the experiment with pulsed laser equipment, if this can be done.

I would appreciate your giving me the addresses of Professors Stroke and Leith at the University of Michigan and any other workers you know of, considering this problem.

E.R. Schildkraut

Cambridge, Mass.

■ G.W. Strobe and Emmet Leith, who developed the technique, can be reached at the University of Michigan, Physics Department, Ann Arbor, Mich.

Revisions for a robot

To the Editor:

I am most gratified to learn of others who are interested in the prosthetic end of medical electronics. I have been interested in this area for several years, however I have not had much spare time to devote to strictly personal research efforts.

I had planned to build an en-

db db db db \$\$\$\$

FOR MAXIMUM GAIN AT MINIMUM COST...

You can't beat

MADT*

Communications Transistors

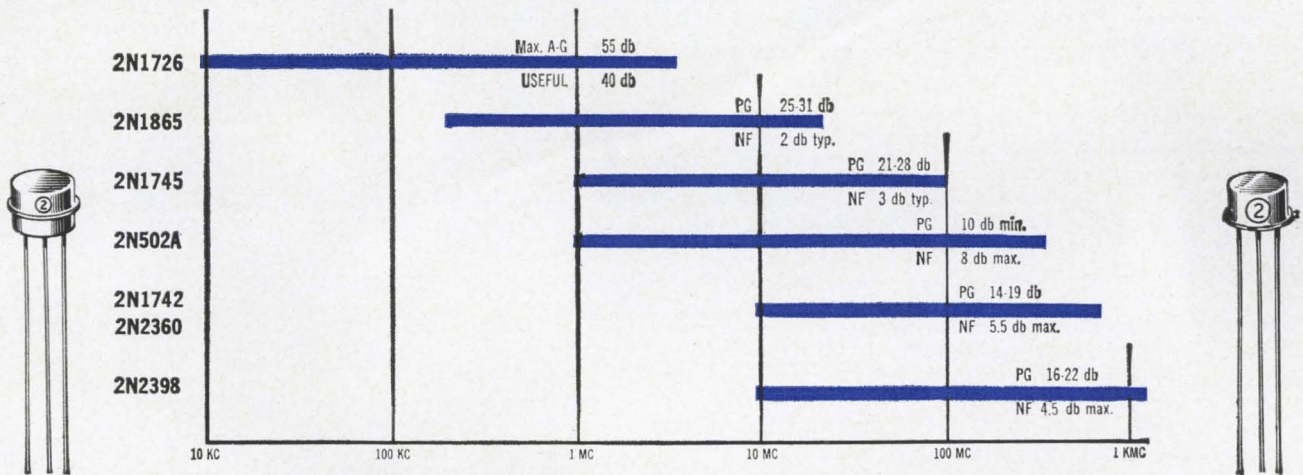

MADT Communications Transistors are proven, in production, and in field service!

For complete information on these and other MADT High-Performance Amplifier Transistors, write to Technical Literature Service, Sprague Electric Co., 35 Marshall St., North Adams, Mass.

*TRADEMARK OF PHILCO CORP.

SPRAGUE COMPONENTS

- | | | |
|-------------------------|------------------------|--------------------------------------|
| TRANSISTORS | PULSE TRANSFORMERS | CERAMIC-BASE PRINTED NETWORKS |
| CAPACITORS | INTERFERENCE FILTERS | PACKAGED COMPONENT ASSEMBLIES |
| RESISTORS | PULSE-FORMING NETWORKS | BOBBIN and TAPE WOUND MAGNETIC CORES |
| INTEGRATED CIRCUITS | TOROIDAL INDUCTORS | SILICON RECTIFIER GATE CONTROLS |
| THIN-FILM MICROCIRCUITS | ELECTRIC WAVE FILTERS | FUNCTIONAL DIGITAL CIRCUITS |



*Sprague' and '2' are registered trademarks of the Sprague Electric Co.

45T-182-03R2

EXTRALYTIC[®]

+125 C

**EXTENDED
TEMPERATURE
RANGE**

**ALUMINUM 'LYTIC
CAPACITORS**

-55 C



- Voltage ratings to 150 vdc, unlike other so-called "wide temperature range" aluminum electrolytics with compromise voltage ratings only to 60 volts.
- Capacitance stability over entire temperature range. Even at -55 C, capacitance drop is very small.
- Operating and shelf life comparable to or better than that of foil tantalum capacitors.
- Less expensive than foil tantalum capacitors, yet meet electrical requirements of proposed military specification MIL-C-39018.
- Smaller and lighter than tantalum capacitors in equivalent capacitance values and voltage ratings.

For complete technical data, write for Engineering Bulletin 3455 to the Technical Literature Service, Sprague Electric Co., 35 Marshall St., North Adams, Mass. 01248

45C-4144



"Sprague" and "®" are registered trademarks of the Sprague Electric Co.

gineer's model of a programmed robot which could walk erect; could feel varying degrees of cold or heat, could react to accoustical stimulations; and could sense pressure changes—actions which are now possible with microcircuitry and transducers.

The robot would be no larger than the average male adult human with most of the mental machinery of the average lower animal.

Its actions would be controlled by muscles, similar to the human counterpart. Its muscles would be tiny, flexible capillary tubes, stretchable laterally, not linearly. For nerves, tiny conductors would connect the expandable fluid within the tubes to differential amplifiers, like dendrites in the body of a neuron.

Two-way inputs were to be used with these amplifiers; one from the sensors in the limbs and other parts of the body and the other from the robot's brain, similar to the afferent and efferent neuron circuits of the human body.

My thoughts on prosthetic limbs were not concerned with the use of computers, other than the analog equivalents such as the effector neurons which are used as the input and output devices of mother nature. However, with the stimulus of Lee Harrison's article ["Paralytic's brain + myocoder = Hope", Electronics, Nov. 30, 1964, p. 74] tickling my reticular formation, I find that my planned receptors (diode ring counters with set thresholds) might better be replaced with the AND, OR and NOR microcircuits of modern technology.

S. Hamilton McNeill
G.E.E., Inc.
Addison, Ill.

Vote for one-man vehicles

To the Editor:
I want to second N.R. Griswold's recommendation for a system of local transportation made of one-person automated vehicles [Electronics Nov. 2, 1964, p. 6].

The idea is not new. I first wrote about it in February, 1958 after turning it over in my mind for some time. About 1960 I heard of two other people who had originated similar ideas independently.

After more than six years of further thought, I still feel that the

individual automated vehicle is the only approach that really offers hope of solving our urban transportation problems.

Henry Bowen Brainerd
Wellesley, Mass.

Faster than fast

To the Editor:
In the story "Supercomputer" [Electronics, Nov. 30, 1964, p. 23], you state Univac is designing a computer "to handle one million instruction a second." It should be noted that Control Data has already delivered the first of the Model 6600 which executes an average of three million instructions per second.

Next you state "if all the 25,000 computers now in existence were placed end to end, they could handle at most five or six million instructions a second." Our figures show that as of November 30 the 23,340 odd computers are in fact executing approximately 446 billion operations per second.

If your figures are correct; $6,000,000/25,000 = 240$ instruction a second, for an average of 4.16 milliseconds per. In fact, most modern computers operate in the 2-20 microsecond range. For example the 320- odd IBM-7090's execute an add in 2.0 to 4.4 microseconds, and that one group of computers alone executes 100 million instructions per second every day.

Walter E. Misdom
Control Data Corp.
Minneapolis

FET switched

To the Editor:
Your listing of the French company SESCO as the manufacturer of a power type FET was in error [Electronics, No. 30, p. 48]. SESCO is the manufacturer of a low-power FET but the high-power unit referred to is the result of a cooperative effort between Forges et Ateliers de Constructions Electriques de Jeumont (France) and Ateliers de Constructions Electriques de Charleroi (Belgium). We represent all three companies in the United States.

Anthony H. Lamb
Atlantic Instruments
and Electronics, Inc.
Boston

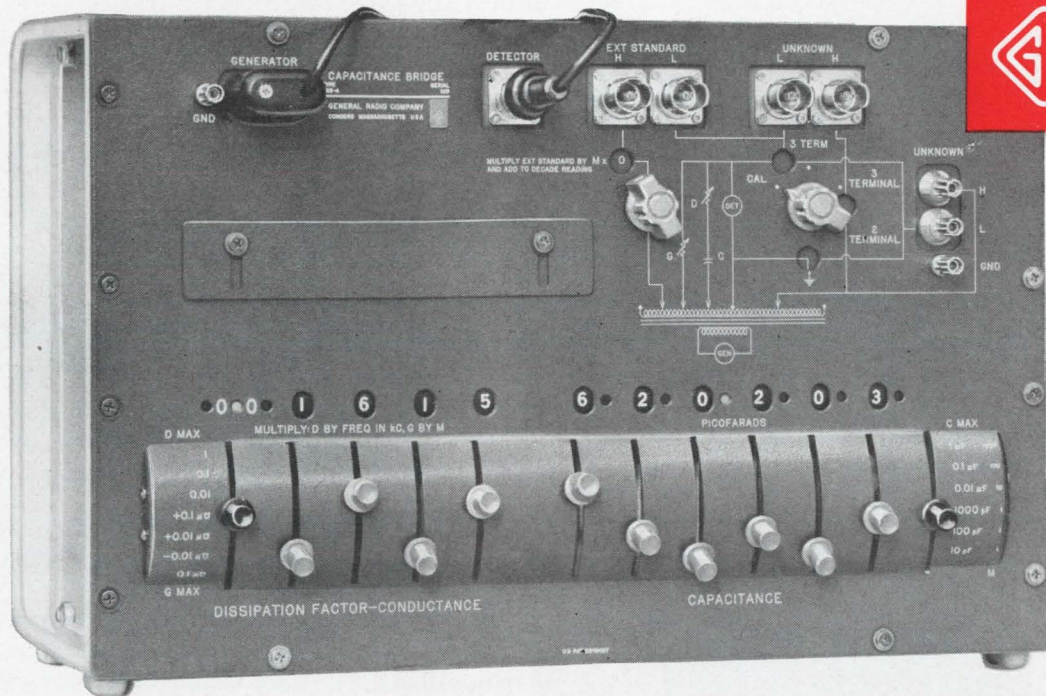

Only One bridge has all these features

Wide Range — Capacitance from 10aF^* to $1.1111\mu\text{F}$; Dissipation Factor from 0.000001 to 1; G from $10^{-6}\mu\text{mho}$ to $100\mu\text{mho}$. C range can be extended to $11.1111\mu\text{F}$ with range-extension capacitor.

High Accuracy — Capacitance $\pm 0.01\%$, better with external standards; D $\pm (0.1\%$ of measured value + 0.00001); G $\pm 1\% + 0.00001\mu\text{mho}$. Accuracy holds over a 100-c to 10-kc range. Useful with reduced accuracy to 100kc/s.

Six-Figure Resolution — Smallest measurable division is 10^{-17} farad. Resolution can be extended to seven figures with external standards.

Easy To Use — Lever balancing controls, digital in-line readout, automatic decimal point location and unit location greatly simplify balancing. Panel engraving automatically indicates proper bridge connections for each measuring situation.

Excellent Stability — All metal parts used in the internal standards are constructed from low-temperature-coefficient Invar alloy to avoid differential stresses and are annealed and temperature-cycled to relieve strains. Plates are all hyperlapped to a tolerance held to better than ± 0.00025 of an inch. The six largest standards are hermetically sealed for life in dry, high-purity nitrogen. The

resulting stability is better than $5\text{ppm}/^\circ\text{C}$ for temperature, and better than $20\text{ppm}/\text{year}$ for aging. D is less than 10ppm at 1kc/s .

2- and 3-Terminal Measurements — The bridge is a transformer ratio-arm type with a guard point and is capable of measuring 3-terminal capacitors in one step without auxiliary balance adjustments.

Practically Checks Itself — All internal standards can be quickly checked against each other for consistency. Only a single external standard is required to establish the absolute calibration of the entire set

Fast — The combination of sensible panel layout, transformer ratio-arm circuitry, three-terminal design, and one-step balancing permits easy, rapid intercomparisons of capacitors differing in value by as much as 1,000 to 1.

Reasonable Price — The Type 1615-A Precision Capacitance Bridge is available for \$1475 (in U.S.A.). The Type 1615-P1 Range-Extension Capacitor for extending measuring range to $10\mu\text{F}$ is \$35.

A Complete Capacitance Measuring Assembly

The Type 1620-A — includes the Type 1615-A Bridge; Type 1232-A Tuned Amplifier and Null Detector, a low-noise high-gain instrument with a 20-c to 20-kc range and a full-scale sensitivity of $1\mu\text{V}$; and the new Type 1311-A Bridge Oscillator, with 11 fixed frequencies from 50c/s to 10kc/s. Price for the complete assembly is \$2090 in U.S.A.

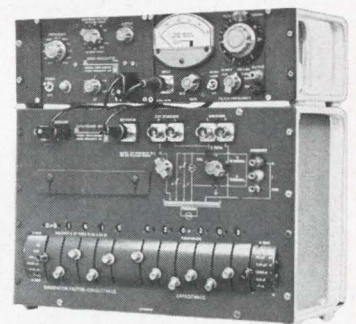

*attofarad = 10^{-18} Farad

IN CANADA: Toronto 247-2171, Montreal (Mt. Royal) 737-3673
IN EUROPE: Zurich, Switzerland — London, England



GENERAL RADIO COMPANY

WEST CONCORD, MASSACHUSETTS

NEW YORK, N. Y., 964-2722
(Ridgefield, N. J.) 943-3140

CHICAGO
(Oak Park) 848-9400

PHILADELPHIA
(Ft. Washington) 646-8030

WASHINGTON, D.C.
(Rockville, Md.) 946-1600

SYRACUSE
454-9323

DALLAS
FL 7-4031

SAN FRANCISCO
(Los Altos) 948-8233

LOS ANGELES
469-6201

ORLANDO, FLA.
425-4671

CLEVELAND
886-0150

WORLD'S HIGHEST POWER TETRODE



The New Vapor-Cooled ML-8545

Another Machlett innovation. The ML-8545 is a general-purpose tetrode capable of 300 kW continuous output as a Class C amplifier or oscillator at frequencies to 50 Mc. Maximum plate input is 420 kW, and is substantially higher during momentary overloads or intermittent operation.

Applications include:

- High-power broadcast and communications
- All-purpose rf generation
- Particle acceleration

For further data on the ML-8545 and the ML-8546, water-cooled version, write: The Machlett Laboratories, Inc., Springdale, Conn. An affiliate of Raytheon Company.



ELECTRON TUBE SPECIALIST

People

William F. Ballhaus, at age 46, made a sharp turn in his career when he became president of Beckman Instruments, Inc., on Jan. 1. He came to Beckman from the Northrop Corp., where he was executive vice president.



Northrop, an aerospace company, had sales in 1963 of \$346.9 million. Beckman, a manufacturer of instruments principally for industry, the medical field and other civilian applications, is much smaller—its 1963 sales totaled \$78.7 million.

Ballhaus succeeds Arnold O. Beckman as president. Beckman, founder of the instrument company in 1935, will remain chairman and chief executive.

Ballhaus, a native of San Francisco, received a doctorate in mathematics and aerodynamics in 1947 from the California Institute of Technology. He is expected to be especially valuable in Beckman's optics group and systems division, both fields in which he has had extensive experience.

John H. Heck considers his new job one of devising "the most precise procurement ever made." The 10 million owners of stock in the Communications Satellite Corp. hope he succeeds, because Heck is Comsat's new manager of procurement.

The 54-year-old executive explains: "Getting equipment to work in the space environment calls for the most exacting workmanship that industry has ever faced. Now add the ingredient of a commercial operation where failures and delays mean a loss of money, and you can see what I mean."

The equipment he talks about is largely electronic.

He warns prospective suppliers that they'll have to gear up for a "reliable, economical performance, on time, with stiff penalties if they don't." Comsat, for its part, will provide precise specifications for industry, Heck adds.

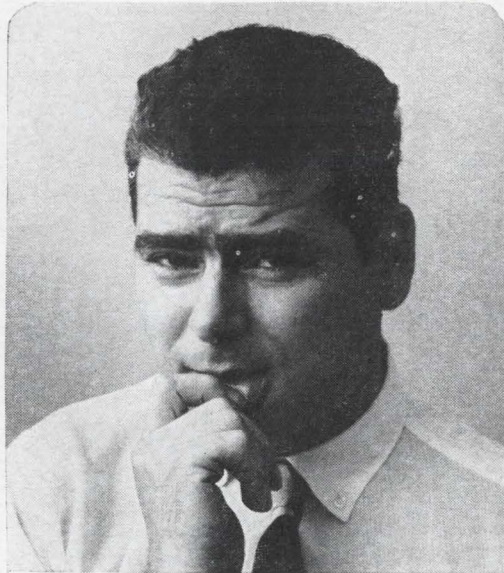

**If Carmine Labriola ever thinks big,
we'll transfer him.**

Carmine is our engineer in charge of reducing transistor package size. One of his latest accomplishments is putting our 3 amp germanium power device into a standard TO-5 case. (You can still get it in stud nut heat sink or hex nut heat sink types, too.)

With the TO-5 case you can save a lot of space in card mounting or any other sort of high density packaging applications. And with the SOAR (Safe Operating Area) specifying technique, you can save a lot of time, trouble and cost selecting the right switching transistor. As long as the unit is operated within the SOAR envelope (according to the specs in the 2N chart) secondary breakdown failure just doesn't happen.

And, if the little package and the SOAR technique interest you, take a look at the ratings. Fast switching time,

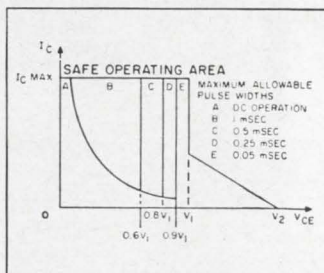

high collector-to-base voltage: V_{CBO} to -100 V; high DC current gain: (h_{FE}) 33 to 200 with $V_{CE} = -0.5$ V, $I_C = -50$ mA; low collector cutoff current: I_{CBO} , -125 μ A maximum; low saturation voltage: $V_{CE(s)}$ = -0.25 V maximum with $I_C = -1$ A, $I_B = -0.1$ A. And on top of all that, eight types are available meeting military specifications, all capable of 12 watt operation at a case temperature of 55°C .

So if you're interested in transistors for audio amplifiers, pulse amplifiers, relay drivers or switching, contact your nearest Bendix Semiconductor sales office. They have complete data on our entire

germanium transistor line. And, if you're interested in saving space in any sort of a transistor application, ask them what Carmine Labriola has been up to lately. It won't be anything very big.

TYPE NO.	I_C A	V_1 V	V_2 V
2N1038,-1,-2	3	30	60
2N1039,-1,-2	3	40	70
2N1040,-1,-2	3	50	80
2N1041,-1,-2	3	60	90
2N1042,-1,-2	3.5	30	60
2N1043,-1,-2	3.5	40	70
2N1044,-1,-2	3.5	50	80
2N1045,-1,-2	3.5	60	90
2N2552	3	30	60
2N2555	3	60	90
2N2559	3	60	90
2N2563	3.5	60	90
2N2567	3.5	60	90

Bendix Semiconductor Division
HOLMDEL, NEW JERSEY



Baltimore (Towson), Md.—(301) 828-6877; Chicago—(312) 637-6929; Dallas—(214) 357-1972; Detroit—(313) Jordan 6-1420; Holmdel, N. J.—(201) 747-5400; Los Angeles—(213) 776-4100; Miami Springs, Fla.—(305) 887-5521; Minneapolis—(612) 926-4633; San Carlos, Calif.—(415) LYtell 3-7845; Syracuse, N. Y.—(315) 474-7531; Waltham, Mass.—(617) 899-0770; Export—(212) 973-2121, Cable: "Bendixint," 605 Third Avenue, New York; Ottawa, Ont.—Computing Devices of Canada, P.O. Box 508—(613) TALbot 8-2711.

Obviously from Sprague!

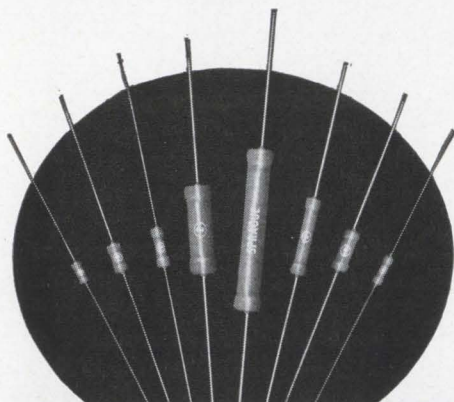

ACRASIL®

**... the precision/power
wirewound resistor
with more
PLUS features!**

Silicone Encapsulated—Seals resistance element. Provides exceptional protection against severe environmental conditions as well as physical damage.

Wide Application—Standard and non-inductive windings. Equally suited for printed wiring boards, custom packaging, and point-to-point wiring.

Close Resistance Tolerances—Standard tolerances to $\pm 0.05\%$.

Wide Range of Ratings— $\frac{1}{4}$ watt to 10 watts. Resistance values from $.05\Omega$ to $66K\Omega$.

Minified Sizes—Smaller than other conventional wirewound resistors.

Excellent Stability—Under extended load life and environmental operating parameters, Acrasil Resistors show exceptionally small change in resistance values.

Outstanding Reliability—Fully meet electrical performance requirements of MIL-R-26C, as well as individual customer high reliability specifications.

For complete technical data, write for Engineering Bulletin 7450 to Technical Literature Service, Sprague Electric Company, 35 Marshall St., North Adams, Mass.

SPRAGUE®
THE MARK OF RELIABILITY

® 'Sprague' and '®' are registered trademarks of the Sprague Electric Co.
45 R-185-63

Meetings

Reliability and Quality Control National Symposium, ASQC, IEEE, IES, SNT; Hotel Fontainebleau, Miami Beach, Jan. 12-14.

NSPE Winter Professional Meeting, National Society of Professional Engineers; Jung Hotel, New Orleans, La., Jan. 20-23.

Fundamental Phenomena in the Material Sciences Annual Symposium, Ilikon Corp.; Sheraton Plaza Hotel, Boston, Jan. 25-26.

Integrated Circuits Seminar, IEEE; Stevens Institute of Technology, Hoboken, N.J., Jan. 28.

Northwestern University Science Symposium, NU; Pick-Congress Hotel and Thorne Hall of Northwestern University, Chicago, Jan. 28-29.

Winter Power Meeting, PEEC/IEEE; Statler-Hilton Hotel, New York, Jan. 31-Feb. 5.

Institute on Information Storage and Retrieval, The American University; Willard Hotel, Washington, Feb. 1-4.

On-Line Computing Systems Symposium, UCLA Extension Service, Informatics, Inc.; University of California Los Angeles, Feb. 2-4.

Winter Convention on Military Electronics, PTGMIL & L.A. Section of IEEE; Ambassador Hotel, Los Angeles, Feb. 3-5.

Electrical/Electronic Trade Show, Electrical Representatives Club, Electronic Representatives Assn.; Denver Auditorium Arena, Denver, Feb. 15-17.

Solid-State Circuits International Conference, University of Pennsylvania, IEEE; University of Pennsylvania and Sheraton Hotel, Philadelphia, Feb. 17-19.

Annual West Coast Reliability Symposium, ASQC, UCLA; Moore Hall, University of California Los Angeles, Feb. 20.

Particle Accelerator Conference, AIP, NSG/IEEE, NBS, USAEC; Shoreham Hotel, Washington, Mar. 10-12.

ISA National Conference on Instrumentation for the Iron and Steel Industry, ISA; Pick-Roosevelt Hotel, Pittsburgh, Mar. 17-19.

Management Conference on Operations Research, Systems Engineering and Electronic Data Processing, University of Pennsylvania, Philadelphia, Mar. 17-19.

IEEE International Convention, IEEE; N.Y. Coliseum and New York Hilton

Hotel, New York, Mar. 22-25.

Society of Motion Picture and Television Engineers Semiannual Conference and Exhibit, SMPTE; Ambassador Hotel, Los Angeles, Mar. 28-Apr. 2.

Electron Beam Annual Symposium, Pennsylvania State University, Alloyd Corp.; Pennsylvania State University, University Park, Pa., Mar. 31-Apr. 2.

Electronic Parts Distributors Show, Electronic Industry Show Corp., New York Hilton and Americana Hotels, New York, Mar. 31-Apr. 4.

National Packaging Exposition, AMA; McCormick Place, Chicago, Apr. 5-8.

Cleveland Electronics Conference, Cleveland Electronics Conference, Inc., IEEE, ISA, CPS, Western Reserve University, Case Institute of Technology; Cleveland Public Auditorium, Cleveland, Apr. 6-8.

Conference on Impact of Batch-Fabrication on Future Computers, PGEC/IEEE; Thunderbird Hotel, Los Angeles, Apr. 6-8.

IEEE Region 3 Meeting, Robert E. Lee Hotel, Winston-Salem, N.C., Apr. 7-9.

Electronic Components International Exhibition, FNIE, SDSA, Parc des Expositions (Fair Grounds), Paris, Apr. 8-13.

IEEE Region 6 Annual Conference, Nuclear Rocket Development Station, Development Station, Las Vegas, Apr. 13-15.

Telemetry National Conference, AIAA, IEEE, ISA; Shamrock-Hilton Hotel, Houston, Tex., Apr. 13-15.

Electronics Instrumentation Conference and Exhibit, IEEE, ISA; Cincinnati Gardens, Cincinnati, Apr. 14-15.

Call for papers

Opto-Electronic Components and Devices Symposium, AGARD; Paris, Sept. 6-9. Feb. 1 is deadline for submitting abstracts to Daniel Coulmy, DRME, 7 rue de la Chaise, Paris, 7, France. Papers are invited on devices having electronic input and output but using photons in an intermediate stage; or on components in which the electrooptical transformation or the optical processing occurs.

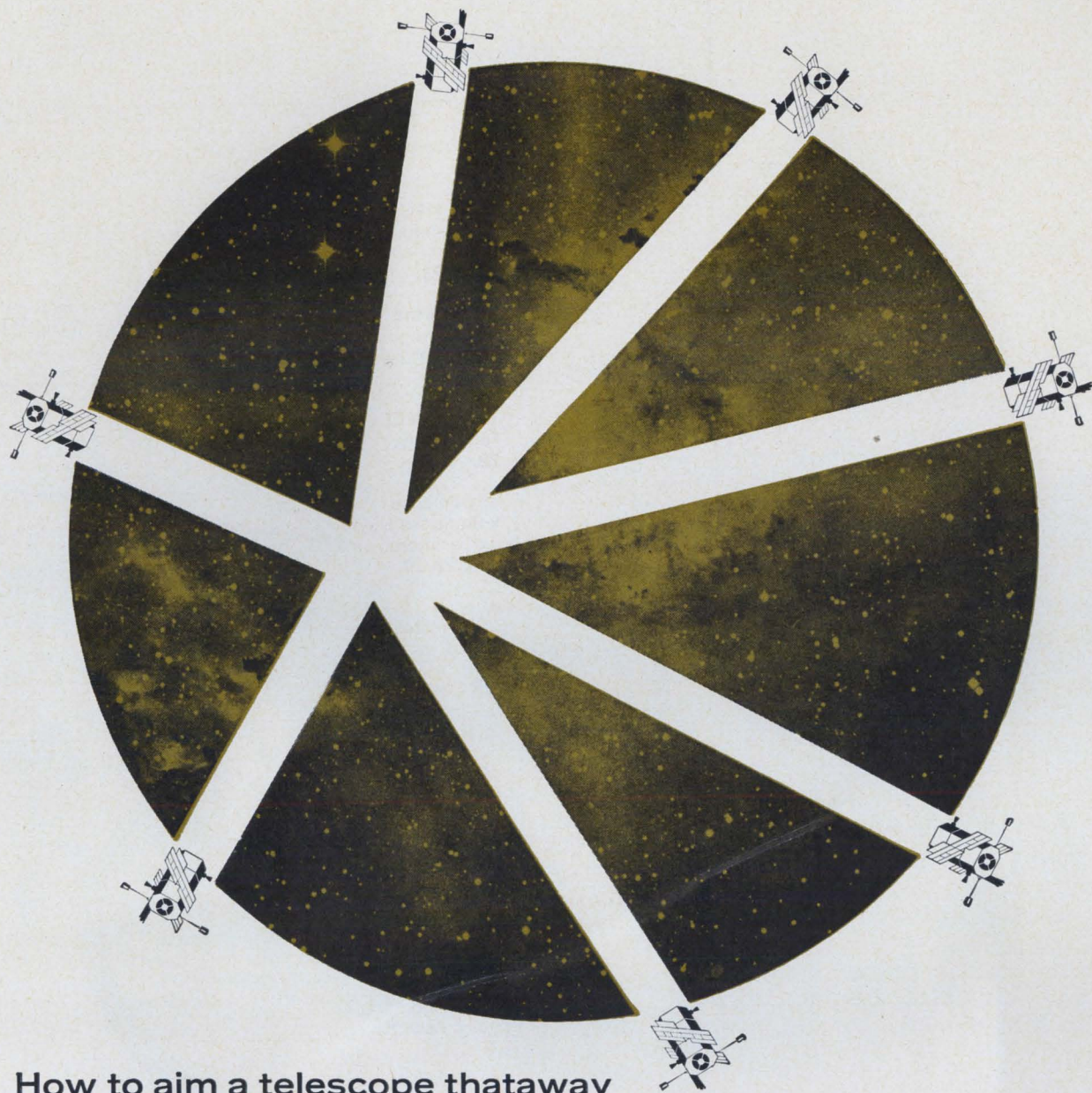

How to aim a telescope thataway when it's **23,000 miles in space**

... that was the astronomers' eventual problem. Plans call for placing a 3600-pound, 38-inch astronomical telescope in stable orbit in 1965. However, the first step in the solution was to design and build a system which could prove the feasibility of remote control for an earth-bound astronomical telescope. The difficulties of aiming a telescope at a distant star and holding this star in view as the earth rotates, are rather like hitting a rolling penny 20 miles away with a rifle bullet. Astrodata built a control system for the astronomers. The system uses computer-control techniques to acquire 30 channels of analog information from the telescope and transmits information received on various experiments, as

they are conducted, to an on-line computer. This computer serves as a stenographer and edits and records the desired data. Certain critical engineering functions (voltages, frequencies, etc.) are also monitored and transmitted to the computer for comparison with their acceptable limits.

Perhaps you don't have an orbiting telescope to control, but you do have other problems in the data acquisition and processing, telemetry, or range timing instrumentation fields where Astrodata's vast experience in dynamic information handling and hybrid computer techniques can help you. Write for your free copy of our 20-page brochure "Astrodata's Systems Experience".



ASTRODATA

P.O. Box 3003 • 240 E. Palais Road, Anaheim, California • 92803

Weston Model 1420



Performance / price breakthrough!

- $\pm 0.05\%$ dc accuracy
- SIX ranges... $\pm 20\text{mv}$ to $\pm 1000\text{v}$
- Input impedance up to 5000 megohms
- Common mode rejection $> 150\text{ db}$
- Price: only \$1500.00

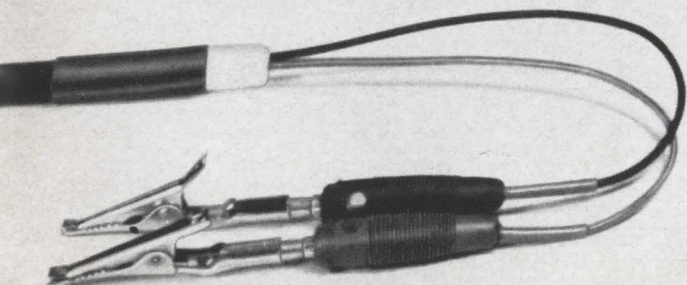

Another outstanding product from the leader in measurement and display

Range	Input Impedance	Basic Sensitivity*
0—20mv	>50 megohms	10 μ v
0—200mv	>500 megohms	100 μ v
0—2v	>5000 megohms	1mv
0—20v	10 megohms	10mv
0—200v	10 megohms	100mv
0—1000v	10 megohms	1v

*Sensitivity on all ranges can be improved by 2 or 4 by increasing counting time. On 20mv range, for example, sensitivity can be increased to 5 μ v or to 2.5 μ v.

The PERFORMANCE of the Weston Model 1420 meets industry's need for accuracy, sensitivity, and noise rejection at a BREAKTHROUGH PRICE.

Accuracy: $\pm 0.05\%$ of range or ± 1 digit.

Common Mode Rejection: Isolated-guarded "box within a box" construction provides excellent CMRR even with considerable unbalance of input leads.

150 db @ dc } with 5000 Ω
130 db @ 60 ~ } unbalance

Series Mode Rejection: Count times are multiples of 60 cycle period, thus, giving excellent 60db rejection to powerline noise. Rejection to higher frequencies is also realized through integration of signal.

Solid State: All solid-state components except Nixie* readouts. Printed circuit boards are hinged to provide easy access without use of extender boards.

Automatic Polarity: The polarity of the input is sensed and automatically displayed.

Operating Modes: Automatic or Manual-Remote. Automatic mode: voltage is sampled and averaged 40 times/sec. In manual mode, sampling occurs with front-panel push button or by remote switch closure or by pulse.

Calibration: An internal Weston standard cell is built-in for quick "on-the-spot" calibration.

Printer Output: BCD printer output

also available at slight addition in price.

Mechanical Construction: Light weight—easily portable with combination carrying handle and tilting support. Available also in rack-mounting case. Size of bench unit 6 $\frac{1}{2}$ " h x 14 $\frac{1}{2}$ " w x 16 $\frac{1}{4}$ " d. Rack mounting size 5 $\frac{1}{4}$ " h.

Applications: Ideal for laboratory, production testing or data logging. Excellent sensitivity makes Model 1420 perfect for direct readout from low-level transducers.

This Performance/Price Breakthrough invites action. Call your nearest Weston office or write our headquarters for complete details and/or demonstration. Price is f.o.b. plant. *T.M.—Burroughs Corp.

New Integrating Digital Voltmeter

QUALITY BY DESIGN



WESTON INSTRUMENTS, INC.

614 Frelinghuysen Avenue, Newark, New Jersey 07114

FREE!



Win this amplifier...



by thinking up a new way to use this one.*

Two winners! If you can suggest a unique or economical application for Fairchild's versatile $\mu A702$ integrated operational amplifier, you may win a superb SCOTT all-transistor stereo tuner-amplifier* shown above. Fairchild will award *two* of these stereo systems, one prize each for:

- (1) the most unusual or original application for the $\mu A702$
- (2) the $\mu A702$ application that results in the greatest reduction in system cost.

To enter, simply send us a brief description of your application, including schematic, performance characteristics, and advantages of using the $\mu A702$. The box at right contains brief specifications for the Fairchild $\mu A702$. If you need more details, write for the data sheet and application note, or contact the nearest Fairchild outlet.

To help spur your thinking, here are a few examples of how the $\mu A702$ has been used: dc instrumentation amplifier, video amplifier, level discriminator, and peak-to-peak detector. Your application may be in any field—space/defense, commercial/industrial.

*SCOTT Model 344 uses Fairchild silicon Planar transistors. The system, complete with 2 SCOTT S-5 speakers, retails for \$549.85.

* $\mu A702$ OPERATIONAL AMPLIFIER INTEGRATED CIRCUIT

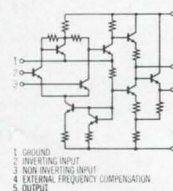

- Low input offset voltage: 2mV
- Low Thermal Drift: $5\mu V/^{\circ}C$
- High voltage gain: 2800
- Large Output Swing: $\pm 5.5V$
- Operation over a wide range of supply voltages

Mail your entry before Feb. 15, 1965, to "Contest," Fairchild Semiconductor, Box 880-C, Mountain View, California. The two winners will be picked by a committee of Fairchild applications engineers, and announced in a future Fairchild advertisement. Fairchild reserves the right to retain and publish any circuit design submitted (with appropriate credits, of course).

FAIRCHILD

SEMICONDUCTOR

FRANCHISED DISTRIBUTORS

AVNET Chicago, Ill., 678-8160; Toronto, Canada, 789-2621 • BOHMAN Orlando, Fla., 425-8611 • CRAMER ELECTRONICS Newton, Mass., WO 9-7700; Hamden, Conn., 288-7771 • CRESCENT ELECTRONIC SALES Orlando, Fla., 423-8586 • DART SALES Syracuse, N.Y., GL 4-9257; Buffalo, N.Y., 684-6250 • DENNY-HAMILTON San Diego, Cal., 279-2421 • DURBIN-HAMILTON St. Louis, Mo., 966-3003 • EASTERN SEMICONDUCTOR Syracuse, N.Y., 454-9247 • E. C. ELECTRONIC SALES Minneapolis, Minn., 888-0102 • HAMILTON Phoenix, Ariz., 272-2601; Los Angeles, Cal., 870-0236; Palo Alto, Cal., 321-7541; Seattle, Wash., 282-3836 • HYER Denver, Colo., 771-5285; Albuquerque, N. Mex., 268-6744; Salt Lake City, Utah, 322-5849 • MARSHALL Phoenix, Ariz., 946-4276; San Marino, Cal., MU 1-3292; San Diego, Cal., BR 8-6350; Redwood City, Cal., EM 6-8214 • NORVELL Dallas, Tex., FL 7-6451; Houston, Tex., MO 5-0558 • POWELL Beltsville, Md., 474-1030; Philadelphia, Pa., 724-1900 • SCHLEY Watertown, Mass., WA 6-0235 • SCHWEBER Westbury, L.I., N.Y., ED 4-7474; Huntsville, Ala., 539-2473 • SEMICONDUCTOR SPECIALISTS Chicago, Ill., 622-8860; Minneapolis, Minn., UN 6-3435; Dearborn, Mich., LU 4-5901 • SHERIDAN Cincinnati, Ohio, 761-5432; Detroit, Mich., 353-3822 • SOLID STATE Chicago, Ill., 889-8033 • SUMMIT DISTRIBUTORS Buffalo, N.Y., 884-3450 • TAYLOR Baldwin, L.I., N.Y., 223-8000 • VALLEY Winter Park, Fla., 647-1216; Baltimore, Md., NO 8-4900; Cherry Hill, N.J., NO 2-9337.

FACTORY SALES OFFICES

HUNTSVILLE, ALA. 536-4428, 4429 • PHOENIX, ARIZ. 946-6583 • LOS ANGELES, CAL. HO 6-8393 • PALO ALTO, CAL. 321-8780 • DENVER, COLO. 761-1735 • ORLANDO, FLA. CH 1-2596 • CHICAGO, ILL. VI 8-5985 • COLLEGE PARK, MD. 779-6868 • BEDFORD, MASS. 275-8450 • MINNEAPOLIS, MINN. UN 6-3301 • ENDWELL, N.Y. 754-2600 • JERICHO, L.I., N.Y. ED 4-8500 • POUGHKEEPSIE, N.Y. 454-7320 • SYRACUSE, N.Y. GR 2-3391 • DAYTON, OHIO 228-1111 • JENKINTOWN, PENN. TU 6-6623 • DALLAS, TEXAS FI 2-9523 • SEATTLE, WASH. AT 2-5344 • CANADA OFFICE: TORONTO, ONTARIO 782-9230.

PLANAR A PATENTED FAIRCHILD PROCESS

FAIRCHILD SEMICONDUCTOR/A DIVISION OF FAIRCHILD CAMERA AND INSTRUMENT CORPORATION/313 FAIRCHILD DR., MOUNTAIN VIEW, CALIF./962-5011/TWX: 910-379-6435

Editorial

Engineer's changing outlook

For the electronics industry, 1965 looks like a good year with sales up 2% to \$17.7 billion despite a continued cutback in military spending [see pp. 87 to 110]. For the individual engineer it's going to be a year fraught with difficulties but sweetened with opportunity for those who know where to look.

Behind the figures is a story of big change in the industry, a change that is radically modifying the engineer's role.

We think the surplus of engineers will continue this year; in fact, unemployment may even get a little worse before it improves. Still, to those engineers unaffected by layoffs, the change in their responsibilities has already started. And the shape of jobs to come—5 and 10 years from now—figures to depart even more radically from the familiar pattern of the late 1950's and early 1960's.

Nowhere is the engineer's role changing faster than in military electronics, still the biggest part of the industry. He can no longer be as interested in pushing the frontier of technology, because the Defense Department is buying more and more off-the-shelf equipment for aircraft and communications.

Cost-consciousness has suddenly forced the engineer in defense work to modify grandiose plans. The day is ending when "defense-industry profits tend to be maximized by maximizing allowable costs," as the Denver Research Institute declared in a recent report. Now the Pentagon is demanding economy with an insistence that would do credit to a buyer at the cost-conscious General Motors Corp.

Engineers on military projects have to learn to think in terms of flexible products that might be used in many applications, rather than a single system designed for a unique operation.

More momentous is the change resulting from the widespread acceptance of microelectronics.

In 1965 for the first time, civilian applications will represent a bigger market than the military for the tiny circuits. In most applications, the reason for the switch is economy. And it is not just a saving of components. Microelectronic circuitry lends itself to automation of manufacture and engineering.

As microcircuits become more common, the design engineer becomes less important and the draftsman is nearly eliminated. In fact, circuit design becomes almost automatic because economy often demands the choice of standard circuits. The big problems become organization of the system and subsystem—putting the off-the-shelf circuits together—also interconnecting and packaging them.

Fortunately for many electronics engineers, these changes are taking place while the industry is enjoying relative prosperity. But there is no guarantee that these good times will last. Now is the time for the engineer to get his personal technological house in order. The scope of his job is growing, and he must increase the breadth of his knowledge.

The alternative is obsolescence.



THIS SENSITIVE RELAY REPLACES COSTLY TRANSISTORS

You can operate this inexpensive relay using low cost, low power transistors. As little as 20 milliwatts of power per movable arm will effect switching. This combination—relays and solid state devices—often results in substantial savings when our ML is used in place of costly power transistors. The ML is especially suited for battery powered equipment.

You can specify up to 18 springs (9 per stack) for multi-pole switching. Single lot prices for standard ML relays range from only \$6.05 (DPDT) to \$8.60 (6PDT). Ask your P&B representative or write us for complete engineering data.

STANDARD P&B RELAYS ARE AVAILABLE AT LEADING ELECTRONIC PARTS DISTRIBUTORS



POTTER & BRUMFIELD

Division of American Machine & Foundry Company, Princeton, Indiana
In Canada: Potter & Brumfield, Division of AMF Canada Ltd., Guelph, Ont.

ML SERIES SPECIFICATION HIGHLIGHTS

Pull-In:

Current: 20 mw min. @ 25°C.
Voltage: 75% or less of nom. DC voltage @ 25°C.

Contacts:

3 amps @ 115VAC, 60 cycles resistive at nominal power. Other ratings available with additional coil power.

Power:

20 milliwatts per movable min., 3 watts max. @ 25°C.

Voltage:

To 110V DC.

Resistance:

33,000 ohms max.

Dimensions:

1³¹/₃₂ x 2⁵/₃₂ x 1⁹/₁₆ (6 Form C).

Electronics Newsletter

January 11, 1965

More competition due in transistors?

Texas Instruments, Inc., has begun selling transistors that are packaged in plastic and are made in the unique germanium planar configuration reported early last year [Electronics, April 6, 1964, p. 62]. The prices, 25 to 35 cents each in production quantities, are aimed directly at the commercial market. The first eight transistor lines in the new series are for radio and television.

TI's transistors are competitive with plastic-cased, silicon planar transistors offered by other producers. The General Electric Co., which had a virtual corner on the plastic-cased transistor market for two years, has more than 50 types that are priced as low as 22 cents in lots of 10,000. The Fairchild Semiconductor division of the Fairchild Camera & Instrument Corp. has been cutting into GE's business with a line of silicon planar transistors costing as little as 28 cents in lots of 1,000.

A Fairchild executive says it makes sense to produce industrial transistors on special lines and to take advantage of the savings made possible by the less rigid specifications required by consumer-industrial customers.

GE says it has sold more than two million plastic-cased units. One Fairchild device, a pnp replacement for the 2N404, is in short supply and production is being adjusted to meet the demand. Even the military is buying some plastic units.

Pentagon drafts Syncom II and III

The military is taking over full control of Syncom II and III from the National Aeronautics and Space Administration. The move may provide a big boost to the Hughes Aircraft Co., which developed the communication satellites.

The military, plagued with poor communications between Washington and South Vietnam, has been using the twin satellites as an emergency radio link. The space agency has about completed its series of tests with the satellites.

The transfer will be completed April 1. In the meantime, the Navy will conduct tests with the satellites. The guided-missile cruiser Canberra is being fitted with electronic equipment for the tests. Additional gear will be supplied by Hughes.

In mid-February, Syncom II will be shifted from its orbit over the Pacific to one over the Indian Ocean.

Electronic voting is election winner

Despite sabotaged pens, human errors and other problems, electronic voting machines [Electronics, Nov. 2, p. 24] seem to have passed the tests of the November elections. Late in December a manual recount in Contra Costa County, Calif., indicated a net change of only 11 votes in ballots counted by the Coleman Engineering Co's Vote Tally system. Election officials accepted the Coleman count as official.

Orange County supervisors in December approved the lease-purchase of two units that were used on Nov. 3. The only problem encountered was the sabotage of pens used to mark the ballots.

Two Coleman units have also been purchased by Hamilton County, Ohio. Coleman officials say six other counties in the Midwest are con-

Electronics Newsletter

sidering purchase of the \$850,000 system.

Other systems reporting successful tests included the Votronics manufactured by the Cubic Corp., the Votomatic made by Harris Votomatic, Inc., the Vote Master by the Cybernetics General Co. and the Coyle by the Coyle Voting Machine Co.

Companies reported that some changes are being made. George Tweed Jr., corporate director of engineering at the Cubic Corp., said, "The difficulties were primarily with people not following instructions. The action we are taking is to reduce the human participation as much as possible."

Higher Telpak rates ordered

Customers of the Bell System's bulk communication package face paying higher rates for the service.

The Federal Communications Commission has ordered the American Telephone & Telegraph Corp. to raise its prices for Telpak's Class A (12 circuits) and B (24 circuits) and to come up with more cost figures to support its rates for Class C (60 circuits) and D (240 circuits). AT&T has until September to file new tariffs.

AT&T is expected to ask the agency to reconsider its decision; meanwhile, some Telpak users may file to alter the FCC's ruling. And the General Services Administration, a major user, may try to pressure the FCC to reconsider.

FET's may enter consumer market

Field-effect transistors may soon be breaking into the consumer market.

Crystalonics, Inc., is about ready to announce two junction FET lines that are designed to interest manufacturers of radio, television and high-fidelity sets. One of these transistor lines will be called gigafets; the units are designed for high-frequency applications and will carry ratings of as high as two watts. Military and industrial gigafets will also be available. The second line will consist of a low-power FET's.

The General Instrument Corp. will offer a metal-oxide-semiconductor FET line specifically designed for the consumer market. The company also is bringing out a line of monolithic integrated circuits for the consumer market.

Major market for avionics

The super-size jetliner proposed for the military is expected to open an avionics market estimated at \$100 million to \$200 million. And if the commercial airlines decide to buy the craft, the sales figure could more than double. The plane would be able to carry 600 to 700 troops.

The Air Force expects to spend \$750 million for development and an additional \$1 billion to purchase 58 of the subsonic C-5A's.

In addition to standard navigational gear, the C-5A will carry inertial and doppler systems and terrain-avoidance radar for low flying. An all-weather landing system is expected to be standard equipment.

California contract to Aerojet-General

Aerojet-General Corp. has won the first of four study contracts that California plans to award to aerospace companies in a move to tackle down-to-earth problems. The company, a subsidiary of the General Tire & Rubber Co., received a \$100,000 contract to apply its engineering and systems development techniques to a long-range plan for disposing of industrial and human wastes.



American Phenolic Company



THE GEORGE W. BORG CORPORATION

BORG EQUIPMENT DIVISION

AMPHENOL-BORG ELECTRONICS CORPORATION



RF PRODUCTS,

AMPHENOL WESTERN CONNECTOR DIVISION



BORG ELECTRONICS

A Division of Amphenol-Borg

All these great component names are now one



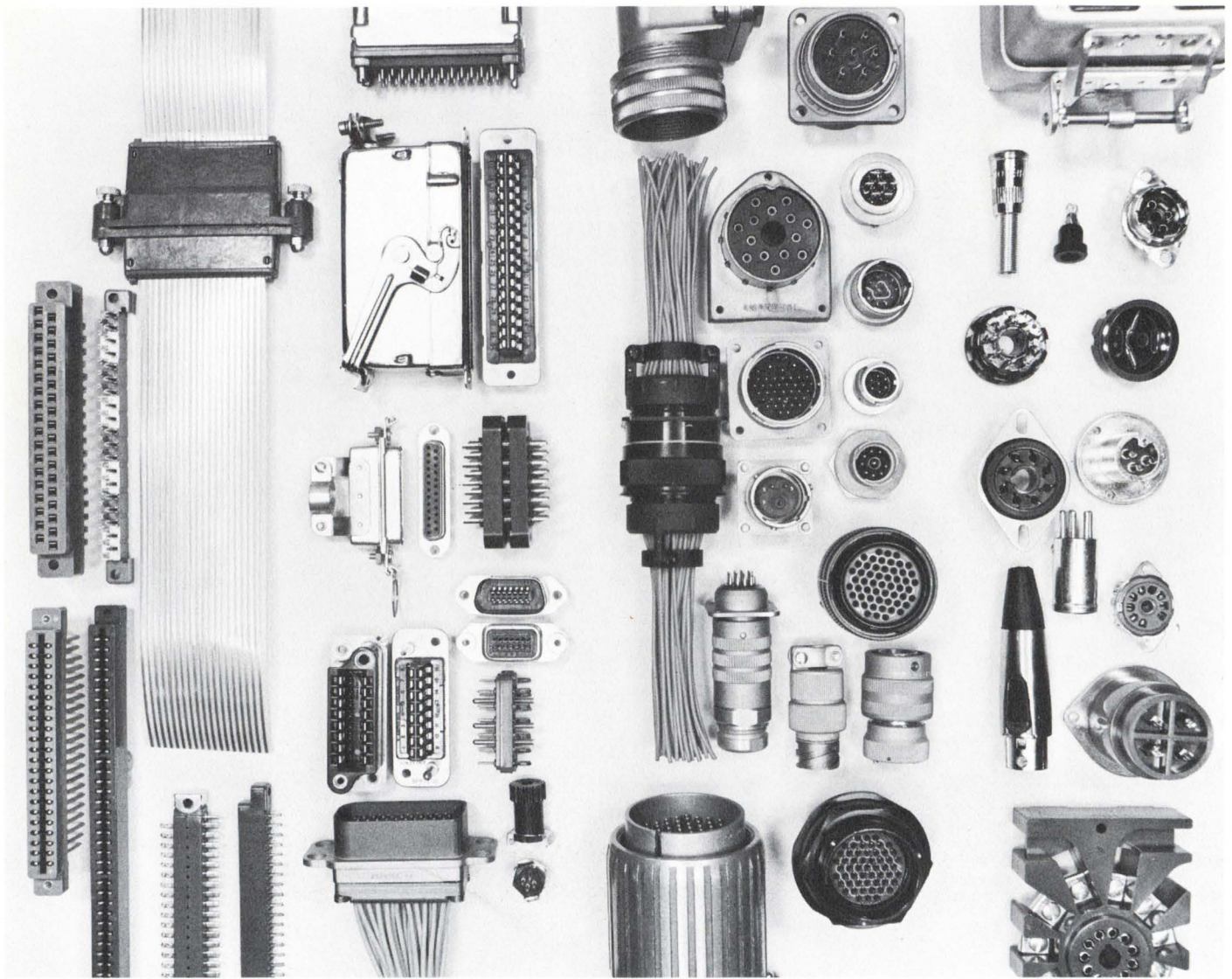

Printed circuit connectors, including new "Flex-1" flat cable connector

Rack-and-Panel connectors, including famous "Blue Ribbon"

MIL-Spec, AN/MS, and hermetically sealed connectors

Commercial plugs, sockets, receptacles, radio & tv components

Amphenol CONNECTOR DIVISION

Now you see just one man

You assign responsibility to one man . . . from Amphenol.

Your nearby Amphenol man can give you complete specs, quantity discounts, and performance data on any connector you see here.

Printed circuits? He can show you dozens of PC connector types. And our new "Flex-1" flat cable connector that will let your production people weld 1,000 contacts an hour!

Reliability is designed into Amphenol

rack-and-panel connectors. One example: 10,000,000 Blue Ribbon connectors have been used without a single reported failure. Our new 217 Series environmental model is the ultimate in ram-home reliability.

Amphenol *military* connectors can be found at almost every USAF, USN, Army, and NASA installation. Reliability is one of the key reasons. (Field data shows a failure rate of only 0.048/million hours on jet aircraft.)

Commercial electronics is big business at Amphenol. We make—and over 500 distributors carry on their shelves—just about every commercially used plug, socket, jack, microphone and circuit breaker type connector, in addition to military connectors.

So talk to your Amphenol Sales Engineer. Or write to: *Amphenol Connector Division*, 1830 S. 54th Avenue, Chicago, Illinois 60650.

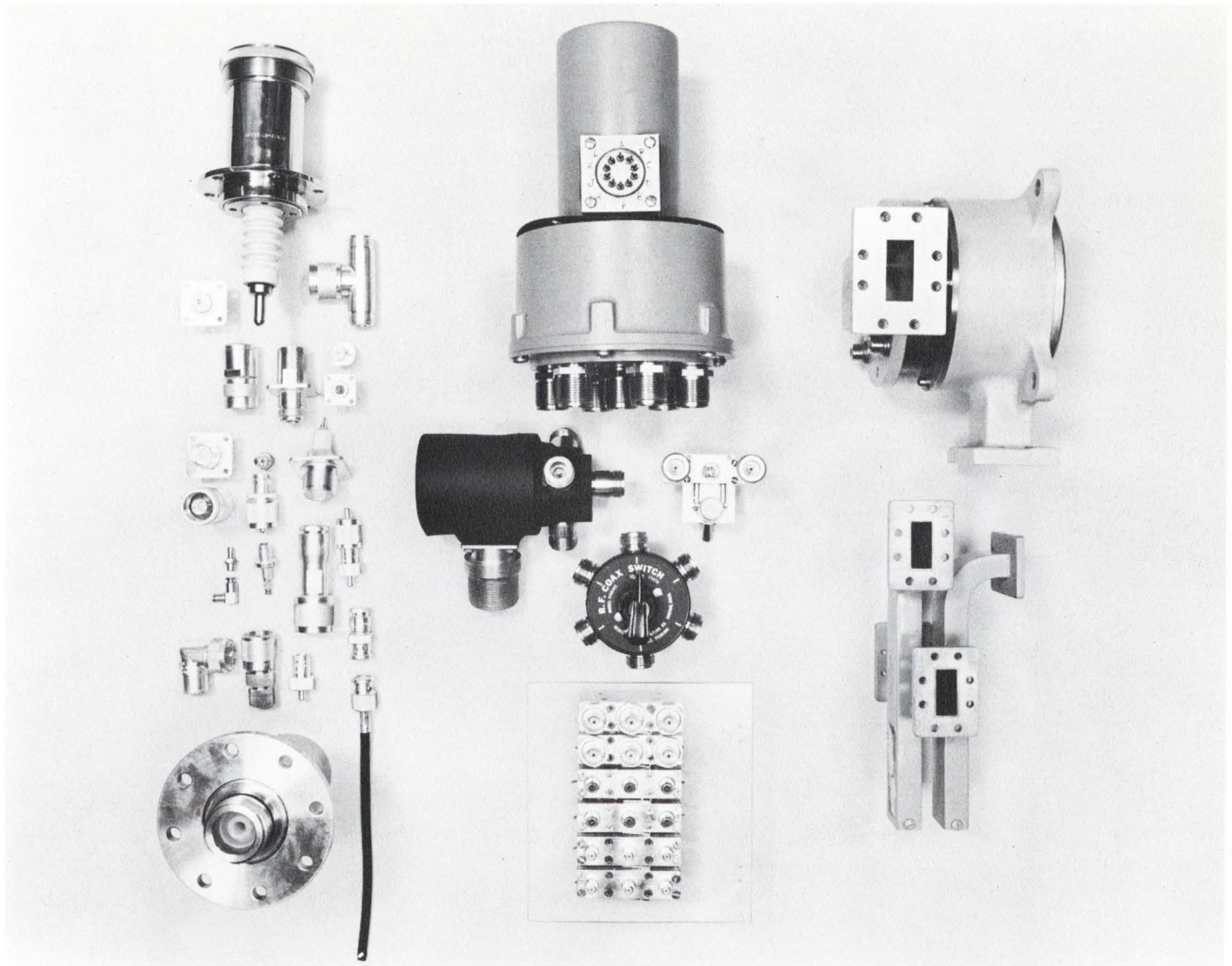

Coaxial connectors for rf, audio, and pure power uses

Coaxial switches—low frequency, high frequency, solid state, and specials

Microwave components: rotary joint (top), cross guide coupler (bottom)

Amphenol RF DIVISION

for any connector or rf switch

Coaxial connectors, coaxial switches, custom microwave components are products of Amphenol RF Division.

That *pulse receptacle*, for example, at the top left of the picture is one of our standard, high voltage connectors. Whatever *coaxial connector* you need, Amphenol's got it. We make standards and specials for radar, microwave, communications and more.

Take the *EDO sonobuoy connector* you see above (lower left). This is just

one of hundreds of special military and commercial connectors we build.

Coaxial switches are our bread and butter. (Ask anyone who the world's leading supplier is.) We've made over 1,500 kinds.

Let's examine the five Amphenol coax switch types in the picture. The high-power, multi-position switch (top) is used for low frequency antenna switching aboard submarines. The high-frequency remote latching type,

the SPDT and our manual high-frequency, multi-position switch are more common. The compact, ganged array you see below is now used for switching bright display radar at FAA installations.

Amphenol is big on *microwave components*, too. Just give us a chance to describe our unique capability.

Who makes all these great components? *Amphenol RF Division*, 33 E. Franklin St., Danbury, Conn. 06813.

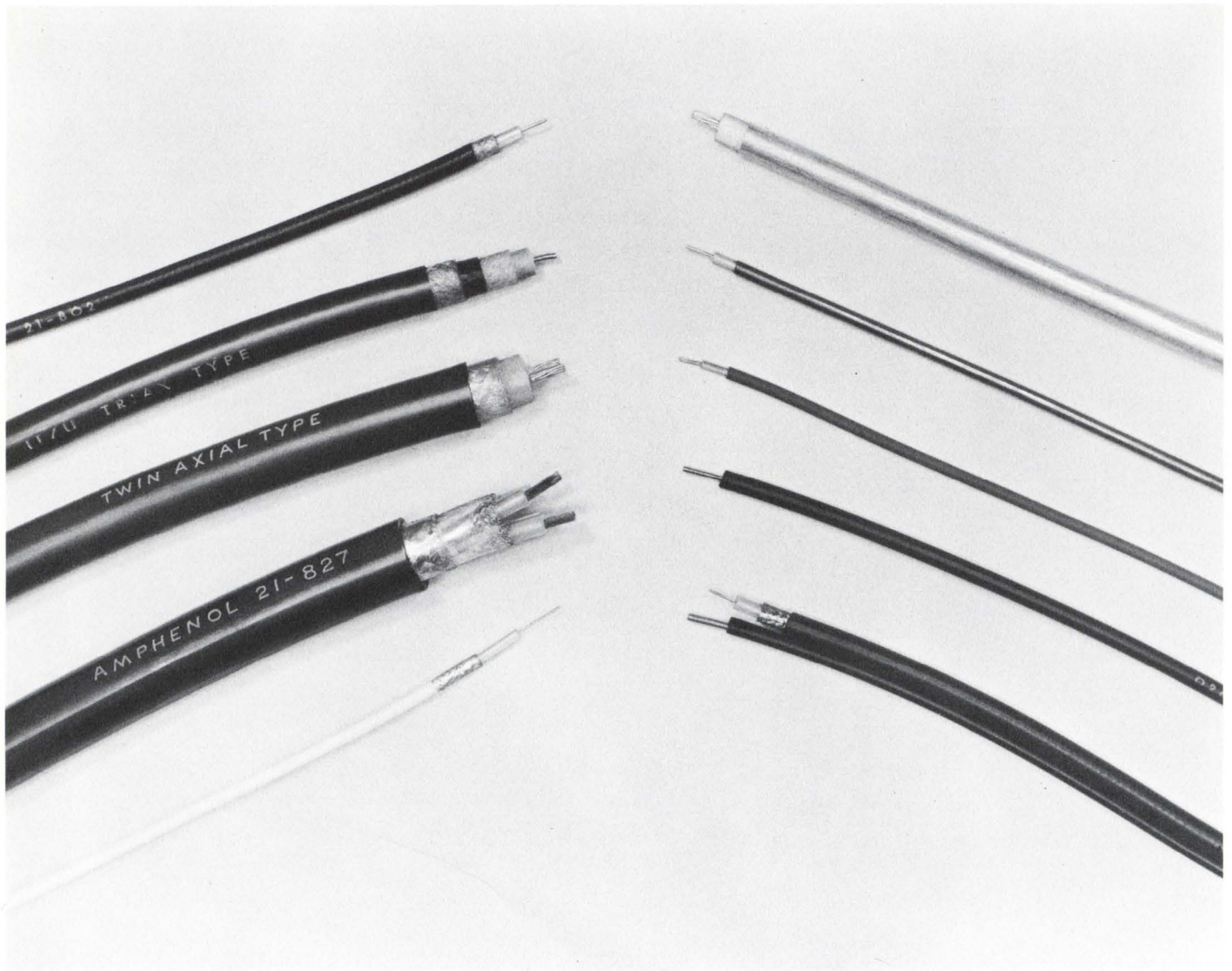

Top to bottom: Coaxial cable,
Triaxial polyfoam cable, Twin-Axial cable,
Multi-conductor cable,
Miniature Teflon cable

Top to bottom: Aluminum jacketed cable,
Copper jacketed cable, High voltage wire,
Antenna wire, Messenger
supported coaxial cable



Ask your Amphenol man about cable, harness

Isn't it just common sense for your Amphenol connector man to know about cable, too?

He can get you any of the cables shown in this picture—and dozens of others, both catalog and special items.

We are probably best known for our *coaxial cable*, especially the RG types.

But maybe you didn't know we make *multi-conductor cables*, too . . . from subminiature to greater than two inches in diameter. Or that our

catalog lists a 1000°F flexible cable.

Amphenol gives you one of the biggest selections of jackets—copper, aluminum, PVC, dacron, fiberglass, polyethelene, polyurethane, and heat-shrinkable materials.

We don't claim to be the world's largest supplier of cable—yet. But we do have a big selection. And if you are concerned with on-the-spot availability, you will be pleased to know that Amphenol has over 500 distrib-

utors throughout the country who carry Amphenol cable in stock for immediate delivery.

Our engineers thrive on problems that may give you headaches. So don't forget to mention your current cable, wire, or harness problem to your Amphenol Sales Engineer next time you see him.

Or drop us a line at *Amphenol Cable Division*, 6235 S. Harlem Avenue, Chicago, Illinois 60638.

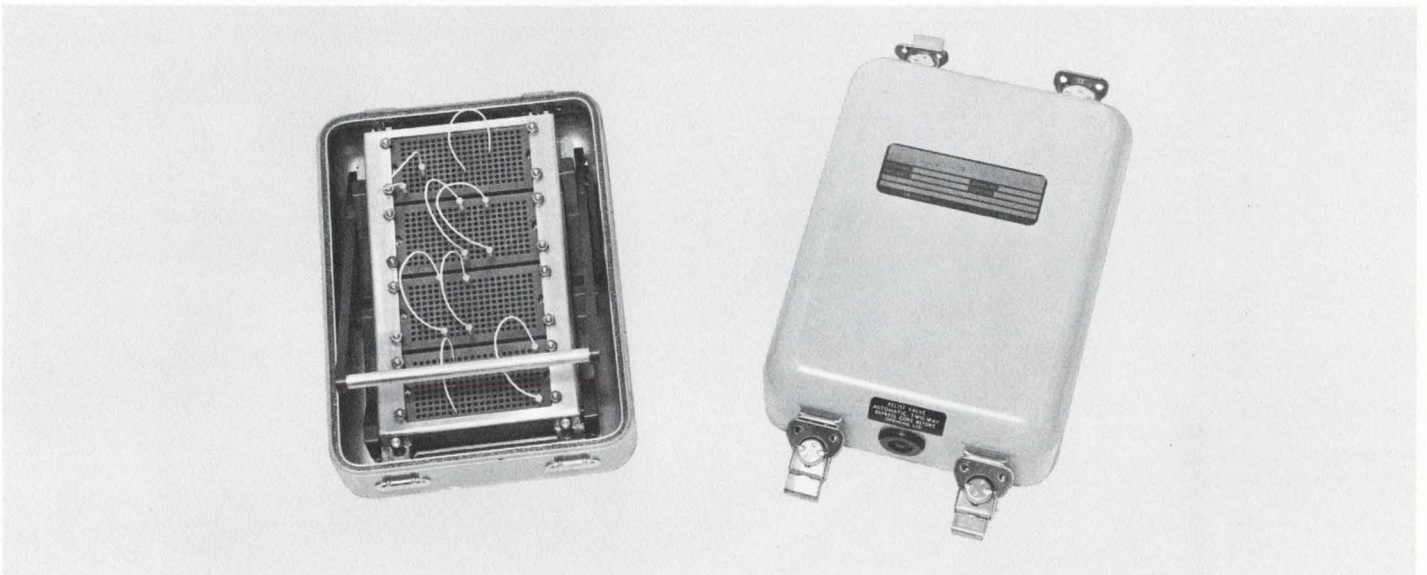

Top: Special ICBM instrumentation connector

Bottom: Patch panel

Amphenol® SPACE AND MISSILE SYSTEMS

assembly, and special interconnections

"You could save thousands of dollars in time alone if you could change circuitry in 90 seconds without removing or unmating a connector." Right. So we developed a Patch Panel that guarantees accurate mating and unmating of 800 contacts just by moving a lever. Old circuit panels are simply lifted out and replaced with pre-programmed ones. That's what we mean by design capability at Amphenol.

"It's going to have to stand temper-

atures to 5000°F for 2½ minutes." Fine. We delivered the Aft Umbilical connector for Polaris. That's a sample of the environmental protection you can get from Amphenol.

"It must meet the highest reliability of any operational ICBM program." So Amphenol Space & Missile Systems introduced the first stretch cable which allows for thermal expansion of solid fuel bottles with no induced stress on circuit wiring.

We've solved interconnection problems involving oceanic, man-made and space pressures, requiring hermetic seals, meeting elevated or cryogenic temperatures, as well as complying with man-rated reliability programs. Our experience can save your project time and money from design through production. Ask your Amphenol man. Or write *Amphenol Space & Missile Systems*, 9201 Independence Avenue, Chatsworth, California 91311.

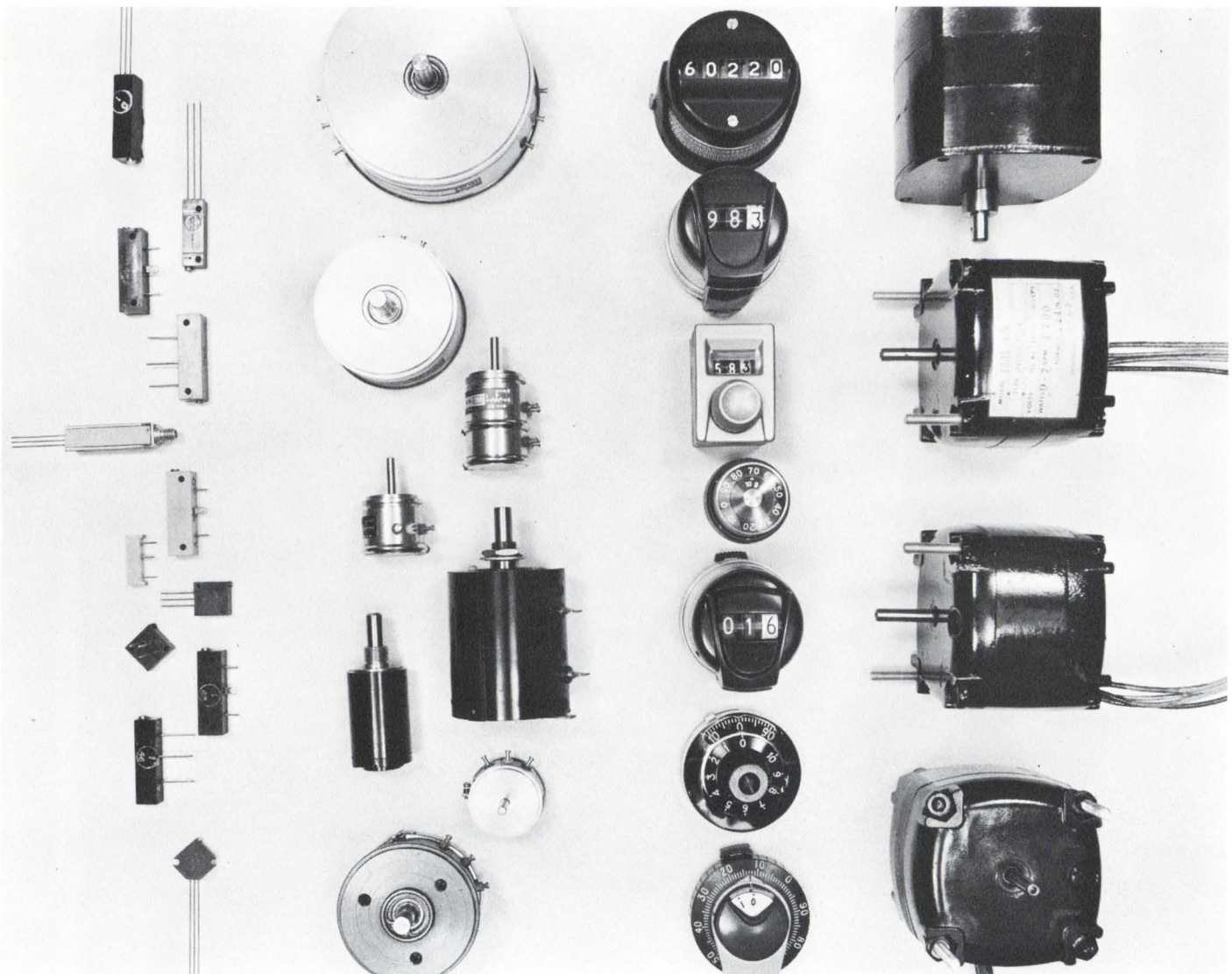

Trimmers—
wirewound and
infinite resolution types

Precision potentiometers—
single turns, 3-turns,
and 10-turns

Turns-counting dials—
concentric scale and
digital types

Subfractional
hp motors—
synchronous, induction,
and hysteresis types

Amphenol® CONTROLS DIVISION

He can help you trim circuits down to absolute

Your Amphenol Sales Engineer lets you choose from the world's largest selection—whether you need a military trimmer, a precision potentiometer, a subminiature dial, or a special low-inertia motor.

We have an infinite resolution trimmer with an ultra-low temperature coefficient. We have a subminiature trimmer with excellent resolution priced under \$1.50. And others with high temperature or humidity-proof

features (or both) in either rectangular or square packages.

Amphenol has one of the most reputable names in *precision potentiometers*—and one of the oldest. Lift off the case of almost any instrument, control, or servomechanism and you'll probably find an Amphenol Micropot® at work.

Dials? We not only offer you the biggest selection, but you can have a standard Microdial® *customized*,

color-coded, or with dozens of options and variations to upgrade your product or control panel.

We make AC control *motors* that contain low-inertia, high-resistance squirrel-cage rotors; and we also make the synchronous and induction types, two or four-pole, with or without gear trains. Write today for your copy of our new short-form catalog. *Amphenol Controls Division, Janesville, Wisconsin.*

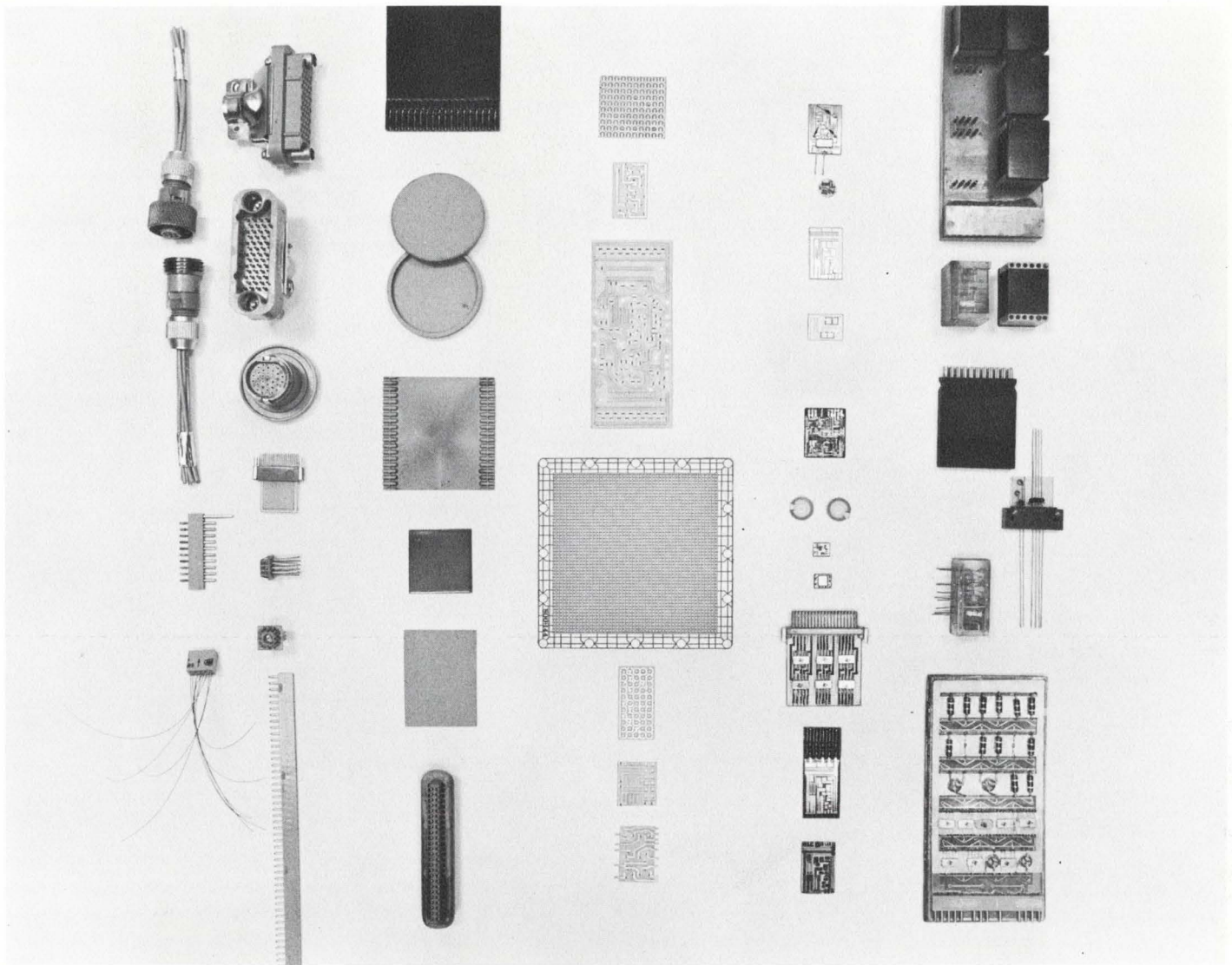

Microminiature connectors, including PC, rack-and-panel, strip, and circular types

Amphenol moldable precision ceramic 100 components and substrates

Prepositioned, miniature weldable nickel circuitry

Thin-film deposited circuitry

Interconnecting systems, modules, and microelectronic packaging

Amphenol MICROELECTRONICS

null or trim the size of the circuit itself.

Just put us to work *designing and packaging your microelectronic products*. Our prices are so competitive that we can do the complete job for less than it would cost you anywhere, including a captive group of microelectronic packaging experts.

We can show you how to miniaturize electronic gear the size of three file cabinets into a microelectronic integrated systems package the size of one cigarette carton.

We can show you how to put a miniature PC amplifier circuit into a thin film hybrid package this big: 

We've produced high-tolerance microelectronic products with our new moldable precision ceramic. We have fabricated prepositioned weldable circuitry that nobody else has been able to match in microelectronics.

Our standard microminiature connectors have been chosen for their

high density, reliability, and low cost features. Applications include everything from airborne computers to implantations into the brains of laboratory animals.

Microelectronics is big business at Amphenol. We are tooled, staffed, and financed in a completely separate facility called *Amphenol Microelectronics*. We can design and package for you today. Just call us at CO 1-2000 in Broadview, Illinois.

Gentlemen:

Yes, I am interested in finding out more about the item(s) I have checked below. Please rush me information on these items:

- Connectors
- Coaxial connectors
- Coaxial switches
- Microwave components
- Cable in general
- Cable type: _____
- Harness assemblies
- Precision pots
- Trimmers
- Dials
- Motors, sub-fhp
- Microelectronic connectors
- Microelectronic packaging
- Have Amphenol Sales Engineer call

Name _____

Title _____

Company or Organization _____

Address _____

City _____ State _____ Zip Code _____

FIRST CLASS
 PERMIT No. 256
 BROADVIEW, ILL.

BUSINESS REPLY MAIL
 NO POSTAGE STAMP NECESSARY IF MAILED IN THE UNITED STATES

- POSTAGE WILL BE PAID BY—

Amphenol-Borg Electronics Corporation
2801 S. 25th Avenue
Broadview, Illinois 60155



PLEASE STAPLE HERE

PLEASE FOLD HERE

Just disconnect this and mail

After you've checked off your specific areas of interest, tear off this coupon. Fold on the dotted line. Then staple the open ends together. Within one week, you'll have the information.

If you would like to be put on our regular mailing list for new

developments in components, subsystems, and electronic materials, just send your name on your company letterhead to Publications Editor, Amphenol-Borg Electronics Corporation, 2801 S. 25th Avenue, Broadview, Illinois.

Or call the Amphenol man nearest you:

ARIZONA

Phoenix.....264-9397

CALIFORNIA

Chatsworth.....341-0710

Los Angeles

(South).....SPring 8-3646

(North).....STate 8-8560

San Francisco.....369-2981

COLORADO

Denver.....794-4269

DIST. OF COLUMBIA

Washington.....EXecutive 3-2205

FLORIDA

Orlando.....647-5504

GEORGIA

Atlanta.....233-1569

HAWAII

Honolulu (14).....993-149

ILLINOIS

Broadview.....261-2000

Chicago.....261-2000

INDIANA

Indianapolis (5)....ATwater 3-1395

MASSACHUSETTS

Boston.....VOLunteer 2-8300

MICHIGAN

Detroit.....646-1262

MINNESOTA

Minneapolis (16)...927-6589

MISSOURI

St. Louis.....838-6996

NEW JERSEY

Camden.....665-2870

Fair Lawn.....791-0303

NEW YORK

New York.....HUnter 2-4700

Syracuse (3).....472-7529

OHIO

Cleveland (16)....EDison 1-9100

TEXAS

Dallas.....ADams 5-8318

WASHINGTON

Seattle.....SHerwood 6-5363



**NEED 14-BIT A-TO-D CONVERSION AT 200 KC?
OR 8-BIT AT 1 MC? ADAGE HAS IT!**

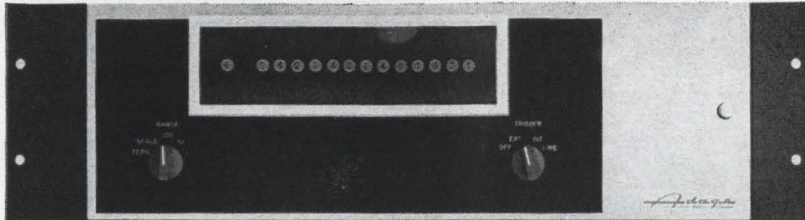

The high-speed, high-resolution VT13-AB and ultra high-speed VT7-AB are the latest additions to the Adage VOLDICON™ line of voltage digitizers. Based on a novel design combining techniques of successive approximation and parallel threshold decoding, the VT13-AB accomplishes a 14-bit analog-to-digital conversion in less than 4 microseconds. The 8-bit VT7-AB performs a complete conversion in under 800 nanoseconds.

Other Voldicon models include:

VS Series A-to-D Converters

2 μ sec. per bit conversion time
14-bit binary or 16-bit BCD
 $\pm .01\%$ accuracy

D-to-A Converters

$\pm 150v$ output
 $\pm .01\%$ accuracy
14-bit resolution.

And look at these other Adage data systems components!

Series VMX™ Multiplexers

100,000 samples per second
 $\pm .002\%$ offset spread; $.01\%$ gain spread — no adjustments required
Systems-organized flexible programming

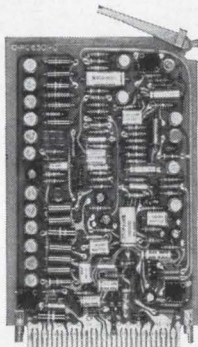

Sample-and-Hold Amplifier, Model SA3

Tracks within $.01\%$ in 10 μ sec. for FS input step change
100 nanosec. aperture
100 μ sec. recovery from 10X FS overloads

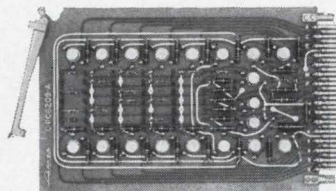

Operational Amplifier, Model OP3

Over 5 MC gain-bandwidth product
Approximately 100 pico-amps leakage current
Less than 30 μv offset drift

HZA™ Isolation Amplifiers

100,000 megohms input impedance
 $\pm 150v$ input voltage range
1 part in 1,000,000 gain accuracy
Single-ended and differential with 120 db common mode rejection

Digital Logic

Designed for analog /digital system requirements
Compatible modules for digital control, decoding, formatting and interfacing

AC Signal Conditioners

$.01\%$ of final value achieved within 15 cycles of lowest frequency
 $\pm .05\%$ accuracy

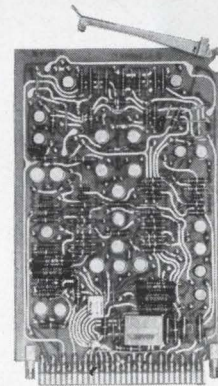

Next time, get a quote from Adage — for components or complete systems. We think you'll like our prices, too. Call or write I. R. Schwartz, Vice President, 617 UN 4-6620.

Adage
INC.
292 Main Street, Cambridge,
Massachusetts 02142

Adage, Inc. welcomes employment inquiries from professional engineers.

Find the manufacturer... Fast!

It's just a matter of seconds to get the valuable information you need about electronic manufacturers and suppliers in the Electronics Buyers' Guide. The EBG has over 200 pages listing the names, addresses, phone numbers and key individuals of manufacturers of electronics equipment, related components and materials. All this plus vital company statistics. At a glance you know important facts about the company, exactly what each company makes, and where to find the manufacturers' representatives in your area. No wonder the EBG is the industry's standard catalog-directory!

Electronics Buyers' Guide

A McGraw-Hill Publication

330 West 42nd Street, New York, N. Y. 10036

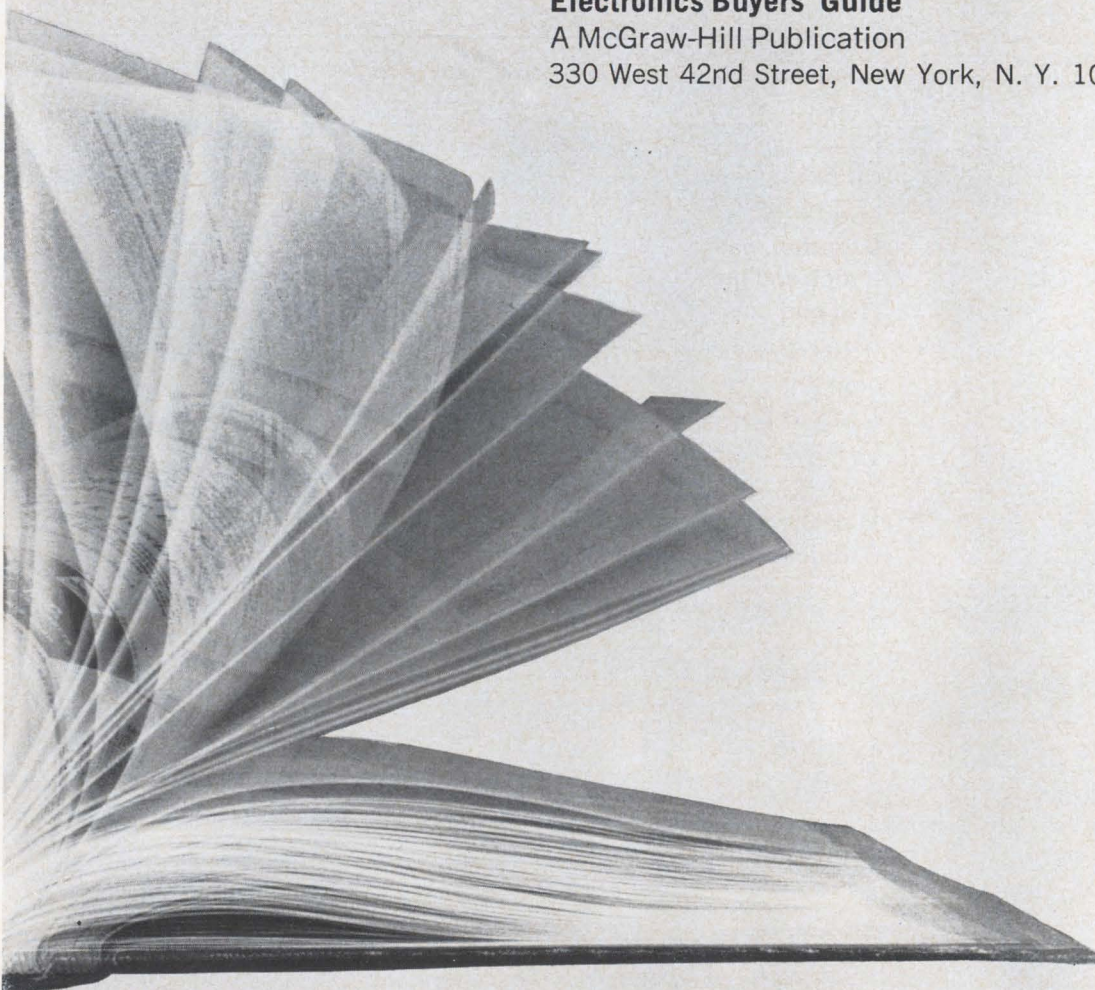

You need

1

very special switch.

Control Switch has

167,921

very special switches.

How can you beat odds like that?

We'll get even more specific.

These 167,921 very special switches include pushbutton, basic precision, toggle, leaf and lever, interlock and limit, lighted panel, hermetically-sealed and environment-free switches.

Another specific. They're good ones . . . for equipment, systems, products that must reflect the integrity of the maker.

Doesn't it seem like a waste of time to pore through catalogs from umpteen suppliers when you're so sure of getting what you want through one of our distributors, one of our salesmen, or through us?



CONTROL SWITCH DIVISION
1420 Delmar Drive, Folcroft, Pennsylvania 19032

P.S. For an idea of what we mean, see our Condensed Catalog. To get your copy, circle the reader service card with the number shown below.

DELAY LINES

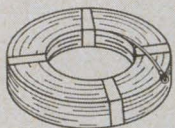
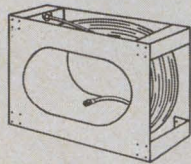
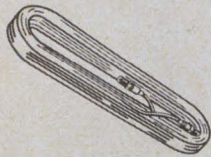

Phelps Dodge Electronics delay lines are fabricated of Styroflex®, Helical Membrane, or Foamflex air dielectric coaxial cables shaped, without mechanical or electrical distortion, into extremely small, lightweight packages. Application parameters are extended by unique characteristics in the areas of attenuation stability, bandwidth, VSWR and peak voltage over frequencies ranging from 60 C to 12 Gc, power from one milliwatt to many kilowatts and impedances of 50, 70, 75, 100 and 125 ohms. And, tight tolerance of delay becomes a reality by calibration in fractions of electrical degrees. Total packaging flexibility allowing use of containers, rack mounting, strapping, encapsulation and potting to MIL-STD 202B completes the picture.

Delay lines . . . another component of Phelps Dodge Electronics systems communication capability. Why not request literature today?

PHELPS DODGE ELECTRONIC PRODUCTS
NORTH HAVEN, CONNECTICUT

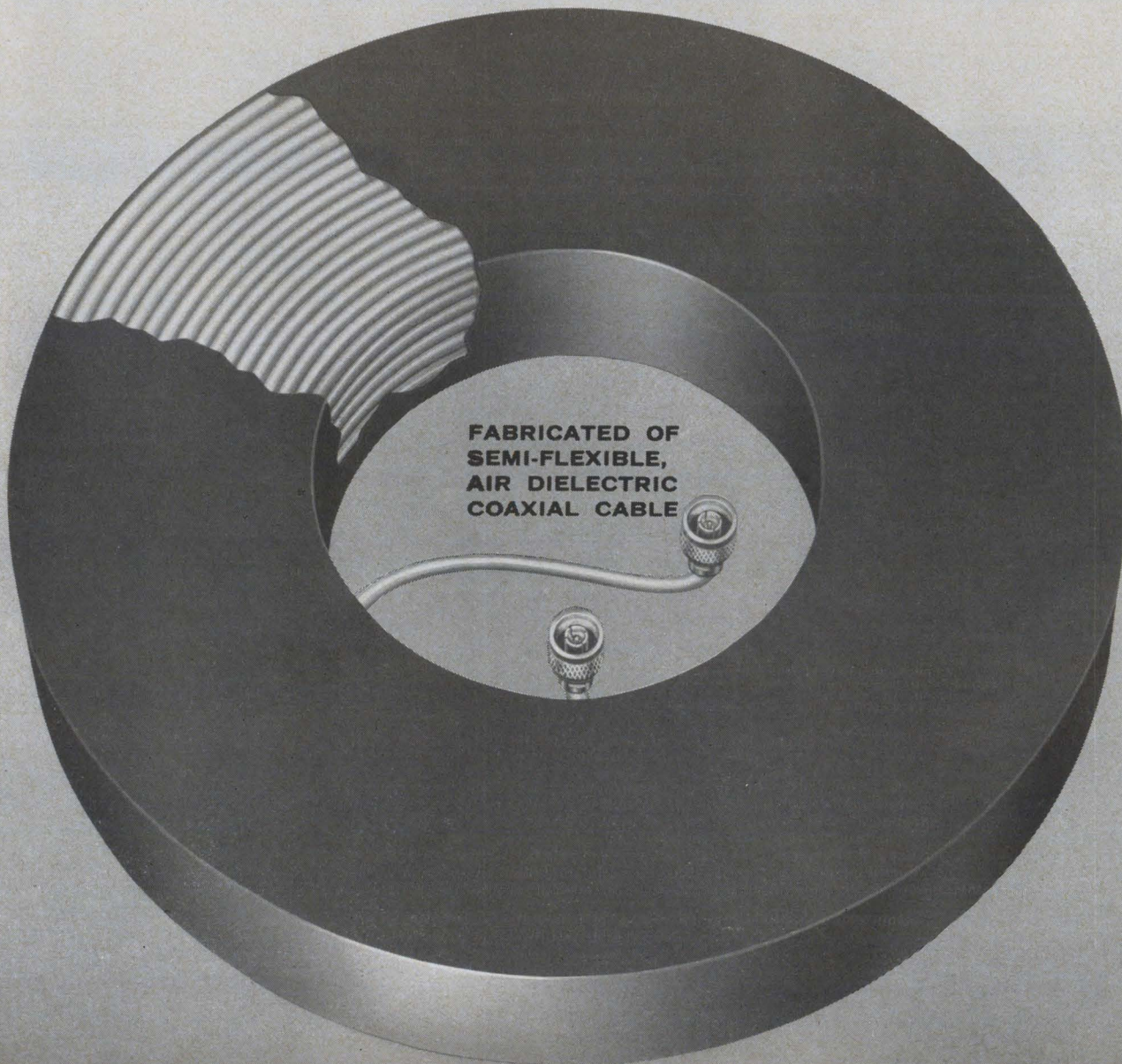

Here's everything you need...

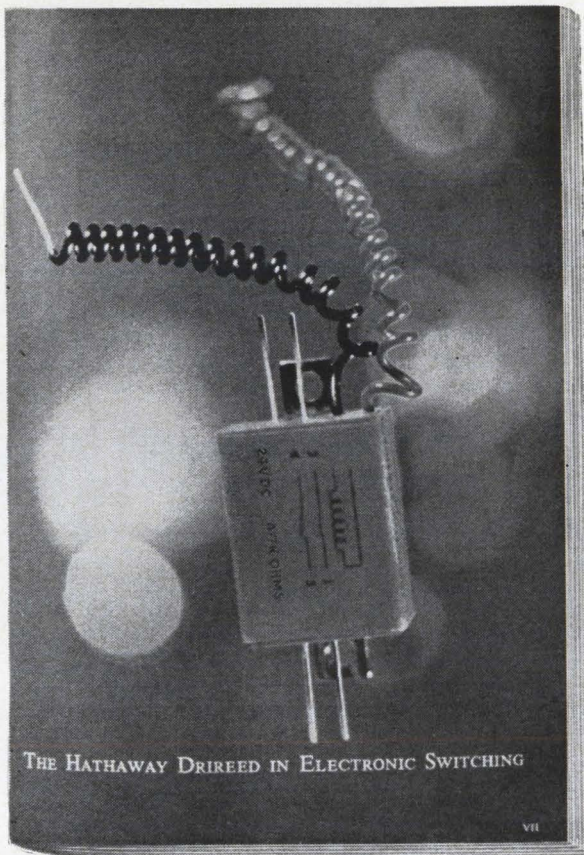

*56 pages
of relay principles,
contact characteristics
and testing parameters*

to properly utilize and specify the reed relay

This 56-page handbook discusses the relay principles and contact characteristics necessary for proper utilization of the Drireed switching concept. Considering the advantages of Drireed switching, this reference is one of the most valuable books you can own.

The Hathaway standard relay line is presented in detail with complete information for part selection. A representative group of customized relays is described with outline dimensions given for each relay. Twenty pages of Drireed testing parameters are included, with reports on test procedures and test equipment.

The handbook is free for the asking... write to your local Hathaway representative or fill out and send in the coupon.

HATHAWAY INSTRUMENTS, INC.
5800 East Jewell Avenue
Denver, Colorado 80222

Gentlemen:

Please send me a copy of
THE HATHAWAY DRIREED IN ELECTRONIC SWITCHING.

NAME.....TITLE.....

COMPANY.....

ADDRESS.....

CITY.....STATE.....ZIP.....

HATHAWAY INSTRUMENTS, INC.



CLIP & SAVE

DAVEN PRECISION WIRE WOUND RESISTORS

INSTRUMENT GRADE STYLES

Daven Type	Dia.	Length	Max. Watts @ +150°C	Max. Res.	Lead AWG	Features
DAX 1/2	3/32	3/16	.15	4K	#22	Economy Line with improved performance characteristics at considerably lower prices.
DAX 1	3/32	1/2	.33	7.5K	#22	
DAX 2	3/32	1/2	.66	20K	#22	
DAX 2B	3/16	3/16	.66	15K	#20	
DAX 3	1/4	5/8	1.0	30K	#20	
DAX 3A	1/4	1 1/16	1.0	35K	#20	
DAX 5	3/16	1 1/16	1.5	60K	#20	

SUBMINIATURE STYLES

Type	Dia. (Inches)	Length (Inches)	Max. Watts @ +125°C	Max. Volts	Max. Res. .001"/Wire	Leads AWG	Max. Res. .0006"/Wire
1409	.1	.235	.03	100	7.5KΩ	#24	50KΩ
1282	.125	.312	.05	100	16KΩ	#22	100KΩ
1402	.142	.375	.1	150	30KΩ	#24	175KΩ
1403	.160	.500	.125	200	50KΩ	#22	400KΩ
1274	.187	.375	.125	200	60KΩ	#22	600KΩ

Features — Epoxy encased for max. insulation, & dielectric qualities designed for structural strength. Meets or exceeds MIL spec rates.

HI-RELIABILITY — AXIAL LEAD STYLES

Daven Type	Dia. (Inches)	Length	Max. Watts	Max. Volts	Max. Res. .001"/Dia. Wire	Lead AWG
HR1282	.125	.312	.05	100	16K	#22
HR1258	.250	.30	.125	100	127K	#22
HR1250	.250	.50	.15	200	226	#20
HR1195	.250	.75	.25	300	511	#20
HR1257	.312	.812	.50	300	750K	#20
HR1252	.375	1.0	.75	600	1.5 Meg.	#20
HR1172	.500	1.0	1.0	600	2.0 Meg	#20

Features — Current failure rate of .02%/1000 hrs at 60% confidence. Over 10 million test hours accumulated with 8,627 units. Conditions: At +125°C and max rated power. Definition of failure: ΔR ±.5%.

POWER WIRE WOUND (Per MIL-R-26)

Daven Type	MIL Type	Char. "V" Watts	Dia.	Length	MIL Max. Res.	Commercial Max. Res.
DAC-7	RW55	7	1/2	1 3/8	5K	90K
DAC-10	RW56	14	1/2	2	9K	175K
DAS-5	RW57	6.5	3/16	1 3/16	3.5K	60K
DAS-10	RW58	11	3/8	1 3/16	8K	175K
DAS-2	RW59	3	1/2	1/2	.9K	20K

HI-FREQUENCY STYLES — AXIAL LEAD

Daven Type	Dia.	Length	Min. Res.	Max. Res.	Max. Watts	Features
1301	1/4	1/2	5K	150K	.15	Designed to provide a rise time of less than .1 μsec (from 10% to 90% of peak pulse amplitude).
1302	3/8	5/8	5K	150K	.15	
1303	1/4	3/4	5K	250K	.25	
1304	3/8	3/4	5K	250K	.3	
1305	1/4	1	5K	500K	.5	

MIL-R-93 AND MIL-R-9444 STYLES

Daven Type	MIL-R - 93C	MIL-R - 9444	Dia. (Inch.)	Lgth. (Inch.)	MIL Watts	MIL Max. Volts	MIL Max. Ohms	Lead AWG
1283	RB56	—	1/4	1 1/2	.125	—	127K	#20
1250	RB55	AFRT10	1/4	1/2	.15	—	226K	#20
1195	RB54	AFRT11	1/4	3/4	.25	300	511K	#20
1251	RB53	AFRT12	3/8	3/4	.33	300	750K	#20
1252	RB52	AFRT13	3/8	1	.5	600	1.5 Meg.	#20
1172	RB57	AFRT14	1/2	1	.75	600	2.0 Meg.	#20
1178	RB58	AFRT15	1/2	1 1/2	1.0	900	3.0 Meg.	#20
1179	RB59	AFRT16	1/2	2	1.25	1200	5.11 Meg.	#20
1173	RB08	AFRT17	1/2	1/2	.25	300	5.11K	#20
1269	RB16	AFRT18	3/16	5/8	.33	300	1.0 Meg.	#20
1270	RB17	AFRT19	3/16	1	.5	600	2.0 Meg.	#20
1176	RB18	—	3/4	1 1/4	.75	600	3.01 Meg.	#20
1271	RB19	—	1/16	2 3/32	1.0	900	6.04 Meg.	#20
1355	RB70	—	3/8	1/2	.25	150	301K	#20
1350	RB71	—	1/4	3/16	.125	—	100K	#22

Features — Many of these styles are available in decade values to ±.01% from factory stock to insure prompt delivery.

**In stock for 48 hour delivery in standard decade values*

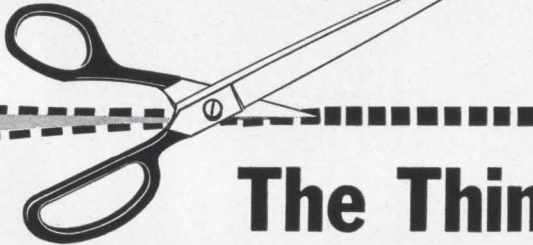

The Thinking Man's Guide to Wire Wound Resistors

If you're thinking about precision wire wound resistors, you've stopped at the right page. Above, in a few square inches, is a short Guide from the folks who have been making them for over 30 years.

Daven, one of the originators of precision wire wound resistors, is today the world's leading source.

Here are the reasons:

- Daven wire wound resistors come in more lead types, including axial wire, radial wire, printed circuit wire, radial lug, printed circuit lug, plus most other wire lead materials and platings.

- Daven wire wound resistors come in 385 styles, including epoxy, varnish or silicone coated; metal encased; solder sealed.
- Daven wire wound resistors come in more sizes, from .1" diameter by .235" long to 7/8" diameter by 2 1/8" long.
- Daven wire wound resistors range from 1 milliohm to 25 megohms.
- Daven wire wound resistors feature the highest reliability, with over 11,000,000 test hours at a calculated failure rate of .02% per 1000 hours on full power at 125° C!

There's more to know, of course. For an extensive course on the subject, or details on a particular type, write today!

DAVEN 
 MANCHESTER, NEW HAMPSHIRE
 (603) 625-9746 • TWX 603 623-4938 • Cable: Daven Manchester N H

These Amperex microwave triodes are worth designing special hardware for...



So we did—



right down to a custom handwrench!

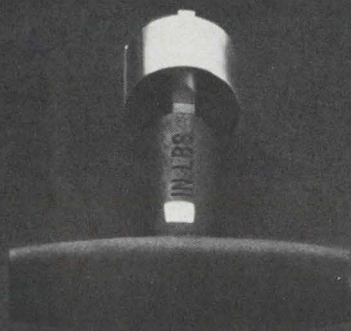

Taken singly, or as a pair, these two disc-seal 2-6 Kmc triodes with 2 or 5 watts output—the Type 8108 and Type 8436 respectively—are unbeatable! Unbeatable because they are available off-the-shelf with matched cavities, wave-guides, attenuators and isolators to fit your particular application. Unbeatable because both tubes are warranted for 6000 hours (their actual life expectancy exceeds 10,000 hours) and yet cost you considerably less (cavities and all) than a travelling wave tube system. Unbeatable because both operate at

only 180 volts, thus simplifying power supply, insulation and safety problems.

The 8436 offers from five to seven watts minimum power output in the S (2-4 Kmc) or C (4-6 Kmc) band, as you specify. As a broadband power amplifier it will deliver 5 watts out at 4200 Mc, with a power gain of 6 db over a 50 Mc bandwidth (0.1 db points). The 8108 is

a 2-watt power output version of the 8436 and is mechanically identical to it.

In addition to unattended link, telemetry and industrial microwave communications applications, either tube can be used as an oscillator or frequency doubler.

For additional information on the 8436, 8108 and other Amperex tubes (and associated hardware) for microwave applications, write: Amperex Electronic Corporation, Microwave Tube Department, Hicksville, Long Island, New York, New York 11802.

IN CANADA: PHILIPS ELECTRON DEVICES LTD., TORONTO 17, ONTARIO

Amperex[®]

NEW:

Digital Thermometer / Temperature Controller

0.1°C accuracy* from -192.0°C to +999.9°C

features:

- High absolute accuracy
- Direct reading
- Easily calibrated
- Fully automatic operation
- Outputs for control, recording, or telemetry
- Modular construction
- High reliability

The PAR Model DTS-1 offers a new order of reliability, convenience, and accuracy in laboratory and process control thermometry. The unit operates by comparing the resistance of a sensor element of platinum (the material whose characteristics define the International Temperature Scale) with an internally generated reference function which employs a unique resist-

ance analog network** that precisely duplicates the temperature-versus-resistance change of platinum. This method allows an absolute accuracy* of 0.1°C to be achieved. A modified self-balancing Kelvin bridge eliminates sensor lead resistance errors, permitting precise remote temperature monitoring.

In addition to the direct visual readout, measured temperature information is available in binary coded or 10-line decimal form for printer or computer input as well as in pulse code modulated form for telemetry applications. For temperature control or strip-chart recording applications, an analog signal is provided which is proportional to the difference between the measured temperature and the desired temperature

selected by front panel thumb-wheel switches.

All circuits use solid state components except the comparator amplifier where two miniature nuvistor tubes are used to obtain high input impedance and the reference function generator where mercury-wetted relays are used. The entire Kelvin bridge, including the resistance analog network, is isothermally enclosed to assure a high degree of accuracy and good long-term stability. Rugged modular construction, utilizing printed circuit boards, contributes to reliable performance and extended service-free life.

Price: Approx. \$4,000 (excluding probe). Write for Bulletin #118.

*Subject to operating range of actual sensor used.

**Patent Pending

PAR **PRINCETON**
APPLIED RESEARCH CORP.
Dept. D
Box 565, Princeton, New Jersey

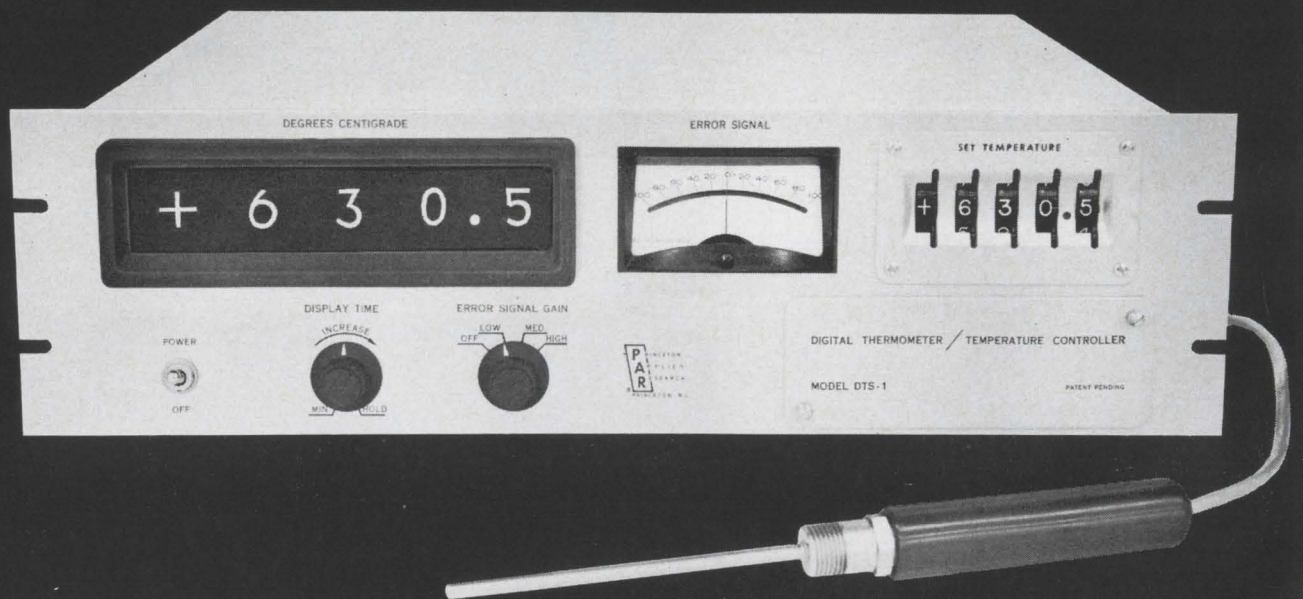

Electronics Review

Volume 38
Number 1

Manufacturing

Ion plating

Today's thin-film plating methods are good, but far from ideal. Some films won't stick to other films, and the best of films will peel off if the substrate isn't scrupulously clean or heated to the right temperature.

These difficulties have been overcome, for most of the materials useful in electronics, by a technique developed over the past two years by Donald M. Mattox, of the Atomic Energy Commission's Sandia Laboratory in Albuquerque, N.M.

Mattox calls it ion plating, because he scrubs the substrate by ion bombardment and then slams ionized metal atoms into the atomically clean surface. The film that forms generally adheres so tightly that the substrate breaks before the film can be pried loose.

All-purpose technique. Ion plating can be used to coat ceramic parts with brazing and soldering metals, to form electrodes on ceramic or quartz transducers and semiconductors, to plate relay contacts with noble metals, and to make printed circuits.

Mattox says that ion plating is as fast as electrodeposition or vacuum evaporation, and faster than sputtering, vapor plating or conventional ceramic metallizing because the cleaning and deposition steps have been merged into a single process.

Practically any metal can be ion plated onto another metal or ceramic—and not just as thin films. Aluminum films up to 250,000 angstroms thick have been deposited.

Sandia thinks ion plating will prove to be one of the most commercially significant developments to come out of its labs—a claim it can't often make since the main business of the lab is atomic weapons development.

Mattox has reported his experimental methods and results to the Electrochemical Society. Details have also been published in two Sandia reports, SC-DR 281-63 (platings on metal) and SC-R-64-1330 (ceramic metallizing).

Reverse sputtering. Ion plating resembles sputtering, but polarity is reversed. The substrate is the cathode in a high-voltage direct-current system, and the material to be deposited is evaporated at a filament anode. The process takes place in an inert gas at low pressure. Commercial vacuum evaporators can be converted to ion platers.

When the current is turned on, the gas breaks down into ions that bombard the substrate's surface. Contaminants sputter off and the surface is atomically clean in about 30 minutes.

The metal to be plated is then evaporated. Some metal atoms are ionized, so they accelerate to the cathode surface and drive into the substrate. The evaporation rate is increased until more metal is deposited than is sputtered away.

The bombardment heats up the surface, further improving adhesion. In conventional vacuum deposition, the substrate is heated too, but in ion plating most of the substrate can be cooled. This is an important advantage. Heat may

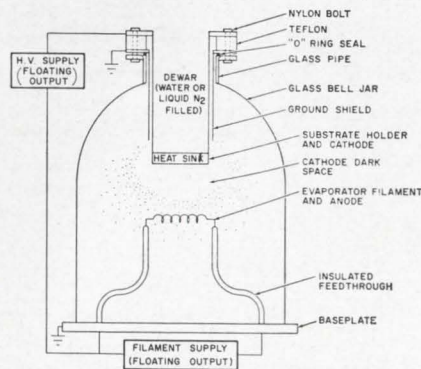

Heat-sinking cools the substrate while it is bombarded by ions traveling at high speed between the anode and cathode.

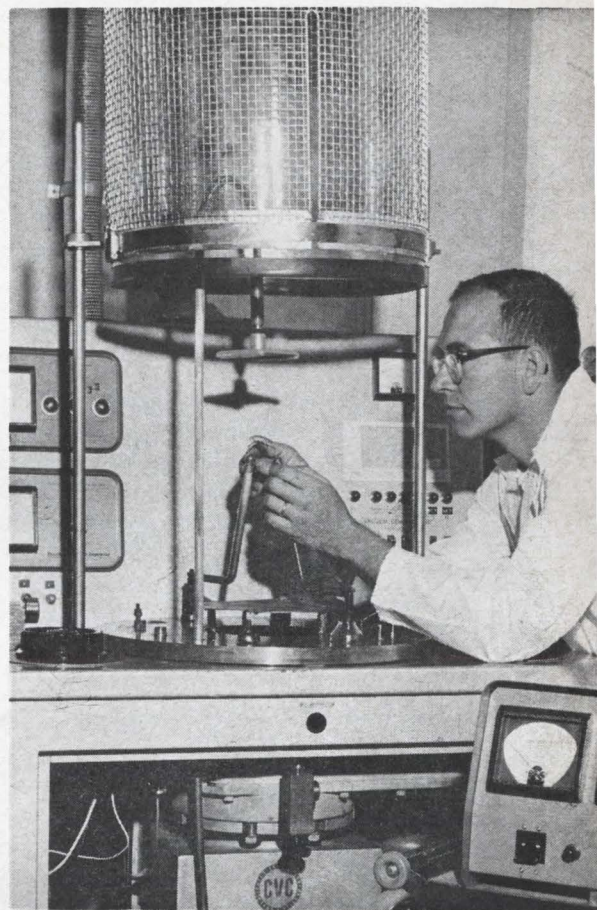

Donald M. Mattox converted a vacuum evaporator into an ion plater by putting insulated electrodes in the bell jar.

change the properties of materials such as piezoelectric ceramic used in transducers.

Deposition rates vary from 500 to 5,000 angstroms per minute. For example, gold is deposited at 1,000 angstroms per minute if the accelerating voltage is 5 kilovolts, cathode current density is 0.3 milliamperes per square centimeter and argon pressure is 10 microns.

The deposition method is similar for metal and ceramic. However, a surface charge that builds up on nonconductors can repel the ions. To get deposition started on insulators, the charge is dispelled by a grid placed in front of the substrate.

Pseudodiffusion. Some films that normally rupture after slight elon-

gation, such as gold on aluminum, withstand 50% elongation when ion plating is used.

Metals that won't normally bond together by diffusion will bond during ion plating by a mechanism that Mattox calls pseudodiffusion. Ion bombardment creates defects in the substrate surfaces; filling these defects locks the film in place.

Mattox can also make graded depositions of different metals, bonded by alloying, by starting to evaporate the second metal before the first is completely evaporated. This is useful for covering oxidizing films, like aluminum, with a more easily soldered or brazed metal like copper.

Another advantage of using a difference in potential to direct the flux is that cavities and odd-shaped parts can be plated. Symmetrical parts, like cylinders, can be plated without rotating the substrate.

Military electronics

A brighter view

Operators of command and control centers want to shed more light on their wall displays.

Scientists at Sylvania Electronic Systems—a division of Sylvania Electric Products, Inc., which is a subsidiary of the General Telephone & Electronics Corp.—will seek to improve electroluminescent techniques in an effort to develop a new generation of brighter and bigger displays. Electroluminescence is light emission resulting from the application of an electric field on phosphors.

Most wall-size displays use film-projection techniques. The units are cumbersome and can only be used in darkened rooms because the display is dim. Large electroluminescent systems have been built, but they too are limited by their lack of light power.

See more. The study is being made under an \$87,000 contract from the Rome Air Development Center. Researchers will attempt to develop devices and methods that could lead to the design of large arrays of electroluminescent ele-

ments—perhaps a million luminescent dots in a flat panel eight feet square—and capable of displaying numbers, letters, line patterns, vectors and any other computer-generated data.

Sylvania will start by building a much smaller display. Each dot of phosphor will have its own switch, mounted behind an electroluminescent panel. In effect, each switch will perform a memory as well as a control function. When the switch is on, it will stay on until pulsed off, and vice versa. In a monostable device, a computer memory outside of the system recycles the information quickly to prevent flicker. This is unnecessary in a bistable system.

Bistable operation is a major factor in boosting the brightness of the display. The storage of energy behind each dot will permit the full brightness that electroluminescent material can provide, and for as long as the information is desired. Each dot will be energized for the full duty cycle and averaging will not be necessary. In monostable operation, brightness has to be averaged over the full array, so the duty cycle to any single dot is low. The information has to be recycled into the display and each dot pulsed in turn. For example, if there are 30 dots and the array is energized for a 30-millisecond cycle, then each dot will have a duty cycle of only 1 microsecond.

Better phosphors. The company will also evaluate materials. Newly developed plastic-based phosphors are expected to provide brighter displays. Ceramic-embedded phosphors, which are now widely used, will reportedly give a satisfactory yield of 10 to 15 foot-lamberts under steady-state conditions.

Sylvania is developing silicon controlled rectifiers in a solid integrated-circuit configuration to fit the unique needs of the system. Thin-film techniques are being considered for the interconnections. The scr's will have to be smaller than anything currently available with comparable voltage-breakdown and low-current characteristics.

"It's a circuit problem as well as a microminiaturization problem,"

says Joseph L. Hallett, who heads the Sylvania project. And the integrated circuits must be reproducible and cheap enough to be considered for million-element displays.

A major design consideration is the choice of a technique for isolating the densely packed elements to prevent arcing. The scr's will be operating at about 250 volts a-c near lower voltage circuits. Either a dielectric film or some type of physical separation will be necessary. "Our size and density situation rules out the use of semiconductor junctions as insulating barriers," says Hallett.

Keeping it apart. On each chip there will be an scr, its input circuit and some type of isolation circuit. The scr will have to be less than 20 mils square and each element must be less than 100 mils square to allow for separation between elements.

The Sylvania group is considering an elongated flatpack construction for packaging the integrated circuits and mounting them to the electroluminescent panel.

Employment

'Dehired,' not fired

Defense companies, which are often faced with the problem of dismissing some engineers while hiring others with different specialties, are studying a new plan that they hope will make it easier for the engineers and the companies.

The Martin Marietta Corp.'s subsidiary, the Martin Co., which recently inaugurated the plan, says it is no longer firing key people it doesn't need after a contract is phased out—it's "dehiring" them.

Finding new jobs. Central to the plan is getting the dehired engineers new jobs. Since these men are highly qualified—but not in an area that the company needs at the time—Martin retains a company to help find them jobs.

Martin laid off 162 people recently when the Titan I and II programs were phased into the

Titan III, a much smaller project. The company found that it was overstaffed in some areas while it was hiring new men for work in other fields.

So far, H. H. Harberts Associates, a Los Angeles management consulting concern that is being paid \$1,500 a month by Martin, has placed 40 men in equivalent positions and others are believed to have found jobs on their own.

There are two kinds of benefits: Martin is able to get rid of men it doesn't need right now, and other companies get a crack at some competent top-level people.

Company's reputation. Martin considers this important because any dismissal program makes the company look bad and it increases the difficulty of hiring new people. Douglas V. Dorman, Martin's vice president for industrial relations, says, "The company wants to maintain its image as a good place to work."

The government's Bureau of Labor Statistics estimates that 10,000 scientists, engineers and other defense-industry specialists are currently between jobs.

The reaction from other companies has been more than offers of jobs. Paul L. Faranda, supervisor of professional and general employment for the Northrop Corp.'s Nortronics division, says: "Most of us in the business would be interested in a follow-up report." Similar interest was posted by such companies as the Aerojet General Corp., a subsidiary of the General Tire & Rubber Co., and by the Fairchild Camera & Instrument Corp.

So far, the de-hiring program includes only men in the \$15,000 salary area. No such program is being contemplated for the blue-collar ranks. "They represent a local hiring program," says Dorman.

Advanced technology

Sighting the enemy

Getting the enemy's range during the night or in bad weather may spell the difference between victory



Laser range finder can measure distance of a target at night, in fog or in heavy rain. A unique memory device helps the operator pinpoint a target despite nearby clutter.

and defeat in a military campaign.

TRG, Inc., had developed a laser range finder that operates in rain, snow, dead of night and all but the thickest fog and is accurate to within 10 meters. The range finder uses a unique memory arrangement to filter out signals produced by rain, snow flakes or fog.

The instrument comes in two models, a 35-pound portable and a 50-pounder tank-mounted unit.

Small and fast. The company, recently acquired by the Control Data Corp., says the pulse-ruby laser unit is smaller and operates faster than conventional optical instruments. Another advantage: because of a periscope arrangement, the artilleryman need not expose himself to enemy fire to take a measurement.

A 0.2-joule laser pulse 20 nanoseconds long travels through the periscope, hits the target and is reflected back to the instrument. The time it takes for the signal to travel both ways determines the distance to the target. A readout in meters is visible in the range finder's telescope, so the operator can

keep his eyes on the target at all times. Ranges can be read between 300 and 10,000 meters.

Radar and relativity

A new test of Einstein's theory of general relativity has been proposed by a scientist at the Massachusetts Institute of Technology's Lincoln Laboratory. Made possible by the development of very-high-power radar, it is the first relativity test devised in 50 years, and the fourth such test ever.

Einstein's theory predicts, among other things, that the speed of a light or radio wave depends on the strength of the gravitational field along its path. Scientists hope to verify this by sending a giant radar pulse to Venus or Mercury in such a way that the pulse and its echo must pass close to the sun. The 300-million-mile round trip will take some 25 minutes, and, if Einstein is right, the sun's gravitational pull will delay the return pulse by about 0.2 millisecond.

MIT's Irwin I. Shapiro believes this delicate measurement can be accomplished using a very-narrow-beam radar antenna, accurate time-keeping techniques and a 500-kilowatt radar transmitter now under development which will work at 8 gigacycles. The 120-foot dish antenna already exists at Lincoln Laboratory's new Haystack Microwave Research Facility in Tyngsboro, Mass. If the transmitter klystron development is completed in time, the experiment can take place this spring, when Venus and Mercury are in a favorable position.

Although radars of comparably high power are not new, they operate in the hundreds-of-megacycles range. At such low frequencies the sun's corona effects would outweigh the relativistic time delay and make the test inconclusive.

Heightened sensitivity. Before undertaking the test, Project Haystack receiver's sensitivity will have to be sharpened by using a maser in its front end; present equipment includes a bank of parametric amplifiers.

The necessary timekeeping equipment already exists at Hay-

stack and at the adjoining Millstone Hill radar installation where, in 1958, radar echoes were first bounced off Venus. The 1958 return echo was so weak it had to be sorted out of background noise by a computer. This time, if all goes well, says Shapiro "there'll be no trouble getting a healthy return signal".

Communications

Sorting space signals

Next month the United States Air Force Cambridge Research Laboratories in Bedford, Mass., expects to put its brand-new decommutator center to work on data from space probes.

The facility will forecast space weather, using observations made by probes like the Mariner 4. Adverse conditions such as solar winds, radiation, cosmic rays and dust will be picked up by sensors on a satellite and transmitted to the decommutator center. There the signals will be sorted, digitized and stored. Analysis of the data can then be performed by a standard computer.

Multiple reception. The quarter-million-dollar installation by Astrodata, Inc., of Anaheim, Calif., will differ from existing decommutators in its ability to receive and process more than one type of signal simultaneously. Initially, the 24-channel reception will consist of 23 frequency - modulation/frequency - modulation (f-m/f-m) channels and one pulse-amplitude modulation/pulse-duration modulation (pam/pdm) channel. Pulse code modulation (pcm) can be added at a later stage.

Synchronizer. At the decommutator facility, the 24 information channels carrying information from the space-borne sensors are received at the same time. The analog signals are put through an analog-digital converter. It can handle only one signal at a time, so a multiplex synchronizer samples each channel in rotation. But it works so fast that all 24 channels are effectively handled at once and

each sample is identified before being fed into the converter. This feature is what makes the new decommutator unique. A rate of 20 kilocycles was chosen for conversion as the best compromise between speed and accuracy. The higher speeds that were used in the preliminary tests reduced the accuracy.

System controller. Bursts of digitized data stream into the controller—similar to a small computer—that sorts out the data, stores it in the proper buffer-store device for recording on magnetic tape in the form of data blocks. A typical recording may comprise a few seconds of plasma-probe data followed by a few seconds of cosmic-radiation data and so on. Each block has been assigned an identification that enables the analyzing computer to use it immediately.

Presently installed decommutators send to a buffer and then to tapes without sorting. As a result, computer time, costing about \$130 an hour, is required to perform an elementary function. It's believed that the cost of the new decommutator can be written off in about four years as a result of savings in computer time.

The tape decks are standard Datamec D2020 holding words that are 12 bits long. Data is checked for errors by conventional parity check techniques.

Versatile. Although the facility is designed for immediate recording of live signals, it can do a number of other useful jobs. Analog charts of space-science and vehicle engineering data can be produced for immediate viewing. The quad-helix tracking antennas are controlled by the facility. And, during its spare time, the equipment will also be used to reduce and digitize data on about 4,000 reels of previously recorded tape.

Telecast insurance

Borrowing an idea from military communications, television station WBKB in Chicago has just gone on the air with two new transmitters connected to the same antenna. If one unit develops trouble, the other continues to broadcast smoothly.

Because this round-the-clock reliability is an important requirement for remote control, Bill Kusak, chief engineer of Chicago's American Broadcasting Co. outlet, says that only minor changes will be necessary to initiate unattended operation.

Extending service. A 140-foot traveling-wave antenna with a power gain of 18, fabricated by the Radio Corp. of America, tops a 425-foot mast above Marina City, the world's tallest apartment complex—60 stories. The new height extends channel 7's so-called grade A (3,560 microvolts per meter) signal contour from 43.5 to 45 miles. The grade B (630 microvolts per meter) signal contour from WBKB's 316-kilowatt effective radiated power has gone from 55 to 61.5 miles.

The teamed operation of two General Electric Co. 12-kw transmitters eliminates the need for a 24-kw standby transmitter that probably wouldn't be used more than a few minutes a year.

The parallel connection, standard practice in critical military installations, also makes it possible to shut down one transmitter for maintenance while the other handles broadcasts.

Dual hook-up. The transmitter driver circuit includes an emergency switching diode and coaxial-cable delay-line compensation loop, that sends exciter radio-frequency power to the transmitters in the proper phase. A hybrid combiner-diplexer adds the output signals from the transmitters in the right phase to drive the traveling-wave antenna.

The new system will permit remote unattended operation from the studio master control room, a quarter of a mile away from the transmitters.

A time-operated switch can be set to bypass the combiner diplexer five seconds after a transmitter failure. In this way, the good transmitter is automatically returned to the air, even in cases when the remote-control operator is unable to act.

Emergency operation. Should one transmitter fail, the 6-decibel drop in signal, shared between the

Look what KIN TEL brings you in a DC voltage standard for just \$1995!

outside view:

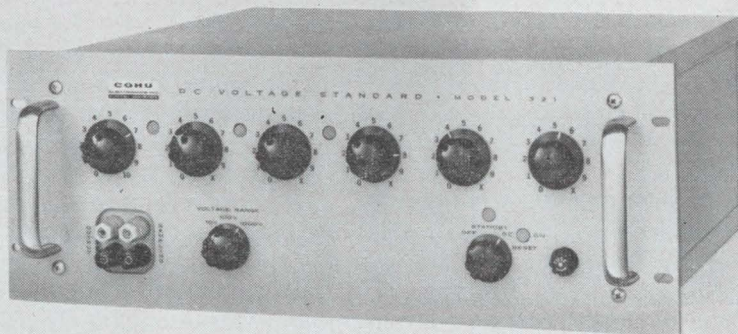

diagrammatic view:

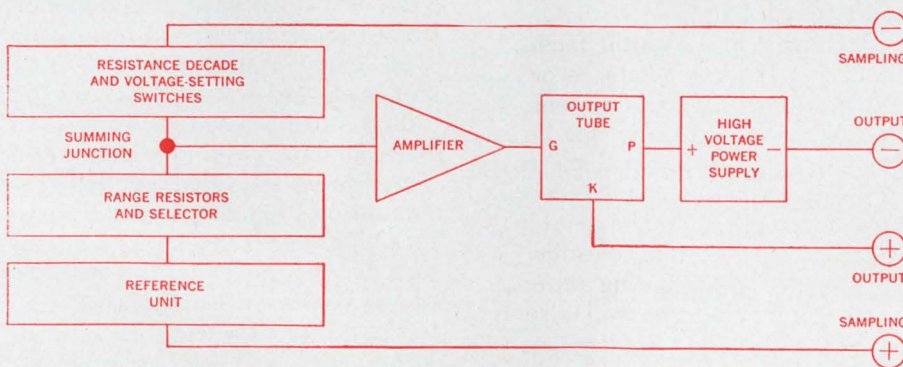

engineer's view:

MODEL 321
DC VOLTAGE STANDARD

0 to ± 1111.110 volts

10 volt, 100 volt, 1000 volt ranges

10- μ v, 100- μ v, 1-mv steps

current up to 25 ma

0.01% accuracy

0.0025% voltage output
stability/8 hours

0.005% voltage output
stability/30 days

0.001 ohm source impedance

floating output

overcurrent protection

Write today for detailed information or a demonstration of this latest voltage standard in the KIN TEL line. Representatives in all major cities. All prices F.O.B., San Diego, California. (Additional export charge.)

Visit our Booth Number 3602 at IEEE Show, March 22-25

Box 623
San Diego, California 92112
Phone (714) 277-6700



down transmitter and the combiner net, would hardly be noticed.

The traveling-wave picture-signal antenna is driven separately from its associated sound antenna, elimination phase delays in the picture signal, that can be caused by notching diplexers or filterplexers.

If the regular picture antenna is ever disabled, sound and picture signals can be fed to the separate bays of the antenna used normally for sound.

Industrial electronics

Gamma scale

Coal, potatoes and, now, fill dirt used in road building are being weighed by a system, called Ray-Weigh, that uses gamma rays. The Michigan State Highway Dept. is testing the system, developed by the Ohmart Corp., on a construction job near Jackson and expects to save \$10,000 for each mile of road.

Two-pronged scale. The receiver-detector portion of the system consists of two prongs, half-way up the conveyor belt. The bottom prong holds radioactive cesium 137, an isotope. Gamma radiation is directed through the belt and its load of fill. The top prong, an Ohmart cell, detects any gamma rays not absorbed by the dirt.

The rays are converted into minute currents that are fed to the grid of an electrometer tube in the input stage of an amplifier. The output of the amplifier, proportional to pounds per foot of belt loading, goes to a solid-state multiplier.

Simultaneously, the multiplier receives the output of a tachometer attached to the belt-drive pulley. This is proportional to the belt speed in feet per minute. Then the multiplier's output, in pounds per minute, is totaled and displayed on a direct-reading digital meter.

Easy adjustment. The system has been accurate, plus or minus one percent, after three and four days of operation without calibration. Calibration tests are routine.



Gamma-ray weighing system for fill dirt used in road construction costs from \$5,000 to \$7,000. It is expected to cut road-building costs by \$10,000 per mile.

An official of the highway department said, "Adjustments can be made by a construction worker. The system is so simple you can forget about teaching the man any electronics."

\$50-million market. According to the Ohmart Corp. there is a \$50-million annual market for the Ray-Weigh. The company says the system can be used wherever conventional scales are employed.

Avionics

Better missile detection

One of the chief headaches in anti-missile technology is the difficulty in quickly distinguishing between live and dummy missile warheads in flight. But now a radar that can measure irregularities of moving targets has been developed by Cornell University's Cornell Aeronautical Laboratory in Buffalo, N. Y.

Nike-X program. The system, called the Delta radar, is being developed under the Nike-X antimissile program. It will be used as a research tool to perform radar cross-section measurements on scale models of potential targets. The radar will also enable scientists to observe, identify and measure quantitatively scattering discontinuities caused by surface curvature and reradiation from the "creeping wave" portion of a target body. Such waves are caused,

among other things, by energy diffraction behind the target body.

The radar is a quasi-monostatic system that uses two antennas and linear frequency modulation. The frequency is swept from 8.2 gigacycles per second to 11.7 gigacycles per second 123 times per second. Ultra-linear frequency modulation is obtained with a broadband backward-wave oscillator. To obtain this modulation, the frequency of the oscillator versus helix voltage characteristics are experimentally determined and the required sweep waveform is then synthesized.

Harmonics canceled. Range sidelobe levels are reduced by modulating the amplitude of the signal with a Taylor weighting function and linearizing the transmission with compensative modulation of the backward-wave oscillator. Residual sidelobes were observed to be related to sweep-rate harmonics. These were canceled by the generation of a similar sinusoid phase locked to the sweep rate and injected onto the helix and cathode of the backward-wave oscillator.

The radar has made range-resolution measurements as small as three inches. The system's primary objective is to measure radar cross-sections with a range resolution equal to a small fraction of the target's length.

Tracking down CAT

Laser beams may shed some light on the meteorological mystery known as clear air turbulence,

9 out of 10 RESISTOR DELIVERIES MADE FROM STOCK...



...and that 10th one goes the next day!



Big inventories of $\frac{1}{4}$, $\frac{1}{2}$, 1 and 2 watt fixed composition resistors permit Stackpole to fill orders fast—make same day shipments nine times out of ten. Production lines in America's biggest tv, radio, phonograph and industrial plants roll without a hitch. That's one side of Stackpole dependability in resistors.

On the other side—**never a catastrophic failure in service.** These rugged resistors exceed all military and industrial requirements; defy erratic resistance changes in severe environments.

Run your own test. Challenge us on "same day" shipments. Better yet, from your standpoint, test these failure-proof resistors in your own lab. For complete specs (or to place an order) write or phone Electronic Components Division, Stackpole Carbon Company, Kane, Pa. Phone 814-837-7000. TWX 814-826-4808.



STACKPOLE
Electronic Components Division

CAT, when an experiment gets underway this month in the Rockies.

A research group from Honeywell, Inc. is setting up its equipment in Rollinsville, Colo. under a contract with the Air Force Cambridge Research Laboratories and will bounce laser beams off a known area of turbulence in the hope that the backscatter from particles in the atmosphere—dust, ice crystals, gasoline and smoke—as small as one micron will provide some clue to the nature of CAT.

Abnormal pattern. "For about two years we've been convinced that it's possible to get scattering from particles trapped in turbulence," says Andrew S. Carten, senior engineer at Cambridge, "and we believe that this scattering will show a characteristic abnormal pattern."

Researchers will be looking for amplitude variations in the reflected laser energy. Signals returned from the turbulent area will be collected by a five-foot searchlight reflector and focused onto photomultiplier tubes. Variations in amplitude will be displayed on an oscilloscope and optical filters will cancel ambient light.

The ruby laser puts out one joule and can be pulsed once or twice every second. It requires 30 kilowatts of input power and, for the feasibility experiments, is mounted on a flatbed trailer.

From the air. Next on the agenda, if these tests show promise, will be an airborne investigation of CAT. The Cambridge group, despite reported pressure to put lasers on planes to "see what happens," decided to try ground experiments first. The forthcoming tests will help determine what kinds of power and equipment might be used in airborne detection systems.

"You can't put five-foot collectors and big laser power supplies on planes," said Wilbur H. Paulsen of AFCRL, "so we'll try to determine what can be done with smaller equipment."

In a tunnel. The hypothesis has been tested in a 100-foot tunnel, with turbulence introduced into the airflow through holes in the side of the tunnel. The results were not

definitive and the Colorado tests were scheduled.

Big questions. Because clear air turbulence is believed to have contributed to a dozen crashes and near-crashes of jet planes during the last five years, civil and military aviation authorities are pushing hard to get answers to two big questions: what causes it, and how can you detect it in advance? Maybe some answers will come this month.

Space electronics

Laser's second chance

Despite initial failures, researchers expect to succeed this month in using lasers to measure distance and direction of the geodetic satellite, Explorer 22. The satellite is due to come back into view some time in January.

Distance is measured by bouncing a laser beam off the satellite and measuring the time it takes to make the round trip. The satellite carries a 10-pound array of fused silica glass reflectors on its base; these cube-corner mirrors reflect the laser beams back to the earth.

So far, two groups of experimenters have reported receiving the reflected beam, but results weren't good enough to measure the satellite's distance from the earth. Three other groups haven't reported yet. Two groups have reported failure.

Improving the aim. At the Goddard Space Flight Center of the National Aeronautics and Space Administration, scientists are working on better aim for the laser. "We were getting signals back (from Explorer 22)," says Henry H. Plotkin, project scientist for the laser tests, "but they were few and far between."

He blamed much of the trouble on atmospheric disturbances. Another problem was that the reflected beam missed the receiver by about 50 yards; Goddard engineers picked up only the edge of the beam.

Goddard engineers have moved their receiver to a point where they expect it to pick up the strongest

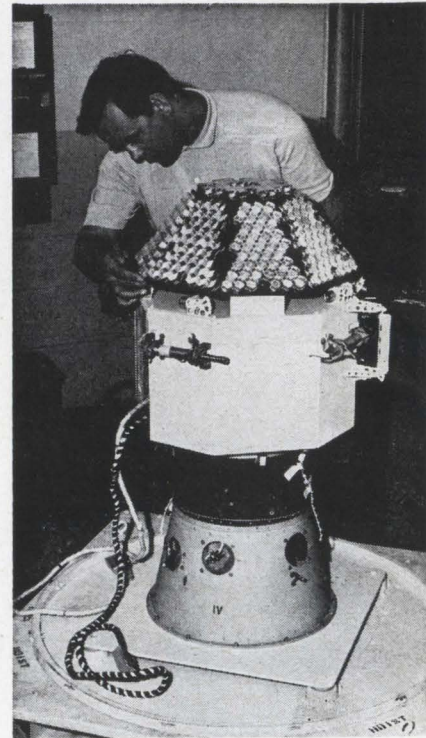

Explorer 22 has mirrors which reflect laser beams

part of the reflected signal. They're also considering a programmed pedestal that would operate with a television camera and long-focal-length telescope. This would permit corrections and finer remote control of the laser.

The transmitter at Goddard is a "giant pulse" laser with a 0.8-joule output and a one-microsecond pulse. Pulses were transmitted, one per second, to the satellite.

How others fared. Results similar to Goddard's were reported at the General Electric Co.'s ground station, where a 0.5-joule ruby laser, air-cooled, fired pulsed four or five times during each pass of the satellite.

Two other teams apparently failed to hit the satellite. The Air Force Cambridge Research Laboratories and NASA's station at Wallops Island blamed atmospheric problems and poor aim of the laser. Both groups tried to photograph, on film, the laser beam against a star background. This would have given additional information about the satellite's direction.

Results still have not been reported by experimenters in Britain, France and an unidentified location in the United States.



MICRO SWITCH Industrial Controls

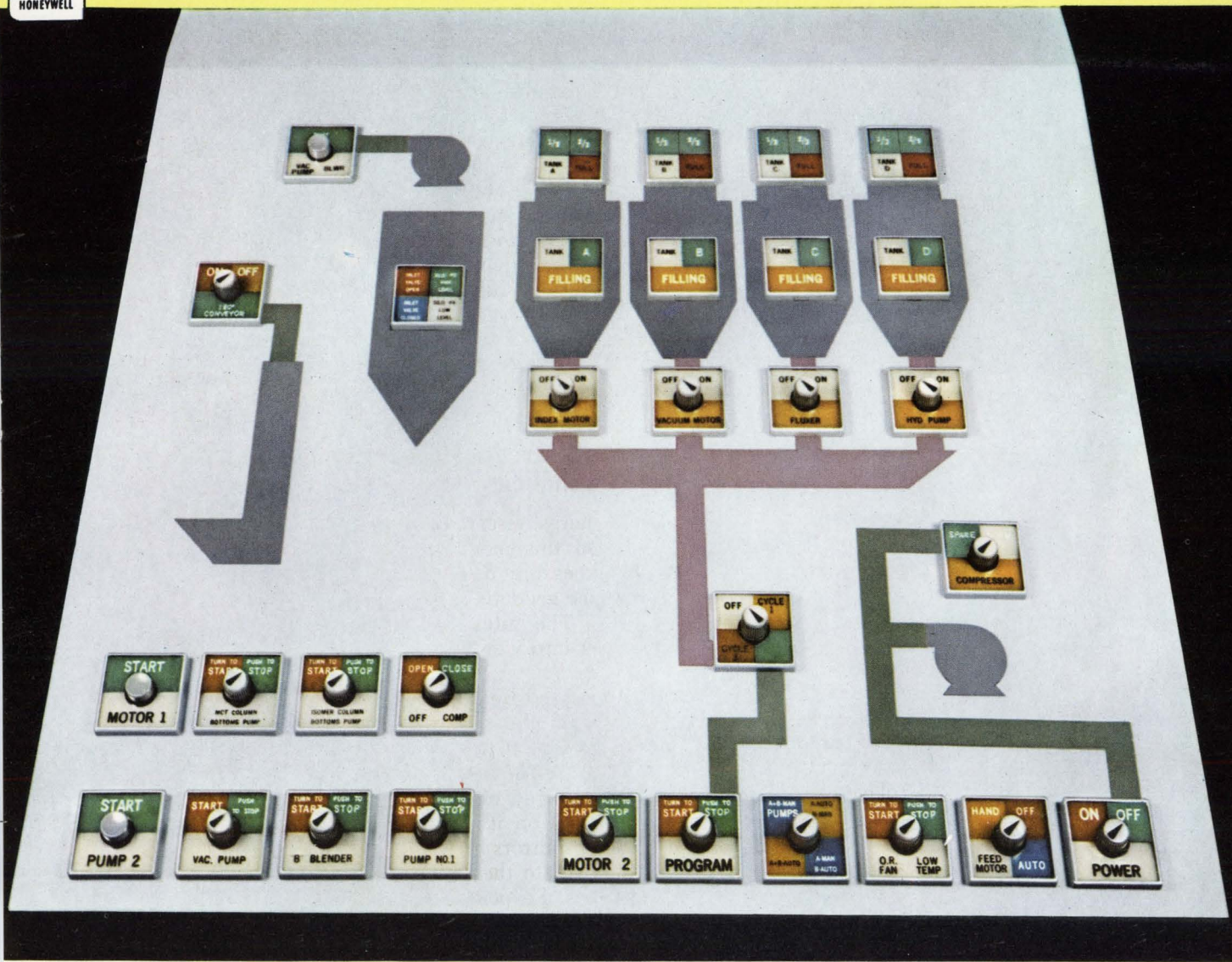

Coordinated Manual Control takes the clutter out of graphic panels

A CMC unit combines up to four large lighted legends and four-position control in one compact assembly—requires panel space only $2\frac{5}{16}$ inches square.

The result: a dramatically simplified graphic layout in as little as two-thirds the space usually required; far less complicated operation with fewer buttons and knobs; greater legibility with larger, more vivid display legends that can be read even at a distance.

UNLIMITED CONTROL CAPABILITIES. Four basic units are available, all oil-tight: Pushbutton, Selector, and Selector-Push units, and an Indicator Unit without control. A wide variety of operators, contact blocks (heavy duty or electronic duty) and many circuit arrangements are available for industrial or electronic requirements.

Write for Catalog 69—fully illustrated and complete with circuitry, dimensions, legend and color information. Or, call our Branch Office or a MICRO SWITCH Distributor (see Yellow Pages).

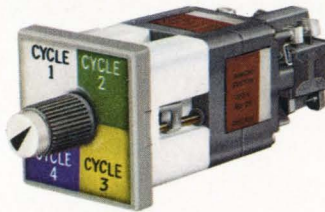

- Up to four heavy duty or electronic duty contact blocks may be stacked in any order.
- Up to 24 letters in each quadrant.
- Choice of six colors.

CMC is a modular assembly that combines up to four lighted legends and four-position control in one compact unit.



MICRO SWITCH

FREEPORT, ILLINOIS

A DIVISION OF HONEYWELL

IN CANADA: HONEYWELL CONTROLS LIMITED, TORONTO 17, ONTARIO

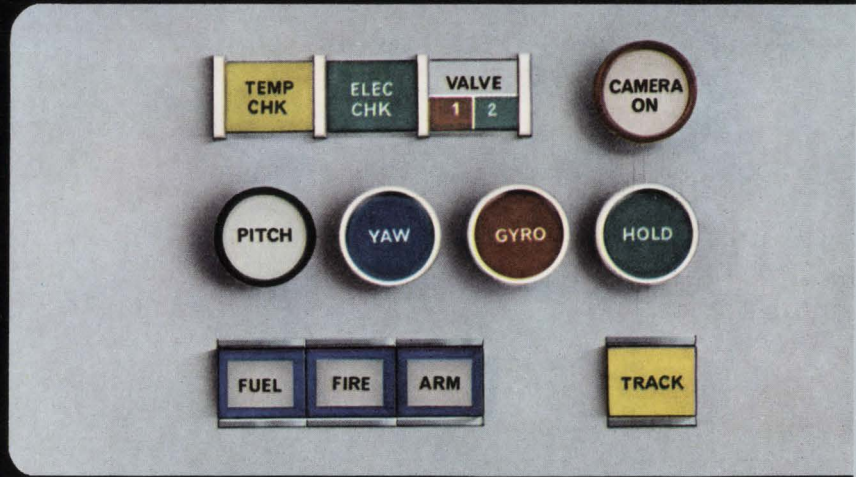
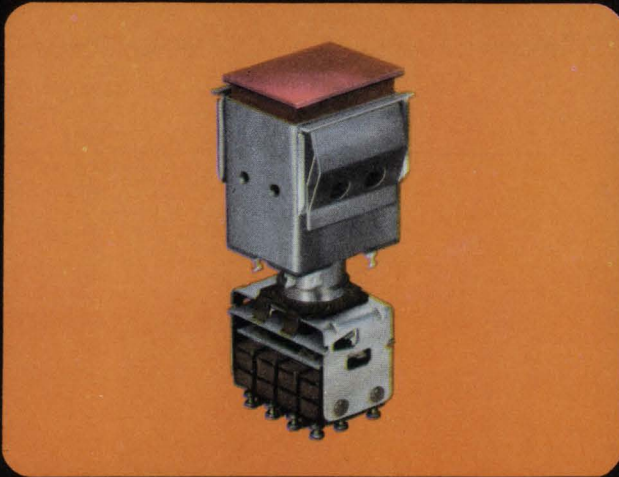
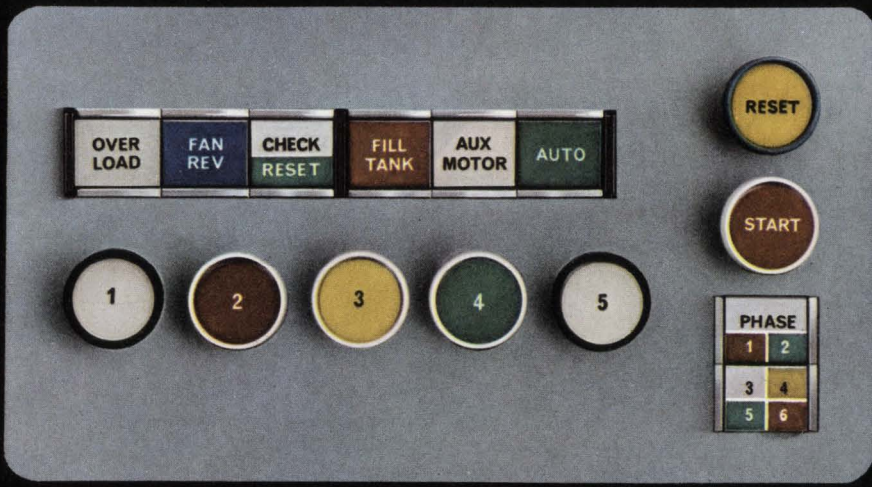

Modular, snap-on pushbutton units for Custom Control and Display

Series 2 Lighted Pushbuttons introduce custom answers to a wide variety of design problems. A broad selection of components and modular, snap-on assemblies provide unlimited possibilities.

Choice of round or rectangular displays for shape coding; four separate lamps in each unit allowing four-color display; variety of screen and hardware colors; 7, 15 or 20 amp. switch units, in sub-miniature or hermetically sealed assemblies; circuitry and electrical ratings you require; momentary or maintained switching action, with or without

remote control. For more information, call our Branch Office or a MICRO SWITCH Distributor (see Yellow Pages), or write for Catalog 67.



MICRO SWITCH

FREEPORT, ILLINOIS

A DIVISION OF HONEYWELL

IN CANADA: HONEYWELL CONTROLS LIMITED, TORONTO 17, ONTARIO

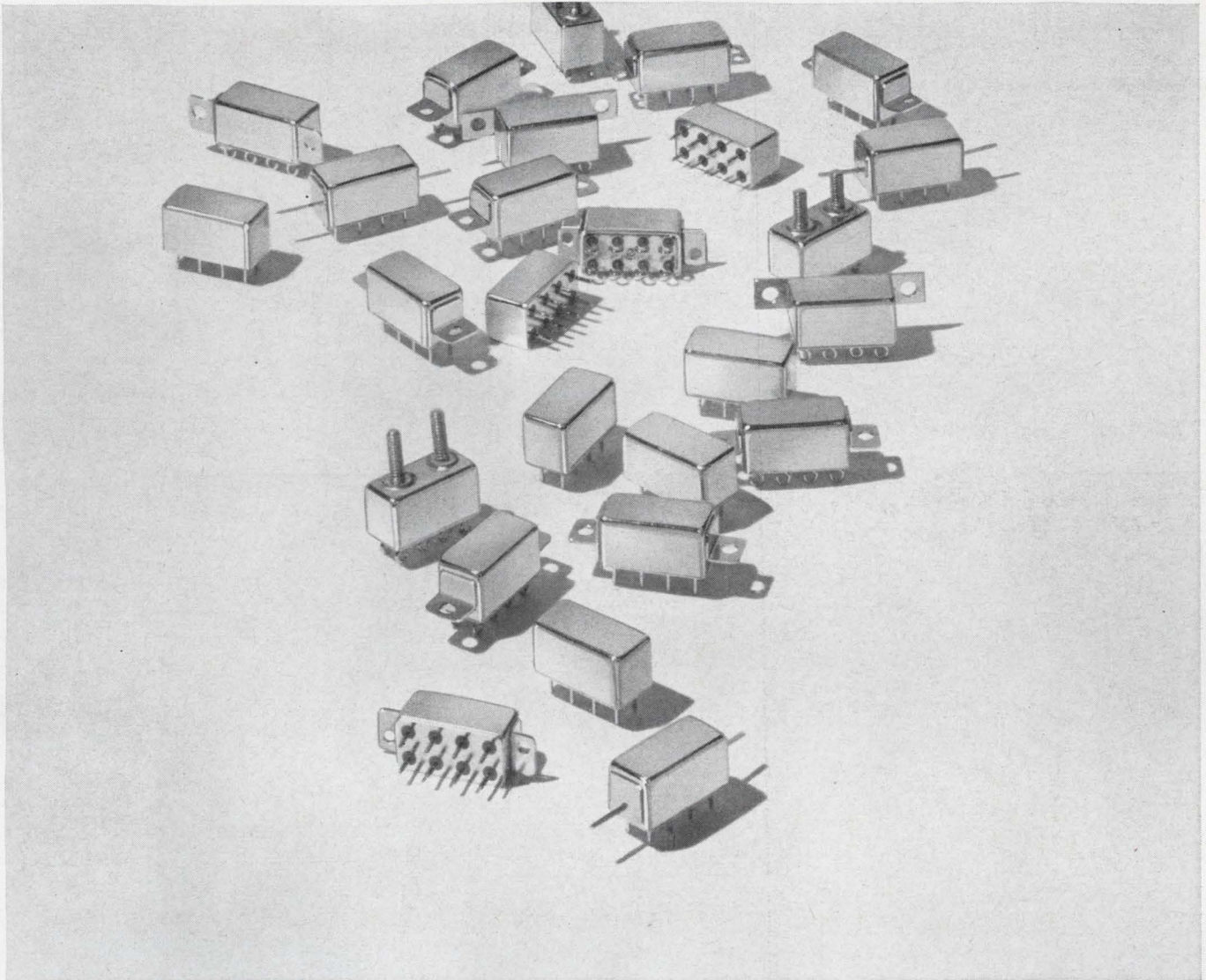

The all-new, all-welded Series E relay sets a new standard of reliability



Significant improvements in reliability have been achieved in the Series E through the use of advanced electron beam welding, the elimination of organic insulating material and simplified design features.

Welding of the contacts and motor assembly directly on the header eliminates internal wiring and the associated problems. Actual fusion of metal by welding gives a stronger joint between the header and can than is possible with soldering, providing maximum stability under shock and vibration. And, complete elimination of solder flux residue insures reliability of performance in dry circuit or minimum current applications.

But, the Series E offers even more! Bifurcated contacts, for instance, provide positive contact throughout the vibration frequency spectrum. Contact bounce and resistance are drastically reduced through increased contact pressure.

And there's more! For complete details write for the Series E technical bulletin.

BASIC SPECIFICATIONS

Contact Ratings: Dry circuit, low level, 2 amp.

Shock: 100 g's, 11 ± 1 ms

Vibration: 30 g's, 10 to 3,000 cps

Temperature: -65°C to +125°C

Weight: 0.28 oz.

Meets or exceeds Mil-R-5757

LEACH CORPORATION

RELAY DIVISION

5915 Avalon Boulevard • Los Angeles, California 90003

Export: LEACH INTERNATIONAL S. A.

CONSIDER YOUR HARNESSING OPERATION ...

SURVEY of HARNESS
TYING OPERATION
for
Your COMPANY



GUDEBROD BROS. SILK CO., INC.
FOUNDED IN 1870
Electronics Division

Area Code 215, WA 2-1122 • TWX 215-869-8861
12 SOUTH 12th STREET, PHILADELPHIA, PENNSYLVANIA 19107

• BRANCH OFFICES •

BOSTON, MASSACHUSETTS 02111
115 Chauncey Street, Area Code 617, HA 6-6347

CHICAGO, ILLINOIS 60654
1362 Merchandise Mart, Area Code 312, DE 7-3025

NEW YORK, NEW YORK 10001
225 West 34th Street, Area Code 212, LA 4-8888

BURBANK, CALIFORNIA 91504
2636 Ontario Street, Area Code 213, SA 8-2968
TWX 213-849-7891

PLANT: Pottstown, Pennsylvania 19464

Would you like to save money while improving the product?

TO FIND OUT HOW
—here is what you
need—and it's FREE

Have you considered that your company may be overlooking the possibility of achieving savings on harness operations while, at the same time, the product is improved? Gudebrod engineers have been making recommendations to companies like yours *with just such results!* Here's how it is done:

FOR THE STANDARDS ENGINEER

As electronic engineering becomes more and more sophisticated, as the use of electronic equipment becomes more widespread, the specifications, even for lacing materials, become more exacting. Gudebrod engineers can suggest the right tying tape for your particular requirements. The two hundred plus types of tape in the Gudebrod line are specially designed for specific purposes and each one of these tapes is engineered for efficiency in the tying operation as well. Our engineers will be happy to work with *your* Standards Engineer to save money while improving the product.

FOR THE METHODS ENGINEER

Gudebrod has engineered its entire tape line with the basic idea of producing tapes that "tie themselves." Easy, safe handling,

non-slip knots, trim harnesses have been kept in mind—features that speed the harnessing operation. In addition, there are dispensing packages, cut lengths, bobbins, color identification—custom designed for the lacing job. Gudebrod engineers will be pleased to work with *your* Methods Engineer to save money while improving the product.

FOR THE PRODUCTION ENGINEER

Gudebrod has a lacing tool, the Cable-Lacer, the first hand tool specifically designed to ease and speed harness tying. No longer need cable lacing be a hand wearing, hand tearing chore. The Cable-Lacer has paid for itself in as little as one day—you can benefit from the savings every day thereafter. A Gudebrod engineer would welcome an opportunity to demonstrate the Cable-Lacer—and to work with *your* Production Engineer to save money while improving the product.

HARNES OPERATION SURVEY—FREE

Consider then, this offer by Gudebrod to work with your Standards, Methods and Operating Engineers in suggesting how to save money on harness operations while you improve your product. A Gudebrod engineer will make, at your convenience, a complete survey of your harness materials, methods and production. It will be a thorough-going review well worth while—and there will be absolutely no cost or obligation. Why not write or phone today requesting *your* survey?



UDEBROD BROS. SILK CO., INC.

FOUNDED IN 1870



Electronics Division

12 SOUTH 12th STREET, PHILADELPHIA, PENNSYLVANIA 19107
Area Code 215, WA 2-1122 • TWX 215-569-8551

Why Ticor II has a name instead of a number

Because it deserves it. Because it's the first and only recorder of its kind. Because of the simple fact that it can do what the others can't.

Record on any standard system, play it back on TICOR II.

Your data analysis will be a thousand times better. This is backed up by months of day-to-day operation in data labs since we put this system on the market last March.

With time displacement error held within $\pm 0.5 \mu\text{sec}$, TICOR II updates all your data reduction equipment. Write for specs. Ask for a demonstration.



Mincom Division **3M**
COMPANY
300 South Lewis Road, Camarillo, California

ULTRASONIC spectrum analyzer

SB-15a / ultra-compact / ultra-versatile / ultra-fast!

100 cps to 600 kc

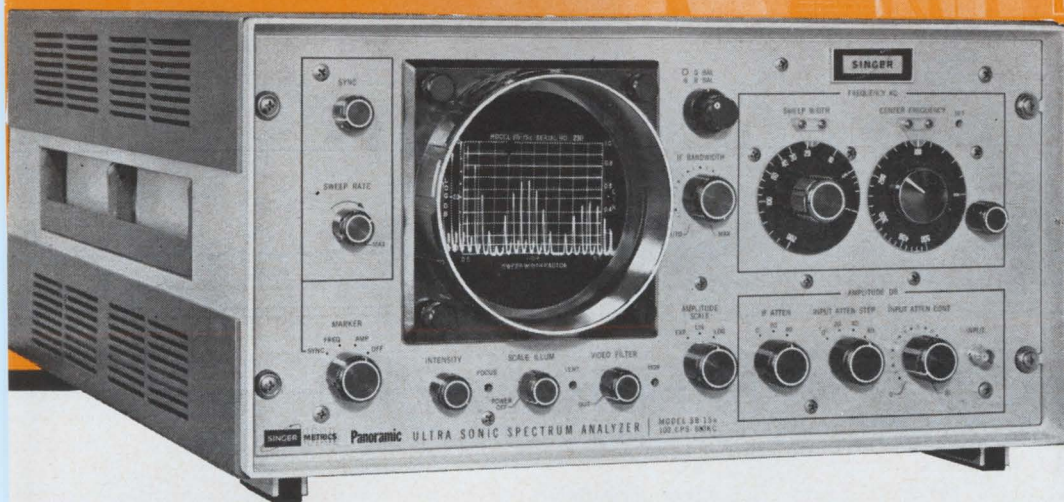

GPL DIVISION ENGINEERS SPECTRUM ANALYZE RADAR DOPPLER SIMULATOR

Panoramic Model SB-15a Spectrum Analyzer automatically and repetitively scans 1 kc to 200 kc spectrum segments through its entire range... plots amplitude vs frequency instantly on a calibrated long-persistence CRT display, or on a 12 x 4 1/2" chart (optional RC-3b/15). Automatic optimum resolution (selectivity) provides detailed examination of signals as close as 100 cps. Selectivity can also be manually set from 100 cps to 4 kc bandwidth. The SB-15a is self-checking with internal frequency markers every 10 kc and internal amplitude reference; 8 3/4" high; and completely self-contained, including power supply.

FEATURES: ■ Quick signal location, minimum chance of missing weak signals or holes in spectrum ■ Faster measurements — no tedious point-by-point plots ■ Reliable spotting of low level discrete signals in noise ■ Positive identification and dynamic analysis of all types of modulation.

APPLICATIONS: ■ Noise, vibration, harmonic analysis ■ Filter and transmission line checks ■ Telemetry analysis ■ Communication system monitoring and testing ■ Spectral density analysis with Model PDA-1 Analyzer ■ Response plotting with Model G-15a Companion Sweep Generator.

Frequency Range — 100 cps to 600 kc, temperature stabilized
Sweep Width — Variable, calibrated from 1 kc to 200 kc
Center Frequency — Variable, calibrated from 0 to 500 kc
Markers — At 10 and 100 kc intervals, $\pm 0.02\%$ acc.
Resolution — IF bandwidth variable 100 cps to 4 kc
Sweep Rate — 1-60 cps, free-running or synchronized

Amplitude Scales — Lin, 40 db log (usable 60 db), 2.5 db EXP
Distortion — Harmonic and IM at least 60 db down
Sensitivity — 200 μ v to 100 v full scale deflection
Accuracy — ± 0.5 db any 200 kc segment 200 cps-525 kc
Attenuators — 0 to 120 db, step and smooth
Smoothing Filter — 0 to 0.25 sec time constant, low pass

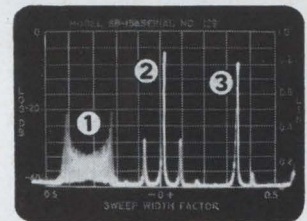

Dynamic analysis shows SB-15a versatility: (1) FM (shows dynamic deviation), (2) AM, (3) SSB with sine wave modulation.

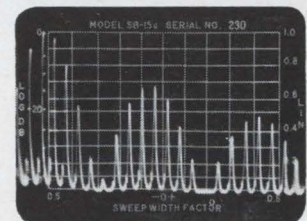

Harmonic analysis of 20 μ sec 11,000 pps video pulse waveform on SB-15a 200 kc sweep width, linear amplitude scale.

ASK YOUR METRICS SALES REPRESENTATIVE ABOUT THE NEW SINGER TIME PAY AND LEASE PROGRAMS



THE SINGER COMPANY
 METRICS DIVISION

915 PEMBROKE ST., BRIDGEPORT, CONNECTICUT
 TELEPHONE (203) 366-3201 • TWX 710-453-3483

Design and production of PANORAMIC • SENSITIVE RESEARCH • EMPIRE • GERTSCH instruments for measurement

We took our cue from the sardine.

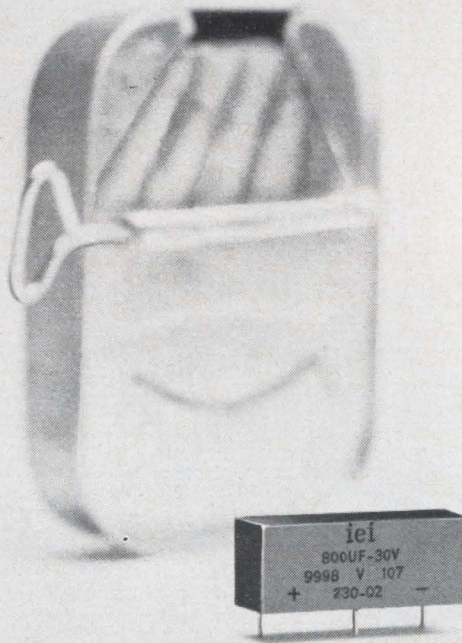

IEI'S NEW WET SLUG TANTALUM SUPER-PAK COMPRESSES THE VALUES OF UP TO FIVE ELECTROLYTICS INTO A SINGLE, COMPACT PACKAGE

The use of new tantalum powder compressing techniques and an ingenious method of internal wiring and packaging have achieved remarkable savings in size and weight: these new SUPER-PAK wet slug tantalum capacitors are as small as one-third the size of other units of similar capacitance and working voltage.

Particularly convenient for printed circuit and terminal board applications, the IEI SUPER-PAKs are manufactured in a flat, rectangular configuration with parallel leads of solder-coated Grade "A" nickel

wire. The lead pattern and an index pin assure correct polarity when assembled into the circuit.

IEI SUPER-PAKs are available in a capacitance range of 160 ufd to 2640 ufd, at working voltages of 10, 15, 20, 25, 30, 50, 75 and 100 volts at 85°C operating temperature (continuous). They may be operated at 125°C by derating the voltage.

The highly reliable SUPER-PAKs assume performance characteristics typical of MIL-C-3965/4C requirements. Special ratings and non-polar construction are available on special order.

Send for complete information.



INTERNATIONAL ELECTRONIC INDUSTRIES
Box 9036-12, Nashville, Tennessee

A DIVISION OF **SPS** STANDARD PRESSED STEEL COMPANY "Where reliability replaces probability"

ELECTRO INSTRUMENTS ANNOUNCES

NEW LINE

OF DIGITAL CAPACITANCE METERS



PROVIDING RAPID, PRECISE MEASUREMENTS
WITHOUT TEDIOUS MANUAL ADJUSTMENTS

By Dr. Walter East
President, Electro Instruments, Inc

It is always a satisfying experience to introduce a product which is an improvement over anything in its field. But it is doubly satisfying when the improvements inherent in the product are such that they may open up whole new areas and fields of usage for it. That may well be the case with our new line of Digital Capacitance Meters.

Their primary users will continue to be those industries and firms which have a need to measure capacitance to

highly precise degrees. As electrical engineers are well aware, this has heretofore required the services of a technically competent operator, and the measuring process itself could not be accomplished with any degree of accuracy in less than minutes of time.

Offer Production Savings

Our new capacitance meters, by completely eliminating the need for manual adjustment, make capacitance measuring a job which can now be handled by relatively unskilled personnel. Also, they cut the time element involved to less than a second. On both counts, therefore, these new capacitance meters offer such firms as manu-

facturers of electronic components, and manufacturers who utilize such components, valuable production savings.

Other Possible Uses

But I can visualize a practical use for these new meters on research and manufacturing jobs where capacitance meters are not now normally employed. Automatically monitoring thicknesses, molecular structure, insulating properties of such solids as paper, plastics, fabrics—and many forms of liquid and gaseous matter.

Let one of our field sales engineers acquaint you with the advantages of our new digital capacitance meters today. Or call or write me directly.



Electro Instruments, Inc.

8611 Balboa Avenue San Diego, California 92112

ELECTRO INTERNATIONAL, INC., ANNAPOLIS, MD. • TRANSFORMER ENGINEERS, SAN GABRIEL, CALIF.

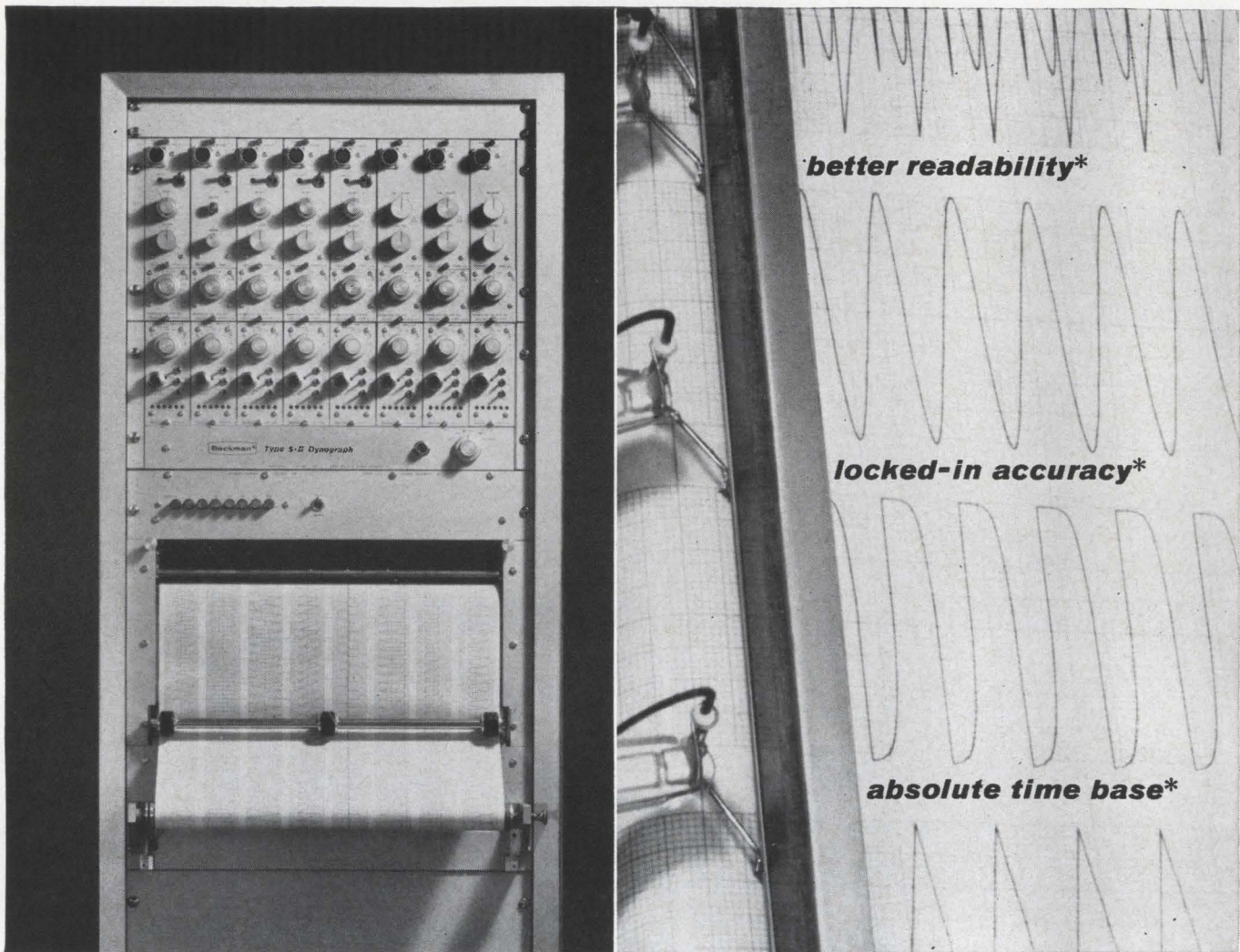

*with every stroke of every pen

Dynograph® pressurized ink-rectilinear recorder

Better Readability... The completely new pressurized ink system is controlled by a pump that maintains an unvarying pressure at all times while the instrument is in operation. This means that the tracing will retain its high resolution characteristics, regardless of variations in paper speed or signal frequency... never any skipping, or broadening of the line.

Locked-in Accuracy... Servo-control feed-back from the pen tip constantly matches the pen position to the input signal... for unsurpassed recording accuracy.

Absolute Time Base... All the pen tips are constrained to the same straight line by the slide-wire assembly... in effect a "straight edge" guarantee that completely valid time comparisons can be made between any or all channels.

Reliability... The all solid-state circuitry in the Dynograph recorder has been proven in the field for over seven years. In the event that problems do arise, the "plug-in" construction expedites service to minimize downtime.

Versatility... A multitude of inexpensive input couplers allow the conditioning of virtually any type of signal, making unnecessary the purchase of expensive special-purpose amplifier systems.

Interested?... Check the specification box, then contact your local Offner sales engineering representative, or write for Data File S645.

SPECIFICATIONS

Number of Channels	1-8 standard
Sensitivity	with preamp, 1 μ v/mm to 5 v/mm. without preamp, 1 mv/mm to 5 v/mm.
Frequency Response	DC to 150 cps
Linearity	$\pm 0.25\%$, or less
Drift	1 mm/hr
Input Impedance	1 megohm DC; 1 megohm shunted by 1,000 p.f. or less AC.
Power Required	230 watts, maximum (8 channels)
Input Couplers	28 standard, plus specials

Beckman® INSTRUMENTS, INC.

OFFNER DIVISION
Schiller Park, Illinois

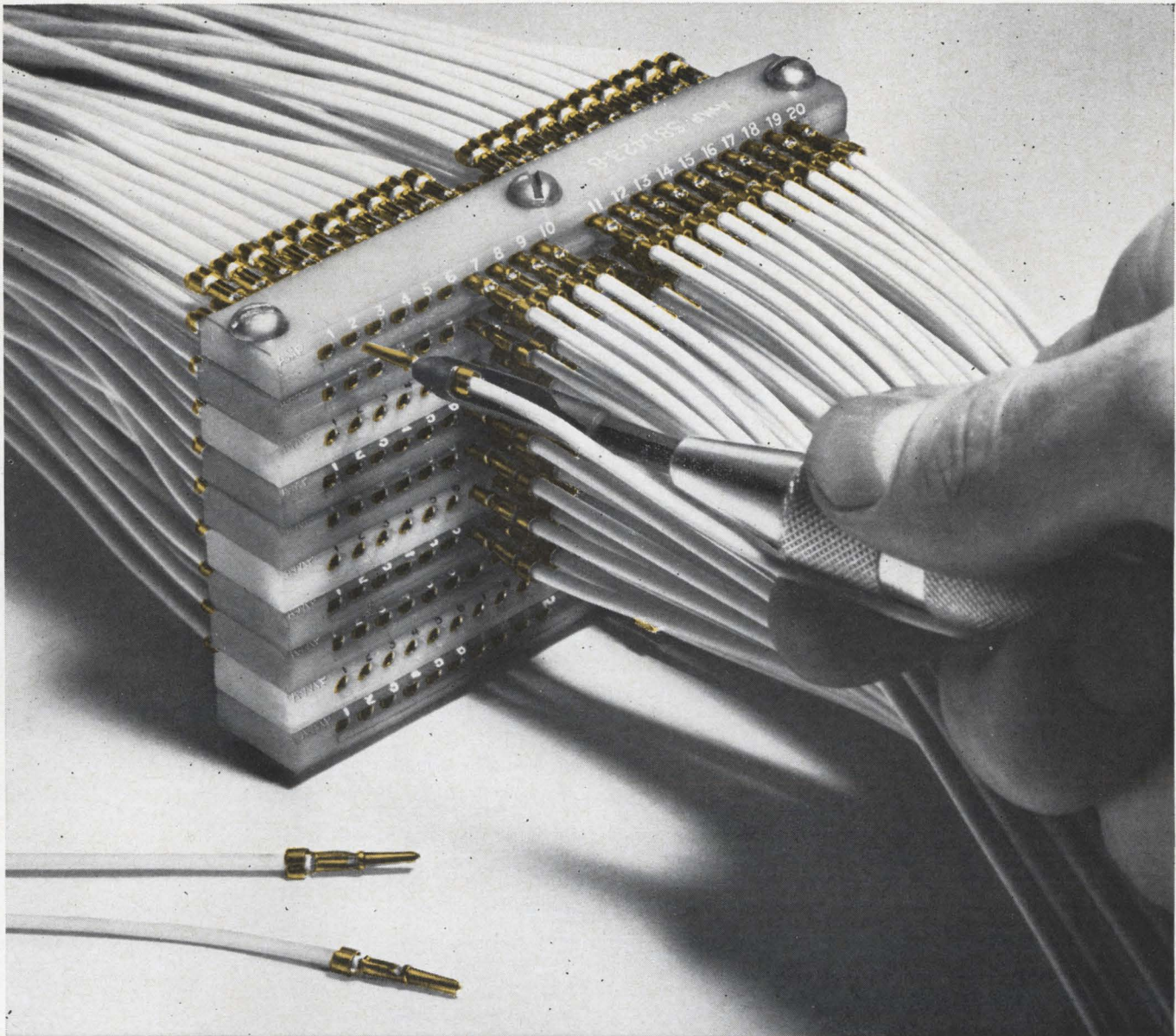

How small can a pin be?

It can be within a mere few thousandths of an inch of the outside diameter of the wire insulation. Or even less. That's the way we engineer our A-MP* Taper Pins.

Anywhere the wire fits, our pins fit. That's the kind of density that gives you the extra design space you need.

With nominal retention strength of 25 pounds, our taper pins assure peak mechanical and electrical characteristics. Even when subjected to temperature cycling of -85°F to $+500^{\circ}\text{F}$, and being vibrated at 150 cps, 20 g accelerations, these taper pins hold fast. And they become better with age—joint resistance decreases, while joint disengagement forces increase. Combine this with a taper design that makes pins self-cleaning and self-locking and you've got reliable performance under the toughest conditions.

Want further assurance? Check these features:

- Our matched crimping tools eliminate cold solder joints, burnt and brittle insulation
- Automatic application for lowest installed cost

- Pre-insulation prevents flash-over and possible shorting
- One piece solid molded blocks and two piece for customer assembly
- Standard configurations, 10, 20 and 30 cavities

So why look further? We have the most complete line of taper products in the industry. Pins stamped and formed, uninsulated and insulation piercing types, screw machine with insulation support and pre-insulated types. Plus all kinds of companion items, such as vertical entrance blocks, taper bus bar and taper tab blocks. Write today for complete information.

*Trademark of AMP INCORPORATED



A-MP* products and engineering assistance are available through subsidiary companies in: Australia • Canada • England • France • Holland • Italy • Japan • Mexico • West Germany

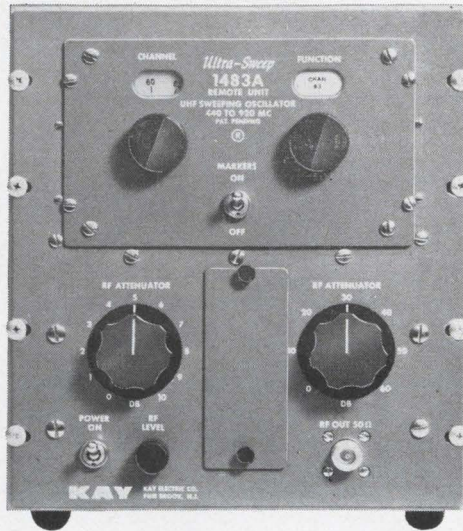

NEW KAY OCTAVE SWEEP

1400 SERIES: Provides full two-to-one fundamental frequency sweep to display broadband circuits in a single sweep. Sweeps an octave, anywhere in the 100 -1,000 mc range; electronically, agc'd flat, and frequency linear. May also be used as a continuously variable (width **and** center frequency) narrow band sweep.

Choose a 200-400 mc model to sweep 225-400 mc receivers. Sweeps the entire input simultaneously; no spurious signals, excellent waveshape. Narrow-down the sweep for IF response. Add an IF band at 20 mc, or 60 mc, etc., on special order. All units contain crystal controlled frequency markers, precision attenuators and remote tuning.

\$895.00

(PLUS MARKERS)

UHF-TV MODEL, 1483-A: Sweeps from 440 to 920 mc at once, or sweeps narrow sweep. Any width anywhere in the range. Contains 3 crystal markers.

\$845.00

FOR COMPLETE LITERATURE, WRITE

KAY ELECTRIC COMPANY
PINE BROOK, MORRIS COUNTY, N.J.

Motorola is your **ONLY COMPLETE SOURCE...**

For

MILITARY SILICON TRANSISTORS

...and they're all
ANNULAR*

Here are just two examples showing the outstanding reliability of Motorola's silicon annular transistors:

1. In one of the nation's major missile programs, three successive qualification life tests were made on Motorola's PNP silicon annular transistors involving a total sample of 9300 devices — with no failures reported!
2. Since the introduction of the first PNP silicon annular Star† transistor, not one lot failure has occurred in a military qualification or acceptance test!

The Motorola-developed annular process has enabled Motorola to design and fabricate virtually any PNP or NPN silicon transistor you need... with performance characteristics (such as high voltage) and reliability previously impossible to obtain with any other manufacturing technique.

For your next military silicon transistor requirements, specify *annular* transistors... for reliability... for performance... for availability... for sure!

Cross Section of an Annular Transistor

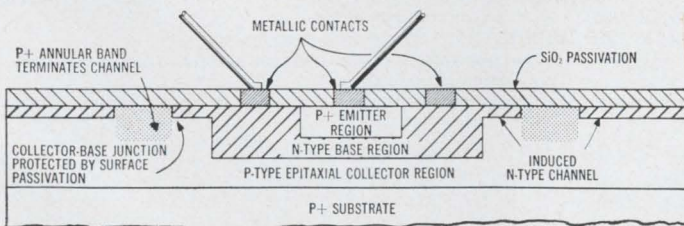

*The annular process provides true silicon oxide surface passivation and eliminates uncontrolled "channeling" and leakage to the edges of the transistor die. Patents pending.

†Trademark of Motorola, Inc.



NPN

USA2N2218 USA2N2219
per Mil-S-19500/251C
USA2N2221 USA2N2222
per Mil-S-19500/255C

PNP

USA2N2904 USA2N2905
per Mil-S-19500/290
USA2N2906 USA2N2907
per Mil-S-19500/291



PNP

USN2N1132
per Mil-S-19500/177A



NPN



JAN2N706
per Mil-S-19500/120A
USN2N2481
per Mil-S-19500/268A



MOTOROLA®
Semiconductors

200-1

QUICK REFERENCE CHART FOR DAYSTROM POTENTIOMETERS

SQUARETRIM® CORNER LEADS	Series Number	Size (In.)	Thickness (In.)	Resistance Range Ohms	Notes	Power Rating at 50°C, Watts	Operating Temperature from -55 Degrees C.	Stranded Flexible Insulated Leads 6" Min. Length								
								Nylon	PVC	Teflon						
	200	3/8 x 3/8	.150	10Ω to 50K	8	1	150			X						
	210	3/8 x 3/8	.150	10Ω to 50K	8	1	175			X						
	300	1/2 x 1/2	.187	10Ω to 50K	8	1	125	X								
	300	1/2 x 1/2	.187	10Ω to 50K	8	1	150			X						
	303	3/4 x 3/4	.280	10Ω to 150K	2, 8	1.5	125		X							
	303	3/4 x 3/4	.280	10Ω to 150K	2, 8	1.5	150			X						
	310	1/2 x 1/2	.187	10Ω to 20K	4, 8	2	175			X						
	311	1/2 x 1/2	.187	5K to 5MEG	3, 5, 8	.5	85	X		X						
	313	1/2 x 1/2	.187	10Ω to 50K	8	1.5	200			X						
	313-118HS*	1/2 x 1/2	.187	10Ω to 50K			.75 (at 85°C)	150			X					
SQUARETRIM® BACK PINS	201	3/8 x 3/8	.150	10Ω to 50K	8	1	150			Solid Bare Terminals 3/16" Length						
	212	3/8 x 3/8	.150	10Ω to 20K	8	1	105			X						
	218	3/8 x 3/8	.150	10Ω to 50K	8	1	175			X						
	301	1/2 x 1/2	.255	10Ω to 50K	8	1	150			X						
	312	1/2 x 1/2	.195	10Ω to 100K	1, 2, 3, 8	1	150			X						
	318	1/2 x 1/2	.255	10Ω to 50K	8	1.5	200			X						
	318-105HS*	1/2 x 1/2	.255	10Ω to 50K			.75 (at 85°C)	150			X					
	358	1/2 x 1/2	.195	10Ω to 100K	1, 2, 3, 8	1	200			X						
368	1/2 x 1/2	.255	10Ω to 6K	7, 8	2	175			X							
SQUARETRIM® SIDE PINS	215	3/8 x 1 3/32	.150	10Ω to 50K	8	1	150			X						
	255	3/8 x 1 3/32	.150	10Ω to 50K	8	1	175			X						
	302	1/2 x 1/2	.260	10Ω to 50K	8	1	150			X						
	315	1/2 x 1/2	.200	10Ω to 100K	1, 2, 3, 8	1	150			X						
	316	1/2 x 1/2	.195	10Ω to 100K	1, 2, 3, 8	1	150			X						
	356	1/2 x 1/2	.195	10Ω to 100K	1, 2, 3, 8	1	200			X						
	357	1/2 x 1/2	.200	10Ω to 100K	1, 2, 3, 8	1	200			X						
*Meet MIL-R-27208A-50Ω to 5K																
Special Features & Modifications Available for SQUARETRIM® <ul style="list-style-type: none"> Resistance Tolerance Resistance Value Resistance Wire Material Temperature Coefficient of Potentiometer Stops within the Resistance Range Lead Length, Insulation Material and/or Color Terminal pin Length, Diameter and/or material for weldability Center Taps Rheostats Marking Packaging Adjustment Screw Location, Length, Diameter and/or Configuration 																
TRANSITRIM® <i>Trademark Applied For</i>	Series Number	Size (In.)	Thickness (In.)	Resistance Range Ohms	Notes	Power Rating Watts	Operating Temperature from -55 Degrees C.	Solid Bare Terminals 1/2" Length								
								510	.360 (Flange) .335 Dia. (Body)	.275	10Ω to 30K		1.25 (at 50°C)	175		X
Available with or without stops.																
COMMERCIAL TRIMMERS	Series Number	Size (In.)	Thickness (In.)	Resistance Range Ohms	Notes	Power Rating Watts	Operating Temperature from -55 Degrees C.	Solid Bare Terminals 3/16" Length 3/8" Length								
								515	.500 Dia.	.317	10Ω to 50K		1 (at 55°C)	150		X
333	1/2 x 1/2	.187	50Ω to 10K	6	.2 (at 40°C)	80			X							
Daystrom commercial trimmers have the inherent reliability of the MIL type potentiometers. The same patented "Wire-in-the-groove" method of winding the resistance element is used, assuring locked-in linearity and resolution.																
METAL FILM TRIMMERS	Series Number	Size (In.)	Thickness (In.)	Resistance Range Ohms	Notes	Power Rating Watts	Operating Temperature from -55 Degrees C.	Solid Bare Terminals 1/2" Length								
								520--526**	1.25 x .310	.360	50 Ω to 200Ω		0.5 (at 85°C)	150		X
								521--527**	1.25 x .310	.360	1K to 25K		0.5 (at 85°C)	150		X
								522--528**	1.25 x .310	.360	50K to 200K		0.5 (at 85°C)	150		X
**High Reliability Units																
Patent No. 2,880,293.	Note 1. Factory quote for values over 50K. Note 2. Stops not available. Note 3. Humidity proof not available.			Note 4. Factory quote for values over 10K. Note 5. Factory quote for values less than 5K. Note 6. Factory quote for values less than 50Ω.			Note 7. Factory quote for values over 6K. Note 8. Slotted or Allen-head screws standard.									
Certified drawings and specifications available on request.	 DAYSTROM POTENTIOMETERS ARE ANOTHER PRODUCT OF WESTON INSTRUMENTS, INC. ARCHBALD, PENNSYLVANIA 18403															

Made to the best of MIL-R-10509E requirements

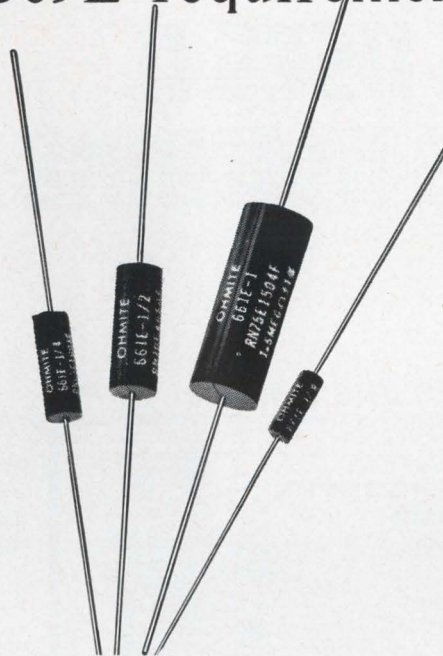

**OHMITE
SERIES
66
METAL FILM
PRECISION RESISTORS**

AVAILABLE ONLY IN 0 ± 25 PPM/ $^{\circ}$ C, CHAR. E

TYPICAL TEST DATA FOR SERIES 66 RESISTORS

TYPICAL TESTS	MIL SPEC. REQ. CHAR. "E"	Series 66 Resistors (Avg. of all tests)	1/8-Watt (RN60E) (661E-1/8)		1/4-Watt (RN65E) (661E-1/4)			1/2-Watt (RN70E) (661E-1/2)			1-Watt (RN75E) (661E-1)		
			309 Ohms	499 K Ohms	402 Ohms	348 K Ohms	1 Meg	402 Ohms	237 K Ohms	1 Meg	365 Ohms	237 K Ohms	2 Meg
Temp. Coeff. $\left. \begin{array}{l} -55^{\circ}\text{C} \\ \text{PPM}/^{\circ}\text{C} \\ +175^{\circ}\text{C} \end{array} \right\}$	0 ± 25	7.93	-8.0 to -10.7	-5.1 to -12.5	-0.5 to -12.0	+0.3 to +5.8	-0.1 to -8.7	+0.3 to +10.6	+1.6 to -10.5	-7.9 to -13.6	-7.0 to -25.0	-1.0 to -19.0	-0.6 to -20.0
	0 ± 25	17.79	+14.8 to +18.2	+10.5 to +23.7	+21.1 to +24.9	+13.0 to +25.0	+15.1 to +24.0	+18.2 to +23.0	+14.0 to +24.0	+6.6 to +24.5	+7.0 to +15.0	+6.0 to +21.0	+15.3 to +24.3
Load Life % Δ R After 1000 Hrs. @ 125 $^{\circ}$ C	± 0.5	0.107	-0.017 to +0.250	-0.002 to +0.407	+0.014 to +0.404	+0.051 to -0.149	+0.049 to +0.069	+0.009 to +0.360	+0.147 to +0.387	0 to +0.129	+0.057 to +0.117	+0.025 to +0.172	+0.004 to +0.115
Short Time Overload % Δ R	± 0.25	0.019	0 to -0.104	0 to -0.043	0 to -0.005	0 to -0.003	-0.003 to +0.010	+0.004 to +0.069	0 to -0.077	0 to -0.010	-0.088 to -0.151	0 to -0.009	0 to +0.009
Moisture Resistance % Δ R	± 0.5	0.058	+0.035 to +0.432	+0.039 to +0.222	+0.024 to +0.034	+0.011 to +0.017	+0.009 to +0.039	-0.030 to -0.065	+0.008 to +0.029	0 to -0.050	+0.021 to +0.032	+0.012 to +0.337	+0.039 to +0.084

NOTE: 440 Units Total Tested; 40 Total for Each Resistance Value; 10 Each Test.

Ohmite's new Series 66 metal film resistors give a significant edge, an extra margin of reliability, wherever you need very low T.C. resistors of this type. And the "why" of this added value is understandable. Series 66 resistors are founded on Ohmite's 10 years of research and production experience in evaporated metal films plus 30 years of concentration on quality resistance products.

There is a difference in metal film resistors. Test these and see for yourself.

The resistance element is a film of special non-noble alloy vacuum-evaporated on to a ceramic core of exceptional surface finish. The film terminates on gold terminal bands fired to the core ends. Gold-plated end-caps are

pressed over the core ends and leads are butt-welded to the caps. The assembly is covered with a special protective resin and completed with a molded coating. Film, core, caps, and coating are matched to provide a stable, moisture-resistant component.

Present sizes are 1/8 watt (309 ohms to 499 K ohms), 1/4 and 1/2 watt (402 ohms to 1 meg), and 1 watt (365 ohms to 2 meg). Tolerances are 1, 0.5, 0.25, and 0.1%. Temperature coefficient, 0 ± 25 ppm/ $^{\circ}$ C over the operating range of -55°C to $+175^{\circ}\text{C}$.

Standard leads are nickel, solder-dip coated for soldering; furnished bare for welding, or gold-plated on order.

Write for Bulletin 110



OHMITE

MANUFACTURING COMPANY

3610 Howard Street, Skokie, Illinois 60076

Phone (312) ORchard 5-2600

RHEOSTATS • POWER RESISTORS • PRECISION RESISTORS • VARIABLE TRANSFORMERS • TANTALUM CAPACITORS • TAP SWITCHES • RELAYS • R.F. CHOKES • SEMICONDUCTOR DIODES

NEARLY EVERY FIRM IN THE WORLD WHICH WINDS COILS USES A GEO. STEVENS MACHINE

CROWN COIL TURNS
ANALYZER

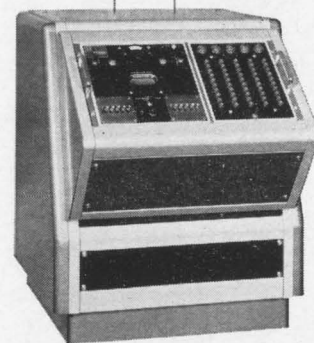

Determines within one minute the precise number of turns in any wound air core coil.

SOME REPRESENTATIVE TYPES ARE SHOWN

**HAND FED WINDER
MODEL 310-AM**

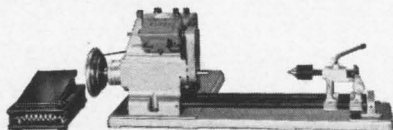

Types of Windings: All random, close, solenoid, and bobbin wound coils. Can be used for space windings on grooved forms.
Max. Coil OD: 6"

**MULTIPLE
TRANSFORMER
WINDER
MODEL 37-S**

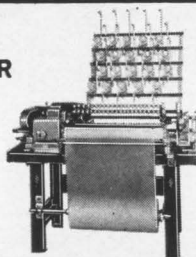

Types of Windings: Multiple winds paper section Power, Audio, Fluorescent Ballast and similar types of transformer coils.
Max. Coil OD: 9" if round, 4 1/2" if rectangular.

**MINIATURE
BOBBIN
COIL WINDER
MODEL 39-AM**

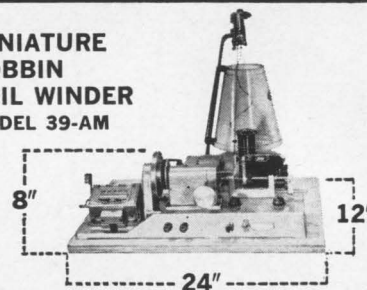

Net Wt. 41 lbs. Types of Windings: Small precision instrument-type and miniaturized Windings.
Max. Coil OD: 1 1/2".

**HIGH PRODUCTION
SEMI-AUTOMATIC VOICE
COIL WINDER**

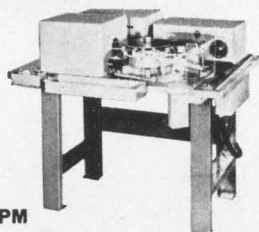

MODEL 62-PM

Covers over 80% of all voice coil winding requirements . . . Can produce over 800 finish wound voice coils per hour. Eliminates coil rejection due to winding errors. Eliminates hand sizing operations; eliminates coil handling during winding.

**VARIABLE PITCH PROGRESSIVE
UNIVERSAL WINDER**

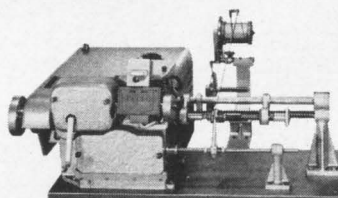

MODEL 600-AM

For lab and production runs . . . Types of Windings: Variable pitch progressive universal coils; variable pitch solenoids; progressive universal coils; automatic pi-wound coils; universal coils; close and space wound single layer solenoids; random wound bobbin coils.

**6" OR 12" PRECISION
SPACE WINDER**

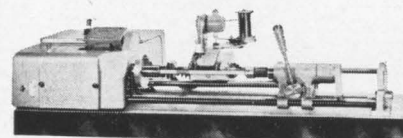

MODEL 332-AM (SCREW FEED)

New solid state circuitry; instant fingertip re-settable wire guide; winding range; 44 to 3040 turns per in. Types of Windings: Space Wound Resistors, Distributed Constant Delay Lines and Precision Linear Potentiometers.
Max. OD: 4".



COIL WINDING

The only book available on coil winding. 192 pages; 100 illustrations. 2700 Gear Ratios (never before available). \$5.00



**CATALOG NO. 65
(FREE)**

Offers an unmatched variety of machines for every coil winding need.

**HIGHLY RELIABLE
PRECISION
ELECTRONIC
COUNTER**

**MODEL 184
SERIES**



SOLID STATE. Only 8 VDC operating voltage. Only 12 watts power consumption. 4 digits within one compact enclosure. Instant easy readability. Counting rate 30,000 RPM or 1.5kc at ±1 turn accuracy with photocell pickup. No warm-up. Downtime virtually eliminated. Very low initial cost.

GEO. STEVENS MFG. CO. INC.

6001 No. Keystone Ave., Chicago, Illinois 60646

The Most Complete Line of Coil Winding Machines Made

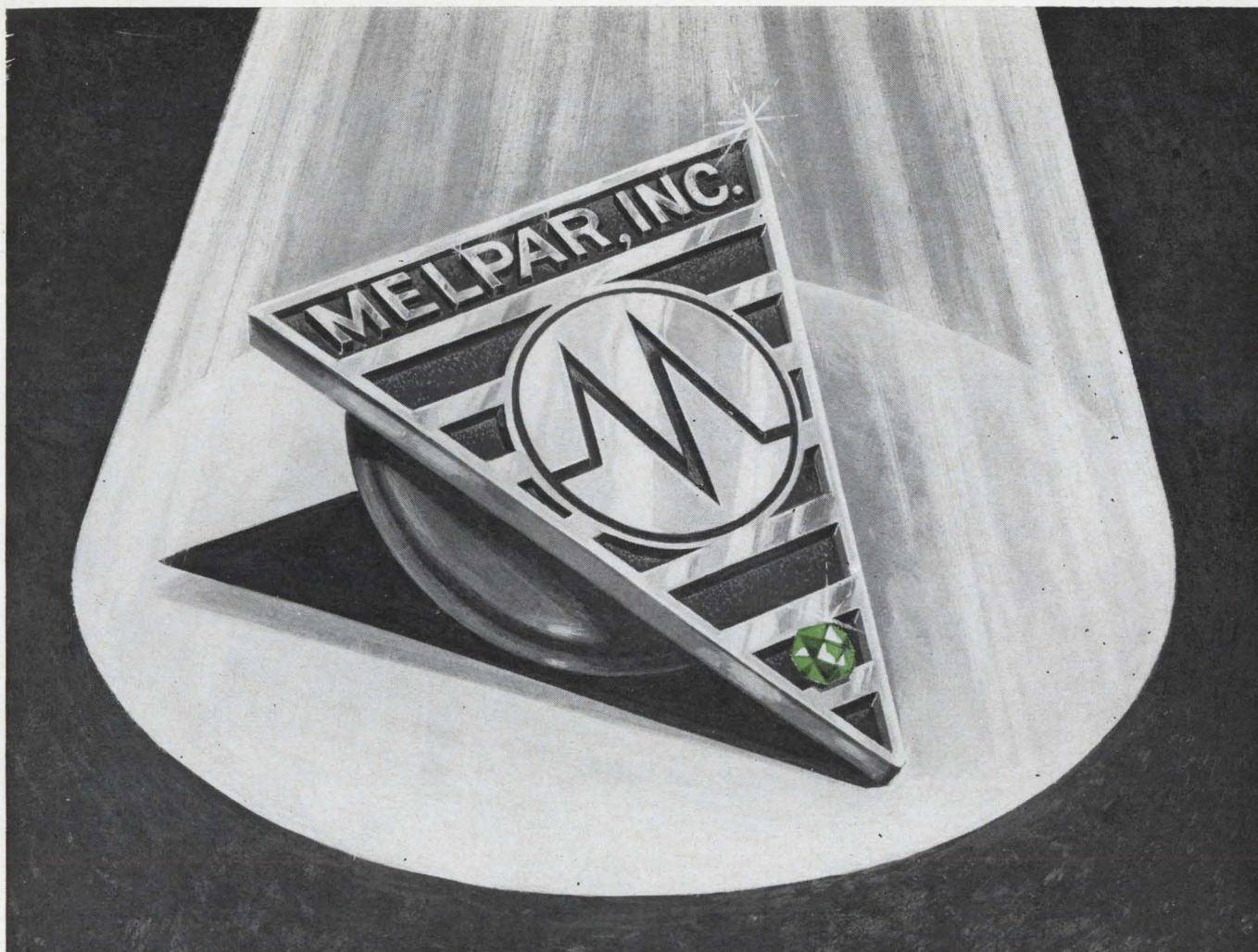

HOW LONG IS TWENTY YEARS?

Not long, for some companies; but for an organization specializing in modern electronic research and development, it is as old as the industry itself. Our first twenty-year man receives a pin like the one above this year.

Melpar has helped pioneer many of the technological breakthroughs of the past twenty years—what will the advances be in the next twenty years? We think we know what a few will be. We're working on them now. If you are a scientist or engineer interested and capable of working ahead of the pack, we want to talk to you now.

We have immediate requirements for:

COMMUNICATIONS ENGINEERS

Hardware design experience in digital communications; audio circuit and receiver design

COMPUTER ENGINEERS

Logic design, circuit design on small special purpose digital computers

TECHNICAL PROGRAMMERS

Symbolic and machine language programming of real time computer controlled man-machine systems for small special purpose digital computers

Write Clarence Endsley, Professional Placement

MELPAR  **INC**

A SUBSIDIARY OF WESTINGHOUSE AIR BRAKE COMPANY

3476 Arlington Boulevard, Falls Church, Virginia

An equal opportunity employer

SPACE SCIENCES • SPECIAL PURPOSE DATA PROCESSING • ELECTRONIC WARFARE SYSTEMS • ORDNANCE DEVICES • SIMULATION AND TRAINING
SPECIAL DETECTION SYSTEMS, BIOLOGICAL AND CHEMICAL • COMMUNICATIONS • LIFE SCIENCES • MICROELECTRONICS • TEST AND EVALUATION

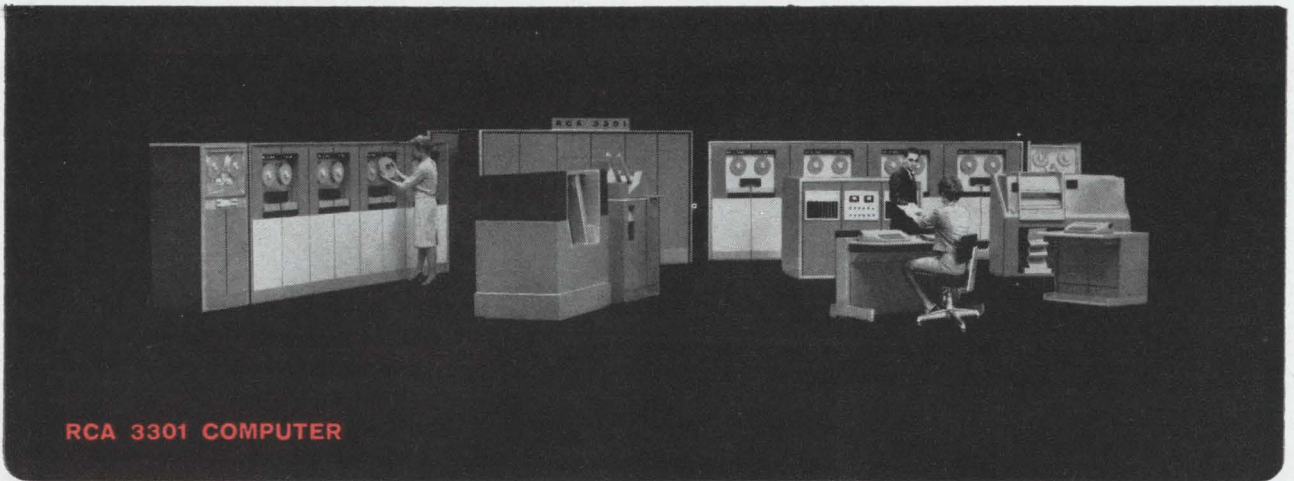

RCA 3301 COMPUTER

RCA
uses **CTC**
memory
test systems

*to test
cores,
planes
& stacks*

... those who build the
most reliable digital systems
standardize on
CTC test equipment

**COMPUTER TEST
CORPORATION**
CHERRY HILL, NEW JERSEY

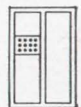

Washington Newsletter

January 11, 1965

Tv-guided bomb studied for Navy

The Navy has selected three companies to begin program-definition studies of Walleye, a 1,000-pound bomb that can adjust its own glide path in flight.

After studying 11 proposals for 3½ months, the Navy's Bureau of Weapons awarded contracts to the Hughes Aircraft Co., the Orlando division of the Martin Marietta Corp. and North American Aviation, Inc.

The bomb will have no propulsion system, but it will have fins that can be adjusted in flight to change the angle of the bomb's fall. A television camera in the nose locks onto a target and feeds signals to the fins.

The bomb would be carried by light attack planes for use against hardened targets that are defended.

Problems beset trade fair plans

The United States may sponsor an international aerospace and science trade fair in June, 1966, at Washington's Dulles International Airport. If the fair is successful, it will be held every two years thereafter.

Two problems can still stall the fair. One is a lack of industry support; electronics companies are more enthusiastic than aircraft makers, who have less trouble selling their wares abroad. The second problem is a financial dispute. Some manufacturers want to write off the cost of participation as an allowable expense on their government contracts. The government is resisting this demand.

President Johnson would have to approve any government sponsorship, and Congress would have to underwrite the administrative expenses and the cost of constructing buildings at the fair. Admission and exhibitor fees would be expected to recover most costs.

The idea for the fair was developed by a task force representing the Federal Aviation Agency, the Pentagon, the National Aeronautics and Space Administration, the Commerce Department and the Civil Aeronautics Board. The group was organized by the Commerce Department, which is seeking to promote exports of aerospace equipment.

Cost may stall mobile missile

Army officials believe that many of the technical problems besetting its mobile anti-aircraft Mauler missile have been solved. **But the future of the weapon is still in doubt because additional work increased the weapon's development cost.** The question now is whether the higher price tag can pass the Defense Department's stiff cost-effectiveness tests.

The General Dynamics Corp. is prime contractor for the Mauler. Electronic equipment subcontractors are the Hughes Aircraft Co. for the infrared guidance system; De Havilland Aircraft of Canada, Ltd., for the infrared acquisition system; the Raytheon Co. for acquisition and tracking radars and the Burroughs Corp. for the computer system.

Most versatile antisub torpedo

The Navy's most versatile antisubmarine torpedo, the Mark 46, has gone into production. The weapon follows a programmed search pattern, using either active echo ranging or passive listening methods. When the target is found, the torpedo pursues and destroys it.

The Mark 46 uses an electronic guidance system, a computer and an autopilot. It is the first antisub torpedo that can be launched from either

Washington Newsletter

a fixed-wing aircraft, a surface ship or a helicopter. The Bendix Corp. developed the guidance control system under a subcontract with the Aerojet-General Corp., a subsidiary of the General Tire & Rubber Co.

The Navy is now concentrating on the Mark 48, formerly the X-10, a weapon that will move faster, deeper and quieter and can spend more time in acquiring a target than the Mark 46.

Although secrecy surrounds the Mark 48, it has been disclosed that the launch vehicle's computer facilities help in guiding the torpedo.

Academy amplifies engineers' voice

The electronics industry is expected to have a stronger voice in shaping federal science and research policies with the establishment of the National Academy of Engineering.

The academy was created in response to objections by engineers that fewer than 10% of the 600 members in the National Academy of Sciences are engineers. One of its principal functions is to advise the government.

Members of both academies represent industry, schools and nonprofit research organizations. About half of the National Academy of Engineering's founding members represent industrial companies, many of which have a stake in electronics.

Navy replacing Tartar and Terrier

The Navy is working on a new anti-aircraft missile to replace both the short-range Tartar and medium-range Terrier for use on destroyers and cruisers. General Dynamics is receiving a \$13-million contract for development and pilot production of the new missile. It would come in two versions, with ranges of 10 miles and 30 miles, and would use semi-active homing techniques for guidance.

The Navy decision to replace the Tartar and Terrier with a new missile came after a crash program failed to correct problems of accuracy and dependability.

NASA extends JPL contract

The National Aeronautics and Space Administration has extended its contract with the California Institute of Technology's Jet Propulsion Laboratory for two more years.

The contract extension seems to be evidence that the peace treaty between the laboratory and NASA is working out. After disagreement mushroomed some months ago over the lab's management of subcontractors, a new arrangement, incorporating many of NASA's recommendations, was instituted.

The lab is responsible for the management of about \$200 million of Ranger and Mariner programs, plus the deep-space tracking network and related projects.

Phantom fighter to be improved

The Air Force plans a new version of the McDonnell Aircraft Corp.'s F-4C Phantom fighter that will have improved electronic equipment for tactical all-weather bombing. Modifications and improvements in the sighting system of the F-4C will give the new Phantom greater accuracy in bombing small targets.

McDonnell is being awarded a \$40.7-million supplement to its existing F-4 contract for items that have long lead times.

You can cool with air...

(if you have a lot of space)

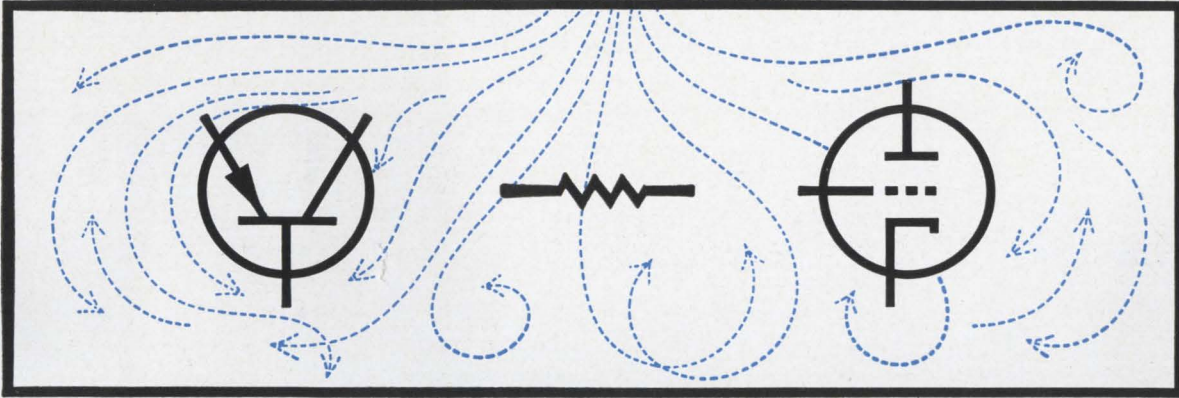

OR

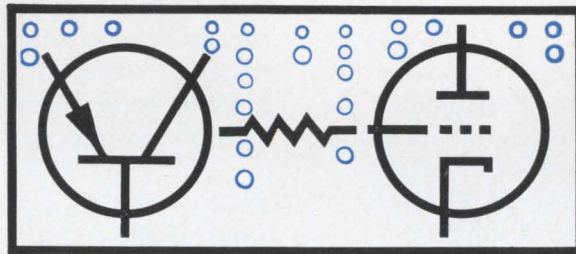

use FREON® dielectric coolants

(if you don't)

FREON carries heat away hundreds of times better than air. Close-packed assemblies can operate efficiently at safe temperatures. FREON compounds have outstanding characteristics as heat transfer media either by boiling or by convection.

These inert coolants will work for you in your high-density electronic equipment—wherever you have a reliability problem from “hot spots” in power tubes, transistors, resistors, transformers, packaged electronics, etc. FREON coolants can make your design more compact—at low to moderate cost, while improving reliability through close thermal control.

These five FREON dielectric coolants range in boiling point from +38.8°F. to +237.0°F., offering a wide range of use:

FREON-114	CCl ₂ CClF ₂	B.P. + 38.8°F.
FREON-113	CCl ₂ FCClF ₂	B.P. +117.6°F.
FREON-215	CCl ₂ CF ₂ CF ₂	B.P. +165.0°F.
FREON-112	CCl ₂ FCCl ₂ F	B.P. +199.0°F.
FREON-214	CCl ₂ CF ₂ CF ₂ Cl	B.P. +237.0°F.

Send the coupon for complete technical information based on our 33 years' experience with cooling problems.



Better Things for Better Living . . . through Chemistry

Du Pont Co.
“Freon” Products Division
N-2430E-2
Wilmington, Delaware 19898

Please send me complete technical information on FREON dielectric coolants.

Name _____

Address _____

City _____

State _____ Zip _____

Offer good in U.S.A. only.

All You Add Is Weightlessness

The Gemini Mission Simulator precreates the sounds, circumstances, faults, smells, temperature conditions and instrument readings of a Gemini orbital rendezvous flight—with the exception of gravity effect.

Designed, developed, and produced for NASA's Manned Spacecraft Center by a McDonnell simulator team who fully understands the training problem and whose skills span many disciplines—celestial mechanics, kinematics, electronics, electrical and mechanical engineering, computer programming, engineering psychology, equipment design, and fabrication—the Gemini Mission Simulator makes possible integrated mission training for both flight crews and ground operations personnel.

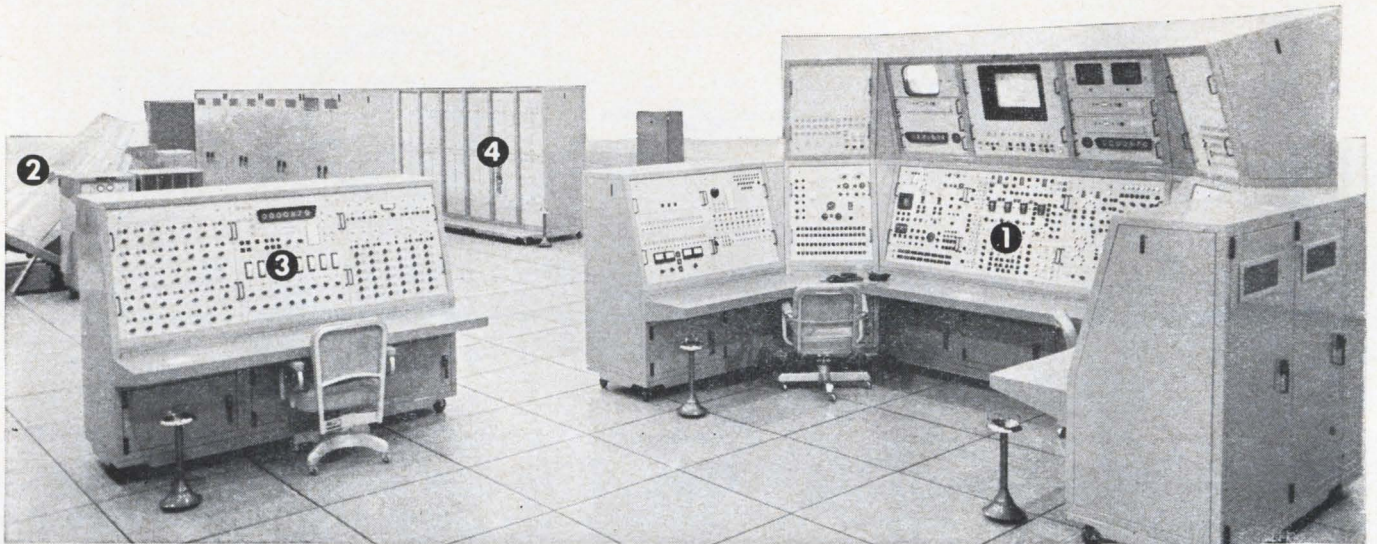

Gemini Mission Simulator Installation at the Kennedy Space Center.

The **Instructors Station ①** permits monitoring of all instruments and controls and allows the introduction of flight control, environmental control, and communication systems malfunctions. It provides crew and instrument panel TV monitors, digital communications with the simulated on-board computer, and the capability for creating realistic noise and communication distortion.

The interior of the **Crew Station ②** is a visual and tactile duplicate of the Gemini Spacecraft cabin. The Crew Station is hydraulically mounted to tilt the cabin for crew comfort.

The Gemini Mission Simulator is one of the products and systems currently being provided by the McDonnell Electronic Equipment Division to industrial and military agencies in the fields of automatic check-out, simulation, training, guidance and control, and space communication. For a brochure describing "Skill in Electronics" at McDonnell, write:

The **Telemetry Control Console ③** enables telemetry processing, monitoring, and fault introduction, before transmission to the operational ground stations, as necessary for ground station operator training.

Peripheral Equipment ④ includes power supplies, audible noise generation equipment, communications subsystems, telemetry systems and other units external to the **Computer Complex** (not shown) which synthesizes the manual data insertion unit and the digital command system. All equipment is solid state and modular.

MCDONNELL ELECTRONIC EQUIPMENT DIVISION

DEPT. 946 • BOX 516 • ST. LOUIS, MISSOURI 63166

APPLYING ELECTRONICS AS AN INTERDISCIPLINARY SCIENCE

Miniature Wet Slug Tantalum Capacitors

Proved by 1,810,000 Unit Test Hours

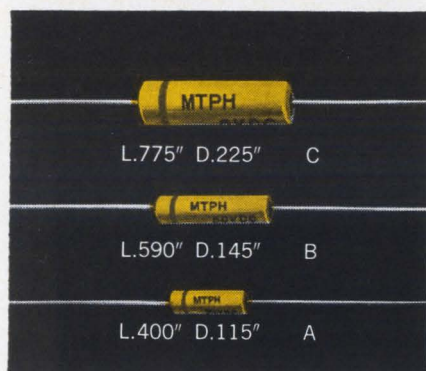

During 1,810,000 unit hours of life test at 85°C, at full rated voltage, using a low impedance power source, not one MTPH capacitor has failed through short circuiting or excessive DC leakage current. Type MTPH capacitors were developed by Mallory as a result of experience

STANDARD RATINGS

MTPH NO.	Rated Cap Mfd.	Rated Voltage D.C.	DCL μ a		DF% +25°C	% of +25°C Cap at -55°C	120 CPS Z at -55°C	DF% +85°C	Case Size
			+25°C	+85°C					
MTPH1	6.8	50	3	10	20	70	400	10	A
MTPH2	30	50	8	25	20	70	120	15	B
MTPH3	78	50	10	30	20	60	55	18	C
MTPH4	10	30	3	10	20	65	290	10	A
MTPH5	45	30	8	25	25	60	100	20	B
MTPH6	120	30	10	30	30	55	48	25	C
MTPH7	60	20	7	20	25	55	90	20	B
MTPH8	80	15	6	18	30	55	82	25	B
MTPH9	200	15	8	25	30	50	44	25	C
MTPH10	120	10	5	15	35	50	66	25	B
MTPH11	300	10	7	20	35	40	35	28	C
MTPH12	180	6	5	15	37	50	40	25	B
MTPH13	450	6	6	18	50	40	33	40	C

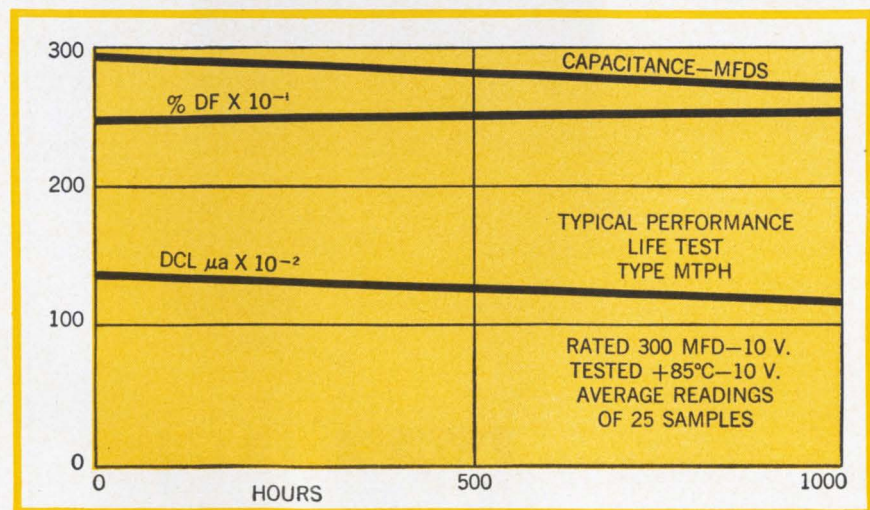
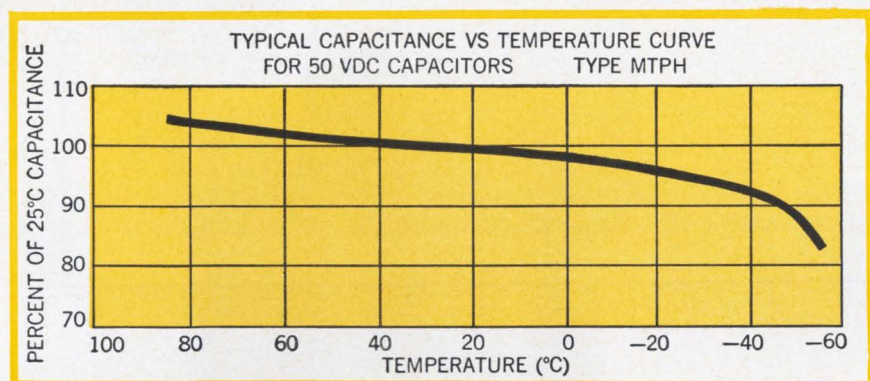

gained producing a similar line for use in the Minuteman II missile system made by Autonetics Division of North American Aviation, Inc.

The MTPH style of capacitors are produced in the same "white room" manufacturing facility and by the same highly trained operators used for Minuteman II parts. The materials, production processes and quality controls are also the same, thereby assuring the highest degree of reliability.

MTPH capacitors have higher capacity-voltage product per unit volume than any conventional wet slug, foil or solid tantalum line. This size factor makes these capacitors very desirable for applications with thin film, integrated and other micro-electronic circuits. An additional advantage of the wet slug construction is the absence of the familiar catastrophic failure mode of solid tantalum devices.

For complete data and prices, write or call Mallory Capacitor Company, Indianapolis, Indiana 46206—a division of P. R. Mallory & Co. Inc.



This is DEI's Solid State Receiver

It's new

Tunes in the range of 100 to 2300 mc

Superior performance characteristics

The TR-711 is virtually spurious free

Sets the standard for comparison

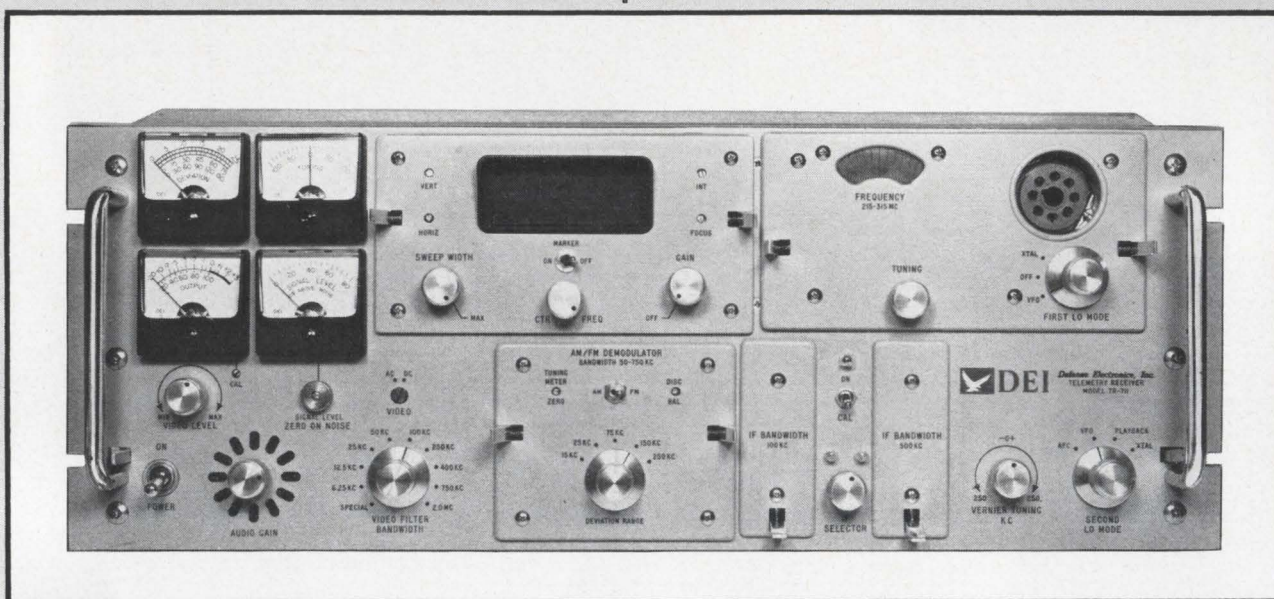

The TR-711 Receiver is modular in construction and can be supplied with a complete complement of plug-in modules including RF tuning units from 100 to 2300 mc, IF amplifiers with 10 kc to 3.3 mc bandwidths, AM, FM, and phase demodulators, and plug-in spectrum display unit, oscilloscope, predetection up and down converter, or high capture ratio discriminator. Any combination of plug-in modules can be utilized, thus providing unlimited receiving combinations adaptable to any known or projected telemetry system.

Characteristics and accessories are described in Bulletin TR-711.

Defense Electronics, Inc.
Rockville, Maryland



DEI
RESEARCH
DEVELOPMENT
MANUFACTURING

ROCKVILLE, MD. (301) 762-5700, TWX: 301-427-4660; SHERMAN OAKS, CALIF. (213) 872-2870, TWX: 213-732-2742; COCOA, FLA. (305) 632-5442; INT'L., ROCKVILLE, MARYLAND.

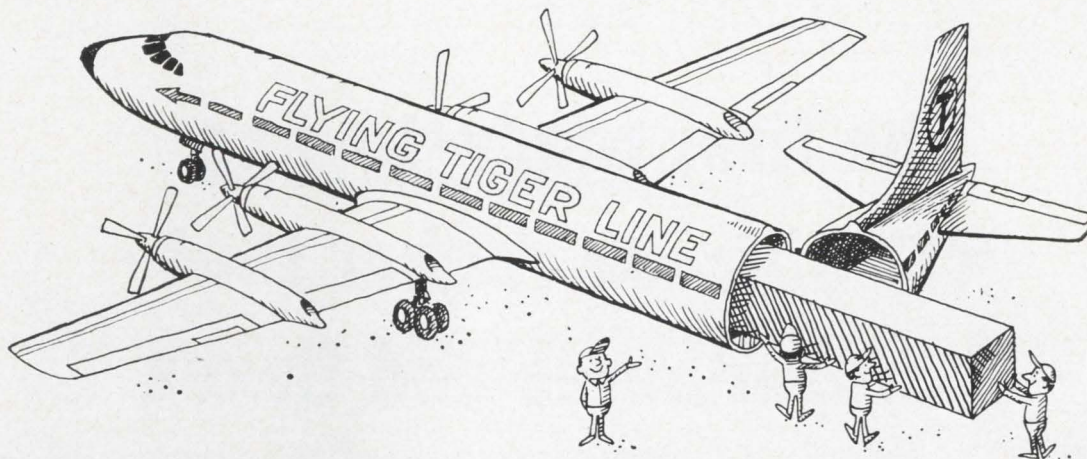

WE'LL GET YOUR OUTSIZE CARGO THERE ON TIME

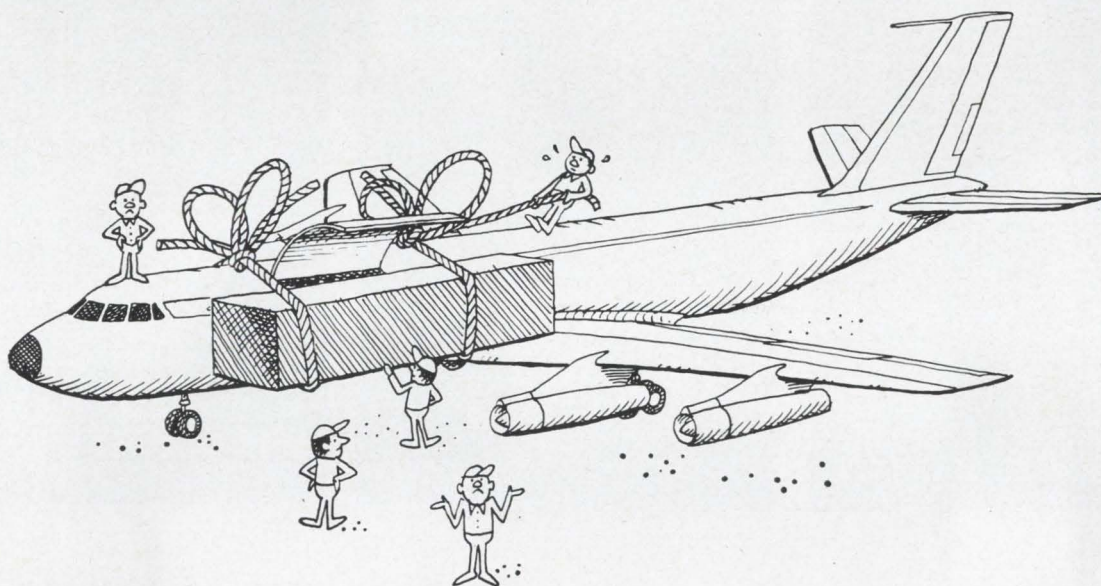

WHEN OTHERS CAN'T GET IT OFF THE GROUND

Stop worrying about nice pretty packages. Or "ideal" sizes. Or containerization. Or pre-palletizing problems. Or loading time spent loading the loader.

Just schedule **all** your cargo on Flying Tigers. We'll put it **straight** in on a Tigers' Swingtail-44—the little ones—the big ones—the odd ones—the regulars—all with no worry for you.

You won't have to worry about pick-up or delivery either. A Tiger truck will pick the

shipment up at your door and deliver it to the door you want, **on time**.

And if you want to check on the shipment at any time, Tigers' exclusive advance manifest data system will give you all the facts immediately—no matter where it is or which Tiger office you call. The **whole Tiger Line** is keeping track of your shipment for you. There's only one thing **we** fuss about: giving you "ideal" **service**.

the airfreight specialist

FLYING TIGER LINE



The first ready-to-use RTV silicone rubber that flows, adheres and flexes

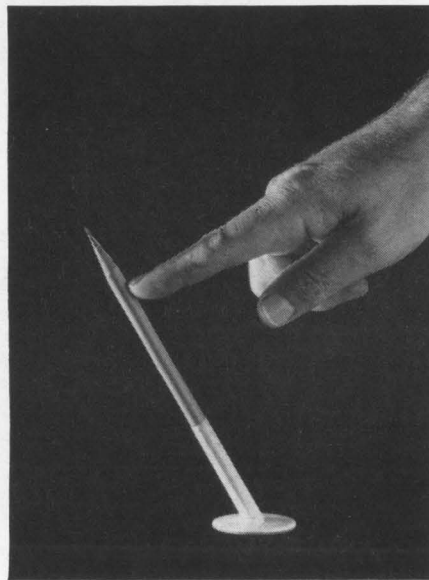
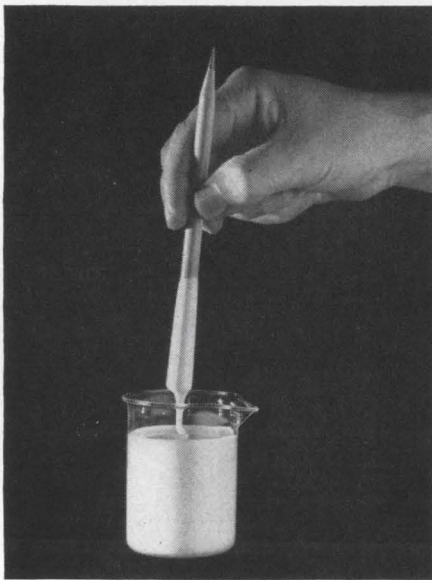

RTV-112 silicone rubber has four characteristics that make it an easy-to-use production line sealant.

Pourable. It's conveniently dispensed automatically or manually.

Ready-to-use. No catalyst to be mixed beforehand. No stirring, either.

Adhesive. Bonds to most surfaces without a primer.

Flexible. Absorbs shock and vibration. Puts no stresses on components.

RTV-112 handles like paint. It can be sprayed and brushed. Parts can be dipped in RTV-112 for easy encapsulation. It's tack-free in 30 minutes, and cures in 24 hours at room temperature. No solvents, so there's no flammability hazards and virtually no shrinkage.

RTV-112 silicone rubber is unique. Virtually ageless, it won't crack, crumble or harden. You can cut it away

and add more for easy repairs. Stays rubbery from -85°F to 300°F . It also has excellent electrical properties. It's waterproof.

Where should RTV-112 be used? Because of its easy pour-on protection, RTV-112 is a natural for many production line applications... conformal coatings for electronic components and assemblies, high temperature seam sealing and potting of intricate electrical apparatus to mention a few.

We'll be glad to fill you in even more on RTV-112, the first free-flowing, precatalyzed, high temperature, elastomeric adhesive, sealant and encapsulating compound. We'll include a list of suppliers of automatic dispensing equipment. If you'd like a free sample, drop a note on your letterhead describing your application to Section N1127, Silicone Products Dept., General Electric Company, Waterford, New York.

GENERAL  ELECTRIC

Technical Articles

Designing for space radiation, part 2: page 70

Part 1 discussed the radiation environment. In this section, the selection of components for radiation-resistant circuits is examined. These radiation-proof circuits—mainly for amplifiers—use transistors and tunnel diodes.

Marketing 1965: page 87

Electronics' annual examination of what's for the industry. (Index on page 191)

- I. Another record year for the industry: page 88
- II. Further decline in arms: page 88
- III. Space race slows down: page 91
- IV. Boom in industrial markets: page 94
- V. Consumers look to color tv: page 95

Comeback for very low frequency: page 80

Almost forgotten, the portion of the spectrum between 1 and 30 kilocycles has bounced back into importance because it penetrates water without appreciable attenuation. In the Polaris program it is the major communication medium for missile-carrying submarines, but its potential includes worldwide time signals and navigation aids.

Annual index of technical articles: page 191

Listing of the technical articles—and their authors—which have appeared in Electronics through 1964.

**Coming
January 25**

- A collection of circuits for display equipment
- New thin-film dielectrics
- Three computers run a steel mill
- An engineer's view of the tape-recorder controversy

Designing against radiation: Part 2

Part I analyzed radiation effects on materials. This concluding article deals with selecting components and designing radiation-proof circuits for use in space

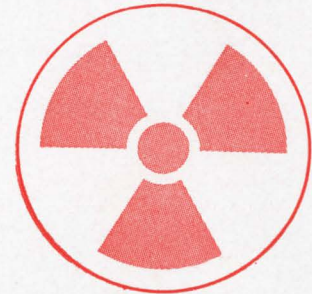

By Henning H. Lind Olesen

Reentry Systems Dept., General Electric Co., Philadelphia

Designing radiation-proof circuits is a matter of selecting components that will survive the space environment with the least possible degradation, and using design techniques to circumvent other radiation problems.

Transistors, for example, are particularly sensitive to radiation, both to ionization and to displacement effects. But field-effect transistors have been found to withstand neutron doses of 10^{15} per square centimeter without drastic change in their electrical characteristics.

Tunnel diodes behave better than transistors when exposed to radiation. Types are available that retain their electrical characteristics in intensities of 2×10^{16} neutrons per square centimeter.

Vacuum tubes' glass envelopes fail at about 10^{16} neutrons per square centimeter. But ceramic tubes have survived 10^{17} neutrons per square centimeter.

Ceramic and titanium construction also improve capacitors' and resistors' resistivity to radiation.

Careful selection of components reduces the danger of permanent damage from neutrons.

Choosing the right transistor

Space radiation poses a double threat to the transistor. The ionization effect unbalances circuit parameters temporarily inducing primary and secondary photocurrents in the transistor. And the displacement effect causes permanent damage by displacing atoms from their usual positions in the lattice; this results in a reduction of current gain.

For neutron-particle doses that are 25% of the amount that causes complete failure of a particular transistor, the change in transistor current gain with neutron dose can be calculated from the following equation to an accuracy of 50%:

$$\frac{\beta_f}{\beta_i} = \frac{1}{1 + \frac{.194 \phi \beta_i}{K f_{\alpha co}}}$$

where β_f = current gain after exposure
 β_i = initial current gain
 ϕ = neutrons/cm² (> 10 Kev)
 $f_{\alpha co}$ = alpha cut-off frequency
 K = degradation constant

Base material	$K \left(\frac{n}{\text{cm}^2} - \text{sec} \right)$
Ge n	5×10^7
Ge p	2.4×10^7
Si n	2.8×10^6
Si p	3.2×10^6

The nomograms at the left represent this equation.¹

Degradation in low- and medium-frequency cut-off transistors (less than 50 megacycles) is caused by a neutron-induced change of the minority-carrier lifetime in the base region. The lifetime is the period during which the carrier injected from the emitter can exist in the base region before combining with an impurity. As neutrons collide with atoms in the base material, the atoms move out of their crystal lattice, creating new impurities with which minority carriers can combine. These combinations shorten the carriers' lifetime.

Neutron collisions also change the base material's conductivity. Except in very-high-frequency transistors (greater than 1,000 Mc), however this effect is much less drastic than the effect on minority-carrier lifetime. The two effects are of approximately equal magnitude in the very-high-frequency transistors.

The current generated in the transistor by ionizing gamma radiation is approximately²

$$I(t) = \frac{q [\dot{R}(t)] \rho A}{e} (x_1 + x_2)$$

where

q = electronic charge = 1.6×10^{-19} coulomb
 $\dot{R}(t)$ = gamma dose rate = ergs/gr(x)/sec; (x = semiconductor material)
 ρ = density of semiconductor material =

$A = \text{area of junction} = \text{cm}^2$
 $e = \text{ionization efficiency} = \text{ergs}$ (for germanium, $e = 4.8 \times 10^{-12}$ ergs; for silicon $e = 5.6 \times 10^{-12}$ ergs)
 $x_1, x_2 = \text{width in cm on either side of the transistor junction containing generated electron ion pairs}$

Recent data shows that the total ionizing dose associated with the dose rate must exceed 10^4 ergs per gram before the above equation applies. The first term of the equation

$$\frac{q [\dot{R}(t)] \rho A}{e}$$

is based upon known data. The second term ($x_1 + x_2$) is determined by device parameters and radiation pulse-time history.²

The recovery time from the induced current is a function of the minority-carrier lifetime, and ranges from 10^{-6} seconds for high-frequency transistors to 10^{-3} seconds for low-frequency devices. Circuit recovery time may be considerably longer, however, because of inherent circuit-time constants. A fast-recovering circuit can be designed by reducing time constants.

Field-effect transistors do not depend upon minority-carrier lifetimes for proper operation. Therefore they are less sensitive to displacement damage.

Two types of FET's are available. The diode-gate type is the more common and the more sensitive. It has a semiconductor junction between the gate and the channel. A small leakage current flows across this junction, increasing with neutron dose as in an ordinary diode. The pinch-off voltage increases with the leakage current.

The other type of FET, the insulated-gate type, introduces a layer of semiconductor material between gate and channel. The leakage current is reduced to a very low value, allowing the pinch-off voltage to be practically unaffected by neutron radiation. The insulated-gate FET retains its electrical characteristics until neutron radiation drastically changes the conductivity of the semiconductor material in the channel. This does not occur until neutron

doses are applied at between 5×10^{14} and 5×10^{15} neutrons per square centimeter (>10 kev). Because both types of FET have comparable degradation at these doses, uhf germanium junction transistors may be better. FET's are also sensitive to the ionization surface effect. Ionization effects in the FET can be calculated as shown for transistors.

The tunnel diode

Another majority-carrier device is the tunnel diode. As the neutron dose increases, the diode's peak-to-valley current ratio decreases. In selecting a tunnel diode for operation in a radiation environment, it is

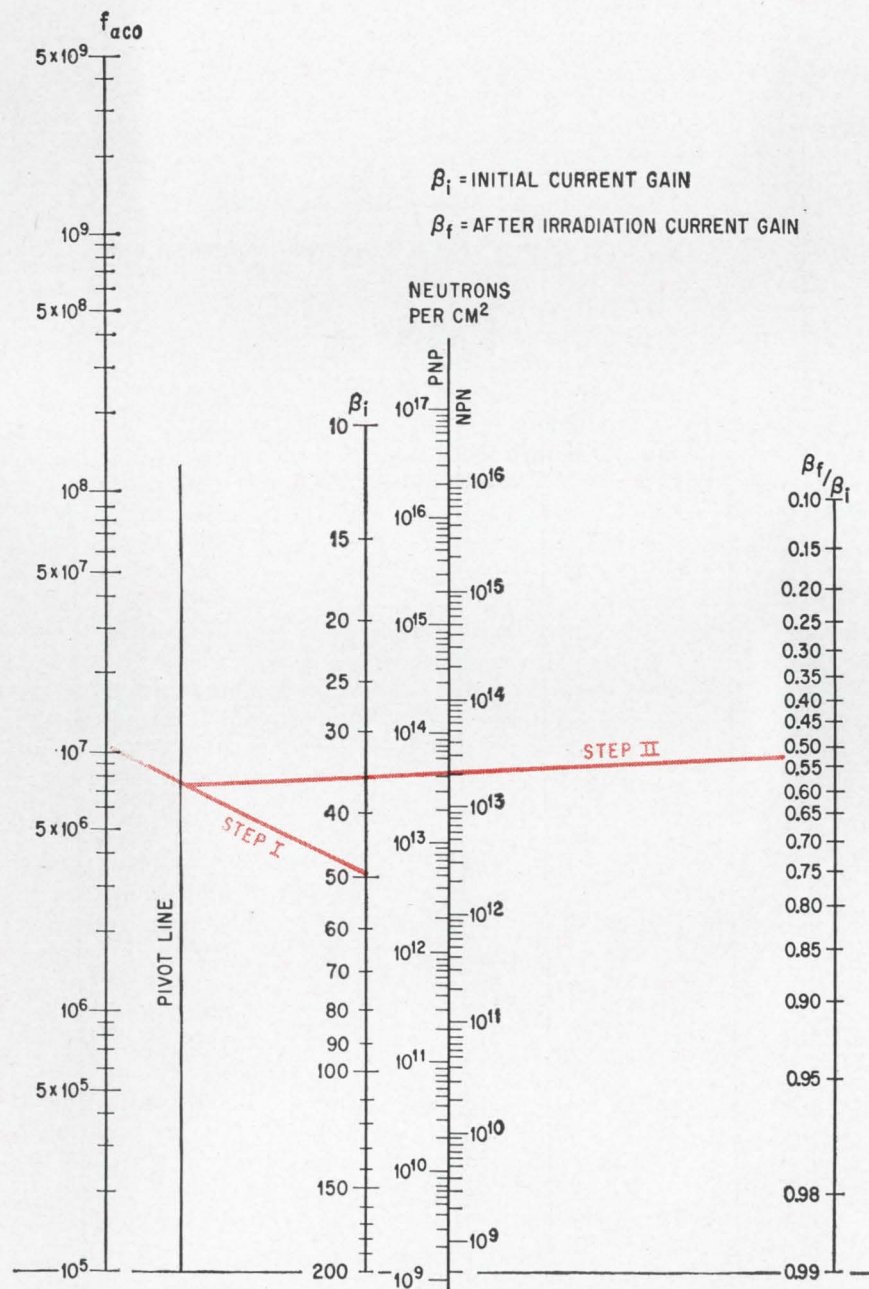

To determine relation of neutron flux to current gain of a germanium transistor, if either value is known, connect $f_{\alpha co}$ (alpha cutoff frequency) with rated β_i . Line intersects pivot line. If neutron flux is known, draw a second line from intersection through this known value to β_f/β_i scale and read off current gain.

helpful to consider that radiation tolerance is a function of current density which, in turn, is related to the ratio of capacitance to peak current. Hence, maximum peak current and minimum capacitance indicate a radiation-resistant tunnel diode.

Tunnel diodes are available that will survive and retain their electrical characteristics in a total neutron dose up to approximately 2×10^{16} neutrons per square centimeter (>10 kev).

For diodes, the figure at the right shows the effects of neutron radiation on a typical diode-rectifier structure. Here are some major changes in a diode's characteristics caused by radiation;

1. Forward resistance increases with the dose.
2. The zener point increases slightly.
3. Reverse leakage current increases.
4. The knee at the zener point becomes less sharp.

The application of the diode then determines which of these changes will affect its operation. A rectifier diode and a switching diode are affected by changes 1 and 3. A zener diode is affected by changes 2 and 4.

Experimental evidence indicates that zener diodes with a low zener point are not as vulnerable as those with a high zener point. For example, a 1N 429 zener diode exposed to 10^{15} neutrons per square centimeter (>10 kv) and 10^6 rads (H_2O does not exhibit an out-of-tolerance change in zener point).

Filamentary vacuum tubes are of two types, glass and ceramic. Many glass envelopes contain boron in radiation, these envelopes often break as the boron captures thermal neutrons and increases the thermal stress in the envelope. Sometimes materials used for the electrode elements outgass. These tubes often fail at between 5×10^{15} and 5×10^{16} neutrons per square centimeter.

Ceramic vacuum tubes have been tested to 10^{17} neutrons per square centimeter (>10 kev) without failure and are estimated to have a failure threshold of between 10^{18} and 10^{20} neutrons per square centimeter.

Ionization effects in vacuum tubes are caused by secondary electron emission from the envelope and the electrodes. The current persists only during the gamma pulse. At 10^7 Rads(c) per second, this current is approximately one milliamperere, in in a ceramic tube. Current generation is a function of dose rate, although experiments have shown that it is not a linear function.

Recovery from ionization effects is also related to a circuit's time constants, and because vacuum-tube circuits generally have high impedances, they also have long recovery times. Low-impedance circuits with shorter recovery times can be designed, but their lower gain requires more stages.

Heaterless vacuum tubes, called thermionic integrated micro-modules (TIMMs), begin operating when heated to $580^\circ C$. They are made with heat-resistant materials such as ceramic

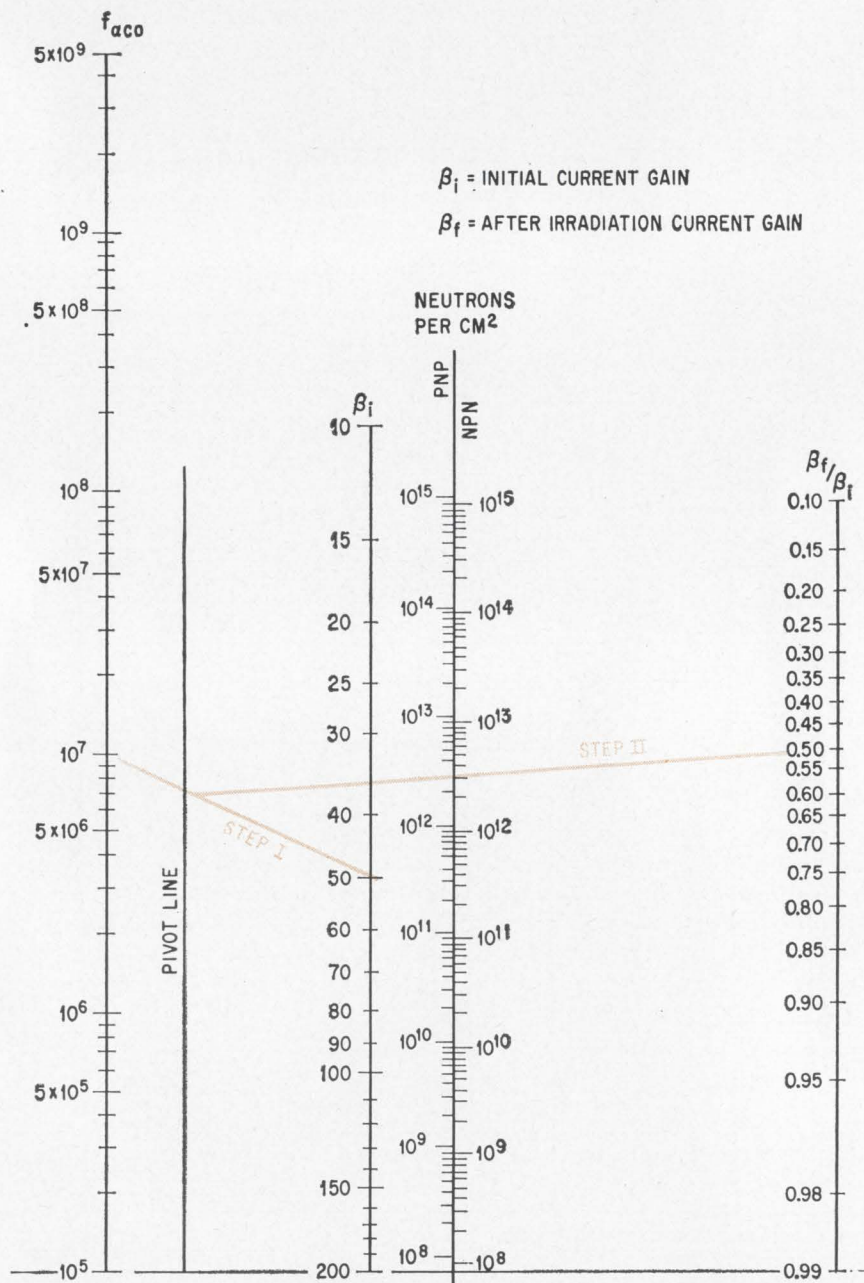

Silicon transistor nomogram shows how grounded-emitter current gain of silicon transistors varies as neutron flux varies. The nomogram is used in the same manner as the germanium transistor nomogram.

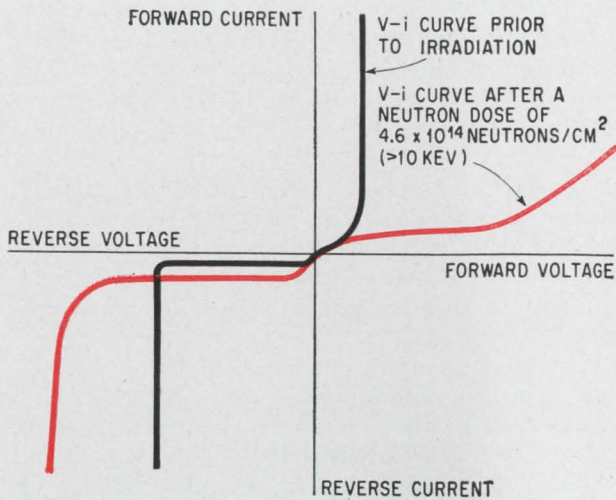

When a diode rectifier is neutron-irradiated, the forward resistance increases with the dose, the zener point and reverse leakage current increase and the knee at the zener point becomes less sharp.

and titanium, which are insensitive to nuclear radiation. Resistors and capacitors have been constructed from similar materials. This has resulted in a component family that makes for radiation-hard designs. The threshold for neutron damage is at least as high as that for the standard ceramic vacuum tube. A design will be described later that

takes advantage of the features of the TIMM components.

Because of their small size and great ability to operate at elevated temperatures, TIMM circuits are less susceptible to ionization effects than the ordinary vacuum-tube circuit. Recent experimental evidence confirms this.³

Radiation effect on the performance of capacitors, resistors, cable and insulation can be compared for devices of different materials. The table below summarizes the effects on electronic components and materials.

Radiation-resistant circuits

Designing a radiation-resistant system begins with an analysis of the nuclear environment to be encountered. The designer must determine, as precisely as possible, what kinds of radiation are likely to be encountered—gamma rays, or particles, or a combination—and how high a radiation level is expected.

The next step is to determine how much shielding is provided by the space vehicle itself, and to calculate the new radiation spectrum and the new total radiation dose. The designer should decide whether further shielding of individual electronic subsystems is necessary and feasible.

The designer should then analyze the entire electronic system to determine how the failure or

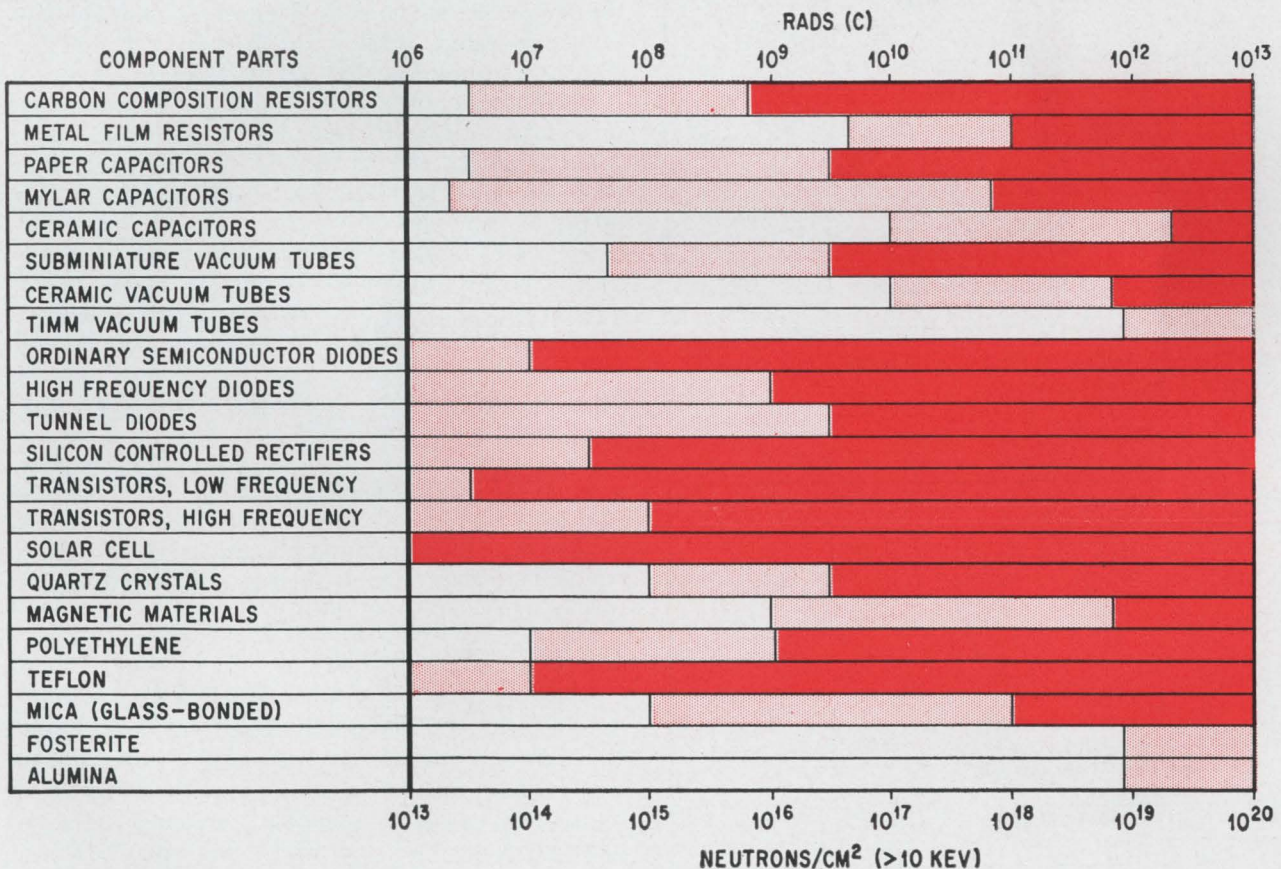

Comparative component sensitivity to a gamma-neutron environment. White area shows region where components can be used without any degradation. Components operating in shaded area lose some of their properties; in solid colored area they fail completely.

Shielding design curves

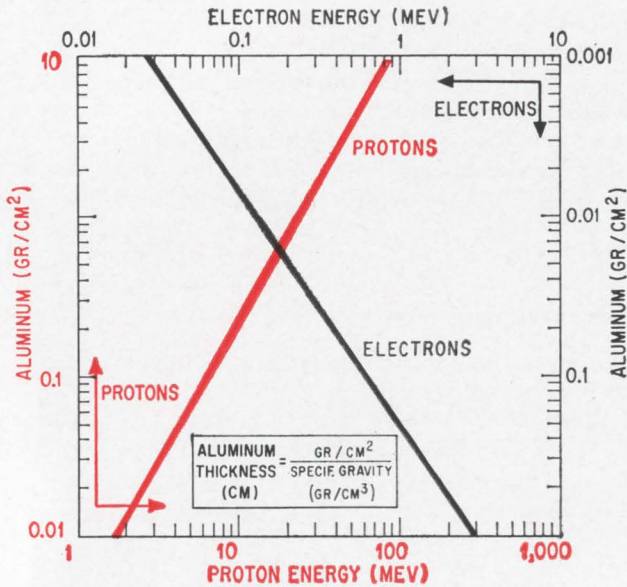

Aluminum shielding thickness required to stop different energy electrons and protons

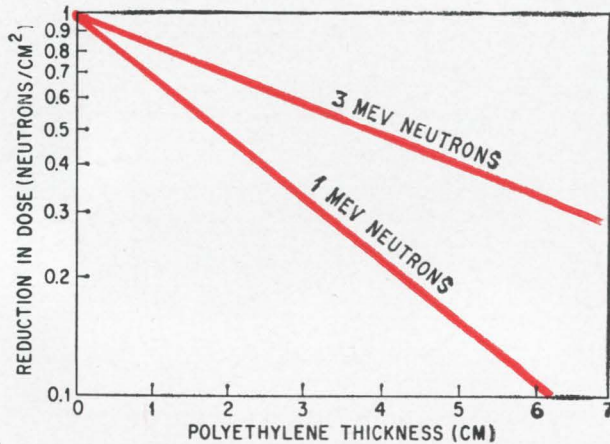

Thickness of hydrogenous material required to reduce a neutron dose

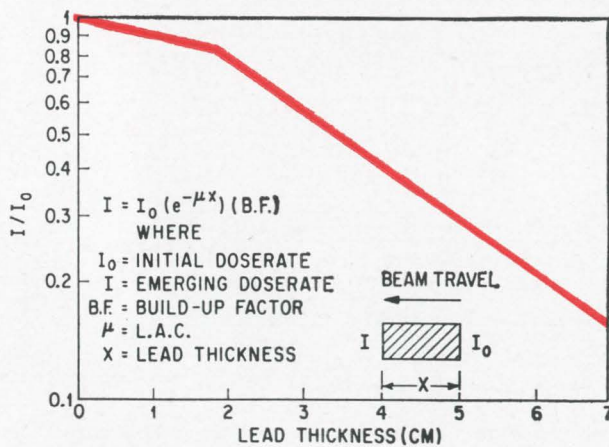

Reduction in gamma dose (1 mev energy) by lead

degradation of any subsystem would affect the over-all operation of the electronic system. With the radiation-sensitive subsystems identified, he can begin designing to make the subsystem's circuits more resistant to radiation.

A circuit's radiation tolerance is no better than its weakest link. The designer, therefore, should analyze all materials and parts for resistance to radiation. He should select parts and materials that will not suffer unexpected degradation in the space environment. The component-sensitivity graph can serve as a guide.

With analysis results at hand, the designer can then substitute radiation-resistant materials and components for those that are known to be poor performers in any particular radiation environment.

Some components have a favorable history of performance in radiation environments. If these components are not available, or suitable, the designer may want to make his own tests. Because radiation testing of electronic components is fairly new, standards are lacking and the various kinds of test data are difficult to correlate. It's important to use care when comparing performance on the basis of test data from different environments.

In a neutron environment, the designer should try to eliminate materials that exhibit a large cross-section to thermal neutrons—such materials as boron, cadmium, gold and silver, when these occur in large concentrations in weight and volume.

If surface effects are a potential problem, transistor devices should be chosen carefully. Only devices with passivated surfaces should be used, and the transistor containers may be evacuated.

Design techniques can compensate for compromises that may have been made in selecting parts. There is no one correct way to solve any particular problem, but two designs are described later in this article as examples.

A circuit's hardness to ionization effects depends to a great extent upon packaging. It is wise to lay out the packaging of the circuit early in the design. From a radiation standpoint, the packaging's main function is to keep air from contact with circuit surfaces; this prevents ionized leakage paths during gamma radiation.

Air can be excluded by evacuation or by encapsulation. If evacuation is used, the vacuum pressure must be reduced to well below 10 millimeters of mercury. Encapsulation should be done with a well-adhering compound such as silicone rubber or epoxy, which adhere tightly.

The trouble with shielding

Shielding as a design technique for space applications can be discounted except for low-energy electrons and protons. Even then, it is important to bear in mind that the absorption of these particles by a shield produces secondary ionizing radiation that may be just as undesirable for other reasons, including surface effects. The curves at the left show the thickness of aluminum shielding required to stop electrons and protons of various energies,

the reduction in gamma dose (1 mev energy) by lead, and the volume of hydrogenous material required to reduce a neutron dose. Neutrons with energies greater than 5 mev may produce photo-nuclear interactions with the nuclei of materials.

Because of its weight, a shield is rarely used exclusively as a design element. But new shielding techniques may become available at any time. For example, electrostatic or magnetic shielding is receiving considerable attention as protection against the charged particles of the Van Allen belts and those produced on the sun⁴.

Designing an amplifier

Here are two examples of radiation-hardened circuits that can be used in space.

For the first circuit, an amplifier is needed for a computer aboard a nuclear-propelled space ship. The system analysis indicates the total environment to be as follows:

Total neutron dose = 10^{13} neutrons/cm² (>10 kev)

Total gamma dose = 10^7 rads(c) (average energy 1 Mev)

Quiescent doserate = 10^3 rads(c)/hour

Short bursts at = 10^6 rads(c)/second

Shielding has been taken into account. The design approach is established by first considering the degradation caused by the total radiation dose. At 10^{13} neutrons per square centimeter and at 10^7 rads(c), most transistors retain much of their inherent gain. It seems reasonable, therefore, that a transistor design will be adequate for this application if the thermal environment is controlled to suit the transistors thermal characteristics.

A severe surface-effect problem is possible in this environment. The transistors to be used must be selected with this in mind. First, the devices⁵ surfaces should be protected perhaps by passivation. This is best achieved during manufacture of the devices. Slight variations in manufacturing processes may affect a transistor's electrical characteristics very slightly but these small changes may have a large effect on the device's response to surface effects.

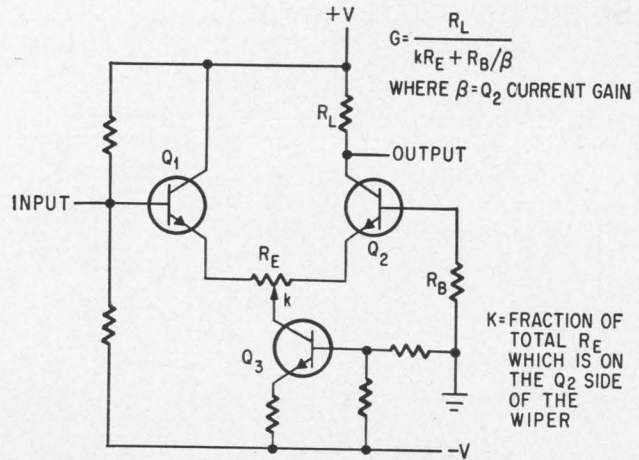

Degradation in circuit gain produced by neutrons is reduced by designing circuits like this, where the transistor-gain term becomes less important in the gain equation.

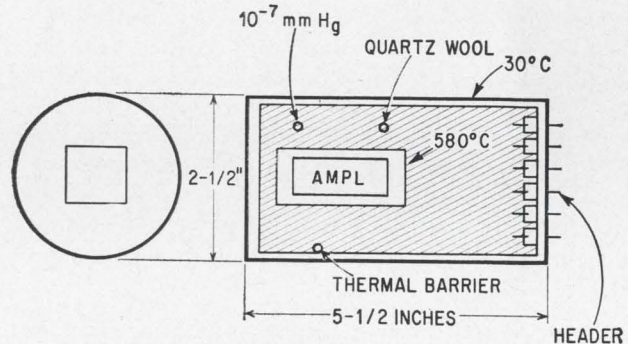

Radiation-proof, direct-record amplifier is packaged in a ceramic chassis which supports the TIMM circuit elements and holds platinum heater wires. Chassis is supported by quartz wool thermal insulating material. Evacuated stainless steel container contains the package.

Work is in progress whose goal is to predict a transistor's response to surface effects as a function of certain electrical characteristics. Creating a vacuum around the transistor surface may also be warranted. Encapsulation of the junction surface has not been successful because of contamination. It may be helpful in designing against this condi-

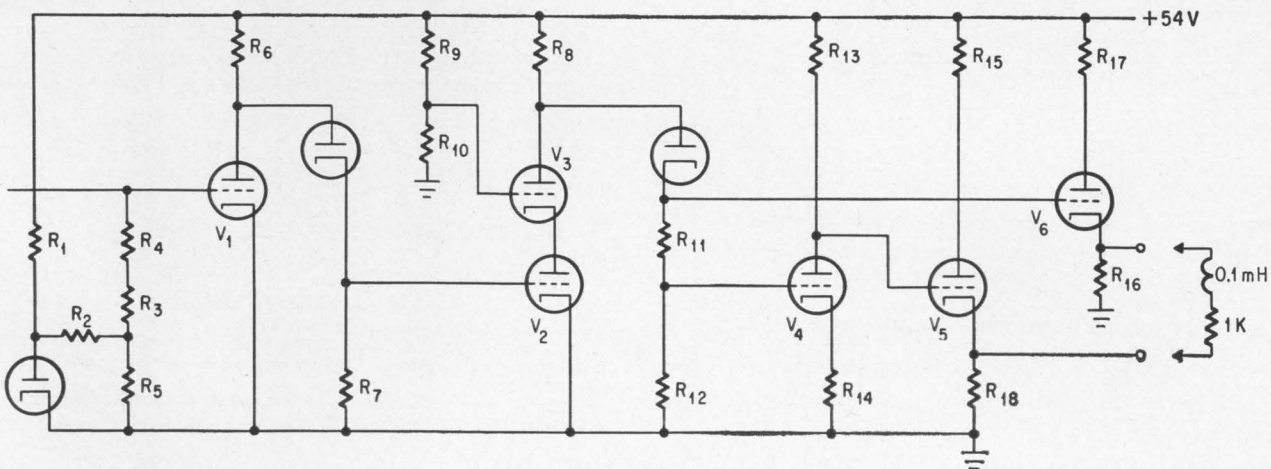

Direct-record amplifier designed with direct coupling. Capacitors were eliminated to reduce time of recovery from ionization effect.

tion to irradiate the transistors prior to use. The circuits can then be designed to accommodate the parameters of the damaged transistor.

Degradation in transistor gain by neutrons is avoided by designing circuits where the transistor gain term becomes less important in the gain equation. Such a circuit is shown at the left. The gain equation for the circuit is:

$$G = \frac{R_L}{KR_E + \frac{R_B}{\beta}}$$

By making R_E much larger than R_B , the circuit's gain becomes almost independent of transistor parameters. The resistors can be any standard type at the given radiation level. Insulation and other materials used for circuit construction are relatively impervious to the given neutron radiation level. However, the total gamma dose is higher so that organic materials should be chosen carefully.

The high gamma-dose rate of 10^6 rads(c) per second produces temporary disturbances in the amplifier which, as in the following switching circuit stages, can be interpreted as trigger signals. It is important to minimize ionization effects in the amplifier. Ionized air, which would create leakage currents across the surfaces, must be removed. In transistor circuits this can be done by encapsulating the circuit in a firmly adhering encapsulant such as silicone rubber.

After transistors, largest producers of ionization effects are capacitors, especially coupling capacitors. These produce large effects while being exposed, and prolong the effect for a period determined by the time constant of that part of the circuit. Therefore, a design is preferred that can either eliminate the capacitor as a circuit element or at least reduce circuit capacitance. Resistors produce ionization effects to a lesser extent, especially if they are encapsulated.

The transistor itself produces ionization effects. By using transistors with small device volumes such as very-high-frequency transistors, the internally produced ionization current can be reduced. By using this type of transistor in the sample circuit, the effect of internally produced currents is reduced. When the circuit is balanced electrically and exhibits good common-mode rejection for electrical noise impulses, it also tends to reduce the circuit ionization currents.

It is difficult to find a pair of transistors in which the common-mode rejection factors for the ionization induced currents are identical. By electrically balancing the circuit, however, the rejection of ionization currents may still be sizable.

A direct-record amplifier

The second example is that of a direct-record amplifier, which was developed by the Reentry Systems Dept. of the General Electric Co. The specification called for no degradation in system performance for a neutron dose of less than 10^{16} neutrons per square centimeter with energies

higher than 10 kev and a total gamma dose of 10^6 rads(c). The system performance had to recover rapidly from the ionization effects caused by 10^{12} rads(c)/second gamma dose rate.

Because of the high neutron dose, the chosen design was based upon the heaterless ceramic-tube family of components, the TIMM. These components were developed by GE to provide a family of components which, when used in circuits, were resistant to both radiation and high temperatures, were lighter and smaller than conventional ceramic vacuum tubes, and consumed less power. All components, vacuum tubes, resistors and capacitors in the TIMM family are of similar design; this makes it possible to design compact circuits. All the components are constructed from titanium metal and insulated with an inorganic ceramic material.

In the TIMM amplifier, direct coupling is used. To reduce the recovery time from ionization effects inherent in circuits with large R-C time constants, capacitors are eliminated. To further reduce the effects of transient ionizing radiation, which develops and persists easily across very high impedances, the highest-value resistor in the design is 63 kilohms.

The amplifier is linear for input voltages from 0 to 15 millivolts. It provides a current gain of 40 decibels. The input impedance varies with frequency, from 100 kilohms at direct current to 20 kilohms at 250 kilocycles per second, which is the band width of the amplifier.

Metals and inorganic insulating materials were used for the package. Metals with low secondary-electron emission efficiency were preferred. A ceramic chassis supports the TIMM circuit elements and holds the platinum heater wires to maintain the TIMM vacuum tubes at their operating temperature of 580°C .

The ceramic chassis is approximately in the center of a cylindrical container, and is supported by thermal insulating material made from inorganic quartz wool. The cylindrical container is made of stainless steel, with a header of kovar metal and steel welded to one end. To eliminate surface ionization effects, this assembly is evacuated to a pressure of 10^{-7} millimeters of mercury.

After the materials' thermal lag is overcome, the heating power required for this package is five watts.

References

1. J.R. Bilinski, "Selecting transistors for radiation environment," *Electronics*, December, 1959.
2. W.L. Brown and J.W. Easley, "The transient ionization pulse in a semiconductor junction," *Conference on Pulse Radiation*, September, 1960.
3. H.H.L. Olesen, "A nuclear hard instrumentation recorder," *Proceedings of the 11th Annual East Coast Conference on Aerospace and Navigational Electronics*, paper 1.5.2, 1964.
4. S.W. Kash and R.F. Tooper, "Active shielding for manned spacecraft," *Astronautics*, September, 1962.
5. R.R. Blair, "Surface effects of radiation on transistors," *IEEE Transactions on Nuclear Science*, November, 1963.

Designer's casebook

Designer's casebook is a regular feature in Electronics. Readers are invited to submit novel circuit ideas, packaging schemes, or other unusual solutions to design problems. Descriptions should be short. We'll pay \$50 for each item published.

Antenna's reflecting surfaces increase beacon bandwidth

By W.A. Cumming

National Research Council, Ottawa

In the microwave region, beacon antennas are commonly designed in the form of slotted arrays cut in the walls of circular or rectangular waveguides. If the radiant energy is to be directed perpendicular to the waveguide, a resonant array must be employed with a resulting restriction in either bandwidth or array length. If a nonresonant array is used, the bandwidth is greatly increased but the energy is no longer concentrated in a plane normal to the array. To obtain a wide bandwidth, a choice of polarization and a simple means of adjusting the beam angle, an antenna was developed that uses reflecting surfaces.

From the antenna model shown in the photo it can be seen that the beacon consists of a circular waveguide illuminating a paraboloidal reflector, which in turn is directed at a 45° cone. The antenna has a base diameter of 12 inches and a vertical aperture of 7 inches. It was tested at a

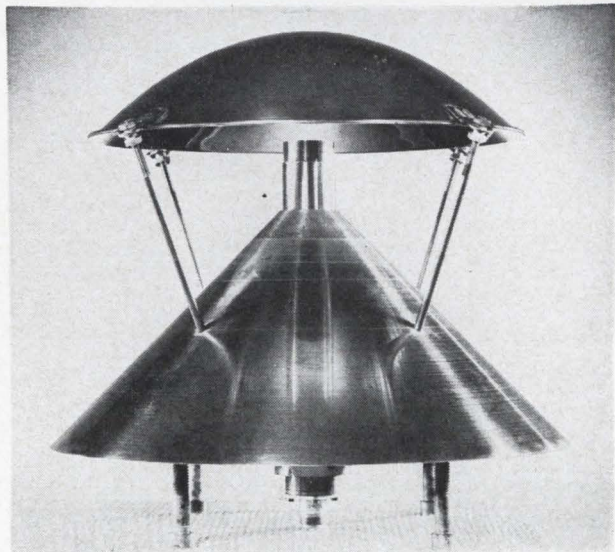

Microwave beacon antenna consists of a circular waveguide that illuminates a paraboloidal reflector, which then directs the radiant energy at a 45° cone.

center frequency of 16 gigacycles.

The circular waveguide can be excited in the TM_{01} mode, in which magnetic field lines are concentric circles and the transverse electric field is radial. This mode produces vertical polarization with respect to the beacon axis. The waveguide can also be excited in the TE_{01} mode, in which electric field lines are concentric circles and the transverse magnetic field is radial. This mode produces horizontal polarization. The TM_{01} was excited directly from a coaxial line by an axial probe projecting along the waveguide axis. The TE_{01} was converted from the TM_{01} by a barrier-type mode-converter and filter.

The mode-converter consists of several conductors placed across the guide in such a way that they are excited by the incident radial electric field. These conductors reradiate a circumferential component of the electric field because of their position in the guide. The filter consists of a series of radial plates that short-circuit the radial field but pass the circumferential field.

In both modes the aperture diameter is 1.53λ at midband. The primary pattern for the TM_{01} mode is given by

$$E \propto \frac{\left(\frac{\lambda_o}{\lambda_g} + \cos \theta\right) \times J_o\left(\frac{2\pi a}{\lambda_o} \sin \theta\right)}{\sin \theta \left[1 - \left(\frac{\lambda_o}{\lambda_c \sin \theta}\right)^2\right]}$$

and the mode for the TE_{01} pattern is given by

$$E \propto \frac{\left(\frac{\lambda_o}{\lambda_g} + \cos \theta\right) \times J_o'\left(\frac{2\pi a}{\lambda_o} \sin \theta\right)}{1 - \left(\frac{\lambda_c}{\lambda_o} \sin \theta\right)^2}$$

where a is the waveguide radius, θ the antenna angle with the waveguide axis, J_o is a zero order Bessel function, J_o' is the first derivative of J_o , λ_o is the free space wavelength, λ_g is the guide wavelength, and λ_c is the cut-off wavelength.

Both of these functions have a null on-axis and a peak about 30° off-axis. As a result, the ratio of the focal length of the paraboloidal reflector to the antenna diameter, f/D , could be as large as 0.4; but a series of measurements showed that this gave excessive spillover, at least for the aperture size

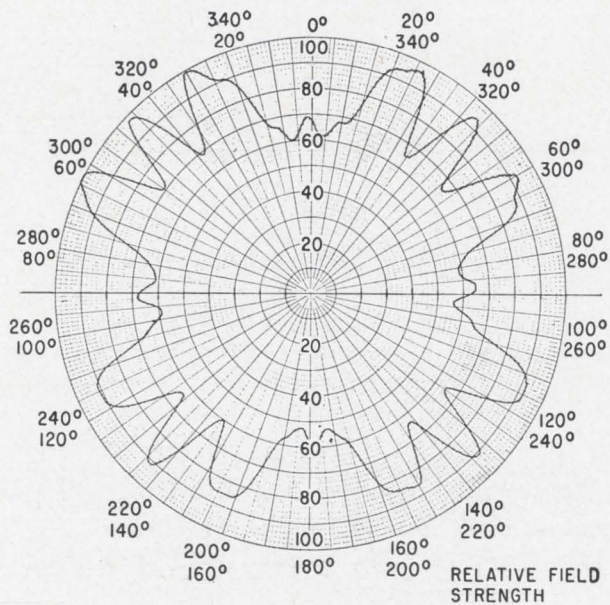

**VERTICAL POLARIZATION
AZIMUTH PATTERN**

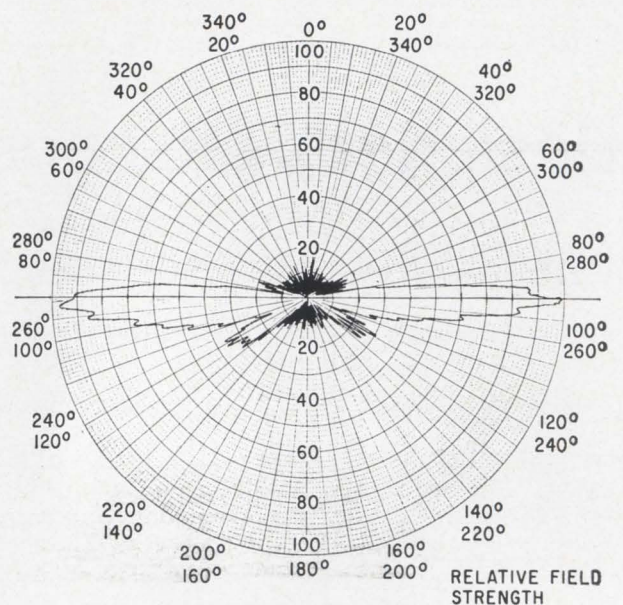

**VERTICAL POLARIZATION
ELEVATION PATTERN**

Azimuth and elevation patterns for the beacon antenna when it is vertically polarized. The dips equally displaced by 90° in the azimuth pattern show the effects of the metal support struts used to separate the two reflectors.

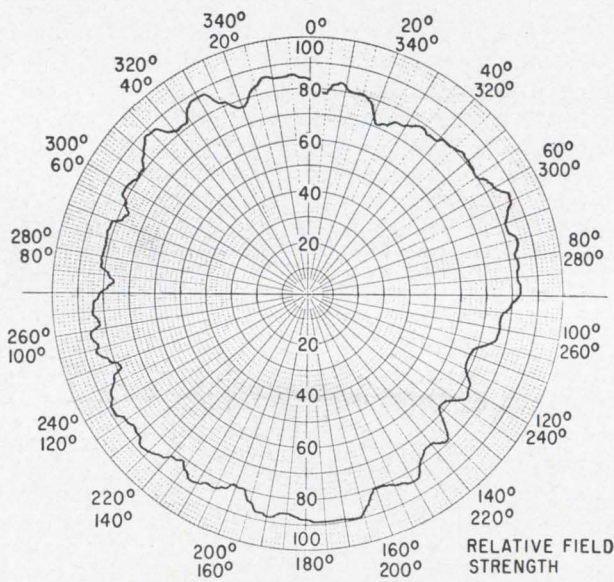

**HORIZONTAL POLARIZATION
AZIMUTH PATTERN**

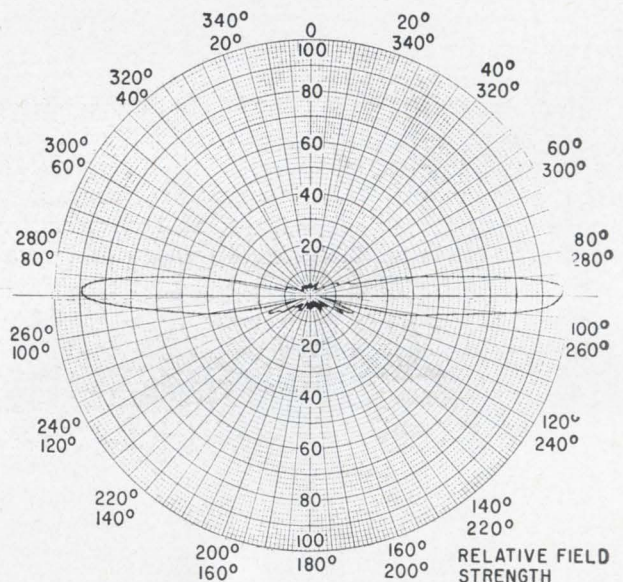

**HORIZONTAL POLARIZATION
ELEVATION PATTERN**

Azimuth and elevation patterns for the beacon antenna when it is horizontally polarized. The reflector support struts do not significantly affect the horizontal patterns.

used. Spillover is that energy radiated by the feed but not intercepted by the paraboloidal reflector, and is therefore lost energy. A larger aperture and a larger secondary gain would permit the use of a larger f/D than the 0.25 used in the present case, with a resulting increase in aperture efficiency.

Patterns for both vertical and horizontal polari-

zation are shown above. The azimuth-plane patterns for vertical polarization show the effect of the metal struts used to separate the two reflectors. This can be overcome by using a dielectric sheet to support the two reflectors continuously around their periphery.

The elevation patterns show that spillover past

the paraboloid is considerably less than spillover past the cone. The spillover past the paraboloid would be reduced if the gain were increased. The spillover past the cone can be reduced by increasing the cone size.

The horizontally polarized patterns are considerably less affected by the support struts. This is expected because of the relative orientation of the struts and of the electric field. Similarly, the diffrac-

tion by the edges of the two reflectors is reduced for horizontal polarization because the field is tangential to the edges.

All patterns shown were obtained with the phase center of the feed located on the focal point of the paraboloid. The secondary beam can be made to squint up or down from the horizontal plane by moving the waveguide either out or in from the focal point of the paraboloid.

Transistor switch passes current both ways

By Robert W. Maloy

North American Aviation Corp., Downey, Calif.

The speed requirements of an operational amplifier control switch prohibit the use of a solenoid-operated mechanical relay. For example, the sampling interval in the sample-and-hold circuit shown above, is about 500 microseconds.

The switch is basically an on-off unit that has very high open-circuit impedance and low closed-circuit impedance. The switch must be able to pass current in either direction; it operates at low voltage because the amplifier input is always close to ground potential—approximately 200 millivolts.

The values of the components shown in the circuit diagram are suitable for an amplifier switch that must pass one milliamperes in either direction. Diode pairs $D_1 - D_2$ and $D_3 - D_4$ are voltage limiters. Transistor Q_1 is the basic switching element. A type TI495 silicon transistor made by Texas Instruments, Inc., was selected for Q_1 because its collector characteristics pass exactly through the origin (zero collector current at zero collector voltage). This is important if the low input voltage is not to become loaded by the switch impedance. The beta of the TI495 is greater than two when the emitter and collector are interchanged.

When the base voltage is negative, Q_1 is off and it presents an open circuit; when its base voltage is positive Q_1 is on, creating a short circuit. Although the circuit operates with either polarity input, the forward current gain of Q_1 is 40 times the reverse current gain.

When Q_2 is open, Q_1 will be biased on because of the current flowing through R_2 and R_3 (collector and emitter interchanged).

R_1 must be adjusted so that the current through R_2 equals the current through R_3 ; otherwise the bias network will contribute extraneous current to the summing junction of the amplifier. Diode D_5

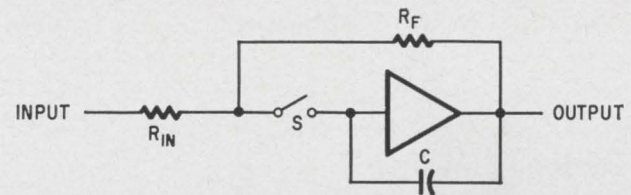

In a sample-and-hold-type circuit, switch must pass current in either direction. Operating voltage level of switch is very low because operational amplifier input is practically at ground potential.

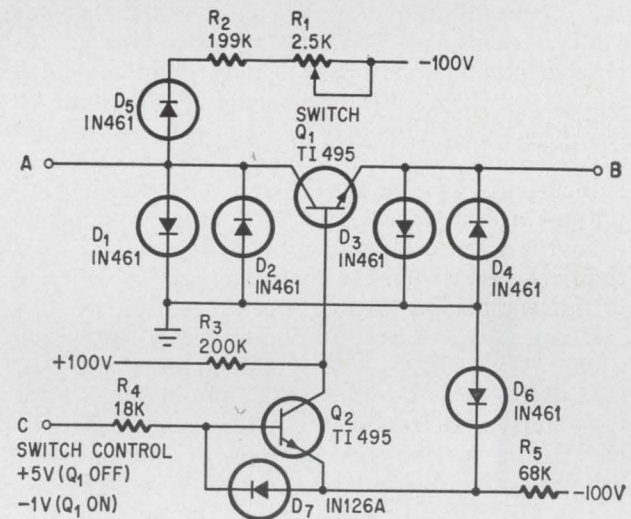

Basic switching element is transistor Q_1 . The collector and emitter can be interchanged to fulfill the requirement that current pass in either direction. However, the forward current gain is 40 times the reverse current gain.

matches the temperature characteristics of Q_1 and limits thermally induced current variations to about 0.001 microampere per degree centigrade.

If Q_2 is driven into saturation, the base voltage of Q_1 becomes negative, turning Q_1 off. When Q_1 is off, the current through R_3 flows to ground through Q_2 and R_5 . The currents through the input and R_2 go to ground through D_1 or D_2 . Diode D_6 is the bias regulator for Q_2 , and D_7 limits excessive reverse bias at the base of Q_2 .

Switching time is about two microseconds.

Very low frequency antennas are going back to work

Abandoned since the 1920's, very long wave technology has made its comeback with reliable, superpower transmission to Polaris submarines

By John C. Walter

Potomac River Naval Command, Washington

The almost forgotten very low frequency portion of the spectrum, from 10 to 30 kilocycles, has become vital. Because it penetrates the water without excessive attenuation it is the only band in which signals can be transmitted reliably from shore installations to submerged submarines many hundreds of miles away. Effective communication to submarines carrying the Polaris missile is as important as the missile itself. Because it depends primarily upon propagation over the ground rather than reflection from the ionosphere vlf is immune to nuclear blackout.

Besides its use in the Polaris missile submarine program, vlf is a valuable tool in other services. It is excellent as a means for disseminating worldwide time and frequency standards. It has been effective as a navigation aid covering large areas, like the Indian Ocean.

The physical characteristics of the antenna system control the bandwidth of the signal and the efficiency with which the power is radiated at vlf. Because of the enormous size of components, potentials in the hundreds of kilovolts, the impossibility of erecting self-resonant structures and the impracticability of cut-and-try methods, careful de-

sign of the antenna and its feeders is imperative at very low frequencies.

Basic trades

Bandwidth and efficiency are important engineering tradeoffs at lf and vlf because bandwidth varies inversely with efficiency. Earlier use of relatively slow-speed telegraphy at data rates of 15 to 20 bauds made it possible to optimize the radiation efficiency of the antenna, which was only 10% to 20%. Modern vlf antennas must be designed for minimum radiation efficiencies beyond 50%, with sufficient bandwidth to accommodate data rates up to 50 bauds.

The absolute or intrinsic bandwidth of an antenna is determined by the Q factor or kva/kw ratio of the antenna for which Q is also the ratio X/R. The reactance X is derived from the static or zero-frequency capacitance of the antenna alone and R is the total resistance looking into the base or driving point of the antenna through its tuning coils. An important difference between design of high-frequency antennas that are long with respect to wavelength and vlf antennas that are shorter than a quarter wave lies in the need to consider static capacitance rather than the apparent capacitance that results from the combination of "top hat" capacitance and inductance of the down leads.

When assessing the bandwidth capability of an antenna system (as contrasted with a simple antenna in free space) it is necessary to consider the loading introduced by losses in the generator, or transmitter, the transmission lines and networks.

Multiple feeds.

Many of the older vlf antenna systems and some of those more recently installed employ one or more variations of the basic multiple-tuned an-

The author



John C. Walter is a consultant on vlf and high-power radio systems for the Bureau of Ships, U. S. Navy. He was responsible, at the Radio Corp. of America, for the design, production and installation of the Jim Creek, Washington, megawatt vlf Navy transmitter. Walter is a captain in the Naval Reserve and a registered professional engineer.

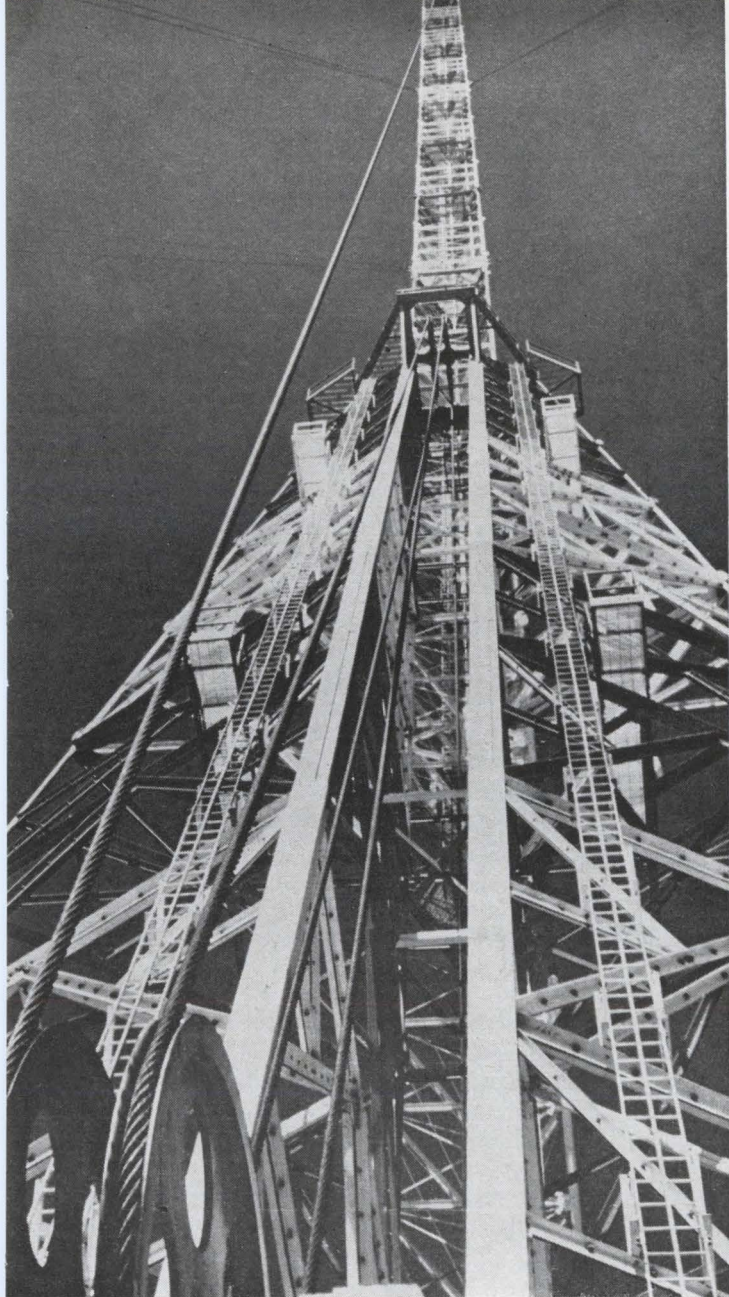

In the foreground a counterweight track of the Cutler, Me. vlf antenna system. The antenna tower, separate from the track, is in the near background. (Continental Electronics Mfg. Co.)

tenna developed by E.F.W. Alexanderson nearly fifty years ago. Unfortunately, the details of his work are only briefly recorded and have proved insufficient for a complete design. As a result, much of the recent work has been costly. It is to prevent further duplication of effort that many of the important design parameters are set forth here.

Since the multiple-tuned type of antenna is derived from the basic capacitance-loaded, single-tuned Marconi antenna, it is convenient to start with the Marconi in developing the concepts represented in the more complex multiple-tuned antenna.

The basic single-tuned Marconi antenna operated below its fundamental frequency, or quarter-wave resonance, may be viewed as a series-resonant loop having two series resistance elements, radiation resistance and loss resistance. The capacitive

reactance of the antenna is neutralized by an inserted inductive reactance so that the input impedance seen by the generator is $R_t \pm jO$, where R_t is the sum of the radiation and loss elements, R_a and R_l . The circuit, A, is shown on p. 82.

It is convenient to break the loss resistance into two parts; R_c , the loss resistance of the series loading inductances and R_b , the remainder.

Power delivered to the antenna system in the resonant condition is $I^2 R_t$ and the radiated power is $I^2 R_a$. Radiation efficiency is therefore R_a/R_t . Determination of R_t is accomplished by resistance variation or resistance substitution methods, while R_a is derived from either field-strength measurements or mathematical analysis of the R_t versus frequency characteristic after the method suggested by A. Hund.

Added downloads

The Alexanderson multiple-tuned system consists of a basic Marconi antenna with one or more added downleads, each downlead being resonated to neutralize a multiple of the capacitive reactance of the antenna. By appropriately spacing these tuning points, the distributed capacitance of the horizontal antenna is divided into equal parts.

The elementary theory of operation is that by dividing the antenna into equal capacitance sections and operating these sections in parallel, a

Vlf—the forgotten art

The hiatus in long-wave technology, spanning two generations of engineers, started in the 1920's with the discovery that short waves—except for periods of radio blackout—could get through better with less power.

Now, very low frequency is making a comeback. Vlf, the range from 10 to 30 kilocycles, is the only known way to communicate with submerged submarines at great distances. The need to control the deployment of nuclear-powered and nuclear-armed undersea craft shares strategic and tactical importance with the Polaris missile itself.

Because of the sudden transition to high-frequency systems and the subsequent abandonment of vlf for commercial use, many engineers are unfamiliar with the fundamental properties of the multiple-tuned antenna. This basic knowledge is essential to further development into new dimensions of higher power.

Antennas, the most critical elements in vlf communications, must be built from designs that provide voltage gradient control to prevent power loss through corona discharge. A major breakthrough is needed to obtain conductors with large effective diameters without lessening their tensile strength or increasing weight per unit length because present conductor-bundling techniques are inadequate. Insulators also need redesigning to equalize dielectric stress.

To melt sleet from today's vast antenna structure requires taking a section out of service for as much as an hour while 60-cycle heating power is applied. Development of better chokes or antiresonant circuits could permit electrical de-icing during radio-frequency operation.

In particular, many engineers familiar with high-frequency antenna design do not immediately recognize the fact that static capacitance, rather than apparent capacitance (which includes the effect of downlead inductance) strongly influence antenna bandwidth at vlf.

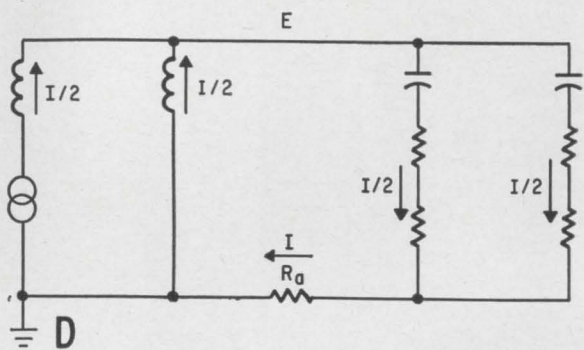
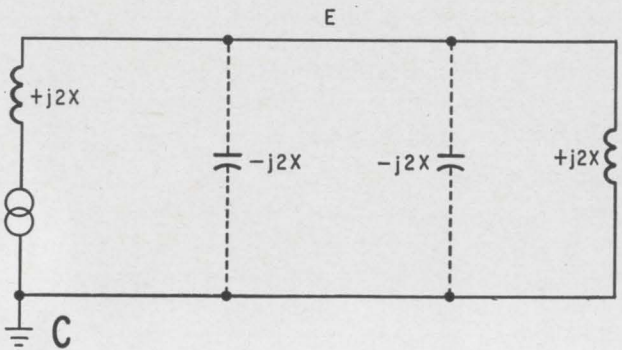
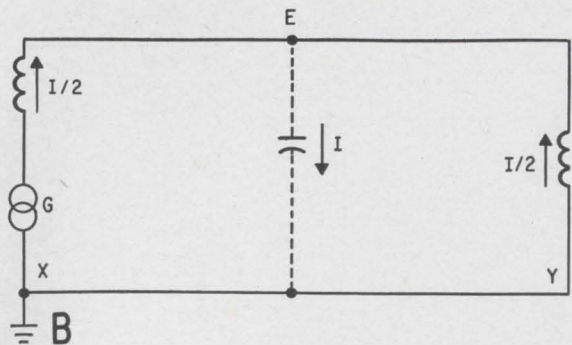
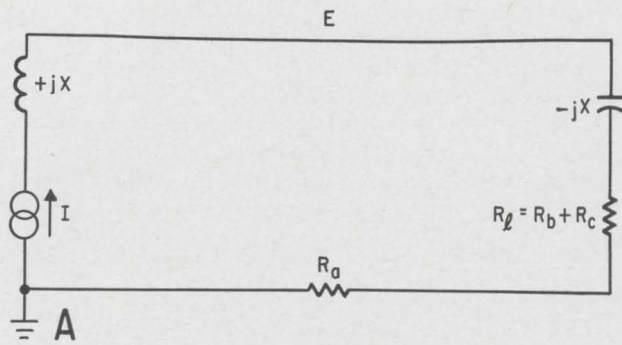

Basic single-tuned Marconi antenna represented as a series resonant loop with radiation resistance and loss resistance (A). Simplified circuit showing current flow in a two-downlead antenna system (B) redrawn in a form that shows division into two equal capacitive elements (C). The previous scheme is redrawn, folded back on itself, and the resistance elements inserted (D).

net reduction in loss resistance is achieved without altering the radiation resistance, thereby improving the radiation efficiency of the system.

Omitting the various resistance elements for the time being, the simplified circuit B shown above illustrates the mechanics of the current flow in a two-downlead system, the most elementary multiple-tuned form.

Downlead X represents the feeder containing the generator, G, which charges the horizontal capacitance element of the antenna to a potential E. The voltage along the horizontal element is essentially constant owing to the very short electrical length of the flat-top capacitance element. If the inductive reactances of downleads X and Y are equal, the voltage E causes equal in-phase currents to flow upward in both downleads.

Because the antenna has been effectively divided into two equal capacitive elements, each fed by its own downlead, the resultant network may be redrawn as in C.

Halving the capacitance doubles the reactance in each half, requiring twice the inductive reactance to resonate each antenna-half. Once the current and reactance conditions are established it is possible to examine the various resistance elements and their effect upon radiated power and efficiency.

Because E is essentially constant, diagram C can be folded back on itself and redrawn as D with the resistance elements in the appropriate places.

Dual feed

The radiation resistance, R_a , is a function of the physical height of the antenna and remains the

same for either single-point or multiple-point tuning. It is therefore shown as a series element.

Loss resistances become parallel elements in multiple-tuned systems. In this case each half of the antenna system contains portions of the loss resistance. It might be assumed that for parallel operation of the two halves the net loss resistance is one-fourth that of the original. Such is not the case, however, because it is necessary to double the downlead tuning inductances in each downlead for multiple operation. The portion of the loss resistance contributed by the inductors is increased by a factor k that is determined by the form factor, copper losses and coupled-in losses of the coils.

It has been determined experimentally that coil resistance varies approximately as the square root of the inductance when the optimum form factor is

Operating data for a multiple-tuned antenna*

Number of downleads	1	2	3	4
R_t , ohms, single downlead	0.565	—	—	—
R_m , ohms, multiple	—	0.307	0.259	0.242
R_d , ohms, per downlead	0.565	0.614	0.777	0.968
Radiation efficiency, %	19.8	36.5	43.3	46.2
Radiated power, kw	112	206	245	261
Q	265	488	579	618
Bandwidth, cps	98.5	53.5	45.0	42.2
Current amp per downlead 1,000	678	493	382	
Coil reactance per downlead	109	218	327	436
E_c , kV, rms, top of helix	109	148	161	167
f_c , kc	49.8	75.0	89.0	100.
E_a , kV, rms	168	182	192	200

* Operating at 26.1 kilocycles with two, three or four downleads compared with a single-downlead Marconi type

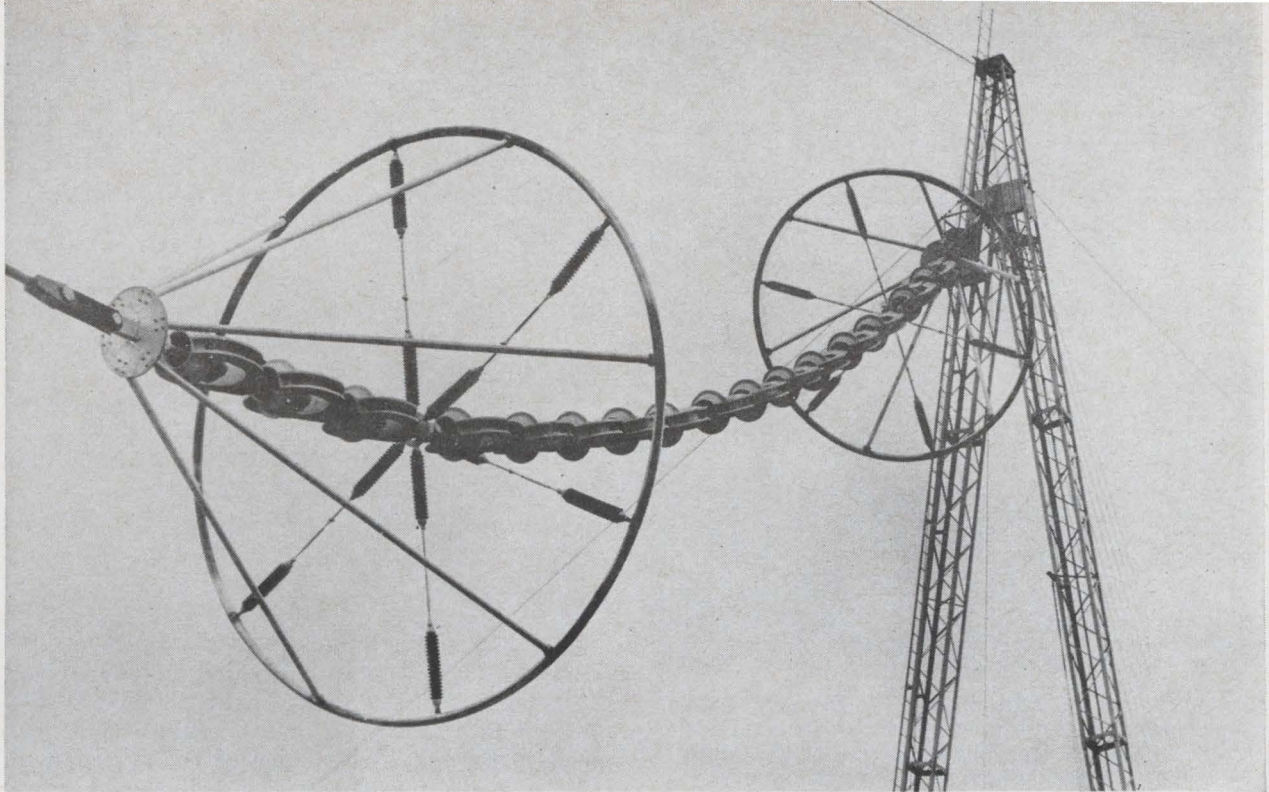

Insulator units at Cutler, Me. Navy vlf station are mechanically fail-safe. Failure of a porcelain unit will not drop the antenna because the coupling rod has a large head that cannot pull through the base of the insulator yoke, frame. The large corona ring assemblies reduce potential gradient and allow corona-free operation up to 250 kilovolts under severe icing.

maintained. Thus, doubling the inductance when reconnecting for two-point tuning increases the coil resistance per download by a factor of 1.41 under ideal conditions. In practice, however, it is not economical to redesign large helices for multiple tuning in the field, nor is it feasible to provide ideal coils for each of the various inductance values required for different operating frequencies. The best coil form factor is necessarily restricted to an initial design aimed at achieving maximum efficiency at a chosen frequency.

Design detail

The total resistance of a single download system consists of three elements: radiation resistance, R_a ; the portion of the loss resistance that is not contributed by the loading inductances, R_b ; and the

portion of the loss resistance due to the loading inductances, R_c .

When an existing antenna system is modified for multiple tuning the loss resistance is redistributed. The b portion follows an inverse square law since it is divided into equal parts by the number of downloads and the parts are paralleled. The b portion of the multiple resistance becomes $R_b/4$, $R_b/9$, $R_b/16$ for two, three and four download operation, or, for n downloads, $R_{b,n} = R_b/n^2$. The R_b element of resistance in each download will be R_b/n .

Subtracting the R_b portion from the total loss resistance leaves a remainder constituting the R_c element. Because the loading coil inductance increases proportionately with the number of downloads and, for the practical case, the k factor is 1.0, the R_c portion of the multiple resistance will be R_c , regardless of the number of downloads, and the R_c element of resistance in each download will be R_c/n .

Since each download contributes half the radiated power with only half the total current flowing in it, the effective radiation resistance in each download is $2 \cdot R_a$.

It is clear that the effective multiple resistance, R_m , of two downloads is one-fourth the total series resistance, R_s , of the two-download system as measured at the driving point.

$$R_s = 4R_a + R_b + 4R_c$$

$$R_m = R_a + R_b/4 + R_c$$

The diagrams shown left illustrate the redistribution of the resistance elements, including radiation resistance, in a two-download system. Section A represents the single download system before modification, where the total resistance, R_t , is

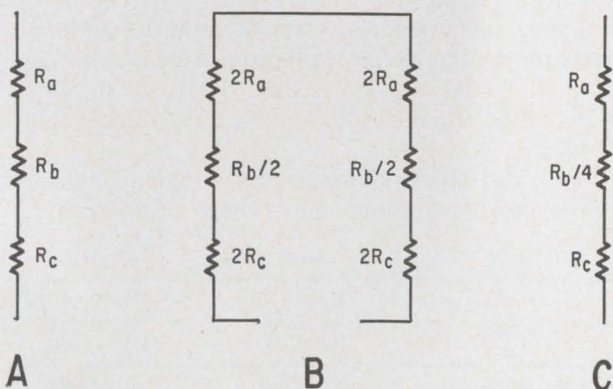

Redistribution of resistance elements, including radiation resistance, in a two-download system showing single download (A), two download series circuit as measured (B) and equivalent two-download circuit showing multiple resistance (C).

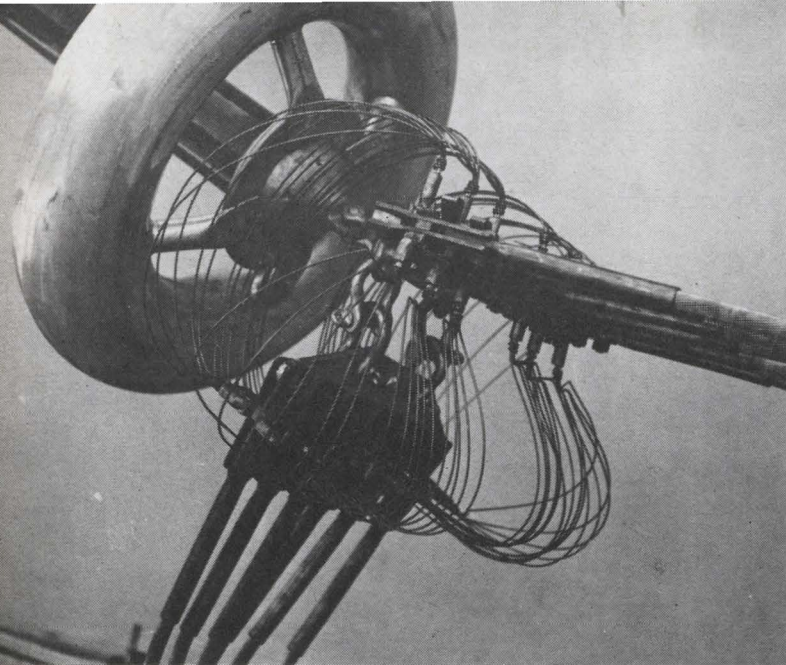

Download hinge point at Jim Creek Navy vlf radio station. Small hard-drawn wires provide a current shunt around flexible mechanical connections. Spread out, they shield rough edges of the hardware assembly and form an anticorona surface. The spun-aluminum ring reduces potential gradient at the end of the porcelain tube-insulator. Conductors handle 1,200 amps at 180 kv.



Anticorona fittings applied to the high-voltage trunk at Navy radio station in Cutler, Me. The room is copper-shielded to prevent eddy currents in building structure.

$R_a + R_b + R_c$. At B the actual two-downlead series circuit as measured, shows R_s is $4R_a + R_b + 4R_c$; the total power is $(I/2)^2 R_s$ and the radiated power is $4R_a (I/2)^2$. The total resistance per downlead is $2R_a + R_b/2 + 2R_c$.

The equivalent two-downlead circuit at C indicates multiple resistance, R_m , is $R_a + R_b/4 + R_c$, or $R_s/4$, and the total power is $I^2 R_m$, radiated power aI^2 .

The foregoing definitions lead to the general expressions for both the multiple resistance, R_m , and the per downlead resistance, R_d , of a multiple tuned antenna having n downleads is

$$R_m = R_a + R_{bn}^{-2} + R_c$$

$$R_d = R_{an} + R_{bn}^{-1} + R_{cn}$$

Application

Two characteristic measurements provide the basic analytical data to check the validity of this design approach. The total resistance of the system must be measured with one downlead connected, and also the series resistance of the system with both downleads connected and the loading reactances doubled in each downlead.

Measurements obtained at an existing installation before and after conversion furnish a means for deriving the values of the two components of loss resistance, b and c , at 26.1 kc. The total resistance with single downlead is 0.565 ohms, series resistance, two downleads, 1.228 ohms and radiation resistance, derived elsewhere, is 0.112 ohms. From the measured series resistance data the equivalent multiple resistance for the two downlead connection may be taken as $1.228/4$ or 0.307 ohm.

The value of 0.112 ohm for the radiation resistance was derived from a mathematical analysis of the recorded resistance versus frequency characteristic of the station used in the example.

Rewriting in equation form to include the derived factors:

Single downlead, total resistance, $R_t = R_a + R_b + R_c = 0.565$

Multiple resistance, two downleads, $R_m = R_a + R_b/4 + R_c = 0.307$

Series resistance, two downleads, $R_s = 4R_a + R_b + 4R_c = 1.228$

Using the expressions for R_t and R_s and subtracting the equivalent radiation resistance in each case, $R_b + R_c = 0.453$ and $R_b + 4R_c = 0.780$. By subtraction, $R_c = 0.109$, and by substitution $R_b = 0.344$.

The resistance elements for single, dual and series downlead connections check as follows

Single	Dual	Series
R_a 0.112	R_a 0.112	$4R_a$ 0.448
R_b 0.344	$R_b/4$ 0.086	R_b 0.344
R_c 0.109	R_c 0.109	$4R_c$ 0.436
R_t 0.565	R_m 0.307	R_s 1.228

Bandwidth vs efficiency

A measured value of $0.0406 \mu f$ has been taken for the static capacitance of the antenna used in the

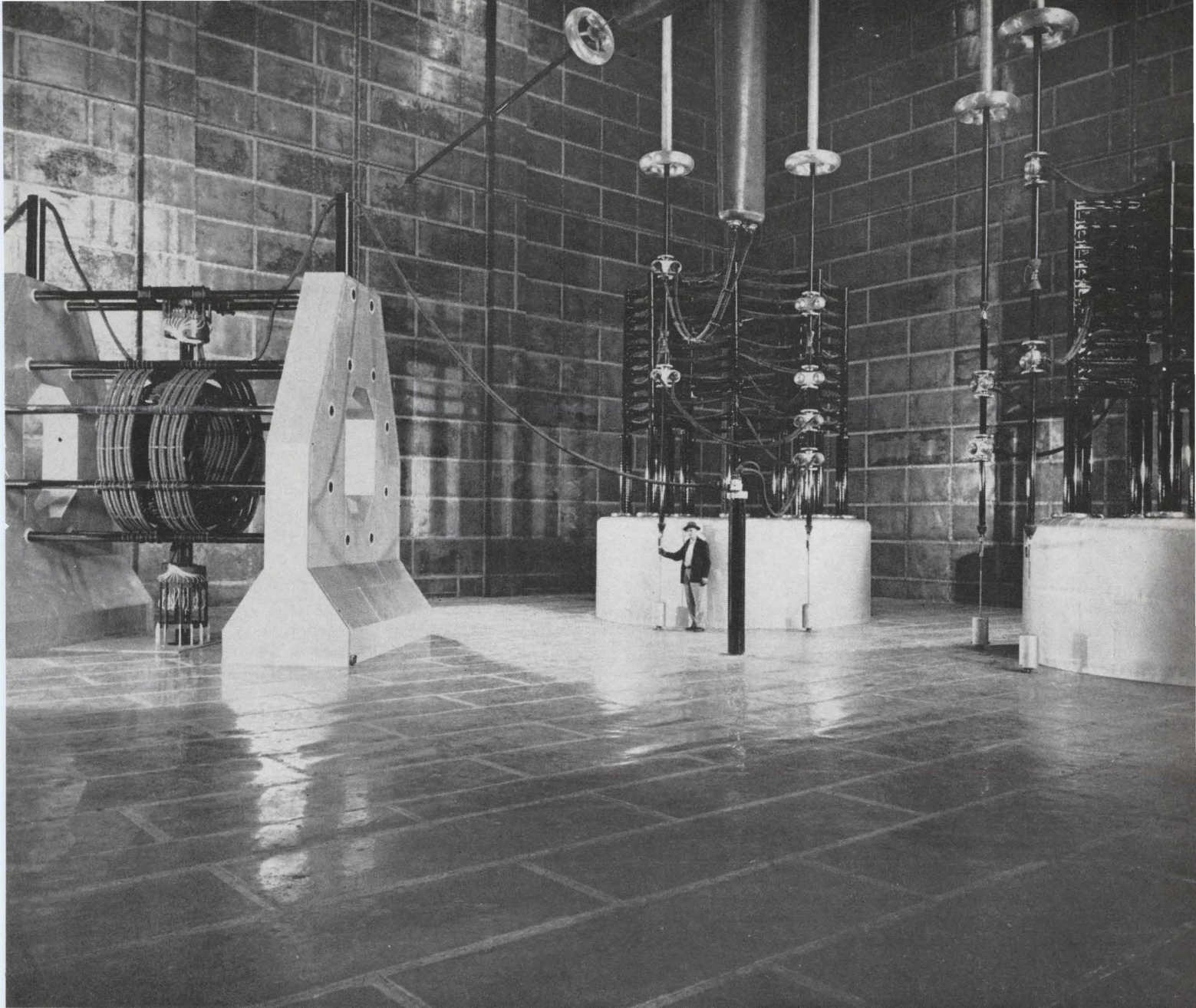

Antenna tuning equipment at Jim Creek Navy radio station. Two Litzendraht conductors, two inches thick, are run in parallel to reduce copper losses and potential gradient. The room is copper shielded to reduce eddy currents in the reinforcing steel of the concrete structure. Pedestals supporting the variometer (left) and the helices (center and right) are completely shielded with 0.025-inch copper. All seams are soldered and fastened by blind rivets to brass furring.

preceding sample calculations of resistance. The frequency of fundamental resonance, f_0 , has been measured as 49.8 kc for single downlead operation and 75.0 kc for two-downlead multiple operation. This information is needed in the determination of the per downlead load coil reactance required to tune out the apparent antenna reactance over the range of operating frequencies. The relationship between the true, or static, capacitance and the apparent capacitance of the antenna is expressed by $C_a = C_s / (1 - f^2 / f_0^2)$, where f is the operating frequency and f_0 is the quarter-wave resonance frequency for a 90° electrical length.

In determining bandwidth, the total effective resistance and the effective reactance as derived from the static capacitance, are the controlling elements. This follows from the basic definition

of Q as the kva/kw ratio of a circuit.

At 26.1 kc, the operating frequency used in this example, the reactance of the static capacitance is 150 ohms. Therefore the circuit Q for the single downlead connection is X_s / R_t , or $150 / 0.565$, resulting in a Q of 265. The bandwidth, f / Q , is 98 cycles per second.

For the two-downlead connection the static reactance of the whole antenna is unchanged, the multiple resistance becomes 0.307 ohms, the Q is $150 / 0.307$, or 488 and the bandwidth 53 cps. The same result is obtained if the Q of each downlead is considered individually, where X_s is 300 and R_d is 0.614. According to coupled circuit theory, the system Q is $(Q_1 Q_2)^{1/2}$, or $Q_0 = Q_1 = Q_2 = 488$.

Since each downlead contains twice the original inductive reactance, two downleads in series must

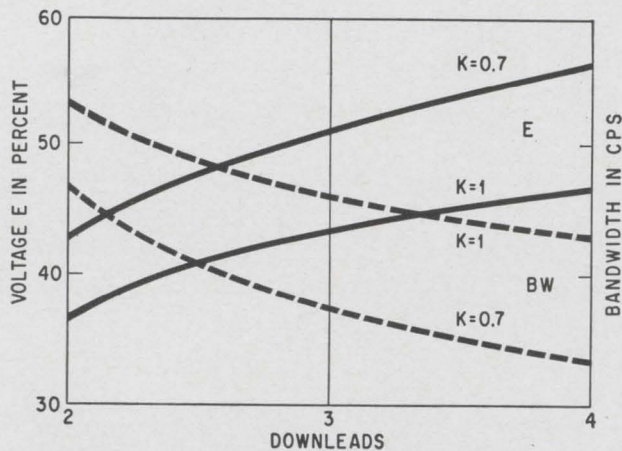

Interdependent characteristics of efficiency and bandwidth plotted for limiting conditions of the coil form factor. Generally, design will be most useful for values of k approaching 1.

have four times the original stored energy in kva. The driving point, or series, resistance has also been multiplied by four, so the kva/kw ratio of the series system, is identical with that of the effective multiple connection and the bandwidth is the same in either case.

Some of the published material on folded unipole radiators may be misleading on this point if it is not critically examined. In the low-frequency area, particularly when dealing with relatively slender vertical radiators, the addition of multiple downleads radically increases the static capacitance of the system so that for a given kw input the system kva is significantly reduced.

The relatively large increase in driving point resistance obtained by using multiple downleads does not contribute to increased bandwidth because the added downleads actually reduce the effective multiple system resistance, but not to the same degree as with a large multiple-tuned flat-top antenna. An increase in bandwidth gained through the use of multiple downleads with a vertical l-f radiator results from a net reduction in the kva/kw ratio of the system.

Radiation efficiency in a multiple-tuned system is simply the quotient of radiation resistance divided by the effective multiple resistance, or R_a/R_m . As in most systems, improved efficiency is gained at the expense of bandwidth.

Voltage considerations

Following a cosine law of distribution, the maximum voltage on an antenna system operated at or below quarter-wave resonance appears at the point most distant from the helix. Terminal voltage is a function of antenna length in electrical degrees. Its voltage effects are somewhat amplified by the lines of stress owing to the edge effect of the capacitor plate formed by the top horizontal loading element of the antenna.

The voltage stress at the far end of the antenna comprises three principal components; the terminal voltage at the top of the helix, computed from $I X_a$;

the potential rise across the self-inductance of the antenna (principally in the downleads), and the capacitance edge effect at the terminal point. The vector potential rise owing to self-inductance may be computed from $dE_{rms} = 1/\cos 90 (f/f_0)$.

The edge effect may vary between 10% for the end of a long isolated span in a catenary suspension to less than 5% for the boundary of a multi-conductor flat-top with peripheral conductors, the condition assumed here. Terminal voltage at the most distant point of the antenna is approximately $E_n = 1.05 I_d X_d [1/\cos 90(f/f_0)]$.

Typical operating data

Using factors developed in the foregoing sections, significant operating data is compiled in the table for 26.1-kc operation of a multiple-tuned antenna having two, three and four downleads and compared with a single-downlead Marconi antenna. An input power of 565 kw to the antenna system is assumed.

The performance figures are computed for a coil factor k of 1.0. The efficiencies of the multiple-tuning system could be improved if the coil designs achieved an ideal k of 0.707. Because the voltage at the top of each helix increases with the number of downleads, corona control requirements will normally outweigh considerations of copper economy and a k of 1.0 is a reasonable upper limit in a multifrequency design. The significant characteristics of efficiency and bandwidth are plotted above/left for the limiting conditions of $k = 1.0$ and $k = 0.707$.

In the usual application with operation at several frequencies, k is usually assumed to be 1.0. A more exact value of k may be obtained by measurement of the coil resistances if required.

General equations can be developed to predict the performance of systems with any number of downleads. But as efficiency increases with the number of tuned circuits the transmission bandwidth is reduced proportionately. This immutable trade-off has the practical effect of limiting the application of multiple tuning to a two-downlead arrangement if a reasonable compromise between bandwidth and efficiency is the design target.

The improved efficiency gained by the use of multiple-tuned systems is not the result of any real increase in radiation resistance but is the direct result of a reduction in losses.

Bibliography

- E.F.W. Alexanderson, "Transatlantic Radio Communications" Proc IRE, Aug. 1920, p. 263.
- R.F. Field and D.B. Sinclair, Proc IRE, Feb. 1936, p. 225.
- A. Hund, "High Frequency Measurements", McGraw-Hill, New York, 1927, p. 863.
- National Bureau of Standards Circular 74.
- J.E. Raudenbush, "Vlf Wave Propagation (transmission pattern of vlf system at Cutler, Me.)", NRL Progress Report, Nov. 1963.
- F.E. Terman, "Radio Engineering", McGraw-Hill, New York, 1947, p. 28.

The views expressed herein are the personal opinions of the author and are not necessarily the official views of the Department of Defense or of the Department of the Navy.

Electronics markets 1965

Page 88 Another record year for the industry

88 Further decline in arms

93 Space race slows down

94 Boom in industrial markets

95 Consumers look to color tv

by Leon H. Dulberger, Staff Writer
and Joel A. Strasser, Space Electronics Editor



Electronics markets 1965

Despite another decline in government spending, the electronics industry will reach new heights in sales this year, with the consumer and industrial markets scoring gains that more than balance the downturn in military procurement.

These are the major findings in Electronics' annual study of the industry's market and outlook for the coming year.

Sales are expected to inch upward 2.13% to \$17.6 billion from \$17.2 billion last year. Federal spending for electronics probably will drop to \$9.5 billion from \$9.8 billion last year, but will still comprise the biggest electronics market. Military spending will drop to \$7.7 billion from \$8 billion.

Consumer electronics will climb to \$2.7 billion from \$2.5 billion, and industrial buyers will spend over \$4.5 billion compared with \$4.1 billion last year. Replacement component sales are expected to remain at the \$700-million level.

The military will continue its swing in emphasis, from strategic weapons to those designed for fighting limited wars. The Pentagon is determined to bolster its ability to squelch brushfire conflicts; it's stressing counter-insurgency aircraft, night-vision equipment that uses ambient-skyglow light, anti-submarine warfare studies and a system of communication satellites.

The National Aeronautics and Space Administration will continue to buy electronic equipment for space probes and for manned flights into space, with spending expected to rise to \$1.7 billion from \$1.6 billion last year.

In civilian fields, the biggest gains are expected in sales of computers and data-processing equipment. Industrial sales will be spurred by increased spending for automation. Makers of equipment for testing and measuring also should share in the gains.

The biggest consumer gains should be in color television, with two million sets expected to be sold in 1965. More consumer appliances will contain solid-state controls, and integrated circuits will invade the commercial and industrial electronics fields.

Military electronics: Slower decline in spending

The Pentagon will continue to be the electronics industry's biggest customer this year, although military procurement is expected to slide to \$7.7 billion from \$8 billion in 1964.

The swing will continue away from strategic systems and toward tactical weapons for brushfire wars. In fiscal 1964 the military spent twice as much for tactical as for strategic weapons; in 1965 the ratio jumped to 3½ to 1; in 1966 the difference will be even wider.

The multibillion-dollar strategic projects are being phased out, and few successors are in sight. The military is seeking new tactical equipment with

which to fight in jungles, deep below the ocean's surface and in other places far from Pennsylvania Avenue.

Over-all military spending next year is expected to decline \$500 million to match a drop in the Soviet Union's military budget, but the total will still be \$49.3 billion. Reductions will hit hardest at suppliers of military hardware; spending for research and development will decline slightly if at all. Nonelectronic expenses—such as military pay—will get a bigger share of the budget.

For electronics concerns, the decrease will be magnified. Higher military salaries and mainte-

What's in the marketing report

	Page
Avionics	93
Communications	100
Components	104
Computers	101
Consumer electronics	96
Educational electronics	99
Industrial electronics	94
Instrumentation	105
International markets	110
Lasers	108
Medical electronics	98
Microelectronics	103
Microwave	106
Military electronics	88
Oceanography	93
Solid state	103
Space electronics	91

nance costs will give those categories a bigger share of the smaller budget, leaving less money for electronic hardware.

No more bombers

No bombers of any kind will be purchased next year. If anything is done toward building a new manned bomber, it will probably be no more than a token study.

The Air Force may get a green light, however, to develop an advanced avionics program for a bomber. Hardware from such a project would be useful in other aircraft, such as the Navy and Air Force versions of the F-111 tactical fighter. At present, F-111's are getting only off-the-shelf avionics gear—called Mark I equipment. Mark II, with advanced equipment, won't comprise a market until 1967.

A new troop-transport aircraft, planned by the Defense Department, will be able to carry 600 troops and some large equipment. It will result in a healthy market for aircraft electronics. The jet-powered CX transport, with a range of about 5,000 miles, will fly at about 550 miles an hour. The aircraft is scheduled to become operational by 1969. About \$750 million will be spent for development of the CX, and \$1 billion more for operational squadrons. The Pentagon plans to ask Congress for about \$160 million to start development on the transport. Airlines are also interested in civilian versions of the plane.

The Navy hopes to begin research and development of a fourth-generation Polaris missile, called the B-3; testing and evaluation also may be done. The B-3 would have the same range as the present A-3, but would carry a bigger payload.

Purchasing of air-to-surface missiles will be small-scale next year, but there's a chance that a program-definition contract will be awarded for SRAM—Short Range Attack Missile—air-to-surface missiles with a 60-mile range.

Surface-to-surface missiles will be confined largely to the Polaris and Minuteman II's.

No mobile medium-range ballistic missile (MMRBM) will be developed in the coming fiscal year.

Gain for penetration aids

On the positive side, spending is expected to continue heavy for penetration aids such as ballistic decoys and electronic devices to deceive enemy radar. To date, \$1 billion has been spent on this program, mostly for research and development. This year the emphasis will be on procurement.

Substantial funding also is likely for the SR-71 reconnaissance plane, scheduled for initial delivery this year to the Strategic Air Command. President Johnson calls this a \$1-billion program. The outlook for the YF-12A fighter plane is foggier. The Air Force wants the aircraft but the Pentagon is still doubtful.

Military communication satellites

At least \$50 million will be spent on electronics in a communication satellite system for the military, but the funds won't show up in the new budget because most of the money is already on hand from deceased satellite programs such as the Advanced Communication Satellite.

The fate of the Nike X won't be decided until August; that will put off funding until fiscal 1967. If the Pentagon orders it into production, and if there are no comparable reductions elsewhere in the military budget, the antimissile program would propel the budget upward again by \$4 billion to \$5 billion and keep it there for a few years.

Barring a turn for the worse in U. S.-Soviet relations, however, production of Nike X is unlikely. The best bet is that R&D will continue to be maintained at a minimum level.

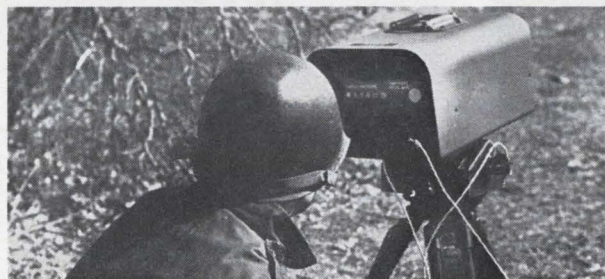

Laser range finder developed for the Army by RCA uses pulsed laser and digital readout. Integrated sighting and receiving telescope developed by Bausch & Lomb, Inc., transmits light to photo detector and protects the user's eyes. The Army is testing several laser range finders for possible field use.

The search for new ways to defend against submarines probably will get a 10% boost in funds from the present \$350-million annual level. Spending for antisubmarine warfare will climb more steeply, however, to about \$3.5 billion from this year's anticipated \$2.75 billion.

The major needs are in detection, particularly

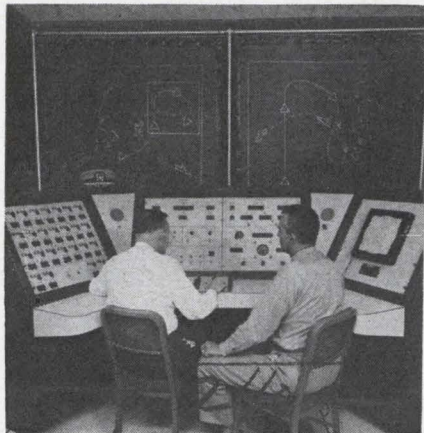

◀ Antisubmarine warfare is simulated by system developed for the Navy by Sylvania Electric Products, Inc., a subsidiary of General Telephone & Electronics Corp. It simulates conditions that aircraft encounter in finding and killing subs in a 250,000-square-mile portion of the ocean.

Manned interceptor ▶ aircraft, the YF-12A is designed to travel twice as far as conventional aircraft. It's being tested by the Air Force. The 2,000-mile-an-hour plane has an advanced fire-control system and is equipped with very-long-range missiles.

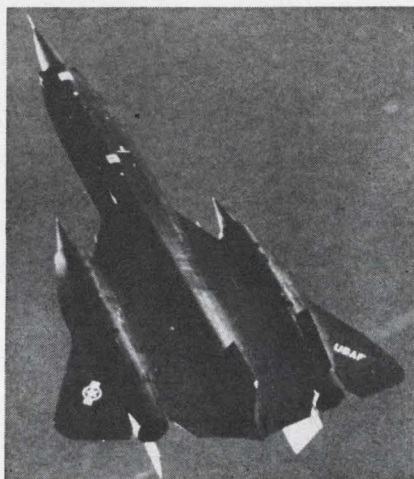

Navy's new utility helicopter is demonstrated in missile transfer exercises. The tandem rotor aircraft, built by the Boeing Co., Vertol division, can take off and land on water. Its hull is watertight.

sensors. Signal-processing techniques also are sought, for better evaluation of received data.

For limited warfare

The Army's light observation helicopter, the LOH, will create a big avionics market in fiscal 1966. This equipment will be off-the-shelf navigation, identification-friend-or-foe, and communications gear. Microminiaturized equipment will be installed in later models of the LOH. This is the same procedure being used for the F-111 fighter and Val, the light attack plane now being developed for the Navy.

No decision has been made yet on how far to go in buying air-assault helicopters for the Army. They'll be tested thoroughly in spring maneuvers. Any purchase would be big.

Installing more modern equipment in the F-4 tactical fighter aircraft with a new fire-control system will be an expensive program. The F-4, used by the Air Force and Navy, fires the Sparrow air-to-air missile and the Bullpup air-to-surface missile. It will also use Walleye, the bomb guided by television, when the bomb is developed.

Nuclear ships will be absent from the 1966 budget. Defense Secretary Robert S. McNamara is said to favor a nuclear aircraft carrier, but this decision doesn't have to be made until 1967.

New radar

The plan to initiate a new generation of tactical radars—ground-based for surveillance, and for

tracking aircraft and missiles—will stimulate one segment of the industry. Others will be used to locate mortars and artillery. Some of the new radar will be height finders, some three-dimensional. The units to be assigned to the unified Army-Navy-Air Force Strike Command, must be highly mobile.

The first generation of night-vision equipment will be bought for the Army. These low-light-level systems will use photomultiplier techniques for gunsights and binoculars, and closed-circuit tv for aircraft.

Electromagnetic reconnaissance and countermeasures—jamming, antijamming, electronic spying—may be off a little next year. Purchases will be for pretty much the same gear that was bought last year. Nothing new or exciting is scheduled.

Communications will continue healthy but nothing new is planned. Communications systems are vital to command-and-control systems, strategic and tactical, which will comprise a big market in fiscal 1966.

Proposals for bids for new tactical command and control systems should be sent out this month. Initial work will consist of feasibility studies to determine how existing communications and data-processing equipment can be used in the field for command-and-control. A way of automating the equipment also will be studied. No development of data-processing methods will be initiated this year—but it may come in 1967.

Procurement for navigation and guidance will slack off, but is expected to pick up in 1967 and

1968, when the F-111 is ready for such equipment. Research and development will slow down even more.

Lasers are no longer only experimental. The first big application will be in optical range finders for tanks. For this function, lasers have overcome serious doubts by the Army.

The research outlook

Two profitable areas this year are basic research and exploratory development. Funds will be provided for both categories and there is always the possibility that a development may be so important that the Defense Department would have to go

beyond research and order its production.

Good research prospects seem to exist in such fields as materials, propagation, quantum theory of lasers and mathematics in all these areas.

Exploratory development could be profitable in communications, navigation, laser application and quantum theory.

The Pentagon is also receptive to new equipment and techniques developed with private funds. There are two advantages to a company's concentrating such efforts on weapons for limited warfare: work on smaller weapons costs less than for big systems, and smaller weapons for brushfire wars are in present demand.

Space electronics: New components needed

The United States will continue its race into space next year, but at a somewhat slower pace. Like an advancing army, the space explorers have outdistanced their "supply lines"—in this case, communication technology and adequate electronic components.

The National Aeronautics and Space Administration is expected to spend \$1.7 billion for space electronics in calendar 1965, up from \$1.67 billion last year. Huge new markets are opening up, but much of the government appropriations are already spoken for. Money for prime contracts is increasing, but the number of new contracts is getting smaller.

The military's glamor project is still very "iffy." Though the Air Force proposed the manned orbital laboratory, NASA may ultimately build it. MOL could need as many as 30 to 35 vehicles before 1980, with electronics costing \$600 million to \$700 million.

Electronic gear for a manned space lab would include navigation equipment, star trackers, inertial navigation equipment and geodetic instrumentation, communication gear for vehicles and ground stations, and instruments for control and ground checkout.

NASA's manned-flight program offers few markets that aren't already spoken for through the Apollo project that's tentatively scheduled to take men to the moon around 1970.

Communication satellites

New electronic products are needed in communication satellites. For such satellites, says a top NASA official, "we need a reliable, wideband-microwave output tube that's more efficient than the present traveling-wave tube." But an engineer at the Communications Satellite Corp. says, "We've



Saturn I launch vehicle is forerunner of the giant Saturn V booster that is expected to carry three astronauts to the moon by 1970. The Saturn I is shown during a radio-frequency-interference test prior to a recent launch at Cape Kennedy.

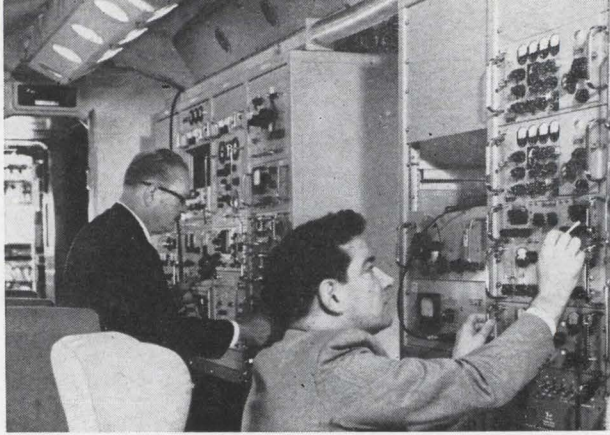

Dual-diversity telemetry receivers, built by the Vitro Corp. of America for space use, are shown in a NASA aircraft. At right are the predetection combining and recording systems that extend the receiver's signal-noise threshold and permit use of a small airborne antenna.

given up expecting more efficient tubes. Now we're looking to solid-state devices."

The solid-state amplifiers could be transistors or power varactors with power outputs of at least five watts and efficiencies of 20% to 30%, to operate at 4,000 megacycles, the Comsat man adds. Present solid-state devices have efficiencies of less than 10%.

Another cry of Comsat engineers might be paraphrased as: "What this country needs is a cheaper front end for a ground-station receiver." The demand is really international. Commercial satellite systems will create a market abroad for satellite ground stations, says one NASA project manager. Many countries would be interested in a more economical front-end package that costs about \$100,000. It should have a low-noise, broadband (25 Mc) traveling-wave maser and a closed-circuit cryogenic system to cool the maser, the NASA man declares. Today's front ends cost about \$500,000.

NASA and Comsat agree that there will be demand for low-noise antenna feeds, receivers with improved feedback threshold-extension detection, multiple-access communication systems and low-cost antenna dishes.

Day-and-night sensors

Television and infrared sensors that can operate day and night in operational weather satellites are sought by NASA's Goddard Space Flight Center. NASA wants a television sensor, which now sees in daylight, to be able to see in the dark, too. And it wants an infrared sensor, which takes cloud pictures at night, also to be able to operate in daylight.

NASA seeks a tv tube with a low-light capability of nearly 10^{-5} foot-lamberts illumination, with near-infrared spectral response for night operation, and a resolution of about 1,000 tv lines. Image orthicons and image dissectors are among those being considered.

One obstacle to using infrared sensors has been the inability to cool them so i-r detectors will

operate at 50°K, in a spacecraft. In January, Goddard will ask suppliers to bid for the hardware development of a solid argon cooler weighing 30 to 35 pounds.

If detectors can be cooled to 50°K, they can operate in the 11-micron region to obtain infrared pictures day and night. At 50°K, a germanium-silicon alloy, doped with zinc-antimony, can operate out to 14 microns wavelength, with high sensitivity. If the detectors could be cooled even lower, say to 28°K, NASA could use photoconductive detectors. They are even more sensitive and easier to work with.

Space communications

"The space communications problem will become more complex as we build larger boosters able to loft bigger spacecraft," predicts Albert J. Kelley, deputy director of NASA's Electronics Research Center. Besides the weight limit encountered in space-vehicle design, he continues, "we could run into a communications-data limit." "We want industry to come up with new multiplexing equipment," says another NASA official.

To increase data-handling ability, later space programs will require equipment that provides "as much bandwidth as possible for voice, television and telemetry," an industry source adds. "There will be an increasingly large market for digital transmission techniques—vocoders, digital television and audio," he continues.

Eyeing another technical shortcoming, Kelley adds, "We need a broad range of measuring instruments, counters of high-speed particles and high-temperature measuring devices. These are available but they're not packaged for the space environment."

NASA favors digital instruments and digital communications equipment over analog. These would eliminate the analog-to-digital converter and would be "compatible with pulse-code telemetry and digital systems on the ground." Another NASA expert advises, "All products should be digitally oriented."

Components—the key to success

The key to making profit from space technology is to design components to operate in radiation, in high vacuum, at space-temperature extremes, and at high levels of shock and vibration. "We've used up our inventory of military specifications," says Kelley. "Now we've got to have space specs. The biggest problem is understanding the space environment."

Components manufacturers must understand the problem, he continues. They need a good applied-research and development staff.

"The problem is to develop components and to be able to specify them," according to Kelley. "One of the things we expect to do here at the Electronics Research Center is come up with a set of standards. And of course reliability is always a problem."

Avionics: Same size, new stress

The market for avionics will be about the same size this year as last, but there will be many changes in emphasis.

Inertial guidance systems for the Apollo spaceship are nearly all purchased or spoken for. With that big project practically over, the market for such equipment will continue to slip until it bottoms out around 1968. Military procurement will continue to dominate the field, but the civilian market should represent a steadily growing portion.

The Federal Aviation Agency expects to spend \$100 million on electronics this year, down slightly from \$103 million in 1964. But by 1968 the FAA figures it will be spending \$225 million a year.

Construction of airport facilities is expected to decline because the FAA has added about all of the operational facilities it needs for the present. Immediate needs are for equipment—all-weather landing systems and semi-automated control of air traffic. That's why outlays for research and development are staying about at the 1964 level.

The boost in FAA funds by 1968 is expected to come when the agency speeds the construction of 21 air-traffic control centers. One semi-automatic center is already being built in Jacksonville, Fla. Each center should cost \$12 million to \$18 million.

As more airlines shift to high-speed jets and NASA's space flight program moves into high gear this year, the development of sophisticated electronic training aids such as flight simulators will be an important part of the avionics market.

Oceanography: Prospecting for future markets

At a recent government-sponsored briefing on oceanography, one participant remarked, "The funds involved wouldn't even pay the transportation costs of the people attending this meeting." As many as 40 firms bid for a \$10,000 contract.

The sea is becoming increasingly important in defense and in economics, and it's expected to account for higher and higher expenditures. Meanwhile, however, companies' interest is in "getting a foot in the door" rather than any immediate windfall prospects.

In submarine warfare, the game of seeing with-

out being seen cannot be played without a lot more information about the ocean. In the not-very-distant future, control and instrumentation of deep-sea research vehicles will comprise a healthy market for electronics companies. Sea houses and "flying submersibles" may also come someday. But at present the markets consist almost entirely of fundamental devices such as sensors.

Needed: measuring devices

The most urgent need is for instruments and techniques for long-term measurements, both stored and telemetered. Subsurface variables which are unaffected by winds and waves are getting increased attention. Temperature and pressure both affect the speed of sound; precise measurements of both gradients are necessary for better oceanographic studies and for submarine warfare.

On a broader scale, oceanographers are seeking ways to find out where the water enters and leaves the ocean, and how oceans affect the earth's heat.

Buoys that surface when told

A market is developing for 4,000 to 5,000 deep-sea buoys a year, to which sensors and special power supplies would be attached. The instruments would sense and transmit information on currents, salinity, pressure and other ocean variables.

The problem of tracking and recovering is becoming more serious. Conventional subsurface buoys return to the surface at a time fixed by a clock mechanism. "As often as not, they surface during a screeching gale," says Robert G. Walden of the Woods Hole Oceanographic Institution. Woods Hole is sponsoring development of acoustic anchor releases that would bring buoys to the surface only on command from an encoded signal. To pinpoint locations, ocean research groups are turning to high-frequency beacons that can operate unattended over long periods.

"We have found that a reliable, simple, low-power transmitter, operating in the two-to-five-megacycle band and working into a relatively short but rugged whip antenna is the most satisfactory single-buoy location device," Walden states.

The Navy buys about 200,000 sonobuoys a year to pick up underwater sounds and radio them back to antisubmarine patrol aircraft. A new design, by Sanders Associates, may change the technical direction of the sonobuoy market. Sanders has shrunk the conventional cylindrical form, five inches in diameter and 39 inches long, to a sphere only a fraction as large. The new sonobuoy requires no mechanical rotor to slow down its descent, and its miniaturized electronics on printed circuit boards are shock-mounted to permit launching of the sphere from aircraft at about 10,000 feet.

Electrical fishing

To test a theory, that the sea's surface temperatures can lead fishermen to schools of tuna and other fish, a trawler from the Exploratory Fish Base in Gloucester, Mass., is going to sea equipped with

a marine radio facsimile recorder. The device will receive temperature charts radioed by the Navy's Fleet Weather Prediction Service, and determine whether tuna can be found in small areas where sharp temperature changes are detected.

Also under investigation at Gloucester are techniques for electrical fishing. Transformers and electrodes are positioned on nets, and the electrical fields stun the fish so that more of them are scooped into the net.

With conservation in mind, the laboratory hopes to be able to set the pulse rate of the electronic firing circuits to catch only fish of a specific size.

An electronic clam sounder, a modification of the jet clam dredge that is used to dig surf clams, is another target of electronic fishermen. On conventional dredges, the scraping noise from the clams is picked up and transmitted by hydrophones to a monitor who directs the dredging. "We'd like to do this electronically," says Leon E. French of the Exploratory Fishing Base. Hydrophone signals are being put through wave analyzers to see if clams, striking the prongs emit a characteristic vibration that is distinguishable from the vibrations caused by collision with rocks, sand and gravel. The Hewlett-Packard Co. is analyzing the waveforms from tape recordings made during clam dredging operations.

Industrial electronics: Automation on land and sea

The industrial electronics market is expected to soar in 1965.

A big factor in this growth will be advances in mass-transit electronics, process-control computers, numerical-control systems and automation of ships; in the past, engineers have shunned electronic equipment in those areas.

"The process industries are expected to spend between 20% and 35% more (for process-control computers) in 1965 than in 1964," says Lewis S. Geiger, marketing manager for the General Electric Co.'s process computer section. The market last year was about \$22 million.

Utilities are expected to remain the biggest customers. And their sales are likely to rise about 10% in 1965 from a year earlier. The primary metal-working industry, such as steelmakers, is expected to boost its buying nearly 80% while chemical and petroleum processors' buying levels should about match 1964's level.

Currently, there are about 500 computer-controlled process installations around the world, and

by the end of 1965 that level should reach 700. The average price of a system is \$275,000.

Auto industry

Computers are being given a broader role by car makers and by producers of automotive equipment. One computer maker says it is negotiating with several companies in this area for the sale of at least 11 machines. These computers would be used in machine shops, for warehouse and conveyor-belt control and for quality testing.

Marshall Brittan, manager of marketing for the Westinghouse Electric Corp.'s computer systems division, puts it this way: "The trend today is for small computer systems. The price tag is low enough to allow smaller companies to buy, and they are buying."

Direct digital control

No sudden increase this year is seen in the market for direct digital control. Most potential customers are waiting to see the outcome of tests now being conducted in this area. The Monsanto Co., for example, recently installed a trial DDC system at a detergent plant.

Numerical control

Machine tool producers are looking for low-cost and simplified numerical-control equipment. Jay Gorham, manager of marketing for the Bendix Corp.'s industrial control division, believes sales of such electronic positioning systems will increase 20% to 25% this year from 1964 to a record \$25 million. But, he adds, "This is for equipment that has some of the frills cut out, and gives more responsibility to the parts programmer and the machine-tool operator."

Electronics on ships

Ship automation is one of the newest markets for electronic gear. Ship owners and maritime unions are beginning to accept the idea of electronic monitoring and control. The equipment is used to monitor and record data about the ship's power plant. Sales in 1965 are expected to rise to between \$3 million and \$5 million from \$2 million last year.

But the growth of this market is limited by a slump in America's shipbuilding industry, which is being undercut by foreign competitors.

According to a spokesman for the Westinghouse Electric Corp.'s marine systems division, "The market will never be worth more than \$5 million in any one year." There will only be about 17 or 18 new ships a year that could use electronic controls, he adds. And older ships being refitted with electronic gear wouldn't be given complete systems, he says.

Mass transit

Certainly, the greatest potential for electronic gear is in the mass-transit field. Every city in the United States with a population over about 250,000 is stuck with the problem of moving peo-

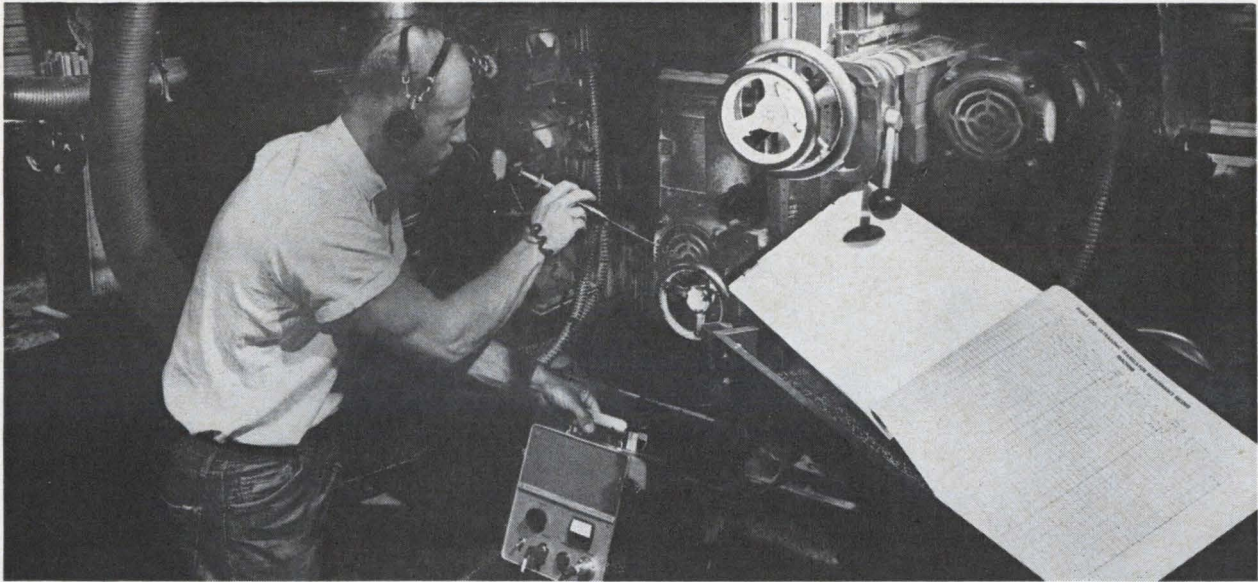

Sound analysis of machine bearings is done by translating 30-to-50 kc ultrasonic energy into audible sound in a Delcon Corp. instrument. Transistor-operated unit is applied to 42 identified probe points on bearings of wood bevel-and-tenon cutting machine, to listen for wear and plan replacements.

ple from one place to another. Mass-transit railway systems with electronic controls may provide a solution to the problem and 1965 may be a significant year in this field. Test results of mass-transit systems in Japan, San Francisco and Pittsburgh will begin pouring in by mid-year.

W. J. Walker, manager of transit systems for Westinghouse, says, "Cities will buy after they see the results of the systems to be tested in 1965."

The San Francisco tests, says Thompson A. Nooner, director of marketing services for the General Railway Signal Co., one of the companies involved in the project, are the most extensive in the history of mass transportation.

According to Nooner, these tests point the way to the future use of electronics in the transit industry. The building-block concept, adding addi-

tional functions to a basic system, isn't new to the electronics industry, but to the transportation industry, the idea is revolutionary.

"In 1964," he says, "transit companies spent about \$13.1 million for electronics to update old systems, add electronic interlocking controls or timing systems and consolidate control. In 1965, the industry is expected to buy \$15.3 million of new equipment to replace old systems."

But Walker of Westinghouse estimates that the 1964 market was only between \$10 million and \$12 million and the market in 1965 is likely to equal or be a bit below that level. In 1966 and 1967, however, he sees a sudden surge if the tests are successful.

"The market for digital computer-directed systems using solid-state controls could be \$35 million to \$45 million (at that time)," he estimates.

Consumer electronics: Another big year for color tv

It looks like a banner year in consumer electronics for two million reasons—the number of color television receivers that are expected to be sold in 1965.

Officials generally agree with Ted Herkes, vice president of consumer electronics at Motorola, Inc., who predicts that color tv will score another re-

sounding success while other consumer fields remain at the high levels attained last year.

Receiver sales at the factory are expected to climb to \$600 million this year from \$430 million in 1964. This climb would be accomplished in the face of price-cutting; in addition, prices are expected to drop below \$400 by 1970 from the present average of about \$500.

Price competition has already set in, even in broadcasting equipment. The Radio Corp. of America insists that its profit was unaffected by a \$50 cut in the price of its least expensive model, which now sells for \$400. Competition was intensified last in 1964 by Sears, Roebuck & Co., charging \$300 for a color set that uses a 16-inch tube made in Japan.

The color boom should get a boost from engi-



Color-tv receivers in Bloomington, Ind., tested at RCA Life-Test Labs. Many receivers are selected at random from this group for test and evaluation. Two million color-tv sets are expected to be sold in 1965.

neering that perfected the rectangular color tube. These color tubes allow reception of the complete, uncropped picture as sent from the transmitter.

The National Video Corp. is building a 23-inch rectangular color tube for Motorola and has started developing a 25-inch model. RCA will push its 25-inch rectangular tube this year after selling limited quantities over Christmas. The move should increase sales of higher-priced receivers.

Rectangular 19-inch tubes will be introduced early this year. Sets using them will employ an automatic degausser so the receiver can be moved around in an apartment without additional service charges, to overcome the effects of magnetic fields.

National Video will introduce its 19-inch rectangular tube in April. At Sylvania Electric Products, Inc., a 19-inch rectangular color tube is being developed; plans are to introduce it early this year. Sylvania is a subsidiary of the General Telephone & Electronics Corp.

Lynn Long, product sales manager at Sylvania's electronic-tube division, predicts that color tv sales will surpass black-and-white "in a few years" and that black-and-white will begin to decline by 1970, eventually perhaps to suffer the fate of the player piano and the stereopticon.

For 1965, however, the round 21-inch tube will remain the basic color-tv component, and manufacturers are selling all they can make. Rectangular tubes are still expensive. They require complex technology to make their triple electron beams and the complicated circuitry needed to deflect these beams through sharper angles and to achieve positioning of color-dot triads on the face of the tube.

Black-and-white tv

Not everybody agrees with Long, of Sylvania, on the impending demise of black-and-white tv. One reason for continued optimism in some quarters is the growing popularity of small, personal

units for every member of the family. Herkes, of Motorola, predicts that 12 million to 14 million black-and-white sets will be sold annually by 1969, up from a predicted 8 million this year. But Herkes adds that the biggest volume will come in small sets in \$59-to-\$69 range.

The addition of ultrahigh-frequency channels should bring broader programming to nearly every area, even in secondary cities. The new channels will dilute the importance of networks and maybe even of rating services.

The community antenna business should boom for three or four more years, according to Bryce Durant, president of RCA's service subsidiary. But Durant says the community-antenna business' days are numbered; the systems will be replaced by multiple uhf channels in five years, he declares.

Sound systems for the home

Quality sound equipment, housed in quality furniture, is attracting more and more consumers. The Magnavox Co., for example, says sales of high-fidelity consoles have been growing "incredibly well." Magnavox introduced all solid-state hi-fi more than two years ago and developed transistors to eliminate cross-modulation in tuning circuits. Magnavox's top-of-the-line units include remote-control tuning with signal-seeking circuitry similar to that in car radios.

The addition of f-m multiple stations are spurring sales of home tape recorders. However, the lack of standard cartridge sizes throughout the industry restricts the owner of any particular system to a limited library of prerecordings.

An electronic message center for recording brief messages has been introduced by the Westinghouse Electric Corp. The five-pound unit, about the size of a hard-cover book, lets a housewife store up to three minutes of instructions, telephone numbers or other information on a closed loop of tape that can be played back on demand. Since its introduction last summer, sales of the unit have taxed Westinghouse's ability to supply the home appliances at \$39.95 apiece.

Home video tape recorders

No licenses have been awarded for the home video recorder that was made available last summer by the Illinois Institute of Technology Research Institute. Almost every company in the industry has taken a look at it, according to John Skinner, manager of magnetic tape recordings at IITRI. Production would be at least a year or two away even if a manufacturer were licensed now. RCA has also been working on home video tape recorders, according to Durant.

But much technical work remains if these recorders are to achieve technical maturity and a price near that of a home movie system.

Electronic extras for autos

A trend in automobile radios is an a-m/f-m stereo unit, as an extra by Chevrolet. The stereo system uses multiplex circuitry, four speakers and a cross-

over network. The equipment, by the General Motors Corp.'s Delco Radio division, employs the same circuitry as home stereo instruments.

F-m reception in car radios also is being improved by adding vertical polarization to f-m broadcasts that are horizontally polarized. The aim is to achieve better reception with whip antennas that are standard for use in autos. Automobile f-m should hit 200,000 receivers this year, according to Frank Brewster of Motorola's Automotive Products division.

The newest trend in auto electronics is toward capacitor-discharge ignition systems that use silicon controlled rectifiers rather than transistors. A condenser accumulates voltage, which is discharged across the ignition coil's primary winding by the scr trigger. Spark plug life of 100,000 miles is forecast with capacitive systems.

Home appliances

Solid-state electronic controls should find a big market in consumer appliances this year according to John Mungenast, a General Electric Co. sales manager executive. Low-cost remote controls, using carrier current, will be introduced for ovens, air conditioners, fans and furnaces. Pioneered in a model train, and tested in carrier intercommunications and hi-fi speaker systems, all by GE, these remote controls code and insert low-level signals on 117-volt service lines at any outlet. Receivers decode these signals and deliver them to the control gates of scr's. The remote controls transmit variable-amplitude commands and on-off functions.

Half a dozen manufacturers will offer variable-speed scr controls for blower motors in 1965, for air conditioners and furnaces. The systems will vary speeds automatically with heating or cooling loads.

Silicon-controlled rectifier systems for vacuum cleaners, blenders and floor polishers will be introduced this year, with similar controls for cooling and baking expected in 1966.

More consumer trends

The rapid development of integrated circuitry holds great promise for appliance designers. According to Texas Instruments, Inc., low-cost integrated-circuit packages are ideal for decision-making logic in automatic appliances. The trend is toward more direct sensing controls that measure and monitor progress and control cycles of such appliances as dryers.

Citizen-band radio

A single-sideband technique has been introduced by the Dynascan Corp. for 27-megacycle citizen-band radio. A power gain is achieved by eliminating one sideband. The bandwidth reduction permits assigning to ssb systems to each 10 Kc channel. Dynascan says the technique doubles the number of channels available. A built-in oven holds the transceiver's frequency stability at 0.0005%.

A communication antenna, exploiting the phased-array principle, is now available for citizen-band



Tape recorder, built by Craig-Panorama, an "electronic notebook." It uses a half-hour tape pack and rechargeable nickel-cadmium batteries. Microphone is built in. Market for miniature tape recorders is considered strong.

use. It's made by the Antenna Specialists Co. Electronic scanning selects among three 120° sections of the horizon surrounding the antenna. Directional gain is 7.75 decibels, according to the manufacturer. The pulsed-array technique has long been used in radio telescopes and for satellite tracking.

In electronic pianos, a professional 73-key model with 100-watt output has been introduced, using four 12-inch speakers. It's for pianists who are tired of being overwhelmed by electronically amplified bass and guitar. Developed by Harold Rhodes of the Fender Electric Instrument Co. in Fullerton, Calif., the instrument uses a modified tuning fork and pickup coil on each key.

The Wurlitzer electronic piano has grown in popularity in the past year, especially in colleges that employ clusters of the instruments. The piano uses steel reeds to vary their capacitance relative to pickup plate. The piano uses a nine-transistor amplifier and produces 10 watts, more acoustic power than a spinet, Wurlitzer says.

Electronic organs are the most promising consumer applications for integrated circuits. They should become big sellers within a couple of years, says John Brand, chief design engineer of the Thomas Organ Co., a subsidiary of Pacific Mercury Electronics. One use might be for repetitive tone generators and similar circuitry.

The Thomas line is completely transistor-operated. Industry sales are growing at 10% to 15% a year, and reached 120,000 units last year, according to Thomas Organ.

Medical electronics: Bigger than space effort by 1975?

To make money in electronics, you often have to become a specialist in another field. This is particularly true in medical electronics.

Prof. James B. Reswick of the Case Institute of Technology predicts a national program of medical electronics in 10 years that will surpass even the space effort. But first, engineering companies must acquire medical know-how.

The doctor is a necessary ingredient in the development and marketing of medical hardware. He is the only person who knows what physiological functions need to be measured or treated. But too few doctors know much about electronics, and fewer engineers know much about medicine. Furthermore, doctors are a notoriously cautious group, and almost inaccessible to salesmen. A wedding of medicine and engineering is in order, and there are signs that it's being planned.

A few schools—Washington University in St. Louis, for example—have begun to turn out doctors with strong electronics backgrounds. And Northwestern University is creating a biophysics department designed to give engineering physicists a solid understanding of the human body.

Companies whose staffs include medically trained engineers—or electronics-conscious doctors—will have a big head start in the coming race into medical electronics.

If physicians do not keep up with engineering techniques, one specialist warns, they may one day find themselves unable to direct and control them in developments, and they could be forced into the position of assisting the engineers.

Prof. Reswick, director of the Engineering Design Center at Case declares "We are going to see engineering systems branch out more and more from the diagnostic applications into therapy and assistive devices." Therapy systems will cure bodily malfunctions, assistive systems will replace malfunctioning organs and appendages," he explains. Diathermy treatment, heart pacemakers and laser-beam operations on the eye are examples of these advanced applications of electronics in medicine.

Previews of some future roles

A few advances in 1964 hint at exciting develop-

ments ahead as the medical profession learns to use electronic aids. An ultrasonic diagnostic instrument was used last year for the first time to remove a large piece of brass from a boy's eye. Some specialists believe ultrasound will also complement x-ray techniques some day in nondestructive diagnostic applications.

Diagnostic and therapeutic uses of lasers are receiving extensive study. Some researchers believe that the laser will lead to many medical instruments.

More regulation proposed

The Food and Drug Administration wants tighter control over medical devices that use electronic techniques. The agency is concerned that some devices may not perform as well as their manufacturer's claim they do. The FDA is gathering data from other agencies on their use of electronic medical devices.

Early this year, the FDA will submit another proposal to Congress asking for more control over medical electronic devices; at the last session of Congress, no action was taken.

Educational electronics: A \$100 million market, and growing

Many college buildings are now being designed with large, elaborate wiring ducts under the floors, easily accessible, to accommodate electronic teaching equipment—most of which hasn't been invented yet. That's how confident the educators are that automation is going to move into the classroom although widespread use of sophisticated apparatus is still years away.

Whether solid-state circuits will ever replace teachers en masse is highly doubtful. But electronic equipment already accounts for about \$100 million a year in education expenses.

Much of the electronic equipment for education is conventional. A spokesman for the Educational Equipment division of the Radio Corp. of America says educational electronics is merely a fashionable new term for audio-visual aids.

The equipment sold to schools and colleges is designed mostly for other uses: consumer-type tape decks, commercial distribution systems and industrial closed-circuit television systems.

Teaching languages electronically

Innovation consists almost entirely of ways to combine the equipment into systems and use them. Ingenious programming techniques and an increasing amount of available software make tape-recorder language laboratories increasingly useful.

Language laboratories are one field of education where electronics has found practical application. According to RCA, about 5,500 classroom-size systems are now in use, principally in colleges. A system may serve from one to 64 pupils; and portable systems are also manufactured. A system may cost up to about \$7,000. The electronic systems help students to correct pronunciation and inflection, either with the aid of prerecorded tapes or with a teacher at the console. This market, estimated at \$8 million a year and growing is spurred by the government's use of such labs.

Video equipment

Federal funds are also nourishing educational television. Educational tv stations now exist in major cities, though generally not connected with any particular school or college.

However, the use of closed-circuit networks in schools and colleges is growing. Such networks frequently serve two purposes: to supply educational programs, and to train students in all phases of television production, both technical and programming. The closed-circuit tv market in education is

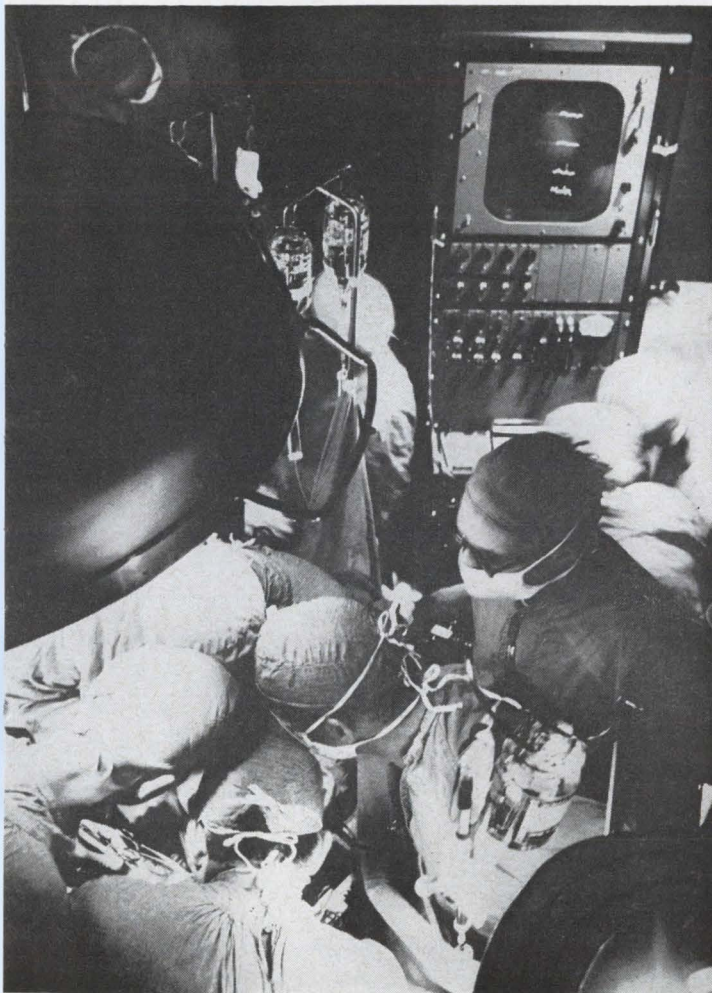

Electronic system in operating room measures depth of anesthetic and critical physiological reactions. The system, at upper right, is built by the Hewlett-Packard Co.

about \$4 million to \$5 million a year, while the educational tv market for general broadcasting is about \$8 million.

Mass teaching and individual learning

Two major trends are emerging in educational electronics. One is toward mass instruction systems that enable one teacher to lecture to larger numbers of students, perhaps scattered over a campus or through a city. The other is toward individual instruction—learning machines—that enable a student to study at his own speed and in his own way. The two are expected to complement each other in different phases of the learning process.

Individual-instruction machines have not yet won wide acceptance. Those available today are mostly books and other printed material such as printed rolls contained in cardboard or metal boxes, arranged in a sequence designed for step-by-step learning. The electronic teaching machine is only experimental so far; several have been developed and some are being evaluated. But they all cost too much.

Electronics in the library

College libraries are buying more and more playback turntables, tape decks, amplifiers and headsets. They're also showing increasing interest in

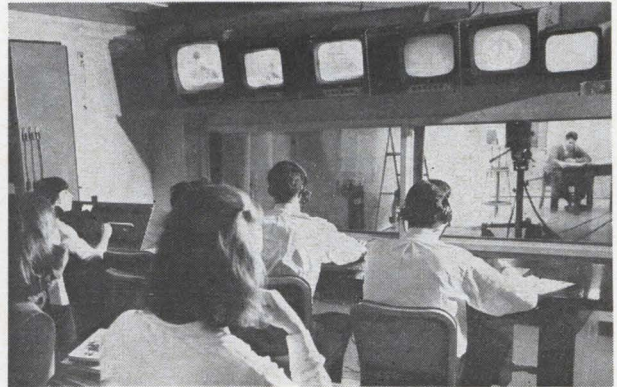

Educational television center at Brooklyn College was installed by RCA. Students are studying tv program production. Educational electronics had \$100 million sales in 1964.

audio lessons to which pupils can listen with headphones.

However, the great revolution in electronic information-retrieval in school libraries is still a long way off. No simple method for video retrieval of book material exists and the same problem of information storage and retrieval prevails in education as in other fields.

Communications: Trend toward digital techniques

Digital computers started a swing away from conventional analog communication techniques. During the past seven years, the shift has become irreversible.

Data is transmitted around the world digitally by telephone line and microwave. Aircraft send digital messages to air-traffic control stations. NASA transmits pictures from satellites and space probes by digital television. Now telephone experts predict that the general public will start using digital techniques for communications soon.

At a recent demonstration, a Florida housewife told her bank—through a push-button telephone that generated numbers—to pay her shopping bills.

The International Telephone & Telegraph Corp. predicts a large increase in data transmission using pulse-code modulation and time division. Both satellites and cables will carry the extra traffic. There will be a demand for wideband transmission and terminal equipment, including specialized computers and switching devices.

Eavesdrop-proof communications equipment for

Automatic card-dialing and push-button telephones may be used soon for paying bills, sending billing information, getting a voice answer from a computer, and handling retail billing and accounting. The plastic card used with the American Telephone & Telegraph Co.'s system can be punched to serve as a bank credit card, because it can deal directly with a bank's computer.



the military and other government agencies will be one big market; one big seller is expected to be the vocoder, a digitizing device for conversion of voice to bit codes.

Solving scatter problems

The coming-of-age of digital communications

poses problems, especially for troposcatter circuits. Occasional short-term dropouts of signals, which do not noticeably affect voice and are not troublesome to moderate-speed data, can produce disastrous errors in high-speed data transmission. Various solutions have been proposed, including development of threshold-extension circuits and combiners for diversity reception.

Tropo equipment is being used in mobile and transportable military situations. This may speed the design and development of commercial equipment for applications outside the United States. In Africa and Asia there is a need for a better system than standard high-frequency, but one that is less complete than most military tropo. Often two, three or four channels could handle the information, compared with the military's 30 channels.

Mobile radio growing

The land mobile radio consists of police and taxicab communications and other such equipment. It is a big market, with over two million transmitters licensed. The industry expects 3.7 million transmitters to be in use by 1970.

The only limiting factor seems to be a lack of operating frequencies. The Federal Communications Commission has received many petitions to provide more channels, but it generally replies by urging additional study by industry. Plans to date include further splitting of existing channels to accommodate more transmitters, greater sharing of existing channels by present users, and sharing of television channels—very-high and ultrahigh-frequency—in regions where tv is not using its assignments.

Telemetry shifts to S-band

The government is the biggest user of telemetering radio equipment. The market should expand when users shift to S-band, which the FCC has ordered by 1970, and as preparations are made for space flights through 1968. Ground stations are beginning to add S-band capability well in advance of the 1970 deadline, and purchasing should start to increase this year. A big upcoming telemetry market is the Apollo program to send a man to the moon by 1970. Apollo requires extensive outfitting of ground stations. About 26 surface vessels must also be equipped.

Ham growth slowed

The growth of amateur radio seems to be leveling off at 260,000 licensed amateurs, not all of them active. John R. Huntoon, secretary of the American Radio Relay League, is at a loss to explain exactly why. He thinks the reason may be a combination of stiffer rules proposed for amateur licenses, and the fact that FCC now charges a fee for an amateur license.

Hams used to be largely builders and fabricators. Now they buy about 90% of their basic units ready-made or in kit form. Only smaller items are still home-built.

Computers: Year of change

This may be a year of radical change in computer design and organization. A small revolution is being wrought by three developments: time-sharing, to allow many people to use the same computer; microcircuits, which should reduce computer size and cost; and associative memories, to speed information-storage and retrieval.

Time-sharing

Time-sharing has already made inroads in multiple-terminal fixed-program systems for airline reservations and bank systems. Now the state of the art is being sped up to perfect "open shop" computation facilities that would be available to any participant in a sharing program.

Equally important are new input-output programs that permit the scientist or engineer to communicate with the computer in simple English. A logical extension of time-sharing would be a system that allows a small business to have a direct connection to a computer center.

In 1965, the first computers with microcircuits will be delivered. System 360, the International Business Machines Corp.'s big entry in the field for 1964, will use hybrid microcircuits. But the Radio Corp. of America will use monolithic integrated circuits in two of its Spectra 70 machines.

Several other companies offer integrated-circuit computers. But the fastest computer now in operation, built by the Control Data Corp., uses discrete-component cordwood modules. According to John Baird, director of research at Control Data, it will be three to five years before completely integrated circuits are available with propagation delay times low enough to permit the design of very fast computers and only then will Control Data use them, Baird says.

Not everybody agrees. IBM claims that its components in the System 360 operate at a rate of 300 to 500 megacycles—or a operation time of 2 or 3 nanoseconds.

Integrated circuits now available have at best about a 10-nanosecond delay time, due mostly to capacitance between electrodes. The cordwood modules have 3-nanosecond delay time; hybrid, thin-film and discrete circuits are even faster.

The Spectra 70 computers, announced in December, are noteworthy for two reasons: They use monolithic integrated circuits, and their prices are reported to be 15% lower than IBM's System 360, which RCA units resemble in programing and performance.

Some of the 360's hybrid microelectronic circuits have been improved to the point where they are several times as fast as monolithic integrations. They'll probably be around for several more years



Core-memory at left (single plane in foreground) stores up to eight million characters, accessible in .000008 second, a major advance in IBM's system 360 computers. Another important feature, in photo at right, is the 360's hybrid microelectronic circuits, which combine thick films (passive elements silk-screened on a ceramic wafer) and discrete components (active elements such as transistor and diode chips, made separately and soldered to the wafer).

—at least until the integrated circuits catch up in speed.

Beyond integrated circuits

Much work is being done on optical logic elements, such as gallium-arsenide diode lasers small enough for several to fit into a transistor can. Optical logic gives promise of logic speeds as high as anything now available, plus larger ratios of circuit fan-in and fan-out with much less power dissipation. But they won't be sold this year—1970 is a better guess.

Readout techniques

Associative memories, also called content-addressable and parallel-search memories, are storage devices in which the storage locations are identified by their information content rather than by an arbitrarily assigned address. Being independent of address location, the entire memory can be queried in one access cycle; this increases the speed of data retrieval 10 to 1,000 times. The military is interested in associative memories for providing tactical

commanders with large amounts of up-to-date information on local conditions. The Goodyear Tire & Rubber Co.'s aerospace unit has developed an associative memory for the Navy's Bureau of Ships, to be tested as part of a tactical data system. The computer's performance in the data system is theoretically increased 100 times by adding the associative memory. Goodyear says this area is not yet a big market but that the sales curve should rise steeply in the next few years.

Future libraries

Improving computer techniques may revolutionize libraries. The library of the future will be part of a network in which large ones will share computerized files of bibliographical data with the small ones. Graphic storage and retrieval systems will reproduce copies of the documents at any library on demand. Computers and information retrieval techniques have a friend in Vice President-elect Hubert H. Humphrey. He was instrumental in getting the National Library of Medicine to use computers.

Solid state: Advances in FET's

Silicon field-effect transistors should provide most of the activity in the transistor field this year. They're certain to surpass the present frequency limit of 300 megacycles for use as amplifiers and operation at frequencies of 1,000 megacycles is likely.

Only six companies made field-effect transistors in 1963. Last year the figure rose to 14. It's likely to reach 25 this year.

Much of the new activity will center on the insulated-gate metal-oxide-semiconductor version of the field-effect transistor. The MOS FET has already achieved input impedances of 10^{15} ohms with low noise levels. Power field-effect transistors, almost nonexistent today, should also appear before 1966 as transistor manufacturers battle for new markets.

Varactor-diode manufacturers will be highly competitive as they bring out new devices to replace tubes for generating microwave power. Tubes will also give way to new high-power, high-frequency transistors in aircraft and mobile transmitters, air-rescue gear and other communication equipment.

Solid-state manufacturers will continue to extend the capabilities of junction transistors, eclipsing the 2,800 megacycles of gain bandwidth that was achieved experimentally by the Philco Corp. on a transistor, and the 300-watt, 150-ampere power transistor that the Silicon Transistor Corp. announced late last year.

Silicon and germanium devices will continue to dominate the solid-state market. Specialized materials, such as gallium arsenide, indium antimonide and silicon carbide, will find uses in devices that require high-frequency response, operation at very cold temperatures, and stability at high temperatures. But these specialized materials will not make a noticeable dent in the market.

More solid-state in consumer products

Solid-state devices will make broad inroads into consumer product areas in 1965. The long-awaited invasion of the large-screen television market finally seems imminent. High-power gate-turnoff silicon-controlled rectifiers permit the design of horizontal-output stages for 19- and 21-inch tv sets. The Emerson Radio & Phonograph Corp., which brought out an 11-inch set in September that uses 35 devices made by Texas Instruments, Inc., has announced plans for a 21-inch line by mid-1965. Other manufacturers are expected to follow Emerson's example.

Continued penetration of the high-fidelity stereo market will discourage manufacturers from carrying both tube and solid-state high-fidelity lines.

The price gap between tube and comparable solid-state products will narrow enough in 1966 to threaten seriously new tube-equipped hi-fi gear.

Transistorized clock-radios, both line-operated and battery-operated, will take over their field. Transistorized light-dimmers for the home will increase in popularity, and scr-controlled tools for the home workshop will become more common. Solid-state devices will also appear widely in phonographs, tape recorders and intercommunication systems, and will enlarge their toehold in camera-exposure modules. Transistorized toys will become more common and more complicated. More advanced toys may even require servicing by radio-television shops when they malfunction.

Several makers are quoting transistor prices to toy manufacturers by the pound. At least one company ships transistors in barrels.

Automobile manufacturers will be wooed again by the solid-state manufacturing industry. But this time the scramble will be for ignition-system sales instead of transistorized radios. Makers of scr's will compete with transistor manufacturers for the ignition-system market. Breakthroughs also are expected in programmed home appliances; one field is the solid-state controlled washer-dryer unit.

Microelectronics: Donning mufti

Nineteen sixty-five will probably be the year in which microelectronics became a civilian electronics field. It should be the first year in which civilian sales surpass military volume.

New designs of instruments, industrial-controls, computers and appliances are already in the prototype stage and many are expected to go into production this year.

Initially, monolithic and hybrid microcircuits were designed for military use, primarily to improve reliability by reducing size and the number of connections. Now automation has reduced manufacturing costs and increased production capacity to the point where manufacturers are cutting prices. Both kinds of microcircuits are becoming more attractive in increasing numbers of industries.

Storming the industrial market

The use of integrated circuits in computers is growing rapidly. Last December, many experts were surprised to see the Radio Corp. of America use monolithic integrated circuits throughout its new Spectra 70 commercial data processor. They thought it would be years before monolithic devices would be used in such. Several smaller machines also will have microcircuitry this year.

Two companies are known to be developing busi-

ness machines that use GME integrated circuits: General Micro-Electronics, Inc., and the Victor Comptometer Corp.

Several makers of integrated circuits confirm that they are working with manufacturers of mass-produced consumer products. Although they're reluctant to talk, almost all of them see an attractive potential in television and automobile-radio markets by 1966. The Westinghouse Electric Corp. and Motorola, Inc., both have developed integrated circuits for high-fidelity equipment. Texas Instruments, Inc., is developing appliance controls for laundry equipment and dishwashers.

But it won't be an easy year for microcircuit companies. Monolithic integrated circuits—those in which transistors, diodes, resistors and capacitors are deposited in electrically isolated areas on a single silicon chip—will run into stiff competition from multichip and thin-film microcircuits. Multichip circuits are constructed by making several identical components on the same wafer, dicing them apart into microelements, then combining them with other components to form circuits.

Activity in thin-film circuits will increase this year. Recent advances at the Autonetics division of the North American Aviation Co. and at RCA indicate that thin-film circuitry, in which transistors and passive elements are deposited on the same substrate, will be feasible early this year.

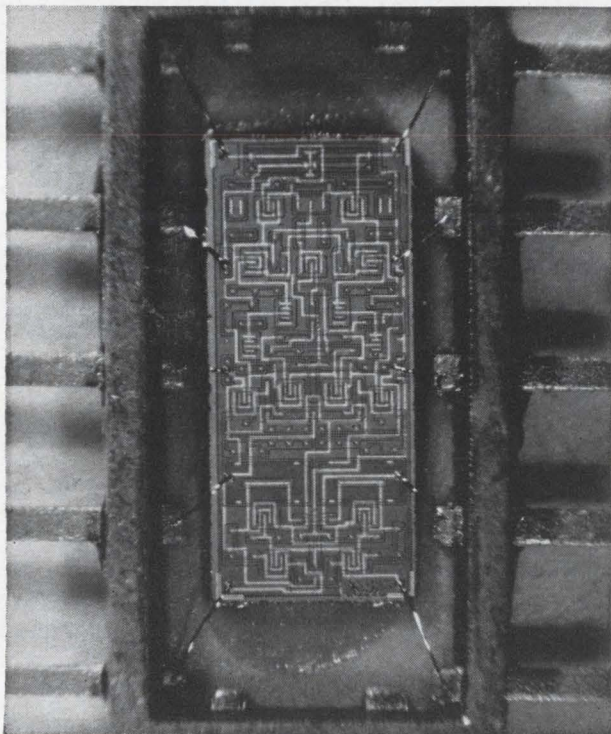

Monolithic broad-band-amplifier integrated circuit. It is sealed in a standard flat package measuring $\frac{1}{4}$ by $\frac{1}{8}$ by $\frac{1}{32}$ inch. Texas Instruments, Inc., uses epitaxial technique to fabricate 17 transistors, 31 resistors and two capacitors on the chip. A major use is to amplify signals from film memory circuits to trigger logic circuits. Typical frequency response is d-c to 10-Mc; typical gain is 36-db single-ended, 42-db differential.

Components: Where the squeeze hurts the worst

Almost everything that happens these days puts more pressure on the component business. Now, intensive price-cutting follows a drop in defense business, inroads by foreign manufacturers, and the continued gains of integrated circuits and thin-films; this may be the last turn of the screw. Competitive bidding for military contracts—favored by the Defense Department—has produced some dog-eat-dog struggles. Some companies are winning bids with quotations that barely cover overhead costs and leave no room for profit. A few military contracting officers have charged that these low prices are responsible for a flow of “junk” components.

Competition has driven the price of some components so low that a few companies have stopped selling military-specification components. The hardest hit items: passive components in standard sizes, such as quarter-watt resistors and tubes.

Companies selling high-quality components, however, report a rising demand from the field of industrial electronics. Then, too, some consumer items that must meet environments almost as tough as those faced by military equipment—such as better quality auto radios—are outlets for better components.

Military systems

A change in the military's design approach to major weapons systems is complicating suppliers' problems. More of the work is done on paper—using design definition studies—than by developing competing prototype systems. Thus, fewer components suppliers get in on the ground floor in new weapons systems.

The rapid acceptance of microelectronics in new and proposed military electronics systems—especially military computers, air navigation and guidance systems, and missile systems—hurt the sales of discrete components to the military.

While some discrete components are still used in military microelectronics systems, the quantities are smaller. Far fewer are used when the system is designed with integrated circuitry, and even fewer in systems employing thin-films. Thin-film circuits still require transistors and diodes, but most of them don't need resistors and capacitors. Where discrete components are used, they are usually unpackaged devices that sell for less than packaged devices. Though a number of military systems, particularly communications equipment and radio-command guidance for tactical missiles, are using or being designed to use conventional

components, the trend toward the use of microcircuits seems irreversible. As microelectronics technology improves, it is expected that thin-film transistors and higher-power integrated circuits for linear applications will reduce the demand for all types of discrete components even further.

Industrial components

Industrial electronics companies, particularly those making or planning digital control and instrumentation equipment, are shifting to microcircuits. Some digital integrated circuits can now

be purchased for only half the cost of the same type of circuit in discrete component form. Sales of industrial digital control equipment are still small but an impressive growth is anticipated. Microcircuits should capture most of the industrial market by the time digital control sales hit their stride.

Power-type components, such as microwave tubes, are doing well in sales volume but poorly in profit because of the intense competition. Specialized tubes based on proprietary designs, however, bring good profit margins.

Instrumentation: New products are the answer

A major share of the electronics market will continue to go to instrument makers even though reduced defense needs will make a heavy dent in some instrument companies' sales. The companies that alter their marketing goals to serve industrial and commercial markets will fare best.

For today's changing industry some instrument

makers are adopting the systems concept in test and measuring instrumentation. One aim is to develop systems for the check-out of complex automation and data processing.

Others are diversifying into more sophisticated instruments such as new frequency synthesizers and spectrum analyzers. For example, new spectrum analyzers can plot the entire signal spectrum through microwave regions with an error of only two parts in 10^{10} . Even better accuracy is possible by coupling the analyzer to an atomic clock but few such instruments would be sold at \$15,000 each.

Programed testing for production

Programed instrument systems for production testing are sought by the manufacturers of sophisticated electronic items. This kind of equipment



Test and maintenance of instrumentation used in commercial jet aircraft are carried out using an impedance-measuring instrument by Hewlett-Packard's Boonton Radio division.

reduces confusion and requires less-skilled test technicians.

Old-time bench instruments are changing, too. According to John M. Cage, manager of advanced technical planning for the Hewlett-Packard Co., research and development engineers try to get flexibility by stacking their benches with a huge variety of devices. The alternative to bench overcrowding will mean bigger sales as new instruments are developed to perform the variety of jobs now handled by individual instruments. Bench-type test instruments will make increasing use of solid-state techniques.

The reliability and compactness of general-purpose test instruments is being improved. For better performance and to lower the manufacturing cost of new instruments some integrated circuit techniques will be used and discrete components will be coupled with them to get precise performance. Except for digital instruments the emphasis is not on size.

Right now, the noise characteristics of diodes and transistors are a limiting factor in instrument sensitivity. Electroluminescent devices and photo diodes will become more common in bench instrument design.

More versatile oscilloscopes

To almost every electrical engineer, the oscilloscope is the instrument used most often. Now the scope is becoming more versatile, accomplishing more functions. It has improved stability, a brighter display, and a capability for handling higher fre-

quencies. Still in the experimental stage is a flat display tube that could shrink the size of scopes so that even more functions could be designed into the standard instrument.

Voltmeter design continues to improve. New instruments have higher input impedance, increased common mode rejection, and faster response. Voltmeters are still fragile; the new taut-band meters improve reliability and reduce zero shifts, starting friction, and sticking. Taut-band meters also cost less and scales can be calibrated individually.

Microwave instrument squeeze

Instrument makers serving the microwave market are in a squeeze. They are being asked to provide more accuracy, better sensitivity and more sophistication, but the over-all market is too small to justify expensive development programs. Too little systems business may be the reason. For example, a deep space system may have only 15 ground stations, and 15 pieces of test equipment of any one type isn't much business.

Most efforts in microwave instrument development are directed to the problem of spectrum analysis, or spectrum measurement. The radio-frequency interference (now called electromagnetic compatibility) business could be as much as \$10 million a year.

Phase measurement was expected to trigger a big instrument market, but so far it hasn't. If the interest in phased arrays grows, phase-measuring equipment could go into quantity production.

Microwave: Decline will continue

The microwave market, hit hard by cutbacks in defense spending, will probably experience further declines this year, according to marketing officials.

A few companies expect to buck the tide and score sales increases this year. One of these is the Hewlett-Packard Co. in Palo Alto, Calif., which is diversifying and expanding its microwave division. Precision machine-shop facilities are being used to produce the company's new line of low-cost tape recorders for instrumentation. The division has also moved into chemical instrumentation with a complete system of microwave spectrometry with which chemists can identify molecules and study their structure.

But smaller concerns, without the capabilities to diversify, are going to suffer. John Minck, sales manager of H-P's Microwave division, predicts that many small microwave companies will go out of business this year and next. Other industry

executives agree. One big reason for gloom is that no major technological achievement seems to be in the works.

Industrial applications

Continuous, high-speed microwave processing of thin materials is expected to continue to dominate the industrial market. Both Litton Industries, Inc., and Eitel-McCullough, Inc., have active microwave programs.

According to James A. Jolly, manager of Eitel-McCullough's Industrial Applications Laboratory, thin-film processing is used in drying paper, paint, cloth, and even in a new application for processing potato chips. This in contrast to microwave cooking, where the food is a bulkier workpiece.

Applications cover a wide range of materials. The lumber industry will be able to process lumber at 1,600 feet per minute, producing preprimed dry lumber. Liquid may be pasteurized by pouring it onto a belt and passing it under a microwave generator. The Eastman Kodak Co. is going to experiment with a microwave technique for cleaning solvents off a magnetic recording strip that has been applied to eight-millimeter movie film.

Many developments are expected in microwave



Microwave repeater system for television transmission, similar to the system shown operating in Canada, will be supplied to Yugoslavia by the General Telephone & Electronics Corp.'s Italian subsidiary, Marelli Lenkurt S.p.A. The equipment, costing \$1 million, will consist of four microwave links operating over 600 miles.

cooking. But the home market will still be small in 1965 compared with the commercial market, which includes restaurants and hospitals. Both commercial fields will grow rapidly this year.

Communication systems

The biggest potential market for microwave relay systems in the next few years is statewide educational television. Gerd D. Wallenstein, vice president of product planning at the Lenkurt Electric Co., a subsidiary of the General Telephone & Electronics Corp., estimates that about \$25 million to \$30 million will be spent for television transmission systems now being planned.

Most of the proposed systems are in the southeast. These will include closed-circuit and open-circuit tv systems. The transmission systems are being designed to accommodate color, although receivers for classroom use are still too expensive.

There's also a good market in replacement of

older microwave equipment with higher-capacity gear. Ten years ago, the typical 900-megacycle link contained 48 channels. Today that equipment is designed to carry 960 voice channels. A trend toward higher frequencies also exists because of wider bandwidth requirements. Better voice quality and capability to carry color tv is needed.

Millimeter-wavelength market

Millimeter systems are turning out to be a disappointment. Few specialists see any potential in millimeter waves any more. There are problems of atmospheric absorption and production difficulties.

Now it is possible to use optical techniques instead, and the problems are no more severe, without the added difficulties involved in manufacturing the millimeter devices. One application in controlled fusion research is heating plasma with large amounts of millimeter power. But such a market is very small.

Lasers: Further practical applications loom

For the laser, 1965 will be another year of gestation: many novel uses but few sales. But by year-end, some applications should appear with good market potential.

About 500 companies are making or testing laser equipment. The curiosity market for laser parts is still the only substantial one, but laser systems for scientific and industrial use are beginning to appear.

Applications are becoming established in such fields as microscopy, metrology, spectroscopy, microwelding and micromachining; these will probably be joined in the next year or two by up to 50 new industrial and scientific applications. Some producers are restating, with more assurance than before, their expectation of \$300 million in civilian sales by 1970.

Shortcomings for the military

But government money still dominates the laser scene. Military laser development goals are chiefly in ranging and tracking systems, eavesdrop-proof communications on land, navigation and guidance aids, and optical analog computers.

Prototypes have been built for most of these systems, but the military is still not satisfied with the laser's efficiency and reliability. The wavelengths needed for some applications still are not available, nor is the power available that is required to overcome atmospheric attenuation for long-range radar and communications.

In contrast to the military demands, no further breakthroughs are required for many industrial and scientific applications of lasers. If anything, low-power lasers have been underexploited. For most present applications, the laser is a source of intense light energy as in welding, illuminating microscope samples, vaporizing spectroscopic samples or pulsing a laser beam like a strobe light for high-speed photography.

Welding and machining

Pulse lasers have already been developed with enough power and simplicity for precision welding and machining. Getting them onto production lines will be the big task this year—a selling job that was made difficult by the premature marketing of inadequate systems a few years ago. Companies believe such a laser system must sell for less than \$10,000 to compete with conventional equipment.

High-power lasers may also find uses with heavy-duty tools for welding and machining. Massive expensive structures now keep machine tools accurate under the mechanical stresses of cutting. Accuracy could be maintained at less cost if lasers

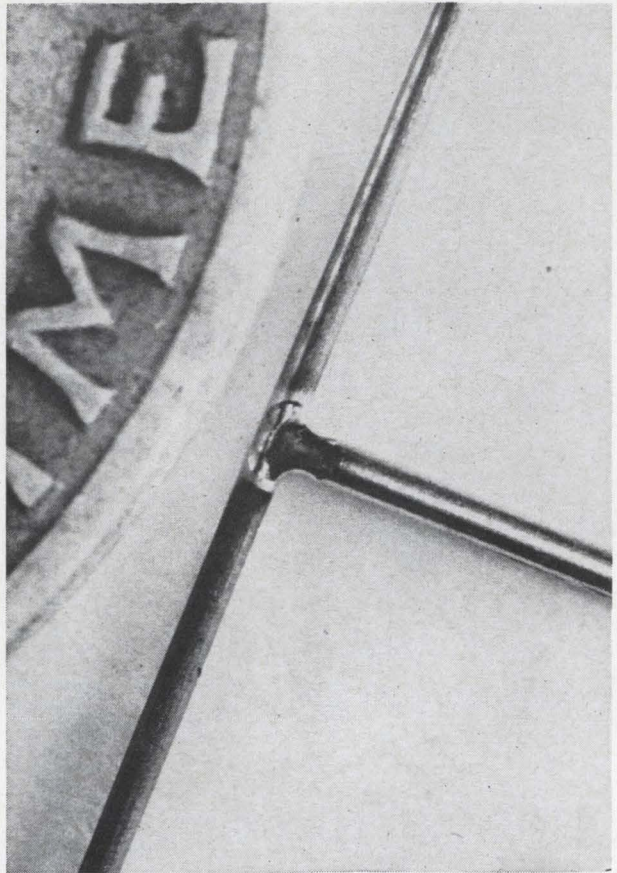

Dissimilar metal wires, near the edge of a dime, were welded by ruby-operated laser equipment shown on page 109.

could shape metal by melting and ablation.

Analysis and measurement

The Raman spectrometer, in which samples are excited by a laser beam, is already on the market. Lasers are also being used for inspection of optical parts with interferometers, also in polarimeters, in systems that photograph stress patterns in materials through the use of plane-polarized light, and in schlieren and other types of high-speed photography. None of these is a mass market.

A recent development, the use of lasers to photograph three-dimensional objects, may eventually lead to 3-D optical recorders and perhaps stereo television.

Interferometer-type equipment that can measure dimensions with an error of only one part per million was placed on the market last year. At least 100 measuring-standards laboratories will be customers in the next few years.

Lasers are also beginning to show up in surveying equipment for measuring angles and distances and for optically aligning large structures and machine tools.

Communications becoming practical

Transmitting data and voice over short distances by amplitude-modulated beams is now practical.

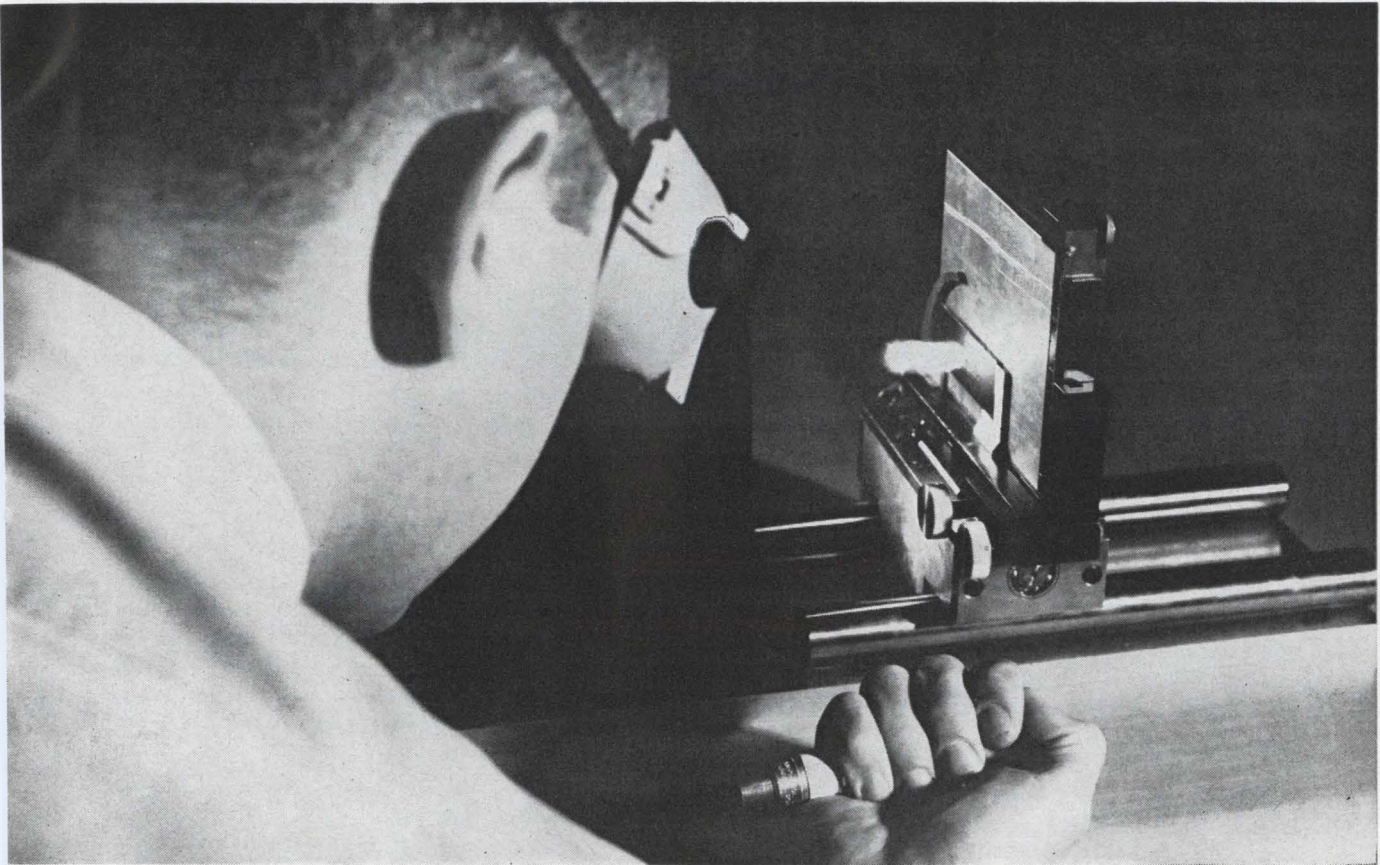

Laser welder system, developed by Union Carbide Corp., has a ruby-operated laser-head that produces a pulse output focused on the workpiece by an optical system. Laser welders are expected to be one of the most practical applications of high-energy coherent light.

Analog signals can be transmitted conveniently by modulating the beam with a transducer output. The photodetector at the other end receives the signal in analog form. The best prospects for early sales of such systems are space-launch centers that require a large number of short communication links without overcrowding the radio-frequency bands. Another early application is expected in remote relays, in which a photodetector turns on apparatus when it receives a laser signal.

More clinical testing

Despite considerable research, doctors will be slow in adopting lasers for clinical uses. Too little is known about side effects and techniques. This is expected to remain a courtesy market for at least a year, with much of the equipment donated or loaned by laser manufacturers or by a laboratory that owns a laser.

The only laser instrument in medical use is an ophthalmoscope to repair detached retinas.

Ranging and radar

Production contracts for short-range tracking systems and weapon rangefinders are anticipated this year or early in 1966.

Optical radars can accurately track cooperative targets such as space boosters equipped with re-

flectors. Lasers can track these boosters as they lift off the ground, a phase during which radio-frequency systems are blind. Installations at launch facilities are anticipated this year or next.

Small ranging units, to monitor distances between ships refueling at sea, are expected to appeal to the Navy. Another type of laser ranger that may become practical soon is a clear-air-turbulence detector for high-speed aircraft. A compact pulse system with a range of 25 or 30 miles should suffice to detect wind shear, a phenomenon that accompanies turbulent air.

Optical computers.

Optical computers are being developed for recognition systems. Because the beam is coherent, it provides a way to obtain, process and display information. One anticipated use is an analysis of recorded curves such as cardiographs. The cardiograph obtained from a patient can be correlated with curves that are characteristic of certain heart ailments.

Ways of cross-correlating two unknown functions are also being developed, as are ways of phasing a laser beam with electro-optical crystals to solve equations with the beam. Some optical computers are already being offered for sale, and are expected to comprise a substantial market within five years.



Nerve center for the State Department's communications operations in Europe is this Paris facility that switches and processes digital information. Developed by International Telephone and Telegraph Corp., the system accepts information from high-speed computers and slow-speed teleprinters, and stores low-priority messages for later transmission.

International markets: Firm but competitive

Exports by United States electronics companies are expected to top the \$1 billion mark in 1965 for the first time. But competition is increasing, particularly from Japan and Western Europe.

Unofficial government estimates put 1964 exports at just under \$1 billion, up substantially from \$865 million in 1963.

Increases are predicted this year in exports of computers, television transmitting and receiving gear, test equipment such as oscilloscopes and wave analyzers, and some components—high-quality crystal diodes, transistors, capacitors and resistors.

The biggest foreign market for U. S. military electronics equipment seems to be in the air-defense and ground-environmental systems that link national defense networks in various parts of the world. They're used for ground surveillance, aircraft detection, calculation of a plane's speed and direction, and in similar functions.

Brighter markets for U. S. electronics products are seen in the following countries:

- **West Germany**—U. S. industrial equipment and components that use advanced technology should be especially attractive. Short delivery time is important. West Germany imported \$187 million of electronic products in 1963. Of this, \$65 million was bought in the United States. Computers and advanced electronic components offer the best prospects for sales to Germany.

- **Great Britain**—The British government's new 15% import duty could hurt. But Britain lags behind the U. S. in equipment and components and is trying to catch up through licensing agreements. U. S. manufacturers will probably find the best opportunities in the more sophisticated and ad-

vanced product areas where quality and reliability are in demand, rather than in standard product areas where local producers have the edge. Britain imports about 10% of her electronic products with U. S. producers competing primarily with West Germans for a share of the market.

- **Japan**—The government recently liberalized import regulations, and sales of U. S. electronic products are expected to climb. The best prospects seem to be electronic equipment and components that incorporate advanced technology, also color tv receivers. In 1963, Japanese imports from U. S. electronic companies totaled \$63 million, largely in commercial, industrial and military electronics. Digital computers led the list with \$35 million in imports from the U. S.

President Johnson has announced an interest in liberalizing trade with the Communist countries. The Commerce Department will continue to study ways to pare lists of equipment, especially electronics, that are embargoed by the U. S.

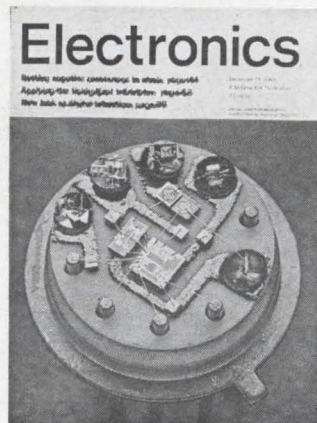

The cover

Hi-fi power amplifier, built with integrated circuits, does work of 8 transistors and fits in a TO-5 transistor can. The one-watt device, built by Motorola, Inc., is part of the invasion of consumer field by integrated circuitry. Inset photos show some future application of integrated circuits in the electronics industry.

Credits for inset photos: industrial control by General Electric Co.; a GE-425 digital computer; color Tv by Philco Corp.; Syncom communications satellite. NASA; electron microscope by Radio Corp. of America.

Reprints of this report are available. See the reader service card at the back of this issue.

© copyright 1965 Electronics ® A McGraw-Hill Publication

Electronics Markets

1965

TOTAL ELECTRONICS INDUSTRY

	(millions of dollars)			
	1963	1964	1965	1968
ELECTRONICS INDUSTRY TOTAL	16,506	17,225	17,600	20,001
Consumer Electronics	2,432	2,550	2,750	3,150
Industrial-Commercial Electronics	3,883	4,131	4,570	6,088
Federal Electronics (incl. military and government adjusted for calendar years)	9,516	9,844	9,580	9,963
Replacement Components	675	700	700	800

Consumer Markets				Federal Markets			
	1964	1965	1968		1964	1965	1968
	(Millions of dollars)				(Millions of dollars)		
CONSUMER ELECTRONICS, TOTAL	2,550	2,750	3,150	FEDERAL ELECTRONICS MARKET, TOTAL	9,844	9,580	9,963
Television Receivers	1,290	1,379	1,500	Department of Defense,			
Monochrome	860	780	615	Electronics Portion, Total	8,000	7,700	7,825
Color	430	599	885	Procurement	4,518	4,163	4,023
Radio Sets	368	358	345	Communications	1,150	1,100	1,250
A-M and F-M	174	179	173	Aircraft	1,300	1,360	1,360
Auto	194	179	172	Missiles	1,460	1,135	820
Phonographs	470	480	525	Mobile and Ordnance	125	100	100
Monaural	40	38	33	Ships	483	468	493
Stereophonic	430	442	492	Research, Development, Test and			
Records & Tape	289	295	301	Evaluation	2,000	2,000	2,100
High Fidelity Components, (incl. tuners, amplifiers, speakers, etc.)	50	52	58	Operations and Maintenance	1,482	1,537	1,702
Kits, except toys	50	53	58	Nat. Aeronautics & Space Adm.,			
Other consumer electronics	33	133	363	Electronics Portion, Total	1,675	1,715	1,850
				Federal Aviation Agency,			
				Electronics Portion, Total	103	100	225
				Atomic Energy Commission,			
				Electronics Portion, Total	66	65	62.5

The market estimates in this tabulation are based on a mail survey conducted by Electronics magazine. Detailed questionnaires were sent to marketing managers, analysts and planners in all segments of the electronics industry. Estimates obtained are United States factory sales in millions of dollars—projections of output for 1964, 1965 and 1968. The data was tabulated from the questionnaires and analyzed in three ways: obtaining the median, the mode, if one existed, and, in some cases, calculating the mean. But only one number was chosen in each category based on the following criteria: the median was used if the selection was large enough, the mode was used if one existed at or near the median, or the mean was chosen if the responses were limited. Finally, industry, government and trade groups verified the figures in appropriate areas.

FEDERAL ELECTRONICS MARKET, TOTAL

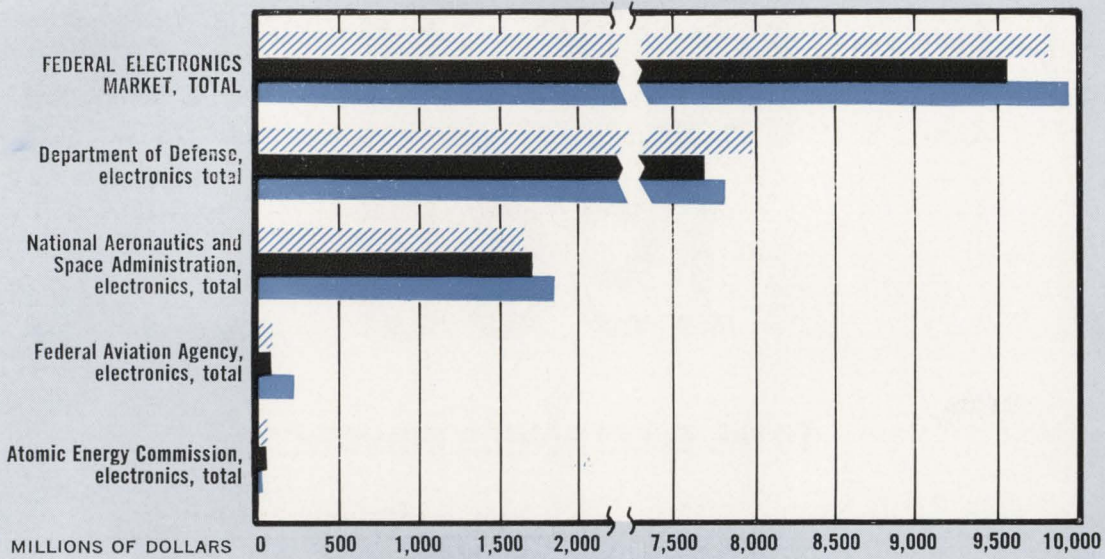

SEMICONDUCTORS, TOTAL

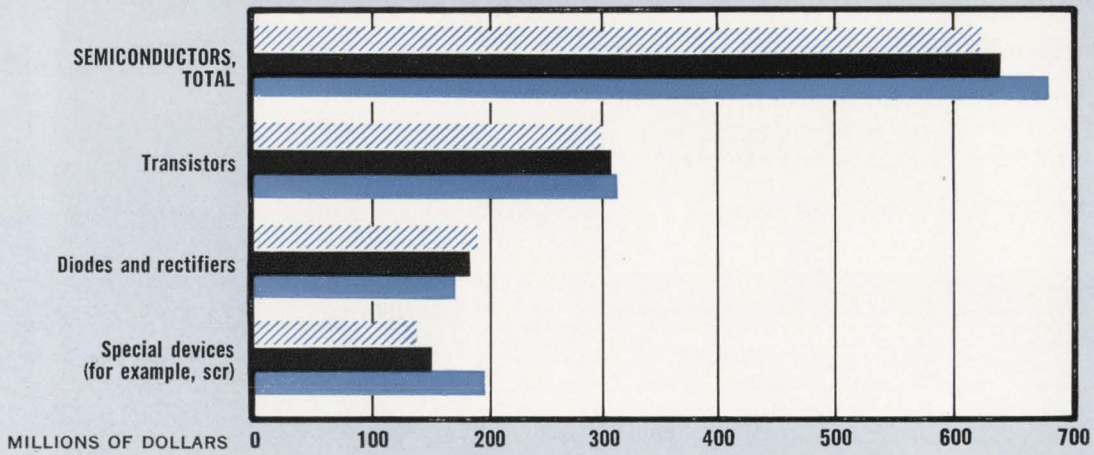

MEDICAL EQUIPMENT, TOTAL

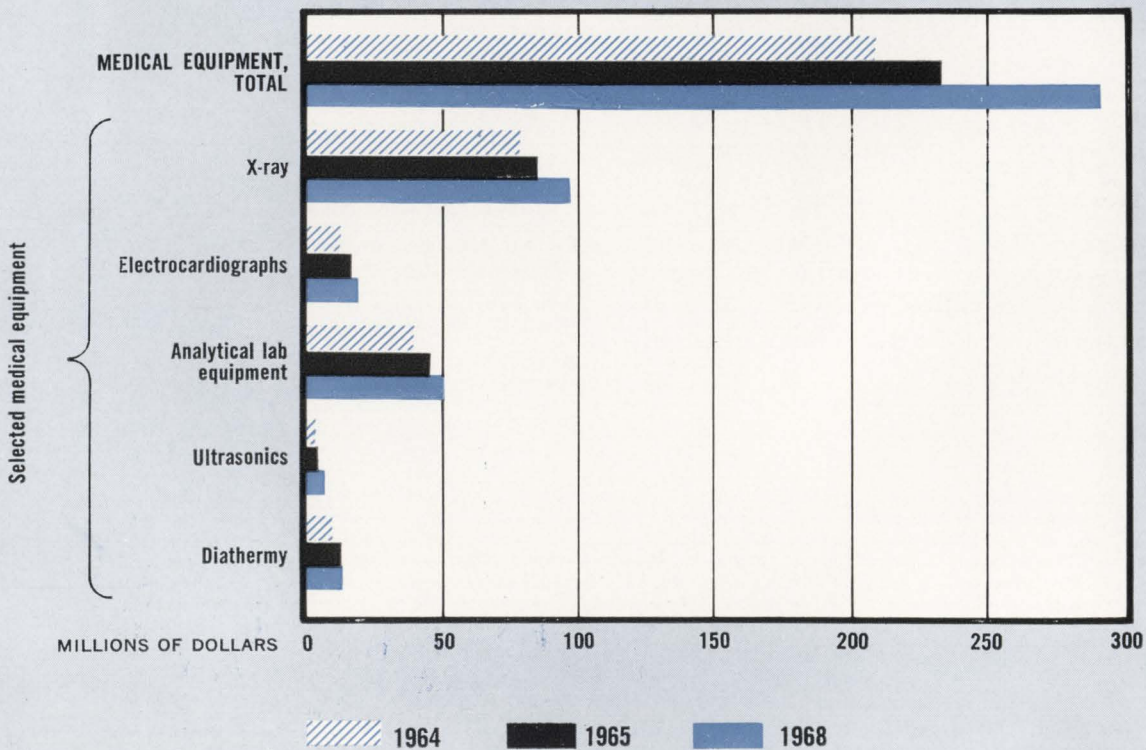

1964
 1965
 1968

Industrial - Commercial Markets

	1964	1965	1968		1964	1965	1968
	(Millions of dollars)				(Millions of dollars)		
INDUSTRIAL-COMMERCIAL, TOTAL	4,131	4,570	6,088	Computers and Related Equipment, Total	1,850	2,045	2,820
Test and Measuring Instruments, Total	454	498	622	Digital Computers, except process control	1,462	1,564	1,950
Spectrum Analyzers, subaudio to 1 Gc	10	11	12.5	Analog Computers, except process control	75	100	140
Signal Generators, 100 Kc to 1 Gc	40	42	50	Hybrid Computers, except process control	13	16	30
Oscillators, subaudio through video	18.3	20.1	25.5	Peripheral Equipment	300	365	700
Waveform Generators, square, pulse and special	9	9.8	11	Converters, A to D	82.5	105	240
Waveform Analyzers and Distortion Meters	7	7.5	10.5	Converters, D to A	45	55	88
Counters, time and frequency, zero cps to 1 Gc	30	35	40	Converters, Card to Tape	3	4	9
Voltmeters and Ammeters, d-c to 1 Gc	14	15	16	Readers, Paper Tape	25	31	63
Power Meters, d-c to 1 Gc	2	2.2	3	Readout Devices	15.5	19	31
Digital Voltmeters	20	22.5	25	Mass Storage Memories	129	151	269
Calibrators and Standards, active and passive	10	12	14	Communications Equipment, Total	1,121	1,241	1,633
Oscilloscopes, d-c to 1 Gc	80	92	100	Land Mobile	170	185	230
Recording Instruments, digital and analog	44	46	55	Microwave and Radio Relay	68	76	100
Components Testers, (transistor, capacitor, etc.)	19.5	20	21.5	Terminal and Switching	85	93	120
Power Supplies, laboratory type	45	49	60	Navigational Aids	70	79	120
Amplifiers, laboratory type	5	6.5	11	Radar	50	55	75
Microwave Measuring Equipment, 1 Gc to 100 Gc	55	60.5	76	Other	20	24	45
Impedance Measuring Equipment	12	14	18	Marine Communications	12	12.5	15
Power Measuring Equipment	5	5	6	Airborne, including ground links	150	155	163
Frequency Measurement and Analysis	10	11	15	Carrier-current	16	17	20
Noise Measuring Equipment	10	11	14	Intercom and Sound	225	250	325
Signal Generators	18	19.5	23	A-M Station Equipment	28	30	34
Other Test and Measuring Equipment	45.5	47	91	F-M Station Equipment	44	50	65
Medical Equipment, Total	209	234	292	TV Station Equipment	110	130	225
Radioactive Tracer Equipment	3	5.1	7.5	Citizens Band	31.5	34.5	55
X-Ray Equipment	80.1	85.2	98.5	Amateur	6.7	6.3	4
Diagnostic	73	78	91	Facsimile	18	18	25
Therapeutic	7.1	7.2	7.5	Light Communications, (lasers, i-r)	1.5	2.5	8
Patient Monitoring Systems	7.5	10	16.5	Telemetry	70	85	100
Hearing Aids	41	43	47	Other	15	17	24
Electroencephalographs	2.5	3	5	Closed Circuit Television, Total	24	29	48
Electrocardiographs	12	15	18	Industrial	14	16	23
Electron Microscopes	6	7	9	Educational	8	10	18
Analytical Lab Equipment (incl. blood colorimeters)	40	45	50	Theater	1	1	2
Ultrasonic (diagnostic and therapeutic)	3	3	5	Medical	1	2	5
Diathermy, shortwave and microwave	9.5	10.2	12.1	Dictating Devices, Total (for office and business)	35	40	50
Lasers	1.5	1.9	3.5	Industrial Operations Equipment, Total	334	370	465
Other	3	6	20	Motor Speed Controls	30	34	40
Nuclear Instruments and Equipment, Total	104	113	158	Welding	6	6	5
Semiconductor Detectors	2	2.9	3.2	Power Supplies, (complete equipment)	90	94	100
Analyzers	17.6	20.8	24	Photoelectric	6.2	6.4	9.9
Pulse Height	15	17.5	20	Infrared	30	35	50
Other Spectrometers, (for nuclear applications)	2.6	3.3	4	X-Ray, except medical	23	25	30
Accelerators	21	23	27	Lasers	2	3	10
Linear	6.8	7.5	10	Measurement and Surveying	1	1	3
Other	14.2	15.5	17	Welding and Machining	1	2	7
Power Supplies	6	7	12	Process Control Computer Systems	49	58.5	89
Amplifiers	8	9.6	11	Analog	18	20	25
Pulse Generators	3	3.5	4.2	Digital	29	34.5	56
Radiation Monitoring Instruments	10.5	11.5	12.5	Hybrid	2	4	8
Portable Survey	8.5	8.5	8.5	Other Process Controls	90	98.5	111
Fixed Monitoring	2	3	4	Controllers	12	13	15
Reactor Controls	18	20	38	Actuators (incl. valves)	23	25	28
Other	17.9	14.7	26.1	Indicators	5	5.5	6
				Recorders	50	55	62
				Other Equipment	8	10	23

Electronics Markets 1965

TOTAL ELECTRONICS INDUSTRY

	(millions of dollars)			
	1963	1964	1965	1968
ELECTRONICS INDUSTRY TOTAL	16,506	17,225	17,600	20,001
Consumer Electronics	2,432	2,550	2,750	3,150
Industrial-Commercial Electronics	3,883	4,131	4,570	6,088
Federal Electronics (incl. military and government adjusted for calendar years)	9,516	9,844	9,580	9,963
Replacement Components	675	700	700	800

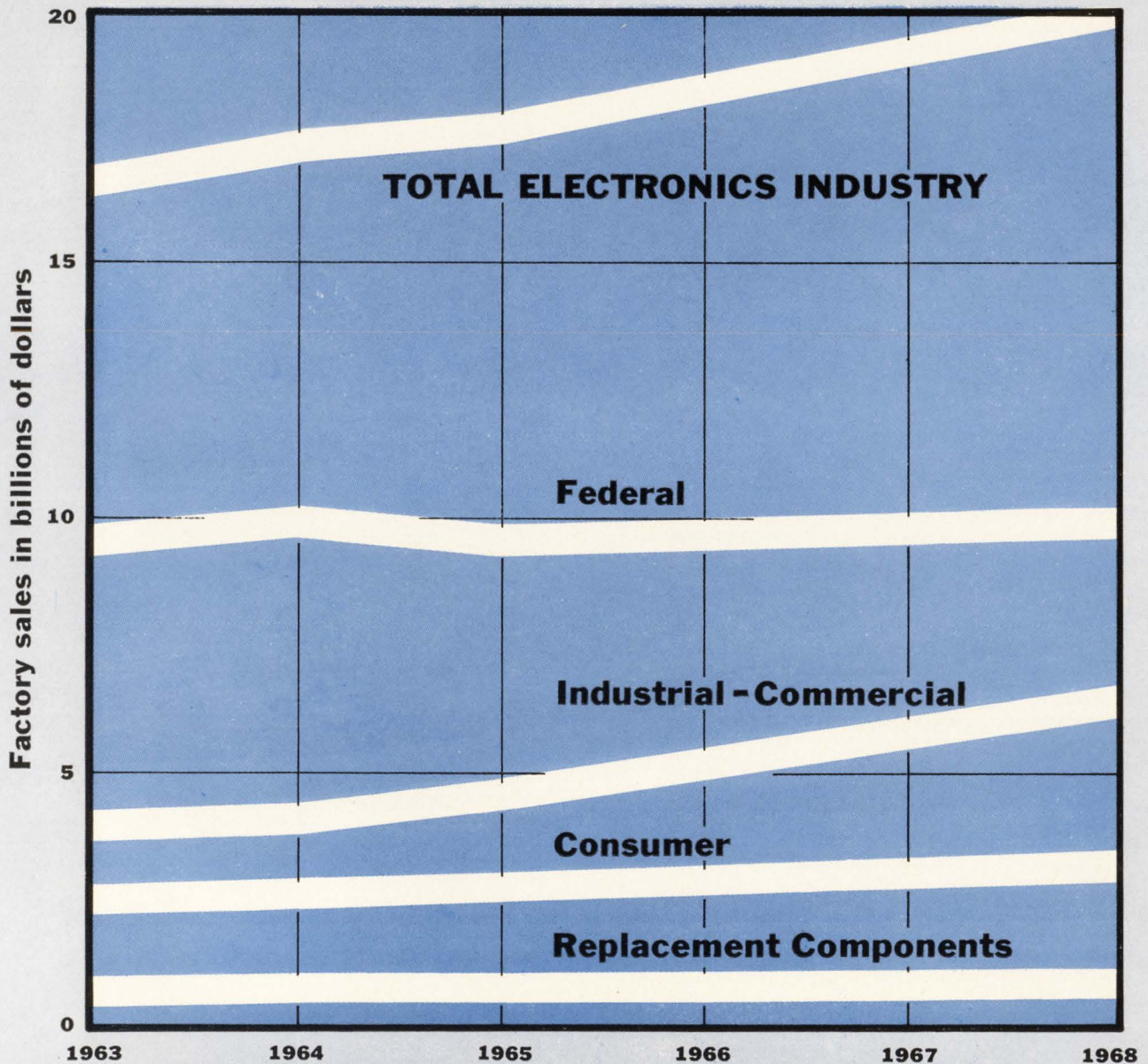

Components Markets

	1964	1965	1968
	(Millions of dollars)		
ALL COMPONENTS, TOTAL	4,157	4,370	5,286
Antennas and Hardware, Total	45	53	60
Capacitors, Total	354	364	377
Paper and Film	104	110	115
Electrolytic	130	135	142
Mica	25	25	24
Glass and Vitreous Enamel	17	17.5	18
Ceramic	47.5	50	54
Variable	30	26	24
Complex Components, Total	242	316	585
Multicomponent Packages, (two or more separate active or passive components in a single package)	193	226	375
Microelectronics	48.5	90	210
Semiconductor Integrated Circuits, (monolithic)	33.5	60	160
Hybrid Microcircuits, (semiconductor and/or thin film components on the same or separate substrate)	15	30	50
Connectors, Total	243	246	255
Coaxial	29	29	32.5
Standard	22.5	22	23
Miniature	6.5	7	9.5
Cylindrical	88	88	90
Rack and Panel	60	62	65
Printed Circuit	30	32.5	37.5
Special Purposes and Fused	36	34	30
Delay Lines, Total	15	18	25
Electroluminescence, Total	6	7	10
Electron Tubes, Total	832	881	1,141
Receiving Tubes	252	236	170
Power and Special Purpose	245	252	273
High Vacuum	60	61	64
Gas and Vapor	18	18	18
Klystrons	45	44	44
Magnetrons	33	32	31
Traveling Wave Tubes, including backward wave osc	40	40.5	47
Light Sensing	20	25	32
Storage, Light Emitting, Display	19	20	23
Other	10	11	14
TV Picture Tubes	335	393	698
Black and White	165	173	198
Color	170	220	500
Ferrite Devices, Total	20	22	28
Filters, Total	52	55	85
Gyros, Total	300	300	350
Loudspeakers, Total	48	50	52
Magnetic Tape, Total	84.4	101	173
Audio	25	30	35
Instrument	52.4	63	123
Video	7	8	15

	1964	1965	1968
	(Millions of dollars)		
Quartz Crystals, Total	43	50	63
Resistors, Total	350	352	383
Fixed	176	174	174
Composition	70	67.5	66
Carbon, deposited	22	20	16
Metal Film	33.5	36	45
Wirewound	50	50	47
Variable (potentiometers)	138	141	155
Nonwirewound	59	61.5	65.5
Wirewound	79	79.5	89
Other, (incl. nonlinear resistors as varistors and thermistors)	36	37	54
Relays, Total	214	225	238
Solid-State Relays	1.5	4	7.5
Electromagnetic Relays	114.5	119	124
Contact Meter Relays	6.5	6.7	7
Crystal Can	20	19	20
Dry Reed	10	12	19.5
Stepping	11	10.5	9.5
Telephone Type	28.5	28.5	28
Mercury Wetted	12.5	15	17
Other Electromagnetic Relays	26	27.3	23
Other Relays (except electromagnetic)	98	102	106
Semiconductors, Total	630	641	680
Transistors	300	310	313
Silicon	150	175	185
Germanium	150	135	127.5
Diodes and Rectifiers	191	179	170
Silicon	140	132.5	132
Germanium	32	29.5	19.6
Selenium and Copper Oxide	19	17	18
Special Devices	139	152	197
Silicon Controlled Rectifiers	25	30	37
Microwave and Variable Capacitance Diodes	10.5	12.3	15.7
Tunnel Diodes	2.4	2.5	4
Light Sensitive Devices	60	67.5	84.2
Field Effect Transistors	2.8	5	13.9
Voltage Reference and Regulator Diodes	38.4	35	42
Servos and Synchros, Total	63	63	63
Resolvers	10	10	10
Synchros	27	27	27
Motor Generators, Rate Generators, Servo Motors	26	26	26
Thin Films, Total (resistors, capacitors, but not an integral part of a microcircuit)	5.5	8.5	22.5
Transducers, Total	150	150	200
Transformers and Reactors, Total	210	212	220
Wire and Cable, Total	250	255	275

COMPLEX COMPONENTS, TOTAL

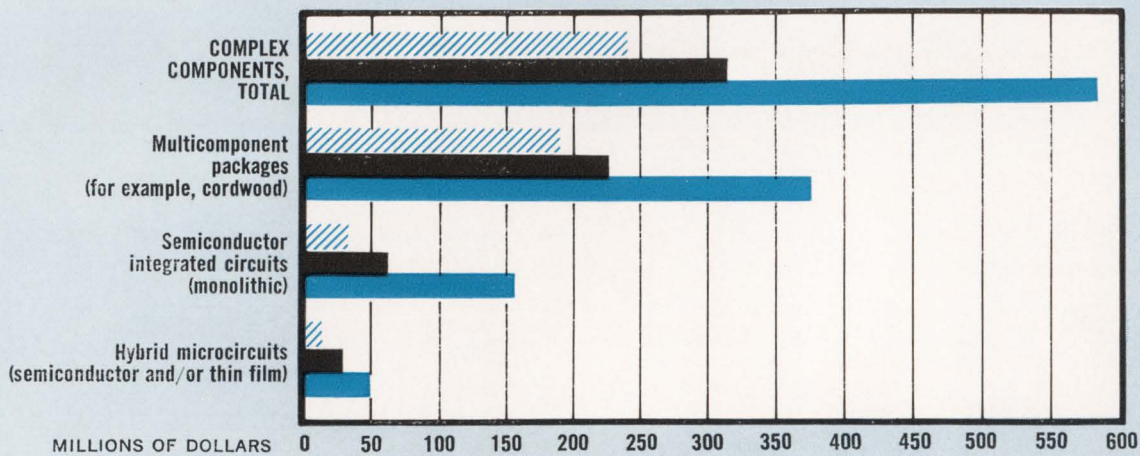

TEST AND MEASURING INSTRUMENTS, TOTAL

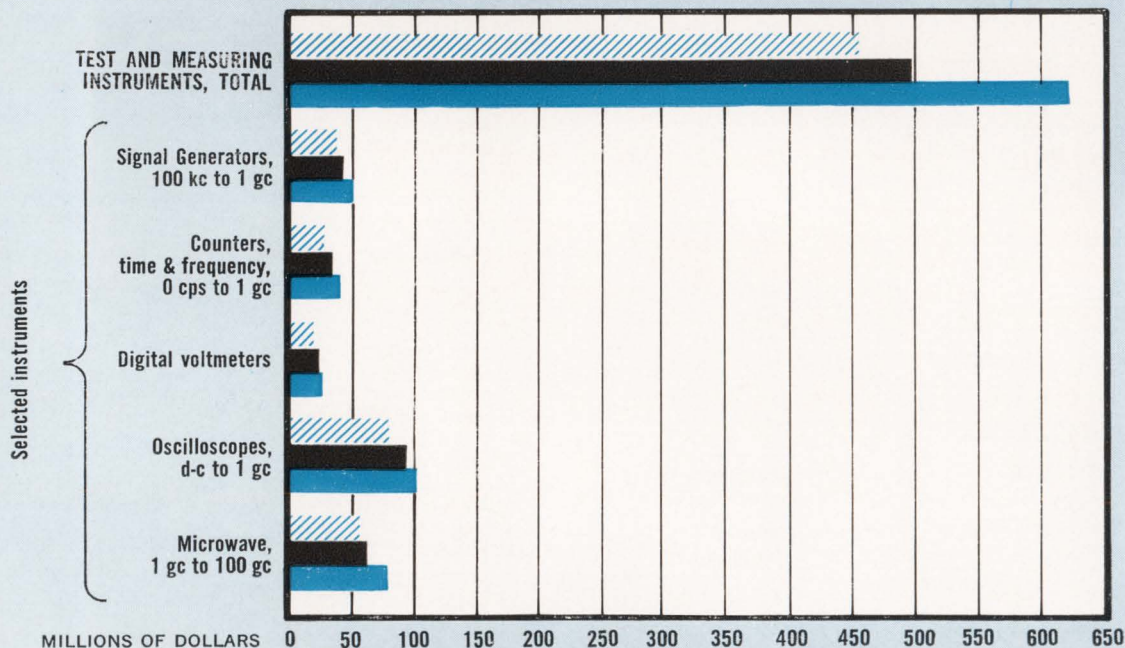

COMPONENTS AND PERIPHERAL EQUIPMENT, TOTAL

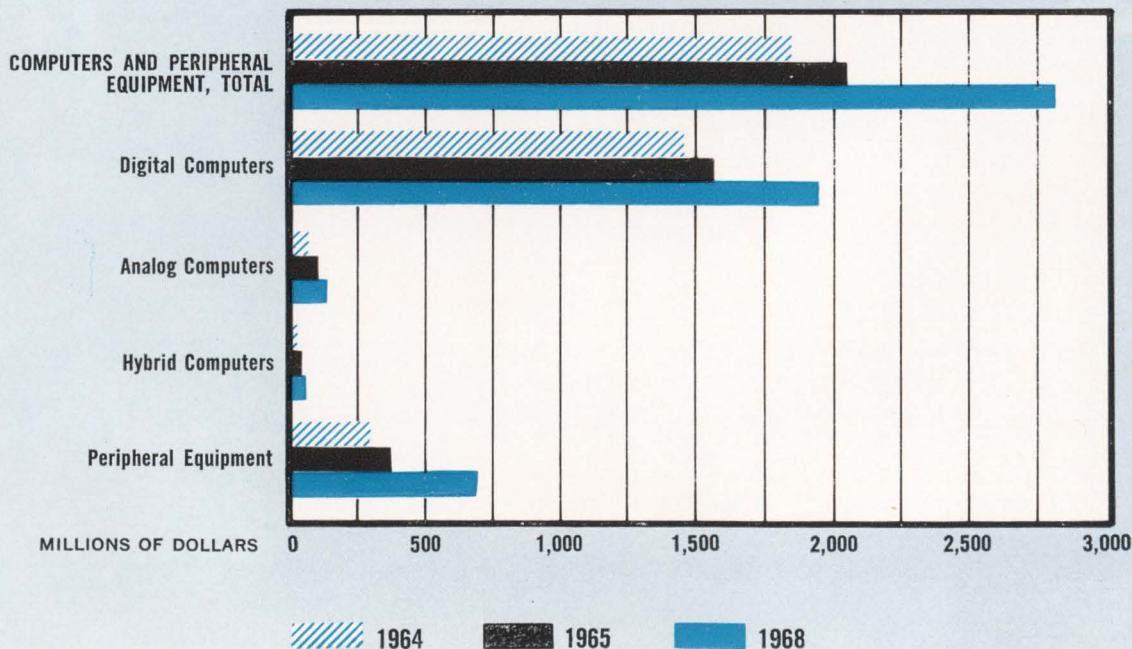

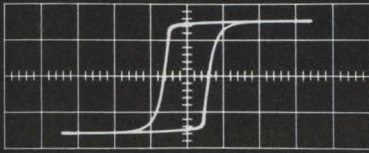

DISPLAY OF INTEGRATED WAVEFORM—transformer secondary voltage integrated and plotted against the transformer primary current—for enabling study of B-H loops of transformer cores.

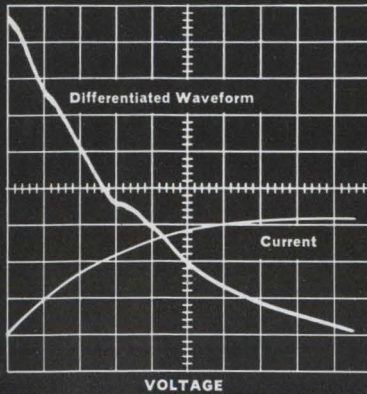
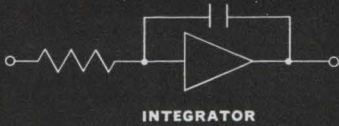

DISPLAY OF DIFFERENTIATED WAVEFORM—tunnel diode in liquid helium—for enabling detection of quantum phenomena at low temperature.

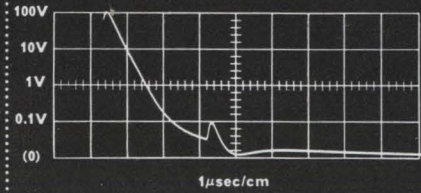
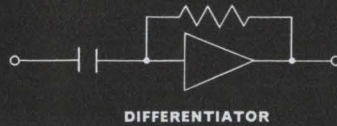

DISPLAY OF LOGARITHMIC RESPONSE—two pulses of widely varying amplitudes—for enabling observation of 100-volt pulse and 0.1-volt pulse in the same viewing area (simplified schematic shown below).

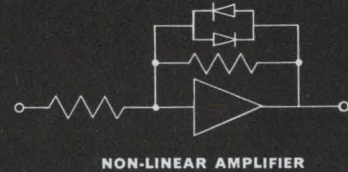

Operational Amplifier Plug-In Unit Permits Oscilloscope Measurements Under Dynamic Conditions

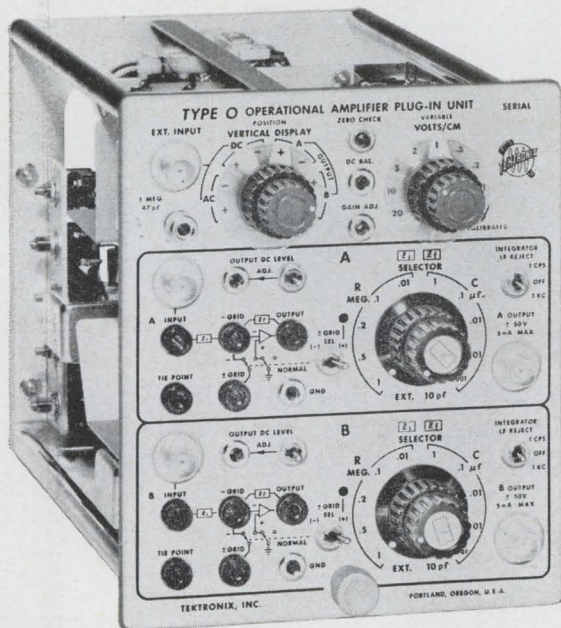

Type O Unit \$525
 Accessory Log Adapter \$75
 U. S. Sales Prices, f.o.b. Beaverton, Oregon

**For a demonstration—
 please call your Tektronix Field Engineer.**

Tektronix, Inc.

P.O. BOX 500 • BEAVERTON, OREGON 97005 • Phone: (Area Code 503) 644-0161 • Telex: 036-691
 TWX: 503-291-6805 • Cable: TEKTRONIX • OVERSEAS DISTRIBUTORS IN OVER 30 COUNTRIES
 TEKTRONIX FIELD OFFICES in principal cities in United States. Consult Telephone Directory

Tektronix Australia Pty., Ltd., Melbourne; Sydney • Tektronix Canada Ltd., Montreal; Toronto
 Tektronix International A.G., Zug, Switzerland • Tektronix Ltd., Guernsey, C. I. • Tektronix U. K. Ltd., Harpenden, Herts



TYPE O UNIT—for Tektronix Oscilloscopes that accept letter-series plug-in units.

Using this new Operational Amplifier Unit in your Tektronix Oscilloscope, you can perform precise operations of integration, differentiation, function generation, linear and non-linear amplification. You can accomplish many of these operations by simply manipulating the front-panel controls—for the Type O Unit features convenient selection of precision input and feedback components.

You can use the Type O Unit as a gated integrator . . . as a high-input-impedance amplifier . . . as a bandpass amplifier . . . as a constant-current-drive amplifier . . . as a peak-memory amplifier . . . as a function generator . . . as a capacitance-measuring device . . . as a low-current measuring device . . . and for many and varied other specialized operations—some performed *with* external circuitry and some *without*.

CHARACTERISTICS

The Type O Unit contains two complete operational amplifiers and one complete vertical preamplifier.

Each operational amplifier features 15 mc open-loop gain-bandwidth product, open-loop dc-gain of 2500, selectable input and feedback impedances, drift rejection for ac integration. The output of one operational amplifier can be applied to the input of the other for combined operations.

The vertical preamplifier can be used independently or to monitor the output of either operational amplifier. In a Tektronix Type 540-Series Oscilloscope, the passband is dc-to-25 mc, the risetime is 14 nsec, and the maximum calibrated sensitivity is 50 mv/cm.

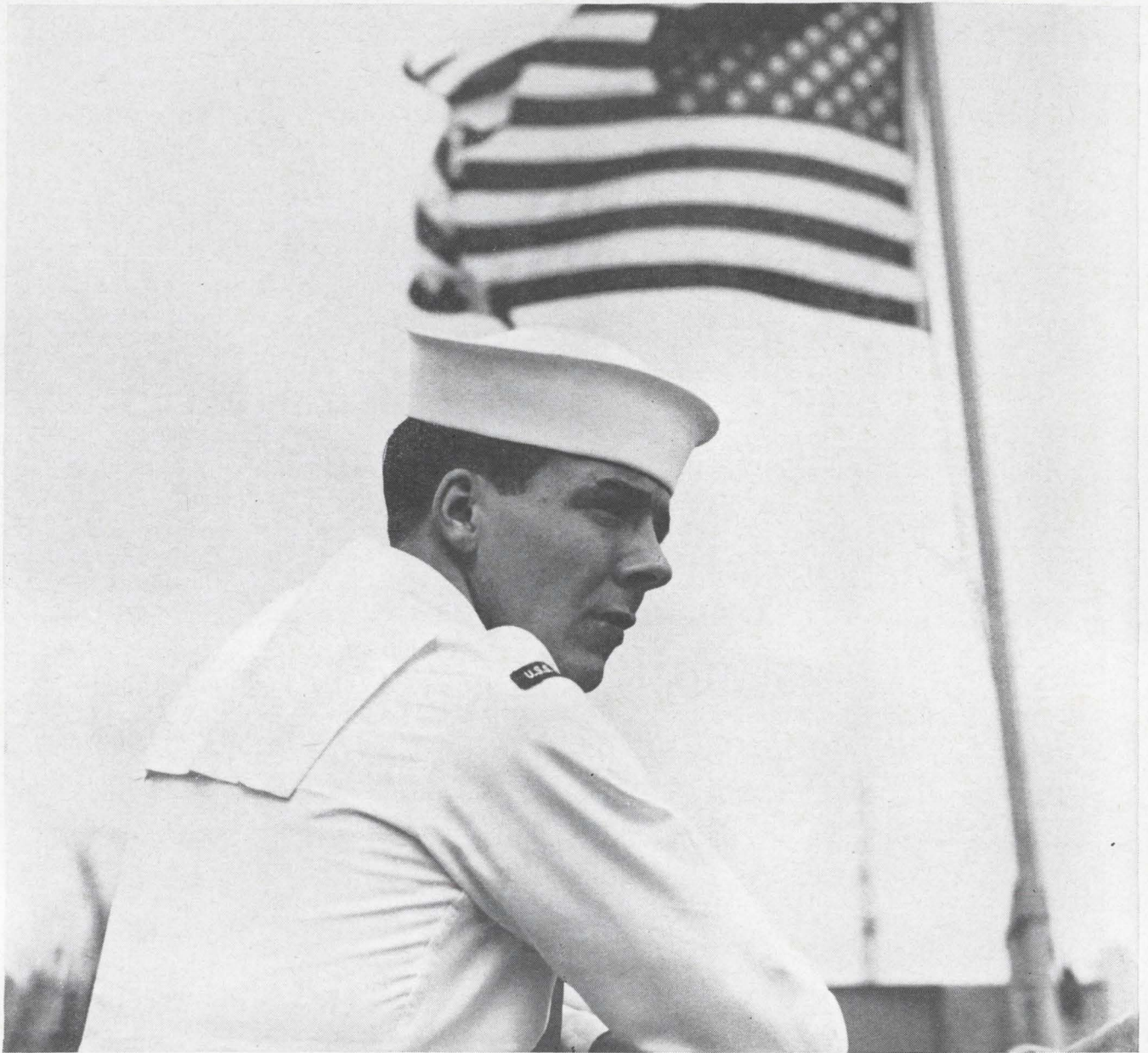

Investment Opportunity

He is a member of your plant security force. Probably your most important member. On duty 24 hours a day, his presence is a symbol of American freedom and of our determination to protect this freedom.

This young man and thousands like him stationed at key points throughout the world guarantee the future liberty and stability which fosters our free enterprise system.

This protection does not come cheap. He must be supplied with the best equipment, the best training and the most responsible leadership for decisive yet prudent actions.

You have an investment in this young man. To protect this investment, you can join with other leading

American businessmen in promoting the Treasury Department's Payroll Savings Plan for U. S. Savings Bonds. The Plan works for a sound, stable economy while providing strength for our defense.

When you bring the Payroll Savings Plan into your plant—*when you encourage your employees to enroll*—you are investing in the young men dedicated to the preservation of our free society. To the continuation of our free economy. You are investing in America's future. In freedom itself.

Don't pass this investment opportunity by. Call your State Savings Bonds Director. Or write today to the Treasury Department, United States Savings Bonds Division, Washington, D. C., 20226.



in your plant...promote the PAYROLL SAVINGS PLAN for U.S. SAVINGS BONDS



The U. S. Government does not pay for this advertisement. The Treasury Department thanks, for their patriotism, The Advertising Council and this magazine.

MOVE UP

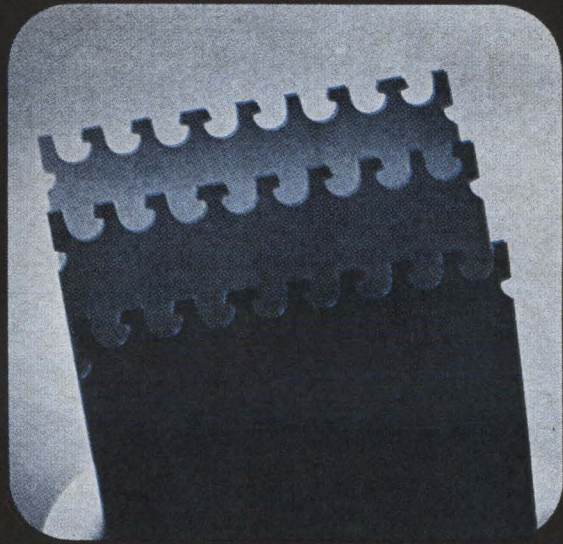

IN DIGITAL SYSTEMS AT NCR, LOS ANGELES

You can step into that bright future now at NCR. This division is generating ideas and hardware today for NCR markets in 120 countries. The success of such best-sellers as the NCR 315 EDP system, the CRAM magnetic-card concept in random-access memories and the 420 Optical Journal Reader has tripled the size of the division in three years. Continued success is in store—thanks to the NCR 315 RMC, the first commercially available system with an all-thin-film main memory, advanced studies in integrated-circuit technology and promising work in many other new areas. Here you'll command everything you need in facilities and equipment. You'll match ideas with some of the nation's keenest systems minds. Like NCR equipment, you'll start off fast and have very little downtime. As a result, you'll move ahead as rapidly as your own ideas can take you. All this and Southern California, too.

At NCR, the footing is firm, the direction forward, the progress certain. If your career is stalled, now could be the time to shift gears.

BRIGHT REAL-TIME OPPORTUNITY AT ALL LEVELS, IN ALL THESE AREAS ADVANCED COMPUTER DEVELOPMENT*

- MEMORY DEVELOPMENT
- LOGIC DESIGN
- CIRCUIT DESIGN
- MECHANISMS DEVELOPMENT
- MAGNETIC RECORDING

PRODUCT ENGINEERING

- PACKAGING DESIGN
- ELECTRONIC AND MECHANICAL PRODUCT DESIGN
- COMPONENT ANALYSIS

SYSTEMS ANALYSIS

- ADVANCED CENTRAL AND ON-LINE SYSTEMS
- EVALUATION

PROGRAMMING DEVELOPMENT

- SOFTWARE DEVELOPMENT
- DESIGN AUTOMATION SUPERVISION

If you do not have direct digital-systems experience, but feel that your background and interests would enable you to make a contribution in any of the areas listed above, your resume is cordially invited.

To arrange a personal interview, please send a resume immediately, including training, experience and salary history, to Bill Holloway, Personnel Dept., or telephone collect.

The National Cash Register Company



ELECTRONICS DIVISION
2816 W. El Segundo Blvd., Hawthorne, Calif.
Telephone: Area Code 213-757-5111

An equal-opportunity employer

New Modular Telegraph Relays

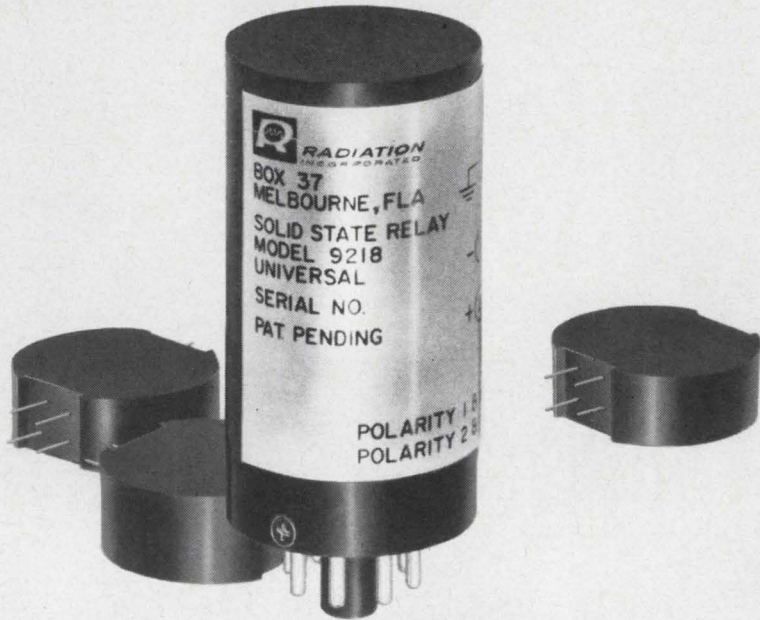

eliminate up to 54 spare parts



Radiation Solid State Units require only 3 different modules

Eliminate maintenance and adjustment, gain unlimited service life, and carry your inventory in your pocket!

Look inside the case of a new Radiation Solid State Modular Relay. You'll never find more than three different parts. You'll also notice the "checker" construction—a new concept in telegraph relay design. These modules are used in various combinations to duplicate any mode of operation presently handled by electromechanical units.

Inventory headaches are now a thing of the past. With conventional electromechanical units, you have to stock up to 54 parts. With new Radiation Solid State Relays you stock only three different modules. That's all!

Design Features . . .

Welded solid state circuitry is transfer molded to form rugged checkers which are exceptionally resistant to vibration and environmental extremes. Neutral relays consist of one Oscillator module and one Keyer module. Polar relays consist of two Oscillators and two Keyers. Add a Latch module and you have a Universal relay.

The stacked checkers and base are connected with either printed circuit cards or wiring, and inserted into the case. Should a module be damaged, it can be replaced quickly and easily. Pin connections are programmable, and any base wiring can be selected with simple changes.

Electrical Characteristics . . .

New Radiation Modular Relays are completely solid state—there are no moving parts. Thus, they eliminate the

need for maintenance and adjustment. Inputs are essentially resistive, and they do not induce transients in the line. The relays operate on current supplied by the input signal, and provide isolation of 50 megohms at 500 v dc. Conductive and radiated RF interference is 30 db better than standard electromechanical types (MIL-I-26,600). Radiation Solid State Relays operate at speeds to 2,400 bits/second with less than 1% distortion, and have been tested to show 56,000 hours MTBF. There are other features!

Radiation Modular Relays are available now in production quantities. Send the coupon for detailed information. We will also be glad to arrange for evaluation samples. Radiation Products Division, Dept. EL-01, Melbourne, Florida. Telephone: (305) 723-1511.

Relay Type	Base — Model Number — Price		
	Octal	202	255
Polar	9228 \$ 95.00	9229 \$110.00	9230 \$110.00
Neutral	9238 \$ 56.00	9239 \$ 65.00	9240 \$ 65.00
Universal	9218 \$110.00	9249 \$120.00	9250 \$120.00
Oscillator Module	Part No. 509972G1		\$23.40
Keyer Module	Part No. 509971G1		\$27.50
Latch Module	Part No. 509970G1		\$23.80
(All prices quoted for quantities of 1 to 49 items.)			



RADIATION PRODUCTS DIVISION
A DIVISION OF RADIATION INCORPORATED

Melbourne, Florida 32902

Gentlemen: Please send details on the new Radiation Modular Solid State Telegraph Relays.

Name _____ Title _____

Firm _____

Address _____ City _____ State _____ Zip _____

ANDREW



... Factory attached fittings



... Long lengths

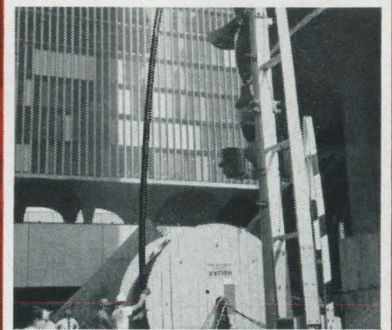

... No splices

HELIAX 5" air dielectric coaxial cable hoisted from street to Marina Tower rooftop in one continuous length for ABC-TV, Chicago

HELIAX® FLEXIBLE COAXIAL CABLE guaranteed reliability for high power RF transmission

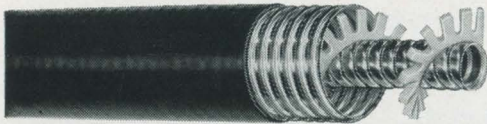

Actual measured VSWR for installed 742 foot length of 5" HELIAX

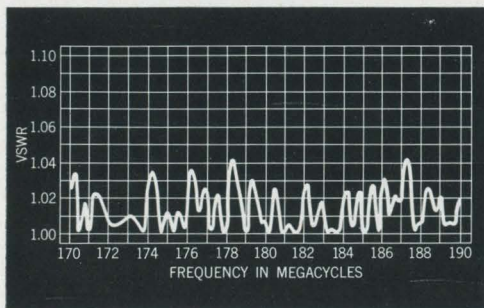

Long continuous lengths, and flexibility of Andrew HELIAX cable made this critical transmission line system possible. Installation required less than six hours. Cost was dramatically reduced.

Type H9-50 HELIAX cable insures long term reliability in high power RF transmission*. Corrugated copper inner and outer conductors absorb stress and cable retains superior electrical qualities after repeated flexing. Andrew end connectors firmly anchor inner to outer conductor and eliminate any RF noise from vibration or temperature changes.

Contact your Andrew sales engineer, or write for information on this superior transmission line.

*Handles average power of 250 kw @ 10 Mc or over 50 kw @ 200 Mc

28 YEARS OF ENGINEERING INTEGRITY

4-65

Andrew
CORPORATION
P. O. BOX 807 • CHICAGO, ILLINOIS U. S. A. • 60642

Probing the News

Microelectronics

Integrated-circuit makers are ready for the big buying boom to start

Sales expected to climb to \$90 million in 1965 from \$48.5 million last year; 1968 volume put at \$210 million

In the five years since its birth, the microelectronics industry has been concentrating on finding applications. Now that many markets have been opened, the industry is geared for mass production.

It has taken five years for sales of integrated circuits—monolithic and hybrid—to build up to the present \$48.5-million level. Volume should zoom to \$90 million this year and 1968 sales are expected to explode to \$210 million.

Carving a market. Competition for a market has been so intense that few companies have made profits from microelectronic circuits. Now, although there are more buyers, productivity has increased even faster—and the industry is plagued by overcapacity. Small companies are hanging on precariously, waiting for the expected boom to start. Such relatively small producers as General Micro-Electronics, Inc., and the Molectro Corp. have been forced to seek additional financial help to tide them over this period.

I. Still too expensive?

The biggest buyer of microelectronics has been the military. The Pentagon pushed the use of such circuits primarily because systems made with them are reliable. And there has been an economic bonus.

Some producers of military systems say they have been able to cut equipment costs in half by using mass-produced integrated circuits.

Integrated circuits are considered to be so reliable that a com-

puter being designed to provide navigation and guidance controls for the Apollo moon probe won't have redundancy and the designers are making no provision for mid-flight repairs.

A matter of price. Although the price for integrated circuits seems to be low enough for the military, it's still too expensive for most industrial customers. Computer makers are the exception. Some digital

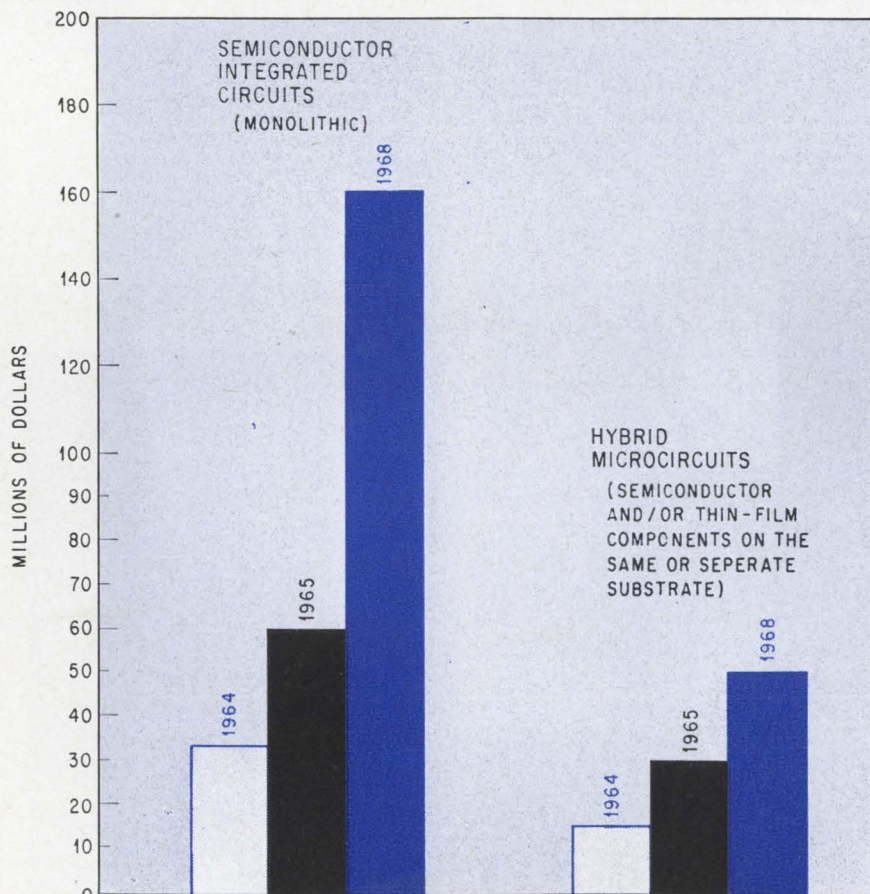

Microelectronics sales in the U.S. are expected to nearly double during 1965, according to a survey by Electronics magazine. The market for semiconductor integrated circuits should increase almost fivefold by 1968. From \$33.5 million in 1964, it is expected to rise to \$60 million in 1965 and \$160 million by 1968. The hybrid microcircuit market should climb from \$15 million in 1964 to \$30 million this year. By 1968 it should reach \$50 million.



Robert Noyce of Fairchild's Semiconductor division: Too many people in the business.

integrated circuits that are being used in computers are half the price of discrete-component circuits. Because computer companies are aware of these savings, all the major manufacturers are designing microelectronic computers.

Three firms cite profits. Only recently have system manufacturers been buying integrated circuits in large numbers. Among the few companies reporting profits from the sales of such circuits are Texas Instruments, Inc., the Fairchild Camera & Instrument Corp. and the Raytheon Co. Observers of the market estimate that Texas Instruments and Fairchild together control as much as 70% of the market.

Robert N. Noyce, vice president and general manager of Fairchild's Semiconductor division, sees prices going down as production steps up, with some companies forced out of business by the competition. "The business will start getting better when there are fewer people in it," he adds.

Richard J. Hanschen, assistant vice president and general manager of Texas Instruments' semiconductor unit, thinks the shakeout is over. "It's been possible to open up the industrial market nine months earlier than we initially forecast," he says.

C. Lester Hogan, vice president of the Semiconductor Products division of Motorola, Inc., sees the industry on the verge of the explo-

sion. "The industry is now in the phase where everyone is redesigning all kinds of circuits, a lot of engineering is being done, but no customer's volume is up very high," he says.

Trygve Ivesdale, product manager of the Raytheon Co.'s semiconductor operations notes that the use of integrated circuits in military equipment and in commercial computers is on the increase. "Business is coming along very nicely," he added.

II. The custom builder

The early going has been tough because there is not much off-the-shelf business. Custom designers of integrated circuits expect some of their products to be mass-produced some day. But for the most part, makers of integrated circuits must continue to cater to the custom needs of a big potential customer. Comments Motorola's Hogan: "It is difficult and costly to develop integrated circuits for a customer's special needs. Until the customer's buying goes up significantly, we are bound to lose money on him."

One attractive market for the custom builder is in linear circuits. The biggest market is in digital circuits, and the linear-circuit field is less crowded. Besides lower sales, it's more difficult to engineer and produce linear circuits than logic

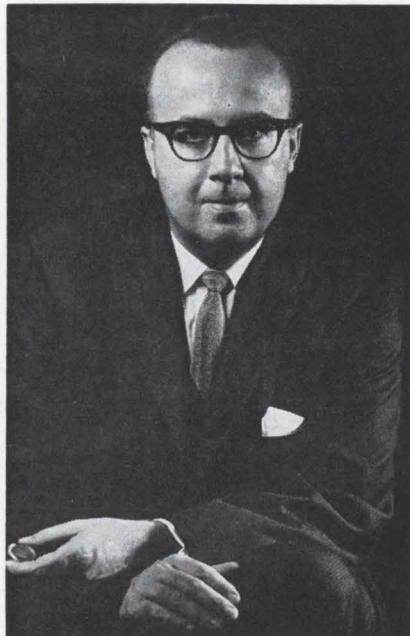

C. Lester Hogan of Motorola: It's costly to cater to the big buyer, but we must.

circuits. The digital-circuit orders often can be filled with standard logic circuits, but linear circuits require special tailoring and a special price.

Jean Hoerni, manager of research and development at the Union Carbide Corp.'s semiconductor division, agrees this is the "best way to compete with the digital-minded industry." One of Union Carbide's first linear-circuit products will be for a differential amplifier.

Another company, Amelco, Inc., says more military money is available for linear circuits than in the



Richard J. Hanschen of Texas Instruments: The shakeout in integrated circuits is over.

past. The company soon will offer a highly stable operational amplifier for guidance control in space vehicles.

III. Mass production sought

Even though the custom business is attractive, integrated-circuit manufacturers are striving to develop families of linear circuits that will have a broad range of applications, so they can be produced in quantity at low cost.

Many customers that used to buy conventional linear circuits for military radar and navigation, process control and servo systems, are now asking for digital integrated circuits. The families of circuits needed to produce digital versions of traditionally analog systems are already available.

Companies with a stake in linear integrated circuits figure they have to go after this market with general-purpose linear circuits. If they don't make such circuits available, they reason, somebody else will.

According to Frank Pittman, who heads linear-circuit development at

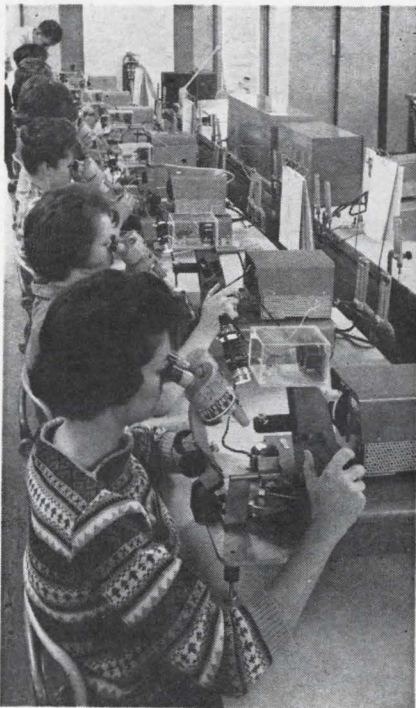

Integrated circuits being produced at Texas Instruments plant. In the first few years industry searched for applications, now it's geared for mass production.

the Westinghouse Electric Corp.'s Molecular Electronics division, development is concentrating on three lines of circuits: broadband amplifiers, operational amplifiers and power devices.

Westinghouse recently developed a feedback amplifier, called the 1146, that covers the frequency ranges of four earlier circuits in its amplifier line. The amplifier operates at frequencies from direct current to 60 megacycles per second. With a 330-ohm load, the circuit's gain is 23 decibels at 40 Mc. However, gain falls off to 16 db at 60 Mc. The circuit can be used for numerous applications: video amplifiers for radar and television and in intermediate-frequency strips.

This bandwidth, which represents a doubling of the bandwidth of circuits that were produced a year or two ago, has been achieved through size reductions to reduce stray capacitances in the circuits, and by the development of higher-frequency transistors. The oxide isolation techniques that are coming into general use in the industry should achieve the same gain at 60 Mc that is now attained at 30 to 40 Mc.

Operational amplifiers are al-

ready being used in systems such as the Minuteman II missile. But Pittman says general-purpose circuits are needed, with the ability to deliver up to 60 db gain at frequencies up to 1 Mc, and with input impedances greater than 100 kilohms.

Drive a speaker. The 1- to 5-watt audio amplifiers appearing on the market are the first linear integrated circuits with sufficient power to drive transducers such as loudspeakers. Integrated-circuit designers are pushing the power level up to 10 watts and at the same time working to make the amplifiers inexpensive enough for use in consumer electronics. They are also working on series voltage-regulator circuits that can handle one ampere, and on circuits capable of driving electromechanical devices in servo systems. For this goal, oxide isolation is considered a key technique; another is the deposition of high-value precision resistors as thin films on top of the semiconductor circuit.

IV. Vying for the computer market

Computer makers are a hefty market for integrated circuitry. The fight for this business has brought on some frantic races for ultrafast circuits. Texas Instruments, for example, says it is working on a circuit with only a 2- to 3-nanosecond delay. And the Signetics Corp., a company controlled by the Corning Glass Works, is putting 25% of its research-and-development efforts into the commercial computer markets.

James F. Riley, the president of Signetics, says: "The industry has gone through its adolescence very quickly. We are just now starting to mature."

Walter W. Finke, president of Honeywell, Inc.'s Electronic Data Processing division says that integrated monolithic circuitry will be standard in virtually all new equipment announced in 1965.

Although most computer companies are interested in monolithic circuits, the biggest one—the International Business Machines Corp.—is the exception. IBM uses hybrid circuits in its new System 360. IBM seems to be stressing hybrids because of their speed and power.

Although IBM now makes all its own circuits, the company is ex-

pected to seek outside suppliers of hybrid circuits if computer sales rise fast.

Both used. The Radio Corp. of America, in announcing its new series of computers, the Spectra 70, reported that the upper end of the line would be monolithic and the lower end hybrids. RCA is buying, as well as making, its circuits.

Most computer makers don't expect to be producing computers with 100% integrated circuits for several years. Integrated circuits don't yet have the power required for use in memory and input-output circuits. Integrated circuits are being used in logic sections. But for memory driving, discrete components or hybrid circuits are now used, and for input and output circuits, which have to drive electro-

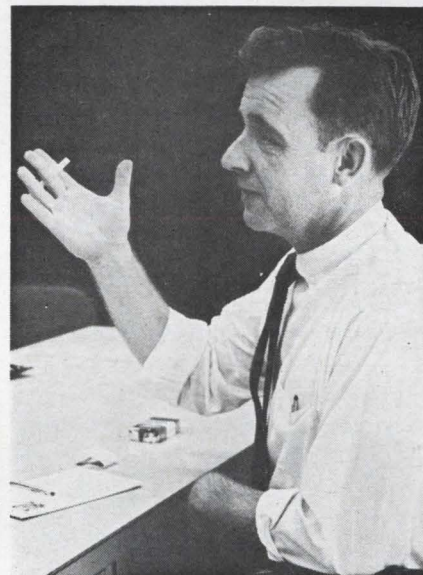

James F. Riley of Signetics: We are just now starting to mature.

mechanical equipment such as printout systems and tape recorders, discrete components are used.

Although most companies are stressing monolithic circuits, many also maintain a capability for making hybrids.

Despite the shakeout and the struggle of some companies to stay in business, others such as Signetics and Stewart-Warner Microcircuits, Inc., are moving into new facilities.

For as one executive says, "Even though the big-volume market may be a few years off, now is the time to start developing our capability."

AMPERITE

Thermostatic DELAY RELAYS

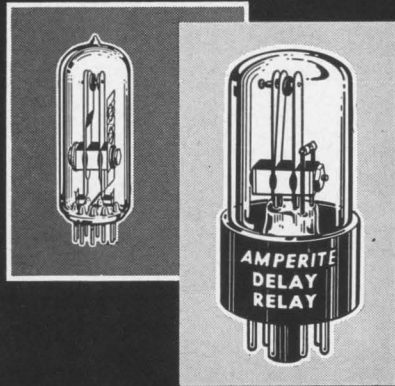

Only a glass seal
offers true hermetic sealing
... assuring maximum stability and life!

Delays: 2 to 180 seconds . . . Actuated by a heater, they operate on A.C., D.C., or Pulsating Current . . . Being hermetically sealed, they are not affected by altitude, moisture, or climate changes . . . SPST only—normally open or normally closed . . . Compensated for ambient temperature changes from -55° to $+80^{\circ}$ C. . . Heaters consume approximately 2 W. and may be operated continuously . . . The units are rugged, explosion-proof, long-lived, and—inexpensive!

TYPES: Standard Radio Octal, and 9-Pin Miniature.
List Price, \$4.00

PROBLEM? Send for Bulletin No. TR-81

AMPERITE

BALLAST REGULATORS

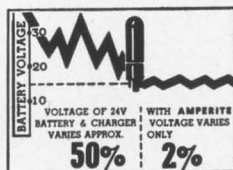

WITH AMPERITE
VOLTAGE VARIES
ONLY
2%

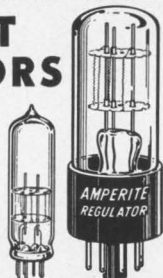

Hermetically sealed, they are not affected by changes in altitude, ambient temperature (-50° to $+70^{\circ}$ C.), or humidity . . . Rugged, light, compact, most inexpensive . . . List Price, \$3.00.

Write for 4-page Technical Bulletin No. AB-51

AMPERITE

600 PALISADE AVE., UNION CITY, N.J.
Telephone: 201 UNION 4-9503
In Canada: Atlas Radio Corp., Ltd.,
50 Wingold Ave., Toronto 10

Microwaves

Millimeter-wave research is coming back in style

Renewed interest in millimeter waves is reflected in varied studies and improved equipment

Millimeter-wave research, pushed into the background by interest in lasers, is stirring again.

In 1960, when the first laser was developed, scientists generally shelved millimeter-wave projects, which had run into major technical obstacles, and looked to the laser to provide a revolution in the communications field. But so far, there has been no revolution—only incremental advances in laser tech-

nology. And some of the early forecasts of what a laser can do have been toned down, leaving room for millimeter-wave technology to fill the gap.

Back to work. So researchers have been drifting back to millimeter-wave studies. Despite the problems, millimeter waves offer an enormous potential: a capacity that, in terms of cycles per second, is about five times the bandwidth

PHOTOGRAPH OF AREA VIEWED IN THE EXPERIMENT

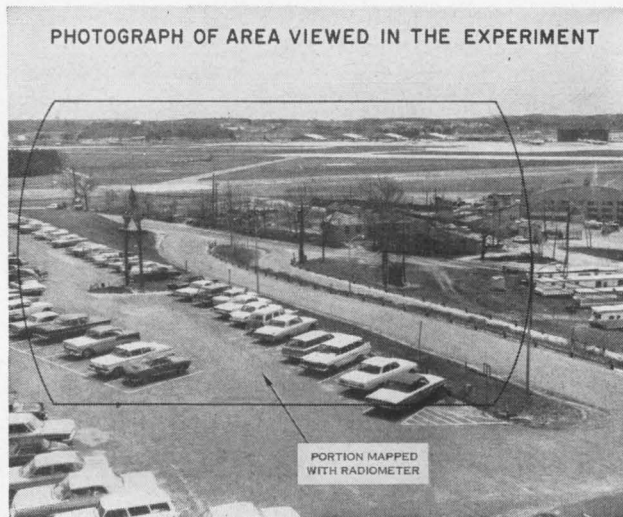

PORTION MAPPED
WITH RADIOMETER

Ground mapping can be accomplished with millimeter-wave equipment. The Raytheon Co. is developing gear that receives radiation in the millimeter range. The photo above shows the area scanned by the equipment, and the picture at the right is the radiometric image that was picked up.

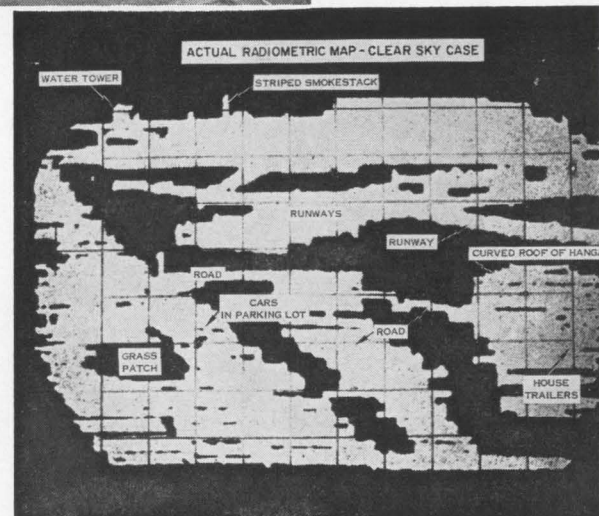

ACTUAL RADIOMETRIC MAP - CLEAR SKY CASE

of the rest of the radio spectrum; ultrahigh resolution radar, and long-range space communication.

The biggest hurdle to successful millimeter-wave systems is the development of a transmitter with substantial power. Most equipment used so far has been either scaled-down models of longer wavelength transmitters or exotic devices practical only in laboratories. Since most of this gear was inefficient, the major effort, today, is to boost efficiency ratings.

Early manufacturing methods were generally inadequate to meet the high tolerances needed. But precise manufacturing techniques developed over the past few years are helping to provide miniaturized components that will handle millimeter waves as efficiently as standard components now deal with the lower frequencies.

I. Signs of revival

Several recent events point up the new interest in the millimeter-wave field:

- The National Aeronautics and Space Administration recently awarded a contract to the Raytheon Co. to study the feasibility of using millimeter wavelengths for space communication. Experiments will be designed to define channel characteristics of earth-to-space communications.

- The Aerospace Corp., a non-profit research company, is preparing a 15-foot diameter, 94-mega-cycle antenna to test tracking of fast-moving objects in space. So far the equipment has been used to study the face of the moon. The company also is exploring the effects of the earth's atmosphere on video transmission [Electronics, Dec. 28, 1964, p. 23]. Researchers have set up a 12-mile line-of-sight television link between their plant at El Segundo, Calif., and a mountain top. Transmissions from local tv stations are picked up on top of the mountain and the video portion is retransmitted on a three-millimeter link to the plant.

- TRG, Inc., is building an experimental communication system that will operate at fixed frequencies between 45 and 80 gigacycles. The project is under a contract with the Rome Air Development Center. TRG will use a new broadband harmonic mixer, which

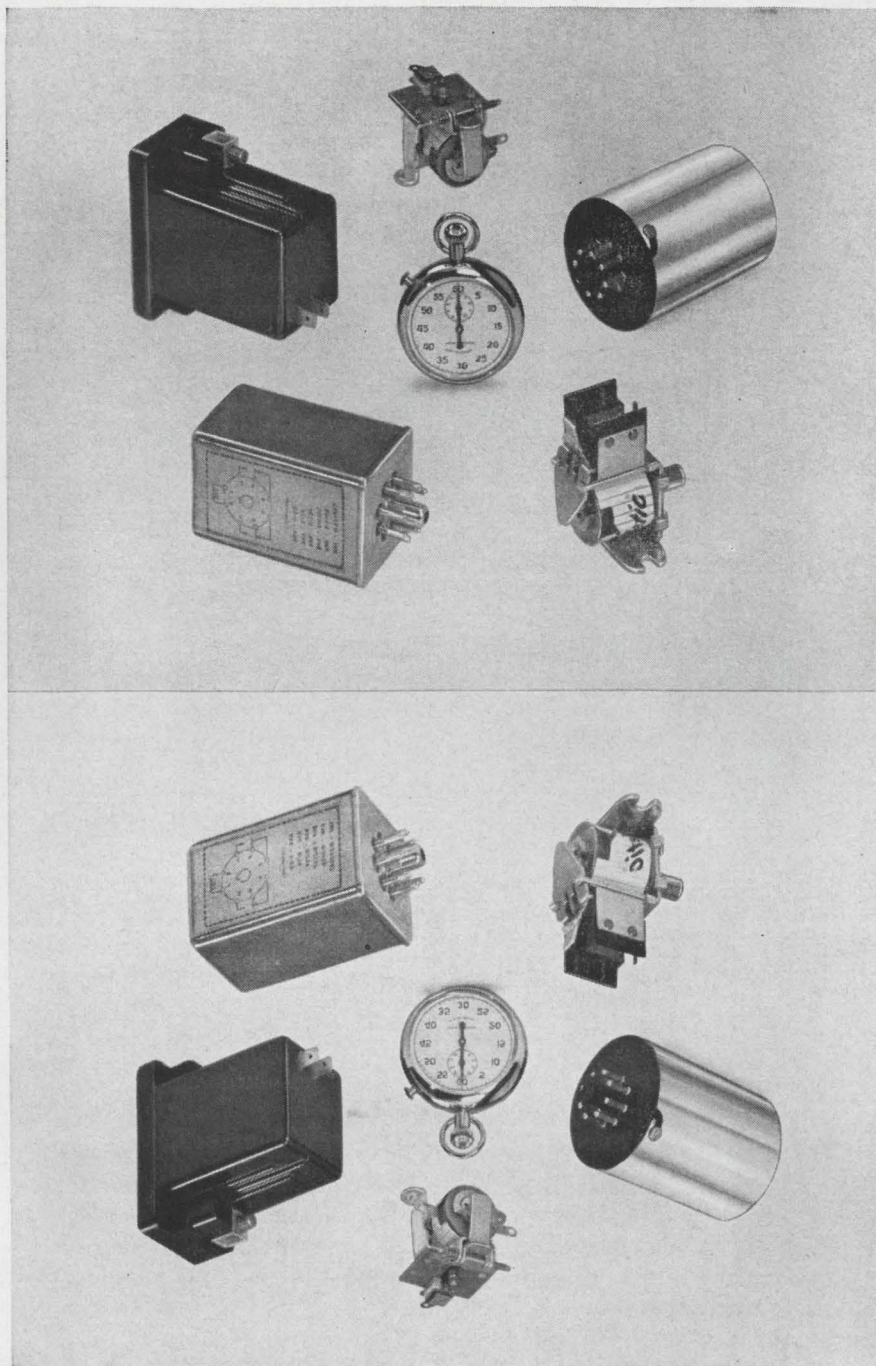

2 for 1 sale

Buy a Heinemann time-delay relay and you get a load relay free. In one and the same component. Heinemann Silic-o-Netic® time-delay relays are designed for continuous-duty service, can remain energized indefinitely after actuation. This unique capability permits them to function as their own load relays wherever their contact capacity (up to 5 amp) is sufficient. Sound like a bargain? Bulletin 5005 will give you detailed technical data.

HEINEMANN Electric Company
2600 Brunswick Pike, Trenton, N. J. 08602

SA-3020

How to reduce control complexity (and cost)...

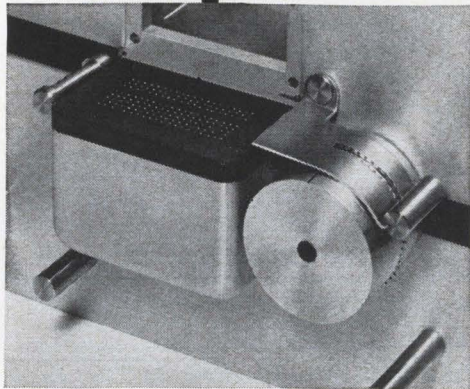
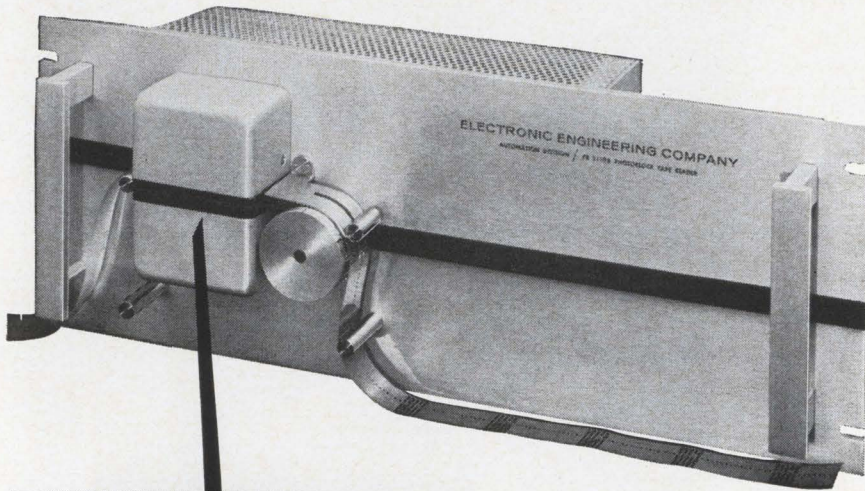

Use an **EEOO**
PHOTOBLOCK
Tape Reader that
reads up to 160 bits
at a glance...

Important advantages result from automatic programming using the block concept . . . and an EEOO PHOTOBLOCK TAPE READER:

Simplified system design because you can handle a complete test with a single block of 160 bits . . . lower costs because complex control functions are handled without extra circuits for storage and addressing . . . and many more.

First block reader with the reliability of photoelectric readout, the EEOO PHOTOBLOCK Tape Reader utilizes photodiodes to sense light through code holes punched in the tape. All solid state, the drive mechanism is whisper quiet. And the electrodynamic tape positioning eliminates clutches, ratchets and solenoids. Bi-directional operation is provided for random access, tape rewind, or search modes. Militarized versions available. PHOTOBLOCK TAPE READERS—another reason to look to EEOO for automatic programming equipment . . . precision timing products . . . test instrumentation . . . data handling equipment . . . and complete timing and data systems.



Write... wire... or phone

Electronic Engineering Company of California
1601 EAST CHESTNUT AVE. • BOX 58 • SANTA ANA, CALIF. • KIMBERLY 7-5501

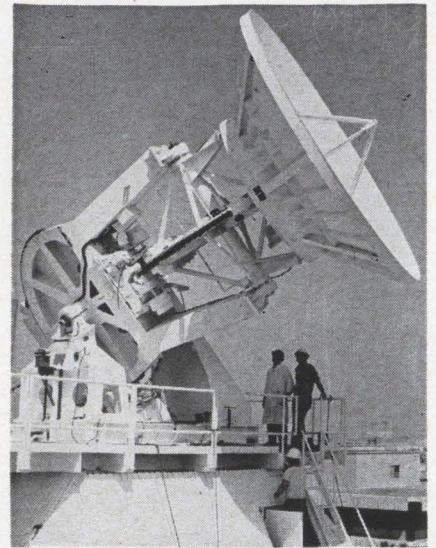

Millimeter-wave antenna built by the Aerospace Corp. is being tested for possible space-to-earth communications. The 15-inch-diameter antenna operates at 94 gigacycles.

has a sensitivity of -55 to -80 decibels below one milliwatt. Antennas are three feet in diameter. The system will probably be packaged as a mobile unit.

II. Nothing on the shelf

The dearth of millimeter-wave equipment plagues researchers, and many components must be custom-made, delaying studies in the field. However, this problem is slowly being solved, especially in the area of tubes.

For example, Hughes Research Laboratories, a division of the Hughes Aircraft Co., has made available laboratory samples of its type 814H traveling-wave tube with a continuous output of 100 watts over the range of 90 to 99 gigacycles; the tube has an efficiency rating of 20%. A 30-watt traveling-wave tube operating over a range of 135 to 150 Gc is under development.

And the Watkins-Johnson Co. has developed a high-power amplifier tube with a 1,000-watt output at 35 Gc.

New process. Harmonic generation using varactors hasn't shown much promise because of low power capabilities. However, the Autonetics division of North American Aviation, Inc., is working on a new diode fabrication technique and Hughes also is investigating new diode configurations.

Waveguide, test bench and system components are available from

Insulation of MYLAR[®] on Sigma relay increases thermal range 50% ...costs remain the same

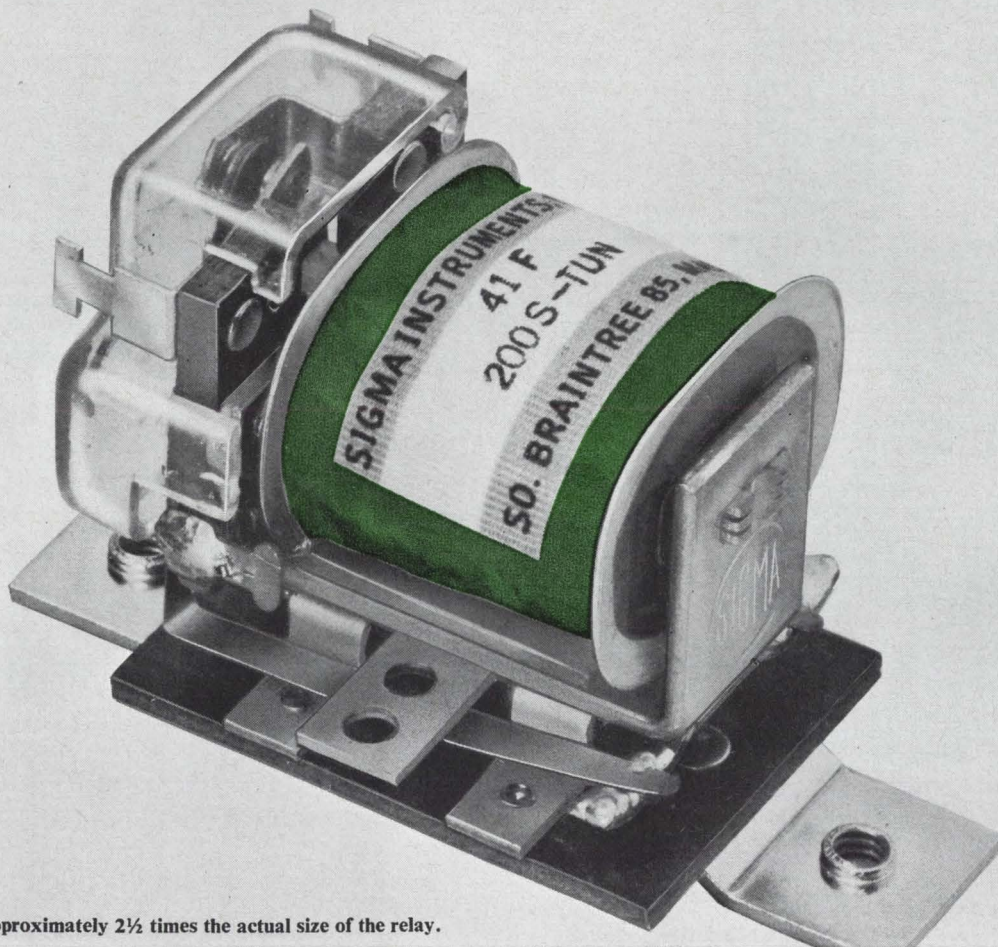

This photo is approximately 2½ times the actual size of the relay.

Sigma met the problem of increased thermal specifications by switching to insulation of MYLAR* polyester film. With its higher temperature rating, MYLAR upgraded the thermal range of Sigma's Series 41 relay by 50%. This surpassed the specifications required and broadened applications for the relay.

In addition, the switch from acetate film to MYLAR in other relays made by Sigma Instruments, Inc., of Braintree, Massachusetts, also meant:

- a smaller coil, since the high dielectric strength of MYLAR permits the use of thinner, more pliable film.
- longer life is designed into the coil by the use of MYLAR, which does not dry

out or change characteristics with age.

- insulation costs remain the same, because less MYLAR is needed for equivalent dielectric strength, as compared with most other insulators.

As a result, relays are now more reliable and versatile and are used in a wide array of applications ranging from furnace flame-out safety controls to automatic traffic and street-lighting controls.

For information on how MYLAR can probably help you design a better product—lighter, smaller, lower in cost—mail coupon today.

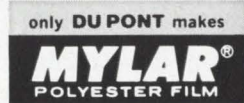

*Du Pont's registered trademark for its polyester film.

Du Pont Company, Room 2200B
Wilmington, Delaware 19898
Please send me information about MYLAR[®]
I am especially interested in its application for

Name _____

Title _____

Company _____

Address _____

City _____ State _____ Zip Code _____

In Canada: Du Pont of Canada Limited, P.O. Box 660, Montreal

Raster

PPI

GCA Display

Elevation Scope

Character Display

Composite Display:
Horizon-Altitude-Airport

Off Centered Sector Scan

Precision Linear Sweeps

Loran

O Scope

DF Scope

A YOKE FOR ANY SCAN to your Specifications

COMPLETE LINE of deflection yokes for every military and special purpose—in production quantities or custom designed to your exact requirement.

For engineering assistance with your display problems, call on your nearest

SYNTRONIC YOKE SPECIALIST today:

Boston-New Eng.:	762-3164
Metropolitan N.Y.:	695-3727
Upstate N.Y.:	315, 652-7911
Phila. Area:	789-2320
Wash.-Balt. Area:	277-1023
Florida Area:	813, 527-5861
Los Angeles:	283-1201

syntronic

INSTRUMENTS, INC.

100 Industrial Road, Addison, Illinois
Phone: Kingswood 3-6444

a few suppliers for use in equipment testing up to 200 Gc.

The limits of scaled-down tubes are stimulating some interest in finding other ways of generating and amplifying millimeter waves. One approach is the attempt to develop a beam-plasma amplifier. Work on this is going on at Microwave Associates, Inc., and at Stanford University. The beam-plasma amplifier would exploit the interactions of electron beams and plasma to get signal generation and amplification.

Receiver sensitivity is also a formidable obstacle to the development of millimeter-wave systems. Autonetics is working on a low-noise parametric amplifier. Engineers there are trying to get the noise figure down to 10 decibels at 94 Gc, but now have to strain to get 15 db, they say. TRG is building a low-noise parametric amplifier for the Signal Corps. It will operate at 94 Gc, with an expected noise temperature of 20° Kelvin, or a fraction of a decibel.

III. Detection systems

Interest in millimeter waves is evidenced outside of the communi-

cations field. Some systems are under development for commercial diagnostic purposes. TRG is aiming at the petroleum and chemical companies that use plasma-diagnostic techniques for analysis of flame processes in manufacturing and process control. TRG has built a millimeter-wave interferometer for this use.

Plasma-diagnostic techniques involve transmitting a wave through a plasma. Characteristics of the plasma can be determined by the ways the waves are affected.

At the University of Illinois, research Paul Coleman and his associates have developed a submillimeter wave spectrometer for the 100- to 1,000-micron range for about \$100. A commercial unit built around a stabilized klystron could provide accuracy to between $\pm 0.0001\%$, but the instrument would cost thousands of dollars. The group will use the spectrometer to investigate radiation from various gases and gas mixtures to try to find new lasing lines and to extend the frequency range of lasers.

Used for mapping. A Raytheon group is working on a millimeter

Industrial electronics

Putting zip into mail-sorting

Post Office abandons address-reading machines and seeks one that reads zip codes electronically

By Louis S. Gomolak

Industrial Electronics Editor

The Post Office's zip code is speeding more than the mail. It's also stepping up development of electronic address-reading machines, and competition among manufacturers of these rapid readers.

Next June, four machines will be tested on-line, side by side, in the Detroit Post Office. One, made by the Philco Corp., is alphanumeric—it reads zip-code numbers and the names of cities and states by

flying-spot scanning. The other three, which read only numbers, are made by the Burroughs Corp., National Cash Register Co. and Rabinow Electronics, Inc., a subsidiary of the Control Data Corp.

Tests began in '58. Since 1958, the Post Office had been testing a machine that recognizes groups of characters through slit-scanning. But the machine, made by Farrington Electronics, Inc., reads only

radiometry system for mapping that has major military applications. The group says it is able to get precise radiometric measurements of ground targets with no active radiation to betray the operation.

Designers at Raytheon have breadboarded high-gain, noncoherent pulse radars operating at 35 to 70 Gc for search and mapping systems. These high-resolution, continuous-wave radars could obtain radar signatures from moving vehicles or even parts of vehicles, such as scanning radar antennas or turrets. For such work, designers need clean carriers with low noise.

The total dollar volume of the millimeter-wave market for 1964 was between \$2 million and \$3 million, and in 1965 the market is projected at between \$3 million and \$5 million.

Additional research in the field is being hamstrung by a lack of money. Industry is generally in a waiting mood and isn't jumping in to subsidize too much basic research, while the military is apparently waiting for industry to come up with more uses for millimeter systems before making additional funds available.

city and state names. With the advent of a machine that can read zip codes, the government canceled its development contract with Farrington.

The department's goal is a device that automatically reads machine-addressed mail, which comprises 65% of the mail that the Post Office handles.

"We knew slit-scanning worked," says Richard Hessinger, the Post Office's director of research. "The alphanumeric approach, with flying-spot scanning, was still only theory until tests proved the Philco machine far superior to Farrington's."

"Slit-scanning," Hessinger continues, "is limited to a maximum scanning rate of about 1,000 characters per second. We still don't know what the maximum alphanumeric rate is. Also, Farrington's group-of-characters recognition approach can cause ambiguities, in that words such as Sonora and Sonoma are electronically the same. Mail might have been mis-



This is PEMCO'S 17-pound Portable

It stands apart from the crowd of "portable" instrumentation recorders that weigh anywhere from 65 to 200 distressingly unportable pounds. It logs data from DC to 100 KC with laboratory precision* on only 20 to 45 watts (d-c or a-c). And it offers such large-instrumentation-recorder features as:

- Tape widths of ¼", ½", or 1"
- Standard speeds from 15¹/₆ to 60 ips
- Record times from 3¹/₃ minutes to 3¹/₂ hours
- All-solid-state, plug-in Direct or FM electronics
- Up to 14 channels (I.R.I.G. compatible)
- Performs in any position to altitudes of 70,000 feet

It could be just what the doctor ordered. If the prescription fills your need, ask about the PEMCO Model 110 General-Purpose Data Recorder. You'll receive our 12-page product brochure forthwith.

*FOR EXAMPLE

- FM center carrier drift within 0.1% over a full reel of tape
- Signal-to-noise ratio of 40 db FM, 35 db Direct at 30 ips



**PACIFIC
ELECTRO
MAGNETICS**

942 Commercial Street, Palo Alto, Calif. 94303 / (415) 321-1177 / Cable: PEMCO

LAPP HEAVY-DUTY ANTENNA INSULATORS

...in all these standard sizes to save you time and money

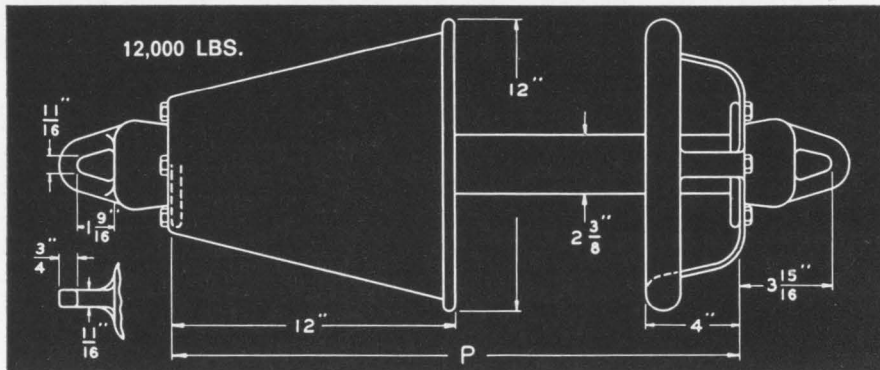

No. 9171, without ring or shield, for most high-strength applications. Standard "P" dimensions: 12, 16, 20, 24, 30 inches.

No. 9172, with two grading rings to raise voltage at which corona starts, and to distribute voltage to reduce heating of porcelain. Standard "P" dimensions: 20, 24, 30 inches.

No. 9173, with corona ring and rain shield, preferred for vertical installations. Standard "P" dimensions: 24 and 30 inches.

9,000 and 10,500 LBS.

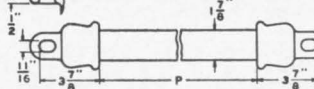

No. 43812 in porcelain (rated at 9,000 lb. average ultimate strength) or No. 43813 in steatite (10,500 lbs.), in standard "P" dimensions of 12, 14, 16, 20 inches.

6,000 and 7,000 LBS.

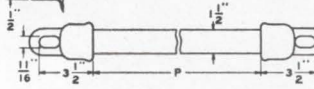

No. 43810 in porcelain (rated at 6,000 lb. average ultimate strength) or No. 43811 in steatite (7,000 lbs.), in standard "P" dimensions of 10, 12, 14, 16 inches.

4,000 and 5,000 LBS.

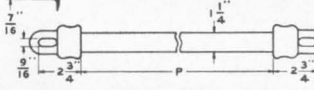

No. 43808 in porcelain (rated at 4,000 lb. average ultimate strength) or No. 43809 in steatite (5,000 lbs.), in standard "P" dimensions of 8, 10, 12, 14 inches.

FLASHOVER AND RADIO RATINGS

WET FLASHOVER 60 μ KV eff.				RADIO RATING KV eff.		
"P" Inches	All except No. 9172 No. 9173	No. 9172	No. 9173	All except No. 9172 No. 9173	No. 9172	No. 9173
8	45			21		
10	54			22		
12	62			23		
14	70			24		
16	77			24		
20	88	88		25	34	
24	96	96	60	27	37	34
30	108	108	108	28	40	38

Steatite Insulators will have the same Flashover but twice the Radio Rating.



WRITE for Bulletin 301-R.
Lapp Insulator Co., Inc.,
226 Sumner Street, LeRoy, N. Y.

directed with this method."

Keith G. Huntley, Farrington's vice president of engineering, says, "The Post Office's statements are without foundation. Our chairman of the board will soon have a conference with the Postmaster General. Things aren't what they seem."

Philco's rivals. The Burroughs Corp. is working on a system that uses flying-spot scanning and a best-match technique to recognize the zip code. The National Cash Register Co. is developing a system that uses a flying spot but recognizes the code through the use of a set of photographic plates.

Rabinow uses 540 photomultipliers to read the code, and a best-match technique for recognizing zip-code numbers.

Jacob Rabinow, president, says the Rabinow system, if ordered in a quantity of about 200, would cost about \$200,000 apiece. The system uses two stages for reading. The first stage finds the address, the second reads the code. An alphabetic section, for reading cities and states, can be added later," he declares.

The Detroit test will compare the efficiency of reading only zip code versus reading both zip codes and place names. Joseph Uhland, Philco's project engineer, asks, "What happens when the zip-code is missing or smudged beyond reading? A zip reader can't handle the letter. Our alphanumeric reader, in this case, would read the city and state, then still be able to sort by zip codes that would be stored in the memory. We've got more capability, and the price would be competitive with the zip-code readers."

But Rabinow disagrees. "If the code is smudged, the entire address will probably also be unreadable," he notes.

Burroughs and National Cash both decline to comment on the reading program.

During recent trials by the Post Office the Philco machine sorted 18,000 letters an hour, missing only 90, according to reports. It read 82 different zip codes, 20 cities and all 50 states. An advanced version will go to Detroit. It is reported to be able to sort 36,000 letters an hour and its cost, according to the best estimates obtainable, will be \$125,000 to \$150,000.

CLARE STEPPING SWITCHES

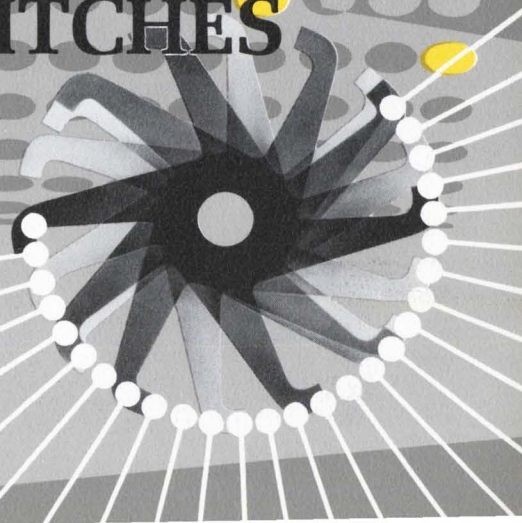

MASS SEQUENTIAL SWITCHING *with*

CLARE STEPPING & CAM SWITCHES

Longer Service Life • Greater Capacity • Freedom from Maintenance

Clare Stepping Switches provide the most compact, least expensive way to perform such sequential switching functions as counting, totalizing, sequence control, monitoring and similar operations. Special applications frequently involve such problems as shorting together all contacts of a level except one on a sequential basis. Clare has special assemblies available for this and other complex switching needs.

Clare Stepping Switches have many improved features which contribute to longer service life, greater capacity and unusual freedom from maintenance. These switches are compact, ruggedly built, and available in a wide variety of hermetically sealed enclosures and dust covers to insure long operating life under extremely severe environmental conditions.

Pound for pound, space for space, dollar for dollar, Clare Stepping Switches deliver maximum efficiency.

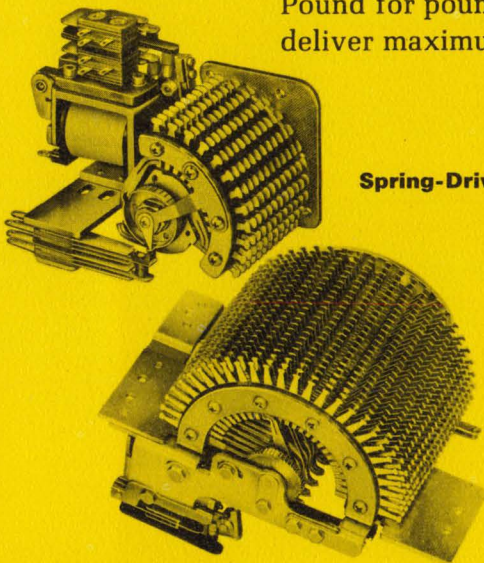

Spring-Driven Stepping Switches

For successively connecting one of a series of points to a common terminal. Multi-pole construction permits several circuits to be switched simultaneously, offers large switching capability in relatively small space. A variety of interrupter and "off-normal" contacts are available.

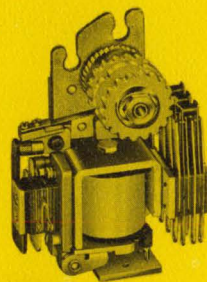

Spring-Driven Cam Switches

The Type 200 Cam Switch is a variation of the basic stepping switch, utilizing the same driving mechanism to rotate cams which, in turn, actuate cantilever contact assemblies. Interrupter contacts available.

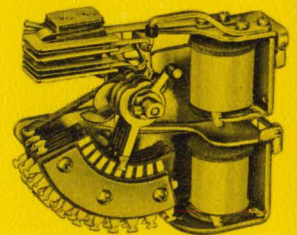

Direct Drive Stepping Switches

Direct Drive Stepping Switches offer a mode of switching quite similar to that provided by Types 210 and 211 Stepping Switches.

ELECTRICAL AND MECHANICAL CHARACTERISTICS OF SPRING-DRIVEN STEPPING SWITCHES AND CAM SWITCHES

Type	Points per Level	Levels (max)	Total Points (max)	Operating Speeds (sps)		Nominal voltages and Coil resistances
				Self-Interrupt	Remote Impulse	
210	10, 20 or 30	12	120	60 at nominal voltage; 25°C	30 at nominal voltage with 66% "on" time; 25°C	6, 12, 24, 48, 60 and 110 vdc 1.5-600 ohms
211	11, 22 or 33	12	132			
20	20 or 40	16	480			
26	26 or 52	16	624			
200	Up to 8 cams with up to 6 contact springs per cam and 30, 32 or 36 steps per revolution					

ENCLOSURES: Hermetically-sealed enclosures or dust covers, with solder terminals or plug connectors, are available for all Clare Spring-Driven Switches.

Use the Reader Service Card I Complete data, circle 285.



relays and related control components

C. P. CLARE & CO., GROUP 1N6, 3101 PRATT BLVD., CHICAGO, ILLINOIS 60645

ULTRA-COMPARATOR* Dual Limit Controls keep a test rocket engine on its best behavior

At the Rocketdyne Division of North American Aviation, scientists and engineers are continually checking out the most advanced rocket engines. Costly to build, these rocket engines may unexpectedly head for destruction when critical parameters go outside rated limits. To monitor or shut down rocket engines and prevent damage, fast, sensitive, reliable controls are needed. For this job, Rocketdyne is using Carter-Princeton Model 2020 ULTRA-COMPARATOR Dual Limit Controls at five critical points. The 2020 combines two 100K input impedance comparators on one small-size, computer-type, plug-in circuit card. Highly reliable, capable of evaluating low-level electronic signals without pre-amplification, it has the fastest power-relay output yet achieved—5 milliseconds from signal to full 2-ampere output. Here are Rocketdyne's applications:

1. Monitors at "Ignition Start" to pre-determine potential "stall condition," providing fast cut-off. 2. Monitors an actuator-posi-

tion signal from a linear feed-back transducer, causing an instant engine cut if engine is not following a pre-determined pattern. 3. Monitors hydraulic pressure across the piston on gimbal actuators, permitting quick check to see that the load is below safe acceptable limits. 4. Aids in bleeding air from the gimbal actuators by permitting a constant velocity actuator displacement. 5. Monitors function generator output for level detection in order to set up logic circuits which give wave shapes for the determination of gimbal patterns.

The Model 2020 circuit is one of a series of new ULTRA-COMPARATOR units offering high sensitivity, compactness, reliability and adaptability at substantial savings. A limited number are available for free trial and evaluation.

For information, details, and specifications, contact Carter-Princeton, Electronics Division, Carter Products, Inc., 178F Alexander Street, Princeton, N.J. 08540. Phone (609) 921-2880.

 **CARTER-PRINCETON**

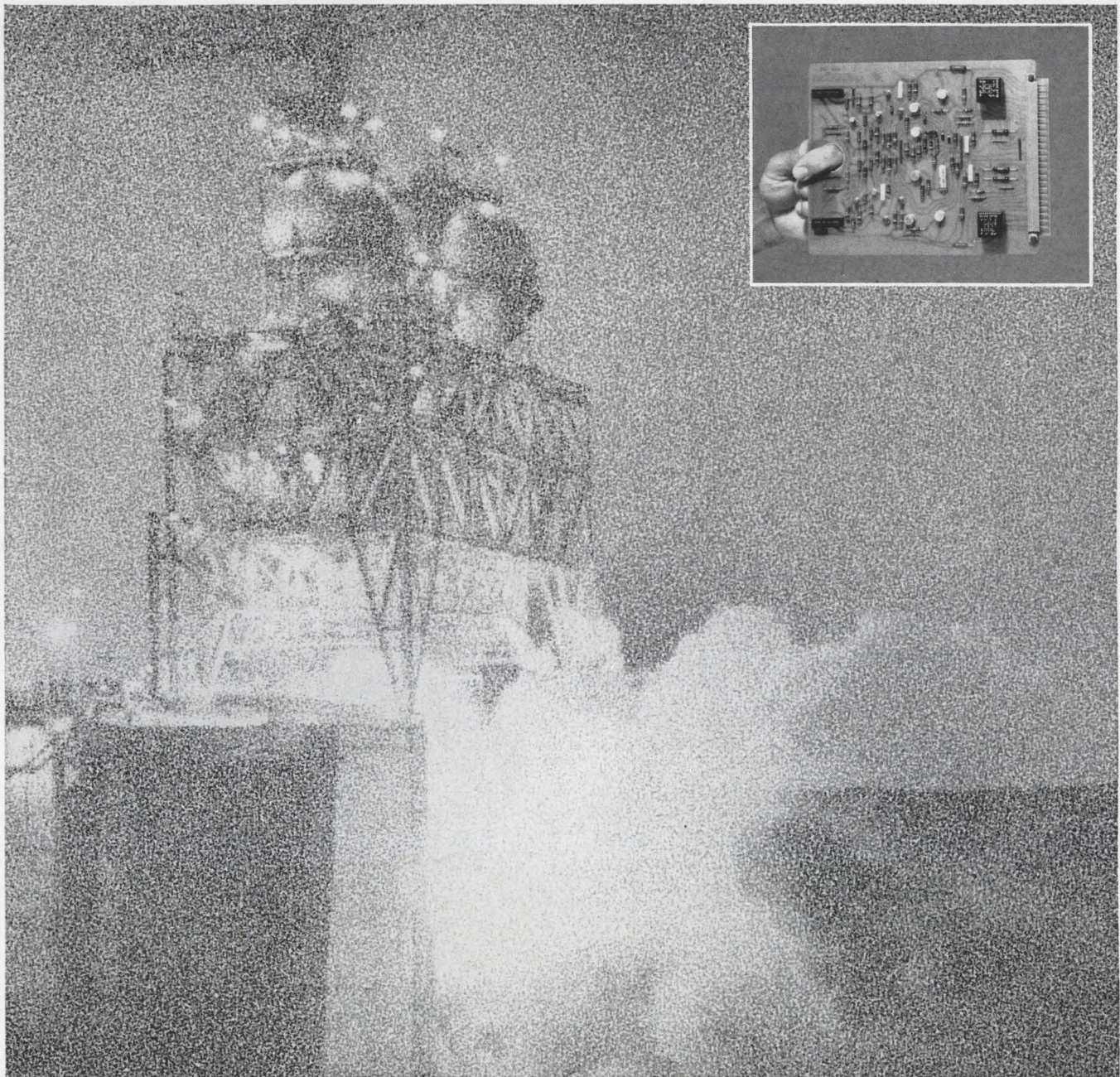

* Trademark Pats. Applied For



It's got a lot of living to do!

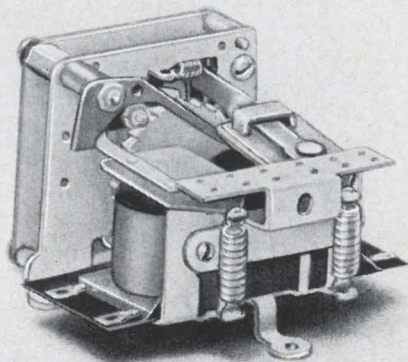

This long-life Guardian MER electrical-reset stepper was good before—had a life of at least 1,500,000 steps. But our Product Improvement Laboratory wasn't satisfied . . . felt that even more was possible. So they went to work. And through changes in design and materials they tripled its life . . . without increasing its cost.

Now you can anticipate at least 5,000,000 operations from this MER stepper—and chances are you'll do even better. This isn't wishful thinking—we actually operate these steppers to failure to find out what they'll do.

So if you need smooth, high-speed stepping with dependable responses and long life, specify Guardian MER Steppers. Bulletin F tells all. Write today for your copy without cost or obligation.

GUARDIAN®  ELECTRIC

Guardian Electric Mfg. Company, 1550 W. Carroll Ave., Chicago, Ill., Dept. EC 51

~~5,348~~ relay types...

Chalk up another line
at Struthers-Dunn...

MERCURY WETTED CONTACT RELAYS!

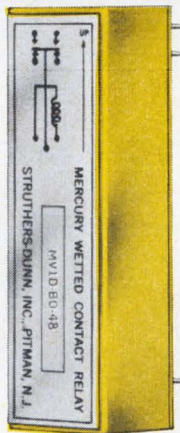

Bridging Types

Non-bridging types

- * Operating life of 1,000,000,000 operations, minimum
- * Spring biased, single side-stable, polarized, or chopper types.
- * Plug-in or printed circuit mounting.
- * Get catalog from your Struthers-Dunn Distributor. Or write us direct.

STRUTHERS-DUNN, Inc.

Pitman, New Jersey 08071

WORLD'S LARGEST, MOST DIVERSIFIED RELAY LINE.



SALES ENGINEERING OFFICES IN: Atlanta • Belmont, Calif. • Boston • Buffalo • Charlotte • Cincinnati
Clearwater, Fla. • Cleveland • Clifton • Dallas • Encino • Englewood • Glen Ellyn, Ill. • Kansas City
Memphis • New York • Orlando • Phoenix • Pittsburgh • St. Louis • Salt Lake City • San Antonio
Seattle • Southfield • Wichita • Wilmette. Canadian Licensee: Renfrew Electric Co., Ltd., Toronto.
Export Department: 1505 Race St., Philadelphia, Pennsylvania 19102, U.S.A.

Microelectronics

The Cermet Story

A Highly Sophisticated Versatile Material
with Unique Features and Varied Applications

Scientists and Engineers at CTS Corporation, Elkhart, Indiana, began over thirty years ago a continuing search for superior resistive materials. Hundreds of basic materials and thousands of resistive compositions have been analyzed, and the search will undoubtedly continue indefinitely. But several years ago a portion of this search was focused on ceramic-metallic compositions. The outcome of these investigations and the resulting applications are "The CERMET Story".

Most mixtures of ceramics and metals are either highly conductive or highly insulative depending upon their percentage composition, but several years ago mixtures of noble metals and glass frits were discovered which were semiconductive over narrow ranges. These early formulations were not commercially useful because of high current noise, high voltage and temperature co-efficients of resistance, and very poor reproducibility. These early formulations could be varied through a range of only a few hundred ohms per square. If formulations varied beyond a critical point, the resistivity of the film often decreased abruptly from a relatively high value to a very low one.

The Discovery

After several years of continuous study the CTS research staff learned to control the relationship between resistivity and the ingredient formulations. Improvements in noise, temperature and voltage stability, and reproducibility were also achieved. By 1958 CTS scientists and engineers had perfected a family of stable, reliable, economic, semiconducting films. This result led to the now famous CTS CERMET product line.

Production Methods

CERMET films are produced by screening formulations of conductive and insulating materials onto

ceramic substrates. After firing at temperatures in excess of 600°C, a semiconducting alloy is formed which is permanently bonded onto the insulating substrate. A circuit or component produced in this manner is remarkably rugged and able to resist abrasion, heat-shock, humidity, oxidizing atmospheres, overload, and other environmental stresses.

Applications

CERMET films can also meet the demands of severe economic environments. Screening is a relatively simple process well adapted to automation. Resistors, capacitors and conductive networks can all be applied to a substrate by the same techniques and fired to fuse the components into an integrated circuit. External lead connections can be made by solder dipping the entire unit. (CERMET components are not damaged by the temperature of molten solder.) No costly high vacuum methods or elaborate mask making is required. Thus, many CERMET products are directly competitive with conventional items.

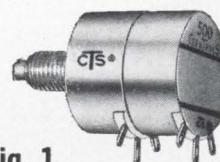

Fig. 1

CTS Corporation initially used CERMET films as resistive elements in potentiometers and trimmers. The dual tandem CERMET potentiometer (Fig. 1) is being used to replace wirewound units in commercial communications equipment for greater reliability and improved resolution.



Fig. 2

The reliability and the stability of CERMET films has been confirmed by the use of CTS CERMET trimmers, (Fig. 2) in electronic pacemakers inserted into the bodies of heart disease patients.



Fig. 3

CERMET films have also found ready acceptance as a material for manufacturing fixed resistors. The very high resistances available in short straight paths (for example, one megohm in .025" x .075" size) have made CTS CERMET films the logical choice for fixed resistors deposited on T05 headers (Fig. 3).

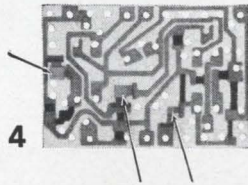

Fig. 4

In 1963 CTS developed a CERMET capacitor which is fully compatible with the CERMET resistance film. The CTS CERMET capacitor can be manufactured by the same inexpensive screening techniques and is fully operable over the same severe environmental conditions as are CERMET resistance films (Fig. 4).

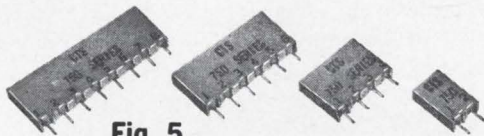

Fig. 5

CTS customers also asked for semiprecision resistor networks deposited onto ceramic blocks which can be automatically inserted into printed circuit boards.

The resulting product (Fig. 5) has found extensive use in commercial data processing equipment.

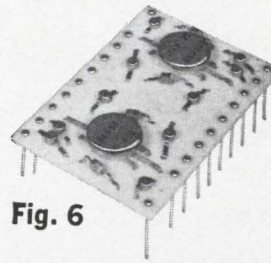

Fig. 6

The most recent chapter of the CERMET story has been written by a family of CTS CERMET hybrid integrated circuits which provide the basic building blocks for digital logic functions. The dual flip-flop (Fig. 6) has 14 diodes and 4 transistors on the upper side and 20 CERMET resistors, 4 CERMET capacitors, a CERMET lead crossover, and a CERMET conductive network on the under surface. A dual nand gate, a bistable flip-flop, a one shot multi-

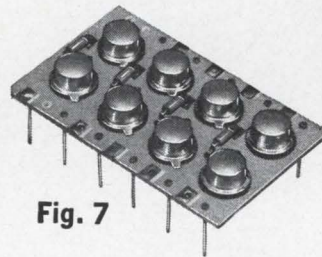
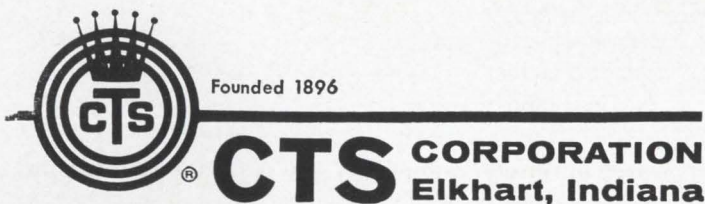

Fig. 7

vibrator, an oscillator, a quad nand gate, and a quad analog gate (Fig. 7) are also being produced. These CERMET hybrid integrated circuits permit the circuit designer to combine the best available discrete active devices with rugged CTS CERMET passive components manufactured to extremely close tolerances. CTS hybrid integrated circuits provide excellent power handling capability, superior high frequency performance, and freedom from parasitics. CTS CERMET hybrid integrated circuits can also be made available in production quantities with relatively short lead times. The Re-entry Systems Department of General Electric Company was recently able to develop and deliver, in only sixteen weeks, a re-entry vehicle using CTS CERMET hybrid integrated circuits.

What are your requirements for advanced micro-electronic components or circuits? Your latest "design headache" may provide the plot for the next chapter in "The CERMET Story".

Write for a complete CERMET data kit.



Sales Offices and Representatives conveniently located throughout the world.

Principal Products
Variable Resistors
Selector Switches
Loudspeakers
Trimming Potentiometers
Microminiature Components
& Circuit Packages

Subsidiaries
CTS of Asheville, Inc., Skyland, N. C.
CTS of Berne, Inc., Berne, Indiana
CTS of Paducah, Inc., Paducah, Kentucky
Chicago Telephone of California, Inc.,
South Pasadena, Calif.
CTS of Canada Ltd., Streetsville, Ontario
CTS Microelectronics, Inc., Ridgefield, Conn.
CTS Research, Inc., Lafayette, Ind.

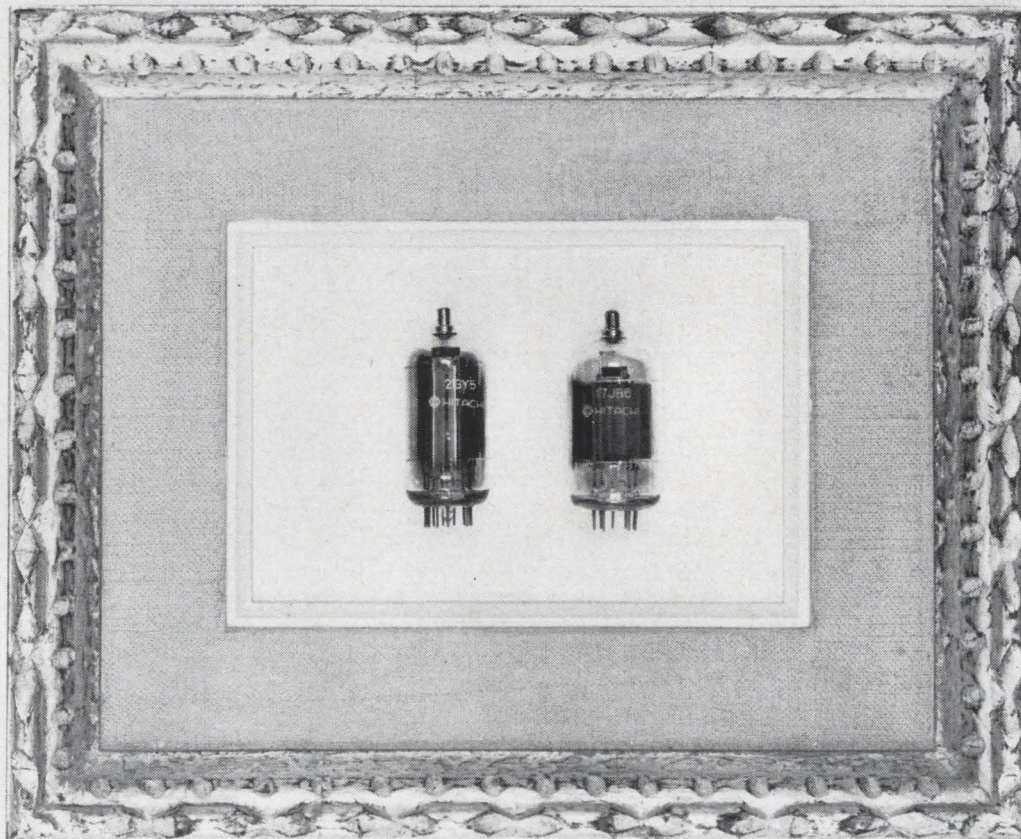

A masterpiece in color

A Tintoretto may be your preference . . . but these nine and twelve pin receiving tubes can bring in a color TV picture that's just as much a masterpiece. They're the latest in the Hitachi receiving tube family.

As we're speaking to experts there's little point trying to blind you with science. It's sufficient to say simply, that Hitachi manufactures the whole gamut of receiving tubes. For radios, phonographs and TV sets.

Hitachi experience and research facilities rank with the most formidable in the world. And their ceaseless and tenacious efforts in developing for tomorrow are without regard for time or expense. The budget for this development work alone runs to \$ 3,000,000 yearly!

That's our message put down as simply as possible . . . we hope you get the picture.



HITACHI SALES CORPORATION 333, N. Michigan Avenue, Chicago 1, Ill., U.S.A. 666, 5th Avenue, New York, N.Y. 10019, U.S.A. 12715, S. Daphne Avenue, Hawthorne, Calif., U.S.A. HITACHI, LTD. DUESSELDORF OFFICE Graf Adolf Strasse 37, Duesseldorf, West Germany BUENOS AIRES OFFICE Avenida de Mayo 666 Piso 12, Buenos Aires, Argentina SAO PAULO OFFICE Rua Direita, 250-23 Andar S/5, Sao Paulo, Brazil INTERNATIONAL IMPORTERS, INC. (Agent in U.S.A.) 2242, S. Western Avenue, Chicago, Ill., U.S.A.

If you think
the BR-16
(half size) is a
small Hy-Rel
relay



Check our BR-10
(1/6 size)

units shown actual size

Babcock's new BR-10 1/6-size crystal can relay will switch dry circuit to 1-amp loads with the same sensitivity as DPDT types many times its size. Designed for low profile mounting, it exceeds MIL-R-5757D requirements and withstands severe environmental conditions encountered in airborne applications. Available both single pole and double pole.

For 2-amp contact requirements, the Babcock BR-17 (latching) and BR-16 (non-latching) half-size crystal can relays provide the same reliability and, like the BR-10, incorporate the exclusive Babcock Vycor getter to adsorb outgassed organic contaminants after production degassing. Various mounting arrangements and either plug-in or solder hook terminals can be supplied as standard. Write for complete details in our new 24-page catalog.

	BR-16	BR-17	BR-10T	BR-10W
Operation	Non-Latching	Latching	Non-Latching	Non-Latching
Contact Arrangement	DPDT	DPDT	DPDT	DPDT
Construction	All Welded	All Welded	Solder Seal	All Welded
Sensitivity	175mw	175mw	100mw	100mw
Contact Rating	2A @ 26VDC	2A @ 26VDC	1A @ 26VDC	1A @ 26VDC
Size	.131 cu. in.	.131 cu. in.	.046 cu. in.	.046 cu. in.
Weight	.25 oz.	.25 oz.	.15 oz.	.15 oz.
Vibration	30g 30-2000 cps	30g 30-2000 cps	30g 40-3000 cps	30g 40-3000 cps
Shock	50g 11 msec.	50g 11 msec.	150g 11 msec.	150g 11 msec.

BABCOCK RELAYS

A DIVISION OF BABCOCK ELECTRONICS CORPORATION
3501 HARBOR BLVD., COSTA MESA, CALIF. - (714) 546-2711

The Ultimate in COMMUTATION
**FIELD EFFECT
LOW LEVEL
COMMUTATORS - MULTICODERS
MULTIPLEXERS**



THE NEW DYNAPLEX
TYPE 360 UNITS

Featuring

- ✓ Extremely Low Backcurrents
- ✓ Higher Differential Input Impedance
- ✓ RUGGED Environmental Capability
- ✓ IRIG Output Formats, PAM, PDM, Record PDM
- ✓ Self-Contained Amplifier Set For Your Full Scale Input Range
- ✓ Lower Offsets

POST OFFICE BOX 341

PRINCETON, N. J. 08540

Phone: (609) 394-5201

DYNAPLEX
CORPORATION

TWX No. 609-695-3381

Differential v-m's offer high accuracy

Completely portable, these solid-state instruments may be either line-only, or line-and-battery powered

Two new solid-state differential voltmeters have been developed. Series 871 and 873, d-c and a-c/d-c units, respectively, are available in either 50 to 440 cps, 115/230 v line-powered-only, or combination line-and-battery powered models. Battery life is 30 hours minimum, and the instruments' performance is not degraded in any manner while the batteries are being recharged. One of the great advantages of battery operation is the elimination of measurement inaccuracies caused by ground loops.

Range of the new instruments—0 to 1,000 v a-c or d-c with 10% overranging—is said to be more than twice that of the manufacturer's earlier voltmeters. Sensitivity is ten times as great. Input impedance is infinite at null up

to 11 v d-c for true potentiometric measurements, and an excellent 10 megohms above 11 v d-c.

D-c accuracy is $\pm 0.03\% + 10 \mu\text{v}$. A-c accuracy from 30 cps to 10 kc is $\pm 0.2\%$ of input $+ 25 \mu\text{v}$ (0.001 to 1,100 v) and $\pm 0.3\%$ from 0.1 to 1,100 v over the 20 cps to 20 kc range. The manufacturer processes each zener diode reference to prove 0.005% per year stability. Ratio stability of the company's resistors is 0.0025% per year. Temperature coefficient for reference and critical resistors is 0.0005%/°C and 0.0004%/°C, respectively.

A major application for these new voltmeters, and where they do a better job than the 500 v reference units, is to monitor stability of voltages as a function of time.



Model 871AB is a line-and-battery powered d-c differential voltmeter

In analog computers, a reference level, normally 100 v, is established. The accuracy of the computer is dependent on the accuracy and stability of the 100 v. It is common to use a differential voltmeter to monitor the 100 v in conjunction with a strip chart recorder. Thus a 24-hour record of the 100 v can be made with excellent resolution (2 ppm/division). Because of the stable reference in the 871A, voltmeter instability can now be neglected in making measurements.

Five-digit readout with automatic decimal point and mode indicator insures quick, accurate readings. Perfect null is obtained by using a precision, single-turn pot at the output of the Kelvin Varley divider.

The completely portable voltmeters weigh 13 lb in the line-power-only version and 14 lb with battery power too. Size is 7 in. high by 8½ in. wide by 11¾ in. deep. Instruments are equipped with resilient feet and tilt-up device for field and bench use. Attaching metal handles allows half-rack or side-by-side mounting. The clean sealed cabinet keeps dirt and moisture out.

Price of the series 871 d-c differential voltmeter is \$565 for the line-powered model and \$695 for the battery-and-line-powered model. John Fluke Mfg. Co., Inc., Box 7428, Seattle, Wash., 98133.

Circle 350 on reader service card

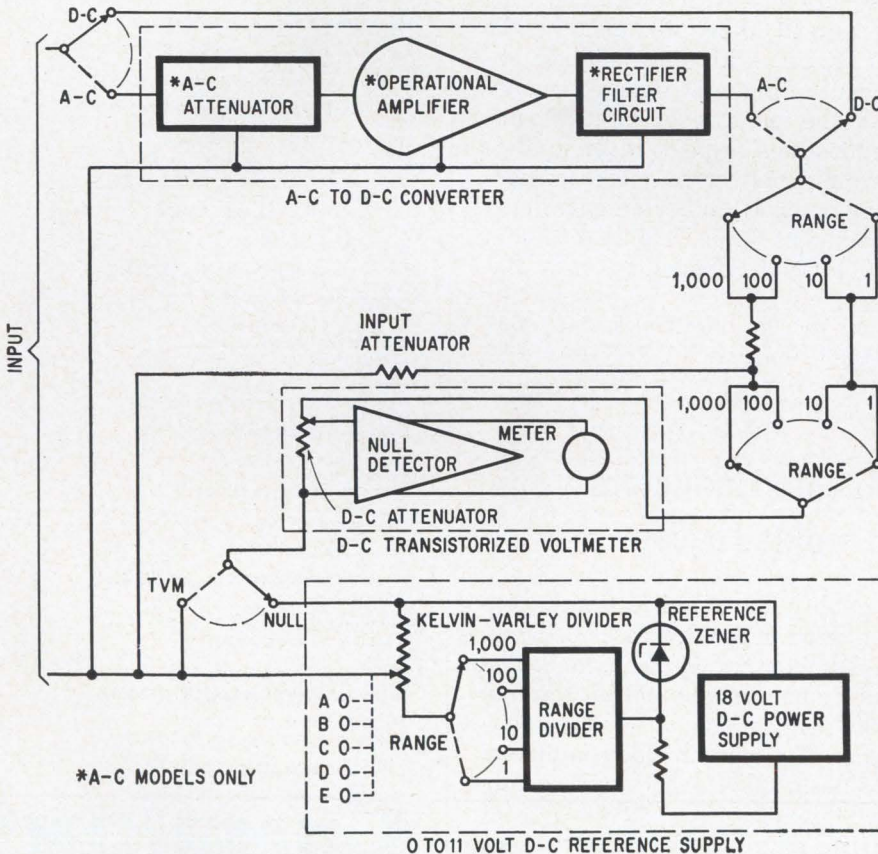

Block diagram is valid for either model, with the a-c/d-c converter used in the 873 line-powered model only

Mercury-wetted miniature reed relays

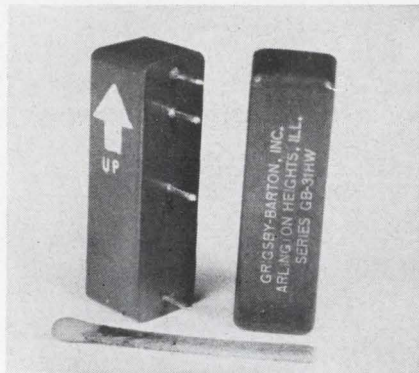

New miniature reed relays with mercury-wetted contacts provide a switching mechanism yielding the ultimate in reliability, according to the manufacturer. They are tested to exceed one billion operations under dry circuit conditions (current passing through the contacts in the microamps). The relays are

said to be the ideal combination of high-speed switching with low-contact resistance and high-power capacity. They can be used with other discrete components that have been reduced in size. Measuring only 1.375 by 0.450 by 0.450 in., the relay is transfer-molded in epoxy (blue is standard—other colors are optional). The contacts are conservatively rated at 3 amps 28 v d-c resistive, and there is no contact bounce. Life at full load is 10×10^6 cycles, and at dry circuit a minimum of 10^{12} cycles. Since mercury-wetted reed relays must be mounted within 30° of vertical, the contact pin locations for p-w board mounting have been arranged nonsymmetrically to prevent incorrect assembly.

Grigsby-Barton, Inc., 107 N. Hickory Ave., Arlington Heights, Ill. [351]

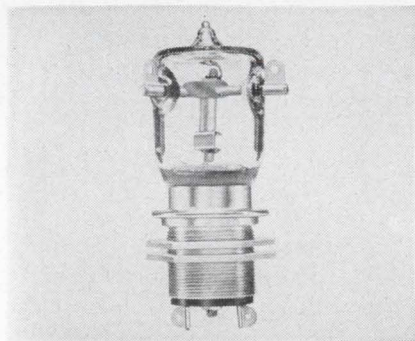

Vacuum relay adapts to many applications

A high-voltage vacuum relay now in production is available in any of three contact forms, and three mounting configurations. It can be supplied in spst, spdt, and dpdt configurations, and with solder-flange mountings, threaded-base, or 3-hole mountings—all standard. Operating voltage is 20 kv; max current, 15 amps d-c; max switching time, 15 millise; nominal coil voltage, 26.5 v d-c. Units measure $1\frac{1}{16}$ in. diameter by $2\frac{3}{4}$ in. high. Variations of the aforementioned

are supplied with operating voltages up to 30 kv (oil), and a height of $\frac{1}{4}$ in. with only slightly reduced ratings. Designated model H-8, the unit is used in ecm, communications, sonar, radar, pulse-forming networks, medical electronics, and other high-voltage equipment. Price, 1 to 24 pieces, is \$90 to \$100, depending on variations.

High Vacuum Electronics, Inc., 537 Mission St., South Pasadena, Calif. [352]

Shielded inductors in molded cases

A quality line of shielded inductors is offered in molded cases 0.156 in. in diameter and 0.375 in. long. The inductance range is 0.1 μ h through 1,000 μ h in standard 10% tolerances. Type 15 shielded inductors are designed to meet requirements of MIL-C-51305C (MS90537) and MIL-C-39010. Axial leads are of oxygen-free copper with 60/40 solder coating. For increased copper

Exclusive CAMBION Distributors

- ALABAMA, Huntsville
Electronic Wholesalers, Inc. (534-2461)
- ARIZONA, Phoenix
Midland Specialty Co. (258-4531)
- CALIFORNIA, Gardena
Santa Monica Bell Electronic Corp. (FA1-5802)
Inglewood
Newark Electronics Co., Inc. (OR8-0441)
Menlo Park
Bell Electronic Corp. (DA3-9431)
Paramount
Elwyn W. Ley Co. (NE3-5108)
San Carlos
Moulton Electronics Distributors, Inc. (591-8292)
- COLORADO, Denver
Newark-Denver Electronic Supply Corp. (SK7-3351)
- CONNECTICUT, Brookfield
Lobdell Sales Co. (354-2000)
- DISTRICT OF COLUMBIA, Washington
Electronic Wholesalers, Inc. (483-5200)
- FLORIDA, Melbourne
Electronic Wholesalers, Inc. (723-1441)
Miami
Electronic Wholesalers, Inc. (OX6-1620)
Orlando
Crescent Electronic Sales Company (423-8586)
- GEORGIA, Atlanta
Specialty Distributing Co., Inc. (TR3-2521)
- ILLINOIS, Chicago
Merquip Electronics, Inc. (AV2-5400)
Newark Electronics Corp. (ST2-2944)
- INDIANA, Ft. Wayne
Ft. Wayne Electronics Supply, Inc. (743-3431)
Indianapolis
Graham Electronics Supply, Inc. (MC4-8486)
Radio Distributing Co. (ME7-5571)
- LOUISIANA, New Orleans
Southern Radio Supply Co., Inc. (524-2345)
- MARYLAND, Baltimore
Kann-Ellert Electronics, Inc. (TU9-4242)
Silver Spring
Federated Electronics (JU8-6830)
- MASSACHUSETTS, Boston
DeMambo Electronics (783-1200)
Cambridge
R & D Electronics Supply Co., Inc. (868-6644)
- MICHIGAN, Detroit
Newark-Ferguson Electronics, Inc. (J04-5490)
- MINNESOTA, Minneapolis
Northwest Electronics Corp. (331-6350)
- MISSOURI, Kansas City
Engineering Supply Co. (HA1-5670)
University City
Olive Industrial Electronics, Inc. (V03-4051)
- NEW JERSEY, Camden
General Radio Supply Co., Inc. (W04-8560)
Springfield
Federated Purchaser, Inc. (DR6-8900)
- NEW MEXICO, Albuquerque
Kierulff Electronics Co., Inc. (268-3901)
- NEW YORK, Bellmore, L.I.
Car-Lac Electronic Industrial Sales Inc. (CA1-1441)
Binghamton
Stack Industrial Electronics, Inc. (RA-3-6326)
Buffalo
Standard Electronics, Inc. (883-5000)
New York City
Newark-Electronics Center, Inc. (AL5-4600)
Terminal-Hudson Electronics, Inc. (CH3-5200)
- NORTH CAROLINA, Winston-Salem
Electronic Wholesalers, Inc. (725-8711)
- OHIO, Cincinnati
United Radio, Inc. (241-6530)
Cleveland
Pioneer Standard Electronics, Inc. (432-0010)
Columbus
Hughes-Peters, Inc. (AX4-5351)
Dayton
The John A. Becker Co. (BA4-1071)
Radio Distributing, Inc. (299-2333)
- OKLAHOMA, Tulsa
Engineering Supply Co. (LU3-8121)
- PENNSYLVANIA, Harrisburg
D & H Distributing Co., Inc. (CE6-8001)
Philadelphia
Philadelphia Electronics, Inc. (L08-7444)
Pittsburgh
Cameradio Co. (EX1-4000)
- TENNESSEE, Nashville
Electra Distributing Co. (AL5-8444)
- TEXAS, Dallas
Engineering Supply Co. (FL7-6121)
El Paso
McNicol, Inc. (L06-2936)
Houston
Busacker Electronic Equip. Co., Inc. (JA6-4661)
- UTAH, Salt Lake City
S. R. Ross, Inc. (DA8-0591)
- WASHINGTON, Seattle
C & G Electronics Co. (MA4-4355)
- CANADA
ONTARIO, Ottawa
Wackid Radio Television Labs, Ltd. (CE2-3563)
Toronto
CESCO Electronics, Ltd. (921-5111)
Electro-Sonic Supply Co., Ltd. (WA4-9301)
- QUEBEC, Montreal
CESCO Electronics Ltd. (UN1-2411)

CAMBION®

Standardize on CAMBION...

The Guaranteed Electronic Components

Circle 144 on reader service card

Electronics | January 11, 1965

Exclusive CAMBION® DIAL-A-PART Night/Day Service

“Can Cambion rush me from stock, 500 quarter inch tunable printed circuit coils with 8.20 μ h mean inductance?”



“Yes, or 48 other values... 400 other standard coil types, too!”

Need it “yesterday?”

Place your order when you place your call. Just phone your local distributor now, or take advantage of CAMBION'S new DIAL-A-PART 24-hour service. Simply dial (617)876-2800 any time Monday through Friday.

West Coast customers — don't wait a day! CAMBION'S exclusive DIAL-A-PART day and night service is your best bet to beat the clock.

Call out the part you need from easy-to-use CATALOG 700 listing more than 15,000 guaranteed CAMBION electronic components. There's no delay for time consuming paper work — your shipment of uniform top quality standard components gets to you directly with record speed. It's the closest thing to automated ordering in electronics. CAMBION'S extensive dis-

tributor network backed up by new DIAL-A-PART service gives you definite product availability daytime, nighttime . . . anywhere you are.

Need assistance on the right part for a specific application?

DIAL-A-PART! Whenever, wherever you need specifying aid, CAMBION applications engineering service is at your beck and call. To save you the expense of specials, or for your complex applications, we'll dispatch a CAMBION Field Engineering Representative qualified to evaluate your problems on the spot — and recommend the CAMBION components tailored to your application. Call Now, Call Anytime . . . DIAL-A-PART . . . (617)876-2800, CAMBRIDGE THERMIONIC CORPORATION, 201 Concord Avenue, Cambridge, Massachusetts 02138.

CAMBION®

Standardize on CAMBION . . . The Guaranteed Electronic Components

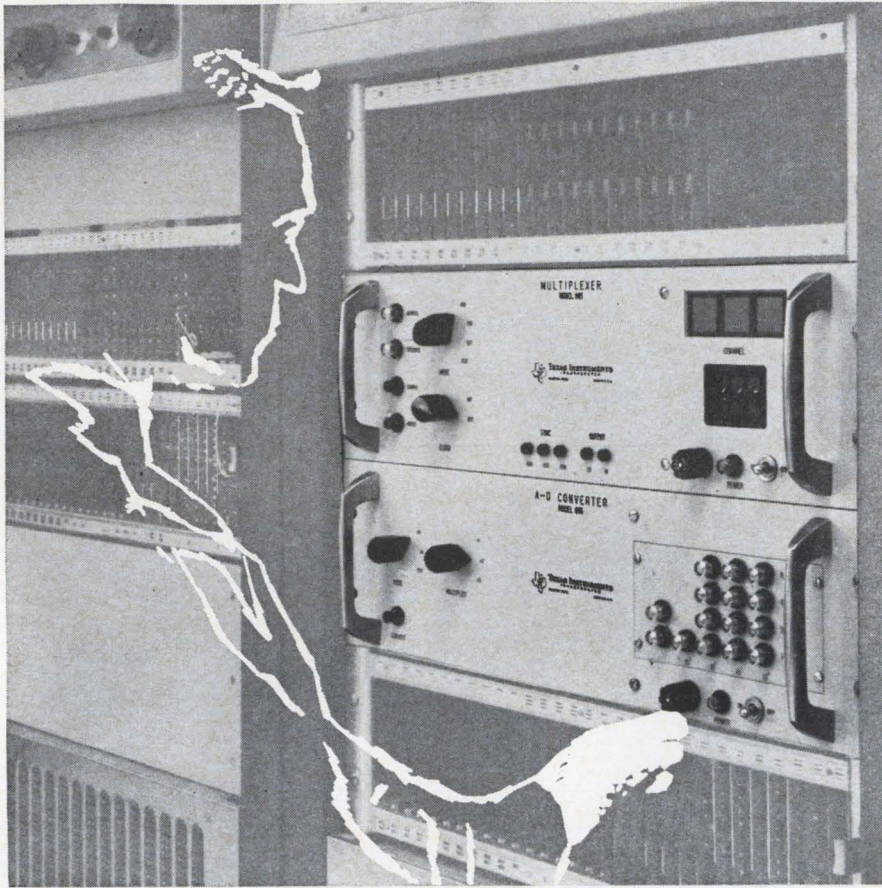

Accurate Data Sampling and Conversion at 50 KC plus

Model 846 A-D Converters, in straight binary or BCD code, include an integral sample and hold circuit with 100 nanosecond aperture and automatic zero stabilization. Accuracy at 50 kc is 0.025% full scale . . . *sample and hold included!* Offered in a wide choice of input specifications, logic levels and output codes, plus D-A conversion option.

Model 844/845 Multiplexers feature 0.01% linearity with low dynamic crossfeed, fast settling time and variable sample duration. Choose from addressable, sequential, direct channel select, or combined addressable/sequential—all accommodate input levels to ± 10 volts. Basic capacities of 10 and 16 channels can be expanded tenfold with plug-in PC cards.

Ask a TI Application Engineer for further information on digital data handling equipment for your specific needs; one model must meet your requirements!

INDUSTRIAL
PRODUCTS
GROUP



TEXAS INSTRUMENTS
INCORPORATED
P.O. BOX 66027 HOUSTON, TEXAS 77006
7 RUE VERNONNEX GENEVA, SWITZERLAND

New Components

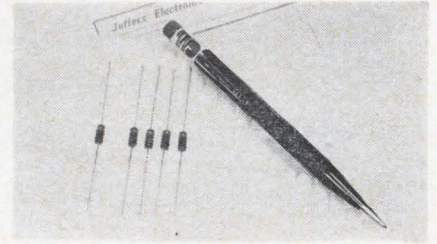

weldability, a pure tin coating can be supplied. The manufacturer can also supply various weldable lead materials.

Jeffer's Electronics, a division of Speer Carbon Co., Theresia St., St. Marys, Pa. [353]

Metalized Mylar miniature capacitors

A series of miniature, metalized Mylar capacitors—types MDWR and MDW—feature a self-healing capability. Utilizing Mylar film as a dielectric, these capacitors are wrapped in a skin-tight plastic tape with an epoxy resin end fill. This construction offers excellent resistance to humidity and is intended for use where space is at an absolute premium. Type MDWR is a tubular model; type MDW is available as a flat-case unit. Both models are available in 200, 400 and 600 v d-c, in capacitance ranges from 0.01 to 10.0 μf . Capacitors are designed to operate over a temperature range of -55° to $+125^{\circ}\text{C}$ without derating. Capacity tolerance is $\pm 20\%$ at 1,000 cps for units up to 0.82 μf , and $\pm 20\%$ at 60 cps over 1.0 μf ; tolerances of 10%, 5% and 1% are available upon request. Film Capacitors, Inc., 100 Eighth St., Passaic, N. J. [354]

Variable capacitor features high Q

A new variable air capacitor, measuring only 0.220 in. in diameter and 15/32 in. long, features a Q factor of better than 5,000 at 100 Mc. The capacitors are available with printed-circuit terminals (model 4642) or turret terminals (model 4640). The new units also feature

a capacitance range of 0.4 pf to 6 pf. Manufactured in coin silver, gold-plated brass and glazed alumina ceramic insulation, the capacitors are nonmagnetic and extremely rugged. Threaded caps with internal silicone-seal washer provide moisture and dust seal.

Johanson Mfg. Corp., 400 Rockaway Valley Road, Boonton, N.J. [355]

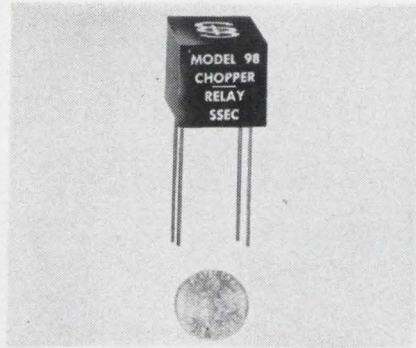

Chopper-relay for d-c to 5 kc

The model 98 chopper-relay is said to represent a breakthrough in isolated-switching circuit design capable of creating new versatility of application within electronic systems. It is a completely solid-state inertialess design, employing silicon semiconductors and magnetic components to achieve complete isolation between drive and signal, previously unattainable, according to the manufacturer. Model 98's typical low noise of 25 μ v makes it ideal for switching low-level signals. The dynamic range can extend from $\pm 75 \mu$ v to ± 20 v. Solid State Electronics Corp., 15321 Rayen St., Sepulveda, Calif. [356]

Foil heating elements for space industry

FEP heat-sealable-Teflon insulated foil heating elements are being made as thin as 0.004 in. and having a 1,500-v dielectric capability. They combine the ruggedness of heat-sealable Teflon-coated glass cloth with the superior thermal characteristics of a foil resistance element, satisfying the rigid environmental requirements of the

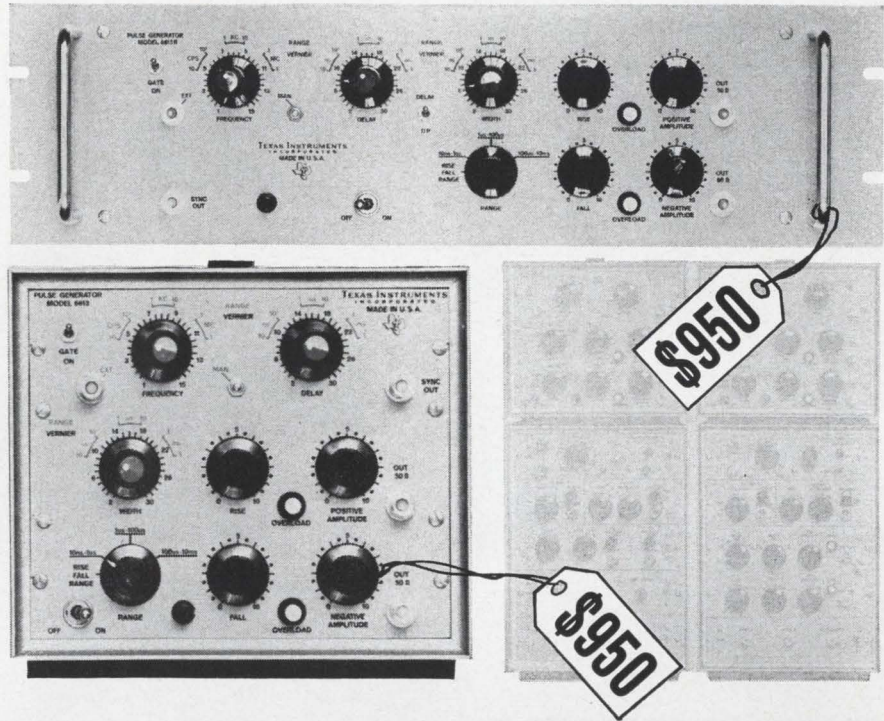

more general-purpose features, higher performance and quality with TI's 6613 pulse generator

The Model 6613 General Purpose Pulse Generator fills the need for a low-cost, high-quality test instrument with exceptional performance specifications. It is a general purpose instrument ideal for most pulse applications such as testing integrated circuits, digital circuit design, system design and checkout, testing of diodes and transistors.

The 6613 provides coincident positive and negative pulses determined by an internal clock generator or external source, with rep rate variable in 6 steps. Pulse width and delay are also variable in 6 steps. Amplitude is variable from near zero to 10 volts, with overload protection provided. Solid-state circuitry is utilized throughout. The compact unit measures 8½ in. high, 8½ in. wide, 12 in. deep and weighs only 10 lb.

SPECIFICATIONS

Clock Pulse Repetition Frequency

15 cps to 150 cps	15 to 150 kc
150 to 1500 cps	150 kc to 1.5 mc
1500 cps to 15 kc	1.5 mc to 15 mc

Delay

30 to 300 nano-sec	30 to 300 microsec
300 nanosecs to 3 microsec	300 microsec to 3 millisecc
3 to 30 microsec	3 to 30 millisecc

Width

30 to 300 nano-sec	30 to 300 micro-sec
300 nanosecs to 3 microsec	300 microsec to 3 millisecc
3 to 30 microsec	3 to 30 millisecc

Pulse Amplitude—10 v into 50 ohms

Rise and Fall Times—variable: less than 10 nanosecs to 1 microsec, 1 microsec to 100 microsec, 100 microsec to 10 millisecc, minimum rise time typically 8 nanosecs

INDUSTRIAL PRODUCTS GROUP



TEXAS INSTRUMENTS INCORPORATED

P. O. BOX 66027 HOUSTON, TEXAS 77006
7 RUE VERNONNEX GENEVA, SWITZERLAND

712

MORE

Value
IN
METERS

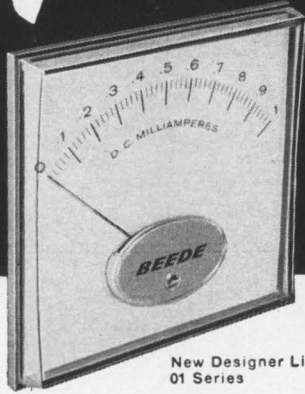

New Designer Line
01 Series

FROM BEEDE



Edgewise Model E-25

Traditional Style Model 16

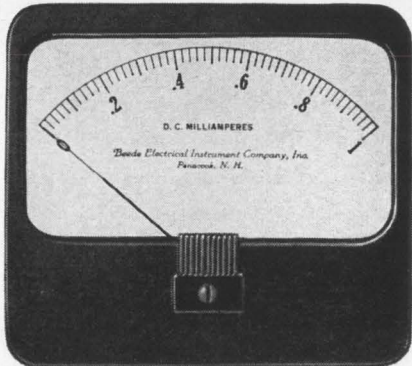

Quality.... Beede's quality control program insures meter performance to customer's specifications.

Delivery... Dependable promises every time so that you can set and meet your production schedule.

Style.... A variety of styles for every need from our new "Designer Line" to the traditional case styles.

Price.... Realistic, competitive prices on every style.

D.C. current sensitivities from 20 microamps; D.C. voltage sensitivities from 3 millivolts.

Write for our new illustrated brochures giving full specifications on our complete line.

BEEDE

ELECTRICAL INSTRUMENT CO., INC.
PENACOOK, NEW HAMPSHIRE

Area Code: 603-753-6362 TWX: 603-753-4727

New Components

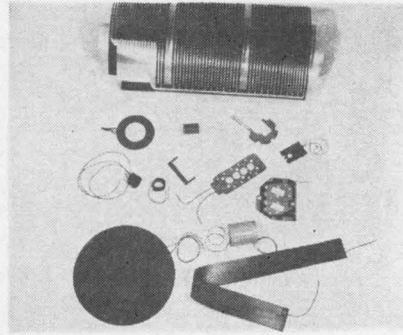

space industry. The heat-sealable Teflon insulation eliminates the need for volatile adhesives which in the past have caused contamination in high vacuum applications. The foil elements spread the heat over 97% of the surface of the blanket to permit greater watt densities than possible with conventional wire element types. Alternate insulation materials include: silicone rubber, neoprene rubber, and Mylar. Foil heating elements can be manufactured in practically any size or configuration from 1 in. by 1/2 in. up to 10 ft by 30 ft. Thermal Circuits, Inc., Park St., Beverly, Mass. [357]

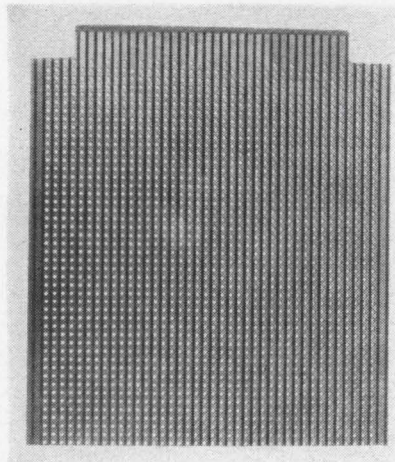

Weldable wiring board cuts production costs

A new weldable Veroboard is announced. The universal wiring board consists of a series of metal strips, each a three-layer composite of nickel, steel and aluminum bonded to an epoxy fiberglass board and then pierced with a reg-







VACUUM RELAYS

by

HYVAC[®]

— a broad line of high voltage relays, in quantity production. Delivery: stock to 45 days.

CONDENSED SPECIFICATIONS

Hyvac No.	Contact Form	Oper. Volt.	Max. Curr.	Nom. Coil Volt. (DC)
 H-14	DPDT	20 KV	10 amps DC	26.5
 H-11	SPST, N.O.	12 KV	15 amps DC	26.5
 H-8	SPDT	20 KV	15 amps DC	26.5
 H-5	SPST, N.O.	5 KV	2 amps DC	24
 HVS-1	SPDT	17 KV	7 amps DC	28
 HVS-4	SPDT	17 KV	8 amps RF	24
 HVS-10	SPDT	17 KV	350 amps Pulse	40

SEND FOR COMPLETE CATALOG

Engineering representatives in principal cities

HIGH VACUUM ELECTRONICS, INC.

541 Mission Street, South Pasadena, Calif. 91030
MU 2-2149 (213) • TWX 213 449 2552

Circle 202 on reader service card
Circle 149 on reader service card →

Fast! Precise! RFI measurements!

SOLID STATE CIRCUITRY! LIGHTWEIGHT! COMPACT!



20 cps – 15 kc
(narrow band)

20 cps-250 kc
(wide band)

Model NF-315 Noise and Field Intensity Meter

EMPIRE* Noise and Field Intensity Meter Model NF-315 is a self-contained highly versatile RFI measuring instrument combining both a narrow band tunable super-heterodyne receiver and a complete wideband video receiver—plus indicators, pickup devices, and internal frequency and amplitude calibrators.

Narrow band operation covers 20 cps to 15 kc, in a single band, and its two bandwidths (7 and 70 cps) provide faster measurements, more precise signal identification, and optimum sensitivity. As a wideband receiver, the NF-315 simultaneously measures all signals in the 20 cps to 250 kc range.

Solid state circuitry, together with time-tested tuning techniques assure reliable short and long term stability plus complete freedom from instabilities caused by external effects. Highly stabilized circuits eliminate the need for recalibration when tuning to a new frequency. The instrument comprises a single unit completely shielded electrically and magnetically, and filtered to permit operation in areas of high ambient signal level. A built-in nickel-cadmium rechargeable battery and charger contribute to portability for field operation.

Model NF-315 Applications: field intensity measurements, electromagnetic interference measurements in accordance with commercial and military requirements, as a sensitive tunable transistorized voltmeter, a sensitive wideband video receiver, a receiver for acoustic and vibration analysis, a sensitive audio harmonic wave analyzer, a tunable high-sensitivity null detector, and in shielding effectiveness.

SPECIFICATIONS

- Frequency range 20 cps - 15 kc, narrow-band; 20 - 250 kc, wideband.
- $\pm(1\% + 5 \text{ cps})$ freq. calib. accuracy
- 50, 600, 100,000 ohms input imped.
- $\pm 0.5 \text{ db}$ amplitude accuracy (used as 2-terminal voltmeter).
- Voltage range as a 2-terminal voltmeter: 0.15 μV -10 v for 100 k Ω , narrowband
0.015 μV -1 v for 600 Ω , narrowband
0.005 μV -1 v for 50 Ω , narrowband
10 μV -10 v for 100 k Ω wideband
1 μV -1 v for 50 or 600 Ω wideband
- Over 70 db spur. response rejection.
- Average, rms, peak, slideback metering.
- Built-in spot-frequency stabilized amplitude calibrator.
- Recording and X-Y plotting outputs.
- 17" w x 10 $\frac{1}{2}$ " h x 11" d, adapter brackets avail. for rack mounting.
- 3 ft. dia. loop antenna and high-sensitivity flat-response rod-type antenna.

ASK YOUR METRICS SALES REPRESENTATIVE ABOUT THE NEW SINGER TIME PAY AND LEASE PROGRAMS



THE SINGER COMPANY

METRICS DIVISION

915 PEMBROKE • BRIDGEPORT, CONNECTICUT
(203) 366-3201 • TWX 710-453-3483

ELECTRICAL AND ELECTRONIC INSTRUMENTS FOR TEST, CALIBRATION, AND MEASUREMENT

TRYLON CONICAL MONOPOLE ANTENNA
Vertically-polarized, omnidirectional, for any
4:1 range from 2 to 30 mc. 4 db/iso gain.
50-ohm input. Power to 50 kw PEP

Here in one stable are physicists, electrical and structural designers and engineers, production and control technicians, artisans and expeditors—all fired with one purpose: to build the finest antenna systems in the world.



Elverson, Pa. 19520 (215) 942-2981 — International Division, 750 Third Ave., New York, N.Y. 10017, U.S.A.

Circle 203 on reader service card

New Components

ular hole matrix at 0.1 in. It is also available with 0.156 in. and 0.2 in. matrices. The Veroboard concept allows any circuit to be constructed quickly and easily without expensive art work, tooling or the normal delays in printed-circuit production. It is now available for microelectronic application where welding is used for the high reliability interconnection of integrated circuits and other electronic components.

Vero Electronics, 48 Allen Blvd., Farmingdale, N. Y. [358]

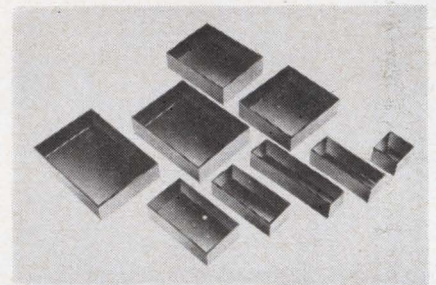

Molded plastic encapsulating shells

A broad standard product line of plastic encapsulating shells is announced. Available are more than 60 round, square and rectangular shells molded of flame-proof glass-filled diallyl phthalate meeting specification MIL-M-14, type SDG-F. Shells are designed for encapsulating of toroids, miniature delay lines, capacitors, laminated transformers, resistors, welded modules, pulse transformers, and semiconductor networks. New tooling concepts allow fast, economical production of new shell designs without tooling cost to the customer, based on production requirements.

The Robinson Co., 3636 W. 139th St., Hawthorne, Calif. [359]

Transistor holder for Micro-modular units

A transistor holder has been designed to accommodate the new 8-lead, TO-5 can, Micro-modular units. In the RTC-0808-SL the tran-



March 22-26, 1965
ELECTRICAL-ELECTRONICS

◆ Exhibit hours (4 days): Monday & Thursday, 9:45 a.m.-9 p.m.; Tuesday & Wednesday, 9:45 a.m.-6 p.m.

◆ Technical sessions (5 days) 10 a.m.-5 p.m. (Hilton, Tuesday to 10 p.m.)

◆ 80 subject-organized technical sessions presenting 400 vital "break-through" papers.

◆ Over 1000 Exhibits using 140,000 running feet of display units in N.Y. Coliseum & N.Y. Hilton.

◆ Gala IEEE Banquet on Wednesday, March 24, 1965 at 6:45 p.m. in Grand Ballroom, N.Y. Hilton.

◆ Registration: \$2.00 IEEE Members, \$5.00 Non-members. High School students admitted Thursday afternoon only, \$2.00 if accompanied by an adult (not over 3 per adult).



NEW YORK COLISEUM and the NEW YORK HILTON

Buses every few minutes

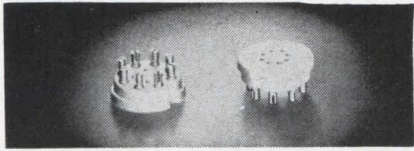

WHAT'S THE LATEST IN DISC CATHODES? ASK SUPERIOR.

sistor leads are passed through holes in the Teflon bushing and then soldered to adjacent lugs. Shoulder diameter of the holder is 0.562 in. with a minor diameter of 0.513 in. Height above the chassis is just 0.060 in. Lugs are of brass with gold flash over silver, and the socket body is of 100% pure virgin Teflon for maximum reliability and life. For past positive insertion in the chassis, the manufacturer makes a companion installation tool identified B-42.

Sealectro Corp., 225 Hoyt St., Mamaronck, N. Y. [360]

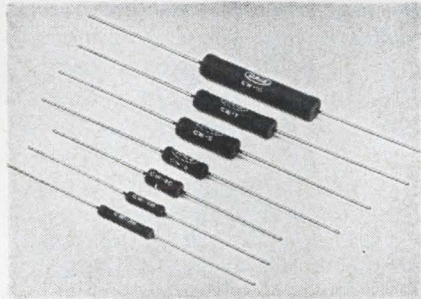

Wirewound resistors rated from 3 to 13 w

Axial-lead, commercial wirewound resistors are announced. The CW series combine all-welded construction with a high-temperature silicone coating. This enables them to offer a ratio of power to size which should be valuable in commercial circuit design. For example, the CW-2, rated at 4.25 w, has a body length of only 0.625 in. and a body diameter of only 0.250 in. At present, CW resistors are being produced in seven different models with power ratings ranging from 3 w to 13 w. Resistance range of the line is from 1 ohm to 273,000 ohms. Standard tolerance is $\pm 5\%$ with a standard temperature coefficient of ± 260 ppm/ $^{\circ}\text{C}$. The power rating of CW resistors is based on 100% at 25°C ambient. From this point they derate on a linear basis to zero power at $+350^{\circ}\text{C}$. Dale Electronics, Inc., P. O. Box 488, Columbus, Nebr. [361]

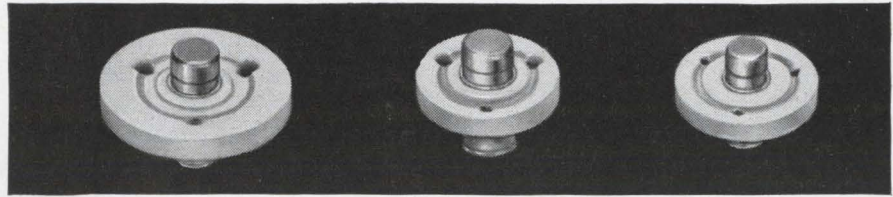

Full power for 6.3 volt-600 ma heater applications

Full power, narrow-neck for 600 ma heater applications

$\frac{3}{4}$ power for 450 ma heater applications



$\frac{1}{2}$ power for 300 ma heater applications

Shielded full power for better temperature uniformity in 600 ma heater applications

Shielded low power for 12.6 volt 85 ma heater applications

Widest choice of disc cathode designs

There are three basic types of Superior disc cathodes. Each has its own advantages. All feature close control of the E-dimension (distance between top of cap and top of ceramic), flare at the shank opening to facilitate assembly, shadow groove in the ceramic to inhibit electrical leakage and are available in wide choice of both cap and shank materials. Available in 0.121", 0.100" and 0.090" outside diameter shanks. Ceramic diameters can be either 0.490" or 0.365", with either round or triangular center hole.

New shielded disc cathodes—Full power and low power

In the full power design the emitter is separated from the ceramics by a shield which minimizes the conducting X-section from the shank to the ceramic. In the low power design, the slender shank, thermal shield and thin ceramic permit low heater power consumption and fast rise time. The shield also acts to eliminate leakage if sublimation takes place.

Widest choice of disc cathode materials

Superior's disc cathodes feature separate nickel cap and shank alloys. Hence you may choose the most suitable material for each. The Cathaloy® series, developed and controlled by Superior Tube Co., offers alloys with high strength, high activity, low sublimation, freedom from interface impedance, or any desired combination.

Cathaloy A-31. Approximately twice as strong as tungsten-free alloys at high temperatures.

Cathaloy A-33. Combines the high emission of active alloys with freedom from sublimation and interface impedance.

Cathaloy P-51. More than 100% stronger than X-3014 at high temperatures.

X-3014. Powder metallurgy pure nickel for resistance to sublimation. Suggested for shanks.

X-3015. Special shank alloy for strength with resistance to sublimation and for non-emitting characteristics.

Nickel 220, Nickel 225, Nickel 230 and Nickel 233. Suggested for caps requiring normal emission with rapid activation.

Driver Harris 599 and 799. Provide rapid activation plus high level d-c emission. For caps only.

For your copy of our Catalog 51, write Superior Tube Company, 2500 Germantown Ave., Norristown, Pa.

Superior Tube

The big name in small tubing

NORRISTOWN, PA. 19404

West Coast: Pacific Tube Company, Los Angeles, California

Johnson & Hoffman Mfg. Corp., Carle Place, N.Y.—an affiliated company making precision metal stampings and deep-drawn parts

NEW DI-ACRO 24-INCH BOX FINGER BRAKE

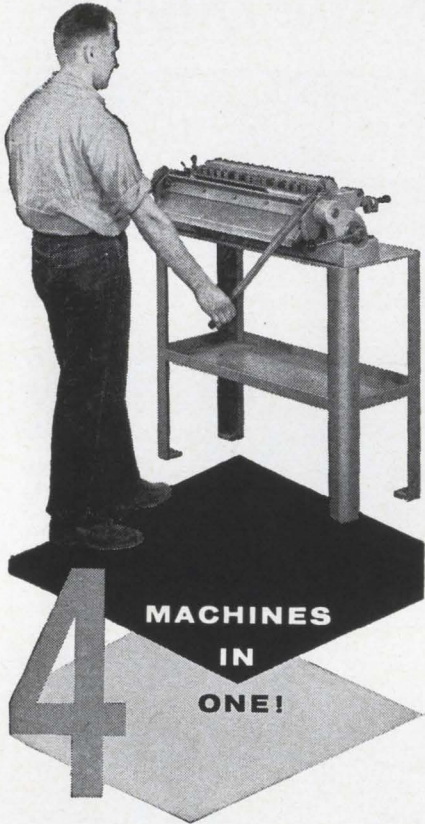

UNDERCUT FINGERS

and one inch clearance permit forming chassis with up to 1/2-inch flange and clearing reverse bends from front of machine. Micrometer Gauge instantly positions material for forming to die accuracy in experimental labs, model shops, short-run production.



A NEW
12-inch
Brake with

16 gauge steel capacity is available for forming smaller parts.

For free illustrated folder see your nearest Di-Acro distributor or write to us.



DI-ACRO CORPORATION

431 Eighth Avenue Lake City, Minnesota

152 Circle 205 on reader service card

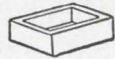

1. BOX AND CABINET FORMER... forms all widths from 3/4" to 24" by 1/4" steps.



2. BAR FOLDER... folds or hems up to 16 gauge mild sheet steel across full width.



3. RADIUS FORMER... forms radii by positioning forming edge or with special radius fingers.



4. OPEN END FORMER... forms open end shapes by replacing box fingers with open end finger.

New Instruments

IR gauge measures water in paper

An infrared back-scatter moisture gauge is available for on-and-off-line measurement of water in paper. The Inframike moisture-monitoring gauge can sense total water content from 0% to 12% for paper with a basis weight in the range of 6 to 70 pounds per 3,300 sq.ft. It is accurate to within $\pm 0.1\%$ moisture. Gauge accuracy is limited primarily by standard gravimetric techniques, but is better than 0.25% moisture. Daily drift is less than 0.1% moisture. The Inframike can be fixed mounted for continuous monitoring of moisture content on a single paper machine, used as a portable unit for troubleshooting on several paper machines, or as a laboratory test instrument. Principal components of the gauge are the scanning head (left foreground), a hermetically sealed unit containing both the infrared radiation source and a lead sulfide sensing cell, and the control cabinet. The control unit features

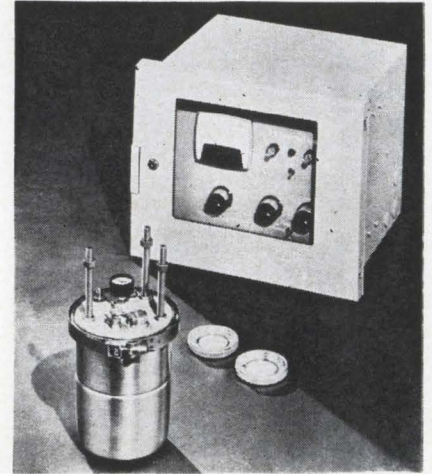

solid-state circuitry and has three simplified controls for standardizing the gauge for moisture content and setting basis weight compensation. The two disks in the photo are long-term stable standards provided with the gauge for checking calibration and performance. General Electric Co., X-Ray Dept., 4855 Electric Ave., Milwaukee, Wis. [381]

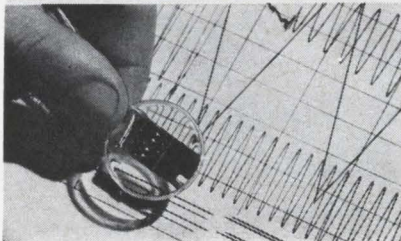

High-speed 10-channel event recording unit

A new ten-channel event recording unit fits into a light beam oscillograph without disturbing existing

analog channels. The new accessory unit permits recording of ten channels of high-speed events within a one-half inch space on the chart paper margin. It contains ten pinhead-size incandescent lamps and is situated at the edge of the chart paper with the lamps practically butted up against the chart paper. When a lamp is energized a trace appears on the chart paper. In the conventional light beam oscillograph the standard procedure for obtaining event recording is by converting one of the analog channels to event marking, thus eliminating one of the analog channels. Since one analog channel costs \$200, that also is the cost for one channel of event recording in the conventional approach. Cost of the new ten-channel event recorder unit is only \$30 per channel, and the full complement of analog channels is retained. Two leads from each lamp go to a connector at the rear of the recorder. Lamps

Unclassified gratification

Aerogel-General Corporation informs us of an investigation they have conducted on the image-spoiling properties of the optical materials that are available for transmitting and refracting infrared. Out to 21μ — that sort of thing. Some were found to do grave violence to a collimated infrared beam. The five hot-pressed polycrystalline materials tested acted more

like thin air in their effect on the beam geometry. In response to our inquiry, they disclose these to be KODAK IRTRAN 1, 2, 3, 4, and 5 Optical Materials, respectively. We feel pleased.

A copy of their report, which is fortunately not "classified," and extensive data on these materials can be furnished by Apparatus and Optical Division, Eastman Kodak Company, Rochester, N. Y. 14650. We can work them to outlandish shapes, with or without holes.

From the banks of the Genesee

A certain kind of sausage that must have originated in the Italian city of Bologna brings joy to unnumbered millions. Quite a different kind, identified with the Thuringian duchies of olden Germany, also sells very well. Wieners, still another kind of sausage, are loved by virtually every American with little thought to the Austrian capital or its possible rival Frankfurts on the Main or Oder.

Inedible but more up-to-date commodities can likewise be geographically identified, though manufactured by companies instead of guilds. One such is magnetic tape for aerospace telemetry and other raw-data recording applications. One company on the Mississippi and a smaller rival near the Pacific shore have won eminence in the field. Now an unfettered economy further widens the choice that faces the instrumentation-tape buyer. He must now consider tape from the banks of the Genesee in New York State.

For the benefit of his conscience as an engineer, he must be told that while the three principal sources of supply can equally assuage the hunger of his data recorders, their products are no more identical than are wieners, thuringer, and bologna. The engineers of Consolidated Electrodynamics Corporation, a leading manufacturer of recorder/reproducers that use instrumentation tape, have announced their decision to give their preference and "CEC" name to our Rochester-made tape on the following grounds:

- **Smoothness:** Pleasant in shaving, drinking, or riding and essential in recording frequencies up to 1.5 mc. Well known rule-of-thumb says you lose 55 db when oxide surface jumps one wave-

length from polepiece. At 1.5 mc and 120 in/sec, a wavelength is 0.00008". Pimples had better be low, few, and far between on "wideband"-class tape. We also do very well by CEC in this respect on the three other classes down to "standard telemetry," which claims only 100 kc at 60 in/sec. Differences come in particle-size distribution. Each of our classes excels in response out to its frequency limit. When you can afford to reduce gain in the amplifier at high frequencies, you are cutting broad-band noise. Signal-to-noise ratio is the cause worth fighting for. In audio tape, which we also make, it's low print-through. The human brain balks at strange echoes. The human ear needs no frequencies above 20 kc and little power above 5 kc. But signal power at high frequency keeps the instrumentation-tape user in business.

- **Straightness of edge:** Wandering out of alignment with the polepiece gap after a few thousand feet can be as fatal as a coating defect. We have slit film to better accuracy than that from time immemorial.

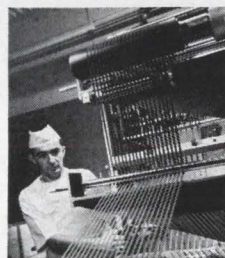

We don't even have to slit in the dark.

- **Uniformity of characteristics end-to-end and reel-to-reel:** CEC, who have tested plenty of tape in their day, say they have never before encountered any so uniform. We think we can do better later.

- **Little things:** Extreme cleanliness is the price of admission to the tape-making game. We had to pay it a generation before magnetic tape came in. It seems a pity to risk sifting dust from paperboard packaging over such a clean product. Therefore we put all our tape for CEC in metal cans and the cans in rectangular cartons that can be stored on edge and marked for identification. On the tape itself we print our name and a code number every few inches. We wonder why the others don't.

Any questions? Ask Eastman Kodak Company, Magnetic Products Division, Rochester, N. Y. 14650.

The time has come to quit kidding ourselves.

Beautiful photography is a great art that has virtually nothing to do with the purposes for which physical scientists and engineers justify their heavy consumption of 16mm, 35mm, 70mm, and larger widths of film during working hours. We had better see things their way. We now know they are seldom in a mood to treat film with veneration. All they seem to want are the data—the quicker the better.

The exact nature of these data is really none of our cotton-pickin' business, except insofar as the users care to talk or honor us with reprints some fine day. The best we can contribute to their radar recordings, their studies of bioluminescence or of the stratigraphy of Antarctica, their improvement of sugar-beet pulping machinery or of ignition systems for vernier rockets, their logging of oil wells, their probing of the Saturnine at-

mosphere, their counting of taxis on the Golden Gate Bridge, and all the other vaguely imagined tasks they perform with film—the best we can contribute is a fierce determination to make them demonstrably better film for their multifarious purposes than anybody else can make.

To this end we are placing upon the market a new line of films. We don't want them confused with films designed for beautiful movies either by us or by our competitors. You will get to know them by a trademark that hardly suggests softness and beauty. It happens to consist of the initials for "Rapid Access Recording."

The five films which will first carry this mark are primarily designed for processing at temperatures up to 130° F. Four of the five are on ESTAR Base, tops for dimensional stability in film with strength and thinness. A sixth new one, KODAK 2475 Recording Film, likewise

on ESTAR Base, has extended red sensitivity to make it the fastest film you can buy, but it is not yet suitable for hot processing.

Hardly less important than the characteristics of the new films is ready information about said characteristics so that user and maker can sit down together and make the best choice for the work at hand. Get in touch with Eastman Kodak Company, Photorecording Methods Division, Rochester, N. Y. 14650. See what happens. The new trademark, by the way, is:



This is another advertisement where Eastman Kodak Company probes at random for mutual interests and occasionally a little revenue from those whose work has something to do with science

The best solution to YOUR high voltage rectification problem is demonstrated here!

Your requirements for high voltage rectification for practically any application, in almost any circuit, can be met better with Varo silicon rectifiers.

For example: The Varo 1N4441 features 1500 V PRV and 300 nanosec. reverse recovery time. In the 7701 series, PIV ratings from 1.5 KV to 20 KV are available.

Other rectifiers include voltage doublers, full wave bridges and half wave circuits with diffused silicon junctions and PIV ratings from 1 KV to 10 KV. For electrostatic power supplies, a new series of multiplier diode bank modules features low leakage current with PRV ratings of up to 4000 V per diode at .15 pf max. capacitance. Reliability has been demonstrated to be greater than 150,000 hrs. MTBF. *Your special design requirements can also be met by Varo. Write today for complete information and a better answer to your rectifier needs.*

varo inc
SPECIAL PRODUCTS DIVISION
2201 WALNUT ST., GARLAND, TEXAS
AC 214 / BRoadway 6-6141

New Instruments

can be energized either externally or internally. External excitation can be obtained through a battery and capacitor. A lamp will be triggered on or off by 1.5 v at 15 ma. Response is 10 millisecc on and 2 millisecc off.

Brush Instruments, Division of Clevite Corp., 37th and Perkins, Cleveland 14, Ohio [382]



Transistor checker has remote connector

The new transistor checker gives a direct dial reading for checking all important transistor d-c parameters, including those in the inverted connection. Featuring a remote connector, the model 9001 permits checking of parameters while a transistor is in an environmental chamber or if the transistor has an unusual case or base style. The remote connector provides unlimited flexibility, according to the manufacturer. For example, small signal beta may be achieved by external insertion of additional base resistance. This resistance may be adjusted to provide any base current the user desires, thus providing beta measurements for any value of base current from 0 to 100 μ a. In the inverted connection, the applied voltage is dropped to 1 v. This feature accommodates a maximum tolerable inverse voltage as low as 1 v and permits inverted parameter reading of many transistors that otherwise could not be checked. Because the beta of many transistors exceeds 100, a beta-times-ten scale has been provided to permit accurate indication of betas up to 1,000. The meter's 50- μ a movement increases the capability to read I_{c0} and I_{e0} . Model

9001 also provides a diode test capability for testing inverse leakage current as well as the forward d-c resistance. The transistor checker is powered by a mercury cell battery, assuring long life at constant voltage.

Spectra-Strip Wire & Cable Corp., P.O. Box 415, Garden Grove, Calif. 92642. [383]

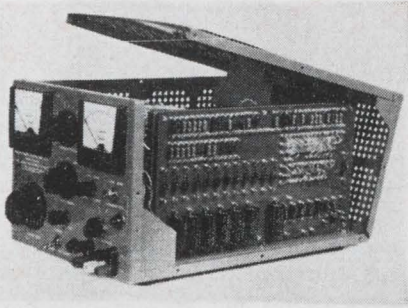

Highly regulated d-c power supply

All transistor, portable model VAS60-5 divides output into 0-6/30/60 v d-c and 0-0.1/0.3/1/3/5 amp and employs multirange meters to improve down-scale reading accuracy over standard 2% single range meters by an order of magnitude as great as 10. Other features include 0.005% full load/line regulation throughout any point on any selected range, ripple 1 mv peak, overload mode selector for either current limit or current trip, and automatic power shut-down in less than 20 μ sec for inadvertent range switching. Price is \$875; delivery, 4 to 6 weeks.

Space Power Associates, Inc., 161 Brielle Ave., Staten Island, N.Y. 10314. [384]

Data amplifier offers three output terminals

Simultaneous recording of wide-band and narrowband data from a single amplifier source is possible with the model 3630 amplifier. This direct-coupled differential amplifier is designed specifically for use in high-precision data gathering and instrumentation systems. It features a total of three output terminals. One terminal is used to obtain a full bandwidth representation of the input signal. The second terminal provides a filtered output

Dual readout— in-phase and quadrature voltage ratios —with high accuracy

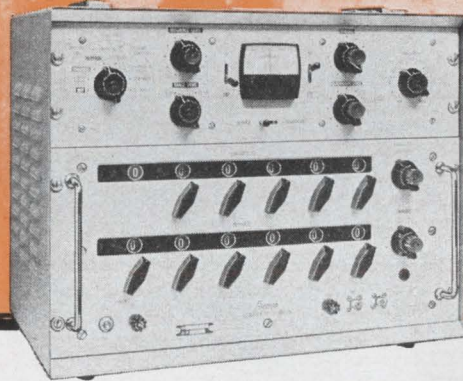

CRB-8 complex ratio bridge for testing transformers, synchros, AC transducers, resolvers, tach-generators, amplifiers, and gyros.

This *Gertsch* bridge measures both in-phase and quadrature ratios of 3- and 4-terminal networks to an accuracy of .001% (10ppm). Voltage ratios are read from the *RatioTran** dials as rectangular coordinates (R+jX), or phase angle between signal and reference may be read directly in degrees.

Broad-band coverage—Instrument makes measurements at all frequencies from 350 to 5100 cps without using plug-in filters or networks. Completely self-contained, the CRB-8 requires no external calibration sources or detector.

Continuously tuned null amplifier drives the detector circuit so that minute values of off-null voltage can be detected without harmonics or noise. Extremely high signal input impedance minimizes loading of the device under test. Except for five tubes, instrument is designed with all solid state circuitry.

Other complex ratio bridges in the *Gertsch* line, available in both cabinet and rack-mounted types, include compact, fully transistorized units...militarized units designed to withstand severe environments, and a complex ratio bridge

which makes precision voltage and phase comparisons automatically, in less than 10 seconds.

For complete details and applications assistance, contact your nearest *Gertsch* representative or the address below, requesting Bulletin CRB.



Model CRB-6—militarized to withstand wide temperature extremes.

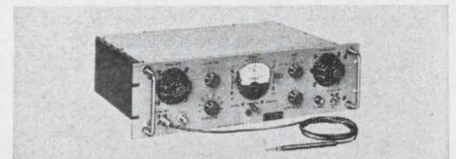

Model CRB-4RS—rack-mounted unit with connector for plugging in external oscilloscope.



**THE SINGER COMPANY
METRICS DIVISION**

3211 S. LA CIENEGA BOULEVARD, LOS ANGELES, CALIFORNIA • TELEPHONE (213) 870-2761 • TWX 213-836-0466

Design and production of PANORAMIC • SENSITIVE RESEARCH • EMPIRE • GERTSCH instruments for measurement

5 μ V PEAK-TO-PEAK (.8 μ V RMS)

RANDOM NOISE AT 10KC BANDWIDTH

2.4 μ V PEAK TO PEAK (.4 μ V RMS) AT 1 KC BANDWITH



WITH

THE NEW SEL 9016 DC INSTRUMENTATION AMPLIFIER

SPECIFICATIONS

- COMMON MODE REJECTION..... 150 db at DC and
120 db to 60 cps with 1000 ohm source
unbalance
- COMMON MODE VOLTAGE..... 300 volts DC or peak AC
- FREQUENCY RESPONSE..... Standard: 3 db \pm 1 db at 10 KC, 30 db/octave,
5 pole 0.1 db ripple

Optional Filters: 2 pole Butterworth, for various
frequency response
- DC LINEARITY..... \pm .02% from best straight line
- LOAD CURRENT..... 10 ma (Standard) Galvo (Optional)

SEL SYSTEMS ENGINEERING LABORATORIES, INCORPORATED
P. O. BOX 9148 / FORT LAUDERDALE, FLA. 33310 / AREA CODE 305 / LOGAN 4-7616

New Instruments

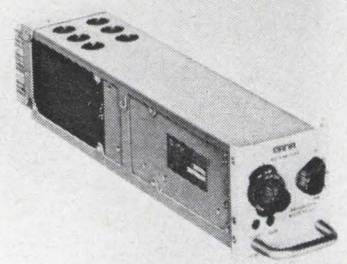

ideally suited to drive narrowband recording or display devices. The third terminal is common to both outputs. In a typical instance, the wideband output would be directed to an oscilloscope for a "quick look" monitoring of the data in real time, while the narrowband output would be fed into a time-shared digitizing and print-out system. The wideband output is capable of handling a full-scale load current of 100 ma. The 3 db small-signal bandwidth of this output signal is 50 kc, providing more than sufficient frequency response for most wideband applications. The narrowband output, which is used primarily with digital devices, has a full-scale load current capability of 10 ma. The bandwidth of the output is determined by a front-panel switch and may be set at 10 cps, 100 cps, 1 kc, 10 kc, or full bandwidth. The amplifier design provides total isolation between the input terminals and both sets of output terminals. Common-mode rejection on both outputs is better than 1,000,000 to 1 with up to 10 v of 60-cycle common mode voltage and 350 ohms unbalance on either input lead. No external "ground return path" is required between the input and output commons.

Dana Laboratories, Inc., Irvine, Calif.
[385]

Compact tape recorder for rugged environments

Portable tape recorder/reproducer, model MTR-3200, offers precision instrumentation performance in extreme environments. Weighing only 44 lb, occupying less than 1 cu ft of space, and operating on less than 55 w of power, the unit can be

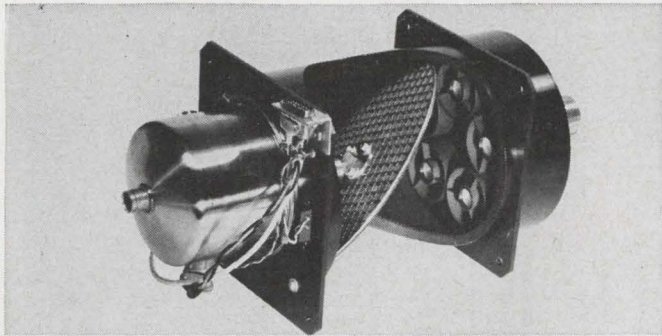

Radiometer for NIMBUS weather satellite

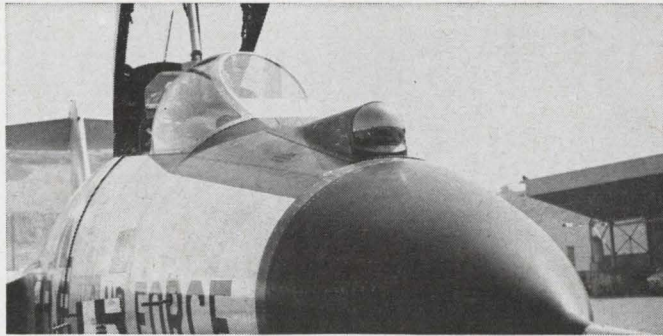

Interceptor IR installation

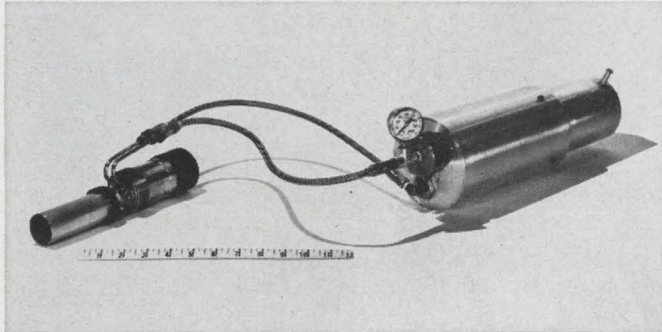

12°K closed-cycle cryostat

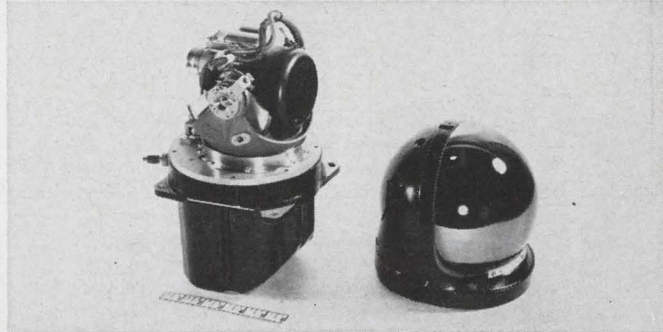

90C IR search/track set

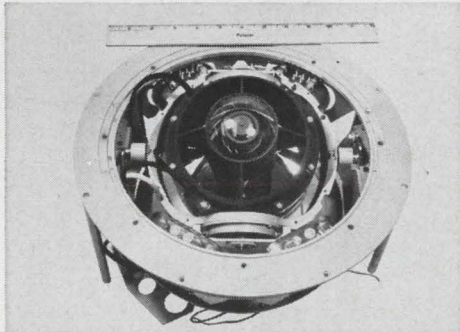

IR multi-channel tracking radiometer

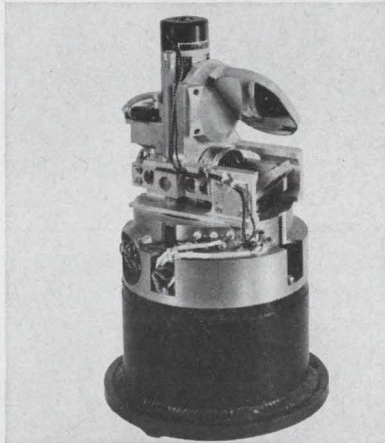

Star tracker for SURVEYOR spacecraft

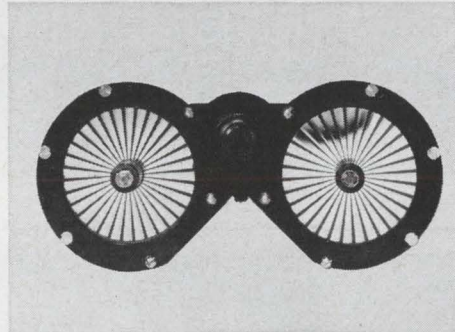

Modulated IR source

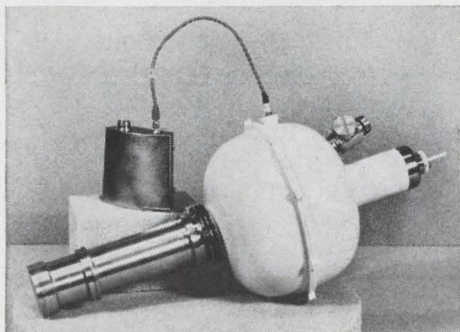

Liquid-helium-cooled IR detector



IR anti-tank missile controller

Expanding Infrared Programs

create new career assignments

Rapid growth of HUGHES Infrared activities in the Aerospace Divisions and the Santa Barbara Research Center has created many responsible positions for qualified engineers and scientists in all phases of IR systems development from conception through production engineering.

Immediately available assignments include openings in such diverse technologies as semiconductor physics, optical design, cryogenics, mechanical

engineering, precision electro-mechanisms, electronic circuit design, servo systems...and many other areas.

For immediate consideration, please airmail your resume to:

MR. ROBERT A. MARTIN
Hughes Aerospace Divisions
11940 W. Jefferson Blvd.
Culver City 13, Calif.

HUGHES

HUGHES AIRCRAFT COMPANY
AEROSPACE DIVISIONS
An equal opportunity employer

Current HUGHES IR contracts include advanced systems for space exploration, weather reconnaissance, anti-ballistic missile defense, anti-submarine warfare, interceptor weapon guidance & fire control, bomber defense and tactical weapon control.

Professional experience, an accredited degree and U.S. Citizenship required.

DO-IT-YOURSELF MAGNETIC SHIELDS

*Cut Quickly—
Wrap Easily*

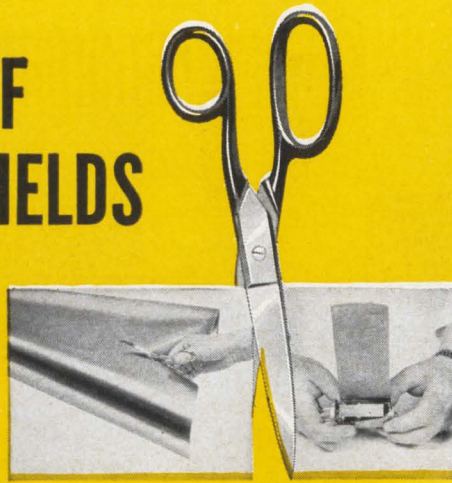

With ordinary scissors, cut flexible Co-Netic and Netic foil to any size or outline. Your component is quickly wrapped and protected—within seconds. Component performance is dramatically enhanced. Co-Netic and Netic foils stop degradation from unpredictable magnetic fields. When grounded, they also shield electrostatically. Foils are not significantly affected by dropping, vibration or shock, and do not require periodic annealing. Available in thicknesses from .002" in rolls 4", 15", and 19-3/8" wide. High attenuation to weight ratio possibilities. Widely used in experimental evaluation and production line operations for military, commercial and industrial applications.

MAGNETIC SHIELD DIVISION

Perfection Mica Company

1322 N. ELSTON AVENUE, CHICAGO 22, ILLINOIS

ORIGINATORS OF PERMANENTLY EFFECTIVE NETIC CO-NETIC MAGNETIC SHIELDING

Circle 209 on reader service card

Specialist in

CUSTOM-BUILT TRANSFORMERS

TO YOUR SPECIFICATIONS

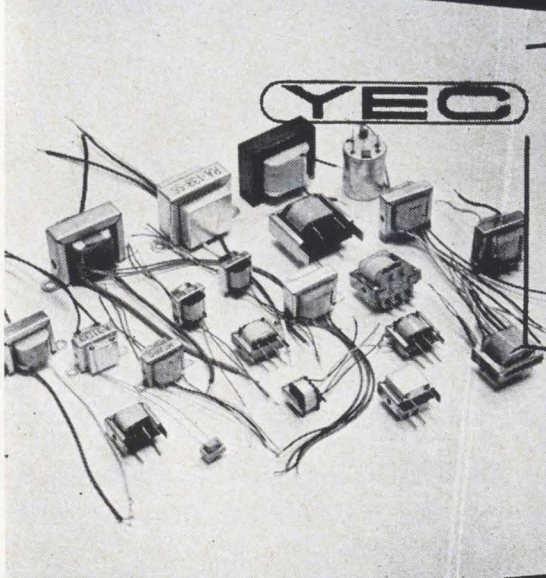

YUTAKA ELECTRIC invites you to submit your detailed specifications and quantity information to our engineering and production staff.

**YUTAKA
ELECTRIC
MFG.
CO., LTD.**

1253, 1-chome, Yutaka-cho,
Shinagawa-ku, Tokyo, Japan
Tel: (04472) 2171~3 Cable
Add: "EDOYUTACO" Tokyo

158 Circle 158 on reader service card

New Instruments

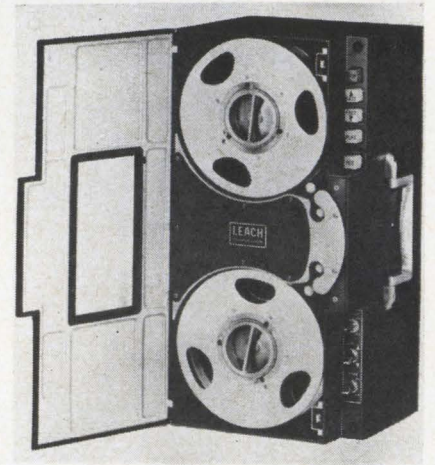

hand-carried to any test site. It can be used in land, sea, airborne or space applications where space and power are at a premium. It offers standard IRIG or extended broadband recording. Electronic components for each record/reproduce method are modularized, and plug in for easy record/reproduce mode selection. Six standard recording speeds ranging from 1 7/8 ips to 60 ips are offered in electrically selectable pairs operated by pushbutton controls on front of the machine. Optional speeds from 0.5 ips to 240 ips are also available. A constant speed of 120 ips is used for fast forward and rewind. Using Mil-type components throughout and special tape transport design features such as dual capstan drive, high reliability and accurate data recording are ensured with flutter, for example, held to less than 0.5% peak-to-peak at 60 ips.

Leach Corp., 1123 Wilshire Blvd., Los Angeles 17, Calif. [386]

Voltage-controlled signal generators

Models 104 and 105 voltage-controlled generators are announced. They may be frequency-modulated both at very low frequencies and high frequencies without moving parts. Each new unit provides up to 20:1 VCG frequency range, selectable in bands of 3:1 ratio, with the capability of changing frequency on external electrical control without physical movement of the dial.

Electronics | January 11, 1965

Reliable remote operation is obtained through solid-state components. Without external VCG control, the new units are versatile, general-purpose generators. Each VCG can do the combined work of several items of test equipment previously used. The units have a frequency range of 0.0015 cps to 1 Mc and generate clear and stable sine, square, or triangle waves with any external modulating function provided. The wide frequency range enables use in l-f applications such as servo and electro-mechanical systems as well as audio or video amplifier work. Complex oscilloscopes can be completely checked out in the field or

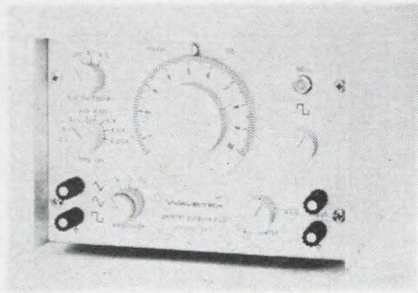

lab with this one versatile, portable instrument. The VCG can f-m a servo, sweep test i-f strips, f-m or sweep a triangle wave, sine wave, or square wave. The ultrafast rise and fall times (as low as 4 nsec) can trigger high-speed computer circuits. Weight is 8 lb and dimensions, 7 $\frac{3}{4}$ in. wide by 5 $\frac{1}{8}$ in. high by 7 $\frac{1}{2}$ in. deep. Model 104 has three power supply options: a-c line, rechargeable nickel cadmium cells with built-in charger, or dry cell battery. Price is \$595 to \$675. Model 105 (a-c only) incorporates an all-silicon 30 v p-p output. Price is \$695.

Wavetek, 8133 Engineer Road, San Diego, Calif., 92111. [387]

Instrument measures radiation emission

A newly developed Densimeter includes complete frequency coverage from 200 Mc to 11,000 Mc. Model 1200 is a standard portable, battery operated instrument that provides a simple, positive means for detecting and measuring the amounts of microwave energy radiating from transmitters and re-

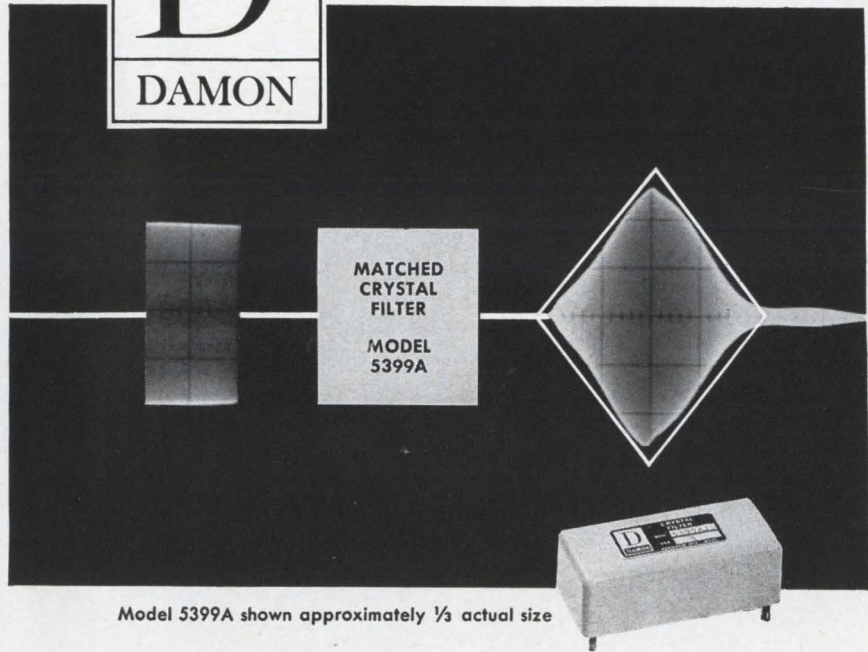

Model 5399A shown approximately $\frac{1}{3}$ actual size

Matched Crystal Filters

**Provide Optimum Signal-to-Noise Ratios
with Pulse Modulated Inputs**

Another FIRST from DAMON . . . the application of Time Domain Techniques to match crystal filters to rectangular pulse-modulated inputs. Utilizing a near optimum transfer function developed at M.I.T. Lincoln Laboratory for this filter class, Damon has realized the first multi-pole Matched Filter using piezo-electric resonators.

Typical filter response is shown in the illustration. Since the filter frequency characteristic approximates the signal transform, the output time function is triangular. Note the close coincidence between actual and theoretical performance.

Damon Matched Crystal Filters are aligned and tested under pulse conditions simulating actual equipment operation. Applications include Pulse Radar, Pulse Doppler Radar, Pulse Communication Systems, Data and Telemetry Transmission Systems or any system in which pulsed signals are subject to intense interference.

Write for Data on Matched Crystal Filters

DAMON ENGINEERING, INC.

240 HIGHLAND AVENUE, NEEDHAM HEIGHTS 94, MASS.

(617) 449-0800

Gold Bonding Wire

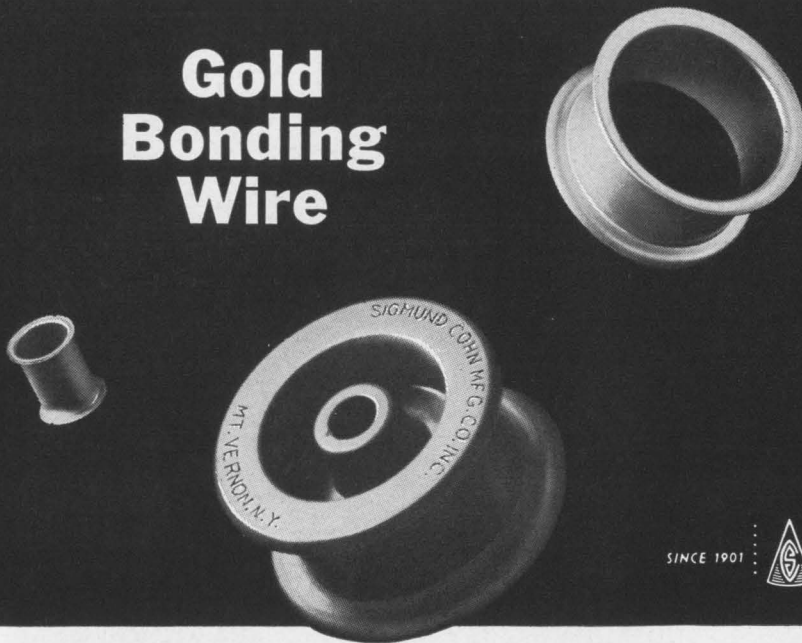

SINCE 1901 

Custom Spooled

Readily available in unlimited quantities...
Diameters: .0003" to .005". Dimensionally uniform.
Clean. ... Write for brochure.

SIGMUND COHN CORP.
121 South Columbus Ave.
Mount Vernon, N.Y.

SIGMUND COHN CORP. OF CALIFORNIA, Burbank, Cal. / SIGMUND COHN-PYROFUZE, INC., Dallas, Texas

Circle 210 on reader service card

Micro-Modular & Sub-miniature

PERMACOR®

Electronic
Powdered

IRON CORES

4 TIMES SIZE

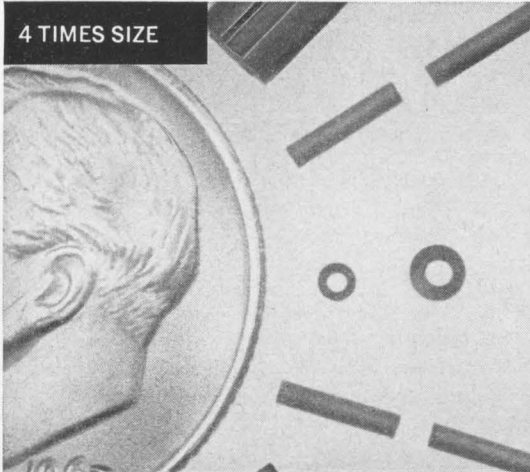

ACTUAL SIZE

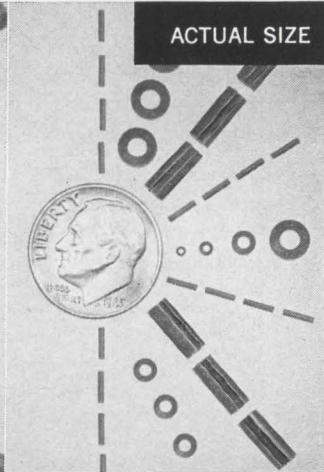

Average Tolerances as close as .0005

Conventional shapes and sizes available.

PERMACOR®

A Division of Radio Cores, Inc.

9540 Tulley Ave., Oak Lawn, Ill. • Phone: 312-Garden 2-3353

Write for
Literature
Today!

New Instruments

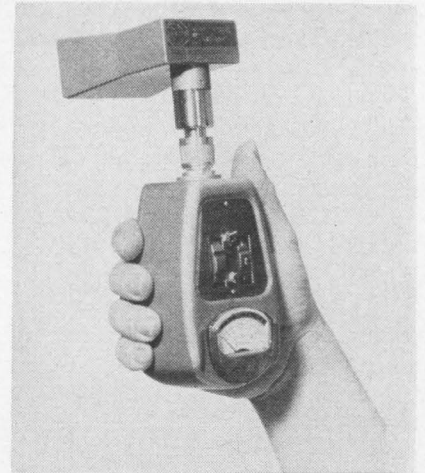

lated equipment. With it, even unskilled personnel can check unsafe areas with rapid, easy-to-read detection of the trouble spots. Model 1200, designed for universal use in plants, laboratories or in the field, is normally furnished with seven antennas to cover uhf through X bands.

Ramcor Inc., 190 Duffy Ave., Hicksville, L.I., N.Y. [388]



Sweep generator spans wide band

A 500-kc to 1,200-Mc sweep generator has been introduced. Model 890 is expected to be widely used on production lines where accuracy and ease of operation are prime considerations. In two ranges—vhf and uhf—the instrument supplies a sweep signal with center at any frequency from 500 kc to 1,000 Mc and with sweep widths as broad as 200 Mc or as narrow as 100 kc. The r-f output, carefully monitored by matched crystal diodes feeding a two-stage, push-pull, automatic-level-control amplifier, is flat within ± 0.5 db up to 800 Mc and ± 1.5 db from 800 Mc to 1200 Mc (at maximum sweep width). Because this

instrument is reliable and stable, even semiskilled production line workers can use it to make highly accurate quantitative sweep frequency measurements. Applications of the 890 include measurement of gain, loss, and vswr. The unit can also be used to measure the unloaded bandwidth and Q of cavities and resonant circuits as well as to test impedances in order to determine the degree to which they match a transmission line.

Jerrold Electronics Corp., Industrial Products Division, 15th and Lehigh Ave., Philadelphia 32, Pa. [389]

Tri-contact probes for in-circuit testers

Two new tri-contact probes can be used as accessories for all types of in-circuit semiconductor testers. Designed specifically for tests on printed-circuit boards, the probes have pointed stainless steel tips whose vertical and lateral spreads are controlled by two thumb wheels, operable by one hand. The center tip is insulated to prevent shorting. The first of the probes has a three-wire lead cable shielded to prevent stray pickup. Two models are available, one with standard

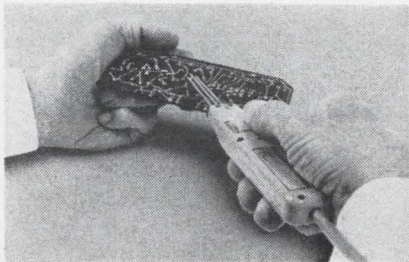

connectors, and the other with optional connectors to meet MIL specifications. The second, similarly available in two models, depending on type of connector required, is supplied with a shielded five-wire cable, permitting the use of a self-contained snap-action switch for actuating a remote function such as found in testers having automatic lead selection (that is, AEL models 236 and 240). Customers may specify connectors of their choice, in all models. Price is \$29.50.

American Electronic Laboratories, Inc., Richardson Road, Colmar, Pa. [390]

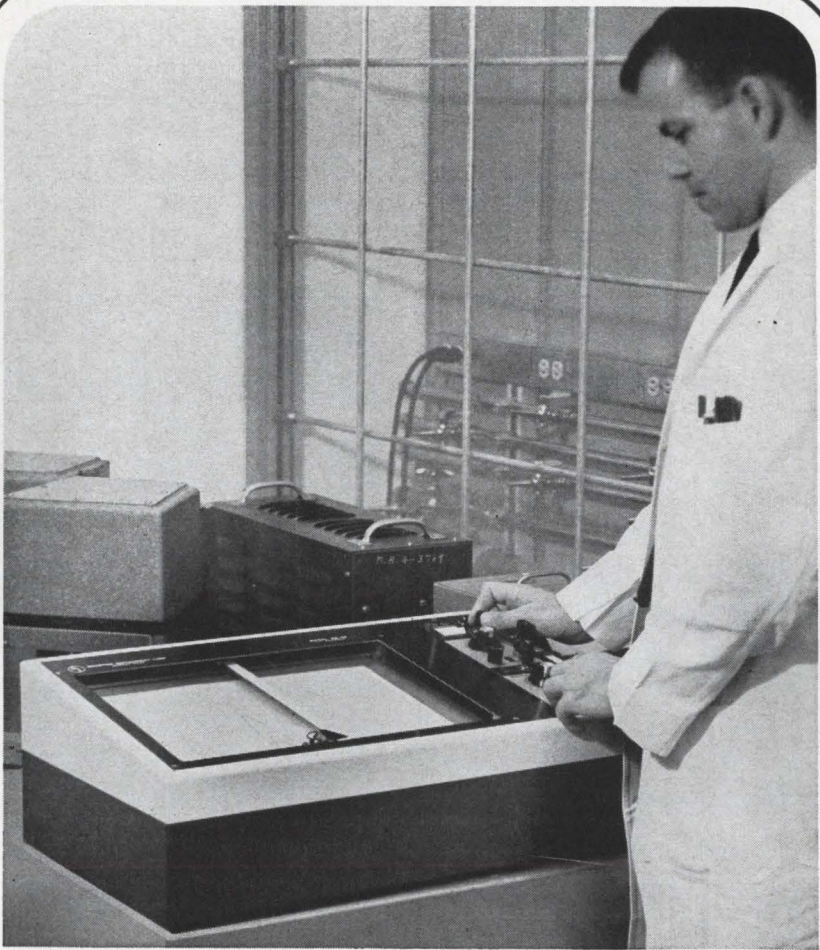

eliminate hand plotting of data

Now you can afford

the convenience and accuracy of automatic data plotting with an X-Y recorder. This new unit offers all the specifications and features necessary to insure the ease of operation usually found only in recorders twice the price.

- 8½" x 11" or 11" x 17" chart size
- Zener reference voltages which eliminate periodic battery replacement
- Front panel switch allows easy chart paper insertion
- 100 K input impedance
- 0.25% accuracy
- Built-in electronic time base
- 1 mv/in. maximum sensitivity, switch selectable in 5 steps to 10 v/in.
- Electric pen lift
- Snap-on pen assembly
- Model HR-96T (8½" x 11") \$1050
- Model HR-98T (11" x 17") \$1150



houston instrument corporation

4950 Terminal Avenue / Bellaire, Texas 77401 / MOhawk 7-7403
Cable: HOINCO / TWX 713-571-2063

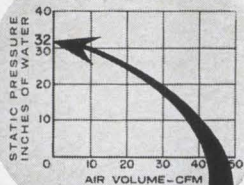
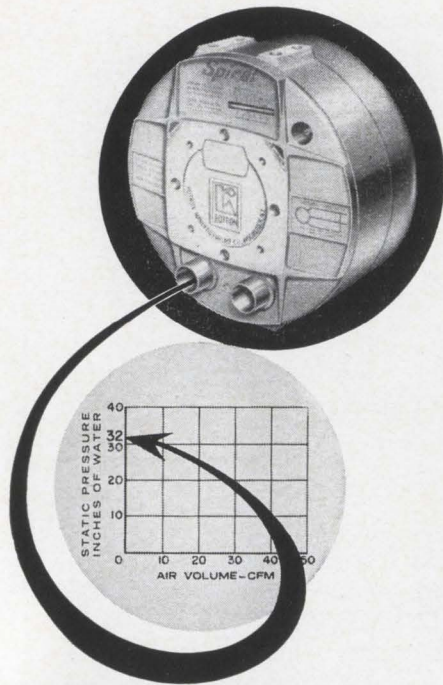

UP TO 32 INCHES W.G.

Spiral (T.M.)

**HIGH PRESSURE/VACUUM
AIR MOVER**

■ ECONOMICALLY PRICED ■ ONLY 10" IN DIAMETER BY 5½" IN DEPTH ■ HIGH STRENGTH ALUMINUM DIE CASTINGS ■ ADJUSTABLE AIR TRIMMER VALVE (OPTIONAL) ■ AVAILABLE IN 1 OR 3 Ø 50-60 CPS MOTOR, 208V.

The "Spiral" is a high pressure/vacuum air mover suitable for applications in the computer and electronic industries for tape transports, pressure source for tape air bearings, differential source for card handling equipment, high speed paper sorting machines and as a source of cooling air for high density electronic packages. Optional accessories include an adjustable trimmer valve and a differential pressure gauge to permit instantaneous trimming to system requirements. New Rotron induction motor features precision cartridge ball-bearings. Elimination of RF noise makes the "Spiral" especially attractive for applications where spark generated interference is a problem. Call or write Rotron for complete technical details and the surprisingly low price!

*integrated
with integrity*



ROTRON
MANUFACTURING CO., INC.
WOODSTOCK, NEW YORK
ORiole 9-2401

West Coast: Rotron/Pacific, Glendale, Calif.
Canada: The Hoover Co., Ltd., Hamilton, Ont.

New Semiconductors

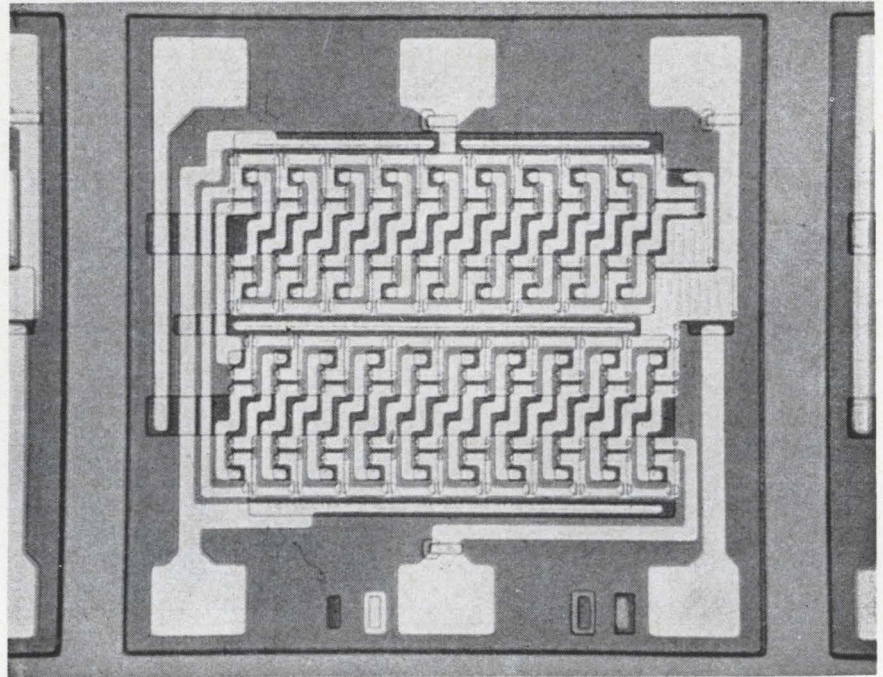

Shift register contains 120 MOS FET's

The pL5000 is claimed to be the first integrated circuit that uses metal oxide silicon technology. This 20-bit serial shift register offers a 20-to-1 increase in functional complexity over the most complex conventional monolithic integrated circuits currently available, according to the manufacturer. The pL5000 is designed to be used in a two-phase clocked sequential digital system. When used open loop, the element provides a 20-bit delay to the input signal. When operated closed loop, the element can be used as a circulating 20-bit memory. Moreover, pL5000 elements can be cascaded to provide longer delays or larger capacity memories. At a clock rate of 1 Mc. the power dissipation is typically 60 mw for clock pulses with

a 50% duty cycle. For a constant clock pulse width, the power consumed will be proportional to the clock frequency. At 100 kc the power dissipation will be 6.0 mw or 0.3 mw/bit for a clock pulse width of 500 nsec. The pL5000 contains 120 MOS FET's on a 41 by 41 mil die. This means that there is a possibility of 350 circuits per 1-in. wafer. The register has less metal over the thin oxide (gate electrode) than a conventional DTL capacitor input binary element. It is contained in a die area smaller than the DTL binary, which, in its smaller form, is 53 by 43 mils. Price for 1 to 49 is \$250 each; for 50 to 199, \$167.50 each.

General Micro-electronics Inc., 2920 San Ysidro Way, Santa Clara, Calif. [371]

Signal diodes offer high reliability

A line of high-speed signal diodes is said to have greater reliability than other commercially available signal diodes. The increased performance of these "double heat-

sink" diodes (DHD's) results from their planar epitaxial passivated design. Measuring under $\frac{3}{16}$ in. in length by $\frac{1}{16}$ in. in diameter, the DHD (shown at top) is one-third the size of the company's DO-7 line of signal diodes, and can be substituted directly for DO-7's in most applications. The DHD's can dissi-

MITSUBISHI MICROWAVE ANTENNAS FOR TELECOMMUNICATIONS

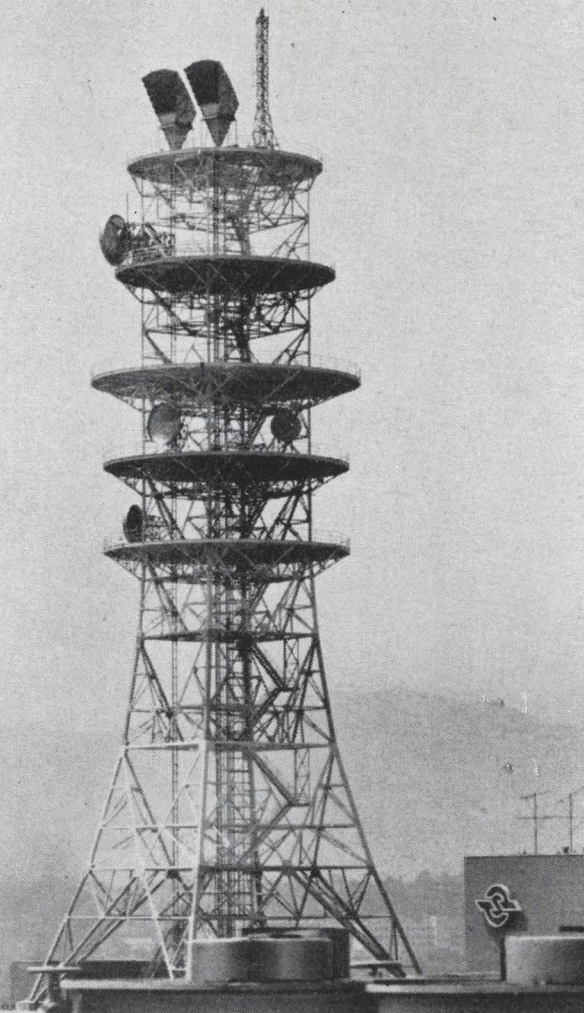

Japan today has the second largest microwave network in the world. Mitsubishi Electric, with the longest microwave antenna experience in Japan, has supplied 90% of the antennas used in the trunk lines of this extensive network. Mitsubishi antenna systems include parabolic, scatter, horn reflector and radar types, as well as a complete line of waveguide components and accessories. Frequencies from 900 Mc. to 24 KMc. are covered. The IU-62, shown above and specified at the right, is typical of the outstanding performance of Mitsubishi microwave antennas. Full technical information on any of these types of antennas is available at your request.

IU-62 Horn Reflector Antenna

Frequency Range : 3,000-12,000 MC
 Aperture : 9m²
 Max. width : 4,050mm
 Max. depth : 2,560mm
 Max. height : 7,418mm
 Gain at 3,900MC : V 41.5 db
 H 41.2 db
 Gain at 6,100MC : V 44.9 db
 H 45.0 db
 VSWR : 1.01
 Front/Back : 67-70 db
 (over 60 degrees)
 Discrimination of : V 57 db
 cross polarization : H 78 db (at 3,900MC)
 V 45 db (at 6,100MC)
 H 37.5 db

Guaranteed wind velocity : 140 miles/hr



MITSUBISHI ELECTRIC CORPORATION

Head Office: Mitsubishi Denki Bldg., Marunouchi, Tokyo. Cable Address: MELCO TOKYO

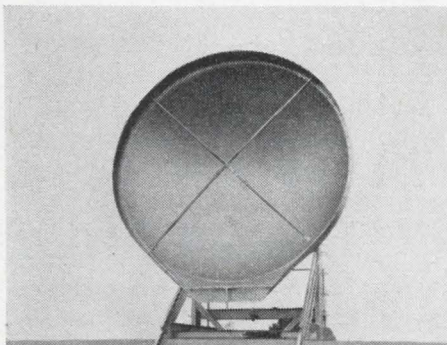

■ IU-61 parabola antenna

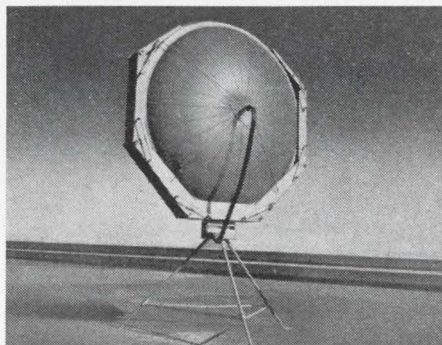

■ Air inflated parabola antenna

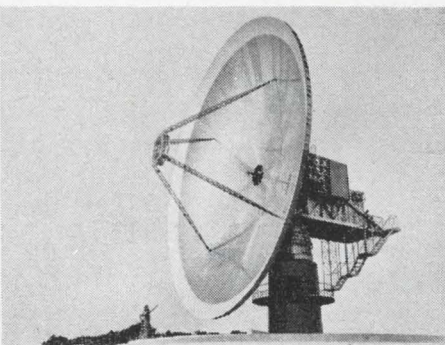

■ 20 meter diameter antenna for satellite communication

AT LAST!

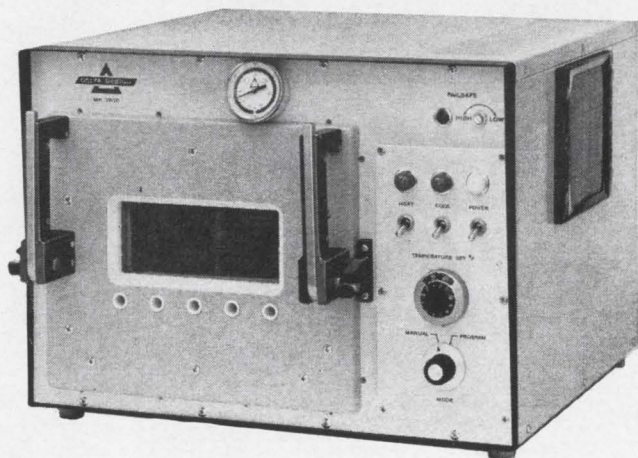

A Temperature Chamber You Can Set... and Forget!

Here for the first time is a temperature chamber that's really automatic. You set it to the desired temperature and Delta Design's Mark III does the rest. Without decisions by human operators, it heats or cools automatically to maintain the set temperature—even in the presence of heat generated by parts under test. Surprisingly enough, only Delta chambers have "set it and forget it" control.

Another Mark III exclusive — an ease and flexibility of programming never before possible. With a Mark III and a Delta programmer, complex heat/cool cycles like the one below are routine ... ranging from -300°F to $+1000^{\circ}\text{F}$.

This plus provable $1/10^{\circ}\text{F}$ control... positive protection against "runaways"... all solid state design... low temperature gradients throughout the entire test volume ... and more—at competitive prices. Three sizes starting at \$785.

Contact Delta or your nearby Delta/ Non-Linear Systems office on the Mark III or any problem involving accurate control of environments. It's our specialty.

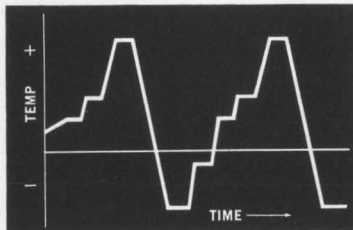

The Environmental Control People

8000 Fletcher Parkway • La Mesa, Calif.

Phone: (714) 465-4141

New Semiconductors

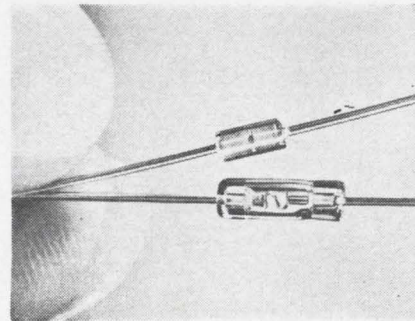

pate up to 700 mw at 25°C when properly heatsinked. Their design meets and exceeds mechanical testing requirements of MIL-S19500C. Samples have withstood over 3,000 hours of life tests without significant change in parameter values. Leads are anchored. A lead pull of approximately 1 lb for each of three 90° arcs of the case will not dislodge the leads. The construction provides for the uniformity of electrical parameters for large-scale production. Single-pellet DHD's may be used in low-level limiters, computer logic, core drivers, hammer drivers and a large variety of general-purpose applications covering the broad spectrum of diode usage. Multipellet DHD's, called stabistors, are designed for use as low-voltage regulator diodes, amplifier nonlinear bias elements and as a level shifting diode in diode-transistor logic circuits. The DHD offers high breakdown voltage (up to 125 v), low leakage current (as low as 100 picoamps) and capacitance under 1 pf. Prices of the DHD's, including stabistors, range from 35 cents to \$3.65 in lots from 100 to 999.

General Electric Co., Semiconductor Products Dept., Syracuse, N.Y. [372]

Alloy-diffused scr's rated to 16 amps rms

A series of alloy-diffused silicon controlled rectifiers have been developed with continuous current ratings to 16 amps rms, 10 amps average. The 2N1842 series offers 12 transient peak reverse voltage ratings from 35 to 960 v. This rating is the maximum instantaneous value of the reverse voltage across

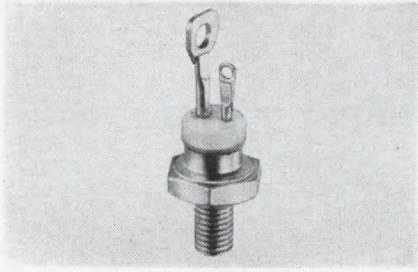

the scr, including all nonrepetitive transient voltages. Peak 1-cycle surge current for the series is 125 amps. The rectifiers are manufactured in an all-welded TO-48 case with glass-to-metal hermetic seals. All internal joints are hard-soldered for maximum resistance to thermal stress. All units in the 2N1842 series deliver 16 amps rms forward current for all conduction angles, a peak gate power of 5 w, peak forward gate voltage of 10 v, peak reverse gate voltage of 5 v, and peak forward gate current of 2 amps.

Tung-Sol Electric Inc., One Summer Ave., Newark 4, N.J. [373]

High-voltage silicon transistor

A new pnp silicon transistor is available. The 2N3527 is a 30-v unit that has a typical d-c current gain of 60 at 0.1 μ a of collector current, and maximum leakage current of 0.1 na. The device requires

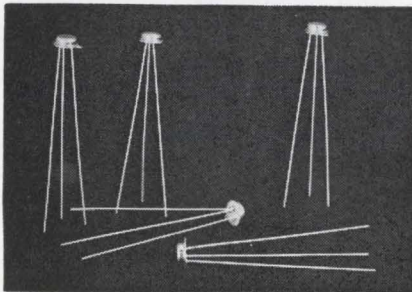

only nanowatts of d-c operating power. The 2N3527 is manufactured by the epitaxial junction process, which combines the advantages of alloyed, epitaxial, and planar techniques, and provides extreme ruggedness and parameter stability. Unit price is \$12 in 1-99 quantities.

Crystalonics, Inc., 147 Sherman St., Cambridge 40, Mass. [374]

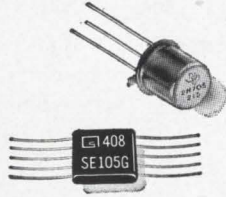

Need to say a lot
in a little space?

(or make markings
more **durable**...or
more **economical**...
or at higher rates?)

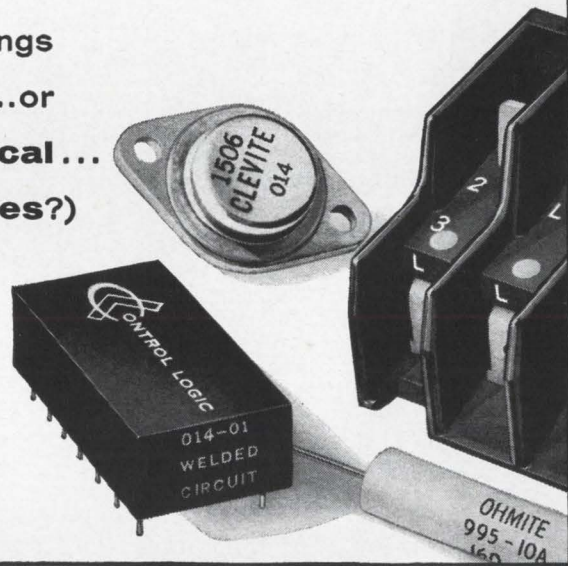

We can show you how

We can show you how to identify products so they will resist extreme amounts of handling, abrasion, many solvents and other atmospheric conditions . . . or how to sequentially number and identify components with savings of more than \$50 per 1000 . . . or how to print trademark, type number, value and date code on 90 units a minute . . . or how to produce an imprint that remains readable after 1000 hours at 200°C. . . or get 10 digits and 2 letters in a micro-circuit area of 0.090" — or 21 characters on a TO-5 case with interchangeable type number and date code . . . or save 75 cents of every dollar you now spend on buying, applying, inventorying and discarding obsolete preprinted labels.

The answers are in proven Markem machines, type and specialty inks, which daily produce better product or package identification by reducing costs, smoothing production control and increasing customer acceptance. And while Markem machines, type and inks are helping to produce better products through more complete and lasting identification, they frequently pay for themselves in the savings they make possible. Tell us what *you* make, what it must say, and for how long: we'll give you a specific recommendation and cost estimate right away. Write Electrical Division, Markem Machine Co., 305 Congress St., Keene, New Hampshire 03431.

MARKEM



Did you say
**SOLID-STATE
 WIDEBAND
 LOG
 AMPLIFIERS?**

You'll find the most extensive selection of solid-state, log IF amplifiers available anywhere, at LEL. These units are truly broadband, possess wide dynamic range and are capable of achieving extremely fast logging action with the greatest possible accuracy. LEL's standard log amplifiers are available in bandwidths from 4 to 20 mc, at various IF center frequencies between 20 and 70 mc.

Naturally, LEL also excels in solving your special system problems. Take this new solid-state, wideband log IF amplifier for example. It features a dynamic range of 90 db with ± 1 db log accuracy, has a 30 mc bandwidth, offers high stability, operates on CW or pulse and meets the requirements of MIL-E-5400.

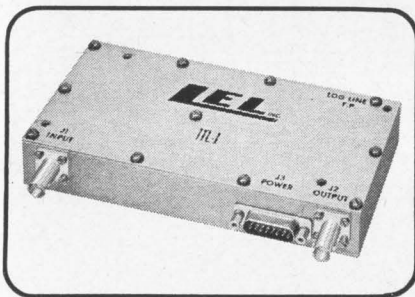

**For all your receiver
 requirements...
 call on LEL capability!**

Send for your **FREE** copy
 of LEL's Catalog '64



LEL INC.
 AKRON ST., COPIAGUE, L. I., NEW YORK 11726
 (516) AMityville 4-2200 / (516) PYramid 9-8200
 TWX Code 516-691-5085

New Subassemblies and Systems

Automatic pacing component blender

A new digital, in-line blending system keeps all product components at correct ratios, regardless of a reduction in flow. The system is expected to be used to process chemicals, foods and petroleum; and to manufacture fertilizers. Featuring new M/98300 automatic pacing digital controllers, the system blends either liquids or solids and is particularly useful for short runs involving relatively small total quantities. The advanced system operates on the principle of pace setting, that is, allowing the lagging component to set the pace for the other streams. With the system in operation, a master demand module paces the blend, sending a pulse signal, whose frequency is proportional to total blend rate, to the new digital controllers. One controller is on each component line. As long as the component flows satisfy this particular demand, the blend rate is maintained. However, if one component falls behind—which is likely

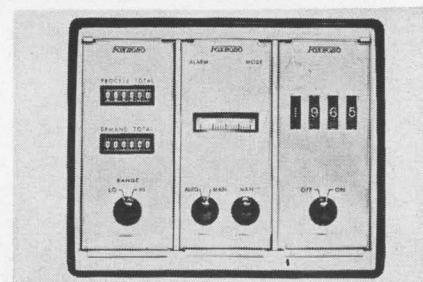

to happen at start-up, or when a strainer clogs, or a pump cannot meet flow requirements—the controller on that line takes over, slowing all feeds in proportion to the troublesome one so that the blend is on spec at all times. A typical system consists of a master demand module, measurement transmitters control valves or speed control devices, and the component control stations, which include a standardizer, the new automatic pacing digital controller and a ratio module.

The Foxboro Co., Foxboro, Mass. [401]

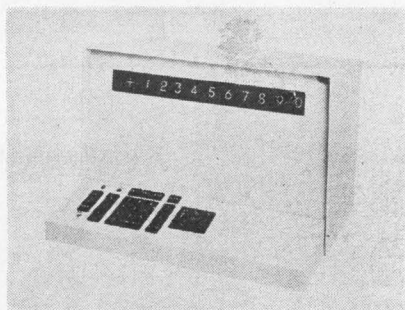

**Compact, logarithmic
 computing instrument**

This compact electronic computer can be used on desk tops or tables. The LOCI-1 is designed to extend the personal computing power of the scientist and the engineer. With its storage registers and keyboard, it performs all of the operations found in ordinary calculators. However, its logarithmic principle of operation enables it to function with a unique flexibility and unpar-

alleled power, according to the manufacturer, reducing the number of steps needed for many types of complex calculations. For example, square roots and reciprocals of square roots may be computed with one-key strokes. Exponential and logarithmic operations are accomplished with equal ease. LOCI-1 has a logarithmic register which accumulates the logarithms of numbers much as an ordinary accumulator stores the result of additions and subtractions. The logarithms are automatically generated when the appropriate function keys are pressed. The anti-log of a number in the logarithmic register is also obtained upon a single key command. Careful construction from completely solid state components is said to assure the most reliable and long-term performance. Answers of 8- to 10-digit precision are instantly available at electronic speeds upon the clearly legible Nixie display. Simple to operate, the LOCI-1 is more flexible than

WHAT WILL **Acme Electric**

GET INTO NEXT?



THIS RECTIFIER HAS INTEGRAL WATER-COOLED CONDUCTORS

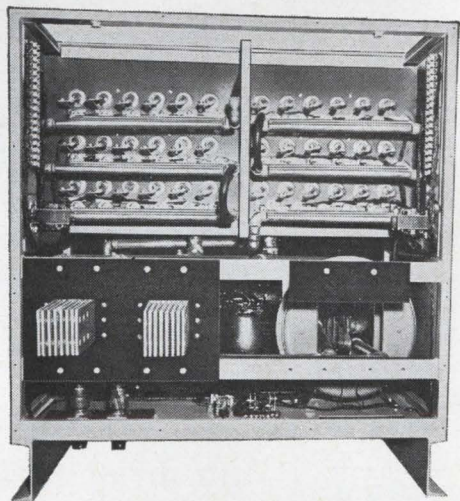

Instead of solid copper conductors, Acme Electric engineers employed hollow copper conductors for both transformer and reactor to reduce size and control temperature rise. All semiconductors and even the outside covers were water cooled.

As a result of this ingenious construction, this 45,000 watt static power rectifier, rated for 7500 amperes at 6 volts, was compressed in physical size, delivering 1200 watts of power per cubic foot; 36 watts per pound of physical weight!

Acme Electric engineers have an accumulation of experience for almost twenty years in building static power rectifiers and power supplies for applications that require out-of-the-ordinary performance. Acme Electric is ready to help you.

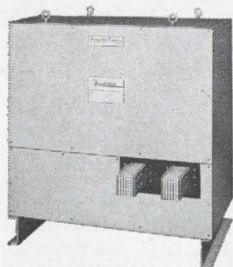

SPECIFICATIONS OF WATER-COOLED CONDUCTOR RECTIFIER

INPUT: 460 volts, 3 phase, 60 cycles

OUTPUT: 6 volts D.C., 7500 amperes

SIZE: 48" high x 44" wide x 30" depth

WEIGHT: 1250 lbs.

SAA3815-3120

Acme Electric

Engineers and Builders of...

311 WATER STREET, CUBA, NEW YORK
Canadian Representative: Polygon Services, Ltd.
50 Northline Rd., Toronto 16, Ont.

REGULATED POWER SUPPLIES
STATIC POWER RECTIFIERS
VOLTAGE STABILIZERS
VOLTAGE REGULATORS

Circle 211 on reader service card

POLAR RELAY TYPE 21

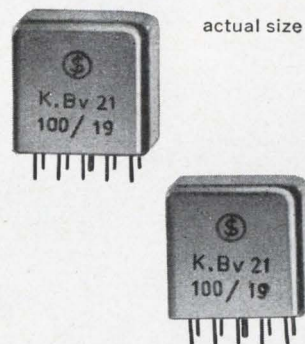

This subminiature polar relay of advanced design is widely applicable in small-size, light-weight communications equipment and control equipment for telephony, carrier telegraphy, data transmission in telemetry, automatic control, data processing, etc. It features extremely efficient magnetic circuits, unique chatter-free contact mechanism, and long-life contacts. Advanced hermetically sealed design is combined with long life (100 million operations), high sensitivity (0.7 mw), high speed (1.5 ms), and high stability against external magnetic fields.

MICRO RESONANT REED SELECTOR

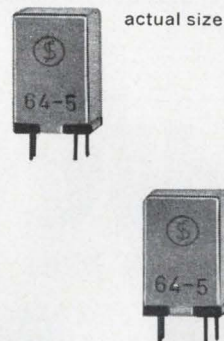

This radically miniaturized micro resonant reed selector of the single-reed, plug-in type finds widespread use in diverse types of tele-controlling systems, portable equipment, and other transistorized circuits. It is composed of a composite cantilever vibrator, driving system, contact, and their supporting structures, all accommodated in a metallic case. In addition to its small size and light weight, since the vibrator is mechanical, its selectivity is sharp, and since variation of the resonant frequency due to changes in ambient temperature or aging is very slight, a high order of stability is obtained.



FUJITSU LIMITED

Communications and Electronics

Marunouchi, Tokyo, Japan

THE NISSHO AMERICAN CORP. 80 Pine St., New York 5, N.Y.
Phone: Whitehall 3-7840

THE NISSHO PACIFIC CORP. 120 Montgomery St., San Francisco 4, Calif.
Phone: YUkon 2-7901-7908

NISSHO (CANADA) LTD. 100 University Avenue, Toronto
Phone: EMpire 2-4794

Circle 167 on reader service card

167

**rugged and
reliable**

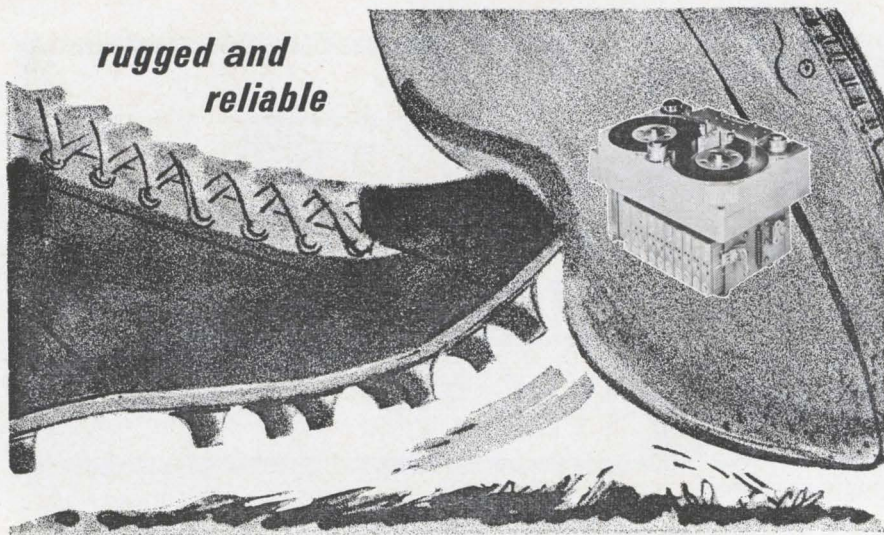

Impact ability...proved in the field Genisco's high-environment 10-110 Tape Transport has demonstrated its reliability repeatedly in applications where shocks exceeded 100 g's for 20 ms...vibrations to 70 g's peak-to-peak...and accelerations over 50 g's.

This member of Genisco's ruggedized family of tape transports offers FM, direct or digital recording capability in a full range of recording speeds with low flutter even during the peak environment period of applications such as aircraft crash conditions...nuclear environments...and sled test programs.

For complete information on the right tape recording system to meet your most exacting specifications, write or call today about your application requirements.

Genisco TECHNOLOGY CORPORATION
DATA DIVISION

18435 Susana Road, Compton, California (213) 774-1850

Circle 212 on reader service card

MICO

PRECISION DRILL PRESSES

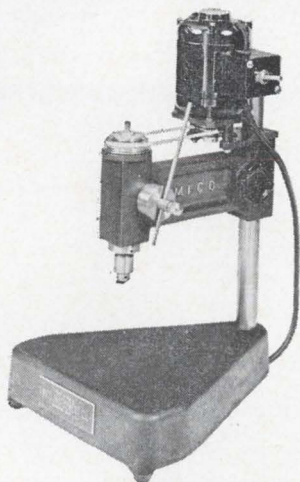

FEATURES

1. Durable, accurate, sensitive, variable speed;
2. Four models—with various size bases and throat dimensions from 6 1/2" to 12 1/2";
3. Ball bearing spindle assemblies with built-in dust protectors. Spindles with taper-oilless bearings available.
4. Drill head can swing radially and is adjusted vertically.

Send for illustrated catalogs

MICO INSTRUMENT CO.

77 Trowbridge St. Cambridge 38, Mass.

GRAPHIC VISUAL CONTROL

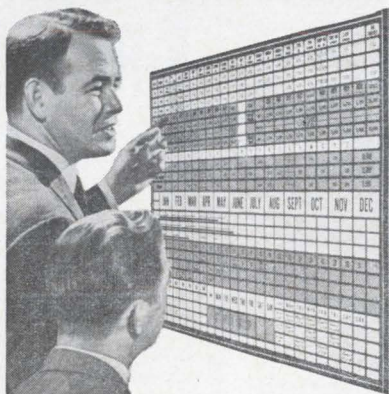

You SEE How To Get Things Done With The BOARDMASTER System

You see a Graphic Picture of your operations, spotlighted in color. You have facts at Eye Level. Saves time, cuts costs and prevents errors.

Ideal for Production, Maintenance, Scheduling, Inventory, Sales, Traffic, Personnel and many other uses.

Simple and flexible tool. You write or type on cards and post on board. All cards are interchangeable.

Compact and Attractive. Made of Aluminum. Over 1,000,000 in use.

Complete Price \$49⁵⁰ Including Cards

FREE 24-Page BOOKLET No. C-10
Mailed Without Obligation

Write Today for Your Copy

GRAPHIC SYSTEMS

925 Danville Road • Yanceyville, N.C.

Circle 213 on reader service card

New Subassemblies

a slide rule and more accurate than most mathematical and engineering tables. Price is \$2,500.

Wang Laboratories, Inc., 836 North St., Tewksbury, Mass., 01876. [402]

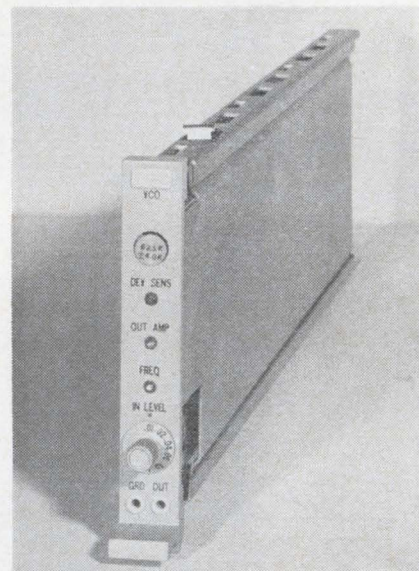

Millivolt-controlled subcarrier oscillator

An inexpensive oscillator, model 238, is designed for f-m telemetry systems where a number of millivolt-level, high-frequency transducer signals must be transmitted simultaneously over some distance or recorded for later data reduction. As f-m record electronics, the unit offers performance an order of magnitude better than conventional tape-recorder electronics, according to the manufacturer. Model 238 features high voltage-to-frequency conversion gain: a 10-mv input produces full-scale deviation of $\pm 40\%$. The oscillator incorporates an internal mixing network and provides an output of up to 2 v rms, permitting a number of model 238's to be operated in parallel without a buffer amplifier. It is available for use in proportional-bandwidth and constant-bandwidth systems. Plug-in channel selectors provide operation at frequencies between 300 cps and 1.6 Mc and deviations of up to $\pm 40\%$. Design features include: $\pm 0.1\%$ -of-bandwidth linearity, 100-db common-mode rejection at 60 cps, 1-meg-

ELECTRONIC HARDWARE COMPONENT PRODUCTS

FASTENER SPECIALISTS for ELECTRONICS

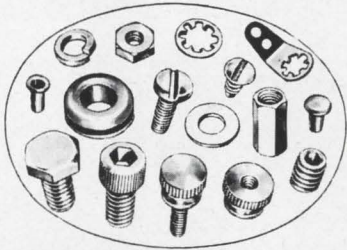

ONE SOURCE OF SUPPLY FOR FASTENERS

SCREWS - NUTS - BOLTS - WASHERS - LOCK-WASHERS - SPADE BOLTS - WELD SCREWS - SEMS SCREWS - THREAD CUTTING SCREWS - SOCKET SCREWS - LOCK NUTS - STOP NUTS - SWEDGE NUTS - WELD NUTS - MINIATURE FASTENERS - RIVETS - EYELETS - NON-CORROSIVE FASTENERS - AN-MS-NAS FASTENERS - NYLON FASTENERS - NYLON FASTENERS - INSULATING WASHERS - SPACERS - STANDOFFS - GROMMETS - BUMBERS - TERMINALS - SPRING PINS - COMPONENTS

Distributors For
UNITED SHOE MACHINERY CORP.
Complete Stocks of SE Eyelets

We carry in stock thousands of Standard and Special Items essential to the
ELECTRONIC • INSTRUMENT • AUTOMATION
Manufacturing Industries
SPECIAL COLD HEADED PRODUCTS
STAMPINGS — SCREW MACHINE PRODUCTS
Made to order in all metals

FEDERAL SCREW PRODUCTS, Inc
3917 N. Kedzie Ave., Chicago, Illinois 60618
Area Code 312—Tel. 478-5744

Write for CATALOG 64E for Purchasing & Design

Circle 214 on reader service card

NIMS

**NATIONWIDE IMPROVED
MAIL SERVICE PROGRAM**

**For Better Service
Your Post Office
Suggests**

**That You Mail Early
In The Day!**

ohm input impedance, less than 10- μ v equivalent input noise, and less than 1% carrier distortion. Price is \$590.

Electro-Mechanical Research, Inc., Sarasota, Fla. [403]

Pulse generator with 1.5-amp output

A new pulse generator, model SP, features no-droop output waveform, with rise and fall times of 1 and 10 μ sec, respectively. Output is 1.5 amps, resistive or inductive. Input voltage is 18 to 30 v d-c.

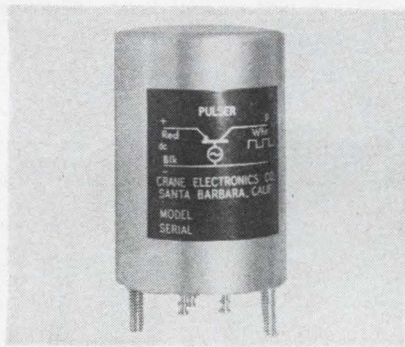

Frequency range is 0.01 to 5,000 cps, and its on/off duty cycle limits are from 2% to 98%. Its applications—as a controller—include stepping motors, relay cycling, solenoid actuators and relay life testing. Units are priced from \$88 each.

Crane Electronics Corp., 1401 Firestone Road, Santa Barbara Airport, Goleta, Calif. 93017. [404]

High-speed solid-state arithmetic processor

A new rack-mounted arithmetic processor is a high-speed, solid-state device with capability ranging from single instruction arithmetic operations including square-root to complex function subroutines. Its features include three arithmetic registers, three memory registers, and an optional keyboard and crt display which can be remotely located. The unit is specifically designed for use as the arithmetic element of on-line systems in applications where larger scale computers are economically impractical. This central processor

4ways NEW

SPACE-SAVERTM PANEL METERS

WITH VALUABLE FEATURES
ENGINEERS HAVE
ALWAYS WANTED

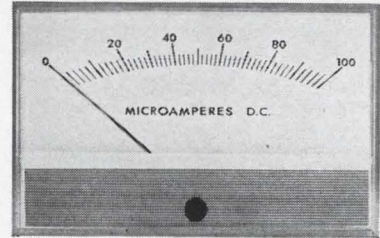

**Minimum height design
to save panel space!**

NEW! 15% longer scale —
40% less space.

NEW! Crisp, low profile for
modular styling. Permits the equipment designer to achieve the ultimate in design.

NEW!

Quick clip mounting saves 90% of normal installation time. No washers, nuts or screws.

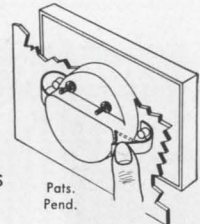

NEW! Recessed terminals require less chassis depth, leave more space for components.

FOR YOUR APPLICATION,
MAY WE QUOTE ON YOUR
SPECIFICATIONS, OR HAVE
OUR REPRESENTATIVE CALL?

Experienced manufacturers of meters in volume, for both commercial and military applications, including ruggedized and sealed meters to military standards

Designed and Manufactured by

DIXSON, INC.

METER DIVISION  DEPT. B

GRAND JUNCTION, COLORADO

INSTANT

Instant drafting with symbols and drawing details preprinted on tri-acetate sheets ready for use. Your own engineering details can be applied in seconds, rather than drawn in hours.

The STANPAT formula gives permanent adhesion without ghosting. Crisp, clean reproduction everytime on all types of tracing media. Excellent for microfilm reproduction.

Write today and find out how STANPAT can save you hours of routine drafting time. Literature and samples on request, or enclose your symbols for quote.



*faithfully serving
the engineer for
over two decades*

STANPAT Products Inc.

Whitestone 57, N.Y., Dept J1
Telephone: 212-359-1693



Circle 216 on reader service card

CHECK TENSION QUICKLY

WITH THE GENALEX TENSION GAUGE

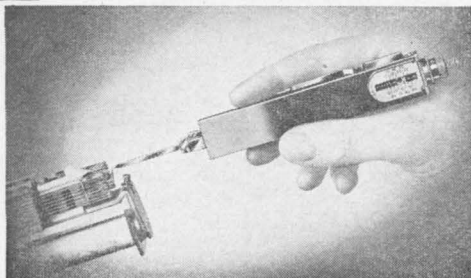

FOR checking the tension of springs or similar resistive forces.

- Most precise
- Easiest to read

Available in six tension ranges from 4 to 2500 grams

for free illustrated leaflet, write to



11 UNIVERSITY ROAD, CAMBRIDGE 38, MASS.

170 Circle 170 on reader service card

THE MOST SELF-CONTAINED READOUT EVER DEVELOPED!

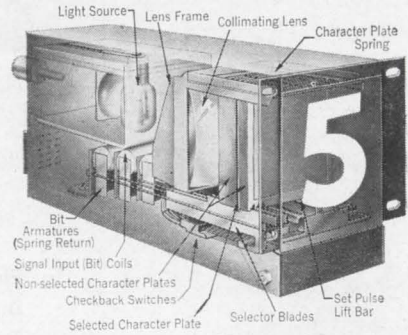

IEE BINA-VIEW®: BINARY INPUT, SELF-DECODING, ALPHA-NUMERIC READOUT WITH MEMORY

Bina-View takes any binary code up to six bits and translates it into bright, readable numbers and/or letters. 41-message capacity permits additional display of colors, symbols, words. Automatic memory retains last message displayed after signal and set-pulse power have been removed. Optional contact closures provide storage of input for subsequent electrical readout of original binary input.

BINA-VIEW OFFERS THESE ADDITIONAL FEATURES:

- LONG UNIT LIFE. Certified for 20,000,000 operations. Uses new extra-brightness lamp, replaceable in 30 sec.
- FLOATING DECIMAL POINTS available from separate lamp circuit.
- LOW POWER. Requires only 100 mw per bit.
- BRIGHT, READABLE CHARACTERS appear entirely in a single plane on non-glare Lucite viewing screen. Characters up to 1 3/8" high; any style you specify.
- COMPACT. Bina-View is only 3 3/8" H, 1 7/8" W (without mounting brackets), 7" D.

SEND FOR COMPLETE INFORMATION ABOUT BINA-VIEW AND OTHER IEE READOUTS!



INDUSTRIAL ELECTRONIC ENGINEERS, INC.

7720 Lemona Avenue • Van Nuys, California
Phone: (213) 787-0311 • TWX (213) 781-8115
Representatives in Principal Cities

©1965 IEE

Circle 217 on reader service card

Planning to change your address?

Use the form below to indicate a change of address. Because our issues are addressed in advance, please try to allow at least 5 weeks for change of address to become effective. Attach the address label from your most recent issue in the space provided below.

[Please print the following information for proper service]

Title or position

Name

Chief job responsibility

Company and Div.

Product or Service Approx. No. of employees

Address

City Zone State or Prov.

Mail to: Fulfillment Manager, **Electronics**
P.O. Box 430, Hightstown, N.J. 08520

*Paste present mailing label or address

from wrapper or envelope here.

Electronics | January 11, 1965

New Subassemblies

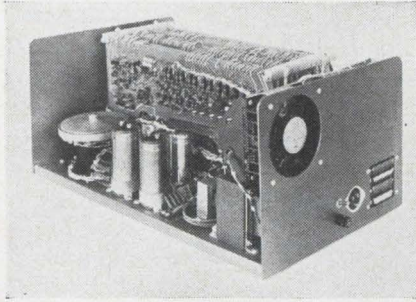

can communicate with a wide variety of input/output devices such as paper tape, punched cards, plotters, keyboards, crt displays, or d/a converters. Problem areas where the arithmetic processor is directly applicable are linearizing, conversion to engineering units, limit comparisons, repetitive computations involving more than one variable, and real-time statistical analysis on input data. Priced at \$3,450, the processor is said to provide for the first time an economically feasible digital computation facility for the single control loop or small instrumentation system. Wyle Laboratories, 128 Maryland St., El Segundo, Calif., 90246. [405]

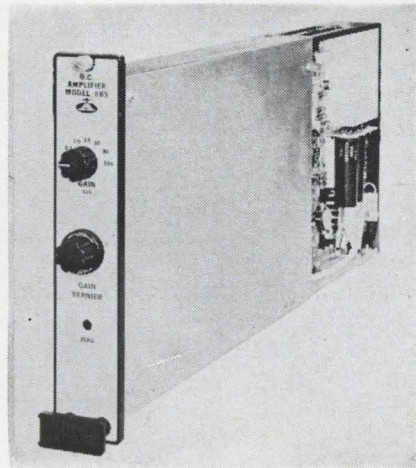

Wideband amplifiers for data and systems

A line of low-cost wideband amplifiers is announced. Especially designed for data and systems, the models 884-101, 885-135 and 885-235 are all-solid-state and contain their own internal power supply. Chopper stabilization without me-

SPECIAL OFFER: Reprints of Special Reports from Electronics

Now, for your reference file—a complete set of Special Reports reprinted from the pages of Electronics in 1964. A total of 172 pages of valuable and informative articles combined in an attractive folder. The reports are individually bound. The special discount price for the reports is \$2.50 which includes both handling and shipping costs. Order now, using the coupon below. The following reprints are included in this offer:

Electronic Telephone Switching 16 pages.
 Direct Digital Control in Industry 24 pages.
 Transistor Heat Dissipators 32 pages.
 Oceanography 15 pages. Digital Instrumentation 16 pages.
 Magnetics 24 pages. Modern Electronic Packaging 16 pages.
 Electronic Markets New Directions 1963-64-67 24 pages.

Send your order to: **Electronics Reprint Dept. McGraw-Hill Inc.**
 330 W. 42nd Street, New York, N.Y. 10036

Reprint order form

A-1

For reprints of feature articles or special reports fill in below:

Send me reprints of Key No.(s) at ¢ each.

For prices and listing please see the reader service card.

Send me complete set(s) of special reports listed above at \$2.50 per set.

Name

Number of street

City, State, Zip code

New Stability Specs

vibrating capacitors

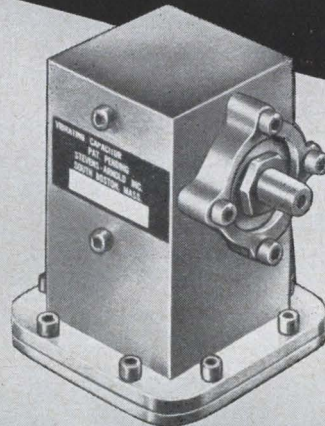

Difficult Electrometers made easy.

Drift with constant temperature 0.05 to 0.1 mv/24 hours noncumulative.

Models for AC drive or oscillator drive.

Particularly suited for long term stability.



Write for Catalog 523 G

**STEVENS
 INCORPORATED
 ARNOLD**

QUALITY SINCE 1943
 7 ELKINS ST., SOUTH BOSTON 27, MASS.

S/A-36-5 1/3

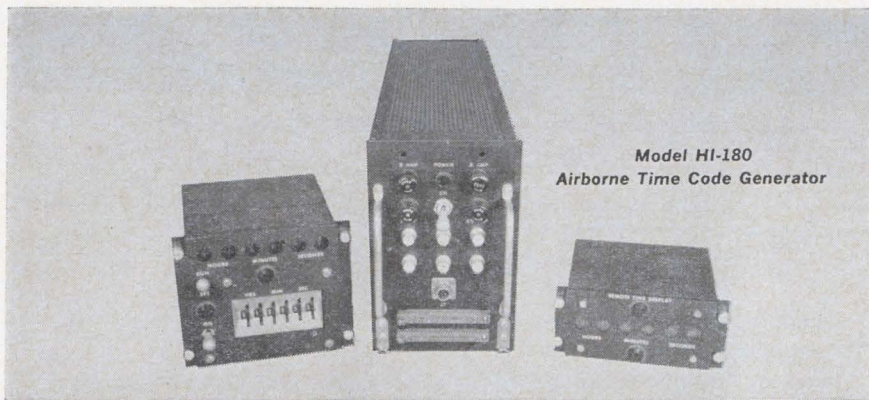

Model HI-180
Airborne Time Code Generator

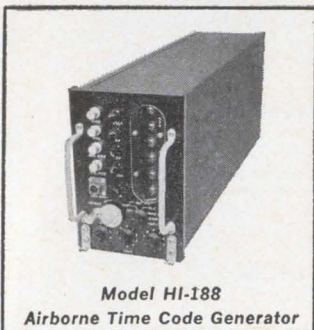

Model HI-188
Airborne Time Code Generator

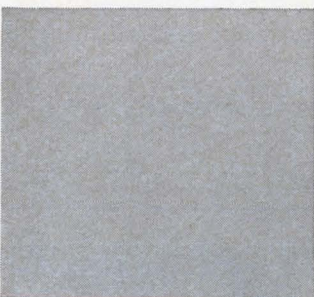

Hyperion

THE NAME
FOR PRECISION TIME
INDEXING AND AUTOMATIC
SEARCH EQUIPMENT
AND SYSTEMS

Hyperion's digital field of concentration is precision time indexing and automatic search for desired data blocks on different recording media such as magnetic tape, camera film, oscillograph strip chart recordings, etc.

Hyperion can furnish to your specifications and application requirements. Your inquiry is invited.

Hyperion

INDUSTRIES, INC.

134 COOLIDGE AVENUE, WATERTOWN, MASSACHUSETTS, 02172
TWXN: WTNW MASS - 860 TEL: WA 6-0140

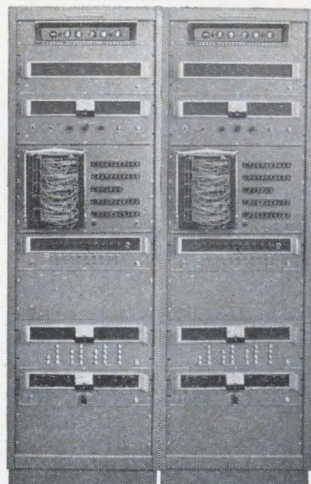

Range Timing and
Countdown System

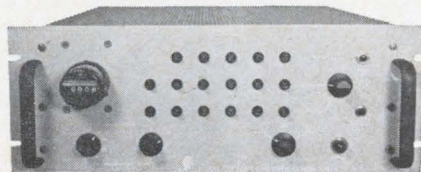

Model HI-117 Precision Time Code Generator

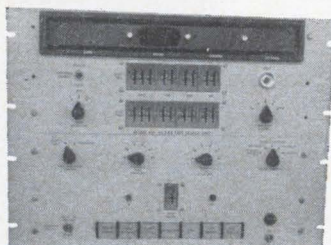

Model HI-231 Magnetic Tape Search Unit

New Subassemblies

chanical choppers is achieved through the use of newly-developed field-effect transistors. This new circuitry provides chopper stabilization to obtain low drift rates previously found only with mechanical choppers. The amplifiers' input circuits are floating and guarded and isolated from the output and power ground circuits. The output is also isolated from the input and power ground circuits. Common mode rejection of 160 db at d-c and 120 db to 60 cps is achieved with up to 1,000 ohms source resistance unbalance in either input lead. Common mode voltages may be as great as ± 300 v d-c or peak a-c.

Astrodata Inc., 250 E. Palais Road, Anaheim, Calif. [406]



Uncoated laser optics have high reflectivity

A series of uncoated laser optics, known as resonant reflectors, are in production. They are said to upgrade the reliability of laser systems with which they are used through their ability to withstand peak power densities orders of magnitude greater than those which destroy commonly used dielectric coatings. Peak powers over 10^8 w per sq cm have been successfully and repeatedly handled. The resonant reflectors are broadband in operation. They have a high reflectivity from 0.4 to 4.0 microns. The manufacturer describes the units as assemblies of parallel sapphire or quartz plates which have been polished and positioned to interferometric tolerances. The assemblies are being made available with both a choice of reflector materials and in the number of elements, thus offering a wide range of reflectance values. Reflectivity peaks are separated by ap-

Save time with these tested transistor design circuits

Here's a ready source of quick, time-saving answers to your transistor circuit problems . . . practical guidance on essential phases of today's semiconductor developments. Because these three volumes bring you the successful work of practicing engineers, every topic has permanent reference value and contributes to the Library's usefulness in your work.

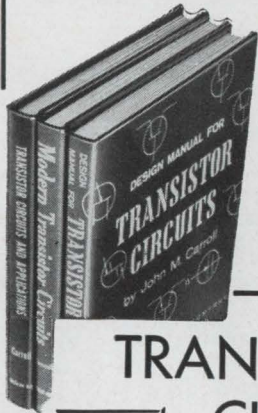

You'll have at your fingertips hundreds of *proved* transistor circuits — with all the necessary design information and component values required to utilize them in your own designs — and save valuable man-hours of time and effort.

TRANSISTOR CIRCUITS LIBRARY

Edited by John M. Carroll
Managing Editor
Electronics

3 vols. 932 pp., 1735 illus. and tables, \$24.95—payable \$8.95 in 10 days, \$8.00 monthly

Praise by experts . . .

" . . . a valuable reference to the circuit designer and engineer."
—*Electronics*

" . . . useful to those who are entering the field of semiconductor circuit design."
—*Control*

" . . . a convenient and comprehensive source of transistor information."
—*Radio-Electronics*

Save \$5.05. Bought separately, books would cost \$30.00. But under special Library offer, they come to you at a \$5.05 saving—and you may pay in small, convenient installments.

SEE LIBRARY 10 DAYS FREE Direct from Publisher

McGraw-Hill Book Co., Dept. 11-1111
327 W. 41st St., N. Y. C. 10036

Send me the Transistor Circuit Library. In 10 days I will (check one) remit full price of \$24.95; or only \$8.95 in 10 days and \$8.00 monthly. Otherwise I will return books postpaid. (If you remit in full with coupon, plus local tax, refund and return privileges still apply.)

Name
Address
City State Zip
Company
Position

For price and terms outside U. S. write McGraw-Hill Int'l., N.Y.C. 10036 11-1111

proximately 1 angstrom. An additional benefit gained through the use of resonant reflectors is that they have intrinsic mode selection properties which significantly improve laser beam divergence.

Lear Siegler, Inc., Laser Systems Center, 2320 Washtenaw, Ann Arbor, Mich. [407]

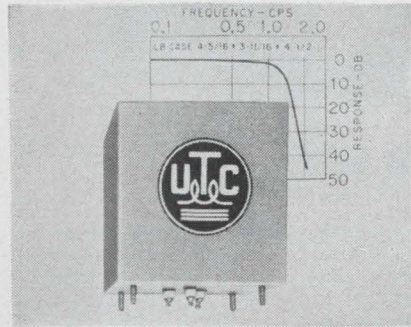

Low-frequency low-pass filters

New low-frequency low-pass filters are announced. These stable units are engineered to perform with an unvarying frequency response over extended periods of time and usage. Designed to pass signals from d-c to 1 cps, the response to this filter is flat to within 1 db for signals up to 0.75 cps and is within 2 db to 1 cps. At frequencies above 2 cps, the filter has an attenuation of at least 40 db. The source and load impedances are 10,000 ohms. The filter is manufactured and guaranteed to MIL-F-18327B. It is hermetically sealed and ruggedized being MIL type FR4RX11LB. It measures $4\frac{5}{16}$ by $3\frac{11}{16}$ by $4\frac{1}{2}$ in. and weighs 6 lb. The unit fills requirements frequently found in medical electronics, geophysical and similar low-frequency applications.

United Transformer Corp., 150 Varick St., New York, N.Y. 10013. [408]

Rear-projection readout device

A new rear-projection readout device will display a 2-in.-high character. This satisfies the basic human engineering requirement as to the ideal character height for a display that must be easily read from a distance of up to 50 ft away. Designated as the series 360, the

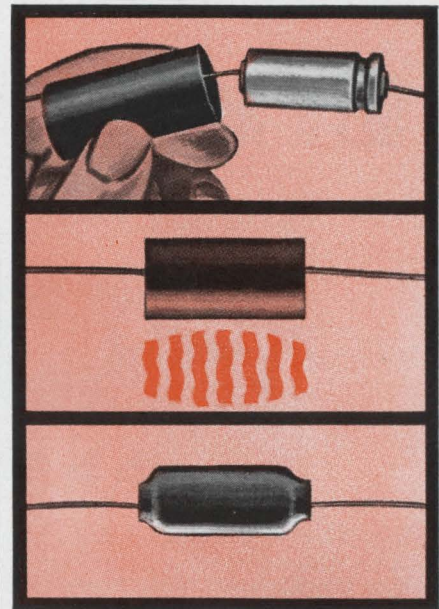

FLEXITE SHRINKDOWN HEAT SHRINKABLE PLASTIC TUBINGS

Simple as one-two-three. Slip a piece of Shrinkdown Tubing over a component or connector; apply heat . . . watch it shrink to one-half its expanded size, forming a smooth, tight-fitting covering of insulation over the irregular shape. Shrinkable tubing is finding many applications . . . as insulation over components, to cover coils, as cable jackets, for marking leads and connectors. To meet broad requirements Markel offers four different FLEXITE Shrinkdown Tubings: Type PO (cross-linked polyethylene); Type TE (Teflon); HT-105 (flexible vinyl); and Semi-Rigid Vinyl. Installation is easy. Immersion in hot water (less than 200°F) will activate the vinyls; a heat gun can be used with the higher temperature types. Why not join the designers who are cutting production costs by discovering countless uses for Shrinkdown Tubings. Try some at our expense; we'll gladly send free samples, data, and prices. Call, write, or wire for fast action.

L. FRANK **MARKEL** & SONS
SINCE 1922
NORRISTOWN, PA.



SOURCE FOR EXCELLENCE

Insulating Tubings and Sleevings
High Temperature Wire and Cable

CEI's New Surveillance Receiver



... has the 10-90 mc watch

Now you can cover 10-90 mc with a single surveillance receiver. CEI's new Type 965 receives AM, FM and CW signals, incorporating separate RF tuners to span the 10-30 and 30-90 mc bands. No longer do you need both an HF and VHF receiver to cover this range.

Bandwidths of 10, 50 and 200 kc are selectable by a front panel switch, and each position has a BFO for CW reception. The 965 provides audio, video, IF and signal monitor outputs, the last two at 21.4 mc. This facilitates use of a CEI signal monitor if a visual display is desired. Transistors and nuvistors are used throughout to assure compactness (just 3½" high) and reliability.

For complete information about this and other CEI products, please write:



COMMUNICATION ELECTRONICS INCORPORATED

6006 Executive Boulevard, Rockville, Maryland 20852, Phone (301) 933-2800

Circle 218 on reader service card

NEW TRANSISTOR TV TUNER

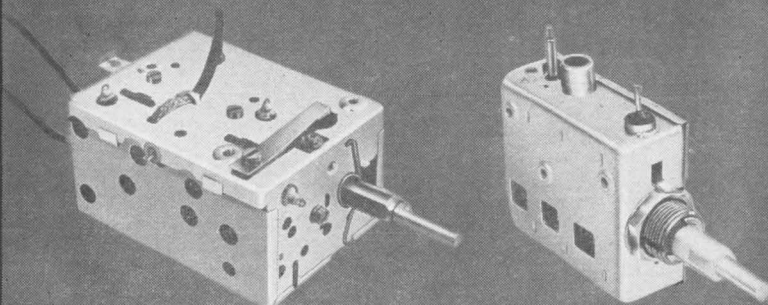

VHF V-AS11

UHF U-AS11

MITSUMI transistorized TV tuners are the most reliable TV accessories because of their unique design and high quality. Electronic reliability is maintained by carefully selected material and strict quality control.

Mechanical reliability is completely guaranteed. Spurious radiation have been eliminated in line with FCC standards.

Mitsumi Electric Company Limited is one of top electronic apparatus manufacturers in Japan. The Mitsumi poly-varicon and IFT have been put into 80% of the total transistorized radio set produced in Japan. Mitsumi Electric Company specializes in the manufacture of poly-varicon, IFT oscillator coils, variable registers, FM tuners, TV tuners, micro motors, CdS photoconductive cells and sockets.



MITSUMI ELECTRIC CO., LTD.

Head Office: Komae Kitatama, Tokyo, Japan
New York Office: 11 Broadway, New York 4, N.Y., U.S.A.

New Subassemblies

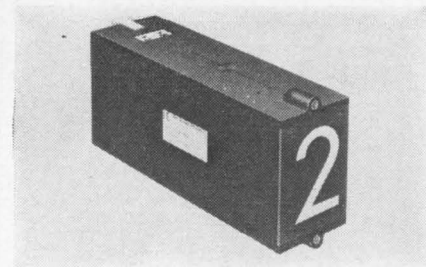

unit is 3 in. high by 2 in. wide by 7¾ in. long. It may be used wherever visual data display is required and is capable of displaying anything that is photographically reproducible. Each series 360 is capable of displaying up to 12 different messages, which are on film inside the unit mounted in front of an assembly of 12 incandescent lamps. When one or more of the lamps is lighted, the corresponding film message or character is illuminated, focused through a lens system and projected onto the viewing screen at the front of the unit. Series 360 is said to be the smallest rear-projection readout device capable of displaying a 2-in.-high character. It is priced at \$33 in 1 to 9 quantities with a decreasing price scale for larger quantities. Industrial Electronic Engineers, Inc., 7720 Lemona Ave., Van Nuys, Calif. [409]

Module displays luminous captions

This caption-display module presents luminous captions or symbols to describe the data read in the numeric portion of the readout. It is equipped with a film transparency which is lighted from the rear by four neon or incandescent lamps. The module can be mounted on a common bracket with the series R-100-T numeric readouts and is available for operation on 14 to 160-v circuits. The display area may be divided horizontally into upper and lower sections, or vertically into left and right sections, each lighted by two lamps and capable of being switched for alternate display. By further subdivision, there may be four areas, each lighted by one lamp, that can be selectively displayed. The four dis-

FOR
POSITIVE
SHOCK
PROTECTION

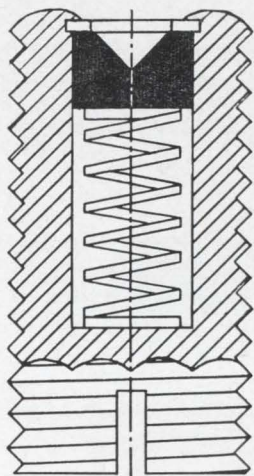

USE **BIRD**
CUSHION JEWELS
IN INSTRUMENT
ASSEMBLIES

Bird Jewel Assemblies mounted with resilient silicone rubber or spring cushioning provide inexpensive shock resistance for any instrument. Variable cushioning absorbs acceleration and deceleration shocks and severe vibratory stress without damage to pivot point.

Cushion Jewels maintain perfect alignment, through controlled jewel movement, provide greater accuracy and longer life. For only pennies more Cushion Jewels will protect your instruments.

BIRD COMPLETE JEWEL ASSEMBLIES are available in screws or bushings of any style, ready for product assembly. Our engineering staff is at your service for all your jewel bearing needs. Write for our catalog with full details on properties and uses of sapphire and glass jewels.

Richard H. Bird & CO., INC.
1 SPRUCE STREET, WALTHAM, MASS. 02154

Serving Industry with Fine Jewels since 1913

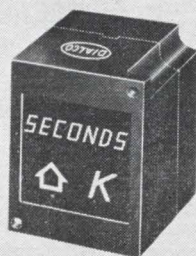

play areas are suitable for symbols or abbreviations.

Dialight Corp., 60 Stewart Ave., Brooklyn, N.Y., 11237. [410]

**Computer system
for process use**

A new high-speed computer system for process use has been announced. Model 97600A is described as the fastest medium priced industrial computer system

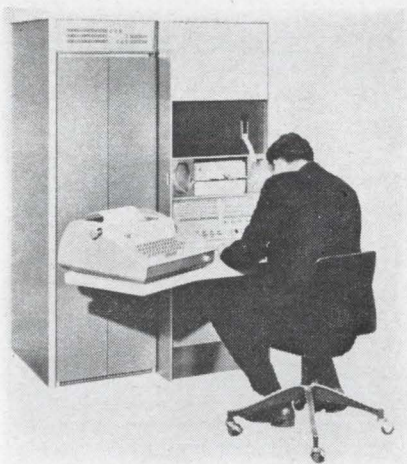

available. It is designed for a full range of industrial applications and is especially suited for involved process calculations which are time-shared with production scheduling and direct digital control. The computer features 10 Mc silicon circuitry with a memory cycle time of 1.75- μ sec. The fast cycle speed enables many subroutines transferred from bulk storage to be completed without interruption. Options available are a high-speed arithmetic unit and wired-in double precision circuitry. Because the 97600A computer is program-compatible with its predecessor, the 97600, the new machine can be provided with a library of industrial programs already tested in on-line applications. In addition, the

now
available:

high-
power
Trygon
half
racks!

Up to 300 watts — precision regulated power — constant voltage — constant current — remote sensing — remote programming! Models for every application, from \$149. For the lab: self-cased; for systems: single or dual in 5¼" panel. Write today for complete specs. Dept. E-28.



TRYGON[®]
POWER SUPPLIES

Roosevelt, L. I., N. Y. (516) FReeport 8-2800

New Electronics Books For Your Reference Bookshelf

All available on 10-Day examination

• NEW IN JANUARY •

HANDBOOK OF ELECTRON TUBE AND VACUUM TECHNIQUES

BY FRED ROSEBURY, *Research Laboratory of Electronics, Electron Tube Laboratory, M.I.T.*

This is a greatly expanded and revised edition of the widely used MIT "Tube Laboratory Manual." Here is a single volume containing virtually all the current data required to obtain the vacuum and to handle the materials associated with the fabrication of electron tubes and similar devices used in science and industry, today. The *Handbook* is carefully cross-indexed and copiously documented.

c. 832 pp, 120 tables, charts and illus (1965)
About \$15.00

• PUBLISHED LATE 1964 •

INTRODUCTION TO SEMICONDUCTOR DEVICES

BY M. J. MORANT, *University of Durham*

Written at the advanced undergraduate level, this book provides an introduction to the physics of semiconductor devices. Its primary purpose is to bridge the gap between the applications textbooks and those dealing with pure semiconductor physics or device design. In general the emphasis in the first four chapters is on developing a concise and relatively non-mathematical description of the physical phenomena leading up to the d.c. and a.c. characteristics of p-n junctions and transistors. More recent junction devices, such as the tunnel diode and the controlled rectifier, are described in the final chapter.

126 pp, 35 illus (1964) \$2.95

LINEAR ANALYSIS OF ELECTRONIC CIRCUITS

BY GLENN M. GLASFORD, *Syracuse University*

Provides the reader with a sound technical background for the analysis and design of electronic circuits. Although it is primarily concerned with the applications of electron tubes and transistors and other transistor-like devices, the treatment is sufficiently general that the reader who studies the material with understanding can apply it to other classes of devices.

c. 592 pp, 272 illus (1965) \$15.00

• ALSO •

INTRODUCTION TO THE LOGICAL DESIGN OF SWITCHING SYSTEMS

BY H. C. TORNG, *Cornell University*

This book is designed as an aid to practicing engineers, dealing with the logical design of computers or switching systems. Besides presenting new results in switching theory, such as the geometrical interpretation of the thresholdswitching function, systematic approaches in state reduction, and sequential circuit decomposition, the book also stresses electronic as well as other switching components.

286 pp, 173 illus (1964) \$9.75

MATRIX ALGEBRA FOR ELECTRICAL ENGINEERS

BY R. BRAAE, *University of Rhodes*

A self-study text to enable the electrical engineer of reasonable mathematical ability to read journal articles and other material employing matrix techniques. Assuming no more than a standard engineering mathematics background, the text progresses from first principles to advanced topics and applications. In the course of the exposition, the concepts, transformation, invariance, and group are defined, and the theory of matrices is developed in such a way as to dovetail with that of tensors.

162 pp, 22 illus (1964) \$4.50

Please send for my inspection and approval, a copy of each book I have checked. (I understand that I can return the books in ten days if I decide not to keep them.)



**ADDISON-WESLEY
PUBLISHING COMPANY, INC.**

Reading, Massachusetts

- () Rosebury, Handbook of Electron Tube and Vacuum Techniques About \$15.00
- () Morant, Introduction to Semiconductor Devices \$2.95
- () Glasford, Linear Analysis of Electronic Circuits \$15.00
- () Torng, Introduction to the Logical Design of Switching Systems \$9.75
- () Braae, Matrix Algebra for Electrical Engineers \$4.50
- () Please send free 1965 Catalog.

Name Title

Affiliation

Address

City State Zip Code

- () Please extend College Professor's Discount
- () Payment Enclosed. (We pay postage if you enclose check—same inspection privilege)

New Subassemblies

97600A can perform on-line compiling in Fortran II language. The new computer will utilize the manufacturer's data bus input-output system, which has been successfully applied to the power, steel and food processing industries. This data bus concept is described as industry's first totally buffered input-output system. It provides simultaneous reading of analog process measurements, contact closures and priority interrupts. It can, at the same time, provide outputs to valve actuators and computer set point stations. In addition, the system communicates with operator consoles, prepares punched tape records and typewritten logs.

The Foxboro Co., Foxboro, Mass. [411]

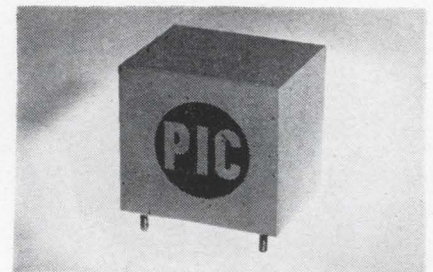

Voltage-controlled crystal filters

New active crystal filters provide adjustable and controllable bandwidth. The CF series was developed especially for use in spectrum analyzers and frequency synthesizers. It can be used in other applications where bandwidth must be adjustable and controllable. Standard center frequencies range from 100 kc to 1 Mc; specials up to 10 Mc are available. Bandwidth can be controlled by d-c or a-c (sawtooth) control voltage. Ratio of maximum bandwidth to minimum bandwidth is approximately 40 to 1.

Polyphase Instrument Co., Bridgeport, Pa. [412]

Ultrasonic delay lines store digital data

New ultrasonic delay lines are



available for digital data storage. The series 150 offers advantages in size, cost, environmental stability and provides improved pulse timing and fidelity through low dispersion, wider bandwidths; low temperature coefficient and high signal-to-noise ratio. Working over a wide range of bit rates and delays, the series 150 lines are capable of storing 10 to 2,000 bits at rates from 2 Mc to 50 Mc for RZ operation with delays to 800 μ sec. Over-all loss varies from 10 to 80 db dependent upon total storage and type of transducer used. Size, environmental stability, and costs as low as a few cents per bit storage are said to make this delay line memory superior to drum and core memories for many applications. Richard D. Brew and Co., Inc., Airport Road, Concord, N.H. [413]

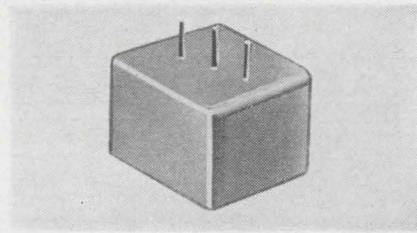

Voltage-controlled crystal oscillator

Model 643 voltage-controlled crystal oscillator is a 1-cu in. unit available at a fixed frequency between 170 and 500 kc. A frequency swing of $\pm 0.008\%$ can be accomplished by applying a 0 to 15-v bias voltage. Input is 26 v d-c with output of 10 v peak-to-peak into a 5,000-ohm load. Wave form is square with 0.2 μ sec rise and fall time. Operating temperature range is 0 to 70°C. The unit measures 1 by 1 by 1.06 in. seated and has three 0.1 in. grid spaced wire leads for p-c board mounting. The oscillator meets the vibration requirements of Mil Std 202, Method 204A (10 to 500 cps, 10 g); rfi of Mil-I-6181; environment of Mil-E-5400; and is suitable for in-flight missile applications.

Monitor Products Co., Inc., 815 Fremont Ave., South Pasadena, Calif. [414]

ADD RF GAIN TO YOUR COUNTER

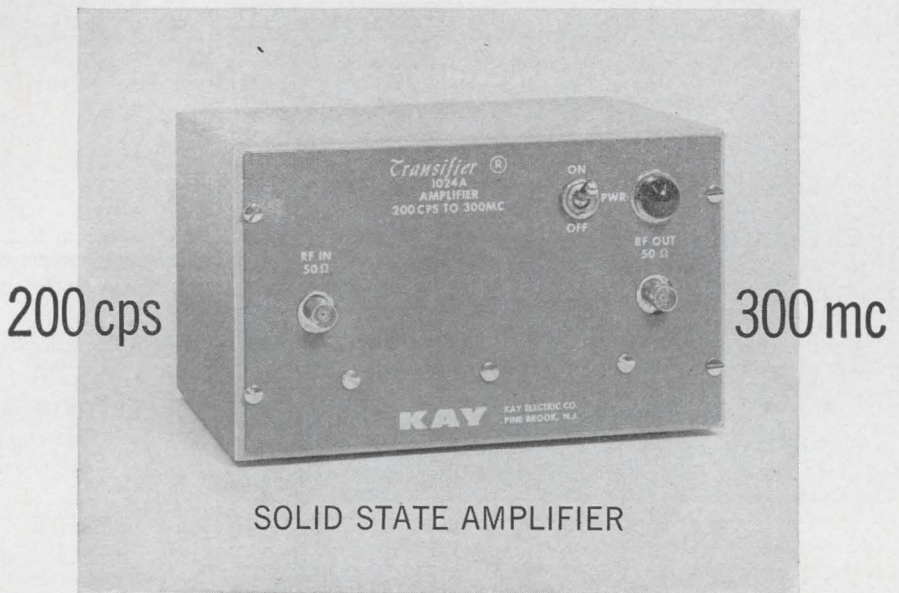

IT'S TOO GOOD for this simple application—check its noise spec, flatness, rise time—STILL its unique low cost design uses fewer parts, makes it pay for just this use alone. Pulse it, sweep it, hook it in for boost. Small, compact, portable.

SPECIFICATIONS

- | | |
|--|--|
| Gain: 30 db \pm 0.5 db | Noise Figure: Less than 13 db
(below 40 microvolts equivalent, wide band, input noise) |
| Flatness: \pm 0.5 db, 500 cps to 300 mc, Down 3 db at 200 cps | Rise Time: Approx. 1.5 ns |
| Frequency: 200 cps to 300 mc | Dimensions: 7 $\frac{3}{4}$ " x 4 $\frac{3}{4}$ " x 5 $\frac{3}{4}$ " |
| Max. Output: $\frac{1}{2}$ VRMS into 50 ohms | Power Supply: 117 volts, 50/60 cps, 6 watts |
| Impedance: 50 ohms | Price: \$295.00 |

FOR COMPLETE LITERATURE, WRITE

KAY ELECTRIC COMPANY
PINE BROOK, MORRIS COUNTY, N.J.



Induction Heating's Most
Trusted and Creative
Craftsmen Since 1926

High Frequency INDUCTION HEATING UNITS

for

- BRAZING
- MELTING
- SOLDERING
- ZONE REFINING
- HEAT TREATING
- CRYSTAL GROWING
- BOMBARDING
- PLASMA TORCH

ELECTRONIC TUBE GENERATORS

Kilocycle Frequency Units
Megacycle Frequency Units
Dual Frequency Units

- SPARK GAP CONVERTERS
- ACCESSORY EQUIPMENT

FREE APPLICATION ENGINEERING SERVICE—Our engineers will process your work samples and submit recommendations.

WRITE FOR NEW LEPEL CATALOG
Lepel HIGH FREQUENCY LABORATORIES, INC.

55th St. & 37th Ave., Woodside 77, N.Y.C.
Chicago Office for Sales & Service: 6246 W. NORTH AVE.

Circle 220 on reader service card

Around the world ...

KYORITSU Measuring Instruments

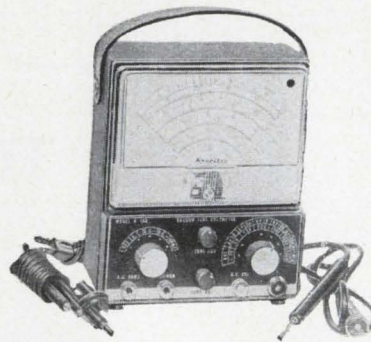

K-142
Vacuum Tube Voltmeter
(190x170x105 m/m)



VR-2P VU Meter
(42x42x37 m/m)

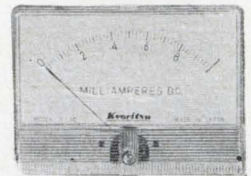

P-60 6" Meter



Kyoritsu

ELECTRICAL INSTRUMENTS WORKS, LTD.

120, Nakane-cho, Meguro-ku, Tokyo, Japan

Cable address: KYORITSUKEIKI TOKYO

Telex: TK 2849

Direct Inquiry Welcomed

Circle 221 on reader service card

NOW
AVAILABLE

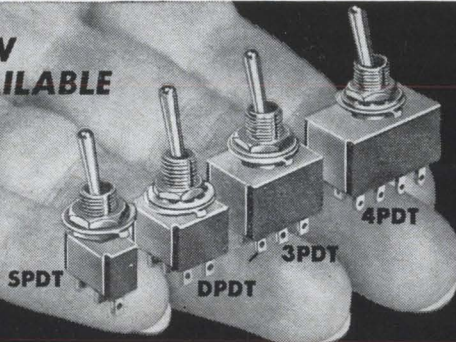

A COMPLETE LINE OF MINIATURE TOGGLE SWITCHES

**UNITIZED
BODY**

One-piece "unitized body" reduces parts, weight, size to a minimum for ultra-miniature space requirements — maintains good specs.

**ULTRA-TINY
1/2" SIZE**

Supplied with miniature bat handles or plastic color-coded caps. Solid silver contacts and terminals. Easy wiring, good soldering ability.

**5 AMPS @
115 VAC**

Overload over 100% Insulation over 100 megs
Breakdown over 1000V Over 80,000 on/off cycles

**IMMEDIATE
DELIVERY**

Available immediately from ALCO stock and thru your local distributor in SPDT, DPDT, 3PDT, 4PDT, momentary and center-off configurations.

**LOWEST
COST**

SPDT \$1.65 — DPDT \$2.15 — 3 PDT \$3.85 —
4PDT \$4.85. Ask for O.E.M. quantity price schedule on the complete line of ALCO switches.



ALCOSWITCH

SEND FOR FREE
CATALOG

Lawrence, Mass. Dept. M-60

Planning to change your address?

Use the form below to indicate a change of address. Because our issues are addressed in advance, please try to allow at least 5 weeks for change of address to become effective. Attach the address label from your most recent issue in the space provided below.

[Please print the following information for proper service]

Title or position

Name

Chief job responsibility

Company and Div.

Product or Service Approx. No. of employees

Address

City Zone State or Prov.

Mail to: Fulfillment Manager, Electronics
P.O. Box 430, Hightstown, N.J. 08520

*Paste present mailing label or address

from wrapper or envelope here.

New Microwave

All solid-state tv relay receiver

Model MA-8512 is a solid-state microwave relay receiver of rugged, lightweight design for reception of television video and sound in the 11.7-to-12.2 Gc or 12.7-to-13.2 Gc tv relay bands. No tubes are used. A major feature of this design is crystal-controlled channel selection. The receiver is a superheterodyne and is used with the latest klystron transmitters using low-drift klystrons. The all-weather chassis and solid-state electrical design permit full receiver performance in vans, helicopters and other remote locations where conventional receivers are not suitable. Full crystal-controlled local oscillator output assures excellent performance in



high-signal environments. Metering circuits are provided to monitor receiver age voltage, discriminator d-c voltage and internal line voltages. Total weight is approximately 23 lb., and the size is 8¾ in. by 12 in. by 8 in.

Microwave Associates, Inc., Burlington, Mass. [421]

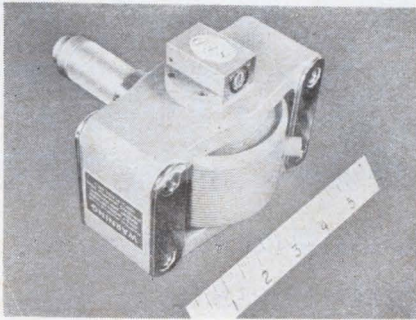

Coaxial magnetron delivers 125 kw peak

A new high-power, Ka-band coaxial magnetron has been introduced. The compact SFD335 delivers 125 kw peak power output at a fixed frequency in the range 34.5 to 35.2 Gc. Production fixed-frequency tubes are normally supplied to within ± 50 Mc of the customer's designated center frequency in that band. The tube weighs only 8.9 lb and offers the inherent long-life capability of the inverted magnetron. A tunable version, designated the SFD338, is also available across the band indicated. The tube is ideally suited for airborne, ground transportable, and mobile system applications because of its rugged construction and high efficiency. It

is warranted for 1,000 hr, and life test data to date has shown typical life expectancies of 3,000 to 4,000 hr. Output is in circular waveguide (WC-59). Transformation into RG96/U rectangular waveguide, if desired, may be accomplished by the use of the SFD 803 or 805 transitions. Standby heater voltage is 16 v; standby heater current, 5 amps; peak voltage range, 17 to 19 kv; peak current range, 15 to 30 amps. Dimensions are 6 in. by 6¼ in. by 3¼ in.

S-F-D Laboratories, Inc., a subsidiary of Varian Associates, 800 Rahway Ave., Union, N.J. [422]

Coaxial attenuator spans d-c to 1 Gc

A coaxial power attenuator has been designed to dissipate a full 50-w energy in the frequency range of d-c to 1 Gc. Model FA-815 may be used as a dummy load for a transmitter, or to reduce transmitter output. It is particularly useful for isolating measuring devices such as bolometers and couplers from higher powered transmitters and other signal sources. The vswr is no more than 1.3:1 over the frequency range while accuracy is

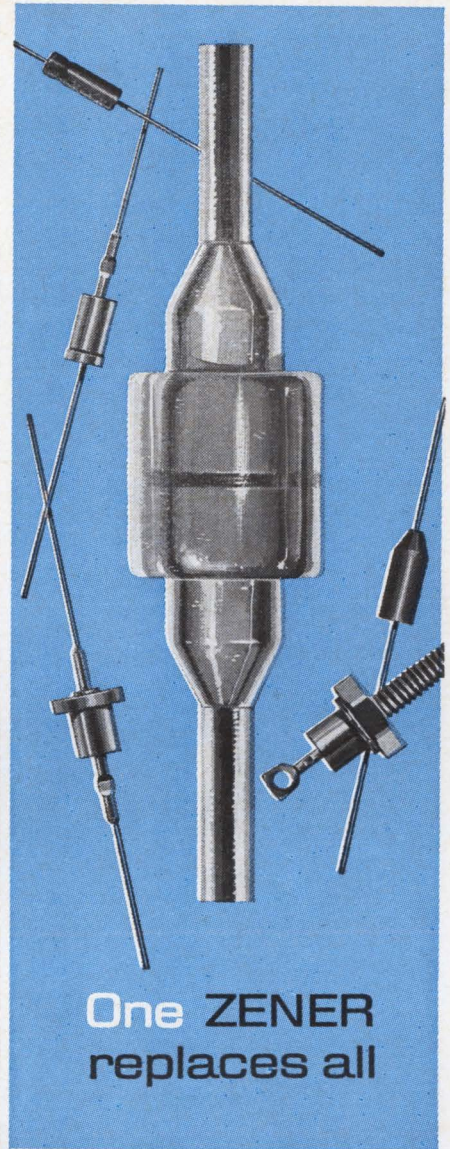

One ZENER
replaces all

One zener for six wattage ratings! Now just one miniature axial-leaded zener — Unitrode's general purpose, universal UZ type — replaces all devices for applications between 400 mw and 3 watts.

That means only one type of zener to buy, to work with, to stock, to test. You can even specify the test current you want, simply by changing a part number suffix. Yet these "in-plant" savings cost no compromise in performance. Operating characteristics are better at every wattage rating . . . in a device no bigger than:



For performance/profit proof, just turn the page.

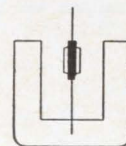

UNITRODE

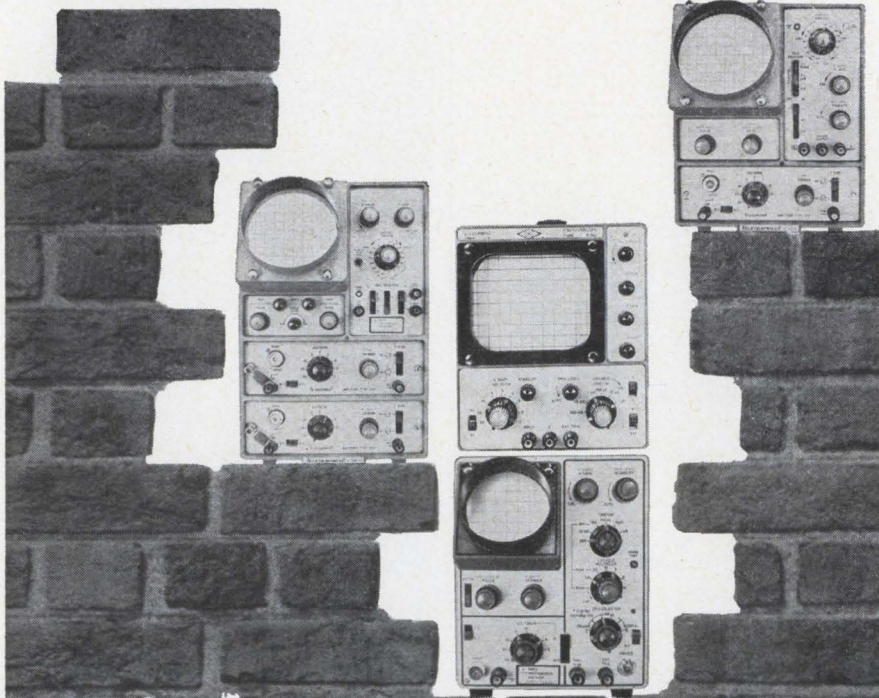

**RULES
SCHMULES**

**AND
UP!**

PRECISION WIDEBAND OSCILLOSCOPES \$235

We are told the rules for selling instruments require a big picture and full specs. With one of the most comprehensive ranges of oscilloscopes in the industry, we can't give you all the information in a single ad. Mail the coupon below today for a short form catalog giving all the information.

data instruments



Name _____

Address _____

Company _____ Title _____

**data
instruments**
7300 Crescent Boulevard
Pennsauken, New Jersey
609-662-3031

A Division of Industrial Electronic Hardware Corp.

New Microwave

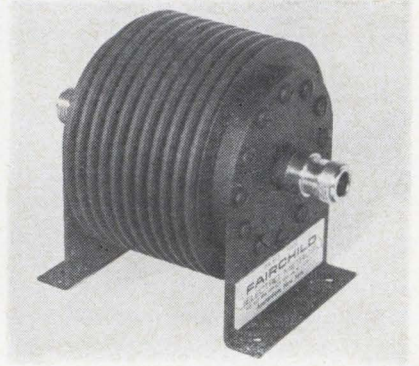

within ± 0.5 db of the attenuation. Model FA-815 is available in values of 3, 4, 5, 6, 10, 12, 15 and 20 db. Connectors furnished are normally type N, and other types are available on request.

Electro-Metrics Corp., 88 Church St., Amsterdam, N.Y. [423]

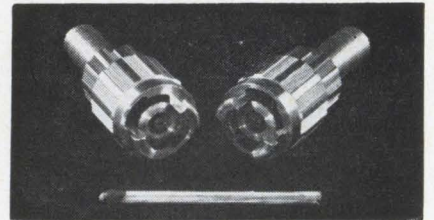

**Coaxial connectors
for use to 18 Gc**

A line of high precision coaxial connectors is available for microwave applications up to 18 Gc. They offer additional freedom to the microwave system engineer, permitting the use of smaller, lighter precision coaxial cable and rigid transmission lines with electrical efficiency approaching waveguide performance. The bayonet-type coupling is standard. Screw-type and bolted flange-type couplings are also available. The connectors are sexless, so identical units will mate. The connector size, based on the inner diameter of the outer conductor is seven mm. Over-all size will vary with the type coupling used. The connector is available in two versions—ultra-high-precision units labeled LPC-7 or GPC-7 for lab test equipment applications, and high precision FPC-7 units for field applica-

PAMOTOR

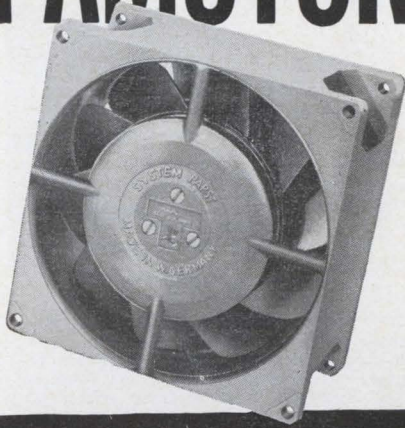

A VERSATILE NEW LINE OF MINIATURE AXIAL FANS

with features that surpass
other cooling devices in
**CONSTRUCTION,
PERFORMANCE,
RELIABILITY!**

Superior inside-outside rotating motor design for higher torque • Flywheel effect produces constant, quiet fan speed • Available in both induction (capacitor-type squirrel cage) and shaded-pole types • Large surface sinter-metal sleeve bearings for permanent lubrication • Die-cast, warp-free metal construction, unlike plastic housings of conventional fans • Ruggedly-built, yet extremely light in weight—18 to 33 oz. • Wide range of characteristics to meet specific requirements.

model no.	volts	overall size (inches)			freq. (cy.)	air flow (cfm)
		w.	h.	d.		
1000A	115	4½ x 4½ x 2	60	125	50	100
1100	115	4½ x 4½ x 2	400	100		
1200	115	4½ x 4½ x 2	60	60	50	50
1300	220	4½ x 4½ x 2	60	125	50	110
2000	115	4½ x 4½ x 2	60	130	50	110
2050	220	4½ x 4½ x 2	60	134	50	116
2500*	115	4½ x 4½ x 2	60	100		
2510*	220	4½ x 4½ x 2	60	100		
2550*	220	4½ x 4½ x 2	50	80		
3000	115	3½ x 3½ x 2	60	60	50	54
3050	220	3½ x 3½ x 2	60	60	50	54
5000	115	5 dia. x 2½ deep	60	115		
5050	220	5 dia. x 2½ deep	50	105		

*Series 2500 is shaded-pole type. All others are induction type, equipped with appropriate capacitor.

For complete specifications and name of nearest stocking distributor, write to:

PAMOTOR, INC.
312 SEVENTH STREET • SAN FRANCISCO, CALIF.

tions. Lab connectors range in price from \$27 to \$35 each, depending on the quantity. The field precision connectors sell for about half the price of the lab units.

Amphenol RF Division, Amphenol-Borg Electronics Corp., 33 E. Franklin St., Danbury, Conn. [424]



Sampler-attenuator in five new models

This sampler-attenuator precisely levels the output of a sweep oscillator and provides 60-db power control. With the model 1150 series, the output from sweep oscillators may be leveled and attenuated at the load, thereby eliminating perturbations caused by interconnecting cables and components. Power variation with frequency from maximum power down at least 20 db is ± 0.5 db and at minimum power is typically less than 1.5 db. Insertion loss is less than 5 db. Five models are available in the series covering the following ranges: 1 to 2, 1.4 to 2.5, 2 to 4, 3.5 to 6.75, and 4 to 8 Gc. Price is \$570. Alfred Electronics, 3176 Porter Drive, Palo Alto, Calif. [425]

Ku-band signal source has 700-Mc tuning

A new Ku-band signal source consists of an oscillator multiplier assembly. Outstanding characteristics, according to the manufacturer, are tuning range, r-f power output and small size. It has ideal capabilities for use as a parametric amplifier pump or local oscillator application because of low power input requirements, low spurious noise and long term stability. It can be modified to cover frequencies as high as 18 Gc. Part number is 9507-1000; output frequency,

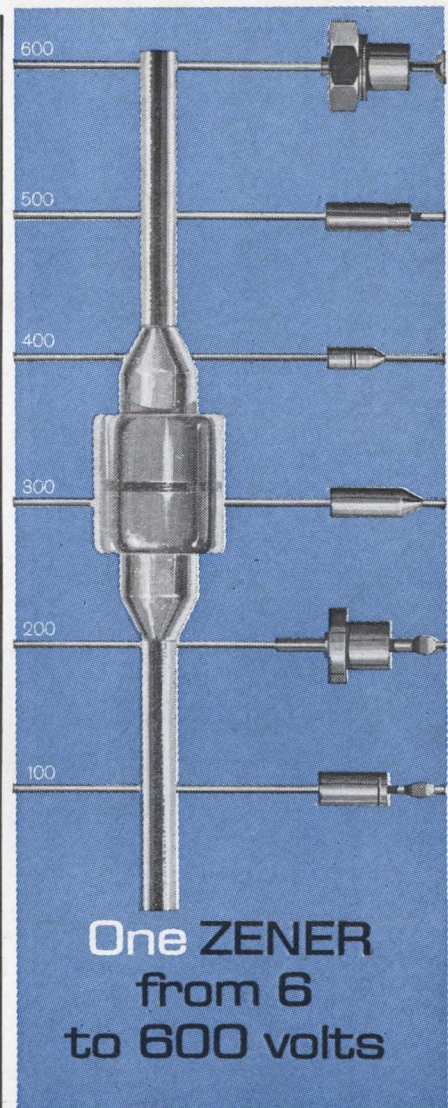

One ZENER
from 6
to 600 volts

The Unitrode® 6-volt universal UZ zener is actually this size:



So is the 600-volt type! That's right, *one* miniature body size, from 6 to 600 volts . . . not only for standard catalog voltages, but *any* intermediate value, with any voltage tolerance from 1% to 20%. And for ultra compact packaging, Unitrode can couple these units into double-anode zeners or even 1200-volt zeners — only .4" long by .085" in diameter!

In any configuration, Unitrode whiskerless construction is "shock-proof" against repeated 50-watt surges — electrical characteristics are preserved *permanently* in a unique glass-fused junction.

Can this be *low-cost* zener performance? Turn the page once more!

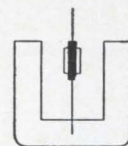

UNITRODE

The Next Time You Need Counters Count on Janus...



B100-2

HERE'S WHY:

① Janus high-speed counters and related products are application-engineered, with you the system designer in mind. ② They incorporate such outstanding user features as all-silicon circuitry, counting rates to 2 mc, easy-to-read in-line displays, -20 to +85 deg. C operating temperature ranges. And ③ Janus counting products are available now off-the-shelf for your immediate installation and use.

*Above, the Model B100-2 high-speed counter can count at rates to 2 mc and features a unique latching display circuit. The Janus product lines also include: Decade Dividers / Forward-Backward Decade Counters / Frequency Counters / Counter-Timers / Digital Clocks.

A complete new technical catalog and brochure is available now. Write for your free copy today.



JANUS CONTROL CORPORATION
HUNT ST. · NEWTON, MASS. · TEL. 926-1037

New Microwave

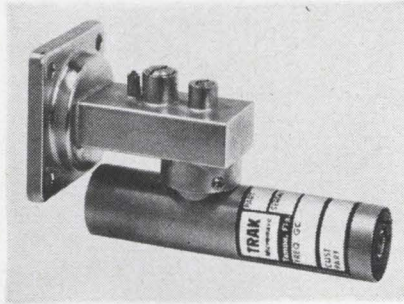

16.05 to 16.75 Gc (c-w); manual tuning range, two screw 700 Mc, one screw 100 Mc; r-f power output is 50 mw, typical, at band edges. A guaranteed 50 mw minimum can be supplied at band center for frequencies up to 18 Gc. Power input requirements are 175 v d-c at 30 ma, 6.3 v at 250 ma nominal. Trak Microwave Corp., Tampa, Fla. [426]

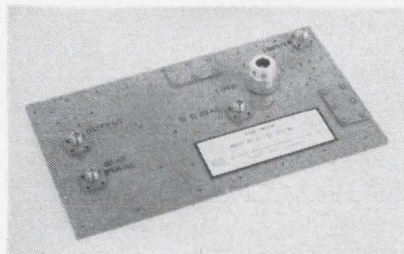

Solid-state microwave switch

Model 02-62 is a spdt diode switch designed for operation at 300 Mc over a 10% frequency band. Features include: nanosecond switching; less than 1 db insertion loss; greater than 35 db isolation between terminals; less than 1.3:1 vswr in both on and off conditions. The switch can handle up to 4 w of average power and requires no negative bias potential. Size is 7½ by 4¼ by ½ in. less connectors; weight, 10 oz.; price, \$375.

Advanced Development Laboratories, Inc., 24 Simon St., Nashua, N.H. [427]

Broadband, high-power coaxial circulators

New, temperature-compensated co-

Reed Relays

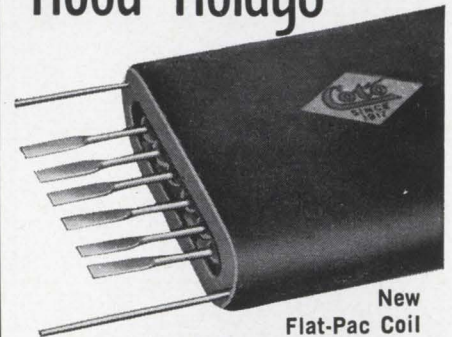

New Flat-Pac Coil
accommodates 3, 4, 5 or 6 Form C reed switches. Ideal for encapsulation or direct tie-down to printed circuit board or chassis, its shape is more compatible with advanced packaging. (Shown actual size)

New Double Pole, Double Throw
miniature relay contains 2 Form C reeds, operates as low as 96 milli-watts. (Shown actual size)

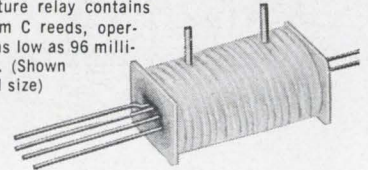

Write for catalog and prices of our standard line of magnetic reed relays. For special requirements, give complete details for quotation.

Coto-Coil COMPANY INC.
65 Pavilion Ave.
Providence, R. I., 02905
Phone: (401) 941-3355

Circle 224 on reader service card

Reprint order form

Send to: **Electronics Reprint Dept.**
330 West 42nd Street
New York, N. Y. 10036

For listing of reprints available see the reader service card.

To help expedite mailing of your reprints please send cash, check or money order with your order.

For reprints of the latest special report:

Electronics Markets 1965

Send me . . . reprints of key no R-67 at 50¢ each.

For reprints of previous special reports fill in below:

Send me . . . reprints of key no.(s) . . . at . . . ¢ each.

For prices see the reader service card.

Name

Number & Street

City, State

Zip code

MISSIMERS PRECISION SERIES TEST CHAMBERS

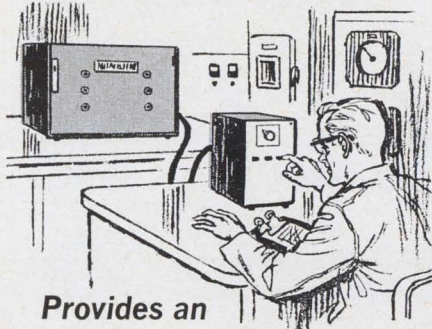

**Provides an
"Instrument" approach
for extreme Accuracy
in Temperature Testing**

This unique design provides close temperature gradients of special variations in the test area, as well as providing for flexibility of use, performance, ease of maintenance and repair. Accessories such as component mounting boards, electrical access connectors, load cards, power supplies, scanners etc. can be added.

The BFT series is CO₂ or LN₂ cooled and can be bench or rack mounted. The units are available in four models; sizes of one-half and two cubic feet and temperature ranges of -100° F. to +600° F. and -300° F. to +600° F. The FT 1.5 series is mechanically refrigerated with a temperature range of -100° F. to +350° F.

WRITE FOR FREE BROCHURES

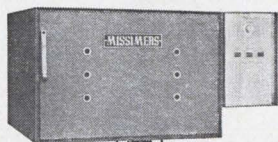

BFT 2

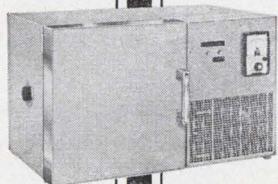

FT 1.5

Reliable Test Equipment Since 1932

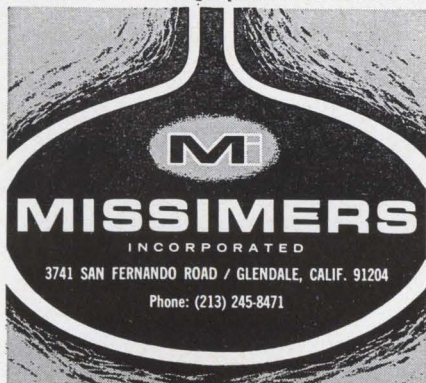

Circle 226 on reader service card

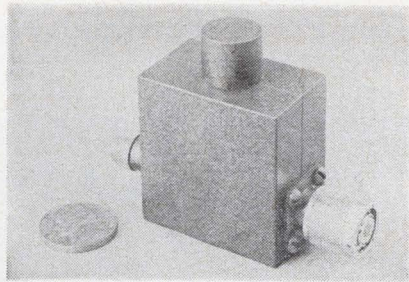

axial circulators are three-port devices. The T-563L has the third port terminated internally to realize isolator operation. Frequency range is 2.0 to 4.0 Gc (any 22% band). With the proper connectors and high power load this unit is capable of handling 400 w c-w. Over the temperature range -55°C to +85°C, the device exhibits the following characteristics: isolation, 20 db minimum; insertion loss, 0.5 db maximum; vswr, 1.20 maximum. Connectors are TNC; weight, 6½ oz; size, 1⅝ by 1¾ by 1⅞ in. (excluding connectors).
Ferrotec Inc., 217 California St., Newton 58, Mass. [428]

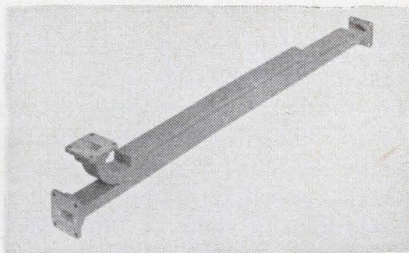

Precision waveguide directional coupler

A new series of waveguide directional couplers are designed with an extremely flat (± 0.2 db) coupling characteristic. Fifteen standard versions are available to provide coupling values of 10, 20, or 30 db over the frequency range of 3.95 to 18.0 Gc. The new couplers are essential for precision measurement work at any power level where ultimate flatness of coupled output is required over the full waveguide operating frequency range. A new design concept provides for a flat compensated response with an extremely high directivity characteristic. Minimum directivity is 40 db. Main line vswr is 1.10 max; secondary line vswr, 1.20 max.

Waveline Inc., Caldwell, N.J. [429]

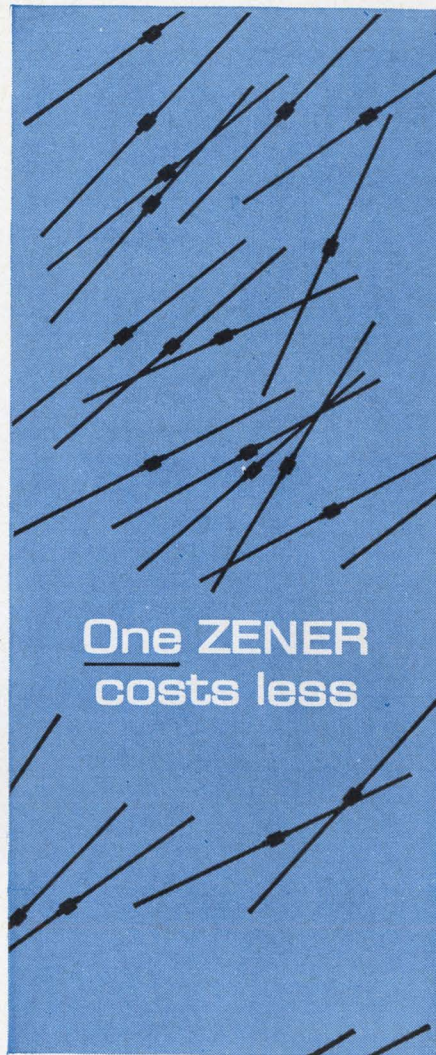

**One ZENER
costs less**

Now you pay less for *all* the zeners you need! Ordering just one type — Ultra-reliable Unitrode Universal UZ zeners — for all your requirements between 400 mw and 3 watts, you profit from volume price reductions. What's more, for even greater quantity discounts, you can combine voltages . . . even place blanket orders with deliveries scheduled over 12 months!

These price advantages guarantee you *direct savings*, plus the operating economies you gain using the only zener offering unmatched characteristics — fused permanently in glass — in a unit this small:

One all-purpose type, a generation ahead in design, yet actually at lower cost . . . Shouldn't this triple-threat zener be working for you? Contact Unitrode Corporation, 580 Pleasant St., Watertown, Mass. 02172. Tel: (617) 926-0404, TWX: (617) 924-5857.

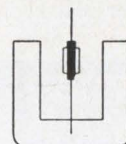

UNITRODE

Circle 179 on reader service card

GREEN

**PRINTED CIRCUIT
DRILL for versatility
at
LOW COST**

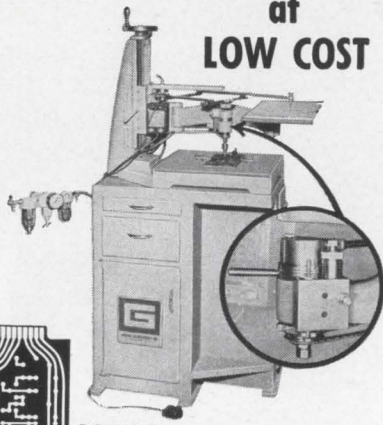

NEW... Spindle feed control provides infinite range of controlled feed rates.

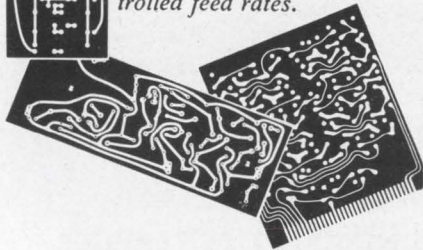

For prototype panels or high production work, drill quickly and easily without specialized labor or expensive tooling. The Green D2 Pantograph Engraver with D2-201 Pneumatic Attachment provides manufacturers with a Printed Circuit Drill having unlimited application flexibility. Check these features:

- Spindle speeds to 26,000 R. P. M.
 - Drill speeds and feeds independently adjustable
 - May be used for profiling and engraving
 - Boards can be stacked 4 deep for fast production
 - Operates on "In Plant" compressed air or tank air (very small volume required)
- drills
up to
100
holes/min.**

Whatever your requirements, the Model D2-201 is the answer—complete and ready to operate. Write or call today for full details.

**GREEN INSTRUMENT
COMPANY, INC.**

Dept. 63 • 295 Vassar Street
Cambridge, Mass. • Eliot 4-2989

New Production Equipment

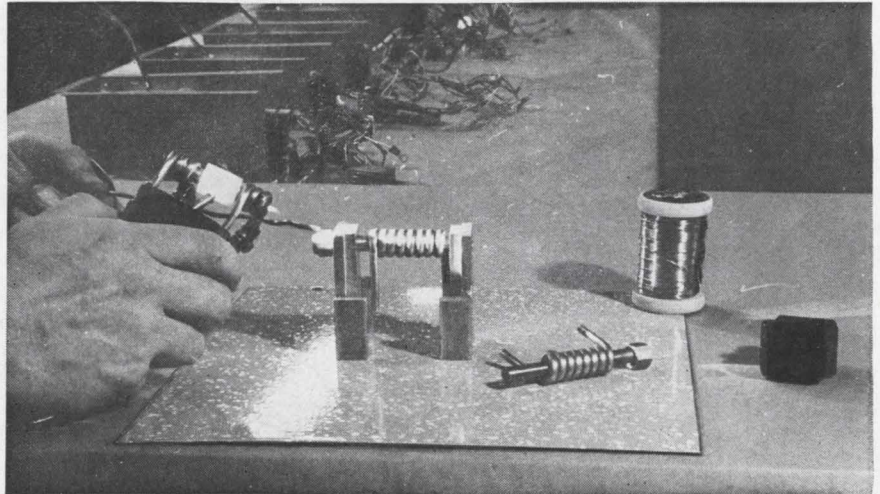

Arc-torch system speeds brazing

Rapid brazing of small ferrous and nonferrous parts is now possible using a highly stabilized arc-torch method. This arc technique of brazing is said to combine the best features of induction heating and protective furnace atmosphere systems with the low cost of gas-torch operation. Also, the rate of heat transfer to the work is three to four times that of oxygen-gas heating methods. One important feature of the arc torch technique is that no toxic fluoride salts or other metal salt flux is required for brazing many metals. Clean brazes have already been achieved with tungsten to copper, tungsten to nickel-flashed or plain stainless steel, brass and bronze to Monel metal,

carbon steel to Hastelloys as well as on the more common joints of copper to brass and copper to copper. Mildly reducing atmospheres of helium-hydrogen, argon-hydrogen, nitrogen-hydrogen, or CO₂ have also been used successfully. Even ETP copper can be brazed without significant loss in tensile strength. The correct combinations of gas in the new arc systems offer exceptionally high temperatures, good oxide reduction and a suitable atmosphere for most brazing jobs. The brazing operation also can be carried out in a simple glass enclosure or in a vacuum flushed inert gas chamber.

Dynamic Controls Co., 2225 Massachusetts Ave., Cambridge, Mass. [451]

Space winder assures accurate repeatability

A linear/non-linear space winder has been designed with very high accuracy for repetitive windings because of all ball-bearing and ball-bushing movement. Possibility of coil rejects is eliminated by positive cam reset. Model 918-PM winds all types of variable pitch (nonlinear) or linear space windings up to 3½ in. maximum length. The machine also winds many types of tuner and similar single layer multi-wound coils in a great

variety of spacings and number of turns in one operation instead of in several operations. Open work area in front permits faster, easier handling by operator. Possibility of clutch slippage is eliminated by a powerful clutch torque feature. Automatic cam return reduces operator fatigue, speeds production and saves up to 20% of operator's time. Wire sizes wound are 18 to 46, winding speeds are variable up to 2,100 rpm, and set-up time is only 5 to 10 minutes for complete job change-over. The machine is furnished with tension, one winding set-up, motor, self-adjusting

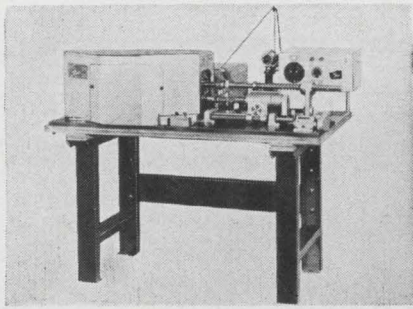

magnetic brake and automatic stop feature.

Geo. Stevens Mfg. Co., Inc., 6001 North Keystone Ave., Chicago, Ill. [452]

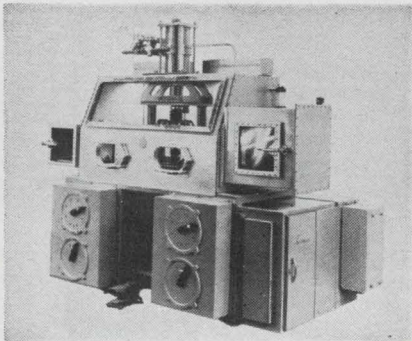

Projection welder for semiconductors

A new machine is announced for general semiconductor welding applications. Model 2400 projection welder is available with integral dry box for controlled atmosphere welding. It offers the ability to encapsulate semiconductor and transistor components by resistance welding over a wide range of sizes—diameters ranging from 0.3 in. to 1.25 in. Specifically, this capacity range is realized through use of twin 75 kva transformers coupled to the welding head through balanced secondary circuits and a new welding head design unique with the model 2400. Welding force may be varied from a minimum of 300 lb to a maximum of 2400 lb energized by 80 psi air. The two-column construction assures that electrode parallelism is accurately maintained. Production rate for projection welding TO-3, TO-5 and TO-8 transistors with ring projections up to and including 1¼ in. diameter is up to 1,000 per hr.

Thomson Electric Welder Co., Inc., 161 Pleasant St., Lynn, Mass. 01901. [453]

She's welding wires 1/6th the size of a human hair...



Engineer StereoZoom into your product as a component, or use the complete microscope . . . for quality-control inspection, for production-line fabrication and assembly . . . of micro-miniature parts and products.

... using Aerojet-General's MICROWELDER Mark II, teamed with Bausch & Lomb's StereoZoom® Microscope

With very little training, this girl learned to weld wires that are almost too small to see. The Bausch & Lomb StereoZoom Microscope incorporated in the Mark II helps her perform the delicate operation easily and precisely. StereoZoom gives her big, sharp *three-dimensional* images of the subminiature parts and microwelder tip.

The Commercial Products Division of Aerojet-General Corporation, Azusa, California, developed and is marketing the Mark II for welding wires as small as .0005 inch in diameter for microelectronic

application. To provide operators with bright 3-D magnification of the minute work, Aerojet chose the Bausch & Lomb StereoZoom . . . an optically-superb instrument, ruggedly built for hard industrial use.

If you have a small-parts assembly or inspection problem, there's a Bausch & Lomb StereoZoom to fit your requirements—24 models with magnification ranges from 3.5X to 120X. Call your dealer, or write Bausch & Lomb Incorporated, 61413 Bausch St., Rochester, N. Y. 14602

BAUSCH & LOMB 

In Canada, write Bausch & Lomb Optical Co., Ltd., Dept. 623, Scientific Instrument Division, 16 Grosvenor St., Toronto 5, Ont.

HSI

**SIX REVOLUTIONARY PRODUCTS INDUCE
A NEW DRAMATIC BREAKTHROUGH IN THE
FIELDS OF ELECTRONICS AND ELECTROMECHANICS!**

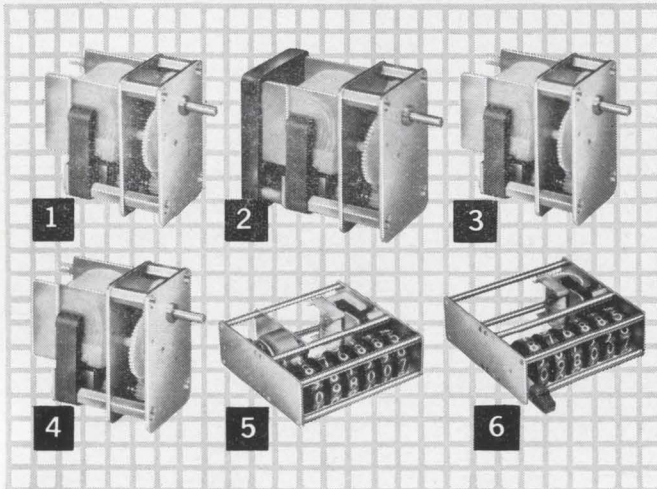

**HSI Announces New Inventions in Motors,
Counters and Timers That Are Major
Breakthroughs in The State of The Art!**

Right now you are looking at "six wonders of the modern electronic and electromechanical world!"

- NO. 1** – 2-Wire Stepper Motor
- NO. 2** – Brushless D.C. Motor
- NO. 3** – 3-Wire Stepper Motor
- NO. 4** – A.C. Synchronous Motor
- NO. 5** – Planetgear® Pulse Counter
- NO. 6** – Planetgear® Digital Stopclock

Be honest now! In your lifetime did you imagine you would ever see these features:

Now, a 2-Wire Stepper Motor – controlled by single throw switching – simplifies your circuitry – 360° rotation per pulse.

Now, a Brushless D.C. Motor – almost any desired speed accuracy – no brushes or contacts.

Now, a 3-Wire Stepper Motor – compact size – high pulse rate – integral gear train for any step angle – 360° rotation per pulse.

Now, an A.C. Synchronous Motor – ½ watt input and 100 oz./in. at 1 RPM. Integral gear reducer.

Now, a Planetgear® Pulse Counter – quiet, resettable, stepper motor driven, offering exceptional life at high pulse rates.

Now, a Planetgear® Digital Stopclock – with larger, more easily read numerals. Manual or electrical reset. Extremely accurate.

These six fabulous products are in stock for immediate delivery to meet your basic commercial, industrial or military requirements.

But put the inventive genius of HSI engineers to the fullest test. Bring HSI your problems that seem incapable of solution. They will transfer ideas that now live only in their imaginations to their drawing boards for your eventual and profitable use. As always, HSI products are reliable and economical.

Send for your copy of new 1965 HSI catalog.
Dept. E-1



**HAYDON SWITCH &
INSTRUMENT, INC.**

Building Confidence Through Dependability

1500 MERIDEN ROAD, WATERBURY, CONN. 06720
AREA CODE (203) 756-7441



**NEW SIZE 18
A.C. SERVO-GEARMOTOR**

Use Size 18 servos? Send your prints to Globe for a proposal. Globe's new low cost Size 18 a.c. servo-gearmotor has an output torque of 50 oz. in. with a reversing time of 0.08 sec. Gear ratio is 1649:1. Unit is 1.7" dia. by 2.8" long and weighs 12.5 oz. It is the first of an important new Globe servo family.

The Size 18 motor is a 2-phase, 2-pole, 60 cps unit with 115 v.a.c. (fixed) and 0-115 v.a.c. (control) encapsulated windings, available either alone or with integral geartrain. Many ratios and winding variations can be supplied to suit the exact application. Request Bulletin 18-SG.

Globe Industries, Inc., 2275 Stanley Avenue
Dayton, Ohio 45404, U.S.A. Tel.: 513 222-3741



Circle 227 on reader service card

**Now you can make
thermocompression bonds
without a heat column!**

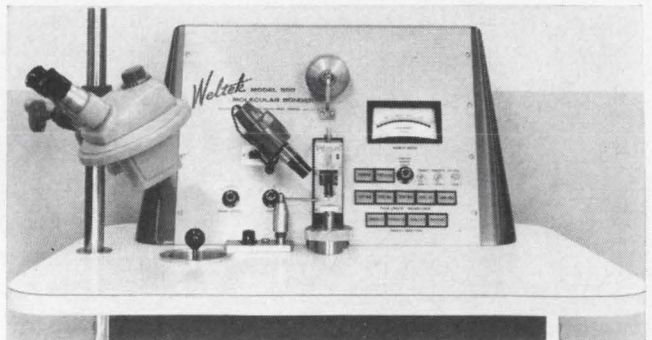

Weltek's new MODEL 800 Molecular Bonder makes diffusion bonds of fine wire to thin films, integrated circuits, semiconductor devices, and crystals. Process is similar to conventional thermocompression bonding but more controllable since it requires *no heat column*. Accommodates gold, palladium, platinum and aluminum wire from .0007" up to .004" diameter. Will do repeatable wedge and stitch bonding as well as regular nail head bonding. Suited for either lab or production operation. Send for literature.

Free Sampling Service!

Send us sample materials for experimental bonding or welding. No obligation.



Precision Welders

by **WELLS ELECTRONICS, INC.**

1701 S. Main Street, South Bend, Indiana, U.S.A.

New Materials

Polyolefin tubing is heat-shrinkable

An all-purpose, irradiated, polyolefin, heat-shrinkable tubing is available with a 2:1 shrinkage ratio. Within 7 seconds after it's applied at 135°C, Alphlex FIT-221 shrinks to half its original diameter, forming a permanent, tight-fitting mechanical bond, even over irregularly shaped objects. Because of this ability to shrink 50% when heated, it is ideally suited for insulating components and cables with a wide variation in shape and size. The expanded diameter also enables the tubing to be easily slipped over the material to be covered. Longitudinal shrinkage has been minimized at only 5%. FIT-221 is thermally stable and will not cold-flow or melt; it retains form stability throughout its temperature range, -55°C to 135°C. High dielectric and mechanical strength, plus resistance to fungus growth and moisture absorption, add to its value as an insulating material. The use of a hot air gun is recommended as the easiest heating

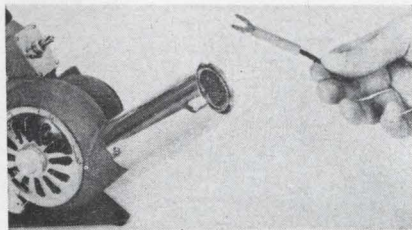
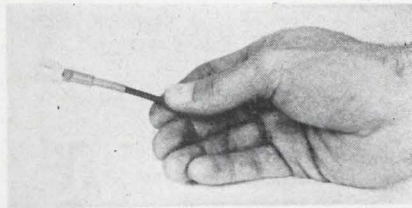

method. However, satisfactory results may be achieved by the use of an oven, radiant heat, dipping in hot liquid, soldering iron or open flame. Alphlex FIT-221 is marketed in standard packages of 4-ft and 6-in. lengths and small quantity assortments of 6-in. lengths. It is available in sizes from 3/64 in. to 4 in., and in 6 colors.

Alpha Wire Corp., 180 Varick St., New York, N.Y. [441]

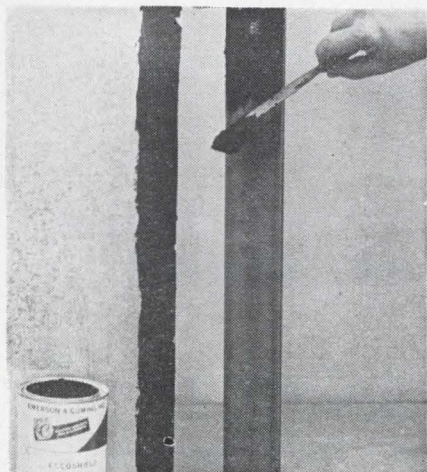

Compound provides r-f shielding

A one-component caulking and sealing compound has been developed to insure r-f integrity of structures, where the shielding requirements are such that the cost of

high performance sealants, such as Eccoshield VX or Eccoshield VY is not justified. Eccoshield CO is of a grease-like consistency, and easy to apply either by trowelling or with a gun type applicator. It does not harden with time. It has proven particularly useful and economical in providing an r-f shield in joints of large structures, where the joints are periodically taken apart for access. It is also useful in filling large gaps in an assembly where an r-f shield is required. The volume resistivity of Eccoshield CO is in the range of 75-125 ohm-cm, but in structures where there is a sizeable overlap of metal faces that require r-f integrity, insertion losses in excess of 50 db have been achieved. The compound is priced at \$4.70 per lb in small quantities, and in the \$2 to \$3 per lb range in quantities of 100 lb.

Emerson & Cuming, Inc., Canton, Mass. [442]

big in '64 bigger in '65

Semi-Elements
ANNOUNCES

Its NEW
GB Series
of

LASER SYSTEMS

Semi-Elements recorded another Laser "first" with its GB Series used to set off the first explosive charge at the groundbreaking ceremonies for the construction of the Allegheny Power Systems' new \$85,000,000 power plant at Ft. Martin, W. Va., on Sept. 12, 1964.

S-E is proud that its
MAGNETOTHERMOELECTRICITY

Single Crystals were selected among 1964's 100 most significant technical developments.

*For Complete Literature
Write Dept. 6*



emi-elements, inc.

Saxonburg Boulevard,
Saxonburg, Pa.
Phone: 412-352-1548

Machine easily handles bobbins from sub-miniature up to 3" in diameter & 2 1/4" long. Infinitely variable winding pitch and traverse length. Accurate pre-set counter.

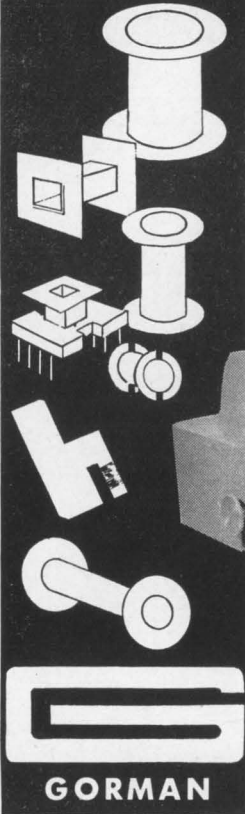

GORMAN

GORMAN

NEW SPIN WINDER

2 Machines in One!

Speed up your production! Cut costs of producing coils! Eliminate wasted operators time! It can be done with Gorman's unparalleled new spin winder available today!

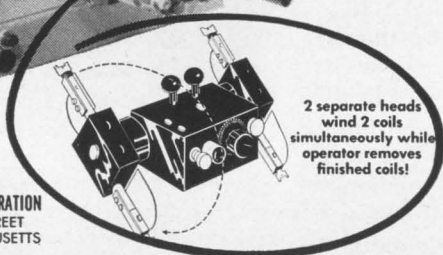

2 separate heads wind 2 coils simultaneously while operator removes finished coils!

GORMAN MACHINE CORPORATION
483 SOUTH MAIN STREET
RANDOLPH, MASSACHUSETTS

Circle 229 on reader service card

New Books

Electronic theory

Physical Electronics
G.F. Alfrey
D. Van Nostrand Co.
1964, 220 pp., \$8.50

In a descriptive way, this volume deals in considerable detail with the basic mechanisms of present-day electronics. The electronics engineer will find here a readable and valuable introduction to the physics behind semiconductor devices, plasma applications and electron optics. All these, and other, recent advances in the electronic art tend to involve more physics than the average engineer knows. This book fills in some of the gaps painlessly.

The book opens with a historical chapter about the electron, and continues with an explanation of the present-day theory of the atom, with special emphasis on the electron.

Forces between atoms are covered in the next chapter, followed by a detailed treatment of electron emission from solid materials.

After a chapter on electron optics, which also deals with the various forms of the cathode-ray tube, the book goes into a consideration of electron current flow, space charge, and velocity modulation. Electrical conduction in gases and plasma is covered next, with references to magnetohydrodynamic power generation, nuclear fusion and nuclear reactors.

The next group of chapters deals with semiconductor theory and the nature of the transistor. The final few chapters are on magnetic properties of matter, dielectric materials, electrical noise, and molecular amplification—the concept on which the laser and maser are based.

Frequent reference to useful devices and new developments gives the book great practical value.

Pulse networks

Pulse Circuits
Raphael Littauer
McGraw-Hill Book Co.
1964, 530 pp., \$12.75.

This volume, written by a Cornell University physicist, uses a novel approach to introduce pulse cir-

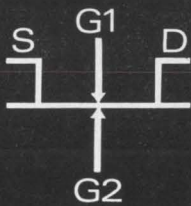

FIELD EFFECT TRANSISTORS

LOW NOISE
N-CHANNEL
DOUBLE GATE
SILICON
PLANAR

Code	Pinch off current I_{D0}	Transconductance g_{m0}^1
SI 221N	0.05 - 0.15 mA	400 - 1200 μ mhos
SI 222N	0.1 - 0.3 mA	700 - 1800 »
SI 223N	0.2 - 0.6 mA	1000 - 2400 »
SI 224N	0.5 - 1.5 mA	1600 - 3600 »
SI 225N	1.0 - 3.0 mA	2200 - 5000 »
SI 226N	2.0 - 6.0 mA	3000 - 7000 »

¹⁾ Both gates connected.

BV_{DGO}	Drain to Gate Breakdown Voltage	8 V min.
I_{GO}	Drain to Gate Leakage Current	2 nA max.
C_{sd}	Source to Gate Capacitance	30 pF typ.
NF	Noise Figure, $V_{GS} = 0, R = 1$ Mohm	
	$f = 1000$ c/s	0.5 dB max.
	$f = 90$ c/s	2.0 dB max.



AKERS ELECTRONICS A/S
S.I. - Blindern - Oslo 3 - Norway -
Telephone 69 58 80 - Telex 0-1536

NEW! FREE! NEW! FREE! NEW!

FREE! New! NEWARK 1965 INDUSTRIAL ELECTRONICS CATALOG!

LISTING



GROWING SILICON POWER TRANSISTOR LINE



Three new additions to RCA's growing family of 200°C. silicon transistor types, RCA-2N3440,* -2N3441, and -2N3442 offer these important design and application features:

- Freedom from second breakdown
- New, high dissipation packages
- Flange cases offer easy heat sinking
- Expanded coverage from 12-volt operation to transients up to 450 Volts
- Meet industrial and military requirements

*Flanged version of 2N3440, 40256

• **Immediate Delivery from Stock
Factory OEM Prices**

NEWARK CATALOG 80

- Industry's Most Complete Catalog
- Over 640 Pages • Over 70,000 Items
- Over 600 Standard Brand Lines
- Eight Stocking Warehouses
- Over \$6,000,000 Industrial Electronics Inventory

NEWARK ELECTRONICS CORPORATION

Main office and warehouse • Dept. EL
223 West Madison • Chicago, Ill. 60606

Authorized RCA Warehouses in:

- CHICAGO, ILL.**
(312) ST 2-2944
- CINCINNATI, OHIO**
(513) 421-5282
- DENVER, COLORADO**
(303) SK 7-3351
- DETROIT, MICHIGAN**
(313) JO 4-5490
- LOS ANGELES AREA**
(213) OR 8-0441
- NEW YORK CITY**
(212) AL 5-4600

Other Newark Warehouses in:

- GRAND RAPIDS, MICHIGAN**
(616) 452-1411
- SAN FRANCISCO AREA**
(415) 593-1881

cuits. It attempts to develop an intuitive method of combining circuit elements so that their functions can be readily visualized; a rigorous circuit analysis is undertaken only after this visualization, rather than the more usual other way around.

The book begins by describing pulse signals, information coding and basic circuit theorems such as Thevenin's and Norton's. It then discusses simple linear filters made up of inductance, resistance and capacitance, and transient response of their combinations.

Next, all aspects of modern diodes are examined. The use of junction, point-contact and thermionic diodes, in circuits for clipping and d-c restoration, among other applications, is explained.

Active components are covered in the next group of chapters, starting with vacuum triodes and their applications in pulse circuits, and continuing with the triode junction transistor. In each case, specifications of typical components are given with examples of actual pulse circuits.

The following chapters deal with biasing considerations, the pentode tube and the more unusual triode circuits such as followers, cascodes and difference amplifiers. Nonlinear circuits, negative- and positive-feedback circuits are dealt with next. Then comes a group of chapters on bistable, monostable and free-running trigger circuits and their applications.

The blocking oscillator configurations, ramp generators, time coding and sweep-voltage sources are considered next, as is time-amplitude conversion. A separate chapter deals with coincidence and transmission gates, including the diode gate, emitter-coupled gate, saturating and bridge gates, and tunnel-diode applications in this class of circuits.

The final chapter discusses register circuits, ring counters, transfer circuits and decoding matrices.

The circuit-oriented approach will make this book a highly practical addition to the engineer's bookshelf. Actual practical examples of working circuits are given as illustrations throughout. Each of the 18 chapters also carries a set of problems for the reader. There is also a bibliography of recent literature on pulse circuits.



WHERE
QUALITY
COMES
FIRST

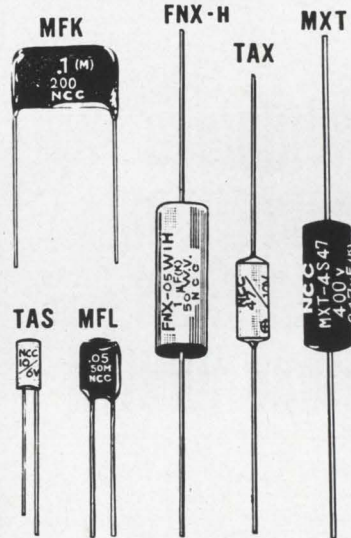

POLYESTER FILM CAPACITOR:

	Capacitance Range:	Voltages
TYPE MFL Dipped Flat Shape	.001 MFD to .47 MFD	35, 50, 100, 200v.DC.
TYPE MFK Dipped Flat Shape Non-Inductive Construction	.01 MFD to .22 MFD	100, 200, 400, 600v.DC.
TYPE MXT In Plastic Tube	.001 MFD to .22 MFD	100, 200, 400, 600v.DC.

METALLIZED POLYESTER FILM CAPACITORS

TYPE FNX-H Mylar Wrapped Semioval With Epoxy End Seal	1 MFD to 10 MFD	50v DC.
---	-----------------	---------

SOLID TANTALUM CAPACITORS

TYPE TAX MIL-C-26655A Hermetically Sealed	1 MFD to 220 MFD	3, 6, 10, 15, 20, 25, 35v.DC.
TYPE TAS Sealed with Epoxy Resin	1 MFD to 220 MFD	3, 6, 10, 15, 20, 25, 35v.DC.

MATSUO ELECTRIC CO., LTD.

HEAD OFFICE :

3-5, 3-CHOME, SENNARI-CHO, TOYONAKA-SHI,
OSAKA, JAPAN.

TOKYO OFFICE :

25-2-CHOME, KANDA AWAJI-CHO, CHIYODA-KU,
TOKYO, JAPAN.

Cable Address "NCC MATSUO" OSAKA

new

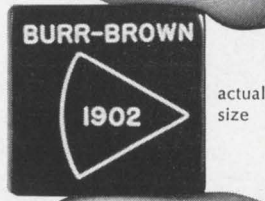

miniature operational amplifiers from BURR-BROWN

These two new Burr-Brown differential input operational amplifiers let you pack high performance in extremely small space. Actual size is only 1.0" x 1.0" x 0.7" . . . smallest full-performance units yet available commercially. And, just look at the specs on these precision solid-state units:

	1901	1902
Low Current Drift	± 0.5	± 0.5 na/ $^{\circ}$ C
Low Voltage Drift	± 10	± 10 μ v/ $^{\circ}$ C
High Gain	100	90 db
Broad Bandwidth	1.0	1.0 Mcps
Output Voltage	± 10	± 10 volts
at Output Current	20	2 ma
Temperature Range		
Operating	-40° C to $+85^{\circ}$ C	
Storage	-65° C to $+100^{\circ}$ C	

These all-silicon Burr-Brown units are designed for applications requiring high density packaging and dependable stability and reliability. Unit prices are \$125 for the 1901 and \$110 for the 1902 with immediate availability.

FOR COMPLETE TECHNICAL INFORMATION write, wire or phone Burr-Brown, today.

BURR-BROWN

RESEARCH CORPORATION
Box 6444 TUCSON, ARIZONA
Telephone: 602-623-0328 • TWX: 602-792-2681

Technical Abstracts

Thin-film memory

A 16k-word, 2-Mc, magnetic thin-film memory*
Eric E. Bittmann,
Burroughs Corp., Defense and
Space Group, Great Valley
Laboratory, Paoli, Penn.

This new thin-film memory operates with a 0.5-microsecond cycle and a 0.3-microsecond access time. It represents a significant achievement in a program of magnetic thin-film development for computer storage begun at the Burroughs laboratories in 1955. The 16,000-word capacity and the half-microsecond memory-cycle speed clearly indicate that magnetic thin films have become the best storage elements for reliable, nonvolatile, fast-access memory.

The storage cells are planar ferromagnetic thin films, produced by vacuum deposition of Ni-Fe alloy onto glass substrates. The film elements are deposited 768 per substrate, in a 32-by-24 array. Five substrates in a row provide storage for 32 words of 120 bits each. A single five-substrate film word stores two 52-bit computer-language words. Four such rows (128 words on 20 substrates) make up a plane. A plane, along with associated circuit cards and connectors, is assembled as an integral plug-in unit called a frame. Thirty-two frames constitute a 4,096-word stack. Edge-board connectors on the frames permit easy insertion, or removal.

The memory module has a total capacity of 16,384 words. The 52-bit word contains 48 data bits, 3 control bits, and 1 parity bit. The control bits act as tags to tell the program whether or not the instruction has been executed.

The 6-bit address is decoded at the input of every word driver word switch by a diode-transformer matrix that contains 4,096 transformers. A reference bit was included in each 104-bit film word because the sense readout signal is only 50-60 nanoseconds wide, and the delay in the stack can vary as much as 70 nsec for different address locations. To generate a variable-time strobe pulse, a strobe reference bit, which is always a ONE,

is the 105th bit in the stack. The 15 spare bits in each 120-bit word can be used to replace weak or faulty bits.

The bit current flows parallel to the sense conductor, and induces noise in the sense lines. This noise is reduced by transposing each sense line with the corresponding bit line by a crossover connection in the middle of the memory plane; the connection is made after the glass substrate has been sandwiched between the printed-circuit boards. Some noise (as much as 5 millivolts) remains, because of mechanical imbalance between each sense-line/bit-line pair; this can be reduced by manually adjusting the small sense end-around loops on the plane.

To further reduce noise in the sense lines, the flow of bit current is restricted to a single memory plane during a write cycle, rather than being permitted to flow through the entire stack.

The films are 1,000 angstroms thick; the glass measures 70 by 43 millimeters, and is 0.2 (8 mils) thick. The 786 rectangular cells on one substrate measure 30 by 80 mils each, spaced on 50-mil and 100-mil centers. The glass substrates of each memory plane are sandwiched between two printed-circuit-board assemblies 20 inches long and 9 inches wide. Three conductors address every memory cell: a word conductor 20 mils wide; a 10-mil-wide sense conductor, which has on each side the split bit conductor, each half of which is 20 mils wide, separated by 50 mils.

By reducing the total sense delay and eliminating the bit recover pulse (which is selectively applied to bit lines to eliminate magnetizing energy that would otherwise remain stored in the bit circuits) it is possible to get a shorter memory cycle. Pulse transformers would be replaced by active solid-state devices. A reduction of 150 nsec (50 nsec from a shorter sense delay and 100 nsec from elimination of the bit recover pulse) makes a cycle time of 350 nsec, or 3-Mc operation.

* Presented at the Fall Joint Computer Conference, San Francisco, Oct. 27-29.

Electronics index

Technical articles

Volume 37, 1964

Technical articles

A

ADVANCED TECHNOLOGY

Comeback for wireless power? p. 86 Sept. 21
Conditioned-reflex circuits p. 66 Aug. 24
Cryogenic flux pump switches high currents p. 61 Mar. 23
Evaluating light demodulators p. 54 Apr. 6
IEEE preview p. 35 Mar. 13
Microwaves for remote sensing p. 66 Nov. 2
P-n junctions as radiation sources p. 61 July 13
Research in microwave acoustics spawns compact delay lines p. 69 Nov. 30
Storage orthicon holds image for hours p. 36 Mar. 6
Ultrasonic approach to data storage p. 67 May 4

AMPLIFIERS

Amplifier can be adjusted to cancel unbalanced noise p. 60 Aug. 24
Amplifier improves peak voltmeter response p. 73 Apr. 20
Basic uhf circuit forms amplifiers and multipliers p. 59 July 13
Buffer supplies bipolar output p. 75 July 27
Circuit protects amplifier against short circuit p. 61 Aug. 24
Combined feedback stabilizes amplifier p. 76 May 4
Complementary amplifier offers high input impedance p. 92 May 18
Compressor amplifier features balanced push-pull circuit p. 36 Jan. 24
FET micropower amplifier p. 74 Dec. 14
Field-effect transistor as high-frequency amplifier p. 71 Dec. 14
Getting transistors into single-sideband amplifiers p. 72 June 1
High-gain d-c amplifier drives crt display p. 53 June 29
How to design micropower transistor amplifiers: part 1 p. 73 May 18
part 2 p. 48 June 1
Operational amplifier suppresses third harmonic p. 74 Apr. 6
Optoelectronics at work p. 58 July 27
Param system achieves high stability p. 34 Feb. 28
Servo comparator amplifier handles high voltages p. 75 Aug. 10
Squeeze in more components by adding a micro amplifier p. 73 Mar. 23
Symmetrical limiting i-f reduces second harmonic p. 72 Mar. 23
Variable resistor controls differential amplifier gain p. 74 Nov. 16

ANTENNAS

Lens-line antenna: low noise, less space p. 25 Feb. 28
Practical log-periodic antenna designs p. 91 May 4
Rotating subreflector produces circular scanning p. 44 Feb. 14

AVIONICS

Cutting through clutter in flight-control radar p. 83 Aug. 10
Digital loran-C receiver uses microcircuits p. 23 Jan. 31
Light-airplane marker-beacon receiver p. 33 Jan. 17
Majority voting protects aircraft and pilot p. 85 May 18
SST: challenge to avionics designers p. 60 Sept. 7
Wanted: ways to spot rough air p. 49 Feb. 7

C

CIRCUIT DESIGN

Added capacitor sweeps power supply p. 62 June 1
Added transistor decreases multivibrator reset time p. 72 July 27
Advantages of free-running cascode multivibrators p. 28 Jan. 31
Amplifier can be adjusted to cancel unbalanced noise p. 60 Aug. 24

This abridged index lists only technical feature articles. A separate, complete index is available to readers and libraries for \$1.00. Attractively bound, the complete 1964 index catalogs all articles—technical features, newsletter items, Electronics Review, Electronics Abroad, and Probing the News stories — manufacturers mentioned in these articles, and advertisers.

For a copy, send \$1.00 to:

Reprint Manager, Index
Electronics Magazine
330 W. 42nd Street
New York, N.Y. 10036

Amplifier improves peak voltmeter response p. 73 Apr. 20
Analog switching circuits use field-effect devices p. 46 Dec. 28
Basic uhf circuit forms amplifiers and multipliers p. 59 July 13
Buffer supplies bipolar output p. 75 July 27
Chart provides alpha components p. 72 Nov. 16
Checking oscillation in cathode followers p. 52 Oct. 19
Circuit always applies correct operating voltage p. 77 Sept. 21
Circuit protects amplifier against short circuit p. 61 Aug. 24
Cold-cathode gas tubes switch high voltage fast p. 72 Apr. 20
Combined feedback stabilizes amplifier p. 76 May 4
Comparator controls battery charging rate p. 72 Mar. 23
Complementary amplifier offers high input impedance p. 92 May 18
Complementary shaper replaces Schmitt trigger p. 66 Oct. 5
Constant-current source controls sweep rate p. 82 Sept. 7
D-c voltage converter needs no transformer p. 64 Nov. 2
Designing with low-noise MOS FET's: a little different but no harder p. 53 Dec. 14
Diamond circuit measures phase shift p. 74 Sept. 21
Diode-coupled Schmitt trigger p. 50 Dec. 14
Displaying the contents of a computer register p. 72 July 27
Double-tuning simplifies superhets p. 39 Jan. 24
Electronic timer provides long delay p. 63 June 1
Electronically controlling auto's engine spark p. 43 Dec. 28
Field-effect transistor controls pulse oscillator p. 80 June 15
Four-layer diodes form staircase generator p. 55 July 13
Four-terminal controlled switch divides frequencies by 10 p. 81 June 15
Frustrating problem of inductors in integrated circuits p. 50 Mar. 13
Gate circuit eliminates pedestal effect p. 77 May 4
Generating two rectangular waves p. 82 June 15
Germanium transistor as avalanche switch p. 44 Nov. 30
Graphs aid deflection system design p. 59 Feb. 7
High-current converter is small, quiet, low-cost p. 41 Nov. 30
High-efficiency voltage regulator p. 64 Aug. 24
High-gain d-c amplifier drives crt display p. 53 June 29

High performance voltage regulator p. 75 Apr. 6
How modules make complex design simple p. 50 Dec. 28
How to design high-speed d-a converters p. 28 Feb. 21
How to design micropower transistor amplifiers: part 1 p. 73 May 18
part 2 p. 48 June 1
How to suppress rate effect in pnpn devices p. 30 Jan. 10
Insurance against transistor failure p. 72 Sept. 21
Interrogator circuit can tell good data from bad p. 58 July 13
Junction diode regulates low-voltage supply p. 55 Oct. 19
Laminated dissipator improves heat transfer p. 84 June 15
Low-cost time delay controls recorder p. 84 June 15
Low-noise FET's sound good to circuit designers p. 58 Dec. 14
Monostable circuits need power only when they work p. 56 Aug. 24
More for your money p. 66 Sept. 21
Network filters stabilize d-c supply over wide range p. 83 June 15
Noise-figure nomograph for multistage systems p. 64 Oct. 5
Nomograph shows phase-shift angle p. 73 July 27
Nomograph simplifies delay-line design p. 42 Nov. 30
Novel multivibrators test tape transports p. 40 Feb. 14
On and off time adjusted independently p. 50 Dec. 14
100-Mc pulse generator provides 50% duty cycle p. 42 Dec. 28
One-shot multi provides constant pulse width p. 74 Apr. 6
1,500-volt hybrid switch has low "on" impedance p. 74 Aug. 10
Operational amplifier suppresses third harmonic p. 74 Apr. 6
Oscillator generates sine, cosine waves simultaneously p. 74 Aug. 10
Positive-pulse amplifier p. 74 July 27
Push button plus scr equals fast pulse p. 41 Nov. 30
Reed switches for breadboarding p. 93 Mar. 18
Sensistor produces long, reliable pulses p. 51 Dec. 14
Servo comparator amplifier handles high voltages p. 75 Aug. 10
Silicon controlled rectifier triggers ignition p. 62 June 1
Simple voltage regulator limits load current p. 63 Nov. 2
Simplified r-c ladder network design p. 71 Apr. 6
Single transistor provides low-cost phase shifter p. 92 May 18
Squeeze in more components by adding a micro amplifier p. 73 Mar. 23
Staircase generator triggers a unijunction transistor p. 80 Sept. 7
Symmetrical limiting i-f reduces second harmonic p. 72 Mar. 23
Temperature rise in rigid waveguide p. 36 Jan. 17
Temperature sensor for strain-gate transducer p. 77 May 4
Thermistor measures dielectric gas content p. 54 Oct. 19
Thermostat operates with 0.01°C differential p. 65 Oct. 5
Transistor becomes sensor in temperature regulator p. 65 Nov. 2
Transistor circuit converts voltage to regulated frequency p. 73 Nov. 16
Transistor's stored charge controls pulse delay p. 52 June 29
Tunnel diode generates two microwave frequencies p. 62 Aug. 24
Tunnel diode multi recovers quickly p. 75 Sept. 21
Unijunction circuit generates specific number of pulses p. 78 May 4
Using feedback in FET circuits to reduce input capacitance p. 63 Dec. 14
Using negative reactance for independent phase and attenuation p. 44 Dec. 14
Variable-phase, polyphase from single-phase supply p. 56 Oct. 19
Variable r-f resistor attained with photocell p. 67 Oct. 5
Variable resistor controls differential amplifier gain p. 74 Nov. 16
Voltage controls dual-pulse scr trigger p. 62 Nov. 2

Voltage controls solid-state nonlinear resistance
p. 36 Feb. 21

COMMUNICATION

Comsat comes on strong with a really big show: The Olympics p. 60 Oct. 5
Digital television: shrinking bulky bandwidths p. 77 Dec. 14
Early Bird: a bigger and better communications satellite p. 90 Aug. 10
Foreign broadcasts get a stronger voice p. 87 May 4
Getting transistors into single-sideband amplifiers p. 72 June 1
IEEE preview p. 35 Mar. 13
New era in telephony: Electronic switching p. 71 Oct. 19
New look for the old telegraph p. 85 Mar. 23
One circuit: phase modulation, frequency modulation p. 71 Nov. 2
Plotting coverage circles for satellite communications p. 27 Jan. 24
Pocket-size transmitter uses body heat to control frequency p. 66 July 13
Practical log-periodic antenna design p. 91 May 4
Quest for compatibility p. 79 May 18
Solid-state transmitter ready for uhf telemetry p. 76 June 1
Space-borne recorder triples packing density p. 84 Aug. 24
Sweeping carrier signals through interference p. 94 May 18
Tropo goes commercial p. 88 July 27

COMPONENTS

Attractive alternative at uhf: the ceramic vacuum tube p. 50 Aug. 24
Boost for electronic tuning: part 1 p. 49 Apr. 6
part 2 p. 61 Apr. 20
Cool world of components p. 75 June 15
Cooling high-power equipment by forced-air convection p. 69 Sept. 21
H-shaped ceramic filter forms miniature i-f p. 55 Feb. 7
Relays that challenge semiconductors p. 56 Mar. 23
Resistors improve performance while their size decreases p. 62 May 4
Simple cell competes with complex components p. 67 Nov. 16
Stray signals can't throw this desensitized switch p. 68 July 27
Wescon preview p. 60 Aug. 10

COMPUTERS

Automatic circuit tester p. 76 July 27
Balanced bipolar circuits improve magnetic shift-register performance p. 54 Oct. 5
Case for magnetic logic p. 40 June 1
Conditioned-reflex circuits p. 66 Aug. 24
Direct digital control at the threshold p. 49 Mar. 23
Direct digital control in industry p. 73 Oct. 5
Displaying the contents of a computer register p. 72 July 27
IEEE preview p. 35 Mar. 13
Incremental digital recorder puts more data on less tape p. 48 June 29
Majority voting protects aircraft and pilot p. 85 May 18
New era in telephony: Electronic switching p. 71 Oct. 19
New semiconductor networks reduce system complexity p. 25 Jan. 10
Permanent optical memories for compact systems p. 64 Apr. 20
Square-root computer uses Hall multiplier p. 30 Jan. 24
Survey of digital-logic training devices p. 71 Aug. 24
Take two tons of flour p. 82 Apr. 20
Ultrasonic approach to data storage p. 67 May 4
Using a computer for circuit analysis p. 56 Nov. 2
Wescon preview p. 60 Aug. 10

CONSUMER ELECTRONICS

IEEE preview p. 35 Mar. 13
Low-cost oscillator transistors revamp uhf tuner design p. 90 Apr. 20
New ignition system for cars p. 68 Oct. 5
Transistors instead of relays tune tv volume p. 32 Feb. 28

INDUSTRIAL ELECTRONICS

Better and faster design by machine p. 64 June 1
Boiler control p. 85 June 15
Boredom-proof inspectors p. 79 May 4
Direct digital control at the threshold p. 49 Mar. 23
Direct digital control in industry p. 73 Oct. 5
Farewell to free time on city parking meters p. 72 Dec. 28
Finding malfunctions before they happen p. 75 Nov. 16
IEEE preview p. 35 Mar. 13
Light-activated switch expands uses of silicon controlled rectifiers p. 53 May 4
SCR control in paper mills p. 42 June 29
Take two tons of flour p. 82 Apr. 20
Widening world of the scr p. 78 Sept. 21

INSTRUMENTS

Data acquisition system expects the unexpected p. 57 June 1

Digital instrumentation p. 57 May 18
Frequency sensor stabilizes triangular-wave generator p. 38 Feb. 28
IEEE preview p. 35 Mar. 13
Low-cost digital system records weather data p. 34 Jan. 10
Modified ramp generator develops high d-c input impedance p. 33 Feb. 21
Noise-proofing a digital voltmeter with off-the-shelf microelectronics p. 92 Nov. 16
Operational trigger for precise control p. 50 Nov. 2
Problem: standardizing instruments—Solution: digital systems p. 65 Oct. 19
Radar-tracking accuracy increased p. 73 May 4
Ten signals at a glance p. 54 June 29
Wescon preview p. 60 Aug. 10

M

MAGNETICS

Balanced bipolar circuits improve magnetic shift-register performance p. 54 Oct. 5
Case for magnetic logic p. 40 June 1
Magnetics: its applications in electronics p. 60 June 29
New uses for Hall-effect modulators p. 30 Jan. 17
Square-root computer uses Hall multiplier p. 30 Jan. 24

MANUFACTURING

Automatic circuit tester p. 76 July 27
Can electron beams produce incredibly small circuits? p. 82 Nov. 16
Electronics in Israel p. 23 Jan. 17
Integrated-circuit system keeps costs down to earth p. 36 Nov. 30
Linear microcircuits scarce? Now you can breadboard your own p. 58 Oct. 19
Modern electronics packaging p. 33 Feb. 7
Photo-etching thin-film circuits p. 94 June 15
Precision electron welder uses low beam voltage p. 32 Mar. 6
Production-line packaging of solid-state circuits p. 73 Sept. 7

MARKETS

Electronics markets p. 37 Jan. 3

MEASUREMENTS

Direct-reading meter gives impedance and phase angle p. 57 Jan. 3
How to measure FET noise p. 62 Nov. 30
Linear scales show mixer harmonics p. 37 Jan. 10
New use for the oscilloscope: measuring signal-to-noise ratio p. 36 Dec. 28
Quinary scalars measure time intervals digitally p. 34 Jan. 31
Testing transistors in-circuit p. 53 June 1
Thermistor measures dielectric gas content p. 54 Oct. 19

MEDICAL ELECTRONICS

Electronic weapon against cancer p. 88 Apr. 6
Paralytic's brain + Myocoder = Hope p. 74 Nov. 30

MICROELECTRONICS

Can electron beams produce incredibly small circuits? p. 82 Nov. 16
Depositing active and passive thin-film elements on one chip p. 53 Apr. 20
Digital Ioran-C receiver uses microcircuits p. 23 Jan. 31
Forward step in microcircuits: Thin-film transistors from scanning generator p. 23 Feb. 21
The frustrating problem of inductors in integrated circuits p. 50 Mar. 13
How to design micropower transistor amplifiers: part 1 p. 73 May 18
part 2 p. 48 June 1
Integrated circuits shrink a doppler radar system p. 74 Mar. 23
Linear microcircuits scarce? Now you can breadboard your own p. 58 Oct. 19
Low-frequency integrated circuits achieved with thermal transfer p. 54 July 27
Molecular blocks simplify microcircuits p. 36 Feb. 14
Noise-proofing a digital voltmeter with off-the-shelf microelectronics p. 92 Nov. 16
Squeeze in more components by adding a micro amplifier p. 73 Mar. 23
Wescon preview p. 60 Aug. 10

MICROWAVES

Charge storage varactors boost harmonic power p. 42 July 13
Comsat comes on strong with a really big show: The Olympics p. 60 Oct. 5
Interferometer analyzes microwave transmitter p. 58 June 29
Metal base transistor pushes back the frequency barrier p. 42 Mar. 13
Microwaves for remote sensing p. 66 Nov. 2
New magnetron shifts frequency fast p. 76 Apr. 6
Research in microwave acoustics spawns compact delay lines p. 69 Nov. 30
Superpower tubes: their capabilities and limitations p. 48 July 13
Tunnel diode generates two microwave frequencies p. 62 Aug. 24
Wescon preview p. 60 Aug. 10

MILITARY ELECTRONICS

Electro-optics: modern war-game munitions p. 27 Mar. 6
IEEE preview p. 35 Mar. 13
New magnetron shifts frequency fast p. 76 Apr. 6
Quest for compatibility p. 79 May 18
Silent war: electronic spying p. 74 Apr. 20
USS Dace: portrait of a killer p. 99 June 15

O

OCEANOGRAPHY

Frontier of the deep p. 71 July 13

R

RADAR

Cutting through clutter in flight-control radar p. 83 Aug. 10
Integrated circuits shrink a doppler radar system p. 74 Mar. 23
Radar-tracking accuracy improved p. 73 May 4
Research in microwave acoustics spawns compact delay lines p. 69 Nov. 30
Sampling ten million words a second p. 52 Feb. 7

S

SOLID-STATE ELECTRONICS

Analog switching circuits use field-effect devices p. 46 Dec. 28
Beating the heat in semiconductor devices p. 92 Sept. 7
Boosting d-c voltage with silicon transistors p. 56 Nov. 16
Charge storage varactors boost harmonic power p. 42 July 13
Designing noise immunity into high-speed circuits p. 66 Sept. 7
Designing with low-noise MOS FET's: a little different but no harder p. 53 Dec. 14
Drivers for optical diodes p. 77 Aug. 10
FET complementary integrated circuits: aerospace natural p. 55 Dec. 28
FET micropower amplifier p. 74 Dec. 14
Field-effect transistor: a "curiosity" comes of age p. 46 Nov. 30
Field-effect transistor as high-frequency amplifier p. 71 Dec. 14
Future of thin-film active devices p. 23 Jan. 24
How to measure FET noise p. 62 Nov. 30
How to suppress rate effect in pnp devices p. 30 Jan. 10
IEEE preview p. 35 Mar. 13
Interrogator circuit can tell good data from bad p. 58 July 13
Light-activated switch expands uses of silicon-controlled rectifiers p. 53 May 4
Liquid cooling p. 101 Sept. 7
Long-pin approach to dissipator design p. 99 Sept. 7
Low-frequency integrated circuits achieved with thermal transfer p. 54 July 27
Low-noise FETs sound good to circuit designers p. 58 Dec. 14
Magnetoresistance: better than Hall-effect multipliers p. 66 Apr. 6
Metal-oxide-semiconductor field-effect transistors p. 50 Nov. 30
Modules simplify design of complex functions p. 50 Dec. 28
New semiconductor networks reduce system complexity p. 25 Jan. 10
New technology sparks an expansion for germanium p. 62 Apr. 6
Now the gate turn-off switch speeds up d-c switching p. 64 Mar. 23
Optoelectronics at work p. 58 July 27
Orbiting observatory to measure stars' dim light p. 28 Feb. 28
Param system achieves high stability p. 34 Feb. 28
P-n junctions as radiation sources p. 61 July 13
Scanning the sun for solar flares p. 31 Feb. 14
Space-borne recorder triples packing density p. 84 Aug. 24
Space radiation affects MOS FET's p. 59 Dec. 28

T

TRANSISTORS

Boosting d-c voltage with silicon transistors p. 56 Nov. 16
Chart provides alpha components p. 72 Nov. 16
Depositing active and passive thin-film elements on one chip p. 53 Apr. 20
Designing noise immunity into high-speed circuits p. 66 Sept. 7
Designing with low-noise MOS FET's: a little different but no harder p. 53 Dec. 14
FET micropower amplifier p. 74 Dec. 14
Field-effect transistor: a "curiosity" comes of age p. 46 Nov. 30
Field-effect transistor as high-frequency amplifier p. 71 Dec. 14
Forward step in microcircuits: Thin-film transistors form scanning generator p. 23 Feb. 21
Germanium transistor as avalanche switch p. 44 Nov. 30
Helpful transistor analog: 4-layer pnp = 2 transistors p. 66 Aug. 10
How to measure FET noise p. 62 Nov. 30
Insurance against transistor failure p. 72 Sept. 21
Low-cost oscillator transistors revamp uhf tuner design p. 90 Apr. 20

Low-noise FET's sound good to circuit designers p. 58 Dec. 14
 Metal base transistor pushes back the frequency barrier p. 42 Mar. 13
 Metal-oxide-semiconductor field-effect transistors p. 50 Nov. 30
 Modules simplify design of complex functions p. 50 Dec. 28
 New technology sparks an expansion for germanium p. 62 Apr. 6
 Preventing second breakdown in transistor circuits p. 66 June 15
 Researchers turn to germanium for a MOS field-effect transistor p. 64 Nov. 30
 Silicon replacing germanium as power transistors get bigger p. 42 Nov. 2
 Space radiation affects MOS FET's p. 59 Dec. 28
 Staircase generator triggers a unijunction transistor p. 80 Sept. 7
 Testing transistors in-circuit p. 53 June 1
 Trading off radiation resistance and second-breakdown performance p. 48 Oct. 19
 Transistor becomes sensor in temperature regulator p. 65 Nov. 2
 Transistor bridge switches microvolts p. 60 Jan. 3
 Transistor circuit converts voltage to regulated frequency p. 73 Nov. 16
 Transistors instead of relays tune tv volume p. 32 Feb. 28
 Understanding and using the MOS FET p. 66 Dec. 14
 Using feedback in FET circuits to reduce input capacitance p. 63 Dec. 14

Author index

A

Aaland, K. & Hill, R., Precision electron welder uses low beam voltage p. 32 Mar. 6
 Ahn, B. S., Germanium transistor as avalanche switch p. 44 Nov. 30
 Ailen, R. J. & Niehenke, E., The cool world of components p. 75 June 15
 Ammann, S. K., Noise-proofing a digital voltmeter with off-the-shelf microelectronics p. 92 Nov. 16
 Andren, C., High-efficiency voltage regulator p. 64 Aug. 24
 Andres, R. K. & Correard, L. P., A new look for the old telegraph p. 85 Mar. 23
 Angel, K. W., Graphs aid deflection system design p. 59 Feb. 7
 Anton, A., Comparator controls battery charging rate p. 72 Mar. 23
 Arnold, J. G., Pocket-size transmitter uses body heat to control frequency p. 66 July 13
 Ashby, A. T. et al, Testing transistors in-circuit p. 53 June 1
 Austin, N. A., Electronic weapon against cancer p. 88 Apr. 6

B

Bailey, R. W., Push button plus scr equals fast pulse p. 41 Nov. 30
 Barnes, H. B. & Luettgenau, G. G., Designing with low-noise MOS FET's: a little different but no harder p. 53 Dec. 14
 Beeler, F., Incremental digital recorder puts more data on less tape p. 48 June 29
 Beene, G., Variable resistor controls differential amplifier gain p. 74 Nov. 16
 Bell, S. A., Adder transistor decreases multivibrator reset time p. 72 July 27
 Blais, P. D., Checking oscillation in cathode followers p. 52 Oct. 19
 Blumenthal, R. H. & Williams, F. E., Transistor's stored charge controls pulse delay p. 52 June 29
 Bonin, E. L., Drivers for optical diodes p. 77 Aug. 10
 Borkan, H., Depositing active and passive thin-film elements on one chip p. 53 Apr. 20
 Bouchard, R. J., Positive-pulse amplifier p. 74 July 27
 Breece, H. T., III, Boosting d-c voltage with silicon transistors p. 56 Nov. 16
 Buchhold, T. A., Cryogenic flux pump switches high currents p. 61 Mar. 23

C

Caddes, D. E. & McMurtry, B. J., Evaluating light demodulators p. 54 Apr. 6
 Callahan, T. & Cuikay, R., Orbiting observatory to measure stars' dim light p. 28 Feb. 28
 Callahan, T. & Vuozzo, A., Drive-brake circuit positions ultraviolet spectrometer in spacecraft p. 47 Mar. 13
 Carlson, F. M., Tunnel-diode circuits invert direct to alternating current p. 56 Sept. 21
 Carroll, F. L., How to achieve stability in space telemetry p. 32 Jan. 24
 Carroll, J. M., The quest for compatibility p. 79 May 18
 The silent war: electronic spying p. 74 Apr. 20
 USS Dace: portrait of a killer p. 99 June 15
 Carroll, J. M. & Hood, H. C., Frontier of the deep p. 71 July 13
 Carroll, J. M. et al, Electronics markets p. 37 Jan. 3
 Caywood, W. P., Jr. et al, Using negative reactance for independent phase and attenuation p. 44 Dec. 14
 Charters, T. H., Low-cost time delay controls recorder p. 84 June 15
 Chiles, W. H. & Lafuse, H. G., Sweeping carrier signals through interference p. 94 May 18
 Chubbuck, E. L., Jr., Foreign broadcasts get a stronger voice p. 87 May 4
 Cohen, J. M., How to measure FET noise p. 62 Nov. 30

Collins, J. J., Constant-current source controls sweep rate p. 82 Sept. 7
 Displaying the contents of a computer register p. 72 July 27
 Single transistor provides low-cost phase shifter p. 92 May 18
 Cook, A. D. & Daniels, R. E., Cold-cathode gas tubes switch high voltage fast p. 72 Apr. 20
 Cook, C. R., Jr., & Martin, B. M., New semiconductor networks reduce system complexity p. 25 Jan. 10
 Coppen, P. J., FET complementary integrated circuits: aerospace natural p. 55 Dec. 28
 Cordes, E. V., Jr., Boredom-proof inspectors p. 79 May 4
 Correard, L. P. & Andres, R. K., A new look for the old telegraph p. 85 Mar. 23
 Cottrell, D. E., Frequency sensor stabilizes triangular-wave generator p. 38 Feb. 28
 Crothers, M. H., Added capacitor sweeps power supply p. 62 June 1
 Cuikay, R. & Callahan, T., Orbiting observatory to measure stars' dim light p. 28 Feb. 28

D

Dakin, C. J., Novel multivibrators test tape transports p. 40 Feb. 14
 Daniels, R. E. & Cook, A. D., Cold-cathode gas tubes switch high voltage fast p. 72 Apr. 20
 Dargis, A. A., A high performance voltage regulator p. 75 Apr. 6
 On and off time adjusted independently p. 50 Dec. 14
 DeNegri, F. P., Permanent optical memories for compact systems p. 64 Apr. 20
 Deveraux, H. R., Diamond circuit measures phase shift p. 74 Sept. 21
 Domchick, R. J. & Slevin, R. L., Paramp system achieves high stability p. 34 Feb. 28
 Dooley, H., SCR control in paper mills p. 42 June 29
 Down, B., Using feedback in FET circuit to reduce input capacitance p. 63 Dec. 14
 Downs, N. & van Sutphin, B., Solid-state transmitter ready for uhf telemetry p. 76 June 1
 Dulberger, L. H., Low-cost oscillator transistors revamp uhf tuner design p. 90 Apr. 20
 Dulberger, L. H. et al, Electronics markets p. 37 Jan. 3
 Durocher, A. J., D-c voltage converter needs no transformer p. 64 Nov. 2

E

Eastman, L. F., Superpower tubes: their capabilities and limitations p. 48 July 13
 Eberle, J. W., A new use for the oscilloscope: measuring signal-to-noise ratio p. 36 Dec. 28
 Edwards, R. E., New magnetron shifts frequency fast p. 76 Apr. 6
 Eimbinder, J., Profile: the heat-sink industry p. 84 Sept. 7
 The field-effect transistor: a "curiosity" comes of age p. 46 Nov. 30
 Engelmann, R., Quinary scalars measure time intervals digitally p. 34 Jan. 31
 Epstein, H. & Flanagan, C., Insurance against transistor failure p. 72 Sept. 21
 Ernst, L. J., Complementary amplifier offers high input impedance p. 92 May 18
 Evezia, W. J., Cutting through clutter in fight-control radar p. 83 Aug. 10
 SST: challenge to avionics designers p. 60 Sept. 7

F

Fadely, J. K. et al, Digital television: shrinking bulky bandwidths p. 77 Dec. 14
 Fairley, D. O., One circuit: phase modulation, frequency modulation p. 71 Nov. 2
 Feitler, H., Simple cell competes with complex components p. 67 Nov. 16
 Feldman, C., The future of thin-film active devices p. 23 Jan. 24
 Ferrie, R. G., Thermostat operates with 0.01°C differential Unijunction circuit generates specific number of pulses p. 78 May 4
 Fines, N. R., Chart provides alpha components p. 72 Nov. 16
 Flanagan, C. & Epstein, H., Insurance against transistor failure p. 72 Sept. 21
 Flynn, G. J., Digital instrumentation p. 57 May 18
 Frank, R. L. & Phillips, A. H., Digital Ioran-C receiver uses microcircuits p. 23 Jan. 31
 Frenzel, L. E., Jr., Gate circuit eliminates pedestal effect p. 77 May 4
 Silicon controlled rectifier triggers ignitron p. 62 June 1
 Freytag, R. W. & Gratian, J. W., Ultrasonic approach to data storage p. 67 May 4
 Frye, E. O., Microwaves for remote sensing p. 66 Nov. 2

G

Garibotti, D. J. & Ullery, L. R., Jr., Production-line packaging of solid-state circuits p. 73 Sept. 7
 Gault, J. M. & Sanford, R. J., Stray signals can't throw this desensitized switch p. 68 July 27
 Geppert, D. V. & Mueller, R. A., Metal base transistor pushes back the frequency barrier p. 42 Mar. 13
 Gertz, D. & Leavitt, L., Problem: standardizing instruments—Solution: digital systems p. 65 Oct. 19
 Gilson, R. et al, How to design micropower transistor amplifiers: part 1 p. 73 May 18
 part 2 p. 98 June 1
 Gipp, D. R., Designing noise immunity into high-speed circuits p. 66 Sept. 7

Giroux, R. R. & Hughes, H. L., Space radiation affects MOS FET's p. 59 Dec. 28
 Goldman, W. E., Torque and thermal resistance p. 104 Sept. 7
 Goldwater, F. J., Low-cost digital system records weather data p. 34 Jan. 10
 Gomolak, L. S., Better and faster design by machine p. 64 June 1
 Direct digital control in industry p. 73 Oct. 5
 Take two tons of flour p. 82 Apr. 20
 Grafham, D. R., Now the gate turn-off switch speeds up d-c switching p. 64 Mar. 23
 Gratian, J. W. & Freytag, R. W., Ultrasonic approach to data storage p. 67 May 4
 Gray, S. B., A survey of digital-logic training devices p. 71 Aug. 24
 Greenblatt, S., Transistor becomes sensor in temperature regulator p. 65 Nov. 2
 Grelot, M., Nomograph shows phase-shift angle p. 73 July 27
 Griswold, D. M., Understanding and using the MOS FET p. 66 Dec. 14
 Grossman, D. & Merlen, M., Interrogator circuit can tell good data from bad p. 58 July 13
 Gulbenk, J. & Prosser, T. F., How modules make complex design simple p. 50 Dec. 28
 Gutlove, N. & Morrison, S., Scanning the sun for solar flares p. 31 Feb. 14

H

Hakim, E. B. & Reich, B., Trading off radiation resistance and second-breakdown performance p. 48 Oct. 19
 Hakimoglu, A. & Kulvin, R. D., Sampling ten million words a second p. 52 Feb. 7
 Hammond, J. H., Jr. & Murphree, F. J., High gain d-c amplifier drives crt display p. 53 June 29
 Harrap, V. et al, Researchers turn to germanium for a MOS field-effect transistor p. 64 Nov. 30
 Harrison, L., Paralytic's brain + Myocoder = Hope p. 74 Nov. 30
 Hayes, A. R., Electronically controlling auto's engine spark p. 43 Dec. 28
 Heffner, P., Tunnel diode multi recovers quickly p. 75 Sept. 21
 Hegner, H. R. et al, Testing transistors in-circuit p. 53 June 1
 Heiman, F. P. & Hofstein, S. R., Metal-oxide-semiconductor field-effect transistors p. 50 Nov. 30
 Hejhall, R. C., Getting transistors into single-sideband amplifiers p. 72 June 1
 Hey, J. C., The widening world of the scr p. 78 Sept. 21
 Hilbinger, A. R., New uses for Hall-effect modulators p. 30 Jan. 17
 Hill, R. & Aaland, K., Precision electron welder uses low beam voltage p. 32 Mar. 6
 Hilles, L. M., Compressor amplifier features balanced push-pull circuit p. 36 Jan. 24
 Hines, H. W. & Radzik, L. C., Electronic timer provides long delay p. 63 June 1
 Hofstein, S. R. & Heiman, F. P., Metal-oxide-semiconductor field-effect transistors p. 50 Nov. 30
 Holcombe, W., Relays that challenge semiconductors p. 56 Mar. 23
 Hood, H. C. & Carroll, J. M., Frontier of the deep p. 71 July 13
 Hoisington, D. B., Double-tuning simplifies superhets p. 39 Jan. 24
 Houston, J. A., Electro-optics: modern war-game munitions p. 27 Mar. 6
 Howell, E. K., Light-activated switch expands uses of silicon-controlled rectifiers p. 53 May 4
 Hughes, H. L. & Giroux, R. R., Space radiation affects MOS FET's p. 59 Dec. 28
 Hunter, C. M. & Rich, E., Jr., Bird's-eye view of the weather p. 81 July 27

I

Ishii, K. et al, Tunnel diode generates two microwave frequencies p. 62 Aug. 24

J

Jacoby, J. H., Long-pin approach to dissipator design p. 99 Sept. 7
 Jones, C. I. et al, Using negative reactance for independent phase and attenuation p. 44 Dec. 14

K

Kalfaian, M. V., Transistor bridge switches microvolts p. 60 Jan. 3
 Karlov, F. J. & Smoot, C. H., Boiler control p. 85 June 15
 Katz, A. S., Space-borne recorder triples packing density p. 84 Aug. 24
 Katz, L., Cooling high-power equipment by forced-air convection p. 69 Sept. 21
 Kawakami, M. et al, H-shaped ceramic filter forms miniature i-f p. 55 Feb. 7
 King, B. C. et al, Digital television: shrinking bulky bandwidths p. 77 Dec. 14
 King, J. & Rogers, J., The case for magnetic logic p. 40 June 1
 King, S. & Pacifico, E. M., Integrated circuits shrink a doppler radar system p. 74 Mar. 23
 Kirkpatrick, R. F. & Stouffer, R. C., Symmetrical limiting i-f reduces second harmonic p. 72 Mar. 23
 Kiss, W. et al, How to design micropower transistor amplifiers: part 1 p. 73 May 18
 part 2 p. 48 June 1
 Kleinberg, L. L., Complementary shaper replaces Schmitt trigger p. 66 Oct. 5
 Monostable circuits need power only when they work p. 56 Aug. 24
 Sensistor produces long, reliable pulses p. 51 Dec. 14

Kloch, H. F. & Schoeffler, J. D., Direct digital control at the threshold p. 49 Mar. 23
 Knight, J. M. et al, Digital television: shrinking bulky bandwidths p. 77 Dec. 14
 Knight, M. B., Reed switches for breadboarding p. 93 May 18
 Kohnke, G. H. P., Simple voltage regulator limits load current p. 63 Nov. 2
 Kolk, P. E. & Maloff, I. A., The field-effect transistor as high-frequency amplifier p. 71 Dec. 14
 Kopski, R. L. & Weldon, L. A., Boost for electronic tuning: part 1 p. 49 Apr. 6
 part 2 p. 61 Apr. 20
 Kruse, J. R., Automatic tv tracker keeps eye on missiles p. 82 Apr. 6
 Kuehler, H. et al, Researchers turn to germanium for a MOS field-effect transistor p. 64 Nov. 30
 Kulvin, R. D. & Hakimoglu, A., Sampling ten million words a second p. 52 Feb. 7

L

Lafuse, H. G. & Chiles, W. H., Sweeping carrier signals through interference p. 94 May 18
 Lamorte, M. F. & Liebert, R. B., P-n junctions as radiation sources p. 61 July 13
 Landress, K. B., New technology sparks an expansion for germanium p. 62 Apr. 6
 Leavitt, L. & Gertz, D., Problem: standardizing instruments—Solution: digital systems p. 65 Oct. 19
 Leferts, P., Operational trigger for precise control p. 50 Nov. 2
 Levine, D. & Welch, W. H., Plotting coverage circles for satellite communications p. 27 Jan. 24
 Levine, S., Silicon replacing germanium as power transistors get bigger p. 42 Nov. 2
 Liebert, R. B. & Lamorte, M. F., P-n junctions as radiation sources p. 61 July 13
 Lovelace, B. K. et al, Researchers turn to germanium for a MOS field-effect transistor p. 64 Nov. 30
 Luettgenau, G. G. & Barnes, H. B., Designing with low-noise MOS FET's: a little different but no harder p. 53 Dec. 14
 Lund, P., Direct-reading meter gives impedance and phase angle p. 57 Jan. 3

M

MacDonald, W. W., Electronics in Israel p. 23 Jan. 17
 MacDougall, J. S., Servo comparator amplifier handles high voltages p. 75 Aug. 10
 Maeda, H. et al, H-shaped ceramic filter forms miniature i-f p. 55 Feb. 7
 Maine, R. W., Generating two rectangular waves p. 82 June 15
 Maloff, I. A. & Kolk, P. E., The field-effect transistor as high-frequency amplifier p. 71 Dec. 14
 Martin, B. M. & Cook, C. R., Jr., New semiconductor networks reduce system complexity p. 25 Jan. 10
 Matzen, W. T. & Meadows, R. A., Low-frequency integrated circuits achieved with thermal transfer p. 54 July 27
 McAdam, J. C., Beating the heat in semiconductor devices p. 92 Sept. 7
 McKenzie, A. A., Modern electronics packaging p. 33 Feb. 7
 New era in telephony: Electronic switching p. 71 Oct. 19
 Tropo goes commercial p. 88 July 27
 Wanted: ways to spot rough air p. 49 Feb. 7
 McMaster, R. C., Finding malfunctions before they happen p. 75 Nov. 16
 McMurtry, B. J. & Caddes, D. E., Evaluating light demodulators p. 54 Apr. 6
 Meadows, R. A. & Matzen, W. T., Low-frequency integrated circuits achieved with thermal transfer p. 54 July 27
 Meieran, S., Temperature sensor for strain-gate transducer p. 77 May 4
 Meindl, J. D. et al, How to design micropower transistor amplifiers: part 1 p. 73 May 18
 part 2 p. 48 June 1
 Merlen, M. & Grossman, D., Interrogator circuit can tell good data from bad p. 58 July 13
 Mickelwait, A. B. & Spangler, E. R., Dolling up a space probe p. 80 Mar. 23
 Monser, G. J., Practical log-periodic antenna designs p. 91 May 4
 Moreines, H. et al, Majority voting protects aircraft and pilot p. 85 May 18
 Morrison, S. & Gutlove, N., Scanning the sun for solar flares p. 31 Feb. 14
 Moyer, L. K., Circuit always applies correct operating voltage p. 77 Sept. 21
 Mueller, R. A. & Geppert, D. V., Metal base transistor pushes back the frequency barrier p. 42 Mar. 13
 Munich, A. E., Basic uhf circuit forms amplifiers and multipliers p. 59 July 13
 Murnhree, F. J. & Hammond, J. H., Jr., High-gain d-c amplifier drives crt display p. 53 June 29
 Murphy, E. B., Thermistor measures dielectric gas content p. 54 Oct. 19
 Murphy, R. H., Static alternator controls three-phase motor p. 30 Jan. 31
 Murphy, T. F. et al, Tunnel diode generates two microwave frequencies p. 62 Aug. 24

N

Nakayama, Y. & Odagawa, K., Storage orthicon holds image for hours p. 36 Mar. 6
 Newell, W. E., The frustrating problem of inductors in integrated circuits p. 50 Mar. 13
 Newhall, E. E., Balanced bipolar circuits improve magnetic shift-register performance p. 54 Oct. 5
 Neu, F. D., Voltage controls solid-state nonlinear resistance p. 36 Feb. 21
 Niehenke E. & Allen, R. J., The cool world of components p. 75 June 15

Novotny, G. V., comeback for wireless power? p. 86 Sept. 21

O

Odagawa, K. & Nakayama, Y., Storage orthicon holds image for hours p. 36 Mar. 6
 Okamura, S. & Tanaka, S., Rotating subreflector produces circular scanning p. 44 Feb. 14
 Oleson, H. H. L., Designing against space radiation: part 1 p. 61 Dec. 28
 Osborne, W. E., Farewell to free time on city parking meters p. 72 Dec. 28

P

Pacifico, E. M. & King, S., Integrated circuits shrink a doppler radar system p. 74 Mar. 23
 Panico, J. J., Staircase generator triggers a unijunction transistor p. 80 Sept. 7
 Pearman, C. R. & Popodi, A. E., How to design high-speed d-a converters p. 28 Feb. 21
 Peddie, J. G., Network filters stabilize d-c supply over wide range p. 83 June 15
 Oscillator generates sine, cosine waves simultaneously p. 74 Aug. 10
 Pendleton, F. A., Integrated-circuit system keeps costs down to earth p. 36 Nov. 30
 Phelps, J. H., Transistors instead of relays tune tv volume p. 32 Feb. 28
 Phillips, A. H. & Frank, R. L., Digital loran-C receiver uses microcircuits p. 23 Jan. 31
 Pierson, G. et al, Researchers turn to germanium for a MOS field-effect transistor p. 64 Nov. 30
 Pitzalis, O. et al, How to design micropower transistor amplifiers: part 1 p. 73 May 18
 part 2 p. 48 June 1
 Popodi, A. E. & Pearman, C. R., How to design high-speed d-a converters p. 28 Feb. 21
 Prosser, T. F. & Gulbenk, J., How modules make complex design simple p. 50 Dec. 28

R

Radzik, L. C. & Hines, H. W., Electronic timer provides long delay p. 63 June 1
 Raga, G. L. et al, Digital television: shrinking bulky bandwidths p. 77 Dec. 14
 Revall, D. R. et al, Tunnel diode generates two microwave frequencies p. 62 Aug. 24
 Reich, B., & Hakim, E. B., Trading off radiation resistance and second-breakdown performance p. 48 Oct. 19
 Rhoades, W. T., 100-Mc pulse generator provides 50% duty cycle p. 42 Dec. 28
 Rich, E., Jr. & Hunter, C. M., Bird's-eye view of the weather p. 81 July 27
 Robertson, J. G., Light-airplane marker-beacon receiver p. 33 Jan. 17
 Robertson, R., Interferometer analyzes microwave transmitter p. 58 June 29
 Robinson, D. D., Diode-coupled Schmitt trigger p. 50 Dec. 14
 Linear microcircuits scarce? Now you can breadboard your own p. 58 Oct. 19
 Rodgers, G. V., Lens-line antenna: low noise, less space p. 25 Feb. 28
 Rodrigue, G. P., Research in microwave acoustics spawns compact delay lines p. 69 Nov. 30
 Rogers, J. & King, J., The case for magnetic logic p. 40 June 1
 Ross, T. C., Field-effect transistor controls pulse oscillator p. 80 June 15
 Rush, J. W., Jr., Attractive alternative at uhf: the ceramic vacuum tube p. 50 Aug. 24
 Russell, J. E., Ten signals at a glance p. 54 June 29

S

Sanford, R. J. & Gault, J. M., Stray signals can't throw this desensitized switch p. 68 July 27
 Schaffner, G., Charge storage varactors boost harmonic power p. 42 July 13
 Schiff, P., Preventing second breakdown in transistor circuits p. 66 June 15
 Schmidt, M., Operational amplifier suppresses third harmonic p. 74 Apr. 6
 Schoeffler, J. D. & Kloch, H. F., Direct digital control at the threshold p. 49 Mar. 23
 Schroeder, F. H. & Wennerberg, A. L., High-current converter is small, quiet, low-cost p. 41 Nov. 30
 Schweitzer, J. C., & Van Houten, R., A new ignition system for cars p. 68 Oct. 5
 Scidmore, A. K., Junction diode regulates low-voltage supply p. 55 Oct. 19
 Seatis, E., Circuit protects amplifier against short circuit p. 61 Aug. 24
 Shaifer, T. R. & others, Testing transistors in-circuit p. 53 June 1
 Shergalis, L. D., Data acquisition system expects the unexpected p. 57 June 1
 Comsat comes on strong with a really big show: The Olympics p. 60 Oct. 5
 Sherwin, J. S., Sr., An FET micropower amplifier p. 74 Dec. 14
 Sideris, G., Can electron beams produce incredibly small circuits? p. 82 Nov. 16
 Shipley, M., Analog switching circuits use field-effect devices p. 46 Dec. 28
 Sing, C., Advantages of free-running cascade multi-vibrators p. 28 Jan. 31
 Skagns, C. W., Photo-etching thin-film circuits p. 94 June 15
 Slevin, R. L. & Domchick, R. J., Paramo system achieves high stability p. 34 Feb. 28
 Smith, B., Low-noise FET's sound good to circuit designers p. 58 Dec. 14
 Smith, F. E., Buffer supplies bipolar output p. 75 July 27
 Smith, J. R., Jr., Amplifier can be adjusted to cancel unbalanced noise p. 60 Aug. 24
 Smoot, C. H. & Karlov, F. J., Boiler control p. 85 June 15

Spangler, E. R. & Mickelwait, A. B., Dolling up a space probe p. 80 Mar. 23
 Stevens, R. T., Linear scales show mixer harmonics p. 37 Jan. 10

One-shot multi provides constant pulse width p. 74 Apr. 6

Stewart, C. H. & Vincent, G. J., Radar-tracking accuracy increased p. 73 May 4
 Stasiar, R. A., Helpful transistor analog: 4-layer pnpn = 2 transistors p. 66 Aug. 10
 Stasiar, R. A., How to suppress rate effect in pnpn devices p. 30 Jan. 10
 Stouffer, R. C. & Kirkpatrick, R. F., Symmetrical limiting i-f reduces second harmonic p. 72 Mar. 23
 Strasser, J. A., Early Bird: a bigger and better communications satellite p. 90 Aug. 10
 Strasser, J. A. et al, Electronics markets p. 37 Jan. 3
 Sun, S. F., Magnetoresistance: better than Hall-effect multipliers p. 66 Apr. 6
 Sununu, J. H., Liquid cooling p. 101 Sept. 7

T

Tanaka, S. & Okamura, S., Rotating subreflector produces circular scanning p. 44 Feb. 14
 Thomas, F. et al, Majority voting protects aircraft and pilot p. 85 May 18
 Thomas, R. E., 1500-volt hybrid switch has low 'on' impedance p. 74 Aug. 10
 Tripple, K. R., Noise-figure nomograph for multistage systems p. 64 Oct. 5
 Trunk, E., Laminated dissipator improves heat transfer p. 84 June 15
 More for your money p. 66 Sept. 21
 Tsuchiya, H. et al, H-shaped ceramic filter forms miniature i-f p. 55 Feb. 7

U

Ullery, L. R., Jr. & Garibotti, D. J., Production-line packaging of solid-state circuits p. 73 Sept. 7
 Uno, M., Amplifier improves peak voltmeter response p. 73 Apr. 20
 Uzunoglu, V. & White, M. H., Molecular blocks simplify microcircuits p. 36 Feb. 14

V

Van Houten, R. & Schweitzer, J. C., A new ignition system for cars p. 68 Oct. 5
 van Sutphin, B. & Downs, N., Solid-state transmitter ready for uhf telemetry p. 76 June 1
 Vaughan T. J., Temperature rise in rigid waveguide p. 36 Jan. 17
 Vincent, G. J. & Stewart, C. H., Radar-tracking accuracy increased p. 73 May 4
 Vithayathil, J. J., Variable-phase, polyphase from single-phase supply p. 56 Oct. 19
 Voelker, W. H., Transistor circuit converts voltage to regulated frequency p. 73 Nov. 16
 Vuozzo, A. & Callahan, T., Drive-brake circuit positions ultraviolet spectrometer in spacecraft p. 47 Mar. 13

W

Wade, N. A., Combined feedback stabilizes amplifier p. 76 May 4
 Wagner, R. H., Variable r-f resistor attained with photocell p. 67 Oct. 5
 Wakeen, K., Automatic circuit tester p. 76 July 27
 Wall, H. M., Using a computer for circuit analysis p. 56 Nov. 2
 Wehr, K. C., Conditioned-reflex circuits p. 66 Aug. 24
 Weinberg, R. C., Modified ramp generator develops high d-c input impedance p. 33 Feb. 21
 Welch, W. H. & Levine, D., Plotting coverage circles for satellite communications p. 27 Jan. 24
 Weldon, L. A. & Kopski, R. L., Boost for electronic tuning: part 1 p. 49 Apr. 6
 part 2 p. 61 Apr. 20
 Wellard, C. L., Resistors improve performance while their size decreases p. 62 May 4
 Wennerberg, A. L. & Schroeder, F. H., High-current converter is small, quiet, low-cost p. 41 Nov. 30
 Wieder, H. H., Square-root computer uses Hall multiplier p. 30 Jan. 24
 Wieder, H. W., Four-layer diodes form staircase generator p. 55 July 13
 White, C. F., Simplified r-c ladder network design p. 71 Apr. 6
 White, M. H. & Uzunoglu, V., Molecular blocks simplify microcircuits p. 36 Feb. 14
 Williams, E. M. et al, Using negative reactance for independent phase and attenuation p. 44 Dec. 14
 Williams, F. E. & Blumenthal, R. H., Transistor's stored charge controls pulse delay p. 52 June 29
 Wilson, T., Voltage controls dual-pulse scr trigger p. 62 Nov. 2
 Wold, R. J., 4-terminal controlled switch divides frequencies by 10 p. 81 June 15
 Wolf, M. F., Forward step in microcircuits: Thin-film transistors form scanning generator p. 23 Feb. 21
 Worthinton, R. et al, Majority voting protects aircraft and pilot p. 85 May 18
 Wunderman, I., Optoelectronics at work p. 58 July 27

Y

Young, L. H., Wescon preview p. 60 Aug. 10

Z

Zane, R., Nomograph simplifies delay-line design p. 42 Nov. 30
 Zukowsky, W. S., Aligning Saturn missile's guidance system p. 26 Feb. 21

QUALIFICATION FORM FOR POSITIONS AVAILABLE

ATTENTION: ENGINEERS, SCIENTISTS, PHYSICISTS

This Qualification Form is designed to help you advance in the electronics industry. It is unique and compact. Designed with the assistance of professional personnel management, it isolates specific experience in electronics and deals only in essential background information.

The advertisers listed here are seeking professional experience. Fill in the Qualification Form below.

STRICTLY CONFIDENTIAL

Your Qualification form will be handled as "Strictly Confidential" by Electronics. Our processing system is such that your form will be forwarded within 24 hours to the proper executives in the companies you select. You will be contacted at your home by the interested companies.

WHAT TO DO

1. Review the positions in the advertisements.
2. Select those for which you qualify.
3. Notice the key numbers.
4. Circle the corresponding key number below the Qualification Form.
5. Fill out the form completely. *Please print clearly.*
6. Mail to: Classified Advertising Div., Electronics, Box 12, New York, N. Y. 10036.

COMPANY	SEE PAGE	Key #
ATOMIC PERSONNEL INC. Phila. 2, Pa.	196	1
ELECTRONIC COMMUNICATIONS, INC. St. Petersburg, Florida	106*	2
MOTOROLA Military Electronics Div. Scottsdale, Arizona	107*	3
NATIONAL CASH REGISTER CO. Electronics Div. Hawthorne, Calif.	119	4
SPERRY RAND CORP. Univac Div. St. Paul, Minn.	196	5

* These advertisements appeared in the Dec. 28th issue.

(cut here)

Electronics WEEKLY QUALIFICATION FORM FOR POSITIONS AVAILABLE

(cut here)

(Please type or print clearly. Necessary for reproduction.)

Personal Background

NAME
 HOME ADDRESS
 CITY ZONE STATE
 HOME TELEPHONE

Education

PROFESSIONAL DEGREE(S)
 MAJOR(S)
 UNIVERSITY
 DATE(S)

FIELDS OF EXPERIENCE (Please Check)

1/11/65

- | | | |
|--|--|---------------------------------------|
| <input type="checkbox"/> Aerospace | <input type="checkbox"/> Fire Control | <input type="checkbox"/> Radar |
| <input type="checkbox"/> Antennas | <input type="checkbox"/> Human Factors | <input type="checkbox"/> Radio—TV |
| <input type="checkbox"/> ASW | <input type="checkbox"/> Infrared | <input type="checkbox"/> Simulators |
| <input type="checkbox"/> Circuits | <input type="checkbox"/> Instrumentation | <input type="checkbox"/> Solid State |
| <input type="checkbox"/> Communications | <input type="checkbox"/> Medicine | <input type="checkbox"/> Telemetry |
| <input type="checkbox"/> Components | <input type="checkbox"/> Microwave | <input type="checkbox"/> Transformers |
| <input type="checkbox"/> Computers | <input type="checkbox"/> Navigation | <input type="checkbox"/> Other |
| <input type="checkbox"/> ECM | <input type="checkbox"/> Operations Research | <input type="checkbox"/> |
| <input type="checkbox"/> Electron Tubes | <input type="checkbox"/> Optics | <input type="checkbox"/> |
| <input type="checkbox"/> Engineering Writing | <input type="checkbox"/> Packaging | <input type="checkbox"/> |

CATEGORY OF SPECIALIZATION

Please indicate number of months experience on proper lines.

	Technical Experience (Months)	Supervisory Experience (Months)
RESEARCH (pure, fundamental, basic)
RESEARCH (Applied)
SYSTEMS (New Concepts)
DEVELOPMENT (Model)
DESIGN (Product)
MANUFACTURING (Product)
FIELD (Service)
SALES (Proposals & Products)

CIRCLE KEY NUMBERS OF ABOVE COMPANIES' POSITIONS THAT INTEREST YOU

1 2 3 4 5 6 7 8 9 10 11 12 13 14 15

en- rich

...yourself professionally.

Join UNIVAC-Twin Cities where the very shape of logical design itself is under intensive investigation... particularly algorithms used in arithmetic processes which permit a minimization of total hardware without sacrifice of performance. Studies focus on the control of stochastic systems.

Pioneering work such as this has kept UNIVAC in the #1 position technically in the computer field. New techniques and devices, usually UNIVAC developed, are put to the test of practical application without delay... in programs involving the very smallest aerospace computer to very large multiprocessor systems. They are applied in wide ranging uses—to guidance and control of the Nike-X anti-missile missile, to command and control systems and ASW systems, to reconnaissance and missile range instrumentation systems.

Assignments now open require men with BS or MS degrees to perform logical design of high speed digital equipment using solid state circuitry, and the logical design of systems taking into account the interfaces between the central computer and its input-output equipment.

Inquire about an enriching career at UNIVAC-Twin Cities. Write Mr. R. K. Patterson, Employment Manager, Dept. A-17, Univac Park, St. Paul, Minn. 55116. An Equal Opportunity Employer.

UNIVAC
DIVISION OF SPERRY RAND CORPORATION



EMPLOYMENT OPPORTUNITIES



E. E.'s
for **FEE-PAID Positions**
WRITE US FIRST!
Use our confidential application for professional, individualized service... a complete national technical employment agency.
ATOMIC PERSONNEL, INC.
Suite 1207L, 1518 Walnut St., Phila. 2, Pa.

ADDRESS BOX NO. REPLIES TO: Box No. Classified Adv. Div. of this publication. Send to office nearest you.
NEW YORK, N. Y. 10036: P. O. Box 12
CHICAGO, Ill. 60611: 645 N. Michigan Ave.
SAN FRANCISCO, Cal. 94111: 255 California St.

SELLING OPPORTUNITY AVAILABLE

Salesman—Excellent add'l income! Mfg. of precision engraved Dials, Scales, Panels, Nameplates. If you call on OEM in Electronics and Industry, sell this lucrative Side-line. Nationally advt. We quote on blueprints. Liberal Comm. RW-5751, Electronics.

Don't forget—

the box number when answering advertisements. It's the only way we can identify the advertiser to whom you are writing.

PROFESSIONAL SERVICES

GIBBS & HILL, Inc.

Consulting Engineers
Systems Engineering
Operations Research • Development
Field Studies • Design • Procurement
Power • Transportation • Communications
Water Supply • Waste Treatment
393 Seventh Avenue New York 1, N. Y.

Your Inquiries to Advertisers Will Have Special Value . . .

—for you—the advertiser—and the publisher, if you mention this publication. Advertisers value highly this evidence of the publication you read. Satisfied advertisers enable the publishers to secure more advertisers and — more advertisers mean more information on more products or better service — more value—to YOU.

CLASSIFIED ADVERTISING

SEARCHLIGHT SECTION

BUSINESS OPPORTUNITIES
USED OR SURPLUS EQUIPMENT

GOVERNMENT SURPLUS

- Buy costly electronic and mechanical surplus from Government Agencies and from world famous, nationally known SURPLUS CENTER. Purchase \$4,100 Electronic Amplifiers—\$13.91; \$500 Motor Gyroscopes—\$12.47; \$110 Automatic Stepping Switches—\$12.91. Hundreds other electronic surplus bargains.
- Send 50¢ (stamps) for list of "where and how to buy" from Government Sales Depots plus our three large illustrated electronic, hydraulic, mechanical sales catalogs.

SURPLUS CENTER

Box 713-E15 Lincoln, Nebraska

CIRCLE 951 ON READER SERVICE CARD

V-I-S* SERVICE

FASTEST TO BOTH COASTS

FOR YOUR VERY IMPORTANT SHIPMENTS

2nd DAY

between Chicago—
Milwaukee and
Eastern Terminals'

4th DAY

between Chicago—
Milwaukee and West Coast.

LIFSCHULTZ FAST FREIGHT

NEW YORK — CHICAGO — PHILADELPHIA — BOSTON
HOLYOKE — BALTIMORE — BLOOMFIELD, N. J.
NEW HAVEN — PROVIDENCE — MILWAUKEE
LOS ANGELES — SAN FRANCISCO

CIRCLE 952 ON READER SERVICE CARD

Mr. Used Equipment Dealer:

When you advertise in the Searchlight Section . . . You have hired your most persuasive salesman:

He's efficient . . . He thrives on long hours . . . His territory is the entire nation . . . and overseas . . . He doesn't see buyers of used and new surplus equipment: They see him—regularly. They depend on him.

He is Searchlight—The section of this publication where wise dealers advertise and list their stocks for sale.

SEARCHLIGHT SECTION

Classified Advertising Div.

Post Office Box 12

New York, N. Y. 10036

AUTOTRACK ANTENNA MOUNT

360 degree azimuth, 210 degree elevation sweep with better than 1 mil. accuracy. Missile velocity acceleration and slewing rates. Amplidyne and servo control. Will handle up to 20 ft. dish. Supplied complete with control chassis. In stock—immediate delivery. Used world over by NASA, USAF. TYPE MP-61 B. SCR-584. NIKE AJAX mounts also in stock.

SCR 584 AUTOMATIC TRACKING RADARS

Our 584s in like new condition, ready to go, and in stock for immediate delivery. Ideal for telemetry research and development, missile tracking, satellite tracking, balloon tracking. Used on Atlantic Missile Range, Pacific Missile Range, N.A.S.A. Wallops Island, A.B.M.A. Write us. Fully Desc. MIT Rad. Lab. Series, Vol. 1, pps. 207-210, 228, 284-286. Compl. inst. Bk. avail. \$25.00 each.

PULSE MODULATORS

MIT MODEL 9 PULSER

1 MEGAWATT—HARD TUBE

Output 25 kv 40 amp. Duty cycle .002. Pulse lengths .25 to 2 microsec. Also .5 to 5 microsec, and 1 to .5 microsec. Uses 6C21. Input 115v 60 cycle AC. Mfr. GE. Complete with driver and high voltage power supply. Ref: MIT Rad. Lab. Series, Vol. 5, pps. 152-160.

500KW THYRATRON PULSER

Output 22kv at 28 amp. Rep. rates: 2.25 microsec. 300 pps, 1.75 msec 550 pps. .4 msec 2500 pps. Uses 5C22 hydrogen thyatron. Complete with driver and high voltage power supply. Input 115v 60 cy AC.

2 MEGAWATT PULSER

Output 30 kv at 70 amp. Duty cycle .001. Rep rates: 1 microsec 600 pps, 1 or 2 msec 300 pps. Uses 5948 hydrogen thyatron. Input 120/208 VAC 60 cycle. Mfr. GE. Complete with high voltage power supply.

15KW PULSER—DRIVER

Biased multivibrator type pulse gen. using 3E29. Output 3kv at 5 amp. Pulse lgths .5 to 5 microsec, easily adj. to .1 to .5 msec. Input 115v 60 cy AC. \$575. Ref: MIT Rad. Lab. Series, Vol. 5, pps. 157-160.

MIT MODEL 3 PULSER

Output: 144 kw (12 kv at 12 amp.) Duty ratio: .001 max. Pulse duration: .5, 1 and 2 microsec. Input: 115 v 400 to 2000 cps and 24 vdc. \$325 ea. Full desc. Vol. 5, MIT Rad. Lab. Series, pg. 140.

250KW HARD TUBE PULSER

Output 16 kv 16 amp. duty cycle .002. Pulses can be coded. Uses 5D21, 715C or 4PR60A. Input 115 v 60 cycle ac. \$1200 ea.

5949 THYRATRON AGING RACK

Compl. Chatham Electronics Console incl. 15 kv power supply & PFN's. \$1800.

H.V. POWER SUPPLIES

1) 12 kv .75 amps nominal \$1400 ea. 2) 22 kv 300 ma nominal \$2200 ea. Std. 60 cycle inputs.

MICROWAVE SYSTEMS

E-4 FIRE CONTROL SYSTEM

Hughes Aircraft X Band. Complete. In stock.

C-BAND RADAR

250 KW output, C-band, PPI indicator, 5C22 thyatron modulator. Antenna hi gain parabolic section. Input 115 volts 60 cycle AC, complete \$2750.00.

300 TO 2400MC RF PKG.

300 to 2400 MC CW. Tuneable. Transmitter 10 to 30 Watts. Output. As new \$475.

500KW "L" BAND RADAR

500 kw 1220-1350 mcs. 160 nautical mile search range P.P.I. and A Scopes. MITL thyatron mod. 5326 magnetron. Complete system.

PHILCO MICROWAVE LINKS

C Band Microwave Link terminal bays and repeater bays in stock. New \$1500 each or \$2500 per pr.

10KW 3 CM. X BAND RADAR

Complete RF head including transmitter, receiver, modulator. Uses 2J42 magnetron. Fully described in MIT Rad. Lab. Series Vol. 1, pps. 616-625 and Vol. II, pps. 171-185. \$375. Complete System \$750.

50KW 3 CM RADAR

Airborne radar. 50 kw output using 725A magnetron. Model 3 pulser. 30-in. parabola stabilized antenna. PPI scope. Complete system. \$1200 each. New.

100KW 3CM. RADAR

Complete 100 kw output airborne system with AMTI. 5C22 thyr. mod. 4J52 magnetron, PPI. 360 deg az sweep, 60 deg. elev. sweep, gyro stabilizer, hi-gain revr. Complete with all plugs and cables.

M-33 AUTO-TRACK RADAR SYSTEM

X band with plotting board, automatic range tracking, etc. Complete with 1 megawatt acq. radar.

400 CYCLE SOURCE

Output: 115v 400 cycle 1 ph 21.7 amps cont. duty input: 208v 60 cycle 3 ph. req. 30v dc static exc. New. \$325 ea.

3KW RCA PHONE & TELEG XMR

2-30 MC. 10 Autotone channels plus MO. Input 220 vac. 50/60 cycles.



Radio-Research Instrument Co.
550 5th Ave. New York 36, N.Y.
Tel. JUdson 6-4691

CIRCLE 953 ON READER SERVICE CARD

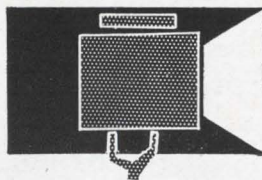

SEARCHLIGHT SECTION

• CLASSIFIED ADVERTISING • BUSINESS OPPORTUNITIES
• USED OR SURPLUS EQUIPMENT

OVER 2,000,000

RELAYS

IN STOCK!

Send for Catalog \$5
Universal RELAY CORP.

42 WHITE ST., N.Y. 13, N.Y. • WAlker 5-6900

CIRCLE 954 ON READER SERVICE CARD

ELECTRON TUBES

KLYSTRONS • ATR & TR • MAGNETRONS
SUBMINIATURES • C.R.T. • T.W.T. • 5000-
6000 SERIES

• SEND FOR NEW CATALOG A2 •

A & A ELECTRONICS CORP.

1063 PERRY ANNEX
WHITTIER, CALIF.
696-7544

CIRCLE 955 ON READER SERVICE CARD

REFERENCE BOOK

"TRANSISTOR CIRCUIT ANALYSIS"—

Joyce and Clarke

Presents the basic methods of analysis involved in the understanding and design of junction transistor circuitry, limiting the transistor models employed to a few easily interrelated ones. Write for free brochure.

Dept. 439, Addison-Wesley, Reading, Mass.

CIRCLE 956 ON READER SERVICE CARD

SMALL AD but BIG STOCK

of choice test equipment

and surplus electronics

Higher Quality—Lower Costs

Get our advice on your problem

ENGINEERING ASSOCIATES

434 Patterson Road — Dayton 19, Ohio

CIRCLE 957 ON READER SERVICE CARD

Somebody—Somewhere,

needs your idle equipment! Reach that buyer quickly and economically thru the

"SEARCHLIGHT SECTION"

The meeting place of Used Equipment Buyers and Sellers



FREE CATALOG!
NEARLY 4,000 BUYS
FOR INDUSTRY

OPTICS! SCIENCE! MATH!
GIANT 148 PAGES

Many on-the-job helps . . . Quality Control Aids! Write for this completely new, 1965 Catalog. New items, new categories, new illustrations. 148 easy-to-read pages packed with hundreds of charts, diagrams, illustrations. A treasure-house of optical and scientific information . . . unusual bargains galore! Optics for industry, research labs, design engineers, experimenters, hobbyists! Instruments for checking, measuring—to speed work, improve quality, cut production costs. We give you facts: what it is—how it works—where it's used!

COMPARATORS, MAGNIFIERS, MICROSCOPES

Hard-to-get war surplus bargains—ingenious scientific tools—imported—domestic. Thousands of components: lenses, prisms, wedges, mirrors, mounts—accessories of instruments: magnifiers, stereo microscopes, telescopes, binoculars, infrared equipment, photo attachments. Shop by mail. No salesman will call. Use the Catalog of America's greatest Optics—Science—Math Mart. Known for reliability. Mail coupon below for catalog "EX". No obligation.
EDMUND SCIENTIFIC CO.
Barrington, N. J.

MAIL COUPON FOR FREE CATALOG "EX"!

EDMUND SCIENTIFIC CO., Barrington, N. J.

Please send FREE Giant 148-page Catalog 'EX'

NAME

ADDRESS

CITYZONE.....STATE.....

CIRCLE 961 ON READER SERVICE CARD

FOR
DRILLING
AND ROUTING
CIRCUIT BOARDS
AND
REINFORCED
RESINS

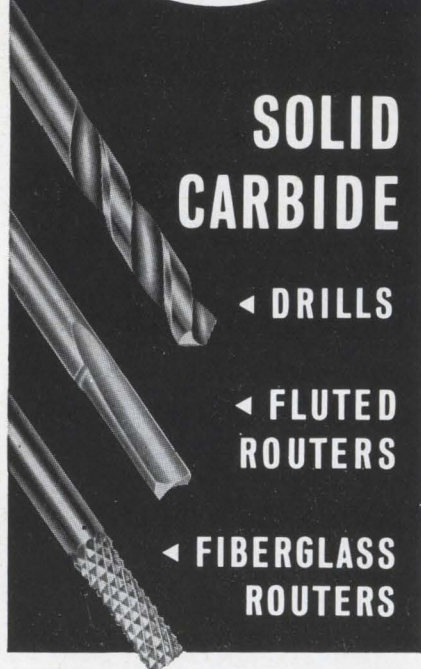

**SOLID
CARBIDE**

◀ DRILLS

◀ FLUTED
ROUTERS

◀ FIBERGLASS
ROUTERS

UNEQUALLED METAL REMOVAL
COMPANY SERVICE, QUALITY
AND SELECTION INCLUDING:

1. World's largest inventory of centerless ground drill blanks and finished tools ready-for-shipment.
2. Fifteen centerless grinders in production of drills and rotary carbide tools.
3. Every size carbide drill, ground from-the-solid . . . the smallest — .008" diameter to the largest — 1.500" diameter.
4. Precision ground to 5 micro-inch finish or better.
5. Delivery from stock, through our distributors, of any standard solid carbide tool in 48 hours.

Your assurance of product quality, lowest cost and dependable service is the fact that the nation's leading carbide tool users are placing their tool contracts with The Metal Removal Company.

THE METAL REMOVAL COMPANY
1859 W. Columbia Avenue
Chicago, Illinois 60626

Plants Located in CHICAGO • LOS ANGELES • SAN JUAN



**MASTER TOOL AND WHEEL
MAKERS FOR THE WORLD**

New Literature

Relays. Universal Relay Corp., 42 White St., New York, N.Y., 10013, has issued its 60-page 1965 catalog that includes over 2 million relays in approximately 40,000 types.

Circle 461 reader service card

Lighted pushbutton switches. Oak Mfg. Co., a division of Oak Electro/Netics Corp., Crystal Lake, Ill., 60014. New design possibilities available to the engineer whose circuiting requirements include lighted pushbutton switches are described in catalog SP-165. [462]

Power fans. Dynacool Mfg. Co., Inc., West Hurley, N.Y. A two-page bulletin illustrates and describes a series of fourteen 8-in power fans capable of delivering 200 cfm to 1,000 cfm (nominal). [463]

Cable shielding. Metals & Controls Inc., a corporate division of Texas Instruments Inc., 34 Forest St., Attleboro, Mass. Technical data bulletin IND-5 describes copper-clad stainless steel shielding material for communication cable. [464]

Solid-state preamplifiers. Applied Technology Inc., 3410 Hillview Ave., Stanford Industrial Park, Palo Alto, Calif., has available a technical application bulletin on its series of solid-state preamplifiers. [465]

Angle-repeating instruments. Theta Instrument Corp., Saddle Brook, N.J., 07663, has published its 1965 engineering catalog giving full details of digital instruments for repeating precise angular position. [466]

Subminiature indicator lights. Dialight Corp., 60 Stewart Ave., Brooklyn, N.Y., 11237. A 12-page catalog presents a complete line of subminiature indicator lights that meet or exceed the environmental and operational requirements of MIL-L-6723 and MIL-L-3661. [467]

Counter data file. Computer Measurements Corp., 12970 Bradley Ave., San Fernando, Calif., has issued a complete data file on its 600 series of all-silicon solid-state electronic counters and universal counter-timers. [468]

Cryogenic x-ray equipment. Materials Research Corp., Orangeburg, N.Y. A brochure describes a cryogenic x-ray attachment for x-ray diffraction studies at temperatures from 4.2° K to room temperature. [469]

Fixed-head drums. Bryant Computer Products, 850 Ladd Road, Walled Lake, Mich. Data sheets describe two of the company's lower priced fixed-head drums—C-105 and C-675. [470]

Silicon-rectifier multiple circuits. Edal Industries, Inc., 4 Short Beach Road, East Haven, Conn. Bulletin 109 offers details on series K silicon-rectifier multiple circuits. [471]

Analog/hybrid computer. Comcor Inc., 1335 South Claudina Ave., Anaheim, Calif. A six-page brochure describes the all-solid-state model Ci-5000 analog/hybrid computer. [472]

Electrometer. Keithley Instruments, 12415 Euclid Ave., Cleveland 6, Ohio. An engineering note describes the model 610B electrometer—almost a complete d-c laboratory—that measures over 79 ranges. [473]

Transfer lettering. Chart-Pak, Inc., One River Road, Leeds, Mass., has available literature citing the vital characteristics and applications of Deca-Dry transfer lettering. Included is a section devoted to a new electronic marking kit. [474]

High-voltage reference elements. U.S. Semcor, 3540 W. Osborn Road, Phoenix, Ariz., 85019, has published data sheets on three new series of epoxy-encapsulated, high-voltage reference elements in a total of 10 different packages. [475]

Component packages. Helipot Division of Beckman Instruments, Inc., 2500 Harbor Blvd., Fullerton, Calif. A four-page brochure describes applications and the component complement of typical servopackage assemblies. [476]

Digital logic modules. Wyle Laboratories, 128 Maryland St., El Segundo, Calif. Catalog GLM-G covers a line of germanium solid-state logic cards and accessory equipment. [477]

Memory unit. Andersen Laboratories, 501 New Park Ave., West Hartford, 10, Conn., offers a bulletin on its 20,000-bit, 10-millisecond, 2 Mc NRZ delay line that is designed for use as a serial memory unit. [478]

Servo system. Sciaky Bros., Inc., 4915 W. 67th St., Chicago, Ill., 60638. Descriptive bulletin 343A illustrates a highly precise electronic servo system with graphs and photographs. [479]

Encoder-readout display system. Guidance Controls Corp., Plainview, L.I., N.Y., offers a brochure on an encoder-readout display system that combines highly accurate position sensing in a high-speed, low-cost package. [480]

Readout line. Burroughs Corp., Electronic Components Division, Plainfield, N.J. A 28-page, illustrated brochure presents full information on a line of readout devices, support modules, and readout systems. [481]

Photoconductive cells. Clairex Corp., 8 W. 30th St., New York, N.Y., 10001. A single-page bulletin contains technical data on the CL5M series of small, high-wattage photoconductive cells. [482]

Tunnel diode mixers. Aertech, 250 Polaris Ave., Mountain View, Calif., has prepared a two-page data sheet discussing parameters of tunnel mixers, and listing various models together with specifications and prices. [483]

Aerospace facilities. The Aerospace Division of Haveg Corp., Wilmington, Del., has issued a 12-page brochure that describes in detail the equipment and facilities available for aerospace programs. [484]

8 AU 13 AVRIL 1965 - PORTE DE VERSAILLES - PARIS



salon
international des

COMPOSANTS ELECTRONIQUES



1^{er} salon international de
L'ELECTROACOUSTIQUE

RENSEIGNEMENTS S.D.S.A. 16 RUE DE PRESLES PARIS 15^e

April in Paris...

SPRINGTIME FOR ELECTRONICS



April is without a doubt the month when Paris is at its fairest. Gentle breezes, evenings growing longer, trees in full bloom everywhere—along the avenues, in the squares and by the Seine, where the first “bateaux-mouches” are carrying sight-seers down the river—and flowers everywhere, even in the ladies’ dresses.

April—dazzling-bright stone—for the recent renovation of Paris’ monuments and palaces has restored her buildings to their original glory.

Le Louvre, la Place Vendome, la Place de la Concorde, l’Ile Saint-Louis—all the places of Paris are waiting to be seen.

For electronics experts, the pleasure of rediscovering, in all of her spring finery, one of the most beautiful cities of the world will only add to the interest that is ever increasing in the *International Exhibition of Electronic Components*, in Paris, April 8-13.

Created in 1934 and elevated to an international stature in 1958, only for manufacturers, it now constitutes the *greatest worldwide assembly* in the field of electronic parts and accessories.

Its success is growing every year. The total number of exhibitors has more than doubled in the course of the last seven years. Its international spirit was established in 1964 by the presence, out of 772 exhibitors, of 346 foreign exhibitors belonging to 15 different countries. Throughout the world 50 technical and international periodicals cover this event. The number of foreign visitors to the Exhibition is constantly growing. In 1964, 65 countries were represented.

The Exhibition is truly a *crossroad* where manufacturers and technicians alike from all countries meet, exchange views on materials and techniques, and work out together what will be the innovations of tomorrow.

In 1965 the Exhibition will be more important than ever. Bringing together 800 exhibitors it will hold forth for the first time in the *Hall Monumental* of the *Parc des Expositions de la Porte de Versailles*, in a setting worthy of the scope of this specialized presentation of superior technicality.

Along with it, and at the same time, the First International Exhibition of Audio Equipment will take place—new professional meeting of a branch of electronics which is in full growth.

And from the 5th to the 10th of April, in UNESCO’s Salles de Conferences, the first *International Symposium on Techniques of Memories* will get under way. Users and producers will be brought up to date on the actual data of a problem and on the evolution of techniques whose applications are proving to be more and more important.

To be in Paris in springtime, to be there when so much that is important in the world of electronics is going on, is a date not to miss.

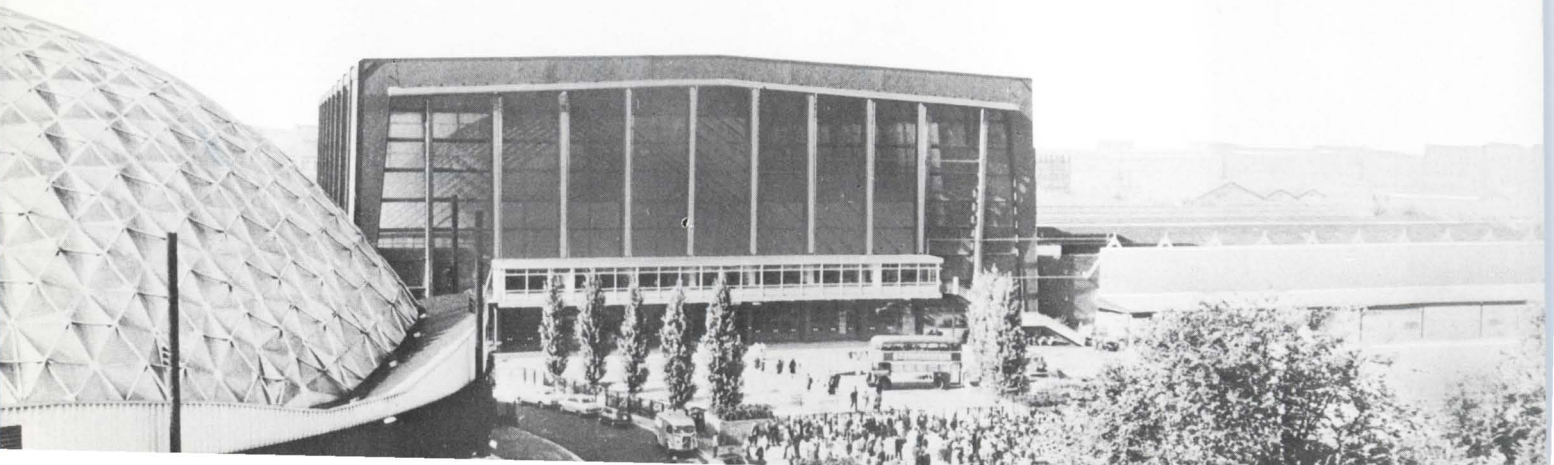



INTERNATIONAL EXHIBITION OF ELECTRONIC COMPONENTS

PARIS 8th to 13rd APRIL

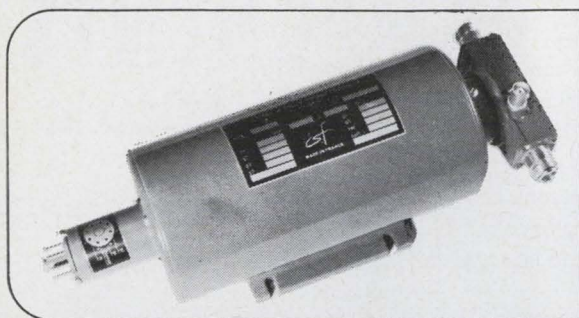

low noise

Type	F (Gc/s)	NF (dB)
F 4064 (TPO 251)	1.2 - 1.4	4.5
F 4107 (TPO 101)	2.7 - 3.3	6.5
F 4068 (TPO 741)	3.8 - 4.2	6.5
F 4065 (TPO 301)	8.5 - 9.6	7.5

INPUT TUBES
PROVIDING 40%
RANGE INCREASE
BY IMPROVING
THE SENSITIVITY
OF RADAR RECEIVERS

wide bandwidth

Type	F (Gc/s)	NF (dB)	Gain (dB)
F 4123	1 - 2	11	35
F 4100	2 - 4	11	35
F 4101	4 - 7	12	35
F 4102	7 - 11	13	35

LIGHT WEIGHT
COMPACT
INPUT TUBES
FOR MOBILE OR
AIRBORNE EQUIPMENT

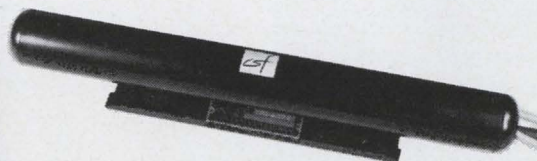

low and medium power

Type	F (Gc/s)	Ps (W)
F 4087	1 - 2	1
F 4134	1 - 2	10
F 4133	1 - 2	50
F 4017	1.7 - 2.7	10
F 4050	2.7 - 3.3	10
F 4088	2 - 4	1
F 4135	2 - 4	10
F 4059	5.9 - 6.4	20
F 4056	5.9 - 7.4	10

OUTPUT
AMPLIFIERS
FOR RADIOCOMMUNICATION
TRANSMITTERS,
RADIO LINKS, OR
METERING SYSTEMS

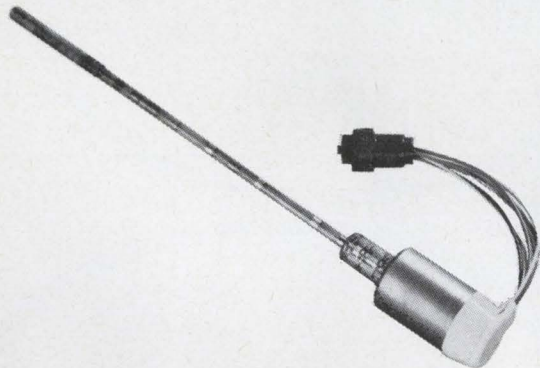

2 MILLION HOURS' OPERATION PER YEAR
ON LONG DISTANCE RADIO LINKS.
THESE NEW TUBES
WILL PROVIDE GREATER CAPACITY AND
NEW APPLICATIONS TO SPACE TRANSMISSIONS
AND EFFECTIVE IMPROVEMENT OF
RECEIVER SENSITIVITY.

TRAVELLING WAVE TUBES



CSF - COMPAGNIE GÉNÉRALE DE TÉLÉGRAPHIE SANS FIL

HOME SALES - CSF - DIVISION TUBES ÉLECTRONIQUES
55, Rue Greffulhe - Levallois-Perret - (Seine) - Tél. PER. 34.00
EXPORTS - CSF - DIVISION TUBES ÉLECTRONIQUES
79, Boulevard Haussmann - Paris 8^e - Tél. ANJ. 84.60

OTHER MANUFACTURES: TRANSMISSION TUBES • "MINIATRON" • "SUBNITRON" • REPEATER TUBES • "O" AND "M" CARCINOTRONS • KLYSTRONS • MAGNETRONS • DUPLEXER TUBES • CATHODE-RAY TUBES • STORAGE TUBES • ETC.

S.P.I. 51 - 391 A



INTERNATIONAL EXHIBITION OF
ELECTRONIC COMPONENTS
PARIS 8th to 13rd APRIL



ELECTRONIC COMPONENTS

FIABILITY

**NEWEST
DEVELOPMENTS**

in

**Semiconductor
Crystals
(Ga As-In As-GaP-
Epitaxy)**

**Special S.C.
Devices**

Microelectronics

**Magnetic
Memories**

Cathode Ray Tubes

Photomultipliers

and others...

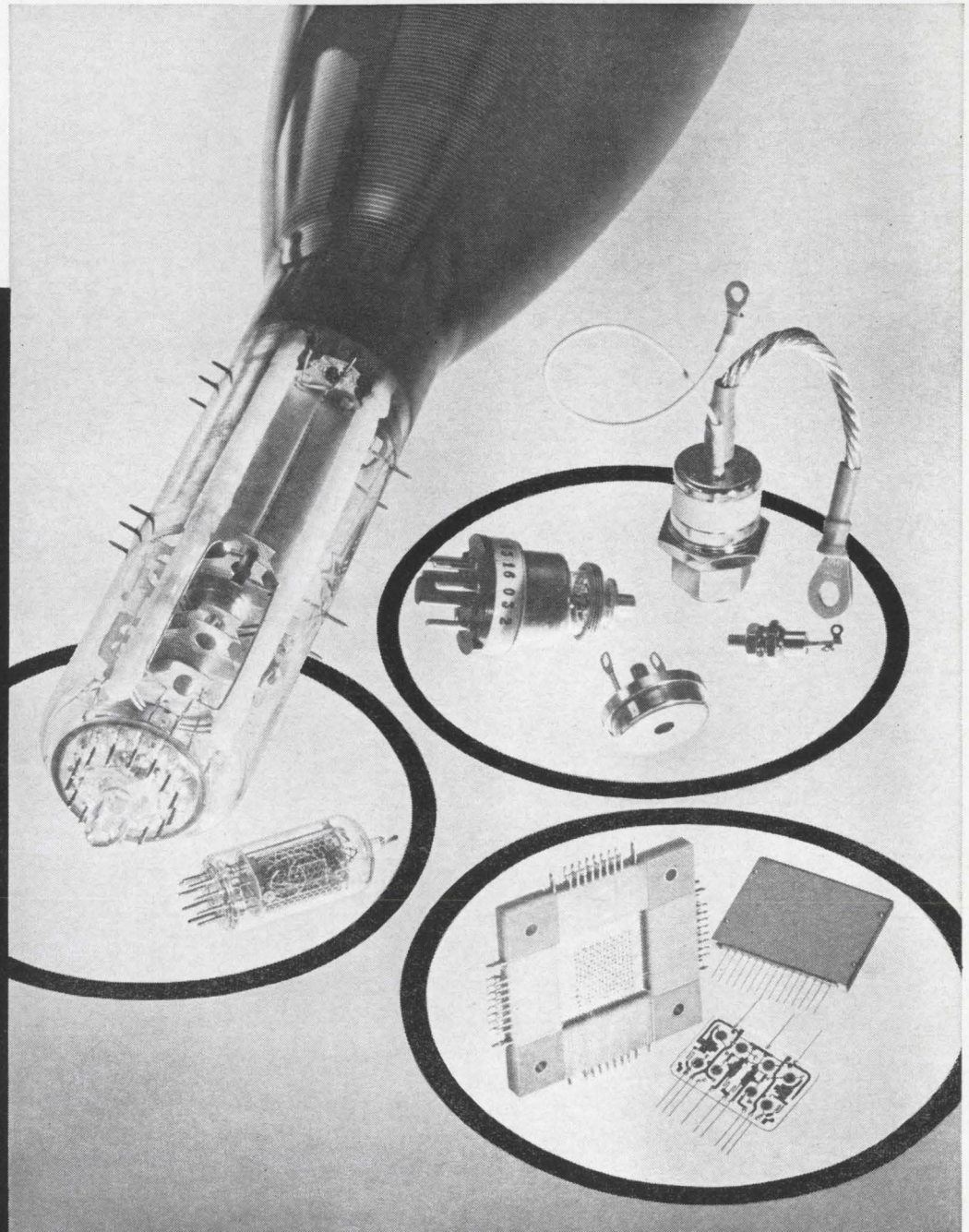

Photo SCHALL

LA RADIOTECHNIQUE

Société Anonyme au capital de 90 millions de francs
Research Laboratories at SURESNES - CAEN - EVREUX
Write to : Electronic Components Div., 130 Av. Ledru-Rollin - PARIS (France)

Circle 233



INTERNATIONAL EXHIBITION OF
ELECTRONIC COMPONENTS
 PARIS 8th to 13rd APRIL



**a new triumph
 in the nanoseconde field.**

**FOR PURE RESEARCH
 OSCILLOSCOPE TYPE 205 A
 RIBET-DESJARDINS**



Dimensions :
 52 x 37 x 75 cm
 Weight : 50 Kg.

CHARACTERISTICS :

- Passband : 0 – 1000 Mc.
- Risetime : < 0,35 nsec.
- Vertical deviation factor : 10 V/cm.
- Input impedance : 100 Ω
- Maximum input power : 2,25 watts
- C R T Accelerating potential : 24 kv
- Pulse and standard voltage built-in generators.

Further information and price on demand.

It's a product:

RIBET-DESJARDINS

Instrument Department, 13, rue Périer MONTROUGE/PARIS France.

INTERPLANS 2112

SOURIAU ET C^{IE}

**ELECTRICAL
 CONNECTORS**

**AERONAUTICS
 NAVY
 ELECTRONICS
 RADIO**

9 Rue Gallieni
 BOULOGNE
 BILLANCOURT
 FRANCE

SOURIAU ELECTRIC
 G. m. b. H. Dusseldorf
 Rathausufer 17

SOURIAU ITALIANA
 S. p. A. Milan
 Piazza Velasca 5

SOCIÉTÉ ÉLECTRIQUE
 BENELUX SOURIAU
 Bruxelles
 Rue Royale 163

S. E. B. S. NEDERLAND
 Rotterdam



Ariane publicité



INTERNATIONAL EXHIBITION OF ELECTRONIC COMPONENTS

PARIS 8th to 13rd APRIL

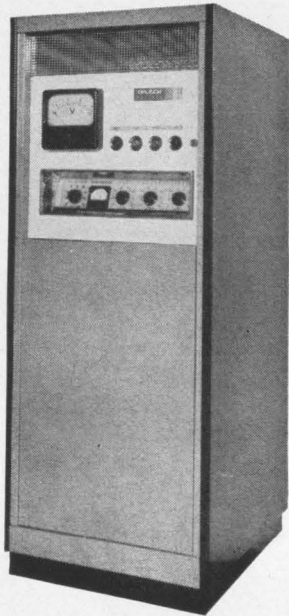

HIGH SPEED STATIC VOLTAGE REGULATORS

Input:

- Mains supply voltage fluctuation $\pm 15\%$
- Mains supply frequency 48-52 cycles
- Power factor of regulator at full load more than 0.86

Output:

- Regulation accuracy $\pm 0.2\%$
- Overall harmonic distortion. Less than 3%
- Admissible load variation 0 to 100%
- Recovery time constant:
 - For 20% mains variation 0.04 sec.
 - For 95% load variation 0.03 sec.
- Efficiency at full load 96%
- Radiation free — Instantaneous start up
- 10 Standard ratings: 0.5—1-2-5-10-15-20-30-40-60 Kva
- Mains supply: 110-117-127 and 220 V.

SATURABLE REACTORS

- Power rating from 0.05 to 300 Kva (oven supply, motor control, etc.)

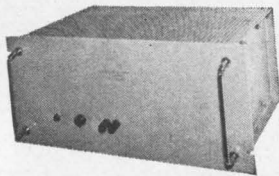

MAGNETIC AMPLIFIERS

- For proportional temperature control

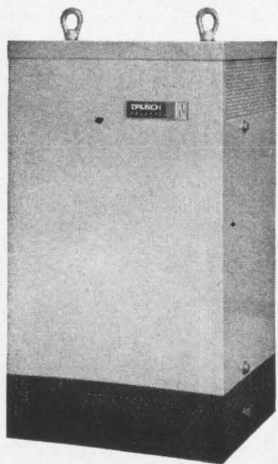

STATIC CONSTANT-CURRENT SUPPLIES FOR ELECTROMANETS

Input:

- Single-phase or three-phase mains supply $\pm 10\%$

Output:

- Power rating 1 to 100 Kva
- Regulation accuracy: Drift less than 0.002% in 8 hours
- Set point adjustment 2 to 100%
- Recovery time constant for 10% mains supply fluctuations, 3 millisecc.
- Also: field stabilization with Hall effect and nuclear resonance-devices

STABILIZED POWER SUPPLIES

- For electron-beam furnaces

DRUSCH

V O L T R E G

138, RUE GALLIENI-PARIS/RUEIL-MALMAISON (S.-&O.)

Tel.: 967-11-33 et 967-20-54

RAPY



MICROPHONE

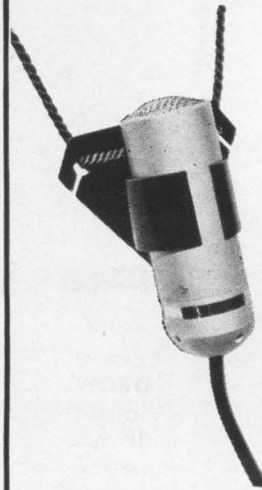

A miniature lavalier type of outstanding design and broadcast quality. This LEM model has small dimensions and weight and is particularly suitable for use with a micro-transmitter. Finished in satin chrome. Used by European Broadcasts.

Manufactured by



145, avenue de la République
CHATILLON (près PARIS) Seine • FRANCE.
T. 253.77.60

Sole Representatives for Great Britain:
DOUGLAS A. LYONS and Associates Ltd, LONDON S.E. 19.

Circle 237 on reader service card

STOCKLI 18, RUE GALILÉE
MONTREUIL
SEINE FRANCE

PRECISION DIALS and CONTROL KNOBS
FOR PROFESSIONAL ELECTRONIC APPARATUS

**THE LARGEST
EUROPEAN
PRODUCTION**

WRITE NOW FOR FULLY
ILLUSTRATED CATALOG



INTERNATIONAL EXHIBITION OF ELECTRONIC COMPONENTS

PARIS 8th to 13rd APRIL



VIDEON



More than half of all television receivers manufactured in France use **VIDEON** components: the first French specialists in manufacture of UHF tuners, VHF rotary switches, intermediate-frequency coils, deflection coils, high-voltage transformer, chokes, etc. for tubes and transistors.

VIDEON

95 rue d'Aguesseau, Paris/Boulogne-sur-Seine, France

Tel.: 825 55-95

Plant in Monville near Rouen (Seine Maritime)

RAPY

Circle 239 on reader service card

AUDAX

the most important european Firm of loudspeakers informs you of

THE MINIATURE ENCLOSURE

"OPTIMAX I"

a sealed system, with a diaphragm suspended by pneumatic balancing.

- **Size:** height 220 mm (8.7") × depth 260 mm (10.2") × width 130 mm (5.1").
 - **Frequency range:** from 40 to 15,000 Hz.
 - **Sensitivity:** 98 dB above 2×10^{-4} microbars (1 watt, distance 0.5 m).
 - **Permissible power:** rated power: 8 watts. Maximum power 12 watts.
 - **Presentation:** de luxe finish; oiled teckwood.
 - **Connection:** universal screws attached to embedded plates.
 - **Utilisation:** for use with modulation generators having an output between 0.5 and 10 watts, high fidelity systems, radio receivers, turntables, television sets.
- Impedance: 4-5 ohms (8 or 15 ohms on request).

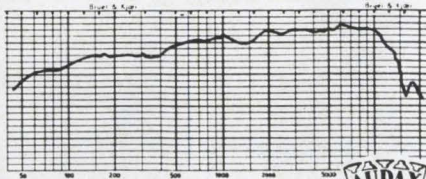
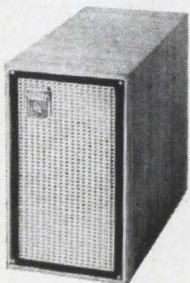

AUDAX

FRANCE

45, Avenue Pasteur - Montreuil (Seine) Tél. : 287-50-90 +

Adr. Télégr. : OPARLAUDAX - PARIS

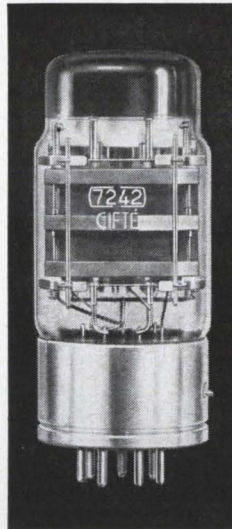

7242

Photo S. Borron

A wide range of

SERIES REGULATOR TUBES

for any of your requirements :

- **Current output**
cathode currents from 200 to 1800 mA
- **Environmental conditions**
shocks, vibrations, temperature
- **Reliability**

TYPES	Pa W max	Va V max	Ik mA Max	
3T100R	150	3 000	750	
4Y75R	35	800	200	
4Y100R	2 x 50	800	700	
6080WA	2 x 13	250	250	reliable
6080WB	2 x 13	250	400	reliable
6336	2 x 30	400	500	
6336A	2 x 30	400	800	rugged
7242	2 x 100	400	1 800	rugged



COMPAGNIE INDUSTRIELLE
FRANÇAISE
DES TUBES ÉLECTRONIQUES

Write
for information :

C.I.F.T.É.
50 rue J. P. Timbaud - COURBEVOIE
(Seine) FRANCE

Telephone : 333.37-50

Telegram : CIFTÉ-COURBEVOIE



INTERNATIONAL EXHIBITION OF ELECTRONIC COMPONENTS

PARIS 8th to 13rd APRIL



HIGH POWER PULSED KLYSTRON

CW KLYSTRONS

REFLEX KLYSTRONS

MAGNETRONS

TR-ATR

SOLID STATE DEVICES

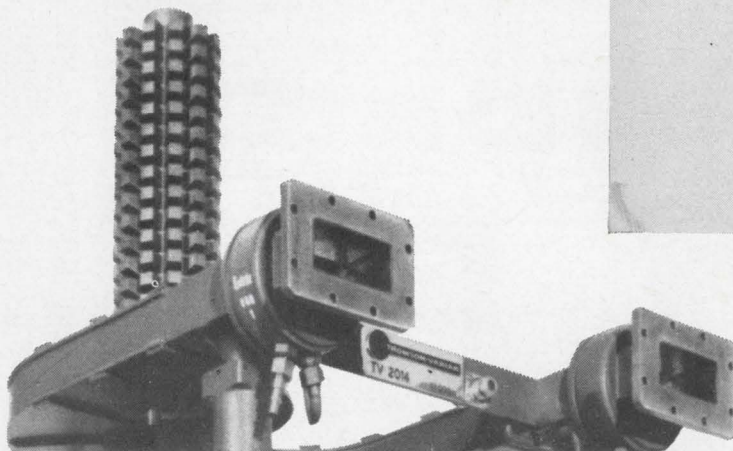

ALL MICROWAVE TUBES AND COMPONENTS



Write for full information

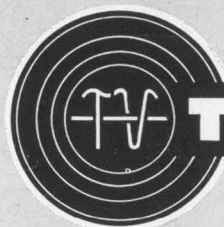

THOMSON-VARIAN

**THOMSON-VARIAN TUBES ET COMPOSANTS HYPERFREQUENCES - 6, RUE MARIO-NIKIS - PARIS 15^e - TEL. SUFFren 91-00
VARIAN ASSOCIATES - PALO ALTO - CAL. FOR THE U. S. AND CANADA**



INTERNATIONAL EXHIBITION OF ELECTRONIC COMPONENTS

PARIS 8th to 13rd APRIL



2 m V 500 V

*très haute impédance
d'entrée en C.C.
very high DC input
impedance* **1000 MΩ**



Type A 1335

voltmètre numérique

continu ou alternatif • entièrement automatique

DC/AC digital voltmeter

automatic model

*transistorisé
transistorized*

	en continu DC	en alternatif (Fréq. max. 200 KHz) AC (max. Freq. 200 Kc)
Précision	0,2 % ± 2 unités	classe 0,5 % (20 Hz à 10 KHz)
Exactitude	0,2 % ± 2 unités	class 0,5 % (20 cps to 10 Kc)
Impédance d'entrée	> 1000 MΩ sur 5 V 5 MΩ sur autres gammes	10000 Ω/V
Input impedance	> 1000 MΩ on 5 V 5 MΩ on other ranges	

Autres modèles

- A. 1175 Voltmètre continu (0,1%)
0,2 mV à 2000 V
- A. 1176 Voltmètre Ohmmètre ampèremètre
continu et alternatif (0,1%)
0,1 mV à 2000 V
1 Ω à 20 M Ω
1 nA (10⁻⁹ A) à 20 mA

Other models

- A. 1175 D.C. Voltmeter
0.2 mV to 2000 V
- A. 1176 DC/AC Digital Amp. Volt. Ohm Meter
(0.1%)
0.1 mV to 2000 V
1 Ω to 20 M Ω
1 nA (10⁻⁹ A) to 20 mA

For complete information on our line of products and address of our agency in your country please apply to

Distributed in U.S.A. and Canada by:
WESTON—Newark (N.J.)

Rochar

électronique

GROUPEMENT
D'INSTRUMENTATION SCHLUMBERGER

51, rue Racine, Montrouge (Seine)

France

Tél. 735-31-40+



INTERNATIONAL EXHIBITION OF ELECTRONIC COMPONENTS

PARIS 8th to 13rd APRIL



Alcatel

SOCIETE ALSACIENNE DE CONSTRUCTIONS ATOMIQUES,
DE TELECOMMUNICATIONS ET D'ELECTRONIQUE
69, rue de Monceau—Paris (8^{ème})

ALCATEL GENERAL ACTIVITIES

In its laboratories and factories ALCATEL exercises its research or production activities in the following fields:

- 1—Telecommunications: long-distance liaison by frequency carriers; radiodiffusion equipments.
- 2—Nuclear energy; control panel and charge-discharge of the reactors.
- 3—Sub-marine acoustics and detection.
- 4—Numerical codifying of information.
- 5—Navigation by inertia: platforms and components.
- 6—Physic of the solid: thermo-electricity, piezo-electricity.
- 7—Measurement instruments and nuclear instrumentation.
- 8—Vacuum techniques and electronic shelling.

PARTICIPATION IN THE PARIS ELECTRONIC COMPONENTS SHOW

Alcatel presents:

- an analogic-digital multi-channel converter.
- standard logical moduls.
- transistorized generators and millivoltmeters.
- numerical voltmeter.
- resistors boxes, capacitors and precision-damping boxes.
- thermo-electricity applications: cooling plates, photomultipliers, coolers, stable-zero, refrigerated rooms.
- piezo-electricity applications: ceramics and welding and cleaning transducers.
- nuclear instrumentation.

Two electrifying reasons for coming home with us to Paris:

1. The Electronic Components Exhibit. 2. Paris.

The first may turn out to be an excuse, although it's the largest exhibition in the world, but that's up to you. Either way, Air France (official carrier for the exhibit) will joyously jet you nonstop to Paris from New York, Los Angeles or Montreal direct from Chicago or Washington, D.C. And we'll start your Paris orientation in the air, from the memorable French cuisine to the matchless comfort and service. We want you to feel at home when you get to Paris. That's why you'll find an Air France Welcome Service desk at the exhibit. We'll be happy to show you around when you arrive: Let us arrange all the details of your stay before you leave. Fares? There are none lower. Cargo Service? None better. For complete information, clip and mail the coupon below.

AIR FRANCE
Overseas Trade Show Department
AMN—CG
683 Fifth Avenue
New York, N.Y. 10022

Please send me, free, the detailed technical brochure and admission card for the 8th International Exhibition of Electronic Components

Name _____
Company _____
Address _____
City _____ State _____ Zip Code _____



AIR FRANCE
THE WORLD'S LARGEST AIRLINE
à Votre Service

Electronics Abroad

Volume 38
Number 1

Africa

Mapping Liberia

A rebuilt World War II attack bomber, custom-fitted with electronic equipment, is crisscrossing tiny Liberia on Africa's west coast. Its immediate mission is to make a mineral and mapping survey for the United States Army Map Service. Its long-range goal is to help the U.S. get a healthy share of about \$3 billion a year that's expected to be spent soon for roads, power plants, dams and other facilities in Africa.

The Douglas A-26 began its flights near the end of 1964. Its owner, the Los Angeles engineering company of Daniel, Mann, Johnson and Mendenhall, calls it "the most sophisticated survey aircraft in Africa." It's equipped with \$100,000 worth of electronics: gravimeters, doppler navigation equipment, high-precision short-range navigation gear, computer-linked photogrammetric gear and ground-based geodetic transponders to go with it.

Oil hunt. When the weather prevents mapping, the gravimetric equipment goes to work seeking offshore petroleum for the Gulf Oil Co. The oil survey and some of the mineral survey work employs continuous magnetometers developed by Gulf.

Jess Thompson, electronics chief at Daniel-Mann, says the instruments are self-orienting, with continuous readout, and are capable of resolution "better than 0.25 gamma."

International race. But it's the other electronic survey gear on which the engineers think U.S. hopes for African business rest. Barry F. Mountain, vice president of Daniel-Mann and a member of the foreign policy committee of the U.S. Chamber of Commerce, explains: "If we're going to get our fair share of the African market

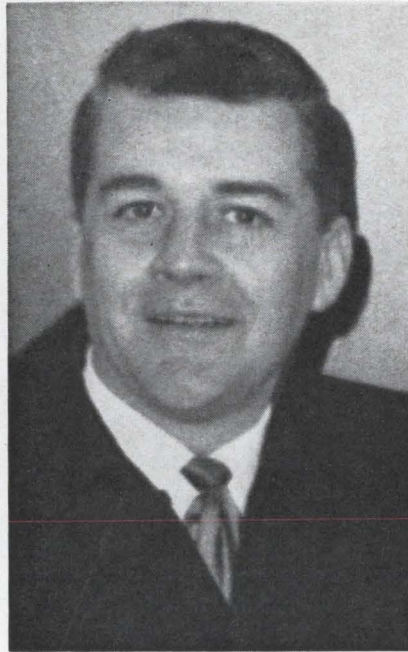

Barry F. Mountain sees rich markets in Africa.

we've got to get in there first and specify U.S. equipment and standards."

Mountain says engineering survey firms like his are the narrow end of the wedge that can open up the African market to American business. Competition is coming from many countries, chiefly Britain, France, Canada and West Germany.

Continuous measurement. The Douglas A-26's electronic gear includes a precision RC5A aerial camera in the bomb bay, linked to a straight-line computer to take automatic overlapping photographic maps of 4,000-square-mile strips of country at a run. The computer is made by the Vectron division of the Itek Corp.

The Hiran navigation equipment is geared to continuous-distance measurements between the aircraft and transponders at mountain-top beacon stations. The transponders, made by the Radio Corp. of America, receive pulsed radio signals from the plane, amplify them and transmit them back. Distance meas-

urements are said to be accurate to within six inches in 250 miles.

For navigation over known terrain, Hiran can hold the plane automatically on a course within a 35-foot tolerance.

For rough-control reconnaissance in the absence of ground checkpoints, the plane employs doppler radar navigation equipment linked to preprogrammed flight paths.

Price of apartheid

South Africa, the continent's most prosperous country, may be one of the last to get television service. Tv seems to be another victim of the government's effort to maintain apartheid, or segregation, of the four million white citizens and the 12 million blacks.

Tv has been vetoed again by the minister of posts and telegraphs, Albert Hertzog, who controls all communication in the country. In his latest speech on the subject, he explained that South African tv would be "mainly dependent on British and American films which are drenched with liberalistic and demoralizing propaganda."

White against white. Among the white population, there's another schism that Hertzog fears would be aggravated by tv. That's the split between British and Dutch settlers. Afrikaners, settlers of Dutch descent, comprise 60% of South Africa's white population. But they're afraid their language would be completely submerged by English if tv were introduced.

South Africa's radio system offers two services, in English and in Dutch, and there's increasing pressure for a service for the country's black majority, which speaks a variety of native dialects. The same would be true of tv.

Election issue? There are some indications, however, that public pressure may one day force the government to adopt tv. The segregated school systems are consider-

ing closed-circuit tv. When enough people come into contact with the medium, the demand is likely to extend into tv for the home. This could become an irresistible groundswell by the time of the next general elections in 1968.

Technically, the South African Broadcasting Corp. is ready to begin television service quickly. F-m towers throughout the country have provision for tv antennas and transmitting equipment.

When Philips Gloeilampenfabrieken, N.V., of the Netherlands, opened its newest electronics plant in South Africa, there were reports that the facility was capable of making tv equipment. That rumor was quickly spiked by Philips. Nevertheless, many observers suspect that Philips, and other companies, are ready to get into tv production whenever the government approves, but that the companies won't talk about it.

Radio-controlled elevator

Now electronics makes it possible to operate a push-button elevator in a mine shaft in Zambia, formerly Northern Rhodesia.

The Anglo American Corp. of South Africa uses a radio-controlled winding device at a 1,585-foot-deep shaft in a copper mine.

The system was developed by Associated Electrical Industries, Ltd., of Britain. It eliminates the need for a cable that carries electrical control signals to and from the elevator cage.

Shaft-long antenna. A transmitter, mounted on the cage, feeds a continuous signal into an antenna mounted in the cage. A receiver antenna, extending the length of the shaft, receives the signal and passes it to a receiver in the elevator-control room.

Each pushbutton in the cage modulates the carrier with a different selected frequency. In the engine room the signal is demodulated; then it operates a frequency-sensitive relay that initiates the correct circuit to control the winder as instructed from the cage.

The cage controls both vertical and horizontal movement.

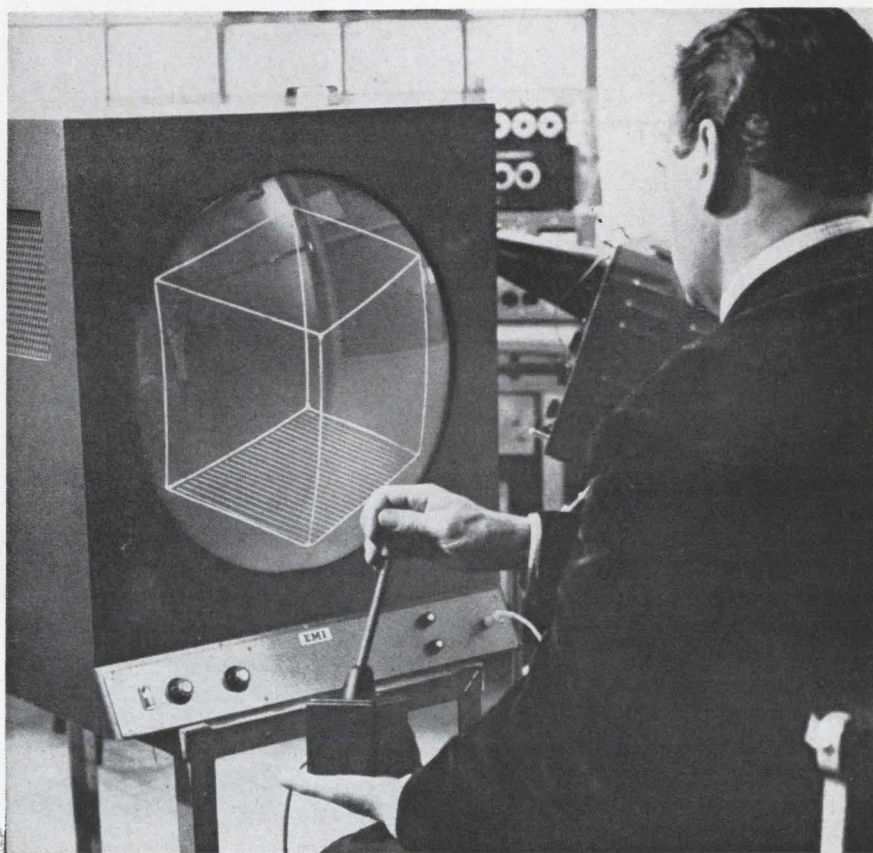

3-D radar picture is an image of a transparent cube representing airspace being controlled for air traffic. Within the cube, aircraft appear as luminous spots.

Great Britain

Display in 3-D

Now radar screens are turning to three-dimensional displays.

EMI Electronics, Ltd., is testing a system that converts raw radar video data into a 3-D picture on a cathode-ray tube. The approach, utilizing the technique of variable parallax, produces an impression of depth and of relative position. An air-traffic controller, using this display, could introduce graticules into any of the three planes and get a clear picture of the density of plane traffic.

Two operations. A conventional 21-inch cathode-ray tube can be used in the EMI system. A picture is painted on the tube's face in two operations. First the radar beam traces the outline of a cube and, by transforming coordinates, places airways, geographical features and any graticules that may

be required. Then it paints the aircraft echoes by sequentially interrogating a computer memory bank and converting the digitally stored aircraft-position information into analog form.

Twenty pictures a second are painted on the display tube.

The picture's size can be changed at will, thereby also enlarging or contracting the area viewed.

Sweden

Spy scare

An electronics dealer is responsible for Sweden's latest spy scare.

The 50-year-old businessman was scheduled to be indicted Jan. 9 on espionage charges. If convicted, he could be imprisoned for life. He is identified only as "Mr. Zebra," the code name by which the police referred to him during a year's surveillance.

Specifically, he is accused of sell-

ing integrated circuits, micromodules and transistors to an unnamed Eastern power, presumably the Soviet Union. He is also accused of delivering microelectronics information.

Another electronics dealer was quoted in a Stockholm newspaper as saying that if sales of these components to Russia now means espionage, at least a dozen businessmen in Sweden "have one leg in state prison."

Top secret. As in all security cases, the police are releasing no information. The trial itself may be held in secret if the judge agrees that disclosure of the testimony could jeopardize the national security.

An amendment to the espionage law, which took effect Jan. 1, places certain business transactions in the same class as direct military espionage, and permits a sentence of life imprisonment. There's some question as to whether the new law is retroactive. Mr. Zebra was arrested Nov. 30 and arraigned Dec. 5; both actions were taken in secret. Under the old law, the maximum penalty is 10 years.

Sven Andersson, Sweden's defense minister, says the case is "not of great consequence."

In search of sales. The microspy, as he's called by Swedish newspapers, is said to have dealt for a year with a technical expert attached to the Soviet trade mission in Stockholm. Mr. Zebra reportedly was trying to increase his business with the Communist bloc. To get in the Russians' good graces, according to this report, he delivered information on the use of integrated circuits in Swedish equipment.

Sweden is not aligned in the cold war, but buys highly sophisticated circuits and components from the United States for her defense organization. She is believed to be anxious to demonstrate to the West that she can be trusted with classified military equipment.

Officials have indicated that the microspy case is not connected in any way with Air Force Col. Stig Wennerstrom, who received a life sentence as a spy for Russia.

West Germany

Jet-noise monitor

Frankfurt's Rhine-Main Airport, the busiest in Germany, has enlisted some electronic innovations in its war on jet noise.

A salvo of complaints from residents of five nearby towns led the airport administration to call for help from Rohde and Schwarz, a manufacturer of meters and instruments.

The airport wanted monitors of sound vibrations at six different checkpoints. It also wanted the sound to be interpreted automatically, and the results recorded in a form that would prove to an offending airline that there was excessive noise. The system also was supposed to check whether pilots observed proper flight paths and altitude requirements.

Elevated microphones. Rohde & Schwarz came up with a system that uses raised microphones [photo at right] in nearby residential areas. The signals are amplified and transmitted along commercial telephone lines at 300 to 3,000 cycles per second.

At the monitoring center in the airport administration building, a classifier channels all data into five categories. These range from 10 decibels below to 10 decibels above a reference level that corresponds to the average noise that comes from aircraft observing speed and altitude regulations at each checkpoint. Noise levels at or near the reference level are indicated by signal lamps, a different color for each checkpoint. A printer records these levels on a continuous tape, together with the time of day. The printer correlates this data with preprogrammed flight numbers and times of takeoff or landing for each flight.

Planes that cause excessive noise can be identified from the data. Cumulative noise-level printers record the period during which the reference level was exceeded, and print the sum every hour.

Monitoring systems have been in service since 1963 in various cities,



The roofs have ears in towns surrounding Frankfurt. This microphone picks up aircraft noise which is then analyzed to determine whether plane was off course, flying too low or too fast, or creating excessive noise in another way.

including New York. But there is no system in the United States similar to the Frankfurt network, according to the Federal Aviation Agency and the Port of New York Authority, which operates the John F. Kennedy International Airport.

Soviet Union

Electronics market

Soviet reactions to several Western trade missions and exhibitions give some new clues to the state of the electronic art and of the potential market in Russia.

Last July, Elliott-Automation, Ltd., of Britain, demonstrated \$3.5

SELL IN EUROPE

Major U. S. quality-component manufacturer with powerful, experienced European marketing organization is in position to handle export sales for limited number of other manufacturers' lines.

WE OFFER—

- 1—Competent, technically trained sales & administrative personnel.
- 2—Multilingual ability (English, French, German, Italian, Spanish, Swedish, Dutch, Turkish).
- 3—Knowledge-in-depth of European markets & customers.
- 4—Experience in both American & European business methods.
- 5—Experience in export-import procedures & regulations.
- 6—Representation by *nationals* in each country.
- 7—Strong advertising support in 6 languages.
- 8—Participation in every major European trade show.
- 9—Investment in *local* stocks of *your* products in key market areas.
- 10—Future production capabilities, if desired.

WE WANT—

- 1—Quality lines *only*.
- 2—Growth potential
- 3—Marketing-oriented management, to provide solid factory backup.

Send full details to:
P. O. BOX RA5827

Electronics

330 WEST 42ND STREET
NEW YORK, N. Y. 10036

Electronics Abroad

million worth of computers in Moscow's Sokolniki Park. Now Elliott reports that the Russians bought them all. Included were Elliott's new 503 digital machine for industrial control and an industrial modular process-control computer system. The Soviets also ordered another Elliott modular unit for on-line control of an ammonia plant.

These sales increase Elliott's total behind the Iron Curtain to nine industrial computers: five to the Soviet Union, two to Rumania and one each to Czechoslovakia and Bulgaria.

Disbelief. The latest exhibit in Sokolniki Park is a United States communications show, which already has appeared in Leningrad and Kiev. In Moscow, for the first time on the tour, the Russian-speaking guides are getting a verbal workout in questions from Soviet engineers and scientists.

Many Russians at the exhibit express disbelief at what they see. In the Soviet Union, the purpose of such a show is to preview the future, not depict the present. Spectators openly declare that Americans don't really have tiny television sets or Princess telephones. They also doubt that airplane tickets are sold by computers, as shown in the pavilion.

But they enjoy being dazzled by the electronics fairyland. At their peak, lines at the exhibit are two hours long.

Shopping list. In recent meetings with businessmen from the United States, Soviet officials for the first time have named specific electronic equipment they would like to buy. Most of the gear seems to be on the U.S. Commerce Dept.'s embargo list, but the Russians—like many American businessmen—expect that list to be reduced soon.

The Russians expressed strong interest in high-speed computers such as the IBM System 360. They said they'd like to buy either the hardware or licenses to manufacture it themselves.

Soviet officials also have suggested exhibitions in Russia of some U.S. equipment that can be used in data-processing and information-searching. They have

even asked American newsmen to help persuade U.S. companies to set up such exhibits.

Here's some other equipment that the Russians would like to obtain: spectrometers and spectrographs of high resolution for the visible ultraviolet and infrared parts of the spectrum, radiospectrometers of nuclear magnetic resonance in the 100-megacycle range, mass spectrometers, x-ray spectral analyzers, chromatographs and sensitive elements for chromatograph detectors.

Japan

Colorful new year

For the Japanese the year ended in red, blue and green. Viewers were treated to a record 31½ hours of color television programming during the holiday weekend.

A highlight was a 2½-hour broadcast on New Year's Eve featuring Japan's most popular singers. This program marked a technical milestone: the first indoor broadcast in Japan using the new two-image orthicon camera developed by NHK, the Japanese Broadcasting Corp. It's the same system that televised the 1964 Olympics outdoors for Japanese viewers.

Although the New Year's Eve program was broadcast in color, viewers at black-and-white sets noticed practically no degradation of the picture. That's because the black-and-white luminance channel is separated from the color channels. The black-and-white image was sharp, with none of the fuzzy focus that's often caused when the three image orthicons in conventional cameras are slightly out of register.

Sensitive camera. The Japanese system generates the same NTSC color signals that are used in the United States. The camera [Electronics, June 7, 1963, p. 28] uses highly sensitive image orthicons of magnesium oxide, and requires only 1,000 lux of illumination. This is far below the 2,500 lux usually needed for color tv and 500 to 1,000

lux common for black and white. Incoming light is split in two by a half-silvered mirror directly behind the camera's front lens. Half of the light falls on the luminance channel's 4½-inch image orthicon; the other half goes through an optical filter with vertical stripes of red, blue and green, then strikes the color channel's 3-inch image orthicon.

Sales charts. Increased color programming dovetails with the Japanese tv industry's plans to produce more color sets. The Yaou Electric Co. expects to begin selling its nine-inch transistor set this month or next in limited quantity. The Sony Corp. plans to begin sales of its 19-inch chromatron set in April. The Toshiba Electronic Industry Co. is completing an expansion that will double its monthly capacity of color-tv output to 10,000 sets from 5,000.

Foreign markets play a big part in Japan's color-tv plans. More than one-half of Toshiba's output now goes to Sears, Roebuck and Co. in the United States. Yaou concedes that its prime market will be in the U.S. initially. Sony, on the contrary, will sell only in Japan in the beginning.

Manufacturers of standard 16-inch shadow-mask sets are watching Sony, whose chromatron units will have the same list price, about \$550. If Sony produces in quantity, the other Japanese manufacturers may lower their prices by about \$100 and start production of 19-inch shadow-mask sets.

Japanese industry produced about 50,000 color-tv sets in 1964, while 1.25 million were turned out in the U.S.

Tax cloud. The only cloud on the color-tv horizon is a doubling of taxes, from 10% to 20%, scheduled to take effect April 1. The increase would add nearly \$30 to the retail price of an average set.

However the Diet, Japan's parliament, is expected to scrap the one-step tax boost in favor of three smaller annual increases. The new plan, which is gaining acceptance in the ruling Liberal-Democratic party, would increase the tax to 13% this year, 16% in 1966, and 20% in 1967.

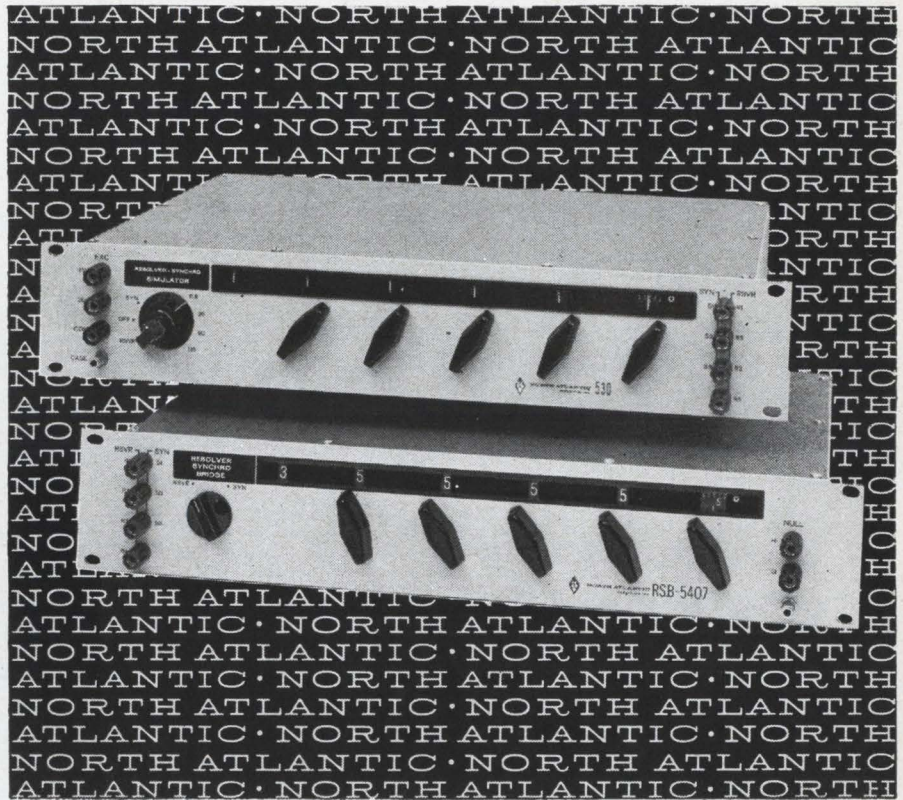

you are looking at the state-of-the-art in resolver/synchro testing

These two instruments provide the widest measurement capability available today for resolver/synchro testing. Each is a dual-mode unit, measuring **both** resolvers and **and** synchros. Series 530 Simulators are ideal transmitters, and Series 540 Bridges are ideal receivers.

In addition to their dual-mode capability in 3½" of panel space, both series provide in-line decimal readout continuously switched through 360°, 2 second accuracy at any angle, and input/output isolation.

SERIES 530 SIMULATORS FEATURE

- Resolution 0.001°, 1°, or 5°
- Dual 26/115 volt excitation
- Switch selected line-line voltages 11.8, 26, 90, and 115 volts
- Low matched output impedance

SERIES 540 BRIDGES FEATURE

- Resolution 0.0001°, 1°, or 5°
- 500K input impedance
- Constant null-voltage gradient at all line-line voltages
- Unaffected by null detector loading

Prices range from \$1480.00 to \$2680.00

The flexibility of these instruments meets every need for rapid and accurate testing in the engineering laboratory, in production, and in ground support equipment. Used with a Phase Angle Voltmeter, they provide a complete facility for component or system test.

Programmable models with decade or binary input are also available. Your North Atlantic representative will be glad to arrange a demonstration. Call or write him today.



NORTH ATLANTIC industries, inc.
TERMINAL DRIVE, PLAINVIEW, L. I., NEW YORK • Overbrook 1-8600

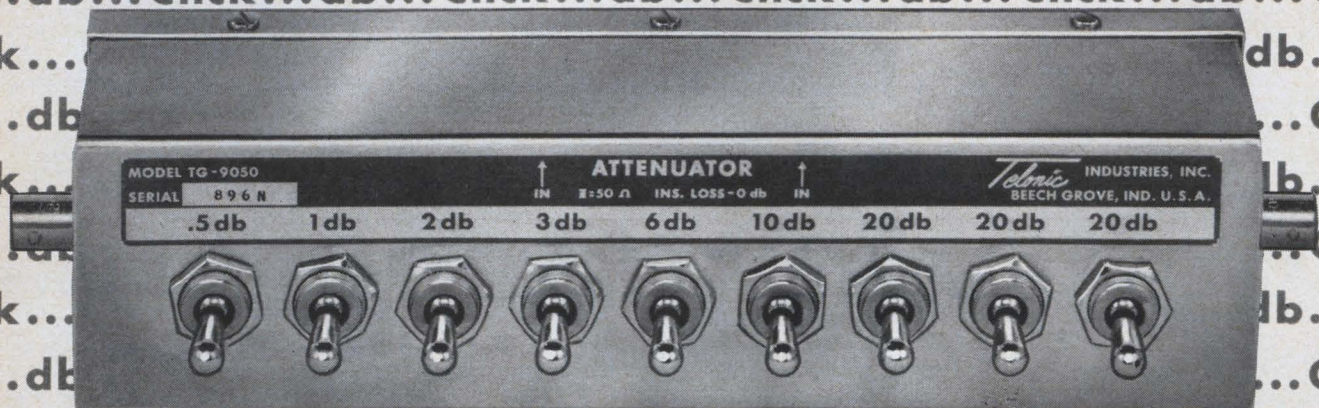

Telonic Toggle Switch Attenuators Keep Repeating Themselves

KEEP
db
CLICKING

Because of its straightforward, simple mechanical design the Telonic Toggle Switch Attenuator has an exceptionally long life. It's made for bench or panel mounting, requiring a minimum of set-up time. Everything about this attenuator is rugged except the price. The switch controls are double knife edge and the self-wiping action assures excellent repeatability. The pads are individually shielded to prevent leakage and allow the maximum attenuation to be used. A double shielded box further prevents leakage.

The attenuators are available with attenuation steps of 0.5, 1.0, 2.0, 3.0, 6.0, 10 and 20 db. Six-step units of 0 to 42 db in 1 db steps and 9-step units of either 0 to 102 db in 1 db steps or 0 to 82.5 db in 0.5 db steps are currently available from stock. Other combinations are available on request. They can be furnished in 50 or 75-ohm characteristic impedance.



60 North First Avenue, BEECH GROVE, INDIANA

Representatives in: Baltimore, Boston, Chicago, Cleveland, Dallas, Dayton, Denver, Huntsville, Indianapolis, Los Angeles, New York City, Orlando, Philadelphia, San Francisco, Seattle, St. Louis, Syracuse and principal cities throughout the world.

• SWEEP GENERATORS • RF ATTENUATORS • CW OSCILLATORS • COAXIAL SWITCHES

Circle 248 on reader service card

Electronics advertisers

January 11, 1965



■ AMP Inc. Garceau, Hargrave & McCullough Inc.	53	Data Instruments, Div. of Industrial Electronic Hardware Corp. A.D. Adams Advertising Inc.	180	Hughes Aircraft Company Foote, Cone & Belding	157
■ Acme Electric Corp. Scheel Adv. Agency	167	Daven, Div. of McGraw Edison Keyes, Martin & Co.	32	Hyperion Industries, Inc. S. Gunnar Myrbeck & Company	172
Adage Inc. Fuller & Smith & Ross Inc.	27	Defense Electronics Inc. Compton Jones Associates	66	IEEE Raymond Schoonover Adv.	150
Addison-Wesley Publishing Co. Inc. L.K. Frank Co.	176	Delta Design Inc. Barnes Chase Advertising	164	■ Imtra Corporation S. Gunnar Myrbeck & Company	170
Air France Fuller & Smith & Ross Inc.	208	Di-Acro Corp. Charles E. Brown Adv.	152	Industrial Electronic Engineers Inc. Gumpertz, Bentley & Dolan Adv.	170
Akers Electronics Central Institute for Industrial Research	188	Dixon Inc. Gail Advertising Company	169	International Electronic Industries Buti-Roberts Advertising	50
Alcatel Publi-Service	208	Drusch Voltreg Publi-Service	204	Janus Control Corporation L.K. Frank Co. Inc.	182
Alco Electronic Products, Inc. Marketronics Adv.	178	DuPont de Nemours & Co. Inc., E.I. Batten Barton Durstine & Osborn Inc.	63, 129	Kay Electric Company Josephson, Cuffari & Co.	54, 177
■ Amperex Electronics Corp. Sam Groden Incorporated	33	Dynaplex Corporation	142	■ Kyoritsu Electrical Instrument Works, Ltd Nichiden Adv. Ltd.	178
Amperite Co. H.J. Gold Co.	126	Eastman Kodak Company The Rumrill Company Inc.	153	LEL, Incorporated Snow, & Depew Advertising	166
Amphenol-Borg Electronics Corporation Marsteller Inc.	19-26	■ Electro Instruments Inc. Teawell Inc. Adv.	51	LEM Publi-Service	204
■ Andrew Corporation The Fensholt Advertising Agency	122	Electronic Engineering Co. of California Barnes Chase Advertising	128	■ Lapp Insulator Company Inc. Wolf Associates, Inc.	132
Astrodata Inc. Bonfield Associates, Inc.	11	Fairchild Semiconductor Johnson & Lewis Inc.	14	■ Leach Corporation Hixson & Jorgensen Inc.	45
Audax Publi-Service	205	Federal Screw Products Inc.	169	Lebel High Frequency Laboratories Inc. Apex Graphic Company	178
Babcock Relays Jay Chiat and Associates	141	Flying Tiger Line Hixson & Jorgensen, Inc.	67	Machlett Laboratories Inc., The Fuller & Smith & Ross Inc.	8
Bausch & Lomb, Inc. Wolf Associates, Inc.	185	■ Fujitsu, Limited Hakuhodo Inc.	167	Mallory & Co. Inc. P. R. The Aitkin-Kynett Company	65
Beckman Instruments Inc., Offner Division Erwin Wasey, Ruthrauff & Ryan, Inc.	52	■ General Electric Co., Silicon Products Dept. Ross Roy Inc.	68	■ Markel & Sons, L. Frank George Moll Advertising Inc.	173
Beede Electrical Instruments Company Inc. S. Gunnar Myrbeck & Company	148	General Radio Co. K.E. Morang Co.	7	Markem Machine Culver Advertising Inc.	165
Bendix Semiconductor Products MacManus, John & Adams Inc.	9	Genisco Technology Corporation Getz and Sandborg Inc.	168	Matsuo Electric Co., Ltd. Asahi Advertising Agency & Co.	189
■ Bird & Co. Inc. Richard H. Stanley R. Tippet & Associates	175	■ Globe Industries Inc. Odiorne Industrial Adv. Inc.	186	McDonnell Electronic Equipment Div. John Patrick Starrs Inc.	64
■ Brush Instruments, Div. of Clevite Carr Liggett Adv., Inc.	3rd cover	Gorman Machine Corporation Mann Advertising Associates	188	McGraw-Hill Book Co. Inc.	173
Burr-Brown Research Corp. N.A. Winter Adv. Agency	190	Graphic Systems Inc. Caswell Adv. Agency	168	Melpar Inc. Arthur J. Lamb Inc.	59
C.I.F.T.E. Publi-Service	205	Green Instrument Company Inc. S. Gunnar Myrbeck & Company	184	Metal Removal Company, The Advertising Producers Associated Inc.	198
CSF Publi-Service	201	Guardian Electric Mfg. Co. K & A Incorporated	136	Mico Instrument Company	168
■ CTS Corporation Burton Browne Adv.	138, 139	Gudebrod Bros. Silk Co. Inc. Lee Ramsdell & Co. Inc.	46, 47	■ Micro Switch Div. of Honeywell Batten Barton Durstine & Osborn Inc.	43, 44
Cambridge Thermionic Corp. Chirurg & Cairns, Inc.	144, 145	Hathaway Instruments Inc. Marshall Robertson Adv. Agency	31	Minnesota Mining & Mfg. Co. Mincom Division Reach, McClinton & Co., Inc.	48
Carter-Princeton, Electronics Div Gaynor & Ducas Inc.	135	Haydon Switch & Instrument Inc. Cory Snow Inc.	186	Missimers Inc. Ad Lab Advertising & Public Relations	183
Clare & Company, C.P. Reincke, Meyer & Finn Adv.	133, 134	Heinemann Electric Co. Thomas R. Sundheim Inc.	127	■ Mitsubishi Electric Corp. Hakuhodo Inc.	163
■ Cohn, Sigmund Corp. William G. Seidenbaum & Co.	160	■ Hewlett Packard Co. Lennen & Newell Inc.	1	■ Mitsumi Electric Co., Ltd. Dentsu Advertising Ltd.	174
Cohu Electronics, Kin Tel Division Erwin Wasey, Ruthrauff & Ryan	39	High Vacuum Electronics Inc. Balsam Advertising Inc.	148	Motorola Semiconductor Products Inc. Lane and Bird Advertising Inc.	55
Communication Electronics Inc.	174	Hitachi Ltd. Dentsu Advertising Ltd.	140	National Cash Register Company Allen, Dorsey & Hatfield Inc.	119
Computer Test Corporation Technical Marketing	60	■ Houston Instrument Corp. Cooley & Pate Inc.	161		
Controls Company of America The Harry P. Bridge Company	29				
Coto Coil The Williams Company	182				
Damon Engineering Inc. L.K. Frank Co., Inc.	159				



Newark Electronics Corporation Stral Advertising Company Inc.	189
North Atlantic Industries Inc. Murray Heyert Associates	213
Ohmite Mfg. Company The Fensholt Adv. Agency	57
Pacific Electro Magnetics Co. Inc. Sturges and Associates	131
Pamator Inc. Harry P. Bridge Co. The	181
Perfection Mica Company, Magnetic Shield Div. Burton Browne Advertising	158
Permacor, A. Div. of Radio Cores Inc. Sander Rodkin Advertising Agency	160
Phelps Dodge Electronic Products Smith, Dorian & Burman Inc.	30
Potter & Brumfield Div. of American Machine & Foundry Co. Grant, Schwenck & Baker Inc.	16
Princeton Applied Research Corp. Mort Barish Associates	34
Radiation Inc. G.M. Basford Company	120, 121
Radio Corp. of America Al Paul Lefton Co.	4th Cover
Radio Technique Publi-Service	202
Ribet Desjardins Inter-Plans	203
Rochar Electronique Publi-Service	207
Rotron Mfg. Co. Lescarboursa Advertising Inc.	162
SDSA Paris Electronics Show Publi-Service	199, 200
Sanborn Co., A Div. of Hewlett Packard Co. Culver Adv. Inc.	2
Semi-Elements Inc. Axelband & Brown Associates	187
Singer Company, Metrics Div. Hepler and Gibeny, Inc.	49, 149
Singer Company, Metrics Div., Gertsch Instruments Inc. Balsam Advertising Inc.	155
Souriau et Cie Publi-Service	203
Sprague Electric Company The Harry P. Bridge Co.	5, 6, 10
Stackpole Carbon Company Meek and Thomas Inc.	41
Stanpat Products Inc Morton Advertising Inc.	170
Stevens-Arnold, Inc. Meissner and Company Inc.	171
Stevens Mfg. Co. Inc., Geo. Burton Browne Advertising	58
Stockli Publi-Service	204
Struthers-Dunn, Inc. The Harry P. Bridge Company	137
Superior Tube Company Gray & Rogers, Inc.	151

Syntronic Instruments Inc. Burton Browne Adv.	130
Systems Engineering Laboratories Adams & Keyes Inc. Advertising	156
Tektronix Inc. Hugh Dwight Adv. Inc.	117
Telonic Industries Inc. Burton Browne Adv.	214
Texas Instruments Incorporated Industrial Products Group Robinson-Gerrard, Inc.	146, 147
Thompson Varian Publi-Service	206
Trygon Electronics Carpenter, Matthers & Stewart Inc.	175
Trylon Inc. George Moll Adv. Inc.	150
United Transformer Corp. Philip Stogel Company Inc.	2nd Cover
Unitrode Corporation Chirurg & Cairns Inc.	179, 181, 183
Varo Inc. Warren Associates	154
Videon Publi-Service	205
Wells Electronics Inc. Weco Adv.	186
Weston Instruments Incorporated G.M. Basford Company	12, 13
Weston Instruments & Electronics Hazard Adv. Co. Inc.	56
Yutaka Electric Mfg. Co., Ltd. Nichiden Adv. Ltd.	158

Classified advertising

F. J. Eberle, Business Mgr.	
Professional Services	196
Employment opportunities	196
Equipment (Used or Surplus New) For Sale	196-197

Classified advertisers index

A & A Electronics Corp.	197
Addison-Welsey	197
Atomic Personnel Inc.	196
Edmund Scientific Co.	197
Engineering Associates	197
Lifschultz Fast Freight	196
Mars Sales	197
Radio Research Instrument Co.	197
Rudland Manufacturing Co	197
Surplus Center	196
Telephone Engineering Co.	197
Univac Div. of Sperry Rand	196
Universal Relay Corp.	197

Advertising sales staff

Gordon Jones [212] 971-2210
Advertising sales manager

Atlanta, Ga. 30309: Gus H. Krimser, Michael H. Miller, 1375 Peachtree St. N.E., [404] TR 5-0523

Boston, Mass. 02116: William S. Hodgkinson McGraw-Hill Building, Copley Square, [617] CO 2-1160

Chicago, Ill. 60611: Robert M. Denmead, Daniel E. Shea, Jr., 645 North Michigan Avenue, [312] MO 4-5800

Cleveland, Ohio 44113: Paul T. Fegley, 55 Public Square, [216] SU 1-7000

Dallas, Texas 75201: Richard P. Poole, The Vaughn Building, 1712 Commerce Street, [214] RI 7-9721

Denver, Colo. 80202: John W. Patten, David M. Watson, Tower Bldg., 1700 Broadway, [303] AL 5-2981

Houston, Texas 77025: Kenneth George, Prudential Bldg., Halcombe Blvd., [713] RI 8-1280

Los Angeles, Calif. 90017: Ashley P. Hartman, John G. Zisch, 1125 W. 6th St., [213] HU 2-5450

New York, N.Y. 10036: Donald R. Furth [212] 971-3615 Frank LeBeau [212] 971-3615 George F. Werner [212] 971-3615 500 Fifth Avenue

Philadelphia, Pa. 19103: William J. Boyle, Warren H. Gardner, 6 Penn Center Plaza, [215] LO 8-6161

San Francisco, Calif. 94111: James T. Hauptli, 255 California Street, [415] DO 2-4600

London W1: Edward E. Schirmer, 34 Dover Street, Hyde Park 1451

Frankfurt/Main: Gerd Hinske, 85 Westendstrasse Phone: 77 26 65 and 77 30 59

Geneva: Michael R. Zeynel, 2 Place du Port 244275

Paris VIII: Denis Jacob, 17 Avenue Matignon ALMA-0452

Tokyo: Nobuyuki Sato Shiba, Minato-ku (502) 0656

Osaka: Kazutaka, Miura, 163, Umegae-cho, Kita-ku [362] 8771

Nagoya: International Media Representatives, Yamagishi Bldg., 13, 2-Chome, Oike-cho Naka-ku

Hugh J. Quinn: [212] 971-2335
Manager Electronics Buyers' Guide

David M. Tempest: [212] 971-3139
Promotion manager

Milton Drake: [212] 971-3485
Market research manager

Richard J. Tomlinson: [212] 971-3191
Business manager

Theodore R. Geipel: [212] 971-2044
Production manager

■ For more information on complete product line see advertisement in the latest Electronics Buyers' Guide

Executive, editorial, circulation and advertising offices: McGraw-Hill Building, 330 West 42nd Street, New York, N.Y., 10036, Telephone Area Code 212-971-3333, Teletype TWX N.Y. 212-640-4646, Cable: McGrawhill, N.Y. Officers of the Publications Division: Shelton Fisher, President; Vice Presidents: Joseph H. Allen, Operations; Robert F. Boger; Administration: John R. Callahan, Editorial; Ervin E. DeGraff, Circulation; Donald C. McGraw, Jr., Advertising Sales; Angelo R. Venezian, Marketing. Officers of the Corporation: Donald C. McGraw, President; Hugh J. Kelly, Harry L. Waddell, L. Keith Goodrich, Executive Vice Presidents; John L. McGraw, Treasurer; John J. Cooke, Vice President and Secretary. Title R registered U.S. Patent Office; © copyright 1965 by McGraw-Hill, Inc. All rights reserved, including the right to reproduce the contents of this publication, in whole or in part.

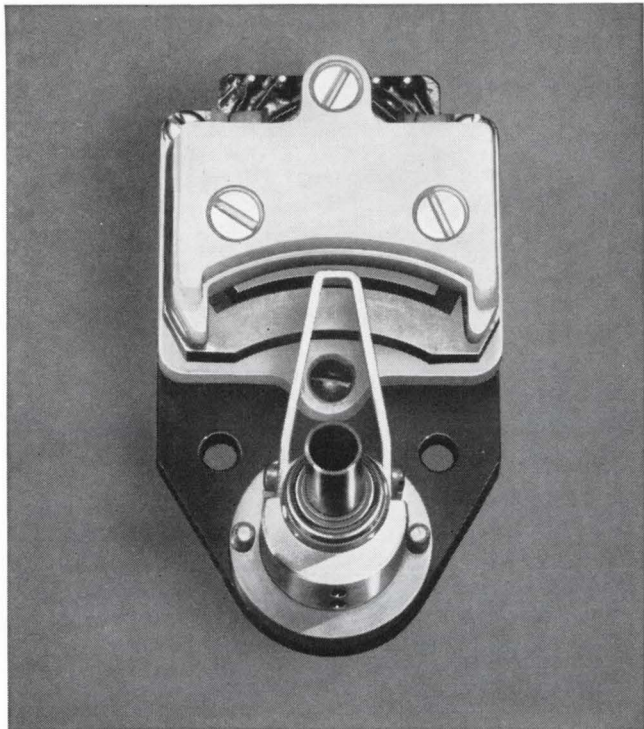

This is a **brush**
Angular Position, Contactless
Transducer with 0.1% Accuracy.

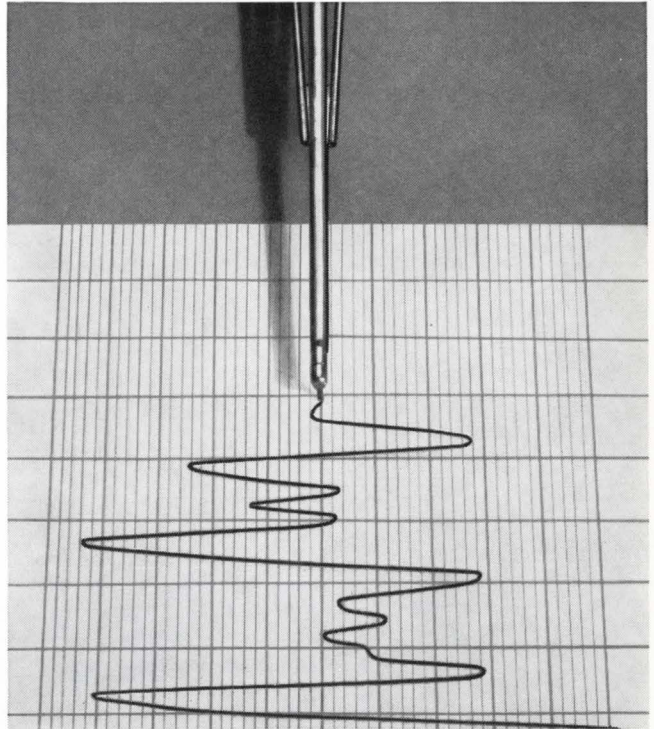

It keeps this pen honest.

(modern oscillography will never be the same)

This super-sensor is one of several Brush innovations that change previous notions about today's direct writing recording. It's called the Metrisite and helps produce permanent Mark 200 chart records . . . so accurate, so crisp, so readable, so economical . . . you'll never believe it unless you see for yourself. The Metrisite continuously senses the pen position. If the input signal is not precisely matched, instant self-correction is applied . . . and no springs attached! Add a unique pen-linkage that converts rotary motion to a straight line that's 0.1% accurate (this is *true* rectilinear motion) . . . a pressurized ink system that forever eliminates spatter or smear . . . and you'll understand why the rule book of oscillography is changing. Many models are available for many jobs. Your letterhead request will bring the complete, exciting story.

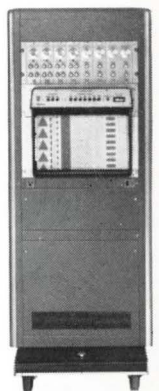

brush INSTRUMENTS
DIVISION OF **CLEVITE** 37TH AND PERKINS, CLEVELAND 14, OHIO

Circle 901 on reader service card

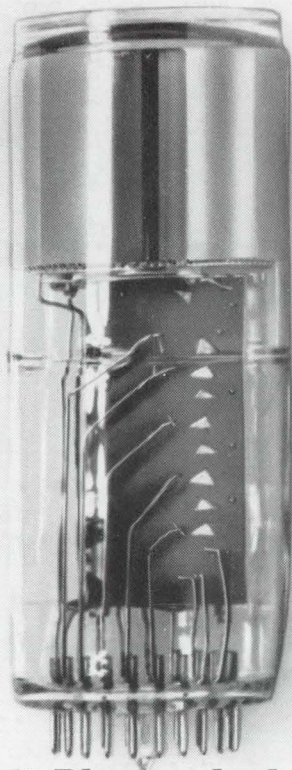

RCA-C31000 Bi-Alkali Photocathode... 2 Nsec Rise Time

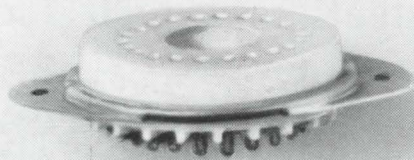

UNPARALLELED QE... 24% (Typical) @ 3850 Å

10 $\frac{\text{electrons}}{\text{Cm}^2 \text{ Sec}}$ @ 25°C

RCA now offers a heretofore unobtainable combination of highly desirable photomultiplier characteristics in one tube. Foremost of these attributes are unparalleled high speed and low noise characteristics coupled with high quantum efficiency.

These are just a few of the exciting benefits of RCA's new Photomultiplier—the developmental RCA-C31000. A “universal” type of tube for pulse applications, this 2” photomultiplier has a rise time of less than 2 nanoseconds. In addition, the improvement in the noise characteristic has been demonstrated by the measurement of thermionic emission values as low as 10 elec-

trons $\text{cm}^{-2} \text{ sec}^{-1}$ at 25°C from the photocathode.

This new phototube offers unexcelled QE. For example: RCA-C31000, with its bi-alkali photocathode, has a typical quantum efficiency of 24% at 3850 angstroms. Many S-11 types with CS_3Sb cathodes have a QE of only 16% at 4200 angstroms. And of high importance, its dark current values are improved by as much as three orders of magnitude over S-11 types.

RCA-C31000, already finding application in liquid scintillation counting, time-of-flight measurements, medical equipment, and coincidence counting, has as

among its numerous features: Low residual radioactivity envelope • 50 ohm output line to eliminate ringing • Teflon socket supplied, to accommodate base of rigid-pin construction • Uniform collection efficiency • CuBe substrate for stability • 8% (max.) Pulse Height Resolution • Freedom from shock excitation • No after pulse.

For more information on RCA-C31000, or other RCA Photomultipliers, including versions with semi-flexible leads, or potted voltage dividers, see your RCA Representative. For technical data, write: RCA Commercial Engineering, Section K31Q, Harrison, New Jersey.

RCA Electronic Components and Devices



The Most Trusted Name in Electronics