

Electronics[®]

Picking the right potentiometer: page 78

Special report on unijunction transistors: page 87

The new discipline of biotelemetry: page 111

June 14, 1965

75 Cents

A McGraw-Hill Publication

Below: one unijunction transistor switches four scr's, page 87



new



A Solid-State 100-Mc Digital Frequency Meter for \$1995 ... with direct counting over the entire dc to 100-Mc Range

This is a complete digital frequency meter with features you'd expect to find only in much more expensive units. Adjustable input sensitivity and trigger-level control ensure maximum measurement accuracy with any waveform, from sine wave to random pulse train. In-line readout is bright and sharp — decimal point, units, and spill indication (when count exceeds register capacity) are presented automatically. The counter is easy to use; direct-counting methods, rather than heterodyning, make frequency measurement an automatic operation over the entire range. A second model, the Type 1144-AP, is available with data output for printer or D/A converter.

The Type 1144-A Digital Frequency Meter is a combination of two new instruments: a decade scaler and a 10-Mc counter. The Type 1156-A Decade Scaler divides the unknown frequency, providing an output signal whose frequency is exactly one-tenth the unknown frequency. The Type 1153-A Digital Frequency Meter measures the frequency of this signal and displays the value on a five-digit bank of indicators. Choice of four gate times allows eight-figure resolution at the low cost of a five-digit counter.

Since both the counter and the Decade Scaler are self-sufficient instruments, they can be used to advantage in other measurements — the scaler as a precision 10:1 frequency divider, the counter as a complete 10-Mc digital frequency meter.



A 500-Mc Frequency Meter with High Sensitivity and Selectivity

Sensitivity is better than 10 mV from 100 kc/s to 500 Mc/s, better than 100 mV from dc to 100 kc/s... choice of narrow-band or wide-band operation.

Type 1143-A Frequency Measuring Assembly, \$3090, includes:
Type 1153-A 10-Mc Digital Frequency Meter,
Type 1133-A 500-Mc Frequency Converter,
time-base frequency multiplier, and all interconnecting cables.

INPUT: dc to 100 Mc/s

Sensitivity: (switch selected) 0.1, 0.2, 0.5, and 1.0 Volt, peak-to-peak at 50 Ω , 1.0 Volt at 500 Ω .

Maximum Input: 20 times sensitivity, or 1/2 watt, whichever is smaller.

Impedance: 50 Ω or 500 Ω (switch selected).

VSWR: 1.1 max at 100 Mc/s (50 Ω).
Reflection: 10% max with 0.4ns step (50 Ω).

ACCURACY: For 1153-A Digital Frequency Meter, ± 1 count \pm time-base accuracy.

TIME BASE:

Frequency: 100 kc/s from room temperature crystal oscillator — no warmup required.

Temperature Effects: less than 6 ppm,⁰ to 50°C ambient.

Temperature Coefficient: ± 0.1 ppm per °C, 20° to 30°C ambient.

Aging: Less than 0.1 ppm per week.
GATE: (Counting Times) 0.01 sec, 0.1 sec, 1.0 sec and 10. sec.

DISPLAY TIMES: 0.16 sec to 10.24 sec in binary sequence, plus "hold" position.

DATA OUTPUT: 10-line for each decade

PRICE: Type 1144-A 100-Mc Digital Frequency Meter ... complete ... \$1995.
Type 1144-AP, same as above, but with data output ... \$2050.
Type 1153-A 10-Mc Digital Frequency Meter ... \$1495.
Type 1156-A Decade Scaler ... \$490.

Prices shown apply in U.S.A.

IN CANADA: Toronto 247-2171, Montreal (Mt. Royal) 737-3673
IN EUROPE: Zurich, Switzerland — London, England



GENERAL RADIO COMPANY

WEST CONCORD, MASSACHUSETTS

BOSTON NEW YORK, N. Y., 964-2722 CHICAGO PHILADELPHIA WASHINGTON, D. C. SYRACUSE DALLAS SAN FRANCISCO LOS ANGELES ORLANDO, FLA. CLEVELAND
(W. Concord) 646-0550 (Ridgefield, N. J.) 943-3140 (Oak Park) 848-9400 (Ft. Washington) 646-8030 (Rockville, Md.) 946-1600 454-9323 FL 7-4031 (Los Altos) 948-8233 469-6201 425-4671 886-0150

Circle 900 on reader service card

BREADBOARD

with this solid state operational amplifier

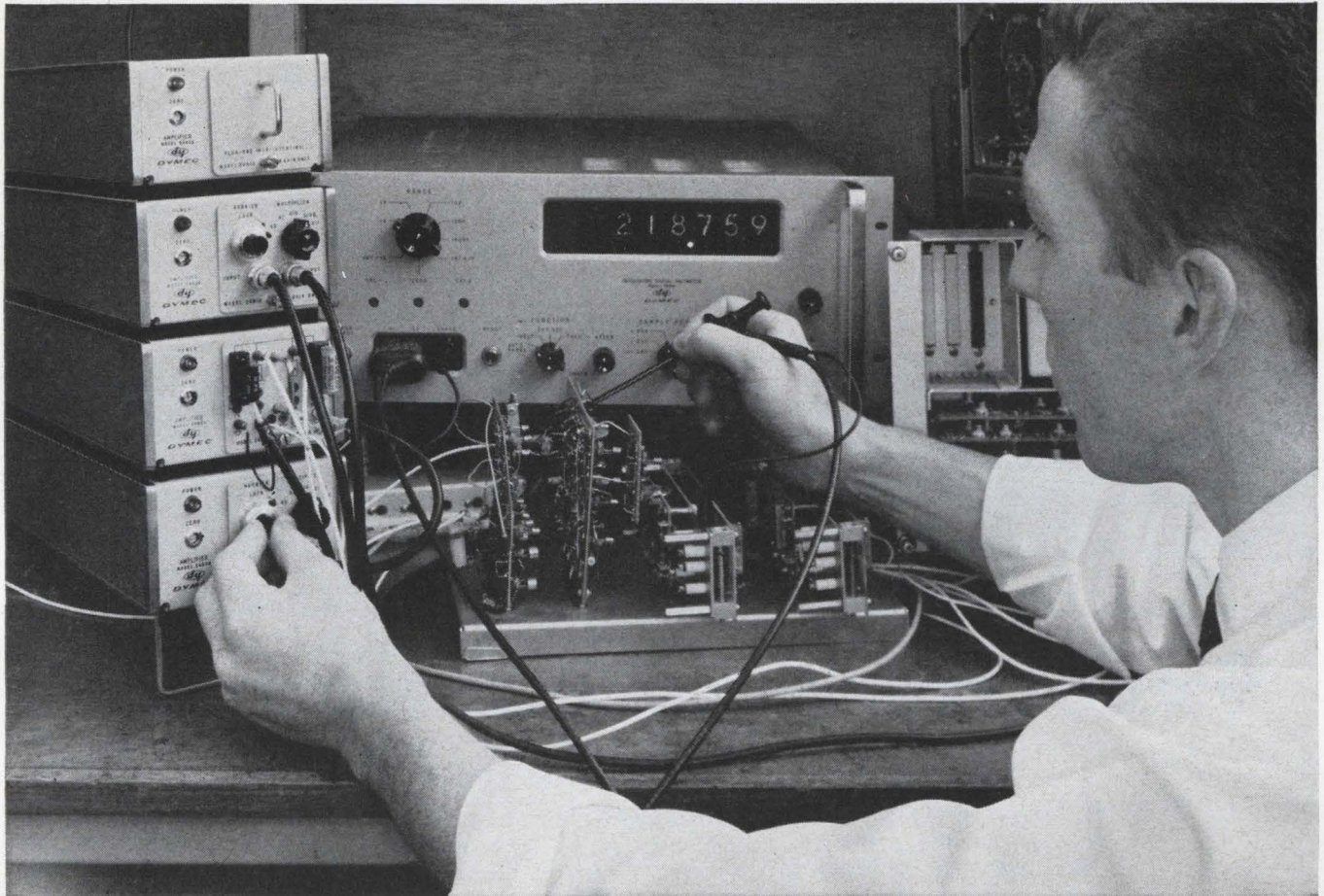

Use the DY-2460A as an active element of your newly designed circuits...

AMPLIFIER ■ SUMMER ■ HIGH IMPEDANCE ISOLATOR ■ INTEGRATOR ■ INVERTER

Check out new design concepts and ideas in a hurry with the DY-2460A DC Amplifier as a circuit element. This wideband, solid state instrument is ready-made for a wide variety of circuit applications which will save you time and effort.

The low-cost DY-2460A is designed for general purpose use. Amplitude and phase response are properly controlled beyond unity gain to permit a variety of feedback networks. A self-contained power supply in each instrument provides highest isolation when operating a group of amplifiers at different potentials. A non-synchronous photoconductive chopper eliminates all effects of ac pickup.

Plug-in design of the 2460A increases its versatility. A patch unit plug-in brings input, output, summing point and feedback circuit to the front panel; other plug-ins

provide switchable gains in steps from 1 through 1000, vernier adjustment through 11,000, and a high-accuracy plus-one configuration with greater than 10^{10} ohms input resistance.

The 2460A will supply an output of ± 10 v peak at 10 ma. Zero drift is less than $1\mu\text{v}$ per week, noise less than $4\mu\text{v}$ peak to peak.

Ask your Dymec/Hewlett-Packard field engineer for all the details on how the DY-2460A can make your breadboarding easier.

Price: DY-2460A Amplifier, \$445. DY-2461A-M1 Data Systems Plug-in, \$85; DY-2461A-M2 Bench-use Plug-in, \$125; DY-2461A-M3 Patch Unit Plug-in, \$75; DY-2461A-M4 Plus-one Gain Plug-in, \$35.

Data subject to change without notice. Prices f.o.b. factory.

DYMEC

A DIVISION OF HEWLETT-PACKARD COMPANY

DEPT. E-6. 395 PAGE MILL ROAD, PALO ALTO, CALIF. • PHONE (415) 326-1755 TWX 415-492-9363



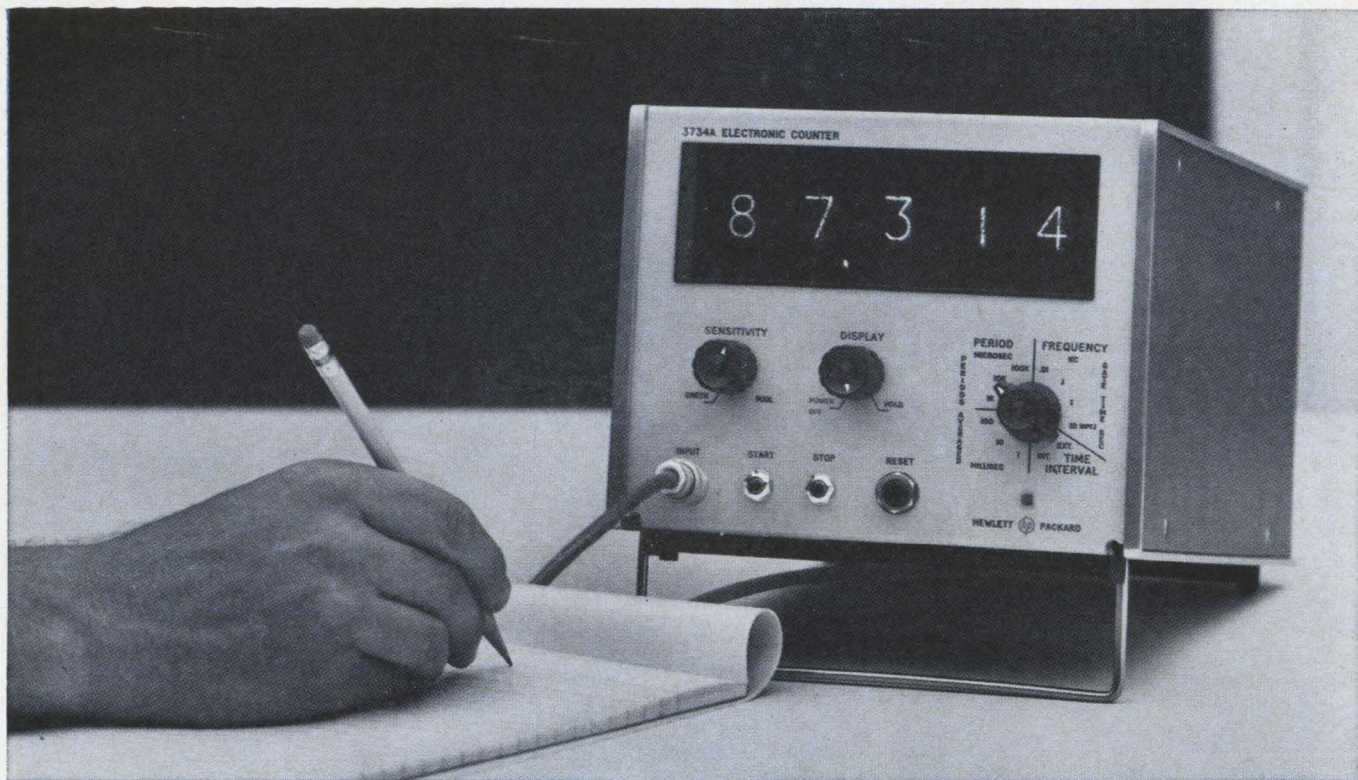

General Purpose Counter—only \$1075!

New compact, solid-state, 2 mc electronic counter

Here's the new Hewlett-Packard Model 3734A Counter—only 8" wide and 6" high—ideal for bench use, yet easily rack mounted (with room for another modular hp instrument in a standard rack width).

- Measure frequency—2 cps to 2 mc*
- Measure period and multiple period average*
- Measure frequency ratio and multiple ratio*
- Measure time interval*
- Make cumulative measurements*

With five-digit in-line readout, the 3734A displays any of these measurements in clear, easily read numerals. High sensitivity and a one-megohm input impedance assure accurate measurement of signals as low as 100 mv rms. The decimal is automatically positioned.

The internal time base is a stable 100 kc oscillator—an external time base may be used if desired.

Display storage provides a continuous display of the most recent measurement, changing only when the count actually changes; a display control, adjustable 0.2 to 5 seconds, can be used to set the period of time between the end of one count and the start of the next. A reset disable function permits cumulative measurements.

Front-panel pushbuttons provide convenient manual control in time interval mode—for electrical operation there are separate start-stop inputs on the rear panel.

The size of the counter and a tilt stand provided for easy viewing make it ideal for bench use. At only 12½ pounds, it is excellent for portable applications. Price: hp 3734A, \$1075*.

Ask your Hewlett-Packard field engineer for a demonstration, or write for complete information to Hewlett-Packard, Palo Alto, California 94304, Tel. (415) 326-7000; Europe: 54 Route des Acacias, Geneva; Canada: 8270 Mayrand Street, Montreal.

*Data subject to change without notice. *Price in U.S.A. f.o.b. Palo Alto, California. For price in other countries, call your local hp sales office.*

HEWLETT  **PACKARD**
An extra measure of quality

12760

Electronics

June 14, 1965

Volume 38, Number 12

| | |
|--------|------------------------|
| Page 4 | Readers Comment |
| 8 | People |
| 10 | Meetings |
| 15 | Editorial |
| 17 | Electronics Newsletter |
| 53 | Washington Newsletter |
| 145 | New Products |
| 194 | New Books |
| 199 | Technical Abstracts |
| 205 | New Literature |

Electronics Review

| | | | |
|---------|---------------------------------|----|------------------------------|
| Page 39 | The little computer that didn't | 42 | Picture that Belling the CAT |
| 40 | IC transistor islands | 44 | Height of accuracy |
| 41 | Sick Phoenix | 44 | Later bird |
| 41 | Radar penmanship | 46 | Movies take off again |

Probing the News

| | |
|-----|--|
| 129 | Nike X has McNamara on the spot |
| 136 | Digital techniques tried for jamproof messages |

Electronics Abroad

| | | | |
|-----|---------------------|-----|-------------------|
| 207 | All together now | 209 | Well stacked |
| 208 | Multistable cores | 210 | Traffic lab |
| 209 | IC price reductions | 210 | Better resolution |
| 209 | Tariff cuts? | | |

Technical articles

| | | |
|----------------------------|-----|--|
| Components | 78 | Picking the right potentiometer Comparison of characteristics of four kinds of pots helps engineers choose the right one L. Thomas Peart, Beckman Instruments, Inc. |
| Circuit design | 84 | Designer's casebook Detector circuit measures phase and amplitude; Triangle generator adjusts output slopes and peaks |
| Solid state | 87 | Special report: the unijunction transistor (cover) New interest in the unijunction transistor Device finds new applications from ball park scoreboards to missiles Jerome Eimbinder, Solid state editor |
| | 93 | Now, new unijunction geometries Two new types are compared with the older bar structure and alloy junction Lowell Clark, Motorola, Inc. |
| | 98 | Unijunction device gets high marks for reliability Study of life tests indicate failure rate of less than 0.01% per thousand hours T. Peter Sylvan, General Electric Co. |
| | 105 | Quick-on-the-trigger design Unijunction transistor simplifies design of a variety of delay, flasher and sensing circuits Dwight V. Jones, General Electric Co. |
| Medical electronics | 111 | Bioengineering: a new discipline Life scientists turn to electronics in their quest for more information about the body. Part I of a two-part series W.H. Ko and L.E. Slater, Case Institute of Technology |

Electronics

Editor: Lewis H. Young

Senior editors

Technical: Samuel Weber
News: Kemp Anderson, Jr.

Senior associate editors: John F. Mason, George Sideris

Department editors

Advanced technology: Joan Blum
Avionics: W.J. Evezia
Circuit design: Michael Elia
Components: Michael F. Tomaino
Computers: Wallace B. Riley
Consumer electronics: Richard Lipkin
Instrumentation: Carl Moskowitz
Manufacturing: George Sideris
Military electronics: John F. Mason
New products: William P. O'Brien
Solid state: Jerome Eimbinder
Space electronics: Peter R. Sigmund
Staff writer: Stanley Zarowin

Regional editors

Boston: Thomas Maguire, editor; Robin Carlson
Los Angeles: William B. Wallace, editor; June Ranill
San Francisco: Laurence D. Shergalis, Edmond G. Addeo, editors; Mary Jo Jadin
London: Derek Barlow, editor

Copy editors

Howard Rausch, Sally Powell, Walter Barney

Graphic design

Art director: Saul Sussman
Assistant art director: Donna M. Marchyn
Editorial production: Ann Mella
Production editor: Arthur C. Miller

Editorial secretaries: Claire Benell, Mary D'Angelo, Lynn Emery, Kay Fontana, Carolyn Michnowicz, Lorraine Longo, Lorraine Werner

McGraw-Hill news service

Director: John Wilhelm; **Atlanta:** Fran Ridgeway; **Chicago:** Bruce Cross;
Cleveland: Arthur Zimmerman; **Dallas:** Marvin Reid;
Detroit: Donald MacDonald; **Los Angeles:** Michael Murphy, Ron Lovell; **San Francisco:** Margaret Ralston, Ed. Addeo;
Seattle: Ray Bloomberg; **Washington:** Arthur L. Moore, Glen Bayless, Charles Gardner, Herbert W. Cheshire, Seth Payne

McGraw-Hill world news service

Bonn: Richard Mikton; **Brussels:** Arthur Erikson; **London:** John Shinn;
Mexico City: Wesley Perry; **Milan:** Bruce Bendow;
Moscow: Donald Winston; **Paris:** Dan Smith;
Rio de Janeiro: Leslie Warren; **Tokyo:** Marvin Petal, Charles Cohen

Circulation manager: Hugh J. Quinn

Reprints: T.M. Egan

Publisher: C.C. Randolph

Electronics: June 14, 1965, Vol. 38, No. 12

Printed at 99 North Broadway, Albany, N.Y.
Second class postage paid at Albany, N.Y.

Subscriptions are solicited only from those actively engaged in the field of the publication. Position and company connection must be indicated on orders. Subscription prices: United States and Possessions and Canada, \$6.00 one year, \$9.00 two years, \$12.00 three years. All other countries \$20.00 one year. Single copies, United States and Possessions and Canada 75¢. Single copies all other countries \$1.50.

Published every other Monday by McGraw-Hill Inc. 330 West 42nd Street, New York, N.Y. 10036. Founder: James H. McGraw, 1860-1948.

Subscribers: The Publisher, upon written request to our New York office from any subscriber, agrees to refund that part of the subscription price applying to copies not yet mailed. Please send change of address notices, subscription orders or complaints to Fulfillment Manager, Electronics, at the address below. Change of address notices should provide old as well as new address, including postal zone number if any. If possible, attach address label from recent issue. Allow one month for change to become effective.

Postmaster: Please send Form 3579 to Fulfillment Manager, Electronics, P.O. Box 430, Hightstown New Jersey 08520

Readers Comment

Patent fights

To the Editor:

The Common Market countries are considering, but have not adopted, the deferred examination system for patents [Electronics, May 3, p. 105].

As many of your readers know, statistics based on samples are worthless without information on how the sample was chosen. Statistics based upon a nonrandom sample are particularly dangerous and very seldom can be used to predict the properties of the group from which the sample was chosen. "Legal challenges on patent rulings are already 60% to 70% successful" is such a statistic.

The Patent Office is currently issuing approximately 50,000 patents per year. A statistically insignificant portion of these are ever challenged in the courts. Such patents are chosen because of their value to the litigants and because validity or infringement is doubtful. If attorneys were better predictors of court decisions, the statistical result would be that in patent litigation, as in any other litigation, plaintiffs and defendants would each win half the time.

F. Eugene Davis IV
Stamford, Conn.

Clean soldering

To the Editor:

In the article "Dip Soldering in Miniature—a New Way to Assemble Modules" [May 31, p. 94], the author has overlooked one important point—cleanliness. The primary purpose of using a thoroughly cleaned soldering iron tip, and feeding fresh solder to the junction of iron and work, is to prevent carrying crystallized solder and oxides to the work. The NASA School for Reliable Electrical Connections has found that a large portion of student work rejects are directly related to contamination from an improperly cleaned soldering iron.

His proposal that enough solder be placed on the iron tip to perform several operations is at variance with MSFC-PROC-158B, and

Another Industry First!

NOW...THE NEWEST **DUET*** TRANSISTOR IS A TWIN IN A FLAT PACK!

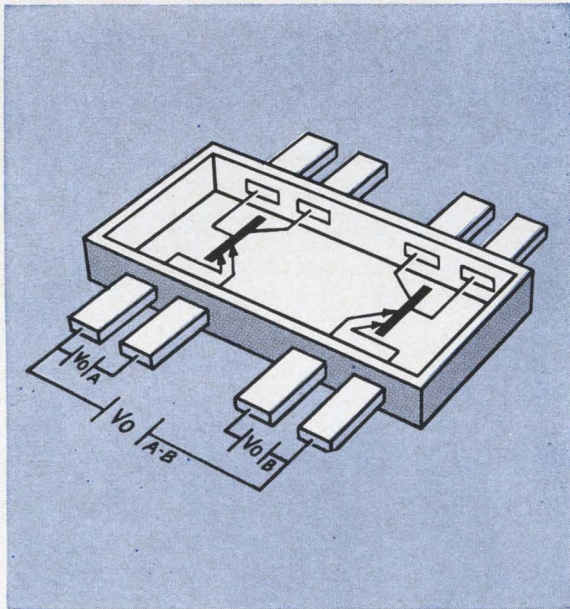

Sprague leads again with two dual-emitter chopper transistors in one flat-pack case, with tight V_{OFF} matching of both devices

CHECK THESE KEY PARAMETERS

| Type No. | V_{EEO} | V_{ECO} | $ V_o $ A-B |
|----------|-----------|-----------|-------------|
| 3N112 | 30V | 30V | 20 μ V |
| 3N113 | 50V | 50V | 20 μ V |

Standard TO-18 case Duet* Transistors... the broadest line of dual-emitter choppers

| Type No. | BV_{EEO} | V_o | Type No. | BV_{EEO} | V_o | Type No. | BV_{EEO} | V_o | Type No. | BV_{EEO} | V_o |
|----------|------------|-------------|----------|------------|-------------|----------|------------|-------------|----------|------------|-------------|
| 3N90 | 30V | 50 μ V | 3N94 | 50V | 100 μ V | 3N110 | 30V | 30 μ V | 3N116 | 12V | 200 μ V |
| 3N91 | 30V | 100 μ V | 3N95 | 50V | 200 μ V | 3N111 | 30V | 150 μ V | 3N117 | 20V | 50 μ V |
| 3N92 | 30V | 200 μ V | 3N108 | 50V | 30 μ V | 3N114 | 12V | 50 μ V | 3N118 | 20V | 100 μ V |
| 3N93 | 50V | 50 μ V | 3N109 | 50V | 150 μ V | 3N115 | 12V | 100 μ V | 3N119 | 20V | 200 μ V |

For complete information, write to Technical Literature Service, Sprague Electric Company, 35 Marshall Street, North Adams, Mass. 01248

SPRAGUE COMPONENTS

- | | | |
|-------------------------|------------------------|--------------------------------------|
| TRANSISTORS | PULSE TRANSFORMERS | CERAMIC-BASE PRINTED NETWORKS |
| CAPACITORS | INTERFERENCE FILTERS | PACKAGED COMPONENT ASSEMBLIES |
| RESISTORS | PULSE-FORMING NETWORKS | BOBBIN and TAPE WOUND MAGNETIC CORES |
| INTEGRATED CIRCUITS | TOROIDAL INDUCTORS | SILICON RECTIFIER GATE CONTROLS |
| THIN-FILM MICROCIRCUITS | ELECTRIC WAVE FILTERS | FUNCTIONAL DIGITAL CIRCUITS |



*Sprague' and '®' are registered trademarks of the Sprague Electric Co.

Battery

150 Volts/inch³

20 Yrs. Shelf Life

1. How would I keep a capacitor charged for up to 20 years?
2. Is it *really* possible to pack 150 volts/cu. in. into a battery?
3. Where can I get a *solid* electrolyte battery whose mass and center of gravity will not change with time or use?
4. Can I find a battery which will endure short circuits (for hours) and recover to its original open circuit voltage within seconds?
5. Is it possible to obtain high voltage batteries in almost any configuration?
6. Where can I find a battery which will behave like this . . .

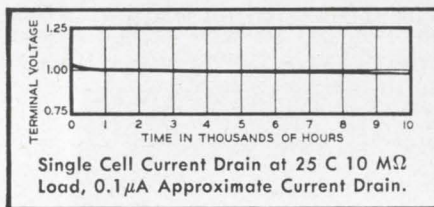

. . . and which has a total available charge of 1500 microampere-hours or 5 coulombs per cell?

The answers to these questions are:

1. Using *Sprague Solid Electrolyte Batteries*.
2. *Yes indeed!*
3. *Sprague Electric.*
4. *Yes.*
5. *Yes.*
6. *Sprague Electric. For complete technical data, write for Engineering Bulletin 11,101 to Technical Literature Service, Sprague Electric Co., 35 Marshall Street, North Adams, Massachusetts 01248*

45B-4150

SPRAGUE[®]
THE MARK OF RELIABILITY

[®]'Sprague' and [®]'(2)' are registered trademarks of the Sprague Electric Co.

the current NPC-200-4, in several respects:

- Oxidation of the solder referred to above.
- Poor control over the amount of solder applied to each individual joint.
- Probable solder points, or icicles, on work.
- Probable excess flux on work, because flux deposit is controlled by operator.
- Excessive hardening of flux due to extended time between cleaning (PROC0158B and NPC-200-4 require cleaning each joint immediately after soldering).
- Moving work, rather than iron, which could, in some cases, cause cold, or fractured, joints.

Proper use of various heat sink devices, coupled with proper design in selection and placement of components, and proper procedures in the soldering operation, have eliminated, almost entirely, heat damage. This so-called new technique is not new, but rather an old problem that the NASA Specifications for Reliability are attempting to eliminate.

Joseph D. Perdue

NASA
Langley Research Center
Hampton, Va.

The author replies:

The hazards enumerated in Mr. Perdue's letter have not been any harder to control when using the technique described in my article than when using conventional soldering techniques. In either case, proper operating training and monitoring is needed to ensure reliable joints. To answer Mr. Perdue's specific points:

- Oxidation does not appear on the iron before reapplication of solder if the iron is temperature-controlled at 600° F, and if not more than three joints are made, which takes only a few seconds.
- The technique results in good control over the amount of solder applied to the joint, when properly performed. The wetting and flowing of the solder results from meeting temperature, fluxing and cleanliness conditions needed for good soldering and are not dependent on an operator's judgment.
- Icicles do not occur when the technique is properly followed.
- The amount of flux appears to

be more uniform than when using rosin-cored solder, when the flux is of the right viscosity. Also, the flux is applied at the joint and there is no excess on the outside of the joint, as is the case with rosin-cored solder.

- If required, the joints can be prefluxed one at a time and the flux can be cleaned immediately after the solder is applied.

- The moving of the work is not essential to the technique. Motion can also result from the use of a hand-held iron. Both techniques depend on a mechanical bond between the parts to ensure against relative movement during solder solidification.

- Heat sinks are effective only if there is a significant length of lead between the component body and the joint, and a temperature drop can occur along the lead. In designs where space is at a premium and where it isn't practical to apply a heat sink away from the joint, the heat sink cools the joint and actually acts as a heat reservoir, prolonging the amount of time the heat must be applied to the joint.

To sum up, reliable joints can be made with either technique. The one described has the advantage of improving the reliability of the components soldered. How important this advantage depends on how susceptible the components are to thermal damage.

H. M. Isaacson

General Electric Co.
Utica, N. Y.

Park Gate's products

To the Editor:

In the editing of my article, "Computer trio runs the works at big British steel mill" [Jan. 25, p 80], some unfortunate confusion was introduced.

The diagrams on pages 82 and 83 suggest that Park Gate Iron and Steel Co. produces beams, plate and tinplate. Actually, the company's main products are billets, bars, narrow strip and sections. In addition, some steel industry jargon was oversimplified, and I did not have the opportunity to correct these terms before they appeared in print.

J. T. Jones

English Electric, Ltd.
Stafford, England

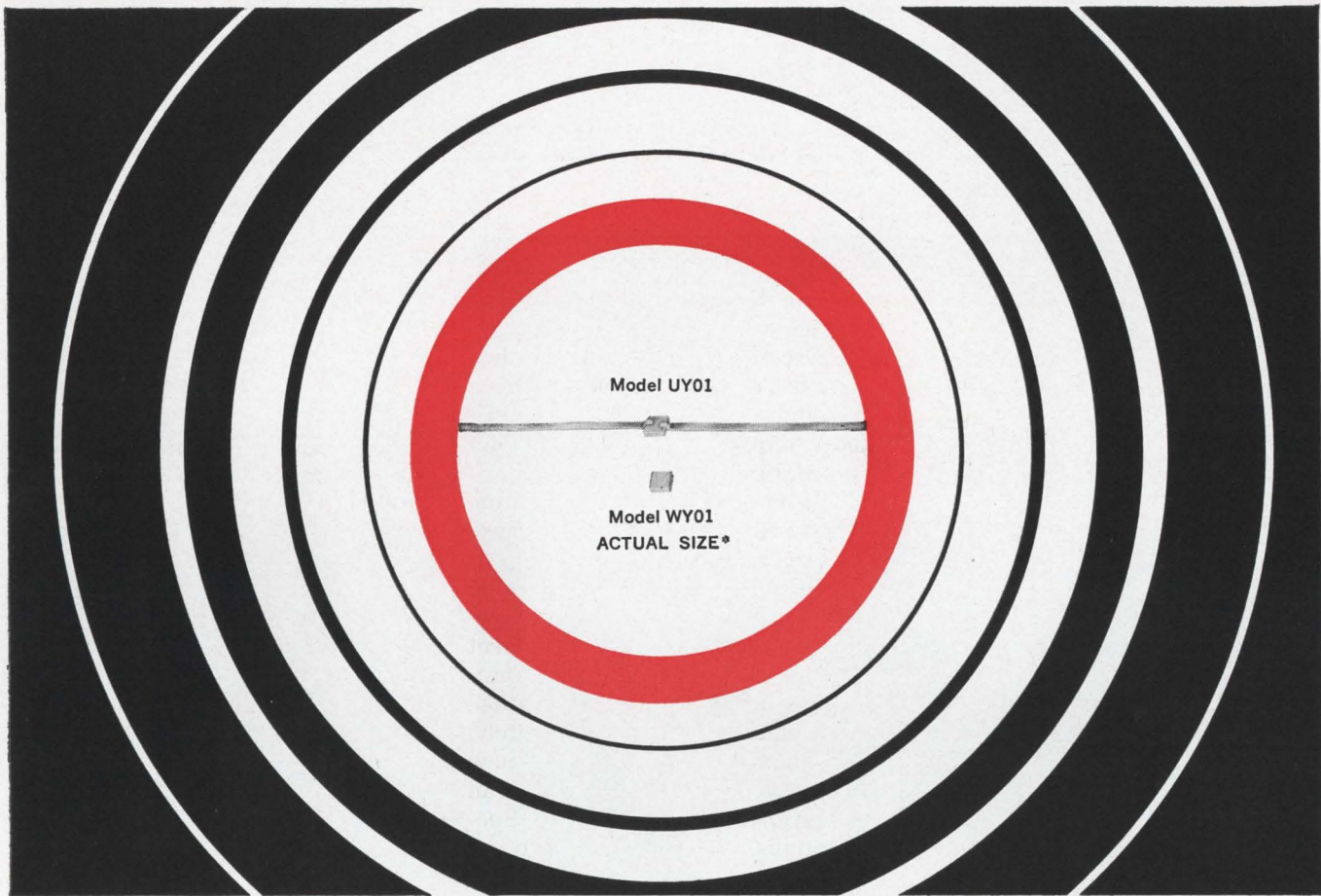

*In this size both are offered in 38 models of various capacitance values from 0.5 to 62 pf.

Now JFD Uniceram® High Q Fixed Capacitors COME TWO WAYS

Uniceram High Q ceramic fixed capacitors offer a unique combination of small size, exceptional stability and a guaranteed minimum Q of 5000 . . . with up to ten times more capacitance per unit volume than competitive units . . . up to .2 mfd/in³.

105 glass encapsulated models, with capacitance values from 0.5 to 3000 pf, provide the ultimate in High Q, reliability and stability. All models meet or exceed requirements of MIL-C-11272B.

Uniceram High Q capacitors are also available as unencapsulated wafers with metalized edges. 88 low-cost units, with capacitance values from 0.5 to 3000 pf, offer the same outstanding electrical properties. These wafers are ideally suited for hybrid integrated circuits, can be soldered directly to printed circuit boards or used as discrete components.

A High K series of Uniceram ceramic fixed capacitors with up to 1 mfd capacitance per unit volume is also available. These glass encapsulated units meet or exceed requirements of MIL-C-11015C. Volumetric efficiency . . . up to 48 mfd/in³.

Some typical Uniceram applications

IF strips • Crystal master oscillators
• Padder capacitors • Critical RC timing networks • Temperature stabilizing devices • Radio frequency filters • Critical timing delay lines • Fixed tuned resonant circuits • Suitable as cordwood between printed circuit boards • All types of communication circuits

WRITE FOR CATALOG UNM 65-2

JFD-117

JFD ELECTRONICS CORPORATION

THE \neq AMERICA KNOWS BEST!

Components Division
JFD ELECTRONICS CORPORATION, 15th Ave. at 62nd St., Brooklyn, N. Y. 11219
JFD NORTHEASTERN, Ruth Drive, P. O. Box 228, Marlboro, Mass. 07152
JFD NEW YORK-NORTHERN, Damiano Pl., P. O. Box 96, New Hartford, N. Y. 13503
JFD MID-ATLANTIC, P. O. Box 5055, Philadelphia, Pa. 19111
JFD MID-ATLANTIC-MARYLAND, P. O. Box 7676, Baltimore, Md. 21207
JFD MIDWESTERN, 6330 W. Hermione St., Chicago, Ill. 60646
JFD MIDWESTERN-OHIO, P. O. Box 8086, Cincinnati, Ohio 45208
JFD WESTERN, 9 Morlan Place, Arcadia, California 91006
JFD ISRAEL LTD., Industrial Area B, Bldg. 23, Azor, Israel
DUCON CONDENSER PTY., LTD., Christina Road, Villawood, N.S.W., Australia
MURATA MANUFACTURING CO., LTD., Nagaoka Otokuni, Kyoto, Japan
STANDARD TELEPHONE & CABLES LTD., Footscray, Sidcup, Kent, England
JFD ELECTRONICS, EUROPE S A, 7 Rue de Rocroy, Paris, 10, France

Variable Trimmer Piston Capacitors ■ Metalized Inductors ■ LC Tuners ■ Ceramic Fixed and Variable Capacitors ■ Fixed and Variable Distributed and Lumped Constant Delay Lines

Pentode Pattern for Performance

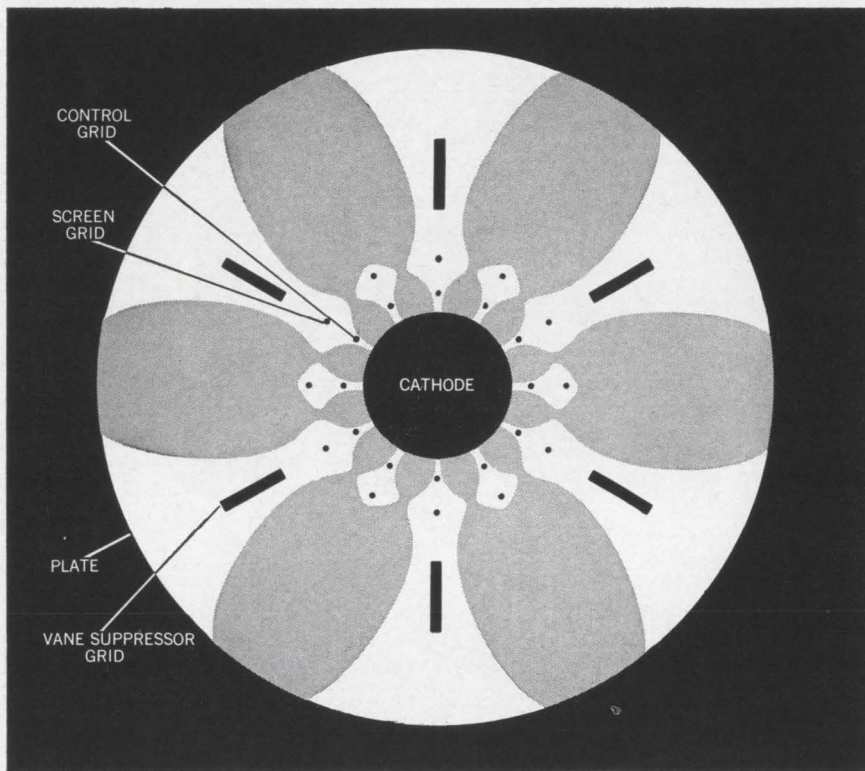

To prevent electrons from returning to the screen region of a transmitting tube, Penta's exclusive, patented vane-type suppressor grid does the trick. Plate current is practically independent of plate voltage. Kinks and wiggles are absent. Plate voltage can swing well below screen voltage without appreciable loss of current. The result is outstanding linearity, efficiency, stability. For example, Penta's PL-8295A—the ceramic version of the famous PL-8295/172—delivers 1000 watts of Class AB₁ useful output at only 2000 plate volts . . . more than 1500 watts at maximum Class AB₁ ratings. Penta tubes with vane-type suppressor grids were introduced in 1955 and their use in high-quality linear amplifiers is growing daily. Enjoy the advantages of this years-ahead design by specifying the PL-177A, PL-175A, PL-8295/172, or PL-8295A, for 100-watt to 1.5-kilowatt power output applications. Write for data sheets and Penta's latest Summary Catalog, which describes all Penta products, with prices. The Penta Laboratories, Inc., a Subsidiary of Raytheon Company, 312 North Nopal Street, Santa Barbara, California 93012.



People

Francis J. Sullivan, who has been putting his technical and administrative talents to use as acting director of the National Aeronautics and Space Administration's electronics and control division since last fall, now has the title to go with the job.



As director of the rapidly expanding division, Sullivan has responsibility for planning and coordinating the electronics research carried on by the various NASA centers, including the new Electronics Research Center at Cambridge, Mass.

The division is spending some \$25 million this year, but this figure will increase to \$34 million in 1966 and to about \$65 million annually in the next three or four years.

Sullivan sees a need to establish more in-house competence, "so that we can properly direct research we are funding in industry." Currently, NASA's staff of engineers is tied closely to existing projects that are bound by schedules.

"It means they have to make good with available equipment," Sullivan complains. His goal is to remove these schedules so that the staff can have more time for research unrelated to going programs. The areas he would like to see investigated further are space optics and laser application and technology.

Sullivan, 43, took over as acting head of the division when Albert J. Kelley left to become director of the research center at Cambridge.

Sullivan has been with NASA since 1962. Before joining the space agency, he was a Navy aviator and test pilot. He has a bachelor of science degree from the Massachusetts Institute of Technology and has done graduate work in electronics at the University of Pennsylvania and the University of Maryland. After leaving the Navy, he joined the Naval Air Development Center at Johnsville, Pa., and worked on the Navy's Eagle missile system, which was later scrapped.

High Energy Physics and Machlett High Power Electron Tubes

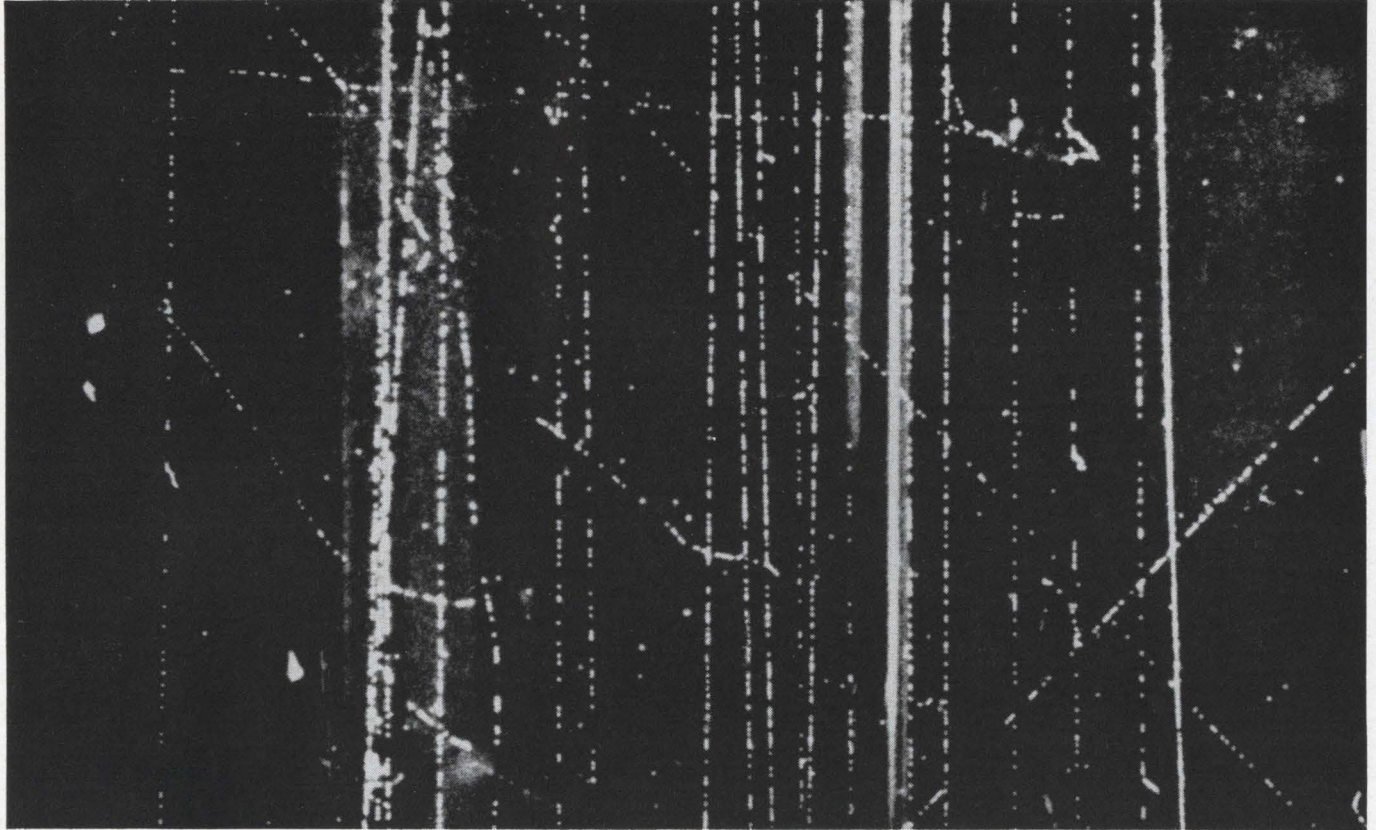

High energy physics, as represented by this "hydrogen bubble chamber" photo and Machlett's high power electron tubes, have had a long association in the nation's foremost Particle Accelerators—helping to accelerate protons from the early cyclotron (22 million electron volts) to the modern synchrotron (33 billion electron volts). Reasons for this long association lie in the performance reliability of Machlett tubes, and reflect continued confidence in the capability of the Machlett organization. Whether you require high power/high voltage triodes or tetrodes, UHF planar triodes, X-ray tubes, vidicons, or you need assistance in research or design development, write: The Machlett Laboratories, Inc., Springdale, Conn. 06879. An Affiliate of Raytheon Company.

MACHLETT

ELECTRON TUBE SPECIALIST

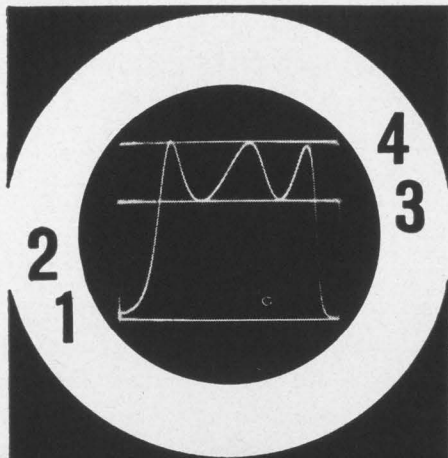

see **4** response traces on single-trace scope

measurement by comparison up to 1,200 mc



NEW
JERROLD
SOLID-STATE
3-POSITION
COAXIAL SWITCHER

Model TC-3 \$295⁰⁰

Turn any single-trace oscilloscope into a 4-trace scope; insert two reference traces automatically in addition to test trace and baseline. These references have advantage of permanent relative accuracy over scribed or painted lines.

Results are repeatable, as accurate as your reference attenuators. Generator and scope drift do not affect accuracy of measurements. Frequency from dc to 1,200 mc extends usefulness of comparison technique well into the UHF band. The TC-3 Coaxial Switcher can save you thousands of dollars in speed and accuracy. Write for literature.



Industrial Products Division,
Philadelphia, Pa. 19132
In Canada: Jerrold Electronics,
60 Wingold Ave., Toronto 19, Ont.
Export: Rocke International,
13 E. 40th St., New York, N.Y. 10016

SWEEP GENERATORS • AMPLIFIERS
PRECISION ATTENUATORS • COMPARATORS

Meetings

Broadcast and TV Receivers Conference, G-BTR/IEEE; O'Hare Inn, Des Plaines, Ill., June 14-15.

Midwest Symposium on Circuit Theory, G-CT/IEEE; Colorado State University, Ft. Collins, Colo., June 14-15.

Ocean Science and Ocean Engineering National Conference/Exposition, ASLO, MTS; Washington Hilton Hotel, Washington, June 14-17.

Simulation, A Management Tool, AMA; AMA Headquarters, N.Y.C., June 16-18.

National Navigational Meeting, Institute of Navigation; Edgewater Inn Marina Hotel, Long Beach, Calif., June 21-23.

Solid State Device Research Conference, IEEE; Princeton Univ., Princeton, N.J., June 21-23.

Aerospace Technical Conference and Exhibit, PTGAS/IEEE; Shamrock-Hilton Hotel, Houston, Tex., June 21-24.

Aerospace Technical Conference and Exhibit, PTGAS/IEEE; Shamrock-Hilton Hotel, Houston, June 21-24.

Joint Automatic Control Conference, ASME, IEEE, ISA, AIAA, AICE; Rensselaer Polytechnic Institute, Troy, N.Y., June 22-25.

Electronic Standards Committee F-1 Meeting, ASTM; Randolph House, Syracuse, N.Y., June 23-24.

Fluid Mechanics & Heat Transfer Symposium, USAF, Lockheed Co.; Lockheed Research Labs, Palo Alto, Calif., June 24-25.

Summer Power Meeting, G-P/IEEE; Detroit, Mich., June 27-July 2.

International Colloquium on Applications of Mathematics in the Engineering Sciences, Institut f. Mathematik; Hochschule fur Architektur und Bauwesen, Germany, June 27-July 4.

Electromagnetic Compatibility National Symposium, G-EMC/IEEE; Waldorf-Astoria Hotel, New York, June 28-30.

Physics of Quantum Electronics Conference, ONR; San Juan, Puerto Rico, June 28-30.

International Data Processing Conference and Business Exposition, DPMA; Benjamin Franklin Hotel and Convention Hall, Philadelphia, June 29-July 2.

Microwave Applications of Semiconductors Meeting, IERE-IEE;

University College, London, June 30-July 2.

Biomedical Engineering Symposium, IEEE, US Naval Hosp.; San Diego, Calif., July 6-8.

Technical Communications Conference, CSU; Colorado State Univ. Campus, Fort Collins, Col., July 6-10.

Nuclear and Space Radiation Effects Conference, G-NS; Univ. of Michigan, Ann Arbor, Mich., July 12-15.

Chemistry and Metallurgy of Semiconductors, Gordon Research Conferences, Univ. of Rhode Island; Proctor Academy, Andover, New Hampshire, July 12-16.

Educational Technology Conference, American Management Association; Americana Hotel, N.Y.C., July 12-16.

Nuclear & Space Radiation Effects Annual Conference, G-NS/IEEE; University of Michigan, Ann Arbor, Mich., July 12-16.

Flight Control Conference and Engineering Display, SAE; International Hotel, Los Angeles, July 13-15.

Instrumentation Science Research Conference, ISA; William Smith College, Geneva, N. Y., Aug. 2-6.

American Astronautical Society National Meeting, AAS; Sheraton-Palace Hotel, San Francisco, Aug. 18-20.

Call for papers

Vehicular Communications Conference, Vehicular Communications Group of the IEEE; Sheraton Park Hotel, Washington, Dec. 2-3. **July 15** is deadline to submit 500 word abstract to W. F. Biggerstaff, Papers Committee Chairman, USFS Electronics Center, ARC, Beltsville, Maryland.

Ultrasonics Symposium, Group on Sonics and Ultrasonics of the IEEE; Hotel Sheraton, Boston, Dec. 1-3. **Sept. 1** is deadline for submitting 100 word abstract and completed paper to J. H. Rowen, Chairman of the Technical Program Committee, Bell Telephone Laboratories, Murray Hill, New Jersey 07971.

Introducing Item #6 in the Fluke '65 Pacesetter Line.

It's a tough little "Luigi Meter" or our new solid state 841 Electronic Galvanometer by any other name. Virtually indestructible, the 841 meets mil-spec environmental parameters. Takes million-to-one overload without damage. Sensitivity is 2 na per scale division. Never needs external damping. Recorder output. Works in any position.

Fluke electronic galvanometers are available in the 841 A&B for laboratory use or the 840 A&B for OEM requirements. "A" models have a power sensitivity of 8×10^{-10} watt per division. Input resistance is 180 ohms on three ranges of ± 30 na, ± 300 na, and ± 3 na. "B" models differ in these respects: sensitivity, 5×10^{-9} amp/scale div.; 4.5×10^{-10} watt/scale div. power sensitivity; input resistance 18 ohms; ± 100 na, ± 1 na, and ± 10 na current ranges. The 841 A or B is priced at \$220 including case and batteries. The 840 A or B costs \$175 plus \$20 for the case and \$5 for the batteries. A rechargeable battery pack and case costs \$100. AC line power pack costs \$25.



FLUKE • Box 7428, Seattle, Washington 98133 • Phone (206) 776-1171 • TWX: (910) 449-2850

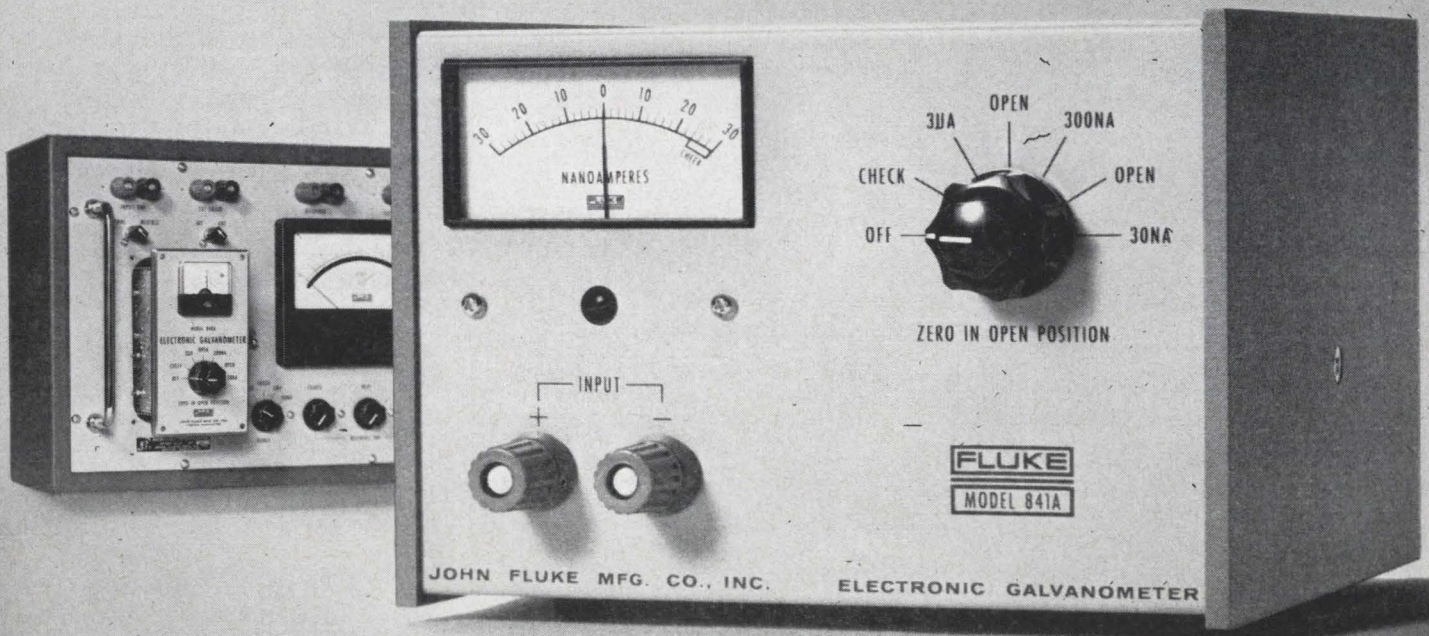

Model 841 in foreground with Model 840 at the rear.

ASK
AMPHENOL

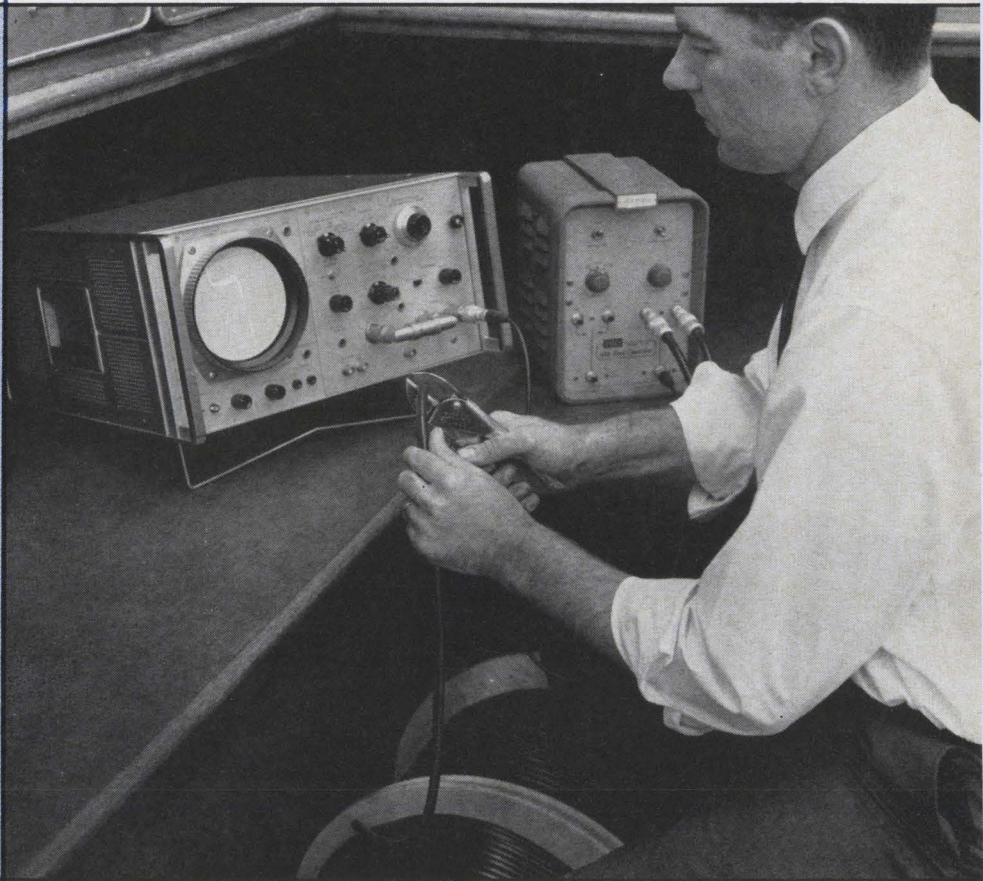
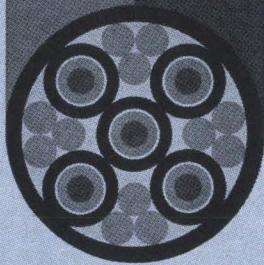

The Amphenol Cable Division of Amphenol-Borg Electronics Corporation today reports the Hewlett-Packard Time Domain Reflectometer an essential part of its thorough quality-control and trouble-shooting facilities. Design, production and quality-control engineers at Amphenol use the TDR technique in three vital areas:

1. Testing coax and multi-conductor cables and cable assemblies to insure low vswr;
2. Matching the electrical length of cables;
3. Quality inspecting the junction of the cable and connector in a cable assembly.

The time saved is money saved, plus delivery of a better Amphenol product.

Because designing high-reliability multi-conductor cable assemblies requires extensive testing, a simple and accurate method of locating discontinu-

ities which cause high vswr is essential. Tests are speeded with the hp 1415A plug-in because the location and amplitude of discontinuities are seen directly. And customers are assured of a more reliable cable because every point in the cable is checked.

To insure that cables will perform under the most severe

**WHAT HP
TIME DOMAIN
REFLECTOMETRY
DOES FOR
AMPHENOL,
IT CAN DO FOR YOU**

circumstances, high voltage breakdown tests are conducted on sample cables. Using the hp 140A scope and 1415A TDR Plug-in, Amphenol can locate a point of cable failure quickly. Without the hp equipment, it would be necessary to cut the cable into pieces until the exact location of the breakdown point is found. By measuring ratios of trace length and cable length to the breakdown point, it is easy to find the approximate location of the trouble; then, by flexing the cable along that area and viewing the scope trace, the exact breakdown point is located.

The 1415A in the 140A Scope is an integrated broadband system for testing cables, transmission lines, striplines, connectors and other broadband devices. It is essentially a "closed-loop radar," the 1415A consisting of a fast-rise pulse generator, a single-channel sampler and a time base gener-

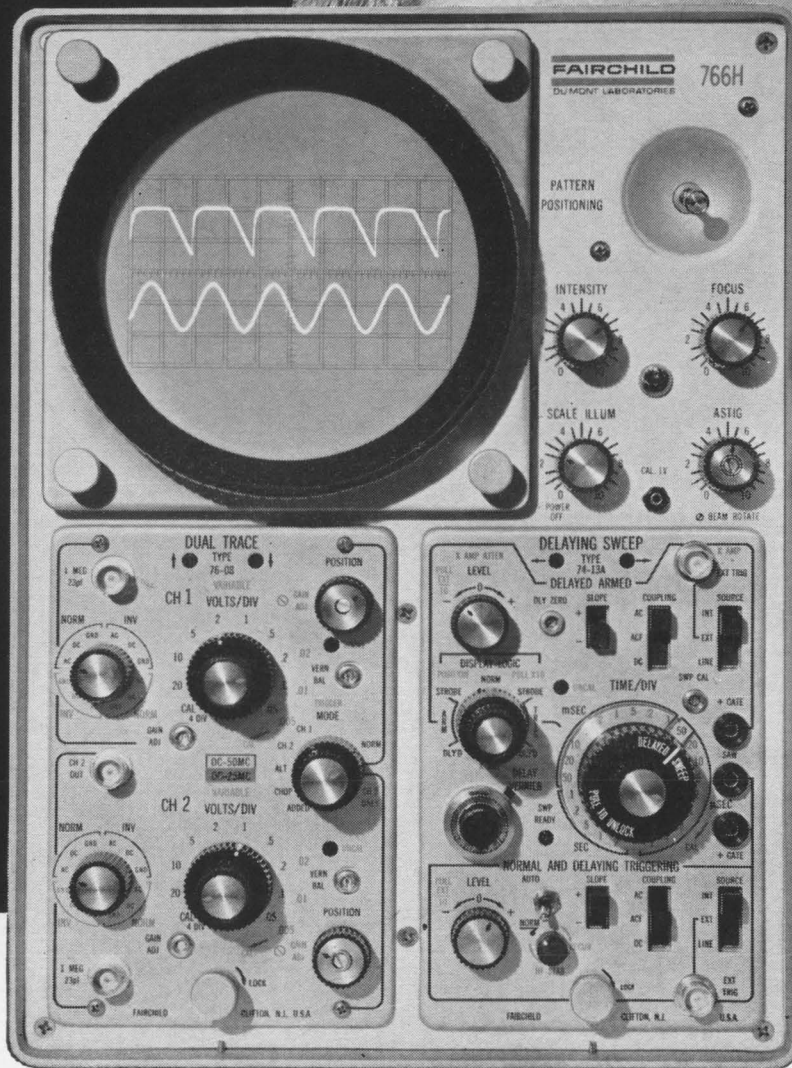

WE KEEP AN EYE ON EVERY SCOPE WE SELL...

because at Fairchild, service is just as important as the sale. After we deliver an oscilloscope, we also provide the industry's most extensive network of Service Centers and Field Engineering offices. 60 locations across the U.S. and 19 abroad are staffed by Fairchild trained technicians and professional engineers whose sole purpose is to keep an eye on your equipment. They are always ready to provide expert

service and help you with your application and maintenance requirements. While service is always available, it is seldom required. For example, the predicted reliability of Fairchild's 765H Series is 6,200 hours M-T-B-F, and many of our oscilloscopes have operated 15,000 hours without a single parts replacement.



*Technological Obsolescence

Circle 14 on reader service card

Speaking of M-T-B-F, ask for Reliability Study No. 3. See why Fairchild scopes cut downtime and maintenance cost, give you maximum precision and versatility. Fairchild Instrumentation, Clifton, N. J.

FAIRCHILD

INSTRUMENTATION
A DIVISION OF FAIRCHILD CAMERA
AND INSTRUMENT CORPORATION

Editorial

Plain talk

Engineers who used to spend their working hours adding to the technology are now waging a frustrating struggle. They are applying knowledge gained in military and space projects to areas that have never before enjoyed the benefits of electronic techniques or equipment. And they are finding that a good technical solution is not enough in such new areas—that economic, political and even sociological considerations can sometimes torpedo a good technical proposal.

In this environment what's needed desperately is an articulate engineer who can put into plain language the advantages of electronic equipment and how it works. Too many engineers stick to the jargon of their electronic specialties, leaving those unfamiliar with electronic equipment to flounder in ignorance.

The opportunities are real. For example, an article on page 111 describes a whole new discipline, the application of electronics to biology, which could be a ground-floor opportunity for engineers with backgrounds in telemetry and integrated circuits. But those who would participate must be ready to communicate with biologists—and that means no electronics jargon.

Still another promising field is the application of electronics to the education process. The pressure is on in every community for better schools and more efficient use of teachers. School populations are mushrooming, and the civil rights movement has added to the demands on many school systems. In California recently, the state legislature passed a law requiring all schools to teach Spanish in the sixth, seventh and eighth grades. But there is a serious obstacle: the schools will need 3,000 teachers of Spanish, and the entire state now has only 300. Electronic

equipment—closed circuit television, audio and video tape recorders, or electronic teaching machines—might be the only economic solution.

But reaching educators, school boards and teachers who have flimsy electronics backgrounds is trying work. It takes patient explanation that emphasizes what the equipment can do for the educational system, not how fancy or how simple the design is, or how neatly the device is packaged.

Further, educators tend to be very conservative in considering new devices for the classroom. A demonstration is the worst place in the world for a malfunction; no matter how attractive the mean time-between-failures rate may be, an educator will never forget that the machine broke down while he was watching it, and he'll never understand what caused the failure.

One electronics company suffered an experience like that recently in a related field. Cubic Corp., the San Diego-based company best known for its missile tracking systems, has acquired and improved an electronic vote-counting machine. Just as orders started coming in last month, a California legislator introduced a bill to ban the machines, and orders went into limbo instantly. Then, while Cubic was showing state officials how reliable and effective the machine really was, it suffered one well-publicized breakdown in the Secretary of State's office. Now Cubic has an uphill fight to convince the officials that the machine is truly reliable. It's a job that falls mainly on engineers, not salesmen.

In Washington, administrators of the antipoverty program, which already feels the sting of congressional charges of inefficiency and waste, want to apply the techniques of aerospace systems engineering to run their social programs. For the engineer who has specialized in data handling, processing and communication, an opportunity is on hand. But he'll have to work with social workers, political scientists and economists who do not understand Boolean algebra, Shannon information theory, magnetic tape packing densities or integrated circuits.

Never has the opportunity been brighter for electronics engineers to spread their technology into new areas. But to cash in, the engineer will have to become articulate in terms that specialists in other fields can understand.

TOGETHERNESS

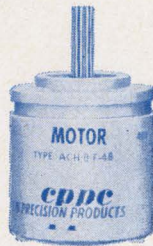

A great motor...

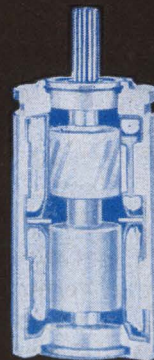

a great tach...

make a great motor tachometer

Look at these parameters in a "synchro size" size 8 full drag cup motor rate tachometer.

We chose a Clifton motor with good torque (.275 in-oz), low power consumption (3 watts/phase) and high acceleration (120,000 rad/sec²), and added a tachometer with exceptionally high output for length. Combining them produced a tachometer with the lowest inertia in the industry for the size, output and torque.

One further ingredient was added. This component (and our whole, new line of servo motors and tachometers) is produced by a quality-minded company deeply experienced in the design and manufacture of

Small: .75" diam x 1.241" length

T/J: 90,000 rad/sec²

Output: .3V/1000 rpm

Nulls: .015V max

Power Consump. <3W/phase

rotating components. Look to CLIFTON for leadership in the servo motor and tachometer field.

Clifton Precision Products, Division of Litton Industries, Clifton Heights, Pa., Colorado Springs, Colo.

cppe

CLIFTON PRECISION PRODUCTS
DIVISION OF LITTON INDUSTRIES



Electronics Newsletter

June 14, 1965

Early Bird spreads its wings

Early Bird, the Communications Satellite Corp.'s first project, is proving as useful in transmitting messages and data as it has been in carrying television programs. Last week, the International Business Machines Corp. sent specifications and diagrams of a new model in the System/360 computer line from Poughkeepsie, N.Y., to a plant in Essonnes, France.

This week, too, the Western Union Telegraph Co. exchanged messages with England, France and Germany via the satellite instead of cable circuits, trying its full line of services: high-speed data and alternate voice/data channels at speeds up to 2,500 words a minute; telex service (two-way telegraph service with direct dialing to overseas correspondents) and private leased wire service at speeds from 16½ to 100 words a minute.

Meanwhile, the scramble is on to lease circuits on the communication line, which is now slated to go into regular commercial operation on June 27, instead of the earlier date of June 8 that Comsat wanted. The American Telephone & Telegraph Co. has applied to the Federal Communications Commission for 100 channels, the International Telephone & Telegraph Co. 41 channels and RCA Communications, Inc., a subsidiary of the Radio Corp. of America, 30 channels.

The government, too, through the Defense Communications Agency, is showing a strong interest in renting a few channels. Within the next couple of weeks, the agency will be running a five-day test on data transmission, linking Early Bird into DCA's present communications network.

Honeywell steps up changeover to IC's

Honeywell, Inc., in its drive to apply integrated circuits to its electronic designs, is establishing a solid state center at Minneapolis. The company believes that if all its integrated-circuit specialists are in one center, it can hasten conversion of equipment to integrated circuits.

Sony introducing video tape recorder

Within eight weeks, the Sony Corp. of America will offer a combination home video tape recorder and nine-inch receiver for \$995. The Sony Videocorder is the first helical-scan recorder designed especially for home use. Other attempts at home recorders have used linear-recording methods, where the tape must be pulled over the head at speeds of about 120 inches per second; single reels record for only 10 minutes. The Sony recorder, however, has a tape speed of only 7½ ips with a one hour recording time on a seven-inch reel of half-inch tape. A video camera accessory is also available for "live" recording for \$350 extra.

Cabinet unit asks more cash for SST

President Johnson is expected to ask Congress within the next few days for \$150 million to cover continued development of the supersonic transport (SST) for the fiscal year starting July 1.

A recommendation that the money be allocated came from the Cabinet-level committee headed by Defense Secretary Robert S. McNamara. Under the development program, the Lockheed Aircraft Corp. and the Boeing Co. are competing for the airframe contract and the General Electric Co. and the Pratt & Whitney division of the United Aircraft Corp. are seeking the engine order.

Electronics Newsletter

AF seeks tactical radar centers

Requests for technical proposals will go out to industry in about six weeks for the largest procurement to date in the \$100-million program to bolster the tactical air control system [Electronics, Oct. 5, 1964, p. 114]. **The Air Force Electronics Systems division at Hanscom Field, Mass., will buy six combat reporting centers and 12 combat reporting posts to provide radar surveillance and control functions.**

The division also plans to buy tactical air control centers and other data processing and display equipment for control of air support in brush-fire wars. The procurement is part of the 407L program to buy transportable electronic systems for tactical warfare.

The Rome Air Development Center is testing search radars that a few men can assemble and dismantle quickly and haul into remote areas without trucks. The radar would be used to watch for supplies and men being parachuted into an area by the enemy, as well as for aircraft.

Military company enters stereo field

Non-Linear Systems, Inc., a company whose previous output has been digital voltmeters and other instrumentation gear, **has applied its military-aerospace technology to a stereo receiver for the consumer market.** The receiver is Non-Linear's first product outside the aerospace or military area; the move was seen as a way to buck up the company's sales, which sagged last year.

The solid state receiver is built on an aluminum chassis; **to keep the system cool and make maintenance easy, each subassembly is mounted on separate $\frac{3}{16}$ -inch thick glass fiber circuit boards—a technique never before used in the consumer market.** When introduced in August, the receiver's price will be about \$700.

Jukebox manufacturers are expressing an interest because malfunctioning subassemblies can be replaced quickly, reducing down time.

Motorola to offer tv transistor line

Motorola, Inc., will announce this week a complete line of semiconductor devices for television receivers. For the first time, a designer will be able to buy any solid state device required for a line-operated television receiver from a single supplier. The only exception is a high-voltage rectifier. Most of the transistors are silicon, housed in plastic packages.

The company also is bringing out a line of variable threshold logic integrated circuits for use in noisy environments—such as industrial control equipment. The power supply required to operate the devices can be varied from low levels up to 10 volts, depending upon the amount of noise immunity required.

FCC wants more small tv stations

The Federal Communications Commission wants to increase the number of small television stations in sparsely populated areas. Under an FCC proposal, ultrahigh frequency channels 70 to 83 would be reserved for stations of 10 kilowatts or less, with antennas no higher than 300 feet.

Food irradiation: \$15 million by '80

The food-irradiation field is expected to grow into a \$15-million annual market for the electronics industry by 1980, the Commerce Department says. The technique is used to preserve food. Equipment that will be sought, says the department, will be electron accelerators and monitoring and control instrumentation.

Look to Deeco for fast service on these new small-signal TI semiconductors

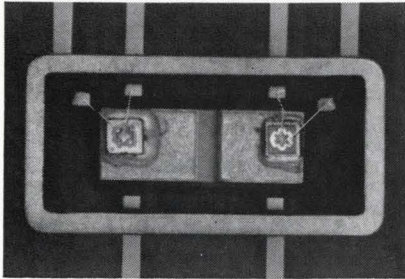

Now — complementary transistors in flat package

A new dual silicon transistor offers complementary NPN and PNP active

elements in a single flat package. The new device, known as the 2N3838, is now carried in stock. It makes possible smaller high-reliability circuitry including complementary flip-flops and complementary amplifiers.

This new device is one of a rapidly-expanding line of "compatible components" — especially designed to be electrically and mechanically compatible with integrated circuits*. Ask us for a file of compatible component data sheets in a miniature form.

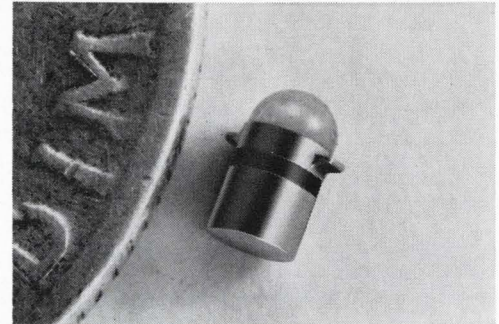

New solid-state light source combines small size and high reliability

The new TIXL01 planar gallium arsenide light emitter gives users of silicon light sensors high efficiency, long life and freedom from the catastrophic failures characteristic of incandescent lamps.

As shown above, the TIXL01 measures only 1/16-inch diameter by 1/10-inch high. Emitters may be mounted directly in 1/16-inch printed circuit boards, simplifying assembly.

We have added these new devices to our stock, ready for immediate delivery. Call us.

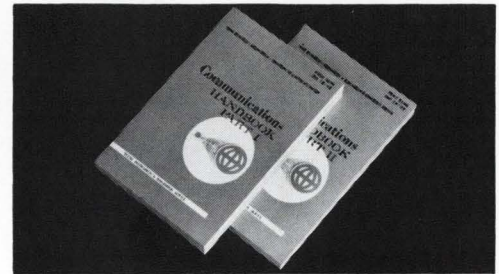

Get your new TI Communications Handbook from Deeco

We have a new shipment of the latest communications handbook available — a set of two 6- by 9-inch paperback volumes that total 366 pages and contain 417 illustrations. Special price for the set is only \$3.50. Order from us and get immediate delivery.

*Patented by TI

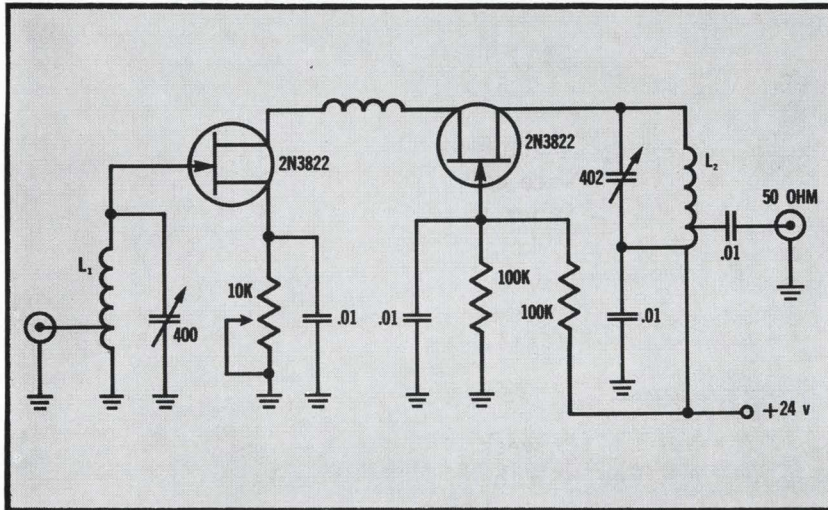

N-channel FET's provide low-noise amplification beyond 200 mc

You can improve RF amplifier performance by using new TI N-channel field-effect transistors. Two 2N3822's, used in the 200 mc cascode amplifier shown above, gave 12 db gain and only 2.5 db noise at 200 mc. Cross-modulation was less than one percent when a 1000 μ v, 200 mc signal and a 200,000 μ v, 150 mc signal were combined.

The new series, numbered 2N3821,

TI cannot assume any responsibility for any circuits shown or represent that they are free from patent infringement.

22 and 24, offers y_{fs} as high as 3000 min at 100 mc. Noise figure is typically 3 db at 10 cps. Gate leakage current is typically 10 pa, and maximum input capacitance is less than 6 pf. Other advantages include zero offset voltage (in chopper applications) and high input impedance.

We have just received a shipment of these new devices and can offer immediate delivery. Call us.

DEECO  **Inc.**

AUTHORIZED DISTRIBUTOR 

DISTRIBUTORS — SERVING INDUSTRIALS EXCLUSIVELY

618 FIRST STREET N. W. • CEDAR RAPIDS, IOWA • PHONE 365-7751

NEW
PARALLEL
DIGITAL

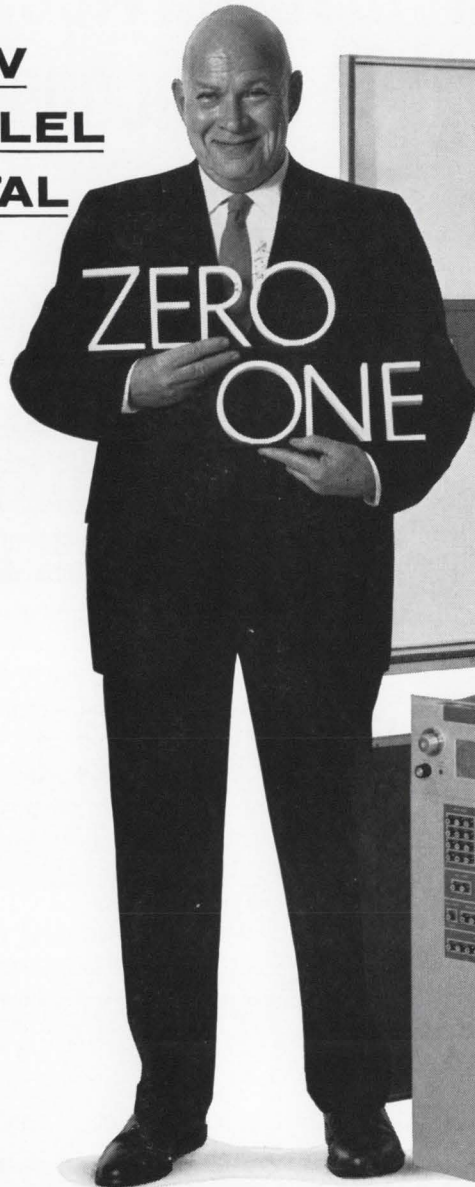

MINCOM'S PD-1000 PARALLEL PCM RECORDER

The cards are stacked in this newest Mincom system for telemetry's simplest, most advanced and most reliable digital data recording and playback. Standard packing rate of 1000 bpi, of course—plus new and compact solid-state advantages like the signal electronics pull-out housing illustrated above. Approximately seventy-three PCs of sixteen different types, according to your requirements, are



instantly front-accessible. Twelve PCM NRZI channels on one-inch tape with two NRZ time-code tracks, one audio track, and one clock pulse track, plus optional modifications. One read-head adjustment aligns all sixteen channels on the monitor scope, eliminating individual track adjustment. Seven push-button speeds, from $1\frac{7}{8}$ to 120 ips. Write today for details and complete specifications.

Mincom Division **3M**
COMPANY
300 South Lewis Road, Camarillo, California



EVERYONE KNOWS A DECENT TRIMMER COSTS MORE THAN A BUCK (EVERYONE BUT HELIPOT)

Here's a great new trimmer, the Model 62 Helitrim[®], with a foxy combination of fine performance and low price. Only 0.250 inches in diameter and 0.250 inches high,

it's one of the world's two smallest trimmers (both are from Helipot)!

Power rating is 1/2 watt at 70°C.

It's packaged in a sealed metal housing. And it has a Cermet element, which means essentially infinite resolution at resistance values from 10 ohms to 1 megohm.

Cunningly priced below a dollar in large quantity, single units start at \$1.75. Delivery details and other data are available from your local Helipot[®] sales rep.

Beckman[®] INSTRUMENTS, INC.
HELIPOT DIVISION
FULLERTON, CALIFORNIA • 92634

INTERNATIONAL SUBSIDIARIES: GENEVA, SWITZERLAND;
MUNICH, GERMANY; GLENROTHES, SCOTLAND; PARIS, FRANCE;
TOKYO, JAPAN; CAPE TOWN, SOUTH AFRICA.

Compact, long-life industrial controls

CLARE

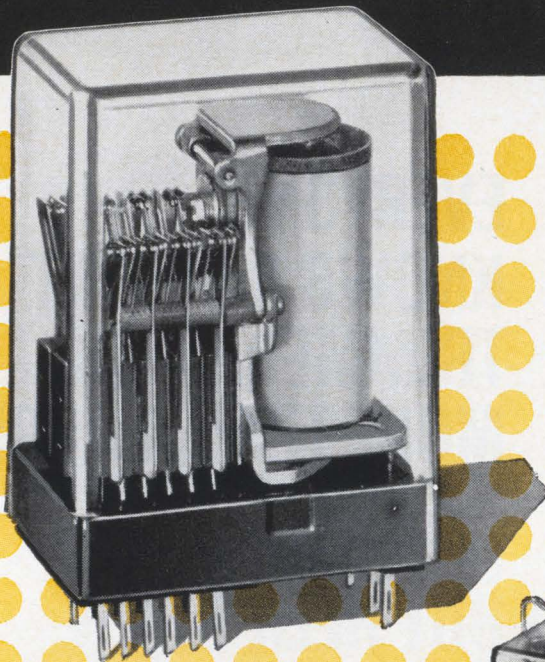

Type JDP Relay with mating socket for plug-in mounting

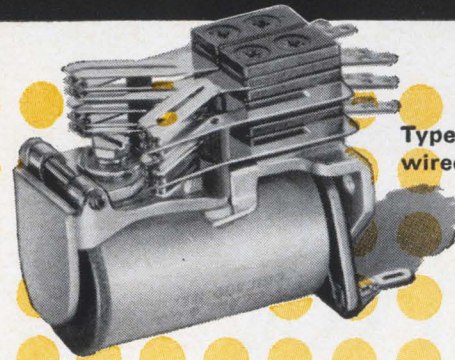

Type J Relay for wired assembly

Relays shown actual size

Type LBP with mating socket for plug-in mounting

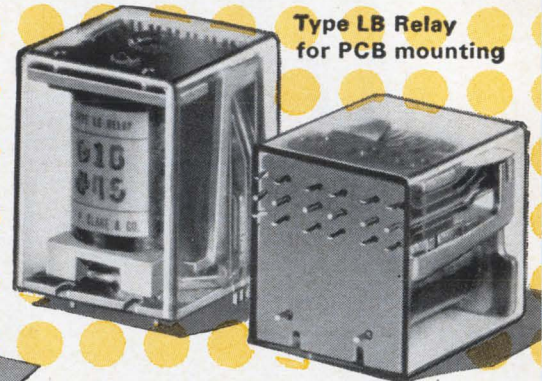
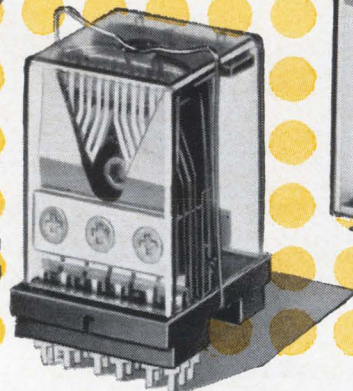

Type LB Relay for PCB mounting

for printed circuits, plug-in or wired assemblies!

■ Compact CLARE telephone type relays offer versatility of performance and flexibility of installation that meet the requirements of the widest variety of control designs.

■ Their stable operation and adjustment, together with consistently reliable performance, make them ideal components for applications where inches and ounces count. They have the same sturdy construction, large contact spring capacity, sensitivity and adaptability found in larger, more conventional relays of this type.

■ These features contribute to the reliable, long life operation of these relays: Independent twin contacts, enhancing contact reliability; Largest possible armature bearing surface, providing stable, adjustment-free operation; Extremely rigid heel-pieces, making fine adjustment practicable.

■ For commercial, industrial or military applications, CLARE telephone type relays solve a wide variety of switching problems.

TELEPHONE TYPE RELAYS

CLARE TYPE J RELAY

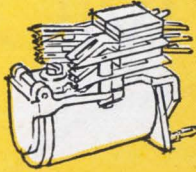

A general purpose relay whose consistent performance has been demonstrated in thousands of applications. It is available unenclosed, in dust covers, or hermetically sealed. Solder, taper-tab or direct plug-in terminals are provided for wired assembly mounting.



CLARE TYPE JDP RELAY

An assembly providing direct plug-in mounting of Type J Relay using contact springs and coil terminals as plug pins. This eliminates costly wiring and saves 20% in height over conventional octal plug relays. Clear plastic dust cover. Two socket sizes: 28 terminals for 24 contact springs; 16 terminals for 12 contact springs. Both with four coil terminals.

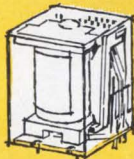

CLARE TYPE LB RELAY

Mounting height—
1.24 inch maximum.

A high quality, low cost relay which meets the demands of functional PCB applications where small size (1.33 cubic inches), versatile contact arrangements, wide range of contact load capacities, high contact reliability and direct PCB mounting is desired. Clear plastic dust cover. Phenolic bottom plate with tinned nickel-silver terminals.

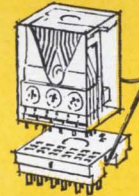

CLARE TYPE LBP RELAY

Mounting height: 1½ inches
for wired assembly;
1¼ inches for PCB.

A plug-in version of the Type LB Relay with the same operating and design characteristics. Clear plastic dust cover. Choice of two socket styles: (1) solder type terminals with elongated slots for wired assembly mounting, or (2) tab terminals for PCB mounting.

ELECTRICAL AND MECHANICAL CHARACTERISTICS OF TYPE J, JDP, LB, AND LBP RELAYS

| | Contact Arrangements | Contact Ratings | Coil Resistance | Nominal Operating Voltages | Operate Time | Release Time |
|------------------|---|----------------------------------|-------------------|---|--|---|
| Types J and JDP | Forms A, B, C, D, E with up to 24 contact springs max | Low level to 1000 watts, 10 amps | Up to 21,000 ohms | Up to 300 vdc Up to 220 vac 50-60 cps | Fast operate: 5 ms min Delayed operate: 60 ms max | Fast release: 5 ms min Delayed release: 125 ms max |
| Types LB and LBP | Forms A, B, C, D with up to 6 contact forms | Low level to 2 amps | Up to 6,550 ohms | Up to 100 vdc | 6 ms min | 2.5 ms min |

For complete information contact your nearest CLARE Sales Engineer

CALL— NEEDHAM (Mass.): (617) 444-4200 • GREAT NECK, L.I. (N.Y.): (516) 466-2100 • SYRACUSE: (315) 422-0347 • PHILADELPHIA: (215) 386-3385 • WASHINGTON: (202) 393-1337 • ORLANDO: (305) 424-9508 • CHICAGO: (312) 262-7700 • MINNEAPOLIS: (612) 824-7064 • CLEVELAND: (216) 221-9030 • XENIA (Ohio): (513) 426-5485 • CINCINNATI: (513) 891-3827 • MISSION (Kansas): (913) 722-2441 • DALLAS: (214) 741-4411 • HOUSTON: (713) 528-3811 • SEATTLE: (206) 725-9700 • SAN FRANCISCO: (415) 982-7932 • VAN NUYS (Cal.): (213) 787-2510 • TORONTO, CANADA: C. P. Clare Canada Ltd. • TOKYO, JAPAN: Westrex Co., Orient

write: Group 06N5
C. P. CLARE & CO.
3101 Pratt Boulevard
Chicago, Illinois 60645



relays and related control components

Measure TRANSISTOR PARAMETERS

500 KC to 250 MC

Features:

Handles most popular TO packages
Convenient plug-in test circuits

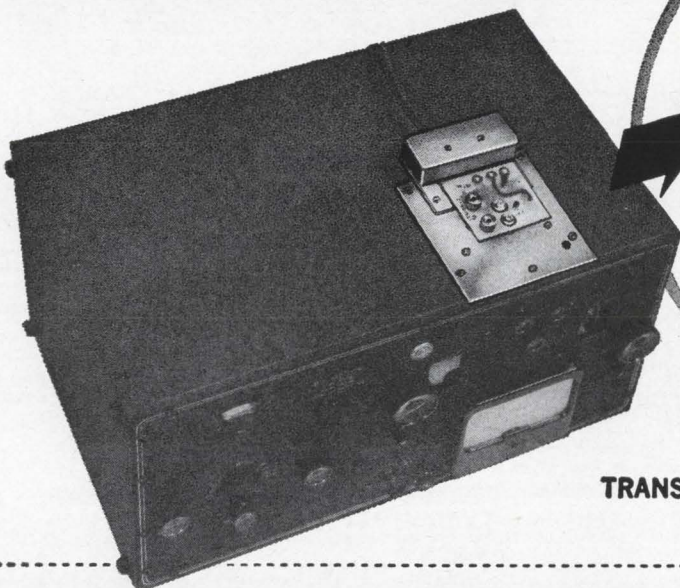

TRANSISTOR TEST JIG TYPE 13510A

The Transistor Test Jig, Type 13510A, is designed to provide a convenient means for measuring the Y parameters of transistors on the RX Meter, Type 250A, over the frequency range from 500 kc to 250 mc. The jig consists of four basic components: a Mounting Adapter and three separate plug-in test circuits for measuring Y_{11_b} , Y_{11_e} and Y_{22_e} .

The Mounting Adapter mounts conveniently on the RX Meter and includes bias feed and bypassing for an external power supply (hp 721-A). Each of the test circuits is constructed on a printed circuit board for maximum stability and repeatability. Residual reactances have been minimized, providing maximum measurement accuracy.

Specifications:

RF RANGE: 500 kc to 250 mc

TEST CIRCUITS: Provide for readout of R_p and C_p on RX Meter to yield Y_{11_b} , Y_{11_e} and Y_{22_e} .

$$\boxed{Y_{()} = \frac{1}{R_p} + j\omega C_p}$$

EXTERNAL BIAS RANGE:

50 ma. dc maximum
30 volts dc maximum

TRANSISTOR MOUNTING:

Accommodates TO-1, 5, 9, 11, 18, 23, 24, 39 and similar packages.

PRICE: 13510A: \$195.00

F.O.B. Rockaway, New Jersey

GREEN POND ROAD
ROCKAWAY, NEW JERSEY 07866
Telephone: (201) 627-6400
TWX: (510) 238-8461 Cable Address: BOONRACO

HEWLETT
PACKARD  BOONTON
DIVISION

FOR FASTEST

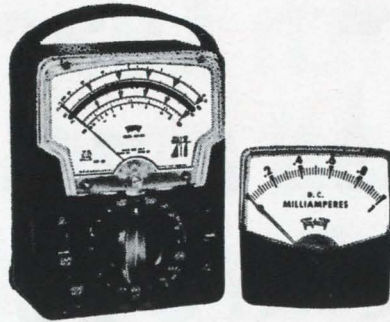

**Modification
Application Engineering
Prototypes
Small Quantity Orders
Maintenance
Repairs**



Call Your Local Sales / Service Modification Center

| | | |
|--|--|---------------------|
| Astoria, L. I., New York, 11103..... | A & M Instrument, Inc., 48-01 31st Ave..... | RAvenswood 6-4343 |
| Atlanta, Georgia, 30310..... | Electro-Tech, Inc., 690 Murphy Ave., S.W..... | 758-7205 |
| Cambridge, Massachusetts, 02138..... | Alvin S. Mancib Company, 363 Walden St..... | UNiversity 4-2494 |
| Charlotte, North Carolina, 28206..... | Electro-Tech, Inc., 3107 Cullman Ave..... | 333-0326 |
| Chicago, Illinois 60625..... | A & M Instrument, Inc., 4801 N. Ridgeway..... | 539-4460 |
| Chicago, Illinois, 60614..... | Meter Makers, Inc., 1101 W. Armitage Ave..... | LIncoln 9-5252 |
| Cleveland, Ohio, 44103..... | Pioneer Standard Electronics, 5403 Prospect Ave..... | 432-0010 |
| Cleveland, Ohio, 44135..... | Weschler Electric Co., 4250 W. 130th St..... | CLearwater 1-4609 |
| Dayton, Ohio, 45404..... | Pioneer Standard Electronics, Inc., Srepcu Electronics Div., 314 Leo St..... | 224-0871 |
| Englewood, New Jersey, 07457..... | Instrument Masters, Inc., (Subs. of A & M), 12 William St..... | 567-3756 |
| Ferndale, Michigan, 48220..... | Ram Meter, Inc., 1100 Hilton Rd..... | LIncoln 7-1000 |
| Glendale, California, 91201..... | J S D Engineering Co., 6915 San Fernando Rd..... | VIctoria 9-6187 |
| Honolulu, Hawaii, 96813..... | Hawaii Instrument Service, Dillingham Transportation Building Annex, 182 Halekauwaha St., Rm. 24..... | 566-787 |
| Houston, Texas, 77027..... | Nelson Electronic Labs, Inc., 4223 Richmond Ave..... | MOhawk 6-1914 |
| Los Angeles, California, 90017..... | Croft Electrical Laboratories, 1016 W. 8th St..... | MADison 6-6894 |
| Los Angeles, California, 90022..... | Metermaster/LA, Div. of Kierulff Electronics, Inc., 5645 E. Washington Blvd..... | 685-4340 |
| Minneapolis, Minnesota, 55404..... | Instrument Control Company, 2309 Snelling Ave..... | PArkway 1-5335 |
| New York, New York, 10011..... | Electro-Tech Equipment Co., 85 Tenth Ave..... | ORegon 5-2400 |
| Orlando, Florida, 32806..... | Electro-Tech, Inc., 307 27th St..... | GArden 3-5589 |
| Philadelphia, Pennsylvania, 19115..... | Sunshine Scientific Instrument, 1810 Grant Ave..... | ORchard 3-5600 |
| Phoenix, Arizona, 85016..... | Metercraft, Inc., 3308 N. 24th St..... | CR 9-6249 |
| Plano, Texas, 75074..... | Nelson Electronic Labs., Inc., 1717 Dallas Pkwy..... | AD 5-1217, 995-7553 |
| San Diego, California, 92111..... | Metermaster, Inc., 8139 Engineer Rd..... | 278-2200 |
| San Francisco, California, 94114..... | Schmidt Electronics, 3463 16th St..... | HE 1-1088 |
| Seattle, Washington, 98199..... | Instrument Laboratory, Inc., 934 Elliot Ave., West..... | ATwater 3-5850 |
| Shawnee Mission, Kansas, 66205..... | Sturtz Instrument Co., 4705 Mission Rd..... | 236-4705 |
| South Bend, Indiana, 46600..... | Radio Distributing Co., 1212 High St..... | 287-2911 |
| Weston, Ontario..... | Electro-Meters Co., Ltd., 184 Milvan Dr..... | 741-5972 |

TRIPLETT ELECTRICAL INSTRUMENT CO. - BOSTON, MASS.

Last month Leach introduced a new line of subminiature relays

{ so how come we haven't heard from you yet? }

We heard from 2476 other engineers but you weren't one of them — and the new series was designed for you.

You kept saying you wanted true subminiature relays for difficult aerospace and printed circuit applications. You bugged us about environment, packaging density, contamination, and like that. And then you said, the problem really revolves more around reliability than mere size and weight. A really new solution, you said, don't just put old reliable in the shrink tank.

OK — so we started from scratch — complete new design to assure highest technological development; electron beam welding to eliminate solder flux contamination; "balanced armature" design to deliver positive force to drive moving contacts; bifurcated contacts to increase contact pressure and reduce contact bounce and resistance; contacts and motor assembly welded right to the header to eliminate internal wiring; even Teflon to prevent outgassing. We went all the way, and still we haven't heard from you.

But it's not too late. If you act now you can still get a complete set of specifications on these new models, plus your own personal Subminiature Relay Design Kit. But don't delay. This offer expires sometime in the future.

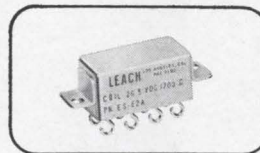

Series E

Dry circuit through 2 amps 2PDT all welded, half size, subminiature relay ideal for PC; 6 mounting and 3 terminal types; 6, 12, 26.5 VDC operation; 100-G shock, 30-G vibration; 0.28 ounce — MIL-R-5757

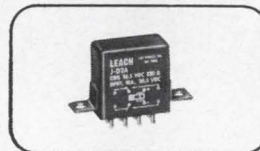

Series J

10 amp 2PDT all welded hermetically sealed subminiature relay; 6, 12, 26.5 VDC operation; 6 mounting and 4 terminal types; 100-G shock, 30-G vibration; 1.2 ounces — MIL-R-6106 also available as 115 VAC, 400 cps

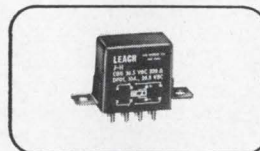

Series JH

10 amp polarized 2PDT all welded, special environment subminiature relay features increased contact pressure; 4 mounting and 3 terminal types; 500-G shock, 50-G vibration; 1.4 ounces — MIL-R-6106 also available as 115 VAC, 400 cps



Series KH

10 amp polarized 4PDT special environment subminiature relay four pole version of JH series; all other specifications identical



Series C-200

10 amp midjet 2PDT all welded subminiature relay; 6, 12, 26.5 VDC operation; 4 mounting and 3 terminal types; 50-G shock, 20-G vibration; 1.1 ounces — MIL-R-5757 also available as 115 VAC, 400 cps

LEACH

C O R P O R A T I O N

RELAY DIVISION: 5915 Avalon Boulevard, Los Angeles 3, California. Export: LEACH INTERNATIONAL, S.A.



Mix
& match.

From breadboard to prototype to production.

Sub-miniature coax, standard machined or formed strip contacts can be intermixed instantly in the same connector block.

You can begin wiring your breadboard or prototype with standard wire. If noise develops, just switch signal leads to sub-miniature coax without changing the connector block.

Here's a twist. You can also convert standard leads to twisted pair. In case we forgot to mention it, the sub-minia-

ture coax contacts take twisted pairs as well as coax cable.

And the formed contact is a big money saver in initial and installed costs. Throw in the automatic Burndy Hyfematic™ and crimp up to 3000 contacts per hour. Blocks available for 14 to 152 positions.

Now put it all together. Contact intermixing, economy, universality. Get in touch with Burndy for all the details. Hurry.

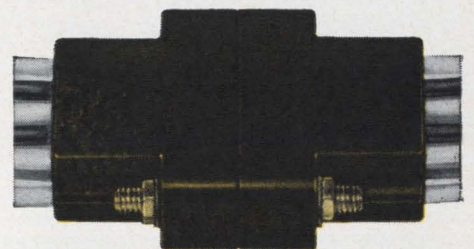

BURNDY

Norwalk  Connecticut

Circle 27 on reader service card

FROM GUDEBROD—A CONSULTANT'S REPORT

SURVEY of HARNESS
TYING OPERATION
for
YOUR COMPANY

Area Code 215 WA 2-1122 • TWX 215-560
ROS. SILK CO., INC.
FOUNDED IN 1870
Silks Division
PHILADELPHIA, PENNSYLVANIA

OFFICES •
NEW YORK, NEW YORK
25 West 34th Street, Area Code 212
BURBANK, CALIFORNIA
1836 Ontario Street, Area Code 818
PHILADELPHIA, PENNSYLVANIA 19464
TWX 215-560

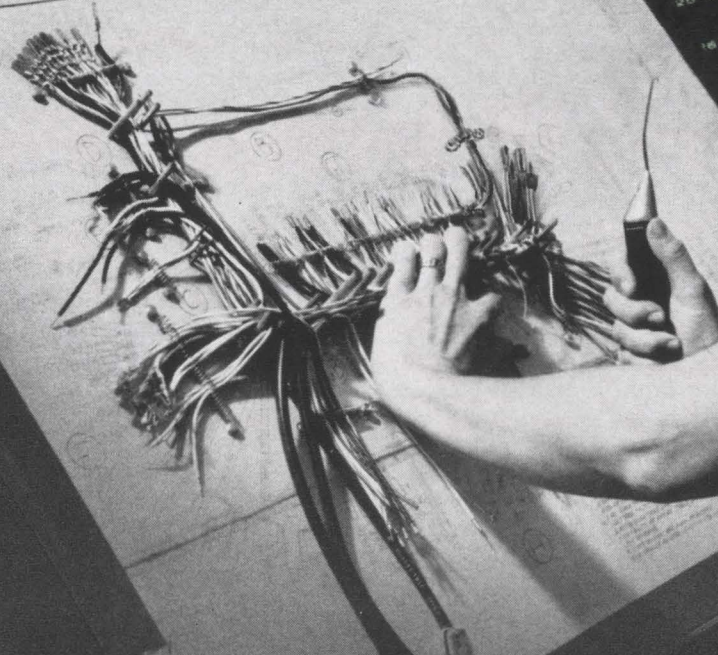

... so that you may improve your harnesses
... while you save money, too!

**GIVE YOUR HARNESS OPERATION
A FULL REVIEW ... with this
Gudebrod Survey (AT NO COST TO YOU, OF COURSE)**

"Improve" is the guide-word of the electronics field—but has your harness operation kept pace? If you could improve your harness product—and save money at the same time—wouldn't you be interested? Where do you go for help in achieving this desirable situation? To Gudebrod—there is no comparable source for such help in the industry. That's why management at the Gudebrod Electronic Division is offering to make a Consultant's Report on your harness department operation. With self-interest they believe that improving the state of the art in the industry will improve their own business atmosphere. So—why not take advantage of Gudebrod's wealth of tape engineering experience and knowledge—there is no cost or obligation attached to it!

STANDARDS

To improve your standards specifications, Gudebrod can suggest tapes for high or low temperature use, for fungistatic qualities, for burnproof features, for vacuum use, as well as for material specifications and for tensile strength. The more than 200 types of flat tape in the Gudebrod line are specially designed, not only to meet various specifications but to facilitate the tying operation. Production quantities of tape especially for your use can be made if necessary. With this intimate knowledge of lacing tape, the recommendations contained in the Gudebrod Consultant's Report will help your Standards Engineer—to improve your product and to save money.

METHODS

In designing lacing tapes to meet various specifications, the Gudebrod research and de-

velopment operations have kept in mind the basic idea of producing tapes that "tie themselves." The originator of the flat braided tape which did so much to improve wire harnessing and at the same time tremendously increase the safety factor for workers, Gudebrod continues to pioneer in the use of better materials, and in a closer regard for specifications. Taking advantage of the "tie-ability" of Gudebrod tapes is important to your Methods Engineer. The recommendations contained in the Gudebrod Consultant's Report will help your Methods Engineer to improve your product and save money.

PRODUCTION

Implementing the requirements of the Specifications and Methods Engineers in economical operation is the problem of the Production Engineer. Gudebrod can show how to use the Cable-Lacer, how to take advantage of dispensing packages, cut lengths, special rigs and other labor speeding and easing means. Whether your harness work is custom or production there are ways of improving your operations that may not have occurred to you—that's why the recommendations contained in the Gudebrod Consultant's Report will help your Production Engineer—in improving your product—in saving money.

SURVEY AND CONSULTANT'S REPORT —FREE

Here is all you have to do—write or phone Gudebrod. At your convenience a Gudebrod representative will complete a survey working with your Standards, Methods and Production Engineers. This will be reviewed by engineers at the Gudebrod Home Office. Written recommendations will be prepared and sent to you. There will be absolutely no cost or obligation. Why not get your Consultant's Report under way—get in touch with Gudebrod today.



GUDEBROD BROS. SILK CO., INC.

FOUNDED IN 1870



Electronics Division

12 SOUTH 12th STREET, PHILADELPHIA, PENNSYLVANIA 19107

Area Code 215, WA 2-1122

Circle 29 on reader service card

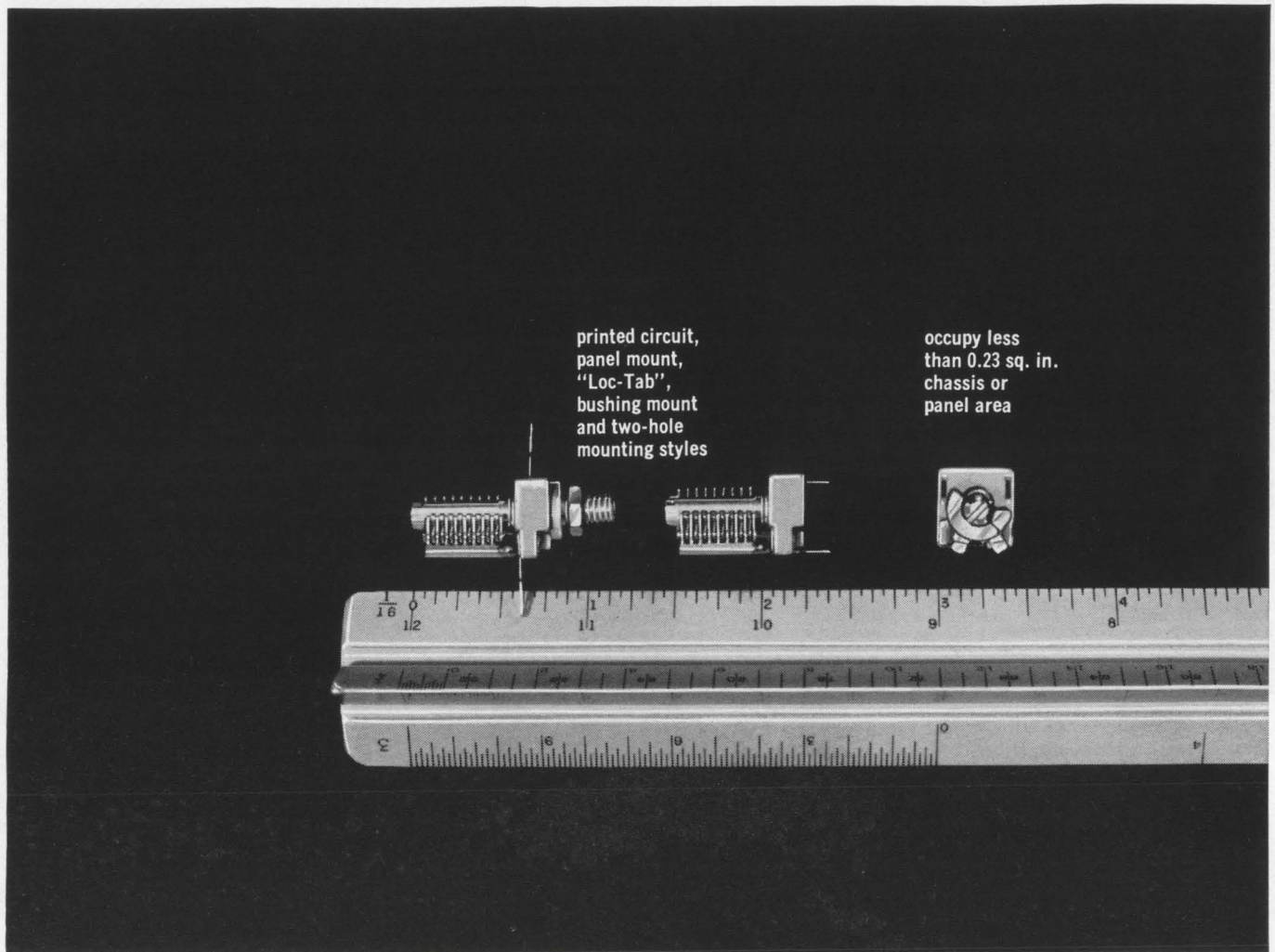

printed circuit,
panel mount,
"Loc-Tab",
bushing mount
and two-hole
mounting styles

occupy less
than 0.23 sq. in.
chassis or
panel area

THESE TINY AIR VARIABLES SOLVE BIG DESIGN PROBLEMS!

Cut costs—improve performance—and save valuable space with these tiny sub-miniature air variable capacitors! "U" requires less than 0.2 square inch for chassis or panel mounting . . . types "UA" and "UB" require less than 0.23 square inch! Unique precision design with stators and rotors machined from one piece of solid brass, provides outstanding mechanical stability and uniformity. High "Q"—greater than 1500 at 1 Mc. High torque-to-mass ratio— $2\frac{1}{2}$ to 10 inch-ounces. Exceptionally low temperature coefficient—plus 45 ± 15 PPM/°C. Provides absolute freedom from moisture entrapment found in trimmer capacitors of the enclosed or solid dielectric type. All metal parts silver-plated. Ceramic is Grade L-423 steatite, or better. Exceptionally uniform delta C and voltage characteristics. Choice of wide, double-pierced or printed circuit style terminals. Single-section models available in "Loc-Tab"; 2-Hole; Printed Circuit; and #10-32 Bushing Mount Types—Differential and Butterfly models available in Printed Circuit Types.

TYPE "V" MINIATURES—Slightly larger than the Type "U" series, the "V" miniatures offer all of the design, construction and performance features of the "U"s plus higher capacity with little increase in mounting area requirement. Available in Single Section types for printed circuit or panel mounting.

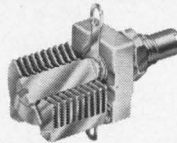

"U-LC" TUNERS—Combines precision machined Type "U" capacitor with air-wound, silver-plated inductor. Offers low cost, compact tuneable L-C circuit with excellent "Q" and temperature stability!



DETAILED CATALOG AVAILABLE—In addition to the variable capacitors described above, Johnson also manufactures other electronic components. For complete specifications and current prices, write for Components Catalog 984.



E. F. JOHNSON COMPANY
3332 TENTH AVE. S.W. • WASECA, MINNESOTA 56093



Take the 5894 out of the Amperex line of twin tetrodes and what have you got...

what have you got?

You've got the best developed, best manufactured, best proven line of indirectly-heated push-pull tetrodes in the world!

You've got the kind of tube quality, uniformity and applications assistance that only the oldest and biggest producer of vehicular communications types can offer!

You've even got new tetrodes on the way that'll revolutionize your design thinking as completely as the 5894 already has.

So you've got everything except the

5894. Isn't it lucky you can get that from Amperex, too.

But come to think of it you always could. We developed the 5894 in the first place, you know.

To get the word on Amperex Indirectly-Heated Twin-Tetrodes for your special vehicular communications application, wire or write:

Amperex Electronic Corporation, Tube Division, Hicksville, L. I., N. Y. 11802.

TYPICAL OPERATING CONDITION

| Tube Type | Freq. (Mc.) | Approx. Drive Power (Watts) | Approx. Load Power (Watts) | Approx. Output (Watts) |
|-----------|-------------|-----------------------------|----------------------------|------------------------|
| 5894..... | 250..... | 6..... | 96 | |
| | 470..... | 3..... | 33 | |
| 6252..... | 200..... | 2..... | 67 | |
| 6360..... | 175..... | 1.0..... | 16 | |
| 6907..... | 470..... | 3.0..... | 24 | |
| 6939..... | 470..... | 1.2..... | 6.0 | |
| 7377..... | 470..... | 1.4..... | 12.5 | |
| | 960..... | 1.5..... | 5.0 | |
| 7854..... | 175..... | 3.5..... | 163 | |
| 8458..... | 175..... | 1.2..... | 30 | |

Circle 31 on reader service card

Amperex®

IN CANADA: PHILIPS ELECTRON DEVICES, LTD., TORONTO 17, ONTARIO.

Is your line going critical?

New Radiation Digital Distortion Monitor offers visual readout, operates automatically!

Why pay \$4,000 or more for a digital *analyzer*, when you need a distortion *monitor*? Radiation's new Model 7525 is specifically designed to measure distortion on telegraph lines and data links. It costs only \$1,195, yet offers unique operational features which were previously unavailable!

This solid state unit is engineered for simplicity of operation, and may be used for 24-hour unattended surveillance of lines if desired. Numerical readout of peak distortion is indicated with an accuracy of $\pm 2\%$. Speed, display time, and distortion levels from 0 to 50% are all selected from the front panel. Another feature is its alarm output, which actuates recording or counting equipment when distortion levels reach a pre-selected point.

Model 7525 is supplied with standard speeds of 45.5, 50, 55.6, 75 and 150 bauds. However, any speed from 0 to 4,800 bits can be added at any time by using Radiation plug-in crystals. The unit requires only 3.5" of vertical rack or panel space, and weighs only 14 pounds.

Radiation Model 7525 Digital Distortion Monitor may be used alone or in conjunction with other equipment such as the Model 7210 Automatic 10-Line Scanner. Write for details. Radiation Incorporated, Products Division, Department EL-06, Melbourne, Florida. Phone: (305) 723-1511.



RADIATION
INCORPORATED



a whole Blooming Family

of MIXERS and MIXER PREAMPS

From 125 Mc to 40 Gc

Look how LEL's stock of tested field-proven mixers and mixer-preamps has grown...1721 different standard units

ready for use in your radar, guidance, countermeasures or communications systems.

Talk about doing the job...how's this for just one example. It's our series XFO-9 operating from 8.0 to 12.4 Gc. Units with 160 mc IF and 50 mc passband have typical noise figure of 10.5 db, L.O. to R.F. isolation of 15 db minimum and 23 db gain. Standard models are available with various center frequencies and output impedances. Units with special characteristics can be quickly delivered to meet your specific requirements.

Now get all the facts from LEL, world's largest manufacturer of mixer-preamps. Send for full information today.



75 AKRON STREET COPIAGUE, L. I., NEW YORK 11726

(516) Amityville 4-2000 / (516) PYramid 9-8200 / TWX Code 516-691-5085

CEC's VR-3600 establishes new record for head life

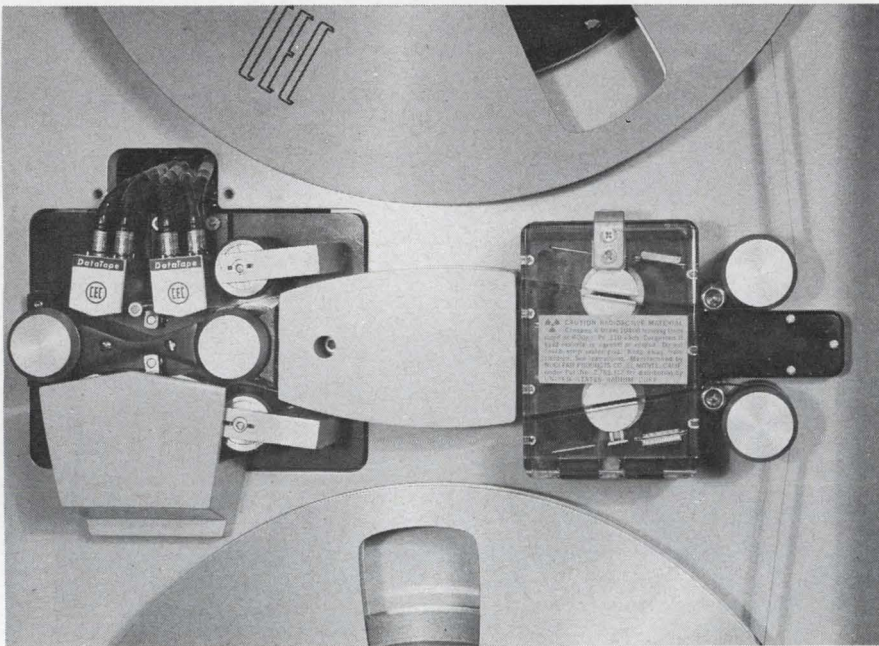

It is not news that the VR-3600 is the most advanced of all magnetic tape recorder/reproducers. This has been proved in countless telemetry and laboratory applications. But what *is* news, is the remarkable durability of the instrument's recording heads.

All reports have shown that CEC's head life guarantee of 1000 hours is not only realistic but very conservative, since in virtually every case the new recording heads have surpassed this figure with little sign of wear. Compare the 1000 hour achievement with the performance of the VR-3600's closest competitor, and the savings to the user become significant indeed.

Reason behind the performance: these CEC recording heads are of a unique material and solid metal pole-tip design which completely eliminates the weaknesses of conventional head lamination or other solid-tip designs.

Result: a head that both provides superior performance at frequencies to 1.5 mc and reduces head wear and cleaning to a minimum.

Other advantages of the VR-3600 include...

- 1** **Bandwidth switchability.** With a mere flick of a switch, the operator may instantly change from wideband to narrow band, and back again — thus *doubling* the unit's capability with *no change* of components required. (On special order.)
- 2** **Constant flux recording** for assured machine-to-machine compatibility at all frequencies and tape speeds (with IRIG standards).
- 3** **Six speed switchable video FM—** d-c to 500 kc.
- 4** **Single source responsibility.** All components are designed and manufactured by CEC...including the video FM!

Important features:

- ☐ Pushbutton selection of *six* transport speeds along with associated electronics.
- ☐ Each of the VR-3600's 7 or 14 record/reproduce channels can be used for data storage in the 400 cps to 1.5 mc or d-c to 500 kc frequency range.

- ☐ Automatic end-of-reel sensing stops tape without leaders; transfer switch provides start command for nearby recorder and 30 second overlap of recorded data between machines—at no extra cost.

- ☐ IRIG or 18.24 kc AM servo system or time expansion/contraction servo system using common assemblies mean low cost for any version or combination of servo systems.

- ☐ Tape is constantly cleaned by optional vacuum/ionization; tension controlled, in all modes, by closed-loop servo control.

- ☐ Individual plug-in equalizers (6 per amplifier) meet all specifications simultaneously. Buy only those required, then set and forget.

- ☐ Record and reproduce amplifiers are solid state; the direct system fully amplitude- and phase-equalized.

- ☐ Tape transport skew is less than 0.5 μ sec; complete cumulative flutter less than 0.30% p-p at 120 ips.

- ☐ The system may be supplied in single or dual rack configurations, with or without a dolly.

For all the facts about the VR-3600, call CEC or write for Bulletin 3600-X14.

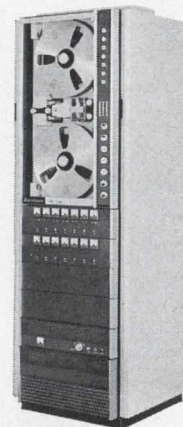

CEC
Data Recorders Division

**CONSOLIDATED
ELECTRODYNAMICS**

A SUBSIDIARY OF BELL & HOWELL/PASADENA, CALIF. 91109
INTERNATIONAL SUBSIDIARIES: WOKING, SURREY, ENGLAND
AND FRIEDBERG (HESSON), W. GERMANY

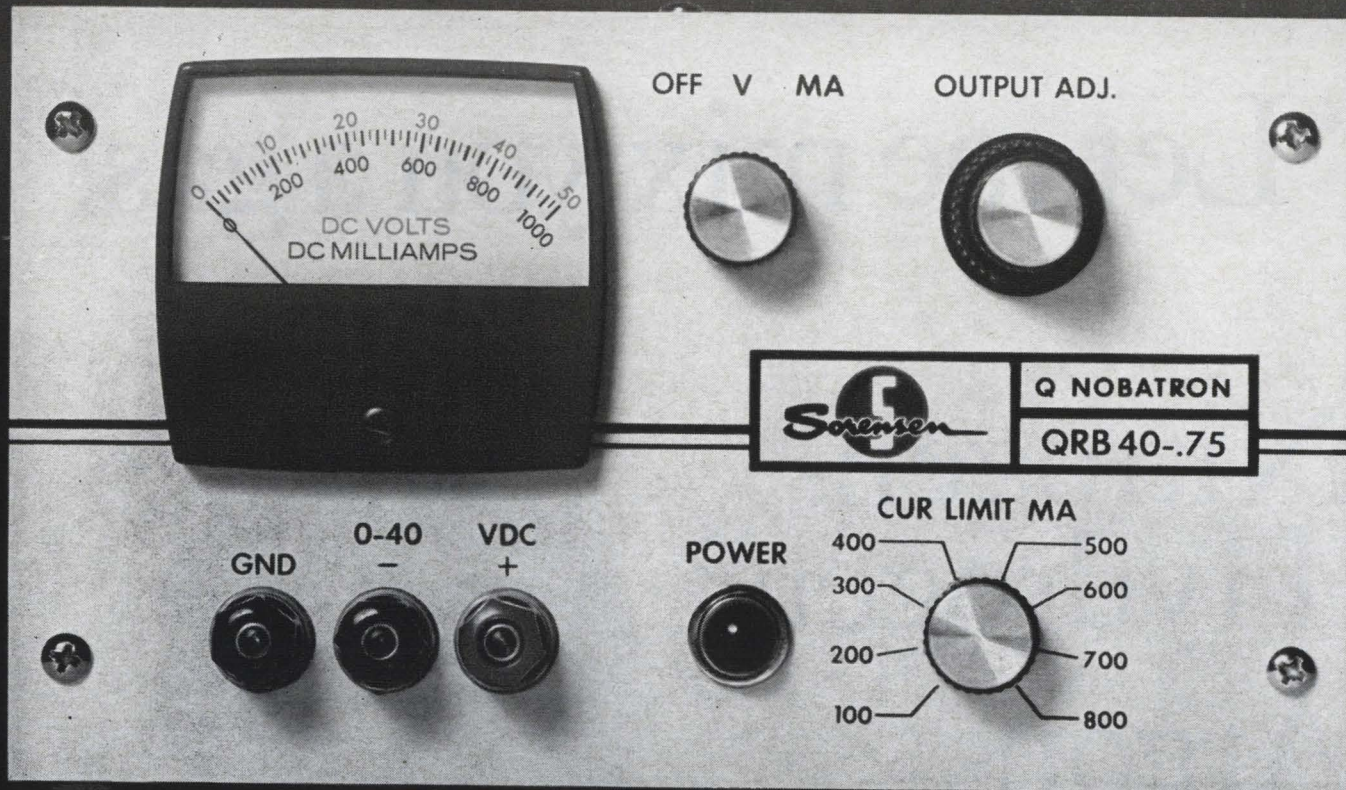

power supply close-up:

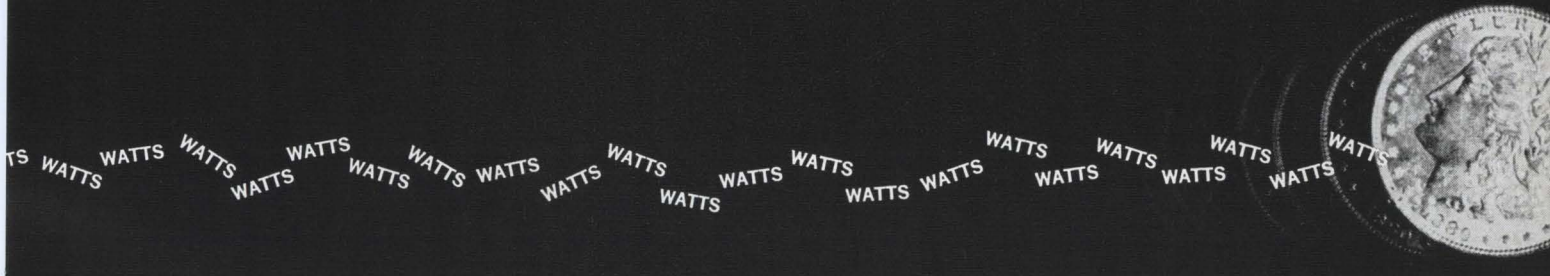

more watts per dollar

Check the specs and the price (\$145) and you will find: Sorensen's new QRB40-.75 "ranger" delivers 1½ times the watts per dollar of most competitive power supplies... with no stinting on performance.

CONSTANT CURRENT... Unit can be externally converted to a highly regulated (0.15%) constant current supply.

CURRENT LIMITING... Provides automatic protection against short circuit or overload. Also acts to provide automatic transfer from the normal constant voltage mode to a constant current mode whenever the load demands more current than the limiter has been set to supply.

RESOLUTION... Output can be finely adjusted to 4mv on the 40-volt model; 3mv on the 30-volt model; and 2mv on the 20-volt and 15-volt models. **OTHER QRB FEATURES** include programmability, series/parallel operation, and remote sensing.

For complete data on the QRB series and other Sorensen products send for the new, 140-page "Controlled Power Catalog and Handbook." Write Sorensen, Richards Avenue, South Norwalk, Connecticut. Or use reader service card number **200**.

ELECTRICAL & MECHANICAL SPECIFICATIONS

| MODEL NUMBER | OUTPUT VOLTAGE RANGE (VDC) | OUTPUT CURRENT (AMPS.) | % REG. (LINE & LOAD COMB.) | RMS RIPPLE (MICROSEC.) | RESP. TIME | TEMP. COEF. (%/°C.) | CABINET SIZE | | | RACK PANEL INCHES HEIGHT | WEIGHT (LBS.) |
|--------------|----------------------------|------------------------|----------------------------|------------------------|------------|---------------------|--------------|--------|-------|--------------------------|---------------|
| | | | | | | | WIDTH | HEIGHT | DEPTH | | |
| QRB15-2 | 0-15 | 0-2 | ±(0.01% + 1mv) | 0.15mv | 50 | ±0.015 | 8¼ | 5½ | 9 | 5¼ | 10.75 |
| QRB20-1.5 | 0-20 | 0-1.5 | ±(0.01% + 1mv) | 0.15mv | 50 | ±0.015 | 8¼ | 5½ | 9 | 5¼ | 10.75 |
| QRB30-1 | 0-30 | 0-1 | ±(0.01% + 1mv) | 0.15mv | 50 | ±0.015 | 8¼ | 5½ | 9 | 5¼ | 10.75 |
| QRB40-.75 | 0-40 | 0-.75 | ±(0.01% + 1mv) | 0.15mv | 50 | ±0.015 | 8¼ | 5½ | 9 | 5¼ | 10.75 |



A UNIT OF RAYTHEON COMPANY

Circle 35 on reader service card

“Let me mix you a gas!”

Nitrogen- Hydrogen?

Argon- Helium?

Argon- Carbon Dioxide?

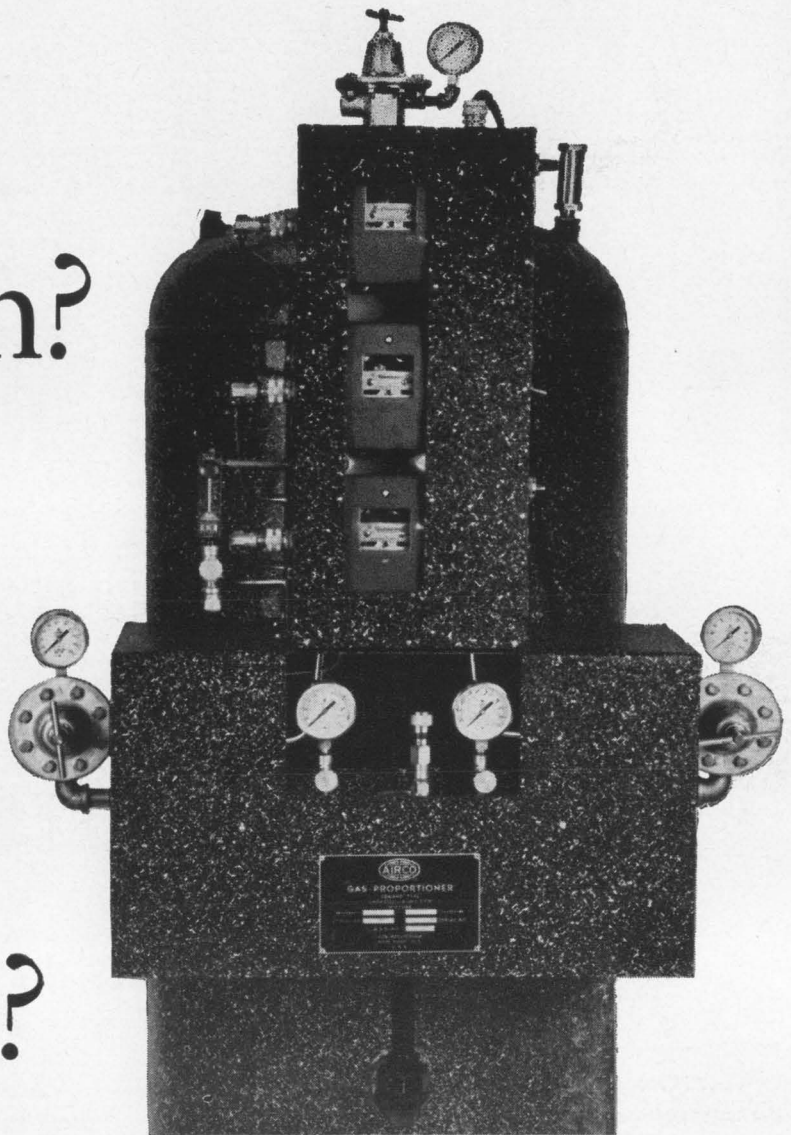

You're looking at a new Airco gas proportioner, one of the most versatile units manufactured today. It meters, mixes, and delivers the gases you order, in any ratio from 50:50 up to 100:0 with pinpoint accuracy. Whether you select Airco's 1000 CFH variable, or 6000 CFH fixed proportioner, you're always assured of precise gas mixture.

With the 1000 CFH unit, only one proportioner is required for any ratio of gas mixtures. Multiple-control consoles can be interconnected to produce complex gas mixtures.

The 6000 CFH unit is designed to mix two

gases to your specification and is factory calibrated and the ratio is preset to assure continuous delivery of your mixture into your shop pipeline. After the proportioner is placed into operation, accuracy of the required mixture is assured by precision-designed and machined metering orifices.

These proportioners can be interconnected to increase the CFH output. For further information on design features, installation and operation, get your copy of our new booklet on demand-type gas proportioners. Contact your local Airco office or Authorized Airco Distributor.



AIRCO WELDING PRODUCTS

A DIVISION OF AIR REDUCTION COMPANY, INC.
150 EAST 42ND STREET, NEW YORK, N.Y. 10017



NOW...A QUALITY EDGE BOARD CONNECTOR THAT COSTS LESS THAN 90¢

MEET OUR NEW 8 BALL SERIES! 100 of these 12 position, 24 contact connectors sell for only 89¢ each. That's why we call it the 8 Ball Series. It gets you out from behind high costs, gives you a quality product at one-half the former price. Put that in your side pocket and you've got military-type performance at commercial prices.

These newly designed connectors have bifurcated contacts plated gold over tin-nickel for high conductivity and durability. The dielectric is a high temperature, moisture-resistant phenolic which meets MIL M-14, type MFG. These 8 Ballers will maintain minimum contact resistance even during vibration. They're offered in 6, 10, 12, 15, 18, 22, 28 and 30 contact pairs with 4 termination types: for #53 taper pins, for dip soldering, 90° for dip soldering, and solder terminal. Accom-

modate printed circuit boards from .054 to .071 in thickness. Here is high quality, rugged reliability for 1/16" double or single sided boards at the lowest cost ever.

Prompt delivery and engineering assistance by factory trained sales engineers are assured through a nationwide network of distributors and regional offices in 17 major cities.

For complete specifications on the 8 Ball Series and the Winchester line, ask for the 1965 Handbook of Standard Connectors. Write: Main Street and Hillside Avenue, Oakville, Connecticut, U.S.A. In Europe: N.V. Litton Benelux, S.A., 16 Rue du Musee, Brussels 1, Belgium.



WINCHESTER ELECTRONICS
DIVISION OF LITTON INDUSTRIES

Here is the D52

It is the best scope you can buy

\$495.

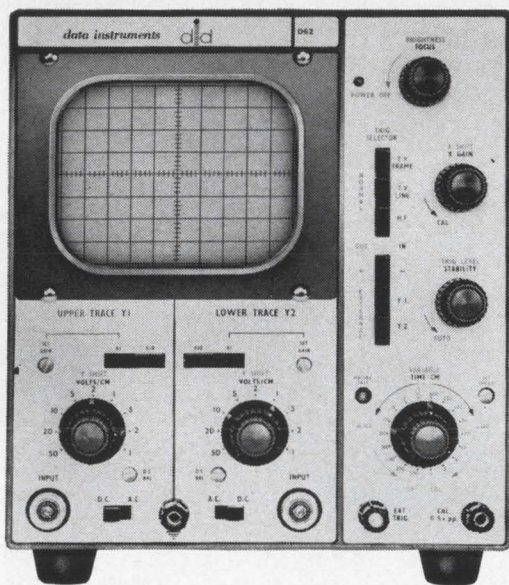

We have to qualify that statement, of course. But not very much. Within its range of application no dual beam scope will perform better or more reliably than Data Instruments D52. Consider the features: A five inch precision flat face CRT with an illuminated graticule. Built-in critically damped amplifiers for accurate response. Frequency compensated attenuators and an extremely linear time base with trigger level and stability controls. A full year warranty and complete field and factory service. Look at the specs:

data instruments



| VERTICAL AMPLIFIER | | | | |
|-----------------------------------|--------------------------|---------------|--------------------|--|
| BANDWIDTH | SENSITIVITY/cm | RISETIME | IMPEDANCE | ACCURACY |
| (1) DC-6mc | 100mv to 50V | .06 μ sec | 1M Ω + 30pf | \pm 5% |
| (2) DC-300kc | 10mv to 5V | | | |
| TIME BASE | | CRT | | PHYSICAL |
| SPEED/cm | TRIGGER & HOR. AMP | DIA. | PHOSPHOR | VOLTS |
| 1 μ s to 0.5 sec. \pm 5% | Exp. x 10 10cps-400kc | 5" | P1-P7 dual beam | 3.6kv |
| | | | | DIM. & WT. 15"x9 $\frac{1}{4}$ "x8 $\frac{1}{2}$ " 24 lbs. |

The S52, with matched X and Y Amplifiers is also available at \$575

Better still, use it. Drop us a note and we'll arrange a demonstration in your plant. You'll agree, that within its range the D52 is the best scope you can buy. And at \$495 you can buy it.

Data Instruments Div. • 7300 Crescent Blvd. • Pennsauken, N.J.

Electronics Review

Space electronics

The little computer that didn't

"Busy little computer. Handy thing to have aboard when you are traveling over 17,000 miles an hour," said the International Business Machines Corp. advertisement that appeared in several newspapers the morning before Gemini 4 splashed down successfully in the Atlantic. Handy it was—but only for the first three-quarters of its 97-hour, 58-minute mission in space. On Sunday, the day before reentry, the 59-pound, hatbox-sized computer wasn't busy any more. It quit guiding the astronauts through their complex maneuvers when a little light went on, indicating a malfunction in the computer or in associated circuitry.

The astronauts, Maj. James A. McDivitt and Maj. Edward H. White 2nd, still landed safely, only 40 miles short of the planned spot. Actual splashdown was 390 miles east of Cape Kennedy and 230 miles north of San Salvador island. The reentry path was plotted by the National Aeronautics and Space Administration's Manned Spacecraft Center in Houston, which was directing an orbital flight for the first time.

Ironically, in the earlier Gemini flight of Virgil I. Grissom and John W. Young, the computer worked perfectly; but during reentry, the astronauts received data from ground control that conflicted with that produced by the on-board instrument. They assumed that the midget instrument was wrong, used the data from ground—and steered into a reentry path that ended 58 miles short of the target area.

Because of severe space limitations, the Gemini computer was designed without redundant circuits [Electronics, May 3, p. 71].

Successful mission. In most respects, the second Gemini was A-OK. On Thursday, the first day, the cabin was depressurized and White slipped through one of the hatches into space. There he floated for about 20 minutes, maneuvering with an oxygen-powered, hand-held rocket gun. His space walk—twice as long as Cosmonaut Aleksei Leonov's in March—elated space officials and the public. Even the Russians congratulated White on his brief experience as a satellite.

Gemini 4 performed several experiments that may affect the design of future spacecraft. It may take several days, however, before full details on the experiments are released.

In one test, a sensor on the skin of the craft measured the electro-

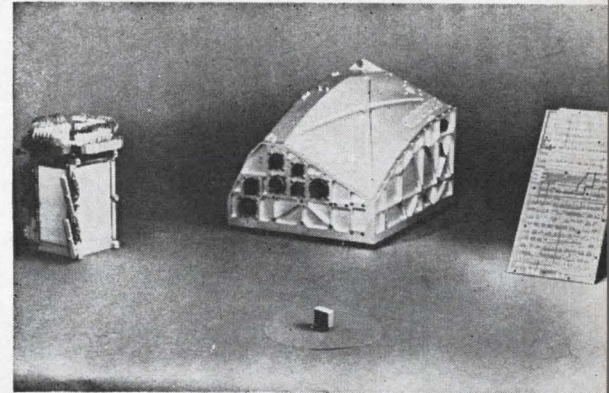

Gemini computer (center) shown with its memory element (left). In foreground is example of microcircuit used; these are interconnected with printed wiring plane similar to that shown at right.

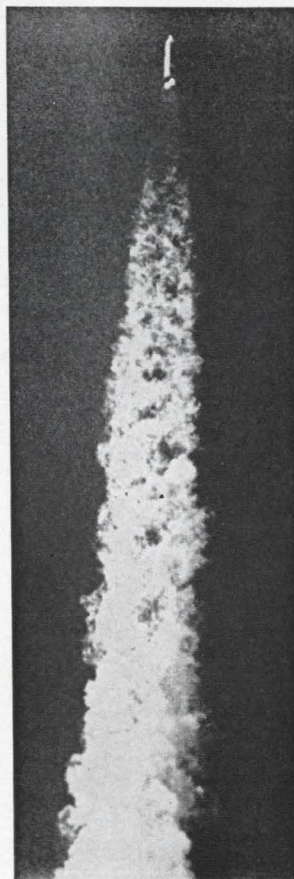

Gemini-Titan 4 blasts off on four day mission.

static charge that builds up as the ship rockets through the atmosphere during launch. A vibrating, disk-shaped sensor was extended from the retro adapter section of the ship during orbit to make the measurement. NASA believes that no more than one volt builds up on the skin of the ship; but it wants to be sure before it attempts docking between a Gemini capsule and an Agena rocket stage. If a high potential were present, space officials fear, an arc could ignite the fuel remaining in Gemini.

Radiation shield. In another experiment, designed primarily to improve the radiation shielding for future craft, a spectrometer measured the frequency and energy level of protons and electrons that struck the ship. The spectrometer was used in conjunction with a magnetometer that measured the various levels of the earth's magnetic field as the craft orbited the earth.

The United States' first attempt at rendezvous in space was a failure. The launch vehicle went into a slightly different orbit soon after the capsule separated from it, and the astronauts had to quit trying to "catch up" with the rocket when

it became apparent that they were using too much fuel. In the next Gemini launch, in mid-August, NASA will attempt a rendezvous with the rocket stage—but this time with the help of radar. And in October, during a two-day mission, astronauts will try to dock with an Agena rocket stage.

Manufacturing

IC transistor islands

A couple of new processing tricks and a couple of known ones have been combined by International Business Machines Corp. scientists into a new way of isolating the transistors of integrated circuits and improving performance at high frequencies.

IBM says its methods sharpen the impurity gradients between the layers of silicon in transistors and reduce the collector resistance, isolation capacitance and current leakage. To a large extent, these factors determine how effectively a monolithic circuit can operate at very high switching speeds.

Forming an island. Isolation is needed in integrated circuits for electrical separation of the circuit components. Usually, separation is achieved by diffusing impurities into the silicon crystal, forming "islands" in which the components are then formed by further diffusions. A high-speed transistor is

generally made by diffusing an n^+ buried layer into a substrate of p silicon, epitaxially growing an n layer on the substrate, isolating the n region by a p diffusion forming the collector and then diffusing a p base and an n emitter.

IBM's processes are primarily concerned with forming and isolating the first two layers, by methods which do not require diffusion of a p-n junction. The n-n junctions are formed by epitaxial growth of an n-layer on top of a p layer, or they are eliminated. The methods were described last month at the Electrochemical Society meeting in San Francisco by V. Y. Doo, D. K. Seto and R. E. Jones of IBM's Systems Development division, Poughkeepsie, N. Y.

Grown junctions: One basic non-diffusion method of isolation is a process that IBM calls etch regrowth. It is similar to the mask-epitaxy process that was recently developed in Japan by the Tokyo Shibaura Electric Co. [Electronics, April 5, p. 185], and has similar advantages.

IBM says that etch-regrowth isolation is a simpler, less expensive process than diffusion isolation. To date, at least, integrated-circuit manufacturers have generally agreed that diffusion is the simplest way.

IBM forms p barriers out of the silicon substrate. The substrate is oxidized, windows are etched in the oxide and the exposed p silicon is etched. The holes are then filled with n material that is grown epi-

taxially. This provides the type of islands illustrated in sketch A below.

Dielectric isolation. The second process, dielectric isolation, has already been used by several other companies [Electronics, April 6, 1964, p. 23, and June 1, 1964, p. 23]. Channels are etched in the n material and are oxidized and filled with polycrystalline silicon. Then the n material is lapped away until only islands, surrounded by insulating moats, remain.

Usually, the moats are formed after the epitaxial layer is grown. IBM grows the n layer afterwards, by the etch-regrowth method. This means that the junction between the n^+ and n layers is not disturbed by the high-temperature processing required to form the moats. Also, virgin n material is grown in the islands. Other integrated-circuit manufacturers have complained in the past that lapping down the n-type silicon is a messy process, hard to control.

Sketch B illustrates the type of islands IBM gets.

Isolation combination. Sketches C and D illustrate a composite of dielectric and junction isolation. The islands are formed by diffusing p^+ guard rings into the p-substrate, growing n and n^+ layers in oxide windows, and depositing polycrystalline silicon atop the remaining oxide, to form the structure seen in sketch C. Then the excess polycrystalline silicon is removed, leaving the islands seen in sketch D.

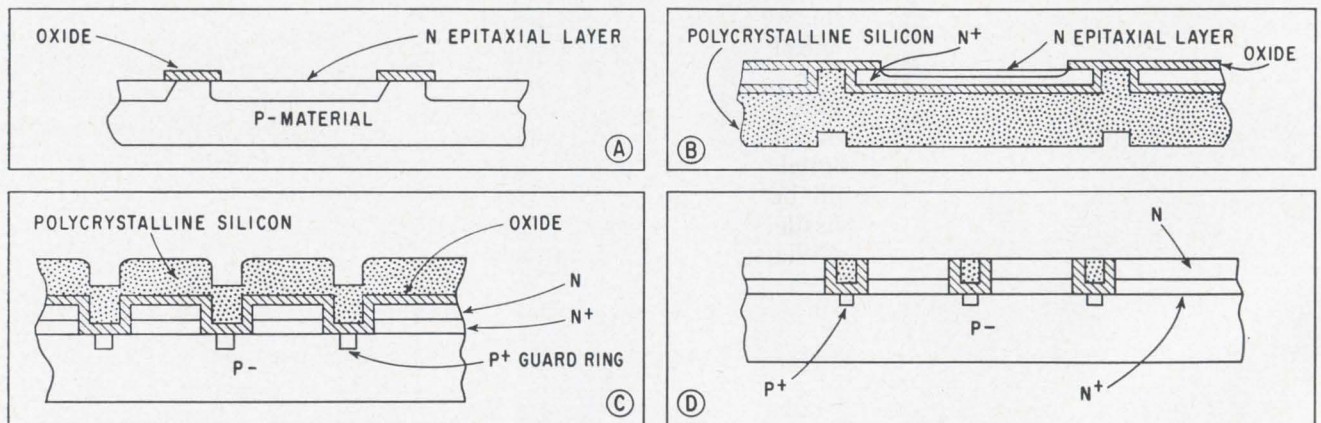

Three routes to the transistor islands: Sketch A illustrates etch regrowth; B shows dielectric isolation and etch regrowth; C and D show dielectric-junction isolation before and after the excess polycrystalline silicon is removed.

Military

Sick Phoenix

Phoenix, the long-range air-to-air missile that's being designed for the F-111B, the Navy version of the TFX, appears to be getting embroiled in as much controversy as the fighter plane itself. Already a year behind schedule, and with development costs skyrocketing, the missile faces new delays that may keep it grounded for a couple of years.

Late last month, the Hughes Aircraft Co., prime contractor for the top-secret missile, apparently convinced the Navy that Litton Industries, Inc., wasn't performing adequately on the job of developing the computer—the heart of the complex guidance systems. Hughes is understood to be phasing Litton out of the project.

"There have been many problems with the computer. It will be necessary to rebuild or redesign (it) . . .," disclosed Robert Morse, Assistance Secretary of the Navy for Research and Development, in recently released and partially censored testimony before the House Defense Appropriations subcommittee.

What this will mean to the overall project is still unclear. It isn't even known at this time whether Hughes will undertake development of the high-speed digital computer itself or farm the project out to another subcontractor. However, Hughes is understood to be negotiating with two computer builders—the Univac division of the Sperry Rand Corp. and the Control Data Corp. It's understood that the prototype computers that Litton produced were far too bulky for the already overweight F-111B.

Eye on the Sparrow. The Navy is hedging its bet on the Phoenix. Although the military won't disclose when the missile is scheduled to be in operation, the best guess is that late 1968 or early 1969 is the target date. However, Harold Brown, the Pentagon's director of defense research and engineering,

recently told a congressional committee that the Navy is giving some thought to upgrading the Raytheon Co.'s Sparrow III missile in case the Phoenix doesn't pan out. But he was quick to add that the Defense Department still wants to go ahead with the Phoenix.

Development of the missile, started in 1963, is expected to cost about \$275 million. But the new delay may nudge that figure much higher; already it is estimated to be \$12 million over the budget.

The delay apparently is affecting the F-111B both favorably and unfavorably. Although production scheduling of the craft is being slowed, distressing the Navy, aeronautical engineers are getting more time to trim the excess weight from the plane, which now is well over the 64,000-pound limit.

Company squabble. A dispute between Litton and Hughes over development of the computer has been going on for some time. At one point, a source close to the companies says, costs of the computer climbed so high that Hughes, in anger, cut off some development money to Litton, causing a layoff of some of the engineers working on the project. Litton countered by blaming poor management at Hughes for some of the problems, the source adds.

Another source asserts that Hughes "may not have kept as tight a control over its subcontractors as it should have."

The task set for the Phoenix missile, according to Morse, "is a pretty formidable one." The system will be able to launch and control up to six missiles at one time. Signals from infrared and radar target sensors on the missile will be processed by the solid state digital computer, and the output will be visually displayed for the missile control officer. The systems will have built-in self-test features.

Radar penmanship

A radar operator tracking a moving target has to perform some fast dial twirling to get the range of the

target on his scope. To determine range, he turns two dials, or cranks, that center a spot of light on the target's blip. On a radar's plan position indicator, the distance from the center of the scope to the blip—representing the range of the target—is mechanically converted into a digital readout, with typical errors of 20 to 30 yards at a range of 10,000 yards. And it may take the operator up to a minute to center the spot on the blip.

But a system now being tested by the Navy eliminates the mechanical technique that's used to obtain range and replaces it with an electronic method which is 10 times more accurate and significantly faster.

The system, developed by Eldorado Electronics Co. of Concord, Calif., in cooperation with the Navy's Mine Defense Laboratory, uses a pen-like photosensitive sensor to track a target on the radar's cathode-ray tube.

No jitter. As in conventional radar, a pulse is emitted by the transmitter's magnetron. But the trigger that fires the pulse doesn't start the counter, which measures the time it takes for the pulse to reach the target and return. Instead, the spillover from the transmitted pulse triggers the counter, eliminating the error caused by the varying time it takes for the magnetron's gas to ionize and fire a pulse. By avoiding "jitter"—the lag between the moment the tube is triggered and the moment the pulse is emitted—the designers have eliminated any slow drift in the electronic system.

When a blip appears on the radar's cathode-ray tube, the operator places the photosensitive pen over the light before it begins to fade. At the next sweep of the radar's antenna, the blip brightens and the light picked up by the pen stops the counter.

Thus the interval between the moment the pulse leaves the magnetron and the moment its return signal is picked up by the photosensitive pen represents the target's range. Circuitry in the systems converts this interval into a

distance reading and the figure appears on Nixie tubes.

The cathode-ray tube's video system is adjusted to react to the leading edge of the return signal, further increasing the accuracy of the radar.

Bearing on the blip. A separate electronic system provides digital readout on the target's bearing. It contains a magnetic encoder which is attached to the radar antenna's servomotor. Pulses representing a tenth of a degree of rotation are fed into the system. When a blip is picked up by the photosensitive pen, not only does it stop the counter but at the same time it activates circuitry that stores the last bearing code. That code is then translated and read out on other Nixie tubes.

The basic concept for use of the photosensitive pen in the radar system came from Marlow Henne, ~~project manager at the Navy's Mine Defense Laboratory.~~ So far, Eldorado has built two units for the Navy. One is being tested on a minesweeper, where an error of a few yards in locating a mine may spell disaster. The second is under test at the Navy's mine lab at Panama City, Fla.

Computers

Picture that

Computer users are sometimes swamped by the flood of data spewing out of the machine on punched cards, magnetic tape or paper. A system with graphic input and output, with which a scientist could write a question into a computer and get the answer displayed on a screen, would help control the flood.

A light pen that "writes" on a cathode-ray tube is one such aid. A more sophisticated device that will accept graphic data and simultaneously display the data on a screen has been developed by the Data Equipment Corp., a subsidiary of Holt, Berenak & Newman,

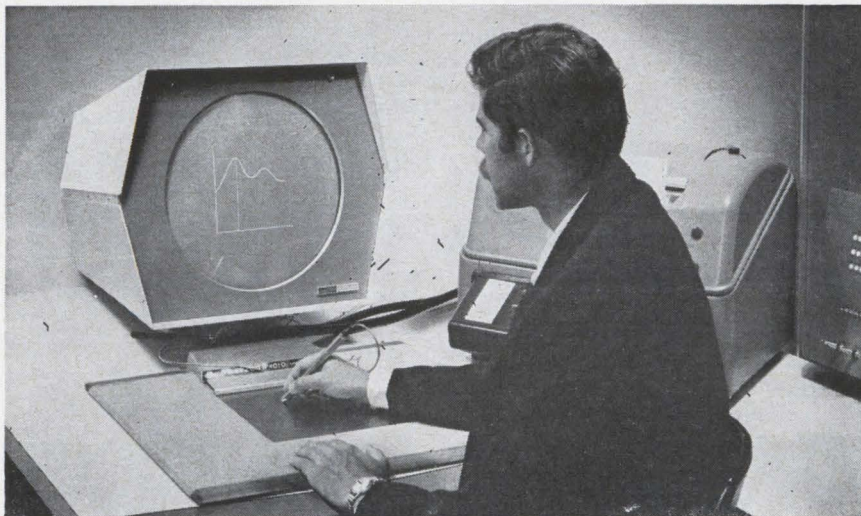

Data is "drawn" directly into computer with a stylus. The Grafacon 1010 translates the information, corrects it and adds to it—all in real time.

Inc. And National Aeronautics and Space Administration engineers have devised a system in which data on the position of an orbiting spacecraft is translated directly onto film, so an observer can watch a "cartoon" of the craft as it changes position in space.

Copper pad. Data Equipment's instrument, called Grafacon 1010, consists of a stylus and a 10-inch-square "writing pad" that's made of a copper grid etched on a Mylar subsurface. There are more than a million intersecting points on the grid. Coded signals are placed on each of the points by applying a train of 20 positive and negative pulses at each of the intersections every 220 microseconds. When the stylus passes over the grid, it capacitively picks up the codes and feeds them into the computer. These signals may then be displayed on a cathode-ray tube.

The user can draw a curve onto the grid, and the computer can quickly calculate the area under it, its length, or its mathematical formula. The system can also straighten a crooked line and adjust a curve or a diagram to fit into a formula or execute any programmable task—all in real time.

Doing the twist. In the technique being developed at NASA's Goddard Space Flight Center at Greenbelt, Md., data on the complex twisting motion of the Orbiting

Geophysical Observatory (OGO) is fed into a computer. It is difficult for the NASA engineers to determine from these millions of bits of data whether OGO's sensors are pointing in the right direction. To make it easy to determine OGO's attitude, the satellite information is translated into a graphical output, which is recorded on moving film by a high-speed Stromberg-Carlson 4020 printer made by the General Dynamics Corp.

The film is automatically developed inside the system and then shown on an ordinary projector. OGO, then, appears as a cartoon, going through its turn in space.

Avionics

Belling the CAT

For more than a year, several laboratories around the country have been trying to track down CAT (clear air turbulence), a meteorological phenomenon that is suspected of contributing to a dozen crashes or near-crashes of jets in the past five years.

In some of the experiments, scientists have aimed laser beams into the sky, hoping that backscatter off dust particles or water vapor



SILICON HIGH VOLTAGE ASSEMBLIES UNITRODE MAKES THEM ALL

ALL ASSEMBLIES FEATURE:

- Controlled Avalanche Diodes
- Void-free Individually Glass Sealed Junctions
- Matched Thermal Coefficients
- Vacuum Encapsulation
- Designed-in Anti-corona Protection
- High Surge and Overload Capability
- Maximum Power for Minimum Size

Call, Write, or TWX Your Requirements to
The Factory or Your Local COMPAR Office

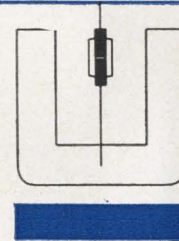

UNITRODE®
"better always/by design"

UNITRODE CORPORATION
580 Pleasant Street, Watertown,
Mass. 02172 Telephone (617) 926-0404
TWX (617) 924-5857

would provide clues to the origins of CAT and suggest techniques for detecting it [Electronics, Jan. 11, 1964, p. 40]. In all of these experiments, the research tools have been single beam lasers operating on a single wavelength. The Office of Naval Research, however, believes that research can be speeded by using multiple laser beams operating virtually simultaneously, but with different wavelengths and polarizations. Each beam, it is thought, would detect different atmospheric characteristics, providing a better over-all view of the weather in the area under observation.

Four-headed laser. Work on a system employing four-headed laser radar is nearing completion at the Stanford Research Institute at Menlo Park, Calif., under a Navy contract. Although the Navy is pri-

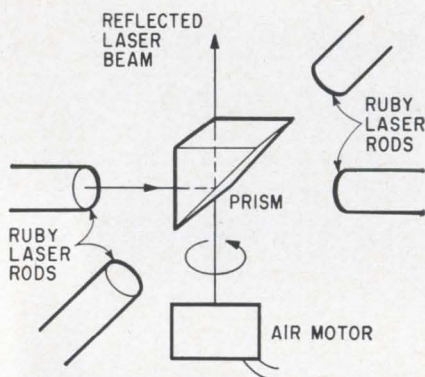

Four-headed laser system will be used to gather data on clear air turbulence.

marily interested in learning the causes of CAT and developing airborne hardware so that turbulence can be avoided, the researchers at Stanford will be using the tool for broader weather studies. Related work is under way at Cornell University's Aeronautical Laboratory; and at the University of Michigan, researchers are about to test an aircraft system that will warn the pilot of CAT's ahead.

In the Stanford system, four ruby lasers are triggered sequentially, the interval between pulses being about a quarter of a microsecond. The lasers, operating at wavelengths of around 6,943 angstroms, are mounted around a prism. The

output window of each rod is aimed at the prism, which is rotated by an air motor at 2,000 revolutions per second. As the laser rods are pulsed, the spinning prism reflects the 10-megawatt peak power pulses from each rod in turn, transmitting the radiation through an optical system. The laser power ratings will be increased later to 50 megawatts peak.

In some experiments, the laser cavity will be heated or cooled to alter the laser's radiating wavelength. Stanford scientists say the ability to shift wavelength and polarization will enable them to "see" into some clouds to detect their complex internal structure.

Height of accuracy

The accuracy of any radar altimeter is limited by the precision of the counter that measures the time it takes for a signal to travel to the ground and back to the craft, and by the width of the beam at the point where it hits the ground. Since one nanosecond is equivalent to one-half foot of range, an error of a few nanoseconds is significant. When there is too wide a beam, return signals indicate only the highest altitude over uneven terrain lying within the area of the beam.

For most purposes, errors of several yards at high altitudes are insignificant, but for photomapping, errors of that magnitude introduce appreciable inaccuracies. Litton Industries, Inc., in conjunction with the Eldorado Electronics Co., has developed a photomapping system that contains a laser altimeter, which measures accurately to within ± 3 feet at altitudes of 100,000 feet.

Narrow beam. The altimeter overcomes both the problem of beamwidth and of counting precision. From an altitude of 100,000 feet, the laser beam broadens to only 25 feet, compared with above 2,600 feet for a typical radar beam. The counter, developed by Eldorado, provides readings accurate to within 0.5 nanosecond.

In the Eldorado system a coher-

ent oscillator eliminates the built-in ± 1 -count error common to digital type counters. It does this by a phase-locking technique; with it, any measured time interval is referenced to a common starting point on each of the clock signals, thereby eliminating the ambiguity due to lack of coherence between the start signal and the clock frequency.

Two clocks. Another innovation is the use of an electronic vernier, which contributes even further to the system's precision. The Eldorado counter uses two reference clocks—one operating at 10 megacycles, or 100 nanoseconds per cycle, and the second at 10.1 megacycles, or 99 nanoseconds per cycle. When the laser pulse leaves the craft, the 10-Mc clock begins counting. When the reflected beam is detected, the start channel clock pulses are totaled on Nixie tube decade units.

The return beam then gates the 10.1-Mc clock into the counter. Pulses are simultaneously fed from the 10.1-Mc clock to another pair of Nixie tube decade units and a coincidence-sensing circuit. When coincidence between the 10-Mc and 10.1-Mc clocks is sensed, the 10.1-Mc pulses are inhibited. Thus the first pair of Nixies displays the number of 100-nanosecond intervals in real time and the second pair indicates the number of one-nanosecond intervals.

Communications

Later bird

Can anyone with \$10 million put up his own communications satellite? The unofficial opinion in Washington is that the Communications Satellite Corp. has an exclusive franchise for such operations; but it became apparent last week that Comsat might have to supplement Early Bird with a domestic satellite or lose that franchise.

Following the lead of the Amer-

TRW will put hair on your zeners



OR COPPER

OR TINNED
COPPER

OR GOLD-PLATED
COPPER

OR TINNED DUMET

OR GOLD-NICKEL
DUMET (very fancy)

OR YOU NAME IT

We'll give you any lead material, diameter or length — or no lead at all, if that's the way you want it. We'll put the same leads on both ends — this should be a big help. We do all this on other diodes too — try us for rectifiers or Varicaps. In short, TRW diodes are made just for you.

If you have a hairy welding or soldering problem, write us at 14520 Aviation Blvd., Lawndale, Calif. or call 213-679-4561 (ext. 263). TRW zeners are products of TRW Semiconductors Inc., a leading manufacturer of specialized semiconductor devices.

TRW SEMICONDUCTORS

Who needs this surprising new quarter-rack power supply?

You might—if you're looking for precision regulation with the versatility needed in today's labs. Consider the advantages.

The new Series HH Silicon Quarter-Racks give you the ranges you need, without derating—even at +60° C! Three precisely regulated supplies—0-7V at 4 amps (HH7-4), 0-14V at 3 amps (HH14-3) and 0-32V at 1.5 amps (HH32-1.5). And you can put any four of them in a 5¼" rack, series or parallel them—or combine them with Trygon's renowned half-racks for added flexibility.

Small? Sure. But they're big in performance! Regulation: .01%, load and line. Ripple: .5mv rms. Stability: .05% (.01% optional). There's more.

Constant voltage and constant current operation. Automatic adjustable current limiting. Front panel overload indicator. Remote voltage programming. Remote sensing. Vernier voltage adjustment controls. Optional automatic tracking over-voltage protection.

Who needs it? If you want a versatile, compact precision lab or system supply for as little as \$189... plus Trygon reliability,

you do!

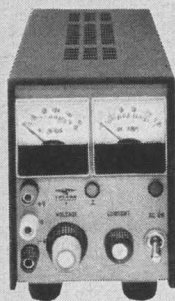

For all the exciting features, write

TRYGON
POWER SUPPLIES

Roosevelt, New York

TEL (516) 378 2800 • TWX (516) 868 7508

Electronics Review

ican Broadcasting Co., other broadcasters, airlines and wire services have been flooding the Federal Communications Commission with requests for permission to orbit a bird. After some hesitation, Comsat responded. Its president, Joseph V. Charyk, disclosed that his company may soon call for aerospace industry proposals on a satellite to serve broadcasters and the airline industry.

Such a satellite might choke off debate on who should be allowed to own satellites by satisfying the demand for them. It would relay tv shows that otherwise would be transmitted over communication links of the American Telephone & Telegraph Co. It could also relay radio messages from in-flight airliners to any area of the world.

Money talks. Money is the heart of the matter. American Broadcasting System's president, Leonard Goldenson, who first raised the question, drew the following financial picture: ABC alone spends some \$15 million a year to distribute tv programs. (Together, the other two networks—the National Broadcasting Co. and the Columbia Broadcasting System—pay close to \$35 million.) After talks with the Hughes Aircraft Co., builder of Early Bird, Goldenson concluded that ABC could save millions of dollars if it owned its own satellite.

Shortly after ABC's request, Charyk wrote the FCC that "since establishment of a communications satellite system for commercial purposes is a matter entrusted to the corporation under the Communications Satellite Act, we have undertaken discussions with the American Broadcasting Co. to determine the nature of its requirements. We shall analyze these requirements and give consideration to the manner best suited for meeting them."

The domestic satellite envisioned by Comsat would have a 500-watt primary power supply and could be lifted into orbit by the highly reliable Atlas-Agena booster. Its effective radiated power would be about one kilowatt, to service airlines' needs, and slightly more to provide a 12-television channel ca-

capacity—more than enough to meet present tv needs.

Channel division. Comsat's thinking now is to parcel out three tv channels to each network, set one aside for educational tv and use the other two for closed-circuit telecasts. The satellite communication company estimates the cost of such a satellite at about \$5 million, with another \$5 million required to launch it.

Comsat engineers say that ground stations that do nothing but receive the signals can be built for about \$100,000. Transmitting stations, however, will run quite a bit more.

Consumer electronics

Movies take off again

Now that the Civil Aeronautics Board has refused to go along with a proposed international ban on in-flight visual entertainment, it is expected that most of the world's major airlines will have to go into show business to meet the competition.

The two electronics companies that will gain most from the decision are the Sony Corp. of America, and the Ampex Corp., suppliers of video in-flight entertainment systems. In direct competition with them is Inflight Motion Pictures, Inc., offering wide-screen color movie projection systems.

Booming business. Many airlines that had held back pending the CAB decision are now taking the plunge. Pan American World Airways, which had previously canceled a \$750,000 order for video equipment from Sony, has since re-ordered. About 35 of Pan Am's 82 jets will be fitted by early July, and Sony is hopeful of more orders. Sony has already outfitted 47 American Airlines planes, and expects to fit systems for European airlines when the summer tourist season is over.

Originally, Trans World Airlines contracted with Inflight Motion Pictures for exclusive use of its

movie system. The Inflight system calls for no capital investment; movies and projection equipment are leased to the airlines at \$150 per flight. The TWA-Inflight contract forced other airlines to install expensive video equipment to provide competitive entertainment. A video system consisting of monitors and a video tape playback cost about \$42,000 installed. Taped first-run movies from Sony rent for \$62.50 per flight.

Harder for electronics. Now the competitive picture has swung in favor of Inflight and against the electronic companies. TWA will waive its exclusive rights on Inflight's equipment, thus opening the market for conventional movies. Inflight has already entered negotiations with four foreign and two domestic airlines.

Sony plans to meet the threat from Inflight by leasing its system, also for \$150 for each flight, including installation, maintenance and films.

Furthermore, present black-and-white monitors will be replaced by Sony color sets as they become available this year. Sony will deliver about 10 color monitors to Pan Am this summer for evaluation.

Ampex has a contract to equip 14 Continental Air Lines jets with video and sound, and has installed video systems in KLM Royal Dutch Airlines and Air Canada planes for evaluation.

Vote ban voided. The member airlines of the International Air Transport Association had voted earlier this year to ban visual entertainment on international flights. The CAB decision last week voids this vote since unanimous approval is necessary.

IATA members termed in-flight movies a wasteful competitive practice which will inhibit fare reductions. This view was opposed chiefly by Sony and Inflight, with an assist from the U. S. Justice Department, which considered the IATA agreement a violation of antitrust laws. The CAB claims in-flight entertainment is a legitimate passenger service that will not necessarily result in uneconomic practices.



Du Pont Reagents assure you of fast, dependable service while also fulfilling your needs for high quality, safety and convenience in handling.

You Can Depend on Du Pont Reagents for SERVICE

A nation-wide distributor network assures you of fast delivery and dependable service on Du Pont reagents...and in many cases on other Du Pont quality chemicals. There are 160 Du Pont Reagents distributor locations across the country to give your order prompt attention. Your source of supply is

as close as your phone. The next time you need reagents, contact your nearest distributor and specify "Du Pont."

You'll get the fast delivery and service you need and the finest quality reagents. Available in 1 and 5 pint bottles and 6½ and 13 gallon carboys.

HYDROCHLORIC ACID

| | |
|-----------------------------------|------------------------|
| Hydrochloric Acid (HCl) | Min. 36.5%, Max. 38.0% |
| Sulfites as SO ₃ | Max. 0.00008% |
| Sulfates as SO ₄ | Max. 0.00008% |
| Free Chlorine (Cl) | Max. 0.00005% |
| Heavy Metals as Pb | Max. 0.00005% |
| Residue after Ignition | Max. 0.0004% |
| Iron (Fe) | Max. 0.00001% |
| Arsenic (As) | Max. 0.000001% |
| Ammonium (NH ₄) | Max. 0.0003% |



**You Can Depend on Du Pont Reagents
...for Quality, Service and Safety Features**

NITRIC ACID
SULFURIC ACID
HYDROCHLORIC ACID

GLACIAL ACETIC ACID
AMMONIUM HYDROXIDE
FORMIC ACID 90%



REG. U.S. PAT. OFF.

Better Things for Better Living
...through Chemistry

Du Pont Company, Room 2233C
Wilmington, Delaware 19898

Send name of nearest Distributor Reagents Catalog Sheet
 prices.

Name _____

Title _____

Firm _____

Address _____

City _____ State _____ Zip _____

COMPONENT COMMENTS *From Speer*

Take an armchair tour of our resistor plant

We were recently rather surprised to discover just how fanatical we've become on the subject of quality. Did you know, for example, that we test samples of every lot of our fixed carbon composition resistors in live steam? It's a fact. The resistors are exposed to steam pressure for four hours as an accelerated control test for moisture resistance.

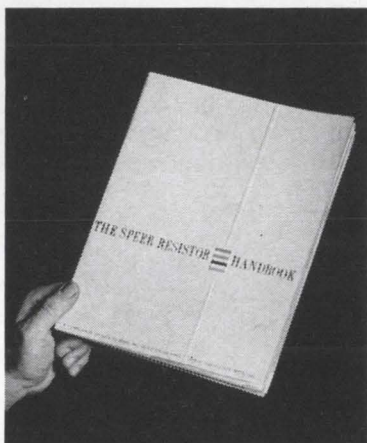

Scenic view of our free, 16-page, lavishly illustrated "Resistor Handbook."

For a more comprehensive revelation of our fanaticism, we refer you to "The Speer Resistor Handbook." This colorful new 16-page illustrated brochure is actually an armchair tour of our entire resistor operation. You'll see how our resistors are made and how we assure quality at every stage - in raw materials, in manufacturing and in meeting military standards. You'll see the wide range of specifications we offer. And you'll see how our resistors have performed under MIL-R-11 test conditions.

Browsing through "The Speer Resistor Handbook" is almost as fascinating as touring our plant in person. (And it's decidedly easier on the feet.) If you'd like a copy just mail the coupon.



The comprehensive reliability program at our Jeffers Electronics Division assures that all of our non-shielded inductors (and our shielded ones too) meet MIL-C-15305 specs.

The heart-warming comeback of the non-shielded inductor

Don't get us wrong. On the issue of shielded versus non-shielded inductors, we're completely unprejudiced.

We'd be delighted to sell you either type.

We have felt distressed, however, to think that you might be using shielded inductors in more applications than you need to. After all, while the non-shielded inductor may be thin-skinned, it does offer the advantages of lower cost, higher reliability and higher stability.

We've therefore taken steps to help this useful inductor make the comeback it deserves.

Step one: Our Jeffers Electronics Division has developed a number of non-shielded inductors that provide high inductance values in a small case size. Example? Our unshielded-molded jacket

inductors now offer values through 1800 microhenries, in a case size of 0.156" x 0.375". This size conforms to the new MIL standard MS90537 for shielded coils, which specifies a 0.157" x 0.385" case size.

Step two: A suggestion. Consider rearranging your components. This will sometimes enable you to switch to non-shielded inductors.

Step three: We've prepared an essay that deals with this whole subject at greater length. It's entitled "Can Non-Shielded Inductors Save You Money?" and you can get a copy by merely mailing this coupon.



Do we have your name?

To receive reprints of "Component Comments," use the coupon. We'll place you on our mailing list.

JEFFERS ELECTRONICS DIVISION,

Speer Carbon Company
DuBois, Pennsylvania
Speer Carbon Co. is a Division of Air Reduction Company, Inc.

- Rush "Can Non-Shielded Inductors Save You Money?"
- Rush "The Speer Resistor Handbook."
- Arrange for me to receive reprints of "Component Comments."

Name _____

Title _____

Company _____

Address _____

City _____

State _____ Zip _____

See our demonstration, Booth 1020, WESCON Show, Aug. 24-27, 1965

ADD 2N1722 & 2N1724 TO A GROWING PLANAR LINE...

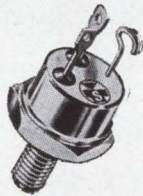

SILICON TRANSISTOR CORPORATION'S TRIPLE DIFFUSED PLANAR SILICON POWER TRANSISTORS

2N1722 in the TO-53 package, and 2N1724 in the TO-61 package, are the latest. These, and all our triple-diffused, planar, silicon power transistors, have high frequency, high gain and high reliability characteristics, plus Silicon Transistor Corporation's overall quality and service. Use them in high frequency, linear amplifiers, for high speed switching, and converter and inverter circuits operating at 50 to 100 KC. Low leakage and stable electrical characteristics are inherent in the planar process.

| | Package | Pc @ 100°C | Ft | VCEO | hFE |
|--------|-------------------|------------|-------|------|---------|
| 2N1722 | TO-53 | 50 watts | 10 MC | 80 | 20 @ 2A |
| 2N1724 | TO-61 | 50 watts | 10 MC | 80 | 20 @ 2A |
| 2N2657 | TO-5 | 1.25 watts | 20 MC | 60 | — |
| 2N2658 | TO-5 | 1.25 watts | 20 MC | 80 | — |
| 2N2877 | TO-59 (1/16" DES) | 30 watts | 30 MC | 60 | 20 @ 1A |
| 2N2878 | TO-59 (1/16" DES) | 30 watts | 50 MC | 60 | 40 @ 1A |
| 2N2879 | TO-59 (1/16" DES) | 30 watts | 30 MC | 80 | 20 @ 1A |
| 2N2880 | TO-59 (1/16" DES) | 30 watts | 50 MC | 80 | 40 @ 1A |

For complete information and specifications, write to:



EAST GATE BOULEVARD, GARDEN CITY, NEW YORK 11532, 516 Pioneer 2-4100. TWX 510-222-8258
REGIONAL OFFICES: CHICAGO, ILL. 60625, 5555 NORTH LINCOLN AVE., 312-271-0366-7, TWX 910-221-1304
 LOS ALTOS, CALIF. 94022, 1 FIRST STREET, 415-941-2842. HUNTSVILLE, ALA. 35807, POST OFFICE BOX 1467

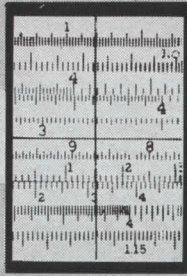

MALLORY

New combination circuit breaker line switch—volume control

The Mallory OCB breaker switch eliminates the need for a separate rear-of-chassis circuit breaker, and affords the convenience of front panel reset from the on-off control switch.

In a television set, for instance, the OCB breaker switch can be sup-

plied attached to the volume control just like the usual line switch. When a voltage surge or transient overload causes the breaker to open, all the user needs to do is turn the switch to the OFF position (this resets the breaker) and then turn it back ON.

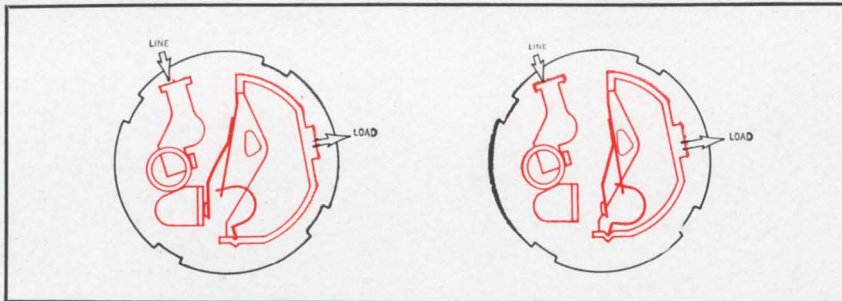

Diagrams show operation of breaker mechanism: at left, in MAKE position; at right, in BREAK position.

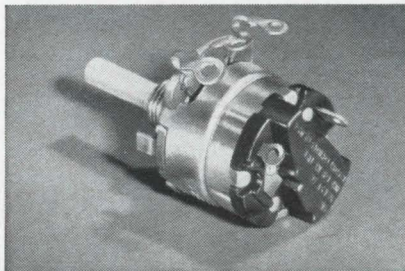

OCB breaker switch attached to volume control.

The OCB switch is the same size as a conventional line switch. It can be supplied in rotary, push-pull or push-push models—either attached to a volume control or as a separate switch. It is temperature compensated to operate reliably from 25°C to 65°C. The standard model is rated 2.4 amperes break current and 1.60 amperes hold current. Other ratings are available on request.

CIRCLE 240 ON READER SERVICE CARD

Dual control... triple switch for auto radios

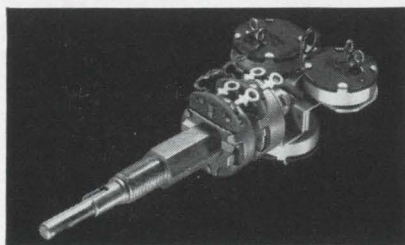

This is a special multi-purpose control which Mallory has designed and made for auto radio manufacturers. It's a combination on-off control, raise and lower control for a powered antenna, volume control and tone control.

Press or pull the inner shaft, and the antenna goes up or down. Rotating the inner shaft activates the on-off switch and the volume control. Outer shaft operates the tone control.

The entire assembly is a compact, rugged unit, precision-produced at economical price. It is typical of the special configurations of switch-control combinations which we have been supplying to leading electronic manufacturers for years. If you have a special problem, or a standard one, call on us.

CIRCLE 241 ON READER SERVICE CARD

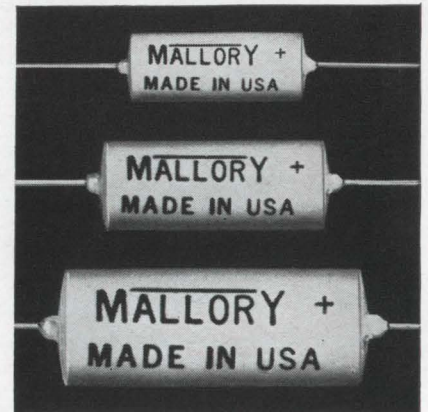

New molded aluminum electrolytics have high quality, low price

These new white plastic molded electrolytics are a new kind of capacitor—the Mallory MTA. They're well worth investigating for any application where you need good quality at low cost, in home instruments, radio, stereo, hi-fi, television, electronic organs, portable instruments.

The MTA has a fully molded plastic case... molded in one shot around the finished capacitor element. This process produces a positive seal that assures long, stable life—plus accurate centering of leads and uniform case size, important in automated assembly.

Electrical properties are excellent. DC leakage is less than 0.03 microamperes per microfarad-volt. Temperature range is -20° to +65°C, and to +75°C or +85°C in many applications. Three case sizes, covering the following ratings:

| Case size | Volts WVDC | Max. capacity—mfd. | |
|----------------|------------|--------------------|---------------|
| | | polarized | non-polarized |
| 5/16" x 7/8" | 3 to 50 | 60-8 | 40-4 |
| 3/8" x 1 1/8" | 3 to 50 | 180-20 | 100-10 |
| 1/2" to 1 1/2" | 3 to 50 | 600-80 | 400-35 |

CIRCLE 242 ON READER SERVICE CARD

DESIGNER'S FILE

P. R. MALLORY & CO. INC., INDIANAPOLIS, INDIANA 46206

Miniature tantalum capacitors for high density packaging



The Type TLS-E is a new miniature wet slug capacitor which offers opportunities to put a lot of capacitance in a little space. Microfarad-volt ratings per unit volume are as much as 40% higher than most comparable tantalum units . . . or, rating for rating, these capacitors are about half the size of most others. Their combination of compactness and high reliability make them applicable to space and missile circuitry, computers and industrial electronics. They are particularly suitable for cordwood and printed circuit packaging.

The TLS-E is an outgrowth of the Type TLS which we supply as styles CL64 and CL65 under MIL-C-3965. At the positive lead, an epoxy bead is formed over the welded junction between the lead wire and the tantalum wire connecting to the anode. The epoxy bead permits the capacitor to be mounted vertically on printed circuit boards with the metal case clear of the board. The bead also strengthens the weld joint, permitting the lead wire to be bent 90° to the body of the capacitor without danger of damaging the end seal.

CIRCLE 243 ON READER SERVICE CARD

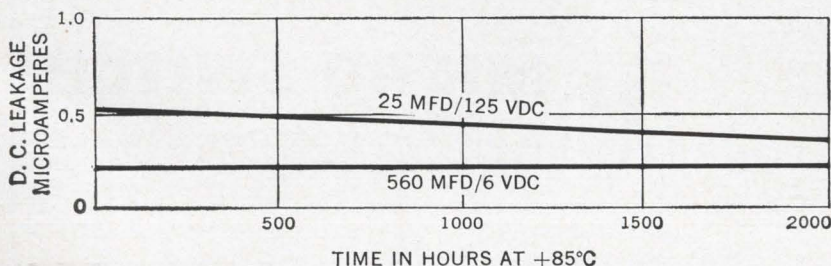

Typical life-test data: TLS-E capacitors.

New "Reserve" Mercury Cells can be stored for years



Reserve cell in flashlight D size.

The capacitor is produced under quality control procedures comparable to MIL specifications. DC leakage is exceptionally low. Electrical values show excellent stability over the rated temperature range of -55° to $+125^{\circ}\text{C}$. Available ratings: 1.7 mfd, 125 WVDC to 650 mfd, 6 WVDC. Three case sizes: $\frac{3}{16}$ " dia., .578" long; $\frac{9}{32}$ " dia., .765" long; $\frac{3}{8}$ " dia., .890" long uninsulated. Also available with insulating sleeve.

Here is a new kind of energy source that may spark the imagination of designers. It is a mercury battery capable of storage for indefinite periods of time without deterioration—yet capable of delivering high milliampere-hour capacity the instant it is activated.

The electrolyte is contained in a vial, of glass or impact-resistant plastic, and does not contact the anode and cathode until the vial is broken by the activating mechanism. Because there is no electrochemical action until the electrolyte is released, this type of cell can remain in the standby condition for years without loss of inherent capacity. It withstands storage temperatures up to 150°F or as low as -60°F . Indicated applications include security devices, alarms, self-destruct systems, emergency circuits and weapons systems.

Activation can be accomplished by a variety of methods of breaking the electrolyte vial by external devices. We have been supplying a screw-actuated mechanism, and have also developed a plunger arrangement—both of which maintain appropriate sealing of the container after activation.

Once activated, the reserve cell delivers approximately 75% as much energy as a conventional Mallory cell of the same size. It delivers the flat discharge and long life performance which have made the Mallory Mercury System the leading choice of electronic designers for transistor circuitry. Three cell sizes are now available in pilot production:

| Cell size | Capacity |
|---------------------|------------|
| Flashlight D | 10,000 MAX |
| Flashlight C | 5,500 MAX |
| .622" dia. x 1.953" | 2,700 MAX |

CIRCLE 244 ON READER SERVICE CARD



Taking full advantage of this subminiature switch?

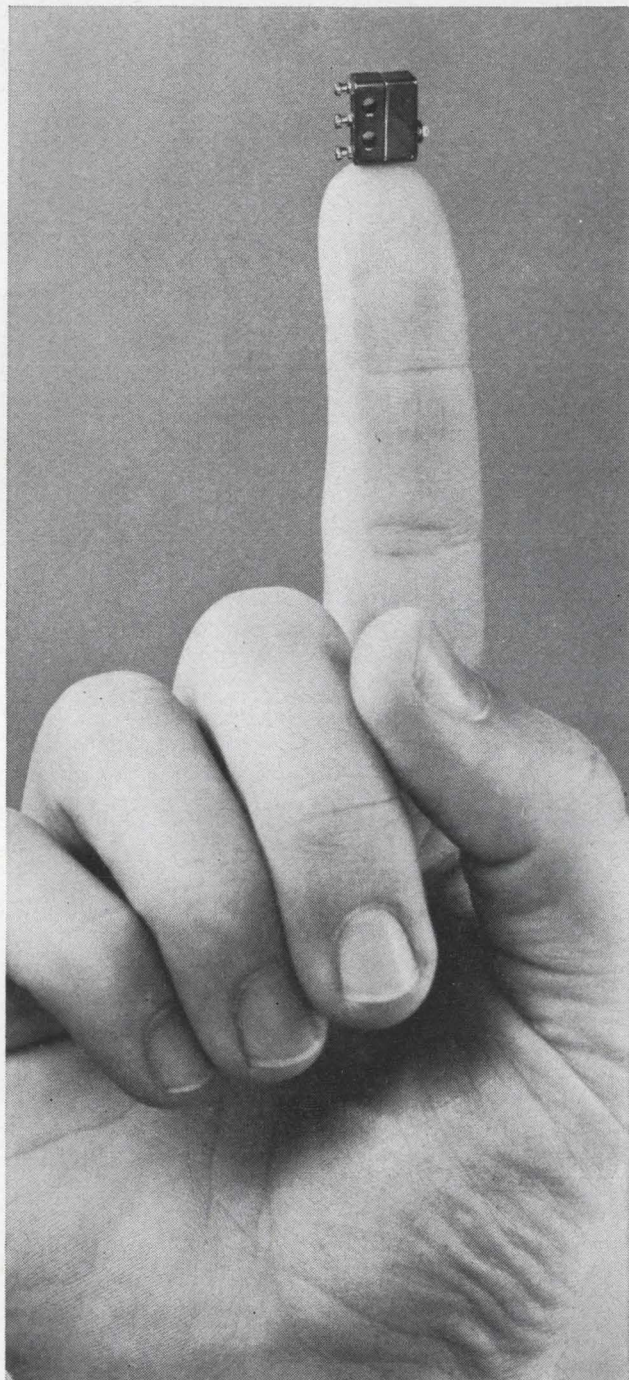

The famed "1SX" Subminiature Switch is one of the smallest, lightest precision snap-action switches available. Many newer applications are now taking greater advantage of its full capabilities; new users are discovering that the "1SX" can now do far more than they expected.

Main reason: this line of subminiatures is growing in variety and adaptability.

For example, note the features now available:

- Temperature range, -100°F to $+250^{\circ}\text{F}$ or $+375^{\circ}\text{F}$
- Operating force as low as 3 oz. or as high as 5 oz.
- Differential travel as low as .002 in. to .005 in.
- Silver or gold contacts. Silver—7 amps. 115 or 230 vac; 4 amps. ind. and 7 amps. res., 28 vdc. Gold—28 vdc; 2 amps. inrush; .5 amp. ind; 1 amp. res. Contact arrangement, SPDT.
- High arc-resistance; high-impact case.
- Six auxiliary actuators.

For details on how this Subminiature Switch can help solve design problems involving space, weight and environmental limitations, call a MICRO SWITCH Branch Office or Distributor. (See Yellow Pages.) Ask for Catalog 63.

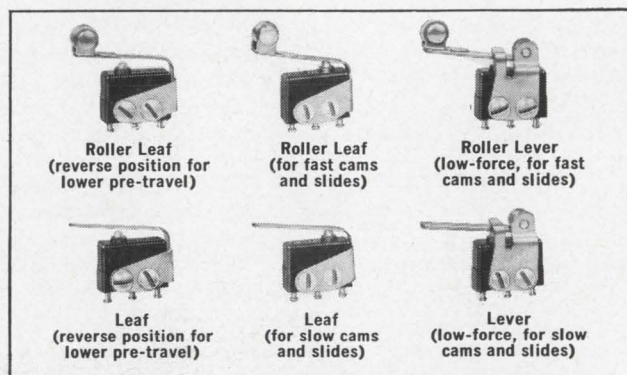

MICRO SWITCH

FREEPORT, ILLINOIS 61033

A DIVISION OF HONEYWELL

IN CANADA: HONEYWELL CONTROLS LIMITED, TORONTO 17 ONTARIO

Washington Newsletter

June 14, 1965

Sen. Long losing patent battle

Efforts by Sen. Russell Long (D., La.) to tighten governmental control of patents developed by industry under federal contracts have backfired. Long wants government agencies to keep title to such patents, and has tacked amendments to that effect to several bills. Now his pressure has generated a counterpressure that has led to:

- Rallying of Johnson Administration and industry forces to block Long's effort to tack a patent rights rider to the National Aeronautics and Space Administration appropriations authorization bill when it passed the Senate.

- Translation of Administration patent policy—allowing waiver of patent rights to contractors under certain conditions—into legislation proposed by Sen. John L. McClellan (D., Ark.), chairman of the Patents subcommittee.

The 59-26 vote by which the Senate put down the proposed Long amendment to the NASA bill is a measure of the support the flexible Administration policy has now, and just about insures passage of the McClellan bill. Earlier, Long's patent amendments to water desalinization and other research and development bills had been approved by the Senate and enacted.

Chairman Glenn T. Seaborg of the Atomic Energy Commission—a key agency that has been insisting on tight government proprietorship of patents stemming from contract R&D—says that enactment of the McClellan bill would supersede restrictive patent provisions of the Atomic Energy Act, as well as procedures followed by the Federal Aviation Agency, the Weather Bureau and other R&D-sponsoring agencies.

'Hot line' probable for NATO

The United States wants—and will probably get—an improved NATO communications network somewhat comparable to the "hot line" linking Washington and Moscow.

No specific proposals have been made, but Washington is thinking in terms of additional links and cross-ties to permit direct, secure and uninterrupted conference calls between political leaders for instantaneous consultations during crises, particularly when the issue of using nuclear weapons might arise.

The latest advances in communications, presumably including military communications satellites, would be utilized.

NATO weapons: mixed bag unlikely

Defense Secretary Robert S. McNamara's suggestion for a "Common Market" in weapons buying within NATO appears to be more of a gesture than a substantive proposal. McNamara encountered complaints, particularly from Britain, that the U. S. is invading the European military market too heavily. In answer, he said that the U. S. wants to buy as well as sell in Europe, provided that European weapons are competitive in quality and price with American products.

He informally suggested competitive bidding on weapons among companies within the alliance, and more joint weapons development arrangements. But in practice, competitive bidding would be more likely to increase, rather than decrease, the U. S. share of the market—at least for the most expensive, complex weaponry.

Washington Newsletter

Pentagon pushes value engineering...

The Defense Department is sharply stepping up its emphasis on value engineering. It plans within the coming year to double its present force of 250 value engineers. By mid-1966, Defense Secretary McNamara wants to double the current \$250 million saved yearly by value engineering. A special study group concluded that the 100% increase in personnel is necessary if this goal is to be realized.

... and centralized management control

The Pentagon is also speeding up the trend toward more centralized management control for major weapons systems. Under a new directive, the project manager concept, which has been used on a limited basis, is being extended to most new major engineering development, operational system development and production programs. This entails centralizing full program responsibility in one man.

Contractors will realize a major benefit from this step: they will have a single source from which to obtain decisions on technical, managerial and funding problems.

The Pentagon also is considering imposing uniform configuration management over the engineering, production and operational phases of major systems. Configuration management is the process of evaluating and approving or disapproving changes in the physical or functional characteristics of a system.

Congress fencing Aerospace in

The House Armed Services Committee has written into the military construction appropriations authorization bill a clause forbidding the Aerospace Corp., a nonprofit company doing work for the Air Force, to buy new property or build additional facilities without first getting clearance from Congress. A recent congressional inquiry disclosed that Aerospace built new facilities at two privately owned California locations instead of using nearby government properties. The General Accounting Office said that the new buildings cost \$22 million, while the government installations could have been converted for \$4.7 million.

Shut the door by hand, please

Both the Federal Aviation Agency and the Federal Communications Commission are considering regulation of the manufacture of electronic gadgets to open garage doors. The transmitters clutter up the airwaves. The FCC is concerned with a broad range of frequencies; the FAA is specifically concerned with the 230- to 290-megacycle range, which takes in the 243-Mc military emergency frequency and a sizable portion of the entire military ultrahigh-frequency band used for aircraft communications and air navigation. The garage door openers use this band, and some of them, the FAA finds, are improperly shielded.

Curbs on GAO not expected

The House Government Operations Committee's hearings on General Accounting Office practices will result in a critical report—but not much else. Both industry and the Pentagon have complained that the GAO performs its watchdog function on government contracts in a high-handed and arbitrary manner. But it's considered unlikely that the committee report will be followed by any substantive action, aside from closer congressional supervision [Electronics, May 31, p. 44].

SYSTEMS OR PRODUCTS, DEI has full capability for quick reaction

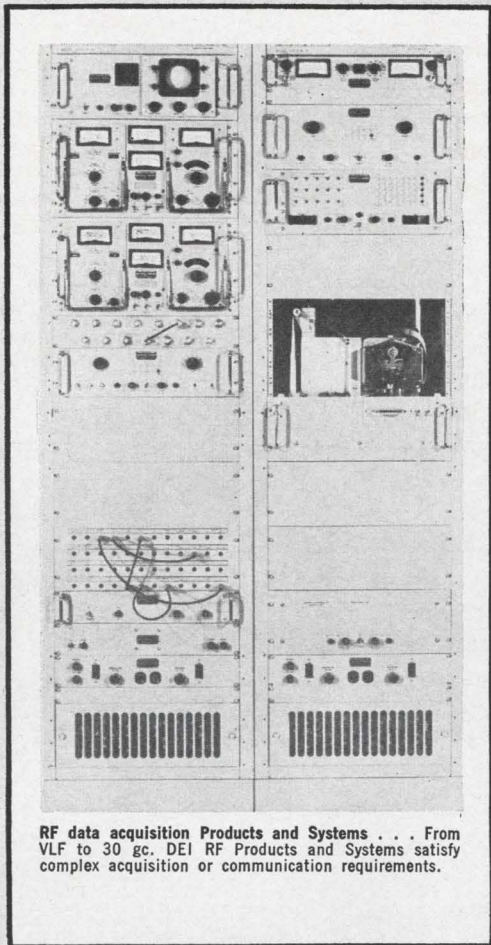

RF data acquisition Products and Systems . . . From VLF to 30 gc. DEI RF Products and Systems satisfy complex acquisition or communication requirements.



Surveillance, RFI and Intercept Instrumentation . . . Laboratory, mobile van, airborne or shipboard, the complete installation from antenna to data storage, decoding and processing can be provided.

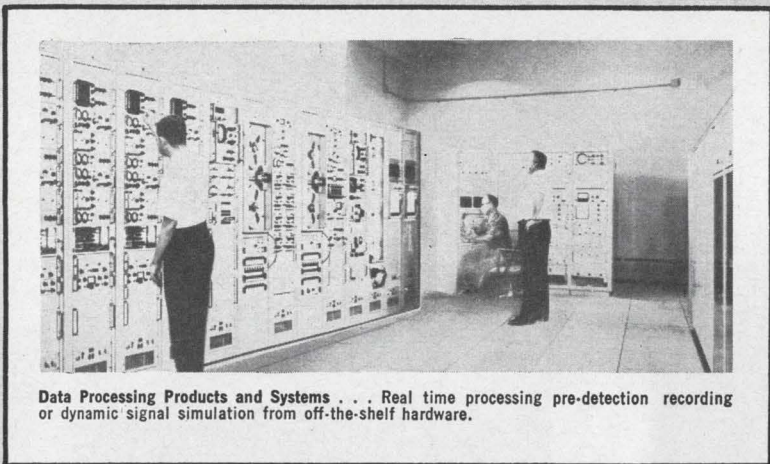

Data Processing Products and Systems . . . Real time processing pre-detection recording or dynamic signal simulation from off-the-shelf hardware.

When system problems arise, consider the following

DEI designs, manufactures and continues to improve a wide range of modular receiving systems and ancillary products including special phase tracking demodulators, pre-detection recording units, formatting and data reduction products.

For product or system, QRC or normal cycle, this balanced capability has proved its value in solving difficult problems including design and delivery on major programs for both government and industry. Our Engineering staff would be pleased to discuss the specifics of your requirements.

These products are in continuous manufacture under rigid quality and production control. For further information write for DEI product catalog and capabilities brochure.

Defense Electronics, Inc.

Rockville, Maryland



DEI

RESEARCH
DEVELOPMENT
MANUFACTURING

ROCKVILLE, MD. (301) 762-5700, TWX: 302-427-4660; SHERMAN OAKS, CALIF. (213) 872-2870, TWX: 213-783-2742; COCOA, FLA. (305) 632-5400; TWX: 305-632-5442; HUNTSVILLE, ALA. (205) 881-5139; WILLOW GROVE, PA. (215) 659-5051; DALLAS, TEXAS (214) EM 3-7263; INT'L, ROCKVILLE, MD.; CABLE: DEIUSA; EXPORT (212) Circle 6-2133, TELEX: TRIL 224326, N.Y., N.Y.; OTTAWA, ONT. EMISCO Ltd. (613) CEntral 6-0811, Cable: EMISCO

Prize Crop of BOURNS® Precision Potentiometers

With smaller housings, higher resistances, better linearity, finer resolution, and higher operating temperatures than any other line.

Now you can obtain a 25 to 40% increase in total resistance together with standard linearity as low as 0.1% and resolution as fine as 0.01% — in a potentiometer that's shorter than any competitive unit. Our 10-turn Model 3500, for example, is just 1" long, a full 1/2" shorter than units available elsewhere. The secret: new design techniques including a thin-wall molded plastic case and reduced helix pitch that let us put a 20%-longer resistance element in a shorter package. The new case also improves heat dissipation, thus increasing power-handling ability and raising the maximum operating temperature 20°C above most poten-

tiometers available elsewhere. Sealed against humidity, these units exceed steady-state requirements, and most can even be specified to meet MIL-STD-202B, Method 106 (cycling humidity). Reliability is further enhanced by the virtually indestructible Bourns Silverweld® termination.

Units are individually inspected and subjected to the stringent double-check of the Bourns Reliability Assurance Program. Prices are competitive and delivery is immediate. Write today for complete technical data.

Don't MIL-SPECulate — SPECify Bourns!

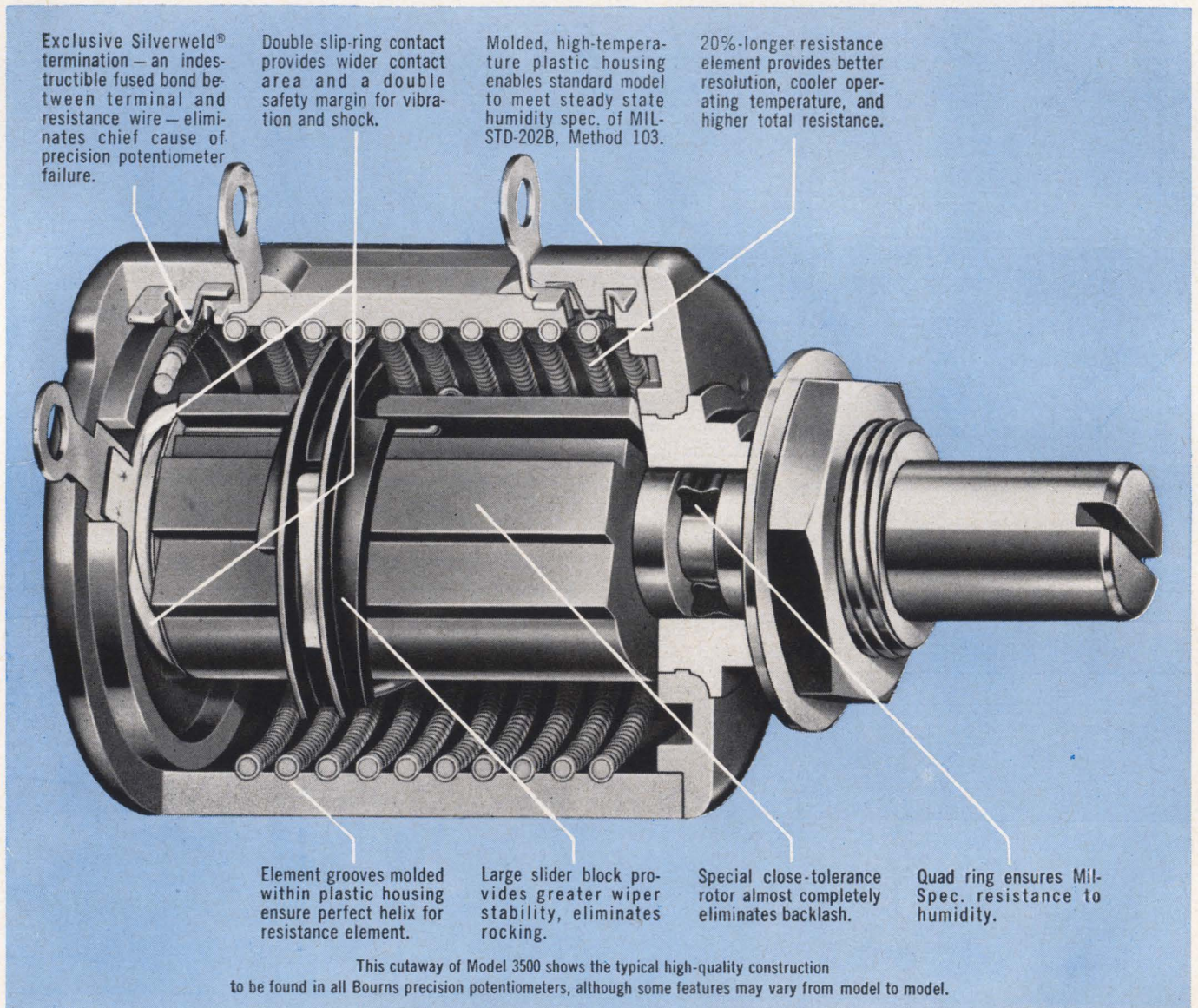



Model 3400

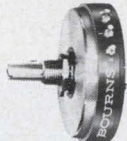

Model 3410



Model 3500



Model 3510



Model 3520



Model 3530



Model 3700



Model 3507

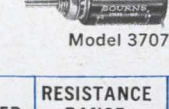

Model 3707

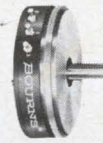

Model 3460



Model 3550



Model 3560



Model 3570



Model 3580



Model 3750

| | MODEL NUMBER | SIZE (inches) DIA.—CASE LENGTH | NUMBER TURNS | RESISTANCE RANGE (ohms) | STD. TR TOL. (%) | STD. LINEARITY (%) | POWER (watts) | MAX. OP. TEMP. (°C) | HUMIDITY (MIL-R-12934C) |
|---|--------------|------------------------------------|--------------|-------------------------|------------------|---------------------|---------------|---------------------|-------------------------|
| BUSHING MOUNT | 3400 | 1 $\frac{1}{16}$ x 1 $\frac{1}{4}$ | 10 | 100-1 meg | ±3 | ±0.15 | 5.0 | 105 | yes |
| | 3410 | 2 x $\frac{5}{8}$ | 1 | 50-100K | ±3 | ±0.3 | 4.0 | 125 | yes |
| | 3500 | $\frac{7}{8}$ x 1 | 10 | 50-500K | ±3 | ±0.2 | 2.0 | 125 | yes ⁽¹⁾ |
| | 3510 | $\frac{7}{8}$ x $\frac{9}{16}$ | 3 | 25-100K | ±3 | ±0.30 | 1.0 | 125 | yes ⁽¹⁾ |
| | 3520 | $\frac{7}{8}$ x 1 $\frac{1}{16}$ | 5 | 25-250K | ±3 | ±0.30 | 1.5 | 125 | yes ⁽¹⁾ |
| | 3530 | $\frac{7}{8}$ x $\frac{1}{2}$ | 1 | 25-50K | ±3 | ±0.50 | 1.0 | 125 | yes |
| | 3700 | $\frac{1}{2}$ x 1 | 10 | 50-250K | ±5 | ±0.25 | 1.0 | 125 | yes |
| LOW COST, INDUSTRIAL BUSHING MOUNT | 3507 | $\frac{7}{8}$ x 1 $\frac{1}{8}$ | 10 | 100-250K | ±5 | ±0.50 | 2.0 | 105 | no |
| | 3707 | $\frac{1}{2}$ x 1 | 10 | 100-50K | ±5 | ±1.0 | 1.0 | 105 | no |
| SERVO MOUNT | 3460 | 2 x $\frac{5}{8}$ | 1 | 50-100K | ±3 | ±0.3 | 4.0 | 125 | yes |
| | 3550 | 1 x 1 $\frac{1}{16}$ | 10 | 50-500K | ±3 | ±0.20 | 2.5 | 125 | yes |
| | 3560 | $\frac{7}{8}$ x 1 $\frac{3}{64}$ | 3 | 25-100K | ±3 | ±0.25 | 1.5 | 125 | yes |
| | 3570 | $\frac{7}{8}$ x 1 $\frac{3}{16}$ | 5 | 25-250K | ±3 | ±0.25 | 2.0 | 125 | yes |
| | 3580 | $\frac{7}{8}$ x $\frac{5}{8}$ | 1 | 25-50K | ±3 | ±0.5 | 1.0 | 125 | yes |
| | 3750 | $\frac{1}{2}$ x 1 $\frac{1}{16}$ | 10 | 50-250K | ±5 | ±0.25 | 1.0 | 125 | yes |
| KNOBPOT® POTENTIOMETERS | 3600 | $\frac{3}{4}$ x 1 | 10 | 100-250K | ±5 | ±0.5 ⁽²⁾ | 1.5 | 125 | yes |
| | 3640 | 1 $\frac{1}{4}$ x 1 $\frac{1}{2}$ | 10 | 100-500K | ±3 | ±0.1 ⁽²⁾ | 2.5 | 125 | yes |

(1) Std. models exceed steady-state requirements of MIL-STD-203, METHOD 103. Optional models are available meeting humidity cycling requirements of MIL-STD-202, METHOD 106. (2) Standard dial accuracy, including linearity.

MODEL 3660 LABPOT™ PRECISION POTENTIOMETER



A compact, dial-readout precision potentiometer designed as a convenient tool for a variety of laboratory applications. Incorporates Bourns' exclusive KNOBPOT® potentiometer for high readability through its unique "clock-dial" face. Portable, lightweight, yet remains firmly in place when in use. Large five-way binding posts permit easy hookup of any kind of leads. Fused for protection against burnout. An extra fuse is provided inside for added convenience.

Specifications:

Std. Resistances 1K, 10K, 100K (others available on request)
 Resistance Tolerance ±1%
 Dial Accuracy15%, 1K; .10%, 10K and 100K
 Repeatability ±.05% voltage ratio
 Operating Temp. Range -65 to +125°C
 Power Rating 2.5W at room temp.
 Mechanical Life 200,000 dial rev.
 Weight 1.4 ounces

KNOBPOT® POTENTIOMETERS

Precision potentiometer, clock readout dial and knob in a single, compact package. Mounts in front of panel. See specs above.



Model 3640

KNOBPOT Sr. potentiometer—similar to Model 3600, but more accurate and slightly larger. See specs above.

KNOBPOT POTENTIOMETER ACCESSORIES FOR MODELS 3600 AND 3640 unless otherwise specified



1. COLORED PLASTIC SNAP RINGS in red, yellow, blue, green, white per MIL-STD-595.
2. STANDARD MIL-SPEC 1" DIA. SLIP-OVER KNOBS of plastic, in MIL-SPEC red, yellow, blue, green, black, gray. For Model 3600 only.
3. STAINLESS STEEL SKIRTS (for use without brake).
4. STAINLESS STEEL LOCKING BRAKE (left) with plastic handles for Model 3600. All-plastic friction brake (right) for Model 3640.
5. STAINLESS STEEL, PANEL-RECESSED MOUNTING BRACKET permits recession of dial.

TURNS-COUNTING DIALS



Easy-to-read vernier dials requiring only 1" of panel space are available for all Bourns precision potentiometers (except KNOBPOT® units, which incorporate their own readout).



NEW 10-TURN H-351 SERIES TURNS-COUNTING DIAL, only $\frac{1}{2}$ " dia. by $\frac{5}{8}$ " long. Clock-face readout; continuous, full-gear engagement.



BOURNS, INC., TRIMPOT DIVISION
 1200 COLUMBIA AVE., RIVERSIDE, CALIF.
 PHONE 684-1700 • TWX: 714-682 9582
 CABLE: BOURNSINC.

MANUFACTURER: TRIMPOT® & PRECISION POTENTIOMETERS, RELAYS; TRANSDUCERS FOR PRESSURE, POSITION, ACCELERATION. PLANTS: RIVERSIDE, CALIFORNIA; AMES, IOWA; TORONTO, CANADA

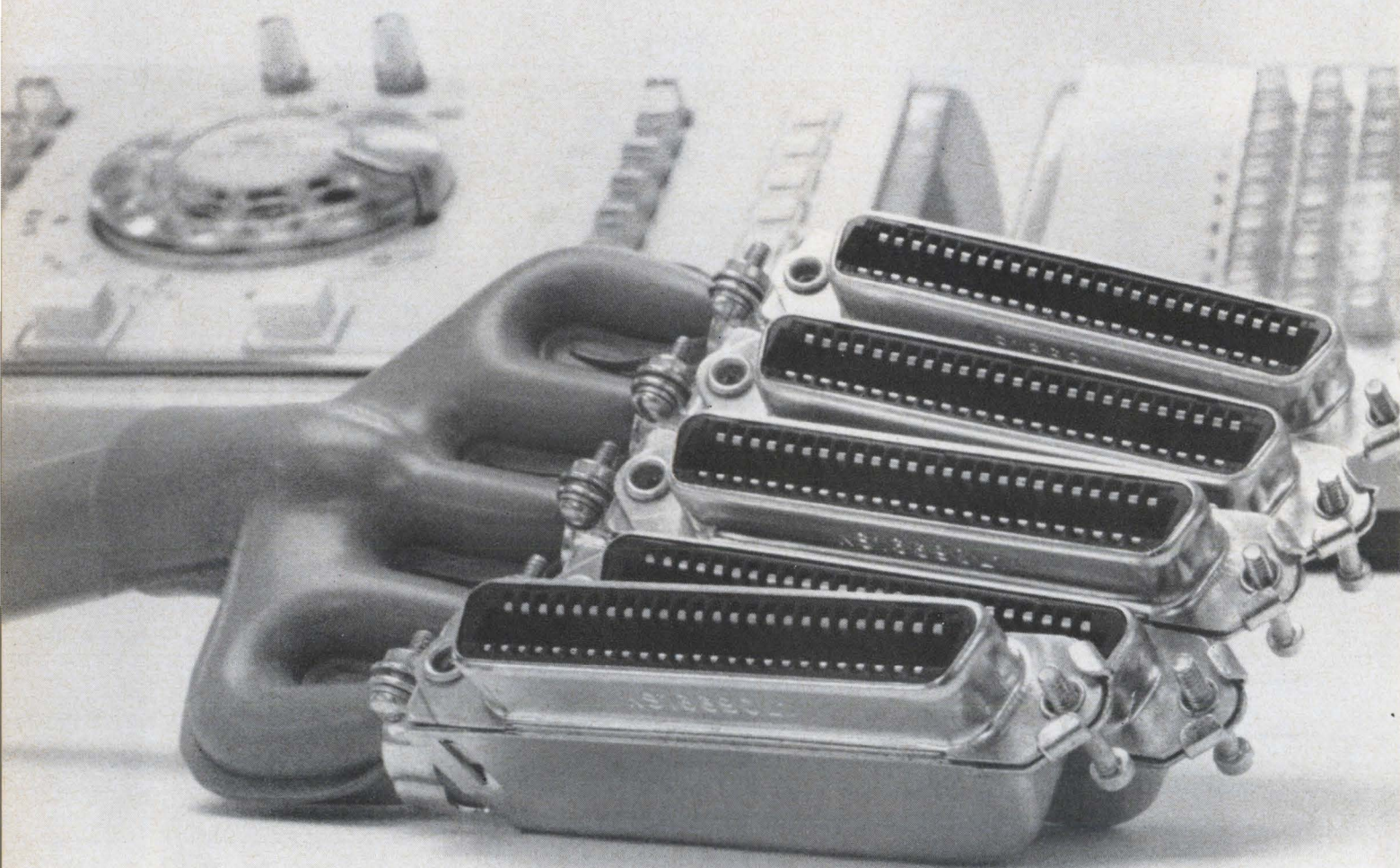

***How Amphenol helps
put a 200-phone
switchboard on a desk top***

The Bell System reduced the switchboard to a tenth of its usual size, then called on Micro-Ribbon® connectors to simplify desk-top installations.

Five Micro-Ribbon connectors route the 250 circuits Bell needs for the two-console, 200-phone board—plus they offer these three important advantages:

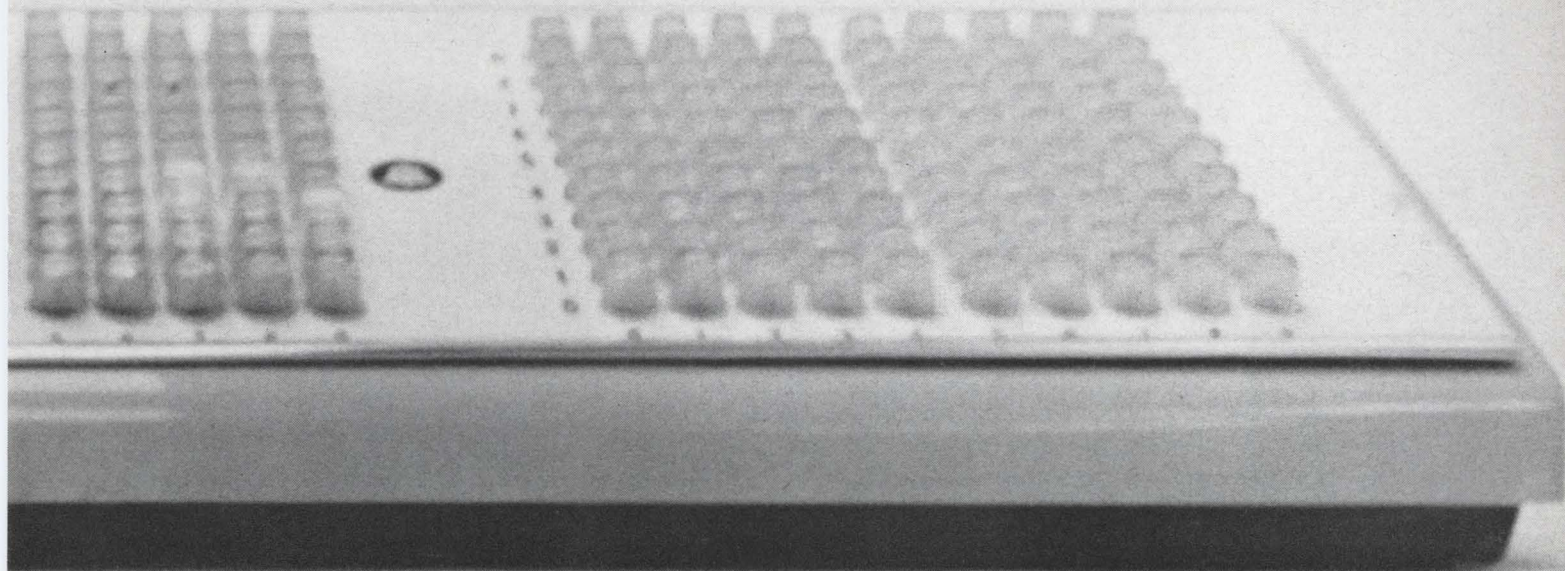

1. **SIZE.** Each 50-contact Micro-Ribbon connector takes little more space for the connection than the cable itself.

If your application calls for fewer circuits, you can gain similar miniaturization advantages with Amphenol 14, 24 or 36-contact Micro-Ribbons.

2. **RELIABILITY.** Bell demands long service life from its equipment

... usually 25 years. To date, Amphenol Micro-Ribbon connectors with self-cleaning, self-wiping contacts have been equal to the task. Not one failure has been reported in over 500 million contacts.

3. **COST REDUCTION.** Competitive in initial price, Amphenol Micro-Ribbon connectors helped cut installation time and maintenance

costs. Estimates on Bell's savings range from 20% to 30%. Equipment replacement is more simple for Bell, too. Unplug the old; plug in the new.

For complete information about Micro-Ribbon or any of the other 36,000 connectors Amphenol makes, call your Sales Engineer. Or write *Amphenol Connector Division, 1830 S. 54th Ave., Chicago, Illinois 60650.*



CONNECTOR DIVISION

amphenol corporation

Specify Amphenol . . . the leading name in cable, connectors, assemblies, RF switches, potentiometers, microelectronics

Now You Can Specify 80, 100, 120, 140, 175 and 300-Volt Silicon Annular* Transistors for PNP and NPN Applications!

Only Motorola high-voltage *annular* transistors offer uncompromising *full performance* with high gain, high frequency and low leakage.

Since the introduction of the first high-voltage annular transistors in early 1963, annular process devices have become the most often specified types for high-voltage applications. Today PNP and NPN annular transistors are available with voltages up to 300 volts, with intermediate values of 80, 100, 120, 140, 150, and 175 volts.

Why should the new annular fabrication process make these devices so universally desirable? First, in conventionally passivated devices a phenomena called "channelling" caused high leakage at high voltage levels, thus wiping out the advantage of the passivation . . . and causing unreliable device performance. Annular devices, which use a "guard band" around the operating region to prevent channelling and controlled channel formation under the oxide to minimize variations due to ions settling on the surface of the glass (another source of high leakage in conventional devices), solved this problem.

Second, even though some high voltage transistors (100 volts or more) have been offered in the past, because of the processes used, they have had to compromise voltage performance with gain/frequency characteristics. In effect, you get high voltage without the holdup of gain at high frequency, or, in other words, you give up normal transistor gain characteristics in order to get voltage. With annular devices, you get *full performance* in all parameters.

Motorola annular transistors have undergone a series of improvements culminating in the latest devices offering 300-volt breakdown ratings for both PNP and NPN transistor types. Moreover, you obtain this new voltage freedom without sacrifice in frequency response ($30 \text{ mc} - f_T$), gain (h_{FE} up to 250), or any increase in leakage current ($I_{CBO} = 0.2 \mu\text{A}$). And you get the added benefit of extreme parameter stability which was the primary goal achieved by the annular process.

CHOOSE YOUR ANNULAR HIGH VOLTAGE TYPE!

PNP

| BV _{CEO} Voltage | Type No. | Collector Current |
|------------------------------|-------------|----------------------|
| 80 | 2N3494 & 96 | 100 mA |
| 120 | 2N3495 & 97 | 50 mA |
| 140 | 2N3634 & 35 | 150 mA |
| 175 | 2N3636 & 37 | 150 mA |
| 300 | 2N3743 | 50 mA |

NPN

| BV _{CEO} Voltage | Type No. | Collector Current |
|------------------------------|-------------|----------------------|
| 100 | 2N3498 & 99 | 500 mA |
| 150 | 2N3500 & 01 | 300 mA |
| 300 | 2N3442 | 50 mA |

These Very High Voltage annular transistors offer you a new degree of design freedom. Whether you wish to operate deflection systems of small cathode ray tubes directly from the collector of a transistor, or develop entire systems operating directly from line voltage, thereby making it possible to eliminate transformers, or whether you merely want greater protection from high voltage spikes, Motorola Very High Voltage annular transistors offer you the answer.

If you haven't tried these devices in your most demanding circuits, we'd welcome the opportunity of proving their superiority. Simply call your nearest Motorola semiconductor field representative and request samples of the new 300-volt annular transistor — type 2N3742 for NPN applications, and 2N3743 for PNP designs.

*Patent Applied For

ANNULAR MAKES THE DIFFERENCE IN SILICON TRANSISTORS

MOTOROLA



Semiconductor Products Inc.

HERE IT IS!

The new low-priced DIGITAL VOLTMETER and RATIO METER

- **COMPACT**
- **LIGHTWEIGHT**
- **VERSATILE**
- **ACCURATE**
- **RELIABLE**

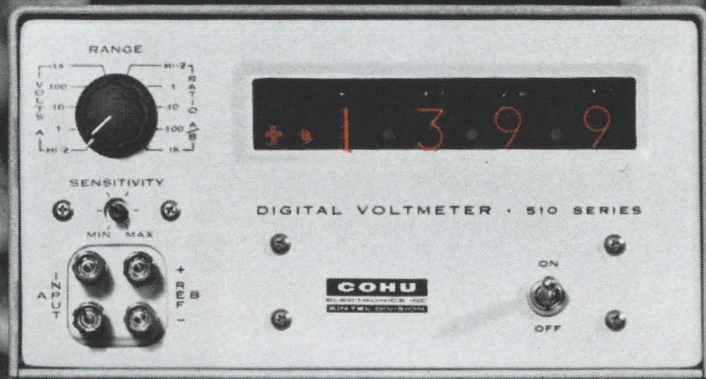

developed by COHU ELECTRONICS and designated the model 511

CHECK THESE ABBREVIATED SPECIFICATIONS:

- 0.01% ACCURACY, ± 1 DIGIT
- 4 DIGITS RESOLUTION ON ALL RANGES
- AUTOMATIC POLARITY INDICATION
- 10 MANUAL RANGES, 1V TO 1000V, 1:1 TO 1000:1 RATIOS
- HIGH INPUT RESISTANCE
- SOLID-STATE REFERENCE AND CIRCUITRY
- BI-DIRECTIONAL, TRACKING LOGIC
- PRICE: \$995.00 F.O.B. San Diego. Additional export charge

Box 623, San Diego, California 92112 Phone 714-277-6700



for detailed specifications contact your nearest representative

See us at WESCON, booth 3923

EAGLE *Cycl-Flex*® TIMERS/COUNTERS

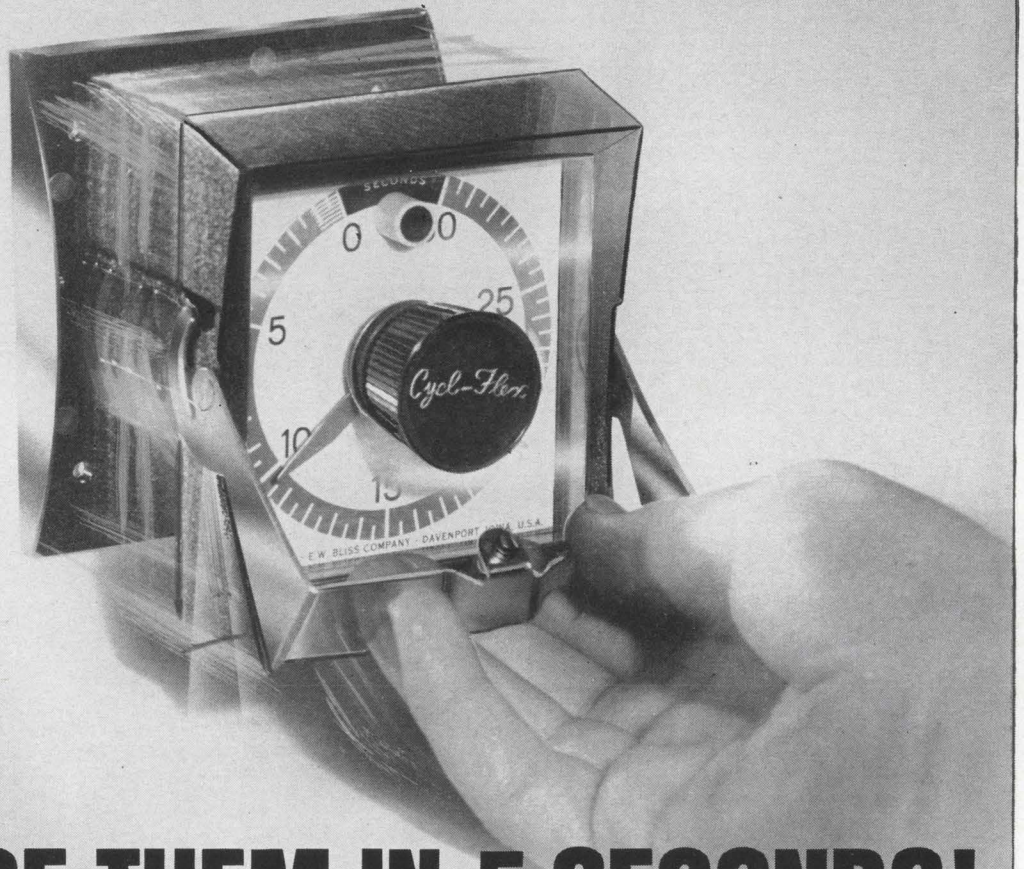

REPLACE THEM IN 5 SECONDS!

Cut down-time and increase production with Eagle Cycl-Flex time and count controls. You can remove them, check them and replace them in 5 seconds or less...no tools needed!

- Cycl-Flex plug-in timers can be controlled to within 0.5% of the dial range.
- Front-panel mounting makes them easy to install and set.
- Long cycling life—through extensive quality control and life testing programs.
- A synchronous motor and toothed clutch, produced by a special Eagle process, assure totally accurate settings and performance.

Add all these features together. Then add Eagle's special consultation, development and design services... and custom production of all types of units.

Compare. You'll choose Eagle.

165-1

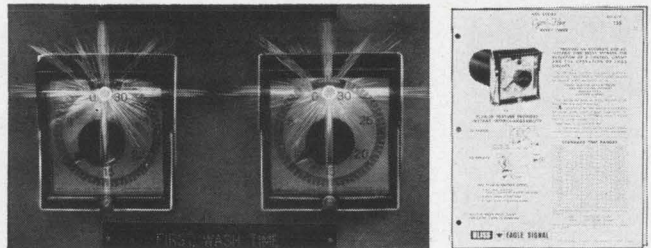

NEW—Now standard on all Cycl-Flex timers, a built-in pilot light, to indicate, even from a distance, that the timer is operating.

For full details on Cycl-Flex timers, write for Bulletin 125, Eagle Signal Division, E. W. Bliss Company, Federal Street, Davenport, Iowa.

BLISS  **EAGLE SIGNAL**

A DIVISION OF THE E. W. BLISS COMPANY

Electro-Mechanical, Electronic, Solid State Timing/Counting/Programming Controls General Purpose, Medium Power Relays

NEW EAGLE RELAYS

COMPARE
Better Life Characteristics

COMPARE
Higher Reliability

COMPARE
Fewer Parts

COMPARE
More Design Flexibility

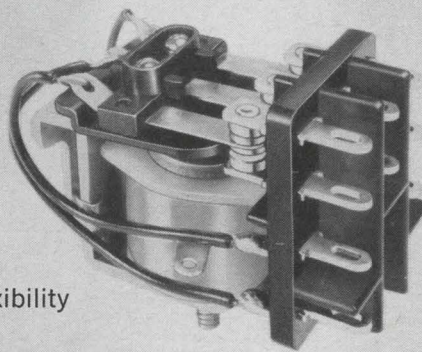

Eagle 25AA
General Purpose
Relay (Actual Size)

COMPARE
Lower Pull-in Voltages

COMPARE THEM!

New Eagle relays...more than 3,000 types...are the best you can get anywhere. Be crafty. Check the specs and the product. Convince yourself.

One example: Gold-plated contacts are *standard* on every general purpose Eagle relay. And on medium power relays, silver cadmium oxide contacts are standard, since they deliver the best possible current-bearing characteristics in this power range.

Check some more. Note the sturdy designs...the ratings that exceed all other competitively-priced units...the precise engineering and inventive use of materials. They're all what you'd expect from Eagle—leaders in time/count control devices.

If you've ever dealt with Eagle you'll expect more, and you'll get it. We're talking about unequalled service...service that frankly has never before been available from any relay manufacturer.

Compare. You'll choose Eagle.

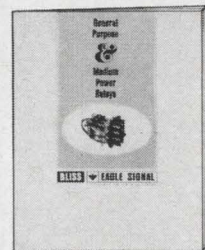
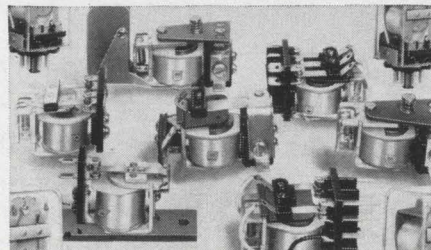

Part of the "big" picture...more than 3,000 types: plug-in with dust covers; dual latching; hermetically sealed; custom-engineered styles.

Get full details in our new, 16-page color catalog. Send for your free copy to Eagle Signal Division, E. W. Bliss Company, Federal Street, Davenport, Iowa.

BLISS  **EAGLE SIGNAL**

A DIVISION OF THE E. W. BLISS COMPANY

Electro-Mechanical, Electronic, Solid State Timing/Counting/Programming Controls General Purpose, Medium Power Relays



TRIDEA "TRACKS" WITH MCDONNELL

In joining the McDonnell organization, Tridea has extended its production capabilities and developed an *end-mission* association that includes contract assignments for fighter aircraft, manned spacecraft, winged glide vehicles and other lifting reentry spacecraft. As a subsidiary of McDonnell, its allied electronics goals and dynamic scientific and engineering talents provide increased opportunity for transmission of ideas and experience.

The combined talents of Tridea and McDonnell Electronics Division make it plain that Tridea is going to make large and lasting "tracks" in the electronics industry, in radar systems, ECM, GSE, telemetry and air navigation and traffic control.



TRIDEA ELECTRONICS

Subsidiary of

MCDONNELL

For information write Dept. 946 • Box 516 • St. Louis, Missouri 63166

Applying Electronics as an Interdisciplinary Science

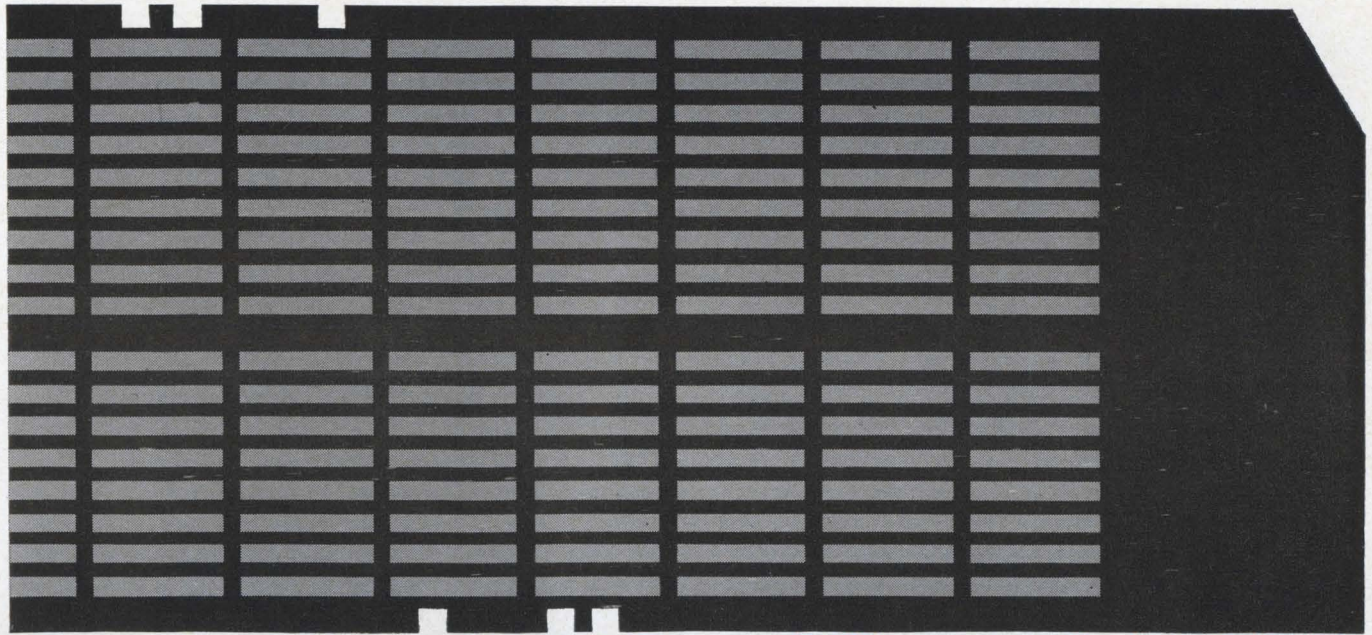

The Long Awaited Breakthrough In EDP

Via Magnetic Iron Oxides The rapidly developing science of Electronic Data Processing has received an impetus of explosive significance through the stepped-up use of magnetic iron oxide coated cards.

Handling mass storage and retrieval of voluminous data and utilizing advanced random access techniques, in some cases the cost per 10,000 alpha-numerical characters has been driven down to as low as one-tenth of their former costs!

Engineering the 'packing density' of the data into radically tighter units on the cards has brought EDP within the pocketbook range of scores of companies not previously in the 'live prospect' class.

Pfizer, as a major supplier of magnetic iron oxides congratulates the EDP industry for its enterprise. Pfizer for its part will continue to provide the chemical purity and uniform magnetic properties that make their product a standard of reliability.

Yes — Pfizer stands ready and willing to dispense all pertinent, technical information. Write Department 75

**MINERALS
PIGMENTS
& METALS**
DIVISION CHAS. PFIZER & CO. INC.



Dept. 75, 235 East 42nd Street
New York 17, N.Y.

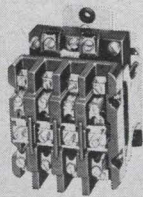

A. C. Industrial Contactors

RBM STANDARD CONTROLS

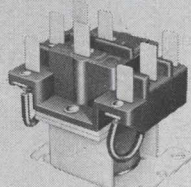
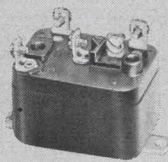

A. C. General Purpose Relays

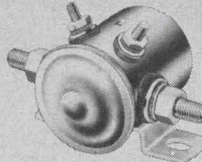

D. C. Power Contactors

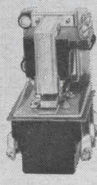
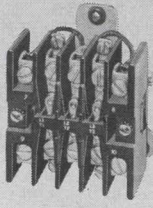
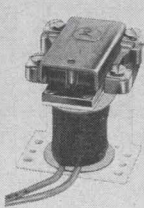

A. C. Power Contactors

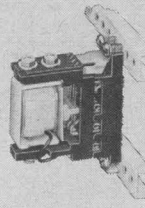

D. C. Computer Relays

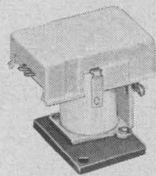

Miniature D. C. Sensitive Relays

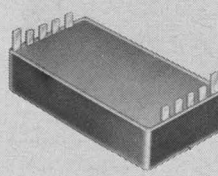
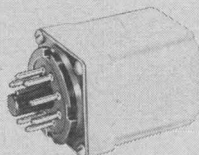

Bi-Reed Relays

When you use RBM STANDARD CONTROLS you are assured of...

Immediate Availability—sold by leading Industrial Electronic Distributors* in major marketing areas — AT OEM PRICES IN ANY QUANTITY.

Highest Quality—millions of controls—field proven under most exacting requirements —have earned mass market customer acceptance.

Competitive Prices—RBM CONTROLS mass production facilities—geared to serve major markets—assure lowest cost.

Stocked In Depth—all standard controls stocked in Chicago warehouse with bulk (back-up) stock at the factory.

Service Replacement—over 8,000 custom designed controls are replaceable from standard catalog stock. Consult nearest RBM CONTROLS Authorized Distributor or Branch Sales Office for replacement recommendations.

MINIATURE D.C. CURRENT SENSITIVE RELAYS / AN RBM STANDARD



Type MS25



Type MS50P

1PDT 40 MW. • 2PDT 125 MW. • 3PDT 200 MW.
Isolated Contacts • Protective Covers
Coil Res. 15,000 Ohms Max. • Molded Coil Bobbin
Open Type • Plug-In

RBM STANDARD CONTROLS
ARE DISTRIBUTED BY

**ELECTRONIC MARKETING DIVISION
ESSEX WIRE CORPORATION**

3501 W. Addison Street • Chicago, Illinois 60618

In products, performance, purpose... Essex measures up!



*RBM DISTRIBUTORS

- ALABAMA**
Specialty Distributing Co.
Mobile
- ARKANSAS**
Bluff City Distributing Co.
Jonesboro
- ARIZONA**
Kierulff Electronics Inc.
Phoenix
- CALIFORNIA**
Fisher Switches
Palo Alto
Kierulff Electronics
Los Angeles
- COLORADO**
Kierulff Electronics, Inc.
Denver
- CONNECTICUT**
Cramer Electronics, Inc.
Hamden
- FLORIDA**
Electronic Equipment Co.
Miami
Hammond Electronics
Orlando
- GEORGIA**
Specialty Distributing Co.
Atlanta
- ILLINOIS**
Allied Radio Corporation
Chicago
- INDIANA**
Graham Electronics Supply Inc.
Indianapolis
- MARYLAND**
Powell Electronics
Beltsville
- MASSACHUSETTS**
Cramer Electronics, Inc.
Newton
- MICHIGAN**
Radio Electronic Supply Co.
Detroit
- MINNESOTA**
Lew Bonn Company
Minneapolis
- MISSISSIPPI**
Bluff City Distributing Co.
Greenville
- MISSOURI**
Burstein-Applebee Co.
Kansas City
Interstate Industrial
Electronics, Inc.
St. Louis
- NEW MEXICO**
Kierulff Electronics, Inc.
Albuquerque
- NORTH CAROLINA**
Dixie Radio Supply Co.
Charlotte
- NEW YORK**
Electro-Tech Equipment Co.
New York
Roburn Agencies, Inc.
New York (Export)
- OHIO**
Pioneer-Standard Electronics
Cleveland
SREPCO-Div. Pioneer-
Standard Electronics
Dayton
- OKLAHOMA**
Engineering Supply Co.
Tulsa
- OREGON**
Lou Johnson Co., Inc.
Portland
- PENNSYLVANIA**
Powell Electronics
Philadelphia
- SOUTH CAROLINA**
Dixie Radio Supply Co.
Columbia
- TENNESSEE**
Bluff City Distributing Co.
Memphis
- TEXAS**
Engineering Supply Co.
Houston
Tekko, Inc.
Dallas
- WASHINGTON**
Western Electronics Co.
Seattle
- WISCONSIN**
Radio Parts Company
Milwaukee

FREE
WRITE FOR
SC-1 CATALOG

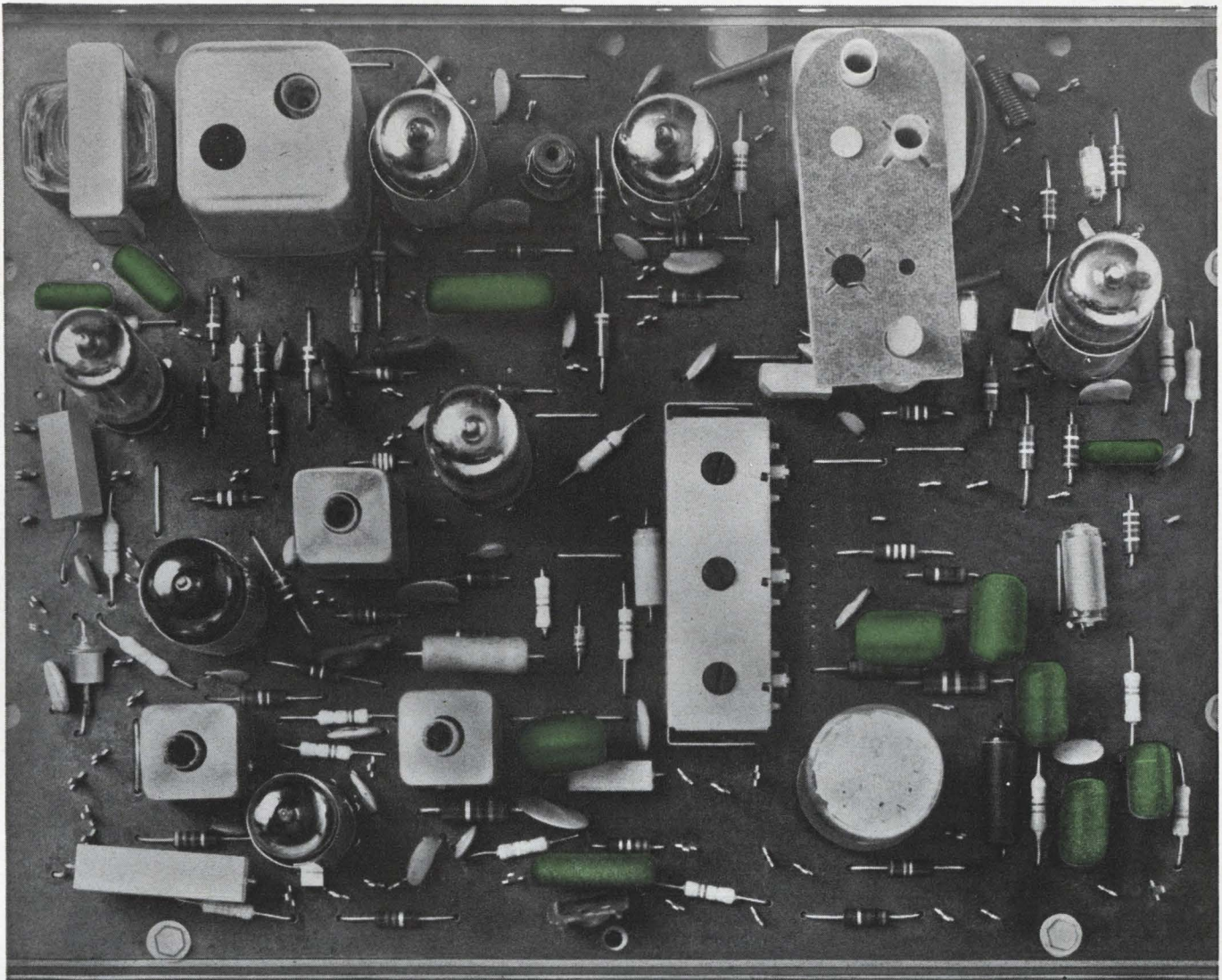

In Westinghouse TV, capacitors of "Mylar"® replaced those of molded paper-

Bob Tesno, TV Engineering Supervisor, tells why:

1. Reliability

"We ran extensive tests comparing capacitors with a dielectric of 'Mylar'* with ones of paper, molded paper and dual dielectric. We found that the capacitors of 'Mylar' came out on top—with virtually no temperature, humidity or leakage problems. In the four years since their adoption, the reliability of capacitors of 'Mylar' in the field has been nearly perfect."

2. Size

"Actually, we first adopted capacitors of 'Mylar' for all Westinghouse TV receivers when printed circuit boards became important factors in production. Capacitors of 'Mylar' are considerably smaller than molded-paper ones of equivalent value. This avoids crowding of components on the board."

*Du Pont's registered trademark for its polyester film.

3. Price

"As a clincher," adds Tesno, "in most cases* capacitors with a dielectric of 'Mylar' cost no more, and, in fact, often cost less than molded-paper or dual dielectric capacitors."

*(Note: This applies to capacitors that are up to .1mfd 400v in size.)

Can your designs benefit from the many advantages of capacitors of "Mylar"? For complete data, write Du Pont Film Dept., N10452 B-22, Wilmington, Delaware 19898.



Better Things for Better Living
...through Chemistry

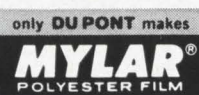

LOOK!

This Model 630 Integrating Digital Multimeter From Electro Instruments Is The World's

MOST VERSATILE



It has 1 megacycle frequency counter...eliminates errors in measurements near zero and/or involving polarity changes...lets you measure DC voltages, frequencies and time intervals with one instrument...has built-in storage to eliminate "rolling" of digits in readouts...and 1 microvolt resolution. And its price is only

\$3,295

Electro Instruments, Inc.

8611 Balboa Avenue San Diego, California 92112
Electro International, Inc., Annapolis, Md.



Now: Signetics new LU-Series Integrated Circuits less than \$1.50 per gate function



Now: a new low-cost Utilogic series that provides more insurance against random noise errors than any other integrated circuits being offered for commercial/industrial applications. LU-Series circuits have an 800 mv minimum noise margin. Operation is guaranteed from +10°C to +55°C. Fan-outs of up to 17 from Gates and J-K Binary element assure low system can-counts. High capacitive driving capability eliminates most commonly encountered line capacity problems. Available in TO-5 can...and guaranteed by the world's oldest exclusive manufacturer of integrated circuits: Signetics. New address: 811 E. Arques Avenue, Sunnyvale, California.

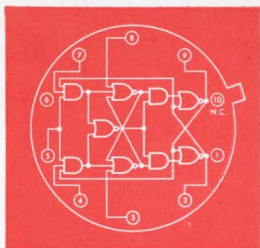

LU320
J-K BINARY ELEMENT

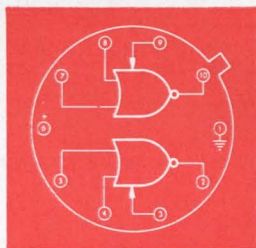

LU316 DUAL EXPANDABLE
NOR GATE

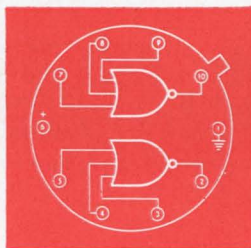

LU315
DUAL 3-INPUT NOR GATE

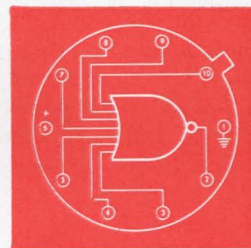

LU314
7-INPUT NOR GATE

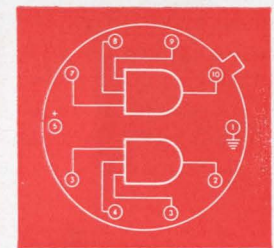

LU306
DUAL AND GATE

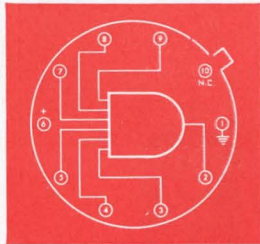

LU305 AND GATE

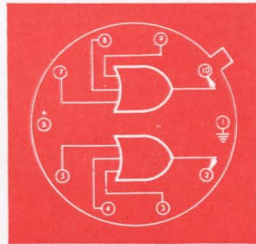

LU300 GATE EXPANDER

| Prices | 1-24 | 25-99 | 100-999 |
|--------|--------|--------|---------|
| LU300 | \$4.05 | \$3.25 | \$2.70 |
| LU305 | 4.45 | 3.55 | 2.95 |
| LU306 | 4.45 | 3.55 | 2.95 |
| LU314 | 4.45 | 3.55 | 2.95 |
| LU315 | 4.45 | 3.55 | 2.95 |
| LU316 | 4.45 | 3.55 | 2.95 |
| LU320 | 9.50 | 7.60 | 6.35 |

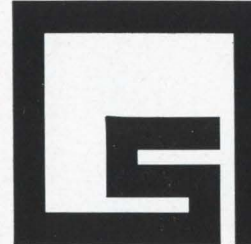

**SIGNETICS
INTEGRATED
CIRCUITS**

Signetics is the oldest exclusive maker of integrated circuits in the world. Founded: 1961. Sunnyvale, California. Subsidiary of Corning Glass Works.

AUTHORIZED SIGNETICS REPRESENTATIVES AND DISTRIBUTORS: ALA. Compar Southern, Huntsville, 881-3294 □ ARIZ. Compar Rocky Mountain, Phoenix (Scottsdale), 947-4336 □ CALIF. Compar Los Angeles, Los Angeles (Glendale), 245-1172; Jack Pyle Company, San Francisco (Representative) 349-1266; Compar San Francisco, San Francisco (Distributor) 697-6244, □ COLO. Compar Rocky Mountain, Denver (Littleton), 798-2431 □ CONN. Compar New England, Hamden 288-9276 □ DISTRICT OF COLUMBIA (see Hyattsville, Md.) □ FLA. Compar Florida, Orlando, 855-3964 □ ILL. Compar Chicagoland, Chicago 46, 775-5300 □ MD. Compar Chesapeake, Baltimore, 523-7700; Compar Chesapeake, Hyattsville, 927-7222 □ MASS. Compar New England, Boston (Newtonville), 969-7140 □ MICH. Compar Michigan, Detroit, 865-5550 □ MINN. Compar Twin Cities, Minneapolis, 922-7011 □ MO. Compar Ozarks, St. Louis, 428-5313 □ N.J. Compar Philadelphia, Camden (Haddonfield), 429-1526 □ N.M. Compar Rocky Mountain, Albuquerque, 265-1020 □ N.Y. Compar Albany, Albany, 436-8536; Compar Albany, Binghamton (Endwell), 723-8743; Compare Albany, Buffalo (Depew), 684-5731; Compare New York, Clifton, New Jersey, 471-6090 □ N.C. Compare Southern, Charlotte, 333-7743 □ OHIO Compare Ohio, Cleveland (Fairview Park), 333-4120; Compare Ohio, Dayton (Fairborn), 878-2631 □ ORE. (see Washington) □ PENN. Philadelphia (see Camden, New Jersey) □ TEXAS Compare Southwest, Dallas, 327-3944; Compare Southwest, Houston, 645-2135 □ VA. Compare Southern, Richmond, 266-2060 □ WASH. Compare Northwest, Seattle, 622-0622 □ CANADA Aero Sales Engineering Company, Rexdale, Ont., 249-9139; Aero Sales Engineering Cooper, Ottawa, Ont., 828-8560.
SIGNETICS METROPOLITAN NYC SALES OFFICE: Newark, New Jersey, Phone (201) 992-3980; Irving Cooper, Brian Brackle
SIGNETICS EASTERN REGIONAL SALES OFFICE: Francis J. Bigda, 591 North Ave., Wakefield, Mass., Phone (617) 245-8200, TWX: (617) 245-8367
SIGNETICS WESTERN REGIONAL SALES OFFICE: Jack Halter, 8820 Sepulveda, Los Angeles 45, Calif., (213) 776-2295/2296, TWX: (213) 670-4303

If you know one of our Sales Engineers, you know what's most important to know about synchros.



Now you know. One of our Sales Engineers can help you with *any* synchro problem. Including those you've almost given up on. He represents the most complete line of synchros in the industry, and his knowledge about them stays as up-to-date as today.

That's why he's one of the few people around who doesn't break out

into a sweat when customers ask about those new high-temperature synchros that can take up to 800 degrees F.

How about synchros resistant to nuclear radiation? Space and missile applications? He knows, he knows. All about the new line of military and Autosyn® synchros, too. So, if you're

up against a tough synchro problem, get in touch with one of our Sales Engineers.

He's just the man to help you solve it. Phone 717 278-1161, Montrose, Penna.

Send for new catalog.



Montrose Division



Eastman Kodak Company
Special Applications
Rochester, New York 14650



This is one way to get an answer

**This is
another**

Your need for data capture is specific to the job at hand, and photography is a possible answer. So you put your problem to us in a letter (a phone call to 716-325-2000, Ext. 5129, may do just as well). If the photographic method is not a practical answer for you, we tell you so. If it is, we get you together with the two or three photo-engineers on our staff who are best qualified to respond to your special requirements.

We can extend this broad-gauge invitation because a new line of Kodak films designed for quick, compact, fuss-free processing offer a new potential for removing the nuisance aspects of photorecording and leaving only its great benefits. Now we are ready for many high-volume data-recording applications. Yours may be one.



Kodak

New IBM miniature dry reed switches give you low contact resistance —less than 100 milliohms throughout life

But that's not all.

These new reed switches are now double plated, rhodium over gold, to give you low noise as well.

And long life too—up to 125 million error-free operations (mean time to first error).

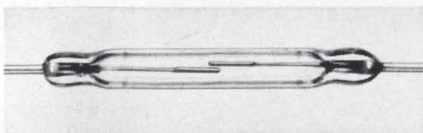

We dynamically set the air gap for each switch (shown here 2X actual size).

Whether you use IBM miniature dry reed switches in relays or magnet actuated applications you get highly consistent performance throughout life. Here's why.

First, we *dynamically* set the air gap between the reeds. This means a stable sensitivity of ± 7 NI (maximum) in every reed switch. No need to select or grade them.

Then we check contact resistance of each switch (including leads) under low level conditions. Result: a mean of 50 milliohms.

To verify long switching life we conduct life tests on a regular basis. Here we monitor every switching operation to identify every error—all the way up to end of life.

Finally we test our reed switches to meet rigid standards of quality in 34 important areas, such as alignment,

leakage and voltage breakdown.

But perhaps the best proof of their life/performance is our own testimonial: We use them in practically all of our own computers, including the new System/360.

Why not put IBM miniature dry reed switches to the test in one of your applications. For complete specifications, life ratings and test criteria write to the IBM Industrial Products Division, 1000 Westchester Avenue, White Plains, New York 10604.

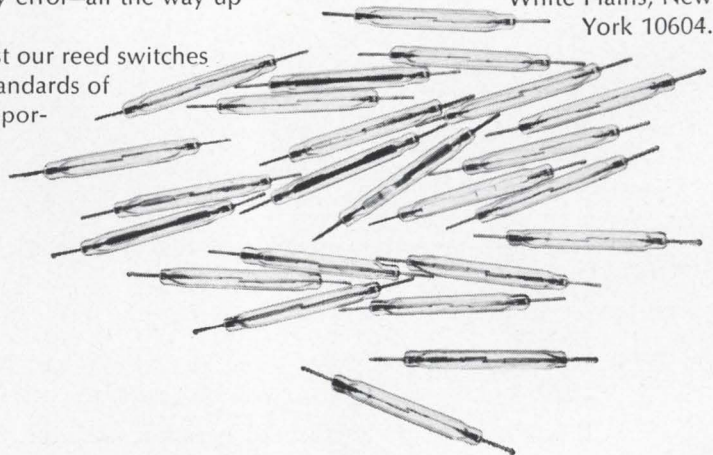



type 422

portability

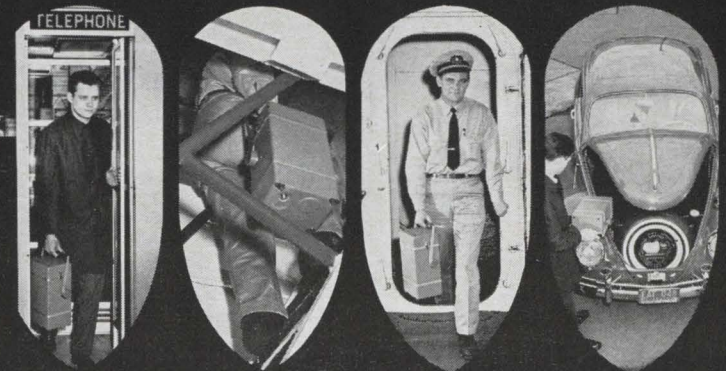

awkward situations

easy carrying

tight squeezes

small spaces

The Type 422 is dimensionally proportioned for comfortable portability and on-the-job convenience.

Small Size — with maximum overall dimensions of 6¾" high x 10" wide x 17½" deep, including panel cover and handle, making it easy to carry anywhere, even through a revolving door.

Light Weight — ~21 pounds, with panel cover and included accessories.

Low Power Requirements—for AC model, ~40 watts; for AC-DC model, ~28 watts AC, ~22 watts DC; power drain on external DC is constant for 11.5v—35 v range.

Rugged Construction — designed and tested to meet Tektronix environmental requirements:

Storage (without batteries) —55°C to +75°C, to 50,000 ft.

Operating (without batteries) —15°C to +55°C, to 15,000 ft.

Storage (with batteries) —40°C to +60°C

Operating (with batteries) —15°C to +40°C, to 15,000 ft.

No fan used. Runs cool and stays clean.

Versatile Performance—with bandwidth of dc-to-15 Mc, sensitivity to 10 mv/div, sweep speed of 0.5 μsec/div to 0.5 sec/div, and dual-trace operation in a compact instrument. Ch 2 X10 to 1 mv/div (AC only).

Sharp, Bright Displays—even under high ambient light conditions. Rectangular 4" CRT provides 7.9 square inches of usable graticule area. (For comparison, 6 cm x 10 cm = 9.3 square inches.)

Quality — same ±3% calibration accuracy, value engineering, careful manufacture, strict quality control, and international engineering support as other Tektronix laboratory oscilloscopes.

Type 422 Oscilloscope (AC only) \$1325

Type 422 Oscilloscope (AC-DC) \$1750

(Includes set of 20 NiCd cells)

U.S. Sales Prices f.o.b. Beaverton, Oregon

For a demonstration—call your Tektronix Field Engineer

Tektronix, Inc.

Type 422

Designed to handle the shocks, vibrations, temperatures, and other adverse conditions encountered in industrial environments. Proportioned to fit the job for ease in viewing and operation. Carrying handle adjusts for various tilt positions and is a sturdy support stand; front cover serves as accessory and storage case.

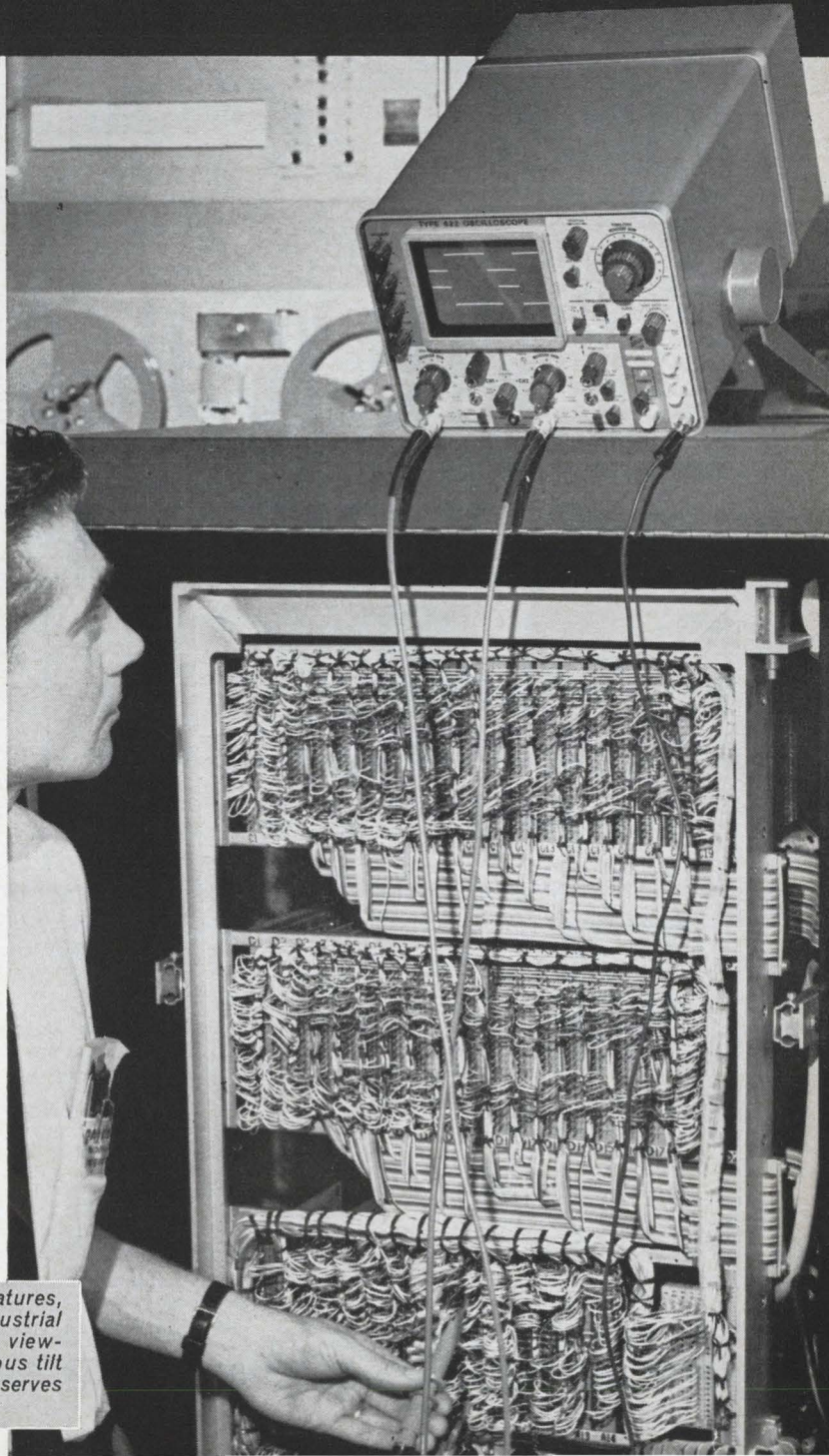

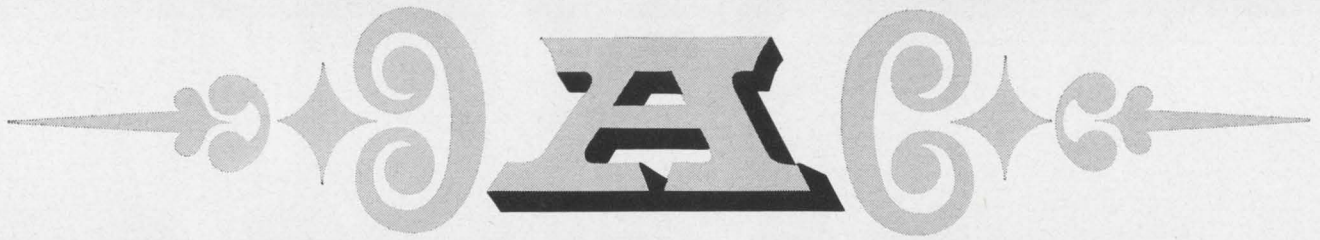

BLATANT APPEAL



TO YOUR EMOTIONS and your wallet

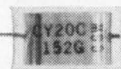
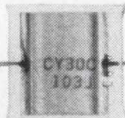

CORNING CYFM Capacitors: CYFM 10, 0.5—300 pf; CYFM 15, 220—1200 pf; CYFM 20, 560—5100 pf; CYFM 30, 3600—10,000 pf; VDCW, 300 and 500 volts.

Here's a chance to exercise your American sense of fair play and sportsmanship—and, at the same time, do a shrewd bit of capacitor-reliability buying.

Specify CORNING® CYFM Capacitors. Is it that simple? Yes.

Look at the rewards for you first. Our glass-dielectric CYFM capacitors give you *stability* that's invariable with time, temperature, and environment, and a TC that's always retraceable within 5 ppm on the curve.

You get *reliability* that's inherent from

the way they're made—in basically the same process that turns out our ultra-high-reliability CORNING CYFR Capacitor.

But you can save *dollars* on the CYFM because we don't put it through all the rigorous CYFR testing.

pf for pf, you can't buy more stability and reliability for fewer dollars than you get in the CORNING CYFM Capacitor.

Now, the emotional. Our CYFM lives constantly in the shadow of its glamorous Autonetics/Minuteman CYFR older brother. The CYFR has just successfully completed over 41 million unit test hours and 45 months of continuous testing!* You can well understand the

frustration, the second-best, underdog feelings of the CYFM.

Have a heart. Use your head. Specify CORNING CYFM Capacitors. You will make everybody happy—reliability engineers, comptrollers, and us.

For complete data and for parts, send to Corning Glass Works, 3909 Electronics Dr., Raleigh, N. C., or call your Corning distributor.

*Autonetics lot-acceptance testing program.

CORNING
ELECTRONICS



WHY
SOLID
STATE
POWER
IS
SQUEEZING
OUT
THE OLD
MG
SET

Almost overnight, SCR Thyristor power has grown to the point where it is now the only logical choice for adjustable speed drives. Here's why:

Almost instantaneous response. Signals from sensing devices are converted into power changes so fast that power supply is no longer the limiting factor in achieving maximum system performance.

True Solid-State reliability. With no moving parts, SCR Thyristor systems are completely free from the wear, tear and repair associated with rotating apparatus. Downtime is sharply reduced; production curves climb.

Lower maintenance and installation costs. SCR Thyristor systems require no special foundations, no critical alignment, less overall floor space, no preventive

maintenance, no periodic shutdowns. An occasional visual inspection is all that's needed.

Higher load efficiency. SCR Thyristor systems improve full load efficiency more than 20% over motor-generator sets, according to a detailed study of typical drive applications.

With all these advantages, why not specify SCR Thyristor Power on your next adjustable speed drive? And for the ultimate in performance and reliability, make sure your supplier uses Westinghouse SCR's. Ask him about our semiconductor guarantee. SC-203B

You can be sure if it's Westinghouse



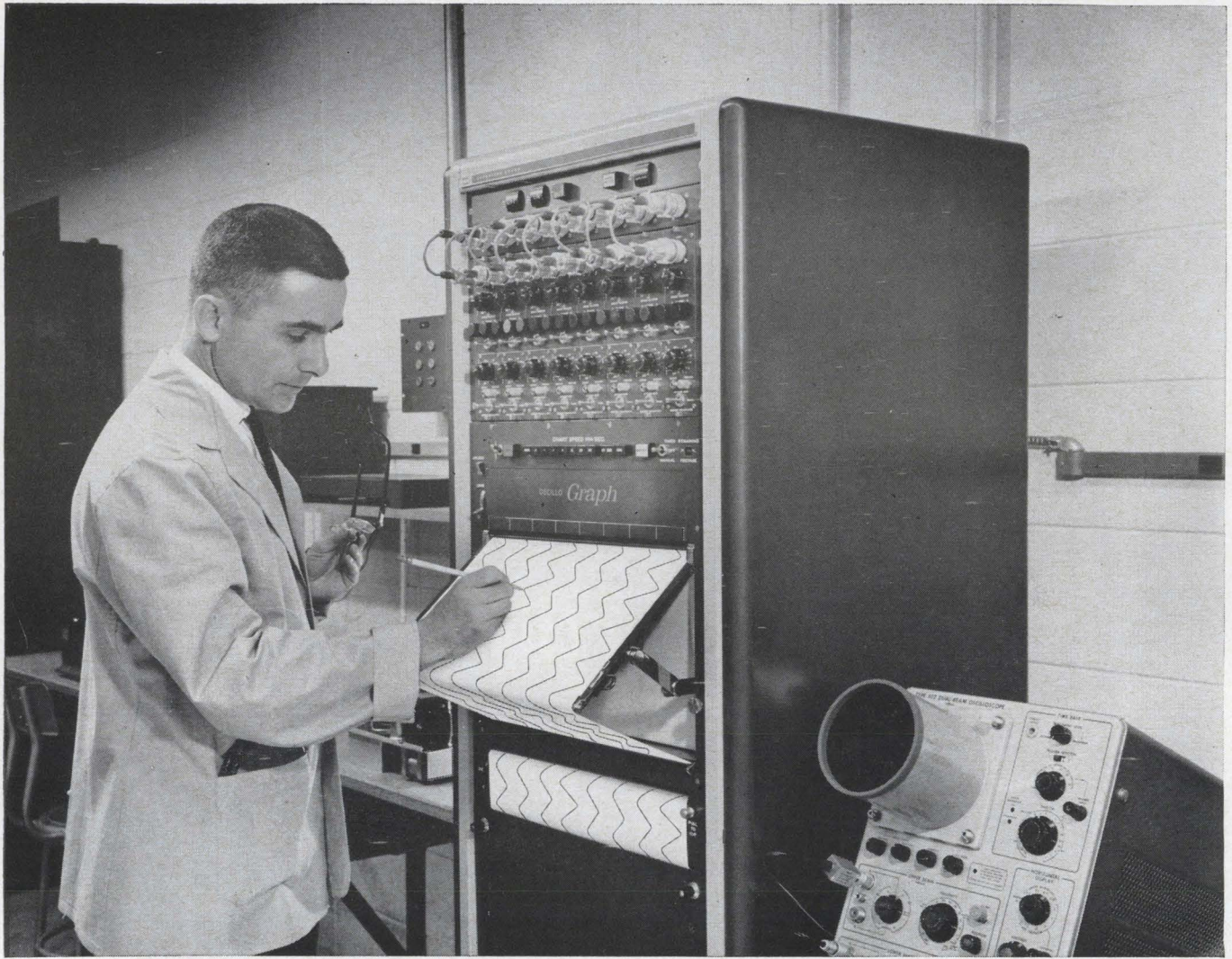

110 cps full scale response
+
greatest resolution

= your best Oscillo Graph buy

No other oscillograph recorder can match the frequency response of Esterline Angus . . . flat to 110 cps ($\pm 1\%$) at 40 mm peak-to-peak deflection.

At 140 cps, frequency response of these four, six and eight channel recorders is down only 3 db from full scale. Even at 200 cps, stylus excursion is 8 to 10 mm.

Resolution? Esterline Angus combines highest chart speeds (to 500 mm per second) with highest frequency response.

Exceptional resolution is further assured because of the exclusive Direct-Carbon-Transfer writing method. Even the one, two and three channel portables feature this inkless and heatless writing method. Advantages of D-C-T?

- 0.005 inch wide trace occupies only $\frac{1}{2}\%$ of full scale. Traces of competitive oscillographs are three times wider.
- Chart paper at half the cost of heat sensitive paper. Charts can be easily, economically reproduced.

- No start-up problems because there are no pens to clog or ink to splatter.
- No stylus temperature adjustments to bother with.

Interchangeable, plug-in amplifiers and couplers provide a multitude of signal channels to record signals from a few microvolts to hundreds of volts.

The stylus motor uses no permanent magnets. This eliminates the clutter of brushes, slip rings, armature leads and linkages normally found in stylus drive mechanisms.

For highest resolution, unequalled response and trouble-free writing, investigate Esterline Angus Oscillo Graph Recorders.

Write for informative Series "O" Catalog.

ESTERLINE ANGUS INSTRUMENT COMPANY, INC.
Box 24000 E • Indianapolis, Indiana 46224

ESTERLINE ANGUS

Excellence in instrumentation for over 60 years

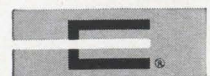

Technical Articles

How to specify potentiometers:
page 78

There are few comparisons of potentiometers available to help an engineer choose the right one. In this article, however, the author has examined the important characteristics of pots and tabulated them to make the selection easier.

**Special report—
New interest in the unijunction transistor:**
page 87



Probably the best known job of the unijunction transistor is to switch a silicon-controlled rectifier. With wider use of the scr, more interest has been generated in the device that triggers it. For the cover, Vincent Pollizzotto photographed the circuit for a car-top emergency light where one unijunction transistor switches four silicon control rectifiers sequentially to

create the effect of a revolving light.

Included in the special report:

- A review of the industry
- Now, planar unijunction transistors
- Reliability of the unijunction transistor
- Timing and level-sensing applications

Bioengineering, a new discipline:
page 111

As biology moves into a new area of research, biologists need systems that can gather, amplify, and measure signals for inside the body. Part 1 of a two-part series.

**Coming
June 28**

- Low light level television
- More on biotelemetry
- Measurement of stored charge in a diode
- Electronic variable attenuator

Picking the right potentiometer

Types differ markedly in performance. Here are some comparisons to help in specifying the best variable resistor for a particular task

By L. Thomas Peart

Helipot Division, Beckman Instruments, Inc., Fullerton, Calif.

Although the potentiometer is older than electronics itself, circuit designers frequently lack the information necessary in specifying the best type for a specific purpose. Particularly with precision pots, where the trend is to higher requirements by the component user, there are few comparisons of each type's performance characteristics.

The table on page 79 lists the accuracy of output and the mechanical arrangement for mounting and adjustment, of the four broad types of variable resistors: volume control or radio pots, semi-precision, precision, and trimming pots.

This article describes precision pots and their performance, although many of the descriptions apply to all the other types of variable resistors. A precision pot differs from other types mainly in its higher output accuracy and its better performance under stringent environmental conditions.

All wirewound precision pots share two basic weaknesses: they are subject to catastrophic failure because the wire is subject to breakage and wear, and they are noisy.

The reliability problem has been reduced with greater uniformity of the wire's cross section and with superior winding techniques resulting in better encapsulation of the coils. New oils and greases inhibit oxidation, reduce wear and entrap wear debris away from the contact path.

The author



L. Thomas Peart is the chief engineer in charge of trimmer potentiometer development at the Helipot division of Beckman Instruments, Inc. He is the author of many technical articles on potentiometers.

Despite these precautions, noise may still appear and behave in an unpredictable manner; it may remain constant, increase, shift position, or clear up entirely.

However, it is necessary to put the noise problem in perspective. For years, practically all noise measurements have been made in a rheostat circuit using a one-milliamper constant current source and an oscilloscope-detection technique as specified in both NAS 710 and MIL-R-12934 (diagram, p. 80). This test was established primarily to measure potentiometer quality; when used quantitatively, however, the test does not apply to all circuits.

The fallacy of using a test procedure that is not applicable to all circuits can be shown with an example (diagram, p. 80). In a potentiometer application, even a noise level 10 times the maximum allowed by the noise standard would result in an output error no more than 0.01% at the highest end of the potentiometer's output; at the low end, the error would vanish. As the output load ratio decreases, this error increases, but not nearly as much as the deviation from linearity that was introduced by the loading.

When the pot is used as a rheostat, the noise-induced error equals the ratio of noise magnitude to total resistance. This is one major reason why it is preferable to use a potentiometer as a voltage divider rather than as a variable resistance control.

Nonwirewound potentiometers

Four materials are used in nonwirewounds' resistive elements: cermet, conductive plastic, carbon film and thin metal film.

Cermet pots are made of a 0.0005- to 0.005-inch layer of finely divided precious-metal particles, suspended in a glass matrix and fused to a ceramic base at temperatures of 1,400° to 2,000°F.

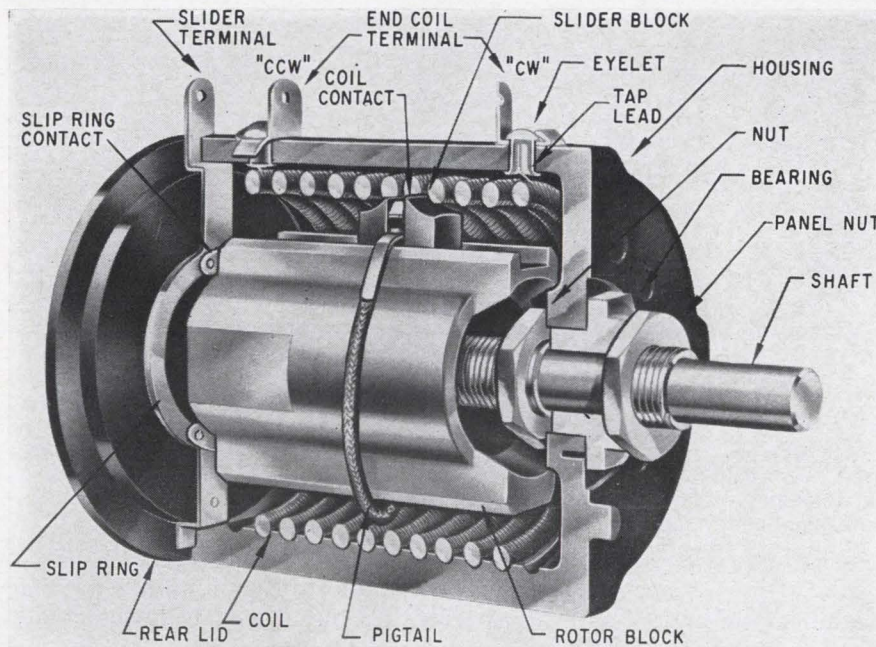

Multiturn wirewound potentiometer, shown in cutaway view, has been greatly improved by using more uniform wire and better coil-encapsulation techniques; new oils and greases lubricate wire paths, inhibit oxidation and entrap wear debris away from the contact path.

Conductive plastic types contain a mixture of conductive materials in a filler of insulating plastic, usually bonded to a plastic base. The materials are molded into the required element shape by heat and pressure.

Carbon film is a thinly deposited carbon coating, usually on a plastic or ceramic base.

Thin metal films are usually vapor-deposited metals, such as Nichrome, on a glass or ceramic base. The films are extremely thin; often they are measured in hundreds of angstroms.

For the table on page 81, the advantages and disadvantages of the types of potentiometers were extrapolated from specifications given by various manufacturers. This information was modified on basis of the author's experience, test reports, technical articles, reports and discussions with manufacturers and users. Each type is given a numerical rating, with number 1 signifying the best performance.

The table shows marked differences in electrical

characteristics and in accuracy and performance characteristics. Size, weight and expected rotational life also are described.

Electrical characteristics

Single-turn wirewound potentiometers perform best in the range between 1,000 and 50,000 ohms. At lower resistances they are noisier, with higher temperature coefficients of resistance; resolution is poorer than in other types because single turns of wire have wider spaces between them for points of contact to the slider arm. When more turns of wire are used, the available range of resistance is widened and resolution is improved.

All nonwirewound types perform better in a-c circuits than wirewounds. They do not have the inductance or the wire-to-core capacitance of wirewounds, and have satisfactory phase-shift performance well into the megacycle region. Metal-film types are limited to low-to-middle resistances; carbon film is confined to the middle-to-high range.

Types of potentiometers

| Radio | Semiprecision | Precision | Trimming |
|------------------------------|--|--|---|
| Wirewound | Wirewound | Wirewound | Wirewound |
| Materials | | | |
| Carbon | Hot molded carbon film Cermet Conductive plastic | Cermet Conductive plastic Carbon film Metal film Photoconductive | Cermet Conductive plastic Metal film Carbon film Hot molded carbon |
| Mechanical | | | |
| Single-turn Bushing mount | Single-turn Bushing mount | Single-turn Multiturn Bushing mount Servo-mount with ball bearings | Single-turn Lead-screw actuated Lead wires Printed circuit pins Solder lugs |

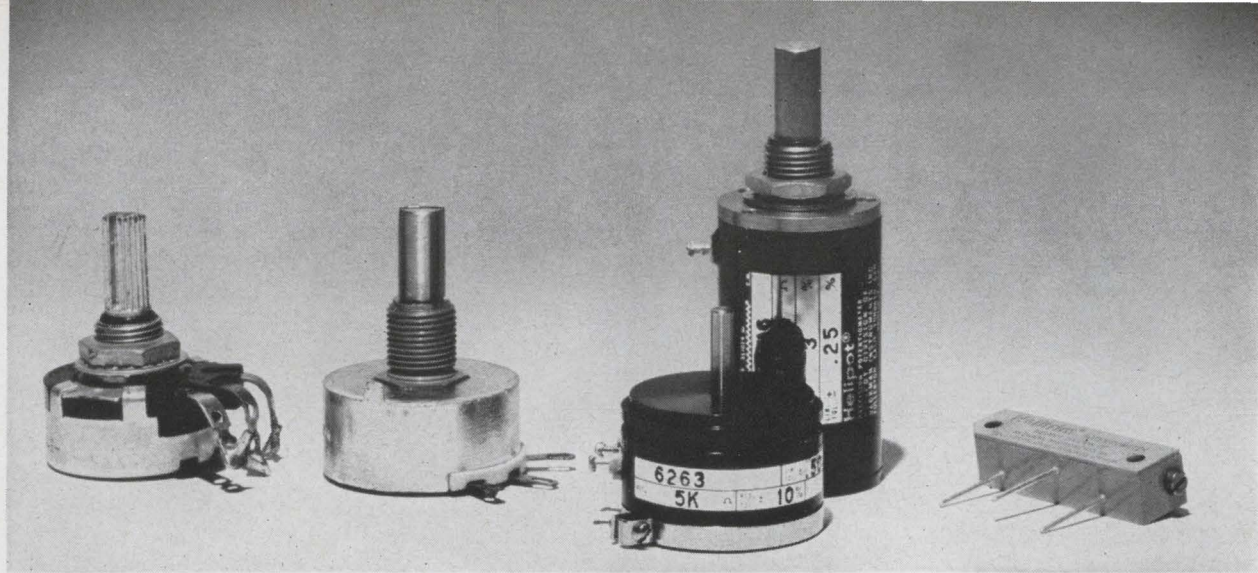

Potentiometers come in a wide variety of shapes, sizes and capabilities. Five types shown are radio or volume control, semiprecision, single and multiturn wirewounds, and trimmer.

Cermet has the widest range.

Cermet and metal-film pots use inherently high-temperature materials, and can handle higher power than either conductive plastic or carbon-film wirewounds. However, wirewound units with ceramic cores can also dissipate high wattage.

Linearity errors

If a variable resistor had ideal linearity, its electrical output would change in proportion to its angular rotation.

Deviation from linearity is the amount the electrical output departs from the mechanical input function.

Multiturn wirewound pots have the best linearity because longer resistive elements are available. Linearity error, expressed as a percentage of input, is decreased when the contact path is lengthened by using many turns of wire, wound around a multiturn core.

Percentage error, due to nonuniformity of wire and wire spacing, irregular mechanical contact, and lack of concentricity of the resistive element, is reduced.

Linearity of nonwirewounds is equal to or greater than that of single-turn wirewounds. When multiturn nonwirewounds become more widely available, their linearities should be superior because these pots can be tailored, by removing resistance material to achieve final output accuracy.

Response to input signal

Resolution is a measure of the degree to which the output voltage of a potentiometer responds to the mechanical input.

In wirewound types, the theoretical resolution equals the reciprocal of the number of wire turns, converted to a percentage. In operation, the wiper arm of a potentiometer seldom bridges one wire turn at a time; when some are higher or lower than the others, additional error in resolution is introduced. Shorted turns also lower the resolution. These factors may cause the actual resolution to depart from the theoretical by as much as 10 times, and to vary over segments of the resistance element.

In nonwirewounds, resolution can be affected by variations in particle size of the materials used, by dispersion of the metal carbon or oxide particles in the binding matrix; and in the surface of the material. The smallest increment of resistance change in nonwirewound pots is usually so small that manufacturers rate resolution of these pots as infinite (see diagram at bottom of p. 81).

Temperature coefficient of resistance

Although the raw wire used in potentiometers may have temperature coefficients as low as ± 10 parts per million per degree centigrade, this coefficient may rise to ± 50 to ± 70 parts per million per degree in a completed pot because of strains and thermal expansions introduced by winding the wire around the core, and because of thermal expansion of the core and housing assembly.

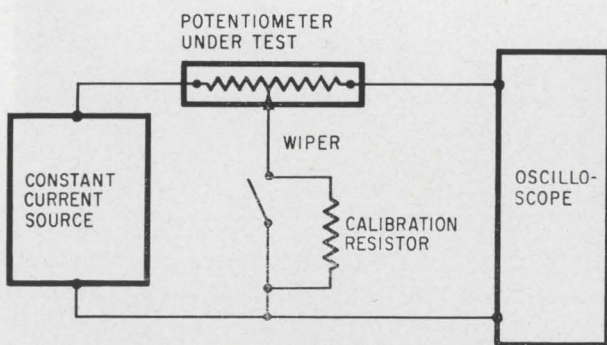

Noise-test circuit, established to measure potentiometer quality, may give false picture of noise performance.

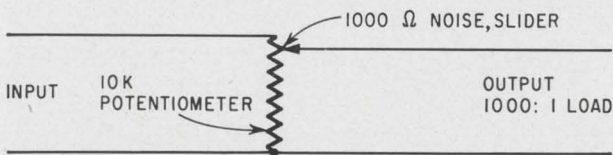

Error due to 1,000-ohm noise would result only in a maximum output error of 0.01% at the highest end of a 10,000-ohm potentiometer.

Among nonwirewounds, cermet and metal films have the best temperature coefficients of resistance. Over a wide range of resistance values, these two types have temperature coefficients of resistance better than ± 100 parts per million per degree centigrade.

Conductive plastic and carbon film generally have high negative temperature coefficient of resistances—from -400 to $-1,000$ parts per million per degree centigrade.

Solving the noise problem

Electrical noise may be caused by intermittent contact between slider and track, and resistance fluctuations caused by irregularities in materials

and construction. Although noise on wirewounds is initially lower than in other types of pots, it usually increases during the operational life. In nonwirewounds, in contrast, although the initial noise may be higher, it remains constant, or may even decrease with changes in operating environments.

In wirewounds, noise has a random, nonrepeatable characteristic. It results from high resistance paths between the sliding contact and the resistance element caused by oxidation, wear debris, and other contaminants on the wire.

Noise in a potentiometer is usually measured with a standard noise-test circuit, as shown on page 80. With this method, a display of the noise is provided on an oscilloscope.

This is the currently accepted standard, and includes all noise frequencies from d-c to 50 kc. However, since few circuits using pots can respond beyond a few hundred cycles, this test was unduly restrictive, and the PPMA (Precision Potentiometer Manufacturers Association) published new test standards and recommended changes to incorporate a 1,000 cycle low-pass filter across the output. It has been shown that noise wirewounds, as measured by the accepted standard test circuit, is often a function of the test circuit and does not exist in actual potentiometer circuits.^{1, 2, 3}

Output smoothness and window resolution tests have been recommended as more indicative of actual circuit noise requirements for nonwirewounds.

In an output smoothness test, changes to the output slope, noise, and discontinuities will appear as spikes on the filtered output. The range of noise may be evaluated by the use of suitably designed electronic filters in conjunction with a strip chart recorder.⁴

In the window method, the slope of the output characteristic is analyzed, by observing the voltage difference at the beginning and the end of a very small shaft movement.

At present, both methods are being evaluated by industry.

Size and weight

The trend toward potentiometer miniaturization will ultimately be limited by the resistance materials available.

Because of limits on the resistivity that can be obtained, wirewound and metal-film pots are not suitable for drastic reduction in size. For a wirewound pot, higher resistance is achieved by using maximum-resistivity wire of smaller diameter with smaller wire-to-wire spacing and a larger core or mandrel.

All types of pots are now produced in relatively small sizes, to keep pace with the demands for miniature units. However, there are limitations as to the minimum size that pots can be mass produced without causing serious degradation of their performance characteristics. One of the smallest cermet trimmer types is $\frac{1}{4}$ inch in diameter.

Characteristics of precision potentiometers

| Operating characteristics | Wirewound | Cermet | Conductive plastic | Carbon film | Metal film |
|-------------------------------------|-----------|--------|--------------------|-------------|------------|
| Electrical | | | | | |
| Resistance range..... | 3 | 1 | 1 | 2 | 4 |
| A-c performance..... | 2 | 1 | 1 | 1 | 1 |
| Wattage..... | 2 | 1 | 2 | 3 | 3 |
| Dielectric withstanding.. | 1 | 1 | 1 | 1 | 1 |
| Insulation resistance.... | 3 | 1 | 2 | 2 | 1 |
| Accuracy and precision | | | | | |
| Linearity..... | 1 | 2 | 2 | 2 | 2 |
| Resolution..... | 2 | 1 | 1 | 1 | 1 |
| Electrical angle..... | 1 | 2 | 2 | 2 | 2 |
| Backlash..... | 2 | 1 | 1 | 1 | 1 |
| Temperature coefficient | 1 | 2 | 3 | 4 | 2 |
| Jump-off voltage..... | 1 | 2 | 2 | 2 | 2 |
| End resistance..... | 2 | 1 | 1 | 1 | 1 |
| Noise..... | 2 | 1 | 1 | 1 | 1 |
| Mechanical | | | | | |
| Size and weight..... | 3 | 1 | 2 | 2 | 3 |
| Torque..... | 2 | 1 | 1 | 1 | 1 |
| Rotational speed..... | 2 | 1 | 1 | 1 | 1 |
| Mechanical angle..... | 1 | 3 | 3 | 2 | 3 |
| Expected rotational life.. | 5 | 2 | 1 | 3 | 4 |
| Environmental | | | | | |
| Humidity..... | 2 | 1 | 3 | 4 | 1 |
| Vibration, shock, acceleration..... | 2 | 1 | 1 | 1 | 1 |
| Load life..... | 1 | 1 | 2 | 2 | 1 |
| Thermal shock..... | 1 | 1 | 2 | 3 | 1 |
| High temperature exposure..... | 3 | 1 | 2 | 2 | 1 |
| Low temperature exposure..... | 2 | 1 | 1 | 1 | 1 |
| Other capabilities | | | | | |
| Non-linear functions.... | 1 | 1 | 1 | 1 | 2 |
| Integral resistors..... | 3 | 1 | 2 | 2 | 3 |
| Shorted segments..... | 3 | 1 | 2 | 2 | 1 |
| Taps—voltage..... | 1 | 1 | 2 | 2 | 3 |
| Taps—current..... | 1 | 2 | 3 | 2 | 4 |

Numeral ratings are relative with number 1 signifying the best performance.

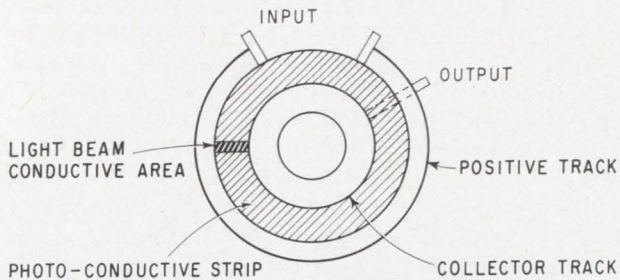

Photoconductive pot has no mechanical contact, uses a light beam as its wiper arm. Angular position of the light-source beam is controlled by input shaft.

Available resistances of metal films are now limited to the low-to-medium resistance range. The higher resistivity of conductive plastic and carbon film permits smaller packaging of potentiometers in the low-to-medium resistance range.

Cermet pots can operate under a wider range of temperature, wattage and humidity than other materials. These characteristics, along with their wide resistance range, allow cermet pots to be smaller than all other types.

Expected rotational life

Life span of the rotary elements, or rotational life, is difficult to determine without specifying limits of degradation of various other performance characteristics. For example, with repeated rotation, linearity error may increase, the total resistance of the pot may change or complete electrical failure may occur.

Conductive plastic, with its smooth track surface and large material bulk, has the longest rotational life without catastrophic failure. Wirewounds have the shortest rotational life and are the most vulnerable to catastrophic failure due to a broken wire. The exceedingly thin films of the vapor-deposited metals make them susceptible to wear

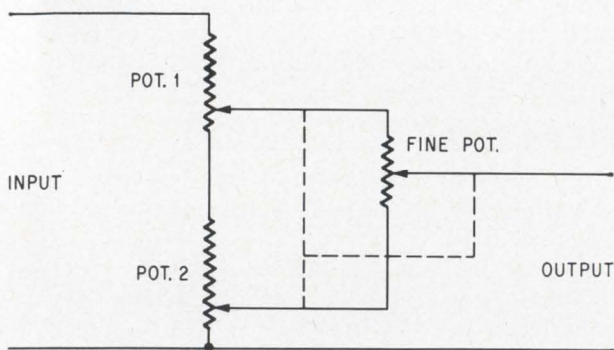

Vernier potentiometer is used to improve accuracy of hand-set resistance values.

Expected rotational life

| Type | Shaft revolutions (in millions) |
|-------------------------|------------------------------------|
| Wirewound..... | 2 |
| Metal film..... | 5 |
| Carbon film..... | 10 |
| Cermet..... | 20 |
| Conductive plastic..... | 50 and greater |

and to abrasion from slider contact. The extreme hardness of the cermet film and the lubricity of the carbon film assure excellent wear properties. The rotational life values commonly associated with the various materials are shown in the table at the bottom of this page.

Effect of the environment

In selecting a pot for operating in various environments, the most important qualities to be considered are resistance stability, moisture absorption and temperature characteristics. For these characteristics, cermet and metal film are excellent. The conductive plastic and carbon films, because of their carbon and organic binders, generally have poorer temperature capabilities, greater moisture absorption and poorer resistance stability than cermet, metal film or wirewound types.

Environmental weaknesses of the wirewound can be traced to the oxidizable wire that is often used, and to the limited operating temperature and high degree of water absorption of the organic coatings used to anchor the wire turns to the core or mandrel. Catastrophic failure can also occur in smaller diameter resistance wires when the wires expand, due to temperature and humidity changes.

Obtaining special outputs

All types of potentiometers can perform nonlinear functions—a vital segment of the precision field. Wirewound types have excellent nonlinear capabilities by virtue of the ease with which the winding spacing wire size and the core or mandrel shape may be varied. Another method of obtaining nonlinear functions is to add intermediate terminations (taps) and attach parallel resistors, or short-circuit wire segments. Materials used in non-wirewound types can be tailored to adjust the resistance of nonlinear outputs.

Several techniques can be used to improve resolution in wirewounds. One of these methods is to place the resistance wire in the position normally occupied by the wound resistive element and core. The wiper then rides on this continuous slide-wire. Even with multiturn construction, the resistance range is limited to low values, and catastrophic failure is still possible.

A vernier potentiometer can be used to set precise resistance values with great accuracy. One method uses three resistance elements—two equal high-resistance units and one equal to a fraction of the higher resistance value—and three sliders that operate on a common shaft. Two sliders are actuated to travel simultaneously, and the third either simultaneously or independently by the movement of the shaft (diagram, left). A coarse adjustment is made first on the higher resistance units, followed by a fine adjustment on the lower resistance. The main limitations are size, cost and limited application in servo systems.

Potentiometers are available that have no mechanical contact, using a light beam as its wiper arm. There is no rubbing contact to wear the ele-

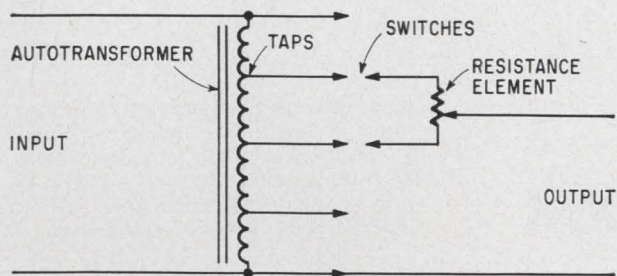

Single-turn pot is switched across the taps of an auto-transformers to obtain lower output impedance.

ment, and driving torque is greatly reduced. This type of potentiometer consists of three concentric rings: a resistive track, a highly conductive collector track and a photoconductive connecting track joining the other two (diagram, p. 82). The angular position of the light beam is angularly controlled by the input shaft, causing the photoconductive track at that point to become conductive, and closing the circuit between the collector track (or third termination) and the resistive track at that point. Usage is limited by high cost, complex circuitry connections, limited accuracy and size.

Potentiometers have been made with improved output characteristics for a-c applications. One method uses a multitapped, wirewound potentiometer connected to a multitap transformer. The transformer windings compensate for output error that is due to voltage change. These devices have excellent linearity, low output impedance and no catastrophic failures due to wire breakage.

Another approach to precision wirewound a-c potentiometers employs a single-turn pot, switched across the taps of an autotransformer (diagram, above). Lower output impedance is achieved, but

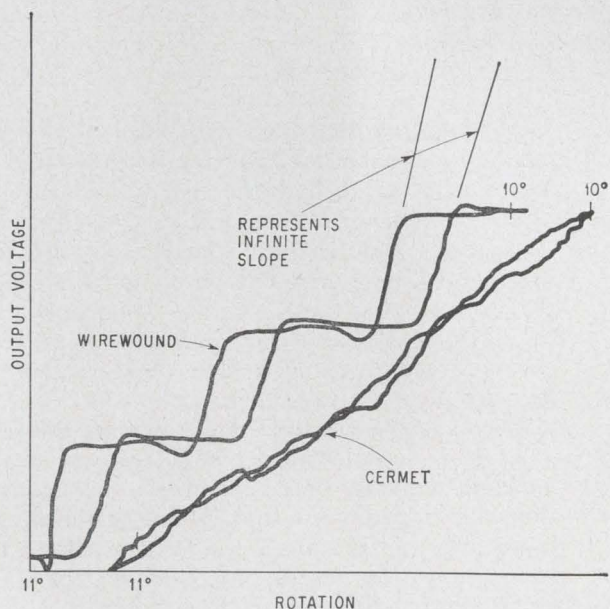

Stripline chart recording shows difference in resolution between two types of pots, wirewound and cermet types, both 5,000 ohm 1 1/16 inch diameter single turns, rotated one degree in both directions.

the price is decreased reliability due to the additional mechanics for switching. Both of these methods for improving a-c output characteristics are expensive, nonwirewound pots often can solve similar problems in general applications.

General design data

Rotary precision potentiometers range in size from 3/4 inch to 3 inches in diameter. These sizes usually allow for radial terminals, ganging multiple units on a common shaft, and choice of servo mounting with ball or sleeve bearings, or bushing.

Metal housing usually are used to dissipate added heat and increase wattage capabilities.

Plastics of high temperature stability, such as diallyl phthalate, are also used to greatly reduce weight and size by allowing the resistive element to be mounted directly in the insulated housing.

Precision single-turn units are available as small as one-half inch in diameter, but these usually have rear-mounted terminals and are not available in multisection models.

Multiturn wirewound potentiometers have better resolution and linearity than single-turn types. But in nonwirewounds, where available resistance ranges are generally larger, the value of a multiturn capability is not as great. However, multiturn nonwirewound construction would improve linearity, reduce fixed-contact resistance (d-c offset) and variations in contact resistance, and reduce error rate. This would result in an increase in total resistance range and in better temperature coefficient of resistance, resistance stability and noise.

At present, multiturn nonwirewound pots are available from only one major manufacturer, the Computer Instruments Corp.

In instrumentation and control, instead of using linkages and gear trains from valves, actuator cables or push-pull rods to actuate rotary motion pots, it is sometimes easier to couple the straight-line mechanical motion directly to a linear-motion potentiometer. The market for such devices is specialized, and units cannot be fully standardized because of the variety of sizes, shapes and stroke lengths of the action device. In linear-motion pots, all of the materials previously mentioned for non-wirewound, films are available. The factors previously discussed for rotary precision units generally hold true here also.

The designer can obtain the best performance at the lowest cost only if he selects his pot for the particular characteristics he desires.

References

1. Stanley Schneider and David Silverman, "Resolution and noise—their significance and measurements in nonwirewound potentiometers," paper presented at the National Electronics Conference, Chicago, Oct. 20, 1964.
2. Stanley Schneider and L.T. Peart, "Cermet potentiometers, a new technology," paper presented at the Precision Potentiometers Manufacturers Symposium, Chicago, Aug. 19, 1963.
3. Manual on Industry Standards, Wirewound Precision Potentiometer. Inspection and test procedures, Precision Potentiometer Manufacturers Association, Chicago, July 1964.
4. Hans Wormser, "Potentiometer output smoothness," paper presented at the Precision Potentiometer Manufacturers Association Symposium, Los Angeles, Aug. 20, 1962.

Designer's casebook

Detector circuit measures phase and amplitude

By George S. Parks Jr.

Communications Laboratory, Stanford Research Institute, Menlo Park, Calif.

Although primarily applied to pulse-code modulation receivers, the synchronous detector is also valuable as an amplitude modulation detector and as a measuring device for phase and amplitude of unmodulated signals. By operating two such detectors in quadrature (at a phase difference of 90°), it is possible to measure the signal amplitude independent of phase and the phase independent of amplitude. The detector is easily implemented with a transistor switching circuit.

Signal-to-noise ratio at the detector output is directly proportional to the input signal-to-noise ratio and to the cosine of the angle between the carrier and the local oscillator. Hence, detection is truly linear.

The detection process can be described as mixing or multiplying a signal frequency with a local oscillator frequency. To achieve a truly linear frequency translation, the mixer's input-output characteristics should be constant whether the signal is present or not; and the mixer should not contain a nonlinear device in which rectification of the signal can take place.

The transfer characteristics of such a circuit can be described as a general Fourier series:

$$e_o = e_s [a_0 + a_1 \cos(\omega_{10}t + \phi_{10}) + a_2 \cos 2(\omega_{10}t + \phi_{10}) + \dots]$$

where e_o is the detector output, e_s is the input signal, $a_0 \dots a_n$ are the Fourier coefficients that describe the local oscillator waveshape (normally a square wave) ω_{10} is the local oscillator frequency and ϕ_{10} is its phase with respect to an arbitrary standard.

The input signal is

$$e_s = E_s \cos(\omega_c t + \phi_c)$$

where E_s is a modulating waveform, ω_c is the car-

Designer's casebook is a regular feature in Electronics. Readers are invited to submit novel circuit ideas, packaging schemes, or other unusual solutions to design problems. Descriptions should be short. We'll pay \$50 for each item published.

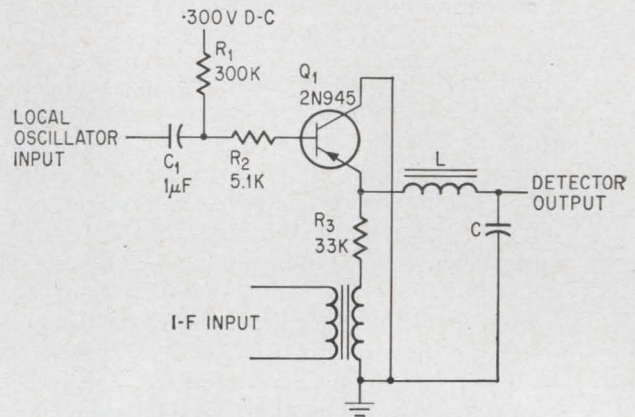

Synchronous detector has linear detection characteristics that allow receiver's bandwidth to be varied easily after detection, losing none of the usual advantages of predetection bandwidth with regard to noise response.

rier frequency, and ϕ_c is the phase of the carrier with respect to the same arbitrary standard as that of the local oscillator.

After substituting for e_s in the Fourier series, multiplying through, making trigonometric substitutions for the case where $\omega_{10} = \omega_c$, and eliminating terms at frequency ω_c or higher (equivalent to low-pass filtering), the expression for mixer output becomes

$$E_o = \frac{a_1 E_s}{2} \cos(\phi_c - \phi_{10})$$

By using two detectors with local oscillators in quadrature, output signals may be generated that are proportional to both the sine and cosine of the phase difference between the local oscillator and the carrier. If one of these signals is applied to the horizontal axis of an oscilloscope and the other to the vertical axis, the incoming signal appears on the screen as a phasor from which the phase difference between the signal and the local oscillator can be conveniently measured.

The synchronous detector shown in the circuit diagram is designed to detect a signal at an intermediate frequency of 2.5 kilocycles. The transistor is usually biased on, so that the voltage at the input to the LC filter is zero. If the local oscillator input is a square wave (at the i-f frequency), the transistor is alternately switched from saturation to cutoff. When Q_1 is at cutoff, the i-f signal is applied

through the transformer to the input of the filter. Thus the action of the transistor is virtually that of the ideal switch. The LC low-pass filter removes the higher-frequency components of the output.

The resistance of the transistor (2N945) in cutoff is higher than the impedance level of the circuit so that its effect can be neglected. However, the offset voltage of this transistor when saturated is typically two millivolts, which can be an appreciable part of the d-c output.

In the synchronous detector, the relationship between the input and output signal-to-noise ratios is linear

$$S_{out} = 2 S_{in} / \cos(\phi_c - \phi_{10}).$$

Triangle generator adjusts output slopes and peaks

By R. Zane

Lawrence Radiation Laboratory
University of California, Berkeley

The output of this triangular wave generator is a waveshape with peaks and slopes that can be varied independently. Usually, when a triangular wave is generated by integrating a square wave with an operational amplifier, the triangular wave is asymmetrical, the integration time constant must be adjusted for each operating frequency range, and—within a certain frequency range—the amplitude varies directly with frequency.

However, none of these limitations exists in a generator where triangular waveshapes are formed by a bistable current source.

In the circuit diagram at right, the stability of the off state is maintained because the transistors are silicon types and the values of R_2 and R_3 are selected so that transistor leakage current is low.

A positive pulse e_{on} at terminal A causes Q_2 to conduct momentarily. This momentary collector current produces a voltage drop across R_2 and zener diode D_1 that causes Q_1 to conduct. The collector current of Q_1 produces a voltage drop across R_3 and zener diode D_2 that causes Q_2 to remain in conduction. Thus, a stable on current is established by the voltage-limiting action of D_1 and D_2 .

The circuit returns to its stable off state when a positive pulse at terminal B momentarily turns Q_3 on. When Q_3 conducts, it removes the turn-on voltage from Q_2 's base, Q_2 turns off and removes the turn-on voltage from Q_1 's base. The current source remains in the off state until another on

Small signal-to-noise ratios degrade significantly from input to output in other detectors. Here, unlike other detectors, the detection process can be improved equally by integrating the received signal either before or after detection while losing none of the usual advantages of predetection bandwidth with regard to noise response. As a result, the effective bandwidth of a receiver can be narrowed by mathematical averaging.

Acknowledgment

Equipment described was developed by Stanford Research Institute in research supported by the Navy Bureau of Ships under Contract NObsr 85271. The synchronous detector in this article was designed by Leonard Orsak of the Communications Laboratory of Stanford Research Institute.

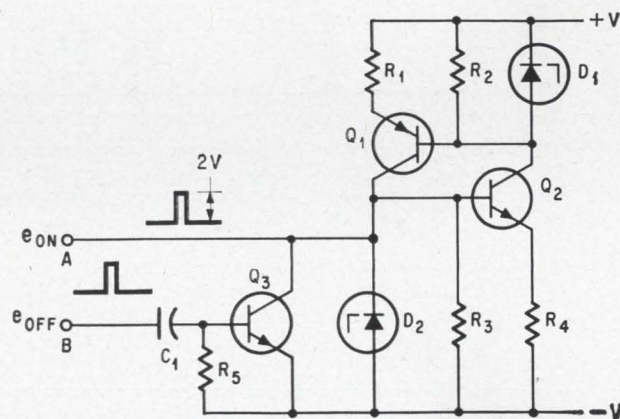

Bistable circuit turns on (Q_2 conducts) when a positive pulse is applied at terminal A. Circuit remains in conduction until a positive pulse is applied at terminal B.

pulse is provided.

The effective impedance of the current source may range from hundreds of ohms to megohms depending on the values of R_1 and R_4 , the impedances of D_1 and D_2 , and the betas of Q_1 and Q_2 .

The triangle wave generator shown in the block diagram on the next page has two bistable circuits. One acts as a current source and the other as a current sink. The source produces current flow into capacitor C, causing an increasing voltage across the capacitor according to the relation

$$dV/dt = I/C \quad \text{or} \quad V = \frac{1}{C} \int (I) dt$$

The current sink provides a current flow out of the capacitor, causing a decreasing capacitor voltage according to the same relation. The two bistable circuits are cross-coupled so that when one circuit turns on, it provides a turn-off pulse for the other

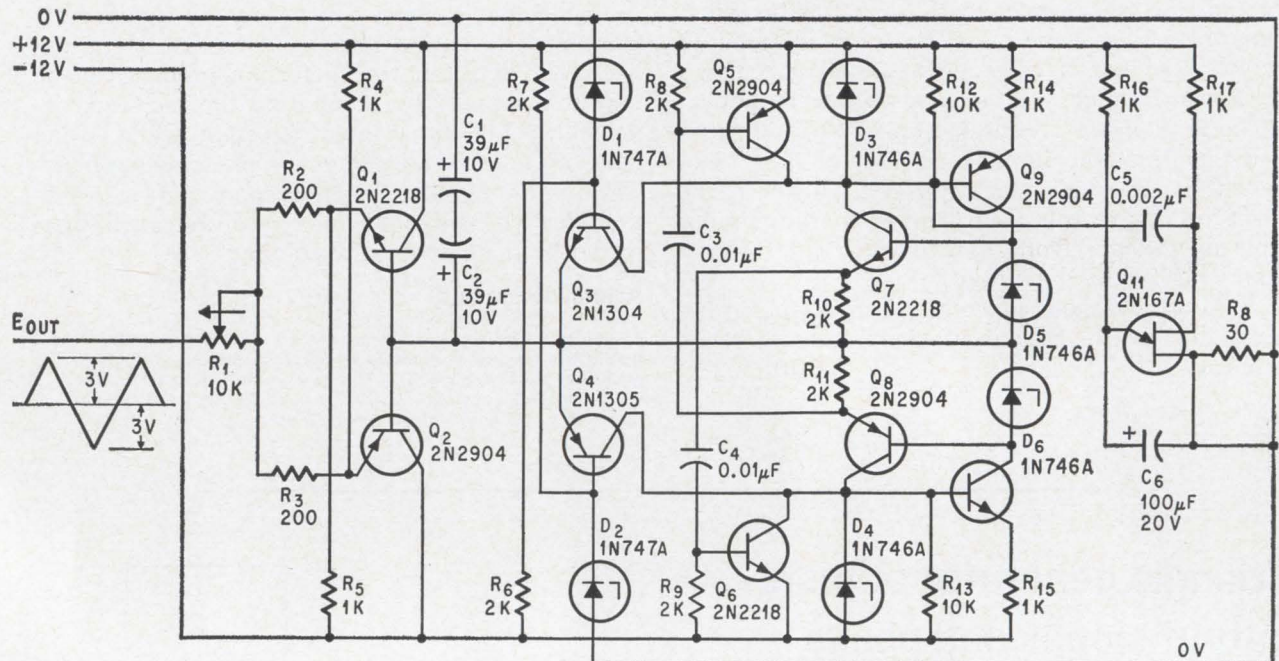

Generator produces triangular waveshapes with independently adjustable positive and negative peaks, slopes and frequency. Positive slope varies as R_{10} and R_{11} , negative slope varies as R_{11} and R_{15} . Capacitance of C_1 and C_2 affects both slopes simultaneously. Waveshape peaks determined by the zener voltages of D_1 and D_2 . Ujt circuit (tickler) starts the generator.

Triangular wave generator contains two bistable circuits, one used as a constant current source that controls the current flow into capacitor C , and the other serving as a constant current sink that determines the rate of discharge current from C . Sensing circuits adjust waveshape peak voltages and provide turn-on and turn-off pulses for the bistable circuits.

circuit. The current source turns on when the voltage across C reaches $-V_{ref}$, and the current sink turns on when the voltage across C reaches $+V_{ref}$. With the current sources interconnected as shown in the block diagram, four possible stable states exist:

- **Both current sources off.** This state can occur immediately after power is applied; and it may be eliminated by a turn-on or "tickler" circuit that switches on only one of the bistable circuits at the instant power is applied.
- **Source on and sink off.** During this state, the positive slope is produced until the $+V_{ref}$ sensing circuit turns on the current sink, which provides a turn-off pulse to the current source.
- **Source off and sink on.** Negative slope occurs until the $-V_{ref}$ sensing circuit turns on the current source, which provides a turn-off pulse for the current sink.
- **Current source and sink on.** This state can occur if the off state of both bistable circuits is not sufficiently stable. By momentarily removing power from the generator, this state may be corrected.

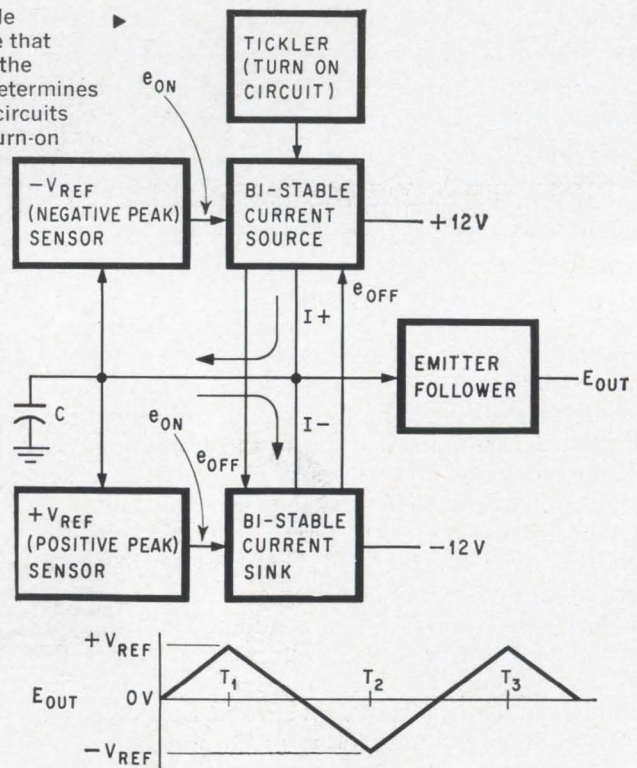

In the circuit diagram above, Q_1 and Q_2 form a push-pull emitter follower, and Q_3 and Q_4 are positive and negative peak detectors.



Special report:

The unijunction transistor

From ball parks to ballistic missiles, it's finding more and more uses.

As the market grows, so does competition among manufacturers

By Jerome Eimbinder

Solid State Editor

The electronic scoreboard at Houston's new Astrodome Stadium does more than keep baseball fans apprised of the progress of the game. It dramatizes a trend in the semiconductor industry toward unijunction transistors.

For years, manufacturers conceded the unijunction-transistor market to the General Electric Co. because most applications required just one such device, or a few at most; GE's potential rivals didn't consider a field of this size worth fighting for.

The Astrodome scoreboard employs 200,000 semiconductor devices; of these, 25,000 are unijunction transistors. More displays using unijunction devices are being considered at other ball parks; also, the American Machine and Foundry Co. is developing an automated bowling scoreboard, designed with unijunction transistors. The devices also are finding their way more and more frequently into military and industrial applications.

Sales climbing

With the biggest producer, GE, reluctant to disclose figures, it's difficult to assess the size of the market for unijunction transistors. However, some industry observers estimate that sales will exceed \$1.5 million in the current fiscal year and \$2.5 million in the year ending in June, 1966. GE says it commands about 80% of the market; other estimates put GE's share as high as 95%. A GE spokesman says profit on these devices is "very healthy."

But competition is growing, particularly from two giants in the semiconductor industry: Texas Instruments Incorporated and Motorola, Inc.

Texas Instruments is no newcomer to the unijunction field. For three years it has been a second source for several types introduced by GE.

Motorola's decision to enter the competition last

summer was prompted by feedback from its salesmen, according to Tom Conners, marketing manager. Conners says, "We've gone into the unijunction field because we've found that many of our customers use unijunction transistors to trigger our silicon controlled rectifiers." He adds, "This will give us the ability to offer the customers a complete package." Undoubtedly, Motorola's decision was also influenced by the presence on its staff of the developer of the first commercial unijunction transistor, I. Arnold Lesk, as director of applied research.

GE has been slow in adapting planar technology to unijunction manufacturing. Besides its high speed and low saturation voltage, the planar device is especially attractive because of its potentially low manufacturing cost.

Both Motorola and Texas Instruments brought out planar unijunction devices last fall; GE's planar unit is still on the drawing board. GE may find some consolation, however, in its competitor's problems. Texas Instruments tried at first to make its two planar unijunction devices, the TISO1 and the TISO2, in plastic packages, but reportedly had trouble obtaining good stability and removed both of them from the market. Motorola has, for undisclosed reasons, withdrawn two of the six planar unijunction devices it introduced last October.

Texas Instruments is delivering samples of two metal-can planar diffused devices, the SJ993 and the SJ1127, to replace the two withdrawn silicone-plastic encapsulated units. It is also developing a low-cost line of silicon planar unijunction transistors to compete with General Electric's 2N2646 family, which sells for as little as 60 cents apiece in quantities of 1,000 or more.

One article in this issue (p. 93) discusses alloy and planar unijunction construction and compares

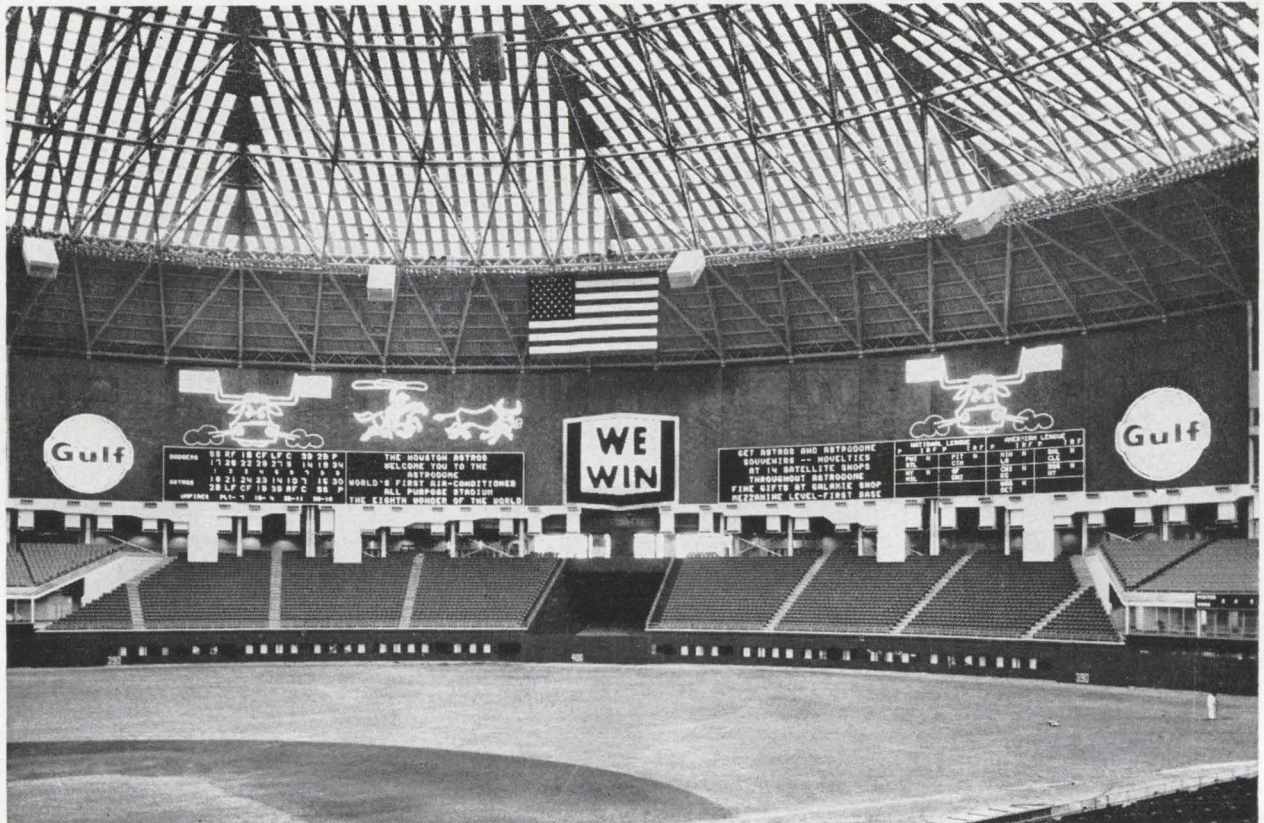

Scoreboard at Astrodome Stadium contains nearly 200,000 semiconductor devices including about 25,000 unijunction transistors. The center section of the scoreboard, showing the message "we win," can also display scenes and pictures of players. The manufacturer is the Fair Play Scoreboard Co.

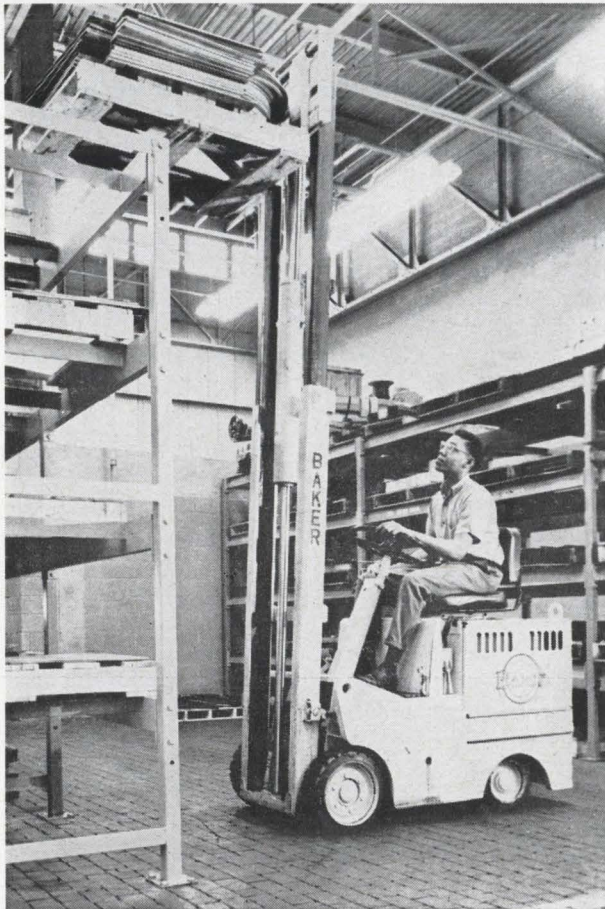

Electric-powered fork-lift truck uses a unijunction transistor in its control system. The transistor supplies a 50-milliampere signal to turn on a silicon controlled rectifier. The rectifier delivers pulses up to five amperes to the d-c motor. By varying the pulse frequency from 45 to 300 cps, the average voltage to the motor can be varied and the motor speed controlled from minimum to maximum. In the photograph, a load of welded transformer parts are being stacked for storage. Truck was built by the Baker division of the Otis Elevator Co.



Engineering-laboratory test set for measuring unijunction transistor's characteristics. This instrument whose circuitry contains unijunction transistors, measures seven characteristics including intrinsic standoff ratio and interbase resistance. It is manufactured by the Syracuse Electronics Corp.

Unijunction transistor characteristics chart

ABSOLUTE MAXIMUM RATINGS

CHARACTERISTICS

| TYPE NUMBER | STRUC-TURE | Emitter reverse voltage (volts) | RMS emitter current (ma) | Dissipation at 25°C (mw) | Emitter reverse current at 30V. (μ a) | | Intrinsic stand-off ratio at 10V. | | Peak-point emitter current at 25V. | | Interbase resistance at 3V. $I_E=0$ (kilohms) | | Base-one peak pulse voltage (volts) min. | CASE | MFR. |
|-------------|------------|---------------------------------|--------------------------|--------------------------|--|------|-----------------------------------|------|------------------------------------|------|---|------|--|------|------|
| | | | | | max. | min. | max. | min. | max. | min. | max. | min. | | | |
| 2N489 | bar | 60 | 70 | 450 | 2.0 | .51 | .62 | 12 | 4.7 | 6.8 | — | TO5 | GE, TI | | |
| 2N489A | bar | 60 | 70 | 450 | 2.0 | .51 | .62 | 12 | 4.7 | 6.8 | 3 | TO5 | GE, TI | | |
| 2N489B | bar | 60 | 70 | 450 | 0.2 | .51 | .62 | 6 | 4.7 | 6.8 | 3 | TO5 | GE, TI | | |
| 2N490 | bar | 60 | 70 | 450 | 2.0 | .51 | .62 | 12 | 6.2 | 9.1 | — | TO5 | GE, TI | | |
| 2N490A | bar | 60 | 70 | 450 | 2.0 | .51 | .62 | 12 | 6.2 | 9.1 | 3 | TO5 | GE, TI | | |
| 2N490B | bar | 60 | 70 | 450 | 0.2 | .51 | .62 | 6 | 6.2 | 9.1 | 3 | TO5 | GE, TI | | |
| 2N490C | bar | 60 | 70 | 450 | 0.02 | .51 | .62 | 2 | 6.2 | 9.1 | 3 | TO5 | GE | | |
| 2N491 | bar | 60 | 70 | 450 | 2.0 | .56 | .68 | 12 | 4.7 | 6.8 | — | TO5 | GE, TI | | |
| 2N491A | bar | 60 | 70 | 450 | 2.0 | .56 | .68 | 12 | 4.7 | 6.8 | 3 | TO5 | GE, TI | | |
| 2N491B | bar | 60 | 70 | 450 | 0.2 | .56 | .68 | 6 | 4.7 | 6.8 | 3 | TO5 | GE, TI | | |
| 2N492 | bar | 60 | 70 | 450 | 2.0 | .56 | .68 | 12 | 6.2 | 9.1 | — | TO5 | GE, TI | | |
| 2N492A | bar | 60 | 70 | 450 | 2.0 | .56 | .68 | 12 | 6.2 | 9.1 | 3 | TO5 | GE, TI | | |
| 2N492B | bar | 60 | 70 | 450 | 0.2 | .56 | .68 | 6 | 6.2 | 9.1 | 3 | TO5 | GE, TI | | |
| 2N492C | bar | 60 | 70 | 450 | 0.02 | .56 | .68 | 2 | 6.2 | 9.1 | 3 | TO5 | GE | | |
| 2N493 | bar | 60 | 70 | 450 | 2.0 | .62 | .75 | 12 | 4.7 | 6.8 | — | TO5 | GE, TI | | |
| 2N493A | bar | 60 | 70 | 450 | 2.0 | .62 | .75 | 12 | 4.7 | 6.8 | 3 | TO5 | GE, TI | | |
| 2N493B | bar | 60 | 70 | 450 | 0.2 | .62 | .75 | 6 | 4.7 | 6.8 | 3 | TO5 | GE, TI | | |
| 2N494 | bar | 60 | 70 | 450 | 2.0 | .62 | .75 | 12 | 6.2 | 9.1 | — | TO5 | GE, TI | | |
| 2N494A | bar | 60 | 70 | 450 | 2.0 | .62 | .75 | 12 | 6.2 | 9.1 | 3 | TO5 | GE, TI | | |
| 2N494B | bar | 60 | 70 | 450 | 0.2 | .62 | .75 | 6 | 6.2 | 9.1 | 3 | TO5 | GE, TI | | |
| 2N494C | bar | 60 | 70 | 450 | 0.02 | .62 | .75 | 2 | 6.2 | 9.1 | 3 | TO5 | GE, TI | | |
| 2N1671 | bar | 30 | 50 | 450 | 12.0 | .47 | .62 | 25 | 4.7 | 9.1 | — | TO5 | GE, TI | | |
| 2N1671A | bar | 30 | 50 | 450 | 12.0 | .47 | .62 | 25 | 4.7 | 9.1 | 3 | TO5 | GE, TI | | |
| 2N1671B | bar | 30 | 50 | 450 | 0.2 | .47 | .62 | 6 | 4.7 | 9.1 | 3 | TO5 | GE, TI | | |
| 2N1671C | bar | 30 | 50 | 450 | 0.02 | .47 | .62 | 2 | 4.7 | 9.1 | 3 | TO5 | GE | | |
| 2N2160 | bar | 30 | 50 | 450 | 12.0 | .47 | .80 | 25 | 4.0 | 12 | 3 | TO5 | GE, TI | | |
| 2N2417 | bar | 60 | 70 | 450 | 2.0 | .51 | .62 | 12 | 4.7 | 6.8 | — | TO18 | GE | | |
| 2N2417A | bar | 60 | 70 | 450 | 2.0 | .51 | .62 | 12 | 4.7 | 6.8 | 3 | TO18 | GE | | |
| 2N2417B | bar | 60 | 70 | 450 | 0.2 | .51 | .62 | 6 | 4.7 | 6.8 | 3 | TO18 | GE | | |
| 2N2418 | bar | 60 | 70 | 450 | 2.0 | .51 | .62 | 12 | 6.2 | 9.1 | — | TO18 | GE | | |
| 2N2418A | bar | 60 | 70 | 450 | 2.0 | .51 | .62 | 12 | 6.2 | 9.1 | 3 | TO18 | GE | | |
| 2N2418B | bar | 60 | 70 | 450 | 0.2 | .51 | .62 | 6 | 6.2 | 9.1 | 3 | TO18 | GE | | |
| 2N2419 | bar | 60 | 70 | 450 | 2.0 | .56 | .68 | 12 | 4.7 | 6.8 | — | TO18 | GE | | |
| 2N2419A | bar | 60 | 70 | 450 | 2.0 | .56 | .68 | 12 | 4.7 | 6.8 | 3 | TO18 | GE | | |
| 2N2419B | bar | 60 | 70 | 450 | 0.2 | .56 | .68 | 6 | 4.7 | 6.8 | 3 | TO18 | GE | | |
| 2N2420 | bar | 60 | 70 | 450 | 2.0 | .56 | .68 | 12 | 6.2 | 9.1 | — | TO18 | GE | | |
| 2N2420A | bar | 60 | 70 | 450 | 2.0 | .56 | .68 | 12 | 6.2 | 9.1 | 3 | TO18 | GE | | |
| 2N2420B | bar | 60 | 70 | 450 | 0.2 | .56 | .68 | 6 | 6.2 | 9.1 | 3 | TO18 | GE | | |
| 2N2421 | bar | 60 | 70 | 450 | 2.0 | .62 | .75 | 12 | 4.7 | 6.8 | — | TO18 | GE | | |
| 2N2421A | bar | 60 | 70 | 450 | 2.0 | .62 | .75 | 12 | 4.7 | 6.8 | 3 | TO18 | GE | | |
| 2N2421B | bar | 60 | 70 | 450 | 0.2 | .62 | .75 | 6 | 4.7 | 6.8 | 3 | TO18 | GE | | |
| 2N2422 | bar | 60 | 70 | 450 | 2.0 | .62 | .75 | 12 | 6.2 | 9.1 | — | TO18 | GE | | |
| 2N2422A | bar | 60 | 70 | 450 | 2.0 | .62 | .75 | 12 | 6.2 | 9.1 | 3 | TO18 | GE | | |
| 2N2422B | bar | 60 | 70 | 450 | 0.2 | .62 | .75 | 6 | 6.2 | 9.1 | 3 | TO18 | GE | | |
| 2N2646 | cube | 30 | 50 | 300 | 12.0 | .56 | .75 | 5 | 4.7 | 9.1 | 3 | TO18 | GE | | |
| 2N2647 | cube | 30 | 50 | 300 | 0.2 | .68 | .82 | 2 | 4.7 | 9.1 | 6 | TO18 | GE | | |
| 2N2840 | cube | 30 | 50 | 300 | 1.0 | — | — | 10* | 4.7* | 9.1* | — | TO18 | GE | | |
| 2N3480 | planar | 30 | 50 | 400 | 12.0 | .56 | .75 | 20 | 4.7 | 9.1 | 3 | TO5 | MOT | | |
| 2N3481 | planar | 30 | 50 | 400 | 12.0 | .70 | .85 | 20 | 4.7 | 9.1 | 3 | TO5 | MOT | | |
| 2N3483 | planar | 30 | 50 | 400 | 1.0 | .60 | .72 | 5 | 4.7 | 9.1 | 4 | TO5 | MOT | | |
| 2N3484 | planar | 30 | 50 | 400 | 0.2 | .70 | .85 | 5 | 6.2 | 9.1 | 6 | TO5 | MOT | | |
| 5E35† | cube | 30 | 50 | 300 | 12.0 | .62 | .82 | — | 4.7 | 9.1 | — | TO18 | GE | | |
| 5E36† | cube | 30 | 50 | 300 | 1.0 | .62 | .82 | — | 4.7 | 9.1 | — | TO18 | GE | | |
| SJ993 | planar | 30 | 50 | 300 | 10.0 | .56 | .75 | 5 | 4.7 | 9.1 | 3 | TO18 | TI | | |
| SJ1127 | planar | 30 | 50 | 300 | 10.0 | .68 | .82 | 2 | 4.7 | 9.1 | 6 | TO18 | TI | | |

† Frequency and period guaranteed in multivibrator test circuit

* At 1.5 volts

Emitter reverse current measured at specified V_{BE} and $I_{B1}=0$

Intrinsic stand-off ratio measured at specified V_{BB}

Peak-point emitter current measured at specified V_{BB}

Interbase resistance measured at specified V_{RB} and $I_E=0$

Base one peak pulse voltage measured in manufacturer's test circuit

GE = General Electric Co.
MOT = Motorola, Inc.
TI = Texas Instruments Incorporated

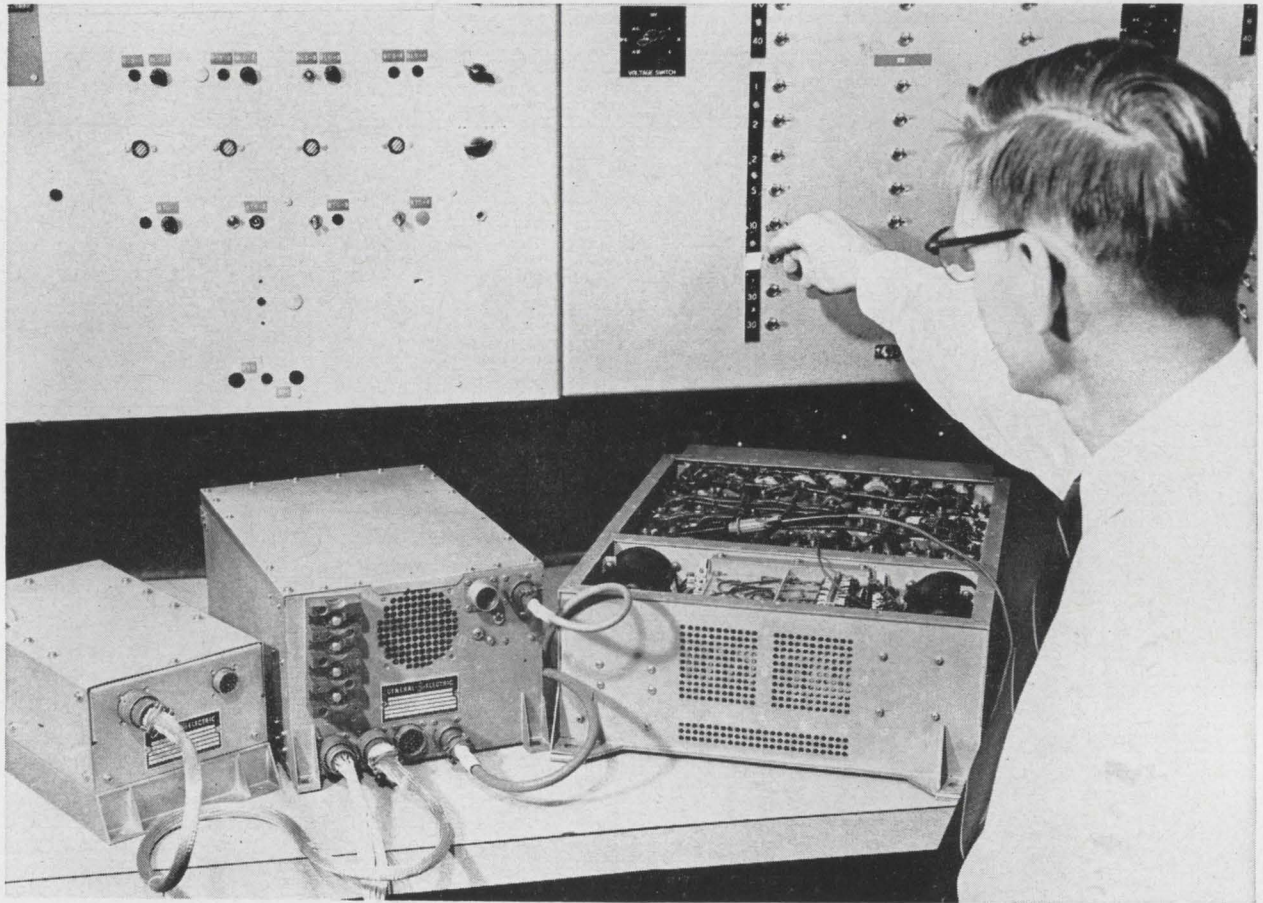

Aircraft power system developed by General Electric uses circuitry containing unijunction transistors and silicon controlled rectifiers to replace hydraulic constant-speed alternator-drive arrangement. System components shown being tested are protective controls, waveform filters and unijunction-scr converter circuitry.

them with the bar structure employed in most currently available unijunction transistors.

The market

Military applications of unijunction transistors have been considerable. The devices have important functions in the Polaris and Minuteman control systems, and have been used in the circuitry of most space satellites. They are also used extensively in military communications. The Collins Radio Co. uses unijunction transistors in the AN/ARC-80 airborne data-communications system and in the 618T single-sideband transmitter-receiver for level detection, tone generation and frequency division. The Magnavox Co. and Bendix Corp. are also using unijunction transistors in mobile communications systems.

The unijunction transistor has also found its way into a variety of industrial applications—the latest of which is the regulated power-supply circuitry of commercial jet aircraft. More typical of its industrial applications is its widespread use in timing. The Industrial Timer Corp., for example, offers five precision timers using unijunction transistors. Each of the units, which sell for \$69.95, has been in the company's line more than four years.

According to GE, the owners of two-engine com-

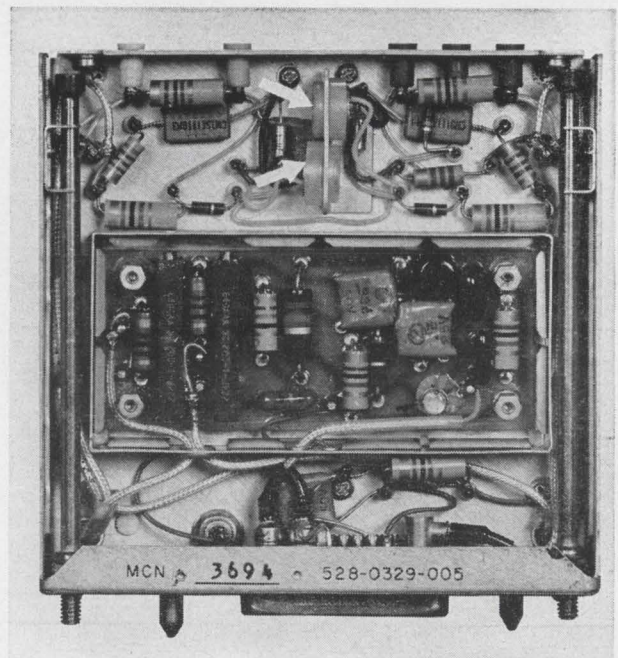

618T single-sideband transceiver manufactured by Collins Radio Co. uses unijunction transistors for frequency stabilization. Arrows indicate unijunction transistors.

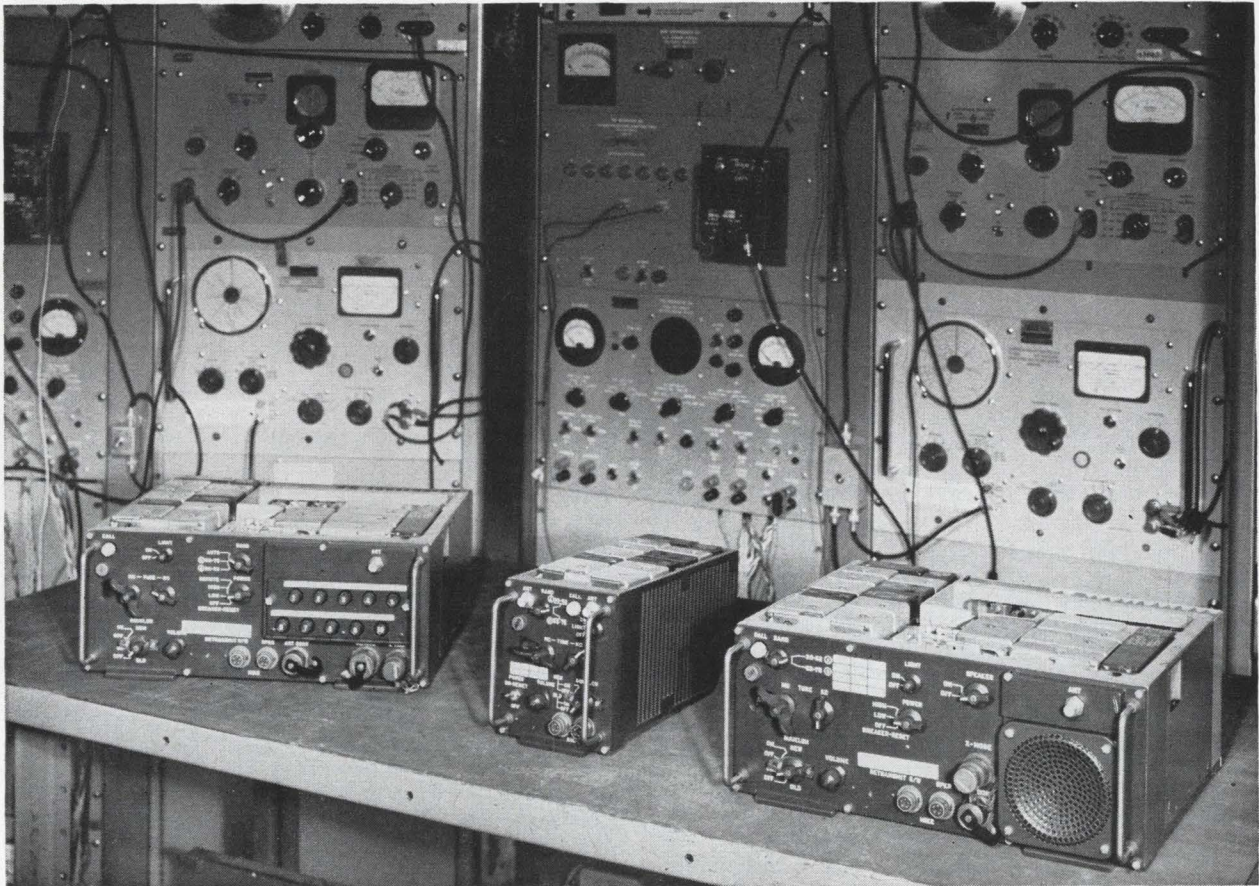

The AN/VRC-12 jeep radio communications system, built by Magnavox Co., employs unijunction transistors as saw-tooth oscillators in frequency-sweep generators. Being tested are the push-button transceiver RT-246 (lower left), the auxiliary receiver R-442 (lower center) and the manual-tuned transceiver RT-524.

mercial jet aircraft will save about \$8,000 a year per plane by using a regulated power supply designed with unijunction transistors. Applications for unijunction transistors also include electronic organs (for frequency division) and a music-light display at the New York World's Fair. The Woods Hole Oceanographic Institution uses a five-unijunction transistor pulse-generator in instruments placed on the ocean floor. This provides a beacon to help the pickup crew find the instruments.

No integrated circuits have been marketed yet with unijunction transistors. However, the practicality of such devices has been shown in the construction of planar unijunction transistors and in work on unijunction integrated circuits at the University of California, financed by an Air Force grant.

The main restriction on the use of unijunction transistors in integrated circuits is that the large pellet size of the unijunction's frequent working companion, the medium- or high-power silicon controlled rectifier, restricts its manufacture in integrated form.

Military types

A military specification for unijunction transistor types 2N489 through 2N494 was issued by the Air Force in July, 1959. The specification, MIL-T-

19500/75, calls for a series of environmental tests including moisture resistance, noise fatigue vibration, and stringent electrical tests. Currently both Texas Instruments Incorporated and the General Electric Co. have been approved by the Air Force as qualified to supply these types. Individual military projects, such as the Minuteman and Polaris missiles, also have rigid specifications for unijunction transistors. The Minuteman specification is for the 551B transistor, Polaris the G319.

Lead arrangement

Although the chart on page 89 refers to standard TO-5 and TO-18 transistor cases, the basing arrangement for unijunction transistors differs from conventional TO-5 and TO-18 bases. For the unijunction-transistor base, the index tab is between the emitter lead and the base two lead instead of between the emitter and the vacant lead location.

An in-line lead arrangement was used for the discontinued plastic-case unijunction-transistor types.

Family tree

The unijunction transistor is generally considered to have been born in 1952 in the electronics laboratory of the General Electric Co. Its developer was I. Arnold Lesk, then a GE scientist working

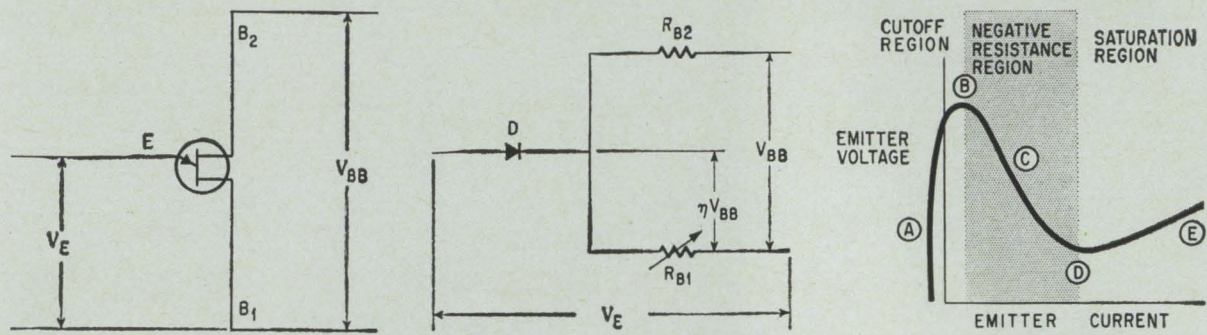

Symbol for a unijunction transistor having p-type emitter and n-material base region is at left. Simplified equivalent circuit containing only three components is in center. Emitter-to-base-one voltage current characteristic, at right, exhibits five key points: (A) cutoff, (B) peak point, (C) negative resistance region, (D) valley point, and (E) saturation.

Theory of operation

The simplified equivalent circuit (off condition) for the unijunction transistor, shown in the center diagram, requires only two resistors and a diode, although more complex equivalent circuits have been derived.

The diode represents the junction between the p-material emitter and the n-material base region. Resistor R_{B1} represents the resistance of the base region between the p-n junction and the base-one (B1) contact; R_{B2} is the resistance between the junction and the base-two (B2) contact.

The fraction of the applied interbase voltage V_{BB} that appears across R_{B1} is designated by η . If the emitter-to-base-one voltage V_E is less than ηV_{BB} , the p-n junction will be reverse-biased, and only leakage current in the order of a few microamperes (nanoamperes for some types) will flow. This condition is represented by point A on the voltage-current characteristic shown in the

diagram at the top, right. By increasing V_E until it is greater than V_{BB} , the p-n junction becomes forward-biased and emitter current starts to flow.

At point B, the emitter voltage reaches the peak-point voltage and the unijunction transistor fires. The majority of the holes, being injected from the p-material emitter, travel to base one, lowering the resistivity of the emitter-to-base-one region. This, in turn, results in a decrease in the emitter voltage as the current rises, and the device exhibits a negative resistance characteristic (B-D). As the current rises, the emitter voltage continues to drop until it reaches the valley-point voltage (point D). The valley-point voltage depends on the resistances in series with base one and base two. It decreases as resistance in series with base two is increased, and rises with resistance in series with base one. The region beyond point E, in which the current-voltage relationship is positive, is called the saturation region.

under an Air Force grant to study semiconductor phenomena. But its history goes back further than that.

Its feasibility was demonstrated in 1948 by Heinrich Welker in France. In 1949, William Shockley and J. R. Haynes described the principles governing unijunction action.

The first line of commercial units, using germanium-alloy construction, found limited use in multivibrators, oscillator circuits and filter circuits, and as pulse generators, switches and voltage or temperature sensors. But sales were restricted by high prices and certain technical deficiencies (p. 99).

In 1956, GE changed the name of the device from double-base diode; it also switched from germanium to silicon, and eliminated some technical drawbacks. Two years later, GE made several improvements in the device structure and abandoned the use of silicon produced by the Czochralski method; it switched to silicon made by a floating-zone process. A considerable increase in device uniformity resulted.

In 1960, T. P. Sylvan, working at GE, designed a small unijunction cube structure, more compact than the then-conventional bar structure and with faster turn-on.

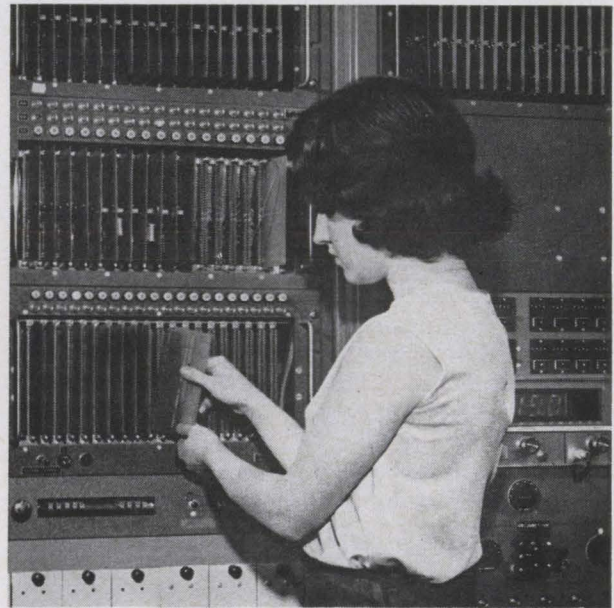

Unijunction-transistor classifier at the General Electric Co. facility in Syracuse. Each panel board, such as the one being loaded by the operator, controls a standard go, no-go test. The classifier allows rapid grouping of transistors, according to principal characteristics.



Now, new unijunction geometries

Comparison of two new types of unijunction transistors with older bar-structure and alloy-junction types reveals some important differences

By Lowell Clark

Motorola, Inc., Phoenix, Ariz.

Unijunction transistors, until recently have been exclusively of the bar-structure and alloy-junction types. Now two new types of oxide passivated unijunction transistors are being produced. In this article both of these devices are compared with the two older unijunction devices to show the advantages of one over the other and to describe the present state of the art for each. Diagrams of the construction of all four devices are shown on the next page.

Older devices

As shown on the next page, the bar device has ohmic base contacts and an alloy emitter. For reasons which will be explained this device has the slowest response time of unijunction transistors.

The cube-structure alloy-junction device is made with silicon having a resistivity of about 100 ohm-centimeters. In the cube-structure device, each edge of the chip has a length of about 0.01 inch. Gold or gold-antimony may be used for the base contacts.

The base-one contact is formed by alloying a gold wire to the top face of the silicon chip. The radius r of the contact area determines the value of the interbase resistance R_{BB} .

If its thickness is substantially greater than the base-one radius r , the interbase resistance R_{BB} may be approximately expressed as:

$$R_{BB} = 63\rho/r \quad (1)$$

The author



Lowell Clark is the manager of the exploratory devices section of the Applied Science Department of Motorola's semiconductor operation. He joined Motorola in 1962 after receiving a master's degree in electrical engineering from Stanford University.

where r = radius of base-one connection in thousandths of an inch

ρ = resistivity of the n-type silicon in ohm-centimeters

Assuming hemispherical equipotentials, the voltage standoff ratio η is given by:

$$\eta = x/(r + x)$$

where x = minimum distance between the emitter junction and base one.

An alloyed aluminum wire is usually used for the emitter. It may be placed on the same face as base one or on another edge of the chip. The face of the chip opposite to base one is usually used for base two and is placed in thermal and electrical contact with the header.

Basic difference

An important difference between the cube alloy-junction device and the bar-geometry unijunction transistor is the structure size. If both devices are made from silicon having the same resistivity, a smaller cube structure is needed to provide the same key characteristics as in the bar geometry. The values of η and R_{BB} in a bar-geometry device can be duplicated in a cube device having much smaller base-one-to-emitter spacing. This, in turn, means that both the emitter saturation voltage and the switching time are substantially reduced. For example, a bar structure having a resistivity of 100 ohm-centimeters and a cross-section measuring 0.01 inch by 0.01 inch would need an active length of 0.015 inch to provide an R_{BB} of 6,000 ohms. Since $\eta \cong 1/2$, the emitter-to-base one spacing would be at least 0.0075 inch.

An alloy-junction structure with a base-one radius of 0.001 inch fabricated from silicon also having a resistivity of 100 ohm-centimeters, would need an emitter-to-base-one spacing of approximately 0.001 inch. In addition, the saturation voltage for a bar-type unijunction transistor ordinarily increases rapidly with standoff ratio, while these parameters are nearly independent in the cube alloy-junction device.

Oxide-passivated devices

Oxide-passivated unijunction transistors with one diffused base (base one) may be made in two ways. One possible configuration for these devices has the base-two contact attached to the back of the silicon chip. This method has the disadvantage of requiring contacts on more than one surface. If the base-two contact is made at the top surface as shown in the diagram, the structure becomes compatible with processing techniques for silicon monolithic integrated circuits.

This passivated device has some advantages over its alloyed counterpart. Passivated construction results in low emitter leakage current I_{EO} and may also result in a lower peak-point current due to improved emitter efficiency at low currents. However, certain problems may be encountered with this configuration because of uncontrollable variations in surface potential which occur near the surface of base one during operation. As a result in the typical planar diffused unit, the intrinsic standoff ratio may turn out to be 0.2 to 0.3, rather than 0.6 to 0.7 calculated for the emitter-to-base one-spacing being used. This problem with surface potential is well known in n-type devices having oxide passivated surfaces. The standoff ratio may be increased by increasing the emitter-to-base-one spacing, but this procedure has the disadvantage of increasing the saturation voltage and switching time. Variations in the surface potential may also lead to an undesirably large spread in the limits of standoff ratio achieved in production. Except for difficulty in controlling standoff ratio, this diffused device appears to be satisfactory.

Two diffused bases

During cutoff, the unijunction transistor is essentially represented by a diode connected to a resistance divider network consisting of R_{B1} and R_{B2} . The intrinsic standoff ratio η is equal to $R_{B1}/(R_{B1} + R_{B2})$ and the interbase resistance R_{BB} is equal to $R_{B1} + R_{B2}$. The required resistance values may be obtained by diffusing two small base contacts of different diameters into the n-type silicon. The p-type emitter may then be placed anywhere on the surface of the silicon die at a distance several diameters from either base. Since any shift in surface potential tends to affect the base spreading resistance of both bases equally, close control over the standoff ratio may be obtained. This structure, a diffused (double) unijunction transistor, is the

Four common constructions of unijunction transistors. The bar structure has an alloy emitter and ohmic base contact. The cube device also has an alloy emitter but in addition the alloy process is used to form base one. The diffused unijunction transistor has base one diffused into the silicon substrate. The double diffused device has both base one and base two diffused into the substrate.

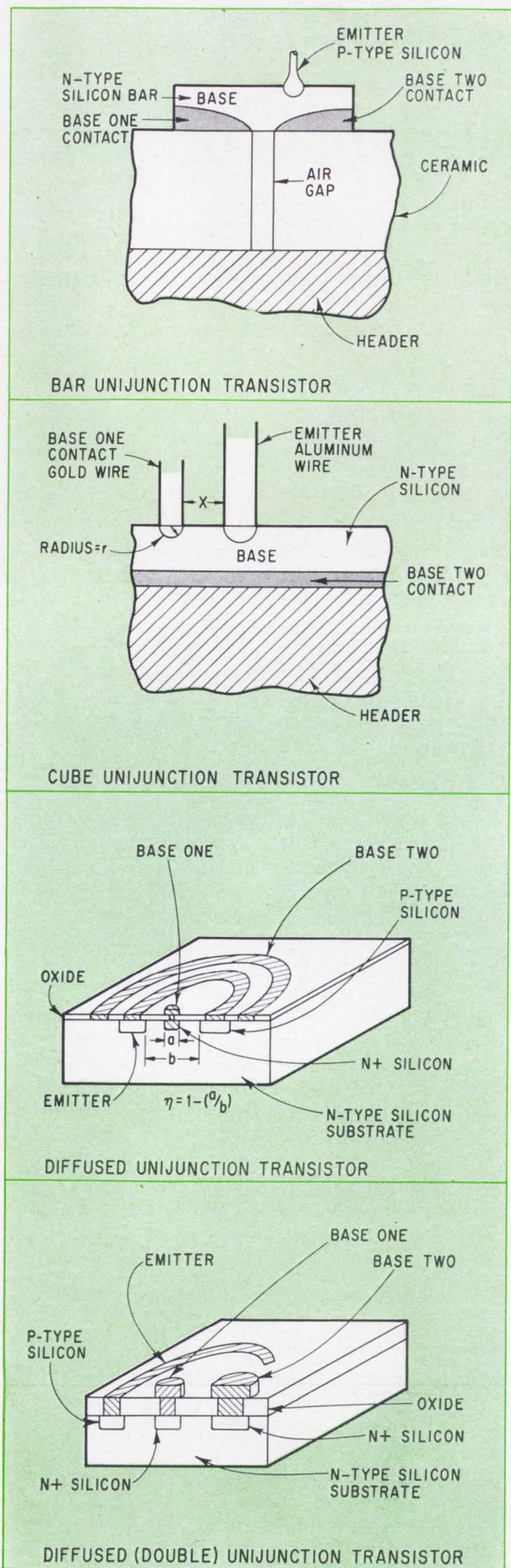

bottom diagram on the previous page.

There are several advantages to this approach. The standoff ratio is determined solely by the base contact diameters and not by base-to-emitter spacing. It may be expressed as follows:

$\eta = \frac{D_2}{D_1 + D_2}$, where D_1 and D_2 are the diameters of base one and base two respectively.

Since two base spreading resistances are utilized, high interbase resistances may be obtained with low substrate resistivities. The emitter size, efficiency, and dimensional relationship with both

bases are now independent variables and may be used more easily to determine other electrical characteristics of the unijunction device.

The configurations described represent unijunction transistors which are currently available in sampling or off-the-shelf quantities. The exact analysis of unijunction-transistor characteristics is exceedingly difficult because simplification of its geometry for analysis involves approximations in most cases. However, examination of the relationship between the unijunction transistor's electrical characteristics and the physical properties of its structure can illustrate meaningfully the depend-

Glossary of unijunction terminology

Base-one resistance (R_{B1}). Effective resistance between base one and the emitter.

Base-two resistance (R_{B2}). Effective resistance between base two and the emitter.

Base-one peak pulse voltage (V_{OB1}). The voltage across the base-one load resistor after the unijunction transistor turns on. A minimum value of this voltage is usually specified to assure that the pulse will be adequate to fire a silicon controlled rectifier or trigger other types of circuits.

Diode voltage (V_D). The voltage drop across the emitter diode with a forward current equal to the peak point current.

Double-base diode. Name commonly used for the unijunction transistor until 1956. Still appears occasionally in literature.

Emitter channeling. A detrimental condition in which a low resistive path is formed between the emitter and one of the bases.

Emitter-channeling test current (I_{EX}). The emitter current which flows when measured in a special test circuit to indicate the occurrence of emitter channeling.

Emitter reverse current (I_{EB20}). The emitter current measured with a reverse voltage applied between base two and the emitter, with base one open-circuited. The emitter reverse current varies with voltage and temperature in the same way that the collector cutoff current in a con-

ventional bipolar transistor varies for these conditions.

Emitter saturation voltage ($V_{E(SAT)}$). The forward voltage drop from the emitter to base one when the transistor is operated in the saturated conducting region of its voltage-current characteristic curve. At saturation, the slope of the emitter characteristic is positive.

Emitter valley voltage (V_V). The emitter to base-one voltage measured at the valley point (the point at which the device enters the saturation region of its characteristic). This voltage usually increases with the supply voltage V_{BB} and decreases with rising temperature.

Interbase modulated current ($I_{B2(MOD)}$). The base-two current flowing during saturated operation.

Interbase resistance (R_{BB}). The resistance measured between base one and base two with the emitter open-circuited. Due to the decrease in carrier mobility, this resistance increases with temperature, until the thermal generation of carriers overrides this relationship: (usually at

temperatures over 100°C). Then, further increases in temperature lower the interbase resistance. Because of the large electric fields which exist in the high-resistivity base material, there may be a tendency toward field saturation of mobility causing R_{BB} to increase with interbase voltage.

Intrinsic stand-off ratio (η). The ratio of the peak point voltage minus the diode forward voltage drop to the interbase voltage.

Interbase voltage (V_{BB}). The d-c bias voltage (positive for the p-emitter unijunction transistor) applied at base two.

Negative resistance region. The portion of the emitter characteristic between device cutoff and saturation. In this region, the slope of the emitter characteristic is negative.

Peak point current (I_P). The minimum emitter current required to turn on the unijunction transistor. Also the minimum current required to cause oscillation in a relaxation oscillator circuit. The peak point current occurs at a transition from device cutoff to the condition of negative resistance.

Peak point emitter voltage (V_P). The maximum emitter voltage reached before the unijunction transistor turns on.

Valley current (I_V). The emitter current corresponding to the valley voltage. The valley current increases as the interbase voltage increases, and decreases with resistance in series with base one or base two.

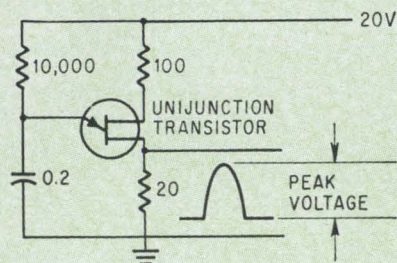

Test circuit commonly used for measuring base-one peak pulse voltage

ence of device parameters on geometry and semiconductor parameters.

Relationship between parameters

In the equivalent-circuit diagram at the right, G_n and G_p are the excess electron and hole conductivities between the emitter and base one. The efficiency with which holes move from the emitter to the base-one contact is represented by γ , and G_1 and G_2 are the conductivities corresponding to the base one and base two sections of the interbase resistance. Recombination is neglected. The current-node equation for the central junction (point A) is:

$$I_E + I_{B2} = V_2(G_1 + G_P + G_n) \quad (1)$$

Where V_2 is the voltage between point A and ground.

The following relationship may now be used to rewrite equation 1 in terms of V_2 :

$$\frac{G_n/G_P}{I_E} = \frac{U_n/U_P}{V_2 G_P/\gamma} \quad (2)$$

After some manipulation of terms, the following equation can be obtained:

$$V_2 = \frac{[I_{B2} - \left(\frac{U_n}{U_P} + 1 - \frac{1}{\gamma}\right)\gamma I_E]}{G_1} \quad (3)$$

Equation 3 may be used to obtain the emitter voltage V_E which is equal to V_2 plus the voltage drop across the diode D, or:

$$V_E = \frac{I_{B2}}{G_1} - \frac{\left[\left(\frac{U_n}{U_P} + 1 - \frac{1}{\gamma}\right)\gamma I_E\right]}{G_1} + V_F \quad (4)$$

where V_F = diode voltage drop.

The first of the three terms in the expression for V_E is the voltage contributed by the flow of current from base two through the base-one region. The middle term represents the voltage created by

Changing one parameter of a device affects the other parameters. Plus sign represents positive correlation; minus sign represents negative correlation; and zero stands for negligible correlation.

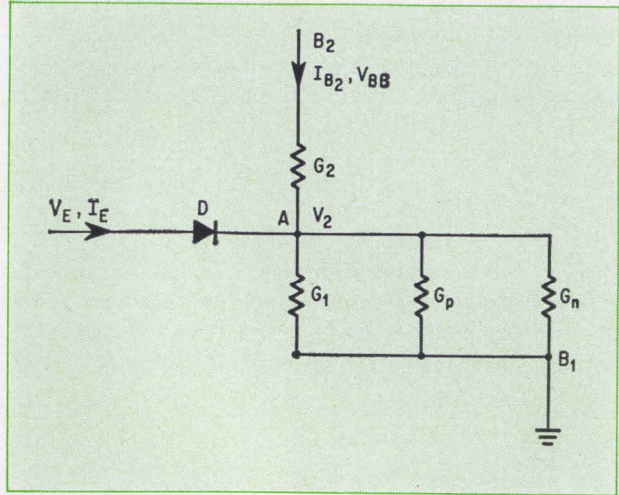

Equivalent circuit for a unijunction transistor. G_p and G_n represent the excess hole and electron conductivities between the emitter and base one. G_1 and G_2 are the conductivities corresponding to R_{B1} and R_{B2} .

Effect of change

| Parameter | Parameters being affected | Bar device | Alloy device | Dif-fused device | Dif-fused (double) device |
|---------------------------------|---------------------------|------------|--------------|------------------|---------------------------|
| Intrinsic standoff ratio η | R_{BB} | 0 | 0 | 0 | 0 |
| | I_V | + | + | + | + |
| | $V_{E(SAT)}$ | + | 0 | + | 0 |
| | I_p | + | + | + | + |
| | $I_{B2(MOD)}$ | + | + | + | + |
| Interbase resistance R_{BB} | T_{on} | + | 0 | + | 0 |
| | I_V | - | - | - | - |
| | $V_{E(SAT)}$ | + | + | + | + |
| | I_p | - | - | - | - |
| Valley current I_V | $I_{B2(MOD)}$ | - | - | - | - |
| | t_{on} | + | 0 | 0 | 0 |
| | $V_{E(SAT)}$ | + | + | + | + |
| | I_p | + | + | + | + |
| Saturation voltage $V_{E(SAT)}$ | $I_{B2(MOD)}$ | + | + | + | + |
| | I_p | + | + | + | + |
| | t_{on} | 0 | 0 | 0 | 0 |
| Peak-point current I_p | $I_{B2(MOD)}$ | + | + | + | + |
| | t_{on} | 0 | 0 | 0 | 0 |

Comparison of devices

| Structure | Bar device | | Alloy device | | Diffused device | | Diffused (double) device | |
|--|------------|------------|--------------|------------|-----------------|------------|--------------------------|------------|
| | Typical | Obtainable | Typical | Obtainable | Typical | Obtainable | Typical | Obtainable |
| η | 0.6 | 0.8 | 0.7 | 0.3-0.9 | 0.7 | .2-.9 | 0.7 | 0-.95 |
| R_{BB} (kilohms) | 7 | 0-25 | 7 | 0-25 | 7 | 0-25 | 7 | 0-25 |
| I_V at $V_{BB}=20V$ (milliamperes) | 15 | 10-20 | 2 | 1-20 | 12 | 1-20 | 3 | 1-20 |
| $V_{E(SAT)}$ (volts) | 3 | — | 1.5 | — | 3 | — | 1.5 | — |
| I_p (microamperes) | 1.0 | — | 1.0 | — | 2.0 | — | 1.0 | — |
| $I_{B2(MOD)}$ at $I_E=50$ ma and $V_{BB}=10v$ (milliamperes) | 15 | 10-20 | 15 | 6-22 | 15 | 6-22 | 4 | 3-20 |
| T_{on} (nanoseconds) | 4000 | — | 100 | — | 400 | — | 200 | — |

Design ranges and typical parameter values obtainable with currently available unijunction devices.

the flow of emitter current through the base-one region. The last term V_F results from the flow of emitter current through the diode D. The voltage V_F is given by:

$$V_F \approx \frac{KT}{q} \ln(I_E/I_o)$$

Where K = Boltzmann constant
 q = electron charge
 T = absolute temperature (degrees Kelvin)
 I_o = diode saturation current

Since $\eta = R_1/(R_1 + R_2) = G_2/(G_1 + G_2)$ and at low values of I_E , $I_{B2} = (V_{BB} - V_2) G_2$, equation 4 (for low I_E values) can be written as:

$$V_E = \eta V_{BB} - \frac{\left(\frac{U_n}{U_P} + 1 - \frac{1}{\gamma}\right) \gamma I_E}{G_1 + G_2} + V_F \quad (5)$$

Taking a partial derivation for V_E with respect to I_E yields:

$$\frac{\partial V_E}{\partial I_E} = - \frac{\left(\frac{U_n}{U_P} + 1 - \frac{1}{\gamma}\right) \gamma}{G_1 + G_2} + \frac{KT}{qT_E} \quad (6)$$

At the peak point, $\partial V_E / \partial I_E = 0$. Thus, the peak-point emitter current is:

$$I_P \approx \frac{KT}{q} \cdot \frac{(G_1 + G_2)}{\left(\frac{U_n}{U_P} + 1 - \frac{1}{\gamma}\right) \gamma} \quad (7)$$

Since the first two terms in equation 4 both represent current flowing to base one through a positive resistance, their sum is positive.

The approximate valley current is obtained by setting the first two terms of equation 4 equal to 0. This provides the following expression:

$$I_V \approx I_{B2V} \cdot \frac{1}{\gamma \left(\frac{U_n}{U_P} + 1 - \frac{1}{\gamma}\right)}$$

where $I_{B2V} = I_{B2}$ measured at the valley emitter current.

Because of the reduction in value of γ at the valley point, a good approximation for many devices is:

$$I_V \approx I_{B2V} \approx V_{BB} G_2$$

The above equation holds if G_2 is not substantially affected by conductivity modulation which, for example, could occur if base two is located very closely to the emitter.

The expressions that have been presented can be used to compare the performances of the various types of unijunction transistors. The major difference between units of various configurations appears to be in the correlation of η with $V_{E(SAT)}$ and switching time. The type of unijunction structure used does have a considerable influence on the absolute value of the device's major electrical parameters. The alloy device and the diffused (double) device have much lower saturation voltages than the bar-geometry or the diffused (single) uni-

junction transistor. The alloy and planar devices have considerably faster turn-on time than the bar-type device. The two-base diffused unijunction transistor offers the possibility of obtaining extremely low-peak and $I_{B2(MOD)}$ currents together with a wider designable range of standoff ratios.

Desirable characteristics

While the optimum parameter values for a unijunction transistor are determined by the specific application, certain general characteristics are desirable. The interbase resistance should normally be as high as possible so that minimum interbase power is dissipated. Compensating a unijunction-transistor oscillator to obtain constant frequency over a wide temperature range requires a positive temperature coefficient of interbase resistance.

The intrinsic standoff ratio, η , is normally useful in the range of 0.40 to 0.85, but some applications require tighter production control of this parameter. The emitter saturation voltage should be as small as possible, particularly in switching applications. The valley current may be high or low, depending on the application. For example, in oscillator and trigger applications, a high value is usually desirable to handle a heavy load current and to avoid latching, while low valley current allows bistable operation at low power levels. The peak-current should normally be as low as possible to allow sensitive triggering.

Two other important parameters are turn-on and turn-off time. These are closely tied to the geometrical configuration. The distance between the emitter and base one establishes the carrier transit time while the active volume of high resistivity material between the emitter and base one determines the amount of charge that participates in turn-on or turn-off.

The devices which have been compared reflect the current state of the art. As more familiarity with passivated unijunction develops, it is expected that devices with faster switching capabilities and lower saturation voltages will be constructed. The planar devices are also expected to provide low manufacturing costs. Eventually, they should find widespread use in integrated circuits.

Bibliography

- I.A. Lesk and V.P. Mathis, "The Double-Base Diode—A New Semiconductor Device," IRE Convention Record, Part 6, March, 1963, pp. 2-8. R.W. Aldrich and I.A. Lesk, "The Double-Base Diode—A Semiconductor Thyatron Analog," IRE Transactions on Electron Devices, ED-1, Feb., 1954, p. 24.
- J.J. Suran, "Low Frequency Circuit Theory of the Double-Base Diode, IRE Transactions on Electron Devices," ED-2, Apr., 1955, pp. 40-48. B.K. Eriksen and J.J. Suran "Transient Response Characteristics of Unijunction Transistors," IRE Transactions on Circuit Theory, CT-4, September, 1957, pp. 267-275.
- J.G. Linville and J.F. Gibbons, "Transistors and Active Circuits, pp. 196-200," McGraw-Hill Book Co., 1961.
- L.E. Clark, "Problems in the Fabrication of a Diffused Silicon Unijunction Transistor," 1964 Spring Meeting, Electrochemical Society, Toronto.
- V.A. Bluhm and T.P. Sylvan, "A High Performance Unijunction Transistor Using Conductivity Modulation of Spreading Resistance," Solid State Design, Vol. 5, Number 6, June, 1964.



Unijunction device gets high marks in stringent tests of reliability

Study of life tests, field returns, acceleration factors and failure mechanisms indicates failure rate of less than 0.01% per thousand hours

By T. Peter Sylvan

General Electric Co., Syracuse, N.Y.

Over the last decade the silicon unijunction transistor has demonstrated its reliability and versatility in an ever-widening range of commercial and military applications.

It is used in many timing, current-sensing, and flasher circuits, in telemetering oscillators, and in satellite controls. In one case, a unijunction transistor is the main timing device of a missile programmer; in another, it is the master clock generator in a multiphase power inverter.

In many applications, failure of the unijunction transistor to perform its assigned task would cause the entire system to fail. In military and space systems, where critical functions are performed by unijunction transistors, several high-reliability specifications have been written for unijunction devices. These include MIL-T-19500/75, an Air Force specification for the 2N489 through 2N494; the Minuteman specification for type 551B, and the Navy specification for type G319.

Record of reliability

Analyses and evaluations of reliability data on silicon unijunction transistors indicate that failure rates of less than 0.01% per thousand hours can

The author



T. Peter Sylvan, an engineering consultant in the Semiconductor Products department has been with the General Electric Co. for 13 years. In 1953 and 1954 he attended Cornell University on a General Electric-Swope fellowship. He came to his present job from the Light Military department in 1957. Sylvan holds 10 unijunction-transistor circuit patents and two unijunction device patents.

be achieved with standard commercial devices in many applications. By comparison, the typical failure rate for conventional junction transistors operated at one-half their dissipation rating in low-temperature applications is about 0.05% per thousand hours. Even the extremely low failure rate of 0.004% required of silicon controlled rectifiers for the Minuteman Program has been attained by commercial unijunction transistors in some circuitry.

High reliability for any semiconductor device can be achieved with device design that minimizes critical processing and tolerance requirements; production techniques whose in-process quality controls eliminate reliability problems before they occur; quality assurance programs that independently monitor product quality and provide fast feedback to the production line should quality problems occur; and finally, application of the device, basing its use on knowledge of the predominate failure modes of the device and on the long-term variations of important parameters.

Unijunction transistor types

There are three different unijunction transistor types: bar-structure, cube-structure, and planar-structure devices. Since the bar-structure unijunction transistor came first it is the device for which there is most reliability information. And it is the only type of unijunction transistor currently being supplied to military specifications. The reliability data in this article covers bar-structure devices.

Commercially available unijunction transistors made with bar geometry include the 2N489 through 2N494, the 2N1671, the 2N2160 and the 2N2417 through the 2N2422. All, except for the 2N2417 series, are packaged in the Jedec TO5 case (with a modified lead arrangement). The 2N2417 family is supplied in the TO18 case.

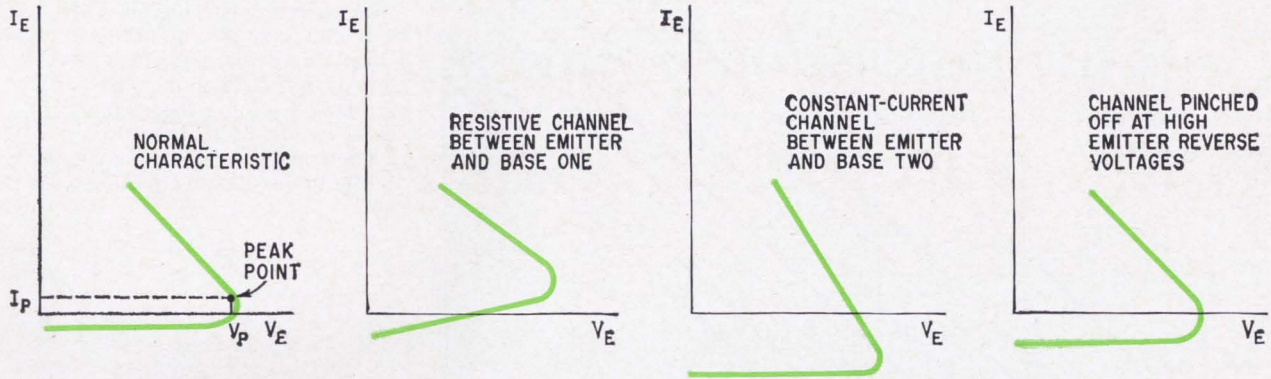

Normal characteristic of unijunction transistor and characteristics of three types of emitter channeling. Channeling, a problem in timing circuits with long-periods, is detected by I_{EX} test.

Constant improvements in design have given the unijunction transistor greater reliability. Early versions were made of germanium, had low values of interbase resistance, and exhibited excessive variation of peak-point voltage with temperature.

The first silicon unijunction transistors were made by mounting a silicon bar between two metal tabs. While this structure overcame the more serious shortcomings of the germanium devices, it had its own disadvantages. These included high thermal resistance, poor sensitivity to shock, and poor

uniformity between devices. Fixed-bed mounting was introduced in 1958 to correct those problems.

In fixed-bed construction, the silicon bar is mounted between two metalized areas on a ceramic disk. The metalized areas form the two ohmic contacts (base one and base two) and the emitter junction is formed by an aluminum wire placed in the top of the silicon bar and fastened at the other end of a short span to a third metalized area on the ceramic disk.

The entire structure is rigidly supported on the

Reliability data

| Life test | Amount of units tested | Accumulated device hours | Failure limits R_{BB} (%) | Standoff ratio (%) | I_{EB20} at 60 v. (ua) | Observed failure rate %/1,000 hrs. | Estimated mean time to failure (in hrs.) |
|---|------------------------|--------------------------|-----------------------------|--------------------|--------------------------|------------------------------------|--|
| 600 mw operating | 1,900 | 1,900,000 | 30 | 10 | 100.0 | 1.10 | 91,000 |
| | 1,900 | 1,900,000 | 10 | 5 | 1.0 | 6.2 | 16,000 |
| 300 mw operating | 215 | 1,225,600 | 30 | 10 | 100.0 | 0.081 | 1,224,000 |
| | 215 | 1,225,600 | 10 | 5 | 1.0 | 0.71 | 140,000 |
| 600 mw operating | 370 | 370,000 | 30 | 10 | 100.0 | 0 | 585,000 |
| | 370 | 370,000 | 4 | 4 | 0.5 | 1.35 | 74,000 |
| | 370 | 370,000 | 6 | 6 | 0.5 | 0.81 | 124,000 |
| 175°C storage | 950 | 950,000 | 30 | 10 | 100.0 | 0 | 1,370,000 |
| | 950 | 950,000 | 10 | 5 | 1.0 | 1.56 | 64,000 |
| 150°C storage | 1,156 | 1,156,000 | 30 | 10 | 100.0 | 0.087 | 1,150,000 |
| | 1,156 | 1,156,000 | 10 | 5 | 1.0 | 0.69 | 145,000 |
| 175°C storage | 370 | 370,000 | 30 | 10 | 100.0 | 0 | 585,000 |
| | 370 | 370,000 | 4 | 4 | 0.5 | 0.81 | 124,000 |
| | 370 | 370,000 | 6 | 6 | 0.5 | 0 | 585,000 |
| 200°C storage | 600 | 600,000 | 30 | 10 | 100.0 | 0.17 | 599,000 |
| | 600 | 600,000 | 10 | 5 | 1.0 | 1.68 | 59,500 |
| 1-ampere peak oscillator circuit at 100°C | 25 | 25,000 | 30 | 10 | 100.0 | 0 | 35,000 |
| | 25 | 25,000 | 4 | 4 | 0.5 | 4.00 | 25,000 |

Life-test results for the 2N489 through 2N494 family. The figures in the standoff ratio and failure limits column represent allowable percentage of change.

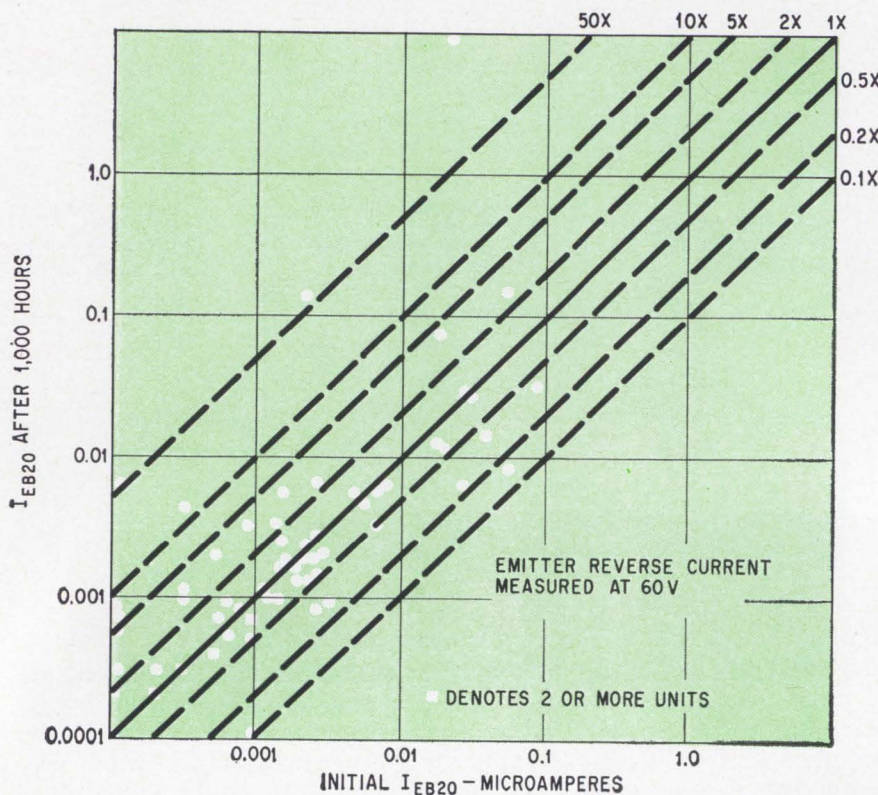

Plotted data shows how emitter reverse current I_{EB20} changes after 1,000 hours of testing at 60 volts, 600 milliwatts and with temperature cycling. Most of the 70 units tested showed variations ranging from a 50% drop in I_{EB20} to an increase of nearly five times the original I_{EB20} value. 50 X means the characteristic value increased by fifty times, 10 X by ten times, etc.

ceramic disk and can withstand extremely high shock and vibration without mechanical failure. Because the ceramic has a temperature coefficient of expansion which closely matches that of silicon, there is no mechanical failure when the device undergoes large thermal shocks. This structure has been heated to 300°C and then immersed in liquid nitrogen (-196°C) without damage. Hard solder is used exclusively in the structure, matched-coefficient glass-to-metal seals are used in the header, and resistance welding makes the final seal. This construction permits the transistor to tolerate extreme temperature cycling while being subjected to abnormal operating environments such as conditions of high humidity.

An analysis of life-test data for the first silicon unijunction transistors and the examination of failure units showed that large variations in interbase resistance and emitter leakage current over a long period of time were related to moisture and contaminants on the surface of the silicon. A big improvement in device stability was made by putting a getter inside the transistor package to drop the moisture content to a low level. But long-term life tests indicated a gradual increase in emitter leakage current and a gradual decrease in interbase resistance.

The getter was eliminated by the next step in the effort to improve stability—the post-passivation process where a protective oxide coating is put on the silicon pellet.

With post-passivation, device stability has im-

proved markedly and there has been no systematic parameter variation with time during life tests run for more than 25,000 hours.

Quality assurance

Many of the quality and reliability control procedures used for the unijunction transistor were developed specifically for the Minuteman program. During manufacture of the device there are automatic monitoring and warning systems for all critical gas and water supplies.

When the manufacturing steps are completed, each transistor undergoes a 168-hour 200°C burn-in period to stabilize the electrical parameters and to see whether the device exhibits any characteristics symptomatic of early failure. For quality control, randomly selected transistors are removed from the manufacturing line daily and collected over a two-week period.

All characteristics of the randomly selected transistors are measured and recorded. The information provides distribution data for line control and customer service. A portion of the sample undergoes the mechanical and environmental tests set forth in military specification MIL-T-19500/75. The tests cover temperature cycling, glass strain, moisture resistance, shock, vibration fatigue, vibration noise, operation at high and low temperature, salt spray, lead fatigue, constant acceleration, and high pressure. The conditions and limits for these tests are described in the table on the preceding page.

In another quality control procedure, one group

Changes in emitter reverse current I_{EB20} are shown after 10,000 hours of cycled life testing at 60 volts and 600 milliwatts. The 49 units are represented by dots. The units depicted here are not from the same group for which data are plotted at left.

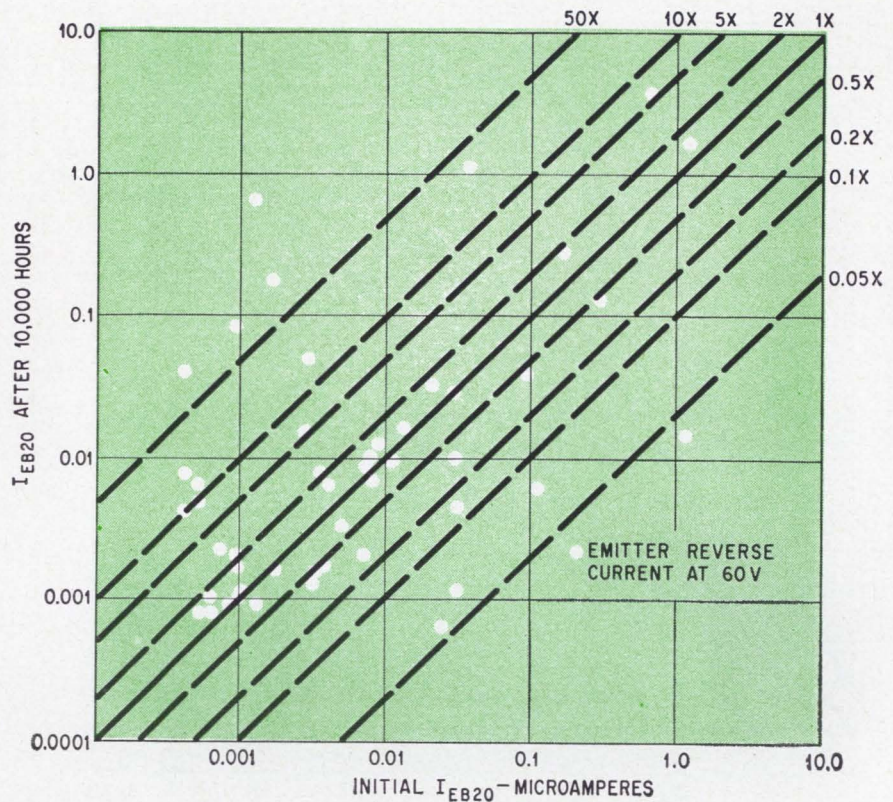

of randomly selected devices is placed on storage life test at a temperature of 200°C, a second group is placed on 25°C life test at 600 milliwatts cycle power, and a third group is stored at room temperature. The devices are taken off life test at 1,000 hours and checked. Should a lot have sample groups that do not pass any one of the three life test conditions, the entire lot is destroyed. When a lot meets the 1,000-hour life-test conditions, a smaller number of units from the sample go back on life test to provide information on device stability over time intervals to 25,000 hours.

Conducting life tests

For unijunction transistors the operating life test usually starts with the application of interbase power through a 2,000-ohm limiting resistor, with the emitter open-circuited. Power is applied for 50 minutes, then cut off for 10 minutes to provide thermal cycling stress.

Since failure modes can change with operating conditions and from lot to lot, there is a periodic check on life-test behavior under other operating conditions. Tests have been run with steady-state emitter reverse bias, with steady-state emitter forward bias, and with the unijunction transistor in a relaxation oscillator circuit. The relaxation oscillator test, which most closely duplicates typical operating conditions, is normally made at an ambient temperature of 100°C with a one-microfarad capacitor, a 10-ohm emitter series resistor, and an interbase bias sufficient to develop a peak emitter

current of one ampere.

Because a comparison of the various life-test conditions shows that the 600-milliwatt cycled power test provides the worst-case condition, it is considered the best test for quality assurance. However, in assessing the life-test performance data, it should be remembered that the 600-milliwatt stress level is not encountered in typical operating circuits whose operating power range is usually from 10 to 80 milliwatts. Therefore, the failure rates observed are considerably higher than in actual practice.

Two failure modes

Catastrophic failure of a unijunction transistor can be defined as a condition where the device ceases to exhibit a negative resistance characteristic and consequently will not function in a relaxation oscillator circuit.

When a degradational failure occurs, the device may still function in a relaxation oscillator circuit but one or more of its electrical characteristics will have changed beyond a prescribed limit.

Good circuit design can often prevent the most frequently encountered catastrophic failure mode. If a unijunction transistor is used in a relaxation oscillator circuit with insufficient limiting resistance in the interbase circuit, the device can go into thermal runaway, causing a short circuit between base one and base two. This can happen even if the average power dissipation is low.

The interbase resistance has a positive temperature coefficient for temperatures below 140°C and

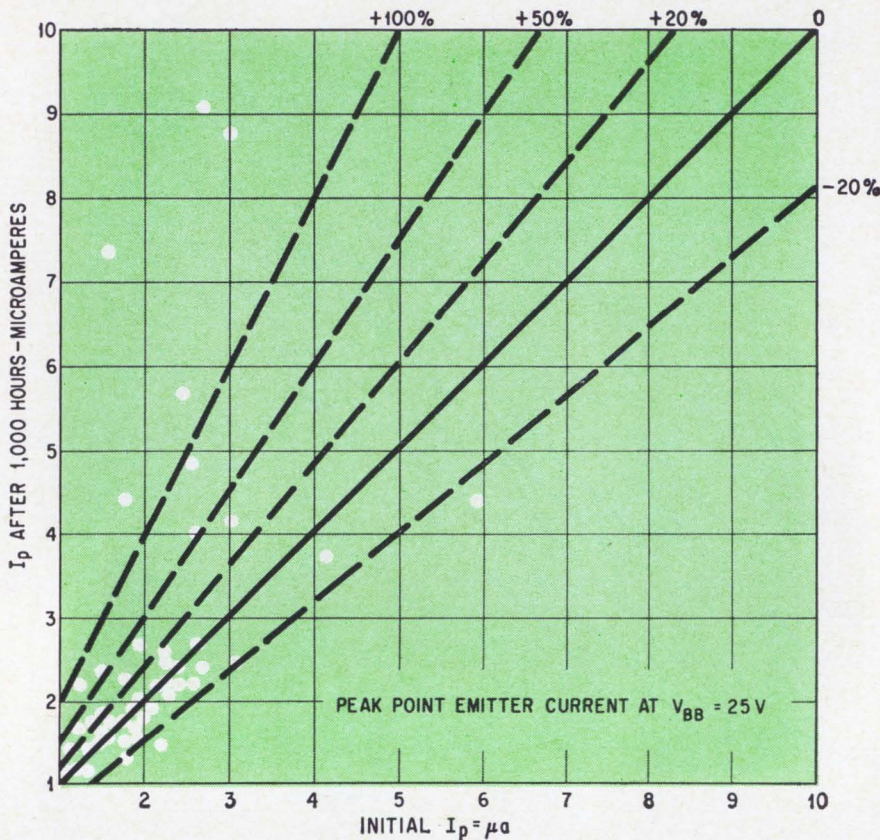

Changes in peak-point emitter current after 1,000 hours of temperature-cycled life testing at 600 milliwatts vary from -20% to more than +100%. Forty-seven units were tested at an interbase voltage of 25 volts.

the unijunction transistor is unconditionally stable if the temperature of the device is kept below this value. Above 140°C, however, the interbase resistance has a negative temperature coefficient and thermal runaway can occur. Because of the high peak power generated in a relaxation oscillator, the internal temperature of the unijunction transistor may rise instantaneously above 140°C.

Thermal runaway becomes more likely when higher supply voltages are used in combination with large values of emitter capacitance. However, this type of failure can be avoided by controlling the interbase power available to the unijunction transistor, either by using a current-limited supply or by placing sufficient resistance in the interbase circuit. For conservative design the available interbase power should be kept below the 600 milliwatt maximum rating in accordance with the relation

$$P = P_{max} - \phi(T_2 - T_1)$$

where P = allowable power at upper temperature limit T_2 ,

P_{max} = power rating at room temperature T_1
 ϕ = derating factor

For example, if a 28-volt power supply is used and the maximum ambient temperature is expected to be 75°C, the interbase power should be limited to $600 - (4)(75 - 25) = 400$ milliwatts.

Since the available power from a voltage source V having an output impedance R is $P = V^2/4R$, the minimum limiting resistance is calculated to be $(28)^2/400 (0.004) = 490$ ohms. This value of resistance generally may be added to the circuit without

compromising circuit performance.

Degradational failures consist of changes in those electrical parameters which are critical to a particular application. The allowed variation in each parameter will, of course, depend on the application. For example, a variation in standoff ratio in excess of 0.5% may constitute a failure in a precision timing circuit, whereas a variation in standoff ratio of 10% may cause no noticeable effect in an scr temperature-control circuit where the change can be compensated automatically in the closed-control loop.

Emitter channeling

Emitter channeling—formation of a low resistance path from the emitter to one of the bases—can cause degradational failures in some applications. Channeling can occur in all types of unijunction transistors, but is most troublesome in planar devices. It can be detected by a special measurement test, described later, of the emitter characteristic of a unijunction transistor biased with a high value of interbase voltage (20 to 30 volts). The current-voltage characteristics resulting from various types of channeling are shown on page 99. A normal emitter characteristic is also shown.

In the normal characteristic, the curve crosses the voltage axis at a voltage slightly below the peak point voltage. At low voltages, the emitter current has a negative value approximately equal to the emitter leakage current.

Undesirable channel conditions may be: a re-

Emitter saturation voltage variations after 1,000 hours of testing range from -10% to +20% for 43 of the 44 tested units. One unit exhibits nearly 30% variation. Test was conducted at an emitter current of 50 milliamperes and an interbase voltage of 10 volts.

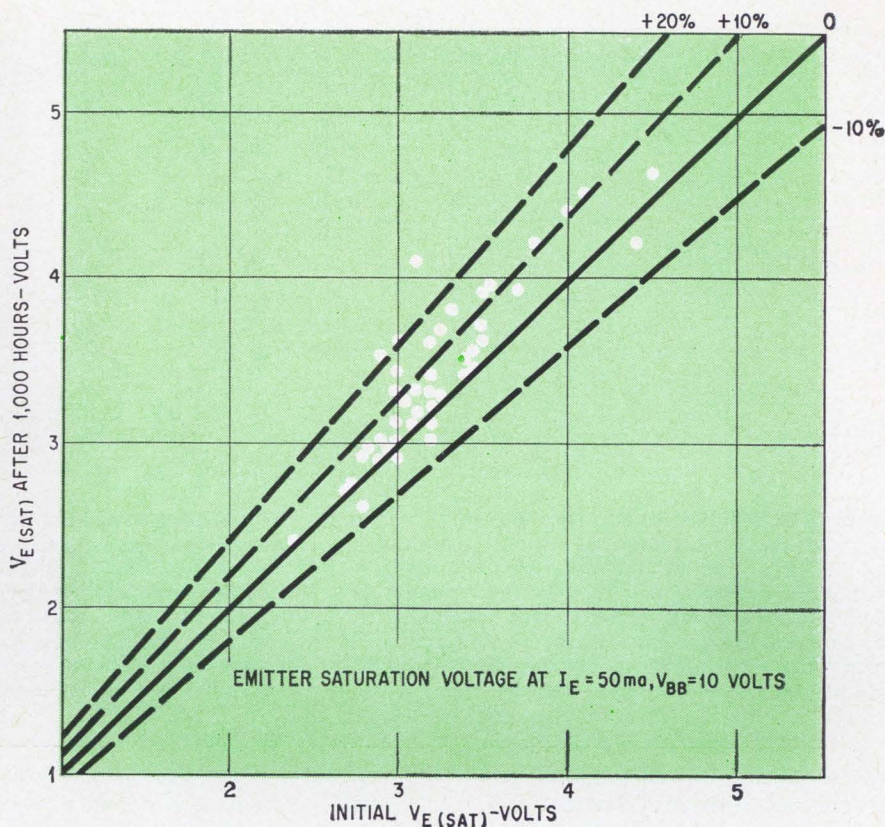

sistive channel between emitter and base one; a channel, between emitter and base two, which has a constant current characteristic; or a channel that is pinched off with high reverse voltage across the emitter diode portion of the unijunction, causing the characteristic curve to exhibit a break point (the point at which turn-on occurs). The three types of emitter channeling are shown on page 99. Channeling can increase or decrease the peak point current and can also change the effective emitter reverse current. A channel effect cannot be detected usually by the conventional emitter leakage current test (I_{EB20} or I_{EO}). An increased emitter current occurs when an increase in interbase bias is applied.

In a special current measurement test the current measured, I_{EX} , is defined as the emitter current which flows at an interbase voltage of 20 volts and with an emitter voltage that is 300 millivolts below the peak point voltage. For devices with a negligible channel condition, the magnitude of I_{EX} is less than 50 nanoamperes and may be positive or negative. Life-test results show that if I_{EX} is initially low, it will tend to be stable over long-term intervals even at extreme operating conditions.

Generally, channeling is a problem only in such applications as long-period timing circuits where low values of emitter leakage current and peak point current are required. For these applications, transistors like the 2N490C, 2N492C, 2N494C, and 2N1671C which have a I_{EX} limit of 50 nanoamperes should be used.

Life-test results

A summary of life-test results for a number of unijunction transistor production lots under various test conditions is given on page 99. The data reveals that the failure rate percentage decreases very rapidly as the power and temperature stress levels are reduced.

Units for which the data was compiled were randomly selected over a period from August, 1962 to February, 1964. The estimated mean times to failure listed are calculated to the upper 90% confidence limit using the Poisson exponential binomial limit approximation. In other words, if a large number of lots with units similar to those tested are subjected to the same life-test conditions, 90% of the lots will have a higher mean time to failure than the value given in the table. This assumes a constant failure rate. Since extended life tests have demonstrated that the unijunction transistor has a decreasing failure rate when plotted to end times at least as high as 25,000 hours, the estimated mean time to failure is quite conservative for time intervals in excess of 1,000 hours.

The normal method of showing degradational failure data of semiconductor devices is to indicate failure rates at specified parameter limits. In cases where the operating conditions may not be known in advance, a more useful presentation shows the percentage change in a significant parameter from its original value. The curves in this article illustrate this method. Changes in emitter reverse current

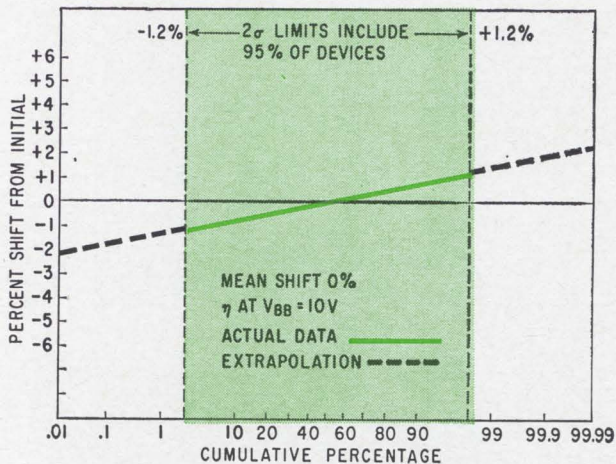

Probability distribution for intrinsic standoff ratio shows that 95% of devices exhibited a shift of less than 1.2% after 1,000 hours. Fifty units were tested at 600 milliwatts and 10 volts with temperature cycling. The mean shift was zero. Since a typical delay circuit is designed to withstand a shift of 5%, this performance is highly satisfactory. Green area indicates range of shift by 95% of units.

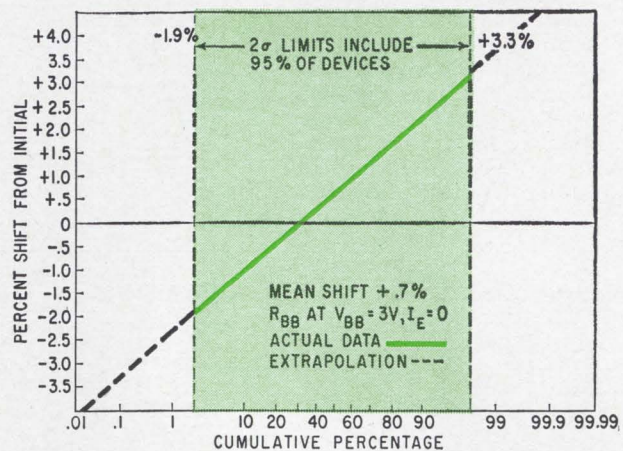

Probability distribution for interbase resistance reveals that 95% of devices experienced variations ranging from -1.9% to +3.3%. Fifty units were submitted to 1,000 hours of temperature cycling at a dissipation of 600 milliwatts, an interbase voltage of 3 volts and with zero emitter current. The mean shift was 0.7%. Again, a typical circuit would be designed to perform with changes in interbase resistance in the vicinity of 5%.

emitter saturation voltage and peakpoint emitter current with time are shown.

In the curves, the initial value of a parameter is given on the x-axis and the final value of the y-axis. This presentation is useful for design work since it shows clearly five important items of life-test information. These are the number of transistors involved, the initial parameter distribution, the final parameter distribution, the relative shifts in parameter values, and the correlation, if any, between the initial parameter values and stability with life.

The change in emitter leakage current with life is shown at 1,000 hours and at 10,000 hours for two different lots. The 10,000-hour data shows a wider dispersion than the 1,000-hour data, but it is evident that there is no long-term gradual shift in emitter leakage current.

The shift in peak point current after 1,000 hours of testing is small but it would be advisable to use the 12-microampere maximum specified value of peak point current in circuit design even though the initial value of peak point current might be considerably lower. Little variation in emitter saturation voltage at 1,000 hours is shown although the trend is towards increasing voltage. This indicates that it would be advisable to design for extra voltage margins in silicon controlled rectifier triggering circuits.

This type of presentation is less satisfactory for showing life test variations in standoff ratio and interbase resistance since the percentage variation of these characteristics is too small to be seen clearly. Accordingly, the probability distribution plots shown on this page are used to present such changes. These curves reveal that the mean shift in standoff ratio is virtually nonexistent and only 0.7% in interbase resistance. Individual data points can be plotted with this type of graph. However,

when the distribution is normal (usually the case) it is satisfactory to represent the data with a single straight line.

The standoff ratio curve indicates that there is negligible shift in the mean value of the standoff ratio with life and that 95% of all units shift less than 1.2%. Life tests at lower stress levels, which are more representative of typical operating conditions, indicate that stability of the standoff ratio is within the $\pm 0.2\%$ resolution of the test equipment.

To determine the long-term stability of the standoff ratio at normal operating conditions, a life test was performed on six devices operating in 400-cps relaxation oscillator circuits at room temperature. The frequency was monitored over a 2,000-hour period and was found to shift less than 0.01% for all units over the entire test period. The equivalent stability of the standoff ratio would be better than 0.006%.

Shifts in standoff ratio of up to 1% have been observed with some unijunction transistors when they are subjected to extreme temperature cycling, particularly to -65°C . No correlation has been found between this characteristic shift and any of the standard electrical characteristics. Accordingly, for applications which require high stability of standoff ratio, it is advisable to perform temperature-cycling screening tests to eliminate those devices which show any tendency to shift.

Failure rate

The study of extensive life tests, field returns, acceleration factors, and failure mechanisms indicates that commercial unijunction transistors in properly designed circuits will exhibit failure rates of less than 0.01% per thousand hours if extreme stability of characteristics is not required.



Quick-on-the-trigger design

Unijunction transistor simplifies design
of a variety of delay, flasher and sensing circuits

By Dwight V. Jones

General Electric Co., Syracuse, N.Y.

A triggering device, with a highly stable firing voltage, can simplify the design of timing and level-sensing circuits. The unijunction transistor does more than meet the requirement of stability. Before triggering it presents a high input impedance. After its short conduction period, it returns to the off state.

High costs have restricted the use of unijunction transistors. But prices have been dropping and one popular type, the 2N2646, now sells for only 60 cents in quantities of 1,000 or more. The high-volume unit cost for the 2N2647 is \$1.80.

A circuit on page 106 shows how the unijunction can be used to obtain a delay in the operation of a relay. When switch S_1 is closed, capacitor C_T is charged to the peak point voltage; the unijunction transistor is triggered, and the capacitor discharges through the relay, causing it to close. One set of relay contacts holds the relay closed and a second set can be used for control. The relays must have fast operating times, low coil resistance and low operating power. The circuit will give time delays from about a half-second up to three minutes.

Another switch S_2 may be placed in the load circuit and tied to switch S_1 . When the relay is activated, a second set of relay contacts, contacts 3 and 4, allows current to flow in the load circuit.

Scr trigger

A typical time delay circuit combining a unijunc-

tion transistor with a low-cost silicon controlled rectifier (scr) is shown on page 106. The timing interval is initiated by the application of the 28-volt power supply and is determined by R_T and C_T . When C_T is sufficiently charged the unijunction transistor conducts and fires the scr. Nearly the full supply voltage—approximately 27 volts—is applied across the load.

By choosing correct values of R_T and C_T , the circuit will provide time delays ranging from 0.4 millisecond to four minutes. Load current levels are limited only by the current rating of the scr; up to 6 amperes is allowable with the stud-mounted C20F used in this application. If a precision calibrated resistor is used for R_T , time delays can be set very accurately over a wide range after initial calibration.

If too large a value for timing resistor R_T is chosen, the minimum trigger current requirements of the unijunction transistor may not be met. The transistor needs more than the minimum triggering current to compensate for leakage current loss occurring through timing capacitor C_T as the unijunction emitter is biased to the peak point voltage. In this circuit, a 2N2647 unijunction transistor is used. It requires only a 2-microampere maximum trigger current with a base-to-base voltage of 20. This means that values of R_T up to about 2.5 megohms can be used but they would not be sufficient for long time delays. Another circuit is required for delays ranging from several minutes to a few hours.

Long time delays

A pair of unijunction transistors can be used with an scr to provide delays of up to two hours or longer.

The circuit shown on page 106 employs one unijunction transistor, Q_1 , as the triggering device for the scr and another unijunction transistor, Q_2 , as a free-running oscillator. The circuit requires low-

The author



Dwight V. Jones has been an applications engineer with the Semiconductor Products department since 1956. He joined General Electric in 1947. In his present position he aids field personnel in applications involving unijunction transistors, power transistors and plastic-case planar transistors. He holds two patents.

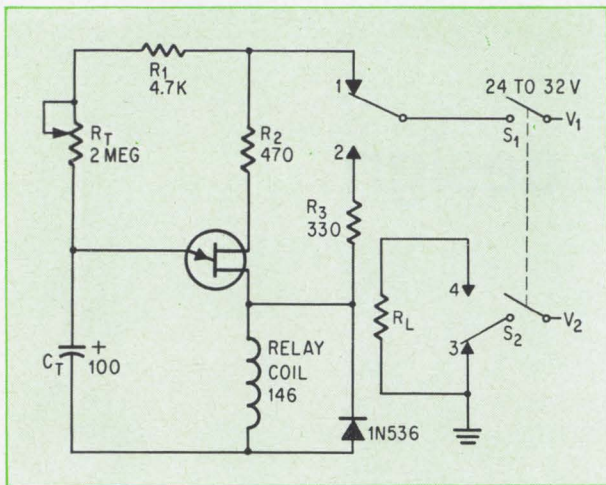

Use of a single unijunction transistor and a microminiature relay is practical and provides excellent isolation for time delays ranging from 0.5 second to 3 minutes. Capacitor C_T and resistor R_T determine the timing interval.

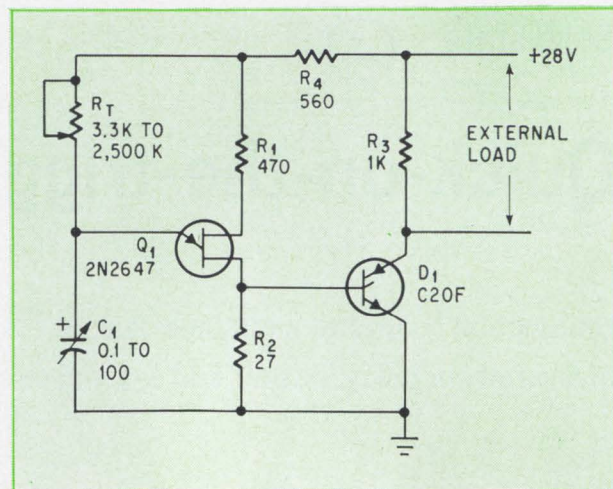

Time delays from 0.4 millisecond to 4 minutes can be obtained by using a unijunction transistor with a silicon controlled rectifier in this circuit. The timing interval is determined by C_T and R_T .

Long-delay circuit provides delays from 0.4 millisecond to 2 hours with a pair of unijunction transistors and a silicon controlled rectifier. R_1 and C_1 , together with R_2 and C_2 determine the time delay interval.

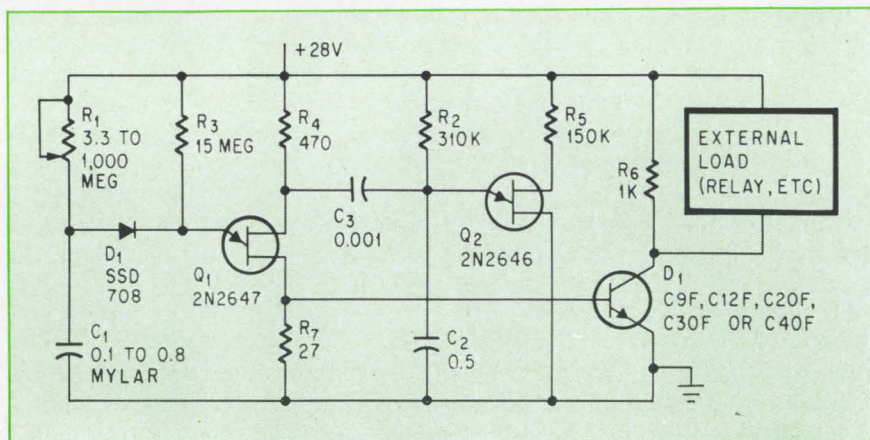

leakage Mylar capacitors (particular for C_1) and a silicon diode having extremely low leakage. The planar diode type SSD708, with a leakage current of under 20 picoamperes at 25°C was used.

In a sense, this circuit reduces the effective triggering current required by the one-transistor circuit by a factor of more than 1,000. The previous circuit used one unijunction transistor to fire the scr and required a 2-microampere current to flow through R_T for the unijunction transistor to be triggered. The circuit above can be triggered with only 2 nanoamperes of current flowing through the timing resistor.

Easy on the trigger

The timing interval is initiated by applying power to the circuit. At the end of the timing interval, which is determined by time constant $R_1 C_1$, transistor Q_1 triggers the scr D_2 . The 2N2647, although in the off condition, is biased continuously by a small trickle current which flows from the supply through the 15-megohm resistor R_3 . At the same time, a charging current flows from the supply through R_1 to C_1 , the timing resistor and

timing capacitor, for Q_1 . The charging current causes a slow buildup of potential having a sawtooth waveform across Q_1 . Transistor Q_2 operates as a free-running oscillator. An 0.75-volt negative pulse is supplied by Q_2 to the upper base of Q_1 . Its frequency is determined by C_2 and R_2 . The negative pulse rate is not critical, but it should have a period which is equal to or less than $0.02 C_1 R_1$.

Because Q_2 supplies the upper base of Q_1 with negative pulses, less triggering current is required by Q_1 . The negative pulse causes the peak point voltage (required triggering voltage) to drop slightly. When the voltage level at C_1 becomes greater than the slightly reduced peak point voltage, Q_1 is triggered.

Thus, the negative pulses provide periodic sampling of the voltage on the timing capacitor. Between samples, timing capacitor C_1 is isolated from the emitter of Q_1 by low-leakage diode D_1 .

A pulse transformer may be used in place of R_4 if the timing circuit has to be isolated from the power switching (controlled rectifier) circuit which, for instance, might be connected to the a-c line.

Time delays from 0.4 millisecond to two hours are provided. Rather than a tantalum or an electrolytic capacitor, a Mylar capacitor is used because of its low leakage. Load current is limited only by the scr rating, which ranges from 1 ampere with a type C9F, to 25 amperes if a C40F is used.

Quality components must be used and component layout planned carefully to minimize leakage. The maximum time delay is dependent mainly upon the maximum component values that can be used for R_1 and C_1 while leakage is kept low. If diode D_1 is eliminated, the value of R_1 is limited to 15 megohms.

Line-operated delay

A delay circuit which can be operated directly from a 117-volt a-c supply line, thereby eliminating separate power supplies, is shown on this page. All of the semiconductor devices (unijunction transistor, controlled rectifier, conventional and zener diodes) are silicon devices. The circuit can be used with incandescent lamp loads and can handle up to 100 watts.

Time delays from 8 milliseconds to 5 seconds can be preset with the component values given in the circuit diagram. The low leakage requirement for C_1 is easily met by using a Mylar capacitor. The time delay can be extended to about 2.5 minutes by using a 50-microfarad low-leakage tantalum capacitor for C_1 . Very accurate timing is achieved despite variations of line voltage. The accuracy with ambient temperature variations (0° to 70°C) is typically $\frac{1}{4}\%$ to 1%. The desired accuracy can be obtained by selecting or adjusting R_2 to achieve stabilization over the required temperature range. The 2N494C unijunction transistor should be used where more precision is needed and higher ambient temperatures are encountered.

Closing switch S_1 initiates the time delay interval. The timing circuit is the basic unijunction

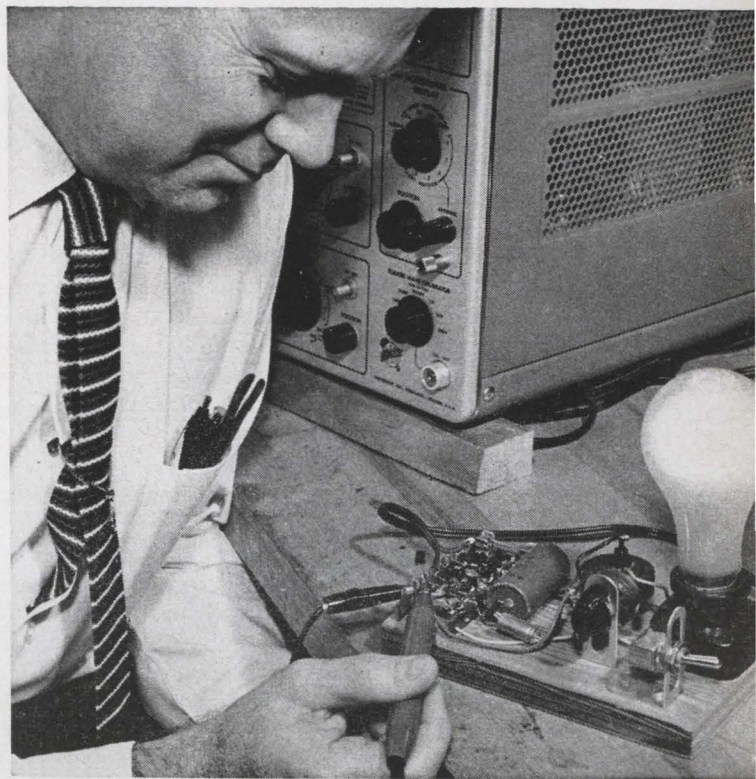

The author checking out a breadboard version of the line-operated delay circuit. Actual circuit is shown below.

relaxation oscillator circuit. At the end of the timing interval, the discharge of C_1 across R_5 triggers the controlled rectifier. This places the full-wave rectified line voltage across the load. During the time interval, C_2 is able to maintain a d-c potential of approximately 165 volts (see discharge slope A of waveform) because of the low current drain.

At the end of the timing interval, the higher bridge current supplied to the load causes the ca-

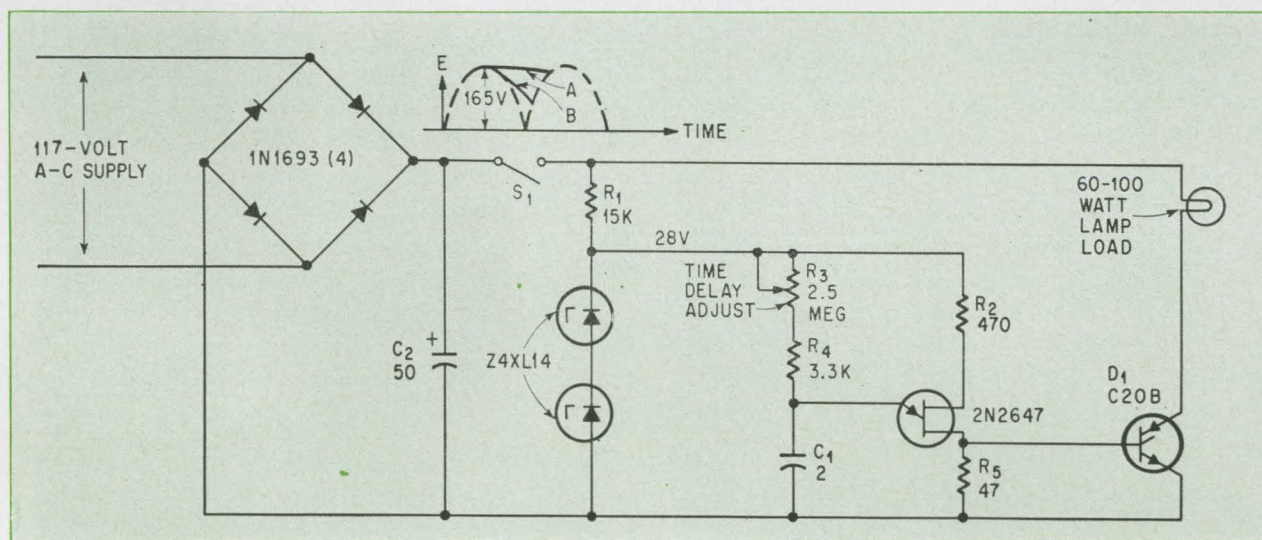

Direct line operation of a delay circuit is made possible by the use of four 1N1693 silicon diodes. This circuit can handle loads up to 100 watts. Time delays range from 8 milliseconds to 5 seconds.

capacitor to discharge at a rate represented by the slope of B in the waveform. The minimum value for capacitor C_2 is dictated by the load current, since its waveform must maintain a minimum current value in excess of 30 milliamperes (the holding current requirement for the scr C20B).

Flashers

Incandescent-lamp flasher circuits are used in traffic lights, navigational beacons, aircraft beacons and illuminated signs. Unijunction transistors and silicon controlled rectifiers make ideal partners for these applications since they permit a wide frequency range and a high degree of frequency stability to be obtained economically.

The circuit shown below illustrates the basic principles of a flasher circuit using one unijunction transistor and two scr's. This circuit can be easily simplified or modified to meet specific requirements; as shown, it operates a lamp load of up to 3 amperes with a supply voltage ranging from 17 to 35 volts and a temperature range of -50°C to 100°C . Basically, this circuit is a parallel inverter with capacitor commutation. The scr's conduct alternately and are triggered by the free running unijunction transistor relaxation oscillator. The flashing rate is determined by the time constant, $(R_1 + R_2) C_1$, and may be adjusted to the value desired by potentiometer R_2 . The circuit was tested at up to 80 flashes per minute.

Eighty flashes per minute are provided by flasher circuit with a 50% duty cycle. The rate can be changed by varying the values of C_1 , R_1 and R_2 .

Two-unijunction transistor flasher circuit with separate adjustments for flashing rate (R_1) and duty cycle (R_2).

When the supply voltage is applied, both scr's are off; if a pulse is applied to the gates of the controlled rectifiers simultaneously, both will turn on and the circuit will not function. This problem is overcome by the gating action provided by D_2 , R_8 , and C_4 . If D_3 is off it will be turned on by the first trigger pulse, but D_4 will not be turned on since D_2 is reverse-biased by approximately 28 volts and therefore blocks the trigger pulse from the gate of D_4 .

If D_3 is on, however, D_2 will be reverse-biased by less than 1 volt so that the trigger pulse will be able to fire D_4 . The conducting D_4 then turns off D_3 through the commutating capacitor C_3 . In this case, triggering D_3 and D_4 at the same time is permissible, since the time constant $R_6 C_3$ is much longer than the trigger pulse width and D_3 remains reverse-biased long enough after the end of the trigger pulse to assure reliable commutation of D_3 .

Resistor R_7 and capacitor C_2 are used in the anode circuit of D_3 to furnish a higher current to D_3 during the turn-on interval. This prevents D_3 from turning off due to the effect of inductance in the power supply. In some cases it may also be necessary to place a capacitor directly across the circuit shown as C_5 in the diagram, or to reduce the value of R_6 .

Alternate lighting

The circuit operates the lamps at a 50% duty

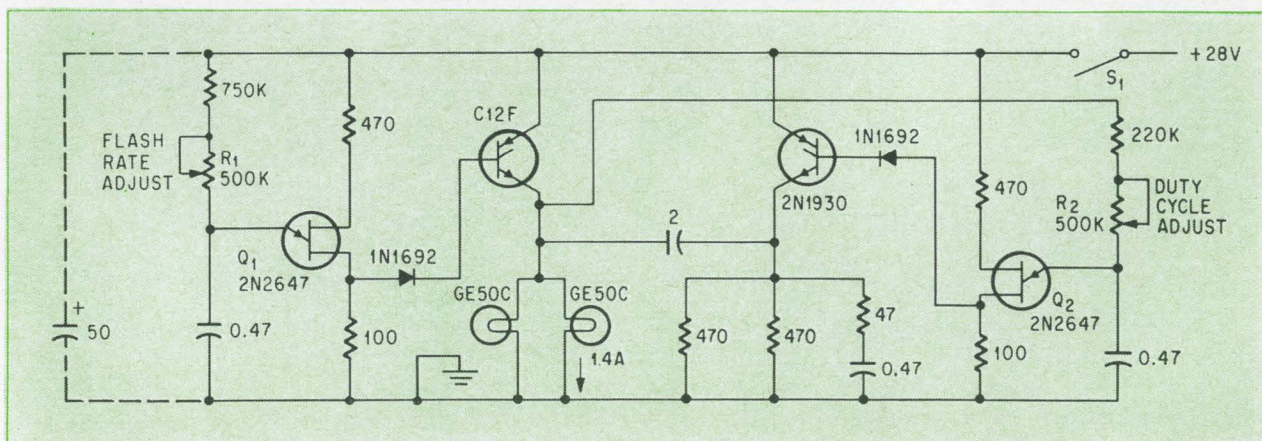
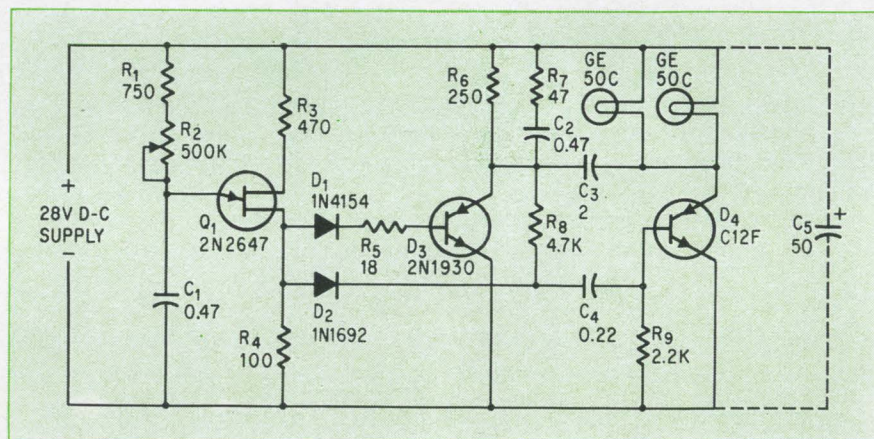

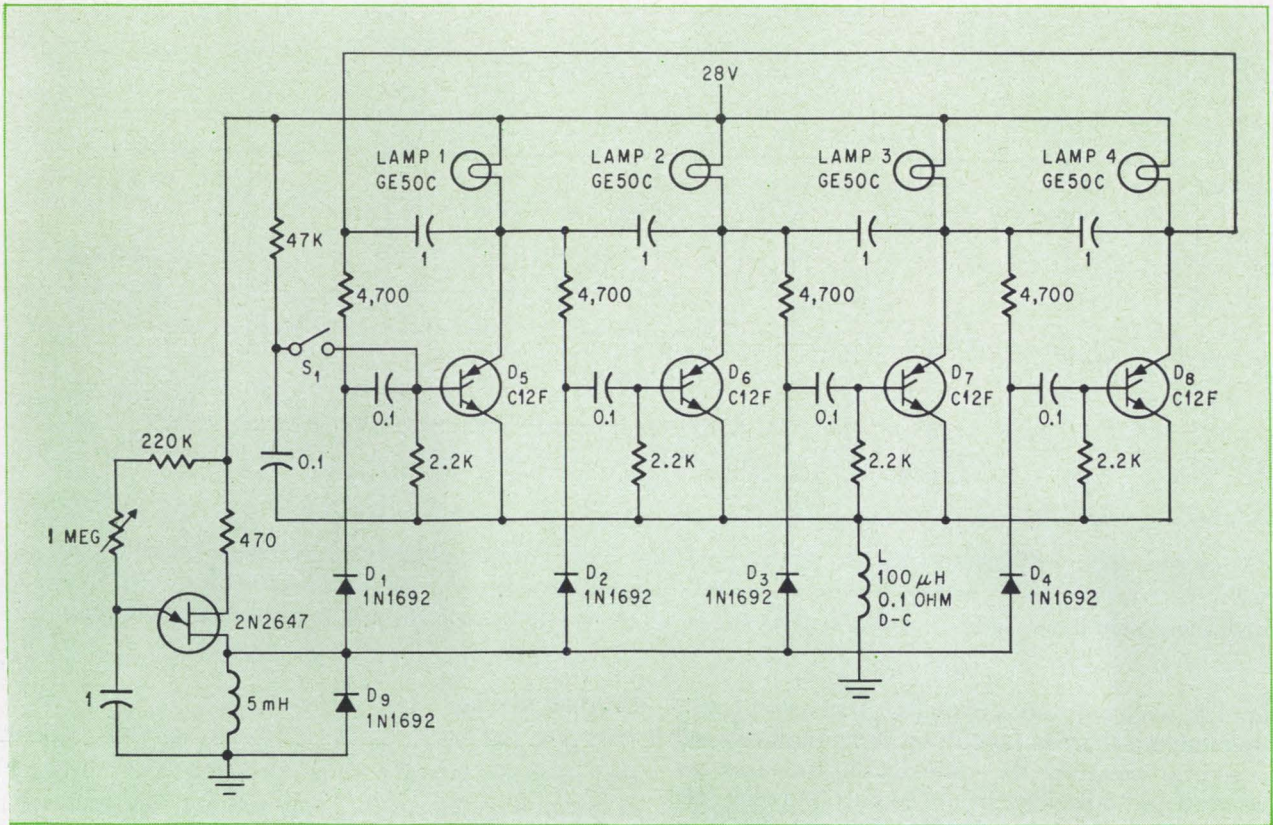

Rotating light (beacon) circuit. Lamps light one at a time beginning with L_1 when power is applied.

cycle. If R_6 were replaced by half the lamp load, the lamps would light alternately. C_3 could be halved to 1 microfarad and type C12F silicon controlled rectifiers could be used. A variation of this circuit, using a second unijunction transistor to control the on-time of the lamp load, is shown on the preceding page.

If the inverter (flasher) circuit on page 108 is expanded by adding more stages and then closing the loop, the ring counter shown on this page is formed. Pushing a momentary contact switch will turn on the first scr D_5 and lamp L_1 . All of the diodes are now reverse-biased by the 28-volt supply except for D_2 ; therefore a trigger pulse supplied by the free-running unijunction relaxation oscillator will turn on D_6 . The inrush current of L_2 plus the com-

mutating capacitor current generates a positive pulse across the 100-microhenry air-core inductor L , which turns off D_5 and L_1 . The succeeding pulses supplied by the unijunction transistor are applied to the next adjacent stage around the ring. The speed of operation may be adjusted by potentiometer R_T . One use for this circuit is as a replacement for a mechanical rotating beacon on a police car, ambulance or other emergency vehicle. Four lamps, turning on and off, simulate a rotating light.

Voltage sensing

The sensitivity of the unijunction transistor and the stability of its triggering voltage are ideally suited for use in go no-go voltage sensing circuits such as the one that is shown below. If the input

Drift in trigger voltage of sensing circuit is less than 2 millivolts over ambient temperature range from 0°C to 55°C.

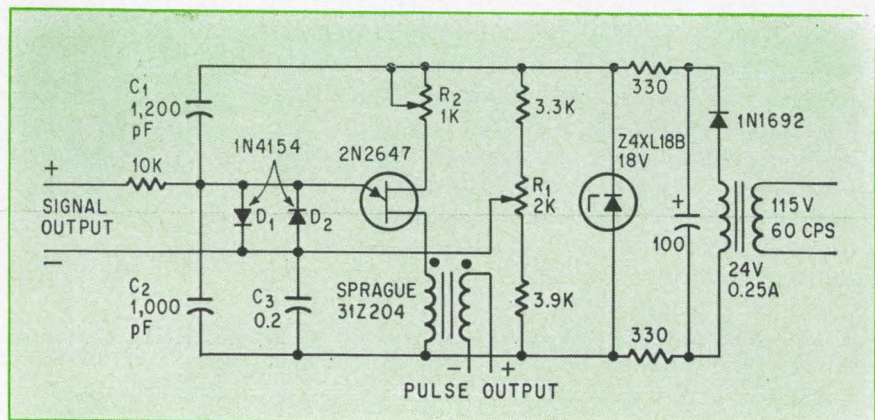

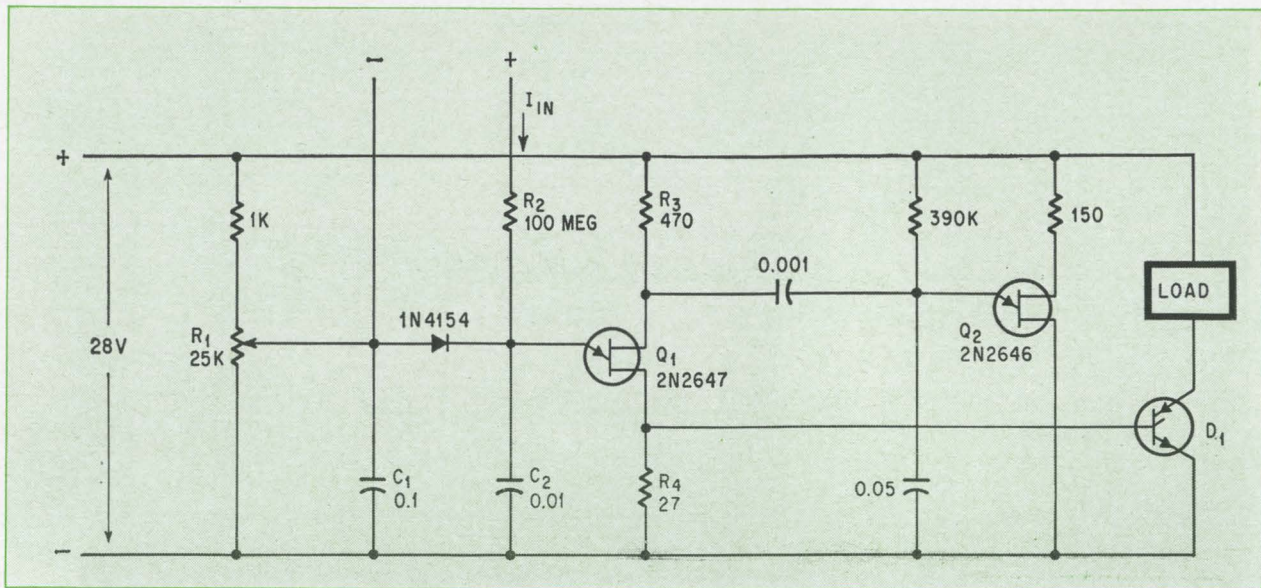

Forty-nanoampere trigger level of current-sensing circuit is not affected by wide changes in ambient temperature.

signal is negative, the unijunction transistor is not triggered and there is no output. If the input signal is slightly positive, the unijunction transistor is triggered and pulses occur at the output as long as the input signal remains positive. The output pulses are of sufficient magnitude to trigger a flip-flop, or to turn on silicon controlled rectifiers or other pulse-sensitive devices.

The floating supply permits the designer flexibility in choosing the point for ground.

Quick charge

Most of the output pulse energy is supplied by capacitor C_3 . C_3 is charged very rapidly through R_1 after each pulse and therefore does not limit the response time of the circuit. Diode D_2 provides a discharge path for C_3 , and diodes D_1 and D_2 clamp the input voltage to enable C_3 to charge to its steady state voltage when very large voltages are present at the signal input. Capacitors C_1 and C_2 provide the initial trigger energy for the unijunction transistor and also serve as a filter for transients appearing at the signal input and across the supply. In some cases, a small capacitor will also be required across the primary of the pulse transformer to prevent false triggering due to transients.

The circuit is initially adjusted by shorting the signal input and setting R_1 so that the circuit is on the verge of being triggered. If close temperature compensation is needed, R_2 is adjusted so that the triggering voltage does not change appreciably when the unijunction transistor is heated or cooled. Usually it is possible to adjust the temperature compensation so that the drift in trigger voltage is within ± 2 millivolts from 0°C to 55°C . After the temperature compensation adjustment is completed, it is invariably necessary to reset R_1 . The long-term stability of this circuit is good; drift normally is less than ± 10 millivolts and hysteresis less than 1 millivolt.

Current sensing

The circuit shown on this page is a sensitive current detector. Resistor R_1 is set so that the voltage at point A is 0.5 to 0.75 volts below the trigger level of Q_1 . A small input current of 40 nanoamperes will charge C_2 and raise the voltage at the emitter to the triggering level. When Q_1 is triggered, both C_1 and C_2 are discharged through R_4 . The generated pulse triggers scr D_1 . Capacitor C_2 is kept small for faster triggering response time; C_1 provides the pulse output energy. Rapid recovery is obtained after Q_1 triggers, since both capacitors are charged through R_1 . In this configuration, the leakage current of the silicon diode effectively counteracts the leakage current of the unijunction transistor, thus providing some temperature compensation.

The input current flowing through R_2 is much lower than the minimum trigger requirement for the 2N2647 (Peak point current needed to trigger this device is 2 microamperes). Pulsing the upper base of Q_1 with a 0.75 volt negative pulse drops the peak point voltage V_P slightly and if the voltage level at C_2 is sufficient, the unijunction transistor will be triggered. The necessary triggering current I_P is supplied by C_2 .

For this sensing circuit, a floating power supply using a zener diode will permit grounding one of the sensing input terminals if desired. Resistor R_1 should be adjusted so the circuit will not trigger accidentally at the highest ambient temperature in the absence of the current or voltage sensing signal. Resistor R_3 can be adjusted or selected for stabilization of the triggering voltage over the required temperature range.

Reprints of this report are available. See the reader service card at the back of this issue.

© copyright 1965 Electronics ® A McGraw-Hill Publication

Bioengineering: a new discipline

For studies of living creatures, life scientists need more engineering knowledge. Increasingly, they are looking to engineers experienced with microcircuits. First of 2 parts

By Wen H. Ko and Lloyd E. Slater

Case Institute of Technology, Cleveland

In their quest for greater understanding of people and animals, the life scientists—physicians, biologists and ecologists—have found ways to use electronics to monitor bodily functions directly. Instruments they have developed have been used on astronauts; also on sharks, moths, bears and other species of animal life.

For difficult problems, biologists have found adequate electronic solutions. But the almost-impossible problems of tomorrow will require microelectronic techniques that can be designed only by engineers who are informed about what's needed in the life sciences. These systems must gather data inside the body, measure and amplify the signals without interfering with the process being monitored, and transmit the signals to a remote receiver; they must have long life, resist reaction with the body's chemical system, and operate over broad changes in environment.

The authors



Wen H. Ko is associate professor of engineering at Case Institute of Technology and head of the institute's research program in solid state electronic devices, circuit designs, biomedical electronics and microelectronic technology. He received his doctorate from Case in 1959.



On July 1, Lloyd E. Slater will become executive secretary of the American Institute of Biological Sciences' bio-instrumentation advisory council. He is associate director of research at Case Institute.

These needs are in both the biological and engineering realms. They will succumb only to collaboration between life scientists and engineers. As a first step toward filling these technological needs, the American Institute of Biological Sciences has created a bioinstrumentation advisory council whose goal is to link the two disciplines—biology and engineering—for their common benefit and for humanity's.

Observing the heart at work

What kinds of electronic devices are needed in the life sciences? A survey of users of biotelemetry devices has disclosed some recent electronics accomplishments and spotlighted others that will be needed for future research.¹ They form a clear guidepost for engineers interested in applying their knowledge in the life sciences.

The success of implanted pacemakers in the heart demonstrates the possibility of placing electronic packages permanently in the body to provide bioelectric stimulation. Researchers are now using implants that will telemeter electrocardiographic information directly from the heart muscle to remote receivers. Eventually, through biotelemetry, the use of prosthetic devices in the heart should be increased by automatic self-regulating and self-powering techniques.

Biotelemetry in the space program has permitted research that was previously considered impossible. The pictures on page 112 show a study of the heart's performance under zero gravity, with a free-floating man cradled with a telemetering package to gather information about the effect of various mechanical forces on the heart's pumping action. The technique permits measurement as the body is free to move in six axes.

Researchers are currently seeking ways to couple the heart itself to piezoelectric or other types of



Instrumented couch is used to study a subject under zero gravity. In this experiment, by W.C. Hixson and D.E. Beischer of the Naval Aviation Medical Center, the free-floating couch provides an ideal way to obtain whole-body ballisto-cardiograph measurements.

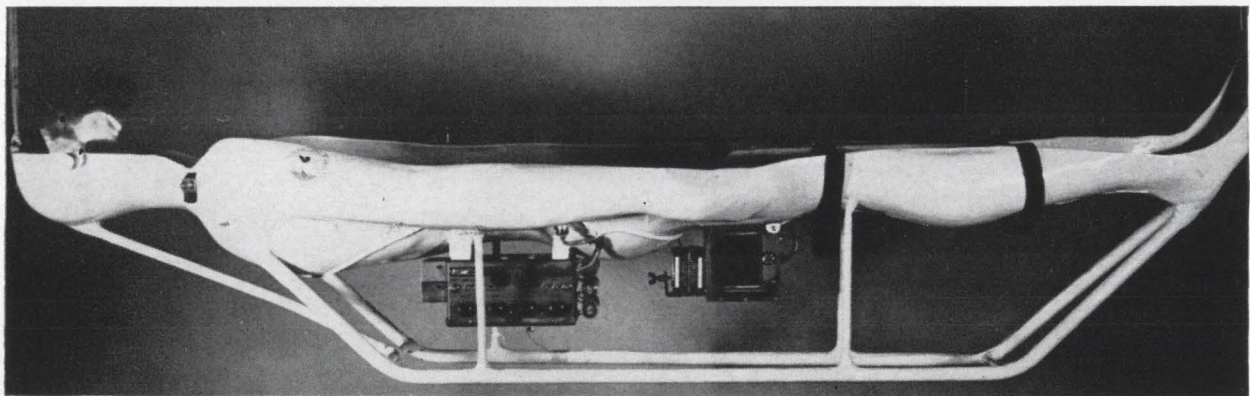

Glass-fiber platform supports biotelemetry for zero-gravity experiment. Platform protects instrumentation and subject during the experiment. Miniature transducers measure body functions, which are telemetered to the aircraft.

mechanical-electrical transducers to provide the electrical power for implanted biotelemetry devices. The human heart generates about eight watts of power; a dog's heart produces about 0.6 watts.² Some work already has been reported on a system for coupling transducers to the heart muscle. G. H. Myers of the Bell Telephone Laboratories, for example, has described a cardiac pacemaker powered by two Clevite PZT-5 ceramic transducers clamped to the throbbing aorta of a dog. The pacemaker required 2.4 microwatts into a load of 1,000 ohms.

Affecting animals' behavior

Biotelemetry has enabled researchers to gather valuable information about animal behavior; the unanswered question is: how much does the telemetry equipment affect the subject's behavior? On the next page is a picture of a rat undergoing extensive monitoring; the subject is nearly lost in the maze of equipment. Nobody knows how much the rat's functioning is changed by the presence of the bulky instruments.

Microelectronics has made it possible for im-

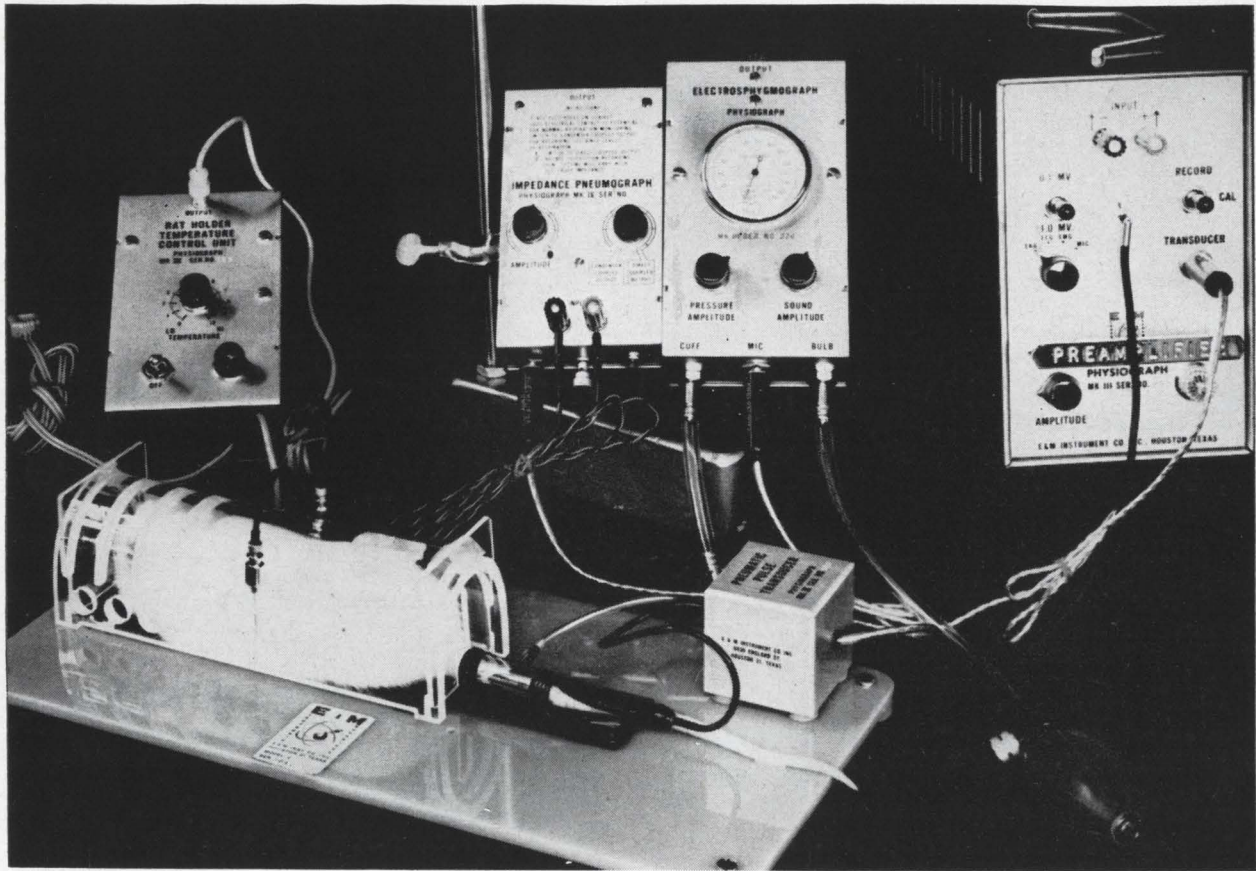

Biotelemetry devices surround a rat, restrained so its movement won't break the wires. Transducers on animal measure indirect systolic blood pressure from its tail, as well as respiration, heart rate and electrocardiographic data. Animal-study unit in background was supplied by E&M Instrument Co., Houston, Tex.

planted sensors to make measurements while the rat wanders freely among his brothers, many yards away from an automatic recording station. Already, researchers are mounting tiny instrument packages onto animal bodies and inserting them physically inside the body. They are surgically implanting them at the precise site of the physiological occurrence or introducing them into the body by means of pills. Such pills have been used extensively in studies of the human gastrointestinal systems.

One innovation is the use of ultrasonic waves, rather than radio transmission, to telemeter command information to a control box mounted on a freely swimming shark; the control box activates three syringes which spray stimulants into the water in front of the shark. Reaction to the chemical stimuli, which shows up as changes in the sharks' heart rate, are measured by transducers and transmitted by a return ultrasonic path. This allows observers to monitor and record the changes in the physiological patterns of the shark to various chemicals. This concept of two-directional telemetry has some strong proponents among students of animal behavior. One of the most promising applications seems to be in behavior studies. Monkeys already have been stimulated with electric signals and the resulting actions recorded using reverse-loop telemetry. [Electronics, Feb. 22, pp. 90-93].

At present, most biotelemetry is open loop; that is, information is transmitted from the subject to the observer. However, reverse-loop techniques coupled with improved packages for implanted telemetry devices should allow two-way communications between subject and observer.

In studies of animals' feeding and migratory habits, biotelemetry permits tracking from airplanes or other mobile stations without disturbing the animals. Devices similar to the one shown on page 117 on the collar of the grizzly bear have enabled researchers to track animals 60 days over four miles, even into hibernation dens; flocks of birds also have been trailed for up to two miles. This data has enabled conservationists to map accurately the animal concentration in a locale.

Monitoring a moth in flight

Imaginative experiments are not confined to the larger species. The two pictures on page 116 show a primitive form of telemetry that has been used to study the lowly housefly as well as the night-flying moth. Both applications employ optical waves in the infrared region of the spectrum for carrying information. The housefly study compared the movements of sterilized insects with those of normal males. The flies' activity level was controlled by varying the ambient visible light, and was measured by counting negative voltage pulses

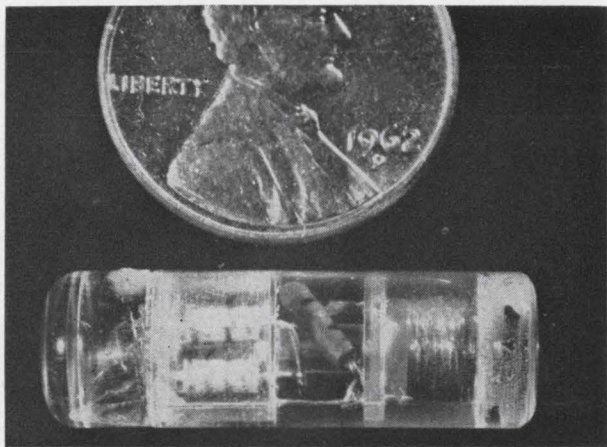

Intragastric pill, designed by R. B. Barrueto of the Boeing Co., is half the size of its predecessors, with a useful life at least 20 times greater. Acting as a pulse-position-modulation telemeter, it has a power output of 10-microwatts and a range of 75 feet. It can be used to monitor temperature, pressure or acceleration and pH (concentration of hydrogen ions in the blood).



Small pack transmitter was designed by W. W. Cochran of the Illinois Wildlife Survey for tracking birds and small animals. It weighs 20 to 40 grams, depending upon battery size, and is attached to animal's collar. Parts for the circuit, a one-transistor crystal-controlled oscillator, cost \$8 per unit.



Low-power temperature-sensitive radio transmitter and its associated battery are inserted into the body in the rim of an arching domeless diaphragm. Designed by Dr. Alvin Singer of American Electronic Laboratories, Inc., it continuously transmits vaginal temperatures for up to six months.

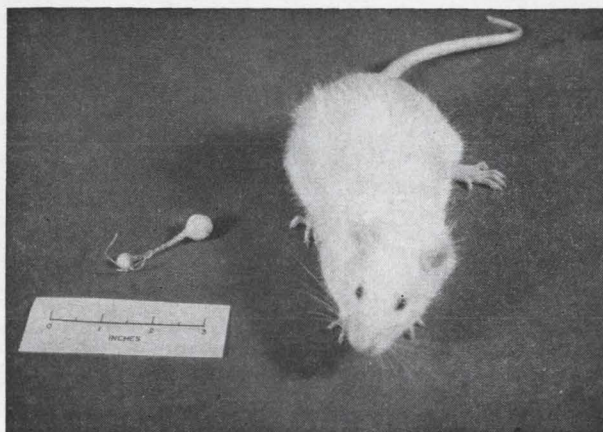

Biotelemetry transmitting package on the left is implanted beneath skin of a rat from the base of the skull to the tail. The unit, designed by Wen Ko of Case Institute, senses and transmits electrocardiograms more than 50 feet.

produced by a photocell detector as the flies moved through the beam. This project by the United States Department of Agriculture employed telemetry only in the broadest interpretation of the word, because what were transmitted were only the negative pulses. However, the system did meet the requirements of remote measurement under natural conditions; many extensions of this technique can be expected in other experiments.

The experiment with moths used the insect as the source of the infrared transmitting medium. The study was conducted to confirm indications that these nocturnal travelers exhibit response patterns determined by the wavelength of incoming light in the 8- to 13-micron region; these reactions were found to be similar to those of an infrared spectrophotometer. The moth's emitted energy was measured during the experiment, and their re-

sponses to varying wavelengths recorded. The designer of the study, Philip Callahan of the Agriculture Department sees a variety of opportunities for using microelectronics to study insects; he has written a "how-to" booklet for other entomologists interested in applying telemetry to their experiments. Both experiments further man's knowledge of insects and their life patterns. Recent concern with the control of these pests with poisons has increased scientists' incentive to perfect these experiments; they plan to gather more data. Eventually, it is hoped that knowledge of insect life patterns and processes will yield ways to eliminate them selectively without also killing desirable forms of life.

Think big and design small

For future studies, researchers are calling for

miniaturized electronic devices that can work inside the body; the demand is for smaller and smaller units that can gather more and more information.

One promising use for telemetry is in the study of how the body's normal functions, such as metabolism, are influenced by external factors such as changes in the time between meals. This could lead some day to microminiature instruments that would diagnose pathologies such as hormone deficiencies and trigger the chemical or physical activities necessary to remedy the situation.

In a sense, the cardiac pacemaker is a coarse example of this technique. Implanted microelectronics could produce more dynamic information on cardiac pathology and more precise and controlled stimulation of the heart. It could also detect the onset of epileptic seizures and diabetic shock, and initiate therapy. Similar measures to accommodate drastic physiological demands could also help astronauts to maintain safety and comfort during journeys in space.

In the field of sterility and birth control, a temperature-sensitive transmitter has been incorporated into an arching domeless diaphragm. It continuously transmits vaginal temperatures for up to six months before the battery needs to be replaced. Temperature changes are a good indication of the stage of a female's ovulation cycle.

Biology imposes severe demands on telemetering devices. They must be light—no more than 2% of the animal's weight if the telemeter is attached externally, and less for implants. They must have long life, impose a minimum restriction on the subjects movements, and create as little reaction as possible in the body's biological defenses against foreign matter. With microelectronic circuits, these requirements can now be met.

The largest component by far in a biotelemetry system is the battery. Its short life is another drawback. The most popular battery is the mercuric-oxide, alkaline primary dry cell—the so-called mercury or Ruben cell. It has four advantages over other power sources: a high ratio of energy to volume and weight, very long shelf life, freedom from corrosion, and approximately constant discharge voltage over 80% of its operating life. Its theoretical open-circuit voltage is 1.345 volts; its nominal capacity-weight relationship is 200 milliampere-hours for each 1.6 grams of active material. After 2¾ years of storage, a Ruben cell's capacity will have decreased approximately 10%. Materials used in its construction are less likely to break down in highly humid environments than are those used in zinc-carbon cells and are, therefore, more suitable for implantation.

With microwatt-power circuits now available, it is possible to power implanted units with energy derived from temperature differences, chemical potential, body-fluid fuel cells, mechanical converters (piezoelectric and others attached to moving organs), and radio waves. So far, only radio induction has proved practical in power implants; the other



Tranquilized shark being equipped with a syringe assembly that will eject a chemical in front of the shark as it swims. The experiment, devised by H. A. Baldwin, at Cape Hays Marine Laboratory to study the effect of various odor stimulants on shark behavior, employs a two-way biotelemetry using ultrasound as the transmitting medium. Effect of EKG reaction to chemical is recorded remotely by transmission over a return ultrasonic loop.

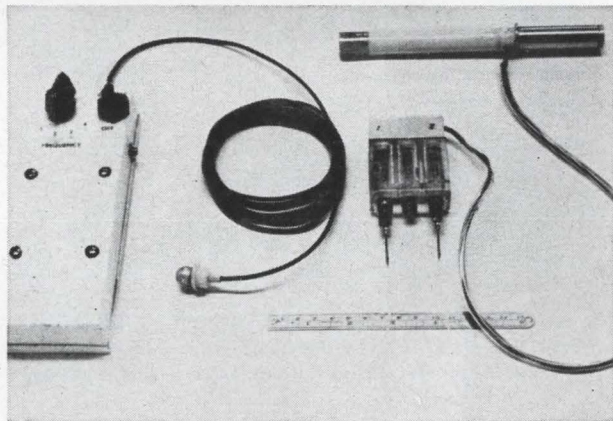

Control transmitter, left, is connected to small spherical hydrophone with coaxial cable. The receiving hydrophone, upper right, contains decoder circuitry that operates, on command, three hypodermic syringes (above foot rule). The system was designed by H. A. Baldwin and G. F. Ingle of the Sensory Systems Laboratory.

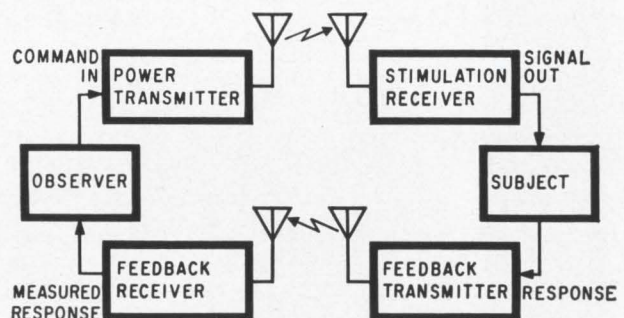

In closed-loop biotelemetry, the subject can be monitored closely in his natural environment. Observer can add stimuli, measuring the subjects' responses via the telemetry loop.

Box score of biotelemetry equipment

| Application | Number of responses | Equipment performance | | Equipment source | | |
|--------------------------------|---------------------|-----------------------|------------|------------------|---------------|------------|
| | | adequate | inadequate | commercial | self designed | contracted |
| Aerospace-oriented..... | 8 | 7 | 1 | 2 | 5 | 1 |
| Studies in animal ecology..... | 8 | 7 | 1 | 1 | 3 | 4 |
| Physiological research..... | 7 | 3 | 4 | 4 | 1 | 2 |
| Animal-behavior experiments... | 4 | 2 | 2 | 2 | 2 | |
| Biomedical-oriented..... | 9 | 7 | 2 | 5 | 3 | 1 |
| Equipment development..... | 6 | 6 | | | 6 | |

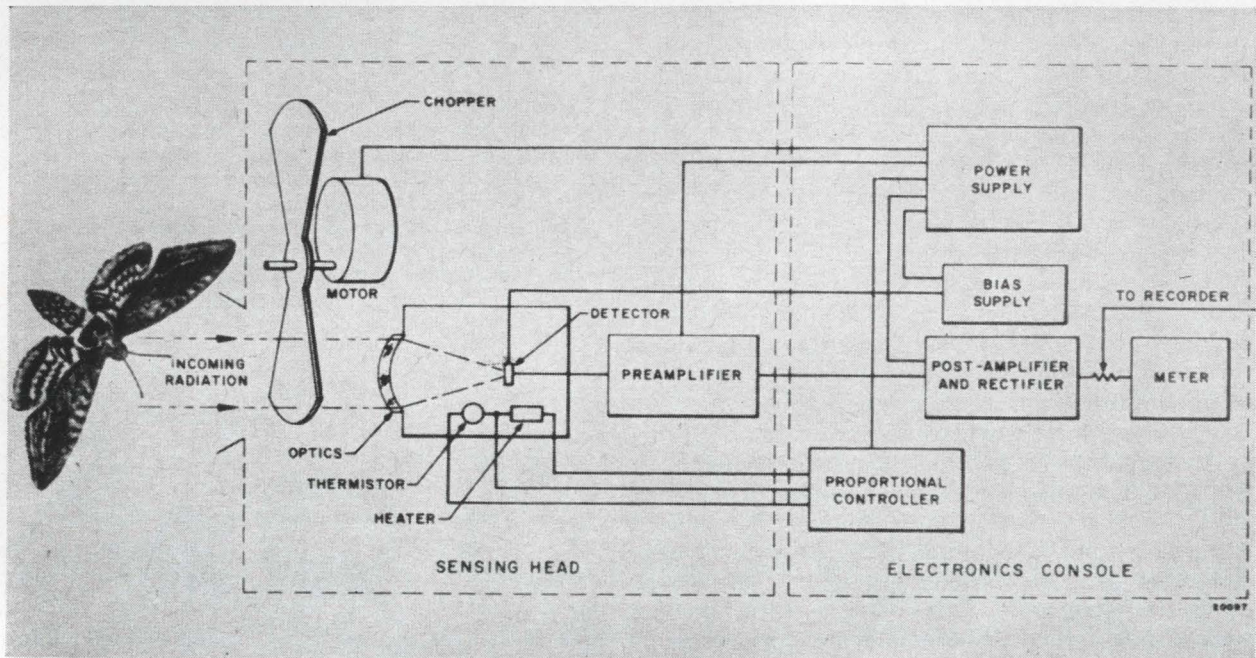

System for testing theory that nocturnal moths act as "flying infrared spectrophotometers and transmitters and receivers". Used in experiment by Phillip Callahan of the Department of Agriculture, the system employs a bolometer to measure infrared radiation from the moths. Behavior in response to return radiation is also being investigated.

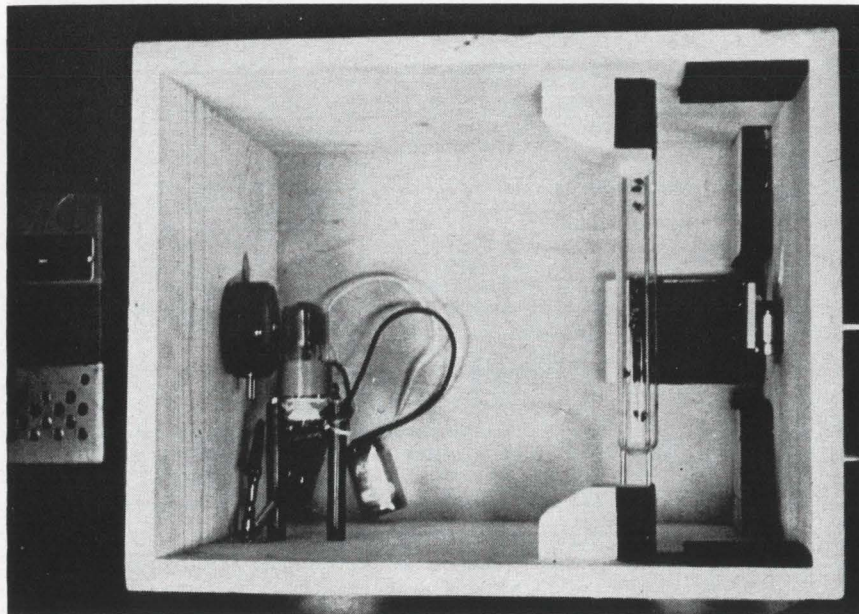

Movements of chemically sterilized houseflies, in tube at right, is measured by passing a beam of infrared light through the tube containing the subjects. Movements are compared with those of normal male houseflies. The activity level was controlled by varying the ambient visible light.

approaches, limited by present technologies, have not yet been found practical for long-term use. However, the mechanical and electro-chemical methods seem to have great potential.^{3, 4, 5, 6, 7}

Many kinds of circuits have been employed in biotelemetry. The three common types are described in the panel on page 118. The second part of this article, in the June 28 issue, will describe in more detail these circuits and problems associated with their design.

Chemical conversion of energy into electrical form is also under extensive study. Researchers at the General Electric Company have reported that a system of stainless steel-platinum/platinum black electrodes, approximately 3 by 4 centimeters, implanted in a rat, can produce 0.3 volts into a load of 1,000 ohms for several months.

Approaching the neurocircuit

Is electronics technology ready to cope with the problems of size inherent in biotelemetry? Transmitters have already been built small enough for implantation in rats without affecting the animals' bodily functions. E. J. Casey at the University of Ottawa says present integrated-circuit components are only 1,000 times the size of an average neuron cell. It seems possible that devices the size of nerve cells may be available by 1975.

When neurocircuits are attained, there will still be the problem of packaging. The electronics must be firmly anchored in the body, protected from body fluids, and prevented from upsetting the body's chemical balance.

Most of the present packaging compounds are permeable to body fluids and permit corrosion of electronic parts. Therefore several layers of encapsulants are usually necessary: one to seal the circuit (paraffin is excellent), at least one to provide the mechanical protection (epoxy is commonly used), and one to be compatible with the body (Silastic, Teflon, nylon and polyethylene have all been used successfully).

Advances in electronics and solid state physics, however, could result in new semiconductors and materials with properties that may be exploited in transducers. For example, silver electrodes are often polarized, because of skin salinity and other electrolytic effects, causing the generation of false information. Now electrodes of silver/silver chloride are eliminating this problem. It is entirely possible, moreover, that "molecule-identifying" effects will also be applied to biomedical research; these effects are electrical changes exhibited when conductive or semiconductive materials are exposed to certain molecules. These could result in pinhead-size transducers for such hard-to-measure quantities as the amounts of oxygen in blood or glucose in urine.

For ecological studies, low-cost equipment free from thermal effects is important. So are improved antennas and power-radiating techniques. Only with these will researchers be able to receive precise information from herds of animals roaming

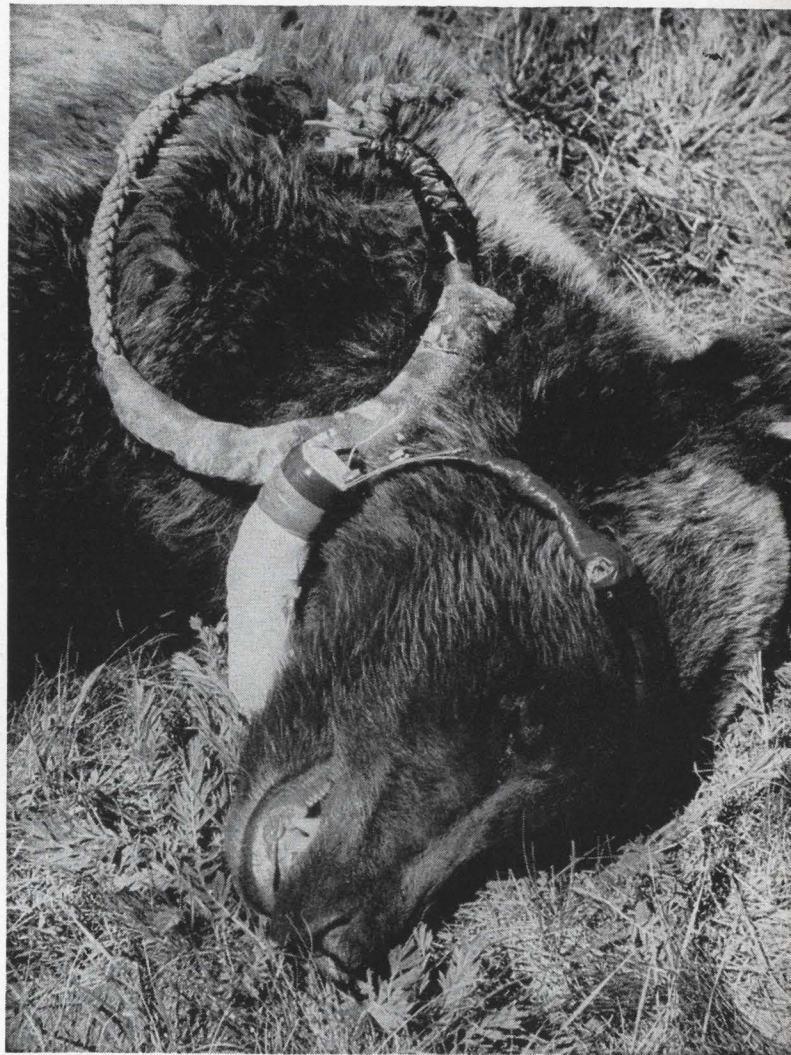

Transmitter in grizzly bear's collar is powered by seven mercury cells. It operates at 32.02 megacycles and has a range of 4 miles. It was designed by Frank and John Craighead, two physicians working with the Montana Cooperative Research Unit in Yellowstone National Park.

freely, far from the receiver.

For controlled studies of behavior, improved mounting for sensors and transducers are needed, also equipment that will neither drift nor create erroneous signals. Other important needs are a greater variety of miniature transducers for physiological measurements, and better methods for sterilizing implants.

Some of these problems are obvious to anybody who thinks about them; others require close cooperation between engineers and life scientists. For example, scar tissue is known to form around an implanted radio transmitter. Although, the tissue's electrical properties are unknown, they have had certain effects on the transmission of the radio waves and have attenuated the signals picked up by the transducers.

Electronic revolution in biology

These problems pose difficult challenges for the engineers; they also open to them a rich field virtu-

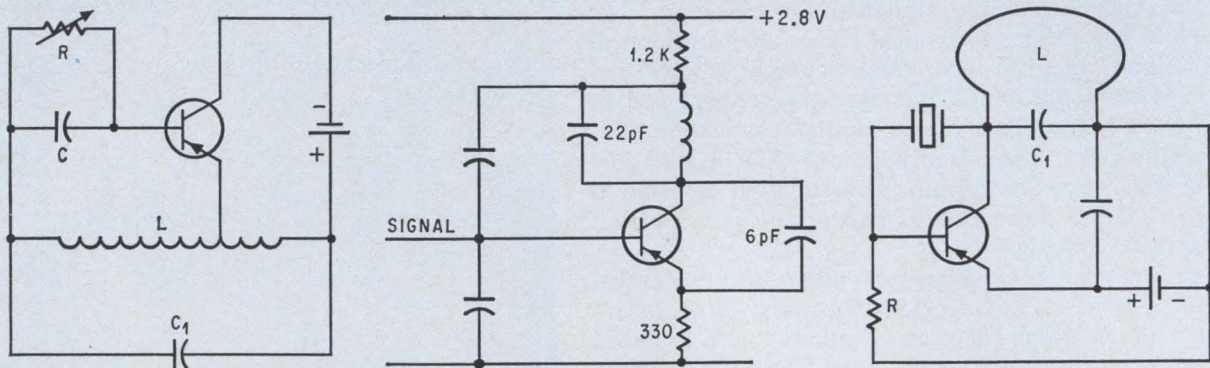

Three oscillator-modulator circuits are the basis for most of the recent circuit developments in biotelemetry. Developed in the early days of biotelemetry research, these simple circuits have proved reliable and as a result have been incorporated into the modern devices. In the pulsed carrier oscillator-modulator, shown in the circuit on the left, the carrier frequency is modulated by the motion of a magnetic rod in coil L or by the microphonic action of C₁. The pulse rate of the carrier trains may be varied by the value of either R or C. For example, a thermistor used for R can transmit temperature information. A continuous-wave, f-m oscillator-modulator, middle circuit, uses the input signal to vary the base-emitter voltage, and therefore the base-emitter capacitor, to produce a frequency change on the carrier. The crystal-controlled oscillator, circuit on the right, is used in animal tracking. A tank coil, L, forms the harness or collar on the animal. The circuit may be made to give a pulsed carrier by adding a capacitor in parallel with resistance R.

ally untouched by electronics technology. When these problems are solved, the impact on human and animal biology will be of revolutionary proportions; the implications are infinite. If progress continues at its present exponential rate, here are some of the advances that might be expected in the 1980's:

- The physiology and social behavior of free-roaming animals will be under massive surveillance. Animal sounds will be classified and man will begin to synthesize animal "language," leading toward two-way audio-telemetry between man and certain animal species. The day may not be very far off when a man will instruct a dolphin assistant to undertake a deep-sea tracking experiment, and businesses will control the flight of instrumented birds as they carry interoffice mail.

- Experience gained from the space program will lead to techniques for regulating complex machinery from physiological inputs, without bringing the brain into play. An electronic sensor attached to an astronaut may be able to detect the buildup of impurities in his blood and initiate measures to remedy the situation while the man in the capsule continues to concentrate on navigation between the planets.

- In hospitals, low-cost miniature telemeters will be used to monitor the condition of ambulatory or bedridden patients at home or on their jobs. Artificial limbs and organs will be made to respond to stimuli that are of little more than thought processes. Implants may become so common that packaging will be devised that can be dissolved into the body-waste system after a predetermined period.

- Continual diagnosis inside the body will be performed through electronic sensors. They will

sense the onset of disease and, in some cases, treat it automatically.

Better biotelemetry will develop better biology, and imaginative use of the technique will eventually lead to more exact knowledge in the life sciences.

References

1. L.E. Slater, "Some Facts About Bio-Telemetry" Case Institute of Technology, Cleveland, Nov. 1, 1964. Available from the author.
2. H. Dukes, *Physiology of Domestic Animals*, Comstock Publishing Co., 6th Edition, 1947.
3. R.S. Mackay, "Radio telemetering from within the human body," *Science*, Vol. 134, pp. 1196-1202; October, 1961.
4. J.T. Farrar and V. K. Zworykin, "Telemetering of gastrointestinal pressure in man by means of an intraluminal capsule energized from an external wireless source," *the Physiologist*, Vol. 2, p. 37; August, 1959.
5. J.T. Farrar, V.K. Zworykin, and C. Berkley, "Telemetering of physiologic information from the gastrointestinal tract by an externally energized capsule," presented at Third International Conference on Medical Electronics, London, July, 1960.
6. S.J.M. England and B. Pasamanick, "Radiotelemetry of physiological responses in the laboratory animal," *Science*, Vol. 133, pp. 106-107; January, 1961.
7. J. Nagumo, A. Uchiyama, S. Kimoto, T. Watanuki, M. Hori, K. Suma, A. Ouchi, M. Kumano, and H. Watanabe, "Echo capsule for medical use (a batteryless endoradiosonde)," *IRE Transactions*, Vol. BME-9, No. 3, July, 1962.

Bibliography

General

- L.A. Geddes, "A bibliography of biological telemetry," *American Journal of Medical Electronics*, October-December, 1962, 1:294-298.
 L.E. Slater, *Bio-Telemetry*, Pergamon Press, N. Y. 1963; 373 pp.; some facts about bio-telemetry, Case Institute of Technology, Cleveland, Nov. 1, 1964.

Animal tracking

- L. Adams, "Progress in ecological biotelemetry," *BioScience (Journal of the American Institute of Biological Sciences)*, February, 1965, No. 2, pp. 83-87.

Implant telemetry

- R.C. Grotz, "Implantable radio transducers for physiological information and implant techniques, Proceedings of the Second Annual Biomedical Sciences Instrumentation Symposium, I.S.A. Pgh. 1964, pp. 145-153.
 R.S. Mackay, "A progress report on telemetry from inside the body," *Proceedings of the Second Annual Biomedical Sciences Instrumentation Symposium, I.S.A. 1964, Pgh. pp. 275-292.*

you can
solve this
space problem...

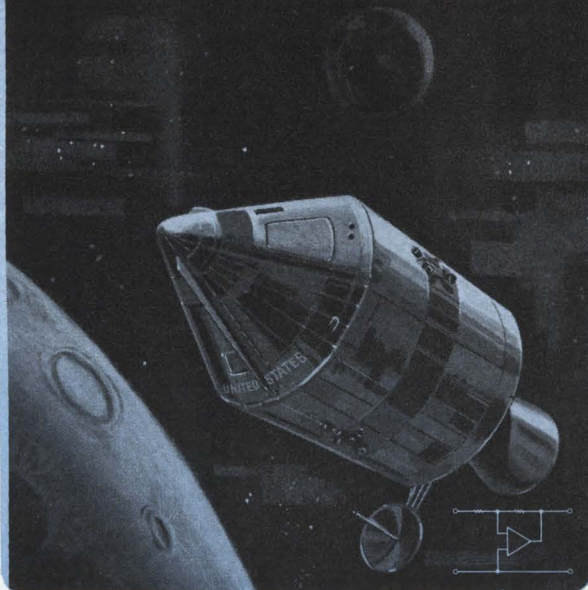

If you are squeezed for a tight delivery schedule to meet a launch deadline, and need an operational amplifier built by the book* for an outer space system, Nexus can get you the performance you need and build it to —

*NASA NPC 200-4
MIL-E-5400
MIL-Q-9858
ETC.

Made with cordwood construction
to NASA standards.

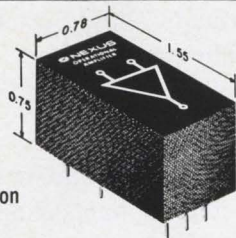

or this
space problem...

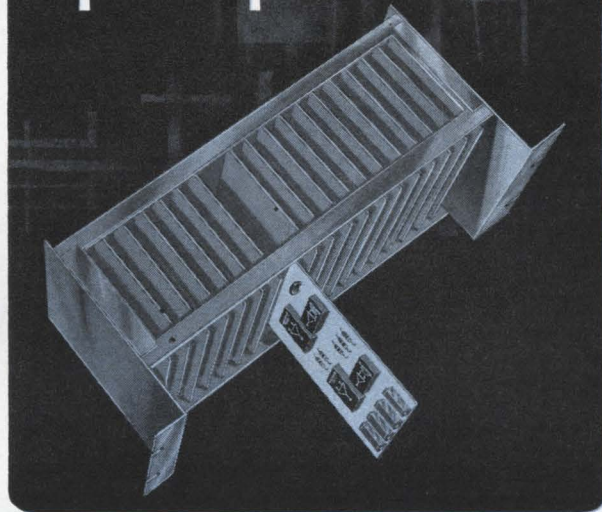

If you are squeezed for board-to-board clearance in a card rack system assembly and need a high-grade operational amplifier with superb performance in a low-height low-cost package, you can now get a standard Nexus operational amplifier in the new off-the-shelf "K" package.

NEW
LOW PROFILE
"K" CASE
FROM \$50

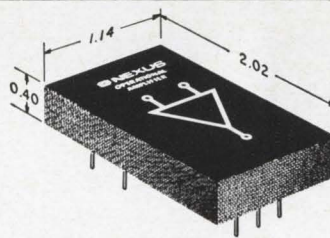

with operational amplifiers by
 **NEXUS**[®]

☒ **NEXUS RESEARCH LABORATORY, INC.**
480 NEPONSET STREET, CANTON, MASS. 02021
TEL: (617) 828-9000 TWX: (617) 828-1022

By encircling the reader card you will also be put on our list to receive "Nexus Notes" monthly, an informal paper covering basic analog designs and specific applications for operational amplifiers.

**You've just
decided to use
a lighted
pushbutton,**

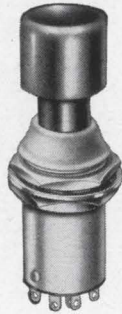

**instead
of a
toggle
switch.**



Are you going to have to switch SWITCH suppliers?

Well, if you have been considering one of the 3,150 toggle switches we have at Control Switch, you can quietly stay right where you are and start considering one of our 1,800 lighted pushbutton switches.

Same salesman. Same distributor. Same supplier. Same superior engineering for applications where you can't afford to have a switch goof, even after a hundred thousand actuations.

You can stay with us just as easily, too, for leaf and lever, interlock and limit, hermetically-sealed and environment-free switches.

 **CONTROLS
COMPANY**
OF AMERICA
CONTROL SWITCH DIVISION
1420 Delmar Drive, Folcroft, Pennsylvania 19032

NEW DICKSON "W" CASE TANTALUM CAPACITORS

"projecting stand-offs at the base of these compact devices provide adequate circulation for heat transfer and serve as an access area for cleaning solvents used in removing residual flux from circuit board"



"Nickel leads are radially positioned at .200" centers to conform to standard circuit board design. Leads are solderable and weldable."



designed for high density packaging and printed circuit applications

■ As you can see, these unique Dickson "W" case solid tantalum capacitors are ideal for high density and printed circuit applications. They should be, because that's what they were designed for . . . at the request of customers who were impressed with the quality and reliability of our standard tantalum capacitor line. This series, like all Dickson units, is manufactured under the most stringent QC procedures.

■ Units are encapsulated in an epoxy casting system exceptionally resistant to impact and thermal shock. They may be used at full rated voltage at the upper limit of their -55°C to $+85^{\circ}\text{C}$ temperature range. And, since there are 374 types in the series, you are assured of the exact unit for your particular application. Give them a try.

DICKSON "W" SERIES SOLID TANTALUM CAPACITORS

| VOLTAGE | CAPACITANCE RANGE |
|-----------|-----------------------------|
| 6 Volts | .0047 to 220 mfd - 57 types |
| 10 Volts | .0047 to 150 mfd - 55 types |
| 15 Volts | .0047 to 82 mfd - 52 types |
| 25 Volts | .0047 to 47 mfd - 49 types |
| 35 Volts | .0047 to 33 mfd - 47 types |
| 50 Volts | .0047 to 18 mfd - 44 types |
| 75 Volts | .0047 to 3.9 mfd - 36 types |
| 100 Volts | .0047 to 2.7 mfd - 34 types |

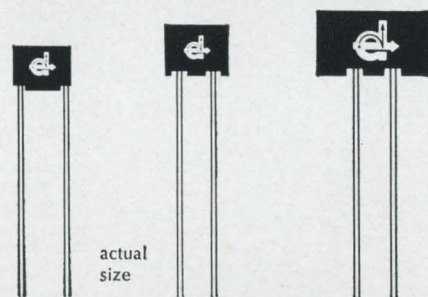

FOR COMPLETE TECHNICAL INFORMATION
use this publications reader service card
or write, wire or phone Dickson.



DICKSON
ELECTRONICS CORPORATION

310 WELLS FARGO, SCOTTSDALE, ARIZONA
PHONE (602) 947-5751, TWX 602-949-0146

Manufacturers of quality zener diodes, rectifiers, tantalum capacitors, solid state circuit breakers, field effect transistors.

Compact 5" Storage Tubes

3 New High-Reliability Types

Three compact new 5-inch storage tubes by ITT combine exceptionally large viewing area with greatly reduced overall length. They are designed for ruggedness, will withstand 10G vibration. A high-resolution, on-axis writing gun greatly reduces the distortion in the scanned pattern and simplifies equipment packaging.

COMPACT . . . Only 7.5 inches long for EM deflection and 10 inches long for ES deflection, 5.5 inches in diameter . . . designed for space-critical, solid-state display applications.

RELIABLE . . . Application-engineered for exceptional shock and vibration resistance.

VERSATILE . . . For a variety of airborne multiple-mode displays: terrain and turbulent-weather avoidance; fire control; navigation; guidance—PPI; sector scan; B-scan; mixed modes—radar, TV.

FOR DATA . . . Write: ITT Electron Tube Division, International Telephone and Telegraph Corporation, P. O. Box 100, Easton, Pa.

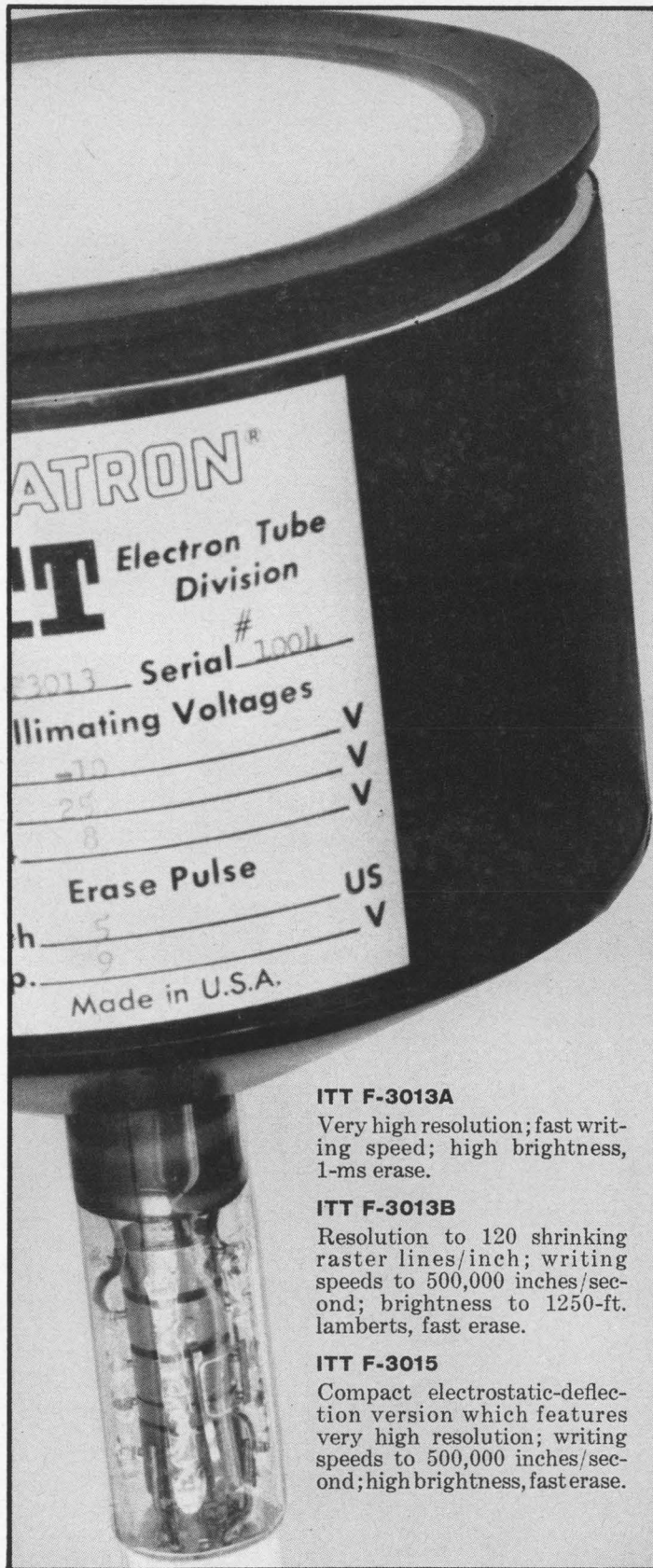

ITT F-3013A

Very high resolution; fast writing speed; high brightness, 1-ms erase.

ITT F-3013B

Resolution to 120 shrinking raster lines/inch; writing speeds to 500,000 inches/second; brightness to 1250-ft. lamberts, fast erase.

ITT F-3015

Compact electrostatic-deflection version which features very high resolution; writing speeds to 500,000 inches/second; high brightness, fast erase.

Self-collimating features available with all of the above tubes.

electron tube division



The Mohawk Data Sciences 1101 Keyed Data-Recorder Unit.

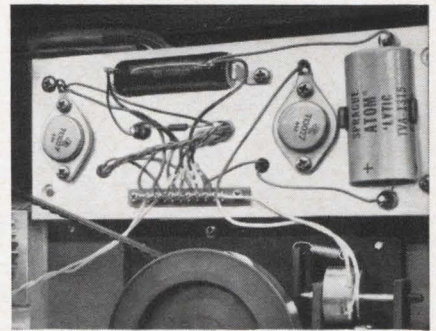

Ten-position Junction Block, accepting TERMI-POINT terminals, connects various components in the rear tape deck section.

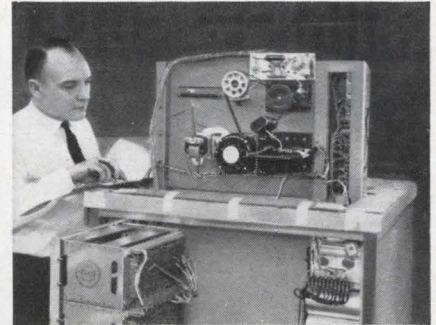

Interior view of Mohawk Data Sciences 1101 Keyed Data-Recorder Unit showing various TERMI-POINT product applications

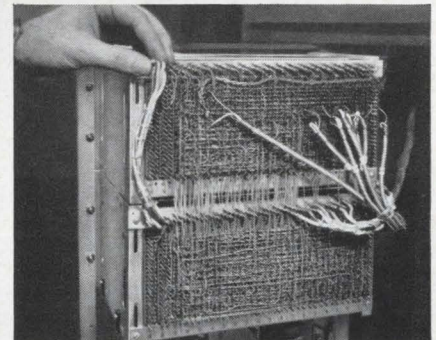

AMP's TERMI-POINT Terminals are used extensively in the logic "card library" section of the MDS 1101.

It might have been just an improved machine with some important new features . . .

But this keyed data recorder is *all* new . . . inside and out. We're particularly happy about the inside because we helped design it.

Our customer, Mohawk Data Sciences Corporation, built this machine to both transcribe and verify source data directly on magnetic tape, while offering users a saving of up to \$603 per month. Inside the unit is a logic board section with hundreds of tightly spaced wire connections. It's called a card library, and it might have been wired in the usual way, except that an evaluation of our TERMI-POINT★ Tools and Terminals for point to point wiring convinced Mohawk engineers that ours was the better method.

In addition to the TERMI-TWIST★ Connectors used to wire up the card library, we developed a bus bar for voltage and ground distribution to the cards, and a special junction block for the tape deck wiring. All three items, developed to accommodate our TERMI-POINT product line, gave our customer not only the high den-

sity connections required in the application, but serviceability and reliability far surpassing other, more familiar wiring techniques.

This is one reason why this manufacturer can state with justifiable pride that the MDS 1101 is not merely the rehash of an obsolete machine, but "an entirely new, original, better approach to faster, lower cost management of information through electronics."

Wouldn't you like to say the same thing about your product? Why not let us design TERMI-POINT devices into your application.

★Trademark of AMP INCORPORATED



A-MP★ products and engineering assistance available through subsidiary companies in: Australia • Canada • England • France • Holland • Italy • Japan • Mexico • Spain • West Germany

Specialist



IN WIRE & CABLE CONSTRUCTIONS

Wiring problems can't always be answered by standard materials, even from the broad range of wire products available today. Markel's capacity for engineering high temperature wire and cable constructions to meet particular needs has grown steadily with the demand. The toughest requirements in temperature, corrosive atmospheres, flexing, corona effect, etc., can be solved—with long range economy and reliability — by specially designed products from our FLEXLEAD Division.

Teflon, Silicone Rubber, Fiberglass, Nylon

Any combinations of insulations, shielding, fillers, liners, and jacket materials—for temperatures from -90° to 260°C —with single, twisted pair, or multiple conductors. May we help you solve your wiring problems?

Norristown, Pa. L. FRANK **MARKEL** & SONS

FLEXLEAD

HIGH TEMPERATURE WIRE AND CABLE

Get more facts. Write or call for a FLEXLEAD Wire and Cable Selector

NEW--solid state, regulated DC Power Supply

with only .0005V Ripple

... at less than \$100.

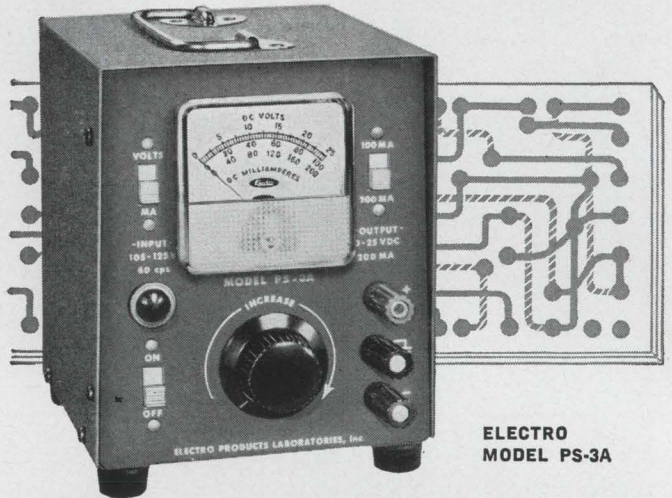

ELECTRO MODEL PS-3A

0-25 VDC at 0-200 MA, 0.02% regulation

12 to 1 ratio voltage adjustment

(FOUND ONLY ON EXPENSIVE UNITS)

GENERAL SPECIFICATIONS

| | |
|-----------------|--------------|
| Voltage output | 0-25VDC |
| Amperage output | 0-200MA |
| Load regulation | 0.02% |
| Line regulation | $\pm 0.02\%$ |
| Maximum ripple | 0.5MV |
| Size overall | 6¼ x 5 x 6" |
| Net weight | 3½ lbs. |
| Price, wired | \$99.50 |

For transistor circuit design, development and experimental use requiring a stable, extremely low ripple, well-regulated voltage source. This new power supply is ideal for design, development, testing, and equipment operation applications in industry and educational institutions.

Again, the PS-3A offers Electro's rare combination of performance, quality, and reasonable price... and a 1-year guarantee!

Write for complete information and name of your Electro distributor.

18 other models from 6 to 500 VDC starting at \$27.50



Since 1936—Pioneers in Low Voltage DC Power Supplies
• Proximity Switches • Magnetic Pickups • Tachometers
• Pres-Con Controls • Dynamic Micrometers

ELECTRO PRODUCTS LABORATORIES, INC.
6125-F HOWARD, CHICAGO, ILL. 60648 • 312/775-5220

New low-cost Daystrom Model 333 commercial trimmer has knurled finger-tip adjustment knob. It also has an Allenhead for fine adjustment . . . 4 to 1 ratio, nominal. Designed for PC board use, it requires approximately 1/2 cubic inch of space. Price is another unusual feature — only \$1.45 in 100 lot quantities!

Model 333's unique resistance element is the same as used in MIL-type Squaretrim® pots. Thus, it provides high resolution, linearity, and low noise. In addition, it is vibration and shock resistant.

This is just one of the special-purpose Daystrom units—from industry's broadest line of subminiature square-trimming potentiometers. Chances are that we can fill your most exacting requirements with a standard, off-the-shelf model.

Weston, originator of the Squaretrim pot, celebrates its tenth year of experience in this field. See your Weston distributor for catalog, prices and evaluation units. Weston Instruments, Inc., Archibald, Pennsylvania 18403. Phone: (717) 876-1500. In Canada: Daystrom Ltd., Cooksville, Ont.

From Weston's broad trimmer line

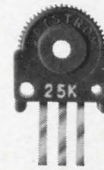

actual size

Model 333 — 1/2" by 3/16" by 3/16". Dual adjustment: knurled finger-tip knob and Allenhead. For PC board mounting. Resistance: 50Ω to 10k, up to 50k on special order. Rating: 0.2w @ 40°C in still air.



Series 200 — 3/8" Squaretrim, 0.150" thick, slotted or Allenhead adjustment screws. This is just one of a full line of 3/8" pots. Operation: from -55 to 150°C. Resistance: 10Ω to 50k. Rating: 1w @ 50°C in still air.

Only Weston's exclusive wire-in-the-groove offers **LOCKED-IN LINEARITY**

let your
fingers
do the
trimming

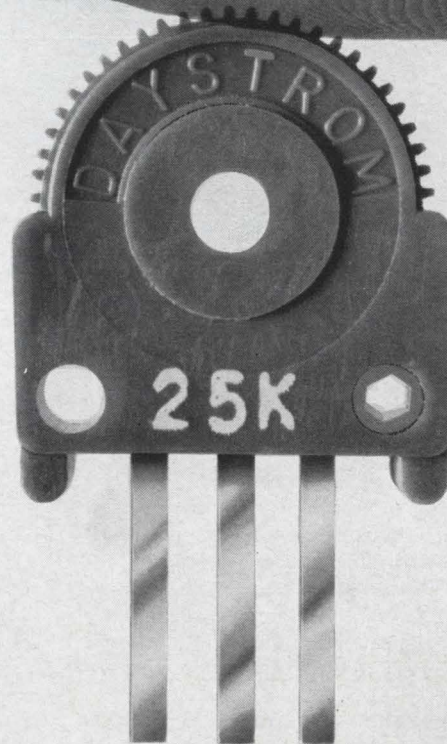

QUALITY BY DESIGN



WESTON INSTRUMENTS, INC.

Archibald, Pennsylvania 18403

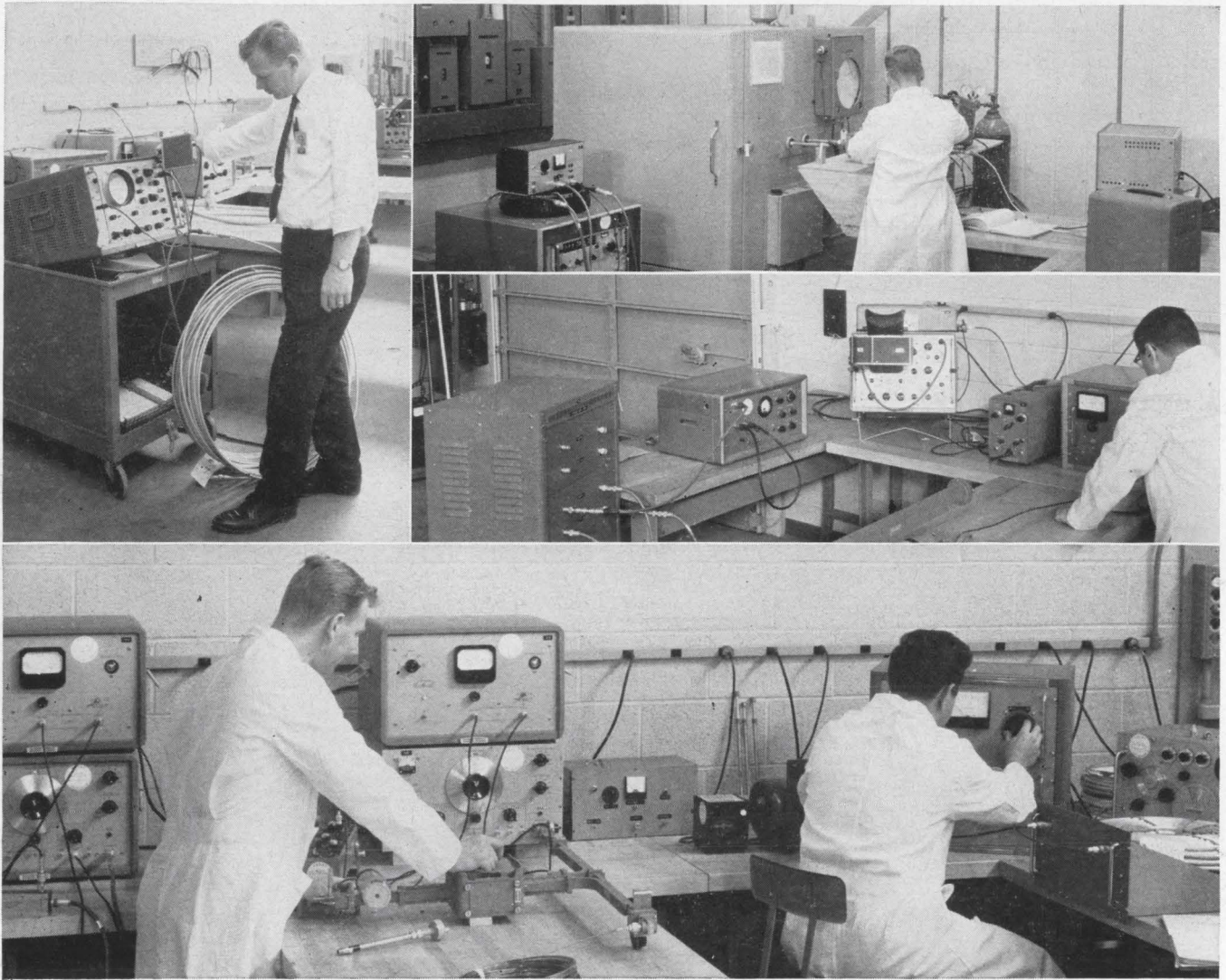

**Have you been buying your coaxial cable by the twelve inch foot?
Here is a new set of rules to specify by.**

When you buy coaxial cable, by the mile or the foot, straight lengths or shaped, you buy a passive element for the transmission of a signal. Why settle for less than the *now available* in accuracy of electrical or mechanical length? Newly developed techniques in testing and measuring permit you to establish new parameters in coaxial cable performance, to a degree never before possible.

Whether you are considering standard Styroflex® coaxial cable, Helical Membrane, Foamflex or

Corr-O-Foam. Or, if your application calls for an entirely fresh approach in cable design, we now establish these new extensions of the state-of-the-art: Delay Time: accurate to .02 ns. Phase Length: accurate to 0.4° relative. VSWR: accurate to 1.01. Insertion Loss: 0 to 40 db ± 0.5 db, 40 db to 60 db ± 1.0 db. Impedance: absolute value of average, 1%. Impedance Discontinuities: accurate to 0.2%.

Tell us about your requirements. Or request Bulletin SF-1 for full details.

PHELPS DODGE ELECTRONIC PRODUCTS
NORTH HAVEN, CONNECTICUT



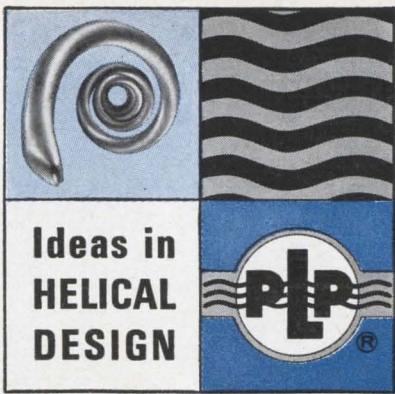

A fitting line for Antennas & Grids

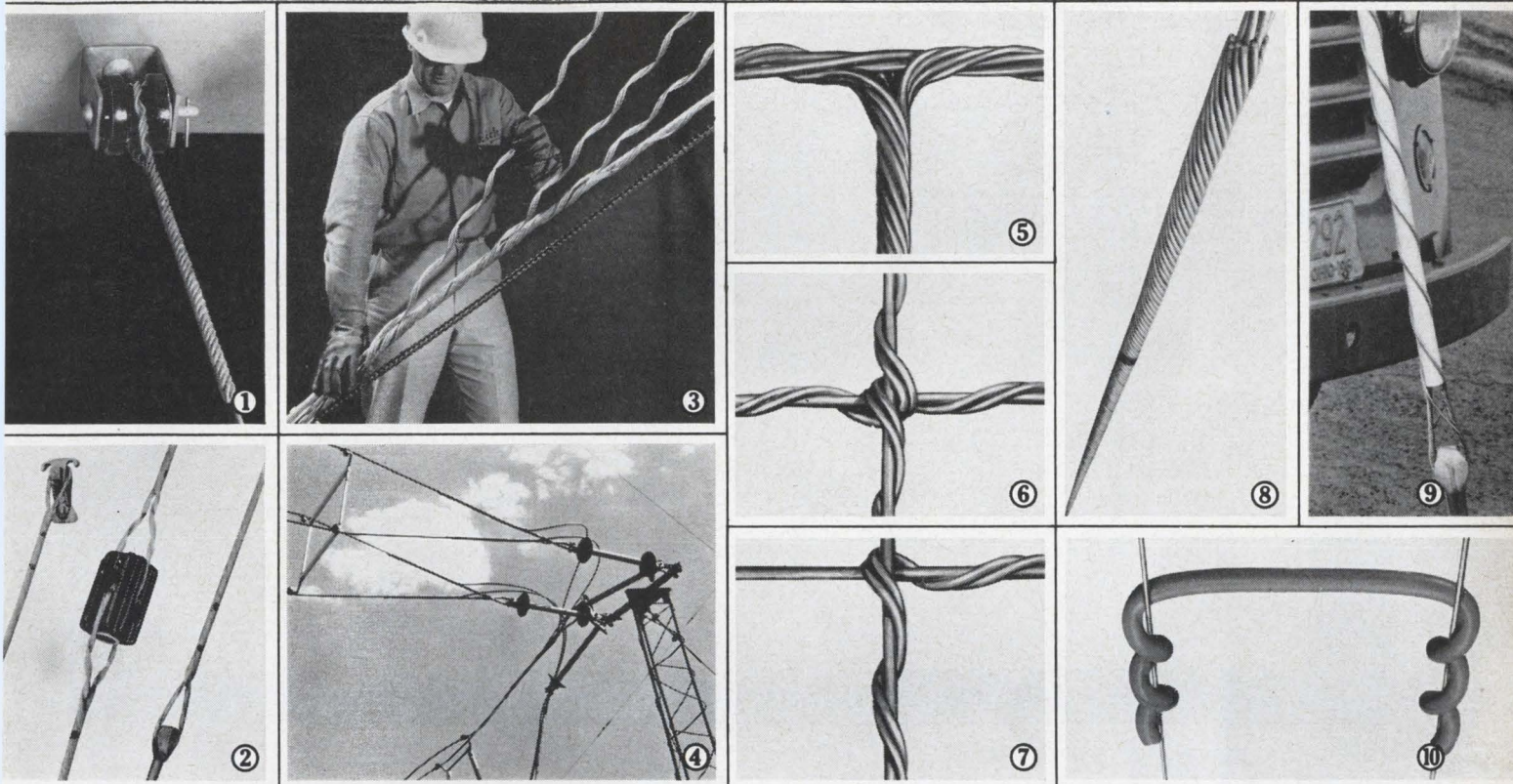

PREFORMED fittings have earned wide acceptance on up-to-date signal installations. They have important advantages in common: Fast, easy to apply by hand. Cannot shift or loosen. No maintenance required. Lowest installed cost. Low concentration of stresses. Material compatibility. Check these fittings: ① PREFORMED DEAD-ENDS for line wire. ② GUY-GRIP dead-ends for guying of poles and uprights. ③ BIG GRIP dead-ends, larger version of GUY-GRIP, used to guy high towers, antennas. ④ DOUBLE and TRIPLE GRIP DEAD-ENDS used on Rhombics to make connections at a common point. ⑤ T-CONNECTORS join two perpendicular wires of varying or identical diameters. ⑥ CROSS TIES and ⑦ L-

CONNECTORS join intersecting grid wires of the same or different diameters, connectors provide uniform holding, no stress points, excellent electrical conductivity, high mechanical strength, material compatibility.

⑧ PREFORMED SPLICES join strand or wire; restore full mechanical strength to damaged or severed sections. ⑨ GUY GUARDS provide 360° protection. Eliminate sharp edges. Plastic won't bend or break on impact. ⑩ PLASTIC SPACER UNITS, inexpensive way to eliminate mid span hits.

Write for complete data to: PREFORMED LINE PRODUCTS COMPANY, 5349 St. Clair Avenue, Cleveland, Ohio 44103; dial 216-881-4900.

PREFORMED



Circle 127 on reader service card

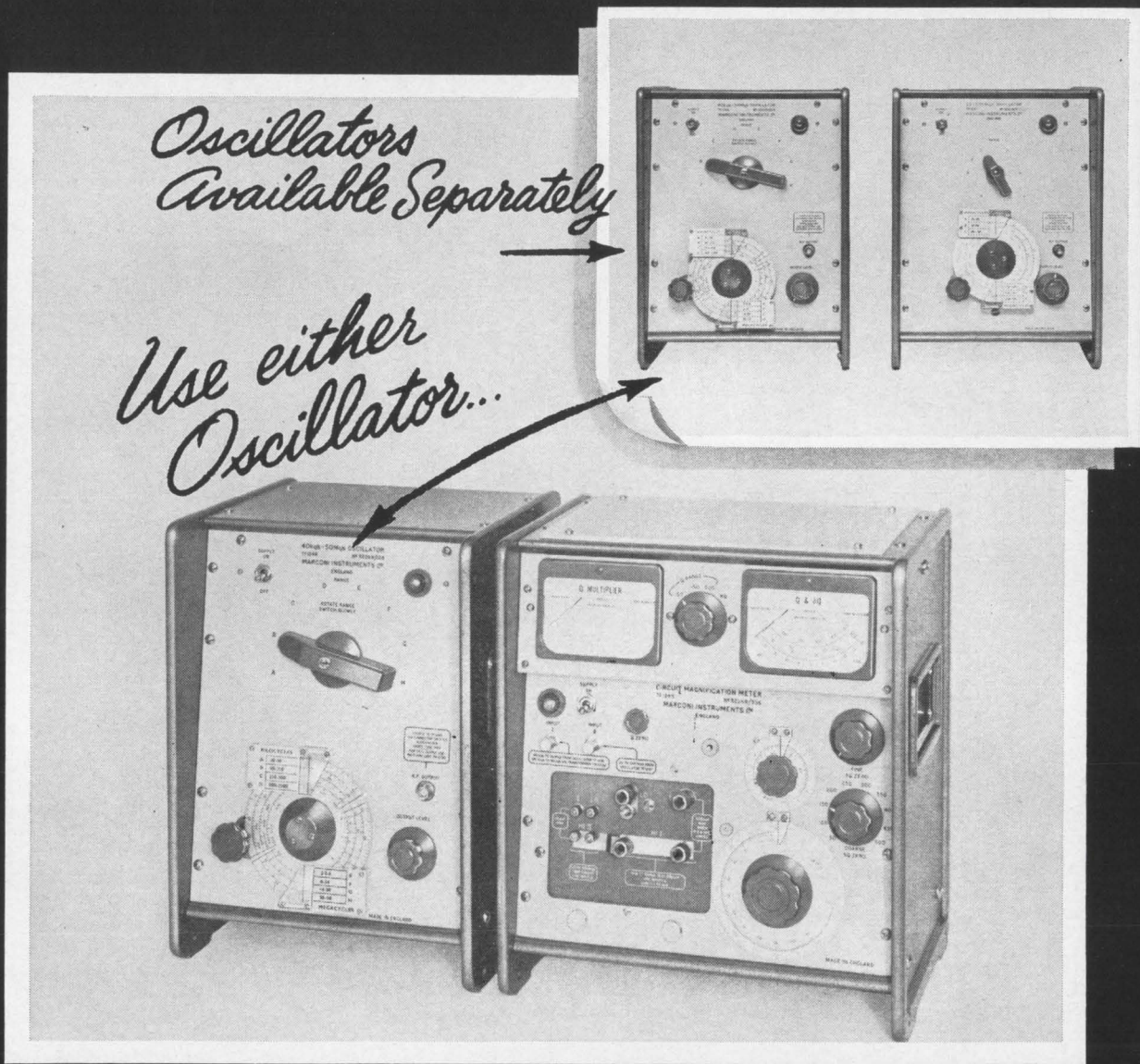

THE **ONLY** Q-METER COVERING 1KC TO 300MC

Q-METER MODEL 1245

- Frequency Range: 1kc to 300mc
- Q Range: 5 to 1000
- Delta Q: 25-0-25
- Tuning C: 7.5 to 500 pf
- Price: \$520

POWER OSCILLATOR MODEL 1246

- Frequency: 40kc to 50mc calibrated 1% accuracy when used with Q-Meter or matching unit
- Output: Up to 4V into 50Ω
- Output impedance: 0.5Ω or 50Ω when using matching unit TM5726 supplied
- Price: \$330

POWER OSCILLATOR MODEL 1247

- Frequency Range: 20mc to 300mc calibrated 1% accuracy when used with Q-Meter or matching unit
- Output: Up to 4V into 50Ω
- Output impedance: 0.5Ω or 50Ω when using matching unit TM5727 supplied
- Price: \$330

The Marconi Model 1245 Q-METER features dual measuring circuits and add-on oscillators for flexibility and reduced cost. Outstanding stability, fully regulated power supplies, high accuracy and precision controls are a few of the many features. The oscillators, available separately, supply high outputs up to 4 volts into 50Ω for use as bridge drivers, power oscillators, etc. A demonstration in your own plant can be easily arranged.

The Q-METER in theory and practice . . . a 36-page booklet plus literature on the above units is available upon request.

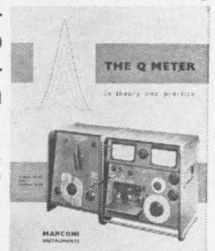

MARCONI INSTRUMENTS

Division of English Electric Corp.

111 CEDAR LANE, ENGLEWOOD, NEW JERSEY
Main Plant: St. Albans, England

Probing the News

Military electronics

Nike X has McNamara on the spot: it works, but is it worth building?

The Administration must decide by this fall whether antimissile system can justify huge cost—and whether Russia or China poses main threat

By Herbert W. Cheshire

Washington News Bureau

Even though there is no longer any serious doubt that the Nike X anti-missile will work, its future is uncertain.

The question that President Johnson and Defense Secretary Robert S. McNamara must soon answer can be stated simply: will the Nike X defense be good enough to warrant the staggering outlay for its production and deployment? Inherent in this question is another which rose with the mushroom

cloud of Communist China's first atomic explosion: against which potential enemy will Nike X be deployed—Red China or the Soviet Union?

The present timetable calls for a decision late this fall, when work begins on the defense budget that will be submitted to Congress for the fiscal year starting July 1, 1966.

Deployment. There are indications that McNamara's recommendation will call for some deploy-

ment of Nike X; but it is expected to fall far short—initially, at any rate—of the hopes of some of the system's backers. McNamara appears to lean strongly toward the view that Nike X would be more valuable as a defense against a primitive nuclear attack by Red China than against the huge numbers of Russian missiles equipped with penetration aids, decoys and other techniques that increase the defense problem. The implications

Sprint streaks toward target. High-acceleration, short-range missile can cover nearly a mile in the space of two heartbeats.

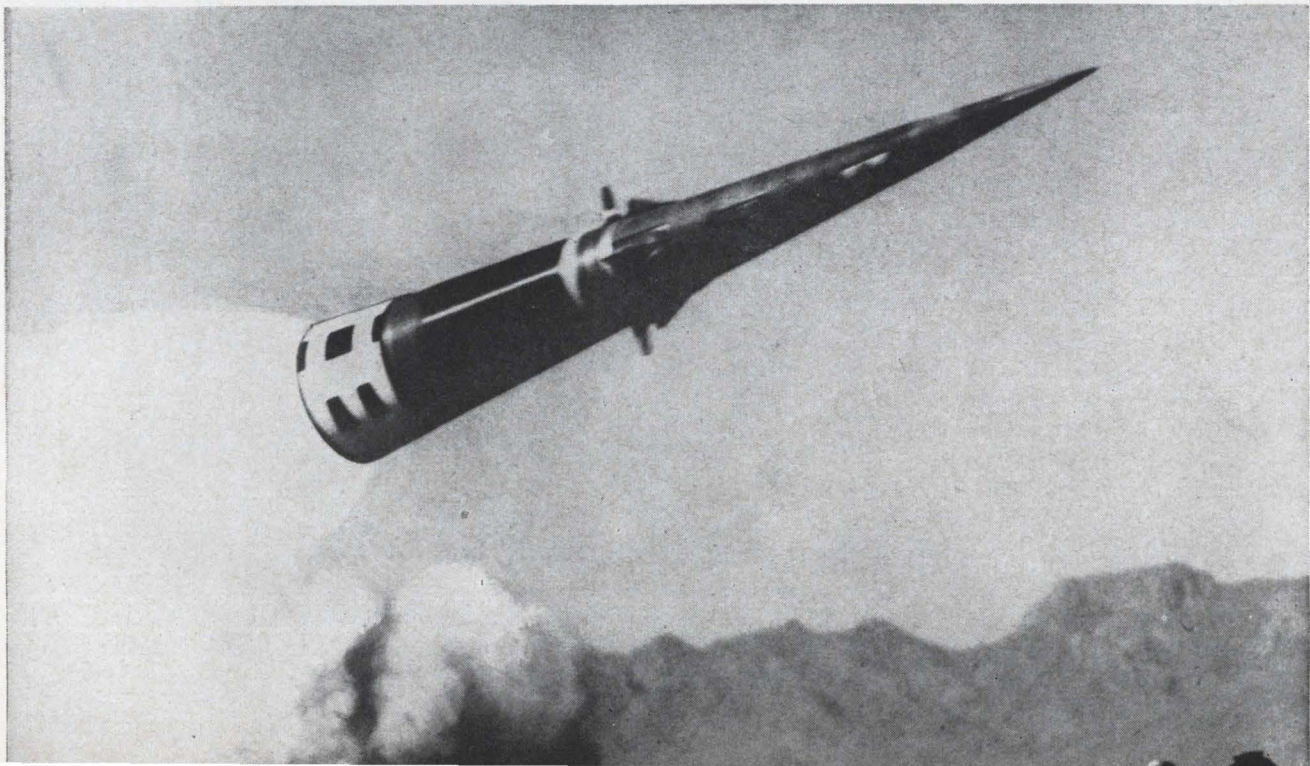

of this view, if it prevails, are important.

A "thin" deployment of a comparatively simple anti-Chinese defense system around a large number of U.S. cities would cost far less than an anti-Russian system, which would be concentrated heavily around only the most important targets. Including the \$5-billion fallout shelter program McNamara insists upon as a corollary to any antimissile system, the cost would be \$8 to \$10 billion for a simple system protecting about 40 cities, and \$17 to \$20 billion for the more complex deployment protecting about 23 cities. Some of those billions would go to the electronics industry.

I. Assessing the danger

McNamara does not expect the Chinese to be able to deliver even a crude intercontinental missile until 1970, which is the year by which Nike X would be deployed if funds for a production go-ahead were provided in mid-1966. And he does not expect them to have a sizable missile arsenal or to match current U.S. and Soviet sophistication until 1980 or 1985. If he is right, the stripped-down version of Nike X would provide protection against a Chinese nuclear attack for a decade or a decade and a half.

A decision to build only against a Chinese attack would not mean that the U.S. is abandoning the idea of developing a defense against Russia's missile force. But it would signal a belief that right now Nike X would not be effective enough in saving lives during a Russian attack to warrant its cost. It could be used, however, as a building block for an anti-Soviet system if a break-through in reducing costs could be achieved.

Nuclear folly. Without a missile defense against Russia, the U.S. would have to continue to rely solely on its strategic offensive power as a deterrent to a Soviet nuclear attack. Despite Russia's recent show of missile strength in the May 9 parade celebrating VE Day, intelligence reports indicate the U.S. still has a three-to-one-lead in intercontinental missiles, with 900 of them on launchers, not including submarine-launched Polaris missiles, against Russia's 270.

Implicit in the current thinking

about Nike X is the Administration's belief that the Soviets understand the extent of U. S. strength and the folly of starting a nuclear exchange. But U. S. officials believe that China, because of its continuing intransigence toward the West and its recent entry into the atomic power club, might be reckless.

II. Reaching a decision

McNamara feels there are five major elements that must enter into his decision on Nike X. The first is whether the technical problems have been or can be met, a question he seems likely to answer in the affirmative. There is greater uncertainty about the others:

Concept of deployment. There already is considerable debate within the Pentagon over this. The Army, which is in charge of the Nike X development, would like to move ahead faster and with a more complex system than McNamara seems to favor.

Alternative programs the relationship of Nike X to other so-called damage limiting programs that might be undertaken. The question here is whether the tremendous sums required for even a

low level of Nike X deployment might not be better spent on some other military need. The Air Force tends to the view that the money should be spent on further strengthening of offensive weapons and that more emphasis should be put on beefing up bomber defenses.

Fallout shelters. McNamara insists—with backing in principle from the military services—that a missile defense system without fallout shelters makes little sense. The enemy could overshoot the defense with nuclear ground bursts and then allow fallout drifting back on populated areas to accomplish what could not have been achieved by trying to penetrate the defense.

In fact, McNamara argues, fallout shelters should have first priority. He estimates that in a full scale nuclear war with Russia, the United States would suffer 149 million casualties. With an investment of \$5 billion for shelters, he figures 30 million of those lives could be saved. Saving an additional 30 million lives with a Nike X system capable of handling a sophisticated Russian attack would require the expenditure of an additional \$15 billion. In other words, for Nike X

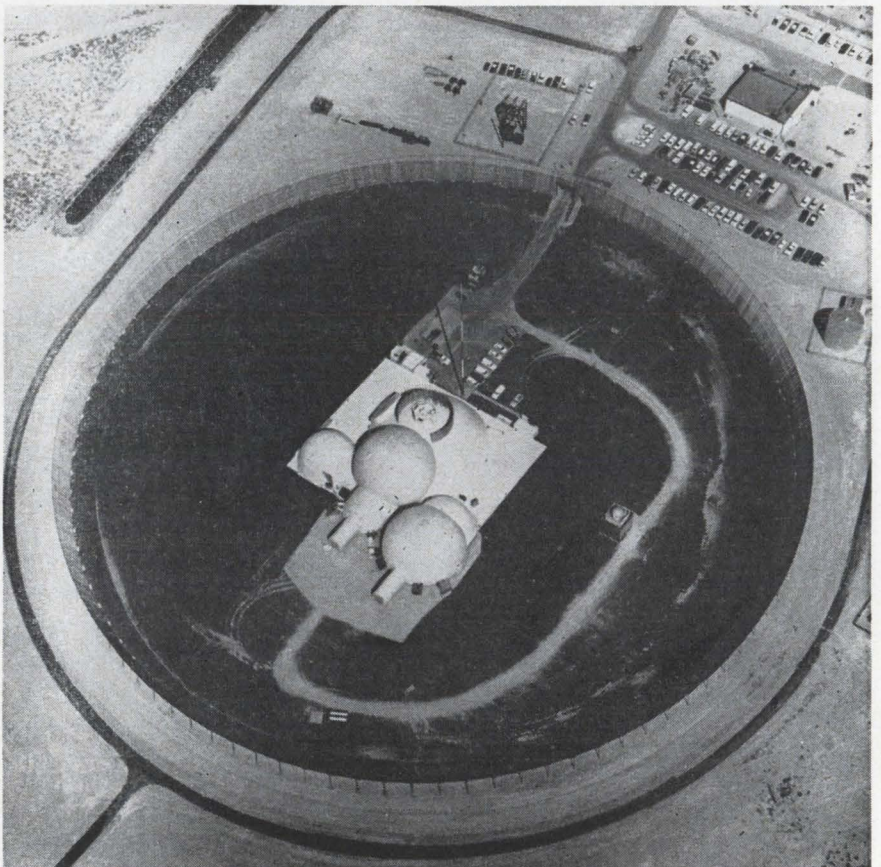

Multifunction Array Radar (MAR) at White Sands Missile Range. Bubble-like protective domes are made of fabric and inflated with air.

to save the same number of lives as shelters requires three times the expenditure.

Soviet reaction. The question here is whether Russia would try to offset Nike X simply by stepping up its offensive missile force. In that event, the net effect would not improve the U.S. position.

McNamara points out that for each higher level of expenditure made on a Nike X system with a fallout shelter program, the ratio of U.S. expenditures on defense to the enemy's costs for stepping up his offensive power becomes less and less favorable to us. This is another way of saying that beyond a certain level of defense, the cost advantage lies increasingly with the offense.

McNamara acknowledges that this argument is not conclusive against undertaking a Nike X program extensive enough to cope with a Russian attack. In a contest of spending on military security, the U.S. could outdo the Russians. This is a point the Army emphasizes. Our investment in a missile defense program would hurt the Russians financially much more than it would us.

McNamara counters that the Russians might not react at all as assumed.

Beyond this consideration is the question of whether deploying Nike X is worth the risk of upsetting the current detente with the Soviets and whether it might damage chances for an eventual arms control agreement.

III. Secret ingredients

The Nike X development was begun in 1963 as a follow-on to the Nike Zeus antimissile program. Col. I. O. Drewry, Nike X project manager, describes the difference between the two systems as the difference between a box of soap and a high-powered detergent. He says "They were both designed to scrub out ICBM's, but the Nike X will be a new improved product. It will also have a number of secret ingredients designed to get those hard-to-reach ICBM's, if you will."

Nike Zeus had two basic deficiencies that Nike X will overcome. One was lack of adequate traffic-handling capabilities because of reliance upon individual, mechanically slewed radars for acquiring

Acme Electric STOCK MODEL POWER SUPPLIES ARE ENGINEERED TO CUSTOM DESIGN PERFORMANCE

Acme Electric magnetically regulated power supplies were designed for industrial control and systems applications where high reliability of performance is of prime importance.

Simplicity of design, employing a minimum of components, avoids the possibility of failure present in more complex circuits. Components are conservatively rated for continuous duty at full output under conditions of industrial use.

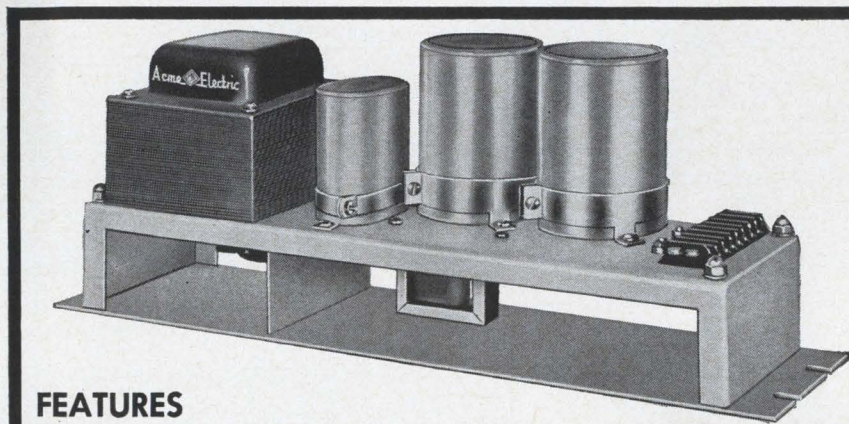

FEATURES

All solid state components for stability and reliability. Convection cooled — no fan or other moving parts. Available for operation on 50 cycles as well as standard 60-cycle frequency. May be paralleled in operation for multiplying current capacity. Fast response to line and load changes.

REGULATION

Line: $\pm 1\%$ for $\pm 13\%$ line voltage change. Load: $\pm 2\%$ for any load change between $\frac{1}{2}$ load and full load. Ripple: 1% RMS maximum. Operating temperature range: 0°C. to 50°C.

PARTIAL LISTING OF STOCK MODELS AVAILABLE SINGLE PHASE, 100-130 VOLTS; INPUT, 60 OR 50 CYCLES

| CATALOG NUMBER | D.C. OUTPUT | | | CATALOG NUMBER | D.C. OUTPUT | | |
|----------------|-------------|------|-------|----------------|-------------|------|-------|
| | Volts | Amps | Watts | | Volts | Amps | Watts |
| PS-47509 | 10 | 4 | 40 | PS-47638 | 28 | 8 | 224 |
| PS-47508 | 15 | 2 | 30 | PS-47712 | 28 | 25 | 700 |
| PS-41422 | 24 | 2 | 48 | PS-41424 | 48 | 4 | 192 |
| PS-41423 | 24 | 6 | 144 | PS-47519 | 48 | 10 | 480 |
| PS-47125 | 24 | 15 | 360 | PS-47718 | 100 | 4 | 400 |
| PS-47173 | 24 | 25 | 600 | PS-41425 | 125 | 2 | 250 |
| PS-1-47127 | 24 | 50 | 1200 | PS-47457 | 125 | 6 | 750 |
| PS-1-47461 | 24 | 75 | 1800 | PS-41426 | 150 | 2 | 300 |
| PS-1-47200 | 24 | 100 | 2400 | PS-41427 | 200 | 1 | 200 |
| PS-47202 | 26 | 4 | 104 | PS-41428 | 250 | 1 | 250 |

Acme Electric

Engineers and Builders of...

316 WATER STREET, CUBA, NEW YORK

Canadian Representative: Polygon Services, Ltd.
50 Northline Road, Toronto 16, Ont.

SAA-3854-3154

REGULATED POWER SUPPLIES
STATIC POWER RECTIFIERS
VOLTAGE STABILIZERS
VOLTAGE REGULATORS

Lambda Announces

a complete line of

all-silicon MODULAR power supplies

**VOLTAGES UP TO 60 VDC
0.08 AMPS. TO 8.3 AMPS.**

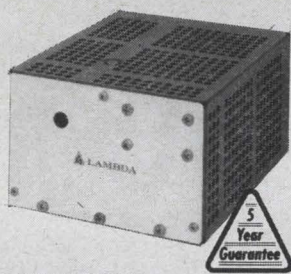

PATENTS PENDING

**4 DC
outputs in
3 1/2" rack
adapter
LRA-4**

MOUNTED THIS WAY

MOUNTED THIS WAY

MOUNTED THIS WAY

MOUNTED THIS WAY

**Full ratings
on 3 vertical
chassis
mounting
surfaces**

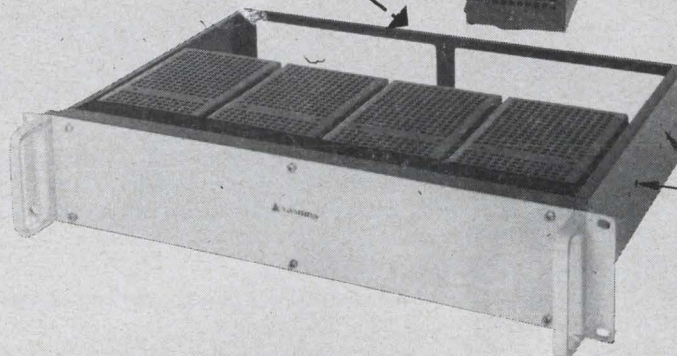

**Rack
mounting for use
with chassis
slides**

Mounting provisions made for
all popular brands of
chassis slides.

- **Maximum amps per dollar—starting at \$79.00**
- **Multi-Position-Rated™—3 mounting surfaces**
- **Multi-Current-Rated™ for 40°C, 50°C, 60°C, 71°C ambients**

- A-C INPUT 105-132 VAC, 45-440 cps
- REGULATION—Line .05% + 4 mv
—Load .03% + 3 mv
- RIPPLE — 1 mv rms — 3 mv
peak-to-peak
- REMOTE PROGRAMING
200 ohms/volt over voltage range
- NO VOLTAGE SPIKES OR OVERSHOOT
on "turn on, turn off" or power failure

- TEMPERATURE COEFFICIENT — .03%/°C
- MEET RFI SPECIFICATIONS — MIL-I-16910
- THERMALLY PROTECTED AND SHORT
CIRCUIT PROOF — CURRENT LIMITING
- REMOTE SENSING
- RACK ADAPTERS AVAILABLE
- MAXIMUM RATINGS WITHOUT EXTERNAL
HEAT SINKING OR FORCED AIR



LAMBDA ELECTRONICS CORP.

515 BROAD HOLLOW ROAD, MELVILLE, L. I., NEW YORK • 11749

Circle 132 on reader service card

LM Series available in 4 package sizes for chassis and rack mounting

Package A 3 1/8" x 3 1/8" x 6 1/2"

| Model Number | VDC | CURRENT RANGE AT AMBIENT OF: (1) | | | | Price |
|--------------|----------|----------------------------------|---------|---------|---------|----------|
| | | 40°C | 50°C | 60°C | 71°C | |
| LM 201 | 0-7 (2) | 0-0.85A | 0-0.75A | 0-0.70A | 0-0.55A | \$ 79.00 |
| LM 202 | 0-7 (2) | 0-1.7A | 0-1.5A | 0-1.4A | 0-1.1A | 99.00 |
| LM 203 | 0-14 (2) | 0-0.45A | 0-0.40A | 0-0.38A | 0-0.28A | 79.00 |
| LM 204 | 0-14 (2) | 0-0.90A | 0-0.80A | 0-0.75A | 0-0.55A | 99.00 |
| LM 205 | 0-32 (4) | 0-0.25A | 0-0.23A | 0-0.20A | 0-0.15A | 79.00 |
| LM 206 | 0-32 (4) | 0-0.50A | 0-0.45A | 0-0.40A | 0-0.30A | 99.00 |
| LM 207 | 0-60 | 0-0.13A | 0-0.12A | 0-0.11A | 0-0.08A | 89.00 |
| LM 208 | 0-60 | 0-0.25A | 0-0.23A | 0-0.21A | 0-0.16A | 109.00 |

Package B 3 1/8" x 4 7/8" x 6 1/2"

| | | | | | | |
|--------|--------|---------|---------|---------|---------|----------|
| LM 217 | 8.5-14 | 0-2.1A | 0-1.9A | 0-1.7A | 0-1.3A | \$119.00 |
| LM 218 | 13-23 | 0-1.5A | 0-1.3A | 0-1.2A | 0-1.0A | 119.00 |
| LM 219 | 22-32 | 0-1.2A | 0-1.1A | 0-1.0A | 0-0.80A | 119.00 |
| LM 220 | 30-60 | 0-0.70A | 0-0.65A | 0-0.60A | 0-0.45A | 129.00 |

Package C 3 1/8" x 4 7/8" x 9 1/2"

| | | | | | | |
|--------|---------|--------|--------|---------|---------|----------|
| LM 225 | 0-7 (2) | 0-4.0A | 0-3.6A | 0-3.0A | 0-2.4A | \$139.00 |
| LM 226 | 8.5-14 | 0-3.3A | 0-3.0A | 0-2.5A | 0-2.0A | 139.00 |
| LM 227 | 13-23 | 0-2.3A | 0-2.1A | 0-1.7A | 0-1.4A | 139.00 |
| LM 228 | 22-32 | 0-2.0A | 0-1.8A | 0-1.5A | 0-1.2A | 139.00 |
| LM 229 | 30-60 | 0-1.1A | 0-1.0A | 0-0.80A | 0-0.60A | 149.00 |

Package D 4 7/8" x 7 3/4" x 9 1/2"

| | | | | | | |
|--------|---------|--------|--------|--------|--------|----------|
| LM 234 | 0-7 (2) | 0-8.3A | 0-7.3A | 0-6.5A | 0-5.5A | \$199.00 |
| LM 235 | 8.5-14 | 0-7.7A | 0-6.8A | 0-6.0A | 0-4.8A | 199.00 |
| LM 236 | 13-23 | 0-5.8A | 0-5.1A | 0-4.5A | 0-3.6A | 209.00 |
| LM 237 | 22-32 | 0-5.0A | 0-4.4A | 0-3.9A | 0-3.1A | 219.00 |
| LM 238 | 30-60 | 0-2.6A | 0-2.3A | 0-2.0A | 0-1.6A | 239.00 |

(1) Current rating applies over entire voltage range and at 55 to 65 cps. For operation at AC input of 45-55 cps and 360-440 cps, derate output current 10%.

(2) Can be operated at 0-10 VDC—derate output current 30%.

(3) Can be operated at 0-20 VDC—derate output current 30%.

(4) Can be operated at 0-40 VDC—derate output current 30%.

 **LAMBDA**
ELECTRONICS CORP.

and tracking a large number of targets simultaneously and for guiding interceptor missiles. The other was reliance upon a single, comparatively slow-reaction interceptor, the Zeus.

New configuration. Western Electric Co. is the prime contractor for Nike X; Bell Telephone Laboratories is in charge of system design and development. The configuration they have come up with consists of five main elements:

MAR. A multifunction array radar which Sylvania Electric Products, Inc., developed under subcontract. Because it scans electronically rather than mechanically and can shift from one sector of the sky to the opposite literally with the speed of light, MAR will perform target detection and identification, tracking, discrimination and some interceptor missile tracking, simultaneously and as a single unit.

The number of targets MAR can handle is limited only by data-processing elements of the Nike X system. Just how many is secret, but Drewry says the number is large.

Fabrication and installation of MAR I was completed at the White Sands, N.M. missile range in early 1964. It went on the air a year ago. A tactical prototype, MAR II, is being designed and developed for installation at Kwajalein atoll in the Marshall Islands, where system tests of Nike X will be carried out. MAR II incorporates design changes resulting from test experience gained at White Sands.

Unlike conventional radar antennas, MAR can be hardened against nuclear blast.

MSR. Missile site radar, a Raytheon Co. development, which provides a guidance link with interceptor missiles en route to their targets. Also a phased array radar, MSR will be able to handle a number of interceptors at once. Its configuration has been established and design and fabrication have begun. The prototype will go to the missile launch area at Kwajalein.

Zeus. The Zeus missile, a product of Douglas Aircraft Co., which is being retained in the Nike X system for long-reach intercepts, primarily outside the atmosphere. Its range is on the order of 70 to 100 miles. When it was originally designed, the most important objec-

tive of antimissile defense appeared to be the interception of targets as far away as possible. But the growth in knowledge of atmospheric reentry characteristics and the possibility of using them to distinguish between real warheads and decoys dictated development of another missile with shorter range and quicker reaction time. Dense layers of atmosphere tend to heat or retard decoys and act as a filter favoring the defense.

The Zeus has repeatedly demonstrated that it can intercept ICBM targets during tests against Atlas and Titan missiles over the Pacific. A "live" intercept in these tests is considered successful if it occurs within the lethal radius of a Zeus nuclear warhead. The firing program of the missile, as it now exists, has just been completed. The Zeus is now being redesigned to take advantage of advancing missile technology.

Sprint. The Sprint missile, being developed by the Orlando, Fla., division of the Martin Co. This high-acceleration, short-range missile is so fast that its firing can be held off until an incoming missile enters the atmosphere and a quick determination of whether it bears a real warhead is made from its reentry pattern. The Sprint can reach a height of 23 to 30 miles within 10 to 15 seconds after launch.

The Sprint's acceleration exceeds 100 G's, which means it can cover about a mile in the time of two heartbeats. Such high acceleration required development of new propellants and means of protecting both electronic components and the airframe from the crushing load and high friction heating. At 100 G's, a 10-pound component has an equivalent weight of 1,000 pounds.

Another unusual feature of the Sprint is its launch method. Instead of being flown out of its underground cell, it will be "popped" out by a rocket propellant slug in much the same way that Polaris missiles are ejected from submarines, with the first stage igniting as it clears the lip of the cell.

Sprint's ejection system has been tested successfully. The missile itself has had a successful flight test not involving the ejection system.

Data-processing equipment. The Univac division of the Sperry Rand Corp. has the main development

subcontract for the data-processing equipment. The Nike Zeus computer was capable of 2,000 arithmetic calculations per second. The Nike X system will perform nearly two million multiplications and five million additions and subtractions per second. The primary system, to be located with MAR, will perform all of the system digital data processing, including commands for Sprint and Zeus, missile launching, and steering orders to intercept attacking warheads. A second, considerably smaller processing unit will be located at MAR.

Other major subcontractors are Avco Corp. for discrimination techniques and studies and General Electric Co. for radar techniques and signal processing equipment.

IV. Bag of tricks

A missile defense system must be capable of not only knocking down a warhead traveling at 17,000 miles per hour; if it is to cope with a sophisticated attack, it must also be able to detect and counter or ignore a wide range of potential tricks that an enemy such as Russia might employ.

These include saturation attacks, in which the offense tries to overwhelm the defense with sheer numbers; varying atmospheric reentry angles to confuse observation of reentry characteristics; use of warheads hidden behind the charged atmosphere of precursor atomic blast; active electronic countermeasures to jam and confuse radars; use of decoys, maneuverable reentry vehicles and multiple warheads; and special materials to reduce radar reflections and detectable infrared energy.

How close the Nike X now comes to countering these tactics is cloaked in secrecy. But whatever capabilities have been programmed for it apparently can be achieved.

Cost counts. The sole challenge is cost. "The technical problems remaining in the development, while still formidable in terms of the effort that will be required for solution, all seem amenable to solution in the sense that the components can surely be made to work," Harold Brown, Director of Defense Research and Engineering, recently told Congress. "The technological challenge is rather that the over-all system be capable of operation

without prohibitive cost."

Nike X has the highest priority in the defense research and development budget. By mid-1966, more than \$2 billion will have been poured into both the Zeus and X development. The total will rise to well over \$2.5 billion before the development program is completed.

For the coming fiscal year, the Defense Department has budgeted over \$1 million a day for spending on the program, including \$10 million for preproduction engineering. The \$10 million will be spent in planning a production capability for thousands of specific components rather than in coming up with production designs for specific end items.

Just in case . . .

Although Nikita Khrushchev boasted in 1962 that the Soviet Union had an antimissile missile that could "hit a fly in outer space," Defense Secretary McNamara says there is no reason to believe the Soviets are ahead of the United States in antimissile development. He asserts that there is no operational antimissile system deployed in the Soviet Union today.

In recent testimony before the House Armed Services Committee, McNamara spelled out what this country was doing about the possibility that the Russians might deploy an antimissile system.

"We have anticipated they would be working on an antiballistic missile system. We recognize that if they do deploy such a system, we must have the capability for penetrating such defenses without any qualifications whatsoever, in the same way that we say we can, without qualifications, penetrate their future air defense system.

"For that reason, in about March 1961, we substantially increased the funds then being planned for expenditures on research and development for penetration aids. These are devices associated with the offensive warhead, which are designed to insure that our warheads will penetrate an antiballistic missile defense.

"In fiscal 1962 through fiscal 1965, we will have spent about a billion dollars on research and development of penetration aids, and we now have those penetration aids being introduced into our deployed forces, particularly into the Polaris force and into certain of the Minuteman missiles."

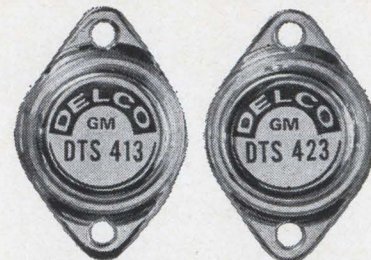

DELCO RADIO SEMICONDUCTORS AVAILABLE AT THESE DISTRIBUTORS

EAST

BINGHAMTON, N. Y.—Federal Electronics
P. O. Box 1208/PI 8-8211
PHILADELPHIA 23, PENN.
Almo Industrial Electronics, Inc.
412 North 6th Street/WA 2-5918
PITTSBURGH 6, PENN.—Radio Parts Company, Inc.
6401 Penn Ave./361-4600
NEWTON 58, MASS.—Greene-Shaw Company
241 Watertown Street/WO 9-8900
CLIFTON, N. J.—Eastern Radio Corporation
312 Clifton Avenue/471-6600
NEW YORK 36, N. Y.—Harvey Radio Company, Inc.
103 West 43rd Street/JU 2-1500
BALTIMORE 1, MD.—Radio Electric Service Company
5 North Howard Street/LE 9-3835

SOUTH

BIRMINGHAM 5, ALA.
Forbes Distributing Company, Inc.
2610 Third Avenue, South/AL 1-4104
WEST PALM BEACH, FLA.—Goddard, Inc.
1309 North Dixie/TE 3-5701
RICHMOND 20, VA.—Meridian Electronics, Inc.
1001 West Broad Street/353-6648

MIDWEST

BATTLE CREEK, MICH.—Electronic Supply Corporation
94 Hamblin Ave./P. O. Box 430/965-1241
MINNEAPOLIS 62, MINN.—Admiral Distributors, Inc.
5333 Cedar Lake Road/545-8811
INDIANAPOLIS 25, IND.
Graham Electronics Supply, Inc.
122 South Senate Avenue/ME 4-8486
CLEVELAND 1, OHIO—The W. M. Pattison Supply Co.
Industrial Electronics Division
777 Rockwell Avenue/621-7320
CHICAGO 30, ILL.—Merquip Electronics, Inc.
4939 North Elston Avenue/AV 2-5400
CINCINNATI 10, OHIO—United Radio, Inc.
7713 Reinhold Drive/241-6530
KANSAS CITY 11, MO.—Walters Radio Supply, Inc.
3635 Main Street/JE 1-7015
ST. LOUIS 17, MO.
Electronic Components for Industry Co.
2605 South Hanley Road/MI 7-5505

WEST

DALLAS 1, TEXAS—Adleta Company
1907 McKinney Ave./RI 1-3151
HOUSTON 1, TEXAS—Harrison Equipment Company, Inc.
1422 San Jacinto Street/CA 4-9131
SAN DIEGO 1, CAL.
Electronic Components of San Diego
2060 India Street, Box 2710/232-8951
LOS ANGELES 15, CAL.—Radio Products Sales, Inc.
1501 South Hill Street/RI 8-1271
LOS ANGELES, CAL. 90022—Kierulff Electronics
2585 Commerce Way/OV 5-5511
MOUNTAIN VIEW, CAL.—Kierulff Electronics
2484 Middlefield Road/968-6292
DENVER, COLO.—L. B. Walker Radio Company
300 Bryant Street/WE 5-2401
SEATTLE 1, WASH.—C & G Electronics Company
2600 2nd Ave./Main 4-4354
PHOENIX, ARIZ.—Midland Specialty Co., Inc.
1930 North 22nd Ave./258-4531
ALBUQUERQUE, N.M.—Midland Specialty Co., Inc.
1712 Lomas Blvd., N.E./247-2486
TUCSON, ARIZ.—Midland Specialty Co., Inc.
951 South Park Ave./MA 4-2315

Ask for a complete catalog

DELCO RADIO

DIVISION OF GENERAL MOTORS • KOKOMO, INDIANA

400V 2.0A 3.5A SILICON TRANSISTORS

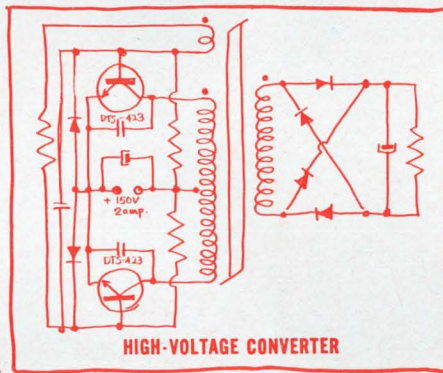
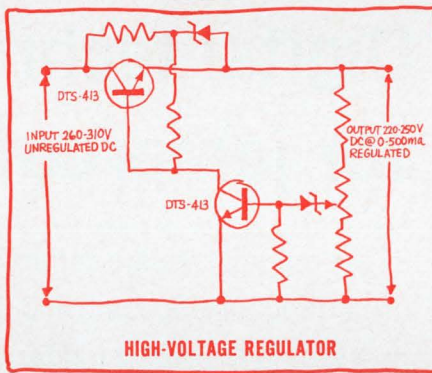
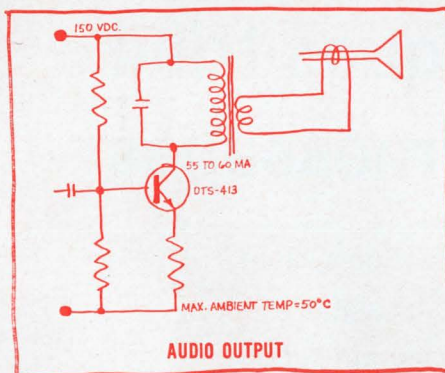
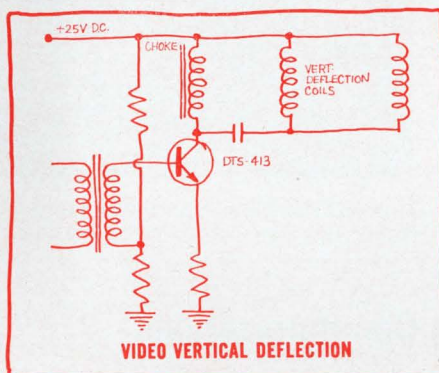
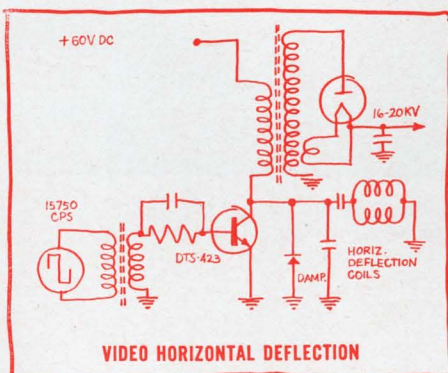

INEXPENSIVE

From Delco Radio, come two new silicon power transistors that transcend the known limits of semiconductor cost and capability. ■ **V_{CEO} 400V at less than three cents a volt—even in sample quantities!** ■ The DTS-413 and DTS-423 open the door to a host of new ideas, new circuits, new products and product improvements. ■ As an example, practical—and immediate—applications are both vertical and horizontal TV outputs. Large-screen all-transistor TV is, for the first time, technically and economically practical. ■ Delco's achievement also permits a reduction in current, reduction in size of other components, and a hike in efficiency in circuits where high energy output is needed. ■ High punch-through voltage, high frequency response, and low saturation resistance are provided by the silicon element itself, which is fabricated by our unique triple sequential diffusion process. ■ Complete freedom from "purple plague" and exceptional resistance to thermal and mechanical shock are a result of ultrasonic bonding of aluminum to aluminum base and emitter contacts. ■ Contact us right now for data sheets and prices. Be one of the first to take advantage of these Delco Radio high-voltage silicon power transistors.

| RATINGS | DTS 413 | DTS 423 |
|---------------------------|-------------|-------------|
| VOLTAGE | | |
| V _{CEO} | 400 V (Max) | 400 V (Max) |
| V _{CEO} (Sus) | 325 V (Min) | 325 V (Min) |
| V _{CE} (Sat) | 0.8 (Max) | 0.8 (Max) |
| | 0.3 (Typ) | 0.3 (Typ) |
| CURRENT | | |
| I _C (Cont) | 2.0A (Max) | 3.5A (Max) |
| I _C (Peak) | 5.0A (Max.) | 10.0A (Max) |
| I _B (Cont) | 1.0A (Max) | 2.0A (Max) |
| POWER | | |
| | 75 W (Max) | 100 W (Max) |
| FREQUENCY RESPONSE | | |
| f _t | 6 MC (Typ) | 5 MC (Typ) |

FIELD SALES OFFICES

UNION, NEW JERSEY*
Box 1018 Chestnut Station
(201) 687-3770

SANTA MONICA, CALIFORNIA*
726 Santa Monica Blvd.
(213) 870-8807

DETROIT, MICHIGAN
57 Harper Avenue
(313) 873-6560

SYRACUSE, NEW YORK
1054 James Street
(315) 472-2668

PALO ALTO, CALIFORNIA
201 Town & Country Village
(415) 326-0365

CHICAGO, ILLINOIS*
5151 N. Harlem Avenue
(312) 775-5411

*Office includes field lab and resident engineer for applications assistance.

DELCO RADIO
DIVISION OF GENERAL MOTORS, KOKOMO, INDIANA

WHO SAYS YOU'RE A SEMI- CONDUCTOR EXPERT?

We do! No one knows more about your specific semi-conductor problems than you. And no one knows the production or research equipment necessary to solve those problems better than K & S.

MODEL 752 AUTOMATIC SCRIBER

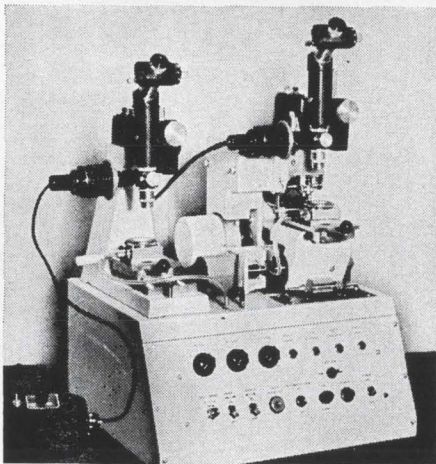

A new concept in wafer scribing . . . completely automates scribing and indexing . . . produces 45 to 50 scribes a minute. Range 0 to .200" in increments down to .00025". Optional prealignment station. As first set of scribe lines is completed, preset limit switch halts machine . . . operator merely rotates chuck 90°. . . scribing is then automatically completed. New low mass, spring-mounted tool design greatly reduces impact. Industry's widest range of speed, tool and chuck adjustments.

Have a production problem? Get the full story on K&S equipment and confidential engineering services. Fill out the quick-action coupon.

When at Wescon visit our new San Francisco facility, 840 Mitten Road, Burlingame, Cal. —Phone 415-697-0157.



**KULICKE
and SOFFA**
MANUFACTURING COMPANY
135 Commerce Drive, Fort Washington, Pa.
Telephone: (215) 646-5800

YES! Please send more data on Model 325.

NAME _____
TITLE _____
COMPANY _____
ADDRESS _____

EM-65

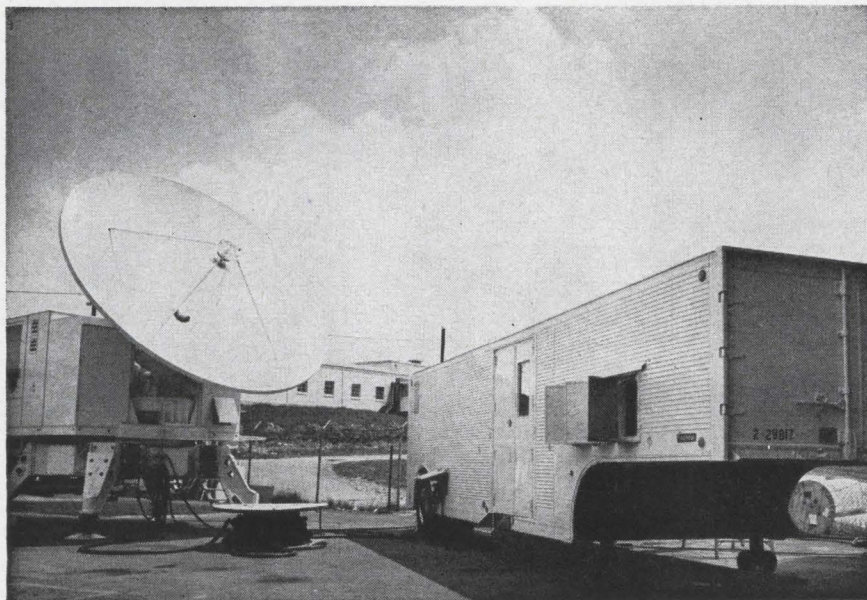

Lincoln Experimental Terminal. From the laboratory grounds at Lexington, Mass., this transportable terminal communicates with experimental satellite.

Communications

Digital techniques tried for jamproof messages

Experimental satellite communication system uses frequency hopping and digital signal processing to protect military communications

By Thomas Maguire

Boston Regional Editor

High on the Pentagon priority list is the development of techniques that will protect military communications against jamming or interference.

Last week, at the IEEE Annual Communications Convention in Boulder, Colo., staff members of the Lincoln Laboratory of the Massachusetts Institute of Technology spelled out the first details of their work in this area.

For the last month, the Lincoln Experimental Terminal (LET) has been communicating in a single terminal set-up with the Lincoln Experimental Satellite (LES-2) launched on May 6 from Cape Kennedy [Electronics, May 17, p.

18]. Irwin L. Lebow of Lincoln told the conference that the primary purpose of the system was "the communication of vocoded speech in a hostile environment."

I. Test bed

The LES/LET system, operating with a single voice and two teletypewriter channels, is the first system to use all digital signal processing together with a frequency shift modulation system.

In addition to evaluating new digital communications techniques, the experimental system is expected to provide engineering guidelines for the development of operational circuits and devices for tactical

communications.

X band. Operating on both the up and down frequencies of 8 gigacycles, the system provides an environmental test bed for development of new ground based X-band receiving terminals. Together, LES-2 and LET comprise the first system to operate completely in the X-band frequencies set aside for military communications satellites. Military experiments with Syncom have used the X band for up-link transmission, but lower frequencies for reception. The long-range purpose of the experimental system, which is sponsored by the Air Force, is to develop solid state X-band components that will meet military specifications.

All satellites. The experimental ground terminal is the first capable of transmitting and receiving via all types of satellites: passive reflectors, active repeaters and the moon.

The entire LET facility is housed in a two-part vehicle that can be towed on the ground or airlifted.

On the Lincoln Laboratory grounds at Lexington, Mass. the terminal has been operating both as transmitter and receiver during the two or three hours per day that LES-2 is in range. Experiments in voice and teletypewriter have been conducted on a regular basis since May 7.

II. New approach

The combination of advanced modulation, voice compression and coding techniques in the LET/LES system permits high-quality speech communications at approximately one-tenth the signal power required by the conventional frequency modulation approach.

To achieve reliable voice communications in conditions of heavy natural interference or jamming, the experimental system uses a 20-megacycle bandwidth to transmit the single voice and two teletypewriter channels. The antijamming capability is obtained by digitizing the incoming signals and transmitting them as 16 narrow-band signals within the 20-megacycle bandwidth.

The position of the 16 transmitted frequencies is randomly varied over the 4,096 available frequencies spaced uniformly over the system's bandwidth. On reception,

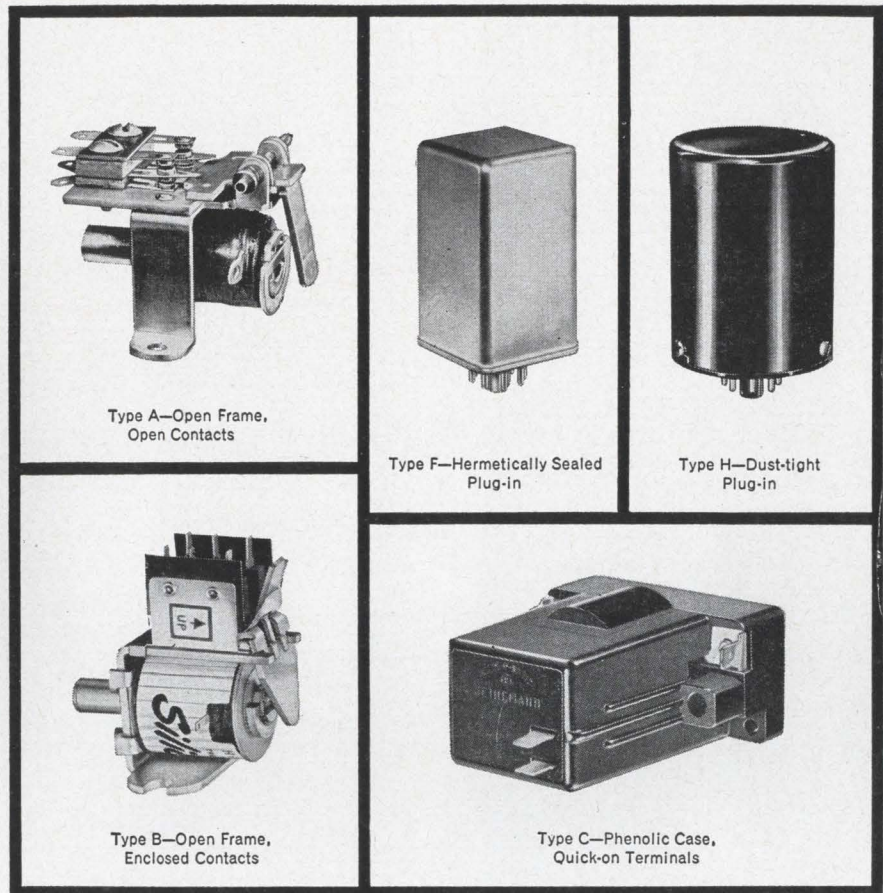

TIME-DELAY RELAYS in five economy-size packages

Any of these five Silic-O-Netic® time-delay relays can save you money. And space.

But not because the price is cheap (though it is competitive). Or because of any miracles of miniaturization (though the relays are small and compact).

The economy comes from our relays' continuous-duty construction.

The coil is specially built to enable it to remain energized indefinitely after relay actuation. This gives the relay a unique dual-function capability. It can serve as both a delay device and a load-carrying component.

If you can get by with up to 5 amps' contact capacity and SPST, SPDT or DPDT switching, you won't need a separate load relay or slave circuit.

Even if this dual-function capability holds no special allure for you, you may be interested in our Silic-O-Netic relays simply as well-made, reliable time-delay switching devices. They're available in a wide range of timings from ¼ to 120 seconds, and with a variety of AC and DC coil voltage ratings. Bulletin 5005 will give you detailed specifications. We'll be glad to send you a copy.

HEINEMANN ELECTRIC COMPANY

2600 Brunswick Pike, Trenton, New Jersey 08602

SA3189

Induction Heating's Most Trusted
and Creative Craftsmen Since 1926

Lepel

INDUCTION HEATING FOR EPITAXIAL GROWTH

- Minimum contamination since induction coil is outside the decomposition chamber.
- Uniform and controlled growth of the epitaxial layer.
- Design flexibility of gas chamber.
- High production—large number of wafers processed simultaneously.

Arrangement for induction heating within bell jar...

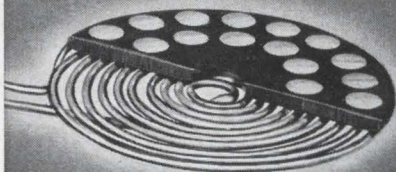

another arrangement using quartz tube...

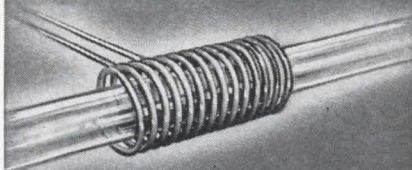

Many solid state devices used in the Electronic, Computer and Aerospace industries depend upon material produced by Epitaxial Growth. Several methods have been developed for decomposition of the carrier gas to form an epitaxial layer on the substrate. Induction heating has been found most effective, particularly when high temperatures are required.

The silicon wafers are heated to decomposition temperature of the silicon tetrachloride by conduction and radiation from the graphite susceptor which is heated by the induction coil, producing the epitaxial layer on the wafers.

WRITE FOR NEW LEPEL CATALOG

Lepel HIGH FREQUENCY
LABORATORIES, INC.

Manufacturers of INDUCTION HEATING EQUIPMENT
55th ST. & 37th AVE., WOODSIDE 77, N. Y. C.

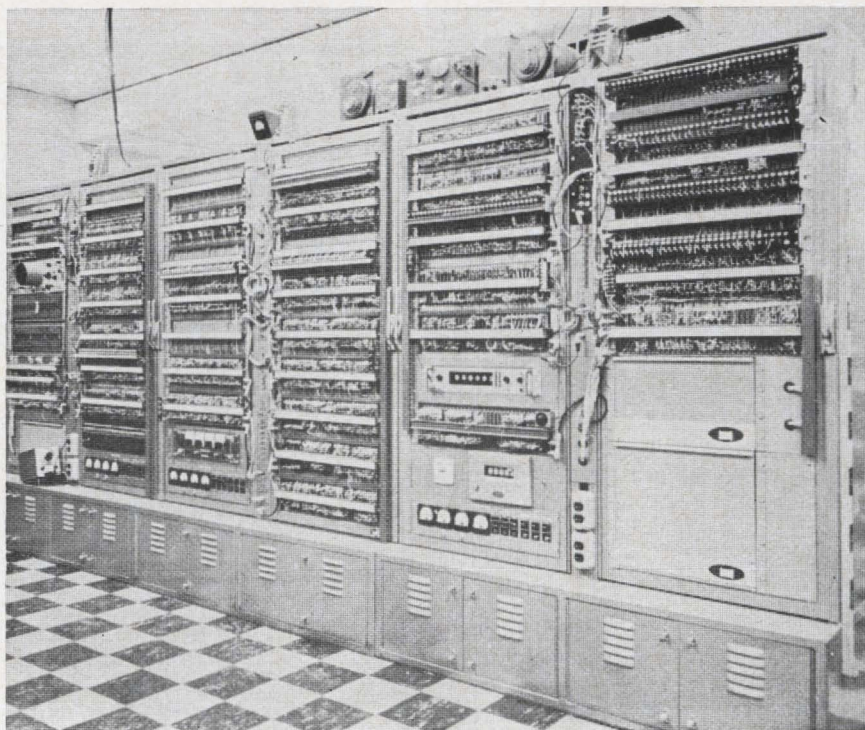

MIT's sequential encoder/decoder (SECO) here in lab form transmitted one billion bits without error. The LET uses a modified SECO system.

the signals are sequentially decoded and recombined.

Flexible digitizing. To transmit speech in digital form and to do it efficiently, the system uses a vocoder designed at Lincoln Laboratory. Normally, speech digitization would require a bit rate of about 40,000 per second. The vocoder permits transmission in one of three modes. The prime modes operate at 4,800 and 9,600 bits per second.

Vocoders are now operating in other military communications systems, principally to permit digital encoding of secret information. Lincoln's dual-mode vocoder is believed to be the first which can accept speech from remote telephone-line inputs.

Voice and pitch. When a voice comes in on the telephone line, the vocoder operates in the voice-excited mode at 9,600 bits per second. In the pitch-excited mode, the vocoder operates at 4,800 bits per second with the sender using a high-quality microphone at or near the terminal. For this mode, Lincoln Laboratory designed a highly accurate pitch detector which permits reception of speech with a high degree of voice recognizability.

In both voice-excited and pitch-excited modes, the 100-word-a-

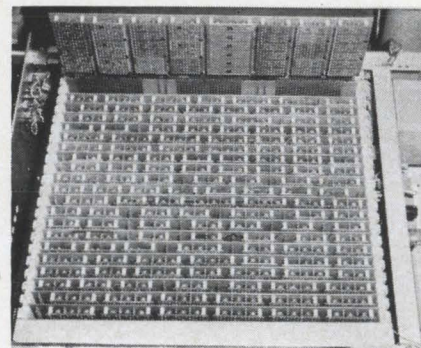

Integrated circuits cut LET's SECO size to five inches of panel space from three 6-foot racks.

minute teletypewriter channels are multiplexed in with the speech transmission. When only teletypewriter signals are being transmitted, a third mode operating at 200 bits per second is available.

Integrated-circuit elements are used throughout; as a result the entire vocoder occupies only 21 inches of rack space.

III. Frequency hopping

Generation of the modulation pattern for transmission by LET's 10-kilowatt klystron transmitter incorporates sequential coding and pseudo-random frequency selection within the transmitter bandwidth. This is the first system application of the sequential coding and de-

coding system (SECO) developed by MIT for high-speed data transmission with minimum error probability [Electronics, June 21, 1963, p. 18].

Quick changes. In the LES/LET link, the basic channel signals comprise 200-microsecond pulses located within the transmitter's 20-megacycle bandwidth. The information content of the signal is contained within a set of 16 frequencies; the frequency of each pulse depends on the information it is to transmit.

To prevent intersymbol interference on multipath channels, and to provide security against interference and jamming, the set of 16 frequencies changes from one pulse interval to another. The basic pulse interval is 200 microseconds.

Reducing errors. To reduce error probabilities, redundant information from earlier signals is added before the transmitted frequency is selected. In an encoder unit, a core store holds up to 60 previously transmitted information bits.

During each 200-microsecond interval, four bits from the encoder select one of the 16 frequencies that have been generated for transmission in that interval. Of these four bits, three are parity check digits derived from past information.

The received signal is detected in a 16-channel data receiver; the 16 channels correspond to the frequencies in use during a pulse interval. The outputs of the channels are arranged in order of amplitude, and the list of channels containing the seven largest outputs is fed to the sequential decoder.

The decoder contains a 1,000-word buffer memory with the receiver's output listings from the most recent 1,000 intervals. To derive the final output signal, probabilistic techniques are used by the decoder.

Multiplexing and demultiplexing of the digital voice and teletypewriter channels is done in a Univac 1218 general purpose computer that forms an integral part of the LET terminal.

In addition to its signal processing activities, the computer drives the 15-ft diameter antenna and also compensates for doppler frequency shift and the time delay produced

"NO LIGHT?" JUST RIGHT FOR MTI ORTH CAMERAS!

mti

World's Largest Manufacturer of Low Light Level TV Systems

This is the MTI ORTH III IMAGE ORTHICON CAMERA...

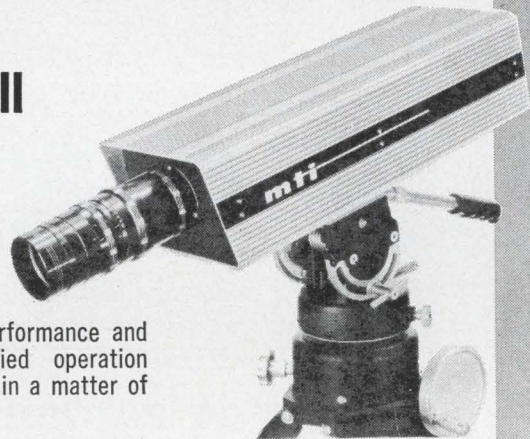

... unequalled in performance and adaptability. Simplified operation makes you an expert in a matter of minutes.

The advanced engineering, rugged construction, compact size and light weight of the MTI Orthicon TV Cameras permit adaptability in many situations where other image orthicon cameras are rendered useless.

Stability is assured by: Solid State regulated power supplies and the generous use of self-compensating feedback circuits in both sweep and video sections. Controls pre-set stay set.

Solid State, modular construction used throughout the camera and control unit. Reliability is "designed in."

With selected Image Orthicon tubes, (available at MTI) MTI Image Orthicon TV Cameras will produce high resolution pictures even at 1×10^{-5} foot candles of ambient darkness (approaching total darkness).

THE ORTH III IS ONE OF ELEVEN DIFFERENT MODELS AVAILABLE. LINE SCAN FREQUENCIES INCLUDE: 525; 675; 875; 945; 1023; 1029 OR 1201. CHOICE OF INTERNALLY GENERATED FULLY INTERLACED SYNC OR EIA SYNCHRONIZATION.

**CALL
AN MTI MAN
TODAY!**

mti

MARYLAND TELECOMMUNICATIONS, INC.

VIDEO INSTRUMENTATION

York & Video Roads — Cockeysville, Maryland (301) 666-2727

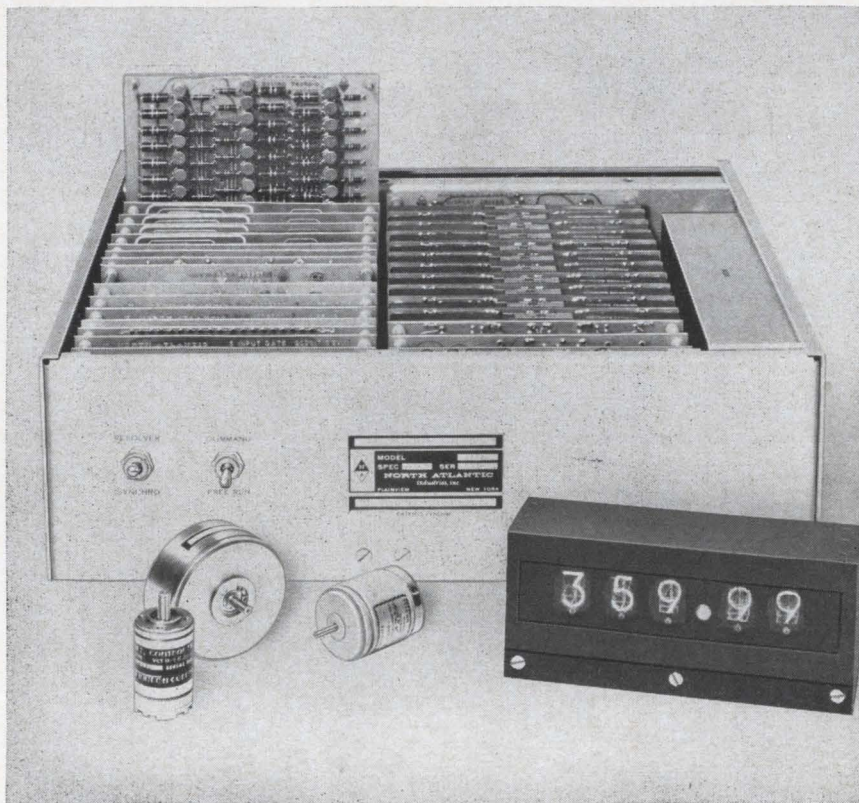

how to convert resolver and synchro angles to digits (and vice versa)

North Atlantic now brings you a new family of solid-state analog-to-digital and digital-to-analog converters for resolver and synchro data. They offer a major advance in conversion accuracy in modern navigation, simulation, data processing and measurement systems.

Typical of these new instruments is the Model API-5450 shown here. It provides both continuous and command conversion of both resolver and synchro angles, accommodates all line-to-line voltages from 11.8 to 90 volts at 400 cps. Output data is in decimal digits and is presented both as a Nixie-tube display and a five-digit printer output with supplementary print command. Accuracy is 0.01° and update time is less than 1 second.

All instruments in this family are designed to MIL-T-21200 and feature all solid-state circuitry and precision transformers—there are no motors, gears, or relays. Their flexible plug-in modular circuit design permits a wide range of variations to suit your specific requirements. For example:

- 18 bit or 10 second accuracy and resolution
- binary, BCD, or decimal inputs/outputs
- multiplexed channels
- multi-speed inputs/outputs
- high conversion speeds
- other signal frequencies

Your North Atlantic representative has complete application information. He'll be glad to help you solve interface problems in measurement and data conversion. Simply call or write.



NORTH ATLANTIC industries, inc.
TERMINAL DRIVE, PLAINVIEW, L. I., NEW YORK • Overbrook 1-8600

by transmission to and from the satellite.

IV. Antismear tactics

The combination of source and signal processing techniques protect against smearing in frequency and time by a dispersive reflector like the moon. While the computers at the terminal compensate for gross doppler and multipath effects, smaller effects, called smearing, are handled by comb filters at the receiver. These filters are set up in sets of 16 passbands. Because of synchronization of terminals, the receiving equipment knows that the desired frequency is one of 16. The sequential decoding system looks at the outputs of all 16 frequencies, and picks the strongest as the desired output. Even if the spectrum is smeared and the energy spills over into adjacent bands, the system will pick the correct output.

Low noise reception. Special care has been taken to improve the signal-to-noise ratio. The Lincoln designers expect the receiver noise temperature to be less than 100° Kelvin. A refrigerator cooled tunable parametric amplifier forms the first stage of the receiver. This is followed by a mixer to produce the 60 megacycle i-f signal. The refrigerator operates around 17° K; with correctly matched terminations on the amplifier, its noise temperature at the terminating flanges is about 55° K.

A second receiving channel is included for deriving an error signal for autotracking. But this uses an uncooled parametric amplifier running about 300° K. Control, calibration and measurement of receiver performance is accomplished remotely from a separate trailer in the two-vehicle LET system. One vehicle contains the data processing equipment and the power plant, while the other carries the antenna, receiver and transmitter.

The various approaches to the goal of secure military communications now being evaluated in the LES/LET system were reported at Boulder by the following members of MIT's Lincoln Laboratory: Paul R. Drouilhet, Jr., Irwin L. Lebow, Joseph Tierney, John Harris, Paul Rosen, R. V. Wood, Jr., Herbert Sherman, Robert M. Lerner, Philip Waldron, and Donald C. MacLellan.

An oscilloscope picture in 10 seconds: any longer is a waste of time.

Polaroid Land films don't make you wait to see if your trace zigged when it should have zagged.

They let you know in ten seconds.

They give you an oscilloscope picture you can study, attach to a report, send as a test record with a product shipment, or file for future reference.

You have a choice of 5 films for oscilloscope recording.

The standard film has an A.S.A.

equivalent rating of 3000. It comes in both roll film [Type 47] and pack film [Type 107]. They both give you 8 pictures $3\frac{1}{4} \times 4\frac{1}{4}$ inches. This emulsion is also available in 4 x 5 sheets [Type 57].

For extremely high-speed recording, there's Polaroid PolaScope Land film [a roll film, Type 410]. It has an A.S.A. equivalent rating of 10,000.

It can take pictures of traces too fleeting for the human eye: such as a scintillation pulse with a rise time of less than 3 nanoseconds.

One thing all these films have in common is a sharp, high-contrast image that's easy to read. Because the films are so sensitive, you can use small camera apertures and low-intensity settings.

To put these films to work on your scope, you need a camera that will take a Polaroid Land Camera Back.

Most oscilloscope camera manufacturers have one. For instance: Analab, Beattie-Coleman, BNK Associates, Fairchild, EG&G, General Atronics, Hewlett-Packard, and Tektronix.

You can get complete information by writing to Polaroid Corporation, Technical Sales Department, Cambridge, Massachusetts 02139, or by writing to one of the manufacturers mentioned above.

It will probably take a little longer than 10 seconds, but we promise the information won't be a waste of time.

"Polaroid" and "PolaScope"®

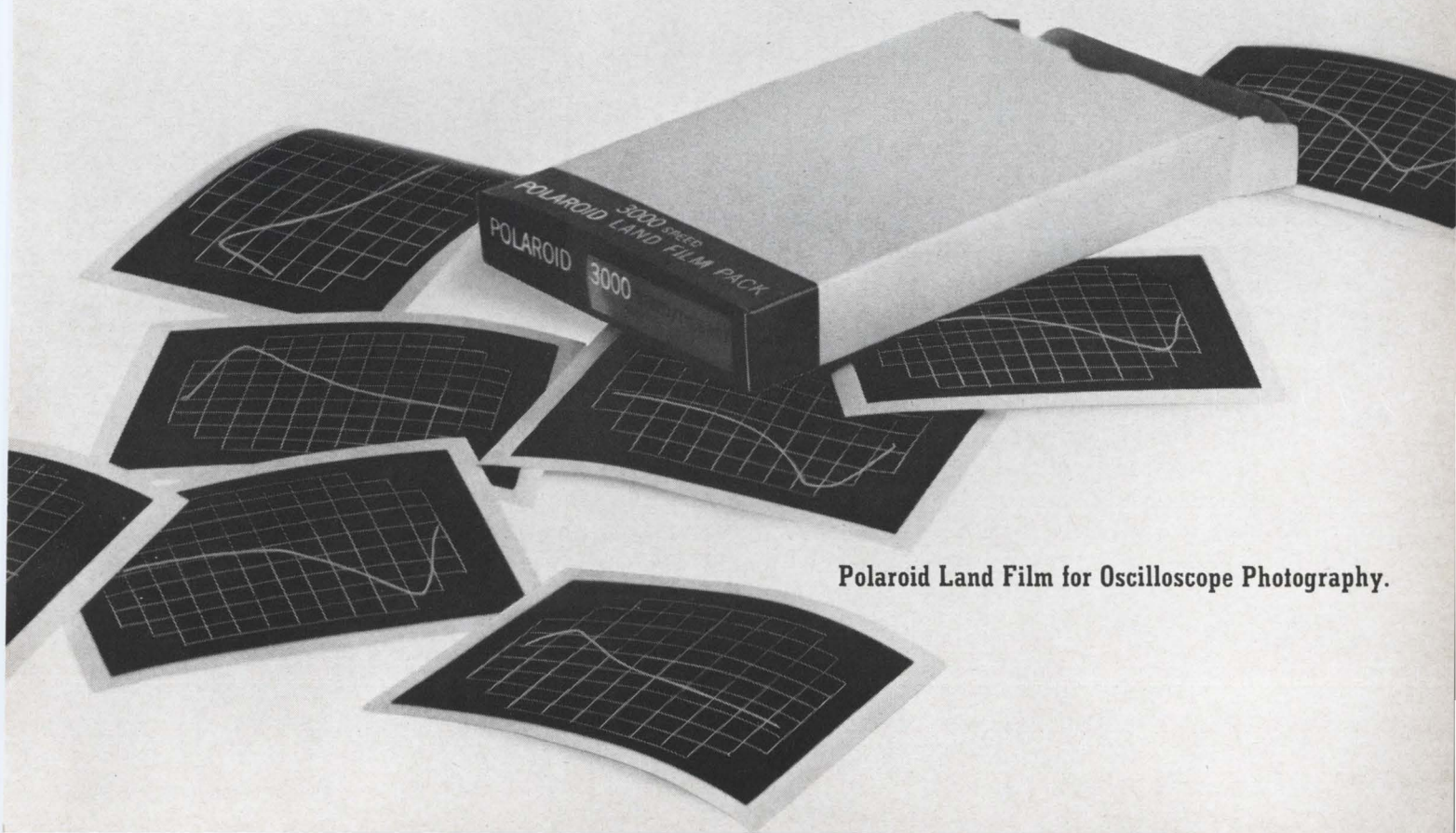

Polaroid Land Film for Oscilloscope Photography.



RESISTOR PROVING GROUND: RELIABILITY TESTING

Resistors are run under the most difficult operating conditions they might be expected to meet. Even after 1,000 hours under load, Stackpole resistors are well within the limitations of MIL-R-11 specs. This exemplifies the continual rigid testing that creates resistors of the highest quality and dependability.

Other tests are conducted to determine temperature/resistance characteristics. Perhaps you'd like to discuss this or other tests with us. Write or call: Don Kirkpatrick, Manager-Engineering, Electronic Components Division, Stackpole Carbon Company, St. Marys, Pa. Phone 814 834-1521. TWX 814 826-4808.



GOOD NEWS REPORTS:



MARIETTA, GEORGIA:

“Two 10-channel, type S-II Dynograph® recorders operating continuously since installed, May, 1964. No difficulties.”

SCOVILLE, IDAHO:

“Fourteen six-channel Type S-II instruments, used on 24-hour-day basis on tests up to eight weeks, provide most accurate data. No test data lost. No problems.”

LOS ANGELES, CALIFORNIA:

“Eighty channels on Type S-II Dynograph recorders operating perfectly. No artifacts evident in six months on high sensitivity product check-out certification tests. Customer delighted.”

This reliability and fine performance is typical of the solid-state Beckman Type S-II Dynograph Recorder. Representatives all over the country report the same thing, again and again.

Just as importantly, users find recorded data is the most accurate and best recorded of any direct-writing oscillograph. Servo feedback from every pen tip gives a locked-in trace. Between-channel time comparisons are of the highest accuracy – across 8 channels pen traces are within .010” of a straight line. Type S-II specs assure sensitivity of 1mv/div to 5v/div; differential and

floating input; system accuracy to 0.25%; and linearity of $\pm 0.25\%$ full scale. The zero weave paper and the pressurized ink supply assure fine readability and no paper drift at all speeds.

Over 30 input couplers allow the conditioning of virtually any input signal, so you can adapt the Dynograph Recorder to your changing requirements at very little cost.

This combination of reliability, accuracy and flexibility comes only with a Beckman Dynograph Recorder. For more information contact your local Offner Division Sales Engineering Representative, or write for Data File 722.

Beckman®

INSTRUMENTS, INC.

OFFNER DIVISION

SCHILLER PARK, ILLINOIS • 60176

INTERNATIONAL SUBSIDIARIES: GENEVA, SWITZERLAND; MUNICH, GERMANY;
GLENROTHES, SCOTLAND; PARIS, FRANCE; TOKYO, JAPAN; CAPETOWN, SOUTH AFRICA

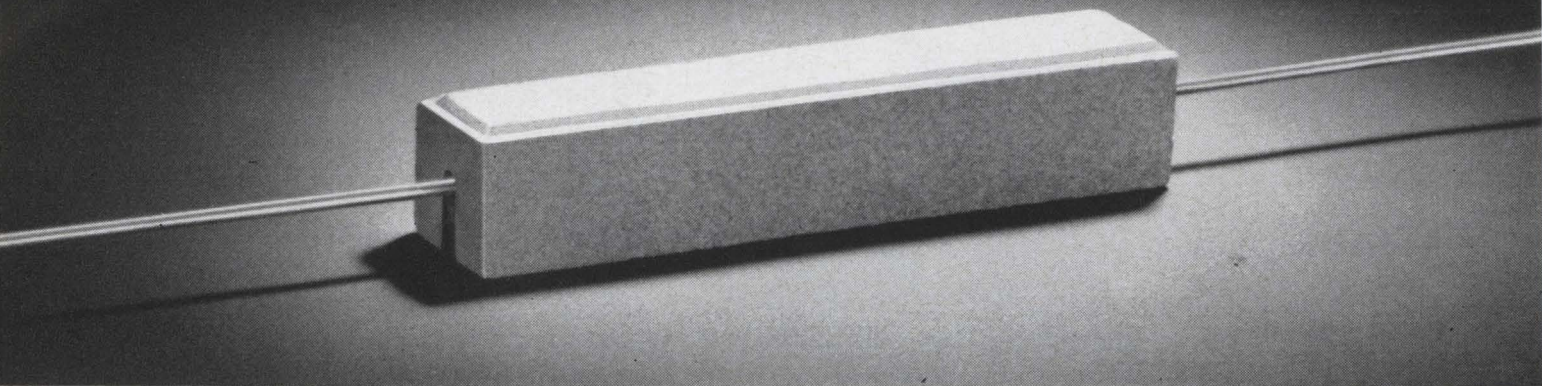













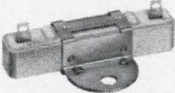

If you can find one **POWER RESISTOR**
that's best for all your needs

...order it

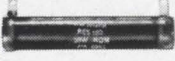
We don't think you will.

Only IRC makes all these different types... can recommend without bias.

| | | | | |
|--|---|--|---|--|
|  <p>MINIATURE PRECISION WIREWOUND MIL-R-22379. ½ to 15 watts, 20 ppm max. T.C. Tolerances to .05%.</p> |  <p>METAL GLAZE POWER FILM Stable thick-film element. Moisture resistant, non-inductive. 2 to 7 watts.</p> |  <p>UNINSULATED WIREWOUND Least expensive. Wide variety of mounting terminals.</p> |  <p>HIGH VOLTAGE RESISTORS Up to 100 kv, continuous to 90 watts. Lead, lug and ferrule types.</p> |  <p>HIGH FREQUENCY RESISTORS Unique resistance film element. Lead, lug and ferrule types.</p> |
|  <p>CERAMIC CASE WIREWOUND Low cost commercial grade. Fireproof inorganic construction. 2 to 50 watts.</p> |  <p>FUSE RESISTOR Resistor, or fuse under overloads. Low cost, fully insulated. Axial or plug-in leads.</p> |  <p>TEMPERATURE COMPENSATING WIREWOUND Wirewound current limiters. Compensates up to 0.55%/°C.</p> |  <p>PRINTED CIRCUIT WIREWOUND Rated at 5 watts. Resists humidity and shock.</p> |  <p>IGNITION BALLAST WIREWOUND Ignition, appliance or motor start ballast. 50 watts.</p> |
|  <p>FLAT WIREWOUND Vertical or horizontal stack mounting saves circuit space. 30 to 95 watts.</p> |  <p>TUBULAR WIREWOUND MIL-R-26. 6 to 250 watts. Available with lugs or leads. Resisteg coated.</p> |  <p>ADJUSTABLE WIREWOUND For resistance or voltage adjustments. Tubular and flat styles. Spring contact adjustment. 12 to 250 watts.</p> |  <p>TAPPED WIREWOUND Save space and cost. Use as voltage divider network. Tubular and flat. 12 to 250 watts.</p> |  <p>FERRULE WIREWOUND Fast installation and interchangeability. Standard fuse clip mount. 20 to 215 watts.</p> |

Write for Power Resistor Selection Chart... complete data in handy 11" x 17" size.



INTERNATIONAL RESISTANCE COMPANY

Bellows focuses electron beam gun

Mechanical technique eliminates complex optical systems to obtain optimum focus while maintaining vacuum

A mechanical bellows which can move the filament and grid of an electron beam gun in a high vacuum, thus changing the focus, has resulted in beam heating equipment that is simple in design and considerably lower in price than previous equipment. The technique, recently patented by the National Research Corp., a subsidiary of the Norton Co., achieves optimum beam focus by moving grid and filament in two perpendicular planes. In previous designs, these pieces were fixed and had to be preset while the vacuum system was open. The new technique also eliminates the complex optical system which was used to focus the beam.

Electron beam heating is used for welding, etching, annealing, refining and melting by bombarding material with a narrowly focused beam of electrons to produce intense heat at the target point. Since it is carried out in a vacuum, the method provides freedom from contamination. By confining the heat-affected area to microscopic size, power density higher than that of lasers can be achieved (4 kw on a spot 0.025 in. in diameter). For microcircuits, use of lower power can confine the heat-affected area to a spot 0.003 in. in diameter, and an 0.002 in. spot is possible.

A frequent problem in microcircuit etching is to produce a pattern in thin films. In many cases, this is done by photographic techniques, but these involve multi-step chemical processes which introduce contaminants. Electron beams can be used to etch away undesired areas of a pattern from a continuous film under the high purity of a vacuum. An NRC spot gun can also be used to outgas, evacuate, weld and seal in a single



C.B. Sibley, senior development engineer at the National Research Corp. equipment division, adjusts electron beam gun to change focus during operation.

operation, as for example, in hermetic sealing of electronic components, potted electronic devices or nuclear fuel elements.

The new design is incorporated in an electron beam welder (NRC 2406). This unit is capable of welding a 1/8-inch thick piece of tungsten in a single pass. In addition, the equipment can be used for pre-heating, post-heating, button melting and sintering.

The price of the basic equipment, which includes gun and focusing system but not the vacuum system varies from \$5,000 to \$9,000, depending on application requirements. An electron beam welder making use of this gun, for example, might use equipment costing about \$20,000. Compared to the prices of competitive units,

these figures represent a savings of about half. However, the system's biggest advantage is in its reduction of set-up and processing time, which may also be as great as 50%.

Specifications

| | Electron gun |
|--------------------------|-------------------------------------|
| Spot diameter | 0.002-0.003 inch |
| Beam voltage | 20-25 kv |
| Operating frequency | 500 cps, maximum |
| Beam current range | 20-100 microamperes |
| Beam deflection | ±1/8 inch |
| Average working distance | 2 inches from end of gun tube |
| Deflection input signal | provided by customer |
| | Grid control unit |
| Bias-activating pulses | 10 microseconds duration |
| Pulse magnitude | 50-70 volts (50 ohm source) |
| | Pulsed source supplied by customer. |

National Research Corp., 70 Memorial Dr., Cambridge, Mass.
Circle 350 on Reader Service Card

Protection for costly r-f tubes

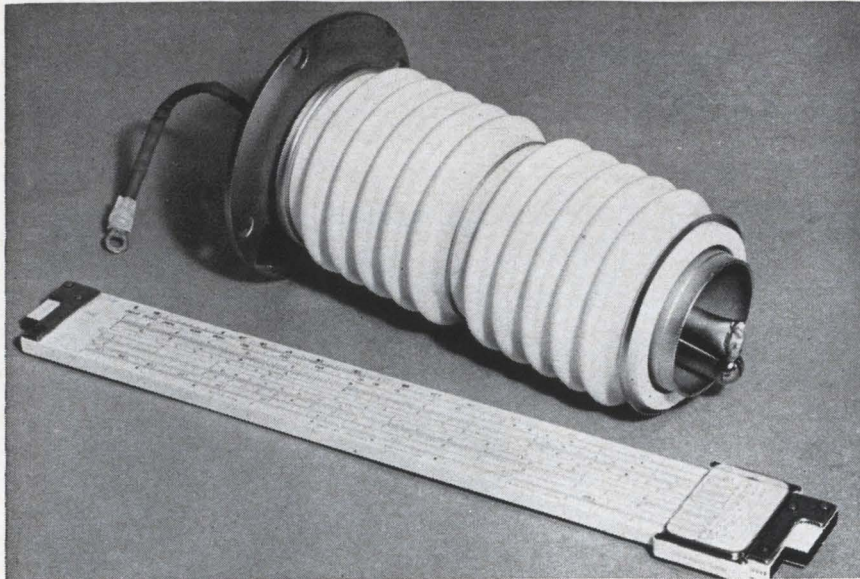

When sudden faults, such as breakdown or flashover, occur in high-powered radar or other high-voltage systems, excessive current can completely destroy the expensive r-f tubes commonly used unless, almost instantaneously, the current is diverted from flowing through them.

Presently available energy diverters, commonly called crowbars, have several disadvantages: they take up a lot of space, protect the tubes only over a limited range of voltages, and are extremely noisy. When a short circuit occurs in air-gap crowbars, the energy is diverted from the main circuit through a bank of capacitors that discharges with a bang loud enough to disconcert anyone operating the equipment.

A new family of energy diverters has been developed to overcome these disadvantages. Although their main purpose is to protect costly r-f tubes, they can also be used to switch nonrepetitive current pulses into low-impedance loads.

These energy diverters incorporate a new feature called a triggered vacuum gap. In effect, they are extremely high vacuum tubes when inactive, and vapor tubes when a fault appears.

This is the operating principle: in its nonconducting state, a high-vacuum gap maintained within a ceramic tube withstands high voltages. A fault is detected by a logic circuit that triggers an ionic discharge within the tube. A metal vapor plasma is generated inside the tube by evaporation of the electrode material as current passes through it. The amount of metal vapor formed is proportional to the current being conducted through the tube. The vapor forms a diverting current path away from the main circuit. When the fault ceases, vapor generation stops, and the gap recovers its vacuum state very quickly.

Triggered vacuum gaps have characteristics which are not found in other crowbar devices: they can operate at voltage levels ranging from a few hundred volts to many kilovolts; can be triggered in less than a microsecond by energies of only a hundredth of a joule, operate equally well in any position; and are not affected by temperature, pressure, or humidity variations. Additionally, they have a high tolerance to nuclear radiation, and are much smaller than other devices used for the same purpose.

General Electric has introduced one model, ZR-7512 (see table),

**AUTHORIZED
ERIE
DISTRIBUTOR**

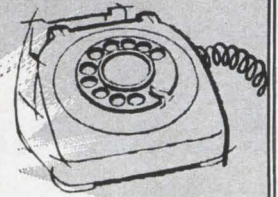

For Erie Components In-Stock Call

ARIZONA
Phoenix
Kierrulff Electronics Corp.—273-7331

CALIFORNIA
Glendale
R. V. Weatherford Co.—849-3451
Inglewood
Newark Electronics Corp.—OR4-8441
Oakland
Elmar Electronics, Inc.—TE4-3311
Palo Alto
R. V. Weatherford Co.—DA1-5373
San Diego
R. V. Weatherford Co.—BR8-7400
South Pasadena
Capacitors, Inc.—MU2-3541

COLORADO
Denver
Newark-Denver Elect. Supply—757-3351

DISTRICT OF COLUMBIA
Hyattsville, Maryland
Milgray/Washington, Inc.—UN4-6330

FLORIDA
Orlando
Crescent Elect. Sales Co.—423-8586

ILLINOIS
Chicago
Newark Electronics Corp.—ST2-2944

INDIANA
Indianapolis
Graham Elect. Supply, Inc.—ME4-8486

MARYLAND
Baltimore
Whlse. Radio Pts. Co., Inc.—MU5-2134

MASSACHUSETTS
Boston
DeMambo Electronics—783-1200
Newton
Cramer Electronics, Inc.—WO9-7700

MICHIGAN
Detroit
Newark-Ferguson Elect., Inc.—548-0250

MISSOURI
St. Louis
Electronic Components for Industry Co.—647-5505
Kansas City
ECI Semiconductor, Inc.—931-0829

NEW MEXICO
Alamogordo
Kierrulff Electronics Corp.—437-0370
Albuquerque
Kierrulff Electronics Corp.—268-3901

NEW YORK
New York
Arrow Electronics—MY4-6800
Newark Electronics Center—255-4600
Milgray Electronics, Inc.—YU9-1600
Rochester
Rochester Radio Supply Co.—454-7800

NORTH CAROLINA
Winston-Salem
Electronic Wholesalers, Inc.—PA5-8711

OHIO
Cincinnati
Newark-Herrlinger Elect. Corp.—421-5282
Columbus
Electronics Marketing Corp.—299-4161

OKLAHOMA
Tulsa
Engineering Supply Co.—LU3-8121

PENNSYLVANIA
Philadelphia
Radio Elect. Serv. Co. of Pa., Inc.—WA5-5840
Pittsburgh
Cameradio Company—391-4000

TENNESSEE
Nashville
Electra Distributing Co.—AL5-8444

TEXAS
Dallas
Engineering Supply Co.—FL7-6121
Houston
Engineering Supply Co.—MO6-2175

WASHINGTON
Seattle
Universal Electronics Co.—MA3-2783



FORMERLY ERIE RESISTOR CORP.

644 West 12th Street
Erie, Pennsylvania

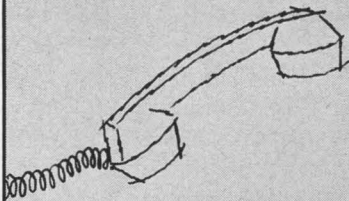

CALL YOUR AUTHORIZED
ERIE DISTRIBUTOR FOR...

ERIE SUBMINIATURE BROAD BAND RFI FILTERS

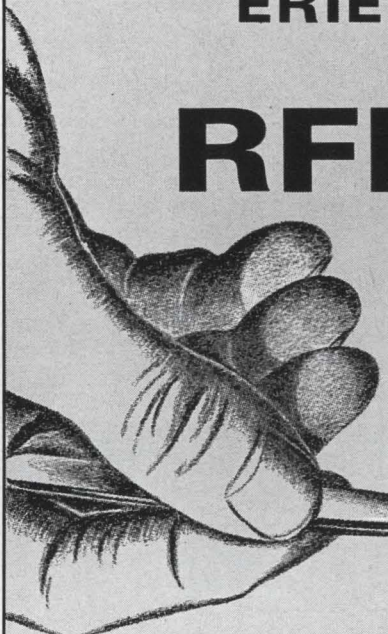

Actual Size

Exclusive Features!

**HIGH ATTENUATION • HERMETICALLY SEALED
SUBMINIATURE • RELIABLE • IN-STOCK**

Erie's Subminiature Broad Band RFI Filters are only *one-fourth* the size of conventional filters . . . yet they provide better attenuation performance in the 10KC to 10KMC frequency range. That's why they are selected for major Aerospace Systems . . . size and efficiency.

These hermetically sealed Filters are designed to eliminate the problem of Electro-Magnetic Interference caused by switches, relays, motor commutators, SCR and transistor switching. No longer is it necessary to use bulky paper capacitor-coil combinations . . . or large conventional filters. Erie Broad Band Filters provide better attenuation *in only a fraction of the space*. AND THEY ARE AVAILABLE FROM STOCK . . . NOW.

The attractive price of these reliable filters makes them ideal for Commercial and Industrial applications as well as for Aerospace circuitry. Mounting arrangements to suit application.

In addition to Broad Band RFI Filters, Erie produces a complete range of subminiature filters suitable for YOUR SPECIFIC application. These too are available from stock.

Call or write now for quality ERIE RFI FILTERS. Remember, your ERIE distributor is your one-stop filter source.

Typical Attenuation Curve

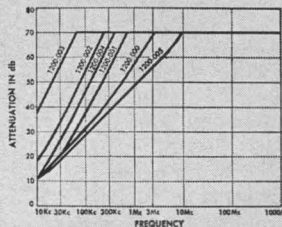

OTHER ERIE RFI FILTERS IN-STOCK

- Subminiature High Frequency, Low Pass 
- Miniature High Capacitance and High Voltage Types 
- Miniature Threaded Bushing and Eyelet Mount Types 
- Miniature 6 and 12 Section Filters 

Call Your
AUTHORIZED
ERIE
DISTRIBUTOR

- **CAPACITORS**
Subminiature Monobloc
Tubular and Disc Ceramics
Stand-Off
Feed-Thru
Mica
Film
Solid Tantalum
Trimmers (Ceramic, Glass, Quartz)

- **FILTERS**
Broad Band EMI Filters
EMI Filters (High Freq., Low Pass)
Multi Section Filters
- **SEMICONDUCTORS**
Silicon Diodes (Diffused Junction)
Germanium Diodes
Silicon Rectifiers
Semiconductor Assemblies

Advanced Components Through Increased Volumetric Efficiency

Formerly
Erie Resistor
Corporation

ERIE
TECHNOLOGICAL
PRODUCTS, INC.



644 West 12th Street
Erie, Pennsylvania



Ask us! Perhaps we can tailor "SCOTCHPAR" polyester film to fit your needs

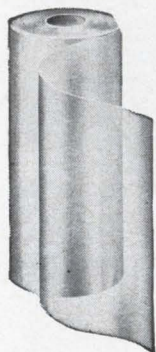

No other polyester material comes in so many patterns. Thick or thin! Slippery or non-skid! Or, even sealable! A tailored "SCOTCHPAR" electrical grade film may be the answer to your specific need. Perhaps you've a special insulation problem . . . if so, why not let us know exactly what you need. Our laboratories are equipped to provide hundreds of variations to basic polyester film. Contact: 3M Co., Film & Allied Products Division, 2501 Hudson Rd., St. Paul, Minnesota, Dept. ICL-65.

Scotchpar[®]
BRAND
electrical grade
polyester film

"SCOTCHPAR" IS A REG. T.M. OF 3M CO.

3M
COMPANY

New Components

and has several others under development, including a 350-kv model to protect a klystron used in equipment for the Signal Corps.

Specifications

| | |
|---------------------|---------------------|
| Model | ZR-7512 |
| Voltage range | 300v to 45kv |
| Peak current | 70 kiloampere |
| Energy diverted | 15 kilojoules |
| Over-all dimensions | 3½ in. x 8 in. |
| Response | less than 0.1 μsec. |

General Electric Co., Microwave Tube Dept., Schenectady, N.Y. [351]

Photocell and lamp in compact package

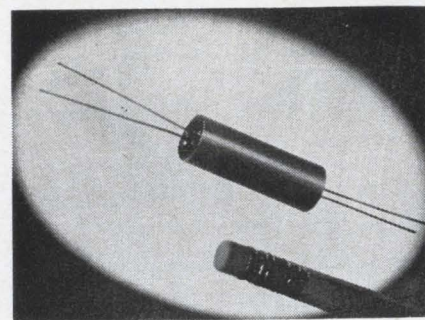

The Photomod, a new family of devices, makes available two types of photocells and two types of lamps in one cylindrical package measuring 0.375 in. in diameter by 1.125 in. long. Within this module, the lamp and the photocell are optically coupled to provide a switching device in cases requiring isolation between a tuned input and an output.

The cells are either cadmium sulfide or cadmium selenide; lamps are neon or incandescent. The CdSe line is suited for switching and low power "on" applications in a variety of circuits, while the CdS unit is designed for high-quality audio circuits, motor controls and other electrical configurations where a scratchless potentiometer is desired.

Switching times range from 5 to 80 ms, depending on the type of lamp specified. Voltage ratings are 6, 12, 24 and 120 v. Current ratings for Photomods using incandescent lamps are 40 ma; neon-based Photomods are rated at 3 ma. Minimum "off" resistance for the line

is in the 100-megohm range.

Delivery is within one or two weeks and unit prices range from \$1.25 to \$4 depending on quantities. The units are capable of 5,000 hours of operation at rated voltages.

Clairex Corp., 8 West 30th St., New York, N.Y., 10001. [352]

Coil form tubing is miniaturized

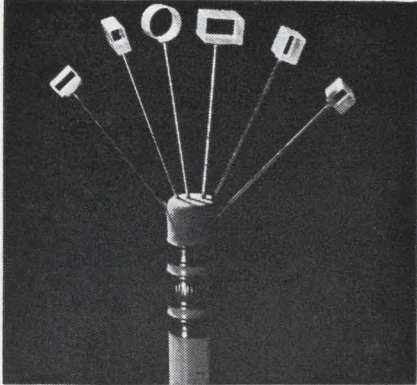

To meet the requirements of miniaturized magnetic windings, coil form tubing is now being produced with wall thicknesses of 0.005 in. and cross-sections of 1/4 in. square or less. Fiberglass cloth 0.001 in. thick and Class F epoxy resin are the ingredients. The material is wrapped on precision mandrels and fully cured under heat and pressure to make lengths of tubing up to 4 in. Microminiature coil forms of glass-laminated epoxy exhibit excellent physical strength and compatibility. Inside corners are a sharp 90°. Open stock tooling in a variety of sizes can be delivered in 7 to 10 days.

Stevens Tubing Corp., 128 N. Park St., East Orange, N.J. 07019. [353]

Package combines diode and terminal

A unique type of component incorporates a diode as part of a solderless wire terminal, the manufacturer reports. Termed a diode gating terminal, the unit houses any type of switching diode or low current rectifier diode (limited to 1 amp for the present). These gating terminals (or splices) are available with certain popular diodes or



Making something out of polyester film? "SCOTCHPAR" is the answer to your needs



It's true! "SCOTCHPAR" polyester film can be modified in many ways to suit your specific electrical insulation needs. Clear or opaque! Thick or thin! Releaseable or bondable surface! Or, perhaps you have some other requirement that calls for surface changes in basic polyester. Ask us! We'll be happy to serve you. Contact: 3M Co., Film & Allied Products Division, 2501 Hudson Rd., St. Paul, Minnesota, Dept. ICL-65.

Scotchpar[®] electrical grade
BRAND polyester film

*SCOTCHPAR[®] IS A REG. T.M. OF 3M CO.

3M
COMPANY

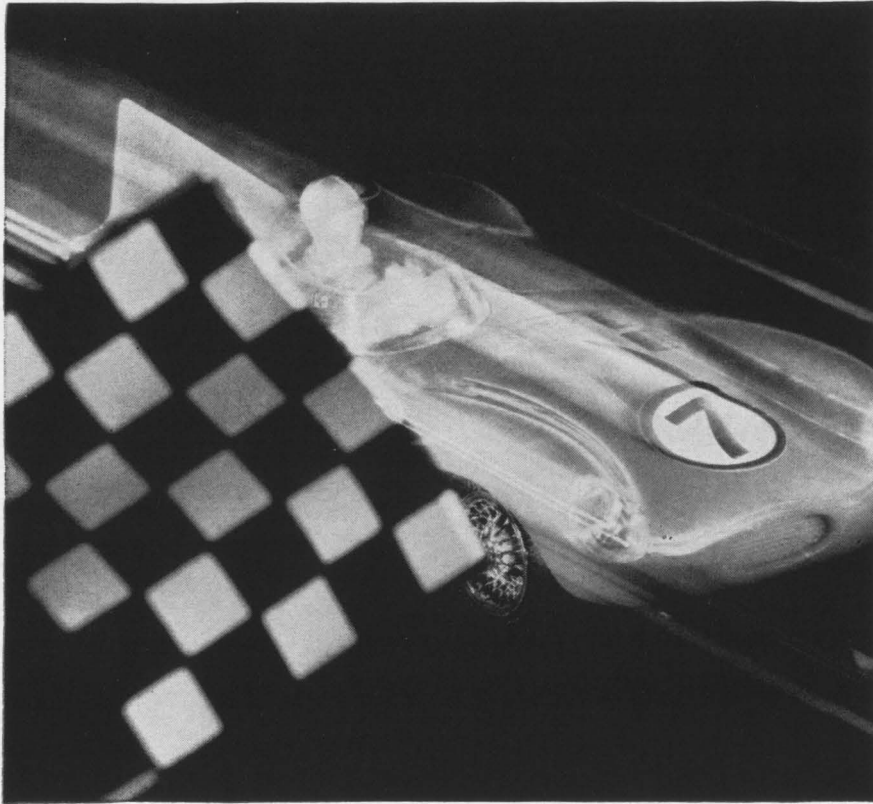

Mystik 7420 gets the checkered flag...

from model racing buffs everywhere! These miniature speedway magnates use Mystik copper foil pressure sensitive tape as the conductive track for their high speed model racing cars.

The reasons? Mystik 7420 can be readily conformed to meet curved track patterns. With cars reaching speeds scaled to 140 mph. on the straightaway, the conductive track must take a rugged beating. That's where our copper foil tape really shines. And, 7420's pressure sensitive, synthetic adhesive grips like a vise!

But, you don't *have* to be a model racing bug to use our 7420. It's great for printed circuit layouts, electrostatic shields, microwave strip transmission line components, and many other electrical and electronic applications.

Mystik 7420 is just one of a complete line of quality special purpose tapes Mystik offers at competitive prices.



A DIVISION OF BORDEN CHEMICAL COMPANY

FREE SELECT-A-TAPE SAMPLE GUIDE!

Takes the guesswork out of tape selection. Gives physical characteristics of all Mystik tapes, typical applications, sizes, principal advantages. Send for your copy today. MYSTIK TAPE, INC., 1700 Winnetka Ave., Northfield, Ill.

NAME _____
 COMPANY _____
 ADDRESS _____
 CITY _____ STATE _____ ZIP _____



New Components

may be packaged utilizing the customer's diode in various terminal-head configurations. Typical applications include patch cord gates, interchassis or intercard cabling in place of matrix assemblies, reverse current blocking devices, and point-to-point wiring.

One end of the diode/terminal is equipped with a crimping insert, the other end with a terminal or another crimping insert (splice configuration). Terminal types available include ring or rectangular tongue, spade, block spade, spade flared, and hook or taper pin, as well as splices. The diode is housed in a plastic (PVC) outer tube. Mechanical, electrical and environmental requirements will meet customer specifications. Sample quantities are available from stock. A free kit of diode/terminals with cathode facing terminal or cathode facing insert as well as gating splice samples are available upon request.

Hollingsworth Solderless Terminal Co.,
 4320 NW 10th Ave., Ft. Lauderdale,
 Fla. [354]

Slide switch works at right angles

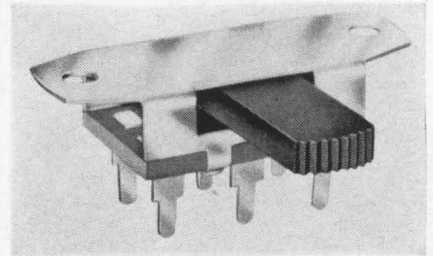

This switch will be useful where switch action is required at right angles to that normally available. Called the Sydewynder, it is designed specifically for printed-circuit applications where front panel switch actuation is required. The extended right-angle knob is long enough to project directly through the front panel, eliminating the need for supplemental mechanical devices.

A wide selection of terminal types, knob lengths, and mounting configurations permits broad use of this new component. Made of

one-piece nickel-plated steel, the switch is available with solder terminals as well as standard printed-circuit terminals. Terminals are normally silver-plated although silver alloy or gold plating can be supplied. Electrical specifications for this U-L approved unit include a current rating of 3.0 amps a-c or 0.5 amp d-c at 125 v. Continental-Wirt Electronics Corp., 26 W. Queen Lane, Philadelphia, Pa., 19144. [355]

Teflon-insulated transistor sockets

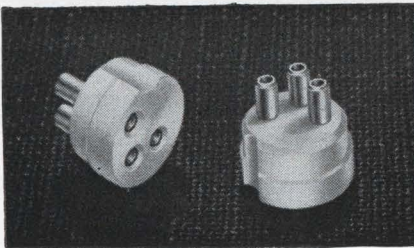

A Press-Fit holder has been designed for the 2N3229 power transistor. The TS-310 holder has three floating lugs on a 0.200-in. pitch circle. They will accept 0.037-in. diameter leads. Press-Fit hardware for electronics assemblies is designed for rapid, permanent installation into prepunched holes. This Teflon-insulated socket is pressed into place at production rates with a special tool, the B-35, available from the manufacturer. Only 100% pure Teflon is used. All terminals are available in any of the ten EIA colors.

Seaelectro Corp., 225 Hoyt St., Mararoneck, N.Y. [356]

Time delay relays use solid state design

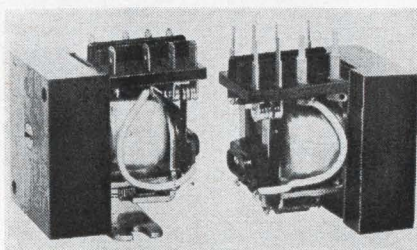

Inexpensive, transistorized time delay relays, known as the TIR series, are designed for use in industrial and commercial applications

Ballantine AC-DC Digital Voltmeter

Model 355

Price: \$590



Measures Full Scale AC to 10 mV

Measures AC & DC from 0 to 1000 V

1/4% Accuracy f.s. for AC & DC Voltages up to 500 and for mid-band AC Frequencies

NEW The only Digital Voltmeter of its type in the U.S.A.

Ballantine's new Model 355 is a versatile, economical digital voltmeter . . . ideal for production line and quality control applications.

You'll find it useful in place of analog instruments in reducing personnel errors, in speeding up production. Its accuracy and reliability, so typical of Ballantine equipment, should start saving you time and money in its first day of operation.

The Model 355 features a servo-driven, three-digit counter with over-ranging . . . combines many virtues of both digital and analog voltmeters in one small, compact, economical package. Its large, well-lighted readout with illuminated decimal point, mode and range information, allows fast, clear readings, while the indicator can follow and allow observation of slowly varying signals. The position of the last digit can be interpolated to the nearest tenth, thus avoiding the typical "± 1 digit" restriction of a fully digitized display. An optional foot-operated switch retains voltage readings and enables you to cut the time between successive readings materially. Another aid in reducing personnel errors is provided by an over-range indicator that signals excessive input or voltage of the wrong polarity.

PARTIAL SPECIFICATIONS

| Voltage Range | AC | DC | Accuracy in % of Full Scale | AC | DC |
|--|------------------|-----------|-------------------------------------|--|-----------------------|
| | 0 to 1000 | 0 to 1000 | | 1 mV to 500 V | 1/4%, 50 Hz to 10 kHz |
| Full scale, most sensitive range | 10 mV | 100 mV | | 1/2%, 30 Hz to 50 kHz | |
| Frequency Range | 30 Hz to 250 kHz | DC | | 1%, 50 kHz to 250 kHz | |
| Optional Model 600 Resistors are available for measuring current directly in volts | | | | Power Requirements 115/230 V, 50-60 Hz, 52 W | |
| | | | | Relay Rack Version Model 800 rack mounting kit is optional | |

Write for technical data sheet

Member Scientific Apparatus Makers Association

— Since 1932 —



BALLANTINE LABORATORIES INC.
Boonton, New Jersey

CHECK WITH BALLANTINE FIRST FOR DC AND AC ELECTRONIC VOLTMETERS/AMMETERS/OHM METERS, REGARDLESS OF YOUR REQUIREMENTS. WE HAVE A LARGE LINE, WITH ADDITIONS EACH YEAR. ALSO AC/DC LINEAR CONVERTERS, AC/DC CALIBRATORS, WIDE BAND AMPLIFIERS, DIRECT-READING CAPACITANCE METERS, AND A LINE OF LABORATORY VOLTAGE STANDARDS FOR 0 TO 1,000 MHZ.

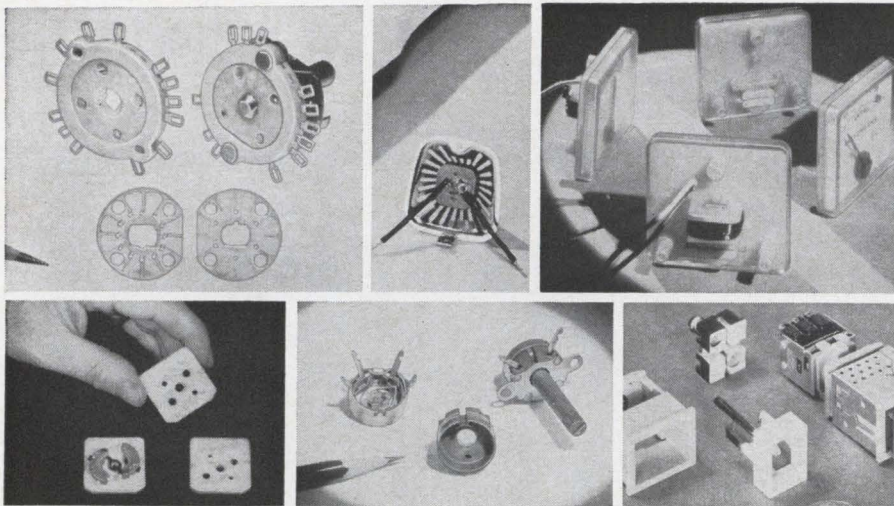

Fiberglass reinforced thermoplastic molding compounds are solving problems of precision, strength and reliability in dozens of electrical-electronic applications.

Get FREE Manual of physical and dielectric properties of high performance FRTP® materials for electronics!

Fiberglass reinforced thermoplastic injection molding compounds have extra dimensional stability, strength, precision molding characteristics, and improved dielectric properties. Such advantages make these high-performance materials ideally suited to a wide range of connectors, coil forms, mountings, receptacles, frames, housings and structural parts for a variety of electronic components. Investigate these materials for your product today.

FREE ENGINEERING MANUAL

New manual is most complete compilation available of data on FRTP's. Pages of charts, tables, applications and comparisons of properties. Send for your free copy today.

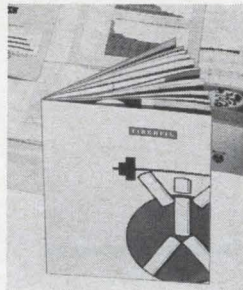

FIBERFIL®

FIBERFIL, INC.
Evansville 17, Indiana

Circle 213 on reader service card

New Components

and are directly interchangeable with mechanical, pneumatic and thermal timers where delay upon energization is required. The TIR series is a solid-state electronic timer with a dpdt relay output rated for 10 amps resistive at 115 v a-c. It is available to operate from standard a-c and d-c voltage sources with fixed delay periods of 1 to 100 seconds in one-second increments. The manufacturer offers a life expectancy of 5,000,000 mechanical operations, a choice of five different mounting configurations, and a list price of \$9.96 each in 1-9 quantity.

Syracuse Electronics Corp., P.O. Box 566, Syracuse, N.Y., 13201. [357]

Lamps imbedded in colored rubber

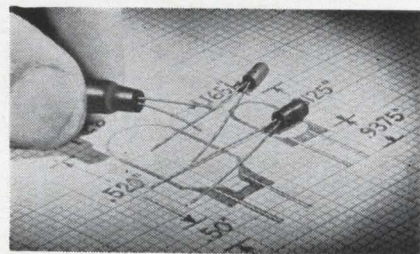

A new series of miniature lamps is available for wedge lighted instruments, illuminated word indicators, switches and other information display devices featuring standard, unbased lamps completely imbedded in colored silicone rubber. Imbedded lamps cannot leak light from the rear to cause color dilution under illumination, as is often the case when boot-type filters are used. An added feature is the shock-mount protection against breakage afforded the glass envelope and fine wire leads of the lamp itself. Lamps are available in the T-3/4, T-1, and T-1 3/4 types. They are stocked in a variety of standard mil-spec colors for immediate delivery, or can be produced on order to any special color requirement. All lamps are imbedded in silicone rubber conforming to Mil-R-5847, Class III, assuring maximum resistance to salt spray, sunlight, ozone and many

1 KC to 600 KC Receiver from CEI



Receives AM, SSB, CW, MCW & FSK with digital frequency display

CEI's new Type 351 receiver covers ELF through MF frequencies, tuning 1 to 600 kc in a single band. Modes of reception include AM, SSB, CW, MCW and FSK, with tuned frequencies shown on a big, bright digital display. For increased versatility four IF bandwidths (150 cps, 1, 3 and 6 kc) can be selected with a front panel control. An input attenuator control (0, -20, -40 and -60 db) is also mounted on the front panel. The Type 351 features low noise, excellent sensitivity and good image and IF rejection. BFO can be adjusted ± 3 kc, while incidental FM is less than 10 cps peak deviation.

Using solid state circuitry throughout (except for the neon display tube), the Type 351 weighs 20 pounds and requires just 3 1/2 inches of rack space. It operates from a standard 115 vac source.

For complete information about this or other CEI products, please write:



COMMUNICATION ELECTRONICS INCORPORATED

6006 Executive Boulevard, Rockville, Maryland 20852, Phone: (301) 933-2800

acids, and will withstand temperature extremes ranging from -62°C to $+225^{\circ}\text{C}$.

Master Dynamics, 165 San Lazaro, Sunnyvale, Calif. [358]

Trim capacitor's end is sealed mechanically



Small, high-capacitance, piston trimmer capacitor GS11184 features a sealed end that has been mechanically closed without use of solder. According to the manufacturer this permits repeated soldering to the turret cap without fear of the unit's falling apart, which sometimes happens in units where the turret cap is soldered to the capacitor. Maximum diameter is $\frac{5}{16}$ in., the length behind the panel is $\frac{5}{16}$ in., capacitance is $1.0\ \mu\text{mf}$ to $10.0\ \mu\text{mf}$, and Q at 1 Mc is 1,000 minimum. Temperature coefficient is $\pm 50\ \text{ppm}/^{\circ}\text{C}$. Insulation resistance is 10^6 megohms. Dielectric strength is 1,000 v d-c at 50% relative humidity at maximum rated capacitance. D-c working voltage is 500; operating temperature is -55° to $+125^{\circ}\text{C}$; torque is 1 to 5 in.-oz.

Roanwell Corp., 180 Varick St., New York, N.Y. 10014. [359]

Multipattern board for flatpaks

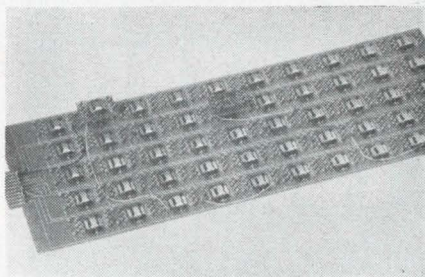

Breadboarding of a complete integrated circuit computer is possible with a new multipattern board for

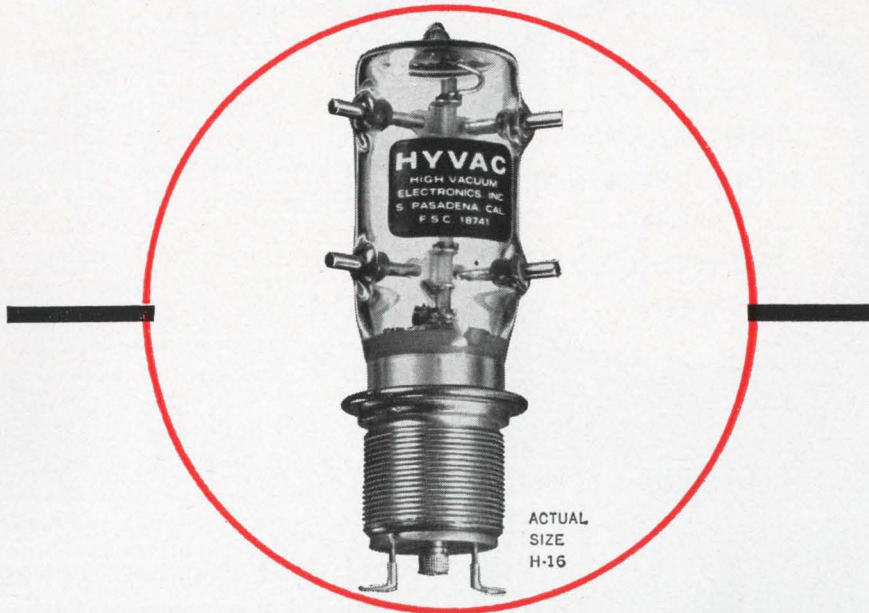

Why Hyvac puts a high voltage relay in a vacuum—

one word... **RELIABILITY!**

VACUUM RELAY RELIABILITY means short contact travel, low contact mass, contacts free of oxides and pitting and minimum contact bounce. These long-life reliability features are made possible only because of operation in a high vacuum dielectric. Vacuum technology has made high reliability, long life high voltage switching practical, with considerable savings in space and weight. Developed for high voltage, high peak current applications, Hyvac relays are well suited and widely used in radar, communications, pulse forming networks, ECM, sonar, medical electronics, antenna switching and antenna couplers, microwave systems and switching in explosive atmospheres. Hyvac's broad line and "Quick Reaction Time" is geared to your most critical delivery schedule. We have the high vacuum experience, design and production capability to provide special modifications of our standard off-the-shelf designs in unbelievably short order. Hyvac, a company small enough to be responsive, large enough to be responsible. Check the brief specifications of our "H" series:

| HYVAC TYPE | H-8 | H-9 | H-11 | H-12 | H-14 | H-16 | H-17 |
|--------------------------------------|------|------|------------------|-----------------|-----------------|------------------|------|
| Contact Arrangement | SPDT | SPST | SPST | SPDT | DPDT | DPDT | SPDT |
| Rated operating voltage (kv dc) | 20 | 20 | 12-air 18-oil | 8-air 12-oil | 8-air 12-oil | 12-air 18-oil | 25 |
| Continuous current, *max. (amps-rms) | 15 | 15 | 15 | 15 | 15 | 15 | 25 |
| Operating time, max (ms) | 15 | 15 | 18 | 18 | 18 | 20 | 25 |
| Coil voltage, nominal (vdc) | 26.5 | 26.5 | 26.5 | 26.5 | 26.5 | 26.5 | 26.5 |
| Approx. price (1-9 pcs) | \$98 | \$98 | \$105 | \$110 | Factory quote | | |

*Carry only

For complete technical information, contact your nearest sales engineering representative, or write directly to us.

HYVAC

HIGH VACUUM ELECTRONICS INC. • 538 MISSION STREET
SOUTH PASADENA, CALIFORNIA • PHONE: (213) 682-2149 • TWX 213-449-2552

FOR
DRILLING
AND ROUTING
CIRCUIT BOARDS
AND
REINFORCED
RESINS

SOLID CARBIDE

◀ DRILLS

◀ FLUTED
ROUTERS

◀ FIBERGLASS
ROUTERS

UNEQUALLED METAL REMOVAL
COMPANY SERVICE, QUALITY
AND SELECTION INCLUDING:

1. World's largest inventory of centerless ground drill blanks and finished tools ready-for-shipment.
2. Fifteen centerless grinders in production of drills and rotary carbide tools.
3. Every size carbide drill, ground from-the-solid . . . the smallest — .008" diameter to the largest — 1.500" diameter.
4. Precision ground to 5 micro-inch finish or better.
5. Delivery from stock, through our distributors, of any standard solid carbide tool in 48 hours.

Your assurance of product quality, lowest cost and dependable service is the fact that the nation's leading carbide tool users are placing their tool contracts with The Metal Removal Company.

THE METAL REMOVAL COMPANY

1859 W. Columbia Avenue
Chicago, Illinois 60626

Plants Located in CHICAGO • LOS ANGELES • SAN JUAN



MASTER TOOL AND WHEEL
MAKERS FOR THE WORLD

New Components

flatpack integrated circuits. The company started making individual test sockets for flatpacks and found that increasing use of these integrated circuits was creating a demand for convenient breadboarding hardware. The glass epoxy board permits life and reliability testing of up to 50 integrated flatpack circuits. There is no need to solder or weld the circuits; a snap-action cover holds them. Each flatpack pattern on the breadboard is equipped with a molded plastic lead separator to prevent lead damage and keep them separated to prevent lead shorting. Jumpers of various lengths permit connections on either side of the board. Pin connections are designed with close-entry, beryllium copper contacts. Price is \$197 each for small quantities (1 to 4); delivery is in about three weeks.

Augat, Inc., Attleboro, Mass. [360]

Dual-latcher relays have high reliability

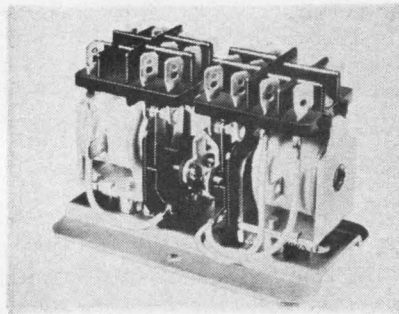

A general purpose dual-latcher relay, the 25BL, is said to offer greater reliability and better performance than competitively priced relays. In the new unit, two relays are mounted on a common base connected by a latching mechanism. A momentary impulse on the unlatched coil causes the contacts to close and remain latched until the other coil is pulsed.

The relay is said to have extremely long mechanical life—in excess of 20 million operations. Electrical life is dependent on load characteristics. Another advantage is lower pull-in voltages (d-c, 75% of nominal voltage; a-c, 78% of

NCC

Where quality comes First

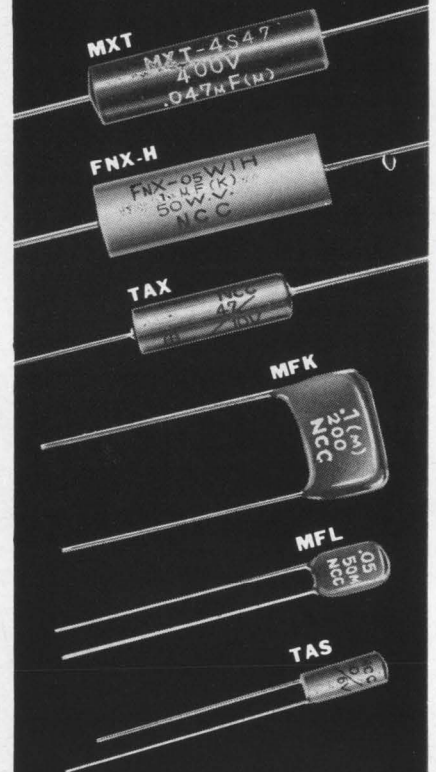

POLYESTER FILM CAPACITOR:

| | Capacitance Range: | Voltages |
|---|--------------------|-------------------------------|
| TYPE MFL Dipped Flat Shape | .001 MFD to 47 MFD | 35v, 50v, 100v, 200v, DC |
| TYPE MFK Dipped Flat Shape Non-Inductive Construction | .01 MFD to 22 MFD | 100v, 200v, 400v, 600v, DC |
| TYPE MXT In Plastic Tube | .001 MFD to 22 MFD | 100v, 200v, 400v, 600v, DC |

METALLIZED POLYESTER FILM CAPACITORS

| | | |
|--|----------------|--------|
| TYPE FNX-H Mylar Wrapped Semoval With Epoxy End Seal | 1 MFD to 10MFD | 50v DC |
|--|----------------|--------|

SOLID TANTALUM CAPACITORS

| | | |
|---|-----------------|---|
| TYPE TAX MIL-C-26655A Hermetically Sealed | 1 MFD to 220MFD | 3v, 6v, 10v, 15v, 20v, 25v, 35v, DC |
| TYPE TAS Sealed with Epoxy Resin | | |

MATSUO ELECTRIC CO., LTD.

HEAD OFFICE:

3-5, 3-CHOME, SENNARI-CHO, TOYONAKA-SHI,
OSAKA, JAPAN.

TOKYO OFFICE:

25-2-CHOME, KANDA AWAJI-CHO, CHIYODA-KU,
TOKYO, JAPAN.

Cable Address "NCC MATSUO" OSAKA

nominal voltage. Designed for heavy duty, 2pdt, 4pdt or 6pdt switching, on a-c or d-c inputs, the 25BL relays are rated at loads of 5 or 10 amps at 115v a-c. They weigh 4.5 oz. Standard contact material is gold-plated silver cadmium oxide, with other materials available on request.

The a-c version of the 25BL relay has operating voltages of 0.5 to 250. Current range is 0.005 to 10 amps and temperature range -55° to $+72^{\circ}\text{C}$. The d-c version has operating voltages of 1.5 to 130. Current range is 0.015 to 10 amps and temperature range, -55° to $+85^{\circ}\text{C}$. Coil voltages on the a-c range from 6 to 230; on the d-c, from 6 to 110. E.W. Bliss Co., Eagle Signal division, Davenport, Iowa. [361]

Tiny reed relay for printed circuits

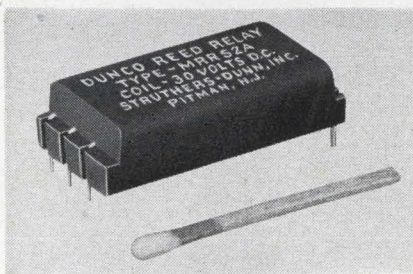

A low profile, subminiature reed relay has been designed to meet the compact packing requirements of printed circuits. Only 1.3 in. long by 0.625 in. wide, the units mount tightly against the mounting board and stand only 0.350 in. high.

Designated as type MRRS2A, the units contain two Form A (normally-open) reed switches rated at 10 watts each. Single or dual-coil models are available for operation on 6, 12, or 24 v d-c. The units are electromagnetically shielded internally and encapsulated into rigid, homogeneous structures that provide maximum protection. Standard, 0.172-in. grid-spaced right angle leads are positioned by slots in the molded case. Arrangement of leads makes it impossible to insert relays incorrectly into circuit boards. Single-coil types are also available with electrostatic shielding in addition to the standard electromagnetic shielding. Struthers-Dunn, Inc., Pitman, N.J., 08071. [362]

Some Conservative Comments on Our Superlative Switches

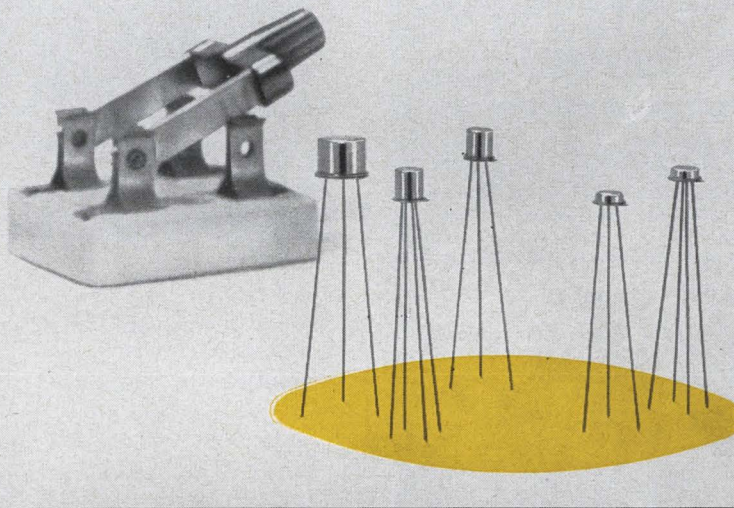

The world's broadest line of low level switching devices is now broader than ever. As of yesterday, we have over 50 different types.

Among the newest are our CM600-603 **Switching FETs**, which are designed specifically for low level choppers and multiplexers. They feature inherent zero offset voltage and low on-resistance, together with low gate current and low capacitance. Because these devices are voltage-operated, no drive transformer is needed for most applications.

For ultra low leakage, check our 2N2944-2N3219 line of **PNP Silicon Switching Transistors**. They're available in standard pairs with offset voltage matched to 50 microvolts from -25°C to $+100^{\circ}\text{C}$.

For circuit simplicity, we offer 26 types of **Integrated Choppers** (3N90-95 and 3N100-119) featuring high voltage ratings and 50 microvolts maximum offset voltage. Contrary to the popular belief that integrated choppers are expensive, our prices start at \$5.00 in 100 quantities.

We placed the knife switch in the picture because it exemplifies a high ON-OFF ratio, which is a major feature of any Crystalonics chopper. Our high switching efficiencies are largely due to our exclusive **Silicon Epitaxial Junction Process**, which combines the advantages of alloyed, epitaxial, and planar techniques, and provides extreme ruggedness and parameter stability.



Crystalonics, Inc.

147 SHERMAN STREET • CAMBRIDGE 40, MASS. • TEL: 617-491-1670
6715 HOLLYWOOD BLVD. • HOLLYWOOD 28, CALIF. • TEL: 213-463-6992

RELIABILITY
is built-in



PERFORMANCE
is read-out

KEITHLEY DC Differential Voltmeters

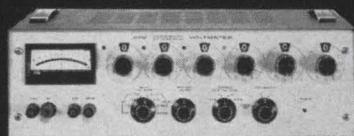

The 0.02% 660A and 0.01% 662 dc differential voltmeters are so stable they maintain their accuracy for a full year. You can forget about periodic standardization or manual recalibration!

Only these differential voltmeters feature a guarded null detector with f.s. sensitivities from 100 μ v to 500 v. At null, input resistance is infinite to 500 v. Each model uses a photochopper-stabilized 500 v supply with T.C. Zener reference, and a Kelvin-Varley divider. Annoying reversal error is virtually eliminated. Easy operation is accentuated by a front-panel polarity switch and in-line readout.

Choose the features
that meet your needs

| Feature | Model 660A | Model 662 |
|---------------|-------------------------|-------------------------|
| Accuracy | 0.02%, or 20 μ v | 0.01%, or 10 μ v |
| Repeatability | 0.005% | 0.0025% |
| Readout | 5 dials | 6 dials |
| Price | \$650 | \$995 |

Send for Engineering Notes
on our Differential Voltmeters



**KEITHLEY
INSTRUMENTS**

12415 Euclid Avenue • Cleveland 6, Ohio

New Instruments

Three-in-one gaussmeter

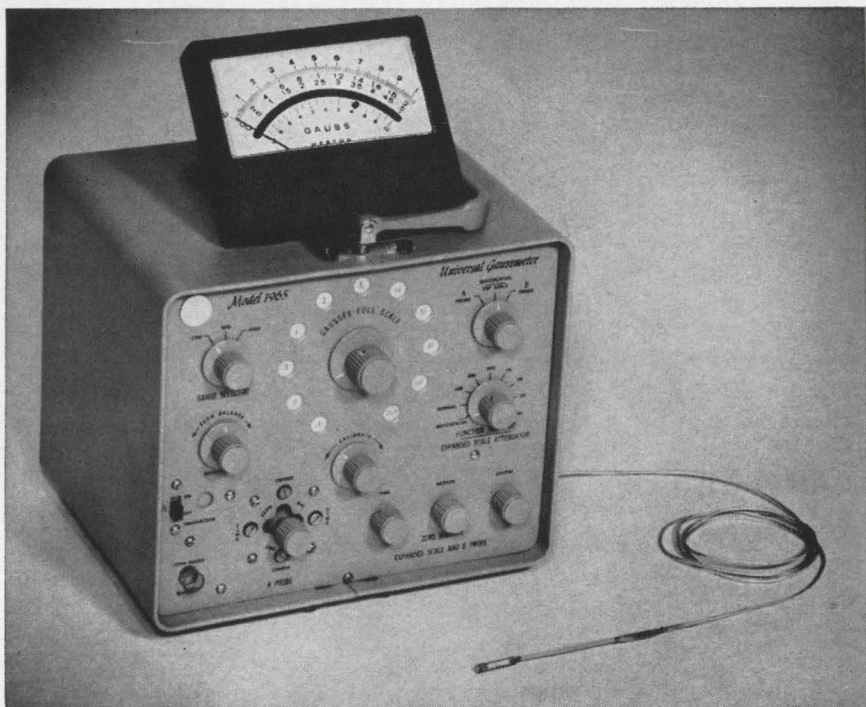

A gaussmeter, using Hall elements, combines in one instrument the capability to measure absolute magnetic field densities, make differential or gradient flux measurements and detect incremental variations of a magnetic field. The new model 1965 gaussmeter, developed by Radio Frequency Laboratories, Inc., can make measurements from 0.03 gauss to over 20,000 gauss, either d-c or a-c, from 20 cycles to 400 cycles per second.

The application of Hall generators to magnetic circuit-testing has opened new vistas to investigators of magnetic structures. RFL's development is a successful attempt to increase the versatility and precision of these instruments.

Indium arsenide, crystalline in form, is the Hall element mounted on a substrate of inert material—alumina. The resulting element is only a few thousandths of an inch thick and is protected by a coating of epoxy. Fiber glass isolates the element from the epoxy to prevent strain resulting from thermal expansion of the epoxy. The probe is flexible—with the exception of the tip—and no metal is exposed, mak-

ing it safe for use around electrical circuits.

RFL's gaussmeter has three distinct modes of operation. One probe measures the absolute value of static or a-c magnetic fields. An expanded scale technique allows the same probe and instrument to measure extremely small changes in static fields. The expanded scale feature enables determination of field variations to a maximum resolution of four parts per million. Maximum scale expansion is by a factor of 100 and variations as small as 0.001 gauss can be seen in a field of 100 gauss. Measurements are read on a meter which can be set to a center zero in the expanded scale mode. In this manner, polarity of field variations can also be sensed.

The third mode of operation involves the use of two matched probes. The differences between two fields, or small variations in a given field, can be determined by a single reading. In this mode, the gradient of a magnetic field can also be measured; the probes are inserted in a small slotted fixture to keep them parallel and at a

known separation. This gradient measurement is much simpler and more accurate than the method of using a single probe to plot field levels at various points.

The differential technique also provides scale expansion. For example, if the field being measured has a flux density of 1000 gauss and the gradient is on the order of 10 gauss, the gaussmeter may be operated in its differential mode at a full-scale range sensitivity of 10 gauss. A zero gauss chamber is built into the front panel of the instrument, facilitating electrical balance of the Hall probes in a near-zero magnetic field.

The accuracy of model 1965 is $\pm 1\%$ of full scale. It can be operated from a 50/60 cycle line or from a battery supply. Its versatility permits measurements, during production, of leakage fields in relays, external fields around wave guides, and the effects of machinery operation on magnetic fields.

The device can be combined with other RFL equipment to form systems for permanent magnet-charging, measurement, and stabilization. The attached meter, an oscilloscope, or a printer handles the readout.

Specifications

Accuracy

Absolute and differential modes

$\pm 1\%$ plus reference magnet accuracy when using probe reference data supplied

Expanded scale mode

An additional 0.1% may be evident depending upon scale expansion used

Magnetic field frequency

Permanent magnetic and electro-magnetic field and a-c fields from 20 to 400 cycles per second. Gaussmeter reads average value of a-c fields

Temperature stability

Less than 1% change of sensitivity and less than one gauss zero balance shift for 10°C change of element temperature

Size

10" x 9" x 9"

Weight

17 lbs.

Availability

From stock

Price

\$1,050 (standard unit)

Radio Frequency Laboratories, Inc., Boonton, N.J. [381]

Recorder-sweeper drive permits direct recording

Series 1570 recorder-sweeper drive unit permits direct, automatic recording of frequency versus ampli-

REMOTE dual feedthrough sampling head (for the Lumatron Model 120A Sampling Oscilloscope) brings the sampling to *your circuit*, eliminating hookup cable losses and distortions. You measure what is actually taking place at your circuit. In addition, the *straight* feedthrough coax is free of distortions caused by elbow bends.

FAST risetimes less than 0.1 ns can be displayed and measured with fidelity with less than 4 mv noise (reduced by smoothing) through calibrated ranges of 2-200 mv/cm . . . a NOT CAL light warns when the 3:1 vernier is in use.

MATED with the standard Lumatron Model 2170 Horizontal Unit the Oscilloscope has over 4 Kmc triggering . . . plus an unusual 60 ns of viewing range at a sweep speed of 1 ns/cm and faster using the delay controls . . . and all the convenience of the basic Model 120A Oscilloscope . . . *at no added cost.*

AUTOMATED readout of a 100 ps risetime oscilloscope is possible with the use of a Model 2440 Automatic Waveform Reader inserted in the "3rd plug-in" compartment of the 120A Oscilloscope (lower right section). The Remote Sampling Head is brought to the test fixture for maximum response.

PRE-TRIGGER can be provided in the Oscilloscope frame by inserting a Model 2305 Pre-Trigger Pulse Generator in the "3rd Plug-in" compartment (lower right section). The Generator provides a delayed 1 ns R.T. output to drive the circuit under test with ± 25 V max. (2305A to ± 40 V).

HIGH-IMPEDANCE operation is possible using a standard oscilloscope probe by terminating the feed through Sampler with an impedance higher than 50 ohms. (normal 30 mc oscilloscope probes give a few ns risetime when used with the 2161)

Lumatron Nanosecond Instruments are manufactured by

General Applied Science Laboratories, Inc.
Merrick and Stewart Avenues, Westbury, L. I., N. Y. • 516—ED 3-6960

(ask for Russ Jones, Instrument Sales Manager)

Limitron Fuses

...for the Protection of Semi-Conductor Rectifiers



LIMITRON fuses provide extremely fast opening on overload and fault currents, with a high degree of restriction of the let-thru current.

If each SCR and individual diode is protected by a proper size Limitron fuse, the fuse will open to protect the unit when the current drawn exceeds the rating of the unit. Thus the SCR or individual diode is taken out of the circuit before damage can be done to other diodes in the rectifier.

For full information and opening time charts ask for BUSS Bulletin HLS.

MORE **BUSS QUALITY** FUSES

BUSSMANN MFG. DIVISION
McGraw-Edison Co., St. Louis, Mo. 63107

For Protection of

Circle 159 on reader service card

New Low Cost
Solid State Oscillators
(Available in volume from Sanders)

DG41
DG42
DG43

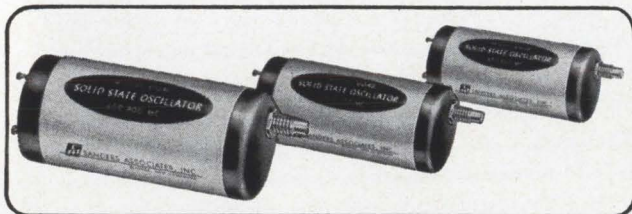

Designed for a miniature cylindrical outline, three new Sanders low power, all solid state UHF oscillators are available to you in ratings that cover the range from 0.6 to 1.2GC in 200 mc bandwidths.

The minimum output power for the series is DG41, 25 milliwatts, DG42, 20 milliwatts and DG43, 10 milliwatts. D.C. input voltage for the three devices remains at 30V maximum and typical D.C. input current is 16ma @ 28V. Operating temperature range between -55°C and +71°C. Frequency stability with temperature is typically 120ppm/°C. Each oscillator-cylinder is 1-1/16" diameter.

See how Sanders is a full year ahead in advanced design solid state oscillators that will generate the required frequency at any power level. Get all the facts, they're free! Write Sanders Associates, Inc., Microwave Products Dept., Nashua, New Hampshire.

*T.M., Sanders Associates, Inc.

CREATING NEW DIRECTIONS IN ELECTRONICS
SANDERS ASSOCIATES, INC.

Circle 158 on reader service card

**Smallest 3-Phase
Electronic Frequency Converters
Ever Made!**

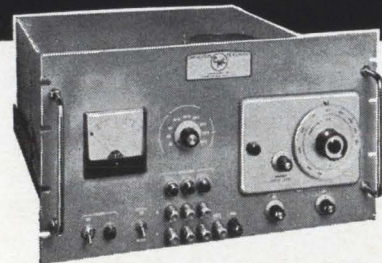

Now, from CML, comes a series of the smallest 3-phase Electronic Frequency Converters ever made... featuring fixed or adjustable plug-in oscillators at frequencies ranging from 45 to 6,000 cycles. Write today for details on Models T500A through T2500A!

| Model | 3 ϕ Output VA | Dimensions (For standard 19" relay rack mounting) |
|--------|--------------------|--|
| T500A | 500 | 8 $\frac{3}{4}$ " h x 21" d |
| T750A | 750 | 14" h x 21" d |
| T1200A | 1200 | 14" h x 21" d |
| T1750A | 1750 | 14" h x 21" d |
| T2500A | 2500 | 14" h x 21" d |



CML, Inc.

A Subsidiary of Tenney Engineering, Inc.
350 Leland Avenue • Plainfield, New Jersey
Telephone (201) 754-5502 • TWX: 201-756-2064

Circle 215 on reader service card

New Instruments

tude response (gain, standing wave ratio, insertion loss, power, etc.) in log (40 db), linear or square-root presentation. Incorporating variable-speed, bidirectional drive with automatic limit stops, the unit synchronizes the sweeper frequency with the recorder chart system's servo amplifier. Designed for use with most modern sweepers, it can be used with servo-driven strip-chart recorders and X-Y recorders, in addition to the manufacturer's series 1500 antenna pattern recorders. Other features include a times-ten chart expansion for narrow-band operation and a frequency indicator so that sweeper frequency can be read directly.

Scientific-Atlanta, Inc., P.O. Box 13654, Atlanta, Ga., 30324. [382]

Frequency synthesizer is small and fast

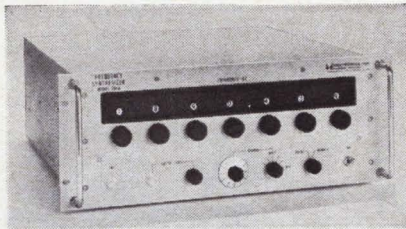

Model 304A is a solid state synthesizer that offers small size, low price and 1-millisecond switching time. According to the manufacturer, it is less than half the size and weight of comparable equipment. At a base price of \$6,950, it is said to offer performance equivalent to instrumentation costing twice as much. Units employ the direct synthesis method. No phase-

locked oscillators are used in this form of synthesis, which results in extremely pure output signals that can be multiplied to the microwave frequencies. Harmonic content is more than 30 db below the fundamental, and spurious content is 60 db down. Long-term stability and accuracy are the same as that of the input standard. An optional internal standard is also available.

Model 304A generates frequencies up to 11 Mc in steps of 1 cps. Output is 1 v rms \pm 1 db. Frequency may be selected by front panel decade knobs or remote contact closures. Special purpose programmers can be used to operate the synthesizer from a remote position on a preset program providing any number of outputs on command.

A search oscillator may be used to vary continuously the output frequency. The oscillator may be

Semi-Conductor Rectifiers

Limitron Fuses

...for the Protection of Semi-Conductor Rectifiers

LIMITRON fuses are available in ampere sizes up to 800 and voltages up to 600.

They come in various types and sizes to fit various types of application.

Should you have a special problem, our staff of fuse engineers are ready to assist you at any time.

For full information on LIMITRON fuses for the Protection of Semi-Conductor Rectifiers ask for BUSS Bulletin HLS.

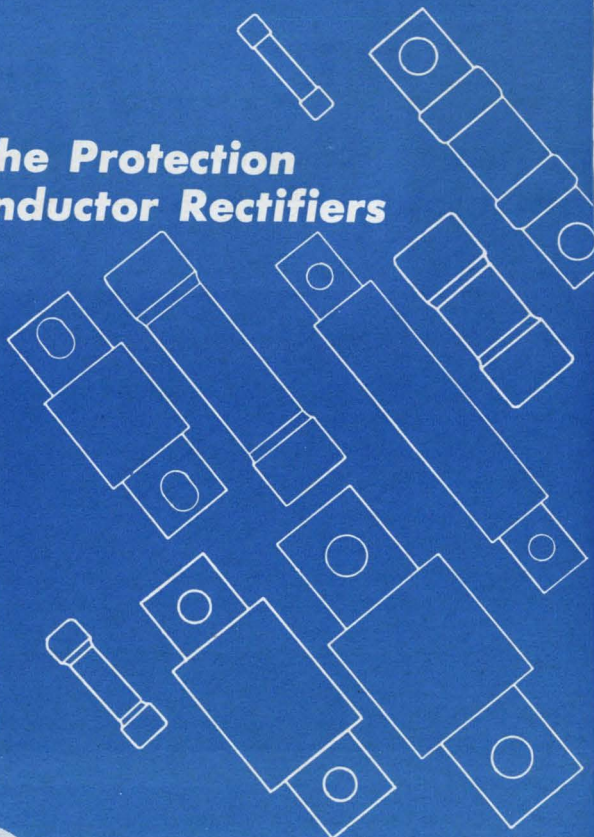

MORE **BUSS QUALITY** FUSES

BUSSMANN MFG. DIVISION
McGraw-Edison Co., St. Louis, Mo. 63107

"SPECIALS"

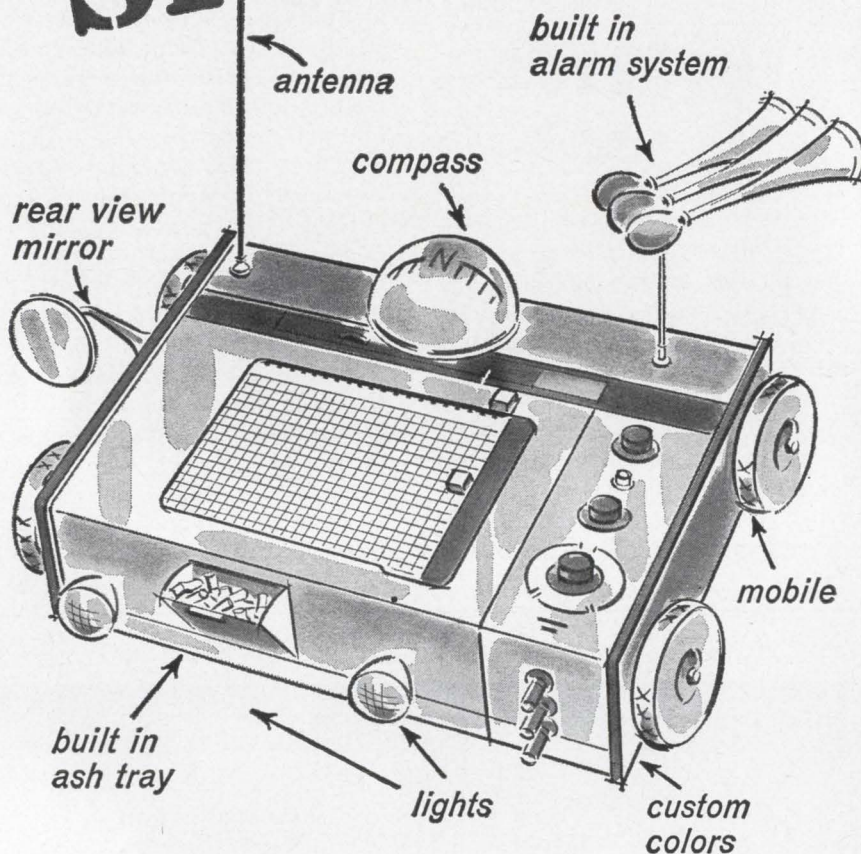

IN V.O.M. RECORDERS

Ever seen a Recorder that looks like this? Neither have we—yet! But we've made just about every other modification in the book for our customers—with 1 range, 2 ranges, with push-button zero, with different scales, and with special chart papers. We've painted them custom colors, put a variety of customer designations on them. You name it, we'll do it! Just let us know what, and the quantity. We'll work up a quote that'll be a pleasant surprise to you.

There are a goodly number of people who buy the standard instruments without modification, singly and in O.E.M. quantities. Boring, really, but we *do* fill these orders along with the specials. The standard Bausch & Lomb V.O.M. Recorder is a 5 inch Strip Chart Recorder that will record volts, ohms and milliamps directly. It has 5 built-in chart speeds, built-in event marker, built-in take-up reel, 5 voltage ranges, 6 linear ohms scales, 4 D.C. current ranges. Full scale sensitivity is 10mv, 2.5mv or 500 microvolts depending on the model selected. It has a number of other advantages, too. And, we have accessories, a variety of them, that make our recorders so versatile it hurts (other recorder manufacturers, that is!).

If you want further information on our standard recorders, so that you can tell us how you want them changed, write for Catalog 37-2068. Bausch & Lomb, 61418 Bausch Street, Rochester, New York 14602.

BAUSCH & LOMB

New Instruments

voltage controlled from either a front panel calibrated dial or an external source. Reliable circuit design, modular construction, and direct in-line readout make these frequency synthesizers particularly adaptable to high volume production test systems as well as data reduction systems, communications and laboratory use. Delivery is stock to 60 days.

Montronics, Inc., P.O. Box 345, Bozeman, Mont. [383]

Rapid aiming infrared scanner

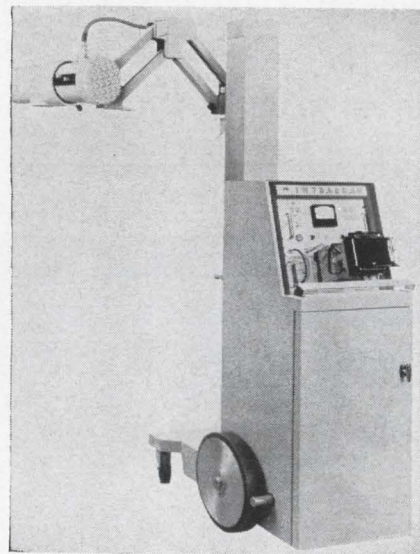

This highly mobile, rapid aiming infrared scanner features a one-minute photographic readout. Called Infracan, the unit is used for nondestructive testing of p-c boards, jet engines, helicopter blades and solid rocket motor cases. Infracan is able to discern minute heat differences over the surface of the item being tested and thereby detect flaws such as faulty bonds, delaminations, and cracks which may not be apparent by any other type of nondestructive test. In checking p-c boards, voltage applied to the board heats the components as in any electronic circuit. The scanner reads the resulting infrared radiation. If a particular part of the circuit shows up either hotter or colder than its norm, trouble is likely to occur in

that area. Many aerospace agencies have been conducting tests in infrared thermography or heat-mapping as a means of nondestructive testing and are reported to be highly optimistic about results. It is thought that infrared thermography could be used in quality control of such electronic components as microelectric modules. Currently there is no method for nondestructive testing of such modules, according to the manufacturer. Since Infrascan does not use radiation of its own, but rather relies upon the natural surface radiation of the object under test, there is no hazard to personnel or to the object being studied. Infrared Industries, Inc., Santa Barbara, Calif. [384]

Preamplifier connects into recording system

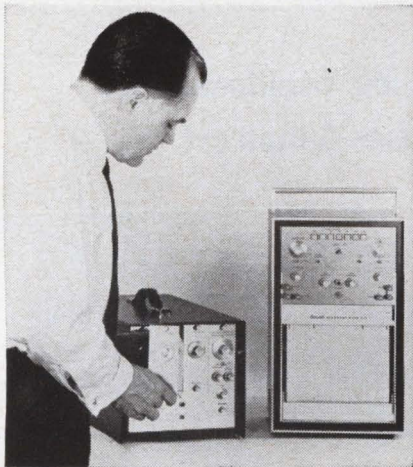

A full-floating, high-voltage d-c preamplifier accepts microvolt-level signals up to 1,000 v off-ground on the low-level channel, or a potential difference up to 1,000 v d-c on the high-level channel. The instrument is said to contain a minimum of operating controls and has been designed for simple, safe operation even by inexperienced personnel. With the new preamp, the system monitored and the amplifier-recorder are all protected through current-limiting and over-voltage devices. The new unit insures safe noise-free operation when high voltages are being recorded in installations such as steel and aluminum rolling mills, wire drawing mills, and in locomotives

MONOLITHIC DIFFERENTIAL AMPLIFIER BY AMELCO PROVIDES EXCELLENT TRACKING

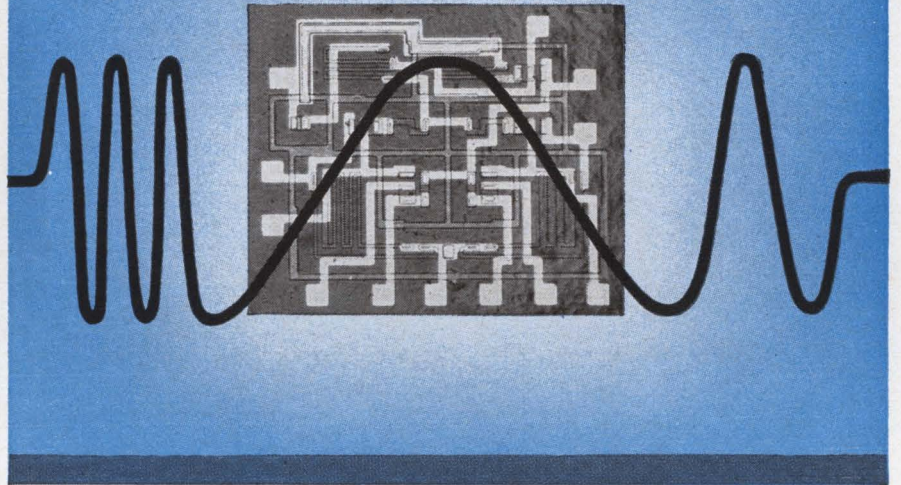

DESIGNED for low level differential input applications, type D13-001 provides excellent tracking and great stability. It is manufactured in a single silicon chip using diffused resistors and transistors. Because of this, beta and V_{BE} are closely matched and thermal coupling is very tight. The result is shown by the specifications below. Type D13-001 is available from stock at \$35.00 for 1-99 and \$28.00 for hundred quantities.

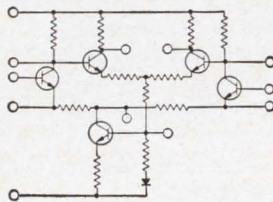

SPECIFICATIONS:

- ▲ TRACKING = $5\mu V/^\circ C$
($-55^\circ C$ to $+125^\circ C$)
- ▲ OFFSET = 8 mV (untrimmed)
- ▲ COMMON MODE REJECTION = 90 db
- ▲ GAIN = 400
- ▲ BANDWIDTH = 400 Kc

Other Types of This Family Are Also Available



AMELCO SEMICONDUCTOR

DIVISION OF TELEDYNE, INC.

1300 TERRA BELLA AVE., MOUNTAIN VIEW, CALIFORNIA

Mail Address: P. O. Box 1030, Mountain View, Calif./Phone: (415) 968-9241/TWX: (415) 969-9112/Telex: 033-914

REGIONAL OFFICES

Southwest

12525 South Daphne
Hawthorne, California
(213) 756-9121, 756-9122

Northwest

1300 Terra Bella Avenue
Mountain View, California
(415) 968-9241

East

P. O. Box 1927
Paterson, New Jersey 07509
(516) 334-7997

Northeast

543 High Street
Westwood, Massachusetts
(617) 326-6600

Midwest

103 North State Road
Arlington Heights, Illinois
(312) 392-8810
2428 West 22nd Street
Minneapolis, Minnesota
(612) 374-1969

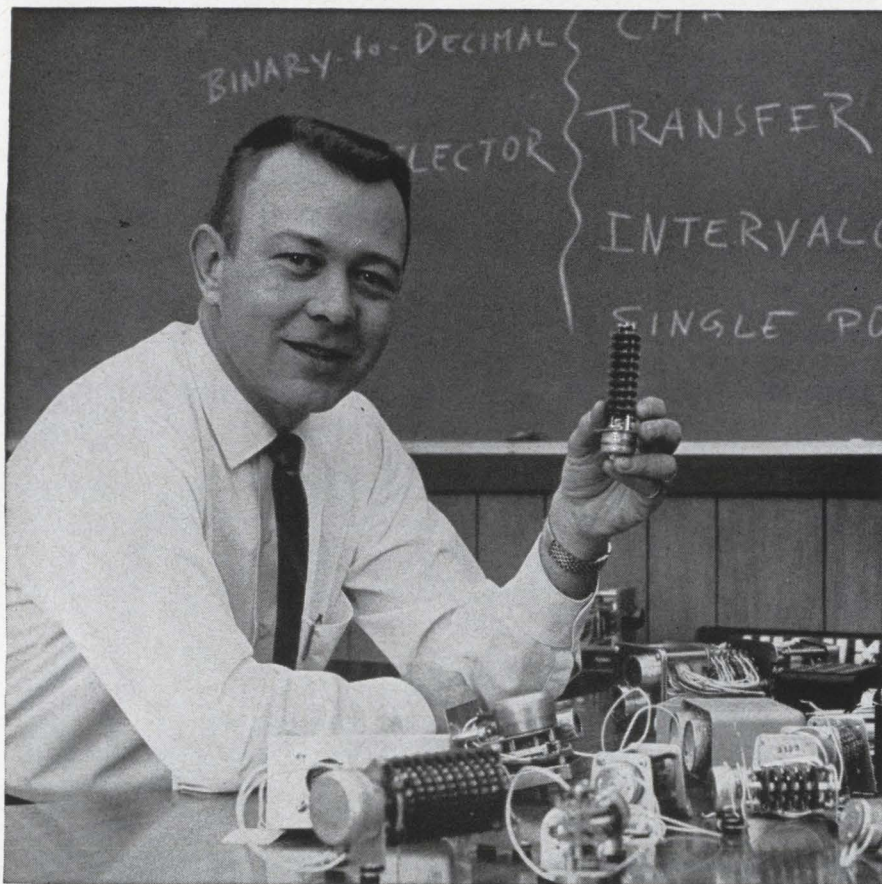

This is a Ledex Stepping Switch.

It has many sizes and shapes.

It is called different things by different people.

You might put it in a black box and call it a programmer, a transfer switch or a batch accumulator.

Somebody else might call it a light dimmer, sequencer or a binary-to-decimal converter.

For others this switch is a thermo-couple scanner, a figure-gram (readout) controller, a memory pulse decoder, a destruct switch, a multi-pole double throw relay or a channel selector. For others it is an intervalometer, a mode selector or a coin counter.

This switch will be found in space, in the air, on the ground, and under water. Its economy puts it in commercial equipment; its reliability and miniature size put it in rockets. Its "hard" contacts are wiping and self cleaning. It does more work in less space.

It's ready to take on new, tougher assignments. Do you have one? In the U. S., Telephone 513-224-9891.

Sincerely,

Gerald Leland
President, Ledex Inc.

P.S. In Europe, address these Ledex licensees: □ France—Appareillage Electro-Mecanique G.P., 115 Avenue J.B. Clement, Boulogne s/Seine □ Germany—EBE Elektro-Bau-Elemente GmbH, 7021 Stetten/Filder, Uber Stuttgart-Vaihingen □ Britain—NSF Limited, 31-32 Alfred Place, London W.C. 1, England. And in Canada and Japan: □ Marsland Engineering Ltd., 350 Weber Street, North, Waterloo, Ontario □ Shindengen Electric Mfg. Co., Ltd., Shin-Ohtemachi Bldg., 4, 2-Chome Ohtemachi, Chiyodaku, Tokyo.



LEDEX INC., 123 WEBSTER STREET, DAYTON, OHIO 45402
Designers & Manufacturers Electronic & Electro-Mechanical Components
& Remote Control Switching Systems

New Instruments

and rapid-transit trains using high-voltage d-c traction motors. The preamp can also be applied for recording transients in line voltage and line current (from 50-mv or 100-mv shunts) on high-voltage d-c power systems, and in control devices that may be full-floating, semifloating or grounded on either side of the line. Design of the preamp is made possible by the development of high-voltage signal transformers and noise-free chopper-input preamps that exhibit floating inputs and good common-mode rejection. In-phase rejection is better than 135 db at d-c and 120 db at 60 cps with 1,000 ohms unbalance. This is said to assure noise-free operation in troublesome industrial locations. Price is \$875, delivery 30 days.

Brush Instruments, division of Clevite Corp., 37th and Perkins, Cleveland 14, Ohio. [385]

Field oscilloscope uses 4-inch crt

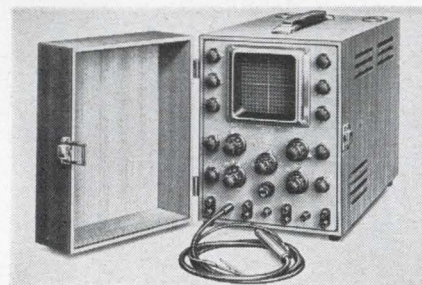

A portable, industrial field oscilloscope has been announced. Model 90954 is 7½ in. wide, 9½ in. high and 16¼ in. deep, including cabinet, and weighs 25 lbs. The small size and weight are made possible by using a rectangular 4 KP cathode-ray tube instead of the conventional 5-in. round tube. The 4-in. tube gives a display area of 7 by 7 cm., nearly that of the 5-in. tube. The oscilloscope is well insulated and can be used with complete safety when the chassis is connected to a 1,500-v line. The scope is also magnetically shielded and may be used in the proximity of very high current lines without having the trace displaced. The

90954 has seven calibration voltages ranging from 0.1 to 100 v d-c, and is accurate to within 2% regardless of the line voltage. The sweep synchronizing voltage is limited so that horizontal deflection can be calibrated without the sync control changing the calibration. The 90954 oscilloscope requires 105 to 125 v a-c, 50/60 cps, 80 watts power.

James Millen Co. 150 Exchange St., Malden, Mass., 02148. [386]

Null detector offers nanovolt resolution



This electronic null detector features resolution of better than 3 nv ($0.003 \mu\text{v}$) with 10-ohm source resistance and 10-nv resolution with 300-ohm source resistance. Model 147 also features zero shift less than 15 mv for source resistance changes from 0 to 300 ohms, line frequency rejection of better than 5,000 to 1 on the most sensitive range, line and self-contained rechargeable battery operation, recovery in less than 20 seconds from an overload of 60 million times on the most sensitive range, and internal zero suppression up to $100 \mu\text{v}$.

The new instrument, which has 16 ranges from 30 nv full scale to 100 mv in $1\times$ and $3\times$ steps, is also useful as a direct-reading nanovoltmeter. It can be used for making very sensitive potential measurements from source resistances up to 100,000 ohms. Model 147 has an input resistance of more than 30,000 ohms on the $0.1\text{-}\mu\text{v}$ range, increasing to 10 megohms on the 0.03-mv range and above, 2% accuracy on the panel meter, and a 1% accurate output for driving a recorder or oscilloscope. Specifically designed as a null detector, the unit has sufficient sensitivity to be used in most applications with all commercially available poten-

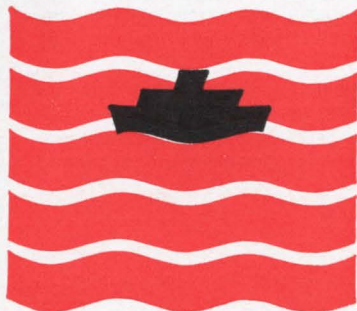
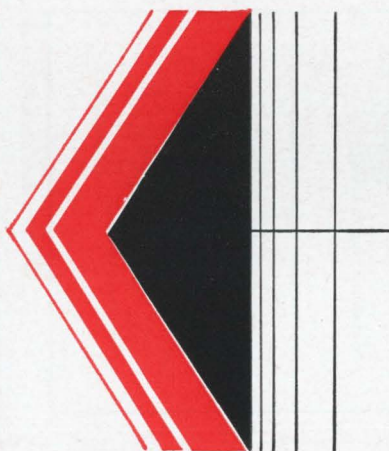

IT'S NEW RJ2A



High Current Ceramic Vacuum Relay

The era of ceramic vacuum relays was first ushered in by Jennings with the introduction of the fabulous 50 kw interruptive RF10. Now comes the equally great RJ2A with outstanding design features of its own.

In the RJ2A Jennings has combined field-proven patented design with two important additions not usually found in lesser relays.

1. A thorough knowledge of the problems involved in designing relays for high voltage airborne, mobile or marine communications systems.
2. The best combination of elements; vacuum for unchanging, low, contact resistance and high voltage withstand, copper to carry high current, and ceramic to withstand shock and high temperature.

In such applications as airborne electronic systems these advantages are invaluable. Especially for antenna switching, switching between antenna couplers, tap changing on RF coils, switching between transmitter and receiver, or pulse forming networks. The proof of superiority is evident in the following ratings which reflect only the minimum capabilities of the relay.

| | |
|-------------------------------|-------------|
| Contact Arrangement | SPDT |
| Operating Voltage (60 cycles) | 12 KV peak |
| 16 mc | 8 KV peak |
| Test Voltage (60 cycles) | 18 KV peak |
| Continuous Current | |
| 60 cycle | 25 Amps RMS |
| 16 mc | 15 Amps RMS |
| Contact Resistance | .012 Ohm |
| Net Weight | 3 oz. Nom. |

We will be pleased to send you more detailed information about the RJ2A and the rest of our complete line of vacuum transfer relays.

RELIABILITY MEANS VACUUM-
VACUUM MEANS

ITT Jennings

JENNINGS RADIO MFG. CORP., 970 McLAUGHLIN AVE., SAN JOSE, CALIF. 95108, PHONE 292-4025

COMPARE PHYSICAL SIZE CAPACITANCE AND COST

YOU'LL SPECIFY
RMC MAGNACAPS

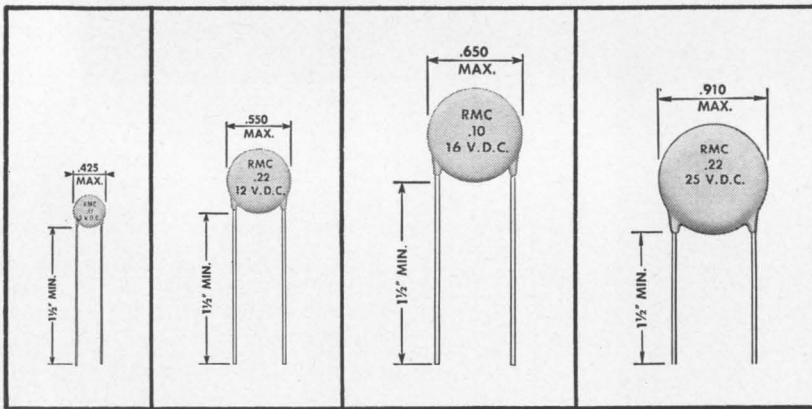

GENERAL SPECIFICATIONS

CAPACITANCE: Within tolerance @ 1KC, 0.05 vrms max. and 25°C.
TEMPERATURE COEFFICIENT: M-3—Z5R, Y5S, X5S, M-12, 16 and 25—Z5T, Y5T, X5U.
LIFE TEST: 250 hours @ rated voltage and maximum temperature.
BODY INSULATION: Durez phenolic—vacuum wax impregnated.
LEAD STYLES AVAILABLE: Long leads—#22 AWG tinned copper and kinked lead plug-ins for printed wire circuits.

■ For their size RMC Magnacaps offer the ultimate in the development of capacitance with acceptable temperature stability. Considering their small size and their proven reliability you'll find that Magnacaps are very economical.

Type M3 and M12 "MAGNACAPS" offer an extremely high efficiency ratio and are recommended for applications with lower operating voltages. The M3 type is available with a capacitance range of .05 mf to 2.2 mf. M12 Magnacaps cover the range from .05 mf to 1.0 mf. Their use as emitter bypass components is particularly suggested, as they retain their proper impedance characteristics well into the radio frequency range.

M16 and M25 "MAGNACAPS" offer an economical general purpose component for wide application with a capacitance range of .01 mf to .22 mf. Their conservative design rating, and high value of insulation resistance (10 megohms at rated voltage) has made these units particularly popular in mobile or portable battery operated equipment.

For additional information, write on your letterhead.



RADIO MATERIALS COMPANY

A DIVISION OF P. R. MALLORY & CO., INC.
 GENERAL OFFICE: 4242 W. Bryn Mawr Ave., Chicago 46, Ill.
 Two RMC Plants Devoted Exclusively to Ceramic Capacitors
 FACTORIES AT CHICAGO, ILL. AND ATTICA, IND.

New Instruments

tiometers, including 6-dial models, and bridges requiring null-detector resolution of a few nanovolts. Keithley Instruments, Inc., 12415 Euclid Ave., Cleveland 6, Ohio. [387]

Solid state pulser can be programed



Model 171 pulse generator combines the versatility of a general-purpose instrument with digital-control capability, either manually or remotely programed. The pulse period and width are digitally programable to within 0.01%. Rise and fall times are independently variable from 6 nsec to 100 μsec. Availability of the solid state instrument is 14 days. Price is \$2,875.

E-H Research Laboratories, Inc., 163 Adeline St., Oakland, Calif. [388]

Dual-beam scope offers high gain

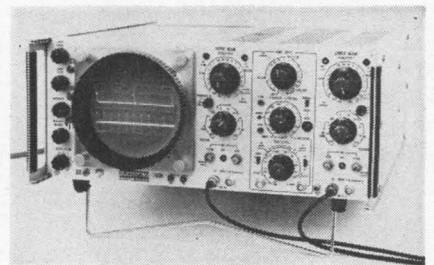

This dual-beam, 10-μv sensitivity oscilloscope features a new, high-resolution crt. Type 708A incorporates simple panel controls for total ease of operation, while its electrometer type input stage is said to give exceptional amplifier position stability. The sweep is wide range from 100 nsec per cm to one minute full scale. The dual-beam crt achieves high brightness with 5 kv accelerating potential and is driven

by transistorized amplifiers. Viewing area is 8 by 10 cm. Vertical amplifiers are identical and stabilized. Bandwidth is d-c to 500 kc (down 3 db). The scope's universal type cabinet is suitable for both laboratory bench, and system rack mount applications (7-in. height). Among applications for the 708A are indicator use for transducers, electromedical research, servo work, and general-purpose test and measurement work which requires a dual-beam display without time sharing. Price is \$995. The 708A is available from stock.

Scientific Instrument Department,
Fairchild Camera & Instrument Corp.,
DuMont Laboratories Divisions, 750
Bloomfield Ave., Clifton, N.J. [389]

Spectrum analyzer covers wide range

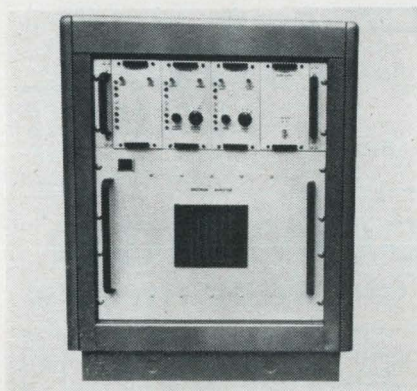

A real-time spectrum analyzer has a dynamic range of 50 db. Model 132 provides for separation and undistorted presentation of simultaneous signals whose frequencies differ by only a few cycles per second and whose power levels differ by up to 10^5 . The manufacturer explains that conventional dynamic ranges for these types of instruments are on the order of 25 to 30 db. The company adds that large signal-level ratios ordinarily result in distortion of both spectrums or in loss of the smaller signal, particularly in machine-generated noise. Pure sine-wave signals falling within the model 132's 50-db range result in spectral line widths of 0.25 cycle, measured at the half-power levels. Applications include high-resolution radar- and sonar-signal processing, and seismic detection where relatively large

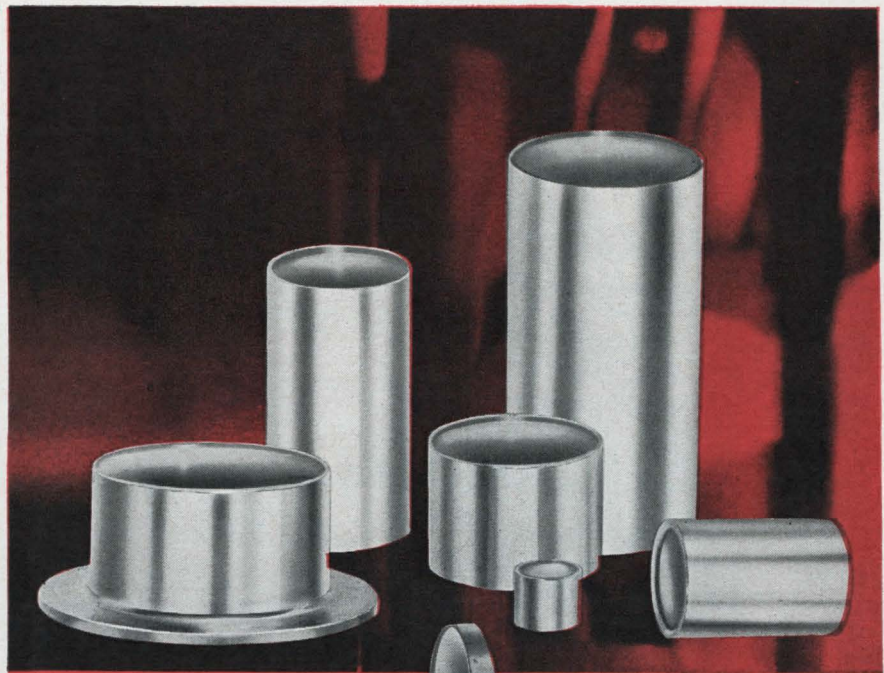

high temperature, high reliability SAPPHIRE-TO-METAL WINDOWS...off the shelf!

Sapphire-to-metal windows manufactured by Ceramics International meet the most exacting requirements of military and aerospace applications. The techniques developed at CI produce a sapphire window with unsurpassed flatness and clarity, and rugged enough to withstand the most severe environmental conditions. At CI we are producing, faster and cheaper, sapphire-to-metal windows of superior quality for the broadest range of standard and special applications.

Applications include:

- Detector windows for military infrared guided equipment.
- Optical windows in high pressure or high temperature systems.
- Satellite thermionic converters for converting sunlight directly to electricity.
- Windows for transmission of ultraviolet and X-rays.
- Output windows for microwave tubes such as klystrons or magnetrons.
- Internal supports for vacuum tubes, insulators, and low leakage detectors.

We also make ruby-to-metal seals to the standards required for laser application.

Our seal is guaranteed to leak less than 10^{-10} std. cc/helium sec. All our parts are hydrogen brazed with OHFC copper, fine silver or BT solder—72% Ag. 28% Cu Eutetic.

For further details write for our new bulletin #S110.



CERAMICS INTERNATIONAL CORP.
MAHWAH, NEW JERSEY

HIGH TEMPERATURE CERAMIC-TO-METAL PRODUCTS FOR THE AEROSPACE AND ELECTRONICS INDUSTRIES

GLASS ENCLOSED

AMPERITE

Thermostatic DELAY RELAYS

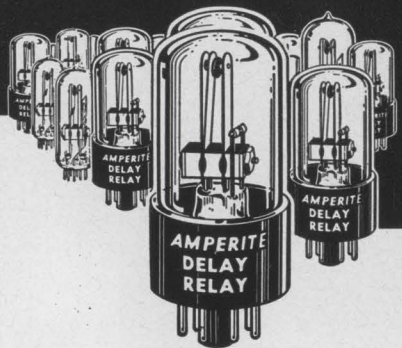

Offer true hermetic sealing
-assure maximum stability and life!

Delays: 2 to 180 seconds . . . Actuated by a heater, they operate on A.C., D.C., or Pulsating Current . . . Being hermetically sealed, they are not affected by altitude, moisture, or climate changes . . . SPST only—normally open or normally closed . . . Compensated for ambient temperature changes from -55° to +80° C. . . Heaters consume approximately 2 W. and may be operated continuously . . . The units are rugged, explosion-proof, long-lived, and—inexpensive!

TYPES: Standard Radio Octal, and 9-Pin Miniature.
List Price, \$4.00

PROBLEM? Send for Bulletin No. TR-81

AMPERITE

BALLAST REGULATORS

Hermetically sealed, they are not affected by changes in altitude, ambient temperature (-50° to +70° C.), or humidity . . . Rugged, light, compact, most inexpensive.

List Price, \$3.00

Write for 4-page Technical Bulletin No. AB-51

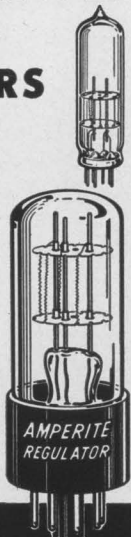
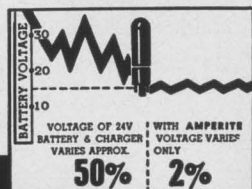

AMPERITE

600 PALISADE AVE., UNION CITY, N.J.

Telephone: 201 UNION 4-9503

In Canada: Atlas Radio Corp., Ltd.,

50 Wingold Ave., Toronto 10

New Instruments

reverberations or clutter usually accompany desired signals. The company includes vibration analyses of complex systems among uses, where a multiplicity of resonances cause wide variations in frequency intensity. Price of the unit is \$7,500. Acton Laboratories, Inc., subsidiary of Bowmar Instrument Corp., 531 Main St., Acton, Mass. [390]

Lightweight scope has 2-gun display



A light weight oscilloscope offers high performance for field use, industrial tests and laboratory measurements. Its two-gun display permits viewing of two separate signals simultaneously without the necessity for beam-switching or time-sharing.

Other features include a 3½-in. flat-faced cathode-ray tube with choice of phosphors for short, medium or long image persistence, sweep range from 1 μsec per cm to 1 sec per cm, a calibrated sweep magnifier, and horizontal positioning beyond 10 diameters. Bandwidth is d-c to 5 Mc (3 db) and sensitivity is 100 v per cm to 100 mv per cm with high sensitivity of 1 mv per cm on one beam at reduced bandwidth. A built-in precision signal generator allows rapid calibration at the front panel. Snap-in mount for the bezel permits quick changes of light filters. The instrument uses only two types of vacuum tubes in addition to the crt, greatly simplifying maintenance.

A full line of accessories such as

Telrex



The Choice of the Discriminating Communication Engineer . . . the Man who Never Settles for Anything Less than THE-VERY-BEST!

telrex "BEAMED-POWER" ANTENNAS and ANTENNA SYSTEMS

Provide optimum performance and reliability per element, per dollar. Antennas from 500 Ke to 1500 Mc. Free PL88 condensed data and pricing catalog, describes military and commercial antennas, systems, accessories, Towers, Masts, Rotators, "Baluns" and transmission line data.

Communication and TV Antennas

ANTENNAS SINCE 1921 **telrex** LABORATORIES

Asbury Park 41, New Jersey, U.S.A.
Circle 216 on reader service card

COMINCO high-purity metals

| Available forms in 99.999% and/or 99.9999% purities | ALUMINUM | ANTIMONY | ARSENIC | BISMUTH | CADMIUM | COPPER | GOLD |
|---|----------|----------|---------|---------|---------|--------|------|
| BARS | X | X | X | X | X | X | |
| SHEETS | X | | | | X | X | X |
| WIRE | X | | | | X | X | X |
| POWDER | | X | X | X | X | | |
| SHOT | | X | | X | X | X | |
| ROD | X | | | X | X | X | |
| RIBBON | | | | | | | |
| PREFORMS | X | | | | X | X | X |
| SALTS | | | | | X | | |

| Available forms in 99.999% and/or 99.9999% purities | INDIUM | LEAD | SILVER | TELLURIUM | THALLIUM | TIN | ZINC |
|---|--------|------|--------|-----------|----------|-----|------|
| BARS | X | X | X | X | X | X | X |
| SHEETS | X | X | X | | | X | X |
| WIRE | X | X | X | | | X | X |
| POWDER | X | X | X | X | X | X | X |
| SHOT | X | X | X | | | X | X |
| ROD | X | X | X | | | X | X |
| RIBBON | X | X | | | | X | |
| PREFORMS | X | X | X | | | X | X |
| SALTS | X | | | | | | |

COMINCO PRODUCTS, INC.

ELECTRONIC MATERIALS DIVISION
818 West Riverside Ave., Spokane, Wash. 99201
Phone 509 747-6111 Telex 032 610

5609 TWX 509-328-1464

multiplier probes, camera adapter, etc., enhance usefulness. The unit is 10½ in. high by 8¾ in. wide by 13½ in. deep. Weight is 23 lb. Model 5MC2P sells for \$950.

Binary Electronics of California, 1429 N. State College Blvd., Anaheim, Calif. [391]

Recorder plots points at high speed

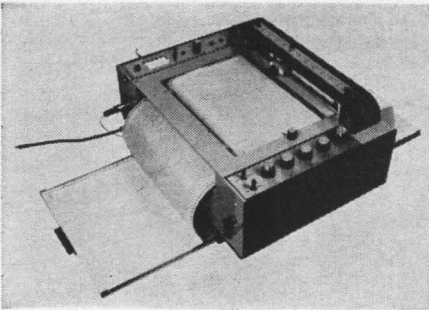

A point-plotting recorder is designed to read out the memory of multichannel analyzers, of average transient computers and of digital oscilloscopes four to five times as fast as was possible with null-detecting X-Y recorders. Model 6550 plots small excursions at rates in excess of 1,200 points per minute. A powerful 10-w output servo drives the character printer at 45 in. per sec. Typically, records with frequent large excursions are plotted out at an average of 16 channels per sec as compared to an average of 3-4 channels per sec obtained when using an X-Y recorder.

Maximum accuracy and resolution are provided by an incremental chart paper drive that automatically advances the chart 0.025 in., 0.050 in., 0.075 in. or 0.100 in. per channel, as selected by a panel resolution switch. The folded chart paper is stored in a tray under the recorder and is deposited into a tray on the opposite side. The folded packet with perforated edges removed is 8½ by 11 in.

The panel switches and controls permit many different operating modes and satisfy the interface problems involved with all known computers and analyzers, according to the manufacturer. Price is \$2,850; availability, 60 days.

Houston Omnigraphic Corp., 4950 Terminal Ave., Bellaire, Texas, 77401. [392]

*Does a metals problem have you
up the creek without a paddle???*

*use the
theory of
probability
to solve your problem*



This is where experience counts! Chances are Hamilton has the answer for you . . . as we have for hundreds of others . . . whether it is ultra-thin tape for a computer, wire for a microscopic spring, or magnetic and high-temperature metals for missiles. The Precision Metals Division of Hamilton Watch has the metallurgical "know-how" and the unique precision production facilities to do the almost "impossible!" □ What can you lose? Before you give up . . . ask us. Invest a postage stamp and ask for the brochure on Precision Metals. You will receive facts and information that you can use.

PRECISION Metals Division

 **HAMILTON**
WATCH COMPANY

• LANCASTER, PA.

CEC's 5-133 Oscillograph now features three significant improvements

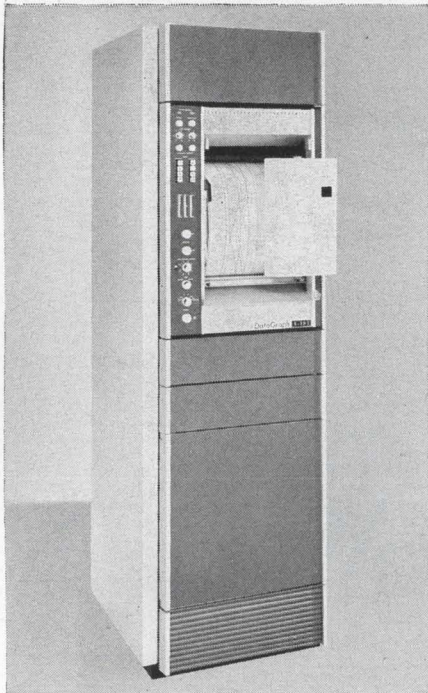

RACKMOUNT WITH DATAFLASH

Long accepted as the world's best recording oscillograph, the 5-133 DATAGRAPH® has advanced its capabilities even further. It now combines *reverse operation*, a completely new capability, with high speed operation and CEC's exclusive DATAFLASH®, all in *one universal transport*.

1 REVERSE OPERATION of the 5-133 represents today's highest refinement of this capability.

2 TWELVE SPEEDS provide complete control at all forward speeds to 160 ips.

3 IMPROVED DATAFLASH of the universal transport provides faster platen heat. At speeds to 16 ips, rapid latensification makes data available less than one second after it occurs.

These improvements complement the many features that have already made this instrument the finest available. The

5-133 still records 36 or 52 channels of d-c to 13,000 cps data on 12-inch-wide direct-print light-sensitive paper — may be either rack or bench mounted — and easily surpasses the most demanding technological requirements. Furthermore, RFI conformance to MIL-I-6181D is available as an optional factory conversion.

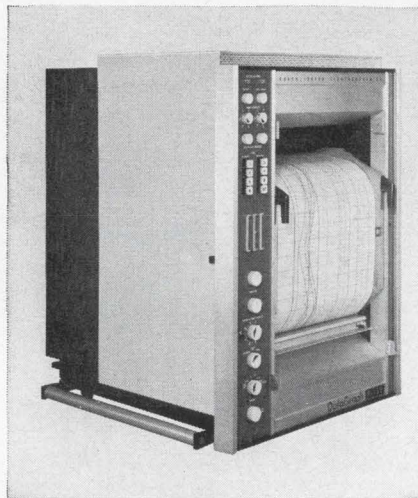

BENCHMOUNT CONFIGURATION

Additional performance advantages:

▣ *Automatic lamp start/restart, hot or cold* through the use of a static magnetic regulated lamp power supply which automatically provides proper power to lamp regardless of input voltage variations.

▣ *Millisecond timing lines with accentuated tenth lines* provided by a timing line generator that electronically flashes timing lines at intervals of 10, 1, 1/10, 1/100 and 1/1000 seconds. Every 10th line accented on 1, 0.1, 0.01 and 0.001 settings.

▣ *Built-in slot exit and internal takeup* with capability of up to 160 ips.

▣ *Automatic record length control* continuously adjustable to 150 feet.

▣ *All galvanometers accessible and adjustable* without removing oscillograph from rack.

▣ *Vibration isolation for best galvo trace quality* assured by four isolator mounts on recorder and four on the drive motor/transmission assembly.

▣ *Individual input connectors for each galvanometer* provide maximum electrical isolation.

Accessories:

The Remote Control Unit operates the 5-133 from distances up to 1000 feet. Complete remote control of all electri-



REMOTE CONTROL UNIT

cal functions is possible—including all speed selection, power ON/OFF and recording lamp ON/OFF.

The Latensification Lamp Assembly uses four 8-watt cool white fluorescent lamps to latensify slow-speed recordings. A readable record is immediately available when recorded at low speeds up to 4 ips.

The Ambient Light Shield permits recording with no latensification, allowing the record to be chemically processed for maximum contrast needed for oscillograms of archival quality.

For complete information on the 5-133, call your CEC Sales and Service Office, or write for Bulletin CEC 5133-X2.

CEC

Data Recorders Division

CONSOLIDATED ELECTRODYNAMICS

A SUBSIDIARY OF BELL & HOWELL/PASADENA, CALIF. 91109
INTERNATIONAL SUBSIDIARIES: WOKING, SURREY, ENGLAND
AND FRIEDBERG (HESSSEN), W. GERMANY

IC has quick response time

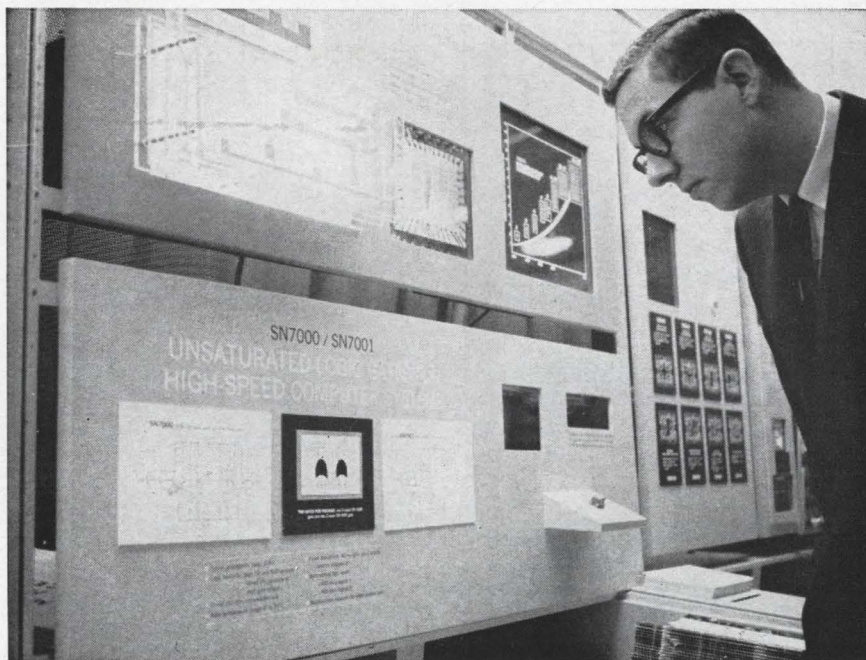

5-nanosecond logic gates were introduced by Texas Instruments Incorporated at the IFIP meeting in New York

Large scientific and industrial computers require gates with extremely fast switching times because of the number of logic decisions that must be made. The propagation delays in the order of 13 to 15 nanoseconds currently provided by integrated-circuit logic gates operated in the saturated mode are too slow for big computers. To meet high-speed requirements, Texas Instruments Incorporated has brought out two new emitter-coupled logic integrated circuits, the SN7000 and the SN7001. Both have response times of only five nanoseconds.

To achieve this speed, compromises had to be made in three characteristics: power dissipation, high temperature capability, and noise immunity. The military market is virtually ruled out because of these compromises. It expects to sell only to makers of large computers.

Both circuits contain a 3-input and a 2-input gate on the same double-epitaxial silicon bar. Both also have 11 npn transistors, with different output arrangements. The SN7001 contains two extra connec-

tions, allowing more flexibility in the use of the output resistors.

The circuits are currently being supplied in the standard metal flat-pack. However, a metal-ceramic plug-in package is also planned.

The new units were announced on May 24 at the International Federation of Information Processors meeting in New York.

Specifications

| | |
|--|------------------|
| Collector supply voltage | 1.25 volts |
| Emitter supply voltage | -3.5 volts |
| Operating temperature range | 0° to 70°C |
| Power dissipation per gate | 40 mw |
| Noise immunity | 250 mv |
| Logic levels | +400, -400 volts |
| Propagation delay time | 5 nsec |
| Outline | Jedec TO-84 |
| Leads | 14 |
| Weight | 0.1 gram |
| Texas Instruments Inc., 13500 North Central Expressway, Dallas, Texas. [371] | |

Computer transistors switch at high speeds

A silicon switching transistor is announced for use in the logic circuits of high-speed computers. Type 2N3261 has a broad current

DATAFLASH or DATARITE®?



It depends. Within this complete CEC family are five types of papers and two developer solutions that cover the entire range of oscillography.

DATAFLASH 56. A high writing speed product which produces superb traces, timing, and grid lines where Xenon lamps are used.

DATAFLASH 55. The extreme sensitivity of this paper now makes it possible to obtain *perfect* oscillograph records at writing speeds in excess of 75,000 ips.

DATAFLASH 54. Direct-print Dataflash 54 is supremely effective at writing speeds up to 50,000 ips.

DATARITE 33. DATARITE refers to CEC's Datarite Magazine in which oscillograms are automatically developed and dried as quickly as data is recorded. DATARITE 33 is ideal for high writing speed applications.

DATARITE 22. Type 22 has less sensitive emulsion than Type 33. At low writing speeds, it will give excellent oscillograms.

Type 49943-4 Datarite Developer Solution is an ammonia-type formula which combines high writing speeds with reduced paper staining in high humidity environments.

Type 49943-3 Datarite Developer Solution is a non-ammonia, general purpose formula which provides exceptionally high trace contrast and high writing speed capability.

For all the facts about CEC oscillograph papers and chemicals, call or write for CEC Bulletin Kit #7062-X2.

CEC
CONSOLIDATED
ELECTRODYNAMICS

A SUBSIDIARY OF BELL & HOWELL/PASADENA, CALIF. 91109
INTERNATIONAL SUBSIDIARIES: WOKING, SURREY, ENGLAND
AND FRIEDBERG (HESSEN), W. GERMANY

WE'LL DESIGN YOUR MAGNETIC SHIELDS



About 80% of all magnetic shield designs now in use originated here.

Maybe it's because our designs work. Maybe our designs work because we've had the most experience. All are good reasons to contact us.

Netic and Co-Netic magnetic shields are the recognized standard all over the world for military, laboratory, industrial and commercial applications. They are insensitive to ordinary shock, do not require periodic annealing, and have minimal retentivity. A few typical applications are illustrated. Our design department is yours.

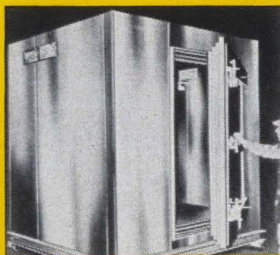

Magnetically Shielded Room

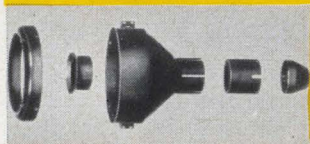

CRT Shield Complex



Scan Converter Shield

Sectionalized P.M. Shield



Nesting Cans

MAGNETIC SHIELD DIVISION

Perfection Mica Company

1322 N. ELSTON AVENUE, CHICAGO, ILLINOIS 60622

ORIGINATORS OF PERMANENTLY EFFECTIVE NETIC CO-NETIC MAGNETIC SHIELDING

Circle 218 on reader service card

90% of all Japanese ITV cameras use COSMICAR lenses.

COSMICAR
INDUSTRIAL TV LENSES



For your vidicon, image orthicon and professional movie cameras, Cosmucar lenses are available in focal lengths from 12.5mm up to 1000mm.

New zoom lenses are now available.



ICHIZUKA OPTICAL CO., LTD.

2-568, SHIMOOCHIAI, SHINJUKU-KU, TOKYO

CABLE ADDRESS: "MOVIEKINO TOKYO"

170 Circle 170 on reader service card

New Semiconductors

capability from 10 ma to over 250 ma and a total switching cycle time of less than 20 nsec (typical) at 100 ma. Above 100 ma, it is said to provide better saturated switching performance than any other commercially available transistor. Because of its broad current capability, the device will fill virtually every socket requirement in the logic circuits of high-speed computers and will also operate effectively in terminated-line-driver and memory driver applications, according to the manufacturer. The 2N3261 is packaged in a TO-52 low-profile case for high-packing density circuit fabrication. Price is \$2 each in quantities of 1,000 and up.

RCA Electronic Components and Devices, Harrison, N.J. [372]

Germanium transistors cut h-f noise figures

A series of germanium transistors offers improved high frequency performance thanks to selective metal-etch, a new fabrication technique. The technique frees the germanium transistors from the limitations of the stripe geometries imposed by the conventional evaporation method and permits optimization of emitter perimeter-to-area ratios for greatly improved operation at high frequencies. In addition, the better resolution of the selective metal-etch process allows closer spacing of the base and emitter contacts, reducing base resistance and, as a result, improving the transistor's noise figure.

The new transistors feature extremely low noise. For example, the 2N3783 has a guaranteed maximum noise figure of 2.2 db at 200 Mc. At 1,000 Mc, the noise figure is guaranteed to be only 6.5 db. To complement the low noise figure, the 2N3783 exhibits a guaranteed minimum gain-bandwidth product of 800 Mc.

The key to the new product line is a series of company developed etchants that can selectively etch a variety of metals employed in germanium transistor fabrication. These etchants permit the use of

Electronics | June 14, 1965

photolithographic fabrication techniques which bring to germanium the same freedom of device geometry enjoyed by the most advanced silicon devices, according to the manufacturer. For example, in place of the parallel emitter and base-contact stripes characteristic of the conventional germanium mesa, the new selective metal-etch transistors make use of the Star configuration.

Motorola Semiconductor Products Inc.,
Box 955, Phoenix, Ariz., 85001. [373]

Miniature diodes rated at 4 amperes



Rectifiers rated at 4 amps are now available in an axial leaded package. These miniature (0.145 in. diameter) diodes can actually be rated to 6 amps with fan cooling. Surge currents of 100 amps are part of the performance specs and leakage at 25°C is typically 0.5 μ a. The units are available at peak inverse voltages from 50 to 800 v. Since these are controlled avalanche diodes, they are ideally suited for ultrareliable assemblies.

Construction features metallurgically bonded pins and dice of identical diameter. Over this, a sleeve of hard glass is fused, forming a void-free, monolithic structure. The resultant glass-fused junction and low thermal resistance ensures that electrical characteristics are stable and do not change even under overloading or environmental extremes. After life testing at rating for 1,000 hours, parts will still meet pre-life testing electrical specifications. Prices vary from 50 cents to \$4 depending on specifications and quantity.

Unitrode Corp., 580 Pleasant St.,
Watertown, Mass. [374]

140 db Common Mode Rejection through balance and electrostatic shielding

with **JAMES**®

INSTRUMENT TRANSFORMERS

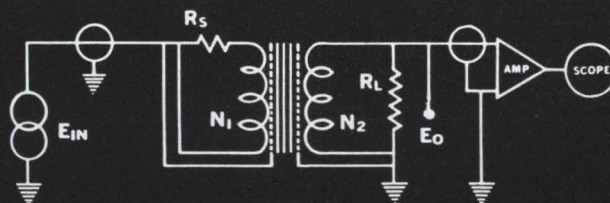

$N_1 = N_2 = 6080$ TURNS

$E_{IN} = 50$ VRMS COMMON MODE SIGNAL INPUT

$E_O = 5 \mu$ VRMS COMMON MODE SIGNAL OUTPUT

$$\text{CMR (COMMON MODE REJECTION)} = 20 \log \left(\frac{N_1}{N_2} \times \frac{E_{IN}}{E_O} \right)$$

CMR = 140 DB

- **MAGNETIC SHIELDING**

Up to 120 db. of magnetic shielding offered. Multiple mu-metal and copper shields give the designer a wide choice of models for each application.

- **LOW THERMAL CONSTRUCTION**

All junctions of windings to leads are made with a special solder that minimizes thermal voltage generation at the junctions. Bare copper leads from each winding are carried to the exterior for further low thermal application.

- **BALANCED WINDINGS**

Each side of these transformers has balanced windings. They are prematched to the exact turn with D.C. resistance unbalance less than .05%.

- **APPLICATIONS**

Especially suited to A.C. Bridge and Differential D.C. and A.C. Amplifier applications.

NOW-JAMES Electro-Guard Shielded POWER TRANSFORMERS

Write for complete technical details and specifications.

KEY SUPPLIER
OF COMPUTER
CONTROLS

JAMES®

ELECTRONICS INC.

4050 North Rockwell • Chicago, Illinois 60618 • 312-463-6500 • TWX 312-222-0745

ASPIRIN
can't cure the
R & D HEADACHES
that call for a

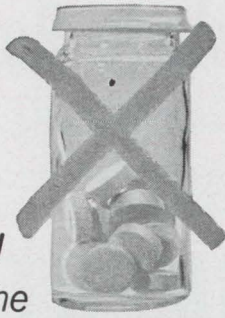

Coax-i-kit



Keep One on Your Shelf

When you suddenly need an experimental bit of semi-rigid coaxial cable, you haven't got time for PO's, letters to the mill, and shipping delays. Then is when a Precision Tube Company COAX-I-KIT on your shelf is worth dollars in the bank. There are four COAX-I-KITS, each containing lengths of different types of COAXITUBE, Precision's semi-rigid metal-shielded coaxial cable for low-loss RF transmission and other high frequency applications. Order the kits that fit your needs. They're priced at only \$20 each, postpaid.

A Three ten-foot coils of 50-ohm cables (one each of '141', '085', '058' sizes) all with Teflon dielectric. Inner conductors of silvered copper & copperweld; outer conductors, copper.

B Four four-foot lengths of 50-ohm cables (two each of RG-87A and RG-143 equivalents) all with Teflon dielectric, silvered inner conductor, and copper outer conductor.

C Two ten-foot coils of 50-ohm, high performance cables (one each of '141' and '085' sizes) with Teflon dielectric; dimension tolerances, $\pm .001$ "; concentricity, within .003".

D Four four-foot lengths of 50-ohm cables (two each of RG-87A and RG-143 equivalents) — as Kit B, but with aluminum outer conductors.

BUY IT—TRY IT Phone or write for your kits; we'll bill you later. Or ask for our folder that describes them in more detail.

YOUR BEST DECISION:



New Subassemblies and Systems

Batch-fabricated monolithic memory

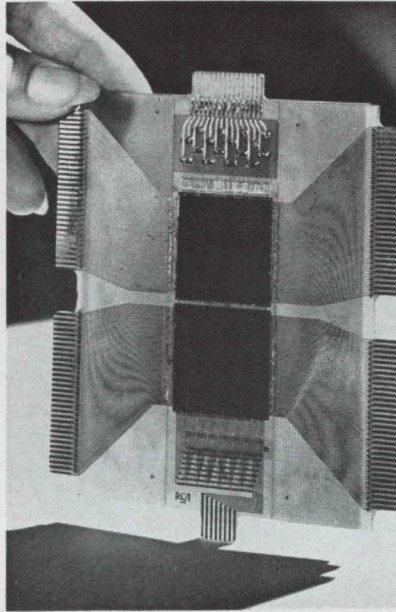

An inexpensive ferrite wafer, which has large data-storage capacity but does not require the tedious and difficult stringing of cores on wire, has been introduced by the Radio Corp. of America, Electronic Components and Devices division. It was shown for the first time at the IFIP Congress 65 (International Federation for Information Processing) in New York.

The device, called the RCA MF-2100, is inexpensive, simple and fast. Its full-cycle time for reading and regeneration of data is 200 to 800 nanoseconds, depending on the application. The device is made by sintering a matrix of insulated conductors between two sheets of ferrite material [Electronics, June 29, 1964, p 66]. The resulting wafer operates much the same as the conventional two-dimensional core array. Two wafers, plus an array of microminiature diodes for address decoding, are assembled on a module that also carries connections for external circuitry.

The matrix of conductors in each wafer comprises 64 parallel word windings perpendicular to 64 parallel bit windings. There is one word winding for each word in the wafer and two bit windings for each bit in the word; hence there

are 2,048 bits in each wafer, and the capacity of 4,096 bits is contained in two wafers assembled on a module. Current applied to a particular word winding places a word in that memory location.

The resultant flux at each intersection of the one word winding and the 64 bit windings is determined by the current in the bit windings; the ferrite material in the immediate vicinity is magnetized accordingly. To read this word from memory, current of opposite polarity is applied to the word winding; this produces a positive pulse in the bit windings for each "one" bit and a negative pulse for each "zero" bit.

RCA offers the MF-2100 to computer manufacturers who require a small, inexpensive reliable memory array. There are no present plans to use the device in any RCA computer product, the company says.

Specifications

| | |
|----------------------------|-------------------|
| Cycle time | 200 to 800 nsecs |
| Equivalent core count | 4,096 |
| Equivalent core size | 5 mils o.d. |
| Wafer size, inches | 1 x 1 x 0.005 |
| Module size, inches | 4.5 x 3.75 x 0.22 |
| Readout mode | Destructive |
| Drive currents: word write | +100 to +150 ma |
| word read | -400 ma |
| bit | ± 30 ma |
| Output amplitude | 30 to 45 mv |

RCA Electronic Components and Devices, Needham, Mass. [401]

Mobile tape transport satisfies MIL-E-5400

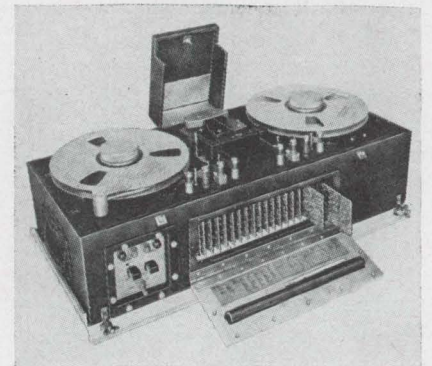

The DT-03 digital mobile magnetic tape transports provide complete computer-compatibility under the

the basic facts about three Hitachi silicon transistors

2SC464

for
45 mc if amplifier

★ $f_T = 400$ mc
 $C_{ob} = 0.85$ pF
 $PG^\dagger = 27$ db

2SC465

for
FM Radio
rf amplifier
converter
oscillator

★ $f_T = 400$ mc
 $C_{ob} = 0.85$ pF
 $NF = 3.5$ db

2SC466

for
vhf tv
mixer
oscillator

★ $f_T = 900$ mc
 $C_{ob} = 0.85$ pF
 $MG^{\dagger\dagger} = 16$ db

This family utilizes a hermetically sealed four-lead package which has a similar shape as the JEDEC TO-18.

| MAXIMUM RATINGS ($T_a = 25^\circ\text{C}$) | |
|---|-----------|
| V_{CBO} | 30V |
| V_{CEO} | 12V |
| V_{EBO} | 2.0V |
| I_C | 20mA |
| I_E | -20mA |
| P_C | 200mW |
| T_J | 200°C |
| $T_{stg.}$ | -55~200°C |

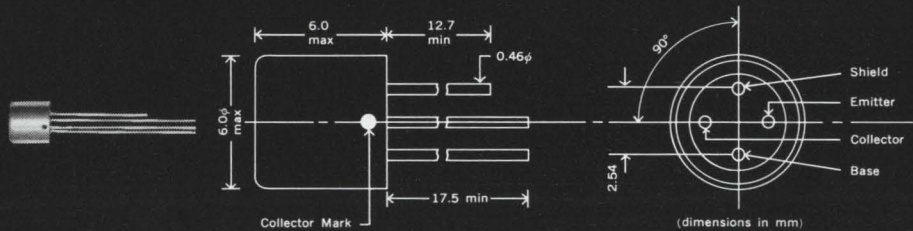

| ELECTRICAL CHARACTERISTICS ($T_a = 25^\circ\text{C}$) | | 2SC464 | | 2SC465 | | 2SC466 | | | | | | | | |
|--|--|-----------------------|-----|--------|------|--------|-----|------|-----|-----|------|-----|-----|---------------|
| I_{CBO} | ($V_{CB} = 10V$) | min | typ | max | 0.5 | min | typ | max | 0.5 | min | typ | max | 0.5 | μA |
| h_{fe} | ($V_{CE} = 6V, I_C = 1mA, f = 1kc$) | — | 40 | — | — | 40 | — | — | 40 | — | — | — | — | |
| f_T | ($V_{CE} = 10V, I_E = -1mA$) | — | 400 | — | — | 400 | — | — | — | — | — | — | — | mc |
| f_T | ($V_{CE} = 10V, I_E = -10mA$) | — | — | — | — | — | — | — | 600 | 900 | — | — | — | mc |
| C_{ob} | ($V_{CB} = 10V, f = 1mc$) | Shield Lead: Open | | — | 1.0 | 2.0 | — | 1.0 | 2.0 | — | 1.0 | 2.0 | — | pF |
| | | Shield Lead: Grounded | | — | 0.85 | — | — | 0.85 | — | — | 0.85 | — | — | — |
| $r_{bb'} C_c$ | ($V_{CB} = 10V, I_C = 10mA, f = 31.8mc$) | — | 10 | 25 | — | 10 | — | — | 10 | 25 | — | — | — | ps |
| PG^\dagger | ($V_{CE} = 9V, I_C = 5mA, f = 50mc$) | — | 27 | — | — | 20* | — | — | — | — | — | — | — | db |
| $MG^{\dagger\dagger}$ | ($V_{CE} = 9V, I_C = 3.5mA, f = 200mc, f_{if} = 45mc, f_{osc} = 245mc, V_{injection} = 150mV$) | — | — | — | — | 18** | — | — | 16 | — | — | — | — | db |
| P_{osc} | ($V_{CE} = 9V, I_C = 7.5mA, f = 275mc$) | — | — | — | — | 8*** | — | — | 6.0 | — | — | — | — | mW |
| $MAPG^{\dagger\dagger\dagger}$ | ($V_{CE} = 9V, I_C = 5mA, f = 50mc$) | — | 42 | — | — | 37* | — | — | — | — | — | — | — | db |
| NF | ($V_{CE} = 6V, I_C = 1mA, f = 100mc$) | — | — | — | — | 3.5* | — | — | — | — | — | — | — | db |

* Values when $V_{CE} = 6V, I_C = 1mA$ and $f = 100mc$

** Value when $V_{CE} = 6V, I_C = 1mA, f_{if} = 10.7mc, f_{osc} = 100mc$ and $V_{injection} = 150mV$

*** Value when $V_{CE} = 6V, I_C = 2.5mA$ and $f = 118.7mc$

† Power Gain

†† Mixer Gain

††† Maximum Available Power Gain



Tokyo Japan

HITACHI SALES CORPORATION: 333, N. Michigan Avenue, Chicago 1, Ill., U.S.A. Tel: 726-4572/4 / 666, 5th Avenue, New York, N.Y. 10019, U.S.A. Tel: 581-8844 / 12715, S. Daphne Avenue, Hawthorne, Calif., U.S.A. Tel: 757-8143
HITACHI, LTD., DUESSELDORF OFFICE: Graf Adolf Strasse 37, Duesseldorf, West Germany Tel: 10846

VACTEC ART + SCIENCE

Vactec blends art and science to produce the ultimate in photo-sensitive devices. Cadmium sulfide, cadmium selenide and selenium photocells available from stock or we will design to meet your specific needs. Get more engineering per photocell dollar. Specify Vactec.

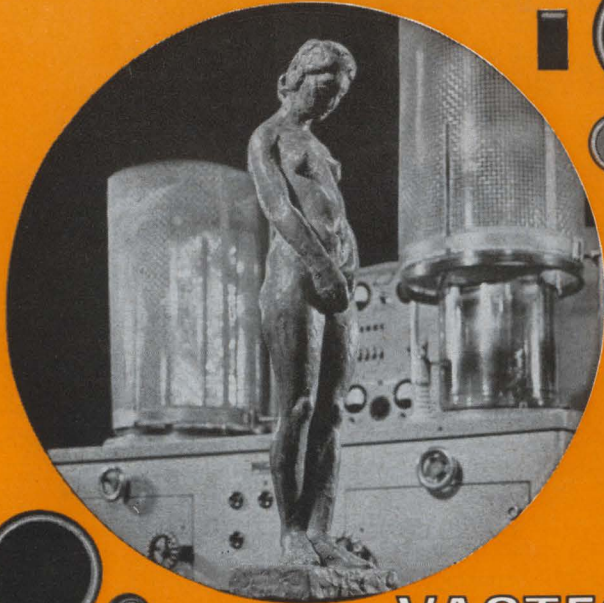

Sculpture by Rudv Torrini

Write for Bulletin
SPV-4 for
selenium,
Bulletin PCD-3
for cadmium
sulfide and
selenide types.

VACTEC
1209 OLIVE WAY
St. Louis, Mo. 63130
Phone Area 314, PA. 6-0633

Circle 219 on reader service card

GET ALL 5

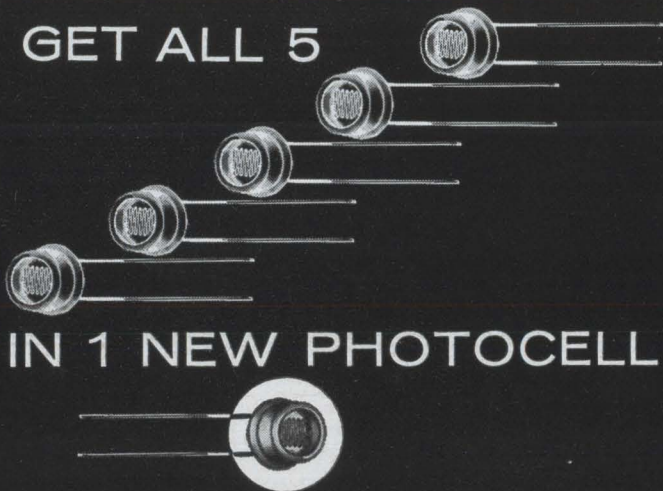

IN 1 NEW PHOTOCELL...

Now, the 5 best characteristics of CdSe and CdS are combined in 1 new Clairex CdS photosensitive material, the type "5H".

1. High speed (1-2 millisecond response)
2. Low temperature coefficient (0.5%/°C)
3. Low memory (15 X lower than CdSe)
4. High linearity (slope of 0.9 from 0.1 to 100 FC)
5. Uniform color temperature response (100% - 106%, 2854°K-6700°K)

Detailed information on type "5H" photocells plus the new Clairex 16 page Designers' Manual free on request.

CLAIREX

"The LIGHT Touch in Automation and Control"

8 West 30 Street, New York, N. Y. 10001, 212 MU 4-0940

New Subassemblies

severest environmental conditions. They are designed to record and to reproduce intelligence according to all standard formats. They utilize standard 10½-in. reels of ½-in. or 1-in. tape, standard computer formats and interfaces, and have a start/stop time of less than 5 msec. All electronics, including the servo system, are completely transistorized. The DT-03 series has been fully qualified under MIL-E-5400, MIL-I-26600, and other environmental specifications. The unit weighs only 95 lb, occupies less than 2.5 cu ft.

S-I Electronics, 103 Park Ave., Nutley, N.J. [402]

Random-action control has many applications

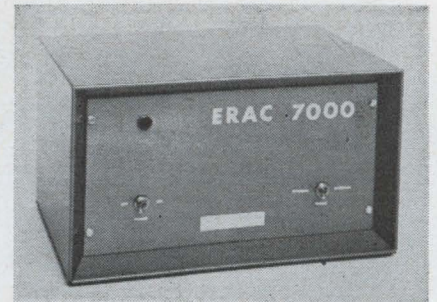

The Erac (electronic random-action control) 7000 can control any group of electrical devices in a completely random and unpredictable sequence. Two models are available. Model S makes a random selection among a number of loads to be energized. Ten selections are standard. Total cycle time is 5 seconds; on time of selected load, 3 seconds. Special cycling sequences are available. This model can also be externally programmed. Model T energizes a single load randomly in time. The average repetition rate is adjustable. Maximum average repetition rate is 100 kc. Minimum average repetition rate is potentially unlimited. In both models various load-current ratings are available from 3 amps to 235 amps. All random sampling in industry to date is done by some manual method, which often follows a certain cyclic pattern even though the person making the selection is not

aware of it. Some involve a direct manual selection, others a tumbling process of the parts followed by a manual selection. Erac 7000 can make a completely automatic random selection as the manufactured items are produced. The average rate of the selections is adjustable, allowing intensive control on a prototype process and a minimal control on a well-established product. Thus the quality-control operation can be fast, economical and completely automated if automatic tests are possible. Many statistical and industrial engineering problems involve the use of random numbers. Most of these problems are usually solved on digital computers where a subroutine generates pseudo-random numbers by some mathematical artifice. However, these introduce appreciable errors in the solutions. Erac 7000 generates true random numbers either digital or decimal. It avoids the previously mentioned errors, saves memory space by eliminating the subroutine, and increases the speed of operation by generating the required random numbers at a high rate. Model S is priced at \$875; model T, \$785. Availability is six weeks.

Trag Automatic Systems, P.O. Box 2101, Detroit, Mich. 48231. [403]

Amplifier modules mounted on p-c cards

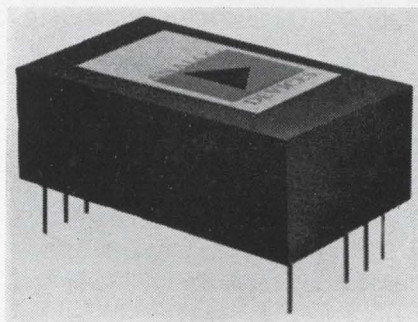

Two chopper-stabilized, operational d-c amplifiers are available for computers, instrumentation, servo and process controls. The amplifier modules, each only three cubic inches, are small and light enough to be mounted on printed-circuit cards. Input voltage and current drift of $0.2 \mu\text{v}$ per $^{\circ}\text{C}$ and 0.2 picoamps per $^{\circ}\text{C}$ for models 201 and 202 make them suitable

ANTENNA and TOWER INSULATORS by LAPP

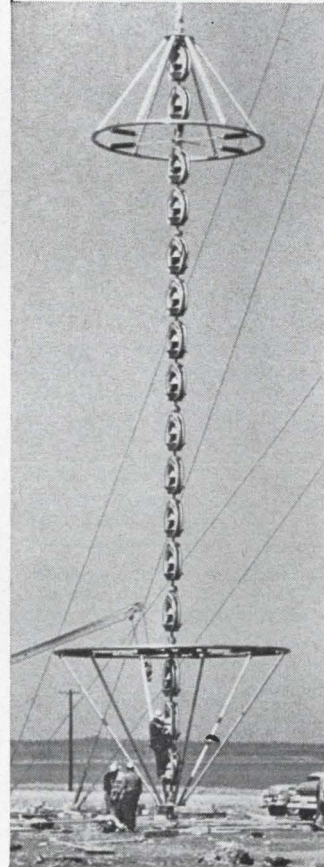
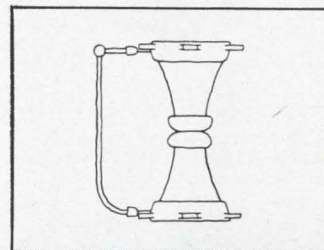
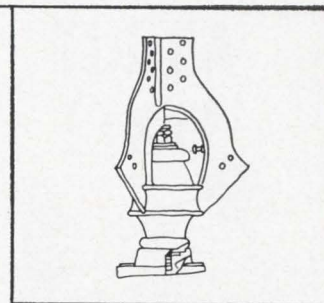
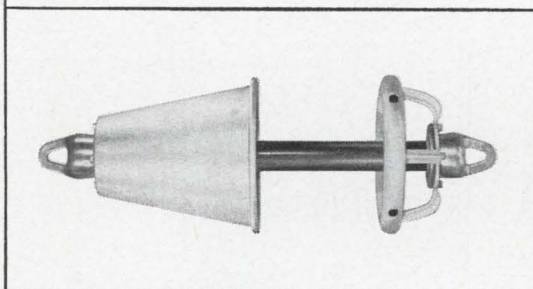

Lapp insulators support most of the world's large radio towers, both self-supporting and guyed masts. Lapp has designed and built base insulators from 80,000 lbs. to 9,000,000 lbs. ultimate strength. Lapp strain insulators have been made from 1200 lbs. to 620,000 lbs. ultimate strength. □ Lapp is also a dependable supplier of entrance, spreader and stand-off insulators for transmission lines. Other Lapp insulators and our gas filled capacitors are used in transmitters and coupling networks. □ Difficult insulating problems are welcome here at Lapp. We've been solving them for almost a half century. Write Lapp Radio Specialties Division, Lapp Insulator Co., Inc., 232 Sumner St., LeRoy, N. Y. 14482.



ABOUT TIME!

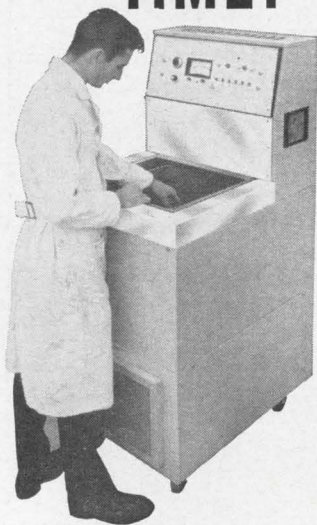

A fluid temperature chamber with phenomenally low gradients... at a sensible price!

Here's stability that only a fluid temperature chamber can provide—combined with Delta Design exclusive Type III Control for programming with ease and unmatched flexibility. All this at prices starting at \$2910—less than half what you might expect to pay for a mechanically refrigerated chamber. Result: new Series 5500 Fluid Chambers are the best buys in environmental test equipment.

Temperature gradients of 5500 Chambers average less than 0.05°C throughout the entire 14" cube of working volume. Rely on resetability of $\pm 0.25^\circ\text{C}$ for inspecting critical electronic components... for calibrating transducers and sensors... for any application where such tight control as $\pm 0.01^\circ\text{C}$ is a must. Standard 5500 models provide temperatures from -30 to $+175^\circ\text{C}$; to -73°C in one model. Special models are available for running "shock treatment" tests at high, low and ambient temperatures at the same time, in the same chamber.

Get all the facts on Delta Design fluid chambers... or tell us your requirements. Contact us directly or the Delta/Non-Linear Systems office nearest you—on any environmental control problem. It's our specialty.



The Environmental Control People

8000 Fletcher Parkway • La Mesa, Calif.
Phone: (714) 465-4141

Overseas Representative: Microwave International Corp., 420 Lexington Ave., New York, N.Y., U.S.A.
Cable: Microken—N.Y.

New Subassemblies

for applications where drift over long periods and wide temperature ranges are important design considerations. Open-loop gain is greater than 180 db, and bandwidth is in excess of 10 Mc. Models 201 and 202 are identical except for output current of 100 ma (201) and 10 ma (202). Output voltages are ± 10 v. Built-in extras, such as fast overload recovery, internal chopper drive, short-circuit protection and rfi shielding save time and expense in applying these amplifiers. The price in small quantities is \$240 each.

Analog Devices, Inc., 221 Fifth St., Cambridge, Mass. [404]

High-temperature module converts d-c

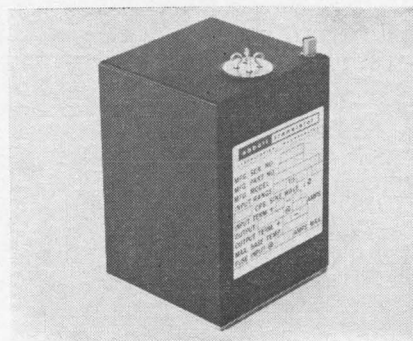

A new family of Hi-Temp d-c to d-c converters, capable of sustained full load operation at 100°C , is in production. The B-10D series converts 28 v d-c to any required output voltage from 5 to 3,650 v d-c at 100 w. Use of modular design concept results in a compact module that measures 3 in. by $5\frac{1}{2}$ in. by $3\frac{1}{4}$ in. and weighs less than 3 lb. Rugged steel containers are used to produce a true hermetic seal. Especially designed for the aerospace industry, these modules are encapsulated to meet the tough environment of MIL-E-5272C at the higher temperature of 100°C . Highest-quality component parts, including all-silicon semiconductors, are assembled with sound thermal design to insure high reliability. Units feature complete isolation of inputs and outputs, an adjustment range of 12% from

JUST PUBLISHED

MODULATION, NOISE, AND SPECTRAL ANALYSIS

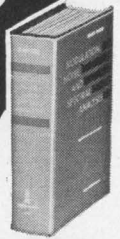

Applied to
Information
Transmission

535 pages
\$19.50

By PHILIP F. PANTER

Here is a full explanation of modulation theory and modulation systems commonly used in the communications field. This book presents recent findings in modulation research, reviews mathematical principles underlying modulation, and thoroughly covers many system design applications. It first summarizes modulation methods and their evolution. Various modulation concepts are then analyzed and criteria cited for measuring actual system performance. The volume gives a complete and graphic breakdown of the Fourier series in relation to linear systems; output signal-to-noise ratios; frequency reception and bandwidth factors; quantizing noise performance; error control and threshold; and of many more specialized aspects of modulation work.

BUY THIS BOOK AT YOUR BOOKSTORE
OR MAIL THIS COUPON

McGRAW-HILL BOOK CO., Dept. 23-L-614
330 West 42 Street, New York, N.Y. 10036

Send me Philip F. Panter's MODULATION, NOISE, AND SPECTRAL ANALYSIS for 10 days on approval. In 10 days I will remit \$19.50 plus a few cents for delivery costs, or return book postpaid. SAVE MONEY: We pay delivery costs if you remit with coupon; same examination and return privilege.

NAME (print) _____

ADDRESS _____

CITY _____

STATE _____

ZIP CODE _____

For price outside U.S., write McGraw-Hill Int'l., N.Y. 10036

23-L-614

the nominal output voltage, and close regulation (0.2%) for input voltage variations of 24 to 30 v d-c. In addition, these converters are protected against short circuits, transient input spikes, and reverse polarity damage. Price is from \$440 each; delivery in 3 to 4 weeks.

Abbott Transistor Laboratories, Inc.,
3055 Buckingham Rd., Los Angeles,
Calif., 90016. [405]

Silicon counter has latching display

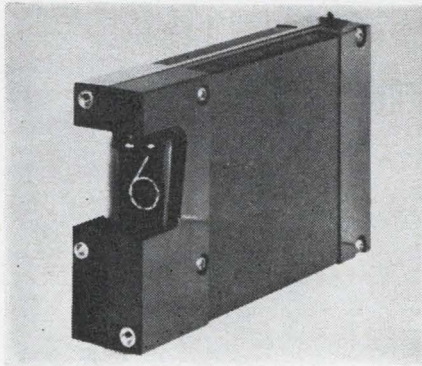

Model B-100-52 is a silicon, ultra-high-speed decade counter with latching display. Counting at rates from 0 to 50 Mc, the module provides an indication only after a latch-command signal has been applied to the input. The unit then displays the decimal count accumulated when the latch command was applied. The display is retained until the next latch command is received. Either periodic or aperiodic signals may be counted. The display includes all decimal digits and the decimal point. The drive signal may have an arbitrary reference level to match requirements of a variety of standard and nonstandard logic-control levels.

This building-block module has been designed for high-speed timing systems, computers, industrial control systems, ranging and tracking systems or any application where blur-free reading of ultra-high-speed signals is required, or where the counter must recognize single pulses of very short duration. Model B-100-52 is a highly reliable unit in a conveniently mounted, rugged case 3 by 5 by 1 in. Operating temperature range is 0° to 60°C. The counter sells for



There's only one way to go...computerized filter and transformer design

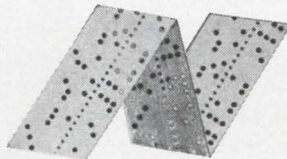

Here's the newest, shortest way to accuracy and top performance in filters and transformers: design by computers.

It's your fastest route. Computer designs take minutes instead of hours. No crossroads or by-passes, either. Computer design explores possible approaches, guides you straight to the best solution when you're in a hurry.

And no detouring for trial-and-error prototype costs. Designs are "performance tested" before production starts. Genisco's computer method searches through existing designs and singles out any that can be used.

Your filters and transformers arrive on time and at lower shipping cost because Genisco plants are on the map in key market areas. Price quotations are fast and accurate. There's never any guessing about costs with Genisco computer design of filters and transformers.

Find out how this new design capability can put you on the right track. Write today for complete information.

COMPONENT DIVISIONS: Combined Sales and Application Engineering Departments

WESTERN UNITED STATES
6320 West Arizona Circle Los Angeles, Calif. 90045
Phone: (213) 776-1411 TWX: 213-670-4765

EASTERN UNITED STATES
111 Gateway Road Bensenville, Ill. 60106
Phone: (312) 766-6550 TWX 312-766-7048

Genisco

**TECHNOLOGY
CORPORATION**



THIS ONE HAS 5 HEADS

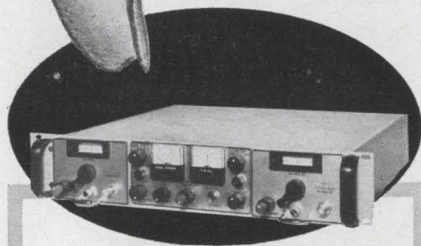

SR-209 VHF/UHF RECEIVING SYSTEM

Not a 5-headed monster — but the sweetest performing receiver in the VHF/UHF frequency range of 30-2000 mc. All plug-in heads are designed for installation without adjustment or alignment of any kind. Choose the one which meets your need—from 30-100 mc to 990-2000 mc.

Reception—AM, FM, CW and PULSE.

IF bandwidths are available from 10 kc through 4 mc.

Plug-in Display Unit for the visual display of signal to which receiver is tuned.

Plug-in Battery Pack also available to make unit completely self-sufficient.

WRITE, WIRE OR PHONE
FOR COMPLETE SPECIFICATIONS

ACL

**ASTRO
COMMUNICATION
LABORATORY INC.**

801 Gaither Road
Gaithersburg, Maryland

Phone: (301) 948-5210 TWX 710-828-9706

"RF Equipment for The Systems Engineer"

New Subassemblies

a unit price of \$142.50 in quantities of 55 to 99; availability, from stock.

Janus Control Corp., Hunt St., Newton 58, Mass. [406]

Circulator handles power to 250 watts

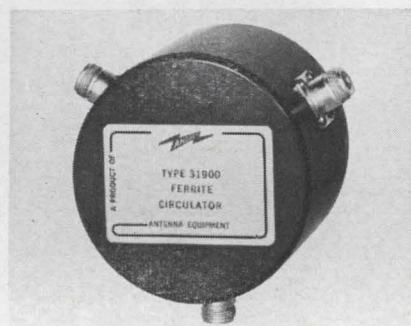

A vhf circulator has been announced for the 450- to 470-Mc mobile communications service. Type 31900 is a three-port junction circulator with high-level isolation over a wide temperature range. It offers a minimum of 20 db isolation between -4° and $+140^{\circ}$ F, and 27 db from 60° to 90° F. The unit can handle transmitter power up to 250 w. It cannot be damaged through operation with any port open or shortened under full power, according to the manufacturer. For use as an isolator, one of the ports may be terminated with a 50-ohm, high-power load. The manufacturer furnishes this matched pair as a factory-tuned unit.

Andrew Corp., P.O. Box 807, Chicago, Ill., 60642. [407]

Tunable vhf receiver is modular, solid state

This solid state, tunable vhf receiver for a-m, f-m and c-w covers the frequency range of 30 to 300 Mc with two plug-in tuning heads of 30 to 100 Mc and 90 to 300 Mc. Additional plug-in tuners can be supplied for multiple-channel, fixed-frequency operation.

The receiver is $4\frac{1}{2}$ in. high, $5\frac{3}{4}$ in. wide and 14 in. deep, and weighs 12 lbs. Three units may be

CONSTANT VOLTAGE TRANSFORMER

Built-in Component Type

- * Completely automatic and continuous regulation within $\pm 1\%$ for input voltage fluctuation up to $\pm 15\%$
- * Regulated AC supply for semiconductor, filament, high voltage for rectifier tube, relay etc.
- * Compact, light weight and the most economical
- * Specialized in quantity production of built-in component type to your specifications. Write for new Bulletin

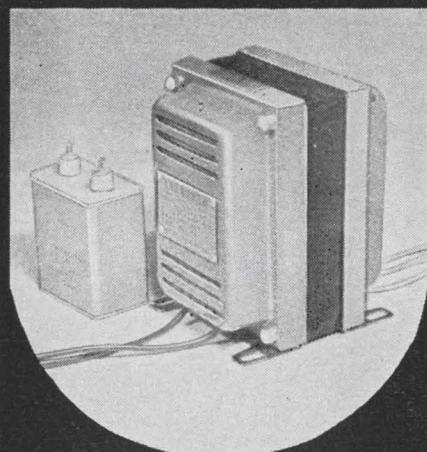

YEC

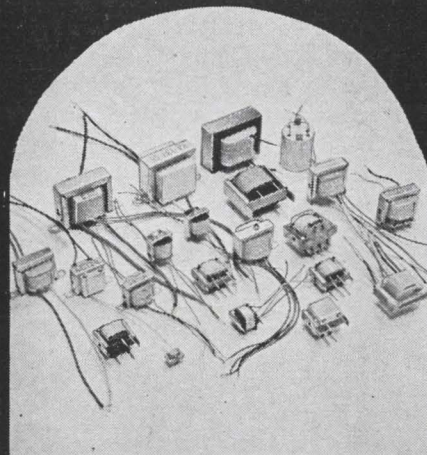

Specialist in

CUSTOM-BUILT TRANSFORMERS

TO YOUR SPECIFICATIONS

YUTAKA ELECTRIC invites you to submit your detailed specifications and quantity information to our engineering and production staff.

YUTAKA ELECTRIC MFG. CO., LTD.

1253, 1-chome, Yutaka-cho, Shinagawa-ku, Tokyo, Japan
Cable Address: "EDUYUTACO" Tokyo

mounted side by side on a standard 19-in. rack, or a single receiver may be used as a tabletop unit, a portable field equipment, aircraft or mobile unit. It is powered from a 50 to 400 cps, 115-v a-c source, or may be supplied for 230-v a-c, 12-v d-c or 24-v d-c sources. A battery pack for field operation is also available.

Two i-f bandwidths are available with a selection from 20 kc to 3 Mc. Maximum noise figure is 4.5 db on the low-band tuner and 7 db on high band. Approximate price is \$2,500; availability, 120 days.

Astro Communication Laboratory, Inc., 801 Gaither Road, Gaithersburg, Md. [408]

DDC computer scans at 1-cps basic rate

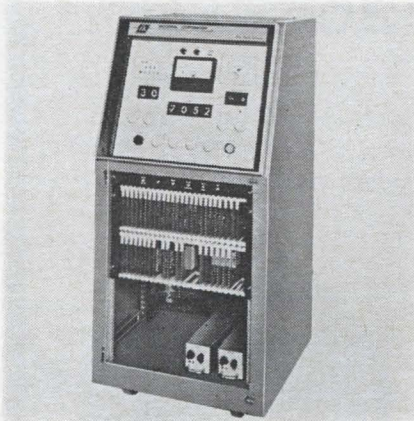

A direct digital control computer with microprogramed position and velocity algorithms has been announced. The EA101 silicon digital computer provides dynamic control through time-shared scanning of up to 100 loops, eliminating the need for numerous single-loop analog controllers. The EA101 features a selection of algorithms, feed-forward control, feedback control, ratio control, cascade control, industrial alarms and alarm summaries. Its circuit and system design is said to combine low cost, modular simplicity and operating flexibility.

The basic scanning rate is 1 cps, each cycle controlling up to 100 loops. With fewer than 100 loops, the scanning rate can be increased by examining individual loops more than once per cycle. Twenty-five-bit registers allow high com-

TRANSISTORISED OSCILLOSCOPES 1Mc/s to 100 Mc/s

FOR LABORATORIES •

340 A

Cabinet (340 A) or Rack-Mounting (340 AR) model
The unit includes : 1 vertical amplifier
1 horizontal amplifier
1 calibrator 0.2 mV at 100 V at 1 Kc/s Accuracy : 2 %
1 delay line 120 nsec
1 cathode-ray tube
1 power supply
The unit can be equipped with :
1 set of time-base plug-in units : BT 210 and BT 110
1 set of plug-in vertical amplifier
P 1100 and P 280 - Soon available : P 110 - DP 100

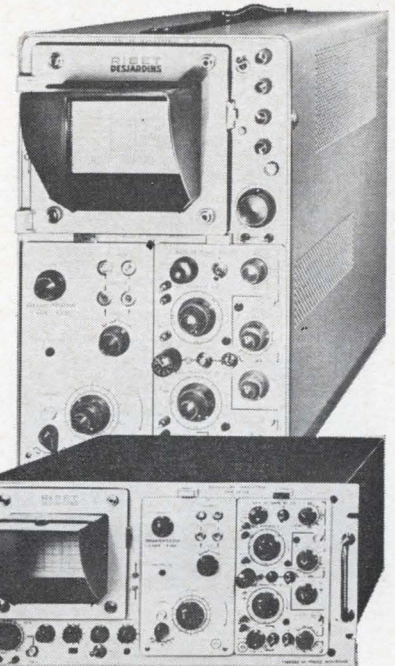

• PORTABLE

345 A

Vertical amplifier
Bandwidth : 0-9 Mc/s Deviation coefficient : 50 mV/div
Sweep system : free-running or triggered
Sweep coefficient : 1 s/div to 0.2 μ sec/div -
Magnifier X2 : 0.04 μ sec/div
Cathode-ray tube
Diameter : 7 cm - Acceleration voltage : 3.8 kv
Power requirements
a) Mains supply : 110/220 v - 50 to 400 cps
b) DC. 7.2-10 v and 10-12 v
Power consumption : 2.25 A approx.

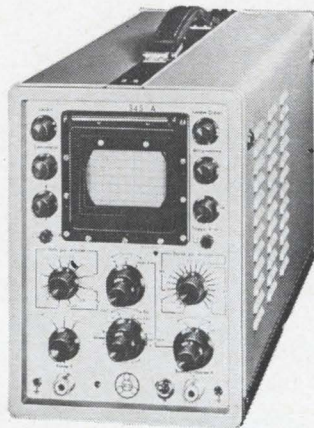

349 A

Vertical amplifier
Bandwidth : 0-1.5 Mc/s Deviation coefficient : 50 mV/div
" 8 cps - 1.5 Mc/s " " 10 mV/div
Sweep system
Sweep coefficient : 10 msec/div to 2 μ sec/div
Triggering : automatic, internal + or - external sync.
External triggering : minimum voltage : 10 V peak-to-peak
Horizontal amplifier
Bandwidth : 0-50 Kc/s Deviation coefficient : 7 V/div
Cathode-ray tube Diameter : 3.2 cm
Power requirements
Mains supply : 110/220 V - 50 cps or DC : 5 V to 9 V

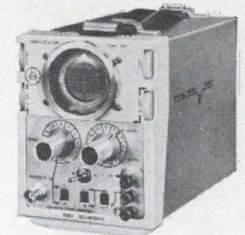

INTER-PLANS 2581



BT 210
2 identical time-bases
5 sec/cm
to 10 nsec/cm
As delaying sweep:
Max delay : 100 sec.

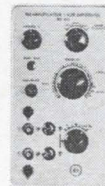

DP 100
0-100Kc/s
100 μ V/cm

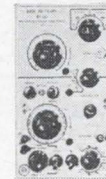

B 110
one single time-base
5 sec/cm
to 10 nsec/cm



P 110
0-10 Mc/s
1 mV/cm



T 110
Bandwidth
0 - 100 Mc/s
Rise-time 3,5 nsec
5 and 50 mV/cm



P 280
2 identical amplifiers
0 - 80 Mc/s
Rise-time 4,5 nsec
5 and 50 mV/cm

OTHER PRODUCTS : GENERATORS, OSCILLOSCOPES CAMERAS,...

RIBET-DESJARDINS

Measure and Control Department - 13-17, rue Périer MONTRouGE/PARIS-TÉL : 253 24-40

free light

Everything currently worth knowing about Cadmium Sulphide Cells and their applications is included in the new, free Amperex manual, "Light Sensitive Semiconductor Devices."

Theory, Practice, even Specific Applications and Circuitry are treated in depth in one or more of these chapters:

- *Physics of Solids*
- *Photometric Concepts: The Properties of Photosensitive Devices*
- *Construction of Photosensitive Devices*
- *Principal uses of Photosensitive Devices*
- *Device Data*

Here, at Amperex, we put theory into practice by manufacturing the most advanced and comprehensive line of CdS Cells in the business. The line incorporates the latest manufacturing techniques and materials: sintered CdS, hermetic-sealing, a unique flat space-saver package... for the ultimate in performance, uniformity and stability. Devices can be had off the shelf in virtually every usable configuration, sensitivity and power level. Applications assistance is, of course, available.

For your free copy of "Light Sensitive Semiconductor Devices," or further information on Amperex CdS Cells, write, on your firm's letterhead: Amperex Electronic Corp., Tube Division, Hicksville, L. I., New York 11802.



Amperex®

New Subassemblies

puting accuracy and all loop parameters can be resolved to one part in 10,000. The standard EA101 includes adjustable high-low alarm limits for every variable.

Control output is available in three forms: pulse count for positioning control of a stepping actuator, pulse rate for velocity control of a stepping actuator, and 4-ma to 20-ma d-c signal for conventional analog control of an actuator. Price of a standard 20-30 loop EA101 is \$25,000 to \$30,000. Three to four months are required for delivery. E-A Industrial Corp., Process Automation division, 2326 S. Cotner Ave., Los Angeles, Calif. [409]

I-f amplifiers occupy small space

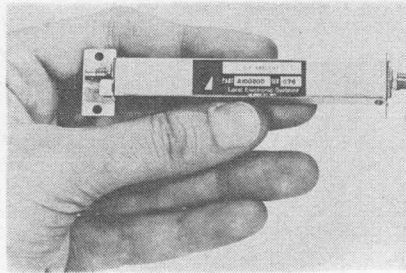

Solid state, microminiature i-f amplifiers have been announced. The multistage high-performance units occupy less than 3/4 cu. in. and are designed specifically for applications in which size, weight, low power consumption and ruggedness are prime considerations.

Models are available with center frequencies from 30 to 160 Mc and bandwidths from 7 to 50 Mc. Typical noise figures are 2.5 db at the lower frequencies and 3.5 db at the higher frequencies. Gain of standard models is 70 db minimum. Each unit weighs 1 1/4 oz.; input power requirements are +15v at 30 ma (max). Operating temperature range is -55° to +85°C. All models meet Mil-E-5400 and Mil-E-5272.

Standard optional features that can be readily provided to meet specific system requirements include changes in center frequency, addition of video detection with or

N P C

Nucleonic Components and Devices Division announces:

ZENER DIODES as low as 30¢ each

1N744 (180v 250mW) to 1N714 (10v 250mW) incl. in DO-7 miniature glass package

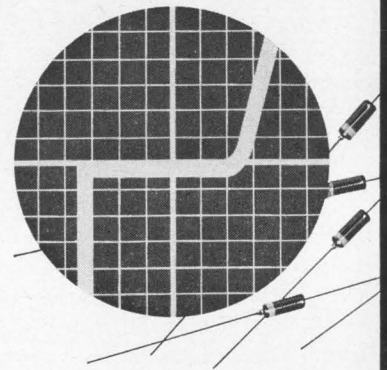

100% reliability tested and inspected after production, and prior to 100% electrical inspection. Total output receives temperature cycle, thermal shock, and storage life tests at elevated temperature. All production lots tested for hermeticity, including radio-active fine leak detector and hydrostatic bomb gross leak test. Tested in accordance with standard military specifications.

For complete information write:

NUCLEONIC PRODUCTS Co., INC.

3133 E. 12th St., Los Angeles, Calif. 90023
Tel.: (213) 268-3464 TWX: (213) 266-6756

without video amplification, electronic gain control, and limiter-discriminator.

Loral Electronic Systems, a division of Loral Corp., 825 Bronx River Ave., Bronx, N.Y., 10472. [410]

Slip-ring capsule contains 67 circuits

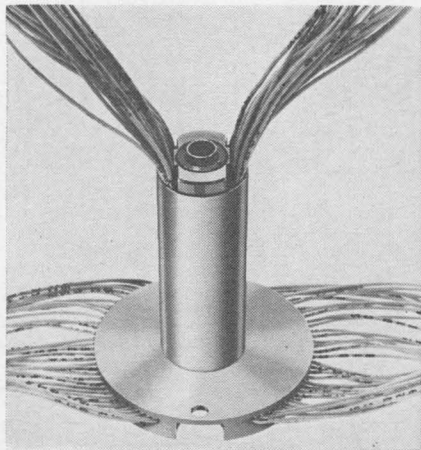

This slip-ring capsule has a hollow bore to permit the passage of coolant fluid through the assembly. Containing 67 circuits, the unit is used for stable platform applications in inertial guidance systems. It is only 2.218 in. long and has a diameter of 0.685 in. Diameter of the bore is 0.191 in. Meeting MIL-E-5400 Class II requirements, the slip-ring capsule has an operating life of 2,000 hours. Temperature range (operating) is 0° to +160°F and (nonoperating) from -65° to +320°F. It withstands vibration from 5 to 2,000 cps at 30 g max and linear acceleration from +10 to -5 g. Dielectric strength from ring-to-ring and ring to frame is 700 v peak minimum. Current rating consists of 37 circuits with continuous load of 2 amps with 2-sec overloads of 3 amps, and 30 circuits with continuous load of 0.5 amp with 2-sec overload of 0.75 amp. Capacitance, exclusive of leads, is 25 pf max ring-to-ring and 9 pf max from ring-to-frame. Contact resistance is rated at 100 milliohms max when stationary and noise is 15 milliohms max when rotated at 1 rpm with superimposed $\pm 1^\circ$ oscillation at a frequency of 1 cps. Torque is 3 in.-oz. max. Structural components of the 67-circuit slip-ring capsule are 303 stainless. Electro-Tec Corp., Box 667, Ormond Beach, Fla. [411]

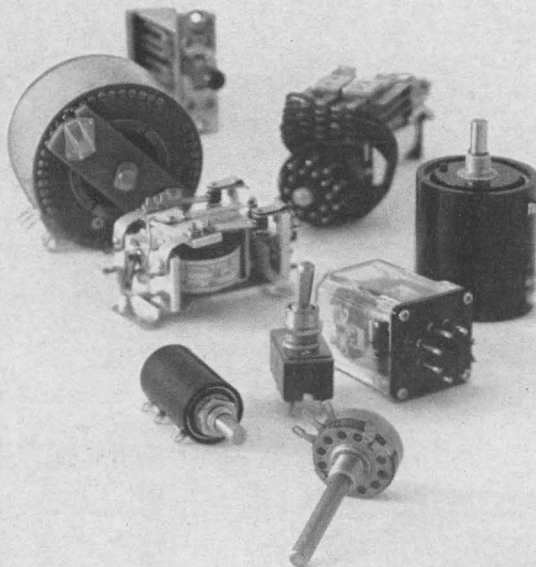

what does it better
and costs less than ever?

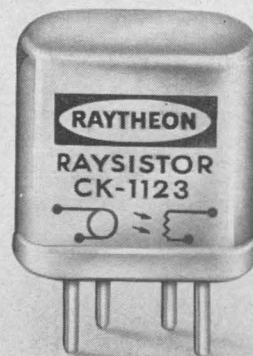

this!

In switching and control applications Raytheon Raysistors provide superior performance at substantially reduced prices. In production quantities, several Raysistor types can now be purchased at a unit cost of less than a dollar.

Raysistors are four-terminal opto-electronic components containing a light dependent resistor and a light source. They have no moving parts; are rugged with exceptionally long life and afford isolation between signal and control circuits. Raysistors make possible low-noise, pedestal-free switching of ac or dc signals over a wide dynamic range without transients — without wiper or contact chatter or sparking. Match the conventional components you may be considering for your switching or control design against these qualifications!

For small orders or prototypes, see your local Raytheon industrial distributor. For technical data and sales information please write Raytheon Company, Components Division, Industrial Components Operation, Dept. 2011, Lexington, Massachusetts 02173.

RAYTHEON

WHERE CAN MAN GO...IN SYSTEMS



In space, on land, in the ocean depths...if his company is exploring those environments. Lockheed's systems activities encompass journeys to near and distant space, automated hospitals and unique land vehicles, and deep submersibles. And indispensable to this broad effort are men able to contribute to systems management. To analyze. Design. Test. To integrate subsystems into entities reaching thousands of miles—or thousands of fathoms—beyond the limits binding men today. Engineers and scientists with a systems flair are invited to write Mr. K. R. Kiddoo, Professional Placement Manager, 462 Industrial Relations Building, Sunnyvale, California. Lockheed is an equal opportunity employer.

LOCKHEED
MISSILES & SPACE COMPANY
A GROUP DIVISION OF LOCKHEED AIRCRAFT CORPORATION

Frequency-generating assembly on board

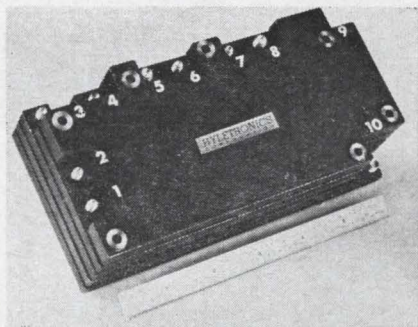

A C-band frequency-diversity signal generator, developed for missile guidance, represents an advance in microwave printed circuitry. Its assembly includes semiconductors, ferrite devices and conventional components on one printed circuit board.

The design is useful where it is necessary to generate a variety of frequencies for local oscillators, and to keep size and weight at a minimum. Applications are opening up in airborne, satellite and manpack radars in addition to missile guidance, says Jack Kline of Hyletronics Corp. In its model AC-11, made of five interconnected tiers of strip-line circuitry, Hyletronics inserts the diodes, lumped capacitors and loads. Everything else in the assembly is printed. Rigid coaxial connectors link the tiers.

Twenty discrete frequencies are generated over a band of several hundred megacycles at C-band. The signal applied to the balanced modulator dictates the center frequency. The logic signal applied to the diode switch selects the desired sideband. Each signal may be shifted in phase by a digital phase shifter, which can change the phase of a signal within 1 nanosecond.

The microwave printed circuitry with dielectric filled strip line permits a high component density, can withstand severe vibration and shock. Power output of the assembly is in the 1-mw range.

"The next step," says Kline, "is to put transistors in the strip line.

The devices now available do not perform any amplification."

According to Kline, dielectric filled strip line performs well over the frequency range from 100 Mc to about 12 Gc.

The input to the assembly is a uhf pulsed signal, which is multiplied up to C-band by a two-stage varactor multiplier. The fixed-frequency C-band signal passes through an isolator to a four-position digital phase shifter which also uses varactor diodes.

After a second stage of isolation, the signal passes through a varactor balanced modulator which has as its purpose the production of first upper and first lower sidebands, and the suppression of other harmonics. The modulation sidebands are transmitted through another isolator to a diplexer that separates the upper from the lower sidebands. The two outputs of the diplexer are combined in a single-pole, double-throw diode switch that acts as a sideband selector. Either of two output terminals may be selected by a second spdt switch. The first and second switches are controlled by external logic inserted in the form of low frequency, video band signals through the bias terminals. The isolators used in the assembly are internally terminated, three-part circulators integrated into the strip-line circuitry.

Delivery takes from 30 to 90 days.

Specifications

| | |
|------------------------------------|--|
| Spdt switches | |
| Insertion loss | 0.8 db |
| Isolation | 35 db |
| Switching speed | 1 nanosecond |
| Ferrite circulator | |
| Insertion loss | 0.3 db |
| Isolation | 20 db |
| Varactor balanced modulator | |
| | Conversion loss into each sideband 5 to 7 db for modulating frequencies from 30 to 300 Mc. |
| Size of entire assembly | 7 x 3 1/4 x 2 1/8 inches |
| Temperature range | -55° to +65°C |

Hyletronics Corporation, 185 Cambridge St., Burlington, Mass. [421]

Got a Problem of DIMENSIONS?

TEMPERATURE?

UNUSUAL CYCLING?

SHOCK RESISTANCE?

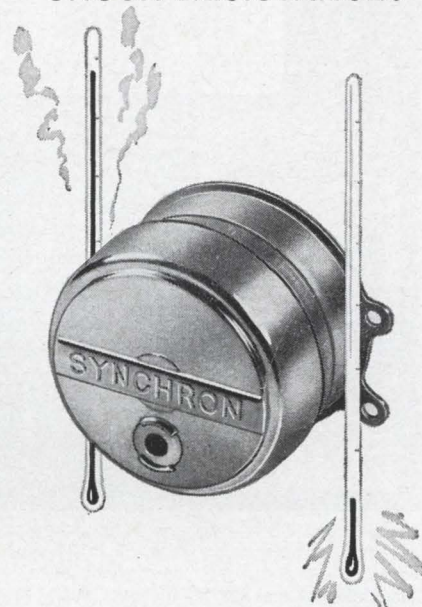

turn the job over to SYNCHRON® MOTORS!

What's the motor problem you face in the design you're working on? One of tricky performance requirements? Difficult environment? Total accuracy? Before you do anything else, see how SYNCHRON Motors can be applied. (Do the same thing even when you have a simple, straightforward application in mind!) Just write us at Hansen Manufacturing Company and tell us what you want a motor to accomplish. You'll get an immediate answer and any help you need for specific problems.



HANSEN REPRESENTATIVES: CAREY & ASSOCIATES, Houston, Tex., R. S. HOPKINS CO., Sherman Oaks, Calif., EICHORN & MELCHIOR, INC., San Carlos, Calif., THE FROMM CO., Chicago, Ill., H. C. JOHNSON AGENCY, INC., Rochester, N. Y., WINSLOW ELECTRIC CO., Essex, Conn., and New York, N.Y. EXPORT DEPARTMENT, 64-14 Woodside Ave., Woodside, N. Y. Handled exclusively in Canada by Sperry Gyroscope Ltd., Ottawa, Canada.

COMMUNICATIONS PROBLEMS

?

SEND YOUR UHF-VHF PROBLEMS TO SINCLAIR

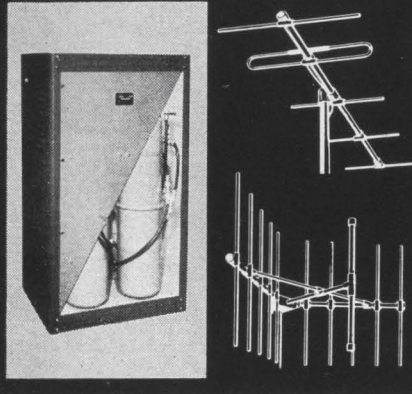

MULTICOUPLERS — use one antenna to simultaneously transmit and receive up to 24 systems . . . with high isolation between channels, low insertion loss and low maintenance costs. Multi-couplers for the 30MC to 10KMC range — specials to meet unusual problems.

DUPLEXERS — for the ultimate in isolation between Tx and Rx for dual simplex or full duplex operation. Separation as low as 0.5 MC at full power load of 250 watts. Perfect for base or repeater station or mobile operations. Frequency ranges from 30 MC to 960 MC — as small as 2" x 4" x 6".

ANTENNAS — a complete line — Isorays . . . Yagis . . . Ground Plane . . . Corner Reflectors . . . Base Station . . . Mobile — for frequency ranges from 30 MC to 470 MC. Gains from 0 db to 20 db. Rugged enough to withstand 125 mph winds with 1/2" ice coating — small enough to fit in a rear view auto mirror.

Also, a complete quality line of Band Pass and Reject Filters, Mounting Accessories and Antenna Hardware. Clip the coupon, attach to your letterhead, and we'll send complete details.



SINCLAIR RADIO LABORATORIES, INC.

523 FILLMORE AVENUE, DEPT. 101
TONAWANDA, NEW YORK

IN CANADA: 21 TORO ROAD
TORONTO, ONTARIO

Name _____ Title _____

Company _____

Address _____

City _____ State _____

New Microwave

Circulator operates from 7.7 to 8.4 Gc

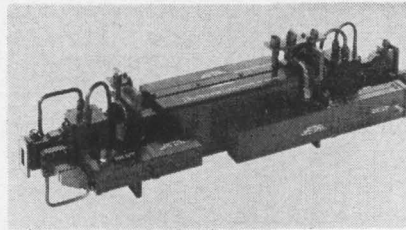

An X-band circulator now available, operates at an average power of 100 kw c-w. This power level is said to be twice that achieved previously for circulators in this frequency band. Model CXH26 has a maximum insertion loss of 0.25 db and isolation greater than 20 db. The unit is a four post differential phase shift circulator designed for application as a duplexer or isolator. An input vswr of 1.10 or less is achieved in the operating frequency band of 7.7 to 8.4 Gc.

The CXH26 is designed to withstand 20 psig waveguide pressurization, and input and output are in WR-137 waveguide. The device has been operated in a resonant ring at power levels up to 125 kw.

Raytheon Co., 130 Second Ave., Waltham, Mass., 02154. [422]

Co-ax termination withstands 50 w

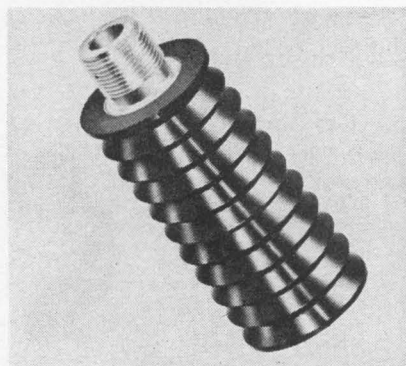

Model 376 medium power coaxial termination combines small size and light weight without sacrificing performance. It is capable of

4ways NEW

SPACE-SAVER

PANEL METERS

WITH VALUABLE FEATURES ENGINEERS HAVE ALWAYS WANTED

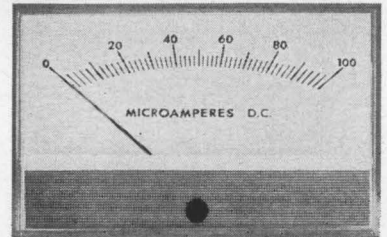

Minimum height design to save panel space!

NEW! 15% longer scale — 40% less space.

NEW! Crisp, low profile for modular styling. Permits the equipment designer to achieve the ultimate in design.

NEW!

Quick clip mounting saves 90% of normal installation time.

No washers, nuts or screws.

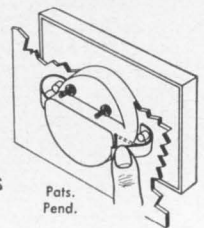

NEW! Recessed terminals require less chassis depth, leave more space for components.

FOR YOUR APPLICATION, MAY WE QUOTE ON YOUR SPECIFICATIONS, OR HAVE OUR REPRESENTATIVE CALL?

Experienced manufacturers of meters in volume, for both commercial and military applications, including ruggedized and sealed meters to military standards

Designed and Manufactured by

DIXSON, INC.

METER DIVISION DEPT. B

GRAND JUNCTION, COLORADO

withstanding 50 watts average power over the entire frequency range of d-c to 12.4 Gc. Construction features a precision-aged resistor with a precisely preformed aluminum body that eliminates the possibility of poor heat conductivity resulting from improperly soldered cooling fins. Vswr from d-c to 4 Gc is 1.2; from 4 to 10 Gc, 1.30.

Narda Microwave Corp., Plainview, L.I., N.Y. [423]

Radar transponder operates at S band

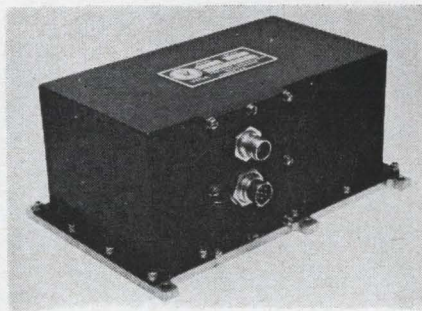

Model 307S radar transponder is an S-band superheterodyne unit for missile, satellite drone and target applications for S-band tracking radars. This unit weighs only three pounds and occupies 50 cubic inches, yet maintains the electrical and environmental characteristics of superheterodyne transponders.

The transponder incorporates a two-pulse decoder and transmitter power of 400 w, sensitivity -65 dbm minimum, 100% firing, with recovery time of less than 50 μ sec. It also can survive severe vibration, shock and temperature.

Vega Precision Laboratories, Inc., 239 Maple Ave. West, Vienna, Va. [424]

L-band multiplier delivers 10 mw at 1.5 Gc

This solid state frequency multiplier delivers 10 mw at 1.5 Gc when driven by a 5-Mc signal. The VFM-103L is a compact, rugged unit consisting of transistor frequency-multiplier amplifiers followed by a cascade of varactor multiplication factors. The frequency multiplication factor is 300. The unit is suitable for use with 5-Mc frequency standards. Frequency is 1.5 Gc; r-f output power at 1.5 Gc,

MEASURE SOUND LEVELS OVER THE FULL DYNAMIC RANGE WITH MASSA SOUND PRESSURE MICROPHONES

M-125
Freq. Range Cps 20-30,000

M-103
Freq. Range Cps 20-30,000

M-141
Freq. Range Cps 20-30,000

M-215
Freq. Range Cps 20-70,000

M-213
Freq. Range Cps 20-100,000

RMS Sound Pressure (Dynes per cm²)

Massa Sound Pressure Microphones provide accurate and reliable sound pressure measurements from low levels to the ultrasonic region under practically any acoustic environment. Important features include:

- Linear Dynamic Ranges to sound pressures in excess of 200 db (re: 0.0002 microbars).
- No D.C. Polarizing required.
- Exclusive ADP (Ammonium Dihydrogen Phosphate) Crystals for uniform reliability, stability, and accuracy.
- Frequency Ranges from 20 cps to 100,000 cps.
- Omni-Directional to high frequencies for sure pickup of sound in difficult areas.
- Near Infinite Acoustic Impedance or no loading of the sound field.

Complete Portable Systems are also available for use where reliable measurements must be made at inconvenient locations.

Write for FREE Pocket Size Sound Level Measurement Chart

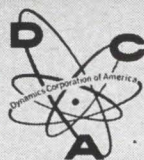
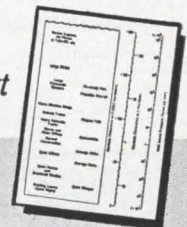

MASSA DIVISION
DYNAMICS CORPORATION OF AMERICA
HINGHAM, MASS. 02043

500 kc all silicon Bi-Directional Counters

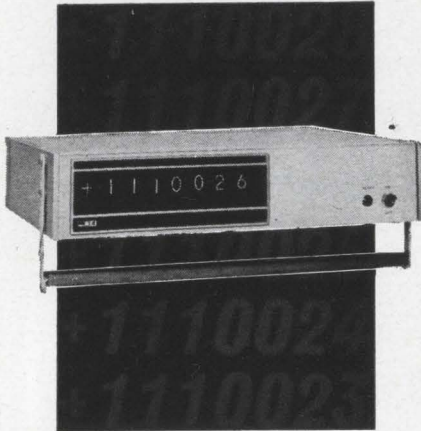

Model 658, 7 digits with polarity sensing, only 3½" high.

Janus Bi-Directional Counters, Series 600, are available with and without polarity sensing for use with machine tool control systems, process control systems, guidance systems or any application requiring the comparison of two input signals such as shaft encoder outputs, accumulation of pulses from one or two sources and the addition or subtraction of random input pulses.

These instruments not only count in both directions at 500 kc but reverse without error at this maximum counting rate. Bright, clear, in-line display is provided for convenient wide angle viewing.

Series 600 Counters are available in 4 to 8 digit models and up to 6 digits in dual packages for convenient two-axis measuring. A few of these other options include printer outputs, preset capability and input sensitivities as low as 25 millivolts peak for both inputs.

Price Range: \$895 to \$2795.

Availability: 30 days A.R.O.

The Next Time You Need Counters
Count on JANUS



JANUS CONTROL CORPORATION
HUNT ST., NEWTON, MASS. TEL. 926-2670

New Microwave

10 mw; power stability, ± 2 db; r-f input power at 5 Mc, 10 mw; d-c input power, 3.5 w; supply voltage, 24 v d-c; spurious response below signal, > 30 db; weight, 1.5 lb.; operating temperature, -25° to $+70^{\circ}$ C.

Solid State Products unit of Varian Associates, Beverly, Mass. [425]

Circulator/isolator operates at X band

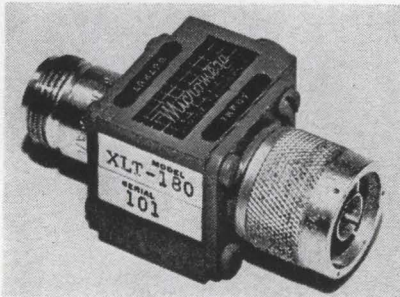

This miniature coaxial X-band circulator/isolator operates from 8.5 to 9.5 Gc with isolation of 25 db, insertion loss of 0.4 db and vswr of 1.15. Model XLT-180 measures 1 by 1½ by ¾ in., excluding connectors. Weight is 4 oz, including type N connectors. Similar units are available at L-, S- and C-band. Micromega Corp., 4134 DelRey Ave., Venice, Calif. [426]

Turret attenuator covers 0 to 109 db

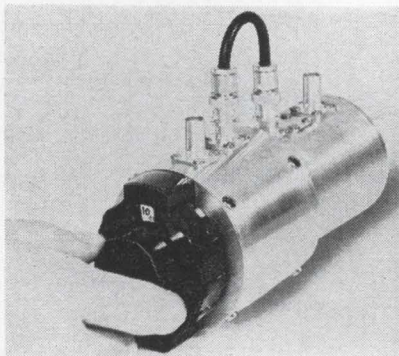

A wide-range turret attenuator, model TA-109, covers a range of 0 to 109 db in 1-db steps. The unit's dial arrangement permits the user to read the attenuation setting di-

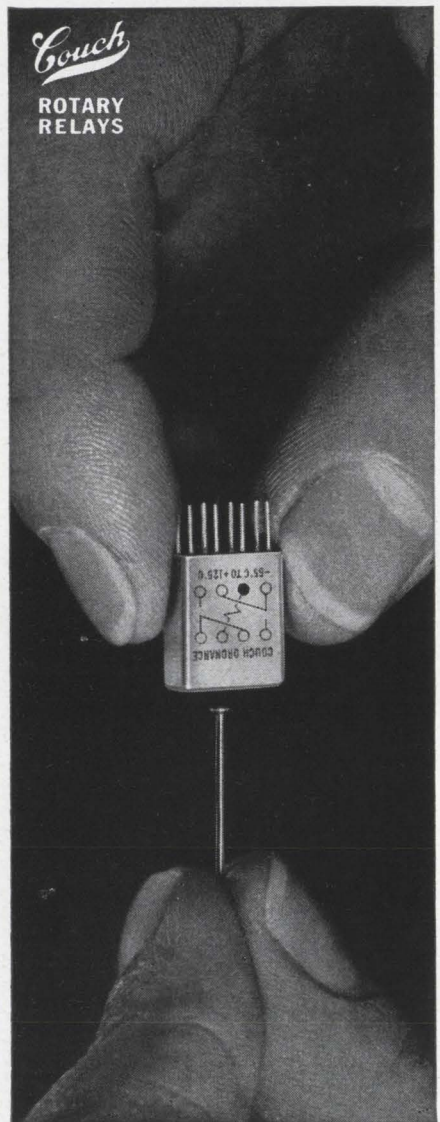

Couch
ROTARY
RELAYS

good and small

This new Couch rotary relay is surprisingly microminiature when you consider the rugged construction inside and the specifications

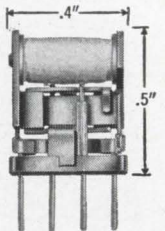

| | |
|----------------------------|-------------------------------------|
| SIZE | .2" x .4" x .5" |
| TERMINAL SPACING | 1/10" grid |
| RATING | .5 amp @ 30 VDC |
| COIL OPERATING POWER | 150 mw |
| COIL RESISTANCE | 60 ohms to 1,000 ohms |
| TEMPERATURE | -65° C to $+125^{\circ}$ C |
| VIBRATION | 20 G |
| SHOCK | 75 G |

Write for Data Sheet No. 9

RUGGED ROTARY RELAYS  Dynamically and Statically Balanced

COUCH ORDNANCE INC.

3 Arlington Street, North Quincy 71, Mass., Area Code 617,
CYpress 8-4147 • A subsidiary of S. H. COUCH COMPANY, INC.

rectly. Used as a test accessory for attenuating r-f signals, the TA-109 offers the design, test, or production engineer a range of attenuation in a rugged, compact, easy-to-use unit.

The attenuator has dual control on concentric shafts for unit and decade db selection. Separate overlapping transparent dials for each control are calibrated so that the setting may be read directly through a single window. The rugged unit meets many military specifications and is easily panel-mounted. It is silver plated and is available with BNC or TNC connectors.

The TA-109 features high repeatability with accuracy ranging from 0.15 to 0.5 db. Low vswr is held to 1.25:1 at 400 Mc and only 1.35:1 at 1 Gc. Power rating is 1 w. The attenuator measures 3 in. diameter by 5¾ in. long, behind panel. Weight is 3 lb 4 oz. Price is \$240; delivery, 90 days.

Telonic Industries, Inc., Beech Grove, Ind. [427]

Coaxial attenuator covers d-c to 18 Gc

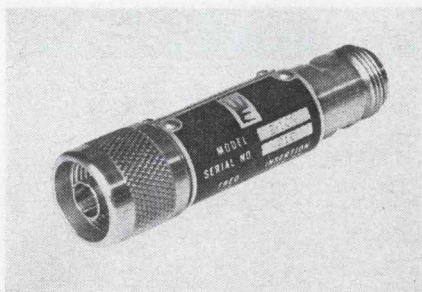

A newly developed frequency attenuator essentially flat from d-c to 18 Gc is announced. Known as the model 2, the device features low vswr and frequency sensitivity. The insertion loss is kept within $\pm 5\%$ for both the 10 and 20 db values. An attenuating card, with a recently developed resistive film deposited at red heat on a ceramic base, in conjunction with an entirely new stainless steel semiprecision type N connector, form the heart of the new design. The new connector, which mates with older type N fittings, had to be developed before work could start on the attenuator. The model 2 is presently available in 10 and 20 db

MODULES POTTED IN *TIMONIUM*

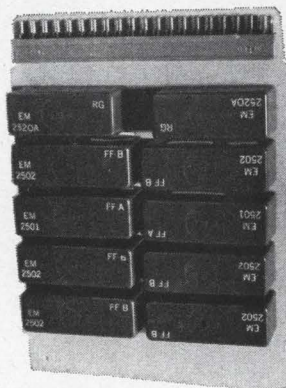

DUAL DECADE COUNTER

Comprises two independent counter chains which can be used in a variety of counter modes. Basic configuration consists of two separate decade counters with reset capability; however, for applications such as digital clocks, "divide-by" functions other than 10 can be provided.

- Standard digital module families to 250 KC and 2 MC
- Power supplies
- Special function boards
- Specialized designs at "off-the-shelf" cost and delivery

EMC
ELECTRONIC
MODULES
CORPORATION

1949 GREENSPRING DRIVE • TIMONIUM, MD.
CLearbrook 2-2900 TWX-301-252-0723



livability

(an industrial location advantage)

There's fun-filled living for you and your employes when you locate your plant in prosperous WESTern PENNSylvania. Ski on nearby slopes . . . fish for wary trout and bass . . . hunt big and small game . . . water-ski . . . listen to music by a top symphony orchestra . . . go to art festivals, operas and straw hat theaters . . . or visit reminders of a romantic past. Large and small industrial sites are available, many on rivers and streams. There's room to spread out . . . room to live and grow, so locate your operation in WESTern PENNSylvania.



WEST PENN POWER
an operating unit of ALLEGHENY POWER SYSTEM

Area Development Department, Room 5611
WEST PENN POWER—Greensburg, Pa. 15602
Phone: 412-837-3000

In strict confidence, I'd like details about WESTern PENNSylvania's: 4-Season Livability Favorable Tax Climate
 Financing Plans Pre-production Training Industrial Properties and Shell Buildings

Name _____
Title _____
Company _____
Address _____
City _____ State _____
Code _____ Phone _____

New Microwave

values with individual calibrations at d-c, 4, 8, 12, 16, and 18 Gc stamped on the nameplate. Price is \$175.

Weinschel Engineering, Gaithersburg, Md. [428]

Telemetry amplifier uses tunnel diodes

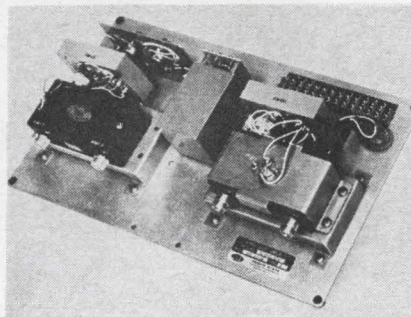

A new tunnel diode amplifier exhibits 30 db of gain in the telemetry frequency range of 2200 to 2300 Mc. Model NC-2209 has an input vswr less than 1.5 and its noise figure is less than 3.5 db over this frequency range. Designed for use in telemetry tracking of deep space probes, the NC-2209 uses custom designed gallium antimonide tunnel diodes to realize the necessary high performance. The Micro State Electronics Corp., 152 Floral Ave., Murray Hill, N.J. [429]

Crystal detector is highly sensitive



This crystal detector provides a flat frequency response of better than ± 0.5 db over a frequency range of

NEW! and NOW!

IRRADIATED

Polyolefin Shrinkable Tubing PENNTUBE[†] V

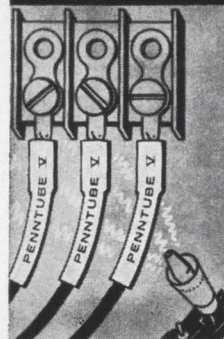

from
**PENNSYLVANIA
FLUOROCARBON
COMPANY**

2:1 shrink ratio.
Meets
all applicable
specifications.

Write for product data
sheet and free sample
NOW!

**PENNSYLVANIA
FLUOROCARBON CO., INC.**
Holley Street & Madison Ave.,
Clifton Heights, Pa.
Phone: (215) MADison 2-2300
TWX: 215-623-1577

Export Dept. Room 5710 Empire State Bldg. N.Y. 1, N.Y.

One source for:

TEFLON* TFE
Shrinkable
(Penntube-I-E)

TEFLON FEP
Shrinkable
(Penntube-II-SMT)

IRRADIATED
Polyolefin Shrinkable
(Penntube V)

*Du Pont Reg. T.M.

†Penna. Fluorocarbon Reg. T.M.

Circle 224 on reader service card

Kyocera

New Ceramic Products from:

Alumina Forsterite Zircon
Beryllia Steatite Cordierite
Magnesia Mullite Multiform Glass

for Better Performance

For Further Information, please contact
MARUBENI-IIDA(America)Inc.
Los Angeles Branch 530 West Sixth Street
Los Angeles 14, Calif. MADison 8-6271

K KYOTO CERAMIC CO., LTD.

11, Haramachi, Nishinokyo, Nakagyo-ku, Kyoto, Japan.

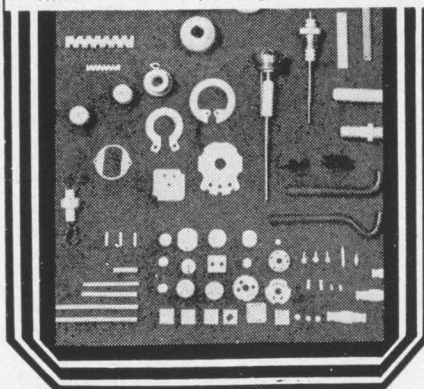

Circle 225 on reader service card

10 Mc to 12.4 Gc. Offering high sensitivity and an swr of less than 1.4 over the entire frequency range, the new detector is ideally suited for a variety of applications such as power leveling, absolute and peak power measurements, broadband detection and in reflectometer systems. Model 1001 has an output capacitance of approximately 30 pf. A power input no greater than 0.4 mw is required to produce 0.1 v rectified output; square law response is within ± 0.5 db from low level to 1 mw output power. The unit is 2.4 in. long, 0.8 in. in diameter. Price per unit is \$115. Delivery is in 30 days.

Alfred Electronics, 3176 Porter Drive, Palo Alto, Calif. [430]

Circulator switch without moving parts

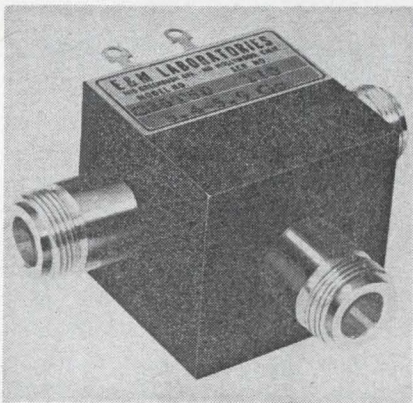

A compact, ferrite circulator switch has been announced. It latches without holding power in the normal operating position. Switching power is required only for the alternate position, thus providing a fail-safe feature. High reliability is achieved since no moving parts are used. Operating life is considered indefinite. Typical characteristics for the model C35T50 switch are: frequency range, 5.4 to 5.9 Gc; isolation, 20 db minimum; insertion loss 0.3 db max; vswr, 1.20 max; coil power, 5 watts nominal; body dimensions, 1½ by 1½ by 1⅝ in.; and weight, 6 oz. This latching type switch is ideally suited for antenna switching, phased-array steering, and push-to-test system calibration. Similar units are available in other frequency ranges.

E & M Laboratories, 7419 Greenbush Ave., North Hollywood, Calif. [431]



Great editorial is something he takes to lunch

(What a climate for selling!)

Electronics

A McGraw-Hill Market-Directed Publication
330 West 42nd Street, New York, N.Y. 10036



HOW'S YOUR THERMISTOR IQ?

Want to learn more about these versatile, precision sensors? Here's FREE literature to help you.

CAPSULE THERMISTOR COURSE BOOK

Ten quick, painless lessons on precision thermistors, their characteristics, and how they are used. Illustrates basic thermistor circuits, compares thermistors with other sensors, gives typical circuit design calculations, etc.

Ask for F.E.I. CAPSULE THERMISTOR COURSE BOOK.

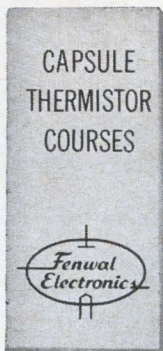

THERMISTOR FACT FOLDER

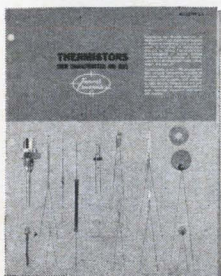

An illustrated booklet which describes various thermistor types, including F.E.I. ISO-CURVE* interchangeable thermistors, and how to apply them in measurement and control circuits.

Ask for F.E.I. THERMISTOR FACT FOLDER.

*MADE UNDER PAT. 3109227 AND OTHERS. ISO-CURVE IS A TRADEMARK OF F.E.I.

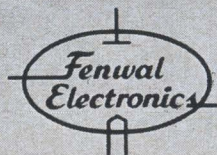

63 FOUNTAIN STREET, FRAMINGHAM, MASS.

New Production Equipment

All-purpose vacuum modules

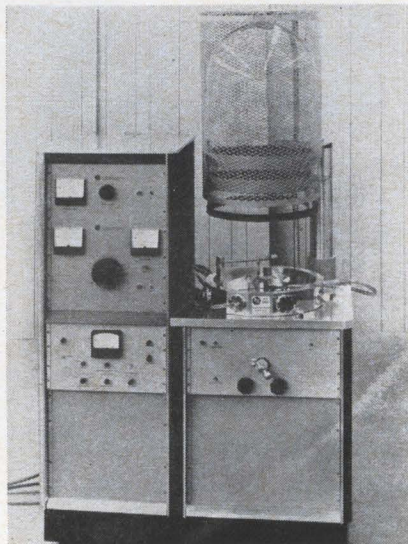

Electron-beam, vacuum-deposition system can be converted into other types of vacuum equipment by adding modular accessories.

There is no universal method of making thin-film components and conductors of microcircuits. Nickel-chromium resistors and aluminum conductors, for example, are evaporated, but tantalum, platinum and many oxides, nitrides and sulfides require sputtering. Buying enough equipment to cover all bets is expensive.

Materials Research Corp. expects to solve this problem for developers and small-volume producers of microcircuits, semiconductor devices and thin-film memories, by supplying a vacuum system similar in concept to the home carpentry shops that boast accessories for sawing, turning, routing and a dozen other jobs.

MRC is offering vacuum evaporators and about 100 modular components and accessories that convert an evaporator into systems able to refine, deposit and microscopically examine a variety of thin-film materials. Since there is no need to duplicate pumps, vacuum collars, bell jars and other components, each system costs less.

The new V4-EVD, an electron-beam, vapor-deposition system is the primary equipment offered by

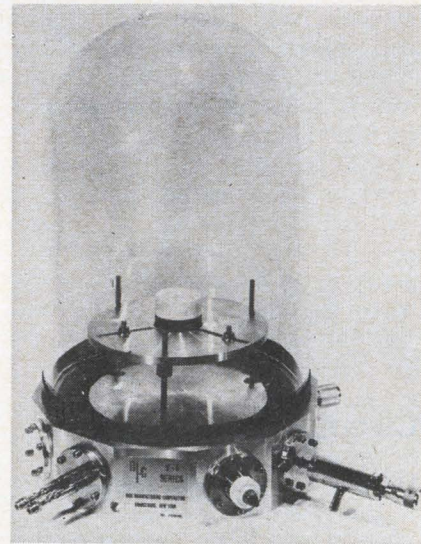

Vacuum collar (bottom) of sputtering module can be fitted with other accessories if cathode assembly (center) is removed.

MRC. This evaporator includes pumps, electron guns, and their power supply, gages, 12 or 18-inch vacuum collar, and accessories. It can be equipped with ion pumps and made bakeable for ultrahigh vacuum, and can have glass or steel bell jars. Cost is \$7,000 to \$8,000.

Mating accessories include an electron-beam, floating-zone refiner for growing crystals and purifying refractory materials, an arc-melting furnace for materials preparation, electron-beam guns for heating or bakeout as well as materials evaporation, a sputtering system, a field-ion microscope and shadowing apparatus for electron microscopy. Most of these units are versions of equipment previously developed by MRC. Prices range up to \$15,000.

Users needn't buy the basic V4-EVD evaporator. The sputtering module is a new design that can be used on any vacuum evaporator, under the existing bell jar. The module's vacuum collar, which holds the various feedthroughs and controls, is placed on the evaporator's base plate. Similarly, the collar can be used to mate other accessories to the evaporator.

The sputtering module's cathode assembly has a three-point holder

Announcing an unexpected development in electron tube conduction cooling

To give you maximum design flexibility while simultaneously reducing equipment size and cost, Amperex has developed an entirely new conduction cooling technique for electron tubes.

The key to the new technique is a beryllia heat-conduction block that is not integral to the power tube it serves. Indeed, its only connection to the tube is through an efficient thermal compound. Thus, for your design purposes, the size of the heat block will be in direct proportion to the power requirements you plan to place upon the tube—the lower the plate dissipation, the smaller

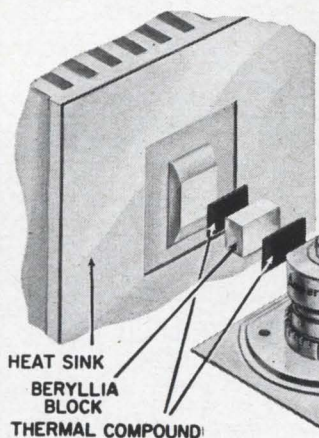
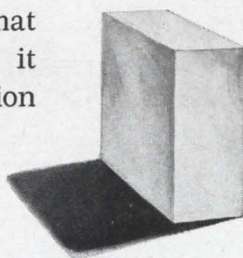

the beryllia block and its heat sink. The position of tube and block in the chassis will be largely a function of your design-layout-requirements (rather than determining them as was the

case heretofore). In the event of tube failure, the new Amperex cooling method means that the tube is all you replace, the customary inconvenience and additional expense of replacing the block being eliminated.

In addition, the Amperex technique, like other conduction cooling methods, eliminates the cost, space and downtime normally associated with most other approaches to cooling.

To implement its new technique, Amperex has developed a new power tetrode, the type 8560.

This rugged, compact, new ceramic and metal tetrode derives from the "4X" tube series, it therefore can be counted on for exceptional efficiency and reliability not only for the popular 50, 150 and 470Mc commercial communications bands, but for SSB and point-to-point AM and FM applications as well.

The 8560 is designed for use as a high-efficiency RF power amplifier at frequencies up to 500Mc.

As a Class C amplifier under CCS conditions it can produce 270 watts output at 175Mc from 4 watts drive. The maximum allowable plate dissipation of the 8560 is solely a function of the effectiveness of the conduction cooling system and approaches 500 watts under the most ideal conditions.

Amperex is ready to put its new cooling technique and its unique new power tetrode to work for you. Applications assistance as well as complete data is available. (Data includes all formulas necessary for designing a conduction cooling system to fit your particular applications.)



Wire or write: Amperex Electronic Corporation, Tube Division, Hicksville, Long Island, New York, N. Y. 11802.

Amperex[®]

IN CANADA: PHILIPS ELECTRONIC DEVICES, LTD., TORONTO 17, ONT.

**You
can
SEE
why
they're
Best...**

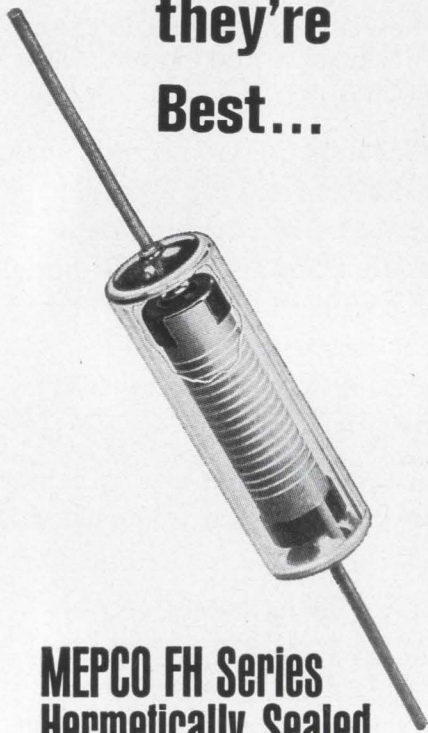

**MEPCO FH Series
Hermetically Sealed,
Glass Enclosed
METAL FILM
RESISTORS**

High reliability resistors for demanding requirements of aerospace and military electronics fields. Conform to MIL-R-55182.

For complete information and detailed specifications, write:

MEPCO, INC.

Morristown, New Jersey 07960
Phone (201) 539-2000
TWX (201) 538-6709



Production Equipment

which accepts sputtering disks in various shapes up to 7 inches in diameter. The substrate holder takes slides up to 7 inches and is water-cooled. The gas feed and the power supply which generates the glow discharge in the gas are adjustable. Two gases can be mixed.

The module costs \$2,170, or \$995 without the high-voltage power supply. Model number is V4-SM-8000.

MRC says it can deliver V4-EVD systems in two to four weeks. Most of the accessories are in stock. Materials Research Corp., Orangeburg, N.Y., 10962. [451]

**Cutter and former
works on house current**

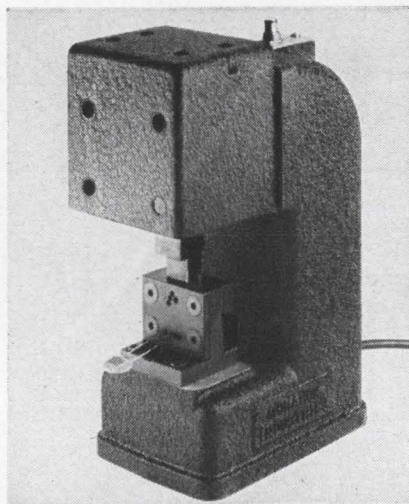

Model 10 wire cutter and former operates from 115 v, 60 cycle power. It is a production lead chopper for transistors, capacitors, and trimmer potentiometers. Economical accessory dies are available for all standard lead configurations. Adjustable stops allow cutting to desired length. The standard machine is equipped with die plates that enable the user to make solid wire cut-offs for component leads, solder preforms, jumper wires, etc., in a wide range of sizes. Cutting blade and die are made of hardened tool steel. The device is rugged, and portable for use in laboratory or shop. Monarch Industries, Inc., 1121 E. El Segundo Blvd., El Segundo, Calif., 90245. [452]

NEW

**TYPE 301
FUNCTION
GENERATOR**

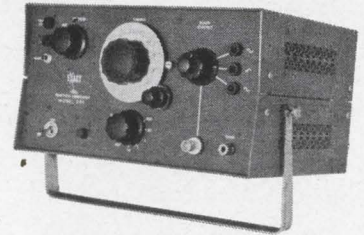

- 0.001 cps to 1 mc
- SOLID-STATE
- SQUARE-TRIANGLE-SINE
- 10 nsec RISETIME
- 10v P-P into 52 ohms
- SIMULTANEOUS OUTPUTS
- TRIGGERED and GATED MODES
- \$550.00 F.O.B. FACTORY

SIMULTANEOUS OUTPUTS

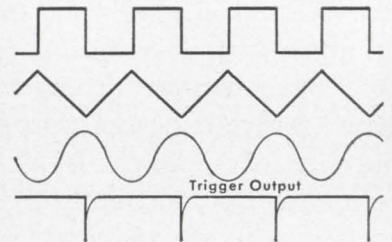

EXTERNALLY TRIGGERED

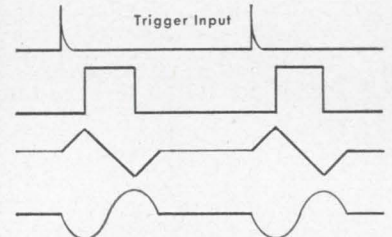

EXTERNALLY GATED

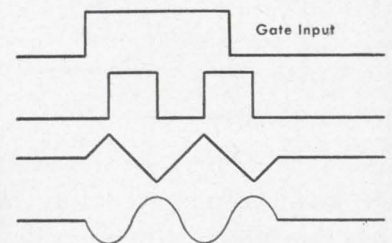

For comprehensive data sheets on the 301 and other EXACT FUNCTION GENERATORS, write, phone or TWX:

EXACT ELECTRONICS INC.

Dept. E-2
455 S.E. 2nd AVENUE
HILLSBORO, OREGON 97123
Phone (503) 648-6661
TWX: 503-821-6927



constant temperature and environmental simulation equipment for MIL SPEC TESTING OF ELECTRONIC PRODUCTS



NEW LIQUID CO₂ SUB ZERO CABINETS . . . for constant temperature operation between -100° F and +300° F, with temp. constancy of ±0.25° F. Latest in a wide range of environmental simulation equipment are the new AMINCO Liquid CO₂ cooled Sub Zero Cabinets. These cabinets feature a large, 30" x 24" x 24", interior work space, fast pull-down time—12 minutes from +80 to -100° F—(with high pressure liquid CO₂) and the added benefit of low cost when compared with mechanically operated units. The Sub Zero Cabinets are ideal for testing electronic products and components for compliance with military specifications. DRY-ICE-operated models also available.



For complete information on these AMINCO products, write for Constant Temperature Catalog 56E-6.

THE AMINCO CLIMATE-LAB . . . provides an environment controlled within ±1% R.H. and ±1° F. AMINCO Climate-Labs offer precise control of temperature and humidity by conditioning the air prior to its entering the test chamber. The PC Model Climate-Lab (illustrated) is fitted with an automatic program controller that permits four types of control: 1—Constant humidity and constant dry-bulb temperature; 2—Constant humidity and varying dry-bulb temperature; 3—Varying humidity and constant dry-bulb temperature; 4—Varying humidity and varying dry-bulb temperature. Other features: 9.6 Cu. Ft. test chamber with stainless steel interior, completely automatic, continuous operation. Type B Climate-Lab, without automatic program control, provides a constancy of ±¾° F and ±½% R.H.

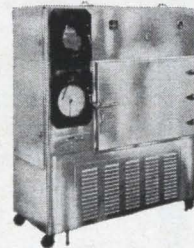

HI-TEMP OVENS . . . feature stabilized, precise temperature control between 125° and 1000° F. These bench-model ovens have electric resistance heaters located in all six walls (including door) resulting in excellent temperature uniformity (point to point: ±4° F at 1000° F) throughout the chamber. Constancy: 0.5° F throughout entire range.

WIDE-RANGE LAB BATH . . . provides constant temp. between -29° and +71° C. A general purpose water bath having both refrigerating and heating units for providing precisely controlled, constant temperature conditions for many test uses. Permits testing of parts, components, sub-assemblies and many complete products. 2 sizes: 16 gal. and 50 gal. capacity.

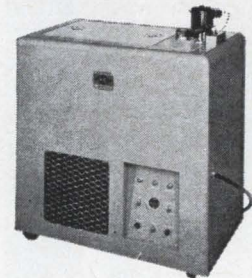

AMERICAN INSTRUMENT CO., INC. 8030 Georgia Avenue, Silver Spring, Md.

Circle 226 on reader service card

Mitsubishi Photo-Conductive Cells For Long Life

As with all Mitsubishi electronic components, these photo-conductive cells are made from only the finest materials—and manufactured under a quality control program which assures you of continuous, trouble-free performance. Mitsubishi Three Diamonds mark, Japan's most famous product symbol, is your guarantee of top quality components.



PZC-3107
A miniature slug type, cadmium sulfide, low voltage cell. Especially applicable to camera equipment. Hermetically sealed, moisture proof and long lived.

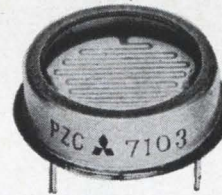

PZC-7103
Especially applicable to automatic relays and automatic switching equipment, this moisture proof cell is designed for a power application of approximately 0.3 W.



PZE-3101G
A glass sealed, slug type, selenic cadmium cell, designed for photoelectric measuring devices, control circuits, non-contact relays etc.

PHOTO-CONDUCTIVE CELLS

| Specifications | | PZC-3107 | PZC-7103 | PZE-3101G |
|----------------------|---------------------|----------|----------|-----------|
| Max. Rating | Voltage (V) | 100 | 200 | 50 |
| | Power (W) | 0.03 | 0.3 | 0.01 |
| | Temperature (°C) | -75~+60 | -75~+60 | -40~+40 |
| Max. Dimension | Thickness (inch) | 0.12 | 0.32 | 0.52 |
| | Diameter (inch) | 0.37 | 1.10 | 0.26 |
| Resistance (at 25°C) | 100 lux | 5 KΩ | 1.6 KΩ | 70 KΩ |
| | 10 lux | 20 KΩ | 8 KΩ | — |
| | 1 lux | 80 KΩ | 40 KΩ | — |
| | Dark (after 30 sec) | 1 MΩ | 5 MΩ | 1,000 MΩ |



MITSUBISHI ELECTRIC CORPORATION
Head Office: Mitsubishi Denki Bldg., Marunouchi, Tokyo. Cable Address: MELCO TOKYO

off-the-shelf,
steel-or-aluminum,

CHASSIS SLIDES

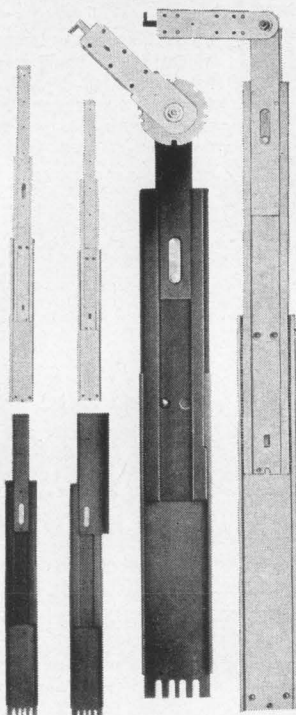

Contact Zero-Pak and choose from a *complete* line of chassis slides: precision steel and ball-bearing aluminum, in over 1000 size and style combinations, in tilt, non-tilt, and detent types, with load capacities from 50 to 275 pounds. Finish the job with Zero-Pak's complete line of chassis, printed circuit card files, handles, and cable retractors.

Materials, processes and finishes meet or exceed MIL specifications; Zero-Pak slides are approved for military installations. Write for Catalogs P (aluminum) and Q (steel).

ONE SOURCE—ONE RESPONSIBILITY

Zero-Pak Products*

DIVISION OF ZERO MANUFACTURING CO.

633 NORTH FRONT STREET
BURBANK, CALIF. 91503

TELEPHONE: (213) 849-6821
TWX 213-846-8455
TELEFAX RHG

*Formerly Chassis-Trak Corp.



New Books

Microwaves

Microwave Circuits
Jerome L. Altman
D. Van Nostrand Co.
Princeton, N.J., 448 pp., \$15.

This book describes passive microwave devices from an equivalent-circuit point of view by emphasizing the use of the scattering matrix. The text, being mostly theoretical, is intended for a graduate course in microwave circuits. However, practicing microwave engineers too will find this book a useful review of important circuit concepts.

In the introduction, equivalent circuits of distributed networks are developed. Circuit theorems are reviewed and definitions of voltage, current and impedances are given. The introduction, though brief, is adequate, assuming the reader is familiar with field theory and matrix algebra. Convenient reviews of both are given in the introduction and in an appendix. However, a few practical examples of the applications of these circuit concepts would have been helpful.

The scattering matrix concept is presented with measurement techniques for obtaining the scattering coefficients. The presentation may be one of the best yet written because of its clarity and completeness.

The principles of the circuit theorems and scattering matrix are applied to a variety of symmetrical microwave circuits such as two-port junctions, "T" and "Y" junctions, directional couplers and turnstile junctions. Scattering matrices for these circuits are developed from the symmetry by use of eigenvalues and eigenvectors, which are also explained. This explanation of eigenvalues and eigenvectors is not as well presented as that of the scattering matrix.

Circuit theory for microwave transmission devices such as matching networks, hybrids, attenuators, ferrite devices, cavities, and filters is presented in three chapters. Circuit performances are predicted from the derived scattering matrices. In the cavity and filter discussion the ABCD matrix is also used. This matrix is adequately discussed in an appendix.

The chapters on cavities and filters are highly recommended for both the student and the designer.

A brief discussion is given on periodically loaded lines, leading to the image parameter method of filter design. This type of filter is compared to the Butterworth and Tchebycheff types described in the preceding chapter.

The final chapter briefly presents the circuit theory of phase shifters, duplexers, discriminators, balanced mixers and modulators, single sideband and amplitude modulators, and directional filters. Following the final chapter are 19 diverse but highly useful appendices.

These appendices include material covering the following areas: scattering matrices of simple networks, low-pass filters, Q and transient considerations for one-port cavities and two cavities in cascade, and carrier suppression and reinjection frequency discrimination.

Generally, the book is well organized and clearly written. The author should be especially commended for the completeness of his derivations; however, there are some minor criticisms. There are several typographical errors, especially in the mathematics. Secondly, the author does not immediately prove some of his statements although the proof may be given later in the book. Finally, the lack of illustrative problems limits the use of this book as a text for a graduate course.

On the whole this addition is a noteworthy addition to any engineer's microwave library.

Gerald Schaffner

Motorola, Inc.

Abstracts of the Electrochemical Society, Inc., Spring Meeting, San Francisco, May 9-13, 1965:

1. Electronics Division, Volume 14, No. 1
Lasers, Luminescence, Semiconductors, Color Television, Phosphor Screen Application
339 pp., \$5.
2. Electrothermics and Metallurgy Division
Volume 3, No. 1
192 pp., \$4.
3. Electro-Organic Division
Volume 2, 76 pp., \$2.
4. Theoretical Division
Volume 3, 70 pp., \$2.
5. Industrial Electrolytic Division
Volume 1, 47 pp., \$2.
6. Electric Insulation Division
Volume 2, 88 pp., \$2.

Opportunities for

Design & Development Engineers in Electronic Signal Processing and Display Systems

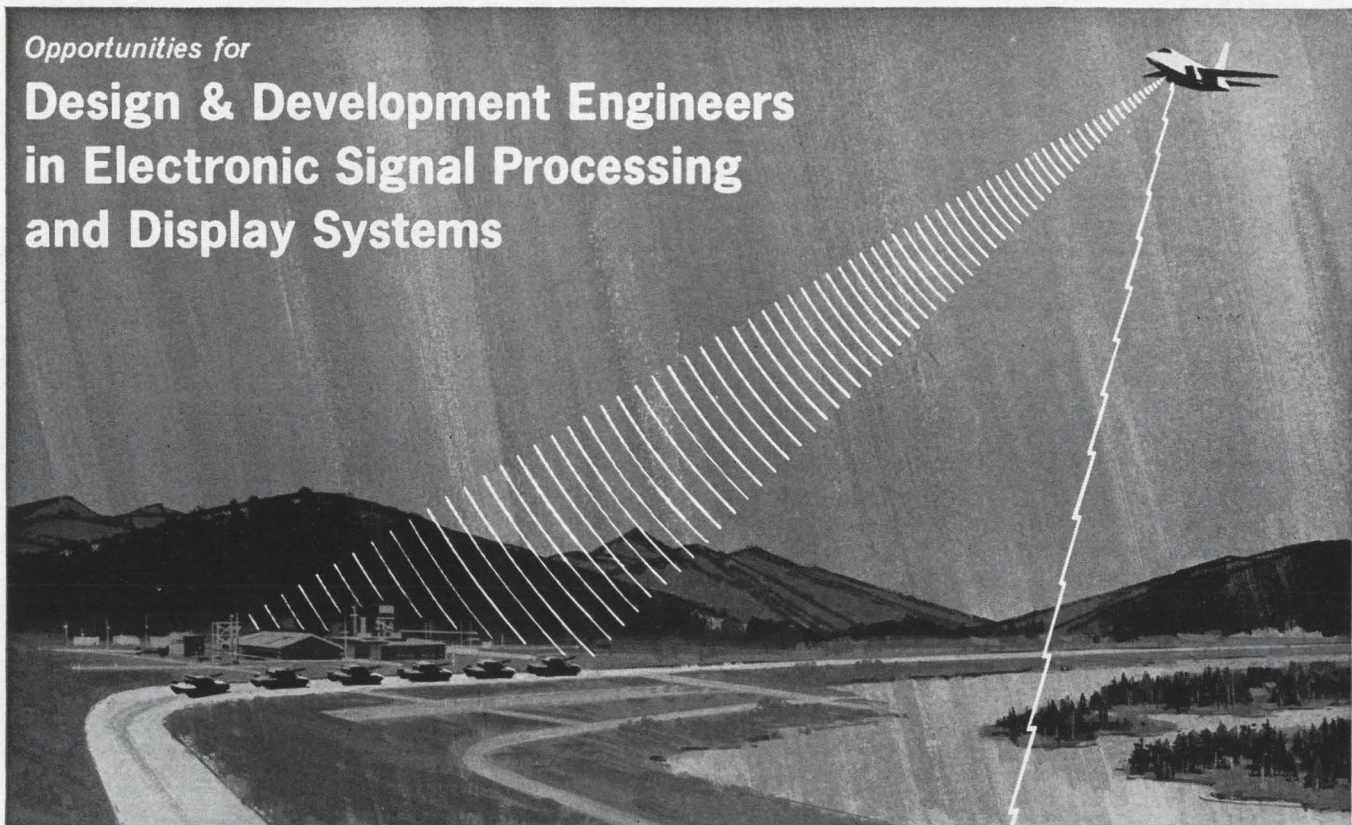

Design and Development activities in the field of Electronic Signal Processing and Display are rapidly expanding today at HUGHES Aerospace Divisions.

Advanced development is being accelerated on **high resolution pulse doppler radars** and other sensors utilizing matched filter, synthetic array, pattern recognition and other exotic correlation techniques.

Specialists will be interested in the many challenging and rewarding assignments now available in Project Engineering, Radar System Design, Performance Analysis, Signal Processing with emphasis on synthetic array, Information Display, System Simulation and Human Factors; in Circuit, Mechanical and Packaging Design.

Stimulating assignments are immediately available for graduate Engineers with accredited degrees and several years of applicable, professional experience in one or more of the following areas:

1. Highspeed Timing & Sampling Circuits
2. Optical & Electronic Moving Maps
3. Ultrahigh Speed Film Development
4. Wideband Video & IF Amplifiers
5. Mixers & Balanced Modulators
6. High Precision CRT Circuitry
7. Scan Converters Storage Tubes
8. Aerospace System Simulation
9. Multisensor Data Display
10. Precision Film Transport

All interested persons are invited to submit resumes in confidence.

For immediate consideration please write:

Mr. Robert A. Martin
Head of Employment
HUGHES Aerospace Divisions
11940 W. Jefferson Blvd.
Culver City 9, Calif.

Creating a new world with electronics



An equal opportunity employer

U. S. CITIZENSHIP REQUIRED

Looking for PROFIT?

The facts favor
NEBRASKA

Sample the facts in a free booklet.

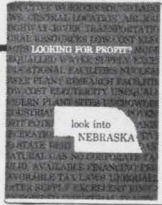

Also ask for *any specific data* on taxes, population, work laws, resources, power, financing. If the information you want about Nebraska is not at hand, we'll research it for you.

CONSUMERS POWER DISTRICT
Community Development Dept.
1401 O Street, Lincoln, Nebraska 68508

Please mail free booklet "Look into Nebraska" to

NAME _____
ADDRESS _____
CITY _____
STATE _____ ZIP _____

(Please attach specific requests for other data)

Circle 196 on reader service card

Reprint order form

Send to: **Electronics Reprint Dept.**
330 West 42nd Street
New York, N. Y. 10036

For listing of reprints available see the reader service card.

To help expedite mailing of your reprints please send cash, check or money order with your order.

For reprints of the latest special report:

Communications on Gemini

Send me reprints of key no R-73 at 50¢ each.

For reprints of previous special reports fill in below:

Send me reprints of key no.(s) at ¢ each.

For prices see the reader service card.

Name

Number & Street

City, State

Zip code

New Books

Recently published

Digital Computers in Action, A.D. Booth, Pergamon Press, 146 pp., \$1.90.

Systems Contracting, American Management Association, 39 pp., \$2.25.

Quarterly Progress Report, No. 77, H.J. Zimmermann, G.C. Harvey, Massachusetts Institute of Technology, 427 pp.

Principles of Electrical Engineering, V. Del Toro, Prentice-Hall, Inc., 775 pp., \$17.

Space Probes and Planetary Exploration, W. Corliss, D. Van Nostrand Co., 542 pp., \$7.75.

Foundations of Trainable Pattern-Classifying Systems, Learning Machines, N.J. Nilsson, McGraw-Hill Book Co., 137 pp., \$10.

System Engineering Handbook, R.E. Machol, W.P. Tanner, Jr., and S.N. Alexander, McGraw-Hill Book Co., 1,054 pp., \$29.50.

Worked Examples in Electronics and Telecommunications, Problems in Electronics, Vol. 1, B. Holdsworth and Z.E. Jaworski, Iliffe Books Ltd., London, 209 pp., \$3.50.

Worked Examples in Electronics and Telecommunications, Problems in Electronic Theory and Communications, Vol. 2, B. Holdsworth and Z.E. Jaworski, Iliffe Books Ltd., London, 134 pp., \$3.25.

Introduction to Electric Circuits, Second Edition, H.W. Jackson, Prentice-Hall, Inc., 554 pp., \$14.

The Marconi Review, First Quarter 1965, L.E.Q. Walker, Editor, 104 pp., \$1.40.

Power Traveling-Wave Tubes, G.F. Gittins, American Elsevier Publishing Co., 276 pp., \$10.

Automatic Control Systems Engineering, Vol. I: Control Systems Engineering, A.W. Langill, Jr., Prentice-Hall, Inc., 376 pp., \$16.

Automatic Control Systems Engineering, Vol. II: Advanced Control Systems Engineering, A.W. Lingill, Jr., Prentice-Hall, Inc. 391 pp., \$16.

The Founder's Touch, H.M. Petrakis, McGraw-Hill Book Co., 240 pp., \$4.95.

Field-Effect Transistors, L.J. Sevin, Jr., McGraw-Hill Book Co., 130 pp., \$10.

Technical Dictionary of Television Engineering and Electronics, Peter Neidhardt, The Macmillan Co., 340 pp., \$20.

Handbook of Vacuum Physics, A.H. Beck, The Macmillan Co., 178 pp., \$6.

Design Theory and Data for Electrical Filters, J.K. Skwirzynski, D. Van Nostrand Co., 701 pp., \$29.50.

Principles of Automation; What a Robot Can and Cannot Do, J.F. Schun, D. Van Nostrand Co., 380 pp., \$12.50.

Modern Control Systems Theory, C.T. Leondes, McGraw-Hill Book Co., 486 pp., \$17.50.

From Semaphore to Satellite, International Telecommunication Union, Geneva, Switzerland, 343 pp., \$9.50.

Photoelectronic Materials and Devices, Simon Larach, D. Van Nostrand Co., 434 pp., \$12.00.

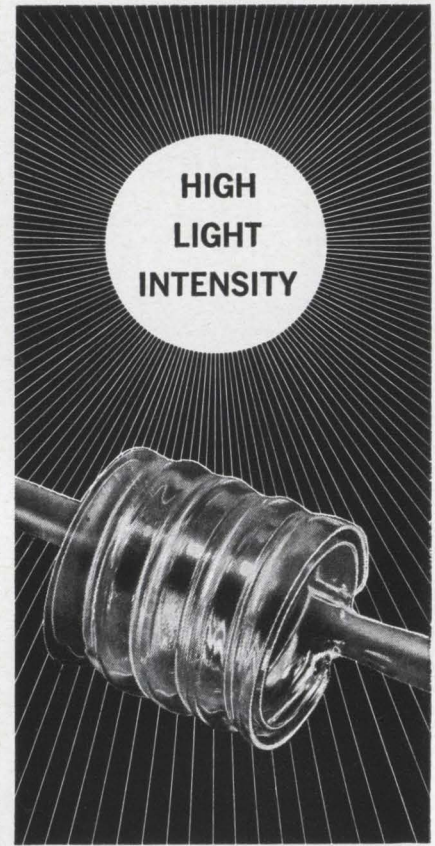

LAM-O-LUME

PURE FUSED QUARTZ LAMP ENVELOPE

The envelope features rugged, unitized construction of great dimensional accuracy, that is produced by centering a cylindrical quartz tube within a second tube of larger diameter. The annular space between the tubes becomes a helical coil as a special high temperature burner fuses inner and outer tubes together along a narrow helical path.

Excellent for outdoor lighting, Ultra-violet irradiation, laboratory heat exchangers, laser pumping, photography and Xenon lamps to provide light intensities many times brighter than the sun.

Comes in lengths up to 30 inches and in diameters of greater than 1 inch, has high chemical purity, low thermal shock, and operates indefinitely up to 1050°C.

Write for details.



THERMAL AMERICAN
FUSED QUARTZ CO.
RT. 202 & CHANGE BRIDGE RD.
MONTVILLE, NEW JERSEY

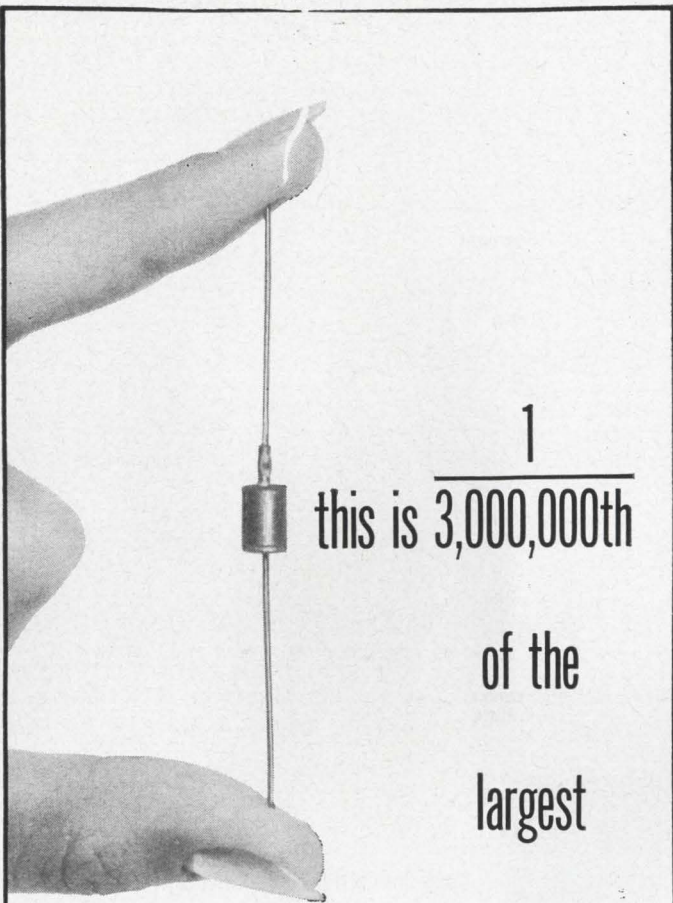

1
this is $\frac{1}{3,000,000}$ th

of the
largest
inventoried
zener diode
line
in the world

Keeping over 3 million zener diodes in our finished goods inventory at the factory (and in stock on your local distributor's shelves) is an expensive undertaking — but it's precisely this extra investment that puts Motorola and its distributors in the best possible position to ship you what you want, when you want it, for sure!



MOTOROLA
Semiconductors

BOX 955 • PHOENIX, ARIZONA 85001

MIAL

polystyrene capacitors outperform micas and other film capacitors ...cut costs, too!

MIAL'S sealed polystyrene capacitors surpass all film capacitors in life span...reliability...freedom from drift ...leakage resistance (more than 500,000 megs) and "Q" factor. MIAL offers the widest range of "polys" in production quantities.

Capacitance, 20 pF to 600,000 pF; capacitance tolerance from $\pm 0.3\%$ to $\pm 20\%$; temperature coefficient, N100 and N150 ± 50 PPM/°C; Voltage, 33 VDCW to 1000 VDCW.

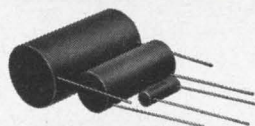

MIAL 602
High Reliability Precision Type

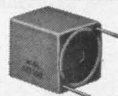

MIAL 603
Printed Circuit Mounting—
High Reliability Precision Type



MIAL 610
Sub-Miniature



MIAL 611
General Purpose N150

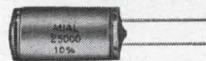

MIAL 612
Printed Circuit Board Mounting



MIAL 613
Axial-Lead Close Tolerance

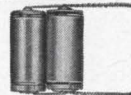

MIAL 614
Radial Lead Close Tolerance

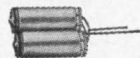

MIAL 615
End Lead Close Tolerance



MIAL 616
Axial Lead

Polystyrene
Capacitors

MIAL

Write today for new complete catalog. Gives environmental, electrical and mechanical characteristics, charts and dimensions.



MIAL

U. S. A., I N C.

165C FRANKLIN AVENUE, NUTLEY, N.J. 07110 • (201) 667-1600-1601

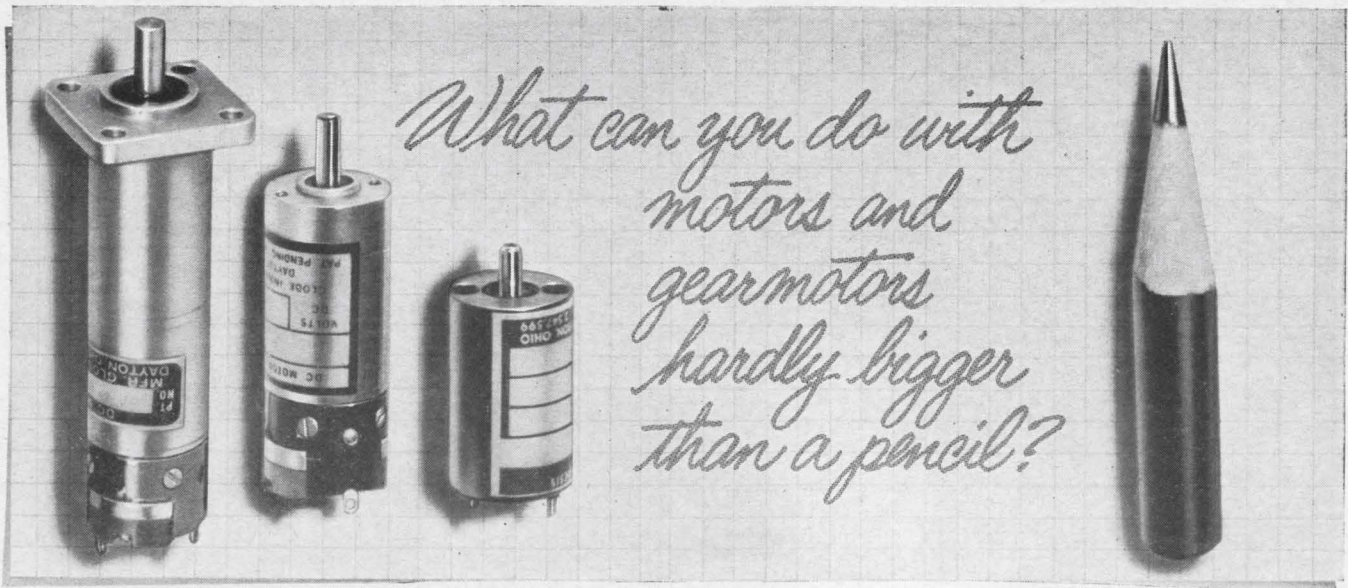

*What can you do with
motors and
gearmotors
hardly bigger
than a pencil?*

You can figure on designing more compact products. As a matter of fact Globe has developed 2 new MIL spec motors—one for a.c. called Type CC, and one for d.c. named VT. Both motors are only $\frac{5}{8}$ " in diameter, weigh $1\frac{1}{2}$ ounces. Type VT uses a system of planetary gearing that multiplies torque up to 50 oz. in.

Choices for designers are fantastic; we have 83 standard gear ratios. Type VT can be wound for any voltage up to 50 v.d.c., and we can furnish them with speed governors. Type CC is a hysteresis synchronous motor. And if you need a smaller or larger power unit, come to the can-do manufacturer. Request Bn. 58.

TYPE VT—Produces .0025 HP in the 8,000 to 17,000 rpm range. Size: $\frac{5}{8}$ " x $1\frac{1}{8}$ " long. 1.48 oz. To 50 v.d.c. Planetary gearing in 83 ratios.

TYPE CC—Produces .07 oz. in. max. sync. torque. Size: $\frac{5}{8}$ " x $1\frac{1}{8}$ " long. 1.5 oz. 26 v.a.c. (115 v.a.c. with series capacitor), 2 or 4 poles, 400 cycles.

GLOBE

Globe Industries, Inc., 2275 Stanley Avenue
Dayton, Ohio 45404, U.S.A., Tel.: 513 222-3741

Circle 228 on reader service card

THE MOST SELF-CONTAINED READOUT EVER DEVELOPED!

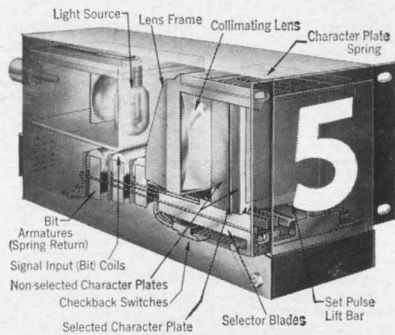

IEE BINA-VIEW®: BINARY INPUT, SELF-DECODING, ALPHA-NUMERIC READOUT WITH MEMORY

Bina-View takes any binary code up to six bits and translates it into bright, readable numbers and/or letters. 41-message capacity permits additional display of colors, symbols, words. Automatic memory retains last message displayed after signal and set-pulse power have been removed. Optional contact closures provide storage of input for subsequent electrical readout of original binary input.

BINA-VIEW OFFERS THESE ADDITIONAL FEATURES:

- **LONG UNIT LIFE.** Certified for 20,000,000 operations. Uses new extra-brightness lamp, replaceable in 30 sec.
- **FLOATING DECIMAL POINTS** available from separate lamp circuit.
- **LOW POWER.** Requires only 100 mw per bit.
- **BRIGHT, READABLE CHARACTERS** appear entirely in a single plane on non-glare Lucite viewing screen. Characters up to $1\frac{3}{8}$ " high; any style you specify.
- **COMPACT.** Bina-View is only $3\frac{3}{8}$ " H, $1\frac{1}{8}$ " W (without mounting brackets), 7" D.

SEND FOR COMPLETE INFORMATION ABOUT BINA-VIEW AND OTHER IEE READOUTS!



INDUSTRIAL ELECTRONIC ENGINEERS, INC.

7720 Lemona Avenue • Van Nuys, California
Phone: (213) 787-0311 • TWX (213) 781-8115
Representatives in Principal Cities

©1965 IEE

NEW! from VULCAN

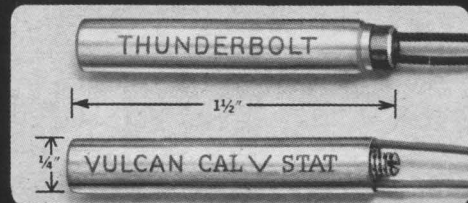

MINIATURE HEATER/THERMOSTATS

Now! The Vulcan Thunderbolt Cartridge Heater and the Vulcan Cal-Stat Thermostat in $\frac{1}{4}$ " diameter x $1\frac{1}{2}$ " long . . . ideal for difficult and critical thermal systems. **Thunderbolt** delivers up to 100 watts/sq-inch under ideal conditions, has stainless steel case, is available for either 110v or 220v. **Vulcan Cal-Stat** is shell sensitive type with -100°F to $+500^{\circ}\text{F}$ range, inherent sensitivity of 1°F , slotted screw for full range adjustment. Both heater and thermostat available with any hardware or environmental "package" required by application.

Simplify your design problems . . . by using these Vulcan miniatures — send for complete details, today. Application assistance also available, with results assured because of single-source thermal systems. Vulcan Electric, 88L Holten St., Danvers, Mass.



YIG-tuned paramp

An electrically tuned parametric amplifier

K.L. Kotzebue, University of California, Santa Barbara, and L.B. Fletcher, Watkins-Johnson Co., Palo Alto, Calif.

A parametric amplifier is a device that normally can be tuned only over relatively restricted frequency ranges. One basic reason for this tuning difficulty is the fact that several simultaneous frequencies of importance exist. In addition to the signal frequency, a pump frequency and one or more sum or difference frequencies must be considered.

In the construction of an electronically tunable paramp, a variety of approaches can be used. Some of these are:

- Use of a fixed-tuned broadband signal circuit, an electrically tunable pump source and a fixed-tuned difference or sum frequency circuit. This has the disadvantage of requiring a complex pump source.

- Use of a fixed-tuned broadband signal circuit, a fixed-tuned pump and an electronically tunable difference or sum frequency circuit. This method is necessarily limited by the signal circuit bandwidth.

- Use of an electronically tunable signal circuit, a fixed-tuned pump and an electronically tunable difference or sum frequency circuit. This is the most difficult technique, requiring simultaneous tuning and tracking of two resonant circuits, but potentially the method has the widest tuning range because its tuning is not dependent upon a fixed circuit resonance.

The authors describe a tunable paramp using the last approach. It is unique in two respects: not only is the amplifier electrically tuned through the use of yttrium iron garnet (YIG) resonators, but useful low-noise performance is achieved over a tuning range of almost one octave.

The amplifier is of the negative resistance, nondegenerate type, using a varactor diode for the nonlinear reactance. The signal circuit operates in S band with a fixed-tuned pump at 17 gigacycles. Two YIG resonators are coupled to the

diode to form the tunable resonator circuits at the signal and idler frequencies. Separate magnetic bias circuits are used to tune the signal and idler circuits with proper tracking assured by the associated tuning control circuitry.

Noise figures between 2.1 and 4.1 db have been achieved over the range of 2.2 to 4 Gc, at approximately 25 db of gain.

Presented at the 1965 Microwave Theory and Techniques Symposium, Clearwater, Fla., May 5-7.

Four-mode switch

Four-bit latching ferrite switch
D. H. Landry and W. C. Passaro,
Sperry Microwave Electronics Co.,
Clearwater, Fla.

Fast switching, light weight, minimal drive requirements and no bulky external magnets are some of the significant characteristics of latching ferrites which may be used in a variety of solid state microwave devices.

This paper deals with the application of latching ferrites to a novel approach for combining polarized input signals. Vertical, horizontal, right circularly polarized or left circularly polarized input signals are combined at a common output by choosing the bit states of a four-bit latching ferrite switch. The heart of the device is a fast switching, phase-stable, temperature-controlled, 90° latching bit with low insertion loss.

The development of a 90° latching bit, and of the subsequent switch assembly, depends in great measure upon the proper selection of a ferrite material—namely, one that combines a high remanence ratio, low loss tangent, minimum coercive force, and a proper selection of saturation magnetization for the required frequency of operation.

When each of the factors above is considered, the materials search is narrowed down to the gadolinium-aluminum substituted yttrium-iron garnet family.

Since differential phase shift is a function of ferrite configuration, as well as ferrite selection, it is

NEWEST from ARNOLD

ORDER DIRECT—
PERFORMANCE GUARANTEED

100°C MICROMINIATURE DC CONVERTER

UP TO 5KV OUTPUT!

Size: Only 2 3/4" x 1 7/8" x 5/8" Thick
Weight: 4 Oz.

| Model No. | Output VDC | Output Ma. | Price Ea. 1-9 |
|-----------|------------|------------|---------------|
| SMU-.003 | 3 | 750 | \$185.00 |
| SMU-.1 | 100 | 30 | 165.00 |
| SMU-2.5 | 2.5KV | 1.2 | 245.00 |
| SMU-5 | 5.0KV | 0.6 | 295.00 |

Input: 25-30VDC. Output Adjustable +5% -10%. Line Regulation: .3%. Ripple: .3% (RMS). Short Circuit, Transient and Reverse Polarity protection. AC Output Model SMV also available. *Delivery from Stock.*

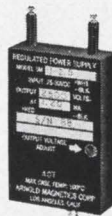

Circle 246 on reader service card

40 WATT DC-DC CONVERTER

8 MODELS—6.3V TO 5KVDC OUTPUT

—senses overvoltage and current in **MILLISECONDS!**

| Model No. | Output VDC | Output Current | Price Ea. 1-9 |
|-----------|------------|----------------|---------------|
| SHU-6.3 | 6.3 | 5.0 Amps | \$159.00 |
| SHU-300 | 300 | 133 Ma. | 162.00 |
| SHU-1000 | 1000 | 40 Ma. | 198.00 |
| SHU-5000 | 5000 | 8 Ma. | 378.00 |



SIZE: 3 1/2 x 3 1/2 x 1 1/8" Thick—Weight: 26 Oz. Input: 28 ±2.0 VDC. Output Adjustable +5% -10%. Load Regulation: 1% -4% Typical Ripple: 0.2% (of E_{out}) Max. *Delivery from Stock—Special Voltages —2 Weeks ARO.*

Circle 247 on reader service card

MINIATURIZED HIGH VOLTAGE

CONVERTER— .44KV/Cubic Inch

Eight models: from 6KVDC at 5MA to 20KVDC at 1.5MA. For CRT, TWT, Klystron. Size: 3 1/2" x 4 3/4" x 2 3/4". Weight: 59 oz.



| Model | Output Volts DC | Output Current | Ripple VRMS | Price Ea. |
|--------|-----------------|----------------|-------------|-----------|
| SFU-6 | 6K | 5 Ma | 18 | \$295.00 |
| SFU-10 | 10K | 3 Ma | 30 | 420.00 |
| SFU-16 | 16K | 1.8 Ma | 48 | 650.00 |
| SFU-20 | 20K | 1.5 Ma | 60 | 890.00 |

Bulletin SFU

Circle 248 on reader service card

STATIC TIME DELAY RELAY

Size 1-15/16" x 17/32" x 15/16" high. Delays application of DC voltage from .5 to 60 seconds. Hermetically sealed Input: 20 thru 30 VDC. Output: 1.5 V less (max.) than input @ 3A (max.). Temperature range: -10°C to 71°C. Wgt.: 1 oz. *Delivery: Stock to 14 days ARO.*



Price: \$68.00

Bulletin RST

Circle 249 on reader service card

INQUIRIES FROM DISTRIBUTORS INVITED!

ARNOLD MAGNETICS

ARNOLD MAGNETICS CORP.

6050 W. Jefferson Blvd., Los Angeles, Calif. 90016

Telephone: 837-5313; 870-6284 (213)

TWX: 213-836-0430



ROHR
CORPORATION

Chula Vista, California
9 Miles South of San Diego

Established in 1940, Rohr has diversified from its basic product line of aircraft components into such products as large steerable antennas, rocket-motor liners and nozzles, and modular housing structures. Rohr is a leader in numerical control equipment. Designing our machines is traditional here.

**ELECTRONICS
ENGINEERS**

Backgrounds should include an EE degree and hardware-oriented design and development experience in solid state circuits, digital logic techniques, and servo-mechanisms.

Positions at the Senior Engineering level are available. Numerical control experience is desirable, but a high degree of interest in the field is even more important.

For a prompt interview, please forward a complete background summary to Mr. N. DeWitt, Professional Placement Supervisor, Dept. 64, Rohr Corporation, Chula Vista, California.



ROHR
CORPORATION

Main Plant and Headquarters: Chula Vista, California; Plant: Riverside, California; Assembly Plants: Winder, Georgia; Auburn, Washington.

An Equal Opportunity Employer

Technical Abstracts

equally important, therefore, that the proper size and geometry be selected—in this case a rectangular toroid. The length and cross-sectional area of the toroid was optimized to provide a minimum variation in differential phase shift, with changes in frequency. More specifically, each latching bit in a waveguide assembly was able to produce a differential phase shift of $90^\circ \pm 4^\circ$ from 5,400 Mc to 5,900 Mc.

The high concentration of a dielectric (toroid), at the center of the waveguide, suggests the possibility of generating higher-order modes. To guard against these unwanted modes, mode suppressors were included on both sides of the toroid. These were brazed into the waveguide walls as an integral part of the waveguide assembly.

Dielectric stepped transformers were designed to match the toroid to the waveguide. The vswr thus obtained was less than 1.2 across the entire frequency range of 5,400 to 5,900 Mc. However, it was found that the slightest air gap at the interface of the longitudinal dimension of the toroid and the top and bottom walls of the waveguide greatly compounds the matching problem. Therefore, extreme care must be taken when inserting the ferrite toroid into the waveguide to assure good contact. Further refinement of the impedance match is accomplished by transformer positioning at the leading and far edges of the toroid.

Input signals arriving at ports A and B of the switch first pass through a set of 90° latching bits and then into a 3-db hybrid. The power is divided at the 3-db hybrid and progresses through a second set of latching bits into a folded hybrid tee. The bit states are so arranged that the power is combined in the folded hybrid tee and is transmitted out port C. A choice of transmission paths is provided by four possible latching modes. The unit operates over the frequency range of 5400 Mc to 5900 Mc at input power levels of 10 watts peak.

Presented at the 1965 Microwave Theory and Techniques Symposium, Clearwater, Fla., May 5-7.

**FREE SAMPLE
ECCOSHIELD® TF
Magnetic-Electric Shield**

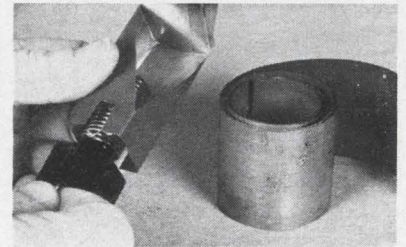

Eccoshield® TF is high permeability metal foil which can be cut and wrapped around components for high insertion loss. Thickness from 1 to 6 mils; width $\frac{1}{4}$ " to 6". Also used to seal joints in shielded chambers and cabinets.

*Sample and literature is yours.
Write or use Reader Service Card.*

EMERSON & CUMING, INC.



CANTON, MASS.
604 W. 182nd St.
Gardena, Calif.
9667 Allen Ave.
Rosemont, Ill.

Circle 232 on reader service card

Reprint order form

Send to: **Electronics Reprint Dept.**
330 West 42nd Street
New York, N. Y. 10036

For listing of reprints available see the reader service card.

To help expedite mailing of your reprints please send cash, check or money order with your order.

For reprints of the latest special report:

Unijunction Transistor

Send me reprints of key no R-74 at 50¢ each.

For reprints of previous special reports fill in below:

Send me reprints of key no.(s) at ¢ each.

For prices see the reader service card.

Name

Number & Street

City, State

Zip code

Employment **Electronics** Opportunities

**QUALIFICATION FORM
FOR POSITIONS AVAILABLE**

ATTENTION: Engineers, Scientists, Physicists

This Qualification Form is designed to help you advance in the electronics industry. It is unique and compact. Designed with the assistance of professional personnel management, it isolates specific experience in electronics and deals only in essential background information.

The advertisers listed here are seeking professional experience. Fill in the Qualification Form below.

Strictly Confidential

Your Qualification Form will be handled as "Strictly Confidential" by Electronics. Our processing system is such that your form will be forwarded within 24 hours to the proper executives in the companies you select. You will be contacted at your home by the interested companies.

What To Do

1. Review the positions in the advertisements.
2. Select those for which you qualify.
3. Notice the key numbers.
4. Circle the corresponding key number below the Qualification Form.
5. Fill out the form completely. Please print clearly.
6. Mail to: Classified Advertising Div., Electronics, Box 12, New York, N. Y. 10036.

| COMPANY | PAGE | KEY # |
|---|------|-------|
| ATOMIC PERSONNEL, INC. Phila., Pa. | 203 | 1 |
| FORD MOTOR CO. Philco Techrep Div. Fort Washington, Pa. 19034 | 166* | 2 |
| GENERAL DYNAMICS Electronics Rochester, NY | 165* | 3 |
| GENERAL ELECTRIC CO. Syracuse, NY | 202 | 4 |
| LOCKHEED MISSILES & SPACE CO. Sunnyvale, Calif. | 182 | 5 |
| MOTOROLA, INC. Chicago, Illinois | 165* | 6 |
| ROHR CORP. Chula Vista, Calif. | 200 | 7 |
| SPERRY RAND CORP. Univac Div. St. Paul, Minn. | 201 | 8 |

* These advertisements appeared in the May 31st issue.

(cut here) ----- (cut here)

Electronics Weekly Qualification Form For Positions Available

(Please type or print clearly. Necessary for reproduction.)

Personal Background

Name
Home Address
City Zone State
Home Telephone

Education

Professional Degree(s)
Major(s)
University
Date(s)

Fields of Experience (Please Check)

6/14/65

- | | | |
|--|--|---------------------------------------|
| <input type="checkbox"/> Aerospace | <input type="checkbox"/> Fire Control | <input type="checkbox"/> Radar |
| <input type="checkbox"/> Antennas | <input type="checkbox"/> Human Factors | <input type="checkbox"/> Radio-TV |
| <input type="checkbox"/> ASW | <input type="checkbox"/> Infrared | <input type="checkbox"/> Simulators |
| <input type="checkbox"/> Circuits | <input type="checkbox"/> Instrumentation | <input type="checkbox"/> Solid State |
| <input type="checkbox"/> Communications | <input type="checkbox"/> Medicine | <input type="checkbox"/> Telemetry |
| <input type="checkbox"/> Components | <input type="checkbox"/> Microwave | <input type="checkbox"/> Transformers |
| <input type="checkbox"/> Computers | <input type="checkbox"/> Navigation | <input type="checkbox"/> Other |
| <input type="checkbox"/> ECM | <input type="checkbox"/> Operations Research | |
| <input type="checkbox"/> Electron Tubes | <input type="checkbox"/> Optics | |
| <input type="checkbox"/> Engineering Writing | <input type="checkbox"/> Packaging | |

Category of Specialization

Please indicate number of months experience on proper lines.

| | Technical Experience (Months) | Supervisory Experience (Months) |
|-------------------------------------|----------------------------------|------------------------------------|
| Research (pure, fundamental, basic) | | |
| Research (Applied) | | |
| Systems (New Concepts) | | |
| Development (Model) | | |
| Design (Product) | | |
| Manufacturing (Product) | | |
| Field (Service) | | |
| Sales (Proposals & Products) | | |

Circle Key Numbers of Above Companies' Positions That Interest You

1 2 3 4 5 6 7 8 9 10 11 12 13 14 15

We've made a practice of good ideas.

Our staff has had plenty of them. That's how we've stacked up all the "firsts" behind our name. (First magnetic element used in computers, first commercial magnetic core memory, fastest ferrite memory system to date, first magnetic thin film memory in use, delivery of first time-limited partial switching core memory.)

If your thinking is as good, you can make it count. At UNIVAC-St. Paul, laboratory research constantly nourishes design and development efforts. It produces not only "hows," but "whys." A recent example is in multi-aperture core behavior.

Look what is being done right now in memory development using multi-aperture core techniques. We came up with an analog magnetic storage device—a practical application of time-limited, partial-switching representing significant technical progress in the field of simplified analog recording through the use of discrete magnetic elements. Transient effects are received as analog data and stored for later read-out.

There are several other advanced development programs which show the same pioneering spirit. Our minimum employment requirements are a BS in Engineering or Physics and 2 or more years experience in memory development including traditional ferrite core configurations, multi-aperture cores (BiAx, Transfluxor) and/or thin films. A concentration on advanced development and advanced manufacturing is particularly desired. Send a resume at once to Mr. R. K. Patterson, Employment Manager, Dept. F-17, UNIVAC Division of Sperry Rand Corp., Univac Park, St. Paul, Minn. 55116. An Equal Opportunity Employer.

UNIVAC
DIVISION OF SPERRY RAND CORPORATION



Engineering career opportunities

**Tie your career
to the world's
most advanced
radar/sonar
systems...
at G.E.!**

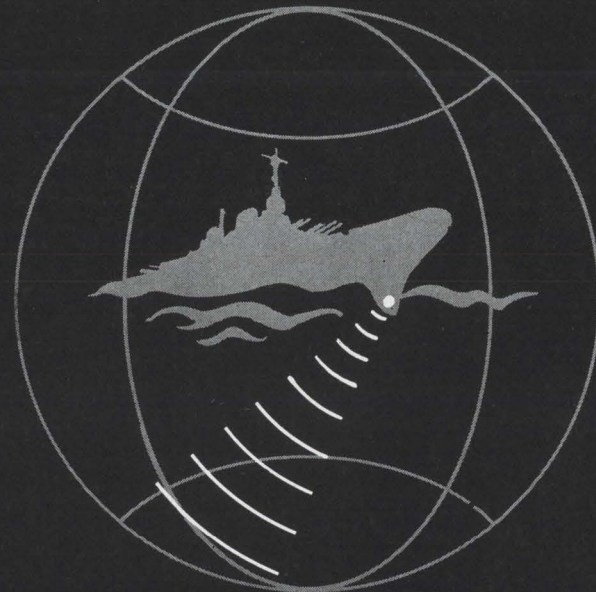
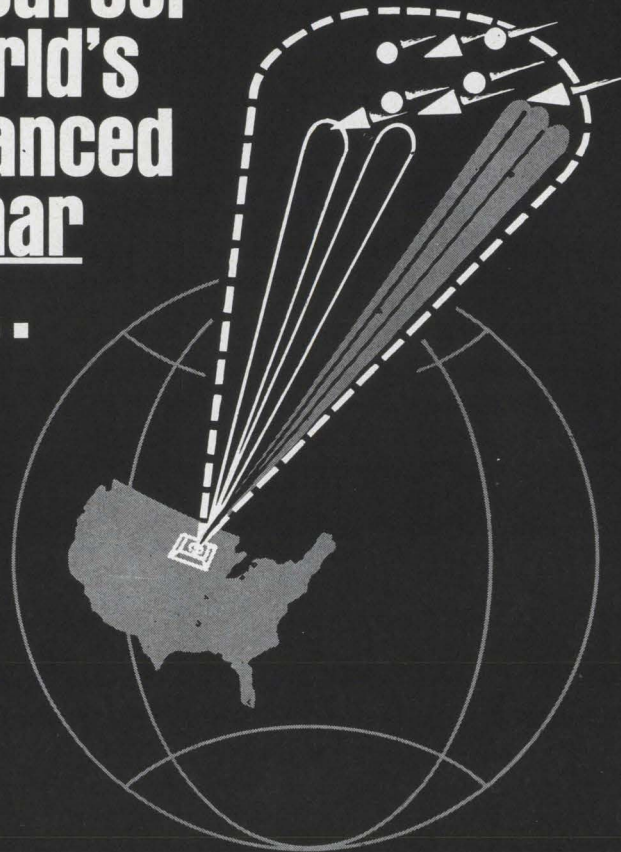

**Investigate your career now
in missile-defense radar; ad-
vanced sonar engineering at
General Electric.**

G.E.'s Heavy Military Electronics Dept.—whose capabilities include the design, development and fabrication of the world's largest and most advanced ASW and radar systems—announces long-term career openings for continuing contributions to large military contracts.

HMED offers you stability based on its broad capability for handling large programs and the experience that goes with front-rank performance on this decade's most advanced projects. Your growth is tied to that of a lean, highly professional engineering group backed by top-flight facilities—both within HMED and throughout General Electric.

At G.E., you'll be treated as a professional who's expected to handle well-defined, delegated responsibility. In most instances you'll deal directly with your customer's organization.

You will be given every opportunity to develop yourself professionally through continuing Company-taught courses and advanced tuition-paid study at nearby Syracuse University. And, in the course of your work, you'll have access to information developed by other G.E. facilities throughout the country.

WHY NOT MATCH YOUR EXPERIENCE AND CAREER DESIRES AGAINST THESE REQUIREMENTS?

SONAR: Advanced Sonar Engineers; Array Beamformer and Signal Processing Development Engineers; Digital Logic Engineers; Sonar Solid-state Circuit Design; Transducer Development; Solid-state Transmitter Development; Pattern Recognition Analysis; Adaptive Filtering Research; Display Development; Propagation Analysis; Sonar Subsystem Development.

RADAR: Monitor and Control Analysis Engineers; Digital Control Eqpt. Engineers; Microwave Component Design Engineers; Consultant, Circuit Design and Development; Instrumentation Circuit Engineers; ME's for Signal Processing Modules; Consultant, Array Radar Subsystem Requirements.

INVESTIGATE NOW! For full information, send a resume of your experience in confidence to J. L. Wool, Professional Placement, Heavy Military Electronics Dept., Section T-48, General Electric Co., Court St., Syracuse, New York.

177-65

An Equal Opportunity Employer

GENERAL  ELECTRIC

EMPLOYMENT OPPORTUNITIES

The advertisements in this section include all employment opportunities—executive, management, technical, selling, office, skilled, manual, etc.

Look in the forward section of the magazine for additional Employment Opportunities advertising.

— RATES —

DISPLAYED: The advertising rate is \$52.00 per inch for all advertising appearing on other than a contract basis. Contract rates quoted on request.

An advertising inch is measured 7/8" vertically on a column—3 columns—30 inches to a page.

Subject to Agency Commission.

UNDISPLAYED: \$2.70 per line, minimum 3 lines. To figure advance payment count 5 average words as a line. Box numbers—count as 1 line.

Discount of 10% if full payment is made in advance for 4 consecutive insertions.

Not subject to Agency Commission.

Send new ads to:

ELECTRONICS

Class. Adv. Div., P.O. Box 12, N.Y., N.Y. 10036



E. E.'s
for FEE-PAID Positions
WRITE US FIRST!
Use our confidential application for professional, individualized service . . . a complete national technical employment agency.
ATOMIC PERSONNEL, INC.
Suite 1207L, 1518 Walnut St., Phila. 2, Pa.

ADDRESS BOX NO. REPLIES TO: Box No. Classified Adv. Div. of this publication.

Send to office nearest you.

NEW YORK, N. Y. 10036: P. O. Box 12

CHICAGO, Ill. 60611: 645 N. Michigan Ave.

SAN FRANCISCO, Cal. 94111: 255 California St.

POSITION VACANT

Communications Engineer—Excellent opportunity for advancement with large midwestern gas and electric company. B.S.E.E. required. Experience in a Utility Communications Section desirable but not necessary. Must be experienced in system design and operation of mobile radio systems and microwave networks. Should be familiar with carrier systems, utility relay practices, supervisory control and telemetric equipment. Will be responsible for all company communications systems. Salary open but commensurate with qualifications and experience. Send complete resume detailing experience, personal data, and salary requirements to P-6624, Electronics.

SPECIAL SERVICES

Nameplates, Decals, Hard-Hat Labels, Tool checks, Signs of all kinds. Free catalog. Seton Corp., Dept. Elec, New Haven 15, Conn.

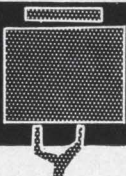

SEARCHLIGHT SECTION

- CLASSIFIED ADVERTISING
- BUSINESS OPPORTUNITIES
- USED OR SURPLUS EQUIPMENT

ELECTRON TUBES

KLYSTRONS • ATR & TR • MAGNETRONS
SUBMINIATURES • C.R.T. • T.W.T. • 5000-
6000 SERIES
• SEND FOR NEW CATALOG A2 •
A & A ELECTRONICS CORP.
1063 PERRY ANNEX
WHITTIER, CALIF.
696-7544

CIRCLE 952 ON READER SERVICE CARD

SMALL AD but BIG STOCK

of choice test equipment
and surplus electronics

Higher Quality—Lower Costs
Get our advice on your problem

ENGINEERING ASSOCIATES

434 Patterson Road — Dayton 19, Ohio

CIRCLE 953 ON READER SERVICE CARD

Color DIAL TELEPHONES \$10.95

Factory rebuilt Western Electric
in white, beige, ivory, pink, green,
or blue. If 4 prong plug is re-
quired add \$2.00. Fully guaran-
teed. Write for free list. All
shipments FOB.



SURPLUS SAVING CENTER
Dept. E-6145
Waymart, Pa.

CIRCLE 954 ON READER SERVICE CARD

“SEARCHLIGHT”

IS

Opportunity Advertising

—to help you get what you want—to
help you sell what you no longer need.

Take Advantage Of It

For Every Business Want

“THINK SEARCHLIGHT FIRST”

SOLID STATE TIMING RELAYS

ADJUSTABLE TIME DELAY • ALL 28VDC ALL 4PDT

| Mfg. & No. | Time-Sec. | | Stk. # | Each |
|---------------|-----------|----------|--------|-------|
| | Operate | Release | | |
| Wheaton E361A | 0.05-1.1 | 0.01 | R5406 | 37.50 |
| Haydon A31892 | 0.05-1.1 | 0.025 | R4027 | 37.50 |
| Wheaton E617A | 0.05-1.25 | 0.015 | R4404 | 37.50 |
| Haydon B31893 | 0.9-16.0 | 0.015 | R4277 | 37.50 |
| Wheaton E617B | 1-15 | 0.015 | R5432 | 37.50 |
| Wheaton E361B | 1-15 | 0.015 | R5462 | 37.50 |
| Wheaton E361C | 5-150 | 0.001 | R5409 | 37.50 |
| Haydon A31894 | 14-150 | 0.015 | R4402 | 37.50 |
| Wheaton E617D | 23-330 | 0.015 | R4279 | 37.50 |
| Wheaton E361D | 50-300 | 0.01 | R5407 | 37.50 |
| Haydon A31895 | 60-300 | 0.015 | R4154 | 37.50 |
| Wheaton E361E | 150-2000 | 0.01 | R5433 | 37.50 |
| Haydon A31896 | 300-2000 | 0.015 | R4074 | 37.50 |
| Haydon B31801 | 0.015 | 0.05-1.0 | R5463 | 37.50 |
| Wheaton E366A | 0.015 | 0.05-1.0 | R5408 | 37.50 |
| Haydon B31802 | 0.015 | 300-2000 | R5434 | 37.50 |

UNIVERSAL

has over
2,000,000
RELAYS in
20,000 dif-
ferent types
. . . Most makes.
Your relay
problems are
elementary
to us. Send
for latest 60-
page free il-
lustrated cat-
alog #E which
describes the
largest inventory
of relays in
the world.

Our modern facilities permit immediate delivery of production quantities. We are equipped to assembly, adjust any type of relay. Average shipment made within 48 hours. Orders requiring coil and frame assembly, special testing or adjustment are shipped within one week to ten days.

“Satisfaction is on the other end of your telephone”

Universal RELAY CORP.

42 WHITE ST., NEW YORK 13, N. Y. • WALKER 5-6900

CIRCLE 951 ON READER SERVICE CARD

AUTOTRACK ANTENNA MOUNT

360 degree azimuth, 210 degree elevation sweep with better than 1 mil. accuracy. Missile velocity acceleration and slewing rates. Amplidyne and servo control. Will handle up to 20 ft. dish. Supplied complete with control chassis. In stock—immediate delivery. Used world over by NASA, USAF, TYPE MP-61 B, SCR-584, NIKE AJAX mounts also in stock plus several airborne trackers.

SCR 584 AUTOMATIC TRACKING RADARS

Our 584s in like new condition, ready to go, and in stock for immediate delivery. Ideal for telemetry research and development, missile tracking, satellite tracking, balloon tracking. Used on Atlantic Missile Range, Pacific Missile Range, N.A.S.A. Wallops Island, A.B.M.A. Write us. Fully Desc. MIT Rad. Lab. Series, Vol. 1, pps. 207-210, 228, 284-286. Compl. inst. Bk. avail. \$25.00 each.

AN/GPG-1 SKYSWEEP TRACKER

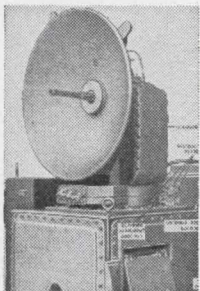

3 cm. automatic tracking radar system. Complete package with indicator system. Full target acquisition and automatic tracking. Input 115 volts 60 cycle. New. In stock for immediate delivery. Entire System 6' long, 3' wide, 10' high. Ideal for infrared Tracker, Drone Tracker, Missile, Tracker, R. & D.

PULSE MODULATORS

MIT MODEL 9 PULSER

1 MEGAWATT—HARD TUBE
Output 25 kv 40 amp. Duty cycle, .002. Pulse lengths .25 to 2 microsec. Also .5 to 5 microsec, and 1 to 5 microsec. Uses 6C21. Input 115v 60 cycle AC. Mfr. GE. Complete with driver and high voltage power supply. Ref: MIT Rad. Lab. Series, Vol. 5, pps. 152-160.

2 MEGAWATT PULSER

Output 30 kv at 70 amp. Duty cycle .001. Rep rates: 1 microsec 600 pps, 1 or 2 msec 300 pps. Uses 5948 hydrogen thyratron. Input 120/208 VAC 60 cycle. Mfr. GE. Complete with high voltage power supply.

MIT MODEL 3 PULSER

Output: 144 kw (12 kv at 12 amp.) Duty ratio: .001 max. Pulse duration: .5, 1 and 2 microsec. Input: 115 v 400 to 2000 cps and 24 vdc. \$325 ea. Full desc. Vol. 5, MIT Rad. Lab. series, pg. 140.

250KW HARD TUBE PULSER

Output 16 kv 16 amp. duty cycle .002. Pulses can be coded. Uses 5D21, 715C or 4PR60A. Input 115 v 60 cycle ac. incl. H.V. pwr supply \$1200 ea.

5949 THYRATRON AGING RACK

Compl. Chatham Electronics Console incl. 15 kv power supply & PFN's. \$1800.

MICROWAVE SYSTEMS

E-4 FIRE CONTROL SYSTEM

Hughes Aircraft X Band. Complete. In stock.

C-BAND RADAR

250 KW output, C-band, PPI indicator, 5C22 thyratron modulator. Antenna hi gain parabolic section. Input 115 volts 60 cycle AC, complete \$2750.00.

300 TO 2400MC RF PKG.

300 to 2400 MC CW. Tuneable. Transmitter 10 to 30 Watts. Output. As new \$475.

500KW "L" BAND RADAR

500 kw 1220-1359 mcs. 160 nautical mile search range P.P.I. and A Scoopes. MITL thyratron mod. 5J26 magnetron. Complete system.

PHILCO MICROWAVE LINKS

C Band Microwave Link terminal bays and repeater bays in stock. New \$1500 each or \$2500 per pr.

100—800MC. CW SOURCE

150 watts CW nominal output 115 V 60 Cy AC input. \$1600.

100KW 3CM. RADAR

Complete 100 kw output airborne system with AMTI, 5C22 thyr. mod. 4J2 magnetron, PPI, 360 deg az sweep, 60 deg. elev. sweep, gyro stabilizer, hi-gain revr. Complete with all plugs and cables.

M-33 AUTO-TRACK RADAR SYSTEM

X band with plotting board, automatic range tracking, etc. Complete with 1 megawatt acq. radar.

INFRARED SOURCES

Collimated radiation simulator and transistorized temp. controller. Temp. range, 200-600 degree C. Absolute Accuracy ± 3 degree C. Type AN/USM, \$1975 New.

3KW RCA PHONE & TELEG XMTR

2—30 MC. 10 Autotone channels plus MO. Input 220 vac. 50/60 cycles.



Radio-Research Instrument Co.
650 5th Ave. New York 36, N.Y.
Tel. JEdson 6-4691

CIRCLE 955 ON READER SERVICE CARD

SYNCHROS • GENERATORS INVERTORS • SERVOS

- 23TR6 Torque Receiver \$32.50
- 23TX6 Torque Transmitter 32.50
- 23CX6 Control Transmitter 32.50
- 1 F Motor 115/90 V. 60 Cy. 24.95
- 1 G Generator 115 V. 60 Cy. 24.95
- 1 HDG Differential Gen. 24.95
- 5 G Navy Ord. Size 115 V. 60 Cy. 24.95
- 5 F Navy Ord. Size 115 V. 60 Cy. 24.95
- 6 G Navy Ord. Size 115 V. 60 Cy. 29.50
- 7 G Navy Ord. Size 115 V. 60 Cy. 39.50
- Bendix Inverter E-1617-1, 24V. Input, 115V. 400 Cy. 3 Ph. s50 V.A. Output 25.00
- Jack-Heintz Inverter E-1617-1, 24V. Input Output 115/230 V. 1/3 Ph. 400 Cy. 2250 V.A. 75.00
- General Electric E-1823- 120/208 V. 400 Cy. Generator 60 KVA 250.00
- Jack-Heintz Inverter E-1725-1 24V. Input, Output 115/230 V. 1/3 Ph. 400 Cy. 2250 V.A. 75.00
- Westinghouse, Generator 120/208 V. 3 Ph. 400 Cy. 75.00
- Pioneer Instrument Inverter 12123-1A Input 24 V. Output 115 V. 3 Ph. 400 Cy. 25.00
- Elinco Generator PM2 18.95
- Deihl FPE49-7 Servo Motor & Tach. 29.95
- Deihl PM Motor 27.5 VDC 4.95

AC MOTORS • DC MOTORS FANS-BLOWERS • RESOLVERS GEARED MOTORS • ACTUATORS

LARGE STOCK OF ROTATING DEVICES
All Items F.O.B. Oakland
Send for Free Catalog
(On Company Letterhead, Please)
ELECTRO GADGET SUPPLY
Doolittle & Langley Streets
Oakland Airport Oakland, Calif.
Phone 562-6641

CIRCLE 956 ON READER SERVICE CARD

SEMICONDUCTORS MAJOR BRANDS

INTERGRATED CIRCUITS • DIF. AMPS DARLINGTONS • POWER DIODES & TRANSISTORS • SPECIAL DEVICES

Write for Catalog S-1
SEMICONDUCTOR SALES OF CALIF.
1063 Perry Annex Whittier, Calif.
(213) 696-7544

CIRCLE 957 ON READER SERVICE CARD

COAXIAL CABLE

RG 213U (former RG 8U)
RG 215U (former RG10U)
RG 219U (former RG18U)

LARGE QUANTITIES—BELOW FACTORY COST

Other types available
Rigid—Flexible—Semi-flex
Call or write for listing

Sierra Western Electric Company

P. O. Box 4668
Oakland, California 94623
Telephone AC 415-832-3527

CIRCLE 958 ON READER SERVICE CARD

INDUSTRIAL—RECEIVING SPECIAL PURPOSE TUBES

BEST QUALITY—LOWEST PRICES

Semiconductors—All Types

FREE CATALOG—write

ROBERT G. ALLEN CO.

P.O. Box 1882 Dept. E-1, Beverly Hills, Calif. 90213
Phone (213) 657-1583

CIRCLE 959 ON READER SERVICE CARD

PRECISION INSTRUMENT OPPORTUNITY AUSTRALIA

Important Australian manufacturer of precision instruments seeks U. S. licensing or joint venture partner. Company with 400 employees, 80,000 square ft. floor area sells throughout Australia. Seeks new products in fields of industrial automation, electronic measuring equipment, marine navigation equipment, radar, nuclear instruments for industry, radio telecommunicating and teleprinting equipment.

Details: write or phone

NEW SOUTH WALES CENTRE
Suite 1306, 680 Fifth Avenue, New York 19
(JU 2-0336)

CIRCLE 960 ON READER SERVICE CARD

TUBES & COMPONENT FREE...CATALOG BARRY ELECTRONICS

512 BROADWAY 212-WALKER 5-7000
NEW YORK 12, N.Y. TWX-571-0484

CIRCLE 961 ON READER SERVICE CARD



FREE CATALOG! NEARLY 4,000 BUYS FOR INDUSTRY

OPTICS! SCIENCE! MATH! GIANT 148 PAGES

Many on-the-job helps . . . Quality Control Aids! Write for this completely new, 1965 Catalog. New items, new categories, new illustrations. 148 easy-to-read pages packed with hundreds of charts, diagrams, illustrations. A treasure-house of optical and scientific information . . . unusual bargains galore. Optics for industry, research labs, design engineers, experimenters, hobbyists! Instruments for checking, measuring—to speed work, improve quality, cut production costs. We give you facts: what it is—how it works—where it's used!

COMPARATORS, MAGNIFIERS, MICROSCOPES

Hard-to-get war surplus bargains—ingenious scientific tools—imported—domestic. Thousands of components: lenses, prisms, wedges, mirrors, mounts—accessories of all descriptions. Dozens of instruments: magnifiers, stereo microscopes, telescopes, binoculars, infrared equipment, photo attachments. Shop by mail. No salesman will call. Use the Catalog of America's greatest Optics—Science—Math Mart. Known for reliability. Mail coupon below for catalog "EX". No obligation.
EDMUND SCIENTIFIC CO.
Barrington, N. J.

MAIL COUPON FOR FREE CATALOG "EX"!

EDMUND SCIENTIFIC CO., Barrington, N. J.
Please send FREE Giant 148-page Catalog "EX"

NAME

ADDRESS

CITYZONE.....STATE.....

CIRCLE 962 ON READER SERVICE CARD

New Literature

Chopper-relay. Solid State Electronics Corp., 15321 Rayen St., Sepulveda, Calif., 91343, has available a four-page folder on the Model 98 silicon transistor chopper-relay.

Circle 461 on reader service card

Motor driven potentiometer. The A.W. Haydon Co., 232 North Elm St., Waterbury, Conn., 06720. Production Newsletter No. 113 gives facts on a reversible potentiometer drive featuring a visual indication of pot position within one part in a thousand on a three-digit counter. [462]

Operational amplifiers. Analog devices, Inc., Fifth St., Cambridge, Mass. Specification sheets are available on a new line of operational d-c amplifiers. [463]

Precision pot testing. Amphenol Controls Div. of The Amphenol Corp., 120 S. Main St., Janesville, Wis., announces a 52-page manual on standard wire-wound precision potentiometer inspection and testing procedures [464]

D-C supplies. Dressen-Barnes Electronics Corp., 250 N. Vinedo Ave., Pasadena, Calif. Bulletin E-65 illustrates various multiple-output d-c power supplies, discusses how and when to specify and gives applications form for determining prices and delivery. [465]

Silicon semiconductor reliability. Fairchild Semiconductor, 313 Fairchild Drive, Mountain View, Calif., 94041. A 32-page illustrated presentation details steps taken in the manufacture of silicon semiconductor devices to assure their reliability. [466]

Flash tubes for laser stimulation. Xenon Corp., 10 Wheeler Court, Watertown, Mass. A four-page brochure includes technical specifications and ordering data describing a line of linear, high-energy flash tubes for laser applications. [467]

A-C planetary gearmotors. Globe Industries, Inc., 2275 Stanley Ave., Dayton, Ohio, 45404. Brochure B-2082 valuable design aids for users of miniature gear reduced motors. [468]

Resistor bobbins. Plasmetex Industries, 8217 Lankershim Blvd., N. Hollywood, Calif., 91605 has issued a catalog sheet on its standard line of resistor bobbins with molded-in leads. [469]

Frequency bands. Electronic Specialty Co., 4561 Colorado Blvd., Los Angeles, Calif., 90039. A wallet-size card listing microwave frequencies from P- to V-band and letter-frequency combinations from vlf to ehf is available. The card also contains a chart with the joint Army-Navy (AN) method of designating systems and equipment. [470]

Instrumentation. John Fluke Mfg. Co., P.O. Box 7428, Seattle, Wash., 98133. A wide line of test, measurement and calibration instruments is described in the 1965 catalog. [471]

Superconducting magnets. Westinghouse Cryogenic Systems Dept., P.O. Box 8606, Pittsburgh, Pa., 15221. An application guide for superconducting magnets is now available in booklet form. [472]

Multiplexers. Scientific Data Systems, 1649 Seventeenth St., Santa Monica, Calif. An eight-page illustrated brochure covers a line of high-speed, solid state multiplexers. [473]

Power tube accessory parts. Westinghouse Electronic Tube Division, Box 284, Elmira, N.Y. A complete listing of a new line of accessory parts for special purpose power tubes may be obtained by writing on company letterhead stationery.

Epoxy-polyamide coating. Columbia Technical Corp., 24-30 Brooklyn-Queens Expressway West, Woodside, N.Y., 11377, offers a data sheet on a new two-component, epoxy-polyamide coating having a 24-hour pot life for use in weapon systems. [474]

Environmental test equipment. Associated Testing Laboratories, Inc., 200 Route 46, Wayne, N.J. Catalog M-4 contains a multitude of equipment photographs, technical specifications, and prices for Econ-O-Lab chambers and accessories. [475]

Ferrite pot core inductors. Ferroxcube Corp. of America, Saugerties, N.Y. Bulletin 220 is a 24-page manual entitled "How to Design Optimum Inductors with Ferroxcube Ferrite Pot Cores for Filters, Delay Lines, Networks and Tuned Circuits." [476]

Ceramic variable capacitors. JFD Electronics Corp., 15th Ave. at 62nd St., Brooklyn, N.Y., 11219. Micromodule ceramic variable capacitors are described in the new two-page bulletin MT-65-1. [477]

Laser metalworking. Applied Lasers, Inc., 72 Maple St., Stoneham, Mass., 02180, has announced availability of a technical application note entitled "Laser Metalworking Techniques and Equipment." [478]

Microwave packaged devices. The Electronic Components and Devices division of the Radio Corp. of America, at Harrison, N.J., has published an illustrated booklet, MWD-105, on its custom-designed, solid-state microwave packaged devices. To obtain a copy, write directly to the company.

rugged

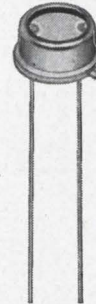

CDS-5 (To-5)

reliable

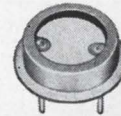

CDS-7

top performance

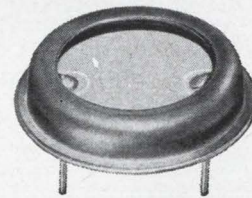

CDS-9

POWERMASTER PHOTOCELLS

Outstanding construction and design of Pioneer Photocells assure long-life and top performance. New heavy base (.080) allows compression glass to metal seal on leads, and eliminates danger of air leakage and cell deterioration.

Available in one inch, half inch and To-5 sizes over a wide sensitivity range.

Consult us on special applications of photo sensitive layers.

Photocells pictured are actual size.

**The Pioneer
Electric & Research Corp.**

Subsidiary of **PENN** Controls, Inc.
743 Circle Avenue • Forest Park, Ill.



MICROWAVE FILTERS • COMPONENTS • INSTRUMENTS

Telonic RF and Microwave devices are engineered and built to perform well within their specified ratings while providing a new level of product dependability. Materials and assembly, as well as design considerations, reflect the quality-conscious attitude that has made Telonic microwave products the choice of engineers worldwide.

In addition to a highly qualified staff of engineers, Telonic also maintains its own digital computer laboratory to expedite designs and to assure performance as specified. Many products, in fact, are available on a convenient 72-hour Jet-order delivery schedule.

A. TUBULAR BAND PASS FILTERS

TBP, TBA, and TBC series available in 2 to 6-section models with center frequencies from 30Mc to 2.5Gc and pass band widths ranging from 2 to 30%.

B. TUBULAR LOW PASS FILTERS

Available in TLP, TLA, TLC, TLR and TLS series in 1 to 8 pi sections with cut-off frequencies from 30Mc to 3Gc.

C. CAVITY, RESONANT and INTERDIGITAL BAND PASS FILTERS

The TCF, TCA, TSF and TIF series have center frequencies ranging from 30Mc to 6Gc and low VSWR and loss constants.

D. TUNABLE BAND PASS FILTERS

The model TTF is available in a 5% series and a telemetry series, covers 50Mc to 3Gc, and is equipped with a direct reading pre-calibrated dial. Model TTA is a miniature type, covering frequencies to 4Gc.

E. TUNABLE VARACTOR MULTIPLIERS

TTM multipliers are available in two models covering .50 to .85Gc and .6 to 1.0Gc (inputs). Wide band frequency doublers, they are equipped with individually calibrated dials.

F. TUNABLE OSCILLATOR PRESELECTOR

The model TOP tunes over a range of 2:1 from 50 to 750Mc. Minimum oscillator output is 10 mw, and can be tracked for any standard I.F. frequency.

G. RHO-TECTOR VSWR DETECTOR

Determining VSWR by reflection coefficient, the TRB series comes in 5 models covering 1Mc to 4Gc.

H. RF TERMINATIONS

Including Matched and Mismatched types, the TRM series is designed for general purpose loading and terminating applications.

J. MICROWAVE MARKER GENERATOR

TMS-1 Generator adds Birdy-type markers every 5, 10, 50, 100Mc to signal trace. Push-button operated, it covers .5Mc to 12.4Gc.

TELONIC ENGINEERING CO.

Division of Telonic Industries, Inc.

480 Mermaid Street,
Laguna Beach, California 92651

Tel: (714) HY 4-7581

TWX 714 673-1120

Complete product line
catalog on request



Electronics Abroad

Volume 38
Number 12

Europe

All together now

A meter is a meter in Paris or Prague, but this product of 18th century Enlightenment has by no means become a model for other European standards. Women travelers are familiar with the changes in voltage and plug size that make a versatile travel iron necessary if they are going to cross any borders. Such basic national differences are reflected in varying manufacturing standards. The larger electronics companies—particularly those of international scope—are beginning to realize that they need true international standards to match Europe's growing economic integration.

A simple table radio can illustrate the difficulty. The radio is made by several dozen branches or subsidiaries of the Dutch Philips Gloeilampenfabrieken N.V. in 11 different countries. Components such as plugs, tubes, switches, resistors and transformers are thus guided by 11 different standards.

In addition, there are differing standards for performance parameters. For instance, all governments have radiation regulations—and they are all different. In some countries, radio tuners must have an oscillator frequency higher than the transmitting frequency, while in others it must be lower. Some countries require that every item of electrical apparatus be tested and approved, and carry a safety mark. All of these marks are different.

Variable voltage. The heart of the matter is the voltage, which varies from 110 v to 250 v throughout the continent and is responsible for the 10 different types of the ordinary light bulb made in Europe today. There are two different voltages used in Italy alone. Wall plugs

change size, shape and construction at every border, though a recently developed "Europlug" seems to be making headway. Power and plug variations have led to a lack of uniformity in color codes for the leads. There is not even a truly international system of instruction symbols.

On another front, the use of three different black and white television systems—625, 405, and 819 lines—provides endless headaches for set manufacturers who rely on export markets. If Europe splits on the question of a color tv system, as now seems likely, the confusion will be compounded.

Many companies are unwilling

2.541 cm of progress

It won't be quite the same when purists have to say "Give him 2.541 centimeters and he'll take 1.6 kilometers," or "all wool and 91.44 centimeters wide," but the British are nonetheless going to abandon their traditional weights and measures for the metric system. Plans call for a switchover to meters, liters and grams by 1975.

The effect on the drive for consistent European standards will not be great, however, since industry has been used to the metric system for some time. And unless the United States can be persuaded to make the switch too, the inch is likely to be around for a long while.

to make the minor sacrifices which would be demanded by international standards, since they do not want to change product lines, modify manufacturing equipment, or otherwise interfere with production, marketing, and servicing policies. But some companies and industrial associations are not only willing to set standards; they have already taken a small step toward that goal.

About a year ago, the European Committee for Passive Electronic Elements set out to standardize the most basic elements. A general

agreement on the dimensions of electrolytic capacitors end cups has been reached, and most manufacturers are ready to adhere to it. Germany's Telefunken A.G. says its production lines have already been adapted to the standard. Wire dimensions for condensers and other passive elements are now under discussion.

Germany leads. Germany is the leader in the standardization drive. That country and France, the continent's two largest electronics producers, recently joined to standardize condensers, resistors, potentiometers, tubes, transistors, and printed circuit boards, and both sides have shown interest in unifying test standards, a heretofore neglected area.

The Germans do not want to establish purely Common Market standards, for to do so would only emphasize the split between that group and the seven European Free Trade Association nations. A European Standards Coordination Committee is trying to bridge the gap between the Common Market and EFTA.

Even the Germans, however, are split on the need for standards. The reason is that there are two breeds of electronics companies—those which sell extensively to England and the United States and those which don't. The German subsidiaries of companies like Philips must adjust their manufacturing and design policies to take into account nations using English measure as well as the metric scale. Companies like Siemens & Halske A.G. and Telefunken, which export less, need not.

Big inch. An example of the conflict is the simple printed circuit board, or plate. Philips spaces its wire holes on a 2.541-cm, or one-inch, scale, with 1/10-inch increments. German component producers base their boards on a 2.500-cm scale and can't see why

they should change. The difference of 0.041 cm is important for connecting wires 0.5 to 0.7 mm in diameter. The conflict may be resolved by the International Electro-Technical Commission, which has adopted the inch scale over German protests.

But the only real solution will come from the companies themselves; once they become convinced of the wisdom of international standards, talk will rapidly be turned into action.

England

Multistable cores

A new cobalt ferrous ferrite material, under development at the Standard Telecommunications Laboratories in Harlow, shows unusual magnetic characteristics that open up new possibilities for controllable multistable magnetic logic devices. It may also find uses later in computer stores.

A byproduct of a development program aimed at finding low-power fast-switching ferrite materials for core stores, the new material has a "reentrant" hysteresis loop, shown in the photograph at the right above. The loop differs from the normal in having horizontal spikes at all four corners. The new material's big advantage over conventional ferrite cores is that it is completely bistable; only two stable states can occur, with no minor loops.

In conventional ferrites used for computer stores, the ideal hysteresis loop obtained by plotting the magnetic flux (B) against the magnetomotive force (H) is nearly square. The two saturated states into which the material is driven by the energizing field are used to denote binary one and zero conditions in the store. To write information into the core, a current pulse is applied to a winding that passes through the core. The pulse's amplitude is sufficient to saturate the ferrite, which remains in this con-

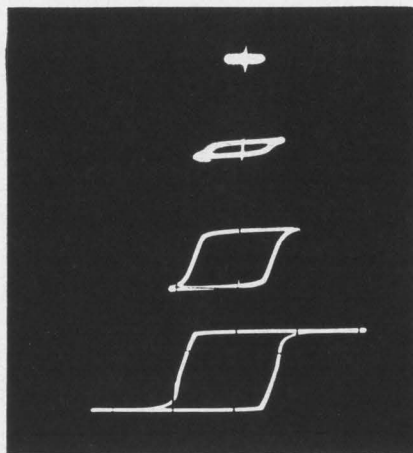

Cathode-ray-tube tracing shows how the size and shape of the hysteresis loop varies in conventional ferrite cores as the energizing field increases (top to bottom).

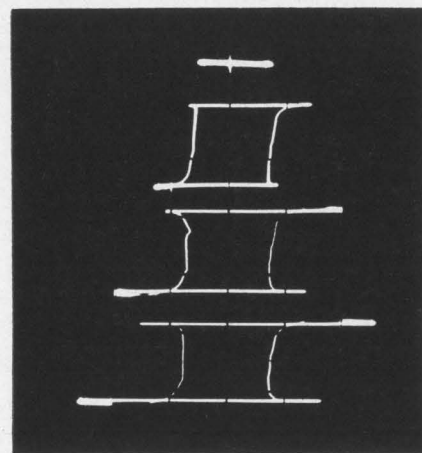

With new cores, the hysteresis loop has a constant shape once the threshold field is exceeded. Threshold is determined by value of horizontal spikes.

dition until a pulse of sufficient amplitude occurs in the reverse direction and drives it into the other stable state. The minimum value of magnetomotive force required to switch the core is less than the core's coercive force, the force required to cancel out any flux remaining in the core when the initial field has been removed.

Minor loops. In conventional cores, minor loops are a problem. Because the loop's changeover path is not truly vertical between the two saturable states, any energizing force that lies between the minimum switching value and the saturation value will cause the core to switch in a minor hysteresis loop. After such an energizing pulse, the core, instead of taking up a saturated value, takes up an intermediate value dependent on the amplitude of the energizing pulse. When this value is read out, the variation can cause erroneous outputs in a computer system.

The picture of the cathode-ray-tube trace at left shows how the hysteresis loop forms for different values of energizing fields. In such a system, deterioration of the drive pulses below the saturation value fail to give clearly defined binary states.

Triggering force. The material developed by STL, the research group for Standard Telephones and Cables, Ltd. (a subsidiary of

the International Telephone and Telegraph Corp.) eliminates this problem. Switching between the stable states in its reentrant hysteresis loop depends not on the material's coercive force but on a larger nucleating, or triggering force, whose value is determined by the length of the horizontal spikes at the corners of the hysteresis loop. As long as the energizing field exceeds this value, the core switches from one state to another. Field values less than the nucleating value have no effect on the core's state. Thus, erroneous switching due to noise or reduced amplitude pulses is prevented.

The crt traces at right show how, in a reentrant hysteresis-loop material, the loop is either absent or formed. There are no intermediate states while the field is being increased. The ratio of this nucleating force to the normal coercive force is 4 to 3.

Multiple states. An annealing technique has been found that produces other stable states within the hysteresis curve. Tristable hysteresis loops have been produced with the additional horizontal spikes inserted in the vertical sections of the loop. As the core is triggered, it takes up an intermediate stable position. Theoretically, according to STL's development team, there is no limit to the number of states that can be inserted.

IC price reductions

Bucking Texas Instruments Ltd. and Motorola, which claim the majority of the British market for IC devices, SGS-Fairchild Ltd. announced price cuts ranging from 10% to 60% on its line of integrated circuits. Fairchild says it made the cuts because it wants to encourage the expansion of IC applications and because it has achieved greater manufacturing efficiency.

Whether Fairchild is setting or following a trend is unclear; IC prices in the U.K. have been moving steadily downward over the last year. A Texas Instruments official claims that current TI prices for some devices are already below the new levels announced by Fairchild. From another IC manufacturer comes the word that published prices cannot be taken as the last word since final prices often depend on hard bargaining between supplier and user.

An official of the parent Texas Instruments Incorporated in Dallas said that while TI will meet any price competition, he knew of no activity in England that would require his firm to cut prices. Usually, he said, such price cuts are announced "after the fact"—that is, after a supplier has negotiated an order for lower-than-list prices.

Fairchild's biggest cuts are in its range of digital micrologic elements. A four-input resistor-transistor gate element is down from \$22.54 to \$11.76. Analog integrated circuit amplifiers are also being cut by as much as 20%.

Canada

Tariff cuts?

Suggestions that the recent United States-Canada trade agreement on auto parts might be extended to the electronics industry are worrying some manufacturers north of the border. They aren't ready for the government's apparent readi-

ness to abandon the "infant industry" concept, the chief justification for Canadian protective tariffs.

Nevertheless, Department of Industry officials from Ottawa will attend the annual meeting of the Electronic Industries Association of Canada this week to detail the arrangements negotiated for the automobile industry and to outline how a similar agreement in electronics could help correct a continuing trade imbalance in that industry.

Canada dropped its 17.5% tariff on U. S. cars and trucks and the 25% tax on parts in January, when the agreement was signed. When Congress approves it, the U. S. will end its tariff of 6.5% to 8.5% on Canadian auto products, retroactive to January.

Despite the fact that the U. S. taxes Canadian electronics imports at only 12½% while Canada charges 20%, the flow of products northward is valued at \$120 million yearly, while the flow southward is only \$28 million.

Ill wind. Electronics producers got an idea of which way the wind was blowing in April when the Tariff Board turned down their recommendations, made through the EIA, to set electronics tariff rates at 15% British preferential and 20% most favored nation. The board instead recommended letting in radio and television receivers originating in the British Commonwealth duty-free, and cutting tariffs for other countries from 20% to 15%.

The manufacturers concede privately that the only way to correct their trade imbalance is by increasing exports. But they don't think that freer trade is the answer. Canadian products are just not com-

petitive in world markets; even if tariff walls to the U. S. were down, and manufacturing costs comparable, suppliers without a sales organization in the U. S. would be at a severe disadvantage.

Some companies, such as Canadian General Electric and Canadian Westinghouse, could exploit relationships with U. S. firms. Others, such as Canadian Marconi, Northern Electric and Philips Electronics, would face tough competition.

Canada is in something of an international squeeze when it comes to cutting tariffs. Successful conclusion of the Kennedy round of trade talks under the General Agreement on Tariffs and Trade (GATT) would make its producers more vulnerable to world competition; but a bilateral agreement with the United States might not sit well with other GATT countries.

Denmark

Well stacked

Any new system for packaging conventional components has a hard time gaining acceptance, especially when bucking the trend towards microcircuits. But engineers in Denmark and Britain have come up with a production application for one special assembly method, known as Ministac.

The component stack, only two inches long and ⅝ inch square, was designed three years ago by Standard Telephones and Cables Ltd. of London, an affiliate of International Telephone and Telegraph. It is now

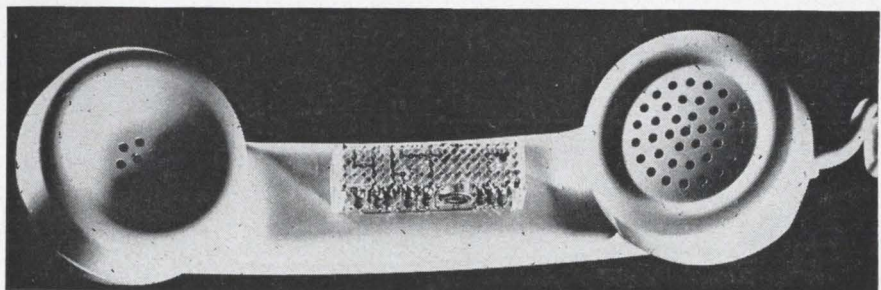

Ministac perched on a telephone receiver. Five of these components stacks are packaged in a Danish transceiver that weighs only two pounds.

LEFT OVER BUDGET FUNDS?

USE IT FOR

SINGLE CRYSTALS

AND

**GAS LASER SYSTEM
ACCESSORIES**

**SPECIAL OFFERS
GOOD TILL JULY 15**

CONFOCAL MIRRORS

Flats of Hemispherical
Mode Sets \$198/pr.

**BREWSTER ANGLE
DISCHARGE TUBES**

Filled, tested, ready
for operation **\$225**

Above Tubes and Mirrors
Ordered together **\$399**

CALCIUM TUNGSTATE

doped with Neodymium

Laser Rod

Continuous Operation
at room temperature
3 mm dia x 1.2" long

\$450

1/4" dia. x 1.2" long

\$650

Also:

**MgO Single Crystal
Substrates**

**Metal Single Crystals
Spinel Single Crystals**



FOR COMPLETE LITERATURE
WRITE DEPT. E-6

emi-elements, inc.

Saxonburg Boulevard,
Saxonburg, Pa.
Phone: 412-352-1548

Electronics Abroad

being incorporated into a portable transceiver built by Standard Electric A/S of Denmark.

The Ministac approach reduced the size of the 10-channel transceiver to one-fifth that of previous equipment and cut the weight to about two pounds. Conventional printed board assemblies, Standard Electric says, are three times the size of the Ministac.

Both sides of the law. The company is so proud of its portable radio-telephone that it advertises it, deadpan, as an ideal device both for customs agents—and smugglers.

The completed Ministacs have conventional components mounted between a pair of parallel metal strips in a plastic sandwich. The wiring pattern and the component terminals are produced automatically by a machine which is controlled by punched tape. (Final production models are identical to the prototype assemblies.) The nickel-silver strip has a special pattern of punched apertures to form the required connection pattern. Since the components are quite accessible, the stacks are extremely easy to repair.

Scotland

Traffic lab

Compared with his counterpart in New York or Tokyo, the motorist in Glasgow has relatively few traffic problems. Still, the Scottish city of 1.8 million will test not one but four computerized traffic control systems. It's an experiment being conducted jointly by the city and the British Road Research Laboratory, an arm of the Ministry of Transport.

The chief interest in the Glasgow method is not in any actual system, but in the approach. Most cities contemplating computerized traffic control model their systems on one existing elsewhere. But problems differ from place to place, and what works in one city may fail in another. Testing a system on the very

streets it is intended to serve may help avoid failure.

The tests will take two years to organize and three more years to carry out, and will cost \$1.4 million. The Ministry of Transport plans a similar experiment for London; it sent experts to New York, Detroit, Los Angeles, Toronto, Frankfurt, Duesseldorf and Stockholm before proposing the Glasgow program.

Versatile computer. Specifications are now being drafted for the one digital computer that will operate all four methods. The computer will receive traffic information from 70 signal controllers. It will decide the best moment to turn any light green.

Glasgow already has a system of treadles in the road to actuate traffic lights. The experiment will also evaluate methods, such as digital and analog control of fixed-time linked systems, used in or contemplated by Washington, Baltimore, and Cologne, Germany. In some systems, the program is varied according to the season and the time of day; in others, real-time measurement of actual conditions determines traffic flow.

The main part of the experiment will use existing traffic detectors, but magnetic-loop detectors will be installed at some signals. More than 15 will have long detectors, traffic loops extending back to the stop line of the previous junction, to count the vehicles in the block between the lights.

As in most traffic control systems, chaos insurance will be built in. Should the computer or any of the links fail, the traffic lights will go back to their normal operating pattern.

Japan

Better resolution

The resolving power of an electron microscope is limited by the wavelength of the illuminating radiation—in this case an electron beam—just as an optical microscope is

limited by the wavelength of the light it uses. Hitachi Ltd. of Tokyo has built an electron microscope that discerns intervals between objects only 1.94 angstroms apart—far better than any resolution previously achieved.

Hitachi experimented with palladium crystals and used an accelerating field of 100 kilovolts in conjunction with the electron lens assembly to produce a beam with a wavelength of 0.037 angstroms. Engineers could clearly discern the intervals in the lattice structure of the crystal.

Like other electron microscopes, the Hitachi device accelerates the beam, focuses it, and transmits it through a specimen before visual display. Earlier microscopes used a field of 50 kv to achieve a beam with a wavelength of 0.05 angstrom, but practical difficulties such as chromatic aberration, astigmatism in the lens assembly, and temperature variations of the specimen made it impossible to achieve the theoretical limits for electron beams of either wavelength.

Smaller and smaller. Optical microscopes, even using ultraviolet light under optimum conditions, have a resolution of about 1,700 angstroms. Resolution for normal electron microscopes is about 10 angstroms; last year, Hitachi obtained pictures of gold monocrystalline film specimens with resolutions of 2.35 and 2.04 angstroms. The company's engineers used three techniques to improve on that figure.

Stabilization of the power supply to within 2 to 5 parts per million reduced chromatic aberration to negligible proportions. Astigmatism errors, caused by mechanical errors in the pole pieces of the magnetic lens assembly, were reduced by special manufacturing methods resulting in a hole for the electron beam within the pole piece accurate to better than one micron. Constant-temperature water cooling around the specimen holder reduced the thermal drift, which can cause a 1-angstrom displacement in the specimen position for each ten-thousandth of a degree centigrade change in specimen temperature.

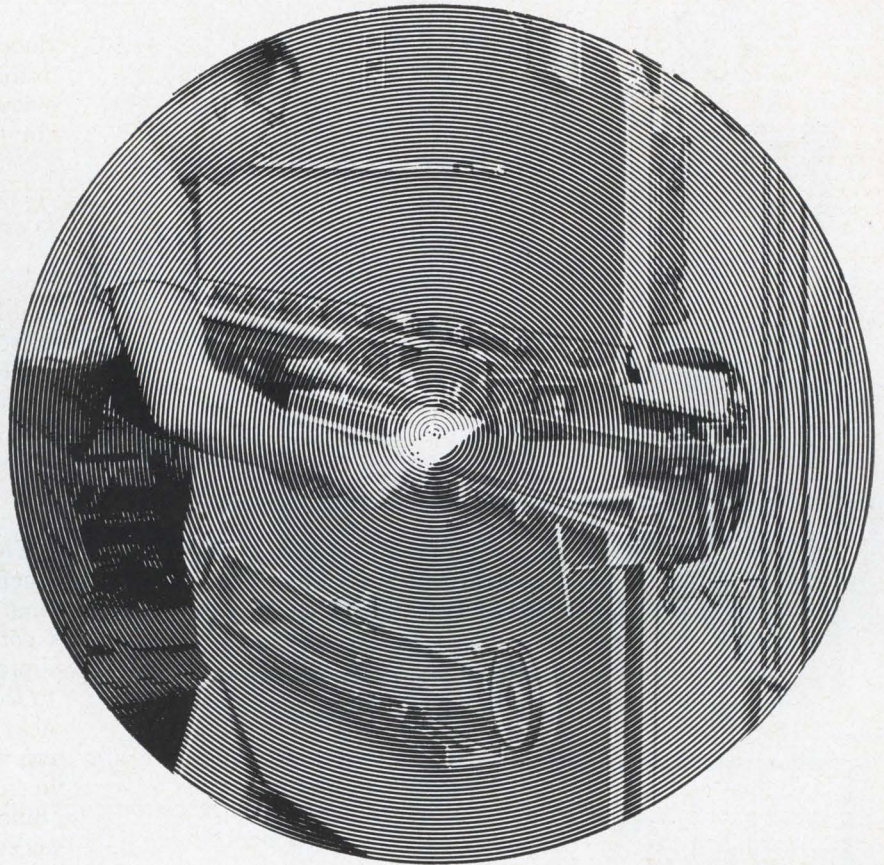

Press Brake Problems Disappear with Di-Acro

Your press brakes are too big an investment to have them miss the mark. Especially when Di-Acro can stay on target for you with such high accuracy, speed and safety. All sizes from an 8-ton hand unit to a 35-ton hydraulic powered unit with stroke adjustment, speed control, dual speed operating cycle and other features you can't buy elsewhere. See your distributor or write us.



DI-ACRO

A Division of Houdaille Industries, Inc.

456 Eighth Ave., Lake City, Minn. 55041

ANOTHER UNIQUE INSTRUMENT FROM ROHDE & SCHWARZ



10 kc
TO
30 mc



TYPE USVH

Selective Microvoltmeter

DELIVERY FROM STOCK

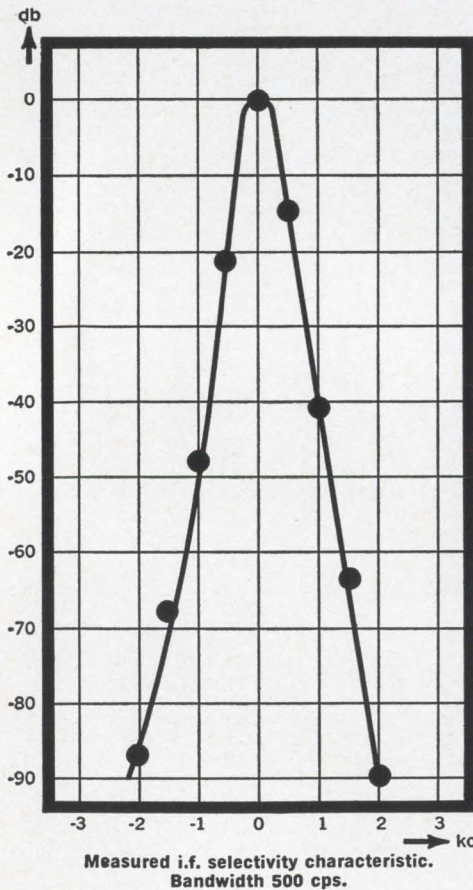

Unique Features

- Extremely wide frequency range: 10 kc to 30 mc.
- Fine frequency adjustment: ± 2.5 kc.
- Bandwidth, selectable: 500 cps and 5 kc.
- Full-scale deflections, $1 \mu\text{v}$ to 1 v.
- Six input impedances from 50Ω to $500 \text{ k}\Omega$ available.

Here is a highly sensitive superheterodyne receiver whose output voltage is indicated by a diode voltmeter. A switch permits selection of any of the conventional input impedances. Single frequency changing is used for input frequencies from 10 to 1000 kc, double frequency changing for 1 to 30 mc, the bandwidth being 5 kc in both cases. Additional frequency conversion takes place in 500-cps narrow-band operation.

The local oscillator can be varied in frequency by ± 2.5 kc and thus permit shifting of the 500 cps pass band over the 5 kc bandwidth present up to this frequency conversion.

The meter is calibrated in volts and decibels, and features an additional expanded scale with a relative calibration from 0.7 to 1. A head-phone output provides aural monitoring. A built-in calibration oscillator permits checking and adjustment. The power supply is electronically regulated for greater stability with regard to gain and frequency accuracy.

Typical Measurement Applications

- Frequency response on four-terminal networks, especially at low voltage levels.
- Frequency response on amplifiers or filters within their pass bands.
- R-f distortion of long-, medium- and short-wave transmitters.
- Modulation depth.
- Envelope distortion.
- Inter-channel cross-talk attenuation.
- Signal-generator attenuation.
- R-f leakage on shields and r-f chokes.

WRITE FOR
ADDITIONAL
INFORMATION



ROHDE & SCHWARZ

ELECTRONIC MEASURING EQUIPMENT FOR THE UNCOMPROMISING

111 Lexington Ave., Passaic, N. J. • PRescott 3-8010

Inquiries outside the U.S.A. should be directed to: Rohde & Schwarz, Muehlhofstrasse 15, Munchen 8, West Germany.

Electronics advertisers

June 14, 1965



| | | | | | |
|--|--------------|---|-----------|--|----------|
| ■ AMP Incorporated | 123 | Crystalonics Inc. | 155 | High Vacuum Electronics Inc. | 153 |
| Garceau, Hargrave & McCullough Inc. | | Impact Advertising Inc. | | Bonfield Associates | |
| ■ Acme Electric Corporation | 131 | Data Instruments | 38 | Hitachi Ltd. | 173 |
| Scheel Adv. Agency | | Technical Marketing | | Dentsu Advertising Ltd. | |
| Airco Welding Products Div. of | | Defense Electronics Inc. | 55 | ■ Hughes Aircraft Company | 195 |
| Air Reduction Company Inc. | 36 | H. Durand Associates | | Footo, Cone & Belding Inc. | |
| Basford Incorporated | | ■ Delco Radio Division of | | | |
| Amelco Semiconductor, Div. of | | General Motors Corporation | 134, 135 | | |
| Teledyne Inc. | 161 | Campbell-Ewald Company | | | |
| Sturges and Associates | | Delta Design Inc. | 176 | | |
| American Instrument Co. Inc. | 193 | Barnes Chase Advertising | | ■ IBM Corp. Industrial Products Div. | 72 |
| G. Bruce West Inc. | | Di-Acro Corporation | 211 | Marsteller Inc. | |
| ■ Amperex Electronics Corp. | 31, 180, 191 | Charles E. Brown Adv. | | Ichizuka Optical Co. Ltd. | 170 |
| Sam Groden Incorporated | | Dickson Electronics Corporation | 121 | Matsushita Inc. | |
| Amperite Company | 166 | N. A. Winter Advertising Agency | | Industrial Electronic Engineers Inc. | 198 |
| H. J. Gold Company | | Dixon Inc. | 184 | Gumpertz, Bentley & Dolan Adv. | |
| ■ Amphenol-Borg Electronics Corp. | | Gail Advertising Company | | International Resistance Company | 144 |
| Connector Division | 58, 59 | DuPont Reagents | 47 | Arndt, Preston, Chapin, Lamb & Keen Inc. | |
| Marsteller Inc. | | The Rumrill Company Inc. | | ITT Components Group Electron Tube | 122 |
| Arnold Magnetics Corporation | 199 | DuPont de Nemours & Co. Inc. E. I. | 67 | Division | |
| Balsam Advertising Inc. | | Batten, Barton, Durstine & Osborn Inc. | | West, Weir & Bartel Inc. | |
| Astro Communication Laboratory | 178 | ■ Dymec, A. Div. of Hewlett Packard | 1 | | |
| Admasters Advertising Inc. | | Company | | | |
| | | Lennen & Newell Incorporated | | | |
| | | | | JFD Electronics Corp. | 7 |
| ■ Ballantine Laboratories Inc. | 151 | Eastman Kodak Company | 71 | Michel Cather Inc. | |
| Lang-Lawrence Advertising Inc. | | The Rumrill Company Inc. | | James Electronics, Inc. | 171 |
| Bausch & Lomb Inc. | 160 | ■ Electro Instruments Inc. | 68 | Burton Browne Advertising | |
| Wolff Associates Inc. | | Teawell Inc. Advertising | | Janus Control Corporation | 186 |
| Beckman Instrument Inc., | | Electro Products Laboratories Inc. | 124 | L.K. Frank Co. Inc. | |
| Helipot Division | 21 | C. M. Gotsch, Advertising | | ■ Jennings Radio Manufacturing Corp. | 163 |
| Erwin Wasey, Ruthrauff & Ryan Inc. | | Electronic Marketing Division of | | L.H. Waldron Advertising | |
| Beckman Instrument Inc., | | Essex Wire Corporation | 66 | Jerrold Electronics Corp. | 10 |
| Offner Division | 143 | Bonsib Inc. Advertising | | Irving Gould Advertising Inc. | |
| Erwin Wasey, Ruthrauff & Ryan Inc. | | Electronic Modules Corporation | 187 | Johnson Company, E.F. | 30 |
| ■ Bendix Corporation, Montrose Division | 70 | Ray Thompson & Associates | | Firestone Advertising Inc. | |
| MacManus, John & Adams Inc. | | Emerson & Cuming Inc. | 200 | | |
| ■ Bliss Company, Eagle Signal Division | 62, 63 | Erie Technological Products | | Keithley Instruments Inc. | 156 |
| Feeley Advertising Agency Inc. | | Co. Inc. | 146, 147 | The Bayless Kerr Company | |
| ■ Boonton, Div. of Hewlett Packard | | Altman-Hall Associates | | Kulicke & Soffa | 136 |
| Company | 24 | Esterline Angus Instruments | | George L. Mallis Inc. | |
| George Homer Martin Associates | | Company Inc. | 76 | Kyoto Ceramic Company Ltd. | 188 |
| Borden Chemical Company, | | Caldwell, Larkin & Sidener-Van Riper Inc. | | Daiko Advertising Inc. | |
| Mystik Tape Inc. | 150 | Exact Electronics Inc. | 192 | | |
| Fuller & Smith & Ross Inc. | | Format | | | |
| ■ Bourns Inc. | 56, 57 | | | | |
| Allen, Dorsey & Hatfield Inc. | | Fairchild Scientific Instruments, | | ■ Lambda Electronics Corporation | 132, 133 |
| ■ Brush Instruments, Div. of | | Dumont Laboratories Div. | 14 | Michel Cather Inc. | |
| Clevite Corp. | 3rd Cover | The Roger & Wilbur Co. Inc. | | ■ Lapp Insulator Company Inc. | 175 |
| Carr Liggett Adv. Inc. | | ■ Fenwal Electronics Inc. | 190 | Wolff Associates Inc. | |
| ■ Burndy Corporation | 27 | Larcom Randall Advertising Inc. | | ■ Leach Corporation | 26 |
| Ted Gravenston Inc. | | Fiberfil, Inc. | 152 | Jay Chait & Associates | |
| ■ Bussmann Mfg. Co. Div. of | | Tri-State Advertising Co. Inc. | | Ledex Inc. | 162 |
| McGraw Edison Co. | 158, 159 | Fluke Mfg. Co. Inc., John | 11 | Yeck and Yeck | |
| Henderson Advertising Company | | Bonfield Associates Inc. | | LEL Division of Varian Associates | 33 |
| | | | | Snow & Depew Advertising | |
| | | | | Lepel High Frequency Laboratories Inc. | 138 |
| ■ CML Incorporated | 158 | General Applied Science Laboratories | 157 | Apex Graphic Company | |
| Keyes, Martin & Company | | Inc. | | Lockheed Missiles & Space Company | 182 |
| Ceramics International | 165 | Samuel H. Goldstein Advertising | | McCann Erickson Inc. | |
| Conti Advertising Agency | | General Radio Company | 2nd Cover | | |
| ■ Clairex Corporation | 174 | K.E. Morang Company | | M.I.A.L. | 197 |
| Michel Cather Inc. | | Genisco Technology Corporation | 177 | Keyes, Martin Company | |
| Clare & Company, C. P. | 22, 23 | Getz and Sandborg Inc. | | Machlett Laboratories Inc., The | 9 |
| Reincke, Meyer & Finn Adv. | | ■ Globe Industries Inc. | 198 | Fuller & Smith & Ross Inc. | |
| ■ Clifton Precision Products Co. Div. of | | Odiore Industrial Adv. Inc. | | ■ Mallory & Company Inc. P.R. | 50, 51 |
| Litton Industries | 16 | Gudebrod Bros. Silk Co. Inc. | 28, 29 | The Aitkin Kynett Company | |
| Ivey Adv. Inc. | | Lee Ramsdell & Co. Inc. | | Marconi Instruments Ltd. | 128 |
| Cohu Electronics, Kin Tel Division | 61 | | | Armand Richards Advertising Agency | |
| Erwin Wasey, Ruthrauff & Ryan Inc. | | Hamilton Watch Company | 167 | ■ Markel & Sons, L. Frank | 124 |
| Cominco Products Inc. | 166 | Beaumont, Heller & Sperling Inc. | | George Moll Advertising Inc. | |
| McKim Productions Limited | | Hansen Mfg. Co. Inc. | 183 | Maryland Telecommunications | 139 |
| Communication Electronics Inc. | 152 | Keller-Crescent Company | | Richard N. Berry Advertising | |
| Consolidated Electrodynamics | | Heinemann Electric Company | 137 | Massa Division of Dynamics | |
| Corporation | 34, 168, 169 | Thomas R. Sundheim Inc. | | Corporation of America | 185 |
| Hixson & Jorgensen Inc. | | ■ Hewlett-Packard Company | 2, 12, 13 | L.K. Frank Co. Inc. | |
| Consumers Power District | 196 | Lennen & Newell Inc. | | Matsuo Electric Co. Ltd. | 154 |
| Swanson, Sinkey, Ellis Inc. | | | | Asahi Advertising Agency & Co. | |
| Controls Company of America | 120 | | | McDonnell Electronic Equipment Div. | 64 |
| The Harry P. Bridge Company | | | | John Patrick Starrs Inc. | |
| Corning Glass Works | 74 | | | Mc-Graw-Hill Book Co. Inc. | 176 |
| The Rumrill Company Inc. | | | | | |
| ■ Couch Ordnance Inc. | 186 | | | | |
| Culver Advertising Inc. | | | | | |

Executive, editorial, circulation and advertising offices: McGraw-Hill Building, 330 West 42nd Street, New York, N.Y., 10036. Telephone Area Code 212-971-3333. Teletype TWX N.Y. 212-640-4646. Cable: McGrawhill, N.Y. Officers of the Publications Division: Shelton Fisher, President; Vice Presidents: Joseph H. Allen, Operations; Robert F. Boger, Administration; John R. Callahan, Editorial; Ervin E. DeGraff, Circulation; Donald C. McGraw, Jr., Advertising Sales; Angelo R. Venezian, Marketing. Officers of the Corporation: Donald C. McGraw, President; L. Keith Goodrich and Hugh J. Kelly, Executive Vice Presidents; John J. Cooke, Vice President and Secretary; John L. McGraw, Treasurer. Title R registered U.S. Patent Office; © copyright 1965 by McGraw-Hill, Inc. All rights reserved, including the right to reproduce the contents of this publication, in whole or in part.



| | |
|--|-----------|
| MEPCO, Inc. Ray Ellis Advertising Corp. | 192 |
| Metal Removal Company, The Advertising Producers Associates Inc. | 154 |
| ■ Micro Switch Div. of Honeywell Batten, Barton, Durstine & Osborn Inc. | 52 |
| Minerals Pigments & Metals Div. of Chas. Pfizer & Co. Inc. Newmark, Posner & Mitchell Inc. | 65 |
| Minnesota Mining & Mfg. Co. Mincom Division Reach, McClintom & Co., Inc. | 20 |
| Minnesota Mining & Mfg. Company, Scotchpar Division Klau-Van Petersom-Dunlap Inc. | 148, 149 |
| ■ Mitsubishi Electric Corporation Hakuhodo Inc. | 193 |
| Motorola Semiconductor Products Inc. Lane and Bird Advertising Inc. | 60, 197 |
| Mystik Tape Inc. Division of The Borden Chemical Company Fuller & Smith & Ross Inc. | 150 |
| Nexus Research Laboratories Larcom Randall Advertising | 119 |
| North Atlantic Industries Inc. Murray Heyert Associates | 140 |
| Nucleonic Products Company Balsam Advertising Inc. | 180 |
| Pennsylvania Fluorocarbon Company Ernest William Greenfield Inc. | 188 |
| Penta Laboratories Kemble & Clapham Advertising | 8 |
| ■ Perfection Mica Company, Magnetic Shield Division Burton Browne Advertising | 170 |
| ■ Phelps Dodge Electronic Products Corp. Smith, Dorian & Burman Inc. | 126 |
| Pioneer Electric & Research Corp. K & A | 205 |
| Polaroid Corporation Doyle, Dane, Bernbach Inc. | 141 |
| ■ Precision Tube Company Inc. George Moll Advertising Inc. | 172 |
| Preformed Line Products The Bayless Kerr Company | 127 |
| ■ Radiation Inc. G.M. Basford Company | 32 |
| Radio Corporation of America Al Paul Lefton Co. | 4th Cover |
| ■ Radio Materials Co. Div. of P.R. Mallory Co. Inc. Rosenbloom/Elias Associates Inc. | 164 |
| Raytheon Company, Industrial Components Div. Fuller & Smith & Ross Inc. | 181 |
| Ribet Desjardins Inter-Plans | 179 |
| Rohde & Schwarz Inc. Armand Richards Advertising Agency | 212 |
| Rohr Corporation Lane & Huff Advertising | 200 |
| ■ Sanders Associates Inc. Chirurg & Cairns, Inc. | 158 |
| ■ Semi-Elements, Inc. Axelband & Brown Associates | 210 |
| Signetics Corporation Cunningham & Walsh Inc. | 69 |
| Silicon Transistor Corporation A.D. Adams Advertising Inc. | 49 |
| Sinclair Radio Laboratories Inc. John E Hayes Company Inc. | 184 |
| ■ Sorensen Inc. Fuller & Smith & Ross Inc. | 35 |
| Speer Carbon Company Hazard Advertising Company | 48 |
| Sprague Electric Company The Harry P. Bridge Co. | 5 & 6 |
| Stackpole Carbon Company Meek and Thomas Inc. | 142 |

| | |
|--|-----|
| TRW Electronics Fuller & Smith & Ross Inc. | 45 |
| Tektronix Inc. Hugh Dwight Adv. Inc. | 73 |
| ■ Telonic Engineering Company Jansen Associates | 206 |
| Telrex Laboratories George Homer Martin Associates | 166 |
| Texas Instruments Incorporated, Semiconductor-Components Division Don L. Baxter Inc. | 19 |
| Thermal American Fused Quarts Company Kniep Associates | 196 |
| Triplet Electrical Instrument Company Burton Browne Advertising | 25 |
| ■ Trygon Electronics The Wexton Company, Inc. | 46 |
| Unitrode Electronic Marketing Assistance | 43 |
| Vactec Inc. Ron Coleman Agency | 174 |
| Vulcan Electric Company Reynolds & Foster Inc. | 198 |
| Westinghouse Semiconductor Division I T S M | 75 |
| ■ Weston Instruments Incorporated Basford Inc. | 125 |
| West Penn Power Company Fuller & Smith & Ross Inc. | 188 |
| Winchester Electronics Div. of Litton Industries West, Weir & Bartel Inc. | 37 |
| Yutaka Electric Mfg. Co., Ltd. Nichiden Adv., Ltd. | 178 |
| Zero Manufacturing Co. Guerein, Johnstone, Gage Inc. | 194 |

Classified advertising

F.J. Eberle, Business Mgr.

| | |
|---|---------|
| EMPLOYMENT OPPORTUNITIES | 201-203 |
| EQUIPMENT (Used or Surplus New) For Sale | 203-204 |

Classified advertisers index

| | |
|--|-----|
| ■ A & A Electronics Corp. | 203 |
| Allen Co., R.G. | 204 |
| Atomic Personnel Inc. | 203 |
| ■ Barry Electronics | 204 |
| Edmund Scientific Co. | 204 |
| Electro Gadget Supply | 204 |
| ■ Engineering Associates | 203 |
| General Electric Co. | 202 |
| New South Wales Centre | 204 |
| ■ Radio Research Instrument Co. | 204 |
| Semiconductor Sales of Calif. | 204 |
| Sierra Western Electric Co. | 204 |
| Sperry Rand Corp. | 201 |
| Univac Div. | 201 |
| Surplus Saving Center | 203 |
| ■ Universal Relay Corp. | 203 |

Advertising sales staff

Gordon Jones [212] 971-2210
Advertising sales manager

Atlanta, Ga. 30389: Gus H. Krimsier, Michael H. Miller, 1375 Peachtree St. N.E., [404] TR 5-0523

Boston, Mass. 02116: William S. Hodgkinson, McGraw-Hill Building, Copley Square, [617] CO 2-1160

Chicago, Ill. 60611: Robert M. Denmead, J. Bradley MacKimm, 645 North Michigan Avenue, [312] MO 4-5800

Cleveland, Ohio 44113: Paul T. Fegley, 55 Public Square, [216] SU 1-7000

Dallas, Texas 75201: Richard P. Poole, The Vaughn Building, 1712 Commerce Street, [214] RI 7-9721

Denver, Colo. 80202: Joseph C. Page, David M. Watson, Tower Bldg., 1700 Broadway, [303] AL 5-2981

Houston, Texas 77025: Kenneth George, 2270 Humble Bldg., [713] CA 4-8381

Los Angeles, Calif. 90017: Ashley P. Hartman, John G. Zisch, 1125 W. 6th St., [213] HU 2-5450

New York, N. Y. 10036: Donald R. Furth [212] 971-3615, Frank LeBeau [212] 571-3615, George F. Werner [212] 971-3615, 500 Fifth Avenue

Philadelphia, Pa. 19103: William J. Boyle, Warren H. Gardner, 6 Penn Center Plaza, [215] LO 8-6161

San Francisco, Calif. 94111: James T. Hauptli, 255 California Street, [415] DO 2-4600

London W1: John W. Patten, Edwin S. Murphy Jr., 34 Dover Street, Hyde Park 1451

Milan: Ludovico Greco, 1, via Baracchini Phone: 86-90-617

Frankfurt/Main: Gerd Hinske, 85 Westendstrasse Phone: 77 26 65 and 77 30 59

Genoa: Michael R. Zeynel, Joseph Wuensch, 2 Place du Port 244275

Paris VIII: Denis Jacob, 17 Avenue Matignon ALMA-0452

Tokyo: Nobuyuki Sato, Shiba, Minato-Ku (502) 0656

Osaka: Kazutaka, Miura, 163, Umegee-cho, Kita-ku [362] 8771

Nafioya: International Media Representatives, Yamagishi Bldg., 13, 2-Chome, Oike-cho Naka-ku

Hugh J. Quinn: [212] 971-2335, Manager Electronics Buyers' Guide

David M. Tempest: [212] 971-3139, Promotion manager

Milton Drake: [212] 971-3485, Market research manager

Richard J. Tomlinson: [212] 971-3191, Business manager

Theodore R. Geipel: [212] 971-2044, Production manager

■ For more information on complete product line see advertisement in the latest Electronics Buyers' Guide

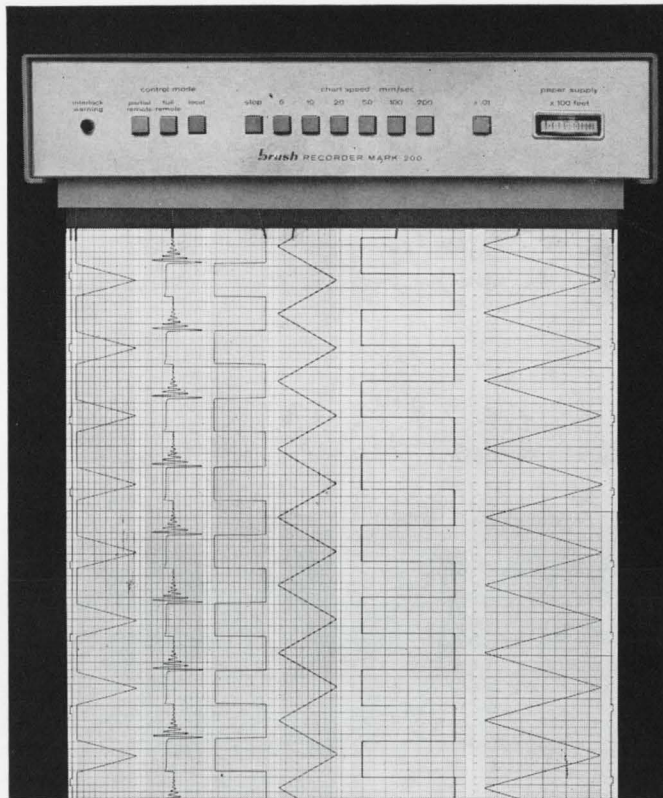
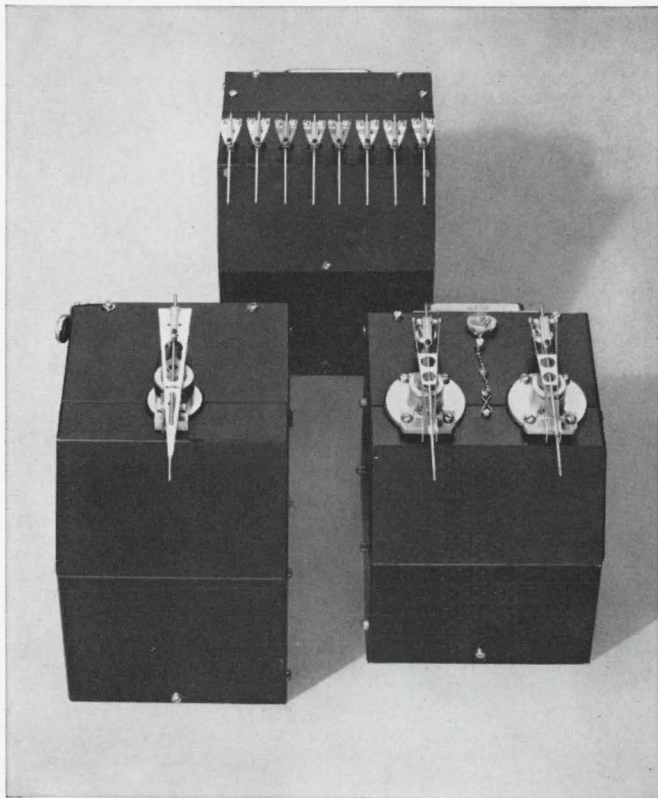

These are Optional Penmotors for the Brush Mark 200 Series 1707 Recorders

You should see the information they give ...in combination!

(modern oscillography will never be the same)

Optional penmotors are the newest of several Brush innovations that change previous notions about today's direct writing recording. The pace-setting Mark 200 now gives you any combination of variables . . . 80mm channels for extreme resolution in absolute measurement . . . 40mm channels for coordination of dynamic information . . . "yes-no" information from time-codes, relays, actuators, etc. *One recorder presents them all . . . in any combination . . . on the same chart . . . on a common time base!* The choice is yours! And, a pressurized inking system with over 10,000 channels of performance produces traces so accurate and crisp that you can't mis-read the signal. *True* rectilinear motion results from a unique linkage that creates a straight line 99.9% accurate. A super-sensor called the Metrisite "polices" the pen position for instant self-correction without mechanical restraint. The rule book of oscillography is changed. Check Brush for *new* standards. Your letterhead request will bring the complete story. Write Brush Instruments Division, Clevite Corporation, 37th & Perkins, Cleveland, Ohio 44114.

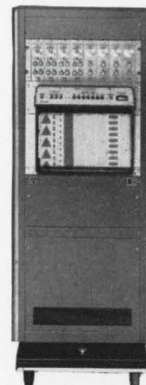

brush INSTRUMENTS DIVISION **CLEVITE**

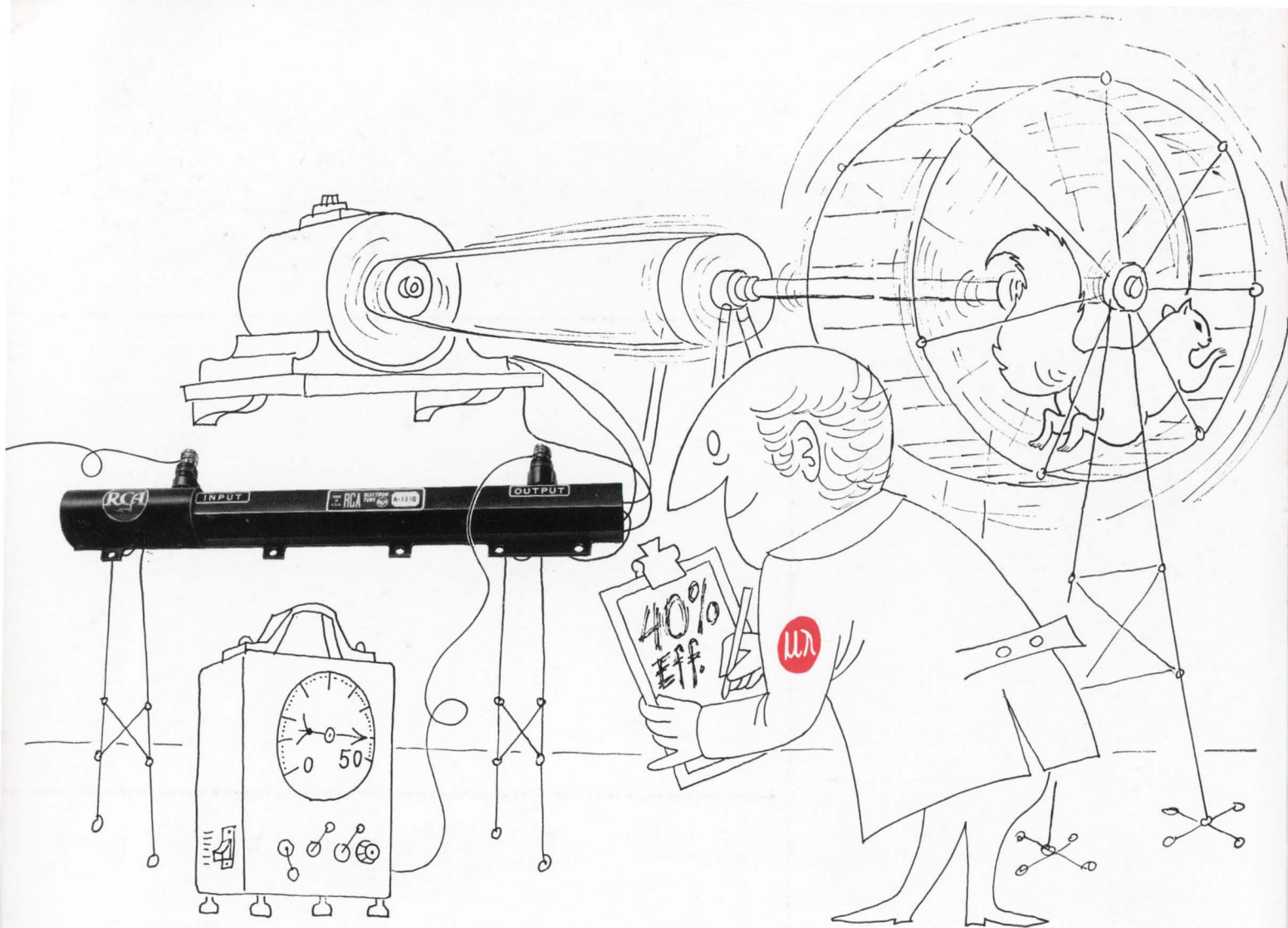

"CAGED IN" BY AVAILABLE INPUT POWER?

Try RCA-A1318 for 5 to 20 Watts Output at 4.5 Gc

RCA-A1318, with highest known efficiency, is a light-weight, power Traveling-Wave Tube now available for the 3.0 to 4.5 Gc band. It operates with 40% efficiency (including heater power) at any CW power level from 5 to 20 watts.

Designed for use in airborne, troposcatter, and satellite communications systems, RCA-A1318 is the latest RCA developmental device based on the successful TWT design approaches used in RELAY and military satellite systems. Actual life-tests begun in early 1964 are already verifying a projected MTBF of 50,000 hours.

RCA-A1318 is available now on a sampling basis. For information on this ruggedly constructed, ceramic-metal

tube, and other RCA Microwave Devices, see your RCA Representative, or write: Manager, Microwave Marketing, RCA Electronic Components and Devices, Harrison, New Jersey.

RCA-A1318 TYPICAL CHARACTERISTICS

| | |
|--|---------------------------|
| Frequency | 3.0—4.5 Gc |
| Power output | 5—20 watts |
| Gain (sat.) | 40 db |
| Noise figure | 23 db |
| Efficiency (overall, including heater) | 40% |
| Cathode current density | 65—140 ma/cm ² |
| Weight | 1.5 lbs. |



The Most Trusted Name in Electronics