

Electronics®

Operating scr's in parallel: page 60

Microwaves working on the production line: page 65

Special report on overlay transistors: page 70

August 23, 1965

75 cents

A McGraw-Hill Publication

Below: New jobs for automatic test equipment: page 88





HI-FI



Transistor output; matches any PP transistor to 4, 8, 16 Ω speaker. Primary 48, 36, 12 Ω C.T.; 20 \sim to 20 KC; 40 watts.

MINIATURE MIL TYPE

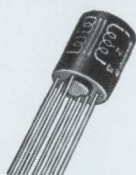

Metal case hermetically sealed to MIL-T-27B. Gold Dumet leads spaced on 0.1 radius, for printed circuit application.

CHOPPER

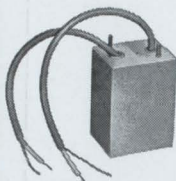

Magnetic shielded plus electrostatic shield for voltage isolation of 2x10⁶. Primary 200K C.T. to within 0.1%. Secondary 50K.

HIGH POWERED AUDIO



Low distortion 2.5 KW output transformer, PP 450 TH's 18,500 ohms C.T. to 24/6 ohms, 20 KV hipot. 520 lbs.

CATHODE FOLLOWER OUTPUT



Provides equal voltages to 5 loads. Primary inductance maintained to 5% with 20% change in DC unbalance and 30% change in AC voltages.

SPECIAL (CUSTOM BUILT) AUDIO TRANSFORMERS TO YOUR SPECIFICATIONS

HI-FREQUENCY CARRIER TO MIL-T-27B



Electrostatically shielded, humbucking, +30 dbm level. Within .5 db 250 cycles to 110 KC. 600/135; 600 centertapped to .1% tolerance.

HYBRID TRANSFORMER



Two transformers each 600 Ω primary, 40K Ω C.T. secondary 250 cycles to 5 KC within 1/4 db. 40 db isolation over band.

MICROMODULE

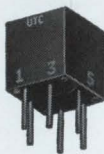

Life tested per micromodule specs.: no failures. 10K Ω C.T. to 10K Ω , 100 mw from 400 \sim to 20KC.

SUBMINIATURE MOLDED TRANSFORMER

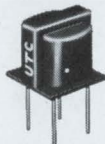

Grade 3 with printed circuit leads for transistor application. 150 Ω to 150 Ω at 10 dbm level. Size 1/2 x 1/2 x 1/2"; weight 5 grams.

BOLOMETER TRANSFORMER

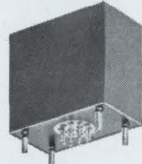

Primary 10 ohms, secondary 530K ohms, 230:1 ratio, response from 1/2 cycle to 25 cycles. 120 db magnetic shielding, plus full electrostatic shielding.

ULTRA-MINIATURE

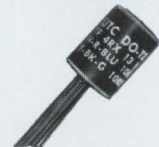

Electrostatically & magnetically shielded output transformer 1/16 D. x 1/4" H. Pri. 15K CT, Sec. 8K CT; max. level 50 mw; audio range response. To MIL-T-27B, grade 4.

Exceptional quality and reliability is provided in all UTC designs. Over 30 years of engineering knowledge and experience substantiated by extensive field performance assure the highest quality and most reliable components in the industry. Complete environmental testing facilities are incorporated to prove out new designs. Full analysis and evaluation of materials are conducted in UTC's Material and Chemical Laboratories. Rigid quality control measures coordinated with exhaustive statistical findings and latest production procedures results in the industry's highest degree of reliability. Range covered in Audio Transformers is from 0.1 cycles to 400 MC . . . microwatts to 50 KW.

MILITARY AND COMMERCIAL TYPES FOR EVERY PHASE OF THE ELECTRONICS ART

- POWER TRANSFORMERS • AUDIO TRANSFORMERS • INDUCTORS • PULSE TRANSFORMERS • ELECTRIC WAVE FILTERS • LUMPED CONSTANT DELAY LINES • HIGH Q COILS • MAGNETIC AMPLIFIERS • SATURABLE REACTORS • REFERENCE UNITS

Write for catalog of over 1,300 UTC HIGH RELIABILITY STOCK ITEMS IMMEDIATELY AVAILABLE from your local distributor.



UNITED TRANSFORMER CORP.
150 VARICK STREET, NEW YORK 13, N. Y.

PACIFIC MFG. DIVISION: 3630 EASTHAM DRIVE, CULVER CITY, CALIF.
EXPORT DIVISION: 13 EAST 40th STREET, NEW YORK 16, N. Y. CABLE: "ARLAB"

Circle 900 on reader service card

**CONTINUOUS
PULSES
OR
PULSE
BURSTS**

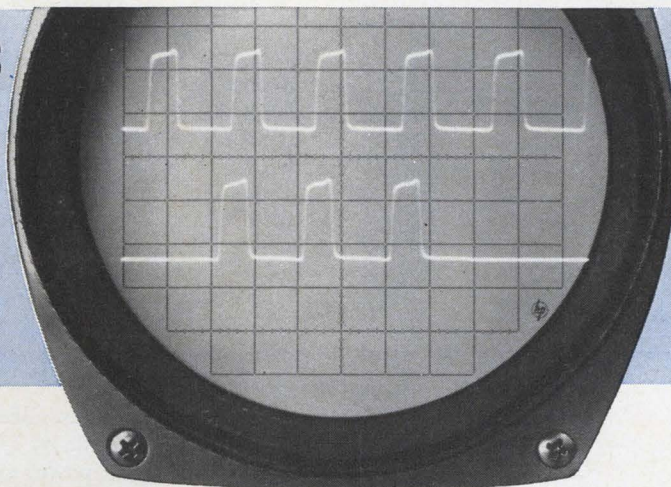

**AT
REP RATES
TO
100
MC**

New hp 216A Pulse Generator

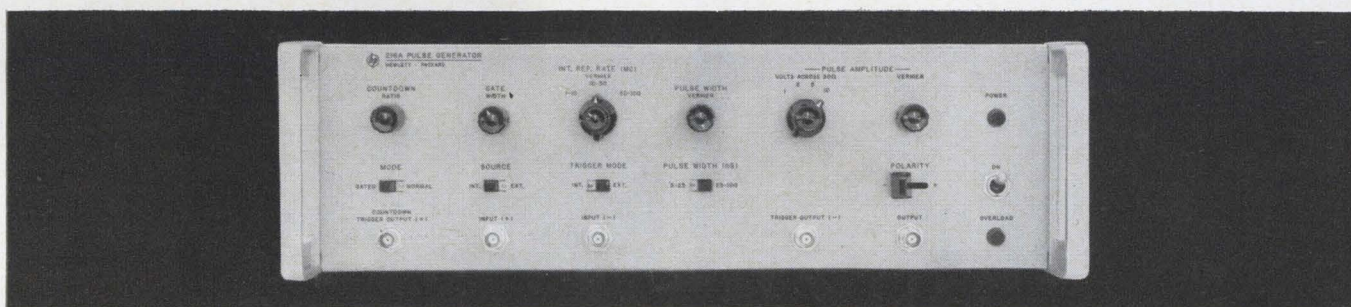

2.5 nsec rise time at 10 v output

Continuously variable pulse amplitudes

DC coupled output to eliminate baseline shift

50-ohm source impedance to eliminate error-producing reflections

Two trigger outputs

A unique combination of clean pulse shape for accurate measurements and rep rates from 1 to 100 mc for fast-circuit testing is yours with the new 216A. In addition to continuous trains of pulses, the 216A provides pulse bursts, 20 to 750 nsec in width, generated internally in sync with individual pulses within the burst.

The 216A also may be triggered externally from 0 to 100 mc for synchronization with other equipment. Trigger signals are available from the front panel at the output pulse rep rate, 130 nsec in advance of the pulse, or counted down, synchronized with the pulse rep rate and also with the burst envelope to allow viewing of burst responses on a sampling oscilloscope.

The 216A provides 10 v pulses into 50 Ω which is ample to switch almost all semiconductor devices. Pulse amplitude is continuously variable to enable you to accurately set the amplitude to match a particular test requirement. Furthermore, the 216A has a 50 Ω source impedance to eliminate error-causing re-reflections when driving non-50 Ω loads. The quality of the pulse is shown in the photo and in the specs. It is carefully controlled and specified to insure accurate, dependable measurements.

Ask your hp field engineer for a demonstration of the 216A. Or write for information to Hewlett-Packard, Palo Alto, Calif. 94304, Tel. (415) 326-7000; Europe: 54 Route des Acacias, Geneva; Canada: 8270 Mayrand St., Montreal.

BRIEF SPECIFICATIONS

- Source impedance:** 50 ohms \pm 3%, approx. 10 pf shunt
- Pulse shape:** (measured at 10 v output into 50-ohm-load)
 - Rise time: <2.5 nsec
 - Overshoot and ringing: overshoot <4% peak, ringing <4% of pulse amplitude
- Corner rounding:** occurs no sooner than 96% of pulse amplitude
- Time to achieve flat top:** approx. 20 nsec
- Preshoot:** <2% on leading edge; <5% on trailing edge
- Perturbations on flat top:** 3% of pulse amplitude
- Pulse voltage:** positive or negative, 1, 2, 5-step attenuator, with vernier, provides continuous adjustment from 0.4 to 10 v (into 50 ohms)
- Pulse width:** continuously adjustable, 2 ranges, 5-25 nsec and 25-100 nsec; width jitter <100 psec \pm 0.05% of pulse width
- Max. duty cycle:** >45% to 50 mc, decreasing to approx. 20% at 100 mc
- Price:** \$1775

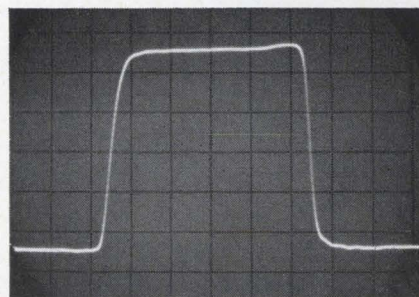

Carefully controlled pulse shape insures accurate measurements; 10 v pulse; sweep speed: 10 nsec/cm.

Data subject to change without notice. Prices f. o. b. factory.

HEWLETT  PACKARD
An extra measure of quality

★ SOLID-STATE ★ DC — 75 KC
★ GAIN OF 1000 ★ NO CHOPPER

Precisely measure thermocouple, strain gage and similar low level dc outputs with this high performance new Model 8875A Data Amplifier. Use it with modern data acquisition systems employing analog-to-digital converters, digital printers, magnetic data recorders, oscillographs, digital voltmeters, and other readout instrumentation. The new 8875A is a solid-state wideband dc amplifier with an output of ± 10 v, 100 ma and features dc — 75 kc bandwidth, 1000x amplification, $\pm 0.1\%$ gain accuracy, $\pm 0.01\%$ gain stability, and 120 db common mode rejection — at \$495 including power supply.

This new Sanborn amplifier measures just 4-3/4" high by 1-9/16" wide by 15" deep, weighs 3.5 lbs., including integral power supply. For multi-channel use, ten units can be mounted in a 5" x 19" modular cabinet which contains input and output connections, power cable, on-off switch, cooling, fuse, and mating connectors for ten amplifiers. These modules can be stacked, or equipped with tilt stands for bench-top use. When used individually, the completely enclosed amplifier requires no cooling.

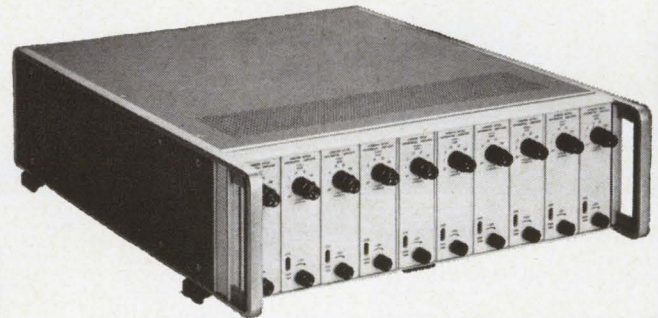

SPECIFICATIONS

Bandwidth:	dc to 75 kc within 3 db.
Gain:	from 1 to 1000 in seven fixed steps
Gain Accuracy:	$\pm 0.1\%$.
Gain Stability:	$\pm 0.01\%$.
Vernier Gain:	continuously adjustable between fixed steps.
Gain Trim:	$\pm 3\%$ with sufficient resolution for setting any one gain to $\pm 0.01\%$.
Common Mode Rejection:	120 db from dc to 60 cps, 40v p-p tolerance.
Output Circuit:	± 10 volts across 100 ohms and 0.2 ohms max. output impedance at dc.
Drift:	$\pm 3 \mu\text{v}$ referred to input, ± 0.2 mv referred to output.
Non-Linearity:	Less than 0.01% full scale value, 10 volts.
Overload Recovery Time:	recovers to within 10 μv R.T.I. +10 mv R.T.O. in 10 msec. for 10 v overload.
Power:	115/230 volts $\pm 10\%$, 50-400 cps, 6 watts.
Available options:	Switch-selected filtering, dual output (± 10 v, ± 10 ma; ± 10 v, ± 100 ma; a short on one output has negligible effect on the other output).

For complete specifications and application assistance, call your local HP/Sanborn field engineering office, or write: Sanborn Division, Hewlett-Packard Company, 175 Wyman Street, Waltham, Mass. 02154.

HEWLETT
PACKARD  SANBORN
DIVISION

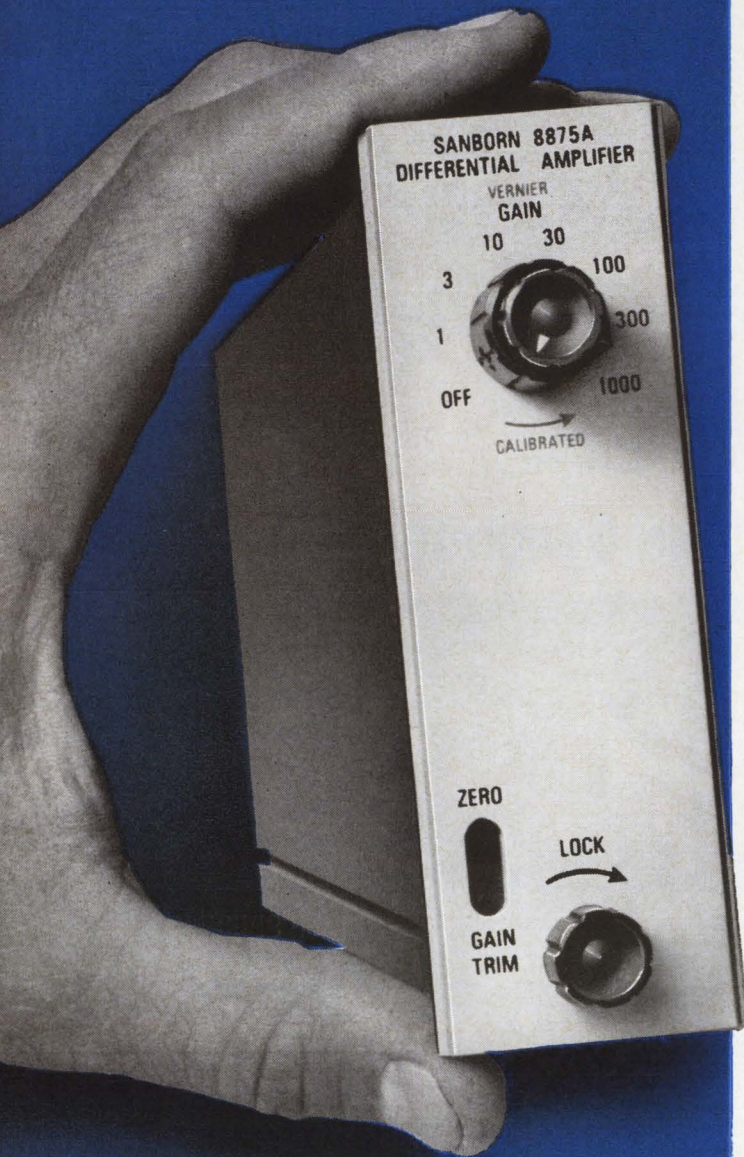

NEW
wideband
DC data amplifier
for \$495

including integral power supply

Electronics

August 23, 1965
Volume 38, Number 17

Page 4	Readers Comment
8	People
14	Meetings
16	Meeting Preview
23	Editorial
25	Electronics Newsletter
51	Washington Newsletter
129	New Products
154	New Books
156	Technical Abstracts
163	New Literature

Electronics Review

Page 39	Time of trial	42	The silent world
40	Monolithic computer	44	Testing the mos
40	Bookbinding	46	Migratory gold
41	Bit of a squeeze	47	Under pressure
42	FET switch		

Probing the News

111	Underwater city: Sealab II
118	A plug for microcircuits
120	Live tv from the moon

Electronics Abroad

165	Bridgehead for Secam	166	Mail sorter
165	Opto-electronics symposium	167	Great expectations
		168	Changing allegiance?
166	GE stakes its claim	168	Automobile pilot

Technical Articles

I. Design

Solid state	60	Good teamwork from scr's Increased power handling comes from operating small silicon controlled rectifiers in parallel Reuben Wechsler, Motorola, Inc.
Instrumentation	65	Measure it, but don't touch Microwaves measure objects on production lines C.F. Augustine and J.E. Ebert, Weinschel Engineering Co.
Special report	70	The overlay transistor Part I: New geometries boost power Multiple emitters improve performance D.R. Carley, P.L. McGeough and J.F. O'Brien, RCA
	78	Part II: Putting the overlay to work In communications the overlay handles 10 watts at 400 Mc D.J. Donahue and B.A. Jacoby, RCA
	82	Part III: Matching the overlay's performance Interdigitated geometry offers an alternative Jerome Eimbinder, solid state editor
Circuit design	85	Designer's casebook <input type="checkbox"/> One transistor multi delays digital pulses <input type="checkbox"/> Simple multivibrator operates at 5 Mc <input type="checkbox"/> Multivibrator provides bidirectional output
Military electronics	88	Million dollar 'screwdriver' (cover) Growth of complex systems has spurred computerized testing W.J. Evezia, military electronics editor

II. Application

III. Manufacturing

Production	98	Aluminum bonding makes high-power microcircuits Aluminum instead of gold bonding produces circuits that can handle up to 40 watts Edward M. Ruggiero, United Aircraft Corp.
-------------------	----	--

Title R registered
U.S. Patent Office;
© copyright 1965
by McGraw-Hill, Inc.
All rights reserved,
including the right to
reproduce the contents
of this publication,
in whole or in part.

Electronics

Editor: Lewis H. Young

Senior editors

Technical: Samuel Weber

News: Kemp Anderson, Jr.

Senior associate editors: John F. Mason, George Sideris

Department editors

Advanced technology: Joan Blum

Avionics: W.J. Evezia

Circuit design: Michael Elia

Components: Michael F. Tomaino

Computers: Wallace B. Riley

Consumer electronics: Richard Lipkin

Industrial electronics: Robert Cushman

Instrumentation: Carl Moskowitz

Manufacturing: George Sideris

Military electronics: John F. Mason

New products: William P. O'Brien

Solid state: Jerome Eimbinder

Space electronics: Peter R. Sigmund

Special projects: Richard M. Machol

Staff writer: Stanley Zarowin

Regional editors

Boston: Thomas Maguire, editor; Robin Carlson

Los Angeles: William B. Wallace, editor; June Ranill

San Francisco: Laurence D. Shergalis, Edmond G. Addeo, editors; Mary Jo Jadin

Copy editors

Howard Rausch, Sally Powell, Walter Barney

Graphic design

Art director: Saul Sussman

Assistant art director: Donna M. Marchyn

Editorial production: Ann Mella

Production editor: Arthur C. Miller

Editorial secretaries: Claire Benell, Mary D'Angelo, Lynn Emery, Kay Fontana, Carolyn Michnowicz, Lorraine Longo, Lorraine Werner

McGraw-Hill news service

Director: John Wilhelm; **Atlanta:** Fran Ridgeway; **Chicago:** Bruce Cross, Louis S. Gomolak;

Cleveland: Arthur Zimmerman; **Dallas:** Marvin Reid;

Detroit: Donald MacDonald; **Los Angeles:** Michael Murphy, Ron Lovell;

San Francisco: Margaret Ralston;

Seattle: Ray Bloomberg; **Washington:** Arthur L. Moore, Charles Gardner, Herbert W. Cheshire, Seth Payne, Warren Burkett, Warren Kornberg

McGraw-Hill world news service

Bonn: Robert Dorang; **Brussels:** Arthur Erikson; **London:** John Shinn;

Mexico City: Wesley Perry; **Milan:** Bruce Bendow;

Moscow: Donald Winston; **Paris:** Dan Smith;

Rio de Janeiro: Leslie Warren; **Tokyo:** Marvin Petal, Charles Cohen

Circulation manager: Hugh J. Quinn

Reprints: T.M. Egan

Publisher: C.C. Randolph

Electronics: August 23, 1965, Vol. 38, No. 17

Printed at 99 North Broadway, Albany, N.Y.
Second class postage paid at Albany, N.Y.

Subscriptions are solicited only from those actively engaged in the field of the publication. Position and company connection must be indicated on orders. Subscription prices: United States and Possessions and Canada, \$6.00 one year, \$9.00 two years, \$12.00 three years. All other countries \$20.00 one year. Single copies, United States and Possessions and Canada 75¢. Single copies all other countries \$1.50.

Published every other Monday by McGraw-Hill Inc. 330 West 42nd Street, New York, N.Y. 10036. Founder: James H. McGraw, 1860-1948.

Subscribers: The Publisher, upon written request to our New York office from any subscriber, agrees to refund that part of the subscription price applying to copies not yet mailed. Please send change of address notices, subscription orders or complaints to Fulfillment Manager, Electronics, at the address below. Change of address notices should provide old as well as new address, including postal zone number if any. If possible, attach address label from recent issue. Allow one month for change to become effective.

Postmaster: Please send Form 3579 to Fulfillment Manager, Electronics, P.O. Box 430, Hightstown New Jersey 08520

Readers Comment

Traffic snarl

To the Editor:

I have read with interest the brief resume of the proposed traffic signal system now being developed for the City of New York [May 17, p. 30], and I also read the letter from Neal A. Irwin [July 12, p. 6].

Certainly I don't want to enter into a controversial discussion with Irwin concerning the merits or demerits of the Toronto system versus that planned for the City of New York. I can only say that while the Toronto system was supposed to have been fully operative some three years ago, it is not as yet in operation. Therefore, while he indicates it is far superior to the New York system, this is questionable inasmuch as neither his system nor ours are operative.

Frankly, if Toronto is happy with their signal system I am most pleased for them. On the other hand, my responsibility is to design a signal system to handle the many extremely complex problems within the City of New York. While Toronto has only a total of about 500 traffic signals in their entire city, New York has more than 9,000; and while Toronto is a city of contiguous areas unbroken by rivers, bridges, tunnels, etc., New York is a city completely made up (except for the Bronx) of islands where one must use bridges and tunnels to get from one part of the city to another. Until the Verrazano Bridge was opened about a year ago, one had to even use a boat to get to that part of New York City.

Our system was designed by engineers who have spent a total of nearly 100 years in the electrical field. Personally I have been in this field for more than 45 years and have been in the traffic control field nearly 30 of them. The Wilbur Smith Associates, who are the consultants on our job, certainly have a vast knowledge of worldwide traffic problems. Our engineering staff, who have worked consistently for nearly three years on the New York system, constitute more people than the entire personnel of the Traffic Research Corp. I would sug-

(ADVERTISEMENT)

Extreme Size Reduction, Unusual Capacitance Stability Achieved with Filmite® 'K' Polycarbonate Film Capacitors

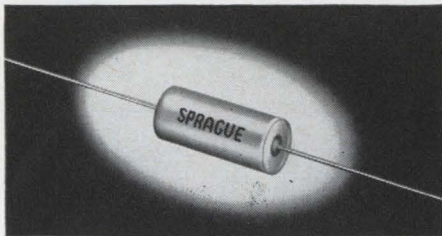

New Filmite 'K' Polycarbonate Film Capacitors are more than 13 times smaller than paper capacitors of equivalent capacitance value and voltage rating.

Designed and developed by the Sprague Electric Company, their polycarbonate film dielectric provides exceptionally high capacitance stability over the entire temperature range, due to the inherently low coefficient of expansion of polycarbonate film and a dielectric constant which is nearly independent of temperature.

Filmite 'K' Capacitors exhibit almost no capacitance change with temperature — dramatically better than polyester-film types, they even surpass polystyrene capacitors. The low dissipation factor (high Q) makes these capacitors extremely desirable where high current capabilities are required, as in SCR commutating capacitor applications.

Low dielectric absorption, considerably lower than that of many other commonly-used film dielectrics, over a broad frequency/temperature spectrum makes Filmite 'K' Capacitors ideal for timing and integrating.

Type 260P Filmite 'K' Capacitors are metallized, utilizing non-inductive construction. They feature special self-healing characteristics in the rare event of dielectric breakdown. Designed for operation at temperatures from -55 C to +105 C, these metal-clad capacitors are hermetically sealed and are available in a variety of mounting styles. Types 237P and 238P are of high-purity foil construction, and are hermetically sealed in metal cases. Their operating temperature range is -55 C to +125 C.

For complete technical data on Type 260P and on Type 237P and 238P Capacitors, write for Engineering Bulletins 2705 and 2700, respectively, to Technical Literature Service, Sprague Electric Co., 35 Marshall St., North Adams, Mass.

Circle 5 on reader service card

6 Reasons Why SPRAGUE is a Major Resistor Supplier

FILMISTOR® PRECISION FILM RESISTORS



metal-film, molded case

Distinct limited temperature coefficients and low tolerances to meet exacting application requirements. Rugged end cap construction for long-term stability and reliability. Superior resistance to humidity and mechanical damage. Surpass MIL-R-10509E requirements. Send for Bulletin 7025B.



deposited-carbon, molded case

Approach precision wirewounds in reliability and stability, yet are smaller in size and have lower self-inductance. Low, controlled temperature coefficient. Dense molded case provides outstanding humidity protection. Send for Bulletin 7000A.



deposited-carbon, conformal coated

Full rated load operation at 70 C with no wattage derating. Assured uprated loads at lower operating temperatures. Ideal for circuitry where small size, humidity resistance, and close tolerance ($\pm 1\%$) are required. Send for Bulletin 7005A.

Circle 270 on reader service card

ACRASIL® PRECISION/POWER WIREWOUND RESISTORS



silicone-encapsulated

Combine the best features of both precision and power wirewound types. Resistance tolerances to $\pm 0.05\%$. Unusually tough encapsulation protects against shock, vibration, moisture, fungus. Meet MIL-R-26C requirements. Smaller than conventional wirewounds, yet greater in stability. Send for Bulletin 7450.

Circle 271 on reader service card

BLUE JACKET® VITREOUS ENAMEL POWER WIREWOUND RESISTORS



All-welded end cap construction with special vitreous coating for long-term dependability. Axial-lead style for conventional wiring or on printed boards. Tab terminals for higher wattage applications. Meet MIL-R-26C requirements. Send for Bulletins 7400B, 7410D, 7411A.

Circle 272 on reader service card

KOOLOHM® CERAMIC-SHELL POWER WIREWOUND RESISTORS



Exclusive ceramic-insulated resistance wire permits "short-proof" multilayer windings for higher resistance values. Standard and non-inductive designs. Non-porous ceramic shell for moisture protection and electrical insulation. Axial-lead, axial-tab, and radial-tab styles. Send for Bulletins 7300B, 7305, 7310.

Circle 273 on reader service card

GLASS-JACKETED POWER WIREWOUND RESISTORS



Ferrule terminals soldered to metallized ends of glass casing for true hermetic seal. Virtually failure-proof, even in extremely corrosive industrial and salt atmosphere. Standard and non-inductive windings. External meter-multiplier types also available. Send for Bulletins 7350, 7420, 7421.

Circle 274 on reader service card

STACKOHM® POWER WIREWOUND RESISTORS

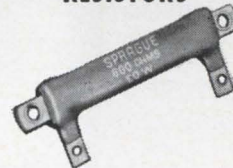

Flat silhouette permits stacking of resistor banks in close quarters. Aluminum thru-bar simplifies mounting and conducts heat from resistance element. Vitreous enamel protective coating. Meet MIL-R-26C performance requirements. Send for Bulletin 7430.

Circle 275 on reader service card

For complete technical data, write for engineering bulletins on the resistors in which you are interested to: Technical Literature Service, Sprague Electric Company, 35 Marshall Street, North Adams, Massachusetts.

4 SR-166-03 R2

SPRAGUE®

THE MARK OF RELIABILITY

Sprague and *®* are registered trademarks of the Sprague Electric Co.

An Extraordinary 2-c to 2-Mc Oscillator



Million-to-one frequency range.

Distortion is less than 0.25% from 50 c/s to 50 kc/s, even at full output and under short-circuit conditions.

Frequency characteristic is flat within $\pm 2\%$ from 20 c/s to 200 kc/s.

Output is over 20 V into open circuit, 160 mW into 600 Ω .

Transistorized, capacitance-tuned RC Wien-bridge oscillator and power supply are completely contained in a 8" x 6" x 8" package.

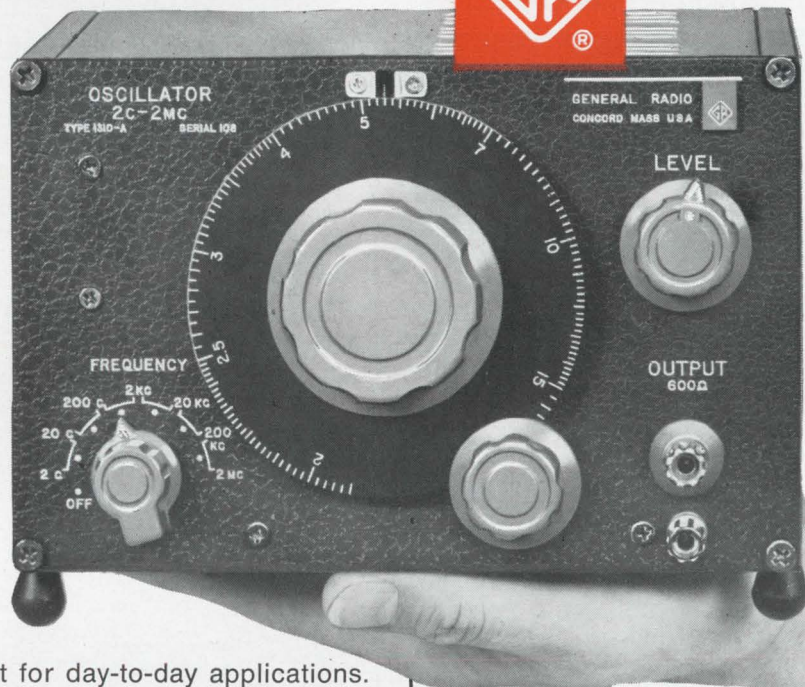

These features make the new GR Type 1310-A Oscillator an outstanding instrument for day-to-day applications. **But, what definitely puts this oscillator in a class by itself is an entirely new feature by which its frequency can be synchronized with an external signal.** Also, the oscillator can itself be used to furnish a sync signal to other equipment. Thanks to this sync provision, unique in an inexpensive oscillator, the new Type 1310 has a much wider range of application than the ordinary oscillator.

In a nutshell, the 1310-A now brings the small size, mechanical ruggedness and reliability of transistorized circuitry to a wide-range, general-purpose instrument. It offers all the benefits you expect in a modern, two-feedback-path RC oscillator including high accuracy and infinite resolution of variable capacitance tuning—plus the new frequency-synchronization provision—all at a surprisingly low price.

Here Are Some Uses For Oscillator Synchronization:

- as a tracking narrow-band filter to reduce hum, noise, and distortion in a signal;
- a source of amplitude-modulated signals;
- an automatic phase-controlled oscillator to reduce frequency modulation or jitter;
- a single-frequency leveling amplifier;
- a phase-locked, sinusoidal frequency multiplier;
- a phase shifter;
- a narrow-band isolation amplifier;
- an amplitude-modulation filter.

Write for Complete Information

Frequency

Accuracy: $\pm 2\%$ of reading

Stability: Typical drift after warmup, 0.001% short term (1 min) at 1 kc/s.

Synchronization: Jack provided for external phase-locking signal. Locking range is about $\pm 3\%$ for 1-V, rms, input reference signal over entire 2-c to 2-Mc range. Locking ranges up to 40% can be used.

Output

Voltage: Over 20 V, open circuit; continuously adjustable attenuator (approximately 50 dB).

Amplitude Stability: Typical drift after warmup, 0.02% short term (1 min).

Impedance: 600- Ω

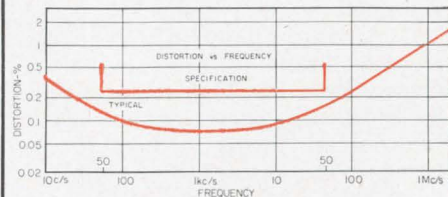

Distortion: As indicated. Hum less than 0.02% independent of attenuator setting.

Synchronization: High-impedance, constant-amplitude, 0.8 V, rms, output for use with oscilloscope, counter, or other oscillators.

General

Power Required: 105 to 125, 195 to 235, or 210 to 250 V, 50 to 400 c/s, Price: \$295 in U.S.A.

IN CANADA: Toronto 247-2171, Montreal (Mt. Royal) 737-3673
IN EUROPE: Zurich, Switzerland - London, England



GENERAL RADIO COMPANY

WEST CONCORD, MASSACHUSETTS

BOSTON NEW YORK, N. Y., 954-2722 CHICAGO PHILADELPHIA WASHINGTON, D.C. SYRACUSE DALLAS SAN FRANCISCO LOS ANGELES ORLANDO, FLA. CLEVELAND
(W. Concord) 646-0550 (Ridgefield, N. J.) 943-3140 (Oak Park) 848-9400 (Ft. Washington) 646-8030 (Rockville, Md.) 946-1600 454-9323 FL 7-4031 (Los Altos) 948-8233 469-6201 425-4671 886-0150

Circle 6 on reader service card

gest that Irwin confine his activities to that of trying to get his Toronto system to function as planned and to leave the problems of New York City traffic to we who are *capable* of solving them.

Henry A. Barnes

Commissioner
Department of Traffic
City of New York

Meteor burst

To the Editor:

In the July 26th issue, you report that Boeing engineers have recently tested successfully a new technique called meteor burst communications [p. 27]. Amateurs have been experimenting with this phenomenon for several years.

In October, 1956, QST (the magazine of amateur radio operators) mentioned pioneering work in 1953 by W2UK (now KH6UK) and W4HHK, in connection with the Perseid meteor shower.

Eric K. Albrecht, K8BFH
Cleveland Heights, Ohio

Loran defended

To the Editor:

The end of loran is not in sight.

Your article [Aug. 9, page 27] entitled "End of loran" does a gross disservice to the manufacturers, distributors, dealers and users of loran equipment.

Unfortunately, it is an extremely biased article which ignores entirely the most serious problem of the Omega system—the location of the transmitters must be on friendly or, at least, neutral soil. So far, satisfactory locations for the eight transmitters have not been found, let alone the 16 to 24 which experts

feel will be necessary for good practical coverage. There are also other problems of a serious nature which have yet to be solved.

In short, contrary to the implication of your article, loran is here to stay for a long time. This writer is not denying that Omega has some attractive possibilities and his firm is acutely interested in the development of the system; however, it will be many years before Omega becomes practically operational, and the end of loran is not in sight.

R. E. Maine

Executive vice president
Electronic Concepts, Inc.
Charlottesville, Va.

▪ Still, the Navy is planning to install the new Omega system. It says finding locations for eight stations, all that is necessary, is easier than locating sites needed for loran. Nobody could argue that loran has not performed superbly; but now something newer and better is coming on the scene.

For the record

To the Editor:

In the New Instrument section [Aug. 9, 1965, p. 161], it was pointed out that the new Tektronix letter series storage oscilloscope, type 549, and their spectrum analyzer units makes it the first storage-type spectrum analyzer.

To set the record straight, Nelson-Ross Electronics has been marketing plug-in spectrum analyzers for use with Tektronix 560 series oscilloscopes for over a year. Included in this series of scopes is the type 564 storage scope.

L. C. Weiner

Nelson-Ross Electronics Inc.
Hicksville, N. Y.

Obviously from Sprague!

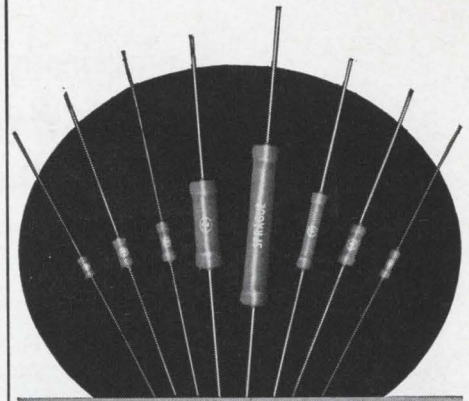

ACRASIL®

... the precision/power
wirewound resistor
with more
PLUS features!

Silicone Encapsulated—Seals resistance element. Provides exceptional protection against severe environmental conditions as well as physical damage.

Wide Application—Standard and non-inductive windings. Equally suited for printed wiring boards, custom packaging, and point-to-point wiring.

Close Resistance Tolerances—Standard tolerances to $\pm 0.05\%$.

Wide Range of Ratings— $\frac{1}{4}$ watt to 10 watts. Resistance values from $.05\Omega$ to $66K\Omega$.

Minified Sizes—Smaller than other conventional wirewound resistors.

Excellent Stability—Under extended load life and environmental operating parameters, Acrasil Resistors show exceptionally small change in resistance values.

Outstanding Reliability—Fully meet electrical performance requirements of MIL-R-26C, as well as individual customer high reliability specifications.

For complete technical data, write for Engineering Bulletin 7450 to Technical Literature Service, Sprague Electric Company, 35 Marshall St., North Adams, Mass.



'Sprague' and '®' are registered trademarks of the Sprague Electric Co. 45R-105-63

SUBSCRIPTION SERVICE

Please include an Electronics Magazine address label to insure prompt service whenever you write us about your subscription.

Mail to: Fulfillment Manager
Electronics
P.O. Box 430
Hightstown, N.J. 08520

To subscribe mail this form with your payment and check new subscription renew my present subscription

Subscription rates: in the U.S.: 1 year, \$6; two years, \$9; three years, \$12. Subscription rates for foreign countries available on request

CHANGE OF ADDRESS

ATTACH LABEL HERE

If you are moving, please let us know five weeks before changing your address. Place magazine address label here, print your new address below.

name _____

address _____

city _____

state _____

zip code _____

Magnetically Beamed Triode 250 kW CW with 1 kW Drive 8 Mw High Duty Pulse



Machlett's new ML-8618 magnetically beamed water-cooled triode features high power gain, plate efficiency and maximum cathode utilization. As a Class C amplifier or oscillator, the ML-8618 is capable of a continuous output in excess of 250 kW with only 1000 W driving power. As a switch tube in pulse modulators, it can deliver more than 8Mw pulse power at long pulse widths and high duty. For details on this or the soon-to-be-available ML-8619 vapor-cooled or ML-8620 forced air-cooled versions, write: The Machlett Laboratories, Inc., Springdale, Conn. 06879. An affiliate of Raytheon Company.

MACHLETT
ELECTRON TUBE SPECIALIST

People

"What some people call molecular electronics, I call chemistry," says **Elliot Berman**, recently named director of the Itek Corp.'s Lexington Research Laboratories in Lexington, Mass.



Berman, a 35-year-old chemist who joined Itek in 1959, says there is little difference today between physics and chemistry, and that development of electronic devices depends heavily on both disciplines.

Much of Berman's work focuses on optical techniques for information storage. He says that optical computer systems are perhaps 5 or 10 years away, but that components of such systems are now beginning to appear.

"It is becoming clear," he says, "that there are better ways of doing things than by hooking wires together."

Itek has developed an optical memory disk on which a laser can write 100,000 bits per second in the form of dark spots and clear spaces. The memory device will be used in an information processing service center that Itek hopes to begin operating in New York before the year's end.

"Other optical devices will be coming along," says Berman, "until eventually whole computer systems will emerge. We will end up with optical and photographic ways of doing many things which today are being performed by electrical connections."

At the National Cash Register Co., where Berman worked from 1955 to 1959, he explored the information storage possibilities of photochromic materials—which can be switched by light beams back and forth from a colorless to a colored state. Itek is also doing research work on photochromic materials.

The Lexington laboratory is exploring electron beam recording, which, says Berman, "is far from being a useful technique, but has interesting possibilities—for print-



Hy Newman has been studying our silicon mesa power transistor competition. They can't teach him a thing.

Because Hy Newman as chief engineer knows that Bendix is alert to all there is to know about silicon mesa power transistors. And that includes a wide range of 2N types, all available in a wide selection of package options. All competitively priced. All with high voltage capabilities. All with diffused construction for faster switching and higher frequency capabilities. Some of the more popular types? 2N389,A, 2N424,A, 2N1015,A-D, 2N1016,A-D, 2N1483-2N1490, 2N1722-2N1725, 2N3055, 2N3232 and 2N3235.

At Bendix you can get SOAR (Safe Operating Area) specified silicon mesas. There are 12 types presently SOAR specified with more on the way. Switching is accomplished in microseconds or less at temperatures up to 200°C without failure due to secondary breakdown. How? SOAR takes into

consideration any type of load; inductive, resistive or capacitive. SOAR takes into consideration the maximum current and the maximum voltage switched. SOAR eliminates complicated calculations and complex derating for operation at various repetition rates, pulse widths, and case temperatures.

Hy's even been expanding the Bendix line to include commercial grades, lower cost types and newer-concept silicon audio power types. In addition, popular types 2N1487-2N1490 are available meeting military specification MIL-S-19500/208(EL).

With I_C to 15 A, V_{CB} to 200 V and P_C to 150 W, Hy will continue to provide you with the latest state-of-the-art technology. More information? Phone or write our nearest sales office. Just say, "Hy... Newman." We'll understand.

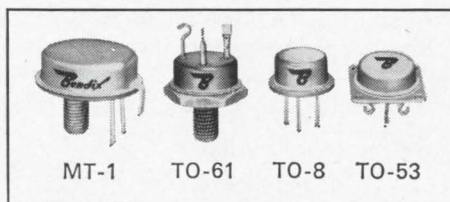
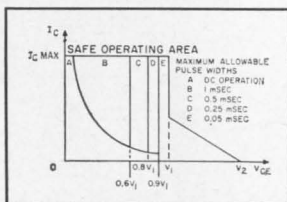

Bendix Semiconductor Division
HOLMDEL, NEW JERSEY



Baltimore (Towson), Md.—(301) 828-6877; Chicago—(312) 637-6929; Dallas—(214) 357-1972; Detroit—(313) JO 6-1420; Holmdel, N. J.—(201) 747-5400; Los Angeles—(213) 776-4100; Miami Springs, Fla.—(305) 887-5521; Minneapolis—(612) 926-4633; Redwood City, Calif.—James S. Heaton Co., (415) 369-4671; Seattle—Ray Johnston Co., Inc., (206) LA 4-5170; Syracuse, N. Y.—(315) 474-7531; Waltham, Mass.—(617) 899-0770; Export—(212) 973-2121, Cable: "Bendixint," 605 Third Ave. N. Y.; Ottawa, Ont.—Computing Devices of Canada, P.O. Box 508—(613) TA 8-2711.

\$2.95

\$2.95

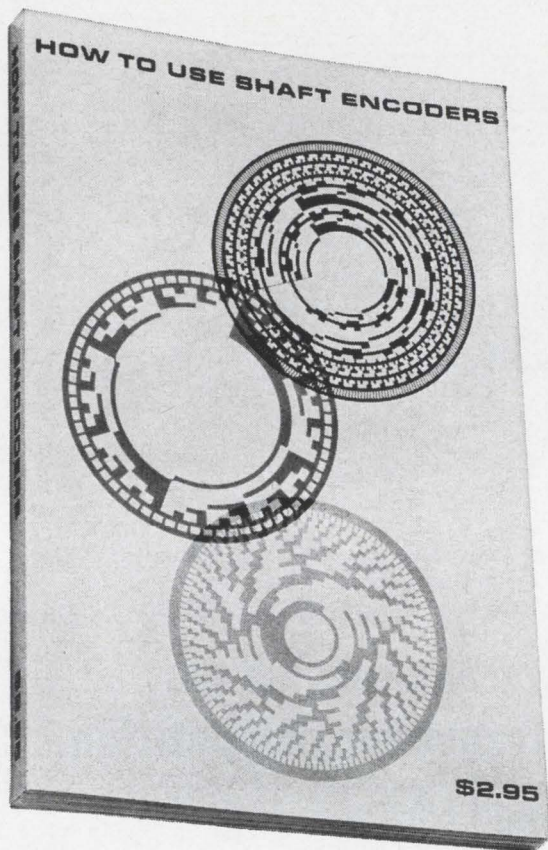

**CONGRATULATIONS
YOU JUST SAVED \$2.95**

We've just published the first truly authoritative text on shaft angle encoders. It's not a brochure. It's not a sales treatise. It's an 84-page text on how to put encoders to work—our encoders or anybody else's encoders. And, even though it's designed to sell for \$2.95, we're willing to give a limited number of copies away gratis.

There's one string attached. It cost a lot to publish the book. And it's not designed for bedside reading. So please don't ask for a copy unless you really have a need to know all there is to know about shaft angle encoders. Otherwise, your free copy awaits your inquiry. Just write for it on your company letterhead.

DATEX

GIANNINI CONTROLS CORPORATION
1307 SOUTH MYRTLE AVENUE, MONROVIA, CALIFORNIA

\$2.95

\$2.95

ing on-line with a computer, for example."

For the past year, Berman has been director of Itek's Research division. Before that, he was manager of the division's chemistry department. He holds chemistry degrees from Brown University and Boston University.

North American Aviation, Inc., which has been concerned with atmospheric and space flight, is invading a different medium—the ocean. The company named 41-year-old **Don H. Pickrell** as manager of its Deep Submergence Systems Program office.



The switch was as dramatic for Pickrell as it was for the company—he has a Ph.D in physics from the California Institute of Technology and served as first program manager for the Polaris missile while at North American's Autometrics division.

To prepare himself for the job ahead, Pickrell has been reading books on oceanography—and may get some firsthand information by taking lessons in skin diving.

He will be working with the Navy again on the deep submergence program. The first project for the new office will be the development of equipment for submersible vehicles.

Although many federal agencies are already working in oceanography, Pickrell hopes the government will resist the temptation to form a sort of "wet NASA" to do the job under the sea that the National Aeronautics and Space Administration does in space. "Having a lot of companies competing is the best way to get the job done in the long run," he maintains.

In the future, North American will study the problem of underwater oil drilling and mining minerals from the sea. Pickrell sees oceanography as a fascinating, almost unlimited field. "It's hard to ignore three-fourths of the earth's surface" he says, "when in some areas the land-based farms cannot produce enough food, and when natural resources are running out."

A NEW KIND OF DVM:

New Integrated Circuit Reliability

Over two-thirds of the transistors in the Model 7100 are in high reliability integrated circuits. Lowest life expectancy of any component is *greater than two years* (the numeric readout tube). A highly dependable photocell chopper replaces a mechanical device.

New stability

Accuracy of the Model 7100 is completely independent of long-term drift. That's because of (1) the inherent stability of integrated circuits and (2) unique Dual-Slope Integration (see diagram). With dual integrating slopes, any changes are self-canceling so the integrator is no longer a critical circuit.



New high noise immunity

No input noise filter is required. Noise merely causes instantaneous changes in the dual integrator slopes. These cancel out leaving total integration area—and the measurement itself—virtually unaffected. Readout accuracy: 0.01%, 10 μ V resolution.

New cost vs. performance ratio

Because of the simplified circuitry of patented Dual-Slope Integration and extensive use of integrated circuits, the Model 7100 at less than \$2000 offers the precision and stability of a \$6000 DVM. See complete price list below.

New versatility

Measures 10 μ V to 1000V; 1 ohm to 15,000 megohms; ratios from 0.0001: 1 to 1.5000: 1. Provides digital display and BCD readout—four digits plus 50% over-range. **WESCON Winner** 1965 Industrial Design Award. See Booth 2914-2917.

DUAL-SLOPE INTEGRATING*

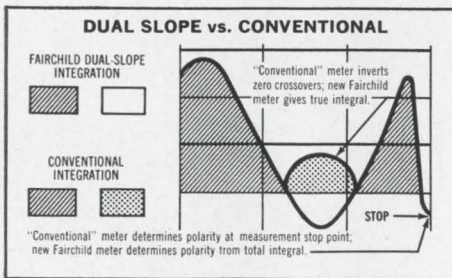

PRICES:

Test Functions	Manual Ranging Model	Price	Auto-ranging Model	Price
Volts-	7100	\$2500	7101	\$2750
ohms-ratio	7110	2250	7111	2500
Volts-ohms	7120	2250	7121	2500
Volts-ratio	7140	1900	7141	2250
Ohms	7150	1900	7151	2250
Ratio	7160	1900	---	---

Plug-ins (one of these is required for proper operation)

Standard Plug-in, Type DM-01	\$ 75.00
High Input Impedance, Type DM-02	400.00
AC-DC Converter, Type DM-03	500.00

For more information, contact the nearest representative listed below or write for the comprehensive data sheet. *Patent pending.

FAIRCHILD
INSTRUMENTATION

FAIRCHILD INSTRUMENTATION REPRESENTATIVES

ALABAMA Huntsville: Gentry Associates, Inc., 534-9771. **ARIZONA** Scottsdale: G. S. Marshall, 946-4276. **CALIFORNIA** Los Angeles: Fairchild Instrumentation, 464-7464/Palo Alto: Fairchild Sales Office and Factory, 962-2451/San Diego: G. S. Marshall, 278-6350/San Marino: G. S. Marshall, 681-3292. **COLORADO** Denver: Hyer Electronics, 771-5285. **CONNECTICUT** Greenwich: Circuit Sales, 869-2244. **FLORIDA** Orlando: Gentry Associates, Inc., 424-0730/St. Petersburg: Fairchild Instrumentation, 867-1824. **GEORGIA** Atlanta: Gentry Associates, Inc., 233-3816. **ILLINOIS** Oak Park: Fairchild Instrumentation, 848-5985. **IOWA** Cedar Rapids: Engineering Services Co., 366-1591. **MARYLAND** Bethesda: Bartlett Associates, Inc., 656-3061. **MASSACHUSETTS** Watertown: Circuit Sales, 926-1031. **MICHIGAN** Detroit: WKM Associates, Inc., 892-2500. **MINNESOTA** St. Paul: Northport Engineering, Inc., 698-3941. **MISSOURI** Kansas City: Engineering Services Co., 363-6000/St. Louis: Engineering Services Co., 726-2233. **NEW MEXICO** Albuquerque: Hyer Electronics, 268-6744. **NEW YORK** Elmsford: SBM Associates, Inc., 592-8850/Long Island: CDB Enterprises, 692-5200/Huntington, L.I.: Fairchild Instrumentation, 692-5735/Rochester: SBM Associates, Inc., 271-7430/Syracuse: SBM Associates, Inc., 454-9377. **NORTH CAROLINA** Burlington: Gentry Associates, Inc., 227-7916. **OHIO** Cleveland: WKM Associates, Inc., 855-5616/Dayton: WKM Associates, Inc., 298-7203. **PENNSYLVANIA** Pittsburgh: WKM Associates, Inc., 892-2953/Wayne: Bartlett Associates, Inc., 688-7325. **TEXAS** Dallas: Norvell Associates, Inc., FL 7-6451/Houston: Norvell Associates, Inc., MO 5-0558. **WASHINGTON** Bellevue: Cane-Jessup Co. Inc., GL 4-0691. **CANADA-ONTARIO** Ottawa: Whittaker Electronics Ltd., 722-7658/Weston: Whittaker Electronics Ltd., 247-7454. **QUEBEC** Roxboro: Whittaker Electronics Ltd., 684-3000. **ASIA-JAPAN** Tokyo: Tokyo Electron Labs, Inc., TBS Building. **EUROPE-BELGIUM** Brussels: Fairchild Instrumentation, 80 Chaussee de Charleroi.

**30W at 40V
and 100°C**

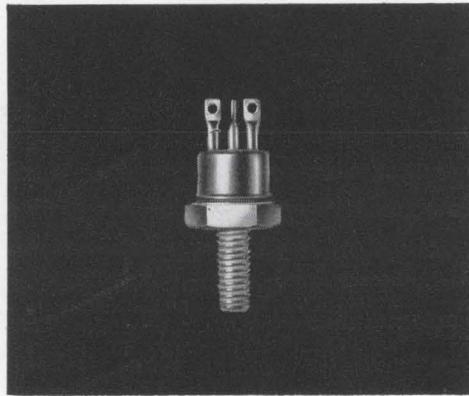

**no secondary
breakdown**

FT7207

NPN planar epitaxial power amplifier

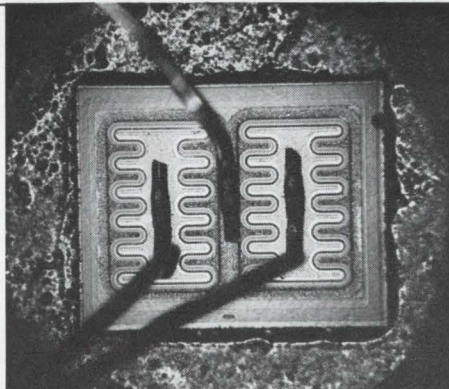
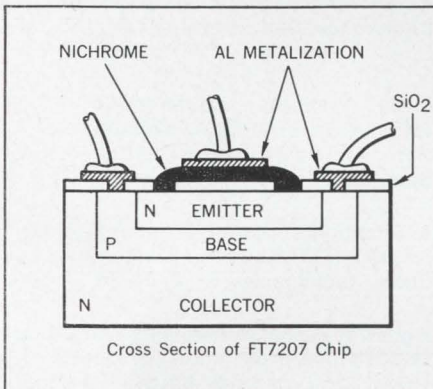

FEATURES

POWER: 30 watts at 40V and 100°C case temperature

V_{CE0} : 80V min. ($I_C = 50 \text{ mA}$)

h_{FE} : 40-120 ($I_C = 2A, V_{CE} = 5V$)

$V_{CE} \text{ (SAT)}$: 1.5V max. ($I_C = 5A, I_B = 0.5A$)

I_{CS} : 10 μ A max. ($V_{CE} = 60V$)

h_{fe} : 3.5 min. ($V_{CE} = 5V, I_C = 0.5A, f = 20\text{mc}$)

PLANAR: A PATENTED FAIRCHILD PROCESS

What Makes It Best: The FT7207 delivers a full 30 watts of power at 40 volts and 100°C case temperature. Not intermittently. Not at peak. At full rated power. Most power transistors are subject to current hogging problems which cause secondary breakdown. Not the FT7207. To solve this problem we had to invent a new method of building power transistors.

So we did. We combined thin film techniques with planar epitaxial processing and came up with nichrome thin film resistors in series with the emitters. Result? No more current hogging. No secondary breakdown. We put the FT7207 in an insulated 7/16" hex stud package, so that a number of individual devices can be attached to a common heat sink without requir-

ing isolation of each individual device. You can get the FT7207 in the 7/16" hex stud package with either 60V or 80V limits. The 80V model costs \$42.00 in quantities up to 99, and \$28.00 in quantities up to 999. If you want the complete story on the FT7207, write for our data sheet. Or, better yet, get in touch with your nearest Fairchild Distributor.

FAIRCHILD
SEMICONDUCTOR

Another Industry First!

NOW... THE NEWEST DUET* TRANSISTOR IS A TWIN IN A FLAT PACK!

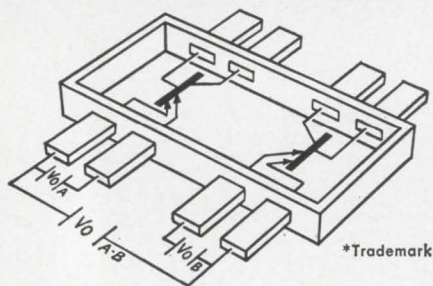

Sprague leads again with two dual-emitter chopper transistors in one flat-pack case, with tight V_{OFF} matching of both devices

CHECK THESE KEY PARAMETERS

Type No.	V_{EEO}	V_{ECO}	V_O A-B
3N112	30V	30V	20 μ V
3N113	50V	50V	20 μ V

Standard TO-18 case Duet* Transistors . . . the broadest line of dual-emitter choppers

Type No.	V_{EEO}	V_O
3N90	30V	50 μ V
3N91	30V	100 μ V
3N92	30V	200 μ V
3N93	50V	50 μ V
3N94	50V	100 μ V
3N95	50V	200 μ V
3N108	50V	30 μ V
3N109	50V	150 μ V
3N110	30V	30 μ V
3N111	30V	150 μ V
3N114	12V	50 μ V
3N115	12V	100 μ V
3N116	12V	200 μ V
3N117	20V	50 μ V
3N118	20V	100 μ V
3N119	20V	200 μ V

For complete technical data, write to Technical Literature Service, Sprague Electric Co., 35 Marshall St., North Adams, Mass. 01248



Sprague and *Duet* are registered trademarks of the Sprague Electric Co.

Meetings

Radio-Products Fair, Stuttgarter Ausstellungs-GMBH; Stuttgart Kellesburg, Germany, Aug. 27-Sept. 5.

International Antennas and Propagation Symposium, IEEE; Sheraton Park Hotel, Washington, D.C. Aug. 30-Sept. 1.

Boulder Millimeter Wave and Far Infrared Conference, IEEE et al; Stanley Hotel, Estes Park, Colorado, Aug. 30-Sept. 1.

International Congress of Physiological Sciences Meeting, AFOSR, National Academy of Sciences-National Research Council et al; National Education Center, Tokyo, Japan, Sept. 1-9.

American Physical Society Symposium, AFOSR and American Physical Society; Univ. of Honolulu, Honolulu, Hawaii, Sept. 2-4.

Opto-Electronic Components and Devices Symposium, Advisory Group for Aerospace Research and Development; Paris, Sept. 6-9.

Technical Conference on Materials Science and Technology in Integrated Electronics, Electronic Materials Committee, Institute of Metals Div. of the Metallurgical Society of San Francisco Section of the AIMMPE; St. Francis Hotel, San Francisco, Sept. 7-9.

International Electronics Exhibit INEL, Swiss Fair Authorities; Basel, Switzerland, Sept. 7-11.

International Congress on Acoustics, International Commission on Acoustics; Palais de Congres, Liege, Belgium, Sept. 7-14.

Industrial Electronics and Control Instrumentation International Congress, IEEE; Sheraton Hotel, Philadelphia, Sept. 8-10.

Recent Developments in the Mathematical Theory of Elementary Particles Conference, AFOSR, Massachusetts Institute of Technology; Endicott House MIT, Dedham, Mass., Sept. 12-15.

Integrated Circuit Seminar, Integrated Circuit Engineering Corp.; Cambridge Charter House, Cambridge, Mass. Sept. 13-17.

Microwave Behavior of Ferrimagnetics and Plasmas Conference, IEE; London, Sept. 13-17.

Theory of Self-Adaptive Control Systems Symposium, IFAC/Teddington; Teddington, England, Sept. 14-17.

National Standards and National Testing Laboratories Meeting, Standards Engineers Society; Royal York Hotel, Toronto, Canada, Sept. 15-17.

Petroleum Mechanical Engineering Conference, ASME; Rice Hotel, Houston, Sept. 19.

Electronic Data Processing Conference, National Retail Merchants Association; Fairmont Hotel and Tower, San Francisco, Sept. 20-24.

Plasma Sheath—Plasma Electromagnetics of Hypersonic Flight Symposium, OAR; New England Life Hall and Classified section at Base Theater, Laurence G. Hanscom Field, Bedford, Mass., Sept. 21-23.

Systems Engineering Annual Conference, Clapp and Poliak, Inc.; McCormick Place, Chicago, Sept. 20-23.

Microelectronics Symposium, IEE; Univ. of Southampton, England, Sept. 21-23.

AE-4 Electromagnetic Compatibility Conference, SAE; Grumman Aircraft Corp., Bethpage, L.I., N.Y., Sept. 22-23.

Military Electronics Conference (MIL-E-CON 9), IEEE; Washington Hilton Hotel, Washington, D.C., Sept. 22-24.

Automation Conference, Cedar Rapids Section, IEEE; Town House Motel, Cedar Rapids, Iowa, Sept. 24-25

Optics in Space Conference, Institute of Physics and Physical Society Optical Group; Univ. of Southampton, England, Sept. 27-29.

Call for papers

Region Six Annual Conference, IEEE; Pioneer International Hotel, Tucson, Arizona, Apr. 26-28. Dec. 1 is deadline to submit 4 copies of 50-word abstract and 3 copies of 500-word summary to Dr. L. O. Huelsman, Technical Papers Chairman, 1966/IEEE Region Six Annual Conference, c/o Dept. of Elec. Eng., Univ. of Ariz., Tucson, Ariz.

Anti-Missile Research Advisory Council Meeting, Advanced Research Projects Agency; U. S. Naval Postgraduate School, Monterey, Calif., Nov. 15-17. Aug. 30 is deadline for submission of papers to Earl Crisler, Chairman AMRAC, Institute for Defense Analyses, 400 Army-Navy Drive, Arlington, Va. 22202.

Meeting preview on page 16

Astrodata's New Astrolock*[®]-loop FM Subcarrier Discriminator



Stability

Within $\pm 0.01\%$ of center frequency for 24-hours after a 5-minute warm-up.

The Astrodata Model 402-201, all solid-state FM subcarrier discriminator utilizes the new Astrolock phase-frequency detector, crystal-referenced, FET chopper-stabilized VCO, and current mode loop filter, which are proprietary developments of Astrodata, Inc.

This completely new and different type of locked-loop discriminator gives performance exceeding that of both conventional phase-locked-loop and pulse-averaging types of discriminators.

The new crystal-referenced, FET chopper-stabilized VCO provides state-of-the-art performance in stability and linearity, without a temperature controlled oven.

The Astrolock detector, with its composite phase-frequency characteristic, assures positive lock-in at any signal

level within the 66 db dynamic range. True locked-loop performance is provided for deviations up to $\pm 40\%$, with specified linearity. A quadrature detector mode of operation, selected by a switch on the front panel, provides correlation detection for extremely low S/N signals.

The Model 402-201 introduces a new method of tape-speed compensation in which the reference frequency is processed in the frequency domain. As a result, tape speed compensation is perfect at any fixed frequency from lower bandedge to upper bandedge, and is better than 30 db for intelligence frequencies up to a modulation index of 4. Deviations of more than $\pm 3\%$ anywhere in the band can be accommodated. No adjustments are necessary.

With this new Astrodata Tape Speed Compensation system, the over-all

Linearity

Better than $\pm 0.02\%$ of full bandwidth, best straight line.

stability for a given data channel is that of the data discriminator alone, whereas in a conventional system the over-all stability is the sum of the stabilities of both the data discriminator and the reference discriminator.

A complete line of accessories is available for use with the Model 402-201. Channel Selectors and Low Pass Filters are provided for all standard IRIG and Constant Bandwidth center frequencies up to 300 kc. Six discriminators and one common power supply mount in a rack adapter which occupies a panel space of 7-in. x 19-in.

For complete technical information on Astrodata's unique Astrolock - loop FM Subcarrier discriminator and full line of telemetry components, call your local Astrodata engineering sales representative or write to us directly.



ASTRODATA INC.

P. O. Box 3003 • 240 E. Palais Road • Anaheim, California 92803

Meeting preview

Systems control in Tokyo

From both sides of the Iron Curtain, engineers are heading for Tokyo this week to participate in an international symposium on systems engineering for control-system design. The four-day meeting, Aug. 25 to 28, is sponsored by the International Federation of Automatic Control.

Transportation, an international problem, will be the subject of five papers. Major interest probably will center on a description of the use of parametron circuits for traffic control on Japanese highways (see p. 168). This paper will be presented by Eiichi Kikuchi, Makoto Kumura and Shuntetsu Matsumoto of the Japanese Government Mechanical Laboratories, and Yasujiro Oshima of the Institute of Industrial Science at the University of Tokyo.

There will also be a report on computer control of train operation and automatic traffic control on Japanese railroads by Shigezu Yamazaki of the Japanese National Railways.

Learning machines. A session on learning systems will include a paper by A. Y. Lerner, N. V. Vapnik and A. Y. Chervonenkis, of the Soviet Academy of Sciences, on problems of learning machines and large-scale systems control. One topic of the paper will be pattern recognition in simulating learning in living organisms.

A paper by Moriya Oda and Kahei Nakamura of Nagoya University will discuss a learning-control system in which the system itself decides whether data is useful, and accepts or rejects it on that basis. Regulation and control in biological systems will be discussed by A. S. Iberall and S. Z. Cardon of General Technical Services, Inc., of the United States. They will compare the body's controls with those employed in electronic systems.

There will also be sessions on system design, stochastic systems, optimum controls, simulation, identification procedure, public utilities, multivariable and multilevel systems, identification of systems, and systems in general.

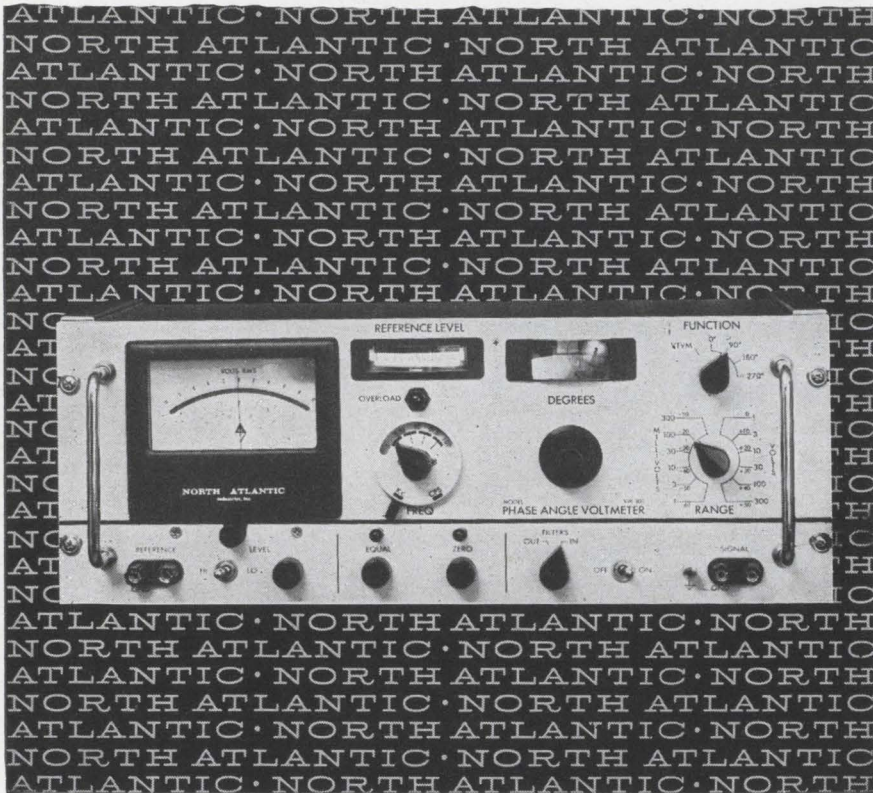

how to measure in-phase, quadrature and angle while sweeping frequency to 100 kc

North Atlantic's latest addition to the PAV line of Phase Angle Voltmeters* enables you to make measurements while frequency is varying over half-decades without recalibration. The VM-301 **Broadband Phase Angle Voltmeter*** provides complete coverage from 10 cps to 100 kc, and incorporates plug-in filters to reduce the effects of harmonics in the range of 50 cps to 10 kc with only 16 sets of filters. Vibration analysis and servo analysis are only two of the many applications for this unit. Abridged specifications are listed below:

Voltage Range.....	1 mv to 300 volts full scale
Voltage Accuracy.....	2% full scale
Phase Dial Range.....	0° to 90° with 0.1° resolution (plus 4 quadrants)
Phase Accuracy.....	0.25°
Input Impedance.....	10 megohms, 30μf for all ranges (signal and reference inputs)
Reference Level Range.....	0.15 to 130 volts
Harmonic Rejection.....	50 db
Nulling Sensitivity.....	less than 2 microvolts
Size.....	19" x 7" x 10" deep
Price.....	\$2290.00 plus \$160.00 per set of filters

North Atlantic's sales representative in your area can tell you all about this unit as well as other Phase Angle Voltmeters* for both production test and ground support applications. Send for our data sheet today.



NORTH ATLANTIC industries, inc.
TERMINAL DRIVE, PLAINVIEW, L. I., NEW YORK • Overbrook 1-8600

*Trademark

Micro Solutions...from Bourns!

Microcomponents

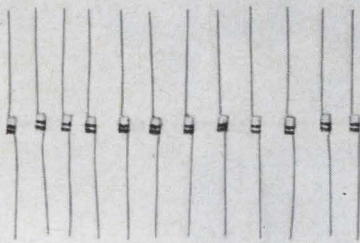

Microresistors

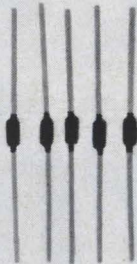

Microcapacitors

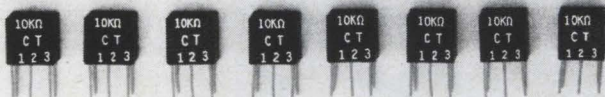
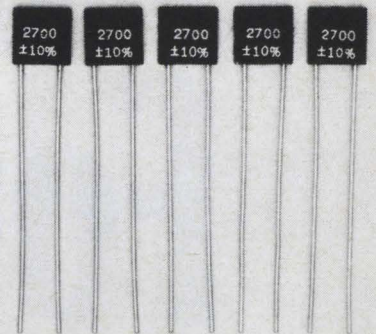
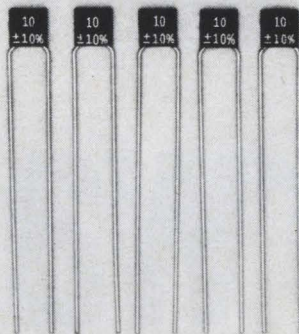

Microtransformers

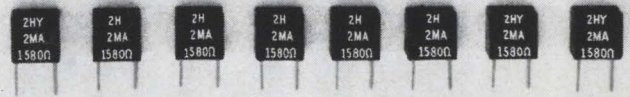

Microinductors

Microcircuits

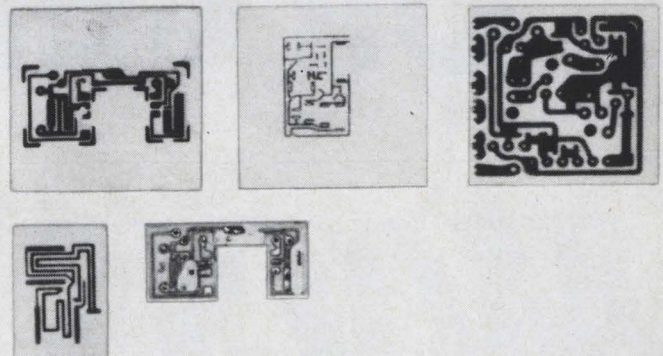
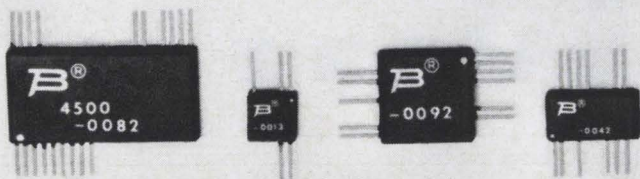

Want design freedom?
Take your choice of a wide selection
of microcomponents... or we will make custom
microcircuits to your specifications!
All products available now!

Write for complete technical information

All units shown actual size



BOURNS, INC., TRIMPOT DIVISION
1200 COLUMBIA AVE., RIVERSIDE, CALIF.
PHONE 684-1700 · TWX: 714-682 9582
CABLE: BOURNSINC.

A Giant Step Forward in Integrated Circuits...

MOGISTERS^{TM.}

(The New Generation of MOS Monolithic Shift Registers)

MOGISTERS ARE:

GENERAL INSTRUMENT'S NEW MOS MONOLITHIC 21-BIT SHIFT REGISTERS

With GI's new MOGISTERS, pronounced "mo'-jisters," the much discussed advantages of MOS (metal-oxide-silicon) circuitry are now a practical, commercially available reality.

This availability represents a significant milestone in MOS technology, not only because of the unique design possibilities offered by MOS units in general, but also because of the **unconditionally assured voltage stability** of these GI devices in particular.

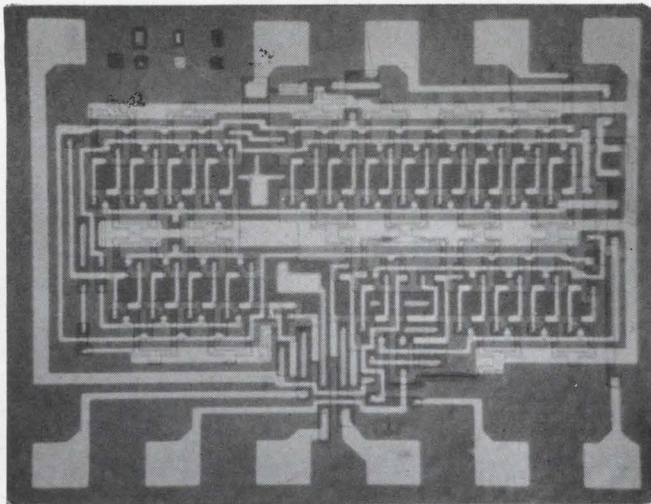

MEM-501 — New General Instrument MOGISTER, 21-bit MOS shift register, magnified 70 diameters; operating from DC to 500kc. This is the first of a complete line General Instrument will announce shortly. Also available, MEM-521 operating from DC to 1 mc.

COST SAVINGS

If you're concerned with lower costs (and who isn't), you'll find MOGISTERS can help you trim equipment costs three ways:

- Lower cost per bit . . . substantially less than individual double-diffused JK flip-flops or single shift registers.
- Fewer packages required . . . MOGISTERS are available in register lengths up to 21 bits (16-4-1), all in a single TO-5 or flat pack.
- Fewer interconnections within your system . . . only one hook-up, instead of 21.

VERSATILITY

Each MOGISTER provides three separate and distinct multi-bit shift registers on one monolithic chip. These may be used as parallel registers, each with its own push-pull output stage; or as 21 bits serially, by simply connecting the output of each register to the input of the next.

In addition, you may directly buffer into double-diffused integrated circuits merely by grounding the $-V_O$ pin and applying +3V or +5V to the ground terminal.

SUPERIOR PERFORMANCE

In terms of in-system performance, MOGISTERS offer a line-up of advantages that just won't quit. Here are a few of the more significant ones:

- capable of operation down to DC
- high fan-out capability; 25 or more
- high noise immunity; 3 volts or more
- large voltage swings; 10 volts or more

MOGISTERS are available now from your authorized General Instrument Distributor.

Call or write today for full data and specifications.

**GENERAL INSTRUMENT CORPORATION
SEMICONDUCTOR PRODUCTS GROUP**

600 West John Street, Hicksville, New York



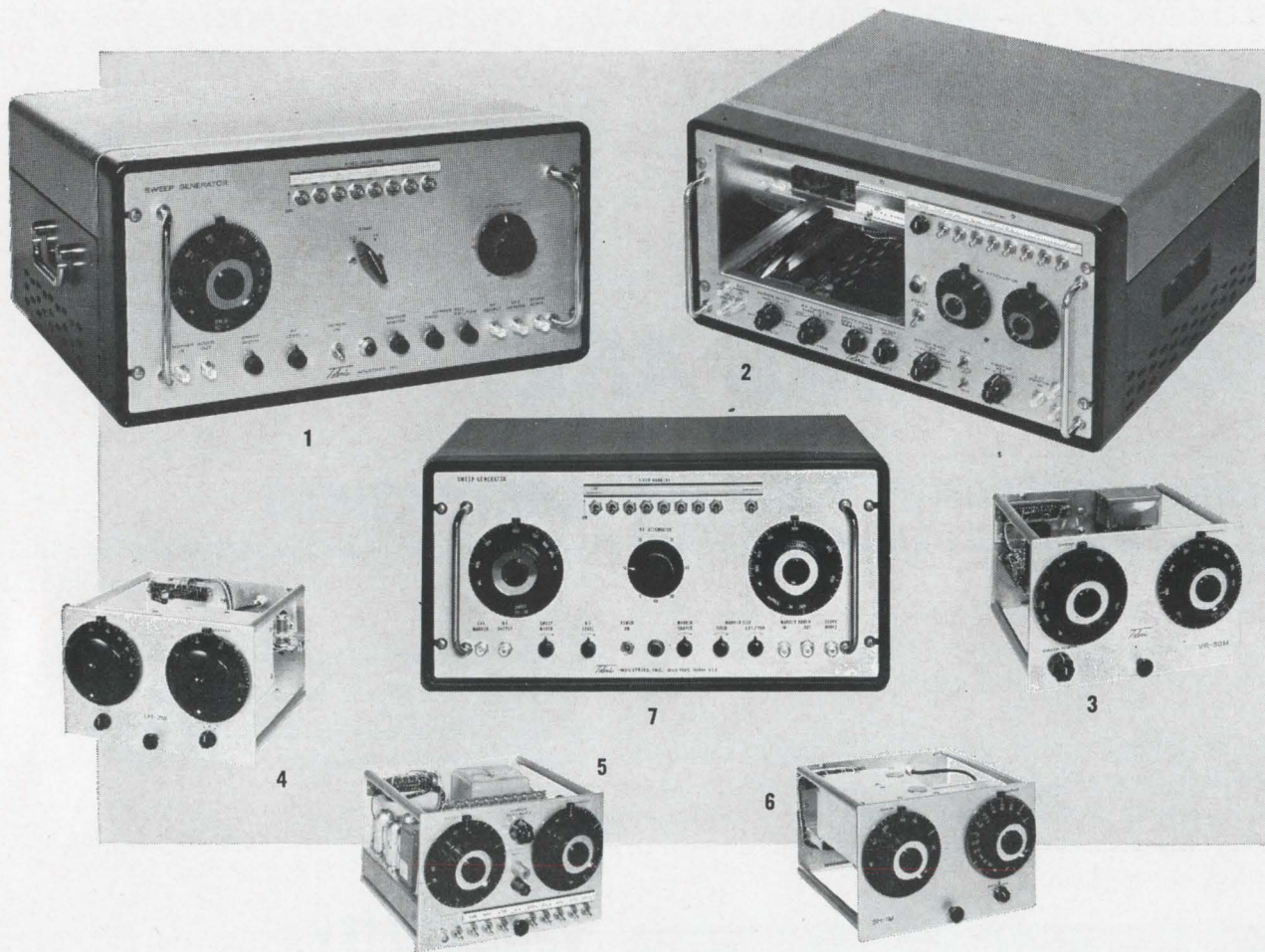

SWEPT FREQUENCY



Frequency response can be measured by no better method than with instrumentation generating frequencies covering the total spectrum of interest. This is the function of the sweep generator—and nowhere is it more effectively realized than in Telonic instruments.

Designed to facilitate test procedures by providing fast, meaningful data, Telonic Sweep Generators and accessory equipment are both laboratory and production line proven. With models in every frequency bracket to 3 GHz, and the universal SM-2000 for maximum versatility, selection of the best instrument for your application is no problem. Performance and dependability factors are inherent, as thousands of users have already discovered.

Telonic Sweep Generators are of many basic design types. Several different sweeping mechanisms are used, assuring the best possible approach for each instrument. All are available with integral or external frequency marking systems to further simplify response testing procedures.

The equipment shown and described here is but a partial listing of Telonic's complete product line. Catalog C-100 covering all Telonic instrumentation in detail is yours on request. Write, wire or call...

TELONIC INDUSTRIES INC.
 60 North First Avenue, Beech Grove, Indiana
 Tel: (317) St. 7-3231—TWX-810-341-3202

"See Telonic Products at Wescon, booths 4114-4118"

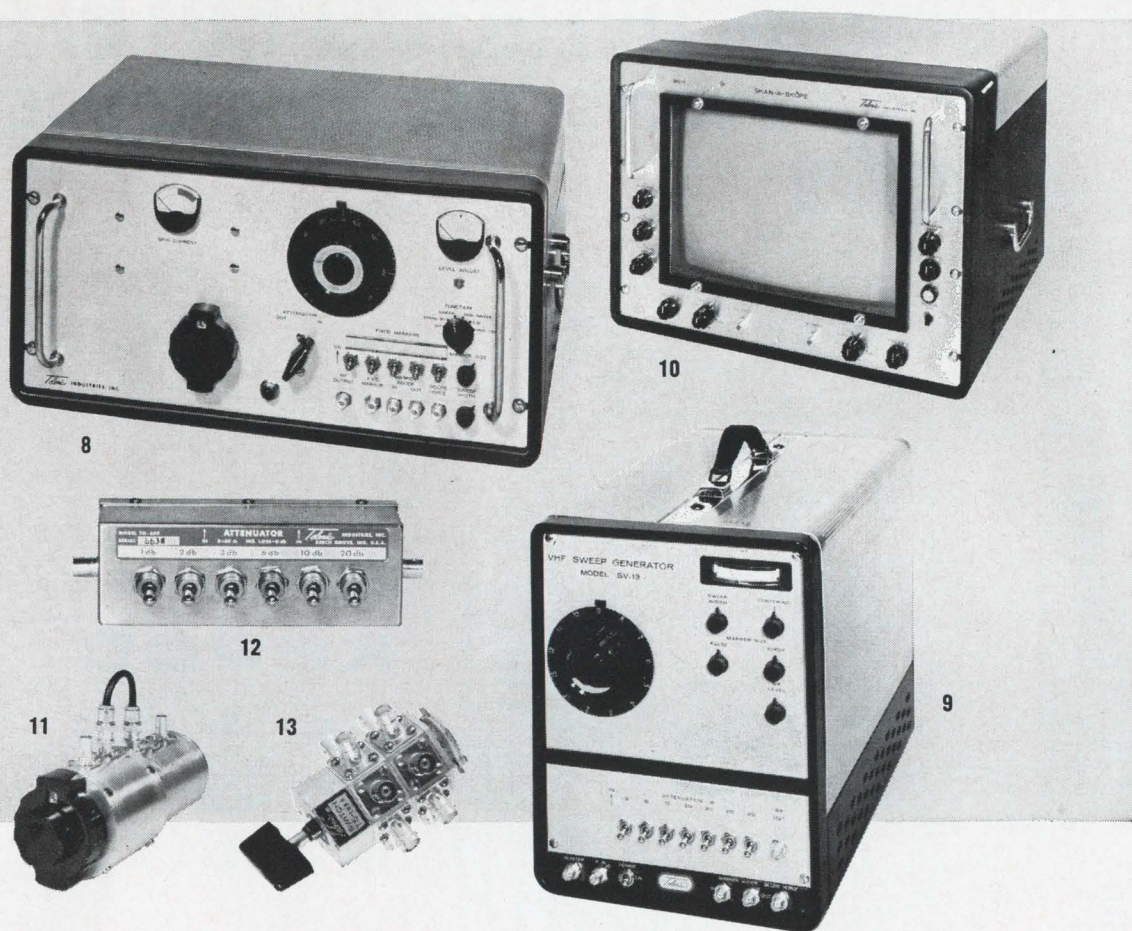

INSTRUMENTATION

Instrumentation for Swept Frequency Generation

MODEL	FREQUENCY RANGE	PRIMARY APPLICATIONS	FEATURES	PRICE
1. HD-1A Sweep Generator	1 MHz to 900 MHz	Design and testing of broad band I-F, R-F, and video amplifiers.	Broad center frequency range — Continuously variable	\$995.00
2. SM-2000 Sweep Generator Control Chassis	20 Hz to 3 GHz (Depending on Oscillator Head)	For lab or production testing throughout its frequency range. 22 plug-in oscillator heads available.	Sweep or CW functions — Variable rate	\$775.00
3. VR-50M Oscillator Head	500 MHz to 1000 MHz	Testing broad band video, I-F and R-F amplifiers.	500 MHz sweep width — Variable rate	\$695.00
4. LH-2M Oscillator Head	400 KHz to 110 MHz	For testing narrow and wide band amplifier and similar circuits.	Multiple octave sweeps — Continuously tunable	\$550.00
5. LA-1M Oscillator Head	20 Hz to 20 KHz	Testing audio amplifiers, filters, telephone equipment and lines, modulator circuits.	Provisions for 8 frequency markers — Flat output	\$995.00
6. SH-1M Oscillator Head	.5 MHz to 460 MHz	Covers radio and TV Broadcast bands, navigational devices, airport control equipment, and other communications equipment.	Wide frequency coverage — 200 MHz sweep width	\$575.00
7. SD-3M Sweep Generator	440 MHz to 920 MHz	Alignment and adjustment of UHF television tuners.	Portable or bench versions — Up to 8 frequency markers	\$895.00
8. PD-8 Sweep Generator	20 MHz to 1000 MHz	Aligning and testing passive devices such as R-F networks, transmission lines, attenuators and R-F filters.	High power — 4 watts output	\$2750.00
9. SV-13 Sweep Generator	20 MHz to 225 MHz	Alignment, adjustment and inspection of R-F channels, I-F Sections of VHF TV receivers.	13 changeable plug-in channels for U.S. and foreign frequencies	\$625.00
10. SK-1 Skan-A-Skope		Used with sweep generator to simultaneously display frequency characteristics with reference lines.	Capable of displaying 5 traces at one time	\$1495.00
11. TAB-50 Turret Attenuator	DC to 900 MHz	Attenuating R-F signals — In 1 db steps up to 59 db.	Direct readout dial — Low insertion loss	\$190.00
12. TG-650 Toggle Attenuator	DC to 250 MHz	Attenuating R-F signals — In 1 db steps up to 42 db.	Negligible insertion loss — Accurate attenuation	\$65.00
13. TS-103 A Coaxial Switch	DC to 1000 MHz	Switching R-F signals.	Negligible cross-talk — Minimum insertion loss	\$100.00

"See Telonic Products at Wescon, booths 4114-4118"

IN FULL RANGE PROGRAMMABLE POWER MODULES

KEPCO'S UNIQUE OVERLOAD CUTOFF MAKES THE DIFFERENCE!

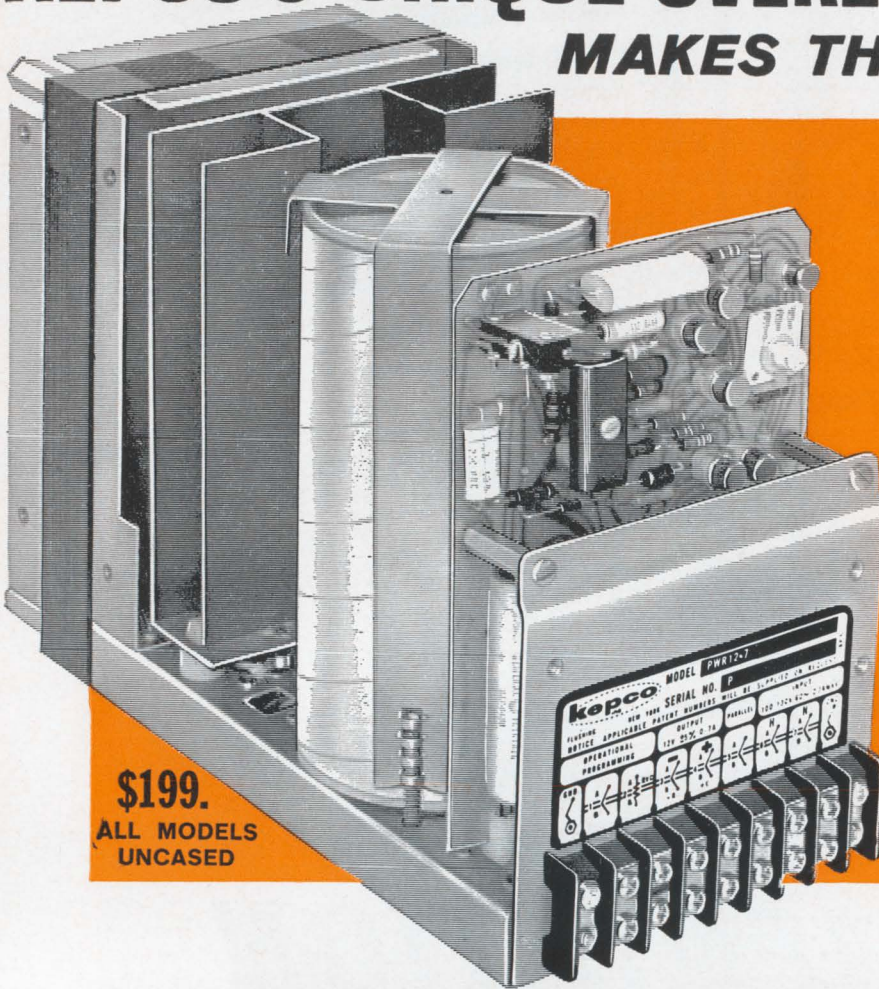

\$199.
ALL MODELS
UNCASED

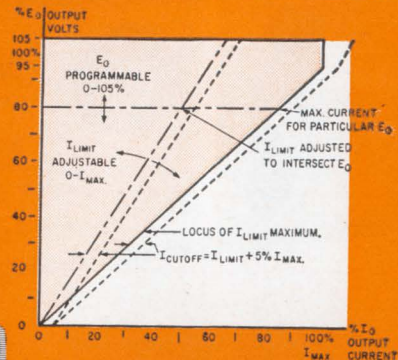

I_{LIMIT} IS THE MAXIMUM OPERATING CURRENT FOR ANY SELECTED CUTOFF CURRENT. I_{LIMIT} IS APPROXIMATELY EQUAL TO I_{CUTOFF} MINUS 5% I_{MAX} .

KEPCO
PWR
REGULATED DC SUPPLY
MODULES

FOR PRECISION, COMPACT POWER

The PWR Design Group comprises line and load regulated power modules incorporating the Kepco patented "Flux-O-Tran" line regulating transformer and the Kepco patented "Bridge" output regulator. Designed for use on the bench, in systems or proprietary products, mounting choices include chassis, bench or rack panel arrangements. Unique overload current cut-off provides unusual degree of load-protection. Output externally programmable 0-100% with linear derating (see graph for operating region).

- Less than 0.005% output voltage change for 100-130V line change
- Less than 0.05% for no load to full load change
- 0.05% or 3 mv (w.i.g.) long term stability
- Less than 0.5 millivolt rms ripple
- 50 microsecond recovery time
- -20°C to +65°C uncased, +55°C cased, ambient temperature range
- 60 cps \pm 1 cps single phase input, standard models
- 50 cps \pm 1 cps units available, for 104, 115, 208 or 230V AC line voltages
- Overload protection, unique current cut-off
- \pm 5% output vernier voltage adjustment
- Open/cased/rack mounting choice, single, dual, treble rack mounting adapters available

REGULATION 0.005% LINE - 0.05% LOAD

MODEL	DC OUTPUT		OUTPUT IMPEDANCE OHMS MAX		
	VOLTS	AMPS	DC to 100 cps	100 cps to 1 kc	1 kc to 100 kc + μ h
PWR 12-7	0-12	0-7	0.005	0.001	0.1 + 0.5
PWR 15-6	0-15	0-6	0.005	0.002	0.1 + 0.5
PWR 24-4	0-24	0-4	0.005	0.003	0.05 + 0.5
PWR 28-3.3	0-28	0-3.3	0.005	0.004	0.05 + 0.5
PWR 48-2	0-48	0-2	0.005	0.015	0.05 + 0.5
PWR 60-1.5	0-60	0-1.5	0.005	0.02	0.05 + 0.5



OUR NEW CATALOG CONTAINING COMPLETE SPECIFICATIONS AND APPLICATIONS NOTES IS NOW AVAILABLE
WRITE FOR YOUR FREE COPY!

Applicable Patent Nos. furnished on request



See our complete Catalog in

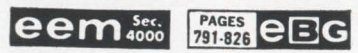

KEPCO, INC. • 131-38 SANFORD AVENUE • FLUSHING, N.Y. 11352 • Phone: (212) 461-7000 • TWX #212-539-6623 • Cable: KEPCOPOWER NEWYORK

See our Newest Products at WESCON—Booths 4323-4324

Editorial

Siren song for companies . . .

The easy life is tempting electronics companies again.

Escalation in Vietnam has finally led to stepped-up military procurement, after months of slow but steady decline. The one-customer way of doing business is again a possibility for electronics companies that for the past 18 months have been developing new muscles of efficiency, aggressiveness, and independence from the Pentagon (see "The changing face of the West," August 9, 1965, page 60).

Nobody is sure just how much additional money the Vietnam affair will cost; nearly \$3 billion extra will be spent this year, and similar expenditures are expected in the next few years. But regardless of what the final sum turns out to be, enough spending is in sight so that some companies may forget diversification plans, drop aggressive marketing strategies and stop putting their own money into new products.

If they do, it will be a crime. They'll throw away the gutwrenching efforts of the past year and a half. The electronics industry will never be healthy

and mature until it stands on its own feet, and is not supported by the Defense Department. Many in the industry refuse to accept the tenet that the industry must have a war—declared or undeclared—to enjoy prosperity. The progress of the past 18 months supports their feelings, even though many of the plans and programs are just reaching fruition.

Should electronics companies shun the current defense business altogether? They can't—if for no other reason than that the troops fighting in Vietnam deserve the best gear obtainable. If properly handled and assessed, this added business can be profitable. But it should be recognized for what it is: a windfall, unexpected and possibly not repeatable. And it should be treated with caution; Defense Secretary Robert S. McNamara's passion for economy seems sure to squeeze some of the profits out of production contracts. Competition will be keen and is likely to be on a price basis.

Probably the greatest danger facing electronics companies is that they may be lulled by the old song sung by some defense contractor diehards. Veterans of one cutback after another, these contractors have been saying all along that diversification, modernization, and change were unnecessary because something would come along—it always has. Now these men are saying "I told you so."

Not everybody will make the good fight. Some electronics companies will take the easy way out even if they risk long-range catastrophe. But if they remember the hard lessons of the past 18 months, they'll continue to operate the new way—on the basis of their planning, not the Pentagon's.

If they don't, the industry will have it all to do over again as soon as the Vietnam affair is settled.

. . . and engineers

Engineers can use a word of caution too. Along with the step-up in military procurement has come a speed-up in engineer recruitment. The advertisements are appearing in all their splendor, again offering dazzling delights of high pay, desirable living, and challenging work.

Many of the engineers who found themselves laid off just a year ago will remember this kind of enticement. It is the same lure that got them in trouble.

At the height of the layoffs in 1964, the unemployed engineers saw that they had chosen the wrong route. Instead of concentrating on building

a career with a soundly managed company, they had jumped from job to job chasing a higher salary. And despite good pay and easy living, they had been doing technicians' work which did not make them better engineers.

Though the offerings are tempting, engineers should keep in mind that the current build-up could be temporary. Our government is exercising every effort to bring the conflict to mediation; and if negotiation succeeds, military electronics will be back where it was at the beginning of 1965. Engineers who have moved to new jobs for a quick salary increase in military work will find the layoffs starting again.

Only you can guarantee your career. When you answer an advertisement, be sure that the job is challenging. Even more important, be sure it is true engineering and isn't temporary.

Is random vibration testing necessary for half-size crystal case relays?

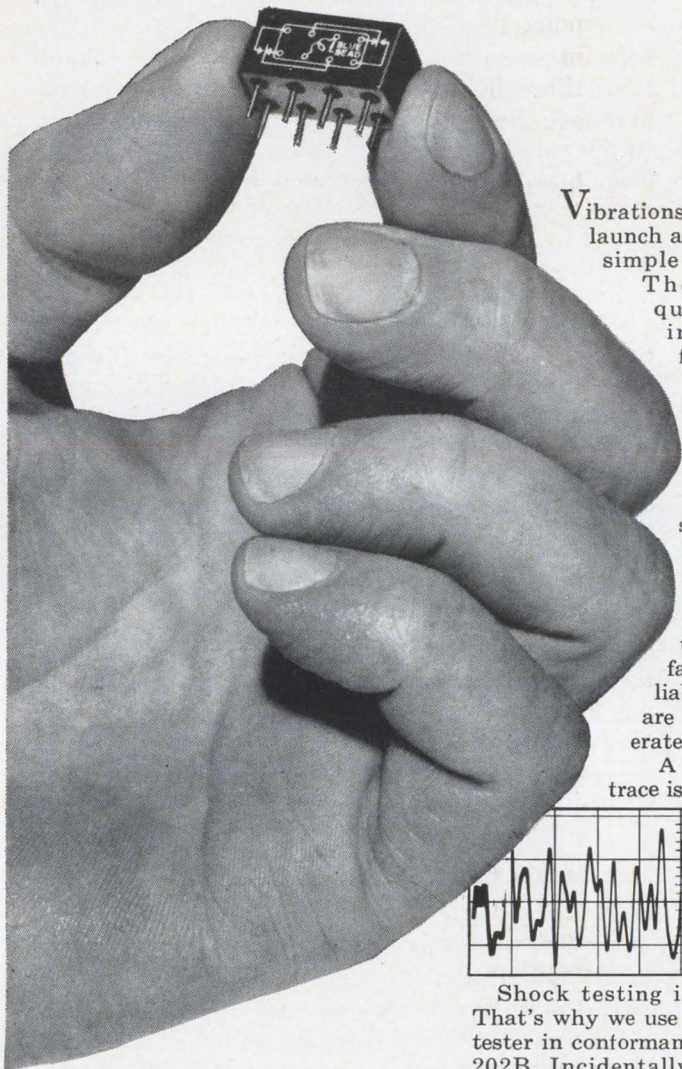

Vibrations of a missile upon launch are far from being a simple sinusoidal affair. They are, indeed, quite random both in amplitude and frequency. It makes only good sense, then, to test our aerospace/military relays for their ability to withstand random vibrations.

This we do. Few if any other relay manufacturers test in this fashion. All high reliability P&B relays are constructed to tolerate random vibration. A typical oscilloscope trace is shown below.

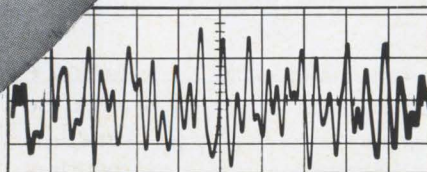

Shock testing is important, too. That's why we use a pneumatic shock tester in conformance with MIL-STD 202B. Incidentally, our HC relay is



conservatively rated to withstand 150g shock for 11 milliseconds with no contact opening.

HC Series half-size crystal case relays are built with loving care and precisely controlled processes. Assembly is done at Whitfield-type laminar flow workbenches. They employ absolute filters which are capable of stopping cigarette smoke (or particles as small as .0000118") and provide what many experts consider to be the cleanest environment available.

Over and above all this, our HC relays are designed to be reliable. They have bifurcated contacts, and make use of some superior materials not found in similar relays. All-welded enclosures are available. Our Quality Assurance program keeps production within the scope of MIL-Q-9858A.

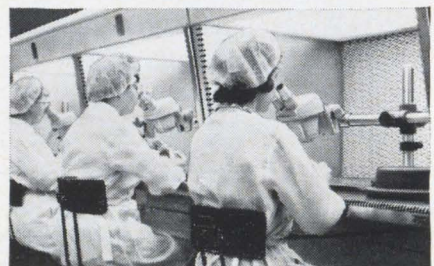

Remember . . . you can buy cheaper relays but you cannot buy P&B quality for less. For more information, call your P&B representative or write us direct.

HC ENGINEERING DATA

GENERAL: Non-polarized half crystal case size.
Shock: 150g for 11 ms. } No contact opening
Vibration: 20g to 3000 cps. } in either armature position.
 Random vibration testing to customer specifications is available.
Operate Time: 3 milliseconds max. at nominal voltage @ +25°C coil temperature.

Life: 100,000 operations at maximum rated load.
Temperature Range: -65°C to +125°C.
Size: .810" long, .410" wide, .410" high (max.).
Weight: Approx. 1/4 oz.

CONTACTS

Arrangement: DPDT (bifurcated, gold-plated silver-alloy).
Rated: Dry circuit to 2 amps at 28.0 VDC res.

HC RELAYS ARE AVAILABLE FROM LEADING ELECTRONIC PARTS DISTRIBUTORS

RIDE THE AMF MONORAIL
 AT THE NEW YORK WORLD'S FAIR



POTTER & BRUMFIELD

Division of American Machine & Foundry Company, Princeton, Indiana
 In Canada: Potter & Brumfield, Division of AMF Canada Ltd., Guelph, Ont.
 Export: AMF International, 261 Madison Avenue, New York, N. Y.

Electronics Newsletter

August 23, 1965

Radiation, Inc. to design Mark 5 ground terminal

About Sept. 1 the Army will announce that Radiation, Inc., has been selected to develop the Mark 5, or AN/TSC-54, air-transportable ground terminal to operate with the military communications satellite system scheduled to be put into orbit next year [Electronics, May 31, p. 86]. Although its bid was reportedly the highest of three made by finalists picked from a long list of contenders over a 6-month evaluation, Radiation's proposal was chosen because of several technical capabilities the others did not have. Important among Radiation's advances are higher aperture efficiencies and higher gain.

The lowest bidder among the three finalists was the Philco Corp.'s Western Development Laboratories; the Bendix Radio division of the Bendix Corp. was in the middle.

Radiation's antenna will be a cloverleaf consisting of four panels, or petals, that are hinged instead of detached. They can be unfolded without having to be bolted.

Hardware for the system must weigh no more than 17,500 pounds; no package can weigh more than 6,000 pounds. A six-man crew must be able to erect or dismantle the terminal in two hours.

Although the amount of the initial contract is not known, each terminal will probably cost about \$1 million and at least nine terminals will be ordered over the next few years. Spares probably will cost \$6 million more, bringing the total of orders eventually to about \$15 million.

Diamonds may be devices' friend

Successful operation of a new type of diamond rectifier is reported by William J. King, director of solid state physics at the Ion Physics Corp., Burlington, Mass. "This is preliminary data and further substantiation is necessary," King warns.

Surface barrier rectification in diamonds has been achieved for years, but this is believed to be the first instance of rectification out of a pn junction in diamonds. The junction was formed by ion implantation, under a program sponsored by the Air Force Cambridge Research Laboratories.

If there is verification of the junction effect it could open the way to the use of diamonds for active devices. Because of the wide band gap in diamonds, semiconductor devices made of this material could operate at extremely high temperatures. Exceptionally good heat-dissipation characteristics would permit such devices to be driven hard without degradation of performance.

King says the diamond rectifier was made by implanting 10^{20} phosphorus ions per cubic centimeter at a maximum energy of 300,000 electron volts in a p-type natural diamond.

Eglin radar to feed Spadats

The Air Force learned enough about the capabilities of the phased-array radar being built at Eglin Air Force Base, Florida before fire destroyed it last January so that the installation will be able to skip the experimental period when it is rebuilt. The radar, known as the AN/FPS-85, will become part of the North American air defense network, as an input to Spadats (the space detection and tracking system) as soon as it is complete.

Original plans were for the radar to be used as an experimental station

for a year after the planned acceptance last January. The rebuilding began in March; the Air Force has not set a target date for its completion.

The blaze [Electronics, Jan. 25, 1965, page 101] began in the transceivers behind the face of the giant array; the open area between the paneling and the electronics created a 13-story "chimney," whipping the flames to an intense heat that even melted cables. On the new array, the area behind the panels will be compartmentalized, to avoid the dangerous chimney effect.

The Radio Systems division of the Bendix Corp. is the prime contractor for the radar.

Comsat invites satellite bids . . .

The Communications Satellite Corp. is shopping for some more satellites—at least six and possibly 24—and a couple of ground stations.

Last week Comsat asked electronics companies to submit proposals for the design and construction of a 240-pound satellite with a capacity of 1,000 two-watt voice circuits, **capable of operating either in a synchronous system at an altitude of 22,300 miles or in a phased system at 6,000 to 12,000 miles.** The 85-pound, \$3.5-million Early Bird has a programmed 240 circuits.

Bids will be opened Oct. 25 and delivery date for the first six satellites will be 24 months after the contract award.

Comsat was scheduled to request proposals for ground stations to be built at Brewster Flat, Wash. and Paumalu, Hawaii.

. . . and makes a bid of its own

Comsat is preparing its own proposal to the National Communications System for synchronous satellites and transportable ground stations that could be used in the National Aeronautics and Space Administration's Apollo and other programs.

The system to be offered NASA involves four synchronous satellites, two of them orbiting as backup. The proposal, due Aug. 23, is based on the single bid which the satellite corporation received from the Hughes Aircraft Co.

Saturn telemetry to be automated

The telemetry ground station for the giant Saturn launch vehicle, at the Marshall Space Flight Center at Huntsville, Ala., will be completely automated. For the first time, a general purpose computer, with one man at a console, will control all the functions of a telemetry station. The system is being developed by Defense Electronics, Inc. under a \$400,000 contract with the National Aeronautics and Space Administration.

If the automated station works well, telemetry at the Manned Spacecraft Center at Houston, and later at Cape Kennedy, will probably be automated. If the entire missile range is automated, a number of engineers and technicians recently hired for the expanded telemetry activity would not be needed.

Prospects bright for night vision

The Army's highly classified night vision program may be very close to the equipment stage. There are reports that the Army Electronics Command at Fort Monmouth, N.J. has taken over the program from the Combat Development Command in Fort Belvoir, Va. The move could mean that the Army is ready to go ahead with production and procurement.

IDEAS

from SYLVANIA Electronic Components Group

INTEGRATED CIRCUITS

Announcing SUHL* II...fastest (40 mc/s) saturated logic, in a hermetic plug-in package

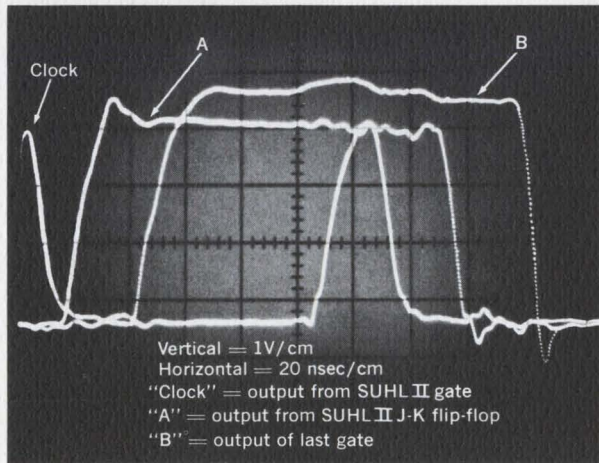
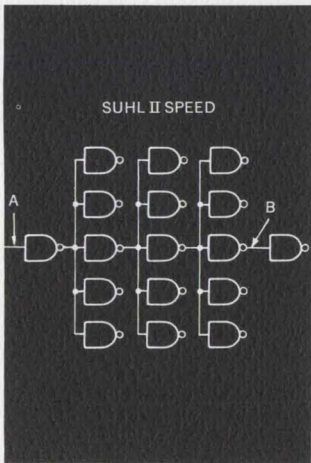

From time to time, several manufacturers have announced high-speed logic circuits based on a variety of design concepts. But in achieving faster speeds each concept compromised total system performance. Tradeoffs were made in at least one of these important system requirements—noise immunity, logic levels, power drain, temperature stability, fan-out vs. fan-in, or capacitance drive capability. Speed per circuit package was achieved by reducing logic function per package. These approaches required level restoration, fan-out buffering, or bias supply regulators, necessitating extra packages. Hence, not only was package speed lost at the system level, but system power, can count, and costs were increased also.

Now a new line of integrated circuits, SUHL II, solves high-speed system requirements without compromise to any performance characteristic. The SUHL II family consists of totally compatible 6-nsec gates and 30mc J-K flip-flops designed to oper-

ate from a single 5-volt power supply.

In addition to the universal electrical characteristics, this newest IC line is available in Sylvania's new hermetically sealed plug-in package, important for manual or automatic insertion. The package is also ideal for flow-soldering installation on two-sided printed circuit boards.

Every SUHL II circuit, including the single logic level NAND/NOR gate, two logic level expandable OR (AND/NOR) gate, and the two J-K flip-flops, has high noise immunity, fan-out, and capacitance drive capability. Still another important feature is that additional packages are not required to restore logic levels or noise margin at the system level. Saturated logic has been used throughout to maintain stable logic swings and propagation times over broad operating temperature excursions without recourse to additional bias supplies, complex loading rules, and external clamping and shielding. Low power OR expansion is accomplished with-

out degradation of fan-out or capacitively loading the gate output.

With new SUHL II circuits, output impedance is low and not subject to oscillations. The low power drain is independent of fan-in or fan-out, typically 20 mw per gate function. High noise immunity (-1.5 to +1.1 volt at 25°C) and high logic swing ("0" = 0.25V, "1" = 3.5V) are among other notable characteristics.

All circuits in the SUHL II line are compatible with the 18 integrated circuit series of SUHL I. Both SUHL lines are supplied in -55°C to +125°C operating temperature ranges for military applications and, for industrial use, in the 0°C to +75°C range.

CIRCLE NUMBER 300

This issue in capsule

Photoconductors—a black spot photocell that finds random defects in opaque, translucent and transparent materials.

Diodes—a new low leakage silicon alloy series replaces many general-purpose diodes.

Receiving Tubes—special trigger tube is used in detecting changes in smoke, heat, gas and other phenomena.

Photoconductor-Lamp Assemblies—a new approach to noise-free switching at audio and video frequencies.

Cathode Ray Tubes—high-resolution photographic recording with preadjusted and prealigned CRT assemblies.

Microwave Diodes—a new Solid-Structure concept for germanium tunnel diodes.

Color TV—what to look for in tubes for damping and horizontal deflection.

This is SUHL* II

*Sylvania Universal High-Level Logic.

EXPANDABLE DUAL 4-INPUT OR GATE

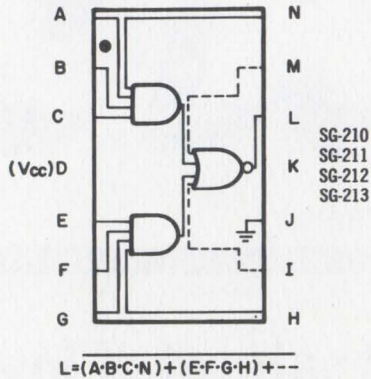

QUAD 2-INPUT NAND/NOR GATE

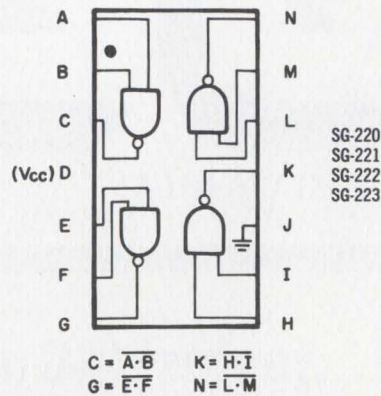

QUAD 2-INPUT OR EXPANDER

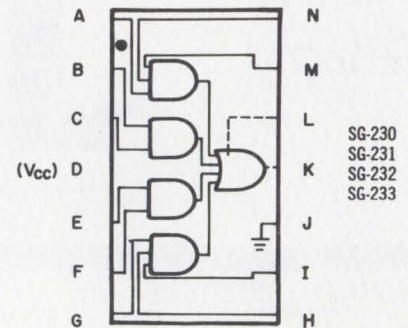

DUAL 4-INPUT NAND/NOR GATE

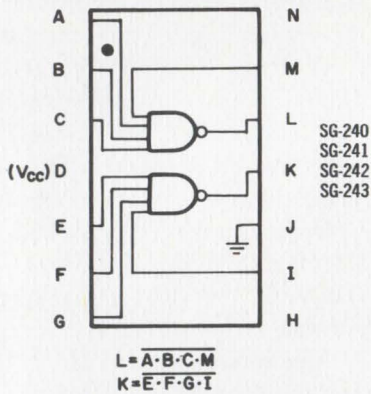

EXPANDABLE QUAD 2-INPUT OR GATE

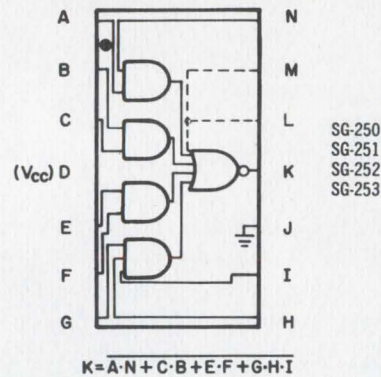

SINGLE 8-INPUT NAND/NOR GATE

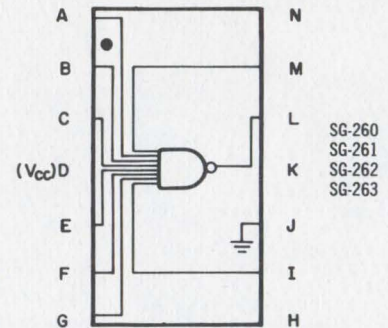

DUAL 4-INPUT OR EXPANDER

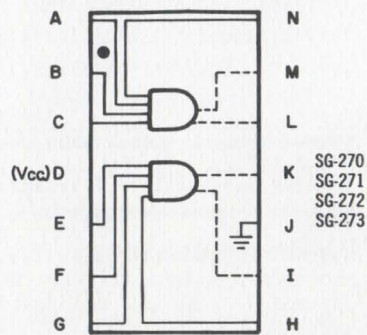

J-K FLIP-FLOP (AND INPUTS)

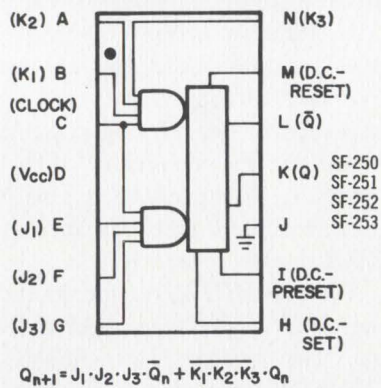

J-K FLIP-FLOP (OR INPUTS)

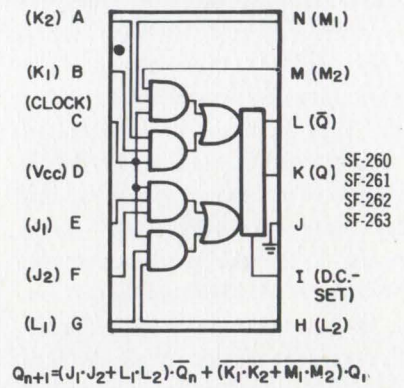

SUHL II TYPICAL CHARACTERISTICS (+25°C, +5.0V)

Function	Type Nos.	t _{pd} (nsec)	Avg. Power mw.	Noise Immunity + (volts) -	Military (-55°C to +125°C)		Industrial (0°C to +75°C)		
					Prime FO	Std. FO	Prime FO	Std. FO	
Expandable Dual 4-Input OR Gate	SG-210, SG-211, SG-212, SG-213	6	30	1.1	1.5	12	6	10	5
Quad 2-Input NAND/NOR Gate	SG-220, SG-221, SG-222, SG-223	6	20***	1.1	1.5	12	6	10	5
Quad 2-Input OR Expander	SG-230, SG-231, SG-232, SG-233	6	30	1.1	1.5				
Dual 4-Input NAND/NOR Gate	SG-240, SG-241, SG-242, SG-243	6	20***	1.1	1.5	12	6	10	5
Expandable Quad 2-Input OR Gate	SG-250, SG-251, SG-252, SG-253	6	45	1.1	1.5	12	6	10	5
Single 8-Input NAND/NOR Gate	SG-260, SG-261, SG-262, SG-263	6	20	1.1	1.5	12	6	10	5
Dual 4-Input OR Expander	SG-270, SG-271, SG-272, SG-273	6	7.5	1.1	1.5				
J-K Flip-Flop (AND Inputs)	SF-250, SF-251, SF-252, SF-253	30mc**	60	1.1	1.5	12	6	10	5
J-K Flip-Flop (OR Inputs)	SF-260, SF-261, SF-262, SF-263	30mc**	60	1.1	1.5	12	6	10	5

Synchronous clock rate. *Per gate.

New plug-in package for assembly ease

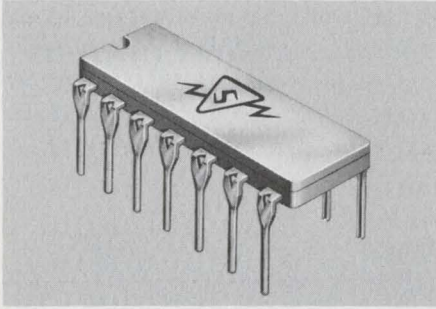

Specifically designed for low cost assembly on two-sided printed circuit boards, Sylvania's new plug-in package is hermetically sealed and tested to a 10^{-8} cc/sec leak rate. The alumina filled glass package provides extremely low thermal resistance and features Kovar leads formed into a 0.020" diameter for both strength and reliable solderability.

The 100 mil pin centers permit both loose drill tolerances and wide printed circuit lines while the leads provide a 0.035" standoff to prevent solder bridging. Another feature of Sylvania's new package is the handy index notch midway in one of the short sides which can facilitate manual or automatic installation.

CIRCLE NUMBER 300

COLOR TELEVISION

What to look for in sweepers and dampers

In previous issues, IDEAS has pointed out the large strides made in recent months and years in enhancing the reliability and performance of receiving tubes. On this page we take a closer look at how this progress applies to color television, with particular emphasis on newer tubes for damping and horizontal deflection.

New Damper Types

Until recently an accepted, but expensive, means of damping called for circuit designs using two dampers in parallel. The economical, but far less reliable, approach was to design a circuit with a single damper that would be pushed to its electronic limits.

Now there are two new dampers specifically designed for low B+ color TV, where good performance is dependent on high current capability and low tube drop. The Sylvania 34CE3 and 6CH3 individually provide all of the damping requirements at no sacrifice to reliability.

Both tubes are indirectly heated half wave rectifiers within T-9 glass envelopes. Both have excellent emission stability, dissipation ratings of 11 watts and 350ma DC plate current. The 6CH3 has a 9-pin base. The 34CE3 has a 12-pin base with controlled heater warm-up time for series connected circuits.

Arc-free operation is assured in both types because of their high peak inverse ratings. Other important characteristics are high average and peak current ratings, along with low tube drop. Because application heating time is fast, the picture image comes into view quickly and not after the

sound. And emission stability is good throughout the tube's life, a result of high heater power input.

Especially important in both the 6CH3 and 34CE3 is the high heater cathode safety factor with an increased voltage rating between the heater and cathode. In achieving a high plate dissipation rating, Sylvania added a double plate wing design with a copper core multilayer plate. This, in turn, gives the tubes a dissipation capability compatible with current ratings and demanding color set usage. The high thermal conductivity plate also provides uniformity in heat radiation, low tube drop and the high peak inverse voltage rating.

Horizontal Deflection Types

Two newer sweep tubes can be used effectively in combination with the 6CH3 and 34CE3. In addition to their roles as horizontal deflection amplifiers, the 31JS6A and 42KN6 share few other characteristics. Both are pentodes featuring T-12 construction with a 12-pin base. The heater opera-

tion in both is for series string operation. Both have low knees to help assure snivet-free operation and, in case further suppression is needed, beam plates are brought out through separate base connections providing ready access to the element.

The 31JS6A was designed specifically for economy of series string operation. Its lower knee also makes it an acceptable deflection tube for some less demanding (70°) deflection requirements at low B+ voltages.

The Sylvania rugged 42KN6 was specifically designed for low B+ high current operation for deflection of 90° or 70° color picture tubes. The 42KN6 eliminates the need and expense for parallel deflection tube.

The 42KN6 uses the new cavitrap plate design to provide a high peak current consistent with the low knee needed at low B+ voltages for deflection of a 90° tube. Outstanding also is its high plate dissipation rating, high screen dissipation rating and high bulb temperature rating.

CIRCLE NUMBER 301

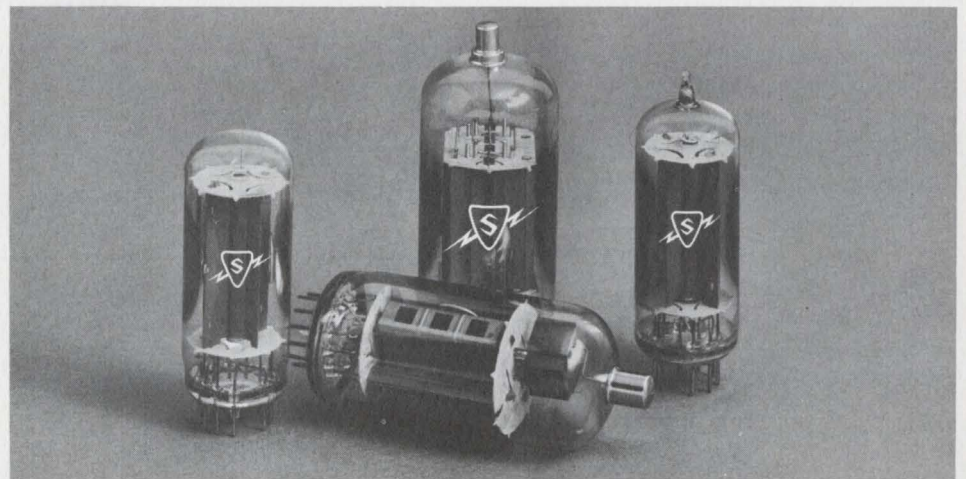

New...a Solid-Structure Germanium Tunnel Diode

With the industry's first Solid-Structure germanium tunnel diodes, Sylvania has increased diode reliability while maintaining electrical characteristics. The design engineer now has a tunnel diode line with long-term stability of characteristics, small replacement factor and the ruggedness of solid one-piece construction, all of which make it inherently adaptable to microwave integrated circuitry.

In Sylvania's new technique, an oxide protection is applied to thousands of diodes on the surface of each slice; the contacts are then placed over the oxide. Thin film technology forms the basis for this process. (Traditional tunnel diodes, sometimes likened in cross-section view to "a boulder on a pinnacle," are individually alloyed and etched.)

All units are completely metal-bonded; no "glues" are used. The result after dicing is individual tunnel diodes, each 20 mils square and ready for immediate application.

In addition to increased diode reliability, Sylvania's Solid-Structure concept offers the economic advantages of batch processing.

The inherent reliability of Solid-Structure tunnel diodes was evident throughout the entire test program. These units withstand cryogenic to +100°C temperature cycles repeatedly. They pass MIL STD 750 mechanical stress testing, i.e. 1500 G shock, 20 G vibration, 20,000 G centrifuge. Exhaustive tests under these conditions prove the long-term stability of Solid-Structure diodes. And, due to the new manufacturing process, they have lower series resistances than standard tunnel diodes. Resistive cutoff frequencies greater than 50 GHz have been obtained.



The Solid-Structure diode line is available in three package styles. Thus, diodes with identical performances are offered in the D-5360, D-5560 and D-5570 series. (See chart.)

Each series offers a wide choice of diode types capable of meeting most tunnel diode requirements. For example, they include resistive cutoff frequencies to greater than 25 GHz

and a peak current range of 1.0ma to 100ma. A controlled peak current-to-capacitance ratio aids in circuit design considerations where uniform and stable performance is critical.

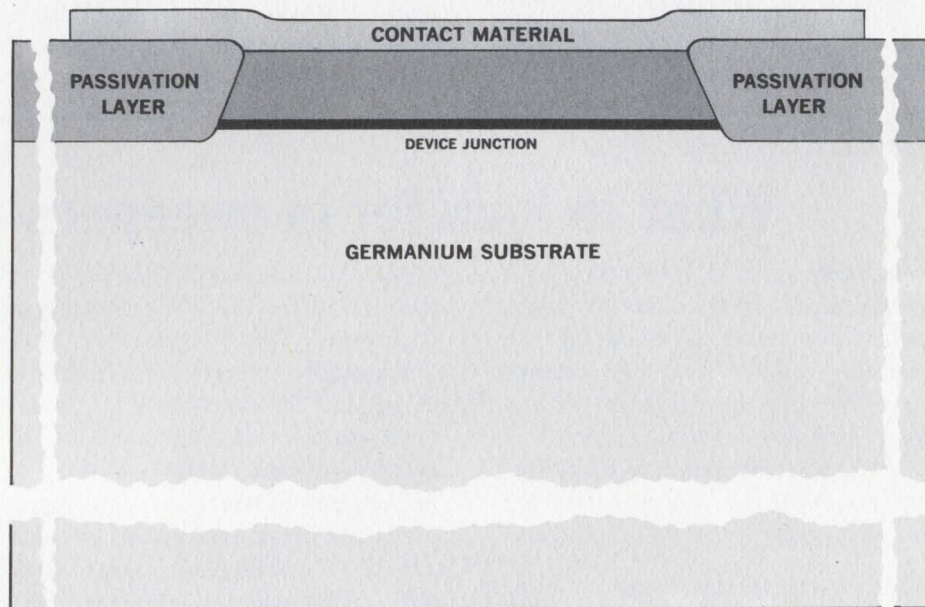
CIRCLE NUMBER 302



	TYPE NO.		I_p Ma $\pm 20\%$	r_j Ohms (typ)	R_s Ohms (max)	C_j Pf (max)	F_{ro} GHz (min)			
	D-5360		D-5560		D-5570	1.2	100	8.0	1.5	5.0
	D-5360A		D-5560A		D-5570A	1.2	100	4.0	0.45	25
			D-5560B		D-5570B	1.2	100	6.0	0.50	20
	D-5361		D-5561		D-5571	1.8	67	7.0	2.0	5.0
	D-5361A		D-5561A		D-5571A	1.8	67	3.0	0.60	25
			D-5561B		D-5571B	1.8	67	6.0	0.70	15
	D-5362		D-5562		D-5572	2.7	44	6.0	3.0	5.0
	D-5362A		D-5562A		D-5572A	2.7	44	2.5	0.75	25
			D-5562B		D-5572B	2.7	44	6.0	1.10	12
	D-5363		D-5563		D-5573	3.9	31	6.0	5.0	5.0
	D-5363A		D-5563A		D-5573A	3.9	31	2.0	1.00	25
			D-5563B		D-5573B	3.9	31	6.0	1.60	10
	D-5364		D-5564		D-5574	5.6	22	6.0	7.0	5.0
	D-5364A		D-5564A		D-5574A	5.6	22	1.5	1.40	25
			D-5564B		D-5574B	5.6	22	6.0	2.30	7.5
	D-5365		D-5565		D-5575	8.2	15	6.0	10.0	5.0
	D-5365A		D-5565A		D-5575A	8.2	15	1.0	2.00	25
			D-5565B		D-5575B	8.2	15	6.0	3.30	5.5

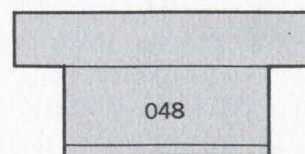
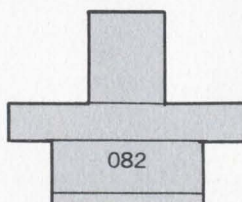
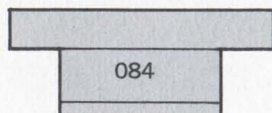

A complete, plug-in CRT assembly for high-resolution photographic recording

Cathode ray tube assemblies, fully preadjusted and prealigned, are of special interest to display designers and users alike.

Consisting of a high-resolution tube, deflection coil, focusing coil, alignment magnets, mu metal shield and supporting hardware, these self-contained packages are individually engineered and custom-built for specific systems. Front end mounting plates are also supplied to specification. Engineers are finding that the assemblies are particularly well suited to high-resolution photographic recording and flying spot scanner usage.

Both installation and servicing are easy. The units can be quickly installed by nontechnical personnel. They are simply plugged in, with no further alignment or adjustment necessary. Should servicing ever be required, disconnecting is easily accomplished and, if necessary, the entire package can be quickly replaced by another assembly. Engineering costs and time are thereby cut to a bare minimum. Since components are prealigned, there is greater assurance

of immediate optimum resolution.

The newest packaged assembly, Sylvania's AT-SK-6000, is designed for use with electrostatic focus tubes, such as the 5CEP and 5ZP, both 5-inch high-resolution CRT's.

The AT-SK-5053 assembly can be furnished with these same two tubes or with any other high-resolution CRT. These other tubes include the 5-inch SC-2782, SC-2809 and SC-3168, as well as the 10-inch SC-3890.

CIRCLE NUMBER 303

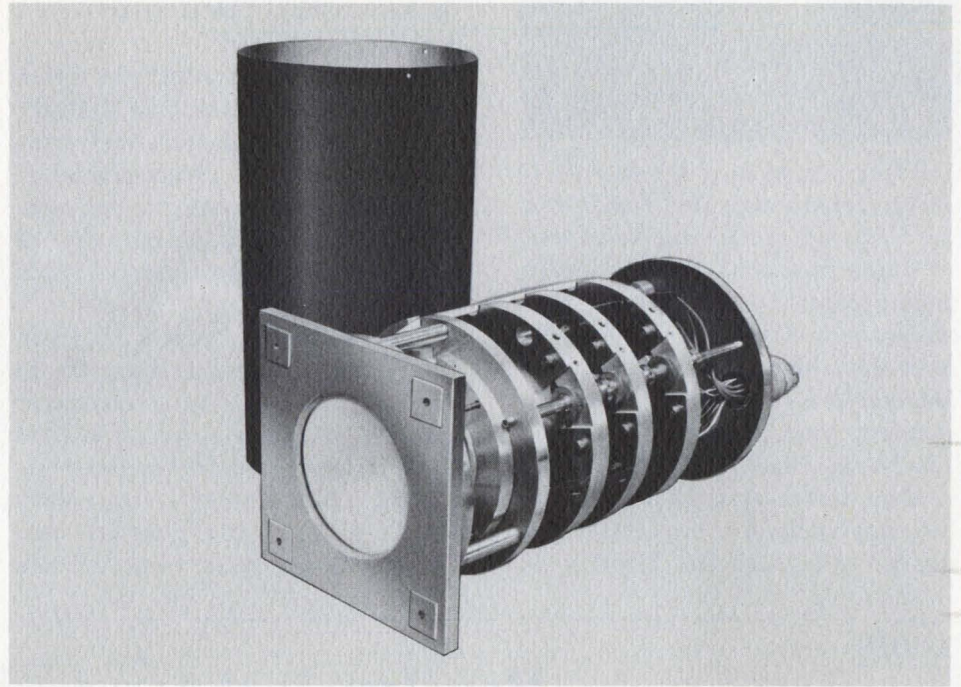

PHOTOCONDUCTOR-LAMP ASSEMBLIES

Noise-free switching at audio and video frequencies

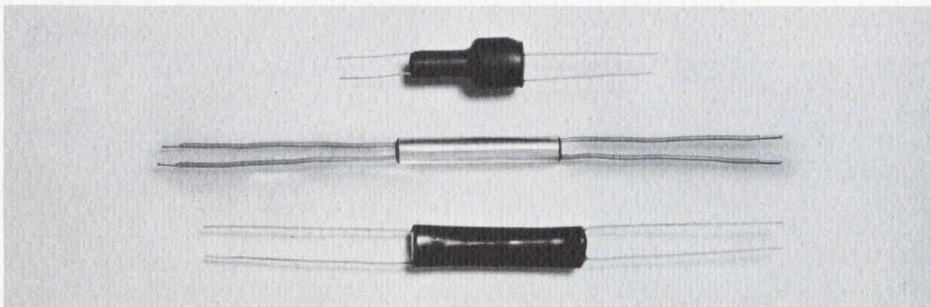

Now switching or continuous attenuation at audio through video frequencies can be noise-free.

The new route to the elimination of electrical noise is a PL assembly, actually a glass-encapsulated cadmium sulfide photoconductor optically coupled to a miniature incandescent indicator lamp. The photoconductor and

lamp are sealed in a small, rugged lightproof housing of plastic or metal.

Using the device in remote control applications, critical amplifier circuits are electrically isolated both from the remote station and from cabling. As a result, inductive or stray magnetic pickup is eliminated as well as all noise from physical movement of

wiper contacts. As applied to the broadcast and television industry, the grid circuit, in effect, can be left back in the transmitter complex.

Sylvania PL assemblies are proving effective in other new applications. Among them are electronic musical instruments (for vibrato, tremolo and percussion effects), "OR" and "AND" logic circuits, noiseless volume or swell control, current-dependent or voltage-dependent noiseless switches, and multi-pole, multi-position switches.

These highly reliable assemblies can be made to order in combinations from any of seven cells and 6, 12 or 24 volt indicator lamps. Non-standard lamp voltages can also be used on special order. To the design engineer, this means that a wide selection of PL assemblies is available in parameters to suit many practical applications.

CIRCLE NUMBER 304

Black Spot Detector seeks out minute defects before the trouble starts

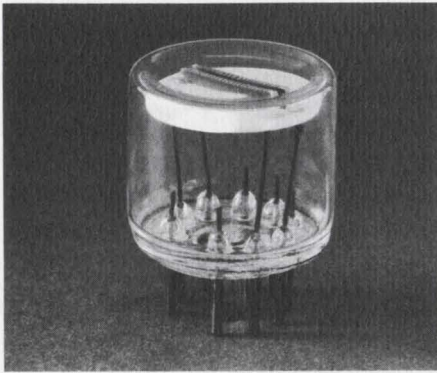

Finding spots and blemishes in opaque, translucent and transparent materials has not always been easy, let alone practical. Until recently, quality control systems used essentially one of two systems, both costly, most often inefficient and often painstakingly slow—the human eye and/or standard photocells.

Sylvania's Black Spot Detector finds random defects as small as 1/32" for such applications as inspecting laundry for stains, eggs for blood spots,

and glass bottles for air bubbles. Before, the best electronic inspection systems were based on standard cells where it was essential that the entire light-sensitive area be masked by a shaded image projected from the defect. Thus many defects of 1/2" and larger would not be detected until a product was in use.

Now an added product plus is that the SRP-3419A Black Spot Detector is available considerably below its original cost. With advanced production techniques turning it out more efficiently, Sylvania can offer the cell attractively priced for critical applications.

This device detects dark images on the surface of opaque materials. In the case of transparent or translucent objects, such as glass or plastic, the cell can look beyond the surface to respond to blemishes either on or within the material. It is generally used in inspecting goods transported on a

conveyor belt. An attendant or automated device can be quickly alerted to remove the defective or unwanted areas.

The Black Spot Detector uses two special photoconductive elements. Each element is made up of a cadmium sulfide strip, which is actually several cells connected in series. Because of this unique dual-element design, varying thermal excursions and changing ambient illumination have little or no effect on the operation of the cell. It also permits the field light source to be operated from AC as well as DC.

The new cell works best in high illumination where its response time is considerably faster than in a low light level. For instance, in taking full advantage of bright light conditions, the SRP-3419A has successfully detected 1/16" spots at a belt speed of 150-foot-per-minute with 12 FC average illumination.

Like all Sylvania photoconductors, this cell also includes the famous Blue Dot, your assurance that the cell is free from moisture.

CIRCLE NUMBER 305

DIODES

New low leakage series replaces many general-purpose types

For the engineer who wants true versatility in a general-purpose diode, Sylvania's new silicon alloy series can be the perfect answer. In this instance, versatility is greatly heightened by the extremely low leakage currents

that are typical of the entire new line.

Using an industry standard diode for comparison, where the long-accepted IN459A shows a current leakage of 25 nanoamps at 175V reverse voltage, Sylvania's new D-6625 is

measured at just 5na, while the D-6625A shows only 1na. At 150°C, again with a reverse voltage of 175V, the newer types are measured at 2µa and 1µa respectively, versus the IN-459A's 5µa.

(continued)

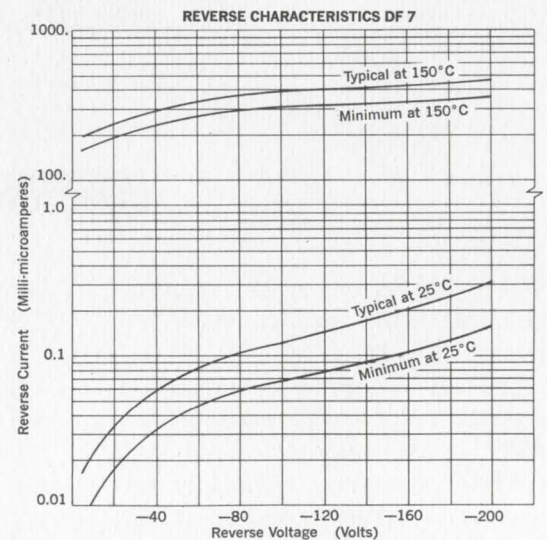
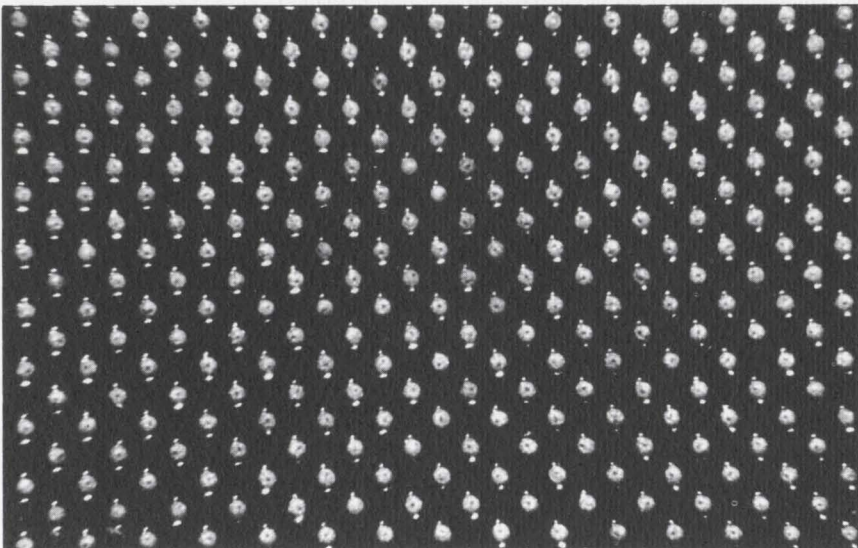

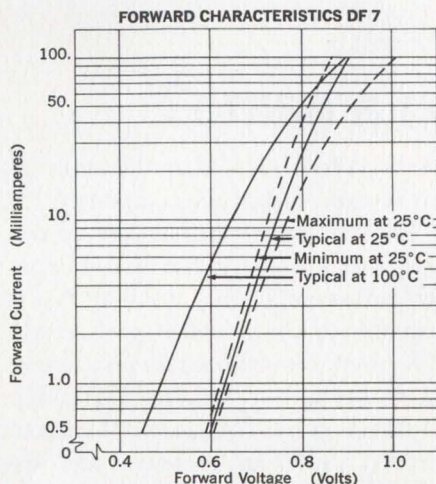

Similar improvements are evident in comparing the low leakage currents of Sylvania's D-6623 and D-6624 diode series with those of standard IN457A and IN458A types.

Their outstanding high temperature and high conductance characteristics are other important considerations to the engineer interested in an unusual combination of features.

The new protected junction is applied simultaneously to make thousands of these diodes during batch processing, a prime reason for both ultra-low leakage current as well as

the series' excellent long-term stability. Inherent also with diode batch processing is uniformity of parameters, assurance to the design engineer of product-to-product compatibility and reliability.

New improved versions of many standard diodes are now available. These products of Sylvania batch processing include:

- | | |
|------------|-----------------|
| IN456, -/A | IN482, -/A, -/B |
| *IN457 | IN483, -/A, -/B |
| *IN458 | IN484, -/A, -/B |
| *IN459 | IN485, -/A, -/B |
| IN461, -/A | IN486, -/A, -/B |
| IN462, -/A | IN487, -/A, -/B |
| IN463, -/A | *IN816 |
| IN464, -/A | IN881 |

*Available MIL approved.

CIRCLE NUMBER 306

RECEIVING TUBES

Trigger tube vital to sensing heat, dust, gas, etc.



Systems with the Sylvania SY-1302, a special-purpose cold cathode thyatron, can detect sudden changes in smoke, heat, dust, gas, moisture, light, pressure and radiation.

Ideal for use with an ionization chamber or other detectors, the SY-1302 has extremely high grid impedance of 10^{12} ohms, an essential characteristic for translating changes that are sudden or minute. Designed as a coupling device between high impedance bridge circuits and devices with lower impedances, it features extremely high insulation resistance and flexible solderable leads. (On order, it can be provided with a 7-pin base in place of the leads.)

A practical illustration of how the tube works is found in a combined smoke detection and alarm system. Smoke enters one of two chambers in the ionization sensor. The heavy smoke particles unbalance the chambers by slowing down the radiation emission hitting the collector. This

results in a sensor output current change. A sudden, though small, change in sensor output current causes the SY-1302 to fire, thus activating the alarm.

Operating life of the SY-1302 is on the order of 1,000 hours or more. Considering that the tube is in use only when the system is in operation, its practical life can be a matter of decades. Its strong advantage is the ability to work on low current under adverse conditions. It is not dependent on ambient light; rather, the tube is designed to function in the complete darkness that a system's housing provides. There is also no measurable radiation output.

Until now, the SY-1302 has been primarily used in smoke detection systems in schools, hotels and other public buildings. But its proven versatility promises it a bright future in helping to solve many other detection systems problems.

CIRCLE NUMBER 307



HOT LINE INQUIRY SERVICE

Use Sylvania's "Hot Line" inquiry service, especially if you require full particulars on any item in a hurry. It's easy and it's free. Circle the reader service number(s) you're most interested in; then fill in your name, title, company and address. We'll do the rest and see you get further information almost by return mail.

BUSINESS REPLY MAIL

No Postage Stamp Necessary if Mailed in the United States

POSTAGE WILL BE PAID BY

SYLVANIA ELECTRONIC COMPONENTS GROUP

Sylvania Electric Products Inc.
1100 Main Street
Buffalo, New York 14209

FIRST CLASS
Permit No. 2833
Buffalo, N. Y.

The ABC's of ECG...or...What's in a name?

Have you ever considered the size of the alphabetical complexity existing in the world today? Just think of it... all sorts of initials and abbreviations, few of which have relatively any immediate meaning. The electronics world is especially inundated, what with initials in place of corporate names, governmental agencies, technical terms, and even products. Does your wife know what a MOS-FET is? Or a CRT, SCR, TWT, or MIL-SPEC? Is it any wonder that people think engineers speak a foreign language?

Silly as initials often seem, in reality they are a useful form of high-speed communications as soon as they gain a functional acceptance. Look at the word "laser." In a relatively brief time it was coined and accepted. Yet it's a fully functional word, one that clearly means Light Amplification by Stimulated Emission of Radiation.

Recently, we at Sylvania dipped into the "alphabet soup" and came out with a few initials of our own—ECG. You may have noticed that we've been using these initials in our recent ads and publicity. They stand for Electronic Components Group, and I'd like to briefly discuss what they mean to you.

To begin with, they represent a complete change in our sales organization... a change made strictly in the best interest of our customers.

We've combined the advanced capabilities of our diverse electronic facilities into one marketing team. The result is an engineering-research-sales organization that delivers information and service from an integrated team of specialists in semiconductors, tubes, microwave devices, readout systems and special components. Compare it, if you will, to one-stop shopping. We feel that an organization of this type is the only practical means of fulfilling Sylvania's role as a major participant in the growing demand for research, development, production and maintenance projects for both industry and government.

Prior to this change, we had separate sales teams for our Semiconductor and Electronic Tube divisions. The two sales forces were calling on essentially the same customers. Some customers were dealing with at least two Sylvania representatives and often with separate policies. Now, as a customer, you can discuss your needs with one man who is familiar with policies, prices, delivery, techni-

cal specifications, and applications for all Sylvania electronic components.

ECG also means that less of our customer's time is taken up in buying Sylvania components, a saving that is valuable to any specifier, particularly if he is concerned with diverse needs. In addition, our Product Marketing department has been strengthened to furnish additional technical and application strength on all products.

We in Sylvania look upon our Product Marketing department as a logistics organization supporting our front-line sales group. The sales organization, therefore, represents any and all electronic components made by Sylvania Electric. In so doing, it is in the best position to advise you on which product to use, whether it be solid-state or vacuum. As a result, we're confident that our customers now receive the best product, service, and advice available today.



Bob Lynch
R. G. LYNCH

SYLVANIA

SUBSIDIARY OF
GENERAL TELEPHONE & ELECTRONICS GTE

NEW CAPABILITIES IN: ELECTRONIC TUBES • SEMICONDUCTORS • MICROWAVE DEVICES • SPECIAL COMPONENTS • DISPLAY DEVICES

NAME _____
 TITLE _____
 COMPANY _____
 ADDRESS _____
 CITY _____ STATE _____

Circle Numbers Corresponding to Product Item

300	301	302	303	304
305	306	307		

Please have a Sales Engineer call



HOT LINE INQUIRY SERVICE

Need information in a hurry? Clip the card and mail it. Be sure to fill in all information requested. We'll rush you full particulars on any item indicated.

You can also get information using the publication's card elsewhere in this issue. Use of the card shown here will simplify handling and save time.

WANT TO SAVE MONEY BY
 USING **GUDEBROD**
 LACING TAPE? . . .



Harness tying may be a relatively minor operation. But it also can be a major cost drain. Lacing tape is one of the smallest costs in the harnessing operation but with Gudebrod Tape you can save dollars in making harnesses. Knots tie easier, workers say they almost tie themselves, knots stay tied, the harness workers can go right on with the harnessing without having to go back for re-tightening. Workers like to use Gudebrod Tape. You cut harnessing time—you have fewer rejects. All of this works for you in saving money on cable harnesses—that's why it pays to specify Gudebrod Lacing Tape, the original flat braided tape. Prove these statements in your own harnessing department—give Gudebrod Tape a comparative test.

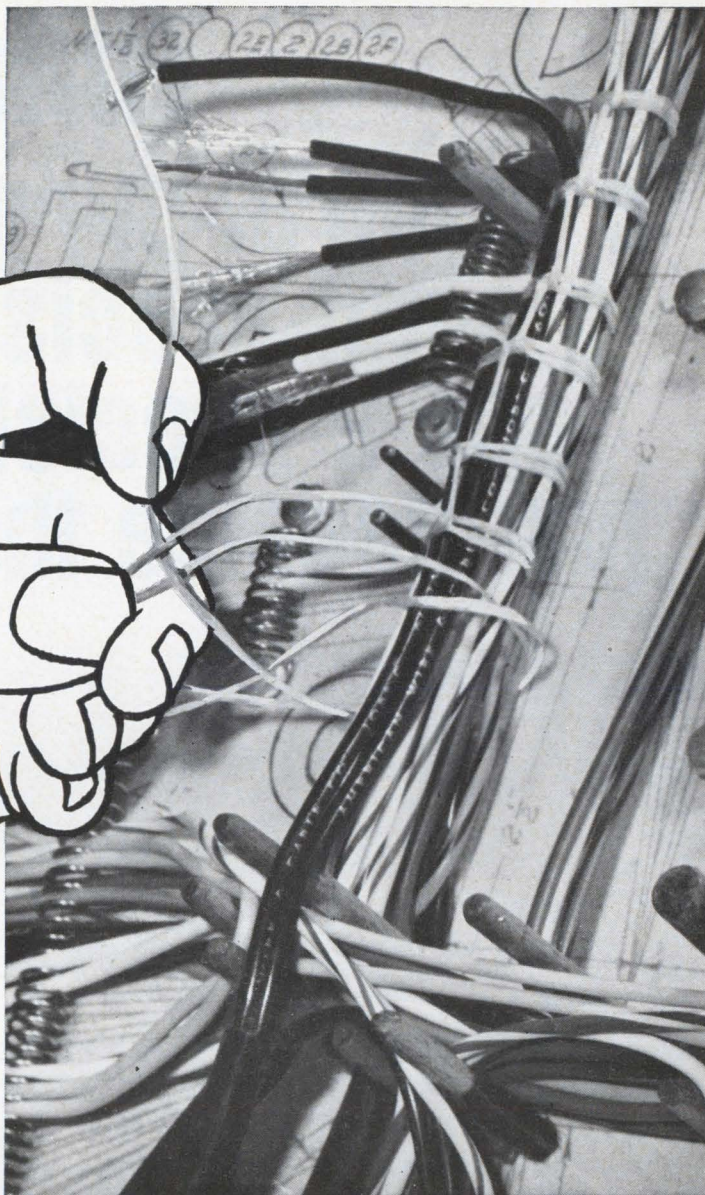

GUDEBROD
 CABLE-LACER



—ANOTHER MONEY SAVER

The first hand tool specifically engineered for continuous wire harnessing. Handle holds bobbin, feeds tape as needed, grips tape for knotting. Speeds, eases harnessing. Has paid for itself in a day in many plants.

CABLE LACING INFORMATION:

When you need help on knots, on spacing, on the type of tape to use—Gudebrod is your one best source for information. We have over 200 different lacing tapes in stock, for temperatures up to 1500° F. or down to -100° F., burn proof

tapes, tapes that do not outgas in vacuum, color coded tapes, cut lengths, tapes of nylon, Dacron*, Teflon*, spun glass, silica fiber. Ask for a copy of our Product Data Book.

*Du Pont Registered Trade Mark

Area Code 215, WA 2-1122



GUDEBROD BROS. SILK CO., INC.

FOUNDED IN 1870

Electronics Division

12 SOUTH 12th STREET, PHILADELPHIA, PENNSYLVANIA 19107

**Today,
a general-purpose resistor,
a semi-precision resistor,
and a precision resistor
just became the same thing.**



New C Styles from CORNING.®

New CORNING[®] C Style Resistors give you precision stability, reliability, 1, 2 and 5% tolerances, 100 ppm T.C.



All of which boils down to this. Only one component to specify, buy and stock. One component you can use for general-purpose, semi-precision and precision use alike. One component that satisfies two military specs, as a look at the table quickly reveals. And you still get all the performance advantages of CORNING Glass-Tin-Oxide film resistor construction. Now for your tests. At our expense. Return coupon for samples.

PERFORMANCE CHARACTERISTICS

Characteristics	New CORNING C-Style Resistors			Mil-R-22684B	Mil-R-10509E Characteristic D*
	70°C	70°C	125°C	70°C	70°C
Temperature Rating	70°C	70°C	125°C	70°C	70°C
Wattage C 4 (RL07S) Resistors, 51 ohms to 150K	¼	¼	1/10	¼	¼
Wattage C 5 (RL20S) Resistors, 10 ohms to 499K	½	¼	¼	½	¼
Load Life ΔR	1.0%	0.5%	0.5%	2%	1%
Design Tolerance ΔR	-2 to +4%	-1 to +2.5%	-1.5 to +3%		
Temperature Coefficient from -55°C to +175°C	±100 ppm			±200 ppm	+200 -500 ppm
Dielectric Withstanding Voltage ΔR	±0.10%			±0.50%	±0.5%
Moisture Resistance ΔR	±0.50%			±1.50%	±1.5%
Short Time Overload ΔR	±0.25%			±0.50%	±0.5%
Temperature Cycling ΔR	±0.25%			±1.00%	±0.5%
Effect of Soldering ΔR	±0.10%			±0.50%	±0.5%
Low Temperature Operation ΔR	±0.50%			±0.50%	±0.5%
Shock ΔR	±0.10%			±0.50%	±0.5%
Vibration ΔR	±0.10%			±0.50%	±0.5%
Terminal Strength ΔR	±0.10%			0.50%	
Voltage Coefficient	±0.001%/Volt				
Shelf Life ΔR	+0.10%/Year				±1.0%

*For Type-marked, military lead Mil-R-10509 E Characteristic D Resistors, specify CORNING NA Style Resistors

CORNING GLASS WORKS, 3913 Electronics Dr., Raleigh, N. C. 27604.
Send complete data, test samples of new CORNING[®] C Style Resistors.

Name _____
Title _____
Company _____
Address _____
City _____ State _____ ZIP _____

CORNING
ELECTRONICS

NEW:

Digital Thermometer/Temperature Controller

0.1°C accuracy* from -192.0°C to +999.9°C

features:

- High absolute accuracy
- Direct reading
- Easily calibrated
- Fully automatic operation
- Outputs for control, recording, or telemetry
- Modular construction
- High reliability

The PAR Model DTS-1 offers a new order of reliability, convenience, and accuracy in laboratory and process control thermometry. The unit operates by comparing the resistance of a sensor element of platinum (the material whose characteristics define the International Temperature Scale) with an internally generated reference function which employs a unique resist-

ance analog network** that precisely duplicates the temperature-versus-resistance change of platinum. This method allows an absolute accuracy* of 0.1°C to be achieved. A modified self-balancing Kelvin bridge eliminates sensor lead resistance errors, permitting precise remote temperature monitoring.

In addition to the direct visual readout, measured temperature information is available in binary coded or 10-line decimal form for printer or computer input as well as in pulse code modulated form for telemetry applications. For temperature control or strip-chart recording applications, an analog signal is provided which is proportional to the difference between the measured temperature and the desired temperature

selected by front panel thumb-wheel switches.

All circuits use solid state components except the comparator amplifier where two miniature nuvistor tubes are used to obtain high input impedance and the reference function generator where mercury-wetted relays are used. The entire Kelvin bridge, including the resistance analog network, is isothermally enclosed to assure a high degree of accuracy and good long-term stability. Rugged modular construction, utilizing printed circuit boards, contributes to reliable performance and extended service-free life.

Price: \$3,950.00 (excluding probe). Write for Bulletin #118.

*Subject to operating range of actual sensor used.

**Patent Pending

PAR **PRINCETON**
APPLIED RESEARCH CORP.
Dept. D
Box 565, Princeton, New Jersey

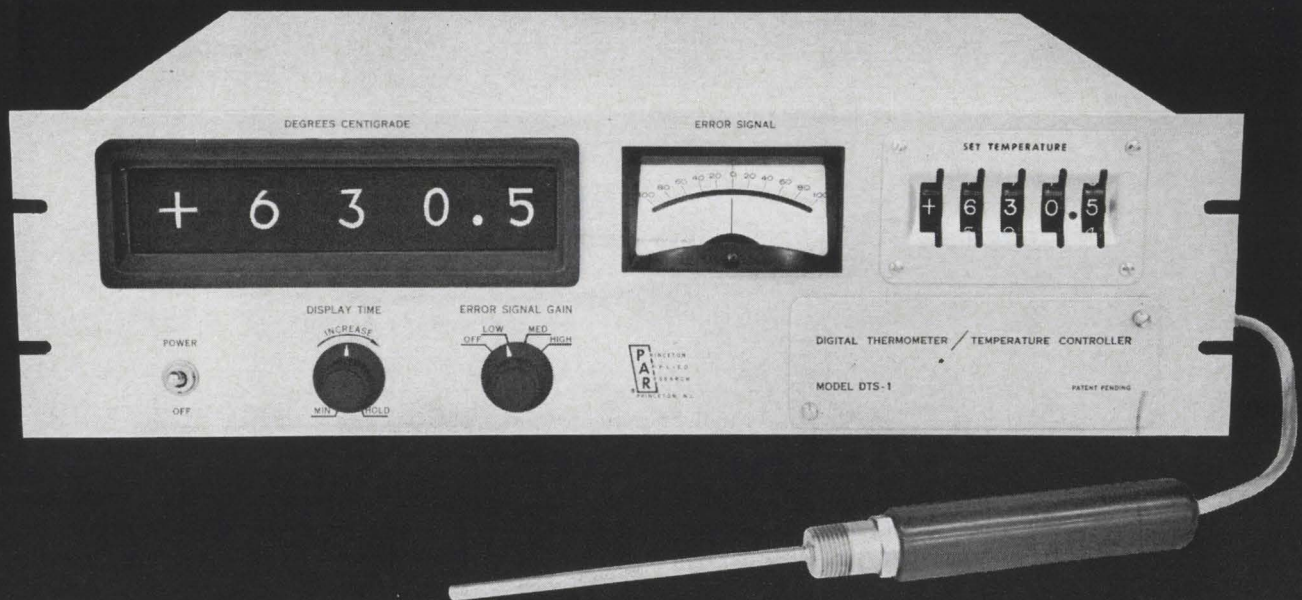

Visit us at booth 4523 and 4524 at the Wescon Show

Electronics Review

Volume 38

Number 17

Military electronics

Time of trial

The war in Vietnam drags on through dense jungles and swampy deltas, in mountain gullies and over rocky hills and flat plains—the wrong place to fight an elusive enemy, but the right place to test new weapons and novel equipment.

The United States military is using this rugged proving ground to experiment with scores of new devices, many of them secret. Some have made the grade, some are still being tested, and still others have been rejected as too fanciful or unworkable.

New headgear. One piece of successful equipment is an eight-ounce radio receiver that is mounted on a soldier's helmet. The grey-green AN/PRR-9 receiver—now being manufactured on an experimental production line by the Delco Radio division of the General Motors Corp.—is said to be able to pick up weak signals that have been attenuated by jungle foliage [Electronics, May 3, p. 64]. Within a month or so, Army officials say, squad leaders in Vietnam will be wearing the receiver-helmets. Some leaders will also carry a lightweight transmitter, the AN/PRT-4, also made by Delco, which can operate on two voice channels at a range of about two miles.

In areas of very dense jungle, where radio signals are too attenuated for voice-grade communication, the Army will use Morse code because a faint dash-dot-dash transmits better than an equally faint voice-grade signal. Combat soldiers won't have to learn how to read Morse code because Army engineers have designed a miniature device that converts the coded pulses into visual signals and displays them on a tube as letters.

Among other combat radios still undergoing extensive field tests



Morse code converter translates dot-dash-dot into letters.

is a lightweight, single-sideband transceiver with many voice channels. It is intended to filter out the extensive radio-broadcast interference that fouls up military communications. For example, some widely used channels pick up programs from both Radio Hanoi and Radio Peking.

Man or beast? Finding the enemy is the toughest job facing Vietnam's defenders. To detect the approach of the Viet Cong, engineers, some at Texas Instruments Incorporated, have developed sensitive seismographs whose tiny transducers pick up the ground vibrations caused by someone walking through the jungle. The equipment is being tried at the perimeters of airfields and near barracks in an effort to avert surprise attacks.

One big problem, still unresolved, is to determine whose footsteps are causing the ground vibrations. The seismograph's au-

tomatic-alarm system must be tuned, for example, to ignore the passage of small animals but not those of guerillas or, in some cases, wandering cows. Getting a device that can distinguish between the footsteps of man and beast is a high-priority task for the engineers.

Other detection devices being tested by the military [Electronics, June 28, 1965, p. 120; Sept. 21, 1964, p. 32], range from trip wires that ring bells and turn on lights when an intruder hits them to an instrument that picks up changes in magnetic field caused by a trespasser.

Of equal interest is a pulse-type loran D navigation system that all the allied military services in Vietnam could use. The low-frequency system being tested is expected to provide accurate position fixes for both air, sea and ground forces.

Flunked. Some of the experimental electronic devices tested in Vietnam have been disappointing. One

was a portable proximity-fuse jammer designed to explode enemy shells prematurely.

Proximity fuses are radar devices that are carried in some artillery shells. When the shell nears the ground, the radar senses a strong signal and the fuse ignites the shell, exploding it just before it lands. An off-the-ground explosion causes more destruction over a wider area than a shell exploding at ground level.

The experimental portable device, a scaled-down version of a model that's carried on a three-quarter ton truck, was designed to confuse the radar by transmitting a wide range of high-power signals. The idea was to match the frequency of the transmitted signal with the frequency of the fuse's radar and explode the shell long before it reached its target. The bigger model does this, Army officials say, but the portable one apparently didn't have enough power to do the job.

Advanced technology

Monolithic computer

In September, a contract that is expected to prove a landmark in the manufacturing of microcircuit computers will be awarded by the Molecular Electronics Branch of the Avionics Laboratory at Wright-Patterson Air Force Base.

The million-dollar contract will be to develop the first "computer on a slice," a type of system that integrated-circuit manufacturers have dreamed of making for years.

The computer is to be built entirely of large arrays of integrated circuits. The monolithic arrays are to have no fewer than 100 circuits, and may have as many as 1,000 circuits. All circuit interconnections are to be located on the array.

In the running for the contract are the Autonetics division of North American Aviation, Inc., General Micro-Electronics, Inc., TWR, Inc., Motorola, Inc. teamed with the Univac division of the Sperry Rand Corp., Texas Instru-

ments Incorporated, Westinghouse Electric Corp., the Radio Corp of America, Litton Industries, Inc., and the Fairchild Camera & Instrument Corp.

MOS or bipolar? The contract competition should help settle a controversy: are conventional integrated circuits made with bipolar devices best for computers, or are metal-oxide-semiconductor (MOS) circuits? Bidders were allowed to choose either, or a combination of both. But they had to be competent in both technologies and justify their choices in terms of reliability, cost, performance and applicability to integrated arrays.

The project officers expect to spend a month evaluating the proposals, which were submitted the week of Aug. 9. But a preliminary reading indicates that most bidders preferred a mix of both types and that they apparently favored MOS for the memory subsystem.

Coincidence. Each bidder was free to choose the type of research system he builds, but the Air Force suggested that it be a general-purpose digital computer that could be used for navigation or to control terrain-following radar in aircraft.

Two of the Molecular Electronics Branch's most important programs are a low-cost inertial-navigation system that will include a low-cost computer [Electronics, May 17, 1965, p. 108] and an airborne phased-array radar made of inte-

grated circuits [Electronics, March 22, 1965, p. 122].

The contractor will have up to three years to build the computer, spending most of the time researching and proving out techniques of making the arrays. The main goals are techniques that will improve system reliability 10 times over systems made with packaged microcircuits, while improving performance and reducing cost.

This should be possible, project officers think, because the intrinsic reliability of an integrated circuit is 10 times as great as the reliability of a system after IC's are packaged and interconnected with wiring. And, they add, packaging doubles the cost.

Computers

Bookbinding

The Alert, the microcircuit flight computer introduced by Honeywell, Inc., this month [Electronics, Aug. 9, p. 17], has a fast add time of 2 microseconds—but the company is also proud of its fast repair time. Where similar computers require an average of 30 hours to repair, Honeywell says, Alert can be made fully alert again in about an hour.

Honeywell's secret is an open book. With 1,199 logic circuits and

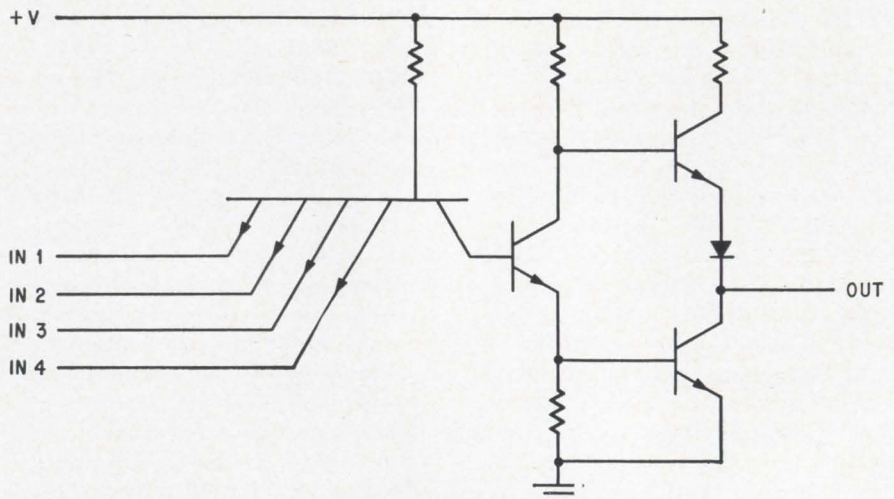

Typical logic circuit in the Alert. This is a four-input NAND. Multiple-emitter transistor at left replaces usual diodes at input.

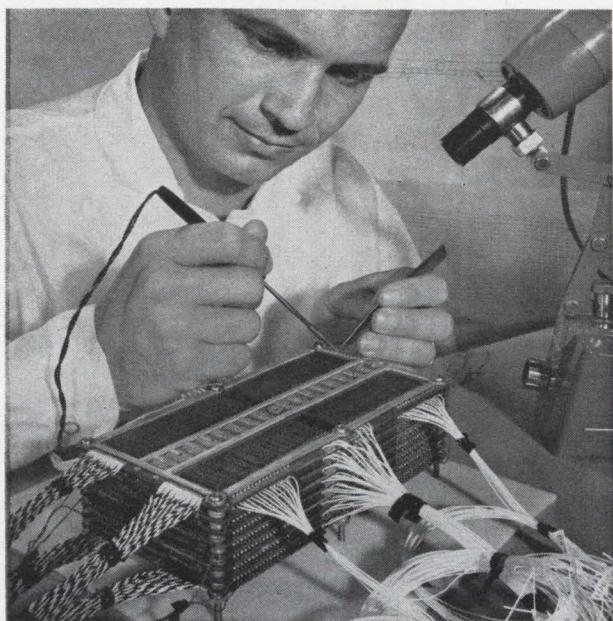

Memory stack (above) can be repaired by using spare words in each plane. Stack is built by wiring board edges (right) and folding up the planes.

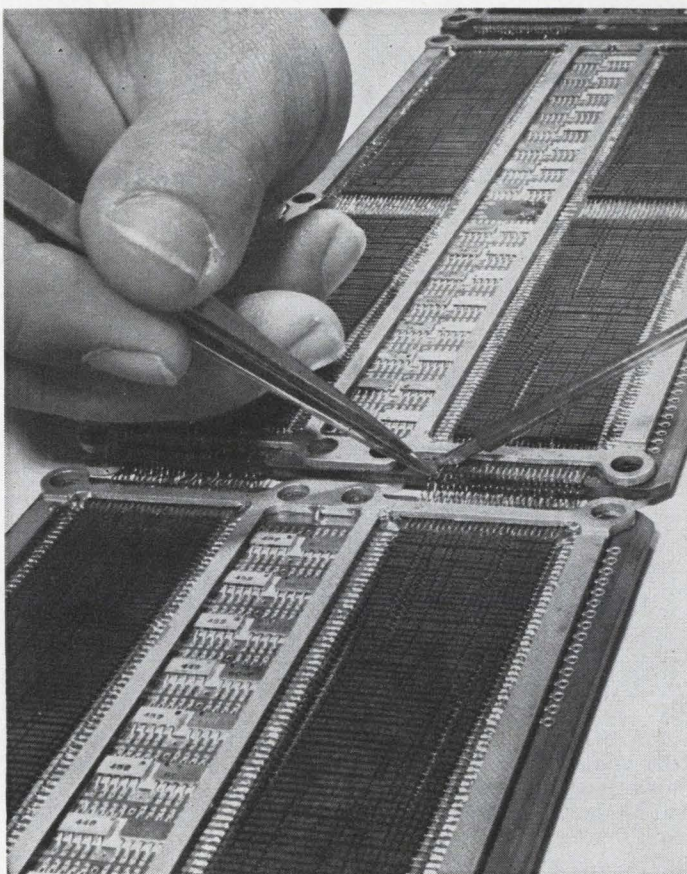

a 4,096-word memory packed into less than a cubic foot, the problem was in gaining access to the sub-assemblies. Honeywell mounted six multilayer logic circuit boards and eight memory boards on hinges, so they can be flipped like pages for easy test and repair.

Quick clip. Isolation of a faulty board is performed by test equipment which itself is computerized. The operator then removes the board and tests it for the bad circuit with another computer that gives him step-by-step instructions. An integrated circuit can be removed by clipping the flatpack leads, and a new one put on with an automatic welder. Robert Acker, a Honeywell engineer who helped design Alert and now sells it, says a technician can learn to weld in a few hours.

The logic circuits are a new family of high-level transistor-transistor logic (HLTTL) integrated circuits. Instead of the diode logic usually found in front of the transistors in diode-transistor logic (DTL), HLTTL has a multi-emitter

transistor that acts as a high-speed cluster of diodes. Circuit speeds are 40 nanoseconds or less. The configuration is illustrated on page 40. The circuit output is of the bi-directional type known as "totem pole," which increases speed. The top output transistor drives the signal level up; the bottom one pulls the level down.

Folded memory. The memory, of 4,096 words of 24 bits each, is a read-only, nondestructive-readout type made of Biax cores. There are eight memory boards, joined end to end with wires, folded up and put into a hinged housing.

Each plane has 32 spare words. A repair job usually consists of finding the bad word with the test equipment, disconnecting it by removing one of the exposed wires at the board edge, and wiring in a spare word. If the memory stack were badly damaged—for example, Acker says, if a bullet went through it—it would take four hours for disassembly and 12 hours to make repairs and put the stack back together.

Book packaging was never a best-seller in conventional computers, because large numbers of circuit boards meant cabling problems. But books are catching on in microcircuit computers, which have relatively few circuit boards. Another computer with a book is the MSP-24 built by Sylvania Electric Products Inc., a subsidiary of the General Telephone and Electronics Corp. The MSP-24 has 4,000 circuits on 38 pages, in an 18-inch cube. That, plus two memory modules about the same size, make up a computer that can do as much work as Sylvania's old Mobidic field computer, which was housed in a 30-foot van.

Bit of a squeeze

The International Business Machines Corp. has modified its phase encoding technique for storing bits of information on magnetic tape to provide a density of 1,600 bits per inch. Phase encoding was previously used on IBM's 7340 Hyper-

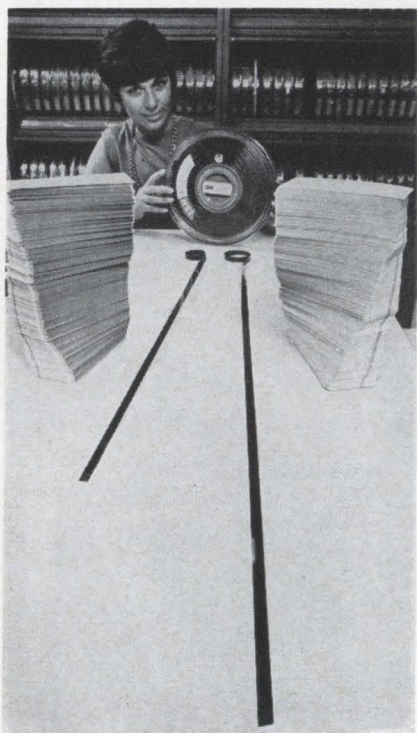

Strips of magnetic computer tape contain equal number of digital bits. Data on shorter tape is encoded with IBM's new phase technique, which doubles digit density.

tape system, which came out in 1961; but the new system, designed as an auxiliary memory for the System 360, can be adapted to take older tapes, with different coding methods—a feature that was not available with Hypertape.

In a phase encoding system, a binary one is represented by a change in magnetic flux from plus to minus, and a zero is a change from minus to plus. The method ensures that a flaw in the tape cannot be mistaken for a mere string of zeroes, as is the case with methods that represent a one as a pulse and a zero as lack of a pulse. Moreover, noise cannot cause a zero to be taken for a one.

However, to represent a string of zeroes, the phase encoding system needs a signal detector that will “blink” at the right times so as not to read a change back to minus as a one.

Timing trouble. Coding systems that represented a one as a change of flux in either direction and a zero as no change of flux ran into timing difficulties, and the best density IBM could achieve with them was

800 bits per inch—using standard tape.

The new system has nine tracks across the tape, for an eight-bit character and a parity bit. The latter is defined so that there is always an odd number of ones in any character. If one bit should drop out because of a tape flaw, a count of the remaining bits will indicate whether the missing bit was a one or a zero.

The new tape units will rent for from \$950 to \$1,535 per month, depending on the model. This is about \$50 a month more than the comparable 2400 series units previously announced for System 360, and compares with the \$950 a month IBM charges for its 729 Model VI tape drives, the workhorse that has been around for several years. Delivery of the new series is scheduled to begin in the spring of 1966.

For an extra \$25 a month, the user can have equipment that will allow him to use his old tapes with the new units. This equipment has an old-style detection circuit in parallel with a phase-encoding detection circuit. A signal on the leader of the tape tells the equipment which circuit to use.

Solid state

FET switch

“It’s the switch we’ve all been looking for,” says James Patmore, an engineer at Electronic Associates, Inc., a major producer of analog computers. “It’s the first solid state device that can switch as well as a relay at low speeds, and as fast as diode and transistor switches,” he adds.

Patmore was talking about field effect transistors and their ability to solve one of the toughest problems in solid state circuits—producing a hybrid analog switch.

Another important consideration, Patmore notes, is that FET’s at their current prices of \$3 to \$5 are cheaper than high-quality relays.

Switching. Electronic Associates will introduce a combination an-

alog-digital computer on Sept. 1 that uses FET’s for the key hybrid-operation switches. And Beckman Instruments, Inc., recently brought out a computer that uses FET switches.

One of the first to switch to FET’s was the Comcor division of Astrodata, Inc., a relatively small producer of hybrid machines. Comcor beat the bigger companies by about two years with its FET model. Now, all the big producers are switching with FET’s.

Isolation. Low leakage is needed to hold voltages “memorized” on capacitors at various times during hybrid computation. “We found that the high input impedance gives us the same isolation between the switching signal and the signal being switched that we obtained with relays,” explains EAI’s Patmore.

About the only drawback to FET analog switches is the large “on” resistance. However, according to Patmore, this is not a problem in the hybrid application because the FET switches are inside an amplifier feedback loop. The resistance, roughly 100 ohms, is small compared with the amplifier’s input resistance. EAI said it is using FET’s made by Texas Instruments Incorporated and Amelco, Inc.

In the Beckman computers, the FET drives a double-emitter type transistor switch; while it’s more expensive, the combination provides switching signal isolation with low output resistance—less than 10 ohms.

Beckman is using FET’s produced by the Raytheon Co. and double-emitter switches made by the Sperry Rand Corp.’s Semiconductor division.

Communications

The silent world

Now that man is developing techniques for working and living in the ocean [see story on p. 111], he is finding the need for talking under water more pressing. For short ranges, sound itself, which

TRW zeners end voltage irregularity!

"They work while you sleep."

See for yourself what science knows! Here are results of a laboratory test comparing TRW voltage regulators with those of other major manufacturers:

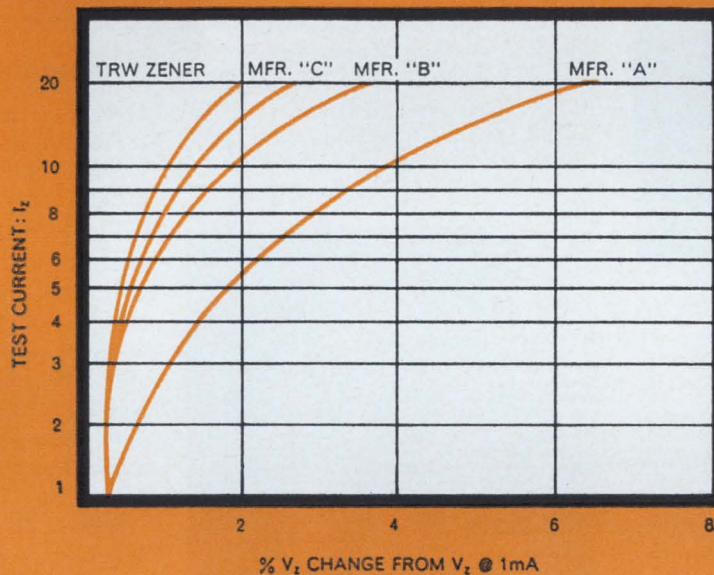

This impartial test shows that TRW gives you the best and mildest internal voltage regulation.* We'll provide complete information on the new TRW 1N4628 premium regulator series—the first specifically characterized for this use. For this, plus a free sample (mailed in plain wrapper), contact us at 14520 Aviation Blvd., Lawndale, Calif. Or call 213-679-4561 (ext. 263).

*TRW is habit-forming. If voltage irregularity persists, see your local distributor.

TRW SEMICONDUCTORS

travels through water better than through air, may be more practical than radio waves; the problem is in devising ways of transmission and reception.

Jetronic Industries, Inc., has developed sonic communications gear for Navy skindivers, which has a range of about one mile, several



Talking under water with Yack-Yack, an inexpensive device for the hobby market . . .

times farther than earlier sonic equipment. This month, Jetronic received a \$165,000 contract to build 210 sets. The 2½-pound, battery-powered device, called the AN/PQC-1A, consists of a microphone and a transceiver, built into a helmet; atop the helmet is a dish antenna that radiates and receives sound waves.

Jetronic engineers decided to transmit the sounds at between 8,000 to 11,000 cycles per second because sound at that frequency travels farther through the water than voice-range frequencies—30 to 3,000 cycles per second. The transmitter boosts the frequency of the speaker's voice, and the receiver tones it down.

The Navy has developed shipboard equipment, not made by Jetronic, to communicate over the side with any skindiver wearing the instrument.

For fun, too. Jetronic currently has no plans to produce the device for the commercial or hobby fields

—largely because of the price, about \$800 a set. But another company, Y Square Marine, Inc., has developed a simpler and cheaper underwater set for the hobby market. Y Square's device, called the Yack-Yack, costs about \$100. It doesn't boost the frequency of the voice and its range is limited to about 100 feet. On the other hand, the person being talked to doesn't need receiving equipment to hear the message. The sounds are heard through bone conduction, the way some near-deaf persons hear.

The developer of the Yack-Yack, Yujiro Yamamoto, who is president of Y Square, says the major problem that had to be overcome before sound could be adequately radiated into the water was the design of a speaker system. Cone-type speakers are nearly useless under water, he explains, because most of the audio energy is lost when the waves



. . . and with more costly Navy device that has a range of about one mile.

are reflected back by the relatively noncompressible fluid.

Vibrating case. Yamamoto designed a transmitter that is impedance-matched to the water; the entire transmitter case vibrates to

generate omnidirectional audio-frequency waves.

To protect the skindiver from swallowing water while he's talking, the Yack-Yack ceramic throat microphone fits inside a full face mask. All the electronics are solid state discrete components. However, integrated circuits are being considered for future models, the company says.

For an extra \$284, Y Square offers a transceiver that can be hung over the side of a boat for communication with the diver.

Microelectronics

Testing the MOS

Only two integrated-circuit manufacturers, the General Instrument Corp. and General Micro-electronics, Inc., are selling lines of metal-oxide-semiconductor (MOS) circuits. But evaluation programs now going on at several companies—chiefly the Sperry Gyroscope Co., a division of the Sperry Rand Corp., and the Autonetics division of North American Aviation, Inc.—may change the picture, and bring other manufacturers into the MOS field.

Since December of last year, Sperry has been studying the performance of conventional monolithic (double-diffused) IC's and MOS circuits in identical applications. On Sperry's decision may depend not only on that company's IC purchases, but also on those of other major users.

Swing the scales. Sperry does not at present use MOS circuits, and won't decide on future use for six months to a year. But Sperry engineers are impressed by two advantages of the MOS: its capacity for more functions in the same chip area, and its low power dissipation. Other factors being equal, these two could swing the scales to the MOS.

Sperry recently tested both types of IC's in a frequency division application. A modified Schmitt trigger and a Darlington amplifier, both built with discrete compo-

little  switch

BIG SAVINGS

Half the cost of conventional multi-position switches and loaded with multiple performance design advantages. Spectrol's miniature switches give you performance characteristics for printed and micro-circuit applications never before available in so small a package at such low prices. Reliable, trouble free operation is assured by the unique construction features of the type 88 rotary indexing switches.

DIRECT MOUNTING — Reduces wiring costs — mounts directly on printed circuit boards.

TROUBLE-FREE OPERATION — Contacts are kept free of oxides and other harmful film deposits by the self scrubbing design that polishes during every duty cycle.

FULL POTTING PERMITTED — Dust-free, moisture-free operation insured by silicone rubber scaling and packing gland techniques.

MILITARIZED — Designed to stand up under high shock, vibration, temperature extremes, and other severe environments per MIL-STD-202B.

LOW ARCING — LOW NOISE — Higher contact force and elimination of tracking made possible by the cam actuated "lift-off," "drop-on" wiper action.

THREE CONFIGURATIONS — Choice of knob, screw driver adjust or bushing panel mount.

88-3-8
SLOTTED
HEAD



ACTUAL SIZE

88-3-10
KNOB



88-5-6
BUSHING



BRIEF SPECIFICATIONS

Switch type.....Single pole, 10 position, non-shorting
 Switch action.....Positive detent action, 36° indexing
 Current rating.....250 MA at 28 VDC
 Case dimensions
 (inches)..... $\frac{3}{16}$ H max x $\frac{1}{2}$ D (88-3-8)
 Price 1 to 9 pieces....\$3.75

MODEL 88

Call your nearest Spectrol distributor for immediate off-the-shelf delivery at factory prices, or write for complete specifications. Spectrol also manufactures a complete line of trimming potentiometers and turns-counting dials.

SPECTROL ELECTRONICS CORPORATION

1704 South Del Mar Avenue
 San Gabriel, California

Adams Court
 Plainview, L.I. New York

"See us at WESCON, Booths 2409-10."

BRANCH-OUT WITH ZT...

CUT DOWN ON CABLING COSTS!



A.



B.

A. ZT Protector Boots let you handle special cabling problems quickly and economically in your own plant. Designed for two or more separate connectors or break-outs, they zip on in seconds and are easily re-opened for inspection or modification. Made of polyvinylchloride, ZT Protector Boots can be permanently sealed if desired.

B. ZT SPLICE COVERS protect spliced cable areas and zip closed. Ends can be clamped or taped to the cable to create an effective moisture barrier.

If you'd like more information on ZT Splice Covers or assistance on intricate design configurations requiring special cable protection, just call or write. Zippertubing® engineers are at your service!



THE Zippertubing® co.

13000 S. Broadway • Los Angeles 61, Calif.
Phone: 213-FA 1-3901 • TWX 213-327-0120

Electronics Review

nents, were used as controls; the IC's were used as flip-flop counters between them. Both MOS and conventional circuits performed well, despite fluctuations in the supply voltage and variations in temperature from -50° to $+125^{\circ}$ C. But the conventional integrated circuits used 80 milliwatts of power, compared with only 20 for the MOS. Both circuits are rated at 10 megacycles.

The comparative power consumption bore out the results of recent activity at General Micro-electronics, which put MOS circuits into a navigational computer originally built with conventional monolithic circuits. The MOS's cut power consumption from 65 watts to 7.

Autonetics has already decided to use MOS integrated circuits, but it declines to say where. It has been building its own MOS circuits as well as buying them, and is currently looking at MOS circuitry containing complimentary transistors.

A close look. Litton Industries, Inc., the Hughes Aircraft Corp., and the Nortronics division of the Northrop Corp. are also evaluating MOS circuits, as are the Raytheon Co., the Lockheed Aircraft Corp., Astrodata, Inc., and the American Machine and Foundry Co. But none of these companies is conducting a program as intensive as Sperry's.

Migratory gold

The use of gold-aluminum bonds in high-reliability military circuits has been severely criticized. The bonds are due to become even more unpopular at Wescon.

Reliability experts from the Autonetics division of North American Aviation, Inc., will strongly recommend that such circuits eliminate gold-aluminum bonds. Autonetics made a comprehensive study of bond failures, using electron microprobes and x-ray diffraction analysis as part of the Minuteman-2 reliability program. The findings will be discussed at a Wescon symposium.

Hidden failures. The study veri-

fied the long-standing suspicion that the migration of gold into the aluminum is a more serious cause of failure than purple plague [see related article on p. 98]. Plague problems caused some circuit manufacturers to get off the gold-aluminum standard.

Plague can be kept under control by careful processing and temperature control, but migration is "cancerous," says Donald Cummings, head of high-reliability component engineering in Autonetics' Data Systems division. "Once migration starts, it will continue."

The formation of gold-aluminum intermetallics between the lead end and the aluminum bonding pad causes stresses and cracks to appear around the intermetallics. The interface apparently is the path along which the gold migrates by diffusion from the edges of the intermetallic bond into the adjacent aluminum stripe that connects the bond to circuit components.

Time-sequence photos show the gold diffusion creeping along the stripe. As the gold migrates, it leaves a void around the bond which may separate the periphery of the lead end from the stripe and in time completely separate the lead from the circuit.

If the lead is separated from the stripe, but not from the circuit, the failure may be difficult to detect and analyze. A voltage pulse, such as a test pulse, can temporarily heal the failure.

The cure. The problem was discovered, Cummings says, before Minuteman systems were produced for operational use, and a cure has been found. If the aluminum is oxidized before the leads are bonded, the bond failure rate is only 0.000025% per thousand hours at 50° C. Apparently, the oxide blocks migration of the gold into the aluminum. Depositing a third metal atop the aluminum can also block the migration.

This finding resulted from an investigation of why circuits made by some manufacturers failed far less than others. All suppliers were baking out the circuits at 425° C in nitrogen before bonding, but some of them also used air. Bonds made to unoxidized aluminum failed 100

times more frequently.

Nevertheless, Cummings says, "Now it is recognized by all suppliers that you don't use gold-aluminum in high reliability circuits." Using other metals is the only sure cure for both purple plague and gold migration. All of Autonetics' suppliers have switched, or will switch soon, to gold wires on gold films, or aluminum wires on aluminum films.

Instrumentation

Under pressure

What began as a quest for a transducer that would measure the pressures of dental fillings as they dried and expanded, ended with an instrument that can withstand up to 75,000 pounds per square inch of pressure and temperatures up to 400°C. Conventional transducers break down after pressures of 40,000 psi.

Frank F. Stucki, an engineer at the Lockheed Missiles and Space Co., did more than develop this rugged transducer that's no bigger than a pinhead; he's walking around with two of them in his teeth. They were placed there by a researcher at the University of California Dental School, where the whole thing started when someone began wondering about the properties of dental fillings.

The Lockheed transducer is made from a ferrite material and shaped like a doughnut, 30 mils in diameter. A drive coil and an input coil are wound around the core and the drive coil is also connected to either a square-wave or sine-wave current pulse source.

Digital output. Aside from its ruggedness, several other features make the miniature core transducer unusually attractive for some measuring jobs. For one, the device generates a digital output and can sample rates up to about 350 kilocycles; conventional transducers, on the other hand, produce an analog output, hence their response is inherently slower.

Secondly, the core device has no mechanical hysteresis, so it could make a series of accurate readings even if the pressure were to rise and then fall; all semiconductor

NEED INDUCTORS FOR PRINTED CIRCUIT BOARD MOUNTING?

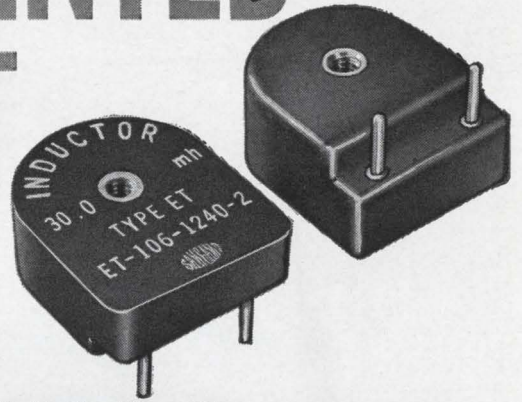

Sangamo offers 72 hour delivery on all prototype encapsulated inductors.

With Sangamo encapsulated inductors, your assembly time is shortened. There's no need to solder individual

wire leads to terminals. Mount the Sangamo inductor onto the card and dip solder—that's all.

SIZE: The type ET is a miniaturized toroidal inductor. Dimensions, shown on diagram, make it ideal for mounting on circuit boards where spacing is critical. Any custom inductance value from 1.00mh to 2.50h is available at no additional cost.

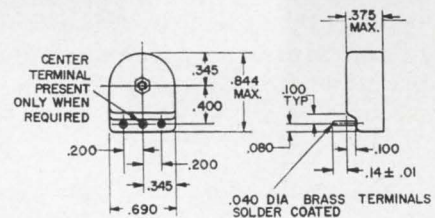

CONFIGURATION: The design of the ET-1 provides an excellent wash area for easy flux removal after soldering. Units are available with a third terminal to provide a tapped inductor.

FEATURES: Vacuum encapsulated units assure a void-free envelope. Inductors are impervious to moisture and have extremely stable electrical and temperature characteristics, plus exceptionally high Q values. Send for Engineering Bulletin 2721A.



EC65-2

SANGAMO ELECTRIC COMPANY • P.O. BOX 359 • SPRINGFIELD, ILLINOIS 62705

MATCHED PAIRS

by AMELCO

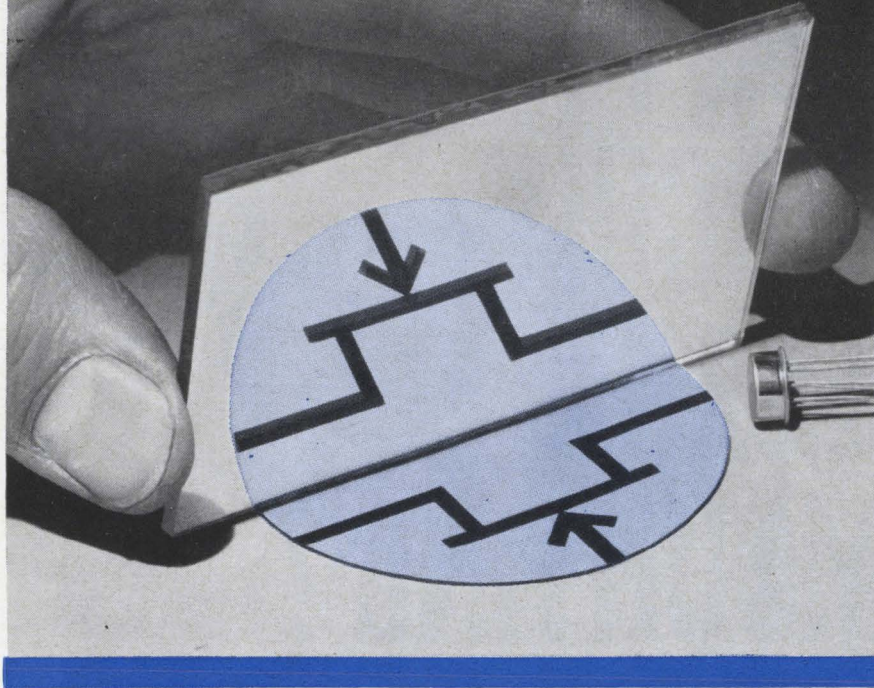

Amelco FET Differential Amplifiers combine high input impedance with minimum tracking error!

Until now, poor tracking was the price of high input impedance when using field effect transistors. Now Amelco is producing the 2N3921 with tracking better than $10\mu\text{V}/^\circ\text{C}$ and input offset of less than 5 mV. The price for this high input impedance, with tight tracking, is extremely reasonable. Where less stringent temperature characteristics are allowed, the lower priced 2N3922 is available with tracking better than $25\mu\text{V}/^\circ\text{C}$.

Prices	1 - 49	50 - 249
2N3921	\$30.00	\$20.00
2N3922	\$22.00	\$14.50

GUARANTEED VALUES 2N3921

- ▲ TRACKING = $10\mu\text{V}/^\circ\text{C}$
- ▲ OFFSET = 5 mV
- ▲ LEAKAGE = 0.25 nA
- ▲ TRANSCONDUCTANCE = 1500 μmhos
- ▲ NOISE FIGURE = 2.0 db



AMELCO SEMICONDUCTOR

DIVISION OF TELEDYNE, INC.
1300 TERRA BELLA AVE., MOUNTAIN VIEW, CALIFORNIA

Mail Address: P. O. Box 1030, Mountain View, Calif./Phone: (415) 968-9241/TWX: (415) 969-9112/Telex: 033-914

REGIONAL OFFICES

Southwest	East	Midwest
3216 West El Segundo Blvd. Hawthorne, California (213) 772-6341	P. O. Box 1927 Paterson, New Jersey 07509 (516) 334-7997	650 West Algonquin Road Des Plaines, Illinois (312) 439-3250
Northwest 1300 Terra Bella Avenue Mountain View, California (415) 968-9241	Northeast 543 High Street Westwood, Massachusetts (617) 326-6600	2428 West 22nd Street Minneapolis, Minnesota (612) 374-1969

and tunnel diode pressure transducers are affected by hysteresis to some degree.

Internal pressures. In one in-house application, Lockheed is using the device to keep tabs on the pressures that build up inside the protective plotting materials which are used to encapsulate complex circuits. With knowledge of the various internal pressures, the circuit designers can safeguard delicate diodes and other devices from being crushed as the potting material hardens.

Lockheed also plans to use the transducer in airplane tires; by vulcanizing them inside the rubber, and attaching probes to the devices, aeronautical engineers would be able to measure the pressure exerted on the tires when a plane lands. Conventional crystal transducers wouldn't stand the heat during vulcanization of the rubber.

Customers. Although Lockheed has no current marketing plans, engineers there foresee a potentially large market in the field of natural resources. Since the device has a low cycle time (as little as 10%) and doesn't use much power (as little as 50 milliamperes), small solar cells would be sufficient to power the transducers in out-of-the-way locations. For instance, water conservation officials might use the device to predict the amount of spring run-off in a watershed area.

Electronics notes

▪ **Coaxial cable.** The Bell Telephone Laboratories has developed a coaxial cable with twice the capacity of any long-distance broadband system now in commercial use. The system, called the L-4, can handle 32,400 voice channels over routes several thousand miles long, using transistor repeaters every two miles.

▪ **Mortar radar.** The Army Electronics Command at Fort Monmouth, N. J., is seeking bids for a radar system, weighing no more than 400 pounds, that can track enemy mortar fire and calculate the launcher site.

Now...the world's most reliable and versatile DVM has a modern new package and new low price!

CONDENSED SPECIFICATIONS ALL THESE FEATURES FOR \$1395!

Read-out speed:	2 readings/per second
Accuracy: DC	.01%
Ratio	.005%
Ranging:	Automatic or manual
Polarity:	Automatic
Accessories:	Optional



Prices and specifications subject to change.

If you consider price, features, and quality . . . the Cubic DV-271 is your best digital voltmeter buy! Based on the time-proved design of the famous Cubic V-71, this new transistorized 4-digit DVM offers a clean-cut front panel for easy read-out . . . and sells for only \$1395!

Versatile DV-271 is ideal for your most highly-specialized measurement needs. It is the only low-cost DVM available with both dependable reed-relay operation and built-in ratiometer!

For complete information on this and other digital equipment, write: Cubic Corporation, Industrial Division, Dept. D-196, San Diego, California 92123.



CUBIC
CORPORATION
SAN DIEGO, CALIFORNIA 92123
INDUSTRIAL DIV.

4 5 6 8 9 7 2 3
 7 5 9 3 8 2 1 6
 2 4 8 6 7 5 1 3

Beckman 1453
*#1,320**

9.99999999
 88.88888888
 777.777777
 6666.666666
 55555.5555
 444444.44
 333333.33
 222222.22
 111111.11
 000000.00

CMC 410 Printer
#1,480

1	3	6	6	6	6	6	4
1	3	6	6	6	6	6	4
1	3	6	6	6	6	6	4
1	3	6	6	6	6	6	4
1	3	6	6	6	6	6	4

Hewlett-Packard 562AR
*#1,715**

Just one darn second!

*Plus extra cost for decimal column.

Actual size facsimile tapes show results of 1-second printing time.

Tear a piece of tape off all three big-name digital instrumentation printers. Compare speed and readability. One obviously prints at least twice as fast. Obviously one can be read without getting ink on your nose. One reason is, our new CMC 410 Printer is not just another rebuilt adding machine. Another reason: our logic conversion is all electronic. 35-millisecond data-gathering won't stall your source. Only the CMC 410 prints a floating decimal without the cost of an extra column. Our printer is quiet, compact (only half-rack size) solid-state, versatile, and all that. It spews out 8-digit columns at 10 lines per sec. 4 to 12 columns are available. This new CMC 410 Printer is another step in our demoniacal plan to unseat some of the other big names in this business. Wait 'til you see what's next! Incidentally, we still have some of our glorious Crusading Engineer medals lying about. We'd sure be happy to send you this status symbol along with the specs for the new CMC 410 Printer. Just write and ask. If you already have a medal, pin this one on your secretary... or are you man enough?



12981 Bradley • San Fernando, California • Phone (213) 367-2161 • TWX 213-764-5993

COMPUTER MEASUREMENTS COMPANY IS A LEADING DESIGNER AND MANUFACTURER OF ELECTRONIC INSTRUMENTATION TO COUNT, MEASURE, AND CONTROL.

Washington Newsletter

August 23, 1965

Robbing Peter to pay Paul?

Headed by Brig. Gen. Hal D. McCowan, a special task force is making an on-the-spot check of United States military supplies in South Vietnam. Reporting directly to Defense Secretary Robert S. McNamara, the team will check on the need for emergency equipment, assess the time required to supply it, and spot potential bottlenecks.

No complaints of shortages of equipment have come from Vietnam. But there have been plenty from Washington, where Sen. John C. Stennis (D, Miss.), chairman of the Senate Preparedness subcommittee, continues to charge that American units in the U.S. and Europe are being stripped of vital equipment to supply Vietnam. Stennis says these units don't have enough backup stock; that they're running low on communications gear, especially radios and antennas; and that there is an inadequate reserve of helicopters, trucks and even firepower equipment.

The administration request for an additional \$1.7 billion for defense spending should meet some of the needs. And McNamara says he'll ask for more money in January.

Westinghouse gets Australian contract

Australia's plans for a new type of flexible coastal defense and early warning system has brought a \$4.7-million electronics order to the U.S. Two air-transportable, 40,000-pound radar stations will be built at the Westinghouse Electric Corp.'s Defense and Space Center in Baltimore for delivery in late 1967. Australian military officials said last week that the stations will save the cost of rimming the continent with permanent installations. Equipment will be airlifted from one side of the country to the other or set up on interior landing strips as defense needs require. The 30-foot antenna dishes will be inflatable, and the electronics rugged and lightweight. Plessey Radar, Ltd., of England has the prime \$15.5-million contract. Westinghouse will build the radar portion of the system, and Marconi, Ltd., will supply computers.

Independents gain in Autovon battle

The Defense Communications Agency this month invited two more independent telephone companies—in Montana and North Dakota—to build and operate sophisticated telephone switching centers, in their respective states, for the Automatic Voice Network (Autovon).

The decision is a small but significant victory for independents who have been battling the American Telephone & Telegraph Corp. for a bigger share of the multimillion-dollar business expected from the Defense Department's worldwide military communications system.

The stakes are high. Each of the 65 centers to be built in the continental United States is expected to cost between \$2 million and \$5 million; the revenue from Autovon in the U.S. has been projected at \$90 million a year.

Equipment for the AT&T-owned stations will probably be produced by the Western Electric Co., the manufacturing arm of the Bell System. But victories for the independents might brighten the competitive picture for other producers of communications gear.

Originally, 53 centers went to AT&T, five were assigned to independents and the remaining seven were contested. The agency has already rejected the contention of independents in Kansas and Ohio that AT&T

Washington Newsletter

has no legal right to compete for the centers, clearing the way for threatened court action. In Minnesota, a suit has already been filed.

Who'll manage federal computers?

Despite the Budget Bureau's assurances to Congress that a new set of interagency procedures will guarantee efficient management of computer use, some congressmen aren't convinced.

A Joint Economic subcommittee wants a congressional review next year of all federal policies on electronic data-processing equipment. The committee says there's disagreement between the General Accounting Office, which wants a central agency to manage computer use, and the Budget Bureau on how much control the central agency should have.

U. S. funds sought for crime study

Even before the riots in Los Angeles shocked the nation, Gov. Edmund Brown of California made a first step toward obtaining some of the \$10 million that will be available should Congress approve the Administration's Law Enforcement Assistance Act.

Brown has been circulating the Justice Department with copies of an engineering study made by the Space-General Corp. on crime and law enforcement in California. He hopes to get federal aid for a follow-on study that will spell out the policies, procedure and electronic hardware needed to remedy some problems cited by the first report.

The systems engineering study, first of its kind, cost \$100,000. It emphasized the police need for improved communications systems, computer identification of criminals and stolen cars, and quicker transmission of fingerprint and arrest records from one city to another.

GE reportedly wins C-5A engine pact

Although defense officials aren't talking, industry sources say that the General Electric Co. has won the jet engine contract for the C-5A transport, over the Pratt & Whitney Aircraft division of the United Aircraft Corp. Last week, the Pentagon stopped funding the development and testing of the P&W engines, while continuing funds for General Electric. Three companies—the Lockheed Aircraft Corp., the Douglas Aircraft Co. and the Boeing Co.—are competing for the air-frame contract. Until Defense Secretary Robert S. McNamara chooses one of them, defense officials won't say whose engines they are buying. The airframe contract is expected to be announced in mid-September.

Gemini 5 may hold space lab's fate

The Air Force seems to be depending on Gemini 5 to bolster chances for a military man-in-space mission. It is expected to hold off sending its recommendation on a manned orbiting laboratory (MOL) and on selection of a contractor until the Gemini flight is analyzed.

Two factors will be watched with special care: the astronauts' physical condition and their ability to distinguish objects on the ground. If Astronauts Gordon Cooper Jr. and Charles Conrad Jr. show no symptoms of space sickness after this longest of all manned space trips by the United States, doctors see no human limitation on manned flight.

High reconnaissance ability would give another boost to a military mission. The astronauts will try to distinguish and photograph 14 landmarks and several man-made geometric patterns on the terrain. They will also make general observations of terrain, railroad and highway networks.

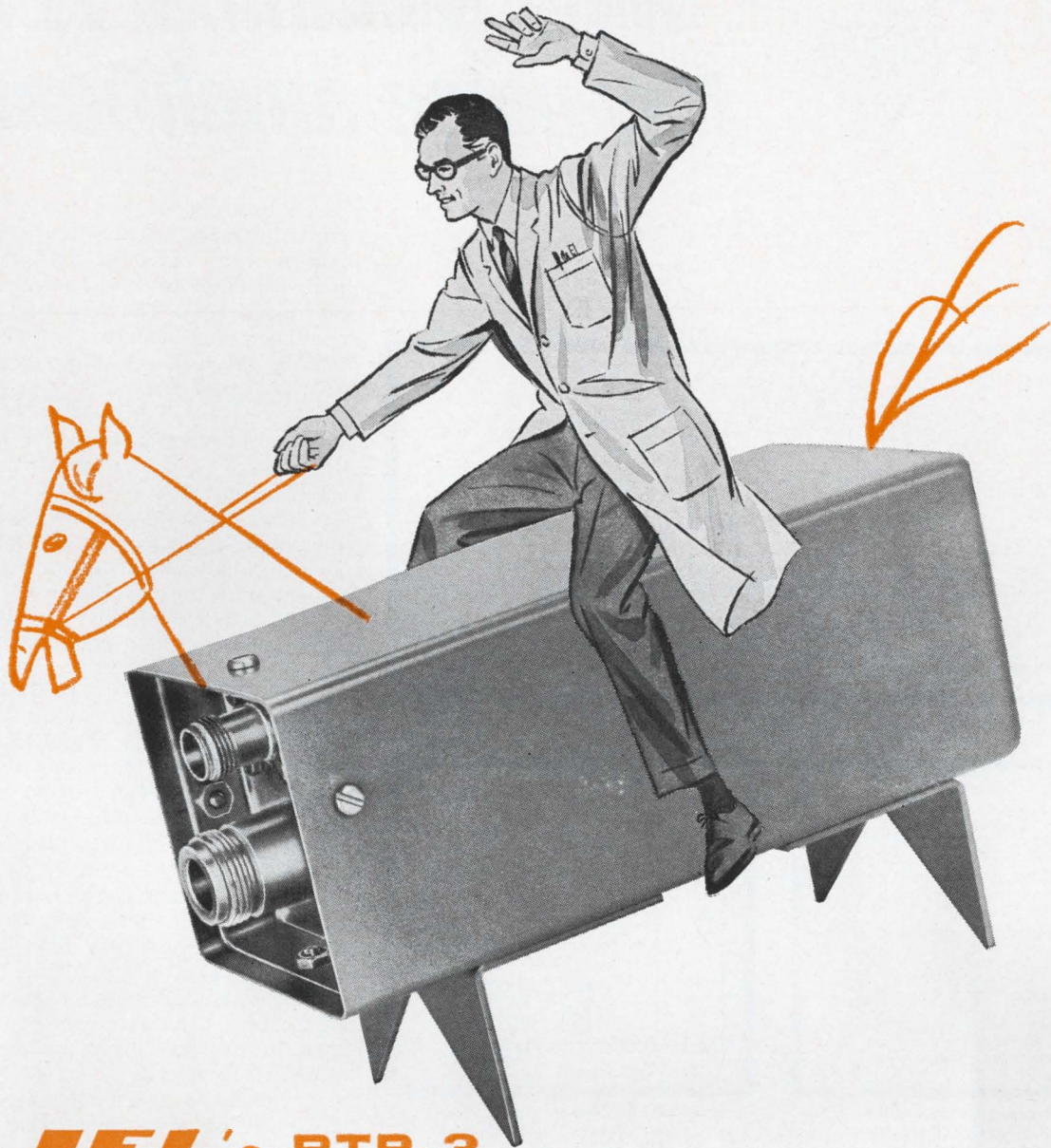

LEL's RTP-3

Helps you Hurdle RF Barriers

Newest in LEL's line of antenna preamplifiers, the RTP-3 offers a choice of RF center frequencies between 10 and 400 mc with noise figures of 2.5 to 4.0 db depending on RF frequency. Minimum bandpass is 10 mc at 3 db, and wider bandwidths are available. Overall gains are as high as 23 db. Designed for pole mounting,

this preamp is completely weatherproof and operates from a remote power supply. Like all LEL RF equipment...amplifiers, converters, multi-couplers, receivers...the RTP-3 offers the advantages of custom-engineering at close-to-production-line prices.

Send now for full information.



AKRON STREET COPIAGUE, L. I., NEW YORK 11726

(516) Amityville 4-2200 / (516) PYramid 9-8200 / TWX Code 516-691-5085



New N-channel FET by low-noise amplification

Texas Instruments has made a "significant contribution" in field-effect transistor technology — an N-channel FET capable of low-noise performance from 10 cycles to more than 500 megacycles. The new FET is priced for consumer and industrial applications while offering the high reliability required for military and space use.

The new FET, designated 2N3823, is available in production quantities in a four-lead TO-18 package. A dual matched pair, typed TIS 25-27, is in a low profile TO-5 type package.

Circuit designers can now take advantage of the unique characteristics of FET's in high frequency circuits and a wide range of other applications when cost is critical. Characteristics of FET's include reduced cross-modulation, low noise and high input impedance.

Reduced Cross-modulation

Since they follow "square law" behavior, 2N3823's give very little cross-modulation when used as RF amplifiers or mixers. The H. H. Scott FM tuner front end shown in Figure 1, for example, exhibited IHF sensitivities of 1.6 to 2 microvolts with cross-modulation rejection of from 96 db to more than 100 db. Two strong signals, equivalent to more than 50 mv per meter and separated by 800 kc, can be fed into the input without having any measurable intermodulation products generated. This performance is at least equivalent to the very best tube front ends and is more than 20 db better than the best bipolar transistorized front ends.

A 200 mc cascode amplifier, using 2N3823's, generated less than one percent cross-modulation when a 1000 μv , 200 mc signal and a 200,000 μv , 150 mc signal were combined.

VHF and UHF Performance

The 2N3823 is the first FET that provides useful amplification at vhf and uhf. Figure 2 shows a 500 mc amplifier that gives 11 db gain and a bandwidth of 5 mc. Typical spot noise figure is only 4.5 db (with an equivalent source conductance of approximately 13 millimhos.) No other FET's can approach this performance. Circle 190 on the Reader Service card for an application note describing this circuit.

FET's also make excellent vhf and uhf mixers. Figure 3 shows a 555 mc mixer that gives conversion gain of more than 7 db and a bandwidth of 10 mc. Local oscillator frequency is 600 mc and output to IF is 45 mc. Noise figure is 6.5 db (measured with 12 db image rejection and an IF amplifier with 3.5 db noise figure).

Low Noise

Figure 6 shows optimum noise figures for the 2N3823 at various frequencies. Notice that the FET is better than two of industry's most

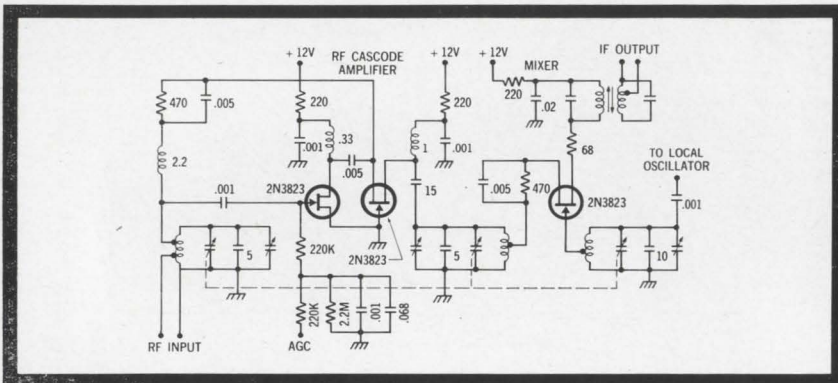

Figure 1. FM front end employs TI 2N3823 FET's. Circuit developed by H. H. Scott, Inc.

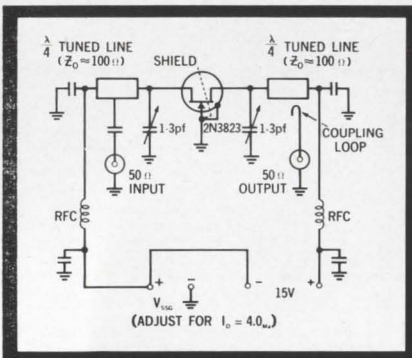

Figure 2. 500 mc amplifier using TI 2N3823 FET gives power gain of 11 db (5 mc bandwidth). Maximum spot noise figure is 4.5 db.

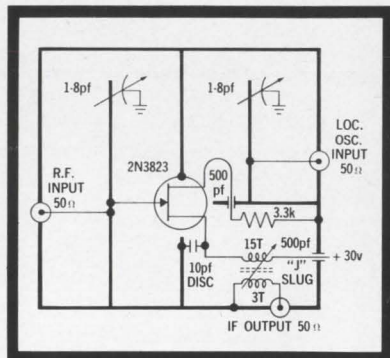

Figure 3. 555 mc mixer employs TI 2N3823 FET. Conversion gain is greater than 7 db for 10 mc bandwidth. Noise figure is less than 6.5 db.

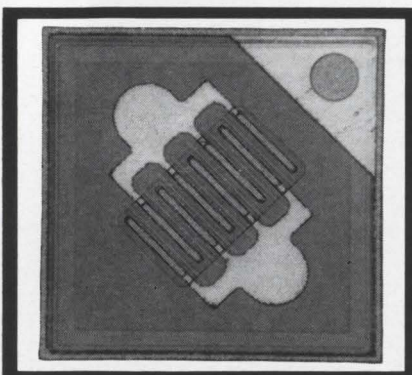

Figure 4. Photograph of active element of TI 2N3823 FET. Notice symmetrical, interdigitated geometry.

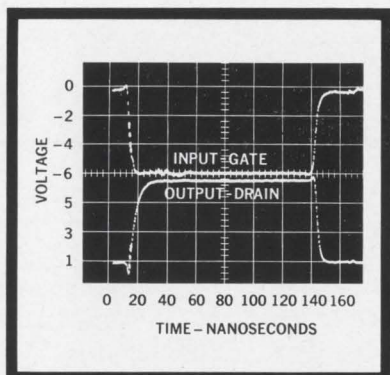

Figure 5. Unretouched sampling scope photograph illustrates zero storage time and fast response of TI 2N3823 FET.

TI cannot assume any responsibility for any circuits shown or represent that they are free from patent infringement.

Texas Instruments gives from 10 cps to beyond 500 mc

widely used bipolar transistors at all frequencies up to more than 500 mc. The amplifier shown in Figure 3 has a maximum spot noise figure of only 4.5 db at 500 mc.

High Input Impedance

Input impedance of the 2N3823 is high. This high impedance, plus the low leakage of 10 picoamps typical at 25°C, with V_{GS} of 10 volts, gives circuit designers many benefits.

In switching applications the high input impedance of FET's permits a virtually infinite fan-in — leading to important reductions in component requirements.

FET's also simplify design and reduce component requirements in both linear and switching applications. In choppers, untuned amplifiers and similar applications, interstage transformers can be eliminated, reducing weight and cost as well as permitting improved performance. Coupling capacitors can be greatly reduced in size or eliminated altogether, particularly in low-frequency applications.

Symmetrical Geometry

Symmetrical geometry (Figure 4) means that drain and source leads are interchangeable. This allows both electrical and mechanical replacement of older devices with non-standard lead configurations.

Zero Storage Time

In Figure 5 a sampling scope photograph shows the zero storage time of FET's. This characteristic is important in switching applications such as digital logic gates.

Other electrical characteristics of this device include high transconductance (3500 to 6000 micromhos) and low input capacitance (4.8 picofarads typical). Extremely small, interdigitated geometry and an epitaxially deposited junction area make possible the exceptional performance. Circle 191 on the Reader Service card for 2N3823 data sheet.

TI Offers Complete FET Line

TI, a pioneer in field-effect transistors, offers 16 families of P-channel and eight families of N-channel FET's. You can select a device from this broad line to meet any requirements.

New Book on FET's

Here is the first definitive work devoted exclusively to the theory, application and behavior of field-effect transistors — the latest addition to the TI Microlibrary of electronic books. It is cloth bound; 130 pages with 140 illustrations. The title: **Field-effect Transistors**. Author is Leonce J. Sevin, Jr. Publisher is McGraw-Hill and price is ten dollars. Send orders to: Texas Instruments Incorporated, TI Microlibrary, Mail Station 7, P. O. Box 5012, Dallas, Texas 75222.

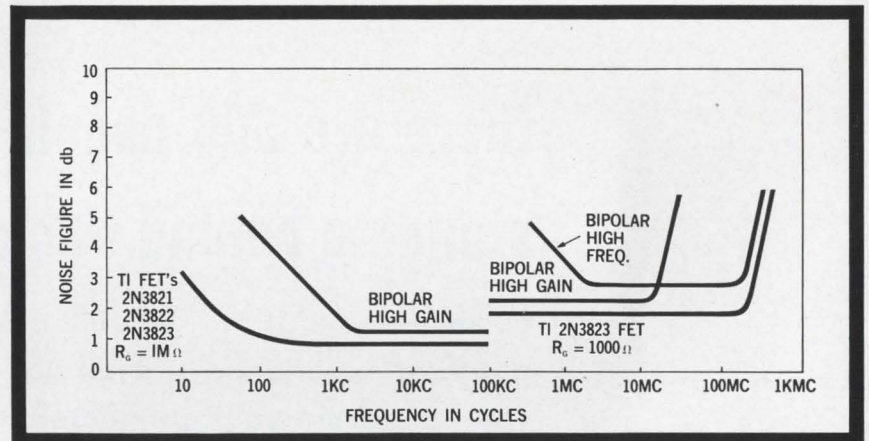

Figure 6. Optimum noise figure vs frequency TI 2N3823 FET vs widely used bipolar transistors.

LINEAR			
APPLICATION	ADVANTAGES OF FET's	APPLICATION	ADVANTAGES OF FET's
D.C. amplifiers	Zero TC Low drift Low noise	Choppers	Zero offset Low leakage currents Simplified circuitry Eliminates input transformers
Low frequency amplifiers	Small coupling capacitors Low device noise High input impedance	A.D. converters multiplex switching (arrays) and sample hold	Improved isolation of input and output Zero offset Symmetrical Simplified circuitry
Operational amplifiers	Summing point essentially zero Low device noise Less loading of transducers	Relay contact replacement	Solid-state reliability Zero offset Symmetrical No inductive spiking No contact bounce High repetition rate
Medium and high frequency amplifiers	Low cross-modulation Low device noise Simplified circuitry	Voltage variable resistor	Symmetrical Solid-state reliability Functions as variable resistor Low noise Improved resolution
Mixers — 100 mc and up	Low mixing noise Low cross-modulation		
SWITCHING			
Logic gates	Virtually infinite fan-in Simplified circuitry Zero storage time Symmetrical		

Figure 7. Advantages of using FET's in various applications.



TEXAS INSTRUMENTS
INCORPORATED
13500 N. CENTRAL EXPRESSWAY
P. O. BOX 5012 • DALLAS 22, TEXAS

there are 500 people standing behind this connector

to assure you of the reliability,
depth of experience and service
you want from your connector source

Progress Webster Corporation has long been a supplier of MIL Spec (10544, 12520) audio and power connectors to the electronics, communication and defense industries. Now they offer this same kind of dependability in their new line of PW Series (MIL-C-26482) miniature connectors. The same rigid testing procedures, the same exhaustive quality control, the same scrupulous attention to customer service and requirements stand behind the new PW Series. If you require MIL-C-26482 connectors, your first order with us could well change your buying habits!

MIL-C-26482 PROGRESS WEBSTER



PROGRESS WEBSTER CORP. 5 Bridge Street, Watertown, Mass. (617) 926-2100



**Here Are
The First Low-Cost
Plastic Silicon Transistors With
"No Compromises" In Performance
And Reliability!**



There's a lot of "low-cost" transistors around these days that got that way by virtue of sacrifices in performance and packaging quality. That's why it's refreshing to find devices like Motorola's new 2N3903-6 series silicon annular Unibloc* plastic transistors — "no compromise" units that offer high performance with topnotch reliability . . . and at *low cost*, too!

Take, for instance, the rugged, high-pressure-molded plastic construction used to form the single-unit encapsulation of "Unibloc" devices. It provides a uniform, dense, solid plastic package free of voids (and leaks) in which moisture can accumulate. It also provides unusual physical strength for internal leads and connections and improved heat transfer characteristics. Because they use the solid transfer molded single-unit package approach, there can be no incompatibility between header and poured epoxy capping. (You may be familiar with the separation that sometimes occurs at the interface of a two-part plastic package under thermal cycling.)

Type	BV _{CEO}	h _{FE} @ 10 mA/1V	C _{ob} @ 5V	f _r @ 10 mA/20V	100- Up Price
2N3903	40V	50-150	4 pf	250 mc	\$.50
2N3904	40V	100-300	4 pf	300 mc	.55
2N3905	50V	50-150	4.5 pf	200 mc	.50
2N3906	40V	100-300	4.5 pf	250 mc	.55

But, reliability is only part of the "no compromise" story!

Each of these four new Motorola annular plastic transistors is a full-spec, full-performance device . . . with no compromises to cost.

For example, the 2N3903-6 series offers such features as:

- Gain (Beta) — Specified from 100 μ A to 100 mA . . . and points in between!
- High Voltage — 40 Volts (BV_{CEO})
- Complete h-parameter specifications
- Completely specified switching limits . . . including t_r, t_d, t_s, and t_f!

You'll find the Motorola 2N3903-6 series literally sets the "performance standard" for low-cost transistors for industrial and consumer product applications.

You can also take advantage of the fact that this key series features device-to-device complements — the NPN 2N3903 and PNP 2N3905 and the NPN 2N3904 and PNP 2N3906.

One more point. They're made by the annular process. That means you get the low-leakage, long-term stability that will set your equipment performance apart from the crowd.

Try these devices in your most demanding circuits. Your local Motorola representative would be happy to supply samples for evaluation and complete specifications on each type.

*Trademark of Motorola, Inc.



MOTOROLA Semiconductor Products Inc.

BOX 955 • DEPT. 67 • PHOENIX, ARIZONA 85001 • A SUBSIDIARY OF MOTOROLA INC.

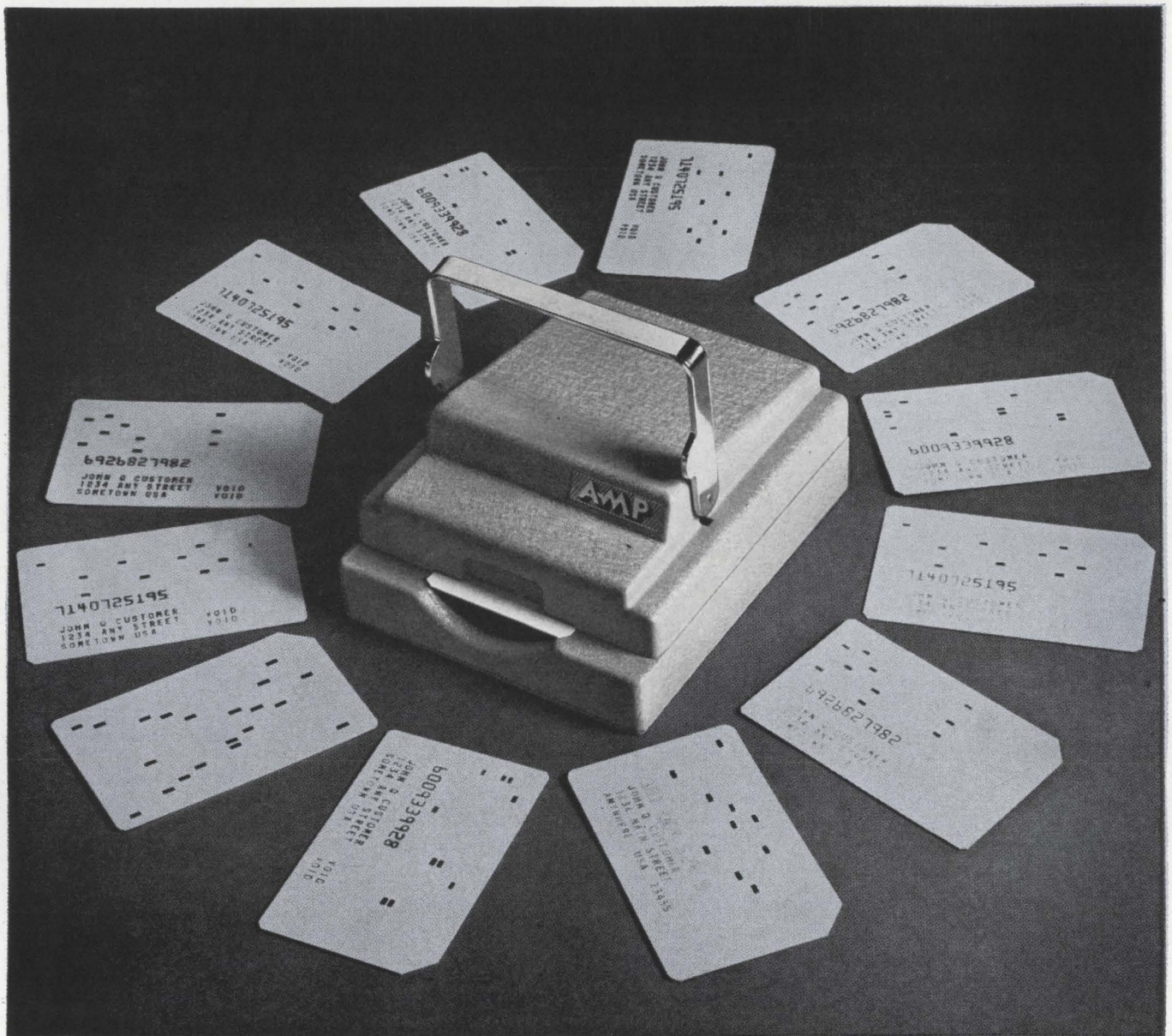

Credit's good here . . . over 1,000,000 times

This new, attractive card reader can register over a 1,000,000 insertions of various credit-type cards and translate the card information to electrical output circuits.

It's fast . . . it's reliable . . . it's foolproof!

Compact and rugged, the A-MP★ Credit Card Reader can be used as an input device for credit handling systems, validating systems, security systems or other data collection and control applications. Available in either desk top or rack mount models, this versatile reader is supplied with either manual or automatic operation. Long, trouble-free operation is assured by the quality features built in this rugged unit. Electrical and mechanical interlocks provide foolproof operation. Redundant contacts with exclusive double wiping action insure a clean electrical surface for reliable sensing.

Here's a sample of other quality features which are engineered into this new product.

- Semi-automatic or automatic card ejection
- Reads plastic credit-type cards 2½" x 3⅜"
- 250 ma, 500 V operation
- Pre-wired or wired to customer's specifications
- Redundant contacts with double wiping action for reliable sensing
- Long life—over 1,000,000 cycles
- Compact size—5" x 6" x 2¾"

Check the applications this item might find in your system, then write for complete information.

★Trademark of AMP INCORPORATED



A-MP★ products and engineering assistance available through subsidiary companies in: Australia • Canada • England • France • Holland • Italy • Japan • Mexico • Spain • West Germany

Technical Articles

Good teamwork from scr's:
page 60

During the past year, the silicon controlled rectifier has moved into a variety of new applications that range from golf carts to steel mills. But about all the current a single pellet can handle is 300 amperes. One way around this limitation is to connect scr pellets in parallel. In one assembly, 30 pellets, each rated at 20 amps, were able to handle 550 amperes, extending the potential of the scr.

**Measure it,
but don't touch:**
page 65

Optical interferometry has rarely been used as an industrial measuring technique because it has so many limitations. A microwave interferometer, on the other hand, is not bothered by such limitations. A new microwave device can precisely measure objects that can't be touched because they are too hot or too delicate, or are vibrating at high frequencies, or are in a vacuum.

**Special report—
The overlay transistor:**
page 70

As communications, telemetry equipment and data links are pushed into higher frequencies, they outstrip the capabilities of conventional solid state components. The overlay transistor has suddenly sprung into prominence because it handles relatively high powers at high frequencies—for example, as much as 10 watts at 400 Mc. In this three-part article:

Part I examines the multiple-emitter geometry that gives this power transistor high-frequency capability;

Part II describes some typical circuits and applications of the device;

Part III reports on other geometries such as the interdigitated approach to high frequency at high power.

**Million dollar
'screwdrivers':**
page 88



Electronic equipment has grown more complex; so have the instruments to test it. To perform the required tests in a reasonable amount of time, the military has turned to computerized test equipment. NASA also uses automatic equipment, and industry is leaning that way too. For this issue's cover, Richard Saunders photographed the automatic checkout equipment the Navy puts on aircraft carriers to test avionics gear. This system was built by PRD Electronics, a division of Harris-Intertype Co.

-
- Coming September 6**
- Safeguarding tantalum capacitors against a-c ripple
 - An optical computer for instrumentation
 - An electronic way to examine reconnaissance pictures
 - Raising the frequency ceiling on solid state power switching

Good teamwork from scr's

Parallel operation of small silicon controlled rectifiers and resistors gives more current handling capability than possible with largest commercially available single scr

By Reuben Wechsler

Motorola, Inc., Phoenix, Ariz.

About all the current that the largest single-pellet silicon controlled rectifier can handle is 300 amperes; a limitation that has often been a problem. Higher currents, however, can be controlled by using a technique often employed with conventional rectifiers—parallel operation. In a test, one parallel arrangement of 30 controlled rectifier pellets, each rated at 20 amperes, handled 550 amperes.

Parallel operation of a number of small scr's means not only higher current handling capabilities but better thermal characteristics and potentially lower cost. In the case of conventional small-pellet rectifiers, high-volume production brought their cost way down and now it is sometimes less expensive to combine a number of small pellets rather than use one large one. This will probably happen with small scr's as their use increases.

Small low-value resistors (typically 5 or 10 milliohms) are also needed to use an assembly of scr's effectively; one resistor is placed in series with the cathode lead of each scr.

Current sharing

Some of the problems that were solved in the case of conventional rectifiers (by close matching) still exist for scr's; the principal one is current sharing during forward conduction. In addition, scr's have the problem of simultaneous gating and current sharing during the turn-on interval and while several techniques, involving transformers

and reactors, overcome these difficulties they are not entirely satisfactory.

Using small resistors in series with the cathode leads of the scr's in the parallel assembly is a simple and economical solution to both the current-sharing and the gating problems. A typical multicell arrangement containing only two controlled rectifiers is shown on page 61. The controlled rectifiers, although selected for similar characteristics, were not identical. The equalizing (compensating) resistors are designated R_c. The arrangement was tested with and without the equalizing resistors.

The group of curves, opposite, depicts operation with and without equalizing resistors. One pair shows that with a total load current of 40 amperes, the anode current of one scr is 18.9 amperes while that of the other is 21.1 amperes.

A second pair of curves shows how two 10-milliohm equalizing resistors improve performance; with them the respective scr currents are 19.4 and 20.6 amperes.

By using conventional copper wire, wound into coils to form nonlinear resistors, the difference between the two current levels can be reduced to less than 1.5%; this is seen in the bottom two sets of the group of curves. In these circuits, the resistors present a low impedance until a specific current level is reached; above this value of current the resistance increases sharply, thus directing some of the current from one scr to the other. All the curves show that as current sharing improves, the total forward-voltage drop increases. This means a greater power loss and the generation of additional heat in the resistors. If the assembly is to be packaged as a unit, the heat created by the power dissipated in the equalizing resistors must be removed. Another way to overcome mismatch between scr's is to add extra scr's to the assembly; they operate below the assembly's maximum capability, eliminating the possibility of failure caused by unequal current sharing. These are

The author



Reuben Wechsler was recently appointed section manager, appliance applications and is currently assisting customers in the design and use of power control circuitry. Prior to joining Motorola, he was with the Standards Laboratory of the Electronic Industry Association.

Resistors improve scr performance

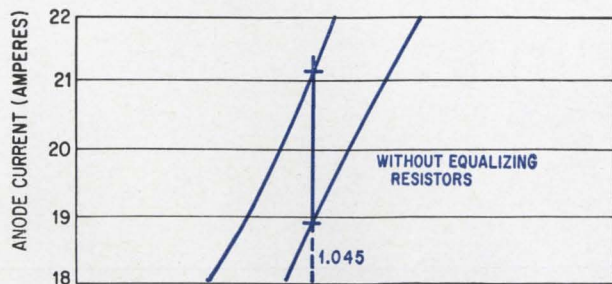

FORWARD VOLTAGE DROP (VOLTS)

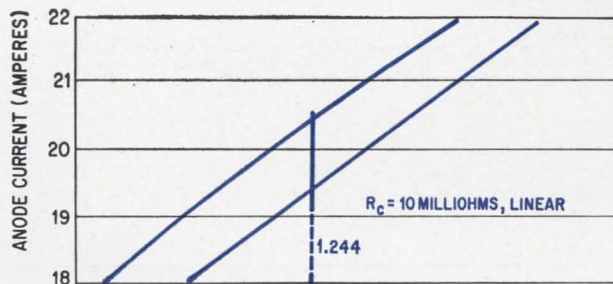

FORWARD VOLTAGE DROP (VOLTS)

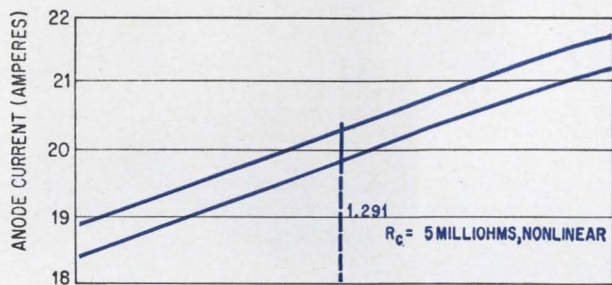

FORWARD VOLTAGE DROP (VOLTS)

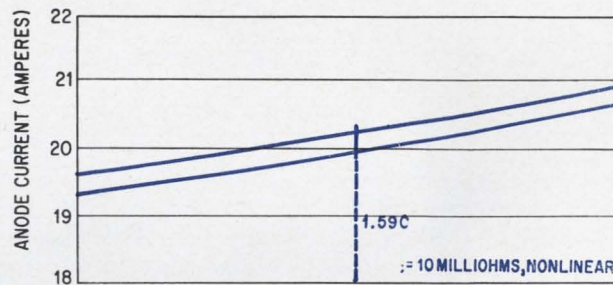

FORWARD VOLTAGE DROP (VOLTS)

Four sets of curves illustrate the operation of a pair of parallel-connected silicon controlled rectifiers. Those at the top, left, show that operation without equalizing resistors produces considerable current unbalance—one scr carries over two amperes more than its companion unit. The other curves show how equalizing resistors reduce the current unbalance. The MCR808-2 is a commercially available dual scr manufactured by Motorola, Inc.

factors to be considered when deciding on the trade off between the closeness of the match, the number of scr's, and the size of the equalizing resistors.

The value and type of equalizing resistors is important in a parallel arrangement for although their purpose is to aid in dividing the total anode current equally among all the multicell scr's in parallel, they are not essential if no individual device is operated beyond its limitations. Ideally, the resistors should have zero resistance for currents up to the maximum that the device is capable of handling, and infinite resistance above that value of current. Although such ideal characteristics are not attainable, they can be approached with copper resistors, wound as coils. It can be seen in the comparison curves on page 63 that the nonlinear characteristic provided by a coil-shaped copper resistor is considerably superior to the linear char-

acteristic obtained with conventional resistors.

Because of their coil construction, the copper resistors are self-heating. The positive temperature coefficient of copper is moderately high (approximately 0.04%/°C). Other materials with higher positive temperature coefficients could be used to make resistors with voltage-current characteristics that have sharper knees than provided by copper.

Halting thermal runaway

If a number of controlled rectifiers are paralleled without the use of equalizing resistors there is the possibility of thermal runaway and it is most likely to occur with a poor heat-sink arrangement. When thermal runaway occurs, the scr having the lowest forward drop will receive the greatest share of the current; its temperature will be higher than that of the other devices. This increase in heating could decrease the forward drop which, in turn, would cause a greater share of the current and additional heating. Under certain conditions this process could become regenerative. In any case, it is undesirable because of the inequality of the stress on the devices.

The use of equalizing resistors with positive temperature coefficients tends to prevent thermal runaway. If the increased voltage drop across the equalizing resistor, caused by an incremental increase in current, is made equal to or greater than the decrease in the forward drop of the scr with which it is associated, thermal runaway is impossible.

In designing equalizing resistors, there is much

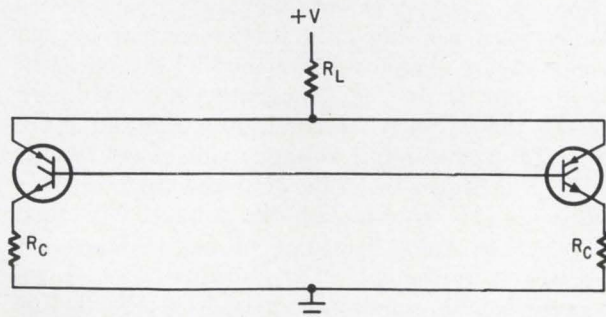

Equalizing resistors connected to the cathode leads of the scr's help distribute the current load more evenly.

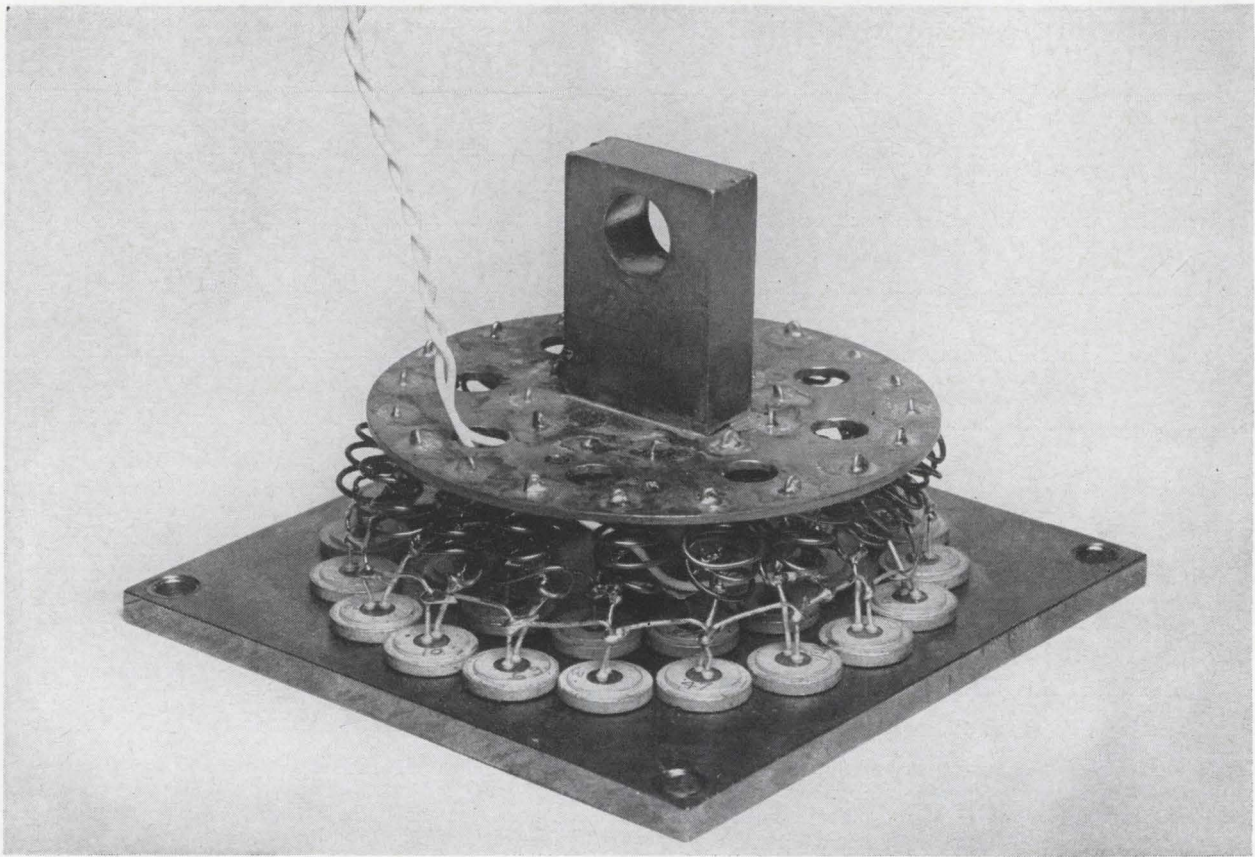

Array of scr's is shown with resistors attached to cathode leads of individual rectifiers. The entire unit is covered by a metal case.

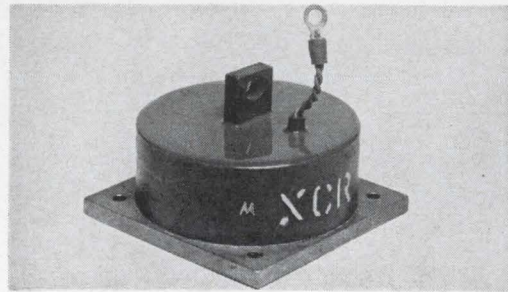

freedom in the trade off between resistor length and diameter. Reducing the wire size, of course, reduces the length of wire necessary for a given resistance. But reducing the wire size also reduces the power handling capability of the resistor. For safety, the resistor power-handling capability should be greater than that of the scr.

When choosing the cathode resistor, current equalization is not the only factor to be considered. The resistors also help assure triggering of all of the scr's in the assembly; this function can be understood with the aid of the characteristics

shown on page 63. One set of curves is for a typical scr operated without a cathode resistor. When the scr turns on, the gate-to-cathode voltage jumps to a level determined by the anode current. The gate current then has little influence on the gate-to-cathode voltage. The curve for a one-ampere load shows that the gate-to-cathode voltage increases by only 90 millivolts under this operating condition. This increase, even though it is small, is useful, since it helps trigger the unfired scr.

Suppose two scr's, both having characteristics similar to those shown in the set of curves just discussed, are connected in a parallel arrangement like the one at the left. The gate trigger voltages for the devices are matched to within 50 millivolts. If the gate source voltage is increased slowly, scr D_1 will trigger when the source voltage reaches 1.02 volts. Its gate-to-cathode voltage will then jump to 1.09 volts. The gate of D_1 will then act as a trigger for the gate of D_2 , turning on D_2 . Even if more than the minimum drive is provided, this step increase in the gate-to-cathode voltage is important since it tends to unload the trigger source

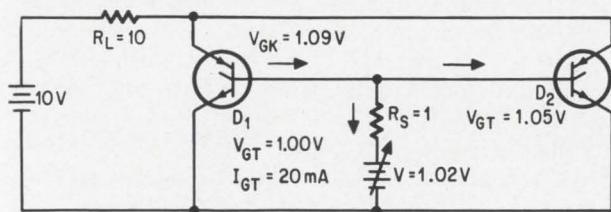

In this dual-scr circuit, D_1 has a lower triggering voltage than D_2 . After D_1 turns on, its gate-to-cathode voltage rises, helping to trigger D_2 .

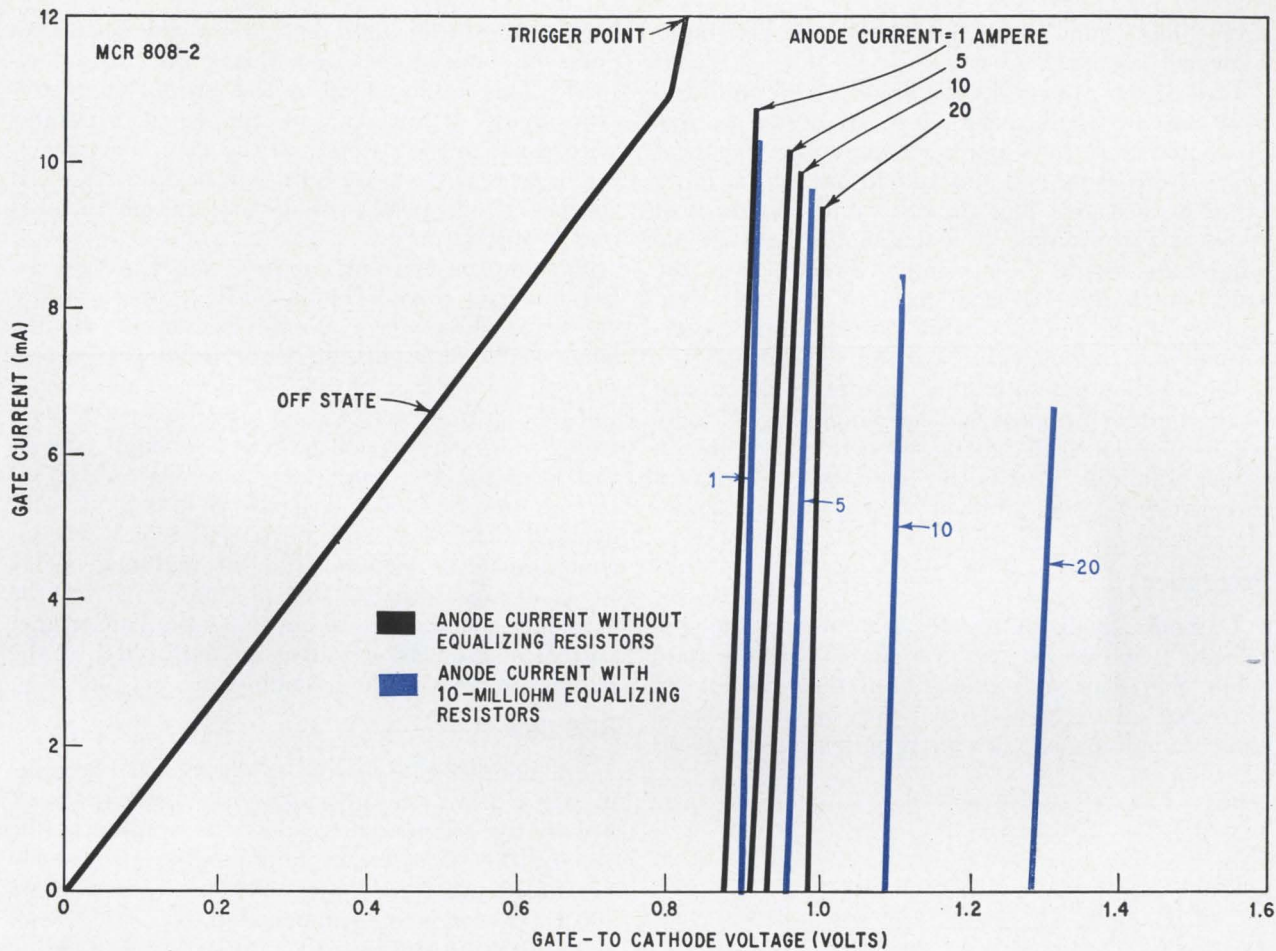

Typical scr gate characteristics: The level to which the gate-to-cathode voltage goes after triggering depends on the anode current and the equalizing resistors.

as each scr fires, steering the trigger current to the other unfired scr's.

The mutual gating effect of the equalizing resistors can be increased by making them inductive since the di/dt during the turn on of each device will cause an even greater voltage drop across the resistor.

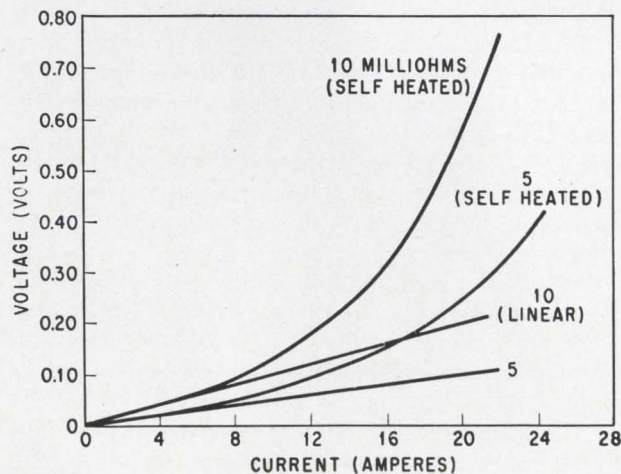

Characteristics of equalizing resistors: The self-heating copper resistors provide sharp increases in resistance at high anode currents. This accounts for the high voltage drops which they produce at high currents.

Examining the gate voltage-current characteristics when a cathode equalizing resistor is used (see the characteristic curves on this page), shows that the inclusion of the resistor further increases the gate voltage to the other scr. The increase, of course, is greater at higher currents since it is a voltage drop. A greater gate voltage step is desirable since it reduces the gate trigger-voltage matching necessary to insure gating of all devices in an assembly. For this reason the resistor value should be chosen not only on the basis of a forward-drop matching trade off, but also to improve gating characteristics.

Another effect of the equalizing resistor is worth mentioning. At very high gate currents, the resistor tends to equalize gate currents in much the same way that it equalizes anode currents. This is important for assemblies where a large amount of total gate drive is applied from a low impedance. Too much drive could cause excessive gate current in some of the scr's.

Both the physical arrangement and the method of assembling the scr's in parallel are important. It is desirable to keep them closely coupled thermally so that with an adequate heat-sink arrangement, they all will be at approximately the same temperature. Individual scr's should be mounted

on a single plate with a low thermal resistance between devices.

One of the principal advantages of the multicell over the single-cell technique is its better thermal characteristics. In a multicell assembly, the heat sources are separated and spread out over a fairly large surface area that provides much better heat removal. For example, in a single stud package the single die would be mounted directly over the stud, the longest thermal path to the heat sink. In a multicell stud assembly the scr's may be arranged in a ring over the heat transfer surface.

Improved di/dt capability is another advantage of the multicell approach. The paralleling of many small devices, each having its own gate contact, is essentially a distributive gate that overcomes the principle gating problem present in large single-chip devices.

Precautions

Cathode equalizing resistors can prevent the possibility that one scr will remain in the off state while the other scr's are on, but they do not assure that all the devices will turn on at the same time. Simultaneous turn-on is important to avoid

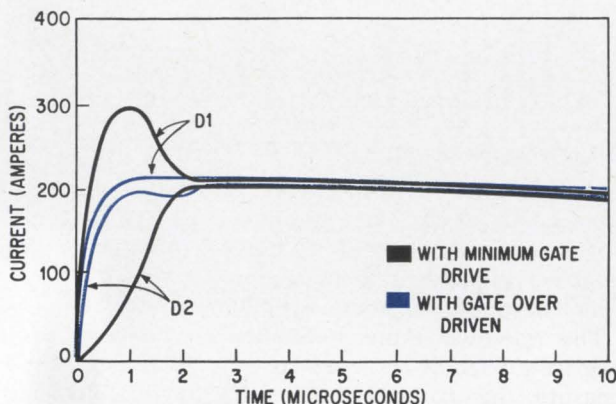

With minimum gate triggering-voltage applied to the MCR808-2, one scr turns on and reaches a peak current of 300 amperes before the second unit is fired. This potentially damaging condition may be avoided by increasing the gate drive.

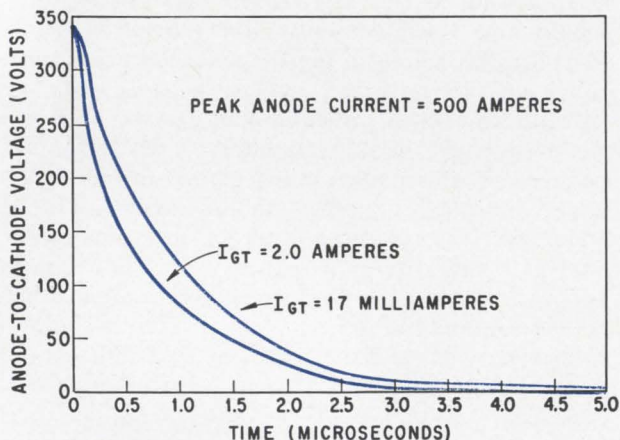

Increases in gate drive-current increases the speed at which the anode-to-cathode voltage falls off following triggering of the scr.

high currents or high di/dt that can cause hot spots in some of the scr's during the turn-on interval. This is illustrated by the current characteristics figure. If two scr's are connected in parallel with equalizing resistors and the gate source voltage is increased slowly until one triggers, the first reaches a high peak-current value before the second is turned on.

Simultaneous turn-on can be assured by increasing the gate drive. The second set of curves in the figure shows the two cathode currents for the same scr's, but with the gate drive current increased by a factor of 10. The devices now share the total current very closely at all times. It isn't enough to make sure that there is enough current to trigger the scr's simultaneously. Gate drive effects on turn-on time and the anode-to-cathode voltage fall time must also be considered. Each scr should receive enough drive to minimize delay time; an approximate value of total drive for the assembly is about five to ten times the gate trigger current of the least sensitive scr multiplied by the number of scr's in the assembly.

Rise time

Still another gate-drive consideration is rise time. To keep delay time at a minimum before turn-on occurs, the required drive must be applied to the gate quickly. Trigger amplitude and rise time may be traded off. A rise time no slower than 50 to 100 nanoseconds is recommended.

At this point it would be wise to discuss holding current, which is the minimum current level required to sustain conduction. It is not desirable to match holding current as well as the voltage drop and triggering voltage, because the additional testing would increase the cost of the assembly substantially. When an assembly, built with devices that do not have matched holding currents, is operated at very low gate currents some of the scr's may drop out of conduction while the others remain on. When this happens, the anode currents of the conducting devices will most likely trigger the remaining devices into conduction.

By closely matching gate trigger voltages, it is possible to prevent those scr's with higher holding currents from turning off when their anode currents fall below the holding level. If the voltage present at the gates of these scr's is equal to the triggering voltage, scr's operating at currents below their holding currents will not revert to the blocking state.

Should the combination of the gate trigger-voltage match and the equalizing resistors fail to prevent a blocking condition, it would be advisable to avoid operation at very low currents except, of course, when turning the unit on or off.

The disadvantages of high gate drive, minimum operating current and the larger size of an arrangement of scr's operating in parallel seem to be outweighed by their higher current-handling and di/dt capabilities and their better thermal characteristics.

Measure it, but don't touch

Improving on optical techniques, microwave interferometer measures objects accurately even when they're too hot to handle—or too delicate, or kept in a vacuum

By Carl F. Augustine and John E. Ebert

Weinschel Engineering Co., Gaithersburg, Md.

As an optical technique, interferometry is more than a century old. It is so well established that, by international agreement, it is used to measure the accepted standard of length, the orange-red radiation of krypton 86; one meter is defined as 1,650,763.73 wavelengths.

But as a laboratory tool the optical interferometer has severe limitations. It requires a good source of monochromatic light. It requires a target whose face is a good reflector, and the light beam must be perfectly perpendicular to the target's face, because the optical system's sensitivity is so low that it needs all of the reflected light. Also, when a light-interference pattern finally is received, it still must be converted into electrical signals before the pattern can be interpreted.

A microwave interferometer has distinct advantages over its optical counterpart. It works with targets of any material, electric or dielectric; alignment is not critical because the electronic instrument is sensitive enough to react only to phase

difference, ignoring the amplitude of reflected energy; its output is electrical from the start, so it doesn't have to be converted; and the microwave instrument is easier to calibrate and to automate.

An interferometer produces and measures the interference between two wave trains coming from the same source.

Precise measurements from a distance

One of the new instrument's most important uses is for precise measurements of objects that can't be touched—because they're too hot, too delicate, or perhaps in a vacuum, or vibrating at a high frequency [Electronics, May 17, p. 30].

The microwave interferometer can detect surface irregularities as small as one microinch, and measure the period and amplitude of complex mechanical vibrations with an accuracy of one microinch at frequencies as high as 20 kilocycles per second. It can also measure, accurately to 10 microinches, gradual dimensional changes that result from stresses or thermal expansion.

The measuring instrument detects changes in the phase of a reflected 35-gigacycle signal. For targets less than one inch away, the signal is fed directly from a waveguide output on the sensing head; for more distant targets the sensing head is attached to an elliptical antenna. In both cases, the energy is focused on a spot approximately 0.15 inch in diameter.

The target can be any surface that exhibits good microwave reflectivity. Modern antennas permit the microwave energy to be focused so efficiently that a target surface of only a few square millimeters can be measured accurately two feet away.

The basic instrument

A microwave interferometer consists basically of five parts: a radio-frequency signal source, phase comparator, transmitting and receiving an-

The authors



Carl F. Augustine is engineering section head at the Weinschel Engineering Co. He is responsible for the design and development of standards for microwave production. He has seven patents pending.



John E. Ebert, executive vice president and chief engineer at Weinschel, has 20 years' experience in the microwave field. He supervises all of the company's research and development.

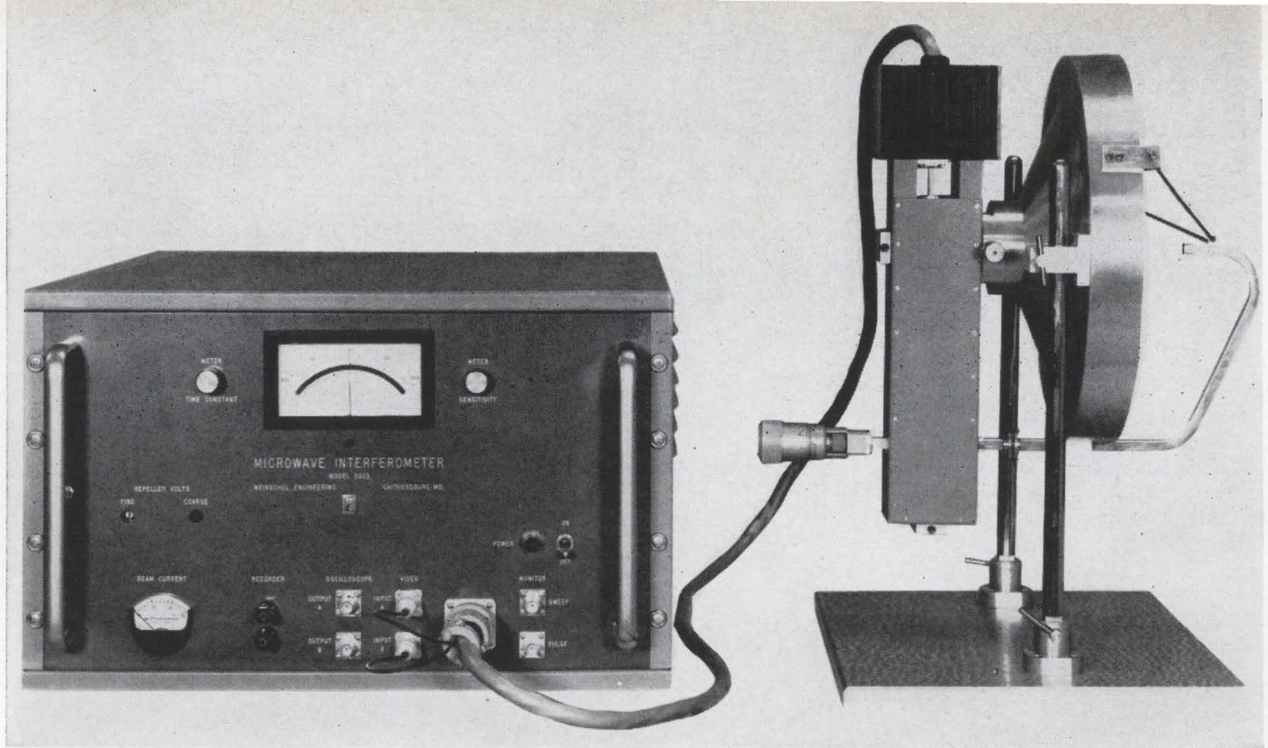

Exterior of microwave interferometer. Module at left contains power supplies, amplifiers, synchronous detectors, volt meter and sweep generator. Micrometer-driven phase shifter, klystron and other microwave components are mounted on rear of the elliptical antenna at right, which is used for distant targets.

tenna, reference path and a micrometer-driven phase shifter; all are shown on page 67. The reference path is the standard against which are measured phase changes along the path between the source and the target and then back to the phase discriminator. This phase change depends upon the target's position; therefore the interferometer can sense and measure small movements of

the target in any direction.

The phase shifter provides a method for calibrating the instrument so that the target's motion in microinches can be read out visually on a meter.

An operator uses the shifter, which is a variable short circuit and acts electrically like the target, to alter the incoming signal to correspond to a change in the distance to the target. Then he ad-

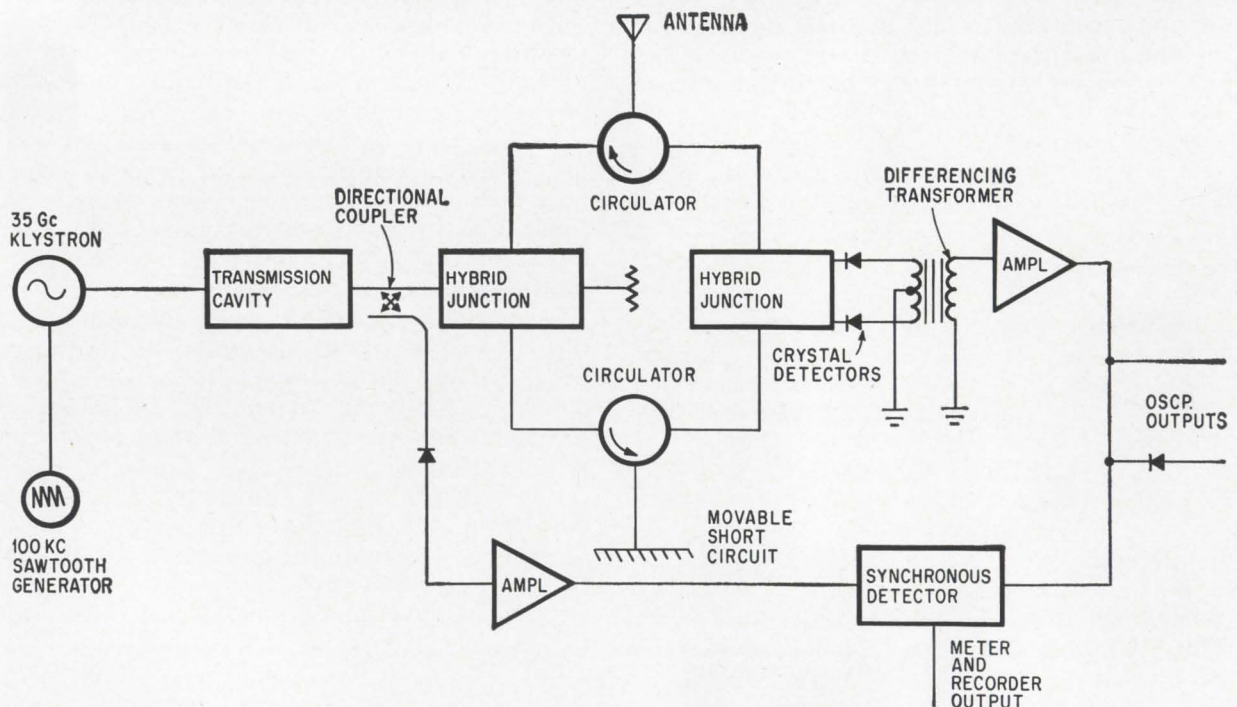

Microwave interferometer includes crystal detectors, circulators, difference transformer and a 100-kc sawtooth generator. Transmission cavity determines frequency of input pulse to first hybrid junction.

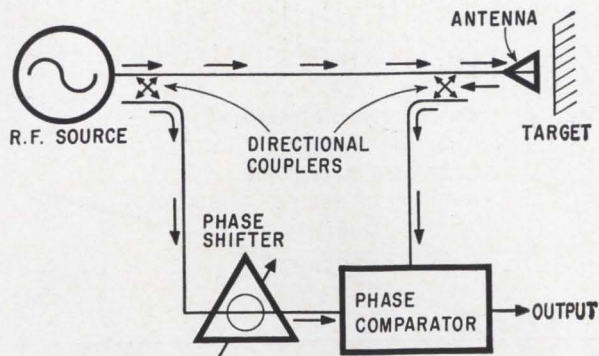

Signal related to target distance is developed in the microwave interferometer as a result of phase difference between signal reflected from the target and that of the reference path.

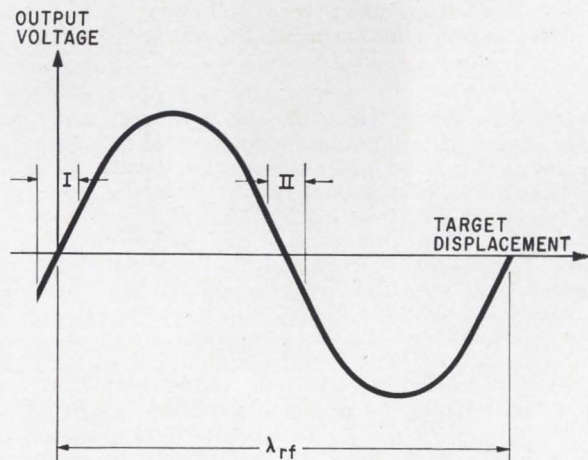

Interferometer output voltage, plotted against target displacement, gives a curve that is basically a sinusoid. The length of one cycle is determined by the wavelength of the radio-frequency signal in air. Operation of the interferometer is restricted to the linear regions of the sinewave, sections I and II near null, to achieve the best accuracy. At 35Gc, this usable portion corresponds to a target motion of 0.05 inch.

justs the meter so that a full-scale deflection corresponds to the known distance.

In designing the instrument, careful attention must be paid to frequency stability, length of the radio-frequency paths, packaging, and operation of the directional couplers, phase discriminator and calibrated phase shifter.

The complete interferometer

The block diagram on page 66 shows an instrument that operates at 35 Gc. Frequency stability is achieved by sweeping a klystron's frequency across the resonance of a transmission cavity at 100 kilocycles; therefore the input to the first hybrid junction is a narrow pulse whose frequency is determined entirely by the transmission cavity.

This hybrid junction acts as a power divider; its properties are not critical. The ferrite circulators direct the energy toward the target and movable short circuit. Energy, reflected from target and short circuit, reenters the circulators and is

The Hybrid junction

In a microwave interferometer, the second hybrid junction, in combination with the crystal detectors on the output ports, acts as a phase detector. It derives an output voltage that is related to the target distance, d . This comes about in the following way:

If the vectors \bar{E}_1 and \bar{E}_2 represent the input signals to the reference and measurement arms of the microwave bridge, then, as a result of the transfer characteristic of the hybrid junction, the signals in the output ports are:

$$\bar{E}_3 = \frac{\sqrt{2}}{2} (\bar{E}_2 + j \bar{E}_1) \quad \text{and}$$

$$\bar{E}_4 = \frac{\sqrt{2}}{2} (\bar{E}_1 + j \bar{E}_2).$$

Their magnitudes are:

$$|E_3| = \frac{\sqrt{2}}{2} \sqrt{(E_1 - E_2)^2 + 2 E_1 E_2 (1 + \sin \theta)}$$

$$|E_4| = \frac{\sqrt{2}}{2} \sqrt{(E_1 - E_2)^2 + 2 E_1 E_2 (1 - \sin \theta)}$$

where $\theta = 4\pi d/\lambda$ and λ is the free space wavelength of the microwave signal. These signals are then detected by crystal detectors having square law characteristics and subtracted in a combining network. The final output signal takes the form:

$$e_o = 2kE_1E_2 \sin \frac{4\pi d}{\lambda}$$

where k is a second-order variable that is a function of the signal level and detector characteristics. The output voltage is basically sinusoidal. A full cycle of the sinusoid is equivalent to a target displacement of 0.17 inches at 35 Gc, and the peak-to-peak voltage swing occurs during a displacement of 0.085 inches.

fed to the two isolated ports of the second hybrid junction.

The second hybrid junction may be considered a simple sum-and-difference device with the output to one diode detector being the phasor sum of the two r-f inputs while the other output is the phasor difference. The crystal diodes are essentially square-law detectors and their outputs are:

$$\text{Output 1} = |\bar{E}_1 + \bar{E}_2|^2 = E_1^2 + E_2^2 + 2 E_1 E_2 \cos \theta \quad (1)$$

$$\text{Output 2} = |\bar{E}_1 - \bar{E}_2|^2 = E_1^2 + E_2^2 - 2 E_1 E_2 \cos \theta \quad (2)$$

where \bar{E}_1 and \bar{E}_2 are the two phasor inputs, E_1 and E_2 their magnitudes, and θ is the phase angle between them.

The combining network forms the difference between these two detector outputs; this difference is directly proportional to the cosine of the phase angle between them. If the phase shifter is set so that this angle is nearly 90° , the cosine approaches zero and becomes very nearly proportional to

Resolution and stability

How small a change in the target's location can the microwave interferometer detect? The answer depends on four factors: klystron power, klystron noise, crystal detector noise and mechanical stability. The effect of noise can be analyzed as follows:

The phase detector output may be expressed as

$$E_o = E_s \sin \frac{4 \pi d}{\lambda} \quad (1)$$

where E_s is the peak input signal voltage. In general, the operating point should be set at the steepest part of the output-versus-displacement characteristic, for example around the null condition. Then small incremental changes in distance, Δd , can be related with sufficient accuracy to output voltage changes by

$$\Delta E = \frac{E_s 4 \pi}{\lambda} \Delta d \quad (2)$$

To find the apparent displacement caused by crystal noise, let $\Delta E_o = E_n$ and, rearranging equation 2

$$\Delta d = \frac{\lambda}{4 \pi} \frac{E_n}{E_s} \quad (3)$$

The signal-to-noise ratio at the crystals is

$$\frac{E_s}{E_n} = \frac{P_s M}{\sqrt{4KT B}} \quad (4)$$

where P_s is the signal power incident on the crystal, M is the detector crystal figure of merit (units of amperes, watts⁻¹, ohms²) and $KT B$ is the product of Boltzman's constant, temperature and bandwidth. From equations 3 and 4, the apparent displacement due to noise is therefore

$$\Delta d = \frac{\lambda}{4 \pi} \frac{(4KT B)^{1/2}}{M P_s} \quad (5)$$

Equation 5 assumes that the crystal generates white noise. This is not the case for frequencies below about 80 kc. At low frequencies, the noise has a 1/f characteristic and is larger than the value assumed in Equation 4. The system described in this article utilizes 100-kc modulation to avoid the increased lower frequency noise.

For our purpose, klystron noise can be divided into amplitude-modulated and frequency-modulated components. The over-all effect of klystron amplitude modulation is not severe because of the balanced arrangement of the phase detector.

90° - θ. Therefore, the output varies linearly with the change in phase angle of either r-f signal input to the second hybrid junction. At 35 Gc, a wavelength in air is 0.338 inch and the linearity of electrical output as a function of target motion is excellent over a range of about 0.050 inch.

The phase shifter is attached to one arm of a microwave phase bridge. External mechanical standards, such as gage blocks, can be used if a more accurate calibration is required.

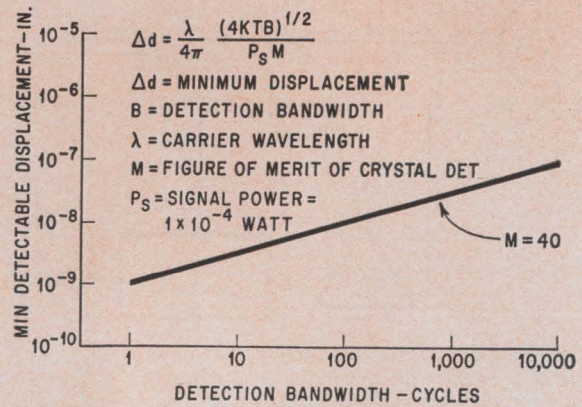

Resolution capability of microwave interferometer is limited by the detection bandwidth, as is shown by graph relating the parameters of equation 5. The figure of merit of 40 was selected as typical for the crystal detector.

If the two crystal detectors are well matched, the effects of amplitude modulation of a high quality klystron oscillator is not a limiting factor.

However, the incidental frequency modulation is important when the path length of the reference arm differs from that of the measurement arm. The phase difference and the phase detector output will then be frequency-dependent. To obtain the magnitude of this effect, assume that the waveguide sections of the two arms are identical and the total path length difference is d , the distance between the antenna and target. The equation relating the pertinent variables is

$$\Delta \omega = \frac{\Delta \beta C}{d} \quad (6)$$

where $\Delta \omega$ is the change in klystron frequency, C , the propagation velocity, and $\Delta \beta$ is a specific change in phase angle for a target displacement of one-microinch.

At 35 Gc the significant constant is 89 kc per microinch per centimeter. This means that if d is equal to one centimeter, the klystron frequency must change 89 kc to cause the phase detector output to give a voltage change equivalent to one microinch of motion.

In the present system, the largest value for d will be about 43 centimeters when the far field antenna is used. This means that the klystron's long-term stability must be approximately one part in 10^6 to maintain the interferometer stability at less than 10 microinches. Measurements have shown that the cavity stabilization technique produces the required frequency stability.

The output signal for static tests is displayed on a front-panel meter whose sensitivity can be adjusted to a maximum of five microinches per division or set for a full dynamic range of 0.07 inch. For vibration or other dynamic tests, the output signal can be displayed on an oscilloscope.

The noise level for both displays is equivalent to 10 microinches. An external bandpass filter can be used to increase the sensitivity of dynamic tests to about one microinch by restricting the instru-

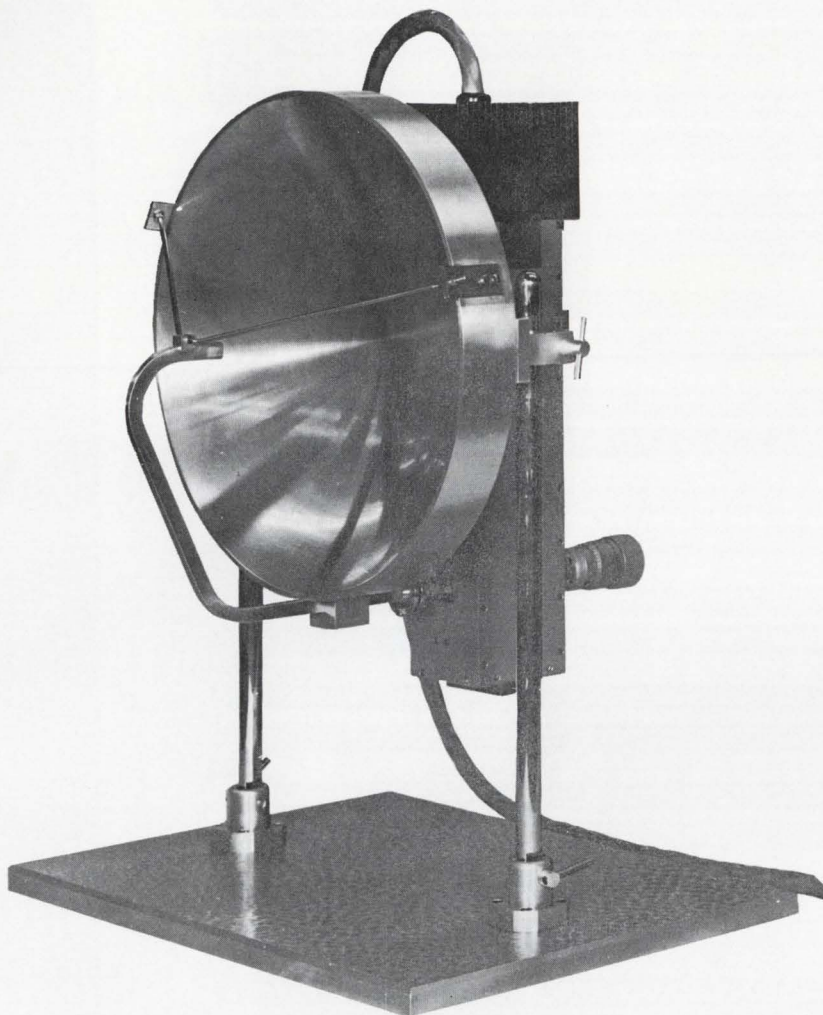

Elliptical antenna focuses microwave energy to a point 17 inches away. It is used for measurements on targets that are relatively inaccessible. Heat sink, at top of assembly at rear of antenna, dissipates heat from klystron.

ment's bandwidth to a narrower range than its full capability of d-c to 20 kc.

One oscilloscope output consists of the 100-kc carrier whose amplitude is proportional to phase change. The second output is the rectified envelope of the carrier. The synchronous detector output is a low-frequency signal that can be positive or negative depending on the phase; and is suitable to be the input to a chart recorder. If the target oscillates, the recorder must have adequate frequency response to follow these oscillations. If not, the oscillations can be viewed with an oscilloscope on either output.

Calibration

With the phase shifter, the instrument can be calibrated easily and accurately in terms of micro-inches of motion per volt change in output. With this technique, accuracy of calibration is practically unaffected by variations in the amount of energy reflected from the target. This direct calibration is applicable when either a recorder or a voltmeter is being used to observe low-frequency displacements,

or with an oscilloscope being used to observe high-frequency displacements. When an oscilloscope is used, the percent modulation of the 100-kc carrier as a function of phase-shifter setting is the basis for calibration. Appropriate filters can be inserted between the instrument's output and the oscilloscope, these filters can also be used with the phase shifter to measure the peak-to-peak displacement of each harmonic of a complex vibration.

Extending range with antennas

Three different antennas can be used to extend the instrument's applications. The "near field antenna" is an open-end waveguide with a wedge of dielectric inserted for matching. It is used when the antenna can be brought close to the target. An elliptical dish antenna sharply focuses the radiated r-f energy to a beam about 0.15 inch in diameter at a point 17 inches in front of the dish, so that if the target is placed at the point the instrument's full sensitivity is achieved.

A third possible antenna is a horn. This requires a larger target than either of the others, but target position is less critical.

A crucial requirement of any microwave instrument in precision work is mechanical stability of the waveguide circuits. Any

small changes in a circuit's location or dimensions can cause drift and be indistinguishable from target motions. In the instrument described, rigidity is achieved by milling all waveguide circuits from a single block of brass. This procedure eliminates any noise and drift that might be generated by microphonics and thermal expansion.

There are many more applications for the microwave interferometer. It can measure expansion coefficients of materials at high temperatures. Also, since it operates independently of the material under consideration, the instrument can be used to measure the thickness of the dielectric coatings on metallic surfaces and over-all thicknesses, and to detect flaws.

References

1. W. Culshaw, "High Resolution Millimeter Wave Fabry-Perot Interferometer," *IRE Transactions on Microwave Theory and Techniques*, Vol. MTT-8, No. 2, pp. 182-189, March, 1960.
2. W. Culshaw, "Further Consideration of Fabry-Perot Type Resonators," *IRE Transactions on Microwave Theory and Techniques*, Vol. MTT-10, No. 5, pp. 331-339, September, 1962.
3. Proceedings of Symposium on Interferometry, National Physical Laboratory, Teddington, England, June 9-11, 1959.



Overlay transistor has multiple emitters connected by an aluminum layer. This is RCA's TA2657, which has 180 emitters (small circles), each 2.5 mils in outside diameter. High emitter edge-area ratio gives power capability.

The overlay transistor, part I: New geometry boosts power

Multiple emitters with high periphery-to-area ratios are connected in parallel to give high current-handling capability for semiconductor operation at high frequencies.

By Donald R. Carley, Patrick L. McGeough, and Joseph F. O'Brien

Radio Corp. of America, Somerville, N. J.

At high current levels, a transistor's emitter current is concentrated at the emitter-base edge; exploitation of this fact has led to new geometries for power transistors that operate at high frequencies. To make the periphery-area ratio as high as possible, the size of the emitter was reduced, and to provide the necessary current-handling capability, a number of emitters were connected in parallel. The overlay transistor has a periphery-area ratio greater than 14 to 1 in some cases; the device has high current-handling capability as well as low capacitance and short carrier transit time between emitter and collector.

Present commercial overlay transistors have from 16 to 216 emitters, while developmental types have as many as 408. They are so small that a lead cannot be directly bonded to the emitter, and an aluminum layer is used to conduct current to the lead. The device is called an overlay transistor because of the position of the aluminum layer directly above the emitter matrix and base region.

Emitter geometry

The current flowing through the base region of a junction transistor, between the emitter and the collector, causes a voltage drop that produces maximum forward bias at the edge of the emitter closest to the base contact. The center of the emitter, then, injects almost no current.

This edge-injection phenomenon has led to design changes of the emitter from the circle type to the line type to the comb type, and finally to the overlay structure.

The maximum frequency of oscillation f_{max} of a junction-transistor structure is:

$$f_{max} = (PG)^{1/2} F = \frac{1}{4\pi} \left[\frac{1}{r_{bb}' C_c T_{ec}} \right]^{1/2} \quad (1)$$

where PG is the power gain, F is the frequency of operation, r_{bb}' is the base-spreading resistance, C_c is the collector capacitance, and T_{ec} is the emitter-to-collector transit or signal-delay time. The latter two terms are very small.

This equation was derived from analysis of the transistor as a low-level class A amplifier, but it can also serve as a guide to performance in the more usual class C circuit encountered in high-frequency power applications. To a first approximation, the frequency f_{max} at which the power gain is unity is independent of collector area. Although the collector capacitance C_c is directly dependent on the collector area, the value of r_{bb}' varies inversely with area. For example, if the stripes and base of an interdigitated or comb-type structure are made twice as long, the capacitance C_c is doubled, but r_{bb}' is cut in half. Thus,

The authors

Patrick L. McGeough is currently engaged in the design of a 1-watt, 1-gigacycle overlay transistor. Since joining RCA in 1961, he has worked on the design and development of high frequency transistors, including the 2N3375. He received an electrical engineering degree from the Newark College of Engineering in 1961.

Joseph F. O'Brien is investigating new geometries and structures for high-frequency power transistors. He was responsible for the development of the photolithographic technology required in the fabrication of the 2N3375. O'Brien received a degree in physics from Fordham.

Donald R. Carley received the 1965 David Sarnoff Outstanding Achievement Award for the design and development of the overlay transistor. In 1960, he was promoted to his present position of engineering leader in the industrial transistor design activity. He joined RCA in 1957 after graduation from the University of Michigan with a B.S. in physics.

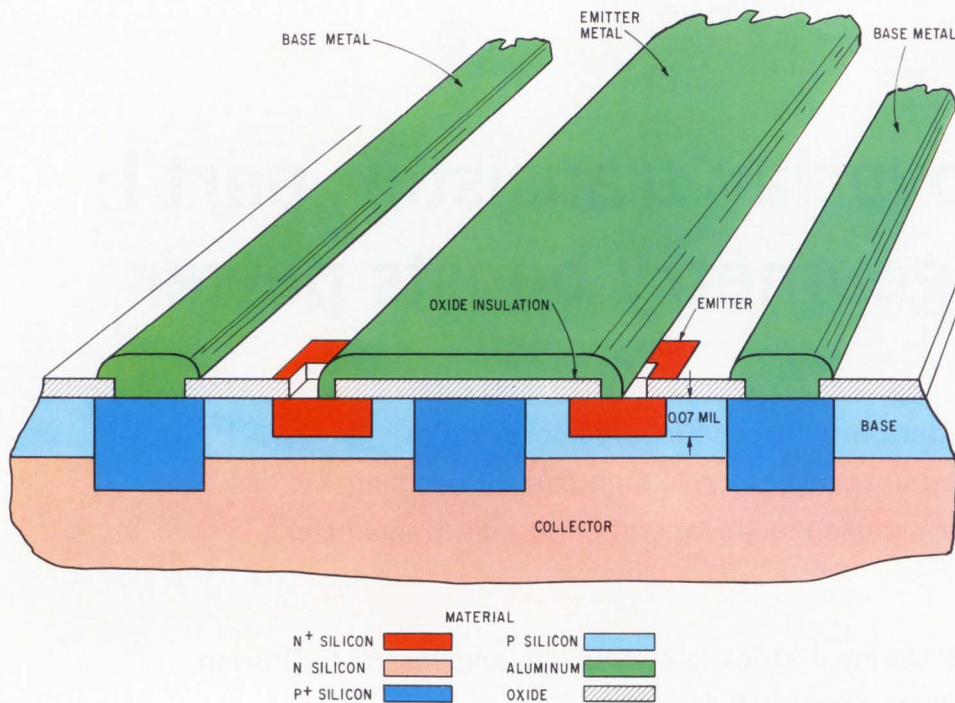

Cross-section of the 2N3375 silicon overlay transistor. The aluminum paths (shown in green) carry the emitter and base currents to the bonding wires. The aluminum path which conducts the emitter current is separated from the base region by silicon oxide insulation. The vertical dimensions are not drawn to scale.

the length of a transistor can be extended and the power dissipation and current-handling capability improved without any increase of the $r_{bb}'C_c$ product.

The collector-to-emitter transit time T_{ec} has four components: the charging time of the emitter capacitance, the transit time through the base, the transit time through the collector depletion region, and the charging time of the collector capacitance and the collector series resistance. The last term is usually negligible in devices made with triple-diffused or epitaxial construction. Of the remainder, only the emitter transit time T_e is current-dependent, as shown by:

$$T_e = r_e C_{ea} = \frac{kT}{qI_e} C_{ea}$$

where r_e is the emitter resistance, C_{ea} is the emitter capacitance, k is Boltzmann's constant, T is the temperature in degrees Kelvin, q is the electron charge and I_e is the emitter current. However, if the emitter edge is increased proportionally as the area of the emitter is increased, the fraction C_{ea}/I_e remains a constant. With suitable scaling, transistors can be enlarged to increase power-handling capability without deterioration of frequency response.

Overlay structure

The new emitter electrode structure called the overlay was first used commercially in the power transistor 2N3375. Introduced in 1964, this transistor has 156 emitters tied together by diffused and metalized regions. This approach provides a considerable increase in the emitter edge-to-area ratio and a proportional reduction in the input time constant. This established a new level of performance for high-

power high-frequency transistors by permitting a 3-watt output at 400 Mc.

The desired overlay structure is fabricated by means of carefully controlled diffusion and by the use of precise photographic processes. By photolithographic techniques, areas are opened in the oxidized silicon surface to permit the subsequent introduction of phosphorus or boron dopant for the formation of electrical junctions. Vapor-diffused techniques produce the diffusant profile shown on the next page.

The 2N3375

The 2N3375 is a planar epitaxial npn transistor. It has a collector area of about 400 square mils, an emitter area of 40 square mils, and an emitter edge of 300 mils. The precise tolerances needed to define the patterns on the oxide layer required five separate masks. Spacing between lines in patterns from these successive masks is as small as 0.1 mil. The photo-masks must have accurate pattern registration over a large area, edge definition of ± 0.01 mil or less, and high contrast (opaque emulsion areas and clear emulsion-free areas).

Techniques were developed for applying the photosensitive material on the silicon wafer in films thin enough to provide high resolution but thick enough to provide protection of oxide during etching. (Thin coatings of emulsion tend to develop defects.) The design and construction of a precise alignment fixture was also necessary to provide accurate control of movements and sufficient pressure for intimate contact between the wafer and the glass mask.

Fabrication of overlay devices begins with large silicon wafers with a thin epitaxial layer. Approxi-

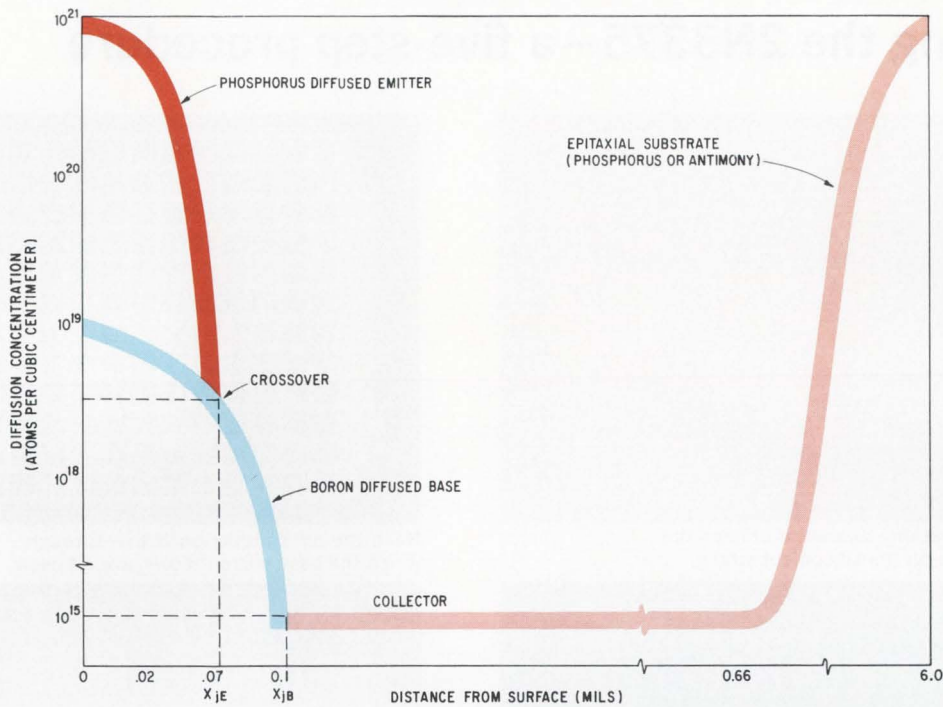

Diffusion profile for the 2N3375. Curves show impurity concentrations at various depths below the top surface. The n-material emitter depth for this device is 0.07 mil; the p-material base depth is 0.1 mil. Impurity concentration in collector is uniform to a depth beyond 0.66 mils.

mately one thousand 2N3375 transistors are processed simultaneously on each wafer. (Another overlay type, the 2N3866, has more than 3,500 transistors on each wafer.) Prior to the etching of patterns into the oxide, the wafers are cleaned and coated with a light-sensitive emulsion, such as one of the Kodak photoresist materials. A few drops of the resist are placed on the silicon oxide layer coating the surface, and the wafer is mechanically whirled to produce a layer of emulsion 3,000 to 4,000 angstroms thick. A photomask is then placed in contact with the emulsion layer and exposed. The clear areas in the photomask permit passage of light to expose and thus polymerize emulsion on the wafer.

The wafer is then placed in a solution to develop the image and remove all unexposed emulsion. The remaining resist is further polymerized by heat to protect the oxide during etching; the unprotected areas are then etched to remove the silicon oxide and produce the desired pattern for the subsequent diffusions.

The five main steps in fabrication are shown by the five photographs on page 74. In the first step, a pattern is provided for the base.

Dopant deposited

A p-type dopant such as boron is diffused into the etched-out area of the base. A relatively light concentration of impurity is used. The surface of the base area is reoxidized during the diffusion.

The wafer is then recoated with resist, and the p+ mask, which has 0.3-mil grid lines, is aligned inside the previously defined base area. The wafer is exposed, developed, baked and etched before diffusion of a p+ conductive material into the wafer

grid lines. The low-resistance grid line distributes the base current and reduces the base-spreading resistance r_{bb}' , and thus improves the frequency response of the device. Another reoxidation occurs after the p+ diffusion.

Aligning the squares

The emitter area is then photographically defined in the oxide. Processing steps are similar to those used previously for the p+ deposition. The emitter pattern consists of 156 squares aligned so that the squares register in the center of the p+ diffused grid lines. Registration and developing techniques must be good enough to keep edge variations in the pattern within 0.05 mil (12,500 angstroms) so that sub-

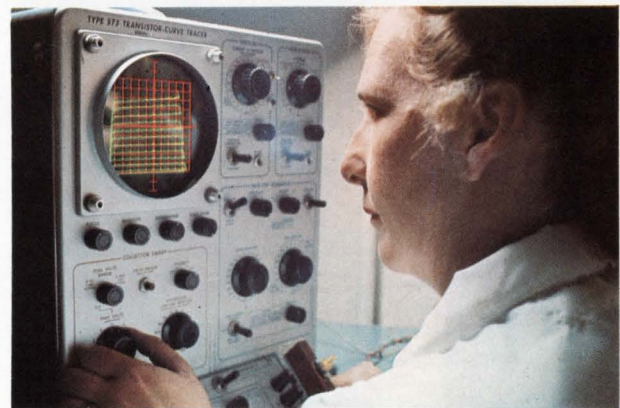

oscilloscope shows voltage-current characteristics for one pellet on a wafer containing more than a thousand 2N3375 pellets. Each pellet must meet minimum current gain requirement of 30 at 100 milliamperes.

Making the 2N3375 – a five-step procedure

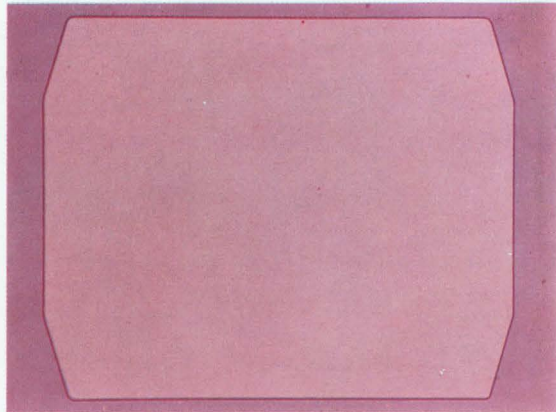

The first masking operation defines the base region on the silicon substrate.

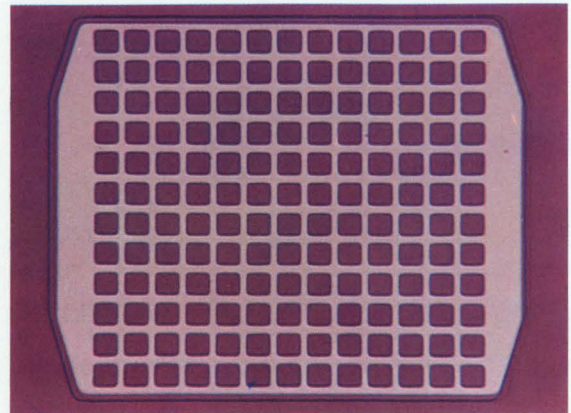

Next, the p+ conduction paths, through which the base current flows, are diffused.

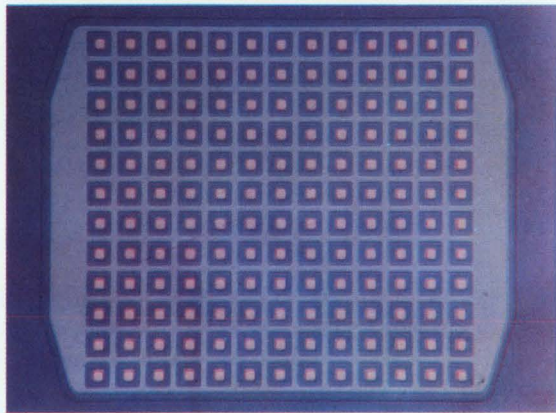

The 156 individual emitter areas are aligned inside the p+ grid lines.

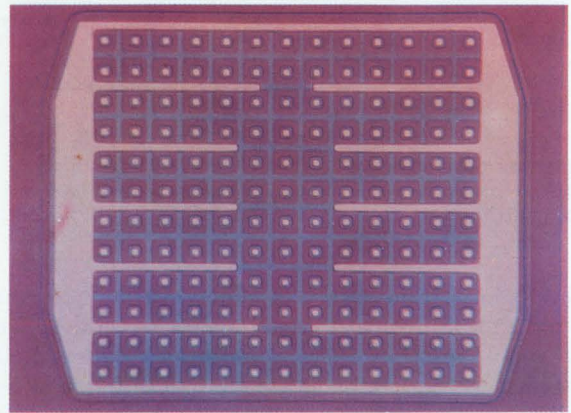

In the fourth step, the contact areas to the emitter and the base are etched.

The metallization pattern for connection of emitters and base contacts (below). The entire sequence of photos shows the five main steps required for processing the 2N3375. Each photograph was taken after the completion of a masking operation. This device contains 156 square emitters, each 0.5 mil on a side, arranged in a 12 by 13 array. In the photograph below, the emitter contact is the small white square inside the larger blue square, which is the emitter. The red square is a portion of the base region. The surrounding purple region is the p+ base conduction area.

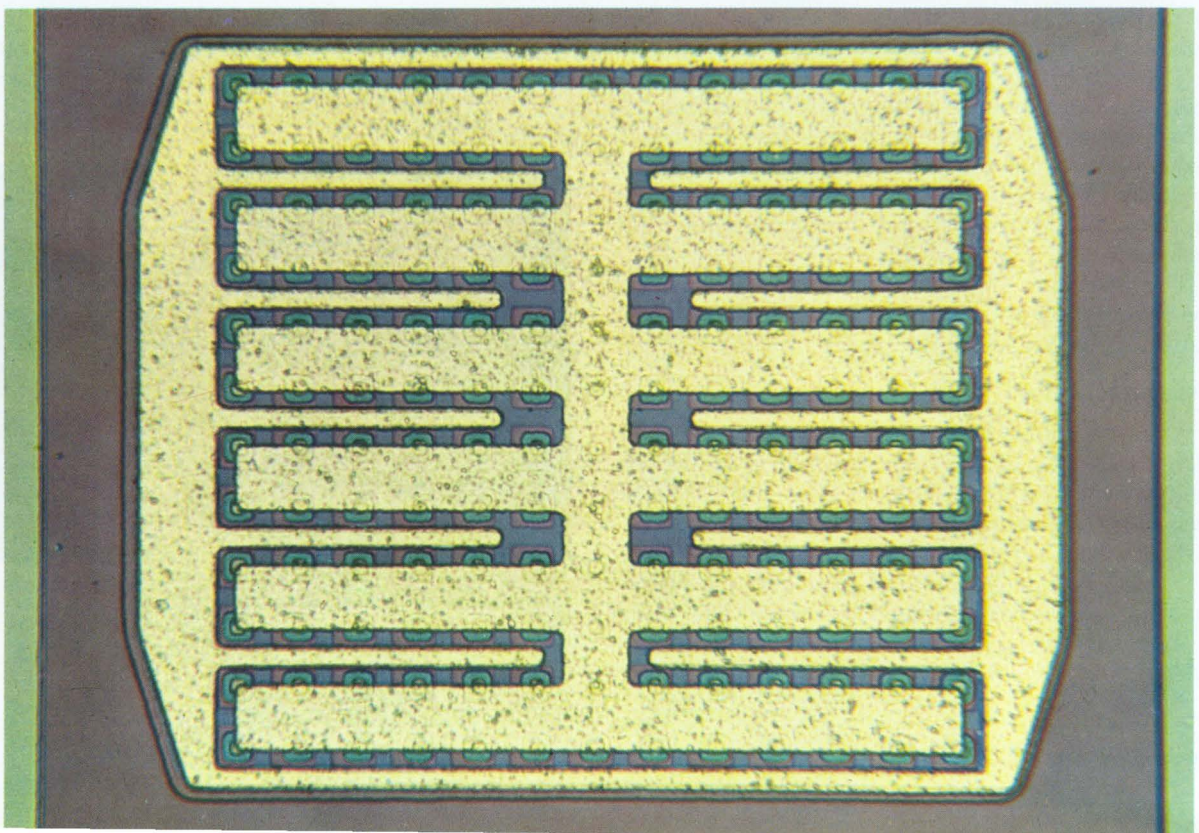

sequent alignment of squares and grid is possible.

After reoxidation during emitter diffusion, contact areas for the emitter and base are defined in the oxide by means of the third and most difficult of the pattern registrations. The metal contact pattern requires a contact area of 0.3 mil in each 0.5-mil emitter.

Aluminum evaporation

Following the etching of the contact regions, aluminum is evaporated over the silicon wafer, and the wafer is then coated with photosensitive resist and again processed as described previously. Etching of the aluminum defines metal areas in which the emitters are connected to the center bonding area by aluminum stripes 1.5 mil wide. Each emitter metalization stripe makes connections to two adjacent rows of emitters. Contact to the base area is made at the metal base stripes.

The diagram on page 72 shows a cross-section of a completed unit. The dark blue area indicates the p+ conductive grid. The emitter metalizing is insulated from the base by the silicon oxide and contacts the emitter in the open region.

Base current is distributed from the bonding area by the base metalization and by the p+ grid under the emitter metalizing. The emitter metalizing "overlays" the base.

After the wafer is scribed for pellet separation, the transistor pellets are mounted in individual 7/16-inch double-ended stud packages that have isolated collector termination. Aluminum wires are bonded to the pellet areas and the corresponding terminal posts as shown on page 76. The cap is sealed hermetically to the stud, and the leads are crimped to complete the package.

Testing for performance

Parameters of the sealed units are measured in tests conducted under d-c conditions and at high frequencies. Characteristics measured include junction breakdown voltage, leakage current, current transfer ratio, saturation voltage, thermal resistance, and junction capacitance.

Ultra-high frequency measurements are made in the tuned-line, common-emitter, class C amplifier shown on page 77. In this circuit, the adjustable stubs are tuned until an impedance match is obtained between the device input circuit and the signal source and between the power meter and the collector. The

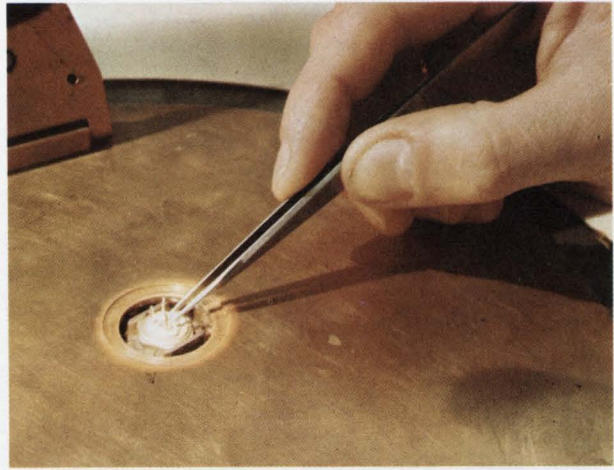

Pellet-mounting process. Here, the header is being inserted into a heating chamber. After a 30-second warm-up period, the pellet is placed on the header and connected to it with a gold-silicon alloy.

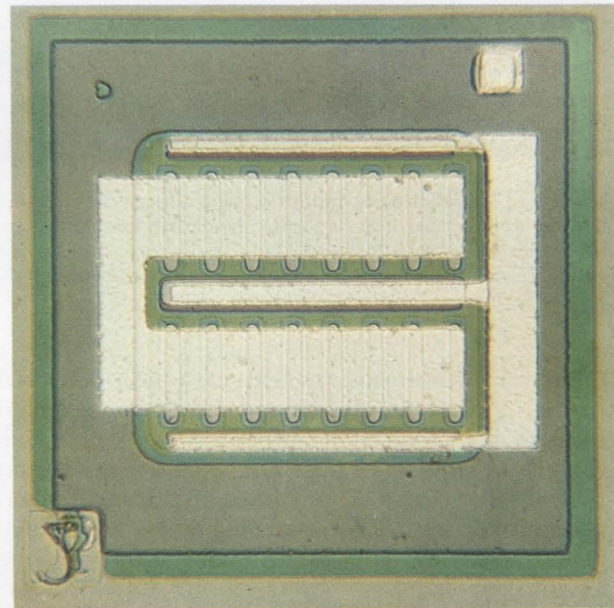

The completed 2N3866, ready for mounting and bonding. Dimensions are 15 mils by 15 mils by 4 mils. The thickness of the oxide determines the color of the different regions of the transistors and varies from device to device, so that there is a difference in color between this 2N3866 photograph and the other one shown below.

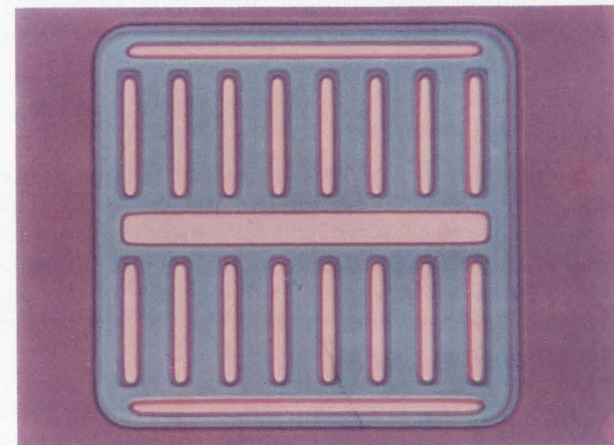

The 2N3866 has 16 emitters, each 0.15 mil wide by 2 mils long. This photograph shows the device after three areas have been exposed to allow contact to the base. This is the step conducted prior to defining the metallization pattern for interconnecting of emitters and contact to the base.

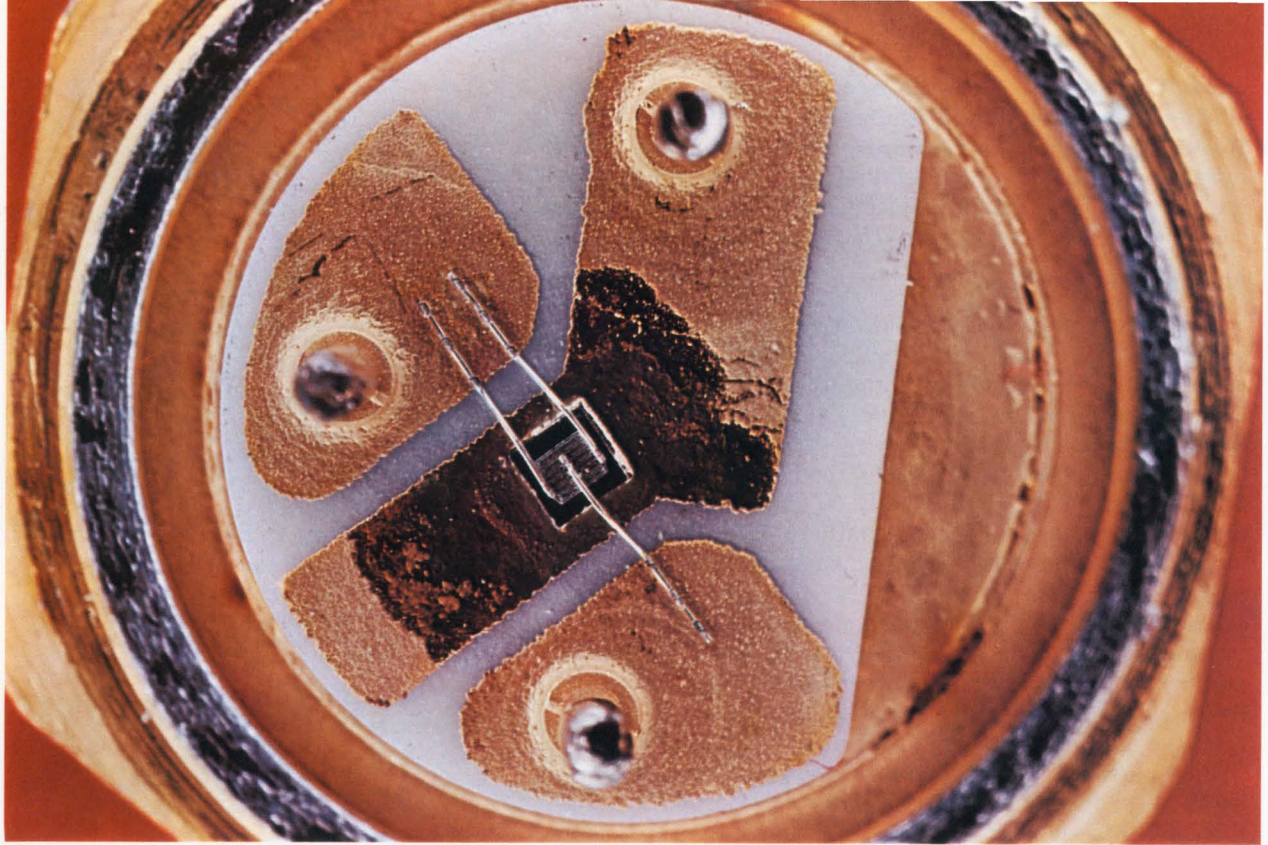

The 2N3375 pellet after mounting and ultrasonic aluminum-to-aluminum bonding. The center lead is the emitter connection. The two outer leads are connected to the base. Center metal area of package carries the collector current to the collector riser wire. Emitter, base, and collector are insulated from the Jedec TO-60 stud-mounted case by a thick layer of beryllium oxide (white region).

inline wattmeter measures both the power delivered to the input of the device and the power reflected back to the driver stage. If no power is reflected, there is an impedance match between the driver and the amplifier circuit. These tuned lines make it possible to obtain impedance matching over a wide range of frequency and impedance values using the same circuit components.

Tests were performed at various frequencies, with 28 volts applied between collector and emitter. The input circuit was biased by means of the parallel RC network shown in the circuit. Curves of typical performance for the 2N3375 in this circuit are shown on page 77. This device is rated for a minimum power output of 3 watts at 400 Mc and 7.5 watts at 100 Mc for 1 watt of drive. The minimum circuit efficiency of 2N3375 units is 40% at 400 Mc and 65% at 100 Mc for 1 watt of r-f drive.

Two pellets in parallel

A power output of 10 watts at 400 Mc can be obtained by parallel operation of two 2N3375's. The 2N3733 uses two 2N3375 pellets connected in parallel and mounted in a 7/16-inch double-ended stud package (TO-60). Typical d-c characteristics of this device are identical with those of the 2N3375, except that the output capacitance is twice as high.

Curves of typical high-frequency performance for the 2N3733 are shown on page 77. For an input power of 4 watts, power output is a minimum of

10 watts at 400 Mc and typically 14.5 watts at 260 Mc.

As a result of improvements in photomask fabrication techniques and photolithographic technology, devices employing tighter tolerances and smaller geometries than the 2N3375 can now be fabricated. The 2N3866, which is used in uhf driver applications, has 16 emitter sites, each 0.15 mil wide by 2 mils long. The ratio of emitter periphery to emitter area is nearly twice that of the 2N3375. In addition, due to a substantial reduction in input capacitance, the frequency response of the device has been further improved. Although the fabrication steps used to make this device are similar to those of the 2N3375, about four times as many pellets can be processed on each wafer. The device has a minimum gain of 10 db at 400 Mc for 1 watt of output power.

Five-step process

Five masks are used to fabricate the 2N3866. The manufacturing sequence is the same as that used for the 2N3375, except that the order of the first two steps is switched. In making the 2N3866, the first pattern defined on the silicon substrate is the set of p+ conductive regions which carry the base current from the base to the base aluminum metalization. In the next step, the remainder of the base is formed.

The third step defines the 16 individual emitters, and the fourth exposes three areas to allow contact to the base. Finally, the metalization patterns for interconnection of the emitters and contact to the base are defined.

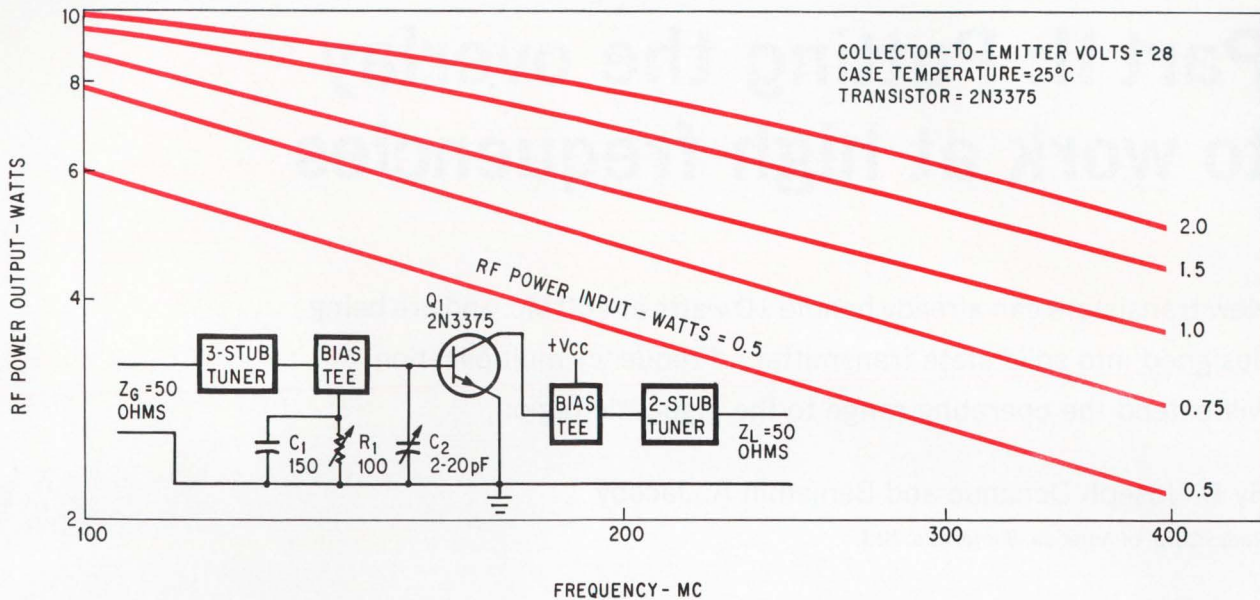

Test circuit for determining power output of 2N3375 at 400 Mc. Tuned lines are used for the impedance matching. Also shown are typical power outputs for various power inputs as a function of operating frequency. For a 1-watt input, the 2N3375 has a guaranteed 3-watt output at 400 Mc and a 7.5-watt output at 100 Mc.

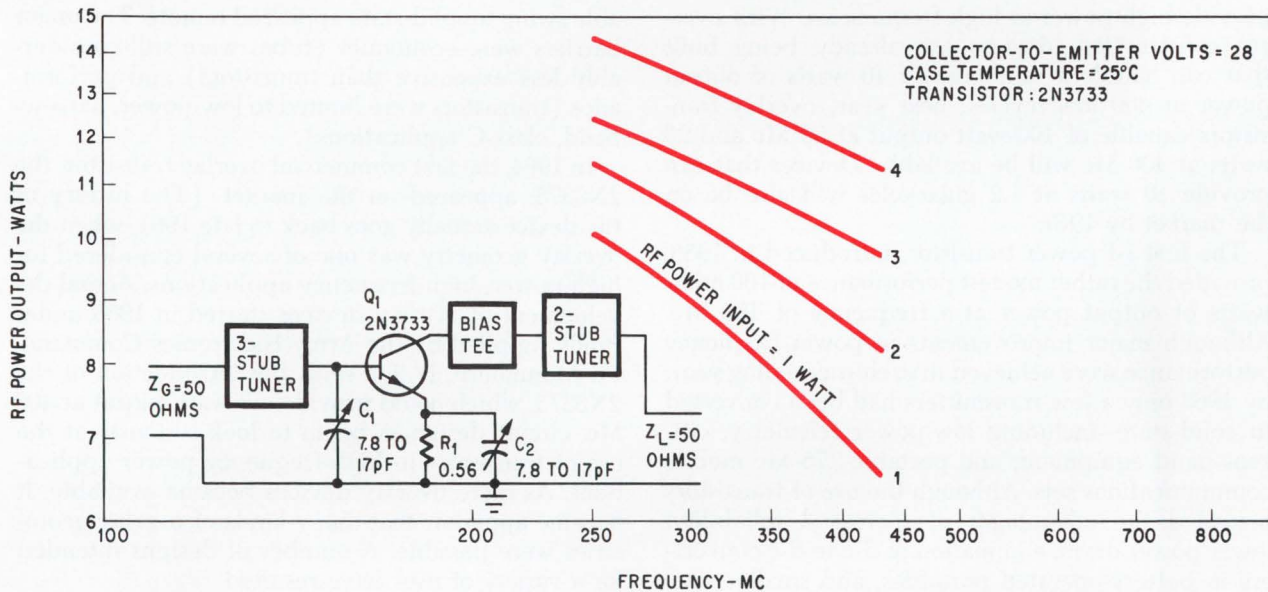

Test arrangement for measuring 2N3733 high-frequency power output and typical power levels obtainable. To reduce the effects of emitter lead inductance, a tuned emitter circuit is used. With a 1-watt input at 400 Mc, 7 watts of output power are produced, as compared with 4 watts with the 2N3375.

The 2N3375 can be driven by another 2N3375; but it is preferable to use a 2N3866 as the driver, since at low power levels the 2N3866 provides more gain and higher output impedance. In addition, the 2N3375 is more expensive. In 1,000 lots, the 2N3866 is priced at \$3, while the 2N3375 sells for around \$14.

The 2N3866 is packaged in the Jecdec TO-39 case. Another version of this transistor, now in development, is intended for operation at frequencies up to 1,000 Mc.

Putting the overlay to work

Some applications of the overlay transistor are discussed in the following article. The development

of the device has been spurred by the need for increased reliability and efficiency in solid state telemetry systems, where transistors have been required for final output stages, as power sources for varactor multiplication, and in amplifier-multiplier stages.

High-frequency transistors are also needed in output stages of citizens band and mobile radio equipment, and for power switching in military and industrial equipment. The advance in geometry that led to the overlay should have a powerful effect.

Acknowledgement

The authors acknowledge the many contributions made by Ronald Duclos, George Gilbert, and Stanley Matyckas in the development of the devices described in this article.

Part II: Putting the overlay to work at high frequencies

New transistors can already handle 10 watts at 400 Mc, and are being designed into solid state transmitters. Frequency multiplication will extend the operating range to the gigacycle region.

By D. Joseph Donahue and Benjamin A. Jacoby

Radio Corp. of America, Somerville, N. J.

The overlay transistor is sure to accelerate the conversion from tubes to semiconductor devices, which has been slowed by the inability of transistors to provide high power at high frequencies. With overlay construction, devices are already being built that can handle a minimum of 10 watts of output power at 400 megacycles; next year, overlay transistors capable of 100-watt output at 50 Mc and 20 watts at 400 Mc will be available. Devices that can provide 10 watts at 1.2 gigacycles will also be on the market by 1967.

The first r-f power transistor, introduced in 1958, provided the rather modest performance of 100 milliwatts of output power at a frequency of 100 Mc. Although major improvements in power-frequency performance were achieved in each succeeding year, by 1963 only a few transmitters had been converted to solid-state—including low-power telemetry, citizens-band equipment, and portable 175-Mc mobile communications sets. Although the use of transistors provided the advantages of increased reliability, lower power drain, elimination of d-c to d-c converters in battery-operated portables, and smaller size, the vast majority of military and commercial transmitters appeared to be considerably out of the range of transistorization.

The authors

In June of this year, D. Joseph Donahue was appointed manager of RCA's industrial semiconductor operations. Since 1963 he had served as manager of engineering for the industrial semiconductor operations group. He joined the RCA Electronics Tube division in 1951, and worked on the development of the color television picture tube. In 1958 he joined the Semiconductor division as manager of advanced development.

Benjamin A. Jacoby was named marketing manager for RCA's integrated-circuit activity in June. He has been with RCA since 1952 and has held positions in purchasing, field sales and product sales administration. From July 1963 to June 1965 he served as manager of market planning for the industrial semiconductor operations group.

Some hybrid circuitry in which semiconductor devices were used up to the final stage were explored in military designs to provide reliability, but a sizable swing to solid-state appeared remote. The major barriers were economics (tubes were still considerably less expensive than transistors) and performance (transistors were limited to low-power, narrow-band, class-C applications).

In 1964, the first commercial overlay transistor, the 2N3375, appeared on the market. (The history of the device actually goes back to late 1961, when the overlay geometry was one of several considered for high-power, high-frequency applications. Actual development of overlay devices started in 1963 under funds supplied by the Army Electronics Command, Ft. Monmouth, N. J.) With the introduction of the 2N3375, which could provide a 3-watt output at 400 Mc, circuit designers begin to look seriously at the use of transistors in high-frequency power applications. As more overlay devices became available, it became apparent that many kinds of overlay geometries were possible. A number of designs intended for a variety of uses have resulted.

Solid state transmitters

The availability of overlay transistors is reshaping the outlook for all-solid-state transmitters. A wide variety of r-f power equipment is already being designed entirely with transistors; examples are mobile communications, radiosonde, telemetry, troposcatter, radio relay, radar transponder, citizens band, sonobuoy, commercial and military aircraft communications, rescue beacons, military tactical communications and community antenna television systems.

Frequency modulation is used extensively in telemetry, microwave relay and mobile equipment. The center diagram, page 81 shows a typical three-stage power-amplifier circuit suitable for telemetry application. The input stage uses a 2N3553 overlay transistor operated as a common-base 100- to-200-Mc frequency doubler. The second stage uses a 2N3375 overlay transistor as a 200- to-400-Mc common-emitter frequency doubler, and the final stage consists of

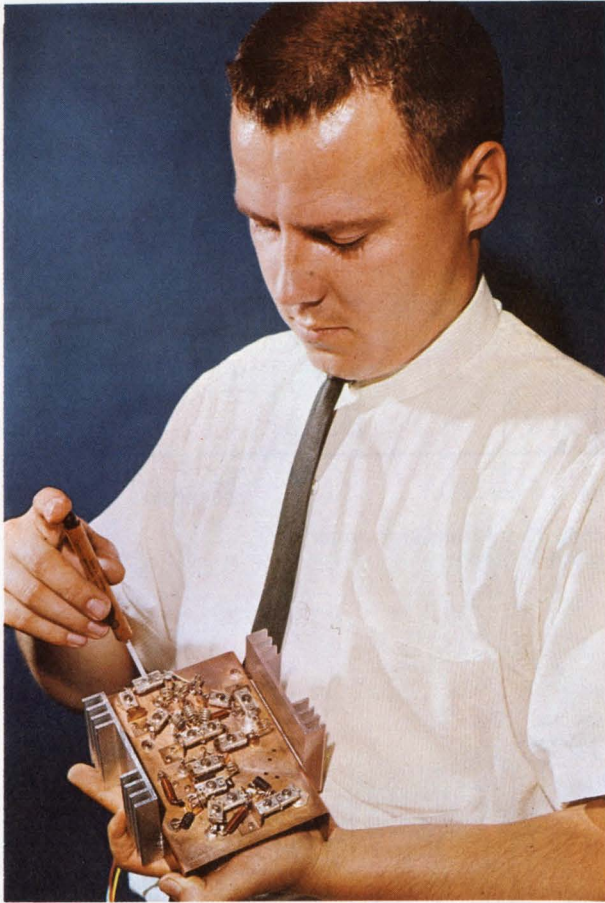

Technician tuning a 35-watt 175-megacycle transmitter power amplifier built with six overlay transistors. The transmitter operates from a 13.5-volt battery and requires only 100 milliwatts of input power to produce 35 watts of output power.

two 2N3375's in parallel. This amplifier is capable of providing a power output of 10 watts at 400 Mc. An over-all power gain of 16 db is obtained.

The center diagram on page 80 shows a 35-watt 175-Mc f-m mobile transistor amplifier. This transmitter uses a family of overlay transistors which have been specially designed to operate directly from 13.5-volt automobile batteries; thus there is no need for a d-c to d-c voltage converter. The output section of the transistor contains three 40282 transistors (selected 2N3632's with their emitters internally connected to the lead to reduce lead inductance). A separate matching network in the base of each output transistor permits drive adjustments to equalize collector currents.

Amplitude modulation is commonly used in the 27-Mc citizens band. The top circuit on page 81 shows a typical 5-watt (d-c input) transmitter, which can handle three watts of carrier power, and can deliver up to 10 watts of peak power under 100% modulation.

Amplitude modulation is also used extensively in aircraft communications. The top circuit on page 80 is for a 10-watt, 135-Mc a-m transmitter used in small aircraft. Amplitude modulation greater than

95% is achieved by modulation of the supply voltage to all three stages. The separate input matching network for each output transistor permits drive adjustments to equalize collector currents.

Transistor frequency multiplication, which had been used for many years at low signal levels, has recently been extended to power levels. In this type of operation, the collector-to-base junction of a transistor is used as a varactor diode to obtain frequency multiplication at the output. Frequency doubling coupled with power gain is becoming commonplace and has begun to eliminate the use of varactor diodes at operating frequencies below 400 Mc.

Of even greater significance are the transistor frequency-multiplication studies now underway which extend the operating range of transistors into the gigacycle region. The 2N3375, 2N3553, and 2N3866 have been found to be particularly suitable for this mode of operation as doublers, triplers, and quadruplers. Substantial power output has been obtained at frequencies approaching 2,000 Mc.

The bottom circuit on page 80 is a 500- to 1000-Mc transistor doubler circuit. Lumped elements are used for the input and idler circuits; a coaxial cavity is used for the output circuit. The 2N3375 transistor is connected in a common-emitter configuration and is located inside the cavity in a position of maximum field strength. Power is taken out through an inductive coupling loop near the shorted end of the cavity. An input of one watt at 500 Mc produces an output of 2.3 watts at 1000 Mc. A 2N3866 in the same circuit provides an output of one watt at 900 Mc from an input of 0.25 watt at 450 Mc.

Higher frequency operation can be obtained with the combination oscillator and frequency multiplier shown in the bottom circuit on page 81.

The outside story

Packaging is extremely important in building high-frequency transistors. Low lead inductance, good thermal conductivity, and isolation of the collector are all-important. Most overlay transistors are packaged in a 7/16-inch double-ended isolation-stud case, the TO-60. Lower-power devices come in a TO-39 case with a solid steel header for good thermal conductivity. New cases are being designed to provide higher resonant frequencies and lower parasitic inductances.

Largely because of the small size of the overlay silicon transistor chips (0.03 by 0.03 inch for the 2N3375), the device can be manufactured inexpensively. The size results in higher yields because of the lower probability of imperfections, and also permits more transistor chips per wafer. As penetration of the commercial communications market increases sales volume, and as new techniques are perfected with experience, r-f power transistor prices should drop even more.

The use of overlay transistors also provides further opportunities for cost reduction in equipment design as a result of increased gain per transistor stage, higher power per transistor, and elimination of voltage converters in battery-operated sets.

Typical circuits using overlay transistors

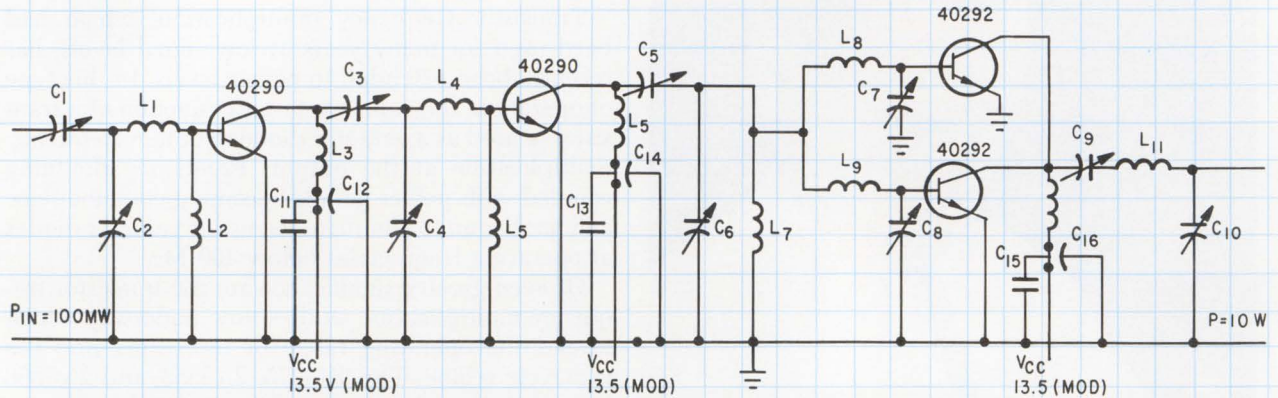

A 135-Mc amplifier circuit for an aircraft communications system. The 4-transistor amplifier increases power from 100 milliwatts at the input to 10 watts at the output.

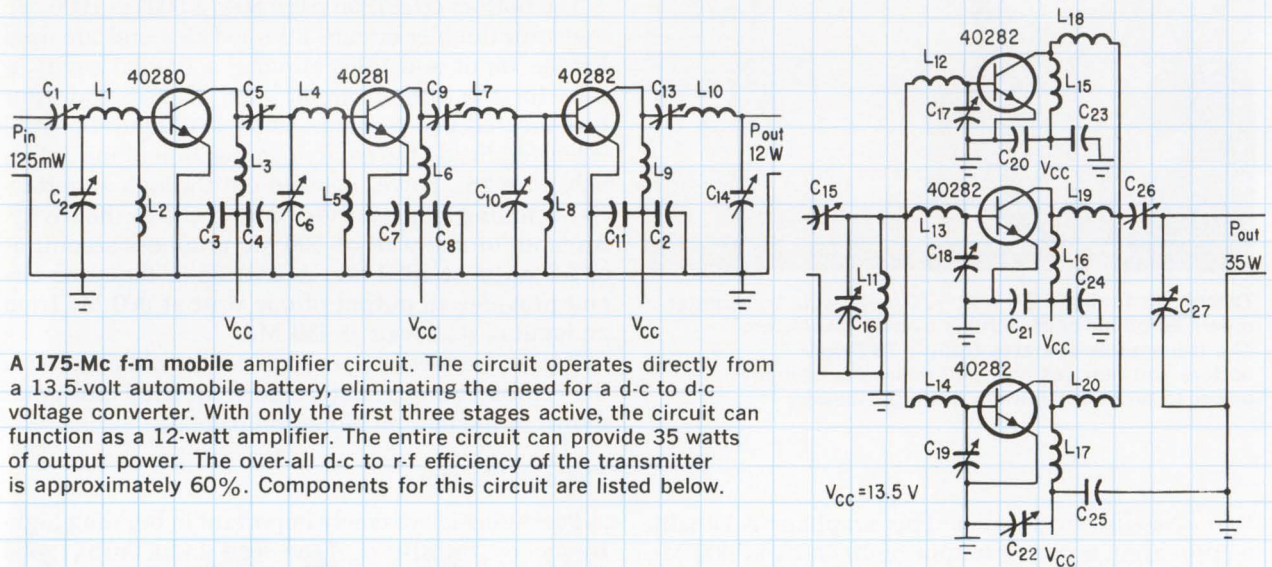

A 175-Mc f-m mobile amplifier circuit. The circuit operates directly from a 13.5-volt automobile battery, eliminating the need for a d-c to d-c voltage converter. With only the first three stages active, the circuit can function as a 12-watt amplifier. The entire circuit can provide 35 watts of output power. The over-all d-c to r-f efficiency of the transmitter is approximately 60%. Components for this circuit are listed below.

	Turns	Wire size	Inside dia. (inch)	Length (inch)
Inductor				
L ₄ , L ₇	3	16	3/16	1/4
L ₉	1	16	1/4	3/8
L ₁₀	2	16	1/4	5/16
L ₁₂ , L ₁₃ , L ₁₄	5	16	1/4	1/2
L ₁₈ , L ₁₉ , L ₂₀	2	16	1/4	1/4
L ₁₅ , L ₁₆ , L ₁₇	2	18	1/8	1/8
L ₁	2	16	3/16	1/4
L ₂ , L ₅ , L ₆	ferrite choke, 450 ohms			
L ₃ , L ₈ , L ₉ , L ₁₁	0.1 microhenry			

Capacitors	
C ₁	3-35 pF
C ₂ , C ₆ , C ₁₆ , C ₁₇ , C ₁₈ , C ₁₉ , C ₂₇	8-60 pF
C ₃ , C ₇ , C ₁₁	ceramic disk, 0.1 μF
C ₄ , C ₈ , C ₁₂ , C ₂₄ , C ₂₃ , C ₂₅	feed-through, 1500 pF
C ₅ , C ₉ , C ₁₀ , C ₁₃ , C ₁₄ , C ₂₆	7-100 pF
C ₁₅	1.5-20 pF
C ₂₀ , C ₂₂	
C ₂₁	ceramic disk, 0.2 μF

This frequency-doubler circuit combines multiplication with power amplification, and eliminates the varactor diode normally used. The circuit converts a 500-Mc, 1-watt input to an output of 2.3 watts at 1,000-Mc.

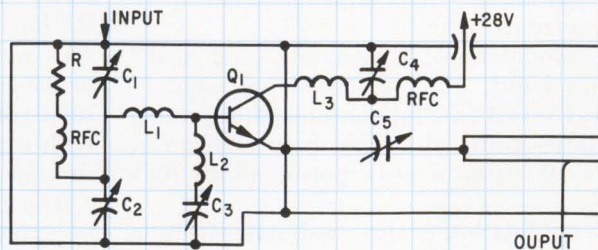

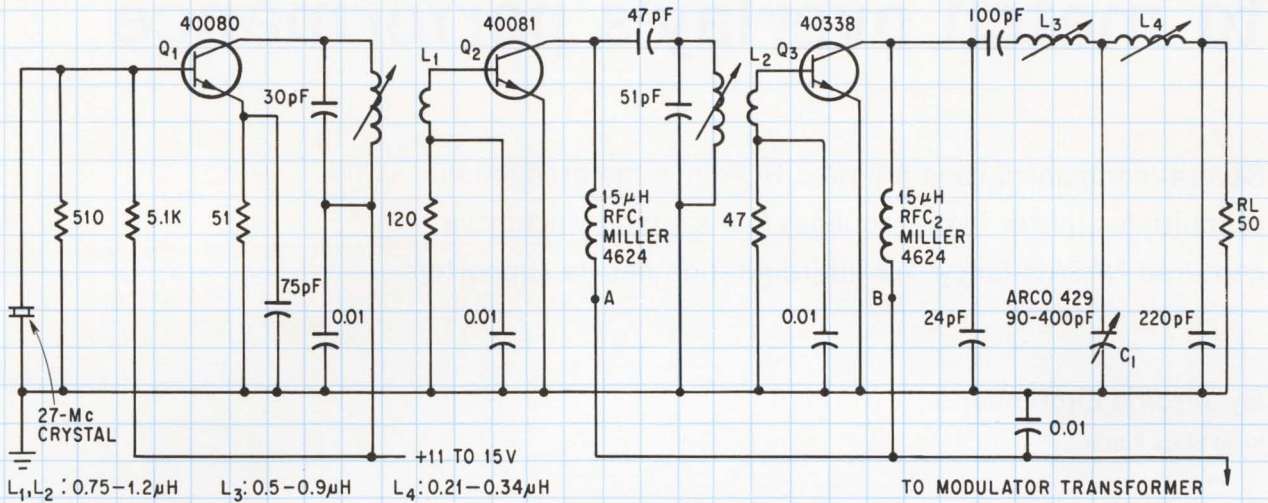

Three overlay transistors are used to form a five-watt 27-Mc citizens-band a-m transmitter. This circuit can handle three watts of carrier power, and can deliver up to 10 watts of peak power under 100% modulation. In citizens-band applications, overlay transistors are competing against conventional silicon planar transistors.

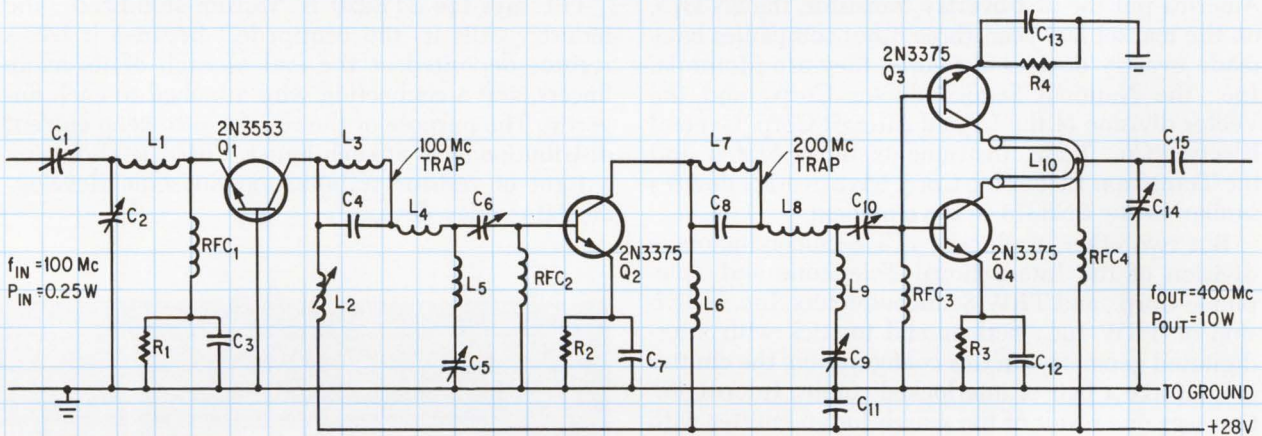

A three-stage power amplifier circuit designed with four overlay transistors for use in telemetry equipment. This circuit serves as both a frequency quadrupler and as an amplifier. In the final stage, two 2N3375's are operated in parallel. The circuit converts a 100-Mc, 0.25-watt input signal into a 400-Mc, 10-watt output signal. The over-all power gain is 16db.

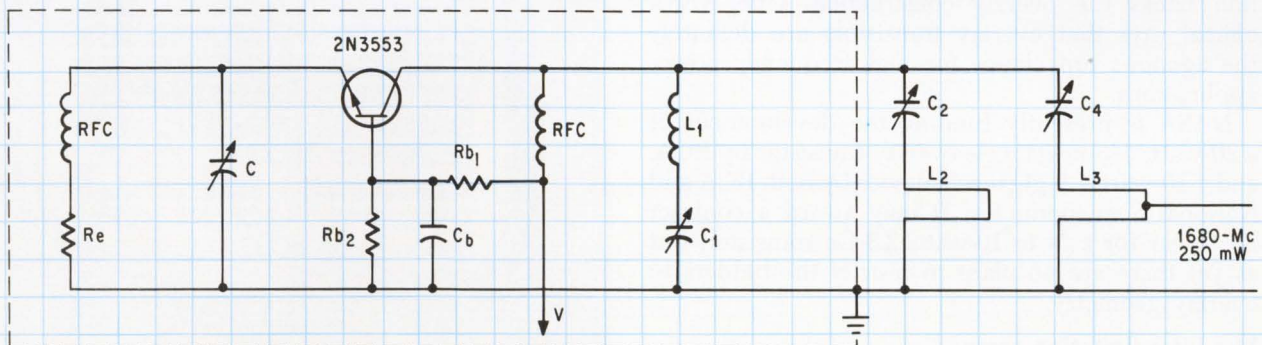

In this frequency-multiplier circuit using a 2N3553, the transistor oscillates at 420 Mc. The frequency is quadrupled to 1,680 Mc by the circuit. Power output is 250 milliwatts.

Part III: Combing the field for ways to match overlay's performance

Several companies have followed RCA into the production of multiple-emitter high-frequency transistors, which have captured NASA's fancy. Yet interdigitation has its supporters

By Jerome Eimbinder

Solid State Editor

Overlay geometry is currently the most popular design for achieving high-frequency performance in a power transistor. Since the Radio Corp. of America put the first overlay transistor, the 2N3375, on the market last year, three other companies have made overlay devices available; they are Motorola, Inc., the National Semiconductor Corp., and the Vector division of the United Aircraft Corp. General Electric Co., Texas Instruments Incorporated and the Transitron Electronic Corp. have overlay devices similar to the 2N3375 in development.

But two other producers, ITT Semiconductors, a division of the International Telephone and Telephone Corp., and TRW Semiconductors, Inc., a division of TRW Inc., both intend to stick with interdigitated geometry. In this configuration, the emitter is built like a pair of interlocked combs. Interdigitation was one result of the search for an emitter with a high periphery-to-area ratio (see Part I of this series).

NASA likes overlays

The National Aeronautics and Space Administration backs the overlay construction. One NASA official says that overlay transistors are definitely the agency's top choice for high-frequency power applications.

NASA is presently funding the development of a 20-watt, 435-megacycle overlay transistor by RCA, and a 10-watt, 1.2-gigacycle device by both RCA and National Semiconductor. It may award a contract next year for a 5- to 10-watt, 2.3-Gc transistor, but as yet there are no plans to restrict the bidders to overlay geometry.

The interdigitation story

Yet ITT and TRW have both been getting good results from "combs." ITT is already selling an interdigitated 2N3375 and plans to market its versions of the 2N3553 and the 2N3632 shortly. ITT also claims top performance for its 3TE220, which can

handle 50 watts of r-f power at 150 Mc; only specially selected overlay transistors can match those figures.

ITT says the 3TE220 is "resistor-stabilized"; the industry calls it "the centipede," because it has a resistor deposited at the end of each of its many fingers, and a connecting wire attached to each fingertip. The purpose of the resistor is to keep current distribution even at each finger. (RCA is also using a form of resistor stabilization on some developmental overlay devices.)

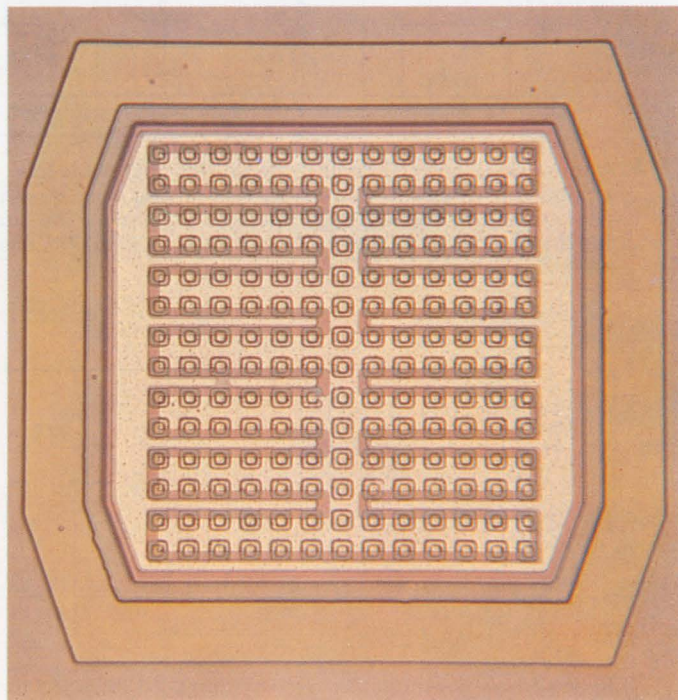

The 156-emitter overlay geometry used by Motorola to build the 2N3375. With a 28-volt supply at 400 Mc, the 2N3375 handles 3 watts of r-f power with 4.8-db power gain. It is packaged in the TO-60 case.

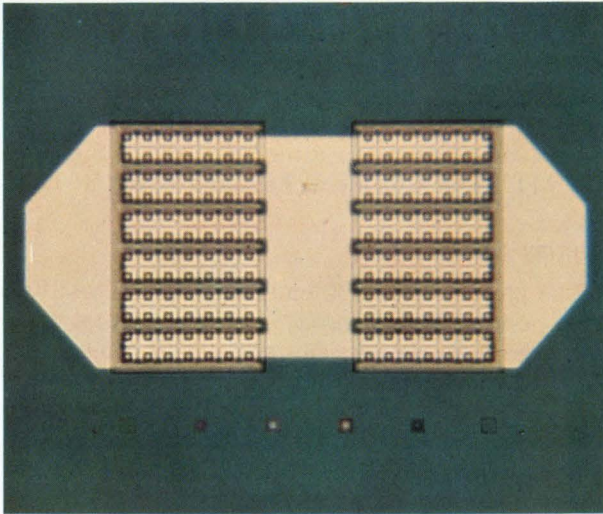

Vector's experimental VX168-10 is a 168-emitter device with a power output of 1 watt and 6-db power gain at 800 Mc. It can dissipate 12 watts.

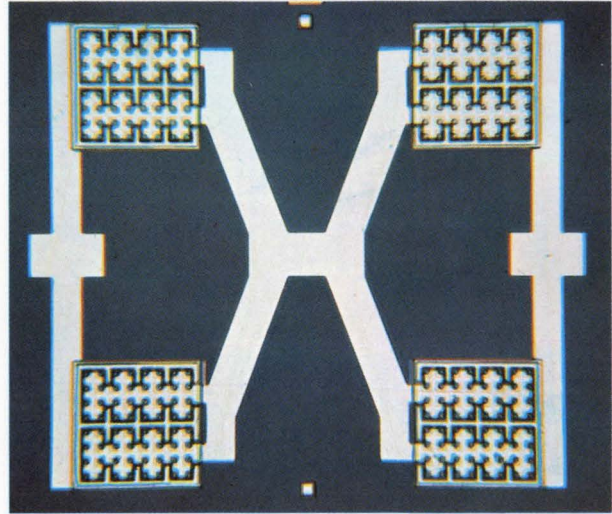

Another Vector experimental unit, the VX256-10, has 256 emitters. At 500 Mc, it provides 10 watts of r-f power with 8-db gain. Dissipation is 20 watts.

Overlay transistor characteristics

Type	Typical f_T (Mc)	Emitters	Power Output			Max. C_{ob} (pF)	Dissipation at 25°C (watts)	Jedec case	Status	Use	Mfr.
			Min. (watts)	at Mc	at volts						
2N3375	500	156†	3.0	400	28.0	8	11.6	TO-60	Com	GP	MOT, NAT, RCA, VEC
VX3375	500	156	6.5*	250	28.0	8	11.6	TO-50●	Com	GP	VEC
2N3553	500	156†	2.5	175	28.0	8	7.0	TO-39	Com	GP	MOT, NAT, VEC
2N3632	400	312‡	13.5	175	28.0	15	23.0	TO-60	Com	GP	MOT, NAT, RCA, VEC
2N3733	400	312	10.0	400	28.0	15	23.0	TO-60	Com	GP	RCA, VEC
2N3866	800	16	1.0	400	28.0	3	4.0	TO-39	Com	Driver	RCA
40279	500	156	3.0	400	28.0	8	11.6	TO-60	Com	Hi-Rel	RCA
40280	550	156	1.0	175	13.5	10	7.0	TO-39	Com	FM	RCA
40281	400	156	4.0	175	13.5	20	11.6	TO-60	Com	FM	RCA
40282	350	312	12.0	175	13.5	40	23.0	TO-60	Com	FM	RCA
40290	500	156	2.0	135	12.5	8	7.0	TO-39	Com	AM	RCA
40291	500	156	2.0	135	12.5	8	11.6	TO-60	Com	AM	RCA
40292	300	156	6.0	135	12.5	15	23.0	TO-60	Com	AM	RCA
40305	500	156	2.5	175	28.0	8	7.0	TO-39	Com	Hi-Rel	RCA
40306	500	156	3.0	400	28.0	8	11.6	TO-60	Com	Hi-Rel	RCA
40307	400	312	13.5	175	28.0	15	23.0	TO-60	Com	Hi-Rel	RCA
40330	500	156	3.0	135	24.0	8	7.0	TO-39	Dev	AM	RCA
40331	500	156	3.0	135	24.0	8	11.6	TO-60	Dev	AM	RCA
40332	400	312	8.0	135	24.0	15	23.0	TO-60	Dev	AM	RCA
40337	500	156	2.5	27	12.0	8	7.0	TO-39	Com	CB	RCA
40338	500	156	3.0	27	12.0	8	11.6	TO-60	Com	CB	RCA
40339	500	156	3.5	27	12.0	8	11.6	TO-60	Com	CB	RCA
40340	125	180	25.0	50	13.5	120	70.0	TO-60	Com	FM	RCA
40341	125	180	30.0	50	24.0	85	70.0	TO-60	Com	FM	RCA
40342	400	312	13.5	175	28.0	15	23.0	TO-60	Com	Hi-Rel	RCA
40343	400	312	10.0	400	28.0	15	23.0	TO-60	Com	Hi-Rel	RCA
TA2657B	125	180	50.0	50	28.0	80	55.0	TO-60	Dev	GP	RCA
TA2658A	800	16	1.0	400	28.0	3	4.0	TO-39	Dev	GP	RCA
VX168-10	1,000	168	1.0*	800	28.0	8	12.0	TO-50●	Exp	GP	VEC
VX256-10	800	256	1.0*	800	28.0	10	20.0	TO-50●	Exp	GP	VEC

† NAT version has 216 emitters
‡ NAT version has 432 emitters
* Typical value
● Case is similar to TO-50
fr = Gain-bandwidth product

C_{ob} = Output capacitance
GP = General purpose
Hi-Rel = High reliability
FM = Frequency modulation
AM = Amplitude modulation

CB = Citizens band
Com = commercial
Dev = developmental
Exp = Experimental
MOT = Motorola, Inc.

NAT = National Semiconductor Corp.
RCA = Radio Corp. of America
VEC = Vector Division, United Aircraft Corp.

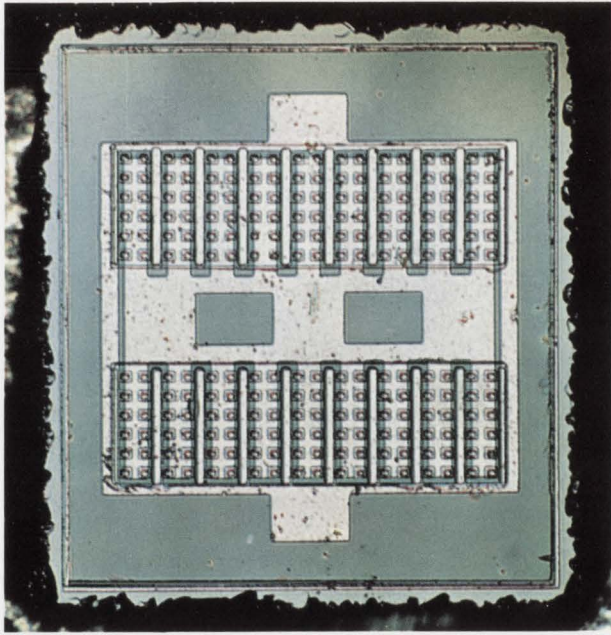

National Semiconductor's 2N3375, an overlay device, has 216 emitters; other manufacturers use 156. However ratings and specifications for National Semiconductor's device agree with those published by Motorola, Vector and RCA.

Silver striplines

At Wescon, ITT is introducing a new line of devices called stripline transistors. They come in a stud-mounted package with an epoxy cap; the stud is the emitter.

The name "stripline" comes from the two flat ribbon leads, made of silver, which extend from the top of the unit.

One stripline transistor, the 3TE440, will handle 20 watts at 400 Mc, with 8 to 10 decibels of power gain. Tom Ciochetti, ITT's transistor marketing manager, calls it the world's more powerful transistor. So far, no price has been set on it.

Like the 3TE220, the 3TE440 has fingers which are resistor-stabilized. The 3TE450, another stripline device which will be shown at Wescon, does not have resistor stabilization, but nevertheless can supply 5 watts at 400 Mc with a low voltage supply. It will cost \$28.

TRW's line

TRW also plans to market an interdigitated 2N3375—a PT4690 pellet packaged in a Jeduc TO-60 case. With a 28-volt power supply, the PT4690 provides a typical power output of 6 watts at 400 Mc, and a power gain of 5 db. TRW's other competitor to the 2N3375, the 2N3502, has a typical output of 3.5 watts at 400 Mc.

Another TRW developmental unit, the PT5690, will handle 40 watts at 175 Mc. Where overlay transistors have emitters connected in parallel, the PT5690 has complete transistors, known as cells, in parallel; 24 cells are used, each built with interdigitated geometry. TRW acquired the technology to build the PT5690 last year when it investigated multiple-cell structure while developing a 50-watt,

175-Mc transistor under an Army contract.

The Semiconductor division of the Fairchild Camera & Instrument Corp. has an interdigitated device, the MT1038, which can compete with overlays in the 1- to 2-Gc range; but the company has no immediate plans to go after the 2N3375 business. The MT1038 is capable of handling 1 watt at 1 Gc.

Overlay configurations

The 2N3375, with 156 emitters, is the oldest and most popular of the overlay transistors; but a number of new overlay configurations will soon be on the market. RCA is already selling a 16-emitter device, the 2N3866, and will put out 180-emitter and 408-emitter transistors soon. Vector has experimental units with 168 and 256 emitters; National Semiconductor is developing a 280-emitter device for operation at 1 Gc and above.

RCA has extended the power of the 2N3375 by putting two of them in a TO-60 case and labeling the product the 2N3632. Vector is also making the 2N3632 this way, but it feels that this type of construction could result in uneven current-handling if there were too large a mismatch between the chips. This company's approach to power extension is a 256-emitter device which has four quadrants of 64 emitters each (see photo on the preceding page). Vector claims this transistor has more uniform current distribution than the 2N3632, and dissipates heat better at the same or higher power.

The 2N3733 is two standard 2N3375's in one case; it provides a minimum of 10 watts at 400 Mc, more than triple the performance of the single 2N3375 but it requires four watts of drive power.

TI's dilemma

Even though Texas Instruments is developing an overlay transistor, the company is not firmly committed to manufacturing it. "The overlay concept looks very promising," says Richard J. Hanschen, assistant vice president of TI's Semiconductor-Components division, "but we have another totally different approach which also looks good."

TI is considering a majority-carrier device similar to a field-effect transistor, and won't decide which way to go until it completes an investigation of the production feasibility of such a device.

Future geometries

Even the overlay advocates believe that other geometries will find a use in high-frequency power transistors, but many engineers believe that these new geometries will be based on the overlay concept. Richard H. Moyer, chief of the Vector Solid State Laboratories, says that "The most significant contribution of the overlay transistor may turn out to be that it was responsible for a new school of thought concerning transistor construction."

Yet Jack E. Kindregan, sales manager for the Vector lab, says "We feel there is no better way to make high-frequency power transistors than the overlay method, at this time." For the present, the overlay is supreme.

Designer's casebook

One-transistor multi delays digital pulses

By Richard A. Karlin

Linear Alpha, Inc., Evanston, Ill.

Digital pulses can be delayed by a circuit that is much simpler than the usual delay line or monostable multivibrator.

Delay lines are stable and reliable, but expensive and bulky. And because they attenuate the delayed signal, delay line outputs must often be amplified. Another disadvantage is that their delay-time-to-rise-time ratio is limited so that pulses of very short duration may be distorted.

Monostable multivibrators are compact and they allow much larger delay-to-rise ratios. But since they have two transistors and a number of resistors and capacitors, they are more expensive than the circuit shown in the top diagram at the right. This simple inverter circuit has only one transistor, two resistors, and a capacitor.

Normally, transistor Q_1 is biased on by R_1 and the circuit output is at approximately ground potential. The base of Q_1 is a few tenths of a volt negative with respect to its emitter. A negative-going input signal is coupled through the input capacitor and injects excess charge into the base of Q_1 without causing any change in output. A positive-going input signal V_A cuts off Q_1 , whose collector immediately goes to -6 volts. The base voltage immediately starts to decrease according to the $R_1 C_1$ time constant. When the base voltage again becomes negative by a few tenths of a volt, Q_1 again conducts and the output returns to ground potential. Thus, the output is negative for the duration of the delay.

Because the circuit inverts the input, successive delays can be provided by cascading several delay stages. Each delayed output acts as the input for the next delay stage.

The delay time of the circuit is determined by the values of R_1 , C_1 , and the magnitude of the input voltage V_A , and supply voltage E_{BB} .

The value of R_2 must be low, so that it will not load the output. R_1 should be chosen according to the following relationship:

Designer's casebook is a regular feature in Electronics. Readers are invited to submit novel circuit ideas, packaging schemes, or other unusual solutions to design problems. Descriptions should be short. We'll pay \$50 for each item published.

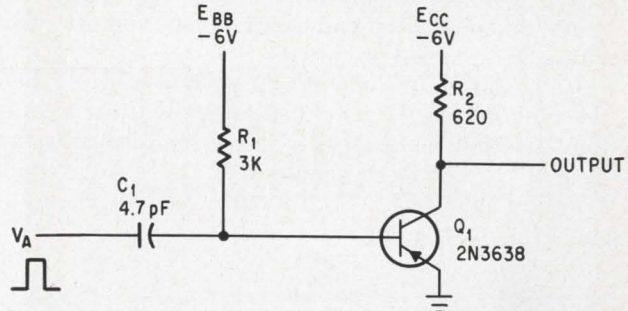

Transistor inverter with capacitor input delays digital pulses with delay-time-to-rise-time ratios of 30 to 1.

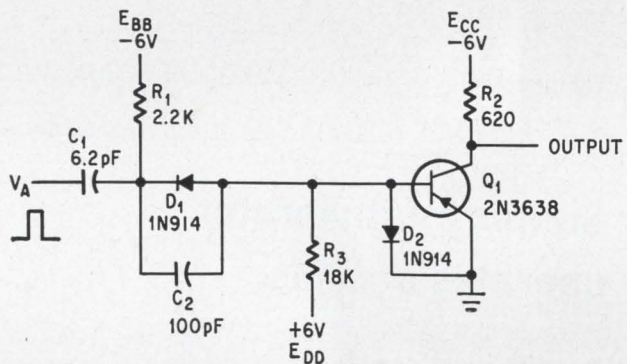

Delay circuit isolates the base of Q_1 from input. This circuit should be used if input voltages exceed rated BV_{EBO} of Q_1 .

$$R_1 \approx \frac{\beta_{min} R_2 (E_{BB} - V_{be})}{2 E_{CC}}$$

where β_{min} is the minimum current gain when Q_1 is in saturation (usually about 10) and V_{be} is the base-emitter voltage drop. This value of R_1 will insure that sufficient base current flows for both static (steady-state) and dynamic (turn-on) load conditions.

After R_1 is calculated, the value C_1 necessary to produce the desired time delay can be calculated from:

$$T \approx \frac{R_1 C_1 V_A}{(E_{BB} - V_{be}) + 0.5 V_A}$$

If E_{BB} is the same supply voltage as that for the stage producing the input signal, the delay time will be approximately independent of E_{BB} and can

be calculated from $T = R_1 C_1 / 1.5$.

The collector current I_{CBO} , which flows when the collector-to-base junction is reverse-biased and the emitter is open, should be low compared to E_{BB}/R_1 . The charge stored in the base junction during the delay interval should be low compared to $V_A C_1$. Also, V_A should not exceed BV_{EBO} , the maximum rated emitter-to-base reverse voltage with the collector open-circuited.

If the last requirement cannot be realized, then the circuit must be modified as shown in the bottom diagram on page 85. This circuit isolates the base of Q_1 . Diode D_1 should be a low leakage type. Speedup capacitor C_2 is optional. The design equations for this circuit are:

$$R_1 \approx \frac{(E_{BB} - V_{be} - 0.6)}{\left[\frac{2E_{CC}}{\beta_{min} R_2} + \frac{E_{DD}}{R_3} \right]}$$

and

$$T \approx \frac{R_1 C_1 V_A}{(E_{BB} - V_{be} - 0.6) + 0.5V_A}$$

Since a change in base voltage of less than 0.2

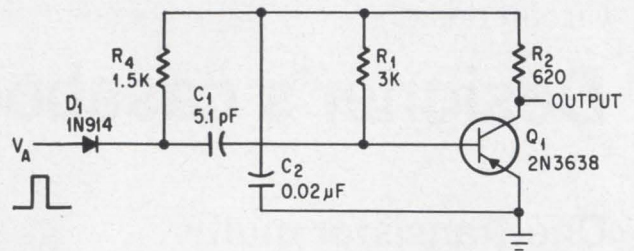

Delay circuit prevents C_1 from loading collector of Q_1 and also decreases noise sensitivity.

volt is sufficient to switch the transistor completely, the delay-to-rise ratio is greater than $V_A/0.2$. For a 6-volt pulse, this gives a delay-to-rise ratio of 30 to 1. Therefore, for delays of up to 0.3 microsecond, only the transistor and load time constants limit rise and fall times. For a 6-volt system that can tolerate a rise or fall time of 50 nanoseconds, delay times as long as 1.5 microseconds can be realized.

The coupling circuit shown above prevents C_1 from loading the driving collector and decreases noise sensitivity. If $R_4 = R_2/2$, the circuit recovery time will be twice the delay time.

Simple multivibrator operates at 5 Mc

By Velimir M. Ristic'

Electronic Laboratory, Faculty of Electrical Engineering
Belgrade, Yugoslavia

An oscillation frequency of 5 megacycles per second can be obtained with the multivibrator shown in the diagram at the right. Output pulse amplitude is 4 volts, and the pulse rise and fall times are about 20 nanoseconds each.

Transistors Q_2 and Q_1 are constant-current generators which always conduct. The bases of Q_2 , Q_3 and Q_4 are held at a constant d-c voltage by the time constants $C_5 R_5$, $C_4 R_4$ and $C_3 R_3$, respectively.

During one half-period, timing capacitor C_1 charges through Q_1 and Q_4 , both of which are in the saturated state. In the next half-period, C_1 discharges through Q_2 and Q_3 , which are also both saturated.

The timing capacitor does not affect the rise and fall times of the output waveshapes because it is coupled through the emitters of Q_1 and Q_3 .

Output pulse rise and fall times can be deter-

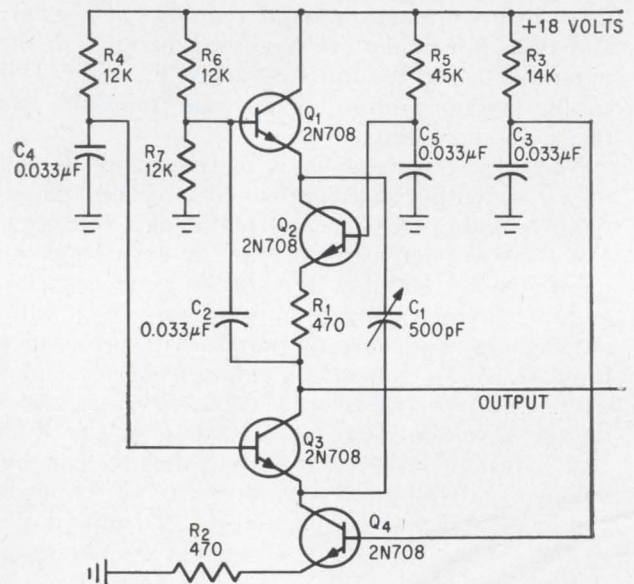

Rise and fall times of high-frequency multivibrator are not dependent on timing capacitor C_1 , because of emitter coupling through Q_1 and Q_3 .

mined from

$$T = 2C'_{bc} \frac{R_6 R_7}{R_6 + R_7}$$

where C'_{bc} is the total collector-to-base capacitance of Q_1 and Q_3 .

The approximate duration of the multi's period can be expressed as

$$T = T_1 + T_2$$

$$\text{where } T_1 = C_1 R_{04} \ln \left(\frac{R_7 + R_{02}}{R_{04}} \times \frac{R_b + R_{04}}{R_b + R_{02}} \right)$$

$$\text{and } T_2 = C_1 R_{02} \ln \left(\frac{R_5 + R_{04}}{R_{02}} \times \frac{R_b + R_{02}}{R_b + R_{04}} \right)$$

R_{02} and R_{04} are the output impedances of the constant current generators Q_2 and Q_4 , respectively.

Output pulse amplitude can be calculated from

$$V_0 = V_{ec} \left[\frac{R_b}{R_b + R_{04}} + \frac{R_7}{R_6 + R_7} \times \left(\frac{R_{04}}{R_b + R_{04}} - \frac{R_{02}}{R_b + R_{02}} \right) \right]$$

Multivibrator provides bidirectional output pulses

By F.C. Ruegg

National Bureau of Standards,
Washington, D.C.

A flip-flop that produces bipolar output voltages with respect to ground is often required in transistor logic circuits. (A positive voltage V_1 represents logical "zero" and negative voltage V_2 represents a logical "one.") The circuit shown below, has a bipolar output; and its ground potential can be varied continuously between the two voltage limits, while the voltage difference between the levels remains constant.

Transistors Q_2 and Q_3 form a bistable multivibrator. Transistor Q_1 is an inverting amplifier for the output of one side of the bistable multi. When Q_2 is on, the output at A is -10 volts, and when Q_2 is off, Q_1 is saturated, causing its collector (output) to be at ground potential. Transistors Q_4 and Q_5 are a cascaded noninverting amplifier that establishes a positive d-c level. When Q_3 is off, the output at B is approximately at ground potential; when Q_3 is on, the output at B is $+10$ volts. The potentiometer connected between circuit points A and B allows the symmetry of the output voltage levels to be adjusted.

This flip-flop, coupled with a pulse generator, provides a clean square wave that is symmetrical with respect to ground, and which can be used to test the frequency response of many transistor circuits.

This simple circuit is useful for a large number of applications in the laboratory.

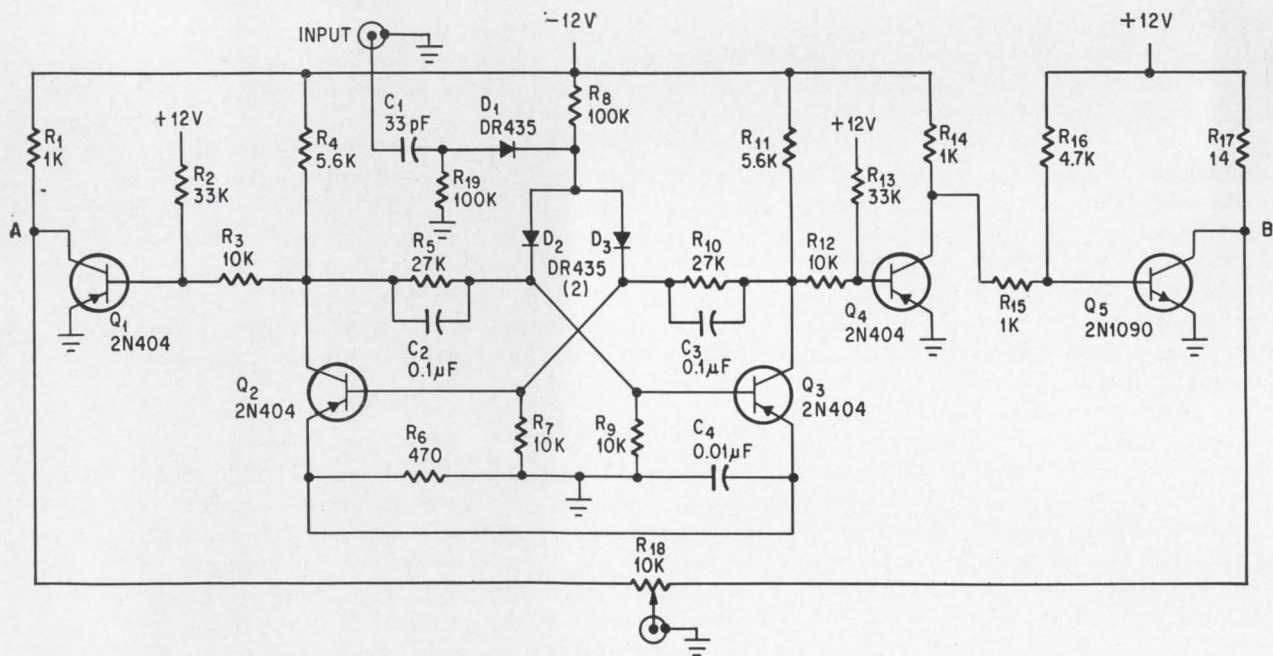

Flip-flop output voltage is bidirectional. Potentiometer R_{18} allows ground potential to be varied with respect to output voltage limits. The difference between the output voltage limits remains constant as the potentiometer is adjusted.

Automatic test equipment: a million-dollar 'screwdriver'

Electronic systems have grown so complex that even a skilled technician can't perform all the necessary checks in a reasonable time. The military has spurred the development of computerized testing

By W.J. Evanzia

Avionics Editor

There was a time when a good electronics technician could test a radio with a screwdriver, but today even the simplest receivers require elaborate test equipment. Correspondingly, where a typical World War II bomber had about 2,000 electronic components with few if any circuit test points, today's combat aircraft has more than 100,000 components and some systems have more than 50,000 test points.

Even though today's maintenance personnel are far better trained than their World War II counterparts, they simply cannot check out such complex systems in a reasonable time with standard multimeters, oscilloscopes and bridges. All three branches of the military have been developing automatic equipment to make faster tests that are more complete and more accurate than a single technician can perform.

A technician will trace a fault logically. If a system fails, he will check the subsystems; if a given subsystem works, he need go no further, for he knows that a good subsystem must have good components. When he has isolated the faulty subsystem, he performs similar logical steps on modules or circuits until he has isolated the faulty component or components. Sophisticated automatic equipment does not always take such syllogistic steps; it is usually programmed so that if a system fails, it will switch serially through the entire system and print out the location of the faulty components.

Costly systems

Automatic test equipment is now a \$400-million-a-year business. By far the largest spender (for systems which cost more than \$250,000 after de-

velopment) is the National Aeronautics and Space Administration, with \$150 million budgeted for checkout on Apollo and the Saturn rocket. The Air Force is spending about \$50 million on three systems, the Army about \$15 million and the Navy \$5.9 million for their basic automatic test equipment.

Industry spends only about \$10 million annually. The balance of the money is spent by the services on a variety of special purpose test programs, such as the Navy's BACE (Basic Automatic Check-out Equipment), which was provided for the Grumman Aircraft Co. to check out the E2A radar picket plane.

Spending on automatic test equipment will continue to increase, so that by 1970 the market should be about \$500 million. NASA's share will drop to about 20%, but Air Force spending should be up to around \$75 million. The Army and Navy together should contribute another \$125 million. Industrial electronics firms, with a \$200 million investment, will thus represent a significant share of the dollar volume.

Feasibility study

Nearly 10 years ago, the Army's Missile Command conducted a study to determine whether or not there were enough common test requirements among missile systems to permit some degree of equipment standardization. The study was specifically aimed at the problem of test equipment becoming obsolete as prime equipment changed.

The study showed that neither the character nor the art of testing changed radically from one system to the next. The testing requirements for new missile systems could be predicted with a

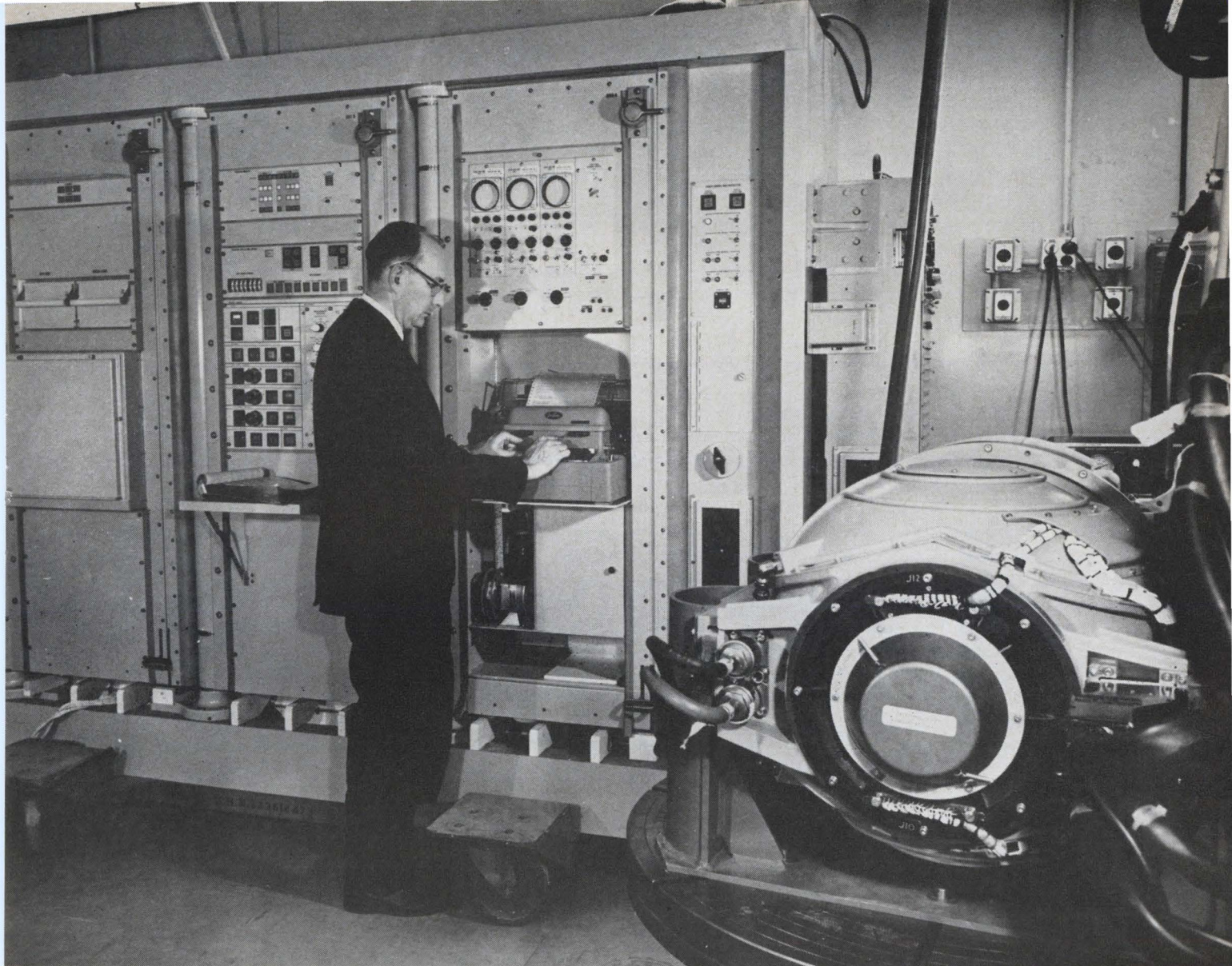

The Polaris missile guidance system is tested by General Electric's MK 462 Autotester. Results are printed on a Flexowriter, and can also be recorded on punched tape for later analysis.

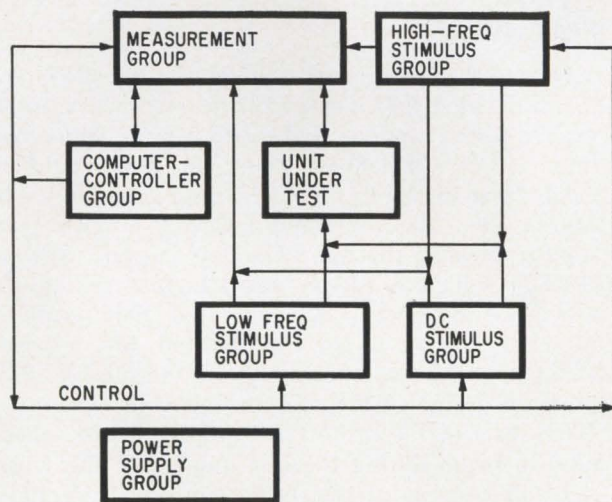

Diagram of a typical automatic test equipment system. Control of both stimulus and measurements is by computer. Measured values are compared with the limits stored in the computer and displayed in decimal form.

high degree of reliability, and the nature and the number of testing parameters changed only 10% to 20% from one system to another. Most fire control radars operated at X-band, and their intermediate-frequency amplifiers were at 60 megacycles; search radars had i-f's of 30 Mc; moving target indicator systems operated at 10, 12 or 15 Mc; and other special purpose radars had i-f's of 120 Mc. In other words, a common denominator in most radar sets is the i-f amplifier, which usually operates at some multiple of 15 Mc.

Many out of one

The first really automatic equipment was the Air Force's programed GS-1 system, built in 1955 for the Navaho intercontinental missile. From GS-1 came the specifications for the first production sets, called the AN/GJQ-9. Since then, more than 100 kinds of automatic test equipment have been manufactured for the military.

Typical examples of the Army's automatic test equipment are the systems being developed by the

Radio Corp. of America's Aerospace division in Burlington, Mass. The Multisystem Test Equipment (MTE) is being built for the Missile Command at the Redstone Arsenal in Alabama, and the Depot Installed Maintenance and Test Equipment (Dimate), for the Electronics Command, at Fort Monmouth, in New Jersey.

MTE is a computer-controlled, special-purpose system designed to test electronic, pneumatic and hydraulic components in a variety of missile systems. Dimate, which is mainly built of MTE components and is being bought by the Electronics Material Agency at Tobyhanna, Pa., is designed principally to test communications equipment. Both systems are capable of automatic, semiautomatic and manual operation, and will perform both maintenance testing and fault location. Like many other automatic test systems, they are made up of functionally related building blocks; a computer-controller, measurement equipment, low and high frequency stimuli, d-c current stimuli, and power supplies.

Three independent test groups in individual portable shelters, which are carried aboard Army trucks, make up the MTE system. The first group, called ETS-1 (for electronic test system), contains a solid state computer-controller, signal generators with a frequency range from less than one cycle to 100 Mc, and programable d-c supplies. The ETS-1 shelter also houses peripheral equipment such as a manual test input keyboard, a magnetic tape transport that carries the programmed test instructions for the computer, and a printer to record results, as well as a control director, switching buffers, an address distribution unit, a comparator time delay, memory units and a visual instructor.

The second group, ETS-2, has microwave signal generation and measurement capability from 1 gigacycle to 18 gigacycles. It contains the same basic input-output equipment, paper tape reader, manual input and printer that is in the ETS-1 shelter, but has no computer. Stimulus signals are harmonically derived to accommodate missile systems using continuous-wave, c-w-doppler, pulsed-doppler, or conventional pulsed radars.

The third group, HTS (hydraulic test system), automatically tests hydraulic, pneumatic and mechanical systems. It also contains a paper tape reader and controller. Individual or joint operation of the three groups are possible, since both the ETS-2 and the HTS have controllers that may be slaved to the master computer-controller in the ETS-1 shelter.

Controlling the test

The ETS-1 console (see photo on page 92) not only provides the basic control for the entire set, but also a work surface for the unit under test. The computer-controller is the fundamental source of intelligence for operating the test equipment. The four lower chassis in its rack—the control assembly, arithmetic assembly, input-output, and memory assemblies—are the heart of the computer, while

the four upper chassis are the peripheral control, which provides the input-output digital interface between the stimuli, the measurement units, and the display devices and tapes.

The operator finds the measurement instruments he needs in a panel just to the right of the control console. There are digital multimeters, an analog adapter or signal conditioner which buffers input signals to the multimeters, and waveform analysers.

The technician can control the test by means of magnetic tape housed in a transport assembly. This tape contains the basic test program information in binary form. The tape's output is fed to the computer, where it is stored in a ferrite core memory; the specific output data is processed by the controller and sent to the various stimuli and measurements units.

Another input that is sometimes used in the manual typewriter keyboard, which gives the operator direct control over the equipment being tested.

He can get test instructions from the visual instructor, which is located at the upper left side of the control console. The visual instructor is a miniature projector whose information is contained on reels of 35-millimeter film that is projected onto a ground glass. This device is not automatic; the number of the particular frame that contains the program information for the unit being tested is given by the printer, the operator dials the number, and the film roll turns to the correct frame. The operator sees on the ground glass the schematic of the particular unit that he is testing.

The "test results" panel is also located on the control console. Here the operator can see a digital display of the test signal voltages in addition to displays of pertinent data such as time, resistance and frequency. The printer gives the operator information about the fault found, identifies specific sequences in the test program, and tells the technician to make particular measurements or adjustments.

Field testing

During the last quarter of 1963, the Missile Command decided that it needed a less complex, more mobile test setup, one that could service some systems at forward field positions and that would be easily transportable by helicopter or truck. In March 1964, the command awarded RCA a contract to develop the Land Combat Support System (LCSS), which would be used to test Shillelagh, a surface-to-surface, tank-mounted field support weapon; Lance, a vehicle-mounted fire support weapon; and Tow, an antitank guided missile. Preliminary design of the system began in November 1964; tests of the prototype equipment are scheduled to begin during the last quarter of this year.

LCSS consists of two basic equipment shelters, the ETS-3 and the Repair and Storage Shelter 1 (RSS-1). RCA will build three ETS-3's and one model of the RSS-1. The first ETS-3 will remain at RCA Aerospace in Burlington, and be used to

Army's "Dimate" automatic test system.

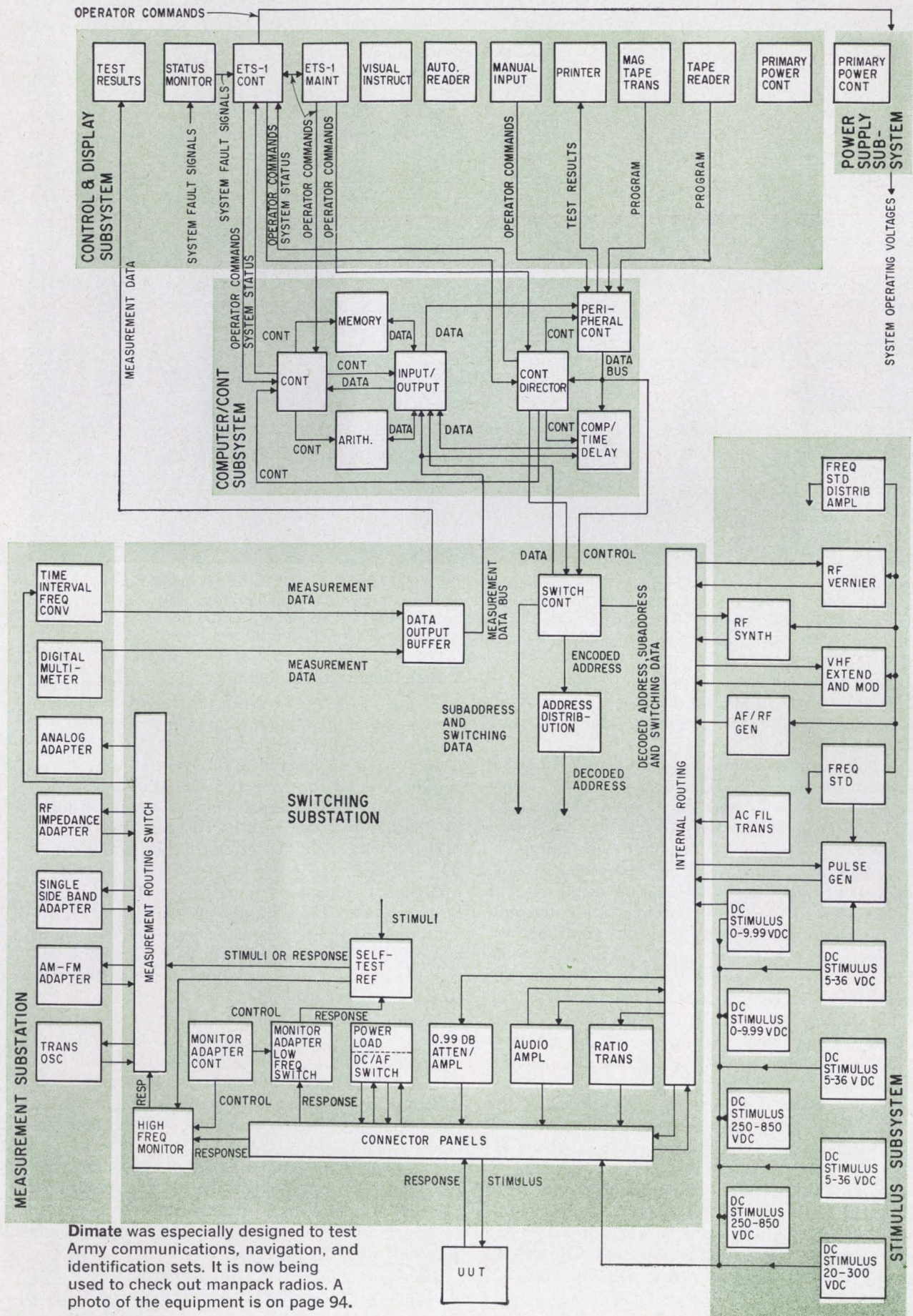

Dimate was especially designed to test Army communications, navigation, and identification sets. It is now being used to check out manpack radios. A photo of the equipment is on page 94.

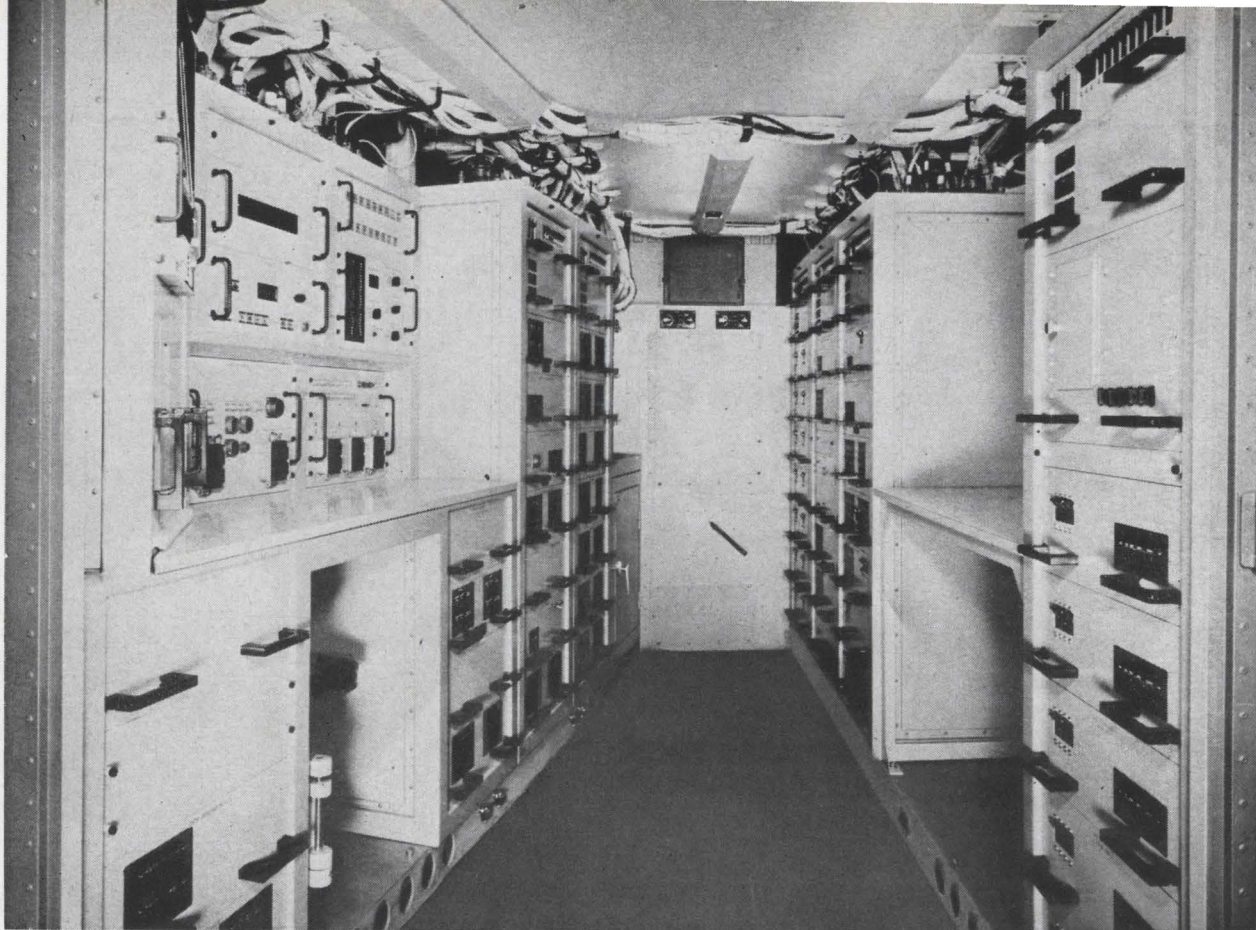

ETS-1 shelter for the Army's Multisystem Test Equipment. Units under test are connected to the panel above the operator's work bench at left. The visual instructor, as well as a test result panel and printer, are also located over the test bench. Measurements chassis are housed in the rack at rear left, to the right of the test bench. Power supplies are at right foreground and low-frequency stimuli at right rear.

develop and validate the test program for the Shillelagh. Sets 2 and 3 and the RSS-1 are expected to be delivered to the command about the last quarter of 1966.

LCSS sacrifices some automatic fault isolation in return for simplicity. The system must be transported to the field, and once there, it must be used by technicians who may not be as skillful as laboratory specialists. Although the equipment is capable of a wide range of performance tests, it does not have the sophistication of the parent MTE system. It does not contain a computer, and program information is fed to the controller by punched paper tape or manual keyboard. Unlike MTE, the manual keyboard which is usually operated by a skilled technician is not stored in the LCSS shelter. Automatic fault isolation is carried out only to the major chassis level. Fault isolation at the subassembly level is performed in the RSS-1 by standard test equipment.

Because LCSS engineers converted much of the MTE design to integrated circuits, the LCSS is much smaller. One LCSS test reference chassis takes the place of a whole rack of equipment in the parent MTE system. Integrated circuits were also used in the digital multimeter, signal generators, pulse generators and power supplies. The power supplies are programable and can deliver up to 40 volts and 2 amperes, with an accuracy of 50 millivolts.

Dimate keeps troops talking

Troops in the field rely on good communications equipment to help them stay alive. Making sure that they get this equipment in top operating condition is the responsibility of Army supply depots spotted around the country. The Materiel Agency at the Tobyhanna Signal Depot is using Dimate to check out radio sets as fast as they can be pulled from stock. [Electronics, July 12, 1965, p. 49].

Much of Dimate is identical to MTE. It contains low and high frequency stimuli, a control console, computer-controller, measurement equipment, and power supplies. Magnetic and punched-paper tapes are used to supply test instructions to the computer-controller.

Dimate programs usually consist of a combination of computer instructions and controller instructions. Program control is shared. Special computer instructions are necessary to transfer the program back and forth; in some cases the system can be programmed so that the computer and controller operate concurrently.

These instructions set up voltage reference levels, power supply voltages and other test stimuli for the units under test. Visual instructions for some tests are also given to the operator by the same projector used in MTE.

There are three basic test sequences. The first is a survey to see whether the Dimate system can

provide the correct stimuli to perform the test and to check out the Dimate system itself; the second is a static test in which the radio equipment is checked for short circuits; the third is an acceptance test.

To permit quick testing of a large number of sets, the acceptance test has two parts. For example, a check of transmitter power, signal quality, and receiver sensitivity can provide go-no-go information for a transceiver. If any factor is below the acceptable limits, the operator can elect to put the set aside, rather than hold matters up by further testing.

When he does complete the test, he can read the results—the kind of defect, and the unit number, manufacturer's number, ordnance number, and federal stock number of the defective component—on an alphanumeric tape printer.

Airplane checker

Another area where the Army is effectively using automatic test equipment is for the avionics systems of some of its surveillance aircraft. In 1961, RCA designed for the Electronics Command a completely automated preflight and operational status test set that could assess the condition of all communications, navigation, instrument landing and identification equipment then installed or planned for the '60s and '70s. The set can be operated by one man and does not require exten-

sive removal of equipment from the aircraft; indirect coupling by radiating techniques reduces complicated test connections.

The finished version is called the Preflight Test Set (PTS); the Army designation is the AN/ASM-88. It can perform an over-all dynamic check of the complete avionics system of an Army surveillance aircraft. For example, when the PTS is used to check out the ARC-73 radio, the operator gets into the cockpit carrying a portable remote control and display unit. He plugs into the audio jack of the ARC-73, and turns on the power to both the test set and the radio. He then adjusts both sets to the same frequency and pushes the start button, and the PTS transmits a signal to the receiver in the plane. If the receiver is operating satisfactorily, a go-light shows on the remote control unit. The transmitter portion of the receiver can be similarly checked. PTS makes an over-all system test; it won't tell which part of the receiver or transmitter is bad. Therefore, if a no-go signal is obtained, the entire set must be pulled and sent back to the service shop for repair.

Because most airborne radar operates at microwave frequencies, PTS needs a frequency range extender, to check out the APS-94 surveillance radar, the AN/APN-129(V) navigation radar; the AN/APN-22 radar altimeter; and the AN/DPN-62(V) radar transponder, aboard the Army's OV-1B Mohawk aircraft. Test of this C, X, and K_u

Quick testing

When a no-go condition is indicated by the RCA's Multisystem Test Equipment, certain diagnostic tests must be made to isolate the fault. MTE performs them automatically. The illustrated circuit, which is part of a Nike-Hercules, interval timer, is being checked for shorts and opens; 61 tests are required to check out all the components in the timer. Pages 3-5 of the test manual for the timer describe the manner in which some of them are performed:

"Test 44 and 45 check that R₁, or C₁ and K₁ are not shorted. This is accomplished by applying a -100 V d-c stimulus between R₂ in the adapter box and P1-15 and

measuring the potential between P1-14 and P1-15. The voltage measured should be approximately -52 V d-c. An absolute measurement of less than 44 volts indicates that either R₁ or C₁ and K₁ is shorted. If R₁ shorts, the reading will be approximately -35 volts and if C₁ or K₁ short, the reading will be approximately -39 volts. Test 45 differentiates between these two conditions.

"Tests 46 through 48 check that C₁ is not open. These tests take advantage of the fact that the coil of K₁ in parallel with filter capacitor C₁ form a tank circuit with a resonant frequency of approximately 135 cps. The -100 V d-c is applied through R₂ to the network in order to forward bias the selenium rectifier CR₁ to a point

where its resistance is very low. A variable frequency a-c signal is then applied through R₃ and C₂ to the same circuit and, since the diode is forward-biased, the a-c signal (without rectification) is impressed across the tank circuit. Test 46 applies a 40 cps signal and an a-c measurement is made across P1-14 and P1-15. This measurement is called TV-1 and is stored in the computer. The test is repeated at successively higher frequencies. The computer compares TV-1 with TV-2 and TV-3. If C₁ is open, TV-3 will be greater than TV-2."

The equivalent circuit diagrams for these tests are shown below. MTE performs the tests in less time than it takes to read about them.

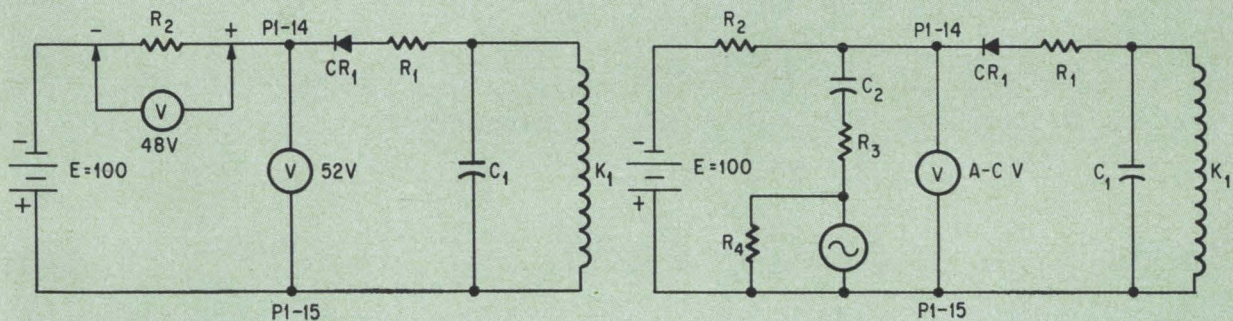

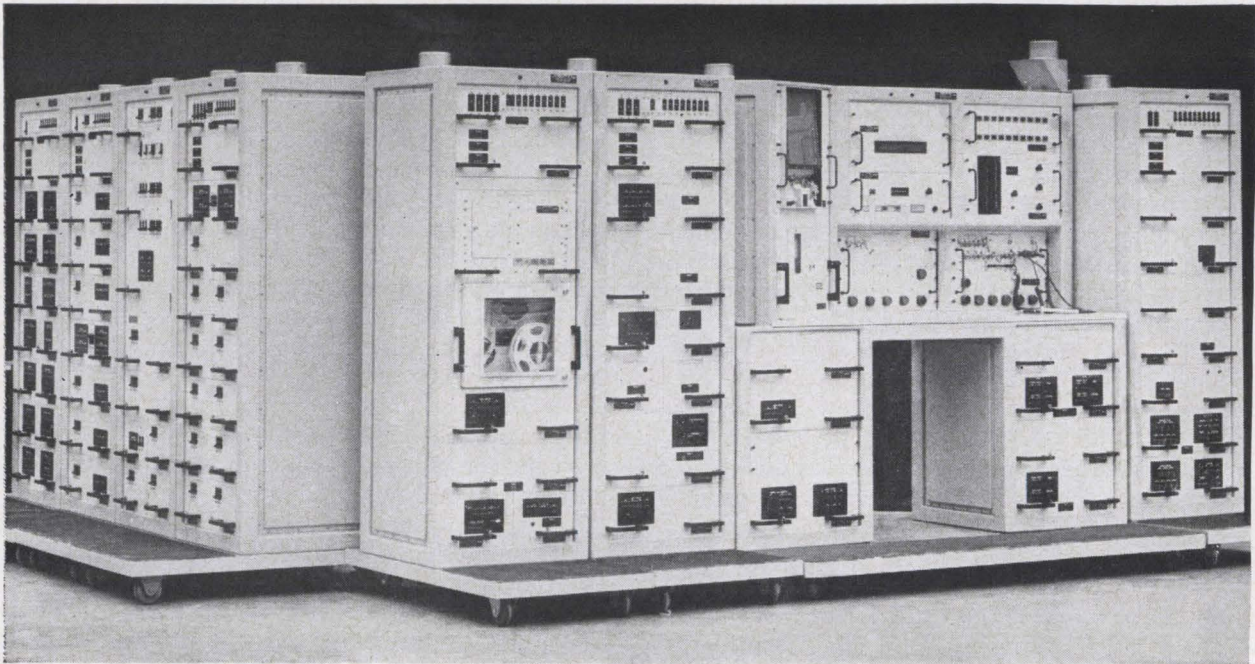

Dimate, the depot installed maintenance automatic test equipment being supplied to the Army Electronics Material Agency, is a modularized test system capable of automatic, semiautomatic, and manual operation.

band equipment is carried out by the Mohawk adapter test unit with no physical connection being made to the aircraft's transmitter or receiver.

Navy saves men and space

The Navy has special space problems which shape its need for automatic test equipment. An aircraft carrier is huge, but its space is strictly allotted. The 48 rated electronics technicians aboard have to be proficient in all kinds of surface radar and avionics. At present, there is a shortage of technicians; the Navy hopes that automated equipment

will perform better testing with fewer men.

The first big automatic test program for the Navy is Project VAST (Versatile Automatic System Test). VAST is an outgrowth of the Navsea studies, which were carried out in 1961 to determine what was required to service fleet avionic equipment, and to devise a more automated method of testing. On July 1, the Navy signed a \$5.9 million contract with PRD Electronics, Inc., in Westbury, N. Y., for a developmental model of the VAST test system. How many systems will be purchased during the entire program is still being decided, but the Navy

Comparison of typical automatic test systems.

Name	Manufacturer	Status	Program Sequencer	Comparator	Service Application
AN/GJQ-9	Bendix Support	operational	paper tape	digital	Air Force
Robotester	Lavoie	operational	paper tape	analog	Mil. and commercial
Dimate	RCA	prototype	magnetic or paper tape	digital	Army (depot)
BACE	North American, Autonetics div.	operational	paper tape	analog	Navy (A6A, EZA, RA-5C)
MTE	RCA	operational	magnetic or paper tape	digital	Army missile systems
VATE	Hughes	operational	magnetic drum	digital	Air Force
Saturn Checkout	RCA	operational	magnetic drum	digital	NASA (C1 and C5)
VAST	PRD Electronics, Inc.	prototype	magnetic drum	digital	Naval avionics

expects to have at least one aboard each large carrier. This would mean about 50 VAST sites, including shore repair bases. Each VAST station will cost about \$2 million.

Despite its name, the VAST system is not physically as large as some of the other major automatic test systems. But it is designed to test about 85% of the avionic systems that are now in the inventory or are expected to be included by 1970. Until now, most of the Navy's avionic test systems have been custom-designed and delivered by airframe manufacturers.

Two-station tester

The VAST system is divided into two main sections: the test station and the computer station. The computer station, which contains the CP 789/UYK (Univac model 1218) computer and mass memory unit (Univac model 1240) serves as the prime source of control commands, and performs all computations and comparisons. One computer station can be time-shared to run as many as six test stations. The test station itself is divided into two subsections: the data transfer unit and the stimulus and measurement section. The data unit acts as the interface between the computer station and the measurement section; it processes signals that pass between the measurement section and the computer, and sets up the test system operating modes.

About 50 independent programable stimulus generators and measurement units are available for use in the measurement system. These modules include 17 signal generators, with a frequency range of 0.1 cycle per second to 18 Gc; pulse and pulse code generators; noise and pressure generators; 14 monitors that measure frequency, impedance, voltage, waveforms, and signal spectra; 6 power supplies; 3 test switches (r-f, video, and power); and miscellaneous amplifiers and standards.

Each generator, measurement block, power supply and amplifier contains a special black box called a universal decoder. Since all the system's addresses are carried by a single instruction line, the decoders are set to respond to a single address. This response then allows the unit to receive subsequent instruction commands from the computer.

Testing at sea

A VAST operating manual designates the correct adaptor cable, hookup instructions, special requirements and test instructions for each set that may be tested by the system. A technician puts the prescribed test connections into the test point switch panel and requests "program start" on the data transfer unit. The computer finds the needed test program on the magnetic tape in the Univac 1240 memory unit and transfers it from the tape memory core matrix.

The computer uses the information stored in the core to set up the test stimuli for the unit being tested, as well as to evaluate the test results. With the data transfer unit, the technician may inject any special steps which he may think necessary to

complete the testing sequence, or to pass over a particular parameter—that is, to continue testing without stopping to repair the fault.

Keeping Polaris on course

The Navy also has an automatic tester for its Polaris guidance system. Designated the MK452, it is built by General Electric's Defense Electronics division in Pittsfield, Mass. Although it was specifically designed to test the Polaris MK1 and MK2 inertial guidance system, it can be adapted to test other kinds of inertial guidance or control systems.

Program information is fed into the MK452 computer by a standard perforated tape. The instructions read by the tape reader set up the equipment for each test, set the limits in the measurement system, set the gains of torque amplifiers, and select the earth rate (the apparent angular motion of a space-stabilized gyroscope caused by the earth's turning on its axis at 15° per hour) input and other inputs appropriate to the location and test.

The computer completes the test by evaluating and printing out the test results on an electronic typewriter called a Flexowriter. It then transmits a "pass or fail" signal to the measurement subsystem and terminates the test.

Air Force spends most

The Air Force's three big programs, VATE (Versatile Automatic Test Equipment), GPATS (General Purpose Automatic Test System), and the ground support system for the F-111 fighter-bomber [Electronics May 31, 1965, p. 37] represent the largest dollar volume spent on automatic test equipment by any of the three branches of the military. The F-111 ground support equipment is special-purpose, designed to test the complete avionics system of this supersonic fighter. The test system consists of 15 Agerds (Aerospace Ground Equipment Requirements Data), or test stations. Each Agerd is designed to test a particular portion of the plane's avionics. Special stations check out infrared trackers, optics, radar, communications flight controls, and power systems. The AN/GJQ-9 will be used to program each Agerd test.

The Air Force and the General Dynamics Electronics division in Rochester, manufacturers of the F-111 ground support equipment, have revised the initial special-purpose concept. The new concept, called TASC (for Total Avionic Support Capability), in effect makes the equipment general-purpose, and able to support other systems such as the advanced Mark II avionics system for the F-111, the avionics systems for the C-5A jet transport and the F-4C fighter, the integrated helicopter avionics system, and the integrated light attack avionics system.

Building blocks for GPATS

GPATS began in 1958 as an Air Force study to determine to what extent automatic electronic checkout could be applied at Air Material areas and depots. The study, conducted by the Dayton

Air Force Dep., resulted in a modular approach which could be made flexible enough to meet the requirements of a variety of airborne systems. The hardware development contract was awarded to the Emerson Electric Co., in St. Louis, Mo., which designed a system that consists of a programmer-controller, 49 building blocks, a tape preparation and verification device, 12 universal equipment racks, and other accessories.

GPATS can isolate faults at five levels; system, subsystem, line replaceable unit, module, and piece part. The system was certified in September 1964, and since that time has logged more than 3,500 hours of test time.

Missile system

The hundreds of defensive missiles, with their complex guidance systems, and the shortage of trained service personnel helped to convince the Air Force that an automatic missile checkout system was necessary. In December 1961, the Air Force contracted with the Hughes Aircraft Co. to build and install the Versatile Automatic Test Equipment (VATE) system at its centralized special repair activity at the Newark, Ohio, Air Force Station. The Air Force wanted VATE to test the Hound Dog, Atlas, Titan II, Minuteman, Skybolt and other missiles.

VATE is a computer-controlled automatic tester that trouble-shoots faults by deductive logic and isolates them to the plug-in module or component level. The VATE system has two or more subgroups, known as HCM-111's, consisting of a general-purpose, high-capacity computer and up to eight test stations. The computer has a 2,300-rpm rotating magnetic drum for its basic memory of 40,000 22-bit words. A number of magnetic core shift registers supplement the system for quick-access temporary memory.

To facilitate programing, all electronic input and output actions at the test stations are performed by direct command. A "2 + 1" address order is used; that is, one command contains the operational instruction, such as "add," plus two memory locations containing the numbers to be added. The command also designates the analog input.

Making all stations 'Go'

When American astronauts take off for the moon, everything in and on their rocket, command module and lunar orbiter will have been checked out by one of the most complex automatic test systems ever devised. Called ACE-S/C, for Acceptance Checkout Equipment/Spacecraft, the system is being built by many different companies, chiefly North American Aviation Inc., the Grumman Aircraft Co., Boeing Aircraft Co., General Electric Co., Control Data Corp. and the Radio Corp. of America.

Tests on the S-1C, the first stage of the Saturn V Apollo launch vehicle, will be controlled by an RCA 110A general purpose digital computer. More than 150 relay racks will house the test equipment.

A separate system, consisting of a Control Data 924A general-purpose computer and a number of test stations, will check out the second stage. Tests are planned on completion of manufacture and both before and after the static firing tests. With both a core working memory and magnetic tape bulk storage, the computer can transfer information at a 200-kilocycle rate, making it capable of an on-line analysis of system operation.

Like the Army's MTE and Dimate automatic systems, this system is capable of performing diagnostic test as well test routines for complete system analysis when performance variations are determined by the computer program. It uses automatic, semiautomatic and manual methods to locate a fault. Which mode is chosen depends to some extent which test stations are in use; some have only manual systems and some only automatic. When the operator has a choice, the complexity of the equipment under test and the reliability requirements will be the determining factors.

Semiautomatic methods

Semiautomatic techniques may be used when the operator wants to save time and yet maintain some personal control over the test procedure. In this technique, the computer generates the primary commands to the circuit under test, while the operator watches displays to verify the test. The operator may command certain tests manually, and have the computer monitor the events; or he can manually operate a circuit and monitor the events on displays. In any case, the signal inputs will go by the same paths.

Extensive self-checks are used to assure correct operation of the test system. For example, echo checks are used to verify the integrity of the signal paths between the computer and the checkout station under control. The computer is programed to transmit a data word which energizes both the computer and test station's input-output circuitry. The original data word is retransmitted to the computer, where it is compared to the original. Signal quality, and checkout station measurement are also computer-tested. For measurement checks, the computer sends a calibrated signal, which is both a command and a reference, to the device under test. The computer then compares the measurement with the known signal input. If the measurement is out of tolerance, the computer proceeds with analytical tests to isolate the fault.

Commercial equipment

The most popular piece of off-the-shelf automatic test equipment is the "Robotester," made by Lavoie Laboratories, Inc., of Morganville, N. J. This universal automatic tape-programmed test set is being used by all branches of the military, as well as by commercial companies, for all types of static and many dynamic diagnostic tests. To date, more than 700 sets have been delivered.

The Robotester can perform up to 100 tests per minute on any two of 250 randomly selected circuit



A truck containing the Mohawk adapter test unit (AN/ASM-88) drives up to an Army OV-1B to check its radar. No connection to the receiver or transmitter is necessary.

points. Programed acceptance standards cause automatic operation to stop when an out-of-tolerance value is met. The system measures resistance, a-c and d-c voltages and impedance. Faulty circuits are identified by digital readout.

No cure-all

Automatic test equipment creates a number of problems even as it solves others. Since the test equipment itself is complex, and sometimes has more component parts than the equipment it is testing, its mean-time-between-failures may be low. Moreover, it may cost as much to program the system as it does to produce the hardware.

The program of a digital device is an orderly configuration of bits—binary ones and zeros. This information, which is stored on magnetic tape or cores, causes the testing device to perform in a desired manner. The total program is a mixture of commands and data and includes three major classes of operation: input-output operation, such as printing and reading information from storage devices; data processing operations, such as arithmetic comparison of digital numbers, and digital message formats; and decision operations, such as go-no-go.

Getting the machine to perform these three operations logically is the function of the programmer, who must translate the test requirements into a language from which the machine will operate.

Machine language itself, the form in which a computer actually sees instructions, is seldom used by programmers because its complexity makes it

unwieldy. Instead, they work in symbolic or problem-oriented languages which can be translated into machine by a special compiler.

Now Berton West, of the Battelle Memorial Institute in Columbus, Ohio, is working on a project called "Place," in which a compiler could be programmed to translate into machine language directly from English. Such a system could work with several kinds of automatic testing equipment and would cut programming cost.

For many years, prime equipment users have complained that the equipment manufacturers ignore maintenance problems in their designs. Testing had been hard to perform; testing areas were physically inaccessible, packaging methods split circuits at sensitive and unnatural points, and circuit-sharing schemes did little to reduce prime equipment cost but doubled test charges. Now "testability" in equipment design must be placed at the same level as any other functional operation of a proposed system, and government purchasing agents specify test access provisions.

Automatic equipment can bypass accessibility problems, but since it is relatively inflexible with respect to its acceptance or rejection limits, the test needs of the prime equipment must be carefully calculated. In addition, the military's interest in general purpose equipment that can check out many different prime systems will require standardization of jacks, connectors, and other interface components.

In short, the screwdriver has become as complex as the radio. But now it does a better job.

Aluminum bonding is key to 40-watt microcircuits

High-power silicon devices run too hot for regular gold bonds. Thick aluminum leads prevent purple plague, while aluminum mounting alloy keeps the chips cool

By Edward M. Ruggiero

Norden division, United Aircraft Corp., Norwalk, Conn.

New aluminum bonding methods and a new alloy have breached the thermal barriers which prevented the operation of integrated circuits at very high power. Proof of this is the circuit on page 99, a 40-watt servo amplifier. Probably the most powerful microcircuit ever made, it can directly drive the motors of heavy electromechanical equipment.

By comparison, previous microcircuit amplifiers, even those made with several silicon chips, have been considered high-power if they operated at a few watts. Amplifiers rated at 5 to 10 watts have been hailed as breakthroughs.

The 40-watt circuit owes its high power rating to the use of a new method of bonding aluminum leads and to an aluminum alloy for mounting the dice (silicon planar chips). Both techniques were recently developed by the Norden division of the United Aircraft Corp.

Norden is now using aluminum leads on all circuits in production and will soon use the die-mounting alloy in a line of integrated amplifiers. These will include Class A amplifiers rated at 1 to 8 watts [Electronics, July 12, p. 127] and Class B servo amplifiers rated at 3 to 40 watts. Initially, these are being made in the multichip form shown,

The author



Edward M. Ruggiero, a chemist, has devoted his professional career to the assembly and packaging of specialized integrated circuits at Norden. He joined Norden's solid state engineering section in 1961. Ruggiero earned his B.S. degree at Fordham University and his master's degree at the City College of New York.

but development work on single-chip versions has begun. Both types are packaged in a modified TO-53 case, a type normally used for high-power transistors. The package is about 0.8 inch square and 0.35 inch high.

Beating the heat

Power ratings can be higher with the aluminum techniques than those with conventional gold bonding for three reasons:

- Gold bonding causes purple plague,¹ which can result in catastrophic failure of a circuit (see panel on page 104). Aluminum leads prevent it.

- As circuit power rises, more heat is generated. The heat must be removed from the package to make circuit operation efficient and extend circuit life. The new mounting alloy, principally aluminum and germanium, avoids plague; but its chief advantage is a thermal resistance far lower than those of gold alloys and other conventional materials.

- The aluminum-based packaging system enables silicon devices to be processed, sealed and tested at higher temperatures, which promotes higher reliability. The Norden circuits now withstand 1,000 hours of storage at 300°C. A new package, in which aluminum-coated feedthroughs replace gold-plated feedthroughs, is undergoing thousand-hour storage tests at 400°C.

Such high-temperature capability is desirable in low-power devices. It is essential to high-power devices, since junction temperatures may reach nearly 200°C.

Aluminum lead bonding

Norden uses 1½-mil-diameter (0.0015-inch) aluminum wire as leads. They are thermocompression-

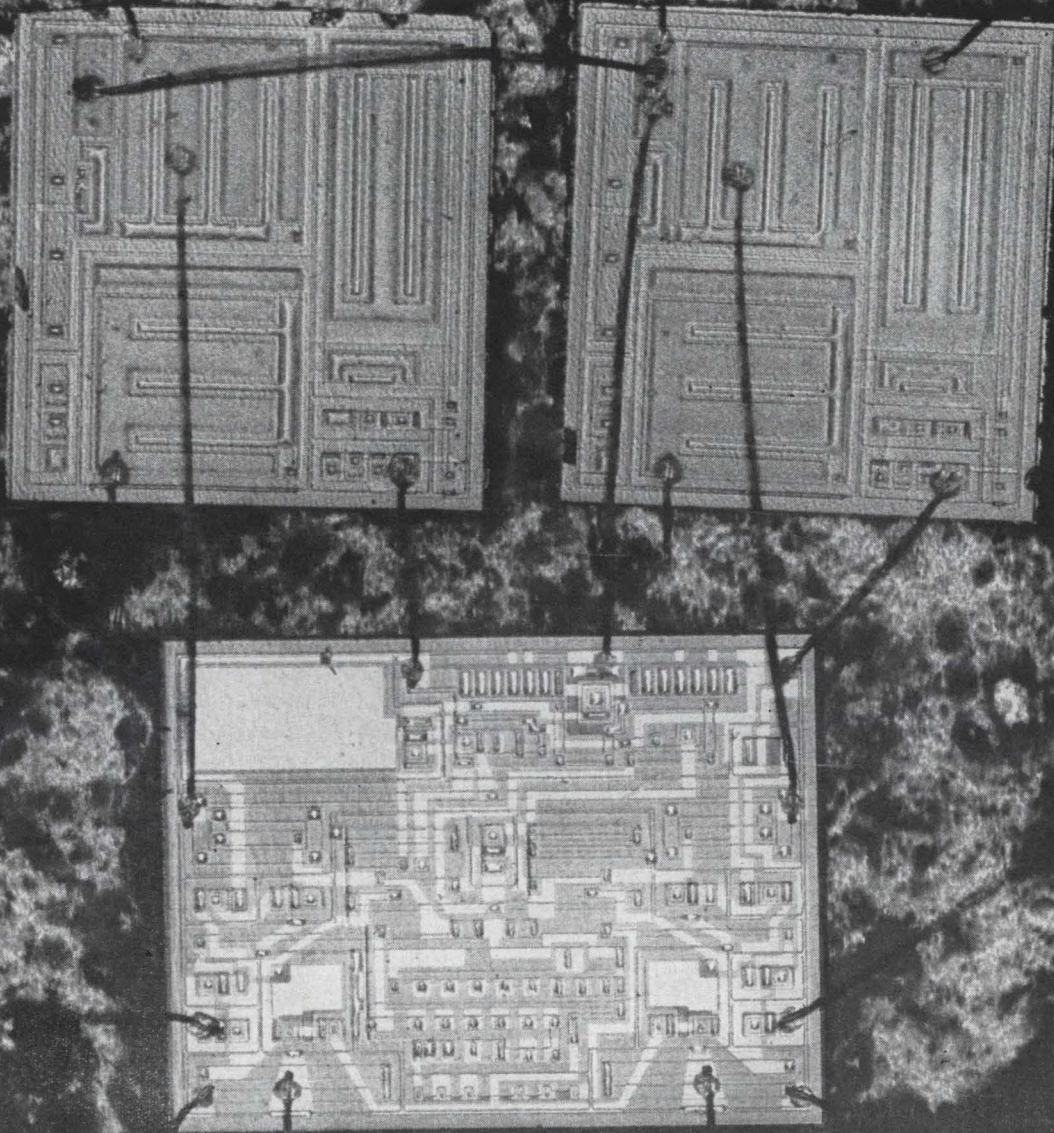

Forty-watt servo amplifier is made with three silicon chips, two carrying high-power transistors and one for control circuitry. Leads are aluminum wire; chips are aluminum-bonded to molybdenum.

bonded to the aluminum thin films on the chips and to the feedthrough posts of the package header. The posts are gold-plated in the present package.

The bonding machine is a modified bird-beak bonder made by the Kulicke & Soffa Mfg. Co. The technique is so named because the wire is fed through a two-jewel bonding tool. The Norden modifications and their use are shown below. The bonding and wire-holding jewels, of synthetic ruby or sapphire, are not heated. The silicon chips are

heated to 350°C in nitrogen, which prevents oxidation of the aluminum.

The underside of the bonding jewel is shaped so that it forms a rib, about 1 mil in diameter, on the wire as the bond is made. The rib adds mechanical strength and current-carrying capacity to the bond, while the flattened underside of the wire makes for excellent adhesion and electrical contact to the underlying thin films.

Once the bond is made, the vacuum clamp holds

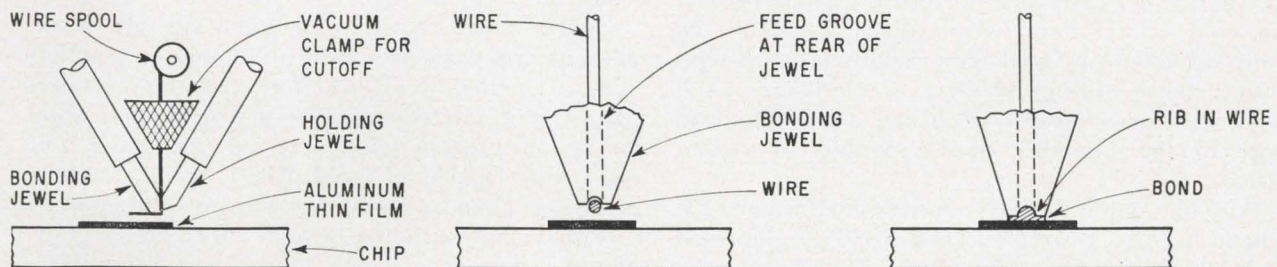

Bird-beak bonding method employed by Norden. Strengthening rib is formed in wire as it is bonded to thin film.

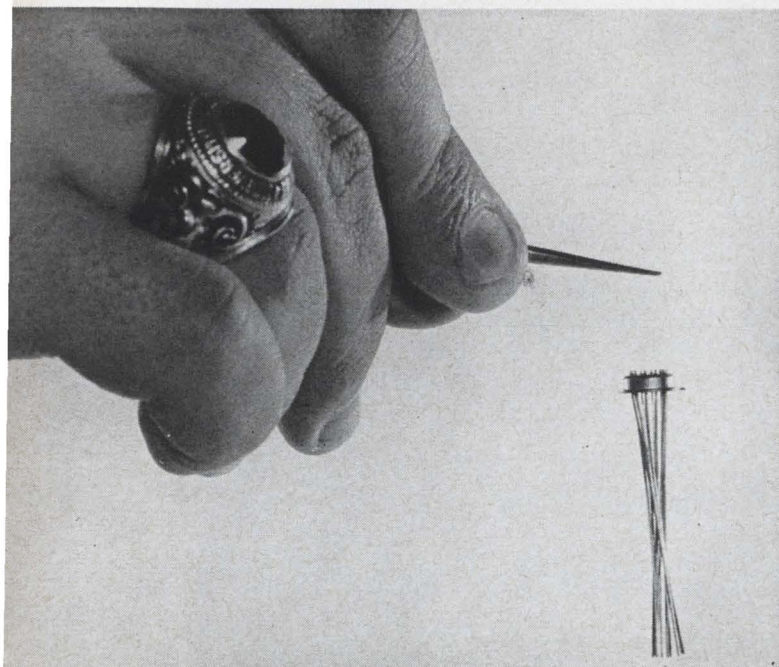

Bond made with aluminum wire supports entire weight of 10-lead header. The wire is too small to see.

the wire. The wire breaks cleanly at the edge of the bond when the tool is moved horizontally away from the bond. This avoids short circuits due to tails or loose ends on the bonded wire. Double bonds are made on the posts before the wire end is broken free.

Bonding pressures vary from 25 to 125 grams and bonding times from 1 to 6 seconds, depending on the thickness, purity and physical conditions of the aluminum film on the chip and gold plating on the posts.

The right wire

Avoiding purple plague was the main reason aluminum leads were selected. The choice of material, wire dimension and bonding technique were also influenced by requirements of strength, conductivity and compatibility with the aluminum thin film on the chips.

The wire diameter, $1\frac{1}{2}$ mils, is the largest that can conveniently be used. It results in a bond area about 4 mils square, as big as most bonding pads can take.

The diameter is ample for the wire to meet military specifications for vibration, shock and acceleration. Since aluminum is lighter than gold (2.7 grams per cubic centimeter for aluminum, 19.3 for gold), the $1\frac{1}{2}$ -mil wire weighs less than the conventional 1-mil gold wire. The aluminum wire won't move during 50,000-g acceleration; 1-mil gold wire does move, which can cause one lead wire to short another during periods of violent stress.

Pure aluminum (99.99%) and aluminum with 1% silicon have been used successfully. Pure annealed aluminum's tensile strength is 6,875 pounds per square inch compared to 19,000 psi for gold. The

pure aluminum wire is strong enough for military specifications; adding 1% silicon makes the tensile strength about as high as gold's.

The $1\frac{1}{2}$ -mil diameter also provides enough material for the bond rib. The rib makes the bond stronger than conventional wedge bonds, which squash the wire. (The other type of conventional bond, nailhead or ball bond, has not been made with aluminum). The strength of a rib bond is indicated by the photo at left.

The $1\frac{1}{2}$ -mil diameter can safely carry an ampere of current. Aluminum's resistance is slightly higher than gold's, but because of its larger diameter, the $1\frac{1}{2}$ -mil aluminum wire is far more conductive than 1-mil gold wire. The rib retains this advantage in the bond.

Plague at the post?

Does bonding aluminum wire to gold-plated posts transfer the plague problem from the chip to the post? No; one photo on page 102 shows a post bond after 1,000 hours at 300°C , and the small amount of discoloration indicates relative freedom from plague. Another photo on page 102 shows what happens when gold wire is bonded to a chip.

On the chip, the problem apparently is consumption of the aluminum thin film and loss of adhesion.³ The film is only about 1 micron thick, while the wire is about 375 microns thick. Even doubling the film thickness wouldn't help much if the 250-micron (1-mil) gold wire were retained. Also, the gold on the post is fairly thick, approximately 6 microns, and has excellent adhesion to the Kovar base material of the post.

The bond shape reduces wire thinning (squash-out), which slows plague formation by limiting the diffusion area. Bonding the wire twice to each post further combats failures due to plague.

Furthermore, silicon—which may promote plague formation—is essentially absent at the post. Even the 1% silicon added as a wire strengthener is apparently too little to be detrimental. Nevertheless, ways of strengthening the wire without using silicon, and of using aluminum posts, are being investigated by Norden.

Plague at the header

Switching to aluminum leads, which is not new, solves only half the plague problem and does virtually nothing to relieve thermal problems in high-power planar devices. The Norden die-mounting technique attacks both these problems simultaneously.

Gold is eliminated from the mounting area of the package header by use of the aluminum-germanium alloy to mount the silicon chip on a molybdenum pad. The usual technique is to use a gold alloy for mounting, often gold-silicon eutectic solder, and make the header of gold-plated Kovar, molybdenum or alumina metalized with molybdenum.

A gold alloy, particularly gold-silicon, and a gold-plated surface should not be used with aluminum lead wires if the metals are to be subjected to high

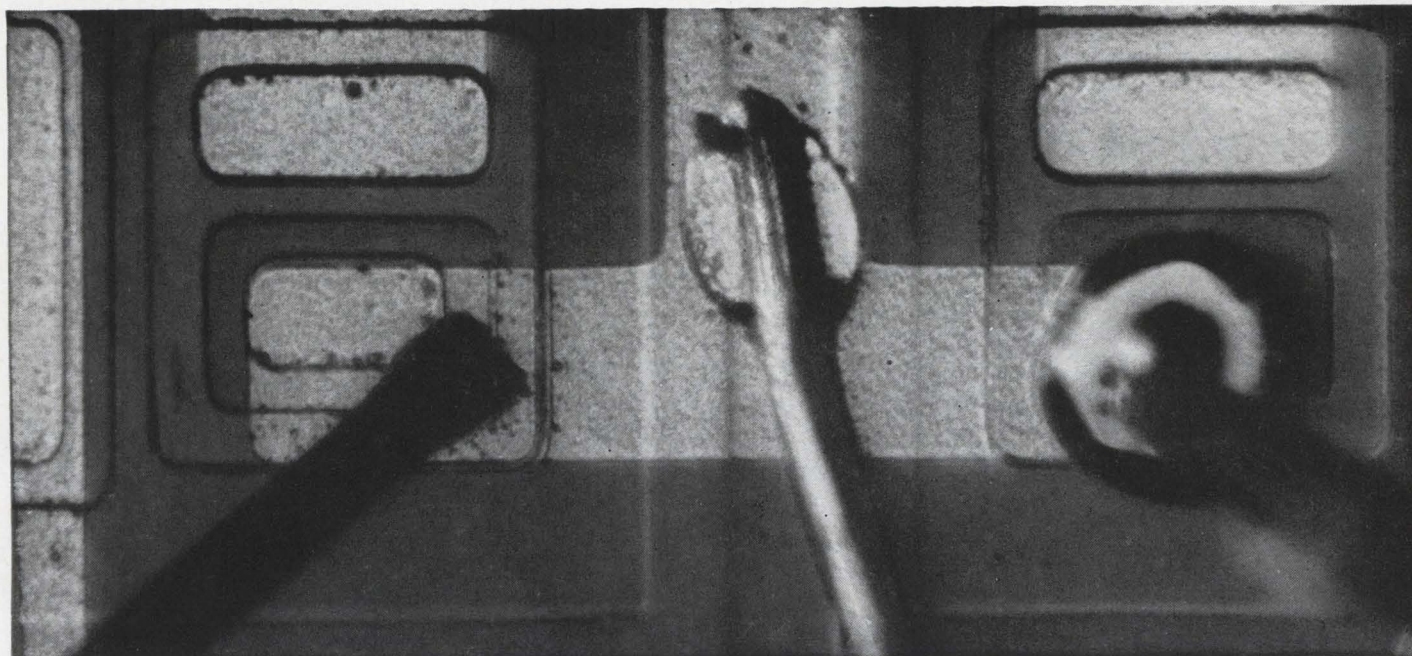

Types of bonds: left to right, wedge, bird-beak and ball.

Thermal resistance of dice mounts

alloy and header	Resistance (°C/watt)		
	run 1	run 2	run 3
Gold-silicon alloy			
gold-plated Kovar.....	6	6	5
nickel-gold-molybdenum...	2	4	5
Aluminum alloy			
unplated Kovar.....	2	3	2
unplated molybdenum.....	<1	<1	<1

temperatures. Often, to provide a base or ground connection, a lead must be bonded to the header. The chances of plague forming at the bond are high. The aluminum is likely to touch the smeared gold alloy. The header is also likely to be hot, since it is the heat sink for the device. The higher the device's wattage, the higher the temperature here.

Aluminum leads, aluminum alloy and the bare molybdenum header eliminate the causes of plague.

Thermal resistance lowered

Molybdenum is used as the die mount because its thermal expansion nearly matches silicon's. The

aluminum-germanium alloy enhances this match because it is soluble in molybdenum (Kovar could be used, but the alloy is less soluble in Kovar). The alloy is also soluble in aluminum, which is alloyed into the underside of the silicon chip to prepare it for mounting. The mounting is done at temperatures above 400° C, without flux and in a nitrogen atmosphere.

The solubility is needed for adequate cooling of the dice by the header. Without solubility, interfaces would be created between the dice and the alloy and the alloy and the header. Such interfaces act as impediments to heat flow, raising thermal resistance between the device junction and the case.

Thermal resistance is negligible with the Norden technique. It is less than 1° C per watt in one device (see table above), but this is an approximation because the resistance was too low for accurate measurement by the method used. The thermal resistance is several times higher when a gold alloy is used, as the table indicates. The gold alloys with the silicon and with the gold plating on the header, but there is an interface between the plating and

Failure rates of gold and aluminum wire bonds

Bond location	Standard gold-wire bonds			Both types on same chips	
	wedge	bird-beak	nailhead	gold bird-beak	Norden aluminum
Interconnections					
Wires bonded.....	94	139	165	60	60
failures.....	14	12	9	5	0
percent of failures.....	14.9	8.6	5.5	8.3	0
Contacts					
wires bonded.....	91	132	113	60	60
failures.....	9	7	4	4	0
percent of failures.....	9.9	5.3	3.5	6.7	0

After 1,000 hours storage at 300°C

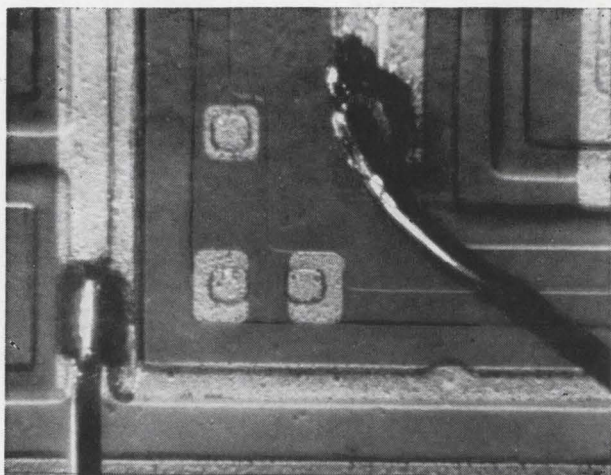

Gold bonds made to alloyed contacts (right) show more purple plague than gold bonds to interconnections (left).

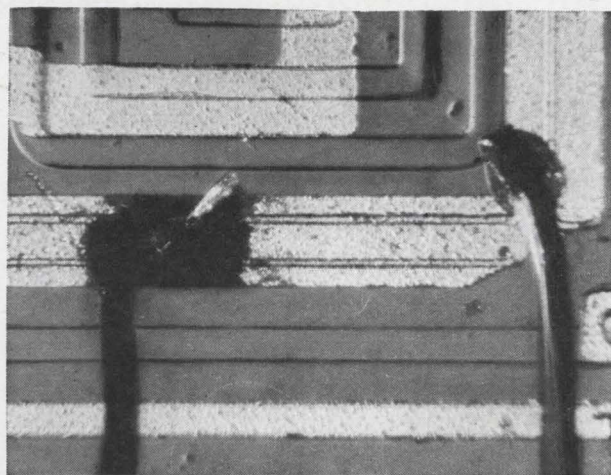

Purple plague surrounds gold bond (left), but aluminum bond (right) is undamaged.

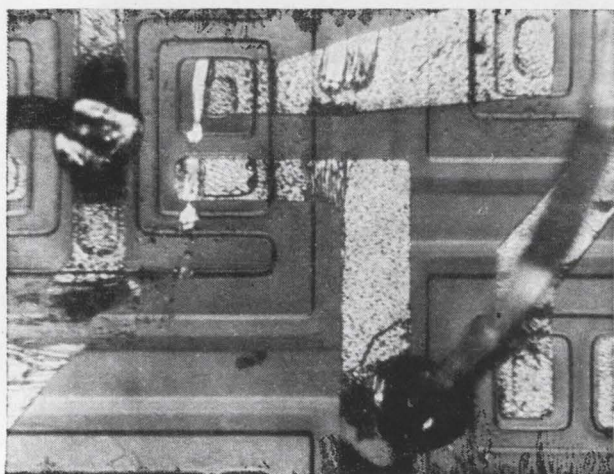

Gold bond to alloyed contact (left) survived despite plague. Loss of film adhesion made bond at right fail.



Aluminum bond made to top of a gold-plated post. Plague has formed, but not enough to destroy the bond.

the base material. A plating just sits on its base; it doesn't alloy with it.

The tabulated data was obtained from a multi-collector, silicon power transistor similar to those in the amplifier shown on page 99. Dice size is 87 by 47 by 5 mils. Each run was conducted over a power range of 1 to 20 watts, giving an average thermal resistance for that range. Junction-to-case thermal resistance was calculated by using transistors as the heat source and for temperature sensing.

A measured amount of power was applied to the transistor. It was switched off momentarily to measure the forward base-emitter drop, which had been calibrated as junction temperature. Internal case temperature was obtained from a reference base-emitter junction mounted close to the power junction. From these measurements, thermal resistance in degrees centigrade per watt was calculated. [Thermal resistance was discussed in a report on transistor cooling in *Electronics*, Sept. 7, 1964, p. 92].

Dice were mounted with gold-silicon alloy on

two kinds of headers: gold-plated Kovar and nickel-flashed, gold-plated molybdenum. Identical dice were mounted with the aluminum-germanium alloy on unplated Kovar headers and molybdenum headers.

As previously noted, the higher thermal resistance of gold-plated Kovar is due to an interface. The lower figure for nickel-gold-molybdenum may be due to a difference in interface resistance. The low figure for aluminum-Kovar and the lowest figure, for aluminum-molybdenum, results from the mounting alloy's solubility in those metals. The interface in the first case, and the absence of it in the latter, can be seen in the photos on page 103.

Processing benefits

The aluminum-germanium alloy also has processing advantages. Its melting point, above 400°C, makes safe the use of sealing temperatures higher than with gold-silicon alloy, which melts at 376°C. The circuits can also be aged and stabilized more rapidly at the higher temperature. Often, a 10°C temperature rise will double a chemical reaction

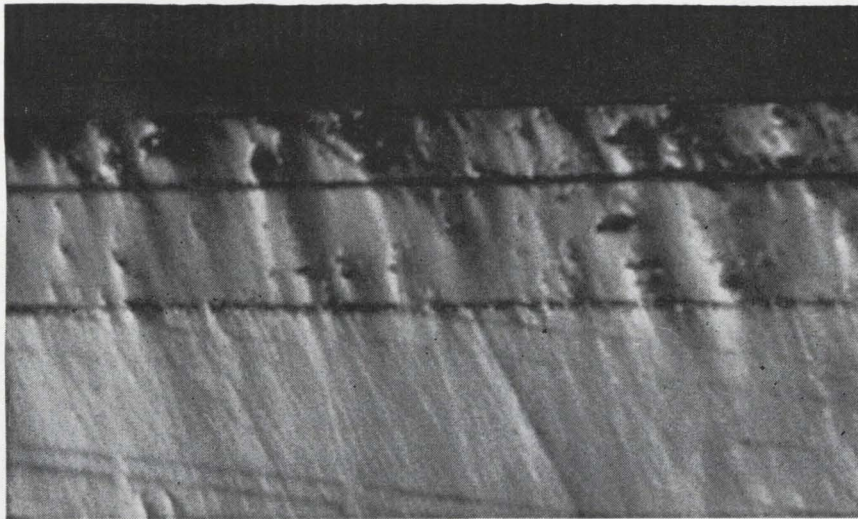

← SILICON
 ← GOLD-SILICON MOUNTING ALLOY AND GOLD PLATING
 ← KOVAR

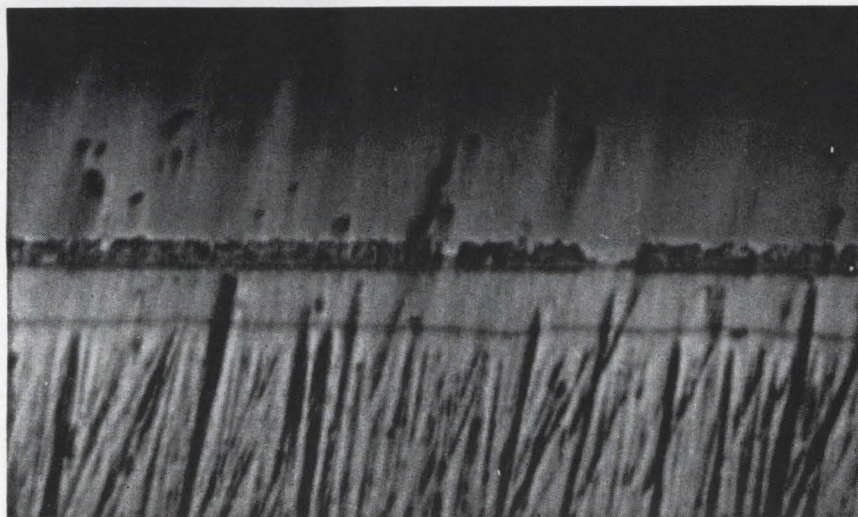

← SILICON
 ← ALUMINUM-SILICON ALLOY
 ← ALUMINUM MOUNTING ALLOY
 ← ALUMINUM-MOLYBDENUM SOLUTION
 ← MOLYBDENUM

Cross-sections cut through chips mounted on headers by the conventional method (left) and with the aluminum alloy (right). The absence of an interface between the aluminum and molybdenum lowers thermal resistance.

rate, while a 25°C rise will double the rate at which impurities diffuse in silicon.

An alternate mounting material is Pyroceram, made by the Corning Glass Works. It does not contain gold and is good up to 425°C. However, Pyroceram gives very high junction-to-case thermal resistance, is not as strong as metal and is an insu-

lator, preventing electrical contact to the mounting surface.

Like the gold-silicon alloy, the aluminum alloy does not match the thermal expansion of silicon. Both, however, are soft enough to absorb thermal strains that might otherwise fracture the chip.

Reliability of wire bonds

Comparative tests of the reliability of gold-wire bonds and Norden's aluminum-wire bonds show a failure rate of 6.7% for gold bonds and no failures for aluminum bonds (see table on page 101).

Test units were Norden integrated circuits which have aluminum-silicon alloyed contacts and aluminum thin-film interconnections over silicon dioxide. The dice were mounted with gold-silicon alloy on TO-5 headers. The gold bonds were made of 1-mil wire with standard bird-beak bonders, the aluminum bonds with 1½-mil wire and the modified bonders. After bonding, caps were welded to the headers in nitrogen.

To prevent processing differences from clouding the results, test units were taken from four produc-

Reliability tests

Tests	Test conditions	
	Wire bonds	Dice mounting
High-temperature storage	1,000 hours at 300° C	1,000 hours at 300° C
Shock MIL-STD-750	Method 2016 (5 blows each direction, 500 g, 1 millisecond)	Method 2016 (5 blows each direction, 800 g, 1 millisecond)
Vibration MIL-STD-750	Method 2056	Method 2056
Acceleration MIL-STD-750	Method 2006 (20,000 g in all six directions)	Method 2006 (20,000 g in Y axis)

The cause of purple plague

It has long been known that purple plague can seriously degrade the reliability of semiconductor devices. Restating the causes and effects of plague helps put the Norden techniques into perspective.

Plague is a compound formed by the intimate contact of aluminum and gold. It forms by diffusion of the metals, slowly at room temperature and rapidly when the metals are hot. A bright purple compound forms almost instantly, for example, when a gold film is vacuum evaporated onto a hot film of aluminum. Silicon also seems to accelerate plague formation.

Plague is the price paid for the desirable characteristics of gold leads and aluminum films in silicon planar devices and integrated circuits. Aluminum is a nearly ideal material for thin-film contacts and interconnections. It alloys easily with silicon, adheres well to silicon dioxide and suits the manufacturing process. Gold is a good lead material and bonds well to the aluminum.

However, device fabrication and operation give plague an opportunity to form. Bonding temperatures go up to 350°C, vacuum bakeout for stabilization before sealing requires temperatures up to 300°C, and package sealing temperature may be as high as 400°C.

In low-power devices, plague formation can be kept below the danger point by careful processing, methods of strengthening gold-aluminum lead bonds, and restrictions on device storage and operating temperatures. Such avoidance techniques only

tion batches, and both gold and aluminum bonds were made to alloyed contacts and thin films of each unit. Tests conditions are given in the table on page 103.

The aluminum-aluminum bonds did not discolor. There was some discoloration where aluminum wire was bonded to the gold-plated posts, but none of these bonds failed. One photo on page 102 shows an aluminum bond next to a gold bond, where plague was formed.

The discoloration of the gold bonds was greater at bonds to aluminum-silicon contacts, bearing out the theory that silicon helps form plague.² However, more of the gold bonds to interconnections failed, indicating that loss of adhesion is a more serious problem than plague alone.³ The contacts are rich in silicon, while silicon can be present at the interconnections only through diffusion, or possibly by reaction of the aluminum with the silicon dioxide.⁴

Tests were also made on similar circuits, with gold bonds made by the three conventional thermo-compression bonding methods: wedge, ball or nail-head, and bird-beak. The table on page 101 gives the results. The lower failure rate of the ball bonds indicates that less squashout of a wire helps retard plague formation. In ball bonding, the wire end is formed into a ball that is pressed on the film.

Reliability of die mounting

To check whether the new mounting alloy produces detrimental effects, transistors and integrated circuits were subjected to the tests tabulated on

postpone the inevitable in high-power devices, whose junction temperatures may be nearly 200°C during operation. The only sure cure is a metal system other than gold and aluminum.

Breeding ground. Plague is a problem at two places on a silicon device chip:

- Alloyed contact. An aluminum film applied to exposed silicon, for example at a transistor collector, alloys with the silicon at 577°C. The gold of a lead bonded to the contact consumes aluminum to form AuAl₂ or another Au-Al compound. However, the plague appears "alloyed" down into the silicon along with the aluminum. This may lower the number of contact failures caused by plague, by helping maintain bond adhesion.

- Thin-film contact. In integrated circuits, leads are normally bonded to aluminum films atop a silicon dioxide passivation coating, not to alloyed contacts. As the gold consumes the aluminum film, the film loses adhesion to the glassy SiO₂ and the bonded wire can easily tear loose. Plague is a more serious problem in integrated circuits than in transistors for this reason, and the need for more leads on the circuits further compounds the problem.

Norden's tests, discussed on page 103, confirm these failure modes and underscore the advisability of aluminum-aluminum bonds. The present package is not an absolute guarantee against plague, since aluminum leads are bonded to gold-plated posts on the header. However, the chance of a harmful amount of plague is negligible and even this possibility will be eliminated by the planned use of aluminum-plated posts.

page 103. Gold-mounted units were used as a reference. No failures were traced to either mounting method.

Preliminary results of further tests, at a storage temperature of 400°C, indicate that the Norden technique will prove reliable at this temperature. The headers have aluminum posts. Gold-mounted units cannot withstand 400°C; the gold-silicon alloy melts and consumes the dice.

The ability to withstand storage at 400°C is added assurance of long life at normal operating conditions. Moreover, it is desirable for reliability testing. In their report on the median life of silicon mesa transistors, G. C. Sikora and L. E. Miller show that 33 hours storage at 400°C would equal 1,000 hours at 300°C and 110 million hours at 50°C.⁵ However, their information for 400°C was extrapolated from data obtained at lower temperatures, while Norden is gathering data at 400°C.

References

1. L. Bernstein, "Gold Alloying to Germanium, Silicon and Aluminum-Silicon Eutectic Surfaces," *Semiconductor Products*, July and August, 1961.
2. T.A. Longo and B. Selikson, "Aluminum Wire Bonding of Silicon Transistors," *Semiconductor Products*, November, 1963.
3. E.M. Ruggiero, "Gold-Aluminum Adhesion and Reaction on Semiconductor Surfaces," 4th Annual Microelectronics Symposium, St. Louis Section, IEEE, May 20, 1965.
4. J.E. Thomas, Jr., and D.R. Young, "Space-Charge Model for Surface Potential Shifts in Silicon Passivated with Thin Insulated Layers," *IBM Journal of Research and Development*, September, 1964.
5. G.C. Sikora and L.E. Miller, "Applications of Power Step Stress Technique to Transistor Life Predictions," Third Annual Symposium on Physics of Failure of Microelectronic Devices, Chicago, 1964 (sponsored by Rome Air Development Center, Rome, N. Y.).

...NOW IN A NEW MINIATURIZED SIZE

Hermetically Sealed ERIE BUTTON® MICA capacitors designed for -55° to +200°C at 2000 Mc.

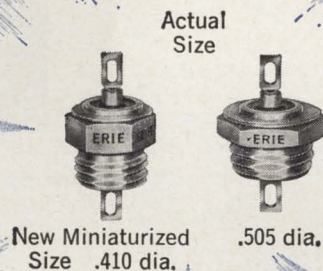

Featuring 508 MECHANICAL VARIATIONS TO SUIT
ANY HIGH TEMPERATURE—HIGH FREQUENCY CAPACITOR APPLICATION

With the addition of these new miniatures, Erie further broadens the most complete selection of Button Mica Capacitors in the industry. These new miniaturized micas provide 33% reduction in mounting area.

Erie Button Mica Capacitors are designed for use in radio frequency circuits for tuning, bypassing and coupling. The outstanding properties of metallized mica dielectric combined with the radial current pattern, make Erie Button Capacitors ideal for low inductance, high frequency applications.

These high quality capacitors are designed for microwave and filter applications, for use in carrier equipment, parametric and RF amplifiers, oscilloscopes... any application where high temperature and high frequency are factors.

The welded hermetic seal of these excellent broad frequency Gold Seal® capacitors for military and commercial use is 100% tested under pressure steam/salt water during production to guarantee a positive moisture seal.

Consider the advantages of Erie Button Mica Capacitors in the equipment you are designing. Write for Gold Seal Bulletin 500-2 or Resin Seal Bulletin 318-3.

GENERAL SPECIFICATIONS

Capacitance:	5 pf. thru 2500 pf.	Frequency Range:	to 2Gc and beyond
Tolerance:	1% or .25 pf thru ±20%	Operating Temp.:	-55°C to +200°C
Working Voltage:	500 WVDC for 1/2" dia. units		-55°C to +150°C
	250 WVDC for 3/8" dia. units		-55°C to +85°C

Q: per MIL-C-10950

TYPES AVAILABLE

HERMETICALLY SEALED (GOLD SEAL®) .410" O. D. or .505" O. D.	RESIN SEALED .375", .447" or .657" O. D.
FEED THRU	FEED THRU
FEED THRU (BUSHING MOUNT)	FEED THRU (BUSHING MOUNT)
STAND OFF	STAND OFF
EYELET FEED THRU	

MINIATURE BYPASS CAPACITOR SYSTEMS FOR TRANSMITTING TUBES...

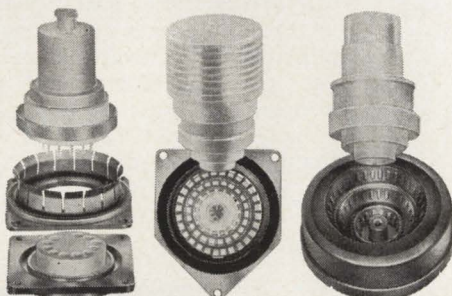

Designed for the 10 to 3,000 megacycles range—and beyond

Erie now provides effective capacitive bypassing and coupling or filtering of all RFI signals in the range of 10 to 3,000 megacycles. Variety of systems to meet your requirements.

Write for Bulletin 525-R

Formerly Erie Resistor Corporation

Another Series of Components in Erie's Project "ACTIVE"
Advanced Components Through Increased Volumetric Efficiency

ERIE
TECHNOLOGICAL
PRODUCTS, INC.

644 West 12th Street
Erie, Pennsylvania

Design for extra performance

... with Mallory high energy batteries

Improved heavy-duty performance available

Recent refinements in Mallory Manganese Alkaline Batteries increase their ability to deliver long life, and further improve their advantage over conventional zinc-carbon batteries. At 70°F, this Mallory system delivers up to 7 times more life on continuous heavy drain than ordinary batteries (see chart).

At 32°F, the improvement in performance is even better. This added capability is the result of new internal construction which increases the effective anode area in relation to cell volume, providing lower internal impedance particularly at low temperatures. Added refinements have also been made to insure reliability of the case seal under even the most severe vibration.

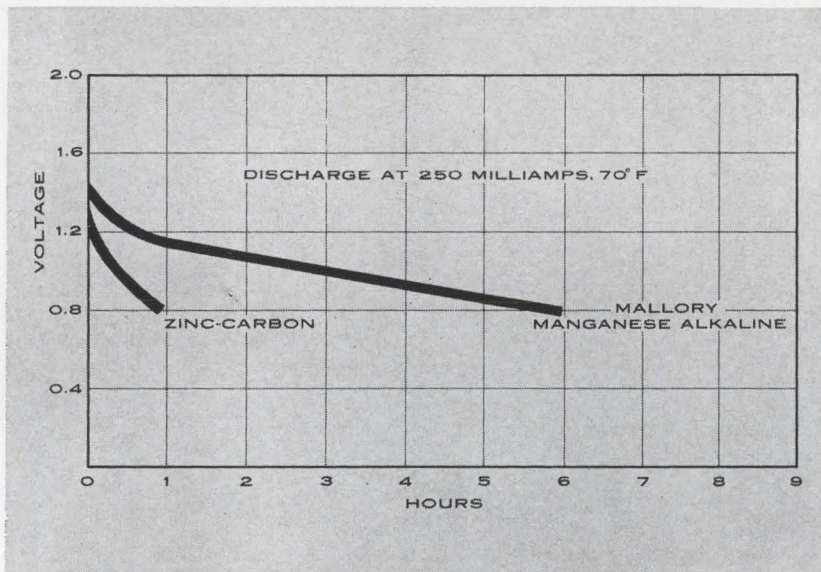

Now—Certified Cells for highest reliability

For applications where maximum reliability is demanded, we are producing Certified Mercury Cells in a separate, "zero defects" manufacturing facility which is unique in the battery industry. All manufacturing operations are performed by skilled technicians. Every component is individually tested and only those coming within optimum specification values are selected. Complete manufacturing controls are in effect during assembly, and test data are permanently kept on each production lot. Each shipment is individually certified to meet the highest level of quality possible under the present state-of-the-art.

Of the many thousands of Certified Cells we have produced, there has not been a single report of premature failure.

One of many inspection operations on the Mallory Certified Cell line.

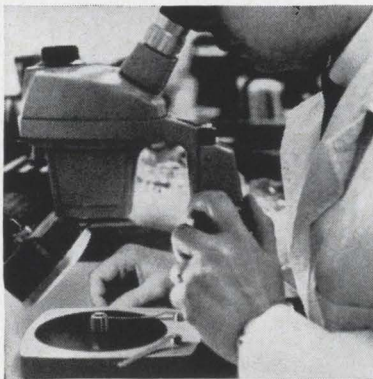

Leading battery-powered products use Mallory Batteries

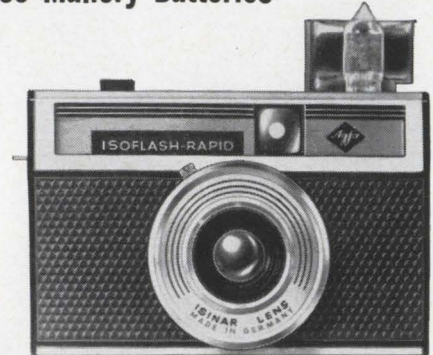

New Isoflash-Rapid camera, by Agfa-Gevaert, uses snap-in loading with automatic film threading and no rewinding. Both this model, with built-in flash, and the electric eye Isomat-Rapid, with accessory flash reflector, use a B-C system powered by a 6-volt Mallory Mercury Battery with life of 2 years in normal service.

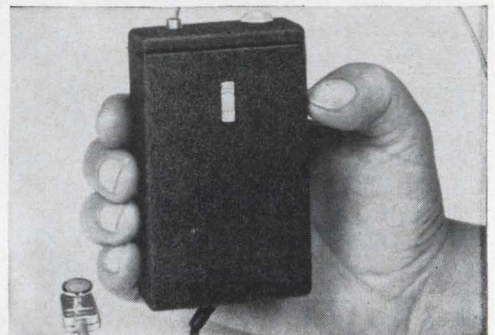

FM Wireless Microphone. Small as a cigarette pack, the "Mike-Caster" made by Federal Division, The Victoreen Instrument Company, transmits with high fidelity, free from interference. Two Mallory Mercury TR-165 Batteries supply power for over 30 hours of continuous service.

Mallory Batteries cost more, but they're worth more because of the extra values of miniaturization, convenience and performance they can add to your product. For a consultation on your specific requirements, write or call Mallory Battery Company, a division of P. R. Mallory & Co. Inc., Tarrytown, New York.

MALLORY

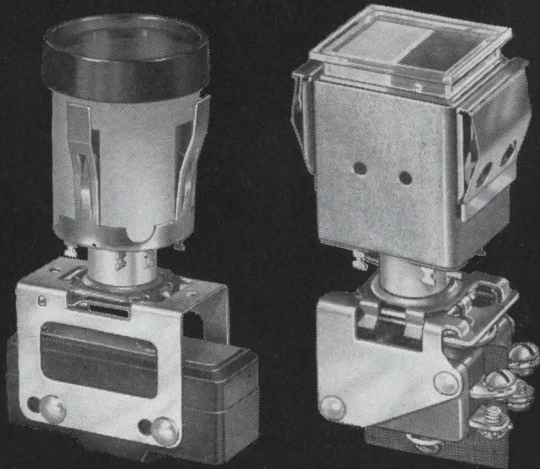
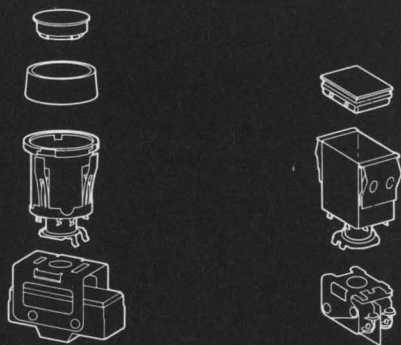

Series 2—The original Series 2 introduced modular construction in lighted pushbutton switches. Choice of round or rectangular display, Snap-in mounting. Available with RFI shield, and solenoid pull-in and/or hold-in coil for remote control.

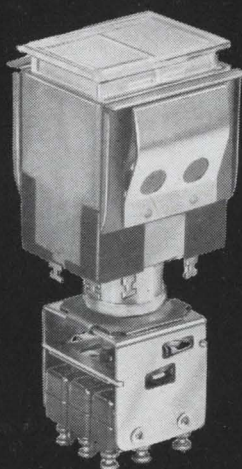

Series 2C200—Snap-in mount. Re-lamp without tools. Optional RFI shield, and solenoid pull-in and/or hold-in coil for remote control.

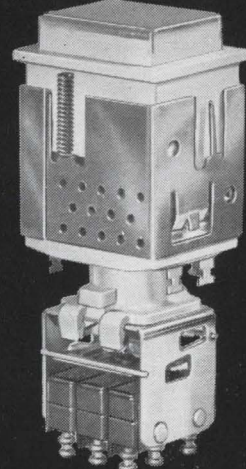

Series 2N—Shock resistant spring-lock mounting. Hold-in coil. Re-lamp without tools.

Now, more design freedom with Modular Lighted Pushbuttons

Many advantages in design, installation, operation and maintenance are available in the expanded line of MICRO SWITCH lighted pushbutton switches. Examples of the basic assemblies are shown. Each series offers a wide choice of interchangeable snap-on modules.

GENERAL FEATURES:

Panel seals. Choice of colored buttons or color filters; slide-on caps for easy legend changes. Choice of 1- to 4-section buttons and 1 to 4 lamps providing up to 4-color display. Choice of 30 different switch modules; 1, 2, 3 or 4-pole double-

throw and twin-break contact arrangements; heavy duty and low energy electrical ratings; momentary or alternate action; solder, screw and quick-connect terminals. Optional hold-in coil modules. Matching indicators for lighted display only.

For information, contact a Branch Office (see Yellow Pages, under "Switches, Electric") or write for Catalog 67.

MICRO SWITCH

FREEPORT, ILLINOIS 61033

A DIVISION OF HONEYWELL

IN CANADA: HONEYWELL CONTROLS LIMITED, TORONTO 17, ONTARIO

HONEYWELL IS WORLDWIDE • Sales and service offices in all principal cities of the world. Manufacturing in Brazil, Canada, France, Germany, Japan, Mexico, Netherlands, United Kingdom, United States.

**TOO SMALL
TO BE A
LIFESAVER?***



**NOT
IF YOU'RE DESIGNING
ELECTRICAL CIRCUITS**

In the race toward smaller circuits and higher density packaging, some electrical design engineers are sinking in a sea of overlarge components. Those in the know are being buoyed up by Magnetics' miniature powder core line—moly-permalloy cores as small as 0.110" I.D.

Designers involved with highly critical inductor stability factors are welcoming another Magnetics innovation—guaranteed temperature stabilization in miniature powder cores. The "D" type limits the change in inductance to $\pm 0.1\%$ from 0 to +55 degrees C. The "W" type limits the change from $\pm 0.25\%$ from -55 to

+85 degrees C. Our new "M" type limits the change to $\pm 0.25\%$ from -65 to +125 degrees C. A wide selection of core sizes and permeabilities broadens the engineer's design scope even more. And all of these sizes are designed so they can be wound on present miniature toroidal winding equipment.

If you are faced with a problem of compacting a circuit design, it will pay you to investigate the condensing potential of Magnetics' miniature powder cores line. For the complete story, write Dept. EL-30, Magnetics Inc., Butler, Pa.

**Actual size of Magnetics' 0.110" I.D. powder core*



Out in Front! New KNOBPOT® Senior Precision Potentiometer with $\pm 0.1\%$ Dial Accuracy

The acclaim and immediate acceptance which greeted Bourns' original KNOBPOT, a major advance in the state-of-the-art, have led to the development of a "Senior" version, to provide higher resistance values and increased accuracy. You can see in the photo below that this new unit saves you nearly all the back-panel space consumed by the bulky conventional type. That's because it's a potentiometer, knob and turns-counting dial all in one, mounting entirely in front of the panel.

KNOBPOT Sr., Model 3640, a companion unit to the revolutionary Bourns KNOBPOT Model 3600, gives you a bonus in accuracy, resolution, and power, too. The whole unit...including the integral turns-counting dial...is more accurate than the best competitive potentiometer/dial combination.

In your production, KNOBPOT Sr. potentiometers save you time and trouble. For example, they put an end to do-it-yourself installation. Phasing is done for you—with extreme accuracy—at the Bourns plant. No separate dial to attach, no complicated mounting procedure. Just drill two holes, put the unit on the panel and tighten the nut. That's the whole installation!

Most important of all benefits, however, is the name on the package! It means that the product has undergone 100% in-process and final inspections as well as the double-check of Bourns Reliability Assurance Program. You can be "out in front" in more ways than one if you specify the Model 3640, KNOBPOT Sr. potentiometer. Write today for complete technical data.

Standard Resistances: 500 Ω to 250K
 Dial Accuracy (correlation of dial reading to voltage output): $\pm 0.1\%$ max.
 Repeatability (ability to return to a previously established setting): $\pm 0.05\%$
 Resolution: 0.03 to 0.006%
 Power Rating: 2.5 watts at 25°C
 Max. Operating Temp.: 125°C
 Dimensions (in front of panel): only 1½" long x 1¼" dia.

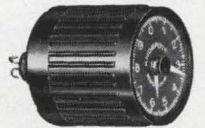

ONE-HALF ACTUAL SIZE

Photo below compares actual-size KNOBPOT Sr. with a conventional potentiometer and separate dial package.

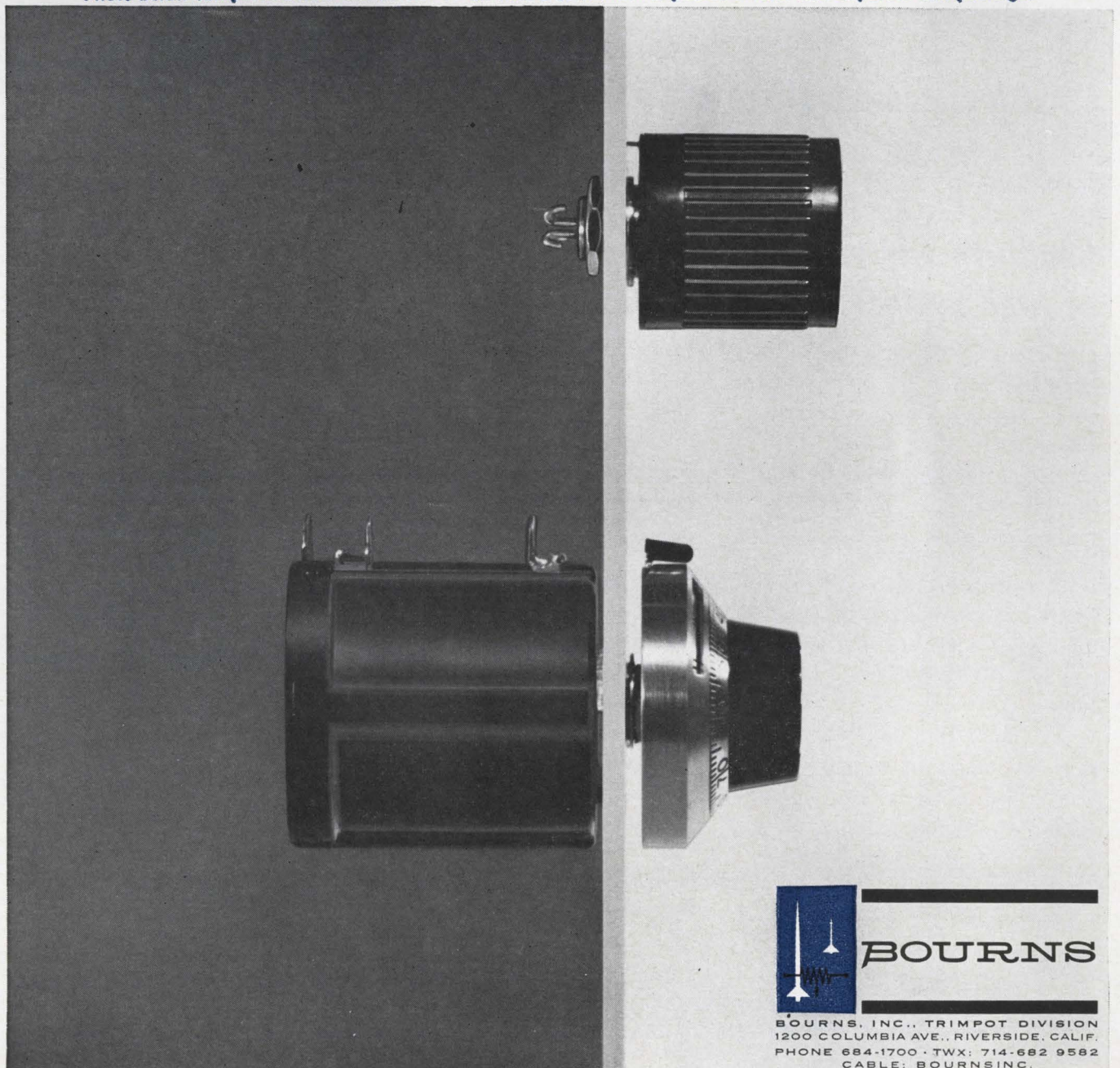

BOURNS

BOURNS, INC., TRIMPOT DIVISION
 1200 COLUMBIA AVE., RIVERSIDE, CALIF.
 PHONE 684-1700 · TWX: 714-682 9582
 CABLE: BOURNSINC.

MANUFACTURER: TRIMPOT® & PRECISION POTENTIOMETERS, RELAYS; TRANSDUCERS FOR PRESSURE, POSITION, ACCELERATION. PLANTS: RIVERSIDE, CALIFORNIA; AMES, IOWA; TORONTO, CANADA

Tests prove it... Mallory MTA capacitors deliver big performance for small cost

Results of performance testing of the new Mallory MTA molded aluminum electrolytic capacitors may change your ideas about how much quality you can now buy in a miniature capacitor at low cost.

Good low temperature stability

The MTA has good capacity retention for a miniature electrolytic—even at -30°C . Take a look at the chart.

Good life and reliability at high temperature

Capacitance, DC leakage and dissipation factor show good stability on life test at 65°C —and at 85°C . The chart shows the first 500 hours' data on a production lot of 100 mfd, 10 VDC units. At 85°C , there hasn't been a single failure of any kind during 1 million piece-hours of life test. And at 65°C , we've had only *one* failure in $2\frac{1}{2}$ million piece-hours of testing.

Both our tests and those by customers indicate that the MTA has reliability superior to many miniature aluminum types, including many metal case models. DC leakage of polar models is less than 0.03 microamps per mfd-volt. We invite you to evaluate the MTA. We believe you'll find its performance applicable to a broad range of entertainment and industrial uses. And we know you'll like its price. For data, write or call Mallory Capacitor Company, a division of P. R. Mallory & Co. Inc., Indianapolis, Indiana 46206.

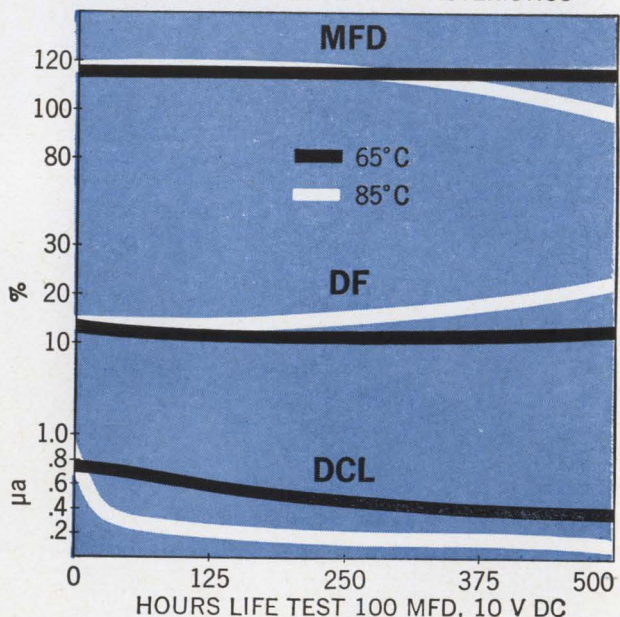
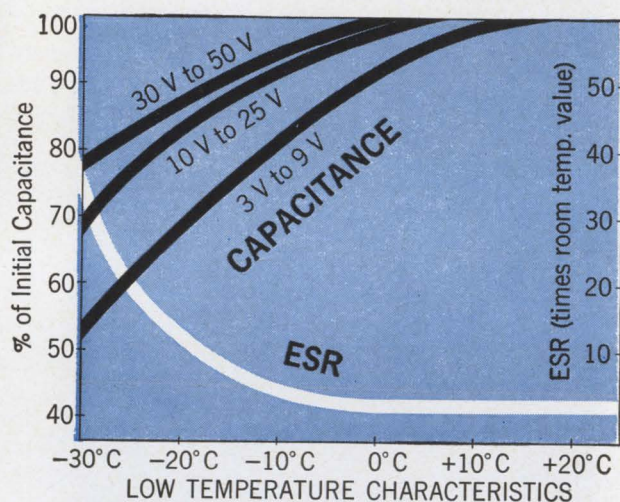

Case size	Volts WVDC	Maximum Ratings—MTA	
		Maximum capacity—mfd. polarized	non-polarized
$\frac{5}{16}'' \times \frac{7}{8}''$	3 to 50	75-8	65-4
$\frac{3}{8}'' \times 1\frac{1}{8}''$	3 to 50	210-20	135-10
$\frac{1}{2}'' \times 1\frac{1}{2}''$	3 to 50	800-85	525-40



Probing the News



Military electronics

Underwater city: Sealab II

Navy outpost on the ocean floor demands a new breed of electronics to support men in a harsh but promising new world

By John F. Mason

Military Electronics Editor

Every morning, ten Navy divers crawl out of their bunks, brush their teeth, shave, then eat a hearty breakfast. Later, some of them put on "wet" suits and breathing gear, climb down a ladder through the floor of their quarters, and swim to work.

Traveling 210 feet below the surface of the sea, two men, on a typical day, might swim off to repair a malfunctioning telemetering station not too far away, while another pair tests the range of underwater communications gear.

At the end of the month-long project, called Sealab II, now under way a half-mile off the coast of La Jolla, Calif., the Navy will have made the most extensive test yet of man's ability to live and work in

the ocean depths for long periods of time under saturated diving conditions—the pressure in the undersea lab is the same as that of the water outside. The environment in the divers' quarters and in the water surrounding it is severe and every piece of electronic equipment is being watched to see how it stands up.

For Sealab II, the Navy is using equipment designed for other Navy programs, commercial scuba diving gear and some built especially for Sealab.

Under pressure. Denzil C. Pauli, assistant project officer for Sealab II, says that what is learned from the performance of this equipment may mean a new generation of underwater sensors, data links,

navigation and reconnaissance gear. It will also provide information on tools for building and making repairs, vehicles for transportation, and the "hydronics" these vehicles will need for navigation and communication.

Pressure in the undersea lab, which is called a habitat by the Navy, and in the water is about 125 pounds per square inch, or seven atmospheres of pressure. This environment requires television and vacuum tubes that will not implode, and transistors that cannot be squeezed out of shape. The atmosphere the men breathe is mainly helium. Because high humidity (60% or more) is essential for physical comfort in a helium environment and because helium

transfers heat five times faster than a standard atmosphere, components must be resistant both to humidity and heat.

I. The objectives

There are many reasons for training men to live and work for long periods at depths they normally visit for only a few minutes at a time. Navy divers could rescue men from distressed submarines, install navigation devices, build undersea habitats, repair sonar installations used for detecting enemy submarines, and retrieve space capsules and instrumentation.

Undersea wealth. Civilian groups are exploring the ocean floor for commercial reasons. Jacques Yves Cousteau, the French explorer, believes—and the U.S. Navy agrees—that off-shore gas and oil wells can be drilled cheaper, faster and more safely by divers than from a barge.

Large supplies of fish can be found deep in the sea. Eventually, there may be fish or plant-food farms that divers will tend.

II. Navy's project

Sealab II is the Navy's second experiment in underwater living. Last summer, off the coast of Bermuda, four men stayed in Sealab I at a depth of 193 feet for 11 days. In Sealab II, a total of 18

men will participate for 30 to 40 days at a depth of 210 feet. Plans are to replace eight of the ten men in the habitat after they have stayed down 15 days; two of the original ten will live in Sealab II for the entire experiment.

Participants. The Sealab project, which is part of the Navy's Man-In-The-Sea portion of the Deep Submergence program, is sponsored by the Office of Naval Research in collaboration with the Special Projects Office. Other naval organizations contributing to the program include the Navy Mine Defense Laboratory, which prepared the plans and specifications for the Sealab II structure, tested and evaluated much of the electronic equipment, and under the direction of astronaut Commander Scott Carpenter, trained the divers, or aquanauts.

III. The site

Approaching Sealab II is somewhat like coming into a small town, because of the cables that lead to it and the number of small structures scattered around it. About 100 feet from the habitat there is an automated telemetering station through which television and audio communications and environmental data are channeled. A cable runs from Sealab to the telemetering

station and from there to shore. **Vital link.** Rising from Sealab, there is an umbilical cord that extends upward to the support vessel. In this cord there are a gas supply hose, a gas-sampling hose that men in the support vessel use to monitor the gas mixture in Sealab, emergency power cables and cables for communication and telemetry.

IV. Communications

The umbilical cord carries all communications between Sealab and the support ship. Future colonies will undoubtedly want to communicate independently of a cable, by radio or other means.

Cables in the cord provide the links for both a two-way electro-writer system and voice communications. To make the men's voices from Sealab up to the barge intelligible—the helium atmosphere in the habitat makes them sound like Donald Duck—speech unscramblers are being used. Developed by the Naval Applied Science Laboratory in Brooklyn, N. Y. for helium diving operations, the device translates the high frequencies of the men's voices to lower, more normal frequencies.

Video monitors. Four television channels are carried up through the umbilical cord to the support ship where doctors and scientists moni-



Berry L. Cannon uses the AN/PQS-1B sonar to search the ocean floor.

Life on the ocean floor

Electronics engineers are working in steaming jungles, arid deserts and the bitter cold of the Arctic. But only one of them is working at the bottom of the sea.

Berry L. Cannon is one of the ten men living in the 57- by 12-foot cylinder ballasted on the ocean floor, 210 feet below the surface, near the coast of La Jolla, Calif. Cannon is responsible for monitoring test equipment; should any of the electronic devices break down, he will repair them. And, several times a day, Cannon and another diver swim out to run tests on the intelligibility of various kinds of swimmer-to-swimmer communications. The tests, repeated frequently, are to determine whether there are changes in range over varying time periods, and if so, what factors, such as turbidity and temperature, cause them.

In August, 1963, Cannon was designing underwater electronic devices for the Navy Mine Defense Laboratory at Panama City, Fla. In order to learn more about the job he was doing, Cannon asked to go to diving school. After some deep-water experience he was transferred to the swimmer-diver branch at the lab. Ever since his graduation from the University of Florida in 1962, Cannon had worked on the control section of towed vehicles, designed an intercom system, and aided in a number of underwater projects.

Cannon is enthusiastic about his role of pioneer in a new world and expects to learn a great deal from his two-week stint at the bottom of the sea.

"I'll be a much better designer after my stay in Sealab II," he told Electronics shortly before the descent.

In addition to Cannon, project Sealab II includes a doctor, an aeronautical engineer, mechanical engineers, geologists, biologists, physical oceanographers, military oceanographers, a medical corpsman and professional Navy divers. Commander Scott Carpenter, an aeronautical engineer as well as astronaut and skin diver, trained the men at Panama City, Fla. and is now in Sealab II himself.

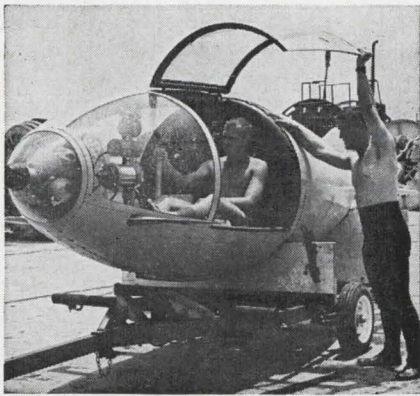

Wet submarines travel at 9 knots but are too maneuverable to use at deep levels where a quick ascent would be dangerous to aquanauts. The miniature sub might be used by surface divers to take supplies to Sealab.

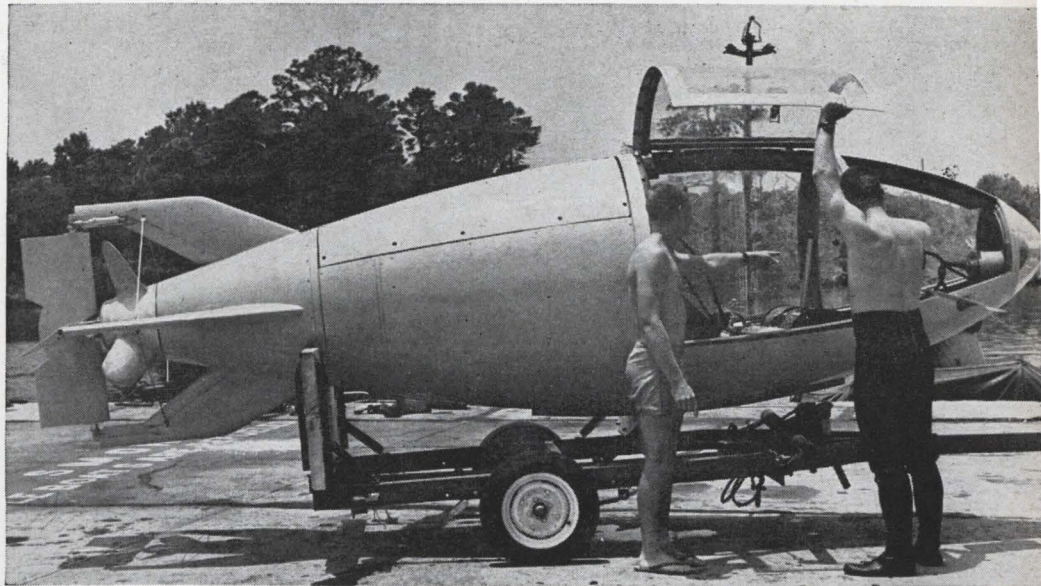

tor the divers. Two cameras are inside the habitat and two are just outside in the water. Commercial tv and f-m radio piped through the cord will be available.

Sealab and the Scripps Institution of Oceanography communicate directly with each other only by cable through the underwater telemetering station. Scripps, a half-mile from the Sealab II site, is assisting in the physiological and oceanographic research.

Swimmer-to-swimmer. The divers have three systems for talking with each other when they are swimming:

- The AN/PQC-1, a standard single sideband, low-frequency (8 Kc) a-m, sonic communicator with a range of 1,000 feet. The main drawback is that the mouthpiece of the breathing unit makes enunciation difficult.

- The Aquasonics communicator is a 42-Kc, a-m, sonic device with a 1,000-foot range. It doesn't use a mouth bit, but has a mask, like an oxygen mask, that fits over the mouth and is subject to flooding.

- A buddy-swimmer intercom system developed at the Navy Mine Defense Laboratory uses bone-conduction microphones, connected by a 24-foot wire. The microphone, fastened to the head, near the ear, picks up the speaker's voice and also enables him to hear. The unit contains an amplifier, switch and battery.

Swimmers talk to the support ship or to Sealab by using the PQC-1. The ship uses an underwater loudspeaker, the AN/BQC-1.

Tape recorder. One tool that the men in Sealab II don't have, but future undersea workers will need, is a watertight tape recorder into which a swimmer can dictate his scientific findings as he sees them.

Lasers have been examined by a number of companies for solving the swimmer-to-swimmer communication problem, but the high attenuation and the narrow beam rule it out for the time being.

V. Instrumentation

To record the ever-changing conditions in the sea, a weather station with conventional electronic equipment is fixed to the sea bottom near the habitat. To measure the height of the waves, some 200 feet above, a Vibrotron pressure sensor is used. Current is measured with a Savonius type rotor. And temperature of the water every ten feet from the bottom up to 50 is obtained with a series of thermistors. Data from the weather station goes to the telemetering station via Sealab and from there to Scripps for recording and storing in the computer.

Visibility is measured by a volume-scattering coefficient meter and by a null balance transmissometer. The amount of light that small marine organisms emit when they are disturbed is measured by a bioluminescent meter that uses a photomultiplier sensor.

Environmental control. Inside Sealab, a number of environmental conditions are constantly monitored: temperature, humidity and partial pressure of the oxygen. Readings of these measurements

are displayed in Sealab, in the ship and in the Scripps lab.

The oxygen content in the habitat is monitored by a device called a Krasberg sensor, built by the Westinghouse Electric Corp. for the Sealab program. In the support ship, another Krasberg sensor checks the oxygen in the samples of air brought up through the tube in the umbilical cord. Other constituents of the gas are analyzed in the support ship by a gas chromatograph. At the Scripps laboratory, a mass spectrometer analyzes the breathing mixture to measure elements not detectable by the chromatograph.

Power supply. Power to keep this elaborate colony of instruments and men going is transmitted from Scripps by cable to a sealed transformer bank near Sealab where the 4,160 voltage is transformed to 450 volts. In case of power failure on shore, 450-volt power can also be obtained via the umbilical cord from the support ship.

Far off shore, future undersea laboratories will require self-contained power sources. Possibilities include fuel cells, isotopes and nuclear reactors. Isotope and reactor sources look very promising because of their useful by-product—heat. Fuel cells are also promising because they provide water as well as heat.

VI. Reconnaissance

Electronic gear helps a diver investigate the ocean floor. When visibility is poor, he uses the AN/PQS-1B handheld sonar. Produced

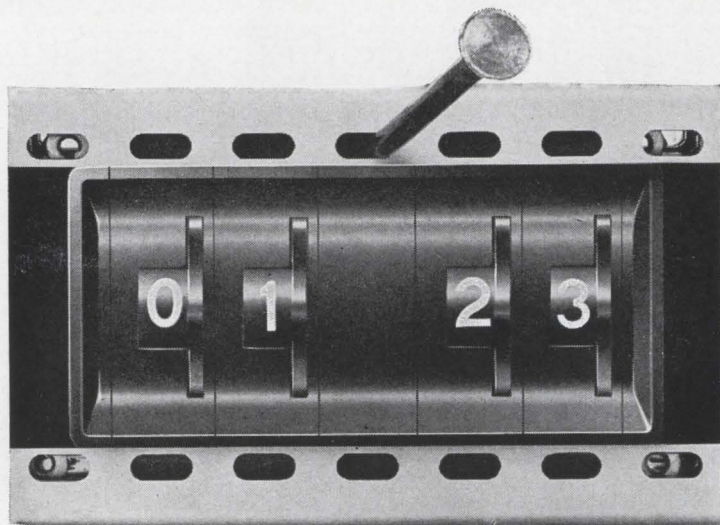

It's almost that easy

with the Universal-Mounting Series 200 EECoS SWITCH

Let's spike the rumors that all thumbwheel switches are alike, for here's the new EECO 200 Series that makes panel cutting, and mounting almost as easy as 0-1-2-3. How? *Here's how...*

Compatible

The Series 200 can be installed with 1 up to 34 switching stations as standard assembly. Any number over 34 can be accommodated to order.

Self-Bevel

No panel beveling is required for an EECoS SWITCH Series 200 installation. Switches, spacers and end pieces form a smoothly contoured bevel of their own that fits flush against the cut-out.

Metal-to-Metal

The upper and lower metal brackets of the assembled switch bolt directly to the panel for an extra-strong mounting.

Captive Nuts

Captive nuts in the end pieces permit quick installation and wide tolerance in locating mounting holes.

Interchangeable

EECoSWITCH 200 Series assembly design makes for easy interchangeability with other makes—a real advantage when specifying switches.

Replaceable

Only two screws need be loosened to remove an individual switch—no long end-to-end alignment bolts are necessary.

And It's EECO—

—with all the advantages of an original EECoS SWITCH; wide range of standard or special output codes, circuit card construction, solder terminals or connectors, positive detent action, and long, long service life.

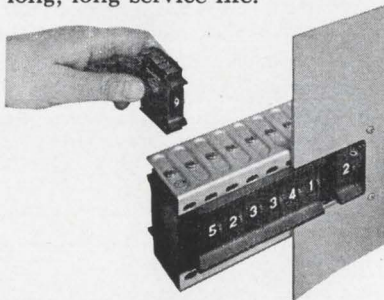

Nail down your own designs now by having full specifications on the 200 Series. Write, Wire or call...

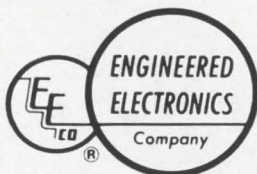

EECoSWITCH — a division of
ENGINEERED ELECTRONICS Company

1441 East Chestnut Avenue, Santa Ana, California 92702
Tel: (714) 547-5651 • TWX (714) 531-5522 Cable ENGELEX

See EECO switches at Wescon, booths 3113, 3114

by the Dalmo-Victor Co., a division of Textron Inc., the instrument, under the right conditions, can find a water bucket at 120 yards and a beer can at 20 yards. Although this is good, the Navy would like still greater range with the same resolution plus visual readout. Readout from the present unit is aural only, with pitch denoting distance. An echo returning from an object 20 yards away has a pitch of 2,500 cycles; at one yard it is 250 cycles. The bandwidth is 30 Kc in the 50- to 9-Kc range.

Improved sonar. The Mine Defense Laboratory has improved the sonar by repackaging it and making it a much smaller unit. To reduce the size of the transducer, the frequency was changed to 200 Kc; the old transducer was one inch in diameter and 8 inches long, housed in a circular cone.

The new unit uses two transducers, one inch in diameter and only a half-inch long, mounted in an end plate one-half inch thick. The original sonar is a 22-pound hemisphere, 15 inches in diameter and 15 inches high. The new one weighs only three pounds, is in the shape of a cylinder, 3/4 inches in diameter and 9 inches long. Both units are fully transistorized. After the new unit is tested, industry will be invited to submit bid proposals for manufacturing it.

VII. Navigation

To prevent the men from straying up or down too far without realizing it, depth gauges that measure pressure are worn on the wrist. In murky water, however, they can't be read easily. The Navy would like an accurate depth gauge a swimmer can read under any condition.

To help the men find their way back, Sealab operates a pinger that sends out sounds in all directions. Swimmers carrying the PQS-1B sonar can pick up these sounds and—no matter how dark the water—home in on their habitat.

Future, more elaborate, missions might use pingers at several sites. These could be coded, or transmit at different frequencies, to identify the particular site.

VIII. Tools and transportation

So little work has been done at great ocean depths that almost

Now-shrink your high power equipment with CBE* design SCRs by Westinghouse

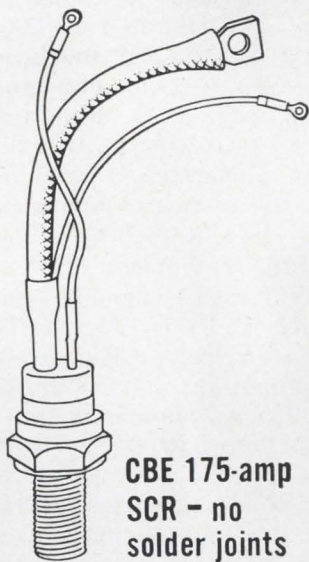

CBE 175-amp SCR - no solder joints

You can get extra power-handling ability in the same space as 150-amp devices. Just change to the Westinghouse Type 220. Added bonus: unique solderless compression-bonding construction eliminates thermal fatigue. Ratings are 4,000 amps half-cycle surge, 275 amps RMS, 175 amps average. Voltages through 1,000. Switching speeds to 20 microseconds, dv/dt 200 volts per microsecond, di/dt 200 amps per microsecond. Ideal applications of the Type 220 are in high power inverters, converters, cyclo-converters, and similar uses.

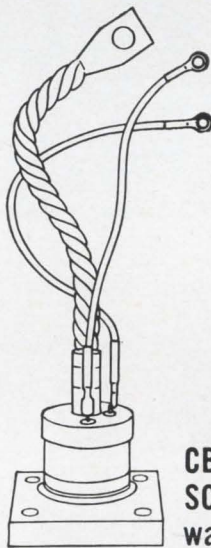

CBE 250-amp SCR for water cooling

The Westinghouse 224 is the industry's only SCR specifically designed to help you get the space savings inherent in water cooling. Its base is designed for high heat transfer and easy mounting to liquid-cooled radiators, heat exchangers, or sinks. Ratings are 5,000 amps half-cycle surge, 400 amps RMS, 250 amps average. Voltages through 1,000. For applications like large motor drives, power inverters, and ignitron and motor generator replacements, the Type 224 may be just the answer you need to solve your design problem.

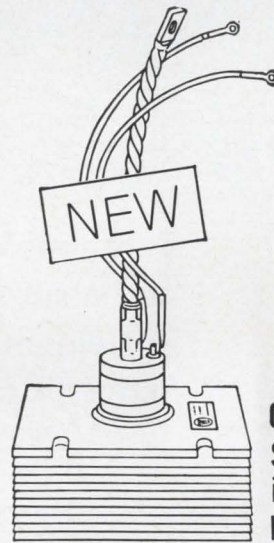

CBE 300-amp SCR with integral heat sink

Only Westinghouse offers you an SCR with a truly integral heat sink. The new Type 223 produces more power at ambient temperature than any corresponding non-integral combination of SCR and heat sink, thus helps you design compact equipment. This efficiency comes from its exclusive construction concept, which eliminates a thermal interface. Ratings are 5,500 amps half-cycle surge, 470 amps RMS, 300 amps average. Voltages to 1,000. In industrial systems and other high power applications, the Type 223 is now finding wide use.

A complete line: Westinghouse manufactures a full spectrum of power SCR's from 10 amps to 470 amps, 50 volts to 1,200 volts. Get full details. Call your Westinghouse salesman or distributor now. Or write Westinghouse Semi-conductor Division, Youngwood, Penna.

*Compression Bonding Encapsulation

You can be sure if it's Westinghouse



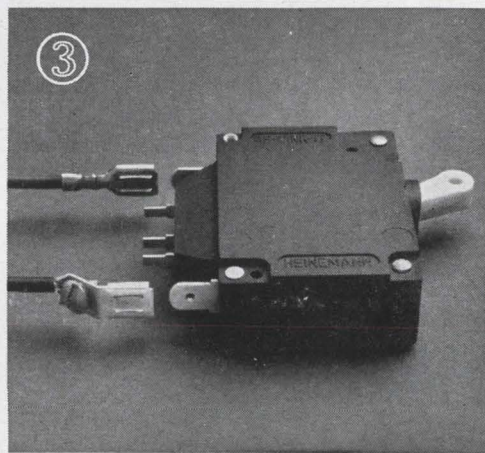
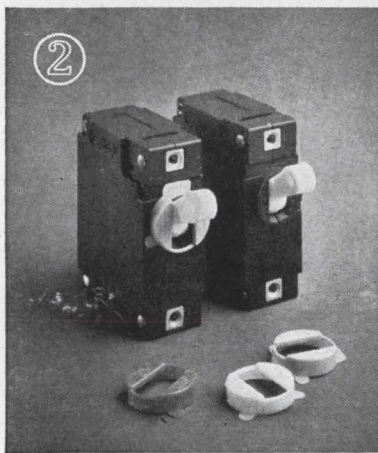
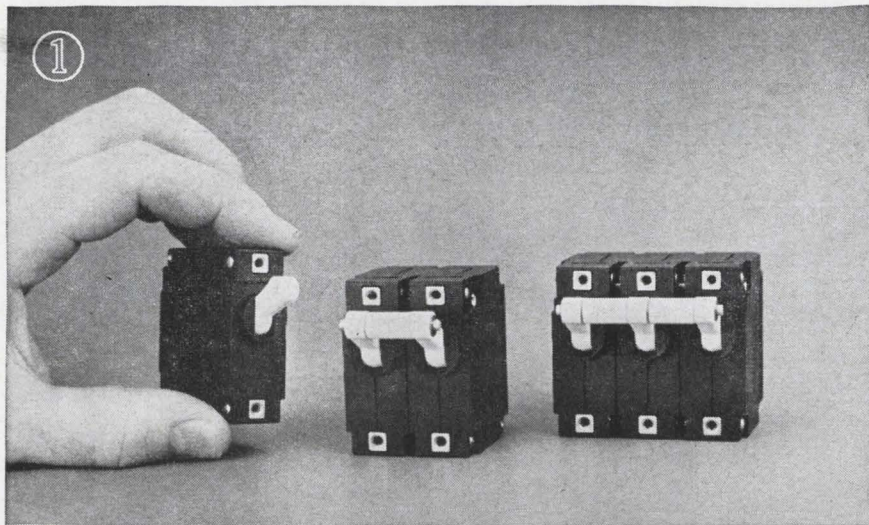

**Three nice features
and a surprise
in Heinemann's new
Series JA circuit breakers:**

1. Natural shoulder packaging. The slim, Ivy League JA weighs in at just 2.5 ounces per pole, including hydraulic-magnetic actuating element, silver-alloy contacts and an uncommonly efficient arc-quenching device.
2. Pizazz—The JA is the first breaker with snap-on color-coding caps that you can mix or match for functional or decorative purposes. Also included: a very dressy white handle.
3. Convenience. The JA's 'universal' terminals are made to accept soldered, crimped-type, or screw-type connections; you can use whichever you're tooled for—or overstocked with.
4. Economy. This is the surprise. The JA actually costs less, model for model, than our Series AM12 breakers, which it can replace to your advantage. The JA is available in current ratings from 0.100 to 20 amps, at up to 250V AC or 50V DC. With a choice of time-delay or non-time-delay response. Special-function internal circuits, too. Bulletin 3350 will give you full technical data. Write, wire or shout for a copy.

Heinemann Electric Company

2600 Brunswick Pike, Trenton, N. J. 08602



Aquasonics communicator is a 42-Kc a-m, device with 1,000 foot range

nothing is known about the kind of tools that will be needed. The Navy and the National Aeronautics and Space Administration are keeping an eye on what the other might come up with for working in weightless and underwater environments. Sealab II should furnish requirements that the electronics industry can try to satisfy.

Wet submarines. More is known about requirements for transportation at deep levels but there is, as yet, little equipment. The aquanauts' average swimming speed is $\frac{3}{4}$ knots and this is far too slow. There are vehicles called wet swimmer propulsion units with speeds up to 9 knots. These miniature submarines, are powered by batteries and driven by a propeller. They won't be used by the divers because they are too maneuverable and might take them up above the safe 33-foot change in depth, or too far from the habitat; the navigation gear presently available won't guide the small craft home. However, a wet sub might be used by surface divers to take supplies to Sealab and then surface quickly.

'Hydronics.' Precise navigation gear will be needed along with pressure gauges, depth measuring devices and communications. As the ocean floor becomes busier and there are more vehicles carrying men faster and over greater distances a new kind of underwater vehicle electronics, or hydronics, will emerge. Undersea exploration offers new vistas to the electronics industry.

distribute any frequency from 80 cps to 5 mc/s

The TRACOR Frequency Distribution System consists of a precision frequency source, the necessary modular units of line amplifiers, receiving amplifiers, distribution amplifiers, and power supplies to distribute one or more precise frequencies to remote locations. Up to 7.0 volts rms output allows transmission distances greater than 1000 feet at 5 mc/s. Greater distances are achievable at lower frequencies. A portable bench amplifier, with self-contained power is available.

Modular construction and advanced solid state design provide maximum flexibility, expandability, and reliable trouble-free operation.

Up to ten plug-in modules mount in a standard nineteen inch rack mounted chassis.

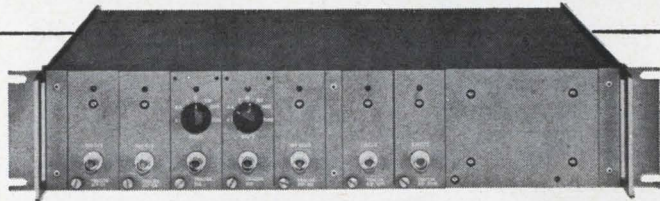

TYPICAL TRACOR DISTRIBUTION SYSTEM

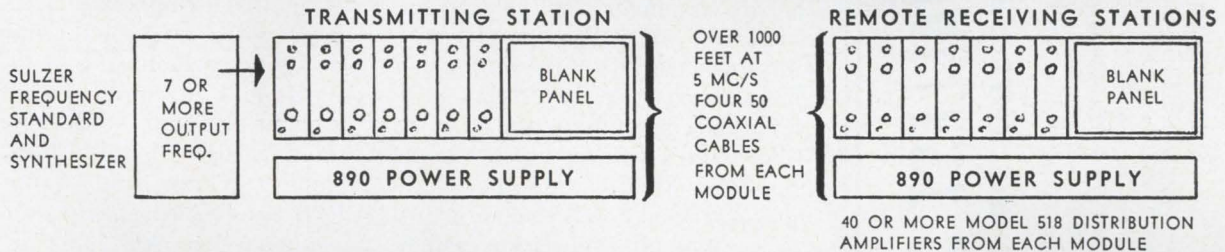

SPECIFICATIONS (typical seven frequency system)

Frequencies: The following frequencies are accepted and amplified, one module for each frequency, by the Model 516 Series B Line Amplifier and the Model 517 Series A Receiving Amplifier: 100 cps; 400 cps; 1.0 kc/s; 10.0 kc/s; 100.0 kc/s; 1.0 mc/s; 5.0 mc/s. Each module (ten each) of the Model 518 Series A Distribution Amplifier will accept and amplify any of the above frequencies, the desired frequency being selectable by a front panel rotary switch.

Input Voltage to Line Amplifier: 0.5 to 1.0 volt rms, 50 ohms (each frequency)

Output Voltage From Line, Receiving, and Distribution Amplifiers: 7.0 volts rms into 50 ohms

Output Voltage Regulation: Output voltage regulation of each amplifier (line, receiving, and distribution) is better than three percent with line variations from 105-125 volts rms.

Connectors: UG-657/U BNC Type Connectors are used for input, output, and monitor connections on each amplifier.

Number of Outputs: Multiple outputs are available from each line amplifier and receiving amplifier module as follows: Line Amplifier — Four separate outputs from each module. Receiving Amplifier — Four separate outputs from each module. Each output will supply ten distribution amplifiers. Each distribution amplifier has all seven frequencies available at a single output jack. The desired frequency is selectable by means of a front panel rotary switch.

Distortion and Crosstalk: System distortion is less than three percent at 7.0 volts rms output from the distribution amplifier, with a sine wave input to the line amplifier. Total crosstalk does not exceed three percent of total output.

Power Requirements: Each amplifier module operates from ± 20 volts dc, 150 ma.

Size: 19" width x 3.5" height x 12" deep

Weight: 15 pounds

For technical data sheets and complete information telephone 512-476-6601 or write TRACOR, Inc., 1701 Guadalupe Street, Austin, Texas 78701.



TRACOR, Inc.
Instruments/Components/Systems

Representatives in principal cities.

A plug for microcircuits

Bigger packages, easily plugged into ordinary boards, get industrial manufacturers' approval

By George Sideris

Manufacturing Editor



VHF Model M-150-4B

NEW... SMALLEST 50 WATT MOBILE DUPLER!
IN EITHER UHF OR VHF... FOR LESS THAN \$60.00*

Sinclair's Mobile Duplexers are only slightly larger than a package of cigarettes, but give big unit performance in the duplex operation of mobile transmitters and receivers in either the 150 or 450 Mc bands. Only 5 Mc separation between Tx and Rx frequencies, too! It's ruggedly engineered to take the bumps and jolts of tough mobile service and go on performing dependably for years.

SINCLAIR RADIO LABORATORIES, INC. 523 FILLMORE AVENUE, DEPT. 101 TONAWANDA, NEW YORK

The units are completely enclosed in self-mounting housings for external installation to the transmitter-receiver cabinet. Special packaging information available on request.

*VHF Model M-150-4B

Investigate today! Write for a complete FREE Sinclair Communications Catalog.

Next to the tiny, shiny flatpacks that set microcircuit packaging styles for two years, the integrated-circuit package introduced in March by the Fairchild Camera & Instrument Corp. seems big, crude and ungainly. But assemblers of commercial and industrial electronic equipment have learned to love the dual in-line package known as DIP. Fairchild claims that its customers are "fighting for deliveries" of DIP-packaged circuits because DIP cuts equipment assembly costs to as little as 10% of flatpack assembly costs.

Fairchild's success has not gone unnoticed. Most of the other leading integrated-circuit manufacturers are now offering packages that resemble DIP and are interchangeable with it.

I. All join in

Sylvania Electric Products Co. will be selling military as well as

commercial circuits in DIP-style packages. Sylvania's package looks like Fairchild's, but, Sylvania contends it is better and cheaper because the circuits are sealed in glass in a single fabrication step. Fairchild seals its circuit in a ceramic sandwich which takes two more steps. Sylvania says its design resulted from an independent analysis of the market.

The Westinghouse Electric Corp., when requested, makes a package interchangeable with Fairchild's, and Motorola, Inc. offers the same service. Neither has revealed design details. Both the Signetics Corp. and Transitron Electronics Corp. have promised customers they will make a DIP-style package.

Thomas A. Longo vice president in charge of integrated circuits at Transitron, says, "Undoubtedly, some time in the future we will make an in-line package. I have

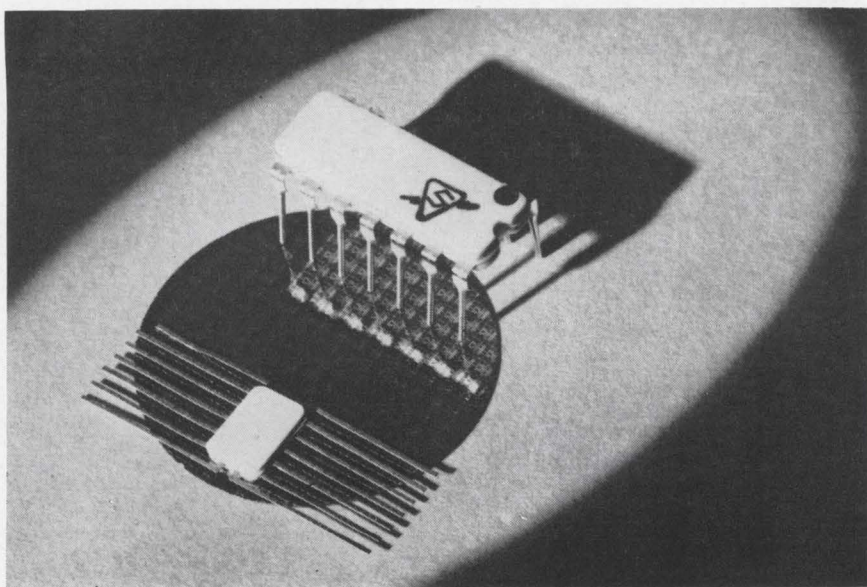

Sylvania's new plug-in package and a flatpack straddle a wafer of circuits.

not decided on when or what type. Obviously, the package will be interchangeable with the Fairchild type."

Since equipment assemblers don't like to be tied down to a single source for circuits, they pressure their suppliers to adopt similar package styles.

Holdout. Not all big integrated-circuit producers are switching to DIP. Texas Instruments Incorporated is sticking with the industrial plug-in package it announced last May that, because of the number and spacing of its pins, is not interchangeable with DIP.

TI is aware of Fairchild's head start, but William Martin, of the company's marketing department, says TI isn't convinced that the industry has made up its mind to standardize on DIP. It's his view that it will be another six months before any big customer reaches a decision.

Texas Instruments is now tooling up for mass production of the package and plans to announce, at Wescon, three new lines of industrial circuits that will use it.

II. Sales booster

At Fairchild, Bryant Rogers, disagrees sharply with the TI spokesman. Rogers predicts that DIP will win 60% of the flatpack market.

Among its major customers Fairchild now counts the Advanced Scientific Instruments division of the EMR Corp., the Burroughs Corp.—both are using DIP's in computers—and the Hughes Aircraft Corp. Fairchild claims that its customers save as much as \$30,000 when DIP's are used in large systems.

In addition, Rogers says, "DIP will help open new industries to us, because the impracticality of handling flatpacks will no longer be a deterrent to potential users."

III. Flatpacks and plug-ins

The reason for DIP's success is its large size and the shape and spacing of its leads.

A DIP is nearly four times the size of a flatpack, so it's easier and cheaper to handle. The largest standard flatpack is about $\frac{3}{8}$ inch long and its thin ribbon leads are only 0.050 inch apart. In contrast, the plug-ins are longer, broader and thicker and the space between

new

5×10^{-11} per 24 Hours

SULZER FREQUENCY STANDARD

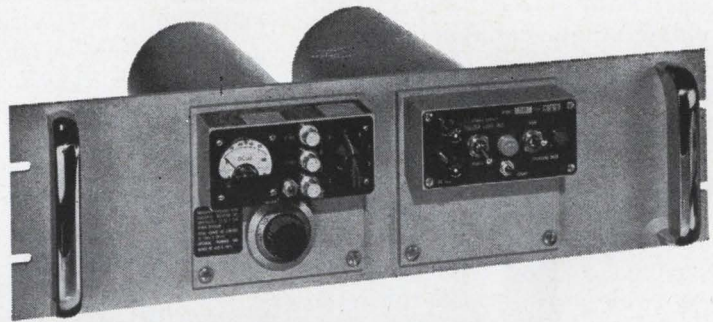

This new SULZER Model 2.5A Frequency Standard is a high quality rugged frequency source of the highest frequency stability available.

Best long and short term frequency stability, spectral purity, and reliability (MTBF in excess of 20,000 hours) plus optional varactor tuning makes the SULZER Model 2.5A an ideal frequency source for laboratory measurements, primary frequency and time systems, synchronous communication systems, microwave spectroscopy, and other applications.

The all-silicon, solid state unit provides output frequencies of 2.5 mc/s, 1.0 mc/s, and 100 kc/s. A 1 pps clock drive output is optional. Operating temperature range is 0°C to 35°C.

The crystal and oscillator circuits are mounted in a double proportional control oven which maintains the crystal and frequency determining elements at the point of zero temperature coefficient within a few thousandths of a degree C.

The cylindrical packaging used in the oven, circuitry, and case design, and the modular construction used make these units withstand a shock of 30G's with a frequency change of less than 1×10^{-8} . The unit meets all technical requirements of MIL-E-16400E, and all RFI requirements of MIL-I-26600.

Front panel vernier frequency adjustment permits setting and resetting to a few parts in 10^{11} .

The Model 2.5A mounts in a standard 19" rack or in a system chassis accepting the 4" square front panel and 4" diameter cylinder. A companion power supply (shown in photograph) is optional. The power supply operates from 105-125 volts, 48 to 400 cps and has 8-10 hour nickel-cadmium battery standby power.

Other SULZER Frequency Standards and related products are available.

Telephone 512-476-6601 or write TRACOR, Inc.,
1701 Guadalupe Street, Austin, Texas 78701
for complete information.



SULZER
Precision Oscillators

REPRESENTATIVES IN PRINCIPAL CITIES

their leads, 0.1 inch, is twice that of the flatpack spacing.

The leads of the new packages are stiff and point straight down for easy insertion in ordinary printed circuit boards. Once a board is filled with packages, all the joints between the leads and the printed wiring can be made simultaneously with conventional flow-soldering machines.

By comparison, flatpacks are usually assembled under a microscope, with special soldering or welding equipment. The leads are not inserted and machine-soldered, but are painstakingly joined, one at a time, to printed wiring on the top of the boards. Flatpack leads can be bent and inserted into boards, but it is tricky work.

Getting a lift. One significant advantage of the DIP leads are their wide tops, which raise the package above the board. This facilitates soldering, board cleaning and cooling. More importantly, it allows the printed wiring to run

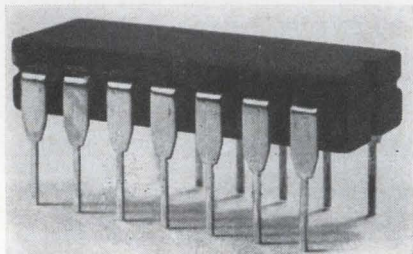

The original dual in-line package, made by Fairchild Semiconductor.

under the package, so the whole surface of the board can be used for wiring. Rarely can this be done with other types of packages.

The DIP's two rows, of seven leads each, are 0.3 inch apart. TI's first package has two rows of eight leads, with the rows 0.2 inch apart; these leads are round pins that come out of the bottom of the package, rather than stamped leads that bend down at the package sides. TI thinks this design feature will be its ace in the hole in the competition between the two package styles. The company believes the round pins stand up better under the strains of automated equipment assembly, and because the pins can't touch each other and short neighboring circuits, the packages can be packed tightly together on the boards.

Space electronics

Live tv from the moon

The Apollo spacecraft will carry a camera that will let the whole world watch the trip and the first walk on the moon

The first American landing on the moon will be a television spectacular. A tv camera weighing less than seven pounds, developed at a cost of more than \$2¼ million, will let the whole world watch the Apollo mission. During liftoff, it will be trained in on the faces of the three astronauts; once in orbit, it will make a straphanger out of one of them, who will have to give up his seat so that the camera will have an unobstructed view of the instrument panel. (Since the standee will be weightless, he won't get tired; in fact, he might float.)

The only gaps in transmission during the entire round trip will be the three- to four-hour periods while two of the astronauts descend to the moon in the lunar excursion module (LEM) and ascend to the command module for the trip home. LEM's antennas will not provide enough gain to send pictures.

On the moon, one of the astronauts will set up a 10-foot parabolic antenna. His companion will stay in LEM with the camera; the first picture viewers on earth will receive of a man on the moon will be of the astronaut standing by the antenna. When the first astronaut returns to the module, the second will step out and take pictures of the spacecraft, the moon, and the earth, hanging in the sky.

For transmission from Apollo itself, the camera will operate through two antennas—omnidirectional for earth orbit and high-gain directional for the trip to the moon.

The tv signals will be relayed around the world by communications satellites. Except for a few seconds delay at ground stations to convert the pictures from 10 frames per second to the commercial rate of 30 per second, they will be "live".

I. Compact—but overweight

Portable as it is, the Apollo camera still doesn't quite meet

specifications. The \$2.29-million contract awarded last October to the Aerospace division of the Westinghouse Electric Corp.'s Defense and Space Center was for a 5½-pound instrument. The first model weighed 9½ pounds; the one to be delivered this month to the National Aeronautics and Space Administration weighs 6½ pounds.

To achieve reduction in weight, Westinghouse had to abandon the original idea of a two-piece camera, with a control set installed permanently in the spacecraft and a viewer that could be carried around. All versions actually built were in one piece.

Solid state components, including 55 integrated circuits, reduced weight by keeping the total number of components down to 250 from the 1,300 that Westinghouse engineers estimate would have been necessary otherwise.

II. Survival in space

"One of our big problems was just making the camera survive," says Charles Hoffman, director of engineering for the project at Westinghouse. Specifications called for an instrument that would operate for at least 14 days—two of them on the moon. Westinghouse came up with a camera that has a mean-time-between-failures of 35 years; the probability that it will fail in any given two-week period is 0.1%.

The camera will have to operate in the shock and vibration extremes of blastoff and weightlessness, in temperatures of from 250° F during the lunar day to -275° F at night, and at pressures of from 5 pounds per square inch in the spacecraft to almost none on the moon.

To reduce heat, a white titanium dioxide coating on the top of the camera will reflect ultraviolet radiation from the sun, and a silver coating on the sides and bottom will reflect infrared radiation from

Synchronous Motors Don't Wear Out! ...THE GEARING DOES!

that's why **hurst** designed the Gearing First
for the **NEW** 600 in. oz. **INSTRUMENT**
hurst GA MODEL **MOTOR**
HYSTERESIS SYNCHRONOUS REVERSIBLE

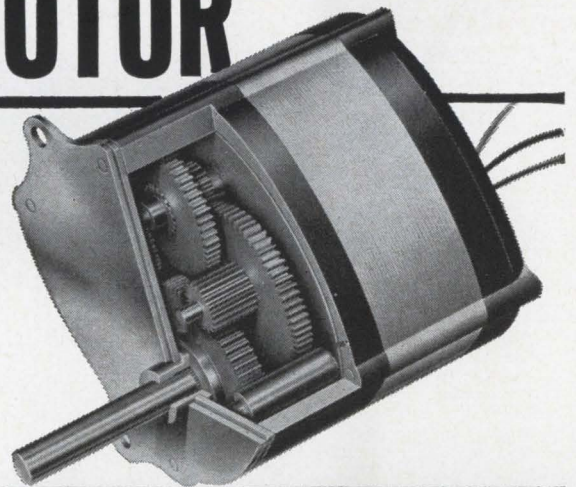
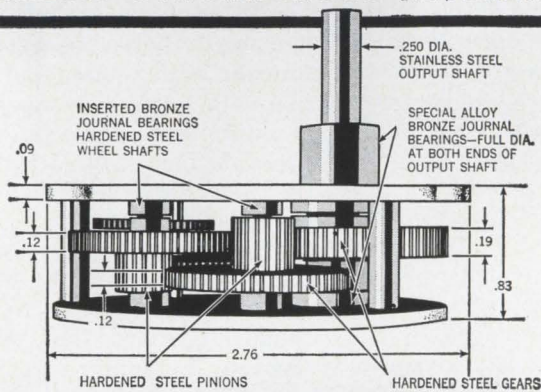

CHECK COMPETITIVE GEARING—THEN COMPARE!

NEW! "BALANCED DESIGN" HEAVY-DUTY GEARING FOR LONGER SERVICE LIFE

NEW! CAN BE STALLED WITHOUT OVERHEATING

NEW! RATED TORQUE 600 IN. OZ. AT 1 RPM

NEW! NO MAINTENANCE LUBRICATION REQUIRED

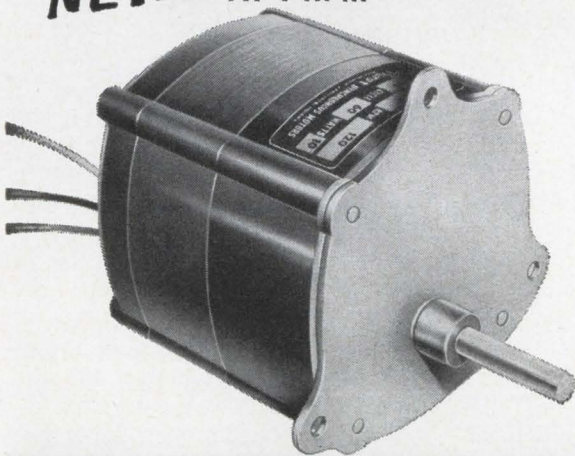

- PRICES START AT \$14.28 (100 LOTS) CAPACITOR INCLUDED
- PRODUCTION: 4 WEEKS
- MANY SPEEDS (1 RPM to 3600 RPM) AVAILABLE FROM STOCK
- ALSO STOCKED BY YOUR LOCAL HURST DISTRIBUTOR

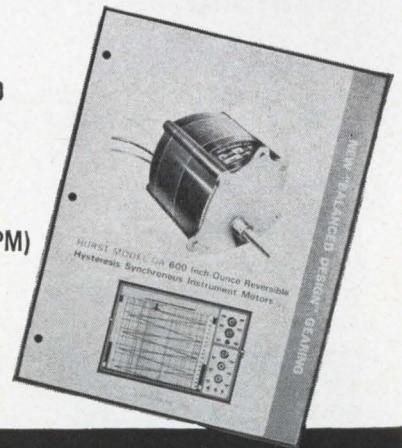

Write Today for FREE Catalog No. 380 with Engineering Torque Loading Chart!



hurst MFG. CORP. PRINCETON, INDIANA

RELIABILITY & PERFORMANCE PROVEN BY 150 MISSILE & AEROSPACE COMPANIES...

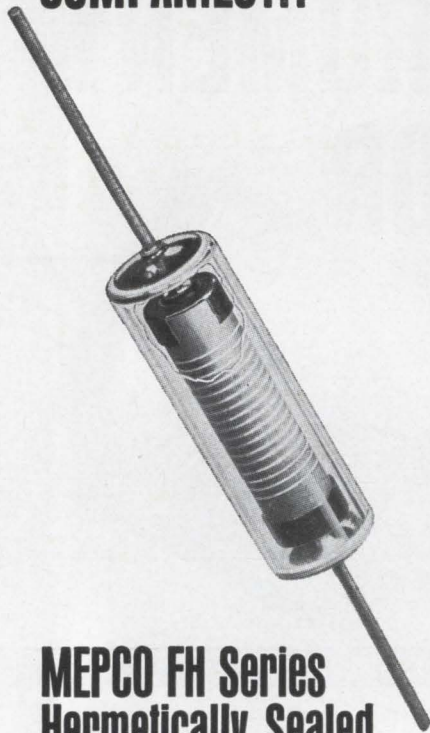

MEPCO FH Series Hermetically Sealed, Glass Enclosed METAL FILM RESISTORS

High reliability resistors for demanding requirements of aerospace and military electronics fields. Conform to MIL-R-55182.

For complete information and detailed specifications, write:

MEPCO, INC.

Morristown, New Jersey 07960
Phone (201) 539-2000
TWX (201) 538-6709



the moon. The camera's normal power consumption will guard against cold, as will a special cover that will be used at night. An aluminum container $\frac{1}{8}$ inch thick on the top and $\frac{1}{16}$ inch thick on the sides will give protection from micrometeoroids. While it's in Lem, the camera is cushioned within a shockproof case.

III. Sunlight and earthlight

Light levels on the moon will vary from blinding sunlight, unfiltered by any atmosphere, by day, to mere starlight and "earthlight" by night. The SEC (secondary emission conductivity) vidicon tube used in the camera is sensitive enough to operate at the night level of about 0.09 foot-lamberts.

The tube is not as sensitive as an orthicon, but it can televise moving pictures at low light levels where an orthicon cannot, since the SEC has faster beam erasure. Moreover, the orthicon requires a bulky package, is sensitive to temperature variations, and must be mounted in a specific way to operate.

Westinghouse will not give details on its camera's light level capabilities, because of its military applications. However, a similar tube now being produced by the Dalmo Victor Co., a division of Textron, Inc., in Belmont, Calif., is known to produce 250-line resolution at 10^{-5} foot-candles.

IV. Getting in focus

The camera has four optical systems, each combining a lens and a fixed aperture:

- An 80° wide angle lens with a focal length of $9\frac{1}{2}$ millimeters will be used inside the spacecraft.
- A telephoto lens with a focal length of 100 mm and a field of view of about 7° can be used for shots of the earth or moon from the spacecraft, and for long-distance pictures on the moon.
- A T-60 lens with a 25° field of view and 25 mm focal length is available for the brilliant daylight on the moon, when illumination is about 14,000 foot-candles.

▪ During the lunar night, a T-1.1 lens with the same field and focal length—but, obviously, a much larger aperture—can be used for pictures in the dark.

The "T" numbers used above are analogous to the f stops on a conventional camera, which give

the ratio of the focal length of a lens to the aperture of the shutter. The "T" number takes into account the light attenuation of the lens as well as the f number.

V. Transmission

The camera will send 320-line pictures at 10 frames per second, although it can be slowed to 0.625 frames per second to transmit pictures of 1,280 lines. The high-resolution pictures will come too slowly to show movement; they will be stills.

Still or moving, the signals will be transmitted over two S-band frequencies — 2,272.5 megacycles from the spacecraft and 2,282.5 Mc from the moon. Under the unified S-band system [Electronics, July 26, 1965, page 98], tv, voice and telemetry can share a single transponder in the spacecraft. The system was chosen because it can transmit large amounts of information with a relatively small amount of equipment. However, the 500-kilocycle bandwidth for tv limited the camera to a slow frame rate and low resolution.

Separate frequencies are used for transmission from the spacecraft and from the moon so that the receiving stations on earth can separate the source. There is only one camera, so there can be no doubt as to its position; but voice and telemetry will be carried on the same carrier as tv. Since one astronaut will remain in lunar orbit while the others descend in LEM, both voice and telemetry will be sent from the moon and the spacecraft at the same time.

VI. Pay television

It would be hard to put a price tag on that first picture of an astronaut on the moon. Certainly it will represent, to the millions of Americans watching at home, some return on their investment.

Yet NASA did not buy the tv camera merely to entertain the public. The main purpose was to provide better communications between the astronauts and the Manned Spacecraft Center.

The next development for space tv is color; NASA is now evaluating proposals for a study contract on a color camera. The one which makes the Apollo trip, however, may find further use in the Apollo Extension System for a space laboratory.

**WORLD'S LARGEST SELLING
AND WORLD'S NEWEST**

Hand Size v-o-m's

TRIPLET

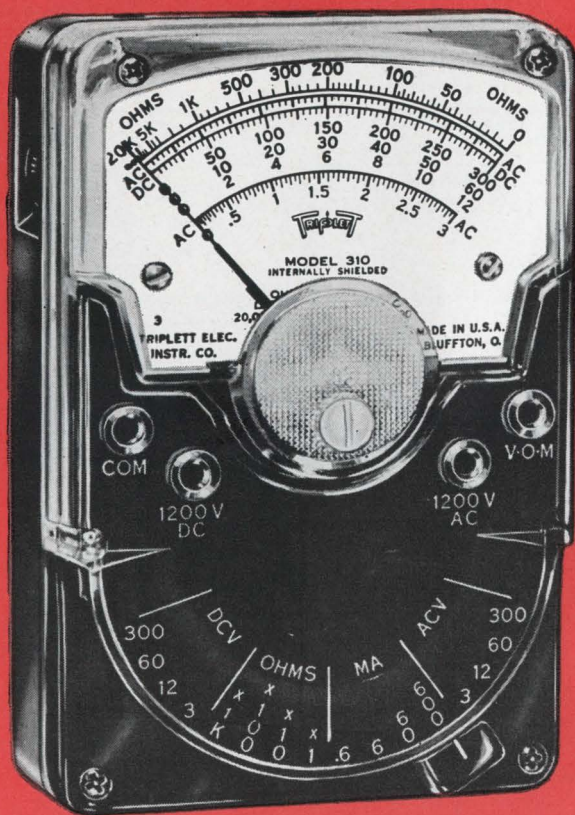

MODEL 310
World's Largest Selling
Volt-Ohm-Milliammeter

MODEL 310-C
World's Newest
Volt-Ohm-Milliammeter

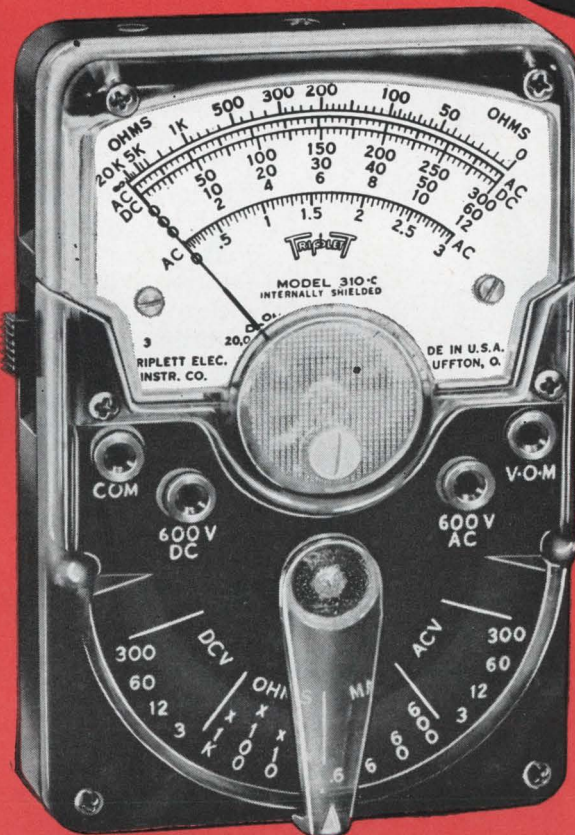

**BOTH TESTERS
SHOWN
ACTUAL SIZE**

- 1** HAND SIZE AND LIGHTWEIGHT, but with the features of full-size V-O-M's.
- 2** 20,000 OHMS PER VOLT DC; 5,000 AC (310)—15,000 AC (310-C).
- 3** EXCLUSIVE SINGLE SELECTOR SWITCH speeds circuit and range settings. The first miniature V-O-M's with this exclusive feature for quick, fool-proof selection of all ranges.

SELF-SHIELDED Bar-Ring instrument; permits checking in strong magnetic fields. FITTING INTERCHANGEABLE test prod tip into top of tester makes it the common probe, thereby freeing one hand. UNBREAKABLE plastic meter window. BANANA-TYPE JACKS—positive connection and long life.

Model 310—\$37.50 Model 310-C—\$44.50 Model 369 Leather Case—\$3.20

ALL PRICES ARE SUGGESTED U.S.A. USER NET, SUBJECT TO CHANGE

THE TRIPLET ELECTRICAL INSTRUMENT COMPANY, BLUFFTON, OHIO

310-C PLUS FEATURES

1. Fully enclosed lever range switch
2. 15,000 Ohms per volt AC (20,000 O/V DC same as 310)
3. Reversing switch for DC measurements

MODELS 100 AND 100-C

Comprehensive test sets. Model 100 includes: Model 310 V-O-M, Model 10 Clamp-on Ammeter Adapter; Model 101 Line Separator; Model 379 Leather Case; Model 311 leads. (\$67.10 Value Separate Unit Purchase Price.)

MODEL 100—U.S.A. User Net. \$64.50
MODEL 100-C—
Same as above, but
with Model 310-C.
Net.\$71.50



USES UNLIMITED: FIELD ENGINEERS • ELECTRICAL, RADIO, TV, AND APPLIANCE SERVICEMEN • ELECTRICAL CONTRACTORS • FACTORY MAINTENANCE MEN • ELECTRONIC TECHNICIANS • HOME OWNERS, HOBBYISTS
THE WORLD'S MOST COMPLETE LINE OF V-O-M's • AVAILABLE FROM YOUR TRIPLET DISTRIBUTOR'S STOCK

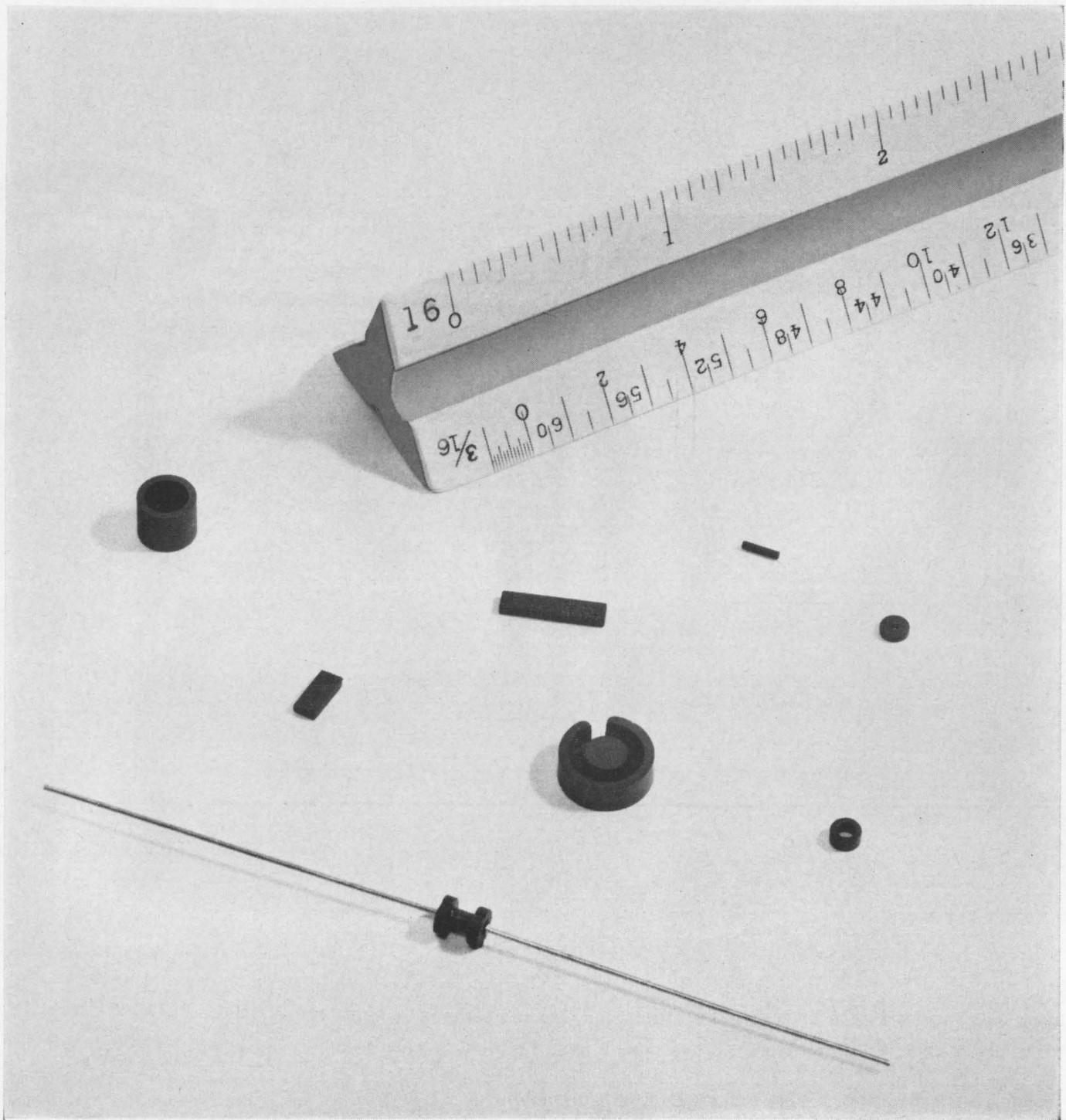

No matter how small the ferrite piece,
**WHEN MECHANICAL AND ELECTRICAL SPECS ARE TIGHT...
 SPECIFY STACKPOLE**

Stackpole makes them all:

- Toroids down to .120" OD
- Cups as small as .250" OD x .130 Hgt.
- Bobbins smaller than .080" OD
- Cores of .031" D x .170" Long
- Coil forms below .060" D x .187" Long
- Sleeves to .075" OD x .028" ID
- Rectangular Solids smaller than .120" x .120" x .218"

But subminiature size isn't Stackpole's only claim to fame in ferrites. One customer put it this way, "Your ferrite cores are more consistent from order to order than any of your competitors."
 Over 30 grades. Isn't that what you're looking for?



STACKPOLE
 ELECTRONIC COMPONENTS DIVISION
 ST. MARYS, PENNSYLVANIA

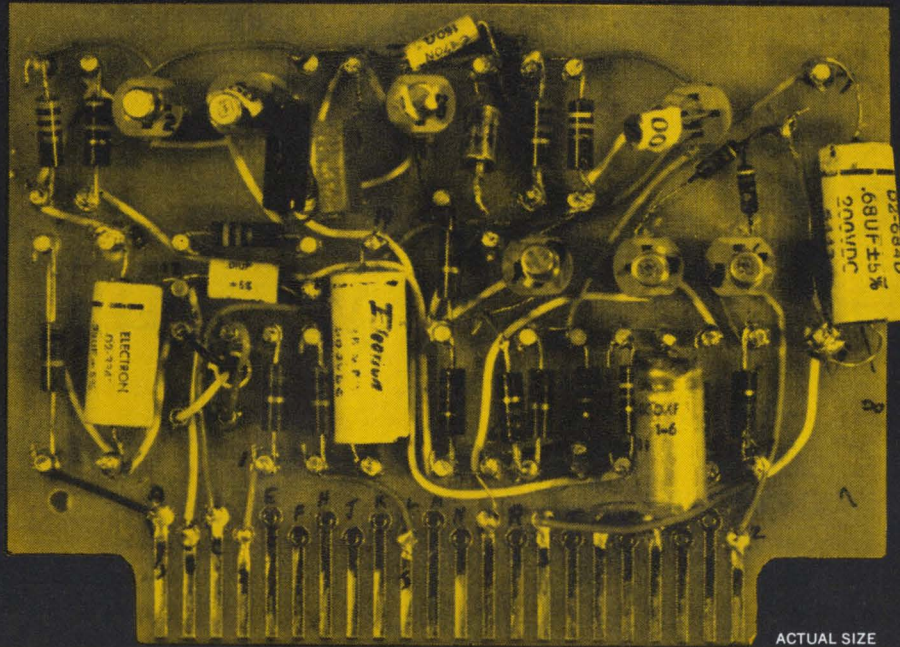

What made this avionic DC amplifier circuit obsolete?



ACTUAL SIZE

Hamilton Standard's new Microcircuit Packaging Technology

The use of Hamilton Standard microcircuit modules has reduced the size and weight of temperature controls in the Navy's advanced Ling-Temco-Vought A7A light attack aircraft. They function as DC amplifiers in two identical controls for the cabin and pilot's vent suit.

Each module replaces a multi-component 3½ x 4½-inch circuit board,

resulting in a 16% weight reduction. Design, production and testing are greatly simplified. Reliability is improved by electron-beam welding of interconnections within the module, and complete hermetic sealing.

Hamilton Standard's design team is experienced in custom circuit packaging and will assist circuit designers in component selection and circuit layout.

This technology allows flexibility in interconnecting and packaging both uncased integrated circuits and semiconductors for both digital and linear applications.

For more information on this new microcircuit packaging technology, write to Sales Manager, Electronics Department, Hamilton Standard, Broad Brook, Connecticut 06016.

Hamilton Standard DIVISION OF UNITED AIRCRAFT CORPORATION

U
A

SEE THIS NEW MICROCIRCUIT
PACKAGING TECHNOLOGY AT
WESCON, BOOTHS 3208-3211

ELECTRONICS • ATTITUDE CONTROLS • STABILIZATION SYSTEMS • ENVIRONMENTAL CONTROLS • FUEL AND AIR INDUCTION CONTROLS
ELECTRON BEAM MACHINES • PROPELLERS • STARTERS • TURBOMACHINERY • GROUND SUPPORT EQUIPMENT • OVERHAUL AND REPAIR

This is AE's Class B relay.

Use it where a less expensive relay would cost too much.

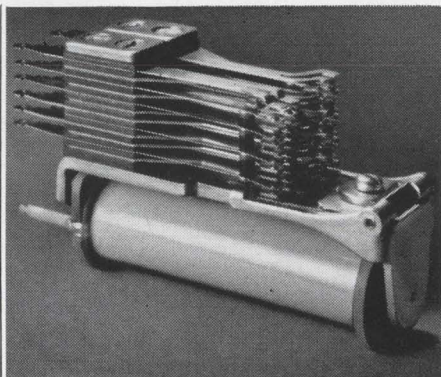

The Class B is a premium-quality telephone-type relay. It can give you at least 400 million operations with unfailing contact reliability. And it seldom needs maintenance.

That's why it's probably the most inexpensive relay you can use—where long-term reliability is a must.

In commercial and industrial control applications, the AE Class B delivers just what you'd expect of a telephone relay. It combines good sensitivity with excellent stability. Withstands extreme temperatures. Provides a wide range of practical operate and release timing... a range much wider than possible with smaller types of relays.

The Class B has two armature ratios (long, for fast acting

or pulsing—short, for slow-release and chatter-free AC operation). It also features twin contacts to insure against contact failure, a permanent wear-free backstop, pin-type armature bearings—plus a sturdy, stable heel-piece.

Newest Class B relay is the Series BRM latching version. When pulsed, remanent magnetism keeps the BRM latched without power consumption until it is restored by a second pulse.

Find out more about the Class B relay—the industry standard for long-term economy. Ask for Circular 1993. Just write to the Director, Relay Control Equipment Sales, Automatic Electric Company, Northlake, Illinois 60164.

AUTOMATIC ELECTRIC
SUBSIDIARY OF
GENERAL TELEPHONE & ELECTRONICS **GTE**

COMPARE!

THESE 9 MAJOR FEATURES OF

MODEL 520 X-Y RECORDER

FROM
ELECTRO INSTRUMENTS
THAT MAKE IT

THE WORLD'S

MOST
PRACTICAL

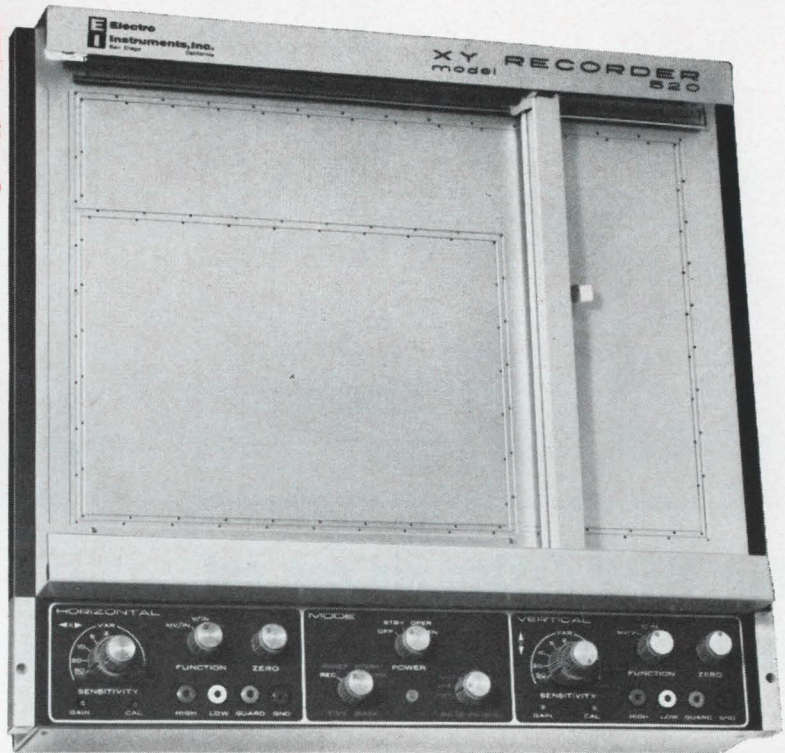

TRUE DIFFERENTIAL INPUT—permits measurements from grounded or ungrounded sources.

HIGH SENSITIVITY—to 100 microvolts per inch . . . eliminates need for preamplification.

HIGH INPUT IMPEDANCE—from potentiometric in microvolt ranges to 10 megohms . . . prevents source loading.

TIME BASE—on both axes . . . for maximum flexibility.

QUIET VACUUM HOLDDOWN—holds paper securely, does not attract dust, contaminants.

TABLE OR RACK MOUNTING—without need for modification kits or adapters.

SINGLE SWING-OUT CIRCUIT BOARD—for easier maintenance, eliminating problems caused by plug-in circuit board connectors.

BUILT-IN EVENT MARKER—for event time recording on both axes.

REAR INPUTS AND REMOTE OPERATION—at no additional cost. Priced Only

\$2095



Electro Instruments, Inc.

8611 Balboa Avenue, San Diego, California 92112

Electro International, Inc., Annapolis, Md.

Electro Instruments s. a., 512 rue de Geneve, Brussels 3, Belgium

SHORT CUTS

TO SUCCESSFUL DATA PROCESSING SYSTEMS

MAGNETIC
SYSTEMS

**This NEW design aid can cut
logic hardware as much as 50%**

MAGNETIC SYSTEMS CORPORATION
2000 Calumet Street
Clearwater, Florida

Gentlemen:

Please send me my free copy of "Short Cuts
to Successful Data Processing Systems."

Name _____

Title _____

Company _____

Address _____

City _____

State _____ Zip _____

Send for your free copy today!

The information in "Short Cuts," a just-published design aid from Magnetic Systems Corporation, will speed and simplify the design and specification of digital logic systems. And it can reduce the number of components required by as much as 50%.

Among other things, "Short Cuts" contains:

- Six rules for foolproof implementation of compatible 1Mc NAND-NOR logic. With these rules — and Magnetic Systems' exclusive new compatible logic modules — you can mix NAND and NOR elements in the same logic system, whether it's positive or negative.
- Specific examples that show you how Magnetic Systems 1Mc NAND-NOR compatibility cuts component requirements by 10 to 50%.
- Detailed specifications for a new, complete line of compatible welded encapsulated modules.
- An easy-to-use selector chart for fastest selection and specification of modules for your system.

The cost? Nothing. The coupon above or the reader service card in this magazine will get you a free copy immediately.

**MAGNETIC
SYSTEMS
CORPORATION**

Recorder reduces time-base error by 99%

By eliminating capstan's cyclical error and reducing skew, it cuts error to 2.0 μ sec at 120 inches a second

When recording data on tape, scientists must know the sequence in which the recorded events took place, and the exact times between events. It may be important to know, for example, that the pulse representing a vibration was ahead of a pulse corresponding to a temperature change. Recorder manufacturers have been striving to reduce time-base error—the disparity between the time separation between events and the time as given when played back through a recorder.

Up to now, the best instrumentation tape recorder had a time-base error of 250 microseconds at a tape speed of 120 inches a second. Now the Ampex Corp., in Redwood City, Calif., has combined two previous techniques and announced a "new generation of instrumentation tape recorders" that offer 2.0-megacycle bandwidth and a time-base error of only 2.0 μ sec at 120 ips—more than 100 times as accurate as the best conventional instruments. This was accomplished by eliminating the cyclical error of the capstan and by reducing skew—the tape's crossing the capstan at an angle rather than in a straight line. The recorders also offer, for the first time, a tape-drive system with only one moving part (excluding reels)—the capstan itself. Through novel design techniques, Ampex engineers have eliminated all other moving parts.

Primary causes of time-base error have been capstan cyclical error due to out-of-round machining; tape elasticity, which causes the tape to speed up or slow down infinitesimally as it "stretches" when being pulled across the capstan; and skew. The new Ampex FR-1600 (shown above) and FR-1800 recorders use a unique dual-re-

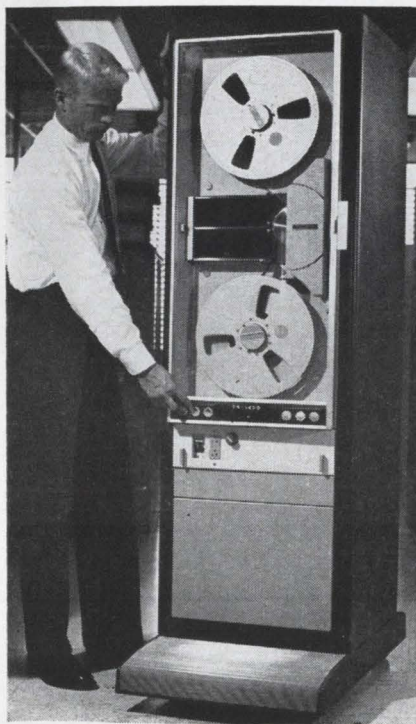

sponse capstan servo to achieve maximum stability during recording and playback. They do this by placing a reference tone on the tape so that during playback, whenever a dissimilarity occurs in playback signal time and recorded reference tone time, the difference generates a signal that causes a servo to adjust the tape speed to provide original time-base integrity of the recorded data. This technique also minimizes pulling or stretching of the tape.

To prevent skewing of the tape across the capstan surface—which disrupts interchannel timing—and further to reduce tape stretching, the new recorders use two-foot vacuum chutes as tape-storage buffers. In the chutes, immediately before and after crossing the capstan, the tape is guided in friction-

less chambers, assuring a smooth, cushioned path with no extraneous disturbances.

The vacuum chambers also help reduce flutter or skipping of the tape across the capstan, because the capstan itself is the only rotating element and hence is the only support of the tape through the head area. All pinch rollers, idlers, rotating tape guides and other moving elements that contribute to tape-motion inconsistency have been eliminated. The capstan itself has two guiding edges.

By permitting the use of 16-inch reels instead of the usual 14-inch reels used with conventional recorders, the FR-1600 and FR-1800 increase the uninterrupted playing time 33%—to 20 minutes at 120 ips.

The complete line includes the stationary FR-1600, a portable model for shipboard or field use called the PR-1600, the FR-1800, and an airborne recorder called the AR-1600 (for use up to an altitude of 70,000 ft.).

Specifications

	1600 Family
Tape widths	$\frac{1}{2}$ or 1 in., field interchangeable
Tape speeds	3 $\frac{3}{4}$ ips to 120 ips, electrically switchable
Heads	Bidirectional; plug-in interchangeable IRIG standard
Servo	3 separate systems for capstan, supply reel, take-up reel. Capstan servo reference frequency 200 kc at 120 ips
Electronics	2.0 Mc direct, 400 kc f-m. Individual record and reproduce modules
Size	
FR	Single 75-in. rack cabinet
AR/PR	25x19x13-in. case

Ampex Corp., 401 Broadway, Redwood City, Calif.
Circle 350 on reader service card

Miniature resonant reed frequency selector

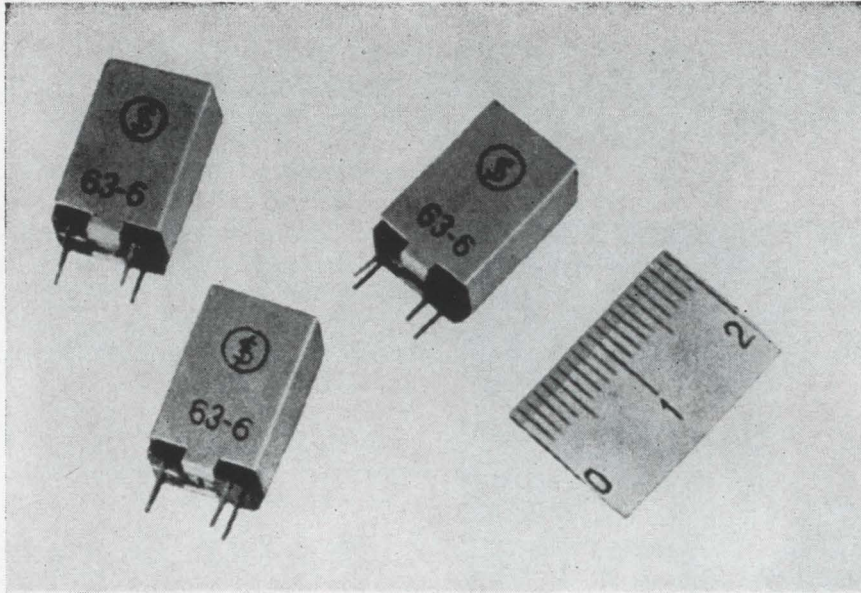

Resonant reed relays have been widely used as frequency selectors in mobile radio receivers, telemetry and industrial controls. But with the spread of miniaturization, their value has been limited by their relatively large size.

The Micro resonant reed selector developed by Fujitsu, Ltd., of Tokyo, is said to be less than one-third the size of existing devices, and compatible in size with transistors and other small components. It was developed for use with personal paging systems whose receivers are small enough to be carried in a man's shirt pocket, but is suitable for other frequency-sensing applications that require compactness.

The basic components of a resonant reed relay are a vibrator, a driving coil, a permanent magnet, contacts and a sensitivity-adjusting mechanism. Over-all dimensions are determined primarily by the size of the vibrator and of the driving system. Although it's possible to reduce the size of these components, problems arise in manufacturing procedures, including the maintenance of accuracy in parts. In addition, contact current-handling capacity and contact breakdown voltage are both reduced with size. For these reasons,

Fujitsu approached the problem as one of arranging components within the package.

The first step was to fold the vibrator into a U shape with a square base. The vibrator is made of a thin strip of iso-elastic magnetic material, such as Vibralloy. The base is soldered to two base blocks, leaving the arms as two identical bent cantilevers, acting as a vibrator that resembles a tuning fork.

The electromagnetic driving system, composed of the permanent magnet and the driving coil, is then inserted into the broad separation between the two "tines" of the tuning fork, and soldered to the base blocks.

The relay's frequency extends over 50 channels, from 475.5 cycles to 1207.5 cycles per second, spaced 15 cycles apart. It operates with a standard driving current of 2.5 milliamperes, but its sensitivity can be adjusted to operate at resonance with 0.7 milliamperes. Impedance of the driving coil is approximately 280 ohms at one kilocycle, corresponding to an operating power of about 140 microwatts. Approximately, 1.75 milliwatts are required at the standard driving current of 2.5 milliamperes.

The device is highly selective

Other **BUCHANAN**[®] cycle- controlled crimping tools

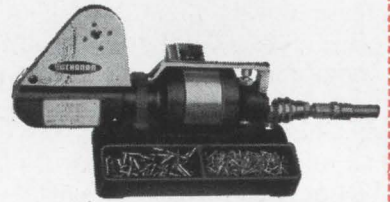

MANUAL FEED PNEUMATIC TOOLS Portable or Bench Mounted.

for moderate volume production. Crimp proprietary and Mil-Spec contacts for wire sizes #8 thru #30. Weighs less than 5 lbs. Bench-mounted model available with foot pedal to permit free use of both hands by operator. Meets performance specs of MIL-T-22520.

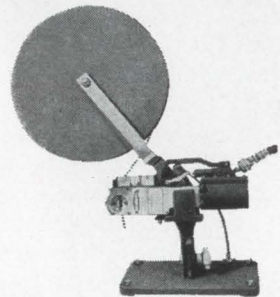

AUTOMATIC FEED PNEUMATIC TOOL Portable or Bench Mounted.

For high volume, it automatically feeds contacts from disposable carriers. For almost any pin and socket contact #12 thru #20. Speed limited only by operator's ability to insert wires. Crimp depth automatically selected by interchangeable snap-in blocks; accommodates foot valve control. In bench-mounted units, carrier reel holds 2,000 or more contacts. For portable applications, carriers in self-positioning "see-thru" magazines hold up to 102 contacts; magazine automatically selects proper crimp depth.

Write today for complete library of crimping data and new catalog on full line.

BUCHANAN
ELECTRICAL PRODUCTS CORPORATION

1077 Floral Avenue • Union, New Jersey
(201) 289-8200 • Telex 1-25471

a subsidiary of Elastic Stop Nut Corporation of America

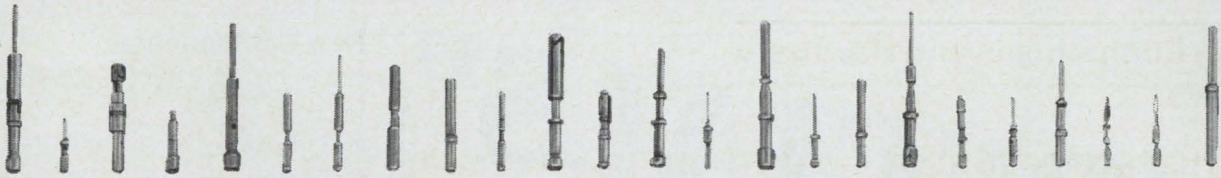

Crimp any of these contacts with no operator adjustment!

MS Hand Tool
For most contacts
#12 thru #22, MS
and proprietary.

Miniature Tool
For most contacts
#20 and smaller.
Only 6 $\frac{3}{4}$ " long.
10 ounces.



You are looking at two crimping tools that take tool adjustment out of the operator's hands. By simply changing inexpensive positioners, **you** program the tool for proper crimp depth, crimp location and point-of-ratchet release. Once the positioner is in, the tool is set. **The operator cannot make changes, cannot make mistakes.** Rejects are virtually eliminated, productivity goes up, Quality Assurance is satisfied.

That is Buchanan's positioner control principle. Really revolutionary! A giant step forward. For details, write for our new T102 Catalog. Buchanan Electrical Products Corporation, 1076 Floral Avenue, Union, New Jersey, or call (201) 289-8200, Telex 1-25471.

BUCHANAN
ELECTRICAL PRODUCTS CORPORATION

a subsidiary of Elastic Stop Nut Corporation of America

See us at Wescon, Booth 2924 and 2925

"SPECIALS"

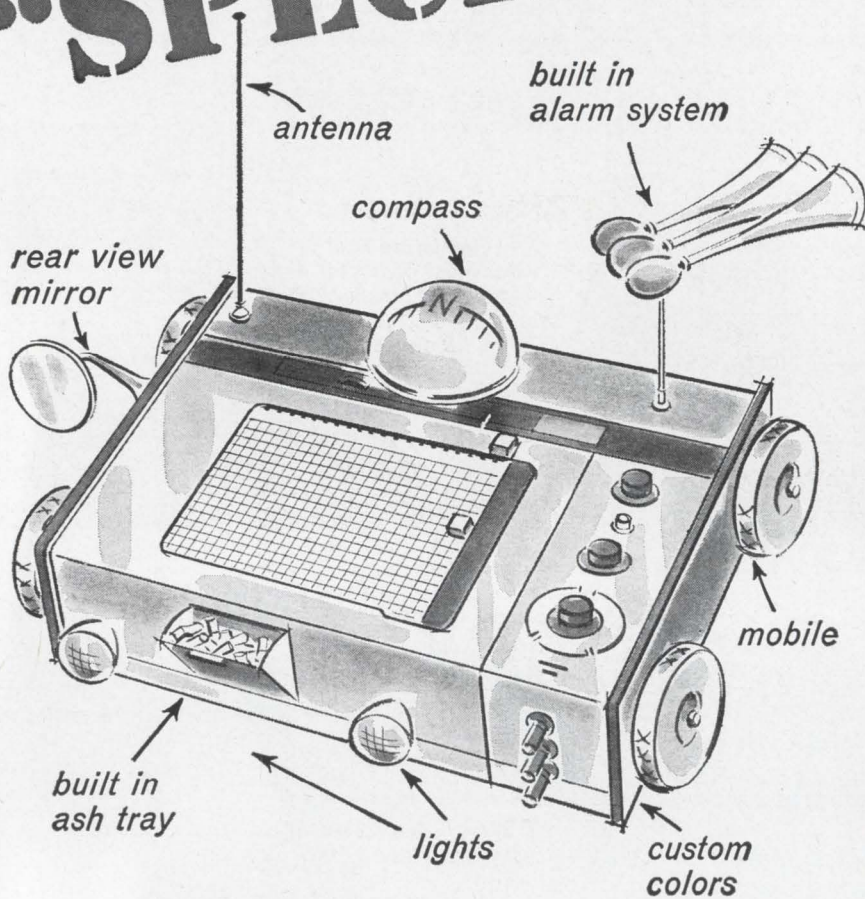

IN V.O.M. RECORDERS

Ever seen a Recorder that looks like this? Neither have we—yet! But we've made just about every other modification in the book for our customers—with 1 range, 2 ranges, with push-button zero, with different scales, and with special chart papers. We've painted them custom colors, put a variety of customer designations on them. You name it, we'll do it! Just let us know what, and the quantity. We'll work up a quote that'll be a pleasant surprise to you.

There are a goodly number of people who buy the standard instruments without modification, singly and in O.E.M. quantities. Boring, really, but we *do* fill these orders along with the specials. The standard Bausch & Lomb V.O.M. Recorder is a 5 inch Strip Chart Recorder that will record volts, ohms and milliamps directly. It has 5 built-in chart speeds, built-in event marker, built-in take-up reel, 5 voltage ranges, 6 linear ohms scales, 4 D.C. current ranges. Full scale sensitivity is 10mv, 2.5mv or 500 microvolts depending on the model selected. It has a number of other advantages, too. And, we have accessories, a variety of them, that make our recorders so versatile it hurts (other recorder manufacturers, that is!).

If you want further information on our standard recorders, so that you can tell us how you want them changed, write for Catalog 37-2068. Bausch & Lomb, 61420 Bausch Street, Rochester, New York 14602.

BAUSCH & LOMB

New Components

and shock-resistant, and its characteristics are said to be stable against temperature change and aging.

Specifications

Frequency	50 standard frequencies from 475.5 to 1207.5 cps spaced 15 cps apart
Coil impedance	280 ohms \pm 15%, at 1,000 cps, 20°C
Standard driving current	2.5 milliamps
Selectivity	Inoperative at a current of less than 7 ma at frequencies more than \pm 15 cps from resonance.
Bandwidth	Frequency \pm 1.5 cps min at 2.5 milliamps
Max. contact rating	10 watts pulse and 100 milliwatts continuous
Life	Over 100,000 operations when driving current is turned on for 1 second and turned off for 2 seconds in an ordinary circuit, at normal temperature and humidity
Over-all dimensions excluding terminals	7.7 mm x 10.2 mm x 16.5 mm
Price, 1 to 50 pieces	\$8.50

Fujitsu Limited, Tokyo, Japan.
Distributed in the United States through the Nissho American Corp., 80 Pine St., New York, N.Y. 10005. [351]

Metal film resistor rated at 1/8 watt

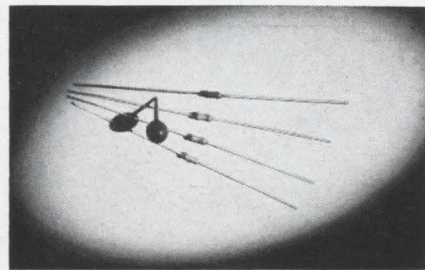

A miniature metal film resistor, type PME50, has a rating of 1/8 w (MIL rating of 1/20 w). This resistor, only 0.147 in. long by 0.060 in. in diameter, is obtainable in resistances from 10 ohms to 250,000 ohms. Standard temperature coefficients of \pm 25 ppm, \pm 50 ppm, and \pm 100 ppm per degree Centigrade may be selected.

Excellent protection against moisture and environmental extremes is provided by special end cap construction plus the manufacturer's Pyroclad protective covering.
Pyrofilm Resistor Co., Inc., 3 Saddle Road, Cedar Knolls, N.J. [352]

New, expanded line of DCR power supplies up to 2500 watts

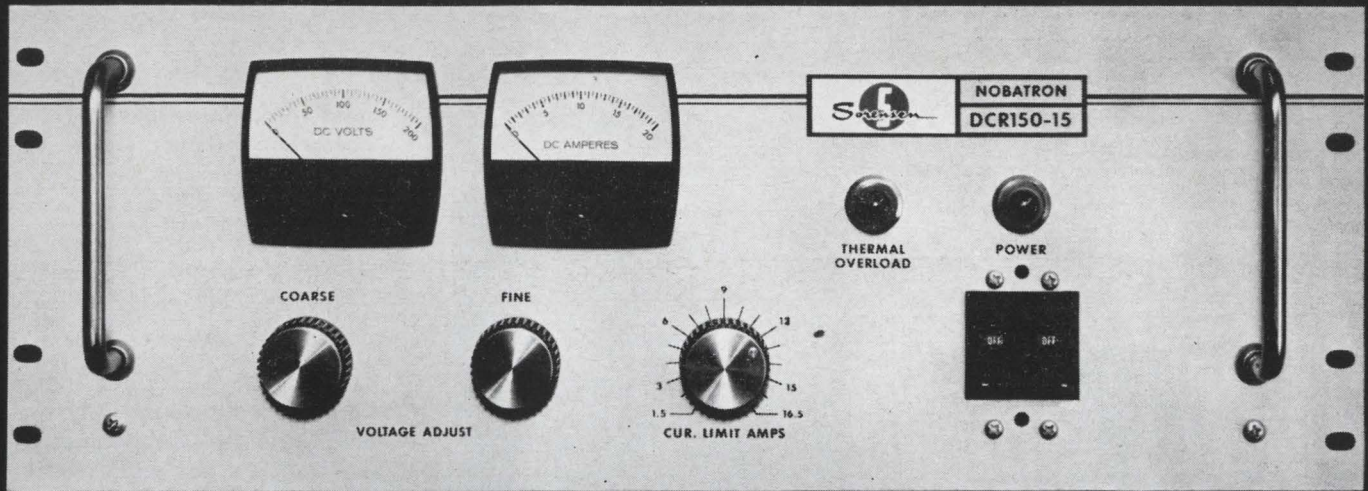

1. 20 SILICON CONTROLLED RECTIFIER SUPPLIES AVAILABLE... Delivery in 30 days or less.
2. LOW PRICES... Starting at \$325 (Voltmeter and Ammeter included with no increase in price)
3. COMPACT PACKAGING
4. HIGH EFFICIENCY
5. CONSTANT VOLTAGE REGULATION... with continuously adjustable current limiting.
6. CONSTANT CURRENT REGULATION... with continuously adjustable voltage limiting.
7. AUTOMATIC CROSSOVER... full automatic transition from constant voltage to constant current operation, or from constant current to constant voltage operation, at any operating point.
8. REMOTE PROGRAMMING... Voltage and Current
9. REMOTE SENSING... At distances up to 200 feet
10. SERIES OR PARALLEL OPERATION
11. VOLTAGE REGULATION... (as low as $\pm 0.075\%$ or 15 mv) line and load combined
12. CURRENT REGULATION... As low as ± 15 ma
13. LOW RIPPLE
14. RFI SUPPRESSION (Typical within 10 db of MIL-I-26600)
15. COARSE AND FINE VOLTAGE CONTROLS

For complete data on the DCR series and other Sorensen products, send for the new, 140-page "Controlled Power Catalog and Handbook." Write to: Sorensen, Richards Avenue, South Norwalk, Connecticut. Or use Reader Service Card Number 200.

DCR ELECTRICAL AND MECHANICAL SPECIFICATIONS:

MODEL NUMBER	VOLTAGE RANGE (VDC)	VOLTAGE REG. (LINE & LOAD COMBINED)	OUTPUT CURRENT (AMPS.)	CONSTANT CURRENT RANGE (AMPS.)	CURRENT REG.	CONSTANT VOLTAGE RIPPLE (RMS)	TRANSIENT RESPONSE	PACKAGE SIZE (INCHES)			WEIGHT (LBS.)	PRICE
								WIDTH	HEIGHT	DEPTH		
DCR 300-1.25	0-300	$\pm 0.075\%$ or 60mv	0-1.25	0.125 to 1.37	± 15 ma	0.4% + 300mv	30msec	19	5 1/4	15	52	\$325
DCR 150-2.5	0-150	$\pm 0.075\%$ or 30mv	0-2.5	0.25 to 2.75	± 15 ma	0.4% + 150mv	30msec	19	5 1/4	15	52	325
DCR 80-5	0-80	$\pm 0.075\%$ or 20mv	0-5	0.5 to 5.5	± 15 ma	0.4% + 80mv	30msec	19	5 1/4	15	56	325
DCR 40-10	0-40	$\pm 0.075\%$ or 15mv	0-10	1 to 11.0	± 20 ma	0.4% + 40mv	30msec	19	5 1/4	15	55	325
DCR 300-2.5	0-300	$\pm 0.075\%$ or 60mv	0-2.5	0.25 to 2.75	± 15 ma	0.4% + 300mv	30msec	19	5 1/4	18	77	525
DCR 150-5	0-150	$\pm 0.075\%$ or 30mv	0-5	0.5 to 5.5	± 15 ma	0.4% + 150mv	30msec	19	5 1/4	18	77	525
DCR 80-10	0-80	$\pm 0.075\%$ or 20mv	0-10	1.0 to 11.0	± 20 ma	0.4% + 80mv	30msec	19	5 1/4	18	77	525
DCR 60-13	0-60	$\pm 0.075\%$ or 15mv	0-13	1.3 to 14.3	± 20 ma	0.4% + 60mv	30msec	19	5 1/4	18	77	525
DCR 40-20	0-40	$\pm 0.075\%$ or 15mv	0-20	2.0 to 22.0	± 25 ma	0.4% + 40mv	30msec	19	5 1/4	18	77	525
DCR 300-5	0-300	$\pm 0.075\%$ or 60mv	0-5	0.5 to 5.5	± 15 ma	0.4% + 300mv	30msec	19	7	18	95	710
DCR 150-10	0-150	$\pm 0.075\%$ or 30mv	0-10	1.0 to 11.0	± 20 ma	0.4% + 150mv	30msec	19	7	18	95	710
DCR 80-18	0-80	$\pm 0.075\%$ or 20mv	0-18	1.8 to 19.8	± 25 ma	0.4% + 80mv	30msec	19	7	18	98	710
DCR 60-25	0-60	$\pm 0.075\%$ or 15mv	0-25	2.5 to 27.5	± 25 ma	0.4% + 60mv	30msec	19	7	18	100	710
DCR 40-35	0-40	$\pm 0.075\%$ or 15mv	0-35	3.5 to 38.5	± 35 ma	0.4% + 40mv	30msec	19	7	18	102	710
DCR 300-8	0-300	$\pm 0.075\%$ or 60mv	0-8	0.8 to 8.8	± 20 ma	0.4% + 300mv	30msec	19	7	18	115	825
DCR 150-15	0-150	$\pm 0.075\%$ or 30mv	0-15	1.5 to 16.5	± 25 ma	0.4% + 150mv	30msec	19	7	18	115	825
DCR 80-30	0-80	$\pm 0.075\%$ or 20mv	0-30	3.0 to 33.0	± 30 ma	0.4% + 80mv	30msec	19	7	18	120	875
DCR 60-40	0-60	$\pm 0.075\%$ or 15mv	0-40	4.0 to 44.0	± 40 ma	0.4% + 60mv	30msec	19	7	20	130	900
DCR 40-60	0-40	$\pm 0.075\%$ or 15mv	0-60	6.0 to 66.0	± 60 ma	0.4% + 40mv	30msec	19	7	20	131	925
DCR 20-125	0-20	$\pm 0.075\%$ or 8mv	0-125	0 to 125	± 125 ma	0.4% + 20mv	30msec	19	10 1/2	20	169	1050



A UNIT OF RAYTHEON COMPANY

Vector Solid State Laboratories

New package improves
RF characteristics...
excellent for strip line
mounting

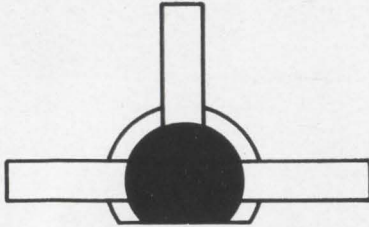

RF PACKAGE VX-3375

- Integrated Structure Distributes Heat Generated At Junction And Increases Reliability.
- Test Data Demonstrates Rugged Construction And Validity Of Package In Variety Of Environmental Stresses.

HIGH FREQUENCY CHARACTERISTICS

SYMBOL	CHARACTERISTIC	TEST CONDITION	TYPICAL
RF Output	Power as Unneutralized Amplifier at 250 Mc	$V_{ce} = 28V$	
P_o		$P_{in} = 1.0W$	6.5 watts
η			55%
F_t		$V_{ce} = 28V$ $I_c = 150mA$	500 Mc
C_{ob}	Output Capacitance	$V_{cb} = 30V$ $I_e = 0$ $f_o = 1 Mc$	10pf max.

ABSOLUTE MAXIMUM RATINGS*

V_{cbo}	Collector-to-Base Voltage	65 volts
V_{ceo}	Collector-to-Emitter Voltage with base open	40 volts
V_{cev}	Collector-to-Emitter Voltage with $V_{be} = -1.5$ volts	65 volts
V_{ebo}	Emitter-to-Base Voltage	4 volts
I_c	Continuous Collector Current	1.5 amperes
P_t	Transistor Dissipation— at 25°C heat sink interface. At case temperature above 25°C	11.6 watts Derate linearly to 0 watts at 200°C
T_j	Operating Temperature (Junction)	-65 to +200°C
T_s	Storage Temperature	-65 to +200°C

*25°C, except where otherwise noted

SEND US YOUR REQUIREMENTS
OTHER DEVICES AVAILABLE
IN THIS PACKAGE
Telephone: (215) EL 7-7600

Vector

U

DIVISION OF UNITED AIRCRAFT CORPORATION

A

SOUTHAMPTON, PENNSYLVANIA

See us at WESCON, Booths 3208-11

New Semiconductors

Everyman's laser and a thermos jar

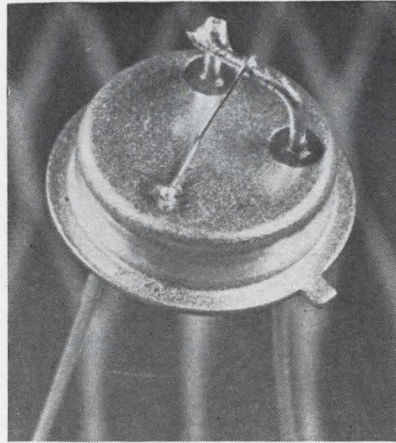

For the budget-poor engineer who wants to know firsthand what a diode laser is, how it is set up, and what it might be able to do for him, Seed Electronics Corporation is marketing a gallium arsenide laser for \$75.

The "laser for everyman" needs a pulser to drive it, and a \$75 companion instrument to do this is available for those whose lab equipment does not include a suitable pulser.

The diode laser must be immersed in liquid nitrogen during operation. For the engineer who does not want to spend another \$15 to \$50 for a liquid nitrogen dewar, Richard Seed, president of the Lexington, Mass., company suggests using a wide-necked coffee thermos jug. "Just shine the laser output up through the open end," he says.

"Any welding supply house will sell you a quart of liquid nitrogen for a dollar," Seed adds, "and it will last for about three days."

No one is going to be able to do anything very profound with the S-27 laser, Seed emphasizes. "It's for investigation of laser applications, rather than for the applications themselves. There seems to be a good market for a cheap unit for engineers to play around with and learn something about laser operation." One research customer, however, is using it to stimulate fluorescence in materials, an-

other in studies of point-to-point ground communications.

According to Seed, a second—unexpected—market seems to be emerging. "We sell one or more of these inexpensive units with almost every one of our more expensive devices," he says. "They use the less expensive one to check experimental setups, try out mounting fixtures, test pulser and current input limits, and in general bang it around the lab—something they don't want to do with a device that costs something between \$300 and \$9,000." In other instances, Seed says, companies and individuals want to try out the inexpensive unit first to help them decide if they need a laser in their projects.

With the S-27 laser, the Seed corporation includes five pages of instructional materials. "Most engineers don't know how to go about using a laser," according to Seed.

The S-27 is operated with pulsed direct current and emits at approximately 8,400 angstroms, in the infrared. It is a p-n junction diode made from a small chip of gallium arsenide, a chip which is, in fact, smaller than its wire contact. The chip is mounted on a TO-5 header, without a cap, and the coherent output is emitted radially from the TO-5 header in the direction of the wire contact. Seed describes the S-27 as "fallout" from manufacture of medium-power c-w laser devices. Characteristics at 77°K are listed below.

Specifications

Minimum average coherent power output	1 mw
Maximum average input power	400 mw
Peak power output, 2 μ sec pulse at 20 amps	0.5 w
Threshold current	3-6 amps
Junction material	Zinc diffused
Base material	Gallium arsenide, tellurium doped
Diode size	0.005 x 0.020 inch
Availability	Off shelf

Seed Electronics Corp., 258 East St., Lexington, Mass., 02173. [371]

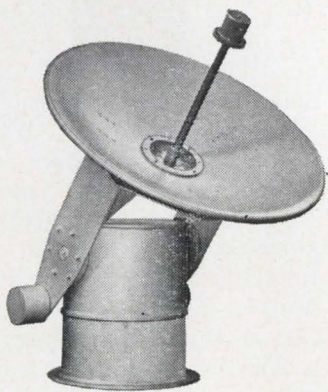
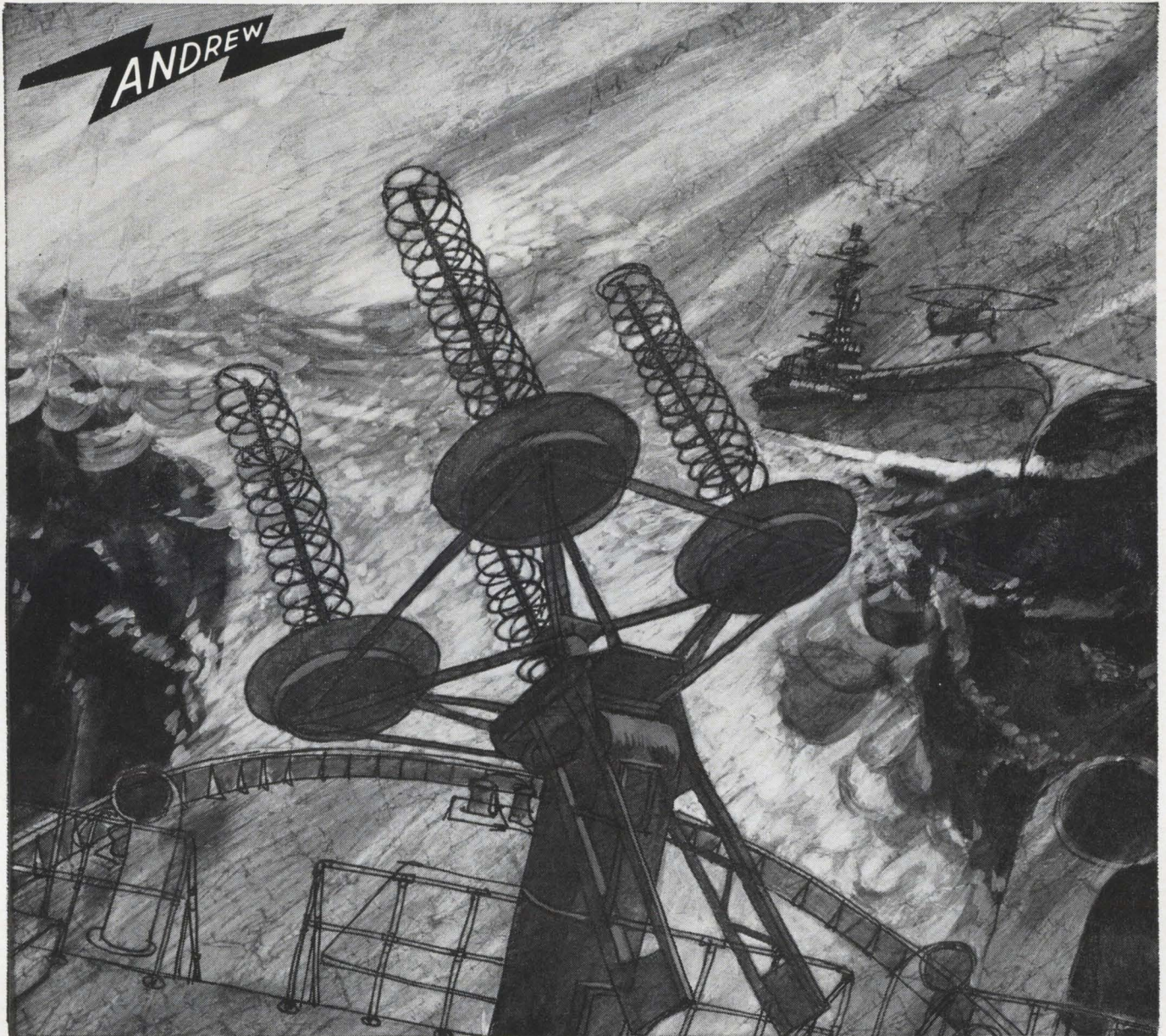

Standard single or dual axis positioners offer electro-manual control, solid state power supply, 125 mph design, and permanently sealed and lubricated motors. Optional features include optical equipment for aligning elevation and azimuth axis, servo controls, mechanical stops and adaptors, special mounts and counterweights.

EUROPEAN OPERATIONS: ANDREW CORPORATION, HØJSGAARDS—ALLE 82, HELLERUP, DENMARK

command control and telemetry antenna systems

DESIGNED...ENGINEERED...

AND MANUFACTURED AS A COMPLETE PACKAGE

Andrew antenna systems are designed as complete packages. Antenna and positioner engineering are integrated to guarantee system performance.

Andrew positioners are available with a wide choice of low, medium and high gain telemetry antennas to meet your requirements. HELIAX® coaxial cable provides the most reliable connection between transmitter or receiver and the antenna.

ONE SOURCE—ONE RESPONSIBILITY...Contact your Andrew sales engineer or write for complete system information and delivery.

6-65

28 YEARS OF ENGINEERING INTEGRITY

Andrew
CORPORATION
P. O. BOX 807 • CHICAGO, ILLINOIS U.S.A. • 60642

You get better results with high speed integrated monolithic circuits that are packaged right

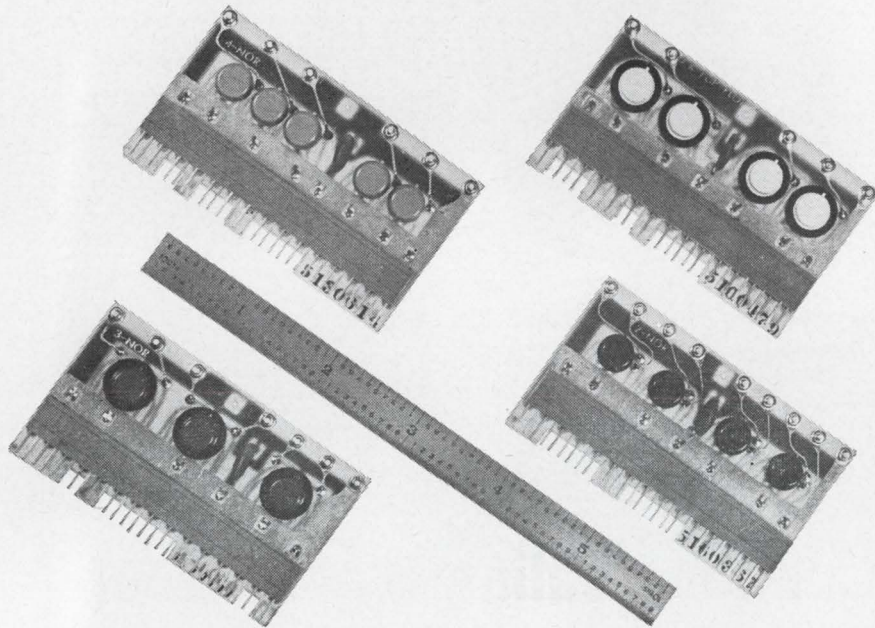

SEL 8500 Series Micrologic Modules

Here is the answer to your digital logic design and assembly problems. Whether your requirements are for an entire system or a single demonstration unit, you will appreciate these operational and packaging advantages: Easily accessible test points, ELCO connectors for quick and reliable wire-wrap inter-connecting. Card shape and size minimize flexing. One power supply voltage is required, and operation speeds are in excess of 5 mc. Noise immunity is excellent. A full line of SEL trays and files is available for compatible packaging.

Write for SEL Bulletin 9031

SEL SYSTEMS ENGINEERING LABORATORIES, INCORPORATED
P. O. BOX 9148 • FORT LAUDERDALE, FLA. 33310

Telephone 305-587-2900

TWX 305-587-1079

Immediate openings for logic design engineers • An equal opportunity employer

New Semiconductors

Controlled-avalanche silicon rectifiers

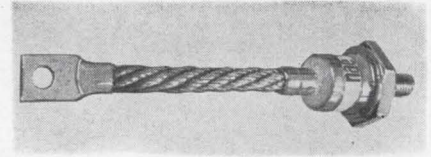

The manufacturer's line of silicon rectifiers now includes 100-amp all-diffused junction units with controlled avalanche characteristics. The new rectifiers, 1N3289-1N3296, which have peak inverse voltages to 1,000 v, offer the circuit designer a wide selection for the most exacting requirements. Operating and storage temperature range is -40° to $+100^{\circ}\text{C}$.

Welded construction, accomplished in a controlled atmosphere, assures hermetic sealing of the contamination-free DO-8 size package. The units are suited for industrial applications, such as motor and power distribution controls.

The devices are priced from \$9.50 each, in lots of 100. North American Electronics, Inc., 401 N. Broad St., Philadelphia, Pa., [372]

Silicon transistors usable to 2.5 Gc

Two new silicon transistors, with frequency capability to 2.5 Gc, are available. The TIXS12 and TIXS13 make possible the replacement of low-power klystrons, bwo's and vacuum-tube oscillators in microwave applications. Broadening the scope of solid-state microwave applications, the transistors are designed for use as microwave power sources from 500 Mc to 2.5 Gc. Guaranteed oscillator power output is 250 mw at 1.5 Gc, and typical current gain-bandwidth product is 1.4 Gc. Both transistors are furnished in a coaxial package that allows maximum power operation at high frequencies. The devices are useful in military and industrial circuitry.

Texas Instruments Inc., 13500 North Central Expressway, Dallas Texas. [373]



NEW



**RTV
CARTRIDGE
PACK**

speeds production-line sealing at lower cost

Get General Electric silicone rubber adhesive sealants in a better package! Get G-E white RTV-102 and translucent RTV-108 at a new low price! And get a handy dispenser gun FREE with your trial purchase!

RTV-102 and RTV-108 are now in new 6 and 12 ounce cartridges designed for use in standard or air-powered caulking guns to speed and simplify production-line sealing operations. Ideal for electrical, electronic, aerospace and general industrial applications such as sealing terminal connections, weatherproofing, caulking, patching... and virtually any application requiring a flexible, durable adhesive bond.

These RTV compounds are ready to use with no mixing required. Their new cartridge-pack makes it a cinch to get into confined areas and hard-to-reach spots. RTV sets in minutes, cures in a few hours... will not sag, flow, shrink, crack, harden or peel... at temperatures from -75°F to above $+300^{\circ}\text{F}$. These RTV compounds meet Federal Food and Drug Administration requirements for use in any application where they might incidentally come in direct contact with food. All in all, there are probably 1000 production problems you can solve... permanently... with these RTV's.

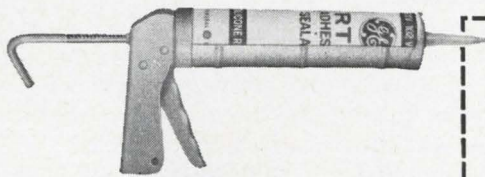

**GENERAL
ELECTRIC**

SPECIAL INTRODUCTORY OFFER

Handy adhesive/sealant dispenser gun FREE with your trial purchase of one 12 ounce cartridge RTV-108 (translucent) or RTV-102 (white) at the new low \$3.27* price. Get yours by sending company purchase order to General Electric Company, Silicone Products Dept., P.O. Box 385, Schenectady, N. Y. Only one free dispenser gun to a customer. Offer expires Oct. 31, 1965.

*Plus applicable state or local tax.

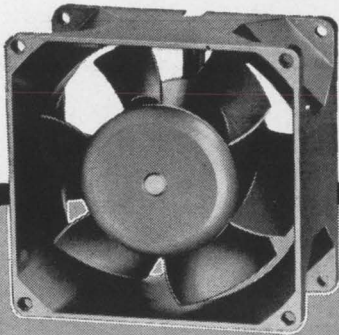

New

3 1/2"

**INDUCTION
Model 3000
PAMOTOR
Miniature
Axial Fans**

- 20,000+ operational hours at 45°C
- All metal construction
- Low-cost design
- Maximum air delivery at higher back pressures
- Unexcelled performance and reliability
- 50-60 cycles at 110 or 220 vac
- In stock for immediate delivery

Write for technical data on the Model 3000 and other PAMOTOR axial fans to:

PAMOTOR, INC.
312 SEVENTH STREET • SAN FRANCISCO, CALIF.

New Instruments

Portable scope meets lab specs

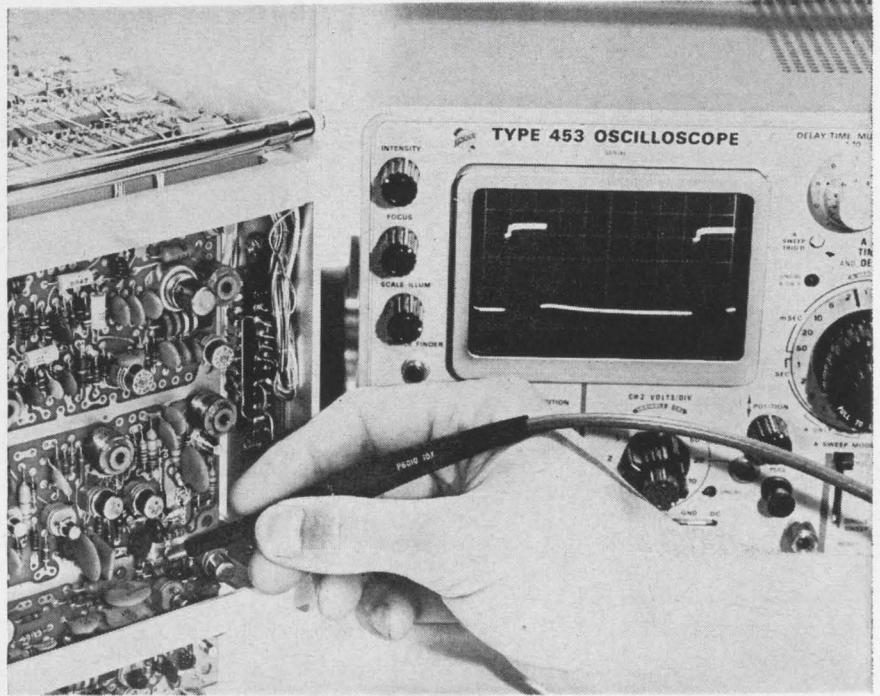

As electronic gear becomes more prevalent and more complex, there is increasing need for a portable oscilloscope that has all the capabilities of laboratory models. Such a scope would be valuable for testing electronic installations in aircraft, aboard ships, at remote missile sites and computer complexes.

To meet this need, Tektronix, Inc., is introducing a portable oscilloscope, called type 453, at Wescon. The instrument is a 50 megacycle, dual-trace oscilloscope that offers all the features and performance of a laboratory instrument in a 28-pound package that measures only 6 by 10 by 19 inches.

Designing a scope of this type gives rise to some conflicting requirements that Tektronix engineers had to resolve. An ordinary portable scope was not the answer; a laboratory scope had to be made about one-quarter of the usual size, with reduced power consumption, and capable of operating in a variety of environmental conditions.

One innovation in the type 453 oscilloscope is a four-inch rectangular cathode-ray tube. An overall accelerating potential of 10 kilovolts results in a short rapid-writing

tube with relatively large graticule area. To simplify the horizontal and vertical amplifiers and reduce the instrument's weight, the Tektronix engineers added a frame grid in the crt between the post accelerating field and the deflection plates to increase the tube's deflection sensitivity. Illuminated internal graticules eliminate parallax. And a mesh-like filter, which can be clipped in front of the crt, improves the contrast so the traces can be viewed under high ambient light.

The dual-trace vertical amplification system has a bandwidth greater than 4 megacycles, with a deflection sensitivity of 5 millivolts to 10 volts per division. The display can be chopped, or the scope can show the two inputs alternately or added. An optional trigger pick-off provides a means for viewing the time relation in the chopped and alternate modes.

A delayed sweep is included in the horizontal amplification system. This provides sweep speeds from 5 seconds down to 10 nanoseconds per division, with calibrated variable delays from 50 seconds to 0.1 microsecond.

Strength and reduced weight



***When this headline was current news...
digital recording tapes
had a packing rate of 200 bpi.***

***Today, 800 bpi is standard;
improvement in tape and base is the reason.***

In analyzing the sensational development of EDP over the past decade, most of us naturally talk in terms of improvement of hardware. But when you stop to examine them, the contributions made by tape manufacturers have been quite remarkable.

The tape of today *looks* like the tape of 1954 . . . but think of the differences: improved oxide coatings to increase total capacity, reduce fluctuations in performance; much stronger binders to reduce dropouts and flaking, lengthen tape life; smoother surfaces to give longer, error-free wear; thinner coatings and better production controls to guarantee reel-to-reel uniformity.

Working hand in hand with the tape manufacturers during this time has been Du Pont. Improvements in the uniformity, stability and overall reliability of the base of MYLAR* have played a vital role in making possible the sophisticated tape in use today. Continuing cooperation of research and development facilities assures continuing improvements in the future. Your guarantee of the most advanced tape is the manufacturer's brand and a base of MYLAR polyester film.

*Du Pont's registered trademark for its polyester film.



Better Things for Better Living . . . through Chemistry

At the base of all tape improvements: Mylar®

WHAT'S THE LATEST IN DISC CATHODES? ASK SUPERIOR.

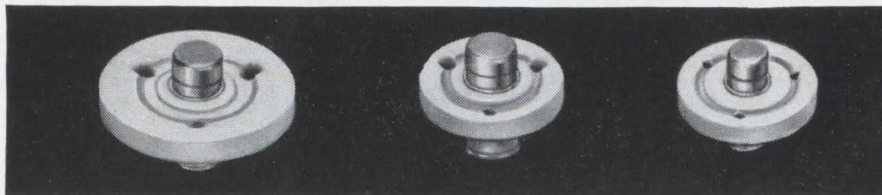

Full power for 6.3 volt-600 ma heater applications

Full power, narrow-neck for 600 ma heater applications

¼ power for 450 ma heater applications

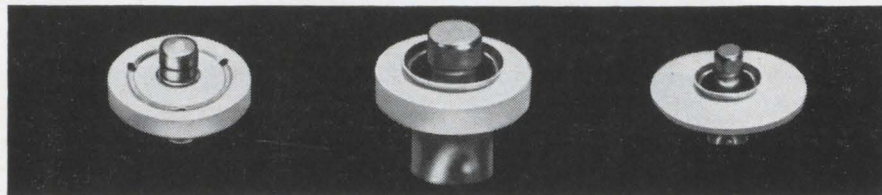

½ power for 300 ma heater applications

Shielded full power for better temperature uniformity in 600 ma heater applications

Shielded low power for 12.6 volt 85 ma heater applications

Widest choice of disc cathode designs

There are three basic types of Superior disc cathodes. Each has its own advantages. All feature close control of the E-dimension (distance between top of cap and top of ceramic), flare at the shank opening to facilitate assembly, shadow groove in the ceramic to inhibit electrical leakage and are available in wide choice of both cap and shank materials. Available in 0.121", 0.100" and 0.090" outside diameter shanks. Ceramic diameters can be either 0.490" or 0.365", with either round or triangular center hole.

New shielded disc cathodes—Full power and low power

In the full power design the emitter is separated from the ceramics by a shield which minimizes the conducting X-section from the shank to the ceramic. In the low power design, the slender shank, thermal shield and thin ceramic permit low heater power consumption and fast rise time. The shield also acts to eliminate leakage if sublimation takes place.

Widest choice of disc cathode materials

Superior's disc cathodes feature separate nickel cap and shank alloys. Hence you may choose the most suitable material for each. The Cathaloy® series, developed and controlled by Superior Tube Co., offers alloys with high strength, high activity, low sublimation, freedom from interface impedance, or any desired combination.

Cathaloy A-31. Approximately twice as strong as tungsten-free alloys at high temperatures.

Cathaloy A-33. Combines the high emission of active alloys with freedom from sublimation and interface impedance.

Cathaloy P-51. More than 100% stronger than X-3014 at high temperatures.

X-3014. Powder metallurgy pure nickel for resistance to sublimation. Suggested for shanks.

X-3015. Special shank alloy for strength with resistance to sublimation and for non-emitting characteristics.

Nickel 220, Nickel 225, Nickel 230 and Nickel 233. Suggested for caps requiring normal emission with rapid activation.

Driver Harris 599 and 799. Provide rapid activation plus high level d-c emission. For caps only.

For your copy of our Catalog 51, write Superior Tube Company, 2500 Germantown Ave., Norristown, Pa.

Superior Tube

The big name in small tubing

NORRISTOWN, PA. 19404

West Coast: Pacific Tube Company, Los Angeles, California

Johnson & Hoffman Mfg. Corp., Carle Place, N.Y.—an affiliated company making precision metal stampings and deep-drawn parts

New Instruments

were achieved by using aluminum alloy castings for the main frame and side rails. The solid state circuitry is mounted on six glass-epoxy boards. The instrument cover is designed to provide storage space for the power cords and measuring probes during transit. The carrying handle doubles as a stand to position the scope for easy viewing. A few of the less commonly used controls are on the side of the instrument which gives more room for the basic controls on the front panel.

Specifications

Sensitivity	5 mv/division to 10 v/division in 11 steps
Frequency response	D-c to 50 Mc for sensitivity greater than 20 mv/div
Input resistance	1 meg paralleled by 20 pf
Maximum input voltage	600 v combined d-c and peak a-c
Trace drift	Less than 1 division/hour at 5mv/div
Sweep rates	0.1 microsecond/div to 0.5 second/div in 21 steps
Trigger sources	Internal, line, external, external divided by 10
Temperature range	-15° to +55° C (operating)
Shock	30 g's
Power requirement	96 to 127, 103 to 137, 192 to 254, or 206 to 274 v a-c, 45 to 440 cps, 100 watts
Price	\$1,950
Availability	90 days

Tektronix, Inc., P.O. Box 500, Beaverton, Ore., 97005. [381]

Air-insulated supply delivers 500 kv

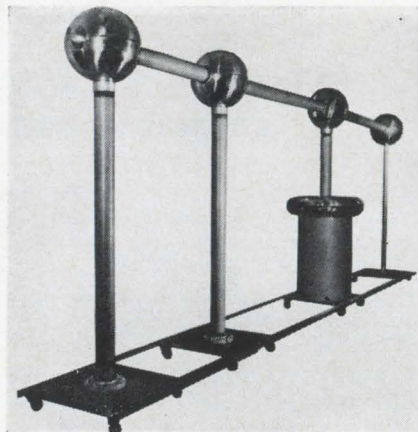

A high voltage assembly, model BAL-500-5.5 uses air as an insulating medium. Output is 0 to 500 kv d-c at 5.5 ma d-c. The unit offers

reversible polarity. Ripple is 2% rms. Load regulation is approximately 20% for no load to full load changes of 5.5 ma d-c when measured at 500 kv d-c. Output will vary directly with line; however, a line voltage regulator is available. The high voltage assembly, mounted on casters, measures 3 ft. wide by 8 ft. high by 18 ft. long. Controls measure 22 in. wide by 16½ in. high by 18 in. deep. Height will increase by 30 in. if a line voltage regulator is included in the package.

This equipment has application in testing of electronic cables, rectifiers and capacitors. Its chief advantages are found in maintenance, mobility and performance. The air design is readily accessible for serviceability and does not require the pumping and pressurizing equipment that is necessary for oil. The equipment may easily be moved by two men around a laboratory and may also be disassembled in a short time for transportation purposes. The modular construction of the high voltage components lends itself to extension to approximately a million volts at some later date. Universal Voltronics Corp., 17 S. Lexington Ave., White Plains, N.Y. [382]

Position transducer in 2 configurations

An improved series of displacement or position transducers is available in a range of standard sizes, from $\pm \frac{1}{2}$ in. to 140 ft., to meet most requirements. These new transducers incorporate many of the improvements that have been developed for units built to meet NASA's and other government agencies' specifications for aerospace environment.

Electrically, the transducers are available in two different configurations. The A circuit provides outputs in the magnitude of 7 to 270 mv per v per in. The B circuit provides outputs in the order of 0.05 to 0.23 mv per v per in. Proper selection of either circuit will provide a transducer capable of driving at highest efficiency the particular equipment available that can read out.

Lockheed Electronics Co., 6201 Randolph St., Los Angeles 22, Calif. [383]

ANTENNA and TOWER INSULATORS by LAPP

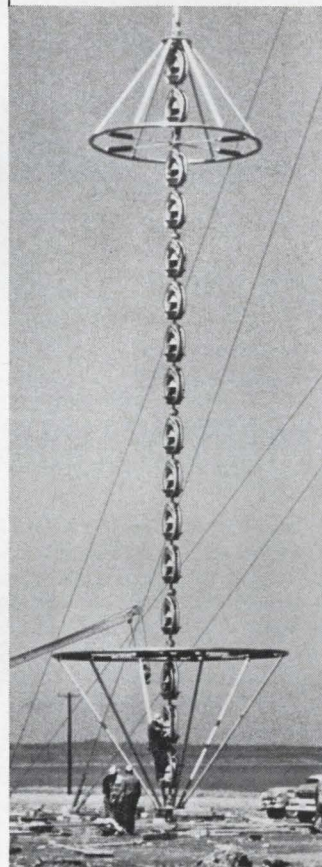
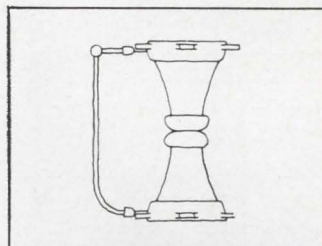
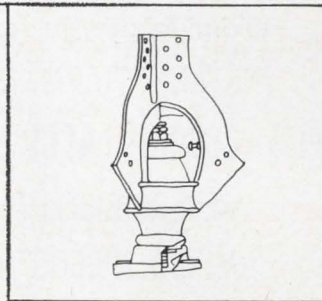
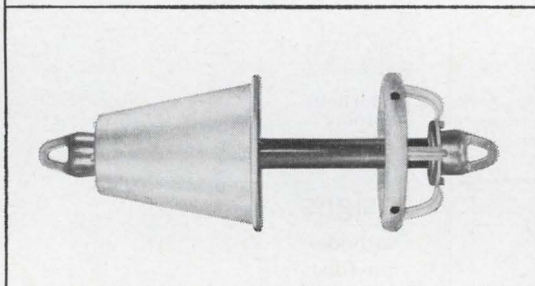

Lapp insulators support most of the world's large radio towers, both self-supporting and guyed masts. Lapp has designed and built base insulators from 80,000 lbs. to 9,000,000 lbs. ultimate strength. Lapp strain insulators have been made from 1200 lbs. to 620,000 lbs. ultimate strength. □ Lapp is also a dependable supplier of entrance, spreader and stand-off insulators for transmission lines. Other Lapp insulators and our gas filled capacitors are used in transmitters and coupling networks. □ Difficult insulating problems are welcome here at Lapp. We've been solving them for almost a half century. Write Lapp Radio Specialties Division, Lapp Insulator Co., Inc., 235 Sumner St., LeRoy, N. Y. 14482.



Want to design for
 INSTANT STARTING? ...
 SPLIT-SECOND ACCURACY?
 REVERSIBILITY? ...
 MIXED SPEEDS? ...

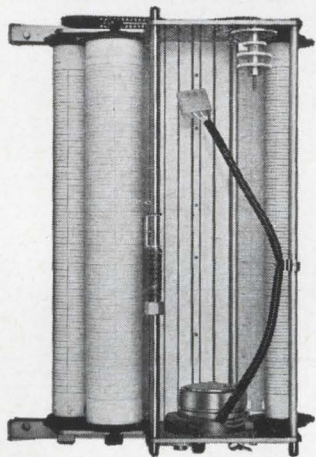

turn the
 job over to
SYNCHRON® MOTORS!



No matter whether you want a motor to withstand swiftly changing temperatures, meet fast-reversing stresses, turn a small part with exact accuracy to 1 Rev. per week or 600 Rev. per minute, there's a SYNCHRON Motor that can do it! It can do a hundred other things as demanding as these — if you tell us how you want it to function. Before you start any design that calls for small drive or timing motors, think of SYNCHRON Motors, and call or write us at Hansen Manufacturing Company. We'll be there at once to help — with experience. Better still — don't wait till you face a problem. Write us now — let us tell you about SYNCHRON Motors and the ways we design them to work for you.



HANSEN REPRESENTATIVES: CAREY & ASSOCIATES, Houston, Tex., R. S. HOPKINS CO., Sherman Oaks, Calif., EICHORN & MELCHIOR, INC., San Carlos, Calif., THE FROMM CO., Chicago, Ill., H. C. JOHNSON AGENCY, INC., Rochester, N. Y., WINSLOW ELECTRIC CO., Essex, Conn., and New York, N.Y. EXPORT DEPARTMENT, 64-14 Woodside Ave., Woodside, N. Y. Handled exclusively in Canada by Sperry Gyroscope Ltd., Ottawa, Canada.

New Subassemblies and Systems

Detector checks explosive bolt firing

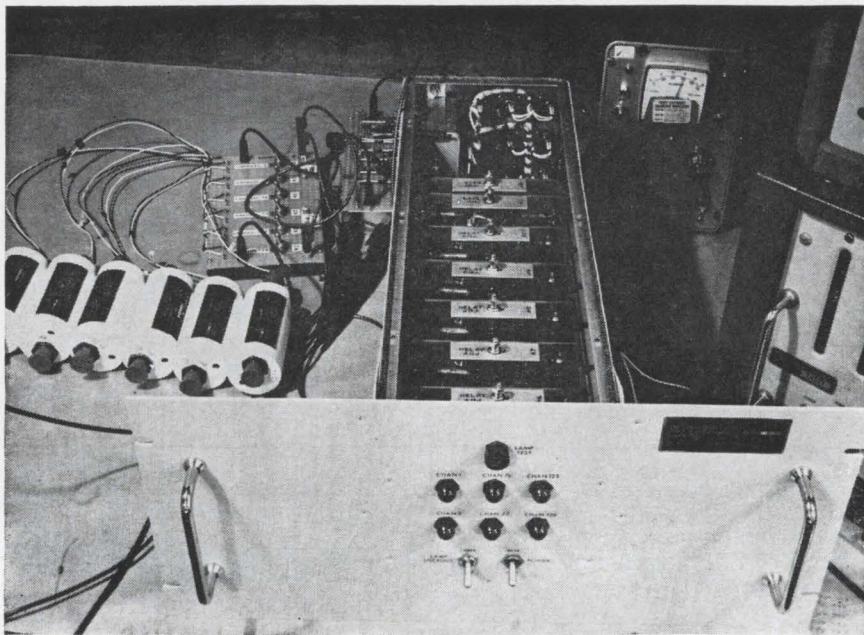

The systems for firing explosive bolts, or squibs, on missiles or other space vehicles must be very carefully checked in the factory and before launching. If a single squib does not fire, or fires at the wrong time, stage separation will not take place properly and the entire mission may fail.

In testing, it is necessary to know if the firing command signal was initiated, when it was initiated, whether it was recognized, and when the reaction occurred. The tests usually require a separate wire connection between each squib location and the checkout equipment, but a system developed to test Gemini's 70 to 90 squibs gets rid of much of the wiring and saves on checkout times.

Dummy squibs are used in the tests; they are resistors with the same general characteristics as the thermal wires in the actual squib. The system consists of one detector module for each squib to be monitored (up to 125 in the present design) and a decoder assembly to provide multiple readout. (The detector modules are the small cylinders at the left in the photo above. The decoder is the large panel.)

Each detector operates on its

own frequency, at increments of one kilocycle between 175 and 300 kc. It is connected in series between the squib simulator and a current probe which is slipped over the common lead of the missile battery that powers the squib. When the missile programmer closes relay contacts between the battery and the squib, a crystal oscillator in the detector begins to rise to full potential. The command initiation is thus recognized.

As long as the squib remains intact, it presents a nearly zero ohm d-c resistance, and a gate between the oscillator and the battery line remains deactivated. But when the squib has blown, the oscillator signal is passed through the gate and an adjustable current driver back to the line.

The signals are picked up by the current probes, and all 125 are sent along a single cable back to the decoder. Here the signal is demodulated into the individual frequencies, and the data is read out for test operators.

Tridea Electronics, a subsidiary of the McDonnell Aircraft Corp., developed the system to test squibs on Gemini; the company is now making it available to other space

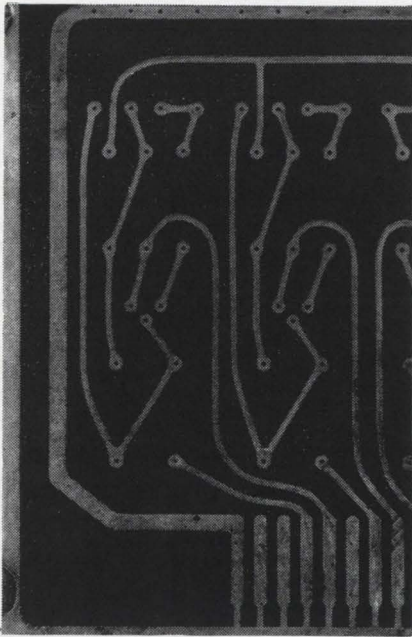

Etching solder plate boards with chromic acid?

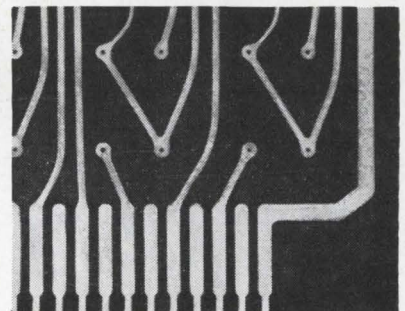
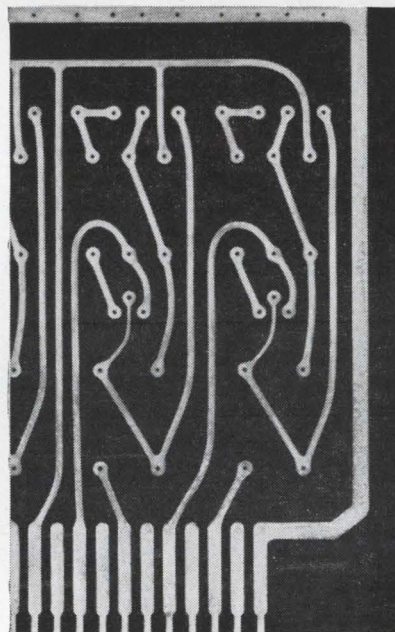
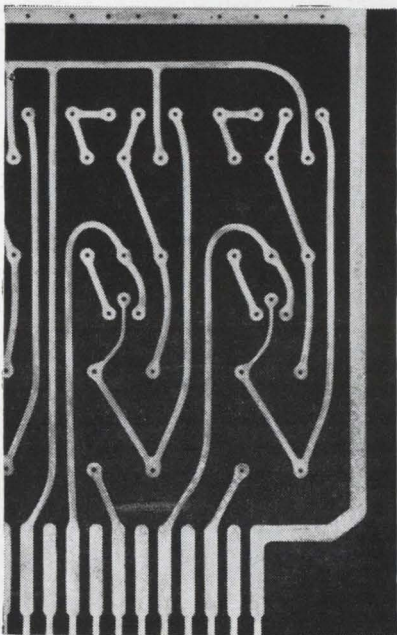

Switch to ammonium persulfate.

Get 2½ times as many boards for your etchant dollar.

Use ammonium persulfate on solder boards and save 60% on every dollar you now spend on etchants.

Standardize on persulfate—for both copper and solder boards—and get further savings on storage and purchasing.

Get clean, shiny, ready-to-use solder boards with our new bright dip formula, for no more than it costs to

clean boards etched with chromic acid.

For full information (including our bright dip formula, easily mixed with standard chemicals), or for a demonstration in your own plant, write department 1088R.

FMC CORPORATION
INORGANIC CHEMICALS DIVISION
633 THIRD AVENUE, NEW YORK, N. Y. 10017



CHRISTIE

SINCE 1929

"TRANSIENT FREE"

D-C POWER SUPPLIES

100-200-250-400-600 AMP

15 to 36 volt d-c
50 microsec
Response

F. L. Regulation:
Static: .01%
Dynamic: .5v

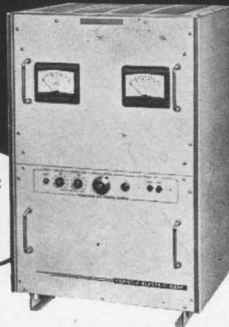

Impedance: 1 milliohm
Ripple: 1 millivolt

Military & RFI Specs
Also Mobile & Rack

Also 200 other Models of Power Supplies & Battery Chargers • Write for Catalog
CHRISTIE ELECTRIC CORP. 3400 West 67th Street, Los Angeles 43, Calif.

Circle 206 on reader service card

COMINCO high-purity metals

Available forms in 99.999% and/or 99.9999% purities	ALUMINUM	ANTIMONY	ARSENIC	BISMUTH	CADMIUM	COPPER	GOLD
BARS	X	X	X	X	X	X	
SHEETS	X				X	X	X
WIRE	X				X	X	X
POWDER		X	X	X	X		
SHOT		X		X	X	X	
ROD	X			X	X	X	
RIBBON							
PREFORMS	X				X	X	X
SALTS					X		

Available forms in 99.999% and/or 99.9999% purities	INDIUM	LEAD	SILVER	TELLURIUM	THALLIUM	TIN	ZINC
BARS	X	X	X	X	X	X	X
SHEETS	X	X	X				X
WIRE	X	X	X				X
POWDER	X	X	X	X	X	X	X
SHOT	X	X	X				X
ROD	X	X	X				X
RIBBON	X	X					X
PREFORMS	X	X	X				X
SALTS	X						

COMINCO PRODUCTS, INC.
ELECTRONIC MATERIALS DIVISION
818 West Riverside Ave., Spokane, Wash. 99201
Phone 509 747-6111 Telex 032 610
TWX 509-328-1464

5609

144 Circle 144 on reader service card

Instrument Line Magnetic Tape Heads by NORTON

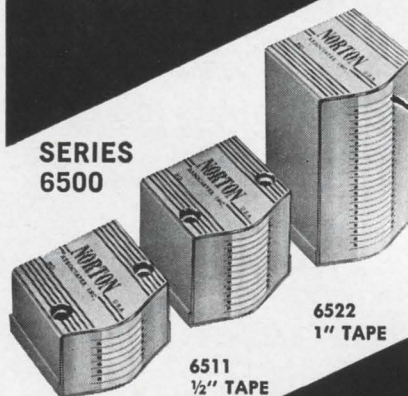

6506
1/4" TAPE

6511
1/2" TAPE

6522
1" TAPE

Send now for technical literature with specifications on the complete Norton line of magnetic heads.

NORTON

ASSOCIATES, INC.

240 Old Country Road, Hicksville, N. Y.

Circle 207 on reader service card

New Subassemblies

contractors. The cost is \$9,510 for the decoder and ancillary gear, plus \$310 for each detector—which would make the price of a complete system, with all 125 channels, \$48,260. Tridea is working on a leasing plan for companies which do not want to make such a large investment.

Specifications

Channel capacity	125
Frequency range	175 kc to 300 kc (1 kc spacing)
Time delay	20 msec ± 2 msec
Signal current	0.1 ma to 5 ma (each channel, adjustable)
Detector size	approx. 2 in. in diameter x 5 1/2 in. long
Detector weight	less than 8 oz.
Decoder size	19 in. rack mount, 24 in. high
Decoder weight	150 lbs.

Tridea Electronics, 1020 Mission St., South Pasadena, Calif. [401]

Tiny preamplifiers are rfi-protected

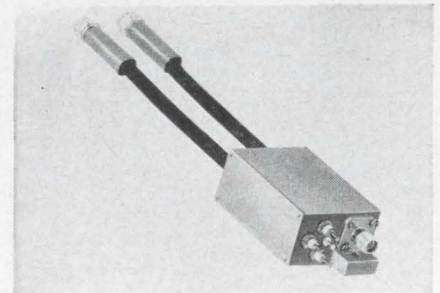

Low noise, solid state preamplifiers are available packaged in ultra-miniature, ruggedized housings. Offering power drains of 0.2 w, less than 3 cu in. volume and a weight of 2 oz, these units are ruggedly constructed for missile and aerospace applications.

Units are conduction cooled and will operate from -55° to +100°C. They are designed to withstand shock of 35 g, acceleration of 15 g, and vibration and acoustic noise from 5 to 2,000 cps. They are rfi protected with MIL-I-26600 as guideline. Standard center frequencies include 30, 60 and 70 Mc with bandwidths to 30 Mc. Prices start at \$395 with delivery of stock to 30 days.

RHG Electronics Laboratory, Inc., 94 Milbar Blvd., Farmingdale, L.I., N.Y. [402]

Electronics | August 23, 1965

Hitachi

germanium power transistors

2SB471 and 2SB472

for audio frequency amplifier
home radio - car radio - phonograph



INEXPENSIVE



<JEDEC TO-3 TYPE>

- ★ LARGE BETA AND SUPERIOR LINEARITY
- ★ LOW THERMAL RESISTANCE

MAXIMUM RATINGS ($T_a=25^\circ\text{C}$)	V_{CB0}	V_{CEr}	V_{EBO}	I_C	I_B	P_C	θ_{jc}	T_j
2SB471	-60	-45	-10	-10	-3	30	1.5	90
2SB472	-80V	-45V	-10V	-10A	-3A	30W	1.5 $^\circ\text{C}/\text{W}$	90 $^\circ\text{C}$

ELECTRICAL CHARACTERISTICS ($T_a=25^\circ\text{C}$)	2SB471			2SB472			
	min	typ	max	min	typ	max	
I_{CBO} ($V_{CB}=-30\text{V}$, $I_E=0$)	—	—	-0.5	—	—	-0.5	mA
I_{CBO} (sat) ($V_{CB}=-0.5\text{V}$, $I_E=0$)	—	—	-0.1	—	—	-0.1	mA
h_{FE} ($V_{CE}=-2\text{V}$, $I_C=-1\text{A}$)	50	90	165	50	90	165	
V_{BE} ($V_{CE}=-2\text{V}$, $I_C=-1\text{A}$)	—	-0.3	-0.5	—	-0.3	-0.5	V
V_{CE} (sat) ($I_C=-10\text{A}$, $I_B=-1\text{A}$)	—	-0.4	-0.75	—	-0.3	-0.5	V
$f_{\alpha B}$ ($V_{CE}=-2\text{V}$, $I_C=-1\text{A}$)	—	300	—	—	300	—	KC



HITACHI SALES CORPORATION: 333, N. Michigan Avenue, Chicago 1, Ill., U.S.A. Tel: 726-4572/4 / 666, 5th Avenue, New York, N.Y. 10019, U.S.A. Tel: 581-8844 / 12715, S. Daphne Avenue, Hawthorne, Calif., U.S.A. Tel: 757-8143 HITACHI, LTD., DUESSELDORF OFFICE: Graf Adolf Strasse 37, Duesseldorf, West Germany Tel: 10846

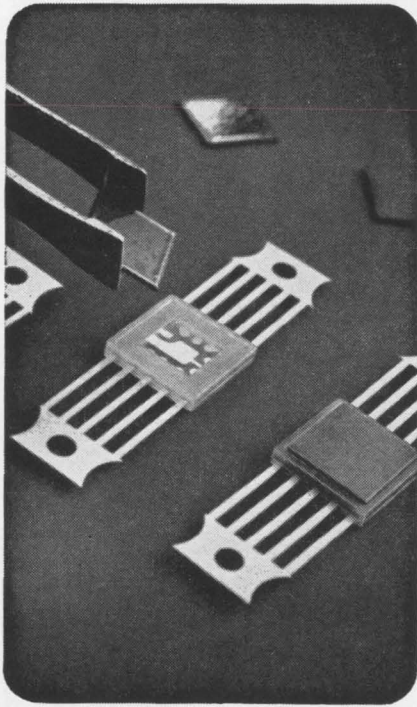

Flat Glass Packages

• In volume production

Ultra Carbon's "quarter-by-quarter" flat glass package in standard 10-lead configuration has been placed in volume production. This package can be purchased with the *pad coplanar with the leads* or *depressed pad* arrangements. Leads and pad are gold plated. Either natural or black glass available.

• Nearing volume production

Ultra Carbon's "quarter-by-three-eighths" flat glass pack with 14 leads is in advanced stages of development. To be released for volume production soon, this package will be available with *depressed* or *coplanar pads*; gold plated pad and leads; and, in either natural or black glass.

• Whatever your glass pack needs

ULTRA/FGP[®] glass pack is a completely flexible technique of providing rugged protection for integrated circuit devices. Final seal made in your plant... assures proprietary security.

Ultra Carbon welcomes the opportunity to work with you in applying ULTRA/FGP packaging to your microcircuit needs. Write P.O. Box 747, Bay City, Mich. 48709.

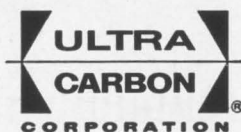

New Microwave

Lightweight microwave relay

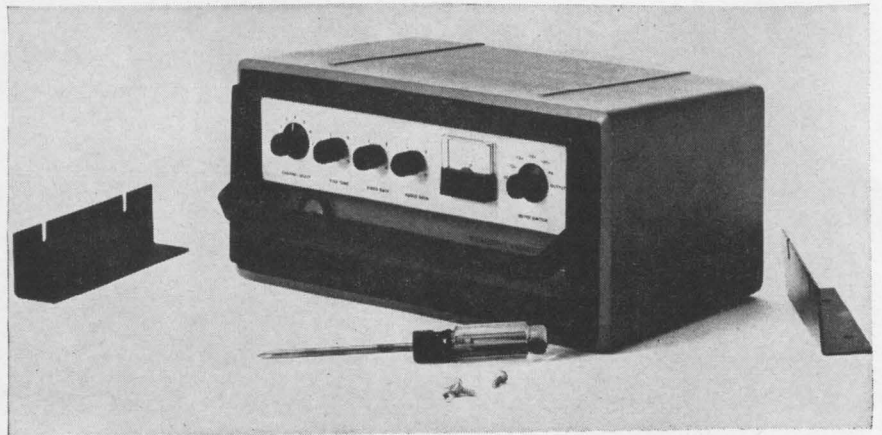

When mountain climbers inched their way up the Matterhorn several weeks ago, the action was televised by two technicians who accompanied the mountaineers. One technician took the pictures, the other carried a portable relay system on his back that transmitted them to the bottom of the mountain.

The solid state microwave relay system, model MA-7A, was developed by Microwave Associates, Inc. It is capable of operating in the microwave relay band—6,000 to 7,000 megacycles. It weighs 30 to 40 pounds, about one-third the weight of relay systems that use klystron tubes in the transmitters' output stage.

Microwave Associates' system uses a transistor capable of several watts output in the ultrahigh frequency range, and a varactor multiplier that gets the transmitter output frequency up into the microwave relay frequency band.

The transmitter's radio-frequency output is 0.5 watt minimum from only 35 watts input. The receiver, which has a crystal-controlled, stable local oscillator, requires only 25 watts. Because it is solid state, the relay system requires no warm-up time. Receiver noise is 10 decibels maximum, but can be reduced to 5.5 db with a preamplifier, which is optional equipment.

Besides monochrome and color-

tv signals, the system can relay multichannel telephony and wide-band data signals.

The transmitter and receiver are contained in separate weather-tight cases that include integral interchangeable power supplies that can accept 12 volts d-c, 24 volts d-c, 110 volts a-c or 220 volts a-c. Each rack mount is 19 by 8½ inches. The transmitter, model MA-8565, is shown above.

Microwave Associates says the MA-7A system is in production for fall delivery. Price is about \$9,500.

Specifications

Transmitter	Model MA 8565
Differential gain	0.2 db typical
Differential phase	Less than 1° at 3.58 Mc
Transmitter frequency	6,000 to 7,000 Mc
Video bandwidth	6 Mc
Tuning	Selecting oscillator frequency only
Receiver	Model MA 8564
Noise figure	10 db maximum
Frequency stability	Within 0.005%
Price	About \$9,500 for both transmitter and receiver

Microwave Associates, Inc., Burlington, Mass. [421]

Frequency extender uses YIG preselector

Type FE-1-2 frequency extender tunes from 1 to 2 Gc in a single band. It employs a four-section YIG preselector that is tuned electronically throughout its range, avoiding

CONSIDER COLORADO ...where research and education are industry's partner...

Directly. Indirectly. From government, university and private sources...

Consider 103 research organizations located in the state... headed by a total of 3500 graduate scientists who guide the efforts of 23,000 employees to discover the unknown. Everything from economics and marketing to cryogenics and advanced nuclear research and neutron generator performance.

In close support of science, research and industry are Colorado's educational institutions: 12 colleges and universities; 7 junior colleges. Plus an increasing number of vocational and trade schools whose primary mission is to serve the needs of Colorado and the nation's industry.

If research and education are important to your business, consider industrial Colorado for your expansion or relocation. Complete information is available from Dwight E. Neill, Director, Division of Commerce and Development, 14 State Services Building, Denver, Colorado.

INDUSTRIAL COLORADO

D-335-B





You get what you see with a FAIRCHILD SCOPE CAMERA

The highest precision and clarity in oscilloscope photography are insured by a long list of Fairchild design features. Pinpoint focusing at any object-to-image ratio within lens range is one. Heavy duty synchro shutters with jam-proof activation are others. With Polaroid Land Back, 6 x 10 cm field can be recorded 0.9 actual size. Option of f/1.9 or f/2.8 lens. Prices start at \$350. For specifications or a demonstration, contact your local Fairchild Field Engineer, or write to Fairchild Instrumentation, 750 Bloomfield Avenue, Clifton, N. J.

FAIRCHILD

INSTRUMENTATION

A DIVISION OF FAIRCHILD CAMERA AND INSTRUMENT CORPORATION

Circle 204 on reader service card

MIDGET
IN SIZE
GIANT
IN POWER
NOW!

New and Smaller Sizes
**TYPE LK Rectangular High Voltage
CAPACITORS**

"The little one" with the tremendous power!
4 times the life of MIL-C-25A in case sizes
reduced up to 80%! And you also get:
superior resistance, better power factor,
withstands greater overloads, may be
operated to 125° and voltage ratings from
600 to 500,000 volts.

Write today for **Bulletin LK**
Also ask for **FREE** pocket size
"Comparator" and "Conversion" chart

Plastic Capacitors, INC.

2620 N. Clybourn • Chicago 14, Illinois
DI 8-3735

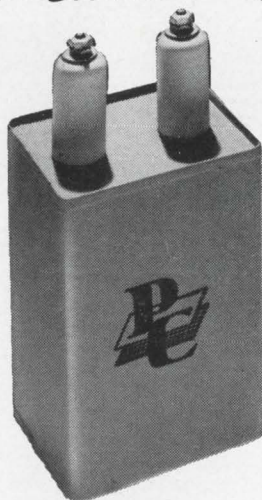

Custom  Engineering at
Production Prices

New Microwave

complex mechanical drives. Signals are converted to a 160-Mc i-f output, and fed into a series 900 vhf receiver or other unit that tunes to 160 Mc. The 160-Mc output can also be connected to a type IFC-21 converter for further reduction to a 21.4-Mc intermediate frequency, acceptable as input by a demodulator system such as the type DM-4. The tunable, four-section YIG preselector assures low oscillator radiation and high image rejection (70 db minimum). Solid state devices are used throughout, with the exception of a ceramic triode in the highly stable local oscillator. As a result, average power consumption is kept to 25 w, and the FE-1-2 requires just 5¼ in. of rack space. The unit operates from a 115-230 v power source, 50 to 400 cps, and weighs approximately 20 lb. Price is \$4,000, delivery in 60 days.

Communication Electronics, Inc., 6006 Executive Blvd., Rockville, Md. [422]

Band-pass filters are extremely rugged

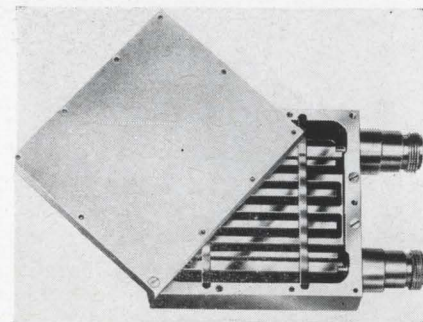

Two lines of coaxial band-pass filters feature improved pass-band performance with extremely rugged construction. The BK series filters are 10% bandwidth comb line filters; the BL series filters are octave bandwidth interdigital units.

Maximum pass-band vswr is 1.5; maximum insertion loss, 0.5 db. The units are available in the 0.25 to 8 Gc region and are supplied with various combinations of pass-band frequencies, connectors, and polarities. Priced from \$125, the units are available on 4 weeks delivery.

Microlab/FXR, Livingston, N.J. [423]

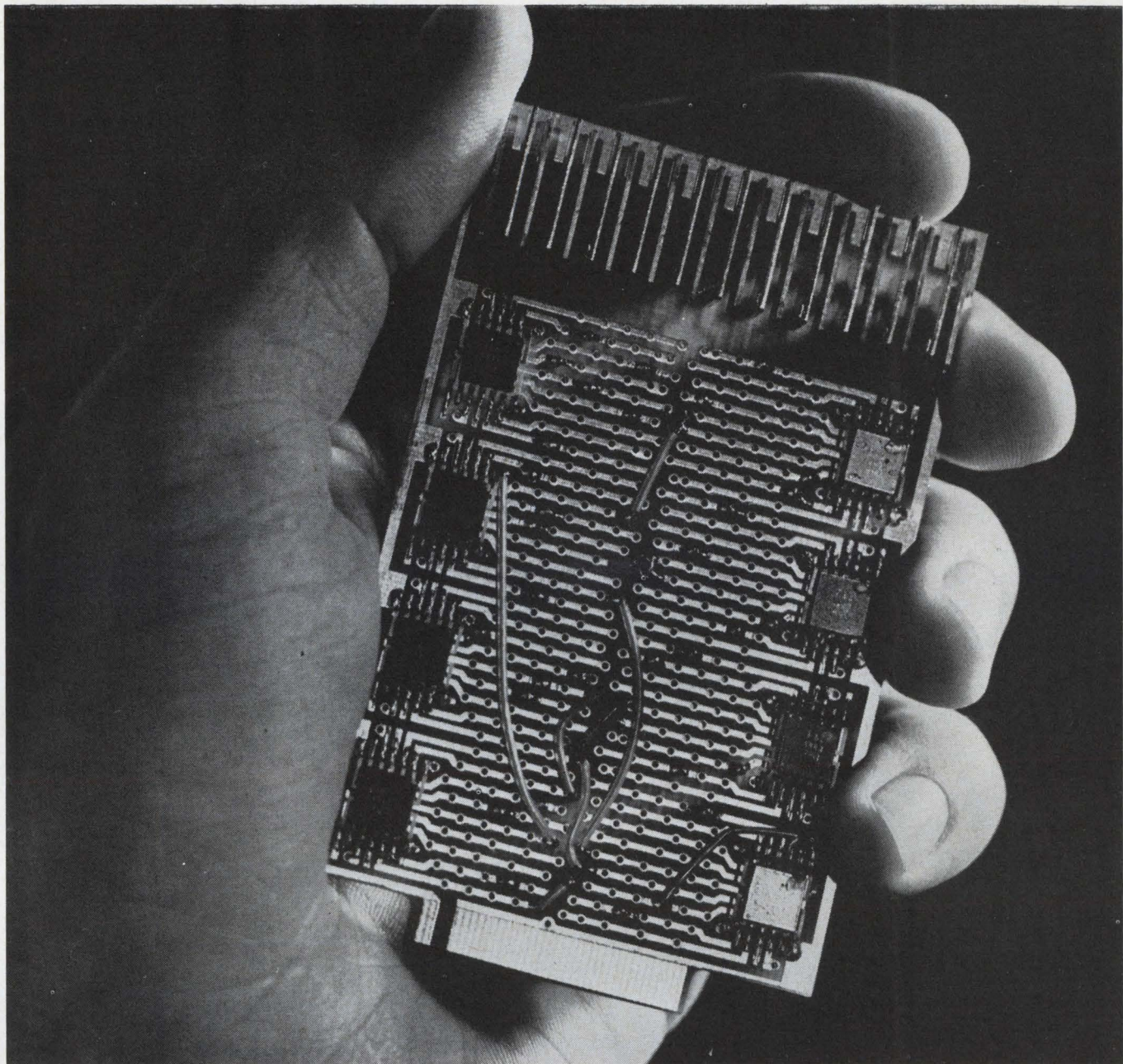

Careers on the move in **solid state electronics**

The Advance Electronics Department of the Douglas Missile & Space Systems Division offers challenging opportunities for physicists with

interests and backgrounds in solid state devices.

Since the work is of a fundamental nature, publication of results is encouraged. Specific areas of interest are:

- Semiconductor and Thin Film Transport Phenomena
- Electronic and Magnetic Measurements
- Electronic Materials Properties
- Device Concepts.

Please send us your resume or the coupon. You will receive a prompt reply.

You gain by going to:

DOUGLAS

MISSILE & SPACE SYSTEMS DIVISION
An equal opportunity employer

Mr. O. R. Snodgrass, Douglas Missile & Space Systems Division, 3000 Ocean Park Blvd., Santa Monica, California.

I am interested in career opportunities at Douglas MSSD.

NAME _____

ADDRESS _____

CITY _____ STATE _____

Degree(s): _____

Field(s): _____

Specialty(ies): _____

U.S. Citizen: Yes No

THERMOELECTRIC COOLERS

Standard line...
for immediate delivery!

MODULE 3950-1

For spot cooling—especially in electronic components. Heat pumping capacity 6.8 watts; voltage 2.6 VDC; current 7 amps DC. Module mounted between aluminum plates for mechanical strength, uniform junction temperatures.

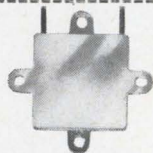
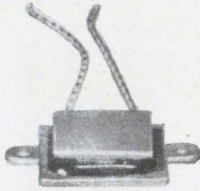

MODULE 3951-1

Similar in configuration to 3950-1, but with higher 20-watt heat pumping capacity. Voltage 6.4 VDC; current 7 amps DC.

MODULE 3952-1

Very low current requirements (1500 milliamps), high heat pumping capacity (2000 milliwatts)—yet very small (.786" sq. x .196" thick) and light (less than 1/4 oz.). Ideal for hot spot problems in circuits with low available power.

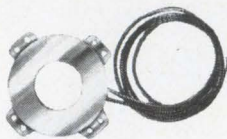

MODULE 3953-1

New annular ring provides high 20 watt heat pumping capacity (68 BTU's per hour). Runs on low 6.5-7.0 amps current rating. Cold plate diameter is 1 7/8" with an ID of 7/8". Four mounting tabs are located at 90° increments on the base plate. Tabs include one 6-32 machine screw feed through hole. Modules specially intended for cooling in a variety of unusual circuit applications.

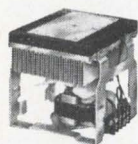

ASSEMBLY 3970-1

Complete TE cooling system: cold plate, heat sink, fan and bracket. High 40-watt heat pumping capacity, low 7-amp DC current load. Unit measures only 4 1/4" x 5" x 4 1/2".

COLD PLATE 7200-1

Newest laboratory device offers researchers a large area cold surface 6" x 3" down to -15°C — yet draws only 1 amp on standard 110-115 VAC, 60 cycle current!

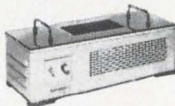

Send for complete data now!

CAMBION®

"DIAL-A-PART" SERVICE

Standardize on CAMBION...
The Guaranteed Electronic Components

CAMBRIDGE THERMIONIC CORPORATION
401 Concord Avenue, Cambridge, Mass. 02138
Tel: (617) 876-2800

New Production Equipment

Solder sniffer in production

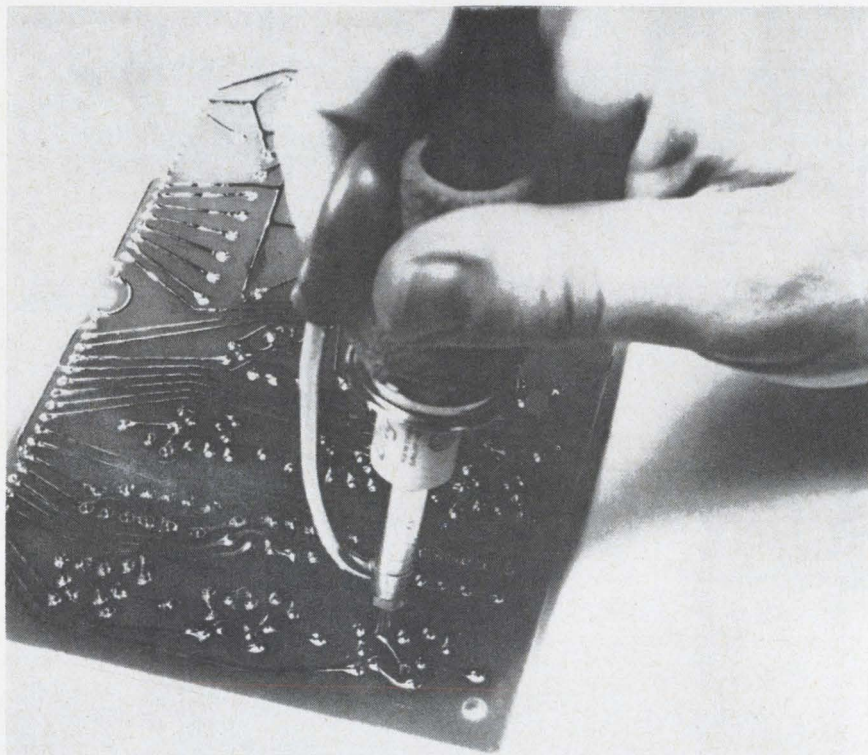

"Where can we buy a solder sniffer?"

Several readers, including one in Canada and another in Japan, wanted to know after an article on the Boeing Co.'s homemade desoldering tool appeared in the April 5, 1965 issue of Electronics, on page 114.

Since then Boeing has licensed Thermo Industrial Products, Inc., to produce the sniffers for sale. That company reports production underway and says that the tool will cost about \$10 retail.

The sniffer is a hollow adapter and tip which fits onto a pencil-type soldering iron. Suction is created in the tip by a small rubber bulb attached to the adapter by a metal tube.

To remove a component from a printed circuit board, the tip is pressed against the solder joint, melting the solder. The solder is sucked up into the tip and then expelled into a receptacle by squeezing the bulb again.

The tips are made in several different sizes and shapes for use on

different kinds and shapes of solder joints.

Thermo Industrial Products, Inc., 918 Central Building, Wichita, Kan. [451]

Sniffer catches waste solder

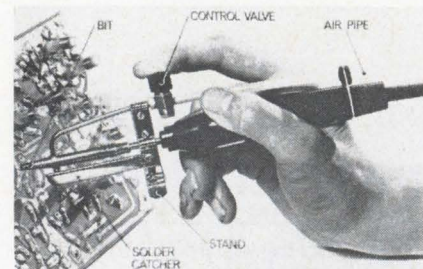

A British entry in the solder-sniffing field is a new desoldering tool made by Antex Ltd. It uses the Venturi principle to suck up the molten solder and then deposits the waste in a receptacle that is part of the tool.

A tube carrying compressed air passes through the tip and into a stainless steel container. The air

Tung-Sol Read-Out Lamp Saves Customer Two Operations, Cuts Shrinkage

Our customer's problem stemmed from handling. The bulbs he bought went first to a wiring company to have lead wires attached. (Shrinkage here due to lead wire damage). After the leads were attached the bulbs went to a molder to have bases added. (More shrinkage due to bulb damage and lead wire breakage). Shrinkage in both operations ran as high as 15 per cent.

Now Tung-Sol does the whole job and the customer has benefitted 4 ways: (1) two processing steps eliminated. (2) valuable production time saved. (3) inventory reduced. (4) gets 1000 usable lamps for every 1000 purchased.

Tung-Sol can harness to any specifications and mold to any configuration. Describe your application to us for free suggestions about how Tung-Sol can solve your problem at a saving.

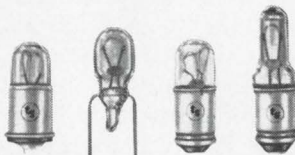

If your application requires only bulbs, ask for a quotation from Tung-Sol. The Tung-Sol line of miniature and subminiature lamps is extensive. Quality is the best that more than half a century of know-how can produce.

TUNG-SOL

INSTRUMENT LAMPS

Tung-Sol Electric Inc., Newark, N. J. 07104

ACTUAL
SIZE



ELECTRO

...EXACTLY THE POWER SUPPLY YOU NEED!

Conservatively-rated components... overload protection.
Top quality construction, long life... guaranteed one year.



1.



2.

1. Need good but not super regulation?

...you can save \$250 to \$650.

Electro "NFB" Power Supply . . . one of the industry's lowest cost-per watt-output, priced at only \$250. Regulation: 13% at maximum output; 0-32 vdc up to 15 amperes; . . . Low dc impedance: 0.3 ohms, no load to full load. (Rack model NFBR . . . \$275.)

2. Need low ripple, high voltage:

...Electro has both for only \$150.

Electro "EFB" . . . a low cost power supply delivering up to 128 watts, with top-load ripple less than 0.1% at only \$150. Low cost-per-watt-output. Two ranges, continuously variable 0-32 vdc up to 4 amperes; 0-16 vdc to 8 amperes. Regulation: 1.25 volts for each ampere of load current change between 0-4 amperes in 32 volt range; 1.0 volt for each ampere of load change between 0-8 amperes in 16 volt range. (Rack model EFBR . . . \$175.)

3. Need others?

. . . 18 standard models, 6 to 500 vdc from \$27.50 stocked at your electronic distributor; custom designs for O.E.M. and special applications.

Write for complete line catalog

5185



Since 1936—Pioneers in Low Voltage DC Power Supplies
• Proximity Switches • Magnetic Pickups • Tachometers
• Pres-Con Controls • Dynamic Micrometers

ELECTRO PRODUCTS LABORATORIES, INC.
6125-F HOWARD, CHICAGO, ILL. 60648 • 312/775-5220

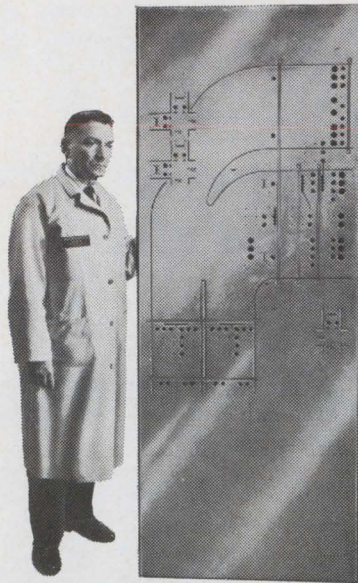

think BIG

(also small)

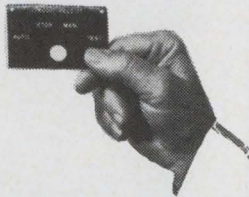

Now engrave anything from 6 ft. panels to tiny nameplates

Engravograph tackles them all. Right in your own shop, effortlessly, speedily — ideal for unskilled workers. Adjustable ratio engraves 21 different sizes.

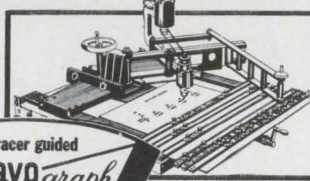

the tracer guided
Engravograph

Write for illustrated catalog # 114

new hermes engraving machine corp.

154 WEST 14th STREET, NEW YORK 11, N. Y. Chicago, Atlanta, Dallas, Los Angeles, Montreal

Amerline Corporation reports:

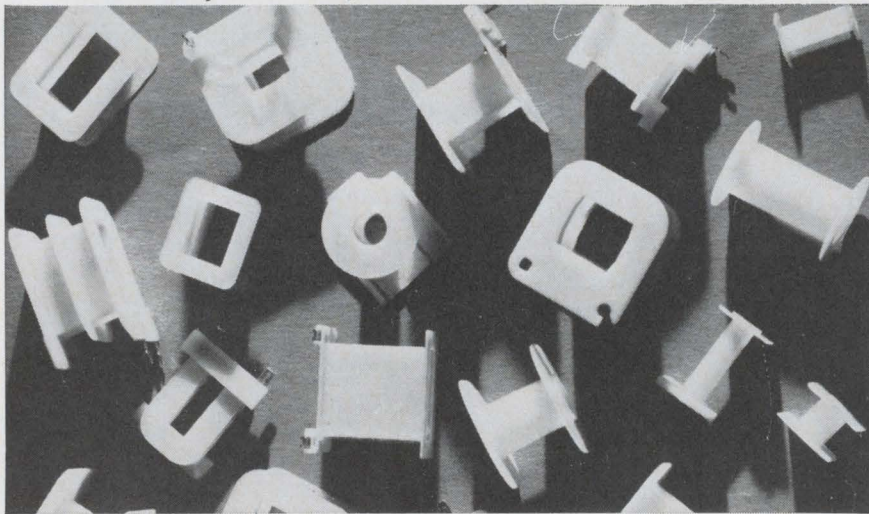

NYLAFIL® molded coil bobbins stay in shape!

Amerline Corporation, Chicago, produces a complete range of stock and custom injection molded coil bobbins for motors, relays, solenoids, transformers, etc. They say, "Our reasons for selecting Fiberfil's NYLAFIL (fiberglass reinforced nylon) in these applications are:

1. Better dimensional stability and better moisture characteristics than the unreinforced material.

2. Better rigidity which prevents the bobbin from distorting during and after the coil winding operation.

3. Increased resistance to heat, especially for soldering."

When you want high physicals not available in an unreinforced thermoplastic, specify Fiberfil FRTP... "reinforced insurance for all injection molding!" Write for technical data.

FIBERFIL

FIBERFIL, INC.
EVANSVILLE 17, INDIANA

Production Equipment

is expelled through the back of the container.

As the air passes a vent which runs to the front of the tip, suction in the vent draws up solder heated by the tip. The air stream carries the solder to the receptacle.

Two models are available, a 25-watt model for radio and television assemblies and an 18-watt model for smaller work, such as computer modules and hearing aids. There are two types of adaptors, one for use with compressed air from an air line and another for use with a foot pump. Versions for 110, 220 and 240-volt operations are available. Each model costs 84 shillings (about \$11.75).

Antex Ltd., Grosvenor House, Croyden, Surrey, England. [452]

Power supply welds through insulation

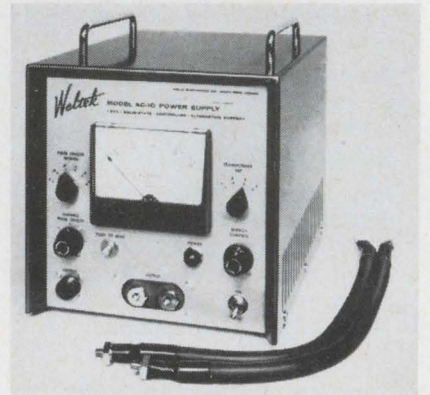

An a-c power supply now available—the AC-10—is capable of welding through the insulation on small wires or soldering all the leads of a flatpack in one operation. It can put out more than 1,000 amperes with an unlimited duty cycle. Discharge times range from 0.1 to 3 seconds; other discharge times are available by changing a simple plug-in circuit module. The output transformer is provided with a convenient tap switch to allow for a wide range of output impedances. The power supply measures 10 in. by 10 3/8 in. by 12 15/16 in. It is usable with practically any welding, bonding, or soldering head, on an adequately rated 110 v, 60 cycle line.

The company provides, without charge, a sampling service to show the manufacturers of miniature motors, coils, solenoids, and memory boards, how to use the new power supply to bond class A or class B insulated magnet wire without stripping it. The time saved by using the new technique is said to be substantial.

Model AC-10 is priced at \$650. Matching welding or soldering heads range from \$220 to \$725. Delivery time is three to four weeks.

Weltek, a division of Wells Electronics, Inc., 1701 S. Main St., South Bend, Ind., 46623. [453]

Hand tool strips shields

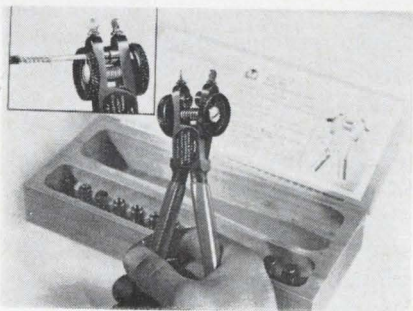

The WT-700 hand tool is designed for stripping the braid on shielded or coaxial conductors neatly and quickly. It is simple and convenient to use and will not nick or damage conductor insulation.

Coaxial or shielded conductors with braid diameters ranging from 0.053 in. to 0.202 in. can be stripped with this tool. Individual die sets to cover any specific shield size may be obtained as needed to accommodate immediate requirements.

To use the WT-700 stripping tool, the shield is inserted into the male die side of the tool. The die set used is a function of the outer diameter of the shielding and is installed in the tool by means of wing nuts on the jaws of the tool. The knurled holding disk is rotated to secure the shield and the tool is opened to expose a short length of shielding. The opposite holding disk is then secured and the tool closed, cutting and stripping the shield.

The Thomas & Betts Co., 36 Butler St., Elizabeth 1, N.J. [454]

Circle 153 on reader service card →



Taber Teledyne® Amplifier built into Polaris fire control by G.E.

Developed by the Navy and General Electric, Mk 84 Fire Control Systems receive, interpret and transmit essential position, flight and target data for rapid-rate firing of Polaris missiles in ranges up to 2500 nautical miles. Shown above is the supervisor's console aboard the U.S.S. Lafayette from which the entire operation of the Mk 84 System is monitored and controlled.

Serving as a pre-amp in an electro-mechanical resolver servo, Taber TELEDYNE® Model 214-12 Solid State Amplifier is part of the inductosyn servo used by the Fire Control System in fine alignment of the inertial guidance platform.

Often selected to meet stringent operational and maintenance standards in applications such as these, Taber Amplifiers are reliable under extremes of temperature and vibration. Available to meet a wide range of AC and DC amplification requirements, they can be combined with Taber TELEDYNE Strain Gage Transducers to provide high level pressure sensing packages. They can also be used for signal conditioning in conjunction with many other sensing devices.

For detailed information, write: Aerospace Electronics Division, Taber Instrument Corp., Section 851, 107 Goundry St., N. Tonawanda, N. Y.



If you're starting from scratch this way...

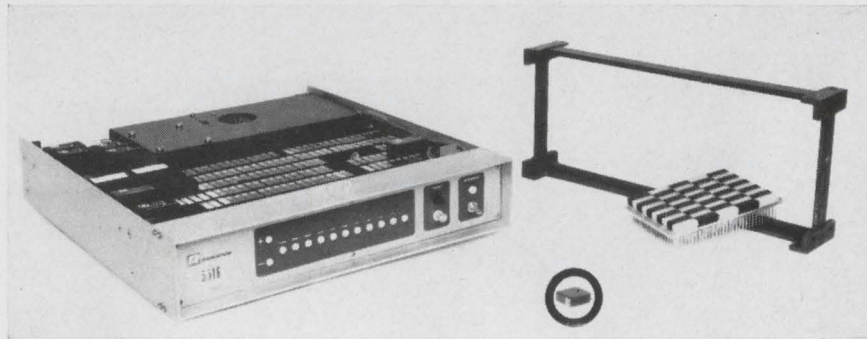
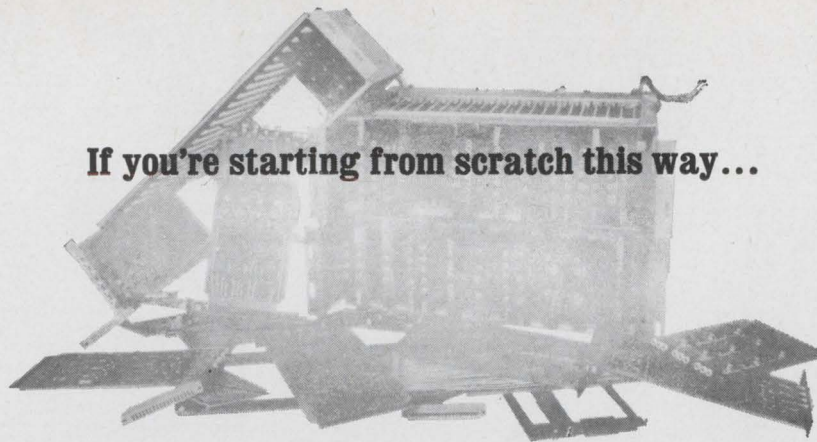

Check the advantages of Radiation's pre-engineered packaging and plug-in modules

- Packaging density compares with integrated circuits
- Cold solder joints and complex wiring eliminated—all components are welded and interconnections made by manual or automatic wirewrap
- Spare parts and logistics reduced *drastically*
- Circuits are individually encapsu-

lated plug-in units, 0.4"x1"x1.1"

- High reliability—up to 5,330,000 hours MTBF

CUT COST on both logic circuits and mounting hardware. For example, a 1 Mc 4-input NOR is priced at \$5.00. Hardware for mounting 400 NOR's is only \$370.00. For more specification data or price information write:

See our complete line of data processing building blocks and communications maintenance/operation equipment at WESCON, Booths 2207-2208 and ISA Instrument-Automation Conference Booth 2014.

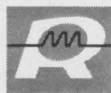

**RADIATION
INCORPORATED**

Products Division • Dept. EL-08 • P.O. Box 220 • Melbourne, Florida • Ph. (305) 727-3711
Circle 154 on reader service card

To order reprints: Fill in, cut out coupon below, insert in envelope and mail to: **Electronics Reprint Dept., 330 W. 42nd Street, New York, N.Y. 10036**

Reprint order form

For listing of reprints available see the Reader Service Card.

Unijunction Transistors

Send me reprints of Key no. R-74 at 50¢ each.

For reprints of previous special reports fill in below:

Send me reprints of Key No.(s) @ ¢ each.

(For prices, see Reader Service Card)

Name

Number of street

City, State, Zip code

New Books

Solid state

Silicon Semiconductor Technology
W.R. Runyan, McGraw-Hill Book Co.
277 pp. \$16.50

This book covers all aspects of silicon semiconductor technology except for surface behavior, which the author considers beyond the scope of the book.

It is the third volume in an engineering series by staff members of Texas Instruments Incorporated. The others are Transistor Circuit Design, 1963, and Field Effect Transistors, 1965. But unlike the other two, which emphasize circuit applications, this volume discusses physical properties and manufacturing processes.

Since silicon technology is primarily responsible for the development of integrated circuits, the need for ready access to information concerning this technology is obvious. Runyan's book answers this need in two ways.

First, it provides a comprehensive discussion of the key areas: silicon manufacturing, silicon casting, crystal growth and orientation, doping procedures, physical properties, and metallurgy. Second, each chapter is extensively referenced for further research by the reader. For example, the chapter on crystal growth contains 112 references. In addition, the book's compilation of key physical and chemical data should prove invaluable to physicists and engineers working in this area.

Runyan thoroughly explores the topic of diffusion, pointing out that diffusion process has two basic requirements: a method of heating the slices and a source for impurity. Various diffusion processes that meet these requirements are discussed in detail. Both closed-tube and open-tube approaches to diffusion are covered.

In describing silicon structure, an analysis of gross crystallographic defects is given, and the orienting of silicon crystals by X-ray is explained. One interesting photograph shows a defect in a silicon epitaxial layer magnified approximately 700 times. Runyan also mentions various techniques for

close control of diffusion during the growth of epitaxial layers.

The optical properties of semiconductor material are discussed in depth. The use of optoelectronic phenomena in integrated circuits, although quite new, appears to have one important advantage: excellent isolation. For example, an optoelectronic integrated circuit can prevent the transfer of noise in coupling subsystems [Electronics, July 26, 1965, p. 52], and this timely discussion of semiconductor photoconductivity will prove useful.

The impressive list of references—nearly 600 authors are given in the index—attests to the author's diligence in his search for source material. The index simplifies the search for references by giving both the page on which a reference appears and the reference number.

Recently published

Electromagnetic Field Theory, R.D. Stuart, Addison-Wesley Publishing Co., 214 pp., \$8.95

Time-Domain Analysis and Design of Control Systems, R.C. Dorf, Addison-Wesley Publishing Co., 194 pp., \$8.95

Probability, Random Variables, and Stochastic Processes, A. Papoulis, McGraw-Hill Book Co., 583 pp., \$12.75

Progress in Radio Science 1960-1963, Volume II: Radio and Troposphere, Francois du Castel, American Elsevier Publishing Co., 291 pp., \$16

Introduction to Electron Tubes and Semiconductors, C. Alvarez and David E. Fleckles, McGraw-Hill Book Co., 294 pp., \$6.95

Electronic Information Handling, Edited by A. Kent and Orrin E. Taulbee, Macmillan and Co., Ltd., 364 pp., \$11

Electronic Instruments and Measurements, P.B. Zbar, McGraw-Hill Book Co., 106 pp., \$3.95

International Telemetry Conference Proceedings 1965, Washington, D.C., Volume 1, International Foundation for Telemetry, 802 pp., \$20

Electrical Machines, J. Hindmarsh, Pergamon Press Inc., 523 pp., \$4.90

Physical Networks, R.S. Sanford, Prentice-Hall, Inc., 576 pp., \$17.25

Quantum Electronics and Coherent Light, C.H. Townes and P.A. Miles, editors, Proceedings of the International School of Physics, Aug. 19-31, 1963, Italy, Academic Press Inc., 371 pp., \$16

Microwave Tubes, Proceedings of the 5th International Conference on Microwave Tubes, Sept. 14-18, 1964, Paris, Academic Press Inc., 528 pp., \$50.

E NOW AVAILABLE!! A complete series of switching matrices for analog or digital switching up to 5 mc., and coax or twinax video switching up to 60 mc. The matrices allow any input or series of inputs to be connected to any output or multiple of outputs. They are available in 1 by 2 up to 20 by 20 crosspoint versions. Also available are multiple pole (up to 25 points) single and multiple throw coaxial switches. Switching control can be accomplished by a remote control panel, pre-programmed punched card or tape, or computer control for automatic checkout applications.

COAXIAL SWITCHING MATRICES

(remote controlled pre-programmable matrices and switches)

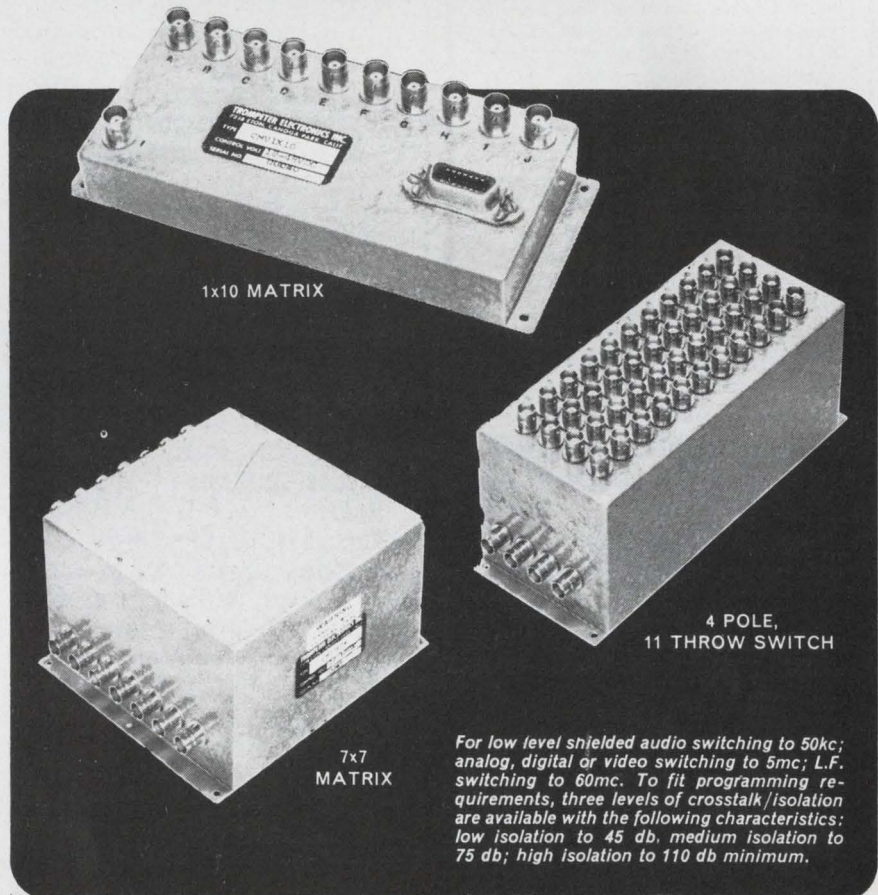

1x10 MATRIX

7x7 MATRIX

4 POLE, 11 THROW SWITCH

For low level shielded audio switching to 50kc; analog, digital or video switching to 5mc; L.F. switching to 60mc. To fit programming requirements, three levels of crosstalk/isolation are available with the following characteristics: low isolation to 45 db, medium isolation to 75 db; high isolation to 110 db minimum.

TROMPETER ELECTRONICS

8936 Comanche Ave., ■ Chatsworth, Calif. 91311 ■ (213) 882-1020

Physicists and Electrical Engineers
for research into

NEW COMPONENT PART CONCEPTS

Unusual opportunities now exist in the field of component development and performance analysis, due to a conceptual approach developed by our Research and Development Laboratories. These positions demand the ability to perform laboratory evaluation on existing components and prepare a critical analysis of their performance. Where the state of the art is a limiting factor, new approaches must be proposed and development work initiated to provide the required component performance.

In the process of developing new approaches to the solution of component problems, papers must be prepared which will be used as the basis for proposals.

Well equipped laboratories are provided in which the applicant can employ the latest techniques in development and instrumentation to assist in the exploitation of his ideas.

Qualifications should include at least a BS degree from an accredited university in Physics or Electrical Engineering. In addition, the applicant must be able to demonstrate 5 to 10 years of progressive creative experience through issued patents or publications in technical journals.

Please airmail your resume to:

MR. ROBERT A. MARTIN
Head of Employment
Hughes Aerospace Divisions
11940 W. Jefferson Blvd.
Culver City 59, California

Creating a new world with electronics

HUGHES

HUGHES AIRCRAFT COMPANY
AEROSPACE DIVISIONS

An equal opportunity employer.

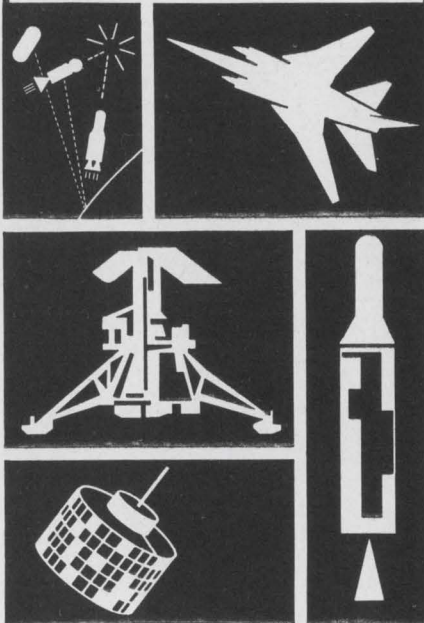

Technical Abstracts

Harmonic sampling

Chromatron tv color processing
using semiconductor circuits
Larry Blaser, Derek Bray
Fairchild Semiconductor,
Mountain View, Calif.

A transistorized version of the one-gun Chromatron color tv receiver has been built using harmonic sampling for its color decoding rather than the more common chroma-gate decoding. Harmonic sampling has the advantage of better color purity, though alignment is easier and circuitry simpler with chroma-gate.

In both systems, a 3.6 Mc sine wave voltage is applied across the color switching grid near the face of the tube so that electrons hit the red, blue and green phosphors in the sequence R-G-R-B-R-G-R-B. . . . In chroma-gate decoding demodulation takes place along the R-Y, B-Y and G-Y axis. These signals are added to Y (luminance) in the cathode in the sequence corresponding to the color grid switching so that R, G and B information reaches the appropriate phosphor.

In harmonic sampling, demodulation takes place at fundamental, second, and fourth harmonics of the 3.6 Mc chroma signal along the axes chosen so that R, G and B information appears at the cathode in the appropriate sequence without gating.

Since dwell time on the red phosphor is half that of the blue and green, the color switching sequence, in terms of equal time increments, is R-G-G-R-B-B-R-G-G. This may be thought of as three periodic square waves—one for each color. A Fourier analysis of these waves gives an expression for each color in terms of harmonics of the subcarrier. Adding these expressions together and solving for the separate harmonic terms (up to the fourth) in terms of R-Y and B-Y coordinates give the required demodulation axes and gains.

The color receiver has a demodulator for each harmonic, which operates on the prescribed axis. The cathode of the tube is fed with the sum of the demodulator outputs. Gating is not needed to synchronize the sequence of color in-

formation from the demodulators with the color switching grid.

Presented at the 1965 Spring Conference
on Broadcast and Television Receivers,
Chicago, Ill., June 14.

Compatible DTL's

High Speed Integrated Monolithic
Thin-Film Compatible Diode
Transistor Logic Circuits
N. Fuschillo, J. Kroboth, T. Pardue
Melpar Inc., Falls Church, Va.

In large commercial machines, such as scientific computers, the information cost per dollar is approximately proportional to the half power of the clock speed of the machine. Therefore, there is a strong economic incentive to develop computers with as high a clock rate as possible. In this paper the author describes monolithic diode-transistor-logic circuits made with compatible thin film technology. They are especially suitable for achieving a high speed, low power system of integrated circuit logic, and have the added advantage of increased reliability.

The compatible technology combines the best features of pure monolithic technology with those of the pure thin-film approach. Photolithographically processed thin-film resistors and capacitors are used for both passive components and interconnections. This produces a system with low parasitic capacitances and a wide range of capacitor and resistor values.

In the DTL logic system, the basic repeating structure is the single NAND gate, and most other DTL logic functions can be derived from it. Dual, tri and quad-NAND gates are simple repetitions of the single-NAND gate. An RS flip-flop is made by interconnecting two single-NAND gates; and a binary counter can be made by interconnecting six single-NAND gates. Topologically, the DTL layout is based on a master die approach. Such a die could have 19 components; and the various circuits, dual-NAND, RS flip-flops, and others, are simply made by changing the interconnection mask.

Presented at the 1965 Aerospace Technical
Conference and Exhibit, Houston, Tex.,
June 21-24.

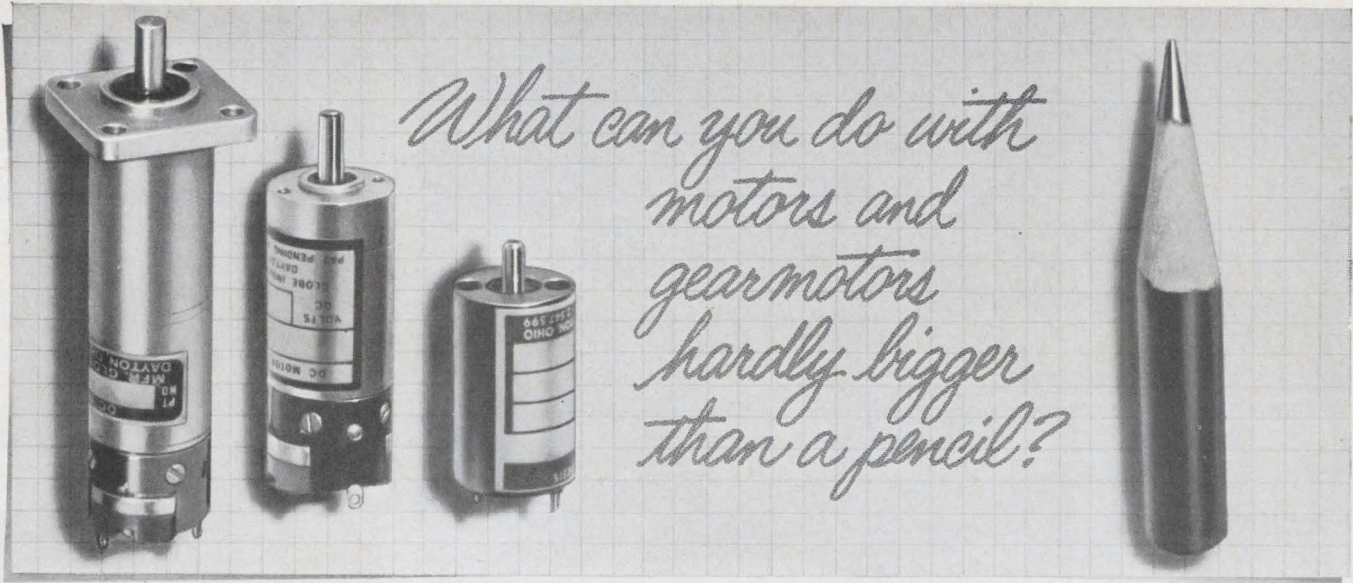

You can figure on designing more compact products. As a matter of fact Globe has developed 2 new MIL spec motors—one for a.c. called Type CC, and one for d.c. named VT. Both motors are only 5/8" in diameter, weigh 1 1/2 ounces. Type VT uses a system of planetary gearing that multiplies torque up to 50 oz. in.

Choices for designers are fantastic; we have 83 standard gear ratios. Type VT can be wound for any voltage up to 50 v.d.c., and we can furnish them with speed governors. Type CC is a hysteresis synchronous motor. And if you need a smaller or larger power unit, come to the can-do manufacturer. Request Bn. 58.

TYPE VT—Produces .0025 HP in the 8,000 to 17,000 rpm range. Size: 5/8" x 1 3/8" long. 1.48 oz. To 50 v.d.c. Planetary gearing in 83 ratios.

TYPE CC—Produces .07 oz. in. max. sync. torque. Size: 5/8" x 1 3/16" long. 1.5 oz. 26 v.a.c. (115 v.a.c. with series capacitor), 2 or 4 poles, 400 cycles.



Booth 2717 WESCON

Globe Industries, Inc., 2275 Stanley Avenue
Dayton, Ohio 45404, U.S.A., Tel.: 513 222-3741

Circle 208 on reader service card

Reprint order form

Send to: **Electronics Reprint Dept.**
330 West 42nd Street
New York, N. Y. 10036

For listing of reprints available see the reader service card.

To help expedite mailing of your reprints please send cash, check or money order with your order.

For reprints of the latest special report:

**Automated Trains:
Whose on the right track?**

Send me reprints of key no R-76 at 50¢ each.

For reprints of previous special reports fill in below:

Send me reprints of key no.(s) at ¢ each.

For prices see the reader service card.

Name

Number & Street

City, State

Zip code

KIT OR ASSEMBLED!

World's Best Values In Electronic Instruments...HEATHKIT®

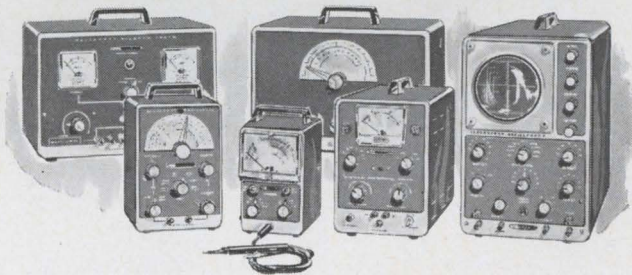

- | | | |
|--|---|---|
| 5" Lab Oscilloscope
Kit IO-12, 24 lbs. . . \$ 76.95
Assembled IOW-12 \$126.95 | VTVM
Kit IM-11, 5 lbs. . . . \$24.95
Assembled IMW-11 \$39.95 | Audio Generator
Kit IG-72, 8 lbs. . . . \$41.95
Assembled IGW-72 . . \$64.95 |
| Laboratory AC VTVM
Kit IM-21, 5 lbs. . . . \$33.95
Assembled IMW-21 \$52.95 | "Service Bench" VTVM
Kit IM-13, 7 lbs. . . . \$32.95
Assembled IMW-13 \$49.95 | "Solid-State" Regulated DC Power Supply
Kit IP-20, 13 lbs. . . \$ 72.95
Assembled IPW-20 \$114.95 |
| RF Signal Generator
Kit IG-102, 6 lbs. . . . \$27.95
Assembled IGW-102 \$54.95 | Variable-Voltage Regulated Power Supply
Kit IP-32, 17 lbs. . . \$56.95
Assembled IPW-32 . \$84.95 | Battery Eliminator
Kit IP-12, 18 lbs. . . . \$47.50
Assembled IPW-12 . \$59.95 |
| Condenser Checker
Kit IT-11, 7 lbs. . . . \$29.95
Assembled ITW-11 . \$49.95 | | |

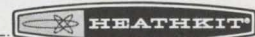

HEATH COMPANY, Dept. 67-8 Benton Harbor, Michigan 49023

In Canada: Daystrom Ltd., Cooksville, Ontario

Please send my FREE Heathkit Catalog.

Enclosed is \$_____ plus shipping. Please send model(s)_____

Name _____

Address _____

City _____ State _____ Zip _____

Prices & specifications subject to change without notice.

TE-138



Engineering career opportunities

**Tie your career
to the world's
most advanced
radar/sonar
systems...
at G.E.!**

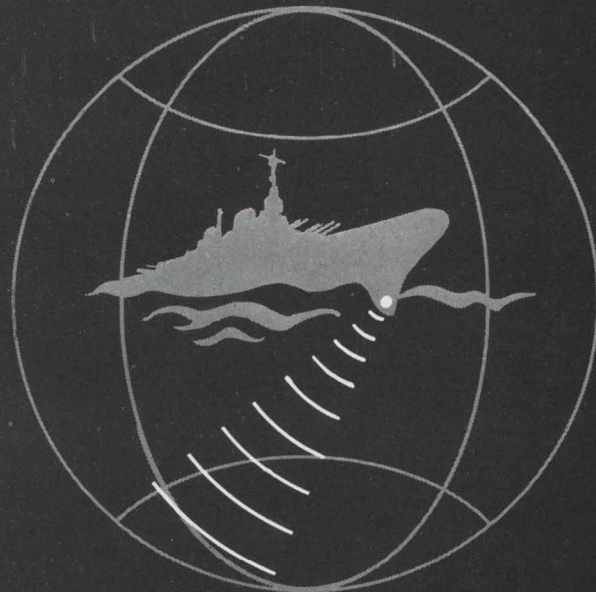
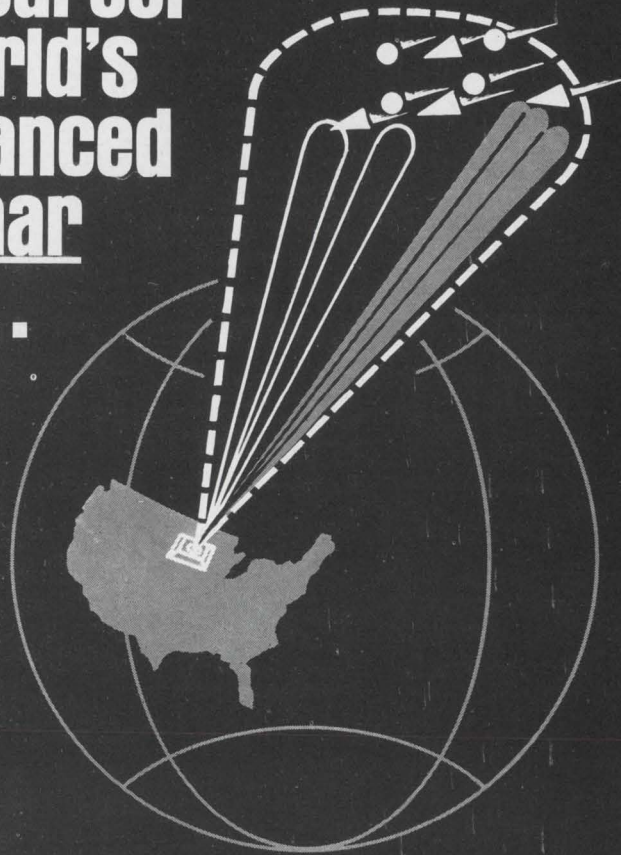

**Investigate your career now
in missile-defense radar; ad-
vanced sonar engineering at
General Electric.**

G.E.'s Heavy Military Electronics Dept.—whose capabilities include the design, development and fabrication of the world's largest and most advanced ASW and radar systems—announces long-term career openings for continuing contributions to large military contracts.

HMED offers you stability oased on its broad capability for handling large programs and the experience that goes with front-rank performance on this decade's most advanced projects. Your growth is tied to that of a lean, highly professional engineering group backed by top-flight facilities—both within HMED and throughout General Electric.

At G.E., you'll be treated as a professional who's expected to handle well-defined, delegated responsibility. In most instances you'll deal directly with your customer's organization.

You will be given every opportunity to develop yourself professionally through continuing Company-taught courses and advanced tuition-paid study at nearby Syracuse University. And, in the course of your work, you'll have access to information developed by other G.E. facilities throughout the country.

WHY NOT MATCH YOUR EXPERIENCE AND CAREER DESIRES AGAINST THESE REQUIREMENTS?

SONAR: Advanced Sonar Engineers; Array Beamformer and Signal Processing Development Engineers; Digital Logic Engineers; Sonar Solid-state Circuit Design; Transducer Development; Solid-state Transmitter Development; Pattern Recognition Analysis; Adaptive Filtering Research; Display Development; Propagation Analysis; Sonar Subsystem Development.

RADAR: Monitor and Control Analysis Engineers; Digital Control Eqpt. Engineers; Microwave Component Design Engineers; Consultant, Circuit Design and Development; Instrumentation Circuit Engineers; ME's for Signal Processing Modules; Consultant, Array Radar Subsystem Requirements.

INVESTIGATE NOW! For full information, send a resume of your experience in confidence to J. L. Wool, Professional Placement, Heavy Military Electronics Dept., Section 107, General Electric Co., Court St., Syracuse, New York.

177-65

An Equal Opportunity Employer

GENERAL  ELECTRIC

living space

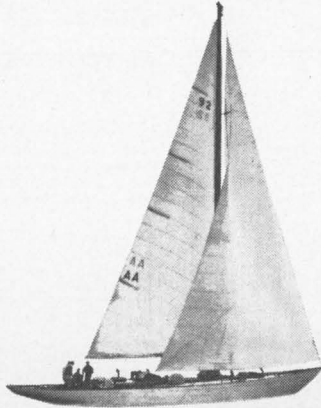

... One of the pleasures of working at Grumman is living on Long Island. Here Grumman engineers are surrounded by 43 golf courses within a ten mile radius. Five beautiful public courses are in Bethpage — two minutes from the plant. White sand beaches stretch for miles along the Atlantic. (12 minute drive). The famed sailing reaches of Long Island Sound are only eleven miles away. Yet, homes in this fine section of Long Island are priced well below the national average!

So much for living space — now for outer ... Grumman, readying the LEM (Lunar Excursion Module) for its historic landing on the moon in the late sixties, is seeking the services of talented engineers and scientists to help speed the launching date. Supersonic aircraft of a revolutionary character compound the challenge. If you're qualified, why not explore immediate openings listed in the space below.

Aircraft Navigations Systems Engineers—BSEE with a major in control theory and 3-8 years experience with small analog computers, inertial sensors and solid-state circuit design. Knowledge of aircraft navigation systems, required; capable of designing small analog computer and investigating total navigation system problems.

Inertial Navigation Systems Engineers—BSEE (MSEE preferred) with major in control theory and 3-8 years experience in the design & development of navigation systems hardware. Should be capable of directing major systems redesign program. Circuit design experience desirable but not essential.

Vendor Liaison Engineers—Space Guidance & Control Systems—BSEE with major in control systems with 3-5 years experience in Guidance and Control, Design and Development. Will conduct technical liaison with vendors to assure compatibility between hardware and specifications, and be responsible for technical interface control.

Senior Illumination Engineers—BS in EE or Physics with a minimum of 10 years experience in Aircraft or Spacecraft Console and Flood Lighting including measurement of lighting parameters.

Microwave Standards Measurements Engineers—PhD or MS in EE, Physics or Electrophysics, with a minimum of 5 years experience in electro magnetic-electronic instrumentation & measurements. Strong theoretical background is required. Will be part of Measurements Science team in establishing state-of-the-art Microwave Standards Measurements & Consultation Services.

Measurements Science Engineers—BS in EE or Physics, experienced in electrical-electronics or microwave standards Measurements & Instrumentation. Duties will include technical adequacy of Measurements techniques & procedures, & measurements advisory consultants.

R&D Electronic Flight Test Engineers—B.S. in E.E. or Physics plus test experience in Electronic Airborne Systems including Radar, computer, navigation & guidance, stabilization & control & communications equipments for application to space programs.

Guidance & Control Integration Engineers—BS or advanced degree with experience in design, analysis and integration of vehicle guidance & control systems. Applicants should possess a working knowledge of both analog & digital feedback system & design techniques. System test or hardware design experience desirable. Position entails conceptual work in defining guidance & control systems, establishing subsystem and component requirements, system development and verification.

Guidance Dynamicists—BS or MS in AE, EE, or Applied Mechanics with a minimum of 2 years experience in the analysis of guidance systems for spacecraft. To analyze and evaluate functional configurations and dynamic systems composed of radar, IR, optical and inertial guidance loops; signal processing and error analysis. Background in sampled data & nonlinear controls systems.

Control Dynamicists—BS or MS in AE, EE or ME with a minimum of 2 years experience in analysis of control systems. Will evaluate automatic flight control system requirements and performance. Familiarity with nonlinear techniques, digital control techniques and adaptive control techniques is desirable.

Space Dynamicists—BS or MS in Physics, Aerospace Engineering, Applied Math or Applied Mechanics, with a minimum of 2 years experience in the analysis of flight dynamics. Experience in space dynamics, e.g. disturbance torques, orbital mechanics, lunar trajectory analysis, and separation system dynamics is desirable.

(Additional opportunities in space as well as aircraft & ASW programs, on following page)



GRUMMAN
AIRCRAFT ENGINEERING CORPORATION
Bethpage • Long Island • New York
An Equal Opportunity Employer

(Continued from previous page)

Aerospace Value Engineers—B.S. in Engineering or equivalent technical ability with experience in one or more of the following: Value Engineering, aircraft design, electronics design.

Programmer-Analysts—2 years experience in test data reduction programming, using large scientific Programmer. Experience with FORTRAN & machine language on either the IBM 7090 or CDC 3000 series computers essential.

Data Engineers—B.S. degree with a minimum of 2 years experience in test data reduction, planning for digital computations, semi-automatic data reduction systems & data reduction stations. Data Engineers will be assigned primarily to Field Test Sites at Houston, Texas, & Cape Kennedy, Fla.

Ground Station Systems Engineers—B.S. degree with 2-3 years experience in an operational telemetry data reduction ground station. Experience should include the use of magnetic tape recorders & playback equipment; FM/FM discriminator; PCM, PDM & PAM Decoms; Oscilligraph & Pen recorders; analog to digital converters & familiarity with digital computer technology.

Flight Operations—BSEE with experience in telemeter and magnetic tape. Assignments involve interesting work with airborne analog & digital data acquisition systems & their use in flight testing.

Instrumentation Applications — BS in ME, EE or Physics with 4 years experience in instrumentation measurement problems. A good theoretical and practical knowledge of transducers, their specifications and application to measurement of temperature, pressure, flow, acceleration, rate, force, is required.

ASW Research Scientists—M.S. or Ph.D. in Math, Electronics or Physics to carry out original research in signal processing, infrared wake detection, ocean reverberation, underwater acoustics, and advanced detection techniques. A well equipped ASW Research Laboratory is available for experimental work. Opportunities are excellent for applicants with initiative and imagination.

ASW Electronics Systems Engineers—B.S. or M.S. degree with a minimum of 2 years appropriate experience. Duties will include conceptual design and sub-system performance analysis, including trade-off studies, for: sonar, radar, ECM, MAD, IR, sensory and signal processing equipments; aircraft navigation systems; tactical communication systems; integrated data processing, display and control systems.

EMC Systems Engineers—With ability to perform system analysis, state-of-the-art reviews, and develop advanced EMC techniques. Will be responsible for generating design data; control plans, test plans, directing tests, analyzing results, generating fixes, and preparing reports for systems in accordance with MIL-E-6051C. Familiarity with WR-27 and MIL-STD-449 is essential.

Radar Development Engineers — BSEE with a minimum of 4 years experience in the analysis, design and development of airborne radar systems. Should be capable of analyzing the radar system with end view of integrating the equipment into a complex space vehicle system. Will fully participate in laboratory and flight development program conducted in the finest facilities available in a professional atmosphere.

Electronic Component Parts Engineers—BSEE preferred plus experience in electronic component part evaluation & applications of semi-conductor devices & other electronic components. Responsibilities will include, part selection, determination of part reliability requirements, establishing derating & establishing test & procurement specifications.

ASW Reliability Engineers—B.S. or M.S. & a minimum of 2 years appropriate experience including systems prospectus & an understanding of mission requirements. Some design background is desired. Responsibilities include: Developing system models, defining mission objectives, performing reliability & maintainability trade-offs & hardware evaluation. Working knowledge of applied statistics, probability & the methods of operations research is essential.

Senior Programmer—Three to five years programming experience on general purpose equipment with an applications background in the scientific fields of systems simulation, real time programming, math, modeling, systems analysis and differential equations. BS in science, Mathematics or Physics as a minimum. Desirability for a strong engineering orientation in systems analysis. Complete programming knowledge of the IBM 7094 including FORTRAN, and FAP languages.

Programming Analysts—Over 5 years experience in programming scientific problems on general purpose and special purpose computers. Competency in real time system programming, problem forming, mathematical modeling, assemblies, compilers, executive control routines, and simulation techniques. BS or MS in Science, Mathematics or Physics, Systems engineering orientation and space project background most desirable. IBM 7094 experience in depth.

NOTE: Positions also available in the above areas to February or June '65 Engineering Graduates

Use the attached inquiry form to arrange a mutually convenient interview.



GRUMMAN
AIRCRAFT ENGINEERING CORPORATION
Bethpage • Long Island • New York
An Equal Opportunity Employer

PROFESSIONAL PLACEMENT INQUIRY

For your convenience and to facilitate your inquiry, please use this form. It will enable the professional staff at Grumman Aircraft to evaluate your background and experience and arrange for a mutually convenient personal interview. All inquiries will be held in strictest confidence. Enclose in an envelope and send to Mr. P. W. Van Putten, Manager, Engineering Employment, Dept. GR 25, Grumman Aircraft Engineering Corp., Bethpage, L.I., N.Y.

Background and experience (Brief resume of experience, recent history of employment. If available, attach prepared resume.)

NAME _____

STREET ADDRESS _____

CITY & STATE _____ TELEPHONE _____

NEAREST MAJOR CITY (IF APPLICABLE) _____

COLLEGE GRADUATE: YES ___ NO ___ Degree Subject Year

Major Specialty _____ Yrs. _____ Other Specialty _____ Yrs. _____

Applying for position(in)(of) _____

Blank lines for entering background and experience information.

ambitious?

go where
the GROWTH is!

10 Fold . . . in 10 Years

Texas Instruments Incorporated has grown from a company of 2293 people in 1954 to more than 28,000 today. Continuing increase in TI's professional employment (25% for the past five years) provides outstanding opportunities for career development in such areas as

Multilayer Circuit Board Process Engineer

The person qualifying for this position will be responsible for process optimization and the evaluation of new production techniques and materials in the manufacture of highly sophisticated multilayer circuit boards. Requires BS in ME, EE or CHE, plus 2 to 5 years experience in printed circuit board manufacture.

Salary commensurate with experience. Excellent benefit program including profit sharing. Outstanding advancement opportunities.

Please send confidential resume to Shelly Leva, Dept. C-179.

MATERIALS & CONTROLS DIVISION

**TEXAS INSTRUMENTS
INCORPORATED**

P. O. BOX 5474 • DALLAS, TEXAS 75222

An Equal Opportunity Employer

INSTRUMENT TECHNICIANS

THE OAK RIDGE NATIONAL LABORATORY

Highly skilled instrument technicians to assist in the installation and maintenance of process control instrumentation systems and devices for chemical pilot plants, nuclear reactors and other large experimental installations.

High school education, plus additional training in either the physical sciences, instrumentation, or electronics, and at least 4 years experience in installation and maintenance of complex instrumentation and control systems. Entrance rate \$3.39 per hour; \$3.45 per hour after six months. Reasonable interview and relocation expenses paid by Company.

Excellent Working Conditions
and
Employee Benefit Plans

An Equal Opportunity Employer

Send detailed resume to:

Central Employment Office

**UNION CARBIDE
CORPORATION**

Nuclear Division
P. O. Box M

Oak Ridge, Tennessee 37831



POSITION VACANT

Electronics Engineer for design of air traffic communication and navigation aid systems. Must be qualified for planning, design, and specifications. P-7117, Electronics.

PROFESSIONAL SERVICES

GIBBS & HILL, Inc.

Consulting Engineers

Systems Engineering

Operations Research • Development

Field Studies • Design • Procurement

Power • Transportation • Communications

Water Supply • Waste Treatment

393 Seventh Avenue

New York 1, N. Y.

data squeeze

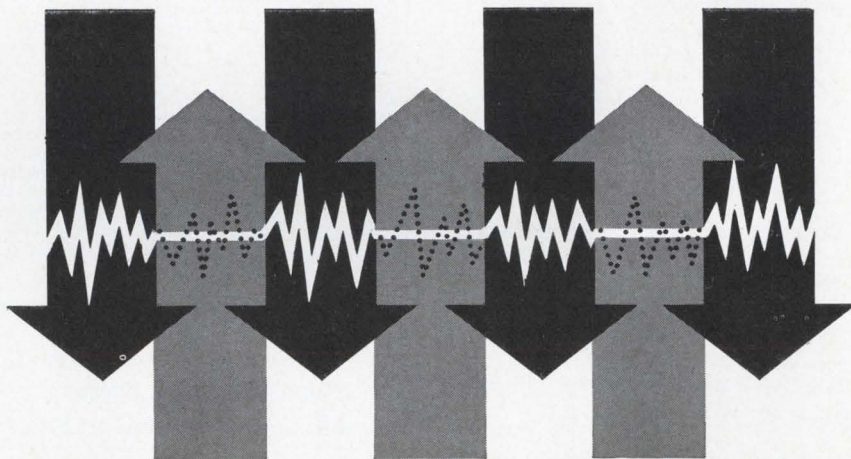

compacting data to increase the transmission capability of the Eastern Test Range

To meet the future demands of range users for transmission of large amounts of trajectory, telemetry, bioastronautic, and color television data from space vehicle to central control at the Cape, Pan Am engineers are studying various compaction techniques that may permit essential information received at the rate of over 1.5 million bits per second to be transmitted over existing narrow-band channels with a 3000 bit/sec capacity.

The feasibility of some 20 compaction methods are being analyzed, including combinations of data adaption, pulse compression, multiplexing, etc. Models are being set up using simulated and real data to determine the necessary trade-offs on compaction vs accuracy. Graduate engineers who can contribute to this effort and to the development of other systems for data processing and real-time computing, digital data transmission, range safety display, target acquisition, and analog-digital conversion are invited to write in confidence to Manager, Professional Employment, Dept. 24H-4.



GUIDED MISSILES RANGE DIVISION

PAN AMERICAN WORLD AIRWAYS, INC.
750 S. ORLANDO AVENUE, COCOA BEACH, FLORIDA
An Equal Opportunity Employer

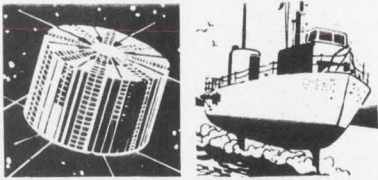

HIGH SPEED Communications & Computer Engineers

BuShips headquarters has a few select openings for engineers capable of directing programs in advanced military communications, computer, command & control systems development. While these are not test-bench jobs, it is important that you have the engineering background to handle any number of broad-gauge assignments... anything from the RDT&E of equipments to the installation and maintenance of operating systems in the following categories:

Submarine & Satellite Antennas • Transmitters & Receivers • Terminal & Security Equipment

(bandwidth compression, modulation techniques, speech processing, pattern recognition, message & line switching, multiplexing, telemetry, facsimile, time & frequency division, crypto devices, etc.)

Data Transmission Systems

(command & control subsystems, high capacity tactical communications, automatic machine language communications, etc.)

Shipboard Command & Control Systems

(systems design, integration, and shipboard installation)

Since many of these projects relate to the entire national military and security picture, you will be expected to coordinate with other Navy and DOD activities... at all levels and locations... as well as with NASA. These are solid opportunities in the \$10,250 to \$15,000 starting range (plus regular increases and full Career Civil Service benefits), with interesting possibilities for the right sort of people.

If you have appropriate education and proven experience, send professional qualifications (or SF-57) to: Mr. W. N. Vaillancourt, Code 263R-23

Bureau of Ships
Main Navy Bldg., Room 2422
Washington, D.C., 20360
An Equal Opportunity Employer

APPLICATIONS ENGINEER

To perform applications analysis of customer systems and to establish the design of hybrid integrated circuitry. Require B.S.E.E. and experience in circuit and systems analysis.

CIRCUIT DESIGNER

Analysis and design of hybrid integrated circuitry and associated systems; determine packaging feasibility and testing methods. Desire graduate E.E. with four or more years of circuit design experience.

DEVICE DESIGNER

To apply theoretical knowledge to develop designs for new electronic passive and active devices. At least M.S.E.E. or M.S. Physics desired with experience in solid state design techniques.

MATERIALS ENGINEER

In advanced development involves process and materials investigation relating to electronic applications. Require M.S. in inorganic or physical chemistry. Some solid state chemistry desirable.

Well defined work objectives provide an excellent opportunity for individual recognition and personal development. Centralab is a leading manufacturer of components for electronic systems; primarily industrial applications. Location is on Milwaukee's north side near desirable living areas. Write in confidence, your background and qualifications to Technical Recruiting.

CENTRALAB

A Division of Globe-Union Inc.

900 East Keefe Avenue
Milwaukee, Wisconsin 53201

(At the WESCON Show, contact Dr. E. M. Baldwin at the Fairmont Motel, 950 Mason Street.)

"An Equal Opportunity Employer"

"Put Yourself in the
Other Fellow's Place"

TO EMPLOYERS TO EMPLOYEES

Letters written offering Employment or applying for same are written with the hope of satisfying a current need. An answer, regardless of whether it is favorable or not, is usually expected.

MR. EMPLOYER, won't you remove the mystery about the status of an employee's application by acknowledging all applicants and not just the promising candidates.

MR. EMPLOYEE you, too, can help by acknowledging applications and job offers. This would encourage more companies to answer position wanted ads in this section.

We make this suggestion in a spirit of helpful cooperation between employers and employees.

This section will be the more useful to all as a result of this consideration.

Classified Advertising Division

McGRAW-HILL, INC.

330 West 42nd St., New York, N. Y. 10036

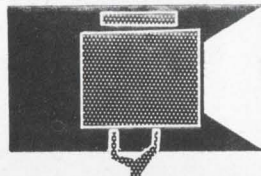

SEARCHLIGHT SECTION

- CLASSIFIED ADVERTISING • BUSINESS OPPORTUNITIES
- USED OR SURPLUS EQUIPMENT

SEMICONDUCTORS MAJOR BRANDS

INTEGRATED CIRCUITS • DiF. AMPS DARLINGTONS • POWER DIODES & TRANSISTORS • SPECIAL DEVICES

Write for Catalog S-1

SEMICONDUCTOR SALES OF CALIF.
1063 Perry Annex Whittier, Calif.
(213) 696-7544

CIRCLE 953 ON READER SERVICE CARD

WRITE FOR NEW KEYSTONE free catalog

We are the leading producers of BATTERY HOLDERS, TERMINALS, TERMINAL BOARDS & ELECTRONIC HARDWARE.

KEYSTONE ELECTRONICS CORP. 49 BLEECKER ST. NEW YORK 12, N. Y.

CIRCLE 952 ON READER SERVICE CARD

Watch—
the Searchlight Section
for
Equipment Opportunities

RADAR AUTO-TRACK & TELEMETRY ANTENNA PEDESTALS 3 & 10 CM. SCR 584 AUTOTRACK RADARS. M-33 RADAR TPS-1D SEARCH. APS-45 TPS-100 HT. FINDERS. WX RADARS. FPN-32GCA. APS-10 APS-15B APS-27 (AMTI) SEARCH. ■ ■ APN-102 DOPPLER. DOZENS MORE CARCINOTRONS. PFN'S. 25-5-1-23 G MEGAWATT PULSE MODULATORS. CAVITIES. PULSE TRANSFORMERS. IF STRIPS. WAVEGUIDE. BENDS 200 MC. 1 KMC. 3 KMC. 6 KMC. 9 KMC. 24 KMC. RF PKGS.

RADIO RESEARCH INSTRUMENT CO.
550 5TH AVE., NEW YORK 36, N. Y. JU 6-4691

CIRCLE 954 ON READER SERVICE CARD

SEARCHLIGHT RATES DISPLAYED

The advertising rate is \$27.25 per inch, for all advertising appearing on other than a contract basis. Contract rates quoted on request.

An advertising inch is measured $\frac{3}{8}$ " vertically on a column—3 columns, 30 inches to a page.

Subject to Agency Commission.

UNDISPLAYED

\$2.70 per line, minimum 3 lines. To figure payment count 5 average words as a line. Box numbers—counts as 1 line.

Position Wanted ads. $\frac{1}{2}$ of above rate.

Discount of 10% if full payment is made in advance for 4 consecutive insertions.

Not Subject to Agency Commission.

Send NEW ADS and Inquiries to Classified Adv. Division of Electronics, P.O. Box 12, N. Y. 36, N. Y.

New Literature

Tiny d-c motor. Globe Industries, Inc., 1784 Stanley Ave., Dayton, Ohio 45404. Bulletin A-1000 contains complete details on the type VF subminiature motor rated at 0.0025 hp in the 8,000 to 17,000 rpm range and available for use at 3 to 50 v d-c.

Circle 461 on reader service card.

Connectors and cables. Gulton Industries, Inc., 212 Durham Ave., Metuchen, N.J. The Glennite C-21 series of miniature multiconductor shielded connectors and cables is described in bulletin A21a. [462]

Telephone-type relays. C.P. Clare & Co., 3101 Pratt Blvd., Chicago, Ill. 60645. Engineering data sheet 552 covers types LB and LBP miniature telephone-type relays. [463]

Microminiature connectors. ITT Cannon Electric, 3208 Humboldt St., Los Angeles, Calif., 90031, offers a pictorial brochure, MMBS-1, illustrating its micro-miniature connector designs. [464]

Microwave tuners. Watkins-Johnson Co., 3333 Hillview Ave., Stanford Industrial Park, Palo Alto, Calif. 94304, has available a technical bulletin on the WJ-195 to WJ-198 family of voltage-controlled microwave tuners. [465]

Remote programing dvm. Dana Laboratories, Inc., Irvine, Calif. Data sheet 464 describes the model 5603 remote programing, 5-digit digital voltmeter with 22-msec reading time. [466]

Random access drum. Bryant Computer Products, 850 Ladd Rd., Walled Lake, Mich. 48088. A 4-page brochure describes the PhD-170 and tells how it offers computer users independent, simultaneous multiple access to the entire information store of over 170 million bits. [467]

Ceramic capacitors. Vitramon, Inc., P.O. Box 544, Bridgeport, Conn. 06601. The complete line of CK05 and CK06 ceramic capacitors is described in two-page data sheet C13. [468]

Pcm decommutator. Telemetrics, Inc., 2830 S. Fairview St., Santa Ana, Calif. Data sheet 348 gives description and specification information on the model 621 single-channel pcm decommutator, which provides economical check-out of pcm telemetry systems and subsystems. [469]

F-m demodulators. General Electronic Laboratories, Inc., Simon and Ledge Sts. Nashua, N.H. Two-page data sheet describes two high-capture, solid state f-m demodulators. [470]

Ferrite toroidal cores. Indiana General Corp., Keasbey, N.J. An engineering data bulletin describes in detail the use of low-loss, high-frequency ferrite toroids in bifilar-coil baluns. [471]

Spectrum analyzers. Tektronix Inc., P.O. Box 500, Beaverton, Ore. 97005. An eight-page illustrated brochure is entitled "Getting Acquainted with Spectrum Analyzers." [472]

Operational amplifiers. Zeltex, Inc., 2350 Willow Pass Rd., Concord, Calif. An eight-page catalog gives specifications for the manufacturer's standard line of operational amplifiers. A custom capability is also described. [473]

Nylon strapping and accessories. Weckesser Co., Inc., 4444 W. Irving Park Rd., Chicago, Ill. 60641. Bulletin 805 contains detailed specifications and physical characteristics on both perforated and nonperforated strapping, as well as Strap-Tite buckles, stud buttons, nylon mounting tabs and mounting cradles [474]

Metal film resistors. Hi-Q division, Aero-vox Corp., Olean, N.Y. A data sheet covers low temperature coefficient, precision metal film resistor types. [475]

Multiplex system. Lenkurt Electric Co., 1105 County Rd., San Carlos, Calif. An eight-page brochure describes the 46A multiplex system, which provides multi-channel service for a wide variety of applications. [476]

Digital data systems. Beckman Instruments, Inc., Berkeley division, 2200 Wright Ave., Richmond, Calif. Bulletin 5B128 discusses capabilities for the manufacture of digital data systems. [477]

Time delay relays. The A.W. Haydon Co., 232 North Elm St., Waterbury, Conn. 06720. Bulletin ESF312 describes electronic time-delay modules featuring factory preset or externally adjustable delays from 0.10 sec to 400 sec. [478]

Microwave equipment. PRD Electronics, Inc., 1200 Prospect Ave., Westbury, N.Y. 11590. A two-page data sheet covers types 130 and 1100 series fixed coaxial attenuators, type 139 series terminations, and type 1203-1213 series of ferrite isolators. [479]

Hybrid junction. Adams-Russell Co., 280 Bear Hill Rd., Waltham, Mass. 02154. A data sheet on a subminiature, high-isolation hybrid that offers excellent phase and amplitude balance from 40 to 400 Mc. [480]

good things
very often come
in small packages

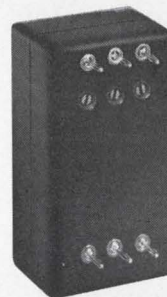

NEW!

multi-channel reed

from S & G Electronics

Here's a printed circuit plug-in module that's no bigger than a pair of dominoes.

S&G Electronics' new Multi-Channel Reed is available for either two or three channel operation. Its extensive frequency range allows over 40 channels of operation. This tiny reed relay module is ideal for portable applications like pocket paging—as well as for telemetry and remote control use. WRITE us now for full details.

multi-channel reed

Another fine product from the leaders in the resonant reed field.



ELECTRONICS

SARGENT & GREENLEAF, Inc.

ROCHESTER, NEW YORK 14621



type 549

STORAGE OSCILLOSCOPE

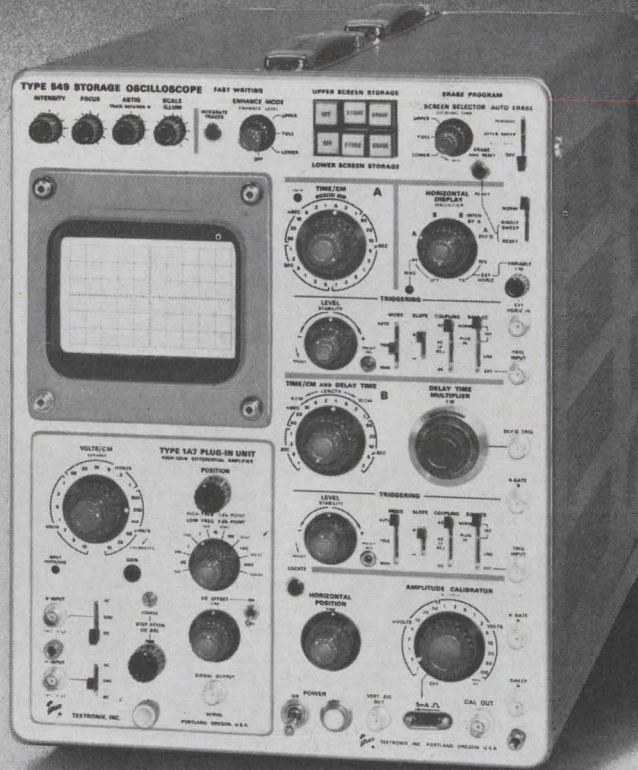

see at
WESCON

New Scope of Versatility

accepts more than 20 plug-in units
for DC-to-30 Mc operation, or for
storage applications

adapts easily to:

- low-level, differential-input applications
- wide-band applications
- sampling applications
- multi-trace applications
- spectrum-analyzer applications
- strain-gage applications

as a storage scope

Enables holding single-shot events, and low duty cycle waveforms, for detailed analysis.

features include:

unparalleled writing speed—up to 5 cm/ μ sec, with enhancement, *split-screen storage*—storage on either upper or lower half of crt (with other half for conventional displays, if desired), *automatic erase feature*—with selectable viewing times from 0.5 seconds to 5 seconds.

Storage feature adds a new dimension to *sampling applications* and *spectrum analysis*—permitting displays not possible with any other oscilloscope.

as a conventional scope

Accepts more than 20 plug-ins—either the Tektronix letter-series units or the newer 1-series units.

features include:

calibrated sweep delay from 1 microsecond to 10 seconds, single sweep, 5X sweep magnifier, and full-passband triggering facilities.

Adaptable and reliable, the Type 549 can handle almost any laboratory application in the DC to 30 Mc range.

Type 549 Oscilloscope (without plug-ins) \$2375
U. S. Sales Price f.o.b. Beaverton, Oregon

Tektronix, Inc.

Argentina

Bridgehead for Secam

France is making a powerful bid in Latin America for her Secam system of color television. Her technique is an old one: free samples.

By the start of 1966 she is expected to install about \$467,000 worth of broadcasting and receiving equipment for a six-month trial in Argentina. If Argentina adopts Secam, the tv gear would remain as a gift from the French government and industry; if she should decide against Secam, the equipment would be removed without cost.

Angel Lapieza, Argentina's director general of broadcasting, says his country has agreed in principle to the French offer. All that's needed, he says, is the signing of a decree by President Arturo Illia.

Lapieza says the agreement gives the French a big advantage over the United States' NTSC and West Germany's PAL systems. "We would like to see the United States system," he adds, "but we have not had any offer."

The offer. The French offer, as described by Lapieza, is to install broadcasting equipment wherever desired by Argentina, and to place 30 to 40 receivers in government offices. Some 300 to 400 more receivers would be sold duty-free to clubs, department stores and other public establishments. Secam broadcasts would start about Jan. 1.

In Paris, a spokesman for Compagnie Française de Television (CFT) describes the offer as a test of Secam. CFT will offer circuits in Argentina for converting NTSC sets to Secam, charging less than \$10 apiece, he says. He does not indicate, however, the charge for the extensive rewiring that would be required. CFT owns rights to the Secam system.

Mission to Paris. The big break in negotiations seems to have come

last March, when a four-man Argentine delegation, including Lapieza, spent eight days in Paris as guests of the French Government. They looked at all three color-tv systems; Lapieza says he "was impressed especially that under Secam broadcasts can be received by black-and-white sets" with "minor" adjustment. About a million tv sets are in operation in Argentina, two-thirds of them in and around Buenos Aires.

The Argentine broadcasting chief says he came away with the impression that the French are not seeking tests elsewhere in Latin America. "They do not have money for mass production," he explains.

New channel. Lapieza says Argentina plans to create a new tv channel to carry Secam programs. Asked whether this bars any chance that NTSC may be tested simultaneously with Secam, he says, "I cannot comment on a non-existent offer." The Argentine Government does not allow any existing channel to broadcast in color.

Elsewhere in Latin America, two private stations in Brazil are reported to be installing NTSC, and the Latin American Free Trade Association Committee has recommended that its nine member adopt the U. S. system.



Edward L. Bonin will discuss optical coupling at Paris symposium.

France

Opto-electronics symposium

A relatively obscure arm of the North Atlantic Treaty Organization is sponsoring a symposium in Paris next month that is attracting as much civilian interest as military. A tutorial meeting on opto-electronics will be conducted Sept. 6 to 9 by NATO's Advisory Group for Aerospace Research and Development.

Attendance at the symposium is by invitation only; about 300 scientists and engineers from nearly every NATO country have been asked. Only a handful of Americans will attend, but United States technology will dominate; 14 of the 24 papers will be given by Americans, 4 by the French, 3 by Britons, 2 by West Germans and one by a Canadian.

The first paper will be given by Pierre Aigrain, a professor at the Sorbonne and an adviser to President de Gaulle on arms development. His paper is on "Perspectives offered by opto-electronics."

Optical coupling. Edward L. Bonin of Texas Instruments Incorporated will discuss the use of electro-optics in integrated circuits. One device he will describe combines a gallium-arsenide light-emitting diode with a silicon photodetector [Electronics, July 26, p. 52]. The device is a low-noise coupler.

He will also describe a transformerless low-level chopper switch with an isolated driving circuit, a photon-coupled transistor switch, and a photon-coupled pnpn switch.

Avionics. The military interest centers largely on avionics, where designers are interested principally in the construction of circuits with a greater degree of input-output isolation.

Applications include altimeters,

an image intensifier for radar, and electro-optical processors for phased-array antennas and for transmission of infrared information.

Roger Voles of EMI Electronics, Ltd., in Britain, will discuss the use of an image intensifier to derive the doppler spectrum of radar returns while preserving range resolution. The returns are painted as brightness modulation along the vertical diameter of a cathode-ray tube whose phosphor decay time is in the order of the interval between pulses. This vertical line is projected onto the photocathode of an image intensifier whose horizontal deflection circuit sweeps the resultant image across an output phosphor that has a long delay time. Voles will show that the output phosphor's brightness represents the radar energy—vertical brightness pattern for range and horizontal for doppler.

Altimeters. Optoelectronic altimeters have been built in prototype, but none is in general use. James E. Hopson of the Raytheon Co. will describe an altimeter based on an injection laser diode, an optical transmission medium and a silicon photodetector. Altitude is calculated from the time required for a light beam to travel to the ground and back.

Two methods are under investigation. One employs continuous sine-wave modulation of a cryogenically cooled injection laser. The light beam's transmit time is measured in terms of a shift in the modulation phase between the outgoing and incoming light waves. The second mode of operation uses an injection laser with a fast-rise optical output; the laser is pulse-modulated at room temperature.

Italy

GE stakes its claim

Although they didn't begin officially until late last month, the General Electric Co.'s operations in Italy have been increasing quietly but steadily since last August, when

GE agreed to acquire the computer business of Ing. C. Olivetti & Co.

In September, 1964, a few weeks after Olivetti-General Electric S.p.A. was conceived, Olivetti began to sell GE's new 400 and 600 series computers, which are bigger and more expensive—about \$500,000 apiece—than any previously offered by the Italian company.

Olivetti-GE is owned 75% by GE and 25% by Olivetti. The joint operation was delayed a year while the companies awaited passage of a law that saved them almost \$1 million in taxes on the merger.

New markets. GE's foothold in Europe was made almost simultaneously in Italy and in France. Last August the American company invested \$43 million in the French Compagnie des Machines Bull. Between them, Olivetti-GE and Bull-GE have already taken orders for more than fifty 400's, a GE spokesman says.

The deal also seems to have helped sales of Italian-made computers by opening foreign markets to them. Last year Olivetti installed only about 50 computers; a 50% increase is predicted this year, and the company expects next year's orders to climb to 300. Two-thirds of next year's computer installations should be made abroad, according to an Olivetti-GE spokesman. The company expects further gains soon when it introduces another member of its series 4,000 line.

To cope with the expected surge in sales, Olivetti-GE is expanding the production capacity of its plant in Caluso.

A world power. In Charlottesville, Va., Louis T. Rader, a vice president, masterminds the transition of GE's data-processing operations from a domestic to an international effort (process-control computers remain entirely a domestic operation). As general manager of the Industrial Electronics division, Rader considers Olivetti-GE and Bull-GE as "departments" on the same level as GE's domestic operations, each to specialize in a particular product area. Olivetti-GE for example, would specialize in small computers and peripheral

equipment under Rader's plan.

How strong a factor has GE become in Europe? According to Arthur D. Little, Inc., an industrial research company in Boston, Olivetti controlled about 15% of the Italian computer market at the end of 1963 and Machines Bull had 21% of the French market and 7% of all European computers. With Machines Bull, GE also acquired representatives in 52 countries, with either subsidiaries or agencies in 27 nations.

In France. A spokesman in Charlottesville says Machines Bull's first-quarter installations this year were up 20% from the 1964 period, and that subsequent installations have been "well ahead of all budgets and forecasts."

The French-made Gamma 10 computer, which was introduced last fall, has received more than 700 orders with "no sign of a letup," according to Bull-GE. The Gamma 10 costs \$75,000 to \$100,000.

GE is still a long way from rivaling the International Business Machines Corp. in the international market—a prospect that GE has never even mentioned publicly. But in one year it seems to have carved a deep niche in the European computer market, a solid accomplishment even for the world's fourth-largest corporation.

West Germany

Mail sorter

West Germany's first electronically controlled mail-sorting center has been in operation since May 31 at Pforzheim. It handles 200,000 letters daily.

The principal missing link, an electronic address-reading machine, is still under development at Siemens & Halske AG. The company says a flying-spot scanner that recognizes zip-code destinations on 18,000 letters an hour is "under test." Its speed is about the same as that of a machine developed by the Philco Corp. for the United States Post Office [Electronics, Jan.

11, p. 131]. An improved version of Philco's alphanumeric reader is said to handle 36,000 letters an hour; Siemens says it is working on a reader with comparable speed.

Typists in funnels. While the electronic scanner is being perfected, girls perform part of its task at the \$1.1-million Pforzheim postal center. Streams of mail, both outgoing and incoming, are funneled automatically through 14 special typewriters. As each letter passes through a machine, a girl reads the zip code on the envelope and punches the figures on the typewriter keyboard.

The typewriters generate signals that are passed through an electronic memory and logic register, where they are translated into a form that will cause the typewriter to print on the envelope, in magnetic ink, a line pattern that represents the zip code; this pattern will later be recognized by magnetic pickups at a sorting station.

Luminescent ink also can be used, to be read later by photoresistors, or phosphorescent ink for reading by photomultipliers.

Forks in the road. From the typewriters, a conveyor system carries the letter along a route past dozens of forks, or sorting stages, at which groups of letters are separated according to their destinations. At each fork, an electronic reader scans the letter and sends its reading to the memory rack; here logic circuits generate signals that open and close gates to conveyor chutes, thereby steering each letter along its proper path.

To save space, the final sorting—into as many as 100 locations—is done in a revolving tower whose surface is lined with letter pockets; each pocket is entered via a door controlled by a reed relay. The relays are actuated by multiple magnets that rotate past the relays.

Tower suite. When each letter drops into the tower from an overhead conveyor, its address signals have already set up combinations of polarizations on the magnets. When the letter passes the slot representing its destination, the magnets actuate the reed relay and the letter slips into a slot.

The memory-logic rack serves

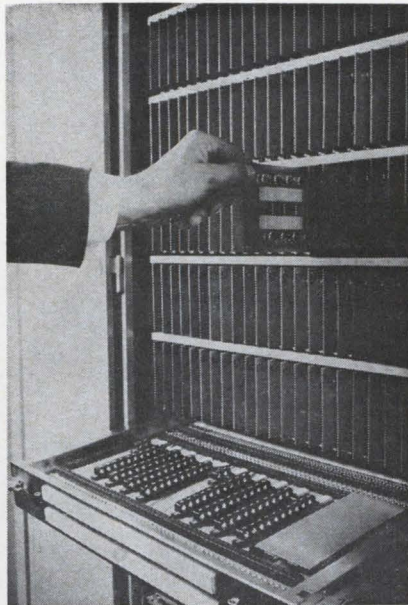

Mail sorting is masterminded from central electronic rack at left, which provides memory and logic. Girl at right stamps zip-code destinations on envelopes, which are sorted in the chandelier-like tower to her right.

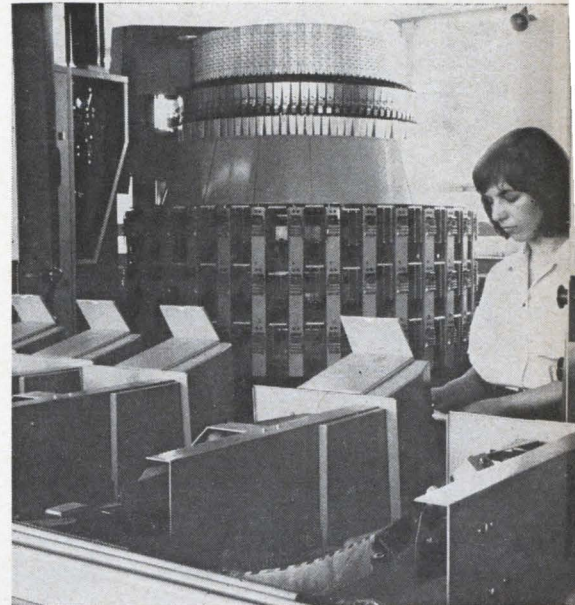

many coding stations and the final sorting towers simultaneously, for both outgoing and incoming mail. At present, 3,000 printed-circuit cards of the central electronic rack are considered sufficient to translate the line patterns on the envelopes into destinations for Germany's 2,800 postal addresses.

To set up address codes, signal wires are inserted by hand through the apertures of large magnetic cores. The signal wires receive their pulses from printed-circuit cards, in racks above the cores.

The scanner. The electronic scanner, under trial at the German Postal Institutes, uses a cathode-ray tube and a photocell to read the zip codes that correspondents have written on the envelopes. The crt beam is deflected in two directions, through lenses, to read codes on two rows of letters at a time. The signals are then picked up by the photocell.

Each letter passes the spot-scanning beam twice: the first time for coarse resolution, the second for higher resolution. The first scanning is horizontal, the second vertical.

Analog signals from the photocell are digitized; for recognition, the digital signals are compared with a set of signals representing the various postal destinations.

Great Britain

Great expectations

One of the Labor Government's first moves upon taking office last October was to create a Ministry of Technology whose job was to bolster Britain's economy with new industrial processes and advanced technology.

After 10 months and two national financial crises, the ministry and its chief, former labor leader Frank Cousins, are targets of increasing criticism in and out of government. A Parliamentary investigating committee has charged it with being slow, inefficient and topheavy. The electronics industry and the trade press generally agree that the ministry has fallen far short of achieving its goals. But many industrial officials concede that the problems of organizing a new department during a period of economic trouble are difficult and that final judgment should be withheld.

The criticisms. Critics point to Cousins' headquarters staff of 500, which is expected to expand to nearly 700 by March; they compare this with the ministry's list of successes, and charge that seldom has so little been owed to so many.

Last November, Cousins ap-

pointed task forces to study problems of four sectors that he considered basic to his modernization program: electronics, telecommunications, computers and machine tools. None of the studies is complete yet, the critics charge. Worse, they add, the teams are made up of the wrong people; instead of looking to industry, Cousins drew his advisers from the civil service.

The accomplishments. Cousins' most ambitious efforts have been directed at the computer industry. Last March he arranged a \$15-million loan for International Computers and Tabulators, Ltd., to develop its ICT 1900 computer system to compete with the IBM Series 360. The Technology Ministry also has placed a \$266,000 research contract with a leading university to develop ways of using digital computers in printing and in type composition.

At the National Engineering Laboratory at Glasgow, a division has been established to find uses for numerically controlled machine tools in British industry. A computer advisory panel has been formed to study computer requirements in the public sector of the economy. Research into computer techniques and development of special equipment also have been initiated. The ministry is now considering creation of a national computer center.

Even in the computer industry, however, there is a feeling that the Technology Ministry is not doing enough to increase the awareness of what automation can do for the economy. Industry officials have called repeatedly for tax incentives to spur the development of new equipment.

New body. A private organization has been formed to coordinate electronics research in Britain. Under the leadership of Lord Mountbatten, who recently retired as Chief of the Defense Staff, the National Electronics Research Council is an association of industry, government and university representatives.

Mountbatten says he has conferred with Cousins and assured him of the council's help in every way possible.

Changing allegiance?

Until this month, Britain was considered a solid supporter of the NTSC color-television system used in the United States. Now the government and private tv companies are showing increasing interest in West Germany's PAL, a slight variation on the American system.

A switch by Britain would make PAL the leading contender for an all-European system. The third method under consideration is France's Secam.

Some officials of the Tv Companies Association are predicting a British switch. They say the big reason is a lack of support for NTSC in Europe; only Britain, Scandinavia and the Netherlands have backed the American system.

"There's no point in going it alone and supporting a system which has little or no chance of becoming a common one for Europe," says one British executive.

Another indication that the government is wavering is the fact that the British Broadcasting Corp. conducted compatibility tests Aug. 10, transmitting NTSC and PAL in color and receiving the programs on black-and-white receivers.

Japan

Automobile pilot

No matter how safe automobiles are made mechanically, drivers can still crack them up. One solution to that problem is to get rid of the driver entirely—and that's what is being done in a highway control system now being tested in Japan by that country's Government Mechanical Laboratories.

The Japanese experiment will be described at a Tokyo symposium on systems engineering Aug. 25 to 28 [see p. 16]. Unlike systems being tested in the United States, it employs parametron circuits to control speed and prevent collisions.

Although it has never gained wide acceptance for computer circuits in the West, the parametron circuit has been favored by the

Japanese for nearly a decade. It amplifies small oscillatory signals by pumping them with another signal at twice the frequency, in much the same way that a child pumps a swing to make it go higher.

Easing traffic jams. With an eye on Tokyo's traffic tangles, which rank among the world's worst, the Japanese have devised a system that seems especially suitable for controlling the speed of a fast-moving, densely packed stream of cars. The system employs inductance loops buried in the 1.25-mile highway, and pickup coils in the automobile that detect the presence of cars ahead and slow the test auto when necessary.

The loops, 15 by 6 feet, are buried at uniform distances along the test highway: their series-resonant circuits are the inputs to stages of a parametron. The loops are activated with 300-kc signals.

One input to the parametron is a 300-kilocycle signal from one inductance loop; the other input is at the same frequency from another loop further up the road, but 180° out of phase. When there is no car crossing either inductance loop, the series-resonant circuit is in its resonant state; the pumping frequency (600 kc) amplifies the original, or zero-phase, signal to overcome the out-of-phase (pi-phase) signal and produce a 300-kc zero-phase output.

Tracking a car. When a car is crossing a loop, the zero-phase input is detuned and the pi-phase is amplified, resulting in a pi-phase output. The car detectors and their parametrons are connected in series, so that the signal that indicates the presence of a car becomes weaker as the car proceeds in one direction and stronger when the car goes the other way.

Pickup coils in each car detect the pi-phase signals that indicate the presence of cars ahead, and their distance from the test vehicle. The coils supply inputs to the throttle control, which can slow the car to prevent a collision or speed it up when the road is clear.

Steering is regulated more conventionally with a guidance cable buried in the highway and with a steering-control device in the car.



Mix & match.

From breadboard to prototype to production.

Sub-miniature coax, standard machined or formed strip contacts can be intermixed instantly in the same connector block.

You can begin wiring your breadboard or prototype with standard wire. If noise develops, just switch signal leads to sub-miniature coax without changing the connector block.

Here's a twist. You can also convert standard leads to twisted pair. In case we forgot to mention it, the sub-mini-

ature coax contacts take twisted pairs as well as coax cable.

And the formed contact is a big money saver in initial and installed costs. Throw in the automatic Burndy Hyfematic,[™] and crimp up to 3000 contacts per hour. Blocks available for 14 to 152 positions.

Now put it all together. Contact intermixing, economy, universality. Get in touch with Burndy for all the details. Hurry.

Circle 169 on reader service card

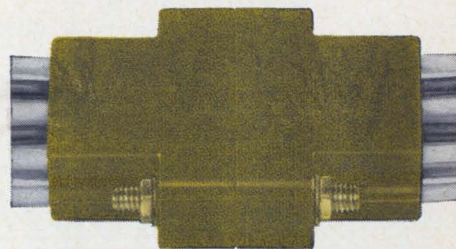

BURNDY

Norwalk  Connecticut

NEW from NYTRONICS

High Stability Precision Wire Wound Resistors

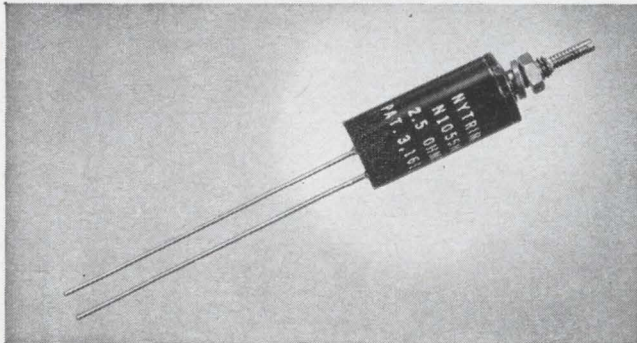

NYTRIM *Adjustable Resistor with
Infinite Resolution*

- ★ 28 Turn Adjustment Over 0.10 to 5.0 ohm range.
- ★ Stocked in four standard designs
- ★ Ultra stability and low thermal noise
- ★ T/C 20 PPM/°C or better
- ★ Package size: 1 1/8" long by 1/2" diameter

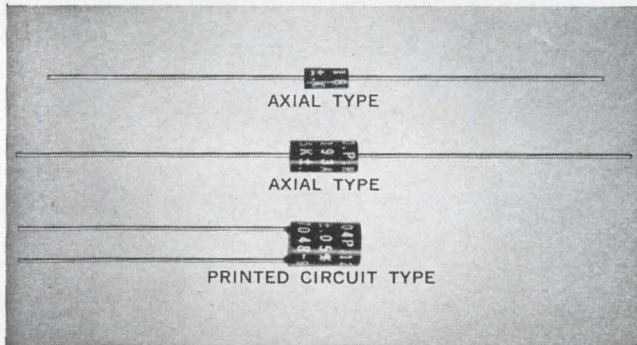

AXIAL AND PRINTED CIRCUIT TYPES
*Precision Wire Wound Resistors with
Ultra Stability and Close Tolerance*

- ★ Conforms to MIL-R-93
- ★ 1.0 ohms to 6 megohms
- ★ Tolerance to .001%
- ★ Stability: to 10 PPM/year
- ★ HTC to 0.5 PPM/°C
- ★ Axial Size: 1/8" to 3/4" diameter by 1/4" to 2" in length.
- ★ Printed Circuit Size: 1/4" to 1/2" diameter by 1/2" to 1" in length

For Complete Engineering Data Write Dept. E or Phone (201) 464-9300

NYTRONICS

550 Springfield Ave., Berkeley Heights, N. J.

Design Leaders — STANDARD Components to Meet CUSTOM Requirements

IN NEBRASKA

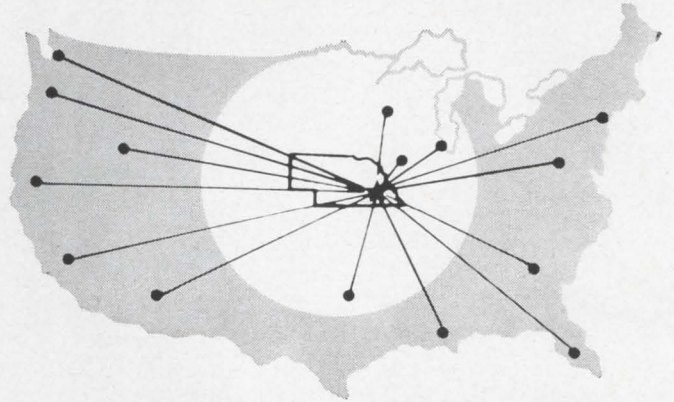

HIGH PRODUCTIVITY assures you of LOWER UNIT COSTS

An officer of one of the nation's largest manufacturers with a plant in Nebraska recently said: "I don't know of any other region where work has the dignity that it does in Nebraska."

Still another manufacturer with plants in Nebraska and six other states said: "What really impresses us is the attitude of the people."

This loyal, highly productive labor force, which is readily adaptable to new skills, is one of the major reasons why manufacturers of all types, including producers of electronic components, enjoy low-cost, trouble-free operations in Nebraska.

OTHER ADVANTAGES

- "Heart of the nation" location served by major transportation arteries.
- Progressive communities ready with low-cost prepared plant sites.
- Low plant construction costs plus a "build-for-you" plan with 100% financing.
- Business-minded, debt-free state government.

For complete information, including individual community surveys, write to David J. Osterhout, Chief, Confidential, of course.

DIVISION OF NEBRASKA RESOURCES
State Capitol • Lincoln, Nebraska

Electronics advertisers

August 23, 1965



■ AMP Incorporated Garceau, Hargrave & McCullough Inc.	58	Hamilton Standard Div. of United Aircraft Corporation Cunningham & Walsh Inc.	125	■ Sorensen Inc. Fuller & Smith & Ross Inc.	133
Amelco Semiconductor, Div. of Teledyne Inc. Sturges and Associates	48	Hansen Mfg. Company Inc. Keller-Crescent Company	142	Spectrol Electronics Corporation Jones, Maher, Roberts Advertising	45
■ Andrew Corporation The Fensholt Advertising Agency	135	■ Heath Company Advance Advertising Service Inc.	157	Sprague Electric Company, The Harry P. Bridge Co., The	5, 7, 14
■ Astrodata Inc. Bonfield Associates Inc.	15	Heinemann Electric Company Thomas R. Sudheim Inc.	116	Stackpole Carbon Company Meek & Thomas Inc.	124
■ Automatic Electric Company Tatham-Laird & Kudner Inc.	126	■ Hewlett-Packard Company Lennen & Newell Inc.	1	■ Superior Tube Company Gray & Rogers Inc.	140
■ Bausch & Lomb Inc. Wolff Associates, Inc.	132	Hitachi Ltd. Dentsu Advertising Ltd.	145	Sylvania Electric Products Inc. Kudner Agency Inc., The	27 to 34
Bendix Semiconductor Division MacManus, John & Adams Inc.	9	■ Hughes Aircraft Company Foote, Cone & Belding Inc.	156	Systems Engineering Laboratories Adams & Keyes Inc. Advertising	136
Borden Chemical Company, Mystick Tape Inc. Fuller & Smith & Ross Inc.	172	Hurst Mfg. Corporation Hathaway Advertising Agency & General Advertising Associates Inc.	121	TRW Electronics Fuller & Smith & Ross Inc.	43
■ Bourns Incorporated Allen, Dorsey & Hatfield Inc.	17, 109	■ Kepco Inc. Weiss Advertising	22	Taber Instrument Corporation Harold Warner Advertising Inc.	153
■ Brush Instruments, Div. of Clevite Corp. Carr Liggett Advertising Inc.	3rd Cover	■ Lapp Insulator Company Inc. Wolff Associates Inc.	141	■ Tektronix Inc. Hugh Dwight Adv. Inc.	164
■ Buchanan Electrical Products Corp. Keyes, Martin Company	130, 131	■ LEL Division of Varian Associates Snow & Depew Advertising	53	■ Telonic Engineering Company Jansen Associates, The	20, 21
■ Burndy Corporation Ted Gravenson Inc.	169	Machlett Laboratories Inc., The Fuller Smith & Ross Inc.	8	Texas Instruments Inc. Semiconductor- Components Div. Don L. Baxter Inc., The	54, 55
Cambridge Thermionic Corporation Chirurg & Cairns Inc.	150	■ Magnetics Inc. Lando Inc.	108	Tracor Inc. David G. Benjamin Inc.	117, 119
■ Christie Electric Corporation Len Woolf Company Advertising	144	Magnetics Systems Corporation Neals & Hickok Inc.	128	Triplett Electrical Instrument Company Burton Browne Advertising	123
Colorado, State of Buchen Advertising Inc.	147	■ Mallory & Company Inc., P.R. Aitkin-Kynett Company, The	106, 110	Trompeter Electronics Writing & Advertising Inc.	155
Cominco Products Inc. McKim Productions Limited	144	Mecco Inc. Ray Ellis Advertising Corp.	122	■ Tung-Sol Electric Inc. E.M. Freystadt Associates Inc.	151
Computer Measurements Company Charles Bowes Advertising Inc.	50	■ Micro Switch Div. of Honeywell Batten, Barton, Durstine & Osborn Inc.	107	Ultra Carbon Corporation Church & Guisewite Advertising Inc.	146
Corning Glass Works The Rumrill Company Inc.	36, 37	Motorola Semiconductor Products Inc. Lane and Bird Advertising Inc.	57	■ United Transformer Corporation Philip Stogel Company Inc., The	2nd Cover
Cubic Corporation Phillips-Ramsey Inc.	49	Mystik Tape Inc. Div. of the Borden Chemical Co. Fuller & Smith & Ross Inc.	172	Vector Department of Norden Div. of United Aircraft Corp. Cunningham & Walsh Inc.	154
Data Corporation Einhorn-Stern Inc.	10	Nebraska Resources Ayres & Associates Inc.	170	Westinghouse Semiconductor Div. ITSM	115
Douglas Missile & Space Co. J. Walter Thompson Company	149	New Hermes Engraving Machine Corp. Doner-Harrison Inc., Advertising	152	Zippertubing Company, The Edward S. Kellogg Company	46
■ DuPont de Nemours & Company Inc. E.I. Batten, Barton, Durstine & Osborn Inc.	139	North Atlantic Industries, Inc. Murray Heyert Associates	16		
Electro Instruments Inc. Teawell Inc. Advertising	127	■ Norton Associates J.J. Coppo Co. Inc.	144		
Electro Products Laboratories Inc. C. M. Gotsch, Advertising	151	Nytronics Inc. Stukalin Advertising Agcy., The	170		
Engineered Electronics Company Barnes Chase Advertising	114	Pamotor Inc. Harry J. Bridge Co., The	138		
Erie Technological Products Company Inc. Altman-Hall Associates	105	Plastics Capacitors Inc. Sander Rodkin Adv. Agcy. Ltd.	148		
FMC Corporation, Inorganic Chemicals Division Muller, Jordan & Herrick Inc.	143 143	■ Potter & Brumfield Div. of American Machine & Foundry Co. Grant, Schwenck & Baker Inc.	24		
■ Fairchild Instrumentation The Wexton Company Inc.	148	Princeton Applied Research Corp. Mort Barish Associates	38		
■ Fairchild Semiconductor Corporation Faust/Day Inc. Advertising	11, 12, 13	Progress Webster Corporation Stern/Frank Advertising Inc.	56		
Fiberfil Incorporated Tri-State Advertising Co. Inc.	152	Radiation Inc. G.M. Basford Company	154		
■ General Electric Company, Silicone Products Dept. Ross Roy Inc.	137	Radio Corporation of America Al Paul Lefton Co.	4th Cover		
General Instrument Corporation Norman Allen Associates Inc.	18, 19	Sanborn Co., A Div. of Hewlett Packard Co. Culver Advertising Inc.	2		
General Radio Company K. E. Morang Company	6	Sangamo Electric Company Winius-Brandon Company	47		
Globe Industries Inc. Odiorne Industrial Advertising Inc.	157	■ Sargent & Greenleaf Inc. Wolff Associates Inc.	163		
Gudebrod Bros. Silk Co. Inc. Lee Ramsdell & Co. Inc.	35	Sinclair Radio Laboratories Inc. John E. Hayes Company Inc.	118		

Classified Advertising

F.J. Eberle, Business Mgr.

EMPLOYMENT OPPORTUNITIES	158-162
PROFESSIONAL SERVICES	161
EQUIPMENT (Used or Surplus New) For Sale	162

Advertisers Index

Bureau of Ships	162
General Electric	158
Globe-Union Inc. Centralab, Div.	162
Gruman Aircraft	159, 160
Keystone Electronics Corp.	162
Pan Am Guided Missiles Range Div.	161
■ Radio Research Instrument Co.	162
■ Semiconductor Sales of Calif.	162
Texas Instruments Inc. Corp.	161
Union Carbide Corp.	161

■ For more information on complete product line see advertisement in the latest Electronics Buyers' Guide

Executive, editorial, circulation and advertising offices: McGraw-Hill Building, 330 West 42nd Street, New York, N.Y., 10036. Telephone Area Code 212-971-3333. Teletype TWX N.Y. 212-640-4646. Cable: McGrawhill, N.Y. Officers of the Publications Division: Shelton Fisher, President; Vice Presidents: Joseph H. Allen, Operations; Robert F. Boger, Administration; John R. Callahan, Editorial; Ervin E. DeGraff, Circulation; Donald C. McGraw, Jr., Advertising Sales; Angelo R. Venezian, Marketing. Officers of the Corporation: Donald C. McGraw, President; L. Keith Goodrich and Hugh J. Kelly, Executive Vice Presidents; John J. Cooke, Vice President and Secretary; John L. McGraw, Treasurer. Title R registered U.S. Patent Office; © copyright 1965 by McGraw-Hill, Inc. All rights reserved, including the right to reproduce the contents of this publication, in whole or in part.

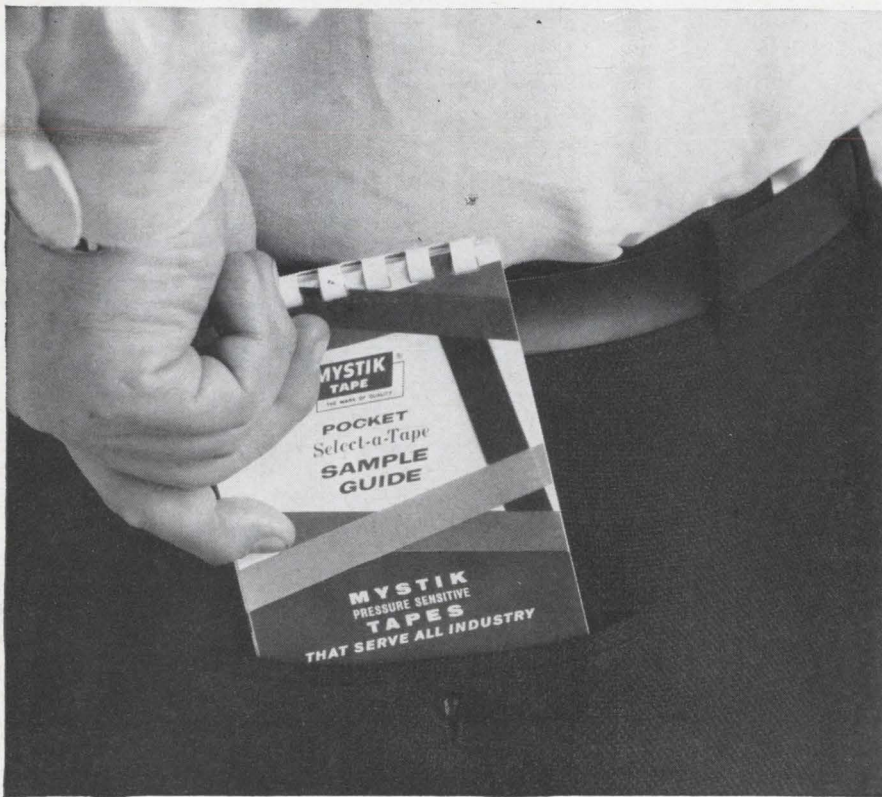

Everything you need to know about tapes you can carry in your hip pocket

It's Mystik's new Select-A-Tape Guide. Here, in a pocket-size, full color edition is a complete catalog of Mystik Tapes. It's the fastest way to find the right tape for any given application.

For easy reference, the guide is indexed by type of tape—masking, packaging, protective, printable and special purpose. Over 100 tapes right at your fingertips! Each tape, its backing material and adhesive, is described in detail, along with physical characteristics, advantages and principal uses.

A word of warning. Once people pick up our new pocket-size Select-A-Tape Sample Guide, they can't put it down. They pocket it instead. So watch it. Mail the coupon below and get yours free of charge. Then you won't have to borrow somebody else's.



FREE SELECT-A-TAPE SAMPLE GUIDE!

Takes the guesswork out of tape selection. Gives physical characteristics of all Mystik tapes, typical applications, sizes, principal advantages. Send for your copy today. MYSTIK TAPE, INC., 1700 Winnetka Ave., Northfield, Ill.

NAME _____
 COMPANY _____
 ADDRESS _____
 CITY _____ STATE _____ ZIP _____



Advertising sales staff

Gordon Jones [212] 971-2210
Advertising sales manager

Atlanta, Ga. 30309: Gus H. Krimsier,
Michael H. Miller, 1375 Peachtree St. N.E.,
[404] TR 5-0523

Boston, Mass. 02116: William S. Hodgkinson
McGraw-Hill Building, Copley Square,
[617] CO 2-1160

Chicago, Ill. 60611: Robert M. Denmead,
J. Bradley MacKimm
645 North Michigan Avenue,
[312] MO 4-5800

Cleveland, Ohio 44113: Paul T. Fegley, 55
Public Square, [216] SU 1-7000

Dallas, Texas 75201: Richard P. Poole, The
Vaughn Building, 1712 Commerce Street,
[214] RI 7-9721

Denver, Colo. 80202: Joseph C. Page, David
M. Watson, Tower Bldg., 1700 Broadway,
[303] AL 5-2981

Houston, Texas 77025: Kenneth George,
2270 Humble Bldg.,
[713] CA 4-8381

Los Angeles, Calif. 90017: Ashley P.
Hartman, John G. Zisch, 1125 W. 6th St.,
[213] HU 2-5450

New York, N. Y. 10036:
Donald R. Furth [212] 971-3615
Frank LeBeau [212] 571-3615
George F. Werner [212] 971-3615
500 Fifth Avenue

Philadelphia, Pa. 19103: William J. Boyle,
Warren H. Gardner, 6 Penn Center Plaza,
[215] LO 8-6161

San Francisco, Calif. 94111:
James T. Hauptli, 255 California Street,
[415] DO 2-4600

London W1: John W. Patten, Edwin S.
Murphy Jr., 34 Dover Street,
Hyde Park 1451

Milan: 1, via
Baracchini Phone: 86-90-617

Frankfurt/Main: Gerd Hinske, 85
Westendstrasse Phone: 77 26 65 and
77 30 59

Geneva: Michael R. Zeynel, Joseph Wuensch,
2 Place du Port 244275

Paris VIII: Denis Jacob, 17 Avenue
Matignon ALMA-0452

Tokyo: Nobuyuki Sato
Shiba, Minato-Ku (502) 0656

Osaka: Kazutaka, Miura, 163, Umegee-cho,
Kiita-ku [362] 8771

Nagoya: International Media Representatives,
Yamagishi Bldg., 13, 2-Chome,
Oike-cho Naka-ku

Hugh J. Quinn: [212] 971-2335
Manager Electronics Buyers' Guide

David M. Tempest: [212] 971-3139
Promotion manager

Milton Drake: [212] 971-3485
Market research manager

Wallace C. Carmichael [212] 971-3191
Business manager

Theodore R. Geipel: [212] 971-2044
Production manager

Another Brush Innovation in Recording:

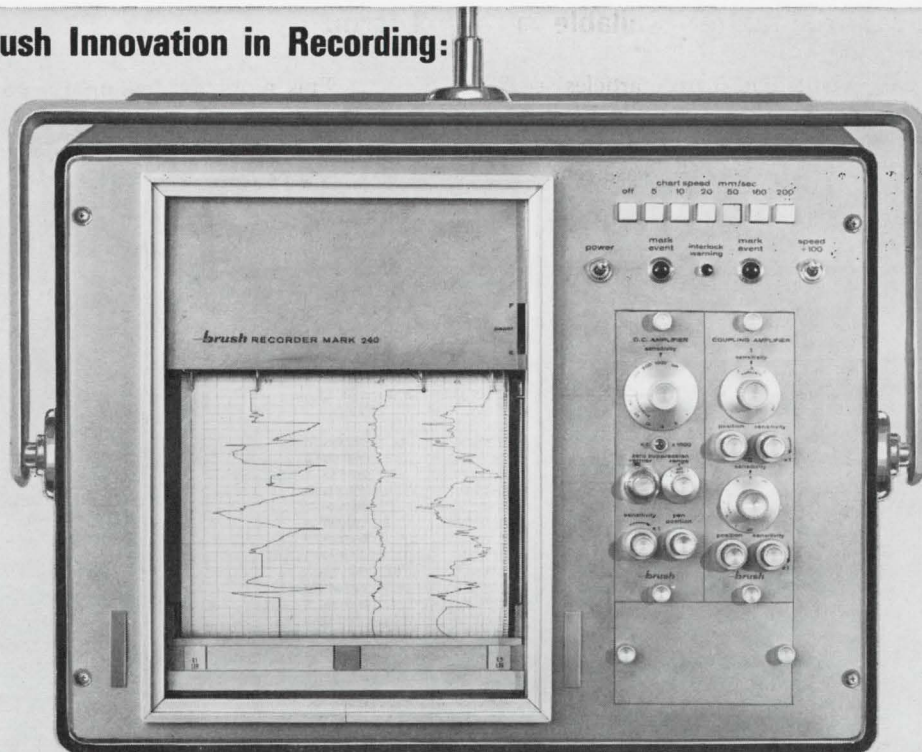

The Brush Mark 240

**If you can't record it
with this recorder,
chances are
it didn't happen!**

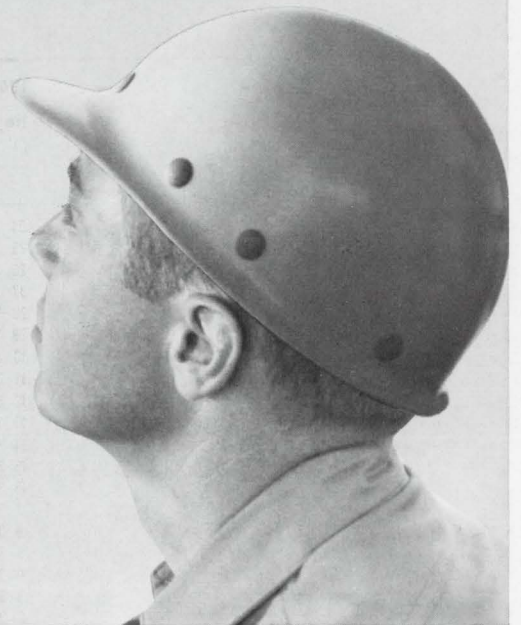

What we've done is this:

We took our famous Mark 200 Recorder and made a 'compact' version for general purpose and medical requirements. Performance? The new 240 will do everything the Mark 200 will do. And as Aerospace people will tell you, that's plenty: System linearity better than $\frac{1}{2}\%$. Pressurized fluid writing system assures incredibly crisp traces on low cost chart paper. Presentation is true rectilinear and there's push-button choice of 12 chart speeds.

Cost? The Mark 240 runs about

half as much as a Mark 200. Still, you have a choice of either four 40 mm analog channels, two 80 mm channels, or a combination* of two 40s and one 80. (You can also have 8-channel event-marker modules). There's a choice of 17 plug-in pre-amplifiers, too. High gain d-c units, straight-through couplers and strain-gage and demodulator types. The Mark 240 is just $17\frac{1}{2}$ " high x 19" wide x $20\frac{1}{2}$ " deep. Mount it vertically or horizontally in standard 19" racks to RETMA specs, on table-top carts or you name it!

If your kind of recording calls for the utmost in resolution, precision and recording flexibility, ask your Brush representative for complete details about the new Brush Mark 240. There's nothing else like it . . . anywhere! Brush Instruments Division, Clevite Corporation, 37th & Perkins, Cleveland, Ohio 44114. *Just out! Three information-packed booklets on strain recording, temperature recording and techniques of low-level recording. Write us today for your copies. They're yours for the asking!*

*see photo

CLEVITE

—brush INSTRUMENTS DIVISION

Circle 901 on reader service card

RCA ECONOMY SILICON POWER GOES HIGH FREQUENCY

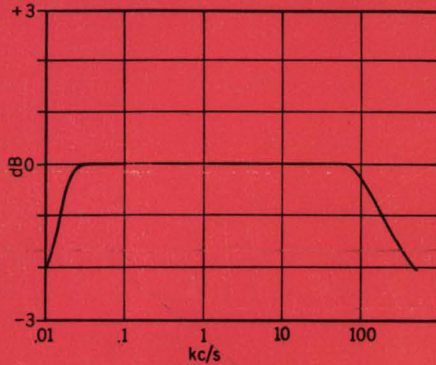

Linear response at 25 watts output from 20 c/s to 200 kc/s for push-pull operation with RCA 2N3878

I_C (Max.) of 7 A

Min Beta of 20 @ 4 A

V_{CE} of 90 V (min.) for 2N3879

$f_T = 40$ Mc/s (min.)

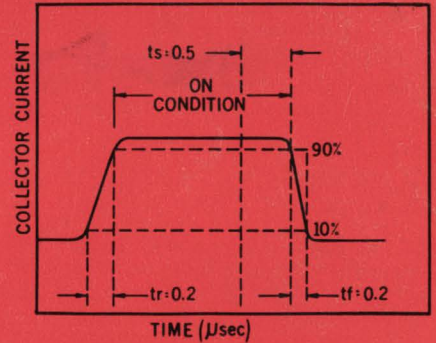

Total saturated switching time at 4 amperes less than 1 µs (typ) with RCA 2N3879

TWO NEW TRANSISTORS...2N3878 and 2N3879

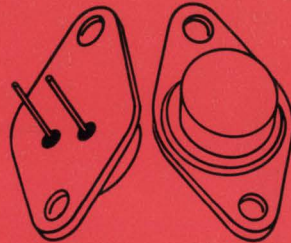

Two new RCA units—2N3878 and 2N3879—are n-p-n epitaxial silicon transistors, in TO-66 cases, offering designers high-current ratings for high-speed switching applications and broad band amplifier circuits.

Available at the low costs you'd expect for mass production requirements, RCA 2N3878 and 2N3879 feature:

- Linear beta over a wide range of collector current
- Rated for safe operation without second breakdown
- Immediate availability at low cost.

Employing epitaxial structure for low saturation voltage and improved switching speeds, 2N3878 and 2N3879 are ideal for high frequency power amplifiers and oscillators, high-speed

inverters, pulse-width modulated regulators, and low distortion power amplifiers.

For more detailed information check the ratings in the chart. See your RCA Representative about prices and delivery. For technical data on these types, write: RCA Commercial Engineering, Section IN8-4, Harrison, N. J.

	2N3878	2N3879	
I_C (continuous)	7	7	A
I_C (peak)	10	10	A
$P_{max.}$	35	35	W
V_{CE0} (sus)	50	75	V
V_{CE} (sus)	65	90	V
V_{CE} (sat) 4A	2.0	1.2	V
h_{FE} 4A	20 min	20-80	

Also Available From Your RCA Distributor
RCA Electronic Components and Devices

Circle 902 on reader service card



The Most Trusted Name in Electronics