

Electronics[®]

Two paths to distortion measurement: page 80

New way to make a thin-film memory: page 102

Controlling megawatts with scr's: page 110

October 4, 1965

75 cents

A McGraw-Hill Publication

Below: Round flatpack for MOS
integrated circuits: page 84

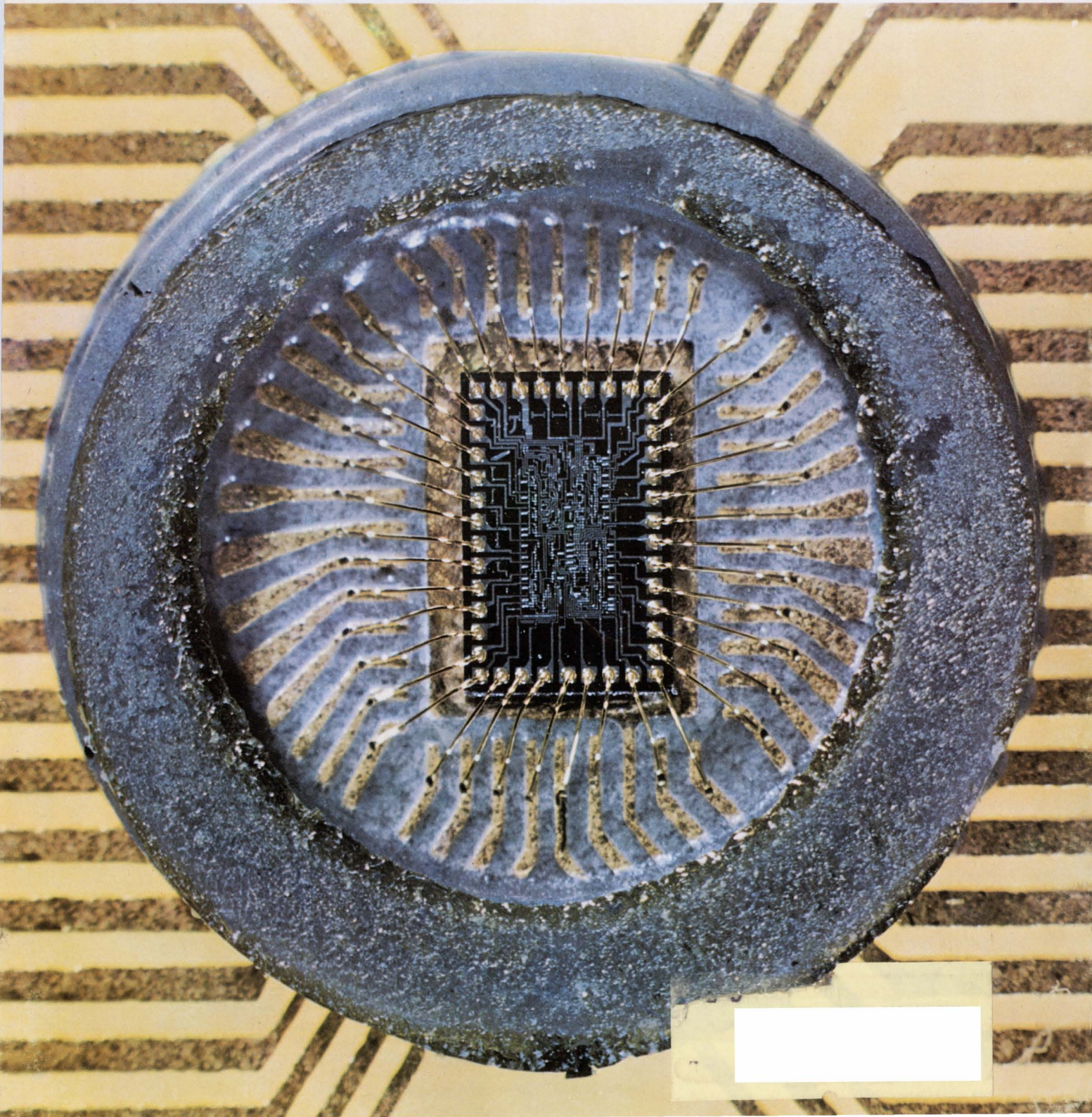

M. Fourier would have liked this Recording Wave Analyzer

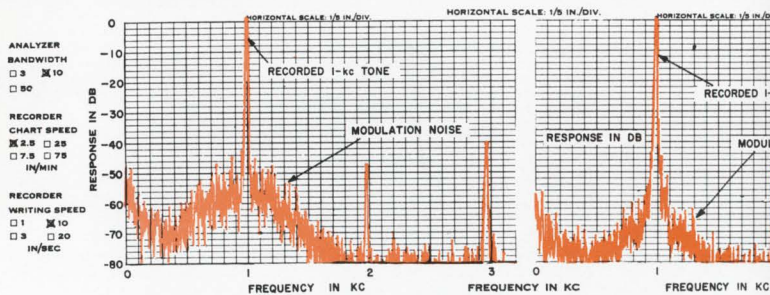
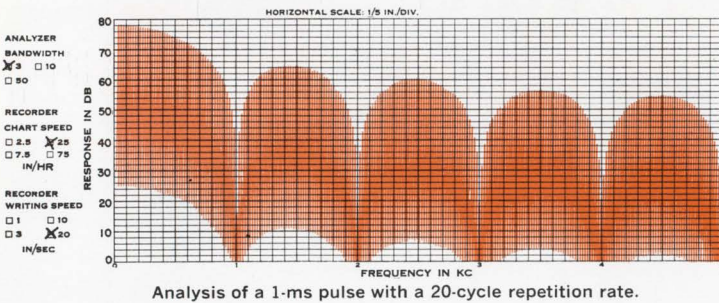
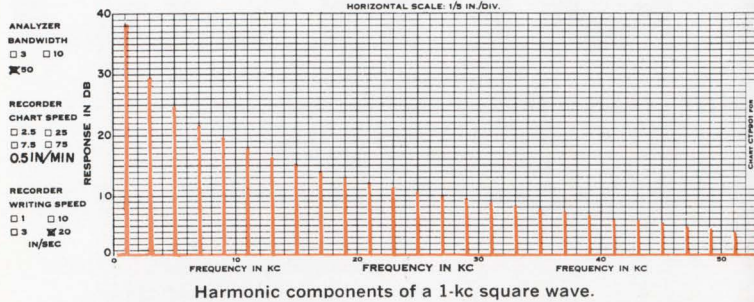

Graphic plot of modulation noise on a 1-kc tone for two different types of magnetic tape. Note that one tape has 10dB less noise. The Recording Analyzer is ideal for this type of measurement since its 80-dB dynamic range permits uninterrupted recording over wide ranges.

- Three bandwidths let you choose the best selectivity for each measurement . . . 3 c/s or 10 c/s for detailed measurements, 50 c/s for rapid analysis or for measurement of drifting signals. Bandwidth skirts are better than 80-dB down at ± 25 c/s, ± 80 c/s, and ± 500 c/s for 3-, 10-, and 50-cycle bandwidths, respectively.
- Linear frequency scale from 20 c/s to 54 kc/s.
- Two outputs for recording, 100 kc/s with 80-dB dynamic range for inputs above 0.1 V, and 1-mA dc.
- 80-dB dynamic range for recording. You can make uninterrupted recordings . . . no attenuator switching in the midst of measurements.
- High input impedance (1-M Ω) on all ranges.
- Voltage range is 30 μ V to 300V, full scale, in 15 ranges. Accuracy, \pm (3% of reading +2% of full scale).
- As a "Tracking Generator," instrument is both a signal source (delivering 2V across 600 Ω) and a detector tuned to each other exactly.

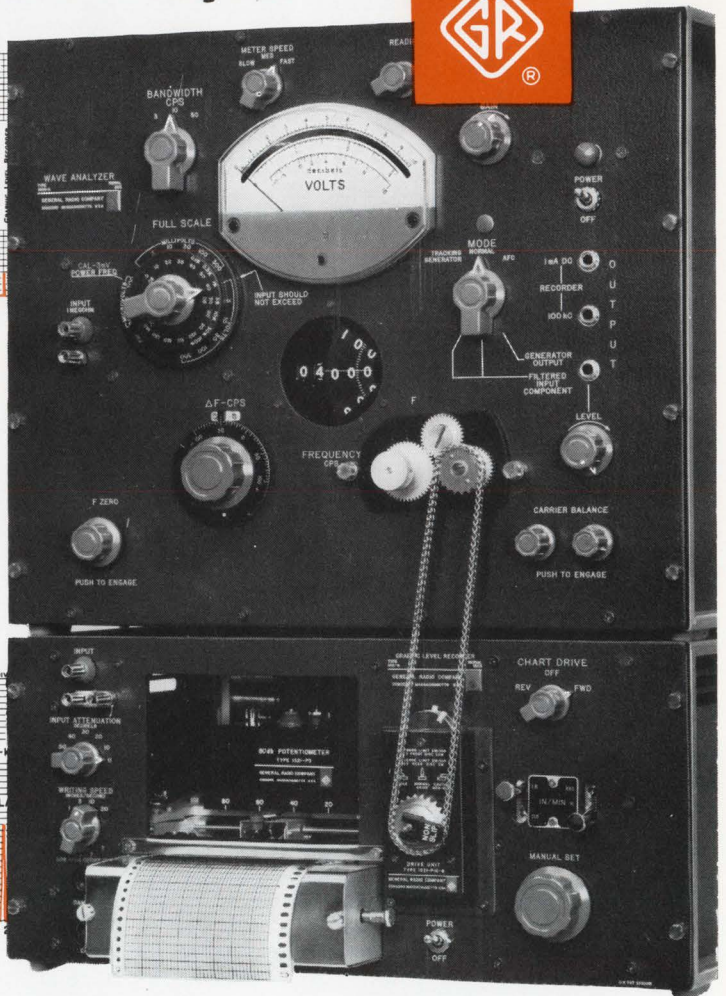

Type 1910-A Recording Wave Analyzer comes complete with Type 1900-A Wave Analyzer, Type 1521-B Graphic Level Recorder, and all accessories.

For point-by-point measurements where the recorder is not used, these additional wave analyzer features add versatility and convenience

- Easy-to-read in-line frequency readout graduated in 10-cycle increments. $\pm 0.5\%$ calibration accuracy. Output for counter where extreme accuracy is desired.
- Incremental-frequency dial lets you fine-tune any component, covers ± 100 -cycle range independently of analyzer setting.
- AFC follows slowly drifting signals.
- Choice of 3 meter speeds - meter does the averaging.
- Excellent tunable filter. For example, the instrument can be used to produce 3-, 10-, and 50-cycle bands of noise over a tunable range from 20 c/s to 54 kc/s when a random-noise generator is connected to the analyzer.
- Price: Type 1900-A Wave Analyzer alone, \$2150; Type 1910-A Recording Wave Analyzer, \$3500 in U.S.A.

We believe M. Fourier's disciples will like this Analyzer, too.

Write for Complete Information.



GENERAL RADIO COMPANY

WEST CONCORD, MASSACHUSETTS

IN CANADA: Toronto 247-2171, Montreal (Mt. Royal) 737-3673
IN EUROPE: Zurich, Switzerland - London, England

NEW YORK, N. Y. 964-2722
(Ridgefield, N. J.) 943-3140

CHICAGO
(Oak Park) 848-9400

PHILADELPHIA
(Ft. Washington) 646-8030

WASHINGTON, D.C.
(Rockville, Md.) 946-1600

SYRACUSE
454-9323

DALLAS
FL 7-4031

SAN FRANCISCO
(Los Altos) 948-8233

LOS ANGELES
469-6201

ORLANDO, FLA.
425-4671

CLEVELAND
886-0150

Circle 900 on reader service card

WIDE DYNAMIC RANGE

(up to 3 times full scale)

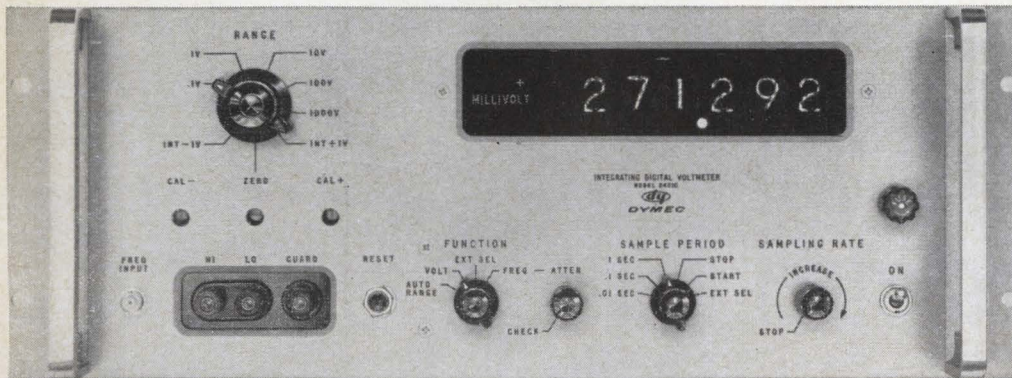

BACKED-UP BY FAST AUTORANGING

(< 6 milliseconds/range)

The wide dynamic range offered by the new DY-2401C Integrating Digital Voltmeter from Dymec lets you measure signals up to three times full scale. It has 5 ranges with highly accurate 300% overranging on the most sensitive 4. Get the convenience of one-setting measurements in the much-used 1-to-3 area (e.g. 3 volts on the 1 v range, 30 v on the 10 v range, etc.) A 6th digit displays the most significant figure.

Should the measured signal exceed 310% of range setting, overload circuitry changes range to 1000 v and tells you your dvm is overloaded.

The autoranger available for the solid-state DY-2401C requires only 6 milliseconds per range to change and lets you take successive readings at opposite ends of the measuring range with <34 milliseconds range-change time. This is the fastest autoranger available. For data acquisition system applications, this means less time changing range, therefore less per-channel time.

Not only are you able to range the 2401C, but you can also set the sixth (10 mv) range provided by the accessory DY-2411A Preamp. When using the DY-2410B AC/Ohms Converter, you can automatically change ac and resistance ranges.

Increases or decreases in signal magnitude are precisely tracked, range is changed where necessary and only the correct answer is displayed. With noisy signals, no waiting while the meter hunts for the answer, and no bad guesses or indecision. You get the right answer the first time.

DY-2401C improvements include a new reversing counter—you can accurately measure signals in the zero region, even with positive/negative going noise on the signal. No zero fold-over problems. You also get higher instrument accuracy: Now 0.01% of reading, +0.005% of full scale +1 digit (at 25°C).

DY-2401C, \$3950; autoranger adds \$250.

Call your local Hewlett-Packard field engineer for information and complete specifications, or write direct to Dymec, 395 Page Mill Road, Palo Alto, California 94306. (415) 326-1755.

Data subject to change without notice. Prices f.o.b. factory.

**HEWLETT
PACKARD**  **DYMEC
DIVISION**

12507



New pulser!

10 MC REP RATE!

4 NS RISE TIME!

10 VOLTS OUT!

...AND ONLY \$690!

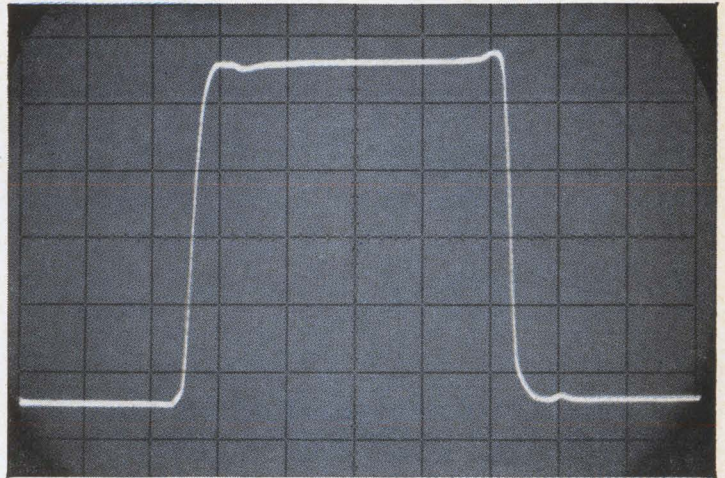

10 v pulse at 10 mc rep rate; sweep speed 10 ns/cm.

Test the range and performance of your circuits and components economically with the Hewlett-Packard 222A Pulse Generator. Priced at just \$690, the 222A provides 10-volt, 4 ns rise time pulses at rep rates to 10 mc, for full-range testing of your switching circuits, components and amplifiers.

Pulse rep rate, amplitude and width are continuously adjustable to match your particular test requirement. Select positive or negative pulses with amplitudes from 0.05 to 10 v, rep rates from 10 cps to 10 mc and widths from 30 ns to 5 ms. Square waves are available from 100 cps to 10 mc.

You can trigger the 222A externally to provide pulses synchronized with auxiliary equipment. In addition, the 222A generates a pulse for triggering other equipment. With the pulse delay control you can delay the output pulse from 100 ns to 5 ms with respect to the trigger pulse—permitting advance triggering of external circuitry.

Pulse shape is carefully controlled and specified to insure accurate, easy-to-interpret measurements. The quality of the pulse is shown on the oscillogram and in the brief specifications below. The pulse circuitry has a 50-ohm source impedance which insures clean pulses when driving non-50-ohm loads, and it is dc coupled to maintain the dc level with changes of amplitude or duty cycle.

Your Hewlett-Packard field engineer is ready to demonstrate the 222A on your bench. Give him a call. Or write for complete data to Hewlett-Packard, Palo Alto, Calif. 94304, Tel. (415) 326-7000; Europe: 54 Route des Acacias, Geneva; Canada: 8270 Mayrand St., Montreal.

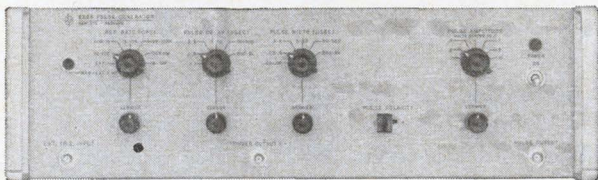

SPECIFICATIONS, output pulse

Source impedance: 50 ohms \pm 3%, approx. 15 pf shunt

Pulse shape

Rise and fall time: <4 ns

Overshoot and ringing: <4% peak of pulse amplitude

Corner rounding: occurs no sooner than 95% of pulse amplitude

Time to settle within 3% of flat top: <20 ns

Preshoot: <2% on leading edge, <4% on trailing edge

Perturbations on flat top: <3% of pulse amplitude

Pulse voltage: positive or negative, 1, 2, 5 step attenuator, with vernier, provides continuous adjustment from 0.05 to 10 v (into 50 ohms)

Pulse width: continuously adjustable from 30 ns to 5 ms in 6 ranges

Max. duty cycle: at least 50%, 100 cps to 10 mc

Price: \$690

Data subject to change without notice. Price f. o. b. factory.

HEWLETT  **PACKARD**
An extra measure of quality

Electronics

October 4, 1965
Volume 38, Number 20

Page 4	Readers Comment
8	People
14	Meetings
16	Meeting Preview
23	Editorial
25	Electronics Newsletter
65	Washington Newsletter
157	New Products
201	New Books
202	Technical Abstracts
211	New Literature

Electronics Review

Page	37	Guided waves	40	Foil coil
	37	Solid state slipstick	42	Artificial heart
	38	Competition from abroad	44	Getting in step
	39	Why did they crash?	44	Malfunction receiver
	39	Small splash	46	Electronics notes

Probing the News

133	Keeping in touch with Apollo
138	McClellan: protect your patent rights
141	Weapon against waste

Electronics Abroad

213	Push-button coal-mining	214	Tool-show stealer
213	Surge in switching	215	Computer challenge
214	Erhard's outlook	216	Growth industry
		216	Around the world

Technical Articles

I. Design

Instruments	80	Two ways to measure distortion The system designer must choose the best method on the basis of the information he seeks Charles R. Moore, Hewlett-Packard Co.
Solid state	84	MOS integrated circuits save space and money (cover) Newest IC technology reduces system cost by allowing more complex functions per chip Donald E. Farina and Donald Trotter General Micro-electronics, Inc.
Solid state	96	The expanding market Only two firms have commercial units, but the list of MOS IC users is growing Jerome Eimbinder, solid state editor
Circuit design	99	Designer's casebook <input type="checkbox"/> Phase demodulator needs no tuning <input type="checkbox"/> Modulated pulse width converted to analog voltage <input type="checkbox"/> Forming accurate dividers <input type="checkbox"/> Phototransistor regulates illumination intensity

II. Manufacturing

Production	102	Chips are down in new way to build large microsystems Face-bonding uncased IC chips produces high-speed thin-film memory Max Bialer and Lt. Albin A. Hastbacka, Wright-Patterson AF Base, and T. J. Matkovich, Univac div. of Sperry Rand
-------------------	-----	--

III. Application

Industrial electronics	110	Powerful scr's control industry's biggest machinery Solid state components are taking on big jobs Robert Cushman, industrial electronics editor
-------------------------------	-----	--

Title R registered
U.S. Patent Office;
© copyright 1965
by McGraw-Hill, Inc.
All rights reserved,
including the right to
reproduce the contents
of this publication,
in whole or in part.

Electronics

Editor: Lewis H. Young

Senior editors

Technical: Samuel Weber

News: Kemp Anderson, Jr.

Senior associate editors: John F. Mason, George Sideris

Department editors

Advanced technology: Joan Blum

Avionics: W.J. Evezia

Circuit design: Michael Elia

Components: Michael F. Tomaino

Computers: Wallace B. Riley

Consumer electronics: Richard Lipkin

Electronics review: Stanley Zarowin

Industrial electronics: Robert Cushman

Instrumentation: Carl Moskowitz

Manufacturing: George Sideris

Military electronics: John F. Mason

New products: William P. O'Brien

Solid state: Jerome Eimbinder

Space electronics: Peter R. Sigmund

Special projects: Richard M. Machol

Regional editors

Boston: Thomas Maguire, editor; Robin Carlson

Los Angeles: William B. Wallace, editor; June Ranill

San Francisco: Laurence D. Shergalis, Edmond G. Addeo, editors; Mary Jo Jadin

Copy editors

Howard Rausch, Sally Powell, Walter Barney

Graphic design

Art director: Saul Sussman

Assistant art director: Donna M. Marchyn

Editorial production: Ann Mella

Production editor: Arthur C. Miller

Editorial secretaries: Claire Benell, Mary D'Angelo, Lynn Emery, Kay Fontana, Carolyn Michnowicz, Lorraine Longo, Lorraine Werner

McGraw-Hill news service

Director: John Wilhelm; **Atlanta:** Fran Ridgway; **Chicago:** Bruce Cross, Louis S. Gomolak;

Cleveland: Arthur Zimmerman; **Dallas:** Marvin Reid;

Detroit: Donald MacDonald; **Los Angeles:** Michael Murphy, Ron Lovell;

San Francisco: Margaret Ralston;

Seattle: Ray Bloomberg; **Washington:** Arthur L. Moore, Charles Gardner, Herbert W. Cheshire, Seth Payne, Warren Burkett, Warren Kornberg

McGraw-Hill world news service

Bonn: Robert Dorang; **Brussels:** Arthur Erikson; **London:** John Shinn;

Mexico City: Wesley Perry; **Milan:** Bruce Bendow;

Moscow: Donald Winston; **Paris:** Dan Smith;

Rio de Janeiro: Leslie Warren; **Tokyo:** Marvin Petal, Charles Cohen

Circulation manager: Hugh J. Quinn

Reprints: T.M. Egan

Publisher: C.C. Randolph

Electronics: October 4, 1965, Vol. 38, No. 20

Printed at 99 North Broadway, Albany, N.Y.
Second class postage paid at Albany, N.Y.

Subscriptions are solicited only from those actively engaged in the field of the publication. Position and company connection must be indicated on orders. Subscription prices: United States and Possessions and Canada, \$6.00 one year, \$9.00 two years, \$12.00 three years. All other countries \$20.00 one year. Single copies, United States and Possessions and Canada 75¢. Single copies all other countries \$1.50.

Published every other Monday by McGraw-Hill Inc. 330 West 42nd Street, New York, N.Y. 10036. Founder: James H. McGraw, 1860-1948.

Subscribers: The Publisher, upon written request to our New York office from any subscriber, agrees to refund that part of the subscription price applying to copies not yet mailed. Please send change of address notices, subscription orders or complaints to Fulfillment Manager, Electronics, at the address below. Change of address notices should provide old as well as new address, including postal zone number if any. If possible, attach address label from recent issue. Allow one month for change to become effective.

Postmaster: Please send Form 3579 to Fulfillment Manager, Electronics, P.O. Box 430, Hightstown New Jersey 08520

Readers Comment

Ampex not first

To the Editor:

I want to point out that in the Aug. 23 issue, the new product article on page 129 is misleading. It reads: "Up to now, the best instrumentation tape recorder had a time base error of 250 microseconds at tape speed of 120 inches per second. Now the Ampex Corp. offers a recorder with time base error of only 2 microseconds at 120 inches per second." This statement implies that Ampex Corp. is first with such a recorder—which they are not.

At the 1964 Wescon show in Los Angeles, Honeywell, Inc., demonstrated its 7700 recorder. This recorder has time displacement error of only 1 microsecond at 120 ips. In the early part of 1964, Winston Research Corp. announced a low time displacement recorder, their Model L-6000. This recorder has an absolute time displacement error of 0.5 microsecond at 120 ips.

Again, during the 1964 Wescon, the Mincom division of the 3M Co. demonstrated a low time displacement recorder—the TICOR II. This recorder specifies time base error of 0.5 microsecond at 60 ips; however, 120 ips is standard speed.

Mordechai Arditti

Engineer

Bell & Howell Research Center
Pasadena, Calif.

Realistic engineers

To the Editor:

What Dean J.D. Ryder has failed to acknowledge [Sept. 6, p. 4] is that while the engineering profession offers challenge at all levels of theoretical competence, it is presumptuous to assume that all engineering graduates will pursue careers in the areas of research of advanced development.

Educators who would mislead the student into believing that the mark of accomplishment and recognition in today's engineering profession is reserved for those who choose to pursue the more theoretical fields of endeavor are committing a gross injustice.

While it is commendable to in-

(Advertisement)

Powerlytic® Capacitors in 42 Case Sizes Insure Maximum Capacitance in Minimum Space

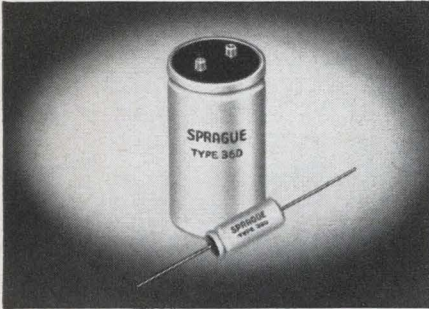

Designed to pack high capacitance into areas that provide limited space, tubular case Powerlytic Capacitors can be procured in 20 different sizes while cylindrical Powerlytics are available in 22 case sizes.

Smaller companion to Sprague's proven 36D cylindrical aluminum electrolytic, the Type 39D Powerlytic is well qualified for transistorized circuitry that requires maximum capacitance in case sizes ranging from 1/2" x 1 1/8" to 1" x 3 5/8".

Type 39D tubular Powerlytics are designed for operation at temperatures up to 85 C. Their unique construction has welds at all critical anode and cathode terminals—there are no riveted or pressure connections. As a result, open circuits are prevented, even in the microvolt signal range.

Improved molded phenolic end seals contribute to an unusually long life (expectancy, 10 years or more) for type 39D Capacitors. They have low effective series resistance and low leakage current. Standard ratings include capacitance values to 18,000 µF, in voltages from 3 to 450 VDC.

Type 36D cylindrical case Powerlytics, designed for space economy in applications such as computer power supplies, industrial controls, and high gain amplifiers, are available in case sizes from 1 3/8" x 2 1/8" to 3" x 5 5/8". Designed with reliable safety vents, Type 36D Powerlytics also have superior seals employing molded covers with recessed rubber gaskets. They are available in standard ratings from 3 to 450 VDC with capacitance values to 270,000 µF.

For complete technical data on Type 36D or Type 39D Powerlytic Capacitors, write for Engineering Bulletins 3431B and 3415, respectively, to Technical Literature Service, Sprague Electric Co., 35 Marshall St., North Adams, Mass. 01248.

45C-5142

Circle 5 on reader service card

6 Reasons Why SPRAGUE is a Major Resistor Supplier

FILMISTOR® PRECISION FILM RESISTORS



metal-film, molded case

Distinct limited temperature coefficients and low tolerances to meet exacting application requirements. Rugged end cap construction for long-term stability and reliability. Superior resistance to humidity and mechanical damage. Surpass MIL-R-10509E requirements. Send for Bulletin 7025B.



deposited-carbon, molded case

Approach precision wirewounds in reliability and stability, yet are smaller in size and have lower self-inductance. Low, controlled temperature coefficient. Dense molded case provides outstanding humidity protection. Send for Bulletin 7000A.



deposited-carbon, conformal coated

Full rated load operation at 70 C with no wattage derating. Assured uprated loads at lower operating temperatures. Ideal for circuitry where small size, humidity resistance, and close tolerance ($\pm 1\%$) are required. Send for Bulletin 7005A.

Circle 270 on reader service card

ACRASIL® PRECISION/POWER WIREWOUND RESISTORS



silicone-encapsulated

Combine the best features of both precision and power wirewound types. Resistance tolerances to $\pm 0.05\%$. Unusually tough encapsulation protects against shock, vibration, moisture, fungus. Meet MIL-R-26C requirements. Smaller than conventional wirewounds, yet greater in stability. Send for Bulletin 7450.

Circle 271 on reader service card

BLUE JACKET® VITREOUS ENAMEL POWER WIREWOUND RESISTORS



All-welded end cap construction with special vitreous coating for long-term dependability. Axial-lead style for conventional wiring or on printed boards. Tab terminals for higher wattage applications. Meet MIL-R-26C requirements. Send for Bulletins 7400B, 7410D, 7411A.

Circle 272 on reader service card

KOOLOHM® CERAMIC-SHELL POWER WIREWOUND RESISTORS



Exclusive ceramic-insulated resistance wire permits "short-proof" multilayer windings for higher resistance values. Standard and non-inductive designs. Non-porous ceramic shell for moisture protection and electrical insulation. Axial-lead, axial-tab, and radial-tab styles. Send for Bulletins 7300B, 7305, 7310.

Circle 273 on reader service card

GLASS-JACKETED POWER WIREWOUND RESISTORS

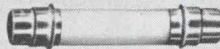

Ferrule terminals soldered to metallized ends of glass casing for true hermetic seal. Virtually failure-proof, even in extremely corrosive industrial and salt atmosphere. Standard and non-inductive windings. External meter-multiplier types also available. Send for Bulletins 7350, 7420, 7421.

Circle 274 on reader service card

STACKOHM® POWER WIREWOUND RESISTORS



Flat silhouette permits stacking of resistor banks in close quarters. Aluminum thru-bar simplifies mounting and conducts heat from resistance element. Vitreous enamel protective coating. Meet MIL-R-26C performance requirements. Send for Bulletin 7430.

Circle 275 on reader service card

For complete technical data, write for engineering bulletins on the resistors in which you are interested to: Technical Literature Service, Sprague Electric Company, 35 Marshall Street, North Adams, Massachusetts.

SPRAGUE®

THE MARK OF RELIABILITY

*Sprague' and '®' are registered trademarks of the Sprague Electric Co.

4 BR-160-63 R2

Once you take the measure of Helipot trimmers, you'll use them as a rule



Here are some of the rules for measuring

What do you look for in trimming potentiometers? Probably the same things that Helipot has established in 20 years of leadership in precision pots. By almost any standard of measure, you get more in the broad line of Helitrim® trimmers. If force of habit has caused you to overlook the important facts below, take a minute to brush up. You'll be doing yourself a favor.

Measure for Mounting Styles. Sizes and shapes to meet any application. Leads, pins, solder lugs and various panel mounts. All pin configurations, too, so they'll fit anywhere any other trimmer will.

Measure for Resistance Range. From 10 ohms to 2 megohms in every model, widest range in the industry. Rugged cermet resistance element, too, that has it all over wirewound or carbon elements. The cermet element is im-

mersible, shock resistant, free from sudden failure and offers essentially infinite resolution. **Measure for Price.** Helitrim trimmers stretch to fit any requirement and price, from military models to commercial trimmers priced *below a dollar* in quantity. They're *all* priced competitively or *below* trimmers you may currently be using.

While you're measuring, don't forget availability. Helitrim trimmers are available from stock in large quantities, and there are 32 Helipot sales offices to serve you. Ask one for the new Helipot trimmer catalog.

Beckman®

INSTRUMENTS, INC.

HELIPOT DIVISION

FULLERTON, CALIFORNIA • 92634

INTERNATIONAL SUBSIDIARIES: GENEVA, SWITZERLAND;
MUNICH, GERMANY; GLENROTHES, SCOTLAND; PARIS, FRANCE;
TOKYO, JAPAN; CAPE TOWN, SOUTH AFRICA

still the desire to perform research and advanced development work in students who possess both the interest and ability, it is equally important that academicians be realistic in assessing the industrial requirements for these embryo engineering scientists.

Since the role of graduate schools should be to introduce courses of an advanced nature in mathematics, physics, and other related tools of the research field, it is imperative that the undergraduate curriculum contain an adequate share of the "nuts and bolts."

Frederick C. Burgwardt
Assistant professor of Electrical Engineering, 1956-1964
Clarkson College of Technology
PotSDam, N. Y.

Chromatron fights back

To the Editor:

In both the June 1, 1964 and the May 31, 1965 issues, articles appeared about a color television tube being developed by the Yaou Electric Co. in Japan. In both of these articles, the Yaou tube was compared to the Chromatron tube, but the comparisons did not reflect the most recent status and performance of the Chromatron tube. For some years, the conjured-up defects, some imagined or predicted on paper, have not existed. Here is an up-to-date correct statement of some of these problems referred to in the articles.

The Chromatron can be and has been made using nonelectronic printing techniques. The electron printing technique is a one-step process. The phosphor position for each color can be determined with one evacuation using differential exposure techniques that have been

developed.

To maintain color purity, Chromatron tubes are now made with one color selector grid which produces a 5- to 7-mil spot on a 13-mil phosphor stripe.

Chromatron picture tubes can be used in transistor sets. Fairchild Semiconductor, a division of the Fairchild Camera & Instrument Corp., has built an 11-inch Chromatron set to demonstrate the use of transistors in color tv. In Japan, the Sony Corp. is producing a transistorized color set for sale to commercial airlines.

Switching power is reasonable, well under the 20 watts charged to Chromatron tubes by Yaou. We have made an eight-inch set which required only 7 watts of d-c power into the switching driver stage, and an 11-inch set which required between 10 and 12 watts.

There is no problem of spurious radiation from the 3.58-megacycle switching. Large Chromatrons—22-inch sets which require more switching power—have been demonstrated side by side with black-and-white sets and other color sets with no interference. Measurements show the Chromatron set is well below the maximum allowable specifications for radiation.

Color bowing is not a problem. We have made 22-inch tubes with a resolution capability of 550 lines and eleven-inch tubes with a resolution of 300 lines.

Using a circuit concept we have patented, a Chromatron set can be and has been operated without any color demodulators in one of its many modes of play.

Peter Ramella

General manager,
Chromatic Division
Paramount Pictures Corp.

New from Sprague!

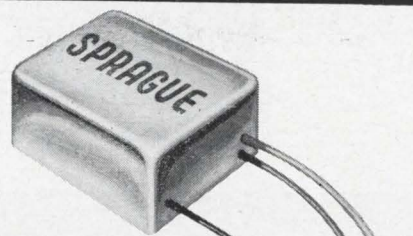

Subminiature Bandpass TELEMETERING FILTERS

**Extremely
flat pass bands
with no sacrifice
in stop band
attenuation!**

Designed for standard IRIG channels, Sprague Telemetering Filters are sealed in metal cases with special potting compound for protection from humidity and other atmospheric conditions. **Check these key characteristics!**

- Insertion loss: < 2 db
- Input and output impedance: 10 K Ω
- Maximum power: 10 dbm
- Operating temp.: -20 C to +105 C
- Bandwidth data: (a) 14.5 kc and below
 - \leq 1 db @ $\pm 7.5\% F_0$
 - \geq 30 db @ .5 and 2 F_0
- (b) 22 kc and above
 - \leq .8 db @ $\pm 16.2\% F_0$
 - \geq 40 db @ .5 and 2 F_0

Application engineering assistance is available to you from strategically located Sprague Filter Development Centers in North Adams, Mass.; Vandalia, Ohio; and Los Angeles, Calif. For complete information, write to Filter Division, Sprague Electric Co., 35 Marshall St., North Adams, Mass.

4SF-177-03 R1



*Sprague' and '©' are registered trademarks of the Sprague Electric Co.

SUBSCRIPTION SERVICE

Please include an Electronics Magazine address label to insure prompt service whenever you write us about your subscription.

Mail to: Fulfillment Manager
Electronics
P.O. Box 430
Hightstown, N.J. 08520

To subscribe mail this form with your payment and check new subscription renew my present subscription

Subscription rates: in the U.S.: 1 year, \$6; two years, \$9; three years, \$12. Subscription rates for foreign countries available on request

CHANGE OF ADDRESS

ATTACH LABEL HERE

If you are moving, please let us know five weeks before changing your address. Place magazine address label here, print your new address below.

name

address

city

state

zip code

Rugged, Ceramic Beam Pentode for Critical Linear Amplifier Applications

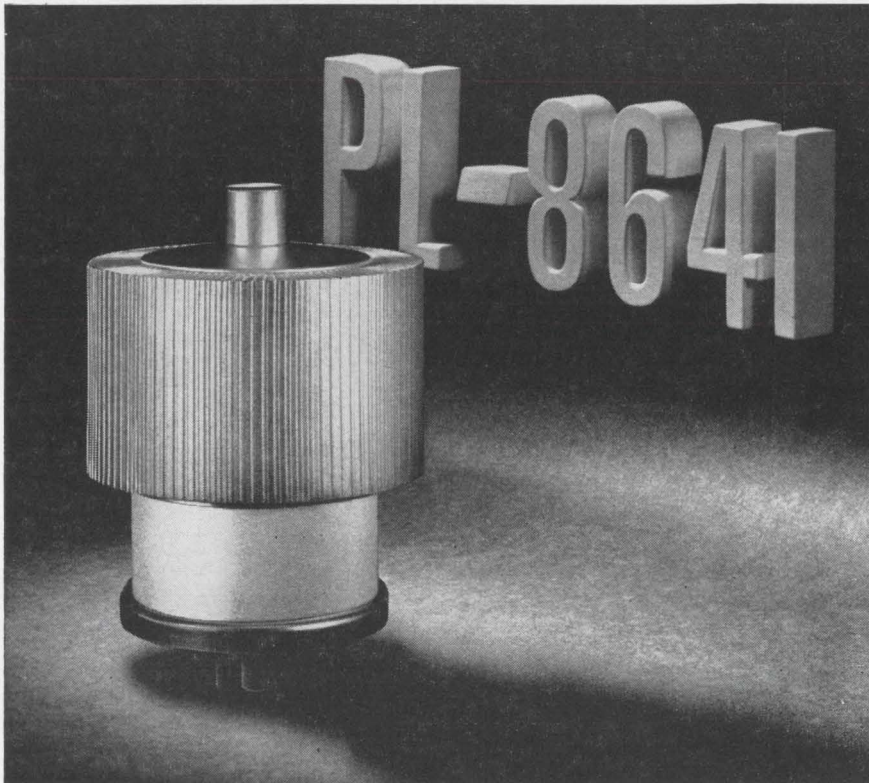

Combine unique, rugged internal tube construction, Penta's patented vane-type suppressor grid, and low interelectrode capacitance and you have the new PL-8641 ceramic beam pentode. You will find it an ideal tube for critical linear applications.

As a Class-AB₁ amplifier, the new PL-8641 will deliver over 5500 watts of useful PEP output, with 5000 plate volts and 1000 volts on the screen grid. Plate dissipation is conservatively rated at 3000 watts.

A unique thoriated tungsten mesh filament is used in the PL-8641, permitting reasonable electrode spacings. This means a rugged, dependable tube.

These are the maximum ratings for the new PL-8641:

Filament Voltage	6.0 volts
Filament Current	85 amperes
Plate Voltage	5000 volts
Plate Current	2.0 amperes
Screen Voltage	1000 volts
Plate Dissipation	3000 watts

Write today for full details on this newest addition to the Penta line of dependable beam pentodes. The Penta Laboratories, Inc., 312 N. Nopal Street, Santa Barbara, California 93102.
A Subsidiary of Raytheon Company.



People

The National Aeronautics and Space Administration has again turned to **James C. Elms** to coordinate work on manned space flights. Elms recently resigned from his post as vice president and general manager of space and information systems at the Raytheon Co. to become deputy associate administrator in the office of Manned Space Flight. In his new job, he will coordinate projects at Cape Kennedy, the Marshall Space Flight Center at Huntsville, Ala., and the Manned Spacecraft Center at Houston.



Elms has had such a task before. In 1963 he left the post of space electronics director at the Ford Motor Co.'s Aeronutronics division to become deputy director of the Manned Spacecraft Center for one year. His principal task was to organize the rapidly growing center, freshly split off from the Langley Research Center at Hampton, Va., to handle the billion-dollar research and development program for projects Gemini and Apollo.

In 1954, Lt. Col. **Albert R. Shiely** opened a management office in New York for the Air Force and set out to attain a radically new air-defense system. He succeeded. For three years he was in charge of engineering for three networks: Sage, the semi-automatic ground-environment system; Dew Line, the distant early-warning line across Canada; and White Alice, the communications network in the Arctic.



Last month Shiely, now a colonel, became vice commander of the Air Force's Electronic Systems division at Hanscom Field, Mass. The division manages the development and procurement of more than 30 command-and-control systems,

10 X More Power With Water-Cooled UHF Planar Triodes

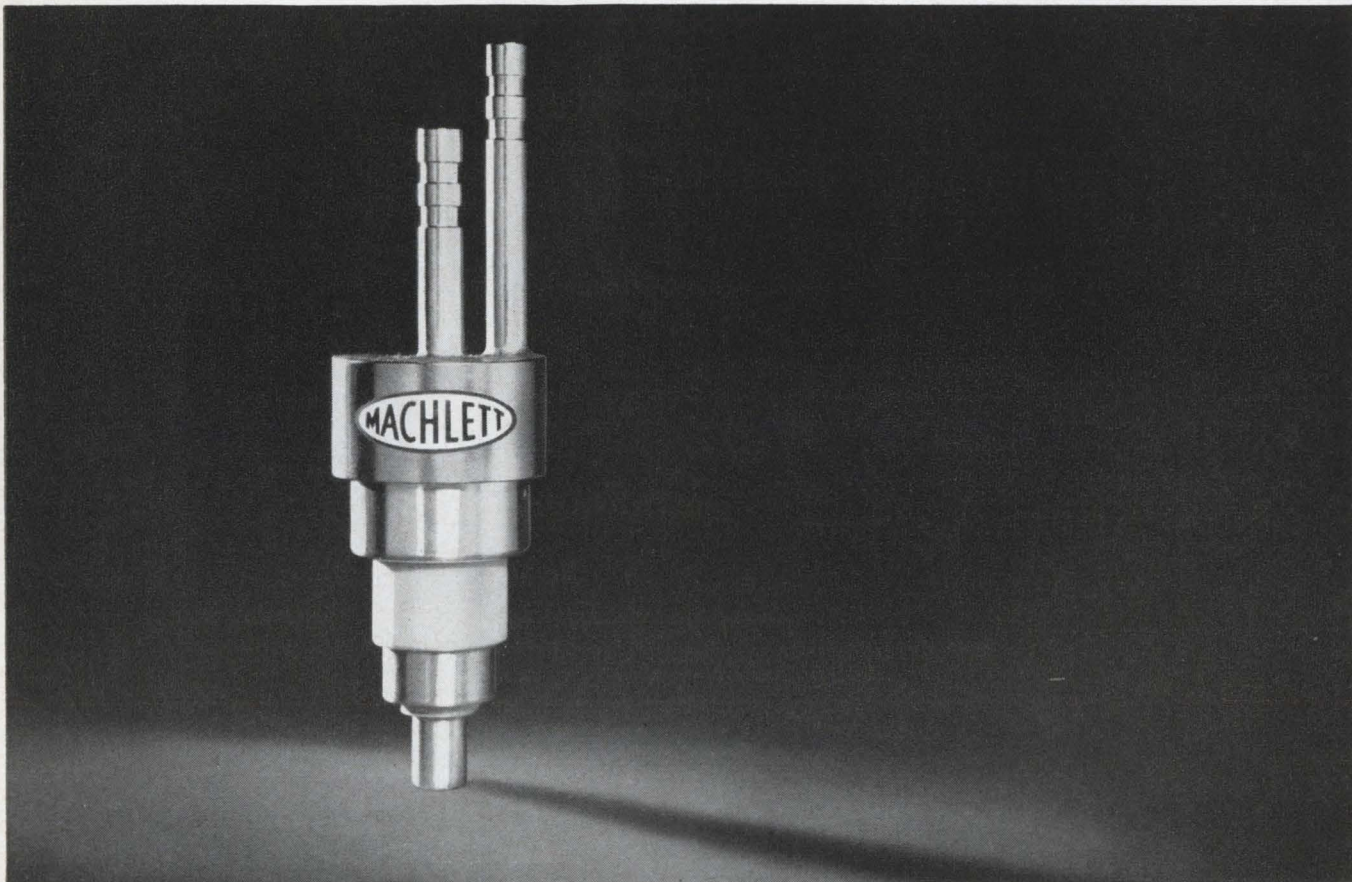

Machlett Laboratories has developed a simple, yet unique water cooling device for UHF planar triodes which permits CW output powers up to 10 X higher than previously attainable. Plate dissipation capability on one tube, the ML-7815, with water jacket, exceeds 400 watts. Comparable figure for forced-air-cooled ML-7815 is 100 watts; same tube with anode cover is 10 watts. Water cooling also makes possible operation at high cathode current densities—eg., a variation of the ML-7289 with water jacket is rated at 2 kV with 400 mA cathode current; a standard ML-7289 is capable of 1 kV and 125 mA cathode current. Water jackets are currently available on special ML-7289, ML-7698, ML-7815, ML-7855, ML-8403 and ML-8533. Write the Machlett Laboratories, Inc., Springdale, Conn. 06879. An Affiliate of Raytheon Company.



ELECTRON TUBE SPECIALIST



LOW NOISE Transistors

THE 2N3880

3.5 db max. System Noise Figure at 450 mc. Selected versions available down to 2.5 db max. System Noise Figure at 450 mc. (5.5 db max. at 1000 mc.) All available in TO-50 packages.

THE K1201 MOS FET

4.5 db max. System Noise Figure at 450 mc, 45 db AGC range, 400 mv Dynamic Range giving 1% cross-modulation. Selected G_m 's to 3000 umhos minimum.



2 Gc OSCILLATOR Transistors

K 2503 : 30 mw @ 2 Gc.

$f_t = 1700$ @ $V_{cb} = 10$ volts, $I_c = 30$ ma.

K 2502 : 85 mw @ 1 Gc in TO-46

K 2501 : 70 mw @ 1 Gc in TO-18



TUNNEL DIODES

Back diodes — — — down to 25 microamps.

Low-noise microwave diodes in Ge, GaSb and GaAs to 50 Gc.

1.0 K — factor max. @ $f_{ro} = 50$ Gc.

KMC MANUFACTURES SEMICONDUCTOR DEVICES ONLY, AND IS NOT YOUR "BLACK-BOX" COMPETITOR.

FOR CATALOGS AND SPECIFICATIONS — — — WRITE OR PHONE



semiconductor corporation

PARKER ROAD, LONG VALLEY, NEW JERSEY (201) 876-3811

most of which are technical descendants of Sage.

The holder of a master's degree in electrical engineering, Shiely is the second electronics engineer to reach the command level at the Electronic Systems command. The other is Maj. Gen. O. J. Glasser.

Under his command are communications and display networks for Air Force headquarters, transportable electronics for tactical warfare, an electromagnetic intelligence gathering system, and the North American Air Defense Command in the Cheyenne Mountains.

Most of these systems are computer-based descendants of Sage. Sage has its critics. They say its price, about \$5 billion, was too high; that it is too big and complex; and that it required mammoth, costly programming. But these critics are vigorously rebutted by Shiely. "It was, and remains, a real technical achievement, approaching in significance our best missile and aircraft programs," the colonel declares. "The Sage project was the first attempt to use digital computers in a real-time tactical situation. An operating system was produced which exceeded Air Force expectations."

After the start of Sage in 1957, the New York management group joined a team from Wright-Patterson Field, Ohio, to establish the Air Defense Systems' Integration Division at Hanscom Field. This blossomed into what was commonly called C²D², the Command-and-Control Development division. In a subsequent reorganization of the Air Force Systems Command this facility was designated the ESP.

Military commands sometimes complain about the increasing complexity of electronic systems. Shiely concedes that this is a special problem, and says ESD is devoting special attention to it. "Developments in weaponry, the advent of missiles, and the changed nature of warfare have led to increased complexity of the equipment needed to command and control the weaponry," he says. This is particularly serious in the development of tactical systems, "where you can easily get into more complexity than you can possibly handle."

Shiely is a graduate of the United States Military Academy at West Point.

New, expanded line of DCR power supplies up to 2500 watts

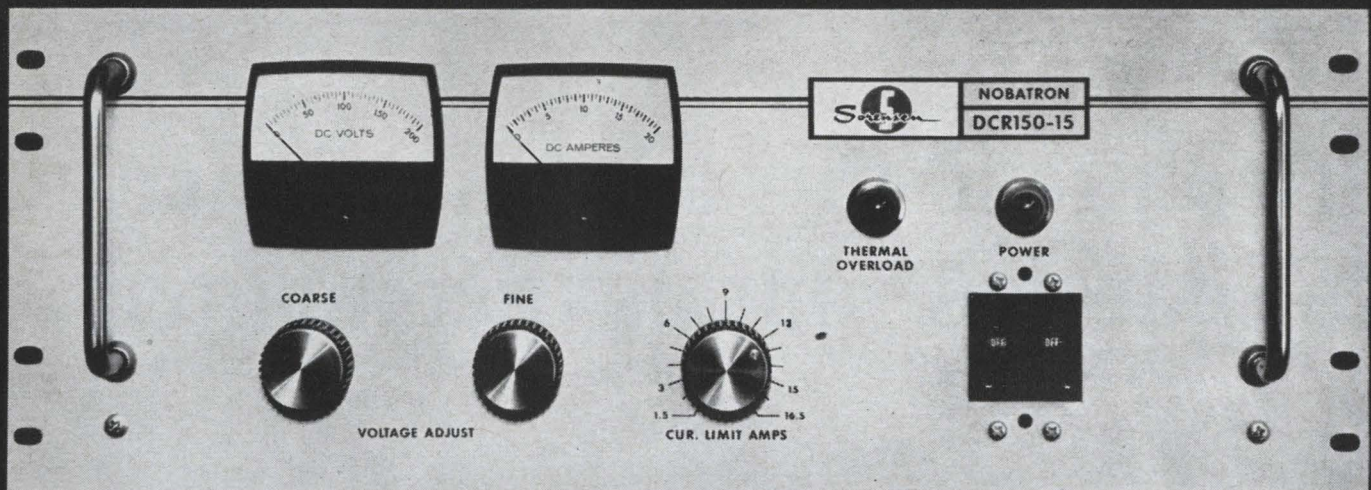

1. 20 SILICON CONTROLLED RECTIFIER SUPPLIES AVAILABLE... Delivery in 30 days or less.
2. LOW PRICES... Starting at \$325 (Voltmeter and Ammeter included with no increase in price)
3. COMPACT PACKAGING
4. HIGH EFFICIENCY
5. CONSTANT VOLTAGE REGULATION... with continuously adjustable current limiting.
6. CONSTANT CURRENT REGULATION... with continuously adjustable voltage limiting.
7. AUTOMATIC CROSSOVER... full automatic transition from constant voltage

8. REMOTE PROGRAMMING... Voltage and Current
9. REMOTE SENSING... At distances up to 200 feet
10. SERIES OR PARALLEL OPERATION
11. VOLTAGE REGULATION... (as low as $\pm 0.075\%$ or 15 mv) line and load combined
12. CURRENT REGULATION... As low as ± 15 ma
13. LOW RIPPLE
14. RFI SUPPRESSION (Typical within 10 db of MIL-I-26600)
15. COARSE AND FINE VOLTAGE CONTROLS

For complete data on the DCR series and other Sorensen products, send for the new, 140-page "Controlled Power Catalog and Handbook." Write to: Sorensen, Richards Avenue, South Norwalk, Connecticut. Or use Reader Service Card Number 200.

DCR ELECTRICAL AND MECHANICAL SPECIFICATIONS:

MODEL NUMBER	VOLTAGE RANGE (VDC)	VOLTAGE REG. (LINE & LOAD COMBINED)	OUTPUT CURRENT (AMPS.)	CONSTANT CURRENT RANGE (AMPS.)	CURRENT REG.	CONSTANT VOLTAGE RIPPLE (RMS)	TRANSIENT RESPONSE	WIDTH	PACKAGE SIZE (INCHES) HEIGHT	DEPTH	WEIGHT (LBS.)	PRICE
DCR 300-1.25	0-300	$\pm 0.075\%$ or 60mv	0-1.25	0.125 to 1.37	± 15 ma	0.4% + 300mv	30msec	19	5 1/4	15	52	\$325
DCR 150-2.5	0-150	$\pm 0.075\%$ or 30mv	0-2.5	0.25 to 2.75	± 15 ma	0.4% + 150mv	30msec	19	5 1/4	15	52	325
DCR 80-5	0-80	$\pm 0.075\%$ or 20mv	0-5	0.5 to 5.5	± 15 ma	0.4% + 80mv	30msec	19	5 1/4	15	56	325
DCR 40-10	0-40	$\pm 0.075\%$ or 15mv	0-10	1 to 11.0	± 20 ma	0.4% + 40mv	30msec	19	5 1/4	15	55	325
DCR 300-2.5	0-300	$\pm 0.075\%$ or 60mv	0-2.5	0.25 to 2.75	± 15 ma	0.4% + 300mv	30msec	19	5 1/4	18	77	525
DCR 150-5	0-150	$\pm 0.075\%$ or 30mv	0-5	0.5 to 5.5	± 15 ma	0.4% + 150mv	30msec	19	5 1/4	18	77	525
DCR 80-10	0-80	$\pm 0.075\%$ or 20mv	0-10	1.0 to 11.0	± 20 ma	0.4% + 80mv	30msec	19	5 1/4	18	77	525
DCR 60-13	0-60	$\pm 0.075\%$ or 15mv	0-13	1.3 to 14.3	± 20 ma	0.4% + 60mv	30msec	19	5 1/4	18	77	525
DCR 40-20	0-40	$\pm 0.075\%$ or 15mv	0-20	2.0 to 22.0	± 25 ma	0.4% + 40mv	30msec	19	5 1/4	18	77	525
DCR 300-5	0-300	$\pm 0.075\%$ or 60mv	0-5	0.5 to 5.5	± 15 ma	0.4% + 300mv	30msec	19	7	18	95	710
DCR 150-10	0-150	$\pm 0.075\%$ or 30mv	0-10	1.0 to 11.0	± 20 ma	0.4% + 150mv	30msec	19	7	18	95	710
DCR 80-18	0-80	$\pm 0.075\%$ or 20mv	0-18	1.8 to 19.8	± 25 ma	0.4% + 80mv	30msec	19	7	18	98	710
DCR 60-25	0-60	$\pm 0.075\%$ or 15mv	0-25	2.5 to 27.5	± 25 ma	0.4% + 60mv	30msec	19	7	18	100	710
DCR 40-35	0-40	$\pm 0.075\%$ or 15mv	0-35	3.5 to 38.5	± 35 ma	0.4% + 40mv	30msec	19	7	18	102	710
DCR 300-8	0-300	$\pm 0.075\%$ or 60mv	0-8	0.8 to 8.8	± 20 ma	0.4% + 300mv	30msec	19	7	18	115	825
DCR 150-15	0-150	$\pm 0.075\%$ or 30mv	0-15	1.5 to 16.5	± 25 ma	0.4% + 150mv	30msec	19	7	18	115	825
DCR 80-30	0-80	$\pm 0.075\%$ or 20mv	0-30	3.0 to 33.0	± 30 ma	0.4% + 80mv	30msec	19	7	18	120	875
DCR 60-40	0-60	$\pm 0.075\%$ or 15mv	0-40	4.0 to 44.0	± 40 ma	0.4% + 60mv	30msec	19	7	20	130	900
DCR 40-60	0-40	$\pm 0.075\%$ or 15mv	0-60	6.0 to 66.0	± 60 ma	0.4% + 40mv	30msec	19	7	20	131	925
DCR 20-125	0-20	$\pm 0.075\%$ or 8mv	0-125	0 to 125	± 125 ma	0.4% + 20mv	30msec	19	10 1/2	20	169	1050



**If you read this ad you may have
to redesign your next computer.**

(you may have to anyway.)

Fairchild Complementary Transistor Micrologic (CT μ L) is drastically changing all existing speed/cost ratios in the computer industry. If you are not already using CT μ L (many computer manufacturers are) here are 10 reasons why you should:

1. Complementary Transistor Micrologic combines PNP and NPN transistors in a single monolithic circuit. As you know from your experience with discrete components this form of logic provides very fast propagation rates but isn't very stable.

2. We added a resistive network to the CT μ L elements to arrive at a circuit which is as stable as DTL logic—and at least twice as fast.

3. In our newer circuits we substitute an input voltage clamp for the resistive network. This damps out ringing, eliminates additive harmonic effects, and stabilizes the circuit to a point where you can drive a 15-foot line instead of a 1-foot maximum.

4. We then turned to the package and designed it for your particular needs: highly reliable, but with less concern for space than is necessary for military applications.

5. As a result you can use CT μ L elements just like discrete components: use standard boards instead of multi-layer; insert by hand or machine instead of using expensive carriers; flow solder instead of precision weld; use standard wiring on your back-panel instead of twisted pair or coaxial.

6. We make a complete line of CT μ L (see listing below) consisting of all the elements you need to design virtually every standard logic function in the book.

7. CT μ L is a field-proven line, in production, available for immediate delivery from distributors.

8. Last, but by no means least, CT μ L costs less per decision than any other logic form on the market today—and that includes the one in your back room.

9. If you don't want to design a computer which is either slower or more expensive than the competition, we suggest that you get some CT μ L circuits now. Or write us for complete information.

10.

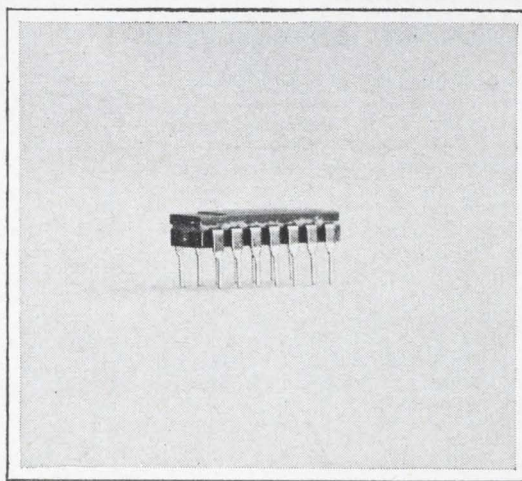

CT μ L Elements: CT μ L952 Dual 2-input inverter/NOR gate CT μ L953 2,2,3-input AND gate CT μ L954 Dual 4-input AND gate CT μ L955 Single 8-input AND gate CT μ L956 Dual 2-input buffer CT μ L957 Dual-rank flip-flop CT μ L964 3,3,1-input AND gate CT μ L965 Quad one-input AND gate CT μ L967 J-K flip-flop CT μ L968 Dual latch. Micrologic and CT μ L are FAIRCHILD Trademarks. Micrologic: FAIRCHILD SEMICONDUCTOR'S Trade Name for Analog and Digital Monolithic Circuits.

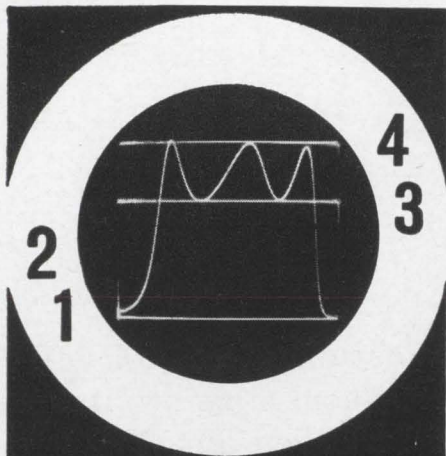

see **4** response traces on single-trace scope

measurement by comparison up to 1,200 mc



NEW
JERROLD
SOLID-STATE
3-POSITION
COAXIAL SWITCHER

Model TC-3 \$295⁰⁰

Turn any single-trace oscilloscope into a 4-trace scope; insert two reference traces automatically in addition to test trace and baseline. These references have advantage of permanent relative accuracy over scribed or painted lines.

Results are repeatable, as accurate as your reference attenuators. Generator and scope drift do not affect accuracy of measurements. Frequency from dc to 1,200 mc extends usefulness of comparison technique well into the UHF band. The TC-3 Coaxial Switcher can save you thousands of dollars in speed and accuracy. Write for literature.

JERROLD
ELECTRONICS

Industrial Products Division,
Philadelphia, Pa. 19132
In Canada: Jerrold Electronics,
60 Wingold Ave., Toronto 19, Ont.
Export: Rocke International,
13 E. 40th St., New York, N.Y. 10016

SWEEP GENERATORS • AMPLIFIERS
PRECISION ATTENUATORS • COMPARATORS

Meetings

National Communications Conference (NATCOM), Mohawk Valley Section of IEEE; Utica, N.Y., Oct. 11-13.

International Congress and Exhibition for Instrumentation and Automation, Arbeitsgemeinschaft Interkama; Exhibition Grounds, Duesseldorf, Germany, Oct. 13-19.*

Exhibition and Congress of Telecommunications, International Television Committee (CIT); Milan Fair Grounds, Italy, Oct. 14-23.

Nuclear Science Symposium, IEEE; Hilton Hotel, San Francisco, Oct. 18-20.

Sensitivity in Control System Synthesis Conference, AFOSR and the Univ. of Illinois; Univ. of Ill., Urbana, Ill., Oct. 19.

Conference on Radio, Astronomical and Satellite Studies of the Atmosphere, AFCRL; Sheraton-Boston Hotel, Boston, Oct. 19-21.

Symposium on Economics of Automatic Data Processing, International Computation Center; Palazzo dei Congress, Rome, Italy, Oct. 19-22.

Systems Effectiveness Conference, EIA; Sheraton Park Hotel, Washington, D. C., Oct. 19-20.

Allerton Conference on Circuit & System Theory, G-CT IEEE, Univ. of Ill.; Conference Center, Univ. of Illinois, Monticello, Ill., Oct. 20-22.

Electronic Interconnection Techniques and Packaging Conference, SAE; International Hotel, Los Angeles, Oct. 20-21.

Annual Technical Meeting, Electronic Devices Group of the IEEE; Sheraton Park Hotel, Washington, D. C., Oct. 20-22.

International Microminiaturization Symposium, IFAC, IFIP; Munich, Germany, Oct. 21-23.

National Electronic Conference, IEEE; McCormick Place, Chicago, Oct. 25-27.

Aerospace and Navigation Electronics East Coast Conference (ECCANE), G-Ane, Baltimore Section of IEEE; Holiday Inn, Baltimore, Oct. 27-29.

Energy Conversion and Storage Conference, Oklahoma State University, Stillwater, Oct. 28-29.

Conference on Men, Machines and Automation, Institution of Production Engineers; Eastbourne, England, Nov. 7-10.

Conference on Hall Effect Applications, Electron Devices Group of IEEE; Kresge Little Theatre, MIT, Cambridge, Nov. 8-9.

Materials for Electron Devices and Microelectronics Meeting, ASTM; ASTM Headquarters, Philadelphia, Nov. 9-10.

Industrial Electric Exposition, Electric League of Western Pennsylvania; Hilton Hotel, Pittsburgh, Nov. 9-11.

Research and Development Meeting, New Jersey Council for Research and Development; Princeton Inn, Princeton, N. J., Nov. 10.

Engineering in Medicine and Biology Conference, ISA, IEEE; Sheraton Hotel, Philadelphia, Nov. 10-12.

Call for papers

Frequency Control Symposium, U. S. Army Electronics Command; Shelbourne Hotel, Atlantic City, N. J., Apr. 19-21. **Dec. 1** is deadline for submission of four copies of 500-word summary to M. F. Timm, Director Electronic Components Laboratory, U. S. Army Electronics Command, Att: AMSEL-KL-ST, Fort Monmouth, N. J. 07703.

Joint Computer Conference, American Federation of Information Processing; Boston, Mass., Apr. 26-28. **Nov. 1** is deadline for submission of five copies of initial draft and 150-word abstract to the Program Committee, 1966 SJCC, P. O. Box 460, Lexington, Mass. 02173.

* Meeting preview on page 16

Here's Lucky Item #13 in the Fluke '65 Pacesetter Line

Accuracy $\pm 0.0025\%$. Maximum meter resolution, 0.1 ppm. Fourteen pounds later you have the new solid-state Fluke 885 DC Differential Voltmeter, the first truly portable laboratory standard. Peak-to-peak reference stability is 15 ppm for 60 days. Use the Fluke 885 as an isolation amplifier. Grounded recorder output is so well isolated that a short-circuit at the output produces no voltmeter reading error. Ground loops are completely eliminated when the battery powered Model 885AB is used.

Other Specifications: Range, 0 to 1100 Volts. Null sensitivity, 100 microvolts full scale. Line regulation better than 2 ppm.

No zener oven, less than 30 seconds warm-up time.

Cabinets can be half rack or full rack mounted with optional mounting kits.

Price of the Model 885A line cord version is \$1,195.

The battery powered Model 885AB is \$1,325.



FLUKE • Box 7428 • Seattle, Washington 98133 • Phone: (206) PR 6-1171 • TWX: (910) 449-2850

Model 885A reading precise voltage from Model 332A Voltage Calibrator on 10V range



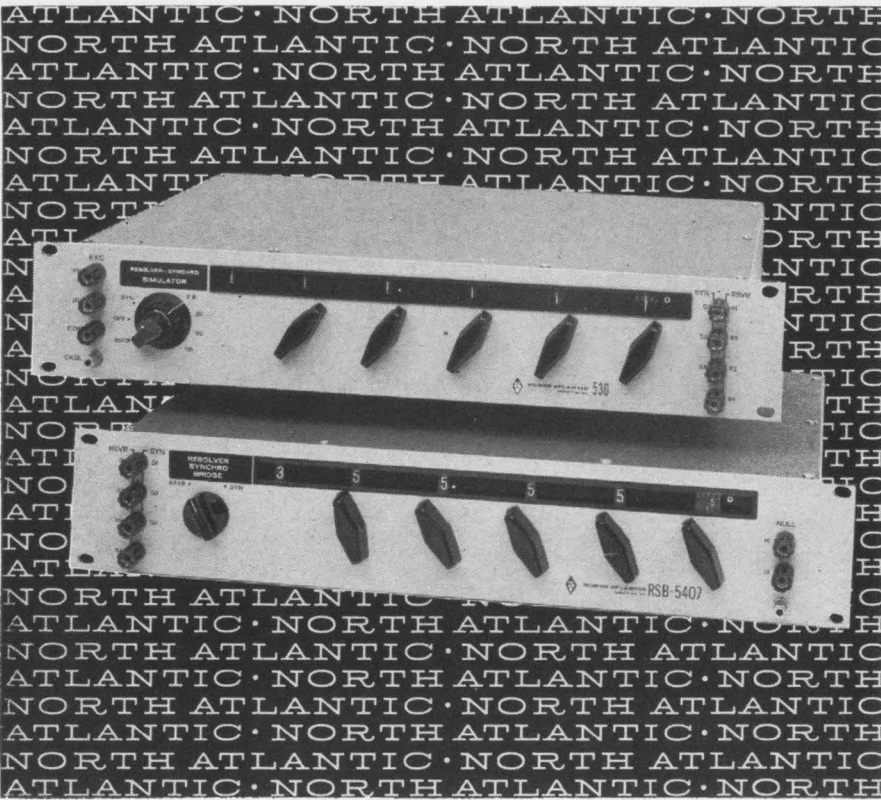

you are looking at the state-of-the-art in resolver/synchro testing

These two instruments provide the widest measurement capability available today for resolver/synchro testing. Each is a dual-mode unit, measuring both resolvers and synchros. Series 530 Simulators are ideal transmitters, and Series 540 Bridges are ideal receivers.

In addition to their dual-mode capability in 3½" of panel space, both series provide in-line decimal readout continuously switched through 360°, 2 second accuracy at any angle, and input/output isolation.

SERIES 530 SIMULATORS FEATURE

- Resolution 0.001°, 1°, or 5°
- Dual 26/115 volt excitation
- Switch selected line-line voltages 11.8, 26, 90, and 115 volts
- Low matched output impedance

SERIES 540 BRIDGES FEATURE

- Resolution 0.0001°, 1°, or 5°
- 500K input impedance
- Constant null-voltage gradient at all line-line voltages
- Unaffected by null detector loading

Prices range from \$1480.00 to \$2680.00

The flexibility of these instruments meets every need for rapid and accurate testing in the engineering laboratory, in production, and in ground support equipment. Used with a Phase Angle Voltmeter, they provide a complete facility for component or system test.

Programmable models with decade or binary input are also available. Your North Atlantic representative will be glad to arrange a demonstration. Call or write him today.



NORTH ATLANTIC industries, inc.
TERMINAL DRIVE, PLAINVIEW, L. I., NEW YORK • Overbrook 1-8600

Meeting preview

Automation in Duesseldorf

Papers on the application of the computer to industrial processes dominate the technical sessions of Interkama, the big industrial instrumentation and automation exposition held every five years in Germany.

The show, which runs Oct. 13 to 19 in Duesseldorf, is sponsored by 13 German scientific and technical groups.

The application of computers to various industrial processes accounts for a large number of the 72 papers to be presented. Papers will be given on the use of the computer in the power industry and in the chemical industry and on automation of production control and electronic material flow simulation and control.

The impact of the computer on Europe's electric power industry is reflected in a number of papers, including discussions of direct digital control in power plants, and the programming of digital computers for application to steam power plants. Three papers will give information on the progress and problems in the use of automation and remote control by electric power companies in France and Switzerland.

Other sessions go into automation in manufacturing plants, in parts inspection and quality control, and in raw and processed material testing. Analog, digital, and hybrid techniques will be discussed, as will fundamental considerations in the use of computers in automatic systems.

The products of some 80 American companies will be displayed in a cooperative exhibit, under the auspices of the Department of Commerce. At least half of the companies have as yet no established sales representation in the German market, and for some it marks the first step into the European market as well.

The technical sessions will be held in Hall A of the Duesseldorf Fairgrounds. A single technical session will be held each morning of the show, and three series of group discussions are scheduled for each afternoon.

The components that have made the Allen Organ famous. Used by America's leading electronic manufacturers.

ALLEN COMPONENTS

- Uniformly High Grade
- Attractive Prices
- Wide Electronic Applications
- Always in Stock
- Small Orders Welcomed
- Quick Delivery

Allen Frequency Sources Types C and P (plug-in type)

Moderately priced compact audio oscillators designed for applications that do not have most-stringent requirements for stability in respect to temperature and frequency drift.

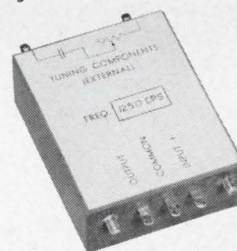

Allen Toroids

Over 150 sizes available from stock include Permalloy, Ferrite and Powdered Iron types. Inductance ranges from 50 henries to 6 millihenries.

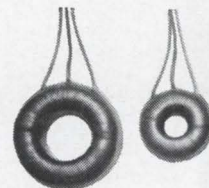

Allen 20-watt and 50-watt Transistorized Amplifiers

Utilize latest developments in solid-state technology. They demonstrate characteristics normally associated with such circuitry (compact design, low heat dissipation). High sensitivity, conservatively rated.



Write for our free catalog!



Allen Organ Company, Macungie, Pa. Phone 215-965-9801

Allen Organ Co., Dept. E10, Macungie, Pa. 18062

Please send me your components catalog.

I am interested in: Toroidal coils Oscillators Amplifiers

Name _____

Firm _____

Street _____ City _____

State _____ Zip Code _____

(C) A.O. Co.

Your Comparative Reference Guide to CEC Analog and Digital Magnetic Tape Recorders and Accessories

This revised guide includes a new addition to CEC's recorder line—the VR-3800*

Type VR-3600 – Considered the ideal “universal” recorder, and the ultimate choice for the most demanding pre- and post-detection and general purpose use.

- 400 cps to 1.5 mc direct frequency response; and d-c to 500 kc FM frequency response.

- Multispeed electrically switchable direct and FM system . . . up to six speeds!

- 7 or 14 channel systems available as standard.

- Available in “Universal” machine configurations for compatibility with lower bandwidth CEC recorders.

- Accessories include monitor meters for display of bias, input and output signals, RFI certification to MIL-I-6181D.

***Type VR-3800** – New data recorder offering the basic advantages of the VR-3600 at a modest price. Destined to become the “work horse” of midband recorders.

- 300 cps to 300 kc direct frequency response; d-c to 40 kc FM frequency response with high accuracy FM system.

- Six speeds to 60 ips, instantly switchable.

- All-metal-front-surface recording heads – reduce cleaning to a minimum; reduce tape and head wear.

- 7 or 14 channel systems available as standard.

- Direct system fully amplitude- and phase-equalized.

Type VR-2600 – Recognized as the finest, most versatile performer in its class.

- Available with any combination of four types of recording/reproducing electronics and configurations (direct, FM, PDM, PCM).

- All solid-state electronics, pushbutton controlled for operation without readjustment at six (6) tape speeds.

- 600 kc direct, 80 kc FM, IRIG PDM, and 1000 bit per inch PCM capabilities.

- 7 and 14 track analog systems as well as 16 track PCM systems available as standard. Accessories include edge track voice recording/reproducing, shuttle control and monitoring equipment, including both meter and oscilloscope presentation.

Type VR-3300 – Unmatched for applications where ruggedness and mobility must be combined with outstanding performance.

- 100 cps to 200 kc direct frequency response; d-c to 20 kc FM frequency response.

- Dual capstan drive system provides closed-loop speed and tension control equal to standard laboratory systems.

- Interchangeable record and reproduce electronics and heads with CEC's

Type VR-2800 laboratory recorder/reproducer and VL-2810 continuous loop recorder/reproducer.

- Six speed record/reproduce system.

Type VR-2800 – A highly reliable wide-band system for use in laboratory environments with direct and FM electronics.

- Six speed record/reproduce operation.

- 100 cps to 200 kc direct system and d-c to 20 kc FM system.

- Up to 7 or 14 channels on ½” or 1” tape respectively on 14” reels provide extended record time.

- Uses all-metal-front-surface magnetic heads, as do all CEC recorders, for long life and minimum tape wear.

Type PR-3300 – Designed for mobility at a modest cost.

- High quality mobile magnetic tape recorder/reproducer for standard 100 kilocycle work.

- 7 or 14 channel systems on ½” and 1” tape respectively; 10½” diameter reels.

- Handles information via direct, FM or PDM techniques in any combination. Like the VR-3300, this unit can be operated from a-c or d-c power sources using its accessory precision frequency power supply.

- Interchangeable electronics with CEC's

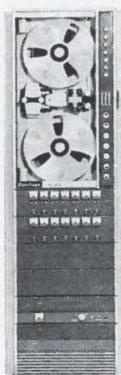

VR-3600



VR-3800

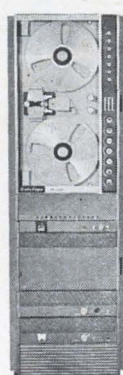

VR-2600

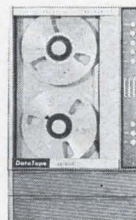

VR-3300

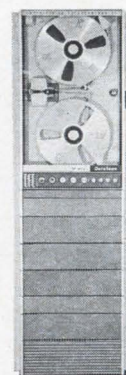

VR-2800

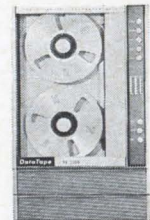

PR-3300

	VR-3600	VR-3800 ^o	VR-2600	VR-3300	VR-2800	PR-3300	GR-2800	GL-2810	DR-2700
TAPE SPEEDS	6 speeds to 120 ips	6 speeds to 60 ips	7 speeds to 120 ips (in two ranges)	6 speeds to 60 ips	6 speeds to 60 ips	6 speeds to 60 ips	6 speeds to 60 ips	6 speeds to 60 ips	up to 150 ips
DIRECT FREQUENCY RESPONSE	400 cps—1.5 mc	300 cps—300 kc	300 cps—600 kc	100 cps—200 kc	100 cps—200 kc	d-c—100 kc	100 cps—100 kc	100 cps—100 kc	
FM FREQUENCY RESPONSE	d-c—500 kc	d-c—40 kc	d-c—80 kc	d-c—20 kc	d-c—20 kc	d-c—10 kc	d-c—10 kc	d-c—10 kc	
CHANNELS	up to 14	up to 14	up to 14	up to 14	up to 14	up to 14	up to 14	up to 14	up to 16
RECORDING METHODS	Direct, FM	Direct, FM	Direct, FM, PDM, PCM	Direct, FM, PDM	Direct, FM, PDM	Direct, FM, PDM	Direct, FM, PDM	Direct, FM, PDM	Digital—Densities to 555.5 bits per inch NRZ-1
ELECTRONICS	Solid-State	Solid-State	Solid-State	Solid-State	Solid-State	Solid-State	Solid-State	Solid-State	Solid-State

GR-2800 and GL-2810 magnetic tape recorder/reproducer systems.

Type GR-2800 — Commonly selected for general lab use in both industrial and military applications because of its operating economy, long life and reliability.

- General purpose laboratory recorder/reproducer system accommodating data in direct, FM or PDM recorded format in the frequency range from d-c to 100 kc.

- Utilizes all solid-state electronics.

- 7 or 14 channel operation on 1/2" and 1" tape respectively, with reel diameters to 14".

- Closed-loop capstan drive system.

- Precision capstan drive electronics and tape speed control servo provide tape speed accuracies to within ±0.02% of recorded speed.

Type DR-2700 — The ideal instrument for reliable data handling in digital form, with a wide selection of tape speeds and data transfer rates.

- 7 or 8 channel configurations on 1/2" tape, or up to 16 channel configurations on 1" tape using standard 10 1/2" NAB or IBM compatible reels.

- Operates at tape speeds up to 150 ips, and at command rates up to 200 per second without programming restriction.

- Full line of computer compatible accessories.

- All solid-state tape transport and read/write electronics. High reliability makes this unit extremely well-suited to on-line computer application.

Types GL-2810 & VL-2810—Specifically designed for data reduction or data monitoring and storage where machine workload is heavy.

- Accommodate tape loop runs from 2 to 75 feet at six tape speeds from 1 1/8 to 60 ips.

- GL-2810 handles data in the range from d-c to 10 kc via FM techniques, and from 100 cps to 100 kc employing direct techniques; VL-2810 handles d-c to 20 kc FM and 100 cps to 200 kc via direct.

- Utilize 1/2" tape for up to 7 channels, or 1" tape for up to 14 channels, using IRIG geometry.

- Accessories include selective erase equipment providing erasure of any combination of 7 to 14 tracks, without removal of the tape loop from the machine. Bulk erase equipment also available.

ranging in frequency from d-c to 1,500,000 cps. Unique features of this unit include up to 500 kc sweep rate and modular construction.



The Type TD-2903 Automatic Tape Degausser is designed to erase data signals from magnetic tape wound on reels up to 14" in diameter and from 1/4" to 2" wide tape. A reel of 1" wide instrumentation tape recorded at saturation level is erased to a nominal 90 db below normal level.

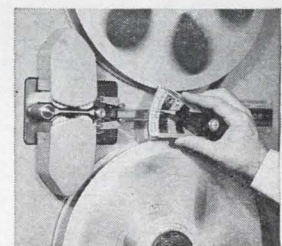

The Dynamic Tape Tension Gage permits accurate tension measurements directly while the recorder is in operation . . . helps keep your recorder in proper operating condition through routine maintenance adjustment.

For complete information on any CEC Tape Recorder/Reproducer, write or call CEC for Bulletins in Kit #7002-X5.

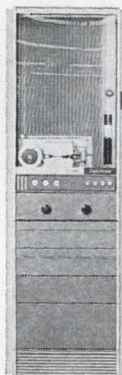

GL-2810

CEC's DataTape[®] Accessories

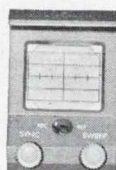

The Monitor Oscilloscope is used with tape recorder/reproducers, or any multi-channel instrumentation system to provide visual display of electrical signals

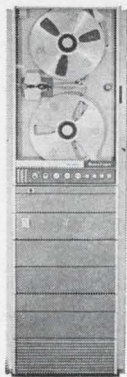

GR-2800



DR-2700

CEC

Data Recorders Division

CONSOLIDATED ELECTRODYNAMICS

A SUBSIDIARY OF BELL & HOWELL/PASADENA, CALIF. 91109
INTERNATIONAL SUBSIDIARIES: WOKING, SURREY, ENGLAND
AND FRIEDBERG (HESSON), W. GERMANY

EAGLE ELECTRIC COUNTER

Batch count a predetermined number. Shut off or actuate a machine or machines.

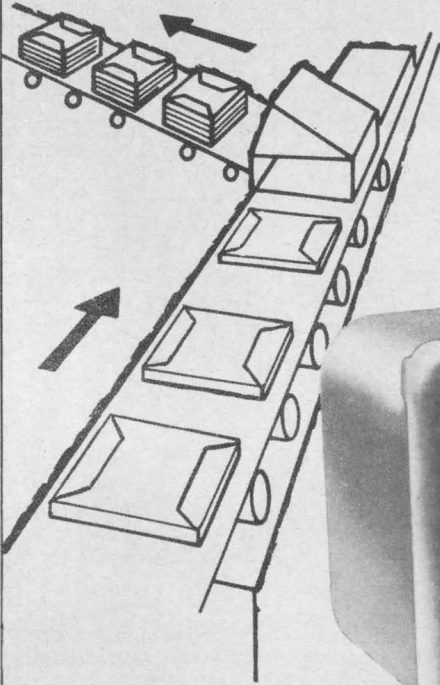

Meter fluids by flowmeter. Control a shut-off or a mixing valve or valves.

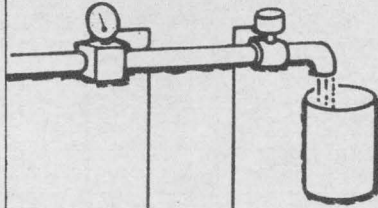

Add-subtract count. Control of parking lot, hopper or conveyor section capacity.

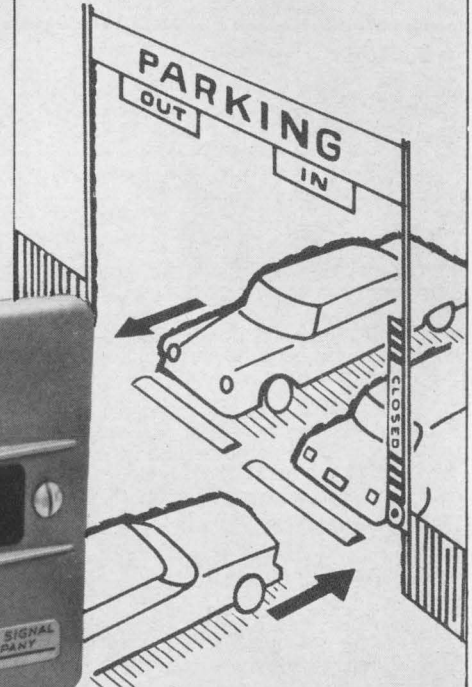

COUNTS...THEN CONTROLS

The HZ760 performs in three ways...as a batch counter...a continuous count counter...an add-subtract counter. Whether you count pills or automobile bodies, this is the unit for the job.

Functionally, the HZ760 registers counts by electric impulse from a limit switch, photoelectric cell, flow meter or similar device. At the preselected number of counts, *adjustable up to 9999*, the unit's control switch turns electronically or electrically controlled equipment on or off. **THERE IS NO RESET TIME.**

The HZ760 is a rugged counter designed for precise, industrial control. Among its outstanding features: pushbuttons to set count...keylock to prevent tampering...large, easy-to-read numerals...10 amp. load switches...counting speeds to 500 per minute...AC coils. HZ762 shaft driven units for revolution counting also available. **Compare. You'll choose Eagle.**

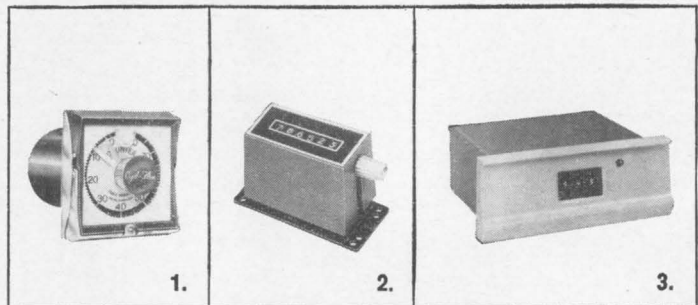

EAGLE's family of counters offers you a wide selection for your most exacting control problems: **1.** 80 count plug-in automatic reset counter. **2.** 6 digit electric count totalizer. **3.** 3 digit electronic counter for high speed counting.

Contact Eagle Signal Division, E. W. Bliss Company, Federal Street, Davenport, Iowa.



Electro-Mechanical, Electronic, Solid State Timing/Counting/Programming Controls General Purpose, Medium Power Relays

NEW EAGLE RELAYS

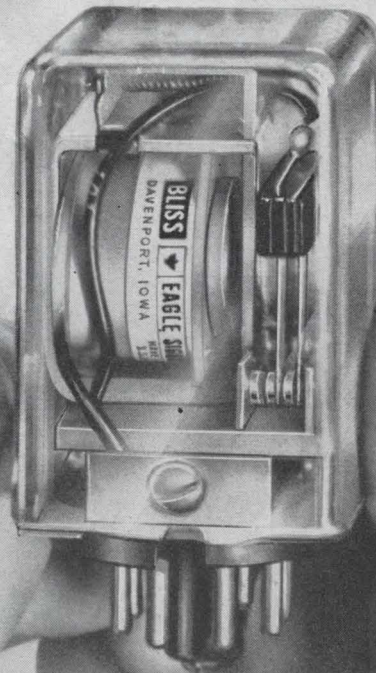

OVER 3,000 TYPES

COMPARE THEM...for Reliability

A unique, unrelenting inspection and quality control program guarantees that Eagle Relays will meet or exceed published specifications. This performance is backed by a solid one-year warranty.

COMPARE THEM...for Quality

Advanced design, engineering know-how and exacting manufacturing methods create relays of the highest quality...insuring reliable performance.

When you specify Eagle Relays, you also get unequalled service from a nation-wide network of experienced sales engineers and stocking distributors.

Compare. You'll choose Eagle.

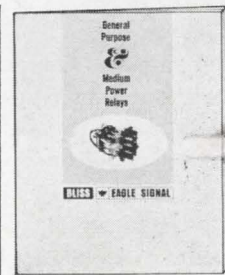
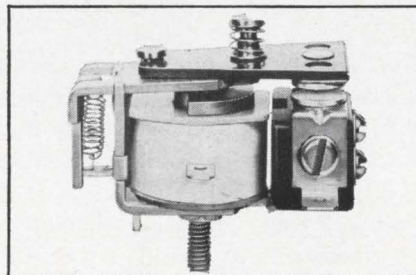

The 25PD Medium Power Relay, shown above, handles loads up to 25 Amps. with ease. It is available with a variety of coils and SPST NO-DB contacts. Get the complete story on Eagle Relays. Send for your free copy of our 16-page color catalog, today. Write to Eagle Signal Division, E. W. Bliss Co., Federal Street, Davenport, Iowa.

BLISS  **EAGLE SIGNAL**

A DIVISION OF THE E. W. BLISS COMPANY

Electro-Mechanical, Electronic, Solid State Timing/Counting/Programming Controls General Purpose, Medium Power Relays

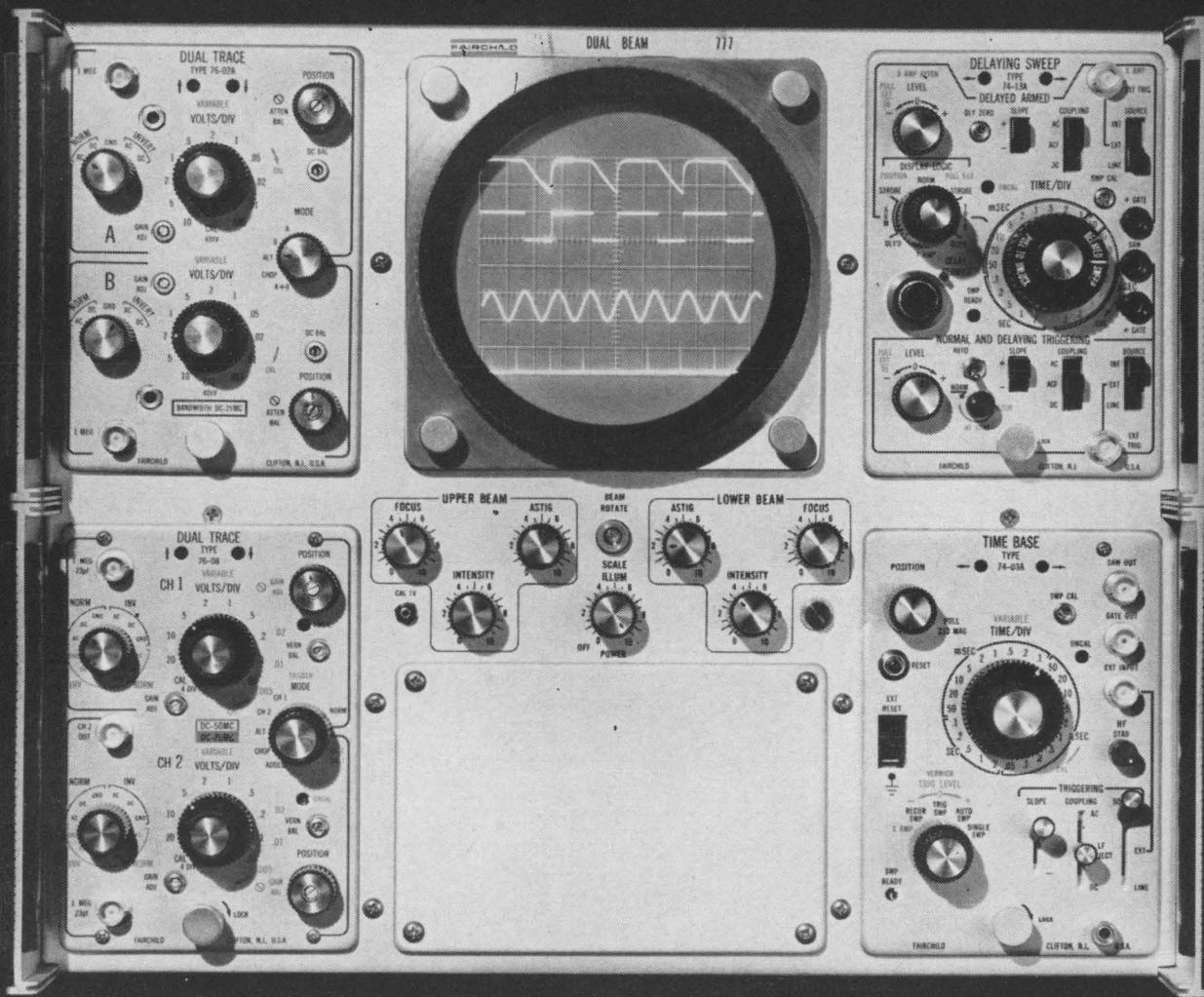

HOW MANY SCOPES CAN THIS ONE REPLACE?

A sizable number, depending upon the range of applications. For this is the Fairchild 777—the most versatile of all industrial scopes. The 777 is a dual beam, dual trace scope in which any four of 22 plug-ins are completely interchangeable in both X and Y cavities. These same plug-ins fit all Fairchild 765H Series scopes. They include DC-100 mc bandwidth, spectrum analyzer and raster display capabilities, sensitivity to 500 $\mu\text{v}/\text{cm}$, risetime to 3.5 ns.

Other features of the 777 include 6 x 10 cm display area for each beam with 5 cm overlap between beams for optimum resolution... unique 13 kv CRT with four independent deflection structures... solid state circuitry (with all deflection circuitry in the plug-ins)...light weight (44 lbs.)... environmentalized for rugged applications. Price (main frame): \$1,600 f.o.b. Clifton, N.J.



The 777 illustrates the Fairchild concept of value through versatility. One scope doing many tasks is only part of it. Future state-of-the-art capability is equally important because it helps you curb the high cost of Technological

Obsolescence. And finally, service. Fairchild has more service centers than any other scope manufacturer.

Ask your Fairchild Field Engineer for details on this and other new generation Fairchild scopes. Or write to Fairchild Instrumentation, 750 Bloomfield Ave., Clifton, N.J.

FAIRCHILD
INSTRUMENTATION
 A DIVISION OF FAIRCHILD CAMERA
 AND INSTRUMENT CORPORATION

*Technological Obsolescence

Editorial

Japan: an industrious competitor

This is the first in a series of editorials on the Far East by Lewis H. Young, editor, who is on a trip through Japan, Hong Kong and Taiwan.

When Japanese companies exhibited for the first time at the International Components Show in Paris last April, European electronics companies were clearly worried. The Japanese have a way of moving into a market and dominating it. Throughout the world, their electronics concerns are feared and respected.

On the surface there seems to be no reason for these companies to cause such agitation in foreign competitors. Japanese technology is "five years behind that in the United States," according to Prof. Hiroshi Inose of Tokyo University, who has worked at the Bell Telephone Laboratories in the U.S. Japanese research facilities are usually small and crowded with equipment. Plants are shabby for the most part, many still bearing the scars of bombings during World War II.

Nor is cheap labor the principal asset of Japan's electronics industry. Wages are rising rapidly, 10% to 13% a year.

Japanese electronics firms' real strength is their engineers, characterized by creativity, ingenuity and an awesome willingness to work long and hard.

American executives who worry about competition from Japan might be surprised at the pains to which the Japanese go to avoid face-to-face competition with American products. It was this reluctance to compete directly that prompted the Sony Corp. to develop a color-television receiver that uses a Chromatron tube instead of the shadow-mask tube used by manufacturers in the United States.

Research money is hard to come by; almost every Japanese executive bemoans the paucity

of government money to finance research and development. Most fundamental research is done at the universities; companies concentrate on development of products.

Until recently, the Japanese electronics industry has concentrated on consumer products. Now the industry is changing, designing more sophisticated equipment for industrial and commercial uses. Before 1966, Japanese firms expect to introduce such new products as a low-priced, large-capacity computer for direct digital control of industrial processes, using integrated circuits and designed around the requirements of a chemical plant; an electronic calculator, also built with integrated circuits; and a microwave oscillator operating on the Gunn-effect principle.

The Japanese engineer must be just about the hardest-working in the world. Although the official work week is 43 to 45 hours, many engineers remain on the job 65 and 70 hours a week. At the Nippon Electric Co. plant at Tamagawa, where an integrated-circuit production line is being installed, the project engineer often works 30 hours at a stretch. Sony's chief engineer for advanced television engineering routinely works 70 hours a week.

Money is not the incentive, because Japanese engineers' pay is shockingly low. A college graduate in his first job receives about 24,000 yen a month—about \$67. After five years, his earning increases to \$84 a month plus an annual bonus of six or seven months' pay. After 15 years, a typical electronics engineer receives \$145 to \$200 a month.

Besides direct pay, the Japanese engineer receives far more fringe benefits than does his American counterpart: such extras as free housing, work clothes, daily tea, hospitalization, free schooling for his children, stays at mountain resorts at ridiculously low rates, and a retirement program.

The Japanese engineer's greatest compensation is likely to be recognition—publication of his work or praise of his technical competence by his associates—particularly recognition from colleagues in the U. S. To many a Japanese engineer, a highlight of a career is an invitation to present a technical paper at an American technical society.

One Japanese executive may have been speaking for the entire electronics industry in his country when he said: "Our engineering is our greatest strength. I think one of our engineers does the work of two American engineers."

That human resource goes a long way toward overcoming Japan's deficiency in natural wealth.

Performance

that
speaks
for
itself

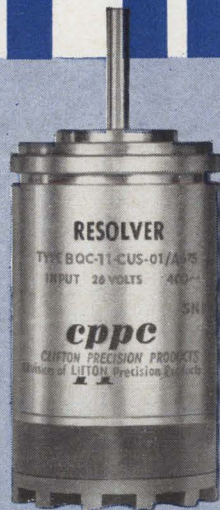

System Accuracy:
 $\pm 0.071\%$ RMS

Total Rotor Null:
0.2 mv/volt

Signal to Noise
Ratio: 74 db min.

Components
Interchangeable
without losing system accuracy

Clifton Amplifier-Resolver Combination

Let's skip the hot air and talk about the performance of this "state-of-the-art" Amplifier-Resolver Combination built for military airborne use.

This Combination is designed for systems requiring interchangeability of resolver or amplifier without adjustment or trimming. System accuracy of $\pm 0.071\%$ RMS is obtained under any combination of voltage, temperature, and frequency within the given ranges. Voltage range is 0 to 26 VRMS. Frequency range: 380-420 cps. Tempera-

ture range -25°C to $+95^{\circ}\text{C}$. Input impedance is 100 k ohms $\pm 1\%$. Total rotor null is 0.2 mv/v of input and fundamental nulls are .05 mv/v. Interaxis error is 3 minutes maximum. Calibration error, 2.5 minutes max. The ratio of the actual output voltage to the undesired output voltage at 20 volts level is 74 db min.

The Resolver is a compensated Clifton Size 11 with the stator as the primary winding. Stator tuned impedance 13.8 k ohms. Stator nominal Q—6.1. Rotor peaking frequency: 40 kc minimum. Weight is 5.5 oz. maximum. Temperature range -55°C to $+125^{\circ}\text{C}$.

The Dual Channel Booster Amplifier is 1.84" x 1.63" x .75". Power requirements +30 VDC ± 2 VDC @ 25 ma. max.; -30 VDC ± 2 VDC @ 35 ma. max. Ripple 10 mv max. Weight 2.5 oz. Temp. range -55°C to $+125^{\circ}\text{C}$. A single channel amplifier 1" x 1.63" x .75" is also available.

'Nuff said? For price and delivery contact any of our sales offices or representatives. Clifton Precision Products, Division of Litton Industries, Clifton Heights, Pa., Colorado Springs, Colo.

cppe

CLIFTON PRECISION PRODUCTS
DIVISION OF LITTON INDUSTRIES



Electronics Newsletter

October 4, 1965

2,150 devices on single chip

Stewart-Warner Microcircuits, Inc., may have the record for the largest number of semiconductor devices ever to go into a single integrated circuit—2,000 diodes, 50 transistors and 100 resistors (total resistance: 10 megohms).

The high component density of the 100-by-100-mil monolithic chip is achieved with three separate oxide layers individually deposited on the surface of the chip. Aluminum wiring, for connections to the bonding pads, are placed on the top layer, rows of diode cathode connections on the center layer, and the bottom layer holds rows of diode anode connections.

Stewart-Warner Microcircuits is a subsidiary of the Stewart-Warner Corp.

Westinghouse puts IC's in NC

The Westinghouse Electric Corp. introduced the first numerical control system using integrated circuits last month at the Production Engineering show in Chicago. The \$5,000 model 20 is a two-axis, point-to-point system. Model 20 is half the price of its discrete-component sister, the five-year-old Prodac, and has one-sixth the number of electronic components. The new system calculates in 30 nanoseconds, compared with seven microseconds for Prodac, and is guaranteed to operate in areas hot as 125°F.

The IC's for model 20 are being supplied by Westinghouse itself and by Motorola, Inc. Three types are used for the diode-transistor logic: single gates, dual gates and RS flip-flops.

The General Electric Co. reports, meanwhile, that it has provided the Ford Motor Co. with an experimental NC system for making automobile parts. A model of the part is photographed and an electronic system converts the photos into a numerical control tape, which controls the machining of the part.

Added safeguards for Agena-Gemini

A fast design change has been ordered for the Agena rocket that will rendezvous with the Gemini 6 spacecraft this month. Equipment is being added to the rocket to protect against sparking, or arc-over, between the two vehicles. Arc-over isn't dangerous to the crew, says a spokesman for the McDonnell Aircraft Corp., builders of Gemini, "but it could affect certain relatively delicate electronic systems."

While the experiments on Gemini 4 and 5 did not indicate any problem with sparking [Electronics, April 5, p. 90], the spokesman said those tests "could not be considered completely conclusive."

One design for dissipating the electrostatic potential between the two craft is undergoing tests at the Ion Physics Corp., a subsidiary of the High Voltage Engineering Corp., Burlington, Mass.

Laser to throw light on fog

Laser holography is finding some practical applications. Technical Operations, Inc., of Burlington, Mass., says it has delivered what is believed to be the first operational holography equipment to Otis Air Force Base in Massachusetts, where it will be used to photograph fog in three dimensions. Holograms [Electronics, Nov. 30, 1964, p. 86] have

Electronics Newsletter

been interesting chiefly for themselves; these will be used to study the physics of fog.

The new equipment includes a Q-switched laser to holograph the fog and a helium-neon laser to reconstruct it in three dimensions from a photographic film.

The system was developed in cooperation with the Air Force's Cambridge Research Laboratory in Massachusetts.

IBM, Fairchild swap patents

A cross-licensing agreement signed by the Fairchild Camera & Instrument Corp. and the International Business Machines Corp. that provides for the exchange of all patents on semiconductors will not involve an exchange of manufacturing know-how or royalties.

The agreement gives each company the right to perpetual use of the patents now held by the other. **IBM, however, will pay Fairchild a flat fee, over five years, for the right to use its planar patents; all other rights were exchanged on a direct-swap basis.**

Top-secret radar fits inside plane

The Army is evaluating a top-secret **side-looking radar that is small enough for its electronics to be mounted inside a plane**—instead of in the huge pod required by current side-looking radar—and uses a **low-profile antenna that can be mounted nearly flush on the fuselage**. The electronic package is solid state, with a few integrated circuits, and weighs 165 pounds. It develops 125 watts peak power.

The antenna, whose design is classified, is said to have a **gain of about three decibels more than conventional antennas**. The radar was developed by the Aeronutronics division of the Philco Corp. in Blue Bell, Pa., for the Electronics Command at Fort Monmouth, N. J. It will probably be used on the Army's Grumman OV-1B reconnaissance plane.

FCC ruling asked on private satellite

The American Broadcasting Co. is forcing the Federal Communications Commission to take a stand on whether a **private company can have its own satellite communications system**. After raising the question informally several months ago, ABC has formally asked the agency for permission to launch its own synchronous satellite to serve its network of about 200 television stations around the country.

The FCC is expected to hold to the concept that Congress, in lending a hand in the establishment of the Communications Satellite Corp., gave Comsat the exclusive franchise to operate a satellite message system. **But the agency is also expected to make it clear that unless Comsat acts within a reasonable time to offer domestic communications service, the franchise will be forfeited.**

Addenda

Beckman Instruments, Inc., the sole United States electronics company at last month's Soviet International Chemical Exhibit in Moscow, sold an estimated half-million dollars worth of instruments. Beckman was represented by its West German subsidiary, Beckman Instruments GmbH. . . . The Air Force is seeking the development of solid state transmitters in land-based phased array radars. Research and development contracts for the transmitters are being solicited by the Rome Air Development Center in Rome, N. Y.

CASH IN ON G-E INNOVATIONS

LIKE THE NEW LOW COST C106 SCR's

... first SCR's ever offered for under 50¢. Now you can afford to take another look at solid-state circuits for many new applications—appliances, auto ignitions and indicator lights, and computers, just to name a few. New C106 SCR's (shown

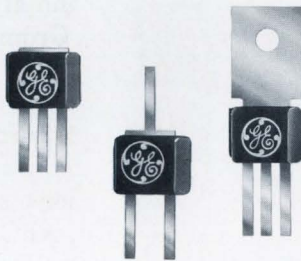

actual size) are plastic-encapsulated, all planar, passivated, and rated up to 200 volts at 2.0 amps. Innovator: Semiconductor Products Department, Auburn, N. Y.

Circle No. 251

Specify General Electric—your No. 1 Source for a full range of electronic components . . . for circuitry knowledge . . . for continuing innovation. **MORE** ▶

GENERAL  **ELECTRIC**

NEW G-E TYPE 195 METER RELAYS

THE LATEST IN LOW-COST RELIABLE INDICATION AND CONTROL

General Electric's new Type 195 meter relays and pyrometers are years ahead in design, yet are priced lower than any other comparable instruments.

Simplicity of design and proved components provide excellent stability and reliability. No special power supply is needed.

Each G-E 195 meter relay and controlling pyrometer is engineered for long operating life and dependability. They also bring you these exciting features:

Light-sensitive solid-state switching!

A contactless solid-state switch controls the load relay directly; no amplifiers, no pointer contacts, no mechanical interference with meter movement. Pointer travel is unrestricted across the entire scale. This means you get continuous indication above and below the meter setpoints.

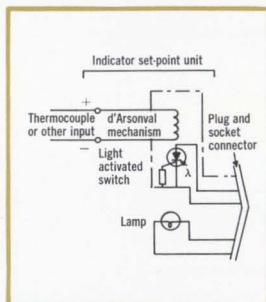

Plug-in "piggyback" control module!

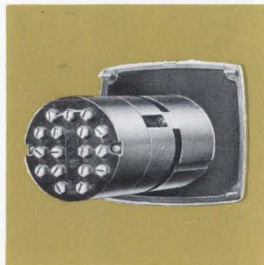

A space-saving control module eliminates the mounting and wiring of separate components... speeds up and simplifies installation. The control module simply plugs into the rear of the indicator and may be removed without interrupting the measurement circuit.

BIG LOOK meter styling!

Each General Electric meter relay or pyrometer matches G.E.'s BIG LOOK panel meter line. You get truly distinctive appearance with the accent on readability. The modern appearance of the meter complements the appearance of your finest equipment.



Available in 2½-, 3½-, and 4½-inch sizes with single or double setpoints, General Electric meter relays are ideal for applications which require accurate on-off switching and indication.

They are being used successfully on test equipment, rate and alarm indicators, nuclear instrumentation, temperature control, over-speed protection, and process control.

Type 195 pyrometers may be used for accurate temperature control on furnaces, ovens, welders, etc. Innovator: Instrument Dept., West Lynn, Mass.

Circle No. 252

DESIGN A 25-FUNCTION COLOR TV SET WITH ONLY 13 TUBES

Introducing "Porta-color"—the first U.S. personal portable color television receiver.



G.E. DID IT... WITH MULTI-FUNCTION COMPACTRONS

Only 10 compactrons and three tubes were needed to do the job of twenty-five functions in General Electric's new "Porta-color" TV set. Result: compact circuitry where compactness is a "must." The new set measures only 17 inches wide by 11¾-inches high by 16½-inches deep. Weight: only 24 pounds.

How was it possible to design so small a set? Among the more significant reasons was the use of G-E multi-function compactrons. Each compactron either combined several tube functions into a single unit or put a single function into a significantly smaller unit. What's more, many of the compactrons required fewer associated components than do conventional tubes. And many were designed specifically for color television, just as compactrons can be designed to serve your own particular equipments. Compactron innovator: Tube Dept., Owensboro, Ky.

G-E MULTI-FUNCTION COMPACTRONS NOW AVAILABLE FOR COLOR TV

TUBE TYPE	DESCRIPTION
6AC10	Triple triode
6AF11	Dissimilar double-triode pentode
6AG10	Gated twin hexode
6AG11	Duplex diode twin triode
6AR11	Twin pentode
6BA11	Triode twin pentode
6BH11	Twin triode pentode
6BJ11	Dissimilar double pentode
6BM11	Dissimilar double pentode
6BN11	Twin pentode
6BQ11	Dissimilar double pentode
6BT11	Dissimilar double triode pentode
6BU11	Twin triode pentode
6J11	Twin pentode
6J28	Triode pentode
6K11	3-section triode
6L08	Triode pentode
6M11	Twin triode pentode
6T10	Dissimilar double pentode
6U10	3-section triode
6Z9	Dissimilar double triode pentode
8AG10	Gated twin hexode
8AR11	Twin pentode
8BM11	Dissimilar double pentode
8BN11	Twin pentode
8BQ11	Dissimilar double pentode
8BU11	Twin triode pentode
9BJ11	Dissimilar double pentode
10T10	Dissimilar double pentode
11AF11	Dissimilar double triode pentode
11BT11	Dissimilar double triode pentode
17Z9	Dissimilar double triode pentode

For details, ask for our new "Catalog of Compactrons for Color TV"

Circle No. 253

Use General Electric's New Lodex® Permanent Magnet Materials

Compare the advantages. Shaped Lodex magnets are tailored to your exact specifications . . . give you maximum design freedom with unparalleled reductions in both labor and assembly costs. Here's why:

- Lodex magnets can be pressed to the exact physical shape and tolerances you require . . . can eliminate the need for costly pole pieces and mounting components. Lodex magnets come ready-to-insert, with plating when desired.
- Lodex magnets offer a high degree of uniformity and close orientation tolerances from piece to piece. This simplifies assembly and calibration.

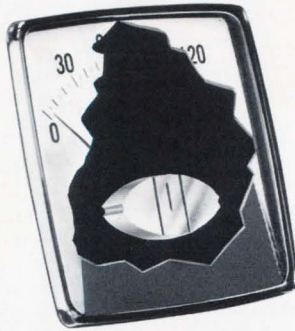

- Lodex magnets come in a wide range of unit magnet properties for perfect matching to your particular magnet circuit.

- Lodex magnets are backed by the industry's best staff of Design and Application Engineers, ready to help you with your requirements.

These advantages apply not only to core meter magnets, but to other precision applications as well, such as a-c and d-c motors, hearing aids, controls and speedometers. Innovator: Magnetic Materials Sect., Edmore, Mich.

CUT COSTS AT THE CORE

G-E Lodex permanent magnets for shaped core meters are already saving time and dollars in exposure meters, linear panel meters, peak indicators and null indicators.



®Lodex is a Registered Trademark of the General Electric Company.

Circle No. 254

OUTPUT AND EFFICIENCY BREAKTHROUGH

DEMONSTRATED WITH G-E CERAMIC TRIODES

Up to 5000 watts pulse (500- μ sec pulse width) and 1000 watts CW have been laboratory-demonstrated at L-band by prototypes of General Electric's new ceramic planar triode designs. This 20-to-1 increase in CW power over the standard 2C39 triode—plus unparalleled Gm and gain bandwidth—could be essential to future radar, phased array, penetration aids, space vehicles, and other applications where maximum performance from minimum size and

weight is imperative.

These sample triodes were equipped with unique grid structures to maintain extremely close grid-cathode spacing. They also employed high-current-density cathodes (up to 2 amps/cm² CW). Result: Gm's of 300,000 to 750,000 micromhos, 5-KW pulsed output with duty cycles as high as 7%, and gain-bandwidth products never before obtained using gridded tubes.

Y1430 Developmental CW Triode

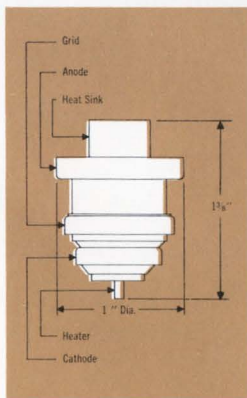

PERFORMANCE CHARACTERISTICS*

Typical Electrical Data

Heater voltage	30 volts
Heater current	0.5 ampere
Amplification factor	200
Grid-plate transconductance (at $I_b = 1.0$ amp)	300,000 μ mhos
Interelectrode capacitance:	
Grid-plate	4 μ mf
Grid-cathode	20 μ mf
Plate-cathode	0.2 μ mf

Typical Operation (at 1.3 Gc) at RF

Power Amplifier	
D-c plate voltage	2100 volts
D-c grid voltage	-8 to -40 volts
D-c plate current	0.57 to 0.76 amp
D-c grid current	approx 0.03 to 0.22 amp
Driving power	approx 5 to 50 watts
Power output	approx up to 1000 watts

Y1498 Developmental Pulsed Triode

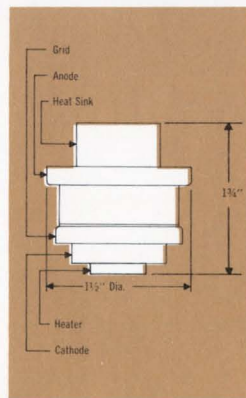

PERFORMANCE CHARACTERISTICS*

Typical Electrical Data

Heater voltage	60 volts
Heater current	0.6 amp
Amplification factor	200
Grid-plate transconductance (at $I_b = 3.0$ amp)	500,000 μ mhos
Interelectrode capacitance:	
Grid-plate	5.7 μ mf
Grid-cathode	65 μ mf

Typical Operation (at 1.3 Gc) at RF

Power Amplifier	
D-c plate voltage	3400 volts
D-c grid voltage	-6 volts
D-c plate current	5.0 amps #
D-c grid current	approx 1.8 amps #
Driving power	approx 200 watts #
Power output	approx up to 5000 watts #

#For duty cycle of 0.07 and pulse length of 500 microseconds.

*Based on data obtained on tubes manufactured by the General Electric Company for the U.S. Army Electronic Command, Ft. Monmouth, N. J., under their contract #DA-36-039-AMC-03215 (E).

While these two developmental tubes are not yet available for purchase, General Electric is prepared to discuss the basis and timing on which they can be built. Their development, furthermore, has enabled G.E. to provide similar characteristics in many microwave tubes already available. Such advantages include:

- high-frequency performance (through Ku band)
- highest triode efficiencies at S, C, and X bands

- excellent tolerance of shock and vibration (such as 20,000-G impact and 48-G RMS at 2,000 cps, 3 minutes each plane)
 - 3-to-4-second warmup (to 90% of rated I_p)
 - nuclear radiation tolerance of 1.5×10^{18} NVT in integrated dosages and 10^{11} R per second
- Innovator: Tube Department, Owensboro, Kentucky.

Circle No. 255

GO AHEAD AND BE CHOOSEY

Select from G.E.'s very broad line of silicon planar epitaxial NPN transistors

Whether you're looking for a special kind of core driver, amplifier or switch, you can forget about packaging problems when you specify from G.E.'s Large Geometry Line transistors. These NPN units come in six different package configurations (shown here) and three separate series groupings. There's a 38-model series for general purpose amplifier and some switching applications, a 32-model series—all with extremely low collector saturation voltages, and a 10-model series—excellent for core driver applications with good switching characteristics as well. Innovator: Semiconductor Products Department, Syracuse, New York.

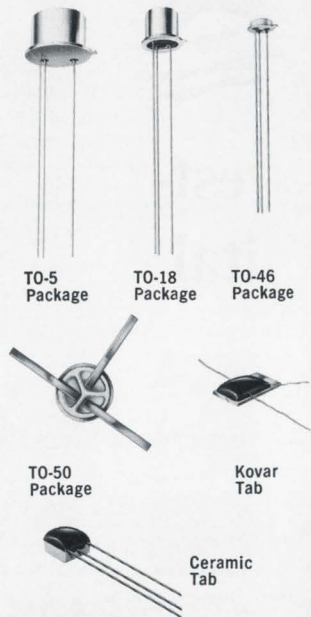

Circle No. 256

ONLY \$6.75*

FOR THIS NEW MULTI-PURPOSE INTEGRATED CIRCUIT AMPLIFIER

... and you can order quantities in either a TO-5 or flat pack configuration. D-c biasing and adjustable gain by means of feedbacks are achieved simultaneously in audio amplifier applications using a single volume control. If desired, positive feedback can be externally applied to result in many unique, non-linear applications of the astable, bistable and monostable types.

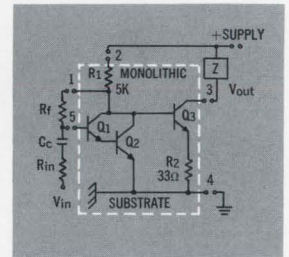

4JPA113 silicon monolithic circuit (TO-5 configuration, 5 leads)

The 4JPA113 multi-purpose unit is fabricated within a 27x29-mil silicon chip using planar epitaxial techniques. This 3-stage direct-coupled integrated circuit features a typical open loop current gain of 60,000 and open-loop frequency response of 250 kc. And it can be operated from supply voltages up to 15 volts. You'll find this low-cost unit excellent for pulse-shaping, pulse-sawtooth or sine-wave oscillators, relay drivers with bistable or monostable control, and many other amplifier applications. Innovator: Semiconductor Products Department, Syracuse, N.Y.

*in quantities of 100-999 in TO-5 package.

Circle No. 257

Want more prices?

Technical facts?

Application help?

Ask your G-E engineer/salesman for full price details on any or all components described on these pages. Ask him for free literature, or send for it yourself by circling the appropriate numbers on the Reader's Service Card. Write or call any local or regional G-E Electronic Components Sales Office for the application help you may be seeking. Or, for other assistance, write us at Section 285-09, General Electric Company, Schenectady, N. Y. 12305.

INNOVATIONS IN ACTION

GENERAL ELECTRIC

ELECTRONIC COMPONENTS SALES OPERATION

ANNOUNCING



The world's lowest-cost 5-digit, automatic digital voltmeter



NLS 5015

\$1985

$\pm 100 \mu\text{v}$ to $\pm 999.99 \text{ v}$ range
($\pm .99999$ ratio range optional)

automatic range and polarity

high common-mode and signal-mode noise rejection

floating input—up to 1000 v

measures microvolts, ac and ohms using NLS accessories

0.01% accuracy

transistor circuits on epoxy-fiberglass plug-in boards

printer operation optional

Why pay 50% more? You won't find a better 5-digit dvm than the automatic NLS 5015. Priced \$1,000 under other 5-digit digital voltmeters, the 5015 delivers all the performance you expect from an NLS instrument. Example: the most critical components of the 5015 were life-tested to the equivalent of 40-years' use, displaying a new reading every 4 seconds, 8 hours a day, 7 days a week . . . and there were no failures. Check the specs above. Look good? Then get the full story. Write, wire or phone NLS or the nearest NLS engineering center. We'll respond with complete data; and a 5015 demonstration when requested.

How does NLS do it—producing the first automatic 5-digit instrument at such a reasonable price . . . without compromising quality, accuracy, reliability or usefulness? The answer: innovation . . . the same type of NLS innovation that originated the digital voltmeter; that produced the first relay-operated dvm; that introduced such advancements as “no-needless-nines” logic, the “factual fifth figure,” “no-pots-at-all” stability, and the first low-cost, industrial dvms. You'll see innovation-in-action when you see the 5015 demonstrated. Just let us know when it's convenient.



Originator of the Digital Voltmeter

non-linear systems, inc.

Del Mar, California, Phone: (714) 755-1134 TWX: 714-277-3191

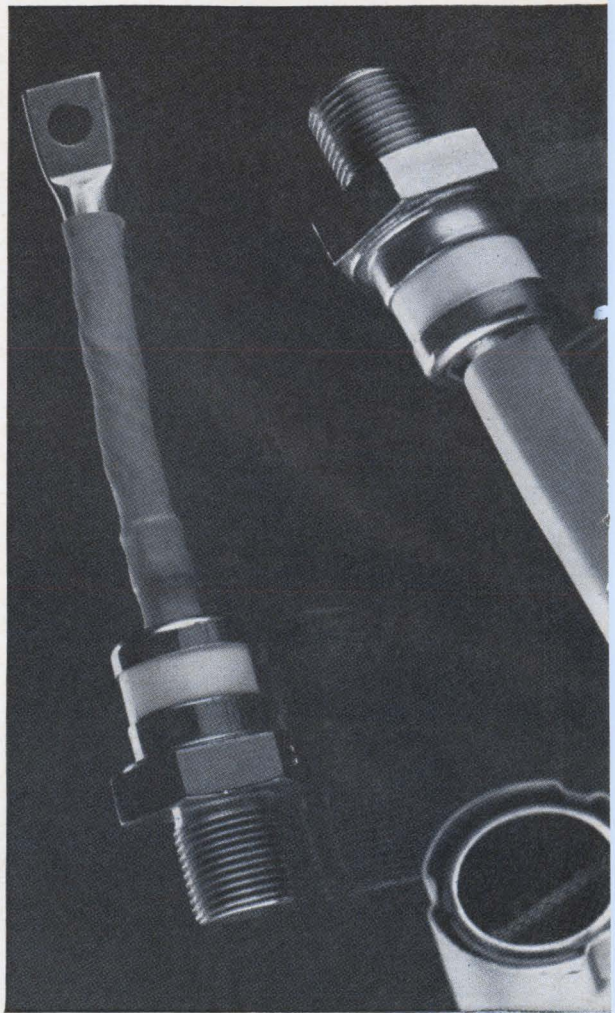

News Briefs

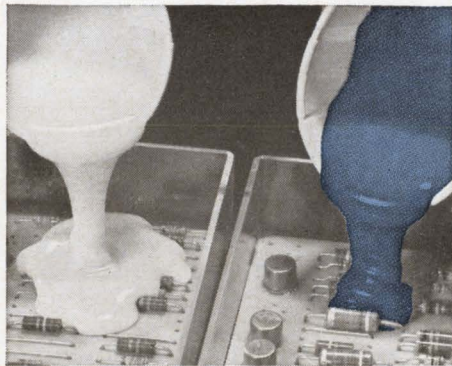

Six new encapsulants of varying viscosities and characteristics now provide a choice of the one best suited to your electronic application or processing requirements. Whether it's for deep section curing or general purpose, low or medium viscosity, reversion resistance, high strength—there's a compound in the Dow Corning® RTV encapsulants for your purpose. For color coding, too . . . fourteen different color pigments are available . . . have no effect on the electrical or physical properties.

CIRCLE 290 ON READER-SERVICE CARD

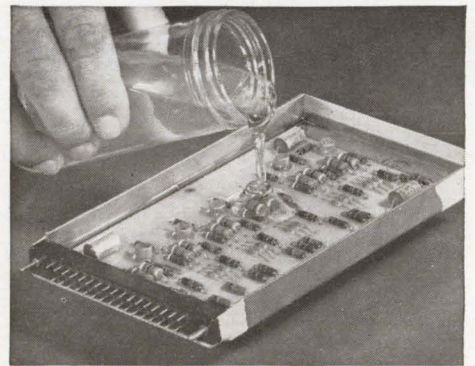

For transparent embedments, specify Sylgard® brand resins, specially designed to meet the exacting requirements of the electronic industry for packaging materials. These solventless silicones cure in deep sections in 24 hours at room temperature without exotherm . . . need no post cure and are serviceable over a wide temperature range. Sylgard resins are designed for potting, filling, embedding and encapsulating electronic circuits and components. Transparent for circuit identification or opaque for security or proprietary reasons.

CIRCLE 291 ON READER-SERVICE CARD

Simplify processing...cut time and cost with this silicone rubber tubing

Now you can save time, save labor on close fitting dielectric coverings. Silastic® heat shrinkable rubber tubing can be the answer to your electrical or mechanical problems where wiring harness and electronic devices or components must be protected.

Made from a non-thermoplastic material, this silicone rubber tubing is supplied by Dow Corning in a stabilized expanded condition. When heated to 300 F or higher, it will shrink to 1/2 its diameter. Shrinkage in the tubing length is less than 5%. And a simple heat gun or lamp is all that is required to do the job or... an existing heat source is normally adequate.

Silastic heat shrinkable rubber will not deform or flow if overheated during

the shrinking operation; it will withstand temperatures to 700 F – twice the required shrinking temperature, and, it remains flexible and resilient.

Simplified processing; high resistance to electric stress, corona, ozone, radiation, heat and moisture; plus long-life flexibility and resiliency make Silastic tubing the ideal protection for electronic components or assemblies... even of irregular shape. Standard tubing is available from stock in a variety of diameters and in lengths up to 20 feet from authorized Dow Corning Electronic Materials Distributors.

Custom molded parts of Silastic heat shrinkable silicone rubber can also be supplied to meet individual customer specifications.

CIRCLE 289 ON READER-SERVICE CARD



Seal, bond, encapsulate with Silastic® 732 RTV rubber. This tough, squeeze-on adhesive/sealant bonds metal, glass, plastics, rubber and many other materials. Tack free in one hour, solid rubber in 24 hours, it cures at room temperature, stays flexible from -85 to 500 F. It waterproofs, insulates and calks. Use Silastic 732 RTV rubber to bond wires, seal connectors, splice and repair cable and lead wires, seal radome and antenna enclosures, to dust-proof cabinets and housings. Recommended as adhesive for Silastic® heat shrinkable tubing.

We'll be pleased to forward information on these and other materials that aid reliability and performance, reduce costs. For details or prompt technical assistance write to Dept. 3922, Electronic Products Division, Dow Corning Corporation, Midland, Michigan 48641. For a free sample, write on company letterhead describing your application... or phone for the name of the Dow Corning representative or the authorized stocking distributor nearest you.

All products shown here are available from our authorized electronic materials distributors. Write for complete list of names and locations.

DOW CORNING

CIRCLE 292 ON READER-SERVICE CARD

Two new 40 mw and 20 mw high-speed, billion-operation CLARE Relays

■ These CLARE Type HGSL and HGSM Mercury-Wetted Contact Relays meet the requirements of modern electronic systems.

■ Their complete freedom from contact bounce, isolation between coil and contacts and high speed qualify them as excellent input buffers to solid state circuitry. As output buffers they can be driven by low power logic circuitry with an input to output power gain of up to 5000. Contacts can handle up to 100 va, ac or dc, over billions of operations without derating.

■ As scanner contacts in checkout systems they can stand off a hi-pot voltage of 1000 vac and, at the same time, offer a contact resistance variation of less than 2 milliohms over life for critical resistance measuring circuits. Their lack of contact bounce, high speed and low noise generation commend them for tape transport read-write head switching. In their compact, space-saving packages these relays meet a wide range of design requirements for both printed circuit boards and wired assemblies.

type HGSM

Module
for printed
circuit boards

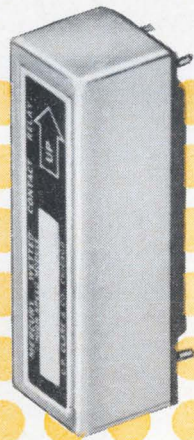

Relays shown actual size

type HGSL

Plug-in
for wired
Assemblies



Sensitive

40 mw Single-Side
Stable
20 mw Bi-Stable

High Speed

Nominal operate
time: 1.0 ms

Long Life

Billion operations
minimum at rated
load

Contact Advantages

Low and consistent
contact resistance
over complete life.

No bounce.

Both form C and form
D contacts available.

OPERATE AND RELEASE TIMES

20 MW BI-STABLE DOUBLE WOUND COIL

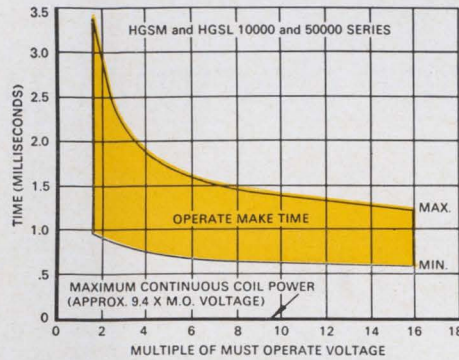

40 MW SINGLE-SIDE STABLE SINGLE WOUND COIL

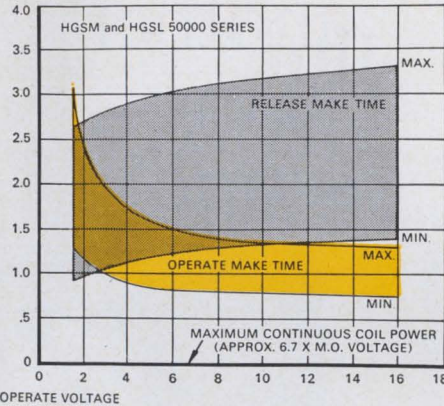
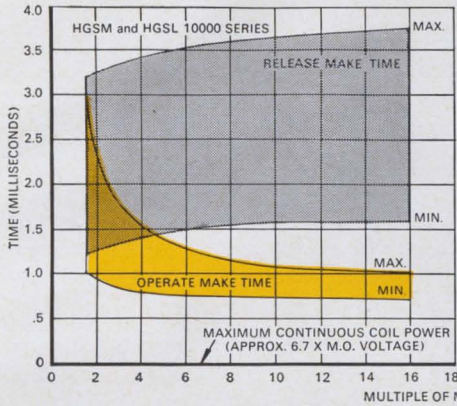

ELECTRICAL CHARACTERISTICS	FOR WIRED ASSEMBLIES		FOR PRINTED CIRCUIT BOARDS	
	HGSL		HGSM	
	Series 10000	Series 50000	Series 10000	Series 50000
Contact Arrangement	1 Form D	1 Form C	1 Form D	1 Form C
Sensitivity	40 mw. Single-Side Stable 20 mw. Bi-Stable			
Contact Rating Low Level	0-100 Microamperes 0-300 Millivolts			
Power (with Contact Protection)	2 amperes max. 500 volts max. 100 volt amperes max.			
Contact Circuit Resistance	35 milliohms max.		20 milliohms max.	
	Variation less than ± 2 milliohms from initial value through 20×10^9 operations (Independent of Current or Voltage)			
Nominal Operating Voltage	Up to 90 vdc			
Nominal Operate Time at Maximum Coil Power	1.0 ms			

Send for Data Sheet 852 giving complete information on these new miniature, high-speed, sensitive relays. Address C. P. Clare & Co., Group 10N8, 3101 Pratt Boulevard, Chicago, Illinois 60645.



relays and related control components

For complete information contact your nearest CLARE Sales Engineer

CALL— NEEDHAM (Mass.): (617) 444-4200 • GREAT NECK, L.I. (N.Y.): (516) 466-2100 • SYRACUSE: (315) 422-0347 • PHILADELPHIA: (215) 386-3385 • BALTIMORE: (202) 393-1337 • ORLANDO: (305) 424-9508 • CHICAGO: (312) 262-7700 • MINNEAPOLIS: (612) 920-3125 • CLEVELAND: (216) 221-9030 • XENIA (Ohio): (513) 426-5485 • CINCINNATI: (513) 891-3827 • MISSION (Kansas): (913) 722-2441 • DALLAS: (214) 741-4411 • HOUSTON: (713) 528-3811 • SEATTLE: (206) 725-9700 • SAN FRANCISCO: (415) 982-7932 • VAN NUYS (Calif.): (213) 787-2510 • TORONTO, CANADA: C. P. Clare Canada Ltd. • TOKYO, JAPAN: Westrex Co., Orient IN EUROPE: C. P. Clare International N. V., TONGEREN, BELGIUM

Will an extra \$379 buy another decimal place—

or another 10 mc scope?

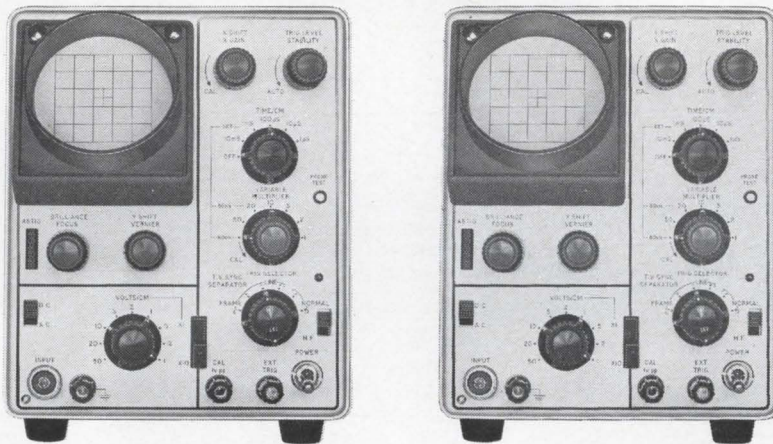

Doing any Value Analysis on your test equipment? Here's something to consider. For less than the cost of a single heavyweight scope, you can get two Data Instruments S32A's. However, forget price. This is a scope that recommends itself from every aspect. It's versatile. The S32A is equally useful on the production line, in the field and in the laboratory. It performs. The extremely small spot diameter of its 3" flat faced tube makes it comparable to any 5" type. Dependable triggering insures positive synchronization over the entire bandwidth. And a 2% calibrator standardizes both time and voltage. It's reliable. The S32A is practically trouble-free, and is warranted for a full year with complete field and factory service. Look at the specs.

data instruments



VERTICAL AMPLIFIER					
BANDWIDTH	SENSITIVITY/CM	RISETIME	IMPEDANCE	ACCURACY	
(1) DC-10mc	100mv to 50V	.035 μ s.	1M Ω +3pf	\pm 4%	
(2) DC- 1mc	10mv to 5V				
TIME BASE		CRT		PHYSICAL	
SPEED/CM	TRIGGER & HOR. AMP.	DIA.	PHOSPHOR	VOLTS	DIM. & WT.
1 μ s. to 0.5 sec. \pm 4%	Exp. x 10 10cps-400kc	3"	P1, P7	3.5kv	13 $\frac{3}{4}$ "x8"x6 $\frac{1}{2}$ " 16 lbs.

Forget the price. Compare it on performance. Drop us a note, and we'll arrange a demonstration in your plant. At \$379 you almost **can** forget the price, can't you?

Data Instruments Div. • 7300 Crescent Blvd. • Pennsauken, N.J.

Communications

Guided waves

Reflector-type antennas lose a considerable portion of their energy through the feed and reflector; some of the waves are diverted in the airspace so that they miss the reflectors entirely. Radiation, Inc., of Melbourne, Fla., has developed a cone of polystyrene (the cheap foam used to make, among other things, heat-resistant disposable cups) which reduces spillover and improves the efficiency of the antenna to 75% from 50%.

The cone, called a Dielguide (from dielectric) works on the principle of total internal reflection: if an electromagnetic wave passes from a relatively dense dielectric medium (the reflector) to a less dense one (the cone) at an angle greater than a critical angle, which varies depending on the material, the wave will be totally reflected.

The Dielguide, developed with the support of the Army Satellite Communications Agency, can be used with both Cassegrain and prime focus antennas. In a Cassegrain antenna, it juts out in front of the main reflector; but in prime focus antennas, which lack a sub-

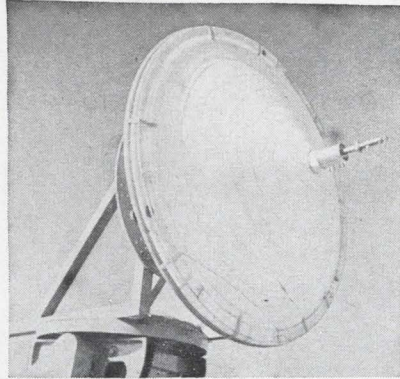

The Dielguide, a polystyrene cone that funnels electromagnetic waves between feed and reflector. In the photo of a Cassegrain antenna, right, the Dielguide juts out in front of the main reflector. Above, in the photo of a prime focus antenna, it covers the entire face of the reflector.

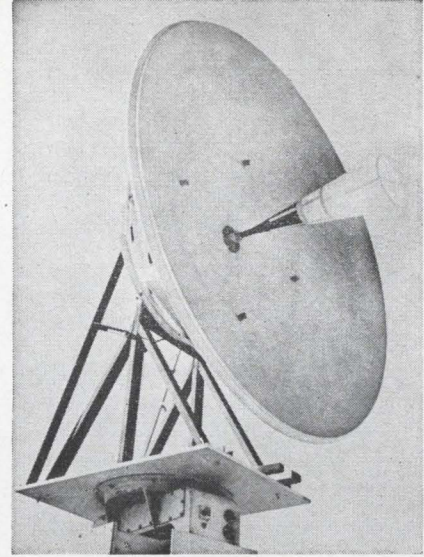

reflector and are usually smaller, the cone is the same size as the main reflector, and fits over the face of the antenna.

Less noise. In the receiving mode, the Dielguide causes the substantial reduction in the antenna's noise temperature by decreasing spillover between the main reflector and the subreflector.

The problem of forward spillover past the subreflector becomes more intense with a conventional antenna when it is aimed low over the horizon, because the earth is in its radiation path. For example, a typical 15-foot antenna aimed 7° above the horizon produces a noise temperature of 55°K. With a Dielguide, and the consequent reduction in spillover, that noise can be cut to 35°K.

When the Dielguide is used in a dual reflector antenna, such as a Cassegrain type, the size of the subreflector can be reduced without loss of gain, the Radiation designers say. And since the subreflector can be mounted directly on the cone, there is no need for supporting spurs on the face of the antenna; thus the radiation pattern produced by the antenna is free of interference.

Radiation engineers tested the Dielguide only in frequencies between 7.2 and 8.4 gigacycles. Results so far indicate that the improvement is constant over those frequencies. The designers now plan to test the equipment at other frequencies, and they believe that they can achieve a frequency range of 2:1 for a Dielguide feed.

Powers up to 20 kilowatts, continuous wave, were used. The researchers believe that level is about the upper limit of the Dielguide.

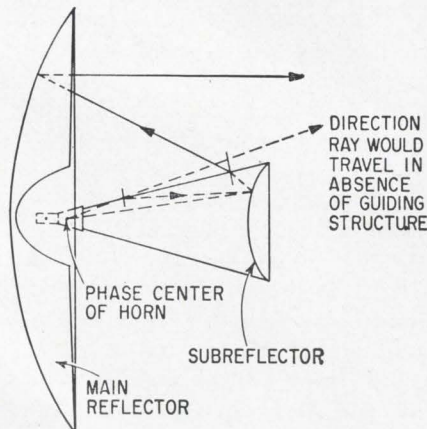

Electromagnetic waves radiating from horn of dual-reflector antenna are confined inside Dielguide until they reach the subreflector.

Computers

Solid state slipstick

An electronic slide rule that utilizes the exponential current-voltage curve of certain transistors has been developed by George Platzer, an engineer in the Chrysler Corp.'s research laboratories in Detroit. The circuit, which is essentially a component for analog computers and similar devices, solves such problems as $\sqrt{AB/C}$, with inputs and outputs represented by variable currents. Chrysler uses the device in control equipment for

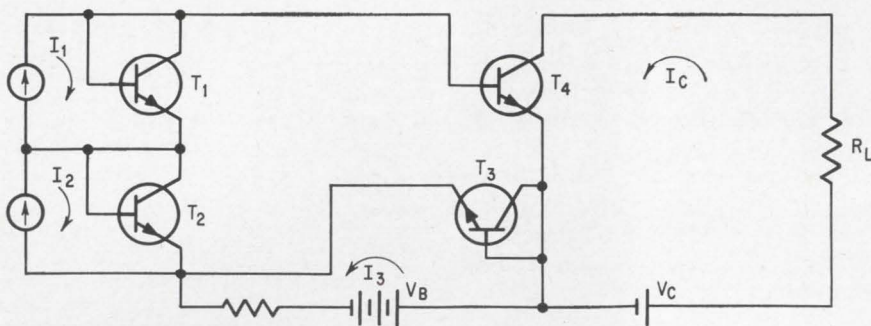

Two-factor multiplier circuit designed as one form of Chrysler's electronic slide rule. The collector current of T_4 is proportional to the product of the two input currents I_1 and I_2 . The bias current I_3 corrects for temperature variations.

its assembly lines.

Theoretically, the current passing through a junction diode is exponentially related to the voltage across the diode; or conversely, the voltage is logarithmically related to the current. Actual diodes vary somewhat from this theoretical ideal, particularly at very high and very low current. Certain types of transistors, however, approach the ideal much more closely, especially when the collector and the base are connected so that the transistor effectively becomes a diode.

Logarithmic translators. The diagram above shows how these transistors are connected to make a two-factor multiplier. In this circuit, transistors T_1 and T_2 are logarithmic translators that produce output voltages proportional to the logarithms of the input cur-

rents. These voltages are in series; therefore their sum is the input voltage to transistor T_4 . The collector current of T_4 is proportional to the antilogarithm of its input voltage; and this current is therefore proportional to the product of the input currents. If the current generator for I_1 is, for instance, a tachometer generator, and that for I_2 is a strain gauge, then I_1 is proportional to speed, I_2 is proportional to torque, and I_c is proportional to speed times torque, or horsepower. Transistor T_3 carries a constant current of I_3 to compensate for temperature variations. The entire circuit is mounted in one TO-5 can, which insures that all the transistors are at equal temperatures.

Full scale for each input and the output is 1 milliamperes; the load impedance R_L is 1,000 ohms. The circuit is designed to operate over a 100 to 1 range, so that the smallest current would be 10 microamperes. It has a full-scale accuracy of $\pm 0.5\%$ and an absolute accuracy of $\pm 2\%$, meaning that for currents near maximum, the accuracy is within 5 microamperes, but for very small currents the accuracy is within 0.2 microamperes. The circuit's frequency range is one megacycle. Because it is so simple, the circuit is highly reliable.

Control function. The circuit can be applied to any instrumentation or control function that involves such mathematical manipulation, as the horsepower measurement just mentioned, or measurement of electrical power (watts equals volts times current). Such

a measurement in turn can be used for control functions—power regulation, for instance, or regulation of fuel mixtures.

Similar circuits can be built to evaluate any kind of mathematical function involving products, quotients, or roots. The number of transistors depends on the complexity of the function. One drawback of the design is that the circuits are all basically one-quadrant computers—that is, they work only with positive numbers, and produce a positive result. It is possible to connect two circuits back-to-back for four-quadrant operation; but a bias current is required and the inputs must be reversed for one of the two circuits.

The transistors are pnp silicon epitaxial planar transistors made by the Semiconductor Products division of Motorola, Inc.

Contracts

Competition from abroad

Representatives of 100 British companies are negotiating with the McDonnell Aircraft Corp. to compete with U. S. suppliers for contracts to install systems—most of them electronic—on F-4 Phantom jet fighter planes being delivered to the Royal Air Force.

The General Dynamics Corp. has been talking with British companies about avionics for the F-111 tactical fighters, which Britain may buy.

Other foreign companies are clamoring for a chance to compete for subcontracts on American equipment sold abroad—about \$1.5 billion worth each year—and indications are that they will get it.

The actions reflect changes in Pentagon policy, brought about by increasing pressure from abroad. Countries which buy U. S. equipment think that the United States should throw a little business their way, too. It is in electronics that the foreign companies think they can make the biggest inroads.

It's free enterprise. Are these changes harmful to American in-

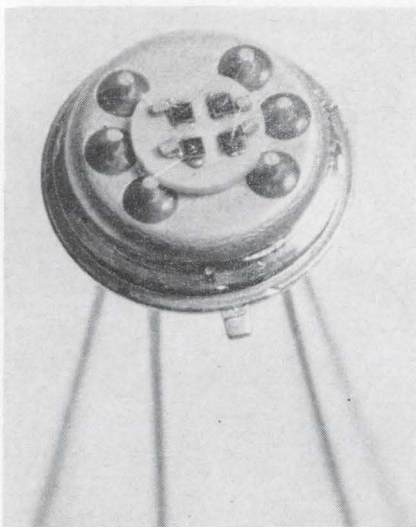

These four transistors make up a new electronic slide rule, which was developed at the Chrysler Corp.

dustry? No, says Henry J. Kuss Jr., deputy assistant secretary of defense for international logistics negotiations. Foreign competition on subcontracts will encourage a swing to purchases abroad of major U. S. military systems, he says.

Over the next 10 years, Kuss estimates, the West will spend \$300 billion for military equipment, and \$100 billion of this will be spent by governments outside the United States. About 15% of these foreign purchases should be made in the U. S., he figures.

He points out that McDonnell would not have received the British order, which was for \$400 million, if London had not canceled development of its own jet fighters. By January, Britain is expected to place a much larger order—for nearly \$41 billion—for the F-111; this plane also would replace one that Britain had planned to develop herself.

Initially, the foreign companies will compete for subcontracts on U. S.-made equipment that is sold to their own countries. But if the foreign concern wins the contract, it might also supply parts for similar equipment bought for U. S. use.

For instance, McDonnell subcontracts about half of its F-4 production; Pentagon officials expect the British to be able to compete for 40%. Of this, 15% is for electronics, and the balance for the Rolls-Royce Spey engine that is already slated to go into the British models. If British companies win the electronics contracts, they could also supply components for F-4's used by the U. S. military.

Buy British. The British, clearly, are the prime movers in cracking the "buy American" policy. They want to sell ground communications equipment, airborne radars, navigational aids, including inertial navigational systems, telecommunications equipment, computers and data recorders. Britain would also like to peddle its Seacat ground-to-air missile, the HS-125 helicopter and conventional arms and ammunition. But other countries are also free to take advantage of the new Pentagon policy.

The breadth of that policy is indicated by the fact that the U. S.

will place orders with British shipyards for \$40 million worth of non-combatant ships, and may order another \$14 million worth next year.

But, Kuss insists, the U. S. will not buy abroad merely to bolster foreign economies. Contracts, he adds, will be awarded on a "best-buy" basis.

Avionics

Why did they crash?

In the decade that the Air Force has been flying the Douglas Aircraft Co.'s giant C-133 Cargomaster, six have crashed—and no one knows why. Earlier this year, the Air Force grounded its remaining 42 operational C-133's for about three months and conducted extensive tests, but still couldn't find anything wrong.

The C-133's are flying again, but the Air Force has not given up its search for the cause of the crashes. Next week, the Lockheed Aircraft Corp. will complete the installation on the huge transports of the most elaborate flight recorder ever carried on an operational military aircraft.

The package, installed in the tail, is designed to separate from the plane if it crashes. A continuous loop tape will store details of the last 15 hours of the plane's operation and the last half-hour of conversation in the cockpit.

Collection service. The recorder package will collect data from 86 transducers situated in strategic locations in the airframe and the turboprop engines. Navigational data and information on the plane's speed and altitude will also be taped.

In addition to the recording system, the package will contain an emergency beacon transmitter. The unit, with a range of 80 nautical miles, will guide rescuers to the downed plane. The entire package has been designed to float.

The C-133 fleet involves an investment of about \$300 million. The

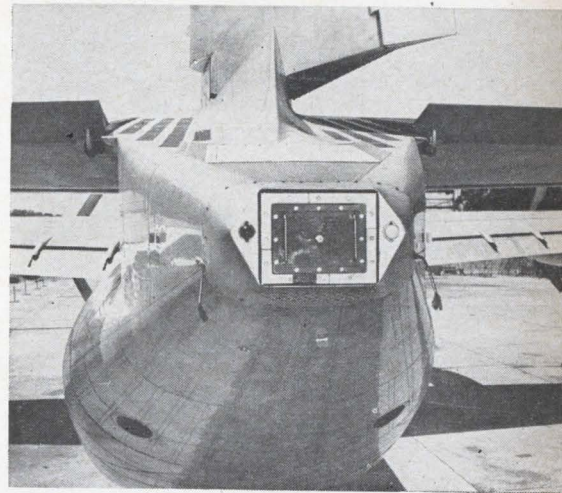

Crash recorder attached to tail of Cargomaster picks up information from 86 transducers and four voice channels.

plane is used by the Air Force and the Army for shipment of outside cargo, such as missiles.

Military electronics

Small splash

The world's largest indoor underwater shooting gallery is being built at the Naval Ordnance Laboratory at White Oak, Md. It's a huge tank which will provide data on missiles that operate both in the water and in the atmosphere, such as Polaris and the antisubmarine missile, Subroc.

The \$3-million facility will be completed next spring. Its first assignment will be to simulate the stresses and rates of turn and deceleration for Subroc, which slams into the ocean at 2,000 miles per hour and generates shock pressures that reach 20,000 pounds per square inch.

Model missile. For this simulation, models of missiles will be fired into a large tank of water. Their behavior before and after entering the water will be picked up by a variety of sensors, triggered by a sequencer which is itself controlled by a special-purpose computer.

The computer is really the heart of the system. From data on muz-

zle velocity and air trajectory, it calculates the time at which the missile model will enter the water. The sequencer, signaled by the computer, causes pictures to be taken and pressure, sound and other data to be recorded. The computer collates the data so that a given picture can be matched with the correct pressure and sound data.

The missile model is actually a tiny f-m radio transmitter, housed in a steel bullet three inches in diameter and six inches long. The

the f-m transmitter, which was developed by the Army's Harry Diamond Ordnance Fuse Laboratory in Washington. The forces are measured by a quartz crystal accelerometer developed at Columbia University.

The tank is 100 feet long, 35 feet wide, and 75 feet high, built of 160 hexagonal cells of precast concrete. Each of the cells is a potential viewing or instrumentation port, and any or all of the sensors can be patched to any of the cell walls.

coating of B-stage epoxy especially formulated for application to foil. The epoxy is applied to one surface of the foil so that it extends over the edge, and then it is partially cured until it is solid. After the coil is wound, it is heated, bonding and insulating the coil layers and completing the curing. While it is being heated, the coil can be shaped into forms like the rectangular box preferred in instrument transformers.

The winding machine resembles a capacitor winder. It can automatically wind 120 coils an hour, a speed comparable to that of copper winding machines, Reynolds says. The foil is unwound from a spool and the leading edge of the foil is taped on a bobbin, wound and finally taped again. The bobbins are brought to the winding position on a turntable. The coil leads are cold-welded in pairs. The machine can interleave insulating material between the foil if the user prefers to buy his insulator separately, and not use the epoxy.

At present, aluminum coils are used mainly in large electrical equipment, such as distribution transformers, where savings in weight and metal cost are large. In such cases, interleaving can be relatively stiff and thick without size penalties, and thick strips of aluminum with rounded edges can be used.

Reynolds designed its winding machine primarily for automobile alternator coils 1½ to 3 inches in diameter. The General Motors Corp. and the Chrysler Corp. are considering switching from wire to foil in these coils, Reynolds says.

In large coils, the company says, 45 cents worth of aluminum can do the job of \$1.20 worth of copper, at a weight savings of two to one. But the company declines to disclose price savings in the use of foil in the automobile alternator coils or other small parts other than to say that the prices are "competitive."

New market. Reynolds' next major target will be instrument transformer coils. It considers the new insulating material the key to this market and to future plans to promote foils in loudspeaker and

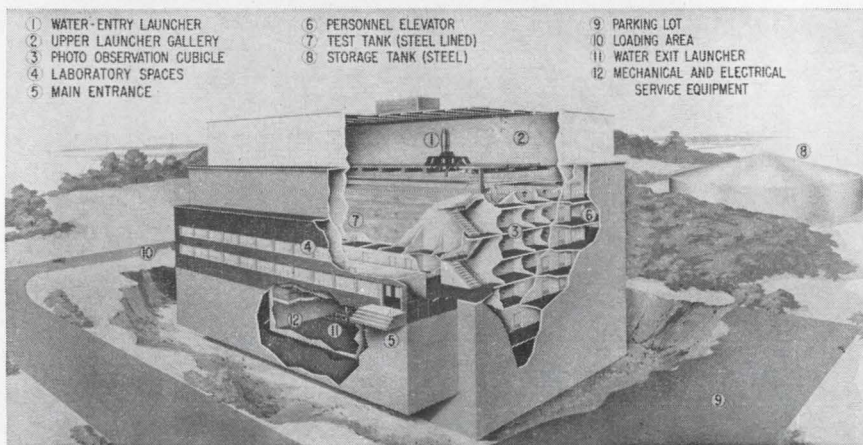

Navy's indoor lab for testing underwater missiles.

telemetered signals help provide tracking information throughout the model's trip.

A wired-logic computer had to be designed for the system, according to William R. Busby, project engineer of Houston Engineering Research Corp., which built it. A general-purpose stored-program computer could not calculate the velocity and other characteristics of the bullet and still keep up with the missile. One of the giant new machines could do it—but these machines are "too good." They are capable of a great many operations that are not needed, and are very expensive.

Samples data. The sequencer controls all the equipment used in the test—up to 30 different instruments—with a resolution of one millisecond. It samples the condition of the bullet every half inch along its flight path.

Forces acting on the bullet are telemetered to the computer from

Manufacturing

Foil coil

For the past 10 years, aluminum producers and coil manufacturers have been investigating the idea of making small coils from aluminum foil, which is cheaper and lighter than copper magnet wire. But the results have not been good, because thin foils are hard to wind at high speed, and because the foil's edges often meet and cause short circuits unless the insulation between the layers extends well over the edges. But last month, at the Electrical Insulating Conference in New York, the Reynolds Metal Co. demonstrated a high-speed coil winder and an insulating material that makes winding easier. With copper becoming scarce and costly, the future of foil coils looks more promising.

Nearly solid. The insulation is a

**DO IT YOURSELF
SILICON HIGH VOLTAGE
ASSEMBLIES**

with this basic "doorbell" rectifier module*

*Pat. Pending



POWER FEATURES

Stackable to 600 KV
Small Size - 5 KW per cu. in.
Heat Sink for Each Diode
Copper Base and Large Cooling Surface

ANTI-CORONA FEATURES

Vacuum Encapsulated
Smooth Polished Surfaces
Curved Profile to Provide Uniform Potential Gradient
Helical Internal Construction for Gradient Distribution

TRANSIENT PROTECTION FEATURES

Controlled Avalanche Diodes
Individual Voidless Glass Sealed Junctions
High Forward and Reverse Surge Capability

ALSO AVAILABLE IN FAST RECOVERY TYPES

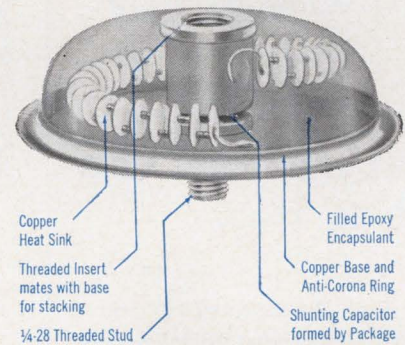

ONLY FOUR MODELS MAKE ALL THESE ASSEMBLIES:

UHV 15	UHV 10	UHV 5	UHV 2.5
15 KV at .8 A*	10 KV at 1.25 A*	5 KV at 2.5 A*	2.5 KV at 5.0 A*

ALL IN STOCK AT THE FACTORY AND YOUR LOCAL COMPAR OFFICE

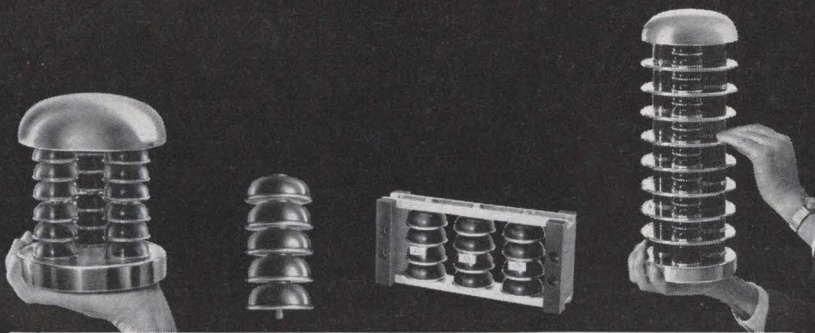

3 phase bridge	Stack	3 phase bridge	Cockcroft-Walton
45 KV per leg	75 KV	10 KV per leg	Multiplier
2.4 A output*	.8 A output*	7.5 A output*	100 KV at 25 mA

*oil cooled ratings

SEND FOR NEW 12 PAGE ASSEMBLY CATALOG

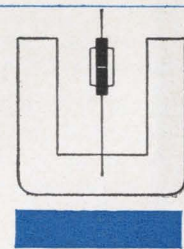

UNITRODE[®]
"better always/by design"

UNITRODE CORPORATION
580 Pleasant Street, Watertown,
Mass. 02172 Telephone (617) 926-0404
TWX (710) 327-1296
Export - Dage Corporation

A 20 amp contactor in a 10 amp can?

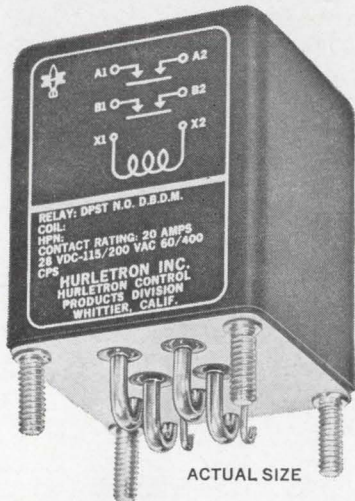

That's about the size of it...

That's right. We designed a 20 amp Balanced Armature Contactor and put it into a package which is 1.5" x 1.5" and 1.812" high, exactly the size shown above.

It weighs only 7 ounces and meets MIL-R-6106E requirements.

Despite its small size and weight, this unit has double-make, double-break contacts rated 20 amperes at 28VDC or 115VAC, 400 cycle, single phase or three phase loads.

Balanced Armature design allows this unit to withstand 50 G's of shock and 15 G's of vibration to 3,000 cycles. Best of all, it is a production item, available for today's needs.

Write today for your free copy of Hurlotron's "Design Engineers Relay Handbook." It will give you full details on the entire series of Hurlotron Balanced Armature Relays and Contactors.



Electronics Review

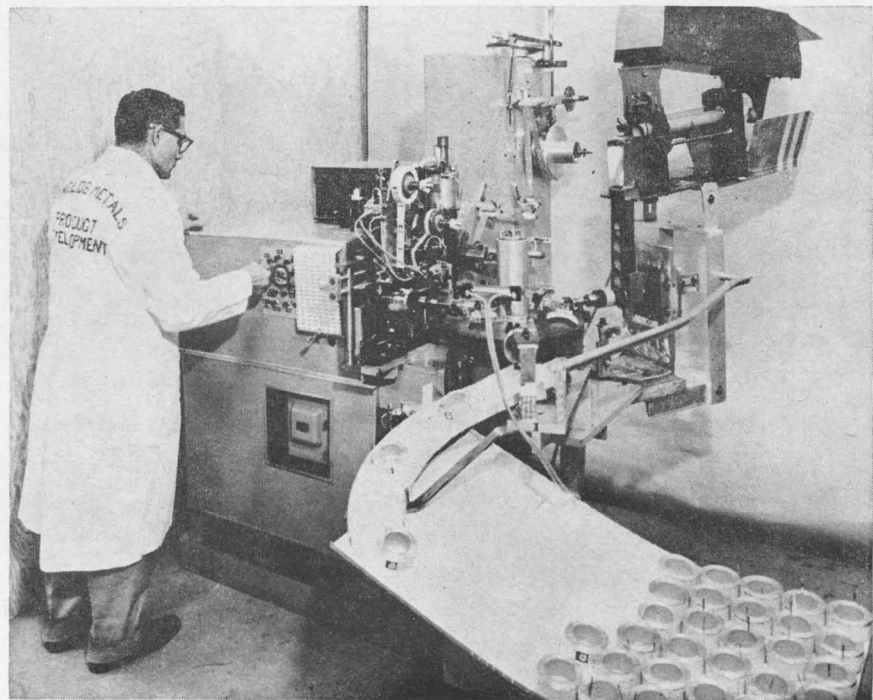

Automatic aluminum foil winding machine introduced by Reynolds. Up to 120 coils an hour can be wound with the machine, and one operator can tend several machines.

power-supply coils. Little use in radio frequency and i-f coils is anticipated.

Coils smaller than alternator coils can be wound by changing mandrel and bobbin size, the company says. In demonstrations, foil thicknesses ranging from 0.65 mils (0.00065 inch) to 1.5 mils have been attained, either epoxy-coated or interleaved with paper 0.25 to 0.5 mil thick. Reynolds makes capacitor foils as thin as 0.17 mil and says it can supply coil foils that thin.

Reynolds does not plan to sell the winding machine. Its design will be made available to winder manufacturers.

Medical electronics

Artificial heart

"I think that sometime in the future, a prime contractor will be selected to develop an artificial heart," says Dr. Frank Hastings of the National Institutes of Health at Bethesda, Md.

Dr. Hastings, a surgeon and a

pioneer in the field of medical electronics, will receive study reports shortly after the first of the year from six electronics-oriented companies which, at a cost of nearly a half-million dollars, are working on the problem of developing an artificial heart.

"All of the companies are approaching the problem from different points of view. We can see that we are going to get different product ideas from them," says Dr. Hastings.

With one exception, electronics is favored for power and for conversion into mechanical energy to sustain human blood flow. The Thermo-Electron Engineering Corp. of Waltham, Mass., prefers direct conversion to mechanical energy through a tiny, isotopic-decay "steam engine" implanted in the heart. Thermo-Electron has a study contract for \$89,709.

The other five contractors are the Stanford Research Institute, \$89,471; the Convair division of the General Dynamics Corp., \$87,700; the Westinghouse Electric Corp., \$84,585; Avco-Everett Research Laboratory, \$86,372, and the Hamilton Standard division of the United Aircraft Corp., \$86,290.

State of the heart. Dr. Hastings says the six companies will produce an over-all view of the state of the art. "We hope to pinpoint areas for further research and development and to find some of the soft spots in research," the doctor says.

The institute has received \$3.9 million this fiscal year from the Health, Education and Welfare Department budget to carry on the program.

It seems certain, whatever the power source or blood pump, that electronic components will have a major role in controlling feedback, monitoring the heart's operation, and warning of impending breakdowns of both the power source and the pump, explained Dr. Hastings.

The major problem, in Dr. Hastings' estimation, is putting together any system which is compatible with the body environment and with the blood chemistry. For unknown reasons, to cite one example, the protein in the oxygen-carrying red cells starts disintegrating after a few hours of pumping, and continues to disintegrate for 10 hours or longer—even after the mechanical heart has been removed and the patient's own heart resumes pumping.

Long or short. In true systems engineering fashion, the companies will analyze the impact of human dependence on a mechanical device for periods ranging from a short time, to assist the patient's own recovery after a heart attack, to the end of what might be a very long lifetime. Dr. Hastings estimates at least 400,000 of the one million deaths from heart and related cardiovascular diseases could be prevented with a good artificial heart.

Not the least important aspect of the study, Dr. Hastings said, will be the companies' recommendations on whether or not the project should aim solely at developing an implantable heart which would totally rehabilitate a heart attack victim. The effect on the total public health picture—and on the victim's families—would be tremendous, he warns, if "we merely keep the heart victims alive in a



ULTRA SENSITIVE NANOVOLT AMPLIFIER

Never has a dc amplifier provided more versatile performance with as precise amplification for signals as low as 100 nanovolts. The completely transistorized Model 120 is specifically engineered for low-level, low frequency transducer outputs typifying geophysical, seismographic, bolometer, cryogenic, cellular, Hall-effect, and related applications. Gains from 200 to 1 million, selected by front panel switch. Operated directly from ac power line or by battery, thus eliminating 60-cycle hum interference and providing floating amplification. Built-in battery charger and front-panel monitor. Just 14 pounds light.

SPECIFICATIONS

Gain Steps . . . 200 to 1 million in 1, 2, 5, etc. sequence
 Input Resistance Greater than 1 megohm
 Bandwidth From dc to greater than 100 cps
 Gain Accuracy $\pm 1\%$ at dc
 Gain Stability . . . $\pm 0.01\%$ /day, $\pm 0.1\%$ /6 months
 Linearity $\pm 0.02\%$
 Noise $< 0.05\mu\text{V}$ pk to pk referred to input
 Drift $< 0.05\mu\text{V}$ /hour referred to input
 Output ± 5 volts at 5 ma
 Size . . . $6\frac{3}{4}$ "w by $8\frac{3}{4}$ "h by $10\frac{1}{2}$ "d portable cabinet
 Power . . 115VAC or self-contained rechargeable batteries



hospital bed at \$20,000 a year in expenses because no one wants to turn the switch off."

Microcircuits

Getting in step

The integrated circuit industry is showing signs of maturity. A committee of the Joint Electronic Devices Council (Jedec), after deliberating for about a year, has approved a registration format for logic gating circuits. IC's will now be identifiable by code numbers like those established for tubes, diodes, and transistors. At present, each manufacturer uses its own house number to designate IC's, and there is no way to tell at a glance that Motorola's Brand X may be the same as Fairchild's Brand Y.

Jedec is sponsored by the Electronic Industries Association and the National Electrical Manufacturers Association. Any manufacturer who wants to have his IC registered may apply to the EIA. Registration numbers will begin with the prefix 6N, and the rest of the number will reflect only the sequence of the applications. Here, in brief, are the characteristics that a manufacturer must submit for registration:

- Type of device (germanium, silicon, etc.);
- Type of logic function and polarity (a dual NAND positive logic);
- Number of inputs;
- Number and logic type of outputs;
- Logic descriptions (logic diagrams, equations and truth tables);
- Mechanical data (outline of package and terminal assignments, handling precautions, and mounting recommendations);
- Limits (temperature, terminal voltages and currents);
- Electrical characteristics (nominal supply voltages, methods of testing, static and dynamic characteristics and power supply current drain).

An earlier draft of the Jedec format, prepared last spring, was limited to monolithic circuits. The new

format includes multichip, film, and hybrid circuits. Requirements for other functions, such as buffers and flip-flops, are in the works.

Long wait. Why did it take so long for an IC format to be developed? Partly, says Jean A. Caffiaux of EIA, because for a long time there wasn't enough duplication to make registration worthwhile; and partly because it took manufacturers a long time to decide which parameters were the most important as far as registration was concerned.

Registration will make it easier for users to compare circuits and to obtain a second source of supply. In addition, it assures that characteristics cannot be changed at will by the manufacturer, and it guarantees a permanent record of characteristics even if the manufacturer discontinues production.

Instrumentation

Malfunction receiver

Shake up an electronic assembly and listen with an r-f probe. If the assembly emits a tiny yelp of r-f noise, it has a faulty component or a bad connection. The faulty part can be pinpointed by scanning the assembly carefully with the probe while tapping around the parts with a plastic rod.

The test, which has been developed into both a malfunction-detection and preventive maintenance procedure by the Aeronautical division of Honeywell, Inc., can be performed with r-f noise meters. One test set which the division built a few years ago for its own use cost about \$13,000.

Since then, the division has stripped the technique down to its essentials, with the result that this month it will start selling an r-f probe that only weighs five pounds and costs \$695. The probe is tuned to a single frequency band and operates on d-c battery power to hold down r-f noise in the set.

Arc transmitter. The test is based on the fact that electric arcs generate r-f energy and that arcing

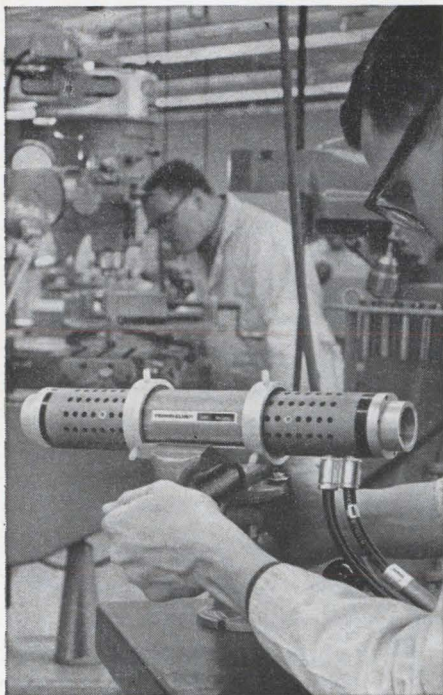

NOW... A PRACTICAL LASER!

Perkin-Elmer's Model 5200 is so compact . . . so rugged . . . so simple to use, that it makes practical almost any application requiring the unique characteristics of a continuous laser beam . . . even on production equipment.

This stable, noise free source of bright coherent light is already replacing expensive and hard-to-use optical alignment and measuring systems. Furthermore, it is extending the use of precise alignment and measuring systems to applications previously considered impractical.

For applications requiring a lot of light in a small diameter beam, the brightness of the Model 5200 is thousands of times greater than the most intense arc lamps.

When precise dimensions are important, the coherent nature of laser light...to a degree never before possible...extends the use of interferometry to entirely new applications.

Are you considering using a laser?

To obtain detailed information on the Model 5200 laser, contact Electronic Products Division, Perkin-Elmer Corporation, 751 Danbury Road, Norwalk, Connecticut. Or phone 203-847-0411.

PERKIN-ELMER

occurs when an intermittent fault is jostled. The fault could be a loose part in an electron tube, a fracture in a resistor, a frayed wire, a cold-solder joint, or even a crack in the silicon crystal of a semiconductor device. Faults such as this often don't result in equipment breakdown until long after the equipment has passed all the usual operational tests.

The r-f noise "spikes" generated

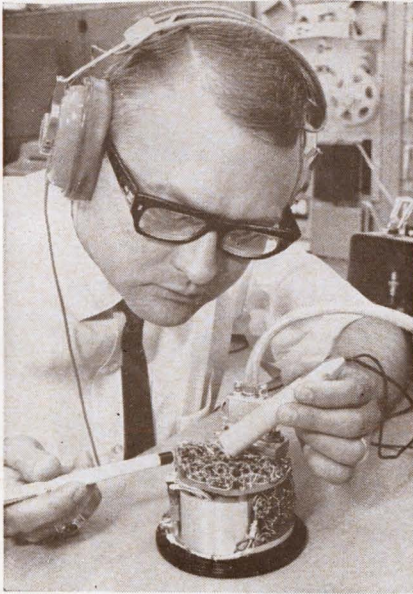

Listening for r-f noise in a micro-electronic assembly is Richard T. Stevens, senior systems development engineer at Honeywell.

by intermittent faults were first noticed by Honeywell engineers while they were making r-f interference measurements on electronic circuits. Their worth as a fault indicator was later proven when the noise test revealed faults in 10 of 140 flight-control assemblies that had passed all operational calibration tests.

Arc receiver. The probe receives a band of 20 to 30 megacycles. Honeywell found that most of the r-f noise energy is in that band. The r-f pickup is an air-core, loop antenna tuned to a center frequency of 26 Mc. In the test set are r-f and audio amplifiers, a head set for listening to the noise and a meter to judge relative strength of the noise.

The r-f amplifier's gain is high, up to 150 decibels of voltage

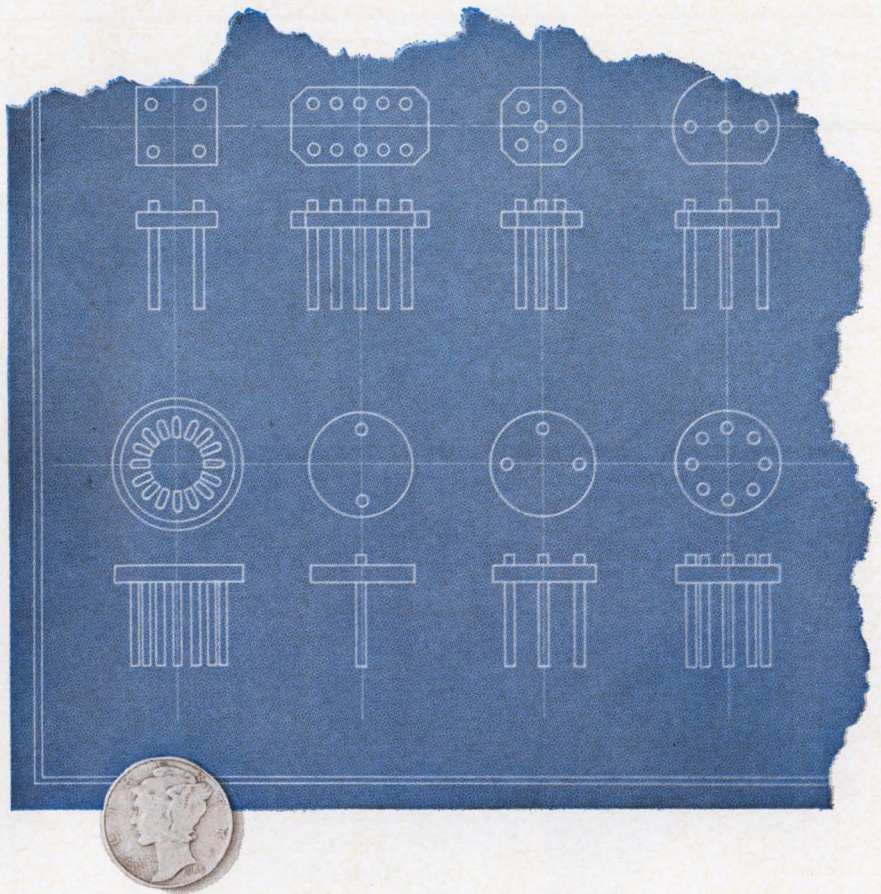

**As low as
10¢
a dozen**

... when you buy G.E.'s new plastic platform headers in quantities of a million or more. Today, General Electric is selling plastic platform headers like these for less than 1¢ to 5¢ each depending on design.

Want to figure your savings? Better plug in a calculator.

And there's more than economy. You have flexibility in the number of leads and in pin configuration. General Electric engineers will work directly with you to develop the plastic header best for your application.

The new plastic platform header is an exceptional product designed for new plastic encapsulated devices. It's available with virtually any type wire desired, including gold plated Dumet. Continuous temperatures to 400°F are taken in stride. The plastic header is ideal for silicon transistors and a wide range of other devices.

Plastic platform headers. A breakthrough. The kind of progress you've come to expect from General Electric.

For more information, or for a quote on your requirements, call or write: General Electric Company, Lamp Metals & Components Dept., 21800 Tungsten Road, Cleveland, Ohio 44117. Tel: (216) 266-2971.

Progress Is Our Most Important Product

GENERAL  ELECTRIC

Three more plug-ins for Analab Oscilloscopes



LF SPECTRUM ANALYZERS

CF RANGES: DC-20KC; DC-100KC; DC-500KC

Analab Spectrum Analyzer Plug-ins, Types SA101-1, SA101-2, and SA101-3, expand the versatility of Analab scopes to include operation as complete low frequency spectrum analyzers. The scope with plug-in features high stability, great sensitivity, very low incidental FM, full scan and center frequency tuning, and wide range calibrated sweep with vernier-adjust manual sweep available for highest accuracy.

The new plug-ins are designed for use with Analab low frequency scope main frames Types 1100 and 1100R (single trace), 1120 and 1120R (dual trace), and also with storage scopes Types 1220 and 1220R — these being ideal for very slow scan displays.

Owners of Analab scopes can now add spectrum analyzer capability at very moderate cost. Others in the market for an excellent spectrum analyzer should consider the sound economy of the Analab scope with spectrum analyzer plug-in, since many other versatile Analab plug-ins, for a wide range of applications, are available for use with the same main frame.

We invite your request for further information on the new spectrum analyzers as well as the complete line of oscilloscope main frames and plug-ins.

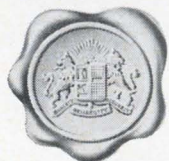

Analab

A DIVISION OF BENRUS

18 Marshall St., Norwalk, Conn. 06856 — Phone 203-838-4148;
Cable ANALAB, Norwalk, Conn.

gain, and its noise is low, less than 4 db.

Zeroing in. The technician using the probe turns down the gain until he can't hear the normal background noise. Then he hunts for noisy parts while the circuits being tested are operating. He does this by tapping the assembly and reducing the gain until he can only hear the noise when the pickup antenna is next to the part making the noise. He can also check for leaks in r-f shielding.

The noise can be recorded or displayed on an oscilloscope for signature analysis. Eventually, Honeywell hopes to develop equipment that could analyze a system's noise signature, to locate faults automatically and quickly.

Electronics notes

▪ **Contract lineup.** New England and Texas are continuing their rise among the states receiving the largest dollar volume of military prime contracts. Figures for the fiscal year ended June 30 show California and New York still holding first and second places, as they have for years, with \$5 billion and \$2 billion, respectively, in military work. Texas, with \$1.4 billion, moved up from fourth place to third; Connecticut, with \$1.2 billion, from fifth to fourth; and Massachusetts, with \$1.2 billion, from seventh to fifth. Missouri, which ranked third in 1964, dropped from fifth to sixth.

▪ **Laser boost.** The Union Carbide Corp. has pushed the power of a continuous-wave solid state laser to 42 watts. The previously reported record output was about five watts. Researchers used a neodymium-doped, yttrium aluminum garnet (YAG) rod. Key to the achievement is a high-intensity radiation source—an arc in a quartz tube filled with argon plasma—which provides up to about 50 kilowatts of input power. A water jacket cools the rod during operation, but details are proprietary. A 100-watt output is expected shortly.



SCREEN PRINTED MICROCIRCUITRY NEWS

Information and ideas on the manufacture of screen printed microcircuitry. Published periodically by E. I. du Pont de Nemours & Co. (Inc.), Electrochemicals Department, Wilmington, Delaware 19898.

DU PONT SEMINAR ON HYBRID MICROCIRCUITRY NOW AVAILABLE TO SMALL GROUPS



Small groups are now seeing Du Pont's presentation on screen printed hybrid microcircuitry.

Since first presented in late May, the Du Pont technical seminar on screen printed hybrid microcircuitry has met with favorable response by over 600 executives and electronic engineers who have seen the presentation.

Now Du Pont electronics industry representatives have available a complete "desk-top" presentation on the subject for groups of six or less. Prepared to meet the widespread interest in screen printing as a method of producing reliable microcircuitry for a low capital investment, the presentation, like the seminar:

1. Compares the major types of microcircuits for versatility, cost and manufacturing ease.
2. Illustrates the techniques used in the manufacture of screen printed hybrid microcircuits.
3. Discusses the characteristics of the components that can be produced with the presently available materials.
4. Indicates the areas in which Du Pont research has set goals for new products.

Availability of the presentation should be discussed with the representative in your area. His name and telephone number appear on page 2.

HOW SCREEN PRINTING OFFERS VERSATILITY IN DESIGN OF MICROCIRCUITS

Many electronic engineers are meeting their particular needs for reliable hybrid microcircuits through the use of

screen printed microcircuitry because of the unusual versatility offered by the process. Some of the key factors influencing their decisions are:

1. The screen printing process provides an economical method for producing large or small quantities of thick film microcircuits. After firing to fix the printed conductors and resistors to the ceramic substrate, active devices can be attached as required. Attaching active devices to printed wiring enables the engineer to call specifically for those devices that will match the close tolerances his design requires.
2. An almost endless variety of resistor-conductor networks is possible because the conductors can be applied in almost any pattern and resistors can be produced over a broad range of values. This is even possible on extremely small wafers.
3. Resistor-capacitor networks are possible by: either (A) sandwiching a screen printed dielectric layer between two printed electrode layers, or (B) attaching discrete capacitors as required, or (C) using a high dielectric constant ceramic such as barium titanate as a substrate.
4. Gate circuits adaptable to repetitive logic circuitry are possible when screen printed passive circuits are combined with transistor and diode chips.

Du Pont offers a growing line of resistor and conductor compositions to give the engineer a wide range of design capabilities. The following table shows some of the characteristics that can be obtained from Du Pont Resistor Compositions:

DU PONT RESISTOR COMPOSITIONS OFFER WIDE RANGE OF RESISTANCE VALUES

Resistor Composition	Nominal Resistance (ohms/sq./mil)	TCR, ppm/°C		Noise db/decade	Drift† %
		25 to 105°C	25 to -75°C		
7826	500*	+425	+270	-5	2
7827	3,500*	+330	+110	0	2
7828	10,000*	+100	-100	+15	2
8020	1**	+300	-250	-35	0.5
8025	20,000**	-50	+300	+15	0.5

*on barium titanate

**on alumina

†after 1,000 hours at 150°C, no load.

Additional compositions are available to provide intermediate values in each of the 7800 and 8000 series shown above.

RECENT SCREEN PRINTED MICROCIRCUITS SHOW VERSATILITY OF THE PROCESS

Screen printed microcircuits are being used in a wide range of applications. Below are two excellent examples of such circuits.

1. Circuit shown on the right is a resistor network on an alumina substrate as designed for a computer system. The 'top hat' configured resistor permits very precise adjustment of resistance value. Shown to the left, the same network has been encapsulated in a typical Durez type coating and subjected to vacuum wax impregnation for protection. (Courtesy, Erie Technological Products, Inc., Erie, Pennsylvania.)
2. Photo #2 shows a dual amplifier circuit for the N-17 inertial guidance system of the Minuteman II ICBM. This chip is one of 580 chips that Autonetics builds for the N-17. Circuit is shown prior to the attachment of a mated pair of transistors and packaging of the circuit in a flat-pack container. (Courtesy North American Aviation, Autonetics Division, Anaheim, California.)

1. 2.

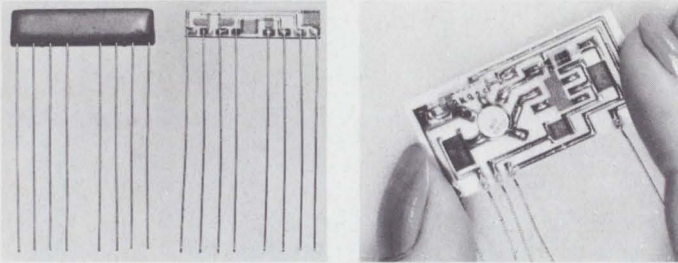

INCREASED RELIABILITY RESULT OF DU PONT RESEARCH ON ADHESION PROCESS

A high level of reliability is possible from screen printed wiring, when steps are taken to carefully control adhesion. In the paper, "Adhesion of Platinum-Gold Glaze Conductors", given at the May IEEE Conference, Dr. L. C. Hoffman, of the Du Pont research staff, presents a characterization of the adhesion process that can lead users to higher initial conductor adhesion and less degradation of

adhesion in high temperature environments. Dr. Hoffman finds:

1. At a given firing temperature, adhesion rises rapidly to a maximum with the passage of time, and having reached the maximum degrades slowly as firing time increases. Unless the temperature is above 850°C., the maximum adhesion cannot be obtained. Since the relationship between firing time and temperature is critical, each user should run tests with his own equipment to determine the best firing time to meet his particular requirements.
2. Higher melting solder (e.g. 30Sn/70Pb) greatly increases the initial adhesion of conductors. In the case of platinum-gold compositions initial adhesion was doubled by using 30Sn/70Pb rather than eutectic solder.
3. At ambient temperatures of up to 110°C., the rate of adhesion decrease over long periods of time is almost negligible.

Copies of Dr. Hoffman's paper are available by mailing the coupon below.

NEW Pd-Ag COMPOSITION FOR RESISTOR TERMINATION

A recent development by Du Pont research is Palladium-Silver Composition #8151. This conductor composition is designed to be fired simultaneously with Du Pont Resistor Compositions and produce a smooth overlap area. Firing results in a conductor path that is firmly bonded to the substrate and can be easily soldered. Full information is available from Du Pont.

PROPERTIES OF ELECTRONIC PALLADIUM-SILVER COMPOSITION #8151

Method of Application:	Stencil screen using 165 or 200 mesh stainless steel screens
Thinner:	Butyl "Carbitol" acetate (Union Carbide Corp.)
Firing Temperature Range:	1280-1400°F. (693-760°C.)
Fired Film Resistivity:	0.04 ohm/square/mil
Solderability:	Excellent—60 Sn/40 Pb or 62 Sn/36 Pb/2Ag.
Adhesion:	On 96% alumina approx. 2000-2500 psi (peeling pull)



Better Things for Better Living
... through Chemistry

E. I. du Pont de Nemours & Co. (Inc.), Electrochemicals Dept.
Ceramic Products, A 16, Wilmington, Delaware 19898

Date _____

- Please send a copy of Dr. L. C. Hoffman's paper "Adhesion of Platinum-Gold Glaze Conductors".
- Please send a copy of your booklet "Screen Printed Hybrid Integrated Circuitry".

NAME _____

TITLE _____

BUSINESS ADDRESS _____

CITY & STATE _____ ZIP CODE _____

FOR MORE INFORMATION ON DU PONT
CONDUCTOR AND RESISTOR COMPOSITIONS, contact any of these Du Pont Electronic Industry Representatives:

SPECIALIST	AREA	AREA CODE—PHONE
Jerry Carson	Philadelphia	215—TR 8-2700
Jim D'Andrea	New York	212—971-4000
Bill Dawson	Cleveland	216—561-1580
Red Kauffmann	Chicago	312—IN 3-7250
Bill Wood	San Francisco	415—467-9040
	Los Angeles	213—283-0741
Jim Mitchell	Atlanta	404—451-2611
	Charlotte	704—375-5561
	Dallas	214—ME 7-0540
Wolly Hille-Dahl	Europe	Geneva 42 16 00

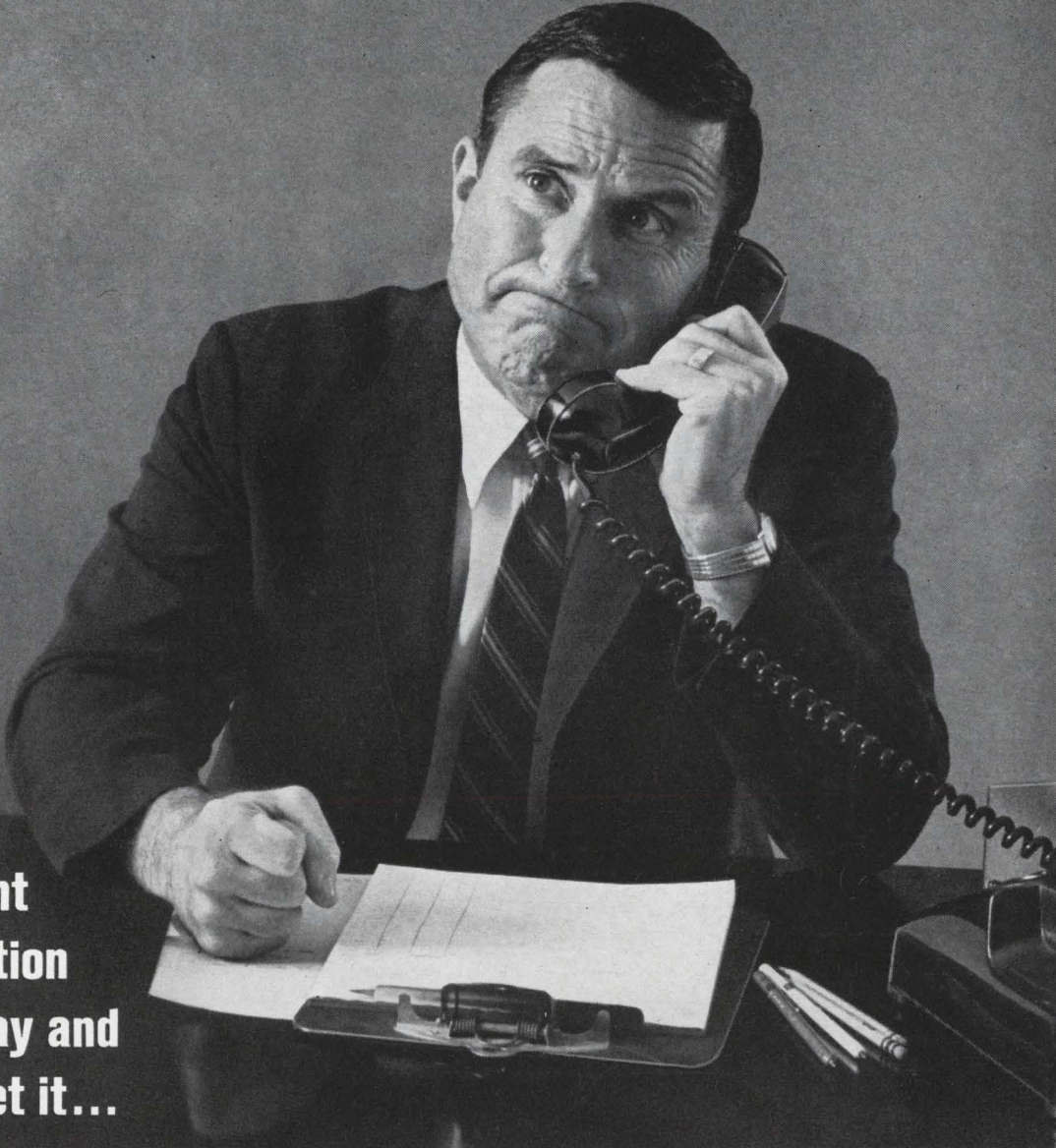

If you
needed
Airfreight
information
yesterday and
didn't get it...

BETTER CALL A MAN ABOUT A TIGER!

Don't put up with "too little and too late" when it comes to airfreight information. Call Tigers. Tigers' large staff of airfreight specialists will get the information you need when you need it—in person or on the phone!

Airfreight is our business—our *only* business. So every Tigerservice is geared to save *you* time, money, effort and worry. Get prompt, on-the-spot attention to every airfreight need. Call us for proof: you can't afford *not* to ship Tigers!

Get These Tiger Extras!

Wholesale "Blocked Space" Rates—save up to 15% coast-to-coast and to Chicago ■ Exclusive Advance Manifest Data System—lets you know where your shipment is at any time and when it will be delivered ■ Only Coast-to-Coast All-Cargo Flights with Nonstop Service Both Ways ■ Swingtail CL-44's—only airfreighter that can carry shipments up to 84 feet long.

FLYING TIGER LINE

THE AIRFREIGHT SPECIALIST



Sigma relay idea of the month

A simple, economical way to control liquid levels within prescribed limits.

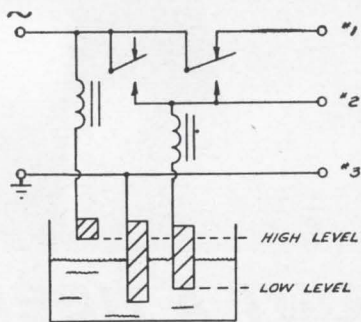

POWER FOR FILL TERMINALS 1 & 3

POWER FOR DRAIN TERMINALS 2 & 3

The circuit shown, utilizing a Sigma Series 5 relay, represents one of the simplest ways to control liquid levels in applications such as water treatment, chemical processing and the protection of immersion pumps in artesian wells.

As can be seen, the liquid level is sensed by immersion electrodes, a convenient and economical method when the liquid is sufficiently conductive. These electrodes can be arranged to give independently controlled high and low lim-

its, and to operate for either filling or draining.

Depending on the size and spacing of the electrodes, the purity of the water, or the type of solution, the equivalent resistance between the electrodes can vary from 100 to 100,000 ohms. In the circuit shown, the Sigma Series 5 relay would be suitable for almost any anticipated resistance. A refinement of the circuit would permit control of solution strength of soap, caustic or acid, between prescribed values.

If you have a relay idea, or can improve this one, we'd like to hear from you. Your idea could be the next one we publish.

Sigma relay of the month

Versatile SPDT Series 5 relay responds precisely to signals as small as 1 mw.

The Sigma Series 5 relay is one of the most versatile relays on the market today. Its 10,000 variations are performing in applications ranging from air navigation systems and liquid level controls, as shown on the left-hand page, to burglar alarms and meter protection equipment. It is particularly useful as an overload or underload device that reacts without amplification to minute changes or differences from normal values.

With the Sigma Series 5, adjustments to 1 mw are standard. Yet, its design enables it to have unusually high contact forces even at these low inputs. Some other reasons why this relay is in such widespread use are:

1. Narrow differential—Drop out to pick up ratios extending to 80% because of easily adjustable fixed contacts and spring force. 2. Accuracy—Trip values can be set readily to within $\pm 5\%$, with micrometer-type screw contacts. 3. Stability—Trip points will not

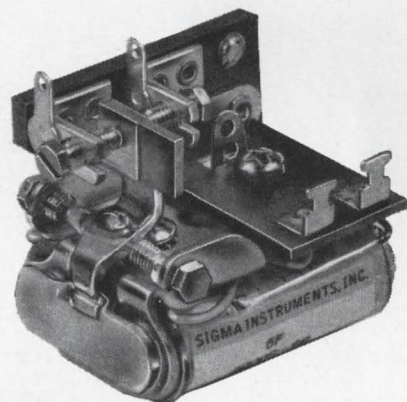

vary more than $\pm 2\%$ throughout life, in the absence of contact erosion, as a result of low friction needle point bearings. 4. Ruggedness—Withstands 100 G's shock without damage, and heavy coil overloads of up to 30-to-1 for voltage or current. 5. Long life—Five million operations, barring contact damage by transients.

Try the Sigma Series 5 for yourself—free of charge. Just send for the Sigma Series 5 bulletin and a free relay redemption certificate.

SIGMA DIVISION  SIGMA INSTRUMENTS INC
Assured Reliability With Advanced Design / Braintree, Mass. 02185

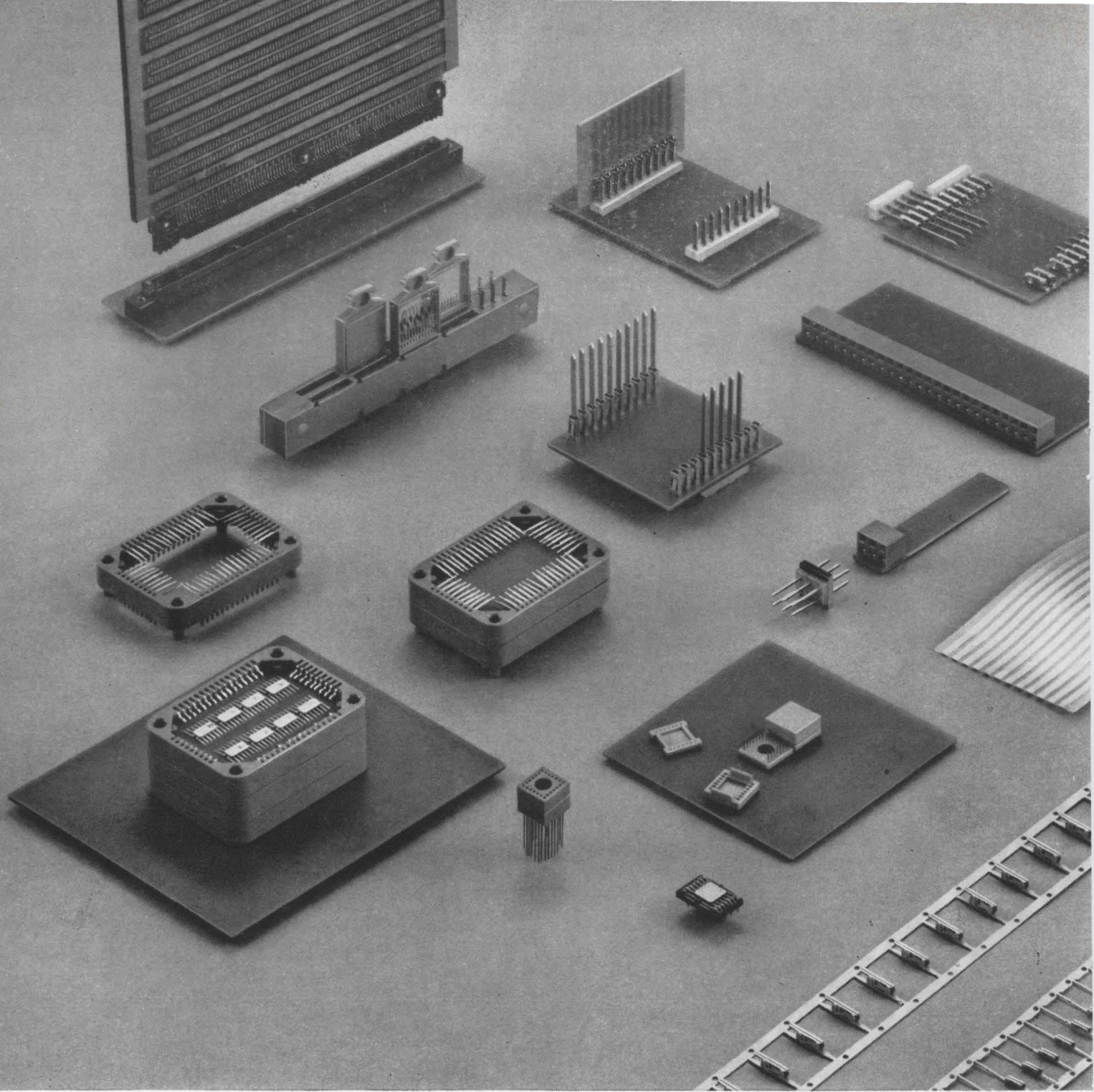

Ever try putting a square peg in a round hole?

Circle 52 on reader service card

Modern packaging requirements are often as frustrating.

High density packaging coupled with "pluggability" has almost become a mania with design engineers. As a result, once novel modular system design is now the rule rather than the exception. There are flatpacs, micro-modules, film structures, mother-daughter board combinations and matrix configurations that defy description. And the only thing standard about them is that they're all different.

Regardless of the problem, AMP has an answer. We've been able to offer many exciting solutions to a variety of packaging problems. Examples: Headers for transistor cans or interconnection modules plugged to circuit boards through AMP's miniature spring sockets . . . flat flexible cable plugged to micromodules by way of AMPMODU* grid plate headers . . . functional flatpacs plugged together with AMP's new active pin multi-level circuit headers . . . connectors with up to 160 contacts on .050" centers.

Our packaging specialists are continually searching for new and better ways to interconnect circuits in the face of a fast-changing technology. You can be assured that if ever industry asks us to design a square peg to fit in a round hole . . . we'll find a way to do that, too.

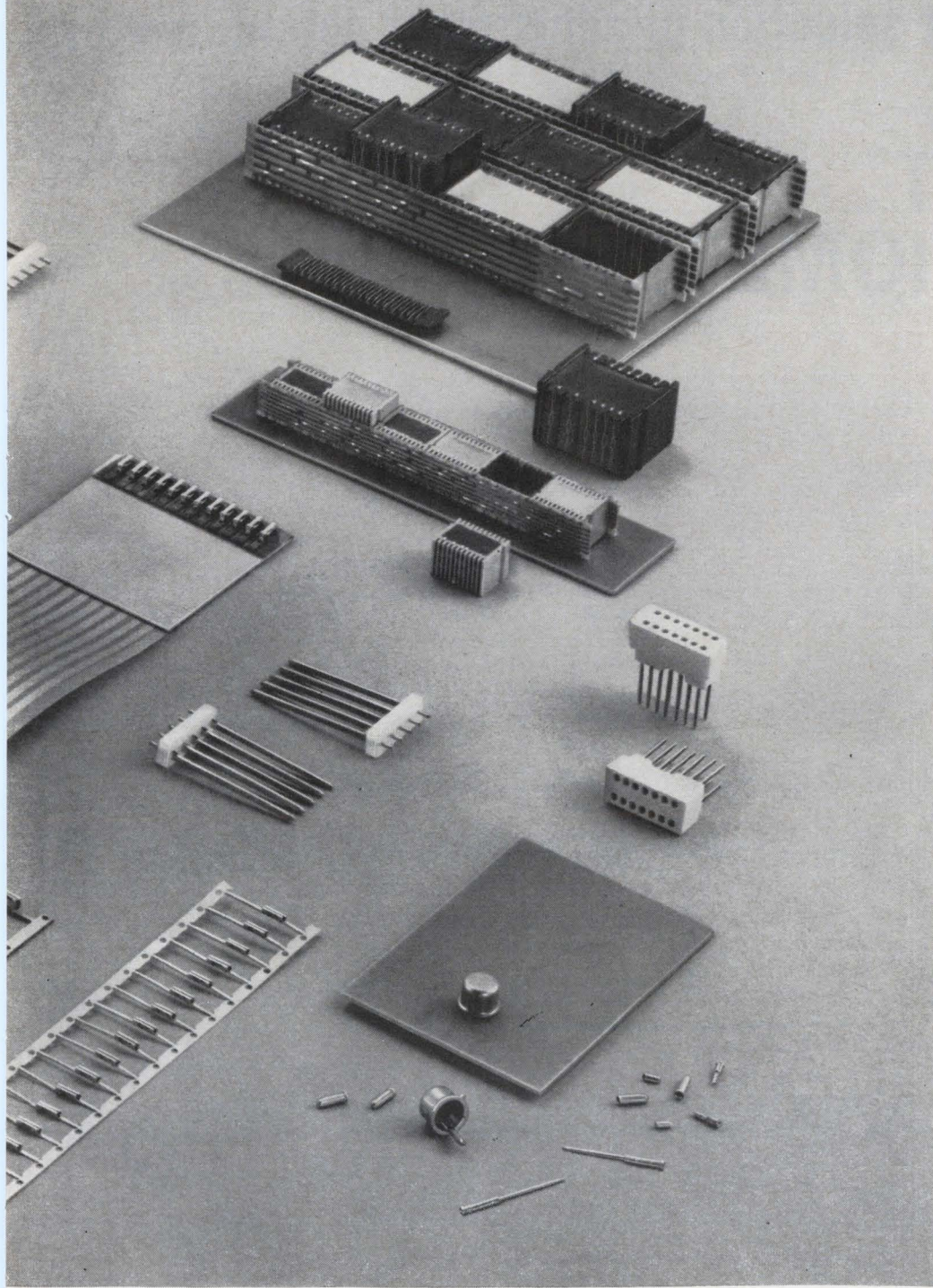

Solid state instrumentation system designed around three-dimensional AMP-MECA modules

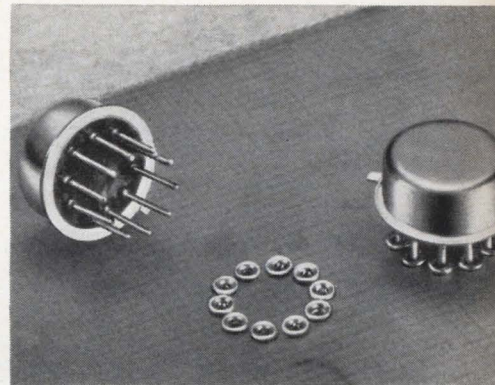

In a typical application, transistor cans are made pluggable to boards by inserting and flow soldering AMP's miniature spring contacts

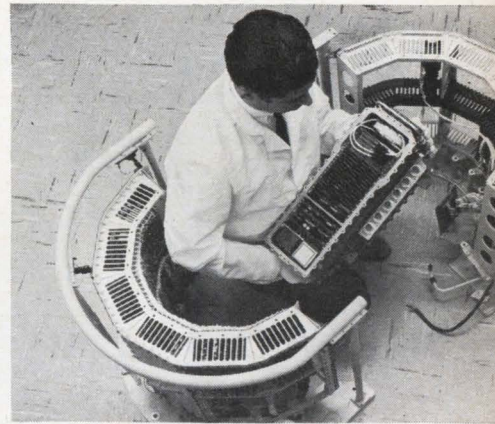

AMP's subminiature printed circuit connectors conserve space in missile guidance and control computer

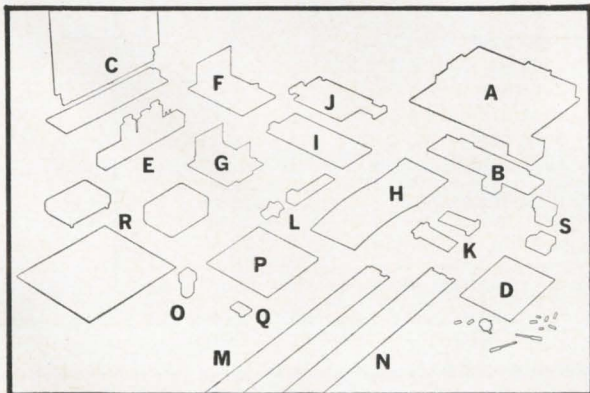

- A. AMP-MECA modular interconnection system
- B. Miniature AMP-MECA modules
- C. 160-position board-to-board MECA connector
- D. Miniature spring sockets for transistor cans
- E. Diode Matrix Assembly
- F. Standard AMPMODU horizontal-mount interconnection systems
- G. Standard AMPMODU vertical-mount interconnection system
- H. AMPMODU flat flexible cable connector
- I. Miniature AMPMODU board-to-board connector
- J. Standard AMPMODU incremental connector
- K. Standard AMPMODU male incremental connector

- L. Miniature AMPMODU Grid Plate connector
- M. Standard AMPMODU contact strips for automatic machine application
- N. Miniature AMPMODU contact strips for automatic machine application
- O. 24-position helical receptacle
- P. Helical flatpack connector
- Q. Crimp pack carrier for flat packs
- R. 50-position active pin multi-level header
- S. 14-position miniature spring receptacle

AMP
INCORPORATED
 Harrisburg, Pennsylvania

World's largest selection of adjustment potentiometers

BOURNS TRIMPOT® POTENTIOMETERS

More engineers specify Bourns TRIMPOT Potentiometers because:

TRIMPOT Potentiometer line is complete:

Bourns offers you the largest selection of adjustment potentiometers...33 standard models—4 terminal types—3 mounting styles.

TRIMPOT Potentiometers are small:

Space-saving size and choice of shapes permit the installation of up to 17 units (and sometimes even more) in one square inch of panel area.

TRIMPOT Potentiometers are accurate:

Screw-driver adjustment gives as much as 9000° of rotation...you can make and repeat the finest adjustments.

TRIMPOT Potentiometers are stable:

Adjustment shaft is self-locking...settings are virtually immune to acceleration, vibration and shock.

TRIMPOT Potentiometers are fully tested:

All units are 100% inspected before shipment and are checked by Bourns' exclusive Reliability Assurance Program to assure you of reliable performance.

TRIMPOT Potentiometers are proven:

They are backed by over 17 years of engineering know-how and have been specified and used in more military, industrial or commercial equipment than any other leadscrew potentiometer in the world!

REMEMBER—IF IT'S TRIMPOT, IT'S BOURNS

Only Bourns TRIMPOT Potentiometers Give You All Of These Outstanding Features

SPRING—Carriage spring provides positive no-slip performance during rotation plus a reliable idling feature at mechanical limits of travel.

LEADSCREW—Stainless steel leadscrew is corrosion-resistant.

O-RING—Silicone rubber O-ring seals potentiometer against humidity, withstands high temperature.

SHAFT HEAD—Stainless steel with machined slot for screw-driver adjustment. Meets military salt spray requirements.

WIPER—Gold-plated wiper carriage and precious-metal wiper for low noise. Carriage and wiper are welded together.

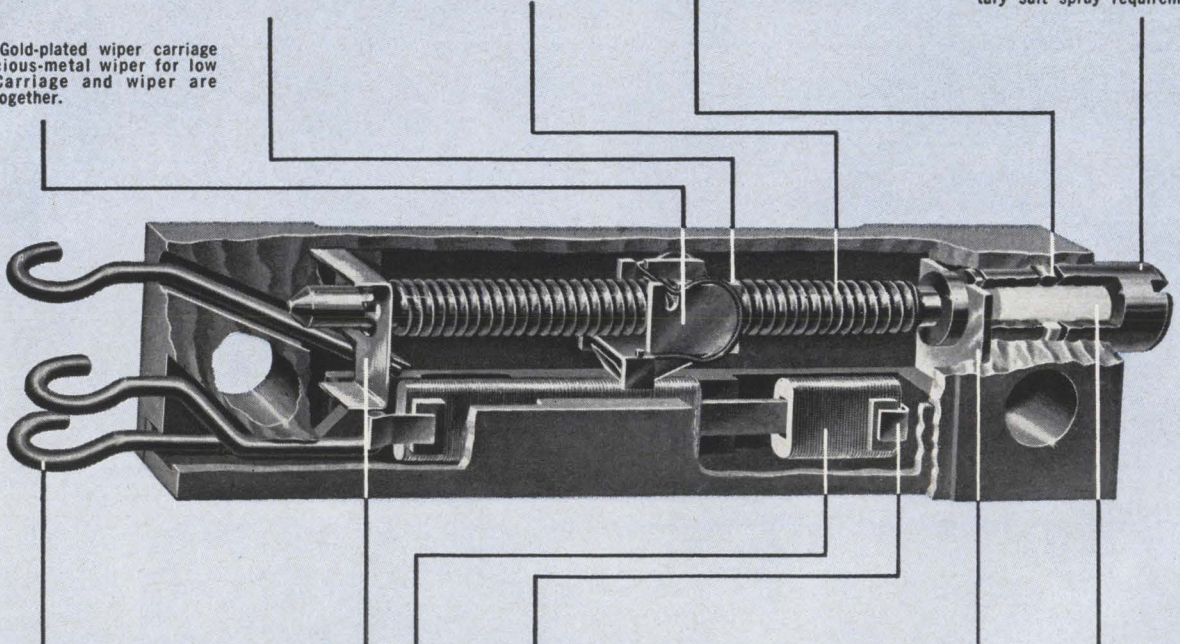

SOLDER TERMINALS—Tinned terminals are compact, yet large enough for easy soldering. Teflon-insulated leads and printed circuit pins are also available.

SILVERWELD® TERMINATION—This exclusive Bourns feature is unequalled in ruggedness. There is a metal-to-metal bond from the terminal to the resistance wire.

PICK-OFF—Precious-metal, positive-contact pick-off assures wiper continuity.

ELEMENT—Special ceramic element card for maximum reliability is precision wound with low-temperature-coefficient resistance wire.

SHAFT RETAINER—Shaft is locked in place for top performance under extreme shock, vibration and acceleration.

SHAFT INSULATOR—High-dielectric-strength, ceramic insulator isolates shaft head from internal circuits.

This cutaway of Model 224 shows the typical high quality to be found in all Bourns TRIMPOT potentiometers, although some features may vary from model to model.

...longest record of reliability

TRIMPOT® POTENTIOMETERS—UNSEALED

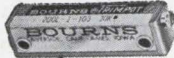

General-Purpose Wirewound Model 200. Max. temp. 105°C / L, S, P terminals / 0.50 watt at 70°C / 10 ohms to 100K.

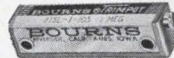

General-Purpose RESISTON® Carbon Element Model 215. Max. temp. 125°C / L, S, P terminals / 0.25 watt at 50°C / 20K to 1 Meg.

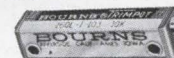

High-Temperature Wirewound Model 260. Max. temp. 175°C / L, S, P terminals / 1.0 watt at 70°C / 10 ohms to 100K.

TRIMPOT POTENTIOMETERS— HUMIDITY PROOF



General-Purpose RESISTON Carbon Element Model 235. Max. temp. 135°C / L, S, P terminals / 0.25 watt at 50°C / 20K to 1 Meg.

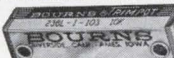

General-Purpose Wirewound Model 236. Max. temp. 135°C / L, S, P terminals / 0.8 watt at 70°C / 10 ohms to 100K.



Micro-Miniature High-Temperature Wirewound Model 3000. Max. temp. 175°C / P terminals / 0.5 watt at 70°C / 50 ohms to 20K.



Micro-Miniature High-Temperature RESISTON Carbon Element Model 3001. Max. temp. 150°C / P terminals / 0.20 watt at 70°C / 20K to 1 Meg.



Sub-Miniature High-Temperature Wirewound Model 220. Max. temp. 175°C / L, W terminals / 1.0 watt at 70°C / 10 ohms to 30K / Mil-Spec style RT10 and meets MIL-R-27208A.



High-Temperature Wirewound Model 224. Max. temp. 175°C / L, S, P terminals / 1.0 watt at 70°C / 10 ohms to 100K / Mil-Spec style RT12 and meets MIL-R-27208A.



Ultra-Reliable High-Temperature Wirewound Model 224-500. Max. temp. 150°C / L, P terminals / 0.5 watt at 70°C / 100 ohms to 20K. Performance and reliability statistically verified to customer.



High-Temperature, High-Resistance RESISTON Carbon Element Model 3051. Max. temp. 150°C / L, S, P terminals / 0.25 watt at 50°C / 20K to 1 Meg / Mil-Spec style RJ11 and meets MIL-22097B.



High-Temperature High-Resistance PALIRIUM® Film Element Model 3052. Max. temp. 175°C / L, P terminals / 1.0 watt at 70°C / 10K to 1 Meg.



High-Temperature, Low-Resistance PALIRIUM Element Model 3053. Max. temp. 175°C / L, P terminals / 0.5 watt at 70°C / 2 ohms to 100 ohms.



High-Temperature Wirewound Model 3011. Max. temp. 175°C / L, P terminals / 1.0 watt at 70°C / 10 ohms to 100K / Mil-Spec style RT11 and meets MIL-R-27208A.



High-Temperature RESISTON Carbon Element Model 3011. Max. temp. 150°C / L, P terminals / 0.25 watt at 50°C / 20K to 1 Meg / Mil-Spec style RJ11 and meets MIL-R-22097B.



High-Temperature High-Resistance PALIRIUM Element Model 3012. Max. temp. 175°C / L, P terminals / 1.0 watt at 70°C / 10K to 1 Meg.



3/8"-Square Wirewound Model 3280. Max. temp. 175°C / L, P, W terminals / 1.0 watt at 70°C / 10 ohms to 50K.



3/8"-Square RESISTON Carbon Element Model 3281. Max. temp. 150°C / L, P, W terminals / 0.5 watt at 50°C / 20K to 1 Meg.



1/2"-Square, High-Temperature Wirewound Model 3251. Max. temp. 175°C / L, P, W terminals / 1.0 watt at 70°C / 10 ohms to 50K / Mil-Spec style RT22 and meets MIL-27208A.



1/2"-Square High-Temperature RESISTON Carbon Element Model 3251. Max. temp. 150°C / L, P, W terminals / 0.50 watt at 50°C / 20K to 1 Meg / Mil-Spec style RJ22 and meets MIL-R-22097B.

BOURNS® SINGLE-TURN POTENTIOMETERS



3/16"-Diameter Micro-Miniature High-Temperature Humidity-Proof Wirewound Model 3300. Max. temp. 175°C / P, S terminals / 0.5 watt at 70°C / 50 ohms to 20K.



3/16"-Diameter Micro-Miniature High-Temperature Humidity-Proof RESISTON Carbon Element Model 3301. Max. temp. 150°C / P, S terminals / 0.25 watt at 70°C / 10K to 1 Meg.



Sub-Miniature Wirewound Model 3367. Max. temp. 105°C / P, S terminals / 0.5 watt at 70°C / 10 ohms to 20K / meets steady-state humidity.



Sub-Miniature RESISTON Carbon Element Model 3368. Max. temp. 105°C / P, S terminals / 0.25 watt at 50°C / 20K to 1 Meg / meets steady-state humidity.

LOW-COST COMMERCIAL POTENTIOMETERS



Wirewound TRIMIT® Potentiometers Models 271, 273, 275. Max. temp. 85°C / L, S, P terminals / 0.5 watt at 25°C / 50 ohms to 20K.



RESISTALLOY® Carbon Element TRIMIT Models 272, 274, 276. Max. temp. 85°C / L, S, P terminals / 0.2 watt at 25°C / 20K to 1 Meg.



Wirewound E-Z-TRIM® Potentiometer Model 3067. Max. temp. 85°C / S, P terminals / 0.5 watt at 25°C / 100 ohms to 20K / Priced under \$1 in production quantities.



Carbon Element E-Z-TRIM Potentiometer Model 3068. Max. temp. 85°C / S, P terminals / 0.2 watt at 25°C / 20K to 1 Meg.

SPECIAL-PURPOSE POTENTIOMETERS



High-Power (2 watts) High-Temperature Wirewound Model 207. Max. temp. 175°C / L terminals / 2 watts at 50°C / 100 ohms to 100K. As Rheostat Model 208, available 100K to 200K.



High-Power (5 watts) Humidity-Proof Wirewound Model 3020. Max. temp. 200°C / L terminals / 5.0 watts at 25°C / 100 ohms to 50K.



Dual-Element Wirewound TWINPOT® Potentiometer Model 209. Max. temp. 135°C / L terminals / 0.50 watt (each element) at 70°C / 10 ohms to 50K.



15 watts, High-Temperature Wirewound Model 3030. Max. temp. 265°C / L terminals / 15 watts at 25°C / 10 ohms to 10K.

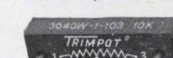

Radiation-Resistant, High-Temperature Wirewound Model 3040. Max. temp. 350°C / W terminals / 5.0 watts at 70°C / 500 ohms to 20K.

PANEL-MOUNTED POTENTIOMETERS

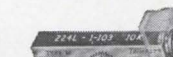

Most models are available with panel mounting. Unique design permits quick factory assembly to "on-the-shelf" units. In addition, mounting screws, brackets and clip brackets are available to meet almost any mounting requirement.

KEY TO TERMINAL TYPES

- L=Insulated stranded leads
- S=Solder lugs (includes panel-mounting bushing on Models 3367S, 3368S, 3300S and 3301S only)
- P=Printed-circuit pins
- W=Uninsulated wires (edge-mounting 3250, 3251, 3280 and 3281).

Write TODAY for detailed specifications on any model in the large BOURNS® Potentiometer and TRIMPOT® Potentiometer line AND a list of factory representatives.

Remember—
Don't MIL-SPECulate...
SPECify Bourns.

TRIMPOT is a registered trademark of Bourns, Inc.



BOURNS

BOURNS, INC., TRIMPOT DIVISION
1200 COLUMBIA AVE., RIVERSIDE, CALIF.
PHONE 684-1700 • TWX: 714-682-9552
CABLE: BOURNSINC.

MANUFACTURER: TRIMPOT® & PRECISION POTENTIOMETERS, RELAYS, TRANSDUCERS FOR PRESSURE, POSITION, ACCELERATION. PLANTS: RIVERSIDE, CALIFORNIA; AMES, IOWA; TORONTO, CANADA

Choosing filter capacitors for line-operated solid state equipment

Getting ripple down to a rock-bottom minimum in a low voltage DC power supply usually means using as much capacitance as is practical. Mallory Computer Grade capacitors are an efficient and economical answer. They were developed to meet the reliability and performance requirements of computer power supplies. This means that they're exceptionally stable; expected life at room temperature is 20 years or more. They have efficient filtering performance.

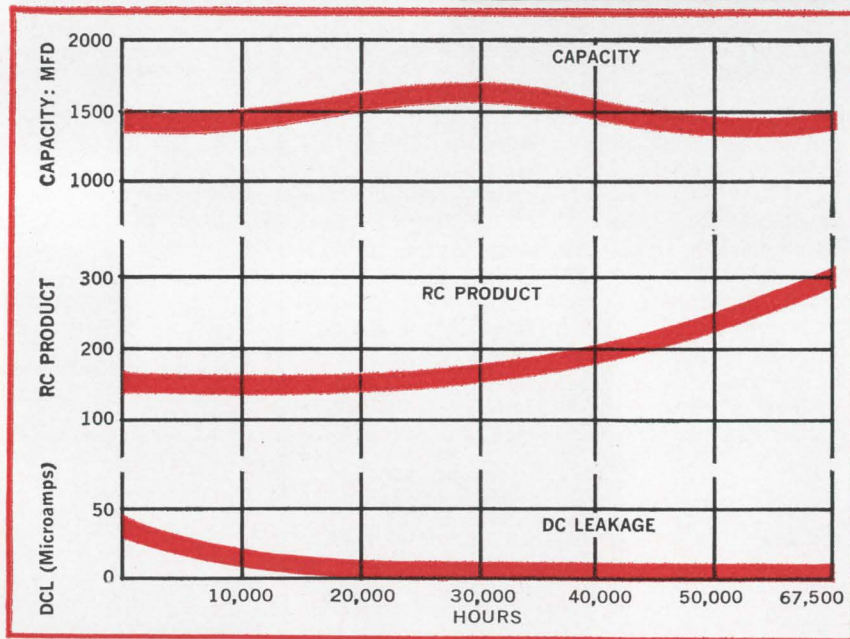
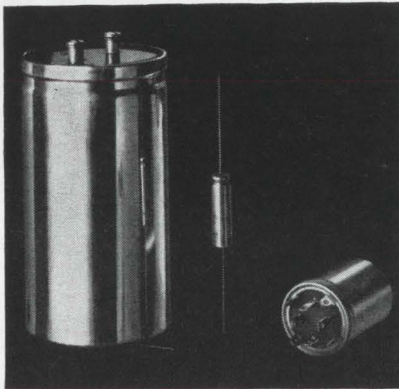

Typical data from 67,000 hour life test shows stability of electrical parameters of CG capacitors. Values shown are for 1000 mfd, 50 volt capacitors.

Equivalent series resistance is low — value for a 108,000 mfd, 10 WVDC unit is .018 ohms max. Excellent capacity retention to -40°C . Frequency characteristics are such that excellent performance is attained at higher harmonics. You can get a lot of capacitance in a single case; up to 200,000 mfd at 3 WVDC in the largest case size. And best of all, CG's give you the most microfarad-volts per dollar. When you need to miniaturize, in-

vestigate the Type TPG. It's a "miniature computer grade", made to similar specifications. Case diameter is $\frac{3}{8}$ ", lengths $\frac{13}{16}$ " to $1\frac{5}{8}$ ". Values range from 450 mfd 3 WVDC to 20 mfd 150 WVDC. A single-ended version called VPG is designed for vertical mounting.

Between these extremes, we have expanded our FP line to include higher capacity values in the lower voltage ratings.

CIRCLE 105 ON READER SERVICE CARD

Power rheostats maintain contact pressure in spite of overloads

A key design feature of Mallory Type K heavy-duty power rheostats is the patented hinged contact arm. A spring, which is not part of the current-carrying circuit, maintains correct contact pressure between the contact and the rheostat winding. Should overloads occur, there is no danger of overheating of the spring and consequent loss of contact pressure.

The hinged construction also makes it easy to lift the contact arm for inspection, cleaning or replacement without affecting spring pressure. The line of Mallory rheostats covers power ratings of 25, 50, 75, 100, 150, 225, 300 and 500 watts. In addition to standard linear taper, Mallory rheostats can be supplied on order in a variety of special tapers to provide custom resistance-rotation characteristics. In these special tapers, resistance wires are permanently joined in sections by a welded splice which assures smooth operation and long, trouble-free life.

CIRCLE 106 ON READER SERVICE CARD

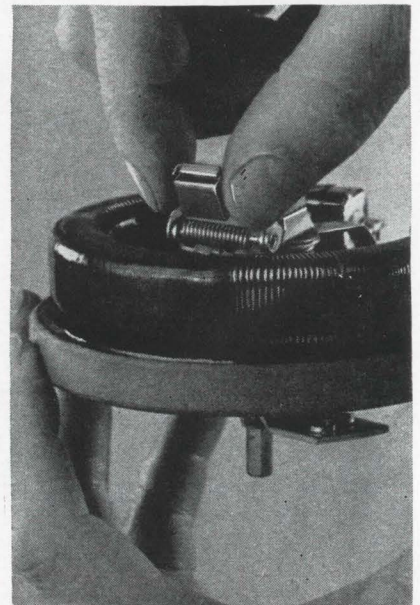

DESIGNER'S FILE

P. R. MALLORY & CO. INC., INDIANAPOLIS, INDIANA 46206

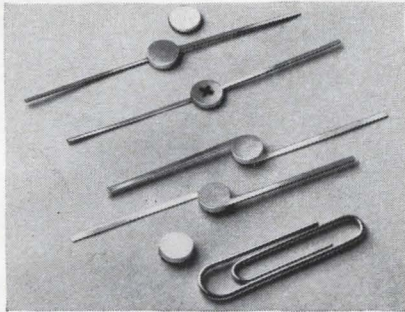

Sealed microminiature tantalum capacitors

The new type THD capacitors are designed specifically for use with integrated circuits when capacity volume over μmf ratings are required. They are flat cylindrical configurations, only 0.250" in diameter and 0.031" or 0.063" thick, the greater thickness being used in the maximum capacitance values for each voltage rating. This construction gives high geometric efficiency, and exceptionally high mfd-volt values per unit volume.

The THD consists of a solid electrolyte tantalum anode, housed in an impervious ceramic ring, with two metal end plates (positive and negative) sealed to the ceramic with high melting point solder. The capacitor can be supplied without leads . . . top and bottom end plates serving as terminals. Or it can be supplied with radial or tangential ribbon leads.

These capacitors are designed to meet the electrical requirements of MIL-C-26655, Characteristic A. Maximum DC leakage at 25°C is 0.02 microamps per mfd-volt or 1.0 microamp, whichever is greater; at 85°C, maximum leakage is 10 times these values. Maximum dissipation factor is 6% at 25°C. Maximum capacitance is 15 mfd at 6 volts, 8.2 mfd at 10 volts, 4.7 mfd at 15 volts, 2.7 mfd at 20 volts, 1.5 mfd at 35 volts, 1.0 mfd at 50 volts. Minimum capacitance at all voltages is 0.047 mfd. Temperature range is -55°C to +85°C at rated voltage, extends to +125°C with voltage derated 33%.

CIRCLE 107 ON READER SERVICE CARD

Mallory Batteries maintain capacity during years of storage

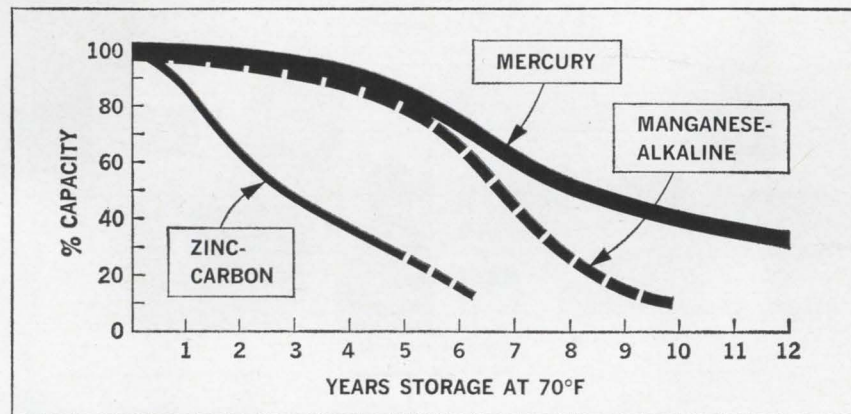

One of the most remarkable characteristics of Mallory Mercury Batteries and Mallory Alkaline Manganese Batteries is their ability to withstand extended periods of storage without serious loss of capacity. This property is useful in powering products which often remain idle for months but must function dependably when the occasion arises . . . such as emergency transmitters, cameras, instruments and alarms.

Mallory Mercury Batteries, which are designed for a wide range of current drain service, have exceptional shelf stability. At normal temperatures (21°C) their capacity loss per year is in the order of a few per cent. We have had cells in storage for 12 years and more which still show useful capacity. In contrast, the conventional zinc-carbon Leclanché cell loses about 25% of its capacity in two years at 21°C, and at 45°C is dangerously depleted in as little as 4 months.

The reason for this stability is that the Mallory mercury system is inherently inactive when not being discharged; and is, in effect, hermetically sealed, preventing evaporation of the electrolyte.

Mallory Alkaline Manganese Batteries are surpassed only by the mercury system in shelf life. They are completely reliable after two or more years of storage. They are an ideal heavy-duty power source, since they can deliver relatively high currents more efficiently.

Mallory Battery engineers will be glad to recommend the system most suitable for your specific application.

CIRCLE 108 ON READER SERVICE CARD

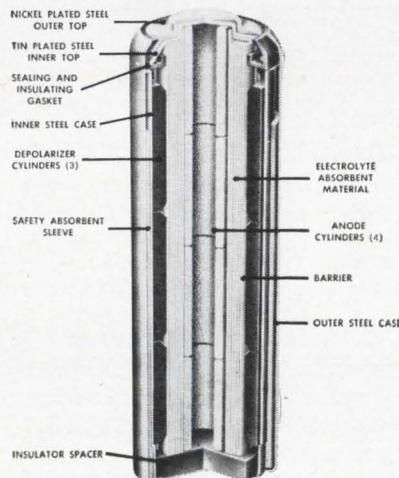

Internal construction of cylindrical Mallory Mercury Cell.



MICRO SWITCH Precision Switches



You are up-to-date on everything available in snap-action switches, if...

...if you've recently asked a MICRO SWITCH field engineer. He can show you the industry's greatest variety—allowing you to select from thousands of variations to meet any combination of requirements: size, weight, environment, circuitry, electrical capacity, actuation and operating characteristics. Some specifiers consider many snap action switches in the MICRO SWITCH line as spe-

cial. But they are off-the-shelf items—giving you the *ideal balance* of design, quality and economy you want. The reason: MICRO SWITCH is *the specialist* in small, precision, snap action switches.

You can take advantage of this special capability by calling a MICRO SWITCH Field Engineer or Distributor (see Yellow Pages, under "Switches, Electric"). Call a Branch Office or write for Catalogs.

Send for Catalogs 62 and 63 for the answers to thousands of basic switch design requirements.



MICRO SWITCH

FREEPORT, ILLINOIS 61033

A DIVISION OF HONEYWELL

IN CANADA: HONEYWELL CONTROLS LIMITED, TORONTO 17, ONTARIO

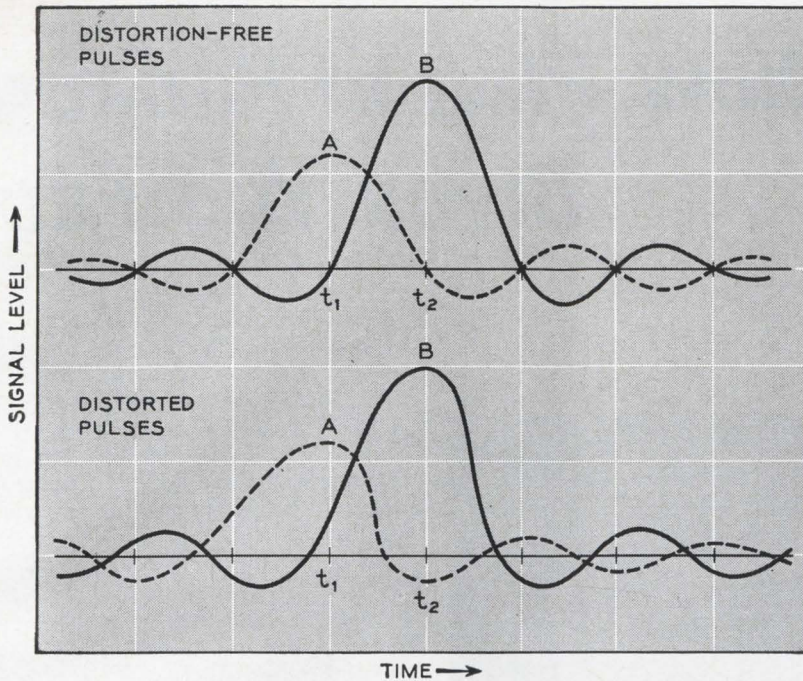

Report from
**BELL
 LABORATORIES**

Concept of the data-distortion problem in simplified form: Two data pulses at top are undistorted because their "tails" all pass through zero signal level at sampling times t_1 , t_2 , etc. Thus, receiving circuit "looking" at the signal at time t_2 would "see" signal energy from pulse B only. Distorted pulses at bottom, however, have tails which do not pass through zero at sampling times. In this case, receiver at time t_2 will see energy from both pulse A and pulse B and might register a false signal level. Such distortion must be reduced to a minimum to achieve high data transmission rates.

AUTOMATIC EQUALIZER MINIMIZES DATA DISTORTION

A communication signal arriving at its destination is never a perfect replica of the original. There is always some distortion, and if this distortion exceeds acceptable limits, it must be reduced by a process known as equalization.

Equalization increases the rate at which data pulses can be transmitted. Ideally, the equalization should also adapt rapidly to changing transmission characteristics, which are caused by varying temperature, humidity and other factors. Otherwise, distortion may cause receiving circuits to register false values for the data pulses (see above drawing).

To solve this problem a new data equalizer promising increased data rates—up to a threefold increase on voice-telephone channels—has been devised at Bell Telephone Laboratories. With this new equalizer, test pulses cause a series of adjustments to be made in the settings of equalizer attenuators. These adjustments, impossible to perform rapidly by hand, are performed automatically by control circuitry. As a result, the equalizer quickly reaches a condition of minimum data distortion. Later, when the transmission characteristics of the line change, the equalizer automatically adapts to the changes by making additional adjustments that keep the attenuators at their optimum settings.

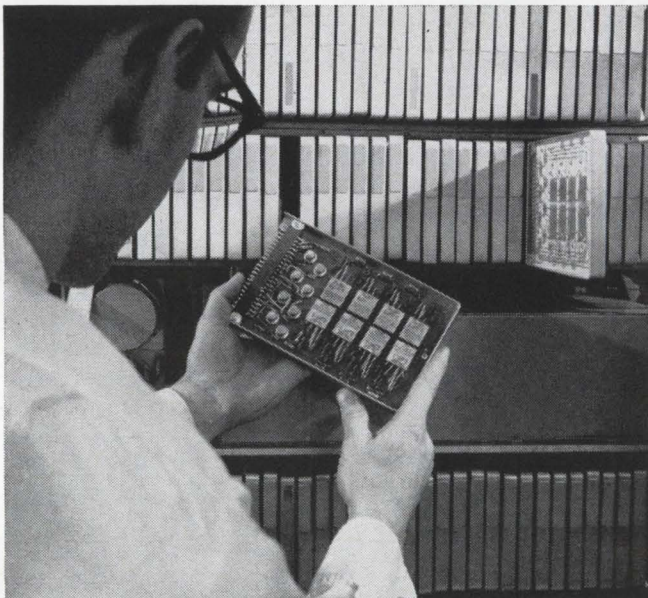

Experimental automatic data equalizer devised at Bell Laboratories. Control section consists of the circuit packages; the package being inspected is one of 12 attenuators, the settings of which determine the degree of distortion-correction of the equalizer.



Bell Telephone Laboratories
 Research and Development Unit of the Bell System

"Steepest descent" minimization

The new data equalizer was made possible by a discovery by R. W. Lucky at Bell Laboratories that a technique of minimizing mathematical functions is applicable to the problem of data equalization. Known as the "steepest descent" technique, it is analogous to a hiker desiring to climb down a hill in minimum time. In the equalizer application, it was shown that the steepest descent technique results in the true minimum, and not a local or relative minimum of the function. It was also shown that an equalizer based on this technique could be built with simple control circuitry. An experimental model of the equalizer (see photo) uses a 12-tap delay line in a transversal filter with an adjustable attenuator at each tap. The control circuitry extracts information from each test pulse, and for each pulse adjusts all attenuators by small steps, each step calculated to reduce distortion in the direction toward the minimum.

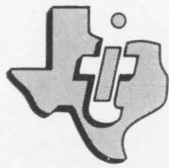

New Plug-in Package Gives You Fast,

Four new families of industrial integrated circuits — Series 70, 73, 74, and 1580 — are now available from Texas Instruments in an advance-design plug-in flat package for reduced equipment-assembly costs. The 28 new circuit types offered in this package provide low cost per logic function, and are designed for operation in a wide range of industrial environments.

The first in a series of modular plug-in packages is a 16-pin version, useful for multi-function logic networks of up to six circuits. Here are features: (numbers refer to cut-away illustration at left)

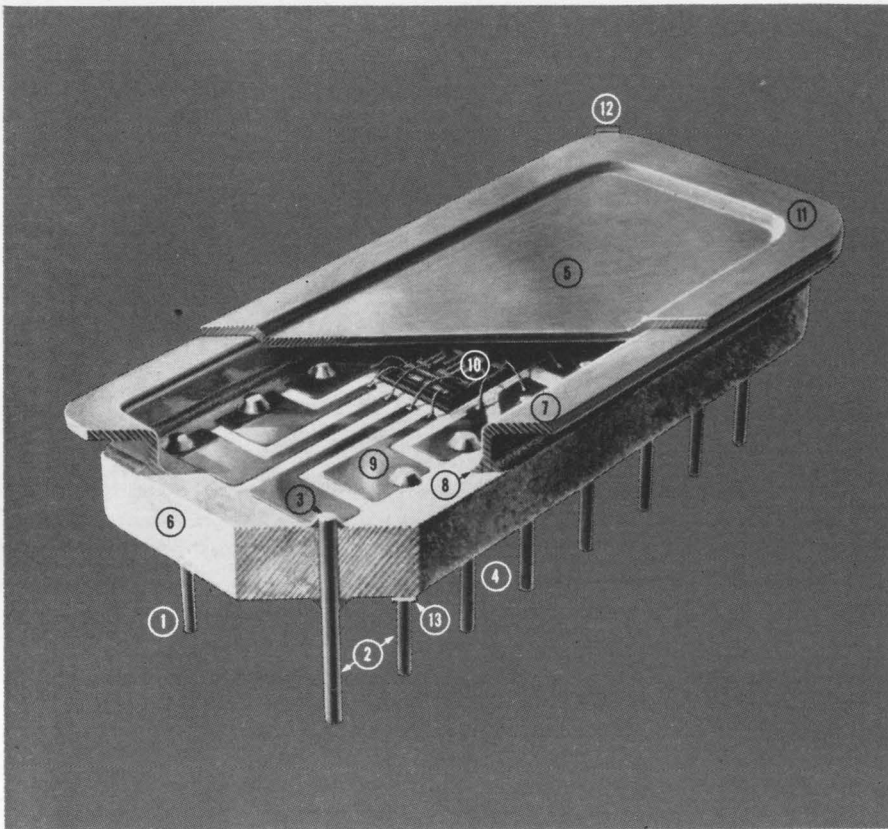

Construction features of TI's new 16-pin plug-in flat pack.

1. Sixteen pins enable you to obtain maximum economies inherent in today's multi-function integrated circuits. Pins are in two rows of eight, with rows a convenient 200 mils apart. Positive alignment of pins is assured for high-speed automatic or manual insertion techniques. Alignment tolerance is ± 10 mils at end of pins.

2. Pin spacing on 100-mil centers is appropriate for fast, economical flow- and wave-soldering techniques and for wire-wrap connections.

3. Round-pin cross-section is full 20-mil diameter (± 2 mils) for strength and rigidity. Pin diameter is compatible with standard PC-board drill fixtures. Pin length is 150 mils, leaving ample soldering space under $\frac{1}{8}$ " PC board. Despite their rigidity, pins are not brittle, will withstand at least four 90-degree bends using a one-lb weight — exceeding TO-5 requirements.

4. Pins beneath package provide maximum rigidity, prevent electrical contact between pins of adjacent packages. With pins projecting from the bottom, additional rows of pins can be added while maintaining same modular length and same form-factor.

5. Package size—390 by 890 mils—is convenient for handling during test and assembly. Packages can be mounted at maximum density on 400-mil centers, side-by-side, and 900-mil centers, end-to-end.

6. Aluminum-oxide ceramic substrate provides strength and good thermal-dissipation properties. Also provides electrical isolation, pin-to-pin and pin-to-package.

7. Rugged, flanged sides provide easy-grip handling without touching pins.

8. Brazed ceramic-to-metal seal assures that package will withstand external helium pressure of 100 psi with hermeticity of 50×10^{-8} cc/sec. Also withstands thermal shock — cycling between -55° and $+300^\circ\text{C}$, and cycling between boiling water and ice water. More than 3,000,000 similar ceramic-to-

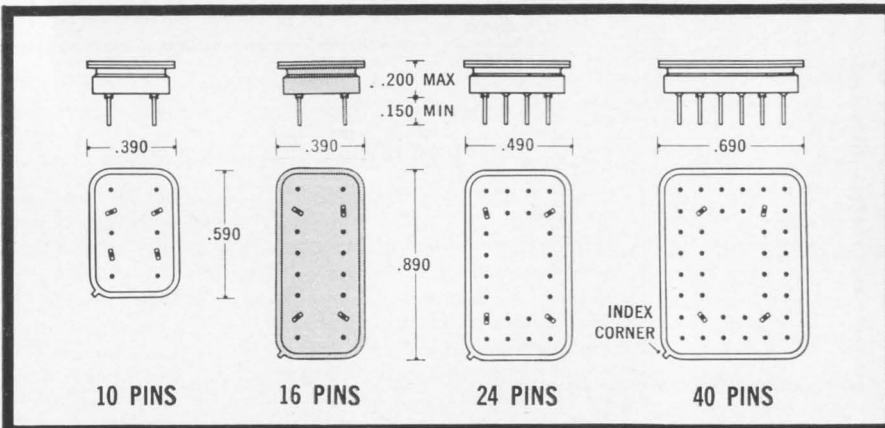

Modular family of plug-in flat packs. First available is 16-pin version.

For TI Integrated Circuits Low-Cost Assembly

metal seals have been applied to TI's TO-50 packages produced for Minuteman and other programs over the past four years.

9. Metallization pattern on face of ceramic makes possible short, reliable bonds to the integrated-circuit bar.

10. Integrated-circuit bar is recessed in a well, resulting in straight-line bonds to raised bonding pads, with no sags or loops.

11. Metal lid is securely sealed with transistor-type "one-shot" resistance weld. Fast, reliable weld means an economical package.

12. Flange tab at corner of package provides indexing at a glance.

13. Stand-off, 45 mils high, allows easy clean-out of flux beneath package, assures good solder contact through PC-board holes.

A major feature of TI's plug-in package is its modular approach, including versions with 10, 16, 24, and 40 pins. See dimensions at lower left. The larger packages are designed to accommodate the more complex logic arrays to be seen in coming months.

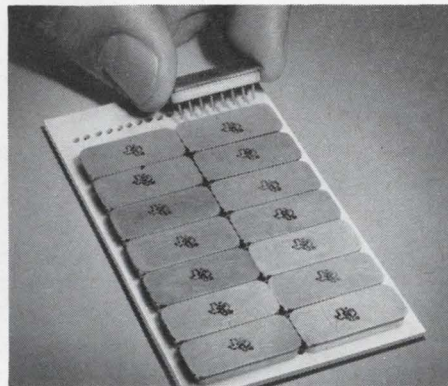

Plug-in flat packs shown mounted at maximum density. Units are easily handled and inserted through PC board.

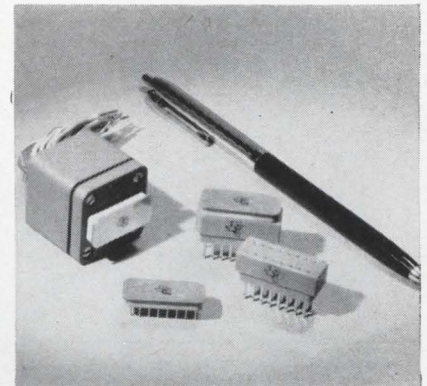

Production test socket (left) and breadboarding sockets (right) are being developed for plug-in flat packs.

28 New Industrial Integrated Circuits Offer Low Cost per Logic Function

TI's new industrial logic families include eight Series 74 TTL networks, 13 Series 73 modified-DTL units, two Series 70 ECL gates, and eight Series 1580 DTL circuits.

Typical gate characteristics for each of the four logic families are listed in the table at right. All these circuits, except Series 70, are reduced-temperature (0° to $+70^{\circ}\text{C}$) versions of established military integrated-circuit lines. They feature the same high performance, same high reliability, and same multi-function economies.

By fabricating two, three, and four circuits simultaneously in a single silicon bar, the cost-per-circuit-function is drastically reduced. Reductions are also obtained in the number of circuit packages, interconnections, and circuit boards — and in inventories, testing, and handling.

The new 16-pin plug-in flat pack is an option available at no additional cost, and is available for Series 70, 74, 1580, and most units in Series 73. The standard package for all four series is the 5-year-proved $\frac{1}{4}$ " by $\frac{1}{8}$ " flat pack.

For additional information on TI's industrial logic circuits and the new plug-in packages, contact your local TI Sales Engineer or circle No. 25 on the Reader Service Card.

TYPICAL GATE CHARACTERISTICS OF TI'S INDUSTRIAL LOGIC FAMILIES

Parameter	Series 73	Series 74	Series 70	Series 1580
Propagation delay, nsec	30	13	5	25
Power dissipation, mw	10	10	40+	5
Fan-out	10	10	N/A	8
Noise immunity, mv	300	1000	250	750
Supply voltage, v	3 to 4	4.75 to 5.25	+1.25, -3.5	4.5 to 5.5
Temperature range, $^{\circ}\text{C}$	0° to $+70^{\circ}$	0° to $+70^{\circ}$	0° to $+70^{\circ}$	0° to $+70^{\circ}$

TYPES AVAILABLE IN TI'S INDUSTRIAL LOGIC FAMILIES

	Series 73 Modified-DTL NAND/NOR	Series 74 TTL NAND	Series 70 ECL OR/NOR	Series 1580 DTL NAND
J-K Flip-flop	SN7300 SN7301	SN7470		SN1590 SN1591 SN1593
Dual J-K Flip-flop	SN7302 SN7304			
Quad gate	SN7360	SN7400		SN1583
Triple gate	SN7331	SN7410		
Dual gate	SN7311 SN7330	SN7420 SN7440	SN7000 SN7001	SN1581 SN1584
Single gate	SN7310	SN7430		
Dual EXCLUSIVE-OR	SN7370	SN7450		
Expander	SN7320	SN7460		SN1580
Inverter, Buffer	SN7350			SN1582
"One Shot"	SN7380			



TEXAS INSTRUMENTS
INCORPORATED
13500 N. CENTRAL EXPRESSWAY
P. O. BOX 5012 • DALLAS 22, TEXAS

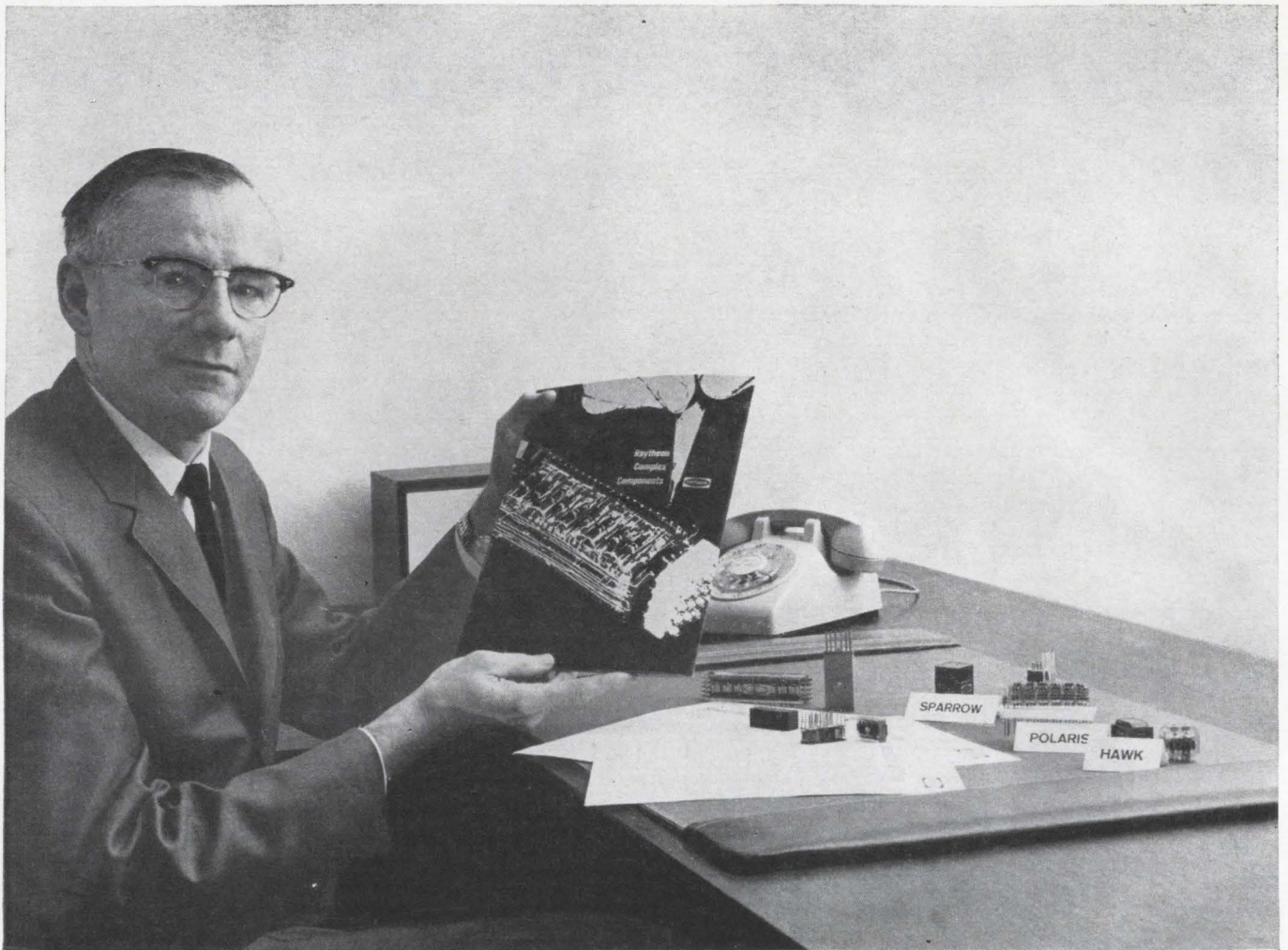

Howard Burgess, Product Specialist — Circuit Modules. On his desk are typical circuit modules including types made for Polaris, Hawk and Sparrow.

Ask Howard Burgess to send you this fact-filled brochure about circuit modules

Howard knows more about our Total Engineering Approach to making circuit modules than anyone else at Raytheon.

Which is an important reason for asking for this brochure.

In it you'll find an explanation of how we design from your block diagram, schematic, black box or retrofit specifications. And how we keep your requirements firmly in mind throughout design, manufacture and test. (Quality control at Raytheon begins with spectrographic, gravimetric, microscopic, X-ray analyses of in-coming materials.)

It will also tell you how engineers like

Howard determine whether your modules should be encapsulated in epoxies or pre-molded shells . . . or filled under vacuum . . . or welded or soldered (by hand, dip or flow).

And how our specialists can devise an encapsulation formula for you. Or analyze your light transmission or thermo-conductivity requirements.

Just send the reader service card for a copy of this Circuit Module Brochure. It even contains forms on which you can outline your problem — get suggestions and quotes from Raytheon. Or write to Howard Burgess at the address below or Raytheon's regional office.



Raytheon Company, Components Division,
Industrial Components Operation,
Lexington, Mass. 02173

When you think small . . .
think Deutsch.
Mass circuitry subminiatures
for hard-to-find connector space.
All shapes and sizes . . .
cylindrical, square, rectangular.
All coupling types . . .
bayonet-lock, threaded, push-pull.
All applications . . .
hermetics, environmentals,
non-environmentals.
When in a tight spot . . .
squeeze in your local Deutschman,



DEUTSCH

ELECTRONIC COMPONENTS DIVISION • Municipal Airport • Banning, California

ADVANCED SPECIFICATION SUBMINIATURE ELECTRICAL CONNECTORS

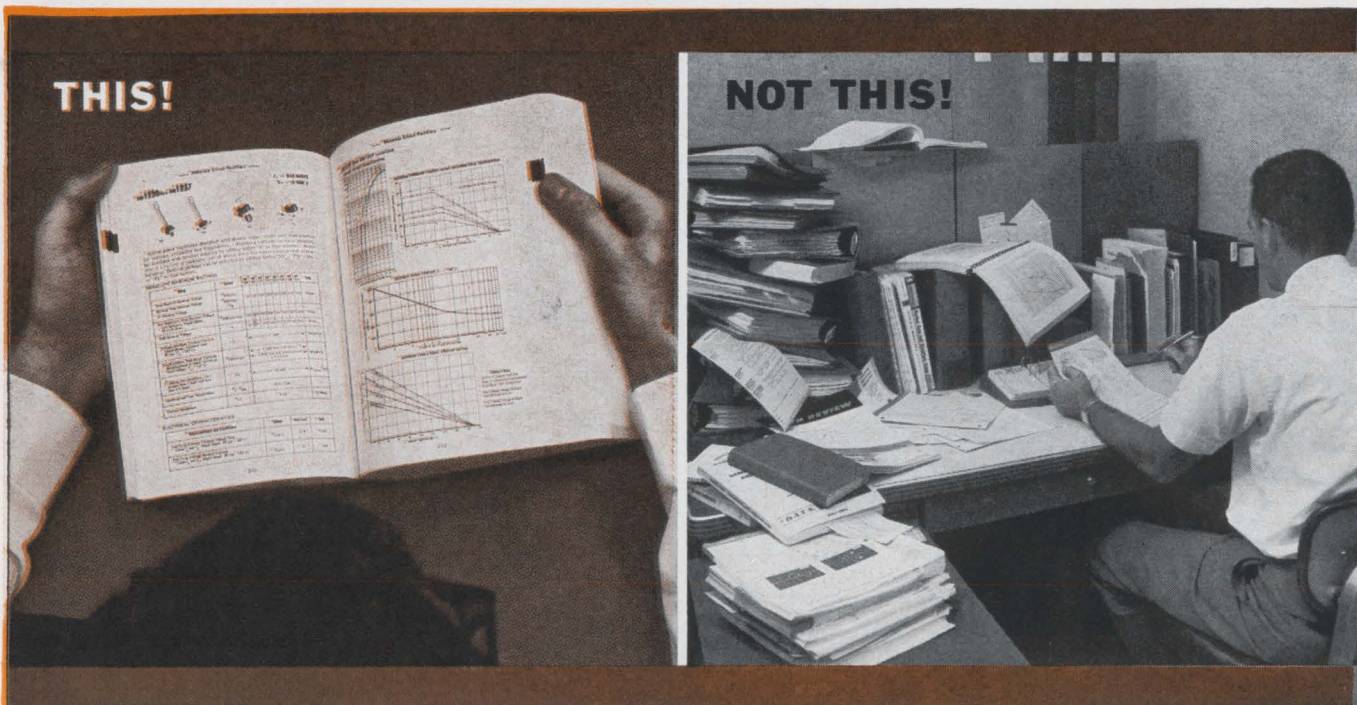

2600 Semiconductor Device Data Sheets At Your Finger Tips...

WITH MOTOROLA'S NEW HANDY-SIZE DATA MANUAL!

Now Motorola has solved the huge "filing and finding" problem for semiconductor device data sheets — with the new **908-page** bound volume Motorola Semiconductor Data Manual for semiconductors!

Here in one place is a collection of data sheet information for over 2600 different basic types of transistors, rectifiers, zener diodes, integrated circuits . . . over 18 device categories . . . plus, selection guides, cross-reference information, and articles on the meaning of specifications for various parameters.

This new data sheet manual will eliminate

literally hours and days of wasted time for each engineer. No longer will he have to hunt up a binder or several binders or file material himself. No longer will he have to borrow specs from someone else, or make a photographic copy of data.

And best of all, the price of the Motorola Semiconductor Data Manual is so low that every engineer can afford to have one. Only \$3.50 per copy. Truly, it will more than pay for itself the first few times you use it. Send today for your own copy of this valuable new reference edition. Fill out and mail the coupon below.

**SEND ME
MY COPY
OF THE NEW
SEMICONDUCTOR
DATA MANUAL
TODAY!**



Please send me _____ copy(s) of the new Motorola Semiconductor Data Manual. My check (payable to Motorola Inc.) for \$ _____ is enclosed (\$3.50 per copy).

NAME _____

COMPANY _____

ADDRESS _____

CITY _____ STATE _____ ZIP _____

Mail To: Motorola Semiconductors
Box 955, Dept. 64, Phoenix, Arizona 85001

MOTOROLA  **Semiconductor Products, Inc.**

Washington Newsletter

October 4, 1965

Project MOL: open or closed?

If certain Pentagon advisers have their way, the manned orbiting laboratory (MOL) project will be carried out behind a high security wall. Although the decision to give MOL to the Air Force was made public with considerable fanfare, the program itself would be top secret. Not even the launches would be announced—though they would be hard to keep secret, since the Titan 3 rocket, with its distinctive trident shape, would be visible for miles around the launch sites at Cape Kennedy and Vandenberg Air Force Base.

Such secrecy measures would match those taken for the well-known spy satellites, Midas and Samos, the existence of which the Pentagon will not even admit. The secrecy would even exceed the Soviet Union's; Russia has admitted photographing Western countries from space.

The advocates of strict classification base their arguments on the military nature of MOL. They are competing for Defense Secretary Robert S. McNamara's ear with a faction which feels that President Johnson's stated aims of exploring space peacefully will be open to less suspicion and cynical comment if MOL is only slightly more secret than the Gemini and Apollo programs. They would permit public discussion of the flights, and classify only some of the equipment and mission assignments.

More research for small schools

At least 30 small university science centers around the country are expected to benefit from a plan to spread the government's research money more evenly. Currently, 20 university science centers receive half of the \$2 billion the government spends in that field. President Johnson plans to divert about \$200 million from the large science centers to the small ones.

Court to review patent standards

The Supreme Court which begins its fall term this morning, has agreed to review a battery of cases concerning "standards of patentability" in inventions. Patent lawyers think that a major tightening of the system may result. Before the Congress passed the 1952 Patent Act, the court was beginning to demand a high degree of invention over existing art to justify a patent; the question now is whether Congress intended to reverse that trend and make patents easier to get, but less valuable. At least four members of the present court have indicated that they lean toward an interpretation of the law that would revert to the pre-1952 stand; thus increasing the competitive value of a patent.

In one of the five cases before the court, the Patent Office argues that lower courts apply a tax standard of invention which "seriously impairs efforts to maintain a predominantly competitive economy, by creating countless unnecessary and unwarranted monopolies."

One of the cases involves Hazeltine Research, Inc.'s application for a patent on a microwave switch. The Patent Office rejected the application on the ground that it wasn't a significant advance over prior art as represented by a co-pending patent. A lower court reversed this ruling on the ground that Hazeltine wasn't aware of the previous patent application and couldn't have taken that new development into account. The company is a subsidiary of the Hazeltine Corp.

Washington Newsletter

DOD to relax invention rules

After hearing industry's objections, the Defense Department has decided to relax its proposed penalties against companies that are slow to report inventions made during government work. The department drew up tough regulations—and asked industry to comment on them—after the General Accounting Office accused several contractors of either failing to disclose inventions or delaying disclosure for unreasonable periods.

A plan to assess damages of up to \$5,000 for each day of failure to report an invention beyond a six-month time limit is being dropped. **Contractors had objected on the ground that it is difficult to determine precisely when an invention is conceived.**

Still under study is a plan to stiffen the withholding of final contract payments to the contractor. The Pentagon originally planned to change the present withholding rate, which is 10% of the final payment up to a maximum of \$10,000, to 5% with no ceiling. Industry clamored for a ceiling, and one of between \$10,000 and \$50,000 is being considered.

The Pentagon still plans to require that contractors forfeit any rights in patents they obtained on unreported inventions.

Contractors want data protected

Government contractors have some complaints of their own. One industry group—the National Security Industrial Association—is asking that **the Pentagon keep from a contractor's competitors technical data submitted as part of an unsolicited proposal.** Current regulations protect a contractor in solicited proposals only.

The association is also concerned "over the frequency with which technical proposals, both solicited and unsolicited, have apparently or actually been used as the basis for subsequent Defense Department-initiated competitive procurements."

Contractors are also decidedly cool to the Pentagon's use of "technical transfusion" in contract definition competitions. Under this concept, the government incorporates the best concepts of the losing proposals into the winner's. **Defense officials insist that since the government pays for contract definition, it is entitled to all the benefits.** Furthermore, they argue, no design secrets are involved in contract definition, which merely defines approaches.

High-power radar goes into field

A new high-power acquisition radar (Hipar) will soon be deployed by the military in the U.S. and overseas. The new units will be supplied by the General Electric Co. under an \$8.1-million Army contract. **The radar will be operated in conjunction with the Nike-Hercules anti-aircraft missile that is already in place in some overseas locations.** Hipar equipment will include a 43-foot antenna, hauled on five semitrailers, each pulled by a five-ton truck tractor.

Common parts sought for missiles

The Defense Department's insistence that similar weapons systems use as many common components as possible will affect the advanced air-defense missiles being proposed by the Army and Navy. A committee representing both services is studying prospects for commonality between the two systems—the Army's SAM (surface-to-air-missile) and the Navy's ASMS (advanced surface missile system).

PCM GROUND CHECK-OUT EQUIPMENT

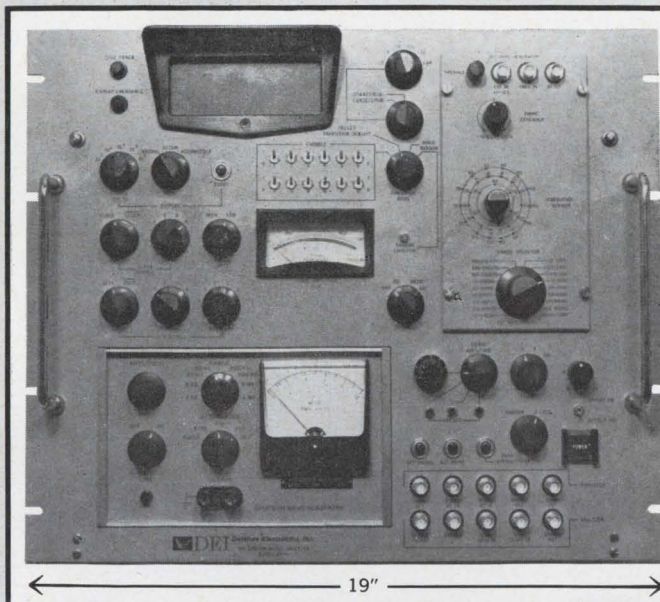

new

BIT SYNCHRONIZER ANALYZER

Self-Contained—No External Test Equipment Required

Special Analytic PCM Test Simulator
Wide Range of Bit Rates: 1.2 bps to 1.2 mb

Measures and Displays Bit Error Rate and Sync Acquisition Time

Built-In Gaussian Noise Source, S/N Ratio: -10 db to +20 db

DEI's model BA-101 Bit Synchronizer Analyzer provides a means of evaluating operation of a PCM Bit Synchronizer (Signal Conditioner) for pre-flight confidence checks, electrical interference detection, or other analytical purposes. Design of the analyzer is such that a synchronizer may be tested for performance using accepted test conditions or using conditions which normally prevail in actual operation. This device will allow convenient measurement of the following performance characteristics: (1) Minimum signal/noise at which synchronization is acquired, (2) Sync acquisition time, (3) Minimum signal/noise at which sync is maintained, (4) Transition density to acquire and maintain sync, (5) Data error rate. A decimal counter display plus overrange indicator serve as visual output. Printer outputs for an external recorder are optional. The Bit Synchronizer Analyzer contains output terminals to monitor the results. For further information write for DEI product bulletin BA-101.

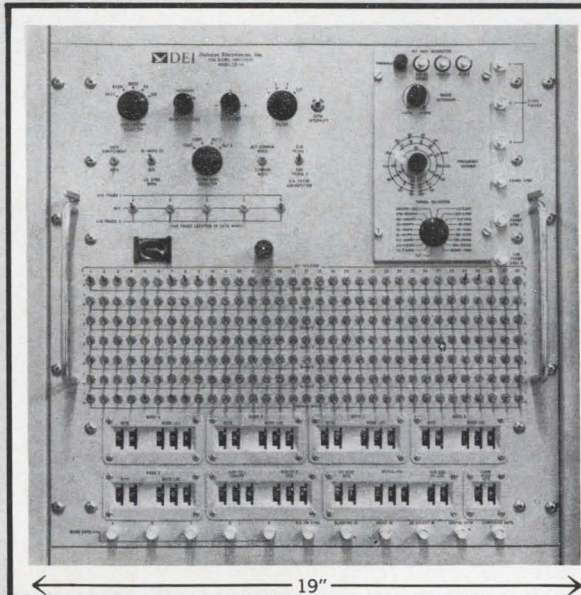

new

PCM SIGNAL SIMULATOR

7 Independently Variable Word Lengths

Wide Range of Bit Rates: 1.2 bps to 1.2 mb

Complementary Sync Patterns Selectable

Complete Error Simulation Capabilities

Pre-Transmission Filter Simulation

Alternate Complement Common Word

DEI's model DS-101 is a general purpose PCM Simulator designed to generate PCM formats currently in use as well as formats developed for the future by means of simple front panel programming. Formats such as the Gemini, Titan, Saturn, and general purpose wave trains are easily generated and controlled. Up to seven words can be generated with independently variable format and word lengths within the same data train. Sub commutation synchronization of both the recycling code and the counting address (ID) types is provided. Low Z output of variable amplitude and DC offset are standard. Amplitude adjustable to ± 10 volts zero centered (20 v p-p maximum) across 50 ohms. For further information write for DEI product bulletin DS-101.

Defense Electronics, Inc.
Rockville, Maryland



DEI
RESEARCH
DEVELOPMENT
MANUFACTURING

ROCKVILLE, MD. (301) 762-5700, TWX: 302-427-4660; SHERMAN OAKS, CALIF. (213) 872-2870, TWX: 213-783-2742; COCOA, FLA. (305) 632-5400; TWX: 305-632-5442; HUNTSVILLE, ALA. (205) 881-5139; WILLOW GROVE, PA. (215) 659-5051; DALLAS, TEXAS (214) EM 3-7263; INT'L, ROCKVILLE, MD.; CABLE: DEIUSA; EXPORT (212) Circle 6-2133, TELEX: TRIL 224326, N.Y., N.Y.; OTTAWA, ONT. EMISCO Ltd. (613) CEntral 6-0811, Cable: EMISCO

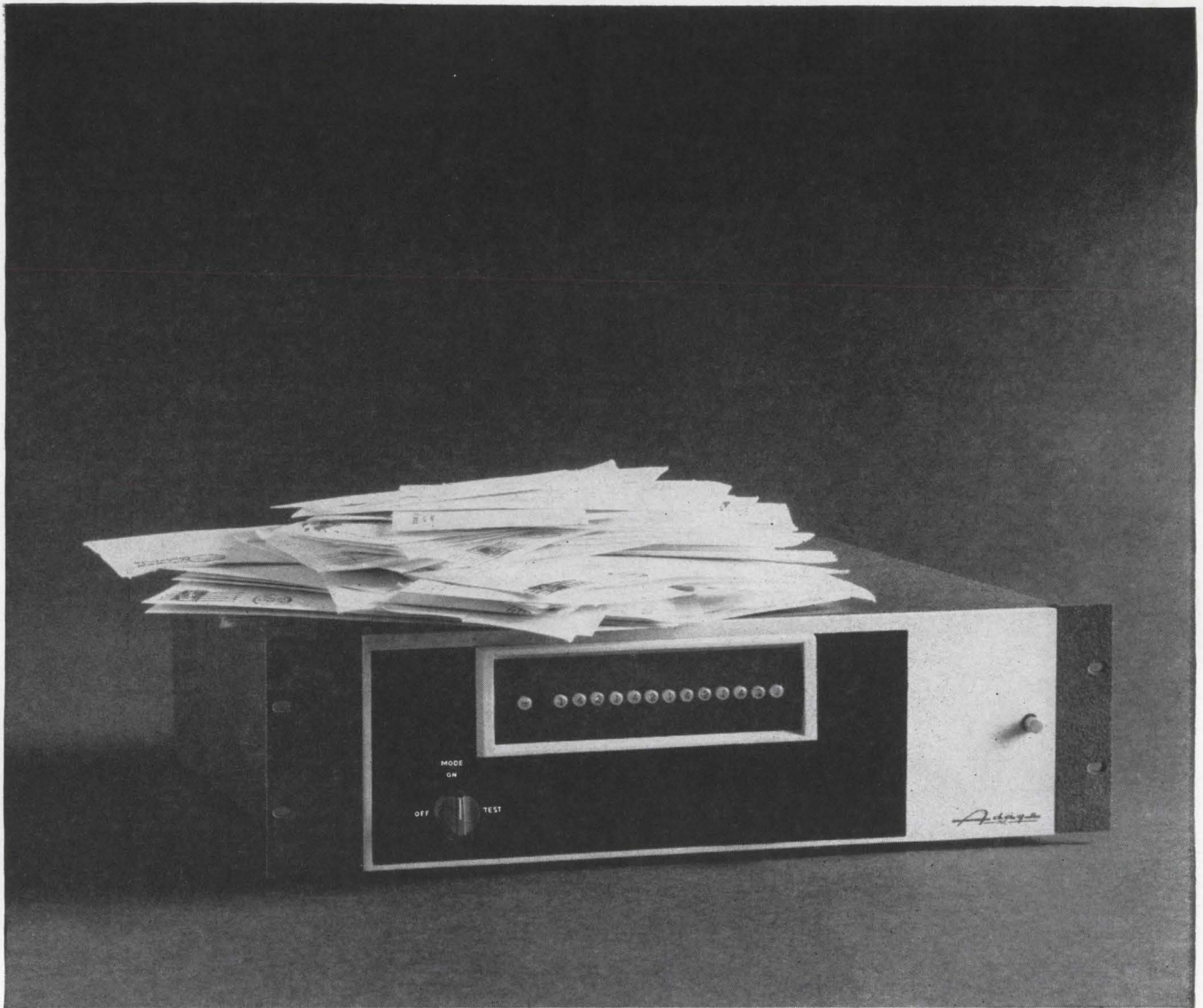

A complete 14-bit A-to-D conversion in under 4 μ sec... that's something to write about!

We're delighted with the overwhelming number of inquiries we've received about our two new additions to the Adage VOLDICON™ line of voltage digitizers.

The high-speed, high-resolution VT13-AB and ultra high-speed VT7-AB are based on a novel design combining techniques of successive approximation and parallel threshold decoding. The VT13-AB ac-

complishes a 14-bit analog-to-digital conversion in less than 4 microseconds. The 8-bit VT7-AB performs a complete conversion in under 800 nanoseconds.

A full line of data systems components, including other A-to-D converters, D-to-A converters, multiplexers, operational amplifiers, and digital logic, is available from Adage, Inc. These components use

all-solid-state circuitry and are designed and tested to meet the most demanding requirements for accuracy and reliability.

Why not add your inquiry to the many we've already received? We would be pleased to send you a technical brochure on the VT13-AB and VT7-AB. Call or write I. R. Schwartz, Vice President 783-1100, area code 617.

Adage, Inc. welcomes employment inquiries from professional engineers.

Adage
INC

1079 Commonwealth Avenue Boston, Massachusetts 02215

While you weren't looking...

We just converted your **Polarad CFI RI/FI Meters and TR Receivers** into dozens of fully-automated, 1.0-21.0 GC Spectrum-Signature/Surveillance Systems...or into push-button all-band spot-frequency (or sector-scan) production test sets ...or into spectral-energy-distribution recorders...or into whatever else we can mutually cook up; and it's all done with a trio of inexpensive Adaptor/Control/Interface Modules. Think of it—overnight we've converted what used to be merely the world's finest **Solid-State Receivers & RI/FI Meters into Microwave & RFI Systems**. How? It's simple—like All really good ideas. Here's how...

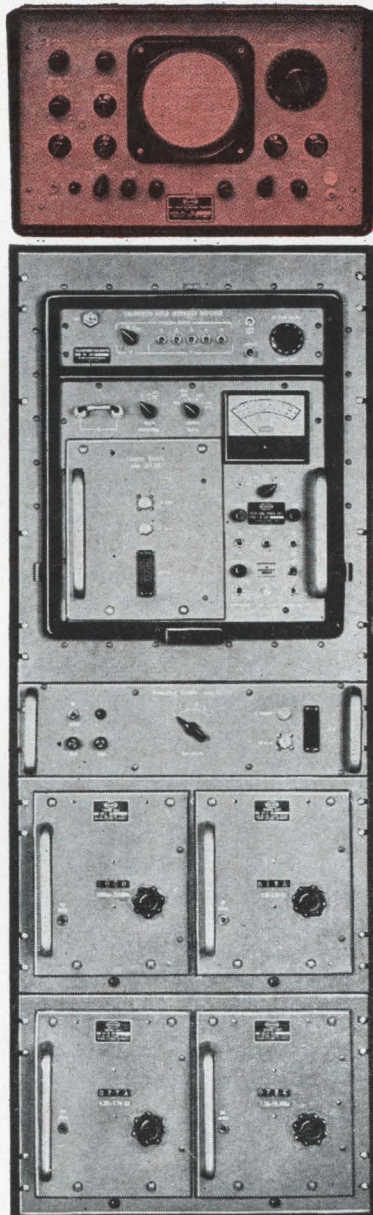

*** Model DM-1**

Mount your CFI or TR basic unit in this Adaptor Panel (CFI-AM or TR-AM)

Then add this Switching Module (CFI-SM or TR-SM)

finally, add one, two, or three of these Tuning Unit Adaptor Modules (CFI-TUM or TR-TUM) ... plug in your tuning units, and you're on the air!

***for that first-class feeling . . . add a DM-1 Spectrum Signature Monitor!**

WHAT? You don't own a CFI or a TR? Good Grief, don't waste another moment! Call (212) EX 2-4500 for immediate relief—from a demonstration to delivery, from (naturally!) the busiest production line in the industry.



World Leader in Microwave Instrumentation

POLARAD

ELECTRONIC INSTRUMENTS

A Division of Polarad Electronics Corporation
34-02 QUEENS BOULEVARD
LONG ISLAND CITY, NEW YORK 11101

**SAVE \$2.00*
PER RELAY
AND GET
EXTRA
CONVENIENCE
TOO!**



**WIRE
THIS**

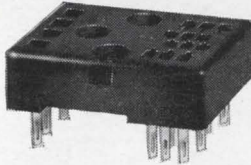

This precision-built socket starts you off to a savings of nearly \$2.00* per installed LS telephone-type relay when you specify our relay-socket-cover combination instead of a similar relay with factory-wired, octal-type plug. Also (1) you have the convenience of a plug-in component, and (2) you can use a relay having more contacts than octal-type plugs will accommodate.

Two sizes of sockets are available. The 16-pin smaller one (1.39" x 1.71") accepts relays with contact arrangements from 1 Form C to 4 Form C. The larger 28-pin one (1.39" x 2.11") will take relays with contact arrangements up to 8 Form C. Each size socket has four coil terminals for single or dual coil relays.

*Approximate. Based on single lot price. Savings depend on contact arrangements.

GENERAL

Description: Medium coil telephone type relay with bifurcated contacts.

Time Values:

AC: Operate: 3 to 15 milliseconds.
Release: 3 to 15 milliseconds.

DC: Operate: 5 to 50 milliseconds.
Release: 5 to 140 milliseconds.

Precise time values depend upon coil power and contact arrangement.

Operate and release time delay slugs and fixed or adjustable residuals are available for DC relays.



**PLUG
RELAY IN**

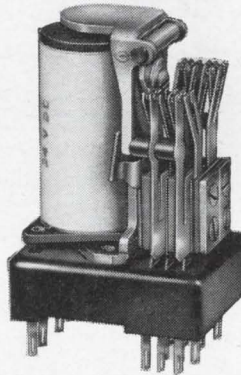

Plug the LS into the socket . . . just as you would a vacuum tube. The relay's tab terminals mate snugly with the socket, will hold the relay in place under normal conditions. When the relay is mounted horizontally, or when vibration is a problem, two banana plugs or two machine screws may be used.

A choice of cadmium or gold plated socket terminals is available . . . and the pierced solder terminals are designed also for AMP-78 taper tab connectors.

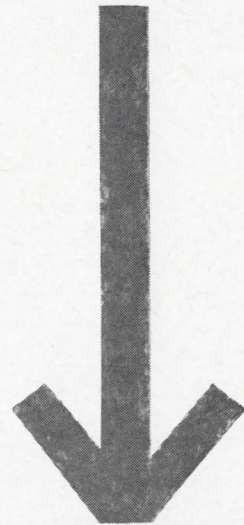

**SLIP ON
DUST COVER**

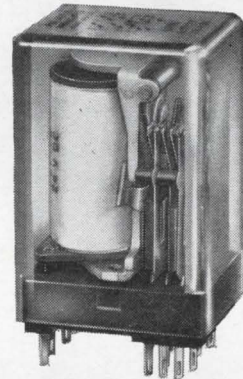

The transparent, high impact, high temperature resistant dust cover fits over the socket nearly flush with the chassis. Covers as well as sockets of either size may be purchased separately. With socket and cover, the LS relay is designated the LSP . . . a sparkling addition to this series of reliable telephone type relays.

Here is a neat, modern, cost-reducing approach to using the reliable, versatile LS relay. Better send for complete information today.

LS SERIES ENGINEERING DATA

Expected Life: 100,000,000 mechanical operations minimum.

Contacts: 100,000 operations minimum at rated load.

Temperature Range: -55°C to +85°C standard (+105°C available on special order).

Weight: Approximately 3¼ ozs. (open).

CONTACTS:

Arrangements: AC: Up to 12 springs (6 per stack-4 movables). DC: Up to 24 springs (12 per stack).

Material: ¼" dia. twin palladium is standard for bifurcated contact arms.

Gold-alloy, other contact materials, and single contacts are available for specific applications.

Rating: AC: 4 amps @ 115 volts AC, 60 cycle resistive (open relay @ +25°C).
DC: 4 amps 28 volts DC resistive.

COILS:

Voltage: AC: To 230 volts 60 cps.
DC: To 220 volts.

Resistance: DC: 55,000 ohms maximum.

Power: AC: 4.37 voltamps.
DC: 65 milliwatts per movable arm minimum, 5 watts maximum @ +25°C.

Duty: Continuous.

STANDARD P&B RELAYS ARE AVAILABLE AT LEADING ELECTRONIC PARTS DISTRIBUTORS



POTTER & BRUMFIELD

Division of American Machine & Foundry Company, Princeton, Indiana
In Canada: Potter & Brumfield, Division of AMF Canada Ltd., Guelph, Ont.

now from ELCO... a complete mil-spec cylindrical connector line

WITH THE PROVEN-RELIABILITY YOU EXPECT
OF ELCO PRODUCTS... AND INTRODUCING OUR
NEW PW SERIES (MIL-C-26482) MINIATURES

Now, when you think of cylindrical connectors, think of ELCO WEBSTER as your complete source! For our acquisition of this facility devoted to Mil-Spec types enables us to provide you with the same engineering, design, production and delivery capabilities you have come to depend upon for your other ELCO connector needs. Our new PW Series (MIL-C-26482) miniatures, for example, are available for immediate delivery. And our Audio and Power connectors will be of significant interest to you, too. Write, wire, phone or TWX us for complete data at once.



MAIN PLANT AND OFFICES: Willow Grove, Pa. 19090; 215-659-7000; TWX 510-665-5573.
ELCO WEBSTER CORPORATION: Watertown, Mass. 02172; ELCO Pacific: W. Los Angeles, 90064.
ELCO Midwest: Chicago, Ill. 60645. Representatives, Subsidiaries and Licensees
Throughout the World.

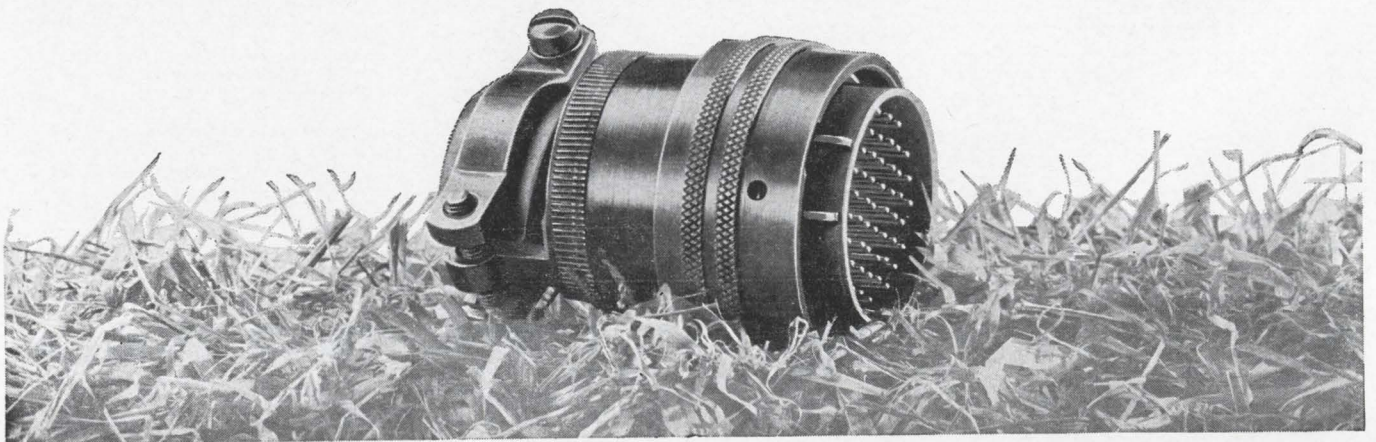

Here's what insulation of MYLAR® meant in: ballast transformers...relays

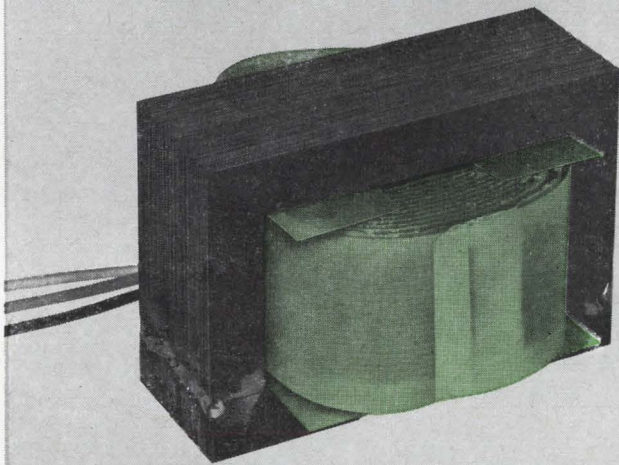

- tripled life of guarantee against failure
- upgraded rating to Class B

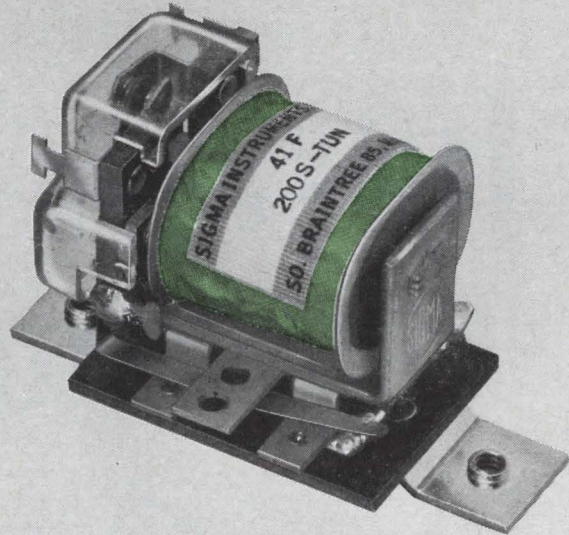

- 50% increase in thermal range
- smaller coil
- longer coil life

Whatever your insulation needs—motors, bus bars, capacitors, relays, transformers, wire and cable—chances are good you can benefit from the ability of MYLAR* to:

- improve insulation performance
- lower costs
- provide greater design capability

This is because MYLAR offers you a unique combination of properties in thin, flexible film form. With MYLAR you can replace heavier, bulkier insulation materials to design smaller, lighter components which have greater insulation resistance.

For the same reason, it's possible to lower insulation costs because often less MYLAR is required for a given insulation value.

Also, the excellent working strength of MYLAR can mean lower reject rates and

faster production speeds for you.

New "Fact File" available!

To get started on your evaluation of MYLAR, send for your copy of the "Fact File". This compact reference piece contains complete technical data, cost comparisons of MYLAR versus other insulation materials, film samples and information on several recent applications. Write Du Pont Co., Room 2796C, Wilmington, Delaware 19898. (In Canada: Du Pont of Canada Ltd., P.O. Box 660, Montreal, Que.)

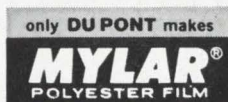
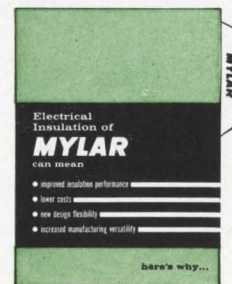

DU PONT'S REGISTERED TRADEMARK FOR ITS POLYESTER FILM.

*Only Philbrick's New
High-Performance*
Operational Amplifiers
can give you...*

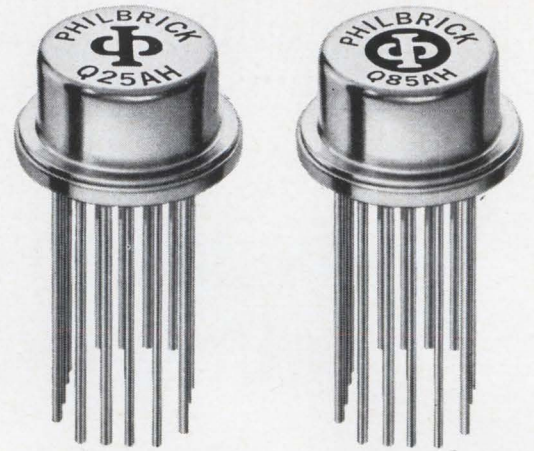

PHILBRICK Q25AH

PHILBRICK Q85AH

shown twice actual size

Integration Without Compromise

* This is the sort of performance Philbrick required before integrating: Output Range $\pm 11V$ @ 2.2 mA; Gain-Bandwidth at least 50 Mcps; Full Output to 100 kcps; Common Mode Range $\pm 10V$; Voltage Gain of 20,000 minimum at rated load; Power Supply $\pm 15V$ @ <7 mA; Offset Current < 150 picoamperes (Q25AH).

To get the complete story: phone the nearest Philbrick engineering representative or get in touch with Philbrick Researches, 22-0 Allied Drive at Route 128, Dedham, Massachusetts, or

Engineering Representatives

Ala.: Huntsville 536-8393; Ariz.: Phoenix 265-3629; Cal.: Los Angeles (213) 937-0780, Palo Alto (415) 326-9800, San Diego 222-1121; Colo.: Denver 733-3701; Conn.: W. Hartford 233-5503; Fla.: Ft. Lauderdale 564-8000, Orlando 425-5505; Ill.: Chicago 676-1100; Ind.: Indianapolis 356-4249; La.: New Orleans 242-5575; Md.: Baltimore 727-1999; Mass.: Wakefield 245-5100; Mich.: Detroit 838-7324; Minn.: Minneapolis 545-4481; Mo.: Kansas City 381-2122, St. Louis 966-3646; N.M.: Albuquerque 268-3941; N.Y.: DeWitt (315) 446-0220, Lancaster (716) TF 5-6188, Valley Stream (516) 561-7791; N.C.: Winston-Salem 725-5384; Ohio: Dayton 298-9964, Westlake 871-8000; Pa.: Norristown 735-3520, Pittsburgh 371-1231; Tex.: Dallas 526-8316, Houston 781-1441; Utah: Salt Lake City 466-4924; Va.: Alexandria 836-1800; Wash.: Seattle 723-3320; EXPORT: N.Y.: New York (212) 246-2133.

CANADA: Quebec: Montreal 482-9750, Ontario: Toronto RU 9-4325.

ELECTRONIC ANALOG COMPUTING EQUIPMENT for MODELLING, MEASURING, MANIPULATING and MUCH ELSE



PHILBRICK





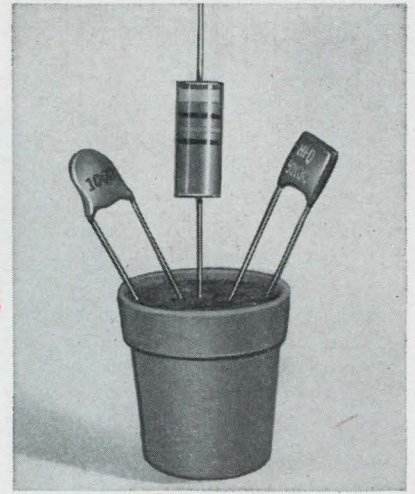

See us at: NEC Show, Booth No. 5; NEREM, Booth No. 1B22 and Interkama, Booth No. 9, U. S. exhibit for Terminal Radio International, Ltd.; Booth No. 4133, Hall D1, for Knott Elektronik.



at Hi-Q we still make the usual garden variety ceramic capacitors

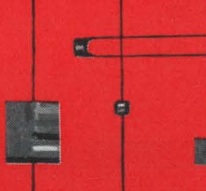
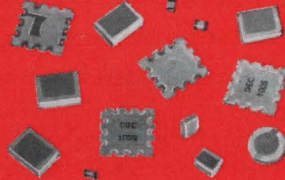

and these second generation ceramic capacitors

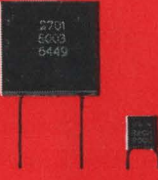
 <p>MC/20/70/90 Miniaturized Tubular Capacitors</p>	 <p>Microminature Capacitor Chips for Hybrid Circuits</p>	 <p>MC 51/505 and MC 61/605 Extended Capacity and Increased Stability in CK05/06 Case Sizes</p>	 <p>CEROL® High Capacity Tubulars</p>
 <p>TP Ultra-Thin Capacitors for Tight Packaging Requirements</p>	 <p>Special Capacitor Designs to Meet Unique Packaging Requirements</p>	 <p>Miniature Feed-Thrus Featuring High Capacitance and Maximum Stability</p>	 <p>CERALAM® Capacitors Offer Maximum Volumetric Efficiency in Axial or Tubular Configurations</p>

The way things move in electronics, we expect to have to develop a third generation any day now. But in the meantime, everyday sees a new and different application of the unusual qualities of CERALAM. Sometimes it's used because its unique, densely stacked structure duplicates the reliability of solid-state devices. Sometimes because it can be "cut" to any configuration that will make your packaging simpler. And sometimes because it offers a higher capacity-to-volume ratio than anything else.

Of course CERALAM is just one of the outstanding state-of-the-art advances that have originated in a need created by our inquiring technology, and been achieved in the fertile imaginations of engineers at Hi-Q. And what's equally important is that Hi-Q turns these unique developments into

production realities, even coping with the seemingly impossible demands for reliability found in missile and space vehicle applications.

Of course, our garden variety ceramic capacitors are still the finest available for radio, TV or similar applications.

Or let us know what you need and we'll develop that third generation right away.



AEROVOX
CORPORATION
OLEAN, NEW YORK
MYRTLE BEACH
SOUTH CAROLINA

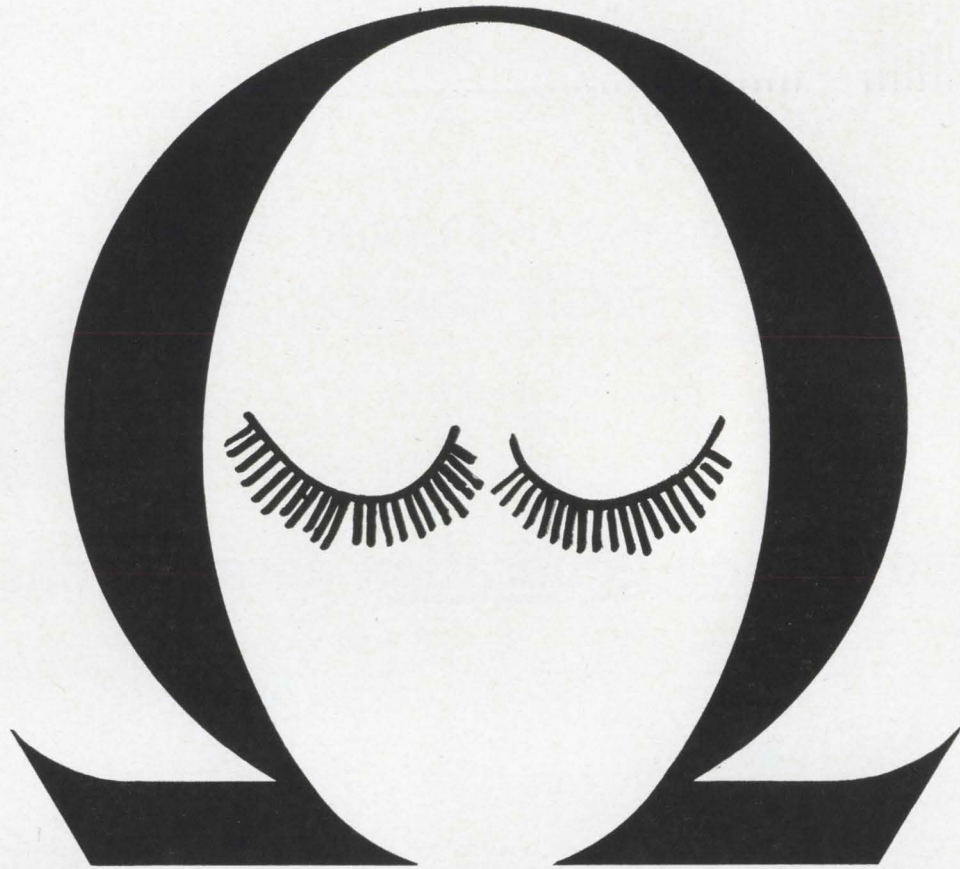

The Absolute Ohm

How a classic ESI system can bring you closer to the absolute in resistance measurement, and why it can be of more than academic interest in many electronic labs and plants.

The Absolute Ohm is a theoretical ideal, which can be ever more closely approached, but never attained.

Its legal value is the resistance standard maintained by The National Bureau of Standards. The accuracy of your resistance measurement depends on the degree of "direct traceability" to this NBS standard.

The ESI 242 Resistance Measuring System permits a chain of measurements to any resistance level from a single, directly traceable reference standard—with comparison accuracies of 1 ppm. Measurements can be made swiftly and simply; results are read directly, without calculation.

Even when you are not looking for greater accuracy in your resistance measurement and calibration, you may have good reason to consider our 242. It could help you speed up the pace of lab or quality control operations. Or in-

crease reliability. Or get better results from less experienced people on your production line.

The 242 includes Ratio Bridge, Decade Standard, Generator-Detector and 4-Terminal accessories.

We can't promise The Absolute Ohm in resistance measurements. But with the 242, we do offer The Definitive System. ESI, 13900 NW Science Park Drive, Portland, Oregon (97229).

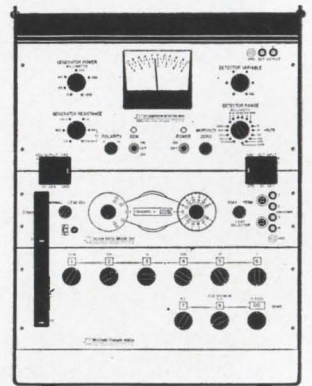

The Absolute Ohm's home away from home — our 242 Resistance Measuring System. Price: \$3400.



The legal residence of The Absolute Ohm is Washington, D.C. — at the National Bureau of Standards.

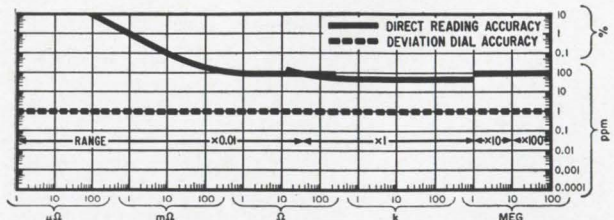

Accuracy of 242 System over specified ranges.

Electro Scientific Industries **esi**®

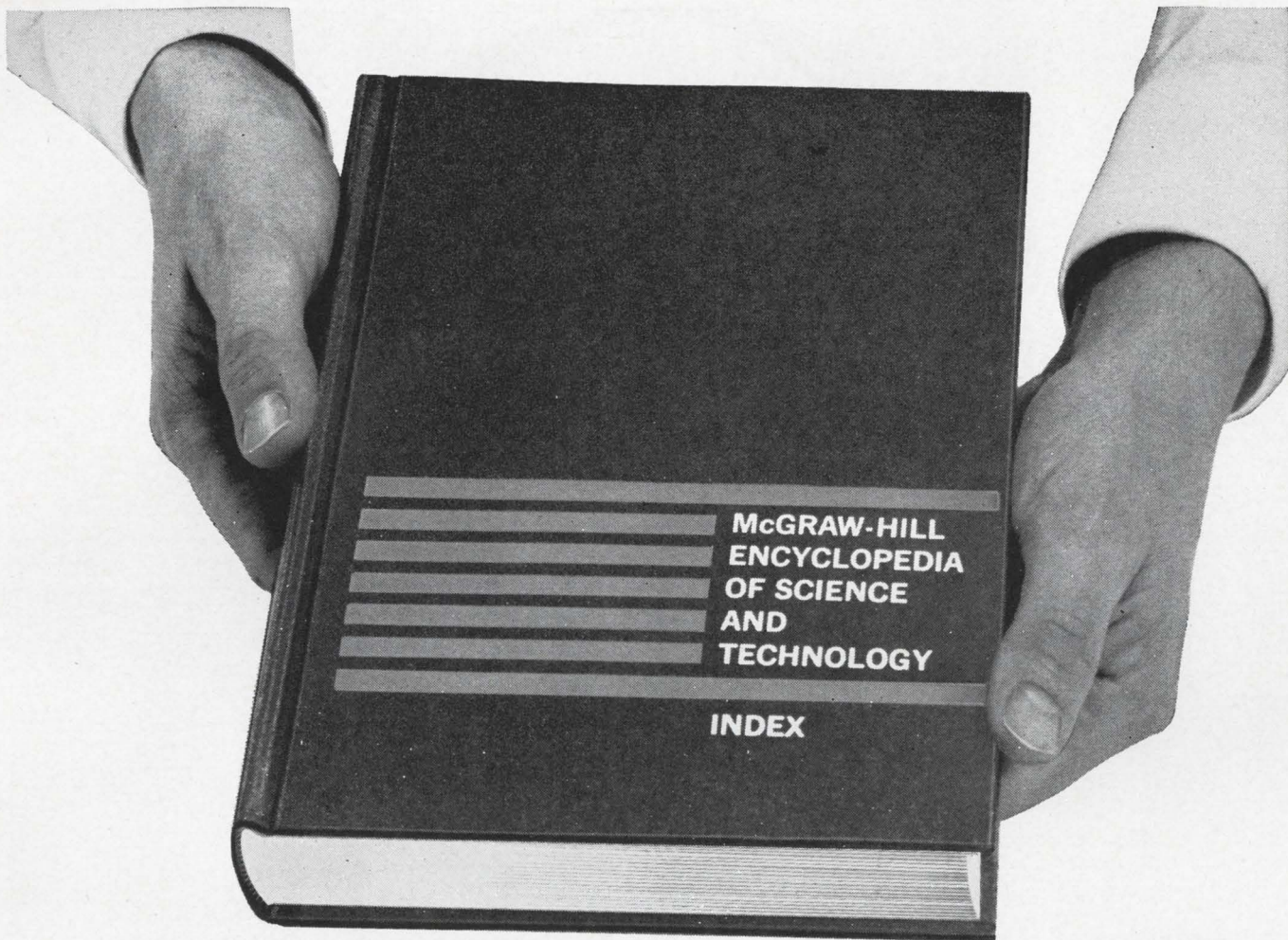

New! **Your key to every scientific and engineering problem**

Announcing the new, revised edition of the reference work which *Scientific American* called, "A first-class tool without substitute." The extraordinary volume you see here puts at your fingertips the latest information on over 100,000 subjects in every engineering and scientific field. It is the heart of a unique *Information Center* in encyclopedia form developed by McGraw-Hill. For concise, authoritative answers to specific questions that come up on the job...for consultation when your work leads you into areas outside your specialty...for keeping abreast of new developments over the whole spectrum of today's exploding technology...there has never been anything like this ready-reference tool.

More than 2,000 respected leaders of science and industry have pooled their knowledge and experience to create this *Information Center*. Here you will find every theory, concept, term...every significant new discovery and application...every major problem currently under study...precisely classified and described in 15 volumes of amazing usefulness. For a free illustrated Prospectus with complete details, simply mail the coupon. There is no obligation, of course. McGraw-Hill Encyclopedia of Science and Technology, 331 West 41st Street, New York, N.Y. 10036.

McGraw-Hill
Encyclopedia of

**science and
technology**



331 West 41 Street, New York, N.Y. 10036

Please send your free illustrated Prospectus with full details of this new *Information Center* for engineers and scientists. I understand there is no obligation.

Name _____

Address _____

City _____

State _____ Zone or
Zip No. _____

Profession _____

Electronics-10-4-65

newest Esterline Angus design breakthrough

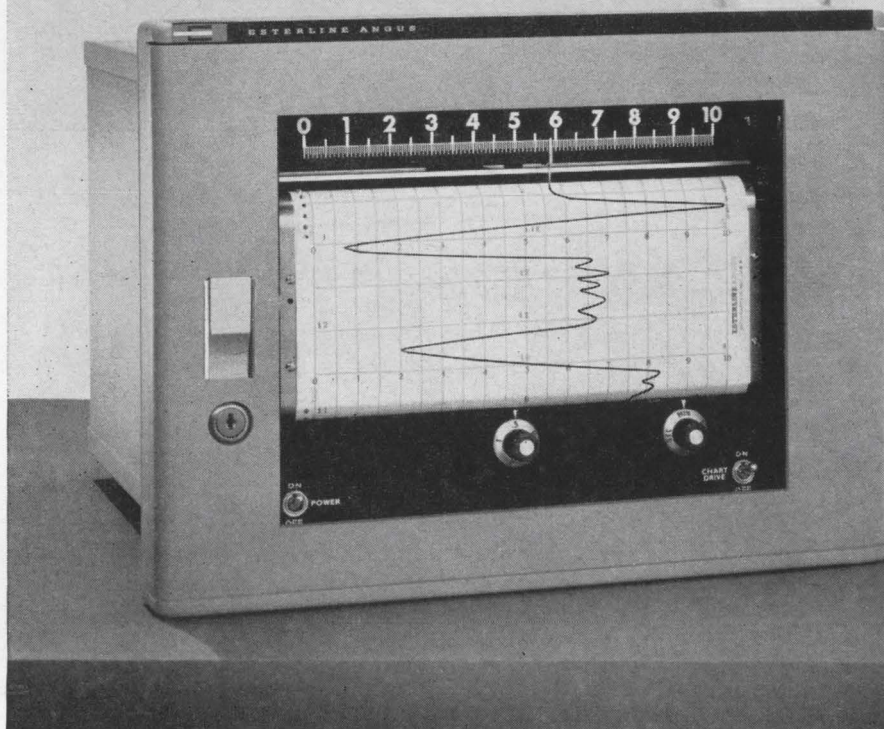

Illustrated is EII/OIS Speed Servo,® one of five new Series "E" recorders

1/5 second response over 10" span
+
inertial ink pump } = **the only wide chart
 Speed Servo®**

Never before has a servo recorder offered the versatility, dependability and reliability of the Wide Chart Esterline Angus Speed Servo.® It delivers:

- 1/5 second response over the full 10" span.
- spans as low as 1 MV.
- a servo mechanism with only one moving part . . . no drive cords to break or gears to wear.
- new inertial ink pump (patent applied for) provides skip-free writing at any pen speed.
- optional adjustable zero—adjustable span . . . zero displacement to ± 100 MV . . . spans from 1 to 100 MV.
- solid state amplifier.
- source impedance of 50,000 ohms.
- conductive plastic feedback potentiometer lasts thousands of hours longer than any wire wound potentiometer.

Our new Series "E" Catalog has the complete story. Write for it.

ESTERLINE ANGUS INSTRUMENT COMPANY, INC.
 Box 24000-E • Indianapolis, Indiana 46224

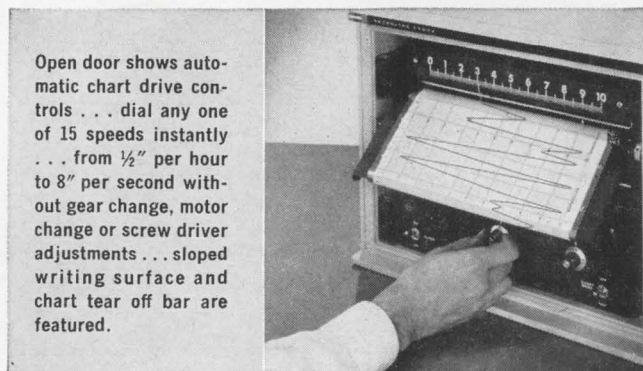

Open door shows automatic chart drive controls . . . dial any one of 15 speeds instantly . . . from 1/2" per hour to 8" per second without gear change, motor change or screw driver adjustments . . . sloped writing surface and chart tear off bar are featured.

ESTERLINE ANGUS

Excellence in instrumentation for over 60 years



Technical Articles

Two ways to measure distortion: page 80

Distortion produced by system nonlinearity can be a big headache to designers. It can cause poor fidelity in audio equipment or it can fill communications channels with noise. Before it can be eliminated, system distortion must be pinpointed, either by total harmonic or intermodulation distortion analysis. A study of the advantages and limitations of both methods has led to a new instrument that provides accurate and automatic measurements.

MOS integrated circuits save space and money: page 84

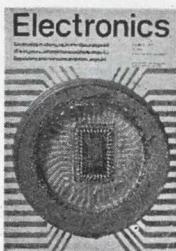

Metal-oxide-semiconductor integrated circuits may realize the designer's dream of lowering system costs to pennies per circuit. A searching look at this newest development in the evolution of solid state technology shows how MOS techniques are being used to produce more complex functions per chip than were previously possible. Our cover shows an MOS shift register in the industry's first round flatpack, made by General Micro-electronics, Inc.

Chips are down in new way to build microsystems: page 102

Without special preparation, ordinary uncased integrated circuit chips can be bonded ultrasonically in one shot to thin-film conductors. The method is being applied to production of a high-speed thin-film memory, which packs 180 IC's and 1,536 bits of memory onto a plane only 3 by 4½ inches.

Powerful scr's control industry's biggest machinery: page 110

Paced by the silicon controlled rectifier, solid state components are moving rapidly into industrial controls. New ways to increase the power-handling capacity of scr's up to megawatts make possible a number of heavy-duty applications, from moving lift trucks to controlling an entire steel mill.

Coming October 18

- IC's start a packaging revolution
- Measuring antenna patterns from the air
- Q-switched lasers
- Low-cost communications via meteor-burst

Two ways to measure distortion

Its cause, system nonlinearity, may be calculated from the output harmonics of a single signal, or from the intermodulation of two

By Charles R. Moore

Loveland division, Hewlett-Packard Co.
Loveland, Colo.

The goal of audio and communications equipment is to reproduce input signals faithfully at the output. But system nonlinearity changes the wave-shape of the signals; the resulting additional frequencies at the output are a measure of the distortion. Poor reproduction brought about by distortion will appear to the user of audio equipment as a change in the quality of musical instruments, or as noise; to the user of communications gear, it may also appear as channel crosstalk.

It is necessary to identify nonlinear distortion before it can be eliminated. Two methods are in common use—total harmonic distortion analysis and intermodulation distortion analysis. The choice depends primarily on the characteristics of the system being tested and the information desired.

Linear system theory

Each input to a perfectly linear system produces a proportional output. For example, if an input $f_1(t)$ produces an output $g_1(t)$, and a second input $f_2(t)$ produces an output $g_2(t)$, the sum, $f_1(t) + f_2(t)$, must produce $g_1(t) + g_2(t)$ at the output. The output of the system can then be defined as

$$G(j\omega) = H(j\omega) F(j\omega)$$

where $F(j\omega)$ is the frequency spectrum of $f(t)$, $G(j\omega)$ the frequency spectrum of $g(t)$, and $H(j\omega)$ the transfer function of the system, which has finite

The author



Charles R. Moore is a group leader at the research and development laboratories of the Hewlett-Packard Co.'s Loveland division. He is a graduate of Princeton University and earned his master's degree in electrical engineering at the University of California.

gain at all frequencies. For every perfectly linear system, therefore, all frequencies in the input will appear at the output, changed only by a scale factor; no frequency that is not in the input can appear at the output.

For a perfectly linear amplifier, the expression is $e_o = Ae_{in}$, where e_{in} is the voltage at the input, e_o the voltage at the output, and A the transfer function—in this case the gain of the amplifier. A nonlinear amplifier, however, produces harmonics at the output, which can be characterized by the power series expansion of its transfer function:

$$e_o = A_1e_{in} + A_2e_{in}^2 + A_3e_{in}^3 + \dots + A_n e_{in}^n$$

The purpose of any distortion measurement is to determine the value of the coefficients of the terms in the series. As an example, if the input signal is

$$e_{in} = e_1 \sin \omega_1 t + e_2 \sin \omega_2 t$$

then the output, e_o , expanded into a Taylor power series, becomes:

d-c component

$$\frac{A_2}{2} (e_1^2 + e_2^2)$$

fundamental component

$$\begin{aligned} &+ \left(A_1 e_1 + \frac{3A_3}{2} e_1 e_2^2 + \frac{3A_3}{4} e_1^3 \right) \sin \omega_1 t \\ &+ \left(A_1 e_2 + \frac{3A_3}{2} e_2 e_1^2 + \frac{3A_3}{4} e_2^3 \right) \sin \omega_2 t \end{aligned}$$

2nd and 3rd harmonic components

$$\begin{aligned} &- \frac{A_2}{2} e_1^2 \cos 2\omega_1 t - \frac{A_2}{2} e_2^2 \cos 2\omega_2 t \\ &- \frac{A_3}{4} e_1^3 \sin 3\omega_1 t - \frac{A_3}{4} e_2^3 \sin 3\omega_2 t \end{aligned}$$

intermodulation components

$$\begin{aligned} &+ A_2 e_1 e_2 [\cos(\omega_1 - \omega_2)t - \cos(\omega_1 + \omega_2)t] \\ &+ \frac{3A_3}{4} e_1^2 e_2 [\sin(2\omega_1 - \omega_2)t - \sin(2\omega_1 + \omega_2)t] \\ &+ \frac{3A_3}{4} e_1 e_2^2 [\sin(2\omega_2 - \omega_1)t - \sin(2\omega_2 + \omega_1)t] \end{aligned}$$

If proper care has been taken during the design of a system, nonlinearity will not be too severe. It is practical to assume that the distortion is less than 10%, so the terms of the expansion higher than the third power have been neglected.

Analysis of the series expansion shows that the relative amplitude of the second and third harmonic terms generated will vary directly with the input signal level. For second harmonics, the amplitude is proportional to e_1^2 or e_2^2 . These terms will, therefore, vary 2 decibels per decibel of signal level change. Correspondingly, the third harmonic terms will vary 3 db per decibel of signal level change.

For the intermodulation terms, a frequency of the form $a\omega_1 + b\omega_2$ varies as $e_1^{|a|} e_2^{|b|}$. For example, the frequency $2\omega_1 - \omega_2$ has an amplitude proportional to $e_1^2 e_2$ and will vary 2 db per decibel of signal-level change in e_1 , and 1 db per decibel of change in e_2 .

Thus, the power series defines the nonlinearity in terms of easily recognized frequency components, whose dependence on signal level can be readily determined.

Total harmonic distortion analysis

Total harmonic distortion analysis requires only one signal source. Because of the system nonlinearity, simple harmonics of the input signal are generated at the output. The measurement technique compares the amplitude of the harmonics to that of the original signal at the output, where the original signal becomes the fundamental frequency of the harmonics. The defining equation is

$$\text{total harmonic distortion} = \frac{\sqrt{\Sigma(\text{harmonics})^2}}{\text{fundamental}} \quad (1)$$

A frequency-selective voltmeter is needed to measure the fundamental; and either a selective voltmeter with a wide dynamic range or a frequency rejection circuit with a true rms detector to measure the harmonics. The frequency rejection circuit nulls the fundamental and passes its harmonics to the detector with no attenuation, so the ratio between the fundamental and harmonics can be determined.

A less expensive way to measure the total harmonic distortion, however, is to use a rejection filter and a broadband detector. Since the fundamental is not directly measured, the equation becomes

$$\text{THD} = \frac{\sqrt{\Sigma(\text{harmonics})^2}}{\sqrt{(\text{fundamental})^2 + \Sigma(\text{harmonics})^2}} \quad (2)$$

If the distortion is less than 10%, the denominator

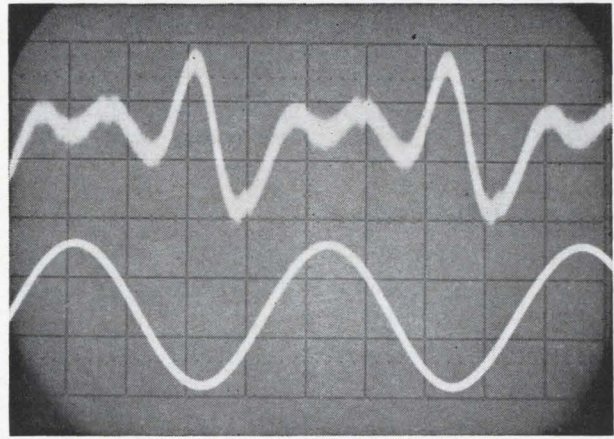

Output signal of nonlinear system, with the fundamental filtered out, is the lower trace on the oscilloscope screen. The residual output shows that seemingly pure sine wave does in fact contain harmonics.

of equation 2 will be within $\frac{1}{2}\%$ of the denominator in equation 1, which is as accurate as any frequency selective voltmeter.

To cut costs further, most manufacturers use an averaging detector instead of a broadband detector. Under certain conditions, this can lead to reading errors in the null that are 20% to 30% low, since the averaging detector responds to the area of the rectified waveform and not to the instantaneous power of the waveshape. Even so, these types of errors are not considered significant; they affect only the over-all percentage of harmonics present in the output signal and not the individual terms, and the percentage is small. For example, a 20% error in reading the null of a system with 0.1% harmonics results in reading of 0.08% instead.

A more important error, much larger than the metering error, is caused by the attenuation of the harmonics by the rejection circuit. This error normally effects the second harmonics more than the higher ones. However, manufacturers of these circuits generally specify the second-harmonic attenuation, which makes it easy to compensate mathematically for the error in the readings.

Disharmonics

There are two difficulties in making total harmonic distortion measurements. First, to get a measurement within the desired accuracy, the harmonic content of the test signal must be not more than a third of the distortion expected to be caused by the system. Second, the chore of nulling the fundamental can be time-consuming. Oscillators that meet the distortion requirements and automatic nulling equipment, which has recently become available, can overcome the difficulties.

The total harmonic method is very useful when testing low-distortion circuits, which require a large amount of negative feedback and must be unconditionally stable. It is important that oscillations that occur in these circuits be detected. In a TH system, the harmonics can be viewed on an oscilloscope, with the fundamental filtered out. Not

only can the character of the distortion be easily determined, but residual oscillations that would have been much harder to find with a wave analyzer, and are too small in comparison to the fundamental to be detected on an oscilloscope, can be viewed.

Intermodulation distortion

There are three major methods of making intermodulation distortion measurements. In the Comité Consultatif International Téléphonique (CCIF) method, two high-frequency signals with amplitudes e_1 and e_2 are applied to the amplifier under test. The difference between their frequencies must lie within the amplifier's pass-band. The low-frequency difference products are extracted from the output signal with a low-pass filter, and their amplitudes are compared to those of the two original signals. If the input-signal amplitudes are equal to each other and represented by $e/2$, then

$$IM(CCIF) = \frac{e}{4} \frac{A_2 + \frac{3}{8}A_4e^2 + \dots}{A_1 + \frac{9}{16}A_3e^2 + \dots} \approx \frac{e}{4} \frac{A_2}{A_1}$$

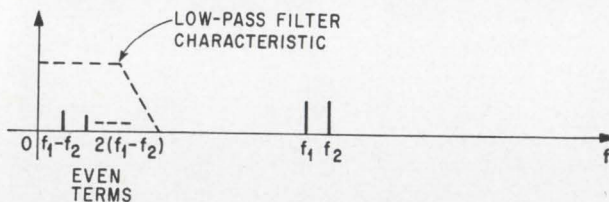

In the CCIF method of distortion measurement, two signals are applied to the system under test. The diagram above shows how the low-pass filter separates the low-frequency intermodulation terms from these two signals. The amplitudes of the intermodulation, or difference terms, can be compared with that of the input signals. The lower frequency intermodulation terms are only even.

There is one serious fault with this method: only the even-order terms in the nonlinearity are detected. As a result, it is not a good method where the system distortion is expected to contain primarily odd-order terms, such as in a push-pull amplifier, or an amplifier that is overdriven.

Another method, used by the Society of Motion Picture and Television Engineers, also requires two input signals, one of which has 50 times the frequency and only one-fourth the amplitude of the

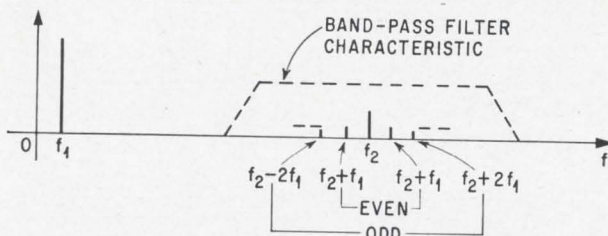

Two signals, f_1 and f_2 , are used in the SMPTE method, with one having 50 times the frequency and one-quarter of the magnitude of the other. The frequencies of interest are restricted, as shown in the diagram, to a pass-band that is 20 times the higher frequency and centered around it. The envelope of these terms is then used to determine the modulation index of the higher frequency, f_2 in the above diagram.

Comparison of techniques

	Total HD	SMPTE IM	IM/HD
Single-ended	$\frac{e}{2} \frac{A_2 + A_1e^2}{A_1 + \frac{3}{4}A_3e^2}$	$\frac{8}{5} e \frac{A_2 + \frac{51}{50}A_1e^2}{A_1 + \frac{99}{100}A_3e^2}$	3.2
Push-Pull	$\frac{e^2}{4} \frac{A_3 + \frac{5}{4}A_5e^2}{A_1 + \frac{3}{4}A_3e^2}$	$\frac{24}{25} e^2 \frac{A_3 + \frac{33}{10}A_5e^2}{A_1 + A_3e^2}$	3.84

Only the SMPTE method of intermodulation distortion measurement and the harmonic distortion technique measure both odd and even order nonlinearities. When used to analyze amplifiers, each method defined the nonlinearities of the system in the same manner and gave the same information. They only differed by a scale factor.

other. The output is put through a band-pass filter, which filters out everything except the intermodulation terms. The latter are envelope-detected, and then low-pass filtered. The distortion is defined as the modulation index of the higher input frequency. With this method, both even- and odd-order nonlinearities are detected. The response to the even ones are the sidebands corresponding to $f_2 + (2n-1)f_1$ and the response to the odd are the $f_2 \pm 2nf_1$ sidebands. The bandwidth of the bandpass filter should be approximately $20 f_1$ to ensure passing all the sidebands.

With the conditions that $e_1/4 = e_2$, the intermodulation distortion of a push-pull amplifier and a single-ended amplifier can be derived from the Taylor series. They are shown in the table at the top of this column.

A serious drawback of this technique is that the envelope detection process is nonlinear. If the signal amplitudes are low, as is often the case in transistor circuits, envelope detection can add significantly to the distortion at the output. Such circuits can be tested, however, if a wave analyzer—basically a selective voltmeter—replaces the envelope detector. This procedure requires tuning to and measuring all the spurious frequencies generated, and then computing the modulation index. The results are very reliable, but the procedure is time-consuming and the equipment is considerably more expensive than that used in the total harmonic distortion method. And since all spurious frequencies must be measured, the upper cutoff frequency of the system being tested must be 50 times greater than the lower cutoff frequency to pass all the significant frequencies.

In fact, all of the methods discussed so far work only with broadband systems. But there is one technique of intermodulation distortion measurement that is designed specifically for such limited passband systems as intermediate-frequency amplifiers. Again, two signals whose significant intermodulation products lie within the amplifier's pass-

band are applied to the system. In this technique, if e_1 and $e_2 = e/2$ then

$$IM(\text{narrowband}) = \frac{\frac{3}{4}A_3(e_1^2e_2 + e_1e_2^2) + \dots}{A_1(e_1 + e_2) + \dots}$$

This method detects only the odd-order terms of nonlinearity, since the sum of the coefficients of the terms in the output closest to the test signal is odd. This method is quite satisfactory in the case of i-f amplifiers, because only the odd terms cause significant spurious responses. The equipment normally used is a wave or spectrum analyzer.

Odd or even

To obtain complete distortion data, it is necessary, in most cases, to detect both even and odd nonlinearities. Of the systems discussed, only total harmonic distortion analysis and the SMPTE intermodulation methods have this capability. A brief summary of a comparison between these two methods, made by W. J. Warren and W. R. Hewlett², is shown in the table on page 82. The ratios of intermodulation to harmonic distortion (IM/HD) shown will hold true for any frequency-independent system in a predictable manner. Both methods give the same information about the coefficients of the power series describing the amplifier; the answers just differ by a scale factor. Even so, intermodulation measurements are more difficult to make and generally require more sophisticated equipment than total harmonic measurements.

Intermodulation measuring requires two test signals which have no prior interaction. The distortion of these two signals does not have to be low, since their harmonics will not usually cause any significant intermodulation products. Setting up a measurement at one set of test frequencies is not difficult; but if measurements are required at several different sets of frequencies, the procedure becomes very complicated—especially if it is necessary to tune to each intermodulation term separately.

With the total harmonic distortion method, however, both high and low frequency response can be easily measured, since only one signal frequency need be changed. This is useful when checking the effects of diminishing feedback gains at either end of the frequency response characteristic or the effect of load capacitance at the high-frequency end. In addition, the total harmonic distortion method requires only that the system have a flat frequency response over a frequency deviation of three to one, whereas the SMPTE method requires a flat response for a deviation greater than 50 to one.

New test instrument

Since the nulling of the fundamental is normally the time-consuming portion of total harmonic distortion measurement, great savings can be realized, especially in production line testing with an analyzer which automatically rejects the funda-

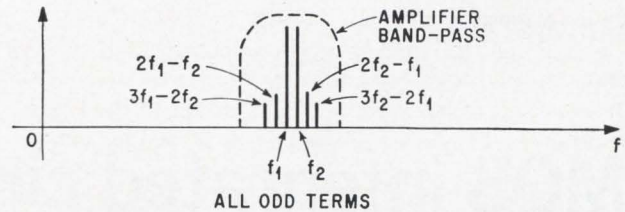

Two signals, close together, are used in the narrow band method of distortion analysis. The amplifier under test has a narrow pass-band, and the intermodulation terms measured are restricted to this band. As shown in the diagram above, these terms are all odd.

mental. The time saved is as much as 25 seconds of a 30-second measurement. With automatic nulling, the accuracy of the null achieved is no longer a function of operator training, manual dexterity or signal source frequency drift.

Automatic nulling circuitry in a new commercial wave analyzer, the H-P 333A and 334A, operates on the principle that the fundamental at either side of a Wien bridge off null follows well-known phase relationships. In this instrument, phase-sensitive feedback loops are employed which drive photocells in parallel with the resistances on either side of the bridge. These loops reject the fundamental and are not critical to adjust, since any imbalance on one side of the bridge is automatically compensated for on the other. Imbalances on either side cause phase errors in the fundamental which are in quadrature, so the phase-sensitive feedback loops are independent of each other.

The analyzer will maintain a null even though there is a slow drift in the input frequency. This ability to "pull" the null has opened the door to a number of applications where the total harmonic distortion measurements were not readily applied in the past. Among them are:

- Single-frequency production line testing of such components as integrated-circuit amplifiers or transformers. As long as the long-term drift of the signal source is less than $\pm 1\%$, a good null will always be achieved. Therefore, time-consuming rebalancing operations at the test position are eliminated.
- Optimizing the performance of an oscillator. Here, any variation in the parameters causes the frequency to shift slightly. The automatic nulling of the analyzer allows the oscillator performance to be improved on a continuous basis, rather than by relying on a point-to-point check, which may or may not find the optimum point.
- Correcting distortion in signal generators which produce sine waves either by mixing or by non-linear shaping. The small frequency shifts that occur in the process would also cause the loss of the null if it were not for the automatic null feature.

References

1. B.M. Oliver, "Distortion and intermodulation," Hewlett-Packard Co., Application note 15.
2. W.J. Warren and W.R. Hewlett, "Analysis of intermodulation method of distortion measurement," Proceedings of the IRE, p. 457-466, April, 1948.

MOS integrated circuits save space and money

In a serial computer, 16 MOS microcircuits can take the place of 971 conventional integrated circuits; in all systems they can cut the costs of testing, packaging and production

By Donald E. Farina and Donald Trotter

General Micro-electronics, Inc. Santa Clara, Calif.

Integrated circuits have dramatically cut the size, weight and power requirements for electronic equipment. The next objective for microcircuit manufacturers is a similarly substantial reduction in the total cost of that equipment.

Metal-oxide-semiconductor integrated circuitry is currently being investigated as the route to low-cost electronic systems. At present it appears that systems built with MOS IC's should be able to duplicate the functions of systems built with conventional monolithic IC's (double-diffused, epitaxial IC's) at less than one-tenth their cost.

The authors



Donald E. Farina is general manager of the subsystems division at General Micro-electronics, Inc. He directs research and development of analog and digital MOS integrated circuits. He came to G M-e in 1963 from the Semiconductor division of the Fairchild Camera & Instrument Corp. where he headed the digital device development group at their research and development laboratory



J. Donald Trotter is in charge of the digital subsystem development department. He is currently engaged in the development of commercial and custom high-complexity MOS integrated circuits. Before joining G M-e in 1963, Trotter was a project engineer with the Fairchild Semiconductor division. He received a master's degree in electrical engineering from Stanford University in 1961.

One requirement

To achieve a price reduction of this magnitude, there is one very important and basic requirement: the number of functions performed by a single chip must be considerably increased without substantially increasing the number of input and output connections to the chip (thereby avoiding higher packaging and testing costs). The MOS integrated-circuit concept meets this requirement. Moreover, complex MOS integrated-circuit yields must be comparable to simple conventional integrated-circuit yields.

By permitting more complex circuitry to be placed on a single chip, the MOS integrated circuit provides economy in two ways. First, by reducing the number of chips to be fabricated to implement a given function, it lowers the production cost per function. Second, again as the result of fewer chips, it decreases the packaging and testing costs.

Use of MOS integrated circuits permits placing more than 40 circuit functions in the space now occupied by a single function in a double-diffused integrated circuit.

Complexity vs. leads

In complex MOS circuits, the number of input-output terminals required increases in proportion to the logic complexity until a complete subsystem function is achieved. Then the number of input-output leads suddenly decreases sharply. Examples of these complete subsystems are arithmetic sections, decoders and analog-to-digital converters. In typical computer applications, from 30 to 50 NOR or NAND functions may be required be-

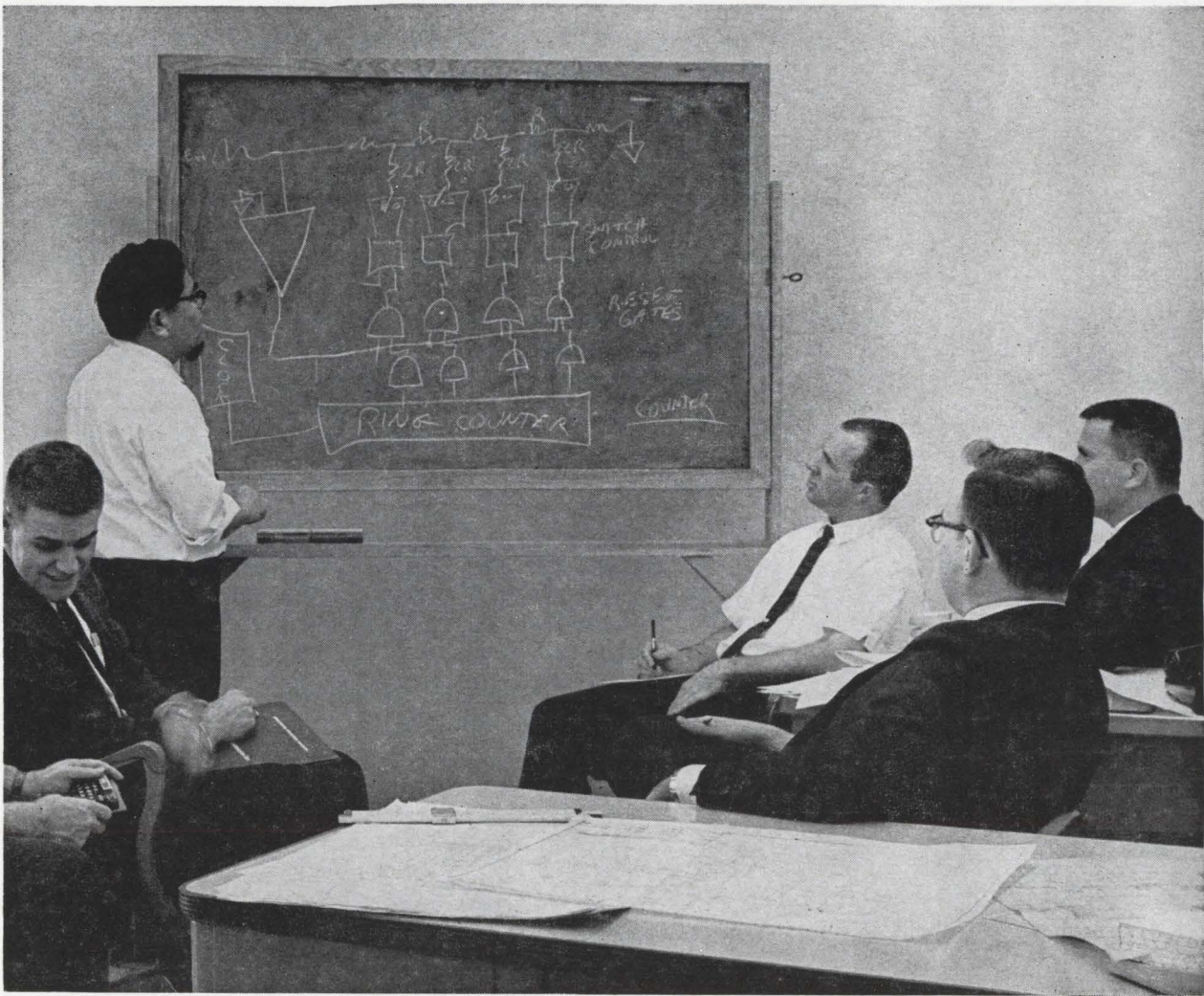

Engineers designing an analog-digital complex metal-oxide-semiconductor subsystem. The design includes a ring counter that drives a current-summing ladder network for digital-to-analog conversion.

tween threshold points. Conventional double-diffused epitaxial integrated circuits are not capable of providing that many functions on a single chip except in special cases. However, MOS integrated circuits do have this capability.

Saving space

The MOS integrated circuit allows a considerable increase in the number of functions per chip because:

- Transistors are smaller. The MOS integrated circuit typically occupies only 5% of the surface area required by an epitaxial double-diffused transistor in a conventional integrated circuit. A complete metal oxide semiconductor NAND function, for example, requires considerably less space than does a bonding pad.

- Large load resistors can be replaced by small transistors. For example, an MOS transistor, one square mil in area, can provide 100,000 ohms of resistance. At the present time, a 20,000-ohm resistor in a conventional integrated circuit requires about 300 square mils.

Resistors much larger than 20,000 ohms take up

so much space that they are not practical.

- Need for isolation regions between elements is eliminated. Forty to sixty percent of conventional integrated-circuit die area (not including the area covered by bonding pads) consists of isolation regions.

- Fewer components per function are required. An MOS shift register stage comprises only six devices as compared to 36 devices (15 transistors, 21 resistors) in an equivalent RTL conventional integrated circuit, or 38 devices (12 transistors, 14 diodes, 12 resistors) in an equivalent TTL conventional integrated circuit.

Additional benefits

Space economy is not the only virtue of MOS integrated circuits. Other important advantages are:

- Low power consumption. For example, a small airborne navigational computer built with conventional integrated circuits requires a power supply capable of delivering 26 watts to operate. Its functions can be duplicated by a unit built with metal-oxide-semiconductor integrated circuits, requiring

Comparison of MOS and standard circuits in a small serial computer

	No. of integrated circuit packages	External inter- connections ^a	Internal inter- connections ^b	Chip crossovers ^c	Lead bonds and welds	Total inter- connections and crossovers
Memory circuits						
Standard.....	800	6,400	76,800	120,000	12,800	216,000
MOS.....	8	40	4,040	16,000	80	20,160
Savings factor.....	100	160	19	7.5	160	10.7
Input circuits						
Standard.....	18	144	1,268	2,000	288	3,700
MOS.....	1	14	76	240	28	358
Savings factor.....	18	10.3	16.7	8.3	10.3	10.3
Memory control						
Standard.....	25	200	1,250	2,000	400	3,850
MOS.....	1	22	97	250	44	413
Savings factor.....	25	9.1	12.9	8	9.1	9.3
Instruction word register and decoder						
Standard.....	36	256	1,968	3,120	512	5,856
MOS.....	2	36	148	400	72	656
Savings factor.....	18	7.1	13.3	7.8	7.1	8.9
Add/sub. unit						
Standard.....	16	128	1,284	2,040	256	3,708
MOS.....	1	14	88	250	28	380
Savings factor.....	16	9.2	14.6	8.2	9.2	9.8
Output display						
Standard.....	36	288	2,168	3,440	576	6,472
MOS.....	1	22	146	440	44	652
Savings factor.....	36	13.1	14.8	7.8	13.1	9.9
Bit and word time						
Standard.....	20	160	1,460	2,300	320	4,240
MOS.....	1	14	94	300	28	436
Savings factor.....	20	11.4	15.5	7.7	11.4	9.7
Special timing generators						
Standard.....	20	160	1,460	2,300	320	4,240
MOS.....	1	14	94	300	28	436
Savings factor.....	20	11.4	15.5	7.7	11.4	9.7
Totals						
Standard.....	971	7,736	87,658	137,200	15,472	248,066
MOS.....	16	176	4,783	18,180	352	23,491
Savings factor.....	60.7	44	18.3	7.5	44	10.6

a. IC package leads or pins.

b. Connections from aluminum to silicon on the clip.

c. Points at which aluminum crosses over a p-material region.

Chart shows what's needed to build a small serial computer with conventional monolithic or MOS microcircuit technologies. To fabricate the computer with standard integrated circuits would require 971 units; only 16 IC's are needed if MOS circuits are used. This means that, on the average, one MOS IC replaces more than 60 conventional IC's. The reduction in interconnections is also impressive; less than 24,000 instead of more than 248,000.

only one watt to operate.

- Higher power-supply efficiency. With MOS integrated circuits the computer just mentioned can be operated from a high-voltage low-current supply (for example: 12 volts and 100 milliamperes) with a power supply efficiency of approximately 75%. In contrast, the equivalent computer built with double-diffused epitaxial integrated circuits requires a 4-volt, 6.5-ampere supply. At this operating current level, the maximum power-supply efficiency that can be obtained is about 50%, and heavy, expensive transformers are required.

- Equipment manufacturer determines design. Since the design rules and tradeoffs are simple to

understand, the system designer's dependence on the integrated circuit manufacturer is small. The equipment manufacturer can carry out all the required steps to design the integrated circuit up to mask fabrication.

- Greater design freedom. MOS technology permits a greater variety of circuit functions than conventional monolithic technology and this results in more advanced system organization. Furthermore, because high resistor values are readily available, MOS circuits don't have to be designed to bypass the resistor problem, nor must deposited thin-film resistors be used, as with conventional integrated circuits, to obtain resistances greater

than 20,000 ohms.

- Simplified manufacturing procedure. Only 38 individual steps are required to produce a typical MOS integrated circuit as compared to 130 for an equivalent double-diffused epitaxial circuit.

- Higher manufacturing yield. In fabricating integrated circuits, three factors can contribute significantly to decreased yields. These are the number of processing steps that require high temperatures, the number of diffusions made, and the number of masking steps required. Only two high-temperature steps are needed for MOS integrated circuits while ten are required to produce a double-diffused epitaxial integrated circuit. Four diffusions (not counting the forming of the epitaxial layer) are required to fabricate a conventional integrated circuit; while only one diffusion is used in making an MOS integrated circuit. Diffusions reduce yield because they may produce pinholes, pitting or surface damage in the oxide. Finally, only four masks are used to produce a MOS integrated circuit compared to the six to eight required for a conventional integrated circuit.

- Larger dies can be used. Because of the simplified MOS manufacturing process and high yields, it is practical to use larger chips. As a result, MOS IC chips as large as 85 by 120 mils are being used. This means that one MOS IC can often replace 50 to 80 conventional IC's. Double-diffused epitaxial die areas greater than 4,000 square mils are extremely rare and costly.

- Greater reliability. The largest source of failure in any electronics system is the interconnections. MOS technology greatly reduces the number of interconnections required. A small computer built with conventional integrated circuits, and containing 72,000 interconnections has been redesigned with MOS integrated circuits. The redesigned unit required only 6,000 interconnections. With the 12-to-1 reduction in interconnections, fewer wiring crossovers and printed circuit boards were required. A more detailed comparison of the difference in required interconnections between the two integrated circuit methods is shown for a hypothetical computer in the table on page 86. The table shows that a serial computer with more than 248,000 interconnections can be duplicated with less than 24,000 interconnections if MOS circuits are used instead of conventional IC's.

Lower costs

Consider two systems designed to do a particular job: one is built with 50 complex MOS IC's, the other with 1,000 conventional IC's. The many economical advantages of the MOS-built system in areas such as ease of repairability, testing, reliability, packaging, and so forth, make it difficult to pick a starting point for make cost comparisons.

However, an interesting comparison can be made at the chip level. A typical J-K flip-flop on a conventional chip requires 3,600 square mils of die area. In that same area, 50 MOS NOR functions, the equivalent of an add-subtract unit, can be

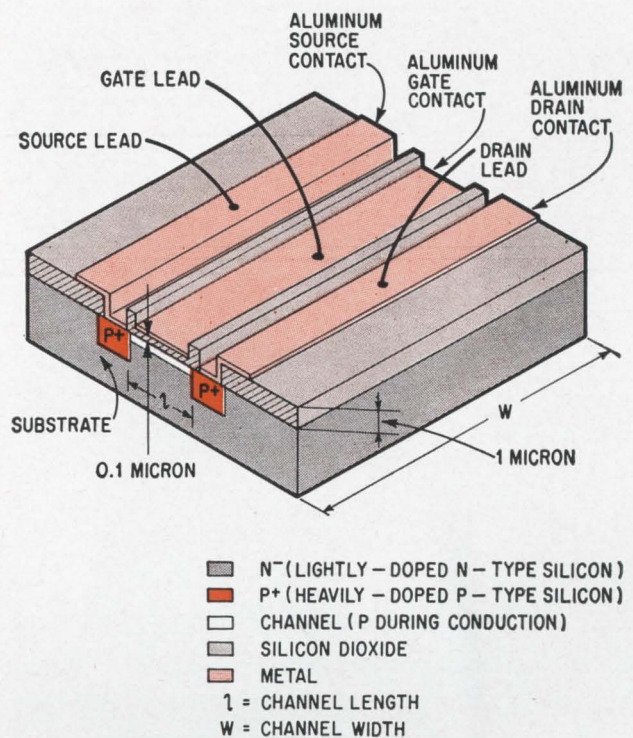

Only one diffusion step is required to fabricate an MOS enhancement field-effect transistor. In this step, two heavily doped p-type islands are diffused into a lightly doped n-type substrate. A thin insulating layer of silicon dioxide is then deposited. Next, holes are etched through the silicon diode and the source, and gate and drain metal electrodes are evaporated onto the chip. The gate electrode is physically separated from the semiconductor material by the oxide layer. A fourth electrode is attached to the substrate. This transistor is known as a p-channel FET even though the material in the channel region is N type prior to current conduction from source to drain.

placed. Because of the simpler MOS manufacturing process and resultant high yields, a die area of 6,500 square mils is feasible. This would allow placing a digital differential analyzer-integrator function containing two 30-bit shift registers and two full adders on one chip. The cost would be only a little more than that of the conventional J-K circuit.

Processing comparison

The table on page 88 lists the eight major steps performed in processing a p-channel, enhancement MOS transistor, compared with 13 steps required for a double-diffused epitaxial transistor. The reduction in process steps becomes even more impressive when translated into the individual manufacturing and packaging operations required for producing a complete integrated circuit (38 compared with 130).

A comparison of the diffusion steps involved in making both MOS and conventional planar types of transistors also demonstrates the simpler procedures used to fabricate MOS devices. First, only one diffusion is needed to make an MOS enhancement transistor. Nothing resembling the carefully

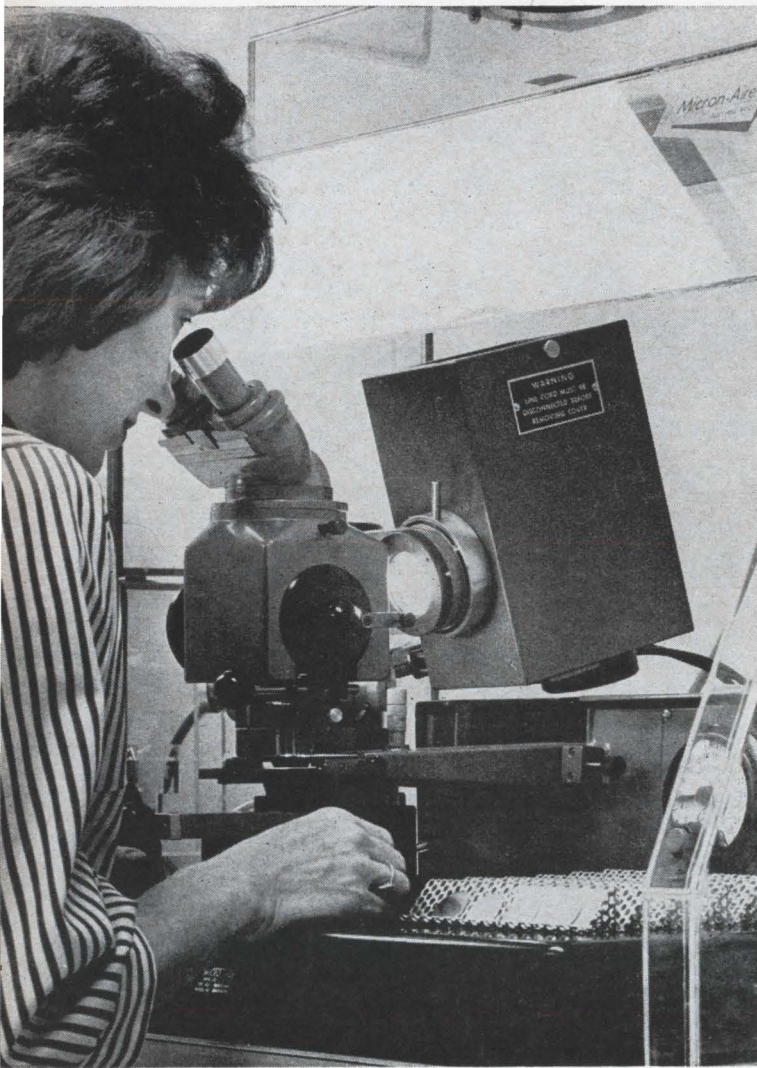

Operator aligns working plate with silicon wafer for exposure of photoresist with ultraviolet source.

controlled emitter diffusion step used to obtain the desired current gain for the double-diffused epitaxial transistor, is required. Second, no isolation regions are needed between MOS transistors. This is because the MOS transistor p-n junctions are reverse-biased during operation; this feature automatically isolates one device from the next and eliminates three of the high-temperature processing steps required in the construction of double-diffused epitaxial transistors.

Crossovers no problem

Crossovers between sets of components are no problem in fabricating MOS IC's. The crossovers are diffused at the same time as the source and drain p-regions. These crossover regions have resistances which are approximately 80 to 100 ohms per square. However, the crossover points are located in series with the MOS load resistors (actually transistors used as load resistors). Since the load resistors have values in the order of 100,000 ohms, the effects of the additional crossover resistance are negligible.

Reliability

Because it is a new device, only limited reliability data is available for the MOS integrated circuit. But what there is, however, is impressive. By mid-August, 1965, equipment built with MOS IC's had undergone 4,356,000 integrated-circuit hours (number of circuits tested multiplied by number of hours under test) of testing with no failures. One indication of the high reliability of the MOS IC is being demonstrated in the IMP (interplanetary monitoring platform) test program. One of the IMP systems, still in operation, contains approximately 360 MOS IC's and has been working continuously for over 6,000 hours. Most of the 1,055 MOS IC's under test in the IMP program are fairly simple circuits; typically they are dual four-input gates and dual J-K flip-flop circuits. However, about 100 very complex circuits with an average of 200 MOS transistors per chip have been performing without failure in other digital systems.

If double-diffused epitaxial IC's had been used instead of MOS IC's, 3,000 would have been required for the IMP program.

Typical applications

One of the most important advantages of MOS IC's is their ability to pack more circuits into a given area. However, as an integrated circuit becomes more complex, the number of different applications to which it is suited, decreases. But even if the circuit becomes so complex that it cannot be used for any job other than the one for which it was designed, its design and manufacture may still be justified. Provided the demand is sufficient, the highly complex MOS integrated circuit is the most economical microelectronic route to take. As a typical example, it would be more economical to build a small computer in high volume quantities with about 15 to 25 MOS IC's than to build the same computer using 1,000 to 1,500 double-diffused epitaxial IC's.

The use of a small number of MOS IC's to design a simple serial computer is shown in the

Transistors: a process comparison

Double-diffused	MOS
1. Collector masking	1. Source and drain masking
2. Collector diffusion	2. P-type source and drain diffusion
3. Epitaxial growth	3. Gate masking
4. Isolation masking	4. Gate etching
5. Isolation diffusion	5. Contact masking
6. Base masking	6. Metal evaporation
7. Base diffusion	7. Metal removal
8. Emitter masking	8. Alloying
9. Emitter diffusion	
10. Contact masking	
11. Metal evaporation	
12. Metal removal	
13. Alloying	

Only one diffusion and a total of eight steps are used in fabricating an enhancement-type MOS transistor. A conventional double-diffused planar transistor requires four diffusions and a total of 13 steps.

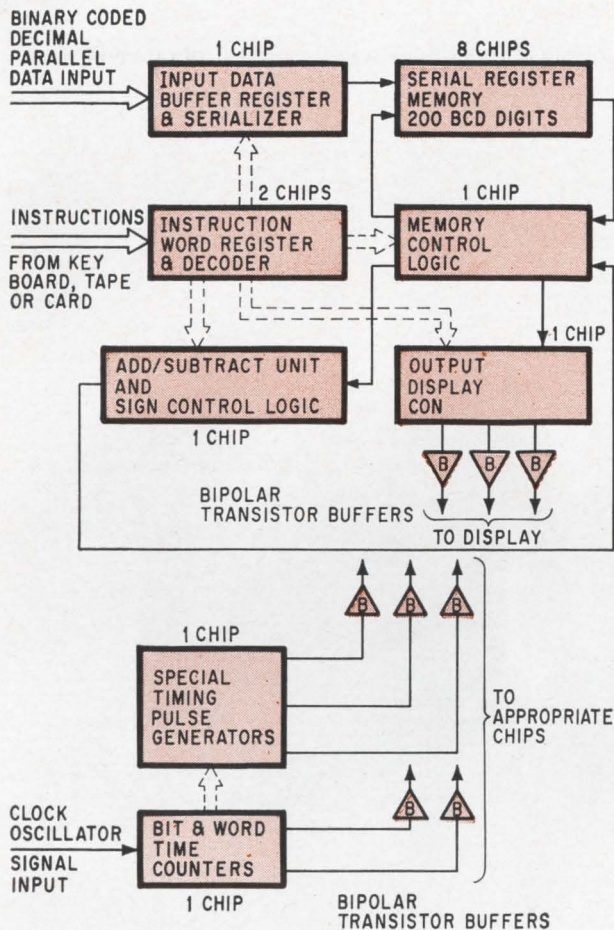

Typical serial computer in block diagram form. By using MOS integrated circuits instead of double-diffused, epitaxial integrated circuits, the number of IC's required is only 16. If conventional IC's had been used, nearly 1,000 would have been needed.

block diagram at the left. In this serial computer, the data being processed is supplied to the input chip and the instructions are externally supplied to a two-chip section which stores each instruction and decodes it into a specific signal for the computer. An eight-chip memory section is provided for storage of the data being fed into the computer and for accumulated results of computations. One chip is used as the memory control section and routes data from the memory to the arithmetic-function chip where the computation is performed. The output data may then either be routed to the memory for storage or to a converter chip for display or both.

The lower part of the block diagram depicts the pulse generator arrangement which provides synchronizing and timing pulses for the computer. The buffer transistors supply the drive capabilities needed to deliver the timing information throughout the computer.

The reductions in integrated circuits, external interconnections, internal interconnections, chip crossovers, lead bonds and welds, and total interconnections and crossovers for a typical small serial computer are given in the table on page 86. The internal interconnections column lists the number of connections from silicon to aluminum on the chip. The external interconnections column gives the number of integrated-circuit package leads or pins. Chip crossovers refer to points at which aluminum crosses over a p-material region. The number of package bonds and welds is double the number of external interconnections because it represents both the connections from the gold wire to the chip bonding pads and to the lead posts (preforms).

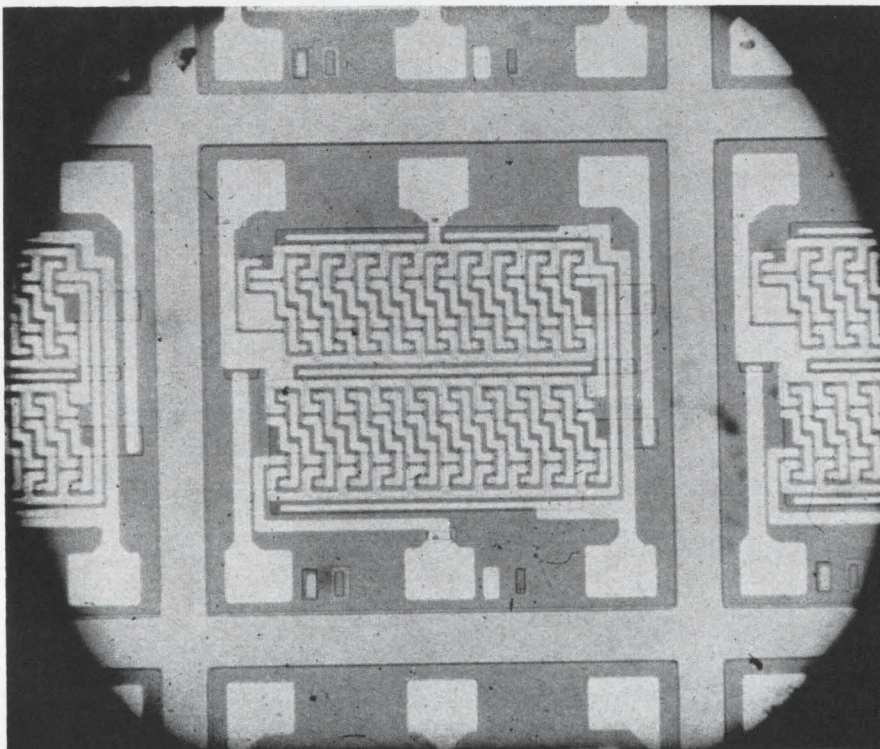

World's first commercially available metal-oxide-semiconductor complex integrated circuit. The 20-bit serial shift register contains 120 MOS devices and was introduced at the Western Electronics Show and Convention in August, 1964.

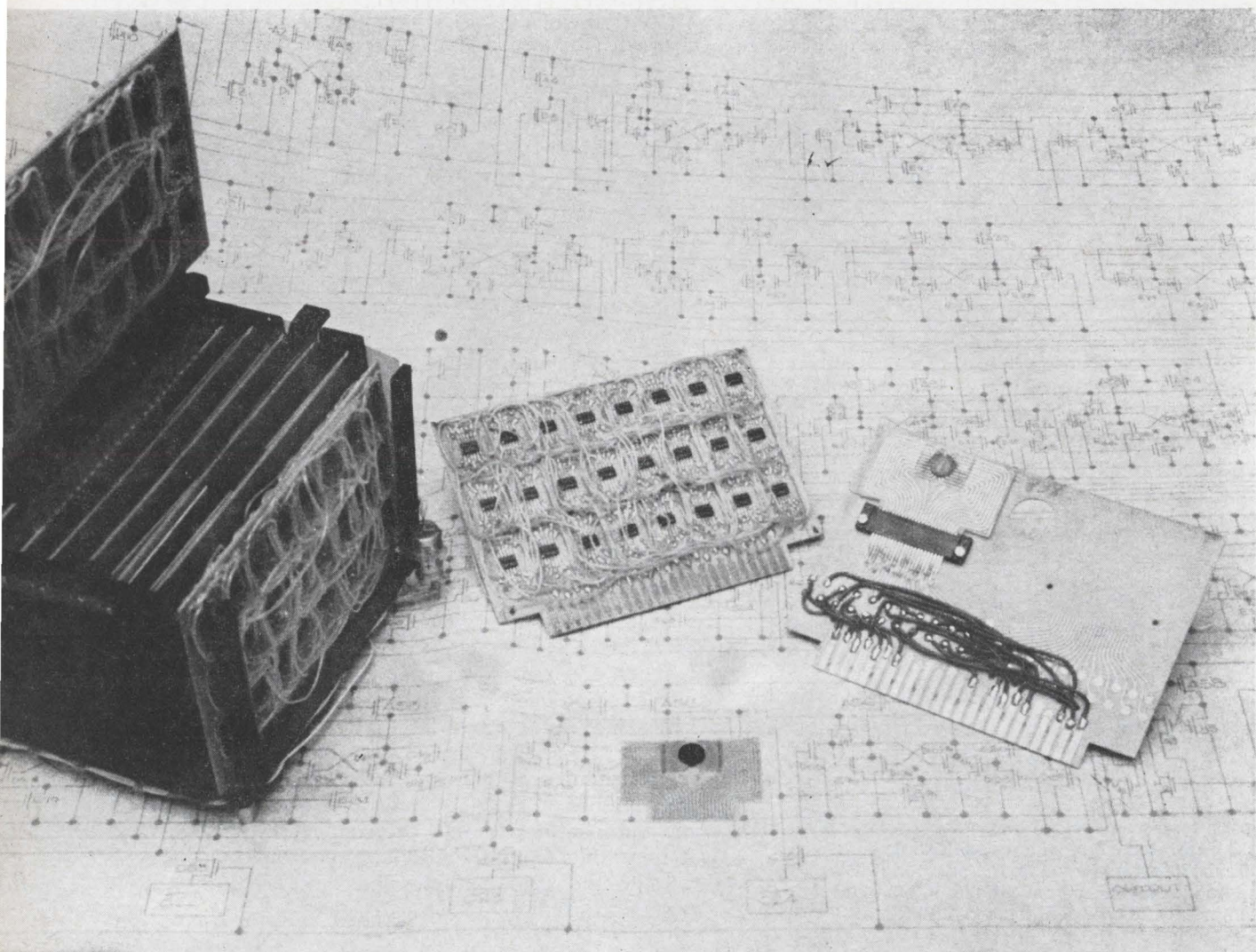

Breadboard system of small serial computer is at the left. Next to it is a typical logic card with 48 MOS integrated circuits: device count: 864 MOS transistors. A substitution logic card with single complex integrated circuit representing the 96 circuits is at the right. Miniature card with complex MOS integrated circuit is at bottom, center.

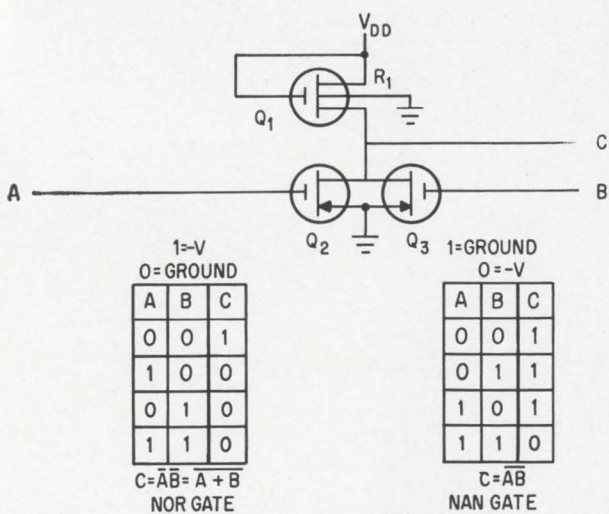

Basic two-input NOR/NAND function. One MOS transistor is used as a load resistor. The circuit functions either as a NOR or NAND gate depending on whether negative or positive logic is used.

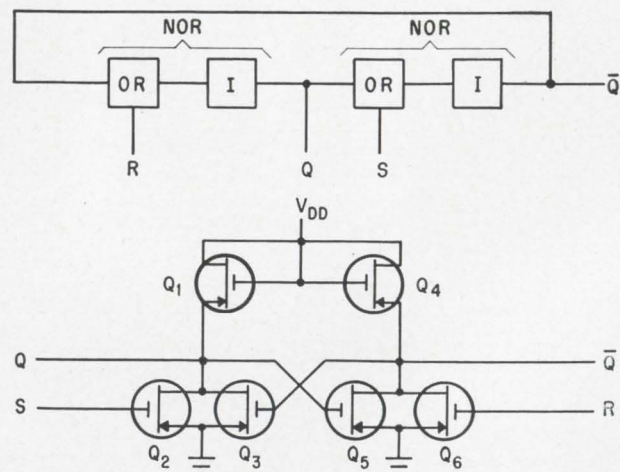

A set-reset flip-flop formed by a pair of NOR gates. The circuit stores one bit of information. The flip-flop state is permanent until the circuit is reset (or set). This circuit is a basic building block for complex counters and shift registers.

Design conductors for MOS circuits

Virtually all digital integrated circuits contain NOR/NAND gate functions. The way in which the NOR/NAND gates are connected is determined by the particular job to be accomplished. For example, a reset-set (R-S) flip-flop can be built from a pair of NOR/NAND gates. Binary counters and shift-registers, similarly, are formed by combining a number of NOR/NAND gates.

A basic two-input NOR/NAND gate is shown on page 90. Although three-input or higher multi-input gates can be used, the two-input gate is the fundamental building block for digital logic circuitry. The two truth tables shown on page 90 illustrate how the same circuit can be used as either a NOR gate or a NAND gate, depending on whether negative or positive logic is used. Columns A and B represent the input signals. The corresponding inverted output signal for the pair of input signals is shown in column C.

The reset-set flip-flop circuit, formed by combining two basic NOR/NAND gates, is also shown on page 90, and represented by the block diagram accompanying the circuit. The input signals are R and S. The letter Q represents the on output. The notation \bar{Q} designates the off output and represents the inverse of Q.

As an example of the operation of this circuit, suppose that the flip-flop is on (Q is at logical 1) and that it is desired to reset it to the off state. When this happens, the output Q will go from the 1 to the 0 state, and the output \bar{Q} will go from 0 to 1. Because \bar{Q} was originally negative, the transistor whose base is connected originally to \bar{Q} was conducting. Initially S and R are both positive, and those transistors whose bases are connected to these points (Q_2 and Q_6) will be nonconducting. Q is positive, and the transistors whose bases are connected to Q will be nonconducting. To reset the flip-flop, R must be made negative, so that Q_6 turns on. Q will rise to ground level, cutting off Q_3 . Then \bar{Q} will drop to the negative level, maintaining the conducting path originally established when R became negative. When this happens, R can return to its positive state. The flip-flop is now off and will remain off regardless of what signals appear on R, until a negative signal appears at S, to turn it on.

Transconductance

In a typical switching function, an inverter (or gate) device and load resistor are used. If both of the devices are MOS transistors, the design of the function can be simplified to topological control of the transconductance (g_m) ratio between the two transistors. This is because the load current (or drain current) for an MOS transistor is directly proportional to the transistor's transconductance at a constant gate voltage. The transconductance, in turn, is proportional to the device geometry. This allows setting of the one and zero levels for

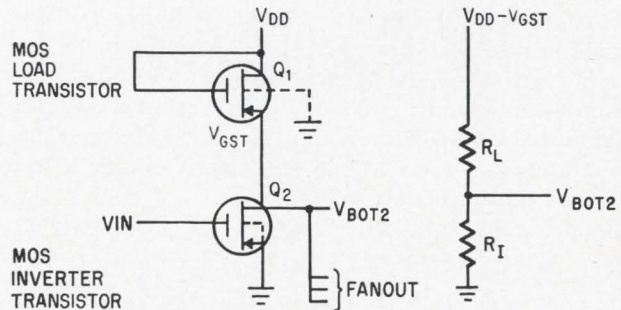

In the equivalent circuit for a switching function composed of an MOS inverter transistor and an MOS load transistor, R_L is the load transistor resistance, R_I is the inverter transistor resistance. The ratio of these two resistances when the inverter transistor is conducting determines the output voltage level. When the inverter transistor is off, the output voltage is nearly equal to V_{DD} .

the inverter transistor by controlling the transconductance.

The role of the transconductance ratio is demonstrated by referring to the equivalent circuit for a pair of p-channel enhancement transistors with a negative drain voltage supply (V_{DD}). This shows that a switching function can be represented by two series-connected resistors (these resistances are inversely proportional to the transconductance of the inverter and load transistors) as shown at the top of this column.

When the inverter transistor is turned on, the two equivalent resistors act as a voltage-divider network. Their values determine one of the logic potentials at their junction point. When the inverter transistor is off, the other logic potential appears at the junction point. This voltage will be more negative than the threshold voltage required at the gate of the inverter transistor to turn it on.

Using the ratio

To illustrate the role of the transconductance ratio, operation will be examined, first with a g_m ratio of 10, then with a ratio of 4. Assume the following operation conditions for the bottom cir-

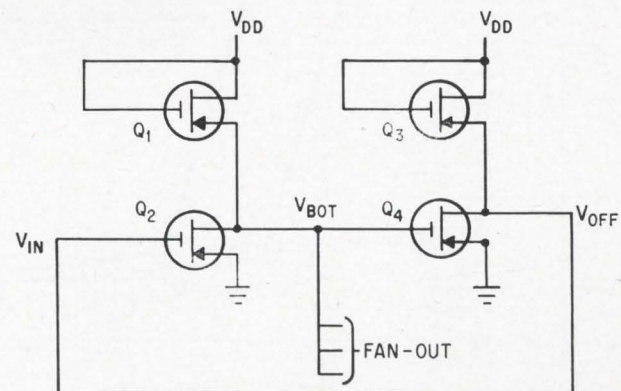

Two metal oxide semiconductor NOR gates in a cascade arrangement with feedback.

cuit on page 91): $V_{DD} = -15$ volts, g_m for $Q_1 = 10$ micromhos, g_m for $Q_2 = 100$ micromhos, $V_{in} = -8$ volts, V_{GST} for Q_1 and $Q_2 = -6$ volts, V_{GST} for Q_3 and $Q_4 = -4$ volts. The resistance of the conducting transistor is the reciprocal of the transconductance (refer to the equivalent circuit at the top of the preceding page):

$$R_{ON1} = (10 \times 10^{-6})^{-1} = 100 \text{ kilohms}$$

$$R_{ON2} = (100 \times 10^{-6})^{-1} = 10 \text{ kilohms}$$

The voltage at the output of the conducting transistor V_{BOT2} depends on the ratio of the two resistances:

$$V_{BOT2} = (V_{DD} - V_{GST}) \frac{R_{ON2}}{R_{ON1} + R_{ON2}}$$

$$= (15 - 6) \frac{10k}{100k + 10k} = 0.82 \text{ volt}$$

The circuit also shows two MOS NOR gates in cascade with a feedback connection, making a latch. Only noise can change the state of the latch. One of the inverter transistors is conducting and the other is off; this condition is permanent, since there is no provision in the circuit for changing it. In a nonfeedback configuration, the noise that can be tolerated is the maximum voltage fluctuation at the input of a circuit that does not affect the output. With feedback, noise tolerance is the voltage fluctuation that will not cause the latch to change its state.

In this circuit, if the first inverter transistor, Q_2 , is conducting and the second one, Q_4 , is nonconducting, the voltage on the feedback line is equal to the drain supply minus the threshold voltage of load transistor Q_3 , or:

$$V_{OFF4} = V_{DD} - V_{GST3} = 15 - 4 = 11 \text{ volts}$$

which is the input voltage to Q_2 . The noise tolerance or noise margin for the off transistor is the maximum fluctuation at its input that will not begin to turn it on. This is the difference between the output voltage of the on transistor and the threshold voltage of the off transistor, or

$$V_N(0) = V_{GST4} - V_{BOT2} = 4 - 0.82 = 3.18 \text{ volts}$$

The noise tolerance for the on transistor is the difference between the input voltage and the lowest voltage that will not begin to turn it off, or

$$V_N(L) = V_{in2} - V_{GON2} = 11 - 7.2 = 3.8 \text{ volts}$$

These tolerances are illustrated in the graphs below. V_{GON2} is read directly from the graph.

For a g_m ratio of 4, let the load transistor have a transconductance of 25 micromhos and the other parameters remain the same. Then R_{ON1} becomes 40 K and V_{BOT2} becomes 1.8 v, calculated as before. It then follows that the noise voltages are

$$V_N(0) = 4 - 1.8 = 2.2$$

$$V_N(1) = 11 - 9 = 2$$

Thus with a smaller transconductance ratio the noise voltages are lower, making the circuit is more susceptible to random fluctuations at its input. Moral: keep the g_m ratio high for a noise-resistant circuit.

In the examples that have just been discussed the effects of the potential between the source and the substrate on threshold voltage have been neglected. In actual practice, it may be necessary to take this voltage into account by increasing the threshold voltage applied to the MOS load resistor.

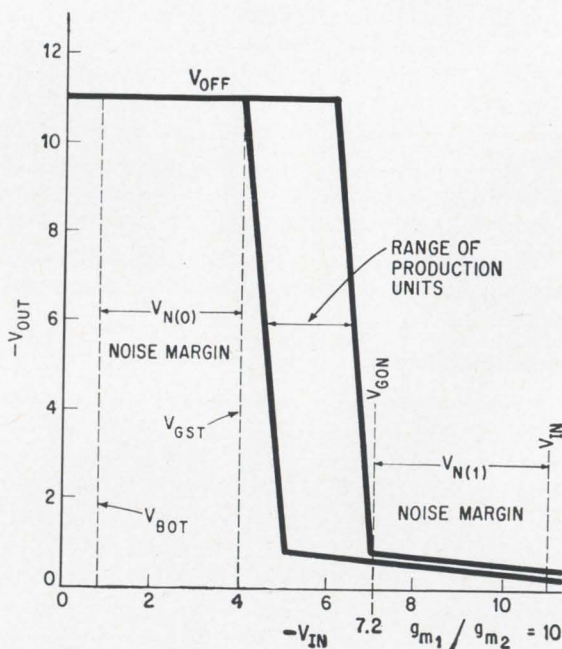
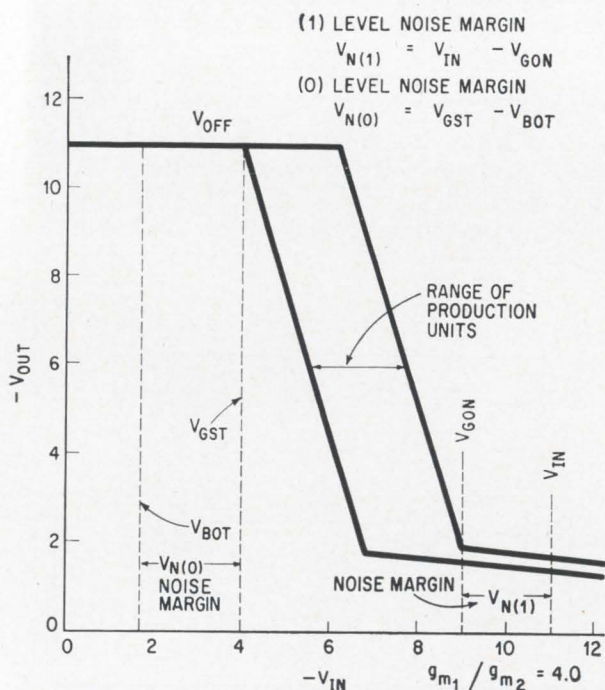

Input-output voltage characteristics for two sets of transconductance ratios. Noise margins are wider with higher transconductance ratios.

Logic functions in MOS

The design of MOS digital logic functions is straightforward and very similar to the design of conventional resistor-transistor or diode-transistor logic functions with epitaxial double-diffused transistors. However, the unique properties of the MOS device make possible new configurations that will be produced commercially by General Micro-electronics Inc. under the trade name SMAL, an acronym for synchronous memory all-MOS logic.

Combinational logic with MOS

The basic two-input NOR gate has already been described on page 90. The NOR function is realized with this circuit if a logical 1 is represented by the more negative of two voltage levels. If the more positive level represents the logical 1, then the NAND function is realized.

Simple logic functions can be implemented in MOS devices by connecting the transistors directly in series, as shown in the diagram at right. This kind of arrangement can seldom be used in transistor-transistor or diode-transistor designs using conventional transistors because of their lower input impedance, which allows some current to be drained off at the base.

The function implemented in the diagram, expressed in Boolean terms, is

$$AB + C = D$$

for which a block diagram is included. The OR part of the function is represented by the two parallel paths; the AND part by the two transistors in series. Both parallel paths must have the same total resistance in order to maintain the proper transconductance ratio between the inverter (logic) transistors and the load transistor; and this is where designers find that a penalty is levied for designing logic this way.

The resistance of the series transistors must be half that of the parallel transistor, or equivalently, the transconductance must be double; so that the area of the mask must be doubled. This is shown in the mask layout in the center diagram. However, even with this penalty of size, the whole logic function occupies a square only 0.004 inch on a side, the size of a single transistor made with epitaxial double-diffused techniques.

With the size penalty in mind, it is advantageous to design logical functions using as many parallel paths as possible, and a minimum of series paths—corresponding to many OR's and very few AND's. Various approaches can be used for some functions; an example is the half-adder, which produces the sum and output carry of two binary inputs. (A full adder also provides for an input carry; a parallel n-bit adder as used in most modern large-scale computers is made of one half-adder and n-1 full adders.) The diagrams on the following page show various implementations of a half-adder with logical diagrams and circuit diagrams using

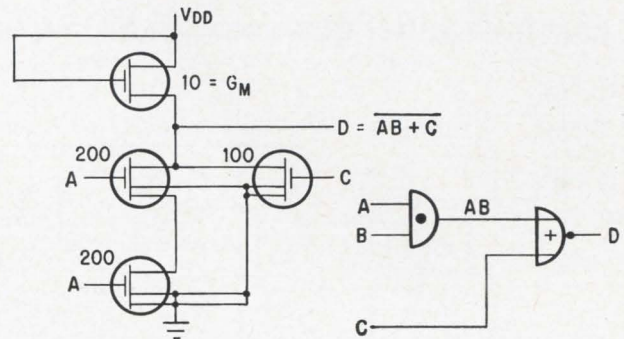

Simple logic function implemented in MOS devices. Note the series connection of two transistors, possible only because of the high input impedance and, therefore, negligible base current found with these devices.

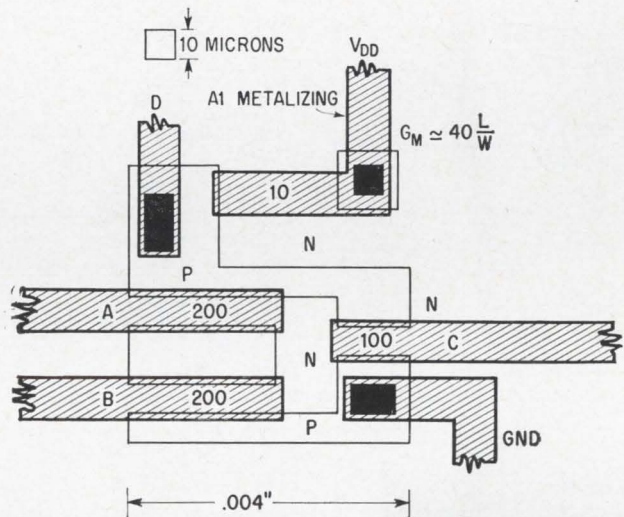

Mask layout to realize the function diagramed in the preceding illustration. The series connection on the left required twice the width for each transistor so that the total resistance of the series branch equals that of the parallel branch on the right.

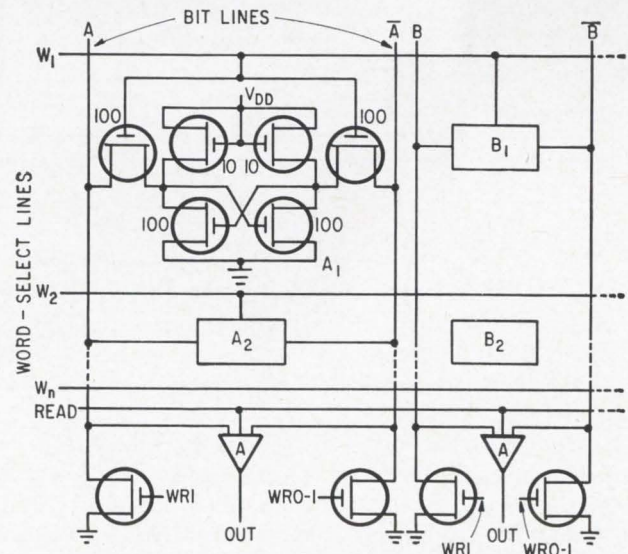

Nondestructive word-select memory laid out in MOS transistors. Each block represents a flip-flop which stores a single bit; one such flip-flop is shown in detail at the upper left.

Five half-adder designs with MOS transistors

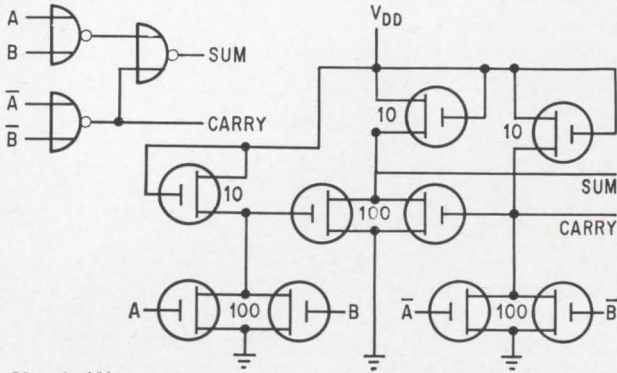

Circuit (A)

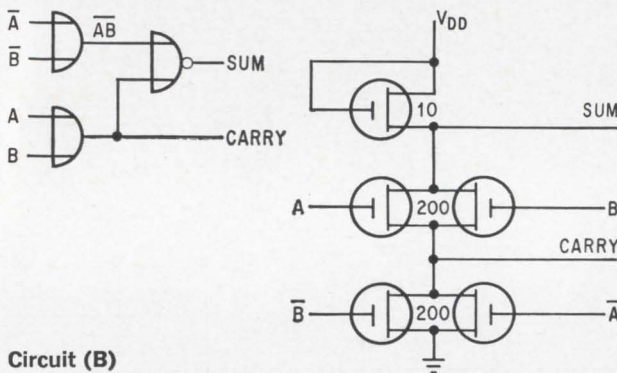

Circuit (B)

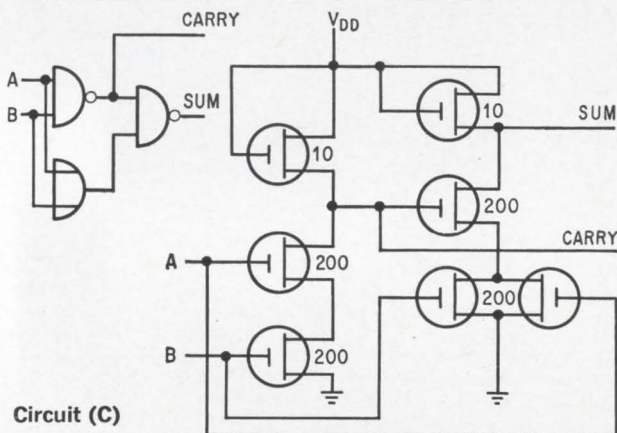

Circuit (C)

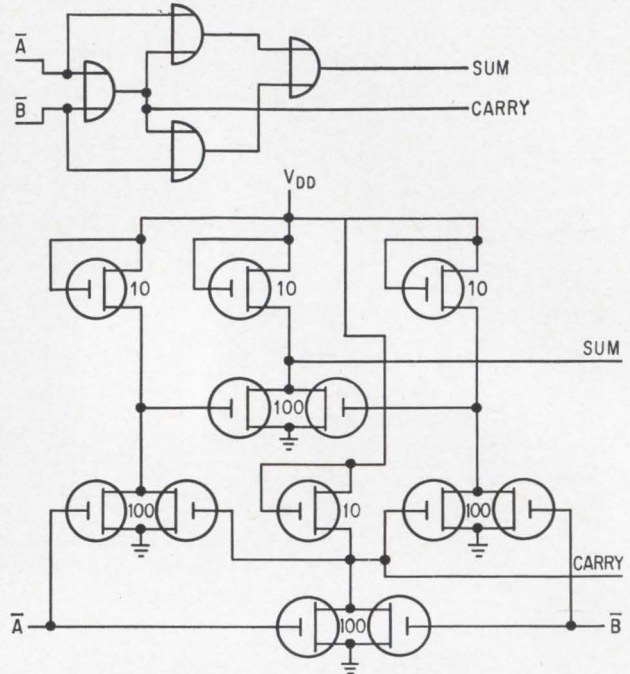

Circuit (D)

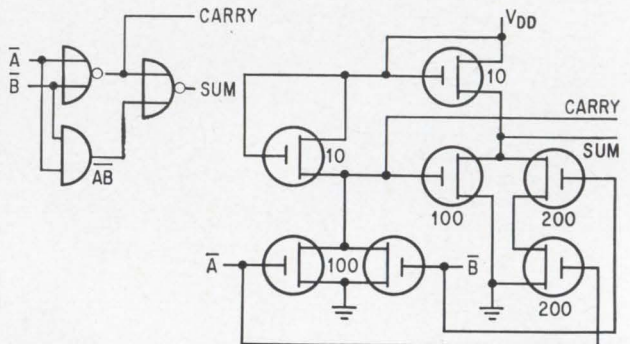

Circuit (E)

Circuit (A) is physically the smallest; circuit (B) uses the fewest transistors. A negative level represents a logical 1 in all cases except the carry output of circuit (C) and the sum outputs of (B), (C), and (D).

metal-oxide-semiconductor transistors.

From the point of view of total transconductance, and therefore total area on the chip, circuit A is the best, because it is smallest, but circuit E is close behind. Circuit B, on the other hand, uses the fewest transistors. Oddly enough, circuits C and E are logical duals; that is, one may be converted into the other by changing all AND's to OR's and all OR's to AND's, and inverting the signal levels. In most technologies, therefore, they would be equivalent; but when MOS transistors are used, circuit C is physically the largest, and therefore least desirable, of all the designs.

A master-slave flip-flop, sometimes called a latch-and-control-latch combination, is at the bottom, left,

of the next page. Several of these circuits can be put on one chip. Sometimes it is necessary to set a flip-flop with a timing pulse that is sampling an external signal. If a signal race exists, that is, if it is possible that the signal may change while it is being sampled, then the state of the flip-flop afterward is uncertain. The circuit shown offers one solution of this difficulty by setting the master flip-flop ahead of time with the leading edge of a timing pulse, and then transferring the state of the master to the slave with the trailing edge of the pulse.

Under certain circumstances transistors Q_{10} and Q_{12} can change state in opposite directions at the same time, as can Q_9 and Q_{11} . This in itself is a

signal race condition, which can be avoided by properly choosing the transconductance of the various transistors to guarantee that the slave does not turn on too soon.

A pure binary flip-flop, which changes state with every clock pulse (CP), is shown in the diagram at the right. Again, several circuits will fit on one chip. In this circuit, MOS transistors Q_4 and Q_6 act as capacitors. They isolate Q_7 and Q_8 from ground but allow them to conduct momentarily and alternately every time the flip-flop changes state. The flip-flop will operate with clock pulses of any frequency down to d-c. The circuit contains several sets of three threshold drops in series; for instance, Q_9 , Q_3 , Q_4 , requiring either lower threshold voltages or higher (negative) supply voltages for the circuit to operate properly.

An important combinational function which is easily implemented with MOS transistors is the matrix, used for decoding, binary-to-decimal conversion, and the like. An example is the binary-to-decimal conversion matrix (see diagram, bottom right). A four-bit binary number representing a decimal digit is placed in a register driving the eight lines A, B, C, D, and their complements. (The register could be made of flip-flops like those described on page 94). The bit lines from the register turn on or off selected MOS transistors in the matrix in such a way that the read pulse produces an output pulse on one and only one of the ten output lines, indicating the presence of a specific decimal number in the register.

A nondestructive, word-select, scratch-pad memory can be built from an array of MOS flip-flops,

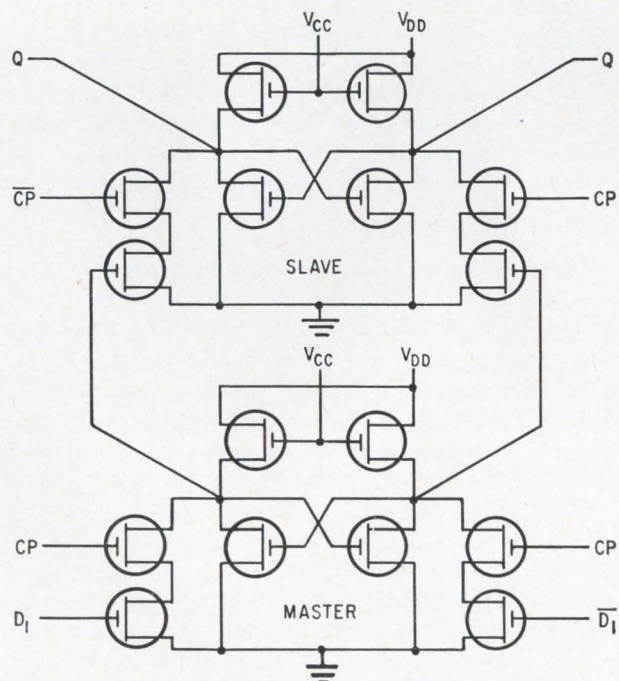

Master-slave flip-flop laid out in MOS transistors. The clock pulse, CP, sets or resets the master in accordance with input D; the state of the master is then transferred to the slave, which provides the output signals while D is free to change.

as shown in the diagram on page 93. To store data in the memory, the 1 or 0 bit line is enabled for each bit in the data, and the word line corresponding to the location in the memory where the data is to be stored is also enabled. The horizontal row of flip-flops corresponding to the location is thus set to match the data being stored. To read out a word in some location, the word line corresponding to that location is enabled, and the data stored appears on the bit lines and is gated by the read line into a set of differential amplifiers. A 1,000-word, 28-bit word length memory with an access time of one microsecond is feasible, packaged on about 30 chips, including the decoding matrix for the word select lines.

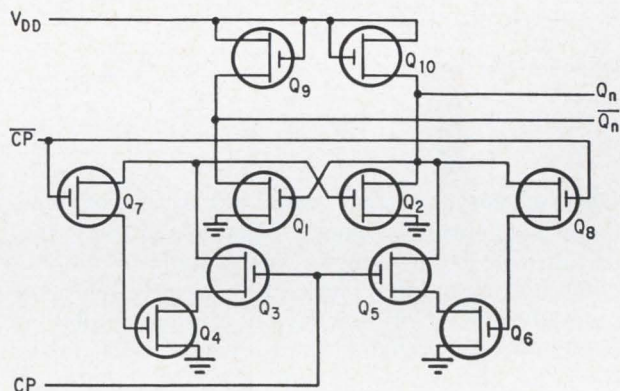

Pure binary flip-flop, in which MOS transistors Q_4 and Q_6 act like capacitors. The circuit will operate at any frequency down to d-c.

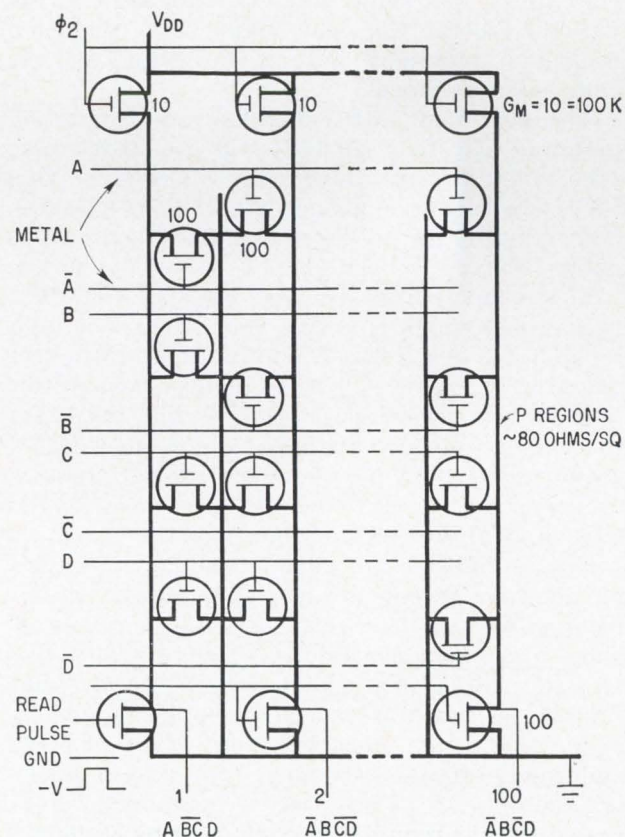

Binary-to-decimal converter made with MOS transistors, illustrating their application to matrix designs.

The expanding market

Reliability of MOS IC's looks good, their performance matches that of monolithic IC's, and low packaging cost keeps over-all system cost down

By Jerome Eimbinder

Solid State Editor

Only a year after they were first made commercially available by General Micro-electronics, Inc., metal-oxide-semiconductor integrated circuits are catching on rapidly. There still are only two commercial sources of the devices, but a number of companies are making their own or will furnish them as custom equipment, and the number of users is growing. The National Aeronautics and Space Administration, the Picatinny Arsenal, the Autonetics division of the North American Aircraft Corp., Astrodata, Inc., the Raytheon Co., the General Electric Co., and others have completed evaluation programs and are designing the circuits into equipment.

The next four IMP (interplanetary monitoring platform) scientific satellites will use digital data processing systems built with MOS IC's. One IMP subsystem containing 360 of them has been on continuous test for more than 6,000 hours without a failure.

"The supposed disadvantage of using MOS IC's is that not enough is known about their long-term reliability," says Hosea D. White, Jr., IMP project engineer. "Actually, their reliability looks better than anything we've ever used." White adds that the circuits provided the best way to meet IMP's requirements from the standpoint of performance at low power levels, minimum number of parts, and rapid breadboard-to-production time.

Double-diffused, epitaxial monolithic integrated circuits have become established in military equipment in the past two years for just such reasons, and the commercial market is opening up. But overall costs for systems built with IC's have not dropped as much as expected, despite reductions in the cost of the circuits themselves. High packaging and testing costs have kept system prices up. Since MOS IC's reduce the number of integrated circuits required in equipment by 60 to one or better, they should provide huge savings in packaging and testing.

In space and on earth

Although the IMP D satellite, the next to be launched, will mark the first use of MOS microcircuits in a space vehicle, they are already operating in ground support data acquisition equipment being used by NASA.

In addition, MOS integrated circuits are being used as timing devices in Army artillery shell fuses, and Raytheon is putting them in a line of commercially available logic modules. Another company, the Victor Comptometer Corp., will soon offer a desk-top calculator built with MOS IC's.

General Electric is using MOS IC's in special-purpose computers built by its Light Military Electronics department. C. W. R. Hickin, an engineer with the department's advanced computer engineering group says, "We evaluated MOS shift-registers earlier this year and found them excellent devices for small-computer memories."

Evaluation programs

Many evaluation programs are still going on. The Air Force's Electronic Systems Division is taking a close look at several MOS IC data handling systems built with microcircuits made by the Radio Corp. of America. It is also funding the development by RCA of complementary MOS IC's (microcircuits in which n-channel and p-channel field effect transistors are contained on the same chip).

The Sperry Gyroscope Co., a division of the Sperry Rand Corp., has been evaluating MOS integrated circuits since last December. Carl Sarine, an engineer in the company's submarine and anti-submarine warfare operation, says that his group is very impressed by the tests, but intends to continue them for at least another six months before making any definite decisions. He cites the low power dissipation of MOS microcircuits, their ability to reduce the size of systems, and their potential low cost, as key factors for Sperry's de-

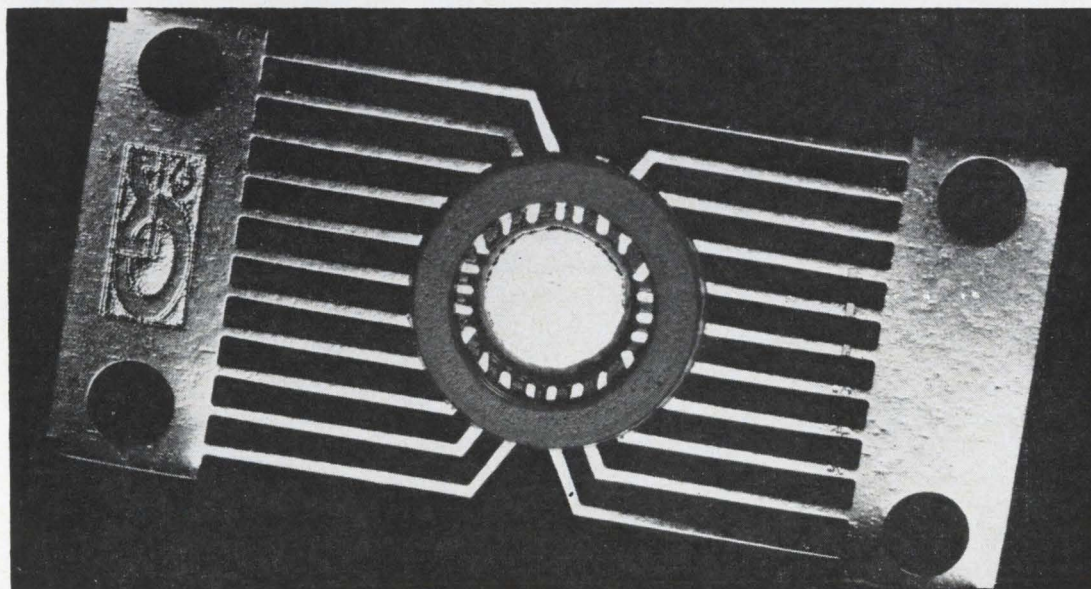
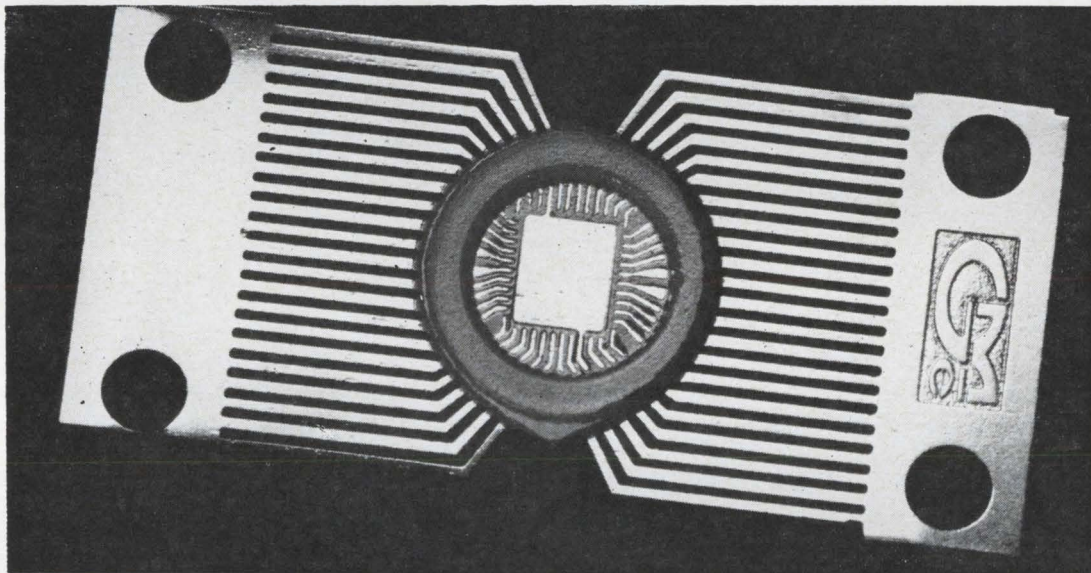
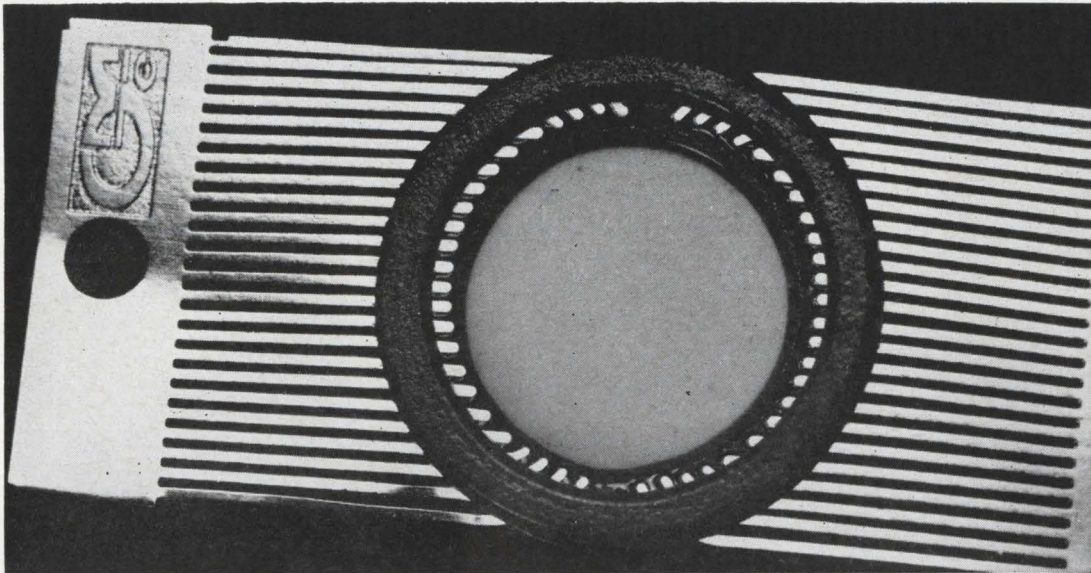

Circular packages with 48 leads (top photograph), 44 leads (center) and 22 leads are planned for complex MOS integrated circuits by General Micro-electronics, Inc.

Commercially available MOS integrated circuits

Mfr's No.	Function	Mfr	Price in quantities of:	
			50 to 99	100 to 999
MEM501	21-bit shift register.....	GI	\$62.25	\$50.00
MEM501-1	21-bit shift register.....	GI	82.50	67.80
MEM521	21-bit shift register.....	GI	65.25	52.50
MEM521-1	21-bit shift register.....	GI	85.00	69.80
MEM529	RST flip-flop.....	GI	10.00	8.80
			50 to 199 units	1,000 units
pL4C01	BCD decade counter.....	GME	34.50	19.40
pL4G01	Dual 41-1 input gate.....	GME	12.60	7.10
pL4G02	BCD-to-decimal decoder.....	GME	35.10	19.70
pL4G03	BCD-to-binary converter.....	GME	21.60	12.20
pL4R01	9-bit shift register parallel-to-serial converter.....	GME	39.95	22.30
pL4R02	9-bit shift register serial-to-parallel converter.....	GME	39.95	22.30
pL4M01	Dual J-K flip-flop.....	GME	16.40	9.25
pL4S01	Four-channel analog switch.....	GME	28.80	21.80
pL4S02	Digital-to-analog converter storage register.....	GME	38.70	16.20
pL5050	Dual decade counter.....	GME	29.75	18.00
pL5100	100-bit shift register.....	GME	52.00	30.00
pL5120	Dual 20-bit shift register.....	GME	56.00	32.50
pL5150	Dual 50-bit shift register.....	GME	56.00	32.50
pL5172	72-bit shift register.....	GME	56.00	32.50
pL5208	Dual 8-bit shift register.....	GME	44.60	27.85
pL5216	Dual 16-bit shift register.....	GME	44.60	27.85
pL5220	Single 20-bit shift register.....	GME	37.80	21.85
pL5232	32-bit shift register.....	GME	41.50	25.80
SC1170	3-input gate.....	GME	8.05
SC1171	Low-power binary.....	GME	11.90

GI: General Instrument Corp.
GME: General Micro-electronics, Inc.

cision to consider using MOS IC's.

Other companies that have bought quantities of MOS IC's and are currently conducting evaluation programs include the Nortronics division of Northrop Corp., the Lockheed Aircraft Corp., the American Machine and Foundry Co., and Litton Industries, Inc.

Little competition

The General Instrument Corp. and General Micro-electronics are the two commercial suppliers. The Semiconductor division of the Fairchild Camera & Instrument Corp. has been supplying custom MOS IC's for several months, but has no immediate plans to announce a commercial line. RCA's Somerville, N.J. semiconductor operation is supplying samples of digital MOS IC's containing 300 transistors, to other RCA divisions. An RCA spokesman says that these circuits will be put on the open market in a few months. Stewart-Warner Microcircuits, Inc., a subsidiary of the Stewart-Warner Corp., says it will deliver MOS IC's on special order but won't add them to its current IC line at this time. All of these companies also market double-diffused monolithic circuits.

At least two other companies, Autonetics and the Hughes Aircraft Corp., have also been making MOS integrated circuits, but primarily for evaluation purposes. One of the MOS IC's built by Autonetics is a digital differential analyzer (DDA)

integrator. It measures 240 mils by 100 mils and contains over 800 MOS transistors; Autonetics says it is equivalent to 100 conventional integrated circuits. The company is using its Recom III computer in producing optical masks for MOS IC's. A numerically coded description of the IC layout is fed into the computer; the computer then punches a paper tape which drives the mask-producing coordinatograph.

1,000 transistors on a chip

The first commercially available MOS integrated circuit was a 120-transistor, 20-bit shift register. More recently, MOS integrated circuits with up to 615 transistors and 100-bit capacity have been announced by General Micro-electronics. General Instrument is supplying one of its customers with a custom MOS IC containing 800 transistors (though its commercial MOS IC's contain only 170 transistors). Both companies say they can put up to 1,000 MOS transistors on a chip. And they both expect to market linear MOS integrated circuits within six months.

General Instrument is also selling multichip circuits which contain both MOS and conventional chips in a single package. It is investigating integrated circuits with both MOS and conventional double-diffused transistors on the same chip, but considers this project still in the experimental stage.

Designer's casebook

Designer's casebook is a regular feature in Electronics. Readers are invited to submit novel circuit ideas, packaging schemes, or other unusual solutions to design problems. Descriptions should be short. We'll pay \$50 for each item published.

Phase demodulator needs no tuning

By Harry F. Strenglein

Sperry Microwave Electronics Co.,
Division of Sperry Rand Corp.
Clearwater, Fla.

A phase sensitive demodulator that needs no tuning can be made to operate over a frequency range between 1 kilocycle and 20 megacycles. In the circuit, which can be used in phase-locking applications, both inputs may be single-ended.

Transistors Q_1 and Q_2 form a difference amplifier for a signal at input 1. This signal appears simultaneously on the collectors of Q_1 or Q_2 , but 180° out of phase. A signal at input 2, in common mode with input 1, is applied to Q_3 , and appears in phase on the collectors of Q_1 and Q_2 . When the two input signals are in quadrature, the vector sum of their components at the collectors of Q_1 and Q_2 are equal, and the diodes produce equal positive and negative voltages, yielding zero volts at the output. For other phase relationships, the signal components produce a difference voltage.

The output need not be referenced to ground. If the inputs vary much in power, limiters must be used at each input. With one volt of each signal appearing on the collectors, an output of 0.8 volt is obtained for a 45° phase shift.

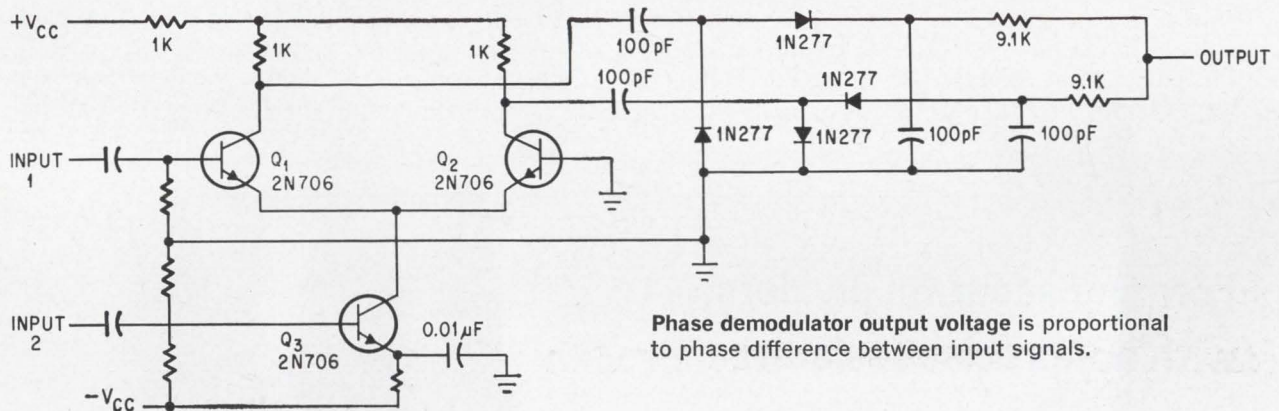

Phase demodulator output voltage is proportional to phase difference between input signals.

Modulated pulse width converted to analog voltage

By Dennis Knowlton

The University of Wyoming, Laramie

A pulse-width modulated signal is converted into an analog voltage, which is often required in control and telemetry applications, by the circuit shown on the next page.

Basically, the circuit integrates the incoming pulse and holds the final value until the next pulse arrives, at which time the output returns to zero for the next integration. By determining the constant of integration (capacitor charging current) the relationship between pulse width and analog voltage is established. An input pulse train and the resulting output are shown by the waveshapes in the diagram. With a simple low-pass filter, the desired analog voltage can be obtained.

The incoming pulse is first differentiated by C_1R_1 to give an impulse to transistors Q_2 and Q_3 . These two transistors are connected in a silicon-

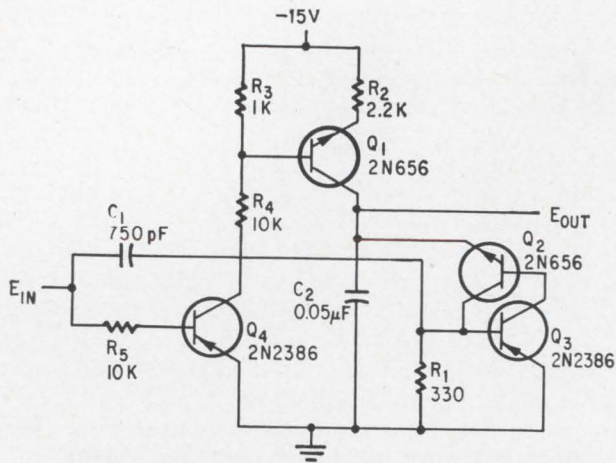

Demodulator converts input pulse duration to a proportional analog voltage value. Demodulation is accomplished by linearly charging C_2 through a constant current source, Q_1 , for duration of input pulse.

controlled switch arrangement. The impulse signal causes Q_2 - Q_3 to switch on and discharge C_2 to nearly zero volts. When C_2 can no longer furnish current to Q_2 and Q_3 , they turn off, and C_2 is charged from the constant current source Q_1 for the duration of the pulse. This linear charging is equivalent to integration; therefore, the output voltage is directly proportional to the area under the pulse. Consequently, the capacitor voltage is proportional to the pulse width (assuming con-

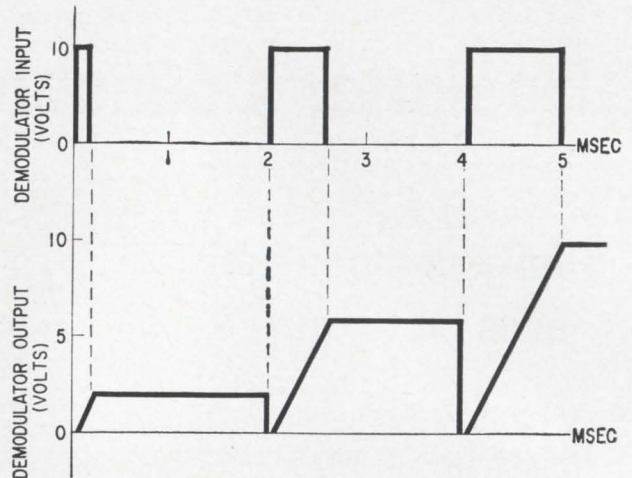

Waveshapes of demodulator output for three input pulse widths. Output voltage is held constant at termination of input pulse.

stant pulse amplitude). Transistor Q_4 switches the current source on and off with the input pulse.

The output cannot be excessively loaded, as any current drain makes the integration nonlinear. A metal oxide semiconductor field effect transistor in a source follower configuration is recommended as an output buffer. If cost is a factor, a Darlington emitter follower may be adequate.

For the components shown, the demodulator will give a 0-10-volt output for a 0-1-microsecond pulse.

Forming accurate dividers with nonprecise resistors

By Robert P. Owen

Owen Laboratories, Inc., Pasadena, Calif.

The accuracy of each step in a multistep voltage divider can be much greater than the tolerance of its individual resistors if the exact values of the resistors are known and if the resistors are arranged in the most efficient way.

Ratio errors in the divider can be held to a minimum by connecting the least accurate resistors near the center of the divider string—where the effect of variations from the average is least—and connecting in sequence resistors that are alternately higher and lower than the average by the same amount (as nearly as possible); this prevents cumulative error in the divider.

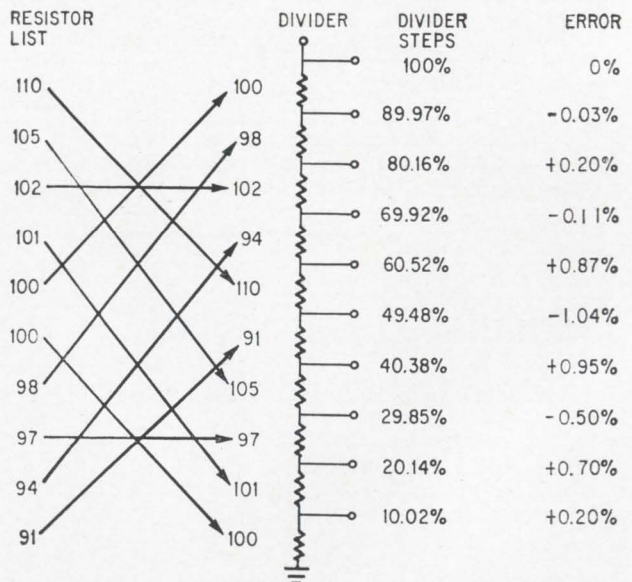

Error in multistep voltage divider is 1% even though tolerance of the individual resistors is $\pm 10\%$.

Chips are down in new way to build large microsystems

Ordinary integrated-circuit chips, without leads or packages, are bonded ultrasonically in one shot to thin-film conductors to build a high-speed memory, only 3 by 4½ inches, with 180 circuits

By Max Bialer and Lt. Albin A. Hastbacka, Wright-Patterson Air Force Base, Ohio, and Thomas J. Matcovich, Univac division, Sperry Rand Corp., Blue Bell, Pa.

An exceptionally fast memory system, fabricated entirely on a small plate of glass, is being developed to prove out a new way of assembling microelectronic systems with large numbers of different types of integrated circuits.

The assembly technique, called face-down bonding, is the latest stage in the evolution of simpler, more effective and more reliable methods of pro-

ducing microelectronic equipment. It enables uncased, leadless, but otherwise ordinary integrated circuit chips to be interconnected with thin-films.

Face-down bonding should find wide use in complex systems, since it offers solutions to a number of assembly and design problems posed by the use of packaged circuits. Packages and wire leads are eliminated by turning each chip face down and welding the conventional thin-film contacts on the chip directly to conductors on the substrate, as shown at right.

An ultrasonic method of face-down bonding, developed as part of an Air Force contract to develop advanced manufacturing techniques, is used to make the small, high-performance memory system. Preliminary test results indicate that the method is practical.

Under the contract, techniques for testing and manipulating uncased chips, and equipment for fabricating and testing the memory planes also have been developed, along with the memory and circuit design.

High-speed memory

All of the memory circuits—approximately 180 chips—plus 1,536 bits of thin-film magnetic storage and the thin-film interconnection wiring are on a glass substrate measuring 3 by 4½ by 1/10 inches. The circuits occupy about half the substrate area. The extremely small physical size of the memory, the shorter signal paths, the elimination of redundant connections, which packaged circuits would have required, all contribute to an improvement in system speed.

The 64-word memory has a cycle time of about 250 nanoseconds (see page 109 for design details).

The authors



Max Bialer, a senior project engineer in the Air Force Materials Laboratory, is responsible for developing solid-state manufacturing technology. He manages programs in microcircuit and random-access mass memories, metal-oxide-semiconductor devices and computer-aided design and manufacturing.



Lt. Albin A. Hastbacka's main interest is memories for avionics systems. He is a computer project engineer with the Systems Engineering Group of the Research and Technology division at Wright-Patterson Air Force Base. Previously, he worked on thin-film memories at the Mitre Corp.



Thomas J. Matcovich heads the memory project at Univac's Engineering Center as the Molecular Systems Section engineering manager. His main research work, for nine years, was in magnetism and magnetic thin films. An electrical engineer with a Ph.D. in physics from Temple University, he joined Univac in 1955.

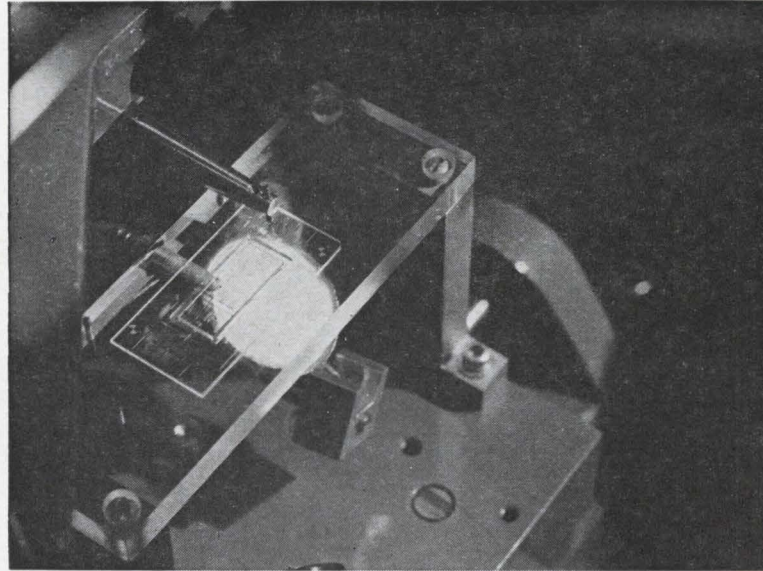
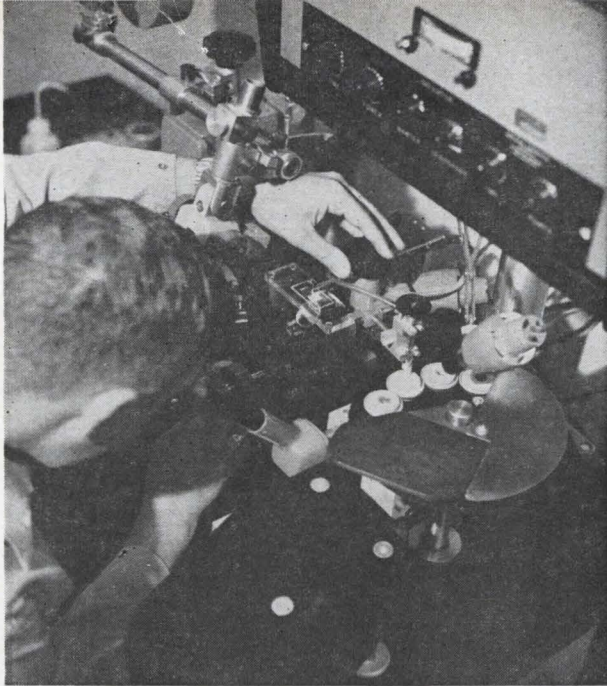

Ultrasonic bonder is set up to weld integrated-circuit chip to glass substrate. The operator peers through a microscope to align the bond points. Although this looks like a fussy, time-consuming operation, it is far faster than conventional circuit-assembly methods because all contact points are welded simultaneously. The substrate is seen in the closeup.

Plans are to build a 256-word memory that is equally fast and expectations are that eventually 50-nanosecond memories can be built with similar design and fabrication methods.

Chips are conventional

Most microcircuit systems are made now with monolithic or hybrid integrated circuits that are packaged. There are discrete leads inside and outside the packages and between the packages. Some modules are built with several integrated-circuit chips bonded face up to thin-films and connected to the films with discrete wire leads.

No discrete leads are needed when the chips are bonded face-down. Some techniques which resemble face-down bonding are now in commercial use. However, they are used to make hybrid integrated circuits rather than systems and depend for their effectiveness on special construction or preparation of the semiconductor devices used [see, for example, *Electronics*, June 28, 1965, p. 66 and p. 68].

Only the functions of the circuits being used in the new memory are custom-designed (the circuits are made by the Semiconductor Products division of Motorola, Inc.). The surface wiring on each chip is the standard form of aluminum thin film which connects the circuit components and terminates in the type of bonding pad normally provided for the thermocompression bonding of lead wires. The chips are 50 mils (0.05 inch) square, a standard size for monolithic silicon circuits.

The circuits include bit drivers, two types of word drivers, selection matrixes, sense amplifiers and data registers.

Key factors in the successful bonding of the

chips to the thin-film conductors are:

- Conductors on the substrate are evaporated aluminum, making that wiring compatible with the thin-film wiring on the chips.
- Raised bonding pedestals, also aluminum, are provided as part of the conductor pattern, as shown on page 104.
- All the chip-to-pedestal bonds are made simultaneously by the ultrasonic welder illustrated above. Typical chips, such as those shown on the next page, require 10 bonds.

Pros and cons

The method does have its disadvantages. The capital investment in equipment is high—primarily

Goal: better systems

Although integrated circuits reduce system power and weight, their small size poses cost and reliability problems. Assembly and test techniques, scaled down to suit circuit size, are needed to fully exploit the many potential advantages of integrated circuits.

To devise such techniques, a memory development contract was awarded to the Univac division of the Sperry Rand Corp. by the Manufacturing Technology division of the Air Force Materials Laboratory. The contract (AF 33(615)-1405) is part of the Air Force manufacturing methods program, which has the broad objectives of developing timely manufacturing processes, techniques and equipment.

Many of the techniques that Univac is using to make the memories can be used to make any multi-chip integrated-circuit module. The progress achieved so far demonstrates conclusively, the authors believe, that low-cost highly-reliable modules can be produced in quantity with evaporated wiring and uncased chips.

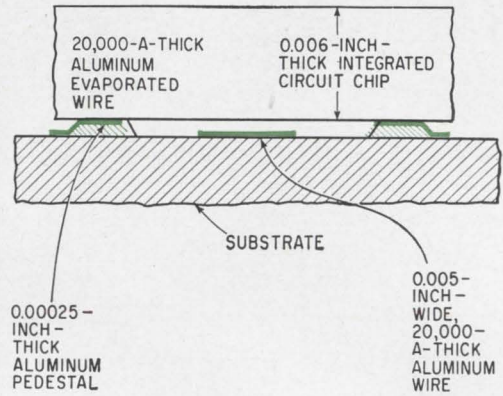
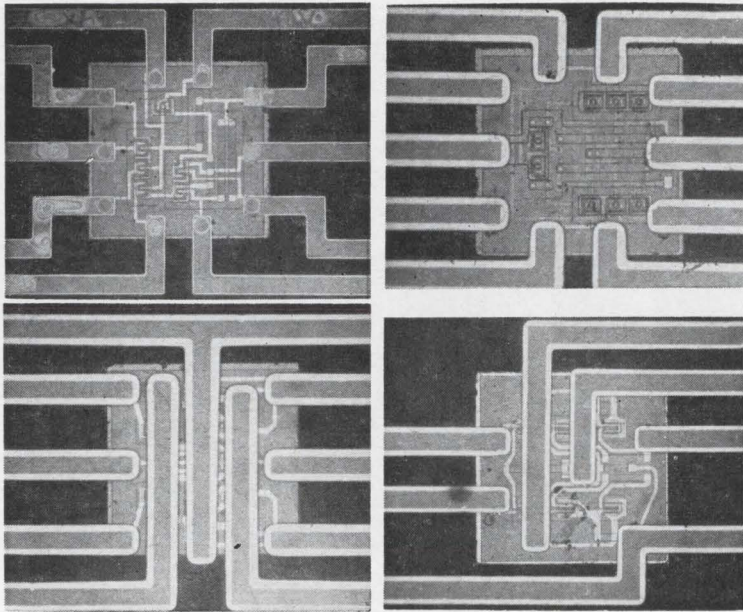

Photographed through glass substrates, these are chips face-bonded to thin-film conductors. The wiring and pedestals on the substrate are shown in color in the drawing.

in the vacuum equipment. It is difficult to modify the design of evaporated wiring. To make circuit operation stable in adverse environments, it is desirable to passivate the circuit chips with glass. Before great numbers of uncased chips can be concentrated safely in a small space, further work on thermal design is advisable. The industry lacks experience in using uncased circuits and there is insufficient test data.

Some of these problems can be minimized by careful planning. The techniques will undoubtedly be further simplified and improved as investigations continue. A long-range evaluation indicates that the advantages heavily outweigh the disadvantages. These are some of the benefits that can be obtained by eliminating the circuit packages:

- The lead wires and extra bonds needed to package a circuit are additional sources of potential failure. Eliminating them increases reliability.
- Circuit costs may be reduced in some cases to 10% that of packaged circuits, due to elimination of packaging materials and labor.
- The system designer has greater freedom. The cost and size reductions make it economical to build modules that are functionally larger. The designer can locate module interfaces where they satisfy design requirements, rather than where they satisfy restrictions imposed by cost and conventional assembly practice.
- Shorter signal paths are an advantage in high-frequency systems, as well as in high-speed memories and logic systems.
- More circuits can be interconnected within a module, minimizing external connections.

Memory fabrication

The memory fabrication cycle is illustrated on page 105. The copper ground plane serves as the conductor for electroplating the magnetic alloy.

The alloy is etched to form an array of dots like that shown on page 109 and the magnetic properties of the dots are measured. Sense and word lines and the wiring to which the integrated-circuits are attached are formed through masks by vacuum deposition. Word lines are on 0.02-inch centers and the bit-line doublets on 0.06-inch centers. After the wiring is tested, the chips are attached, the memory is tested under operating conditions, encapsulated, and finally retested.

Faster bonding, ultrasonically

The ultrasonic bonding procedure is many times faster than hand wiring of conventional circuit modules. Calculations indicate that it is even faster than the automatic wire-wrapping machines used to make wiring matrices for large systems. The procedure is simple, and yields are high. The bonder can be regulated to provide specific bonding conditions for different lots of chips.

Besides making all the bonds to a chip simultaneously, ultrasonic bonding is a relatively cool process. The high temperature required or generated in other bonding methods could damage important elements of a module—in this case, the memory bits. Thermocompression bonding, germanium eutectic welding, and various low-temperature soldering schemes were considered but were not desirable.

The ultrasonic bonder incorporates a standard 20-watt Sonobond welder made by Aeroprojects, Inc. Kulicke and Soffa Mfg. Co. built the bonding machine. The transducer (bonding tool) was redesigned to eliminate undesirable vibration modes; a needle-point transducer tip proved most successful. Good mechanical and electrical connections between 10-pad chips and sets of 10 pedestals are made by setting the bonding time at 1.4 seconds, the bonding power at 5 watts, and the clamping force at 3 pounds.

The machine operator uses two stations, mounted side by side: a pickup station and a bonding station. The pickup station has a rotating table. Transparent glass windows are mounted in a series of holes in the table near its edge. An optical system that is mounted near the table allows the operator to look up through the windows at chips placed on them. He rotates the table to select a chip, picks up the chip with a vacuum pickup probe, and rotates the pickup until the chip is in the correct position for bonding.

The chip is transferred, with the pickup, to the glass substrate of the memory. Another set of optics enables the operator to look up through the substrate and put the chip's pads on the set of pedestals. The bond is then made with the ultrasonic transducer. The silicon body of the chip transmits the transducer energy to the junctions of the pads and pedestals.

Bonds are strong

Tests on sample assemblies indicate that the bonds have excellent strength and low resistivity. For example, four assemblies of six chips potted with silicone gel were subjected to military-type vibration, mechanical shock, and temperature-humidity tests. None of the bonds failed.

Another series of tests showed that raising the clamping force from an average of 0.6 pound to 3 pounds raised the force required for shearing the bonds from 250 grams to 550 grams. Chips bonded under a force of 3 pounds cannot be removed without causing damage to the substrate.

The environmental resistance of the integrated circuits is improved if they are coated with a passivation layer of glass. More complete protection is provided by encapsulating the assembly. Silicone gel is a promising encapsulant. Encapsulated modules are expected to prove as reliable as modules made of packaged circuits.

Power dissipation and cooling

Initially, it was planned to build the memory on a 2-inch-by-3-inch substrate. However, it was

found that due to the limited area available for mounting the integrated circuits, there were undesirable heat concentrations. Total power dissipation of the memory is estimated at 4 watts. In the new 3-inch-by-4½-inch layout, the chips are spread out over four times the area (chip mounting area is approximately 6 square inches), and the temperature rise is limited to about 40° C, a practical value.

The ability of heat generated in a face-down-bonded chip to be conducted through the bonds is another thermal consideration. Power dissipation tests indicate that face-down-bonded chips have a thermal resistance of 340° C per watt, 170% that of a flatpack. If the face-down-bonded chips are encapsulated, the heat conducted from the chips is increased approximately 30%.

Better thermodynamic design can be obtained by using a ceramic such as alumina, which is a good heat conductor, rather than soda-lime glass, which is not. Since ceramics are opaque, the present method of visual alignment of the chips to the pads during bonding could not be used. The alignment problem is not considered significant, since it can be overcome by adding an indexing system to the present bonding equipment.

Neither the thermal data nor the reliability data are considered conclusive, since they were obtained from short-term evaluation of sample assemblies. In the coming year, evaluations will be made on the basis of some three million sample-hours of integrated circuit operation.

Replaceable chips

For practical production of assemblies containing numerous chips, it is important that chips be individually replaceable in case some circuits in the final assembly are defective. This possibility has been provided for by a change in the pedestal design.

Initially, the pedestals were formed by etching them from the relatively thick copper film plated on the substrate to form the ground plane of the magnetic memory elements. The aluminum film for

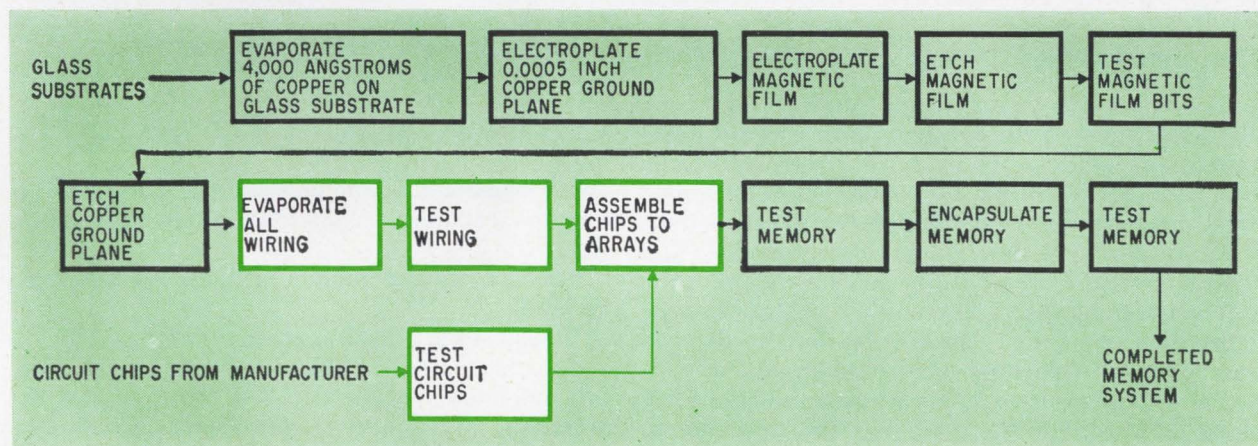

How to build a tiny memory: vacuum-deposit (evaporate) and plate the memory plane conductors, evaporate and etch the magnetic film, evaporate several layers of thin-film interconnection wiring for circuitry connections, add chips and test. Only the steps in color are needed for face bonding.

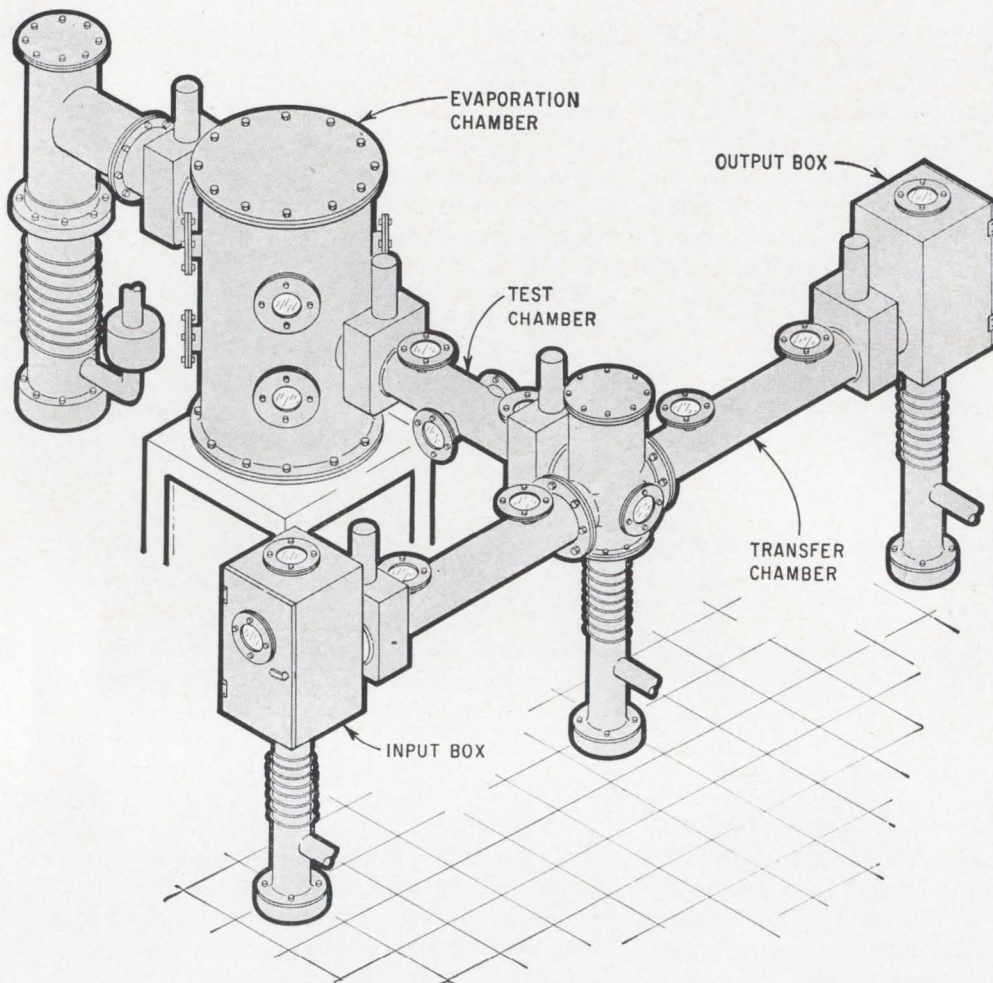

Trolleys carry substrates from the input box to the evaporation chamber. After the films are deposited in the chamber, the trolley carries the substrates to the output box.

the wiring was then deposited over the pedestals. This method is low in cost, but when chips were pulled off the pedestals, the aluminum film frequently pulled free of the copper, preventing re-bonding of chips to the pedestals.

The newer design, shown on page 104, has evaporated aluminum pedestals. In one test, 23 chips were removed from their pedestals and replaced with a second set of chips. All of the rebonds were good, and removal of the replacement chips required shear forces greater than the initial bonds withstood.

Evaporated wiring

The wiring is deposited in multiple layers on the substrate to provide short leads—an arrangement more efficient for logic circuitry—and maximum reliability. Silicon monoxide (SiO) is evaporated between the conducting layers for insulation. This approach is superior in that it provides for consistency in wiring quality and for volume production of modules at low cost. The high-vacuum deposition equipment can also be used to deposit resistors and capacitors on the substrate.

Vacuum deposition is disadvantageous in that deposition equipment is costly, the designer is limited in the component sizes and values he can use, and masks are needed for defining the deposited wiring and components. The need to use

and prepare masks makes changeover times long and limits the opportunity for modifying designs or making repairs.

The point in memory fabrication at which wiring is deposited is shown on page 105. After masks and substrates have been cleaned, inspected, loaded in respective holders, aligned, and set in the deposition equipment, the wiring is deposited. The following operations comprise a typical wiring deposition sequence:

1. Charging vacuum chamber evaporation sources and pumping down chamber to 10^{-6} Torr.
2. Depositing chromium bond layer.
3. Depositing aluminum pedestals, followed by SiO insulation.
4. Depositing aluminum sense lines, again followed by SiO insulation.
5. Depositing aluminum word lines and pedestal interconnect lines, again followed by SiO insulation.
6. Evaporating aluminum bit lines and additional pedestals.
7. Depositing a final, protective layer of SiO.

The thicknesses of the various layers are carefully monitored and controlled. Thicknesses vary according to circuitry requirements. Conducting lines are usually about 2 microns (20,000 angstrom units) thick, and insulating layers range from 2 to 5 microns thick.

The chromium bond layer improves adherence of the aluminum wiring to glass because chromium clings tenaciously to glass; however, chromium is difficult to etch. This difficulty does not pose circuit performance problems because the chromium layer is too thin to act as a conductor, but it does interfere with visual alignment of the chips to their pedestals.

A bond layer is necessary under the film of copper that is evaporated as the base for the memory ground plane, since copper does not adhere well to glass. A recently developed technique is to deposit a layer of aluminum-bronze under the copper. This material is better than chromium because it adheres well and can be etched with the same chemicals that etch copper.

Film adhesion can also be improved by ionically bombarding the substrates, a technique frequently used to clean contaminants from substrates before vacuum deposition.

Vacuum system design

A production vacuum system is being developed. The prototype, built by the Consolidated Vacuum Corp. under Univac specifications and direction, is shown on page 106, along with a drawing of the entire system. Each input and output box can hold 13 substrate holders. A mask changer fits in the evaporation chamber.

Here's how the system works: a trolley carries a substrate from the input chamber to the evaporation chamber. All the wiring is deposited in a sequence such as the one given, as the appropriate masks are brought into position under the substrate by the mask-changing mechanism and as the aluminum and SiO are evaporated from the sources. The trolley then carries the substrate to the output box and delivers a new substrate from the input box to the evaporation chamber.

When the substrate supply is exhausted, the input and output boxes are isolated from the system. The substrate supply in the input box is replenished and the completed substrates are removed from the output box. These boxes can be pumped down to operating pressure in 10 minutes, so the evap-

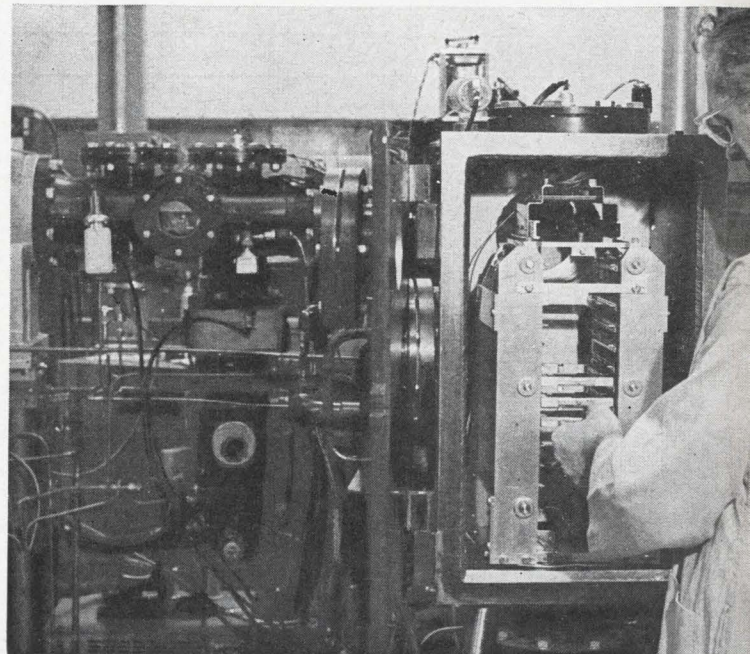

Substrates are loaded into input box. The box can be loaded while the vacuum system is operating. The substrate holder hoists the substrates up to the trolley.

oration process is not delayed for lack of substrates. It takes about 20 minutes to produce a fully wired plane.

The prototype system can easily be expanded by the addition of several more evaporation chambers. Multichamber system advantages include:

- Increased production by parallel operation.
- Continuous production by sequentially isolating single chambers from the system for routine maintenance.
- Combinations of high-vacuum and low-vacuum deposition techniques in different chambers. For example, sputtering, which requires a low-vacuum argon atmosphere, could be included in a multi-chamber system.

Test procedures and equipment

Apparatus and procedures for making d-c, a-c,

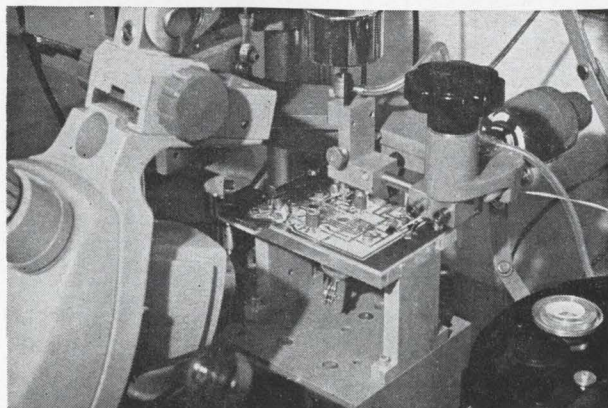

Chips are tested by pressing them on a set of pedestals connected to a test circuit (color). This allows the chips to be tested at their operating frequency as though they were already bonded in place on the system substrate.

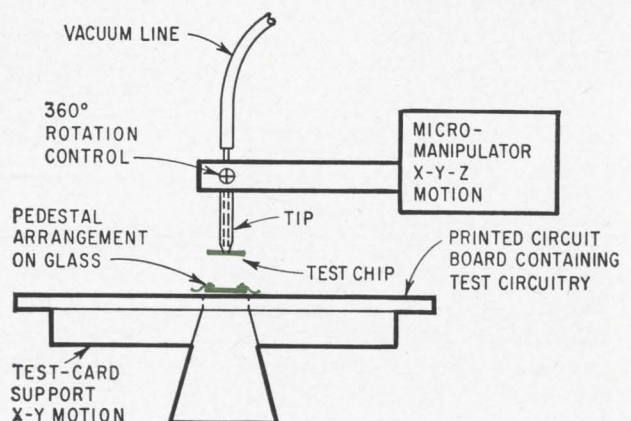

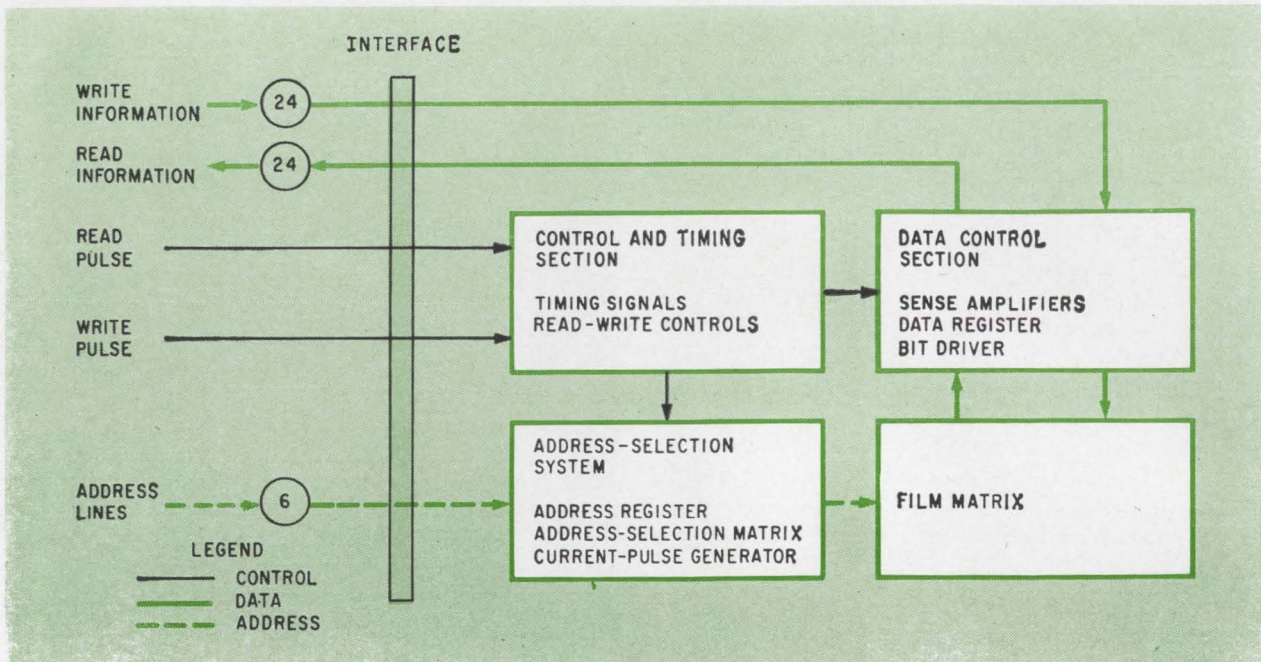

The interface marks the dividing line between the memory system and the computer or other system in which the memory would be used. All the circuitry to the right of the line is on the system's 3-by-4-inch glass substrate. The memory could be used as a scratchpad in a computer's central processor or in other applications requiring high speed.

and functional tests on uncased chips have been developed to support the memory development. Semiconductor manufacturers perform d-c tests on unpackaged circuits and do the remainder of the testing after the circuits are packaged. However, when the chips are to be face-down-bonded, all the tests must be performed before bonding to eliminate faulty chips early in the assembly process and to avoid replacement of chips.

The chips are difficult to handle because of their small size. This problem was solved by using a handling system like that used in the ultrasonic bonder. The chip is picked up with a vacuum pickup and pressed upon a special test substrate

with the aid of a micromanipulator (see p. 107).

The test substrate has pedestals for aligning with the bonding pads on the chip. The substrate is part of a functional test circuit assembled on an etched-circuit board, which is connected to appropriate test instrumentation.

The chip is pressed, by means of weights, firmly against the test pedestals to ensure good contact without damage to the chip or the pedestals. Test pedestals have been used more than 100 times without damage.

This setup has two significant advantages. First, the needle probes normally used to test unpackaged integrated circuits are not required. Steel-

Testing the magnetic thin-film plane provides a quality-control check before wiring is deposited. The plane is put face-down on an inverted set of sense and bit lines which energize 20 bits at selected locations.

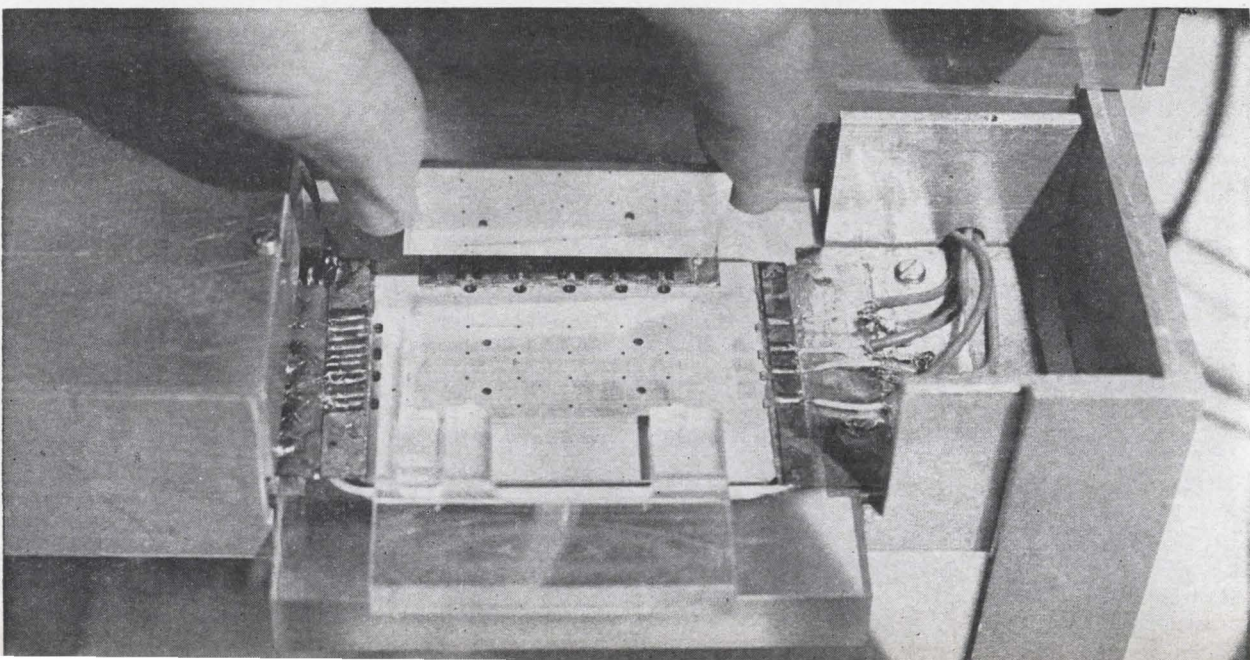

point probes rule out high-frequency tests, because of lead inductance, while the pedestals enable such tests to be made. Since test lead lengths are very short, circuits with rise times of only a few nanoseconds can be functionally tested by using pulse generators and a sampling oscilloscope. Second, the needle probes damage the contact pads while the pedestals do not.

The methods and equipment for inspecting the magnetic bits and evaporated wiring are also new. The properties of the magnetic-film dots are measured in a test setup which simulates memory operation. The plane is placed face down on a test substrate (photo, p. 108) having sufficient word and sense lines, in an inverted pattern, to operate 20 bits. This bit sample is distributed over the plane and is sufficiently large to indicate whether any area of the plane was improperly processed. The test is a process control check and also has the advantage of testing the magnetic elements independently of the actual wiring. Planes with de-

fective bits are rejected while their cost is still low.

After wiring is deposited, it is tested for continuity, short circuits, and resistivity. Connections are made by spring-type pressure contacts to the wiring pedestals. As a test preliminary, a current pulse is applied to the wiring to clean up the wiring contacts.

Word-organized memory

The memory is word-organized with a capacity of 64 words each 24 bits long. Cycle time is approximately 250 nanoseconds. Such memories are suitable for use as "scratchpads" operating within the central processor or input-output control systems of a computer.

The functional organization and the operational characteristics are shown at left. The magnetic storage elements are a 64 by 24 array of dots etched from a film of nickel-iron-phosphorus alloy plated over a copper ground plane. The layout of a single bit is shown below. This configuration reduces transient signals during read operations.

When an external read or write signal is received, the memory address is gated into the address register, and address selection begins. The outputs of flip-flop circuits in the address register are decoded to specify one word line. A word-current pulse is generated by means of a set of transistor switches and routed to the selected word line in the memory matrix. The word current rotates the magnetization of the film element under the word line, and readout voltages are induced in the sense lines linking the storage elements. Voltage polarity depends on the initial position of the magnetic vector. The polarity of the signal obtained for a stored "1" is opposite that for a stored "0".

The readout voltage is increased by a sense amplifier until it is large enough to trigger a data-register flip-flop. The flip-flop's state corresponds to readout-voltage polarity, which, in turn, corresponds to the binary identity of the data that were stored.

Since the readout is destructive, the information is rewritten in the film by means of a recirculation loop. The current pulse is passed down the bit line in the matrix during the fall time of the word current to restore the initial direction of magnetization. The polarity of the bit current is determined by the state of the data-register flip-flop.

During a write cycle, the sequence is similar except that the amplified readout signal is gated out directly and does not enter the data flip-flop. New information is gated into the flip-flop from the computer and is written into the memory by the bit current. One recirculation loop comprised of a sense amplifier, a data register flip-flop, and a bit driver is used for each bit in the word. It serves all the words in a plane. When the bit current pulse ends, the control and timing circuitry generates signals which reset the flip-flops in the data and address registers and restore the memory to its proper state in preparation for the next cycle.

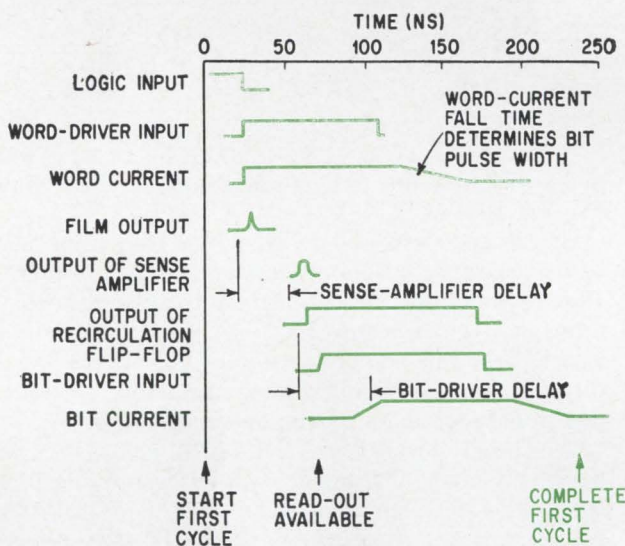

Memory cycle timing diagram. Times to perform each of the memory's read and write operations are measured in nanoseconds. The complete cycle takes 250 nanoseconds.

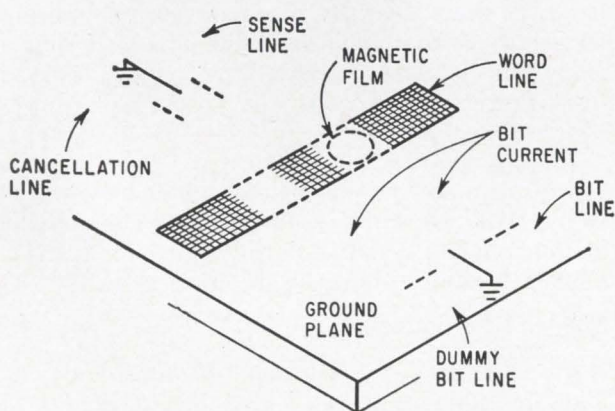

Single bit of memory is formed at the intersection of sense and word lines under the magnetic film. Double bit lines are used. This configuration reduces transient signals during read operations.

Powerful scr's, connected in parallel, control industry's biggest machinery

Silicon controlled rectifiers are paving the way for the extension of solid state technology into heavy industry. One system develops 12,000 horsepower to run a steel mill; another is used in a powerful electric truck

By Robert Cushman

Industrial Electronics Editor

The silicon controlled rectifier has extended the applications of solid state technology to the control of heavy industrial machinery. The manufacture of higher-powered scr's and the development of techniques for hooking up scr circuits in parallel are steadily increasing scr power capabilities to the multimewatt levels.

It is now practical to use solid-state controls in place of the motor-generator sets and ignitron drives for any electric motor—even the largest—that must have variable speed control. Since the first of this year, scr controls have proved their value on a 10-megawatt, 12,000-horsepower motor that powers a big steel rolling mill, and on the motor that drives one of the largest lift trucks ever built. These are both direct-current motors; a system has also been developed that substitutes scr circuits for mechanical commutation, and makes possible the use of solid state techniques to provide variable-speed control for the more economical alternating-current motors.

I. A 10-megawatt steel mill drive

The most powerful scr system at work in industry today is the 10-megawatt rolling-mill at the Bethlehem Steel Corp.'s new Burns Harbor, Ind. plant. This is a 12,000-horsepower d-c motor drive that propels the main plate-mill rolls, which squeeze inch-thick slabs down to 1/4-inch or less.

The tremendous drive power is needed because Bethlehem wants to achieve high production rates; to do so, it has to race a 30-ton slabs of steel back and forth through the rolls, making all the passes

necessary to reduce the dimensions, in less than five minutes.

At the same time, the drive is a true high-performance servo system. It not only has the large, 10-megawatt brute force power for rapidly accelerating and decelerating the huge slabs of steel; it also has the fine control necessary to pass the steel through the rolls evenly, thus maintaining close dimensional tolerances on the finished steel.

The heart of the Burns Harbor servo system is the block labeled "10-megawatt servo amplifier" in the schematic shown on page 112. The transfer function expected of this block can be determined by examining the inputs and outputs. A 20-volt input signal is expected to produce a 700-volt variation in output, driving into a 12,000 horsepower motor load. The typical operating traces diagramed on page 112 show what this means in terms of output current. Note that while the voltage is quite linear and controlled, the currents vary widely. This is because the motor's loads vary widely as the rolls handle the steel slabs.

Thus, while the nominal current to produce the system's rated power (actually 9.6 megawatts) would be 13,600 amperes, the currents can actually go much higher than this during transients (21,000-ampere peaks are shown in the trace).

Making scr's do the job

Available scr's by themselves control only 30-kilowatt (40-horsepower) loads. The designers of the Burns Harbor system—the switchgear department of the General Electric Co., Philadelphia—did not arrive at the 10-megawatt amplifier capability overnight. It took them (and their competitors

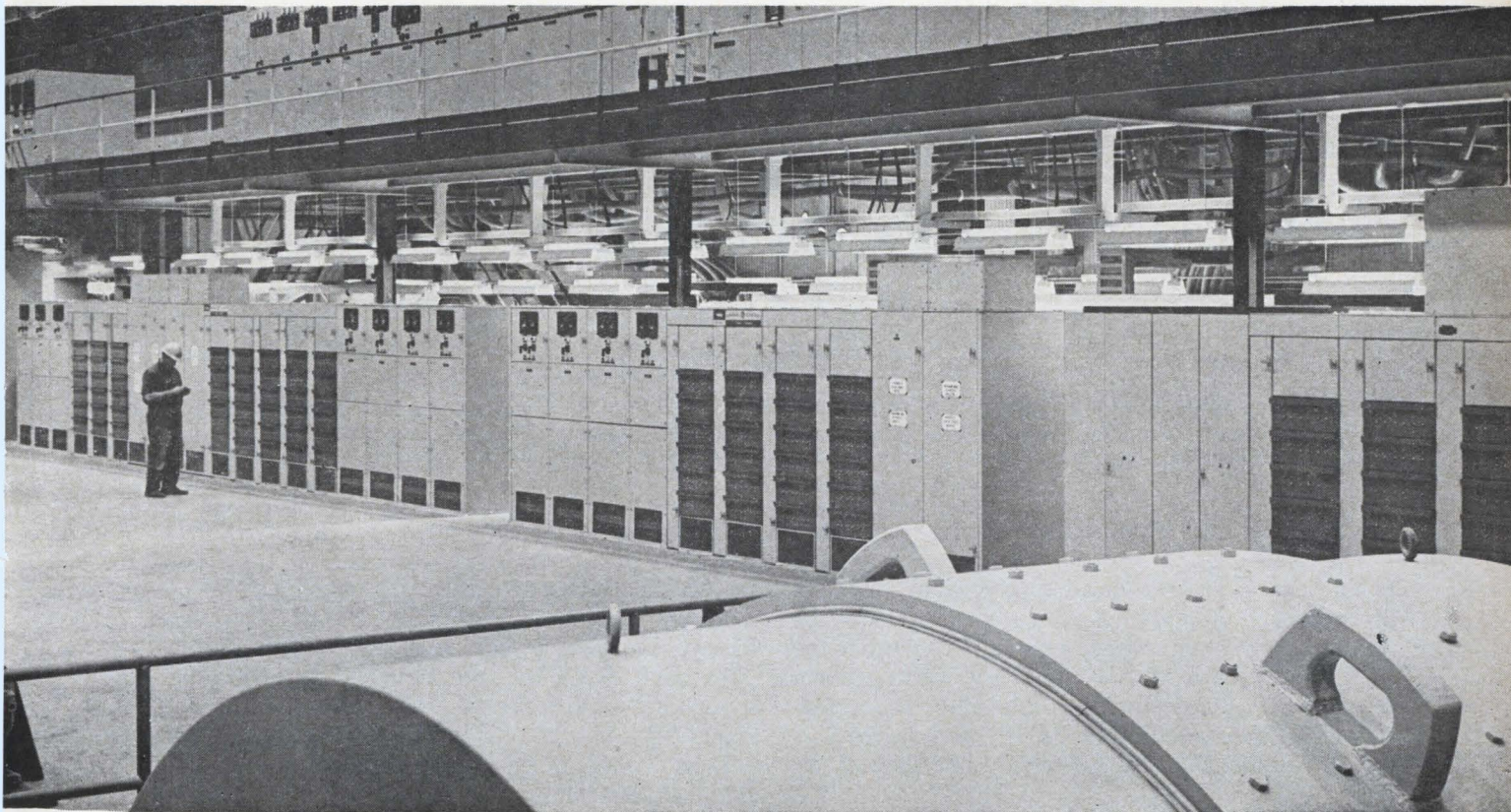

The 10-megawatt servo amplifier at the Bethlehem Steel Co.'s Burns Harbor, Ind., plant. The dark vertical panels are the racks that contain the amplifier bridges. Each rack has five 120-kilowatt bridges. The four racks of 20 bridges are all driven from a single trigger circuit module. Four of these 2.4-megawatt groups are needed to drive the large motor in the foreground in one direction. Another four are needed to drive it in the other direction. All eight are at the command of a single low-level control signal.

in large power systems) three distinct steps:

- Developing the basic bridge circuit for supplying controlled d-c power from three-phase industrial power lines.
- Increasing the voltage-carrying capacity of the basic bridge by putting scr's in series.
- Increasing the current-carrying capacity of systems built from the bridges by adding circuit modifications that permit the bridges to be paralleled.

Step 1: the basic bridge

The basic bridge converts the three-phase power delivered by the electric utility into the d-c that drives the motor. The basic circuit is shown on the right-hand side of the schematic on page 115. This type of three-phase bridge has been widely used for straight uncontrolled rectification for many years; before the advent of silicon diodes, it was used with mercury-vapor rectifiers.

The three-phase power-supply lines will produce the waveforms shown below the bridge. As each power line becomes the most positive of the three, current will flow in the upper arm of the bridge to which the power line is connected. As each power line becomes the most negative, current will flow in the corresponding lower arm.

At time t_1 shown on the waveforms, for example, electrons will flow from incoming power line B

through arm 6 to the negative bus at the bottom of the bridge, through the motor, to the positive bus at the top of the bridge, then down through arm 1 and out to power line A.

At time t_2 , line C becomes more negative than line B, and arm 2 will take over the function of supplying current flow in the lower half of the bridge. At time t_3 , line B becomes more positive than line A and arm 3 takes over the function of supplying current flow in the upper half of the bridge. In this way, each of the upper and lower arms of the bridge will successively take its turn during the power cycle. At any given time, one upper and one lower arm will be acting together to maintain d-c current flow through the motor.

Controlling the rectifier

When the scr's are triggered on at various points during their respective segments of the cycle, rather than at the start, the bridge effectively becomes a power amplifier rather than just a rectifier. The output voltage will vary according to the delay in triggering. If the signal to each scr is delayed for half the scr's 120° cycle, or 60°, the output voltage will be reduced by half. If it is delayed 120°, the bridge output will be zero. Actually, with an inductive load, such as a motor, a delay of 90° will produce a zero output for the bridge (and further delays will

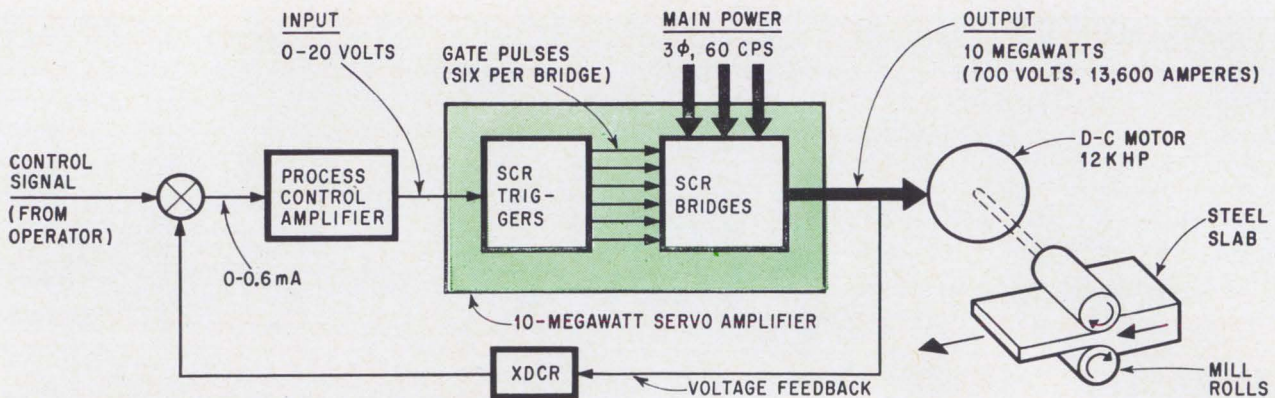

The servo loop in which the 10-megawatt servo amplifier operates. The amplifier is composed of scr bridges and the scr triggering circuits. Together, these circuits must take a 0-20 volt input signal and produce 0-700 volts output. (For simplicity, the identical bridge needed to drive the motor in the opposite direction is not shown).

produce negative output voltage during transients).

The second group of waveforms underneath the bridge circuit shows what happens when the scr's are triggered at a 30° delay. The shading indicates the portion of the power-line voltage cycle that the scr gates to the load. For simplicity, the waveform irregularities that would be produced by the inductances in the circuit (particularly by the power-transformer leakage reactance) are not shown.

Supplying the gating pulses

It takes a fairly complex circuit to supply the gating pulses for the scr's in the six bridges. The pulses must be always spaced 60° apart in each power-line cycle. Each arm's gating pulse must have the proper phase relationship to the anode voltage of the scr in that leg. All the signals must be simultaneously advanced or delayed at the command of the single control signal.

The circuit used at Burns Harbor to provide the triggers or gating pulses for the scr's in the bridge

is shown on the left side of the schematic on page 114. Only the circuit for arm 1 is shown; the others are identical except for different phasing.

In this circuit, triggering occurs whenever the base of transistor Q₁ goes negative. When this happens depends on the interaction of two voltages: the main d-c control signal V₁, and the a-c timing signal V₂.

V₁ is essentially the positive half of the 0-20 volt signal that is shown going into the servo amplifier in the over-all servo-loop diagram above. It is applied simultaneously to all six trigger circuits.

V₂ is an a-c timing voltage that is, for the arm-1 trigger, shifted 90° from the system's reference voltage. As the diagram on page 114 shows, 30° of the shift is obtained from a transformer and the rest from an R-C circuit.

The way in which V₁ and V₂ interact in Q₁'s base circuit is shown in the sketch to the left of the trigger circuit. In the absence of a control signal (V₁ = 0), V₂ becomes negative at 90°. This starts

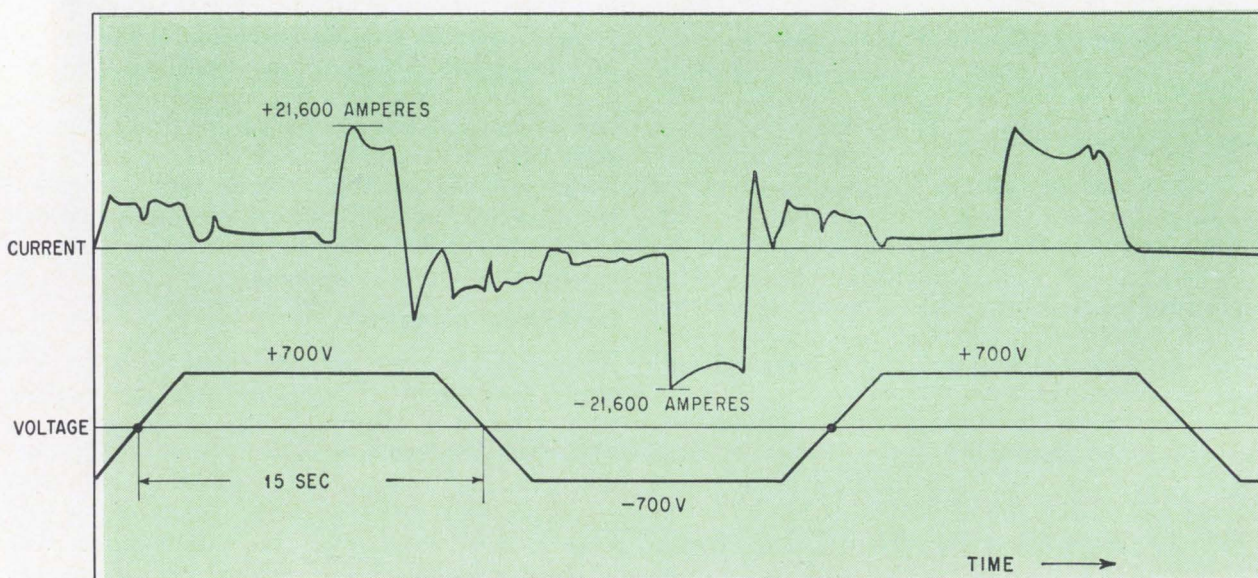

Currents and voltage for driving a 12,000 horsepower motor are immense. These traces taken from data obtained during the operation of the Burns Harbor rolling mill show that while the voltage varied from minus to plus 700-volts (d-c), the current went as high as 21,600 amperes.

the triggering chain through Q_1 and Q_2 to arm 1 of the bridge, which fires arm 1 at 90° delay. The other legs would likewise be triggered by their respective V_2 voltages to fire at their 90° delay points. This sets the whole bridge at zero-voltage output because of the inductive load.

As V_1 becomes more positive, it acts in the Q_1 base circuit (it is connected inversely into that circuit) to bias the V_2 timing wave for less delay. That is, the more positive the incoming control signal V_1 , the sooner the voltage applied to Q_1 's base goes negative. Therefore, an increase in V_1 causes earlier turn-on of the scr's and an increase in the voltage put out by the bridge. In the Burns Harbor system, raising V_1 to 20 volts fully advances the firing angle to zero degrees and causes the bridge to put out the full voltage supplied by the power lines.

Two other voltages applied to the Q_1 base circuit are less important so far as the system control is concerned, but are nonetheless necessary for proper trigger-circuit action.

V_3 is an a-c voltage that is needed in the GE triggering system because some of the arm-1 triggering circuits are shared for circuit economy, with the arm-4 triggering circuits. It is feasible to do this because the firing for the two arms is 180° apart. However some means is needed to disable the arm-4 circuits while the arm-1 circuits are operating, and vice versa. V_3 does this.

For the arm 1 and arm 4 trigger circuits, V_3 is taken from the basic reference voltage. It is fed, via, the transformer T_1 , to the Q_1 base circuit for an arm 1, and by a similar transformer to arm 4's trigger transistor, which is not shown. In the arm-1 circuit, V_3 , with the aid of diode D_2 , overrides voltage V_1 and V_2 during the half cycle, from 180° to 360° , in which arm 1 should be off. The current flowing through the forward-biased D_2 raises the voltage on Q_1 's base in the positive direction and thus holds Q_1 securely shut off. A similar action takes place in the arm-4 circuit from 0° to 180° .

Voltage V_4 is merely a d-c bias that allows fast initial overdrive of Q_1 for rapid, accurate triggering action. V_4 keeps diode D_1 open at first, but when the combined voltages of V_1 and V_2 become large, they reverse the current flow through D_1 and turn that diode off; this limits further growth of base current, because the current must flow through the 18K resistor.

Forming and amplifying the pulses

The rest of the triggering circuitry is fairly straightforward. When Q_1 is turned on, it discharges capacitor C_1 through inductor X_1 . This inductor has

a saturable core; its resistance suddenly drops when the current from C_1 drives the core into saturation. This produces the jump in current that forms the steep wavefront of the trigger pulse.

The pulse is further amplified in the Q_2 stage. This is similar to the Q_1 stage, but it has no saturable reactor, because the pulse waveshape has already been formed. The additional amplification is needed both because prevailing scr design practice calls for overdriving the gates to insure positive, synchronized system gating, and because this one pulse may have to drive the No. 1 arms in more than one bridge.

The amplified pulses are transformer-coupled to the bridge arms. Transformer coupling is necessary because the d-c levels at the scr gates vary widely as the bridge operates.

The action of the trigger circuits for the other arms is identical except, that they have different phasing angles for their V_2 , V_3 and V_4 voltages. The table below the arm-1 trigger circuit gives the phasing for the other arms.

Step 2: increasing bridge voltage

Using 150-ampere (average) 1,300-volt scr's, the basic bridge might be able to handle 60-horsepower loads at 350 volts. To make this bridge a proper building block for systems that handle megawatt loads, it is still necessary to raise the voltage of the bridge and to design the bridge must so that it can be paralleled.

The way GE raised the voltage capacity is shown in the insert above the basic bridge diagram on page 115. Two scr's are used in each arm. Together, they give the bridge the ability to handle 2,600 volts. This gives the 900-volt system at Burns Harbor a safety factor of almost $2\frac{1}{2}$ -1. The a-c supply voltage was purposely made 200 volts more

Bridges are packaged in standardized trays. The scr-indicating lights are on the hinged front. The scr's themselves are mostly out of sight, mounted on their large fan-cooled heat sinks in the center of the tray (though the braided anode leads for three of them can be seen at the front). Note the heavy strapping and large fuses for the nominal 170 amperes that the tray must carry.

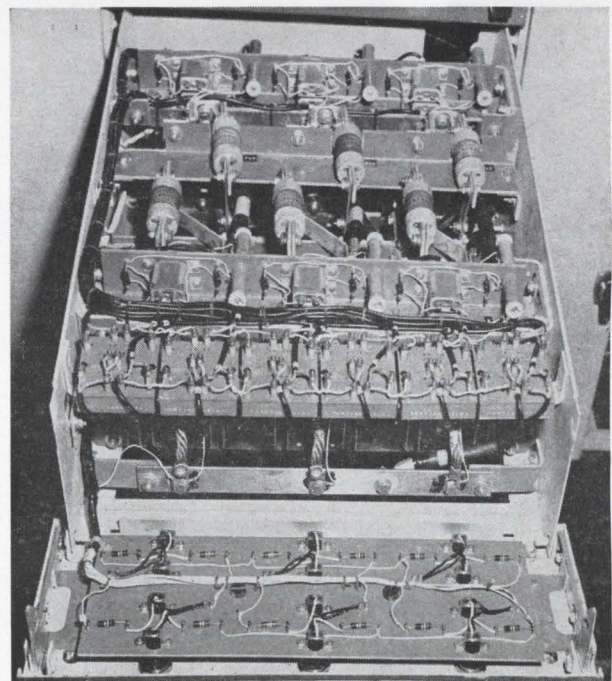

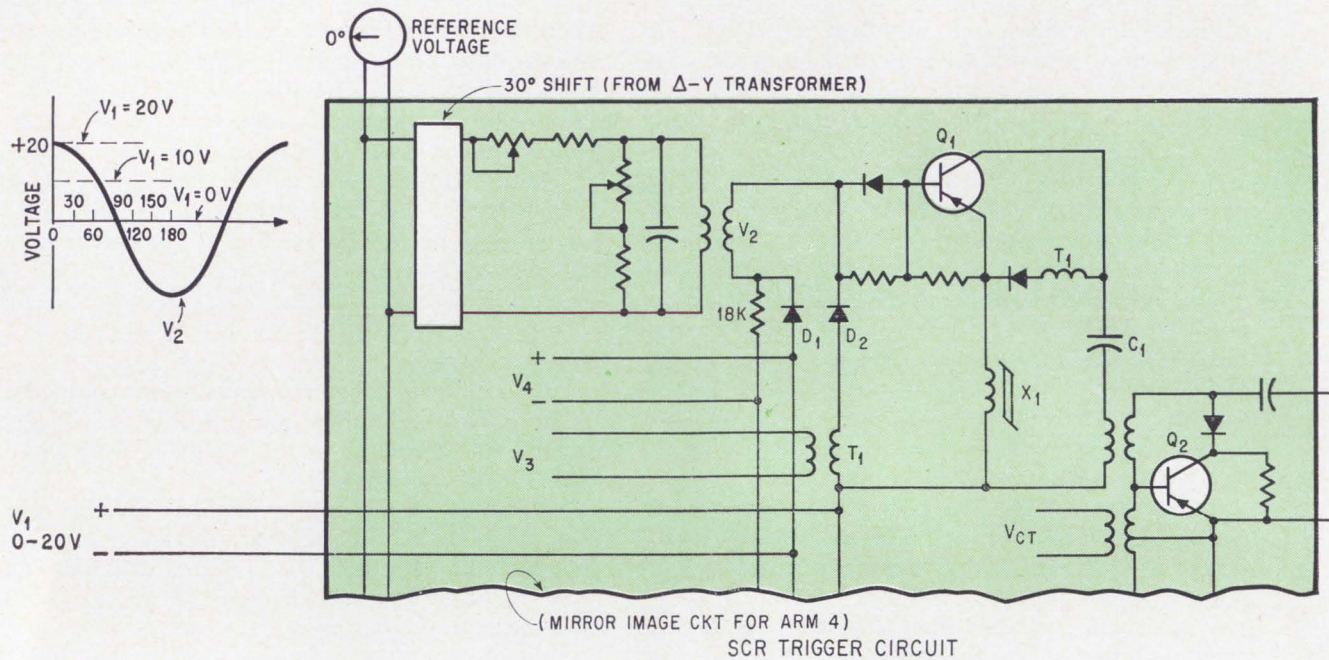

ARM	REF	V ₂	V ₃	CT	RANGE OF DELAY	
1	0°	90°	0°	180°	0	150
4	0°	270°	0°		180	330
3	0°	210°	120°		120	270
6	0°	30°		300°	300	90
5	0°	150°		60°	240	30
2	0°	330°	240°		60	210

PHASING FOR ARMS

The trigger circuit for arm 1 of the scr bridge is shown above. Trigger circuits for the other five arms are identical except that their V_2 , V_3 and V_{ct} voltages have different phase displacements. All circuits are phase-delayed in unison at the command of control signal V_1 . Phasing is shown in the table. In the absence of a control signal, all the triggers are kept at their 90° delay points by their V_2 voltages. This keeps the bridge output at zero volts when there is no signal.

than the 700 volts needed at the motor so that the bridge could function both as a regulated power supply and as a control amplifier.

The R-C networks around the two scr's are needed if the scr's are to be fired in a master-slave manner. In this arrangement the upper scr is fired first from the main winding of the gate-pulse transformer. It then discharges its capacitor and fires the lower scr. The master-slave arrangement is desirable where it is difficult to obtain two high-power scr's with similar turn-on times. It was originally used at Burns Harbor, but earlier this year GE converted all the bridges to simultaneous turn-on circuits. The designers found that they could produce selected large scr's with consistently fast turn-ons, and thus avoid the more complex master-slave arrangement.

Even when the master-slave system is used, a second winding transformer is often added to the gate-pulse amplifier to pulse the slave scr as an added precaution to insure that it will turn on.

Step 3: increasing system current

A basic high-voltage bridge that can be paralleled makes it easy to build megawatt systems. The designers merely add additional bridges, driving them with the same trigger and input signals. The top engineers in this field at GE and the Westinghouse Electric Corp.—the two companies that have produced most of the megawatt systems in this country—say they see no limit to the number of bridges that can be paralleled.

The Burns Harbor servo amplifier parallels 80 scr bridges for its 10-megawatt system. Since there are separate systems for forward and reverse, the total number of bridges is 160. The "top view" of the amplifier, on page 116, shows how the signal is "fanned out" with this paralleling. The incoming 0-20 volt signal feeds four trigger amplifiers of the type just described. Each of these, in turn, feeds pulses to 20 scr bridges.

To make a bridge that can be paralleled, it is

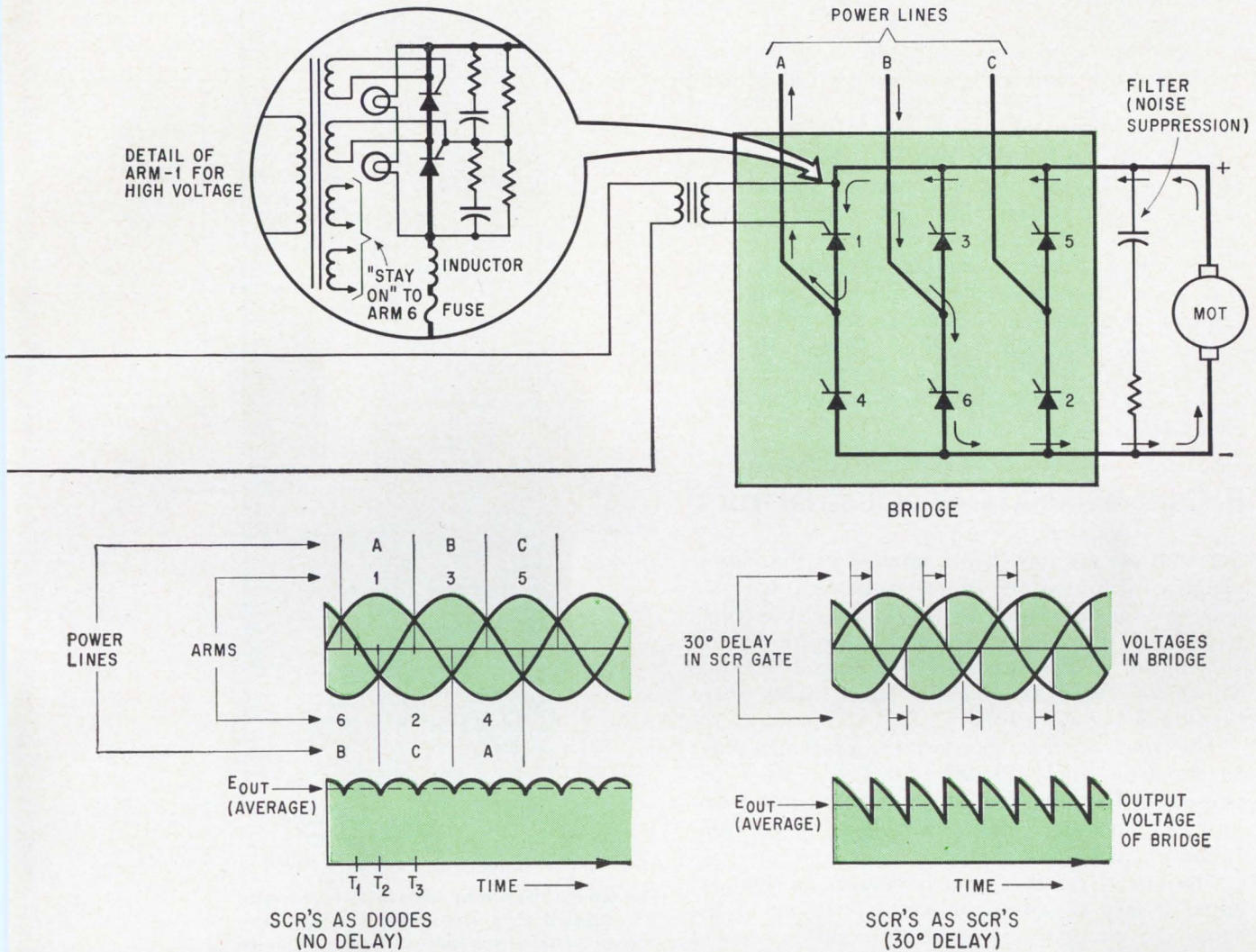

The three-phase scr bridge above is the basic building block of the 10-megawatt amplifier. Two scr's are used per arm, as shown in the insert, to make the bridge able to handle 700 volts with available scr's. The wave forms below the bridge show how the three-phase input is converted by the scr's into variable-voltage d-c output. At zero triggering delay ($V_i=20$ volts), the bridge is at 100% output. At about 30° triggering delay ($V_i \approx 17$ volts), the bridge is at 80% output.

necessary to add circuit elements that insure that all the scr's in the system—all the No. 1 arms of a bank of paralleled bridges, for example—carry their fair share of the load. The inductor shown in the two-scr arm in the insert represents GE's approach. These inductors are in each of the arms and are air-core reactors that enforce current-sharing by slowing down the scr turn-on transients. Because it is important that equal inductances be used in all the arms, GE also uses equal lengths for all the a-c and d-c power buses used with the bridges, and attaches these at a single point.

The inductors serve a second purpose: they prevent the turn-on of one arm from falsely firing the scr's in the opposite arm because of the dv/dt transient.

The fuses in each arm are quick-acting current-sensing types. They are especially important in paralleled circuits because they will isolate shorted scr's and permit the rest of the bridges to continue operation. The indicating lights across the scr's

are useful for locating failed scr's, and are important in systems that may use literally thousands of scr's.

Scr's and flexibility

Engineers who have worked on large systems such as these—for example, H. F. Brinker of GE and L. Stringer of Westinghouse—say that there are many advantages to using many scr's in parallel bridges. They believe they could build much larger systems by further paralleling of their present building blocks, and they are not at all sure that the larger scr's now being discussed by the scr manufacturers (700-ampere units, for example) would benefit them much. GE and Westinghouse engineers point out that their present building blocks are applicable to a wide range of horsepower, from 50 up. If the bridges for large-horsepower systems were designed around larger scr's, they could not profitably apply the same standard line of building blocks to smaller motors. Yet the smaller

units, in the 50-to-200-horsepower range, represent the largest market.

There are advantages for the customer, too. When a great number of scr's are used in parallel, the system can easily carry on after the failure of one unit. The lights across the bridges indicate when an scr has failed or a fuse has blown. (When an scr fails by shorting, the other scr in the same arm is rated to carry the voltage until the arm can be removed from the system).

According to a Burns Harbor electrical foreman, this system has allowed the mill to operate continuously despite an occasional cell failure. He recalls only one such failure in August. He says that operators usually do not even notice when one of the cells fails until an electrician makes a routine check of the panel lights.

II. Controlling a large industrial truck

Scr controls are now being applied to the largest electric lift trucks. A 15-ton truck that has just been put on the market by the Elwell-Parker Electric Co. of Cleveland uses a 300-ampere, 72-volt scr control system made by the Square-D Corp., Milwaukee, Wis., to modulate power delivered to the 40-horsepower motor.

The new solid-state control represents about \$3,000 of the truck's \$45,000 cost. It is twice as expensive as the older four-step rheostat control, but provides smoother vehicle control and better utilization of the battery charge.

The circuit for this truck is shown on the next page. It is a scaled-up (in power) version of the same d-c chopper-type control found in smaller electric vehicles, though some of the smaller vehicles use transistors rather than scr's.

The main obstacles to applying solid-state control to so large a motor are the large current and voltage transients that occur as a result of the "cowboy" fashion in which these trucks are usually operated. Lift truck operators expect to call the motor's overload capacity of up to 600% into play whenever they need it. For example, an operator thinks nothing of bulldozing a stubborn load along a rough factory floor until he is able to get the truck's forks under the load, or of "plugging" the truck to a rapid stop. "Plugging", in d-c motor parlance, means throwing the speed controls suddenly into reverse. These operating abuses cause some severe circuit problems.

Scr switching and triggering

The control has three functional sections: the scr power switching, the scr triggering control, and the motor circuits.

Two large scr's, labeled 1 and 2 in the diagram opposite, control the amount of battery energy allowed to reach the motor. As with all scr circuits, current is either full-on or full-off, the amount of power being controlled by the relative percentage of on time. A smaller scr, No. 3, turns off the two

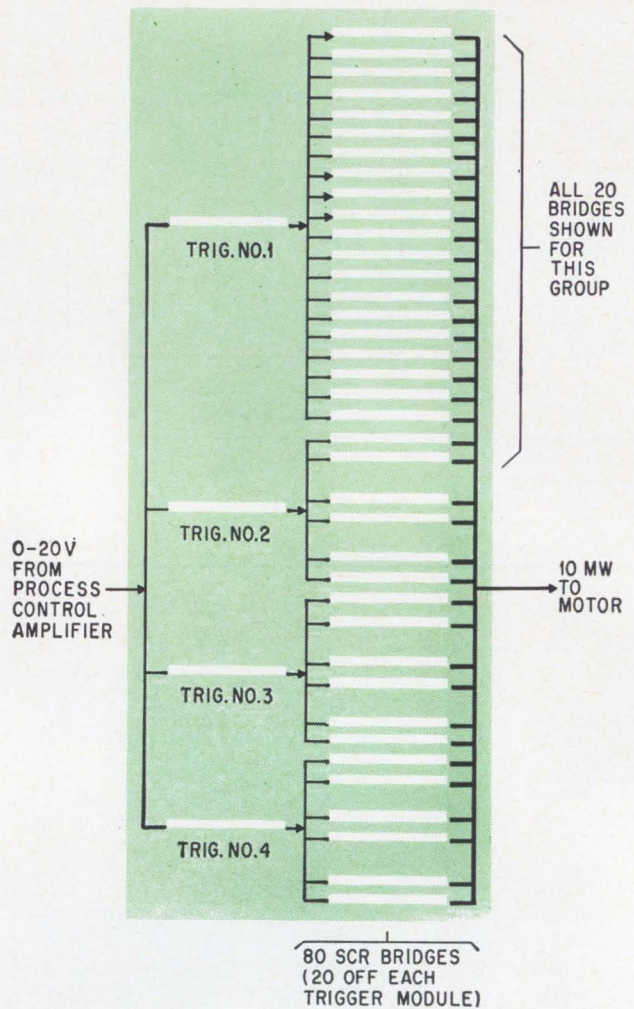

The fan-out needed to achieve 10-megawatts with present scr's. The single 0- to 20-volt control signal drives four scr trigger modules. These modules each drive 20 scr bridges.

main scr's by connecting the reverse voltage stored on a bank of capacitors across the main scr's.

The pulses that alternately trigger first the two main scr's and then the single turn-off scr come from the scr trigger-control module, which also controls the vehicle's speed. Inside this module, a square-wave oscillator generates the basic timing for the system. This oscillator's frequency is varied over a range from 20 to 170 cycles per second by a potentiometer connected to the operator's speed control.

The oscillator pulses are fed—via a pulse amplifier—to a single-shot multivibrator. This produces fixed-duration on-time pulses, whose leading edges gate the main scr's on, and whose trailing edges gate the turn-off scr on.

Thus, when the operator rotates the control for more speed, what actually happens is that the oscillator frequency increases; this in turn causes the single-shot to be turned on more frequently. Since the single-shot's on-time is fixed, this means that the main scr's are turned on more often, thus keeping the motor connected to the battery a greater percentage of the time.

Though the power is applied to the motor in pulses, the mechanical inertia of the motor and vehicle and the electrical inertia of the motor circuit (see below) completely smooth out the final propulsive power flow.

The scr power switching has four steps in each power cycle:

- When the single-shot multivibrator goes on, it delivers a turn-on pulse to the gates of scr-1 and scr-2. The center-tap balancing reactor at the scr cathodes insures that they will share the current within 10%.

- The current buildup when the power scr's are turned on most flow through the primary of transformer T. The voltage in the secondary of this transformer charges capacitor bank C in a few milliseconds to a voltage that is higher than the battery's. The charge is held on the capacitors because diode D₁ is back-biased and scr-3 is off.

- At the end of the single-shot multi's fixed on-time, the trailing edge of the pulse gates scr-3 on, connecting capacitor bank C across scr-1 and scr-2. The reverse voltage from C turns off the two power scr's rapidly, since the bank capacitance has purposely been made large. This stops the current flow from the battery to the motor.

- Scr-3 remains conducting only until the capacitor bank C is discharged. Since it is by then subjected to the reverse voltage of the 72-volt battery, it turns off. The switching system is then ready for another cycle.

The choice of scr's

If it were not for overloads, then two scr's, each rated at roughly 150 amperes and 100 volts, would

be adequate for this circuit. However, the scr's must be able to keep up with the motor's ability to carry up to 600% current overloads for several minutes at a time. The motor can withstand these overloads, since it has a large thermal mass to absorb the heat. The scr's, with their much smaller thermal masses, see the motor loads as if they were practically continuous.

Square-D selected two 400-amp (rms) scr's with 300-volt peak reverse voltage ratings. These scr's can, with the aid of the current-balancing reactor, withstand the 1,800-ampere surges that occur when the motor is being forced. The scr's are of the flange-mounted type, and each is held to the heat sink with four bolts.

Motor circuits

The two circuits around the motor—those containing diodes D₂ and D₃—protect the scr's from receiving even larger current and voltage transients. They also improve the vehicle's operation.

The circuit containing D₂ is the more conventional. It is a so called "free-wheeling" circuit, which is used to dissipate the inductive energy that becomes stored in motor and relay coils during operating cycles. However, in this case, the inductive energy is not thrown away but is allowed to recirculate usefully through the motor during the main scr off-times.

This circuit also performs a "current-amplification" function. As the waveforms above the diagram show, the circuit coasting action between power pulses raises the average current through the motor. The motor windings represent a low-impedance source, so the magnetic field energy is

Circuit diagram of truck motor control shows how the two main scr's, 1 and 2, are in series with the motor and battery power circuit (heavy line). Scr-3 is to turn off the first two scr's by applying the reverse voltage from the capacitor bank C across them.

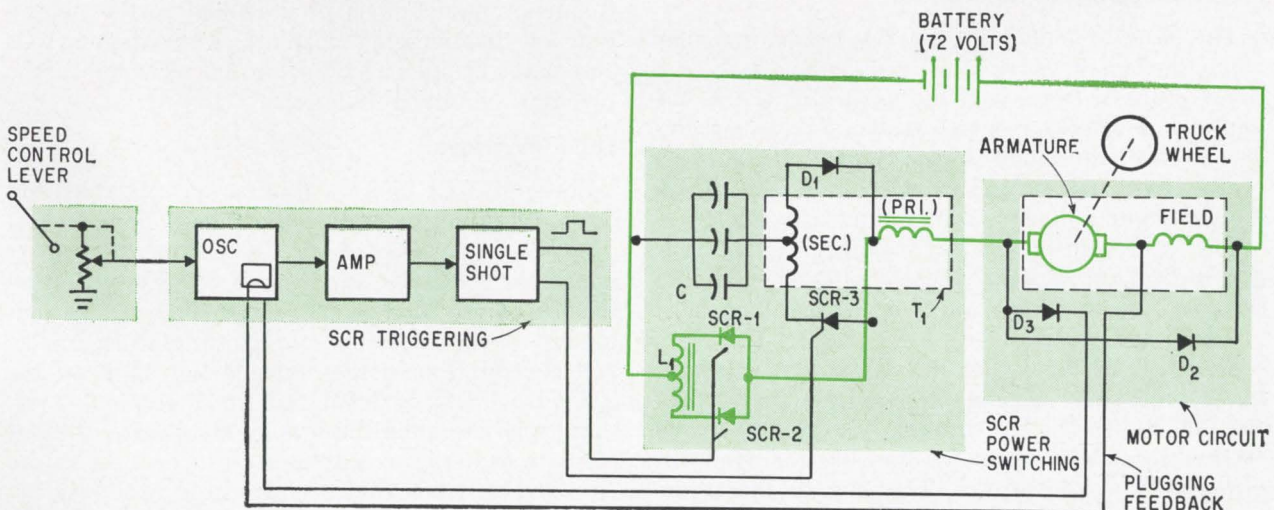
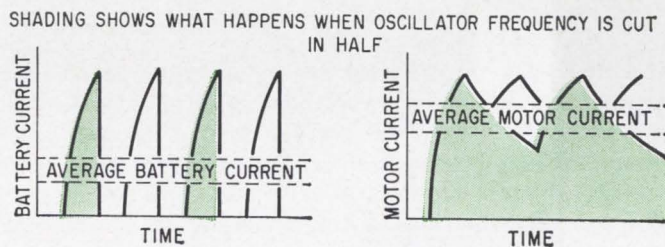

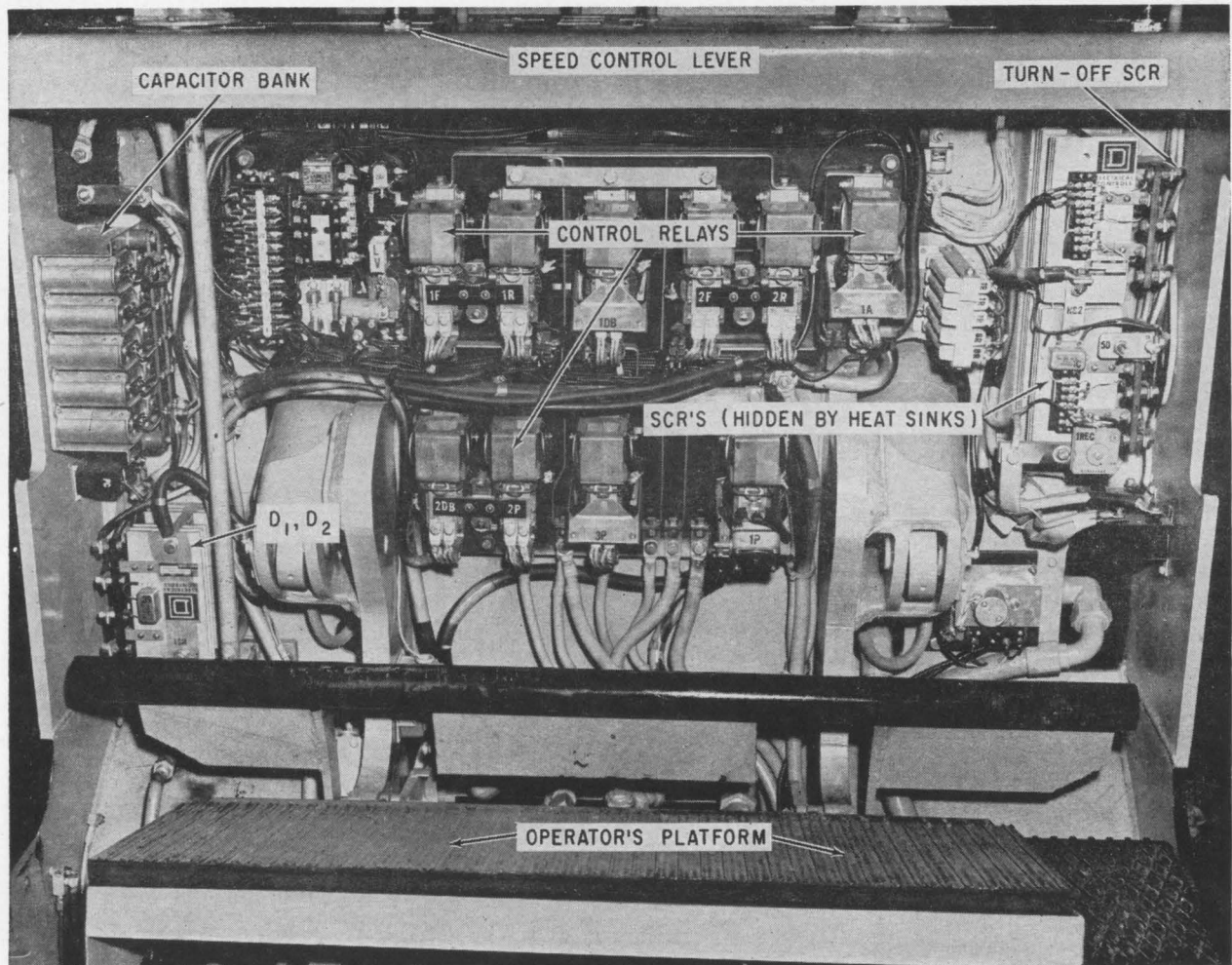

Truck's solid-state control is mounted at the front of the operator's platform. The circuit components were mounted on each side of the large conventional relays retained for turning the system on and off and reversing the motor. This early system used four 235-ampere scr's.

converted back to electrical energy at higher current and lower voltage levels. Square-D engineers say they have observed the average current through the motor being increased four times over that through the scr's. These large increases were noted at low speeds when the off-times were long.

How "plugging" is controlled

The circuit containing diode D_3 comes into play when the operator tries to "plug" the truck to a rapid stop by reversing the controls. When the motor is reversed, it starts to act as a generator. The circuit is designed so that the scr's are on part of the time; thus the battery voltage will block the generated voltage and help brake the truck.

The problem for the scr's during plugging is that the voltage generated by the motor is added to the battery voltage, and thus very high voltages can build up across the scr's.

Square-D prevents this overstressing of the scr's by the feedback sensing provided by the D_3 circuit. This circuit is fed through a "window" in the oscillator module. Here, it acts as a single-turn primary of a transformer. The rest of the trans-

former—the magnetic core and the secondary winding—are encapsulated inside the oscillator module. The secondary circuit biases the oscillator to lower frequencies.

Therefore, the 200-amp pulses that surge through the D_3 circuit during plugging automatically cause a reduction in oscillator frequency. The amount of frequency reduction is proportional to the magnitude of the plugging currents. The frequency is automatically increased to normal as soon as the plugging condition is over.

Other overrides

Square-D also offers a programmed soft start and current limiting to protect the scr's. The soft-start override employs an r-c circuit to limit the rate at which the oscillator can follow a command from the operator to increase frequency. The current-limiting override senses the current through the motor and controls the oscillator frequency to keep the current below a set level. Square-D says, however, that it has designed the system to operate without the current limit, because many users object to the "less lively" truck that such limiting produces.

III. The next step—a-c motors

The **d-c motor** is the workhorse of heavy industry and transportation. Its major advantages over a-c motors are its high torque at low speeds, and its ease of speed control. But most designers would switch to a-c motors if they had the same control characteristics. A-c motors, with their simple "squirrel cage" rotors, are usually cheaper to manufacture and easier to maintain.

Scr's may make the switch to a-c motors feasible for many industrial and transportation applications, for with scr's it becomes relatively easy to supply a-c motors with variable-frequency power.

The most popular approach to the control of a-c motors with scr circuits at this time is the cycloconverter circuit. It converts 60-cycle line power to a frequency range of from about 5 to 20 cycles. Cycloconverter-controlled a-c motor drives are simple and inexpensive. Unfortunately, they cannot really begin to match the control characteristics of d-c motors, and therefore can only be used where low-speed torque is not critical, such as light-duty winches and crane hoists.

An improved scr drive

A more sophisticated way of applying scr's to an a-c induction motor may, however, be the answer. This approach varies the voltage as well as the frequency supplied to the a-c motor, and thus is able to generate higher torque at low speeds. One of these systems has been under development by the Westinghouse Brake and Signal Co., Ltd., of England.

The company's chief of electrical research, K. G. King, says the new system is applicable for the control of a-c induction motors of up to 500 horsepower. King believes the system frequency range can extend to 400 cycles, and therefore will permit

smaller a-c motors than those powered by 50- and 60-cycle cycloconverters (which must always employ frequencies of less than $\frac{1}{3}$ the basic frequency).

This system was described by King in the February, 1965, issue of the British journal, "Direct Current." The circuitry is shown below. It consists of a variable-voltage a-c to d-c scr converter followed by a variable-frequency scr inverter. The system is designed to work with the typical three-phase power lines and a-c motors found in industry.

The a-c to d-c converter is of conventional design. It is simply an scr power supply in which the fixed reference voltage has been replaced by a varying control signal.

The novelty of the system is in the design of the inverter. This has two noteworthy features: digital circuitry is used for the scr triggering, and the inverter scr's are turned off by a single capacitor charged from an external source.

Digital triggering

The triggering circuitry produces the pulse pattern shown alongside the system block diagram. This pattern gates on the scr's in the inverter bridge in the proper sequence to produce a rotating magnetic field in the a-c motor stator. This rotating field turns the motor's squirrel-cage rotor.

The pattern is generated by a ring of six flip-flops. At any instant, two adjacent flip-flops are on and the other are off. In effect, the two on states move around the ring, shifting once for each pulse from the master oscillator. The frequency of the master oscillator can be varied to control the rate at which the stator field rotates, and therefore to control the speed at which the rotor turns. The oscillator must run at six times the desired inverter frequency, because the on states must be

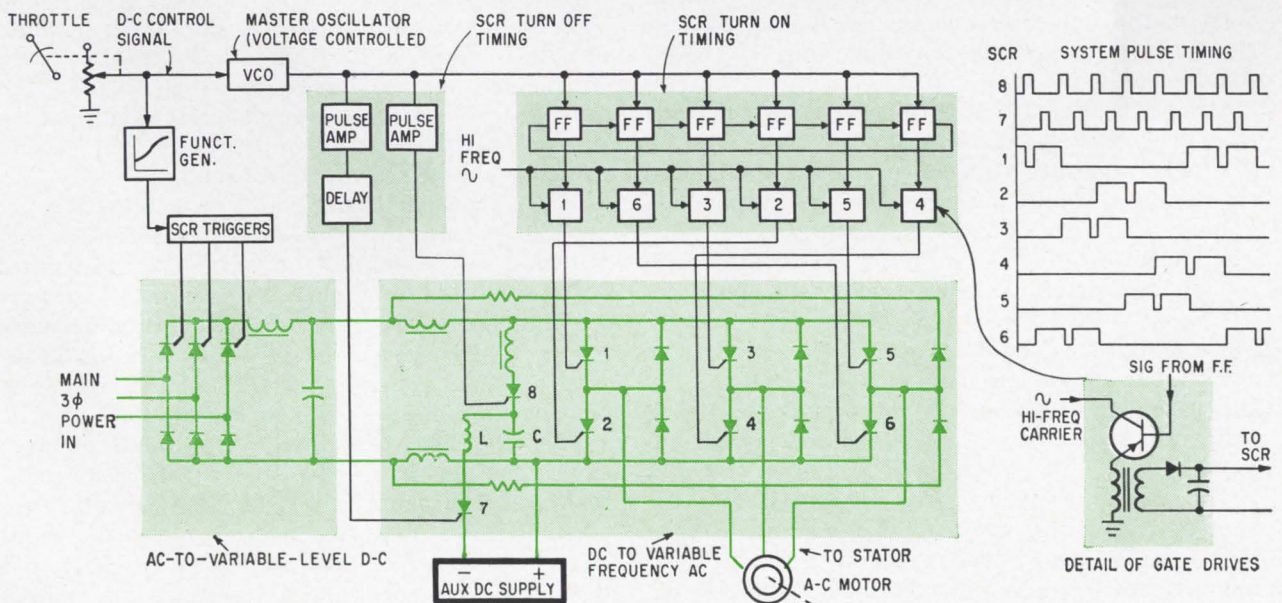

Scr control system for a-c motor first converts line power to variable-voltage d-c, and then inverts this to variable-frequency a-c. The system varies both the voltage and the frequency fed to the a-c motor.

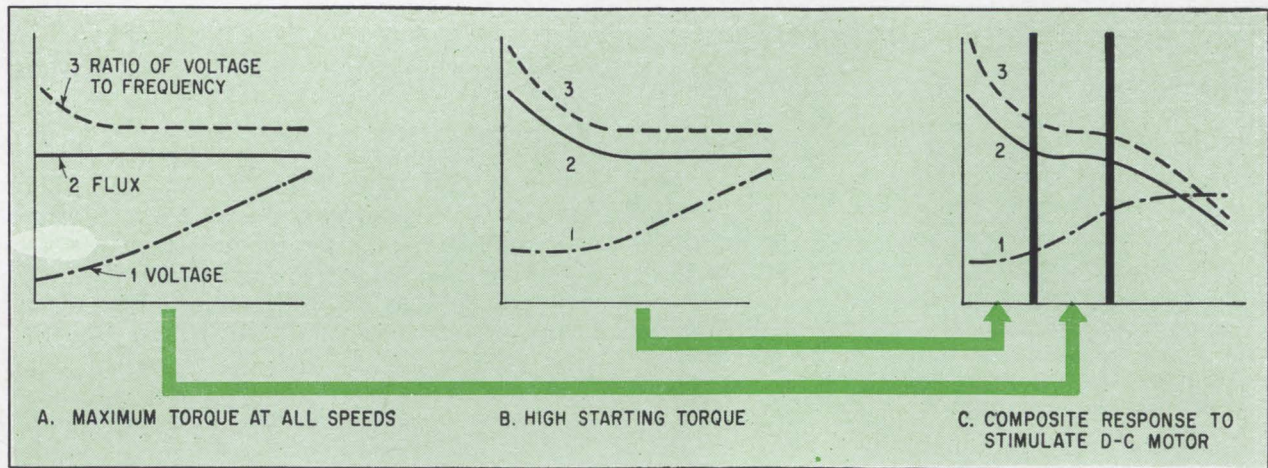

The response of the a-c motor can be tailored in several ways: (a) to produce maximum rated torque at all speeds, (b) to produce high starting torque, and (c) to combine (a) and (b) to produce the characteristics of a series d-c motor.

shifted once around the six flip-flops for each inverter cycle.

The long dwell times provided by the on states are necessary, King says, because the scr's are working into an inductive load, which causes a shift in phase of the scr anode voltage. A short pulse might not always occur simultaneously with a positive voltage on the scr anode, and the scr might not be triggered reliably. The scr triggering signals cannot be taken directly from the flip-flops because the scr cathodes in the inverter arms are not at fixed potentials. A convenient means for obtaining the isolated firing pulses that are floated at the scr cathode potentials is to have the d-c signal from the flip-flops switch a high-frequency carrier on and off. This carrier can then be transformer-coupled to the scr gates, the d-c being restored by a rectifier.

Turning the scr's off

The single capacitor, C, turns off the inverter scr's in the following manner (assuming that the capacitor C is initially charged with its upper plate negative):

- Scr-8 is fired by a pulse that comes directly from the master oscillator.
- This connects capacitor C inversely across the inverter supply lines so that the capacitor's voltage is in opposition to the inverter's.
- The inverse-voltage pulse on the inverter supply lines turns off whichever scr's were on.
- Scr-7 is also fired from the master oscillator pulse, but after a slight delay.
- C is recharged from the auxiliary voltage, the small inductor L giving a "ring" to the charging waveform to increase the voltage that builds up on C.

The commutating arrangement has several advantages, according to King. The auxiliary voltage source makes the system independent of the varying voltages being supplied to the inverter by the controlled power supply, and only one capacitor is needed to commutate all the inverter scr's.

How drive response can be tailored

The designer can use the two control parameters at his command to tailor the a-c motor's response. For example, if maximum torque at all speeds is required, the designer can cause the control system to vary the voltage and frequency to maintain a constant stator flux density, as shown in graph (a) above. As the graph shows, over most of the speed range (motor speed is proportional to the inverter frequency shown on the graph), the voltage will be proportional to the frequency. However, King says, at very low speeds the voltage will probably have to be increased slightly to overcome the d-c resistance of the windings.

If the application requires that the motor develop a large starting torque, then the designer can cause the voltage-to-frequency ratio to be higher at low speeds, as shown in graph (b).

Graph (c) shows how the system would be tailored for a traction drive. Here the high torque indicated by graph (b) at low speeds is combined with the maximum torque of graph (a) for medium speeds. In addition, the high-speed response would be tailored for maximum power by having the voltage level off. The over-all effect would be to produce a drive with characteristics that closely resemble those of a d-c series motor.

The response-tailoring could be achieved in an actual system by various analog computing schemes. For example, the system speed-control command could be applied directly to the voltage-variable master oscillator and, via a function generator, to the trigger system for the converter. The function generator would incorporate such responses as those shown in the graphs.

The efficiency of the a-c drive would in most cases be lower than that of the d-c drive it would replace because the conveyor and inverter are used in series, and the inverter waveform would be less than perfect. However, King predicts that the advantages inherent in replacing d-c motors with a-c motors will ensure wide application for this type of system in the future.

i/c's and modules tested...

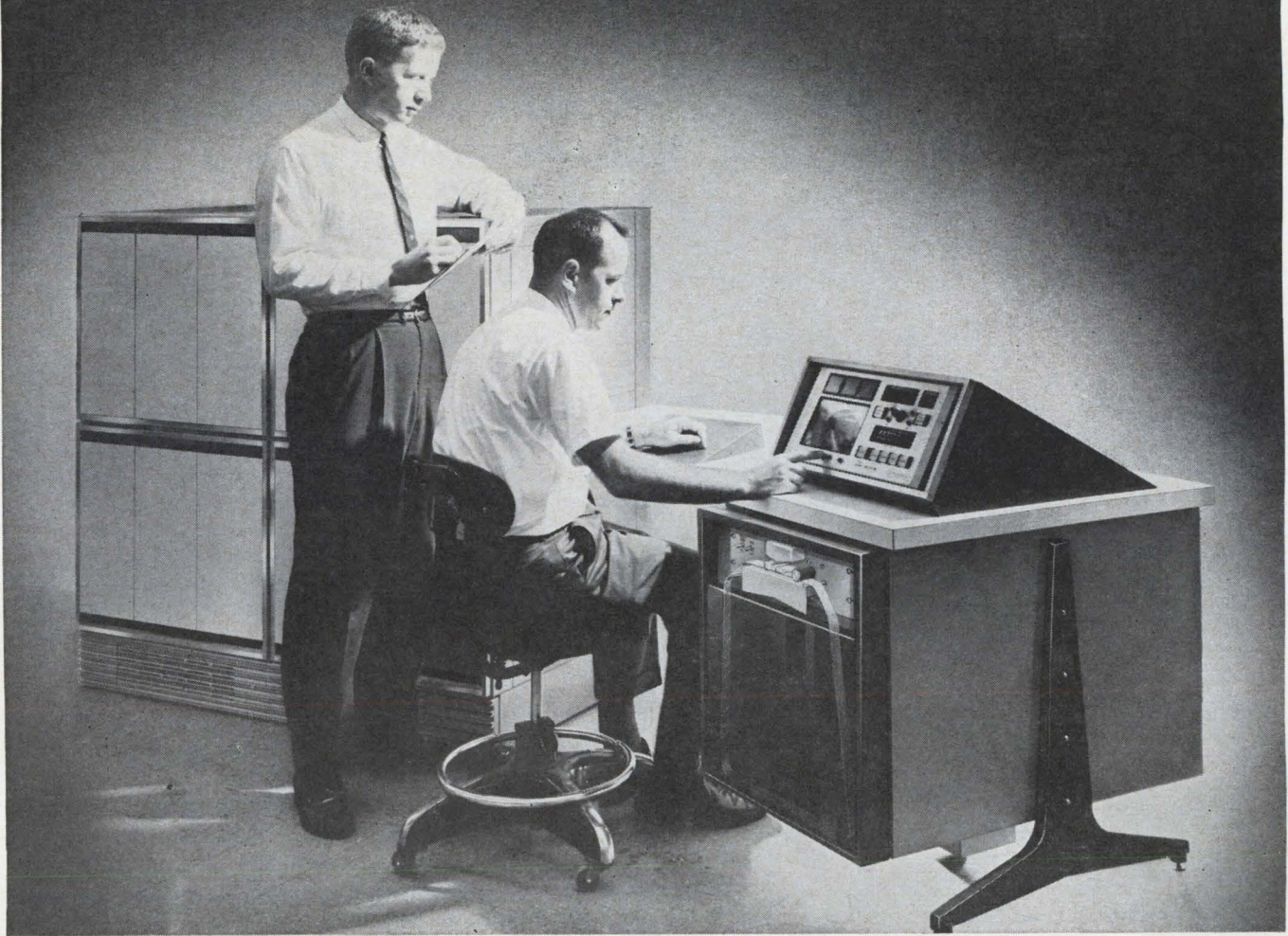

DYNAMICALLY!

Now you can perform important *dynamic* tests in addition to ordinary static (dc) tests with TI's Model 553 *Dynamic Test System*. Measure propagation delay and noise feed-through; *dynamically* determine "fan-in"/"fan-out" ratios, and noise immunity; assess the effects of transients. Now, measure switching times in terms of percentage or absolute values. You save money by performing more tests at high speed with handling reduced by single-socket testing.

The 553 *Dynamic Test System* is designed for integrated circuits, transistors, diodes, thin films, logic cards, other circuit elements with 10, 20, 50, or more active leads. Testing can be done from dc to 50 mc, thereby simu-

lating actual operating speeds. Time or voltage is measured anywhere *on* or *between* pulses (widths from 10 ns to 1 ms) with a resolution of .000001%. Jitter is less than 50 ps; accuracies better than 2%.

Modular design and variable word-length program logic provide for infinite system expansion. Simplified programming language allows operators to learn to program in 45 minutes. Data as well as double-ended hi-lo limits can be produced at test rates faster than go/no-go systems with a wide variety of output recording techniques available.

For detailed information about the 553, contact your TI Field Office or the Test Equipment department, Houston.

INDUSTRIAL
PRODUCTS
GROUP



TEXAS INSTRUMENTS

INCORPORATED

P. O. BOX 66027 HOUSTON, TEXAS 77006
118 RUE du RHONE GENEVA, SWITZERLAND

740B

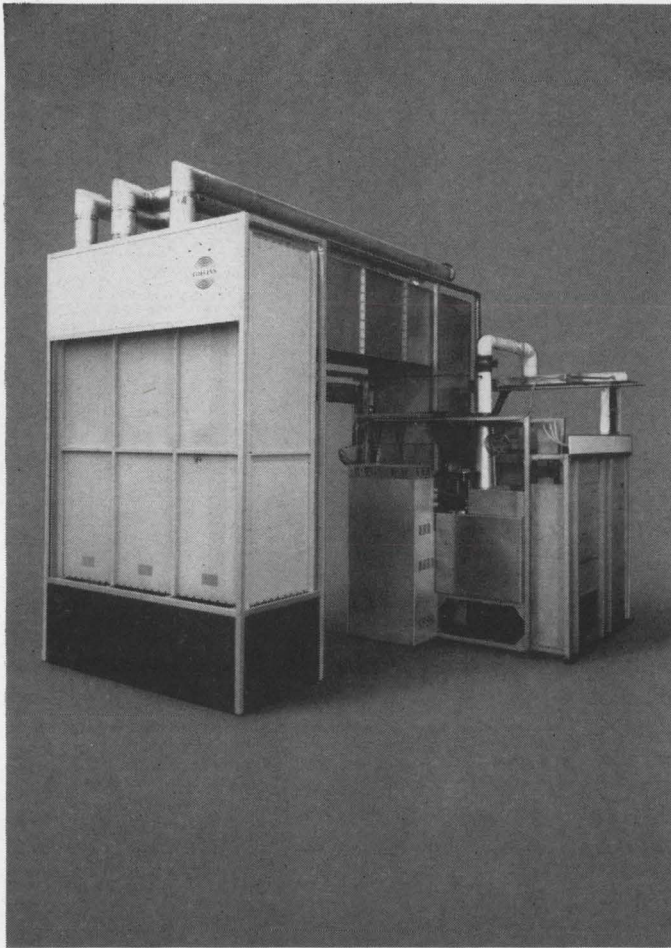

250 KW Transmitter Achieves Extremely High Tank Circuit Efficiency With Jennings Vacuum Capacitors

Two of the most significant features of Collins Radio Company's 821A 250 KW transmitter are the unusually high efficiency of the tank circuits in the final amplifier and the completely automatic tuning techniques. The output network employs large coaxial line sections which are automatically resonated by new internally forced-air cooled Jennings vacuum variable capacitors. It also utilizes the wide capacity range, high frequency response, and high voltage rating of Jennings capacitors to aid in automatic tuning anywhere in the frequency range of 3.95 to 26.5 megacycles.

This permits completely automatic tuning in a maximum of 20 secs and avoids the loss of valuable air time, usually 5 to 15 minutes, consumed by conventional transmitters.

In addition to the low loss dielectric and lowest inductance of any other capacitor Jennings new vacuum capacitors offer (1) highest maximum to minimum capacity change ratios (2) long life (3) high current capability (4) light weight (5) built-in corona rings on many models (6) shock resistant glazed ceramic envelope (7) wide variety to solve most desired combinations of capacitance, voltage, and current.

Whether it's 250 KW or 5 KW, Jennings vacuum capacitors will contribute more to superior transmitter performance than any other capacitor known. A brief examination of our new line of ceramic vacuum capacitors will suggest many new ways in which circuit design can be improved. We will be pleased to send complete details at your request.

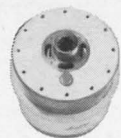
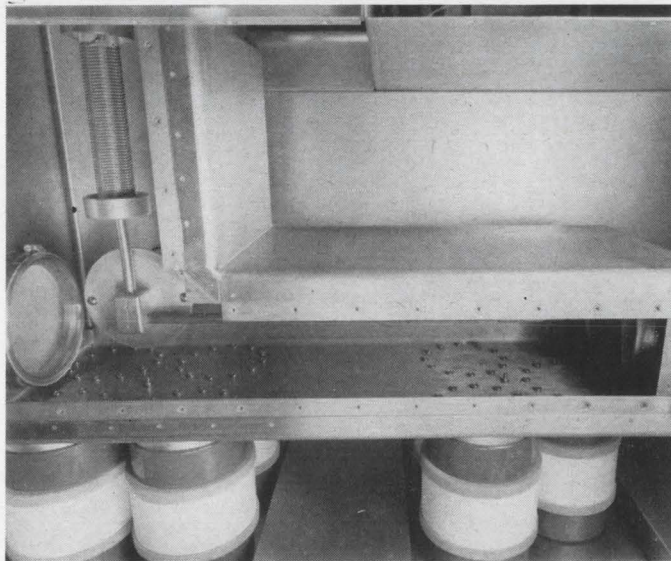

JENNINGS TYPE
CVHP 650

Capacitance Range: 30-650 pf
Voltage Rating: 45 kv peak
Current Rating: 250 amps rms



JENNINGS TYPE
CFHP 1000

Capacity: 1000 pf
Voltage Rating: 45 kv peak
Current Rating: 215 amps rms

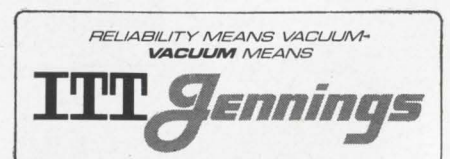

JENNINGS RADIO MFG. CORPORATION • Subsidiary
of International Telephone and Telegraph Corporation
970 McLAUGHLIN AVE., SAN JOSE, CALIF. 95108 • PHONE 292-4025

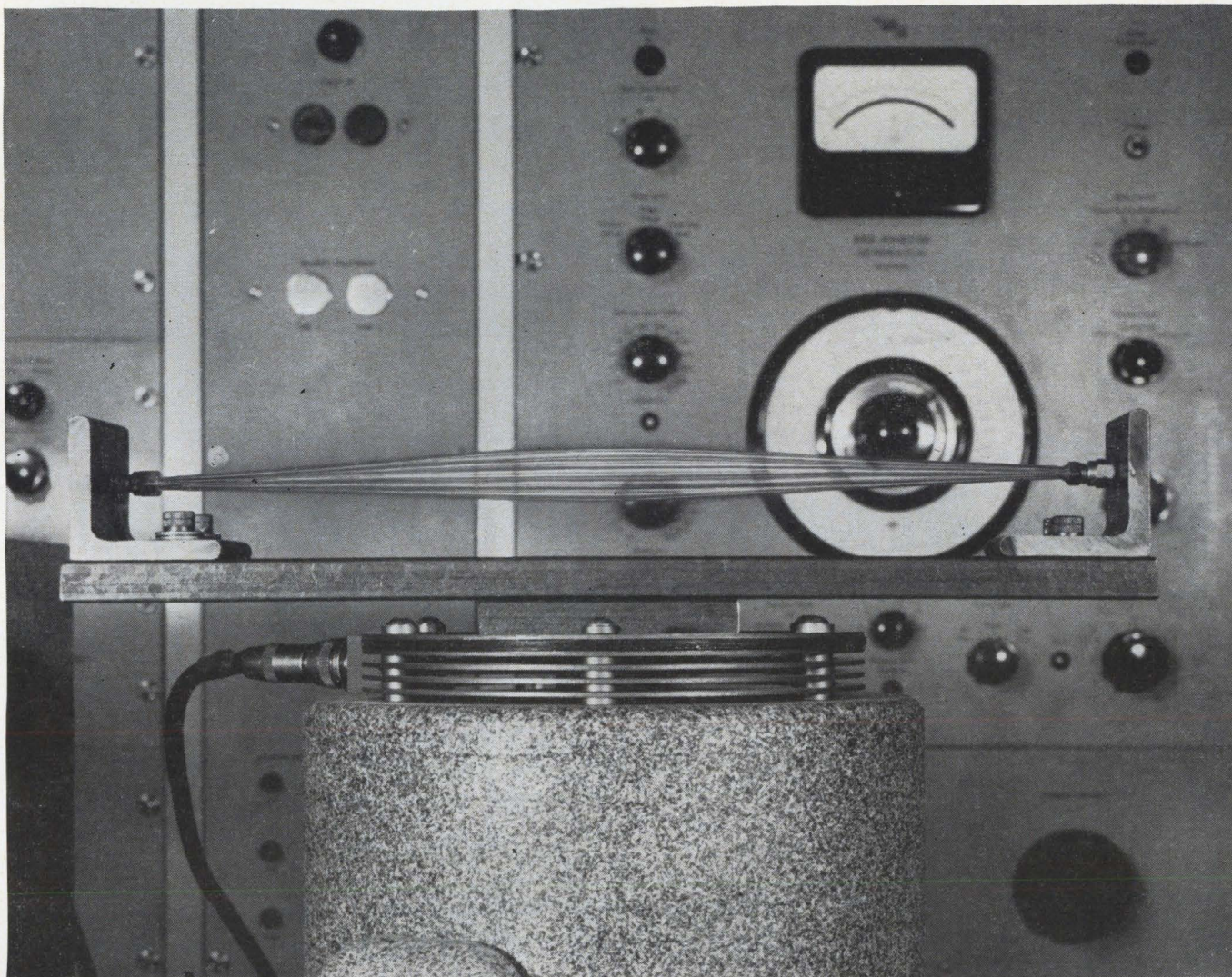

This miniature coaxial cable of ours was vibrated at resonance 7 hours before the sheath cracked. The best competitive cable lasted 55 minutes.

While flexibility is not the only consideration when you are specifying miniature coaxial cable, freedom to form to the needs of the application is a compelling factor in your choice. Think, for a moment, in terms of low noise amplifiers, microwave transmission, high speed computers and the wide range of black box requirements.

Here, then, is your answer. Miniature coaxial

cable with a silver plated Copperweld inner conductor, a TFE Teflon dielectric and solid, practically indestructible copper sheath, in standard, 50 ohm impedances, diameters of .070" and .141", lengths from 12' to 200'. Or, special diameters for your special needs.

Let us know if we can help you. Bulletin MC-1 with full details is yours for the asking.

PHELPS DODGE ELECTRONIC PRODUCTS
NORTH HAVEN, CONNECTICUT



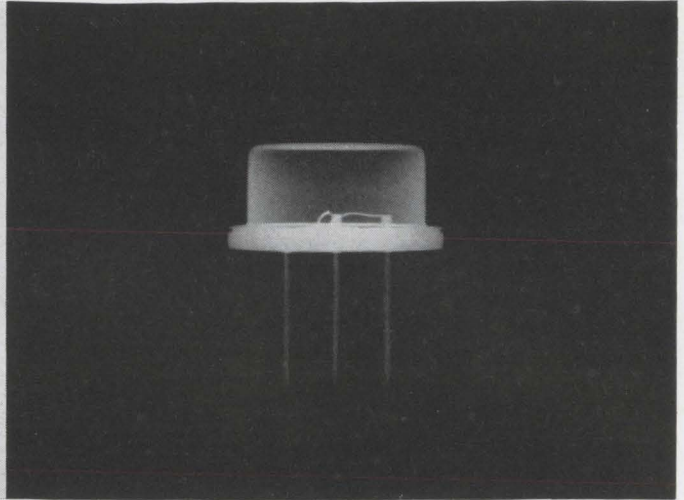
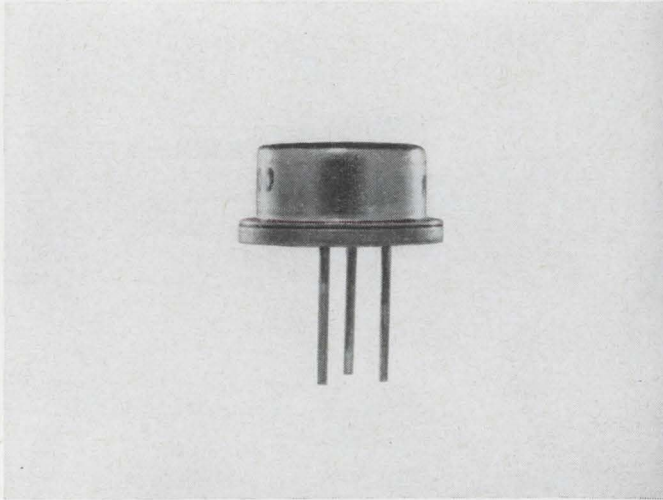

Meeting MIL specs?

***AnSCO film lets you
see the reliability***

If you've invested millions in an in-plant reliability program, you should include Superay® 'H-D' Industrial X-ray film. Why? Because it can show up best the tiniest imperfection in your electronic components. This ultra-fine grain Class I film has very high contrast and microscopic definition throughout the entire KvP range. It's designed for high definition radiography and the ultimate in image quality.

For the X-ray "reliability" your components deserve, ask your GAF Representative about AnSCO Superay 'H-D' Industrial X-ray films. Or write: X-ray film Dept., Box E-104

gaf

GENERAL ANILINE & FILM CORPORATION

140 WEST 51 STREET • NEW YORK 10020

Leadership in Digital Measurement

**STOPPING ON A DIME
AT 186,281 MILES
PER SECOND**



* Model 5420: 1 to 100,000 meter range, 1 meter quantizing resolution with no ± 1 count error and ± 0.65 meter accuracy.

In range finding, the advantages of digital over analog techniques are equally dramatic. Eldorado's digital approach offers you nearly instantaneous range readout, simple operation, complete flexibility in data handling, elimination of operator error and increased system accuracy.

For example, Eldorado Electronics has supplied digital range measurement equipment to update navigation radars to the accuracy of their IF strips which can be 10 to 100 times better than the accuracy of their PPI presentations. Other models

are being supplied for integration with drawing board radar / laser rangefinders, altimeters and photomapping systems.

It is an odds on chance that Eldorado's experience and skills encompass your range finding (and bearing) requirements, whether you need short or long range equipment . . . readout in inches, feet, yards, meters or degrees . . . range gate, start inhibit, range limit or multiple target selection capabilities . . . airborne, shipboard, vehicular or man-pack systems.

Also available are digital delay generators for range simulation/calibration and direct digital GHz frequency counters for CW radar applications.

To learn more of what digital ranging techniques can do in your range finding applications, contact your nearest Eldorado representative, or:



ELDORADO ELECTRONICS

601 Chalomar Road • Concord, California
Telephone (415) 686-4200

Senior Design Engineers: Are you interested in advancing the state-of-the-art in digital instrumentation? If so, we need you in our Research and Development group. Call or write David C. Condon, Chief Engineer.



*When this headline was current news...
digital recording tapes
had a packing rate of 200 bpi.*

*Today, 800 bpi is standard;
improvement in tape and base is the reason.*

In analyzing the sensational development of EDP over the past decade, most of us naturally talk in terms of improvement of hardware. But when you stop to examine them, the contributions made by tape manufacturers have been quite remarkable.

The tape of today looks like the tape of 1954 . . . but think of the differences: improved oxide coatings to increase total capacity, reduce fluctuations in performance; much stronger binders to reduce dropouts and flaking, lengthen tape life; smoother surfaces to give longer, error-free wear; thinner coatings and better production controls to guarantee reel-to-reel uniformity.

Working hand in hand with the tape manufacturers during this time has been Du Pont. Improvements in the uniformity, stability and overall reliability of the base of MYLAR* have played a vital role in making possible the sophisticated tape in use today. Continuing cooperation of research and development facilities assures continuing improvements in the future. Your guarantee of the most advanced tape is the manufacturer's brand and a base of MYLAR polyester film.

*Du Pont's registered trademark for its polyester film.



Better Things for Better Living . . . through Chemistry

At the base of all tape improvements: Mylar®

televisione

テレビ

Television

télévision

Fernseher

ТЕЛЕВИЗИЯ

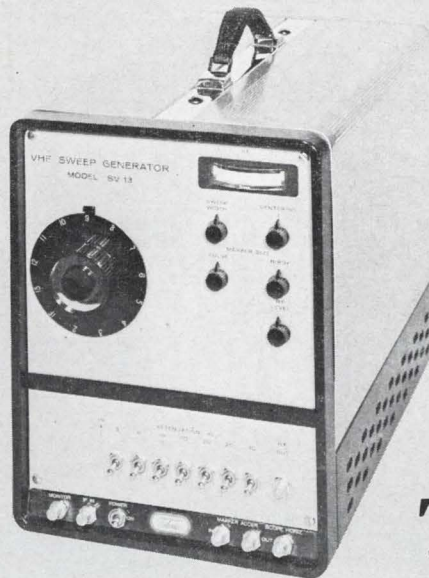

The Universal Telonic SV-13 Sweep Generator "Speaks Television" in any Language

A truly International Test Instrument, Telonic's SV-13 Sweep/Signal Generator is used for alignment and adjustment of TV receivers and tuners world over. Its unique capacity of 13 plug-in channels permits comprehensive coverage of the entire 20-225 MHz frequency range in a single instrument.

Simply by changing these channel plug-in "strips" the user can adapt the SV-13 to check out RF and IF channels and other VHF circuits from Bangor to Bangkok. The instrument may be specified originally with American, European, Italian, Australian, or Japanese channels plus any number of plug-in strips. Channels may even be varied to suit a particular test set-up, e.g. 8 TV channels plus 4 RF bands plus one IF. The instrument's selection dial is engraved according to the standards furnished.

To simplify production application of the SV-13, pulse-type, crystal-calibrated, built-in markers supply frequency indication above and below center frequency at standard 4.5 MHz and 5.5 MHz separation between video and sound carriers.

Other Specifications: RF channels adjustable from 5 to 20 MHz, IF channels from 10 to 40% of center frequency; output is 1 VRMS into 75 ohms; Flatness between markers, $\pm 1\%$, over each channel, $\pm 2.5\%$,

overall, $\pm 5\%$; Attenuation is 99 db in steps from 3 db.

And look at these options available with the SV-13

- Additional RF Output System
- Additional IF Markers
- Local Oscillator Adjustment
- Remote Control Channel

Telonic also produces the SD-3, SD-3M and SN-3 sweep generators for Testing UHF circuits, as well as the SV-14 for FM work. Other Telonic sweep generators cover audio to 3000 MHz in a variety of convenient models. A full product line catalog is yours on request.

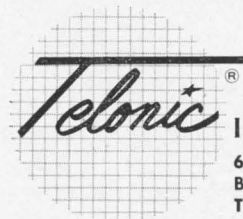

INDUSTRIES, INC.

60 NORTH FIRST AVENUE
BEECH GROVE, INDIANA 46107
TEL: (317) 787-3231 TWX: 810-341-3202

Representatives in all major cities in the U.S., Canada, South America, Europe, Great Britain, Scandinavia, and the Far East.

SWEEP GENERATORS

• RF ATTENUATORS

• DETECTORS

• COAXIAL SWITCHES

Daystrom Trimmers are built to take punishment, can easily handle your humidity requirements. The units in the beaker are just a few of the models from industry's broadest line of sub-miniature square trimming potentiometers. They're available with or without stops in commercial as well as military models. For your special designs, they're supplied with humidity proofing which complies with MIL-R-27208A.

The unique resistance element in Daystrom pots is a major factor in their rugged construction and excellent electrical characteristics. This wire-in-the-groove element provides high

resolution, locked-in linearity and low noise. In addition, the units are sealed against sand and dust, are corrosion resistant, and immune to severe vibration and shock.

If humidity is a factor in your designs, you'll want more information on Daystrom pots. Whatever your needs, you'll probably find a standard, off the shelf model in our catalog. See your Weston distributor for your copy, for price lists and evaluation samples.

Weston Instruments, Inc., Archbald, Pennsylvania 18403. Phone: (717) 876-1500. In Canada: Daystrom, Ltd., Cooksville, Ontario.

Only Daystrom's exclusive wire-in-the-groove offers

↳ **LOCKED-IN LINEARITY** ↲

From Weston's broad trimmer line

Series 510-00HS Transitrin TO-5 case. Slotted adjustment screw. Operation: -55 to 175°C. Range: 10Ω to 30k, with or without stops. Rating: 1.25w @ 50°C in still air.

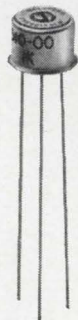

Series 313-00HS 1/2" Squaretrim, 0.187" thick, flexible leads. Operation: -55 to 200°C. Range: 10Ω to 50k. Rating: 1.5w @ 50°C in still air. With base pins: Model 318-00HS.



Series 210-00HS 3/8" Squaretrim, 0.150" thick, flexible leads. Operation: -55 to 175°C. Range: 10Ω to 50k. Rating: 1.0w @ 50°C in still air. With base pins: Model 218-00HS. Side pins: Model 255-00HS.

QUALITY BY DESIGN
 **WESTON INSTRUMENTS, INC.**
 Archbald, Pennsylvania 18403

**Daystrom Trimmers
 are
 water
 tight**

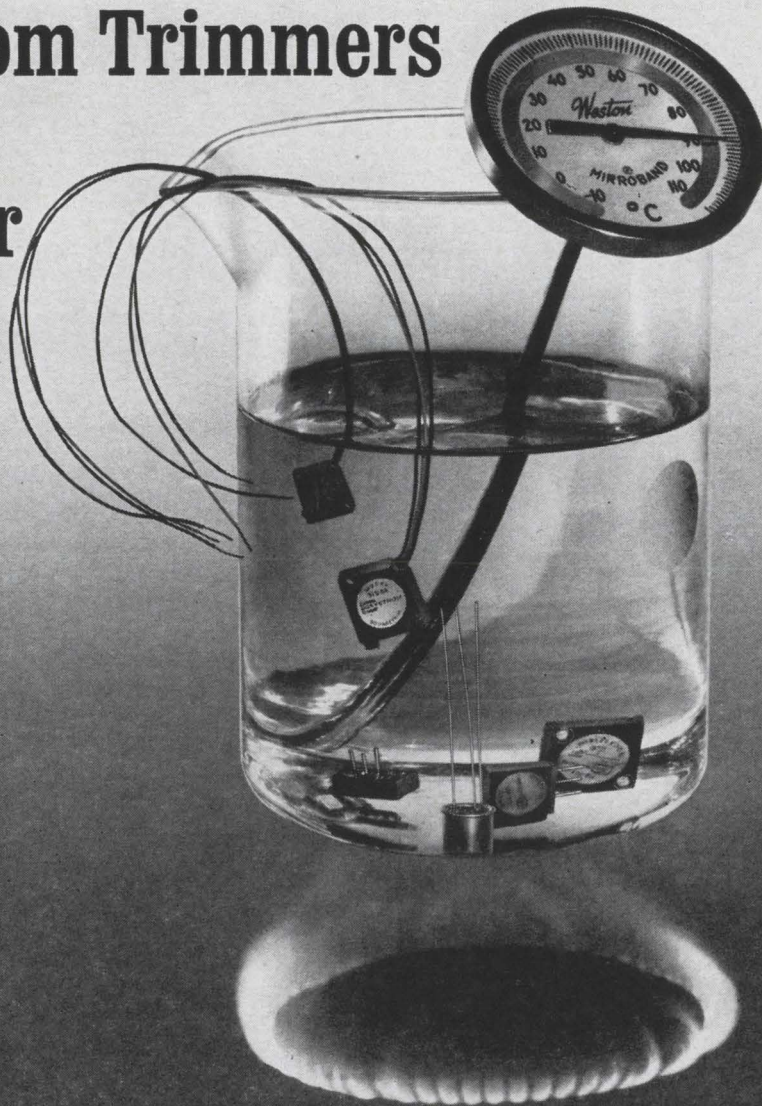

NOW YOU CAN MATCH THE AMPLIFIER TO THE SYSTEM

OFF THE
SHELF!

Tired of designing analog systems to meet the limitations of available amplifiers? Nexus, with the broadest line of encapsulated operational amplifiers in the industry, gives you the greatest design freedom.

Perhaps you are concerned with space. Need a small-volume module? Try our "Q" case. How about an ultra-slim unit for tight card stacking? Our exclusive "K" case measures only 0.40" high.

Maybe cost is a problem. Nexus' wide selection of economy modules are the lowest in price and give the best performance per dollar available anywhere. Our premium amplifiers, on the other hand, have proven superiority in reliability,

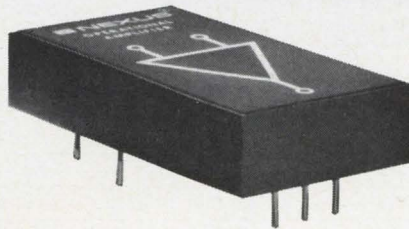

ability, can be made with MIL/QPL components, and can be assembled to NASA specifications.

Looking for high input impedance? We provide standard modules up to 1 megohm (5 megohms, common mode), while our new FET amplifiers provide a differential input impedance as high as 10^5 megohms.

How about low offset? Standard silicon-transistor units are available with offsets as low as $\pm 3 \mu\text{V}/^\circ\text{C}$ and $\pm 0.02 \text{ na}/^\circ\text{C}$, while the FET amplifiers have virtually no offset current.

In other words, at Nexus you stand the best chance of finding exactly what you need in operational amplifiers, without sacrificing design or going to the expense and delay of custom design.

Write for our new *short-form catalog* . . . a convenient guide to quick, easy component selection.

NEXUS
RESEARCH LABORATORY, INC.
480 NEPONSET STREET CANTON MASS 02021 - TEL (617) 828-9000

Visit us at ISA Show in Cal., Booth #2177; NEC in Chicago, Booth #847; Interkama Show in Dusseldorf, Hall "D", U. S. Pavilion.

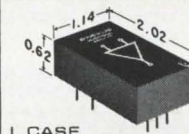
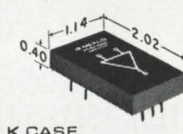
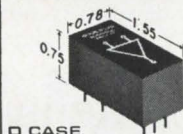
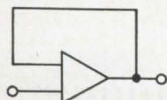

DESIGN ANALOG COMPUTERS WITH MICRO MAGNETICS

General Magnetics'

Micro Magnetic Multiplying Modulators, Monolithic Analog Computing Modules



WORLD'S SMALLEST MOST RELIABLE

G/M Analog Voltage Multiplier

New Micro-miniature G/M Analog Voltage Multiplier as small as 0.1 cubic inch, weighing as little as 0.1 ounce.

MONOLITHIC MICRO CIRCUIT BLOCK for analog voltage multiplying of D.C. and A.C. voltages.

ADDITION, SUBTRACTION, MULTIPLICATION, DIVISION AND EXTRACTING A ROOT of many voltage variables may be handled by one G/M Magnetic Microblock.

PRODUCT ACCURACY of up to 0.2% of full scale, with very slight derating over a wide temperature range.

- Proven reliability—unlimited life
- Extreme stability with negligible change of product accuracy over a wide temperature range
- High shock and vibration proof
- Bandwidth may be extended into the kilocycle range
- Low milliwatt power consumption
- Four quadrant operation
- Repeatable data over years of continuous, unattended operation
- Simple, lightweight, rugged
- May be mounted directly on printed circuit cards

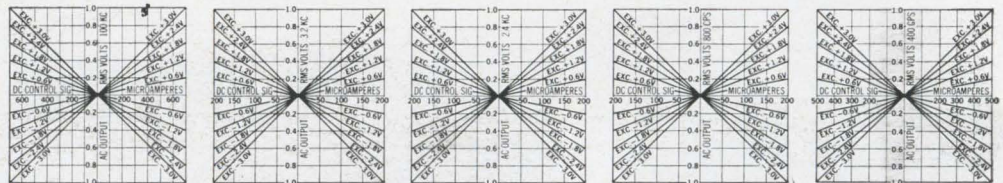

TYPE NUMBER	MCM-827-2	MCM-836-1	MCM-845-1	MCM-847-1	MCM-848-1
Accuracy (% Error of Theoretical Prod.)	1% Maximum	Approx. 0.5%	Less than 1%	2% Maximum	5%
Input Control Signal Range	0 to $\pm 800 \mu\text{a}$ (DC to 5,000 cps)	0 to $\pm 200 \mu\text{a}$ (DC to 200 cps)	0 to $\pm 200 \mu\text{a}$ (DC to 100 cps)	0 to $\pm 200 \mu\text{a}$ (0 to 50 cps)	0 to $\pm 500 \mu\text{a}$ DC (DC to 40 cps)
DC Resistance of Input Signal Range	500 ohms	12.5 K ohms	12.5 K ohms	12.5 K ohms	70 K ohms
Input AC Sig. Range Amplitude, Freq.	0.6 V to 3 V RMS Phase Rev. 100 KC	0 to 3 V RMS Phase Rev. 3200 cps	0 to 3 V RMS Phase Rev. 2400 cps	0 to 3 V RMS Phase Rev. 800 cps	0 to 3 V RMS Phase Rev. 400 cps
AC Output Product Range	0 to 1 V RMS @ 100KC	0 to 1 V RMS @ 3.2 KC	0 to 1 V RMS @ 2.4 KC	0 to 1 V RMS @ 800 CPS	0 to 1 V RMS @ 400 CPS
Null at Max. AC Signal, Zero DC Sig.	15 mv RMS	10 mv RMS Max.	10 mv RMS Max.	10 mv RMS Max.	5 mv RMS Max.
Output Impedance	650 ohms	13 K ohms	12 K ohms	8 to 10 K ohms	15 K ohms
External Load	10K to 100 K ohms	50 K ohms	50 K ohms	50 K ohms	50 K ohms
Temperature Range	-55°C to $+85^\circ\text{C}$	-55°C to $+100^\circ\text{C}$	-55°C to $+100^\circ\text{C}$	-55°C to $+100^\circ\text{C}$	-55°C to $+100^\circ\text{C}$
Null Drift over Temp. Range	0.1% of f.s.	0.1%	0.1%	0.1%	0.2%
Accuracy Variation over Temp. Range	$\pm 0.5\%$	$\pm 0.2\%$	$\pm 0.2\%$	$\pm 0.2\%$	1%
Hysteresis in % of Max. Input DC Sig.	0.1%	0.1%	0.1%	0.1%	0.25%
% Harmonic Dist. in Output Prod. Wave	Less than 5%	3%	3% to 5%	5% Maximum	5%
Overall Dimensions (in Inches)	$\frac{5}{8} \times \frac{25}{32} \times \frac{1}{2}$	$\frac{3}{64} \times \frac{25}{32} \times \frac{1}{2}$	$\frac{3}{64} \times \frac{25}{32} \times \frac{1}{2}$	$\frac{3}{64} \times \frac{25}{32} \times \frac{1}{2}$	$\frac{3}{64} \times \frac{25}{32} \times \frac{1}{2}$
Approximate Weight (in Ounces)	0.26 oz.	0.26 oz.	0.26 oz.	0.26 oz.	0.26 oz.

The Circuit and Fundamental Principles of G/M Magnetic Multipliers are covered by U.S. Patent No. 2758162



THERE IS NO SUBSTITUTE FOR RELIABILITY

For Proven Reliability in Solid State Amplitude Module Applications.

These dependable instruments are widely employed in flight systems, fire control, analog computers, guided missiles, nuclear equipment, antennas and thousands of control systems. Micro-circuit, miniature, subminiature, standard and specials available; request literature. Customized engineering, when required, performed on a no-charge basis.

GENERAL MAGNETICS • INC
135 BLOOMFIELD AVENUE, BLOOMFIELD, NEW JERSEY 07003

COMPONENT, DESIGN AND RELIABILITY ENGINEERS

The Components and Materials Laboratory of Hughes Aircraft Company in Southern California has immediate needs for engineers to fill important positions in the following fields:

COMPONENT ENGINEERS APPLICATION

Provide technical consultation and liaison to design activities, assist in selection and application of component parts, participate in design reviews.

MICROELECTRONIC ENGINEERS

Evaluate integrated and thin film microelectronic devices, analyze failure modes, investigate effects of environments and materials on device characteristics, determine application criteria.

COMPONENT STANDARDS ENGINEERS

Coordinate component-equipment requirements, provide technical consultation, select vendors, determine evaluation programs, initiate procurement documentation.

RELIABILITY ENGINEERS

Coordinate reliability programs, con-

duct component failure analyses, define and direct experiments, establish mathematical models, investigate component performance.

COMPONENT DEVELOPMENT ENGINEERS

Develop components using advanced techniques, investigate new design concepts, study component phenomena, direct experiments and design evaluations.

MAGNETIC DESIGNERS

Design static magnetic components, develop new magnetic devices, investigate and apply new design concepts, initiate evaluation tests.

SUPERVISORS

In addition to requirements for both junior and senior engineers for these positions, several supervisory openings are available.

Requirements: B.S. degree in Physics

or Electrical or Mechanical Engineering and a minimum of three years experience in one or more of the following or associated technical fields:

Display Tubes	Semiconductors
Servo	Potentiometers
Switches	Capacitors
Relays	Resistors
Microelectronics	Magnetics
Instruments	Mechanical

U.S. CITIZENSHIP IS REQUIRED

For immediate consideration, please airmail resume to:

MR. ROBERT A. MARTIN
Head of Employment
Hughes Aerospace Divisions

HUGHES

HUGHES AIRCRAFT COMPANY

11940 W. Jefferson Blvd.
Culver City 26, California

An equal opportunity employer

Today — Raytheon Microwave Technology is Solving These Problems —

Industry today faces increasingly complex scientific problems, that frequently require the application of new disciplines. Here are some from the field of electronics which have been solved by Raytheon microwave technology. Their solutions may provide insights that can be helpful to you.

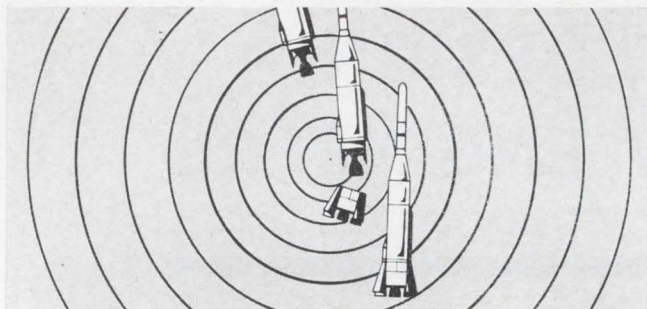

Problem: Pinpoint a space probe's initial track so accurately that any deviation can be corrected instantaneously.

The slightest deviation in a Mariner's course, during the first few seconds of launch and initial parking orbit, can send the Mariner soaring far from its target: Mars. This tracking problem is solved by using two totally integrated solid-state units: a telemetry frequency converter and a tunnel diode amplifier.

The converter has a 2200-2300 Mc input signal and output frequency of 300-400 Mc. Because it is mounted directly on an antenna, it requires a special housing to resist weather and withstand shock and vibration.

The tunnel diode amplifier (used as a front end to the converter) operates over a frequency range of 2200-2300 Mc with 30 db of maximum gain and 3.5 db of maximum noise figure. This unit has special characteristics for extending the dynamic range when tracking at close ranges.

Both the frequency converter and the tunnel diode amplifier are made by The Micro State Electronics Corporation, a subsidiary of Raytheon Company.

Problem: Develop an X-band circulator, to operate at twice the power ever achieved, for the Haystack Microwave Research Facility developed by the M.I.T. Lincoln Laboratory for the U.S. Air Force.

Building an X-band circulator — operable at an average power of 100 kilowatts CW — indicates the ability of Raytheon circulator technology to keep pace with high power tube developments.

The 4-port differential phase shift circulator has a vital role in the Haystack system. In addition to operating as a duplexer, it serves as an isolator — efficiently handling the high power output of the klystron tube and protecting it against reverse power damage. Isolation is greater than 20 db; insertion loss is a maximum of 0.25 db. Thus, less than 10% of the reverse power returns to the klystron and more than 95% of the forward power is transferred through the circulator.

To build this circulator required special manufacturing abilities involving sophisticated flanging, cooling and plating techniques. It also meant developing an unusual power divider.

The device, designed for applications as a duplexer and/or isolator, is a product of the Special Microwave Devices Operation, Raytheon Company.

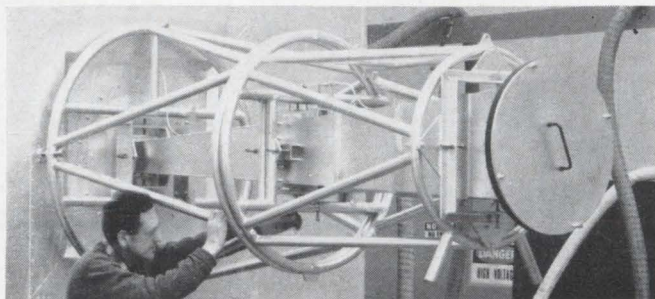

Problem: Build an isolator that can continuously protect a synchrotron's RF generator from damaging reverse power surges.

This problem was posed in 1961, with the construction of the Cambridge Electron Accelerator operated jointly by Harvard University and M.I.T. It was solved by installing a Raytheon UHF isolator that has operated dependably ever since, permitting continuous studies of high energy physics with electrons accelerated at rates up to 6.0 BEV (billion electron volts) and traveling at near the velocity of light (0.999,999,996c).

The insertion loss of the isolator is held to only 0.35 db, allowing 92% of the power to be transferred from the transmitter to the accelerating ring.

The isolator also absorbs power surges reflected from the accelerating system, preventing them from traveling backward to the RF generator. The actual value of isolation is 13.5 db — vital because with this isolation only 1/20th of the forward power can come back to the generator.

This high power Type IUH11 Isolator is made by the Special Microwave Devices Operation, Raytheon Company.

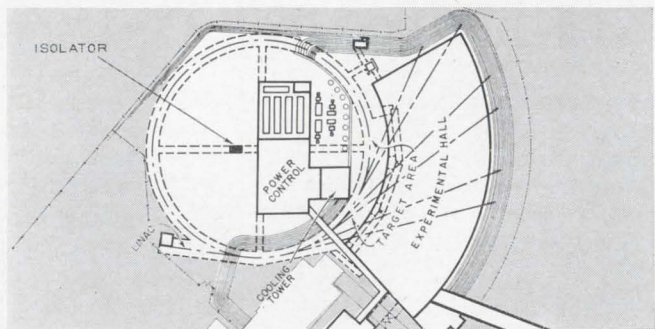

RAYTHEON

Write us in detail about your problem. Data about specific products is available by contacting Raytheon Company, Microwave and Power Tube Division, Department 3035, Waltham, Massachusetts 02154

Probing the News

Space electronics

Keeping in touch with Apollo

The 1969 model, which will make the trip to the moon, will have redesigned communications equipment in which the modular approach has been replaced by built-in redundancy.

By Thomas Maguire

Boston Regional Editor

Spacecraft makers don't change models every year like automobile manufacturers, but the "1969 Apollo" that blasts off for the moon will differ from the 1965 version that will make a suborbital flight late this year by a good deal more than ornamental grillwork. This year's Apollo is known as a "Block I" model, built from designs dating from the early '60's, when design was frozen. "Block II," incorporating improvements in equipment and changes in design philosophy, will be far more than a souped-up Block I. One of the biggest changes will be in the communications and data system.

The new system, which the Collins Radio Co. will deliver to the Apollo prime contractor, North American Aviation, Inc., late next summer, will differ from its predecessor in design, function, and frequency. The system has already gone into production of engineering models at Collins' Cedar Rapids, Iowa, plant.

The big design change is the replacement of the modular approach by units with built-in redundancy. Modules, which work well in sophisticated ground and shipboard systems, pose a housekeeping problem in a cramped spacecraft. "Dead" modules must be physically yanked out and replaced, then labeled and stored separately from unused spares. The redundancy frees the astronauts from main-

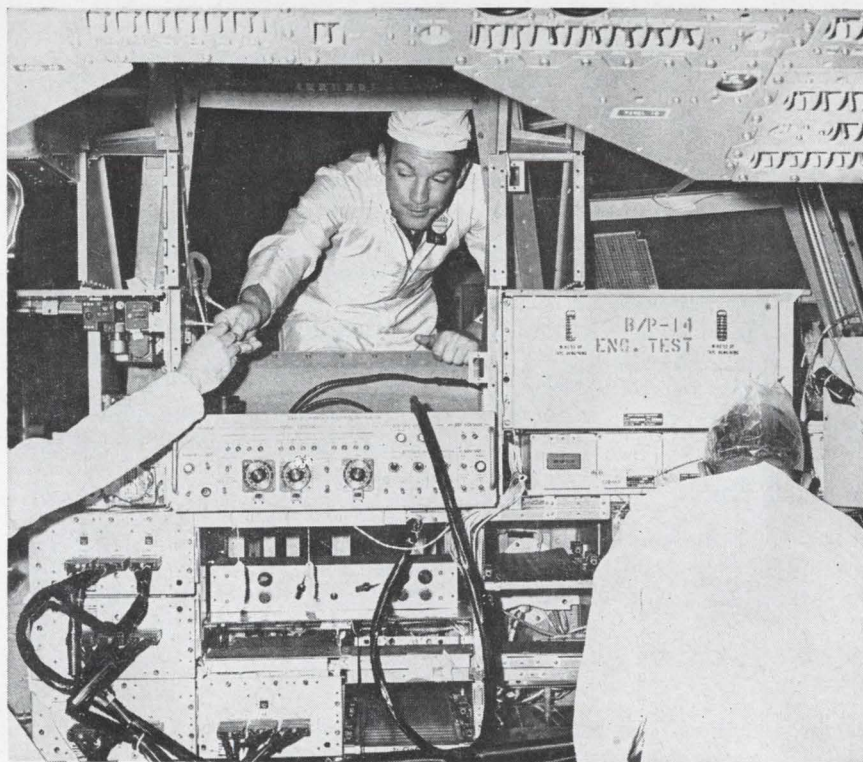

Block I communication and data subsystem, which will fly the first Apollo earth orbital missions, is being tested at North American Aviation, Inc. Many of the front connectors have been removed from the Block II version.

tenance work and saves space.

The function of the system remains, of course, to provide complete communications and telemetry. But when Block I was designed, the National Space and Aeronautics Administration still had not decided whether to build a spacecraft that would land directly on the moon, or to provide

a Lunar Excursion Module (LEM) that would make the actual landing from a mother ship. The eventual decision to go ahead with LEM meant a more complex communications system. The LEM will always be in line-of-sight of the earth, but the command module will orbit the moon and will be behind it half of the time. Commu-

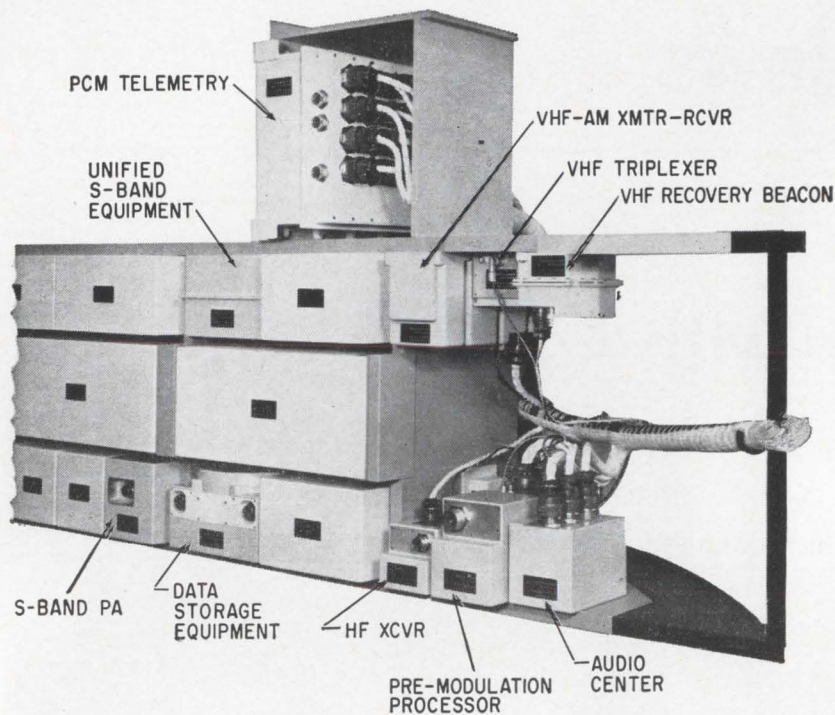

Block II communications subsystem is identical to this mock-up, except that pcm telemetry equipment is sitting on top for demonstration purposes only. It will actually be mounted below, with the other equipment.

communications are required among four points: an astronaut on the moon, LEM, the command module, and earth.

Block I equipment tracked in C band, but improvements in S-band equipment permitted a switch to unified S-band, in which one frequency can be used for tracking, command, telemetry, and voice and television communications.

I. Alternate routes

Block II equipment employs redundancy in instruments as well as in circuits. For example, dual trans-

ponders and dual power amplifiers will be installed, and the astronauts can use any combination of the four "boxes" that they want. The very high frequency transmitters and receivers will also be in duplicate. There will be two redundant units for pulse code modulation telemetry, but here the switchover will be automatic; a comparator circuit will decide which is giving the better output.

Some instruments will have "block redundancy," in which a chunk of circuitry is repeated within the same unit; and some

Audio center in Block II system is new. It uses solid state switching and is supplied in triplicate—one for each astronaut. Completed unit is at left. Upper chassis containing connectors is in the center, with lower and middle chassis at right. The unit in foreground is cordwood module for audio circuits. The entire center is hermetically sealed.

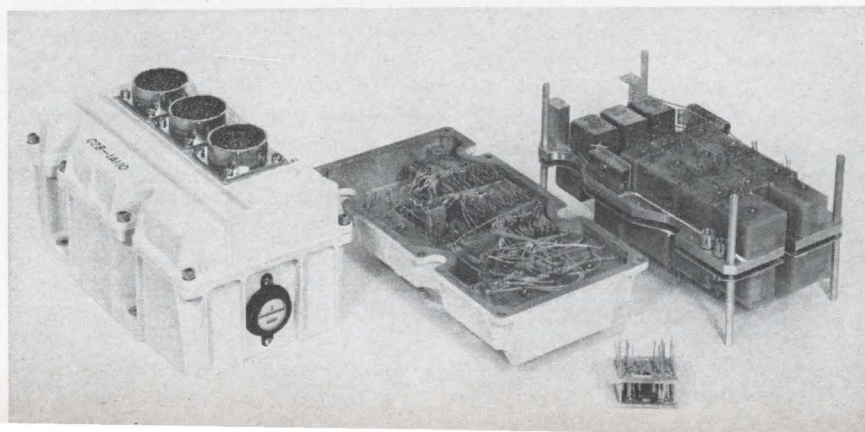

circuits will employ quad redundancy, in which four components, such as resistors, are connected in series and in parallel to guarantee the desired output even if a component fails.

The premodulation processor, which multiplexes data, tv, and voice signals, will not have redundant circuits or blocks; but it does have redundancy of a kind in that it can use a number of modes of communication to bypass failures. The processor goes "right down to Morse code," according to Arthur H. Wulfsberg, assistant vice president of the Collins Spacecraft Systems division.

II. Sealed-in goodness

Redundancy is the strategic approach to prevention of failure; packaging techniques are the tactics. All units will be gasket-sealed in environment-proof boxes, probably in dry nitrogen. The boxes will never be opened after they are sealed at Cedar Rapids.

That precaution was partly a result of Gordon Cooper's Mercury flight, during which droplets from a ruptured urine bag shorted out exposed circuits.

"Apollo will be a shirtsleeve environment," Wulfsberg says. "Droplets of sweat could interfere with vital circuitry."

Wherever possible, Block II will use circuits and components designed for Block I. But simpler construction techniques, along with the use of some hybrid circuits, have permitted redundancy at a system weight equal to Block I's. And in many cases, instruments have been given greater capability. For example, Block II will have three audio centers—one for each astronaut—like Block I; but each center will be able to serve two astronauts, if necessary. The centers will have solid state switching instead of electromechanical relays.

Collins has made four complete Block I systems, plus additional units for qualification tests. Block I will not be junked; one of the systems will be aboard the AF009, an Apollo vehicle that will be launched late this year into a sub-orbital trajectory and will return to earth in powered flight to simulate the conclusion of a lunar mission. The original design will also be used in initial orbital flights.

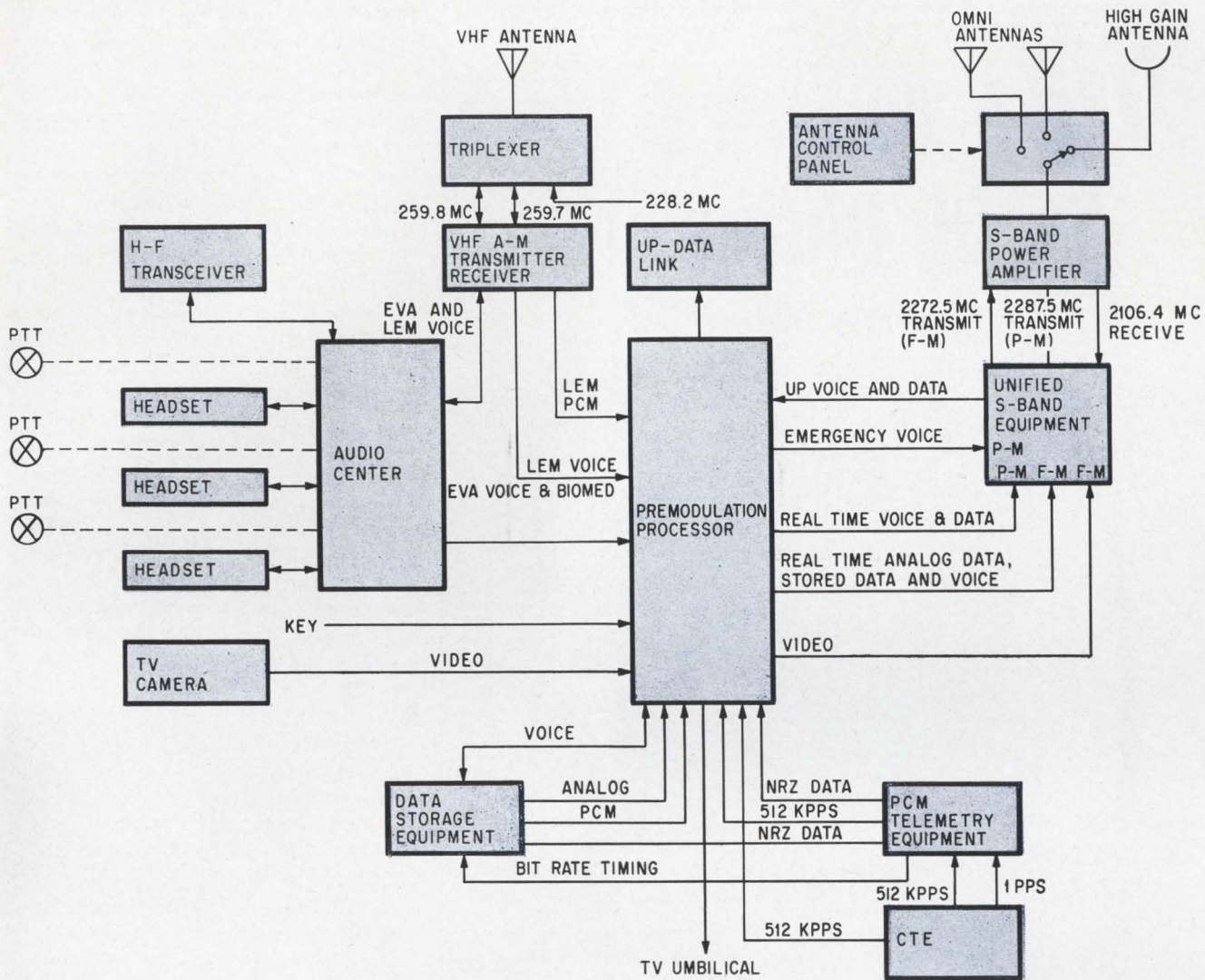

Communications system for Block II system. Tv signals will go to S-band power amplifier on a 2,272.5-Mc f-m channel. Tv umbilical is for prelaunch use. Up-data link and CTE (central timing equipment) are not part of C&D system. (EVA means "extra-vehicular astronauts"—referring to men on the surface of the moon—and PTT means "push-to-talk").

Block II configurations will fly in later orbital missions, in the rendezvous rehearsals, and in the lunar mission itself.

III. System requirements

The communications and data (C&D) network will be the link between the spacecraft and the ground and between all elements of the spaceborne mission. The network comprises:

- A telemetry system (pulse code modulated) to send back data on the spacecraft's condition, the status of the subsystems, the crew's biomedical conditions, and scientific experiments;
- A voice link to enable the crew to talk with the ground throughout almost the entire mission;
- A television camera to provide the ground station and the world at large with real-time coverage of almost the entire mission [Elec-

tronics, July 26, p. 98];

- Recorders to prevent information loss while the spacecraft is behind the moon or when communications are interrupted;
- A transponder to help ground-based radar track the craft while it's in earth orbit;
- Direction-finding devices on the command module to help ground forces locate and recover it after reentry.

IV. Signal flow

The heart of the C&D subsystem is the premodulation processor (see diagram), a switching and multiplexing center that permits selective modes of transmission. The pmp is also a signal-level controller, mixer, filter, subcarrier generator and modulator, and subcarrier detector. Ten types of signals are processed through it.

Biomedical data signals from an

astronaut on the moon's surface, for example, are received by vhf a-m equipment, mixed in the pmp with onboard voice and routed to the unified S-band equipment for relay to earth. The data can also be received on the LEM, and LEM can transmit directly to earth via S-band equipment.

H-f championed. A high-frequency transceiver is included for recovery aid at the conclusion of the mission. It can also be used for long-range earth-orbital communications. This was tried out in Gemini, with less than spectacular success.

"The Gemini experience," says Wulfsberg, "proved what every ham operator knows: you can't do much with five watts a-m at a 20-meter wavelength."

Collins is engaged in extensive computer-based programs to predict h-f propagation factors: opti-

WIN a Bausch & Lomb 7x, 35 Binocular*

...world's finest!

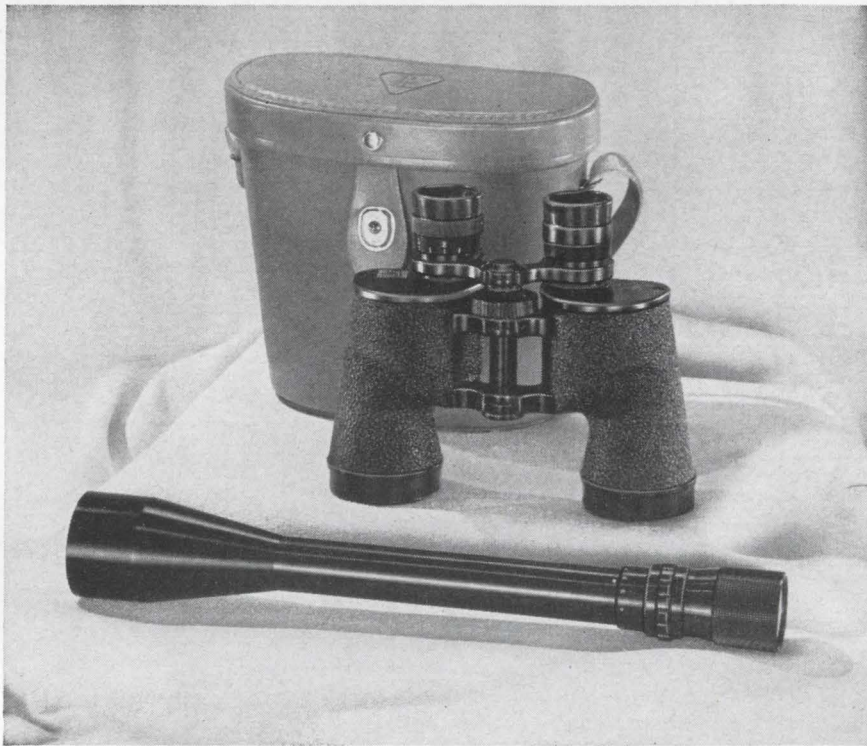

*or you can choose a Balvar 8A Variable Power Rifle Scope.

IN THE BAUSCH & LOMB DZM DERBY FOR ENGINEERS!

All you have to do is submit practical applications for the DZM in the production or inspection of microminiature electronic components.

What's the DZM?

It's a unique optical instrument combining a high power microscope with special illumination. Permits high magnification examination of opaque objects. Each objective has continuously variable zoom magnifications. Range is 25×-800× that can be extended to 3750× with accessories. Choice of bright field, dark field, or polarized light; 5 cameras for photographic work; mechanical or glide stages.



WRITE FOR YOUR COMPLETE DZM DERBY KIT—includes technical literature, Derby rules and official entry form. Send in today—DZM Derby Dept., Bausch & Lomb, 61422 Bausch Street, Rochester, N. Y. 14602.

EVERY CONTESTANT GETS A GENUINE BAUSCH & LOMB MAGNA-RULE MAGNIFIER!

BAUSCH & LOMB 

mum power, frequency and antennas for various circuits and conditions.

"A more knowledgeable use of h-f is our goal," says Wulfsberg. He points out that the Russians must use it for long-haul communications. "Their Vostoks are loaded with h-f antennas. We are lucky enough to have friendly countries where we can set up ground stations for other techniques, but the Russians apparently do very well with h-f."

Personal control. Each astronaut will be able to select a transmit-and-receive mode or a receive-only operation of the h-f, vhf, S-band and intercom circuits. This will be done through the audio centers. A push-to-talk button is located on the umbilical cord for each crew member's suit. This can energize the selected transmitters, or the astronauts can choose the voice-operated mode, energizing the selected transmitters by speaking.

Recovery beacon. Collins is building a vhf beacon for direction-finding in the recovery phase of the Apollo mission; and a power amplifier for the unified S-band transponder being supplied by Motorola, Inc. Radiation, Inc. is supplying the telemetry unit.

A vhf triplexer filter network built by Rantec, Inc. will permit all vhf receivers and transmitters to operate with a single antenna system.

A special tape recorder unit built by Leach, Inc. will store data and voice. Intercom voice signals and LEM voice signals received over the vhf a-m circuits can be recorded when there is a possibility that the transmitted signal will not reach the earth, such as when the spacecraft is behind the moon.

Collins is also prime contractor to Goddard Space Flight Center for the unified S-band ground network, which is being built by Collins' Dallas division. NASA wants 10 new S-band stations, and is converting three existing stations to S band. The company is a subcontractor to RCA for the LEM signal processor, which is a combination audio center and premodulation processor.

Collins' work on both Block I and Block II communications and data systems, will eventually total \$100 million.

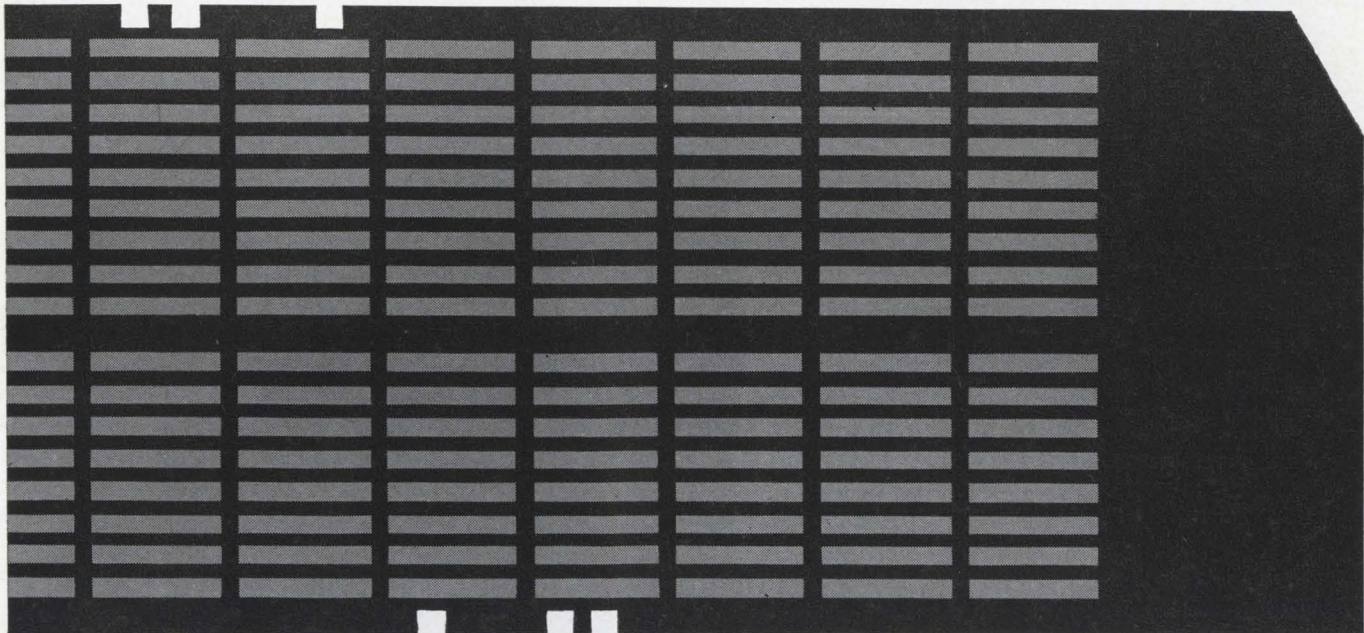

The Long Awaited Breakthrough In EDP

Via Magnetic Iron Oxides The rapidly developing science of Electronic Data Processing has received an impetus of explosive significance through the stepped-up use of magnetic iron oxide coated cards.

Handling mass storage and retrieval of voluminous data and utilizing advanced random access techniques, in some cases the cost per 10,000 alpha-numerical characters has been driven down to as low as one-tenth of their former costs!

Engineering the 'packing density' of the data into radically tighter units on the cards has brought EDP within the pocketbook range of scores of companies not previously in the 'live prospect' class.

Pfizer, as a major supplier of magnetic iron oxides congratulates the EDP industry for its enterprise. Pfizer for its part will continue to provide the chemical purity and uniform magnetic properties that make their product a standard of reliability.

Yes — Pfizer stands ready and willing to dispense all pertinent, technical information. Write Department 75

**MINERALS
PIGMENTS
& METALS**
DIVISION CHAS. PFIZER & CO. INC.



Dept. 75, 235 East 42nd Street
New York 17, N.Y.



WATER COOLED

(MINIATURIZED)

&

**AIR COOLED
CERAMIC
TRANSMITTER
CAPACITORS**

14 kVp—150 Amps RF
1500 kVAr



15 kVp—24 A RF 50 uVAr

For:

**COMMUNICATIONS
INDUCTION HEATING**

Write for literature to:

**United Mineral
&
Chemical Corp.**

129 HUDSON ST.
NEW YORK, N. Y. 10013
(212) 966-4330

Patents

McClellan urges industry: protect your patent rights

Senate panel is likely to whittle away companies' access to their own inventions, made in the course of work for the government

By Warren Kornberg

Washington News Bureau

When a Senate subcommittee resumes the battle of the patents next year, the aerospace and electronics industries must stop sitting it out—or risk losing some of the patent rights they receive as a result of defense work. That warning comes from John L. McClellan (D., Ark.), chairman of a patent subcommittee of the Senate Committee on the Judiciary.

A proponent of more liberal patent policies toward contractors, McClellan has urged the industries to arm him with evidence that potential patent rights encourage companies to bid on government work and, presumably, give the government more proposals from which to choose.

Existing policies are already under assault by influential senators led by Russell B. Long (D., La.), who calls them "discretionary giveaways." Three of the five members of the McClellan subcommittee have opposed a liberalization plan that was put forward by President Kennedy and endorsed by the Johnson Administration. The committee opponents are Philip A. Hart (D., Mich.), Hiram L. Fong (R., Hawaii) and Quentin N. Burdick (D., N. D.); advocates of the Administration plan are McClellan and Hugh Scott (R., Pa.).

I. The Administration's policy

The Kennedy directive was an attempt to formulate a consistent national policy out of the diverse policies of federal agencies, and to give the same patent rights to contractors regardless of which federal agency they work for.

Broadly, the policy says the government should keep a patent in any field of technology in which the government has paramount interest, or which affect the public health, safety or welfare. A contractor can keep his invention if he has an established commercial position in a field, even if the invention was made with public funds. Under the present policy, defense contractors get patent rights in advance, at the time of negotiation, under 75% of research-and-development contracts. The aerospace and electronics industries, by and large, like the policy. Drug companies, held on short tether by the "health and welfare" restrictions, are exposed.

Pig and poke. This assigning of patents in advance, before any work is done, is the most distasteful section to Sen. Hart. There are indications that he and Sen. Fong might be willing to approve provisions that are close to the Administration's if that "pig-in-a-poke" policy, as Hart calls it, were revised. Hart says the invention should be made before, not after, it is assigned to the government or to a contractor.

McClellan favors advance waivers of some patent rights by the government as an incentive to companies to bid. Ever since the start of hearings June 1, he has urged companies to bring case studies or other evidence to prove that development was stymied because the government held onto a patent.

The Pharmaceutical Manufacturers Association made a forceful presentation. Austin Smith, presi-

little  switch

BIG SAVINGS

Half the cost of conventional multi-position switches and loaded with multiple performance design advantages. Spectrol's miniature switches give you performance characteristics for printed and micro-circuit applications never before available in so small a package at such low prices. Reliable, trouble free operation is assured by the unique construction features of the type 88 rotary indexing switches.

DIRECT MOUNTING — Reduces wiring costs — mounts directly on printed circuit boards.

TROUBLE-FREE OPERATION — Contacts are kept free of oxides and other harmful film deposits by the self scrubbing design that polishes during every duty cycle.

FULL POTTING PERMITTED — Dust-free, moisture-free operation insured by silicone rubber scaling and packing gland techniques.

MILITARIZED — Designed to stand up under high shock, vibration, temperature extremes, and other severe environments per MIL-STD-202B.

LOW ARCING — LOW NOISE — Higher contact force and elimination of tracking made possible by the cam actuated "lift-off," "drop-on" wiper action.

THREE CONFIGURATIONS — Choice of knob, screw driver adjust or bushing panel mount.



88-3-8
SLOTTED
HEAD



88-3-10
KNOB

ACTUAL SIZE



88-5-6
BUSHING

BRIEF SPECIFICATIONS

Switch type.....Single pole, 10 position, non-shorting
 Switch action.....Positive detent action, 36° indexing
 Current rating.....250 MA at 28 VDC
 Case dimensions
 (inches)..... $\frac{3}{16}$ H max x $\frac{1}{2}$ D (88-3-8)
 Price 1 to 9 pieces...\$3.75

MODEL 88

Call your nearest Spectrol distributor for immediate off-the-shelf delivery at factory prices, or write for complete specifications. Spectrol also manufactures a complete line of trimming potentiometers and turns-counting dials.

SPECTROL ELECTRONICS CORPORATION

1704 South Del Mar Avenue
 San Gabriel, California

Adams Court
 Plainview, L.I. New York

Now Lambda offers two complete lines of all-silicon

Modular Subrack

LM SERIES

Multi-Position-Rated™ and Multi-Current-Rated™ for 40°, 50°, 60° and 71°C

You can select from 22 models starting at **\$79** voltages up to 60 VDC, from 0.08 AMPS. to 8.3 AMPS....and mount these modules three ways on a chassis or in a rack

A-C Input—105-132 VAC
45-440 CPS

Reg. Line—.05% + 4 MV
Load—.03% + 3 MV

Ripple—1 MV rms—3 MV peak-to-peak

Temp. Coef.—.03%/°C

- Meet RFI Specifications—MIL-I-16910
- Maximum Ratings Without External Heat Sinking or Forced Air
- Thermally Protected and Short Circuit Proof—Current Limiting
- Remote Programming



mounted this way

mounted this way

mounted this way

4 DC OUTPUTS IN 3 1/2" RACK

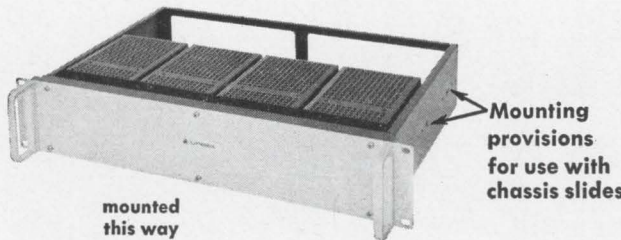

mounted this way

Mounting provisions for use with chassis slides

New

Both LM and LH Series meet these Mil. Environment Specifications:
Vibration — Shock — Humidity — Temp. Shock
Altitude — Marking — Q.C.

LH SERIES

1/4 and 1/2 rack power supplies are Multi-Current-Rated™ for 30°, 50°, 60°

You can choose from 10 1/4 and 1/2 rack models... voltages up to 120 VDC, up to 9 AMPS.... for rack, bench and chassis mounting

A-C Input—105-135 VAC
45-480 CPS

Reg.—.015% or 1 MV line or load

Ripple—1/4 MV rms, 1 MV p to p

Temp. Coef.—.015%/°C

RFI—MIL-I-16910

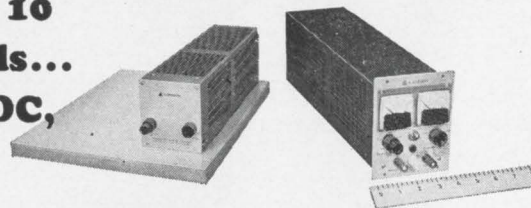

flush chassis mounting

minimum bench width

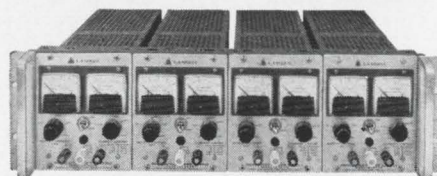

4 DC outputs in a single rack



Package A

3 3/16" x 3 3/4" x 6 1/2"

Model	VDC	I MAX. AMPS ¹				Price
		40°C	50°C	60°C	71°C	
LM 201	0-7 ²	0.85	0.75	0.70	0.55	\$ 79
LM 202	0-7 ²	1.7	1.5	1.4	1.1	99
LM 203	0-14 ³	0.45	0.40	0.38	0.28	79
LM 204	0-14 ³	0.90	0.80	0.75	0.55	99
LM 205	0-32 ⁴	0.25	0.23	0.20	0.15	79
LM 206	0-32 ⁴	0.50	0.45	0.40	0.30	99
LM 207	0-60	0.13	0.12	0.11	0.08	89
LM 208	0-60	0.25	0.23	0.21	0.16	109



Package B

3 3/16" x 4 15/16" x 6 1/2"

Model	VDC	I MAX. AMPS ¹				Price
		40°C	50°C	60°C	71°C	
LM 217	8.5-14	2.1	1.9	1.7	1.3	\$119
LM 218	13-23	1.5	1.3	1.2	1.0	119
LM 219	22-32	1.2	1.1	1.0	0.80	119
LM 220	30-60	0.70	0.65	0.60	0.45	129



LH124FM



LH124

1/4 RACK metered and non-metered
SIZE 5 3/16" x 4 3/16" x 1 5/2"

Model ²	VDC	I MAX. AMPS. ¹				Price ²
		40°C	50°C	60°C	71°C	
LH 118	0-10	4.0	3.5	2.9	2.3	\$175
LH 121	0-20	2.4	2.2	1.8	1.5	159
LH 124	0-40	1.3	1.1	0.9	0.7	154
LH 127	0-60	0.9	0.7	0.6	0.5	184
LH 130	0-120	0.50	0.40	0.35	0.25	225

¹ Current rating is from zero to I max. and applies over entire voltage range.

² Prices are for non-metered models. For metered models add suffix (FM) to model number and add \$25.00 to



LAMBDA ELECTRONICS CORP.

515 BROAD HOLLOW ROAD, MELVILLE, L. I., NEW YORK • 11749

Circle 140 on reader service card

.. power supplies

Ambients



Package C

3 $\frac{3}{16}$ " x 4 $\frac{15}{16}$ " x 9 $\frac{3}{8}$ "

Model	VDC	I MAX. AMPS ¹				Price
		40°C	50°C	60°C	71°C	
LM 225	0-72	4.0	3.6	3.0	2.4	\$139
LM 226	8.5-14	3.3	3.0	2.5	2.0	139
LM 227	13-23	2.3	2.1	1.7	1.4	139
LM 228	22-32	2.0	1.8	1.5	1.2	139
LM 229	30-60	1.1	1.0	0.80	0.60	149



Package D

4 $\frac{15}{16}$ " x 7 $\frac{3}{4}$ " x 9 $\frac{3}{8}$ "

Model	VDC	I MAX. AMPS ¹				Price
		40°C	50°C	60°C	71°C	
LM 234	0-72	8.3	7.3	6.5	5.5	\$199
LM 235	8.5-14	7.7	6.8	6.0	4.8	199
LM 236	13-23	5.8	5.1	4.5	3.6	209
LM 237	22-32	5.0	4.4	3.9	3.1	219
LM 238	30-60	2.6	2.3	2.0	1.6	239

¹ Current rating is from zero to I max. Current rating applies over entire output voltage range. Current rating applies for input voltage 105-132 VAC 55-65 cps. For operation at 45-55 cps and 360-440 cps derate current rating 10%.
² To operate at 0-10 VDC—derate output current 30%.
³ To operate at 0-20 VDC—derate output current 30%.
⁴ To operate at 0-40 VDC—derate output current 30%.

and 71°C Ambients



1/2 RACK metered and non-metered
 SIZE 5 $\frac{3}{16}$ " x 8 $\frac{3}{8}$ " x 15 $\frac{3}{8}$ "

Model ²	VDC	I MAX. AMPS. ¹				Price ²
		30°C	50°C	60°C	71°C	
LH 119	0-10	9.0	8.0	6.9	5.8	\$289
LH 122	0-20	5.7	4.7	4.0	3.3	260
LH 125	0-40	3.0	2.7	2.3	1.9	269
LH 128	0-60	2.4	2.1	1.8	1.5	315
LH 131	0-120	1.2	0.9	0.8	0.6	320

price. For non-metered chassis mounting models, add suffix (S) to model number and subtract \$5.00 from non-metered price.



dent of the association, dealt with specifics. He and his spokesmen demonstrated to the subcommittee's satisfaction that drug companies have curtailed work with universities, hospitals and other nonprofit institutions where the pressure of government grants or contracts might cast a shadow on subsequent patent titles. They would resume such work if there were patent title or exclusive licensing guarantees, they indicated.

Such examples satisfied McClellan, Hart and others that the cost of development of a marketable drug far exceeded the cost of inventing a patentable compound; and that patent title or at least exclusive licenses are necessary incentives, which should be incorporated in legislative proposals.

But aerospace and electronics industries failed to come in with case studies and other evidence documenting the importance of patent rights as a contract incentive. They have dealt in generalities.

Unless documentation comes in before a vote is taken next year, McClellan doubts that he can win the additional vote that would convert his two-man minority into a three-man majority.

II. Industry's position

There have been reports of several aerospace companies obtain-

ing valuable patents as a result of defense contracts. But none of these rumors has been confirmed. Patent specialists in the aerospace and electronics industries are skeptical that anybody has received any commercial value from an invention made for the government.

At the beginning of the dispute, in March, 1963, presidential science adviser Jerome B. Wiesner said he doubted that patent rights provided much commercial incentive for industry to bid on government work. Theodore Bowes, patent counsel for the Westinghouse Electric Corp., agrees. Calling the issue a tempest in a teapot, Bowes says ownership of spinoff patents might be important some day, but not now.

But Bowes favors setting up the ground rules in advance. Otherwise, he says, "you're guaranteeing a lot of little fights later."

Preview. A bill will be reported next year. From all indications, here are what its major provisions will do:

- Give the drug industry considerably greater patent rights than it receives under present practices.

- Prohibit the practice of waiving the government's rights to contractor-developed patents at the time that contracts are being negotiated.

- Give federal officials greater leeway in assigning patent rights.

Contracts

Weapon against waste

Systems effectiveness assurance is the government's new technique to evaluate a system before it is even built

By Herbert Cheshire

Washington News Bureau

Vice Adm. I. J. Galantin, Chief of Naval Material, tells the story of a British officer who had to evaluate an exceedingly complex weapon system. At first, the sophistication of the system's gadgetry almost mesmerized him. But in the end, he couldn't recommend its adoption.

"The extreme ingenuity of this weapon," he reported to his superior, "almost blinds one to its utter uselessness."

Galantin cites the Briton's experience in explaining why the Navy—and indeed the whole defense and space-agency establish-

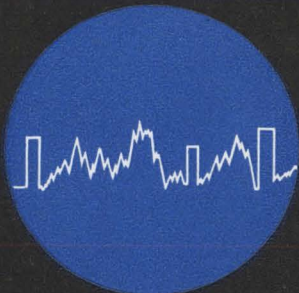

PERFECT REPEATER

E13-511

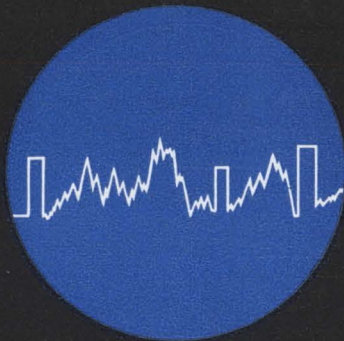

NEW - \$12.00

INTEGRATED VIDEO AMPLIFIER BY AMELCO HAS HIGH STABILITY!

AMELCO's new E13-511 wideband video amplifier features high stability from -55°C to $+125^{\circ}\text{C}$ at a cost of only \$12.00 in one to 99 quantities! ▲ This monolithic integrated circuit amplifies from DC to over 50 mc (-3 db) with an essentially flat gain characteristic to 40 mc. ▲ Constructed by silicon planar techniques using high resolution photoetching and epitaxial material, exceptional isolation between circuit parts and uniformity of characteristics are achieved. The E13-511 simplifies inspection, shortens assembly time, and increases reliability with no sacrifice in performance and, at a remarkably low price!

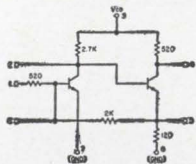

KEY SPECIFICATIONS:

- ▲ Voltage Gain 24 db
- ▲ Bandwidth (-3 db) 50 mc
- ▲ Gain Variation (-55°C to $+125^{\circ}\text{C}$) $\pm 0.3\text{ db}$
- ▲ Limits of Gain Variation (DC to 10 mc) $\pm 0.5\text{ db}$
- ▲ Dynamic Range 7.0 Volts



AMELCO SEMICONDUCTOR

DIVISION OF TELEDYNE, INC.
1300 TERRA BELLA AVE., MOUNTAIN VIEW, CALIFORNIA

Mail Address: P. O. Box 1030, Mountain View, Calif./Phone: (415) 968-9241/TWX: (415) 969-9112/Telex: 033-914

REGIONAL OFFICES

Southwest
3216 West El Segundo Blvd.
Hawthorne, California
(213) 772-6341

Northwest
1300 Terra Bella Avenue
Mountain View, California
(415) 968-9241

East
P. O. Box 1927
Paterson, New Jersey 07509
(516) 334-7997

Northeast
543 High Street
Westwood, Massachusetts
(617) 326-6600

Midwest
650 West Algonquin Road
Des Plaines, Illinois
(312) 439-3250

2428 West 22nd Street
Minneapolis, Minnesota
(612) 374-1969

ment—is turning to a new tool to guard against buying systems of dubious worth. The technique, called systems effectiveness assurance, is a new design and management discipline which measures a system's probable effectiveness before development ever begins and then makes sure that optimum effectiveness levels are actually achieved.

Numbers decide. Contractors are not yet being asked to use the techniques; that will come when the armed forces develop mathematical models that will measure and express a system's effectiveness in numerical terms. Then, if engineer X favors one system and engineer Y another, the argument can be settled by numbers. Basic formulas for measuring effectiveness already have been worked out, but much work remains to be done in refining and testing them.

I. Active programs

The next step for both the Navy and Air Force is to apply the rough numerical expressions for each element of systems effectiveness to going projects; the Navy already has begun to do this. Its program known as Paced, or program for advanced concepts in electronic design, is aimed at developing measuring techniques and methodology for appraising the effectiveness of electronic systems. The Naval Applied Science Laboratory and the Bureau of Ships are carrying on the work.

The appraisal techniques will be broadened to cover large systems in the Seahawk and Frisco programs. Seahawk is an advanced antisubmarine warfare destroyer that is being designed around its electronic systems. Up until now, ships were built first, then the electronic systems fitted in wherever there was room. Frisco is a similar program for a submarine.

Systems effectiveness techniques are also being applied to the VAST (versatile avionics shop test) program, an attempt to develop a standardized avionic shop to be used on aircraft carriers for the maintenance of a broad variety of aircraft.

The Navy is also using the systems effectiveness approach in managing the development of the integrated helicopter avionics sys-



The only *solid-state* counters available? If any electronic counters can be considered *all* solid-state, they're the Beckman 6100 Series. These 2.5, 25, and 50-mc counters use *no* vacuum tubes in any form—even the digital display is solid-state. This spells superior reliability and value backed by these unparalleled benefits: Electroluminescent display guaranteed against catastrophic failure for *three years*. More plug-ins—*nine*—for greater versatility. Plug-ins do *not* just add basic functions but expand and add capabilities (trigger controls and time interval function are available on basic counters). Plug-ins include frequency extenders to 3 gc, integrating DVM, mode expander/preset, and preamplifier. *Active* storage provides BCD output data during next sampling. All these benefits *plus* Mil ratings at no extra cost. Plus standard functions of frequency, period, multiple-period average, ratio, multiple-ratio average, time interval, and random count measurements; automatic decimal point positioning and unit of measurement display. Prices of basic instruments start at \$1,960 and plug-ins from \$440. For your best value in counting, ask your Beckman Berkeley representative for a demonstration of a *truly* solid-state electronic counter—the 6100 Series.

Beckman®

INSTRUMENTS, INC.

BERKELEY DIVISION

RICHMOND, CALIFORNIA • 94804

INTERNATIONAL SUBSIDIARIES: GENEVA, SWITZERLAND; MUNICH, GERMANY; GLENROTHES, SCOTLAND; PARIS, FRANCE; TOKYO, JAPAN; CAPETOWN, SOUTH AFRICA

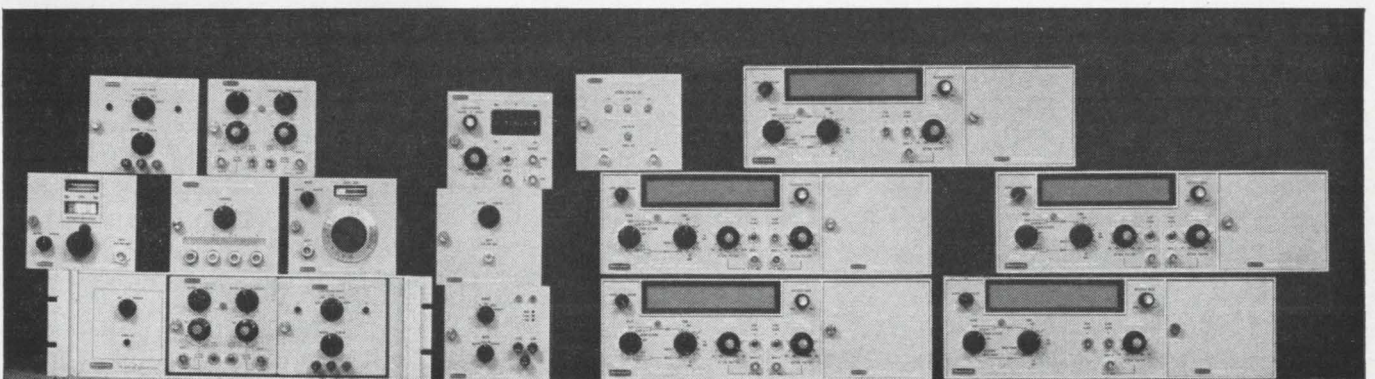



**A⁺
Adlake[®]**
makes
more kinds of
mercury relays
than anybody



Send
for a
free
catalog.

A recent addition to the Adlake line: the polarized bistable mercury wetted contact relay, pictured above, which delivers speeds up to 100 operations per second. Others include: time delay; load (contacts open or closed); wetted contact (including epoxy encapsulated and sensitive non-bridging).



**THE ADAMS &
WESTLAKE COMPANY**

Elkhart, Indiana

Dept. N-4602 Relay Division
Dial Area 219 Congress 4-1141

tem (IHAS) and the integrated light attack avionics system (ILAAS). And, although the companies bidding on these projects did not have the systems effectiveness formula to go by, their proposals were checked against it when they came in. The high scores received by Teledyne Systems Corp. for IHAS and Sperry Gyroscope Co. for ILAAS played a big role in their being selected for the awards.

II. Industry briefing

Defense Department and National Aeronautics and Space Administration officials will explain the systems effectiveness approach and its significance to engineers, scientists and managers at a conference sponsored by the Electronic Industries Association in Washington, Oct. 19 and 20.

The message. This is what industry will be told: that as the tools of modern warfare grow in complexity, the probabilities increase that some element of a military system will be deficient or defective. This is reflected by the number of "get well" programs that are, in essence, attempts to build effectiveness into the system after it's already completed. The necessity for these fixes usually indicates lack of adequate planning at the outset or an ineffective approach.

Systems effectiveness analysis begins with the premise that the *raison d'être* of any warfare system is the accomplishment of its mission. By the military's definition, systems effectiveness becomes a "measure of the extent to which a system can be expected to complete its assigned mission within an established time frame under stated environmental conditions."

III. The ingredients

A wide range of qualitative characteristics contribute to systems effectiveness—operability, reliability, maintainability, compatibility, logistics supportability and human factors.

These elements are considered ends in themselves and treated as separate functional entities. Systems effectiveness aims at pulling all of these elements into an integrated framework that permits tradeoffs for achieving maximum effectiveness.

Leslie Ball of Boeing Co. says

that a host of "cults" have sprung up in systems development. Some of them are product-oriented and emphasize a particular characteristic such as reliability, safety, repairability. Other cults are management-oriented and promote a host of special management techniques, such as value engineering, configuration control and PERT (program evaluation review technique).

But the special areas these cults promote "are only subordinate factors in achieving the basic objective of systems effectiveness," Bell says. "Consequently, the cults that promote them should be viewed as vital but as subordinate segments of an integrated systems effectiveness assurance effort."

The bond that ties. "We can no longer afford the 'build-one-and-try-it' approach with a subsequent 'get-well' effort to patch on reliability, maintainability, value engineering and the like," says Cmdr. Keith N. Sargent, head of the Navy's systems effectiveness branch. "Neither can we accept weapons which must be staffed by Ph.D's."

"We must perfect mathematical modeling techniques with which to do our systems engineering homework. These models require an over-all cohesive discipline within which they can be structured. Systems effectiveness is the bond that ties all the other disciplines together."

IV. Formulas

Both the Navy and Air Force have developed—though they have not perfected—slightly differing conceptual models for determining systems effectiveness and for expressing its qualitative elements in quantitative terms.

The Navy's basic formula states that systems effectiveness is the product of performance, availability and utilization. Performance is a measure of how well a system operates; availability, a measure of how long it will function under certain conditions, and utilization is a measure of how often the system will be used.

Defining these three terms further, the Navy says performance is the end result of design adequacy, design simplicity, compatibility and man-machine interfaces. Availability is a function of reliability, maintainability, repairability, sup-

portability and training. Utilization is determined by mission length, probable deployment and mission environment.

An increase in performance, availability or utilization produces an increase in systems effectiveness.

Cost a factor. But for every such gain, an additional cost must be paid. Tradeoff can be made when systems effectiveness is related to costs. Another formula has been developed which states that cost effectiveness is systems effectiveness divided by the cost of acquisition plus the cost of utilization.

Even more complex is the formula to provide an index for a system's ultimate worth—its defense effectiveness. This relates systems effectiveness, cost, military worth, and the time for desired achievement. All of these factors can be played off against one another to get maximum defense effectiveness.

V. Numerical score

Now the Navy and Air Force are developing and refining methods for converting the separate elements of the generalized mathematical statements into numerical indexes. Since there is no precise mathematical measure for all the factors that determine whether a system is effective, the indexes will be numerical expressions of judgment derived by both empirical and probabilistic mathematics.

Probability. "Education is one of our main problems in perfecting these formulas and getting them accepted," says Sargent. "Too few working designers within and without government understand what we are trying to do. The concepts of systems effectiveness are not widely taught in universities, and the probabilistic reasoning involved is, in a sense, abhorrent to the deterministic exactness which is the hallmark of the engineering profession."

Engineers are quite capable of probabilistic thinking at the poker table, the races, or at their brokers, says Sargent, but they seem to have a block against extrapolating that kind of reasoning to their own jobs.

"Yet, paradoxically, they glibly use the term 'calculated risk'. We are trying to put some real calculation into that term predicting how

YOKE SPECIFYING PROBLEM?



ASK AN EXPERT...

A SYNTRONIC DEFLECTION YOKE SPECIALIST

Since we make more types of yokes than anyone else, it's natural enough for our team of experts to know more about yoke design, application engineering, and quality control.

Specifying can be a challenging problem, and with this in mind, we put our experience at your disposal. Don't hesitate to call or write us when you're puzzled as to the right deflection yoke for your display.

syntronic

INSTRUMENTS, INC.

100 Industrial Road, Addison, Illinois
Phone: Area 312, 543-6444

Circle 209 on reader service card

REMEMBER **RESE**
FOR **MAGNETIC CORE MEMORIES**

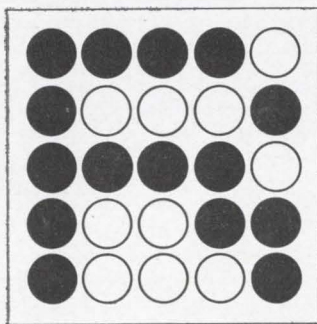

RESE ENGINEERING INC.

A and Courtland Streets, Philadelphia, Pa. 19120 (215) GL5-9000

RMC

HIGH STABILITY, TYPE JE

DISCAPS

are Practically Immune to Severe Temperature Change

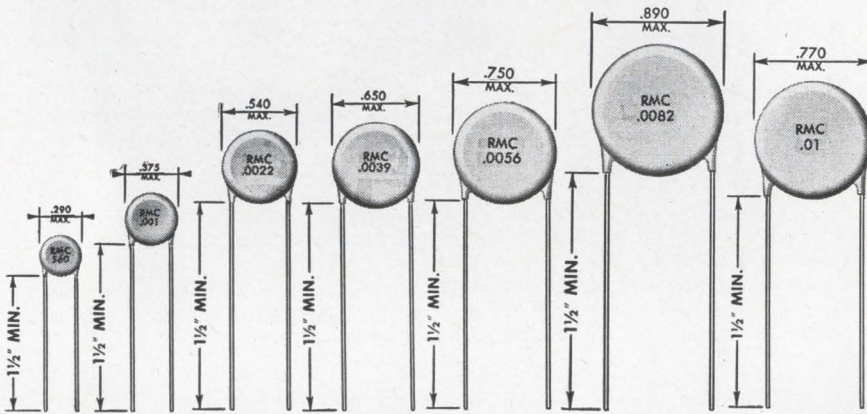

150	330	680	.0012	.0027	.0047	.0068	.01*
180	390	820	.0015	.0033	.0056	.0082	
220	470	.001	.0018	.0039			
270	560		.0022				

*Dual Disc construction—long leads only.
Disc sizes under 1/2" diameter have lead spacing of .250".
Disc 1/2" diameter and over have .375" spacing.

Specifications

CAPACITANCE: Within tolerance @ 1KC and 25°C.
CAPACITANCE TOLERANCES: +10%, +20% or +80 - 20%
WORKING VOLTAGE: 500 VDC
POWER FACTOR: 2.0% @ 1KC
INSULATION RESISTANCE: Greater than 7500 Megohms @ 500 VDC

TEMPERATURE COEFFICIENT: Z5E, Y5E
FLASH TEST: 1250 VDC for one second
LIFE TEST: Per EIA RS-198 Class II
POWER FACTOR AFTER HUMIDITY: 3.0% @ 1KC

INSULATION RESISTANCE AFTER HUMIDITY: Greater than 1000 Megohms @ 500 VDC
BODY INSULATION: Durez phenolic -- vacuum wax impregnated
LEAD STYLES AVAILABLE: Long lead - #22 tinned copper -, fin-lock, kinked lead plug-in and pin type plug-in

RMC Type JE Discaps exhibit only $\pm 4.7\%$ capacitance change over the extended -30° to $+85^\circ\text{C}$ temperature range. These capacitors are especially suited for use in mobile communication and like equipment. Typical usage in R-C response shaping networks and feedback loops, in addition to conventional applications, is indicated.

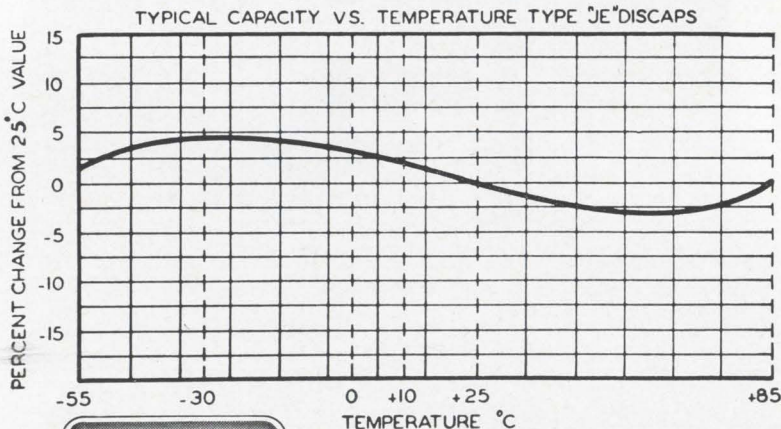

DISCAP CERAMIC CAPACITORS

RADIO MATERIALS COMPANY
A DIVISION OF P. R. MALLORY & CO., INC.
GENERAL OFFICE: 4242 W. Bryn Mawr Ave., Chicago 46, Ill.
Two RMC Plants Devoted Exclusively to Ceramic Capacitors
FACTORIES AT CHICAGO, ILL. AND ATTICA, IND.

successful a system will be."

Put up or shut up. Sargent describes systems of effectiveness measurement as a means of giving "visibility to military judgments" by assigning them numerical values.

"It is a discipline which requires project engineers and managers to put their money where their mouth is because the effectiveness of their approach will be measured in a national way. It will require both the military and industry to explicitly state their judgment values for the edification of the other.

"Furthermore, it is a discipline within which all the factors contributing to the effectiveness of mission accomplishment can be related. Once this is done, gaming techniques can then be employed to determine the optimum combination of factors. All of this will lead to upgrading confidence in management judgments and decisions."

VI. Effect on contractors

So far, systems effectiveness is almost wholly an in-house military conceptual effort. But when the measuring tools are refined, its application will be evident in the guidance furnished to defense firms doing contract definition work. The military will set specific effectiveness goals and the development contractor will be evaluated on how closely he approaches them.

In time, it's expected that industry will start using the conceptual models developed by the Air Force and Navy. "With these tools," says Sargent, "contractors can present their case for the system design they espouse. Further, top management in industry will be in a better position to appraise its own efforts and to understand the military decision process."

Industry associations have not yet taken an official position on systems effectiveness analysis, though an industry advisory group helped the Air Force with its conceptual model.

"If it leads to better definition of what is wanted and more orderliness in development, that is all to the good," says one association official. "But it remains to be seen how many extra controls on the contractor the military may impose in its search for effectiveness."



**Cinch
"Bow-Pin"
...versatile
contacts for
miniaturized
connector
applications**

— ACTUAL SIZE

**TARGET
PRICE FOR
VOLUME
REQUIREMENTS

UNDER 5c
A MATED PAIR**

Whenever a connector application requires both miniaturization and a high degree of reliability, the Cinch "Bow-Pin" is the answer. This versatile little contact can be utilized in strip connectors (as shown), circular connectors or rack and panel connectors.

This unique "Bow-Pin" principle provides distinct advantages over conventional miniature contact devices.

Positive contact is assured by the flexing action of the bowed spring wires (unattached at the front end) that results when the contact is inserted into a tube having an ID smaller than the widest dimension of the bow.

Rugged construction—The flexing members are of relatively large cross-section to withstand abuse. **NO WELDING IS USED IN THE ASSEMBLY**, eliminating the possibility of heat change in spring characteristics.

"Bow-Pin" strip connectors are currently available in 6" lengths with either .075" or .100" center spacing.

For more information on "Bow-Pin" contacts and strip connectors, write to Cinch Manufacturing Company, 1026 South Homan Avenue, Chicago, Illinois 60624.

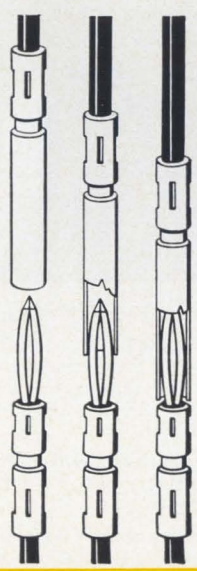

CINCH
DIVISION OF UNITED-CARR

CM-6522

Circle 147 on reader service card

Tektronix oscilloscope displays both time-bases separately or alternately

NEW TYPE 547 and 1A1 UNIT

DUAL TRACE

**DC-to-50 MHz
50 MV/CM
DC-TO-28 MHz, 5 MV/CM**

SINGLE TRACE

**2 Hz-to-15 MHz
500 μ V/CM
(CHANNELS 1 AND 2 CASCADED)**

With automatic display switching, the Type 547 provides two independent oscilloscope systems in one cabinet, time-sharing a single-beam crt.

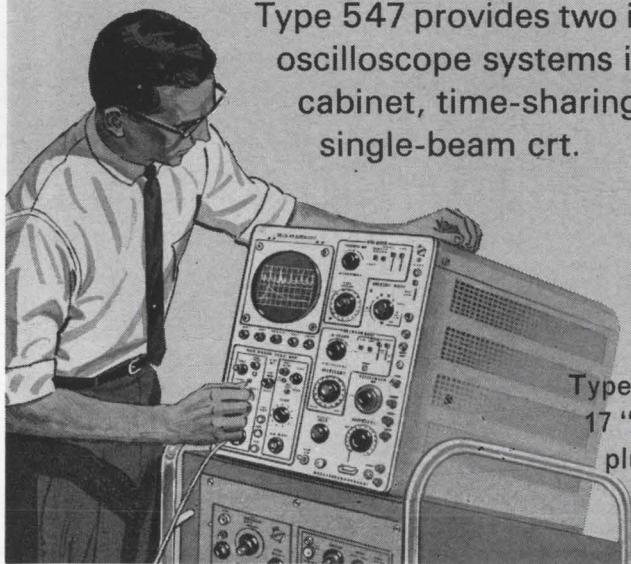

Type 547 also uses 17 "letter-series" plug-in units

Some Type 547/1A1 Unit Features

New CRT (with internal graticule and controllable illumination) provides bright "no-parallax" displays of small spot size and uniform focus over the full 6-cm by 10-cm viewing area.

Calibrated Sweep Delay extends continuously from 0.1 microsecond to 50 seconds.

2 Independent Sweep Systems provide 24 calibrated time-base rates from 5 sec/cm to 0.1 μ sec/cm. Three magnified positions of 2X, 5X, and 10X, are common to both sweeps—with the 10X magnifier increasing the maximum calibrated sweep rates to 10 nsec/cm.

Single Sweep Operation enables one-shot displays for photography of either normal or delayed sweeps, including alternate presentations.

2 Independent Triggering Systems simplify set-up procedures, provide stable displays over the full passband and to beyond 50 MHz, and include brightline automatic modes for convenience.

Type 547 Oscilloscope \$1875
(without plug-in unit)

Type 1A1 Dual-Trace Unit \$ 600

Rack-Mount Model Type RM547 . . . \$1975

U.S. Sales Prices f.o.b. Beaverton, Oregon

For a demonstration, call your Tektronix Field Engineer

Tektronix, Inc.

P.O. BOX 500 • BEAVERTON, OREGON 97005 • Phone: (Area Code 503) 644-0161 • Telex: 036-691
TWX: 503-291-6805 • Cable: TEKTRONIX • OVERSEAS DISTRIBUTORS IN OVER 30 COUNTRIES

TEKTRONIX FIELD OFFICES in principal cities in United States. Consult Telephone Directory

Tektronix Australia Pty., Ltd., Melbourne; Sydney • Tektronix Canada Ltd., Montreal; Toronto

Tektronix International A.G., Zug, Switzerland • Tektronix Ltd., Guernsey, C. I. • Tektronix U. K. Ltd., Harpenden, Herts

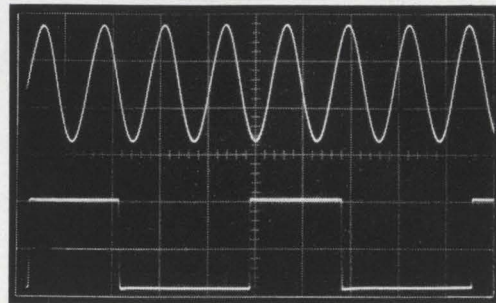

Single-exposure photograph.

2 signals — different sweeps

Upper trace is Channel 1/A sweep, 1 μ sec/cm. Lower trace is Channel 2/B sweep, 10 μ sec/cm.

Using same or different sweep rates (and sensitivities) to alternately display different signals provides equivalent dual-scope operation, in many instances.

Triggering internally (normal) permits viewing stable displays of waveforms unrelated in frequency. Triggering internally (plug-in, Channel 1) permits viewing frequency or phase differences with respect to Channel 1.

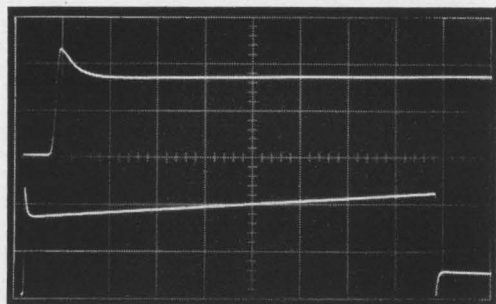

Single-exposure photograph.

same signal — different sweeps

Upper trace is Channel 1/A sweep, 0.1 μ sec/cm. Lower trace is Channel 1/B sweep, 1 μ sec/cm.

Using different sweep rates to alternately display the same signal permits close analysis of waveform aberrations in different time domains.

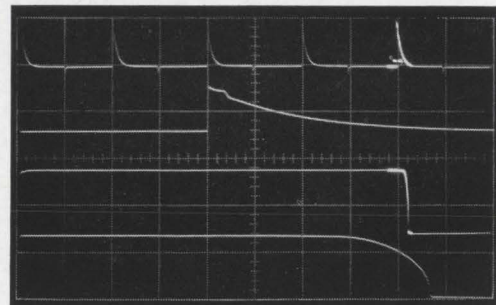

Single-exposure photograph.

2 signals — portions of each magnified

Trace 1 is Channel 2/B sweep, 10 μ sec/cm. Trace 2 (brightened portion of Trace 1) is Channel 2/A sweep, 0.5 μ sec/cm. Trace 3 is Channel 1/B sweep, 10 μ sec/cm. Trace 4 (brightened portion of Trace 3) is Channel 1/A sweep, 0.5 μ sec/cm.

Using sweep delay technique—plus automatic alternate switching of the time bases—permits displaying both signals with a selected brightened portion and the brightened portions expanded to a full 10 centimeters.

B sweep triggering internally from Channel 1 (plug-in) assures a stable time-related display without using external trigger probe.

MORE POWER

★ pulses up to 105 W $P_{o(usable)}$ at 1 Gc/s

★ delivers 5 W $P_{o(usable)}$ in CW service at 1 Gc/s

IN SMALLER PACKAGES

★ only 0.780" seated height

FROM NUVISTORS



A15526 developmental high- μ (100), double-ended nuvistor power triode shown actual size. Designed for low-power Class-C operation through 1200 Mc/s. May be used for cathode-drive pulsed or CW operation as an rf-power-amplifier, oscillator or frequency-multiplier tube. Developed under BuShips, U.S. Navy contract.

RCA's new developmental A15526 nuvistor offers you the opportunity to design more compact high-performance test equipment, transponders, and UHF airborne and navigational gear.

	TYPICAL PERFORMANCE AT 1 Gc/s			
	A15526 nuvistor as rf power amplifier		RCA-8627 nuvistor as driver	
	CW Operation	Grid-Pulsed Operation		
Power Gain	7	5.4	10	dB
Useful Power Output	5	105(peak)	1.4	W
Driving Power	1	30(peak)	0.15	W
Total DC Input	12.2*		**	W
Duty Factor		0.025		
Pulse Duration		5		μ s

*Includes 2.14-W heater power.

**Utilizes a 6.3-V/150-mA/0.95-W heater.

RCA DISTRICT OFFICES—OEM SALES: EAST, 32 Green St., Newark, N.J. 07102, (201) 485-3900 • MID-ATLANTIC, 605 Marlton Pike, Haddonfield, N.J. 08034, (609) 428-4802 • MID-CENTRAL, 2511 East 46th St., Bldg. Q2, Atkinson Square, Indianapolis, Ind. 46205, (317) 546-4001 • CENTRAL, 446 East Howard Ave., Des Plaines, Ill. 60018, (312) 827-0033 • WEST, 6363 Sunset Blvd., Hollywood, Calif. 90028, (213) 461-9171 • INTERNATIONAL OPERATIONS, RCA International Division: Central and Terminal Aves., Clark, N.J. 07066, (201) 382-1000 • 118 Rue du Rhone, Geneva, Switzerland, 35 75 00.

The A15526 reflects the concept of the RCA nuvistor program—to provide high-level performance at practical costs for sophisticated applications. It is another reason why you should investigate nuvistors when initiating new equipment designs.

For complete information on the A15526, contact your nearest RCA District Office. And, at the same time, ask for the specifications on the commercially available RCA-8627 nuvistor power triode which is a perfect driver for the A15526.

Complete technical data on the commercial line of nuvistors for industrial and military applications is also available to you from RCA Commercial Engineering, Harrison, New Jersey 07029.

RCA Electronic Components and Devices, Harrison, N.J.



The Most Trusted Name in Electronics

Circle 149 on reader service card

We get the tough ones

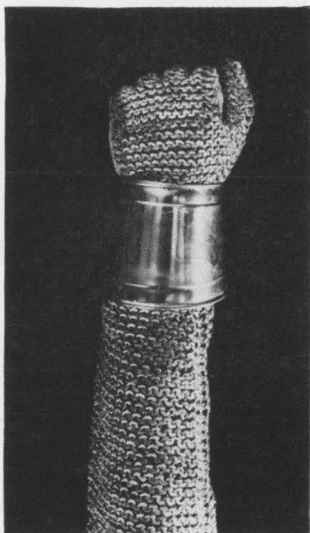

At Sylvania Electronic Systems — West, we take pride in accepting the gauntlet—being challenged with some of the knottiest problems in advanced electronic systems. Involved have been the tasks of developing requirements, formulating concepts, initiating designs, and completing fabrication for a wide variety of electronic warfare, including intelligence systems, electronic counter-measure systems, reconnaissance and anti-intrusion systems.

Outstanding achievements have been made in ultra-reliable miniature equipment for field and aerospace operations; broadband compact antennas such as horn and log periodic antennas of low frequency to millimeter range for ECM tracking and direction finding systems; airborne electronic reconnaissance systems; advanced systems and techniques for electronic intelligence collection; ECM training systems; direction-finding equipment; and electronic counter-measure receiving sets.

Our work requires people who possess a great deal of creativity and individual ingenuity as well as a high level of technical competence.

SES-West is located on a 49-acre site just forty minutes from San

Francisco. In addition to the social and cultural advantages of San Francisco, our employees enjoy year-round outdoor living. For educational advancement, Stanford and other prominent universities are located nearby.

If you like being challenged and have a background in any of the following categories, please write us:

Strategic and Tactical Signal Intelligence

Formulate systems concepts for both airborne and ground-based signal intelligence gathering systems. Develop and evaluate systems designs and participate in final evaluation and check out of the operational system.

Geophysics

Study geophysical propagation of acoustical and electromagnetic energy and develop new systems concepts for electromagnetic reconnaissance systems.

Systems Vulnerability

Perform investigations to determine the vulnerability of weapon systems complexes and their associated sub-systems. These sub-systems include communication, surveillance and target acquisition systems, navigation and guidance, and fusing. These vulnerability investigations consider weapon systems vulnerability to both electronic and physical countermeasures taking into account the likely employment and deployment of these weapons in realistic military tactical environments.

Operations Research

Perform operational analyses of electronic systems including communications by analytical, computer and gaming methods, in such areas as feasibility of electronic warfare concepts, effectiveness and cost-effectiveness of EW systems, threat analysis, analysis of arms control inspection techniques and electronic and physical vulnerability.

Arms Control

Analysis of strategic and tactical arms control problems in aerospace and local situations including inspection and verification criteria.

Electronic Warfare Systems Concepts

Develop and evaluate electronic warfare systems. These systems development efforts are closely associated with the systems vulnerability investigations. They involve synthesis of systems concepts including not only the description of overall technical characteristics but also concepts for their employment and deployment in tactical environments.

Electronic Warfare Design

Develop and evaluate electronic countermeasure techniques and formulate systems concepts: develop state of the art designs for enhancing Army, Navy and Air Force electronic warfare capabilities.

Send your resumé to Manager — Professional Staffing, Sylvania Electronic Systems — West, P. O. Box 188EL, Bldg. 5, Mountain View, California.

GTE

GENERAL TELEPHONE & ELECTRONICS

Total Communications from a single source through

SYLVANIA ELECTRONIC SYSTEMS

An Equal Opportunity Employer

245-A

INSTRUMENTATION'S
MOST POWERFUL
BABY

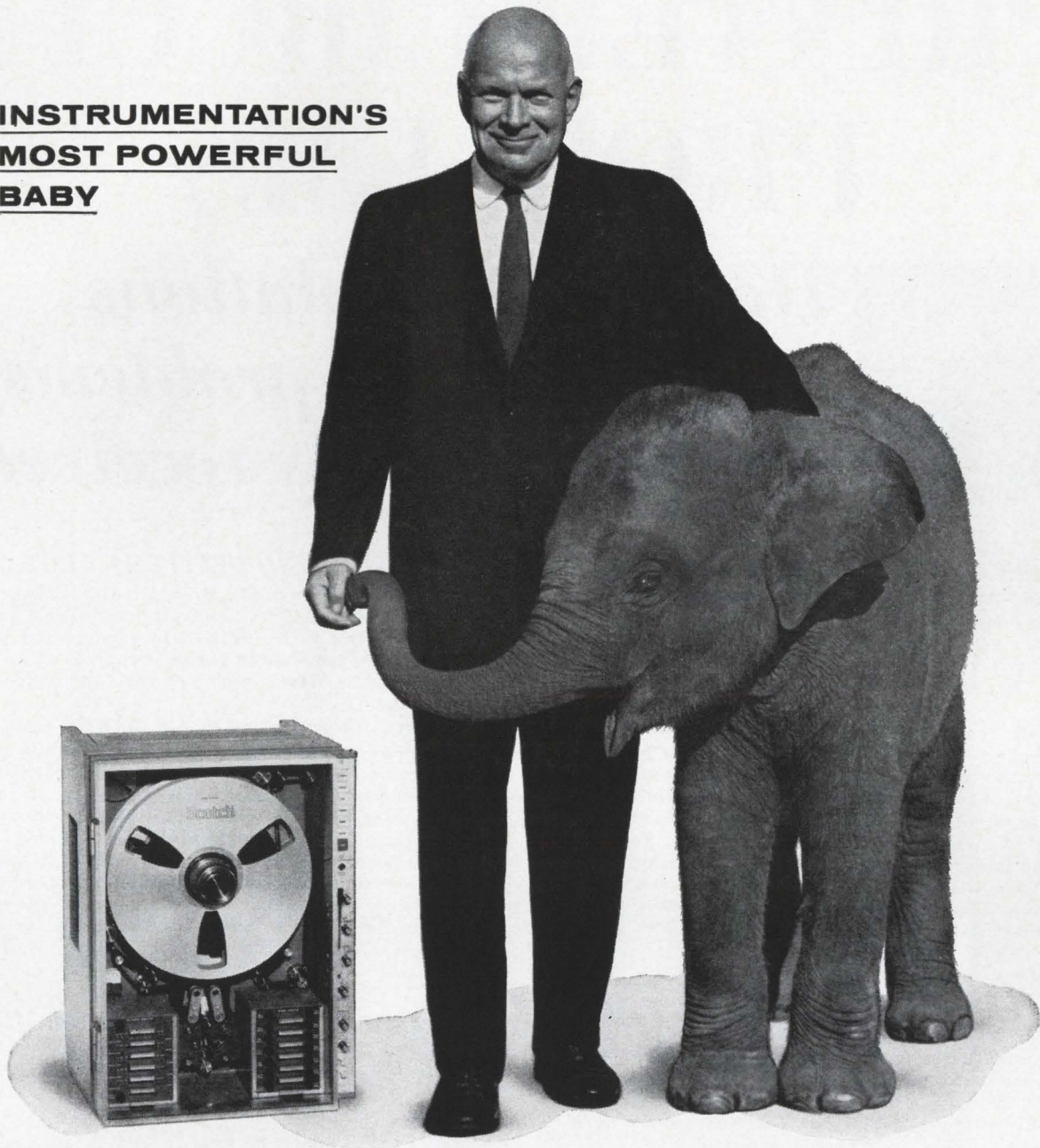

FOURTEEN 1.5-mc CHANNELS IN FOUR CUBIC FEET

Our new PC-500 Coax stands alone among compact field recorders, another working proof of Mincom's leadership in wideband instrumentation. Only twenty-four inches tall, this beautifully designed package contains the industry's highest performance per cubic foot — seven or fourteen 1.5-mc record channels, 14-inch reels, seven switchable speeds from $1\frac{7}{8}$ to 120 ips, two selectable reproduce-monitor channels. PC-500 is IRIG-compatible with all standard playback systems, including Mincom's TICOR II. Record on PC-500 with a 200-kc reference signal, on playback take advantage of TICOR II's unequalled $\pm 0.5 \mu\text{sec}$ time base comparison between events. Solve your basic problems in multi-channel wideband field recording by writing for PC-500 specifications.

Revere-Mincom Division **3M**
COMPANY
300 SOUTH LEWIS ROAD • CAMARILLO, CALIFORNIA 93010

Photocircuits can solve your **PRINTED CIRCUIT PROBLEMS**

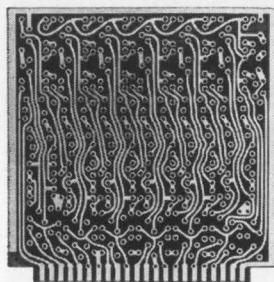

*Here are the solutions
to some typical problems
we have recently received.*

CONCERN OVER MULTILAYER CAPACITY

PROBLEM: A system we are designing requires over 40 multilayer boards. We anticipate a production schedule of five systems per month. Our initial vendor surveys indicate this quantity is too large for the multilayer capacity of local suppliers. Is ours an unusually large multilayer requirement?

SOLUTION: Not for the larger printed circuit manufacturers who have been supplying multilayers for a number of years and have noted the increasing demand for this versatile product. As an example, five years ago Photocircuits was able to fill all customer multilayer requirements with a capability of 50 average size parts per month. Two years ago we had to increase our capacity to 500 parts per month. The newest multilayer facility at our Glen Cove plant is capable of producing over 5000 parts per month. If your boards are typical of those we have made for other systems use, only 5% of our total multilayer capacity would be needed to meet your requirements.

BOARD BREAKAGE

PROBLEM: We are presently using XXXP base material for the printed circuits in our equipment. Production line handling and power driven assembly tools result in cracked and broken boards which have to be scrapped. We can't afford G-10 or epoxy paper. Are there any available low cost materials with high impact strength?

SOLUTION: Photocircuits' new CC-4 additive printed circuit process allows the use of new and unique base materials which are not available as foil-clad laminates. One which seems particularly well suited for your application is a low cost, polyester glass mat material, GL-52R, which was specially developed for use with the CC-4 process. This new material has electrical and mechanical properties superior to XXXP and epoxy paper. Although GL-52R is no more expensive than XXXP, it has an impact strength almost ten times greater. Commercial users have found that breaking, cracking and crazing during assembly and manufacturing are greatly reduced with this material.

*(If you have a problem in printed
circuitry, let us hear from you.)*

SLOW PRICE AND DELIVERY QUOTATIONS

PROBLEM: We often need a quick price and delivery quotation on a number of types of circuit boards for a new application. The time cycle involved in sending out prints to manufacturers and waiting for their reply is often too long for our schedule. How can we get price and delivery information faster?

SOLUTION: Our Standard Circuit Division was set up to help medium quantity users of printed circuits eliminate red tape and delays in quoting and procurement. By only manufacturing boards to a limited number of choices in such areas as base materials, platings and tolerances, the paperwork and communication problems of buying a custom-made component are drastically reduced. The Standard Circuit concept simplifies design and procurement to the point where boards can be ordered from a catalog. The published prices and fixed delivery schedules included in the Standard Circuits catalog should solve your problem. Write us for a copy.

ARTWORK FOR MULTILAYER CIRCUITS

PROBLEM: We've always prepared the master patterns for our printed circuit boards. We have our first application for multilayers and wonder if there are special or unusual requirements for the artwork?

SOLUTION: It would be wise to talk to an Applications Engineer from a reliable printed circuit manufacturer with multilayer experience before beginning the artwork. In addition to requiring much more stringent tolerances and tooling symbols, multilayer artwork almost always requires special attention because of the particular manufacturing process used. Since the artwork for one board may require individual patterns for as many as 15 layers, cost-cutting opportunities should be carefully investigated. Photocircuits' Master Circuit System, for example, uses automatic equipment to produce photographic glasswork for each layer with perfect registration and can save as much as 50% over regular drafting techniques.



Photocircuits

C O R P O R A T I O N

Glen Cove, New York

Anaheim, California

New CORNING[®] C Style Resistors give you precision stability, reliability, 1, 2 and 5% tolerances, 100 ppm T.C.

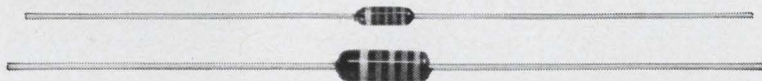

All of which boils down to this. Only one component to specify, buy and stock. One component you can use for general-purpose, semi-precision and precision use alike. One component that satisfies two military specs, as a look at the table quickly reveals. And you still get all the performance advantages of CORNING Glass-Tin-Oxide film resistor construction. Now for your tests. At our expense. Return coupon for samples.

PERFORMANCE CHARACTERISTICS

Characteristics	New CORNING C-Style Resistors			Mil-R-22684B	Mil-R-10509E Characteristic D*
	70°C	70°C	125°C	70°C	70°C
Temperature Rating	70°C	70°C	125°C	70°C	70°C
Wattage C 4 (RL07S) Resistors, 51 ohms to 150K	¼	¼	1/10	¼	¼
Wattage C 5 (RL20S) Resistors, 10 ohms to 499K	½	¼	¼	½	¼
Load Life ΔR	1.0%	0.5%	0.5%	2%	1%
Design Tolerance ΔR	-2 to +4%	-1 to +2.5%	-1.5 to +3%		
Temperature Coefficient from -55°C to +175°C	±100 ppm			±200 ppm	+200 -500 ppm
Dielectric Withstanding Voltage ΔR	±0.10%			±0.50%	±0.5%
Moisture Resistance ΔR	±0.50%			±1.50%	±1.5%
Short Time Overload ΔR	±0.25%			±0.50%	±0.5%
Temperature Cycling ΔR	±0.25%			±1.00%	±0.5%
Effect of Soldering ΔR	±0.10%			±0.50%	±0.5%
Low Temperature Operation ΔR	±0.50%			±0.50%	±0.5%
Shock ΔR	±0.10%			±0.50%	±0.5%
Vibration ΔR	±0.10%			±0.50%	±0.5%
Terminal Strength ΔR	±0.10%			0.50%	
Voltage Coefficient	±0.001%/Volt				
Shelf Life ΔR	+0.10%/Year				±1.0%

*For Type-marked, military lead Mil-R-10509 E Characteristic D Resistors, specify CORNING NA Style Resistors

CORNING GLASS WORKS, 3913 Electronics Dr., Raleigh, N. C. 27604.
Send complete data, test samples of new CORNING[®] C Style Resistors.

Name _____
Title _____
Company _____
Address _____
City _____ State _____ ZIP _____

CORNING
ELECTRONICS

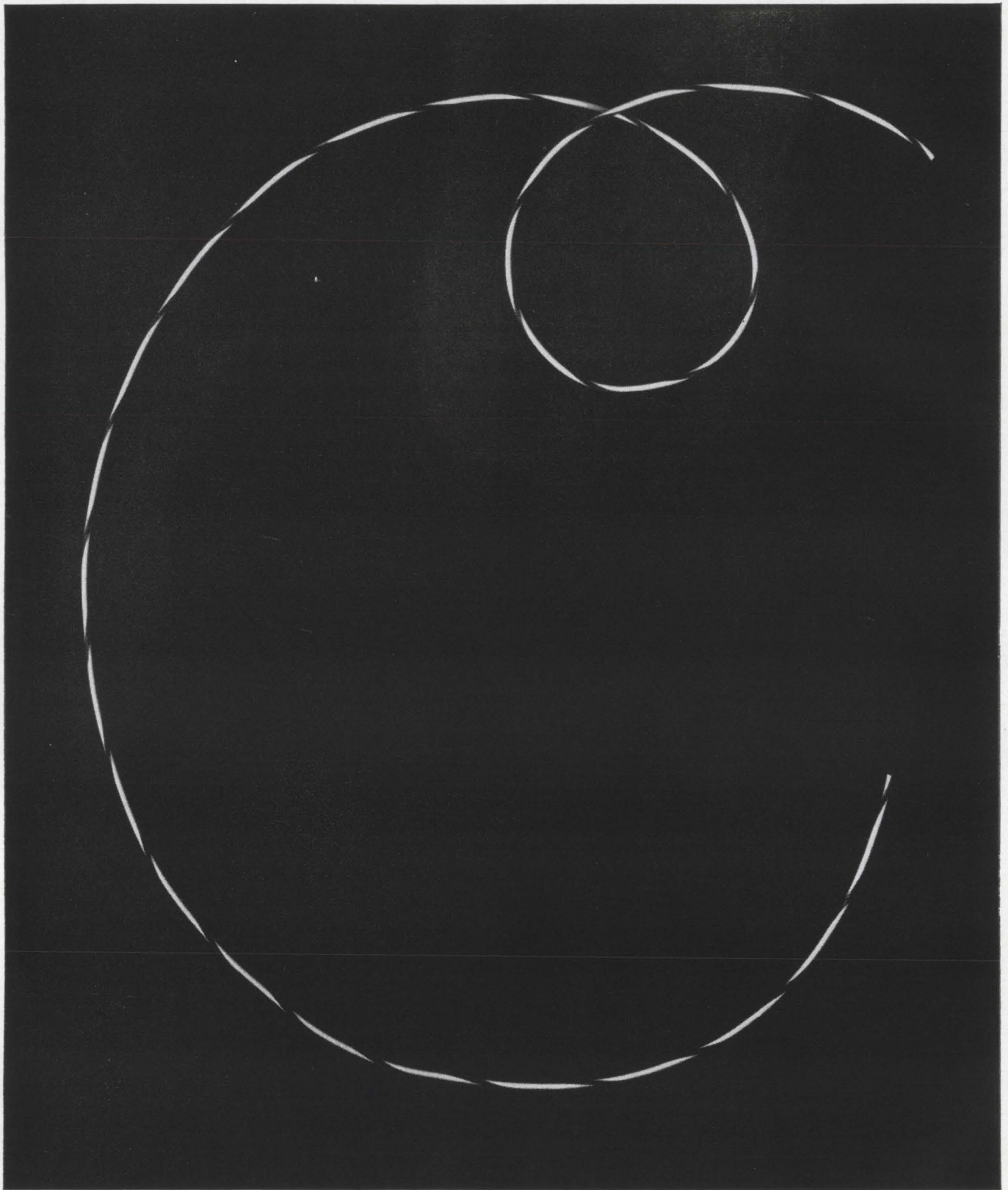

If you ask us for our 3¢ hookup wire, expect a little static.

Before we accept your order, we ask: "What are you using it for? Where? How? When?"

Static? Sure, but we think we know more about wire than any other manufacturer. And we like to pass it on where it'll help.

Based on your answers, maybe we can suggest an equivalent wire that costs less. Or introduce you to a new wire just marketed last week that will work better.

So next time you call Alpha, expect a little static. It'll keep you from getting burned.

Alpha Wire Headquarters: Elizabeth, New Jersey 07207. Write for our new 108-page catalog.
A Division of Loral Corporation

down with "specials"!!



who needs 'em with Ohmite's big variety of *stock* GPR relays

MOUNTING AND CONNECTING VERSATILITY

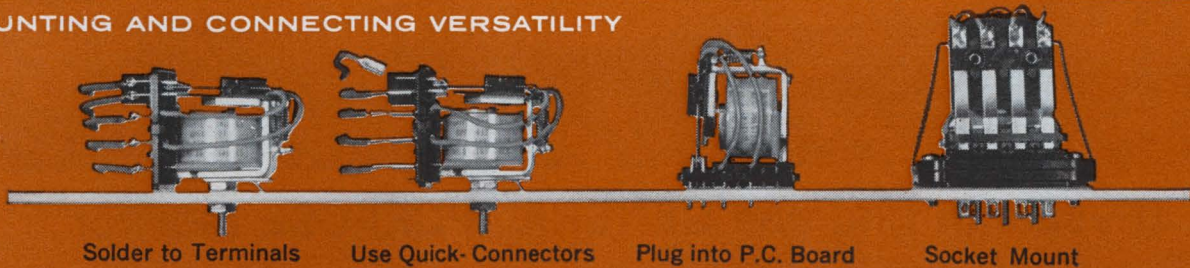

Solder to Terminals

Use Quick-Connectors

Plug into P.C. Board

Socket Mount

VERSATILE ENCLOSURES

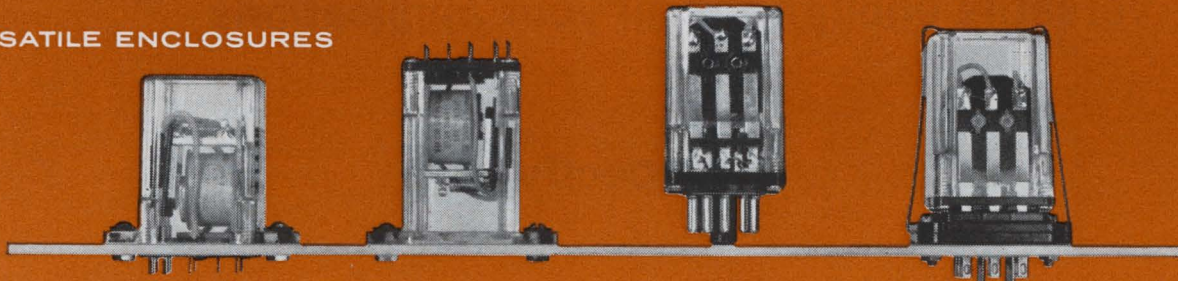

Terminals Through-Chassis

Terminals Above Chassis

Octal Style Plug

Socket for Std. Terminals

EXCLUSIVES AND OTHER VARIETIES

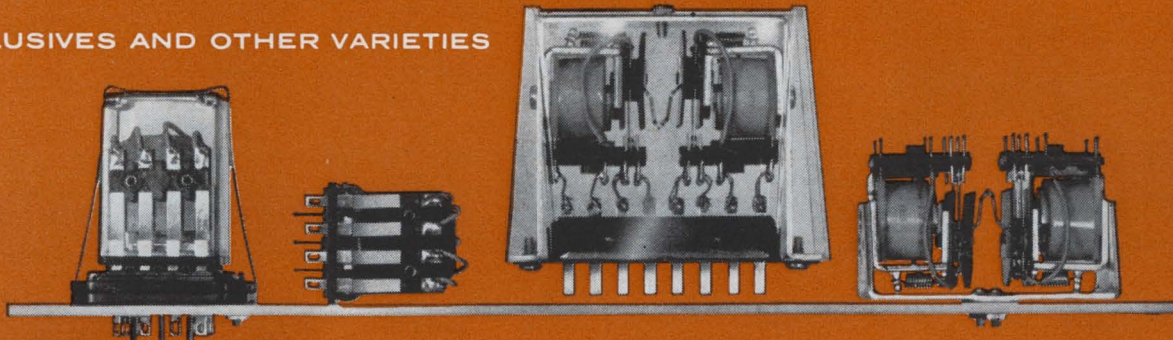

Exclusive Enclosed 4-Pole

Unenclosed 4-Pole

Exclusive Enclosed Latching

Unenclosed Latching

■ All these and other physical variations are stocked for a variety of general purpose and specialized electrical functions such as plate circuit, thyatron, and indicator-light types. Both unenclosed and enclosed relays fit the same SOGPR socket. And don't forget, dual-purpose terminals (for soldering and quick-connectors) are standard on all unenclosed and most enclosed relays. Many models UL and CSA listed.

Contact Combinations—Up to 4PDT.

Contact Ratings—Two ratings: fine-silver contacts, gold-flashed, 5 amps resistive at 115 VAC or 32 VDC; silver-cadmium, 10 amps.

Coil Operating Voltage Range—Up to 230 VAC 60 cycles, or 110 VDC.

Coil Wattage—1.4 Watts DC; 1.6 watts (2.0 volt-amps) AC, except 2.4 watts (3.7 volt-amps) for 4-pole AC relays.

Insulation—Tested at 1500 VAC between terminals and ground.



Yours for the asking...
Catalog 700 showing all
Ohmite relay lines.

RHEOSTATS • POWER RESISTORS • PRECISION RESISTORS • VARIABLE TRANSFORMERS • RELAYS
TAP SWITCHES • TANTALUM CAPACITORS • SEMICONDUCTOR DIODES • R.F. CHOKES

OHMITE

MANUFACTURING COMPANY
3610 Howard Street • Skokie, Illinois 60076
Phone: (312) ORchard 5-2600



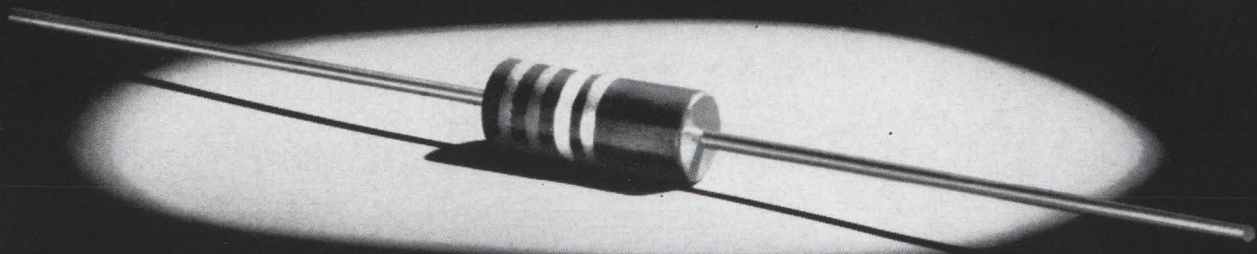









If you can find one **GENERAL PURPOSE** resistor
versatile enough for all your applications

... specify it

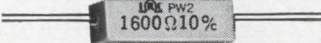
We don't think you will.

Only IRC makes all these different types . . . can recommend without bias.

 <p>COMMERCIAL/INDUSTRIAL FIXED COMPOSITION Most popular, it combines superior performance with economy. ¼, ½ and 1 watt.</p>	 <p>MILITARY FIXED COMPOSITION For MIL-R-11 applications. Controlled carbon composition element. ¼, ½ and 1 watt. 5%, 10% and 20% tolerances.</p>	 <p>ESTABLISHED RELIABILITY FIXED COMPOSITION ½ watt RCR 20 style for MIL-R-39008, levels M, P, and R. 5% tolerance.</p>	 <p>MOLDED WIREWOUND Low cost approach to wirewound stability for low range needs. RC 20 and RC 32 sizes. ½, 1 and 2 watts.</p>
 <p>CERAMIC CASE WIREWOUND Fireproof inorganic construction. Excellent high temperature and overload capability. 2 watts.</p>	 <p>METAL GLAZE FILM For MIL-R-22684. Rugged thick-film element. ¼, ½, 1 and 2 watts. 2% and 5% tolerances.</p>	 <p>POWER METAL FILM Better performance and lower cost than 2 watt carbon composition. Glass hard element.</p>	 <p>UNINSULATED WIREWOUND Least expensive for automotive and appliance needs. Wide variety of terminal configurations.</p>

Write for General Purpose Resistor Catalog . . . complete data in handy form.



INTERNATIONAL RESISTANCE COMPANY

First truly digital x-y plotter

Binary scales, sensed photoelectrically, eliminate problems of drift, mechanical wear and cumulative error

An x-y plotter is basically an analog device because it must physically move a plotting head across a sheet of paper. Most digital x-y plotters therefore specify the position of the plotter from instant to instant through a digital-to-analog converter of some kind. The converter itself is a possible source of error, the output is subject to drift, and the driving mechanism is subject to wear. In addition, if each new position is plotted with reference to the previous position, there is a possibility of cumulative error.

An x-y plotter that gets around these difficulties has been developed by the Discon Corp. under a contract with the Air Force Chart and Information Center, in St. Louis. Discon has built a truly digital x-y plotter that requires no digital-to-analog conversion and is free from all problems of wear and drift that could affect accuracy. The plotting head moves up and down along an arm, and its position is controlled by a 19-track binary scale on the arm. The arm moves left and right over the plotting surface; its position is controlled by a similar scale. Both scales are sensed photoelectrically. Thus, the control is effectively located at the point of plotting.

Six-digit decimal numbers are converted to a 19-bit binary code in the plotter control unit. Photoelectric sensors pick up the position of the head and arm from the 19-track scales, and the head and arm move until the coded position matches the binary numbers specifying the location of the point to be plotted. The sensors are solid-state pnpn photo-switches that work directly into the logic circuits in the control unit. Cadmium-selenide photocells were found to be too slow for the desired accuracy at maximum slewing speed.

A straight binary code is used

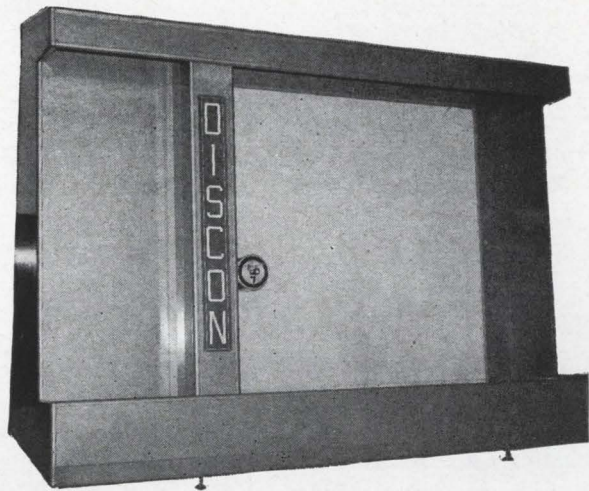
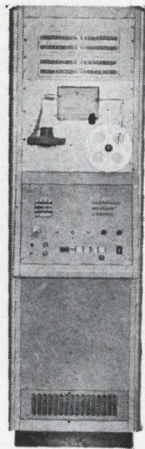

on the scales. Since there is a possibility of ambiguity with binary coding when more than one bit changes at a time, as when 0111 changes to 1000 (decimal 7 to 8), the position of the moving part is sampled only in the center of each increment, the sampling point being determined by a 20th track on the binary scale.

The plotted point is marked by a print head with any one of 11 different symbols, selected manually before plotting begins. Up to eight numeric characters can be automatically printed, four on each side of the plotted point, to identify the point. The print head can be rotated to prevent interference between close-together labels.

Only one of these machines has been built so far, in fulfillment of the contract. It has a plotting size of 1.5 x 1.5 meters, or approximately 5 x 5 feet. Discon is offering the machine for sale commercially, around a basic scale length of one meter (39.37 inches); it has received requests for quotations on sizes up to three meters square.

The accuracy of the unit is quoted as ±0.05 mm (0.002 inch) for points within one foot of each other, plus ±0.0125 mm per foot

for points farther apart. The variation is caused by the dividing engine that makes the binary scales; each mark is accurate relative to those close by, at all points along the scale, but a cumulative error builds up along the scale length. This cumulative error does not affect the repeatability of plotting any given point, since it is in the scale and not in the control.

The input to the plotter is basically paper tape, prepared manually or by a computer. There is also provision for input from punched cards, but there is no card reader attached to the unit.

Specifications

Plotter input	Six-digit numbers per coordinate (0.01 mm)
Printer input	Eight-digit numbers per point
Data source	Paper tape, punched card, or manual keyboard
Plotting area	1.5 x 1.5 meters
Accuracy	±0.05 mm within one foot, plus ±0.0125 mm per additional foot
Repeatability	±0.025 mm
Plotting speed	25 points per minute, 50 mm apart
Slewing speed	50 mm per second
Print symbols	Eight-character word, eleven symbols and blank available at each position.
Over-all size, plotter control	9' 4" x 6' 10" x 3' 4" 26" x 19" x 70"

Discon Corp., 4250 Northwest 10th Ave., Fort Lauderdale, Fla., 33309
Circle 350 on reader service card

ANOTHER ANALOG FIRST

...FROM ZELTEX

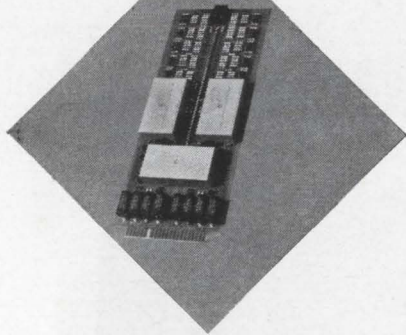

Model 502A Quarter-Square Multiplier with Integral Active Elements! Result: Outstanding Accuracy and Stability at Low Cost!

Now Zeltex introduces the Model 502A Quarter-Square Multiplier featuring integral active elements and inverting amplifiers. Offered in two versions, with (502A) or without (502) the inverting amplifiers, Zeltex multipliers multiply two fixed or continuously varying voltages (X&Y) over a $\pm 100v$ range, providing an output of $-.01XY$, divide: $-100X/Y$, square: $-.01X^2$ and $.01Y^2$ simultaneously, and extract square roots: $10X^{1/2}$ and $-10Y^{1/2}$ simultaneously. Zeltex Multipliers even perform fourth power and fourth root operations.

Excellent for replacement or expansion in general-purpose analog computers, Zeltex Multipliers offer an outstanding performance/economy value:

SPECIFICATIONS:

Static Accuracies: With both inputs zero, error is less than 2 mv

With one input zero, error is less than 25 mv
With both inputs within $\pm 100v$, error is less than 50 mv

Dynamic Accuracy:

At 100 cps, maximum amplitude and phase error is less than 100 mv.

Squaring Accuracy is 20 mv.

Prices: Model 502 \$425 Model 502A \$525 in small quantities!

For more information on Zeltex Multipliers (and other Zeltex analog products, if you wish), call your nearest representative or contact



ZELTEX, INC.

2350 Willow Pass Road, Concord, Calif.

The Broadest Spectrum of Amplifiers and Computer Elements

New Components and Hardware

Potentiometer offers infinite resolution

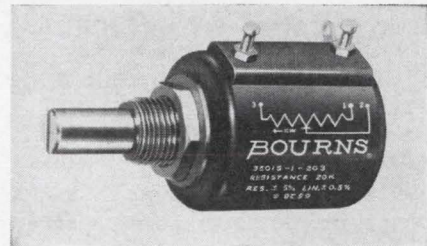
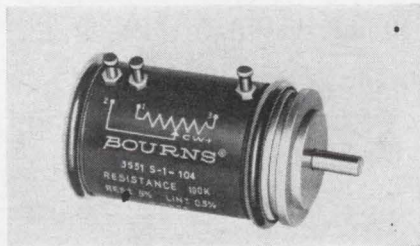

Nonwire potentiometers provide better resolution than wirewound pots because resistance changes in the nonwire types are essentially linear instead of occurring in discrete steps. The ultimate design goal would be infinite resolution, but variations in the thickness of the conducting films make such an achievement difficult.

The Trimpot division of Bourns, Inc., has come up with a technique for laying on the films with such consistent thickness that the resolution is practically infinite. Contact resistance, a major cause of noise, is less than 100 ohms, or 1%, a value comparable to that of wirewound pots. And because of the low noise level, the new pots do not need the special filter circuits for resolution checking required by other nonwire pots.

The first two models to be introduced are both $7/8$ -in.-diameter, 10-turn units. Model 3501 has a bushing mount; model 3551 a servo mount. Maximum resistance change in any environment is only 5% throughout a life of 4 million shaft revolutions for model 3501, 10 million for model 3551. Long-life ball-bearing shaft supports, standard

in the servo-mount model, are also available as optional equipment in the bushing-mount unit. Prices are slightly higher than for comparable wirewound types.

Bourns, Inc., Trimpot Division, 1200 Columbia Ave., Riverside, Calif. [351]

Repeat cycle timers come in 23 models

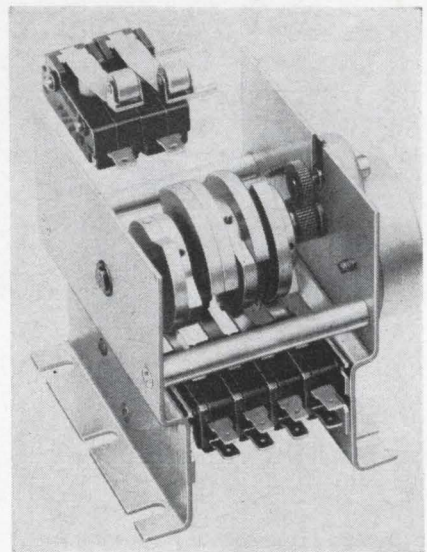

A line of low-cost, industrial-type, repeat cycle timers have series designations of L42401 and L42402. Twenty-three models are offered, providing a selection of 170 different over-all cycle times from 6 seconds minimum to 25 hours maximum. Up to 23 possible combinations of spdt switches are available for 15- or 25-amp loads at 115 v a-c, 60 cps. The switches are snap-in types for easy replacement or maintenance and have a mechanical life rating of better than a million operations.

These timers are synchronous-

Specifications

Resistance range	1K to 500K
Resistance tolerance	$\pm 5\%$
Independent linearity	0.5%
Power rating	2 Watts at 70°C
Temperature coefficient	± 300 ppm/°C
Operating temperature range	-65 to +125°C
Shock	100G
Vibration	20G
Size	
Model 3501	$7/8$ in dia. x 1 in. long
Model 3551	$7/8$ in dia. x 1.58 in. long
Price (100 or more)	
Model 3501	\$11 each
Model 3551	\$25 each

EMC INTRODUCES A COMPLETE FAMILY OF 100 KCPS DIGITAL LOGIC MODULES WHICH OPERATE OVER AN AMBIENT TEMPERATURE RANGE OF -55° TO $+70^{\circ}\text{C}$! HERE IS HIGHEST QUALITY, RUGGED RELIABILITY (OVER $4\frac{1}{2}$ MILLION HOURS MTBF) AT LOWEST COST.*

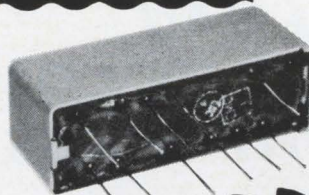
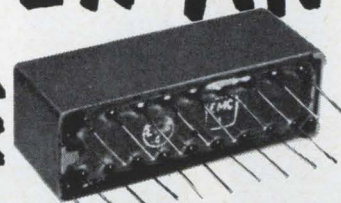
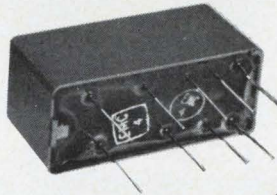

**ELECTRONIC
MODULES
CORPORATION**

* S-R flip-flop module as low as \$3.95 each in quantities of 100.

1949 GREENSPRING DRIVE • TIMONIUM, MD.
TEL-301-252-2900 TWX-301-252-0723

CALL EMC DIRECT OR CONTACT THE EMC REPRESENTATIVE NEAREST YOU:

Md., Va., N.C., S.C. & D.C.
BARNHILL & ASSOCIATES
Towson, Md.—(301) 825-3900
So. Calif.
E. E. ENTERPRISES
Van Nuys, Calif.—(213) 787-5360
No. Calif.
E. E. ENTERPRISES
Palo Alto, Calif.—(415) 324-4448

W. Pa. and W. Va.
AUTOMATED EQUIP. & ENGINEER,
INC.
Pittsburgh, Pa.—(412) 931-7616
Wash. and Ore.
FARWEST AGENCIES
Bellevue, Wash.—(206) 454-7905
E. Pa. and So. N.J.
HILLIARD ASSOCIATES
Jenkintown, Pa.—(215) 884-6100

Ill., Wis. and Ia.
ACTRONIC SALES ENGRG., INC.
Chicago, Ill.—(312) 286-1037
**Colo., Wyo., Kan., Nebr.,
N. Mex., Ut. & Mo.**
INLAND ASSOCIATES
Mission, Kan.—(913) 362-2366
Fla.
LYNCH-GENTRY ASSOC., INC.
St. Petersburg, Fla.—
(813) 347-5131

Ohio, Ind., Mich. and Ky.
BERNARD L. MICHAELSON CO.
Xenia, Ohio—(513) 372-5496
Met. N.Y. and So. Conn.
PODEYN & SCHMIDT
Great Neck, N.Y.—(516) 487-1173
No. N.J.
PODEYN & SCHMIDT
Wood-Ridge, N.J.—(201) 438-2780

Canada
RYCO ELECTRONICS CO., LTD.
Quebec, Can.—(514) 695-6236
**Tex., Okla., Ark., La., W. Tenn.
& Miss.**
THE TEXPORT COMPANY
Dallas, Tex.—(214) 631-6270
Minn., N.D. & S.D.
COUNTRYMAN AND WAGNER
St. Paul, Minn.—(612) 645-9925

Modules Potted in TIMONIUM

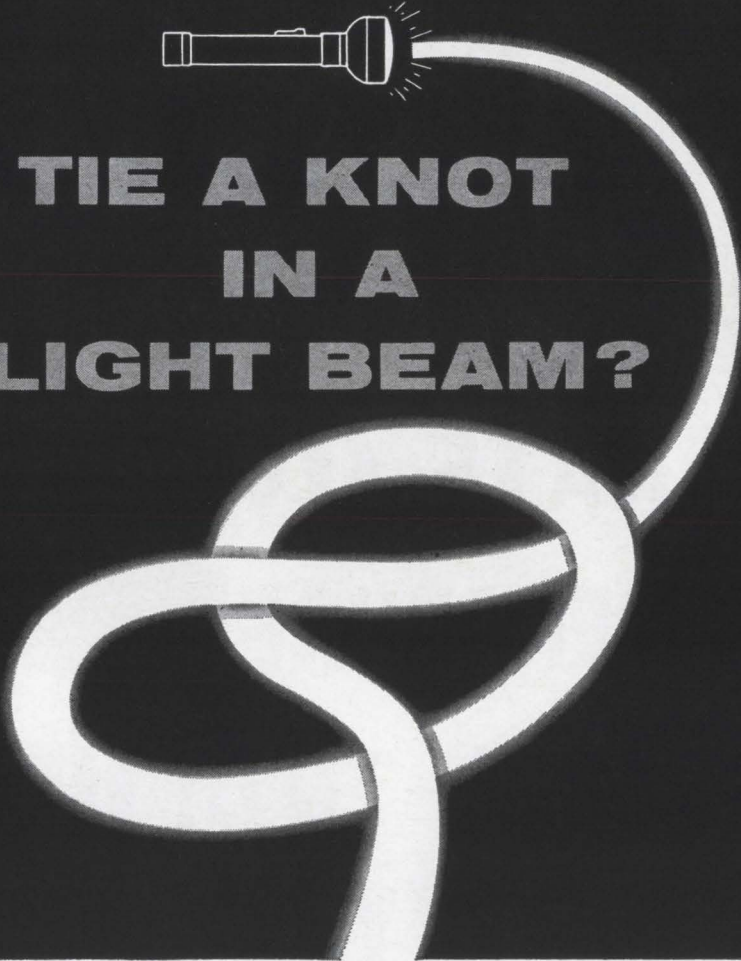

TIE A KNOT IN A LIGHT BEAM?

YOU CAN WITH BAUSCH & LOMB LIGHT WIRES

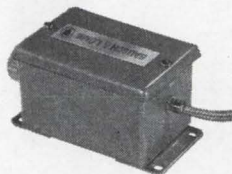

Fiber Optics Light Switch counts objects at a rate of 400/min, measures angular velocity, detects size of objects, acts as a limit switch, can be made sensitive to color with filters, monitors ambient light conditions, and be used in safety and burglar alarm systems. Catalog D-2057 gives the full story.

AND YOU CAN DO MANY OTHER AMAZINGLY USEFUL THINGS TOO!

- Slice the original beam into several beams.
- Pipe the beams under, over and around all kinds of obstacles.
- Pipe the beams into tiny openings.
- Shape the circular beam so that it comes out the other end as a square □, a circle ○, a line — or any shape you can think of } }
- Monitor the face of a CRT tube or radar screen.
- Safely pipe light into explosive areas.

***You can mold light to do your bidding
for practically any application***

Write for Catalog 32-2045. It has much information to excite your creativity. Bausch & Lomb, 62322 Bausch Street, Rochester, New York 14602.

BAUSCH & LOMB 

New Components

motor driven, and models can be furnished for operation on 6, 12, 24, 115 or 230 v a-c, 50 or 60 cps. Over-all cycle timing accuracy is $\pm 1\%$. One-way frictions in the gear trains and split cams provide for easy timing adjustment in the field.

A.W. Haydon Co., 232 North Elm St., Waterbury, Conn., 06720. [352]

Reed relay provides 5,000-v switching

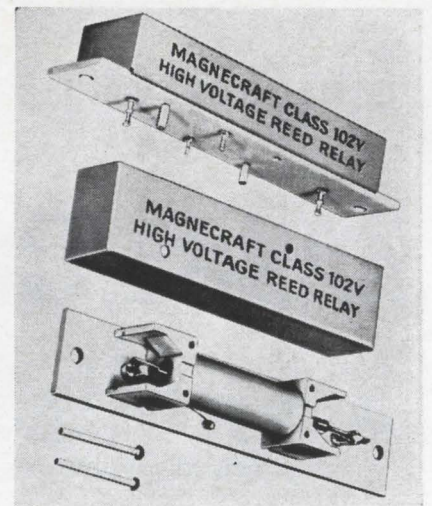

A unique approach to high-voltage switching with reed-relay reliability is featured in the Class 102V high-voltage reed relay. The relay has contacts of special material hermetically sealed in glass capsules to meet the rating of 50 v-a, 5,000 volts maximum or 3 amps maximum. Special molded nylon bobbins and epoxy resin terminal boards combine great dielectric strength with excellent resistance to moisture absorption.

Contact leads of the reed switch are not bent and used for terminals, but soldered to rigid terminal posts. This construction protects the leads from stresses that could be transmitted to the contacts and thus affect relay adjustment. An internally insulated metal cover provides electrostatic shielding and protects the relay from stray magnetic fields as well as from mechanical injury.

The relay operate time is 3 msec average; release time, 0.5 msec average. Life expectancy is 20 mil-

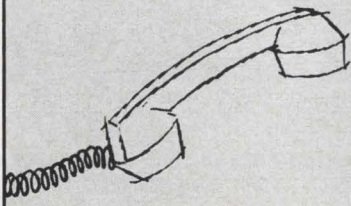

CALL YOUR AUTHORIZED
ERIE DISTRIBUTOR FOR...

ERIE SUBMINIATURE MONOBLOC* CAPACITORS



Featuring CAPACITANCE-TO-VOLUME RATIO TO 20 MF/CU. IN.
IN SUBMINIATURE, VERY RELIABLE CERAMIC CAPACITORS

Erie's new in-stock MONOBLOC ceramic film capacitors represent the most significant design advance in more than a decade. Now, Erie's exclusive Monobloc Process, in which very thin films of ceramic can be bonded into solid structures, permits virtually unlimited range of capacitance values, characteristics and sizes to suit exacting design requirements . . . most of which are stocked by your authorized Erie Distributor. Monobloc Capacitors provide volumetric efficiencies from 10 to 100 times the capacitance (to 20 mf/cu. in.) attainable in conventional components of the same size . . . and still meet Established Reliability specifications for Aerospace, Military and Commercial applications.

We stock these subminiature Erie Monobloc Capacitors encapsulated to suit the design engineers' needs; hermetically sealed, glass encased . . . precision molded . . . and phenolic coated as illustrated at right.

Design Advantages . . .

Volumetric efficiency to 20 mf/cu. in. . . Capacitance values from 10 pf. to .5 mfd . . . IR at room temperature—100 K megohms . . . 100 WVDC . . . High Reliability.

*Trademark of Erie Technological Products, Inc.

ERIE MONOBLOC CAPACITORS IN-STOCK

Commercial and Military

- Hermetically Sealed Glass Encased Types



- Precision Molded Types

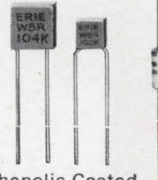

- Phenolic Coated Types Weecons

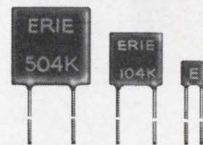

ERIE

TECHNOLOGICAL

PRODUCTS, INC.



Call Your

AUTHORIZED
ERIE
DISTRIBUTOR

MILGRAY/NEW YORK

160 Varick St., New York 13, New York. (212) YU 9-1600. New Jersey (201) HE 2-4300

MILGRAY/WASHINGTON

5133 Lawrence Place, Hyattsville, Maryland. (202) UN 4-6330. Balt. (301) 727-1870

Advanced Components Through Increased Volumetric Efficiency

Formerly
Erie Resistor
Corporation

644 West 12th Street
Erie, Pennsylvania

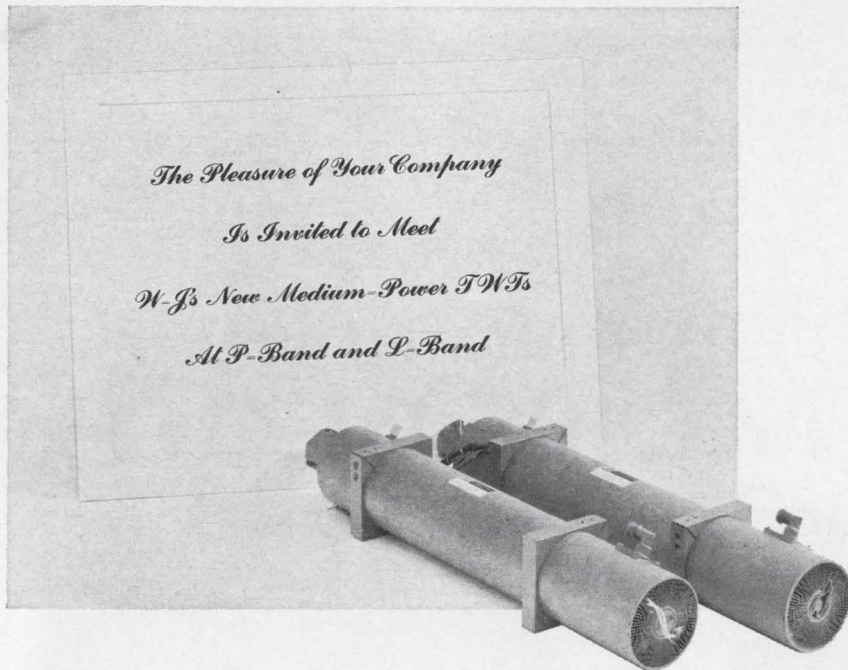

No formal introductions are necessary, actually. It has gotten around that W-J has a new family of tubes for P- and L-bands that features small size, light weight and periodic permanent-magnet focusing at medium power levels. The WJ-323 and WJ-352 utilize a high-perveance solid beam gun to obtain high gain per unit length with very stable operating performance. The units are air cooled and provide a minimum of 150 watts CW power over a wide bandwidth.

These new TWTs should be on the check list of every designer involved with communications, telemetry, wideband data transmission, wideband television, intermediate and final amplifiers and ECM. They have been checked out for airborne, shipborne and ground-base operations.

SPECIFICATIONS

Performance	WJ-323	WJ-352
Frequency Range	400-500 Mc	800-1500 Mc
Gain, Saturated	40 db Min.	37 db Min.
Power Output (CW)	150 W Min.	150 W Min.
Focusing System	PPM (Temperature Compensated +20 to +125°F)	
Cooling System	Forced Air Cooling (75 CFM of Air at 2" H ₂ O)	
Size (Excluding Connectors)	4.25" dia. x 28" long	3.25" dia. x 26" long

Information in more detail available from representative in your area, or from Applications Engineering



New Components

lion operations at rated load. Dimensions are 7/8 in. high (above mounting base), 15/16 in. wide, 4 1/2 in. long. Magnecraft Electric Co., 5565 N. Lynch, Chicago, Ill., 60630. [353]

All-transistor uhf tv tuner

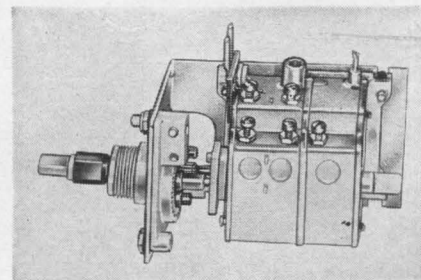

An all-transistor uhf television tuner is available with a 70-channel, single-speed, 10.3:1 planetary drive. The new tuner also offers characteristics for practically any color application.

Shaft rotation is 360° in either direction with 270° stops available. Noise figure averages -10 db, with 13 db maximum. Contacts are noise-free for over 50,000 cycles at 85° C. (A cycle is 360° clockwise and 360° counter-clockwise rotation).

Image rejection is 50 db average, with 40 db minimum. Minimum i-f rejection is 70 db. Variations in frequency stability versus temperature and supply voltage can be to customer specifications.

Oak Mfg. Co. division of Oak Electro/Netics Corp., Crystal Lake, Ill. [354]

Linear motion pot features 111 taps

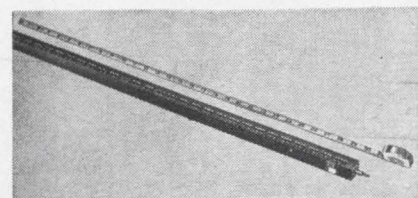

A linear motion precision-film potentiometer, model 111, features 111 taps over its 28-in. electrical stroke. The pot has zero-width

AN IDEA

for silicone grease can win
you one of these prizes

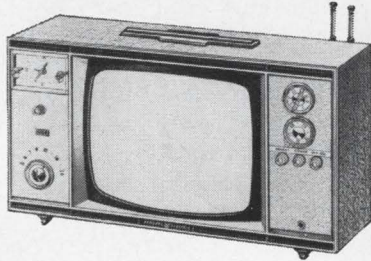

1st award —
GE combination
Radio-TV-Alarm Clock

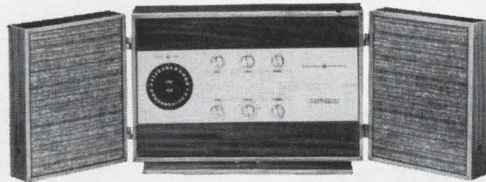

2nd award —
GE FM
Stereo Radio

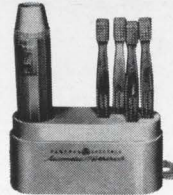

3rd, 4th and
5th awards —
GE Electric
Toothbrush

6th to 50th awards — Parker Jotter Pen

General Electric Silicone Grease resists high temperatures, oxidation and contaminants

Example #1: Electronic gear designed to resist 400°F required the use of G-E silicone grease for better heat transfer. Petroleum grease will oxidize at this temperature, whereas silicone grease won't.

Example #2: To prevent galling of pipe threads used in oil well drilling, silicone grease is applied to the pipe. Pressures of 20,000 lbs. and temperatures of 400°F are common. Also present are contaminants like crude oil, water, acids, hydrogen sulfide, salt and sand, which would be disastrous to other greases. Silicone grease does the job.

Example #3: Silicone grease is used to fill voids in small connector plugs used to link together electronic modules for oceanographic use. This removes pressure differentials and eliminates damaging salt water corrosion.

PROPERTIES OF G-E SILICONE GREASES

excellent dielectric	water repellent
temperature range	no oxidation
—100° to 400°F	low evaporation
non-corrosive	low bleed

Tell us about your idea for using silicone grease and you may win one of these fine prizes. Send for your entry blank using coupon below.

Hurry! Contest expires Nov. 15, 1965

Send for entry blank and rules to:
Engineering Ideas with Silicone Grease
Silicone Products Dept., General Electric Co., Waterford, N. Y.

Name _____

Title _____

Company _____

Address _____

GENERAL ELECTRIC



**Silicone Greases are available
from these distributors:**

- ALABAMA**
ARGO and COMPANY
7 — 18th St., SW, Birmingham
- ARIZONA**
ELECTRICAL SPECIALTY COMPANY
120 S. 29th St., Phoenix
R. V. WEATHERFORD COMPANY
9310 N. Central Ave., Phoenix
- CALIFORNIA**
ELECTRICAL SPECIALTY COMPANY
2820 E. 12th St., Los Angeles
ELECTRICAL SPECIALTY COMPANY
213 E. Harris Ave., S. San Francisco
R. V. WEATHERFORD COMPANY
6921 San Fernando Rd.
Glendale 1
R. V. WEATHERFORD COMPANY
3240 Hillview Ave., Palo Alto
- COLORADO**
ELECTRICAL SPECIALTY COMPANY
2026 Arapahoe St., Denver 5
- CONNECTICUT**
R. H. CARLSON COMPANY, INC.
7 Bruce Park Ave., Greenwich
- DISTRICT OF COLUMBIA**
READ PLASTICS, INC.
317 Cedar St., NW, Washington 12
- FLORIDA**
GULF SEMICONDUCTORS, INC.
129 Almeria Ave., Coral Gables 34
2733 Scarlet Rd., Winter Park
- ILLINOIS**
FEDERAL INSULATION
549 W. Randolph St., Chicago 7
J. J. GLENN & COMPANY, INC.
605 W. Washington Blvd.
Chicago 7
- INDIANA**
HYALINE PLASTICS CORPORATION
1019 N. Capitol St., Indianapolis
- IOWA**
PLASTIC SUPPLY INC.
512 S.W. 9th St., Des Moines
P.O. Box 1482
- KENTUCKY**
GENERAL RUBBER & SUPPLY CO.
3118 Preston Hwy.
Louisville 40213
- MASSACHUSETTS**
NORTHEAST CHEMICAL CORP.
581 Boylston St., Boston 16
- MICHIGAN**
F. B. WRIGHT COMPANY, INC.
9999 Mercier St., Dearborn
- MINNESOTA**
D. A. SCHULTZ COMPANY
801 S. E. 8th St., Minneapolis
- MISSOURI**
D. A. JAMES COMPANY
911 St. Charles St., St. Louis 1
REGAL PLASTIC SUPPLY COMPANY
1735 Main St., Kansas City
- NEBRASKA**
REGAL PLASTIC SUPPLY COMPANY
2324 Vinton St., Omaha
- NEW YORK**
CHAMBERLIN RUBBER COMPANY
455 E. Main St., Rochester 14604
CHAMBERLIN RUBBER COMPANY
210 Marcellus St., Syracuse 4
PUNT, INC.
160 Woodbine Ct., Box 99
Floral Park
- OHIO**
THE PHILPOTT RUBBER COMPANY
2077 East 30th St., Cleveland 15
PARKWAY PRODUCTS, INC.
1230 W. 7th St., Cincinnati 45203
- OREGON**
ELECTRICAL SPECIALTY COMPANY
2360 N.W. Quimby St., Portland 10
- PENNSYLVANIA**
SMITH OF PHILADELPHIA
Second & Somerset St.
Philadelphia 33
SPECK-MARSHALL COMPANY
P.O. Box 110, Nichol Ave.
McKees Rocks 15136
- TEXAS**
HOUSTON INDUSTRIAL SUPPLY CO.
P.O. Box 52507, 1902 Bell Ave.
Houston 52
LAWRENCE ELECTRONIC COMPANY
P.O. Box 20676, 3422 Cridelle,
Dallas 20
- WASHINGTON**
ELECTRICAL SPECIALTY COMPANY
2442 First Ave., S., Seattle
- WISCONSIN**
R. J. WITTENBURG COMPANY
1338 W. Atkinson Ave.
Milwaukee 53206

E NOW AVAILABLE!! A complete series of switching matrices for analog or digital switching up to 5 mc., and coax or twinax video switching up to 60 mc. The matrices allow any input or series of inputs to be connected to any output or multiple of outputs. They are available in 1 by 2 up to 20 by 20 crosspoint versions. Also available are multiple pole (up to 25 points) single and multiple throw coaxial switches. Switching control can be accomplished by a remote control panel, pre-programmed punched card or tape, or computer control for automatic checkout applications.

COAXIAL SWITCHING MATRICES

(remote controlled pre-programmable matrices and switches)

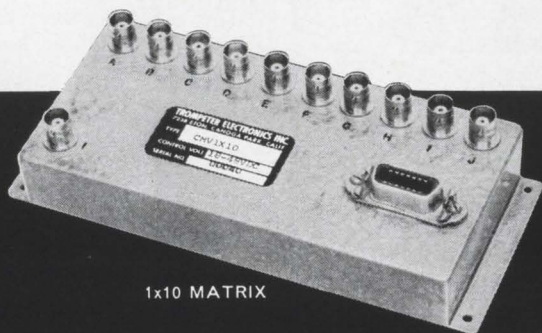

1x10 MATRIX

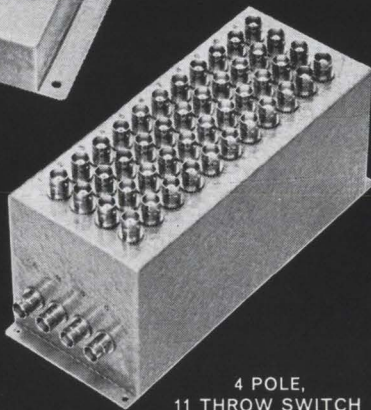

4 POLE,
11 THROW SWITCH

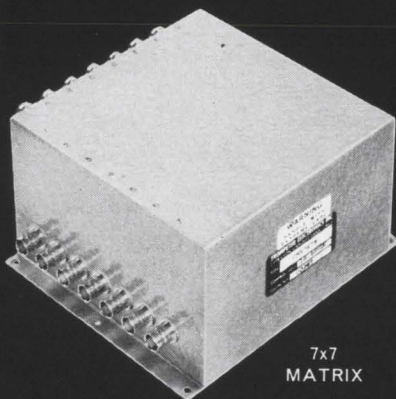

7x7
MATRIX

For low level shielded audio switching to 50kc; analog, digital or video switching to 5mc; L.F. switching to 60mc. To fit programming requirements, three levels of crosstalk/isolation are available with the following characteristics: low isolation to 45 db, medium isolation to 75 db; high isolation to 110 db minimum.

TROMPETER ELECTRONICS

8936 Comanche Ave., ■ Chatsworth, Calif. 91311 ■ (213) 882-1020

New Components

voltage reference taps, no dead band, and provides resolution of 10 millionths of an inch.

The unit was specially produced for use on a machine tool bed as a follow-up mechanism for positioning work. Through the use of the taps a wide variety of nonlinear positioning schedules can be set up. The pot is available in both special and standard specifications. The standard device has a resistance range of 250 ohms/in. to 125,000 ohms/in. ($\pm 10\%$), temperature range of -55° to $+150^\circ\text{C}$. Special specifications call for 150 ohms/in. to 200,000 ohms/in., a temperature range from -75° to $+200^\circ\text{C}$, and electrical stroke up to 28 in. ($+0.005$), with as many taps as required (4 taps to the inch in the standard model).

Computer Instruments Corp., 92 Madison Ave., Hempstead, N.Y. [355]

Commercial trimmer comes in two models

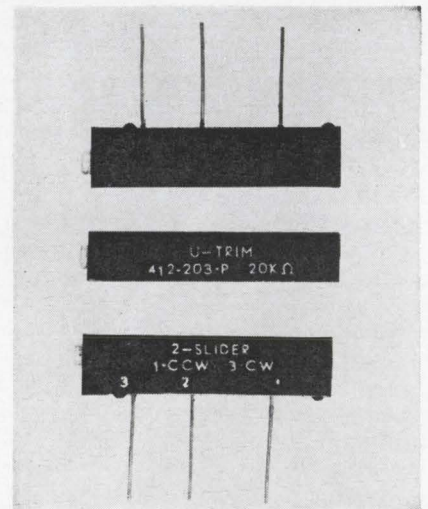

The U-Trim was designed specifically for the computer market. It is a commercial printed-circuit pin trimmer, but can also be supplied with solder terminals or with 30 Awg stranded-copper, Teflon-coated leads.

There are two basic models, the 412 and 512. The case dimensions are identical for both models, (0.25 x 0.300 x 1.25 in.). The actuator screw is 0.050 ± 0.014 in. and has a mounting standoff of 0.02 in. The only difference is the pin configura-

tion; model 412 has an offset center pin and the model 512 has an in-line pin configuration. Prices begin at \$2.95 and will vary depending on value and quantity.

The U-Trim is constructed inside-out, with the lead screw assembly inserted inside the Alkyd encapsulated resistance element. The wiper, made of Paliney No. 7 platinum gold alloy, travels through a 0.020-in. split in the alkyd winding mandrel. The latter is 0.170 in. in diameter, which allows a larger bend radius of the wire, resulting in a more stable resistance element. The 0.020-in. split in the mandrel allows stress relief of the wire due to operating temperature variations and other environmental conditions to which the trimmer may be subjected.

A ratcheting end clutch prevents overtravel and jamming of the slider device, assuring a positive starting grip on the positioning screw. The entire encapsulated resistance element and lead screw assembly are packaged in an alkyd case and epoxy sealed. The power rating is 1.0 watt at 25°C derated to zero at 150°C.

Utron, Inc., 1921 Main St., Grand Junction, Colo. [356]

Mercury relay is highly reliable

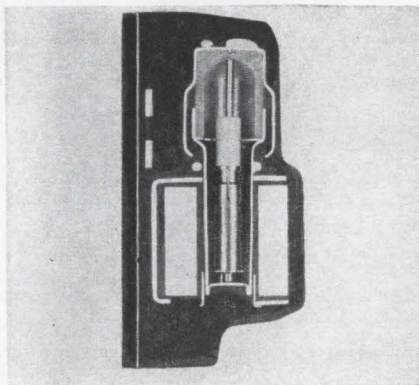

The Hi-Power mercury plunger relay has several unusual construction features: the two steel shells encapsulated in epoxy and separated by an epoxy insulating jacket; the wide top section housing the ceramic-lined contact chamber; the proximity of the two electrodes, one immersed in the pool of mercury in the lower section, the second in the mercury pool in the

Supply Problem for Precision Metals make your head spin?

use Hamilton's

theory of probability

to solve it:



This is where complete production facilities count! Chances are Hamilton's capabilities are the answer . . . as they have been for hundreds of others . . . whether it is radiation-shielding material only .0005" thick . . . a flexible drive band with a strength of 300,000 psi plus extremely high endurance . . . or 99.99% pure copper foil 12" wide and only .0005" thick. The Precision Metals Division of Hamilton Watch has the unique precision production facilities to do the almost "impossible". □ What can you lose? Before you give up . . . ask us. Invest a postage stamp and ask for the brochure on Precision Metals. You will receive facts and information that you can use.

PRECISION METALS DIVISION
 **HAMILTON**
WATCH COMPANY
LANCASTER, PA.

Countdown!

9,8,7,6,5,4,3

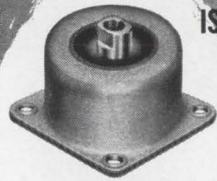

ISOLATORS

MIL SIZE

2



MIL SIZE

1

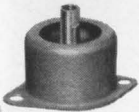

MIL SIZE

0

3 new mounts for industry...

Count up or count down, anyway you figure it, you can depend on the IsoMode Division of Cal/Val to continue to furnish industry with new products. Shown above are three new products, our Mil Size 0, 1 and 2 Cap Type Isolators. They meet all requirements of Mil-C-172. They are also available in reverse plate mounting configurations with choice of core types, elastomers, etc. Send for bulletin 130, and 131.



Please send Free
"POSITIVE MOTION
CONTROL" Brochure

Name _____

Firm _____

Address _____

City _____ State _____

IsoMode DIVISION

CAL/VAL RESEARCH & DEVELOPMENT CORP.
3310 VANOWEN STREET / BURBANK, CALIFORNIA 91504
(213) 849-7181 TWX 213-846-9004
(Formerly: Vibration Control Division—MB Electronics)

New Components

ceramic cup; and the solid metal plunger.

When the coil is energized, the magnetic field pulls the floating plunger into the lower pool of mercury. The displaced mercury flows up into the upper contact chamber and joins with the mercury in the ceramic cup, completing the circuit. When the coil is de-energized, the plunger moves up, allowing the mercury level to drop, breaking the contact. The mercury-to-mercury contact continuously renews itself on each make, thus eliminating two major causes of relay failure—contact deterioration or sticking, and change in contact resistance.

Ebert Electronics Corp., Floral Park, N.Y. [357]

Thermistor device has linear output

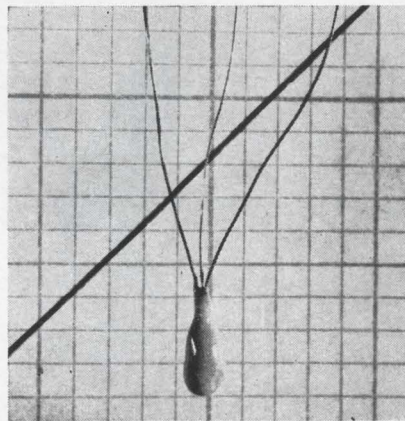

The YSI Thermilinear thermistor device has been announced. This component combines thermistor sensitivity with linear output over wide temperature ranges.

Suited for use as a temperature transducer or as linear temperature compensators, Thermilinear components have sensitivities as high as 20 mv per °C or more. This is said to be 400 times more sensitive than an iron constantan thermocouple. Linearity is better than 2 parts in 1,000 from 0° to 100°C, and as good as 0.075°F over 30° to 100°F. The composite thermistors are interchangeable so that many can be read from one scanning circuit.

Thermilinear components cost

±1% tracking plus taut-band in 20 models, 9 styles---with many in stock

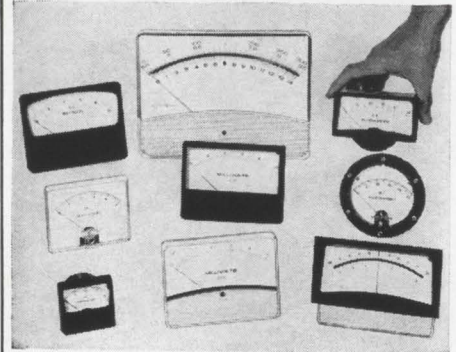

API offers 1 percent tracking, at no extra cost, in virtually every popular DC panel meter style, size and sensitivity—clear plastic, black phenolic, or ruggedized-sealed.

As long as you specify taut-band construction, you'll automatically get ±1 per cent tracking—in all but the smallest and most sensitive API meters.

Taut-band is a bonus in sensitive meters

You don't even have to specify taut-band if you order meters in ranges from 0-3 to 0-50 microamperes and from 0-3 to 0-25 millivolts. These meters just naturally come with taut-band. Besides responding best to exceptionally small signals, this friction-less design is much more resistant to damage from shock and vibration.

(Taut-band costs a little extra for less sensitive meters than those named above. There's also a slight charge for 1 per cent tracking in sensitive ranges of 0-10 μ a or 0-3 mv, or better.)

Immediate delivery for 10 models

Ten API panel meter models, in the most popular taut-band ranges, are now being stocked for off-the-shelf delivery.

*New Bulletin 47 has full information
on all*

API panel meters and pyrometers

api INSTRUMENTS CO.

Formerly Assembly Products, Inc.

CHESTERLAND, OHIO • PHONE: 216-423-3131

\$19.70 each singly. The composite thermistor costs \$11.60 in quantities of 100.

Yellow Springs Instrument Co., Inc.,
Box 279, Yellow Springs, Ohio. [358]

Microminiature film resistors

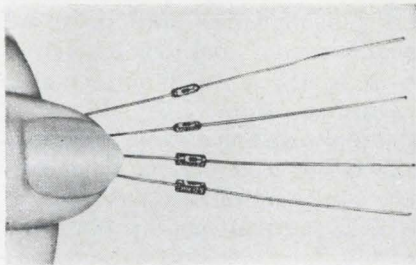

A series of microminiature film resistors features extremely high temperature range, and wide resistance range. Units are rated from 10 ohms to 10 megohms, from 0.12 to 1.0 watts, and have a maximum operating temperature of $+275^{\circ}\text{C}$. Superior performance is based on the use of resistance films processed from a proprietary formula of complex oxides.

Power and precision models are offered in standard resistance tolerances of $\pm 1\%$, with tolerances to 0.1% available on special order. Other specifications include: load life of 1,000 hours at rated power, with 0.5% maximum resistance shift; overload 5 times rated power for five seconds, with 0.2% maximum shift; overvoltage 1.5 times maximum voltage, with 0.5% maximum shift.

Caddock Electronics, 6151 Columbus Ave., Riverside, Calif. [359]

Lightweight heat sinks made of aluminum

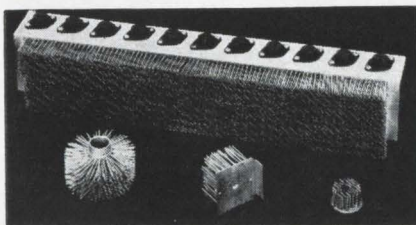

Heat sinks are now offered in aluminum, with either brazed or filled epoxy construction. A new assembly technique permits effectiveness

Mallory Film Resistors

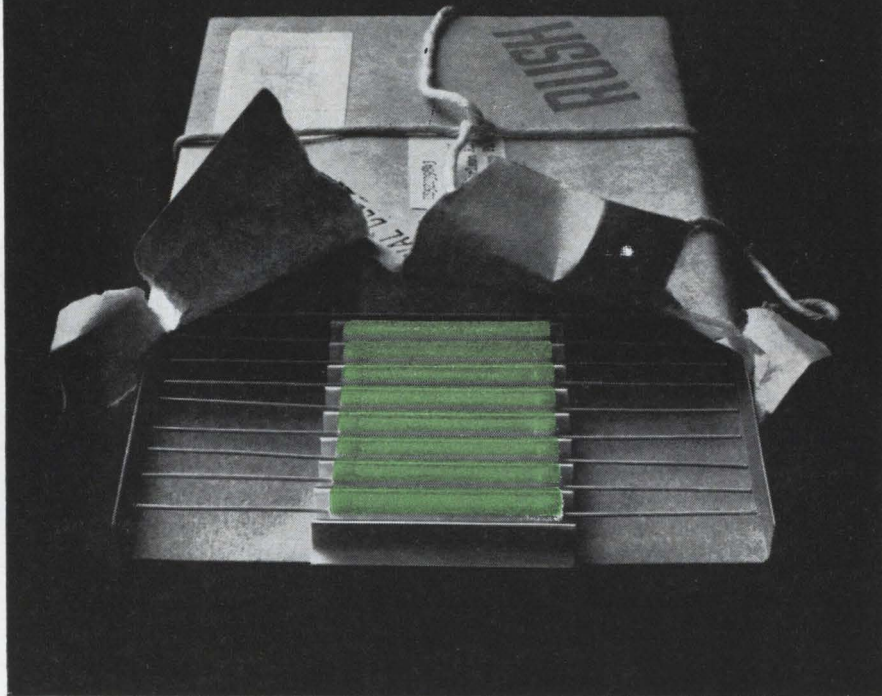

...fast on delivery tops in performance

We can ship orders for standard values of Mallory MOL metal oxide film resistors with reasonably short lead time requirements. Special values or tolerances may take a little longer. Reason: our automated production has been expanded in step with fast-growing demand for these high-stability, low-priced resistors. Five sizes are now in production: 2, 3, 4, 5 and 7 watts, in a broad range of resistance values.

And we do mean high stability. Resistance change on 10,000 hour load-life test is less than 1% ; after 1000 hours at 95% humidity, average resistance change is $\pm 0.7\%$. Temperature coefficient is ± 250 ppm/ $^{\circ}\text{C}$.

Want to see how fast . . . and how well . . . we can deliver? Write or call Mallory Controls Company, a division of P. R. Mallory & Co. Inc., Frankfort, Indiana 46041.

MALLORY

Amerline Corporation reports:

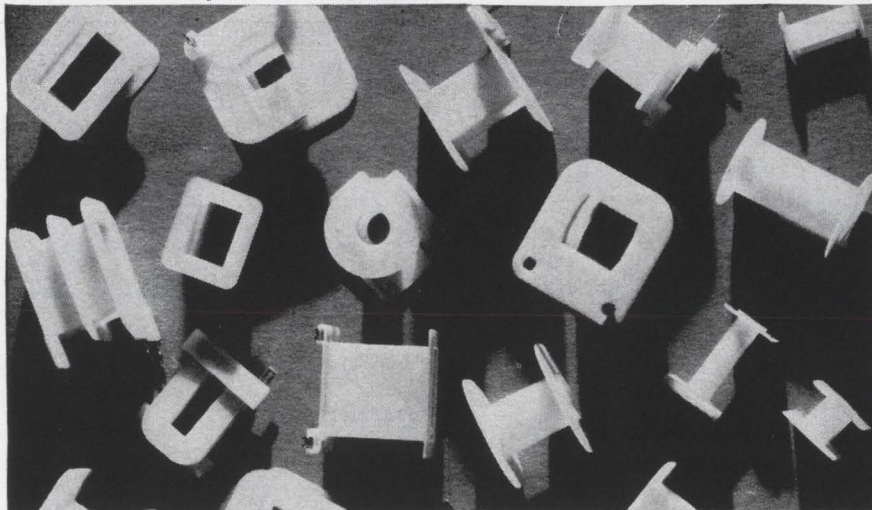

NYLAFIL® molded coil bobbins stay in shape!

Amerline Corporation, Chicago, produces a complete range of stock and custom injection molded coil bobbins for motors, relays, solenoids, transformers, etc. They say, "Our reasons for selecting Fiberfil's NYLAFIL (fiberglass reinforced nylon) in these applications are:

1. Better dimensional stability and better moisture characteristics than the unreinforced material.

2. Better rigidity which prevents the bobbin from distorting during and after the coil winding operation.

3. Increased resistance to heat, especially for soldering."

When you want high physicals not available in an unreinforced thermoplastic, specify Fiberfil FRTP... "reinforced insurance for all injection molding!" Write for technical data.



FIBERFIL, INC.
EVANSVILLE 17, INDIANA

Circle 222 on reader service card

TRYLON VLP T2-8 LOG PERIODIC ANTENNA
Two-curtain, vertically-polarized,
for 3 to 30 mc. 65° azimuth beamwidth;
13 db/iso gain; VSWR: less
than 2:1; power to 50 kw.

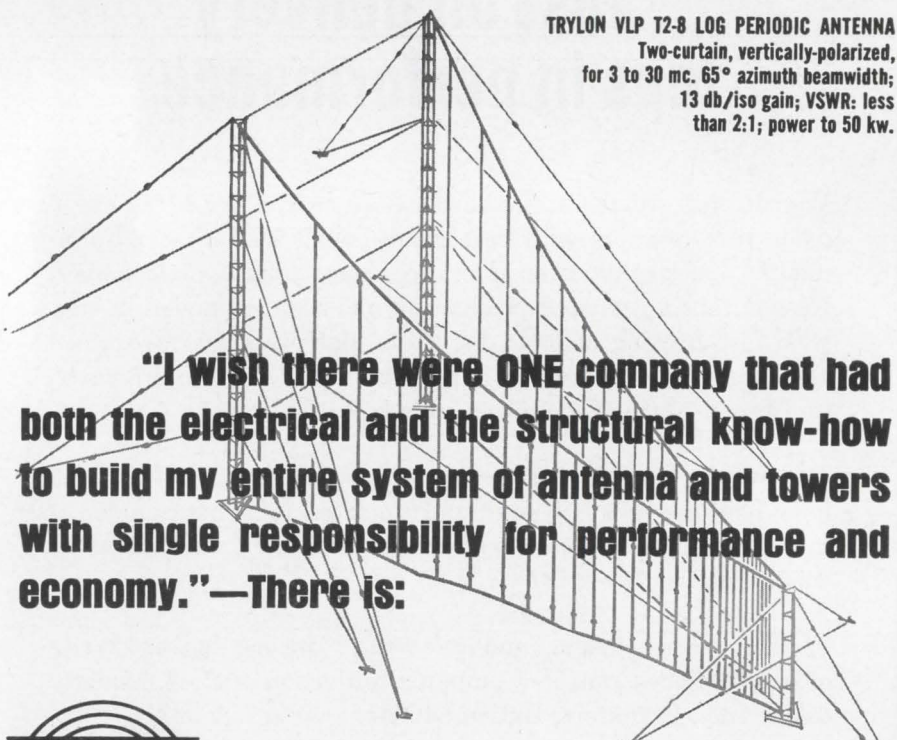

"I wish there were ONE company that had both the electrical and the structural know-how to build my entire system of antenna and towers with single responsibility for performance and economy."—There is:



Elverson, Pa. 19520 (215) 942-2981 — International Division, 750 Third Avenue, New York, N.Y. 10017, U.S.A.

New Components

of epoxy bonded units equal to that of brazed assemblies, with lower production costs.

These heat sinks are said to provide superior surface area to weight ratios, suiting them for airborne or portable equipment systems. Standard pin densities and sizes are available from stock in heights from 1/2 in. to 1 1/4 in., with surface area extensions from 7.5:1 to 16:1. Thermal resistance values are from 1.27°C per watt per sq. ft. of surface in natural convection to 0.047°C per watt per sq. ft. at 800 ft./min. face velocity.

Design requests will be given prompt attention upon receipt of performance requirements, according to the manufacturer.

Pin Fin Inc., 759 Main St., Waltham, Mass., 02154. [360]

Tantalum capacitors for hearing aids

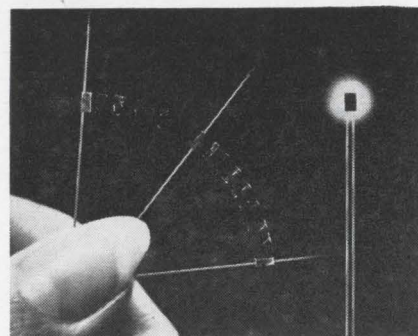

This series of rectangular solid tantalum capacitors can be installed in virtually any position. The small size and rectangular shape of the capacitors, type TC, facilitate high density packaging in modular assemblies and hearing aids. Units are available with axial or radial leads. They offer a wide range of capacitance-voltage ratings with extremely low leakage current and dissipation factor limits.

The capacitors are insulated to prevent short circuits. They remain undamaged by temperature extremes of -80° to +85°C and will withstand surge temperatures up to 125°C for short periods. Dimensions are 0.125 by 0.070 by 0.040 in.

Capacitance ranges from 1.5 µf at 2 v to 0.0047 µf at 20 v. Maxi-

mum leakage current is $0.5 \mu\text{a}$ and maximum dissipation factor 0.10. All units are color coded for easy rating identification. Standard capacitance tolerance is -20% to $+40\%$ at 25°C and 120 cps, with closer tolerances available upon request. The manufacturer reports the capacitors will withstand life tests of 2,000 hours under the following conditions: 85°C at rated voltage, and 40°C at rated voltage with 95% relative humidity. Several hundred hours may be recorded at 125°C at $\frac{2}{3}$ rated voltage. Tansitor Electronics, West Road, Bennington, Vt. [361]

Wafer capacitors require no leads

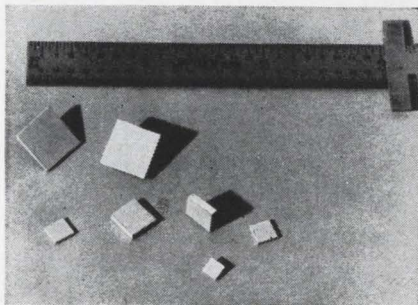

The Uniceram WY series of ceramic wafer capacitors are available without leads in multilayer units that have values from 0.5 to 3,000 pf. They are small, have high Q, excellent temperature stability, and voltage ratings to 300 vwdc.

Metallized edges, for soldering circuit connections, eliminate the need for leads and associated lead inductance; this permits mounting directly onto a circuit board. Low lead inductance is important in high-speed switching circuits and at vhf and higher frequencies.

These capacitors are said to be suitable for hybrid integrated circuits. They are particularly suitable to applications where the entire circuit will be potted and where space is at a premium. A total of 78 standard capacitance values are available in five unencapsulated wafer sizes. For example, values from 0.5 to 62 pf have typical dimensions of 0.10 by 0.10 by 0.05 in. Values from 1,100 to 3,000 pf have typical dimensions of 0.40 by 0.40 by 0.07 in. Temperature coefficient, measured at 1 Mc, is $\pm 95 \pm 20$ ppm per degree centigrade

AT LAST!

An Amazing D. C. BRUSHLESS MOTOR



**Scores Sensational
Breakthrough in
Electromechanics
By Inventing
Motor With
No Brushes-
No Commutator-
No Contacts**

For years and years inventors have considered a Brushless D. C. Motor to be as far beyond their reach as a perpetual motion machine! But the product development teams at Haydon Switch & Instrument, Inc. did it! Thus marking another brilliant milestone on HSI's long road in mating solid state technology with electromechanics!

This fabulous, new BRUSHLESS D. C. MOTOR incorporates these vital features:

No brushes—no commutator—no contacts; long life assured.

Radio Frequency interference minimized by diode suppression of the electronic switching.

The electronic circuitry can be synchronized to any desired accuracy by using the optional synchronizing terminal.

Available with integral gear reduction and standard output speeds.

Rotor and output shaft bearings are sintered bronze and vacuum impregnated for life of motor.

Long life nylon gears and pinions require no lubrication.

For complete technical data on the SERIES 37 BRUSHLESS D. C. MOTOR, including wiring and dimensional diagrams and chart showing standard speeds, write Haydon Switch & Instrument, Inc., 1500 Meriden Road, Waterbury, Conn. 06720 for Bulletin No. 37-1.

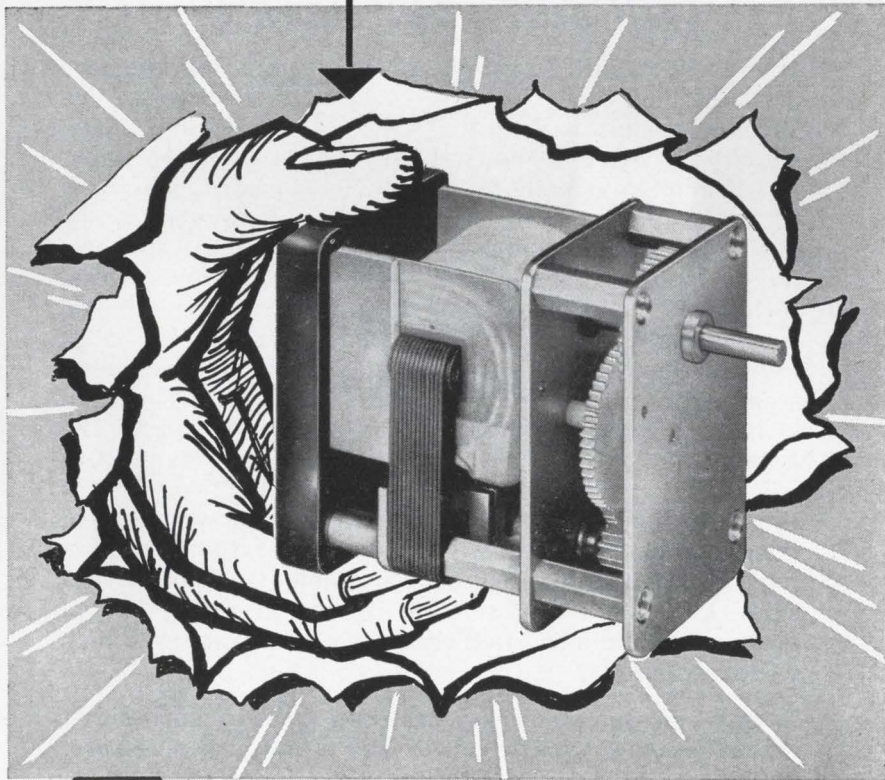

HAYDON SWITCH & INSTRUMENT, INC.
Building Confidence Through Dependability

1500 MERIDEN ROAD, WATERBURY, CONN. 06720 AREA CODE (203) 756-7441

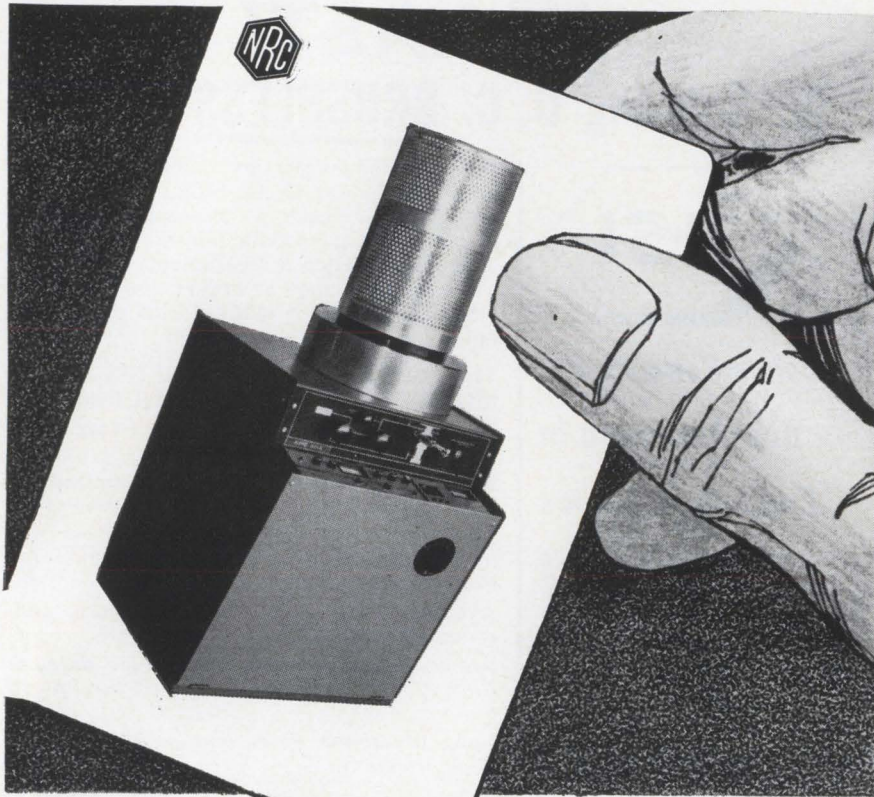

NRC'S *new microcircuit Trump Card will suit your needs!*

If you can't afford to gamble on microcircuit performance and feel that you've been priced out of the **quality** high vacuum coater market, the NRC 3114 economy coater should be welcome news. Designed for general-purpose R & D thin film operations, the NRC 3114 incorporates many of the features of more sophisticated systems, such as the NRC 3176, with the rock-bottom price of a bargain-basement evaporator. The price is about \$3,000. Luxury features include **10⁻⁸ torr range blank-off**, a liquid nitrogen baffle, top-rated NRC 4-inch diffusion pump and the very latest in high vacuum gauge instrumentation — the log and linear-scaled NRC 720 ionization gauge control. Controls are conveniently grouped in an easy-to-read, one-position panel. The compact (31 by 33½") system also features a 5 cfm mechanical pump, an NRC 507 ionization gauge tube, two NRC-521 thermocouple gauge tubes, a raised baseplate with bell jar, guard and gasket. Complete accessibility for routine maintenance is provided through the removable panels on all four sides. For detailed information on our complete line of evaporators and associated equipment for microelectronics, write or call today.

EVAPORATORS • PUMPING STATIONS • POWER SUPPLIES
FEEDTHROUGHS • CRYSTAL PULLERS • TUBULAR FURNACES
ELECTRON BEAM HEAT SOURCES • LEAK DETECTORS



EQUIPMENT DIVISION
NATIONAL RESEARCH CORPORATION
A SUBSIDIARY OF NORTON COMPANY

160 Charlemont Street, Newton, Massachusetts 02161



New Components

from -55° to $+125^{\circ}\text{C}$. Operating voltage is 300 wvdc except for higher values in the WY04 and WY05 sizes. Dielectric test voltage is 300% of rated working voltage.

Available tolerances are ± 0.25 pf, ± 0.50 pf, $\pm 1\%$, $\pm 2\%$, $\pm 5\%$, and $\pm 10\%$. Q at 1 Mc and 25°C is a minimum of 5000, while dissipation factor at 1 kc and 25°C is a maximum of 0.0002.

JFD Electronics Corp., 15th Ave. at 62nd St., Brooklyn, N.Y. [362]

Vacuum relay can switch high voltage



A vacuum relay has been developed that is capable of switching up to 20 kv d-c in air, and of carrying up to 20 amps.

Model H-19 double-pole, double-throw relay has a maximum operating time of 20 msec. Standard coil resistance is 225 ohms; coil voltage is 26.5 v d-c or 115 v d-c. The H-19 will withstand vibration to 5 g's at 2000 cps and shock to 30 g's at 11 msec. Delivery is 20 to 30 days. Price in quantities of 1 to 9 is approximately \$140.

High Vacuum Electronics Inc., 538 Mission St., South Pasadena, Calif. [363]

Intermittent-duty reluctance motor

Type FC intermittent-duty reluctance motor has a starting torque of 8 oz.-in. at 1,800 rpm in a package 1.875 in. in maximum diameter by 2¼ in. long. This permanent split capacitor unit operates from

115 v a-c, 60 cps, 1 phase, with a maximum power input of 80 watts.

Available with or without finned housing, the unit must have an adequate heat sink (12 in. by 12 in. by ¼ in. aluminum plate) and/or forced cooling. Temperature rise with heat sink and duty cycle of 3 seconds on and 3 seconds off is 100°C maximum. Other speeds, voltages, frequencies, etc., can be provided to suit application needs. Globe Industries, Inc., 1784 Stanley Ave., Dayton, Ohio, 45404. [364]

Balanced delay line is semiflexible

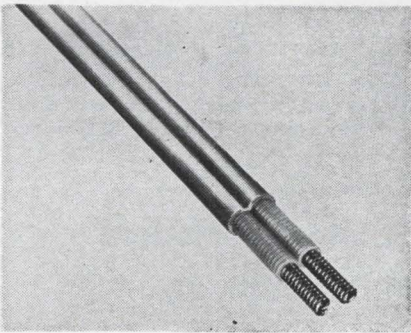

A semiflexible balanced delay line for pulse transmission has been announced. The cable has an impedance of 220 ohms with a delay of 12 nsec per foot. The measured output rise time (10-90) for 100 nsec of delay is 3 nsec, with an input pulse rise of 0.3 nsec. Preshoot of output pulse is less than 4%. Cable o-d is 0.34 by 0.64 in. Minimum recommended bend radius is 3 in. Normal delivery is within two to three weeks.

Times Wire and Cable, Hall Ave., Wallingford, Conn. [365]

Telephone-type jacks reduce wiring time

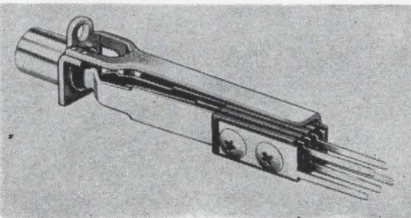

A 50% reduction in wiring time is possible with a new line of telephone-type jacks that feature wire-

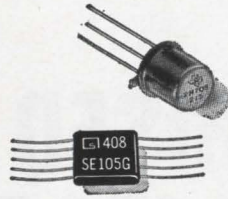

Need to say a lot
in a little space?

(or make markings
more durable...or
more economical...
or at higher rates?)

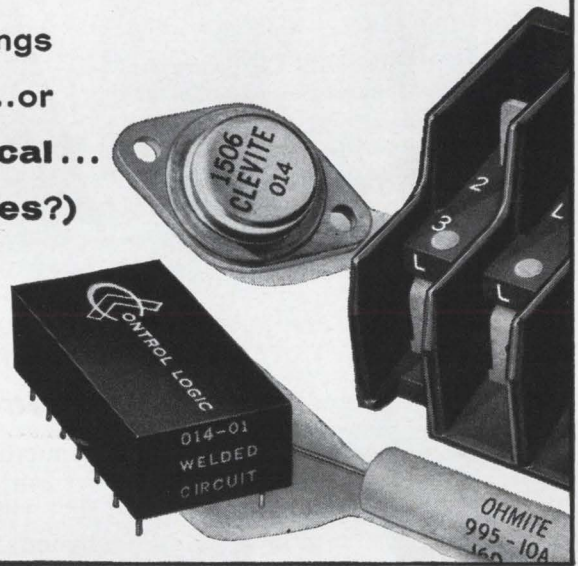

We can show you how

We can show you how to identify products so they will resist extreme amounts of handling, abrasion, many solvents and other atmospheric conditions . . . or how to sequentially number and identify components with savings of more than \$50 per 1000 . . . or how to print trademark, type number, value and date code on 90 units a minute . . . or how to produce an imprint that remains readable after 1000 hours at 200°C. . . or get 10 digits and 2 letters in a micro-circuit area of 0.090" — or 21 characters on a TO-5 case with interchangeable type number and date code . . . or save 75 cents of every dollar you now spend on buying, applying, inventorying and discarding obsolete preprinted labels.

The answers are in proven Markem machines, type and specialty inks, which daily produce better product or package identification by reducing costs, smoothing production control and increasing customer acceptance. And while Markem machines, type and inks are helping to produce better products through more complete and lasting identification, they frequently pay for themselves in the savings they make possible. Tell us what you make, what it must say, and for how long: we'll give you a specific recommendation and cost estimate right away. Write Electrical Division, Markem Machine Co., 305 Congress St., Keene, New Hampshire 03431.

MARKEM

TRANSISTORISED OSCILLOSCOPE 100 Mc

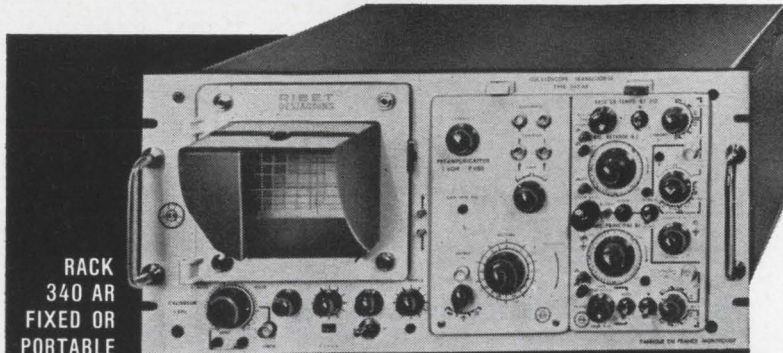

RACK
340 AR
FIXED OR
PORTABLE

- Cathode-ray tube with illuminated internal graticule.
- Interchangeable X and Y plug-in units.
- Bandwidth : from 0 up to 100 Mc. Deviation coefficient 100 μ V/cm up to 50 mV/cm, depending on the type of plug-in unit used.
- 2 identical time-bases, 5 sec to 10 nsec/cm - Magnifier 10 - delayed up to 100 sec.
- Fully transistorised - Reduced consumption (220 VA) and weight (25 kg)
- ALREADY EXISTING : 7 single and dual-trace plug-in units.
SHORTLY AVAILABLE : 1 sampling plug-in unit.

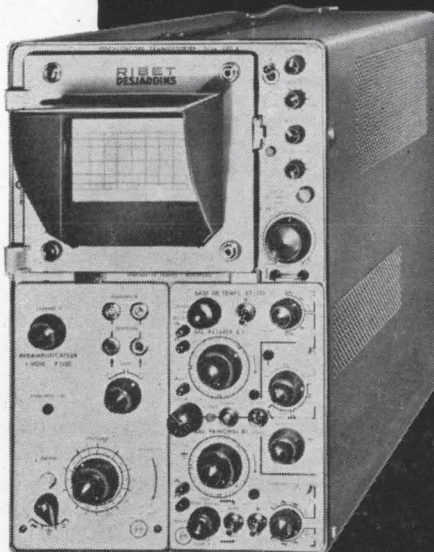

CABINET 340 A

THE FRAME INCLUDES :

- 1 vertical amplifier
- 1 horizontal amplifier
- 1 delay line 120 nsec
- 1 calibrator 0.2 mv to 100 V
- 1 cathode-ray tube
- 1 EHT equipped with semi-conductors 10 kV

Y INTERCHANGEABLE PLUG-IN UNITS

- P 1100 Single-trace 0-100 Mc - 5 and 50 mV/cm
- P 280 Dual-trace 0-80 Mc - 5 and 50 mV/cm
- P 150 Single-trace 0-50 Mc - 50 mV/cm
- P 240 Dual-trace 0-40 Mc - 50 mV/cm
- P 110 Differential 10 Mc - 1 mV/cm
- DP 100 Differential 100 Kc - 100 μ V/cm

X INTERCHANGEABLE PLUG-IN UNITS

- BT 210 Dual sweep : 10 nsec/cm
- BT 110 Single sweep : 10 nsec/cm
- SHORTLY AVAILABLE : Sampling unit

New Components

wrapped terminals, the manufacturer says. This improvement over jacks with solder terminals can be accomplished with any commercially available wrapping tool.

These two- and three-conductor jacks can be used with Termini-Point connectors or any other solderless terminal. Made with nickel-silver springs, they have a chromated protective plated frame that can withstand 50 hours of salt spray.

The 0.032- by 0.062-inch terminals are long enough to allow for three individually wrapped connections per spring. A variety of spring pile-up configurations are available in the two- and three-conductor type. Contacts are of cross-bar palladium.

ADC Products, Inc., 6325 Cambridge St., Minneapolis, Minn., 55416. [366]

Push-type solenoid built compactly

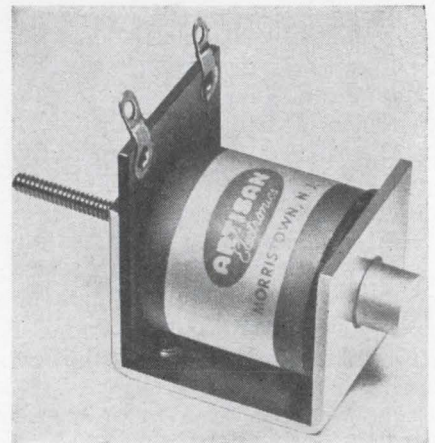

A compact, U-frame push-type solenoid, model BRG, can be used for both continuous and intermittent duty in a-c or d-c applications. It weighs only 2½ oz. and features a vacuum-varnish impregnated coil for long life. The unit is operable up to 110 v d-c or 220 v a-c, 50 or 60 cps, and is valuable for use in automatic equipment, such as business machines, vending equipment and recording instruments.

Stroke is from ⅓ in. to ½ in. In continuous operation, push force is up to 17 oz. a-c, or up to 32 oz. d-c. In intermittent service, push force is up to 60 oz. a-c, or up to 100 oz.

INTER-PLANS

RIBET-DESJARDINS

FURTHER INFORMATION
AND PRICE ON APPLICATION

MEASURE AND CONTROL DEPARTEMENT
13 - 17, RUE PERIER, MONTROUGE / PARIS - TÉL. 253 24-40

d-c. Several plunger styles, plunger extensions and terminal types and locations are offered. Quick-disconnect terminals are available. Model BRG can be furnished for high ambient temperatures.

Artisan Electronics Corp., 171 Ridge-dale Ave., Morristown, N.J. [367]

Toroidal inductor withstands moisture

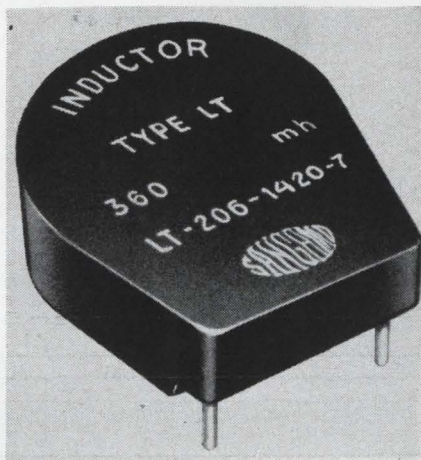

A low-profile, encapsulated toroidal inductor, type LT, is designed specifically for printed-circuit card mounting where board spacing is critical. Outstanding features of the inductor include a unique coil protection scheme and construction that is virtually impervious to moisture. Powdered molybdenum perm-alloy cores and vacuum encapsulation assure inductors with a high Q factor and exceptional stability of inductance.

Type LT inductors cover an inductance range from 1.20 mh to 3.91 henries over a recommended frequency range from 1.0 kc to 100 kc with a $\pm 1\%$ inductance tolerance guaranteed. Two-terminal, three-terminal, and four-terminal units are available.

Sangamo Electric Co., Box 359, Springfield, Ill., 62705. [368]

Two-pole relay in a TO-5 case

A double-pole, double-throw, non-latching relay, series 412, employs all-welded construction within a standard TO-5 type enclosure. Its

.025

This is the
new G-E
readout lamp

Only .025" thick

If you want to convert information into recognizable digits, new General Electric electroluminescent lamps offer a compact, economical way to do it.

Eight lamp choices are available, in three different digit sizes: 2", 1" and $\frac{1}{2}$ ". (In the 1" and $\frac{1}{2}$ " sizes, contacts are pressure-sensitive to make positive electrical connections.) The 2" size has a standard printed circuit base. You get amazing compactness with these new lamps, due to their unusual thinness. The $\frac{1}{2}$ " and 1" lamps are only .025" thick, and the 2" lamp is only .100" thick. You also get exceptional economy with these new lamps and catastrophic failure is unheard of. G-E readouts use very little power, and operate on standard 120v. or 240v., 60-cycle lines, eliminating frequency conversion back-up cost.

If you'd like to learn more about EL applications, write for Bulletin #M-65-7. It's free, of course. If you'd prefer a demonstration of EL, contact your nearby G-E sales office or write General Electric Company, Miniature Lamp Dept. M5-9, Nela Park, Cleveland, Ohio 44112.

Progress Is Our Most Important Product

GENERAL  ELECTRIC

Now twice as many

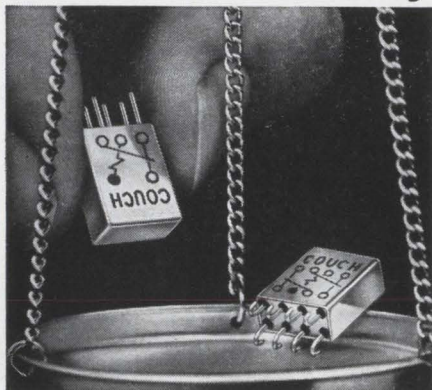

Couch 0.1 oz. rotary relays

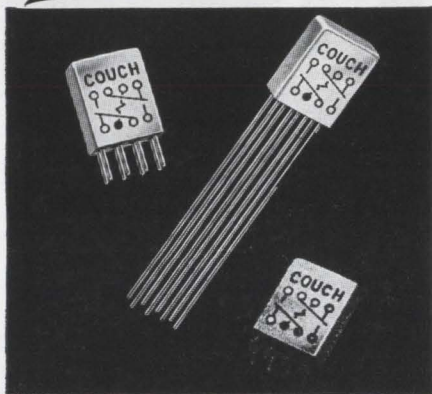

each available in
3 terminal styles . . .

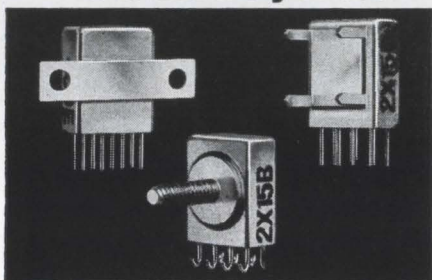

and in many mounting styles

We now offer a full line of SPDT relays, type 1X, to match our DPDT, type 2X, relay line. Except for coil data, specifications are identical for both types:

	2X	1X
Size	0.2" x .4" x .5"	same
Terminal Spacing	1/10" grid	same
Rating	0.5 amp @ 30 VDC	same
Coil Operating Power	150 mw	70 mw
Coil Resistance	60 to 4000 ohms	125 to 4000 ohms
Temperature	-65°C to +125°C	same
Vibration	20 G	same
Shock	75 G	same

Write for Data Sheets No. 9 and 10

RUGGED ROTARY RELAYS  Dynamically and Statically Balanced

COUCH ORDNANCE INC.

3 Arlington Street, North Quincy 71, Mass., Area Code 617,
CYpress 8-4147 A subsidiary of S. H. COUCH COMPANY, INC

New Components

volume is less than 0.025 cu in., and weight is 0.09 oz.

It is designed for continuous operation in ambients from -65° to +125°C, and can withstand 80-g shock and 30-g vibration up to 3,000 cps. Contacts are rated for 100,000 operations at 0.5 amp and for up to 1 million operations at low level.

The hermetically sealed relay requires 130 mw of operating power. Operating time is 2 msec with bounce less than 1.5 msec. The unit meets applicable requirements of MIL-R-5757D. All standard coil voltages are available.

Price is \$22.40 each in quantities of 100 or more; availability is from stock.

Teledyne Precision Inc., 3155 W. El Segundo Blvd., Hawthorne, Calif. [369]

Perforated jacketing for cable venting

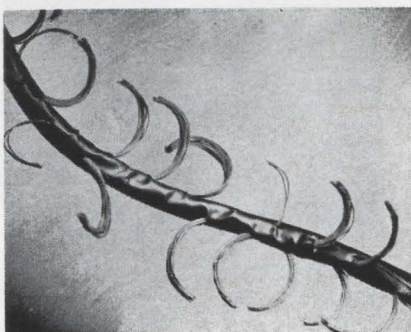

A perforated cable jacketing reduces moisture condensation by permitting water to evaporate or drain out. In addition, it offers an easy method of providing branch-outs for wire harness assemblies. Perforations have been spaced so that wires can be snaked out wherever desired. Perforations may also be ordered to meet individual specifications.

Perforated Zippertubing is available in almost all standard ZT materials including general-purpose and military types. Military types have overlap construction and can be certified to military specifications MIL-I-631-D and MIL-I-7444B.

The Zippertubing Co., 13000 S. Broadway, Los Angeles 61, Calif. [370]

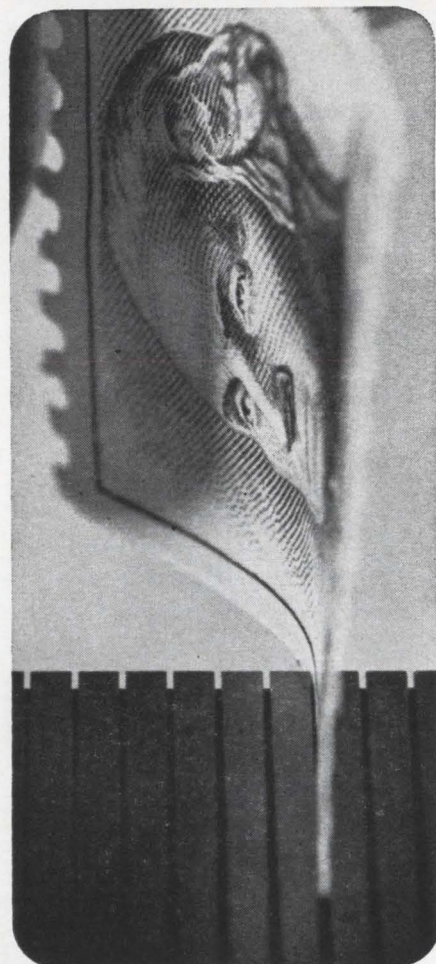

Need graphite with 0.003" slots?

Call on Ultra Carbon. Typical capability: graphite machined with 0.003" slots. Shown, six times actual size, 0.006" slots.

Your most exacting specifications in graphite parts can be met by the microprecision machining capabilities of Ultra. Complex and precise broaching, milling, slotting and drilling of graphite is achieved with the newest and best in machine tools. The Ultra emphasis is on service to meet your tomorrow's demands. An engineering staff of specialists in graphite is always ready to help you. Why not submit your drawings or sketches and an outline of your application to us? Write P. O. Box 747, Bay City, Mich. 48709.

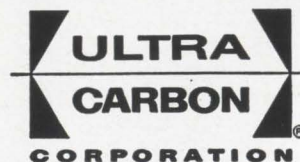

Circle 223 on reader service card

NEW ELGENCO 3 BAND 20 cps to 5 mc RANDOM NOISE GENERATOR



MODEL 602A

- Symmetrical wave form
- Non-clipped wave form
- Constant output Z
- All Solid State
- \$290

SPECIFICATIONS: MODEL 602A — GAUSSIAN DISTRIBUTION: Symmetrical non-clipped wave form all ranges. **FREQUENCY RANGES:** 20 cps to 20 kc, 20 cps to 500 kc, and 20 cps to 5 mc. **OUTPUT SPECTRUM:** Uniform from 20 cps to 20 kc within ± 1 db, 20 cps to 500 kc within ± 3 db, 500 kc to 5 mc within ± 8 db. **OUTPUT VOLTAGE:** Maximum open circuit at least 3 volts for 20 kc range, 2 volts 500 kc range, and 1 volt 5 mc range. **TYPICAL SPECTRAL DENSITY** (with 1 volt rms output): 5 mv/ $\sqrt{\text{cps}}$ for 20 kc range, 1.2 mv/ $\sqrt{\text{cps}}$ 500 kc range, and 0.4 mv/ $\sqrt{\text{cps}}$ 5 mc range. **CONTINUOUS AMPLITUDE CONTROL — FIVE POSITION OUTPUT ATTENUATOR:** X1.0, X0.1, X.01, X.001, and X.0001; Accuracy $\pm 3\%$ to 100 kc, $\pm 10\%$ to 5 mc. **OUTPUT IMPEDANCE:** Constant 900 ohms on direct output; 200 ohms on step attenuated output. **OUTPUT VOLTMETER:** 0-5 volt, calibrated to read rms value of Gaussian noise. **Operating Temperature:** 0 to 50 degrees C. **POWER REQUIREMENTS:** 115/230 volts $\pm 10/20$ volts, 50 to 1,000 cps, approx. 5 watts; rechargeable battery option available. **DIMENSIONS:** 5 1/4" high x 8 3/8" wide x 11" deep. Panel height for 19" relay-rack mounting is 5 1/4". **PRICE:** \$290. **DELIVERY:** Stock to 30 days.

OTHER MODELS: 610A 10 cps to 5 mc — \$1175; 603A 20 cps to 5 mc — \$495; 301A - DC to 40 cps — \$1995; 321A DC to 120 cps — \$2095; 311A DC to 40 cps and 10 cps to 20 kc — \$2395; 312A DC to 120 cps and 10 cps to 20 kc — \$2495; 331A 10 cps to 20 kc — \$1295.



ELGENCO INCORPORATED

1550 EUCLID ST. • SANTA MONICA, CALIF. • (213) 451-1635

For more than 10 years Noise Generators have been our major endeavor.

Circle 224 on reader service card

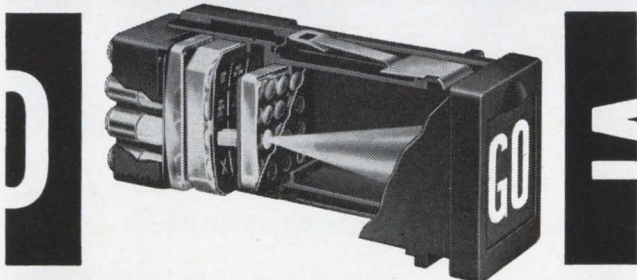

Send today for complete information on the only readout that works like a rear-projector, uses film to display anything (even colors!), gives you 12 message positions all in a single plane, and plugs in and out from the front for quick lamp replacement. All that and it's only 1 1/2" x 1-1/16"! Just think what its bigger brothers can do...



INDUSTRIAL ELECTRONIC ENGINEERS, INC.

7720 Lemona Avenue • Van Nuys, California
Phone: (213) 787-0311 • TWX (213) 781-8115

©1965 IEE

Representatives in Principal Cities

Circle 225 on reader service card

MIAL

polystyrene capacitors outperform micas and other film capacitors ...cut costs, too!

MIAL'S sealed polystyrene capacitors surpass all film capacitors in life span... reliability... freedom from drift... insulation resistance (more than 500,000 megs) and "Q" factor. MIAL offers the widest range of "polys" in production quantities.

Capacitance, 20 pF to 600,000 pF; capacitance tolerance from $\pm 0.3\%$ to $\pm 20\%$; temperature coefficient, N100 and N150 ± 50 PPM/ $^{\circ}\text{C}$; Voltage, 33 VDCW to 1000 VDCW.



MIAL 602
High Reliability Precision Type



MIAL 603
Printed Circuit Mounting—
High Reliability Precision Type



MIAL 610
Sub-Miniature



MIAL 611
General Purpose N150



MIAL 612
Printed Circuit Board Mounting



MIAL 613
Axial-Lead Close Tolerance



MIAL 614
Radial Lead Close Tolerance



MIAL 615
End Lead Close Tolerance



MIAL 616
Axial Lead

Polystyrene
Capacitors

MIAL
-INC-



MIAL

U. S. A., I N C.

Write today for new complete catalog. Gives environmental, electrical and mechanical characteristics, charts and dimensions.

165H FRANKLIN AVENUE, NUTLEY, N.J. 07110 • (201) 667-1600-1601

Circle 175 on reader service card

175

**YOU CAN SPLIT LOGS,
hairs, votes, and some
heat-shrinkable tubings,
BUT YOU CAN'T SPLIT**

**FLEXITE
SHRINKDOWN**



PLASTIC TUBING

when properly selected from these four grades and applied according to Markel recommendations:

1

HT-105, Flexible Class A (105°C) Shrinkdown
Extruded tubing similar to Flexite HT-105; outstanding dielectric properties; adaptable for many uses; it shrinks at less than 200°F.

2

SD-105, Semi-Rigid Class A Shrinkdown
For uses where greater mechanical strength and rigidity are needed, and over components sensitive to higher than 200°F temperatures.

3

PO-135, Flexible Class B (130°C) Shrinkdown
Thermally stable tubing of specially formulated polymers; excellent electricals, chemical and oil resistance. Shrinks at 235°F. Meets MIL-I-23053 (wep), Class I.

4

TE-250, Flexible Class C (250°C) Shrinkdown
Of modified polytetrafluoroethylene; offers exceptional electrical, thermal, and chemical-resistance properties. Shrinks at 621°F.

Markel customers are saving many dollars and much valuable time with these magic tubings that shrink 50% in diameter with the flash of a heat gun—adding a sheath of mechanical and electrical protection over terminals, connectors, cables, components, and other irregular shapes. Let's see how this idea could serve you; write for technical data and samples.

L FRANK MARKEL & SONS
SINCE 1922

ONE SOURCE FOR EXCELLENCE
Insulating Tubings and Sleevings
High Temperature Wire and Cable
NORRISTOWN, PENNSYLVANIA 19404

New Semiconductors

Silicon transistor resists radiation



A silicon planar npn transistor now in production at the Semiconductor division of the Fairchild Camera & Instrument Corp. has a radiation tolerance at least 10 times better than any others available. In cooperation with the Sandia Corp., of Albuquerque, N. M., Fairchild experimented with its highest gain transistor, the 2N918. Studying its characteristics as a function of fast neutron radiation, Fairchild discovered that radiation resistance increases as the gain-bandwidth product (f_T) increases. The f_T of the device increases as the thickness of its base decreases, so Fairchild developed a technique to reduce the thickness of the base. The new transistor, designated FT40, has a small active area and a very thin, heavily doped base, which enables it to offer a gain-bandwidth product of 1 gigacycle, minimum.

The FT40 offers a minimum beta of 90 before exposure and guarantees a minimum beta of 10 after exposure to 10^{15} NVT (neutron velocity X time). The device is

designated for high-speed switching and amplifier applications, and is particularly suited for use in satellites and missiles, where radiation tolerance is imperative.

Fairchild Semiconductor, a division of the Fairchild Camera & Instrument Corp., 313 Fairchild Dr., Mountain View, Calif. [371]

High-voltage silicon rectifier

A series of ½ amp (1 amp in oil) high-voltage, coaxial silicon rectifiers is available with peak inverse voltage ratings of 5000, 7500, 10,000, 15,000, 20,000 and 25,000 volts. The Slimpac is corona-free and is constructed to meet stringent reliability requirements.

The rectifiers feature low forward drop, low leakage at piv (0.1 μ a at 25°C), operating and storage temperature of -55° to +175°C. The package is 0.25 in. deep by 0.53 in. wide; length varies with the piv rating from 1.125 in. to 4.250 in. Units have 0.051-in.-diameter axial wire leads for simplicity of installation.

Slimpac can be utilized in all standard, single and polyphase rectifier circuits. Designed and tooled to be efficiently mass produced, the new rectifier can be used economically in 97% of present applications, the manufacturers says. Semtech Corp., 652 Mitchell Road, Newbury Park, Calif. [372]

Fin-design heat sinks cool semiconductors

Models 202 and 204 heat sinks offer a fin design that permits horizontal or vertical orientation with excellent natural convection performance in either position. Similarly, in forced convection applications the axis of the semiconductor may be oriented either perpendicular or parallel to the air flow.

These featherweight coolers are made from a beryllium copper al-

Specifications

Collector-emitter breakdown voltage	10 v min.
Saturation voltage at collector current of 10 ma	0.1 v max.
H-f current gain (10ma at 5 v)	10 min.
Package	TO-46
Price	\$24 each (1-99) \$16 each (100-999)

Why does AE separate the leads from the terminals in its printed circuit dry reed switches?

Because this construction provides better electrical characteristics.

Should a capsule lead have to "double" as a terminal? *Separate* terminals give you superior electrical contact—and eliminate strain on the glass capsules. That's the AE approach on dry reed switches for PC boards.

AE also uses *welded connections* in these new PC Correeds*. The contact terminals are welded, not soldered, to the capsule leads. This reduces stress—makes more reliable connections, with greater mechanical strength.

These switches are easy to insert.

*U.S. Patent Pending

The terminals are longitudinally ribbed for extra strength and rigidity.

Bobbins are stronger too, because they're made of glass-filled plastic. Besides adding strength, this construction is moistureproof—to prevent electrical failure.

AE Printed Circuit Correeds are made to "standard" measurements: multiples of 0.200 inches between terminals, the industry standard for circuit boards. Standardized terminal size and spacing also allow for greater pack-

age density.

Get helpful, detailed information. Find out how new PC Correeds meet the requirements of modern electronic circuitry. Just write to the Director, Electronic Control Equipment Sales, Automatic Electric Company, Northlake, Ill. 60164.

2-capsule
(Forms 2A, 1B, or
1A Mag. Latch)

3-capsule
(Forms 3A,
2B, or 1A-1B)

5-capsule
(Forms 5A
or 2A-2B)

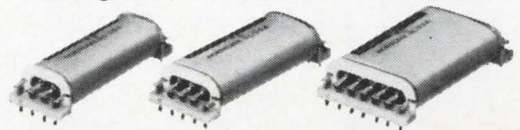

AUTOMATIC ELECTRIC
SUBSIDIARY OF
GENERAL TELEPHONE & ELECTRONICS **GTE**





Need a non-slip electrical grade polyester film? ask about "SCOTCHPAR"

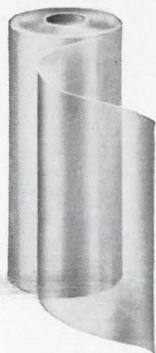

When you want an electrical grade film with a non-slip, friction surface — let us know. Perhaps a modified version of "SCOTCHPAR" can solve your problem. Or, do you have some other special requirement? Want a film that's thick? Thin? Clear? Opaque? Whatever your need present it to our laboratories for consideration. They've already made hundreds of variations to basic polyester. Whether you demand basic or customized "SCOTCHPAR", we'll be happy to serve you. Contact 3M Co., Film & Allied Products Division, 2501 Hudson Rd., St. Paul, Minnesota, Dept. ICL-105.

Scotchpar® electrical grade polyester film
BRAND

"SCOTCHPAR" IS A REG. T.M. OF 3M CO.

3M
COMPANY

New Semiconductors

loy per MIL-C-81021 having twice the thermal conductivity of the more commonly used alloys. Using no grease or joint compound, the maximum contact thermal impedance from the semiconductor case to the dissipator i-d is 5°C per watt for No. 202 and 3°C per watt for No. 204.

Wakefield Engineering, Inc., Wakefield, Mass., 01881. [373]

Plastic-encapsulated power transistor



Type TIP14 plastic-encapsulated power transistor is an npn silicon planar device, specifically designed for cost-critical applications.

The Tab-Pac power transistor features a low-profile, double-ended plastic package with a mounting tab for simplified assembly. It can be mounted using only one chassis hole and one sheet-metal screw, thus reducing mounting hardware and assembly steps to a minimum.

Electrical characteristics include extremely low saturation voltage ($V_{CE(sat)} = 0.1$ v typical at 200 ma), high power dissipation (15 w at 25°C case), and beta linearity over a wide current range ($h_{FE} = 35$ typical at 50 ma and 30 typical at 1 amp).

The low saturation voltage provides maximum circuit efficiency with minimum internal heating and device power losses. The flat beta characteristic makes the transistor particularly well suited for audio amplifier uses requiring linearity over broad current fluctuations.

Texas Instruments Incorporated, 13500 North Central Expressway, Dallas, Texas. [374]

THINK COPPER...for high-performance alloys

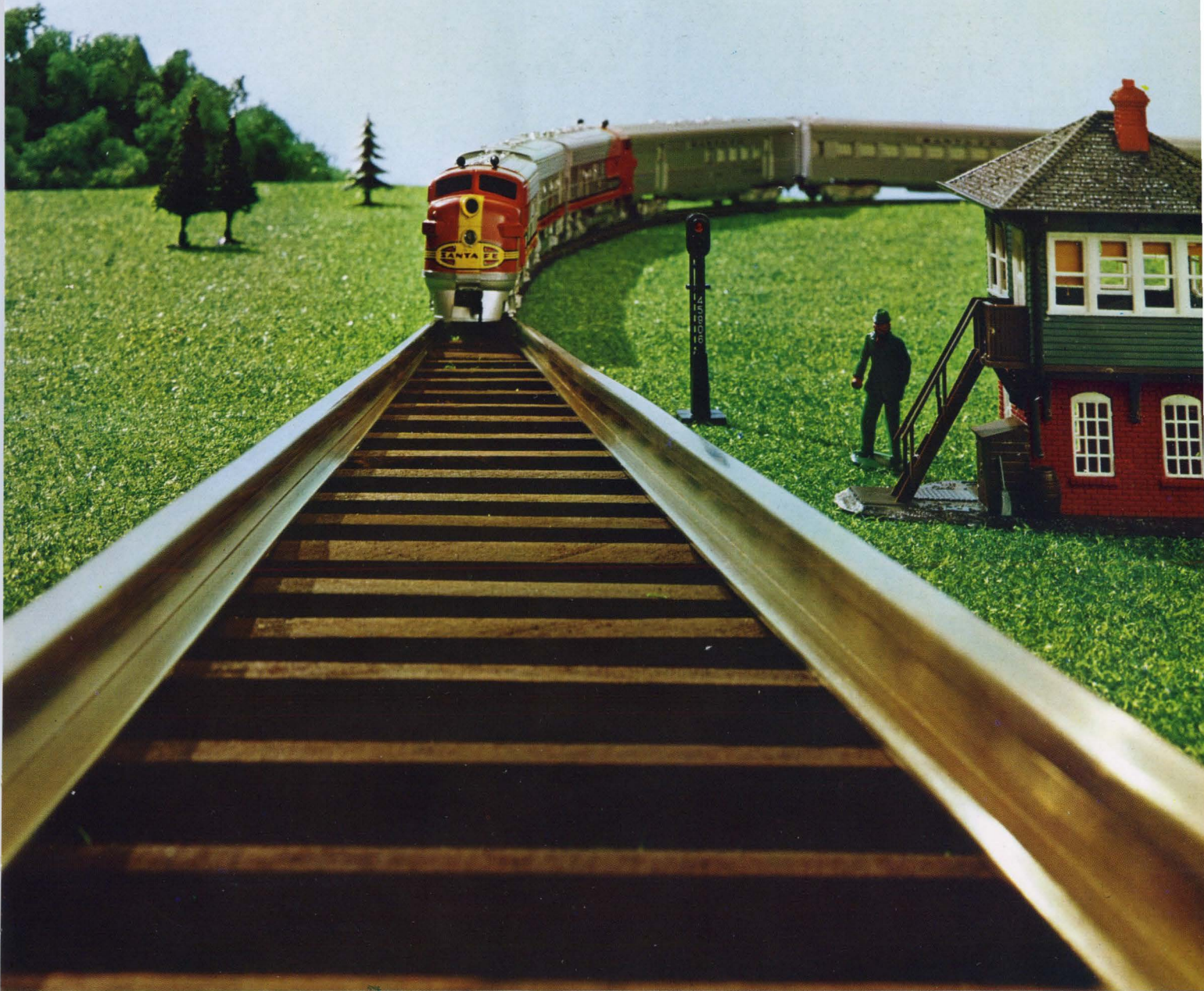

Electricity travels first class via modern coppermetals

Tiny printed circuit or giant bus bar—modern coppermetals developed at Anaconda's Research and Technical Center have what it takes to carry current best. In addition, today's conductive copper alloys offer the electrical/electronic designer a full range of physical and mechanical properties—almost limitless combinations to meet your most sophisticated design requirements.

When you think electrical conductivity, think copper. And take a fresh look at the versatile, high-performance alloys Anaconda offers today.

64-0952

ANACONDA[®]
AMERICAN BRASS COMPANY

Think copper. And when you do...

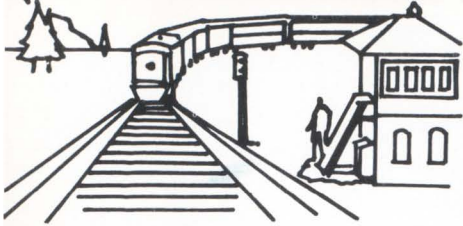

... THINK ANACONDA

for the broadest range of copper alloys and sizes and for experienced technical services

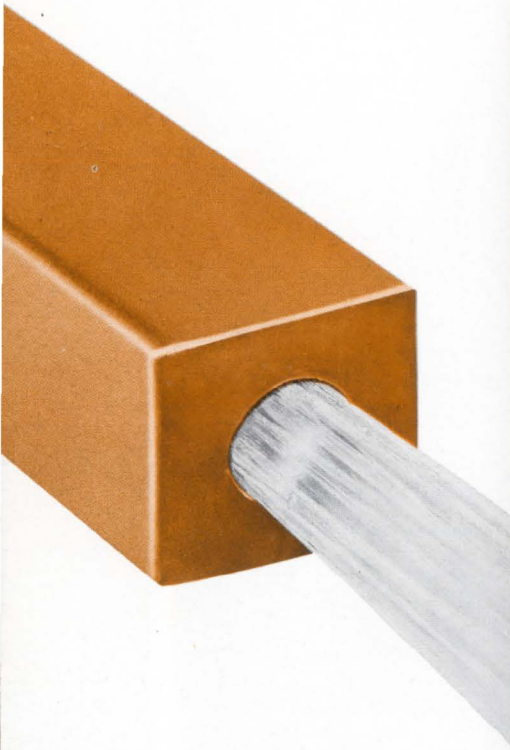

liquid-cooled hollow conductors

To meet needs of heavy current density applications, especially where space limitations confront the designer, Anaconda provides liquid-cooled hollow conductors in a wide variety of sizes, types and cross sections.

Among recent advances made possible by conductors of this type are high-field magnets for basic research, synchrotrons and other particle accelerators for atomic studies, bus systems for electromechanical operations requiring currents of 100,000 amp or more, and silicon-diode rectifier heat sinks.

With water-cooled conductors in stator bars, ratings of turbo-generators have been increased 2½ times without increasing the floor space they occupy.



"ELECTRO-SHEET" for R.F.I. shielding

Economical Anaconda "Electro-Sheet" copper foil is proving itself to be highly effective in radio frequency interference (R.F.I.) shielding applications.

One recent series of tests (complete data on request) followed the procedures of MIL-Std-285. Over the entire frequency spectrum, copper foil by Anaconda showed attenuation characteristics as good as those of copper mesh and galvanized steel.

"Electro-Sheet" is available in long lengths and easily joined widths from 6" to 64". Joints are simpler to make and more dependable than those made in other shielding materials. In addition, this low-cost copper foil is readily bonded to a variety of building materials, using any of a number of different types of adhesives.



conductive and springable coppers

Some coppermetals have extraordinary springability. Duraflex® superfine-grain phosphor bronze, for example. In special fatigue-test apparatus, Duraflex contact springs were deflected at 1 cps from the initial free position to 77,000 psi bending stress. After 4,000,000 deflections—no permanent set, no loss of load, no breakage.

In applications where cost is an important factor, check the performance of Ambronze 430—one of the most economical of the fine spring alloys available from Anaconda. Its average electrical conductivity: 27% IACS. Its modulus of elasticity in tension: 16,050,000 psi hard, 17,300,000 annealed.

ANACONDA
AMERICAN BRASS COMPANY

Calibrating transducers automatically

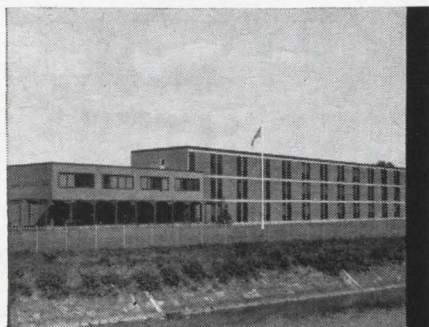

THE HOUSE YOUR NEEDS BUILT

Since its establishment in 1961, Anaconda's impressive Research and Technical Center has been dedicated to finding new ways for coppermetals to serve you better.

The results? New alloys. New mill forms. A new world of facts about coppermetals and their unique capacity for meeting industry's fast-changing needs.

Here is the taproot of Anaconda technical assistance in the field.

If there is a coppermetal answer to your problem, the man from Anaconda has it or can get it for you quickly through the Research and Technical Center. Anaconda field metallurgists are ready to serve you in offices from coast to coast.

Write today for handy, helpful technical information on any of the following alloys and products:

Liquid-cooled hollow conductors
Electro-Sheet
Spring alloys

Anaconda American Brass Company, Waterbury, Connecticut 06720. In Canada: Anaconda American Brass Ltd., New Toronto, Ontario.

64-0952

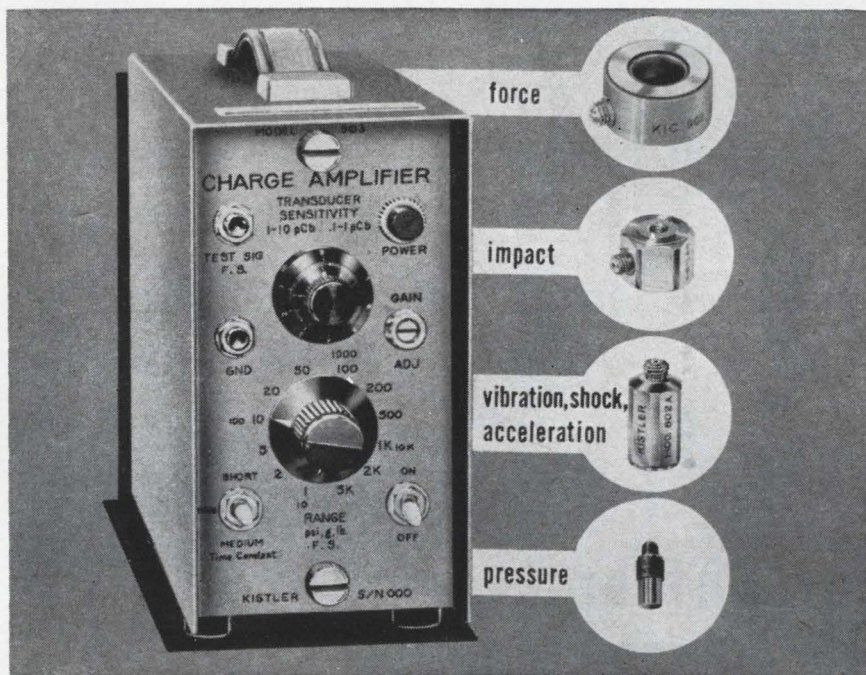

When transducers are used to measure such variables as flow rate, pressure, or acceleration, their voltage output must be calibrated in terms of the variable being measured. Calibration often is not only time-consuming, but it can lead to errors, particularly if it is performed by untrained personnel.

An instrument developed by Kistler Instrument Corp., Clarence, N. Y., performs such calibrations automatically for piezoelectric transducers. Kistler's model 503 electrostatic charge amplifier features a built-in step-function circuit that can calibrate an oscilloscope screen or recorder to read directly in g's, pounds per square inch, or any other desired measurement units.

In operation, the transducer is connected to the amplifier, and a calibrated dial on the amplifier is set to the transducer sensitivity. Applying a known force to the transducer generates a voltage, which is stored as an electrostatic charge in the amplifier. To calibrate the oscilloscope or recorder the test button is pushed, producing a step-function which is viewed on the display. The height

of the step-function is proportional to the applied force on the piezoelectric transducer. The gain of the amplifier can be adjusted so the step occupies the desired vertical height on the display device. Changing the scale multiplier of the display unit does not affect the basic calibration of the transducer.

The instrument basically comprises a precision capacitor, across which the transducer output voltage is accumulated, and an operational amplifier, which keeps the capacitor charge from decaying before the test button is pressed. Since an amplifier of almost infinite impedance was needed, a metal-oxide - semiconductor field - effect transistor was used in the input stage.

Model 503 has 12 full-scale

Specifications

Input resistance (minimum)	10 ⁹ ohms
Sensitivity	0.2 to 1,000 millivolts/picocoulombs
Temperature sensitivity	0.01% / °F
Input power	115 volts, 60 cps @ 5 volt-amperes
Linearity error	less than 1%
Price	\$560
Availability	2 weeks

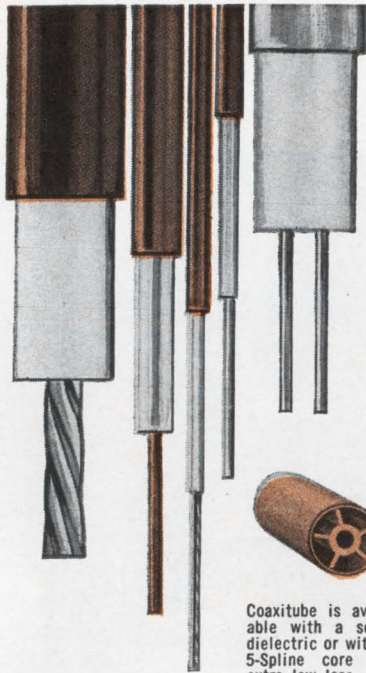

Coaxitube is available with a solid dielectric or with a 5-Spline core for extra low loss.

For Better RF Transmission

COAXITUBE

Tubular-Shielded Coaxial Cable

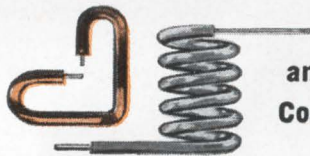

and Pre-Fab
Coax Shapes

For VHF and UHF transmission lines, where perfect RF shielding, excellent frequency response, and low attenuation are important considerations, Precision Coaxitube tubular-shielded coaxial cable is the ideal choice. It is comprised of a solid or stranded inner conductor, insulated with dielectric of Teflon or polyethylene, and covered with a seamless, non-ferrous metal jacket. The resulting coaxial cable construction is impervious to moisture, and has uniform electrical properties which surpass those of conventional braid-shielded cable. Coaxitube is offered in types equivalent to all the standard RG/U cables. Ask for more data.

Phone or write for prices
to your specifications

P **PRECISION**
TUBE COMPANY, INC.
North Wales, Pa.
215-699-4806—Telex: 083-381

New Instruments

ranges, from one to 50,000 of the desired units of measurement, to match the extensive ranges of piezoelectric transducers. Frequency response is from d-c to more than 100 kilocycles. The output voltage is linear to ± 10 volts and ± 10 milliamperes.

Kistler Instrument Corp., 8989 Sheridan Road, Clarence, N.Y. 14031 [381]

Linear, sensitive a-c/d-c converter

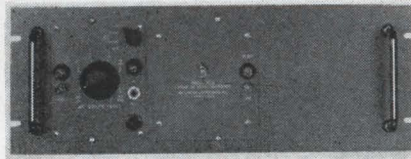

Model 710A is a linear a-c to d-c converter for use in making accurate a-c voltage measurements on any d-c digital voltmeter, and for applications to a d-c recorder, or to a type K potentiometric system. It linearly converts an a-c voltage from 1 mv to 1,000 v in decade steps at frequencies from 30 cps to 250 kc. Its accuracy of conversion is better than $\frac{1}{4}\%$ from 1 mv to 250 v at midband frequencies of 50 cps to 10 kc.

D-c output for each decade of a-c input is 1.000 to 10.00 v, thus making full use of a four-digit d-c voltmeter (10 times the full scale output of the best known converters in use, the company says). A maximum sensitivity is 10 mv full scale a-c for 10 volts d-c output (said to be 100 times the sensitivity of the best known converters in current use). Price is \$510 for the portable model; \$530 for 19-in. relay rack version.

Ballantine Laboratories, Boonton, N.J. [382]

Multichannel oscilloscope recorder

Type 8875 multichannel oscilloscope recorder can be fully integrated with any analog system to provide centralized control of computation and readout. It may be

SINGLE CRYSTAL FERRITES

- Manganese Ferrite
 - Lithium Ferrite
 - Cobalt Ferrite
 - Gadolinium Iron Garnet
 - Yttrium Iron Garnet
 - Gallium Iron Garnet
- and a full line of
Electro-Optic Crystals

SPECIAL

Offer Good Till Nov. 15

RUBY LASER RODS

$\frac{1}{4}$ " Dia. x 2" Long
Coated Ready for
Operation

\$125⁰⁰ each

YTTRIUM ALUMINUM GARNETS

Doped with Neodymium
LASER RODS

with thresholds of
less than 600 watts

Write for Literature Dept. 6



emi-elements, inc.
Saxonburg Boulevard,
Saxonburg, Pa.
Phone: 412-352-1548

equipped with three different channel configurations: eight 40-mm channels for conventional recording, four 80-mm channels for expanded displays, and a combination of four 40-mm and two 80-mm channels.

The unit features a forced-fluid inking system that provides simultaneous, rectilinear display of all analog (voltage) input channels and two timing channels. Maximum recording linearity—within 0.5%—is achieved with pen motors that provide immediate closed-loop pen position feedback control.

Other features include 12 remotely selected chart speeds, ranging from 0.05 to 200 mm per sec, actuation of either or both event markers from remote inputs or an internal timing pulse generator with one- and ten-second outputs, polarity reversal switches, electrical limiters and a complete paper/ink interlock safety system.

Electronic Associates, Inc., Long Branch, N.J. [383]

Quarter-rack size power supplies

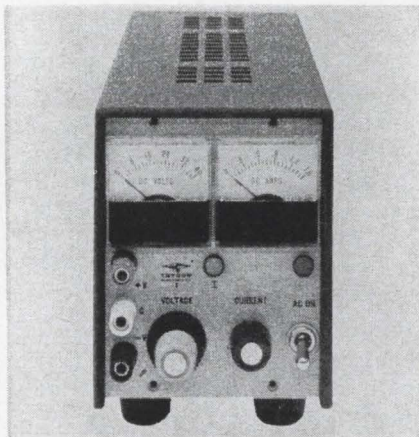

The HH series precision regulated, quarter-rack supplies are of all silicon design. They cover three voltage and current ranges: The HH7-4, 0 to 7 v d-c at 4 amps; HH14-3, 0 to 14 v d-c at 3 amps; and HH32-1.5, 0 to 32 v d-c at 1.5 amps. Units feature 0.01% regulation, both load and line, 0.5 mv rms ripple, and 0.05% stability with 0.01% stability optionally available.

The series includes circuits that provide automatic adjustable current limiting to prevent damage to

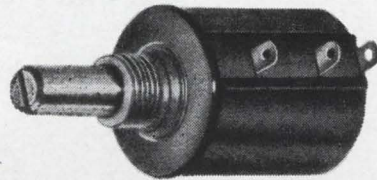

ACTUAL SIZE

The Only Difference is Quality & Price

HERE IT IS! The FAIRCON multiturn potentiometer with all the features of precision 10 turns yet at a price that fits the industrial OEM budget. Check these features: Standard linearity $\pm 0.2\%$ —resistance values from 500 to 125,000 ohms—high humidity, vibration, shock and acceleration resistance—2 watts power dissipation at 40°C—plus excellent resolution, long life, low noise... all for an amazingly low price. Write for our new FAIRCON short form catalog. And for immediate delivery from stock... Call ARCO.

FAIRCHILD

CONTROLS

A DIVISION OF FAIRCHILD CAMERA AND INSTRUMENT CORPORATION

225 PARK AVENUE, HICKSVILLE, L. I., NEW YORK

TELEPHONE: (516) 938-5600 • TWX: (516) 433-9146

CABLE: FAIRCON-HICKSVILLE, NEW YORK, U. S. A.

See us at ISA Show—Booth 1501

telephone quality components

There is no higher standard for switching components. Specify famous Stromberg-Carlson . . . known to telephony since 1894.

RELAYS: Types A, B, BB, C and E. All standard spring combinations are available. Send for Bulletin T-5000R3.

KEYS: Broad selection of push-button, cam and twist types. Send for Bulletin T-5002R2.

HANDSETS: High-efficiency instruments; standard or with switch assemblies. Send for Bulletin T-5017R.

Full-line data on request.

**STROMBERG-CARLSON
CORPORATION**

114 Carlson Road • Rochester, N.Y. 14603



Circle 227 on reader service card

Ever need plug-in power supplies in a hurry? Send for our 1965 catalog. It lists 62,000 different types. The one you need will be shipped in 3 days.

(We've never failed to make good on this promise)

TRANSISTORIZED REGULATED PLUG-IN POWER SUPPLIES

Acopian

TRANSISTORIZED REGULATED PLUG-IN POWER SUPPLIES

Acopian

OPTIONAL FEATURES

WIDE VOLTAGE ADJUSTMENT: An electronic transistorized regulated power supplies are available with wider voltage adjustment. This feature is available on all models.

EXTERNAL OUTPUT ADJUSTMENT: An external output is provided with external voltage adjustment for external equipment and for use with other equipment. External Model DA-10 is for CATV, TV, control systems and have provisions for both internal and external output adjustment. No external output.

CLOSED REGULATED OUTPUT: Some continuous regulation specifications are given for each model. Other regulations can be obtained upon request. All models are full load, which better regulation, when used at load, in external circuit facility.

TEMPERATURE: All transistorized regulated power supplies are available for operation at ambient temperatures up to 100°C and for 40°C. Control features for additional storage and case size.

REMARKS: For special features in electrical and mechanical variations, contact factory.

Acopian Corporation, Easton, Pennsylvania, (215) 258-6149

184 Circle 184 on reader service card

New Instruments

transistors and other circuit components due to inadvertent overloading. In addition, front panel indicator lights signal overload conditions immediately as a secondary precaution. All units are remotely programable over their full voltage range without derating and include remote sensing and continuously adjustable voltage adjustment controls. This quarter-rack series measures 4¼ in. wide by 4½ in. high by 14 in. deep, weighs 13 lbs, and is priced from \$189 to \$199.

Trygon Electronics, Inc., 111 Pleasant Ave., Roosevelt, L.I., N.Y., 11575. [384]

Integrating dvm makes measurements fast

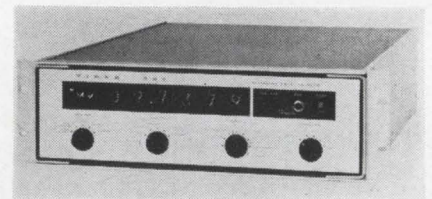

This integrating digital voltmeter makes high-speed digital voltage measurements and provides a six-digit display. Six selectable measurement ranges provide full-scale sensitivities from 10 mv to 1,000 v, with 0.1 μv resolution on the 10 mv range. Model 520 may also be used as a frequency counter capable of counting up to 2 Mc with selectable gate times of 1, 10, and 100 millisecond.

The instrument combines a high sensitivity, floating and guarded, voltage-to-frequency converter and an electronic counter, to display the integral or average value of the voltage. The integration technique, plus the guarded input construction reduces noise effects, and eliminates need for an input filter with its slow response time.

The voltage-to-frequency converter is a high-speed unit, attaining rates as high as 1.8 Mc, to give maximum resolution in short measurement intervals. This makes the model 520 an ideal instrument for use in rapid-scan data-logging systems. Data acquisition times are compatible with high-speed print-

Electronics | October 4, 1965

ers, tape perforators, and incremental magnetic tape recorders.

All functions, ranges, and gate times can be programed remotely. Auto ranging is available as an option. Price is \$3,925; delivery, 30 to 60 days.

Vidar Corp., 77 Ortega Ave., Mountain View, Calif., 94041. [385]

X-Y-Z plotter displays analog signal data

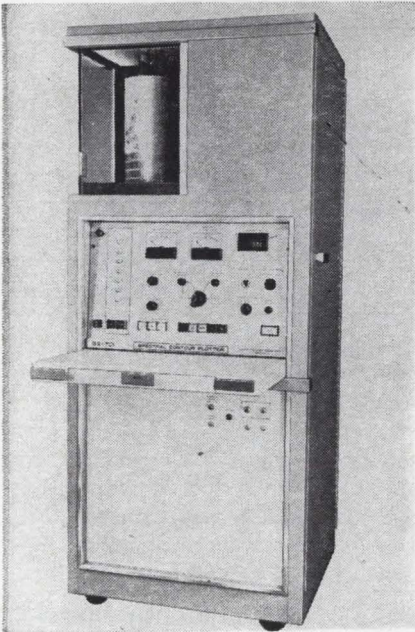

Model ST701 spectral contour plotter is a solid state X-Y-Z plotter for use in displaying analog signal data generated by a sensing device such as a microphone, vibration pickup, or prerecorded magnetic tape. The device will accurately display heart sounds, brain waves, or any signal that can be derived from a sensor placed within or attached to the body. The X and Y coordinates are time and frequency respectively, while the amplitude dimension is represented by a family of closed concentric contours, similar to a topographic map, with each contour line representing a specific amplitude. The use of contour lines permits a display with a dynamic range of 42 db, considerably more than conventional plotters, according to the manufacturer.

Frequency response is from 50 to 20,000 cps, but the use of translation techniques allows extension above and below this range. The plotter will display messages of 1,

Built to operate on MERCURY,
MARS, JUPITER or
VENUS...



.....and just about anywhere
on EARTH

That's the new 300 Series EECoS SWITCH.® Illuminated—for visibility under all ambient light conditions. Sealed—to protect the switch contacts from any atmosphere.

Lighted numerals or black numerals against an illuminated background may be specified for the 300 and you can select 8, 10, or 12 switch positions with 23 different output codes. Lamps used in the new Series are T1 flange base (MS-24515) and can be quickly removed by simply lifting the flip toggle tab (below).



Since the 300 is sealed, it may be used in explosive as well as corrosive atmospheres. It's so well made, in fact, it meets environmental requirements of MIL-S-22710 and explosive requirements of MIL-STD-202B.

In addition, the 300 Series incorporates all the benefits of basic EECoS SWITCH design:

- Easy removal and replacement—only two screws need to be removed to release switch module.
- No hang-up—An exclusive detent design provides positive switching, prevents any possibility of hang-up between positions.
- "Customized" assemblies—Spacers and endpieces to fit with switch modules permit wide versatility in assembly.
- Simple installation—Either printed circuit connector or solder terminals available.

DOWN TO EARTH INFORMATION ON THE SERIES 300 EECoS SWITCH OR ANY OTHER OF EECoS'S BROAD PRODUCT LINE OF THUMBWHEEL SWITCHES IS YOURS FOR THE ASKING. WRITE, WIRE, OR CALL...

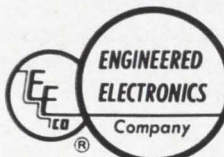

EECoSWITCH®— a division of
ENGINEERED ELECTRONICS Company

1441 East Chestnut Avenue, Santa Ana, California 92702
Phone: 547-5651 (714) TWX: 714-531-5522 • Cable ENGELEX

EECoSwitch is a registered trademark of Engineered Electronics Co.



financeability

(to meet your needs)

In WESTern PENNSylvania you can obtain 100% financing of industrial plant space at average interest rates as low as 3¾%. This can result in savings of as much as \$84,632 on a 62,000-square-foot industrial plant. In addition, financing of machinery and equipment and loans for working capital are readily available. This complete financing ability . . . plus a favorable tax climate . . . plus pre-

production training of a work force, usually at no cost to you . . . give WESTern PENNSylvania a top combination of plant-location values.



WEST PENN POWER

an operating unit of ALLEGHENY POWER SYSTEM

Area Development Department, Room 568
WEST PENN POWER—Greensburg, Pa. 15602
Phone: 412-837-3000

In strict confidence, I'd like details about WESTern PENNSylvania's: Financing Plans Pre-Production Training
 Favorable Tax Climate Industrial Properties

Name _____
Title _____
Company _____
Address _____
City _____ State _____
Code _____ Phone _____

New Instruments

2, or 4 second duration on a 12 by 18-in. sheet of electrosensitive paper. The time needed for generating this plot varies from 4 to 16 minutes. The recording drum around which the electrosensitive paper is wrapped does not rotate while the plot is being generated, as it does with most recording instruments. This allows the operator to study the plot during display generation, thus permitting its effectiveness to be evaluated immediately, without having to wait for the entire plot to be completed. The plotter sells for \$28,500.

Signatection Research, Inc., 223 Crescent St., Waltham, Mass. [386]

Vswr detectors cover wide frequency range

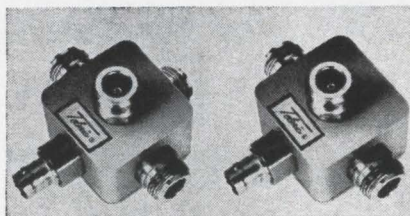

Two precision impedance comparators have been developed to measure vswr values. Models TRB-4 and TRB-5 incorporate frequency-insensitive, r-f bridge-detector circuits to provide fast and accurate swept determinations of vswr. Used with an oscilloscope or X-Y recorder, the instruments supply a direct swept display of vswr.

Model TRB-4 incorporates an automatic level control detector in addition to the r-f bridge-detector circuit for very accurate measurement. It will determine vswr up to a level of 6:1 over a frequency range of 1 Mc to 1 Gc. This model has an unbalance, or return loss, of 50 db minimum, corresponding to an accuracy of 0.633%, and is intended for use with sweep signal sources containing an automatic level control input.

The TRB-5 is a wide-range unit, able to measure vswr over a 1 Gc to 4 Gc frequency range.

Both models are available as single units or as part of a vswr test kit that includes matched and

NEED TO MONITOR IN-FLIGHT VIBRATION ?

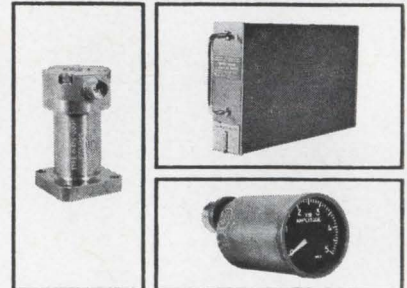

CEC's Airborne Vibration Monitoring System is the accepted standard of the industry — and a "must" for airlines concerned with cost reduction of engine maintenance. So efficient is the system, it frequently pays for itself in less than a year. Reason: the advanced design of the system's three basic components.

CEC 4-125 Vibration Transducers — one to three per engine — will operate continuously at 700°F, are impervious to shock, and are virtually maintenance-free. Special gold palladium bearing rings eliminate the need for lubricants.

CEC solid-state amplifiers — up to four per module with a single power supply — are easily accessible for inspection, and are physically and electrically interchangeable.

CEC's precision indicator — continuously displays the vibration level being measured on a given engine. The indicator is available with a choice of scale graduations and integral lighting to match other instrument panel instruments.

For full details, call or write CEC for Bulletins in Kit #7027-X-9.

CEC
Transducer Division

CONSOLIDATED ELECTRODYNAMICS
A SUBSIDIARY OF BELL & HOWELL/PASADENA, CALIF. 91109
INTERNATIONAL SUBSIDIARIES: WOKING, SURREY, ENGLAND
AND FRIEDBERG (HESSON), W. GERMANY

Tung-Sol Subminiature Lamp Assemblies Improve Production, Cut Costs

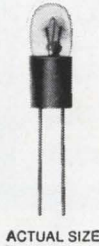

Do you have bulb shrinkage problems where small lamps are wired into circuit boards?

Tung-Sol lamps with molded nylon bases can save you money. The nylon base absorbs mounting strains to permit firm seating of the lamp. Lead wire breakage and bulb damage are eliminated. Production goes up. Costs go down. Inventory is reduced. When you order 1000 lamps, you get 1000 useable lamps. Nylon bases can be color-coded for production identification.

In addition to molding bases to any configuration, Tung-Sol can provide special harnessing. Write for free suggestions about how Tung-Sol can handle your lamp requirements.

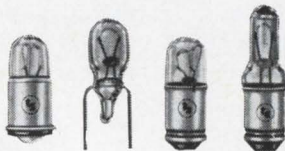

If your application requires only bulbs, ask for a quotation from Tung-Sol. The Tung-Sol line of miniature and subminiature lamps is extensive. Quality is the best that more than half a century of know-how can produce.

TUNG-SOL

INSTRUMENT LAMPS

Tung-Sol Electric Inc., Newark, N. J. 07104

from NYTRONICS

HIGH RELIABILITY CERAMIC CAPACITORS

Over 300,000 in Stock!

- ★ 24 Hour delivery.
- ★ 93 standard values from 5.6 pf. to 2.5 mfd.
- ★ Meets MIL-C-11015 requirements.
- ★ Subminiature components.
- ★ Rugged, epoxy-encapsulated.
- ★ Highest reliability and performance.

MIL-CAP in CK05 and CK06 case styles are 0.200" and 0.300" square by 0.100" thickness; capacitance range — CK05, 47 pf to 1,000 pf; CK06, 1,200 pf to 10,000 pf — both $\pm 10\%$ and $\pm 20\%$ capacitance tolerance; capacitance change $\pm 15\%$ maximum over temperature range of -55°C to $+150^{\circ}\text{C}$. Working voltage 200 VDC, insulation resistance 100,000 megohms at 25°C , 1,000 megohms at 150°C . Dissipation factor $2\frac{1}{2}\%$ maximum at 1 kc.

HY-CAP offers capacitance range 0.01 mfd. to 2.5 mfd. with maximum capacitance change of $\pm 12\%$ over temperature range of -55°C to $+125^{\circ}\text{C}$. Case size range from 0.225" to 0.800" width, 0.175" to 0.550" height and 0.110" to 0.375" thickness; working voltage 100 VDC; dissipation factor $2\frac{1}{2}\%$ maximum at 25°C .

DECI-CAP has greatest capacitance range available in cordwood envelope. Molded 0.100" diameter by 0.250" long; capacitance range 5.6 pf to 27,000 pf; capacitance tolerances $\pm 10\%$; capacitance change $\pm 7\frac{1}{2}\%$ from 5.6 pf to 470 pf and 15% maximum from 560 pf to 27,000 pf over temperature range of -55°C to $+125^{\circ}\text{C}$; working voltages 200 VDC from 5.6 pf to 470 pf and 100 VDC from 560 pf to 27,000 pf; insulation resistance 20,000 megohms minimum and dissipation factor $2\frac{1}{2}\%$ maximum at 25°C .

For Complete Engineering Data Write Dept. E, or Phone (201) 464-9300

NYTRONICS

550 Springfield Ave., Berkeley Heights, N. J.

Design Leaders — STANDARD Components to Meet CUSTOM Requirements

Now — the most adaptable, reliable

DATALITE[®] SYSTEM OF INDICATION

For computers, data processing,
and other readout applications

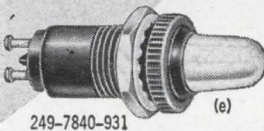
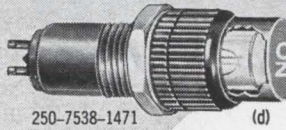
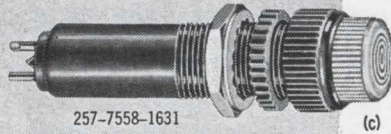
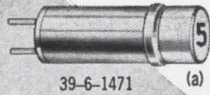

Build your light indicators with a system—the DATALITE system. Here's how: Choose a "Datalamp" Cartridge (a) and combine it with a "Datalamp Holder" (b); or use a screw-on "Data Cap" with a rotatable readout lens (c, d)... For multi-indications, "Datalamp" Cartridges may be mounted on a "Data Strip" or "Data Matrix" in any required configuration.

"Datalamp" Holders accommodate DIALCO's own plug-in ultra-miniature Neon or Incandescent "Datalamp" Cartridges. Complete assembly mounts in $\frac{3}{8}$ " clearance hole. Also available with permanent (not replaceable) Neon lamps (e). Legends may be hot-stamped on cylindrical lenses. Styles shown here are only typical components in the extensive DATALITE system of light indication.

SAMPLES ON REQUEST—AT ONCE—NO CHARGE.

For complete data, request current Catalog.

(Illus. approx. actual size)

Foremost Manufacturer of Indicator Lights

DIALIGHT CORPORATION

60 STEWART AVENUE, BROOKLYN, N.Y. 11237 212 HYACINTH 7-7600

DIALCO[®]

Circle 230 on reader service card

New Instruments

mismatched r-f terminations. Individual prices are \$195 for the TRB-4, \$225 for the TRB-5. Delivery is from stock.

Telonic Engineering Co., 480 Mermaid St., Laguna Beach, Calif. [387]

Versatile, preset frequency counter

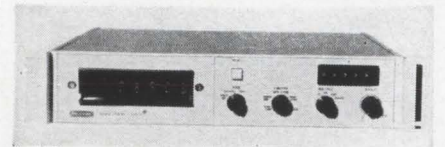

The 2-Mc model 6020 preset events-per-unit-time meter performs accurate measurements directly in engineering units, such as rpm, gpm, psi, and fps. No conversion is necessary—one simply selects the desired conversion factor from 10 μ sec to 100 seconds. Low-frequency measurements can be made by timing up to 10^7 periods with 10- μ sec resolution. With the two inputs provided, two frequencies up to 2 Mc can be measured simultaneously for ratio determination. By selecting multiples of the lower frequency up to 10^7 , ratio measurements are made with a high degree of accuracy. Groups of random events composed of up to 10^7 counts can be totaled.

The wide choice of gate times, timing and count multiples is made possible through the combined use of a preset selector and multiplier. This preset feature also provides the benefit of a preset output for external control, indication, or simulation applications.

Input sensitivity is 100 mv rms at 20,000 ohms. Remote programming is provided by single-line control for each function, the reset control and the multiplier. To record measurements, the model 6020 supplies output data in 1-2-4-8 binary-coded-decimal form. An option equips the unit with a remote digital display. Price of the model 6020 is \$1,450.

Beckman Instruments, Inc., Berkeley division, 2200 Wright Ave., Richmond, Calif. [388]

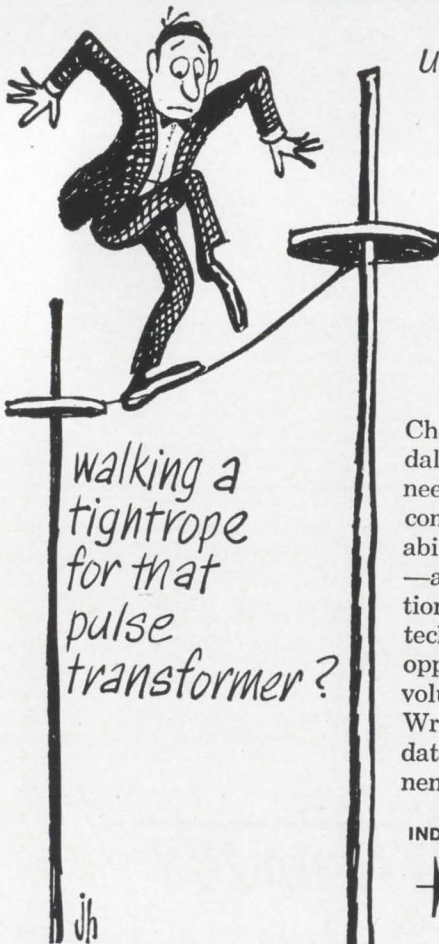

use the
*theory of
probability*
to solve your problems

This is where experience counts! Chances are Hamilton has just the toroidal inductor or pulse transformer you need in the 2 oz. and under class. These components provide the ultimate in reliability—NOT ONE REJECT IN 25,000—and are backed by Hamilton's reputation for extraordinarily high quality and technical competence. We welcome the opportunity to quote on large or small volume requirements for fast delivery. Write for the facts—you'll get useful data on Hamilton's electronic components and other facilities.

INDUSTRIAL AND MILITARY PRODUCTS DIVISION

HAMILTON
WATCH COMPANY
LANCASTER, PA.

Order your copy now,
of the Complete 1964
Electronics Index to
Volume 37

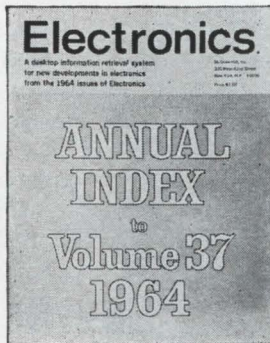

This new, easy to use Index is 40 pages long, and is available for \$1.00.

The Complete Electronics Index for 1964 contains 4 helpful, informative sections:

Subject index—catalogs all articles; technical features, news letter items, Electronics Review, Electronics Abroad and Probing the News stories, also key new product items. They're grouped in more than 250 categories and cross-indexed for easy reference.

Authors index—lists alphabetically all authors of articles which appeared in 1964, so articles may be found when authors are known.

Manufacturers index—This corporate reference gives the page and issue for each mention of an electronics company in the editorial pages of Electronics. It also references government and military organizations.

Advertisers Index: Every advertiser in the 1964 issues of Electronics is listed in this section alphabetically with the issue dates and page numbers of their ads.

This index is a valuable, year round reference tool for your home, office or company library. Use the coupon below to order your copy today. Price is \$1.00.

Send your order to:

Electronics Reprint Dept.
330 West 42nd Street
New York, N.Y. 10036

Enclosed is my check for \$1.00.
Please send me a copy of the Complete 1964 Index.

Name

Number & Street

City, State

Zip Code

crossbar-type SELECTOR SWITCHES

new 10x10 MINIATURE

- Programming
- Rapid Circuit Selection in complex switching

3½ x 3¾ x 1-37/64

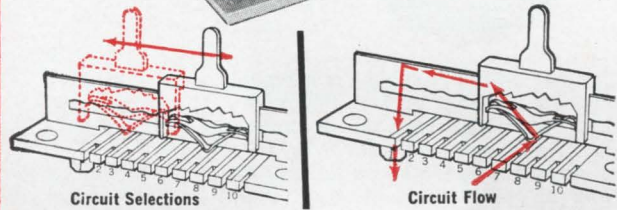
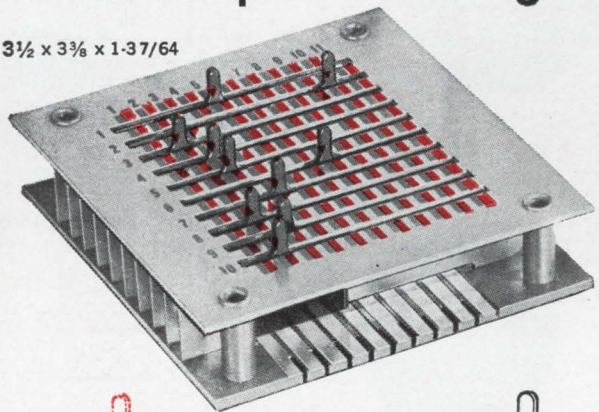

Electrical capacity:

1. Current carrying only (no make or break) 3 amp 125 V AC or DC
2. Make or break 1 amp 15 V DC, 150 m.a. 125 V AC

- High Reliability
- High Density
- All Common Circuits
- No Soldering Needed
- Wiping Contacts
- Rhodium Plated Printed Circuit Strip

We have capabilities of making many versions of this switch to meet your application requirements. We can supply a maximum of 58 sliders with 48 positions on each slider at nominal tool cost.

Additional variations in circuitry, panel size, panel nomenclature, and crossbar slider rail arrangements are also possible.



The complete snap-action switch line!



Cherry Electrical Products Corporation

P.O. Box 437-12 — Highland Park, Ill.

IN CANADA: BARRY ELECTRIC, LTD., REXDALE, ONT.

NEW
FROM EG&G
HIGH SENSITIVITY · LOW
NOISE · LARGE AREA
PHOTODIODE

SGD-444
SERIES

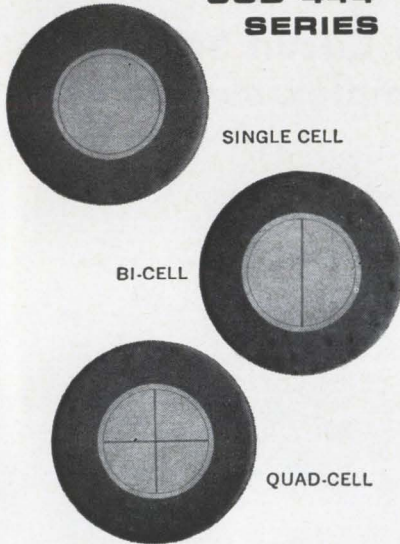

The new SGD-444 series complements EG&G's versatile SD-100 Photodiode. Improved diffused guard ring construction results in higher sensitivity, lower noise and faster response factors than ever before available in large (1 cm² active) area diodes.

Bi-cell and quadrature cell configurations with isolations of greater than 20 to 1 are standard. The diodes are surface passivated and are available either uncapped or in a hermetically sealed package.

SENSITIVITY.....	0.4μA/μW @ 0.9μ
	(55% Quantum Efficiency)
SPECTRAL RANGE.....	0.35 to 1.13μ
LEAKAGE.....	0.2μA @ 270 volts
RISE TIME.....	10 nanoseconds
NEP.....	5.5 x 10 ⁻¹³ watts
LINEARITY OF RESPONSE..	Over seven decades

Applications include CW, pulsed light and laser detection and measurement; star tracking, optical navigation and guidance, and range finding systems. The new SGD-444 series is in quantity production for fast delivery at low price.

For information, write EG&G, Inc., 160 Brookline Avenue, Boston, Massachusetts 02215. Or phone 617-267-9700. TWX: 617-262-9317.



New Subassemblies and Systems

Machine tool computer resists noise

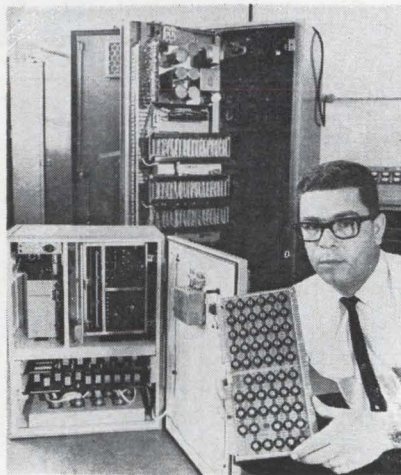

Unhappy experience with an earlier, unsatisfactory model has helped the Westinghouse Electric Corp. produce a numerical-control computer that is practically immune to electrical noise. The Model 20 is designed for the machine-tool builder who wants a compact two-axis point-to-point positioning system.

The earlier computer was an adaptation of Westinghouse's basic Prodac system. About 70% of the installations had problems, most of them involving noise susceptibility; the computers had a tendency to give the machine tool a false command every time some other piece of equipment in the area, such as a relay or a motor, operated.

The photograph above shows one of the problems and its cure. The earlier Prodac (the large rack at the back) had practically no shielding between the electronic circuitry and the relays and power control wiring. The circuit cards were mounted on the back of a large swinging rack; when the rack was closed, the sensitive, noise-susceptible, circuits were right up against the power relays fastened to the back wall of the cabinet.

The new, and much smaller, Model-20, in the foreground, shows how this fault was corrected. The electronic circuitry has its own

compartment, at the upper right. It is separated by heavy metal shielding partitions from the power supply (left) and the input and output relays (bottom). Westinghouse's switch from discrete to integrated circuitry helps make this package rearrangement possible. There is at least the same amount of circuitry in the two systems, but the package is much smaller and more easily shielded. Its wiring is also easier to shield because the wire lengths can be shortened with a compact integrated-circuit system.

To keep the electronics well isolated, Westinghouse engineers put a filter on each line going into the compartment. They also made the complete cabinet as internally noise-free as possible by putting suppression circuits around each relay or other inductively-operated device. Signal lines were well shielded and separated from power lines, and ground-loops were avoided in the system ground-wiring.

The small package permitted by the integrated circuits should be in line with the present trend towards integrating the numerical control right onto the machine-tool frame, says James Jewett, manager of the numerical control department.

The integrated circuits are current-mode NAND gates and flip flops (made by Westinghouse's Molecular Electronics division) he said. They have high noise immunity. The system uses a magnetostrictive delay-line memory.

Specifications

Number of axes	2
Accuracy	
(For 250-inch per minute movements)	0.001 inch
(for 50-inch per minute movements)	0.0001 inch
Number of commands	
for feed, tool selection, spindle speed, and miscellaneous instruction	20 each
Tape coding	EAI-273, EAI RS-244
Prices	\$6,000 to \$10,000

Systems Control division, Westinghouse Electric Co., Buffalo, N. Y. [401].

High-speed, versatile drum memory system

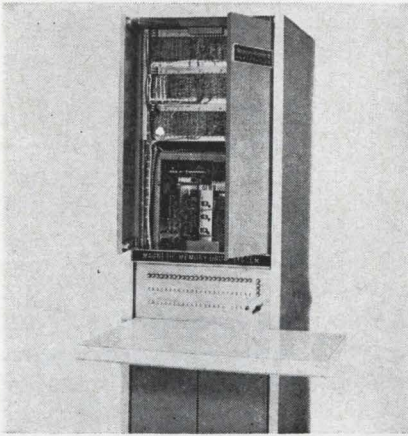

Adaptable to any computer with direct memory access, the type 1116 drum system stores up to 524,000 18-bit words. The system costs less than 10 cents per word, complete, in large-capacity size. It is word-addressable, with 8.5-msec average access time, and sequential words are available at a 17- μ sec-rate.

Additional system features include: phase modulation recording with internal parity generation and checking; high reliability silicon circuitry; and error rates proven less than 1 in 10^{11} . The entire system is contained in a 10-in. rack. Other data storage formats are also available, as are systems custom-designed to fit specific memory requirements.

Vermont Research Corp., Precision Park, North Springfield, Vt., 05150. [402]

Converter enhances hybrid computers

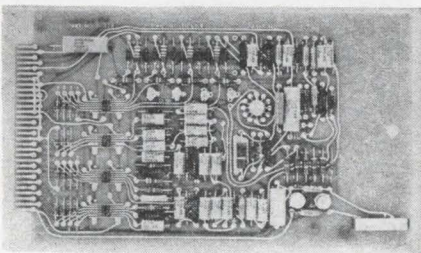

A variable-reference, digital-to-analog converter has been introduced. Model Ci-191 multiplies the applied analog voltage accurately by a digital setting without the usual requirement for an applied volt-

For the Finest Multilayer Printed Circuitry...

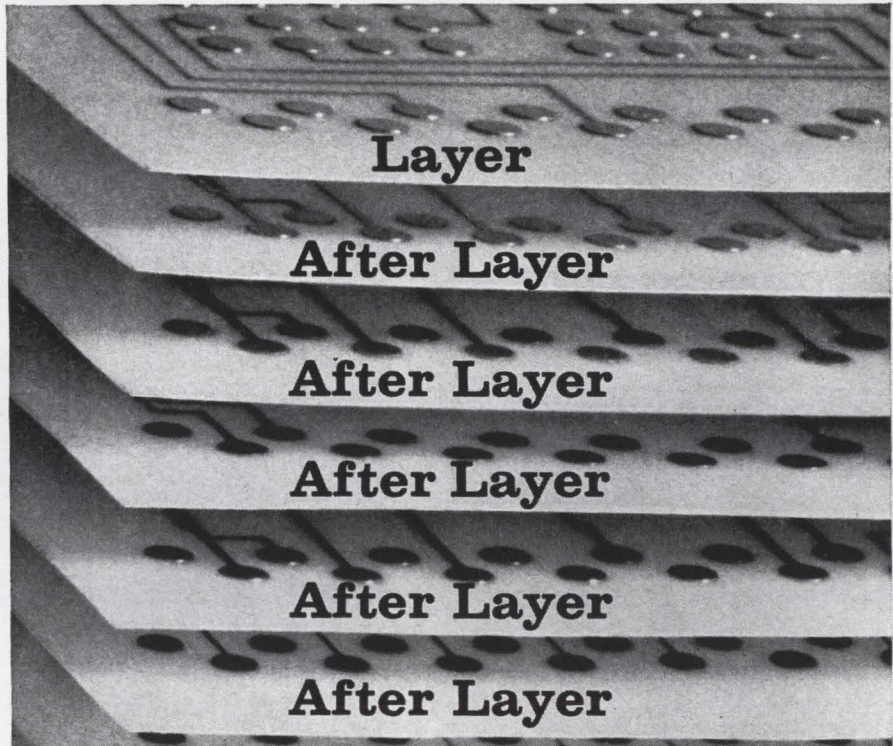

...Specify Cinch-Graphik

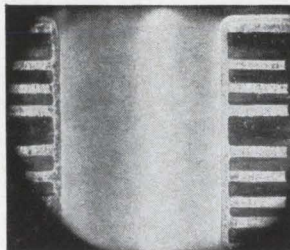

When you specify Cinch-Graphik, you specify unequalled quality. The cross-section microphoto shows why... uniform wall thickness throughout the entire length of the hole and complete interface

bond between individual layers and the plated wall. High density circuitry like this is the result of precision production processes such as the Cu-C Plated Thru-Hole, controlled lamination and ultra-precise multilayer registration ($\pm .005''$ layer to layer for 30 layers or more!). Years of experience in pioneering and perfecting multilayer techniques has made Cinch-Graphik the world's leading producer of advanced multilayer circuits. Write for our new, illustrated brochure.



DIVISION OF UNITED-CARR

200 South Turnbull Canyon Road, City of Industry (Los Angeles), Calif. 91744 • Phone (213) ED 3-1201. Offices in 22 Principal Cities throughout United States, Canada, England and Australia listed under Cinch Mfg. Co. or United-Carr Incorporated • Cinch • Cinch-Monadnock • Howard B. Jones • Ucinite • Palnut

MOLD THERMOSETS in 14 SECONDS!

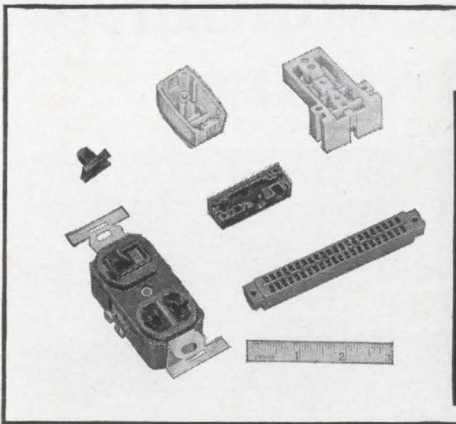

Yes, automatic overall cycles of 14 seconds or less with the "99C"

Now used for high-speed production of:

- MOLDED CONNECTOR BODIES
- WIRING DEVICES
- OTHER ELECTRICAL or ELECTRONIC PARTS

CONNECTOR PRODUCTION in one plant became fully automatic, at five times previous rates, with a "99C" transfer molding machine. Molding costs, exclusive of materials, dropped from 22¢ to 2¢ per piece! Yet precise tolerances were maintained.

In connector cavities with 0.160-in. thick sections, the 99C cures standard glass fiber-reinforced DAP's in as low as 10 sec.—with overall cycles of 15 seconds. Electronic preheat to curing temperatures provides such fast cycles.

FOR WIRING DEVICES, the 99C cures phenolics and ureas in as low as 5 seconds! Automatic, horizontal press action permits easier part ejection and

operation of automatic degating molds.

FOR PARTS MOLDING, the 99C handles any preformable material . . . in short runs as well as long. The machine truly represents a new concept in high-speed, reliable molding of thermosets. For a demonstration in our plant, or literature, write or phone: **HULL CORPORATION**, 5036 Davisville Road, Hatboro, Pa. 19040. Phone (215) 675-5000.



H-24

▶▶▶ SEE THE 99C IN ACTION TO BELIEVE IT! ◀◀◀

Circle 231 on reader service card

NEW! and NOW!

IRRADIATED

Polyolefin Shrinkable Tubing
PENNTUBE ∇

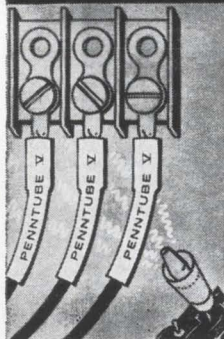

from
**PENNSYLVANIA
FLUOROCARBON
COMPANY**

2:1 shrink ratio.
Meets
all applicable
specifications.

Write for product data
sheet and free sample
NOW!



**PENNSYLVANIA
FLUOROCARBON CO., INC.**

Holley Street & Madison Ave.,
Clifton Heights, Pa.
Phone: (215) MADison 2-2300
TWX: 215-623-1577

Export Dept. Room 5710 Empire State Bldg. N.Y. 1, N.Y.

One source for:

TEFLON* TFE
Shrinkable
(Penntube-I-E)

TEFLON FEP
Shrinkable
(Penntube-IISMT)

IRRADIATED
Polyolefin Shrinkable
(Penntube ∇)

*Du Pont Reg. T.M.

†Penna. Fluorocarbon Reg. T.M.

New Insulating Epoxy Only 4.1¢ cu. in.!



- Low Viscosity
- Remains Semi Flexible
- Long Pot Life
- Excellent Electrical Specs
- Low Cost

Write for Details

H. V. HARDMAN CO., INC.

609 Cortlandt Street • Belleville, N. J. 07109
(201) 759-3700

Circle 232 on reader service card

New Subassemblies

age of fixed value, the manufacturer says. The operation is similar to setting a coefficient potentiometer with one end grounded and the analog input voltage applied to the other end. However, with the Ci-191, the wiper position is set by the digitized input within five μ sec and with up to 14-bit resolution. Accuracies of $\pm 1.01\%$ are available.

The Ci-191 accepts bipolar values on both inputs, giving four-quadrant multiplication that makes it suitable for use in hybrid computing systems. It can then be used both as a communication link and as an operational computing multiplier in the analog system, providing savings in analog equipment.

High-speed field effect transistors provide, in addition to economy, fast and precise multiplication in all four quadrants. Several versions of the converter are available, with different resolution and accuracies. Prices start at \$100 per channel.

Comcor Inc., 1335 S. Claudina St., Anaheim, Calif. [403]

D/A converter for process control

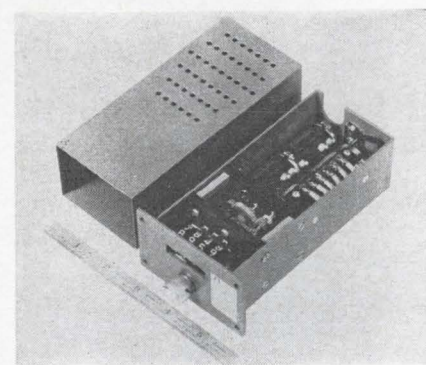

A digital-to-analog converter, model 1650A, may be used for computer set-point control in industrial processes. The basic converter consists of a dual potentiometer and digital counter driven by a digital servo motor through a protective slip clutch. A knob drive is also provided to permit manual override and setting, with corresponding digital display.

When used in conjunction with the manufacturer's digital servo controller, the converter can accept unweighted binary pulses from a digital computer or programmer and convert them into analog voltage for process control. The resolution is 0.1% of full scale, the accuracy is $\pm 0.05\%$ of full scale and the speed of response exceeds 150 increments per second.

Model 1650A converter forms the basic module or building block of the company's computer set-point controls, which can be custom designed to include such other features as adjustable limit settings and higher accuracy, resolution, and response speeds.

Automatic Development Co., a division of Barton Instrument Corp., 644 Monterey Pass Road, Monterey Park, Calif. [404]

Low-pass amplifiers span 5 cps to 70 Mc

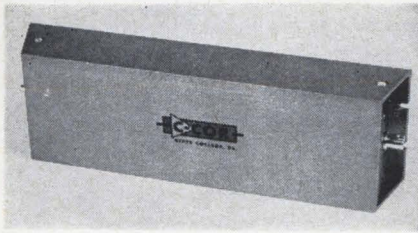

High-output, solid-state, low-pass amplifiers, models 3329, 3368 and 3388, cover the frequency band of 5 cps to 70 Mc. They provide 20 db, 40 db, and 60 db of gain respectively.

Each model is capable of providing as high as 15 v peak-to-peak at 10 Mc into a 50-ohm load. Each also provides two output impedances—one a matched 50-ohm output, and the other a low impedance (approximately 15 ohms) which will provide a higher output if an output match is not required. All models exhibit a band flatness of ± 0.5 db over the band of 20 cps to 50 Mc.

Ideally suited for video and pulse applications, these models are also available in an instrument case designated the 4000 series. All are available with one- to three-week delivery; prices range from \$450 for the model 3329 to \$1,000 for the model 4388.

C-Cor Electronics, Inc., P.O. Box 824, State College, Pa. [405]

WE'LL DESIGN YOUR MAGNETIC SHIELDS



About 80% of all magnetic shield designs now in use originated here.

Maybe it's because our designs work. Maybe our designs work because we've had the most experience. All are good reasons to contact us.

Netic and Co-Netic magnetic shields are the recognized standard all over the world for military, laboratory, industrial and commercial applications. They are insensitive to ordinary shock, do not require periodic annealing, and have minimal retentivity. A few typical applications are illustrated. Our design department is yours.

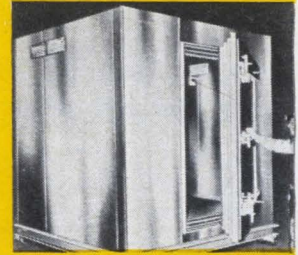

Magnetically Shielded Room

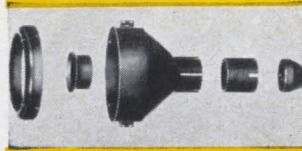

CRT Shield Complex



Scan Converter Shield



Sectionalized P.M. Shield



Nesting Cans

MAGNETIC SHIELD DIVISION

Perfection Mica Company

1322 N. ELSTON AVENUE, CHICAGO, ILLINOIS 60622

ORIGINATORS OF PERMANENTLY EFFECTIVE NETIC CO-NETIC MAGNETIC SHIELDING

Circle 233 on reader service card

90% of all Japanese ITV cameras use COSMICAR lenses.

COSMICAR
INDUSTRIAL TV LENSES



For your vidicon, image orthicon and professional movie cameras, Cosmicar lenses are available in focal lengths from 12.5mm up to 1000mm.

New zoom lenses are now available.



ICHIZUKA OPTICAL CO., LTD.

2-568, SHIMOOCHEI, SHINJUKU-KU, TOKYO

CABLE ADDRESS: "MOVIEKINO TOKYO"

Measure Transients of less than 1 μ s

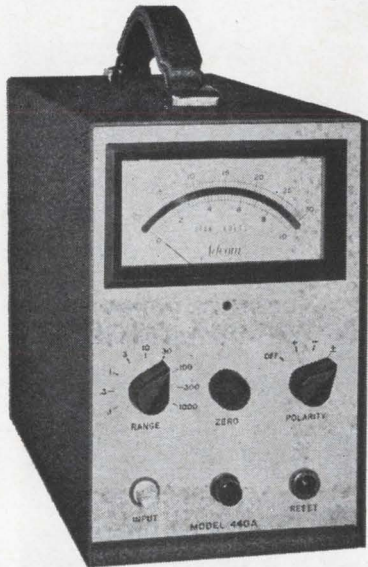

Model 440A PEAK LOK Transient Reading Voltmeter reads and holds the largest signal received over any selected period of time. Pulses shorter than 1 μ s are measured and the reading accurately held until reset.

DC coupling is provided and input ranges from 0.1 volt to 1000 volts may be selected manually. Polarity may also be selected with a front panel switch.

The PEAK LOK Model 440A can be manually or electronically reset. Visual output is on taut-band mirror-backed meter. Output for logging—low impedance 0 to +5 volts with 1% absolute accuracy. Portable or rack mounted versions are available. The Model 440A utilizes Control Data's unique ANALOK* Analog Memory technique. Silicon semiconductors are used throughout to insure reliability in operating temperatures from 0° to +50°C.

*Trademark

FOR INFORMATION on the Model 440A PEAK LOK contact:

ADCOMP Corporation, Dept. 103
20945 Plummer St.
Chatsworth, Calif.
(Area code 213, 341-4635)

ADCOMP CORPORATION
SUBSIDIARY OF

CONTROL DATA
CORPORATION

New Microwave

Twystron pulses 10 megawatts

A klystron has high gain but narrow bandwidth, and a traveling wave tube has wide bandwidth but limited gain. Combining the input section of a klystron with the output section of a twt results in the twystron, a Varian Associates product.

The latest version of this hybrid microwave power tube is Varian's VA-143 pulse amplifier that has 10 megawatts of peak power over a 2.78 to 3.3 gigacycle bandwidth. The VA-143 can be tuned so that its output power varies less than 1 db over the band if the r-f drive power is constant.

The klystron input section provides high power and gain near the edges of the band, and moderate power and gain at the center of the band. The traveling wave tube output section produces high power and gain at the band center and less at the band edges. This results in an exceptionally large instantaneous bandwidth with little variation in gain across the band.

The VA-143's gain is at least 38 db when the tube is operated at 10 megawatts. Integrated random

noise and peak spurious output power is at least 50 db below the power level of the carrier signal. Average output power is 22 kilowatts, nominal.

Specifications

VA-143 twystron pulse amplifier

Frequency	3.0 gigacycles
Peak output power	11 megawatts
Average output power	30 kilowatt, maximum
Gain	38 decibels
Bandwidth, 1 db	10%
Drive power	1500 watts
Beam duty cycle	0.002
Beam pulse duration	20 microseconds, maximum
Peak efficiency	50%
Peak beam voltage	180 kilovolts, maximum
Peak beam current	165 amps
Heater current	33 amps
Heater voltage	7.5 volts
Dimensions	50 inches long by 16 inches diameter
Weight	150 lbs.
Delivery	4 to 5 months upon request
Price	Electromagnet, VA-1543 (4 sections)
Focusing coil voltage (per section)	100 v., maximum
Focusing coil current (per section)	20 amps, maximum
Dimensions	27 in. high x 17 in. dia.
Weight	530 lbs.

Varian Associates, 611 Hansen Way, Palo Alto, Calif [421]

Directional couplers cover 12.4 to 18 Gc



Model 20057 coaxial directional couplers have been added to the manufacturer's complement of K_u-band coaxial components. Covering the frequency range of 12.4 to 18 Gc, they are available in 10-, 20- or 30-db coupling values. Minimum directivity is 15, 18 and 20 db, respectively. With a length of 1 3/4 in. and weight of 1 1/2 oz, these couplers provide high performance

in an ultra-compact, lightweight package. Price is \$175 each in small quantities; availability, 4 weeks. Omni Spectra, Inc., 19800 West Eight Mile Road, Southfield, Mich. [422]

L-band oscillator delivers 22 kilowatts

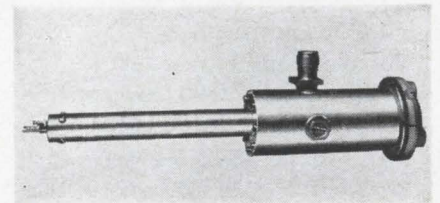

A plate pulse triode oscillator with a power output of 22 kw is designed for use as a high power radar transmitter. The Resonatron 2920-1000 operates at a frequency of 1.3 Gc with manual tuning of

plus or minus 10 megacycles.

Power input requirements are: heater, 6.3 v d-c at 4 amps nominal, 6 kv d-c at 10 amps peak anode current; altitude, 5,000 ft; shock, 100 g, 7 millisecc, 3 axes; vibration, 15 g peak, 20-2,000 cps, 3 axes. Pulse width is 6 μ sec; rise time, 60 nsec typical; decay time, 140 nsec typical; peak power, 22 kw typical; average power, 22 w; duty cycle, 0.001. The unit measures 13 $\frac{1}{8}$ in. long, 2 $\frac{1}{4}$ in. in diameter, less projections.

Trak Microwave Corp., 4726 Kennedy Road, Tampa, Fla. [423]

X-band paramp tunes 1-Gc range

A single control varies the center frequency of the model X-1009 parametric amplifier over a tuning range of 8.5 to 9.5 Gc. Noise figure is under 4.0 db; gain is 17 db nominal; bandwidth, approximately 60 Mc. Designed as part of a Nike-Ajax four-channel monopulse retrofit, the unit is available in a variety of configurations.

Micromega Corp., 4134 Del Rey Ave., Venice, Calif. [424]

Traveling-wave tube is compact, rugged

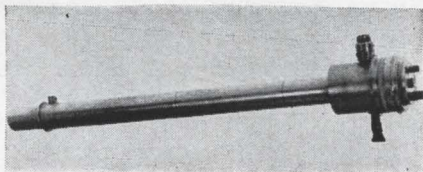

A 5-kw continuous-wave twt covers a full octave from 500 to 1,000 Mc. The MA-2017 provides 27-db gain in a 27 x 4 $\frac{1}{2}$ -in. package. The hollow electron beam, advanced mechanical and thermal design, and precise solenoid-controlled beam provide a compact, rugged, and efficient traveling-wave tube.

The tube is adaptable for operation in either pulse or c-w modes, making it suitable for a wide variety of applications, including electronic countermeasures, radar, and television relay systems. Delivery is 75 to 90 days.

Microwave Associates, Inc., Burlington, Mass. [425]

PRINT ELECTRONIC COMPONENTS ... EFFICIENTLY

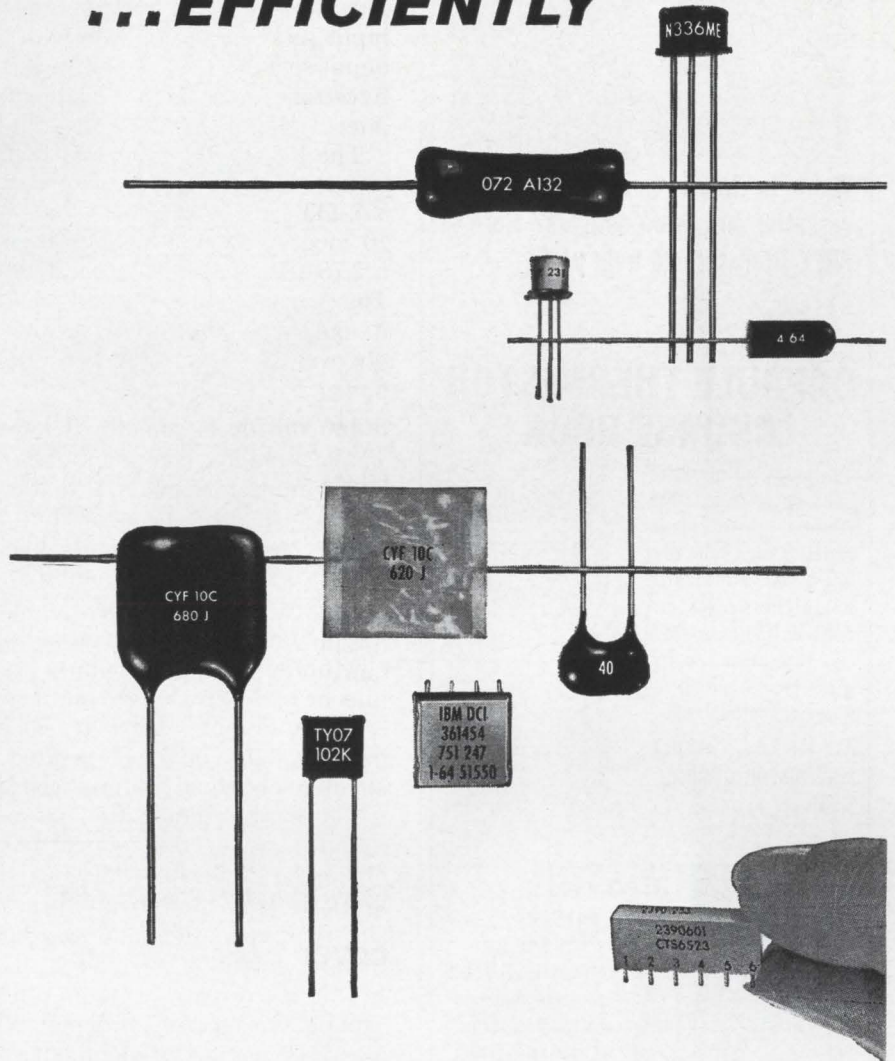

That word *efficient* means a high ratio of output to input. In a MATTHEWS OFFSET PRINTER marking transistors, modules, capacitors and other electronic wonders, it means trouble-free operation, legible printing, it means a spoonful of ink goes a long way—installing a MATTHEWS printer means at least one of your problems is solved.

Write for illustrations of our electronic component printers or send a sample of your product. We'll be glad to see if we can be efficient for you too.



JAS. H. MATTHEWS & CO.
Industrial Marking Products Division
6788 PENN AVE., PITTSBURGH, PA. 15206

MARKING METHODS SINCE 1850

HOW'S YOUR THERMISTOR IQ?

Want to learn more about these versatile, precision sensors? Here's FREE literature to help you.

CAPSULE THERMISTOR COURSE BOOK

Ten quick, painless lessons on precision thermistors, their characteristics, and how they are used. Illustrates basic thermistor circuits, compares thermistors with other sensors, gives typical circuit design calculations, etc.

Ask for F.E.I. CAPSULE THERMISTOR COURSE BOOK.

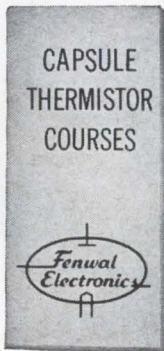

THERMISTOR FACT FOLDER

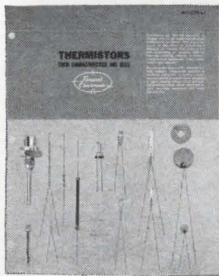

An illustrated booklet which describes various thermistor types, including F.E.I. ISO-CURVE* interchangeable thermistors, and how to apply them in measurement and control circuits.

Ask for F.E.I. THERMISTOR FACT FOLDER.

*MADE UNDER PAT. 3109227 AND OTHERS. ISO-CURVE IS A TRADEMARK OF F.E.I.

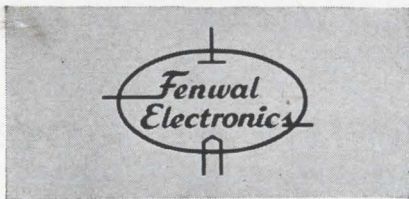

63 FOUNTAIN STREET, FRAMINGHAM, MASS.

New Materials

New threads for better insulation



Boron nitride is sometimes known as the paradox compound: It is a highly refractory material that conducts heat like a metal, but insulates against electricity like a ceramic. This unusual combination of properties would appear to make it valuable for many electrical and electronic uses, particularly as a high-temperature electrical insulator. Up to now, however, it has been available only as a powder or in relatively small sintered chunks.

The Carborundum Co. has now found a way to produce boron nitride as a flexible fiber. In this form, it may find many uses as electrical insulation, and as a heat-transfer medium.

The fine threads of boron nitride can be woven, or combined with plastics, paper, or laminates in varying proportions. The fibers are soft as silk, highly resistant to abrasion, and act as an effective shield against atomic radiation. In addition, the material is chemically inert to most organic solvents and most corrosive acids and bases. The fibers will not react with such molten materials as silicon, aluminum, copper, zinc, or cryolite. Chlorine has little effect upon them up to 1,300°F. In inert atmospheres, the material can withstand temperatures of up to 4,500°F; in oxidizing atmospheres, to 1,700°F.

Boron nitride fibers are presently available in limited quantities. No major technological problems are

anticipated in supplying commercial quantities as demand warrants.

Specifications

Fiber size	10 to 15 in. long 5 to 7 microns diameter 1.8 to 2 grams per cc
Density	
Working temperature:	
inert atmosphere	4,500° F
oxidizing atmosphere	1,700° F
Dielectric constant	4+
Dielectric strength	high
Hardness, Moh's scale	2
Tensile strength	200,000 psi
Modulus of elasticity	13 x 10 ⁶ psi
Price	\$75, 4 oz; \$175, 1 lb

The Carborundum Co., New Products branch, P.O. Box 337, Niagara Falls, N.Y. [441]

Double-doped C-W laser crystal

A double-doped c-w laser crystal, now available, is guaranteed for continuous operation at room temperature at 1.06 microns output. The new material—yttrium aluminum garnet (YAG) doped with neodymium (Nd + 3) and chromium (Cr + 3)—provides at least twice the efficiency and three times the power output of currently available infrared laser crystals, according to the manufacturer.

The technique enables chromium and neodymium to be substituted in the aluminum and yttrium lattice sites, respectively, while retaining the hardness and durability properties of YAG. Double doping increases output and efficiency by broadening the absorption band of the crystal, which also makes it more compatible with existing arc pump sources. The absorption band of the new material is 0.38 to 0.82 micron; this compares with an absorption band of 0.75 to 0.82 micron for crystals doped only with neodymium.

The new crystals are available in laser-rod form, 3 mm. in diameter and 30 mm. long, with coated confocal ends. Prior to shipment, every rod is thoroughly pretested and the test data on crystal operating characteristics are supplied to the customer.

Union Carbide Corp., Linde Division, Crystal Products Dept., 4120 Kennedy Ave., East Chicago, Ind. [442]

**Where do
Electronics
Engineers go
if they're
interested in
RFI work?**

**To IITRI, if they're
looking for the leader.**

As a member of the IIT Research Institute team, you'll see more advanced developments in RFI technology being applied than anywhere else in the country. Programs are conducted at all levels of applied research—from establishment of requirements and concepts to fabrication and check-out of complete equipment and systems. Applications range from complex systems for weaponry or space, to components, devices and sub-systems.

We expect you to contribute your ideas. Last year, for

example, one out of 6 programs in the works was company sponsored. And, of over 1250 separate projects during the year, 65% stemmed originally from a staff member's idea. You'll be working with equipment and facilities that represent the most advanced in the business today. And, you'll be exposed to specialized conferences sponsored jointly by IITRI and military agencies. Recent examples are "Physics of Failure", "Electromagnetic Compatibility", "Communications Satellites", "Impact of Microelectronics", and "Self Organizing Systems".

Our current emphasis is indicated in the following job descriptions. Each position calls for a BSEE with an MSEE preferred. Engineers are required immediately . . .

- To work on critical component areas in millimeter wave systems. Ability to supervise up to four associates desired. 3 to 6 years experience in MICROWAVE SYSTEMS AND COMPONENT DEVELOPMENT, L-band through millimeter wave frequencies. Experience in propagation and antennas helpful; solid theoretical background plus knowledge of measurement procedures required.
 - To work on interference problems involving electromagnetic penetration of cables, systems, etc. Long range programs require background in ELECTROMAGNETIC THEORY INCLUDING TRANSMISSION LINES AND ANTENNA ANALYSIS. Experience with lab instrumentation and good background in experimentation helpful; must have had some supervisory responsibility.
 - To conduct electromagnetic compatibility studies involving 2 to 4 junior engineers and technicians. 3 to 6 years experience in SYSTEMS ANALYSIS required; must have some supervisory and experimental experience plus firm theoretical capability.
 - To work on programs dealing with undesired interactions between electronic equipments. 1 to 4 years experience in field theory, transmission lines, and circuit design primarily in COMMUNICATIONS FROM HF THROUGH VHF. Experience in shielding, bonding, and grounding helpful; firm analytical capability plus experimental experience required.
 - To work on RF FRONT ENDS FOR MILLIMETER WAVE SYSTEMS. Require good background in field theory, transmission lines, antennas, and/or propagation. Firm theoretical plus experimental knowledge required. 3 to 5 years experience and demonstrated capability to conduct individual research desired.
 - To work on programs dealing with undesired interactions between equipments in the AUDIO THROUGH UHF RANGE. Recent grad required with interest in electromagnetic field theory including transmission lines. Areas of interest involve analytical and experimental work in cable coupling, shielding, bonding, grounding and antenna/transmission line coupling. Interest in circuit design, filter theory and propagation desired. Prefer man with excellent academic standing and desire to continue graduate studies.
 - To work on undesired cable coupling, field penetration, and spurious emanations problems. Recent grad required with interests in ELECTROMAGNETIC THEORY, MICROWAVE COMPONENTS, AND/OR ANTENNAS. Outstanding academic standing plus desire to continue graduate studies preferred.
- These positions offer free graduate study and excellent opportunity for advancement. Salaries and benefits are fully competitive with industry. Send a resume of your background and interests to Mr. Ron C. Seipp.



**IIT
Research
Institute**

10 West 35th Street, Chicago, Illinois 60616

An Equal Opportunity Employer

meeting the high
reliability and
performance
requirements of

150

MISSILE AND
AEROSPACE
COMPANIES

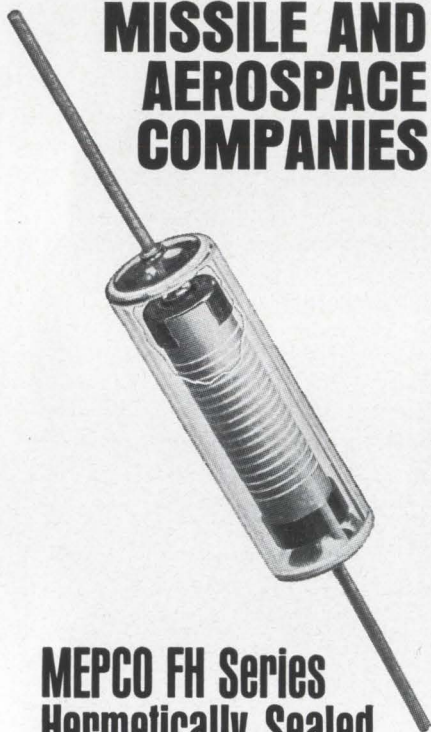

MEPCO FH Series Hermetically Sealed, Glass Enclosed METAL FILM RESISTORS

High reliability resistors for demanding requirements of aerospace and military electronics fields. Conform to MIL-R-55182.

For complete information and detailed specifications, write:

MEPCO, INC.

Morristown, New Jersey 07960

Phone (201) 539-2000

TWX (201) 538-6709

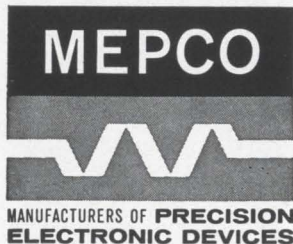

New Production Equipment

Finer lines for printed circuits

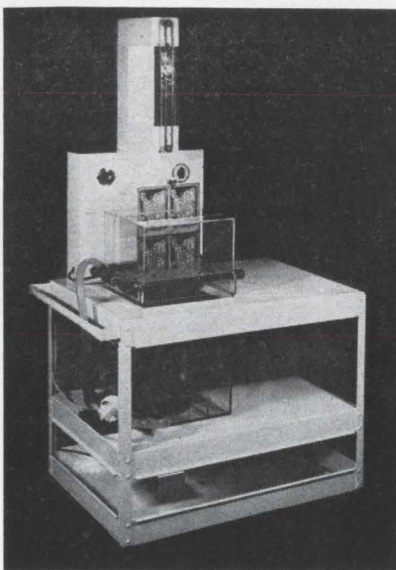

Copper conductors as narrow as one mil (0.001 inch) and spaced only one mil apart can be etched on printed circuit boards with a new spray etcher developed by Cyclo-Tronics, Inc.

These lines are actually far finer than most board users want; in its own products, the company rarely uses lines finer than 15 mils. Micro-circuit assemblers are usually content with 10-mil lines. The real advantage of the more precise etching is not so much that it can make the very fine lines, but that it can hold closer tolerances on broader lines.

Cyclo-Tronics says the new etcher can do such a precise job for two reasons. First, the etchant is sprayed through tiny holes in plastic pipes, and the spray falls gently on the boards, like water from a garden sprinkler hose. There is less undercutting of the copper than when etchant is sprayed from a nozzle. Second, lamps built into the etcher make the boards translucent, so that the operator can see the lines developing as the excess copper is etched and stop the process as soon as etching is completed.

The boards move vertically between two horizontal spray pipes. It takes 12 minutes to etch an 11-

by-14 inch double-sided board clad with two-ounce copper, or two single-sided boards etched back to back.

One-mil straight lines can be etched, the company advises, if the board is turned to equalize etching effect of the etchant dripping down the board. On curved lines, widths and spacing of two or three mils can be maintained. Ammonium persulfate warmed to between 70° and 100°F should be used as etchant, and the supply should be changed when its copper content reaches four ounces per gallon.

Cyclo-Tronics developed the etcher for its own use, but will offer it for sale at the National Electronics Conference show Oct. 25 in Chicago. One model, for laboratory and small-shop use, has a single pump and controls and costs \$695. Another, priced at \$1,295, has two systems, so etchants can be changed or boards rinsed. Both are portable.

Cyclo-Tronics, Inc., 3701 North Kedzie Ave., Chicago, Ill. 60618 [451]

Small parts printer with variable speeds

A small parts printer has been developed for high production operation. Variable speed controls accommodate ranges from 40 per minute up to 300 per minute. The printing unit is a basic standard machine, while conveyor and escapement mechanism are designed for the individual part to be marked.

The offset printing principle provides extremely legible small characters and is suitable for flat, round or slightly irregular surfaces. Character sizes of impressions are as small as 1/32 in. fast drying, heat set, solvent resisting inks permit immediate part handling.

Jas. H. Matthews & Co., 6574 Penn Ave., Pittsburgh, Pa., 15206. [452]

GRADUATE ELECTRICAL/ELECTRONIC ENGINEERS — BS, MS, PHD —
ARE NEEDED FOR PERMANENT ASSIGNMENT IN

SYSTEMS TECHNOLOGY

INFORMATION TECHNOLOGY — Radar, Displays

ELECTRICAL AND ELECTRONIC SYSTEMS — ECM, Reliability

STABILITY, GUIDANCE AND CONTROL — Guidance and Control,
Digital Computers, Flight Controls

SYSTEMS LABORATORY — Circuit Design, Microelectronics, Flight Test
Instrumentation, Mechanical Design

OTHER POSITIONS ARE AVAILABLE ALSO FOR QUALIFIED,
EXPERIENCED, GRADUATE ENGINEERS AND SCIENTISTS

In systems technology, capable, qualified engineers and scientists are needed for assignment to research and development projects involving space vehicles and systems, and other programs — including the F-111 Tactical Fighter. The opportunity for advancement is immediate and continuing. We urge you to investigate the chance to exercise your ability with a professional group that is backed by the very finest facilities. Write to Mr. J. B. Ellis, Industrial Relations Administrator-Engineering, P.O. Box 748-T, Fort Worth, Texas. An equal opportunity employer.

GENERAL DYNAMICS FORT WORTH

FORT WORTH, TEXAS

GROWTH OPPORTUNITIES IN COMMUNICATIONS WITH TRW Systems in Los Angeles and Houston

THESE MAJOR PROGRAMS . . .

- Apollo spacecraft systems
- Advanced Minuteman systems
- Mars mission and spacecraft studies
- Nuclear Detection (Vela) Satellites
- Pioneer interplanetary spacecraft
- Weather satellite systems
- Standardized tracking, telemetry and command system (SGLS)
- Advanced space probes
- Lunar telemetry systems

create these vital openings for degreed engineers in our Communication Laboratory:

Senior Communication Engineers

To design, analyze and manage communication systems and evaluate scientific and military applications of communication techniques for aircraft, spacecraft and underwater craft use. BSEE, MSEE or PhD.

Communication Equipment Design Engineers

Several years' experience in design and analysis in the following fields: RF filters, diplexers, antennas, phased arrays, feeds, frequency-independent, solid-state transmitters, receivers, phase-lock loop techniques, cavity techniques, strip line, very wide and very narrow band circuits, circuit engineering, and modulation techniques. BSEE or MSEE.

Communication System Analysis Engineers

Application of basic statistical communication theory to system analysis. Includes performance analysis and trade-off studies for modulation techniques. Involves the application of phase-lock circuits, principally as demodulators and the relationship between intermodulation effects and link linearity requirements. Should be familiar with analog and digital systems. BSEE or MSEE.

Telemetry System Engineers

Experienced in the functional and logical design of analog and digital telemetry systems. Familiarity with vehicle and spacecraft instrumentation requirements and the characteristics and requirements of scientific experiments. BSEE or MSEE.

Telemetry Circuit Design Engineers

To design signal processing circuits for spacecraft digital telemetry equipment. Experience should relate to the design of analog-to-digital converters, analog and digital multiplexers, logic and data storage. Familiarity with microelectronics desirable. BSEE or MSEE.

Please submit resume and salary history in confidence to R. J. Brown, TRW Professional Placement, Dept. E-10, One Space Park, Redondo Beach, California 90278. TRW is an equal opportunity employer.

TRW SYSTEMS

ONE SPACE PARK, REDONDO BEACH, CALIFORNIA
Formerly TRW Space Technology Laboratories — STL

New Books

Circuit design

Principles and Design of
Linear Active Circuits
By Mohammed Shuaib Ghaussi
McGraw-Hill Book Co.
621 pp., \$16.50

The author has packed into 621 pages what is almost certainly the most complete treatment of active network design available in book form. The book is truly up-to-date, including some of the very latest advances in the field. Much of the material presented is a result of the author's original work.

The book starts off by discussing the basic problems of circuit theory. It proceeds through the operation of vacuum tubes and transistors and treats in depth the problems of active network design and analysis. For the most part, the circuit analysis is carried out using the pole-zero concept.

Three chapters in particular stand out because of their thorough and up-to-date treatment of important circuit problems. These are the chapters on additive or distributed amplifiers, transient response of linear circuits, and synthesis of active RC transfer functions.

The early chapters contain sufficient introductory information on general circuit theory to enable practicing electrical engineers to comprehend the remaining portions of the book.

Several chapters concerning the operation of vacuum tubes and the physics and operation of transistors should also prove useful to those engineers not thoroughly versed in these areas. The treatment of small-transistor equivalent circuits, while not as complete as some of the treatments found in the literature, is more than ample for a thorough understanding of the subsequent material.

One chapter deals with biasing and stabilization techniques for both vacuum tubes and transistors. This again is helpful for those engineers not thoroughly acquainted with these techniques. A very thorough chapter explaining the behavior of RC coupled common-emitter amplifiers under different emitter feedback and coupling con-

siderations is followed by a chapter analyzing broadband common-emitter stages.

The book has a few drawbacks. The treatment of narrow-band and wide-band transistor tuned-amplifier design is inadequate. The analysis of RC active bandpass amplifiers could have been extended to include a discussion of stability problems. Also, the analysis of impedance levels using Blackman's formula might well have been developed in greater detail. A chapter on distributed RC networks would have been a desirable addition to the book. Some of the well-known circuit-design information presented might have been eliminated without reducing the effectiveness of the book.

In general, the material is clear and thorough. The book is recommended both for graduate students interested in active network design and for the practicing engineer. However, portions of it will probably appeal more to the analytically minded engineer than to the practicing designer. One definite asset of the book is the highly organized manner in which the subjects are presented.

Problems are given at the end of each chapter and appear to have been very carefully prepared. In fact, solving the problems is of considerable benefit to the reader.

Perhaps the benefits of this book would have been even greater with a bit more emphasis on circuit-design applications throughout.

Vasil Uzunoglu

Applied Physics Laboratory
The Johns Hopkins University
Silver Spring, Md.

Recently published

Signal Flow Analysis, J.R. Abrahams, G.F. Coverley, Pergamon Press, 158 pp., \$2.45

Introductory Electromechanics, N.L. Schmitz, D.W. Novotny, Ronald Press, 315 pp., \$8.50

Aerospace Ranges: Instrumentation, J.J. Scavullo, F.J. Paul, D. Van Nostrand, Inc., 457 pp., \$15.75

Inelastic Scattering of Neutrons, Vols. I and II, Proceedings of a Symposium, Bombay, Dec. 15-19, 1964, International Atomic Energy Agency, 461 and 574 pp., \$9.50 and \$11.50

Use of Computers in Biology and Medicine, R.S. Ledley, McGraw-Hill Book Co., 965 pp., \$29.50



now...

VITREOSIL® PURE FUSED QUARTZ CONICAL PIPE JOINTS

Designed as a practical demountable joint for vacuum or pressure, liquid or gaseous systems. The conical (or Buttress) joint is available in clear pure fused quartz in sizes to 2" I.D. and in opaque fused silica in sizes 3" I.D. to 6" I.D.

Clear fused quartz joints have grooves into which gasket material is forced for tighter joints. Opaque fused silica joints have precisely ground flat ungrooved surfaces. Gasketing material may be selected to meet requirements.

Conical pipe joints are ideal for joining fused quartz or fused quartz to metal, ceramics, plastics, etc. Interchangeable with borosilicate pipe joints. Joint hardware can be supplied at additional cost.

Special auxiliary apparatus with furnace annealed pipe joints includes thermocouple wells, end caps, closed and/or reduced end furnace tubes in various sizes, one, two and three neck round bottom flasks up to 2 liters capacity in clear pure fused quartz and up to 15 liters in opaque fused silica.

38

THERMAL AMERICAN
FUSED QUARTZ CO.



RT. 202 & CHANGE BRIDGE RD.
MONTVILLE, NEW JERSEY

POWER TO SPARE

HIGHEST POWER COMPLETE
LINE OF MICROWAVE SIGNAL
GENERATORS AVAILABLE

POWER PULSED SIGNAL SOURCES



MODEL PH5K

FREQ. RANGE.... 200 Mc — 35 Gc
POWER UP TO 15 KW

FEATURES

- Precision Calibrated Frequency Tuning
- Plug-In Triode Heads 0.2—6 Gc
- Plug-In Magnetron Heads 5.4—35 Gc
- Continuously Variable Power Output
- Continuously Variable Pulse Width and Rate
- Metering, Monitoring and Safety Features

MODEL	TYPICAL POWER		
	L Band	S Band	C Band
PG1K	2kw	1kw	200w
PH5K	5kw	5kw	1kw
PH20K	15kw	10kw	1kw

POWER CW SIGNAL GENERATORS

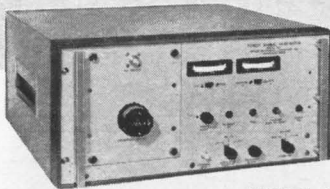

MODEL C201

FREQ. RANGE.... 200 — 6000 Mc
POWER UP TO 125 W

FEATURES

- Precision Calibrated Frequency Tuning
- Plug-In Triode Heads (C201)
- Continuously Variable Power Output
- Calibrated Power Meter
- Stable Frequency
- CW or Square Wave Output
- External Modulation Provision
- Frequency Monitoring Jack

MODEL	TYPICAL POWER			
	UHF	L Band	S Band	C Band
C201	60w	25w	8w	1w
C202	120w	55w	25w	—

Write or call for complete information on
AML microwave instruments.



TEL:
617 245-9393

**APPLIED MICROWAVE
LABORATORY INC.**
106 ALBION ST. • WAKEFIELD, MASS.

Technical Abstracts

Fault detection

Pattern recognition applied to fault detection
V. S. Levadi, Aeronautical division,
Honeywell, Inc.
Minneapolis, Minn.

Detection of a failure in any device in a system requires discrimination between "good" and "bad" systems. Location of that failure requires a series of such discriminations. A designer of test equipment must determine which measurements will indicate failure, and how to interpret test data. When the measurements of the data processing cannot be completely determined in advance, a statistical procedure is required. Then the discrimination problem becomes a form of pattern recognition.

This approach makes it possible to design test equipment that recognizes failures and failure-prone situations which a human observer would not detect. The approach also promises to be very useful in diagnosing failures in nonlinear systems, in which analytical methods are difficult and in which even a large number of test points cannot detect a failure without some degree of ambiguity.

Statistical procedures are useful when certain criteria for failure are subjective and therefore cannot be completely designed into test equipment; or when some measurements are not available to the test equipment being designed; or when failure is to be predicted from measurements taken before it occurs. The statistical procedures are derived from decision theory.

An autopilot was tested by such a method. There were not enough autopilots available to set up a reliable statistical sample, so a mathematical model was set up on the basis of known properties of the components of the autopilot. As might be expected in a statistical process, tests on various versions of this model showed the "good" units to have nearly similar measurements, while the "bad" units had more widely scattered measurements. Likewise, the boundary between "good" and "bad" was by no means well-defined—indeed, some "bad" units were found

within the cluster of "good" units, and on the basis of the measurements taken were indistinguishable from "good" units.

The results show that a good job of fault detection is possible with significantly less data when pattern recognition techniques are applied. It is necessary, of course, for the detection system to learn from a large number of tests, made on equipment whose "good" and "bad" state is known, or on mathematical models.

Presented at the 1965 Military Electronics Conference, Washington, Sept. 22-24.

High-power pulse

Nanosecond microwave pulse generation using a linear accelerator
Howard R. Jory, Daniel G. Dow
Varian Associates,
Palo Alto, Calif.

Short microwave pulses, on the order of 10 nanoseconds in length, with very high peak powers, can be generated by using a linear accelerator. The energy source for the system, a high-power magnetron or klystron, is used to fill a linear accelerator structure with microwave energy for approximately one microsecond. After the filling time, an electron beam is switched on and injected into the accelerator. The beam picks up the stored energy in the accelerator and emerges as a short-pulse, high-peak-power beam, highly modulated at the frequency of the klystron or magnetron. The beam then passes into an output structure that converts it to a microwave pulse. This structure could be a length of loaded waveguide similar to the output section of a traveling-wave tube.

In initial experiments with the system, the authors used an accelerator not designed for energy storage, which prevented very large output powers. Input power was 13 megawatts at a frequency of 2,856 megacycles with an r-f pulse of 315 nanoseconds. The r-f power output was 22 Mw with a pulse length of 43 nsec.

Ultimate peak-power limitations of this approach, however, will depend on the design of high-current linear accelerators. With accelera-

Designed for

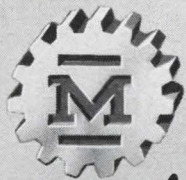

Application

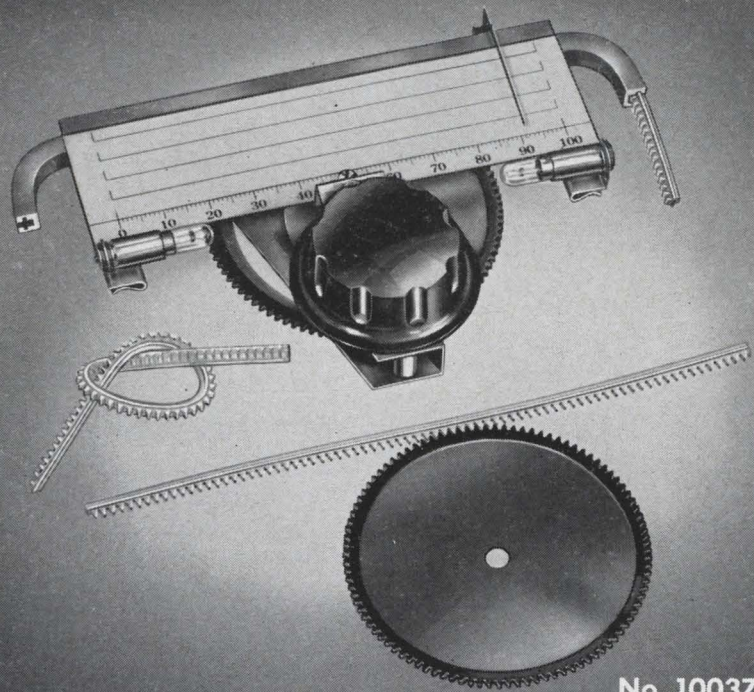

No. 10037

No. 10037 NO-STRING DIAL

No strings: no springs: no pulleys: no back lash: no flimsy assembly. Molded gear driven rack and pointer ride in a sturdy extruded channel. Smooth Teflon bearings. 11:1 reduction. Furnished complete with panel trim bezel.

JAMES MILLEN MFG. CO., INC.

**MALDEN
MASSACHUSETTS**

Circle 234 on reader service card

99.9%
full scale
ACCURACY
100%
OF THE
TIME

NOW!
300% GREATER
VIEWING ANGLE

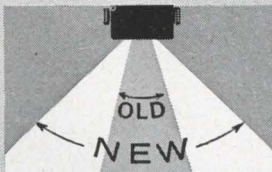

All DigiTec instruments
now being furnished with
the "NEW LOOK"

Rack Panel and Flange
Mounts are available on
all DigiTec instruments

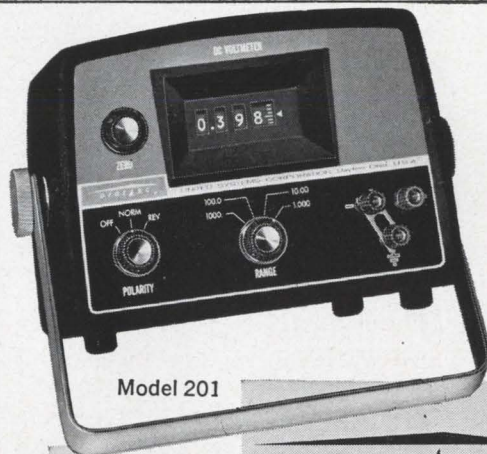

Model 201

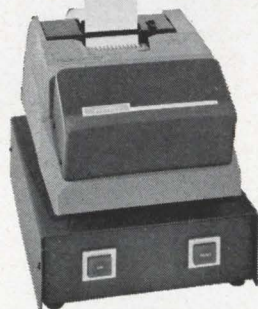

Model 610-620



Model 500

Stocking representatives throughout the world

DIGITAL DC VOLTMETERS

- 9 Models offering F.S. ranges of 10 MV to 1000 V
- Certified accuracy to .1% F.S.
- Floating or grounded input
- Reliable silicon transistor circuitry
- Individually calibrated and certified
- Available options include BCD output, retransmitting pot., auto-polarity, minimum or maximum retention.

From **\$315.00**

DIGITAL PRINTERS

- BCD 1-2-4-8 low level parallel input
- Prints 8 columns in 2 banks of 4
- 45 line/minute print rate
- Uses standard 2 1/4" paper tape
- Remotely programmable
- Designed for use on all "DigiTec" instruments with BCD coded output and other instruments with compatible coding.
- Time, Identification and Scanning Accessories available.

From **\$750.00**

DIGITAL THERMOMETERS

Precision digital measurement of temperature reading directly in degrees C or F.

THERMISTOR BASED (Series 500)

- Ranges covering -50 to +100° C.
- Accuracy to 0.15°
- 18 interchangeable probes.

PLATINUM BULB (Series 530)

- Ranges covering -390° to +2000° F.
- Accuracy to 0.70° F.
- Interchangeable probes.

THERMOCOUPLE (Series 560)

- Ranges covering -300° to +2000° F.
- Accuracy to 1.5° F.
- Reading resolution to 0.05°
- For use with ISA Type "J," "K" and "T" thermocouples.

From **\$345.00**

DIGITEC

UNITED SYSTEMS CORPORATION

918 Woodley Road, Dayton 3, Ohio (513) 254-3567

UPDATE YOUR LITERATURE! Write for new, 32 page color catalog.

THIS PEAK OCCURRED
AT 3:56:13 P.M.
DURING TEST NO. 8

HOW DO WE KNOW?

A Chrono-log Model 3000 Oscillographic Time Code Generator was recording time and test number on the event channel.

If you want to identify your oscillograph recordings by time and test number, independent of chart speed —

If you are tired of tedious marking, measuring or "blip" counting —

Get details on the Chrono-log Model 3000 Oscillographic Time Code Generator. Flexible outputs allow it to be used on all oscillographs and strip chart recorders. And the price is only \$580.00.



CHRONO-LOG CORP.
2583 W. CHESTER PIKE, BROOMALL, PA.

Circle 235 on reader service card

High torque, Self-shielded

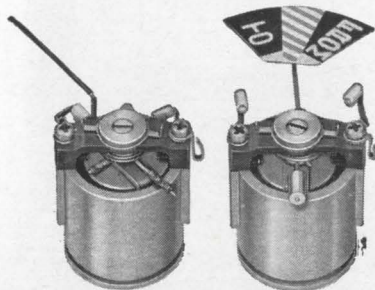

AI-2 (actual size)

moving coil mechanism

Versatile mechanisms for critical indicating and control systems have "On-off", "+, -", "Go-no go", null, left-right, or scale indicators. High torque, self-shielded core magnet design permits grouping of functions in small panel space. Moving coil weighs 100 mg less and provides at least 10% more torque than best previously available mechanism of this type. Wide choice of sensitivities; synchro or standard mounting.

AMMON

AMMON INSTRUMENTS, INC.
345 Kelley Street, Manchester, N. H., 03105

204 Circle 204 on reader service card

Technical Abstracts

tors now being designed for 20-amp beams, r-f output will be between 200 and 400 Mw. The practical limit for S-band accelerators is probably 100 amps. With a 100-amp beam and a 22-Mw, 600-nsec input, power output should be 1,000 Mw with a 5-nsec response.

Presented at the 1965 Military Electronics Conference, Washington, Sept. 22-24.

Regenerative amplifier

A new method of amplification using tunnel diodes in a regenerative mode

A.S. Oberai, RCA Victor Research Laboratories, Montreal

Voltage from a pump oscillator is applied to make circuit conductance alternately negative and positive in a proposed amplifier, which uses an tunnel diode in a regenerative mode. When the conductance is zero, just before becoming negative, the circuit is most sensitive to the input signal current, and a regenerative buildup of voltage starts across the tunnel diode. This buildup continues while the conductance is negative until it is zero again. When the conductance is positive, the voltage across the diode decays so that in the next regenerative cycle, the voltage again is equal to the input signal voltage. The peak transient voltage across the diode is proportional to the magnitude of the input signal, but many times larger.

The gain of the amplifier depends on the conductance slopes at the beginning and end of the regenerative cycle, and on the duration and amplitude of the negative conductance period. These parameters, in turn, depend on the pump magnitude and waveshape.

The frequency response of this amplifier is limited to half that of the pump frequency. A signal frequency above half of the pump frequency is converted to a difference frequency.

To cascade an amplifier of this type, appropriate phase delays must be introduced between the pump oscillator and each stage so that the first stage reaches its peak voltage as the second stage starts regeneration.

Presented at the 1965 Canadian Electronics Conference, Toronto, Oct. 4-6.

COMINCO high-purity metals

Available forms in 99.999% and/or 99.9999% purities	ALUMINUM	ANTIMONY	ARSENIC	BISMUTH	CADMIUM	COPPER	GOLD
BARS	X	X	X	X	X	X	
SHEETS	X				X	X	X
WIRE	X				X	X	X
POWDER		X	X	X	X		
SHOT		X		X	X	X	
ROD	X			X	X	X	
RIBBON							
PREFORMS	X				X	X	X
SALTS					X		

Available forms in 99.999% and/or 99.9999% purities	INDIUM	LEAD	SILVER	TELLURIUM	THALLIUM	TIN	ZINC
BARS	X	X	X	X	X	X	X
SHEETS	X	X	X			X	X
WIRE	X	X	X			X	X
POWDER	X	X	X	X	X	X	X
SHOT	X	X	X			X	X
ROD	X	X	X			X	X
RIBBON	X	X				X	
PREFORMS	X	X	X			X	X
SALTS	X						

COMINCO PRODUCTS, INC.

ELECTRONIC MATERIALS DIVISION
818 West Riverside Ave., Spokane, Wash. 99201
Phone 509 747-6111 Telex 032 610
TWX 509-328-1464

5609

Circle 236 on reader service card

Instrument Line Magnetic Tape Heads by NORTON

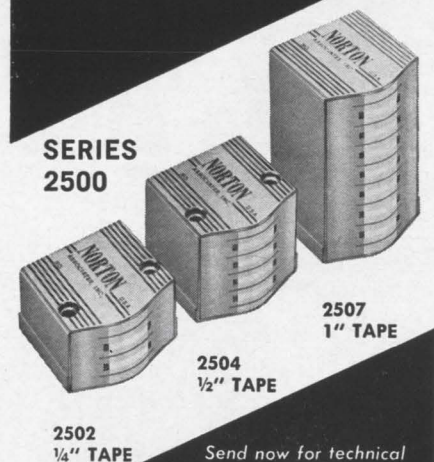

SERIES
2500

2507
1" TAPE

2504
1/2" TAPE

2502
1/4" TAPE

Send now for technical literature with specifications on the complete Norton line of magnetic heads.

NORTON

ASSOCIATES, INC.

240 Old Country Road, Hicksville, N. Y.

Circle 237 on reader service card

No matter what we start discussing at Xerox... sooner or later we're talking about more new jobs.

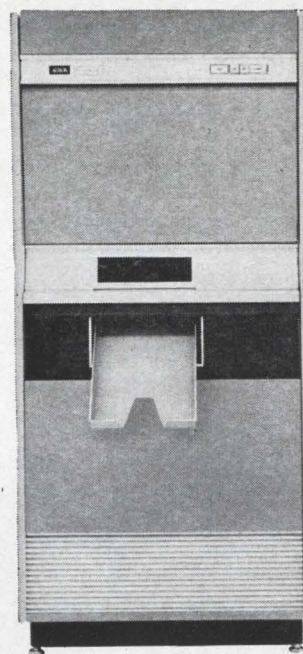
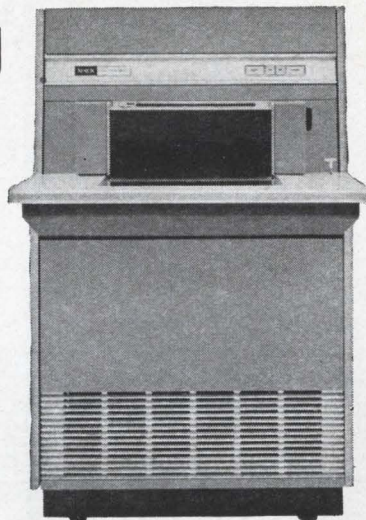

Sometimes people are puzzled when we say that Xerox is in the business of graphic communications. Let's try to clarify. (It could be important, especially if you're intrigued with Xerox, but not perfectly sure why.)

We define graphic communications as the entire spectrum of communications in a graphic sense — the formulation, reception, transmission, recording, storing, retrieving, processing, copying, or presentation of any meaningful images. As you can imagine, graphic communications transcends copying equipment, no matter how advanced. LDX (Long Distance Xerography) suggests some-

thing of our future. The current system recently sent an 8½" x 11" xerographic image 3,450 miles over broadband telephone lines in 7 seconds. For what LDX implies, re-read the definition of graphic communications above. You'll get the picture.

The openings outlined below are abstracts from our current list of immediate vacancies. In most cases they are new, expansion-created spots. In others, the man has been promoted. Isn't this the best way to come on board in any organization?

COMMUNICATIONS SYSTEMS ENGINEERS

To direct a team of Systems Engineers on assigned major projects; evaluate alternative systems concepts; determine cost/performance trade-offs; establish systems requirements; generate concepts leading to future engineering developments and analyze methods for facsimile distribution switching and storage. BS required in EE, Engineering Sciences or Physics (MS preferred) with a minimum of 3 years' experience in circuit and systems design, preferably involving data communications equipment including teletype and/or telephone modern equipment, facsimile, broadband and microwave equipment, and integration of such equipment into larger systems involving network operation. Also, experience with remote input/output equipment, optical character recognition, on-line, real time digital data communication with computers.

ADVANCED CIRCUIT DEVELOPMENT ENGINEERS

For integrated circuit module selection and specification for general purpose logic modules and macro-modules employing microminiature array logic for decoders, code translators, shift registers, multiplexers and D/A converters for computer peripheral and communications products. BE/MSEE with 8 to 10 years' comprehensive experience in general purpose computer products development in areas of circuit design and systems. Must have designed and used

standard card configurations in fulfilling system requirements and be familiar with design automation and automatic fabrication, wiring and checking techniques.

ELECTRONIC DEVELOPMENT ENGINEERS

For experimental design, fabrication and testing of advanced CRT display, character generation, and control equipment. Experience in electronic circuit design, solid state logic, display, communications and/or packaging.

INFORMATION SYSTEMS ENGINEERS

For system configuration study and synthesis leading to detailed specification of information storage and retrieval equipments, computer peripheral equipments and data systems terminals. BS required in EE, ME, or Physics with at least 5 years' experience in design, development and/or systems in digital information processing display, communications, and/or microfilm systems.

Positions are in Rochester, N. Y. Send resume, including salary history, to Mr. R. E. Conboy, Xerox Corporation, Dept. E-10, P.O. Box 1540, Rochester, New York 14603.

XEROX

An Equal Opportunity Employer

XEROX AND LDX ARE TRADEMARKS OF XEROX CORPORATION

QUALIFICATION FORM FOR POSITIONS AVAILABLE

ATTENTION: ENGINEERS, SCIENTISTS, PHYSICISTS

This Qualification Form is designed to help you advance in the electronics industry. It is unique and compact. Designed with the assistance of professional personnel management, it isolates specific experience in electronics and deals only in essential background information.

The advertisers listed here are seeking professional experience. Fill in the Qualification Form below.

STRICTLY CONFIDENTIAL

Your Qualification form will be handled as "Strictly Confidential" by Electronics. Our processing system is such that your form will be forwarded within 24 hours to the proper executives in the companies you select. You will be contacted at your home by the interested companies.

WHAT TO DO

1. Review the positions in the advertisements.
2. Select those for which you qualify.
3. Notice the key numbers.
4. Circle the corresponding key number below the Qualification Form.
5. Fill out the form completely. *Please print clearly.*
6. Mail to: Classified Advertising Div., Electronics, Box 12, New York, N. Y. 10036.

COMPANY	PAGE	KEY #
ATOMIC PERSONNEL INC. Phila. 2, Pa.	209	1
BAUSCH & LOMB INC. Rochester, N. Y. 14602	209	2
CHEMETRON CORP. Votator Div. Louisville, Kentucky 40201	209	3
ELECTRONIC COMMUNICATIONS INC. St. Petersburg, Fla.	189*	4
GENERAL DYNAMICS Electric Boat Div. Groton, Conn.	189*	5
GENERAL DYNAMICS Fort Worth Fort Worth, Texas	199	6
GENERAL ELECTRIC Adv. & Sales Promotion Dept. Schenectady, N. Y.	188*	7
IIT RESEARCH INSTITUTE Chicago, Illinois	197	8
LOCKHEED MISSILES & SPACE CO. Sunnyvale, Calif.	173*	9
McDONNELL St. Louis, Mo. 63166	187*	10
NATIONAL CASH REGISTER CO. Electronics Div. Hawthorne, Calif.	158-159*	11
RCA Camden, N. J.	190*	12
RIXON ELECTRONICS INC. Silver Spring, Md.	210	13
PAN AM Guided Missiles Range Div. Cocoa Beach, Calif.	208	14
SANDERS ASSOCIATES INC. Nashua, New Hampshire	207	15
STEWART-WARNER CORP. Chicago, Illinois	209	16
SYLVANIA Electronic Systems-West Mountain View, Calif.	150	17
SYLVANIA Semiconductor Div. Woburn, Mass.	209	18
TRW SYSTEMS Redondo Beach, Calif.	203	19
XEROX CORP. Rochester, N. Y.	205	20
PV 7433	190*	21

* These advertisements appeared in the Sept. 20th issue.

(cut here)

Electronics WEEKLY QUALIFICATION FORM FOR POSITIONS AVAILABLE

(cut here)

(Please type or print clearly. Necessary for reproduction.)

Personal Background

NAME
HOME ADDRESS
CITY ZONE STATE
HOME TELEPHONE

Education

PROFESSIONAL DEGREE(S)
MAJOR(S)
UNIVERSITY
DATE(S)

FIELDS OF EXPERIENCE (Please Check)

10/4/65

- | | | |
|--|--|---------------------------------------|
| <input type="checkbox"/> Aerospace | <input type="checkbox"/> Fire Control | <input type="checkbox"/> Radar |
| <input type="checkbox"/> Antennas | <input type="checkbox"/> Human Factors | <input type="checkbox"/> Radio-TV |
| <input type="checkbox"/> ASW | <input type="checkbox"/> Infrared | <input type="checkbox"/> Simulators |
| <input type="checkbox"/> Circuits | <input type="checkbox"/> Instrumentation | <input type="checkbox"/> Solid State |
| <input type="checkbox"/> Communications | <input type="checkbox"/> Medicine | <input type="checkbox"/> Telemetry |
| <input type="checkbox"/> Components | <input type="checkbox"/> Microwave | <input type="checkbox"/> Transformers |
| <input type="checkbox"/> Computers | <input type="checkbox"/> Navigation | <input type="checkbox"/> Other |
| <input type="checkbox"/> ECM | <input type="checkbox"/> Operations Research | <input type="checkbox"/> |
| <input type="checkbox"/> Electron Tubes | <input type="checkbox"/> Optics | <input type="checkbox"/> |
| <input type="checkbox"/> Engineering Writing | <input type="checkbox"/> Packaging | <input type="checkbox"/> |

CATEGORY OF SPECIALIZATION

Please indicate number of months experience on proper lines.

	Technical Experience (Months)	Supervisory Experience (Months)
RESEARCH (pure, fundamental, basic)
RESEARCH (Applied)
SYSTEMS (New Concepts)
DEVELOPMENT (Model)
DESIGN (Product)
MANUFACTURING (Product)
FIELD (Service)
SALES (Proposals & Products)

CIRCLE KEY NUMBERS OF ABOVE COMPANIES' POSITIONS THAT INTEREST YOU

1 2 3 4 5 6 7 8 9 10 11 12 13 14 15 16 17 18 19 20

If Nashua living
is too
quiet,

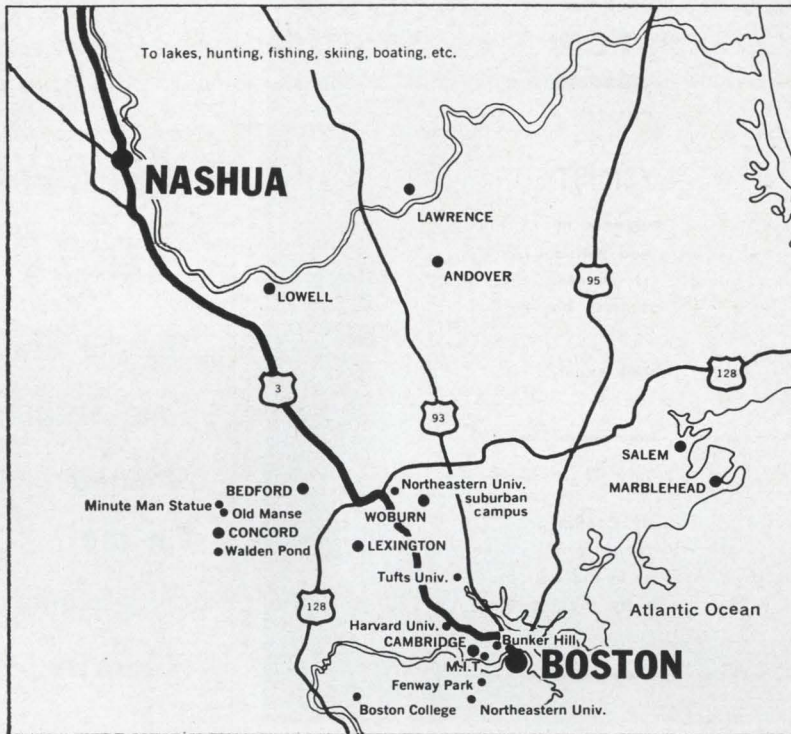

commute
from Boston.

95 per cent of our engineers don't. They prefer the country around Nashua, New Hampshire. It's a pleasant change from the excitement of their jobs. □ □ □ A lot of them came from big cities. They and their families liked what they saw in Nashua. □ □ □ And for those who can't get used to the fresh country air, the Boston commute is about 60 minutes. □ □ □ Like everything else at Sanders, the choice is yours. The working environment is free. The organizational structure can accommodate a new direction swiftly. The President's door is always open. □ □ □ What will your work be? Helping evolve an advanced systems technology, primarily. □ □ □ We're one of the top defense contractors in the country (i.e., weapon systems and prime contractor for the Operation and Display System for NASA's Moon

Shot). □ □ □ Our electronics technology leads the field in many areas (radar and phased array, missile guidance, communications, ASW/oceanography, ECM, tactical limited warfare, information display and data processing, data storage, ground support, navigational aids, instruments, test equipment, microwave, high density packaging). □ □ □ Drop us a resume. We'll show you what we mean about exceptional living and working at Sanders. Immediate senior level openings exist in significant research, development and product design in such areas as infrared systems, advanced military communication systems, microwave components and antennas, power supplies, and CRT display circuitry and systems. □ □ □

Write in confidence to Mr. Lloyd Ware, Staff Engineer.

sanders associates, inc.



NEW DIRECTIONS IN
ELECTRONICS SYSTEMS

NASHUA, NEW HAMPSHIRE

An equal opportunity employer



How Does He Manage It?

On the job, he's a hard-hitting organizer, managing the entire instrumentation complex on his down-range island (whether it be Eleuthera, Grand Bahama Island, Ascension, or one of the other 9 major stations on the Eastern Test Range). Each multimillion dollar space launch depends on his judgment and split-second decision-making.

As Base Operations Manager, he takes full responsibility for directing the real-time monitoring of vehicle performance in flight... using the latest in pulse and CW radar, telemetry, optics, infrared, timing, command/control, data encoding and transmission equipment, and digital computers. Soon he'll be working in support of MOL, Apollo and additional Gemini flights.

He earns his time on the beach.

If you have a strong technical background in these many areas of electronics... if you have engineering management ability and can make the right decision under pressure... if you want broad exposure to the whole world of range technology, a springboard to even more important positions at the Cape, write in confidence to Manager, Professional Employment, Dept. 28K-1.



GUIDED MISSILES RANGE DIVISION

PAN AMERICAN WORLD AIRWAYS, INC.
750 S. ORLANDO AVENUE, COCOA BEACH, FLORIDA
An Equal Opportunity Employer

PINPOINT *your* **RECRUITMENT ADVERTISING**

to the Engineers
and Technical
Management men
in the
Electronics
Industry . . .

When *you* need Engineers—remember this fact: **Electronics** serves thousands of engineers with the latest engineering developments and news of the electronics industry. Engineers read **Electronics** because its high calibre editorial content is *specially designed for them* . . . that's why your Employment advertising in **Electronics** can pinpoint a most concentrated source of experienced engineers. Your **MOST DIRECT LINK** to these qualified men is in the **EMPLOYMENT OPPORTUNITIES** section. For more facts, of placement of your ad,

For Rates and Information Write:

Electronics

A McGraw-Hill Publication
Classified Advertising
Division

P.O. Box 12, New York
10036

ELECTRICAL ENGINEERS

Experienced man needed to manage the development of automotive instruments from the idea stage to the production line. Must have 5 or more years broad technical experience and be of future management potential.

Also need man experienced in transistor circuitry design to work on electrical and electronic aspects of our electronic balancing equipment for tire & industrial applications.

Send resume and salary requirements to:

M. J. JUST.

STEWART WARNER CORPORATION

1826 W. Diversey Ave.,
Chicago, Ill.

An Equal Opportunity Employer



E. E.'s
for FEE-PAID Positions
WRITE US FIRST!

Use our confidential application for professional, individualized service . . . a complete national technical employment agency.

ATOMIC PERSONNEL, INC.
Suite 1207L, 1518 Walnut St., Phila. 2, Pa.

ELECTRICAL ENGINEER

Degree plus 3 or 4 years experience in design and development of large industrial electronic equipment. Radar or other micro wave device experience desirable. Send resume with current salary to Personnel Manager.

VOTATOR DIV.—CHEMETRON CORP.

P. O. Box 43, Louisville, Ky. 40201
An Equal Opportunity Employer

ADDRESS BOX NO. REPLIES TO: Box No.
Classified Adv. Div. of this publication.
Send to office nearest you.
NEW YORK, N. Y. 10036: P. O. Box 12
CHICAGO, Ill. 60611: 645 N. Michigan Ave.
SAN FRANCISCO, Cal. 94111: 255 California St.

POSITION WANTED

German Electrical Engineer with thorough universal technical knowledge, special knowledge of measuring, regulating and control and experiences as operating engineer seeks equal position. I come to USA January 1966; my age: 24. Offers under box PW-7597, Electronics.

*"Put Yourself in the Other
Fellow's Place"*

TO EMPLOYERS

TO EMPLOYEES

Letters written offering Employment or applying for same are written with the hope of satisfying a current need. An answer, regardless of whether it is favorable or not, is usually expected.

MR. EMPLOYER, won't you remove the mystery about the status of an employee's application by acknowledging all applicants and not just the promising candidates.

MR. EMPLOYEE you, too, can help by acknowledging applications and job offers. This would encourage more companies to answer position wanted ads in this section. We make this suggestion in a spirit of helpful cooperation between employers and employees.

This section will be the more useful to all as a result of this consideration.

Classified Advertising Division

McGraw-Hill, Inc.

330 West 42nd St., New York, N. Y. 10036

Bausch & Lomb has openings for ELECTRONIC ENGINEERS

B.S. or M.S. with one to five years experience in the design of analog and digital circuits and systems. Good theoretical background in math, physics and network analyses desirable. Experience in control systems and low signal level circuit techniques helpful. Projects involve development of sophisticated instruments in biomedical, chemical, optical and electronic fields at the applied research stage.

Please send resume in confidence, including salary requirements to: E. J. Walter, Employment Specialist, Bausch & Lomb, 636 St. Paul St., Rochester, N. Y. 14602.

BAUSCH & LOMB

An Equal Opportunity Employer

diode engineers

*For Sylvania's Semiconductor Division
In Hillsboro, New Hampshire*

Excellent positions offering New England living at its finest. Our Hillsboro facility is located in the Dartmouth-Lake Sunapee region and offers relaxed modern country living along with the opportunity for technical contributions in a growing organization where individual performance is recognized.

Current openings exist for R & D oriented engineers with strong theoretical background and experience in gold, boron and phosphorus diffusion as applied to planar technology for discreet and monolithic integrated diodes. Additional exposure to metals evaporation and junction surface protectants helpful. The successful candidate will also be active in the development of processes applicable to production line requirements. The positions report directly to our Engineering Manager and offer growth potential along either administrative or scientific lines.

For appointment, forward resume to

Mr. R. F. Hammond, Professional Staffing

SEMICONDUCTOR DIVISION

SYLVANIA
SUBSIDIARY OF
GENERAL TELEPHONE & ELECTRONICS **GTE**

100 Sylvan Road, Woburn, Massachusetts

An Equal Opportunity Employer

AUTOTRACK ANTENNA MOUNT

360 degree azimuth, 210 degree elevation sweep with better than 1 mil. accuracy. Missile velocity acceleration and slewing rates. Amplitude and servo control. Will handle up to 20 ft. dish. Supplied complete with control chassis. In stock—immediate delivery. Used world over by NASA, USAF. TYPE MP-61 B. SCR-584. NIKÉ AJAX mounts also in stock plus several airborne trackers.

SCR 584 AUTOMATIC TRACKING RADARS

Our 584s in like new condition, ready to go, and in stock for immediate delivery. Ideal for telemetry research and development, missile tracking, satellite tracking, balloon tracking. Used on Atlantic Missile Range, Pacific Missile Range, N.A.S.A., Walllops Island, A.B.M.A. Write us. Fully Desc. MIT Rad. Lab. Series, Vol. 1, pps. 207-210, 228, 284-286. Compl. inst. Bk. avail. \$25.00 each.

AN/GPG-1 SKYSWEEP TRACKER

3 cm. automatic tracking radar system. Complete package with indicator system. Full target acquisition and automatic tracking. Input 115 volts 60 cycle. New. In stock for immediate delivery. Entire System 6' long, 3' wide, 10' high. Ideal for infrared Tracker, Drone Tracker, Missile, Tracker, R. & D.

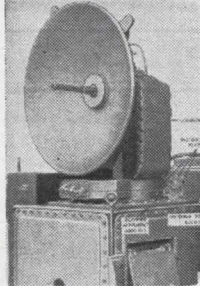

PULSE MODULATORS

MIT MODEL 9 PULSER

1 MEGAWATT—HARD TUBE

Output 25 kv 40 amp. Duty cycle .002. Pulse lengths .25 to 2 microsec. Also .5 to 5 microsec, and 1 to .5 microsec. Uses 6C21. Input 115v 60 cycle AC. Mfr. GE. Complete with driver and high voltage power supply. Ref: MIT Rad. Lab. Series, Vol. 5, pps. 152-160.

2 MEGAWATT PULSER

Output 30 kv at 70 amp. Duty cycle .001. Rep rates: 1 microsec 600 pps. or 2 msec 300 pps. Uses 5948 hydrogen thyratron. Input 120/208 VAC 60 cycle. Mfr. GE. Complete with high voltage power supply.

MIT MODEL 3 PULSER

Output: 144 kv (12 kv at 12 amp.) Duty ratio: .001 max. Pulse duration: .5, 1 and 2 microsec. Input: 115 v 400 to 2000 cps and 24 vdc. \$325 ea. Full desc. Vol. 5, MIT Rad. Lab. series, pg. 140.

250KW HARD TUBE PULSER

Output 16 kv 16 amp. duty cycle .002. Pulses can be coded. Uses 6D21, 715C or 4PR60A. Input 115 v 60 cycle ac. incl. H.V. pwr supply \$1200 ea.

5949 THYRATRON AGING RACK

Compl. Chatham Electronics Console incl. 15 kv power supply & PFN's. \$1800.

MICROWAVE SYSTEMS

E-4 FIRE CONTROL SYSTEM

Hughes Aircraft X Band. Complete. In stock.

C-BAND RADAR

250 KW output, C-band, PPI indicator, 5C22 thyratron modulator. Antenna hi gain parabolic section. Input 115 volts 60 cycle AC. complete \$2750.00.

300 TO 2400MC RF PKG.

300 to 2400 MC CW. Tuneable. Transmitter 10 to 30 Watts. Output. As new \$475.

500KW "L" BAND RADAR

500 kw 1220-1359 mcs. 160 nautical mile search range P.P.I. and A Scopes. MTI. thyratron mod. 5J26 magnetron. Complete system.

PHILCO MICROWAVE LINKS

C Band Microwave Link terminal bays and repeater bays in stock. New \$1500 each or \$2500 per pr.

100—800MC. CW SOURCE

150 watts CW nominal output 115 V 60 Cy AC input. \$1600.

100KW 3CM. RADAR

Complete 100 kw output airborne system with AMTI, 5C22 thyr. mod. 4J52 magnetron, PPI. 360 deg az sweep, 60 deg. elev. sweep, gyro stabilizer, hi-gain revr. Complete with all plugs and cables.

M-33 AUTO-TRACK RADAR SYSTEM

X band with plotting board, automatic range tracking, etc. Complete with 1 megawatt acq. radar.

INFRARED SOURCES

Collimated radiation simulator and transistorized temp. controller. Temp. range, 200-600 degree C. Absolute Accuracy ± 3 degree C. Type AN/USM. \$1975 New.

3KW RCA PHONE & TELEG XMTR

2—30 MC. 10 Autotone channels plus MO. Input 220 vac. 50/60 cycles.



Radio-Research Instrument Co.

550 5th Ave. New York 36, N.Y.
Tel. JUdson 6-4691

CIRCLE 951 ON READER SERVICE CARD



EMPLOYMENT OPPORTUNITIES

ELECTRONIC ENGINEERS

Continuing expansion has created openings for several senior and intermediate engineers. Applicants must have a strong background in solid state circuit design, and experience in system integration of digital devices. Should be interested in acting as project engineer in development of digital handling and data communication devices. BSEE required. Advanced study preferred. These are permanent career positions with a company experiencing steady and rapid growth and with a bright future. These positions offer generous fringe benefits and the many recreational and cultural advantages of the Chesapeake Bay - Washington, D. C. area in Montgomery County, Maryland.

Please submit resume and salary history to PERSONNEL DIRECTOR.



RIXON ELECTRONICS, INC
2121 Industrial Parkway, Silver Spring, Md.
An Equal Opportunity Employer

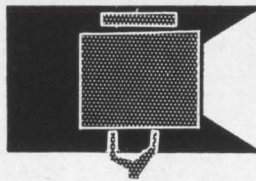

SEARCHLIGHT SECTION

- CLASSIFIED ADVERTISING • BUSINESS OPPORTUNITIES
- USED OR SURPLUS EQUIPMENT

ELECTRON TUBES

KLYSTRONS • ATR & TR • MAGNETRONS
SUBMINIATURES • C.R.T. • T.W.T. • 5000-
6000 SERIES
• SEND FOR NEW CATALOG A2 •
A & A ELECTRONICS CORP.
1063 PERRY ANNEX
WHITTIER, CALIF.
696-7544

CIRCLE 952 ON READER SERVICE CARD

TEST EQUIPMENT

For over 20 years specializing in top brands only. Write for our latest listing. We buy complete inventories.



ELECTRONIC SALES

1413 Howard Street, Chicago, Illinois 60626
Telephone ROgers Park 4-0600

CIRCLE 953 ON READER SERVICE CARD

FOR IMMEDIATE SALE OR LEASE: BALLISTIC FILM ANALYZER (BOSCAR) VARIPLLOTTER—X, Y, & THETA

Benson-Lehner equipment in excellent condition. Favorable terms. Call (215) ORchard 3-4200 or write to:

SCIENTIFIC EQUIPMENT XCHANGE
P.O. Box 6132, Phila., Pa. 19115

CIRCLE 954 ON READER SERVICE CARD

SMALL AD but BIG STOCK

of choice test equipment
and surplus electronics

Higher Quality—Lower Costs
Get our advice on your problem

ENGINEERING ASSOCIATES

434 Patterson Road — Dayton 19, Ohio

CIRCLE 955 ON READER SERVICE CARD

ELECTRONIC COMPONENTS

For Production and Research

Write for new catalog

A. B. INDUSTRIES 743-5006
3133 West Jarlath Ave., Chicago 60645

CIRCLE 956 ON READER SERVICE CARD

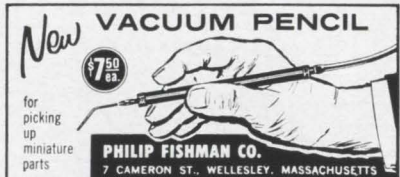

CIRCLE 957 ON READER SERVICE CARD

SEARCHLIGHT EQUIPMENT LOCATING SERVICE

No Cost or Obligation

This service is designed to help you, the reader of SEARCHLIGHT SECTION, to locate used or rebuilt equipment not currently advertised.

HOW TO USE: Check the ads in this SEARCHLIGHT SECTION to see if what you want is advertised. If not, print clearly the specifications of the equipment and/or components wanted on your own letterhead, and mail to the address below.

THIS IS A SERVICE TO OUR READERS. THIS PUBLICATION DOES NOT BUY, SELL OR STOCK EQUIPMENT OR MATERIALS OF ANY TYPE. Your requirements will be brought promptly to the attention of the used equipment dealers advertising in this section. You will receive replies directly from them.

Obviously, the list of such advertisers is limited by comparison with the over 65,000 subscribers to **ELECTRONICS**, all directly engaged in the electronics industry. A small 'EQUIPMENT WANTED' advertisement in the SEARCHLIGHT SECTION will bring your needs to the attention of ALL who read **ELECTRONICS**. The cost is low . . . just \$27.25 per advertising inch— $7/8" \times 2-3/16"$.

For prompt attention write to:

SEARCHLIGHT EQUIPMENT LOCATING SERVICE

CLASSIFIED ADVERTISING

c/o Electronics

P. O. Box 12, New York, N. Y., 10036

New Literature

Events counter. A.W. Haydon Co., 232 North Elm St., Waterbury, Conn., 06720. Product Newsletter No. 116 describes a six-digit, microminiature events counter designed for airborne/military applications such as camera operation. Circle 461 on reader service card.

Computer & integrated circuit terms. Schweber Electronics, Westbury, N.Y., has published an eight-page glossary of computer and integrated circuit terms. [462]

Components handbooks. Sunbeam Electronics, Industrial Airpark, Fort Lauderdale, Fla., 33307. The 1965 edition of the company's three-volume set of components handbooks is available to engineers engaged in the selection of synchros, servo motors, and motor tach generators for aerospace, industrial, and commercial applications. Request the boxed set on company letterhead.

Function module applications. Consolidated Electrodynamics Corp., 360 Sierra Madre Villa, Pasadena, Calif., offers six bulletins on control applications of function modules. [463]

Relay application/selection guide. General Electric Co., 5504 S. Brainard Ave., LaGrange, Ill., 60525. A six-page fold-out guide is designed to help choose the relay best suited to a given application. [464]

Sequential relays. Guardian Electric Mfg. Co., 1550 W. Carroll Ave., Chicago, Ill., 60607, has released a bulletin on its series 660AC and 665DC relays, which are designed to perform switching operations in a desired and repetitive sequence. [465]

Multilayer circuits. Electrolab Electronics Corp., 1105 Second St., Encinitas, Calif. A two-color booklet describes the manufacturer's approach to multilayer circuits, special production techniques such as the Multi-Con process, and facilities, and gives price and delivery information. [466]

Sliding-contact devices. Electro-Tec Corp., P.O. Box 667, Ormond Beach, Fla., has published a well-illustrated brochure describing its facilities for the manufacture of high-performance sliding-contact devices, such as electro-mechanical relays, precision slip-ring assemblies and complementing brush blocks, commutators and high-speed rotary selector switches. [467]

Glass-probe thermistor. Victory Engineering Corp., 122-48 Springfield Ave., Springfield, N.J., 07081. A technical bulletin covers the model 35A40 glass-probe thermistor, which comprises a tiny bead thermistor sintered on platinum-iridium leads and embedded in a solid glass probe only 0.200 in. in diameter. [468]

Overspeed monitors. Airpax Electronics Inc., Seminole division, Fort Lauderdale, Fla. Bulletin F-111-4 describes an overspeed monitor line designed to measure the rpm of rotating equipment and to provide instant protection against overload. [469]

Synchros. Bendix Corp., Montrose division, South Montrose, Pa., offers catalog No. 25 illustrating and describing its line of both commercial and military synchros. [470]

Magnetic drum system. Bryant Computer Products, 850 Ladd Road, Walled Lake, Mich., 48088. Publication BCSS-101 contains engineering specifications for the company's 700-kc standard bit serial magnetic drum system. [471]

Kovar expansion alloy. Westinghouse Materials Mfg. Division, Blairsville, Pa. An eight-page application data bulletin tells how Kovar expansion alloy can be used to provide bonded joints for metal-to-glass and metal-to-ceramic sealing. [472]

High-energy laser system. Applied Lasers, Inc., 72 Maple St., Stoneham, Mass., 02180. A technical specification bulletin describes a high-repetition, high-energy laser system. [473]

Oscillator-demodulator. Kaman Nuclear, a division of Kaman Aircraft Corp., Garden of the Gods Road, Colorado Springs, Colo. Data sheet K-5100 describes a single-channel oscillator-demodulator circuit, designed for driving a variable-impedance transducer and converting the transducer impedance changes to a proportional d-c output signal. [474]

Monolithic integrated circuits. Transatron Electronic Corp., 168 Albion St., Wakefield, Mass., 01881, offers a complete guide to the selection of HLTL (high-level transistor-transistor logic) monolithic integrated circuits. To obtain a copy, write on company letterhead.

Microwave filters. Telonic Engineering Co., 480 Mermaid St., Laguna Beach, Calif., has issued a handy three-section, slide-rule type chart providing specification data for microwave filters. [475]

Microcircuit mounting hardware. Scanbe Mfg. Corp., 1161 Monterey Pass Road, Monterey Park, Calif. A six-page catalog describes microcircuit mounting hardware that includes a new packaging concept for mounting circuit chips on mother boards, card mounting seats, card files, and horizontal and vertical equipment drawers. [476]

Microwave processing. Raytheon Co., Microwave and Power Tube division, Waltham, Mass., 02154, has published an eight-page brochure entitled "Microwave Processing Systems for Industry." [477]

ONE OF 25 NEW 3 WATT MINIATURE POWER SUPPLIES

from **t**ransformer
electronics
Company

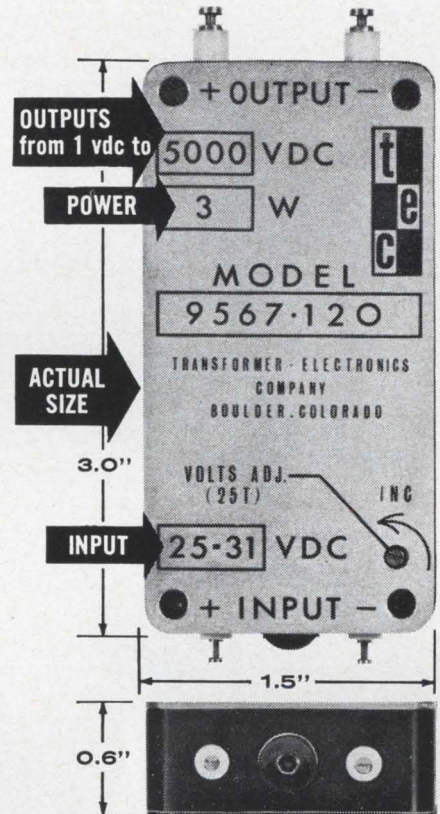

THE 9567 SERIES fulfills many requirements where DC-DC and DC-AC voltage conversion is required. Predominant features are: light weight (4 oz.)... low cost (prices start at \$150.00)... all silicon semiconductors... black anodized aluminum case... silicon rubber encapsulation... transient, reversed polarity and short circuit protection...

INPUT: 25-31 VDC (output regulated to 0.25%)
OUTPUTS: 1.5 VDC to 5000 VDC
± 15 VDC to ± 100 VDC (dual output)
1.5 VAC to 1000 VAC (3 to 5 kc)
(adjustable ± 10%)
POWER: 3 WATTS
TEMPERATURE: -55 to 100°C

FOR ADDITIONAL INFORMATION CONTACT:

**TRANSFORMER
ELECTRONICS
COMPANY**

BOULDER INDUSTRIAL PARK
BOULDER, COLORADO
TWX 303 443-2561 • PHONE (303) 442-3837

**POWER SUPPLIES • INVERTERS
CONVERTERS • TRANSFORMERS**

SWEPT FREQUENCY MEASUREMENT, 5Mc TO 12.4Gc

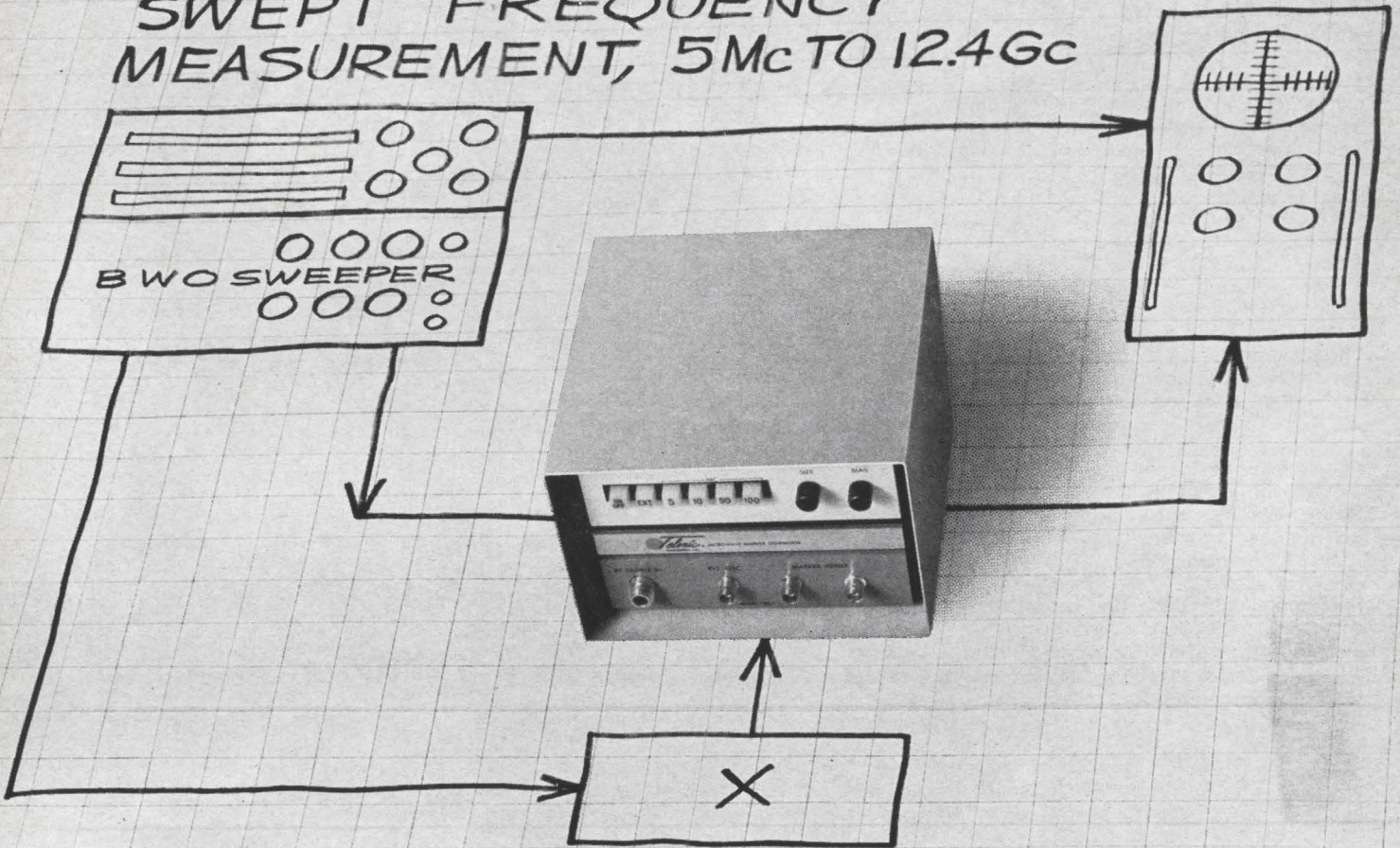

ACCURACY, (.001%) STARTS WITH A SINGLE TMS-1

Telonic's new TMS-1 Microwave Marker Generator makes a .001% system out of any BWO Sweep Generator. That's an improvement in accuracy of about 100X for a frequency range extending from 5 Mc to 12.4 Gc. Test results can be obtained much more quickly and reliably, with a low investment in instrumentation.

Now, you can determine swept frequencies with accuracies approaching that of a frequency counter but at a fraction of the price. What's more, only one TMS-1 Generator is needed to cover this entire band rather than a costly series of .1% wave meters.

The TMS-1 provides sharply defined Birdy-type markers on the scope trace (even on steep slopes) every 5, 10, 50, or 100 Mc, selected by convenient push-buttons. Provision is also made for connecting an external oscillator for any frequency from 2 Mc to 200 Mc if other intervals are desired. An extra push button and an RF connector are available for this purpose.

If you would like to see the new TMS-1 in action contact your local Telonic representative for a demonstration, or write direct for complete details and specifications.

GENERAL SPECIFICATIONS

FREQUENCY RANGE	5 Mc to 12.4 Gc
STANDARD MARKER INTERVALS	5, 10, 50, 100 Mc
ACCURACY001%
POWER REQUIREMENTS	115V, 60 cycle
CONNECTIONS	Sample In, External Oscillator, Marker Adder In, Marker Adder Out
DIMENSIONS	6" high x 8" wide x 10½" deep
WEIGHT	15 lbs.

ENGINEERING CO.

DIVISION OF TELONIC INDUSTRIES, INC.
480 Mermaid Street, Laguna Beach, California
Phone (714) 494-7581, TWX 714-673-1120

Representatives in all principal cities

Electronics Abroad

Volume 38

Number 20

Great Britain

Push-button coal-mining

Coal mining by remote control will be introduced in Britain in November. The National Coal Board has ordered a system from Associated Electrical Industries, Ltd., for installation at the Bevercotes mine in Nottinghamshire.

The agency, which administers Britain's nationalized coal industry, says the electronically controlled system should increase Bevercote's production to 1.5 million long tons a year from 1.25 million, while reducing the work force to 770 men from 2,000. An AEI official says this technique "will set new productivity standards."

Nearly all of the mining process will be automatic: cutting the shaft, removing coal, monitoring methane gas levels and adjusting ventilation. The miner, with his pick and shovel, will be replaced by automatically guided cutters. A nuclear sensor will measure the thickness of the mine wall around

the coal vein, stopping the cutter just short of the rock that protects the mine.

Beyond Bevercotes. If the Bevercotes system works well, the Coal Board envisions controlling several mines with a master computer. Automatic mining, with a simple prototype of the Bevercotes system, has passed tests at the Newstead mine in the Midlands.

The agency is reported to be considering using a CON/PAC 4000 computer for on-line process control. The 4000 is manufactured by AEI under license from the General Electric Co. in the United States.

The sensor. The key to the Bevercotes system seems to be the nuclear sensor, which emits gamma rays and measures backscatter with an array of Geiger-Mueller tubes; the return rate is proportional to the thickness of coal remaining in the vein.

The backscatter rate is the feedback to a servo guidance loop that follows the vein and drives hydraulic actuators, which position the cutters vertically. The count is also sent to an operator who, in a

control room as much as 1,000 feet away, governs movements of hydraulic chocks that follow the cutter into the vein. The chocks support the roof as the cutting face advances into the coal.

In the United States, automatic long-reach cutters usually employ strain-gauge sensors on the cutting head. When the cutters bite into hard rock, the stress creates a feedback signal that stops the cutting. However, when a vein is cut through to rock, the mine shaft is weakened and can collapse onto the machine.

Control room. A conveyor belt takes coal from the face to a 1,000-ton bunker at the bottom of the pit, then into cars for hoisting to the surface. The transport system is operated by one man in an underground control room.

A display gives the operator an immediate picture of the operating condition of mining machinery; he also has closed-circuit television with which to monitor operations in the bunker and along the conveyor system.

The Coal Board calls its system Rolf, which stands for remotely operated long-wall face.

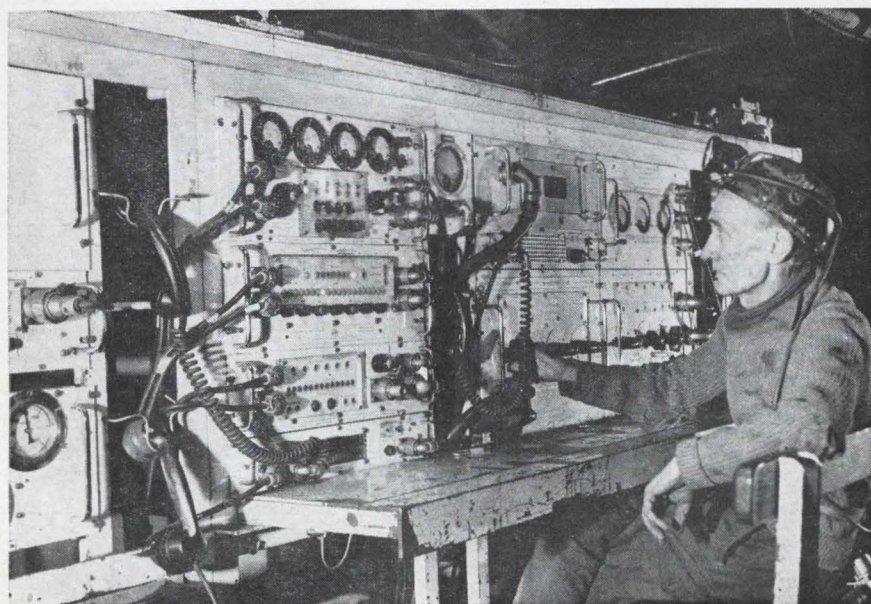

Modern miner. Electronic controls are inspected warily by a veteran miner.

Sweden

Surge in switching

Stockholm's telephones will be linked in 1967 by a new kind of electronic switch, controlled by a computerized central exchange. A larger, more complex switching system will be installed in Rotterdam a year later by the same company, Sweden's giant L. M. Ericsson Telephone Co.

The two developments show that Ericsson is a stronger contender than had been believed by some of its rivals for technical leadership in Western Europe's lucrative tele-

phone-equipment market.

Space division. Like the Bell System's in the United States, the Ericsson exchange uses space division, where a separate wire path is required for each conversation. Bell opened the first commercial electronic switching center last summer in Succasunna, N. J. [Electronics, Oct. 19, 1964, p. 71].

The Swedish company avoids making comparisons with other systems in the highly competitive international telephone business. But Christian Jacobaeus, executive vice president, says: "Our position is rather good."

Computer controls and electronic switching are being tested on a large scale in Britain [Electronics, May 17, p. 160] and France [Electronics, Sept. 20, p. 195], and to a somewhat lesser extent in West Germany, the Netherlands and Belgium.

New capabilities. Electronic switching is fast—50 milliseconds from dialing to connection. The Swedish system will also offer services that are not possible with Stockholm's present equipment. A subscriber will be able to:

- Make conference calls automatically for at least five parties.
- Be connected with an often-called party by dialing just one digit.
- Have calls transferred automatically to another phone when he is away from his own.
- Arrange to be called at a specific time, for example if he wants to be awakened early.

Compact switch. A major innovation in the Swedish system is a "code switch," which contains nearly 2,000 contacts. A company spokesman says the Ericsson switch is smaller than a comparable crossbar that contains only 1,000 contacts.

Unlike most crossbar equipment, the Swedish switch requires no power to remain closed once it is set. Crossbar gear uses a mechanical selection system to bring contacts together, and electromagnets to hold them together. Ericsson's switch reverses the procedure; a spring holds the contacts together and a magnet overcomes the spring pressure to open them. Selection

of contacts is made mechanically on orders from an on-line computer.

In the code switch, contact is made directly between the wires, rather than through spring contacts as in many other systems. One wire is V-shaped, and the other meets both legs of the V, to provide redundancy. The switch has six code bars, which can make 64 combinations—theoretically. In practice only 60 are possible. The combinations represent the number of the party being called or sometimes the code of a circuit within the exchange.

Each code bar contains 10 sub-switches, aligned vertically with a common selection mechanism. The six code bars, operated by six magnets, are used in common for setting any of the 10 sub-switches. Each subswitch contains 12 poles and 17 outlets.

The computer. The switching matrix is operated by a special-purpose digital processor developed by Ericsson. A company spokesman says the computer is suitable for large exchanges but too expensive for small switchboards.

In addition to its space-division system, Ericsson has developed—through an American subsidiary—time-division equipment for the U. S. Air Force.

West Germany

Erhard's outlook

During his successful election campaign, Chancellor Ludwig Erhard traveled extensively in a helicopter—an Alouette 2, made by Sud Aviation of France. The situation dramatizes one problem faced by West Germany's electronics industry: the government's reliance on foreign sources for armaments and for auxiliary equipment such as electronic gear.

Like his opponent, Mayor Willy Brandt of West Berlin, the 68-year-old chancellor promised to expand Germany's role in the design and manufacture of advanced military gear. Industry's confidence that he can keep his pledge was shown in



Erhard in French-made helicopter

the German stock market's spurt on the day after the election; the gain was led by electronics stocks such as AEG, Telefunken AG and Siemens & Halske AG.

A start. Germany's regular army is under command of the North Atlantic Treaty Organization. That means advanced armaments come from NATO bearing the labels "Made in USA," "Made in Britain" or "Made in France." But Germans are developing for NATO such aircraft as fighter planes, vertical-takeoff aircraft, and an amphibious tank; Erhard expects that list to be enlarged during his second term as chancellor.

Outwardly, the Bundestag that convenes in Bonn on Oct. 19 will look much like the coalition that has ruled Germany for the past four years. But his unexpectedly big victory at the polls gives Erhard the popular support he needs when he turns, as expected, to such controversial causes as increased trade with the Communist bloc and a multilateral force for NATO.

Belgium

Tool-show stealer

At the biennial European machine-tool show in Brussels last month, big electronic numerical readouts winked at showgoers from just about every major stand. More than 100 machines had complete numer-

ical-control systems tied into their drives.

In all, 31 producers of NC equipment had their latest wares on display. Philips Gloeilampenfabrieken N.V. of the Netherlands, Europe's biggest electronics company, led the field with controls on eight machines. But the other heavyweights—AEG, Grundig GmbH and Siemens & Halske AG of West Germany, Ferranti, Ltd. of Britain, Ing. C. Olivetti & Co. S.p.A. of Italy and Saab of Sweden—each had five or more systems operating at the show.

Best seller. Philips' best seller is a two-axis system with silicon-transistor switching circuitry built entirely of plug-in NOR circuit cards. The control has a pair of inputs—a set value obtained from a punched-tape program, and the actual value fed in from photoelectric transducers in the machine. The two values are compared continuously to develop command signals for drive motors for both the x axis and y axis. There is no direct information store; the pair of inputs is processed continuously at 225 kilocycles per second.

This Philips system costs slightly more than \$11,000, about the going rate for numerical control on two axes. However, through its Belgian subsidiary, Manufacture Belge de Lampes et de Matériel Electronique, Philips plans to broaden its line with what amounts to bargain-basement systems. Prices will be about \$5,000 for a two-axis system with punched-tape input, and as low as \$2,000 for one with a keyboard input.

Building blocks. Philips' approach here is a series of "function units," building blocks that can be put together by machine-tool builders to make up NC systems. "What we've done," says a Philips engineer, "is to take over circuit design for the machine-tool builder." At the same time, Philips has developed for the tool-drive system a motor that can run in a stepping mode and in an asynchronous mode to drive a machine-tool table to a rough position quickly, then bring it to final position, accurate to within 10 microns.

In the punched-tape version, in-

puts from the tape reader go to a memory. The memory feeds a comparison unit, as does a counter that receives pulses from a photoelectric pickup on the machine. The difference produces command signals for the drive motor. Memories, comparison units, counters, switching circuits and the like are all built up of standard circuit cards so the system can be tailored to the machine tool it controls.

Philips plans to begin marketing the function units next spring.

France

Computer challenge

If France and Britain move ahead with plans to develop a giant scientific computer, the joint project

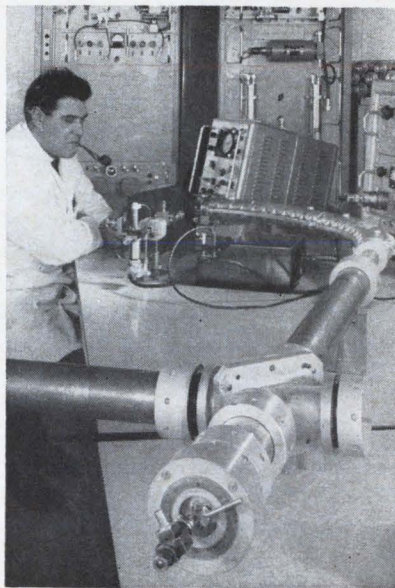

Experimental waveguide being tested at CGE research center in Marcoussis.

may be the making—or the undoing—of one of Europe's most talked-about research centers. The center for basic research at Marcoussis, just south of Paris, was built six years ago by Compagnie Générale d'Electricité at a cost of \$12 million. Since then, CGE has spent \$4 million to \$5 million a year there for electronics research—two-thirds of the center's budget.

To CGE, the Marcoussis facility is "the most advanced research center in Europe in many disciplines," with solid results to its credit in studies of lasers, fuel cells and waveguides. To a major rival, who says the center has yet to turn out its first commercially successful electronic product, Marcoussis is a "huge flop." They may both be right.

Three members. The Anglo-French plan [Electronics, Aug. 9, p. 219] envisions development of a scientific computer to rival the world's biggest, and a line of computers suitable for either scientific or commercial use. The consortium consists of two British companies—International Computers and Tabulators, Ltd., and English Electric-Leo-Marconi Computers, Ltd., a subsidiary of the English Electric Co.—and Citec, a holding company formed by CGE and another French concern, Compagnie Générale de Télégraphie Sans Fil.

The consortium is asking the British and French governments for financial backing—\$30 million to \$40 million according to unofficial reports.

Wave of the future. To Ambroise Roux, CGE's director general, the stress on computers meshes perfectly with the French company's concept of where European electronics is heading. "The future of the industry lies not in tv or the military market," he says, "but in telecommunications and industrial applications, which includes computers."

CGE is confident it can succeed in the computer industry. The proposed scientific computer will compete with any machine made anywhere, says Roux, and the line of smaller computers will not be in direct competition with those of the International Business Machines Corp., the dominant factor in Europe's computer industry. The new line will be designed primarily for industrial use, but will also have general capabilities, he adds.

While industry observers agree that computers have a big future in Europe, they doubt that anybody can build a computer that will not compete with IBM's.

Poland

Growth industry

In Warsaw, where a United States trade mission is scheduled to arrive this week, computers are a growth industry. From a standing start in 1960, the Poles had built 40 computers by the end of 1964 and 50 by last summer. Many Western observers consider their quality superior to those made in neighboring Czechoslovakia and East Germany, two countries with a richer industrial heritage than Poland's.

The seven Americans are seeking ways to sell more products to civilian industries in Poland and Rumania, two Communist countries that have shown increasing economic independence of the Soviet Union.

But continued technical advances in Poland seem to depend on the unlikely prospect that the latest components and peripheral equipment will become available soon from the West. Embargoes, principally by the North Atlantic Treaty Organization, have made it impossible to purchase this equipment on the open market, and Polish trade officials say they refuse to pay the 500% markups demanded by middlemen in Switzerland, Brazil and elsewhere.

Single producer. Poland's computer stock is skimpy compared with that of the United States, where 20,000 units are in operation. But unlike the U. S., Poland's computer production is confined to part of one plant—the 3,000-man Electronics Works in Wroclaw. Design and development are performed at the Institute for Mathematical Machines in Warsaw under Leon Lukaszewicz, Poland's leading computer expert.

At the Poznan industrial fair in June, the Poles showed a prototype of the ELWRO 1103, which is said to be 20 times as fast as its predecessor, the ODRA 1003. The new machine is scheduled to be sold at the same price as the existing one—\$100,000.

The ODRA was designed for use in research, engineering and proc-

ess control, but it's not fast enough to meet many requirements of industrial control. The 1103 is awaited expectantly by state planners trying to increase product quality and plant efficiency in Poland's controlled economy.

Besides domestic use, the transistorized 1003 has been exported to several Soviet-bloc countries. One machine is reported to be undergoing tests in Moscow.

Western components. Although the ODRA 1003's central processing units were designed and built in Wroclaw, the system relies heavily on Western-made peripheral components, including a Swedish tape punch and a Dutch teleprinter console. Transistors are of Russian, French and Italian origin. The magnetic drum memory, of 8,192-word capacity (90,000 decimal digits) has an average access time of 12 milliseconds.

Using a 39-bit word length, the 1003 has an addition and subtraction time of 0.7 milliseconds, performing 1,400 operations per second. With a floating decimal point, the corresponding figures are 1.0 millisecond and 1,000 operations per second. Multiplication speed is 3.7 milliseconds or 270 operations per second with both a stationary and a floating decimal point. Division speed is 7.7 milliseconds or 130 operations per second, also with both types of decimal points.

The faster 1103 should be a commercial success; at least 100 units have been requested in Poland, East Germany has indicated interest in buying 15, and the Soviet Union is expected to order an undisclosed number, as are several other East-bloc countries.

Question mark. Nobody knows when the 1103 will be available. A big factor is the availability of Western components. The Poles already have ordered diodes from France and Italy, a tape puncher and magnetic-tape memory from Sweden, and other equipment from West Germany. But they have been unable to buy urgently needed items such as five-nanosecond switches, also epipolar and field effect transistors.

While manufacturers scrape for hardware, Polish engineers are

working on the design of the ZAM 41, a large third-generation machine in a line of digital computers. The line includes the ZAM 11 and 21, first-generation types intended for scientific applications, and the ZAM 31, a medium-size unit now in production, with average speed of 10,000 elementary operations a second. These computers are expected to be available early next year.

Around the world

Japan. It used to take six hours to get to Osaka from Tokyo—three hours aboard the 125-mile-an-hour Tokaido Express and three hours waiting at the ticket window. Last week a nationwide seat-reservation system slashed the total to three hours and one minute. Designed around a Hitac-3030 computer built by Hitachi, Ltd., the \$5-million system can handle more than 10,000 requests an hour from 96 ticket offices all over Japan, store the reservation data, and print out the tickets.

Soviet Union. Long radio waves are helping prospectors search for water in arid regions of the Soviet Union. The system, developed at Moscow State University, operates on the principle that damp ground absorbs radio waves better than dry ground does.

Hong Kong. A candidate for the world's lowest-priced television line is being produced by a two-year-old company in Hong Kong. The N. Ming Co. offers a 23-inch set for \$140 and a portable model for \$65.

Nicaragua. A telegram from the capital city of Managua takes six hours to cover the 175 miles to Bluefields or the 250 miles to Puerto Cabezas. If the sender expects a reply from either of these major Nicaraguan ports, he has to wait at least six hours more. Yet except for radio, telegraph is the fastest means of communication. By 1967, however, a \$1.5-million telephone expansion will link the Atlantic coast to the rest of the country's system with direct dialing. Siemens & Halske AG in West Germany is the supplier.

Bourns Introduces INFINITRON™ Element 10-Turn Precision Potentiometers*

Here at last are multi-turn precision potentiometers that offer long life and essentially infinite resolution without asking you to compromise on your specifications. Noise in Bourns INFINITRON-element units is so low you can test them as if they were wirewounds. You don't have to hook up special filter circuits or contrive "output smoothness" tests. No need, either, to limit these potentiometers to voltage-divider applications or to guess where the resistance element starts and ends. Precise end-points make our linearity specification a reality in your circuits.

Convince yourself of the higher performance that Bourns INFINITRON-element 10-turn potentiometers can bring to your designs. Write today for product information and actual test data.

STANDARD SPECIFICATIONS

7/8" Diameter, 10-Turn, Bushing-Mount Model 3501
7/8" Diameter, 10-Turn, Servo-Mount Model 3551

Noise Performance:	100 ohms or 1% of total resistance, whichever is greater
Humidity Performance:	MIL-STD-202, Method 103
Independent Linearity:	±0.5%
Temperature Coefficient, All Resistances:	±300 PPM/°C
Total Resistance Tolerance:	±5%
Rotational Life:	Model 3501: 4,000,000 shaft revolutions Model 3551: 10,000,000 shaft revolutions
End Resistance:	1 ohm or .1% max., whichever is greater
Electrical Rotation:	3600° (+10°/-2°)
Power Rating:	2 watts at 70°C
Operating Temperature Range:	-65°C to +125°C
Environmental Stability:	Resistance shift < 5%
Approximate Weight:	1 oz.
Resistance Range:	1K to 500K
Price, 1-9 pieces:	Model 3501 (Bushing Mount): \$14.00 Model 3551 (Servo Mount): \$30.00

Long-life, ball-bearing shaft supports, standard in the servo-mount model, are also available in the bushing-mount unit.

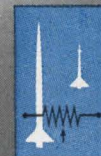
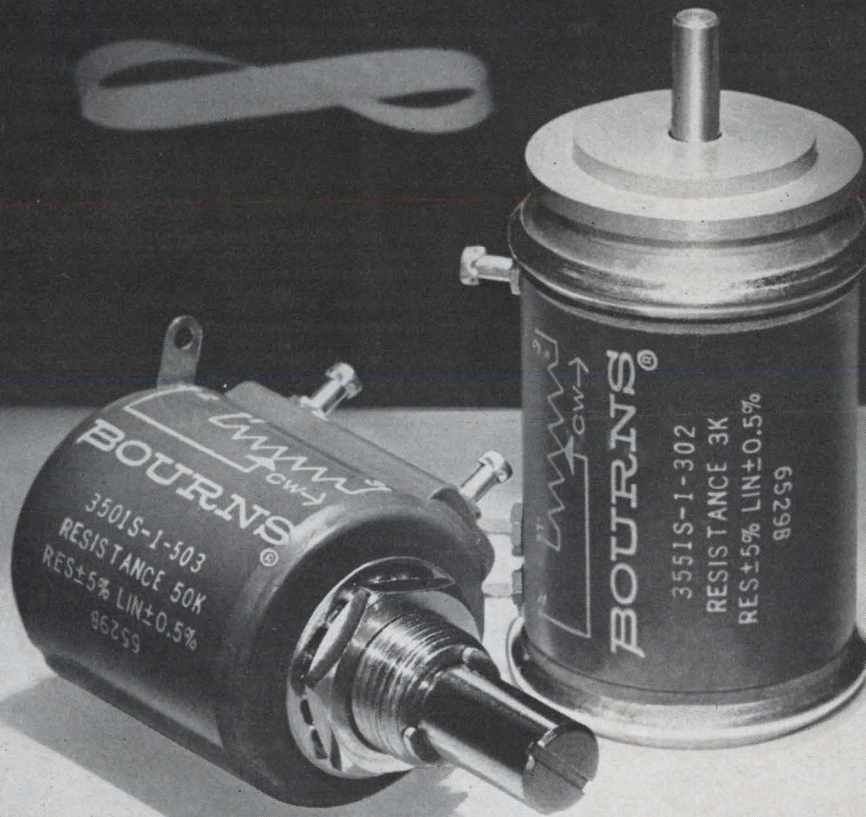

BOURNS

BOURNS, INC., TRIMPOT DIVISION
1200 COLUMBIA AVE., RIVERSIDE, CALIF.
PHONE 684-1700 · TWX: 714-682 9582
CABLE: BOURNSINC.

*Patent pending

MANUFACTURER: TRIMPOT® & PRECISION POTENTIOMETERS, RELAYS; TRANSDUCERS FOR PRESSURE, POSITION, ACCELERATION. PLANTS: RIVERSIDE, CALIFORNIA; AMES, IOWA; TORONTO, CANADA

4 of a series

TRANSICOIL SOLVES SERVO PROBLEMS

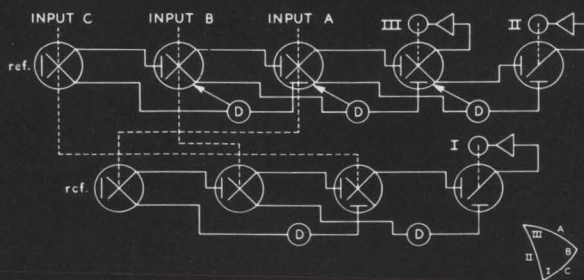
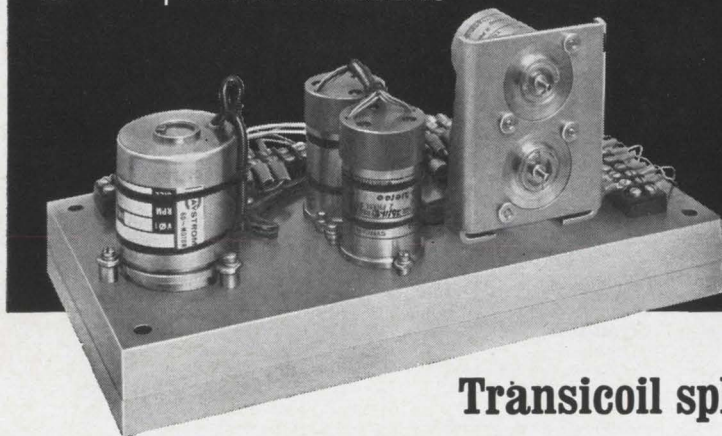

Transicoil spherical trigonometric computer

This unit was designed by Transicoil for solution of a spherical triangle in a planetarium application. The servo chassis illustrated is one of a group of six that comprise an analog computer. ■ With two sides and the included angle given, the required solution is to find the remaining two angles and their included side. Transicoil's basic approach uses two chains of resolvers to perform the required trigonometric functions. Special techniques using dummy resolvers eliminate the need for the conventional buffer amplifiers between computing resolvers. Output information is provided from servoed CX and TX synchros and displayed on readout dials on each package. ■ Transicoil's responsibility in this project included complete mechanical and electrical design from required inputs and outputs. This unit illustrates the unusual capability Transicoil offers for combining servo components into operating servo systems. We'll be glad to supply more information. Write for our 16-page brochure, SERVO ASSEMBLIES.

QUALITY BY DESIGN

 **WESTON INSTRUMENTS, INC.**

WESTON TRANSICOIL
Worcester Pennsylvania 19490

Circle 265 on reader service card

**NEW
FOR 1966**

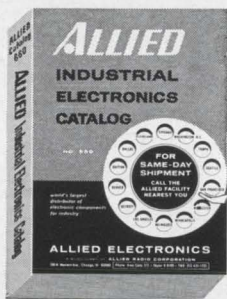

FREE INDUSTRIAL ELECTRONICS CATALOG

Here's the standard of the industry from Allied, the world's largest stocking distributor of electronic components and equipment. 552 pages. 64,000 items, 6,000 new products. Factory OEM prices. Same-day shipment. Get your personal copy now.



FULL CHOICE • FAST DELIVERY • OEM PRICES
Best selection of IRC resistors, including: high reliability, metal film and wirewound precision, metal glaze semi-precision, fixed composition and power wirewound. Metal glaze and wirewound precision trimmers in rectangular, square, round and cube styles. Complete line of multi-turn pots.

For FREE catalog, check reader service card or write direct to:

ALLIED ELECTRONICS

subsidiary of ALLIED RADIO CORPORATION
100 N. Western Ave., Dept. 223, Chicago, Illinois 60680

Ask Murata for Reliability

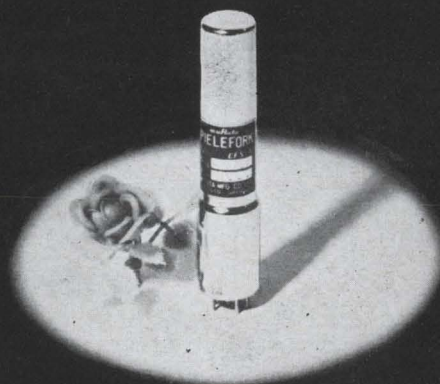

PIELEFORK®

Tuning fork with newly developed piezo ceramics is your best choice for use as audio frequency standard and in selective calling and precise controlling devices.

MICROFORK

Ceramic tuning fork, originally designed for "Bell Boy Service" where compactness, ruggedness and low-cost are required, is now widely used for many purposes.

See electronics show (Osaka Japan) Booth no. A-53

muRata
MURATA MFG. CO., LTD.

Nagaoka-cho, Kyoto, Japan
Cable Address: MURATA KYOTO

Electronics advertisers

October 4, 1965



■ AMP Incorporated 52, 53 Garceau, Hargrave & McCullough Inc.	Corning Electronic Components 153 The Rumrill Company Inc.	General Magnetics Inc. 130 George Homer Martin Associates
API Instrument Company 166 George Z. Griswold	Couch Ordnance Inc. 174 Culver Advertising Inc.	General Radio Company 2nd Cover K.E. Morang Company
Acopian Corporation 184 Mort Barish Associates Inc.	■ Data Instruments, Div. of Industrial Electronic Hardware Corp. 36 Technical Marketing	Hamilton Watch Company 165, 188 Beaumont, Heller & Sperling Inc.
Adage Inc. 68 Fuller & Smith & Ross Inc.	■ Defense Electronics Inc. 67 H. Durand Associates	H.V. Hardman Company Inc. 192 Josephson, Cuffari & Company
Adams & Westlake 144 Juhl Advertising Agency Inc.	Deutsch Electronic Components Div. 63 Michael York/Adv. Consultant	Haydon Switch & Instrument Inc. 169 Cory Snow Inc.
Aerovox Corporation, Hi-Q Division 75 Lescarbourea Advertising Inc.	Dialight Corporation 188 H.J. Gold Co. Advertising	■ Hewlett Packard Company 2 Lennen & Newell Inc.
Allen Organ Company 17 N.W. Ayer & Son Inc.	Dow Corning Corporation 32, 33 Church & Guisewite Adv. Inc.	■ Hughes Aircraft Company 131 Foote, Cone & Belding Inc.
■ Allied Electronics Sub. of Allied Radio Corporation 218 Winius-Brandon Company Adv.	■ DuPont de Nemours & Co. E.I. Electrochemicals Dept. 47, 48 The Rumrill Company Inc.	■ Hull Corporation 192 The Michener Company
Alpha Wire Corporation Div. of Lorai Corporation 154 Campbell-Ewald Company	■ DuPont de Nemours & Co. E.I. 73, 126 The Rumrill Company Inc.	Hurletron-Whittier Inc. 42 Feldman Everett Advertising
Amelco Semiconductor, Div. of Teledyne Inc. 142 Sturges and Associates	Dymec, A. Div. of Hewlett Packard Co. 1 Lennen & Newell Incorporated	IIT Research Institute 197 Deutsch & Shea Inc.
■ Ammon Instruments Inc. 204 Culver Advertising Inc.	Edgerton, Germeshausen & Grier Inc. 190 Reach, McClinton & Co. Inc.	■ Ichizuka Optical Co. Ltd. 193 Matsushita Inc.
Anaconda American Brass Company 179, 180, 181 Wilson, Haight & Welch Inc.	Elco Webster Div. of Elco Corporation 72 Fien & Schwerin Inc.	Industrial Electronic Engineers Inc. 175 Gumpertz, Bentley & Dolan Adv.
■ Analab Div. of Benrus 46 S & S Creative Service	Eldorado Electronics 125 Sturges and Associates	International Resistance Company 156 Arndt, Preston, Chapin, Lamb & Keen Inc.
Applied Microwave Laboratory Inc. 202 Briant Advertising	Electro Scientific Industries 76 Nadler & Larimer Inc.	■ Jennings Division of ITT 122 L.H. Waldron Advertising
■ Astrodata Inc. 43 Bonfield Associates Inc.	Electronic Modules Corporation 159 Ray Thompson & Associates	Jerrold Electronics Corporation 14 Irving Gould Advertising Inc.
■ Automatic Electric Company 177 Tatham-Laird & Kudner Inc.	■ Elgenco Incorporated 175 Wesco Advertising	KMC Semiconductor Corporation 10 Kerner Associates
■ Bausch & Lomb Inc. 136, 160 Wolf Associates, Inc.	Engineered Electronics Company 185 Jansen Associates	■ Lambda Electronics Corporation 140, 141 Michel Cather Inc.
Beckman Instrument Inc., Berkeley Division 143 Hickson & Jorgensen Inc.	Erie Technological Products Co. Inc. 161 Altman-Hall Associates	Machlett Laboratories Inc., The 9 Fuller & Smith & Ross Inc.
Beckman Instrument Inc., Helipot Division 6 Hickson & Jorgensen Inc.	Esterline-Angus Instrument Company Inc. 78 Caldwell, Larkin & Sidener-Van Riper Inc.	■ Mallory & Company Inc., P.R. 56, 57, 167 The Aitkin-Kynett Company
Bell Telephone Laboratories 59 N.W. Ayer & Son Incorporated	■ Fairchild Controls 183 Dunwoodie Associates Inc.	■ Markel & Sons, L. Frank 176 George Moll Advertising Inc.
■ E.W. Bliss Company, Eagle Signal Division 20, 21 Feeley Advertising Agency Inc.	■ Fairchild Instrumentation 22 The Wexton Company Inc.	Markem Machine Company 171 Culver Advertising Inc.
■ Bourns Inc. 54, 55, 217 Allen, Dorsey & Hatfield Inc.	■ Fairchild Semiconductor Corporation 12, 13 Faust/Day Inc. Advertising	Matthews Company, Jas. H. 195 W.S. Hill Company
■ Brush Instruments Div of Clevite Corp. 3rd Cover Carr Liggett Adv. Inc.	Fenwal Electronics, Inc. 196 Larcom Randall Advertising Inc.	McGraw-Hill Encyclopedia of Science & Technology 77 D. Altman Adv. Agency
Cal/Val Research & Development Corp. Isomode Division 166 Packard/Mitchell Advertising Inc.	Fiberfil, Inc. 168 Tri-State Advertising Co. Inc.	MEPCO Inc. 198 Ray Ellis Advertising Corporation
Cherry Electrical Products Corp. 189 Jdculea Advertising Inc.	Fluke Mfg. Co. Inc. John 15 Bonfield Associates Inc.	M.I.A.L., U.S.A. Inc. 175 Keyes, Martin Company
Chrono-Log Corporation 204 Albano Advertising	Flying Tiger Line 49 Cole Fischer Rogow Inc.	■ Micro Switch Div. of Honeywell 58 Batten, Barton, Durstine & Osborn Inc.
■ Cinch Manufacturing Company 147 Stral Advertising Company Inc.	General Aniline & Film Corporation 124 Hazard Advertising Company Inc.	Millen Mfg. Co. Inc. James 203
Cinch-Graphik Div. of United Carr 191 Reach, McClinton & Company	General Dynamics/Fort Worth 199 Glenn Advertising Inc.	■ For more information on complete product line see advertisement in the latest Electronics Buyers' Guide
Clare & Company, C.P. 34, 35 Reincke, Meyer & Finn Advertising	■ General Electric Company, Electronic Components Sales Div. 27 to 30 George R. Nelson Inc.	
■ Clifton Precision Products Co. Div. of Litton Industries 24 Ivey Adv. Inc.	■ General Electric Company, Lamp Metals & Components Div. 45 Dix & Eaton Incorporated	
Cominco Products Inc. 204 McKim Productions Limited	■ General Electric Company, Miniature Lamp Dept. 173 Batten, Barton, Durstine & Osborn Inc.	
Consolidated Electrodynamics Corporation 18, 19, 70, 186 Hixson & Jorgensen Inc.	■ General Electric Company, Silicone Products Dept. 163 Ross Roy Inc.	
Control Data Corporation 194 Barnes Chase Advertising		

Executive, editorial, circulation and advertising offices: McGraw-Hill Building, 330 West 42nd Street, New York, N.Y., 10036. Telephone Area Code 212-971-3333. Teletype TWX N.Y. 212-640-4646. Cable: McGrawhill, N.Y. Officers of the Publications Division: Shelton Fisher, President; Vice Presidents: Joseph H. Allen, Operations; Robert F. Bogert, Administration; John R. Callahan, Editorial; Ervin E. DeGraff, Circulation; Donald C. McGraw, Jr., Advertising Sales; Angelo R. Venezian, Marketing. Officers of the Corporation: Donald C. McGraw, President; L. Keith Goodrich and Hugh J. Kelly, Executive Vice Presidents; John J. Cooke, Vice President and Secretary; John L. McGraw, Treasurer, Title R registered U.S. Patent Office; © copyright 1965 by McGraw-Hill, Inc. All rights reserved, including the right to reproduce the contents of this publication, in whole or in part.

■ Minerals Pigments & Metals Div. of Chas. Pfizer & Co. Inc. Newmark, Posner & Mitchell Inc.	137
Minnesota Mining & Mfg. Co. Mincom Division Reach, McClinton & Company Inc.	151
Minnesota Mining & Mfg. Co. Scotchpar Division Klau-Van Pietersom-Dunlap Inc.	178
Motorola Semiconductor Products Inc. Lane and Bird Advertising Inc.	64
■ Murata Mfg. Co. Ltd. Dentsu Advertising Ltd.	218
NRC Equipment Company S. Gunnar Myrbeck & Company	170
■ Nexus Research Laboratories Larcom Randall Advertising	129
■ Non-Linear Systems Inc. Barnes Chase Advertising Agency	31
North Atlantic Industries Inc. Murray Heyert Associates	16
■ Norton Associates J.J. Coppo Company Inc.	204
Nytronics Inc. The Stukalin Advertising Agency	187
■ Ohmite Mfg. Company The Fensholt Adv. Agency	155
Pennsylvania Fluorocarbon Company Ernest William Greenfield Inc.	192
Penta Laboratories Inc. Fuller, Smith & Ross Inc.	8
■ Perfection Mica Company, Magnetic Shield Division Burton Browne Advertising	193
Perkin Elmer Corporation Gaynor & Ducas Inc.	44
Phelps Dodge Electronic Products Corp. Smith, Dorian & Burman Inc.	123
■ Philbrick Researches Inc. George A. Culver Advertising Inc.	74
Photocircuits Corporation Duncan-Brooks, Inc.	152
■ Polarad Electronic Instruments Keyes, Martin & Company	69
■ Potter & Brumfield Div. of American Machine & Foundry Co. Grant, Schwenck & Baker Inc.	71
■ Precision Tube Company Inc. George Moll Advertising Inc.	182
Radio Corporation of America Al Paul Lefton Company	149, 4th Cover
■ Radio Materials Co. Div. of P.R. Mallory Co. Inc. Rosenbloom/Elias Associates Inc.	146
Raytheon Company, Industrial Components Div. Fuller Smith & Ross Inc.	62
Raytheon Company, Microwave & Power Tube Division Fuller & Smith & Ross Inc.	132
Rese Engineering Inc. Joseph Gering/Graphic Design Associates	145
■ Ribet Desjardins Inter-Plans	172
■ Semi-Elements, Inc. Axelband, & Brown Associates	182
Sigma Instruments Inc. The Marschalk Company Inc.	50, 51
■ Sorensen Inc. Fuller & Smith & Ross Inc.	11
Spectrol Electronics Corporation Jones, Maher, Roberts Adv.	139
Sprague Electric Company The Harry P. Bridge Company	5, 7
Stromberg Carlson Corporation The Rumrill Company Inc.	184
Sylvania Electric Products Inc. Tatham, Laird & Kudner Inc.	150

■ Syntronic Instruments, Inc. Burton Browne Advertising	145
TRW Systems Fuller, & Smith & Ross Inc.	200
Tektronix Inc. Hugh Dwight Adv. Inc.	148
■ Telonic Engineering Company Jansen Associates	212
■ Telonic Industries Inc. Jansen Associates	127
Texas Instruments Incorporated Industrial Products Group Robinson-Gerrard Inc.	121
Texas Instruments Incorporated Semiconductor Components Division Don L. Baxter Inc.	60, 61
Thermal American Fused Quartz Company Kniep Associates	201
Transformer/Electronics	211
Trompeter Electronics Writing and Advertising Inc.	164
■ Trylon Inc. George Moll Adv. Inc.	168
■ Tung Sol Electric Inc. E.M. Freystadt Associates Inc.	187
Ultra Carbon Corporation Church & Guisewite Advertising Inc.	174
United Mineral & Chemical Corp. Advertising & Merchandising Inc.	138
United Systems Inc. Electronic Marketing Assistance	203
■ Unirode Corporation	41
Watkins-Johnson Company William C. Estler Public Relations	162
West Penn Power Company Fuller & Smith & Ross Inc.	186
Weston Instruments Incorporated Basford Inc.	128, 218
■ Zeltex Inc. Sturges and Associates	158

Classified advertising

F.J. Eberle, Business Mgr.	
EMPLOYMENT OPPORTUNITIES	205-209
EQUIPMENT (Used or Surplus New) For Sale	209
Classified advertisers index	
A & A Electronics Corp.	210
A.B. Industries	210
Atomic Personnel Inc.	209
Bausch & Lomb Inc.	209
Chemotron Corp. Votator Div.	209
Engineering Associates	210
Fishman Co., Philip	210
Norman Electronic Sales	210
Pan Am Guided Missiles Range Div.	208
Radio Research Instrument Co.	210
Rixon Electronics Inc.	210
Sanders Associates, Inc.	207
Scientific Equipment Exchange	210
Stewart-Warner Corp.	209
Sylvania Semiconductor Div.	209
Xerox Corp.	205

■ For more information on complete product line see advertisement in the latest Electronics Buyers' Guide



Advertising sales staff

Gordon Jones [212] 971-2210

Advertising sales manager

Atlanta, Ga. 30309: Gus H. Krimsier, Michael H. Miller, 1375 Peachtree St. N.E., [404] TR 5-0523

Boston, Mass. 02116: William S. Hodgkinson McGraw-Hill Building, Copley Square, [617] CO 2-1160

Chicago, Ill. 60611: Robert M. Denmead, J. Bradley MacKimm 645 North Michigan Avenue, [312] MO 4-5800

Cleveland, Ohio 44113: Paul T. Fegley, 55 Public Square, [216] SU 1-7000

Dallas, Texas 75201: Richard P. Poole, The Vaughn Building, 1712 Commerce Street, [214] RI 7-9721

Denver, Colo. 80202: Joseph C. Page, David M. Watson, Tower Bldg., 1700 Broadway, [303] AL 5-2981

Detroit, Michigan 48226: Paul T. Fegley 856 Penobscot Building [313] 962-1793

Houston, Texas 77025: Kenneth George, 2270 Humble Bldg., [713] CA 4-8381

Los Angeles, Calif. 90017: Ashley P. Hartman, John G. Zisch, 1125 W. 6th St., [213] HU 2-5450

Minneapolis, Minn. 55402: J. Bradley MacKimm 1st National Bank Building 120 South Sixth Street [612] FE2-7425

New York, N. Y. 10036: Donald R. Furth [212] 971-3615 Frank LeBeau [212] 571-3615 George F. Werner [212] 971-3615 500 Fifth Avenue

Philadelphia, Pa. 19103: William J. Boyle, Warren H. Gardner, 6 Penn Center Plaza, [215] LO 8-6161

Pittsburgh, Pa. 15222: Paul T. Fegley, 4 Gateway Center, (412) 391-1314

Portland, Ore. 97204: James T. Hauptli, Pacific Building, Yamhill Street, (503) CA3-5118

St. Louis, Mo. 63105: Robert M. Denmead The Clayton Tower, 7751 Carondelet Ave. [314] PA5-7285

San Francisco, Calif. 94111: James T. Hauptli, 255 California Street, [415] DO 2-4600

London W1: John W. Patten, Edwin S. Murphy Jr., 34 Dover Street, Hyde Park 1451

Milan: 1, via Baracchini Phone: 86-90-617

Frankfurt/Main: Gerd Hinske, 85 Westendstrasse Phone: 77 26 65 and 77 30 59

Geneva: Michael R. Zeynel, Joseph Wuensch, 2 Place du Port 244275

Paris VIII: Denis Jacob, 17 Avenue Matignon ALMA-0452

Tokyo: Nobuyuki Sato Shiba, Minato-Ku (502) 0656

Osaka: Kazutaka, Miura, 163, Umegee-cho, Kilita-ku [362] 8771

Nagoya: International Media Representatives, Yamagishi Bldg., 13, 2-Chome, Oike-cho Naka-ku

Hugh J. Quinn: [212] 971-2335 Manager Electronics Buyers' Guide

David M. Tempest: [212] 971-3139 Promotion manager

Milton Drake: [212] 971-3485 Market research manager

Wallace C. Carmichael [212] 971-3191 Business manager

Theodore R. Geipel: [212] 971-2044 Production manager

Another Brush Innovation in Recording:

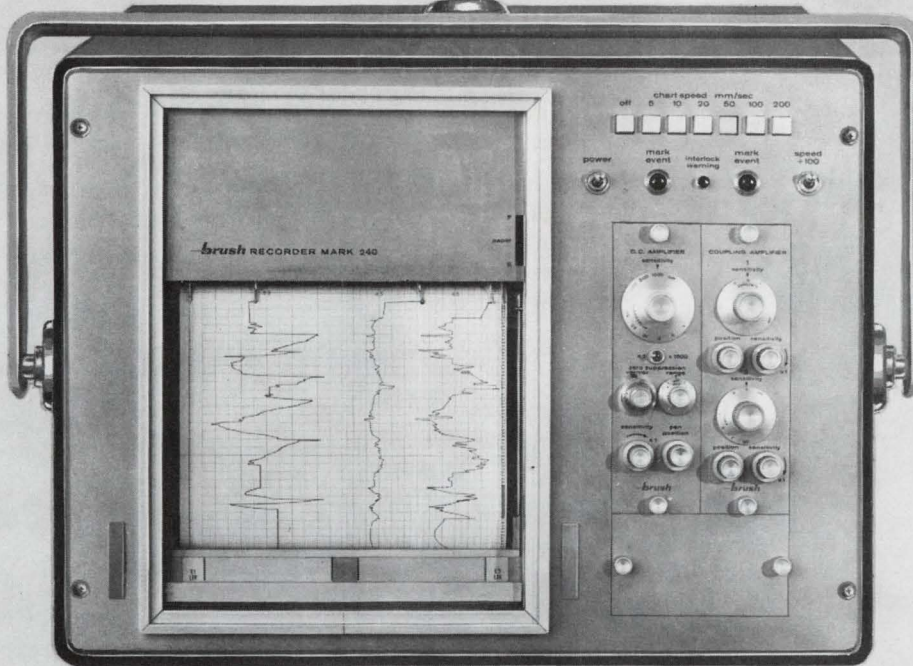

The Brush Mark 240

**If you can't record it
with this recorder,
chances are
it didn't happen!**



What we've done is this:

We took our famous Mark 200 Recorder and made a 'compact' version for general purpose and medical requirements. Performance? The new 240 will do everything the Mark 200 will do. And as Aerospace people will tell you, that's plenty: System linearity better than ½%. Pressurized fluid writing system assures incredibly crisp traces on low cost chart paper. Presentation is true rectilinear and there's push-button choice of 12 chart speeds.

Cost? The Mark 240 runs about

half as much as a Mark 200. Still, you have a choice of either four 40 mm analog channels, two 80 mm channels, or a combination* of two 40s and one 80. (You can also have 8-channel event-marker modules). There's a choice of 17 plug-in pre-amplifiers, too. High gain d-c units, straight-through couplers and strain-gage and demodulator types. The Mark 240 is just 17½" high x 19" wide x 20½" deep. Mount it vertically or horizontally in standard 19" racks to RETMA specs, on table-top carts or you name it!

If your kind of recording calls for the utmost in resolution, precision and recording flexibility, ask your Brush representative for complete details about the new Brush Mark 240. There's nothing else like it . . . anywhere! Brush Instruments Division, Clevite Corporation, 37th & Perkins, Cleveland, Ohio 44114. *Just out! Three information-packed booklets on strain recording, temperature recording and techniques of low-level recording. Write us today for your copies. They're yours for the asking!*

*see photo

CLEVITE
—brush INSTRUMENTS DIVISION

POWER-RATED SCR's AT ECONOMY PRICES

2N3873
600V Press Fit—\$7.24*

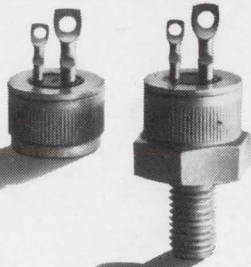

2N3899
600V Stud—\$7.40*

RCA 35-amp types, rated for 120V and 240V line operation, provide a new, more economical way to control 8 kw.

New RCA 35-amp power-rated Silicon Controlled Rectifiers make solid-state control an affordable selling feature for products such as space heaters, dc motor drives, regulated power supplies and battery chargers. And, RCA's new SCR's make circuitry more economical and more reliable, too. Check these features:

- 35 amps I_{FRMS} at 65°C case temperature.
- 350 amps single-cycle surge capability.
- 200 amps/ μ sec di/dt rating in a 35-amp I_{FRMS} device, means low turn-on dissipation that formerly required substantial derating. You don't have to over-design. Result: New Economy.
- 120V and 240V line operation ratings, with plenty of voltage cushion for transients, suits these devices to home appliances and standard industrial controls.
- New gate characterization—made possible by RCA concentric-gate geometry and

shorted-emitter technique—opens new design doors to mass-produced economy SCR circuits.

Evaluate new RCA power-rated SCR's for your projects. Call your nearest RCA Sales Office. For technical data on these new types and a copy of RCA Application Notes: SMA 39 (Gate Characteristic Profile) and SMA 38 (SCR Motor Speed Control), write: RCA Electronic Components and Devices, Commercial Engineering, Section I-N-10-1, Harrison, New Jersey.

RCA Power-Rated Types available
in both Press Fit and Stud Packages.

Type	Line Operation	V_{B00} and V_{RM} (rep)
2N3870		100V
2N3871	120V	200V
2N3872	240V	400V
2N3873		600V
2N3896		100V
2N3897	120V	200V
2N3898	240V	400V
2N3899		600V

AVAILABLE
THROUGH YOUR
RCA DISTRIBUTOR



The Most Trusted Name in Electronics

Circle 902 on reader service card

*Price in quantities of 100-999