

Electronics®

IC models for circuit and system design: page 56

Image sensing with solid state arrays: page 75

Apollo antenna tracks ground stations: page 80

May 1, 1967

\$1.00

A McGraw-Hill Publication

Below: Loom weaves program of read-only memory, page 88

#9
MAY 1-1967

LIBRARY
STATE TECHNICAL INSTITUTE
AT MEMPHIS

wls 2/9/72





NEW DO-T200™ SERIES

ULTRAMINIATURE TRANSISTOR TYPE AUDIO TRANSFORMERS

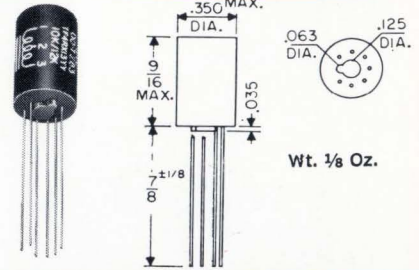

U. S. PAT. NO. 2,949,591; others pending.

This DO-T200 series of transistor transformers and inductors has been newly added to the UTC lines of stock items available for immediate delivery. These transformers provide the unprecedented power handling capabilities and the inherent reliability found only in the basic structural design of the UTC DO-T Family of miniature transformers. This reliability has been dramatically proven in the field.

Leads are 7/8" long, .016 Dumet wire, gold plated, and may be either welded or soldered. They are uninsulated and are spaced on a .1" radius circle, conforming to the termination pattern of the "TO-5" cased semiconductors and micrologic elements.

DO-T200 series of transformers are designed for Class R application. On special order they may be designed to Class S Specifications. No additional life expectancy is gained by using Class S insulation systems at Class R temperatures.

In pulse coupling impedance matching applications, (when measured with a 30 microsecond input pulse voltage wave), typical values for these transformers are: 5% or less droop, zero overshoot, and less than 10% backswing.

Special unit modifications, such as additions and deletions of leads, changed lead lengths, different impedance ratios and incorporation of electrostatic shields, etc., are available in these constructions.

• Manufactured and successfully tested to complete environmental requirements of MIL-T-27B

- Most Ruggedized MIL Structure, Grade 4, Metal Encased
- Immediate Delivery From Stock
- Full Conformance to MIL Mounting Requirements
- Solderable and Weldable Leads
- Hermetically Sealed
- Straight Pin Terminals
- Excellent Response
- High Efficiency
- Low Distortion

Type No.	MIL Type	Pri. Imp.	D. C. ma ^t in Pri.	Sec. Imp.	Pri. Res.	Mw Level	Application
DO-T255	TF4RX13YY	1K/1.2K CT	3	50/60	115	100	Output or matching
DO-T275	TF4RX13YY	10K/12K CT	1	1.5K/1.8K CT	780	100	Interstage
DO-T277	TF4RX13YY	10K/12K CT	1	2K/2.4K split	560	100	Interstage
DO-T278	TF4RX13YY	10K/12.5K	1	2K/2.5K CT	780	100	Driver
DO-T283	TF4RX13YY	10K/12K CT	1	10K/12K CT	975	100	Isol. or Interstage or Pulse
DO-T288	TF4RX13YY	20K/30K CT	.5	.8K/1.2K CT	830	50	Interstage
DO-T297	TF4RX16YY	200,000 CT	0	1000 CT	8500	25	Input and Chopper
DO-T200SH	Drawn Hipermalloy shield provides 15 to 20 db shielding through side of case						

^tDCma shown is for single ended usage. For push pull, DCma can be any balanced value taken by .5W transistors. Where windings are listed as split, 1/4 of the listed impedance is available by paralleling the winding.

THE DO-T FAMILY OF COMPONENTS



All these hermetically sealed, ultraminiature transistor transformers & inductors are to MIL-T-27B, Grade 4, Class R, Life X. Except PIP: to MIL-T-21038B, Grade 6, Class R, Life X.

DO-T Flexible leads. Freq range 300 CPS—10KC & up. Power up to 1/2 W. Size 5/16 dia x 1 1/2" h. Wt approx 1/10 oz.

DI-T Flexible leads. Freq range 400 CPS—10KC & up. Power up to 1/2 W. Size 5/16 dia x 1 1/4" h. Wt approx 1/15 oz.

DO-T200 Series. See above

DI-T200 Series Straight pin gold plated. Dumet leads. Freq range 400 CPS—100KC. Power up to 500 mw. Size 5/16 d x 3/8" h. Wt approx 1/15 oz.

PIL Inductors range from .025 hy to .8 hy, DC 0 to 10 ma. Transformers from 500 ohms to 10,000 ohms impedance. Freq range 800 cps—250 KC; power up to 100 MW. Size 5/16 dia x 3/16" h. Wt 1/20 oz.

PIP (Pulse) Flexible leads. Wide application pulse transformers, to MIL-T-21038B specifications. Size 5/16 dia x 3/16" h. Wt 1/20 oz.

DO-T400 (Power) Flexible leads, power transformer. Power output 400 mw @ 400 cycles. Size 5/16 dia x 1 1/2" h. Wt 1/10 oz.

AND SPECIAL, CUSTOM BUILT COMPONENTS TO YOUR SPECIFICATIONS

Write for catalog of over 1,300 UTC TOP QUALITY STOCK ITEMS IMMEDIATELY AVAILABLE from your local distributor.

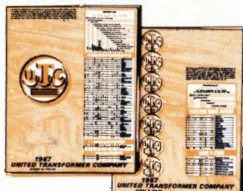

UNITED TRANSFORMER CO.
DIVISION OF TRW INC. • 150 VARICK STREET, NEW YORK, N. Y. 10013

UNIVERSITY of TENN. LIBRARY MEMPHIS MED. UNITS

MAY 1 - 1967

Rugged, Reliable and Versatile!

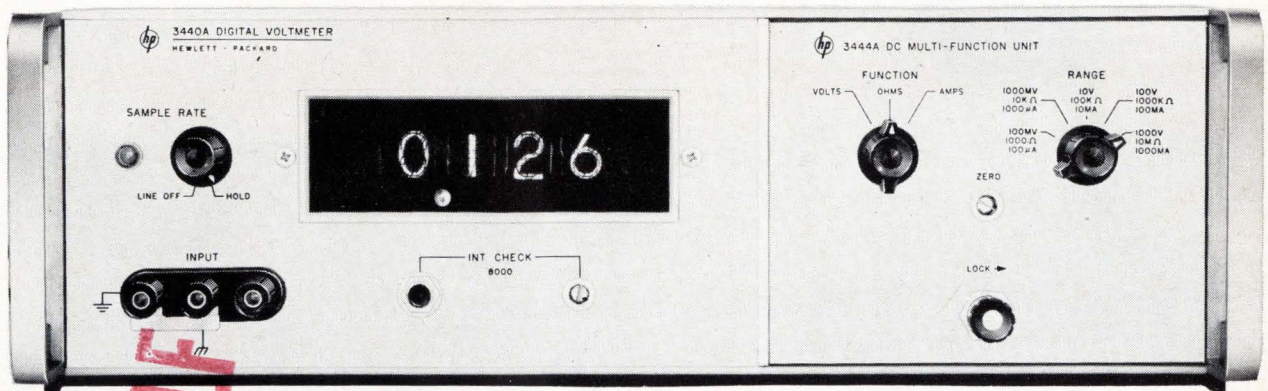

USE THIS hp DVM ANYWHERE!



LABORATORY

PRODUCTION

SYSTEMS

The hp Models 3439A and 3440A Digital Voltmeters are compact, accurate, rapid, multiple function instruments—built rugged, reliable and versatile! With the appropriate plug-in, you get automatic ranging, remote or manual operation with an accuracy of 0.05% of reading on a four-digit readout; 50 Hz to 50 kHz bandwidth with 10 μ V; 10 nA sensitivity!

Rugged!—Models 3439A and 3440A are built with solid-state circuitry and reed relays to provide a rugged instrument. Use of solid-state components also gives a lighter weight for easy portability. These units are test operated at temperatures from 0°C to 50°C with relative humidities of 0 to 95%, vibration tested at 10 to 55 Hz at 0.010" peak-to-peak excursion, and drop-tested four times from four inches. Construction and testing assure you of a rugged instrument—*ideal for bench or systems applications.*

Reliable!—With either the 3439A or 3440A, you get an internal calibration source with a TC better than 0.002%/°C and a stability typically better than $\pm 0.005\%$ over a three month period. You can verify accuracy of these models simply by pressing a front panel button. You get digital readout on large rectangular display tubes which hold the previous reading until the input voltage is changed. Long-term reliability is assured with solid state components—but, if something should happen, the easy-to-service plug-in circuit cards mounted in the modular enclosure can be quickly replaced to minimize down-time.

Versatile!—You get a dc accuracy of better than $\pm 0.05\%$ of reading ± 1 digit. Specified accuracy is retained to 5% beyond full scale. The ac filter has a rejection of 30 dB at 60 Hz. Response time to a step change is 450 msec to read 99.95% of final value. The 10 M Ω impedance presents a constant load on all voltage ranges.

Add the capability of six plug-ins to these features and you have a truly versatile instrument! *But—that's not all!* You can make true RMS measurements using the dc output of the hp Model 3400A RMS Voltmeter and either the 3439A or 3440A. The 3440A has a BCD recorder output to operate with the hp

Model 562A Digital Recorder to produce a printed, six-column readout.

Plug-in*	3441A	3442A	3443A	3444A	3445A	3446A
AC volts 10V to 1000V	**	**	**	**	X	X
DC volts 10V to 1000V	X	X	X	X	X	X
DC volts 100mV to 1000V			X	X		
DC amps				X		
Ohms				X		
Manual ranging	X	X	X	X	X	X
Auto-ranging		X	X		X	
Remote ranging		X	X		X	X
Remote function						X
Floating input	X	X	X	X	X	X

*3439A and 3440A require a plug-in to operate
 **Average response measurements: 100 μ V to 300 volts, 50 Hz to 500 kHz—hp-457A or 1 mV to 300 volts, 10 kHz to 10 MHz with -hp-400E/EL. True RMS measurements: 1 mV to 300 volts, 10 Hz to 10 MHz use -hp-3400A.

Get the full story on the rugged, reliable, versatile hp Model 3439A or 3440A Digital Voltmeter from your nearest hp field engineer. Or, write to Hewlett-Packard, Palo Alto, California, 94304, Tel. (415) 326-7000; Europe: 54 Route des Acacias, Geneva. Price: hp Model 3439A, \$950.00; hp Model 3440A, \$1160.00, plus plug-ins (\$40.00 to \$575.00).

097/9





new disciplines in DC



take the NEWEST CONCEPT in Bench DC Power Supplies

Advanced fabrication techniques result in higher quality at lower cost

Two Compact Models Available

0-25V @ 0-400 MA ... 0-50V @ 0-200 MA • 0.01% Regulation

Two extremely compact, well-regulated DC power supplies designed especially for bench use have just been added to the hp power supply line. New fabrication techniques have been employed for these supplies to minimize manufacturing costs while retaining component and circuit quality. Reliable, yet low cost, these "hand-size" battery substitutes have over-all performance features ideal for circuit development, component evaluation, and other laboratory applications.

The all-silicon circuit uses an input differential amplifier to compare the output voltage with a reference voltage derived from a temperature-compensated zener diode. These stable input and reference circuits are combined with a high gain feedback amplifier to achieve low noise, drift-free performance. Output voltage is fully adjustable down to zero. Special design precautions prevent output overshoot during turn-on or turn-off, or when AC power is suddenly removed.

The front panel meter can be switched to monitor output voltage or current. Constant Voltage/Current Limiting insures short-circuit-proof operation, and permits series and parallel connection of two or more supplies when greater voltage or current is desired.

The molded, impact-resistant case includes an interlocking feature for stacking several units vertically, thus minimizing bench space required for multiple supplies. Alternatively, up to three units can be mounted side by side on a standard 3 1/2" H x 19" W rack panel.

DC Output:	Model 6215A, 0-25V at 0-400 MA Model 6217A, 0-50V at 0-200 MA
------------	--

Either positive or negative output terminal may be grounded, or the supply may be operated "floating" up to 300V off ground.

AC Input:	105-125 VAC*, 50-400 Hz
-----------	-------------------------

Load Regulation:	0.01% + 1 MV
------------------	--------------

Line Regulation:	0.01% + 4 MV
------------------	--------------

Ripple & Noise:	<200 μ V RMS
-----------------	------------------

Temperature Coefficient:	<0.02% + 1 MV/°C
--------------------------	------------------

Stability for Eight Hours	
---------------------------	--

After 30 Minutes Warm-up:	<0.1% + 5 MV
---------------------------	--------------

Transient Recovery Time:	<50 μ s for output recovery to within 10 MV following a full load change
--------------------------	--

Output Impedance:	<0.03 ohms from DC to 1 KHz <.5 ohms from 1 KHz to 100 KHz <3 ohms from 100 KHz to 1 MHz
-------------------	--

Maximum Ambient Operating Temperature:	+ 55°C
--	--------

Size:	3 1/4" (8.26 cm) H x 5 1/4" (13.34 cm) W x 7" (17.78 cm) D
-------	--

Weight:	5 1/4 lbs (2,38 kilograms)
---------	----------------------------

Price—Model 6215A:	\$90.00
Model 6217A:	\$90.00

*210-250 VAC input also available

Contact your nearest Hewlett-Packard Sales Office for full specifications

**HEWLETT
PACKARD**  **HARRISON
DIVISION**

100 Locust Ave., Berkeley Heights, New Jersey 07922 TELEPHONE 201-464-1234 TWX 710-984-7972

21702

Circle 2 on reader service card

News Features

Probing the News

- 105 **Lawmen's bounties lure electronics firms**
- 113 **Down to the sea in simulators**
- 117 **Intelligent robots: slow learners**

Electronics Review

- 33 **Integrated circuits:** Inside look
- 34 **Components:** You name it
- 35 **Packaging:** In the cards
- 35 **Companies:** Executive suite; On balance
- 38 **Medical electronics:** Light touch
- 38 **Communications:** Oops!
- 40 **For the record**

Electronics Abroad

- 163 **Canada:** Pole watchers
- 163 **France:** Beefing up Bull
- 164 **Great Britain:** Selling in the Red
- 164 **Australia:** Posthaste
- 165 **Brazil:** Memories of Sao Paulo
- 165 **Japan:** Tracing trains; Gunn power
- 167 **Around the world**

Departments

- 4 Reader Comment
- 8 People
- 14 Meetings
- 16 Meeting Preview
- 23 Editorial
- 25 Electronics Newsletter
- 47 Washington Newsletter
- 125 New Products
- 126 New Products Index
- 150 New Books
- 154 Technical Abstracts
- 156 New Literature
- 161 Newsletter from Abroad

Title R registered U.S. Patent Office; © copyright 1967 by McGraw-Hill Inc. All rights reserved, including the right to reproduce the contents of this publication, in whole or in part.

Technical Articles

I. Design

- Design theory** 56 **Computer-aided design: part 9
A model approach to IC's**
Give a computer a mathematical model that accurately represents the IC's elements and the computer will evaluate the design and its system application
Gerald J. Herskowitz, Stevens Institute of Technology
- Instrumentation** 62 **Digital pulse-taking**
Automatic all-digital analyzer simultaneously measures pulse rise time, decay time, and duration, and can control closed-loop systems
Chester C. Carroll, Auburn University
- Circuit design** 69 **Designer's casebook**
 - Intersecting waveforms trigger peak detector
 - Differentiating pulse-former requires no capacitor
 - Signal is sampled and held for one minute
 - Diode isolator combines relay and lamp driver

II. Application

- Advanced technology** 75 **Charge storage lights the way for solid state image sensors**
Storage-mode operation makes photodetector more sensitive and sidesteps the need for device isolation in integrated circuits
Gene P. Weckler, Fairchild Semiconductor
- Space electronics** 80 **Apollo antenna fastens on the beam to the moon**
Antenna array on the Apollo spacecraft will automatically track signals from earth stations, while gain is stepped up as the distance from the earth increases
Arthur P. Notthoff, Dalmo Victor

III. Manufacturing

- Production** 88 **Vintage machine produces memories**
Low cost of assembling read-only memory braids with a Jacquard loom widens the field of possible applications for transformer-type storage systems
Ramon L. Alonso, Massachusetts Institute of Technology

Electronics

Editor-in-Chief: Lewis H. Young

Associate managing editors

Design: Samuel Weber

Application: George Sideris

News: Robert Henkel

Copy: Sally Powell

Senior editor

Special projects: Donald Christiansen

Senior associate editors

John F. Mason, Joseph Mittleman, Stephen E. Scrupski

Department editors

Advanced technology: Stephen E. Scrupski

Avionics: W.J. Evanzia

Communications: Leonard Weller

Computers: Wallace B. Riley

Design theory: Joseph Mittleman

Industrial electronics: Alfred Rosenblatt

Instrumentation: Carl Moskowitz

Military electronics: John F. Mason

New products: William P. O'Brien

Staff writer: Paul Dickson

Section editors

Electronics abroad: Arthur Erikson

Electronics review: Stanley Zarowin

Probing the news: Eric Aiken

Regional bureaus

Domestic

Boston: H. Thomas Maguire, manager; Robin Carlson

Los Angeles: Lawrence Curran, manager; June Ranill

San Francisco: Walter Barney, manager; Mary Jo Jadin

Washington: William D. Hickman, Patricia C. Hoehling, correspondents

Foreign

Bonn: John Gosch

London: Michael Payne

Tokyo: Charles Cohen

Copy editors

Albert Tannenbaum, James Chang, Frederick Corey

Graphic design

Art director: Saul Sussman

Assistant art directors: Ann Mella, Valerie Betz

Production editor: Arthur C. Miller

Editorial secretaries: Marlene Angrist, Claire Benell, Lynn Emery, Lorraine Fabry,

Kay Fontana, Patricia Gardner, Lorraine Longo

McGraw-Hill News Service

Director: John Wilhelm; Atlanta: Fran Ridgway; Chicago: James Rubenstein;

Cleveland: Arthur Zimmerman; Dallas: Marvin Reid;

Detroit: N. Hunter; Houston: Robert E. Lee; Los Angeles: Michael Murphy, Gerald Parkinson

Pittsburgh: Louis Gomolak

San Francisco: Margaret Drossel

Seattle: Ray Bloomberg; Washington: Arthur L. Moore, Charles Gardner,

Herbert W. Cheshire, Seth Payne, Warren Burkett

McGraw-Hill World News Service

Bonn: John Johnsrud; London: John Shinn;

Mexico City: Bruce Cross; Milan: Ronald Taggiasco;

Moscow: Howard Rausch; Paris: Peter Kilborn;

Rio de Janeiro: Wes Perry; Tokyo: Marvin Petal

Reprints: Susan Nugent

Publisher: Gordon Jones

Electronics: May 1, 1967, Vol. 40, No. 9

Published every other Monday by McGraw-Hill, Inc. Founder: James H. McGraw 1860-1958.

Printed at 99 North Broadway, Albany, N.Y. 12207; second class postage paid at Albany, N.Y.

Executive, editorial, circulation and advertising addresses: McGraw-Hill Building, 330 W. 42nd Street; New York, N.Y. 10036. Telephone (212) 971-3333. Teletype TWX N.Y. 212-640-4646. Cable address: MCGRAWHILL N.Y.

Subscriptions are solicited only from those actively engaged in the field of the publication. Position and company connection must be indicated on orders. Subscription prices: United States and possessions and Canada, \$8.00 one year, \$12.00 two years, \$16.00 three years; all other countries, \$25.00 one year. Single copies: United States and possessions and Canada, \$1.00; all other countries, \$1.75.

Officers of McGraw-Hill Publications: Joseph H. Allen, President; Bayard E. Sawyer, Executive Vice President; Vice Presidents: J. Elton Tuohig, Operations; John R. Callahan, Editorial; John M. Holden, Marketing; Huber M. Gemmill, Circulation; Angelo R. Venezzian, Production; Robert M. Wilhelm, Controller.

Officers of the Corporation: Donald C. McGraw, Chairman of the Board; Shelton Fisher, President; L. Keith Goodrich, Donald C. McGraw, Jr. and Robert E. Slaughter, Executive Vice Presidents; John J. Cooke, Vice President and Secretary; John L. McGraw, Treasurer.

Title registered in U.S. Patent Office; © Copyright 1967 by McGraw-Hill, Inc. All rights reserved. The contents of this publication may not be reproduced either in whole or in part without the consent of copyright owner.

Subscribers: The publisher, upon written request to our New York office from any subscriber, agrees to refund that part of the subscription price applying to copies not yet mailed. Please send change of address notices or complaints to Fulfillment Manager; subscription orders to Circulation Manager, Electronics at address below. Change of address notices should provide old as well as new address, including postal zip code number. If possible, attach address label from recent issue. Allow one month for change to become effective.

Postmaster: Please send form 3579 to Fulfillment Manager, Electronics, P.O. Box 430, Hightstown, New Jersey 08520

Readers Comment

Positive thinking

To the Editor:

For someone as intimately connected with the business as you are, it's astonishing that you missed the real source of the problem in "Credibility gap in hiring" [March 6, p. 23]. Directly or indirectly, the Government is the largest customer for most of the electronics industry. Government contracts are responsible for more engineering jobs than any other source.

In mentioning Hewlett-Packard Inc., you chose the exception rather than the rule in the over-all industry. This company has wisely developed its own proprietary product line and sells to the Government [and government contractors] much as if it were any other customer. Where Government work is concerned, Hewlett-Packard occupies the marketing base of a huge pyramid.

For all their attempts at diversification to provide corporate (including job) stability, the large aerospace, airframe, and electronic manufacturers and most small primes are married to Government's needs and procurement system. The award of a huge contract will create many new jobs. The end or termination of a large contract will usually cost jobs unless there are many more contracts in the company's hopper; the excess people are not readily absorbed in practice. For the one company of many who may have submitted a proposal on a major program, the award decision is the signal for intensive recruiting—especially because the schedule for the program is invariably tight and requires the substitution of massive manpower for more leisurely consideration of the engineering problems involved. If the losers in the competition had retained engineering personnel from previous contracts in anticipation of an award on a major program, layoffs are the order of the day.

This is, of course, a greatly simplified statement of the problem leading toward the credibility gap on which you editorialized. You certainly cannot expect a recruiter

Did You Know Sprague Makes 51 Types of Foil and Wet Tantalum Capacitors?

FOIL-TYPE RECTANGULAR TANTALEX® CAPACITORS



Type 300D polarized plain-foil
Type 301D non-polarized plain-foil
Type 302D polarized etched-foil
Type 303D non-polarized etched-foil

ASK FOR BULLETIN 3650

Circle 492 on reader service card

FOIL-TYPE TANTALUM CAPACITORS TO MIL-C-3965C

CL20, CL21 tubular 125 C polarized etched-foil
CL22, CL23 tubular 125 C non-polar etched-foil
CL24, CL25 tubular 85 C polarized etched-foil
CL26, CL27 tubular 85 C non-polar etched-foil
CL30, CL31 tubular 125 C polarized plain-foil
CL32, CL33 tubular 125 C non-polar plain-foil
CL34, CL35 tubular 85 C polarized plain-foil
CL36, CL37 tubular 85 C non-polar plain-foil
CL51 rectangular 85 C polarized plain-foil
CL52 rectangular 85 C non-polar plain-foil
CL53 rectangular 85 C polarized etched-foil
CL54 rectangular 85 C non-polar etched-foil

Circle 493 on reader service card

125 C FOIL-TYPE TUBULAR TANTALEX® CAPACITORS



Type 120D polarized plain-foil
Type 121D non-polarized plain-foil
Type 122D polarized etched-foil
Type 123D non-polarized etched-foil

ASK FOR BULLETIN 3602C

Circle 491 on reader service card

85 C FOIL-TYPE TUBULAR TANTALEX® CAPACITORS



Type 110D polarized plain-foil
Type 111D non-polarized plain-foil
Type 112D polarized etched-foil
Type 113D non-polarized etched-foil

ASK FOR BULLETIN 3601C

Circle 494 on reader service card

SINTERED-ANODE TUBULAR TANTALEX® CAPACITORS



Type 109D elastomer seal 85 C
Type 130D elastomer seal 125 C
Type 137D hermetic seal 125 C

ASK FOR BULLETINS 3700F, 3701B, 3703

Circle 495 on reader service card

SINTERED-ANODE CUP STYLE TANTALEX® CAPACITORS



Type 131D 85 C industrial-type
Type 132D 85 C vibration-proof
Type 133D 125 C vibration-proof

ASK FOR BULLETINS 3710B, 3711

Circle 496 on reader service card

SINTERED-ANODE CYLINDRICAL TANTALEX® CAPACITORS



Type 140D
up to 175 C operation,
3/8" diam.
Type 141D
up to 175 C operation,
1 1/8" diam.

ASK FOR BULLETIN 3800

Circle 497 on reader service card

SINTERED-ANODE RECTANGULAR TANTALEX® CAPACITORS



Type 200D negative terminal grounded
Type 202D both terminals insulated

ASK FOR BULLETIN 3705A

Circle 498 on reader service card

SINTERED-ANODE TANTALUM CAPACITORS TO MIL-C-3965C

CL14 cylindrical, 7/8" diam.
CL16 cylindrical, 7/8" diam., threaded neck
CL17 cylindrical, 1 1/8" diam.
CL18 cylindrical, 1 1/8" diam., threaded neck
CL44 cup style, uninsulated
CL45 cup style, insulated
CL55 rectangular, both terminals insulated
CL64 tubular, uninsulated
CL65 tubular, insulated

Circle 499 on reader service card

For comprehensive engineering bulletins on the capacitor types in which you are interested, write to:
Technical Literature Service
Sprague Electric Company
35 Marshall Street
North Adams, Mass. 01248

45C-5158 R1

SPRAGUE®
THE MARK OF RELIABILITY

Sprague and "S" are registered trademarks of the Sprague Electric Co.

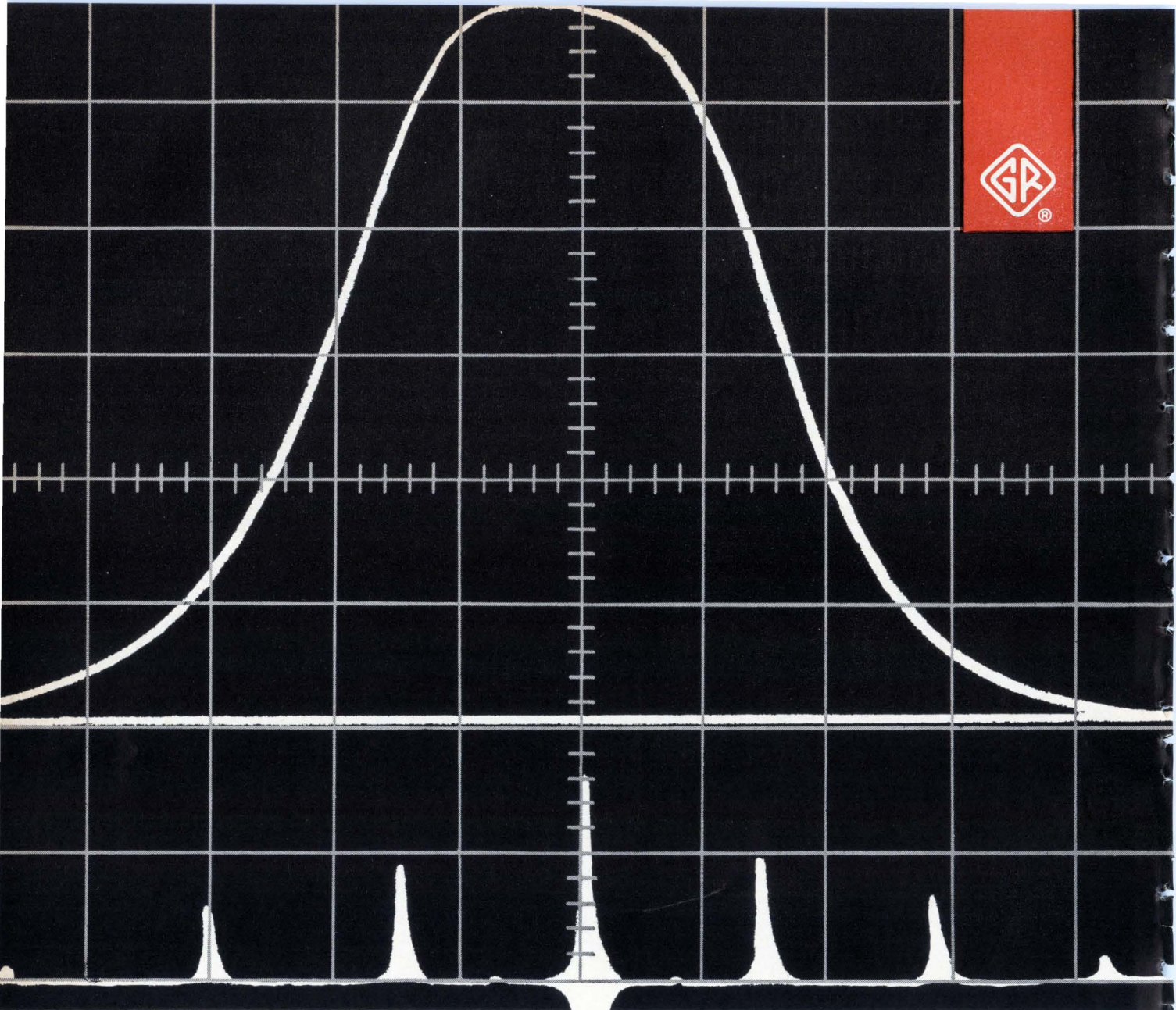

Synthesizer Sweeper

An important new dimension has been added to the versatile GR frequency synthesizers: sweepability. The new 1160-P2 Sweep and Marker Generator lets you sweep the synthesizer output frequency at a controlled, known rate and through an accurately known range. It also generates scope markers for quick calibration of the swept output. You can choose any of nine automatic sweep speeds, from 0.02 to 60 seconds, and can adjust sweep excursion from $\pm .001$ Hz to ± 1 MHz. The synthesized center-frequency marker and the side markers are accurate, stable, and precisely settable. Sweep coverage can be expanded about any center frequency without changing the display width or affecting the selected center frequency.

The extremely wide range of sweep widths, sweep rates, and marker spacing makes

this instrument useful in both narrow-band and wide-band sweeping requirements. Coupled with the GR synthesizers, the 1160-P2 affords versatility and convenience in sweeping. Synthesizer prices range from \$3640 to \$7515; the new Sweep and Marker Generator is only \$495. (Prices apply in USA only.)

For complete information, write General Radio Company, 22 Baker Avenue, West Concord, Massachusetts 01781; telephone (617) 369-4400; TWX: 710 347-1051.

GENERAL RADIO

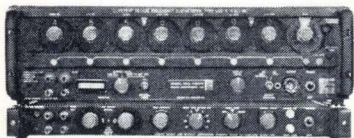

Type 1160-P2 Sweep and Marker Generator used with a Type 1162-A Synthesizer.

Circle 6 on reader service card

to be negative about his company's prospects; on the contrary, the recruiter is a salesman and as such must be enthusiastic about his company.

As long as this industry is Government-oriented, the engineer who expects continuity in employment will have to be damned good, a hard worker, and part of an industrial segment well toward the base of that Government procurement pyramid. Alternatively, he should align himself with a segment of industry which does not deal with Government at all and which has an active present and a clear future in civilian markets.

Credibility gap? Probably not, at least not an intentional one. Management problems? By all means—but it's a function of the environment in which most of us do business today.

Will Connelly

Marketing manager
Marine Acoustical Services
Miami, Fla.

Computer car call

To the Editor:

Frequently, an emergency makes it necessary for friends or relatives to contact an automobile traveler. Due to this need, it appears that a nationwide automatic location and identification system should be investigated.

In such an emergency, the local police would be given the name of the individual to be contacted. They would provide the following information to a "car call" computer by means of teletypewriter: vehicle license number, individual's name, and location of the police department providing the information. The computer would retain

this information until the desired automobile was located.

Several thousand sensors would be connected to the computer system over existing telephone lines. At least one sensor would be located in every town on the curb of a main road. The sensors would instantaneously transmit the identification of every passing auto to the central computer, which would compare the identification to those in its memory.

Automobile plates would be used for the life of the car. In addition to the usual rear plates, two other plates on the front fenders would be coded in areas of high- and low-light reflectivity. The coding could be the binary coded decimal system, which computers understand (one railroad car identification system uses reflective tape).

About a block beyond each sensor would be a special display. If a wanted automobile were located, the display would flash a red light and show the state and license number in illuminated lamps.

A driver who saw his own number would then drive to the nearest police station. Here the central computer would be contacted to find out which city police department was seeking the driver. The traveler could then telephone that police department.

This system could also help in the apprehension of criminals. A police department could request a "private" identification. If a sensor identified the automobile, the roadside display would not be activated. The police would be advised of the location and license number of the vehicle, and the time.

Channing B. Brown Jr.
Oak Ridge National Laboratory,
Oak Ridge, Tenn.

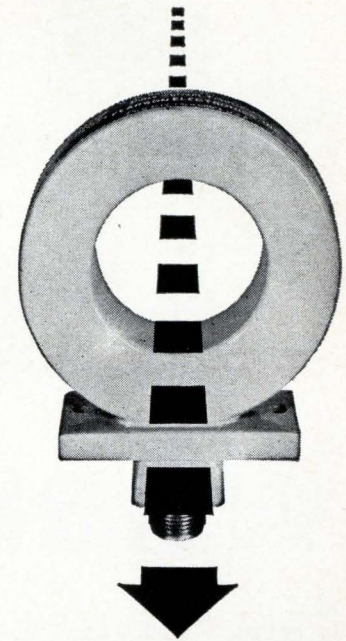

Wide Band, Precision CURRENT MONITOR

With a Pearson current monitor and an oscilloscope, you can measure pulse or ac currents from milliamperes to kiloamperes, in any conductor or beam of charged particles, at any voltage level up to a million volts, at frequencies up to 35 Mc/s or down to 1 c/s.

The monitor is physically isolated from the circuit. It is a current transformer capable of highly precise measurement of pulse amplitude and waveshape. The one shown above, for example, offers pulse-amplitude accuracy of +1%, -0% (typical of all Pearson current monitors), 20 nanosecond rise time, and droop of only 0.5% per millisecond. Three db bandwidth is 1 c/s to 35 Mc.

Whether you wish to measure current in a conductor, a klystron, or a particle accelerator, it's likely that one of our off-the-shelf models (ranging from 1/2" to 10 3/4" ID) will do the job. Contact us and we will send you engineering data.

PEARSON ELECTRONICS INC

4007 Transport St., Palo Alto, California 94303
Telephone (415) 326-7285

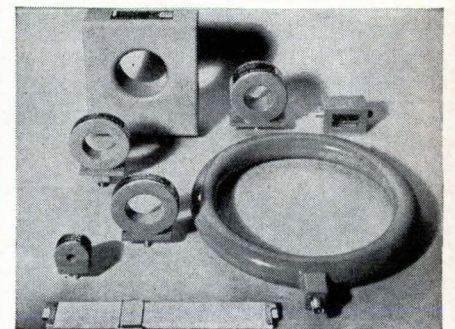

SUBSCRIPTION SERVICE

Please include an Electronics Magazine address label to insure prompt service whenever you write us about your subscription.

Mail to: Fulfillment Manager
Electronics
P.O. Box 430
Hightstown, N.J. 08520

To subscribe mail this form with your payment and check new subscription renew my present subscription

Subscription rates: in the U.S.: 1 year \$8; two years, \$12; three years, \$16. Subscription rates for foreign countries available on request

CHANGE OF ADDRESS

ATTACH LABEL HERE If you are moving, please let us know five weeks before changing your address. Place magazine address label here, print your new address below.

name _____

address _____

city _____ state _____ zip code _____



What's new in computer- grade capacitors?

New ripple ratings—
about 4 times higher
per unit case size.

New capacity ratings—
up to 280,000 mfd at 3 volts;
twice as much rating per case size.

New lower equivalent series resistance;
more efficient filtering.

Get all the news from Mallory.
Write for Bulletin 4-80.

Mallory Capacitor Company,
a division of P. R. Mallory & Co. Inc.,
Indianapolis, Indiana 46206

MALLORY

People

The appointment of **Jobe Jenkins** to the new position of chief of technical planning at the Philco-Ford Corp.'s Western Development Laboratories division (WDL) is another step toward the company's goal of applying military and aerospace experience to civilian systems.



Jobe Jenkins

"The things we're good at represent a growing civilian market," Jenkins says. "We will develop our technology in this market." Some 90% of WDL's sales are now to the National Aeronautics and Space Administration and the military; the company expects to maintain its volume of military and space sales while expanding civilian sales; it's aiming at a 50-50 ratio.

Jenkins, 46 years old, feels his division can enter the growing "middle ground" of civilian command and control systems that need more than lights and dials but less than intricate military wizardry. WDL built the command and control system for NASA's mission control headquarters in Houston. Jenkins, who came to WDL from the Lockheed Aircraft Corp.'s Missiles and Space division, where he was manager of application satellites for NASA programs, believes it will be easier for Philco-Ford to tailor its systems to civilian markets than for other companies to upgrade more conventional control systems.

Year of exploration. Exactly where WDL will go is not certain yet. "This is our year of exploration," Jenkins states. "There are several areas where we're going to apply this technology. All of them look promising right now." He did name education (teaching machines), medicine (for more on a Philco-Ford product, see page 42), transportation (highway communications systems), and industrial command and control systems (it has a contract now with the Houston Lighting & Power Co.).

A current example of WDL's diversification is its \$350,000 contract

MICROWAVE SWEEP OSCILLATORS

And
Now
RF
0.1-110 MHz

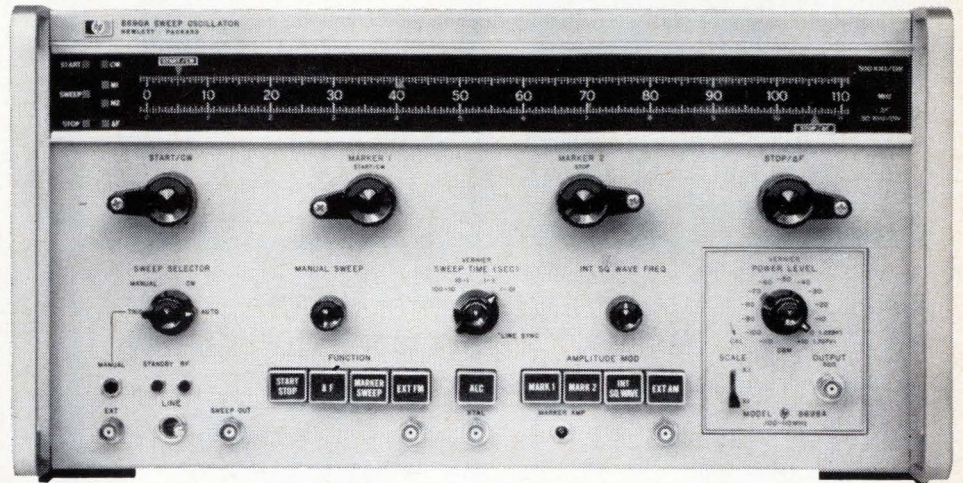

Extend your sweeper coverage into the Video/IF/RF frequency range with the new Hewlett-Packard 8698A RF Sweeper-Generator plug-in for the HP 8690A Sweep Oscillator. □ Frequency range is 0.1-110 MHz with 0.5% linearity for any sweep, wide or narrow. Low residual FM, 1% frequency accuracy, calibrated power output.

Sweep Oscillator/ RF Unit*	Frequency Range	Price	Sweep Oscillator/ RF Unit*	Frequency Range	Price
8698A	0.1-11 and 1-110 MHz	\$ 950	8694A	8-12.4 GHz	\$1575
8691A	1-2 GHz	1875	H01-8694A	7-12.4 GHz	1850
8691B	1-2 GHz	2175	H02-8694A	7-11 GHz	1600
8692A	2-4 GHz	1675	8694B	8-12.4 GHz	1925
8692B	2-4 GHz	1975	H01-8694B	7-12.4 GHz	2200
H01-8692B	1.7-4.2 GHz	2275	H02-8694B	7-11 GHz	1950
8693A	4-8 GHz	1575	8695A	12.4-18 GHz	1700
8693B	4-8 GHz	1900	8696A	18-26.5 GHz	2500
H01-8693B	3.7-8.3 GHz	2200	8697A	26.5-40 GHz	4300

*Models with "B" suffix feature PIN diode modulation and leveling.

The HP 8690A Sweep Oscillator contains power supplies, control and modulation circuitry, function selectors and operating controls. Accepts 8691A through 8698A RF Units. Price, \$1550.

For more information see your Hewlett-Packard field engineer or write Hewlett-Packard, Palo Alto, California 94304, Tel. (415) 326-7000; Europe: 54 Route des Acacias, Geneva.

HEWLETT  PACKARD

**Did you
know
Sprague
makes...?**

**MINIATURE MOLDED-CASE
PULSE TRANSFORMERS**



Molded construction for superior temperature/humidity resistance. Variety of turns ratios and magnetizing inductances with increased bandwidth available. Designed for general digital use.

ASK FOR BULLETIN SERIES 40225

Circle 501 on readers service card

DELAY LINES



Single or multiple delay in lumped constant or distributed constant designs are tailored to meet customer requirements. Furnished in either cast epoxy or molded cases. Applications include digital circuits in computers, radar equipment, etc.

Circle 503 on readers service card

**DYNACOR®
BOBBIN CORES**



Logical flux values in popular physical sizes are stocked in production quantities for fast delivery. Value engineered for quality with economy. Widely used for current regulation and memory drive.

ASK FOR BULLETIN SERIES 50000

Circle 505 on readers service card

**HIGH SPEED, FLAT T.C.
MEMORY TRANSFORMERS**

Featuring nanosecond output rise time, minimum variation of magnetizing inductance with temperature, and balanced output between windings. Ideally suited for inter-stage coupling, output drive, and sense memory applications. Rapid delivery to facilitate prototype evaluation.

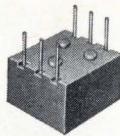

ASK FOR BULLETIN 40350

Circle 500 on readers service card

**MEMORY TEMPERATURE
CONTROLLERS**

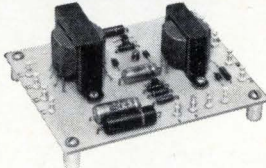

EMI-free. Type VZS Series SCR firing packages employing zero voltage or cross-over switching. Low in cost. Temperature regulation, $\pm 2^\circ$ F typical. Controls resistive or inductive loads.

ASK FOR BULLETIN 87500

Circle 502 on readers service card

**MAGNETIC
LOGIC CIRCUITS**



For those applications where only magnetics will do. Sprague Electric offers custom engineering service and experience in depth. Fixed and variable incremental scalars, shift registers, gates, and associated driving circuitry.

Circle 504 on readers service card

For complete technical data on any of the standard products, write for applicable Engineering Bulletin(s) to Technical Literature Service, Sprague Electric Co., 35 Marshall St., North Adams, Mass. 01247. For information on custom delay lines or magnetic logic devices, address your inquiry to Special Components Marketing.

455C-0157

SPRAGUE®
THE MARK OF RELIABILITY

Sprague and *®* are registered trademarks of the Sprague Electric Co.

People

with California to provide equipment for a test bed control system for 44 miles of the statewide \$2.6 billion water project. And although WDL lost out in the bidding for the Bay Area Rapid Transit District control system, Jenkins says it expects to refine the plan and submit it for other transportation districts.

The key is getting the maximum use out of military knowledge, he notes. "It's a two-way street, however, and not just a matter of applying military knowledge." For instance, WDL developed a slightly off-parabolic dish antenna for Telespazia, the Italian satellite communications company. The new shape improved reception and WDL will use it on some NASA contracts.

The Federal Aviation Administration's push for very-low-visibility landing systems is one good reason why the Lockheed Aircraft Corp. named **John Gorham** head of avionics and controls for the Ten-Eleven jetliner program. An expert in blind landing,

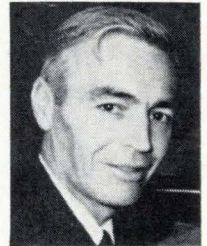

John Gorham

Gorham, a Briton, served in the Royal Air Force from 1940 to 1946 as an autopilot and instrument systems engineer. He was chief of the design drawing office of Britain's blind landing experimental unit from 1950 to 1955, when he joined Smiths Industries Ltd.'s aviation division as manager of development. Lockheed's hopes of re-entering commercial aviation rests with the new jetliner. To be built by the Lockheed-California division, the plane would be capable of a short take-off and carry from 200 to 300 passengers.

Gorham joined the company last September to work on Lockheed's ill-fated supersonic transport project. He plans to build into the Ten-Eleven's avionics system a hands-off, blind landing capability.

Gorham came to the U.S. in 1965. After a year as manager of advanced research and development at Arinc Research Corp., he moved over to Lockheed.

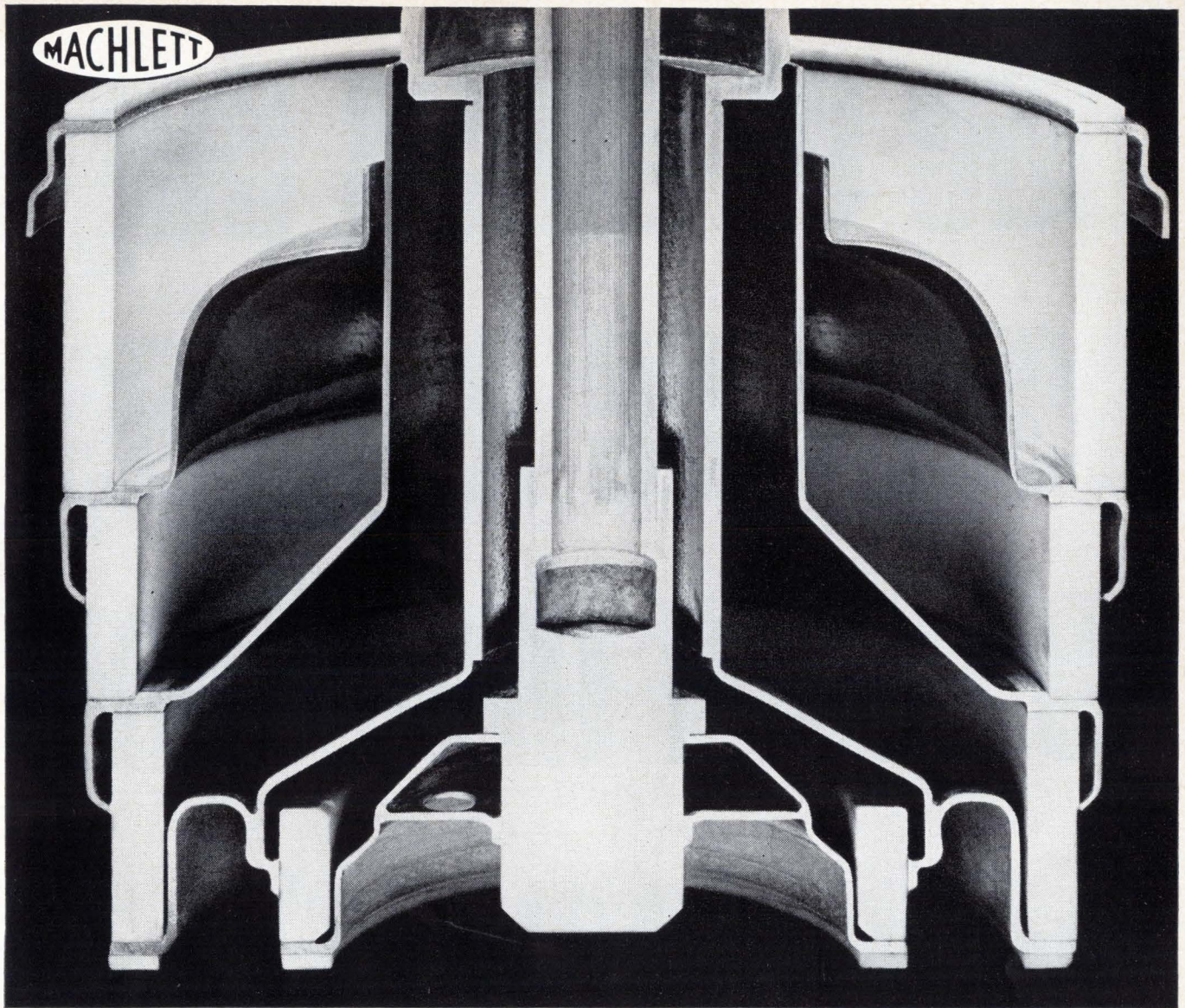

Continuous cone electrode geometry: designed into all these tetrodes only by Machlett

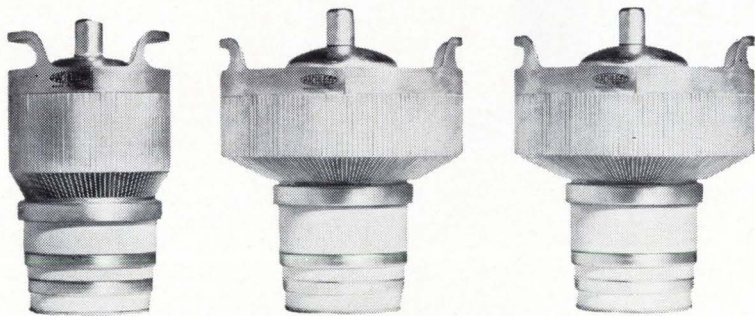

ML-8170/
4CX5000A

ML-8171/
4CX10000D

ML-8281/
4CX15000A

The result: uniform internal r.f. energy distribution and high performance stability.

Write for complete details: The Machlett Laboratories, Inc., Springdale (Stamford), Conn. 06879.

Engineers' resumes invited



THE MACHLETT LABORATORIES, INC.

A SUBSIDIARY OF RAYTHEON COMPANY

**One of these days
someone is going
to put a thousand
components on a
silicon chip.**

This is one of those days.



Fairchild has perfected the MacroCircuit™— a large scale integrated circuit with a packing density of 1,000,000 bits per square inch. And it's in production now — not next year. You can get the 3500, a 256-bit, MOS, Read-Only Memory on a 60 by 80 mil silicon chip. It includes the storage matrix (64 words by four bits), address decoders, and output buffers, and it requires only 14 leads: 6 input, 4 output, 2 supplies and a ground. An additional output provides the option of direct interface with bipolar logic. The MacroCircuit memory opens up a whole new world of systems design possibilities (and you'll find yourself increasingly concerned with systems design rather than circuit design). Because of the high packing density and our batch fabrication, MacroCircuit memories offer you lower cost per bit than any other storage device you can get. That means you can economically use our monolithic read-only memories to store subroutines, executive routines, table look-up routines, and other functions for which you had to use software up to now. MacroCircuit memories reduce the number of components in your system and the number of external connections and so are inherently more reliable. To get some (with information pre-stored to your order) or to get details on our other digital LSIC's, call, TWX or write your Fairchild Semiconductor sales office. Now.

FAIRCHILD
SEMICONDUCTOR

NEW EG&G SILICON DIFFUSED PHOTODIODE

- HIGH QUANTUM EFFICIENCY
- WIDE SPECTRAL RANGE • FAST RESPONSE TIME • LOW NOISE

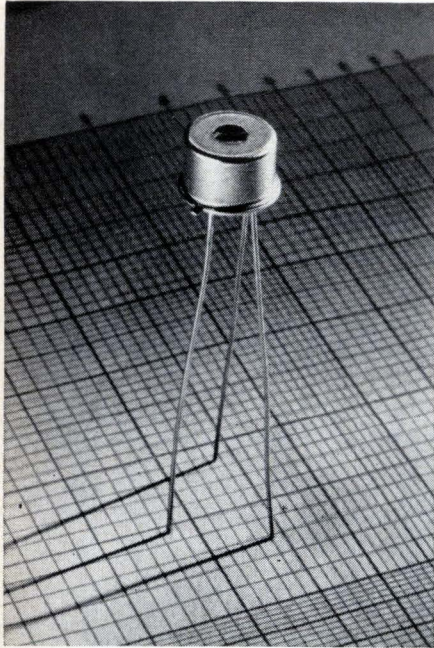

SGD-100 PHOTODIODE

The SGD-100 Photodiode — successor to the popular SD-100 — offers greater sensitivity and lower noise characteristics. Embodying EG&G's improved diffused guard ring design, the SGD-100 has a wide spectral range with an unusually high response in the "blue" region, fast response time and high quantum efficiency. The photodiodes are hermetically sealed in a TO-5 package.

Sensitivity $0.5 \mu A/\mu W$ at 0.9 microns
(70% quantum efficiency)

Spectral Range 0.35 to 1.13 microns

Capacitance 7 picofarads at 90v

Rise Time 4 nanoseconds

Leakage $0.2 \mu A$ at 90v

NEP (0.9μ , 10^3 , 1) 7.9×10^{-13} watts

Linearity of Response over 7 decades

Applications include CW, pulsed light and laser detection and measurement, star tracking, optical navigation, communication and guidance, and range-finding systems. The new SGD-100, also available in calibrated versions, is in quantity production for fast delivery at low price.

For information, write: EG&G Inc., 166 Brookline Avenue, Boston, Massachusetts 02215. Telephone: 617-267-9700. TWX: 617-262-9317.



Meetings

Aerospace Instrumentation Symposium, Instrument Society of America; Marriott Motor Hotel, Philadelphia, **May 2-4.**

Production Engineering Conference, American Society of Mechanical Engineers; Sheraton-Cleveland Hotel, Cleveland, **May 2-4.**

NASA Aerospace Electronic Systems Technology, Electronic Industries Association; Boston, **May 3-4.**

Electronic Components Technical Conference, IEEE; Marriott Twin Bridges Motor Hotel, Washington, **May 3-5.**

Symposium on Human Factors in Electronics, IEEE; Cabana Motor Hotel, Palo Alto, Calif., **May 3-5.**

Commercial and Professional Sound Products Show, Electronic Representatives Association; Sheraton-Atlantic Hotel, New York City, **May 4-5.**

Forum and Exhibit on Product Assurance, Test, and Inspection, American Society for Quality Control; International Hotel, Los Angeles, **May 5-6.**

National Meeting, the Electrochemical Society; Dallas, **May 7-12.**

Fluids Engineering Conference and Fluidics Symposium, American Society of Mechanical Engineers; Sherman House, Chicago, **May 8-11.**

International Microwave Symposium, IEEE; Hilton Hotel, Boston, **May 8-10.**

Power Symposium, Instrument Society of America; Dallas, **May 8-10.**

Packaging Industry Technical Conference, Institute of Electrical and Electronics Engineers; Holiday Inn, New York, **May 9-11.**

Regional Conference, IEEE; Sheraton Western Skies Hotel, Albuquerque, N.M., **May 9-11.**

Space Technology Conference on Low Cost Orbital Transportation, Society of Automotive Engineers; Rickey's Hyatt House, Palo Alto, Calif., **May 9-12.**

Seminar on Photo-Optical Systems Evaluation, Society of Photo Optical Instrumentation Engineers; Sheraton Hotel, Rochester, N.Y., **May 11-12.**

Biomedical Sciences Instrumentation Symposium, Instrument Society of America; University of New Mexico, Albuquerque, N.M., **May 15-17.**

Design Engineering Show, American Society of Mechanical Engineers; American Hotel, New York City, **May 15-18.**

National Aerospace Electronics Conference, IEEE; Dayton, Ohio, **May 15-17.***

Technical Conference, Society of Plastics Engineers; Cobo Hall, Detroit, **May 15-19.**

Appliance Technical Conference, IEEE; Sheraton-Chicago Hotel, Chicago, **May 16-17.**

National Telemetry Conference, American Institute of Aeronautics and Astronautics; San Francisco Hilton Hotel, San Francisco, **May 16-18.**

Call for papers

Conference on Speech Communication and Processing, IEEE; Massachusetts Institute of Technology, Cambridge, Mass., Nov. 6-8. **May 15** is deadline for submission of abstracts to the conference's program chairman, Air Force Cambridge Research Labs, L.G. Hanscom Field, Bedford, Mass. 01730

International Antennas & Propagation Symposium, IEEE; University of Michigan, Ann Arbor, Oct. 17-19. **July 1** is deadline for submission of papers to Thomas Senior, Radiation Laboratory, University of Michigan, 201 Catherine St., Ann Arbor, Mich. 48108

Ultrasonics Symposium, IEEE; Bayshore Inn, Vancouver, Canada, Oct. 4-6. **Aug. 1** is deadline for submission of abstracts to B.A. Auld, H.W. Hansen Laboratories of Physics, Stanford University, Stanford, Calif. 94305

* Meeting preview on page 16.

**the
connector
THING**

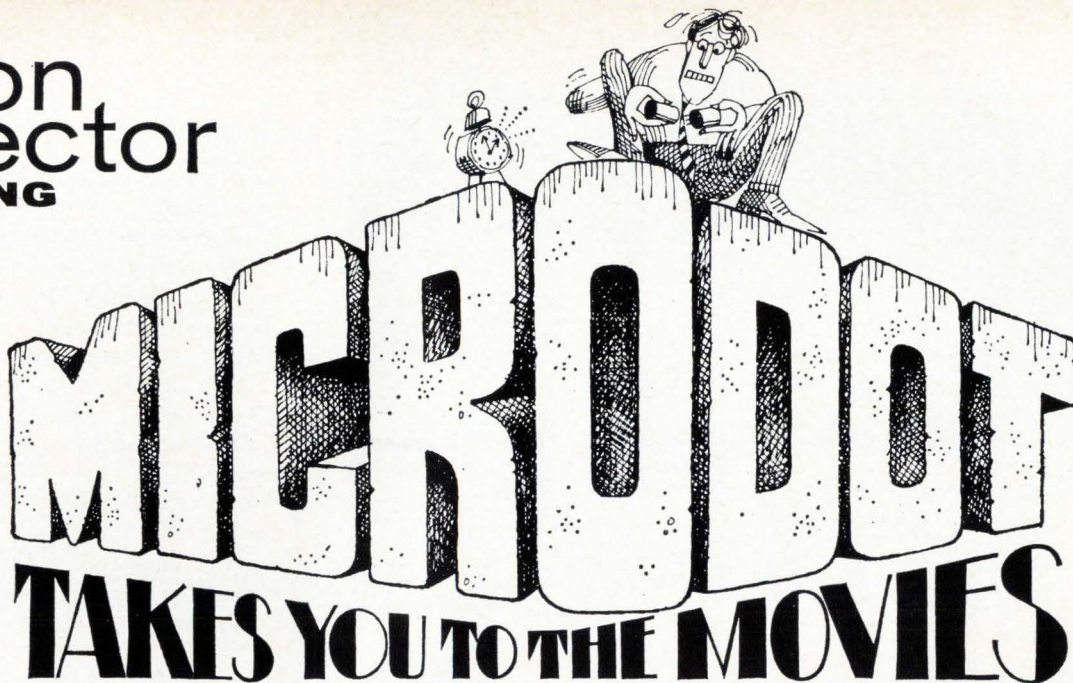

**MICRODOT
TAKES YOU TO THE MOVIES**

*a periodical periodical,
designed admittedly to boom
the sales of Microdot Inc.
connectors and cable. Published
wholly in the interest of profit.*

Once in a lifetime, a motion picture comes along with a scope broader than "Gone With The Wind," a message even more searching than "Mary Poppins." Such a colossal epic is Microdot's new film on the MARC 53 multi-pin connector—the adults-only story of a man and his connector against a world of reliability problems.

**FILMED IN GLORIOUS
MICROCOLOR AND
MICROVISION**

And starring the world's smallest and most flexible microminiature high density cylindrical multi-pin connector: MARC 53. Straight from sterling performances in many of the nation's leading aerospace productions! MARC 53 combines the world's best interfacial seal—our exclusive POSISEAL—with the safest finger-tip push-pulling coupling—POSILOCK. There's no mismatching even in "blind" conditions, and the contacts are completely scuff-proof.

A NEW STAR IS BORN

Now, the rear-insertable MARC 53 RMD also gives you a genuinely field-serviceable version that takes mass-produced pre-crimped wires and requires neither insertion nor extraction tools for assembly. When you see our film you'll thrill at the blurring speed and effortless ease with which both versions of MARC 53 are assembled. But to further pique your curiosity for this 10-minute extravaganza, Microdot is offering tremendous, gigantic prizes:

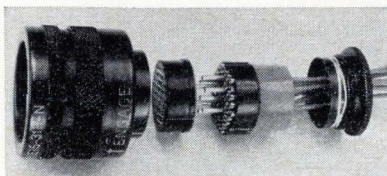

**WIN A COMPLETE
MOVIE OUTFIT!**

Magnificent first prize is an 11-piece movie outfit, from electric eye f1.8 Argus camera to projector, screen, and movie light. Second great prize is a long, long red carpet, suitable for welcoming royal guests to your own movie premiere at home. Third prizes—six of them—are high-class imitation Oscars. Each Oscar will have the winner's name inscribed on it, together with some very complimentary, Hollywood-type superlatives.

**HOW TO SEE MOVIE
AND WIN PRIZES**

First, collect an audience. Any group concerned with connector specifying will do. Send the coupon below to Microdot. We'll have your local representative call you for an appointment to show the MARC 53 film at your office. That's fine about the movie, but how about the prizes?

**GIVE MARC 53
A HOLLYWOOD MONICKER!**

Let's face it, MARC 53 is a lousy name for a film star. What we need is something like Rip Torn or Stark Naked, but suitable for a fast, small, dynamic connector. You make one up. After the movie, we'll give each viewer an entry form for suggested names for the MARC 53. A panel of aging animal stars will select the best names.

CONTEST IS UTTERLY VOID!

...where unpleasant restrictions, taxes or bans exist. Everything's over midnight of July 31, 1967.

WINNERS EVERY MONTH!

For those of you who have become regular devotees of the "Connector Thing" contest, here's a list of winners of our famous TWIST/CON CONCEPT CONTEST held earlier in the year. Each of these men received twelve Capitol record albums of his choice. Winners were Richard Trummer, G. V. Fay, Dale T. Wingo, Claron W. Swonger, Simon T. Wrynn and Don Huelsman. Congratulations, gentlemen.

**MICRODOT
INC.**



Microdot Inc.
220 Pasadena Avenue, South Pasadena, Calif. 91030

Dear C. B. de Microdot:

- I have a few guys who'd like to see that stirring epic of yours. Me, too. Have your Rep call me.
- Send me some technical memorabilia on this MARC 53 and on coax connectors.
- Unable to see movie now, but I'm entering contest anyway. My Hollywood name for MARC 53 RMD is _____.
- I am female, 23, a blonde, cute, and would like to meet your producer and/or director.

Name _____
 Title _____
 Company _____
 Street _____
 City _____
 State _____ Zip _____
 Telephone _____

Note: MARC 53, MARC 43, Posilock and Posiseal are registered trademarks of Microdot Inc. Stark Naked isn't.

Multiplier actual size
3" x 2" x 5/8"



3.75 Cubic Inch Analog Multiplier Requires No External Amplifiers

Advanced design makes possible this solid state DC voltage multiplier that performs multiplication, squaring, division, and square rooting. The multiplying function is accomplished without the use of special non-linear or magnetic devices.

Major features include DC differential inputs with common mode capability, mode selection by shorting pins, no critical supply regulation requirements, and no zero adjustments. The new four quadrant Intronics Model 101 costs less than \$500, requires no external amplifiers and gives systems designers a compact, rugged answer to multiplier problems.

Features

Input Voltage	± 10 volts differential maximum	Operating Temperature	$- 25^{\circ}\text{C}$ to $+ 85^{\circ}\text{C}$
Input Impedance	75,000 ohms minimum	Frequency Response ($- 3\text{db}$)	DC to 1 KHz
Output Voltage	± 10 volts at 5 ma maximum	Supply Voltage	$+ 15$ to $+ 16$ volts DC $- 15$ to $- 16$ volts DC at 50 ma maximum
Output Impedance	less than 1.0 ohm	Package	3" x 2" x 5/8" Solid Epoxy Encapsulated Module with 0.25" Long, .040" Diam. Gold Plated Pins
Linearity	0.25% full scale	Mil Specs:	Meets MIL Standards.
Output Offset (both inputs zero)	0 ± 10 mv DC max.		
Temperature Stability of Output Offset	1 mv/ $^{\circ}\text{C}$ $+ 10^{\circ}\text{C}$ to $+ 85^{\circ}\text{C}$		

Write or call Intronics 617-332-7350 for more information and a quotation.



intronics
I N C O R P O R A T E D

57 CHAPEL ST., NEWTON, MASSACHUSETTS 02158

Meeting preview

Down to earth

New applications of aerospace technology to military systems will highlight the National Aerospace Electronics Conference to be held in Dayton, Ohio, May 15-18. Fourteen technical sessions and a display of hardware and systems will be the meeting ground for men from industry and the military.

The technical sessions will be launched by two Government-industry panels discussing, respectively, the importance of the research laboratory and proposed storage-and-retrieval systems for technical data.

Advanced methods for processing airborne radar and photographic information will be the subject of several papers. John Swab of the General Electric Co., and Derek Orme and Kurt Wallace of the Ampex Corp. will examine the application of electron beam recorders and scanners to real-time data processors. A critique on laser and electron beam pictorial data processing will be given by Stan Rostocki of the Air Force Avionics Laboratory. J.B. Dendy of the Sperry Rand Corp.'s Sperry Phoenix division and E.E. Eddey of the Goodyear Aerospace Corp. will discuss a sampled-data computer and an associative processor which are used as a universal controller and radar correlator in radar data processor systems.

Flight controls. Others will present papers on the self-optimizing and adaptive techniques used in many aircraft navigation systems, and the adaptive flight control systems of the F-111 fighter-bomber and the B-58 bomber.

Components and techniques for developing inertial systems will be the subject of another meeting. Ernest H. Metzger will describe a miniature electrostatic accelerometer which the Bell Aerosystems division of Textron Inc. is developing for airborne use. And a technique by which long-term gyro drift can be evaluated and canceled will be explained by Herbert Sandbert and Stanley J. Jakimczyk of the Dynamics Research Corp.

The technical conference is sponsored by the IEEE.



**DON'T GAMBLE
with your MICROCIRCUITS!**

Specify Rugged, Reliable

ERIE BLUE CHIP[®] CAPACITORS



Actual Size

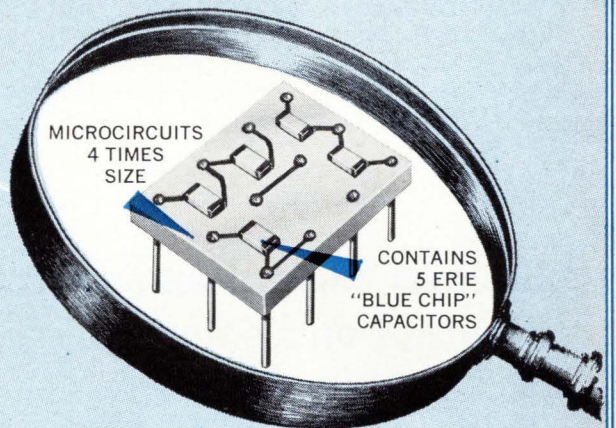

MICROCIRCUITS
4 TIMES
SIZE

CONTAINS
5 ERIE
"BLUE CHIP"
CAPACITORS

**10 to 1,000,000 pF CAPACITANCE RANGE... 50 or 100 WVdc
AVAILABLE NOW FOR MICROCIRCUIT APPLICATIONS**

When one manufacturer . . . ERIE . . . produces the most nearly perfect Ceramic Chip Capacitor in the industry . . . gambling with other chip brands becomes a real game of chance. Erie Chips are considered by knowledgeable engineers as more rugged in construction, they have higher temperature stability, maximum capacitance-to-volume ratio (10 pF to 1.0 mF), greater performance reliability, better solderability . . . and Erie offers an almost infinite variety of Chip Capacitors to suit any microcircuit requirement.

So when you visit Las Vegas . . . gamble. That's why you're there. But when you demand better performance from components in Microcircuit, place the only safe bet . . . ERIE Monobloc Ceramic Chip Capacitors.

Write for technical data on Ceramic Chip Capacitors, Request Monobloc Catalog 8000.

®Trademark for Erie Monobloc Ceramic Chip Capacitors

Another series of components in Erie's Project "ACTIVE" . . .
Advanced Components Through Increased Volumetric Efficiency.

ERIE

TECHNOLOGICAL

PRODUCTS, INC.



Erie, Pennsylvania

DESIGNER'S

P. R. MALLORY & CO. INC., INDIANAPOLIS, INDIANA 46206

Rectangular case molded tantalum capacitor takes minimum space on circuit boards

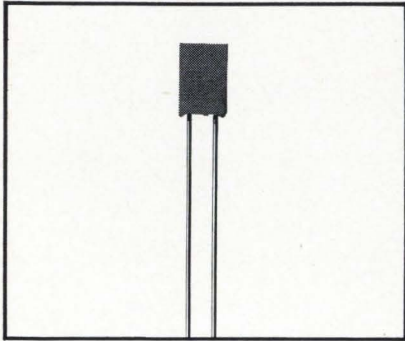

The new TIM miniature solid tantalum capacitor comes in a fully molded epoxy case in rectangular configuration which affords maximum efficiency of space utilization on printed circuit boards. The single standard case size measures .345" by .288" by .105" thick. Stand-off ribs are molded into the base to permit ease in soldering in printed circuits. Parallel leads are spaced .125" apart, fitting the newer

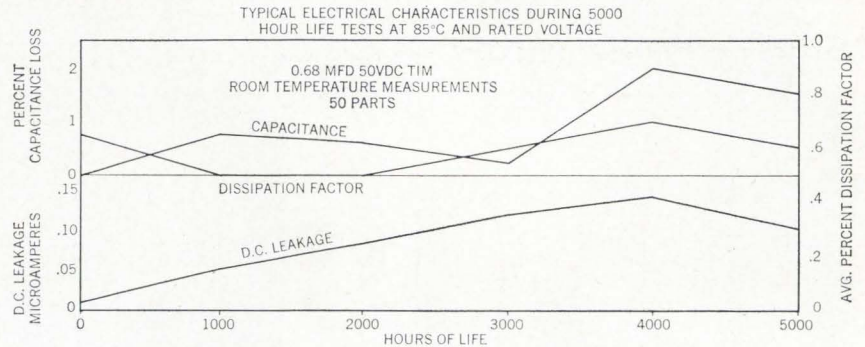

printed circuit designs. The small, uniformly sized case is well suited for automatic insertion.

This new capacitor meets exceptionally high standards of performance and reliability. Tests of 5000 hours, both for high temperature life and humid life, demonstrate the TIM's excellent stability of capacitance, DC leakage and dissipation factor . . . all of which

stayed well within specification limits.

Standard ratings extend from 12 mfd, 3 WVDC to .68 mfd, 50 WVDC. Standard capacity tolerances are $\pm 20\%$ and $\pm 10\%$. The TIM is now in high volume production at attractive price.

CIRCLE 105 ON READER SERVICE CARD

Special control and switch for "instant-on" color TV

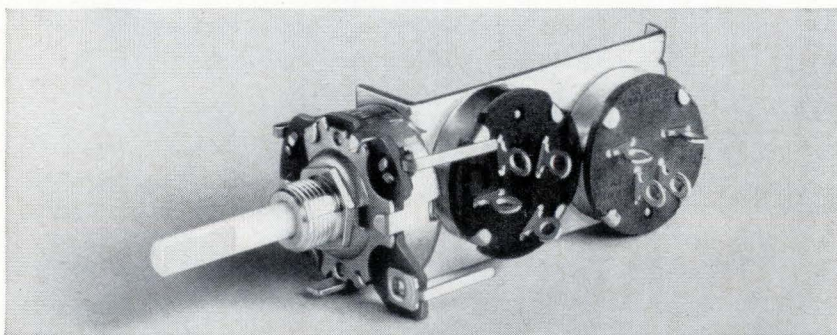

This "instant-on" control and switch for color TV demonstrates Mallory's ability to engineer and produce special assemblies to meet the requirements for specific applications in a variety of electrical and electronic products.

The assembly has two side-mounted DPST switches. In the "off" position, reduced voltage is applied to heaters, and pilot light and B+ voltages are cut off. In the "on" position, normal voltages are ap-

plied to all circuits. Switch action is push-pull.

Both switches are the Mallory type OAC, with proved long life and reliability. Switch ratings can be any desired combination of 2, 3, 5, or 6 amperes, 125 volts AC. This configuration can be supplied attached to any Mallory single or dual carbon control. We welcome inquiries for special assemblies, on your company letterhead.

Extreme high and low values available in Mallory controls

Need a 100-megohm carbon control? Or a 50-ohm? You can get them from Mallory. And practically any value in between. All of them have the unique hard-surface Mallory element that consistently gives 100,000 cycles of rotational life. A broad range of standard and special designs can be supplied promptly.

CIRCLE 106 ON READER SERVICE CARD

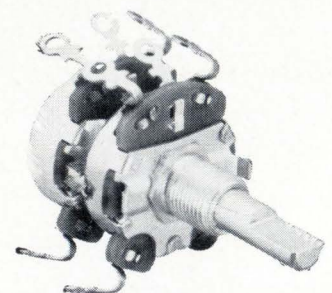

The Rechargeable Batteries You Can Afford



New Duracell® rechargeable alkaline batteries. These are the batteries that will make a new generation of battery-operated devices possible. Because this battery now exists, portable TV sets, radios, phonographs, tape recorders and transceivers can be designed to function at lower operating costs.

The low initial cost of the rechargeable alkaline batteries is one reason why they promise so much for new designs. Another reason is their unique exposed band contact. It lets you design battery-operated equipment with built-in rechargers that automatically prevent charging when a primary cell is in the circuit. (See schematic.) This means that, when necessary, any primary battery can provide the power.

But that's not all. Duracell alkaline rechargeable batteries are lighter than most rechargeables. They come fully charged. They're available in 3 standard sizes, "D", "C" and "AA". And one glance at the discharge-cycles graph will tell you how little they cost to operate.

@Registered trademark of P. R. Mallory & Co. Inc.

CIRCLE 108 ON READER SERVICE CARD

New molded-case miniature solid tantalum capacitors

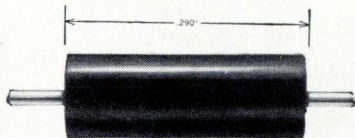

New Type TAC solid electrolyte tantalum capacitors give you, in molded case construction, nearly twice the CV ratings per cubic inch that you can get in MIL-C-26655 metal case solids. They have a fully molded epoxy case only 0.105" in diameter by 0.29" long, precisely molded to facilitate automatic insertion.

Extended life and humidity tests indicate performance of the TAC is exceptionally high. You can use them with confidence anywhere you need a solid tantalum capacitor, including MIL specification environments.

Standard temperature rating is -55°C to +85°C; can go to +125°C with voltage de-rating of 33%. Values range from 18 mfd., 3 WVDC to .47 mfd., 50 WVDC.

CIRCLE 107 ON READER SERVICE CARD

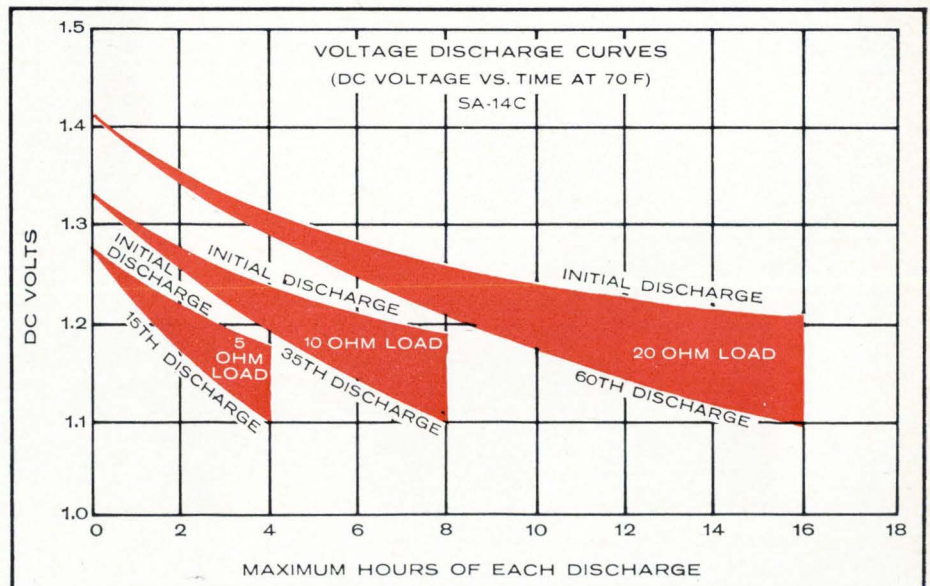
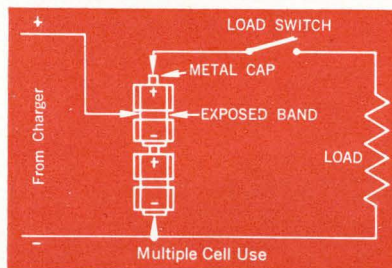

keeping new ideas
for electrical energy moving

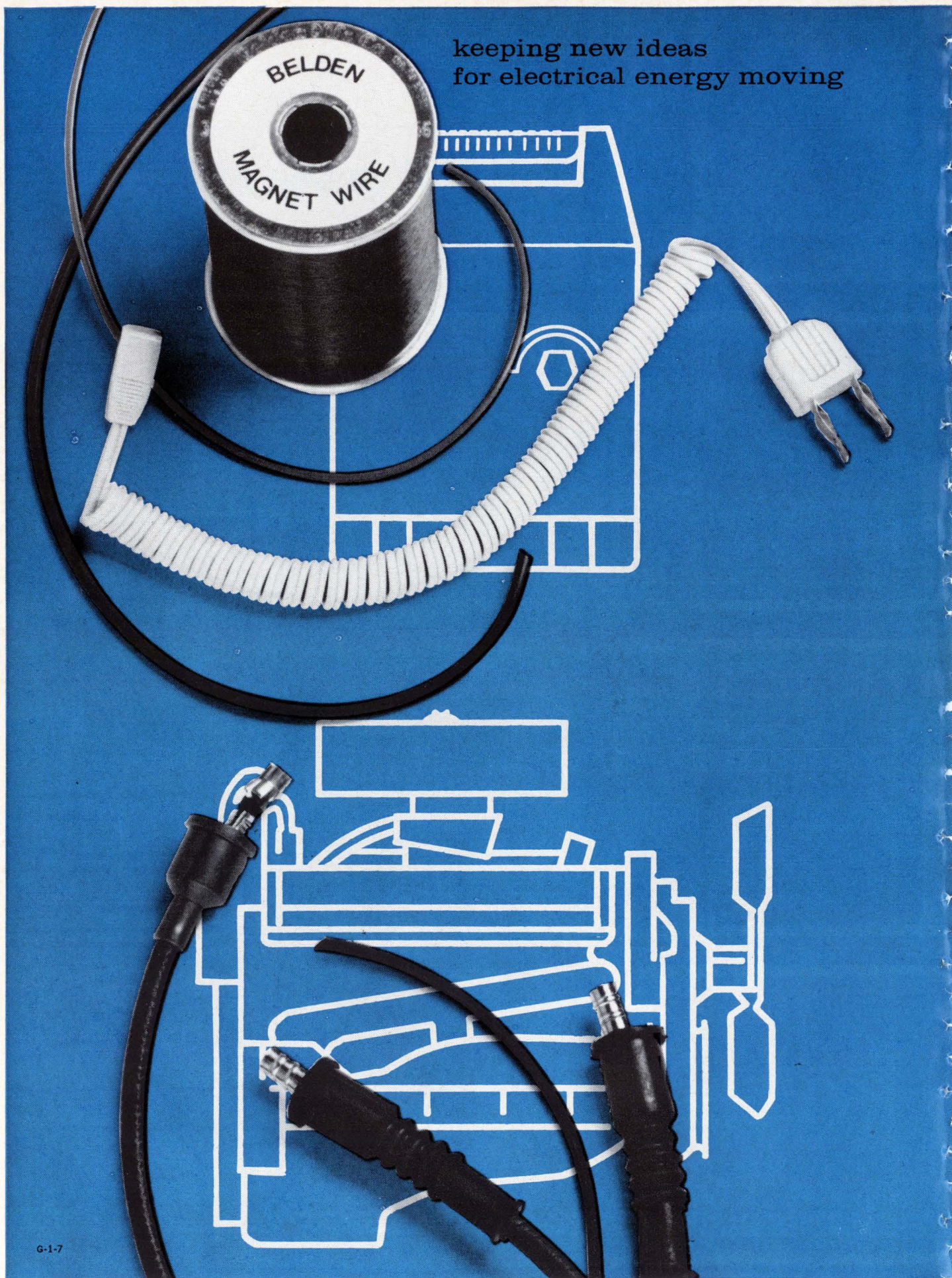

G-1-7

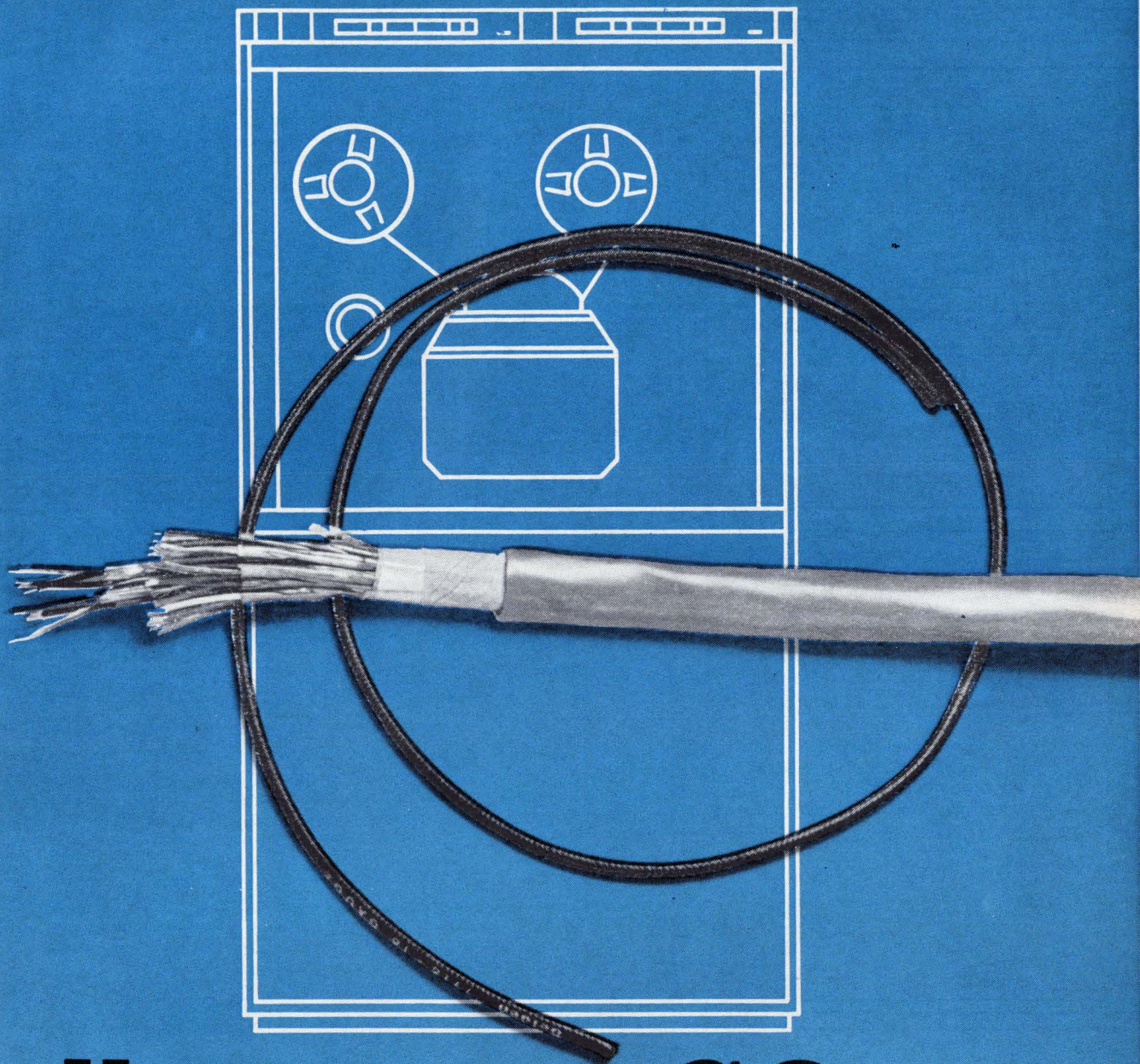

all systems GO

...when a Belden team of wire specialists shows you their dozen or so ways to wring out hidden values and costs. For example you can delve into design..maneuver with materials..analyze assembly..pry into processing..pick different packaging..or a host of others. But success takes a supplier who is really perceptive—one who makes all kinds of wire for all kinds of systems. Want to join us in wringing out values and costs? Just call us in...Belden Manufacturing Company, P.O. Box 5070-A, Chicago, Illinois 60680.

Belden

From RCA "overlay"...

The industry's best performing plastic RF-power transistor...

15 Watts min at 400 MHz

2N5017

Now... get in on the action with the rf-power advantages of RCA "overlay" in plastic!!

RCA's new 2N5017 stud-mounted plastic transistor provides 15 watts at 400 MHz... 22 watts typ. at 225 MHz... operates from 28-v supply! And this circuit capability is delivered in a unique package that sets new standards for performance, ruggedness, and versatility at VHF and UHF frequencies.

Performance—the industry's lowest emitter and base inductances (0.1 nH and 0.2 nH respectively) result in optimum gain and power

capability right up to 700 MHz... efficient for broadband and narrowband transmitters.

Ruggedness—unexcelled mechanical strength with short "anchor" pins eliminating problems due to lead breakage or vibration.

Versatility—"terminal block" structure permits choice of stripline, printed circuit (both flush and bottom-mounted), or lumped circuit mounting.

Call your RCA Representative today for more information on the 2N5017 for military, microwave, and industrial communications usage. If your applications still call for hermetically sealed packages, ask him about the RCA 2N5016—it offers similar electrical performance but in the popular TO-60 case. For technical data, write RCA Commercial Engineering, Section IN5-1, Harrison, N. J. 07029.

Also Available From Your RCA Distributor

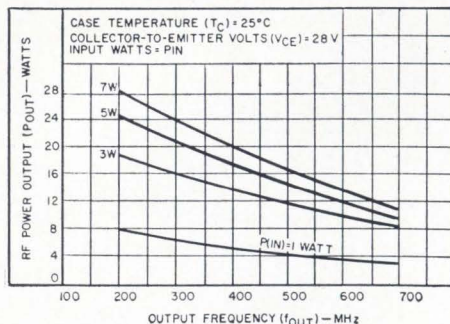

Strip-line leads can be easily soldered to terminal block with pins providing additional mechanical strength.

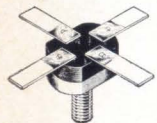

RCA Electronic Components and Devices



The Most Trusted Name in Electronics

Circle 22 on reader service card

Editorial

Closing the door on progress

The French are formulating a national semiconductor policy that seems very wrong to us. Rather than help France speed up its technical development, the new plan may even slow it down.

Before the year is out, the government likely will announce a Plan Composants (Components Plan) that is supposed to make French technology in integrated circuits competitive with that of U.S. companies. Under the plan—like the French Plan Calcul [April 3, 1967, p. 164] to build a national computer industry—the government would pressure semiconductor companies to join forces and would finance a national effort to develop advanced integrated circuits.

Maurice Ruby, an executive of the Fédération Nationale des Industries Electroniques, justifies the plan by insisting, "If we are to have a national computer effort, we must have a national source of components to build the computers."

When Marc Colonna, head of the Industry Ministry's Direction des Industries Mécaniques, Electriques, et Electroniques, announced during the annual International Electronics Components show in Paris, April 5 to 10, that the government was considering such a plan, semiconductor executives smiled broadly for the first time in years. They were pleased both with the plan and with government recognition of their problems.

They have been concerned by the rapid inroads U.S. firms have made in French markets. Last year, a study made by FNIE crystallized the worry by showing that much of the growth of the French electronics industry has been enjoyed by U.S. firms. It has been so obvious that French executives talk of a Yankee invasion.

"There isn't room for everyone," complains an agitated Henri Lerogon, vice president of France's second largest semiconductor company, *Companie Générale des Semiconducteurs*. "Planned production by U.S. companies alone exceeds estimates of Europe's needs for solid state devices over the next five to 10 years," he adds.

Last year, French executives were irritated when the government finally approved the request of Motorola Semiconductor Products to build a semiconductor factory at Toulouse. So they turned grim when they learned last month that approval has been granted to Sprague Electric Co. for a plant at Tours to start producing potentiometers but to add semiconductors and integrated circuits later.

Although semiconductor executives are cheered by the turnabout in government policy towards American firms, the original policy made a lot of sense. Under it, the French encouraged any foreign company to set up shop within France as long as it was bringing new technology to France along with its production facilities. Every American company that has started

manufacturing in France has hired French engineers and trained them in the new technology of semiconductors and integrated circuits. Since technology is transported by people, the training was the quickest and cheapest way for France to catch up with technical developments.

Political pressure has forced the change. Ruby of FNIE suggests that Sprague will be the last U.S. semiconductor company allowed into France. Although that was what a lot of Frenchmen were hoping about Motorola 12 months ago, Ruby says the situation has changed. According to Ruby, the minister of finance who approves such applications is now aware of the danger of allowing American semiconductor firms to operate in France. Ruby says with a smile, "The ministry is better informed today."

French executives believe the proposed Plan Composants will close the technology gap in integrated circuits and shut out American firms. It won't do either.

There is no technology gap as such. The technology to build ic's is already in France. Lerogon's company, Cossem, has started to manufacture resistor-transistor logic and diode-transistor logic. It's developing a line of transistor-transistor logic. La Radio-technique, France's leading semiconductor company, already produces diode-transistor logic compatible with that produced by the Signetics Corp. And by the end of the year, it will be producing transistor-transistor logic not unlike the SUHL units produced by the Sylvania Semiconductor division of the General Telephone and Electronics Corp. Still a third company, Société Européenne des Semiconducteurs, has developed products such as a J-K flipflop—for diode-transistor logic—which has 58 elements integrated on a chip only 1.2 by 1.2 millimeters.

What's missing are determined efforts by both semiconductor companies and their customers to produce ic's and apply them. Plan Composants won't do either. Neither will it erase the lethargy that has plagued French companies. For several years, French executives have been insisting that ic's were an extravagance for those fancy products the U.S. military builds so wastefully. French industry had no interest in such opulence in design and wasn't ready for it. Suddenly these same French companies are complaining bitterly about a gap because the ic parade has passed them by.

The solution to the lag in technical products in Europe does not lie in a Plan Composants or in barring and harrasing American firms, or in a hypnotic fixation with a technology gap. Rather, improvement requires a change in attitude among French executives, a realization that their companies cannot compete in a world of integrated circuits and satellites with timid and penurious product development and marketing.

French semiconductor companies would be better off facing up to technical competition with American firms and searching out areas in which the French could build superiority—rather than hiding behind a shield of nationalism that can disguise and endorse inefficiency.

What's the biggest problem plaguing RFI filter designers? Well, poor attenuation from available filter components has to be one of the most troublesome. Optimum attenuation leaves a lot to be desired. Our engineers tackled the problem and found we already had a solution.

It's a ferrite material we call Ferramic® O-5. This material has established an outstanding reputation for use in chokes, inductors, and transformers operating over the frequency range from audio to the broadcast band. But it does an about face

and its attenuation climbs like a rocket from 10 KHz up through the megacycle range. And it exhibits extremely high permeability and dielectric constant throughout this range.

In short, our O-5 ferrite is about the finest RFI filter material made anywhere and is available as a standard production item. In addition, we have other materials, like H and Q-1 ferrites that do an excellent job for similar applications. This is just one more example of the new uses of ferrites in a widening range of industries.

Because of our demonstrated ability to handle RFI filtering problems we now have various new materials and applications under development for both the military and commercial markets. You'll be hearing about them soon. So if you have an RFI filtering problem, you ought to find out what we've got. Just write Mr. K. S. Talbot, Manager of Sales, Indiana General Corporation, Electronics Division/Ferrites, Keasbey, N. J.

INDIANA GENERAL 

**When it comes to filtering radio frequency interference
Indiana General has what it takes.**



Electronics Newsletter

May 1, 1967

Inferential 'thinking' with a computer

Engineers at Hughes Aircraft have designed a nonnumeric computer that resembles an associative processor. **The machine would use inferential logic to prove mathematical theorems, search for legal precedents, and perhaps even make certain kinds of medical diagnoses.**

In inferential logic, a conclusion is drawn from premises. **Data structures based on inferential relationships are difficult to establish in a general-purpose digital computer.**

The principal part of the machine is its memory, which consists of a very large square array of cells. Each cell contains five registers of 22 or 24 bits, four 22-bit shift registers, and logic for comparison, control, and routing. Each cell is individually connected to an external control unit and to its four nearest neighbors. The control unit's size is negligible by comparison with the memory, which contains more than a million cells in its present design. The machine performs a matching operation by transferring data from cell to cell in accordance with established rules, and following instructions from the control unit.

The programs are in the form of vector charts, which can be entered directly into the memory with a Rand tablet or similar device.

The designers, D.A. Savitt, H.H. Love Jr., and Richard E. Troop, described the machine at the Spring Joint Computer Conference. They haven't yet built the machine; work on a small prototype may be started later this year, but a full-scale machine awaits the development of integrated-circuit chips that can hold as many as 1,800 gates each.

GaAs diode sets frequency high

The oscillating frequencies of gallium arsenide diodes continue to rise. John A. Copeland, a researcher at the Bell Telephone Laboratories, reports a record **150 gigahertz in the limited space charge accumulation mode**, topping the earlier mark of about 60 Ghz, also set at Bell Labs. Efficiency and power measurements haven't yet been determined, Copeland told the European Meeting on Semiconductor Device Research in Bad Nauheim, West Germany.

Laser sees through opaque material

A normally opaque material can be made transparent to a selected frequency of a laser if the coherent light beam is **powerful enough to raise the energy levels in the material to a certain point.** E.L. Hahn and S.L. McCall of the physics department of the University of California, Berkeley, say that a high-power pulse of light can stimulate the material into a form of laser action.

The atoms in the material are raised to a higher energy state and, after a delay, they make coherent transitions to the ground state, **duplicating the original input wavelength at the output.** Observed delays were about 100 times the normal path length and refractive index delays. Hahn said the delay medium must be a two-level absorptive material with the atomic transitions tuned to one of the laser wavelengths.

The same effects should occur at either electromagnetic or acoustic frequencies, the researchers believe.

Delays were found to be proportional to pulse widths, and, as an added bonus, **the output pulses were observed to be considerably cleaned up compared with the shapes of the input pulses.** Applications are seen in studies of interactions of light with atoms and in production of delay lines.

Electronics Newsletter

Ford has IC's in its future

Ford will soon announce plans to include a voltage regulator made with an integrated circuit in some of its 1968 model cars. The company is currently negotiating with three semiconductor firms—Motorola, Fairchild, and its own Philco-Ford division—for the circuits. According to an industry report, the IC's would be monolithics, combining transistor and zener diodes, and would handle 3 amperes at 10 to 20 watts. Details of such a regulator were disclosed by a spokesman for the Integrated-Circuit Corp., Phoenix, Ariz., consultants.

Taking a different approach is Texas Instruments, which until now has been conspicuously absent from the race to develop IC equipment for Detroit [Electronics, Oct. 3, 1966, p. 187]. The company said it is talking "seriously" with auto makers about solid state voltage regulators and ignition systems.

TI's design is a thick-film hybrid that combines silicon controlled rectifier chips and associated circuitry, according to Howard Bonner, applications manager.

TI isn't stopping at the obvious applications of solid state circuits for autos. It's also working on designs for complex modules that will check road and traffic conditions, gauge such key variables as oil, water, and tire pressure, and store maintenance information.

Four-in-one antenna designed for planes

Maxson Electronics is developing a phased-array airborne radar antenna to do the job of four specialized antennas. Maxson engineers expect the design to reduce the weight budgeted for a war plane's radar by up to 75%.

A test model of such an antenna, the Navy's first phased-array airborne design, is expected to be delivered to the Naval Air Systems Command in June. The single antenna would perform terrain following, terrain mapping, air-to-air searching, and fire control nearly simultaneously by quickly shaping and reshaping its radiated beam for each function.

The Maxson unit will be the first antenna system to use diode phase shifters at K_u band (12.5 to 18 gigahertz). Transistors will drive the antenna's 2,000 radiating elements and a special-purpose integrated-circuit computer will steer the radiated beam through a 120° diameter cone.

CAD costs drop

The cost of developing programs for computer-aided design is dropping as CAD becomes more popular. John Durmanian of NASA's Electronic Research Center says a major circuit-analysis program can now be developed for about \$50,000; the first programs cost about \$250,000.

Durmanian, discussing the first cost breakdown of CAD programs, says that NET-1, the best-known program, cost \$250,000 to develop—plus another \$100,000 for translations and documentation. Predict and Sceptre each cost about \$250,000, but the figure includes some studies of radiation effects on semiconductors. ECAP and Circus each cost about \$80,000, including the translation for use on an IBM 360.

Oceanic center picked in Florida

Virginia Key, just south of Miami Beach, Fla., has been selected from a field of 115 locations as the site for the East Coast Laboratory for oceanic research. The Commerce Department's Environmental Science Services Administration will direct the construction of the facility and use it for research in the basic areas of geophysics and oceanography.

You sure act big for such a little guy.

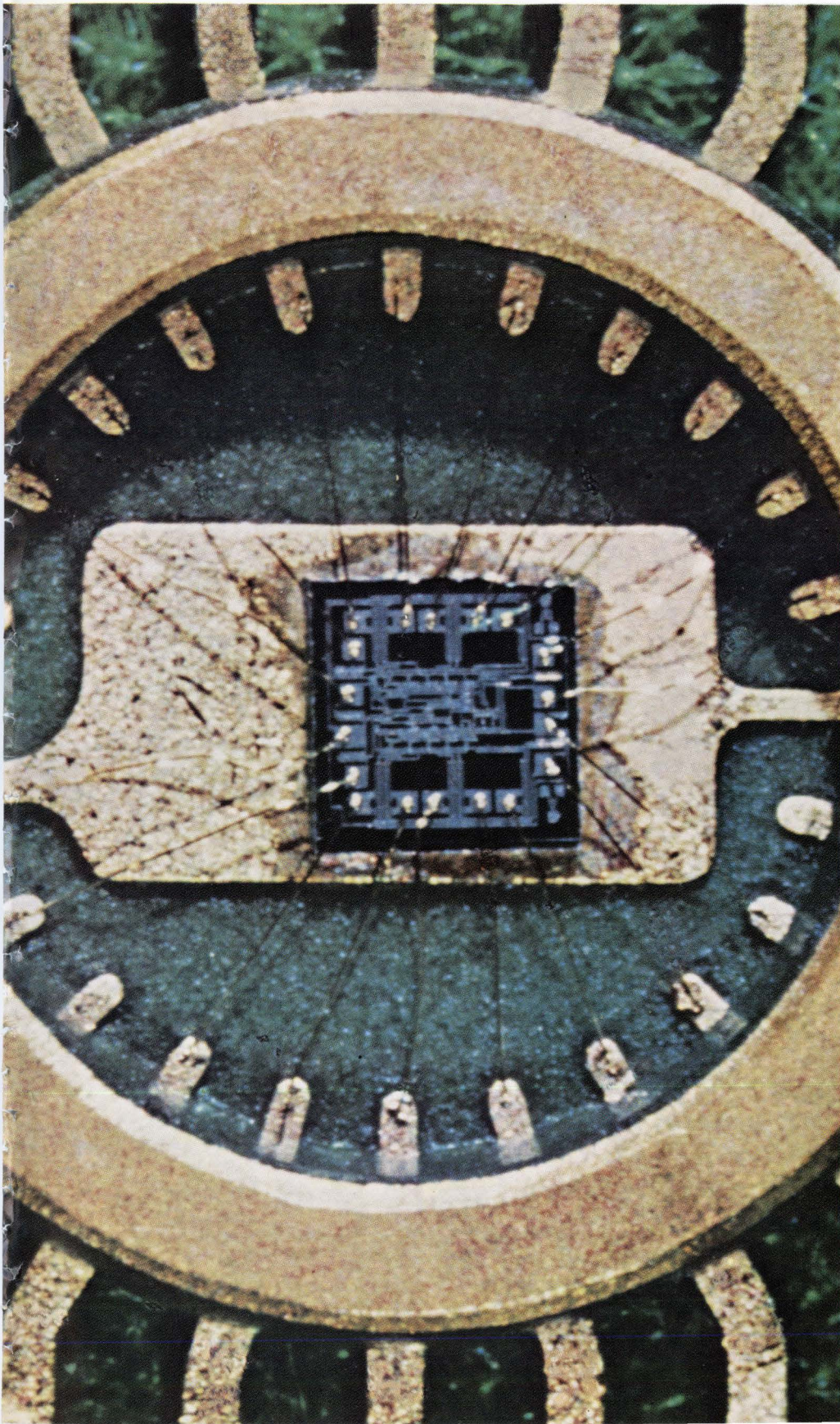

We're in the IC generation. Integrated circuits are taking over everywhere. Ours are there, too.

For instance, our integrated circuitry increases the performance reliability on a numerically controlled machine tool. Because its cycle time is extremely small, it ends many programming limitations that still bother people using the older generation of printed circuit systems.

We have been active in solid state electronics for many years. This is perfectly natural. After all, Union Carbide has been up front, on the frontiers of electronics, in many areas. For instance, we make the country's largest line of single crystals and crystal products. The number one family of solid tantalum capacitors. Sophisticated laser systems and related equipment. Fuel cells in all ranges.

These are reasons why you should keep Union Carbide in mind for help with your advanced electronics projects, while they're still in the talking stage.

Union Carbide Corporation, Electronics Division, 270 Park Avenue, New York 10017.



ELECTRONICS

THE
N ELECTRONICS
IS MUCH
MORE THAN THE
PRODUCT

NEW IDEA

It's the broadest product range in the world available from a single source plus unmatched technical backup assistance

Straight talk! General Electric offers industry the widest variety of electronic component products available—from more than 50 GE product operations. You name it. To mention just a few of the component types available:

foil and wet slug tantalum capacitors
reed switches and photocells
epoxy transistors
molded-case circuit breakers
nickel cadmium batteries
voltage tunable magnetrons
silicon, selenium, germanium rectifiers
and stacks
switchgear components
film and paper-oil capacitors

transmitting tubes
integrated circuits
sealed relays
signal diodes
compactrons
panel meters and meter relays
Volt-Pac* variable transformers
thermistors and Thyrite* varistors
regulators and excitors
*Reg. Trademark of General Electric Co.

Any or all of these products are available to you through one man—your Electronic Components Sales Operation District Sales Manager. He pools all of GE's product and technical resources into meaningful solutions for your total circuitry needs . . . driving, sensing, measuring and controlling.

Think of it. One phone call to one person can marshal GE's total electronic capability. Put the new idea in electronics to the test today. Call your Electronic Components Sales Operation office. There's one located in every major market area.

285-25

ELECTRONIC COMPONENTS SALES OPERATION

GENERAL  **ELECTRIC**

YOU BUY

Helipot's new Model 77 trimmer comes clean without fail.





First \$1.10 cermet trimmer that's sealed for board washing!

The new Model 77 is an inexpensive wash-and-wear trimmer that's sealed for solvent washing on the board without failure. The cermet element gives wider performance parameters than any other adjustment potentiometer now on the market. Its pin spacing also makes it directly interchangeable with competitive models 3067 and 3068.

In the low price field, only Model 77 offers essentially infinite resolution, wide resistance range (10 ohm to 2 megohm), and other spec advantages shown at right. Quantity prices are as low as \$1.10.

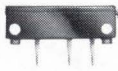
Call your Helipot rep now for a free evaluation sample. Compare Model 77 with unsealed trimmers . . . you'll see there's really no comparison.

	 Helipot Model 77	 Competitive Model 3067 Wirewound	 Competitive Model 3068 Carbon
Resistance Range, ohms	10-2 meg	50-20 K	20 K-1 meg
Resistance Tolerance	10%	10%	20%
Resolution	Essentially infinite	1.7 (100Ω) to 0.3 (20 K)	Essentially infinite
Sealing	Yes	No	No
Power Rating, watts	0.75	0.5	0.2
Maximum Operating Temp. °C	105	85	85

Beckman[®]

INSTRUMENTS, INC.

HELIPOT DIVISION

FULLERTON, CALIFORNIA • 92634

RESOLVER/SYNCHRO INSTRUMENTATION

A very short course for engineers engaged in testing and evaluation of resolvers and synchros as components or as system transducers.

Selecting a resolver/synchro test instrument for any engineering, production or system requirement is remarkably simple from North Atlantic's family of resolver and synchro instrumentation. Because this group has been developed to cover every area of need in both manual and automatic testing, obtaining the desired combination of performance and package configuration usually demands no more than 1) determining what you need and 2) asking for it.

Remote Readout of Angular Position

For remote indication of resolver or synchro transmitters in system testing, North Atlantic's Angle Position Indicators (Figure 1) provide the advantages of low cost and continuous counter or pointer readout. These high-performance instrument servos are accurate to 4 minutes of arc, with 30 arc seconds repeatability and 25°/second slew speed. Dual-mode capability, multi-speed inputs, integral retransmit components and other optional features are available to match application needs. Priced from \$895.



Figure 1. Angle Position Indicators are available in half-rack, quarter-rack and 3-inch round servo packages.

High-Accuracy Testing Of Receivers And Transmitters

Measuring receiver and transmitter performance to state-of-art accuracy is readily accomplished with North Atlantic's Resolver/Synchro Simulators and Bridges (Figure 2). Each of these dual-mode instruments tests both resolvers and synchros, and provides direct in-line readout of shaft angle, accurate to 2 arc seconds. Simulators supply

from 11.8 to 115 volts from either 26 or 115 volts excitation, and so can be used to test any standard receivers. Bridges have constant null voltage gradients, making them ideally suited for rapid deviation measurements. Simulators and Bridges each occupy only 3½ inches of panel height and are available in a choice of resolutions. They are priced in the \$1500 to \$3000 range.

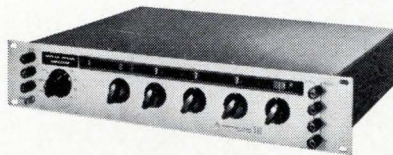

Figure 2. Resolver/Synchro Simulator provides ideal source for receiver testing.

Automatic Measurement And Conversion

Where systems require continuous or on-command conversion of resolver or synchro angles to digits, North Atlantic's Automatic Angle Position Indicators (Figure 3) handle the job without motors, gears or relays. These solid-state automatic bridges accommodate all standard line-to-line voltages and provide both Nixie display and printer output, accurate to 0.01° and with less than 1 second update time. Many variations, including 10 arc second accuracy; binary, BCD or decimal outputs; multiplexed channels and multispeed operation, are available for specific requirements. Ballpark price: \$5900.

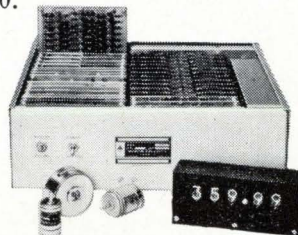

Figure 3. Model 5450 Automatic Angle Position Indicator. It measures shaft angles, converts them to digital data.

Measuring Electrical Characteristics

Combine a Resolver/Synchro Bridge and a Simulator with a North Atlantic Ratio Box, a Phase Angle Voltmeter and a test selection panel and you have an integrated test facility for determining all electrical characteristics of resolvers and synchros in component production or Quality Control. An example is the North Atlantic Resolver/Synchro Test Console shown in Figure 4. It measures phasing, electrical zero, total and fundamental nulls, phase shift and input current, as well as angular accuracy. Standard North Atlantic instruments are used as modules, making it a simple matter to fill the exact need. The unit shown sells for about \$7500.

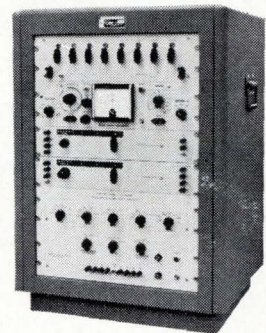

Figure 4. Model RTS-573 Test Console is a complete facility for the production line or in quality control.

If you require performance, reliability and convenience in resolver and synchro testing, we want to send you detailed technical information on these instruments (also on related instruments for computer system interface). Or, if you prefer, we will arrange a comprehensive technical seminar at your plant. Simply write to: North Atlantic Industries, Inc., 200 Terminal Drive, Plainview, N. Y. 11803 • TWX 516-433-9271 • Phone (516) 681-8600.



FROM PAR Detection, Measurement or Comparison of Noisy Signals



New Signal Correlator

PERFORMS AUTO- OR CROSSCORRELATIONS IN REAL TIME

CORRELATION FUNCTION COMPUTED FOR 100 DELAY POINTS SIMULTANEOUSLY

The PAR Model 100 Signal Correlator, a general purpose, high accuracy instrument of wide dynamic and delay range, computes the auto- or cross-correlation function of input signals and makes them available for continuous display. This system computes 100 points of the correlation function over total spans from 100 microseconds to 1 second. It operates by simultaneously multiplying one input signal by 100 separate delayed replicas of the second input signal. The resulting 100 products are individually averaged and stored in analog memory elements. Readout, which may be performed continuously as the correlation function is being computed, is accomplished by scanning the memory bank at a rate consistent with the speed of the external readout device, e.g., an oscilloscope or x-y recorder.

Correlation analysis — an extremely powerful signal processing technique in many areas of science and engineering — has heretofore been neglected, largely due to a lack of availability of suitable equipment. The

PAR Model 100 Signal Correlator will be useful in such diverse fields as aero- and hydrodynamics, plasma physics, vibration analysis, radio astronomy, radar, lasers, medical physics and geophysics.

**PAR Model 100—
Hundred Point Time Delay Correlator
SPECIFICATIONS IN BRIEF:**

Total Delay Range: 100 μ Sec to 10 Sec in 1, 2, 5 sequence.

Input Signal Levels: Peak-to-peak signals of 0.4 volts to 200 volts are accommodated without overload in each channel.

Correlator Gain Factor: At gain of 1 in each channel, 1 volt into each input will give 1 volt of correlated output. Gain for each channel is .01 to 5, in 1, 2, 5 sequence.

Noise and Dynamic Range: Base line noise with no signals, 10^{-3} volts peak-to-peak. Maximum correlated output, ± 3.5 volts.

Frequency Response and Resolution: Channel amplifiers flat to 1 megacycle. Resolution: 100 sampling points on output function.

Averaging Time - Constant: Nominally 20 seconds; May be changed to any value from 0.1 to 100 seconds.

Accuracy: Better than 1%.

Readout: 0-3.5 volts at sweep rates of 20 per Sec, 1 per 10 Sec, 1 per 50 Sec.

Price: \$8500.00. Export price approximately 5% higher, except Canada.

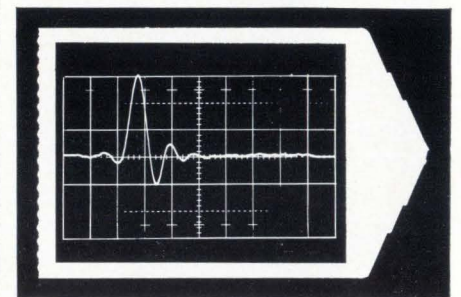

Typical Photograph of Crosscorrelation Function of Input and Output Signals of Complex Passive Network Driven by White Noise.

For more information call (609) 924-6835 or write Princeton Applied Research Corp., Dept. D, P.O. Box 565, Princeton, N. J. 08540.



PRINCETON APPLIED RESEARCH CORP.

Electronics Review

Integrated circuits

Inside look

Old wounds may be reopened if a proposal by engineers at Autonetics is put into practice. Vendors of integrated circuits may reluctantly have to permit their customers to specify and control internal construction and materials of IC's, a practice they've successfully bucked for the past several years.

P. H. Eisenberg, supervisor of special projects at the North American Aviation division, contends that present black-box input-output electrical specifications don't allow systems makers to predict the reliability of devices supplied by vendors. The trend toward large-scale integration further invalidates present methods of predicting the reliability of systems incorporating such devices, says Eisenberg, because the additional functions performed in LSI demand additional criteria.

Toys or missiles. "You get what you ask for," explains Eisenberg. "If you're building toys with integrated circuits, you don't need the reliability demanded of a military systems producer. As a systems producer, you have to tell your supplier precisely what you expect of him."

What is needed, he says, is a new reliability standard that embraces physical-chemical as well as electrical characteristics. Eisenberg concedes that there is a danger of overspecifying. He says there is a pressing need for developing technically sound, easily implemented acceptance criteria with these three fundamental questions as a guide for the new standards:

- How much will the total systems reliability improve?
- Will the additional acceptance

requirements decrease the timely supply of IC's?

▪ What additional costs will the IC manufacturer incur and pass on to the purchaser?

Eisenberg proposes a "physics of acceptance" program, details of which he will present for the first time in a paper, "Integrated Circuit Reliability Through Physics of Acceptance." It will be given on May 3 in Eastbourne, England, at a conference on integrated circuits sponsored by Britain's Institution of Electrical Engineers.

Started last October with Air Force support, the physics-of-acceptance program is still in the research and development stage at Autonetics. Company officials won't disclose the size of the contract.

Eisenberg says the program's chief goal is the setting of numerical values for chemical, geometric, and electrical parameters for integrated circuits. Using these values as a basis the vendor can adjust his manufacturing process and ma-

terials selection to comply with more stringent standards of IC's.

Time bombs. The Autonetics official believes the approach will eliminate the failure mechanisms often found after the IC's have been shown to be electrically acceptable using black-box performance measurements. These defects may not alter a device's electrical performance when it is tested, but, he says, the flaws can be time bombs, causing either drift or catastrophic failure during a lifetime of a system.

Complex systems like the Minuteman 2 guidance computer made by Autonetics have outgrown the failure analyses and life testing methods previously applied to determine system reliability. Thus, the physics-of-acceptance program evolved from the Air Force-developed. Autonetics-applied physics-of-failure program. Physics of failure determines not only where a device failed, but also why the failure occurred, and gives some indication of how long it might take for

Electrical vs. physical-chemical semiconductor parameters

Specified electrical parameters	Physical/semiconductor factors			Geometric factors			
	ρ_B	ρ_C	S	X_B	G_E	G_B	G_C
h_{FE}			X	X			
I_{CBO}			X				
I_{CEO}			X	X			
BV_{CEO}	X			X			
$V_{CE(SAT)}$		X					
C_{OUT}		X					
C_{IN}	X						
$ \beta @100\text{ mc} \approx \omega_T$	X	X		X	X	X	X
T_{OFF}				X	X	X	X

ρ — Resistivity
 S — Surface recombination velocity
 X_B — Base thickness
 ω_T — Current gain-bandwidth product

G_E — Emitter geometry factor
 G_B — Base geometry factor
 G_C — Collector geometry factor

a failure mechanism to degrade system performance.

Proposed for implementing physics of acceptance is a matrix of electrical parameters versus physical-chemical semiconductor parameters. Currently, Autonetics is concentrating on developing the criteria to be used in formulating more stringent specifications, which can be represented in the matrix by a range of values into which a device must fall before its reliability can be confidently predicted. Eisenberg suggests singling out IC elements such as output transistors or resistors for study to develop more sophisticated electrical specifications. The chemistry and geometry of these IC elements can be completely characterized, or fingerprinted, to yield data for establishing relationships between physical-chemical semiconductor parameters and electrical parameters.

Eisenberg says a good way to get an accurate fingerprint of a device is to incorporate a test tab in the device. The tab could be an electrically isolated capacitor on the chip, from which a lead is brought out to test such characteristics as oxide composition and base width.

Eye to eye. To implement the program at a vendor's plant, the purchaser must first agree with the vendor on the specifications he wants in addition to the electrical minimums for a given application. The vendor then measures these parameters either during or after device manufacture. Quality-control tests are conducted automatically on each device. The customer or the vendor would perform a random sampling on a lot of IC's furnished by a supplier. The acceptable quality level is predetermined. If the sampling falls outside the predetermined limits in the matrix, the entire lot will be rejected.

Specification ranges for the physical-chemical parameters can be determined with the assistance of a computer to pinpoint matrix relationships. Once these relationships are established, they can be inserted in a simplified matrix that calls out the desired range of nu-

merical values for a device. Eisenberg mentions thermocompression bond configuration, transistor base widths, package gas ambients, and material properties among the additional parameters the program intends to reduce to numerical values.

He says the physics-of-acceptance program could readily employ existing computer programs to establish the relationship between network operating characteristics and circuit parameters.

Components

You name it

Depending on how you look at it—or more accurately, how you hook it up—a new metal oxide semiconductor circuit from American Micro-Systems Inc. can be a J-K flip-flop, a binary counter, a two-input NOR gate, or 20 other possible components.

The relatively simple dual MOS circuit, called Ultralogic 1, has 68 transistors on a 54-by-61-mil chip and is packaged in a 22-lead round flippack. Each half of the circuit

has an independent five-input gate, two power leads, two clock leads, and a separate bit of delay circuitry. The delay has a true output and a complemented output isolated from each other to minimize capacitance.

The versatility stems from the fact that the Santa Clara, Calif., firm has refrained from making all intraconnections in the final metalization process; the customer determines circuit function by the way he connects the leads. The binary counter, for instance, is a J-K flip-flop with the J and K connected. Changing the fifth input from "clear" to "load" results in a complemented binary counter.

The advantage for the customer is that he can buy different circuits in small volume and at low costs; from the company's point of view, it is selling the same circuit. Prices on the circuits—\$29.50 for one to 49 units and \$19.70 for 50 to 199—are a little higher than those on flip-flops bought separately, but the Ultralogic 1 permits the changing of circuit functions at will. The user can breadboard a system and, once design is frozen, return to the producer to get several functions put on a complex chip.

Take your choice. Having given

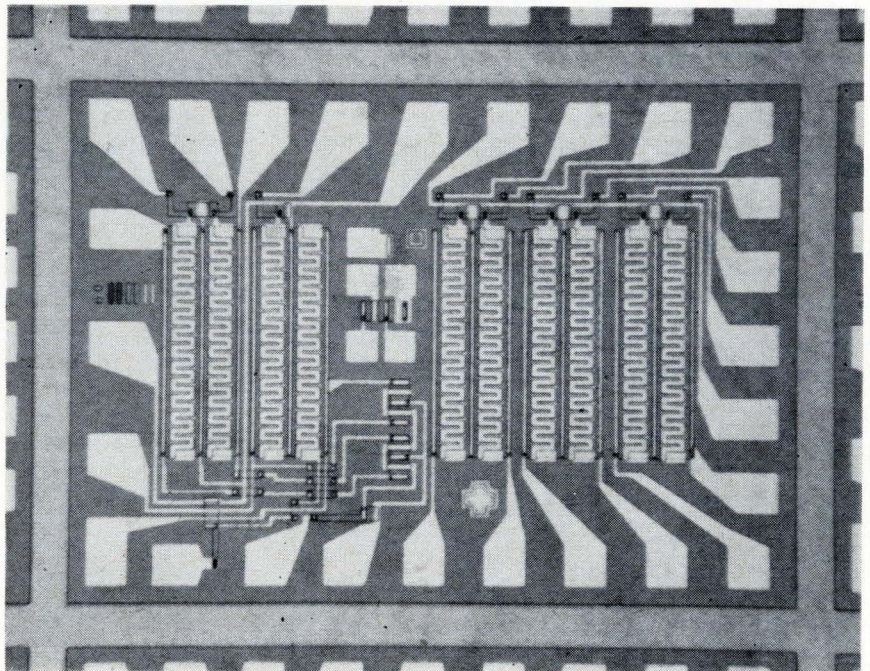

Family of metal oxide semiconductor circuits produced by American Micro-Systems can be altered by either the customer or the producer. The chip above, containing 14 MOS transistors, can be adjusted to do seven jobs.

the customer these options, the firm has gone a step farther with Ultralogic 2, a chip containing 14 MOS transistors, by giving itself the same choice. Depending on the final metalization mask chosen for the chip, seven different products are being offered: a six-channel multiplexer, a dual MOS transistor, a dual MOS transistor with a common source, a 10-channel multiplexer, a dual four-channel multiplexer, a dual two-channel multiplexer, and an expandable gate array.

With the first three on that list, the company is taking aim at some of its competition in the MOS fields. Used in conjunction with Ultralogic 1, the six-channel multiplexer is comparable to the MEM 2009 made by the General Instrument Corp.; the dual MOS transistor is comparable to the same firm's MEM 550; and the dual MOS transistor with a common source with the 2N3609 made by the Microelectronics division of the Philco-Ford Corp.

In introducing the new circuits, American Micro is frankly bidding to sell hardware to customers who may be skeptical about the capability and availability of MOS devices. When the company was formed nine months ago by a group that split off from Philco-Ford it was the captive supplier of one customer—the Radio Corp. of America. Personnel changes at RCA led to the suspension of that contract and, though RCA is now back in the fold, American Micro is displaying the marketing flexibility it acquired during the break.

The company refers to Ultralogic as a "programable logic element." Staff engineers George Avery and Al Pound say that the concept occurred to them after they had designed so many circuits that certain repetitive elements became apparent.

New breed. A customer would normally use Ultralogic 1 by making permanent connections to the leads. He could, however, use MOS switches to make circuit function changes in real time. In that respect, the circuit bears a resemblance to the internally programable complex chip, with cellular logic, that the firm is known to be

working on in cooperation with the Stanford Research Institute.

Ultralogic 1 operates at from 10 kilohertz to 1 megahertz in a military environment.

Avery says that one major advantage of the functional flexibility is that it restores to the user some of the design control that complex chips have tended to transfer to the component manufacturer. A simple calculator, the company says, can be built with 100 Ultralogic chips; once the design is optimized and the actual functions chosen, the high-density capability of MOS can be used to reduce the number of chips in the finished system to 15.

Packaging

In the cards

The Poseidon missile will be the first major program to be affected by the Navy's push to standardize modules in shipboard electronics. In the first purchase of its kind, Sylvania Electric Products Inc., a division of the General Telephone & Electronics Corp., is supplying some \$40,000 of multilayer integrated-circuit cards that have been modified to meet the new packaging standards. They will be used in the Poseidon's fire-control and guidance system.

Only a start. Indications are that the program to standardize hardware interface will also affect other projects—including the guidance portion of the deep-submergence vehicle program—coming from the Navy's Special Projects Office's fire-control and guidance branch (SP-23). The Navy Avionics Facility at Indianapolis, Ind., known as NAFI, is managing the program. It recently issued a revised manual detailing the new electronic packaging requirements.

The multilayer IC cards are being purchased by the Massachusetts Institute of Technology's Instrumentation Laboratory, which is developing the missile's guidance system.

Choice of the card, called

SYL/PAC, indicates that the Navy isn't pressing packaging density limits in the Poseidon program. The eight-layer reach-through boards, measuring 2¾ by 2 inches, contain 16 IC packs—about half the density planned for the Navy's integrated helicopter avionics system (IHAS). For IHAS, Teledyne Inc. is putting 30 IC chips on a single-layer ceramic board, and is also developing a multilayer board [Electronics, Feb. 20, p. 49]. Sylvania's standard SYL/PAC contains only 12 flatpacks, but the MIT-modified version increases this by four while reducing the card's size. The missile module will also be smaller than a standard NAFI package, but will be interchangeable with it.

Although tapped for the development work, the SYL/PAC may not be used in the production version of the missile's computer but certainly a version of the package will be applied. The Raytheon Co., production contractor, is now designing a modified version and hasn't yet reached a final decision on the package.

Dates to 1964. Sylvania started work on SYL/PAC in 1964 as part of a program to develop a multi-purpose IC computer, the MSP-24 [Electronics, Oct. 17, 1966, p. 77]. The company says the card is produced by a special assembly process that reduces interference to a fraction of that encountered with conventional printed-circuit cards. In addition to higher speed and a higher degree of noise immunity, Sylvania claims, SYL/PAC is more rigid than conventional printed-circuit cards.

Defense Secretary McNamara has urged that initial funding on production of Poseidon start in July. Polaris-carrying nuclear submarines would be retrofitted over a 10-year period, during their regular overhaul.

Companies

Executive suite

When Abe Zarem was elected a director of the Xerox Corp. in March

it was speculated that the company might be preparing to move him up from his role as president of Electro-Optical Systems Inc., the company he founded in 1956 and which Xerox acquired in 1963.

Recent events have reinforced that speculation. It appears that Sanford C. Sigoloff, EOS's 36-year-old executive vice president, will be taking over the reins from Zarem. The probability is that Sigoloff will become president of the Pasadena, Calif., firm; Zarem would continue as chairman.

Focus on the future. Such a move would give Zarem more time for Xerox. Unburdened by day-to-day problems at EOS, he would be able to concentrate on the future course of technology for the parent company.

Zarem has had little to do with routine operational matters at EOS for some time. It is Sigoloff, the professional manager, who runs the firm and who had transformed it from a research and development operation to a balanced company with regular product lines.

Zarem, a scientist and entrepreneur, saw the company as an outlet for his ideas—not as a business. Consequently, he hired Sigoloff in 1963—before the Xerox takeover—to manage the company for him. Sigoloff came in as manager of operations, was made a vice president shortly afterwards, and became executive vice president in 1965.

When he first joined the company, sales appeared to have leveled off at around \$8 million or \$9 million. This year, sales are expected to soar to \$42 million, up from last year's \$28 million.

As Sigoloff explained recently: "The problem was we were engaged in a lot of nonrecurring R&D programs and we spent a lot of time trying to get little \$40,000 and \$50,000 projects renewed. We still have a lot of these programs, but they are very carefully selected and directed."

The difficulty, he points out, was deciding which types of programs had no future. Some of Sigoloff's decisions:

- Halting solar cell and solid state research and channeling these efforts into electro-optical tech-

nology—the company's specialty.

- Discontinuing certain areas of laser work because of competition from giants in the field, including Bell Telephone Laboratories. Efforts were then concentrated in areas where the company's electro-optical technology was advanced, primarily in classified military work.

The firm has also drifted away from concentrating on R&D. Its sales are now evenly divided between R&D contracts and manufacturing. Manufactured products include night-vision devices used in Vietnam, tank searchlight reflectors, control chassis for Xerox copying machines, transducers, and ion microthrusters and solar panels for space programs.

New direction. The searchlight reflectors are an outgrowth of EOS's work in building solar concentrators for the thermionic generators used to provide power in space.

Electroforming techniques for making the thin, lightweight nickel mirrors were developed by the firm. Under another contract, about 1,000 mirrors are being supplied to NASA's Manned Spacecraft Center, Houston, for a solar simulator.

EOS is now in the process of integrating and centralizing all its manufacturing operations in a 155,000-square-foot plant in Pomona, Calif.

The acquisition by Xerox provided EOS with a strong financial backing. "As a commercially oriented company," says Sigoloff, "they [Xerox] wanted our technology and our ability to build to NASA specifications, and they wanted a West Coast window. They have also requested us to limit our programs to meet their rules regarding high returns on revenues."

Market conscious. Sigoloff and his young management team ap-



Indications are that Sanford C. Sigoloff, left, the 36-year-old executive vice president of Electro-Optical Systems, will be promoted to president, while the current president and founder of the firm Abe Zarem, will be given more responsibility with Zerox Corp., which acquired Electro-Optical in 1963. Zarem will probably continue as chairman.



What kind of a Linear Monolithic IC do you get when you put a Bipolar and a MOS/FET on a single chip ?

A BiFET, naturally.

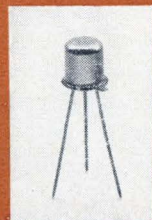

The BiFET's unusual coupling of bipolar and MOS/FET performance on a single chip gives you the unique combination of high input resistance, high transconductance and low noise with high voltage capability.

That's not all. The Amperex BiFET, type TAA320, unlike conventional MOS/FETS can take input transients of 100 volts; it is immune to burnout from static charge and requires no special handling.

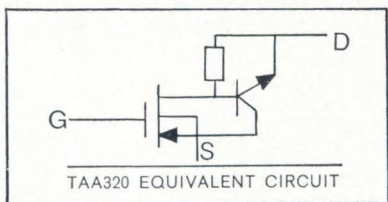

As we see it, the TAA320 is, without qualification, the optimum audio frequency semiconductor device; it's a linear, monolithic IC in a TO-18 with:

- g_m of 50,000 μmhos
- R_{GS} of 10,000 megohms
- V_{GS} of 100 V.

It's available, now, off-the-shelf, in production quantities for under \$1.00. Its low price and its unusual range of applications makes the TAA320 BiFET ideal for large volume production in consumer, professional and industrial applications. It is not only a most universal device, it simplifies circuitry, eliminates discrete components, is extremely simple to work with.

Although it is optimum for audio functions, its importance for professional and industrial applications cannot be overlooked. One TAA320 is a complete preamp and driver for a tape recorder or a high quality phonograph; it's a low-cost IC for timing circuits; an impedance converter; the perfect IC for active filters; it's a high impedance IC for sensing probes that withstand 100 volt transients; it's... it's actually a new, simple, basic building block for electronic circuit designers!

For data and detailed applications information on the TAA320 BiFET and other, new, volume-priced, linear monolithic IC's write: Amperex Electronic Corporation, Microelectronics Division, Dept. 371, Slatersville, Rhode Island, 02876.

Amperex[®]

TOMORROW'S THINKING IN TODAY'S PRODUCTS

pear to be meeting the challenge successfully. Eos is no longer a one-man, research-oriented company, but a many-faceted, market-oriented company. Although his background is technical (he has a bachelor's degree in physics and chemistry), Sigoloff has spent most of his career in management. Prior to joining EOS he spent about five years with EG&G Inc. and started and built up that company's Nucleonics division in Santa Barbara, Calif. Before that he worked for the Atomic Energy Commission for several years as a program director and as a manager of several projects at the AEC Nevada test site.

On balance

Major electronics concerns posted sales gains in the first quarter this year, but an industry sampling shows that a few suffered profit declines at the same time.

Officials of some of the latter firms blamed a sluggish economy, tight money, and the suspension of the 7% investment tax credit, while a few also cited "changing buying patterns." One company explained that it had to keep high-overhead facilities in operation to meet demand.

One of the largest firms to report a first period earnings drop was the General Electric Co. Its net income fell 11% from a year before to \$72.6 million, despite a 13% sales spurt to \$1.77 billion. The Magnavox Co.'s earnings declined 4.2% in the quarter, though its volume jumped 16% from levels reported in 1966.

The Westinghouse Electric Corp. reported a 9% sales rise to a record \$647 million, but a 14% profit drop. The Western Union Telegraph Co.'s earnings plummeted 26% from a year earlier on a 6% revenue gain, while the Columbia Broadcasting Co.'s earnings fell 6% on record sales of \$215 million. Sales were up 4.7% at P.R. Mallory, but net income was off by 14.3%. Sales of Texas Instruments Incorporated climbed 7% to about \$145 million while earnings slipped—but by less than \$100,000.

Medical electronics

Light touch

An electromechanical hand developed by the Army for amputees automatically controls the pressure of its grasp. Currently available electromechanical hands require the user to visually judge the amount of force needed to hold an object, but the new artificial hand senses the appropriate pressure with a piezoelectric device in its thumb.

The hand was developed at Walter Reed Army Medical Center, Bethesda, Md., for those amputees who lack the use of lower or upper arm muscles to control conventional artificial devices. It will be marketed next year.

The sensor is a thin wire held in an ordinary phonograph cartridge in the thumb. Power comes from a nickel cadmium battery that drives a 12-volt electric motor. If the user wants to pick up an object, say an egg, he activates a microswitch on his abdomen or chest by expanding a muscle. Should the object begin to slip as the hand lifts it, the piezoelectric crystal in the thumb generates a signal that is relayed through an amplifier in the hand to the motor in the arm. The motor will tighten the hand's grip enough to hold the object but not enough to crush it. When the user releases the command microswitch, the hand locks. In this state, it can hold the object indefinitely without any effort by the amputee or any use of electric power.

Designers of the hand are Lloyd Salisbury and Albert B. Colman of the medical biomechanical research laboratory at Walter Reed.

Communications

Oops!

Leap Frog, an Air Force study of communications between aircraft and the ground via satellite, has tripped to such an extent that the

latest test series may have to be repeated. These second-stage trials, conducted in January, were so inconclusive that the program's manager conceded last week that the Air Force's Wright Patterson Air Development Center is uncertain how, or even whether, to redesign Leap Frog's communications gear.

Though the project is described as strictly research, with no operational system expected to result, the Air Force did at least expect the work to yield data for the design of future operational equipment.

The project manager, Don Severns, was able to come to one conclusion at the end of the January tests: no available antenna type would have solved Leap Frog's problems. Parabolic antennas work well but are too bulky for high-speed planes, while phased-array antennas operate poorly at low pointing angles and often can't approach the gain or power-handling capacity of dish antennas. His suggestion: boost the power and sensitivity of the satellites.

In phase one, completed last spring, one-way voice signals were relayed by the Early Bird satellite from a 10-kilowatt X-band transmitter aboard a C-121 aircraft to a ground station.

Phase two was to be an attempt at two-way teletype and voice communications via the Syncom 3 satellite over the Pacific. To receive relayed signals, the plane was equipped with an S-band receiver system with a 4-foot-diameter dish antenna. But not a single teletype or voice signal relayed via the S- and X-band links was clearly received.

Problems began to crop up with installation of the new receiver. Intermittent faults baffled troubleshooters, and once, part of the receiver burned out and had to be rebuilt. By the time the testbed aircraft headed for the Pacific, the project was three months behind schedule and the worst was yet to come.

Aloha. Program officials were faced with problems from the time they landed at Hawaii's Hickam Air Force Base. For one thing, Leap Frog was the victim of a

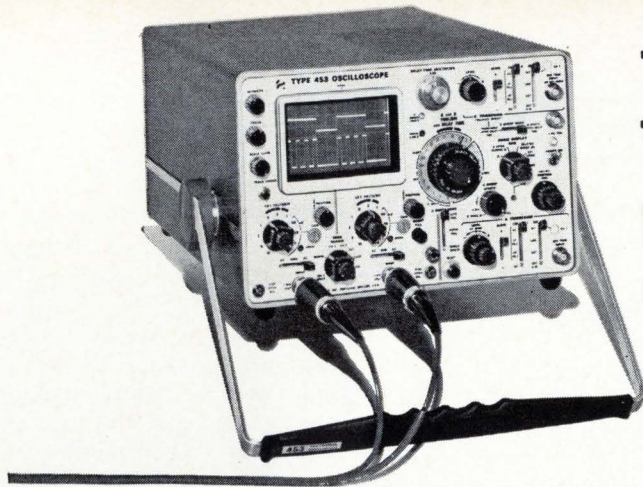

Tektronix Type 453 portable oscilloscope

takes the guesswork out of triggering

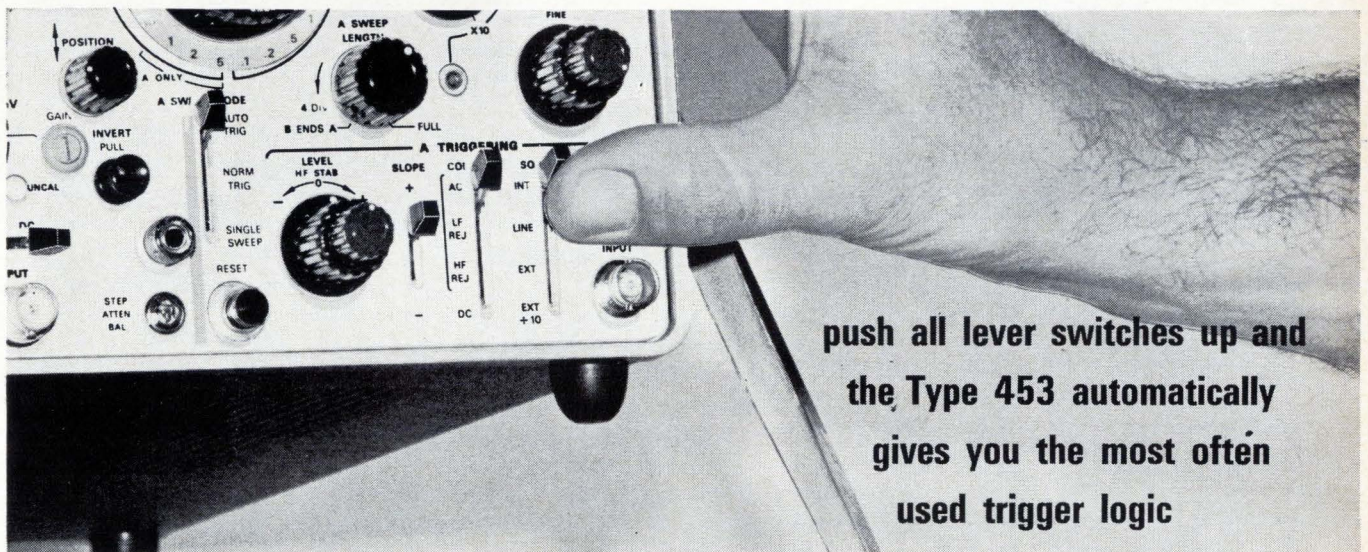

push all lever switches up and
the Type 453 automatically
gives you the most often
used trigger logic

The Type 453 provides the following features when all lever switches are up: automatic triggering that allows discrete trigger level selection with the presence of a signal and provides a bright base line at all sweep speeds when no signal is present; + slope triggering; AC coupling that gives positive triggering regardless of vertical positioning; and internal triggering that makes full use of the vertical amplifier gain and the compact internal delay line. The Type 453 will trigger to well above 50 MHz and a green light gives a positive indication of a triggered sweep.

The Type 453 is a portable instrument with rugged environmental capabilities plus the built-in high performance normally found only in multiple plug-in instruments.

The vertical amplifier provides dual trace, DC to 50 MHz bandwidth with 7 ns risetime from 20 mV/div to 10 V/div. (DC to 40 MHz, 8.75 ns T_r at 5 mV/div.) The two included Type P6010 miniature 10X probes maintain system bandwidth and risetime performance at the probe tip—DC-50 MHz, 7 ns—with an increase in deflection factors of 10X. You can also make 5 mV/div X-Y and 1 mV/div single trace measurements.

You can operate the delayed sweep with ease. Lever control to the right and HORIZ DISPLAY switch to A INTEN DURING B gives delayed sweep operation. Setting the B TIME/DIV and the DELAY-TIME MULTIPLIER to meet your requirements and switching to DELAYED SWEEP allows $\pm 1.5\%$ delay measurements to be made.

The Type 453 is a continuation of the Tektronix commitment to quality workmanship. Its design and layout make it easy to maintain and calibrate. Transistors plug in and are easily removed for out-of-circuit testing. An accurate time ($\pm 0.5\%$) and amplitude ($\pm 1\%$) calibrator permits quick field calibration.

The front panel protection cover carries all the accessories with the complete manual carried in the rain/dust cover. The Type C-30 Camera and a viewing hood that fits in the rain cover also are available.

Type 453 (complete with probes and accessories) . . .	\$1950.00
Type C-30 Camera	\$ 390.00
Collapsible Viewing Hood	\$ 7.50

U.S. Sales Prices, FOB Beaverton, Oregon

Tektronix, Inc.



For complete information, contact your
nearby Tektronix field engineer or write:
Tektronix, Inc., P.O. Box 500, Beaverton, Oregon 97005

LET'S GET TECHNICAL!



OUTPUT IMPEDANCE

In power supplies, "output impedance" at DC, is equivalent to the expression for load regulation. At higher frequencies, the incremental output impedance becomes an expression for what might be called the "dynamic regulation", and is composed of a variety of influences, including:

1. The regulating amplifier gain.
2. The output filter capacitance.
3. Output and wire inductance.

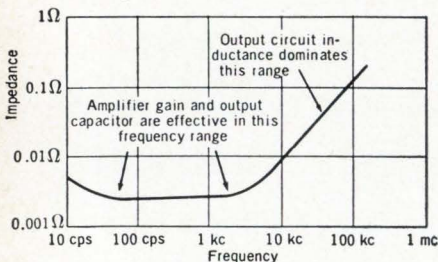

Typical power supply output impedance plot

The regulating amplifier's gain-feedback ratio is mainly responsible for the DC impedance. In the mid-frequency region, (up to a few kc), the power supply's output filter-capacitor produces an impedance dip which quickly yields to the effects of series wiring inductance at the higher plot frequencies. Above 10-15 kc, where most engineers become interested in output impedance as a separate power supply specification, the impedance is almost wholly a function of the internal series inductance, plus the lead inductance of the load wires. In all Kepeco power supplies, the internal series inductance is specified as a means of determining the effective source impedance at high frequencies.

Impedance measurements are covered in depth in the *Kepeco Power Supply Handbook*.

For your personal copy of this handy Handbook, write on your company letterhead to:

HANDBOOK, Dept. 2-O
G.P.O. BOX 67 • FLUSHING, N.Y. 11352

Electronics Review

breakdown in Air Force internal communications. The Space Systems Division had neglected to tell Leap Frog administrators that they had picked the worst possible time of the year to experiment with Syncom. The earth was near winter solstice; because of this and the orientation of the satellite in its orbit, Syncom's electronics were being overheated by the sun. Often the heat caused the satellite to disregard commands from ground controllers.

What hurt Leap Frog most was Syncom's habit of locking in its 50-kilohertz-bandwidth communications mode. To avoid this, the Space Systems Division refused to command the satellite to switch from its alternate bandwidth of 5 megahertz despite the pleas of Leap Frog engineers. Also, overheating of Syncom's electronics made its receiver about half as sensitive as normal, raising noise levels 2 to 3 decibels.

Leap Frog's electronics had been optimized for a 50-Mhz bandwidth, but project engineers were forced to distribute the power of the 10-kw X-band transmitter over a band 100 times wider than anticipated to reach a receiver operating at half its normal sensitivity.

The engineers had also hoped to aim the transmitter antenna automatically with instructions from a preprogrammed computer. Data on the synchronous satellite's position had been collected the month before by the Space Systems Division, but the tracking measurements had failed to disclose a small drift in Syncom's position.

When Leap Frog went on the air, engineers found the data in the computer useless. Because Syncom had moved, technicians had to aim the aircraft antenna by hand, and this was a hit-or-miss operation—mostly miss—although faint signals eventually were received by the Hawaiian ground station.

The transmitter was able to reach the satellite for about two hours before the motor generator powering the transmitter's output tube broke down. In ground tests with the C-121, signals recognizable as voice transmissions were

relayed, but reception wasn't clear. Teletype experiments failed entirely.

The S-band system was able to receive weak voice transmissions and as many as five channels of multiplexed teletype while airborne. However, the teletype signals were never printed out because the recorder taping the demodulated signals aboard the plane and the ground recorder replaying them into a demultiplexer and printer operated at different speeds.

Short-lived success. When all else failed, Leap Frog engineers tried using Syncom's 136.98-Mhz command-and-telemetry transceiver as a relay, and arrays of dipole antennas on the wings and fuselage of the C-121—with success.

The plane was able to receive teletype signals at 100 words per minute and transmit to the ground station at 50 words per minute with good readability. There were no tape-recorder problems because the plane had its own teleprinter connected to the vhf equipment.

But the vhf tests ended early when Leap Frog's signals were drowned out by command signals aimed at the Lani Bird 2 satellite. Leap Frog personnel didn't even know that the National Aeronautics and Space Administration was going to use the frequency until their experiment was ruined.

Late this year, using the same equipment, Leap Frog will try to work with spacecraft of the Initial Defense Communications Satellite Program. These tests will probably be run after a repeat of the phase-two trials.

For the record

Mixed blessing. The Air Force has chosen the International Business Machines Corp. to supply more than 100 computers to perform routine management functions at air bases around the world. This is the largest number of commercial computers ever ordered at one time, and IBM is expected to gain more than \$100 million from the sale. But Rep. Jack Brooks (D., Texas) has announced that his

Our products keep getting smaller... so how come we need more space?

You might say that's the name of the game.

Every year we've managed to pack more power and surge capacity into a smaller package than before. And almost every year we've had to add to the size of our plant.

In fact, we've doubled it twice, and tripled it once in the last five years. This year we're doubling it still again to more than 100,000 square feet.

Now we know you couldn't care less how many bulldozers we keep busy. But to tell the truth, we're a little surprised ourselves.

You see, we didn't develop Unitrode diodes for

every application. We knew they'd simply be better than they have to be for some jobs. We developed them for applications that *need* high power and tremendous surge capacity. That would subject components to extra punishment. That would require parts lasting virtually forever with no change in electrical parameters.

And when we say developed, we mean *developed*. From the ground up. With entirely new design. With entirely new methods of construction. The metallurgical bond that joins the silicon between the two terminal pins is stronger than the silicon itself, so the silicon will break before the bond does. The entire unit is fused in hard glass at over 800°C. It's voidless, so all contaminants are excluded.

Because the pins are bonded over the full face of the silicon die, heat due to surge is carried away quickly from the silicon into the terminal pins.

That's why a Unitrode diode can handle as much energy in avalanche as in the forward direction. And *every* Unitrode diode is controlled avalanche.

After 2000 hours of life testing, our parts still meet initial specified limits. In fact, we can virtually guarantee a Unitrode will never fail. Ever.

We keep packing this kind of reliability into a smaller and smaller package and our plant keeps getting bigger and bigger. So maybe more people want the security of Unitrode reliability in their designs than we first thought.

We hope so. Can we send you samples and complete information? We're at 580 Pleasant St., Watertown, Mass. 02172. Telephone (617) 926-0404. TWX (710) 327-1296.

UNITRODE®

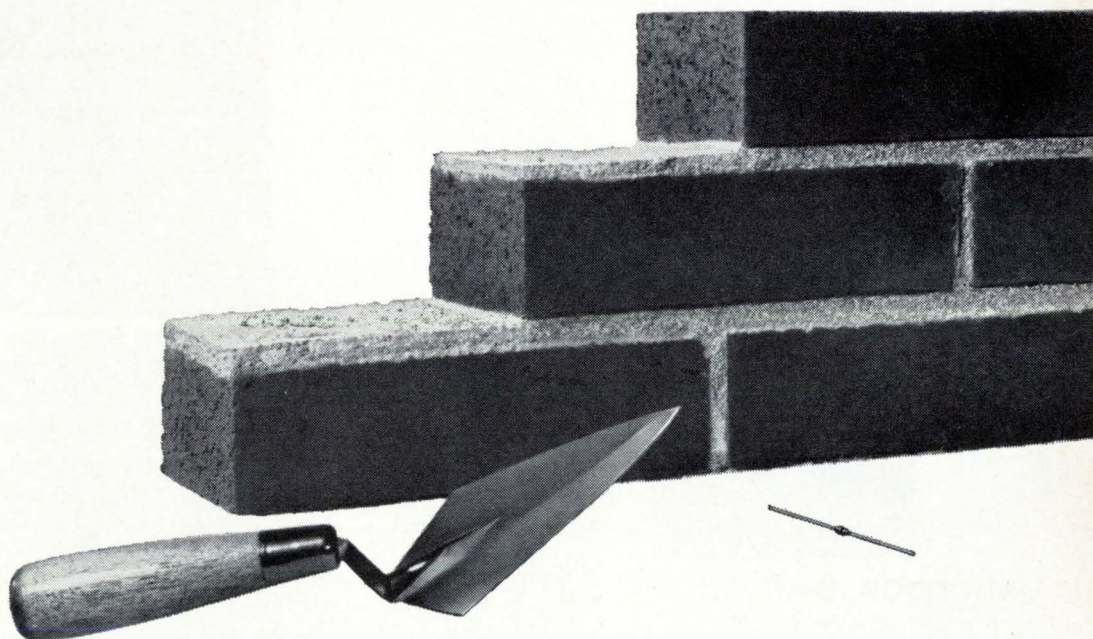



Kepco's original CK design offers true automatic crossover operation with real equality of performance for both voltage regulation and current regulation. VIX® equipped, too. Panel mode lights show at a glance just how the power supply is regulating (with signal provisions for remote alarms, process control, etc.).

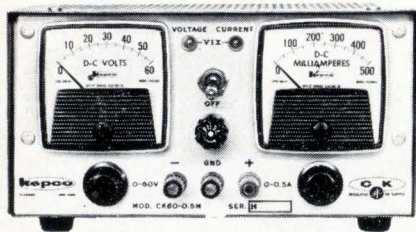

REGULATION

0.005% LINE — 0.01% LOAD

MODEL	DC OUTPUT VOLTS	AMPS	PRICE
CK 2-8M	0-2	0-8	\$345.00
CK 8-5M	0-8	0-5	345.00
CK 18-3M	0-18	0-3	305.00
CK 36-1.5M	0-36	0-1.5	305.00
CK 40-0.8M	0-40	0-0.8	267.00
CK 60-0.5M	0-60	0-0.5	305.00

- Two Temperature Compensated Zener References and Two Ten-Turn Wirewound Controls (For both voltage and current modes)
- 16 Access Terminals for Operational Control (May be programmed by voltage, current or resistance commands)

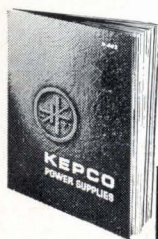

WRITE FOR NEW CATALOG CONTAINING COMPLETE SPECIFICATIONS AND APPLICATIONS NOTES



131-38 SANFORD AVE. • FLUSHING, N.Y. 11352
(212) 461-7000 • TWX # 710-582-2631

Government Operations subcommittee is going to investigate the award as part of a continuing series of hearings on Government use of electronic data processing.

Diagnostic chair. Less than a year after developing it for NASA, the Philco-Ford Corp. is offering a commercial version of its Medi-Screen, an electronic chair that monitors the human heart and breathing without the use of electrodes attached to the body. The instrument, developed by the company's Western Development Laboratories division, uses two types of sensors: a microphone to detect heart and breathing sounds and rates, and electrodes in the chair's arms to detect electrocardiogram signals and pulse rates. The price of the basic MediScreen model is \$5,250. NASA's Electronic Research Center in Cambridge, Mass., is still evaluating the instrument for use in spacecraft.

Choked up. Parts shortages caused by last month's seven-day work stoppage at Chicago trucking companies throttled output at the area's television manufacturers. Production was temporarily halted at more than half the tv and electronics plants in northern Illinois. The Zenith Radio Corp. Motorola Inc., and the Admiral Corp. were among the firms that had to close manufacturing facilities during the labor dispute.

Towering conflict. Owners of the 102-story Empire State Building have sued the Port of New York Authority in an attempt to stall construction of the authority's World Trade Center in downtown Manhattan. The suit asserts that the planned buildings would interfere with television and radio broadcasts from the Empire State Building's transmitters. The Port Authority has countered with an offer to relocate the broadcasters' antennas atop the trade center's twin towers rent free until 1984.

Telemetry meeting. The National Telemetry Conference will be sponsored by the IEEE next year. The Instrument Society of America and the American Institute of Aeronautics and Astronautics, which support the conference along with the IEEE, have announced that they

will withdraw their backing after this year's session. Going it alone, the IEEE has scheduled the 1968 conference for Houston, April 9-11. The technical program should be about the same as in previous years; industry exhibits will be retained.

Building. The Semiconductor division of the Fairchild Camera & Instrument Corp., which has outgrown its Mountain View, Calif., headquarters, has started construction of a 342,000-square-foot building for administrative and support personnel.

Hiring. The Space and Reentry Systems division of the Philco-Ford Corp.'s Western Development Laboratories, Palo Alto, Calif., will hire 400 engineers within the next two months to work on civilian and military communications satellites. Apollo lunar experiments, and in-house research and development studies.

Money for Illiac 4. The University of Illinois has awarded a \$500,000 preliminary development contract to the Burroughs Corp. for the Illiac 4 computer, planned to be 500 times faster than present systems. Development and construction should take about 2½ years. Total cost is estimated as high as \$14 million.

Buying spree. Teledyne Inc. continues to be busy in the acquisition market. Shortly after announcement of its plans to purchase the Continental Device Corp., it received the approval of Brown Engineering Co. shareholders for its bid to buy that firm. In other moves, Ling-Temco-Vought Inc. acquired Memcor Inc. in a stock swap, and the Control Data Corp. proposed to buy the Automatic Control Co.

Smog patrol. New York City has purchased 10 automated smog monitoring stations from the Space and Systems division of the Packard-Bell Electronics Corp. The contract, which includes a year's service, totals \$181,000. The centers will gauge the amount of sulphur dioxide, carbon monoxide, and smoke in the air as well as recording temperature, wind velocity, and wind direction. Data will be relayed through telephone lines.



Proved:
In-circuit reliability
for military uses

More than 20 million GE tantalum foil capacitors have already been applied. They are designed to withstand unsuspected voltage reversals and are self-healing. Low impedance circuits or catastrophic failures are no problem with GE tantalum foils. Ratings are available up to 450VDC, 0.15 to 3500 μ f, -55C to 85C, or 125C with voltage derating. Circle **Number 90** for all the facts on these capacitors.

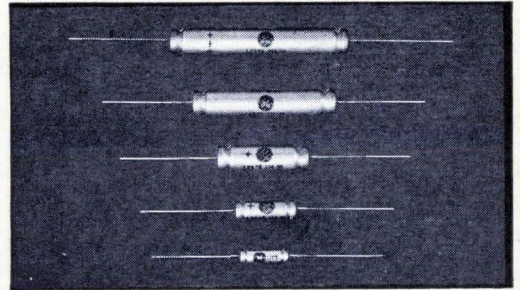

GE tantalum capacitors

Unique:
2-input, 4-output
AND circuit
in a single relay

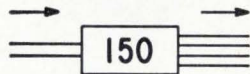

No other components are needed. Just a GE 150 4-pole Grid-space relay thanks to its unique magnetic circuit. The four outputs are switched simultaneously, yet completely independent from each other. And all input and output signals are electrically isolated. Save space. The relay measures just 0.320 by 0.610 by 0.610 inch. Save cost. All GE relay advantages—high power switching, high environmental capability, and GE's unique 150 design—are designed in especially for high performance, military type applications. Circle **Number 91**.

Your choice:
high-speed or
high-voltage
switching
in this compact
SCR

Take your pick.

GE C141 high speed SCR's (2N3654-8) are characterized for applications up to 25 kHz and feature a maximum turn-off time of 10 μ sec. They're ideal for converters and other high speed applications such as triggering a GE H1D1 laser diode.

GE C137 high voltage SCR's are rated up to 1200 volts repetitive peak with both high di/dt and high dv/dt capability . . . excellent for power switching from high voltage sources. Circle **Number 92** for more details on all SCR's available in this compact package from your GE salesman or distributor.

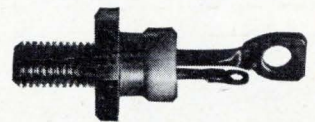

Actual size C141/C137 package

Coming your way . . .
GE's microwave
van



Be sure it visits your plant

See eight interesting displays on new ideas in microwave active components . . . and see them right at your plant. "Live" or operating displays include: distance measuring equipment (DME), radar altimeter, spectrum analyzer, unit oscillator, and some very recent VTM developments.

Ask the questions you want answered about GE klystrons, ceramic gridded tubes, voltage tunable magnetrons, tunnel diodes, and other microwave devices you may use.

Circle **Number 93** for more information.

WE MAY NOT OFFER EVERYTHING YOU WANT FROM ONE COMPONENTS SUPPLIER. BUT WE DO COME A LITTLE CLOSER THAN ANYONE ELSE.

285-18

IBM's newest deskside computing system.



It starts at \$185 a month.

We call it QUIKTRAN-2. It's a new system that puts a computer terminal within easy reach of engineers, scientists, researchers—problem solvers who can't afford to waste time with repetitive calculations. And its initial price is just \$185 a month.

Ten times faster. Not only does QUIKTRAN-2 start at low cost, but it can execute programs up to ten or more times faster than its predecessor QUIKTRAN-1. This means more work done per hour of "on-line" time.

Conversation with a computer. Use the terminal just as you would a typewriter. Carry on a question-and-answer conversation in your office with the big computer in ours. Stop a problem in the middle, change variables, new answers come right back on the terminal.

Available day and night. Dial the QUIKTRAN-2 Center over conventional telephone lines anytime between 8:00 A.M. and 8:00 P.M. Immediately, the computer is available for fast

solutions to problems in design, simulation, planning, analysis.

Easy to learn. QUIKTRAN-2 is so easy to learn you'll be computing effectively within a few hours after installation. And QUIKTRAN-2 offers even more. Bigger memory files. Greater diagnostic power. New application programs. Library pooling. Security coding. Choice of terminals. And more locations. Get the full QUIKTRAN-2 story. Send in the coupon.

Tell me more about QUIKTRAN-2.

IBM Data Processing Division, Dept. E51
112 East Post Road, White Plains, N. Y. 10601

Name

Title

Company.....

Address.....



IBM®

SPERRY
DIVISION OF
SPERRY RAND
CORPORATION

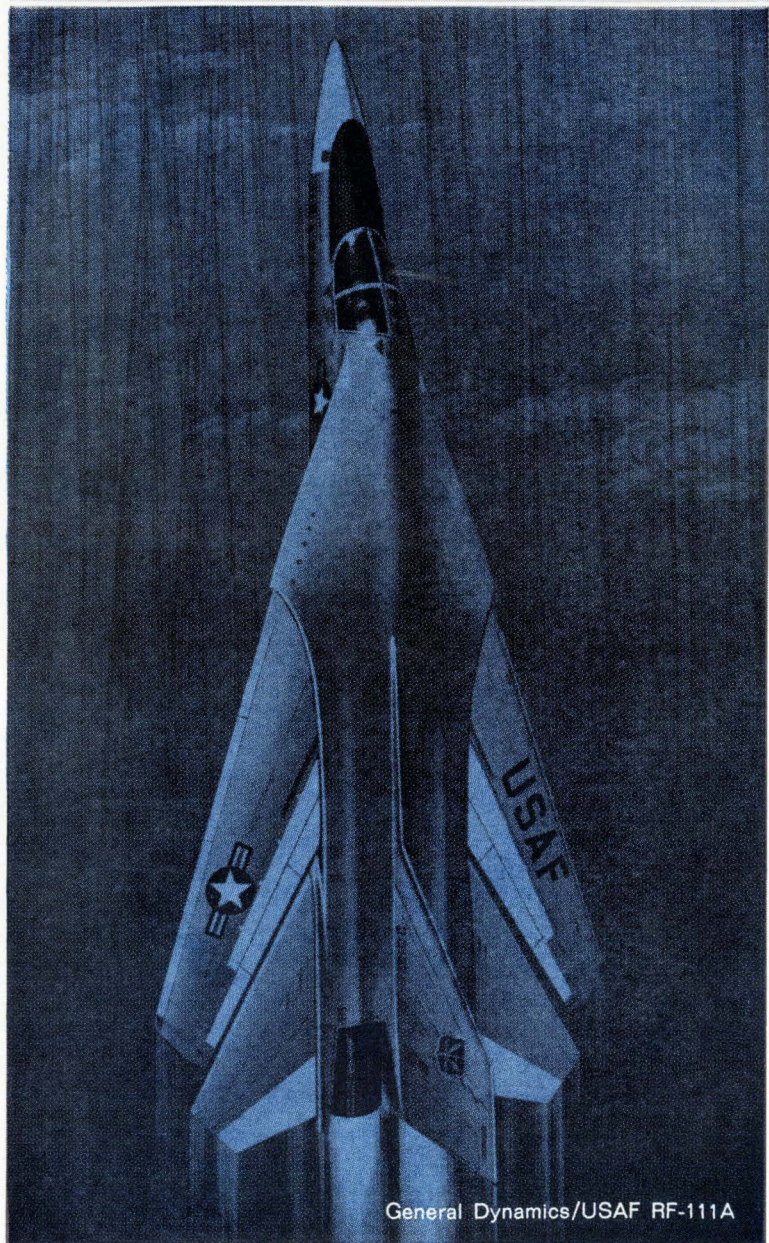
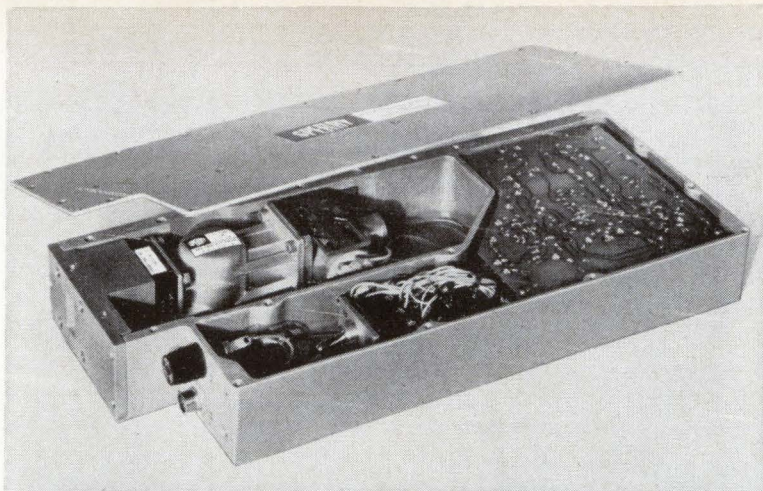

SPERRY RAND CORPORATION has brought its extensive technical resources to bear on the problem of side-looking radar for the RF-111A.

Under contract to Westinghouse Aerospace Group, Baltimore, Maryland, Sperry is providing a complete microwave source, consisting of a klystron oscillator, a stalo cavity and a carefully matched power supply. All these are housed in a single 2½" x 3" x 11" package weighing only six pounds. The unit serves as the radar's local oscillator.

Why Sperry? Because the low-noise, high-environment specifications for RF-111A generated several difficult interfacing problems among tube, stalo, and power supply. Westinghouse engineers elected to buy the entire source as a unit, allowing Sperry to solve the interface problems with techniques available from the "Storehouse of Knowledge." It was a decision which produced an optimum source package, while freeing Westinghouse people to handle the larger, more complex aspects of system integration.

Are there tube/power supply interfaces that annoy and distract you? Why not let Sperry handle them? Contact your Cain & Co. man, or write

SPERRY ELECTRONIC TUBE DIVISION,
Sperry Rand Corp., Gainesville, Florida 32601.

General Dynamics/USAF RF-111A

Why RF-111A taps Sperry's Storehouse of Knowledge.

Washington Newsletter

May 1, 1967

Space budget won't be cut

Despite violent criticism of NASA at the Congressional hearings on the Apollo spacecraft fire, it appears the disaster won't affect NASA's \$5.1 billion fiscal 1968 budget. Still uncertain, though, is how much money will go to the Apollo Applications program. Some Congressmen feel that NASA has all it can take care of now getting the moon program back on the track.

NASA officials and North American Aviation, the Apollo contractor, may be censured by Congressional groups, but there won't be a demand for resignations or contract cancellations. Rumors that James Webb will leave his post of administrator are discounted.

Normally friendly Congressmen were critical of NASA during the hearings and the space agency didn't help its cause by withholding certain reports and documents requested by Congressional committees. Some of the heat was taken off the agency by the surprisingly candid report issued by its own investigating body.

Not quite all the way with LBJ

President Johnson's primary communications link with Washington went on the blink for three hours while he was in Punta del Este last month. The blackout of the secure high-frequency system between the Presidential plane on an Uruguayan field and the National Military Command Center in the Pentagon occurred between 2 and 5 a.m. on April 14 and was apparently caused by ionospheric disturbances. In confirming the trouble, the Defense Department noted that alternate means of contacting the President were available. These links, which aren't considered nearly as reliable as the primary 484L system, known as Soft Talk, included an elaborate patching of land lines, submarine cables, and line-of-sight links, according to sources.

Johnson slept through the outage.

New York seeks classroom computer

An experimental computer-assisted teaching system is planned by New York City. Negotiations began late last month with the U.S. Office of Education for a grant to buy the equipment. If the city gets the money—approximately \$650,000—the computer system would be used to teach reading, spelling, and arithmetic to a group of first- through sixth-grade students. One of the companies expected to compete for the hardware order is the Radio Corp. of America.

Yes, Virginia, there'll always be plenty of red tape

Electronics firms are voicing increased irritation with the Defense Department, charging that the agency isn't keeping its promise to reduce controls over fixed-price incentive contracts. Robert W. Barton, chairman of the Government procurement committee of the Western Electronic Manufacturers Association, told a Congressional panel that such controls cost dearly in dollars and schedules, and may even deter some companies from seeking Federal business. Barton is supporting a bill that would set up a commission to study all aspects of Government procurement. The bill, being considered by the House Government Operations subcommittee on military operations, stands a good chance of enactment.

John M. Malloy, deputy assistant secretary of defense for procurement, claims controls and paperwork have been slightly reduced, but admits,

Washington Newsletter

"We haven't done all that can be done." He notes that industry associations have been asked to suggest ways to cut down controls, and adds: "When you deal with the Government there is always going to be red tape."

Software copyright hits snag in Senate

A bill to modernize copyright laws—including protection for computer programs for the first time—will be allowed to die in the Senate in this session of Congress. The reason: the Senate committee handling the bill has heard unofficially from the Justice Department and other sources that the House—which passed the bill last month—did not give enough attention to the consequences of copyrighting computer programs.

Some officials are questioning whether copyright protection would be an incentive to program innovators. They wonder if copyrights instead would be a deterrent. Critics of the bill point out that the software industry has grown swiftly without statutory copyright protection.

RCA study pays off in Tiros-M contract

The Radio Corp. of America will build four operational models of the Tiros-M satellite. NASA is awarding a \$29.7 million contract to RCA's Astro-Electronics division, which has been studying ways to improve the Tiros satellite. Tiros-M, which may become the nation's meteorological workhorse in the early 1970's, combines some of the best features of the reliable but limited Tiros and the big, sophisticated Nimbus. Nimbus was too expensive for the Environmental Sciences Services Administration [Electronics, Sept. 5, 1966, p. 135].

The first operational Tiros-M is scheduled for launching in early 1969. The other three satellites will follow at six- to nine-month intervals. Once they are in orbit and working, the space agency will turn the satellites over to ESSA.

Wide use planned for FPS-95 radar

If the FPS-95 over-the-horizon radar passes its tests, the Air Force plans to deploy it—as the 440L early-warning system—in six or seven locations at a cost estimated at several hundreds of millions of dollars. The radar would substantially increase U.S. capabilities to monitor missile and space launchings by other nations. The Air Force is now negotiating with the Missile and Surface Radar division of the Radio Corp. of America to build the prototype backscatter unit at a cost of about \$25 million. This prototype would be operational in about three years.

The FPS-95 would bounce pulses off the ionosphere in much the way high-frequency radio waves are transmitted; the beams would sense any disruptions in the ionospheric layers caused by missiles or spacecraft passing through. An estimated \$80 million is in the fiscal 1968 budget for the 440L and 466L systems. Now operational in Europe and the Middle East, the 466L uses earlier Raytheon over-the-horizon prototype radars.

Walkie-talkies set for frequency shift

It's virtually certain the Federal Communications Commission will order that unlicensed walkie-talkie radios be switched from the 27-megahertz Citizens Band to the 49.9-to-50-Mhz band. Manufacturers will have at least two years in which to redesign their sets and retool production facilities.

Industry has until May 22 to comment on the frequency shift.

World's only gas lasers with just 1 control: an on-off switch



Model 240
\$295 complete

Model 200
\$195 complete

Never need adjustment, alignment, or maintenance

As simple to work as a light switch, these new, rugged He-Ne continuous gas lasers are operated by a single on-off control. Nothing more is necessary, because ULI's Lasertron™ plasma tubes have permanently aligned and sealed internal reflectors. Their proprietary design completely eliminates the need for adjusting mechanisms commonly found in other lasers of this type.

The tubes are long-lived and foolproof —will operate even under water! (They are practically complete instruments in

themselves and are available separately to OEMs.)

Since they have no mechanisms to get out of order or out of adjustment, these lasers are excellent performers in tough environments. The solid-state power supplies are simple and thoroughly reliable, assuring immediate, continuing output to specification.

Use the coupon to order now from University Laboratories, Inc./ 1740 University Ave., Berkeley, California 94703 / Telephone: (415) 848-0491.

MODEL 240 \$295 complete
• Power over 0.5 milliwatts • Wavelength: 6328 Å • Uniphase (TEM₀₀) wavefront • Alignment stability guaranteed • Built-in collimator • Adjustable tripod mount • Rugged design • Low ripple DC supply • Full-year warranty.

MODEL 200 \$195 complete
• Power over 0.3 milliwatts • Wavelength: 6328 Å • Uniphase (TEM₀₀) wavefront • Alignment stability guaranteed • Built-in collimator • Low ripple DC supply • Six month warranty.

UNIVERSITY LABORATORIES, INC., 1740 UNIVERSITY AVE.
BERKELEY, CALIFORNIA 94703

Please send technical data on ULI lasers.

Please reserve a Model 200 a Model 240 from your current production. My official purchase order and shipping instructions will follow.

Name _____

Organization _____

Address _____

City _____ State _____ Zip _____

Terms: 2% discount 10 days, net 30 days, ULI products returned for any reason, prepaid and undamaged, within 30 days will receive full credit.

University Laboratories

10 amp subminiature relays at less than a buck an amp

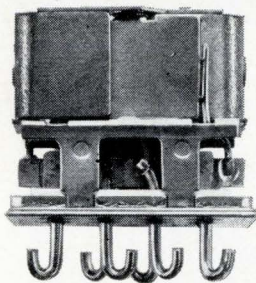

It's a new design. Not a short cut, but an instrumentation quality device that is built to MIL-R-5757.

(Seems we've built them so good, so long, we can't do it any other way, at any price.)

These 10 amp 2PDT relays come up to the 50 G shock and 15 G vibration specs and pass the 100K life cycling test.

They just aren't built to go through all those extreme space environ-

ments, so why pay the missile price? You get them by ordering our Series D. In several mounting and terminal configurations. And, of course, the under-a-buck-an-amp part does mean in quantity.

Get all the details by phoning us at Leach Corporation, Relay Division (213) 323-8221.

Or write: 5915 South Avalon Boulevard, Los Angeles 90003. Export is Leach International S.A.

LEACH

ZENERS

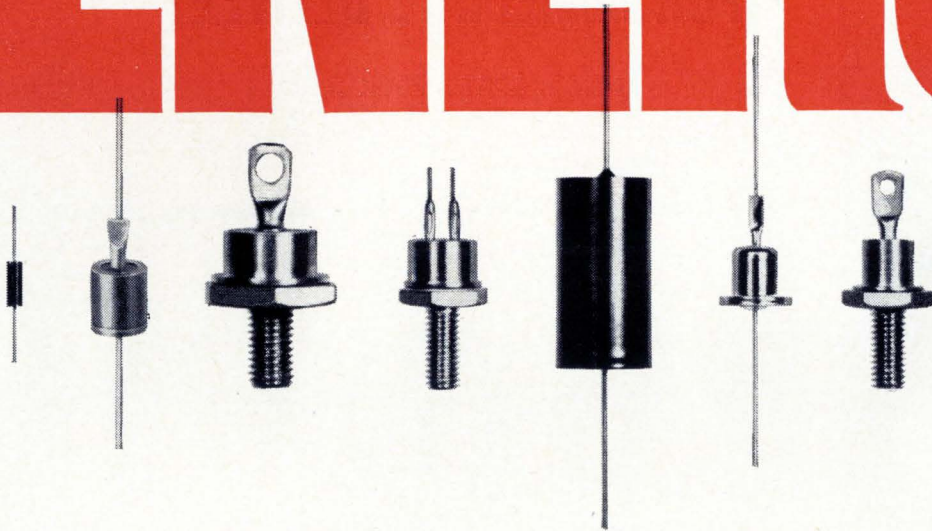

IRC can fill all your MIL and industrial needs

Now, IRC offers one of the industry's largest selections of MIL and industrial zener diodes. And, with the addition of new production facilities, they are immediately available from stock to meet all your application, environment and price requirements.

- 229 MIL devices—power ratings range from 250mW up to 10 watts
- All popular industrial-type devices—power ratings up to 50 watts
- The industry's only 1-watt zener in a DO-7 package

- New high-strength Poly-Sil zeners—up to 30% smaller and up to 2½ times more wattage dissipation than glass packages. Over 400 JEDEC types
- Complete selection of package styles and mechanical configurations

If you specify or buy zener diodes, you should know about the money-saving advantages of IRC's complete zener diode line. Write for new catalog, prices and samples to: IRC, Inc., Semiconductor Division, 727 Lynnway, Lynn, Massachusetts 01905.



RECTIFIERS

Complete choice, including sub-miniature, fast recovery and high-power types. All popular configurations.



AXIAL LEAD RECTIFIERS

AR16—AR24 replaces 363 JEDEC devices for 50 to 1000 V/.25 to 1A needs. Cost less than stud types.



SCR'S

MIL and industrial devices, including fast-switching types. Choice of ratings and package shapes.



SPECIAL ASSEMBLIES

Rectifier stacks, potted bridges, epoxy resin encapsulations and high voltage assemblies.



Rewarding engineering opportunities are immediately available.

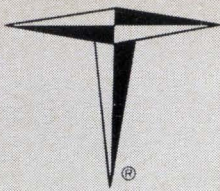

TRYGON POWER SUPPLIES

SHIPPED FROM STOCK

CALL (Mr. Hal Reinish) 516-378-2800
FOR IMMEDIATE DELIVERY

MAY 1, 1967 STOCK LIST

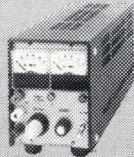

SILICON QUARTER RACK SERIES HH

- Constant Voltage/Constant Current
- 0.01% Regulation/0.5 mv RMS Ripple
- Adjustable Current Limiting



SILICON DUAL LAB SERIES DL

- Dual Outputs, Independently Adjustable
- Dual Ranges on Each Output
- 0.01% Regulation/0.5 mv RMS Ripple

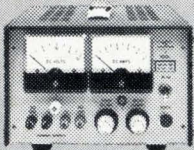

SILICON HALF RACK SERIES HRB/
SILICON HALF RACK SERIES SHR

- Constant Voltage/Constant Current
- 0.01% Regulation/0.5 mv RMS Ripple
- Adjustable Current Limiting

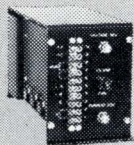

TRYPACK SERIES P

- 0.05% Regulation
- 0.5 mv RMS Ripple



LIBERATOR SERIES

- 0.005% Regulation/0.5 mv RMS Ripple, 3 mv p-p Total Noise
- 0.01% Stability



TRYLAB SERIES T

- 0.05% Regulation/0.5 mv RMS Ripple
- Adjustable Current Limiting

HH SERIES - 1/4 RACK

HH7-4	0-7V	3A	\$172
HH14-3	0-14V	3A	165
HH14-30V	0-14V	3A	210
HH32-1.5AOV	0-32V	1.5A	210

DL SERIES - DUAL OUTPUT 1/2 RACK

DL40-1	2X0-20V	1A	\$249
	2X0-40V	0.5A	

HR SERIES - 1/2 RACK

HR20-1.5OV	0-20V	1.5A	\$257
HR20-5BOV	0-20V	5A	420
HR20-10B	0-20V	10A	389
HR20-10BOV	0-20V	10A	484
HR40-75OV	0-40V	.75A	257
HR40-3B	0-40V	3A	320
HR40-3BOV	0-40V	3A	415
HR40-5B	0-40V	5A	349
HR40-7.5B	0-40V	7.5A	425
HR60-5B	0-60V	5A	415
HR60-5BOV	0-60V	5A	540
HR160-2B	0-160V	2A	495
HR160-2BOV	0-160V	2A	745

SHR SERIES - 1/2 RACK

SHR40-1.5AOV	0-40V	1.5A	\$320
SHR60-1A	0-60V	1A	235
SHR60-1AOV	0-60V	1A	330

RS SERIES - SYSTEM RACK 3 1/4"

RS20-7.5A	0-20V	7.5A	\$415
RS20-15A	0-20V	15A	495
RS40-5A	0-40V	5A	43C
RS40-5AOV	0-40V	5A	525
RS40-10A	0-40V	10A	495
RS60-7.5A	0-60V	7.5A	620
RS160-1A	0-160V	1A	495
RS160-3A	0-160V	3A	615
RS320-1.5B	0-320V	1.5A	550

LR SERIES - SLOT RANGE RACK 5 1/4"

LR6-40	5-7V	40A	\$495
LR12-30	11-14V	30A	445

LIBERATOR SERIES - 3 1/2" - 5 1/4" RACK

L3R4-40	2.5-4.5V	40A	\$445
L5R4-70	2.5-4.5V	70A	550
L3R6-40	4.8-6.8V	40A	445
L5R6-70	4.8-6.8V	70A	550
L3R12-25	11-14V	25A	445

M SERIES - SYSTEM RACK 5 1/4" - 7"

M15-50A	0-15V	50A	\$995
M15-50AOV	0-15V	50A	1170
M36-15A	0-36V	15A	620
M36-30A	0-36V	30A	795
M60-5A	0-60V	5A	715
M60-10A	0-60V	10A	725
M60-15A	0-60V	15A	825
M160-5A	0-160V	5A	925

MS SERIES - SYSTEM RACK 5 1/4"

MS6-30AFMOV	4-8V	30A	\$890
MS36-20A	0-36V	20A	795
MS60-5A	0-60V	5A	675
MS60-10ANM	0-60V	10A	800
MS36-15AM	0-36V	15A	775
MS160-3A	0-160V	3A	795

C SERIES - SYSTEM RACK 10 1/2"

C160-16C	0-160V	16A	\$1995
----------	--------	-----	--------

SR SERIES - SYSTEM RACK 7"

SR36-25	3-36V	25A	\$745
SR20-70	3-20V	70A	995

PHR SERIES - 1/2 RACK MODULE

PHR20-5A	0-20V	5A	\$295
PHR20-5B	0-20V	5A	295
PHR20-5BOV	0-20V	5A	390
PHR40-3B	0-40V	3A	290
PHR40-5B	0-40V	5A	309
PHR40-5BOV	0-40V	5A	404
PHR40-7.5B	0-40V	7.5A	385
PHR40-7.5BOV	0-40V	7.5A	480
PHR60-2.5B	0-60V	2.5A	309
PHR60-5B	0-60V	5A	375
PHR60-5BOV	0-60V	5A	500
PHR160-2B	0-160V	2A	465

PSD SERIES - DUAL OUTPUT MODULE

PSD12-300	±12V	0.3A	\$125
-----------	------	------	-------

PS SERIES 1 - SYSTEM MODULE

PS3-1.5F	2.5-3.5V	1.5A	\$ 95
PS12-900F	10-14V	0.9A	93
PS12-900FOV	10-14V	0.9A	153
PS15-800F	13-17V	0.8A	95
PS15-800FOV	13-17V	0.8A	155
PS18-800F	16-20V	0.8A	95
PS24-700FOV	22-26V	0.7A	155
PS28-600F	26-30V	0.6A	97
PS28-600FOV	26-30V	0.6A	157
PS32-250	0-32V	0.25A	97
PS48-400F	46-50V	0.4A	110
PS60-200F	50-70V	0.2A	110
PS100-200FOV	90-110V	0.2A	179
PS150-120F	140-160V	0.12A	135
PS100-200FOV	90-110V	0.2A	179
PS150-120F	140-160V	0.12A	135
PS200-100F	190-210V	0.1A	135

PS SERIES 2 - SYSTEM MODULE

PS32-1.25	0-32V	1.25A	\$165
PS32-1.25OV	0-32V	1.25A	260
PS50-750	0-50V	0.75A	175

PS SERIES 4 - SYSTEM MODULE

PS6-5	0-6V	5A	\$175
PS12-4	0-12.5V	4A	175
PS20-3	0-20V	3A	175
PS50-1.5OV	0-50V	1.5A	280
PS100-750	0-100V	0.75A	195

FTR SERIES - 1/4 RACK FERRORESONANT

FTR6-25	6.3V	25A	\$149
FTR48-4	48V	4A	179

P SERIES - TRYPACK MODULE

P20-2	0-20V	2A	\$189
P20-20V	0-20V	2A	279
P32-1.5	0-32V	1.5A	189
P32-1.5OV	0-32V	1.5A	279
P50-750	0-50V	0.75A	189
PAM-4 Metered Rack Adapter			200

T SERIES - TRYLAB BENCH SUPPLY

T20-2	0-20V	2A	\$199
T50-2	0-50V	2A	249



SILICON RACK SERIES RS

- Constant Voltage/Constant Current
- +71°C Operation Without Derating
- 0.01% Regulation/0.5 mv RMS Ripple

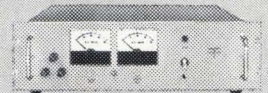

SLOT RANGE SERIES LR

- 0.01% Regulation/1 mv RMS Ripple
- Adjustable Current Foldback



MERCURY INSTRUMENT SERIES M
CENTURY SERIES C

- Constant Voltage/Constant Current
- 0.01% Regulation/1 mv RMS Ripple

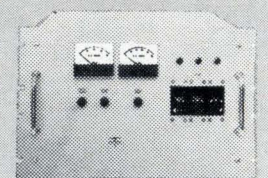

INTERMEDIATE REGULATION SERIES CR
HIGH EFFICIENCY SERIES SR

- Constant Voltage/Constant Current
- 0.2% Regulation/150 mv RMS Ripple
- Adjustable Current Limiting



SILICON MODULES
Series PS

- Single and Dual Output Models
- +71°C Operation Without Derating
- 0.1% Regulation
- 0.5 mv Ripple

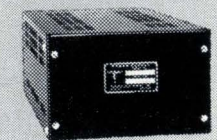

- 0.01% Regulation/0.5 mv RMS Ripple
- Automatic Current Limiting

P.S.: If you don't see what you need on this list, why not give us a call anyhow—chances are that the particular model you are seeking will be coming out of production shortly.

Trygon Power Supplies, Pleasant Ave., Roosevelt, L.I.



SEMICONDUCTORS

NEW IDEAS IN APPLICATION AND DESIGN

■ ACCURACY UP, RFI DOWN WITH GE'S NEW LOW-COST A-C POWER CONTROL MODULE

"Zero-voltage switching" is the key. GE's new S200 synchronous switch power control provides much lower RFI levels than are possible with electromechanical thermostats or phase-controlled semiconductors. And it has high accuracy with control point repeatability better than $\pm 0.5\%$ of sensor resistance. Keys to this high performance are a monolithic integrated firing circuit and a Triac power control device. Its user need only provide power, a resistive load (such as a resistance heater), a variable resistance sensor and a reference control resistor.

Potential uses include any resistive load application where a-c power control is needed. S200 power control modules are available in ratings of 10 and 15 amps RMS, at 120, 240 and 227 volts RMS, 50 to 60 Hz, for controlling resistive loads up to 4150 W. Use with General Electric's new Man-Made[®] diamond thermistor permits sensing and control of temperatures to 450 C. Housing dimensions of the S200 power control module are roughly $1\frac{1}{16}$ by $2\frac{1}{8}$ by $3\frac{1}{8}$ inches.

Circle Number 131 for full details on these new GE power control modules.

■ NEW ECONOMY POWER TRANSISTOR

Thermal dissipation....1.2W (free air)
Beta holdup.....to 500 mA

It's GE's D28A.

- P_T1.2 W at 25 C (ambient)
- h_{FE} 75-225 and 180-540 at 2 mA, 4.5 V 20 min. at 400 mA, 1 V
- BV_{CEO}25 and 50 V
- $V_{CE(SAT)}$...0.05 typical 0.3 V (max.) at $I_C/I_B = 50 \text{ mA}/3 \text{ mA}$

Other characteristics closely match those of the 2N3414-17.

All of this comes in a low-cost plastic package with three in-line leads that can easily be formed to a TO-5 pin circle. Price: less than 30¢ in volume.

Try D28A medium power silicon transistors for output stages in stereos and other phonographs, TV's, radios and other kinds of audio equipment. Or for oscillators, amplifiers, buffers and as drivers for very high power amplifiers. Circle Number 132 on the magazine inquiry card.

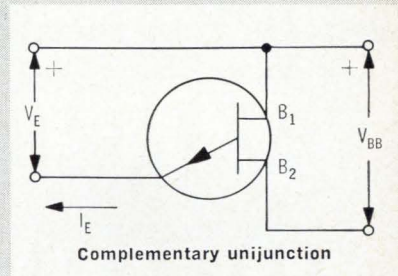
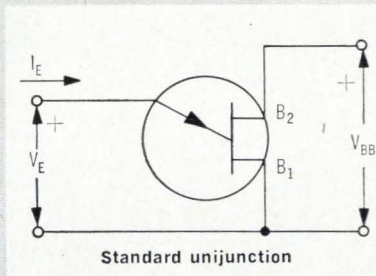

Introducing the Complementary UJT for Improved Stability and Accuracy in Oscillator and Timer Circuits

It's an entirely new kind of unijunction called the D5K. General Electric's D5K has superior temperature stability and product uniformity through utilization of planar processing techniques. Its characteristics are like those of a standard unijunction transistor except that the currents and voltages applied to it are of opposite polarity.

With GE's D5K you can build oscillator and timer circuits with better than 0.5% accuracy from -40 to $+120\text{C}$. Its intrinsic stand-off ratio (η) is just 0.58-0.62 or $\pm 3\%$. You save

test costs by determining your best compensating resistor for temperature stability at room temperature. And the D5K gives you a low base 1 to emitter voltage drop at high current... permits generation of high output pulses with low base-to-base voltages.

GE D5K's are priced at \$4.64 in 100-lot quantities. Take advantage of GE's continuing UJT leadership and superior application help. D5K's are available for both military and industrial uses. Circle Number 133 for more information.

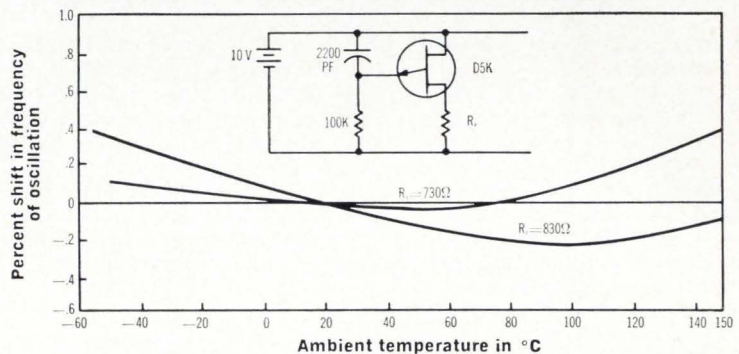

Frequency stability demonstrated by relaxation oscillator test circuit (CUJT only subjected to temperature change.)

These are just three more examples of GE's total electronic capability. For more information call your GE engineer/salesman or distributor. Or write to Section 220-55, General Electric Company, Schenectady, New York. In Cana-

da: Canadian General Electric, 189 Dufferin St., Toronto, Ont. Export: Electronic Components Sales, IGE Export Division, 159 Madison Ave., New York, N.Y., U.S.A.

GENERAL ELECTRIC

These three NIXIE[®] tubes will fill 80% of your digital-readout requirements



STANDARD RECTANGULAR



MINIATURE RECTANGULAR



LOW-COST SIDE-VIEWING

The most popular readout ever made—Type 8422. Combines *readability* (maximum viewing distance of 30 feet), *compact* size (0.6" character in a 1.0" x 0.8" end-reading rectangular envelope) and *high reliability* (MTBF of 1 million hours at 90% confidence level). Also available in a decimal-point version, Type B-59956. For high-density packaging (0.7 cu. in.) and minimal instrument height, it's the choice of virtually every important manufacturer of digital instrumentation.

Small wonder this readout (Type B-4998) is chosen when a combination of *compact* size (0.3" character in a 0.47" x 0.63" rectangular envelope), *long life* (200,000 hours dynamic life) and *readability* (maximum viewing distance of 14 feet) are needed. For the smallest electronic readout with BCD decoding and memory, use the B-4998 with the Burroughs BIP-9401A module. Small wonder, indeed!

Our new side-viewing NIXIE tube, Type B-5440. Combines *long-life* (average life of 600,000 hours) with *low cost* (\$4.95 in 1000 quantity). Tube has low profile and narrow width for minimum panel-area opening (you can line them up on less than 0.80" centers), and its new socket is especially designed for pc-board mounting. Independently-operable decimal points are optional at slight extra cost (Type B-5441).

Call or write for full information.

(and we've got the NIXIE tubes for that other 20%, too!)

Only Burroughs manufactures NIXIE Tubes



Burroughs Corporation

ELECTRONIC COMPONENTS DIVISION
PLAINFIELD, NEW JERSEY 07061

Circle 54 on reader service card

Technical Articles

**Computer-aided design:
part 9, A model approach
to integrated circuits
page 56**

It's difficult to develop an integrated circuit model that accurately portrays the functioning of the circuit elements, but the reward is the time saved by using a computer to design the circuit or predict its performance in a system. Models can sometimes be based on those for discrete components, but often the designer will have to employ distributed or lumped-parameter models. The author explains their structure and suggests the kinds best suited to various IC technologies.

**Taking a digital system's
pulse automatically
page 62**

Help is on the way for engineers bleary eyed from measuring pulse parameters on an oscilloscope screen. A new family of automatic analyzers can measure simultaneously such pulse characteristics as rise and decay times, and duration. The measurement is given more quickly than the engineer can read it from a scale, and more accurately. It matters little to the instruments whether the pulses are repetitive or one-of-a-kind. The laboratory bench isn't the only place for these analyzers; they could control a closed-loop system or automatically show a radar target's distance and direction.

**Apollo antenna fastens
on the beam to the moon
page 80**

Take a satellite communications ground terminal, shrink it to spacecraft proportions, and make it rugged enough to withstand a rocket's blast and the heat and cold of space. That, essentially, is the antenna array the Apollo astronauts will use to keep in touch with home. Like its big cousins, the antenna tracks a moving target—a ground station on the revolving earth. As the earth recedes behind the spacecraft, different combinations of horn and dish antennas will narrow the beam and step up the gain to maintain the long link.

**Loom weaves programs
into read-only memories
page 88**

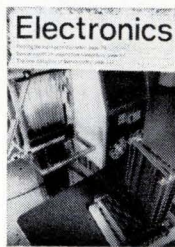

A cliché in the electronics industry is that new systems often have their origin in new manufacturing processes. That doesn't apply to the braid memories that are being developed for space-age use. The design stems from transformer storages and the manufacturing technique dates back more than 160 years to a textile loom programed by punched cards. But in combination, the

two techniques result in production costs so low that new applications are predicted for read-only memories. For the cover, Richard Saunders photographed a web of wires being woven into the braid that programs the memory.

**Coming
May 15**

- Minactor, an IC that plays many filter roles
- Holograms provide a second look at interferometry
- Plated wires, the biggest thing in film memories
- Testing landing radar on the ground

Computer-aided design: part 9

A model approach to IC's

Computers can evaluate an integrated circuit, or help design one, when the engineer supplies a mathematical model to the machine that accurately represents the IC's elements

By Gerald J. Herskowitz

Stevens Institute of Technology, Hoboken, N.J.

Designing a new integrated circuit—linear or nonlinear—or determining which types of existing IC's to use in a system requires accurate models of the components and their interactions. A good mathematical model gives the designer a two-edged tool with which to pare down the size of his design problems.

First, the engineer describes the model to a computer to study a circuit's response and sensitivity as parameters and environmental conditions change. The model can represent a variety of standard IC's substituted at will into larger circuit or subsystem models. Secondly, models may be employed to describe the operation of a proposed IC. Before a single device is fabricated and tested, its performance can be evaluated and modified through simulated operation in the computer.

The difficulty is that a good IC model is not easy to develop. It would be desirable to model an integrated circuit element by element. However, general modeling rules are difficult to formulate since elements within an IC can be fabricated by a variety of techniques,¹ some of which encourage interactions between elements that are difficult to describe. For example, a single integrated circuit might contain both diffused and thin-film re-

sistors, whose models differ. Also models for diffused transistors may vary depending upon how they are isolated from other elements in the same integrated circuit.

Furthermore, the choice of an active device model may depend upon whether the studies are to be made for small signal operation or for switching applications.

In some cases elements within an IC can be modeled identically to their discrete component counterparts. For example, when a transistor is fabricated on a substrate and ideally isolated from the remainder of the circuit, the model would be identical to the discrete transistor model.

Modeling discrete components

Discrete transistors or those within an IC which can be represented as discrete, are modeled according to their signal amplitude and operating frequency in a circuit. For example, bipolar transistors are modeled with either h-parameters or a hybrid- π configuration for small-signal circuits that operate linearly.

An Ebers-Moll or charge-control model can be used for large-signal, nonlinear circuits. The h-parameter model, although a good wideband representation of a bipolar transistor operating in a linear mode is limited because two of its parameters h_{fe} and h_{re} are frequency dependent. A simpler model, the hybrid π , overcomes this limitation because it is composed of lumped network elements that are valid over a limited frequency range [Electronics, Jan. 23, p. 84].

The Ebers-Moll large-signal model represents the nonlinearities of a transistor at low frequencies. However, for nonlinear transient analysis, a modi-

Integrated circuit models discussed in this article can be manipulated with any of the major computer-aided design programs, discussed in "Comparing the 'Big Two' programs," Electronics Feb. 6, page 74. A basic discussion of models for discrete active components was given in "Doing a model job," Electronics, Jan. 23, page 82. The series on computer-aided design began with "The man-machine merger," Sept. 19, 1966.

Models for integrated circuit elements

Component	Technology	Models	Component	Technology	Models	
Bipolar transistor	Discrete	h-parameter	Resistor	Discrete	Discrete resistor	
		Hybrid-pi			Planar diffused	Elemental-equivalent*
		Ebers-Moll				Distributed
	Charge-control	Film		Discrete resistor		
	Lumped-parameter			Capacitor	Discrete	Discrete capacitor
	Elemental-equivalent*					Planar diffused
Distributed	Distributed					
Lumped-parameter	Thin-film	Lumped-parameter				
h-parameter		Thin-film	Discrete capacitor			
Hybrid-pi			Distributed RC	Thin-film	Distributed RC	
Ebers-Moll						
Charge-control						
Field effect transistor	Junction	Controlled-source				
	Metal-oxide	Controlled-source				
	Thin-film	Controlled-source				

* Elemental-equivalent refers to a representation of the basic device with added parasitic elements

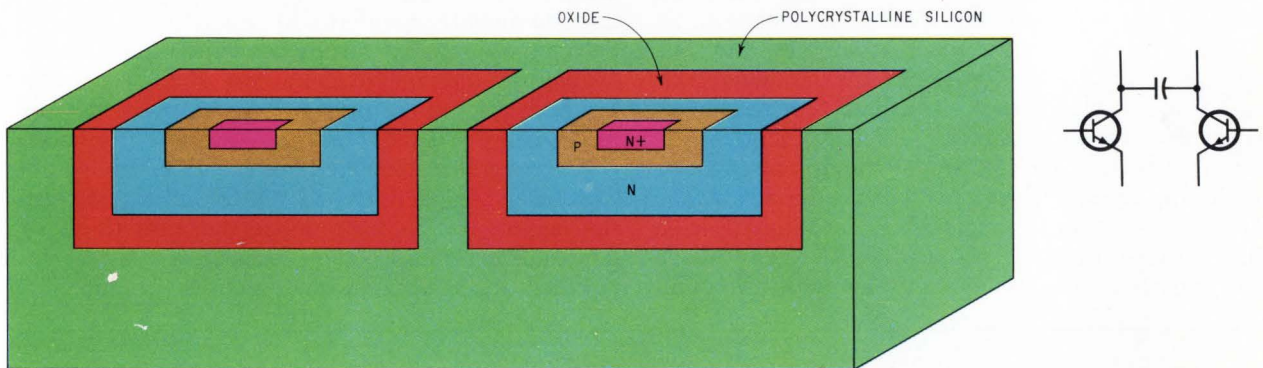

Twin pair of npn transistors in a dielectrically isolated IC are modeled by two npn transistors and a capacitor between their collectors. The model requires a capacitor between dielectrically coupled elements.

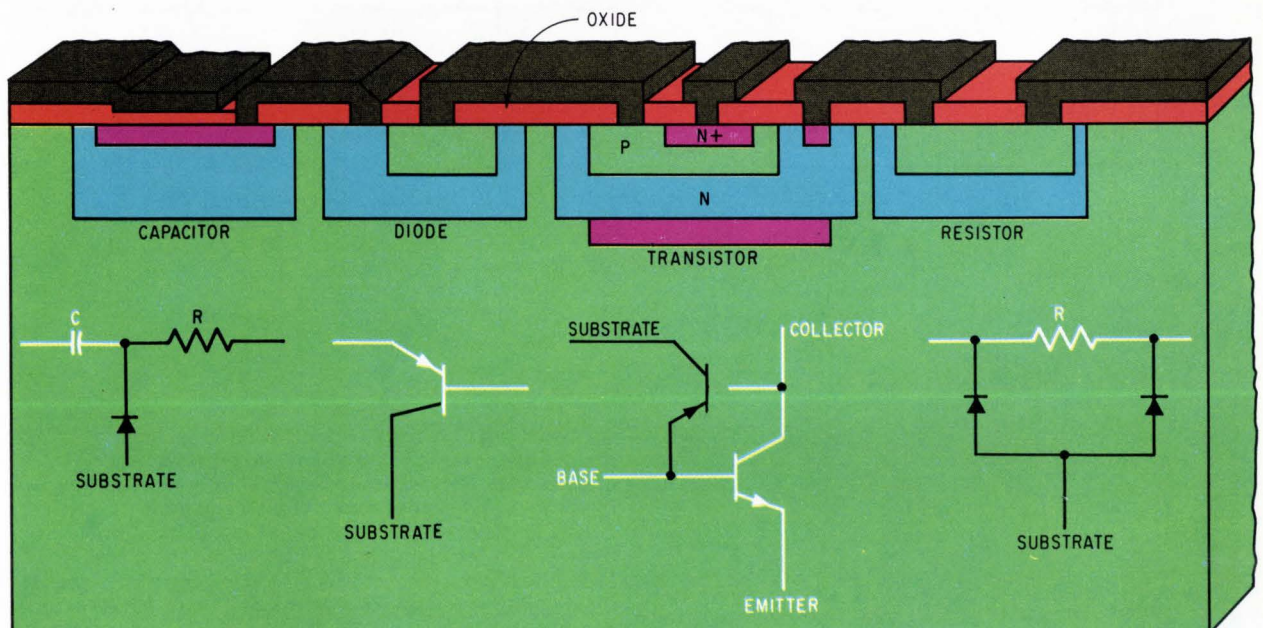

Each element in IC structure above is modeled by a corresponding element below. In each case, the intrinsic element (in white) is connected to a parasitic component (in black) that represents the interacting regions.

fied Ebers-Moll model results in an extremely complicated circuit [Electronics, Jan. 23, p. 85].

A complex but accurate and systematic approach to large-signal modeling is the lumped-parameter representation. This model approximates the non-uniformly distributed characteristics of the structure by partitioning regions into lumped elements. The elements correspond to physical phenomena such as charge storage, charge recombination, charge diffusion, and charge drift.

A thin-film resistor deposited over a diffused silicon ic is modeled as a discrete resistor. Yet a distributed RC structure must be represented by a finite transmission line.² The parameters for distributed RC networks are distributed functions which can be readily manipulated by computer.³

Modeling planar diffused circuits

Since the active and passive regions of planar diffused ic 's are intimately associated, it is often hard to define the structural and electrical boundaries. In some cases the problem is intensified because parameters such as thermal or nuclear gradients vary continuously with position. When this occurs the designer is obliged to apply complex models that represent the spatial parameters.

Fortunately, in most cases a simpler, but less accurate, approach is possible for modeling diffused ic 's. This method is called the elemental-equivalent circuit technique. Each element is represented by its discrete component equivalent along with appropriate components that represent the adjacent interacting regions. For example, in a dielectrically-isolated planar-diffused ic , leakage currents between the circuit elements are elim-

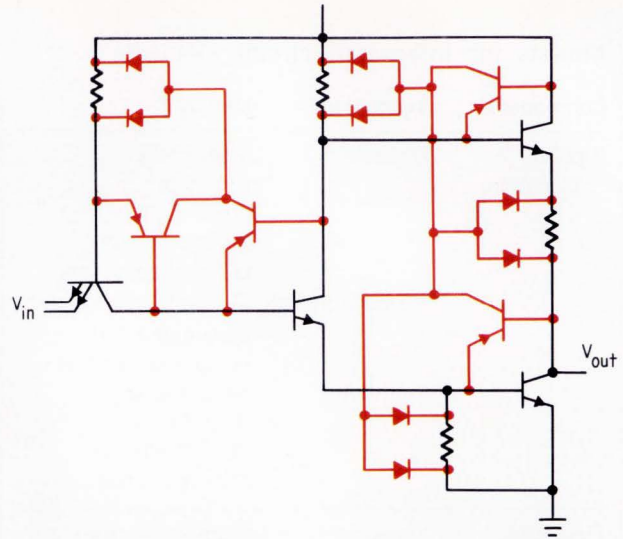

Discrete gate circuit model is a composite of the actual components plus their parasitic elements. The parasitic elements are shown in color and represent the adjacent interacting regions. The model was prepared by the elemental-equivalent technique.

inated. Such ic 's can be represented by equivalent discrete models provided that capacitors are placed between appropriate terminals of the dielectrically-coupled ic components. The pair of dielectrically-isolated npn transistors on page 57 may be represented by a model of two discrete transistors with a capacitor connected between their collectors. Conversely, capacitors are not required between the emitter and base terminals because these regions are not coupled dielectrically.

When reverse-biased pn junctions are used to

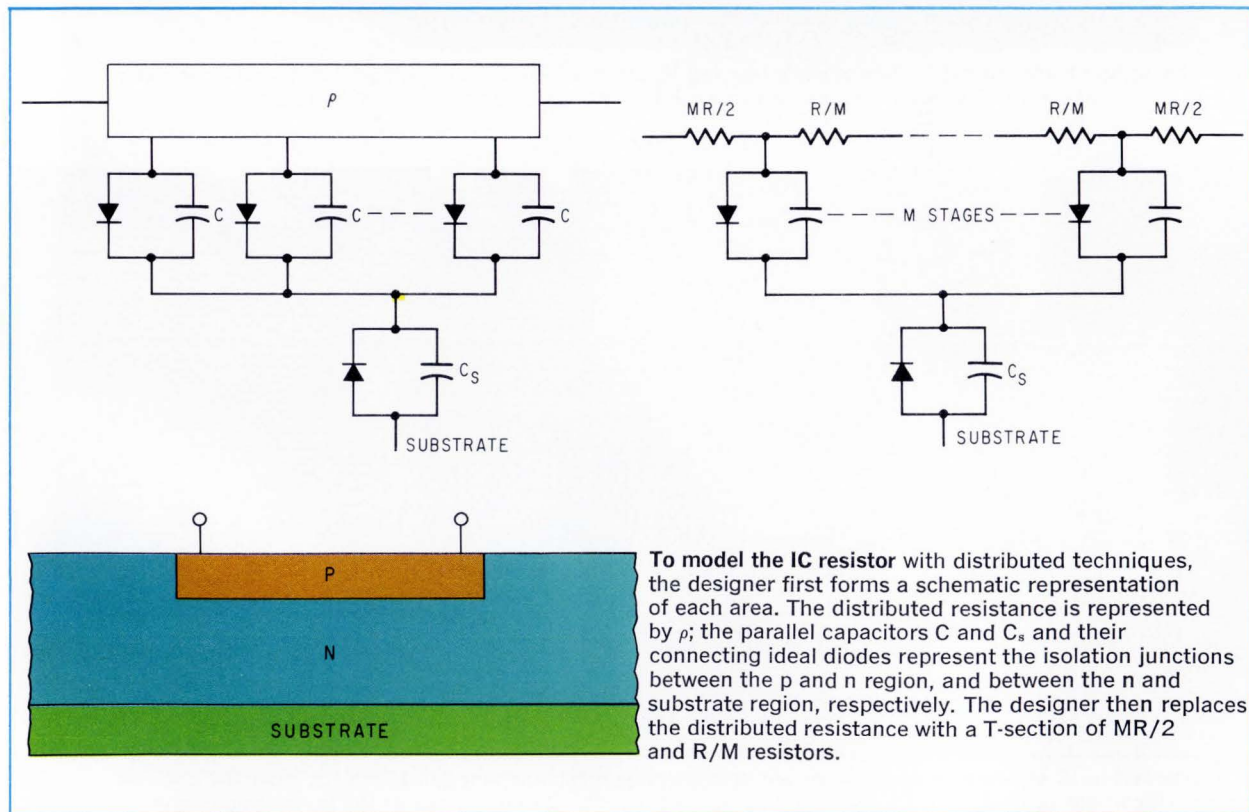

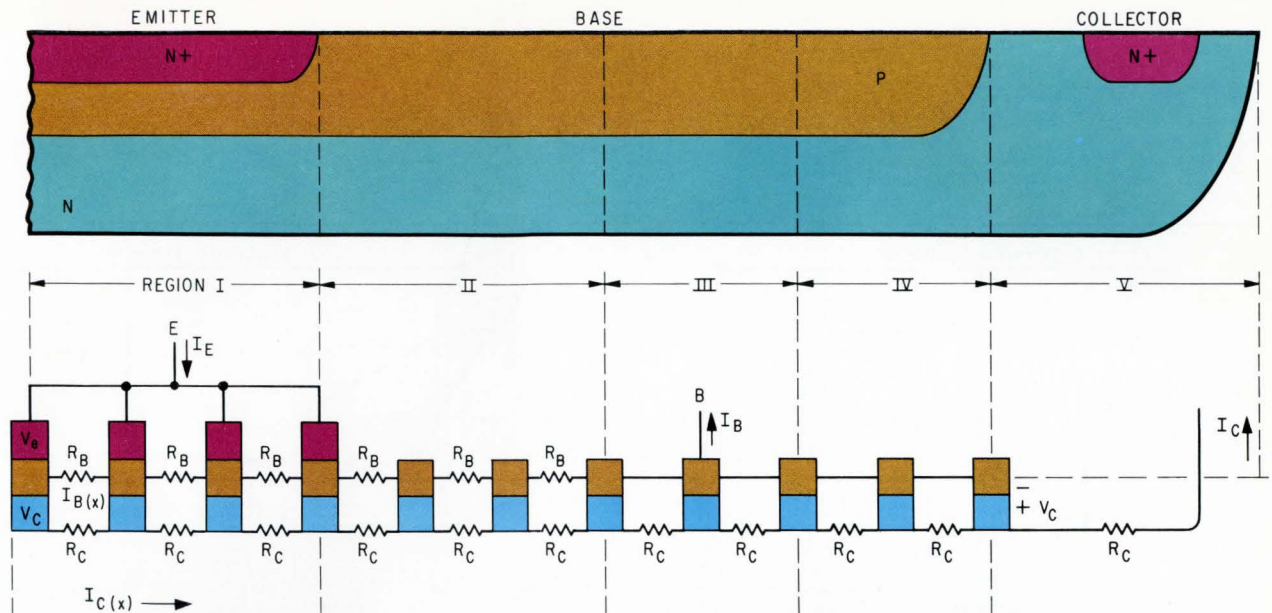

Npn transistor is modeled with distributed techniques by dividing it into several regions, depending on the desired accuracy. Each section of the model (below) is represented by distributed elements for the emitter, base, and collector: R_B and R_C are the distributed base and collector resistances; V_E and V_C represent the emitter and collector voltages; I_E , I_B , and I_C are the emitter, base, and collector currents.

isolate circuit components the model must include the parasitic effects of these junctions. The npn transistor in the diagram on page 57, for example, is fabricated in a planar diffused ic. Its model is composed of two discrete transistors—an intrinsic npn that represents the wanted transistor and a pnp that represents the parasitic junction effects. The intrinsic transistor has terminals labeled emitter, collector, and base in the conventional way, while the collector of the parasitic device is labeled substrate. Equivalent diode, resistor, and capacitor circuits are shown. The model of an integrated gate circuit appears at the top of page 58.

Distributed models

For greater accuracy, a distributed model⁴ is helpful. Consider the diffused resistor on the oppo-

site page. The vertical boundaries of the diffused junction can be neglected, since the length of such a resistor is much greater than its depth, (millimeters compared with microns).

In the model, ρ is the resistance per unit length. The isolation junction between the p and n regions is represented by a parallel combination of several distributed capacitors and ideal diodes. The parallel combination of capacitance C_s and ideal diode represents the isolation junction between the n and substrate regions. The number of elements needed for the distributed model varies depending on the desired degree of accuracy. In a practical problem, the distributed resistance would be represented by a T-section as shown in the M-stage schematic circuit.

An example of a distributed model of a bipolar

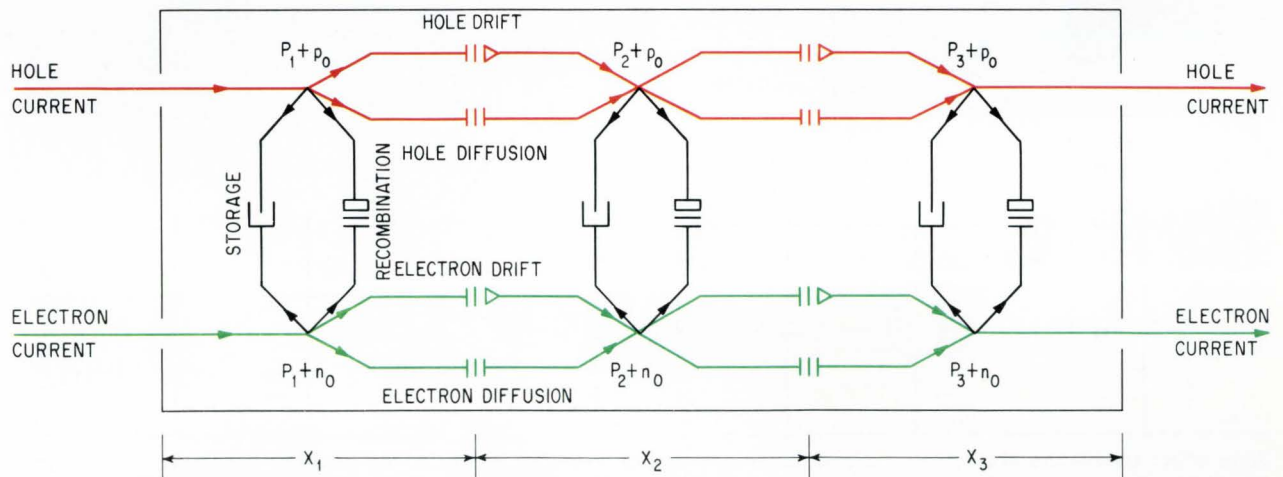

Lumped-parameter model is formed by dividing an integrated circuit into several lumped regions that represent nonuniform sections of the IC. This section is a p-type base region. Carrier currents for the electrons and holes flow between the nodes located in each lump. Symbols are labeled in the left half of the diagram.

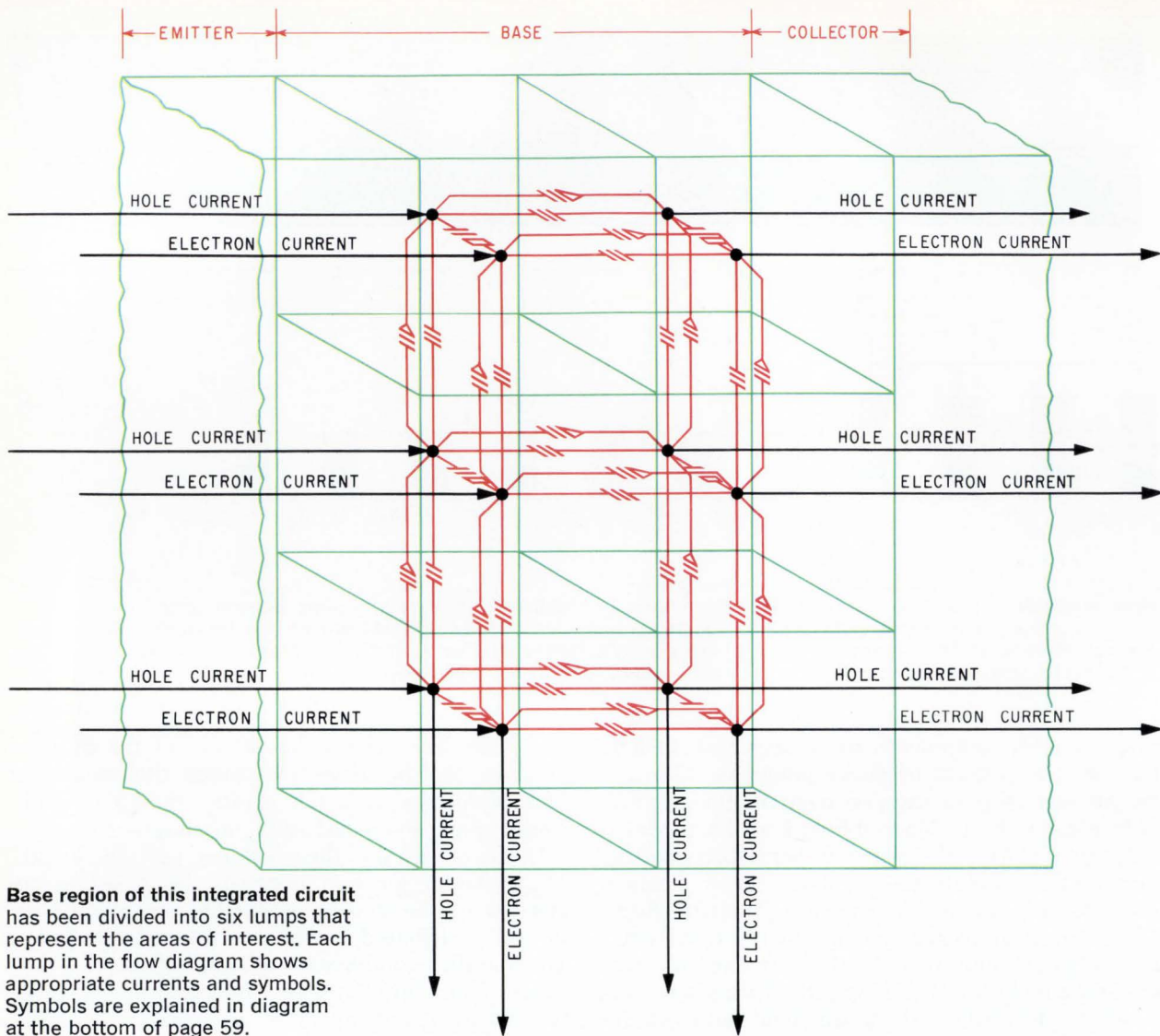

Base region of this integrated circuit has been divided into six lumps that represent the areas of interest. Each lump in the flow diagram shows appropriate currents and symbols. Symbols are explained in diagram at the bottom of page 59.

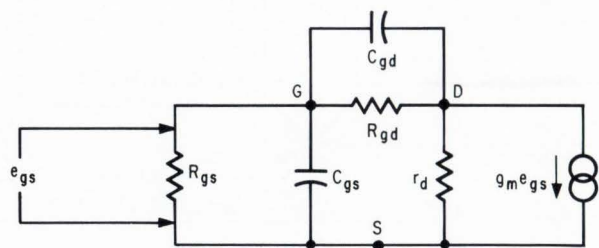
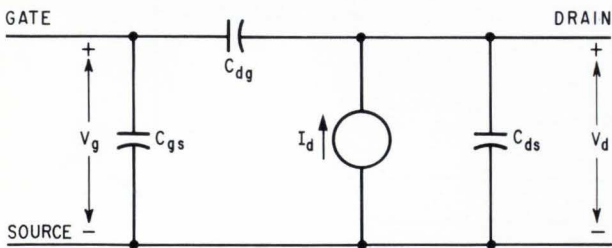
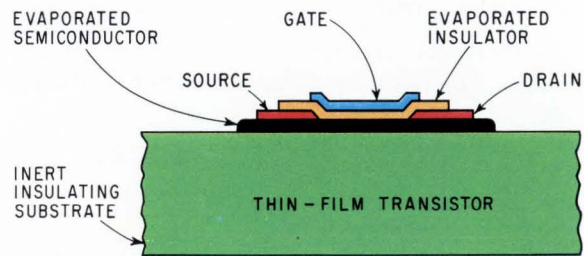
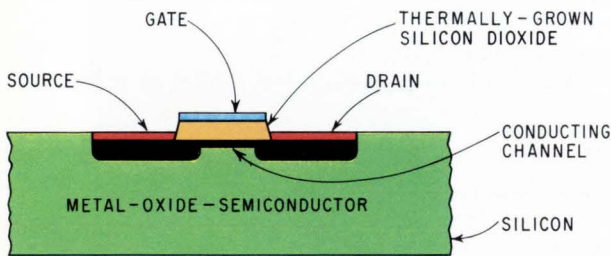

Field effect transistors are modeled with a controlled-source technique. Model for the MOS-FET is a large signal circuit composed of three capacitors and a controlled-current source. The drain current, I_d , is a function of the threshold, substrate-to-source, gate-to-source, and drain-to-source voltages. The thin-film transistor model is for small signal operation. The gate, drain, and source are labeled G, D, and S respectively and connected to the corresponding impedances and sources.

npn transistor is at the top of page 59 together with the schematic of the model.⁵ Note that within each of five regions the model is uniformly distributed. Each region of the model corresponds to its physical counterpart.

Lumped parameter models of IC's

A more complex approach, the lumped-parameter method,⁶ is required for circuits that operate over a wide range of environmental conditions. It is based on the physics of the integrated circuit and is the only technique available that can account for thermal gradients, mechanical stresses, and electromagnetic, nuclear, and cosmic radiation effects.

The method differs from the distributed parameter technique in that it partitions elements of an IC in nonuniform sections of finite lengths X_1 , X_2 , and X_3 —thus representing the physical state of each section separately. It can be done with either a two- or three-dimensional model. The three-dimensional model is used when there are parameters that vary in space.

As an example of the former,⁷ consider a diffused p-type base region, at the bottom of page 59. Each section contains particular average values of excess carrier concentration, P_1 , P_2 , and P_3 . It also has specific values of electron and hole mobilities, diffusion coefficients, and lifetimes, accounted for in the diagram by drift currents, diffusion currents, and recombinations respectively. The terms p_0 and n_0 are the hole and electron carrier concentrations, in the absence of carrier injection.

The gradients in carrier densities and electric fields cause the diffusion and drift of carriers through the region. The symbols used for the lumped-parameter method were developed by J. Linvill of Stanford University, and are explained by labels on the diagram. These hole and electron currents are visualized as flowing between nodes in each lump. Note that the currents divide among the drift and diffusion flows to the corresponding node of the next section. Also shown are the recombination and storage effects within each lump. Choosing separate nodes for holes and electrons allows the designer to describe the transport processes for each carrier. These nodes are used for convenience; the carriers do not physically flow in separate channels within the device.

In the model of a typical IC transistor base region, top of page 60, the currents, drifts, and storage effects are shown for the emitter, base, and collector regions. Only the Nasap⁸ (network and system analysis program) and Sceptre⁹ (system for circuit evaluation and prediction of transient radiation effects) computer programs include the lumped models. However, the lumped models can be added to other computer programs.

Modeling FET integrated circuits

Field effect transistors, may be categorized as either MOS (metal-oxide semiconductor), TFT (thin-film transistor), or junction type.¹⁰ These can be operated in either small or large signal circuits as

previously mentioned. When small signal circuits are used the designer should apply the model shown for the TFT transistor.¹¹ Large signal circuits are modeled with the equivalent circuit for the MOS transistor.¹² Both models contain controlled sources.

In the small signal model, the controlled source is $g_m e_{gs}$, where g_m is a transconductance and e_{gs} is the voltage between gate and source of the FET. Elements C_{gs} , R_{gs} , and C_{gd} , R_{gd} are the capacitances and resistances between gate and source and gate and drain of the transistor. Component r_d is the resistance between the drain and source.

In the large signal model, the controlled source is I_d . It is a function of the gate-to-source voltage, V_g , the drain-to-source voltage, V_d , and the threshold voltage, V_t . Capacitances shown are the values between the gate, source, and drain terminals of the FET, as indicated.

Bibliographies

P. Weimer et al., "An Integrated Thin-film Image Scanner," International Solid-State Circuits Conference Digest of Technical Papers, Philadelphia, Pa., Feb. 1964, p. 68.

S. Bonis, "The Effect of Ionizing Radiation on an Integrated Circuit Resistor," unpublished thesis, Syracuse University, Dec. 1966.

References

1. R. Warner Jr., and J. Fordenwalt, "Integrated Circuits" McGraw-Hill, Inc., 1965.
2. G. Herskowitz and M. Ghausi, "The Effect of Shaping and Loading on Distributed RC Networks," Journal of the Franklin Institute, Vol. 278, No. 2, August 1964, pp. 108-123.
3. G. Herskowitz and R. Wyndrum, "Design of Distributed RC Feedback Networks for Bandpass Amplifiers," Semiconductor Products and Solid State Technology, January 1964, pp. 13-18.
4. H. Gosh, "A Distributed Model of the Junction Transistor and Its Application in the Prediction of the Emitter-Base Diode Characteristics, Base Impedance and Pulse Response of the Device," IEEE Transactions on Elec. Dev., ED-12, No. 10, Oct. 1965, pp. 513-531.
5. L. Dickson and W. Happ, "A Distributed Model of the Saturation Characteristics of Integrated Circuit Transistors," International Solid-State Circuits Conference Digest of Technical Papers, Philadelphia, Pa., Feb. 1967.
6. J. Linvill, "Lumped Models of Transistors and Diodes," Proceedings of the IRE, Vol. 6, June 1958, pp. 949-957.
7. G. Herskowitz and M. Allen, "Modeling of Integrated Circuits," presented at the University of Wisconsin Symposium on Computer-Aided Circuit Design, Madison, Jan. 16-18.
8. R. Carpenter and W. Happ, "Computer-aided design: part 5, Analyzing circuits with symbols," Electronics, Dec. 12, 1966, pp. 92-98.
9. W.A. Bohan, "Sceptre and Component Equivalent Circuits," Nerem Record, Vol. 8, (NW 1966), p. 36.
10. J. Torkel and H. Johnson, "Field-Effect Transistors," Prentice-Hall, 1966.
11. H. Borkan, "The Insulated-Gate Thin-Film Transistor as a Circuit Element," Stevens Institute of Technology Seminar on Integrated Circuits Record, Hoboken, N.J., Jan. 1964, pp. 8-16.
12. J. Dumanian, "Transient Analysis of MOS-FET Arrays," presented at the University of Wisconsin, Symposium on Computer-Aided Circuit Design, Madison, Jan. 16-18, 1967.

The author



Gerald J. Herskowitz is currently researching solid state devices, integrated circuit modeling, and computer-aided design techniques. He received his Ph.D. from New York University in 1963 and is an associate professor at the Stevens Institute of Technology.

Digital pulse-taking

Rise and decay times and the duration of electrical pulses can be measured automatically and simultaneously by an all-digital analyzer; a proposed model would be able to work with undetermined peak amplitudes

By Chester C. Carroll

Auburn University, Auburn, Ala.

and Kilmer L. Hall

U.S. Army Missile Command, Redstone Arsenal, Ala.

Pulse parameters—rise time, decay time, and duration—can now be measured simultaneously by analyzers built with digital circuits. Providing a digital readout of the parameters for both single and repetitive pulses, the instrument can be used to control closed-loop systems.

The digital analyzer's measurements are faster and more accurate than those based on visual interpretation of a pulse trace on an oscilloscope, a conventional technique.

Since many electronic components, devices, and systems operate in a pulsed mode, the rise, duration, and decay times of a pulse can often represent error signals; they can be monitored to generate

the feedback signals necessary to keep the errors within a prescribed range. Rise and decay time can signify the rate of change of an error in a positive or negative direction, while duration can represent the time an error signal exceeds a prescribed level. Visual interpretations of a pulse can't provide such control signals.

Closed-loop systems employing digital analyzers may find use in laboratory, aerospace, and industrial applications. In an airborne radar system, for example, such an instrument could immediately analyze the received pulses to give an automatic readout of distance and direction information. Although a conventional pulse analyzer coupled to an analog-to-digital converter could perform the same function, the combination is much more cumbersome and requires specially designed circuits. The digital analyzer is smaller and lighter, and can be entirely implemented with commercially available integrated circuits.

Among the other disadvantages of conventional techniques is that they can measure only repetitive pulses. For single pulses, photographs must be taken of the pulse's oscilloscope trace, or expensive storage scopes must be used.

Characteristics

A pulse is a variation from a constant value—not necessarily zero—of an electrical quantity such as a voltage or current. The variation lasts for a finite time and returns to the constant value afterwards, and is usually characterized by a finite rise time, decay time, and duration.

The magnitude of the variation from the constant value—the maximum value of the pulse—is called

The authors



Before coming to Auburn University as an Associate Professor of Electrical Engineering, Chester C. Carroll taught at the University of Alabama, where he also directed research sponsored by NASA on the design of encoding systems



Kilmer L. Hall is responsible for automatic control systems design and analog simulation at Redstone Arsenal. Previously, he was a control systems engineer at the Marshall Space Flight Center

the peak pulse amplitude.

The rise time (RT) is the interval between the time the instantaneous amplitude first reaches 10% of the peak pulse amplitude and the time it first reaches 90%, A to B in the figure at the right.

Pulse duration (W) is the interval between the first and last times the instantaneous amplitude reaches 10% of the peak pulse amplitude, from A to A' in the figure at the right.

And the decay time (DT) is the interval between the times the instantaneous amplitude last reaches 90% and last reaches 10% of the peak pulse amplitude, from B' to A' in the figure.

There are three possible approaches to the design of an automatic pulse analyzer.

- If peak pulse amplitude is known from previous measurements, the design can be all digital for a digital readout of the parameters.

- A combination of analog and digital circuits can be used for an analog readout if peak pulse amplitude is known.

- With an undetermined peak amplitude, additional circuitry must be included to measure it.

Constraints

If the automatic analyzer is to yield accurate information, the instantaneous amplitude of the input pulse must never drop below 10% of the peak pulse amplitude during rise time, and must never rise above 90% during the decay time. Further, once the rise time has ended, the instantaneous amplitude must not drop below 90% of peak amplitude until the decay time begins.

Also, the zero axis is the normally constant value of the pulse,¹ and only positive-going pulses can be measured with any of the three designs. The pulse must be clean; spikes, overshoots, and polarity reversals have to be eliminated before peak pulse amplitude is measured.

An all-digital analyzer requires a comparator circuit to convert pulse-parameter information from analog to digital form. This circuit, which marks the instant an arbitrary waveform reaches a critical reference level,² consists basically of two simple comparator elements, essentially flip-flops (figure on page 64).

Comparator A records the instant the pulse level passes through 10% of the peak pulse amplitude, and comparator B marks the instant it passes the 90% level. The comparator elements change their output signals from a binary 0 to a binary 1 as the input waveform goes above the reference level, and return to a binary 0 when the waveform drops below the reference level.

To simplify circuitry in this section of the analyzer, the comparator elements' outputs are available in both complemented and uncomplemented form. The complemented form of 1 is 0, and vice versa; the uncomplemented outputs of comparators A and B are denoted as A and B respectively in the figure on page 64, the complemented outputs by \bar{A} and \bar{B} .

The output waveforms for comparators A and B—

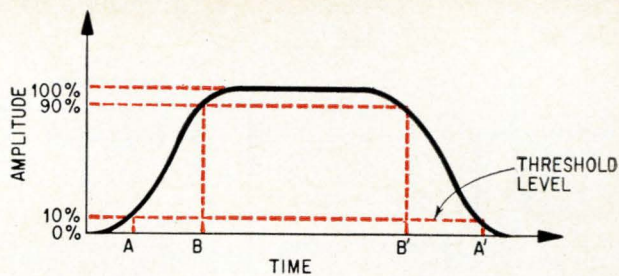

Typical pulse for defining characteristics. Rise time is interval from A to B, decay time from B' to A', and duration from A to A'.

waveforms B and C in the figure shown below—are referenced to the input pulse, waveform A. The problem here is that if the rise time is measured during the time the output of A is 1 and the output of B is 0, it would also be measured during the decay time, and decay time would be measured during the rise time. To solve this, a memory is included for the B signal. The uncomplemented output of the memory element (M)—waveform D shown below. must be available in both complemented (\bar{M}) and uncomplemented (M) forms. Waveforms E and F are the enabling pulses from the control logic that turn the rise and decay time counters on and off.

The waveforms of the outputs of comparator A, comparator B, and the B memory in an all-digital

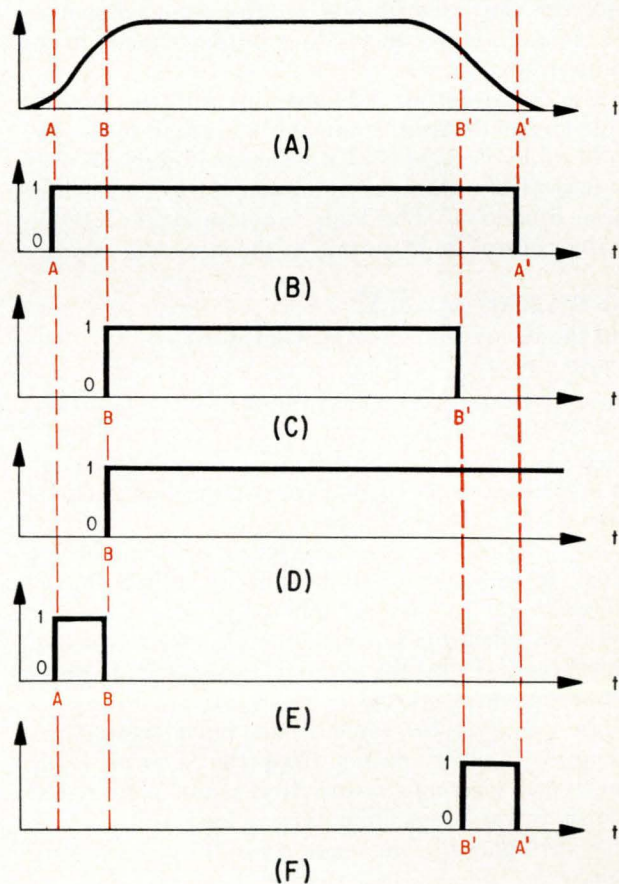

Output waveforms for the two comparators, referenced to the input pulse, are B and C. Waveform D is the uncomplemented signal of the memory element.

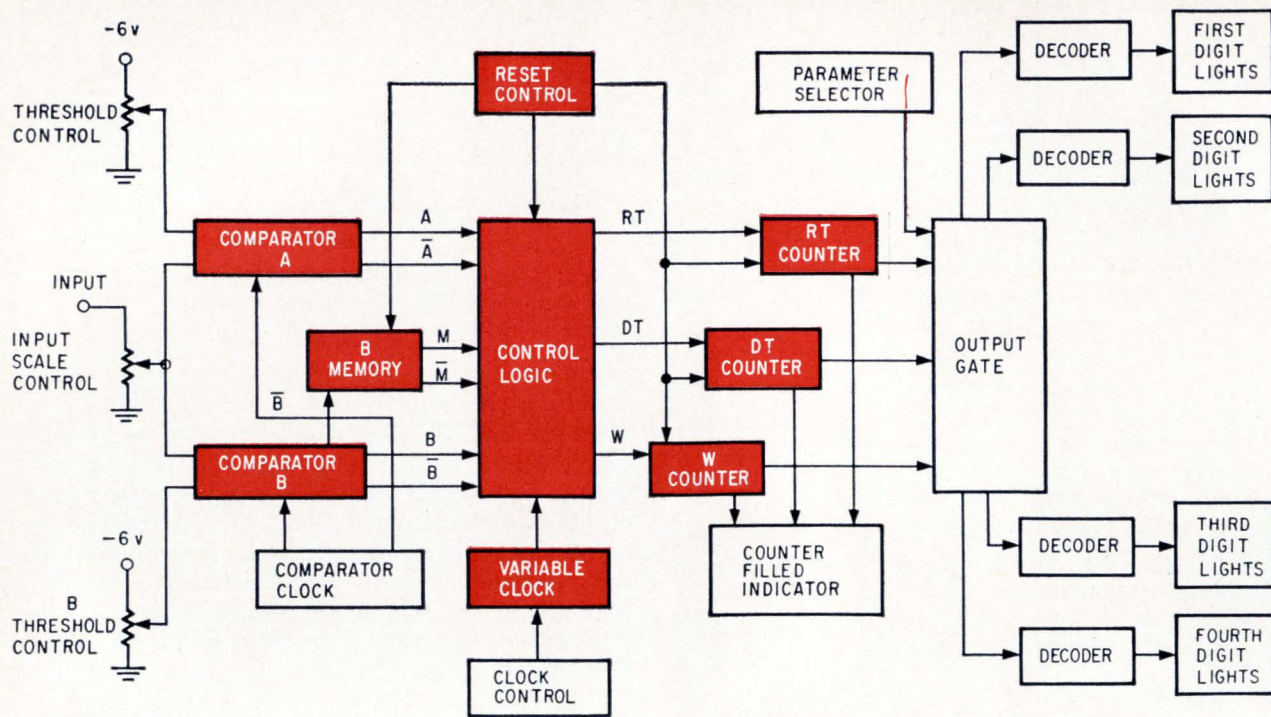

All-digital analyzer's two comparators indicate when the input signal reaches reference levels. The control logic gates clock pulses to the parameter counters. The basic design is shown in color; the additional modules are used in the working analyzer. Overranging capability is provided by the counter filled indicator, and the variable-frequency clock permits the measuring of long-duration pulses.

analyzer are used in the control logic shown in the diagram above to produce output signals to the counter circuits.

The input-output relationships for the control logic were derived from the information in the truth table on page 65. Conventional methods were employed to obtain the minimum form for each of these functions.³ The logic function representation of the control logic output to the rise-time counter is:

$$RT(A,B,M) = A \bar{B} \bar{M}$$

and the decay-time counter control is:

$$DT(A,B,M) = A \bar{B} M$$

The pulse-duration counter input is:

$$W(A,B,M) = A$$

Each function is sampled by a clock pulse through an additional logic input to avoid spurious outputs caused by transients in the input.

To measure the characteristics of a repetitive pulse, an inhibit circuit has to be added to the control logic to prevent any pulse after the first one from destroying the previous measurement. This circuit locks the control logic after a pulse measurement is started.

The counters for each of the pulse parameters accumulate clock pulses from the control logic. The counter sequence runs from zero to nine and returns to zero, repeating this as long as the clock pulses are gated to the counter input by the control logic.

A reset control circuit permits the resetting of each of the memory element's uncomplemented outputs to a digital 0; as shown in the figure

above and on page 65, the B memory and each of the counters have to be reset before another pulse is analyzed. The reset circuit—controlled externally, either manually or automatically—also unlocks the inhibit circuit, enabling the control logic for the next measurement.

While the instrument's range is limited by the number of counts the digital elements can make, time delays can occur in the comparator circuitry. System accuracy, therefore, represents the sum of the errors in the comparator and digital circuits.

For those applications in which pulse duration is much longer than the sum of the rise and decay times, clock frequency may have to be made variable so that the digits of the duration counter won't be filled before the measurement is completed.

Working model

A diagram of a working model of an all-digital analyzer built with diode-transistor logic elements with a limiting frequency of 1 Mhz is above. This instrument can measure the rise and decay times of a pulse of known height to within 10% accuracy, and durations ranging from 10 microseconds to 9.999 seconds. To handle pulses with long rise, decay, and duration times, the model includes an indicator that lights up when a parameter counter is filled—permitting measurements of more than 9.999 seconds. A pulse duration of 12.651 seconds, for example, would be displayed by a lighted indicator and a digital readout of 2.651 seconds.

A pulse analyzer that combines analog and digital

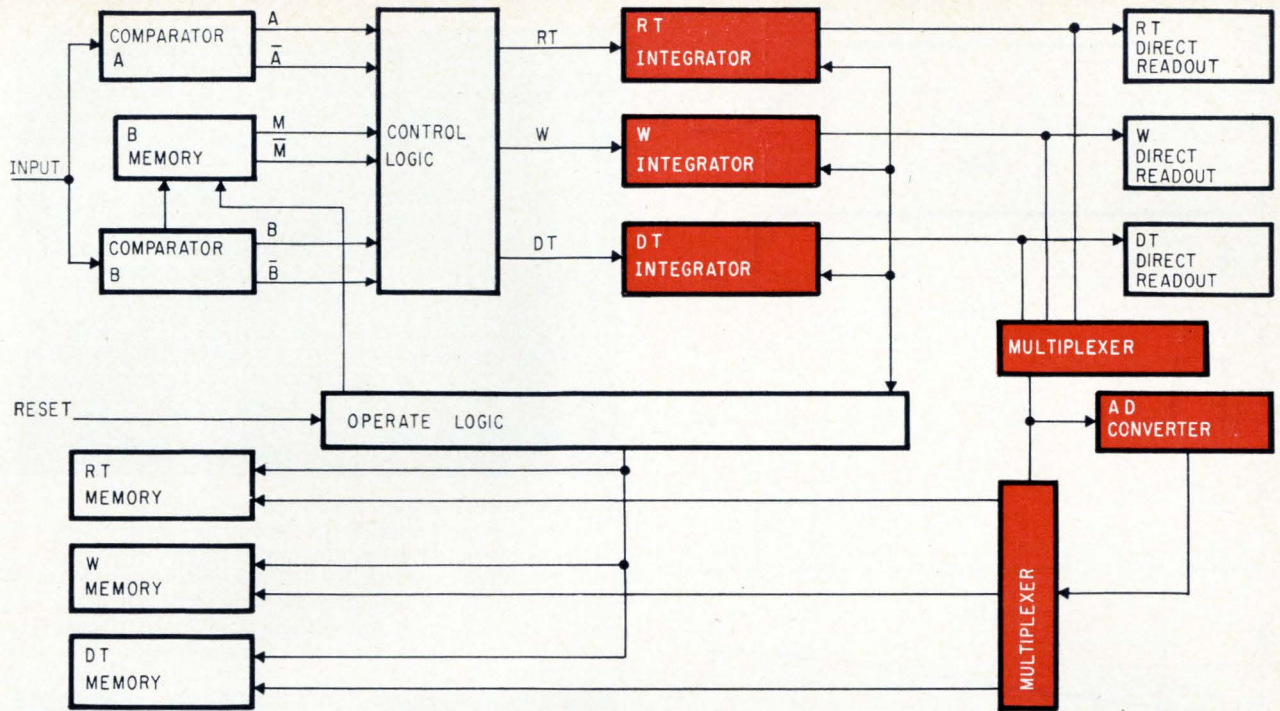

Hybrid analyzer feeds output of control logic to integrators instead of gating clock pulses to counters. Integrators can be read out directly if analog information is sufficient, or multiplexing techniques can be used to assist in analog-to-digital conversion.

circuits (figure shown above) uses the same measuring scheme as the all-digital instrument to measure the same parameters when the peak pulse amplitude is known. In this design, however, integrators replace the counters, and, though comparators A and B, the B memory, and the control logic are the same, a clock signal isn't needed.

Equations for the signals from the control logic to the integrators are:

$$RT(A,B,M) = \bar{A} \bar{B} \bar{M}$$

$$DT(A,B,M) = A \bar{B} M$$

$$W(A,B,M) = A$$

In the figure on page 66, the topmost waveform is a general pulse with the points indicated where the two comparators change states. Waveform B

shows the output of comparator A, which in this case is the same as W—the pulse duration—and waveforms C and D show the RT and DT signals, respectively. The output of comparator B isn't included here since it is the same as waveform C on page 63. The RT, DT, and W signals are connected to operational integrators, as in the block diagram above.

For the duration of the pulse parameter being measured, the input to each integrator is a constant positive voltage, a digital 1. Therefore, the output of each integrator is a linear function of time during the parameter duration. Waveforms E, F, and G show how the output voltage of each integrator increases at a constant rate when the constant input voltage is applied. With the input removed—represented by a digital 0—each integrator's output remains constant and this allows the integrator to serve as an analog memory. The output can then be read any time after the input has returned to a digital 0. In this state, the input voltage to the integrator must be cut off to prevent any error from output drift.

The output of the integrators is proportional to the parameter measured. The output can be multiplied by a scale factor and read directly from an analog display.

Conversion

Some analog-to-digital conversion scheme is needed if digital parameter data from the hybrid instrument is desired. One method, shown in the diagram above, uses multiplexer circuits to

Logic levels

Inputs			Outputs		
A	B	M	RT	DT	W
0	0	0	0	0	0
0	0	1	0	0	0
0	1	0	0	0	0
0	1	1	0	0	0
1	0	0	1	0	1
1	0	1	0	1	1
1	1	0	0	0	1
1	1	1	0	0	1

Truth table shows the logic levels at the output of the control logic for all combinations of inputs to all-digital pulse analyzer.

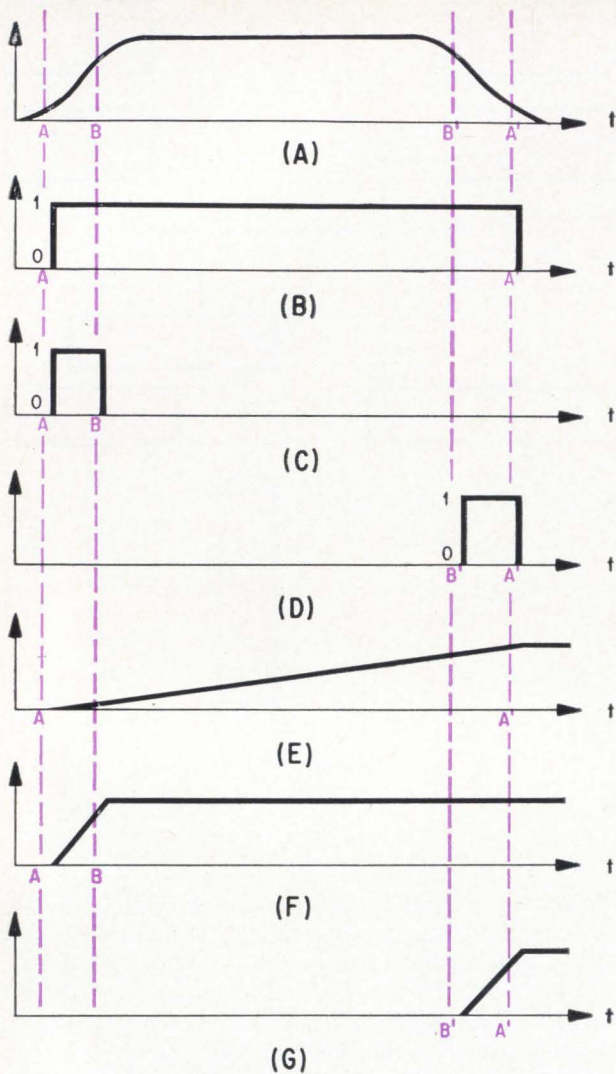

Waveforms associated with hybrid analyzer. The two comparators change states at A and B in typical pulse waveform A. Waveform C and D are the rise and decay time signals, respectively. Waveform E shows that the output of the integrator increases at a constant rate as long as a constant input voltage is applied. For simplicity, waveforms E, F, and G are shown increasing in the positive direction for a positive input, though a change in polarity normally occurs through an operational amplifier.

permit the conversion of the three integrator outputs into digital form by a single converter.

Instead of the reset control of the digital design, this scheme uses an operate logic to produce a signal that resets each of the memory elements. The logic signals also synchronize the multiplexer circuits and the analog-to-digital converter.

In this design, accuracy and range are limited by the comparator, control-logic, and integrator circuits. The comparator limitations are similar to those in the digital approach. The magnitude of the error introduced by the integrator depends upon the hardware used. Again, the errors produced by each of the individual circuits must be combined to determine the system error.

The ideal analyzer would measure pulse height

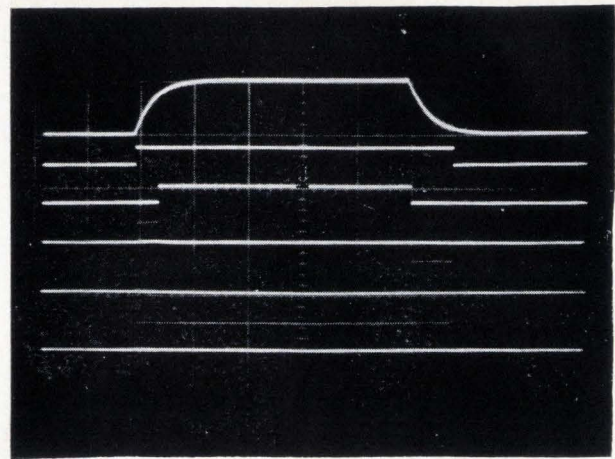

An input pulse of 2 volts amplitude and associated waveforms in the analyzer. The second waveform from the top is the output of comparator A and the third is the output of comparator B. The three remaining traces are of the clock pulses for the rise-time, decay-time, and duration counters. The voltage scale for all traces except the input pulse is 20 volts per centimeter.

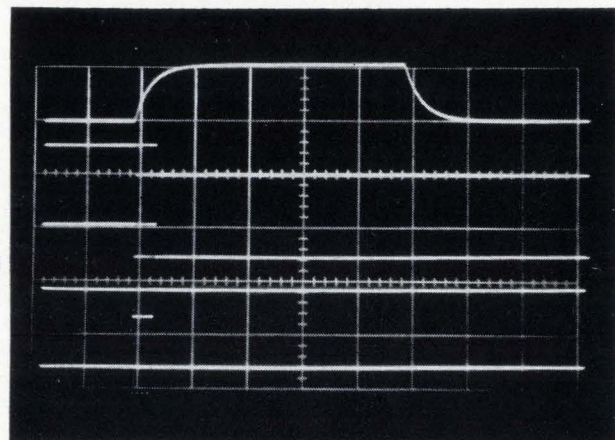

Traces of the four bits of the binary-coded decimal that represent the most significant decimal digit of rise-time measurement. The input pulse, at top, is 2 volts per centimeter. The least significant bit is indicated by the second trace from the top, the most significant bit by the fifth trace. The BCD of the decimal digit is therefore 0011; the corresponding decimal digit displayed on the point-panel readout is 3.

as well as the other descriptive parameters. A third design, again built entirely of digital circuits might be used to automatically measure all these parameters. This approach, as yet unverified, incorporates an analog-to-digital converter to periodically sample the height of a single input pulse. It would produce digital values for each sample and these would be compared to an arbitrary value stored in a memory circuit.

This technique has the same restrictions regarding the input pulse as the other designs have. Also, the definitions for rise time, decay time, and duration are similar to those previously given—with minor exceptions. Instead of basing definitions on the 10% and 90% levels of the peak pulse height, this approach bases them on a threshold level and

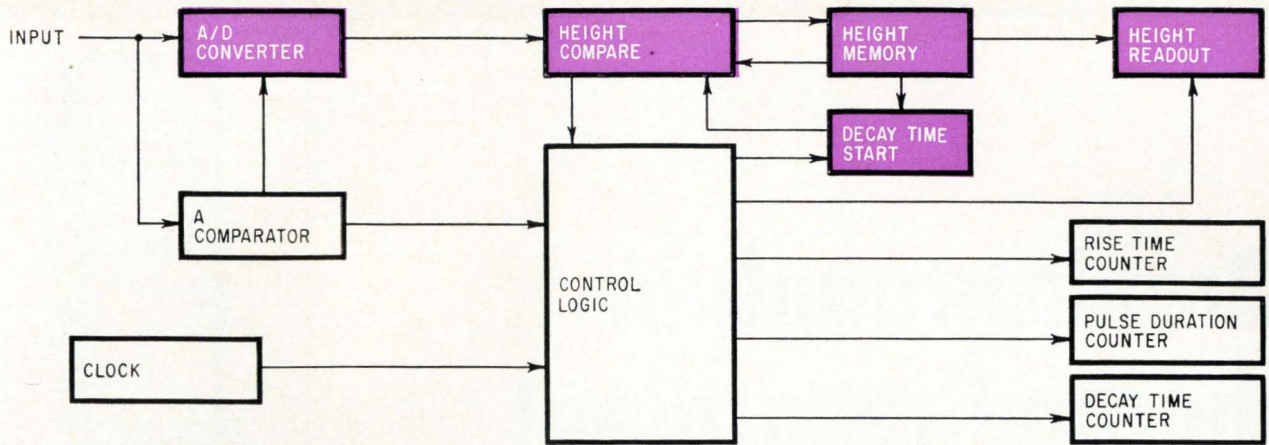

One possible way to measure peak pulse height as well as rise and decay times and duration is to add height-compare circuits.

on the peak pulse amplitude itself. The threshold value can be 10% of the expected peak pulse amplitude, or it can be any arbitrarily small voltage.

In the block diagram shown above, the pulse to be analyzed is entered as an input to the analog-to-digital converter and the A comparator. When the instantaneous amplitude of the pulse reaches a threshold value set on comparator A, the analog-to-digital converter starts to operate. After a signal sent to the control logic indicates the start of rise time and pulse duration, the converter samples the pulse amplitude periodically and produces digitally encoded values for the pulse amplitude for each sampling time. The digital value of the amplitude is then compared to the value stored in the height memory.

Continuous comparisons

If the stored value is less than the sample amplitude, it is shifted out of the height memory and the sample is shifted in until the next value of the amplitude arrives in the height-compare circuit. This process continues until the value stored in the memory is larger than the sample value. At this point, the pulse height stored in the memory is shifted into the height readout and into the decay-time start circuit; also, a signal denoting the end of the rise time is entered into the control logic. The amplitude value in the height readout is locked so that future digital values shifted out of the height memory won't destroy the measurement.

A 90% value of the amplitude shifted into the decay-time start circuit is calculated, and this value is compared with each height sample made after peak amplitude is reached. The control logic prevents the output of the decay-time start circuit from being compared to the present pulse amplitude in the height-comparing circuit until the peak amplitude is reached.

When the height-comparing circuit indicates that the pulse amplitude has reached 90% of the peak amplitude, a signal is sent to the control logic to indicate the start of decay time. When the pulse amplitude drops below the threshold value,

a signal denoting the end of the decay time and pulse duration is entered into the control logic. The operation of the control logic and the rest of the pulse analyzer from this point is similar to that of the all-digital design described earlier.

One disadvantage of the proposed method is that the pulse amplitude must constantly increase during the rise time. This might be partially compen-

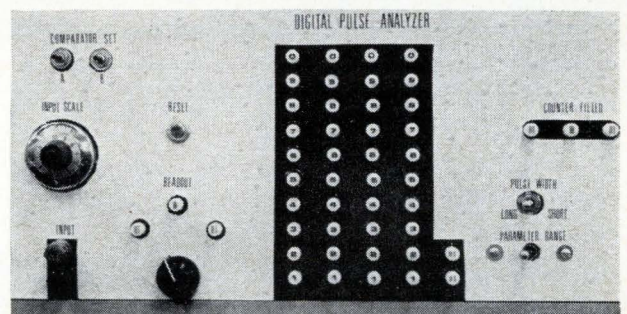

Front panel of laboratory model of digital pulse analyzer.

sated for by setting a dead zone into the height-compare circuit that would allow the amplitude to drop to a value corresponding to the bottom value of the sum of the pulse amplitude minus the dead zone before an incorrect indication would be produced. This dead zone would have to be removed after the peak pulse amplitude was reached.

In this third approach, range is limited by the sampling speed of the analog-to-digital converter. For instance, a set of digital elements designed for a frequency range from d-c to 1 Mhz would typically include an analog-to-digital converter with a sampling rate of only 300 khz.

Also, the complexity built in to measure pulse height raises costs and reduces range and accuracy.

References

1. F.F. Shea and others, "IRE Standards on Pulses: Methods of Measurement of Pulse Quantities, 1955," Proceedings of the IRE, vol. 43, November 1955, pp. 1610-1616.
2. Jacob Millman and H.T. Taub, "Pulse, Digital, and Switching Waveforms," McGraw-Hill Inc., N.Y., 1965, pp. 248-251.
3. Yaohan Chu, "Digital Computer Design Fundamentals," McGraw-Hill Inc., N.Y., 1962, pp. 136-159.

Breakthrough in thermal recording!

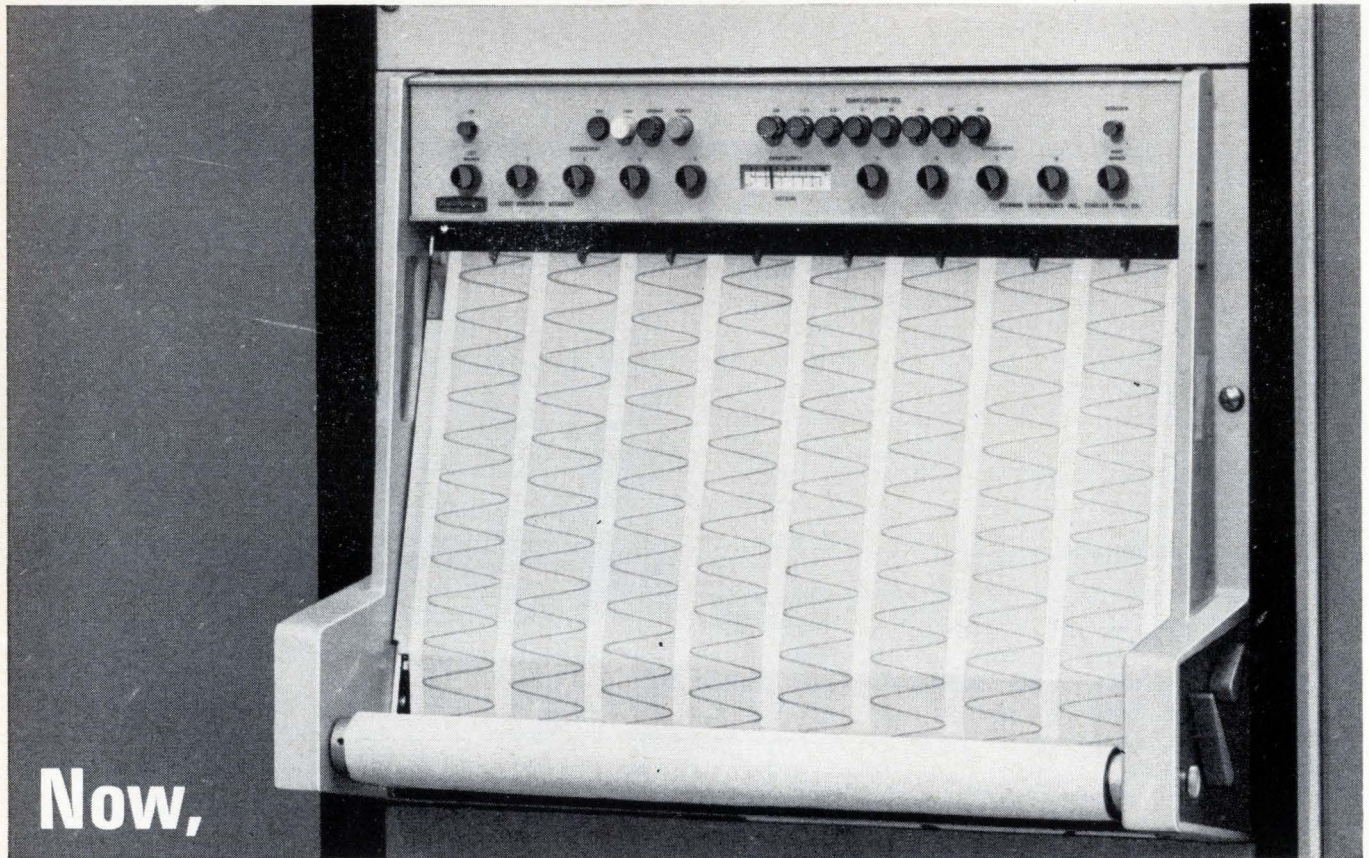
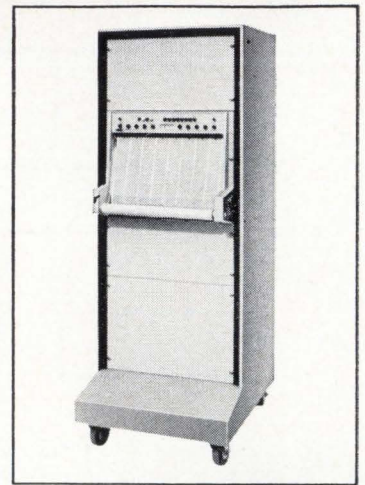

Now,

uniform trace width and contrast at all times —
under all conditions

Behind this dramatic advance in oscillographic performance: the new *Automatic Stylus Temperature Control* incorporated into Beckman's R-2000 Series Dynograph® Recorders. Automatic stylus temperature compensation is proportional to stylus speed. *Now possible*: No skips. No heavy wide lines at slow speed. No sudden invisible traces with an unexpected input of transient phenomena causing rapid pen excursions. All signal changes from steady state to rapid transients are faithfully recorded. *Now possible*: Controlled current applied to each stylus under all conditions, extending stylus life. *Now impossible*: Overheating and burn-out at lower writing rates following recording of high frequency phenomena. The R-2000 leads the field in

high and medium sensitivity, multi-channel thermal recording. No other recorder on the market is comparable. For complete details on the precedent-setting R-2000, contact your local Beckman Dynograph Recorder representative — or write direct.

The Electronic Instruments Division manufactures electronic counters, oscillographic recorders, and systems components.



INSTRUMENTS, INC.

ELECTRONIC INSTRUMENTS DIVISION
SCHILLER PARK, ILLINOIS • 60176

INTERNATIONAL SUBSIDIARIES:
GENEVA; MUNICH; GLENROTHES, SCOTLAND; TOKYO; PARIS; CAPETOWN; LONDON; MEXICO CITY

Designer's casebook

Designer's casebook is a regular feature in Electronics. Readers are invited to submit novel circuit ideas, packaging schemes, or other unusual solutions to design problems. Descriptions should be short. We'll pay \$50 for each item published.

Intersecting waveforms trigger peak detector

By E.B. Dalkiewicz and E. Lybarger*

Scope Inc., Falls Church, Va.

A detector built entirely with inexpensive integrated circuits locates peaks in the envelope of an amplitude-modulated signal by an unusual procedure. An input waveform is simultaneously applied to two integrators having different time constants; this produces output waveforms that intersect each other. The waveforms are then sent to comparison circuitry that detects the intersections of the waveforms and generates a pulse when a peak is detected. The detector shown below can handle modulation frequencies from d-c to 30 megahertz.

*Now with HRB-Singer Inc., State College, Pa.

lution frequencies from d-c to 30 megahertz.

The 1-kilohertz a-m signals are first applied to input diodes D_1 and D_2 , which demodulate the signals and clip their negative half-cycles. The input signals are then fed into integrators I_1 and I_2 to generate the two time-staggered waveforms, F and S, as illustrated. Output waveform F from the faster integrator I_1 overshoots the slower waveform, S, during peaks in the envelope; the two signals intersect each other at points 1 and 2.

Waveforms F and S are then placed, respectively, on the positive and negative terminals of comparator 1. Comparator 1 is an integrated differential amplifier which is adjusted to change from its low state (-0.5 volts) to its high state (3 volts) whenever the difference between the voltages at its input terminals is less than 10 millivolts. Since waveforms F and S always come within 10 millivolts of each other as they approach the points of intersection comparator 1 triggers just before every intersection

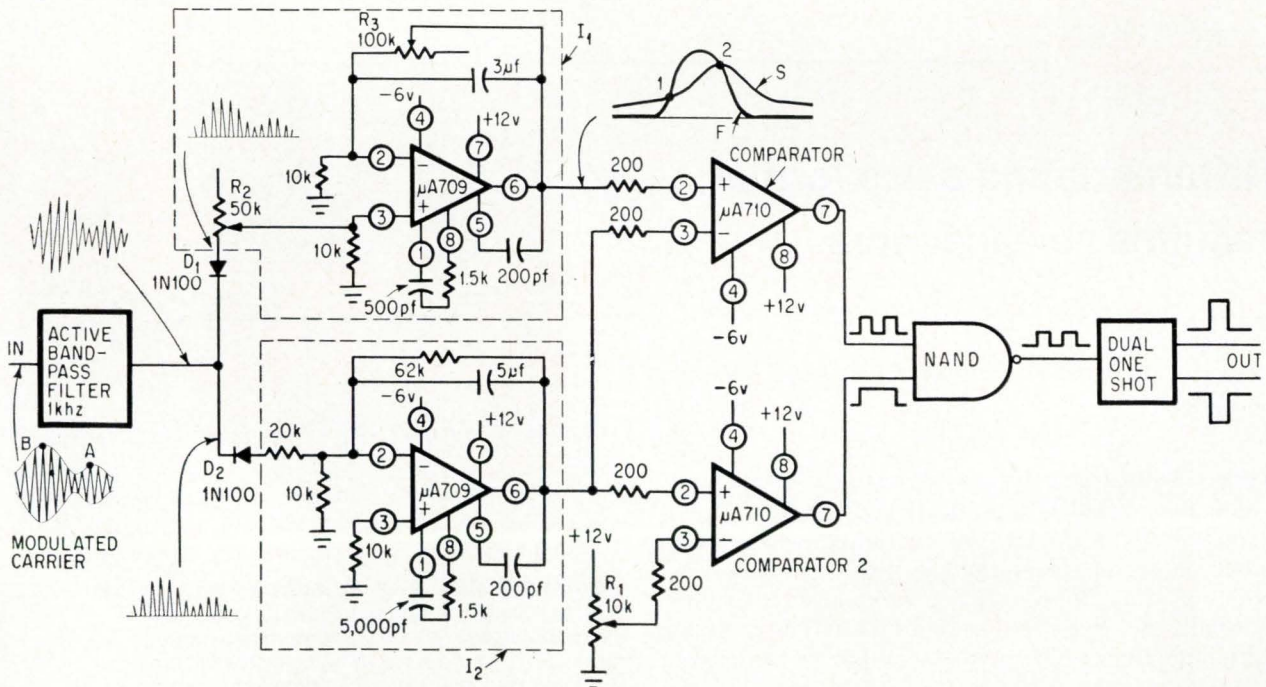

Envelope of a-m signal is integrated by I_1 and I_2 , each having different time constants, to produce time-staggered waveforms that intersect each other.

of the two waveforms.

To prevent the circuit from triggering on noise spikes, the output of integrator I_2 is compared to a reference voltage preset by potentiometer R_1 . Comparator 2, like comparator 1, changes from its low state to its high state whenever the signal levels on its input leads are within 10 mv of each other. Thus, comparator 2 serves as a check on the absolute magnitude of the integrated waveforms by sending a pulse to the NAND gate only when the output of I_2 is within 10 mv of the reference voltage.

The amplitudes of the time-staggered signals must be adjusted carefully to assure that the waveforms will intersect. However, they must be kept more than 10 millivolts apart to avoid triggering when the signals are parallel. Furthermore, the amplitude of I_1 's output must be kept slightly less than I_2 's; this assures that the voltage at the negative terminal of comparator 1 remains greater than the voltage at the positive terminal, locking the comparator in its low state until a pair of intersecting waveforms appear. The relative amplitudes of the signals from I_1 and I_2 can be adjusted by potentiometer R_2 .

When an incoming envelope peak succeeds in tripping both comparators, the NAND gate closes and triggers the dual one-shot multivibrator, generating an output pulse. The second stage of the dual one-shot inhibits the first stage from accepting pulses while the second stage is generating a pulse. By proper adjustment of the inhibiting signal's time delay, the NAND gate's second pulse (cor-

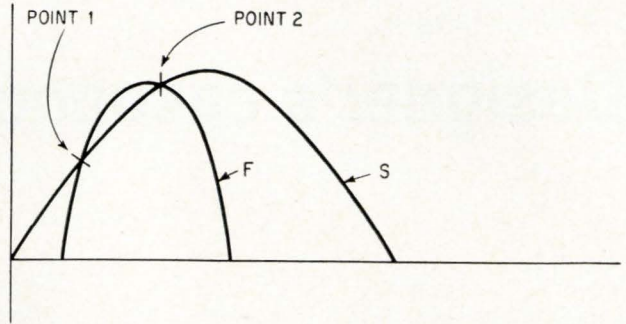

Time-staggered waveforms, F and S, intersect each other at points 1 and 2.

responding to point 2 on the waveform diagram) is prevented from triggering a pulse in either stage of the dual one-shot; hence, only one output pulse is generated per envelope peak.

By altering the time constant of I_1 with potentiometer R_3 , the leading edge of the one-shot's output pulse is made to correspond exactly with the peak of waveform F. The leading edge of the output is roughly synchronized with the waveform's peak and potentiometer R_3 provides a fine adjustment.

The time constant of I_2 may be set at 300 times the period of the signal frequency, but must be kept shorter than the time constant of I_1 . Frequency compensation networks are required for the operational amplifiers of I_1 and I_2 . An active bandpass filter with a passband of 25 cycles enhances detection at the desired modulation frequency.

Differentiating pulse former requires no capacitors

By G.A. May*

Research and Development Laboratories Northern Electric Co., Ottawa

This resistor-transistor pulse forming circuit provides fixed-width triggering spikes less than 20 nanoseconds wide by differentiating the leading edge of rectangular input pulses. A transistor's junction capacitance replaces the large capacitor normally needed in an RC differentiation network. Although the circuit was assembled from discrete components, the procedure enables integrated cir-

*Now at the University of British Columbia, Vancouver

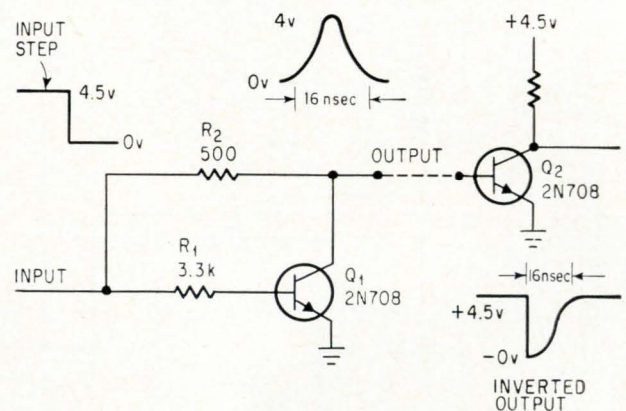

Input voltage step raises the output at the collector of Q_1 to 4 volts through R_2 . Thus Q_1 turns on and the output drops to zero volts. With the input at zero volts the output from the collector of transistor Q_1 is also zero, since the path between input and output occurs through resistor R_2 .

circuits of the resistor-transistor logic type (RTL) to form pulses by differentiation. Thus, a system which is otherwise all-IC need not be encumbered by large capacitors to shape the output of one microcircuit into suitable triggering pulses for another IC.

With a zero-volt input, the output at the collector of Q_1 is zero, as established through R_2 . With a positive-voltage input, the output goes positive in approximately 3 nsec. The output occurs because the collector-emitter junction capacitance of 6 picofarads is charged through the 500-ohm resistance of R_2 , if the output pulse has zero rise-time, otherwise it is determined by the existing input pulse rise time. Meanwhile, the base-emitter junction capacitance of about 5 picofarads

is charged through the 3.3-kilohm resistance of R_1 ; this turns on Q_1 in about 16 nsec and drops the output to zero volts.

Thus, the width of the output pulse, approximately 16 nsec, is determined solely by the time required to charge the base-emitter junction capacitance of Q_1 through base resistor R_1 ; hence, the output pulse width is independent of the input pulse duration. The 3-nsec rise time of the output pulse is limited by the time constant R_2C' . The term C' is the combined load and collector-to-emitter junction capacitance of Q_1 .

The output spike from the collector of Q_1 may be inverted by adding transistor stage Q_2 . Inverting transistor Q_2 also isolates Q_1 from the load to preserve the integrity of the waveform.

Signal is sampled and held for 1 minute

By Richard A. DePerna

Neurophysiology Laboratory, Massachusetts General Hospital, Boston

A low-cost operational amplifier and a single transistor combine to form a \$20 track and hold circuit for use with low sampling rates. This application requires sampling of a 30-hertz sine wave

once per cycle with a 0.4 millisecond sample width; therefore, an off-the-shelf, low performance operational amplifier was used. By substituting more expensive operational amplifiers in the integrator, performance can be upgraded.

Input signal e_s and the feedback signal e_o are fed to the base of emitter follower Q_1 . When gate voltages of +1.5 and -1.5 volts are applied to the +gate and -gate terminals respectively, the diode bridge conducts and capacitor C_1 charges through the low output impedance of Q_1 . In this mode the feedback path through the 10-kilohm resistor causes the output to track the input.

When the voltages at the gate inputs of the

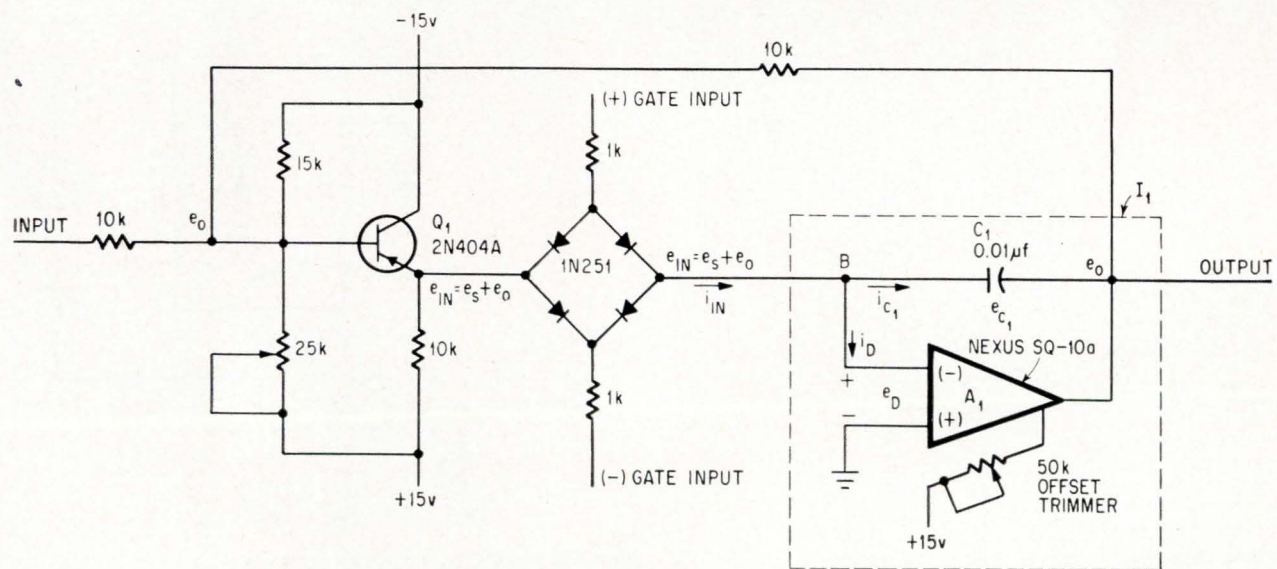

Input signals e_s and e_o are tracked by charging C_1 when the diode bridge is conducting.

diode bridge are reversed, the forward path of the diode bridge is opened and the circuit behaves as a conventional integrator in the hold mode. Thus the capacitor remains charged to the value of the output voltage immediately prior to switching. The 50-kilohm offset trimmer balances out the offset current of the operational amplifier to prevent rundown of the output voltage e_o during the hold mode.

Operation of the circuit is possible with sample widths down to 0.4 milliseconds or track widths of several times this value. In this application the network functions as a sample and hold circuit because with this gate width it is just possible to

charge the capacitor between the most negative and positive output values. With larger gate widths the output will track the input after the initial charging time. The data can be held for periods of up to 1 minute. The minimum sample width is determined by the charging time constant of the capacitor. Although the time constant may be reduced with a smaller capacitor, this makes the offset adjustment more critical. The circuit becomes more sensitive to the time and temperature variations of the offset current of operational amplifier A_1 . Usually, C_1 is chosen as the largest value of capacitance that provides satisfactory operation with the desired sample and track width.

Diode isolator combines relay and lamp driver

By Jerome H. Silverman,
Union Carbide Corp., Cleveland, Ohio

Relays and lamp displays usually require separate driver circuitry. By adding an isolation diode to a conventional relay driver, a single transistor can simultaneously drive the relay and the neon indicator lamps.

When the drive voltage is zero, transistor Q_1 in the circuits shown below is not conducting. Diode D_1 is reverse-biased by Q_1 's collector potential, preventing current flow through the relay from the lamp source. The low leakage current of the RCA 40327 transistor ensures a collector potential high enough to keep the lamp voltage below extinction level.

When a 12-volt drive is applied, Q_1 conducts, the relay energizes and the lamps go on. Lamp operation from an a-c source is possible if diode D_2 is added for rectification.

Operation can be extended to two or more relays having different supply voltages by adding isolation diodes as shown in the modified circuit.

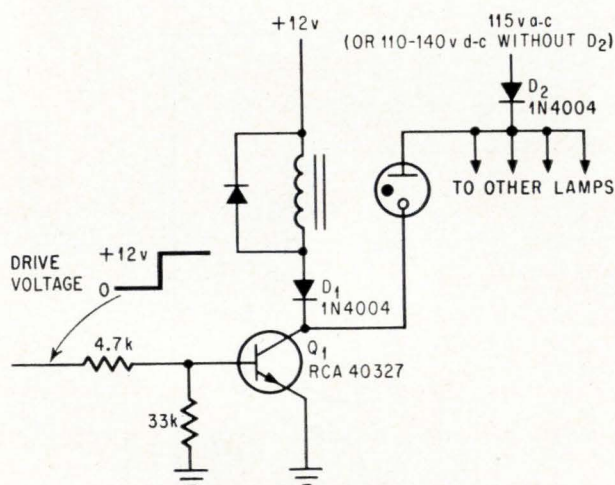

Diode D_1 is reverse-biased with Q_1 off, isolating the relay from the lamp circuit.

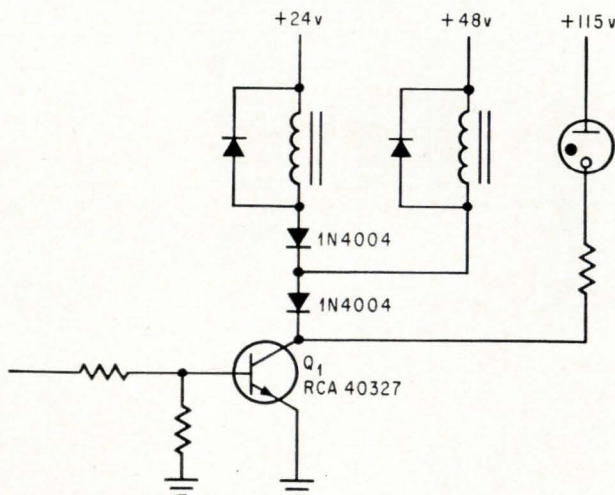

With two diodes, transistor Q_1 controls circuits having three different supply voltages.

why MTOS monolithic shift registers are superior to any previously available...

MEM #	STATIC	DYNAMIC	FREQUENCY		NUMBER OF BITS	INPUT		OUTPUT		NUMBER OF CLOCKS	NUMBER OF POWER SUPPLIES
			LOW	HIGH		PARALLEL	SERIAL	PARALLEL	SERIAL		
			3005 SP	X			DC	1.0MHz	5		
3005 PP	X		DC	1.0MHz	5	X		X		2	2
3008 PS	X		DC	1.0MHz	8	X			X	2	2
3012 SP	X		DC	100kHz	12		X	X		1	1
3016-2	X		DC	1.0MHz	32 (16, 16)		X		X	2	2
3016-2D		X	10kHz	3.0MHz	32 (16, 16)		X		X	2	1*
3020	X		DC	1.0MHz	20		X		X	2	2
3021	X		DC	500kHz	21 (1, 4, 16)		X		X	1	1
3021 B	X		DC	250kHz	21 (1, 4, 16)		X		X	1	1
3050		X	10kHz	500kHz	50 (25, 25)		X		X	2	1*
3064		X	10kHz	5.0MHz	64		X		X	4	NONE

*required for output circuit only

they're LSI

And only General Instrument devices incorporate the exclusive MTOS[†] process which provides Large Scale Integration (without the need for high-cost discretionary wiring) in the only broad line of shift registers available anywhere.

[†]Metal-Thick-Oxide-Silicon

and LSI means...

lower cost: Low initial device cost plus elimination of most printed circuit boards, assembly labor and external wiring.

higher reliability: External connections are minimized, eliminating a major failure mechanism in electronic systems.

highest packaging density ever.

No matter what your design requirements, chances are you'll find the shift register you need in General Instrument's broad line, at authorized GI distributors now. If you don't, contact us. Our line is being broadened regularly. Write for complete data and Application Notes, "MTOS Shift Registers."

GENERAL INSTRUMENT CORPORATION
600 WEST JOHN STREET, HICKSVILLE, L. I., NEW YORK



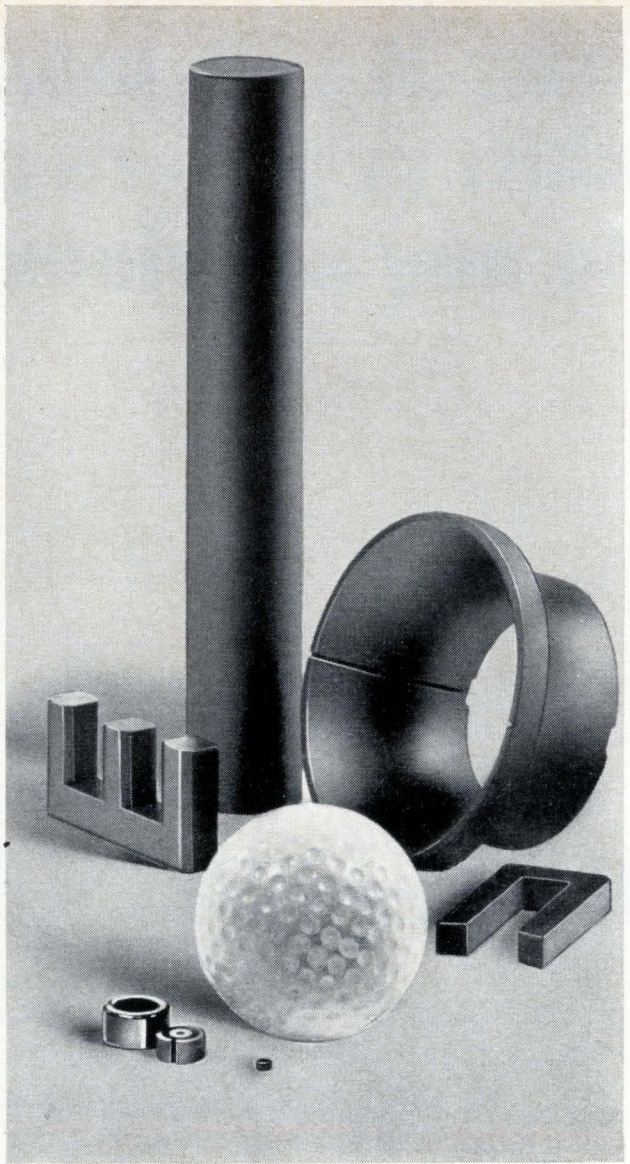
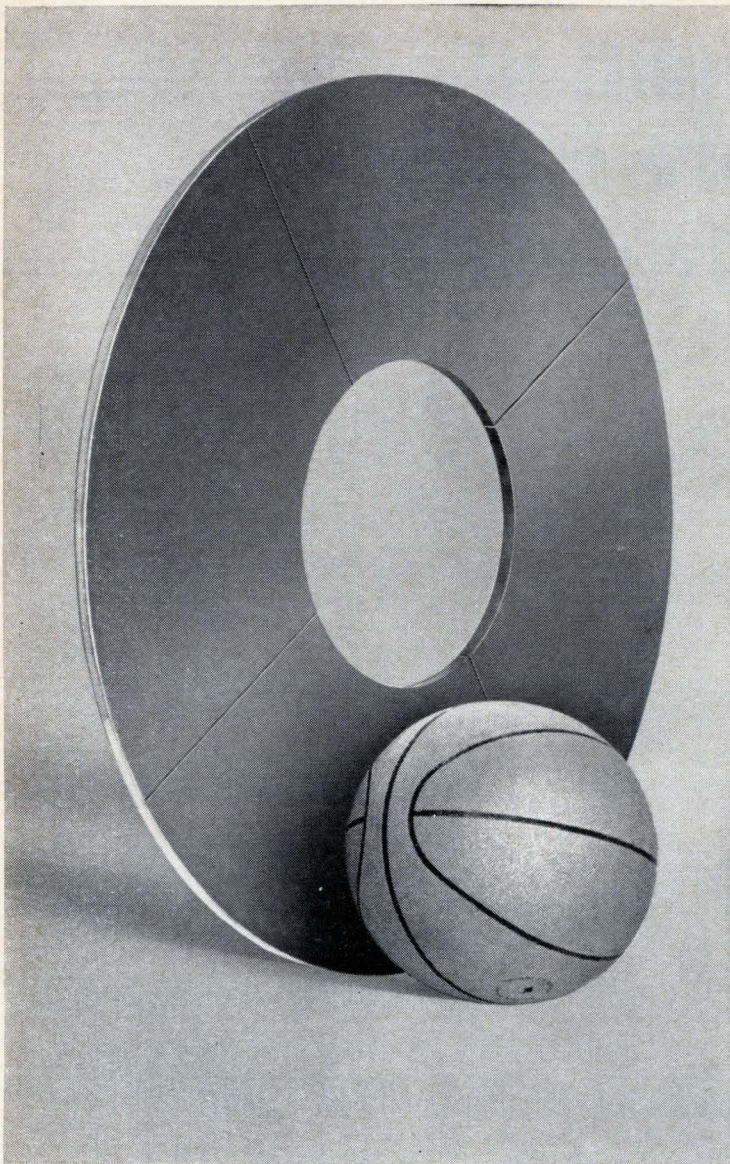

Large or small we're on the ball ... in ferrite capabilities

Stackpole offers over 30 Ceramag® ferromagnetic materials for different applications. Over two thousand Ceramag® parts are already tooled. Sizes range from less than 1/8" toroids to 30-inch-diameter rings for heavy ion synchrotrons. New ferrite materials and tooling are being developed continually.

Research and experience, plus careful control of every production step, assure product uniformity. As one of our customers put it, "Your ferrite cores are more consistent from order to order than any of your competitors."

Working closely with one of the country's leading radiation laboratories, Stackpole scientists and engineers developed the thirty-inch Ceramag® rings—the largest ferrite parts ever made in this country.

Take advantage of Stackpole's ferrite capabilities. Discover how you can save and still insure superior performance. Call or write Stackpole Carbon Company, Electronic Components Division, St. Marys, Pennsylvania 15857. Phone: 814-781-8521. TWX: 510-693-4511.



STACKPOLE
ELECTRONIC COMPONENTS DIVISION

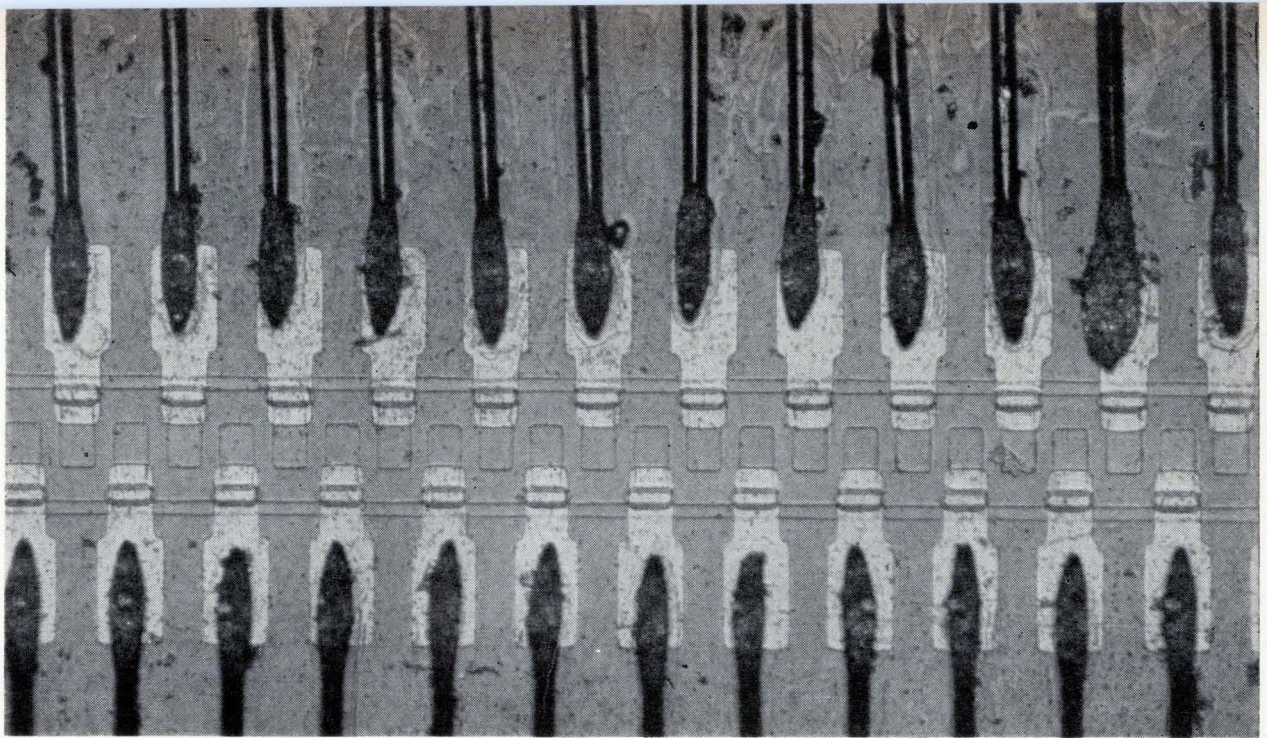

Advanced technology

Charge storage lights the way for solid-state image sensors

Storage mode increases sensitivity of photodetectors and is expected to lead to new applications for infrared sensing; integrated circuit performance is also improved by eliminating the need to isolate the device and substrate

By Gene P. Weckler

Fairchild Semiconductor Division, Fairchild Camera & Instrument Corp., Palo Alto, Calif.

A new mode of operation for phototransistors—the storage mode—brings the goal of solid-state integrated circuit image sensors a step closer. Densely packed arrays of several thousand light detectors will either replace conventional camera tubes in many existing applications or focus on new applications. Discrete photodevices will also be used to perform measurements that are difficult with conventional devices.

In the storage mode, the photosensitive semiconductor junction sums the light falling on the junction over a period of time and gives a readout

in a short interval. It thus enhances the sensitivity of the junction. Most semiconductor light detectors operate in an instantaneous photoconductive or photovoltaic mode in which the output is proportional to the incident light at any given instant.

Arrays of devices operating in the storage mode have responded well to infrared illumination and are thus able to “see” through fog or smog. Other applications will be in image sensors for reading the printed page and in aerial cameras for real-time surveillance.

Both metal oxide semiconductors (mos) and bi-

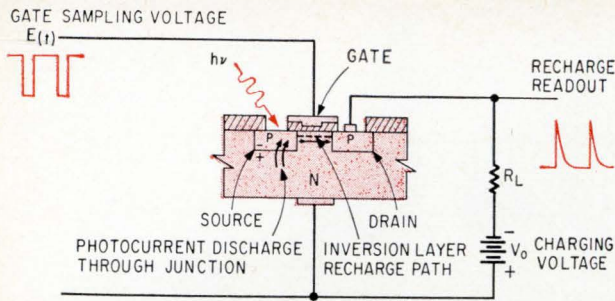

Storage mode operation of metal oxide semiconductor transistor uses source as photodiode and gate as switch.

polar transistors can be operated in the storage mode. Devices operating in this mode have an advantage over those in the instantaneous mode because they are active 100% of the time.

Linear and two-dimensional integrated arrays are now under development. In IC form, the storage mode doesn't require the device to be isolated from the substrate. This results in simpler construction and improved performance. The capacitance between device and substrate is eliminated.

Storage mode operation

A reverse-biased p-n junction acts as a capacitor with a current source. If the junction is reverse biased and then open circuited, it doesn't hold the charge; it discharges slowly as thermally generated electrons and holes recombine with the stored charges on each side of the junction. This discharges the capacitance with time constants in the range of several seconds.

If light is applied to the junction, extra electrons

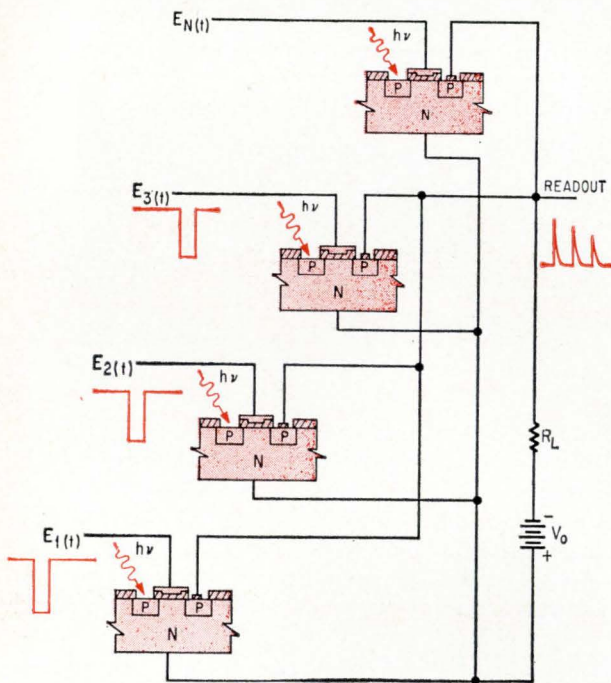

An integrated array of MOS transistors may have a common drain region. Cells are pulsed in sequence; readout is taken at a single terminal.

and holes are created that also discharge the capacitance. The photogenerated current is much higher than the dark current and increases the discharge rate by a factor of about 1000.

The photogenerated current is proportional to the incident illumination. Thus, in a given interval, the amount of stored charge removed from the junction capacitance is proportional to the total illumination falling on the junction. To determine the amount of charge removed during each interval, the initial condition is reestablished and the charge is measured. The result is proportional to the total incident illumination. Advantages of the storage mode include:

- Improved response resulting from integration of the incident illumination.
- Electronic control of response by varying the integration time. This permits a wide dynamic range.

To operate in the light-summing mode, a circuit or device must have a charge-storage element (junction capacitance, for example); a current generator, the output of which depends on the incident illumination level (semiconductor photocurrent effects, for example); and a switch to open circuit the charge-storage element.

An MOS transistor could provide all three of the required functions. Its source-substrate diode could act as the photodiode in the charge-storage mode and the gate could serve as the switch.

MOS transistor

Consider, for example, a p-channel enhancement mode MOS transistor that has diodes at the p-type source and drain areas forming junctions with the n-type substrate. If the drain-substrate diode is reversed biased and a negative voltage is placed on the gate electrode, a low-resistance path is formed between drain and source. The source-substrate diode will charge to the same reverse-bias voltage. By removing the gate voltage, the source-substrate diode thus becomes open-circuited and discharges through the photocurrents caused by illumination of the source-substrate junction.

When the next pulse is applied to the gate, the source-substrate diode will recharge through the low resistance path. The charging current pulse is sensed in a load resistor, and the charge replaced is proportional to the incident illumination in the preceding interval. The time constant for recharging is in the fractional microsecond range. The gate pulse, which must be wide enough to allow full recharge of the capacitance, is about 1 μ sec.

Metal oxide semiconductor devices lend themselves to densely packed arrays. In a linear array, MOS transistors are connected with individual source and gate terminals, but with a common drain. A common diffused region could serve as the drain, or, if desired, a metalization stripe could be used to connect individually diffused drain sites. The common drain lead provides a single output load resistor for a signal recovery. In sequentially sampling the gates, a video signal corresponding

to the distribution of illumination along the array would appear across the load resistor.

Storage-mode operation can also be obtained with two discrete p-n junction diodes (the diodes can be actually the emitter-base and base-collector junctions of a bipolar transistor).

The diodes are series connected back-to-back with common anode terminals. One diode serves as the photodiode and the other as the switch.

When a negative voltage pulse is applied, the switch diode is forward biased and the photodiode is reverse biased to nearly the full amplitude of the pulse. When the pulse terminates, the switch diode, having a smaller depletion layer capacitance than the photodiode, shares the charge initially stored on the photodiode and both junctions become reverse biased to almost the pulse height.

Isolated from the external circuit by the switch, the photodiode's charge is nearly equal to the pulse voltage. The rate of decay of stored charge then depends on the incident illumination.

To provide current gain as well as integration gain, an n-p-n phototransistor is used. The device is connected with its base open circuited, and its

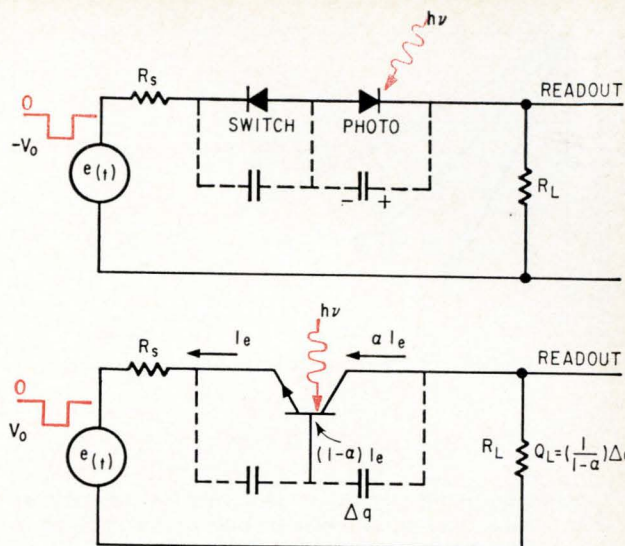

An n-p-n phototransistor in the storage mode is similar to two discrete diodes, but provides extra gain since base current charges junction capacitance.

but it has a much greater variation in impurity concentration and, therefore, a narrower depletion layer. These tend to reduce its leakage current and enable it to perform as an efficient switch.

Storage mode bonuses

Storage mode operation of the phototransistor offers additional advantages when integrated into arrays, particularly two-dimensional. By eliminating the need to isolate the collector from the substrate, it makes increased element density possible and allows improved resolution over conventional integrated arrays. It also makes possible spectral response characteristics typical of a silicon p-n junction photodiode, which includes the near infrared. Infrared (around 0.9-micron wavelength) is absorbed about 32 microns deep in silicon. In the isolation technique, this depth is below the active region, causing sensitivity to be poor for the near infrared part of the spectrum. Since the capacitance of the isolation junction is eliminated, cross-modulation characteristics are also improved.

The output signal of the phototransistor operating in the storage mode is obtained at the collector terminal, requiring only one output terminal in

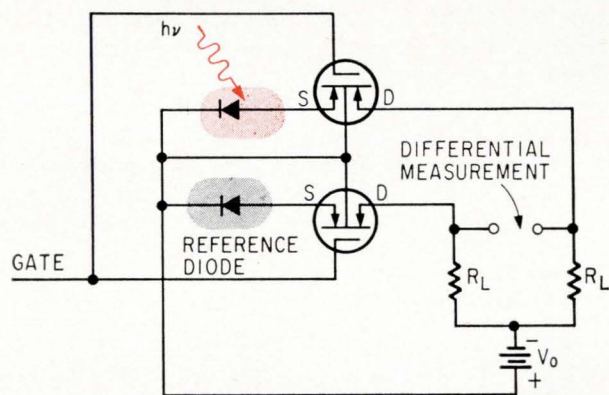

Low light level measurements can be made with two diodes. Differential measurement allows cancellation of photo-diode's dark current with reference diode dark current.

collector and emitter in series with a resistive load and a voltage pulse source. A negative pulse applied to the emitter terminal forward biases the emitter-base junction and reverse biases the base-collector junction. The depletion layer capacitance of the collector junction charges to about the peak value of the pulse. During this interval, the transistor is conventionally biased, permitting current gain; the current flowing in the load is i_E , while the charging current for the capacitor is $(1 - \alpha)i_E$. The current gain is thus $1/(1 - \alpha)$ or $(\beta + 1)$.

When the pulse is terminated, the emitter junction becomes reverse biased and thus isolates the collector junction from the external circuit.

In a double-diffused planar phototransistor, the emitter base junction leakage current is much lower than the base collector leakage for identical reverse bias conditions. Not only is the emitter-base junction's area smaller than the base-collector junction,

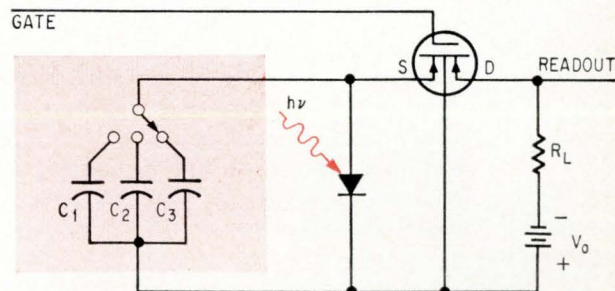

Dynamic range of discrete diode photodetector can be extended with extra capacitance. Photocurrents must discharge total capacitance before saturation occurs.

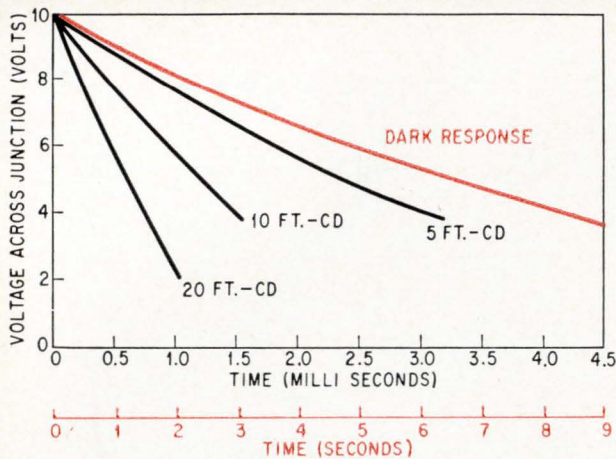

Junction discharge curves with and without illumination; time constants vary from milliseconds to seconds.

an integrated array. Unlike devices—such as vidicons—that act as current sources, high-impedance circuitry isn't required to optimize signal-to-noise ratio because the output is taken from the charging voltage source.

Linear and two-dimensional arrays

In a half-inch MOS linear array, 200 photosensitive elements were placed on 0.0025-in. centers (providing 400 resolution elements per inch). Conventional vidicon tubes have about 400 resolution elements per inch.

The responsivity of one cell to tungsten at 2854°K (1 micron peak wavelength) is 1 volt per footcandle second. This is about 10 times better than a comparable line scan vidicon when illuminated with the visible portions of the sunlight spectrum. With unfiltered sunlight—including infrared—responsivity is about 25 times better than the vidicon's.

A similar linear array using the n-p-n structure gave a responsivity for a cell to 2854°K tungsten of 40 volts per footcandle second. The enhancement in responsivity is provided by the current gain of the structure and is consistent with observed transistor betas.

A two-dimensional array, currently under development, consists of 10,000 phototransistors and 10,000 MOS field effect transistors on the same substrate without p-n junctions or dielectric isolation. The MOS devices are used as logic gates for coincident sampling of the phototransistors. The overall size of the photosensitive area is ½ by ½ in. Element spacing in each dimension is 5 mils.

This two-dimensional structure was selected for process evaluation on large area arrays. Better than 50% of its total area contributes to the photosensitivity. The area required by the MOS devices is negligible compared with what would be lost due to isolation in bipolar arrays.

Access to a particular cell is obtained by pulsing lines connected to gates of MOS transistors in the row, and lines connected to the drains of the devices in the column, on which readouts appear.

The single output terminal eliminates the need for switching between output channels.

Applications for discrete devices

In addition to image sensing, there are other applications for discrete storage-mode devices. Individual silicon-planar junction photodetectors can be used to measure the total light output of a brief, nonrecurrent flash of light—such as exploding wires or a flashbulb. Because an extremely wide bandwidth system is needed for the nanosecond-range flash, real time measurement creates a problem. Also, considerable electrical disturbances are present.

But the storage mode overcomes this by monitoring a flash and enabling the recovery of information after the electrical transients have decayed. A spectral analysis of the flash can be made using several detectors, each with an optical interference filter of a suitable wavelength.

Lower light levels can be detected by making a differential measurement between two matched devices. One device is kept in total darkness while the other is illuminated. Each has its own load resistor and a differential output is taken across the two loads. This technique subtracts the generation-recombination current, allowing the integration of the incident illumination for periods up to several seconds.

A similar technique allows the measurement of the variation of illumination around a preset level by illuminating one device with a fixed source while illuminating a second device with a varying source.

Wide dynamic range

A dynamic range of about six orders of magnitude of illumination level, from about 0.0001 footcandle to about 100 footcandles, may be detected using the storage mode. This range is several times wider than in vidicon tubes and could be extended at the upper end with discrete devices by adding external capacitance in parallel with the junction capacitance. At high light levels, the junction discharges fully between sampling pulses. With extra capacitance across the junction, the light must remove the charge stored on the junction capacitance plus the charge stored on the discrete capacitors before saturation effects occur. The discrete capacitors could be arranged to switch in automatically.

The author



Gene P. Weckler received his master's degree from San Jose State College in 1964 and is now a member of the technical staff at Fairchild Semiconductor's research and development laboratory, where he is working on integrated arrays for image sensing.

The hope of doing each other some good prompts these advertisements

The road to electroluminescence

If you wanted to make some sort of solid object that would glow non-thermally when voltage is applied to it and if your patent lawyers saw no reason to stop you, you would look for a polymer in which phosphors could be suspended, which had a high dielectric constant, high volume resistivity, and low dissipation factor, and which could be cast into self-supporting films. After considerable investigation you would find your way to Cyanoethyl Starch, a material which fills these requirements and which is listed as available from a well known chemical company. Eventually you would learn that they have stopped making it and that we have since started. By reading

this paragraph you seem to have saved some time. It happens that before we started making Cyanoethyl Starch we had already been making Cyanoethyl Sucrose, which has even higher dielectric constant than Cyanoethyl Starch and serves as a plasticizer for it. Cyanoethyl Starch is conveniently insoluble in water and common solvents and conveniently soluble in other common solvents.

Cyanoethyl Starch and Cyanoethyl Sucrose are marketed by Eastman Chemical Products, Inc., Kingsport, Tenn. 37662 (Subsidiary of Eastman Kodak Company), which can supply some quantitative data on their properties and only the scantiest counsel on how to make those properties serve your purposes. But if we told you exactly what to do, the credit would hardly be yours, would it?

INSTATECH Camera Outfit

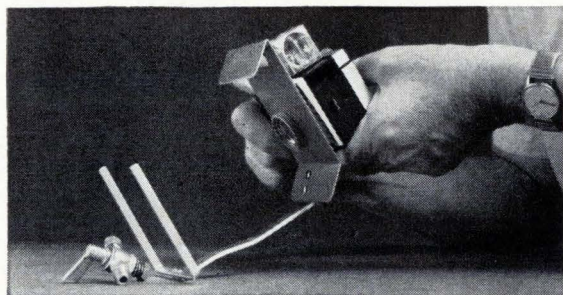

Place any work of nature or of man within this frame and press the button.

If it won't fit in the frame, hold the camera this chain's length away and press the button.

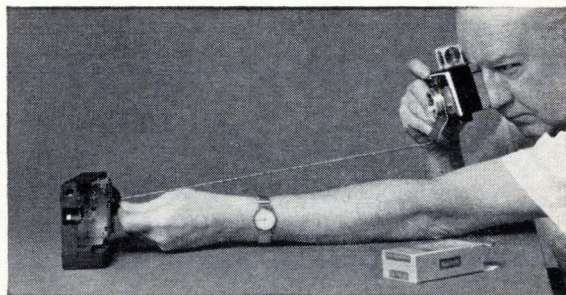

No lighting to arrange. No exposures to calculate. No focusing. No fumbling to load film—just drop in a 126 film cartridge, basis of the incredibly popular system that makes photography cheap by cutting out mistakes. Even less chance for mistakes here than when snaphooting places and people.*

*Dentists, surgeons, and other professionals whose profession is not photography actually do use this equipment on people—in their own professional way. In fact, it was designed for them.

The new KODAK INSTATECH Camera, the above equipment that fits it for its two working distances, 5 flashcubes good for the 20 shots in a KODAK EKTACHROME-X Film cartridge, such a cartridge, and a pair of batteries are offered as an outfit for \$49.75 by Lester A. Dine, Inc., 2080 Jericho Turnpike, New Hyde Park, N. Y. 11041.

Price does not include local taxes and is subject to change without notice.

Restoring the traces

Much technical information on the way from sensing devices to men's minds passes through the conveniently visible form of analog traces on paper. So great is the volume of information passing through this form that the full working time of a score of our men is required to call on places that need the papers and other products we make for the purpose.

Most of our paper for this application is no longer dipped in chemicals to make the traces visible after light beams from oscillograph mirrors have drawn them at around 80,000 inches/sec, which is faster than the old-fashioned needle on the old-fashioned smoked drum. Such is the state of the emulsion-making art that mere ambient light suffices nowadays as the

developer. Eventually, after receiving a great deal more ambient light, the traces do become indistinguishable.

Once in a while this loss causes distress. On those unhappy occasions it would be nice if one could do something that would restore the traces. Now one can. It's very simple. There are two steps: 1) always make sure that oscillographs are loaded with a paper identified as KODAK LINAGRAPH 1843 Paper (1855 if extra-thin stock is desired); 2) then to restore faded traces simply dip for a minute or two in conventional developer like KODAK DEKTOL Developer. Back they come as white on black! Stop bath, fix, and wash then make up the frosting on the cake.

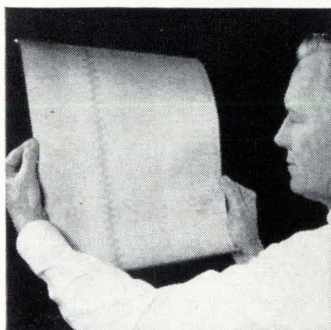

What light creates . . .



light may spoil . . .

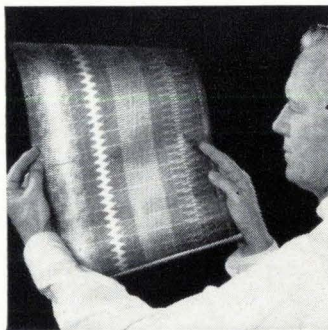

. . . but nothing is lost.

One of those men should perhaps drop in on you occasionally. You might want to ask him whether the same emulsion is available on film. Or about equipment to dispense with the undignified dipping. Or for a free gimmick that calculates writing speed on paper as a function of frequency and amplitude. Leave a call for him through Eastman Kodak Company, Instrumentation Products, Rochester, N. Y. 14650. Phone 716-325-2000, extension 3170.

Kodak

Apollo antenna fastens on the beam to the moon

Astronauts will receive and transmit signals over a variable-gain array that automatically tracks signals transmitted from earth stations

By Arthur P. Notthoff

Dalmo Victor Division of Textron Inc., Belmont, Calif.

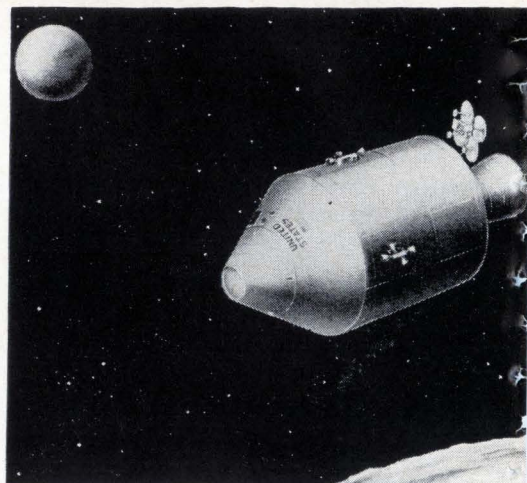

As the Apollo spacecraft streaks toward the moon it will be listening over its shoulder to signals transmitted from earth. Its ear, an array of antennas mounted on the spacecraft, operates at S-band and will carry all data and voice signals transmitted to and from the spacecraft.

The antennas will be the main communications link from the spaceship to earth and will operate until the craft is ready to reenter the earth's atmosphere. During the journey, the array will track on signals transmitted from earth, insuring good real-time communications. The array is mounted on the back of the vehicle as illustrated on this page.

The antenna array goes into operation about 2,500 miles above the earth. When it is deployed, the astronauts, operating controls in the spacecraft's cabin, will position the antenna so that the receiver can lock onto the signal transmitted from earth. Then the astronauts will switch into one of the two automatic tracking modes that will make the antenna follow the earth station's beam.

Why an array?

This is the first time a tracking array has been used in manned space vehicles. In earlier space programs, only ground stations performed tracking operations because the orbiting vehicles were close to earth and their antennas generally had wide beams that produced relatively uniform coverage.

In transmitting from the vicinity of the moon, however, radiation from a wide beam antenna would be wasted; most of it bypassing the earth. In addition, the transmitter power would have to be large to insure adequate signal levels for real-time communications.

To increase efficiency, an antenna must produce a relatively narrow beam that confines the radiation within the diameter of the earth. But because the beam is narrow, the spacecraft's and ground station's antennas must point at one another. This requires a tracking capability.

An array was chosen rather than a single antenna so as to increase the system's efficiency and flexibility. The Apollo array consists of four 31-inch-diameter parabolas clustered around an 11-inch-square wide beam horn. [See picture on page 81]. If a single antenna, such as a large parabola, were used, it would have to have the maximum gain needed at lunar distances. Close to earth, the beam would illuminate such a small portion of the earth's surface that many ground stations would be needed to monitor the spacecraft's signals.

With the array, the transmitting beam can be changed by selecting various combinations of antenna elements. Near the earth the low gain (wide beam) horn is utilized for covering over half the earth's hemisphere. As the spacecraft moves away from the earth, the transmitting beamwidth—measured between half power points—is made narrower; coverage is maintained because of the increased range. Consequently, as the craft moves away from the earth, the transmitted signal is switched from the horn, which is wide beam, to a single parabola which produces a medium beam and finally to all four parabolas which, together, produce a narrow beam.

For receiving and tracking, logic circuitry in the spacecraft automatically switches between a wide receive beam or narrow receive beam. Beyond 26,000 miles, if the antenna is very close to the peak of the earth's signal, the spacecraft's receive

High-gain array at the right consists of four 31-inch-diameter parabolic reflectors clustered around a wide beam horn that is 11 inches square. Circularly polarized feeds on parabola are tilted and offset from center to increase array's beamwidth. The drawing at the left shows the array in its position at the rear of the Apollo spacecraft's command and service module.

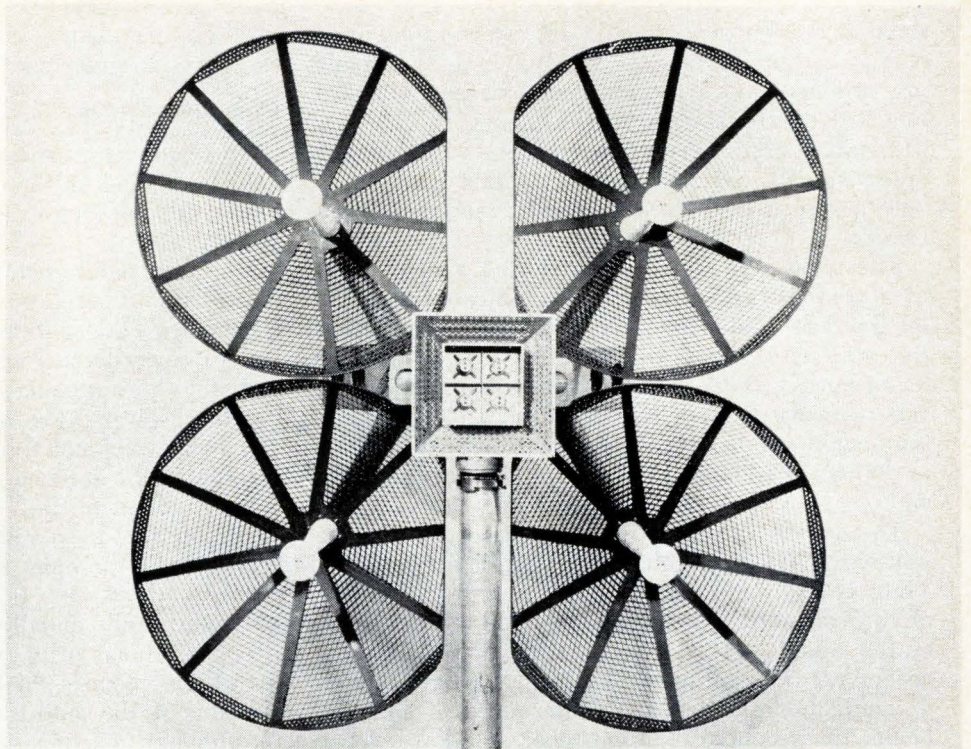

beam is narrow; otherwise the beam is wide.

Ground stations

The Apollo spacecraft will communicate with the stations on the National Aeronautics and Space Administration's manned space flight network. For communications up to about 8,000 nautical miles, the majority of ground antennas are 30-foot dishes located at 13 sites around the world as well as on 5 tracking ships.

For gain needed in deep space communications there are three 85-foot dishes located approximately 120° apart around the earth, at Goldstone, Calif., Canberra, Australia and Madrid. Above 8,000 miles, one of the 85-foot dishes will always be in view as the earth rotates.

The S-band array will track the peak of the radio frequency signal transmitted by one of the ground stations. It will continue to track as long as it can or until another station comes into more favorable position.

Earth stations will transmit a 2,106.4 Mhz carrier that is phase modulated by voice, data, and

pseudorandom noise (PRN) signals used for determining range. Only the PRN signal directly modulates the carrier; all other signals are first frequency modulated onto subcarriers. In the spacecraft the signals are detected by a phase-locked receiver, which is also in the antenna's servoloop.

The spacecraft's antenna will usually be within 0.45° of the peak of the received beam. However, the tracking error can be as great as 1.3° when gaseous exhausts from the rockets and attitude control system strike the antenna.

Transmitting to earth

For sending signals back to earth, the spacecraft has two transmitters which are at different frequencies and can operate simultaneously.

Narrow band information including pulse-code modulated data, voice, and the PRN signals are transmitted to earth on a phase-modulated carrier of 2,287.5 Mhz. The ranging signal or taped voice is directly modulated onto the carrier.

Wide band information including recorded voice information, recorded telemetry, various scientific

Beam mode as a function of altitude above earth

Distance from earth (nautical miles)	Receive beam (2,106.4 Mhz)		Transit beam (2,272.5 Mhz) (2,287.5 Mhz)
	Acquisition mode	Communication and tracking mode	
2,500 to 26,000	Wide	Wide	Wide
26,000 to 107,000	Wide	Narrow	Medium
107,000 to lunar orbit	Wide	Narrow	Narrow

data, and television signals are transmitted on a carrier frequency of 2,272.5 Mhz. The tv signals are produced by a portable camera that will also be used on the surface of the moon [Electronics, March 6, p. 180]. Except for television and recorded voice signals, all information is first modulated onto a subcarrier before frequency modulating the carrier.

The array's predicted gain during transmission to a primary ground station is indicated in color in the left graph on the next page. Jumps in the gain correspond to operation with the wide beam horn, a single parabola, or all four parabolas. For comparison, the lines in black plot the minimum gain needed to communicate with a 30-foot or 85-foot parabolic dish at the primary ground station.

The antenna's beamwidth is varied so that it will cover at least an entire earth hemisphere. Thus two ground stations at the extreme edges of the transmitted beam could monitor the spacecraft's signals. The primary station that the craft's antenna is tracking receives a larger signal because it would be in the peak of the vehicle's antenna beam; the secondary station receives a lower level signal as indicated by the curves in the graph at the right on the next page.

For the secondary ground station, the spacecraft's predicted gain increases continuously because the angle between the station and the spacecraft approaches the peak of the antenna's beam as the spacecraft moves from earth. As with a primary station the jumps in gain, as shown by the

predicted gain curves, are caused by operating with the horn, a single parabola, or all four parabolas.

Operating modes

Three modes of operation are used to keep the antenna homed on the earth station: manual, automatic tracking (auto-track), and automatic reacquisition.

During manual operation, the astronauts change the antenna's direction with two electrical controls. The controls are calibrated in the spacecraft's pitch and yaw coordinates which are automatically converted to the antenna's coordinate system by 13 synchroresolvers. The astronauts can only control two axes of antenna motion at one time. The third axis moves the antenna through the zenith position.

In addition to the initial acquisition, manual operation may be required after a rapid maneuver in which the antenna may not be able to follow the ground station. It is also planned that the astronauts will manually acquire the ground station after each lunar orbit when the spacecraft comes out of the moon's shadow. Manual mode is also available if the auto-track function fails.

Automatic reacquisition is required during passive thermal cycling, when the spacecraft slowly rotates about its roll axis to keep all the craft's surfaces at a constant temperature—the heat of the sun and cold of space are balanced. During each rotation the antenna automatically tracks the earth station until it reaches a gimbal limit. The gimbal limits keep the antenna from pointing at the spacecraft to prevent false signals caused by reflections. At the gimbal limit, integrated logic circuitry drives the antenna back to the opposite gimbal limit so the primary ground station may be quickly reacquired as the antenna emerges from the spacecraft's own shadow. The astronauts can set gimbal limits by operating controls within the command module.

Automatic tracking is employed during mid-course correction or braking into lunar orbit. At these times the craft is not in the thermal cycling mode. The antenna will track until a gimbal limit is reached, at which point gimbal brakes are set. The astronauts must then either position the spacecraft to maintain track or switch to manual mode.

Depending on the distance from the earth, the astronauts can select two beamwidths in either the automatic tracking or automatic reacquisition mode. In the narrow beam mode, four parabolas are used to produce a 4.5° beam. In the coarse (wide beam) mode only the horn antenna is employed and it produces a 40° beam.

Near the earth, the antenna tracks in the wide beam mode and transmits with the horn antenna. At intermediate ranges, the antenna tracks in the narrow beam mode; a diplexer in the microwave circuitry allows the antenna to transmit with a medium beamwidth (11.3°) produced by a single parabola. Near the moon, the four parabolas produce a 4.5° beam for tracking and a 3.9° beam for transmission. The beam mode as a function of distance is summarized in the table on page 81.

Performance requirements for Apollo CSM high-gain antenna

Parameter	Required performance		
Frequency	Receive: 2,106.4 Mhz ± 2 Mhz Transmit: 2,272.5 Mhz ± 2.5 Mhz 2,287.5 Mhz ± 2.5 Mhz		
Polarization	Circular, left-hand		
Gain (absolute)	Beamwidth	Receive	Transmit
	Wide	3.8 db	9.2 db
	Medium	22.8 db	20.7 db
	Narrow	23.3 db	27.0 db
Beamwidth (half power)	Receive	Transmit	
	Wide	40°	40°
	Medium	4.5°	11.3°
	Narrow	4.5°	3.9°
Power capability	15 watts continuous		
Angular coverage	Antenna axis A: 360° Antenna axis B: +30° Antenna axis C: -5° to +132°		
Electrical	28 volts d-c; 115/200 volts a-c, 3-phase, 400 hertz		

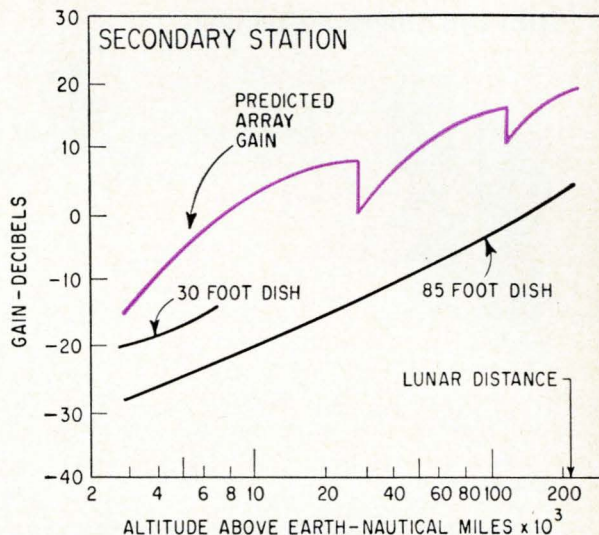
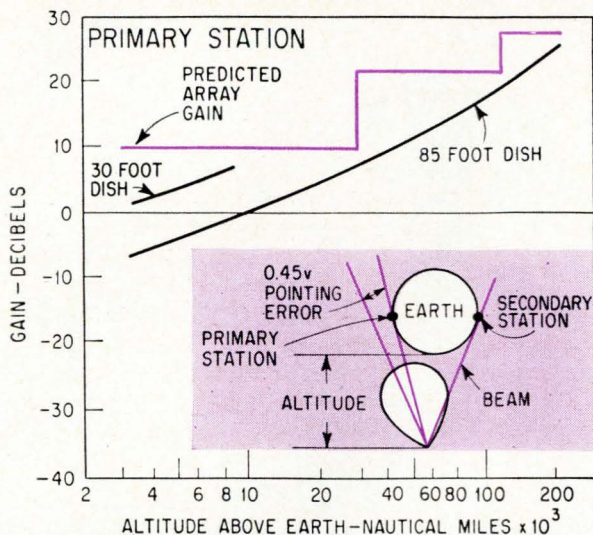

When antenna's beam is pointed at primary ground station, the signal can also be monitored by a secondary ground station within the spacecraft's beam, as shown in color inset. Curves in black indicate the Apollo array's minimum transmission gain needed to operate with 30-foot- and 85-foot-diameter dishes on the ground. The array's predicted gain, in color, increases in steps as a result of switching from the horn, to one parabola and then to four parabolas.

Other system parameters are listed in the table on page 82.

Initial acquisition, whether in the manual or automatic modes, is always done with the horn antenna. If the antenna is automatically tracking with a narrow beam and the antenna's boresight deviates more than 3° from the peak of the received beam, the servosystem will automatically switch into the wide beam acquisition mode. It will continue to track with the wide beam until the error decreases to below 1° . Then the system switches back to the narrow beam tracking mode.

Choosing an array

Two basic types of antenna arrays were initially considered for Apollo's S-band antenna:

- A two-dimensional array consisting of either low gain antenna elements such as crossed slots or dipoles or moderate gain elements such as helices or disk radiators.

- An optical antenna array such as a parabolic or Cassegrain system that uses a focusing surface to collimate energy from a single feed source.

The two-dimensional array of low gain elements has the primary advantage of high aperture efficiency which can approach 100%. High efficiencies are possible because the array can be uniformly illuminated. However, there are disadvantages:

- There are many active elements, each requiring a separate feed line and resulting in a heavy package.

- An equal path corporate feed structure, needed to achieve the desired bandwidth, produces losses that negate the advantage of high aperture efficiency. A corporate structure is a standard arrangement in which a single input line branches out to the various feeds.

- It is difficult to protect the elements from the high temperature exhausts of the spacecraft's

rockets and attitude control system.

A two-dimensional array of medium gain elements also has high aperture efficiency. Furthermore, since the antenna elements are broadband the antenna package is less complex. However, feed losses are still high and thermal protection is difficult.

In an optical antenna array, the principle disadvantage is a poor aperture efficiency that may be as low as 50%. A multiple reflector optical antenna such as a Cassegrain can increase aperture efficiency up to 80%, because the dish can be illuminated more uniformly. However this approach merited only cursory examination because it is unduly complex, results in a heavier antenna, and is more susceptible to beam variations caused by thermal variations in the subreflector.

Although the simple parabolic reflector has an aperture efficiency of only 50% to 60%, its feed system is much simpler than that needed for a two-dimensional array. As a result, system losses are relatively small. Furthermore, the system is useful over broad bandwidths. Good mechanical properties lead to reduced weight and high mechanical stiffness. These considerations led to the choice of the parabolic array.

In choosing a feed for the antenna, spiral, helix, slot dipole, cavity helix radiators, and waveguide were considered, but a small, lightweight crossed V-sleeve dipole was selected. The other feeds were dropped because they suffered from poor efficiency, poor circularity over the band, or difficulty in withstanding the extreme thermal environment. The selected feed is left hand circularly polarized.

The photograph on page 81 shows that the bases of the feeds are offset from the center of the parabolas and the feeds are tilted—a design unique to this application. This arrangement increases the illumination near the center of the array and re-

Sum and difference beams

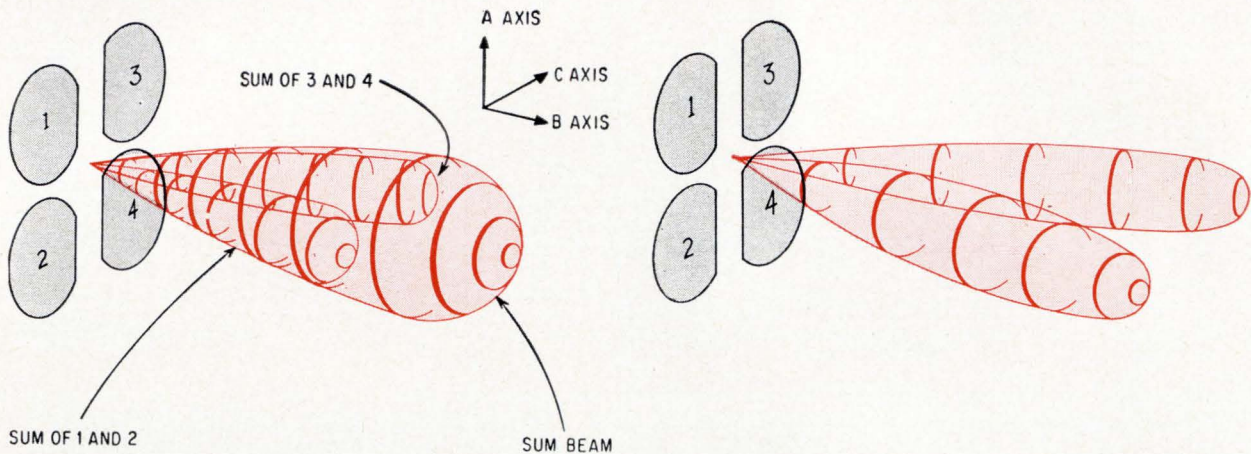

Sum beam is produced by adding beams from all paraboloids. It is also sum produced by beams from paraboloids 1 and 2 added to beam of paraboloids 3 and 4.

Difference beam for A-axis error signal is produced by subtracting the sum of beams 3 and 4 from the sum of 1 and 2.

duces phase-center separation between paraboloids. Electrically the paraboloids are closer together resulting in a wider beamwidth at lunar distances and thus improving secondary station coverage.

In the early design phases, the antenna was required to operate when it reached a distance of 8,000 nautical miles above the earth. The array consisted of five paraboloids. A change in specifications for operation at 2,500 nautical miles made it necessary to replace the center paraboloid with the wide beam horn. The horn contains four crossed-dipole feeds for tracking in the wide beam mode.

The Apollo array must maintain high levels of gain and pointing accuracy even during the portions of the mission when the space vehicle is being maneuvered and undergoes high angular

rotation rates and accelerations. In addition, the hot gases from the spacecraft's rocket engines and attitude control jets may strike the antenna, producing temperatures as high as 1,200°F.

Because of these mechanical and temperature requirements, the paraboloids are open-cell surface constructed from welded and brazed Rene-41 metal, a nickel alloy that withstands high temperatures. The open cell surface minimizes torques produced by the impinging gases and reduces stresses due to thermal gradients. This construction also provides high mechanical stiffness with reduced weight.

R-f tracking system

The feedback loop that maintains track on the

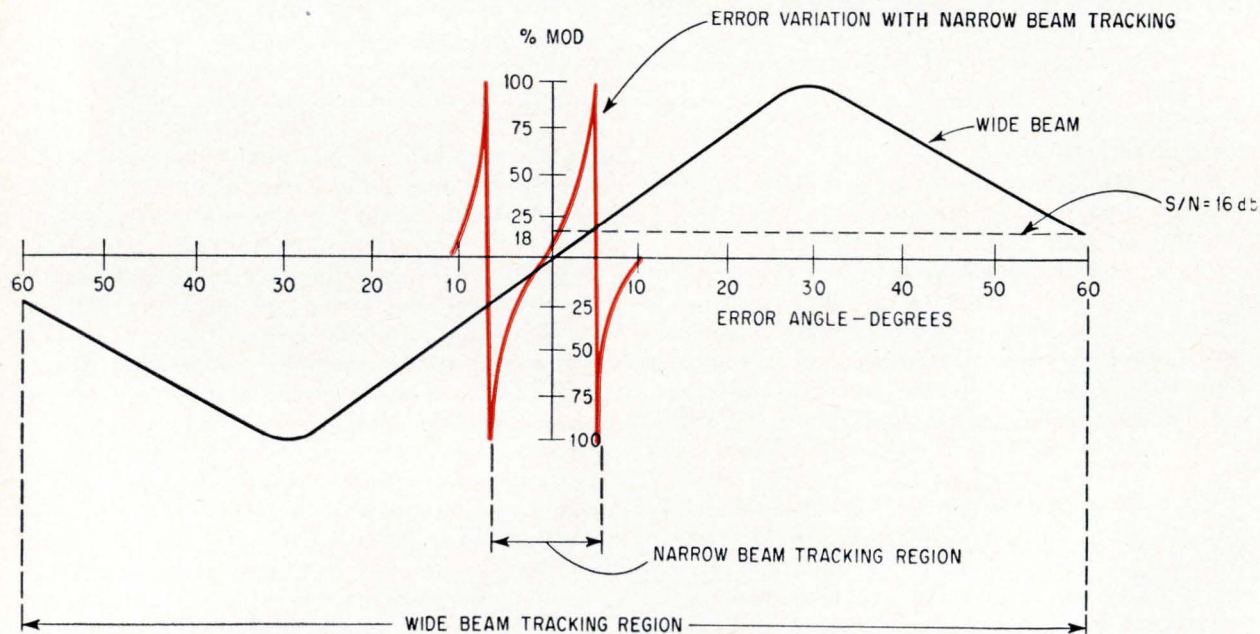

Error signals for narrow beam and wide beam tracking are voltages proportional to the angle between the antenna's boresight and the peak of the received beam. Narrow beam error curve is in color. Error voltage on vertical scale is 0.5 volt rms for every 1% of amplitude modulation at the spacecraft's receiver.

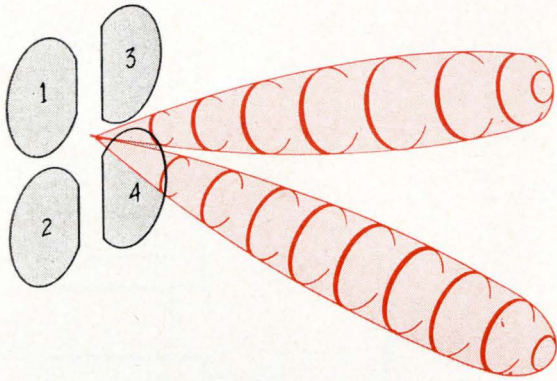

Difference beam for C-axis error signal is produced by subtracting the sum of beam 2 and 4 from the sum of 1 and 3.

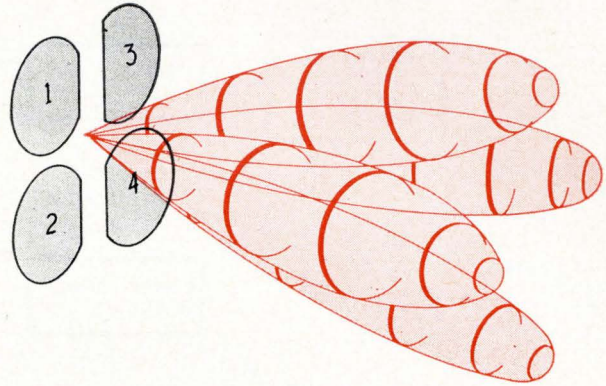

Tracking beams sequentially move around the boresight axis. These beams are the result of combining the sum and difference beams.

signal develops an error voltage that is proportional to the angle between the peak of the received beam and the direction in which the spacecraft antenna is pointed. The error voltages drive servomotors that rotate the antenna towards the peak of the received beam.

Basically the error voltages are established by electrically pointing the spacecraft's beam on either side of the boresight axis. If the antenna is pointed at the peak of the received beam, the signals received on either side of the boresight axis will be the same and there is no error voltage. If the antenna is not pointed at the peak of the received beam, the signals on either side of boresight will differ, producing an error voltage. The beam is shifted sequentially in two perpendicular planes, as in the drawing at the top of the next column.

Error signals as a function of angle for both narrow beam and wide beam tracking modes are plotted in the graph at the left. The signals are in terms of percent modulation of the carrier signal but are equivalent to 0.5 volts rms for every 1% of modulation.

As mentioned, the servosystem switches to wide beam mode when the pointing error exceeds $\pm 3^\circ$. Switching eliminates the need for a conversion in scale factor between the narrow beam and wide beam tracking error curves. Within 3° the slope of the narrow beam tracking error is almost the same as the slope for the wide beam tracking signal.

The tracking system which controls the antenna is diagramed on page 86. It was chosen after an infrared system was found to be unsuitable.

To produce error voltages the system utilizes the sum Σ and difference signals Δ generated by combining the outputs from the various feeds in different ways.

As the name implies, the sum signal is the combined output of all the antennas used in a particular tracking mode. In the wide beam tracking mode, Σ is the sum of the signal received by the four crossed dipoles in the horn; in the narrow

beam mode the sum signal is the combined output of the four parabolas, as shown in the drawing on the left at the top of the opposite page.

To generate the difference signal, ΔA , from the parabolas, the outputs of antennas 1 and 2 are combined and the outputs of antennas 3 and 4 are combined. The difference between these two signals, $1 + 2 - (3 + 4)$ is ΔA . Similarly, the difference signal, ΔC , on the other axis is obtained from $1 + 3 - (2 + 4)$. Each difference signal is equivalent to the signal from two beams pointing off boresight, with a null on the boresight axis, shown in the second and third drawings above.

The p-i-n diode modulator sequentially switches between the two difference signals ΔA and ΔC . The switching rate is 100 hertz and each difference signal is sequentially connected for five milliseconds. During the last 10 milliseconds of each 20 millisecond cycle, a half wavelength of line is inserted in the signal line to reverse the signal's phase. When the switched signals are added to the signal in the frequency sensitive power divider, the effect is to produce the sequentially lobed beams. This combined signal then amplitude-modulates the phase-modulated (information bearing) signal; the resultant signal is sent to the receiver.

Because of the switching in the p-i-n diode modulator, the error signals are actually time-division multiplexed which allows a single phased locked receiver to be used rather than three receivers—one for the A axis error signals, one for the C axis error or B axis error, plus one for the sum signal.

The receiver is the same one used for communications. In this servoloop, however, the receiver's output is the automatic gain control (AGC) line. The AGC voltage—the envelope of the amplitude modulated signal at the receiver's input—is the 100 hertz wave.

In the synchronous demodulator, the 100-hertz wave is synchronously demultiplexed to produce the error signals for each axis. The signals are filtered and go to a modulator which produces a

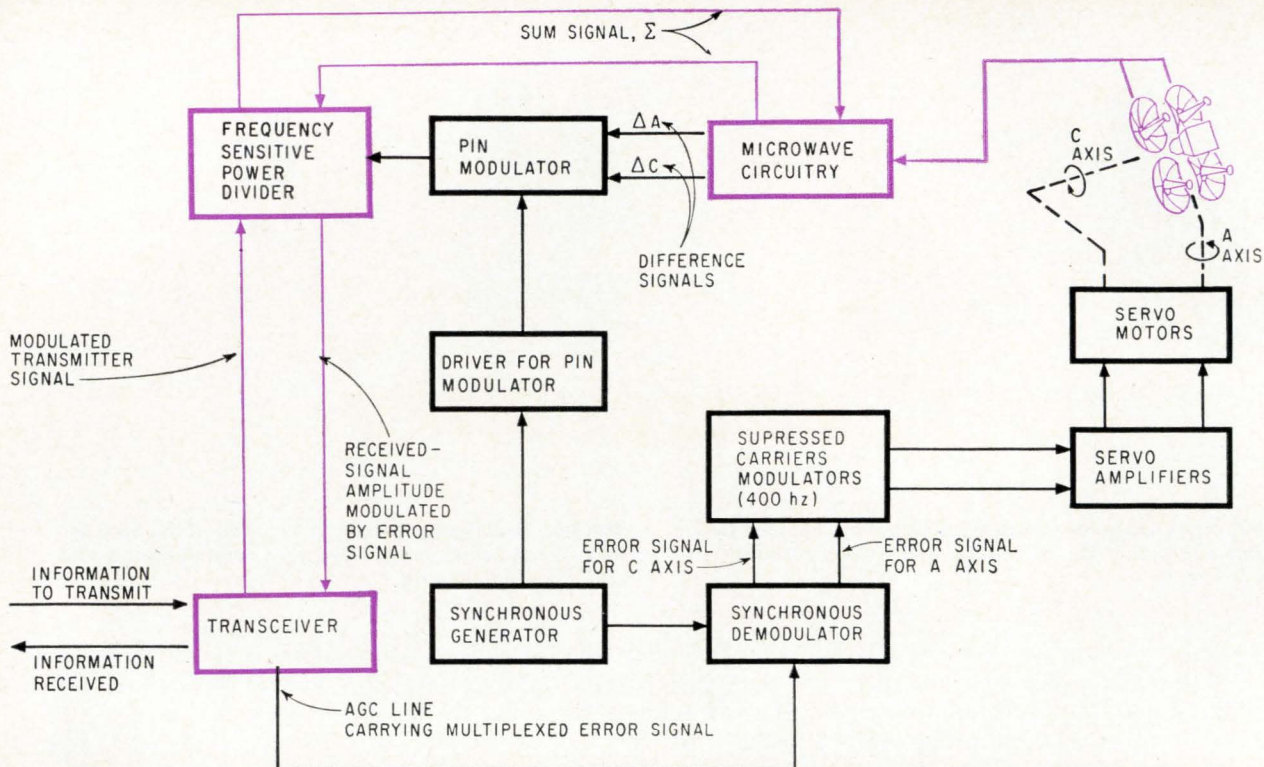

Receiving system is actually two systems in one. The portion in color is for information carrying signals. The full system is the servofeedback loop that aims antenna at peak of received signal's beam. Incoming signals are processed in microwave circuitry to produce a time division multiplexed error signal. After demultiplexing in synchronous demodulator, error signals actuate servomotors that drive antenna in direction that reduces error.

standard 400-hertz, suppressed-carrier modulated signal that drives the servomotors. In the suppressed-carrier modulated signal, the amplitude is proportional to the error voltage; the phase is 0° or 180° depending on the direction that the motor must move to correct the error.

Gimbal drive system

The three-axis gimbal system is designed for a maximum angular rotation of 5° per second and an acceleration of 15° per second per second. Under these conditions the average pointing error will be about 0.45° .

Geared a-c servomotors—rather than d-c motors—were selected because they are simple and reliable. They require no commutators or brushes, thus eliminating a source of r-f interference.

Warning circuitry indicates when a gimbal limit is being approached. When the limit is reached, spring-loaded, solenoid-actuated, friction brakes are set if the receiver loses track while in the auto-track mode. With the brakes set, the antenna's position is fixed to within 15 minutes of arc.

Because a redundant servodrive system is impractical, special care is taken to insure reliability. Air gaps in rotating components are twice normal size—the smallest is 0.004 inch. To minimize voltage breakdown, the highest voltage in servocomponents is 26 volts a-c. Servomotors have copper bar rotors that minimize resistance changes caused by temperature variations, but at the expense of weight and efficiency. To prevent the bearings from weld-

ing to their raceway in the vacuum environment, the gear boxes are pressurized. A unique multi-labyrinth rotor seal maintains pressure.

Thermal control

The parabolic reflectors are coated with high emissivity ceramics to limit the temperature to $1,200^\circ\text{F}$. The antenna is thermally isolated from the support structure and gimbal assembly allowing more conventional materials such as aluminum to be used in these sections rather than Rene 41 alloy. Thermal insulation is applied to the gimbals and support structure to further minimize temperature variations. For reliability, the gimbal's temperature is held within -60° to 160°F .

Acknowledgement

The Apollo CSM high gain antenna was designed and developed by Dalmo Victor under contract to North American Aviation Inc.'s Space and Information Systems Division, prime contractor for the Apollo spacecraft command and service modules. Dalmo Victor is also producing the antenna under contract to North American.

The author



Arthur P. Notthoff Jr. is chief systems engineer. With Dalmo Victor since 1949, he has designed or managed projects on servo, magnetic, and sonar systems. He received his masters degree from the Massachusetts Institute of Technology.

Leadership

We developed this new Operational Amplifier for its combination of high performance and low cost.



TYPICAL SPECIFICATIONS—Model 809CE

- Offset Voltage Drift: $10\mu\text{V}/^\circ\text{C}$
- Offset Voltage: 5 mV
- Offset Current Drift: $1.0\text{ nA}/^\circ\text{C}$
- Offset Current: 50 nA
- Power Supplies: $\pm 15\text{ V}$
- Power Dissipation: 90 mW
- Compensation:
40 db gain—none
0 db gain—two components
- Monolithic Integrated Circuit
in TO-78 or dual inline package
- Common Mode Range: $\pm 13\text{ V}$
- Common Mode Rejection Ratio: 90 db
- Power Supply Rejection Ratio: 90 db
- Gain: 40,000
- Input Impedance: $200\text{K } \Omega$
- Output Swing (5K load): 24 VP-P
- Output Short Circuit Protected
- Temperature Range:
Operating 0°C to $+100^\circ\text{C}$
Storage -65°C to $+150^\circ\text{C}$

Price:	1-99	100-99	1000	10,000
	6.50	5.85	5.00	4.50

Please compare the 809 with other Operational Amplifiers in the same price range, including the one you are now using, and buy the one you think is best.

AMELCO SEMICONDUCTOR

DIVISION OF TELEDYNE, INC. • 1300 TERRA BELLA AVENUE • MOUNTAIN VIEW, CALIFORNIA • Mail Address: P.O. Box 1030, Mountain View, California • Phone: (415) 968-9241 / TWX: (415) 969-9112 / Telex: 34-8416 • REGIONAL OFFICES: Southwest—Suite 213, 8621 Bellanca Ave., Los Angeles, California 90045, (213) 678-3146 • Northwest—1300 Terra Bella Ave., Mountain View, California, (415) 968-9241 • East—P. O. Box 2091, Paterson, New Jersey, (201) 696-4747 • Southeast—711 Magnolia Avenue, Orlando, Florida 32803, (305) 423-5833 • Northeast—805 High Street, Westwood, Massachusetts 02090, (617) 326-6600; 60 Broad Hollow Rd., Melville, L. I., N. Y. 11749, (516) 692-4070 • Midwest—650 West Algonquin Road, Des Plaines, Illinois, (312) 439-3250 • Canada—Deskin Sales, Montreal, Quebec, (514) 384-1420.

Vintage machine produces memories

The Jacquard loom, dating from 1804, can be used to assemble modern read-only braid memories; the simplicity and low cost of the method widens the field of possible applications for the transformer stores

By Ramon L. Alonso

Instrumentation Laboratory, Massachusetts Institute of Technology, Cambridge, Mass.

Space-age read-only memories can be built with a machine rooted in the 18th Century and perfected in the early 19th Century. The technique promises to be substantially cheaper to use than conventional methods, both in the wiring of the memory itself and in the simpler circuits that can be used with it. The low cost, in turn, makes these memories much more attractive in many applications, and suggests some new uses for read-only memories.

The machine is a Jacquard loom, one of the first devices designed to be controlled by a punched card. The loom has been modified to control the placement of wires in a braid to make a braid memory—a kind of transformer read-only memory. The technique, developed at the Instrumentation Laboratory of the Massachusetts Institute of Technology, has been used to build a number of different feasibility models,^{1,2} and most recently to build a complete, self-contained memory containing about half a million bits in the form of 32,768 sixteen-bit words. The memory has only 256 U-shaped cores; it stores data by routing 2,048 wires through or around the cores.

Two cents a bit

Compared to standard memories, the braid unit's electronics are simpler, requiring monopolar cur-

rents rather than bipolar; furthermore, braid word-line currents, at 140 milliamperes, are about a third the 400-to-600-ma. currents needed for conventional core memories. Versions that use only one-tenth as much current are quite feasible. Sensing is also simpler in braid memories, but integrated sense amplifiers for core memories diminish the importance of this advantage.

Most of the cost of conventional core memories lies in the cores themselves, the plane threading, and the number of diodes. On these counts, wired memories should be one-third to one-tenth the cost of conventional read-write units. One report² estimated that the electronics of a braid system could be sold at about 2 cents per bit, and the braid itself replaced at about 0.6 cent per bit. These estimates, though speculative, do indicate market potential.

Wired memories are attractive wherever a large body of data isn't changed often and where random access is required. An interesting question here is the relative price at which additional memory in braid-like form would be more attractive than core for a commercial computer. If an installation has millions of words of operational programs, a large portion could reasonably be left unchanged. In a time-sharing environment, well-established programs should definitely be available on a random-access basis to avoid time-consuming swaps between core and drum, disk and tape. Balanced against this is the fact that, should a change be required, a whole braid might have to be replaced. A possible solution would be to combine an associative memory with the braid to detect the addressing of an obsolete location and provide the correct contents.

Wired memories are clearly desirable in control computers. Their permanence is a virtue, especially if the computer operates unattended or isolated.

The author



Ramon L. Alonso, a native of Buenos Aires, is an assistant director of MIT's Instrumentation Laboratory, where he has worked since 1957. He is also a lecturer in the Department of Aeronautics and Astronautics at MIT. His present interests are multiprocessor organization and logic-circuit simulation.

In certain specialty devices, such as cathode-ray displays or tables for fast table-lookup operation of a control device, the wired memory has a strong appeal.

Wired-in data

A transformer memory is a fixed, read-only memory in which information is stored as a wiring pattern that is not electrically alterable. It offers high density, random access, permanent storage, and low power consumption, all of which make it attractive in special applications. One such unit is used, for example, as the program memory for the Apollo guidance computer;³ others are being used as code converters in commercial printers and as instruction-interpreting sequence generators in some commercial computers.

In one transformer memory design, each wire either threads or does not thread a series of toroids; in another design, each wire passes either to the right or the left of each post in a series of posts. Information is permanently stored according to the routing of the wires, a fundamentally simple system.

The diagram at top right depicts three cores threaded by four wires. In symbolic form, the presence of a slash mark indicates a wire passing through the core, and the angle of the slash shows the direction of the wire. This convention is followed in other diagrams in this article.

Transformer memories can be arranged in two forms; conceptually, one form can be switched to the other by an interchange of cores and wires. The braid memory is arranged in the "word-per-line" form—each word is represented by a single wire, carrying a current pulse, that threads through certain toroidal cores and bypasses others. One sense wire is threaded through each core, and a voltage pulse is generated in the sense wire when any word wire through that core is pulsed. The memory basically contains as many cores as there are bits in each word. Early versions of these memories resembled braids, hence their name.

Although the word-per-line form of memory organization dates back more than 16 years,⁴ interest in it has been revived recently in the context of transformer memories.^{5, 6, 7}

The wires for a braid memory can be preformed into a harness that is laid over a set of U-shaped cores. The magnetic path is then completed through ferrite bars laid across the tops of the U's. Both the U-cores and the bars, which make up split cores, should be made of magnetically linear material for which the hysteresis loop is narrow and in which the degree of magnetization is nearly proportional to the magnetizing current.

No loom for a rope

In the other form of transformer memory, the word-per-core, a single toroidal core made of magnetically nonlinear material for which the hysteresis loop is nearly square, is made to switch its direction of magnetization by a current pulse

Transformers, ropes and braids

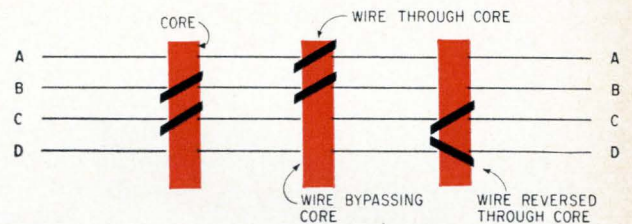
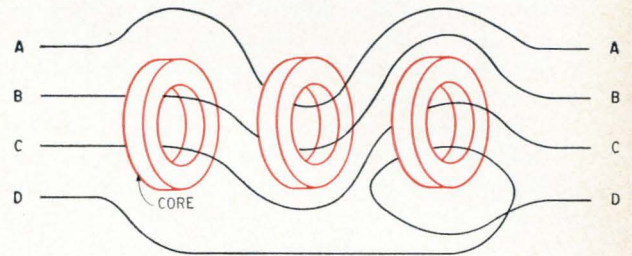

Transformer memory contains, in most cases, a series of cores plus wires that either thread or do not thread each core. In the symbolic diagram at the bottom, a slash mark indicates both the presence and the direction of a wire passing through a core.

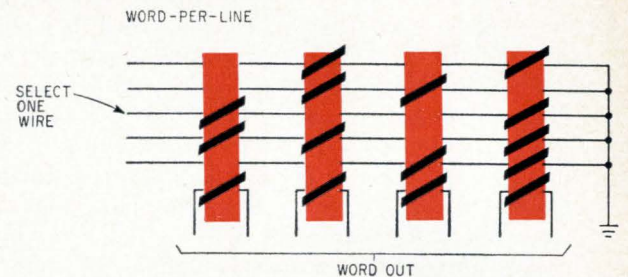

Word-per-line organization is basis of braid memory. The wires making up the braid are word lines. They couple a signal to sense lines by way of the cores.

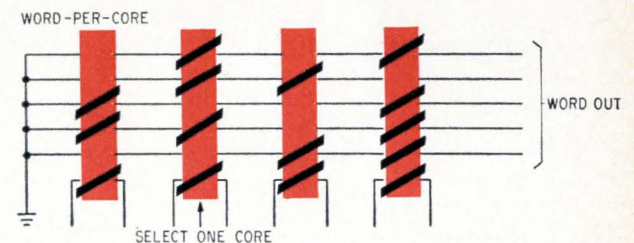

Word-per-core organization is basis of rope memory. The wires making up the rope are sense wires on which a word appears when a single core is switched.

on a word wire threaded through it. Its switching generates pulses in sense wires that thread it, but not in those wires that bypass it. The memory in its basic form contains a separate core for each word and as many wires as there are bits in each word. This form is often called a "rope" memory because of the physical appearance of early versions.⁸ Ropes have a long history of applications

as memories,⁹ code converters,¹⁰ and decoders.¹¹

Rope memories cannot be made with looms or similar machines; for reasons related to the nature of the square-loop ferrite material of which the cores are made, the wires must be individually threaded through the cores, without first being woven into harnesses.

All the cores except one are kept below their switching threshold by a set of inhibiting currents. This permits a single common drive current passing through all the cores to switch only the selected core. The core's square-loop properties are instilled by annealing the previously shaped core at 1,100° to 1,400°C, a temperature range high enough to melt copper wire. The core can't tolerate an air gap, nor can it be assembled from semicircular pieces after annealing, as either would produce a reluctance much higher than that of a single continuous piece of material, causing the loss of non-linearity. The wires must be individually threaded.

Because braid memories can be made with linear material, the cores can tolerate an air gap or a discontinuity where the U-core and the crosspiece meet. Indeed, some versions of braid memories don't have closed flux paths at all; they rely on a straight ferrite rod inserted in the holes in the harness.^{5, 6}

Another advantage of braids over ropes is that the single sense winding on each core in a braid unit can be multiturn, generating a signal large enough to drive transistor logic circuits directly. This advantage is partly offset by the fact that more circuits are required to select one out of N lines ($2\sqrt{N}$ switches driving a diode matrix) than one of N cores ($2 \log_2 N$ inhibit lines plus one drive line). For example, if $N = 256$, the diode matrix must be driven by 32 switches, but only 16 inhibit lines plus a drive line are required for the rope form.

Various proposals for forming the wire harness call for an x-y table to control the routing, or for ladder-like conductive patterns deposited on plastic films.^{6, 7} The latter approach was considered at the beginning of MIT's braid memory project, but discarded for reasons of cost and density. The cost was estimated to be close to 20 cents per bit, considerably more expensive than the loom technique; the plated-through holes accounted for the extra expense. Furthermore, the density appeared to be limited to about 625 bits per cubic inch. It is, however, a perfectly sound and rational approach that could very well become preferable when the manufacturing techniques improve. If the thickness of the laminates, including insulation between layers and air space, can be dropped below 10 mils, the density would be about 2,500 bits per cubic inch, which begins to look attractive. Because the loom technique can use wires less than 3 mils in diameter, its potential density is 10,000 to 20,000 bits per cubic inch. At present, the braid density is approximately 5,000 bits per cubic inch.

Weaving a memory

The technique developed at MIT involves a modified Jacquard loom¹ similar to the machines used for weaving complex patterns into fabrics—for figured neckties or upholstery. The loom separates all the wires at once into two groups: ones and zeroes. [See "Looms and computers," below]. A temporary separator preserves the grouping at each step in the manufacturing process, and permanent separation is later achieved by lacing or encapsulation.

The loom is controlled in textile weaving by a punched card; the holes determine whether a particular thread is raised or not. A large number of these cards (which are large cardboard patterns, not the familiar paperboard cards used in

Looms and computers

Looms are probably the first devices to make use of the punched card. The earliest such application dates back to about 1736, when Jacques de Vaucanson used a form of punched card to determine which threads were to remain above and which below the shuttle. Vaucanson later became famous for making various automata, in particular a mechanical duck that performed so well that it became renowned throughout Europe; he also made a mechanical flutist that could play 12 different tunes.

Joseph-Marie Charles Jacquard perfected the card-controlled loom in 1804; it was an instant success, with thousands in operation in a few years. The Jacquard loom

hasn't changed appreciably since then.¹²

When weaving cloth, the simple loom lifts some threads above a shuttle plane, leaving others below it. A shuttle then carries a thread between the upper and lower threads. When the threads are reversed relative to the shuttle plane, the shuttle returns.

The Jacquard loom permits a completely arbitrary choice of which threads are to be placed above or below the shuttle plane at each step, with the punched card controlling the choice. The absence of a hole causes the push-rod to push the hook (see diagram, p. 92); the hole causes the push rod to remain stationary as the block moves forward. Jacquard cards have about 1,300 hole po-

sitions.

The loom lift mechanism MIT is now using isn't substantially different from either the Jacquard or the Vaucanson looms. However, the punched card has been replaced at MIT by a more versatile electrically alterable equivalent.

Braid memory characteristics

Capacity	32,768 words
Word length	16 bits
Cycle time	2 μ sec
Access time	1 μ sec
Power	10 watts
Input	16-bit address
Output	16-bit word
Number of cores	256
Number of word lines	2,048
Dimensions	11 $\frac{1}{4}$ x 12 $\frac{7}{8}$ x 1 $\frac{7}{8}$ in.

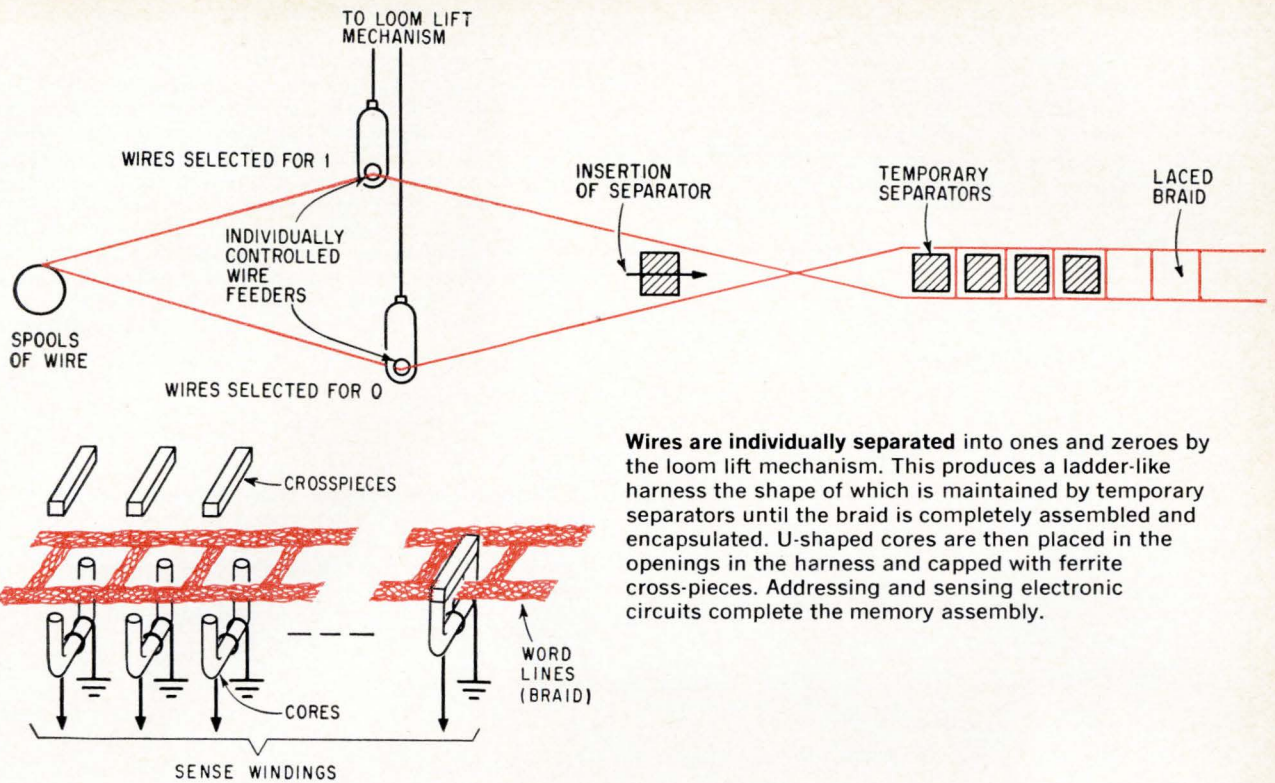

Wires are individually separated into ones and zeroes by the loom lift mechanism. This produces a ladder-like harness the shape of which is maintained by temporary separators until the braid is completely assembled and encapsulated. U-shaped cores are then placed in the openings in the harness and capped with ferrite cross-pieces. Addressing and sensing electronic circuits complete the memory assembly.

computers) are connected edge to edge to make a wide belt. The belt is advanced one card at a time for each step in the weaving process.

At MIT, the belt of punched cards has been replaced by a system of free pins and slides controlled by a punched paper tape [see diagrams and photographs on pages 92-96].

To make a braid, 256 wires are threaded through the loom and each one is connected to a separate diode card. During this stage, the loom selects the wires one at a time to identify them. After all the diode connections are made, the loom establishes the separation of ones and zeroes for each bit position. After one braid has been made, the wires are again selected in groups of 16 for termination at the other end. Eight braids make up a single memory, and the entire assembly is encapsulated after all are in place. After the encapsulating process, the temporary separators are replaced by the U-cores.

For each 256-strand braid, the terminations currently take about two hours and the weaving action, or separation, about one hour.

Switches that sense the separation made by the loom feed back this information to the paper-tape reader, where it is compared with the original separation instructions. If an error is detected, the controller tries again, up to four times. Such an error could be caused by a blockage in one of the air lines, a stuck slide or pin in the tape-controlled block, or a bent hook in the lift mechanism [see diagrams on page 92].

Also, the operator can miss or lose a wire when he inserts the temporary separator or when he

transfers the separated bundle to Teflon-covered nails [see top photo page 95]. To date, the error rate has been about four bits per million. Corrections can be made before encapsulation by cutting erroneous wires from their diodes and connecting new lines in their place.

Self-contained unit

Various braid memories have been made at MIT over the last three years. The models made with the Jacquard loom represent a step beyond the feasibility "breadboards" described in earlier reports.^{1, 2} The latest system was designed as a complete unit, self-contained in all aspects except power supplies. The model was intended to test not only the manufacturing process but the design and operation of the resulting braid memory system as well.

The total package, whose volume is approximately 270 cubic inches, houses about 500,000 bits. A 16-bit input address generates a 16-bit output word. A photograph of a partly assembled system is on page 98, and statistics are listed in the table on the facing page.

The system consists of the braid, the sense board, and the drive circuit board. The drive section, sense board, and cores can be reused if a change in the braid contents becomes necessary. The braid, of course, must be discarded.

The sense board contains the sense windings, the sensing electronics, and the circuitry for selecting one particular subgroup of 16 bits out of the 256 outputs. The board has holes that exactly match the holes in the braid previously occupied by the

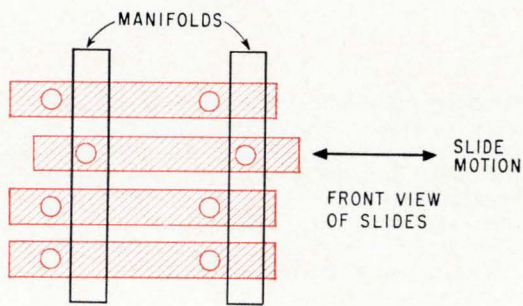
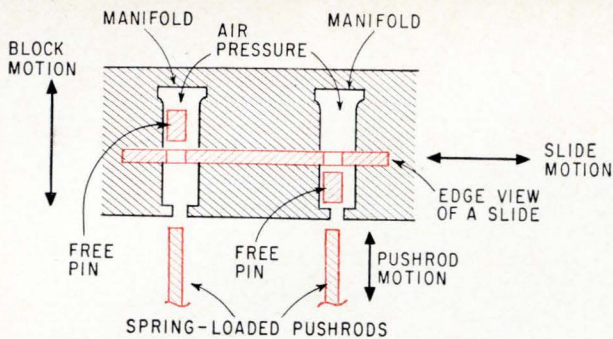

Modified Jacquard loom separates wires for braid memory. The Jacquard lift mechanism is the large green object on the platform; the tape-controlled block, which establishes the combination of wires that are separated with each motion of the lift, is on the right of the lift, behind the plastic air hoses. The copper-colored lines in the lift are actuators. They converge below to link with the wire selectors. The wires from which the braid is made converge into the workpiece in the foreground, into which the light-green Teflon-covered nails are inserted. The nails hold the temporary separators while the braid is being woven. The entire process is controlled by the paper tape reader at lower right.

In the loom, each of sixteen slides moves in turn so that its holes line up with the 16 pins behind it. Some combination of the 16 pins is blown by air pressure through the holes, and the slide then returns to its neutral position, locking the pins in the forward position. For simplicity, this drawing shows only four slides, each controlling two pins.

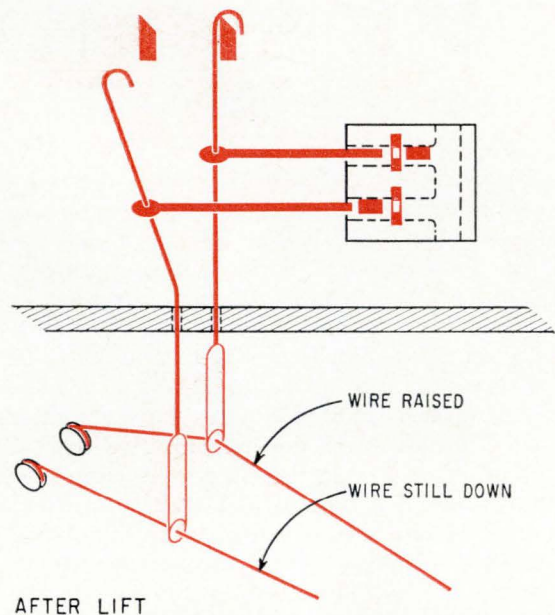
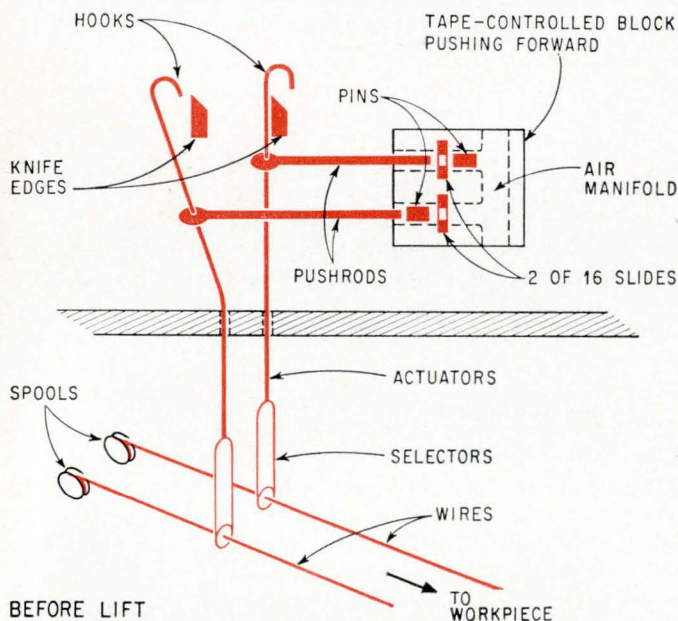

After the pins have been set, the block moves forward against a set of push rods. Where a pin is locked in front of a slide, the push rod pushes a hook connected to an actuator; where the pin is behind the slide, the push rod isn't moved and the hook remains in its vertical position. With the block in its forward position, a set of knife edges moves upward, catching the hooks that haven't been pushed out of the way. The hooks, through the actuators and wire selectors, lift the wires corresponding to a "one" in that position of the braid memory. When hooks are pushed aside, wires corresponding to a "zero" remain in the lower position.

separators. In the detail view, bottom, page 96, the sense board is already mounted on the braid, with some cores in place. Around the holes are 30-turn sense windings, with the turns a part of the wiring in the multilayer board.

The sense windings are connected to low-power NOR gates that serve as sense amplifiers. The output voltages, which exceed 1.2 volts, are sufficient to drive the gates directly, without preamplification.

Each sensing winding is connected to an input of a NOR gate (the sensing gate) and to the output of an inhibiting gate, which, when turned on, ef-

fectively short-circuits the winding. This is how one subset of 16 bits is selected out of the 256 possible outputs. The sensing gates are combined into 16 sets, each set being in effect a 16-input NOR gate. The outputs of the 16 sets form the 16-bit output word from the memory system. Fifteen of the 16 inputs are always inhibited; only one input is left free to show a zero or a one output from the core. Some 220 dual three-input NOR gate packages are used, including some auxiliary decoding.

The final system element, the drive board, de-

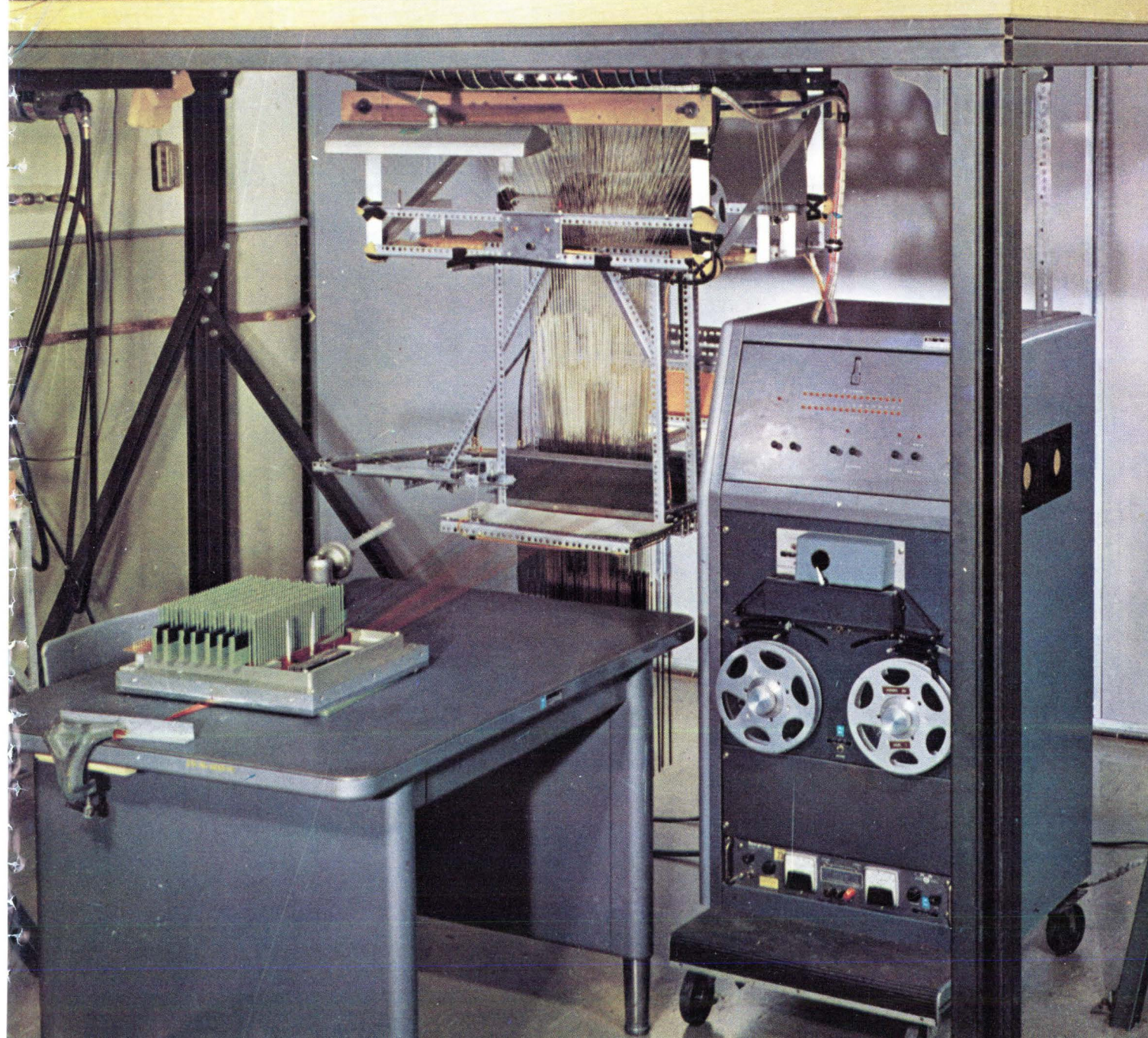
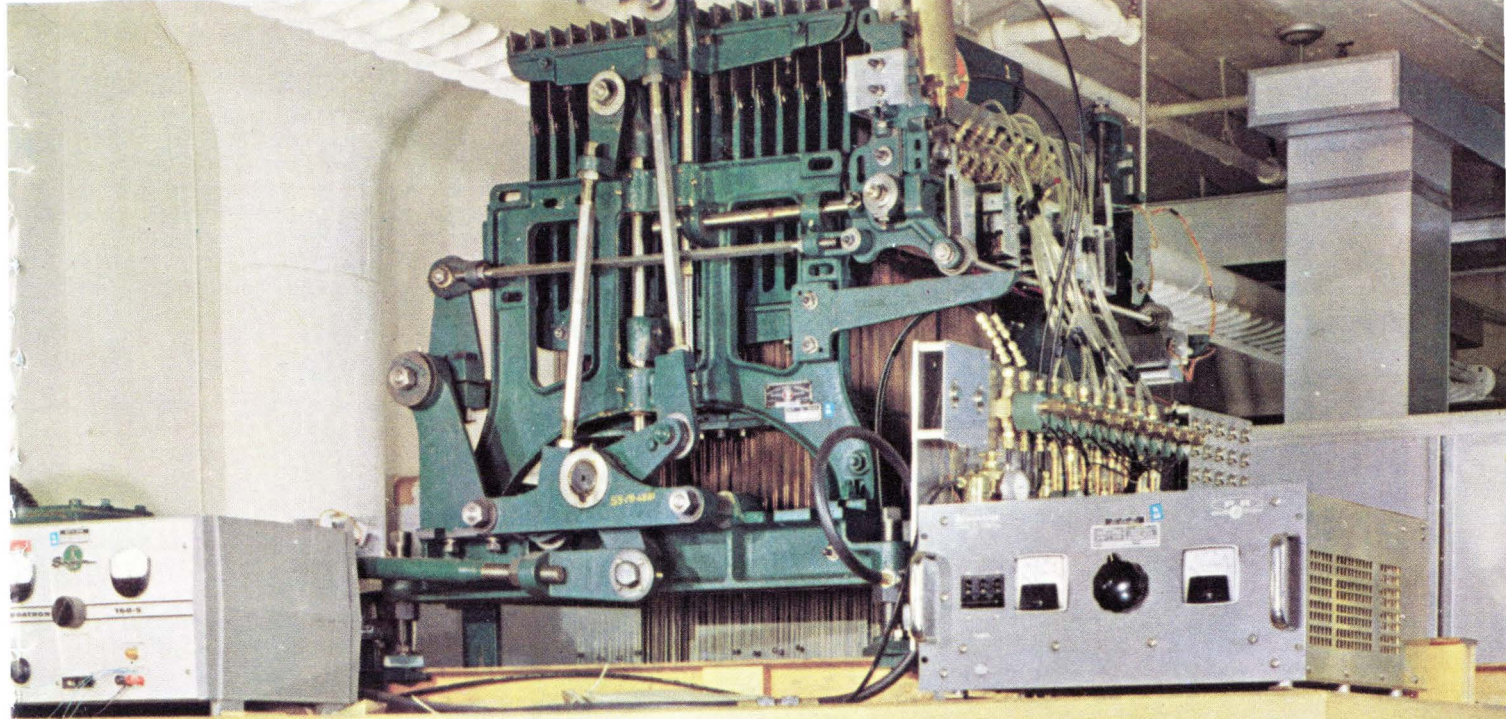

Tape-controlled block, at the upper end of the clear plastic hoses, contains free pins which, with the block lowered, fall to the rear of the block. When the block is in its raised position, shown here, air jets set the pins to establish the combination of wires to be separated during the lift's next move, following immediately.

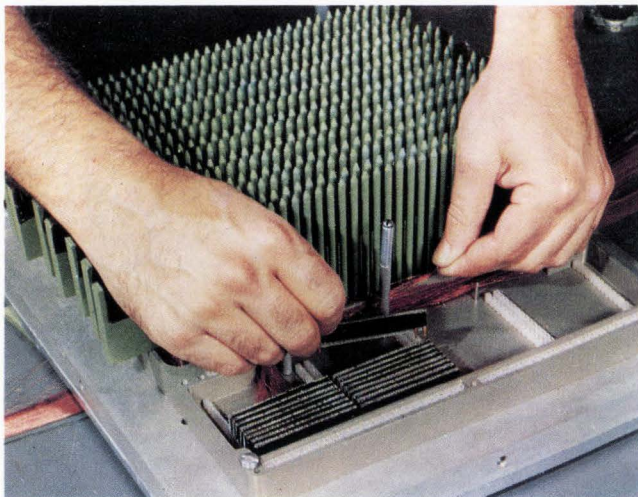
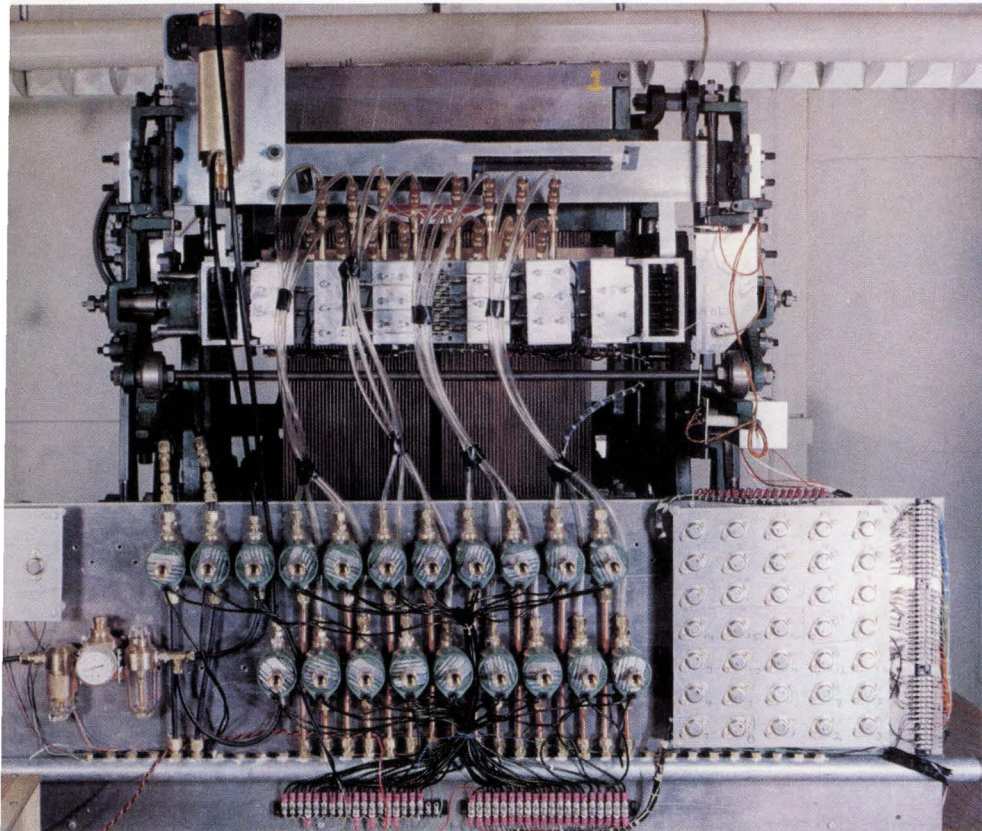

As the second of eight braids is started, the wires are individually soldered to diodes on the black terminal boards. The green Teflon-covered nails will hold the braid separators until encapsulation.



Feedback switches detect any faulty operation of the selection or lift mechanism. The actuators are at the top, with the selectors hanging down below them. The black bead on each selector operates one of the small snap-action switches if that selector is raised. At the completion of the lift motion, the switch settings are compared with the instructions from the paper tape reader. If they don't match, the selection operation is repeated. A few of the beads are just visible peeping over the edge of the platform in the photograph on page 93.

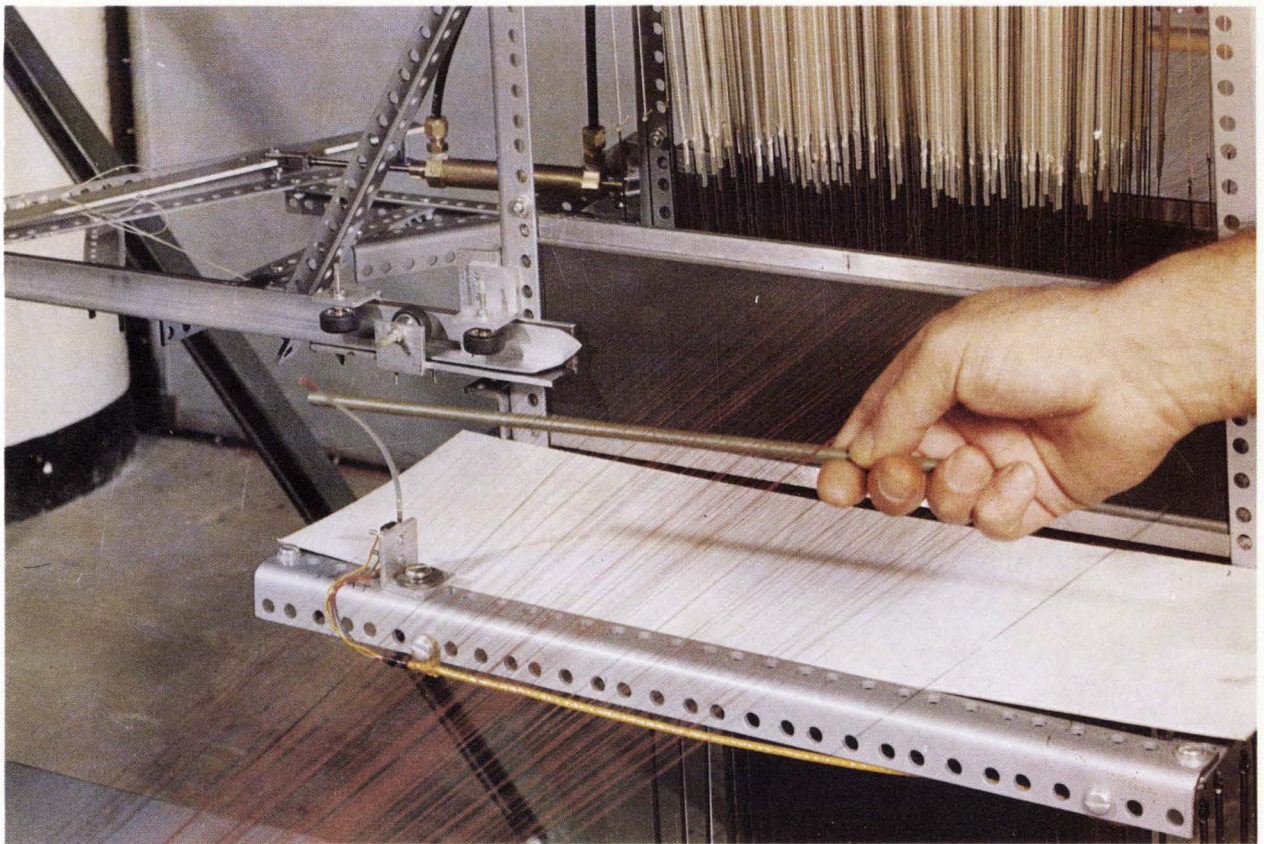

The operator inserts a separator between the upper and lower sets of wires. As he moves the separator toward the workpiece, he trips a switch — the red-topped bar — that initiates the next lift. In this photo, the setting of the pins for the next lift has already begun, with a characteristic “pst-pst-pst” sound. When the lift is complete, the metal angle bar seen just beyond the separator moves forward between the two sets of wires; the operator slides the separator along it to insure that he doesn't inadvertently snag a wire and separate it into the wrong group. The loom will hold the separation indefinitely, until the operator trips the switch with the separator.



As the separator is moved toward the workpiece, the operator twists it into a vertical position. He must be careful not to lose the separation of the wires during this step. He then sets the separator — a hollow tube— onto one of the Teflon-covered nails at the workpiece.

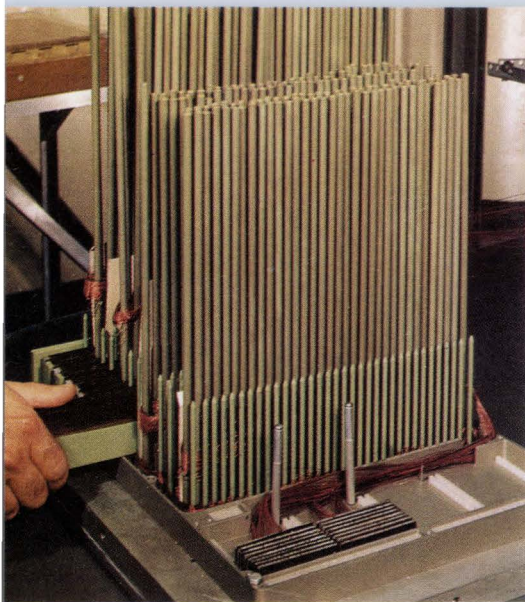

The completed braid is transferred from the temporary separators onto the nails. When the vertical slide is pulled out, the separators and braid drop into the frame. After the separators are removed, the nails retain the braid separations. Replacing the slide holds the braid down so that a new braid can be woven on top of the previous ones.

With the braid in the frame, the wires are soldered to terminals in groups of eight. The loom separates the wires for this operation just as it did in the assembly of the braid itself. As each group is soldered, the wires are cut from the loom. Successive braids in the memory are soldered to the same lugs. When all eight braids are complete, the wires are disconnected from the terminals and the braids are encapsulated. A current-return wire is included in each braid.

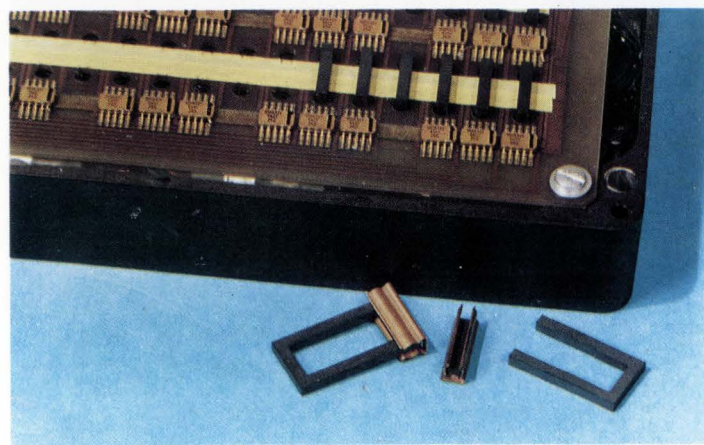
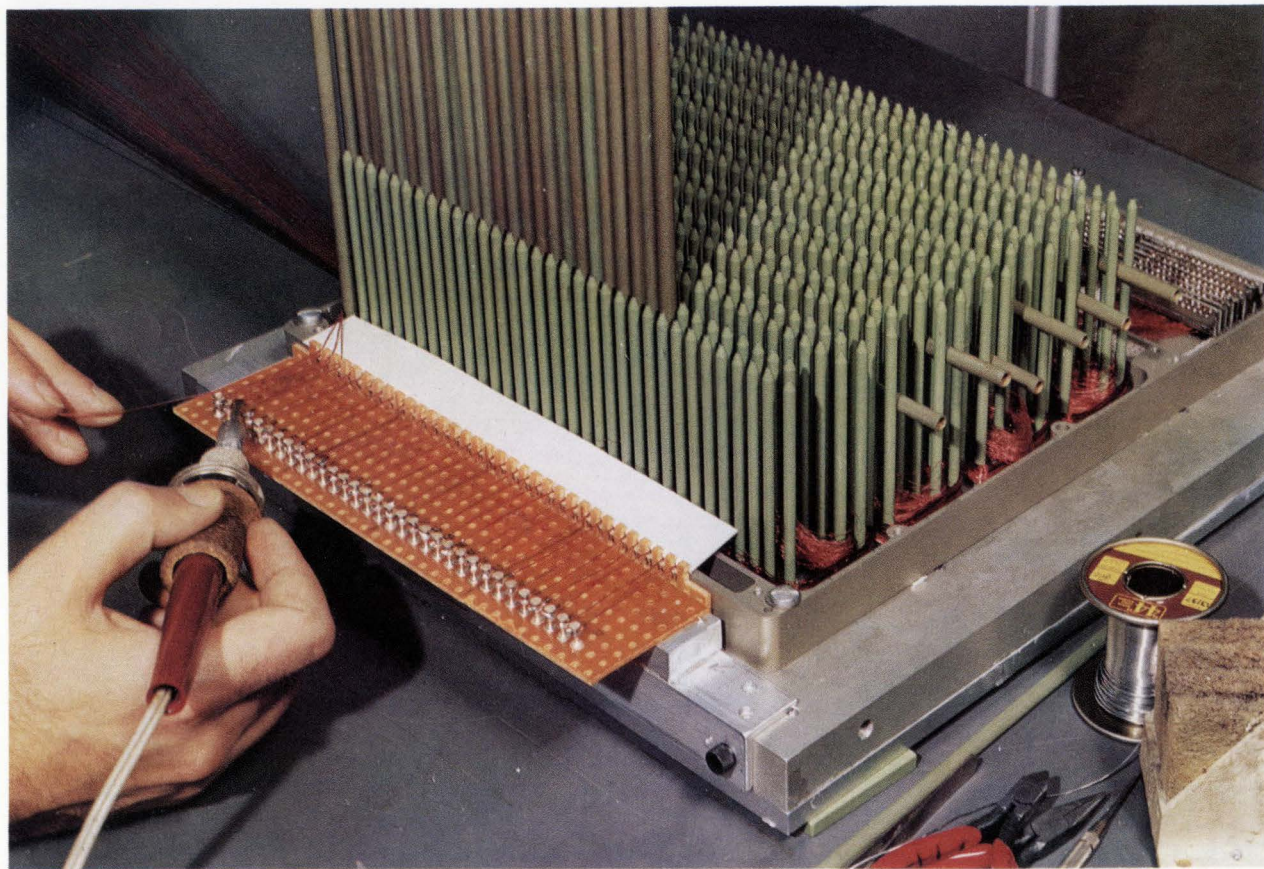

The sense board, with some cores in place, is mounted on the braid. Multiturn sense windings are part of the multilayer board. Two U-cores and their cross-pieces are at the bottom.

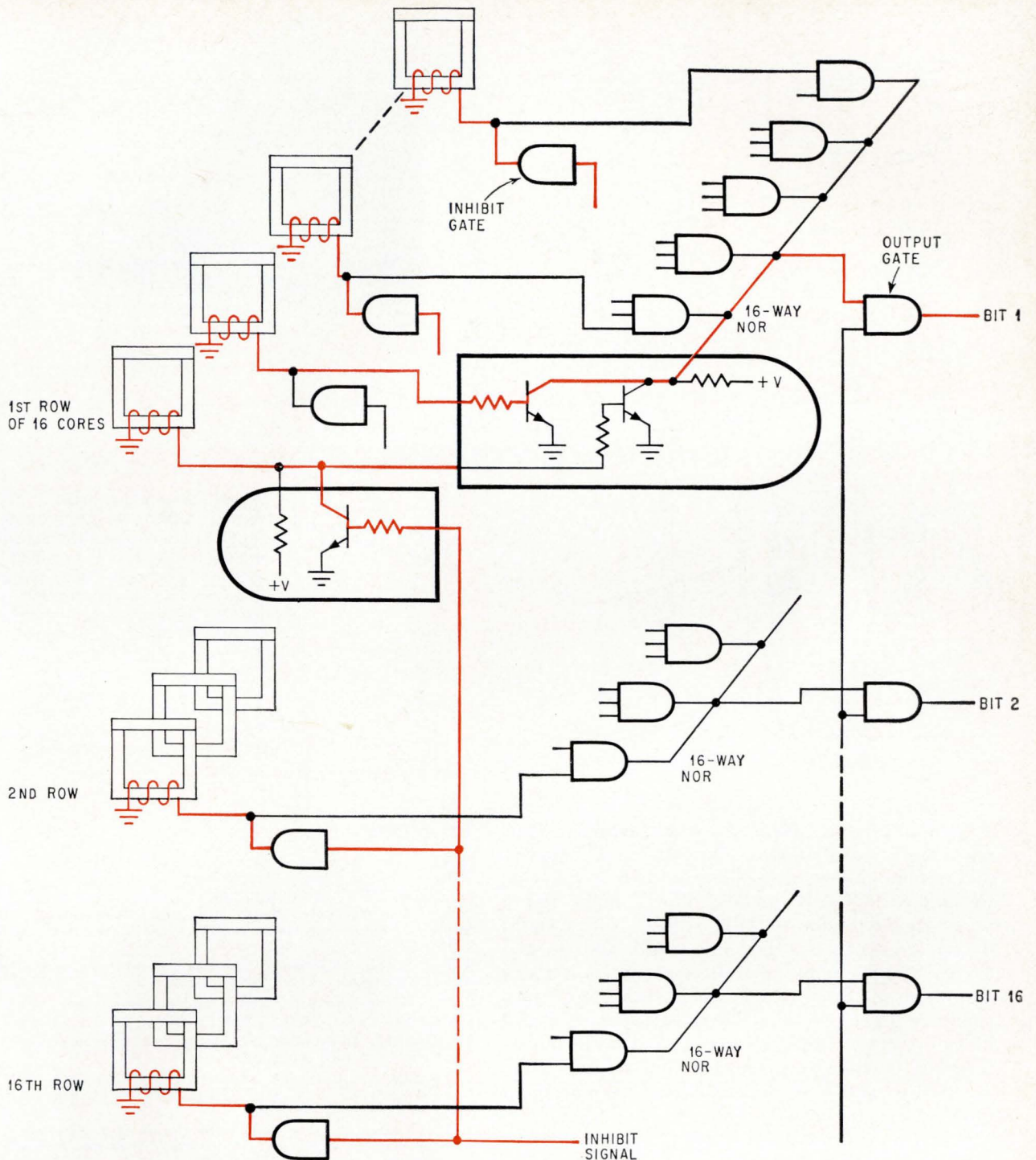

Each word line in the MIT braid memory links 256 cores. A single inhibit signal short-circuits the sense lines from a column of 16 cores; 15 inhibit signals short-circuit 240 cores. In any single row of 16 cores feeding a 16-way NOR gate, 15 are inhibited and one is active. The 16 active cores deliver one 16-bit word to the output gates.

codes 12 of the 16 address bits and generates the current to be sent down a word-line. The other four address bits go to the sense board. The line-selection method is of the conventional diode-steering or diode-matrix type.

Speed vs. size

Wired memories that have very short cycle times can be made at the expense of density, braid

length, and complexity of electronics. Cycle times can be in the neighborhood of 300 nanoseconds. These memories are most useful as microprogram stores of about 100,000 bits. At the other end of the scale, a single braid unit is probably limited to somewhere between 1 million and 10 million bits. Performance deteriorates with length, or number of cores; with present wire dimensions, the practical limit is about 1,000 cores. The braiding of

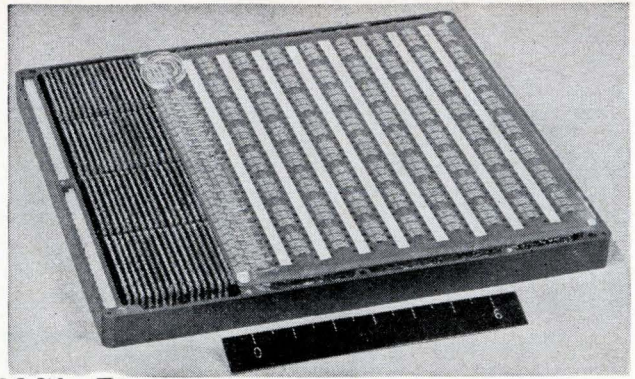
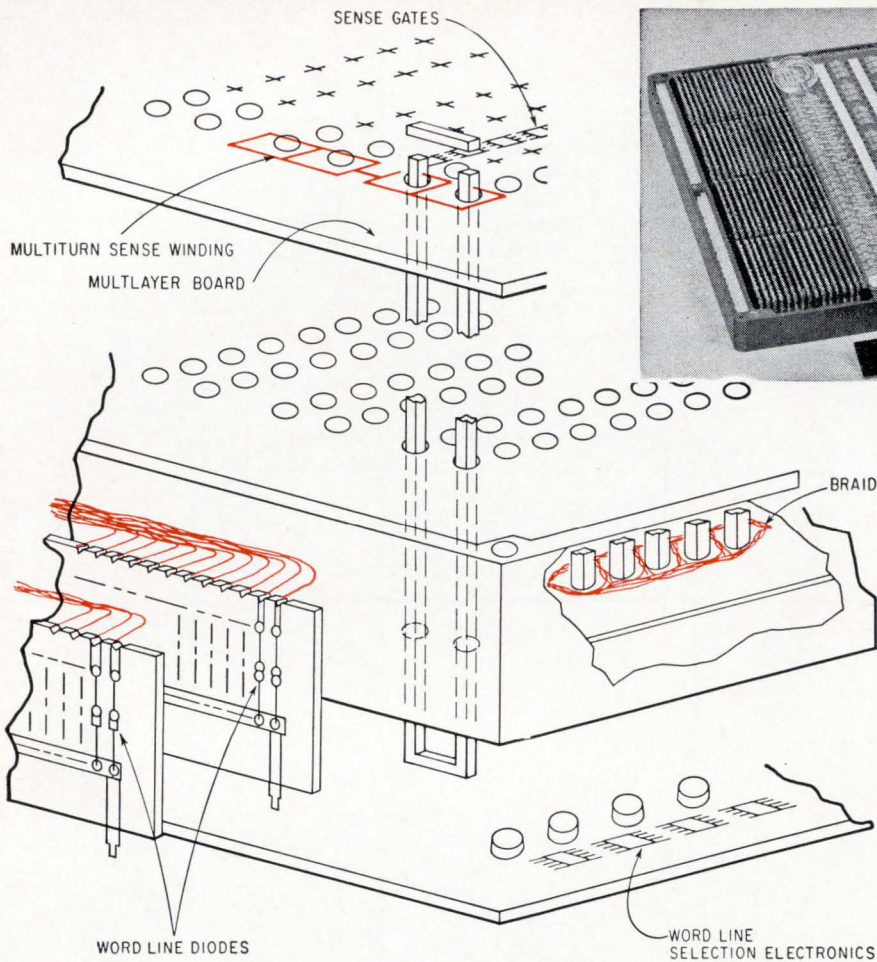

In partly assembled braid memory, above, a large printed-circuit board carrying the sense circuits in flatpacks is installed on top of the braid. The U-shaped cores will be inserted through holes in the p-c board. Adding the drive circuits increases the thickness shown here by about 50%. Complete assembly of braid memory in exploded form, at left, shows drive circuits on the bottom, cores and braid in the middle, and sense circuits on top.

10 million bits on 1,000 cores would require 10,000 wires and 10,000 diodes. For maximum capacity and minimum cost, all numbers should be rounded to the next higher power of 2. For example, 10,000 wires would require a 14-bit address and a 14-bit decoding circuit. But the same length address and a very small amount of additional decoding can handle up to 16,384 wires, which, with 1,024 cores, can store 16,777,216 bits. These large braids would be quite slow, with cycle times of 5 to 10 microseconds. Obviously, a multiple-unit braid system is possible, and even desirable, if the replacement problem can be solved.

Wired memories face competition from large-scale integrated-circuit memories and from photographic storage units. For small amounts of storage, LSI units will soon be reasonable alternatives to the braid—probably as soon as a 1,000-bit chip with its own address decoding becomes available. For very large memories, photographic storage techniques are clearly superior, though they must be read out serially, bit by bit. The relatively large initial investment necessary for even small photographic permanent memories makes them impractical for systems of a few million bits.

The future of wired memories, then, lies in the range of 100,000 to 10 million bits. Within this range, they should be a useful addition to the choices available to system designers.

References

1. R.L. Alonso and W.H. Aldrich, "The Braid Transformer Memory," Report R-498, MIT Instrumentation Laboratory, Cambridge, Mass., September 1965.
2. W.H. Aldrich and R.L. Alonso, "The Braid Transformer Memory," IEEE Transactions on Electronic Computers, August 1966, p. 502.
3. A.L. Hopkins, "Electronic navigation charts man's path to the moon," Electronics, Jan. 9, 1967, p. 109.
4. T.L. Dimond, "No. 5 Crossbar AMA Translator," Bell Laboratories Record, February 1951, p. 62.
5. I.R. Butcher, "A Prewired Storage Unit," IEEE Transactions on Electronic Computers, April 1964, p. 106.
6. G.G. Pick, S.B. Gray, and D.B. Brick, "The Solenoid Array: a New Computer Element," IEEE Transactions on Electronic Computers, February 1964, p. 27.
7. B.W. Kington and D.M. Taub, "The Design of Transformer (Dimond Ring) Read-only Stores," IBM Journal of Research and Development, September 1964, p. 443.
8. P. Kuttner, "The Rope Memory, a Permanent Storage Device," American Federation of Information Processing Societies, Conference Proceedings, Vol. 24, October 1963, p. 45.
9. R.L. Alonso and J.H. Laning Jr., "Design Principles for a General Control Computer," Institute of Aeronautical Sciences, New York; Fairchild Publication Fund Paper FF-29, April 1960.
10. J.A. Rajchman, "Static Magnetic Matrix Memory and Switching Circuits," RCA Review, Vol. 13, June 1952.
11. K. Olsen, "A Magnetic Core Matrix and its Application to a Coincident-Current Memory," Master of Science thesis, Massachusetts Institute of Technology, 1952.
12. U. Ecco and G.B. Zorzoli, "The Picture History of Inventions," Macmillan, 1963.

Acknowledgment

Development of the braid memory was financed by the National Aeronautics and Space Administration under Contract NAS-4065.

When it comes to custom assemblies, we can solve millions of problems.

Like taking millions of plastic and/or metal parts made to the most exacting tolerances, fitting them into an assembly, sub-assembly or finished product, wrapping them, sealing them and shipping them.

Complex components like computer circuit boards, telephone switching equipment, memory core frames, computer control connectors, switches, contacts for plug assemblies, practically anything you specify, we can make and put together.

That means your designers need not be inhibited by

the limitations of your own facilities and machinery.

We're the one single source you need deal with. We'll take care of it all—from initial fabrication of the parts to the finished assembly. And we'll do it all, probably at a lower cost than if you did it yourself.

Let us put our men, machines and plants to work for you. Give us your specifications, we'll do the rest. We've done it for a lot of others.

Sylvania Electric Products Inc., Parts Division,
Warren, Pennsylvania 16365.

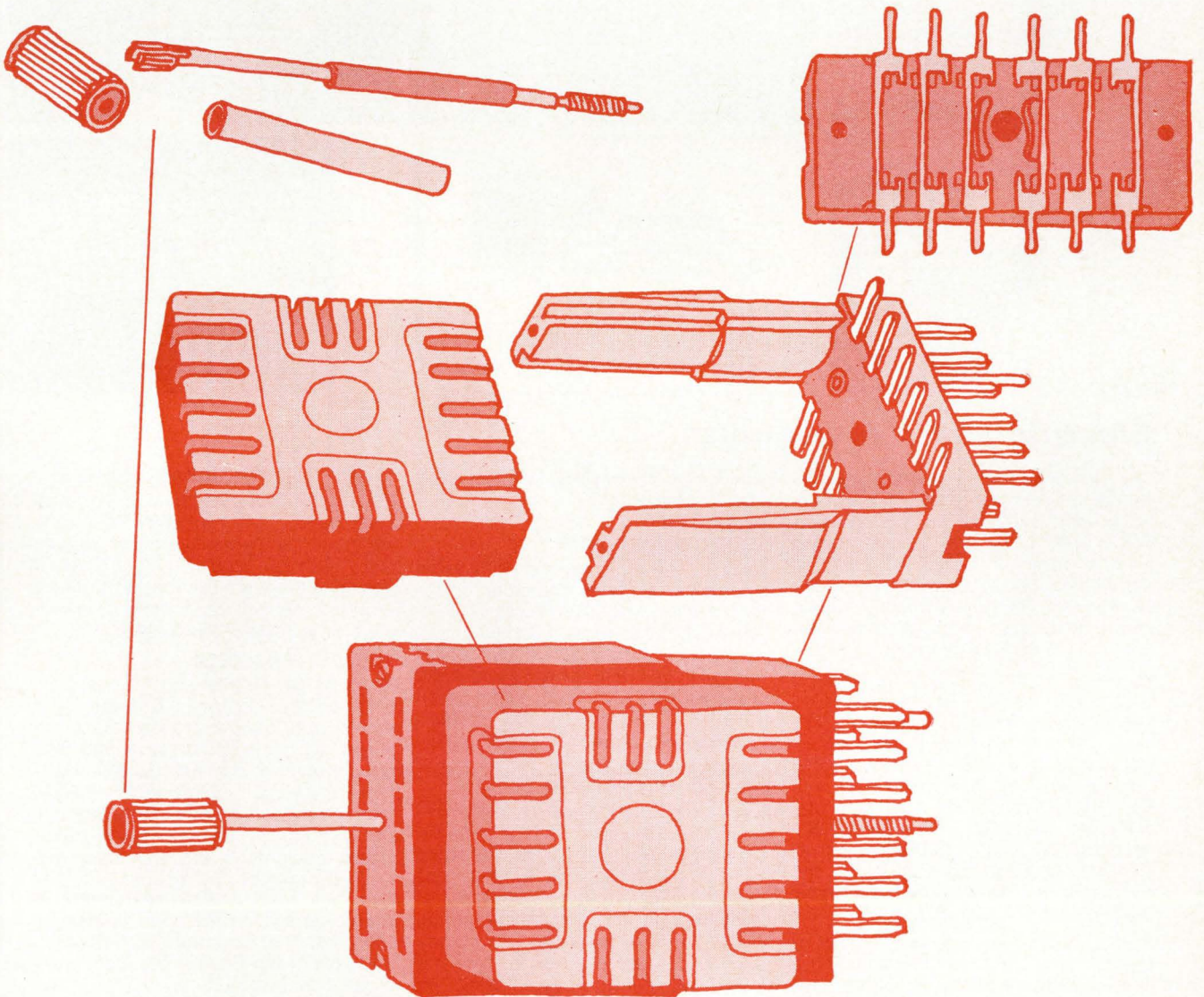

SYLVANIA
SUBSIDIARY OF
GENERAL TELEPHONE & ELECTRONICS **GTE**

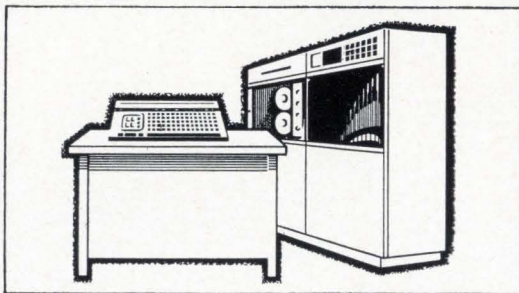
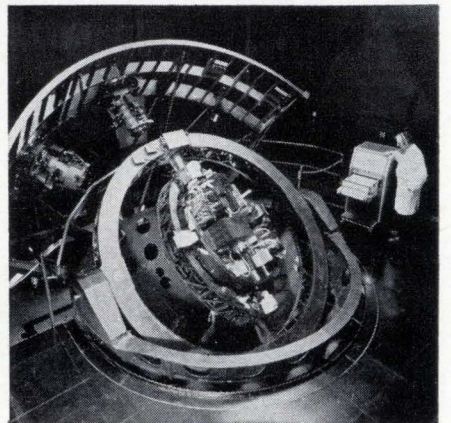
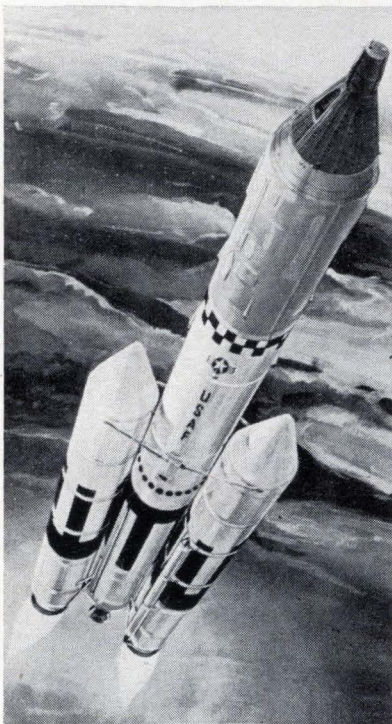
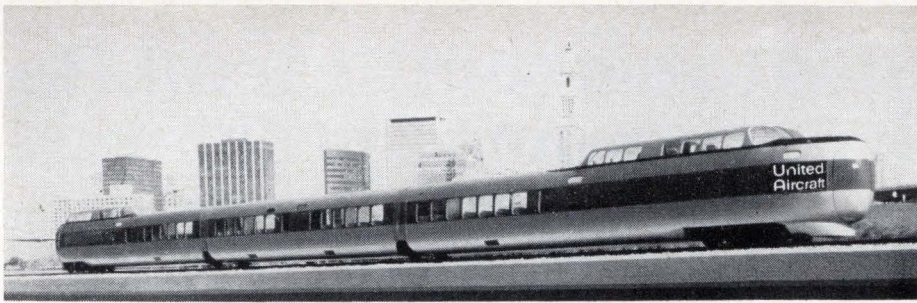

Broaden your talents with the most varied and advanced systems organization in the industry.

Electronics Professionals . . .

Our demonstrated capability has resulted in a constant flow of new contracts and requests to explore new fields, new directions in such broad areas of advanced systems engineering as: Guidance & Control, Computer Engineering, Tactical Weapons, Intelligence, Avionics, Library, Weather, Marine, and Rail Transportation.

At United Aircraft Corporate Systems Center you can be sure of continuing challenge, professional growth and personal progress. A wide range of truly exciting programs has created a multitude of unusual opportunities for top-flight, systems-oriented engineers and scientists. Here in Farmington, Connecticut, you will find the accent on creative, original thinking . . . the emphasis on individuality in a highly professional environment.

If you should feel qualified for one of the following prime openings, please contact us immediately. If not, we have further need for people with systems

experience at all levels. Why not send your resume today?

COMPUTER DEVELOPMENT CHIEF

Requires MSEE degree and 10-12 years experience in digital computer design and development. The successful candidate will head up our Computer Development Group, and will be the key individual between software and hardware groups. Familiarity with digital computer components and systems development absolutely essential.

SENIOR ELECTRONICS PACKAGING ENGINEER

BSME or BSEE (7-8 years experience). Requires experience in micro-miniaturized electronic packaging for space applications — capable of assessing thermal and structural integrity of packaging. Prefer preliminary design and proposal experience — an individual who can assume responsibility for design of electronic packaging for space programs.

SENIOR ELECTRONICS ENGINEER

BS degree in Electrical or Electronics Engineering. MS preferred. Four to eight years experience: should include Logic Design and/or Digital Circuit Design. Computer Systems experience required, as well as a working knowledge of computer languages.

PROJECT ENGINEER

Requires BS degree and 10 years experience. An experienced leader with mechanical, naval or transportation engineering background to direct the development of new transportation systems. Duties will include work package layout, scheduling, manufacturing liaison, system design and layout supervision, equipment selection, cost control, and project coordination.

Resumes and salary requirements should be sent to Mr. John B. Henley, United Aircraft Corporate Systems Center, 1690 New Britain Avenue, Farmington, Conn. 06032. We are an equal opportunity employer.

United Aircraft Corporate Systems Center

DIVISION OF UNITED AIRCRAFT CORPORATION



DIAL DANA... BEFORE YOU BUY A DVM

No need to regret a decision based on catalog claims — not when you can see for yourself why the Model 5400 is the fastest selling digital voltmeter in the 0.01% class... dial your area code number for a demonstration today.

201 201: 687-8737	302 301: 946-0300	408 415: 968-7116	516 516: 433-1421	714 714: 297-4619	International Offices	
201 201: 542-1441	303 303: 934-5505	412 412: 892-2953	517 313: 892-2500	714 213: 684-2840		
202 301: 946-0300	305 305: 723-6924	413 617: 648-2922	518 315: 454-9377	716 716: 271-7430		
203 203: 246-5686	309 312: 539-4838	414 414: 547-5131	602 602: 959-2115	717 717: 761-0577		
205 205: 881-3721	312 312: 539-4838	415 415: 968-7116	603 617: 648-2922	802 617: 648-2922		
206 206: 763-2755	313 313: 892-2500	417 913: 648-4173	606 513: 298-7203	805 213: 684-2840		
207 315: 454-9377	314 314: 837-0597	419 216: 885-5616	607 315: 454-9377	812 317: 253-1681		
212 201: 687-8737	315 315: 454-9377	501 214: 231-6541	609 215: 265-3250	814 412: 892-2953		
213 213: 684-2840	316 913: 648-4173	502 317: 253-1681	612 612: 537-4501	815 312: 539-4838		
214 214: 231-2573	317 317: 253-1681	503 206: 725-2700	614 216: 885-5616	816 913: 648-4173		
215 215: 265-3250	318 713: 528-6904	504 205: 881-3721	616 313: 892-2500	817 214: 231-6541		
216 216: 885-5616	319 319: 365-6635	505 505: 265-7766	617 617: 648-2922	904 305: 783-9407		
217 312: 539-4838	401 203: 246-5686	507 612: 537-4501	618 314: 837-0597	912 215: 881-3721		
218 612: 537-4501	402 913: 648-4173	512 713: 528-6904	703 301: 946-0300	913 913: 648-4173		
219 312: 539-4838	404 404: 261-5459	513 513: 298-7203	712 319: 365-6635	914 914: 769-1811		
301 301: 946-0300	405 214: 231-6541	515 319: 365-6635	713 713: 621-0040	916 415: 968-7116		
						Austria Wien: 82 46 732
						Australia Victoria: 489-1911
						Denmark Jyllinge: (03388) 150
					England Dunstable: 65319	
					France Paris: 722 70 40	
					Germany Munich: 0811 48 65 58	
					Greece Athens: 98 09 34	
					Israel Tel Aviv: 244 311-2	
					Italy Milano: 54 20 51	
					Japan Tokyo: 279-0771	
					Benelux Gennep: 08851 1956	
					Norway Oslo: 28 26 24	
					Sweden Vallingby: 08/87 03 30	

The Poor Man's OP. AMP.

(Amelco 809
Integrated
Operational
Amplifier)

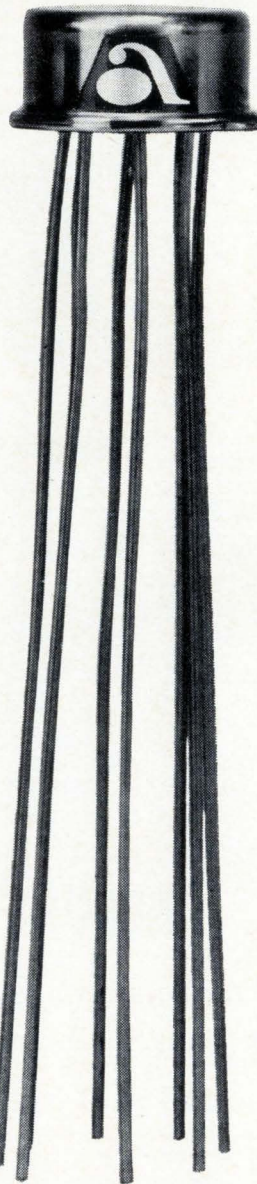

Will it make you rich?

It could.

Because Amelco took the highest performance specs for an integrated operational amplifier, simplified the design, and came up with a TO-5 package that will meet 95% or more of your requirements.

At a fraction of the cost.

The Amelco 809 is ideally suited for applications requiring high common mode range, high input impedance, and low current and voltage offsets and offset drifts.

Check the specs. Then order one, or hundreds, from Milgray. We have them available in depth... for off-the-shelf delivery... anywhere, overnight. (And you can afford more than you thought.)

m
MILGRAY

MILGRAY / NEW YORK / 160 VARICK ST. / N. Y., N. Y. 10013 / 212-YU 9-1600 / NEW JERSEY 201-HE 2-4300 / TWX 710-581-5808 / TELEFAX-FQF
MILGRAY / DELAWARE VALLEY / 2532 N. BROAD ST. / PHILA., PA 19132 / 215-BA 8-2000 / CAMDEN, N. J. 609-WO 6-7750 / TWX 710-670-3400
MILGRAY / WASHINGTON / 5133 LAWRENCE PLACE / HYATTSVILLE, MARYLAND 20781 / 202-864-6330 / BALT. 301-727-1870 / TWX 710-826-1127
MILGRAY / CLEVELAND / 1821 EAST FORTIETH STREET / CLEVELAND, OHIO 44103 / AREA CODE 216 881-8800 / TWX 810-421-8573
MILGRAY / INTERNATIONAL / 160 VARICK ST. / NEW YORK, N. Y. 10013 / TWX 710-581-5808 / TELEFAX-FQF / CABLE-MILGRAYEL-NEW YORK
ENTERPRISE AND ZENITH NUMBERS IN LEADING INDUSTRIAL AREAS

NEW

semi-automatic integrated circuit analyzer

MICA 150

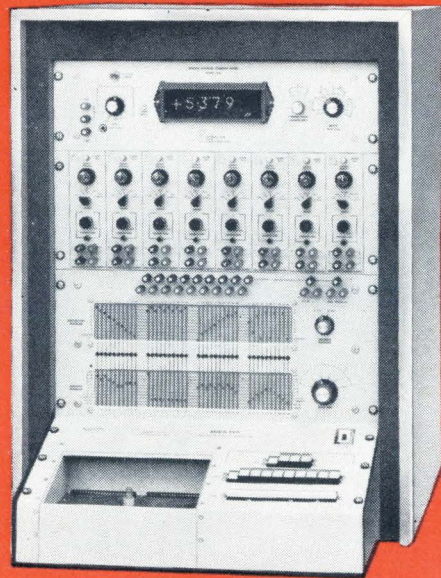

COMPUTER TEST
CORPORATION

Now the integrated circuit user can get all the flexibility and performance of an expensive, large scale IC test system in an accurate and reliable DC bench top analyzer.

The new MICA-150 Modular Integrated Circuit Analyzer tests all IC configurations of up to 40 pins with unique programming, fast pushbutton sequencing and built-in DVM readout.

Fast, Versatile Programming Two independent 10x40 crossbar switches and rapid pushbutton sequencing provide up to 40 tests on a single device without re-programming. For example, it's now quick and easy to check a 10 pin device using four completely different test programs without resetting any switches to advance the test from pin-to-pin or program-to-program. Additional flexibility allows the built-in DVM to measure current on one pin of the device and voltage on another—all pre-programmed.

Universal Test Adapters Through use of universal test adapters, the MICA-150 is designed to check ICs according to the number of pins of a particular package, not device or circuit type. Adapters are available for diode, transistor, TO-5, flat-pack, dual in-line and other package configurations, and can also be provided for Kelvin connections.

Accurate Digital Readout Specifically designed for the MICA-150 analyzer, the built-in Digital Volt/Ammeter has a conservatively rated readout accuracy of 0.1% with a four digit display. Other features include automatic ranging and polarity selection, self-calibration, automatic voltage or current readout selection. Measures currents as low as 1 nanoamp, voltages to 1 mv.

Modular Design Modular construction allows users to select an economical, customized tester without obsolescence problems. Maximum capacity of eight function generators permits later expansion, including modules for AC and pulse testing, without additional modifications.

Variable Soak Time Marginal device operation can be easily detected through use of an adjustable test time control which provides a period for thermal stabilization prior to measurement. A continuous position on the control allows parameters to be varied while observing results.

Precision, Wide Range Power Supplies Highly precise supplies utilize multi-turn calibrated potentiometer controls with high resolution and repeatability. Constant current supplies are continuously variable from 0-100 ma with voltage compliance adjustable to 100v. Constant voltage supplies are variable from 0-100v with automatic current limiting to 100 ma to provide device protection.

QUICK ACTION REPLY

Detailed technical literature on the MICA-150 will be mailed immediately upon receipt of this request.

Attn.: A. Norman Into, Marketing Manager
Computer Test Corporation, Three Computer Drive
Cherry Hill, N.J. 08034 • Phone: (609) 424-2400

Name _____

Company _____

Address _____

City _____ State _____ Zip _____

Circle 103 on reader service card

MONDAY



*Find submini
toggle*

TUESDAY



*Get smaller
pushbutton*

WEDNESDAY



*Check into
RFI-shielded
switches*

THURSDAY



*Need compact
switch lite*

FRIDAY

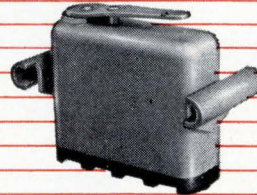

*Find hermetically
sealed switch*

So what if your switch needs do change almost every day?

Why start a big switch hunt every time?

Be logical. Every time you need a different switch, check Control Switch . . . **first!** No one else makes as many switches for the fields we serve. So, Control Switch offers you the greatest odds of finding exactly what you want . . . fast!

Here, for example, you'll connect with the newest in RFI-shielded switches and indicator lights. And with advanced designs in sub-sub-miniature toggles. And with the world's smallest indicator lights. And with answers to tough specs on size, weight, performance for components in control panels, data processing equip-

ment, missiles, industrial equipment.

Send for **all** the Control Switch material listed below. It's the most comprehensive reference file available from any single source.

Then, for switch needs, contact us direct. Or order through your Control Switch distributor. He specializes in selected lines of electro-mechanical and electronic components. He knows your problems and has the Control Switch stock to serve you fast.

SEND FOR THESE TODAY

Check numbers on the Reader Service Card corresponding to those at left below for any or all of these Control Switch references. While you're at it, get 'em all!

- #511 Condensed Switch Catalog 100
- #512 Basic Snap-Action Switch Catalog 110
- #513 Toggle Catalog 180
- #514 Indicator Light Catalog 120
- #515 Hermetic Switch Catalog 130
- #516 Switchlite Catalog 220
- #517 Pushbutton Catalog 190
- #518 RFI-Shielded Component Bulletin 62A

C
C
CONTROLS
COMPANY
OF AMERICA
CONTROL SWITCH DIVISION
1420 Delmar Drive, Folcroft, Pennsylvania 19032
A Subsidiary of
 General Precision Equipment Corp.

Probing the News

New markets

Lawmen's bounties lure electronics firms

Reward money is being put up by the Federal Government to support local programs taking a technological approach to crime-fighting

By Paul Dickson

Staff writer

Apparently convinced that crime doesn't pay—at least not enough—electronics firms have generally ignored the field of scientific law enforcement. But evidence of loosening purse strings at Federal, state, and local levels now has an increasing number of companies maneuvering for a share of what promises to be a rich market.

Alfred Blumstein, on loan to President Johnson's Commission on Law Enforcement and the Administration of Justice from the Institute for Defense Analysis, estimates that the average law-enforcement agency allocates no more than 4% of its annual budget for equipment. However, the golden carrot being dangled before industry should raise this percentage significantly within the next few years.

President Johnson has requested \$50 million for "planning grants, research, and pilot projects" in scientific crime prevention during fiscal 1968, and he expects this amount to increase sixfold the following year. Those states and municipalities already planning or implementing projects of their own will further swell the market for hardware.

Suppliers of computer-based command and control systems, communications networks, and au-

Longer arm of the law. Facsimile gear at the Albany headquarters of the New York State Information and Intelligence System receives incoming fingerprints.



plug-in

new measurement capabilities



new Tektronix Type 1A4

Four Channel Amplifier

- DC-to-50 MHz Bandwidth
- 7-ns Risetime
- 10 mV/cm Deflection Factor
- Solid State Design, FET Inputs

The Type 1A4 Four Channel Amplifier Plug-in has a constant DC-to-50 MHz bandwidth with a 7-ns risetime over its 10 mV/cm to 20 V/cm range in the Type 544, 546, 547, and 556 oscilloscopes. This new plug-in also provides maximum vertical system bandwidth in any other Tektronix oscilloscope that accepts letter and 1-series plug-ins.

The solid-state design with FET inputs provides low drift and fast warm-up. The Type 1A4 trigger take-off is selectable from any channel and the CMRR is greater than 20:1 from DC-to-10 MHz.

Operating modes include alternate or chopped four channel; dual channel differential; 2, 3, or 4 channels added or subtracted; four channel sweep switching with Type 547.

Type 1A4 Four Channel Plug-in. . . . \$750

U.S. Sales Price FOB Beaverton, Oregon



For complete information, contact your nearby Tektronix field engineer or write: Tektronix, Inc., P.O. Box 500, Beaverton, Oregon 97005.

Command performance

With the report of the President's Commission on Law Enforcement and the Administration of Justice now published, the preliminary conclusions of a tacked-on science and technology task force are attracting the most attention. Originally, scientific and technical questions were not within the scope of the commission's study of crime in America. But after a year of work, officials concluded that the subject was too important to ignore and a supplementary task force to cover this area was organized in April 1966. Now some legislators have rallied to the banner of technological crime prevention.

One such is Rep. James H. Scheuer (D., N.Y.). "We're spending more for research on coal, tooth decay, and soybeans than we are on crime prevention," he says. Determined to close this technology gap, Scheuer and Sen. Edward M. Kennedy (D., Mass.) are co-sponsoring a bill to allot \$100 million for a National Institute of Criminal Justice. Last month, to gather support for the proposed research facility, Scheuer organized a showcase of industry's newest crime prevention equipment for members of Congress. Among the 40-odd exhibitors were such electronics-oriented firms as Litton Industries, General Dynamics, GE, RCA, Sperry Rand, ITT, and Aerojet-General.

tomated equipment for manual jobs will be the principal beneficiaries of the boom shaping up in crime-prevention equipment. But with many projects still in formative stages, consulting firms will also be in on the bonanza—at least at the outset. The Kelly Scientific Corp., the Systems Development Corp., and the Systems Science Corp. have already collected fees from governmental agencies for advice on program development and hardware purchases.

I. Gadgets need not apply

Municipal and state officials are apparently going to control the funds available to the crime market. Peter Kelly, president of the Kelly Scientific Corp., says: "Besides the money generated locally, there is a clear understanding that Federal dollars will be channeled through local officials and not directly to industry. The President's Commission on Law Enforcement and the Administration of Justice and the Justice Department's Office of Law Enforcement Assistance agree on this."

Electronics firms will also have to deal with wary Federal advisers riding herd on Government funds. Blumstein warns: "We are getting away from gadgetry in law enforcement. Industry will try to sell gadgets to local groups and it will be the responsibility of Federal agencies to prevent this. Industry has learned that the Defense Department buys systems, not gadgets; the same should hold true in the crime field. Firms with the right

answers will make millions."

This hard-nosed approach stems largely from a very real technology gap in law enforcement and crime prevention. As a partial explanation, Saul I. Gass of the International Business Machines Corp.'s Center for Exploratory Research points out that hundreds of thousands of engineers and scientists are engaged in defense projects while only a handful are working on crime prevention.

Exposing a myth. In February, the President released a report entitled "The Challenge of Crime in the Free Society," prepared by the five task forces making up his Commission on Law Enforcement. Perhaps the most startling aspect of the study was its confirmation that scientific crime detection is largely a myth. The task force that prepared the preliminary section on science and technology will soon release a comprehensive survey. According to Kelly, who served on the panel, "the May report will have more impact since it details what is wrong." Among the problems highlighted by the task force:

- Fingerprinting, though long a clincher in detective fiction, is at present an inadequate means of criminal identification.

- Public officials responsible for crime have "almost no communication with the scientific and technical community."

- Objective statistical information on crime is almost nonexistent.

- The national police community is fragmented; information does not pass freely among agencies that

should be cooperating.

- Most police laboratories have a minimum of equipment and lack skilled personnel capable of using modern instruments.

- In most cities, police radio communications are hampered by congestion of frequencies.

Besides pointing out problems, the task force suggests specific hardware solutions. For example, it recommends that the Government take the initiative in developing low-cost, two-way portable radios for foot patrolmen by guaranteeing the sale of the first 20,000 units.

II. Grassroots gripes

Problems reported by local law-enforcement agencies recently lent credence to the conclusions of the Federal task force. Items:

- The last 400 patrol cars purchased by New York City Police Department were delivered without two-way radios because allotted frequencies were overloaded.

- Because of crowded frequency bands, the Los Angeles Police Department has been unable to operate radios bought to beef up the communications system that proved inadequate during the Watts rioting.

- Police in Washington, D.C., determined that 98% of the 4,450 burglar alarms they received during 1965 were false.

Lt. E.G. Giese of the Chicago Police Department's fingerprinting section says latent prints (those left at the scene of a crime) are a constant source of irritation, explaining that they are only valuable when they can be compared with the prints of known suspects. Chicago's police check latent prints against a relatively small file of habitual offenders, but the Federal Bureau of Investigation won't even open its files without receiving a full set of 10 prints from a local agency.

Some local frustration has national implications. New York State authorities had a possible line on the structure of organized crime when they stumbled on the notorious Apalachin meeting of top racketeers during the late 1950's. To detail the structure of organized crime, the state attempted to collect all available data on the mobsters attending the conclave. Two years later, New York officials still hadn't secured all the information on cer-



Sapphires that write...



...smoothly, evenly—the instant they touch the paper. We've been aware of your pen frustrations, and we've done something about it... our exclusive sapphire-tipped pen. Its fine, clear trace shows every fluctuation. This pen fills easily, writes 2000-3000 inches per filling and requires less than 2 grams of pressure. The ink flow is regulated at all writing speeds and positions.

There's more to a V.O.M. Recorder than a great pen. It has an event marker and 5 chart speeds, a zener diode reference supply for continuous accuracy plus high off-balance input impedance. It attaches easily to most analytical instruments. It's compact—you place it where you need it. Many other built-in features. Models available with the sensitivity you need. Write for Catalogs 37-2174 and 37-2194. Better yet, try one yourself in a no-obligation demonstration. Bausch & Lomb, Electronics Division, 99741 Bausch Street, Rochester, New York 14602.

BAUSCH & LOMB 
ELECTRONICS DIVISION

In Canada, Bausch & Lomb Optical Co., Ltd., 16 Grosvenor St., Toronto, Ontario.

ADVANCING ELECTRONIC/OPTICAL
INSTRUMENTATION

Circle 201 on reader service card →

See us at the
DESIGN SHOW
Booth #2531

GRC®

has more

NYLON FASTENERS

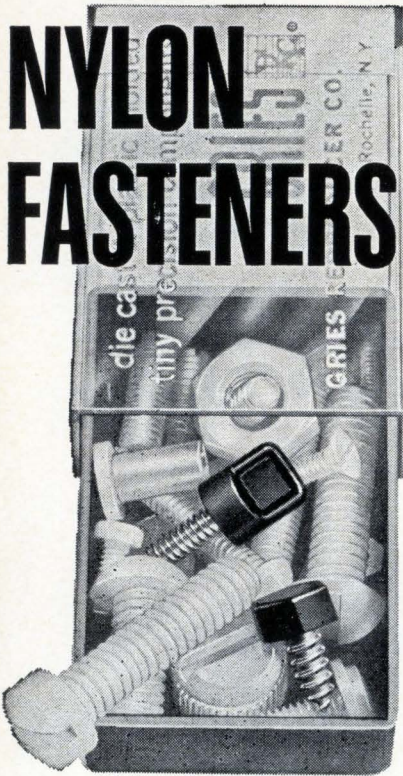

BIG

**SAMPLE BOX
proves it!**

Usable sample assortment shows
WIDEST SELECTION OF
SIZES & TYPES OF MOLDED
NYLON FASTENERS...
SCREWS, NUTS, WASHERS,
INSULATORS & MANY
EXCLUSIVE TYPES
FROM STOCK

Write for it today on your letterhead;
we'll include Catalog and application data.

world's foremost producer of
die castings & plastic moldings

GRIES®

GRIES REPRODUCER CO.

Division of Coats & Clark Inc.

151 Beechwood Ave., New Rochelle, N. Y. 10802
(914) 633-8600

Plants in:
New Rochelle, N. Y.; Warren, R. I.; Toccoa, Ga.

Partial census of electronics crime fighters

Bendix	Fingerprint scanners and license plate readers
Burroughs	Computers for information networks
Ferranti	Mobile teleprinters
General Dynamics	Intrusion detectors and communications
General Electric	Mobile teleprinters and fingerprinting
IBM	Consultation and computers
Litton	Fingerprint processing and transmission
Lockheed	Consultation
Motorola	Mobile and portable two-way radio systems
Muirhead	Facsimile equipment for fingerprint transmission
North American	Systems engineering concepts
RCA	Surveillance devices and computers
Systems Development	Consultation
TRW	Consultation on electronic guards for prisons

tain men. In some cases, they assembled more than 200 police files on an individual, only to find that much of this material consisted of meaningless collections of notes and clippings that duplicated other sources.

Paramilitary. To remedy technical shortcomings, new programs—replete with acronyms and military terms—are being undertaken at all levels of government. Although still in preliminary stages, most are comprehensive in scope, carry large price tags, and promise big rewards for electronics suppliers.

This year alone, for example, New York State will invest \$5.9 million in Nysiis—New York State Identification and Intelligence System. When completed, this system, which was partially spurred by the Apalachin debacle, will furnish information to more than 3,000 law-enforcement agencies around the state. Stage one, facsimile equipment for transmitting fingerprints, is already installed; computers will be added to the system this summer. These machines, programed with such data as criminal records, the physical descriptions of known felons, and forgers' trademarks, will enable local agencies to keep better track of criminal activities in their bailiwicks. Development officials plan scores of additional capabilities for Nysiis. Next on the agenda is an attack on the problem of latent fingerprints and development of automatic scanning equipment to read license-plate numbers so they can be compared with a computer file on stolen cars. Eventually, the state hopes to use Nysiis for research on the structure of organized crime.

Farther west, Michigan's state police are setting up LEIN—Law Enforcement Information Network. At the moment, 35 agencies in the southeastern part of the state can check on the license plates of "suspicious" vehicles and the names of suspect individuals by contacting a computer in East Lansing. According to D.R. Ferguson, the network's data processing manager, 135 remote terminals linking the whole state will be ready by July.

Car pool. On the West Coast, AutoStatix, California's automatic auto-theft inquiry system, has been operating for two years and is still growing. An IBM 7740 computer stores information on 60,000 stolen cars, processing about 12,800 inquiries daily from 228 terminals in four Western states. The California Highway Patrol says the system allows a policeman in his car to check on a suspicious-looking vehicle within a minute simply by radioing a dispatcher who checks with AutoStatix by Teletype.

In Northern California, PIN—Police Information Network—a five-county network centered around San Francisco, keeps tabs on more than 110,000 police warrants issued in the area. The system shares an IBM 7740 with the civilian Alameda County Data Processing Center. California has awarded a contract to the Lockheed Missiles & Space Corp., a division of the Lockheed Aircraft Corp., to study the establishment of a statewide criminal information system. According to Edward Comber, the project's director, the system will make use of such existing data banks as AutoStatix and PIN.

Fund city. At the municipal level,

the New York City Police Department recently announced plans for a new automatic central communications bureau dubbed Sprint—Special Police Radio Investigation Network. The system will eventually include teleprinters in patrol cars and automatic routing of messages to precincts and cars. New York has slated a 1967 Sprint outlay of \$2 million; the International Business Machines Corp. is acting as adviser on the project.

The city is requesting proposals on the system's first stage, which includes computer-aided dispatching and an automated stolen-car file, and a dozen firms have responded. Installation of stage-one gear would permit an operator to reduce an incoming emergency call to a code; for example, M30330W42 would be a Manhattan (M) holdup (existing police code 30) at 330 West 42nd St. The code would be Teletyped to a computer, which, in turn, would provide a dispatcher with a cathode-ray-tube display of the information needed to direct activities at the trouble spot, including such data as the name and phone number of the nearest hospital and the numbers of the nearest patrol cars.

Inspector William Kanz, who is directing the Sprint project, says, "The beauty of the first part of the program is that at the end of each day the computer will print out what has gone on in the last 24 hours, and we can use this information to redeploy our cars the next day."

On the national level, the Federal Bureau of Investigation is now developing the National Crime Information Center to coordinate area information systems. Currently, 16 local agencies, including the police of Boston and St. Louis and the California Department of Justice can interrogate the center's IBM 360-40 computer to determine whether a car is stolen or a man is wanted. More agencies will be joining the network in July.

III. Firms form pusses

Predictably, different techniques—generally compatible with different companies' product lines—are emerging as more firms get into the fight for the crime dollar. Aerospace and computer people generally insist that the systems engi-

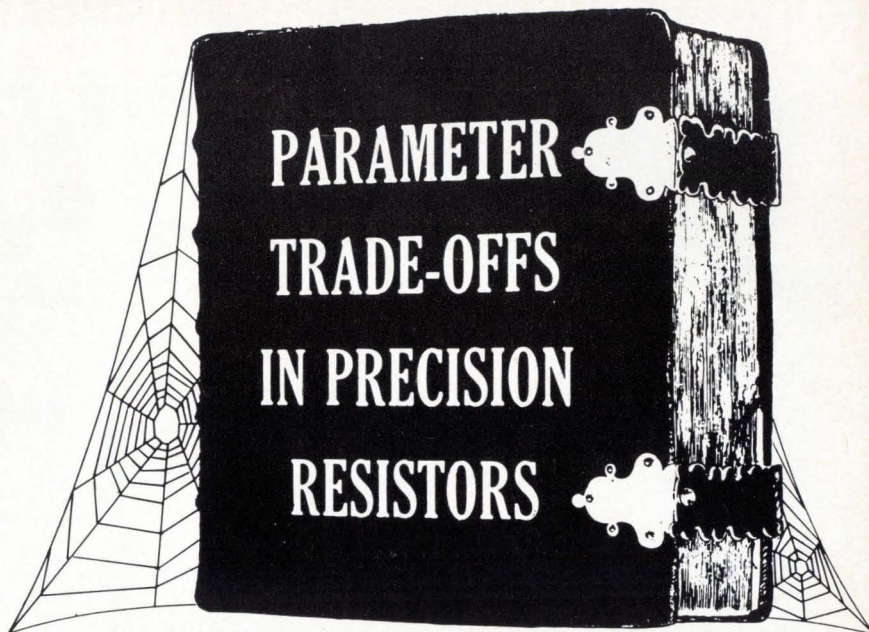

Vishay Closes It, For Good! Forget traditional precision resistor trade-offs. Have 0.01% or better absolute tolerance **with** guaranteed shelf life stability of 25ppm/yr. (50 for 3 yrs.) **with** load life stability of 0.030% (125°C., 2000 hrs.) **with** TC's below 1ppm/°C. (0 to +60°C.) **with** one ns. (1) response time **without** ringing **without** noise. And with resistors this fine, think of the networks they make! If you've been working with resistors a while, it's hard to break the habit, but for new design freedom, better total system performance, these free brochures belong on your desk. Write today.  Vishay Resistor Products



63 Lincoln Hwy., Malvern, Pa. 19355

SPECIALIZED TEST EQUIPMENT

Vitro West Orange Laboratory has fifteen years of proved capability in the development of electronic hardware and software custom engineered to a specific customer requirement.

For example: Message pattern generator for strategic communications systems . . . vibration analyzer . . . gas detector . . . A-blast measuring equipment . . . module test sets . . . solar simulators . . . fault isolation techniques.

For information: Call or write George Reagan, Vitro Laboratories, 200 Pleasant Valley Way, West Orange, New Jersey 07052. (201) 731-3400.

V.46

Vitro

WEST ORANGE
LABORATORIES

VITRO CORPORATION OF AMERICA

neering approach is the ultimate answer to all problems, while others propose solutions on a piecemeal basis. For example, an electronic ignition system to prevent car theft is now being offered commercially by the Emerson Electric Co. [Electronics, March 20, p. 56]. Some observers argue that the widespread use of such a device would make computer-based stolen-car files a moot issue.

Despite the diversity of opinion over methods, aerospace and electronics concerns apparently agree that the crime-prevention market is a potentially rich outlet for their technical talents. One index: more and more firms are bidding spiritedly for relatively small awards to showcase themselves. Last month, when Lockheed Missiles won the \$350,000 contract to study California's statewide information system it had to beat out 13 other companies, including the Aerojet General Corp. and North American Aviation Inc.'s Autonetics division. And in February, no less than 30 electronics and aerospace concerns submitted bids for the first stage of the FBI's proposed automatic fingerprint-processing system.

Headstart. While the number of manufacturers in the law-enforcement business is still relatively small, some companies enjoy an edge. For example, IBM had three employees on the President's Science and Technology task force while no other major firm was even represented. The Burroughs Corp. got a foot in the door by landing the computer contracts for the Nysiis and LEIN systems. And Litton Industries Inc. is building a reputation in fingerprint processing; work has been under way for three years at its Advanced Systems division on fingerprint scanning equipment for project FACT—Fingerprint Automatic Classification Technique. Its Litcom division has already supplied facsimile equipment to the Chicago police for transmitting prints. Along with Muirhead Instruments Inc., which supplied New York's facsimile equipment, Litton is currently in the running for production of a similar system for Los Angeles. Spokesmen for both firms anticipate a nationwide police facsimile network. Engineers at the General Electric Corp., the Bendix Corp.,

the Westinghouse Electric Corp., and the General Dynamics Corp. are experimenting with lasers as a means of handling fingerprints [Electronics, March 20, p. 52].

GE has been working with the Syracuse, N.Y., police to solve various law-enforcement problems. The answer to congested radio frequencies and the path to improved communications, according to GE, may lie in the use of teletypewriter machines in patrol cars. The company is working on a digital overlay technique, using coded tone signals stacked on existing police radio frequencies, to implement its system.

Among others showing early foot, Systems Development of Santa Monica, Calif., has conducted studies for the Nysiis project, the Los Angeles Police Department, and the California Institute for Crime and Delinquency. Now the concern would like to build systems for agencies. The Systems division of TRW Inc. is studying electronic prison security systems for California, and the Radio Corp. of America is working on surveillance gear.

Indictment. Despite its good start, the industry still has some fence-mending to do with officials who deplore the previous lack of corporate action. Eliot Lumbard, Gov. Nelson Rockefeller's adviser on crime in New York State, is one such critic. Lumbard doesn't believe firms are really applying themselves to basic difficulties. "People in public agencies are crying for good answers," he says. "You meet with these people from industry and they tell you that they are really interested in law-enforcement problems, but then you find out that they have no conception of the problems and have no firm ideas on how to help."

Industry is now calling in law-enforcement people for advice, but Lumbard holds that this isn't conducive to imaginative thinking since "bright cops" don't usually have the necessary technical background.

Lumbard would like to see corporations pit their technical skills against the strength of "the syndicate." Up to now, he asserts, "Xerox, IBM, Sperry Rand—I'm just mentioning companies in New York State—have done just about nothing to help us fight organized crime."

Designed for UHF APPLICATIONS

A WIDE RANGE OF

RMC

TEMPERATURE COMPENSATING SOLDER-INS

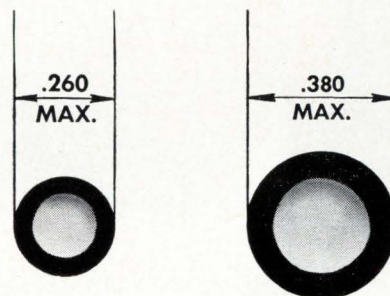

Nom. T. C.	Cap. Range	Cap. Range
NPO	1.5—10.0 pfd.	11— 22 pfd.
N-30	1.5—10.0 pfd.	11— 22 pfd.
N-75	2.2—12.0 pfd.	13— 23 pfd.
N-150	2.2—12.0 pfd.	13— 25 pfd.
N-220	2.4—15.0 pfd.	16— 27 pfd.
N-330	2.7—15.0 pfd.	16— 33 pfd.
N-470	2.7—15.0 pfd.	16— 33 pfd.
N-750	4.7—27.0 pfd.	28— 47 pfd.
N-1500	11.0—47.0 pfd.	48—105 pfd.

SPECIFICATIONS

CAPACITANCE: Within tolerance @ 1 MC and 25°C

CAPACITANCE TOLERANCES: ±5%, ±10% or ±20% (but not less than ±.25 pf)

WORKING VOLTAGE: 500 VDC

INSULATION RESISTANCE: Greater than 7500 Megohms @ 500 VDC

TEMPERATURE COEFFICIENT: As noted on Capacitance chart

FLASH TEST: 1000 VDC for 1 second

ELECTRODE: Pretinned for assured solderability

These new "Solder-In" capacitors are designed for use in UHF applications requiring the absolute minimum in lead inductance effects.

If your applications require special physical or electrical characteristics, contact RMC's engineering department.

Write today on your company letterhead for your copy of the RMC Catalog.

DISCAP
CERAMIC
CAPACITORS



RADIO MATERIALS COMPANY

A DIVISION OF P. R. MALLORY & CO., INC.

GENERAL OFFICE: 4242 W. Bryn Mawr Ave., Chicago 46, Ill.

Two RMC Plants Devoted Exclusively to Ceramic Capacitors

FACTORIES AT CHICAGO, ILL. AND ATTICA, IND.

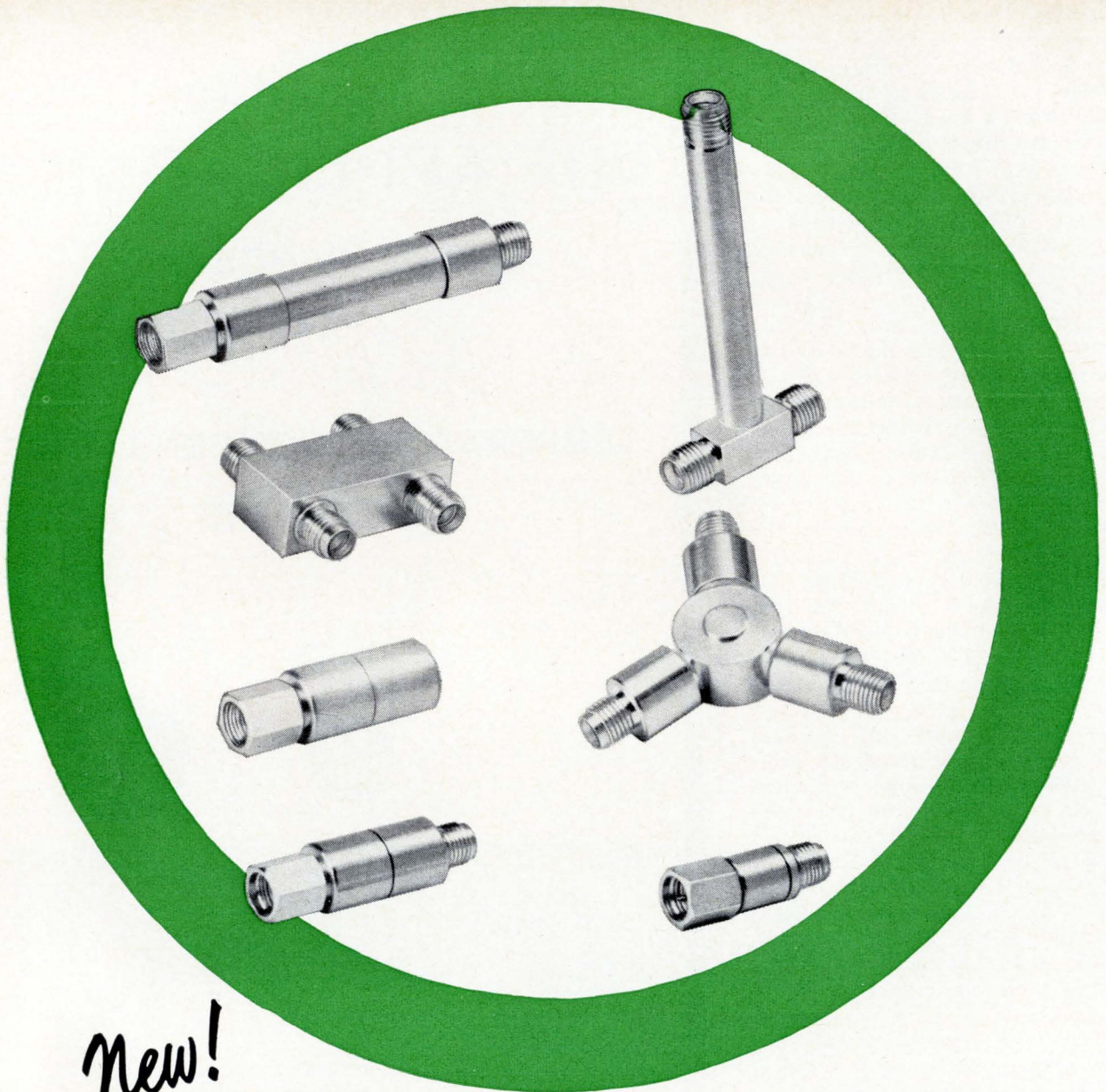

New!

A complete line of high-quality miniaturized coaxial devices—smaller, lighter, lower-priced!

Now available—off the shelf—from Microlab/FXR! A complete line of miniaturized attenuators, terminations, crystal detectors, resistive and reactive power dividers, low pass filters, hybrids, and directional couplers! All with MFM connectors! All useable to 12.4 Gc; some, to 18 Gc! All with specs that far exceed other, higher priced units!

For example, check these attenuator specs:

ATTENUATION (db)	ACCURACY (db)	MAX. VSWR	LENGTH (in.)	WEIGHT (oz.)	PRICE
3	0.75	1.5	1.4	0.5	55.00
6	0.75	1.5	1.4	0.5	55.00
10	0.75	1.4	1.4	0.5	60.00
15	0.75	1.4	1.4	0.5	60.00
20	0.75	1.4	1.4	0.6	60.00
30	1.00	1.4	1.8	0.6	65.00
40	1.00	1.4	1.8	0.6	65.00

Right now, 28 models of 8 basic product lines are available for immediate delivery; additional lines are on their way. What's more, wide use of interchangeable parts means that large-quantity orders can be filled readily and "specials" designed for you quickly. Write for complete information.



FREE! New Catalog 17—showing complete specs of these new miniaturized devices, plus thousands of other microwave products. Circle the Reader Service Card or write us. Address: Dept. E-59.

MICROLAB/FXR

Livingston, New Jersey 07039 Phones: (201) 992-7700; (212) 721-9000

Down to the sea in simulators

New Navy trainer provides on-shore schooling for officers assigned to combat information centers aboard warships

Young naval officers slated for shipboard assignments in combat information centers no longer have to put to sea for realistic training. A computer-controlled digital simulator, put in operation a few months ago, is providing trainees with on-shore "experience" in battle situations as well as instruction in simple tactical maneuvers.

Installed at the Glyco Naval Air Tactics Training Center in Brunswick, Ga., the Navy's new CIC tactics trainer was developed and manufactured by the Amecon division of Litton Industries Inc. The simulator took five years to complete and cost \$9.5 million. It replaces an analog system which was limited in scope and capable of furnishing only "canned" problems.

Officer-students form crews manning mockups of the CIC aboard the type of ships to which they'll be assigned. The basic course, tailored to vessels ranging from destroyers to aircraft carriers, takes 13 weeks.

Gameboard. Designated the 15F6, the simulator generates almost all of the data transmitted to a warship's CIC to the mockup's radar and communications equipment. Commands are transmitted from the students to the simulator. Nine CIC crews can be trained simultaneously and instructors can muster up to 128 surface and air targets on the simulated million-square-mile gameboard ocean.

Realistic training is the simulator's primary mission. At sea the combat center keeps the ship's captain informed of the location, identity, and movements of all surface, subsurface, and air contacts.

The CIC officer has a number of responsibilities. These include air-intercept, antisubmarine, and air-sea rescue operations as well as radar navigation and fire support. His recommendations for action are based on his evaluation of data from sources ranging from sonar

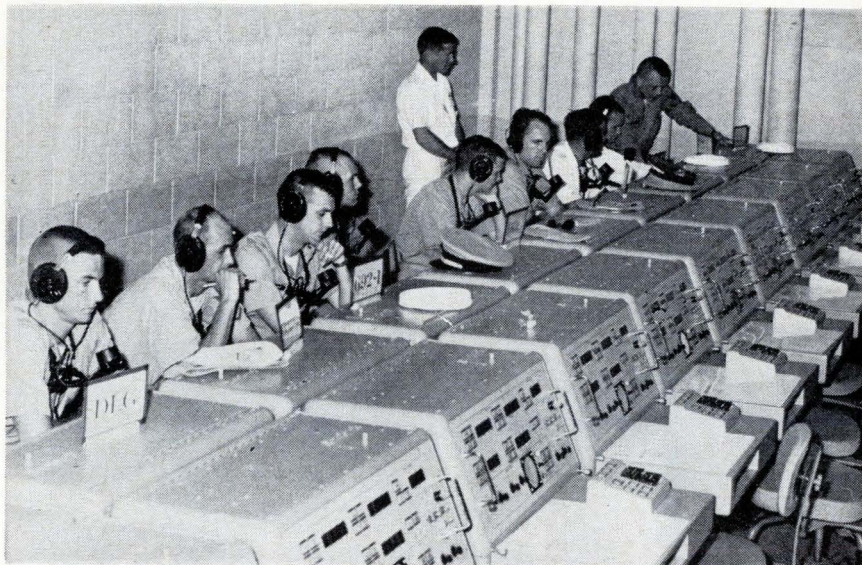

At the helm. Students operating these consoles "maneuver" ships on the gameboard sea after getting commands from CIC mockups.

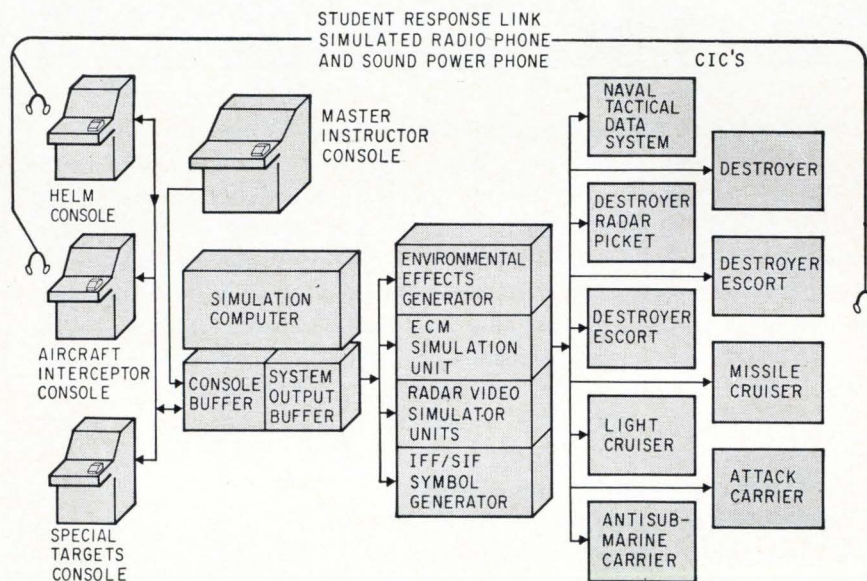

Landlocked. The Navy's new combat information center tactics trainer schools students realistically without their having to board a ship.

to lookouts on deck.

Realistic introduction to the demanding, complex, and hectic duties in a combat information center was hitherto restricted to on-the-job training with the fleet. Says Lt. J.N. Lauer, an instructor who

has been working with the trainer through its shakedown: "Now we are giving students problems and situations with the realism of fleet operation."

New courses. Cmdr. B.L. Rogers, a training officer at the center, says

Give us your microwave measurement problem and 90 days



We'll probably give you the answer off the shelf, with 60 days to spare; but if your problem is really out of the ordinary, we'll build you something like the ETS-24. □ That's one below. Designed for a video detector production line, the ETS-24 Test Set automatically measures and records noise output, tangential sensitivity, and detected pulse height in less than one minute — sweeping across more than an octave. (Accuracy: tangential sensitivity, 0.8 db; video output voltage, 2%.) Two of these sets are in New Hampshire right now, testing 500 units a day each. Rantec designed, built, and delivered them in 90 days. □ Producing precise microwave test equipment is one of our specialties; delivering it fast is another. If we can't fill from our standard line of multi-function tude, impedance) and time-delay measurement our quick-response design service is the next □ Write us your requirements, or nearest office listed below.

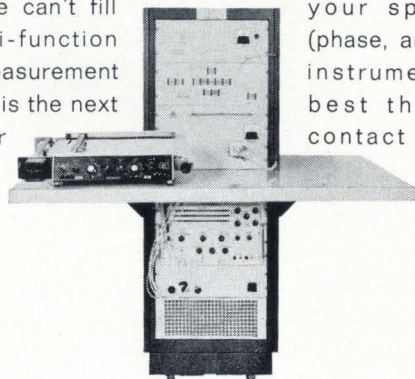

your specs
(phase, ampli-
instruments,
best thing.
contact the

r a n t e c
A DIVISION OF EMERSON ELECTRIC

Rantec Home Office: 24003 Ventura Blvd., Calabasas, Calif. 91302 • (213) 347-5446 • TWX 910-494-1218
Eastern Regional Office: 910 Fox Chase Rd., Rockledge, Phila., Pa. 19111 • (215) 728-7500 • TWX 510-665-4176
Northeastern Dist. Office: 1762 Mass. Ave., Lexington, Mass. 02173 • (617) 861-0502 • TWX 710-320-0203

the trainer has proven itself in its first months of operation and the equipment may be used for other applications.

At present, the 15F6 is being used to train officers in five areas: the basic cic; the Naval and Air Tactical Data Systems [Electronics, Feb. 20, p. 211]; air-intercept control; and antisubmarine aircraft control. According to Rogers, an airborne early warning course and refresher curriculum for officers whose ships have been idled by long overhaul periods are likely. Experimentation with new tactics —without having to call out the fleet—may also be in the offing.

The most dramatic advantage of the simulator says Rogers is in the air-intercept areas. "Until now," he says, "to get a meaningful intercept problem, we had to send two planes up." Commenting on cic training, he says, "We can already see that the quality of training has improved."

Checkmate. Seven warship classes and the Naval Tactical Data System are represented by the nine mockups. They may be operated together in a joint problem or independently. When the mockups are used in concert, the maneuvers of one "ship" appear on all of the other radar screens. Target-console operators work a brace of six surface and subsurface contacts while the men at aircraft-intercept units maneuver a pair of planes, one friendly and one hostile, for intercept problems on the gameboard. Instructors, operating master units, control all targets so they can alter simulated situations.

Commands from the mockups are sent by sound-powered phones to helm-console operators in the same way that recommendations are transmitted from a cic to the bridge of a warship. As operators enter course and speed changes from the console keyboard, maneuvers are simulated.

Data from the target and master consoles are transmitted to a dual-buffered simulation computer, a multipurpose Univac 1206. After processing the data, the computer's output is transmitted to the simulation equipment for conversion to display signals in the mockups. Data on vessels, aircraft, and equipment are programed into the computer, which serves as the central target generation device. Thus,

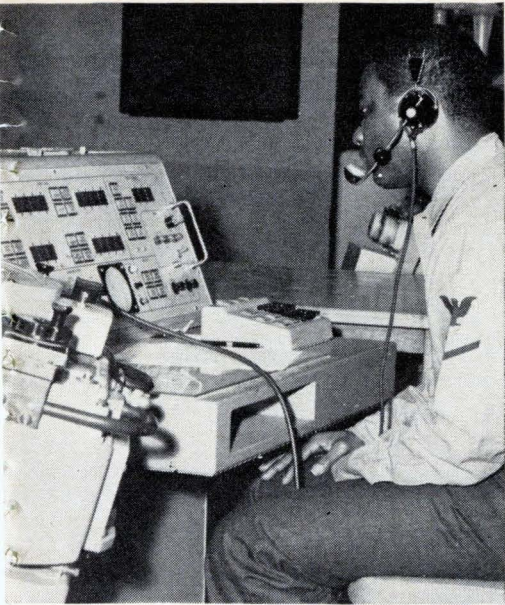

War games. With this console, operator can position six surface or subsurface targets within a given operations area.

when a helm-console operator makes a turn, the "ship's" turn appears on the display.

Three types of radar, along with their associated antenna patterns, can be simulated in the 15F6. Such target characteristics as size, intensity, and range are reproduced on radar repeaters. Also environmental effects—including sea and cloud return, receiver noise, and echoes from nearby land masses—are reproduced. In addition, electronic countermeasure signals are mixed in by the instructors. For added realism in air-intercept work, identification systems for friendly aircraft are simulated.

Sea legs. Roy Pearsall, Litton's project engineer, anticipates additional applications for the equipment and techniques used in the 15F6 trainer at other Navy installations. He also expects the Brunswick facility to be expanded to include another trainer. The next step in the development of the 15F6 trainer, Pearsall says, may be the replacement of the 1206 computer by the Univac 1230 that would, for example, expand the system to 20 mockups and provide as many as 280 targets for the gameboard.

According to Pearsall, failures have been minimal. During March, while the trainer was still getting its sea legs and operating 16 hours a day, only nine of 14,000 circuit boards in the simulator had to be replaced.

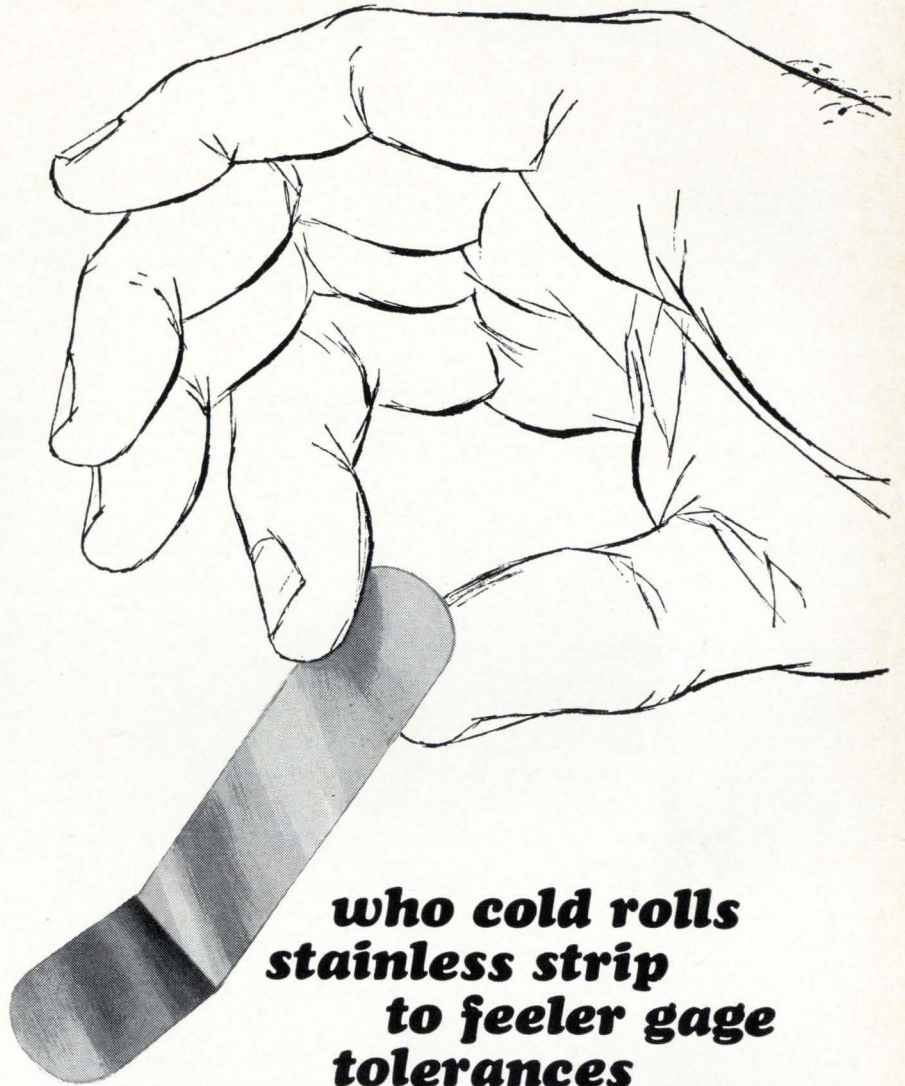

**who cold rolls
stainless strip
to feeler gage
tolerances
eliminating
secondary processing
?**

Feeler gages for use in telephone switchboard installation and maintenance are being stamped out of stainless Type 302 as cold rolled by Hamilton Precision Metals—making no further processing necessary. Tolerances as close as ± 0.0001 " over the entire material surface are held in cold rolling. The change to Precision Metals Type 302 stainless from spring steel has eliminated precision grinding, chrome plating and tumbling. Gages are delivered to the field faster, unit cost is drastically reduced.

Hamilton Precision Metals is your prime source for ultra precision rolled metals in mass production quantities. 7 proprietary metals, 12 pure metals and 112 commercial alloys are available from Precision Metals. Write today for new 48-page data book.

HAMILTON PRECISION METALS

division of Hamilton Watch Company, Lancaster, Pa. 17604

SCIENCE/SCOPE

The Phoenix missile scored a hit March 17 in its first guided launch from the Navy's F-111B. Charged with defending the fleet in the 1970s, the Phoenix system has an airborne radar that can detect attackers at very long ranges and at all altitudes, a high-speed computer to keep track of a swarm of attackers, and long-range missiles that can be launched rapid-fire and guided against multiple attackers. It is designed and built by Hughes for the U.S. Navy.

First laser equipment built to military specifications was included in an array of Hughes laser systems shown recently at a symposium for 200 guests representing the Department of Defense and the aerospace industry. They saw what is believed to be the largest collection of operating military laser equipment ever assembled under one roof at one time. Demonstrations included rangefinders for tanks, helicopters, and bombers; communications systems; and welders.

Canary Bird (COMSAT's Intelsat 2 F-3), launched March 22 and stationed in synchronous orbit just off the west coast of Africa, completed the communications satellite "umbrella" that will link two-thirds of the world by telephone and television. Like its Pacific sister Lani Bird, it contains a linear repeater which enables any number of ground stations to use it at the same time. The Intelsat series was developed for COMSAT by Hughes, builder of the first synchronous commercial communications satellite, Early Bird, which is still in transatlantic service.

First of the new 16,000-channel Manpack radios were delivered to the armed services recently by Hughes. The solid-state combat radio provides reliable two-way communications at ranges from hundreds of feet to hundreds of miles. At close ranges it uses ground waves to penetrate dense jungle and hurdle rough terrain; beyond 25 miles it bounces its high-frequency signals off the ionosphere. Manpack weighs only 29 pounds, operates as efficiently on flashlight batteries as on wet cells. More than 1,000 of the original 10,000-channel sets have been delivered to the Department of Defense for use in Southeast Asia.

New opportunities for engineers are being created daily at Hughes as the pace quickens on several major programs. Most urgent needs: electro-optical, aeronautical systems, circuit design, and radar systems. Requirements: at least two years of applicable experience, accredited degree, U.S. citizenship. We also have several openings for scientific programmers. Please send your resume to: Mr. J.C. Cox, Hughes Aircraft Company, Culver City, California. Hughes is an equal opportunity employer.

High-speed checkouts of complete telephone exchanges are now being made by Automatic Electric of Canada with a Hughes FACT (for Flexible Automatic Circuit Tester). FACT performs continuity, leakage, and fault-isolation tests at an average speed of 2500 per minute. Sud Aviation recently ordered its second FACT from COBELDA, Hughes' joint venture company in Belgium, and will use it to check wiring and interconnections on the new Concorde supersonic transport.

Creating a new world with electronics

HUGHES

HUGHES AIRCRAFT COMPANY

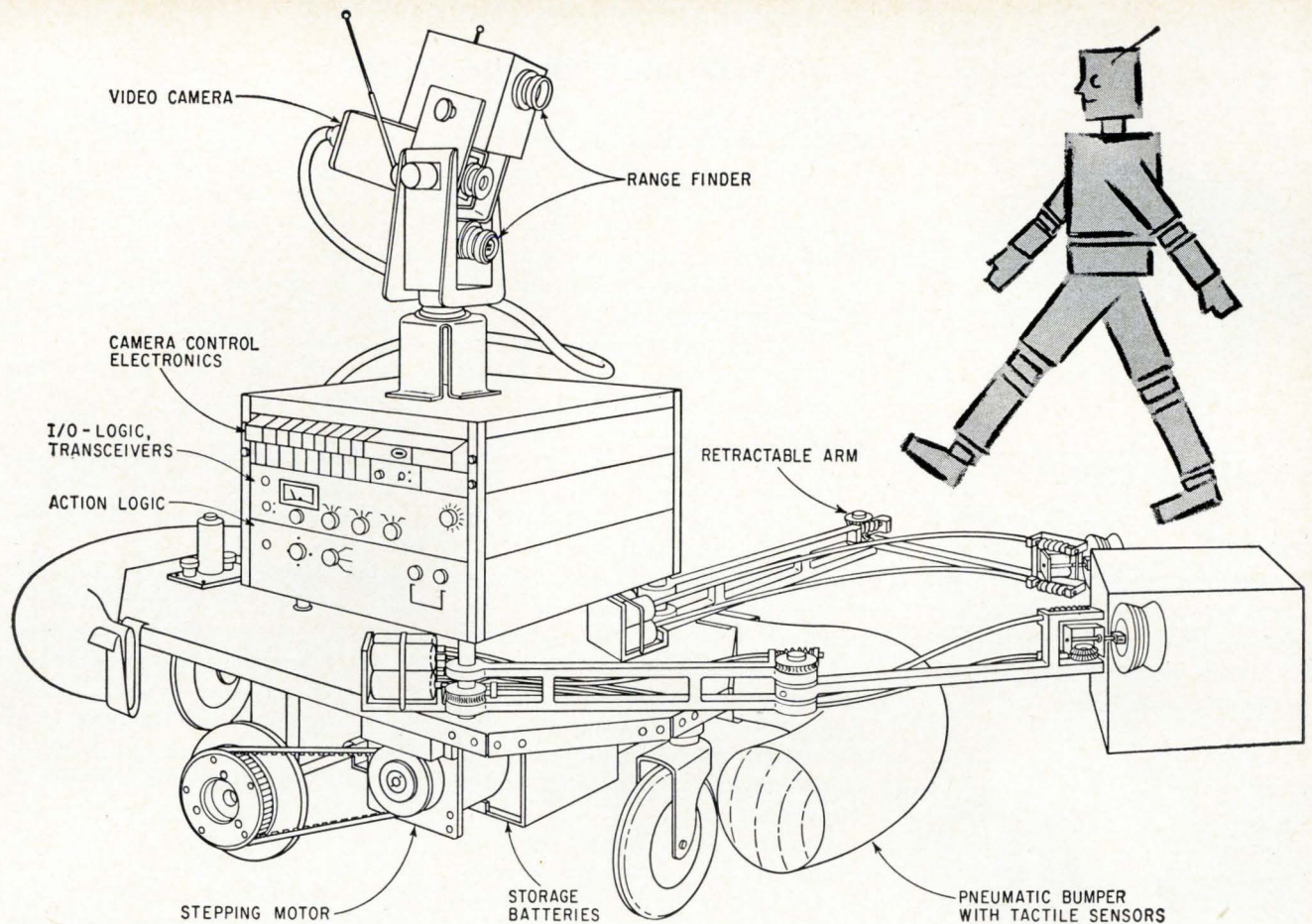

A far cry. Like the other prototype systems in the field, Stanford Research Institute's buggy-mounted intelligent automaton, scheduled for completion later this year, differs markedly from the public's conception of a robot.

Industrial electronics

Intelligent robots: slow learners

But a handful of pioneering researchers are working toward the day their laboratory curiosities will perform useful and complex tasks

By H. Thomas Maguire, Boston regional editor
and William Arnold, San Francisco News Bureau

What may well be the most exclusive fraternity of research scientists in the U.S. is exploring the staggering complexities of artificial-intelligence systems at universities on the East and West Coasts. The researchers' goal is the creation of automatons capable of performing useful tasks.

Artificial-intelligence systems differ markedly from working industrial robots in that they are designed to learn and to discriminate. Industrial machines are

strictly materials handlers and lack the capacity to make decisions affecting their own actions [Electronics, March 20, p. 165].

At the Massachusetts Institute of Technology in Cambridge, Mass., Marvin L. Minsky, a professor of electrical engineering, is working on what he likes to call a visually controlled manipulator. In common with the handful of other pioneers in the field, Minsky generally avoids using the word "robot" because of its sensational sci-

ence-fiction implications.

At the Stanford Research Institute in Menlo Park, Calif., Charles A. Rosen and Nils J. Nilsson are building a free-wheeling research platform that integrates available information-processing techniques into a single system with artificial intelligence. Next door in Palo Alto, John McCarthy, a professor in Stanford University's computer science department, is assembling hardware for an intelligent automaton. Stanford researchers have been

Astrosystems Inc.

Advanced Instrumentation

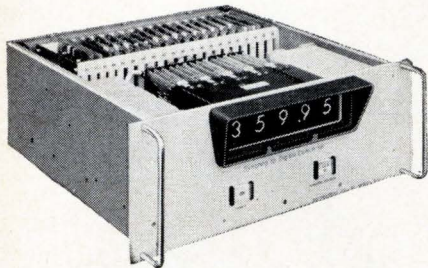

Synchro-to-Digital Converters

A simple, reliable, accurate method of high resolution conversion with **resolution and accuracy to 18 bits**. Available with straight binary code or BCD code outputs. Ideally suited for use as an interface between analog pickoffs and digital computers or off-line equipment.

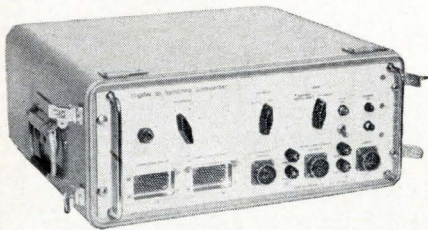

Digital-to-Synchro Converters Digital-to-AC Analog Converters

ASI Converters accept and register digital angles in binary or BCD code and convert these inputs to the equivalent synchro or resolver voltages. Digital-to-Analog AC models convert digital input information to linear AC output signals.

Single-speed resolution and accuracies are available up to **18 bits**.

Miniature Solid-State Airborne Units

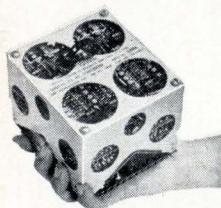

All solid-state converters featuring high density packaging and ultra-reliability. Available as: Digital-to-Synchro

Converters; Synchro-to-Digital Converters; Digital-to-AC Analog Converters; AC Analog-to-Digital Converters.

Astrosystems Inc.
Advanced Instrumentation
6 Nevada Drive, New Hyde Park,
New York 11040 • (516) 328-1600

... the whole system is built around confidence levels for hypotheses ...

working in this field since 1963.

These are the only known U. S. projects along this line, but sources suggest there is a good deal of work being done "under commercial cover" on behalf of Government and military agencies. The National Aeronautics and Space Administration, for one, is said to be interested in intelligent automats.

I. Working model

Minsky's work, a part of MIT's project MAC (Machine-Aided Cognition), is underwritten by the Advanced Research Project Agency of the Defense Department. His machine combines an electronic eye, a computer, and a mechanical arm. Minsky describes it simply as a project "to build a robot that can orient itself to the physical world and do something about things it sees."

But the only activity his machine can yet perform, he says, is stacking identical blocks. The machine's eye sees the blocks, distinguishes them from their background, and tells the computer where they are. The computer-directed mechanical arm then picks them up and erects a tower-like pile.

Next on the agenda is the use of curved blocks of different sizes so the robot can construct a house-like structure with an arched roof. To accomplish this, the machine will have to consider and answer the question: Will this block fit in this spot?

Cyclops. In its present form, there is nothing about the robot to suggest a human appearance. Its eye, an image-dissector tube with 1,000 x 1,000 photosensitive points, selectively measures the amount of light in various parts of its field of view.

The eye Minsky now uses is exposed until a predetermined photocurrent level is reached. At that point, the eye tells the computer how long this exposure lasted, and the computer calculates the light level at the relevant spot. But a new eye, to be delivered soon, will have a programmable signal-to-noise ratio and a dark-current cutoff, "so it won't spend a lot of time

looking at a hole," explains Minsky.

The mechanical arm now used on Minsky's robot is rather primitive. It can move in three axes and has a two-finger grip. Engineers at Minsky's laboratory are working on a new model with greater maneuverability.

Also entering a new phase is the computer portion of the project. To supplement his Digital Equipment Corp. PDP-6 machine, Minsky is adding a core memory with a capacity of more than 260,000 40-bit words.

Line drawing. Minsky concedes that his robot "is minimal in many respects." The system is programmed to watch for line gradients. When it detects an intersection, it puts this fact into its memory and searches for another line until it constructs a picture of a shape in its memory.

A new approach now being programmed begins with a coarse scan based on simple statistics, local color combinations, textures, and the like. "It makes a simple topological analysis," says Minsky. "It finds boundaries and has checks and balances to stop it from going down blind alleys."

In line for Minsky's robot is a program treating objects in the abstract and recognizing partly obscured objects as human beings do. But in no case will the system match or compare an object with a known description or picture in its memory. "This would be disastrous in the case of occluded objects," says Minsky.

The robot starts with an abstract description of its environment, and the relations of objects to make hypotheses. "The hypothesis laid down has to be either confirmed or the machine must come up with a good excuse why it cannot be confirmed," says Minsky. "The whole system is built around confidence levels for hypotheses."

"We aren't doing parallel processing," he states. "Rather it is sequential analysis based on hypotheses." In solving problems, the system inspects the entire structure, recognizes things from small clues, and sets up hypotheses.

"Our project doesn't depend on

the machine seeing the whole object, anymore than a human being does," Minsky says. "We do visual analysis. The machine makes a hypothesis, looks at the scene for a while, and tries first one and then another alternative. It runs up and down through different levels of analysis."

Human processes aren't consciously imitated, the scientist notes, because "virtually nothing is known about human vision and visual analysis."

II. Perambulator

Working under a joint contract from the Air Force's Rome Air Development Center and ARPA, SRI's Rosen and Nilsson are building a "buggy"-mounted automaton. Affixed to the self-propelled vehicle will be a television camera, an optical range finder, touch sensors, and, eventually, retractable arms. The buggy will be connected either by cord or radio signal to a Scientific Data Systems 940 real-time computer.

Two independently driven wheels, using electrical stepping motors with feedback control, will power the buggy. Similar units will actuate the television camera's pan, tilt, and focus functions as well as provide the rudimentary arms with several degrees of freedom. Completion of the buggy is scheduled for later this year.

By any other name. Rosen cautions, "Our main purpose is to make machines that do intelligent things, not to replace humans, who also do intelligent things and some unintelligent things."

What SRI is after immediately is a "somewhat autonomous" machine that "trots around and does simple tasks," Rosen says. But programming has proved difficult. The project will try to combine previous computer experiments in intelligence, including chess and checkers playing, modeling of equations on computers, pattern recognition, and computer learning programs.

Experimentation will begin on a laboratory floor where simple geometric shapes will be placed. The buggy's task will be to map the floor; as it goes around the area and detects objects, the computer would figure out what it saw from models in memory. To go from one place to another it would use

We leave Milwaukee?



FRED F. LOOCK, PRESIDENT, ALLEN-BRADLEY COMPANY

absurd!

... Fred F. Loock, as President of Allen-Bradley Company, one of the nation's largest producers of electronic components and motor controls, is a prime target for "plant raiders", nationwide.

Such "raiders" don't have a chance.

Mr. Loock *believes* in Milwaukee—and with good reason. He started out here as an apprentice draftsman with Allen-Bradley in 1910. Since then his firm has grown into a position of leadership and so has the city he takes such pride in.

Ask him! He'll tell you about our favorable access to world markets and our gateway to a fantastically popular northwoods vacationland. And he'll wrap up his explanation with a few pointed pluses about ambitious, skilled workers, *really* clean air, abundant water, great schools, government and unbeatable fire and police protection. All of these make Milwaukee a great place to work—a great place to play—and a great place to raise a family.

So, come on "plant raiders". Chances are when you visit us we can sell *you* on staying with us. Mr. Loock did and he knows what he's talking about.

If you can't make the trip, write for our little booklet that tells much of our story. Send for it now.

Division of Economic Development
Dept. E-5, Office of the Mayor / Room 201, City Hall / Milwaukee, Wisconsin 53202

Gentlemen: Please send free copy of "there's MORE in Milwaukee". Inquiries handled in strict confidence.

NAME _____

ADDRESS _____

CITY _____ STATE _____ ZIP _____



MILWAUKEE...GREAT FOR BUSINESS, GREAT FOR LIVING...AND GROWING GREATER

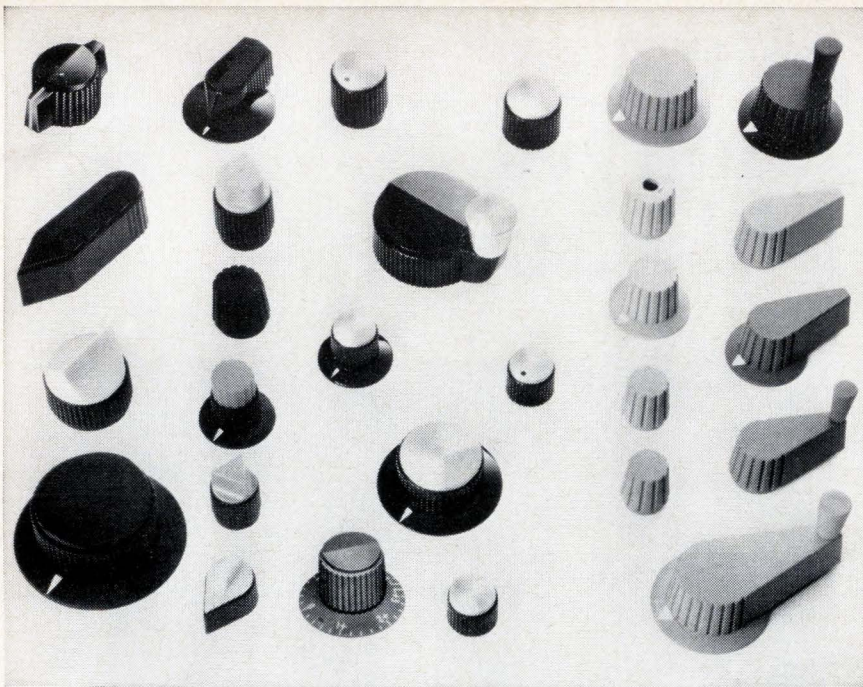

**Standard and custom military knobs,
aluminum cap knobs, color control knobs for
every panel requirement. Send for data kit.**

With Raytheon control knobs, you can meet military specifications—or select styles and colors that harmonize or contrast with any commercial panel decor. And you can get these knobs immediately—through Raytheon distributors from coast to coast.

Meet MS91528C Military Specifications from the more than 300 standard types and the 2,000 “specials” Raytheon has designed. All knobs are functionally designed. All styles have an integrated design to give uniformity to your panel. And all knobs meet specifications for resistance to flame, torque, temperature and humidity extremes, salt spray, and ultraviolet radiation.

Handsome aluminum cap knobs are made of strong plastic with satin finish aluminum caps that are treated with an epoxy coating for corrosion resistance.

Commercial color knobs—available in nine colors and ten styles—harmonize or contrast with commercial equipment design. Raytheon makes these 400 Series knobs of durable, high-impact ABS.

Custom-made control knobs. Raytheon also designs and manufactures control knobs to meet special requirements for color, shape, size, finish. Call your nearest Raytheon regional sales office or write to us. *Raytheon Company, Components Division, Quincy, Mass., 02169.*



Send for Raytheon Control Knob Data Kit

—contains complete specifications on all standard and custom knobs. Just send the reader service card.



another reference.

Where's my basket? Rosen is not sure when, but the SRI researchers would like to bring the buggy into the “real world” of the building hallway. Here they could command it to go to room K-20, pick up a waste basket, and carry it to room K-60. The next command might be the same with changed room numbers. Recognition of the specific rooms or objects would not be a programmed function of the machine. It would have to find them itself. “Can a dog do as well?” Rosen jokes. “We could replace the mail boy, but it would be expensive.”

Rosen stresses that these would be advanced tasks for a simple automaton. “We’re getting into areas we don’t know well,” he says. “Nobody really knows today how to make a computer representation of the real world.” To program individual objects would “use too much computer memory,” he says.

III. Pattern recognition

To handle pattern recognition, an automaton’s computer must deal in abstractions. While a human conceives a chair without a detailed “program” of its structure and shape, “we barely know how to begin line drawings of things now,” Rosen says. He hopes automaton memories will eventually include an array of pattern-recognition programs covering exploration, analysis, and tactics. “It’s difficult interleave these into a hierarchy,” Rosen says. “Humans do it unconsciously. You don’t decide to walk in a series of commands, but with a computer it has to be planned sequentially.”

The work of Stanford’s McCarthy is also being underwritten by ARPA. Still in a formative stage, his automaton project will eventually integrate a computer, an arm, and a television camera.

McCarthy believes it’s possible to program abstractions with 64,000-word memories. He will not, however, elaborate on this theory. Although computers “think” sequentially, he notes, they still react faster than a human mind. Furthermore, if the researchers ever need a faster-reacting computer, they’ll build a parallel simultaneous system, he says. “The problem isn’t the computers’ doing things slowly, but doing them at all.”

If you needed a 5-digit manual voltmeter that was 4 times faster than a conventional differential voltmeter, that automatically carried all transfer points with the twist of a single knob, that provided 0.01% accuracy, that eliminated constant null sensitivity adjustment, that wouldn't overload, that was highly portable, easy to maintain and cost only \$595, you'd know where to go, wouldn't you?

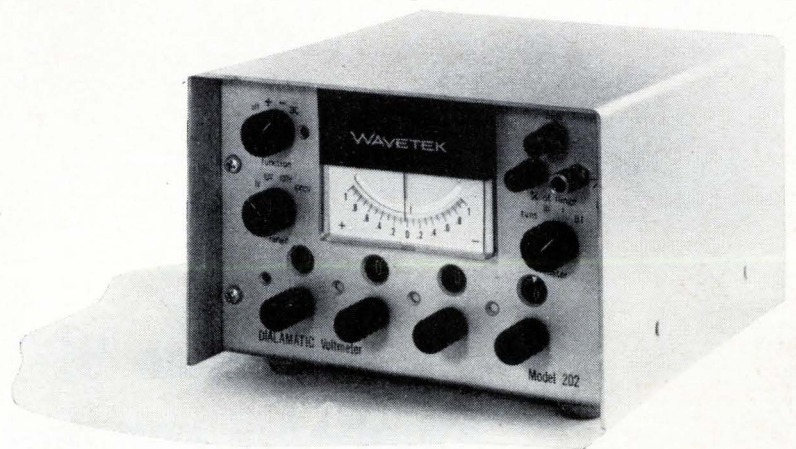

WAVETEK®
8159 Engineer Rd., San Diego, Calif., Tel. 279-2200
European Sales: 3000 Bern 9, Seidenweg 17, Switzerland



**There go 500
Amphenol connectors.**



Speeds to mach 2.5. Altitudes to 65,000 ft. Trans-sonic shock, moisture and temperatures to -65°F . Tough duty, but applications like the F-111 demand reliability.

500 Amphenol connectors fly with the F-111 avionics package. Proof of Amphenol connector reliability.

Build the same confidence into your next project.

Choose standard or special circular power connectors, printed circuit or rack and panel, commercial plugs and sockets, even cable assemblies and harnesses, or a full line of microminiature connectors.

Call your local distributor or Sales Engineer. Or write **Amphenol Connector Division**, 1830 S. 54th Ave., Chicago, Illinois 60650.



AMPHENOL

Specify Amphenol . . . the leading name in cable, connectors, assemblies, RF switches, potentiometers, motors, microelectronics

Circle 123 on reader service card

MATCH PROTECTOR TO HARDWARE

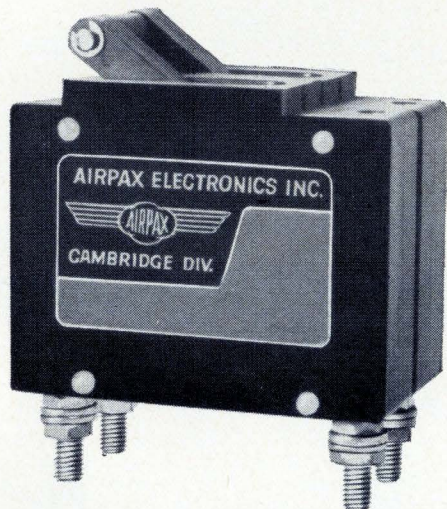

An APL Circuit Protector—

will rupture a fault of 5,000 amperes at 240 volts!



provides a time delay for every demand!



is entirely magnetic — no heater elements!



Tripping coils can be completely isolated!



Gang every circuit together!

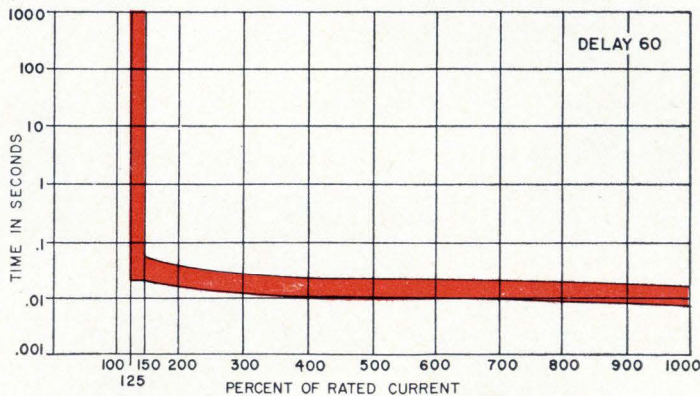
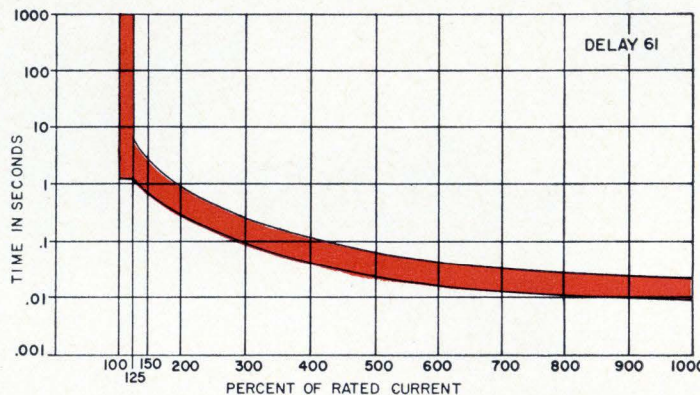
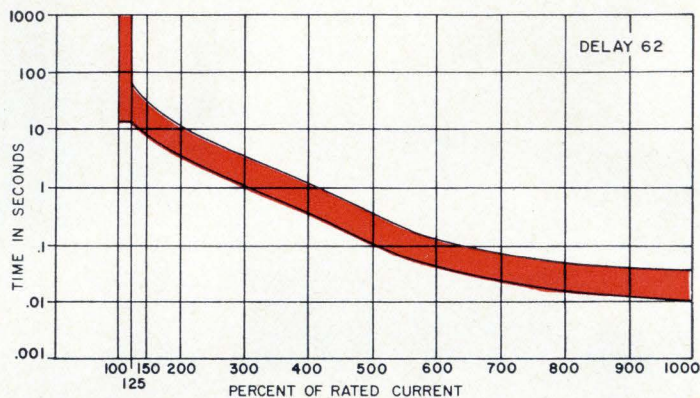
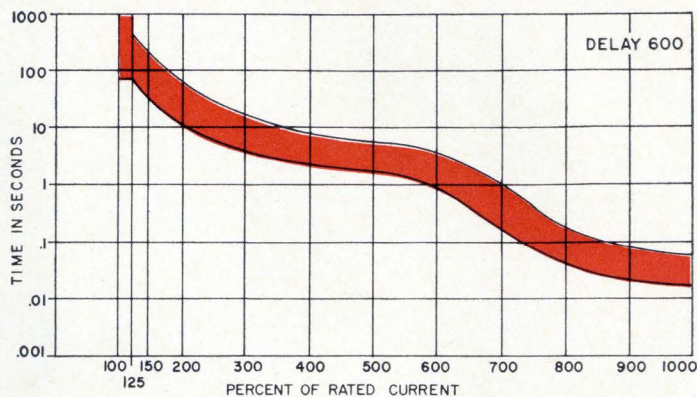
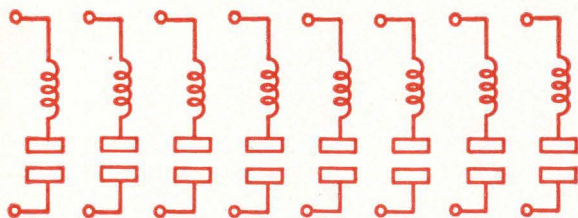

TYPICAL 60 CYCLE DELAYS

AIRPAX ELECTRONICS
CAMBRIDGE, MARYLAND 301-228-4600

The moving finger writes—fast

Computer display that writes a million characters in four seconds can be changed with a touch of the operator's finger

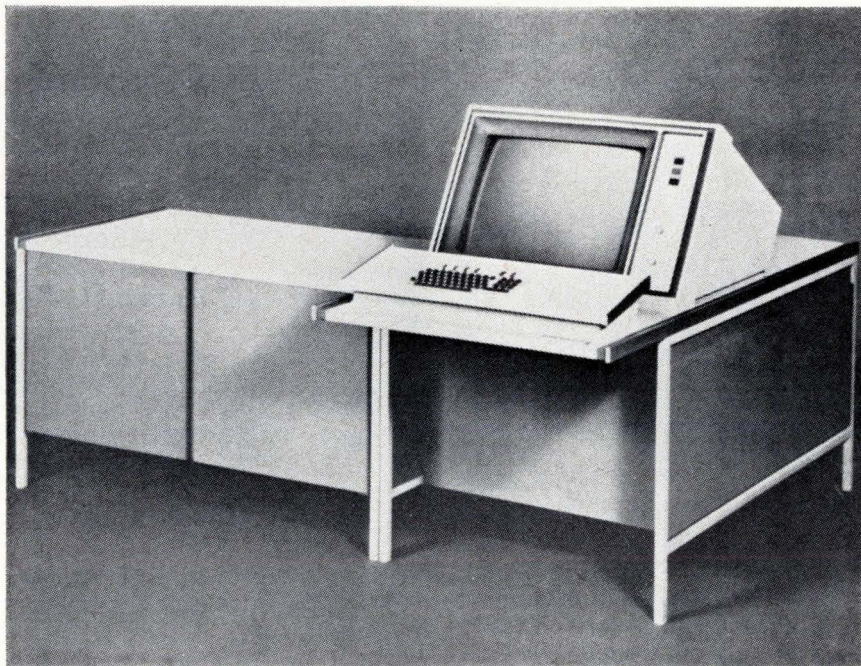

Speed is the main attraction of a computer display that can write a million characters in four seconds on its cathode-ray tube. It's twice as fast as the fastest competitive unit, according to its manufacturer, the Tasker Instruments Corp., but it offers advantages beyond this.

With the machine's speed, many lines of text, or a complicated graphic design, can be shown without such degradation as "rolling." A display rolls when the top fades as the bottom is being regenerated. Some displays avoid rolling at the cost of rounded corners, so that B's look like 8's or V's like U's.

As an optional feature, the design permits the operator to use his finger as a light pen. The operator can simply point his finger at a portion of the display when he wants an enlargement, more detail, or a change. A light pen can also be used to modify the display.

A newly patented means for measuring the flux in the magnetic deflection coils of the display's

cathode-ray tube gives the series 9000 modular display unit its speed. The technique permits measurements to be made accurately at frequencies well beyond the resonant frequency of the coils, the upper limit for other displays. The same technique could increase the speed by yet another factor of two, according to the maker's chairman, Homer G. Tasker.

The deflection amplifiers in the new display module have a bandwidth of 1,000 kilohertz, compared with 375 to 500 khz for other displays, the firm says. Conventional displays with restricted bandwidths can show 1,000 to 1,500 symbols at once; the new display is capable of up to 5,000 symbols, and the company is developing a unit that will show as many as 8,000.

In crt displays, the deflection of the electron beam that traces out the display on the screen must be very accurately established. Accuracy is insured by feeding back a measurement of the flux in the

magnetic deflection coil to the deflection amplifier. The flux is proportional to the current in the coil at low frequencies, and the current, in turn, is proportional to the voltage across a small resistor in series with the coil. In conventional displays, this voltage is the quantity fed back to the deflection amplifier.

But at frequencies near the resonant level—about 750 khz—where the deflection coil and its distributed capacitance between turns become equivalent to a parallel-resonant tank circuit, the current in the series resistor is no longer proportional to the flux. Ideally, the external current at resonance is zero, and the flux is generated by the circulating current in the resonant circuit; practically, the external current is very small and is 180° out of phase with the current that generates the flux. Thus, in conventional displays, feedback control deteriorates as the resonant frequency is approached.

One solution is to raise the resonant frequency through improved coils with less distributed capacitance; but conventional displays have already raised the frequency to its practical limit. Another answer is to use electrostatic rather than magnetic deflections; for large displays, however, the voltages required for electrostatic deflections are inconveniently high, the feedback measurement is difficult and the display linearity isn't good.

Transformer effects

Tasker's solution is to integrate the rate of change of flux to establish the actual value. Through a transformer effect, the changing flux generates a voltage in a secondary coil of a few turns; the magnitude of the voltage is proportional to the rate of change of flux. The secondary coil could be wound under or around the deflection coil, but this would be unnecessarily

New Products

complicated. The same effect is achieved by measuring the voltage across a few turns of the deflection coil, as in an auto transformer.

The integrated measurement is proportional to the flux at all frequencies, regardless of resonance. However, because the transformer action becomes very small at low frequencies, the series resistor is still used. A crossover filter, much like the crossovers used in hi-fi systems between woofer and tweeter speakers, controls the feedback to the deflection amplifier.

As in most computer-driven displays, regeneration is controlled by a buffer—a small, ferrite-core memory containing the information being displayed. The computer sends the data into the buffer and goes about its business; the buffer repeatedly transfers the information to the display for each cycle.

Finger-tip control

The optional "finger-pen" feature is made possible by the use of a transparent address grid, or TAG, a plastic overlay on the display screen. A grid of fine wires imbedded in the plastic makes contact when lightly touched with the finger, or the end of a pencil or similar object. The wires transmit the position of the finger to the control circuitry to cause some programmed action to take place on the display.

While this system isn't a replacement for the conventional light pen, it permits the user to simply point his finger for a display change instead of fumbling for a light pen or other control.

The TAG is actually three sheets of transparent plastic. Vertical wires are spaced a half-inch apart on one side of the center sheet, and horizontal wires, with the same spacing, are on the other side. The center sheet has holes $\frac{1}{4}$ inch in diameter opposite the wire intersections, so that slight finger pressure causes the wires to contact through the holes. The outside sheets are solid for protection.

Like conventional computer display units, the Tasker system can display either alphanumeric or graphic data. The standard 23-inch rectangular screen will show a 13-by-18-inch display.

The display's console has a key board for input of alphanumeric data and either a "joy stick" or a "bowling ball" for moving a cursor—a position-indicating spot of light—or the end points of straight lines to desired locations on the display. A joy stick is a lever that can be moved forward, backward, or to either side; a bowling ball in display parlance is a spherical control projecting from the console that can be "rolled" in any direction. The buyer can choose either control.

Slides selected from a random-access magazine can be projected onto the screen through a window in the back of the crt.

Characters are generated in the usual way—by assembling a variety of straight-line strokes—but the conventional method of programming each individual stroke isn't followed. Instead, the display's character generator has a repertoire of preformed characters on printed-circuit boards; a particular character is selected by addressing the proper circuit on one of the boards.

Specifications

Random positioning time	16.5 to 41 μ sec, depending on model
Writing	4 μ sec/character, test; 2 to 5 μ sec/in., line, depending on model
Position accuracy	1%
Position stability	0.1% to 0.2%
Linearity	1%
Brightness	100 foot-lamberts
Bandwidth	1,000 khz
Resolution	2,048 lines
Spot size	0.012 in.
Character size	0.125 in.
Space between characters	0.06 in.
Space between lines	0.19 in.
Characters per line	88
Lines of text	40
Power	400 watts, 115 volts a-c, to 5 kva, 208 volts 3 phase, depending on model
Price	\$60,000 up

Tasker Instruments Corp., 7838 Orion Ave., Van Nuys, Calif. 91409.
Circle 350 on reader service card

New products in this issue

125 The moving finger writes—fast

Components

- 128 Readout tube beams characters
- 130 Selector switch enhances density
- 130 Tiny transformer and inductor
- 132 Transistor transformer
- 134 Wirewound resistors cased in ceramic
- 136 Thermoelectric cooler

Semiconductors

- 138 Plastic-packaged FET's

139 Pnp silicon transistors

Instruments

- 141 Word generator talks fast
- 142 Wheatstone bridge boasts high accuracy
- 143 Wideband interference detector

Subassemblies

- 144 Extreme-environment tv camera
- 144 Analog multiplexers use IC logic
- 144 Sensitive operational amplifier

145 Frequency standard generates 60 hz

Microwave

- 146 Mixer-preamps feature low noise
- 146 Tunable X-band multiplier
- 146 Compact coaxial circulator
- 147 Multicoupler produces 10 outputs

Production equipment

- 148 Splitting target boosts sputtering speed
- 149 Tape transfer machine speeds disk coating

In Making Masks for
Electronic Components...
... there's no
Margin for Error!

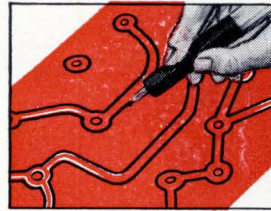

With sharp blade, outline the areas to be masked. Do not cut through the backing sheet. The Ulano Swivel Knife does the job quickly, easily.



Now carefully peel off the film as outlined leaving a completed photo mask, positive or negative, that corresponds exactly to the desired pattern.

THAT'S WHY EXPERIENCED DESIGNERS
AND ENGINEERS ALWAYS INSIST ON...

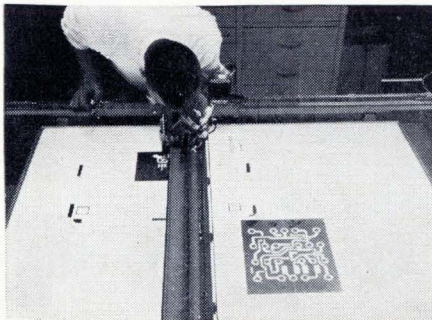

RUBYLITHTM

HAND-CUT MASKING FILM FOR THE GRAPHIC ARTS

THE KNIFE-CUT, LIGHT-SAFE MASKING FILM
LAMINATED TO A STABLE POLYESTER BASE

The most versatile line of hand-cut masking films, including

.0075—RUBYLITH 75 DR* .005 RUBYLITH 5 DR
.005 AMBERLITH 5 DA

These new, thick Ulano films provide the positive answers
where exact register assumes a critical importance.

* Available in sheets only, cut to your specifications.

by

UlanoTM

ulanoTM

610 DEAN STREET, BROOKLYN, N. Y. 11238

NEW YORK • CALIFORNIA • CHICAGO • ZURICH

In Europe: ULANO A. G., Untere Heslibachstrasse 22, Kusnacht 8700, Switzerland

Write on your letterhead for special electronic test kit (no charge) No. 4148

This new DVM from Trymetrics proves—

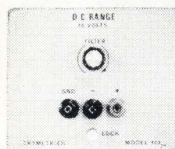

DELIVERY FROM STOCK ON MOST MODELS
Models 103—104—105
Single range plug-in heads
10V, 1V, 100mV

Models 300A—400A—500A
3, 4 and 5 automatic range
plug-ins; 10 μ V—1000VDC

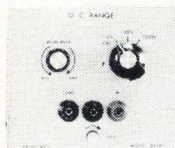

Models 300M—400M—500M
3, 4 and 5 manual
range plug-ins; 10 μ V—1000VDC

Check these Trymetrics features:

- Full 4 digit resolution. ■ Accuracy $\pm 0.01\%$ of reading ± 1 count. Automatic polarity and overscale indicator. ■ High common mode rejection. ■ Complete range of plug-in heads for optimum flexibility. All silicon solid state circuitry. ■ Operation up to 50°C. ■ Sampling speeds up to (10) samples/second. ■ Sensitivity to 10 μ V. ■ BCD printer output. ■ Crystal controlled oscillator guarantees ultra stable voltage-to-time conversion system.

Check this Trymetrics price:

Model 4000 DVM \$840 with Model 103 10V Range Plug-In. For complete information and prices, write to:

TRYMETRICS
Corporation

204 Babylon Tpke., Roosevelt, L.I., N.Y.
Phone 516-378-5020 Zip 11575

New Components and Hardware

Readout tube beams characters

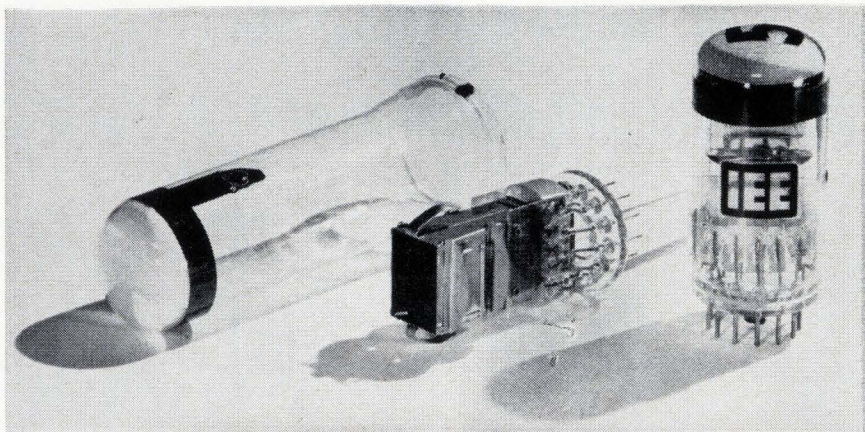

A miniature electron-beam display tube is suitable for the instrumentation readout applications that are now chiefly the province of multicathode glow tubes. The new device can be driven by digital signals from integrated circuits. Any one of 10 characters are selected for display by a 4-volt signal.

Unlike the glow tubes, however, the electron-beam display is planar.

The new display is essentially a 10-gun miniature cathode-ray tube. It is an all-electronic cousin of the optical type of rear-projection display also made by the developer, Industrial Electronic Engineers Inc.

A coated filament passes through 10 grid "cups" with apertures facing the tube screen. In line with the grid cups is an apertured anode that operates at 2 kilovolts. When a grid cup is placed at a slightly positive potential relative to the filament, electrons can flow from the heated filament toward the screen. Once the electrons pass the anode aperture they fly in a straight line toward the screen. The anode has a character mask that intercepts all of the beam except the portion passing through the cut-out, creating a shaped beam that illuminates the phosphor screen.

When the grid cup is made more

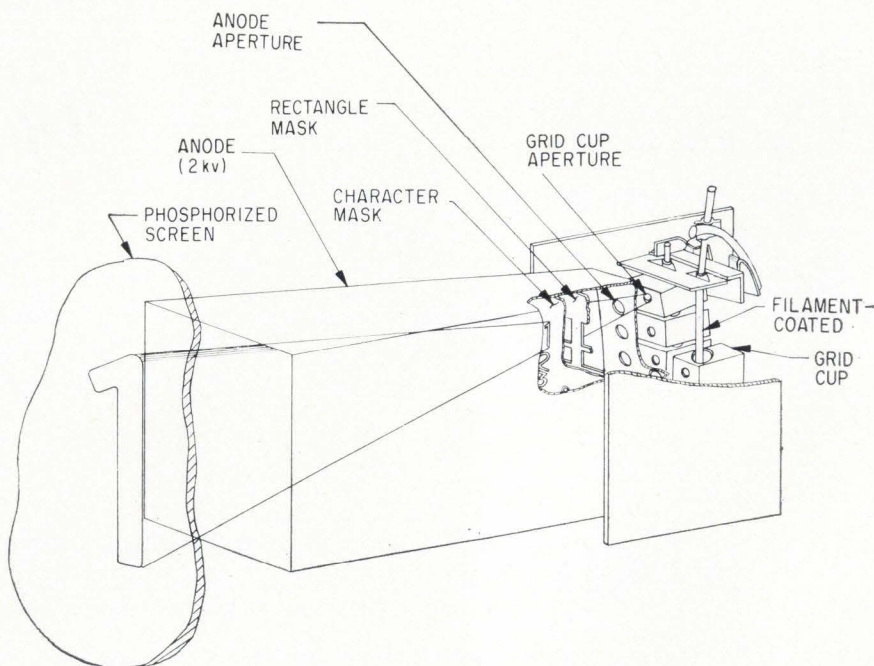

RCA
integrated
circuits

RCA CA3020 LOW COST "UNIVERSAL" AMPLIFIER

- High gain • Low level to $P_{out} = 1/2 w$
- DC to 6MHz • Price \$1.75 (1,000+)

Here's a new answer to economics, packaging, and performance for a broad spectrum of audio and RF applications—RCA-CA3020, a multi-stage, multi-purpose amplifier on a single monolithic silicon pellet. CA3020 is useful in portable and stationary sound systems; in military, industrial, and commercial

communications equipment; in servo-control systems and elsewhere. Available now for evaluation—and production line use. Write for Technical Bulletin and Application Note to Commercial Engineering, Sec. ICN5-1, RCA Electronic Components and Devices, Harrison, New Jersey 07029.

Specification Highlights

- 58 db typical gain in audio applications
- -3 db bandwidth 25 Hz to 6 MHz (typ)
- Operates with single power supply +3 to +9 VDC
- Built-in temperature tracking with voltage regulator—stabilized operation over -55°C to +125°C range
- Single-ended input at 40k Ω (typ); push-pull differential input at 600 Ω (typ)
- High maximum power output 550 mW (typ) @ $V_{cc} = +9V$
- Push-pull output
- Squelch flexibility—three methods for applying squelch

ASK YOUR RCA DISTRIBUTOR FOR HIS PRICE AND DELIVERY

RCA Electronic Components and Devices



The Most Trusted Name in Electronics

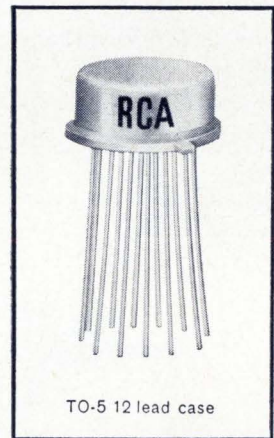
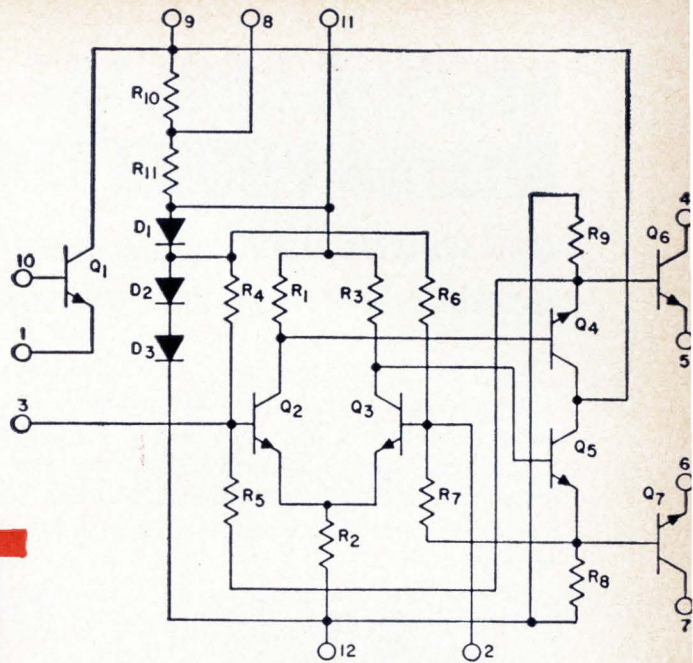

KEEPING COOLANT FROM KILLING POWER TUBES...

One way Barnstead pure-water equipment works for electronics engineers.

Barnstead Coolant Repurifying Loops add thousands of hours to the life expectancy of transmitting tubes and other electronic power gear such as radar components, lasers, and magnets.

They keep water or ethylene glycol coolant free from impurities, oxygen and submicron particles that cause hot-point deposits, corrosion, premature burnouts; and maintain the coolant's electrical resistance.

Shown below: commercial Model PL- $\frac{1}{2}$, for systems up to 150 gallons. Others available for systems up to 12,000 gals. and larger.

Other Barnstead equipment designed for you.

Barnstead Transistor Washers and Microelectronic Cleaning Stations make a few gallons of hot, pure water — do the work of thousands.

Barnstead Demineralizers, Stills, Storage Tanks and Piping put pure water on tap wherever, whenever your process or equipment needs it.

Ask us for a no-obligation recommendation concerning your pure-water needs!

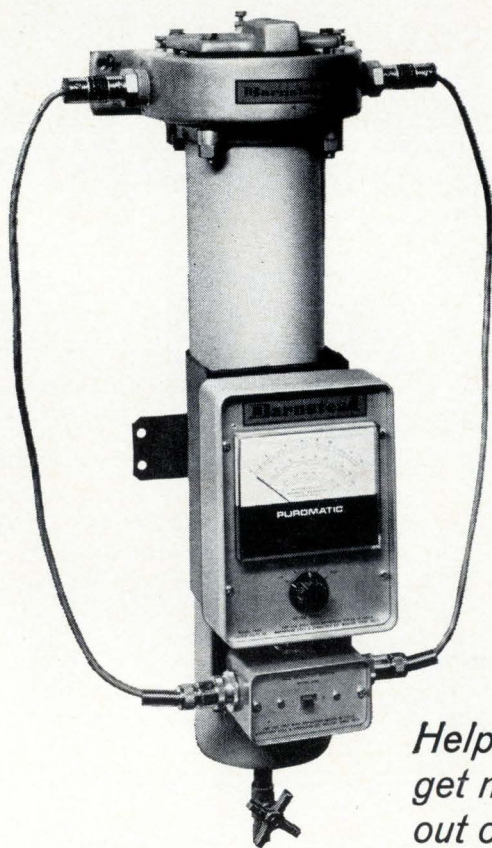

*Helping you
get more
out of water!*

Barnstead
STILL AND STERILIZER COMPANY
441 Lanesville Terrace
Boston, Mass. 02131

New Components

negative than the filament, electron flow is cut off and no beam will be formed. Thus, a character is selected by applying a positive voltage to the associated grid while holding all other grids at a negative potential.

Specifications

Filament voltage (a-c or d-c)	1.1±0.15v
Filament current	0.2 amp
Anode voltage	2,000 v
Anode current	35 microamps
Grid voltage for cutoff	-6.0 v
Grid voltage for display	4.0 v
Character height	$\frac{5}{8}$ in.
Tube size	
outside diameter	1.100 in.
overall length	2.600 in.
seated height	2.250 in.
Cost	\$14
Availability	60 days

Industrial Electronic Engineers Inc.,
7720 Lemona Ave., Van Nuys, Calif.
91405 [351]

Density enhanced by selector switch

Builders of equipment with rapid program changing requirements, such as collators, sorters, and data processing machines, are offered solid advantages by a crossbar selector switch.

The C10-04A switch is easier to operate than rotary switches, and it allows higher density than either pinboards or rotaries. Its effectiveness is increased by high reliability and extremely low installation cost in multiple-circuit situations.

This is a four-module, basic-type switch in which 40 crossbar slider rails and 20 rhodium-plated printed circuit strips form 800 crosspoints.

The switch lists at \$60.50 with quantity discounts starting at 25% on 25 pieces.

Cherry Electrical Products Corp., 1650 Old Deerfield Rd., Highland Park, Ill. 60035. [352]

Ultraminiaturized transformer, inductor

Suitable for welded-module and hybrid-circuit applications, a transformer and an inductor are said to represent a significant advance in

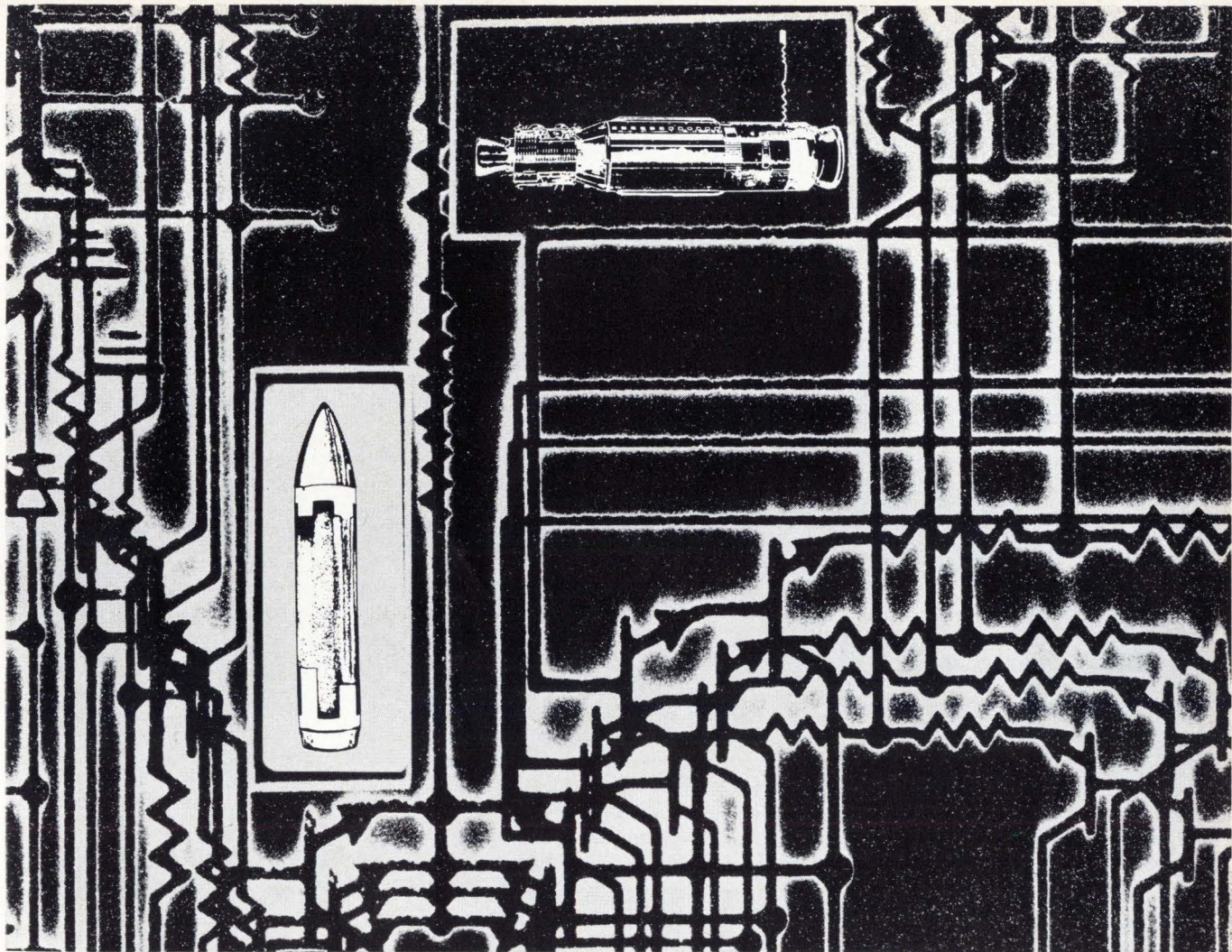

*up.
down.
on the ground.
the place for new electronics advances is Lockheed.*

Whatever environment you now work in—land, sea, or space—you'll find it to your advantage to look into opportunities at Lockheed. Take Agena and Poseidon for example. Major technical expansion is under way on both of these vital programs. And both Agena and Poseidon share the need for new concepts and major technical advances. □ Typical Agena assignments will include: digital communication systems for data transmission and command, digital and analog flight control systems, optical and infrared sensors, solar power panels, and power conditioning. □ Poseidon's general area of requirements ranges from weapon effects on electronics to the design and use of state-of-the-art test check-

out equipment in one of the largest checkout programs ever mounted. □ Undersea, Lockheed is active in the expanding field of deep submersibles and ocean mining. Now under way—the Navy's unique Deep Submergence Rescue Vehicle and Lockheed's Deep Quest research vehicle designed to operate down to 8000 feet. □ On land, Lockheed is engaged in the development of unique land vehicle systems, information systems for states and hospitals, and many other important programs. □ For more complete information, you are invited to write Mr. R. C. Birdsall, Professional Employment Manager, P.O. Box 504, Sunnyvale, California. Lockheed is an equal opportunity employer.

LOCKHEED
MISSILES & SPACE COMPANY
A GROUP DIVISION OF LOCKHEED AIRCRAFT CORPORATION

It took Hughes engineers 3½ years to create the SYNCOM story.

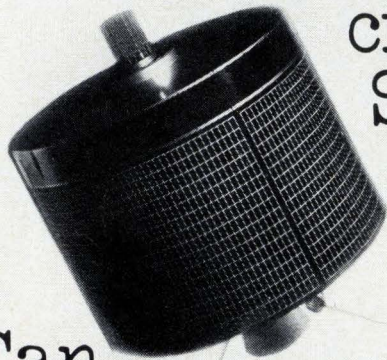

Can you write it?

Hughes Field Service and Support is urgently seeking qualified E.E.'s for a dual challenge—to your engineering know-how and to your writing ability. You will be closely associated with the latest and most advanced aerospace projects. As a Systems Writing Engineer, your assignment will be to **communicate** your knowledge of these projects.

The Syncom series is just one example of the magnitude and significance of the projects involved. Other subjects include space vehicles, weapons systems, electronic computers, guided missiles, radar and communications, programmed instructional devices, and systems trainers.

You will research drawings, specifications, and reports; you will interview project engineers and make first-hand examinations and inspections. Then you'll interpret and analyze this data and write engineering publications for use by other engineers on allied projects.

This is a demanding position and an important one. If you wish to rapidly broaden your engineering knowledge and gain systems-oriented technical experience, if you have a B.S.E.E. or a B.S. in Physics—and if you can write—please send your resume at once to: Mr. B. P. Ramstack, Hughes Aircraft Company, P.O. Box 90515, Los Angeles, California 90009. U.S. citizenship required.

HUGHES
 HUGHES AIRCRAFT COMPANY
 FIELD SERVICE & SUPPORT DIV.
 An equal opportunity employer

New Components

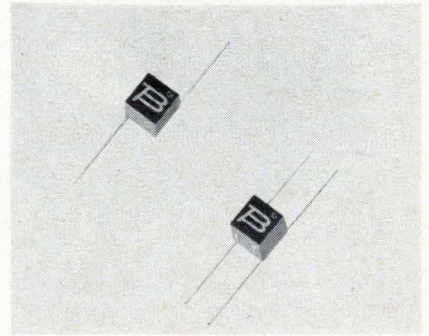

the miniaturization of electronic components. Both models measure 1/8 x 1/8 x 1/8 in. and weigh 0.15 gram maximum. They have a frequency range of 2,000 to 500,000 hz and an operating temperature range of -55° to +105°C. Both units meet or exceed environmental requirements of MIL-T-27, grade 5.

The Model 4211 Microtransformer has primary and secondary impedance ranges of 10 to 10,000 ohms; dielectric strength between windings of 50 v rms; insulation resistance between windings of 10,000 megohms at 50 v d-c; and a life longer than 10,000 hours.

The model 4221 Microinductor has an inductance range of 0.1 to 3.5 henrys at 1 khz, 0.1 v rms; dielectric strength of 50 v rms; and insulation resistance of 10,000 megohms at 50 v d-c.

For improved environmental performance, both models are sealed in high-temperature plastic cases. They have flatpack ribbon leads for hybrid circuits and laminated cores.

Model 4211 transformer is available with taps, custom winding ratios as high as 10:1, split primary or secondary coils, core materials, and electrostatic shielding.

Price of the 4211 is \$23.70 each in 10-to-24-piece quantities. The 4221 costs \$15.80 in similar quantities.

Bourns Inc., Trimpot Division, 1200 Columbia Ave., Riverside, Calif. 92507. [353]

Transistor transformer with pin terminals

Rugged transistor transformers with straight pin terminals and

PROGRESS REPORT



AlSiBase Substrates

AlSiBase Snap-Strates

Thin Flat Ceramic SUBSTRATES with As-Fired Surface for THICK FILM or THIN FILM

Since the early 1950's American Lava technical people have worked closely with customers in developing thin flat ceramic substrates to meet their design requirements. Special requirements are engineered regularly.

Over a period of years, practical solutions to a variety of substrate problems have emerged. Some AlSiMag ceramic compositions and designs are so widely used that they are now carried in stock for prompt shipment. Other designs are classed as "Preferred Style", involve no tooling cost and are promptly available.

Three AlSiMag ceramic materials have emerged as most satisfactory for substrate applications. AlSiMag 614 alumina with an as-fired surface in the range of 25 microinches CLA has been firmly established for thick film uses.

The great need for a smooth as-fired ceramic for thin film work has been met with AlSiMag 772 alumina with an as-fired working surface of 8 microinches or better. This material was especially formulated for this use and has gained followers to such an extent that it seems destined to be the dominant substrate material for thin film.

Where outstanding thermal conductivity is important, AlSiMag 754 beryllia sub-

strates conduct heat like aluminum and have most of the desirable electrical characteristics of the alumina ceramics. AlSiMag beryllia substrates can be pro-

cessed to give you an as-fired working surface on the order of 25 microinches CLA for thick film or as smooth as 8 microinches or better for thin film.

ALSIBASE SUBSTRATES—STOCK ITEMS

ALUMINA	ALUMINA	BERYLLIA
AlSiMag 614. As-fired working surface in range of 25 microinches CLA. Thickness of .025". 1/2" x 3/4" 1" x 1" 1" x 2" 2" x 2"	AlSiMag 772. As-fired working surface of 8 microinches or better. Thickness of .025". 1/2" x 3/4" 1" x 1" 1" x 2" 2" x 2"	AlSiMag 754*. As-fired working surface of 8 microinches or better. Thickness of .025". 1/2" x 3/4" 1" x 1" 1" x 2" 2" x 2"

* Can be supplied with as-fired working surface on the order of 25 microinches CLA about four weeks after receipt of order. Beryllia substrates are stocked only in prototype quantities. Allow normal production time for volume orders.

IN ADDITION TO THESE STOCK ITEMS there are a large number of Preferred Styles where open tooling is available. Give us the approximate size of your interest and your operating conditions and let us see how closely we can approach your needs with Preferred Styles which would mean a substantial saving in time and tooling cost.

SNAP-STRATES have given good results and substantial savings in the finished component in some designs. The basic idea is to complete all film and circuit work on a sizeable ceramic substrate and then divide it into smaller controlled

individual sizes. These ceramics, modified to separate accurately along clean straight lines, were originated by American Lava Corporation and are called SNAP-STRATES.

DELIVERIES: During 1966 our substrate facilities were again approximately doubled including specialized production kilns. A basic part of our expansion was the development of trained personnel. This has been successful, and we are handling new volume in agreed production time. We will be glad to discuss your requirements to develop mutually satisfactory delivery schedules.

CODE IDENT. NO. 70371

PHONE 615 265-3411, CHATTANOOGA, TENN. 37405

American Lava Corporation **3M**
A SUBSIDIARY OF COMPANY

For service, contact American Lava representatives in Offices of Minnesota Mining and Manufacturing Company in these cities (see your local telephone directory): Atlanta, Ga. • Boston: Needham Heights, Mass. • Chicago: Glen Ellyn, Ill. • Cleveland, Ohio • Dallas, Texas • Laurens, S. C. • Los Angeles, Calif. • Metropolitan New York: Ridgefield, N. J. • Up-State New York and Canada: Baldwinsville, N. Y. • Orange, Conn. • Philadelphia, Penna. • Roanoke, Virginia • St. Louis: Lee's Summit, Missouri • So. San Francisco, Cal. • Troy, Mich. • 3M International: c/o American Lava Corp., Chattanooga, Tenn. 37405, U.S.A., 615/265-3411

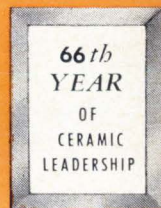

modular thumbwheel switches by Amperex

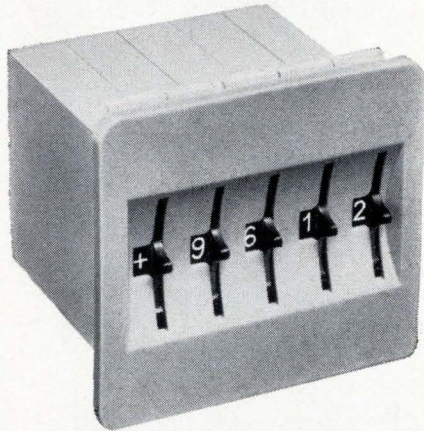
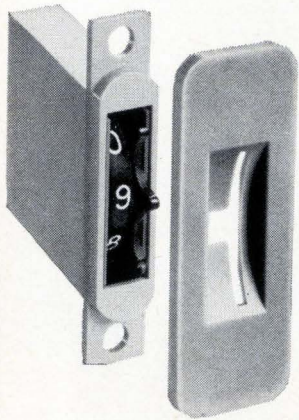

for all single, double and
4-pole applications

easiest to mount:

Individual switches mount with two screws onto the rear of the panel by means of face-plates available in lengths for one to nine switches in cascade.

easiest to wire:

Uniquely designed terminals accept solder or wire wrap connections.

most versatile:

4 independent wipers provide a wide variety of decoding possibilities. The built-in diode gate in decoding switches eliminates mounting external gate and running in extra leads.

Outstanding Features

- Binary decoding and coding
- Bronze, nickel plated, glass epoxy, printed circuit board
- Lightweight, modular design

Immediately available, priced from \$3.60 per unit for the single-pole, 10-position decimal switch.

Savings are achieved through availability of multiple face-plates in various lengths to accommodate from one to nine switches in cascade on 1/2 inch centers.

For complete information, write: Amperex Electronic Corporation, Components Division, Hicksville, Long Island, New York 11802.

Amperex®

TOMORROW'S THINKING IN TODAY'S PRODUCTS

Circle 134 on reader service card

To order reprints: Fill in, cut out coupon below, insert in envelope and mail to: **Electronics Reprint Dept., 330 W. 42nd Street, New York, N.Y. 10036**

Reprint order form

For listing of reprints available see the Reader Service Card.

Computer-aided Design: Part I, The Man-machine Merger.

Send me reprints of Key no. **R-01** at \$1.25 each.

For reprints of previous special reports fill in below:

Send me reprints of Key No.(s) @ ¢ each.

(For prices, see Reader Service Card)

Name

Number of street

City, State, Zip code

New Components

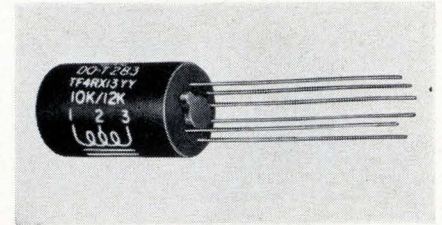

metal casings are suited for printed circuit use.

The DO-T200 series have a maximum diameter of 0.350 in. and a maximum height of $\frac{9}{16}$ in. The mounting base has a key-bearing moisture barrier offset of 0.035 in. Leads are of 7/8-in.-long 0.016 dumet wire and gold plated. These leads are both weldable and solderable. They are not insulated and are spaced on a 0.1-in. radius circle, conforming to the termination pattern of the TO-5 cased semiconductors and micrologic elements.

Primary impedance of the units is 1,000 to 200,000 ohms; d-c in primary is 0 to 3 ma; secondary impedance, 50 to 12,000 ohms; primary resistance, 115 to 8,500 ohms; and operating level, 25 to 100 mw. United Transformer Co., 150 Varick St., New York 10013. [354]

Ceramic adds stability to wirewound resistors

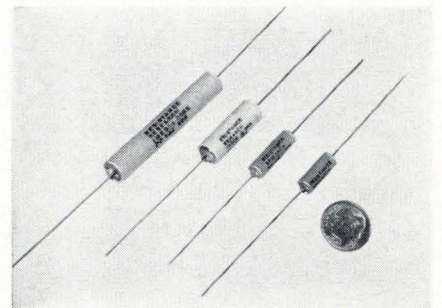

Oil-filled wirewound resistors encased in ceramic are designed for use in precision secondary standards of ratio and resistance. The resistor series is applicable anywhere precision resistance values, long-term stability, low temperature coefficient of resistance, and precision retrace capability are needed.

The ceramic case of the resistors

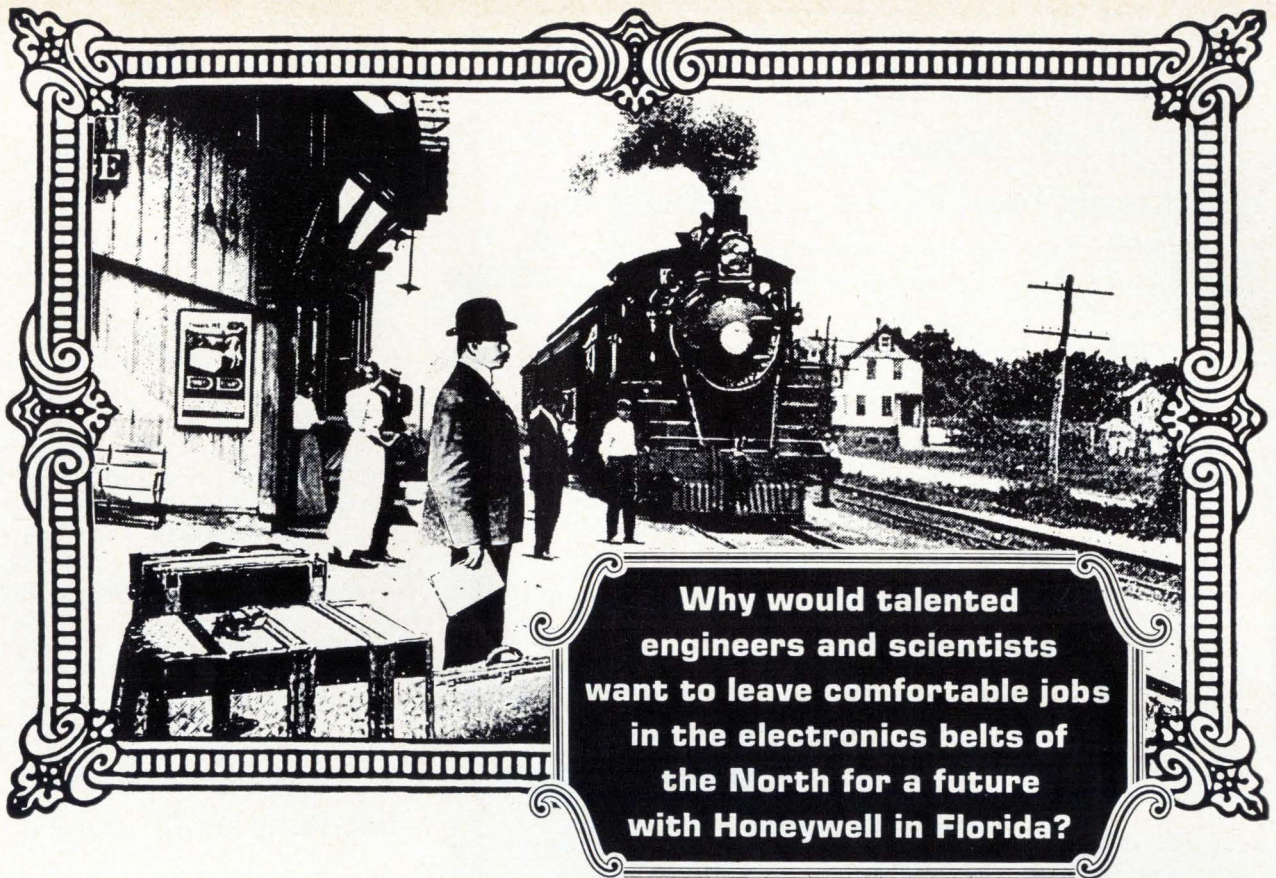

**Why would talented
engineers and scientists
want to leave comfortable jobs
in the electronics belts of
the North for a future
with Honeywell in Florida?**

BECAUSE THE FUTURE IS TODAY AT HONEYWELL IN FLORIDA!

Here you'll work on the forward edge of state-of-the-art in microcircuitry, communications, guidance, navigation and control.

Here you'll join a talented staff of creative colleagues working in an outstanding environment, doing exciting things. From sophisticated R&D (most of which is company-funded), to ultimate manufacturing, Honeywell in Florida is moving ahead. If you feel you are stagnating in your present position, now is the time to escape to a company . . . and to people . . . who are doing intriguing work.

If you are a talented graduate engineer with experience in Digital Communications, RF & Telephone Transmissions, Satellite Communications, Advanced Navigation Techniques or hardware development, there may be an exceptional career opportunity awaiting you in our newly-created Advanced Communications Laboratory.

We are also currently looking for communications systems engineers, receiver development engineers, HF, VHF, UHF, synthesizer development engineers, RF amplifier design engineers, IF and audio design engineers, and component engineers, as well as production engineers and associate production engineers.

In short, if you're looking as far ahead as we are . . . look to Honeywell in Florida. The challenges will be well worth the trip.

Incidentally, your family will look upon you as a hero . . . everytime they swim and sun and surf on Florida's Suncoast.

Why wouldn't talented engineers and scientists want to leave comfortable jobs in the electronics belts of the North for a future with Honeywell in Florida . . . Wouldn't you?

Send us your reasons why you would like a round-trip visit to talk this whole thing over. Write to:

Mr. E. Q. Keese
Honeywell, Inc.
13350 U. S. Highway 19
St. Petersburg, Florida 33733

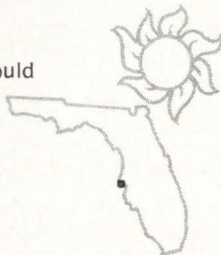

Honeywell

an equal opportunity employer

To investigate professional openings in other Honeywell facilities, send resume to F. F. Laing, Honeywell, Minneapolis, Minnesota 55408.

Ever need plug-in power supplies in a hurry?
Send for our 1967 catalog.
It lists 62,000 different types.
The one you need will be shipped in 3 days.

(We've never failed to make good on this promise)

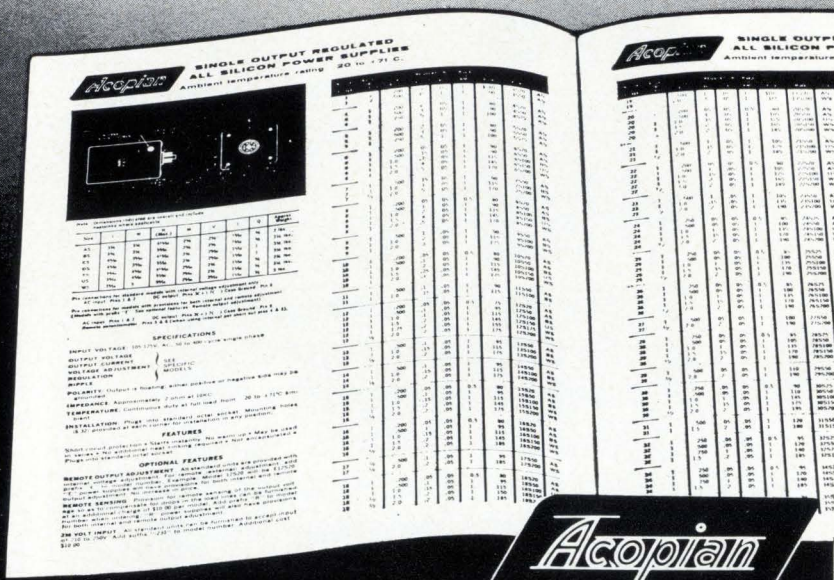

Acopian Corporation, Easton, Pennsylvania, (215) 258-5441

Circle 208 on reader service card

New Components

yields greater stability (within ± 2 ppm per year) than is common in epoxy, dipped, and Mylar-wrapped types, the manufacturer says. A special vacuum oil-filling technique achieves the excellent temperature coefficient of resistance (as low as 0 ± 1 ppm) and retrace capability (within 0.0005%).

Many resistance values are maintained in stock for immediate delivery, while special orders can be filled within four weeks. Price varies with resistance value (up to 6 megohms is available), resistance tolerance, and temperature coefficient.

Resistance Research Co., 146 W. Bellevue Drive, Pasadena, Calif. [355]

Thermoelectric cooler occupies small space

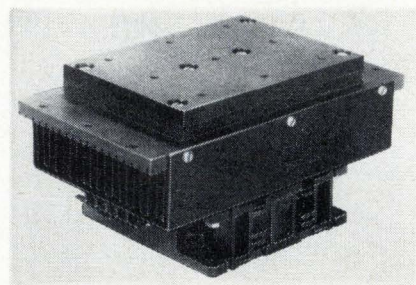

Up to 85 watts of heat removal from electronic packages or chambers is provided by a series of thermoelectric cooling units. Temperature reduction of 55°C below ambient air can be obtained with small loads.

Each unit of the TA series includes heat-transfer fins and fan. To install, the user fastens the load to the cold plate. The units are recommended for environmental enclosures, component test fixtures, controlled-temperature or programmable test facilities, liquid or gas flow temperature-control processes, and other applications where temperature control or reduced temperatures are necessary.

Overall dimensions are $8\frac{1}{2} \times 4\frac{7}{8} \times 5$ in. The cold plate surface measures $6 \times 4\frac{1}{4}$ in.

Ohio Semitronics Inc., 1205 Chesapeake Ave., Columbus, Ohio 43212. [356]

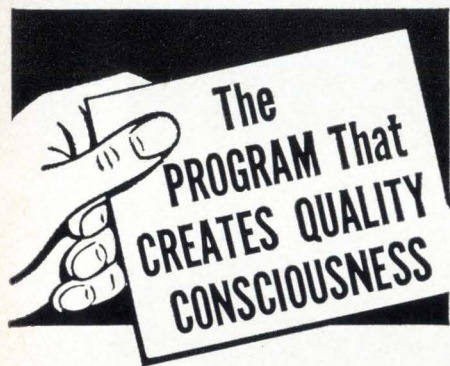

ELLIOTT Q/R SERVICE

This unique visual program achieves remarkable results. It motivates the individual to do his part to improve quality and reliability. Sparks enthusiasm and cooperation in your quality program. Regularly used by top companies throughout U.S. and Canada.



Ask For It on Your Letterhead

ELLIOTT SERVICE COMPANY, INC.
Dept. Q, 30 N. MacQuesten Parkway
Mount Vernon, New York 10550

NOW! APPLY KODAK PHOTO RESISTS this new AEROSOL way



QUICK
CONVENIENT
ECONOMICAL

Three types to suit all your etching needs now available at local industrial photo dealers

TYPE-P containing Kodak KPR* — for copper, copper-clad laminates, other metals. 16 oz. \$5.95

TYPE-M containing Kodak KMER* — for aluminum, stainless steel, titanium, other metals. 16 oz. \$5.95

TYPE-T containing Kodak KTRF* — for high resolution etching of thin films. 16 oz. \$6.95

*KPR, KMER, KTRF are products of Eastman Kodak Co.

INDUSTRIAL CHEMICAL SPECIALTIES CORPORATION

75 Hillside Rd., Fairfield, Conn.

Please rush me more information on Spray Resist products and, also, name of nearest dealer:

NAME _____

COMPANY _____

CITY _____ STATE _____

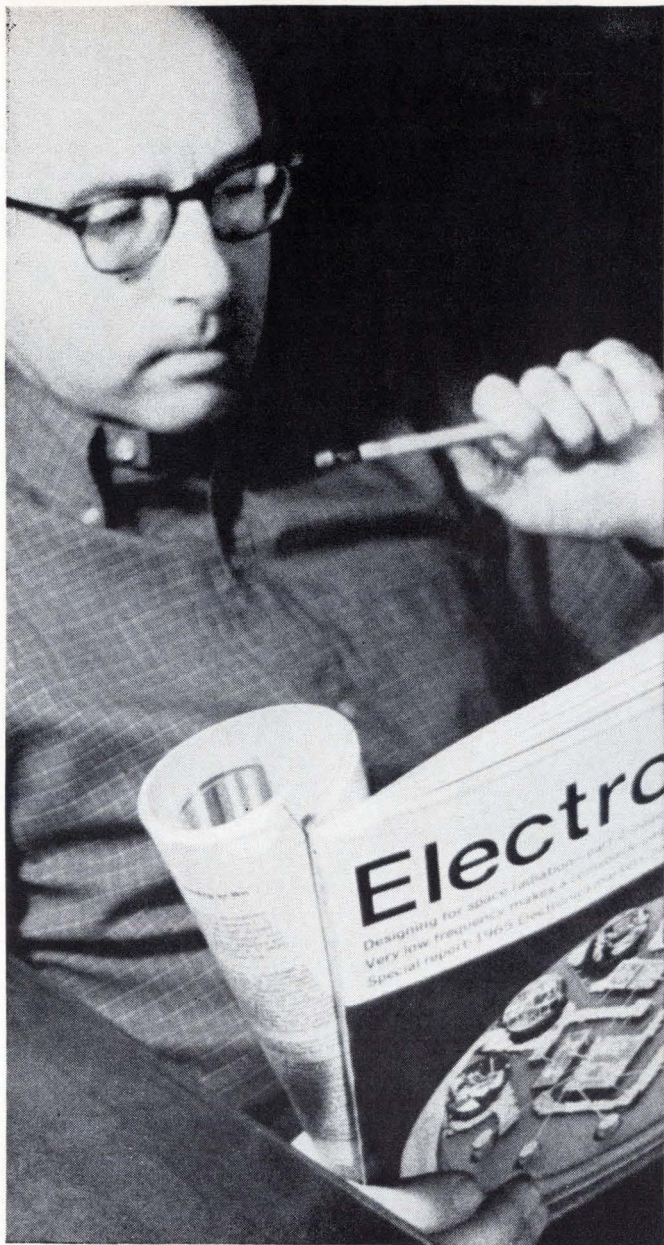

Great editorial
is something
he takes home

(What a climate for selling!)

Electronics

A McGraw-Hill Market-Directed Publication
330 West 42nd Street, New York, N.Y. 10036



RCL power wire wound resistors

- Standard Temperature Coefficient ± 10 PPM
- Standard Tolerance $\pm 1\%$
— available to $\pm .01\%$
- Sub-Miniature Series available at no extra charge
- 23 Special Temperature Coefficients available from -50 PPM to $+5900$ PPM . . . an industry exclusive
- Available in Standard Wattages $\frac{1}{2}$ Watt through 50 Watts
- Resistance Values from .01 ohms to 275K
- Special Silicone Coating impervious to all cleaning solutions without exception!
- **DELIVERY — IN QUANTITY WITHIN TWO WEEKS**

RCL

Main Office and Plant
RCL ELECTRONICS, INC.

700 South 21st Street
Irvington, New Jersey 07111

INTEGRATED CIRCUITS?



**Our flatpack stampings
give you
that critical edge**

Must metal parts for integrated circuits be produced by chemical etching . . . slowly . . . expensively?

No. Volkert stamps and forms these thin, critically precise components—in high volume, and at less cost. No secondary forming is needed.

Volkert's specialized facilities meet your most exacting tolerances for lead frames, frames and bases. We are aware of your design and production requirements as to burr, flatness, finger widths and center distances. And we work with Kovar, Rodar and clad materials. Lead frames can be formed in a continuous strip for automatic assembly.

For your next big job, in flatpacks or any other microminiature electronic components, think Volkert. Where your small stampings get that critical edge. Call or write today.

Volkert STAMPINGS, INC.

Subsidiary of The Stanley Works

222-35 96th Avenue
Queens Village, L.I., N.Y. 11429
Telephone 212-464-8400

New Semiconductors

Plastic-packaged FET's fit the purse

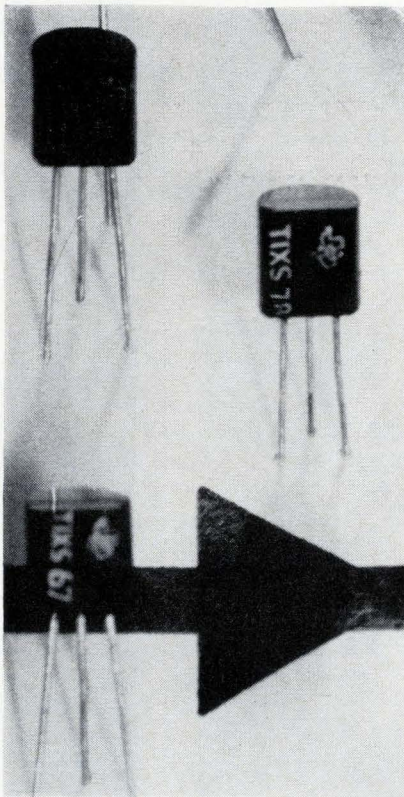

have plastic packaging in every major type, embracing both amplifiers and switches.

The new MOS device, a p-channel silicon enhancement-mode unit designated the TIXS67, is designed for switching and high-input impedance amplifying from d-c to medium frequency a-c. Edward Morrett, TI's merchandising manager for discrete semiconductors, claims "the leakage characteristics of the TIXS-67 are the lowest of all plastic FET's."

Further inroads in the vacuum tube market will be made by a pair of high-voltage FET's—TIXS78 and TIXS79. Both are n-channel silicon planar devices capable of direct-line operation. Breakdown voltage is 300 v minimum for the TIXS78 and 200 v minimum for the TIXS79. The devices are tailored for high-voltage switching and large-signal amplification.

For differential amplifying, a trio of matched-pair devices—TIS68, TIS69, and TIS70—is offered. N-channel silicon planar epitaxial units, the devices can also be used in comparators, instrumentation subsystems, and operational amplifiers. Each pair is electrically matched for gate leakage current and gate-to-source voltage over a wide temperature range. In addition, each pair has a 5% match in drain current (I_{DSS}) and transconductance.

Three new chopper switches are also suitable for amplifying. This is attributed to their low on-resistance values—25 to 60 ohms—and the resultant large value of forward

Thanks to plastic encapsulation, a number of popular field effect transistors are being offered at prices as much as 50% lower than corresponding metal-can devices. Metal oxide semiconductor (MOS), high-voltage, matched-pair, and chopper FET's are now available in epoxy-molded packages.

According to Texas Instruments Incorporated, each of the plastic-encapsulated devices [see table] is a first of its kind in the semiconductor industry. This makes the FET category the first device class to

Specifications

Model No.	Transconductance (min), m-mhos	Reverse-Transfer Capacitance (max) pf	Leakage (max), pa	Breakdown (min), volts	Price (100-999)
TIXS67	3.5	4	50	25	\$2.60
TIXS78	0.75	3	..	300	5.25
TIXS79	0.75	3	..	200	4.00
TIS68	1.0	4	5.50
TIS69	1.0	4	4.80
TIS70	1.0	2	4.00
TIS73	..	0.8	0.25-1.0	..	3.25
TIS74	..	0.8	0.25-1.0	..	3.45
TIS75	..	0.8	0.25-1.0	..	3.65

transfer admittance. Designated TIS73, TIS74, and TIS75, these n-channel planar devices are primarily used for both analog (series-type) and chopper (shunt-type) switching—with auxiliary component needs reduced to a minimum. Other applications are in analog-to-digital converters, gating circuitry, relay-contact replacement, and commutators.

The new devices are encased in TI's solid, molded package with a TO-18 pin-circle configuration. Texas Instruments Incorporated, P.O. Box 5012, Dallas, Texas 75222 [361]

Pnp silicon transistors handle 30 amps

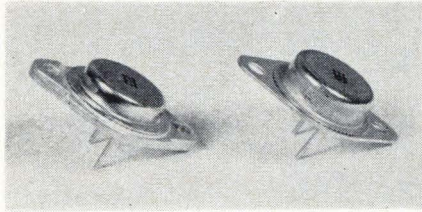

A pair of power transistors with current-handling capabilities to 30 amps reportedly are the first silicon pnp alternatives to germanium devices at that current level. In addition to the superior high-temperature capabilities of silicon the transistors also feature low saturation voltages.

Designated 2N4398 and 2N4399, the new devices have a collector-to-emitter saturation drop of 0.75 v maximum at 10 amps. Speed is another attribute; delay and rise times are only 400 nsec maximum. Current gain is maintained over a wide voltage swing—1 to 30 v, thereby keeping distortion low. Thermal resistance is 0.875°C/w maximum, low enough to permit the use of small heat-sinks. Power dissipation at 25°C is 200 w. Break-down (V_{CE}) of the 2N4398 is 40 v; with the 2N4399 it is 60 v.

Both devices are marketed in a low-silhouette, copper-base TO-3 package. In quantities of 100 and up, the '98' is priced at \$7.50; the '99', at \$9.05.

Motorola Semiconductor Products Inc., P.O. Box 955, Phoenix, Ariz. 85001. [362]

RSC precision is the key to

ROTARY SWITCH

Service Dependability!

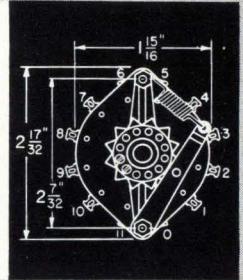
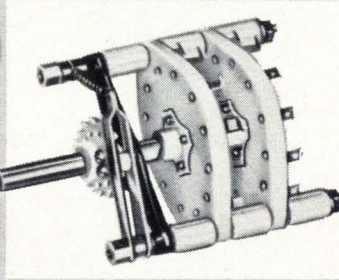
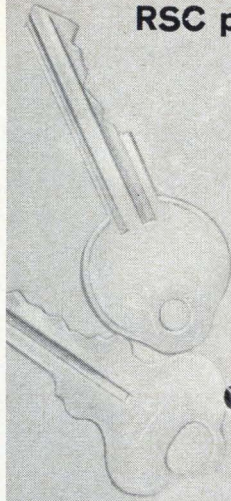

Switch to the Best! These rugged, high precision RSC Rotary Switches are expressly designed for industrial and commercial applications requiring long, trouble-free service. Available in a wide range of standard types including shorting and non-shorting, single to multi-deck, and a diversity of pole-position switching modes. Write for the 16-pg. catalog describing this RSC quality line.

FEATURES OF MODEL 80 SWITCH (Illustrated)

4500 volt peak flashover at 60 cps • 10 ampere current carrying capacity • Current carrying members heavily silver plated • Coin silver contact shoes • Kel-F stators and rotors • Nylon detent wheel • Steatite spacers

RADIO SWITCH CORPORATION

MARLBORO, NEW JERSEY 07746

Telephone: (201) 462-6100



Circle 210 on reader service card

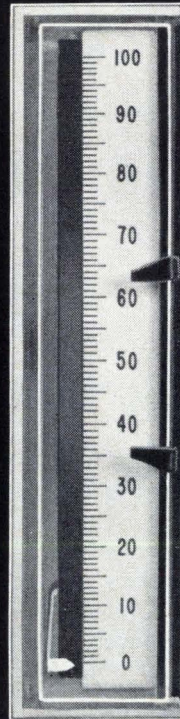

ER-35 MINITROL CONTROL METER (actual size)

of all meter/relays, the **PARKER MINITROL** is the most compact, most rugged, simplest, most dependable

with an array of features never before available in a single instrument:

- **All-solid-state switching** / no physical contacts, mirrors or prisms . . .
- **Positive repeatable switching** over the entire instrument range . . .
- **Completely self-contained** indicating and control . . .
- **Dual or Single Control Points** with simultaneous switching available . . .
- **Selenide or Light-Activated SCR Cells**, as desired . . .
- **Internal-Switching Capability** to 300 MA at 100V . . .
- **Extreme Compactness** / 7/8"-thin case includes all indicating and control elements, etched-circuit design . . .
- **Multi-Unit Assemblies** of edgewise modules for high-density control/display (14 units per foot)

write for bulletin M-10



PARKER INSTRUMENT CORPORATION
200 Harvard Ave./Stamford/Conn/06904
Phone 203-325-4361

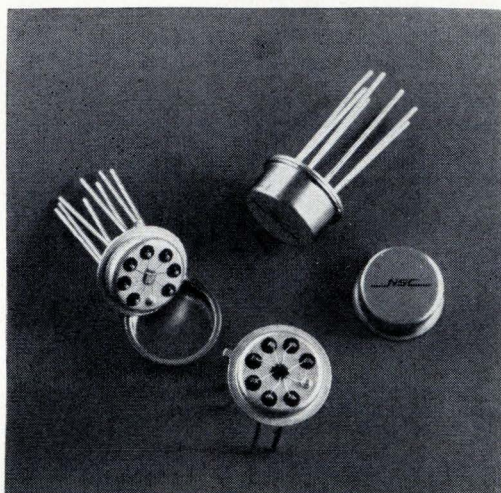

New LM200—Temperature range: 0 to 70°C.
LM100—Temperature range: -55 to +125°C.

Now... a Monolithic Voltage Regulator for less than \$20*

Second of a new line of monolithic linear integrated circuits

- Output adjustable from 2V to 30V.
- Output currents in excess of 5A using external power transistors.
- Can be used as either a linear or a high-efficiency switching regulator.

* 100-999 PRICE

The new LM200 has the same performance characteristics as the LM-100 over the commercial range.

These versatile regulators feature regulation better than 1 percent for widely varying load and line conditions. Temperature stability is better than 1 percent over full temperature range. As linear regulators, both devices provide current limiting, excellent transient response and unconditional stability with any combination of resistive or reactive loads. As

switching regulators, circuits will operate at frequencies up to 100KHZ with efficiencies better than 85 percent.

Both LM200 and LM100 are immediately available from distributor stock.

NSC
MICROCIRCUITS DIVISION
NATIONAL SEMICONDUCTOR CORPORATION
2950 SAN YSIDRO WAY, SANTA CLARA
CALIFORNIA 95051 (408) 245-4320

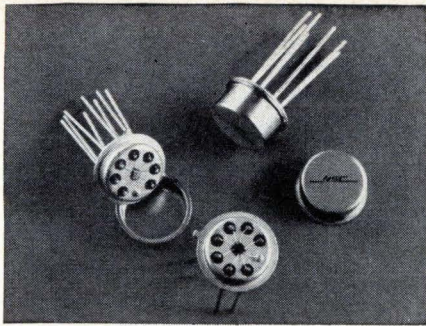

Available from your

NSC
distributor

EASTERN DISTRIBUTORS:

Arco Electronics Inc.
Community Drive
Great Neck, New York 11020
(516) 487-0500

R & D Electronics
71 Pearl Street
Cambridge, Massachusetts
(617) 868-6644 or 868-6645

State Electronic Parts
Corporation
36 Route 10
Hanover, New Jersey
(201) 887-2250

Herbach & Rademan, Inc.
1204 Arch Street
Philadelphia, Pa. 19107
(215) 567-4309

Connecticut Industrial
Electronics, Inc.
854 Main Street
Stamford, Connecticut 06902
(203) 325-3591

Gulf Semiconductors, Inc.
7495 N.W. 48th Street
Miami, Florida 33166
(305) 887-6541

Valley Electronics, Inc.
8809 Satyr Hill Road
Baltimore, Maryland 21234
(301) 668-4900

L. L. Schley, Inc.
108 Water Street
Watertown, Massachusetts
(617) 926-0235

Milgray Electronics, Inc.
160 Varick Street
New York, New York 10013
(212) 989-1600

Peerless Radio Corporation
19 Wilbur Street
Lynbrook, L. I., New York
(516) LY 3-2121

Summit Distributors, Inc.
916 Main Street
Buffalo, New York 14202
(716) 884-3450

New Instruments

Word generator talks fast in 3 languages

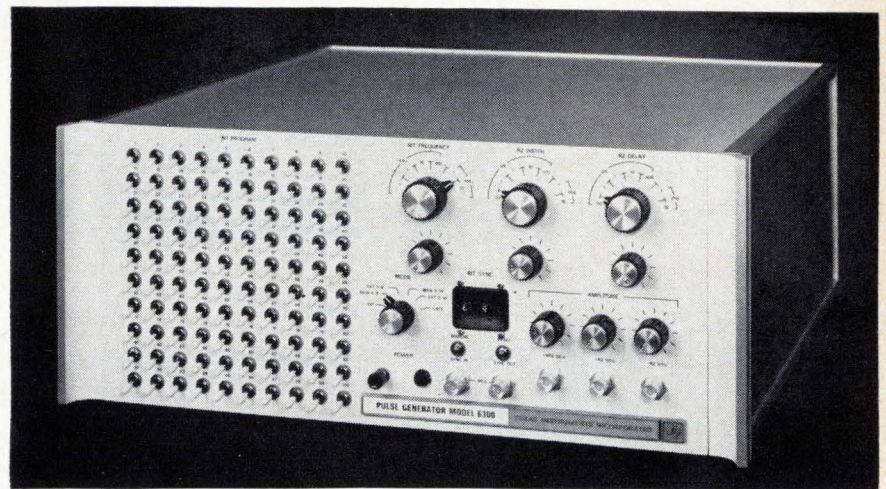

Word generators that check out circuits in digital systems must talk fast to keep testing time short. A word may have to be repeated thousands of times to exercise a computer memory or determine how a data-processing system is performing, for example.

Texas Instruments Incorporated's model 6300 generator supplies words up to 100 bits long at a bit rate of 10 megahertz—a pace the company reports is almost three times faster than most word generators. In addition, TI says the generator is more flexible in word formats and outputs, costs less, and is more compact than previous equipment. Word length can be modified by means of plug-in cards, and word format is programed by toggle switches.

The generator's output impedance of 50 ohms is compatible with normal bipolar logic circuits and metal oxide semiconductor logic circuits. The output amplitude is variable to 5 volts positive or negative, with rise and fall times less than 6 nanoseconds. Both RZ—return to zero—and NRZ—nonreturn to zero—outputs are provided. Delay between the RZ and NRZ channels ranges from 20 nsec to about 10 milliseconds, or 80% of the bit width. The bit width for RZ is adjustable from a 20-nsec minimum. A bit-sync output enables triggering oscilloscopes at any

desired point in a full 100-bit word.

The components of the generator are an oscillator, counter, program decoder, and output sections. Auxiliary sections required for external modes are the trigger and logic circuits.

The counter's coded output represents the bit numbers. The counter repeats the codes after a time interval determined by the product of the oscillator period and the number of bits per word.

The decode section takes the bit program and transforms the counter's coded output into a binary, octal, or decimal output depending on the actual decode circuit selected. With minor modifications, the bit program could be driven by a computer.

The word finally passes through the RZ and NRZ output sections, where it is amplified, shaped, and delayed according to the front-panel settings.

When the word generator is operated in any mode other than internal, the logic and trigger sections are switched in with the oscillator and counter. The trigger section then forms the gating pulses to the logic and oscillator. The logic section directs the flow of gating pulses, determines when the end of the word is reached, and initiates the automatic reset cycle.

The basic instrument, when modified, helps to solve many test-

Off-the-Shelf Only from api

- 1% tracking
- taut-band
- no extra charge
- 20 to 100 μ a

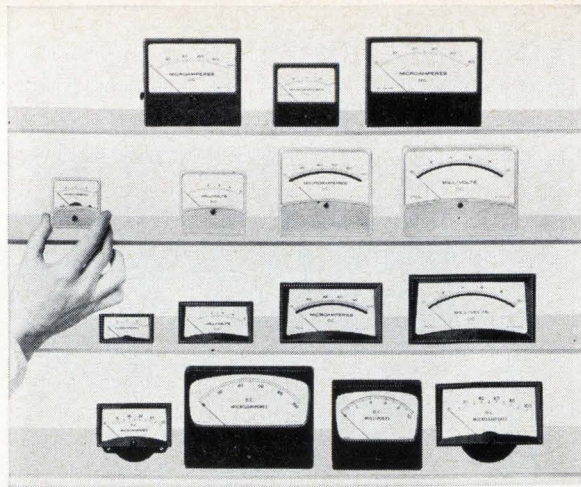

There's extra value, but no extra cost, in API's line of DC panel meters in the 20 to 100 microampere ranges. Tracking of $\pm 1\%$ is standard. Frictionless taut-band construction produces meters that are the most accurate, sensitive to smaller signals, vibration-proof and durable.

No other manufacturer offers these bonus features at firm catalog prices.

15 Models in Stock

You'll get off-the-shelf delivery of the economically priced Panelist, Stylist and

black phenolic meters shown above. Choose from these full-scale DC ranges:

- Microamperes:** 0-20, 0-50, 0-100
Millivolts: 0-5, 0-10

If ultra-precision tracking is the least you'll settle for, API offers 0.5% tracking at reasonable cost. This "super-calibration" is another API exclusive, again backed by published prices.

Ask for Bulletin 47.

Also stocked nationally by Allied Electronics and Newark Electronics.

New Instruments

ing problems. For example, the counter and bit programming cards can be changed to provide multiple channels with independent controls within the 100-bit limit—two channels of 50-bit words, five channels of 20-bit words, or 10 channels of 10-bit words.

The basic 6300 generator costs \$3,000, including accessories. Texas Instruments Incorporated, Industrial Products Group, P.O. Box 66027, Houston 77006. [371]

Wheatstone bridge boasts high accuracy



The most accurate and sensitive ever offered is the claim for a Wheatstone bridge. Model 6003EB features 10 ppm (0.001%) accuracy and is 100 times more sensitive than its predecessor, model 6003EA. Overall stability is better than ± 5 ppm per year.

The self-contained resistance-measurement unit consists of a Wheatstone bridge, solid state null detector, regulated power supply, and an automatic go-no-go percent selector programmer. The go-no-go feature on the bridge's meter reads error in percent or parts per million of the components under test. More than 600 resistors per hour can be measured and sorted to better than 1 ppm relative or ± 10 ppm absolute accuracy.

The most sensitive range has a

api INSTRUMENTS CO.

CHESTERLAND, OHIO 44026 (CLEVELAND-216) 729-1611 • TWX: 810-427-9230

Circle 218 on reader service card

REVOLUTIONARY NEW TWEEZERS

They firmly grip and hold the most delicate objects.
OBJECT CAN'T SLIP BECAUSE OF SPECIAL DIAMOND GRIP.
 Gripping points lined with diamond-powder—(fine grit). The diamond particles are firmly welded. For micro-fine work and micro-surgery.



MILLERS FORGE
DISTRIBUTOR

We stock the most complete variety of tweezers to insure a tweezer for every purpose.

"SPECIAL ORDER WORK
AVAILABLE ON ANY TYPE OF TWEEZER"

ASK FOR OUR EXTENSIVE TWEEZER CIRCULAR

I. KASSOY INC.

30 WEST 47 STREET, NEW YORK 10036,
DIAMOND CLUB BLDG.

WORLD'S LARGEST DISTRIBUTOR OF TWEEZERS

Reed Relay Problems?

A special
AND logic
relay in
the new "UF"
configuration.

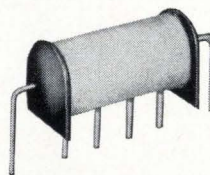

Can We Solve Your Problem?

Operating Inputs: low as 1mA. and 15mW.

Standard Coil Voltages: 6, 12, 24, 32, 48V in stock for immediate delivery.

Special Voltage or Resistance, multiple windings for flip flop, memory and crosspoint selection applications — to customer specifications.

Relay Contacts in Form A, B, C and latching. Also high vacuum type 5000V Form A.

Write for catalog and prices of our standard line of magnetic reed relays. For special requirements, give complete details for quotation.

Coto-Coil COMPANY INC.
61 Pavilion Ave.
Providence, R. I. 02905
Phone: (401) 941-3355

full-scale sensitivity of ± 1 ppm, and each major division on the scale is equal to 0.01 ppm (0.000001%).

The eight-decade resolution is derived from six decades with over-ranging, plus analog meter display. Meter readout is always linear and proportional to the deviation of the resistor under test from the decade arm setting. A digital logging system can be directly connected to the meter to provide a completely automated system. Other features include ± 5 ppm accuracy when calibrated on a 60-day cycle and a 1-ohm-to-111.11-megohm resistance range. Model 6003EB is guaranteed to remain within the precise specifications for a year.

Price is \$3,750; delivery, 60 to 90 days.

General Resistance Inc., 430 Southern Blvd., Bronx, N.Y. 10455. [372]

Wideband detector of interference



An instrument to detect electromagnetic and radio-frequency interference receives signals from 1 to 600 kHz in a single band. A 25-in. calibrated metal-tape tuning dial affords superior resolution at i-f bandwidths of 1, 6, 20 and 50 kHz.

The receiver has a minimum image rejection of 70 db, minimum i-f rejection of 60 db, and a minimum dynamic range of 55 db (agc or manual). Incidental f-m is less than 10 hz peak deviation.

Powered by 115/230 v a-c, 50-400 hz, the receiver draws 5 watts. Intended for standard rack mounting, it is 3.5 in. high, 19.5 in. deep, and weighs about 20 lbs.

Price is \$3,000, with delivery in 45 days. A modified version with outputs for an X-Y plotter costs \$3,200.

Communication Electronics Inc., 6006 Executive Blvd., Rockville, Md. 20852. [373]

Ballantine Sensitive AC-DC Digital Voltmeter



Measures Wide Range of AC or DC Voltages in one Economical Package

Ballantine's Model 355 accurately measures a wide range of ac or dc voltages with a versatility that makes it ideal for production or quality control applications.

FEATURES:

- ★ Replaces analog instruments to reduce personnel errors and to speed up production
- ★ Maximum sensitivity of 10 mV f.s. ac, and 100 mV dc
- ★ Frequency range of 30 Hz to 250 kHz
- ★ Accuracy, % f.s., to 500 V: $\frac{1}{4}\%$, 50 Hz — 10 kHz; $\frac{1}{2}\%$, 30 Hz — 50 kHz; 1%, 50 Hz — 250 kHz
- ★ Servo-driven, 3 digit counter with over-ranging to 4, plus ability to interpolate for additional digit. This feature is not possible with electronic digital displays
- ★ Well-lighted readout, illuminated decimal point. Indicator warns against over-ranging or wrong polarity
- ★ An optional foot-operated switch for retaining readings speeds up successive readings



Write for complete technical data today

BALLANTINE LABORATORIES INC.

Boonton, New Jersey

CHECK WITH BALLANTINE FIRST FOR DC AND AC ELECTRONIC VOLTMETERS/AMMETERS/OHMETERS, REGARDLESS OF YOUR REQUIREMENTS. WE HAVE A LARGE LINE, WITH ADDITIONS EACH YEAR. ALSO AC/DC LINEAR CONVERTERS, AC/DC CALIBRATORS, WIDE BAND AMPLIFIERS, DIRECT-READING CAPACITANCE METERS, AND A LINE OF LABORATORY VOLTAGE STANDARDS FOR 0 TO 1,000 MHZ.

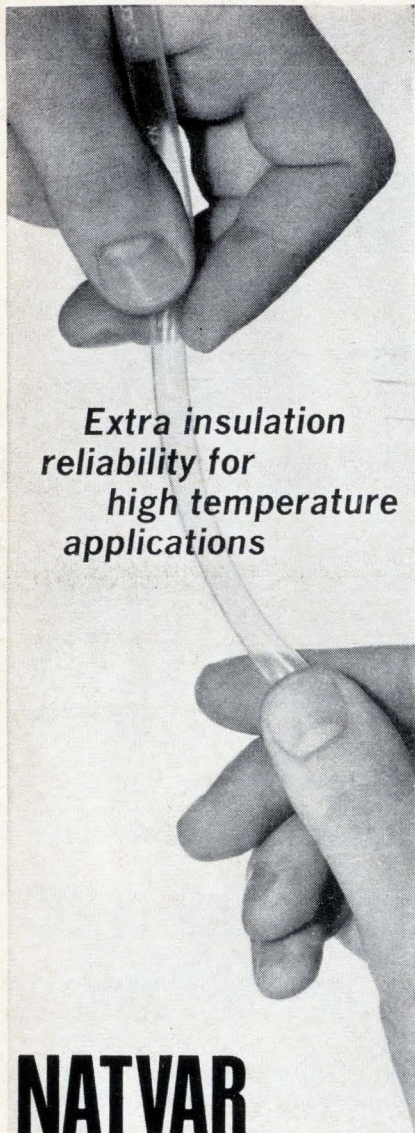

**Extra insulation
reliability for
high temperature
applications**

NATVAR 400 Vinyl Tubing

Here's an insulation you can rely on when the heat's on. Because Natvar 400 vinyl tubing has excellent thermal life. In fact, it's U.L. recognized for 105°C continuous operation. Besides that, it has exceptional resistance to oils.

Use Natvar 400 high temperature vinyl tubing to insulate leads... terminations... wiring... electronic equipment... oil filled transformers... harnesses.

Available in a wide range of sizes and colors—in continuous lengths or cut pieces. Send for FREE samples and complete technical data.

NATVAR CORPORATION
P. O. Box 67, Rahway, New Jersey 07065

New Subassemblies and Systems

Tv camera withstands extreme environments

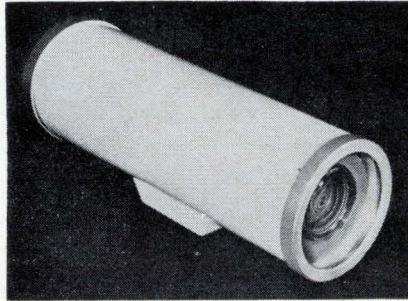

Continuous, reliable operation in untended locations and under extreme environmental conditions is possible with a solid state tv camera. The unit is well adapted to military and industrial security installations and to process observation in high-temperature areas in foundries or rolling mills, low-temperature regions in food processing plants, high-vibration applications aboard ships or around heavy machinery, fine-dust environments in steel mills or desert testing facilities, and explosive atmospheres.

Despite its compact size (5½ x 10 in.) the RGS-20 camera has a minimum horizontal resolution of 800 lines. With the camera placed 3,000 ft. from the control station, resolution is better than 600 lines. The picture has the standard 525 lines per frame and a 4:3 aspect ratio. The camera can also be supplied in a choice of scan rates: 625, 837, 875 or 945 lines per frame. Vertical sweep rates are either 50 or 60 hertz.

Dynamic range has been increased by automatically controlling the picture signal to eliminate monitor "blooming" and provide a stable level of brightness over a wide range of scene illumination. The increased range contributes to excellent contrast ratios which, in turn permit more effective video taping.

The camera resists temperatures from -4° to +140°F; humidity up to 95%; reduced air pressure equivalent to an altitude of 50,000 ft., and shock and vibration re-

quired by military specification MIL-5-5272C.

Price of the RGS-20 is \$3,400. Raytheon Co., 475 S. Dean St., Englewood, N.J. [381]

Analog multiplexers with IC logic design

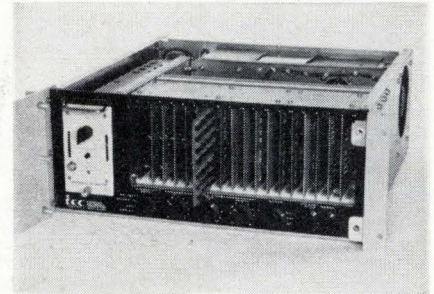

High-speed low-level multiplexers, featuring FET analog switches and IC logic design, can be used in basic analog-to-digital conversion systems. Combined with the company's series 1010 computer they meet complex computer-controlled data acquisition and processing requirements.

Designated the series 500, the multiplexers feature selectable full scale differential floating input ranges from ±5 mv to ±640 mv with a full-scale output of ±10 v. The number of input channels is expandable to 1,000 in blocks of eight or 10.

Other features include maximum sampling speeds of 40,000 samples per second, excellent gain accuracy, linearity, stability, and noise immunity.

Interstate Electronics Corp., 707 E. Vermont Ave., Anaheim, Calif. 92803, [382]

Operational amplifier offers high sensitivity

An epoxy-encapsulated, differential d-c operational amplifier, intended for systems that use phototube input devices, measures less than 0.15 cu. in. Input currents of only a few nanoamperes are feasible

Radar Equipment Design Engineers

The Hughes Radar & Space Electronics Laboratories have important opportunities available for experienced Engineers.

System oriented

Engineers, Physicists and Analysts are required for the conceptual design of advanced radar, laser and telecommunication systems. Desirable background would include a broad knowledge of the state of the electronic art and specific experience in sensors, signal processing and communication theory.

Openings are available on nearly all levels—from those with a minimum of two years of applicable, professional experience through those who are interested in and qualified for senior supervisory positions.

Accredited degree and U.S. citizenship required.

For immediate consideration, please airmail your resume to:

MR. ROBERT A. MARTIN
Head of Employment
Hughes Aerospace Divisions
11940 W. Jefferson Blvd.
Culver City 34, California



An equal opportunity employer — M & F

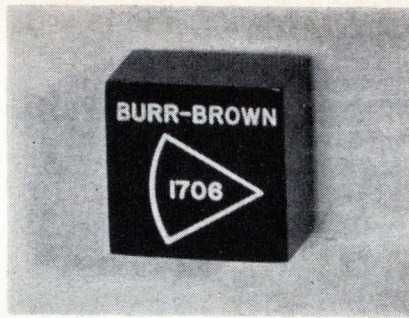
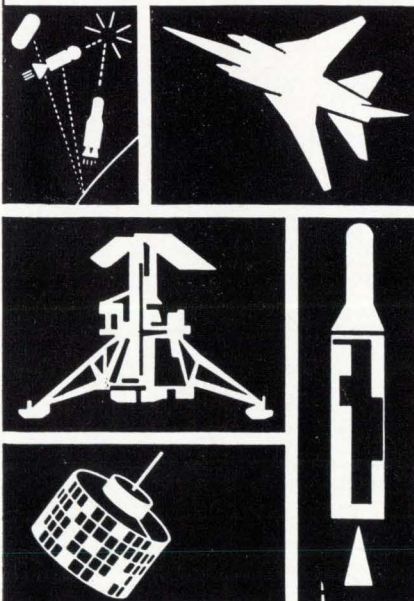

with output currents up to ± 10 ma (can be increased to 50 ma with optional booster in an identical package). Maximum amplifier voltage is ± 10 v.

Output current can be used to drive motor coils, galvanometers, or deflection coils for display or for steering purposes.

Other pertinent specifications for the model 1706 are: gain, 100 db; bandwidth, 1.5 Mhz; voltage drift, 10 μ v; and current offset, 10 na.

The unit is priced at \$125 in quantities of one to nine. Burr-Brown Research Corp., International Airport Industrial Park, Tucson, Ariz. 85706 [383]

Frequency standard generates stable 60 hz

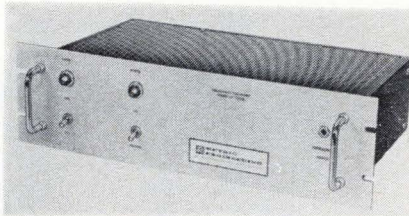

A solid state, 25 volt-ampere signal source generates an accurate and stable 60-hz power signal suitable for driving video tape recorders, tape transport systems, precision clocks, and power-line frequency comparators. Guaranteed maximum frequency change over a 24-hour period for the model 67, 120-60 is ± 1 part in 107. Power company frequency variation is generally about 1 part in 10^4 .

Units are also available at output frequencies from 47 hz to 1,000 hz. The 60-hz units are available from stock; others take one to three weeks for delivery.

Metric Engineering Division of Green-ray Industries Inc., 5235 E. Simpson Rd., Mechanicsburg, Pa. 17055. [384]

INDUSTRIAL OPPORTUNITIES IN MISSOURI

**ELECTRONIC
COMPONENTS
&
ELECTRICAL
MACHINERY**



Arthur D. Little, Inc.

**WRITE,
WIRE
OR PHONE
FOR THIS
FREE**

ARTHUR D. LITTLE REPORT

This free study by Arthur D. Little, Inc., presents an analysis of the Electronic Components and Electrical Machinery Industry. It reports on business structure, consumption, employment trends, location and market aspects, marketing opportunities, industry forecast, and equipment suppliers. Here's the fastest, most efficient way to determine whether Missouri industrial opportunities fit your growth needs. Just attach the coupon to your letterhead for your free copy.



**KEEP
MISSOURI
IN THE CENTER OF YOUR THINKING**

Mr. Henry C. Maddox, Director
Missouri Division of Commerce and
Industrial Development
Jefferson Building, Dept. E-5-7
Jefferson City, Mo. 65101
Phone 314-636-5133

Please send me a copy of the Electronic Components and Electrical Machinery Report.

NAME _____ TITLE _____
COMPANY _____
STREET _____
CITY _____ STATE _____

HIGH
VOLTAGE

MONOLITHIC KILOVOLT DIODE

New horizons of high voltage diode properties have been established by the introduction of a monolithic chip having breakdown ratings from 1 Kv. to 8 Kv.

These high voltage characteristics are built into a single crystalline structure in a glass axial lead package by a unique multidiffusion process. Resulting electrical properties of Semicon's new High Voltage Diodes are:

- $I_R = 25$ nanoamps @ 8 Kv.
- C_j max. = 1 pfd. @ 0 volts
- C_j typ. = 0.2 pfd. @ 8 Kv.
- $T_{RR} = 200$ nanosecs. max.
- $V_f = 10$ volts max. @ 15 Ma.

Designed specifically for Voltage Multipliers, the combination of low junction capacitance, low reverse current, low forward voltage, and fast recovery makes these diodes ideal for laser and flash tube power supplies, fiber optic image amplifiers, ion pulse sources, radiation and pulse detection, deflection systems, solar plasma experimentation and infrared and RF power supplies.

Write for Bulletin 651A

Tomorrow's Needs/Today's Design



Semicon
INC.

Sweetwater Ave., Box 328, Bedford, Mass. 01730
Tel: (617) 275-8542. TWX: 710-326-1919

New Microwave

Mixer-preamps yield low noise figure

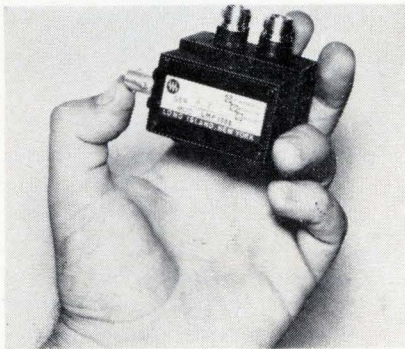

A line of mixer-preamps features an extremely low noise figure. Maximum overall noise figures are 6.5 db in octave band units operating from 500 to 4,000 Mhz; less than 7.0 db at 4,000 to 10,000 Mhz;

7.5 db from 10,000 to 12,000 Mhz; and 8.0 db for a broadband 8,000-to-12,000-Mhz unit. The devices employ Schottky-barrier diodes and meet most military environmental requirements.

Gain from the r-f input to the i-f output is more than 25 db. The intermediate frequency is 30 or 60 Mhz, and bandwidth is 10 or 20 Mhz.

Other specifications include a burnout of $\frac{1}{2}$ w, c-w; 5 ergs, without degradation; local oscillator power of approximately 2 mv; temperature range of -50° to 70° C.

The mixer-preamps measure $2\frac{1}{2}$ x $1\frac{1}{2}$ x $2\frac{1}{2}$ in., typically. Some models are also available in smaller versions. Delivery on most models is four to five weeks.

Microwave Products Division of Consolidated Airborne Systems Inc., 115 Old Country Road, Carle Place, N.Y. [391]

X-band multiplier is tunable and flexible

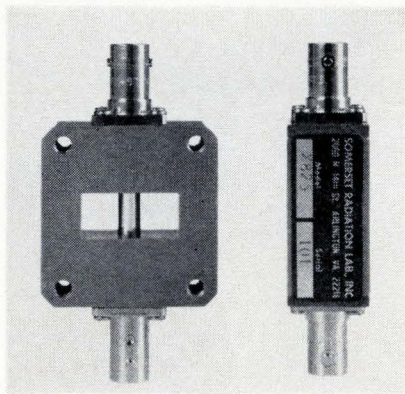

A step-recovery diode multiplier is capable of 150-mw output at 10 Ghz with a 2-w input at 2 Ghz. The modular construction requires only the resetting of an external waveguide sliding short to change frequency over the band of 8.2 Ghz to 12.4 Ghz. The close-tolerance diode in the model X825 is an epitaxial, surface-passivated silicon device with an abrupt junction gradient ensuring high-order multiplication from two times to 100 times. A reverse-bias capaci-

tance of only 0.7 pf allows efficient operation at the higher microwave frequencies.

Model X825 employs a circuit arrangement that completely separates the input circuit from the bias circuit for maximum flexibility in selecting self-bias and fixed-bias configurations.

Price is \$210 each. Delivery takes 10 days.

Somerset Radiation Laboratory Inc., 2060 N. 14th St., Arlington, Va. 22216. [392]

Dual role for compact coaxial circulator

A three-port junction coaxial circulator, measuring $\frac{5}{8}$ x $\frac{3}{4}$ x $\frac{3}{4}$ in. and weighing 1 oz. can be used as a high-performance duplexer or as an isolator, and is available in Y or T configurations. Model 420382 covers a frequency range of 4.2 to 4.4 Ghz. Other models are available in the frequency range of 1 to 10 Ghz, covering 5% to 10% bandwidths.

Other features include: isolation, 20 db minimum; insertion loss, 0.3 maximum; vswr, 1.20 maximum;

Cut

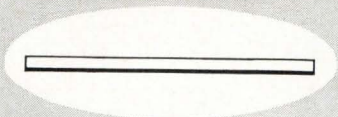

Strip

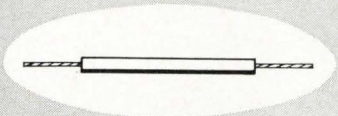

Bend

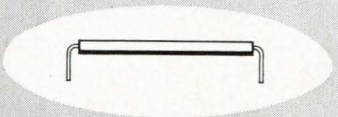

Crimp

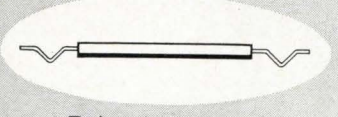

Eubanks automatic wire strippers are fast, easy to operate, and versatile.

Eubanks makes machines that will:

... cut and strip wire as small as #32 AWG and as large as #4 AWG.

... cut, strip and bend pc board jumpers.

... fully strip wire 1½" for solderless wrapped connections.

... strip coaxial cable at one, two or three points.

... Cut, strip and crimp solid wire for insertion in pc boards.

For recommendations on ways of speeding up your wire processing, send us a description of your requirements.

Eubanks
ENGINEERING CO.
P.O. BOX 563 MONROVIA, CALIF.

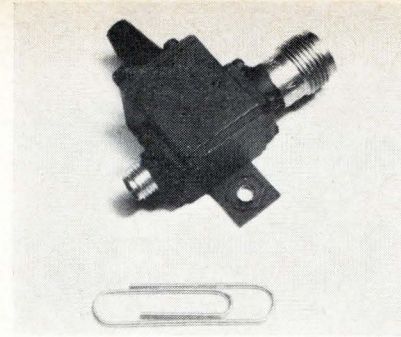

and temperature range, -50° to $+85^{\circ}$ C. The circulator meets applicable military specifications.

Price range is from \$70 to \$100, depending on quantity. Delivery takes 30 days.

Airtron Division of Litton Industries, Inc., 200 E. Hanover Ave., Morris Plains, N.J. 07950. [393]

Multicoupler produces 10 telemetry outputs

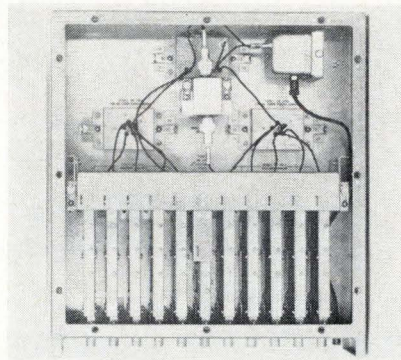

Originally developed for use in the Apollo space program, a multicoupler accepts one antenna input and separates the incoming signals in frequency to produce 10 outputs.

Operating over a frequency range of 1.4 to 2.3 Ghz, the transistorized device has a gain of 5 db and a noise figure of 14 db. The 1-db compression occurs at approximately -20 dbm output with vswr less than 2 to 1.

The multicoupler consists of one preamplifier, 10 post amplifiers, power dividers, and its own power supply. Isolation between each output is 50 db.

Provisions for quick disconnect and replacement of each amplifier and power divider keep the device's downtime to approximately five minutes.

MicroState Electronics Corp., 152 Floral Ave., Murray Hill, N.J. 07971. [394]

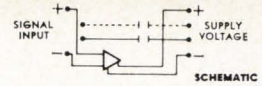

NOW!
AN AMPLIFIED REED RELAY WITH CONTROLLED PERFORMANCE

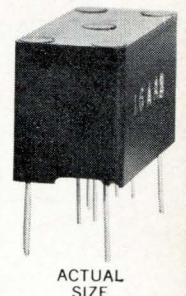

A relay which operates in 1 millisecond; over a 50 to 1 dynamic range; has a life expectancy in excess of 50×10^6 operations; and has advanced internal solid-state circuitry and components; integrated into an encapsulated package that defies adverse environments.

Below are a few general applications of our Model 16 Logic and Model 17 Latching Relays.

TYPICAL APPLICATIONS

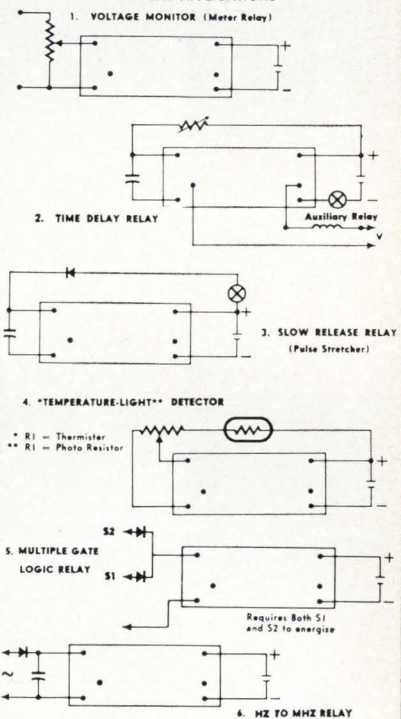

Only \$4.73 in 100 lot quantities. External circuitry can be incorporated into the relay case, on order. Consult us for relay technology to meet individual requirements.

For further information, contact:

SENSITAK[®]
INSTRUMENT CORP.
531 Front Street
Manchester, New Hampshire 03102
(603) 627-1432

Splitting target boosts sputtering speed

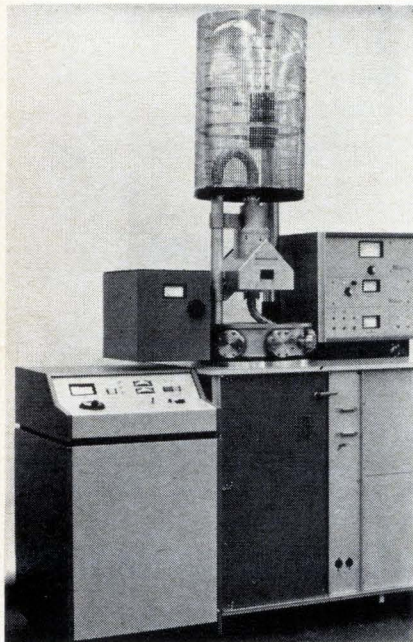

PlasmaPeak deposits uniform films.

Two new radio-frequency diode sputtering systems focus on complementary aspects of thin-film deposition: one system is designed to deposit films of metals and dielectrics at a high rate—400 angstroms of quartz per minute, for example—and the other deposits films that vary in thickness as little as $\pm 4\%$ over a 4 x 4-inch deposition area.

Both systems, the high-rate RF-PlasmaCoil and the high-uniformity PlasmaPeak, were developed by the Vacuum division of Varian Associates. Each incorporates a new design in which the target consists of two plates instead of one.

The PlasmaCoil system operates at pressures as low as 0.2 microns. The lower the pressure, the purer the film, because there is less chance of contamination by the sputtering gas. The r-f field that

ionizes the gas is generated and shaped by a two-turn r-f coil placed horizontally between target and substrate. Two semicircular segments of the material to be deposited form the 8-in.-diameter target.

The r-f coil is biased independently by a control unit that puts out power up to 1.2 kilowatts, at a frequency of 13.56 megahertz. The PlasmaCoil I, which only sputters metals, has an additional 3,000-volt d-c supply to bias the target plates. The PlasmaCoil II, which sputters metals and dielectrics, has a target supply identical to the r-f coil's. Impedance matching networks in the control units can be tuned to compensate for changes in hardware in the sputtering chamber. Cycle times are adjustable up to one hour.

The unusual target design in the PlasmaPeak system gives it its name. The target plates are two 7 x 10-in. rectangles that form a roofed structure. The top is the 90° angle of a right triangle, the hypotenuse of which is parallel to the substrate. Varian tried different

PROBLEM SOLVED / Formica know-

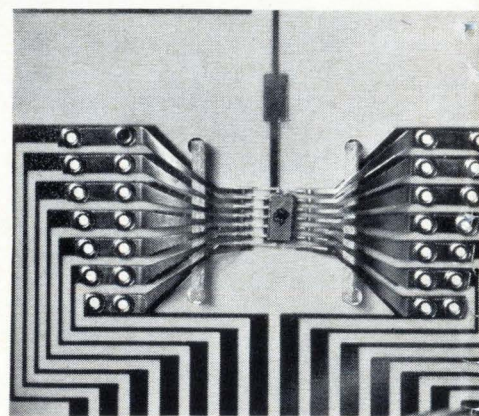

Case #1695-Problem: 4 different copper clad grades were purchased and inventoried, creating multiple paper work, record-keeping. Idea activated: One FORMICA® FR-45 laminate, created to meet NEMA G-10, G-11, FR-4, FR-5.

Case #6520-A-Problem: Pad slippage causing poor registration in production of multi-layer circuitry boards. Idea activated: FORMICA® laminate MLC system created a sandwich with better copper bond strength and registration control at elevated temperatures.

target structures before it found that the 90° peak gave the most uniform films.

Self-bias voltage on the target plates approaches 3,000 volts d-c.

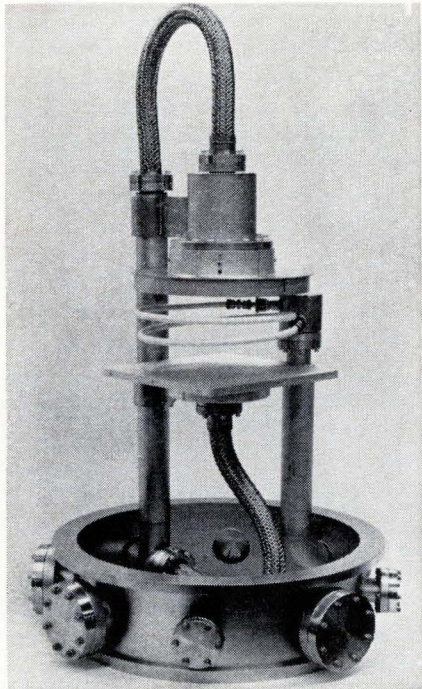

PlasmaCoil deposits films speedily.

The electrostatic field set up by the target plates confines the plasma and the sputtering material, making additional confining coils unnecessary. Pressure ranges from 1.5 to 5 microns.

The usable substrate area is approximately 9 x 9 in. At a deposition rate of 500 angstroms per minute, copper films are uniform to ± 6 over a 6 x 6-in. area in the PlasmaPeak system. The PlasmaCoil system deposits copper at rates up to 1,200 angstroms per minute; copper deposited at 800 angstroms per minute has a thickness uniformity of $\pm 10\%$ over a 6-in.-diameter substrate and $\pm 5\%$ over a 4-in.-diameter substrate. Both systems fit into an 18-in. bell jar and can be cooled by water.

The PlasmaPeak sputtering module can be mounted on a variety of vacuum systems; with its controls, it costs \$10,000. The PlasmaCoil I system costs \$13,000, and the PlasmaCoil II system \$16,000. Delivery after June 15 will take about 30 days.

Varian Associates, 611 Hansen Way, Palo Alto, Calif. 94303. [401]

Tape transfer machine speeds disk coating

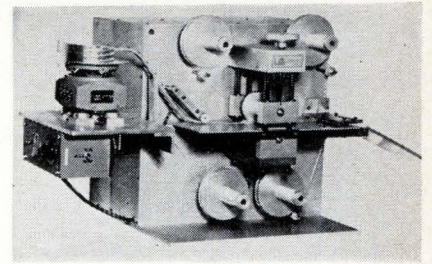

Use of a new tape transfer machine substantially reduces the cost of metalizing thermistors, capacitors, and piezoelectrics by simultaneously coating both sides of a ceramic disk with silver transfer tape.

Precise control over coating thickness and density results in a higher-quality metalizing bond and eliminates the need for outside-diameter grinding.

Coating rates reach up to 8,000 parts per hour. It is estimated that the cost of coating a $\frac{3}{16}$ -in.-diameter disk can be reduced by 75% with the machine.

Vitta Corp., Wilton, Conn. [402]

how activates ideas!

If your problem is printed circuit boards, call us. Continuing innovations at Formica Corporation have created a wide variety of copper clads. One of these could help you!

Small problems in copper clad circuit boards can become big problems in product dependability. Turn those problems into profit and reliability. Call Formica. No one offers as much experience in laminates . . . backed by the research resources of Cyanamid. We make a variety of copper clad grades to solve a variety of problems. Ideas solve problems. Formica know-how activates ideas.

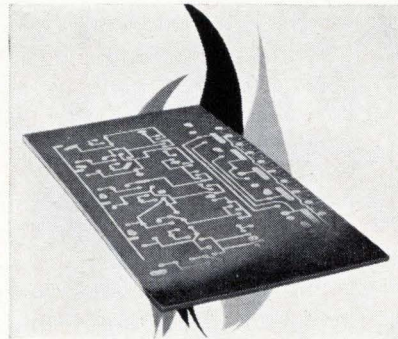

Case #5266-Problem: Flame retardant version of XXXPN-36 required, at no premium price. Idea activated: Flame retardant FORMICA® laminate FR-200 engineered to meet MIL specs, offers high flexural strength, excellent electrical properties.

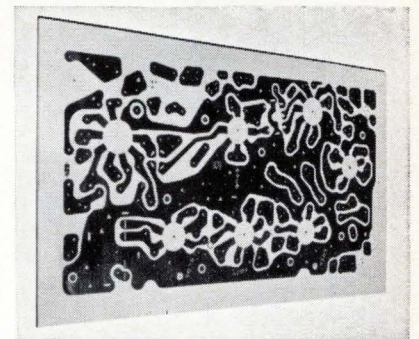

Case #J-9291-Problem: Utility-priced copper clad with quick local delivery required, due to limited inventory space. Idea activated: FORMICA® laminate FF-91 (meets G-10 specs) produced, maintained in Formica regional warehouses for phone-call delivery.

There are other brands of industrial plastics but only one

FORMICA CORPORATION • Cincinnati, Ohio 45232.
Dept. EL 5-7

subsidiary of



Why MARYLAND?

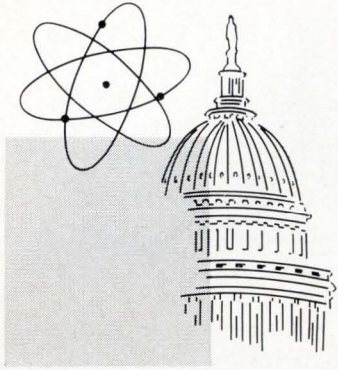

Proximity to federal agencies in Washington, D.C. affords the unique advantage of constant personal contact with government officials working with science-oriented industry. Such contact is an increasingly important locational criterion.

No other state is as convenient to as many Federal agencies as Maryland. For example, Maryland's major government scientific installations include NASA, AEC, NIH, the National Bureau of Standards, plus some 20 others.

Are there other reasons why R&D activities and science-oriented industries should consider locating in MARYLAND?

Yes... emphatically!

The availability of personnel, particularly engineers and scientists, is recognized as a chief criterion governing the location of any science-oriented industry.

There are almost 30,000 scientists and over 25,000 engineers living and working in Maryland and the District of Columbia.

There are 39 four-year colleges and universities in Maryland and the District of Columbia. Graduate and post-doctoral programs considered most significant to research and science industry are available.

Shouldn't you locate in MARYLAND?

Get All The Facts.

MARYLAND DEPARTMENT OF ECONOMIC DEVELOPMENT
DIVISION E

State Office Bldg. • Annapolis, Md. 21404

Write, Wire Or Phone Collect

New Books

Patterns in wiring

Printed Circuits Handbook
Edited by Clyde F. Coombs Jr.
McGraw-Hill Book Co., 563 pp., \$15

Devising a wiring pattern that will interconnect the components to be placed on a printed circuit board is often the easiest part of the design task—one that usually goes to a technician. The difficult job is sorting out the scores of interrelated choices in electrical and mechanical design, laminate and encapsulation materials, etching and plating processes, assembly and soldering methods, testing provisions, and other factors.

The choices are abundantly given in this book, written by men who have obviously been through the mill. They know the design and process pitfalls to avoid, the cures, and the differences between flaws that will affect equipment performance and those that are merely cosmetic. Therefore the book is more than a cookbook compendium, although it does contain directions for all the practical processes in regular use in the industry.

However, the book is not really a handbook. It must be studied before it can be used effectively, at least by the design engineer. This is to be expected because a printed circuit—except for the simplest kinds—is in many ways a complex system.

Some parts of the book are self-contained. Given a design and told what materials to use, the process or manufacturing engineer will have little trouble looking up an appropriate fabrication technique. He can probably find the answer to his specific soldering questions in the five soldering chapters, or follow the directions for spray etching and through-hole plating of a variety of metals in the three fabrication chapters.

But the electrical and mechanical engineers who design the boards and select the materials will have to dig, or depend on feedback from the manufacturing department. Information relevant to design is scattered throughout the book. Current-carrying capacity of solder joints, for example, is discussed in the soldering section, information on

dielectric materials other than the standard laminates shows up in the etching section, and tradeoffs between conductor spacing and the use of insulating coatings is discussed in the chapter which describes those materials. The latter chapter, by the way, fails to concisely summarize the laminate-coating combinations that are most useful before it gets into details, so the amount of digging required is increased.

The location of such information is an editor's choice, since it is relevant to process and materials selection. However, it would help the designer if the editor had given the locations, or summaries of the information, in the design chapters, or had provided a more thorough index. This is an aggravating, but relatively minor shortcoming that is offset by the fact that the book is comprehensive enough to contain the information. Multilayer boards as well as conventional etched and plated boards are covered, and the design checklist and listings of tradeoffs between techniques are well done.

George Sideris
Associate managing editor

Solid information

Solid-State Electronics
Shyh Wang
McGraw-Hill Book Co., 778 pp., \$15.50

Most engineers are familiar with the olive green books which are part of McGraw-Hill's international series in pure and applied physics, so little need be said about the general format and presentation level of the latest addition to the series. This volume deals with the conductive, dielectric, magnetic, and optical properties of materials basic to modern solid state devices.

Although the book would be valuable as a course text at various levels, its usefulness is limited for self-study or engineering purposes. A work of reduced scope with more repetition of principles and illustrations might better satisfy these needs.

The material is well organized and nearly complete, as of 1965. Notably absent are discussions of

SMALL COMPANY

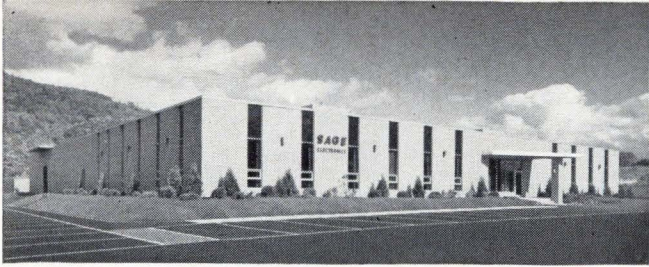

BIG PERFORMANCE



Why knock yourself out when your customer keeps scoring your performance at zero? It makes sense at Sage Electronics, especially when that score is another Zero Defects citation, as evidenced by the examples above.

We are specialists in MINIATURE POWER RESISTOR products. Accordingly SAGE pursues active programs second to none in respect to:

1. Zero Defects
2. High Reliability
3. MIL spec production and test
4. High volume commercial production

Look us over, first by exploring SAGE Catalog R-66. A phone or letter request will promptly bring your copy.



SAGE

SEE OUR SPECIFICATIONS IN
VSMF
THE MICROFILM CATALOG FILE

SAGE ELECTRONICS CORP.

BOX 3926 ROCHESTER, N. Y. 14610

Phone: (716) 586-8010

MSC Series 10E...the lighted pushbutton switch for reliable answers to your toughest control panel design problems!

The MSC Series 10E Twist-Lite® switch unit features four-lamp operation with individual color control for optimum visibility at any ambient light level, versatile lens configurations ranging from full to 4-way split display, internally bussed circuits to reduce wiring, and a positive hardmount without extra hardware. Add the optional features developed to solve critical electrical and environmental problems and the twist/lock design for safe relamping, legend or color filter change from the panel front...without tools...and you'll see why the Series 10E has become the preferred switch for the finest aerospace and industrial control systems. Write and ask for an operating demonstration in your office, or **SEND FOR CATALOG 2000 TODAY!**

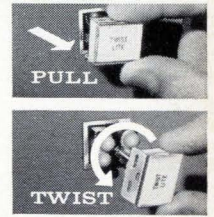

RELAMP WITHOUT TOOLS!
Easily done without fear of accidental switch actuation.

OPTIONAL DRIP-PROOF SEAL
... blocks passage of foreign matter through panel cutout.

OPTIONAL RFI SCREEN
... inhibits radiated and conducted RFI passage through panel cutout.

OPTIONAL SWITCH-GUARD
... prevents accidental switch actuation.

SNAP-ON MASTER TEST CONTROL CAPSULES
Permits lamp verification tests without external circuitry.

INTERNALLY BUSSED COMMON GROUND LAMP CIRCUITS
... reduces wiring time.

SNAP-ON 2PDT or 4PDT SWITCH MODULES
Precision snap-action alternate or momentary modules rated to 5 amps/ 125 or 250VAC.

INTEGRATED MOUNTING SLEEVE
Produces a positive hardmount without brackets or hardware.

FULL TO 4-WAY SPLIT LENS
4-Lamp projected color with individual lamp color control.

Master MSC Specialties Company

25 YEARS IN INFORMATION DISPLAY AND CONTROL DEVICES

Master Specialties Company, 1640 Monrovia, Costa Mesa, Calif. 92627
Telephone (714) 642-2427 • TELEX 6-78433 Offices in Principal Cities.

WITH **KH** ALL SILICON
VARIABLE FILTERS
**YOU GET MORE
THAN ADJUSTABLE
BANDWIDTH!**

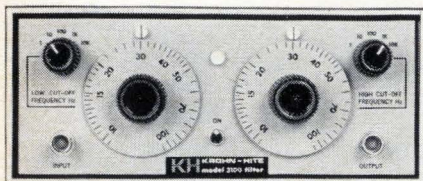

MODEL 3100, one of the new K-H all-silicon Broad Band Variable Electronic Filters providing continuously adjustable bandwidth over the range of 10 Hz to 3 MHz maximum bandwidth.

Frequency- or time-domain filter response is essential for today's complex electronic measurements. You get both, at the flip of a switch in K-H's new line of all-silicon Broad Band variable electronic filters. The frequency-domain characteristics are described, below. Time-domain response is illustrated.

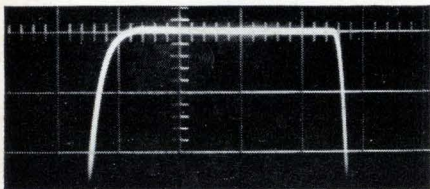

TRANSIENT-FREE RESPONSE to impulse signals demonstrates value of K-H Broad Band Filters for Time-Domain applications.

These responses are typical of the extra value you get from modern Krohn-Hite electronic instruments. Other values increase user confidence further by providing simpler, faster and lower-cost operation.

Frequency-Domain Characteristics: Fourth-order Butterworth with maximal flatness in the passband.

Zero-db Insertion Loss: All silicon amplifiers provide "lossless" passband response. Steep (24 db per octave) attenuation slopes extend to at least 80 db.

90-db Dynamic Range: Low hum and noise (100 microvolts) eliminates costly preamplifiers.

No Impedance Matching Problems: 100 k-ohms input impedance; 50 ohms output impedance (lower when specified).

There's more in K-H Data Sheet 3100/3103.
Write for a copy.

KH KROHN-HITE CORPORATION
580 Massachusetts Avenue, Cambridge, Mass. 02139
Telephone: 617/491-3211

New Books

such recently important principles as the Gunn diode mechanisms, newly observed charge trapping states in mos devices, and the physical processes by which radiation modifies the properties of electronic devices.

A review of modern physics and materials properties is first presented, which brings together many topics that are not found in current texts but are necessary for understanding solid state physics. For example, the author discusses phase equilibria and phase diagrams, and diffusion and alloying effects. Various types of chemical bonds are described, followed by an analysis of crystal structure and its defect state.

The second section covers semiconductor physics and devices. Fundamental concepts such as mobility, diffusion, and effective masses are discussed, with the treatment generalized to 3-5 and 2-6 semiconductors. The author effectively uses a description of tunnel diode properties to provide further insight into fundamental properties of semiconductor band structure.

Of particular interest in the section on magnetic properties is an examination of noise effects in masers, and how coherent effects lead to an extremely low equivalent noise temperature in the maser, as compared with noncoherent radiation emitters and conventional amplifiers. In the chapter on optical properties of solids, techniques are given for laser modulation and the generation of higher frequency harmonics through nonlinear optical effects.

C.G. Thornton

Philco-Ford Corp.
Blue Bell, Pa.

Recently published

Modern Optical Engineering: The Design of Optical Systems, Warren J. Smith, McGraw-Hill Book Co., 476 pp., \$15

The author starts with basics, including a discussion of the eye, and proceeds through prisms, apertures, materials and coatings, and radiometry and photometry. Basic optical devices are briefly described, and there are chapters on computations, image evaluation, and design principles.

another
breakthrough
from
**FRANKLIN
ELECTRONICS**

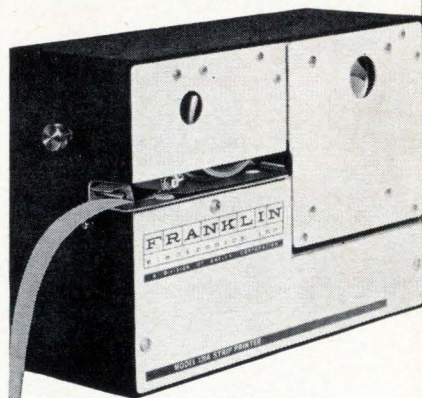

the Model 120A
STRIP PRINTER

- Full alpha-numeric font of 64 characters and numerals.
- 1200 characters per minute.
- Serial entry.
- Impact printing with inked roller option.
- 8 7/8" D x 3" W x 6 1/4" H.
- Less than 5 lbs.
- Front paper exit.
- Less than \$300 w/o electronics, \$500 with.
- Franklin reliability!

SEND FOR
ENG. DATA 3010

FRANKLIN
electronics, inc.

East Fourth St. • Bridgeport, Pa. 19405
A Division of the Anelex Corporation

Audio Amplifier? AC Power Supply?

the Compact
NA Series
gives you
both!

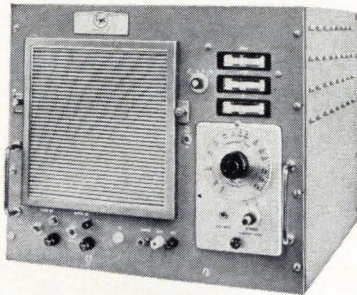

The NA Series of AC Power Supplies are exceptionally flexible sources of audio power. Each power supply consists of a Regulated Audio Power Amplifier with interchangeable fixed or variable Plug-In Oscillators for a wide range of precision AC power

applications. The Amplifier has a full power range of 45-6,000 cycles. With the incorporation of a CML Plug-In Oscillator precise fixed or adjustable output frequencies are available anywhere within this range. For complete information, write today.

CML, Inc. 

A subsidiary of Tenney Engineering, Inc.
350 Leland Avenue • Plainfield, New Jersey
(201) 754-5502 • TWX: 201-756-2064

60

Circle 214 on reader service card

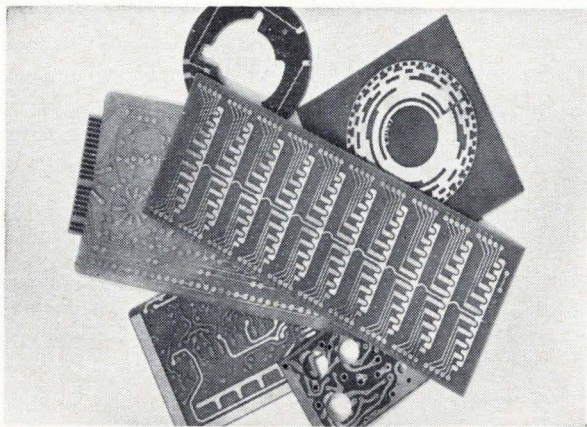

NEW lower-cost, epoxy flame-retardant copper-clad laminate

In response to the demand for a more economical epoxy grade of laminated plastic, Synthane now offers new grade FR-16.

FR-16 is reinforced with a random-oriented glass fiber mat which, because it can be produced on a modified paper machine, costs less than fabric reinforcements used in other flame-retardant grades.

FR-16 is excellent for printed circuits. It is mechanically strong, moisture-resistant, has a low dielectric loss and a high dielectric breakdown. Write Synthane Corporation, 36 River Road for the FR-16 Engineering Data Bulletin.

SYNTHANE

CORPORATION  OAKS, PA. 19456

Laminated Plastic Sheets, Rods, Tubes and Fabricated Parts

Circle 215 on reader service card

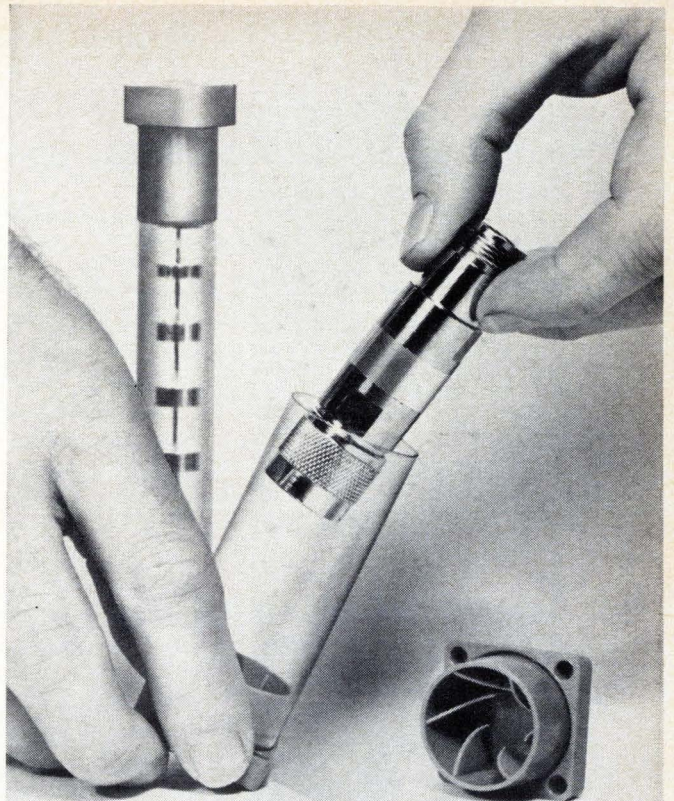

"NEW SHOCKPROOF PACKAGE GIVES US BIG SAVINGS"

That's what leading electronic component makers are saying about the Tiros System. People like Sage Laboratories and Ad-Yu Electronics have found the unique Tiros package to be perfect for delicate, expensive microwave hardware. Key to the effectiveness of the Tiros package is the specially designed injection-molded end caps with integral fins that grip the end of the enclosed part tightly. If the container is dropped, shock is absorbed by the end closures and dissipated over the surface of their rims. The end closures can be color matched and coded. Tiros is also offering a cutting machine for customers wishing to produce their own package lengths. Using the machine, standard 6-foot lengths of tubing can be quickly and economically cut into specified lengths. This solves the problem of having to maintain large inventories of various size packages. Tubing is available with outside diameters of from 1/4 inch to 1 1/4 inches. End closures come with corresponding outside diameters. Write for full details and our new folder. TIROS PLASTICS CORPORATION, 543 Tarrytown Road

• White Plains, N. Y. • 10607
• 914- WH 8-5457.

TIROS®

NEW! CUSTOM-ENGINEERED DIELECTRIC SLEEVES

Want to insulate an active component properly, economically and with an absolute seal? — We can do . . . with a custom-extruded dielectric sleeve! Ask us for details.



Circle 153 on reader service card

153

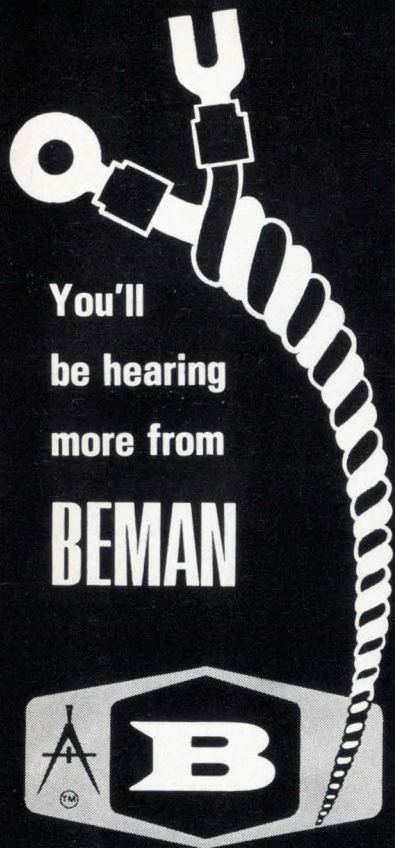

Already there is much favorable comment regarding this alert and aggressive company, a vigorous offspring of our dynamic electronic age, founded in 1961. Industry leaders are entrusting Beman with important assignments in cable and termination manufacture, custom molding and die stamping, and various types of electrical and mechanical assembly work. There is also a growing demand for the creative capabilities displayed by Beman's versatile designers and engineers. A modern, new engineering facility is strategically located in Harrisburg, a few miles from the main plant.

QUALITY, DEPENDABILITY, INGENUITY

Whether asked to follow iron-clad specifications, or to work from scratch on an outline of new requirements, Beman is vitally aware of its responsibilities. Research and development talents are applied to a customer's project with the same all-out effort that is put into one of Beman's own original products. Perhaps your company can benefit from the specialized training and experience which are carrying Beman forward. An illustrated brochure just off the press will be mailed on request. Beman is able ... and ready ... to serve you.



BEMAN MFG., INC.

P. O. Box 370 New Cumberland, Pa., 17070
Phone: (717) 774-0210

Technical Abstracts

Focusing on holograms

Image processing with nonlinear optics
H.J. Gerritsen, E.G. Ramberg, and
S. Freeman
RCA Laboratories, Princeton, N.J.

Because conventional photosensitive plates have to be processed, instantaneous real-time viewing of holograms had been impossible. But by substituting a thin-film liquid dielectric for photographic film, an instantaneous, or transitory, hologram can be produced. Applications are likely in image intensification, three-dimensional magnification, and frequency conversion.

The liquid dielectric, a concentrated alcoholic solution of cryptocyanine injected between two mica sheets, transmits light in direct relation to its intensity. The interference pattern formed by the object and reference beams produces variations in the dielectric's opacity. This pattern—the hologram—is the same as the one that would be produced on photographic film. The liquid hologram requires no developing and persists as long as the light beams are on. With the dielectric method, two reconstructed three-dimensional images of the object are produced simultaneously.

Frequency conversion can easily be accomplished. An image can instantaneously be reconstructed with a third light beam from another laser generating a different frequency. For example, the light used to form the hologram can be in the far infrared region while the light used for viewing can be in the visible range. Magnification of the image is proportional to the ratio of the beam wavelengths used for generation and viewing.

Another way to change the wavelength, not involving transitory holograms, is to place a thick nonlinear material capable of doubling the optical frequency directly in the path of a reconstructed object beam.

For example, a hologram of a transparency was made in a thin layer of Kodak Orthoresist using the 0.5145 (green) line of an argon

laser. The hologram was placed in the beam of a pulsed neodymium laser that produced a 1.06-micron pulse. A clear infrared image approximately twice the size of the green transparency was obtained. The infrared image beam then was passed through an 8-millimeter-long lithium niobate crystal that converted the infrared back into a green image magnified by two times the ratio of the neodymium and argon laser wavelengths.

Presented at the Polytechnic Institute of Brooklyn Symposium on Modern Optics, New York, March 22-24.

Overstress

The application of overstress testing-to-failure to airborne electronics; status report
J. J. Bussolini
Grumman Aircraft Engineering Corp.
Bethpage, N.Y.

Electronic component manufacturers have for some time utilized test-to-failure techniques to establish reliability levels. But whether real benefits in reliability are derived from the application of overstress testing to the design and development of electronic equipment and systems is debatable. The controversy continues because there is little proof, in the form of test data, that the technique does work.

However, there are several examples where overstress testing of equipment helped achieve design reliability.

One case, the testing of an electromechanical servo, showed how step-stress testing could be utilized as a design tool. The result of the testing was to modify the equipment's design so that it met specifications. Another example illustrated how the technique could be used as a means of selecting an equipment supplier from several competing manufacturers. A third example, step-stress testing of a production sample of an airborne power supply, demonstrated how the test technique improved reliability evaluation.

Presented at the IEEE Convention, New York, March 20-23

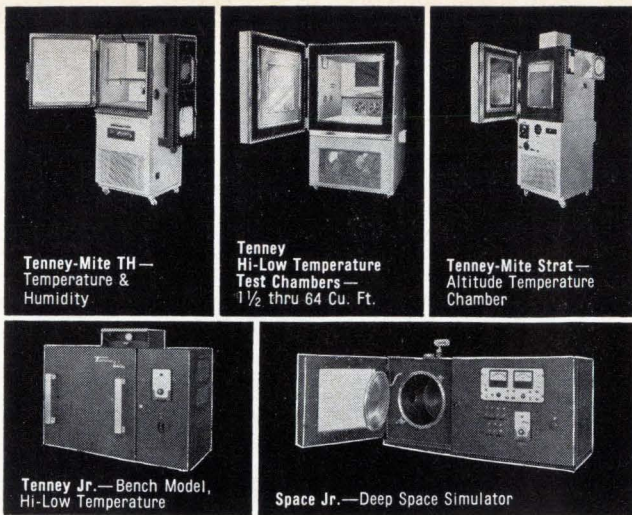

Tenney-Mite TH—
Temperature &
Humidity

Tenney
Hi-Low Temperature
Test Chambers—
1½ thru 64 Cu. Ft.

Tenney-Mite Strat—
Altitude Temperature
Chamber

Tenney Jr.—Bench Model,
Hi-Low Temperature

Space Jr.—Deep Space Simulator

Special Order?

Not at Tenney... These are production run environmental test chambers. Standard, off-the-shelf units ready for immediate delivery. Choose a model best suited for your applications... the cost is lower than you think. Need more information? Write today!



Tenney
ENGINEERING, INC.

1080 Springfield Road, Union, New Jersey • (201) MUrdock 6-7870
Western Div.: 15700 S. Garfield Ave. • Paramount, Calif. 90723

Circle 216 on reader service card

There's a lot to recommend the Tung-Sol Digital Readout for your Application

KNOWLEDGEABILITY—An ideal combination of readout characteristics is based on Tung-Sol's more than sixty years of low-current lamp making experience.

CAPABILITY—Tung-Sol is thoroughly experienced in the production of top quality electrical/electronic components to highest performance requirements.

RELIABILITY—Statistical quality control procedures enable Tung-Sol to maintain volume output to quality standards normally associated with laboratory production.

CREATE-ABILITY—Tung-Sol design engineers have exceptional freedom to explore the solution to a customer's problem. The result is reflected in economy as well as performance.

AVAILABILITY—Wide national representation provides engineering consultation on a local basis. National distribution assures dependable back-up of customers production schedules.

Now let us tell you about the product. Write for complete information about this exceptional digital readout. Tung-Sol Division, Wagner Electric Corporation, One Summer Avenue, Newark, N.J. 07104. TWX: 710-995-4607.



TUNG-SOL®
HI-OPTICS
DIGITAL READOUT

The most thoroughly engineered
readout on the market

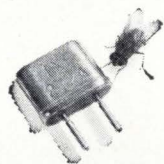

NOW,

IXF integrated crystal filters at HF-VHF

The IXF,® utilizing the acoustical coupling principle, brings new dimensions to receiver IF and RF filtering. Each IXF provides inexpensive, compact filtering for a variety of applications.

Check these features of Model 272A:

- Center frequency, 112 MHz
- Band width, 20 kHz at 3 db
- 2-pole response characteristic
- Stop band attenuation, 25 db min.
- Midband insertion loss less than 2 db
- Units can be operated in tandem for increased attenuation

Other models available at 10.7 MHz, 21.4 MHz, 70 MHz, and other center frequencies up to 210 MHz. Immediate delivery of model 272A in 1-9 quantity for \$35 each. For complete information write:

S. M. Kaplan, Marketing Manager

PIEZO TECHNOLOGY, INC.

2400 Diversified Way, Orlando, Fla., (305) 425-1574

Circle 217 on reader service card

Circle 155 on reader service card

155

ELGENCO Noise Generators



Model 610A

SOLID STATE NOISE GENERATORS

Model 602A 5 cps to 5 mc, 3 Ranges \$ 290
Model 603A 5cps to 5 mc, 3 Ranges \$ 495
Model 610A 5 cps to 5 mc, 8 Ranges \$1,175
Series 624 (Fixed frequency) 5 cps to 500 kc \$245 to \$490. Write for details on frequency ranges and spectral flatness.



Model 312A

VACUUM TUBE NOISE GENERATORS

Model 301A DC to 40 cps \$1,995
Model 311A Two outputs DC to 40 cps and 10 cps to 20 kc. \$2,395
Model 312A Two outputs DC to 120 cps and 10 cps to 20 kc. \$2,495
Model 321A DC to 120 cps. \$2,095
Model 331A 10 cps to 20 kc. \$1,275

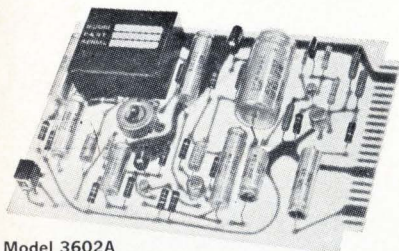

Model 3602A

NOISE GENERATOR CARDS

Series 3602, 3603, and 3606 \$144 to \$389
 Various frequency ranges and output flatness available. Size: 4½" x 6½" x 1". Write for details.

ENCAPSULATED NOISE SOURCE MODULES

Series 1602, 1603, and 1606. \$95 to \$340
 Various frequency ranges and output flatness available. Size: 1¾" x 1½" x ¾". Write for details.

ELGENCO INCORPORATED



1550 Euclid Street
 Santa Monica, California
 Phone: (213) 451-1635
 TWX: (213) 879-0091

DEMONSTRATOR MODELS AVAILABLE
 See EEM or write for name of nearest Rep.

New Literature

Mercury film relay. Fifth Dimension Inc., P.O. Box 483, Princeton, N.J. Technical Bulletin No. 1001 describes the series D Logcell, a mercury film relay that can be driven directly from integrated circuitry.
 Circle 420 on reader service card.

Printed circuits. Industrial Circuits Co., 23 Kulick Rd., Fairfield, N.J. Techniques for the design and production of printed circuits and assemblies for high reliability applications are detailed in "Quality by Design," a 16-page technical booklet. [421]

Piezoelectric accelerometer. Columbia Research Laboratories, MacDade Boulevard and Bullens Lane, Woodlyn, Pa. Bulletin No. 612-TX discusses a micro-miniature, triaxial piezoelectric accelerometer. [422]

Miniature relays. Electro-Tec Corp., P.O. Box 667, Ormond Beach, Fla. 32074, has prepared a brochure detailing the capabilities and characteristics of the Mark II series 400 and series 410 miniature dpdt relays. [423]

Silicon photocells. Sensor Technology Inc., 7118 Gerald Ave., Van Nuys, Calif. 91406. A four-page brochure discusses silicon photocells for readout assemblies. [424]

Thermocouple reference junctions. Scientific Engineering & Manufacturing Co., 11505 Vanowen St., North Hollywood, Calif. 91605, has prepared a catalog sheet on the RJ-5000 series thermocouple reference junctions. [425]

Relays. Potter & Brumfield, Princeton, Ind. A new edition of stock Catalog No. 100 provides data and prices of 60 standard relays in more than 700 different contact arrangements and coil voltages, including recently announced types. [426]

Power aging systems. Micro Instrument Co., 12901 Crenshaw Blvd., Hawthorne, Calif. 90205. A 12-page, color brochure describes component and integrated-circuit power aging systems. [427]

P-c connectors. Elco Corp., Willow Grove, Pa. 19090. A 64-page guide describes and illustrates a wide-ranging line of p-c connectors, enclosures, and installation equipment available. [428]

Rotary stepping switches. Automatic Electric Co., Northlake, Ill. 60164. A 36-page catalog features specifications, application information, and mounting data for a line of rotary-stepping switches. [429]

Heat-shrinkable insulation. 3M Co., 2501 Hudson Road, St. Paul, Minn.

55119. A complete listing of the manufacturer's heat-shrinkable insulation materials is contained in a 12-page brochure, "Scotch Tite Heat Shrinkable Insulation Systems". [430]

Microwave receiver. Sylvania Electronic Systems, P.O. Box 188, Mountain View, Calif. 94042, has published a brochure on a microwave receiver with a yttrium-iron garnet filter that screens out unwanted signals. Copies may be obtained by writing on letterhead stationery.

D-c voltage switch. Betamite Electronic Devices, 6321 W. Slauson Ave., Culver City, Calif. 90230, has issued a specification data sheet on the series RT-120 solid state d-c voltage switch. [431]

Voltage-time integrator. Curtis Instruments Inc., 351 Lexington Ave., Mt. Kisco, N.Y., has available a data sheet on the Model 921 reversible electrochemical voltage-time integrator that uses a capacitive readout technique with analog readout. [432]

Radiation detectors. Westinghouse Electric Corp., Elmira, N.Y. 14902, offers a 12-page, quick reference guide to neutron and gamma radiation detectors. [433]

Laser microwelder. Linde Division, Union Carbide Corp., 270 Park Ave., New York, N.Y. 10017. A six-page brochure (51-852A) illustrates and describes the LWM-1 laser weld miniaturized electronic systems. [434]

Transistor and scr test equipment. Baird-Atomic, 33 University Rd., Cambridge, Mass. 02138, has available a condensed catalog of transistor and scr test equipment. [435]

Wire processing. The A.H. Nilson Machine Co., Shelton, Conn. 06483. Bulletin No. 644 provides information for the electronic production or metalworking requirement for difficult-to-straighten wires in diameters from 0.004 to 0.250 in. [436]

Switching matrix. McKee Automation Corp., 7315 Greenbush Ave., North Hollywood, Calif. 91605. Bulletin SM102A7 deals with a 200-input drawer mount-switching matrix used to select random inputs for testing, ground support, high- and low-level data acquisition, input-output, and communication systems. [437]

Cable strippers. Scientific Engineering & Mfg. Co., 11505 Vanowen St., North Hollywood, Calif. 91605, has issued a bulletin on motorized, portable cable strippers that remove metal sheath from thermocouple materials, high temperature cable, and heating element materials. [438]

generalists design engineers

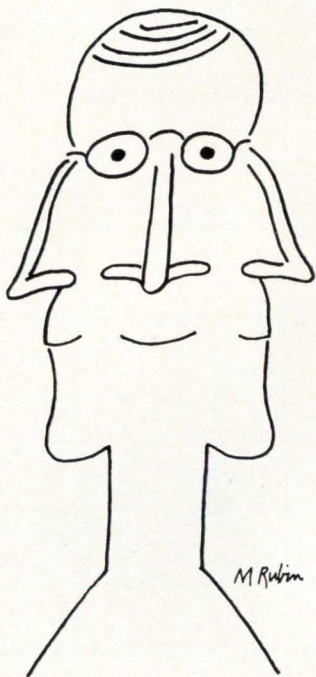

That's what some people call the kind of Engineers we need at RCA Aviation in Los Angeles.

Engineers who can do a start-to-finish job in commercial avionics. Engineers who want to specify, originate, develop, design and consult on the manufacturing and servicing of DME, Transponders, and Weather Radar for our aviation customers.

Not every engineer can — or cares to be — completely responsible and accountable for the tough brand of job we tackle.

If you can — and care to — we make it well worth your while. In terms of both tangibles and intangibles.

If you are interested in circuit design, microwave radar, data acquisition and processing, communications, or mechanical engineering, send your resume to: Fred Dinnsen, Building 1, RCA Aviation Division, 11819 W. Olympic Boulevard, West Los Angeles, Calif. 90064



An Equal Opportunity Employer
**The Most Trusted Name
 in Electronics**

NAVAL ARCHITECT • MARINE • MECHANICAL
 STRUCTURAL • ELECTRICAL • ELECTRONICS
 ARCHITECTURAL • CIVIL

Investigate your opportunities in the world's largest ship-building complex

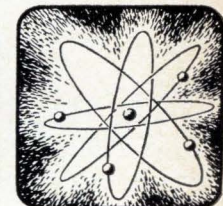
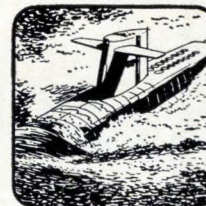

The San Francisco Bay Naval Shipyard provides service to surface and underwater ships and deep submersibles. Assignments include new construction of Polaris nuclear submarines and guided missile frigates; and the repair, overhaul and conversion of all classes of ships. Other projects include research on noise reduction, ASW, replenishment-at-sea, Trieste II and Sea Lab II and III.

Openings exist at all levels in these program areas:

Ship Structure Development

Ship Weight Control

Structural Mechanics

**Nuclear and Conventional
 Propulsion Systems**

**Navigation and Communication
 Systems**

Sound and Vibration Control

**Cargo Replenishment-at-Sea
 Development**

Shipboard Mechanization

Plant Facilities

**Ordnance, Guided Missile, Fleet
 Ballistic Missile and
 Electronic Systems**

**Shipboard Aeronautical Material
 and Equipment**

**Shipboard Electrical and Power
 Systems**

Naval Tactical Data Systems

Job Locations: San Francisco Bay Naval Shipyard has two work sites located 40 miles apart: San Francisco and Vallejo, California. Each location has ready access to the full cultural advantages of San Francisco and the mild year-round climate of the "Bay Area." All types of recreation from ocean surfing to skiing on the slopes of the Sierras are within easy driving distance.

Send your resume or Standard Form 57, Application for Federal Employment, to:

**Coordinator, Professional and Technical Recruitment (Code 174A5)
 Employment Division
 San Francisco Bay Naval Shipyard
 Vallejo, California 94592**

AN EQUAL OPPORTUNITY EMPLOYER

MUST BE A U.S. CITIZEN

engineers

Here is your opportunity to associate with a high calibre staff in its formative state. At our research center in Ithaca we are engaged in exploratory activities in aircraft and ocean instrumentation. Our job is to come up with new ideas and new designs for transducers, modules and sub-systems using the latest techniques and components. We seek the help of talented and resourceful engineers (E.E. & M.E.) having up to ten years applicable experience.

Technical domain of this work will range through... Solid-state applications • Servo-mechanisms • Transducer design • Circuit design • Electromechanical design • Subsystems design & testing • Analog and digital techniques.

This is a real ground floor opportunity. Your opportunity also to live and work in the stimulating atmosphere of Ithaca, the educational, recreational and scenic center of the Finger Lakes region.

Inquiries will be treated in confidence. Send resume to: Mr. R. G. Thrasher, Dept. E

THE BENDIX CORPORATION
FLIGHT & ENGINE INSTRUMENTS DIVISION
 RESEARCH CENTER, CORNELL RESEARCH PARK, ITHACA, N.Y. 14850



An Equal Opportunity Employer

MAY OPENINGS

Cadillac Associates is the nation's largest executive and professional placement service. If you wish to find out your true worth in the electronics field, contact us. Our staff is versed in your particular discipline and can show you the openings now available—coast to coast. Our service is completely confidential and free to the applicant. Here are a few of the many positions now open:

**PHOTOTUBE-CAMERA
 TUBE ENGR.....\$15,000**
 Direct pilot fabrication special purpose tube product line.

DES. RELIABILITY ENGR....\$18,000
 Hvy. exp. in solid state design.

PROJECT ENGINEER.....\$14,000
 Exp. AM/PM intercom-stereo.

DEVELOPMENT ENGINEERS..\$14,000
 Strip-line components. Do adv, D&D.

**SOLID STATE
 MICROWAVE ENGRS.....\$14,000**
 R&D microwave semiconductor devices.

**MECHANICAL
 DESIGN ENGRS.\$14,000**
 3 yrs. exp. in electronic industry.

E. W. MOORE
CADILLAC ASSOCIATES, Inc.
 29 E. Madison Bldg., Chicago, Ill. 60602
 Financial 6-9400

POSITION VACANT

Electronics Technicians—Positions Available in large Mid-Western State University/ Require minimum of one year training in recognized technical school and one year experience/ Starting rate based on background/ Apply Personnel Office, Northern Illinois University, DeKalb, Illinois 60015.

PROFESSIONAL SERVICES

Donald C. Harder., Inc.

Magnetic Component Engineers

Reactors—Transformers—Filters
 Serving the Research Laboratory

2580 K Street, San Diego, Calif. 92102
 Phone (714) 239-8021

THE TREND TOWARD ECONOMY—

The service of the consulting engineer is a real economy. With his knowledge of organization and production problems and his wide and varied experience, he can usually reveal the points of waste and inefficiency that are costing you money and suggest inexpensive means for their elimination.



E.E.'s

For **FEE PAID** positions throughout U.S.

SEND RESUME TODAY

(if none, send coupon for confidential application.)

ATOMIC PERSONNEL, INC.

Suite L, 1518 Walnut St., Phila., Pa.

Experienced Engineers

Working Full Time for You!

Name: _____

Address: _____

City: _____ State: _____

AN EMPLOYMENT AGENCY FOR ALL TECHNICAL FIELDS

YOU'RE H!RED

Do you need electronics engineers or technical management men? Electronics magazine is the way to recruit them. Electronics is designed specifically for the working engineer. 68,000 subscribers and an additional 133,000 pass-along readers turn to it to keep up with their industry. You can find the man that meets your qualifications with an advertisement in the Employment Opportunities Section.

For rates & information write: Electronics, a McGraw-Hill Publication. Classified Advertising Division, Post Office Box 12, New York 10036.

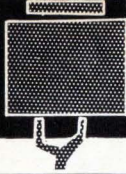

SEARCHLIGHT SECTION

- CLASSIFIED ADVERTISING
- BUSINESS OPPORTUNITIES
- USED OR SURPLUS EQUIPMENT

For Sale

VACUUM METALIZER or COATING SYSTEM

N.R.C. Type 3143B-42301. Chamber size 36" dia. X 6' long complete with diffusion pumps, mechanical pumps, gauges and power supplies. Overall dimensions 19' long, 8' 6" high. Used 3 months.

Also 2 G.E. 5 KW dielectric heaters, 45 megacycles.

INSTRUMENTS & MACHINES, INC.

1200 Grove St. Irvington, N.J. 07111
Telephone: (201) 371-7900

CIRCLE 968 ON READER SERVICE CARD

BIG CATALOG

World's "BEST BUYS" in GOV'T. SURPLUS Electronic Equipment

FULL OF TOP QUALITY ITEMS—Transmitters, Receivers, Power Supplies, Inverters, Microphones, Filters, Meters, Cable, Keys, Phones, Antennas, Chokes, Dynamometers, Blowers, Switches, Test Equipment, Headsets, Amplifiers, etc., etc. SEND 25¢ (stamps or coin) for CATALOG and receive 50¢ CREDIT on your order. Address Dept. E-7.

FAIR RADIO SALES
P.O. Box 1105 • LIMA, OHIO • 45802

SPOT WELDING TWEEZERS



TWI - 36" Lead \$11.65
AC and Stored Energy Power Supplies and Welding Heads

EWALD INSTRUMENTS CORP.
KENT, CONN. 06757

CIRCLE 969 ON READER SERVICE CARD

MINI-FLUID DISPENSER

AIR OPERATED
for miniature potting and encapsulating

Available in 3 sizes
8cc - 12cc - 30cc

PHILIP FISHERMAN COMPANY
7 CAMERON ST., WELLESLEY, MASSACHUSETTS 02181

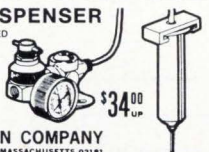

CIRCLE 970 ON READER SERVICE CARD

ELECTRON TUBES

KLYSTRONS • ATR & TR • MAGNETRONS
SUBMINIATURES • C.R.T. • T.W.T. • 5000-6000 SERIES
• SEND FOR NEW CATALOG A2 •
A & A ELECTRONICS CORP.
1063 PERRY ANNEX
WHITTIER, CALIF.
696-7544

CIRCLE 971 ON READER SERVICE CARD

R.U. 1

answering more than advertisement? Then please send a separate reply to each box number. It will help you get an answer sooner.

AUTOTRACK ANTENNA MOUNT

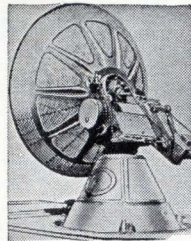

360 degree azimuth, 210 degree elevation sweep with better than 1 mil. accuracy. Missile velocity acceleration and slowing rates. Amplidyne and servo control. Will handle up to 20 ft. dish. Supplied complete with control chassis. In stock—immediate delivery. Used world over by NASA, USAF, MP-61-B. Type SCR-584. Nike Ajax mounts also in stock.

PULSE MODULATORS

MIT MODEL 9 PULSER 1 MW—HARD TUBE
Output 25kv 40 amp. Duty cycle .002. pulse lengths .25 to 2 microsec. Also .5 to 5 microsec. and .1 to .5 microsec. Uses 6C21. Input 115v 60 cycle AC. Mfg. GE. Complete with driver and high voltage power supply. Ref: MIT Rad. Lab. Series, Vol. 5, p. 152.

2 MEGAWATT PULSER
Output 30 kv at 70 amp. Duty cycle .001. Rep rates. 1 microsec 600 pps. 1 or 2 msec 300 pps. Uses 5948 hydrogen thyratron. Input 120/208 VAC 60 cycle. Mfr. GE. Complete with high voltage power supply.

250 KW HARD TUBE PULSER
Output 16 kv 16 amp. Duty cycle .002. Pulses can be coded. Uses 5D21, 715C or 4PR60A. Input 115 v 60 cycle AC \$1900 ea

18 MEGAWATT PULSER
Output 150KV at 120 amps. Rep rate: 50-500 PPS. Pulse length: 5 msec. 15KV 120 amp. into pulse transformer. Rise time 1.5 msec. Filament supply 5V 80 amp. incl. 17.5KV 1.5 amp DC power supply. Input: 220V 60 cycle AC.

VARIAN KLYSTRONS
V-45: .15W output CW 9 to 10 KMC
VA-800: 10 KW output CW 1.7 to 2.4 KMC
VA-806H: 1KW output CW 7.5 to 8.5 KMC
T.W.T.

VA-127C: 5KW Peak, 350 W avg. .87 to 1.0 KMC
RCA-1154: 10 MW output 1.5 to 4.5 KMC
RCA-1161: 1 Watt output 1.9 to 4.1 KMC

SCR 584 AUTOTRACK RADARS
Our 584s in like new condition, ready to go, and in stock for immediate delivery. Ideal for telemetry research and development, missile tracking, satellite tracking. Fully Desc. MIT Rad. Lab. Series. Vol. 1, pps. 207-210, 228, 284-286. Comp. Inst. Bk available \$25.00 each.

MICROWAVE SYSTEMS

L BAND RF PKG.
20 KW peak 990 to 1040 MC. Pulse width .7 to 1.2 micro sec. Rep. rate 180 to 420 pps. Input 115 vac incl. Receiver \$1200

200-225 mc RADAR SYSTEM
1 Megawatt output. 200 nautical mile range for long range detection of medium and high altitude jet aircraft as well as general search. Complete system in stock. Input 120/208 V. 60 cy. Type TFS-28.

C-BAND RADAR
250 KW output. C-band. PPI indicator. 5C22 thyratron modulator. Antenna hi gain parabolic section. Input 115 volts 60 cycle AC. complete \$2750.00

5 MEGAWATT C-BAND
Klystron RF package delivering nominal 5 megawatt pulse RF. Complete with pulser and power supply.

500 KW L BAND RADAR
500 kw 1220-1350 msc. 160 nautical mile search range P.P.I. and A scopes. MTI. thyratron mod 5J26 magnetron. Complete system.

100 KW X BAND RADAR
Complete 100 kw output airborne system with AMTI. 5C22 thyr. mod. 4J52 magnetron. PPI. 360 deg as sweep. 60 deg. elev. sweep, gyro stabilizer, hi-gain revr. Complete with all plugs and cables.

AN/GPG-1 SKY-SWEEP TRACKER

3 cm. automatic tracking radar system. Complete package with indicator system. Full target acquisition and automatic tracking. Input 115 volts 60 cycle New. In stock for immediate delivery. Entire System 4' long, 3' wide, 10" high. Ideal for Infrared Tracker, Drone Tracker, Missile Tracker. R. & D.

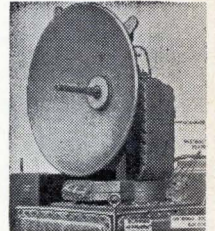

500KW S BAND RADAR
250 miles search 115V 60 cycle AC. Mfg. G.E.

RADAR AUTO-TRACK & TELEMETRY ANTENNA PULSER: A1 S 3 & 10 CM. SCR 584 AUTOTRACK RADAR. M-3 RADAR TPS-1D SEARCH. APS-45 TPS-10D HT. FINDERS. WX RADARS. FPN-32GCA. APS-10 APS-15B APS-27 (AMTI) SEARCH. APN-102 DOPPLER. DOZENS MORE. CARCINOTRONS. PPN'S. 25-51-2-3-6 MEGAWATT PULSE MODULATORS. CAVITIES. PULSE TRANSFORMERS. IF STRIPS. WAVEGUIDE. BENDS 200 MC. 1 KMC. 3 KMC. 6 KMC. 9 KMC. 24 KMC. RF PKGS.
RADIO RESEARCH INSTRUMENT CO.
550 5TH AVE., NEW YORK 36, N. Y. JU 6-4691

CIRCLE 967 ON READER SERVICE CARD

SEARCHLIGHT EQUIPMENT LOCATING SERVICE

No cost or obligation

This service is designed to help you, the reader of Searchlight Section, to locate used or rebuilt equipment not currently advertised.

How to use: Check the ads in this Searchlight Section, to see if what you want is advertised. If not, print clearly the specifications of the equipment and/or components wanted on the coupon below, or on your own letterhead.

This is a service to our readers. This publication does not buy, sell or stock equipment or materials of any type. Your

requirements will be brought promptly to the attention of the used equipment dealers advertising in this section. You will receive replies directly from them.

Obviously, the list of such advertisers is limited by comparison with the over 68,000 subscribers to Electronics, all directly engaged in the electronics industry. A small 'Equipment Wanted' advertisement in the Searchlight Section will bring your needs to the attention of ALL who read Electronics. The cost is low... just \$28.75 per advertising inch— $\frac{7}{8}$ "x2-3/16".

Electronics, Searchlight Equipment Locating Service, P.O. Box 12, New York 10036

Please help us locate the following used equipment:

Name	Title	Company
Street	City	State
		Zip Code

Need a filter that is miniature in size and off-the-shelf?

With the new EG&G-Guillemin Minactor[®] you can make your own active filter... simply by adding a few external components and tuning to the frequency and Q that you require.

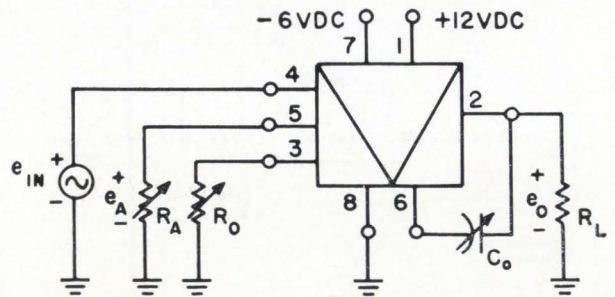
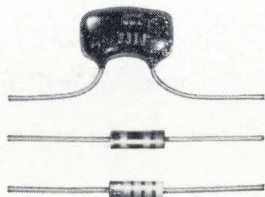
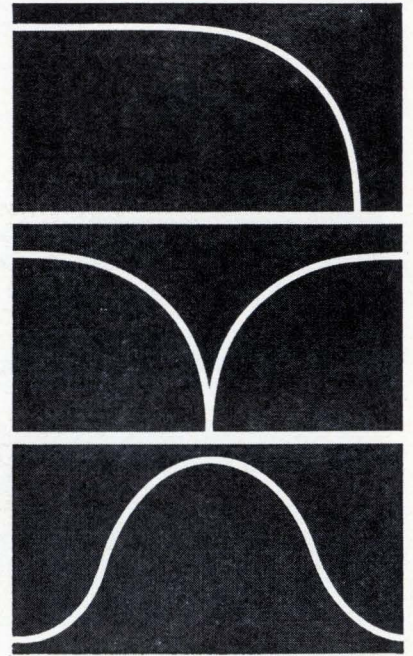

CONNECTION DIAGRAM FOR SINGLE STAGE MINACTOR

This one, off-the-shelf component . . . the Minactor . . . provides 75% of the total active filter synthesis. Other applications include: Low Frequency Oscillators; Low Frequency AGC Circuits; Low Frequency F.M. Modulators; and Low Frequency F.M. Discriminators. With it, you can have your own active filter

capability or you can take advantage of our service by sending specifications for a custom quote. Either way, introduction of the Minactor is going to save you time and money. EG&G, Incorporated, Products Division, 166 Brookline Avenue, Boston, Massachusetts 02215.



Newsletter from Abroad

May 1, 1967

Soviet space effort delayed year at most by Soyuz 1 crash

Last week's test flight of the Soyuz 1 spacecraft that ended with the death of cosmonaut Vladimir Komarov apparently will set back the Soviet Union's space program by 12 months at most. Some experts feel the delay may turn out to be only a few weeks if the third-generation spacecraft, which apparently tumbled during reentry and tangled its parachute lines, doesn't need extensive redesign.

Basis of this estimate is the 25-month lull between the last second-generation Voshkod manned flight and the Soyuz launching. During this period, the Soviets readied the boosters and spacecraft for manned two-stage moon shots and the control techniques for docking and steering. **Although the Soyuz vehicle will have to be retested and possibly reworked, other kingpin hardware for the program can be kept on schedule.** The Soviets still have to make manned test flights of the heavier Proton spacecraft and proving flights of a new lunar rocket.

Singapore woos electronic firms

The tiny Republic of Singapore has launched a drive to lure foreign industry—and particularly electronics firms—into its labor-rich economy.

Along with rock-bottom labor costs—about 18 cents an hour for an unskilled worker—the island country's economic development board is offering companies a five-year tax holiday, a new industrial park, and the promise of a pool of trained workers. **The development board plans to have a training center for electronics workers in operation early next year.**

Singapore opened an investment promotion center in New York City last week. **But the first major electronics company likely to make the swing to Singapore is Plessey Pacific Ltd.,** the Australian holding company for Britain's Plessey group. Plessey Pacific now is considering shifting the capacitor production of one of its units from Australia to Singapore.

Thorn set for color with transistor tv

Thorn Electrical Industries Ltd. looks like the early favorite in Britain's color-tv sweepstakes.

The firm this week will introduce a fully transistorized 25-inch color set that should give the company an edge over its competitors; **the other major British producers have readied hybrid sets for the debut of color tv.** A limited schedule of colorcasts will start in Britain in July; in December, the British Broadcasting Corp. will begin broadcasting a "full" color schedule—15 to 20 hours weekly.

Thorn's 25-inch set has 90 transistors mounted, along with associated passive components, on 17 plug-in circuit boards. Price of the transistorized set will range from \$870 to \$970, depending on the cabinet. The hybrid sets announced by other producers are priced about the same.

Japan to boost plant outlays

The high-riding Japanese electronics industry is set for a solid upsurge in capital investment during the current fiscal year, which started last month. **Plant investment plans filed with the Ministry of International Trade and Industry point to a total outlay of \$186 million, up 40% over last year's \$133 million.**

Bulk of the spending will go to step up production capacity for inte-

Newsletter from Abroad

grated circuits, color-tv sets, computers, and heavily-exported consumer products like radios and tape recorders.

For integrated circuits alone, \$20.3 million has been earmarked, compared to only \$5.3 million last year. Another sector due for a plant-investment spurt is radios, where spending will more than double to reach \$4.7 million for the year. Video tape recorder producers plan to leap forward by pouring \$3.3 million into new production facilities, more than 10 times last year's figure.

The only major segment of the industry in for a slowdown in plant investment is electron tubes. Largely because of heavy 1966 investments in color-tube production facilities, tube makers' outlays for new plant will slip off about \$2.4 million from last year's \$21 million.

Jodrell Bank may get larger telescope

A radio telescope with a 400-foot antenna dish may be in the offing for Britain's Jodrell Bank radio observatory, whose existing 250-foot dish currently ranks as the world's largest fully steerable antenna.

Feasibility studies of the big dish will be completed by the end of the year. It would take three or four years—and cost about \$12 million—to build the new radio telescope.

Britain's Science Research Council financed the preliminary studies "without any commitment that a larger antenna should be built." But Sir Bernard Lovell, who heads the observatory, says he's optimistic about chances for the big dish.

Even with a 400-foot dish, Jodrell Bank quite likely will lose its first-place spot among the world's radio observatories. Next month, the Cambridge Radio Observatory Committee will submit to the U.S. National Science Foundation a detailed proposal for a 450-foot radio telescope to be sited in New England. As with the British project, funds haven't yet been earmarked for the Camroc facility; the preliminary studies were financed by the National Science Foundation.

Alps and Motorola team up to produce tape decks in Japan

Eight-track stereo tape decks destined for 1968 models of U.S. autos will start coming off the assembly line of Alps Electric Co.'s Yokohama plant next month.

Alps will assemble the decks—initially from knocked-down kits imported from the U.S.—under a joint-venture deal with Motorola Inc. The Alps-Motorola target at the moment is a monthly output of 20,000 units by the end of the year.

At the outset, the Yokohama plant's tape-deck production will go to Motorola for sale as original equipment to U.S. auto makers. Later, the joint company will expand into other export markets and may add auto radios to its line. Alps, which holds a 60% share in the venture, expects the joint company will have sales of \$50 million during the next five years.

Addenda

La Radiotechnique, a leading French tv concern, will price its first color sets at \$1,000. . . . Despite objections by the U.S., the British government has okayed the sale by International Computers & Tabulators Ltd. of two medium-size computers to Red China for banking and rationing.

Canada

Pole watchers

Despite seasonal interest in the permanent address of Santa Claus, the exact location of the North Pole is still known only within hundreds of miles.

An attempt to pinpoint the location is one goal of a Canadian-U.S. expedition that this summer will seek data on geophysical conditions in the North polar regions. The studies, directed by Canada's Dominion Observatory, are also expected to produce new information on ocean currents under the polar ice, water density, temperatures, and gravity.

Under the ice. In the pole-finding experiment, an 80-pound acoustic transponder built by Ocean Research Equipment Inc. of Falmouth, Mass., will be dropped through the polar ice cap about 13,000 feet to the sea bottom at the computed North Pole. The transponder, a sonar equivalent of a radar beacon, transmits range and bearing data when interrogated.

Two holes will be drilled in the ice at different angles from the transponder hole and acoustic signals will be directed at the transponder through these holes. A record of the response signals will help define the precise location of the device. By combining this information with data from optical sightings of the sun and stars, the scientists hope to refine their knowledge of the location of the pole.

This may lead to improved navigation and weather-forecasting techniques. Also, since gravity varies from the equator to the pole, exact location of the pole will make gravity measurements more meaningful and will improve scientists' knowledge of the earth's shape.

If the transponder performs as expected, the scientists say, it could be the forerunner of a series of markers planted in the seas for the benefit of surface and air navigators.

The explorers. The expedition, which will take off from the Canadian-U.S. weather station on Alert Bay in the Canadian Northwest Territory, will be headed by J. R. Weber of the Dominion Observatory staff. Included in the group will be E. R. Roots, director of Canada's polar shelf project, who has been working for several years on studies of the Arctic Ocean; R. L. Lillestrand, a staff researcher at Control Data Corp., Minneapolis, and a specialist in solar and stellar navigation [*Electronics*, March 21, 1966, p. 115]; Axel Geiger of Canada's Geodetic Survey; Robert Iverson, a Washington geophysicist; and Michael D. Pearlman, the designer of the transponder.

France

Beefing up Bull

The General Electric Co. is backing its assertions of support for its French operation with money. The U.S. firm proposes to increase the capitalization of 50%-owned Machines Bull by \$30 million, of which it would provide half and its French partners the rest.

Officials at GE say French Finance Minister Michel Debré is reluctant to see a further expansion of the concern's holding in Bull, but may have to allow it if not enough francs turn up. GE has repeatedly voiced its determination to win a substantial share of the fast-growing foreign computer market, and its plans to increase its stake in Bull may silence the barrage of rumors in the French press about a weakening of this resolve

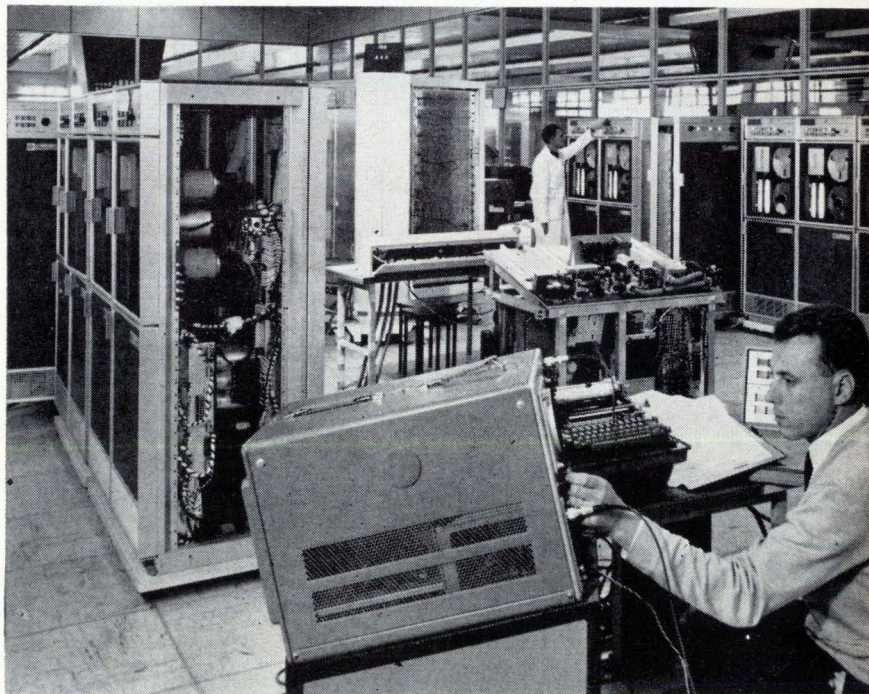

Bull-GE computer undergoes test in production area of French plant. General Electric is seeking a \$30 million increase in the firm's capitalization.

[Electronics, April 3, p. 163].

The French government is less fearful of U.S. domination of the local computer industry than it was three years ago because of the launching of its Plan-Calcul, a state-industrial effort to build an all-French computer company. Government officials and organizers of Compagnie Internationale pour l'Informatique (CII) signed an agreement April 13 under which the state will put up \$84 million for the development of the new computers.

Leasing problems. GE says the primary reason for increasing Bull-GE's capital is the company's heavy commitment to leased equipment. It blamed this commitment for its January decision to drop the French company's newest computer line, the French-designed Gamma 140-145.

The company also clearly wants to be in the strongest possible position to deliver computers to Robert Galley, the French computer czar who heads Plan-Calcul and who will coordinate purchases of data-processing equipment by government agencies.

At the Plan-Calcul contract signing, Galley declared: "We don't want to make of CII a company with a protected market, but I have a large preference for machines made on French soil." He noted, however, that even U.S.-controlled firms in France provide work for Frenchmen and, by exporting, strengthen the country's foreign trade balance.

Great Britain

Selling in the Red

Faced with stiff competition in Western Europe, British firms have turned to the East as an outlet for their computers. Both the English Electric Co. and International Computers & Tabulators Ltd. have clinched large contracts in the last month and the outlook appears to be even more promising.

English Electric sold one of its System 4-50 computers, priced

about \$1 million, to Yugoslavia. ICR has agreed to sell two 1900 series machines to Czechoslovakia's mining authorities for a shade over \$1 million.

Czech sales. Pending, says English Electric, is another 4-50 sale, to the Czechoslovak steel works. The firm has already sold \$5.5 million worth of computers to the Czechs. In recent weeks the company has conducted talks with other Iron Curtain nations—including the Soviet Union, Poland, Rumania, Bulgaria, East Germany, and Yugoslavia—at its London headquarters.

"We see Eastern Europe as a wide open market," said a company spokesman, "where the competitors we face in Western Europe are less well entrenched."

ICR is further advanced in its Soviet bloc operations, having sold 12 machines worth more than \$10 million in the last 18 months.

Australia

Posthaste

"I hope we aren't going to criticize something that is going to have a great export potential," cautioned Australian Postmaster General Alan Hulme after seeing the automated Sydney Mail Exchange in action. It is Australia's largest post office.

Hulme was voicing concern over reports of mutilated letters, heard soon after the system went into operation. Similar incidents have occurred in the U.S. and other countries experimenting with mechanized handling of mail. Australian Post Office officials say many problems are being ironed out in the test phase and the system is gradually working up to a full-capacity production load. It is now processing 600,000 letters a day out of the 2.2 million pieces of mail going through the Sydney post office, located in the Redfern section of the city.

G.H. Dout, managing director of Plessey Pacific Ltd., developer of the electronic sorting machine, says the company "is starting a strong

export drive. We are in the process of advanced discussions with the U.S., Holland, Brazil, and the Soviet Union."

Scanning and coding. It's unlikely, however, that the letter-sorting part of the system will reach an advanced stage of discussion with U.S. postal officials. The Australian and U.S. approaches differ fundamentally.

The U.S. Post Office has decided to go with optical scanning for sorting. An optical scanner has been under test for several months in Detroit, and a second unit was delivered last month. With this method, the sender does the coding when he writes an address and zip code number on the envelope. The optical scanner identifies the destination and sends the letter along to the proper bin. The technique is limited to recognition of typed and printed destinations.

In the Redfern system, a five-bit code marking, visible only under ultraviolet light, is put on each letter, and that coding determines the routing of the letter along conveyor channels to bundling stations.

Unsorted letters are sent to coding machines at high speed by a stream-feed conveyor, and are picked off one at a time for presentation to an operator at one of 150 coding positions.

The operator presses a combination of keys to code the back of the letter with a series of bars. Under control of a data-processing system called a register translator, the coded letters then go into one of 30 primary routing channels. At capacity, several hundred operators could have simultaneous access to the translator, and sorting instructions for more than 15,000 destinations could be stored in the system's magnetic drum.

At one of the decoding machines, farther along in the sorting process, the luminescent code on the letter is detected by photomultiplier tubes that signal a further diversion into sorting channels. These decoders are self-contained and don't require access to the register translator.

The codes on the letters provide for up to three separate sorting

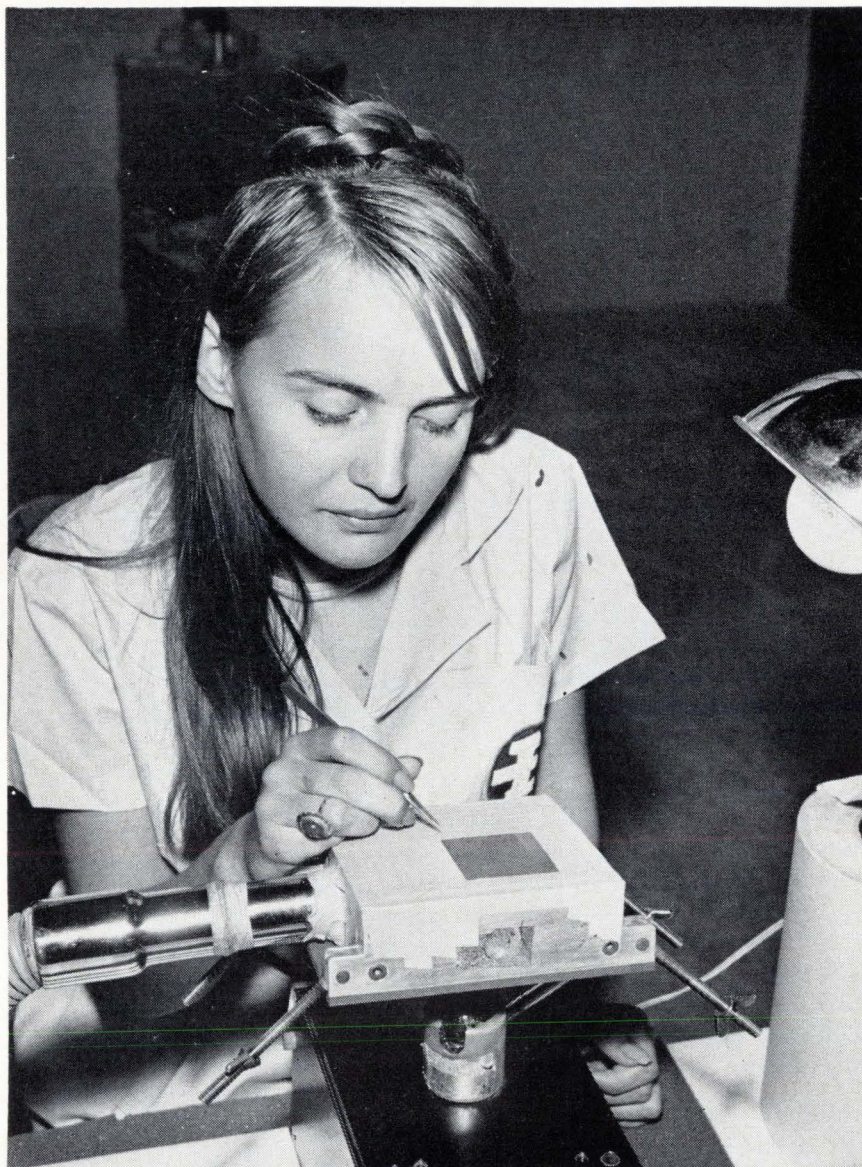

Vacuum chuck holds tiny magnetic cores for alignment by a production worker before threading operation begins.

stages following the primary selection by the register translator. Finally, the letters are taken from the individual machines and bundled for dispatch to destination.

Brazil

Memories of Sao Paulo

Last month, Burroughs do Brasil shipped its first consignment of magnetic core memories to the U.S. A new production line at a plant the Burroughs Corp. has been

operating in Sao Paulo for 12 years is expected to eventually turn out 20 memories a day.

Because it hasn't been possible to fully mechanize the production of core memories, manufacturers still place a high premium on labor costs. The Burroughs facility expects to employ about 200 women to string the tiny cores onto fine wires and to solder the wires onto boards. Other U.S. companies have set up similar operations in Hong Kong, Taiwan, and Mexico.

Three types. The plant is making three types of memories for use in the parent firm's computers, from desk-size machines to the

large systems. Henry V. Eicher, managing director of Burroughs do Brasil, calls the memory operation "a growth line," and predicts that it "could eventually supply all of our system requirements in the U.S."

Burroughs built its Sao Paulo plant in 1955, and went into the Latin American market in 1958 with a series of locally produced adding machines. More recently, the factory has also been assembling heavy accounting machines.

Final electronic trials of the core memories are still done in the U.S., but test equipment is now being sent to Brazil. Eicher says the Sao Paulo plant "will be completely on its own within six months."

Japan

Tracing trains

Anyone trying to board a Tokyo subway train during the rush hour needs the courage of a samurai and the fatalism of a kamikaze pilot. Despite the Teito Rapid Transit Authority's attempts to keep pace, passenger volume is far outpacing the system's growth rate. As more trains are added to handle the load, headway between trains is narrowed. The result: improved traffic control becomes essential.

At a cost of \$150,000, the authority has installed a new route map display system for the Hibiya line. Employing a tracer technique, the system upgrades an earlier one along the 20-kilometer route. A second system will be completed in July for the Ginza line.

Identifies and locates. With the new technique, the traffic controller can pinpoint the location of any train along the route as well as identify which train it is.

The tracer system provides a continuous display at the Hibiya control center. Developed by General Precision Inc.'s Link division, the system was built in Japan by Mitsubishi Precision Inc.—a joint General Precision-Mitsubishi Electric Corp. venture. The rest of the

system was manufactured by the Kyosan Electric Manufacturing Co.

When a train enters the line's tracks, the system picks up its number and transmits it to the control center. From that point onward, the display serves as a giant shift register. The train number is shifted along blocks on the display as the train triggers special contracts in the signal switches along the route. Three interrogator-responder units—one each at the ends of the line, and the third at the point where the track from the storage yards feeds into the line—are used. Between these units and the contacts along the run, the train can be followed without further identification.

Previously, Hibiya used a lighting system on a display to indicate in what section of the route a train is located. But it didn't identify the train.

Under the new system, the display board locates the train—in any of the line's 21 stations or in any one of the three blocks in which the tracks between stations are arbitrarily divided for display purposes—and identifies it. The train number is contained in a transponder block that is manually attached to the second car when the train enters the line. The block is removed when the train leaves the line's tracks and returns to the yard.

Cable link. Identification of trains with the tracer system is on the basis of a 3-out-of-10 code. The interrogator, mounted on the tunnel wall, emits a 90-kilohertz carrier signal modulated by 10 audio tones. A tuned coil and diode within the transponder pick up the signal. Three parallel tuned circuits, connected in series, select the tones corresponding to the train number. These tones modulate a transistor-oscillator signal that is picked up by the interrogator, amplified, and transmitted to the control center via a voice-frequency cable. If a train without a transponder unit passes the interrogator the number 00 appears on the display. A malfunction in the system produces the number 88.

Wire spring relays control the display unit. The signal for shifting a train number to the next block stems from the contacts on the wayside switches.

Data from 220 points along the line is transmitted over a single audio frequency cable pair by a combination of time and frequency multiplex. A clock controls the timing by transmitting a commutating signal consisting of a series of eight positive pulses, followed by eight negative pulses.

Synchronizing pulses on the audio cable pair range from 0 to 4 khz. The band between 5.4 khz and 10 khz is split up among 16 information-signal oscillators. The

combination of 16 synchronizing time slots and 16 oscillator frequencies allows the cable pair to handle up to 256 information signals.

Gunn power

A year ago, Gunn oscillators were offered commercially in the U.S., then quickly withdrawn because the devices were plagued by problems of uniformity and reliability.

Nippon Electric Co. last week reported diodes which passed 4,000 hours of life tests without deterioration. The company says it will test the power sources in experimental microwave and millimeter wave communications systems now in the design stage.

As replacements for klystrons, Gunn oscillators promise advantages in simplicity, reliability, and cost [Electronics, March 6, p. 134].

The prototype oscillators developed in the NEC laboratories generate microwave and millimeter waves from 4 gigahertz to 50 Ghz with application of d-c voltages from 2 to 20 volts.

Power up. Continuous output power of 340 milliwatts has been obtained at 8 Ghz, 150 mw at 10 Ghz, and 7 mw at 50 Ghz. NEC reports an efficiency of 0.5% to 5.5%. The observed frequency-modulation noise is about the same as that of a klystron.

The NEC researchers credit performance of the devices to a new technique for epitaxial growth of the gallium arsenide crystals.

As in the U.S., the materials problem had previously stymied Gunn effect work at NEC's central research laboratories. Gallium arsenide single-crystal material of good quality was hard to come by, so the researchers developed their own carefully controlled technique of epitaxial growth.

The fluctuation of electrical properties in the epitaxial layer of the new devices is reduced, according to NEC. Since the temperature coefficient of the epitaxial layer's resistivity is positive, thermal runaway does not occur. The method permits reduction of the active layer to about one micron, providing oscillation above 30 Ghz.

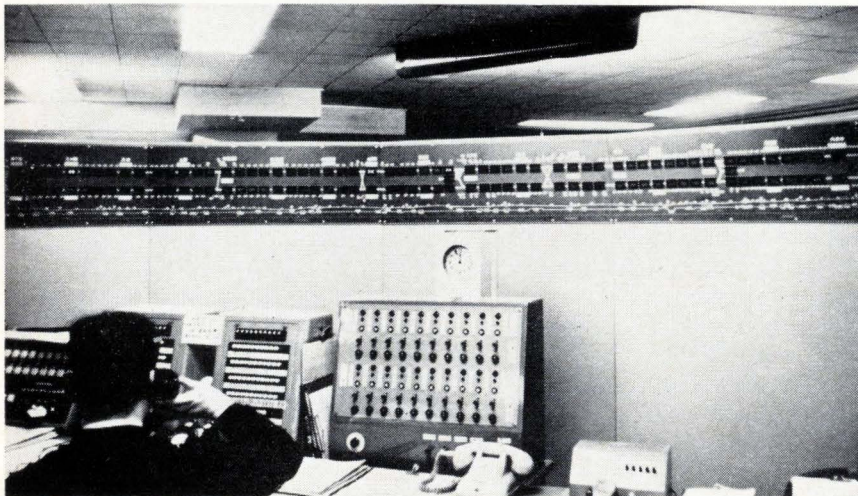

Controller follows progress of train from Hibiya operations center. Identifying number shifts from block to block on wall display after it is picked up by interrogator unit at the start of the run.

Around the world

Japan. Uchida Yoko Co. is about to market a 10-digit desk calculator using integrated logic circuits. Priced at \$650, the device has 350 plastic-encapsulated resistor-transistor logic circuits made by Fairchild Semiconductor, a division of the Fairchild Camera & Instrument Corp. Uchida will also lease the calculator through the Japan Lease International Corp.

France. Cadmium telluride thin-film devices being developed as solar energy converters for satellites will be tested later this year on weather balloons. Jean LeBrun, who heads the project at La Radio-technique-Coprim-RTC, says cadmium telluride promises a greater power-to-mass ratio than silicon solar cells. RTC has achieved 80 watts per kilogram on a 60-micron layer of molybdenum, about double the silicon ratio, and expects to reach 130 to 150 watts per kilogram using the same support. The work is sponsored by the French space agency.

Australia. Researchers at Prince Alfred Hospital in Sydney will attempt to use body energy as a built-in power source for implanted pacemakers [Electronics, March 21, 1966, p. 105]. Zinc and silver cathodes will be placed in living tissue. Because body fluids are predominantly saline, reaction between the electrodes and the electrolyte converts chemical into electrical energy. Initial experiments with the body-battery for pacemakers will be conducted on dogs.

West Germany. Siemens AG will market late this year a new ruby laser welder-driller with a cost per pulse reported at 0.1 cent. The pulse repetition rate can be varied up to 25 per second, with variable energy up to 10 joules. The company says a relatively inexpensive linear flashtube sharply reduces the cost per flash, which went as high as \$1 per pulse in early systems. Siemens' new system, costing about \$70,000, is aimed at micromachining processes on watch rubies, diamonds, ceramics, and microelectronic devices.

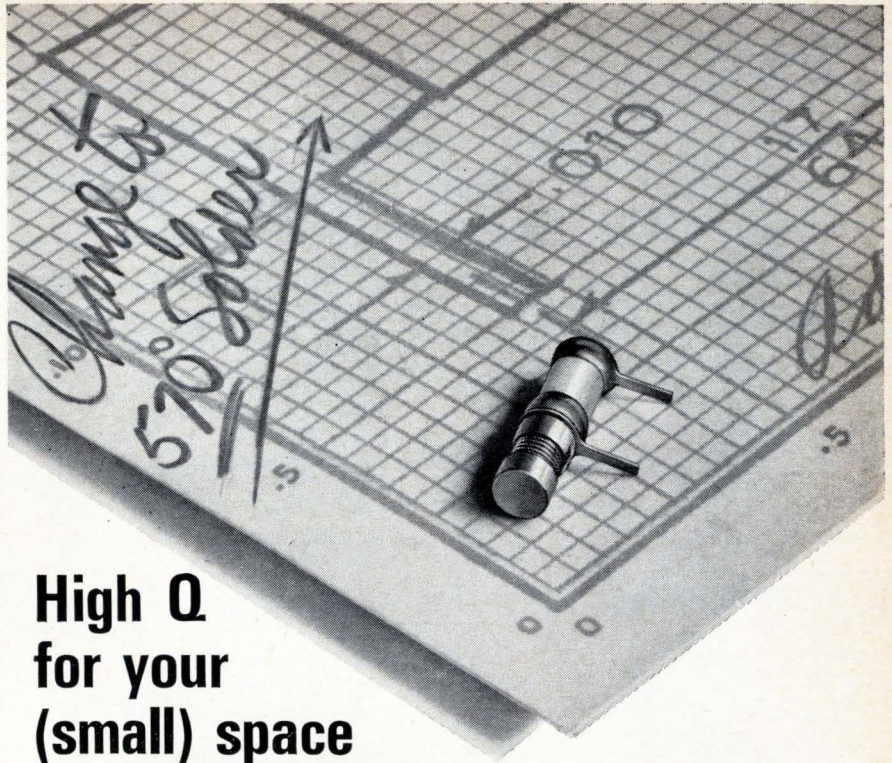

High Q for your (small) space requirements!

The Johanson 4700 Series Variable Air Capacitors provide, in micro-miniature size, the extremely high Q important in demanding aerospace applications. In addition, the ultra-rugged construction of the 4700 Series capacitors assures highest reliability in the most critical environments.

- Available in printed circuit, turret and threaded terminal types.
- Meets Mil Specs for salt spray requirements.
- Features 570° solder, which prevents distortion and is not affected by conventional soldering temperatures.

SPECIFICATIONS

Size: 1/8" diameter, 1/2" length
Q @ 100 MC: > 5000
Q @ 250 MC: > 2000
Capacity Range: 0.35 pF to 3.5 pF
Working Voltage: 250 VDC
 (Test voltage, 500 VDC)
Insulation Resistance: > 10⁶ Megohms
Temp. Ranges: -55°C to 125°C
Temp. Coefficient: 50 ± 50 ppm/°C

**WRITE TODAY
FOR FULL DATA.**

Johanson

**MANUFACTURING
CORPORATION**

400 Rockaway Valley Road, Boonton, N. J. 07005 (201) 334-2676

Circle 204 on reader service card

To order reprints: Fill in, cut out coupon below, insert in envelope and mail to: **Electronics Reprint Dept.,
330 W. 42nd Street, New York, N.Y. 10036**

Reprint order form

For listing of reprints available see the **Reader Service Card.**

U.S. Electronics Markets 1967

Send me reprints of Key no. R-08 at 50¢ each.

For reprints of previous special reports fill in below:

Send me reprints of Key No.(s) @¢ each.
(For prices, see Reader Service Card)

Name

Number of street

City, State, Zip code



■ Acopian Corporation Mort Barish Associates	136	Hewlett Packard, Harrison Div. Healy Adv. Agency	2	Raytheon Company, Components Div.	120
Airpax Electronics, Inc. Welch, Mirabile & Co., Inc.	124	Hewlett Packard, Loveland Div. Tallant/Yates Adv. Inc.	1	Fuller & Smith & Ross Inc.	137
■ Amelco Semiconductor, Div. of Teledyne, Inc.	87	■ Hewlett Packard, Microwave Div. Lennen & Newell Inc.	9	RCL Electronics Inc. Morvay Adv. Agency	OAS 5
■ American Lava Corporation, Sub. of Minnesota Mining & Mfg. Co. Designers Inc.	133	Honeywell, Inc.	135	Publicite Orbis	
■ Ampere Electronics Corporation, Div. of North American Philips Sam Groden, Inc.	37, 134	William Zemp & Associates, Inc. Hughes Aircraft Company	116, 132, 145	Sage Electronics Corporation Mathison Adv. Inc.	151
■ Amphenor Corporation, Connector Div.	122, 123	■ IBM Corporation, DP Division Marsteller Inc.	44, 45	Semicon, Inc. L.K. Frank Company, Inc.	146
■ A. P. I. Instruments George Z. Griswold Adv.	142	Indiana General Corporation, Ferrites Div.	24	Sensitak Instrument Corporation Allied Adv. Agency	147
■ Astrosystems, Inc. The Edward W. Robotham Co.	118	■ Griswold & Eshleman Industrial Chemical Specialties Corporation	136	□ Solartron Electronic Group Ltd. Southern Advertising Ltd.	OAS 13-16
■ Ballantine Laboratories Lang-Lawrence Adv.	143	□ Intertechnique Pema	OAS 10	■ S.P. Electronica	OAS 11
■ Barnstead, a subsidiary of Ritter Pfauder Corporation Creamer Trowbridge & Case Inc.	130	Intronics, Inc. Marketing Assistance, Inc.	16	Sperry Electronic Tube Div., Sperry Rand Corporation	46
■ Bausch & Lomb Inc. Wolff Associates, Inc.	107	I R C Incorporated Gray & Rogers Inc.	51	Neals & Hickok, Inc.	5, 10
Beckman Instruments, Inc., Electronic Instrument Div. Hixson & Jorgensen Inc.	68	ITT Semiconductors Div. Neals & Hickok, Inc.	170	The Sprague Electric Company Harry P. Bridge Company	74
■ Beckman Instruments, Inc., Helipot Division Hixson & Jorgensen, Inc.	30	Janus Control Corporation L. K. Frank Co., Inc.	169	■ Stackpole Carbon Co., Electronic Components Div.	74
■ Belden Manufacturing Co. Fensholt Adv. Inc.	20, 21	■ Johanson Manufacturing Company Josephson, Cuffari & Company	167	Meek & Thomas, Inc.	99
Beman Manufacturing Inc. Krone Art Service	154	Kassoy & Company Harmony Impressions	142	Sylvania Electric Products Inc., Parts Div.	99
Burroughs Corporation, Electronic Components Div. Conti Adv. Agency, Inc.	54	■ Kepco Incorporated Weiss Advertising	40, 42	Tatham-Laird & Kudner Inc. Adv.	153
■ CML, Div. of Tenney Engineering Co. Keyes, Martin & Co.	153	Krohn-Hite Corporation L. K. Frank Company, Inc.	152	Synthane Corporation Arndt, Preston, Chapin, Lamb & Keen, Inc.	39, 106
□ Compagnie des Compteurs S. P. I. Agency	OAS 4	■ Leach Corporation Jay Chiat & Associates	50	■ Tektronix, Inc. Hugh Dwight Adv. Inc.	155
Computer Test Corporation James Lees Adv.	103	Lockheed Missiles & Space Company McCann Erickson	131	Tenney Engineering, Inc. Keyes, Martin & Company	153
■ Control Switch, Div. of Control Co. of America Harry P. Bridge Co.	104	□ LTT Promotion Vente Publicite	OAS 6	Tiros Plastics Corporation Feeley Adv. Agency, Inc.	52
Coto Coil Company, Inc. Williams Co.	142	■ Machlett Laboratories, Div. of Raytheon Company	11	Trygon Electronics Solow/Wexton Company, Inc.	128
□ C. S. F. S. P. I. Agency	OAS 2	■ P. R. Mallory & Company, Manufacturing Div.	8, 18, 19	Trymetrics Corporation Solow/Wexton Company, Inc.	155
Dana Laboratories, Inc. E. L. Van Deusen Co.	101	Aitkin-Kynett Company Maryland Department of Economic Development	150	■ Tung Sol, Div. of Wagner Electric Corporation	155
□ Dow Corning International Ltd. Marsteller-Belgium S.A.	OAS 9	Rosebush Adv. Agency	151	E.M. Freystadt Associates	127
Eastman Kodak Company, Technical Corporate Adv. Rumrill Hoyt Inc.	79	Master Specialties Company William E. Wilson Company	151	Ulano & Company, J. Byrde, Richard & Pound Inc.	127
E G & G Inc. Culver Adv. Inc.	14, 160	Microdot Incorporated Gumpertz, Bentley & Dolan Adv.	15	Union Carbide Corporation, Electronics Div.	27
■ Elgenco Inc. Wesco Adv.	156	Microlab / FXR Frank Best & Company, Inc.	112	J.M. Mathes, Inc.	100
Elliott Service Co. The Powerad Co.	136	■ Microwave Electronics Corporation, Sub. of Teledyne	3rd Cover	United Aircraft Corporate Systems Center	100
□ English Electric Valve Co., Ltd. Allardyce Palmer Ltd.	OAS 12	Bonfield Associates	102	B.E. Bussell & Associates	2nd Cover
Erie Technological Products Co., Inc. Altman-Hall Associates	17	Milgray Electronics Bliss/Gruenwald, Inc.	102	■ United Transformer Company Philip Stogel Company	41
Eubanks Engineering Co. Moore-Bergstrom Co.	147	City of Milwaukee, Div. of Economic Development	119	■ Unitrode Corporation Silton & Huffman, Inc.	49
Fairchild Semiconductor Inc. Faust/Day Inc.	12, 13	Grablin-Shaw Adv. Inc.	145	University Laboratories, Inc. West Associates	109
□ Farbenfabriken Bayer A. G. Werbeagentur Clemens H. Poetz	OAS 3	Missouri Commerce & Industrial Div. Frank Block Associates	145	Vishay Instruments Inc. Alpern Communications	110
■ Formica Corporation, Div. of American Cyanamid Co.	148, 149	National Semiconductor Corporation	140, 141	■ Vitro Corporation of America, Vitro Electronics	138
■ Franklin Electronics Inc., Div. of Anelex Corporation	152	Michel-Cather, Inc.	144	Buchen Adv. Inc.	138
General Electric Co., Component Capsules Div.	43	Natvar Corporation Sanger-Funnell Inc.	31	Volkert Stampings Fred Wittner Company	121
George R. Nelson Inc.		North Atlantic Industries, Inc. Murray Heyert Associates	31	Wavetek Chapman, McQuiston, Suzuki, & Wright Adv.	OAS 8
■ General Electric Co., Electronic Components Sales Operation	28, 29	Parker Instruments William Hill Field Adv.	139	□ ■ N. Zivy & Cie S. A. Hans Buner	
George R. Nelson, Inc.		■ Pearson Electronics William E. Clayton & Associates, Inc.	7		
General Electric Co., Semiconductor Products Div.	53	□ Philips Eindhoven N.V. T. A. G. De La Mar	OAS 1		
George R. Nelson, Inc.		Piezo Technology, Inc. Shattuck/Roether Adv.	155		
General Instrument Corp., Semiconductor Products Div.	73	□ Plessey Electronics Company, Ltd. Roles & Parker Ltd.	OAS 7		
Norman Allen Associates		Princeton Applied Research Corporation	32		
General Radio Company	6	Mort Barish Associates, Inc.			
Horton, Church & Goff, Inc.		Radio Corporation of America	22, 129, 4th Cover		
Gries Reproducer Company Harold Marshall Adv.	108	Al Paul Lefton Company			
Hamilton Watch Company Beaumont, Heller & Sperling Inc.	115	■ Radio Materials Co Div. of P.R. Mallory & Co.	111		
		Gallay Adv. Inc.	139		
		Radio Switch Corporation George Homer Martin Associates	114		
		Rantec, Div. of Emerson Electric Guerin, Johnstone, Gage, Inc.			

Classified Advertising

F.J. Eberle, Business Mgr.

PROFESSIONAL SERVICES	158
EMPLOYMENT OPPORTUNITIES	157-158

EQUIPMENT

(Used or Surplus New)
For Sale

	159
--	-----

ADVERTISERS INDEX

A & A Electronics Corp.	159
Atomic Personnel Inc.	158
Bendix Corp., The	158
Flight & Engine Instr. Div.	158
Cadillac Assoc.	159
Ewald Instruments Corp.	159
Fair Radio Sales	159
Fishman Co., Philip	159
Instruments & Machines Inc.	159
RCA Aviation Eqpt., Dept.	157
U.S. Navy	
San Fran. Bay Naval Shipyard	157

■ For more information on complete product line see advertisement in the latest Electronics Buyers' Guide

□ Advertisers in Overseas Advertising Section following Newsletter from Abroad

Advertising sales staff

Frank E. LeBeau [212] 971-6464

Advertising sales manager

Wallis Clarke [212] 971-2187

Assistant to sales manager

Donald J. Austermann [212] 971-3139

Promotion Manager

Atlanta, Ga. 30309: Michael H. Miller, 1375 Peachtree St., N.E. [404] TR 5-0523

Boston, Mass. 02116: William S. Hodgkinson McGraw-Hill Building, Copley Square [617] CO 2-1160

Chicago, Ill. 60611: Robert M. Denmead, J. Bradley MacKimm, Ralph Hanning, 645 North Michigan Avenue. [312] MO 4-5800

Cleveland, Ohio 44113: William J. Boyle, 55 Public Square, [216] SU 1-7000

Dallas, Texas 75201: Richard P. Poole, 1800 Republic National Bank Tower, [214] RI 7-9721

Denver, Colo. 80202: Joseph C. Page, David M. Watson, Tower Bldg., 1700 Broadway, [303] 255-5484

Detroit, Michigan 48226: Ralph Hanning 856 Penobscot Building [313] 962-1793

Houston, Texas 77002: Kenneth George, 2270 Humble Bldg., [713] CA 4-8381

Los Angeles, Calif. 90017: Ian C. Hill, John G. Zisch, 1125 W. 6th St., [213] HU 2-5450

Minneapolis, Minn. 55402: J. Bradley MacKimm, 1104 Northstar Center [612] 332-7425

New York, N.Y. 10036

500 Fifth Avenue

Donald R. Furth [212] 971-3615

James R. Pierce [212] 971-3616

Stanley J. Kail, Jr. [212] 971-3617

Philadelphia, Pa. 19103:

Warren H. Gardner, Jeffrey M. Preston, 6 Penn Center Plaza, [215] LO 8-6161

Pittsburgh, Pa. 15222: Warren H. Gardner, 4 Gateway Center, [412] 391-1314

Portland, Ore. 97204: James T. Hauptli, 218 Mohawk Building, 222 S.W. Morrison Street, Phone [503] 223-5118

Rochester, N.Y. 14534: William J. Boyle, 9 Greylock Ridge, Pittsford, N.Y. [716] 586-5040

St. Louis, Mo. 63105: Robert M. Denmead The Clayton Tower, 7751 Carondelet Ave. [314] PA 5-7285

San Francisco, Calif. 94111: James T. Hauptli, 255 California Street, [415] DO 2-4600

London W1: John W. Patten, Edwin S. Murphy Jr., 34 Dover Street, Hyde Park 1451

Milan: Robert M. Saidel 1 via Baracchini Phone: 86-90-656

Frankfurt/Main: Gerd Hinske, Dieter Rothenbach, Elsa-Brandstroem Str. 2 Phone: 72 01 81

Geneva: Michael R. Zeynel, 1, rue du Temple Phone: 31 95 60

Paris VIII: Denis Jacob, Kenneth Davey, 17 Avenue Matignon Phone: 359 6637

Tokyo: Nobuyuki Sato, 1, Kotohiracho Shiba, Minato-Ku [502] 0656

Osaka: Ryoji Kobayashi 163, Umegae-cho Kita-ku [362] 8771

Business department

Wallace C. Carmichael, Manager

[212] 971-3191

Stephen R. Weiss, Production Manager

[212] 971-2044

Thomas M. Egan,

Assistant Production Manager [212] 971-3140

Dorothy Carmesin, Contracts and Billings

[212] 971-2908

Circulation and research

Milton Drake, Manager [212] 971-3485

Isaac Siegel, Assistant Circulation Manager

[212] 971-6057

David Strassler, Assistant Research Manager

[212] 971-6058

Chloe D. Glover, Research Associate

[212] 971-6057

Electronics buyers' guide

George F. Werner, General Manager

[212] 971-2310

Regina Hera, Directory Manager

[212] 971-2544

Thomas M. Egan, Production Manager

[212] 971-3140

Low Cost 4 DIGIT

400 SERIES INTEGRATING DC DIGITAL VOLTMETER

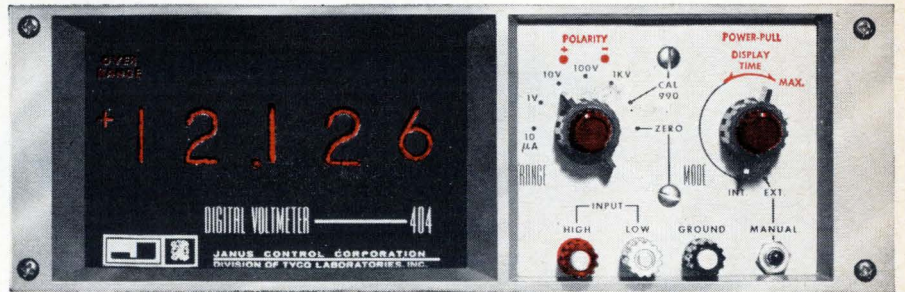

Extended Range Measurements: Fifth digit over-range.

Precise Measurements: With accuracies to 0.05%.

Input Flexibility: Four voltage ranges and a micro-current input for measuring in "Engineering Units" (psi, degrees, etc.)

System Compatibility: BCD Outputs and Remote Programming.

High Noise Rejection: Differential input and integration techniques provide common mode rejection greater than 120 db at 60 Hz.

Economical: 3 and 4 digit models range from \$349.50 to \$495.50.

These DVM's are not only **NEW**, they're **AVAILABLE** from Janus representatives from coast to coast!

CALL OR WRITE FOR A DEMONSTRATION.



296 NEWTON STREET • WALTHAM • MASSACHUSETTS 02154 • TEL: (617) 891-4700

The Predictables.

**Some computer
manufacturers
stockpile diodes.**

**The others order
from ITT.**

ITT ships any size order, any day you say.
Any part number, silicon or germanium,
double plug or DO-7. Make us prove it.
RFQ: The Predictables.

diodes **ITT**

ITT SEMICONDUCTORS IS A DIVISION OF INTERNATIONAL TELEPHONE AND TELEGRAPH CORPORATION
FACTORIES IN WEST PALM BEACH, FLORIDA; PALO ALTO, CALIFORNIA; LAWRENCE, MASSACHUSETTS; HARLOW AND FOOTSCRAY, ENGLAND; FREIBURG AND NURENBERG, GERMANY