

v. 30 #17

Electronics

AUG 21 1967

Linear integrated circuits, part 2: page 78

A choke that simplifies power supplies: page 93

Loop antenna shows up dipoles: page 111

August 21, 1967

\$1.00

A McGraw-Hill Publication

Below: Hardening components to withstand radiation, page 99

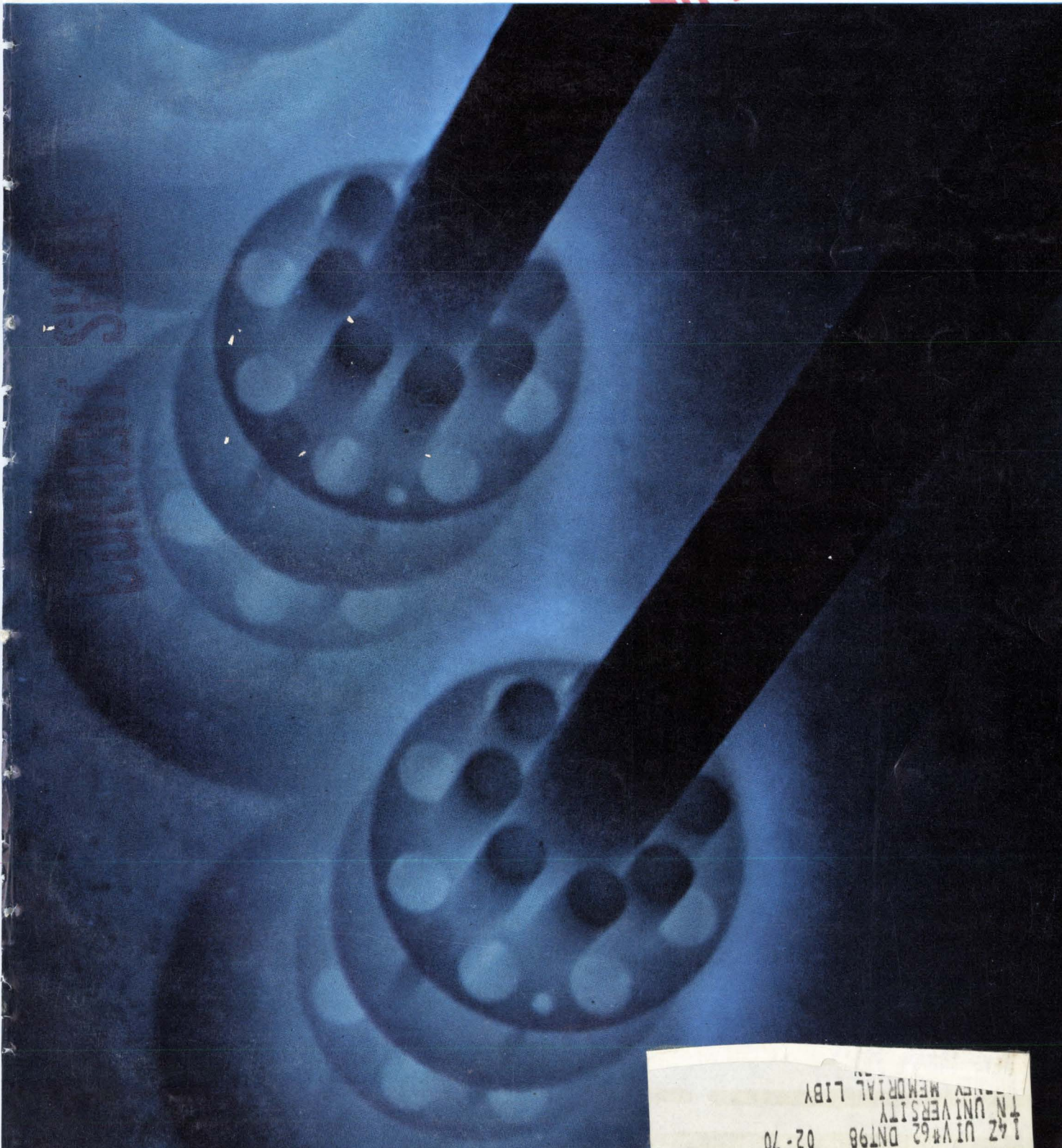

LIBRARY
STATE TECHNICAL INSTITUTE
AT MEMPHIS
NO LONGER

142 UI#62 DNT98 02-70
T.N. UNIVERSITY
MEMORIAL LIBY

**"SPECIAL"
CUSTOM BUILT**



POWER TRANSFORMERS & INDUCTORS

TO YOUR SPECIFICATIONS

Exceptional quality and reliability is provided in all UTC designs. Over 30 years of engineering knowledge and experience backed by complete environmental testing and life testing facilities assure the highest standard in the industry. Full analysis and evaluation of materials are conducted in UTC's Material and Chemical Laboratories. Rigid quality control measures coordinated with exhaustive statistical findings and latest production procedures results in the industry's highest degree of reliability. Range covered in Power Transformers is from milliwatts to 100 KVA. Some typical applications include: Current Limiting, Filament, Isolation, Plate, Transistor Inverter, Transistor Supply.

MILITARY AND COMMERCIAL TYPES FOR EVERY PHASE OF THE ELECTRONICS ART

POWER TRANSFORMERS • AUDIO TRANSFORMERS • INDUCTORS • PULSE TRANSFORMERS • ELECTRIC WAVE FILTERS • LUMPED CONSTANT DELAY LINES • HIGH Q COILS • MAGNETIC AMPLIFIERS • SATURABLE REACTORS • REFERENCE UNITS



Low capacity current limiting filament transformer. Primary 118 V. 60 cycles to 6.3 V. at 3 A., 8 A. at short circuit. 25 MMFD capacity. 30 KV hipot and 200:1 capacity divider; 5 x 3 3/4 x 4 1/2", 9 lbs.



MIL-T-27B ultraminiature Scott connected power transformer, 5/16 Dia. x 13/32" H., 1/10 Oz. Primary 28 V. 400 ~ with taps @ 50% & 86.6%. Two units provide 28 V two phase from three phase source.

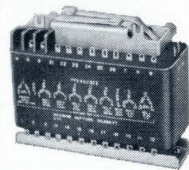

Molded Power Transformer 3 Phase. Input 200V, 380-420 cps. Electrostatic Shield, 8 output windings, 26 terminals. MIL-T-27B, Grade 2 Class S. Max. Alt. 50K Ft. Size 6 x 2 1/2 x 5", 8 lbs.

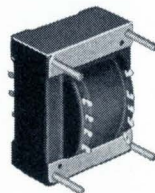

Commercial type molded power transformer. Primary 115/230 V., 50/420 cycles to 680 VCT.-015 A., 6.3 VCT.-1.2 A., 6.3 V.-.6A. Size: 2 1/2 x 3 x 2 7/8", weight: 1.6 lbs.

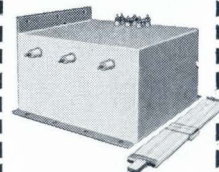

Three phase high voltage power transformer. Primary jumper hardware for easy conversion from delta to wye inputs. Made to MIL-T-27B specifications. Primary: 440 V 60 cycles delta or wye 3 phase input. Secondary: 2100 V line to line or 1215 V line to line @ 242 ma.

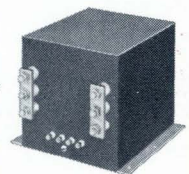

High current filament transformer. Primary 140/156 V., 47/63 cycles to 1.8 V.-1070 A. Current limiting through separate primary reactor, MIL-T-27B; 10 x 10 x 11 1/2", 150 lbs.

Write for catalog of over
1,300 UTC TOP QUALITY
STOCK ITEMS
IMMEDIATELY AVAILABLE
from your local distributor.

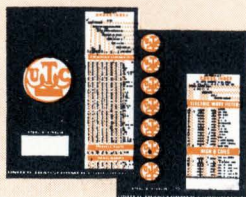

UNITED TRANSFORMER CO.

DIVISION OF TRW INC. • 150 VARICK STREET, NEW YORK, N. Y. 10013

Circle 900 on reader service card

AUG 21 1967

AC MICROVOLTMMETER

SEES THROUGH NOISE!

LIBRARY
UNIVERSITY of TENN. MED. UNITS
MEMPHIS

New hp 3410A Measures
300 nanovolts
Buried in Noise



New hp Model 3410A AC Microvoltmeter measures low level repetitive signals obscured by noise—3 μ V to 3 V full scale—accuracy \pm 3%. RMS noise voltages up to 20 dB above full scale do not affect readings. Sensitivity, low cost and ease of operation are the 3410A's contribution.

This new microvoltmeter uses an hp designed phase-locked synchronous detector to separate effects of noise from signal. The detector is an electronic gate controlled by an oscillator phase-locked to the input signal. No external reference is required to lock to the input signal. Simply adjust front panel tuning control within 1% of signal frequency and phase-lock circuits lock-on and track input signal with \pm 5% variation in the 5 Hz to 600 kHz frequency range. Phase-lock circuits track 0.5%/sec change in signal frequency without a change in voltmeter accuracy. Input impedance is 10 M Ω shunted by 20 pF.

The new Model 3410A has two outputs on the rear panel. One is a dc recorder output for monitoring long term drifting ac voltage amplitudes. The other is an output for driving an electronic counter to make precise frequency measurements.

For full specifications on the new hp Model 3410A AC Voltmeter, call your hp field engineer. Or, write to Hewlett-Packard, Palo Alto, California 94304, Tel. (415) 326-7000; Europe: 54 Route des Acacias, Geneva. Price: hp Model 3410A, \$800.00.

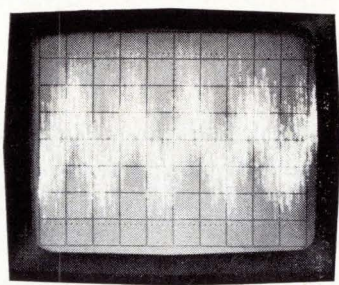

Measure 1 μ V, 500 kHz signal out of 40 dB noise.

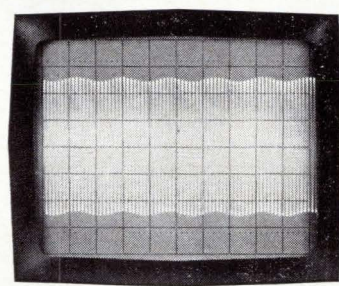

Measure 10 mV, 5 Hz amplitude modulating 1 V, 400 Hz.

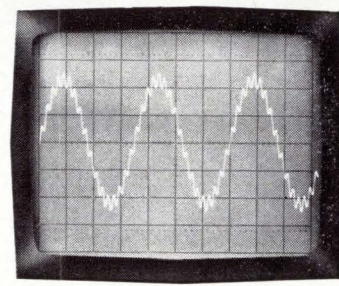

Measure 300 nanovolts, 10 kHz. signal superimposed on 10 μ V, 1 kHz

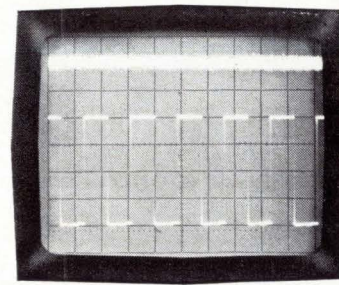

Measure frequency of signal in noise up to 560 kHz by using square wave output, hp as a counter preamplifier.

HEWLETT  **PACKARD**
An extra measure of quality

RECORD DATA IN INK ON Z-FOLD PAPER AND READ IT LIKE A BOOK

The new Hewlett-Packard 7850 Series Rectilinear Fluid-Process Recorder produces ultra-clear traces on Z-fold paper or rolls. The numbered Z-fold pages offer more convenient access to recorded data. Contactless pen tip sensing and a low-pressure ink system produce traces of constant width throughout the recorder's

variable speed ranges of .025 to 200 mm. per second. Designed with modular, solid-state electronics, the 7850 Series Recorder provides high-resolution, permanent, rectilinear recording of up to eight variables from dc to 160 Hz.

A wide selection of 8800 Series Preamplifiers provides signal conditioning to the driver-amplifiers which drive the recording pens of the recorder.

The 7850 Series system includes a preamplifier power supply, a driver amplifier power supply and a cabinet to house the complete unit. The frequency response of the recorder is 160 Hz for 10 div p-p deflection and 60 Hertz maximum for full scale deflection. Maximum ac or dc non-linearity is 0.5% full scale. Additional features include: 14 electrically-con-

trolled chart speeds; built-in paper take-up; low ink supply warning light; plug-in ink supply cartridge that may be replaced while the recorder is in operation and complete modular construction of all components for easy maintenance:



For complete information on the 7850 system, optional and related equipment, contact your local HP Field Office or write Hewlett-Packard Company, 175 Wyman St., Waltham, Mass. 02154.

HEWLETT  PACKARD

17701



57586

Circle 2 on reader service card

News Features

Probing the News

- 129 **China's three-way stretch**
137 **Brokers put stock in electronics**

Electronics Review

- 37 **Communications:** The chirp approach
37 **Avionics:** With flying colors
38 **Oceanography:** Staying put
39 **Components:** Strengthening a link . . . ;
or replacing it
40 **Military electronics:** Where are (were)
we?; Repairs needed; Vastly important
42 **Solid state:** So who's worried?
44 **Advanced technology:** Strangest places
46 **Computers:** Long and short of it
47 **For the record**

Electronics Abroad

- 187 **International:** Economic slowdown
188 **West Germany:** The right type
188 **Japan:** Fit to print; IC's where it counts
190 **Great Britain:** High on ions
191 **France:** Fast film

New Products

- 147 **Low threshold voltages switch MOS registers**
150 **New components review**
150 **New components:** Power transistors—the jump to 50 watts
154 **New instruments review**
154 **New instruments:** Off-the-shelf IC's in new counter; Tiny power supply puts out 17.5 kv
159 **New subassembly review**
159 **New subassemblies:** Increasing accuracy of telemetered data
163 **New microwave review**
163 **New microwaves:** Mesa structure quiets noise
167 **New semiconductor review**
167 **New semiconductors:** Integrating a silicon controlled rectifier; Fine tuner for tv fits on a chip

Title R registered U.S. Patent Office; © copyright 1967 by McGraw-Hill Inc. All rights reserved, including the right to reproduce the contents of this publication, in whole or in part.

Technical Articles

I. Design

- Integrated electronics** 78 **Linear IC's, part 2**
78 **Heart of the matter**
Differential amplifier is the basic configuration
John J. Robertson, Motorola Semiconductor Products Inc.
81 **Power grab by linear IC's**
A monolithic device can drive big power controllers
F. William Gutzwiller and James H. Galloway, General Electric Co.
Circuit design 87 **Designer's casebook**
▪ Sequential switching enables low-frequency multiplication
▪ Bridge circuit cuts contacts in series-parallel network
▪ Low temperature triggers diode relaxation oscillator
Circuit design 93 **Choking up on LC filters**
One choke contains multiple windings instead of many choke filters
Allan G. Lloyd, Avion Electronics Inc.

II. Applications

- Military electronics** 99 **Designing for the worst of worst cases—nuclear war (cover)**
Circuits are hardened to withstand radiation so electronic systems can weather an atomic holocaust
C.F. Johnson
Military electronics 111 **Down-to-earth Army antenna**
A vertical loop antenna performs as well as a dipole
Kenneth H. Patterson, Army Limited War Laboratory

Departments

- 4 Readers Comment
8 People
14 Meetings
16 Meeting Preview
23 Editorial
25 Electronics Newsletter
59 Washington Newsletter
174 New Books
176 Technical Abstracts
180 New Literature
185 Newsletter from Abroad

Electronics

Editor-in-Chief: Lewis H. Young

Associate managing editors

Design: Donald Christiansen
Application: George Sideris
News: Robert Henkel
Copy: Sally Powell

Senior associate editors

John F. Mason, Joseph Mittleman, Stephen E. Scrupski

Department editors

Advanced technology: Stephen E. Scrupski
Computers: Wallace B. Riley
Consumer electronics: John Drummond
Design theory: Joseph Mittleman
Industrial electronics: Alfred Rosenblatt
Instrumentation: Carl Moskowitz
Military electronics: John F. Mason
New Products: William P. O'Brien, Stephen Fields
Solid state: Mark B. Leeds
Staff writers: James Brinton, Kay Sloman, Howard Wolff

Section editors

Electronics abroad: Arthur Erikson
Electronics review: Stanley Zarowin
Probing the news: Eric Aiken

Regional bureaus

Domestic

Boston: H. Thomas Maguire, manager; Robin Carlson
Los Angeles: Lawrence Curran, manager; June Ranill
San Francisco: Walter Barney, manager; Mary Jo Jadin
Washington: Robert Skole, manager; William D. Hickman, Paul Dickson, Patricia C. Hoehling

Foreign

Bonn: John Gosch
London: Michael Payne
Tokyo: Charles Cohen

Copy editors

Albert Tannenbaum, James Chang, Frederick Corey

Graphic design

Art director: Saul Sussman
Assistant art directors: Ann Mella, Valerie Betz
Production editor: Arthur C. Miller

Editorial secretaries: Claire Benell, Lynn Emery, Kay Fontana, Patricia Gardner, Lorraine Longo

McGraw-Hill News Service

Director: John Wilhelm; Atlanta: Fran Ridgway; Chicago: James Rubenstein;
Cleveland: Arthur Zimmerman; Dallas: Marvin Reid;
Detroit: N. Hunter; Houston: Robert E. Lee; Los Angeles: Michael Murphy, Gerald Parkinson
Pittsburgh: Louis Gomolak
San Francisco: William F. Arnold
Seattle: Ray Bloomberg; Washington: Arthur L. Moore, Charles Gardner,
Herbert W. Cheshire, Seth Payne, Warren Burkett, James Canan, William Small

McGraw-Hill World News Service

Bonn: John Johnsrud; Hong Kong: Don Kirk; London: John Shinn;
Mexico City: Bruce Cross; Milan: Ronald Taggiasco;
Moscow: Howard Rausch; Paris: Peter Kilborn;
Rio de Janeiro: Wes Perry; Tokyo: Marvin Petal

Reprints: Susan Nugent

Circulation: Milton Drake

Publisher: Gordon Jones

Electronics: August 21, 1967, Vol. 40, No. 17

Published every other Monday by McGraw-Hill, Inc. Founder: James H. McGraw 1860-1958.

Printed at 99 North Broadway, Albany, N.Y. 12207; second class postage paid at Albany, N.Y.
Executive, editorial, circulation and advertising addresses: McGraw-Hill Building, 330 W. 42nd Street
New York, N. Y. 10036. Telephone (212) 971-3333. Teletype TWX N.Y. 710-581-4235. Cable address:
MCGRAWHILL N.Y.

Subscriptions are solicited only from those actively engaged in the field of the publication. Position and company connection must be indicated on orders. Subscription prices: United States and possessions and Canada, \$8.00 one year, \$12.00 two years, \$16.00 three years; all other countries, \$25.00 one year. Single copies: United States and possessions and Canada, \$1.00; all other countries, \$1.75.

Officers of McGraw-Hill Publications: Joseph H. Allen, president; Bayard E. Sawyer, Executive Vice-President; J. Elton Tuohig, Senior Vice-President-Operations; Vice-Presidents: John R. Callahan, Editorial; John M. Holden, Marketing; Huber M. Gemmill, Circulation; Angelo R. Venezian, Production; Jerome D. Luntz, Planning & Development; Robert M. Wilhelmy, Controller.

Officers of the Corporation: Donald C. McGraw, Chairman of the Board; Shelton Fisher, President; L. Keith Goodrich, Robert E. Slaughter, Executive Vice Presidents; Donald C. McGraw, Jr., Senior Vice-President; John L. Cooke, Vice-President & Secretary; John L. McGraw, Vice-President & Treasurer.

Title © registered in U.S. Patent Office; © Copyright 1967 by McGraw-Hill, Inc. All rights reserved. The contents of this publication may not be reproduced either in whole or in part without the consent of copyright owner.

Subscribers: The publisher, upon written request to our New York office from any subscriber, agrees to refund that part of the subscription price applying to copies not yet mailed. Please send change of address notices or complaints to Fulfillment Manager; subscription orders to Circulation Manager, Electronics at address below. Change of address notices should provide old as well as new address, including postal zip code number. If possible, attach address label from recent issue. Allow one month for change to become effective.

Postmaster: Please send form 3579 to Fulfillment Manager, Electronics, P.O. Box 430, Hightstown, New Jersey 08520

Readers Comment

Two cents worth

To the Editor:

I enjoyed reading the review of the discussions now raging over the subminiature integrated antenna [June 12, p. 145]. Having worked in the field of electrically small antennas for some years, I would pretend to some knowledge of the subject and would like to put in my two cents worth.

We are currently making electrically small antennas commercially. These antennas are constructed in sizes down to 1/36 of a wavelength and handle high power. One, our Hairpin Monopole Antenna, SC-890, has recently been supplied for 10-kilowatt PEP service on the Apollo tracking ships and has proven most effective in service; all this by way of qualification.

Wheeler's comments in the *SIA* story are most cogent and directly to the point. In fact, simple physics tells us that the radiated field from any antenna is proportional to the integral of the current over the length of the radiator. Thus, if the radiator length is reduced, the current must rise correspondingly to preserve the radiated field.

For large radiators, ohmic and skin losses are negligible, but in electrically small radiators these become extremely large since the losses rise as the square of the current. A 36-fold rise in current would correspond to a 1,300-fold rise in the skin ohmic losses.

The presence of these large losses is inimical to the attainment of low noise figure in a receiving device. So the performance of such an antenna is probably suitable only in locations where a large signal is present and small antenna size is a prime necessity.

The argument that high-frequency atmospheric and galactic noise generally exceeds receiver noise is applicable only to frequencies below about 25 megahertz most of the time, and even then, if optimum performance over least noise conditions is to be attained, the receiver noise figure must still be reasonably good. Again, the point is well taken that an ade-

A new concept... optimum-technology integration

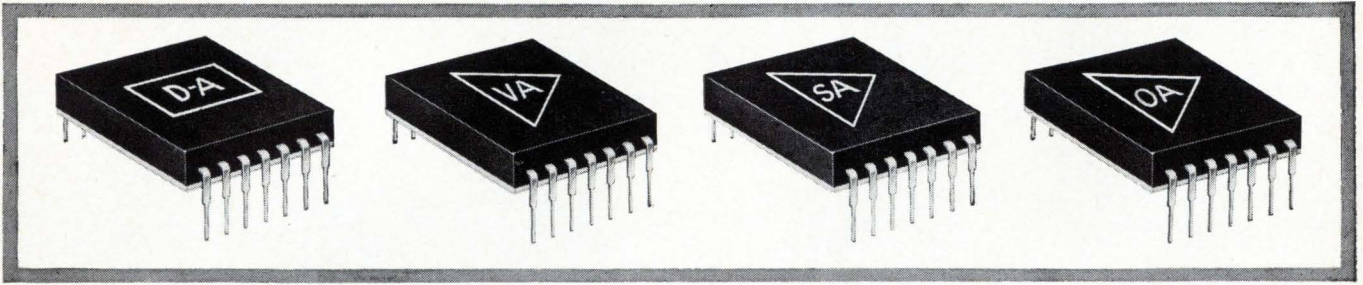

MODULINE[®] microcircuits have solved the problems of technology trade-offs.

Silicon integrated circuits, thick and thin films, tantalum nitride or nickel-chromium on silicon, discrete semiconductor devices active or passive—each has its own technology advantages for the circuit designer.

Until today, the designer lived with the limitations of each technique as well. Circuit design and component selection finally ended after the battle with technology trade-offs.

MODULINE[®] MICROCIRCUITS

Now Sprague introduces Moduline microcircuits. Simply put, Sprague selects the optimum technologies for you, integrates these various techniques into functional or multi-functional circuits, then packages them into dual in-line packages with 100 mil pin spacing.

Moduline microcircuits are complete! No additional "add-on" components are needed. Four standard circuits are available today. More will follow.

D to A CONVERTER

The Moduline UM1000 4-bit D to A converter combines ladder network, ladder switch, and buffer amplifier in one package.

The ladder network is a monolithic silicon chip with 9 deposited tantalum nitride precision resistors. Only this technology could give the UM1000 the ability to be expanded to 12 bits with less than 1/2 bit error.

The ladder switch is constructed from 8 complementary "low off-set" transistors mounted on a thin film circuit. Each transistor is discrete, to permit superior matching.

Lastly, the buffer amplifier consists of 4 NPN transistors and 12 nickel-

chromium resistors, again on a thin film. This type of resistor construction is chosen because of its very low temperature coefficient which provides precision tracking through a broad temperature range.

The Moduline UM1000 D to A converter is in a dual in-line package 0.72" long by 1.35" wide, with 14 pins on 100 mil centers, 1.4" between rows. It is specified over the full military temperature range of -55 to +125 C. Also available is the UM1200, specified for 0 to +70 C commercial applications.

VIDEO AMPLIFIER

Complete, ultra-flexible self-contained circuitry is provided by the Moduline UM1518 video amplifier.

The heart of the circuit is the monolithic amplification section. This is where old integrated amplifiers stopped. The UM1518 adds screen-deposited planar noble metal resistors inside the package, allowing gain from 5 to 50 volts and bandwidth from 40 Hz to 40 MHz to be chosen by nothing more than package pin selection.

Further technology integration adds discrete multi-layer Monolithic[®] micro capacitors to the ceramic substrate for A-C de-coupling of input and output. The single dual in-line package needs only the board space equal to two conventional single-chip DIP packages.

SENSE AMPLIFIER

The UM1519 combines 3 silicon monolithic integrated circuits and 8 deposited resistors on a ceramic substrate.

The resistors form a tappable voltage divider to allow selection of sensing voltage threshold level.

Two identical monolithic analog comparators receive the signal, then feed to a monolithic Exclusive OR gate.

The result is sensitivity and speed—12mV maximum differential input voltage for "1" output, strobe turn-on 30 nsec.—all produced by combining proven, high-volume integrated circuit chips. The UM1519 dual in-line package measures 1.3 inches between rows.

OPERATIONAL AMPLIFIER

The UM1522 operational amplifier answers the need to combine the advantages of discrete and integrated designs.

The discrete input Darlington-connected transistors are closely matched for low off-set. The multi-chip amplifier is a "no compromise" design. All chips are close-proximity mounted on the same substrate. The result is exceptionally low V_{BE} differential and close tracking over the full temperature range.

Six planar resistors are then bonded onto the substrate. They provide stability and high impedance for the input and output.

The UM1522 is in the same package as the video amplifier.

**For further information write to:
Technical Literature Service
Sprague Electric Company
35 Marshall Street
North Adams, Mass. 01247**



Sprague and ® are registered trademarks of the Sprague Electric Co.



Test electrolytics per MIL and EIA specs

With our 1617 Capacitance Bridge, you can measure capacitors that are as large as 1.1 farad or as small as 1 picofarad. But an exceptionally wide C range is only one feature that makes the 1617 "the bridge" for testing capacitors, particularly aluminum and tantalum types. It is no coincidence that most features of this bridge are those required to test electrolytics per MIL and EIA specifications; the bridge was designed specifically to meet these specs.

This bridge is a "must" for any capacitance-test station because it . . .

has a C range of 10^{12} , from 1 pF to 1.1 F, with an accuracy of $\pm 1\%$ to 0.11 F and $\pm 2\%$ from 0.11 F to 1.1 F;

has a D range from 0 to 10 with an accuracy of approximately $\pm 2\% \pm 0.001$;

is completely self-contained; just plug it into a power line and start making measurements. The 120-Hz generator, tuned detector, adjustable dc polarizing voltage and bridge circuits are all contained in a Flip-Tilt cabinet/carrying case;

has an internal, metered dc polarizing voltage that is adjustable from 0 to 600 volts;

provides for 2-, 3-, 4- or 5-terminal connections; effects of residual impedances are practically eliminated;

measures leakage current down to $0.5 \mu\text{A}$;

can be used at frequencies up to 1000 Hz with an external generator;

has panel safety lights to indicate when bias voltage is being applied and when the charge on the unknown capacitor exceeds one volt; has ORTHONULL® balance finder, which eliminates sliding balance when high-D capacitors are measured;

has a phase-reversible 120-Hz generator to reduce the effects of stray voltage; amplitude is selectable and limited to 0.2 V, 0.5 V, or 2 V; meets or exceeds the requirements of MIL-C-39003 (Solid Tantalum), MIL-C-39018 (Aluminum Oxide), MIL-C-62C (Polarized Aluminum), MIL-C-26655B (Solid Tantalum), MIL-C-3965C (Tantalum Foil and Sintered Slug), (EIA) RS 154B (Dry Aluminum), (EIA) RS 205 (Electrolytic), and (EIA) RE 228 (Tantalum).

The many features of the 1617 also make it an excellent general-purpose 1% bridge to measure *any* type of capacitor as well as the capacitance and loss of cables, transformers, insulating materials, and electric motors.

Call your nearest GR office for a demonstration. For complete information, write General Radio, W. Concord, Massachusetts 01781; telephone (617) 369-4400; TWX (710) 347-1051.

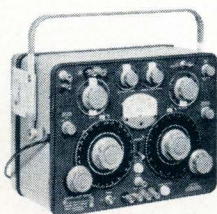

Type 1617-A Capacitance Bridge,
\$1195 in USA.

GENERAL RADIO

Circle 6 on reader service card

quate comparison of noise figure attainable for the SIA over a more conventional electrically small antenna-cum-amplifier has not been made, and there appears to be relatively little advantage in one approach over the other.

Also, as Wheeler has so aptly pointed out, the radiation damped bandwidth or radiation Q and antenna size are inextricably bound together in electrically small antennas. Therefore, broad bandwidth may only be purchased with the coin of efficiency, and this cost may be very high indeed. Antenna losses would naturally be reflected in a high receiver noise figure.

As makers of electrically small antennas, we generally restrict our recommendation to those applications where space or size or weight restrictions are such as to make the tradeoff in efficiency advantageous.

J. A. Kuecken

Radio Communications Laboratory
General Dynamics
Rochester, N. Y.

Antenna gain

To the Editor:

Just what the heck are all the hysterics about, anyway? Let's take another look at the subminiature integrated antenna schematic [June 12, p. 148]. If you redraw it in a more conventional manner, substitute a small inductor L_1 for the rod I, and add some signal polarities, one thing becomes evident: the first stage is about to break into oscillation because inductor L_1 is not furnishing an effective ground to the emitter of Q_1 .

If it weren't for the degenera-

tive feedback provided by capacitor C_p , the stage would, admittedly oscillate. If the reactive values of C_p and L_1 are such that the stage is on the verge of oscillating, the stage gain will be abnormally high.

Perhaps, it was this phenomenon which led Dr. Meinke to the wrong conclusion—that a miniature antenna can be made to have gain.

Wilfred N. Caron
Torrance, Calif.

■ Dr. Meinke never directly suggests that he is increasing the effective height of the antenna—increasing its gain—by including an amplifier within the circuit. His main argument is that the technique increases the bandwidth of the antenna and thus controls input resistance, antenna pattern, and resonant frequency.

Giving FCC the air

To the Editor:

The FCC should be abolished instead of expanded as you seem to think [Aug. 7, p. 23]. The airwaves should be sold to the highest bidder and treated as private property.

The telephone-company monopolies should be revoked and free enterprise competition would quickly produce the most efficient and modern service for the consumer. The most effective means of data transmission would be used, whether it be for voice, data, video or anything else. The profits would automatically adjust themselves to the just free-market level.

Ernst F. Germann
Houston, Texas

SUBSCRIPTION SERVICE

Please include an Electronics Magazine address label to insure prompt service whenever you write us about your subscription.

Mail to: Fulfillment Manager
Electronics
P.O. Box 430
Hightstown, N.J. 08520

To subscribe mail this form with your payment and check new subscription renew my present subscription

Subscription rates: in the U.S.: 1 year \$8; two years, \$12; three years, \$16. Subscription rates for foreign countries available on request

CHANGE OF ADDRESS

ATTACH LABEL HERE

If you are moving, please let us know five weeks before changing your address. Place magazine address label here, print your new address below.

name

address

city

state

zip code

SWITCH INFORMATION CENTER..

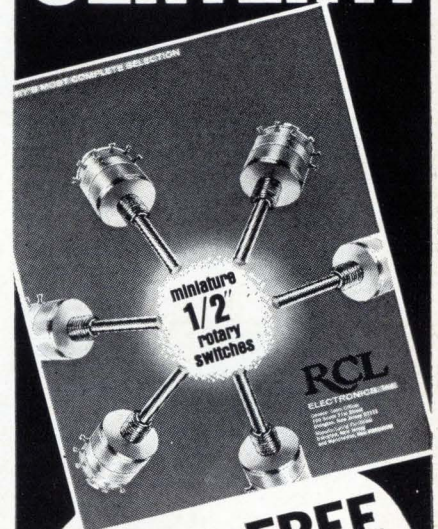

YOURS FREE from RCL

AN EASY-TO-READ TECHNICAL CATALOG OF
INDUSTRY'S MOST COMPLETE SELECTION OF MINIATURE

1/2" rotary switches

WRITE FOR YOUR FREE COPY

RCL

General Sales Office
RCL ELECTRONICS, INC.
700 South 21st Street
Irvington, New Jersey 07111

New bargain in performance!

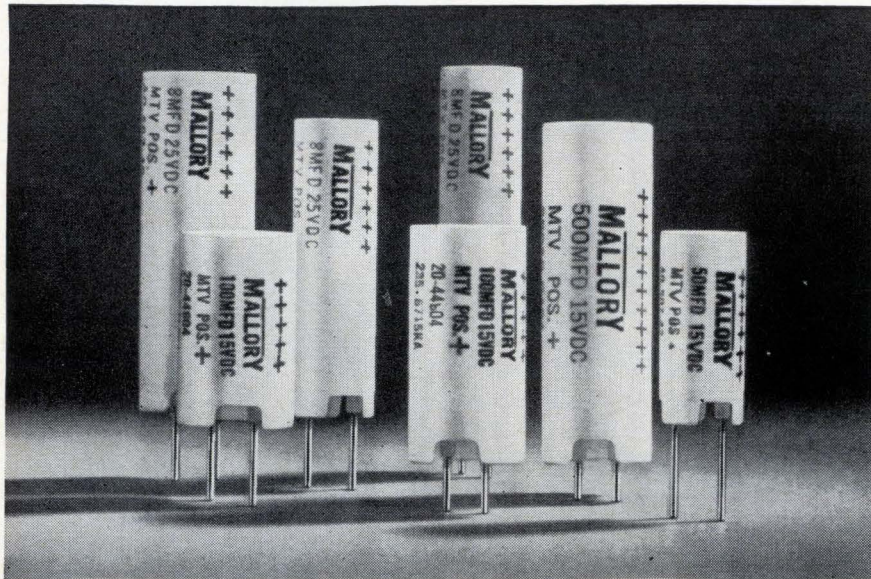

Molded case electrolytics for vertical mounting.

Meet the MTV... newest member of the unique Mallory family of molded case aluminum electrolytic capacitors. It's designed for vertical mounting, with built-in standoffs that facilitate soldering and ease in cleaning printed circuit boards.

Temperature performance? Good stability down to -30°C , excellent life at rated 65°C ... or intermittent 85°C operation.

Reliability? Just ask for our data—the most and best you ever saw for an economy-priced capacitor.

Price? Lower than metal case types and most epoxy-sealed plastic tubulars.

Ratings? Up to 1000 mfd at 3 WVDC and 115 mfd at 50 WVDC. Nine case sizes: diameters of .375" and .500"; lengths .812" to 1.50".

For bulletin and prices, write or call Mallory Capacitor Company, a division of P. R. Mallory & Co. Inc., Indianapolis, Indiana 46206

MALLORY

People

The new director of integrated circuit operations at the Semiconductor Products division of Motorola is unruffled about the widening trend among systems manufacturers, like Autonetics, to encroach on the component maker, particularly in designing and selling custom large-scale integrated (LSI) arrays.



Stephen L. Levy

Stephen L. Levy became a vice president of Motorola at the same time he was promoted from assistant general manager for IC's at the Phoenix facility. He believes there is a place for a small-scale engineering effort in LSI at the systems houses, but adds that these firms still depend on the semiconductor manufacturer for large-volume orders at competitive prices.

"LSI is a new technology," says Levy, "and just about every engineer at the systems houses wants a couple of parts built to his design. While we're all learning the technology, it doesn't make sense for us to try to satisfy all the demands for a few devices. The main thing we want to do is solve the technology so that we can satisfy a large cross section of these requests."

On the way. "There's no question in our minds that LSI is coming, and we're dedicated to it. We're responding to selective demands now, but it has to be economically justifiable."

To get a better grasp on LSI technology, Levy says, some 75% of the IC research and development work at Motorola is in large-scale integration or is LSI-related, but some of this effort is also related to present processes and products. Some of the division's R&D activity, along with a pilot production line, is housed in the still abuilding facility in Mesa, Ariz., to which part of the IC production will be transferred in January. Levy estimates there will be more than 1,000 people working at Mesa after the shift. The site also houses an extensive computer-aided design ef-

Design engineer Bob Alden searched for nearly an hour to find he didn't have the information he needed.

IRI could have told him that in less than 5 minutes.



But chances are 10-1* IRI has it... and it's up-to-date, too! IRI—Information Retrieval Incorporated—is a vendor catalog file on microfilm. Because we make no charge to vendors, and microfilm everything they have in print, IRI has more than 600,000 pages of vendor data including application notes, reliability tests, price lists and names of distributors and reps. What's more, the IRI Vendor Catalog File on microfilm is updated every 60 days!

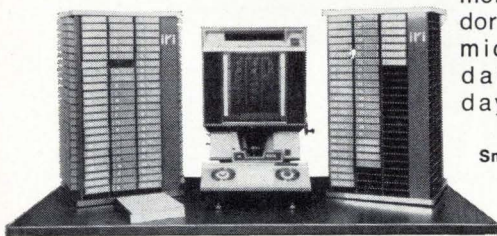

Small wonder.

In addition, the IRI system is tailored to your needs by adding the vendors you want — at no extra cost. We start with a basic file of the most wanted information. Up-date it regularly, and then—to top it off—"personalize" the file by adding the complete vendor information you request. Small wonder IRI enables you to eliminate your hard copy central catalog file. It also reduces storage area by 98%, cuts redundancies in design efforts and increases sources and use of standard items.

You can install an IRI vendor catalog file on an annual subscription for less than the cost of a file clerk. IRI vendor catalog files are in use in plants with as few as fifty employees. The "user-orientated" idea not only provides current knowledge of the component state-of-the-art, but also expedites the purchasing function. Because of its complete coverage, more than 60% of our recent installations have replaced other microfilmed vendor catalog systems.

*IRI subscribers average 90% retrieval of wanted information. We've never scored less than 60% when "surprised" by vendor lists from interested prospects. Have your vendor list ready and test our retrieval average when you arrange a demonstration.

It takes about 2 hours to demonstrate to your key people. But in much less time than that your design, standards, quality control, drafting, receiving, inspection and purchasing people will realize that an IRI system is the next best thing to a raise in pay! We have demonstration teams in most principal cities. To arrange a demonstration, send the coupon today.

Find it fast.
Make a print-out in 6 seconds.

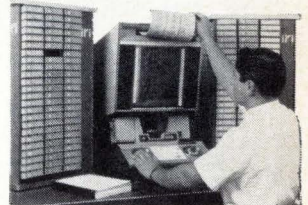

iri INFORMATION RETRIEVAL INCORPORATED

801 Welch Road, Palo Alto, California 94304

Another Information Service of McGraw-Hill/ See it at WESCON—Booth 3907

INFORMATION RETRIEVAL INCORPORATED
801 Welch Road, Palo Alto, California 94304
Dept. # B-38

- I'd like to see a demonstration of the IRI Vendor Catalog File. Have your representative call me for an appointment.
- I'm not ready for a demonstration at this time, but please send further information.

Name _____ Title _____

Company _____

City _____ State _____ Zip _____

Telephone _____ Ext. _____

Number of employees at this location _____

We have have not had experience with a vendor catalog file on microfilm.

In addition to the Vendor Catalog File on microfilm we're interested in Mil Specs Mil Standards.

New from Sprague!

**5 Times the Resistance of
a Conventional Metal-Film Resistor
of Equal Size!**

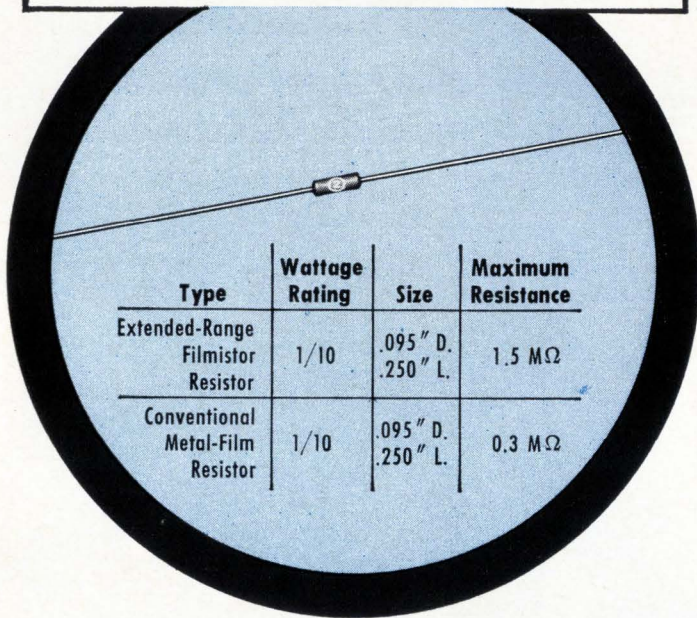

EXTENDED-RANGE FILMISTOR® METAL-FILM RESISTORS

**Substantial saving of space in all wattage ratings—
1/20, 1/10, 1/8, 1/4, 1/2, and 1 watt—with
absolutely NO SACRIFICE IN STABILITY!**

Extended-Range Filmistor Resistors now offer, in addition to accuracy . . . stability . . . reliability . . . resistance values in size reductions which were previously unobtainable. Size and weight advantages of Filmistor Resistors now make them ideal for applications in high-impedance circuits, field-effect transistor circuits, etc. Many designs which previously had to settle for the higher temperature coefficients of carbon-film resistors in order to obtain required resistance values can now utilize the low and controlled temperature coefficients of Filmistor Metal-Film Resistors.

Other key features are $\pm 1\%$ standard resistance tolerance, low inherent noise level, negligible voltage coefficient of resistance, and tough molded case for protection against mechanical damage and humidity.

For complete technical data, write for Engineering Bulletin 7025C to Technical Literature Service, Sprague Electric Co., 35 Marshall Street, North Adams, Massachusetts 01247.

SPRAGUE COMPONENTS

RESISTORS
CAPACITORS
TRANSISTORS
INTEGRATED CIRCUITS
THIN-FILM MICROCIRCUITS
INTERFERENCE FILTERS
45R-6139

PACKAGED COMPONENT ASSEMBLIES
FUNCTIONAL DIGITAL CIRCUITS
MAGNETIC COMPONENTS
PULSE TRANSFORMERS
CERAMIC-BASE PRINTED NETWORKS
PULSE-FORMING NETWORKS



Sprague and ® are registered trademarks of the Sprague Electric Co.

People

fort aimed at making LSI design "more rapid and economical," Levy notes.

Levy maintains Motorola's IC business has been profitable every month this year, and asserts that the division is growing in IC production faster than the industry average. Last year, Motorola's IC business was in the red, primarily due to investment for R&D.

When a microwave radiometer rides into space on an Apollo Applications Program flight in 1970 to measure emissions from the earth's atmosphere, an electronics engineer who helped develop the equipment could be riding with it.

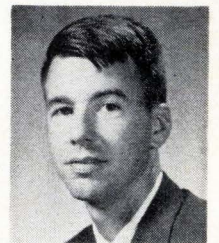

William B. Lenoir

"It's possible, though it will be strictly coincidental if I do become a member of that three-man crew," says **William B. Lenoir**, one of the 11 new astronauts and the only electrical engineer in the group.

Lenoir, at 28 an assistant professor of electrical engineering at the Massachusetts Institute of Technology, is a pioneer in microwave meteorology whose doctoral thesis was on remote sounding of the upper atmosphere by microwave measurements. He heads an MIT program that is developing the special radiometer for the experimental package. The program aims to develop microwave equipment that can be placed in satellites to help provide the data necessary for reliable weather predictions as much as 14 days ahead.

The MIT group works mainly in the 5-millimeter wavelength, where the oxygen molecule is opaque. In the Apollo package, a five-channel radiometer operating at 60 gigahertz will be pointed at the earth to receive emissions from oxygen molecules in the atmosphere. "From these simultaneous measurements," says Lenoir, "we should be able to infer temperature profiles of the atmosphere between 5 and 50 miles above the earth."

MACHLETT

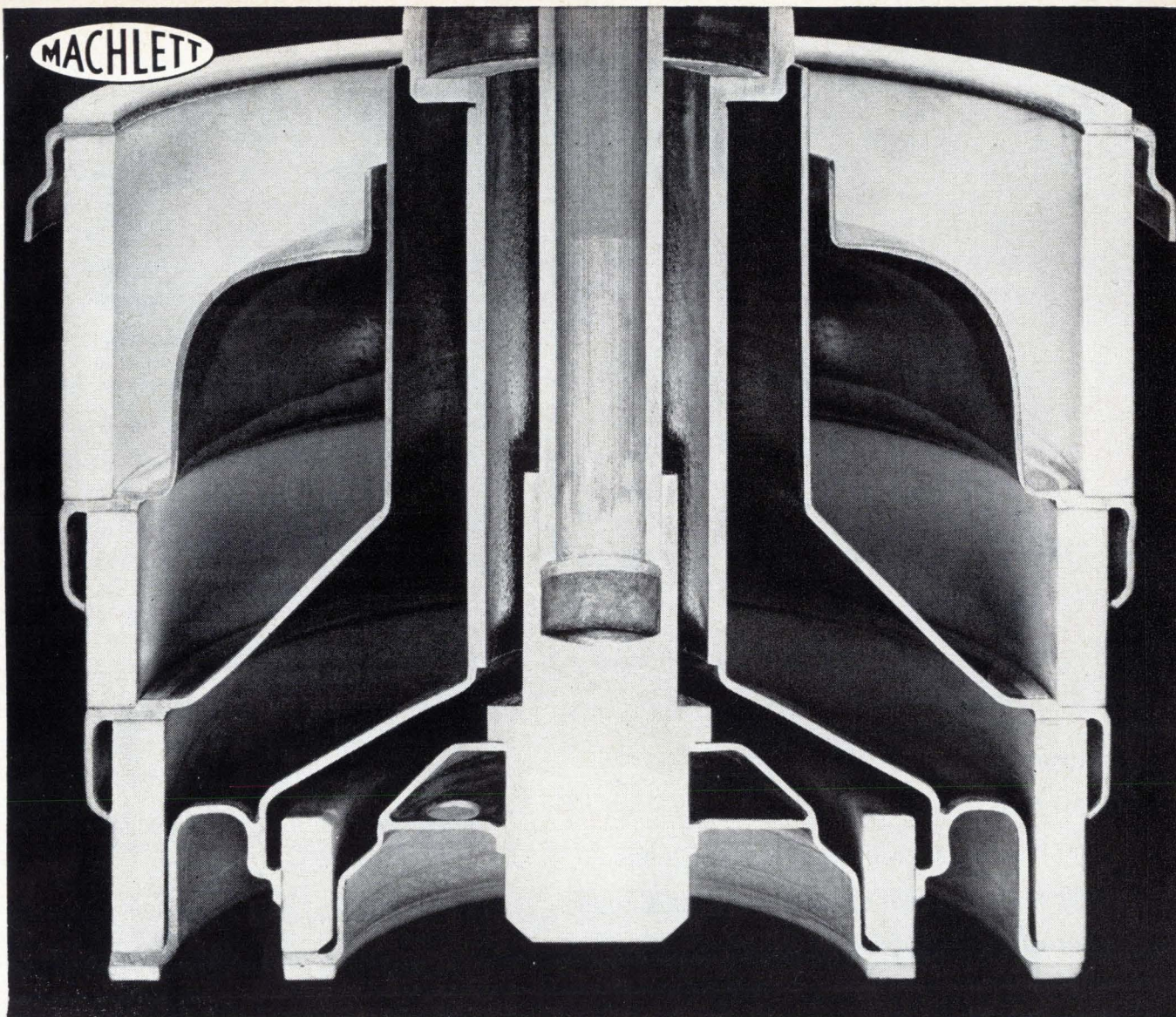

Continuous cone electrode geometry: designed into all these tetrodes only by Machlett



ML-8170/
4CX5000A

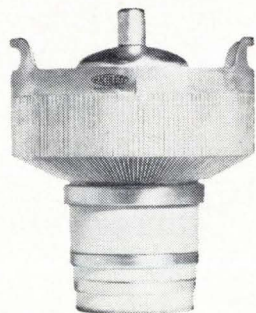

ML-8171/
4CX10000D

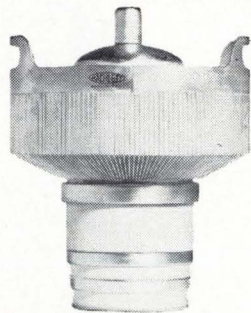

ML-8281/
4CX15000A

The result: uniform internal r.f. energy distribution and high performance stability.

Write for complete details:
The Machlett Laboratories, Inc.,
Springdale (Stamford), Conn. 06879.

Engineers' resumes invited

RAYTHEON

THE MACHLETT LABORATORIES, INC.

A SUBSIDIARY OF RAYTHEON COMPANY

Burroughs the leader...

- Originator of the NIXIE® tube
- Originator of ultra-long life NIXIE tubes
- Originator of wide viewing-angle NIXIE tubes
- Originator of rectangular space-saving NIXIE tubes
- Originator of biquinary NIXIE tubes
- Originator of the decimal point NIXIE tubes
- Originator of the low cost NIXIE tubes
- Originator of alphanumeric NIXIE tubes
- Originator of miniature NIXIE tubes
- Leader with the broadest line of NIXIE tubes
- Leader in quality NIXIE tubes
- Leader in development of NIXIE tubes

Burroughs, the originator of the NIXIE readout tube, has continually led the field in the development of the latest in readout tubes, readout devices and readout systems. Burroughs engineering ability and experience will continue to lead the way in readout displays.

*For further information contact: Burroughs Corporation,
Electronics Component Division, P.O. Box 1226, Department
N2, Plainfield, New Jersey 07061 Tel: (201) 757-5000*

FIRST WITH...



■ **STANDARD**
Character Size ... 0.6"
Viewing Distance ... 30'
for instrumentation



■ **STANDARD
RECTANGULAR**
Character Size ... 0.6"
Viewing Distance ... 30'
for instrumentation —
preferred type for
minimal width displays



■ **MINIATURE**
Character Size ... 0.3"
Viewing Distance ... 14'
for mobile and airborne
instrumentation



■ **MINIATURE
RECTANGULAR**
Character Size ... 0.3"
Viewing Distance ... 14'
for mobile and airborne
instrumentation

continues to lead with

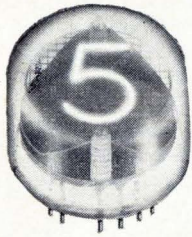

■ **SUPER**
Character Size ... 0.8"
Viewing Distance ... 38'
for instrumentation

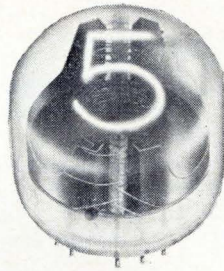

■ **LARGE**
Character Size ... 1.4"
Viewing Distance ... 65'
for large audience
displays to 65'

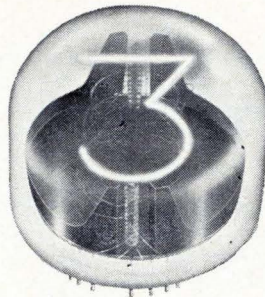

■ **JUMBO**
Character Size ... 2.0"
Viewing Distance ... 100'
for large audience
displays to 100'

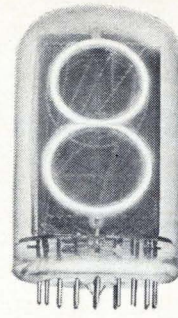

■ **JUMBO SIDE VIEWING**
Character Size ... 2.0"
Viewing Distance ... 100'
for large audience
displays to 100'
preferred type for lower
cost and minimal width



■ **PIXIE® POSITION INDICATOR TUBES**
Character Size ... 0.125"
Viewing Distance ... 8'



■ **STANDARD ALPHANUMERIC**
Character Size ... 0.6"
Viewing Distance ... 30'
for information display
systems readable to 30'



■ **MEDIUM ALPHANUMERIC**
Character Size ... 1.5"
Viewing Distance ... 65'
for large audience
information display
systems to 65'

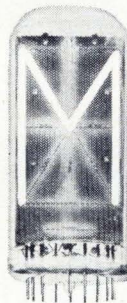

■ **LARGE ALPHANUMERIC**
Character Size ... 2.5"
Viewing Distance ... 100'
for large audience
information display
systems to 100'



■ **BIQUINARY NIXIE TUBE**
Character Size ... 0.6"
Viewing Distance ... 30'
for instrumentation with
biquinary driving



■ **B-5440**
Character Size ... 0.6"
Viewing Distance ... 30'
for **low-cost**
instrumentation



■ **B-5440A SERIES**
Character Size ... 0.6"
Viewing Distance: ... 30'
for **low-cost** highly
reliable instrumentation
with minimal panel
dimensions. This new
improved NIXIE tube is
16 2/3% shorter than the
B-5440 series. Available
options include • built in
"keep alive" for rapid
ionization • two decimal
points, right and left.



■ **B-5560**
Character Size: ... 0.5"
Viewing Distance: ... 25'
new side-view NIXIE tube
offers the maximum
character size for the tube
bulb diameter, providing
the best readability with
minimal instrument panel
dimensions.

■ **B-XXXX**
See this latest Burroughs
NIXIE tube development
at WESCON — Booth
No. 2816-17.

■ **B-XXXX**
Burroughs is continually
developing new and
improved readouts for
future display
requirements. Write us
about your future
requirements.



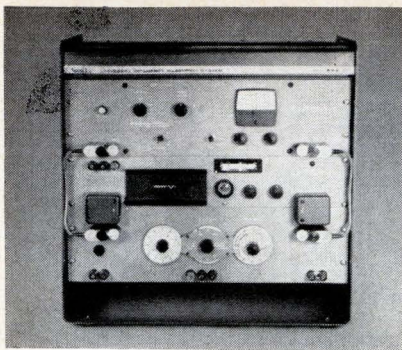

"Bring me your resistors, your capacitors, your other component parts.

(And I will lead you to a measurement accuracy of 0.05%.)"

Let our new Model 292 usher you into the promised land of high accuracy impedance measurement. Here in one system you have the capabilities to measure resistance and conductance to $\pm 0.05\%$, inductance and capacitance to $\pm 0.1\%$.

We've designed it to give you easy access to each circuit element for individual use and ease of calibration. This package "laboratory" of six high accuracy bridge circuits will handle 99% of the measurement requirements of the average inspection, quality control or calibration department. It's so easy to operate you don't need an instruction manual (although one is provided for those who like to read!)

Earlier models of this system have been living up to specifications for eight years now. If you haven't heard about the ESI Impedance Measuring System before this, remember: it took Moses 40 years to discover his promised land. ESI® 13900 NW Science Park Drive, Portland, Oregon (97229).

Model 292 Universal Impedance Measuring System

Resistance and Conductance

Range: 0 to 1200 kilohms - (R)
0 to 1200 milliohms - (G)

Accuracy: $\pm 0.05\%$ + 1 dial division

Capacitance and Inductance (Series & Parallel)

Range: 0 to 1200 microfarads - (C)
0 to 1200 Henrys - (L)

Accuracy: $\pm 0.1\%$ + 1 dial division

Sensitivity:

DC - 5 microvolts
AC - 20 microvolts

Frequency: 1 KC supplied (others available)

Price: \$1380

Note: For related capability in a proven, portable design, inquire about our Model 250 DA at \$550.

Meetings

Western Electronic Show and Convention (Wescon), Western Electronic Manufacturers Association and IEEE; Cow Palace, San Francisco, **Aug. 22-25.**

International Conference on Phenomena in Ionized Gases, International Atomic Energy Agency; Vienna, Austria, **Aug. 27-Sept. 2.**

Space Program Issues of the 70's Meeting, American Institute of Aeronautics and Astronautics; Olympic Hotel, Seattle, Wash., **Aug. 28-30.**

Conference on Preparation and Properties of Electronic Materials, Metallurgical Society of American Institute of Mechanical Engineers; Statler Hilton Hotel, New York, **Aug. 28-30.**

High Frequency Generation and Amplification Conference, IEEE; Cornell University, Ithaca, N.Y., **Aug. 29-31.**

Association for Computing Machinery Conference, Association for Computing Machinery; Sheraton Park Hotel, Washington, **Aug. 29-31.**

Cornell Conference on Engineering Applications of Electronic Phenomena, Cornell University and Office of Naval Research; Cornell University, Ithaca, N.Y., **Aug. 29-31.**

Symposium on Automatic Control of Space, International Federation on Automatic Control; Vienna, Austria, **Sept. 4-8.**

Conference on Solid State Devices, IEEE; Manchester, England, **Sept. 5-8.**

Computer Conference, IEEE; Chicago, **Sept. 6-8.**

Electric Propulsion and Plasmadynamics, American Institute of Aeronautics and Astronautics; Colorado Springs, Colo., **Sept. 11-13.**

Technical Meeting on Space Simulation, American Society for Testing and Materials; Sheraton Hotel, Philadelphia, **Sept. 11-13.**

Meeting on Space Simulation, American Society for Testing and Materials; Sheraton Hotel, Philadelphia, **Sept. 11-13.**

Symposium on Computer Control of Natural Resources and Public Utilities, International Federation of Automatic Control; Haifa, Israel, **Sept. 11-14.**

Instrument Society of America Conference and Exhibit, Instrument Society of America; International Amphitheater, Chicago, **Sept. 11-14.**

International Symposium on Information Theory, IEEE; Athens, Greece, **Sept. 11-15.**

Seminar on Mathematical Systems Theory, Pennsylvania State University; Pennsylvania State University's Residence Hall, Pa. **Sept. 11-15.**

Automotive Conference, IEEE; Howard Johnson's Motor Lodge, Detroit, **Sept. 21-22***

Short Courses

Computer-aided integrated circuit design, Stevens Institute of Technology's Department of Electrical Engineering, Hoboken, N.J. **Sept. 11-15;** \$200 fee.

Computers and modern process control; Purdue University's Schools of Engineering, Lafayette, Ind.; **Sept. 18-22;** \$150 fee.

R&D management program, Ohio University's College of Business Administration and Battelle Memorial Institute; Columbus, Ohio; **Sept. 24-Oct. 6;** \$650 fee.

Calls for Papers

Region III Meeting, IEEE; New Orleans, April 22-24, 1968. **Oct. 15** is deadline for submission of abstracts to Daniel Vliet, Department of Electrical Engineering, Tulane University, New Orleans, La. 70118

Human Factors in Electronics Symposium, IEEE; Marriott-Twin-Bridges Motor Hotel, Washington, May 6-7, 1968. **Nov. 14** is deadline for submission of abstracts to Henry Birmingham, program chairman, 9th Annual Symposium on HFE, U.S. Naval Research Laboratory, Code 5120, Washington, 20390.

Scintillation and Semiconductor Counter Symposium, IEEE; Hotel Shoreham, Washington, Feb. 28-March 1, 1968. **Nov. 17** is deadline for submission of abstracts to W.A. Higinbotham, Program Committee, S&SCS, Brookhaven National Laboratory, Upton, N.Y. 11973

* Meeting preview on page 16.

When you hold a MINIVERTER™ in your hand

... You'll have a 16-channel multiplexer, sample-and-hold and 10-bit, 100 KHz analog-to-digital converter for under \$2,000.

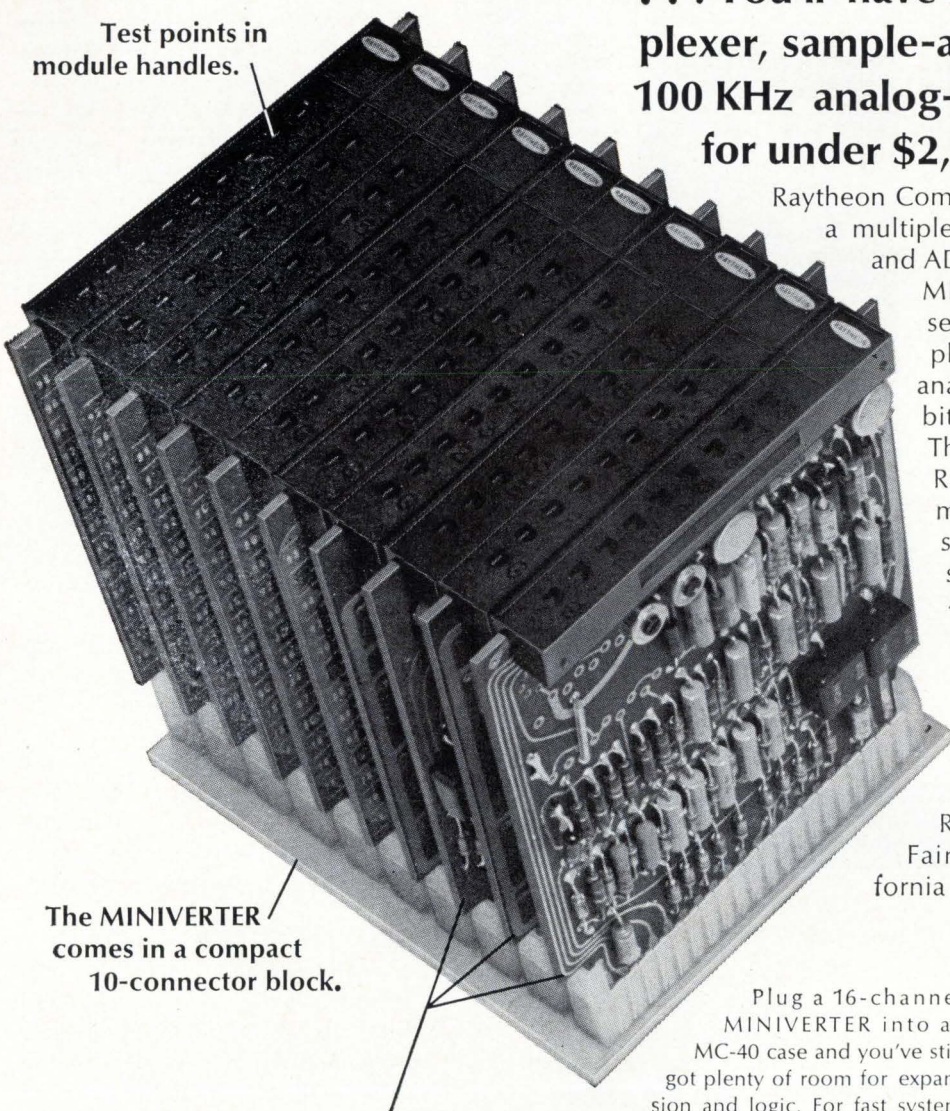

Test points in module handles.

The MINIVERTER comes in a compact 10-connector block.

These three cards make up the ADC. An optional fourth card is a DC power supply that runs on + 5 volts and provides all necessary ADC power.

Raytheon Computer's new MINIVERTER packs a multiplexer, sample-and-hold amplifier and ADC into just ten IC modules. The MINIVERTER (or the ADC) is assembled and pre-wired, ready to plug in and use. ■ Two more new analog IC modules make up a 10-bit digital-to-analog converter. ■ These instruments are built from Raytheon's standard M-Series IC modules and there's a whole stockroom full of compatible systems hardware. More than 40 analog and digital modules, power supplies, three different chassis—all so thoroughly engineered all you do is design your logic. ■ Our literature is almost as exciting as our products. Write or call today. Raytheon Computer, 2700 South Fairview Street, Santa Ana, California 92704. Phone: (714) 546-7160.

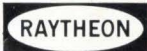

Plug a 16-channel MINIVERTER into an MC-40 case and you've still got plenty of room for expansion and logic. For fast system assembly, module connectors come in blocks of 10, 30 and 40. Power and analog and digital ground are available in module cases via laminated bus bars. And you can have automatic wire wrap if you want it.

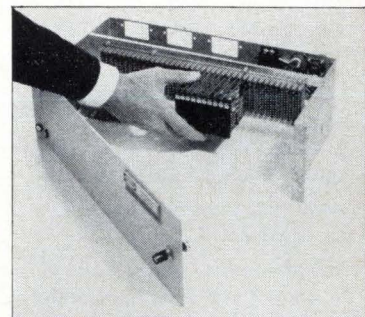

Hold a MINIVERTER in your hand at WESCON, Booths 2001-2002.

Profit from the FJ Enclosure Evolution



FJ enclosures are a natural evolution from the fully gusseted, maximum strength FX units produced by Amco for the military.

They're definitely related in quality workmanship and durability, but the FJ features frame construction suited to more general requirements. All Amco FJ enclosures are fabricated from stock sub-assemblies, so you can count on volume pricing and fast delivery.

Shipment as fast as 2 weeks from receipt of your order!

Typical of volume pricing is the 42" panel height FJ enclosure for under \$100.00 completely assembled, with door.

Besides volume pricing and fast delivery, these rugged FJ enclosures offer greater interior room to allow the

use of thick, heavy-duty slides on a 17" chassis. They are constructed with sturdy 14 ga. steel with 12 ga. adjustable panel mounting angles and formed, 12 ga. caster or floor mounting brackets.

Order any standard enclosure height with 19" panel widths and 25½" depth.

Your local Amco Representative has complete details on FJ enclosures or write the factory direct for Catalog #210.

AMCO ENGINEERING CO.
7333 West Ainslie Street
Chicago, Illinois 60656



Meeting preview

Behind the wheel

Techniques for electronically controlling high-speed vehicles and the use of integrated circuits in automobiles will be among the developments discussed at the IEEE Automotive Conference in Detroit Sept. 21 and 22. The theme of the technical conference will be electronics in vehicle safety and traffic control.

One auto control system developed at Ohio State University by Joseph Treiterer and Richard Campbell applies an infrared detector to furnish continuous information on the differences in velocities between a leading and following vehicle and the distance between them. Gerald Stotts and Robert Owens of Oklahoma State University will describe how a photocell, tracking a stripe painted on a highway, can keep a vehicle on track. and H.W. TenBroek and C.R. Seashore of Honeywell's military products group will outline methods of using electrostatic fields to guide a vehicle.

A better idea. The only auto company to be represented at the conference is Ford. The company's Robert H. Parker, in a paper evaluating automatic vehicle control, estimates that a driver could save an average of \$244 a year from the reduced number of accidents and reduced incidence of traffic congestion.

A number of papers will be presented on the use of electronic components as replacements for conventional electrical and electro-mechanical devices in automobiles. W.G. Tuscany of the Centralab division of Globe-Union Inc. will describe thick-film circuits for voltage regulators, and William B. Hugle of Hugle Industries and B.W. Jalbert of General Electric will tell about the application of monolithic integrated circuits throughout a car.

O.K. Neissen and J. Ziomek of Ford will discuss a transistorized ignition system that would provide higher engine efficiency and reduce current drain. Also from Ford, W.L. Ronci will outline work on a breakerless trigger for a transistorized ignition system.

There's a Tektronix Field Engineer in your area

He can help you solve your measurement problems

Next time you run onto a knotty measurement problem, call the man who spends his time with the technology of measurement.

He's your nearby Tektronix Field Engineer. His specialty is knowing how to measure electrical and physical phenomena and present this information as a useful display on the oscilloscope.

Besides saving you time, he can help you produce the most meaningful data from the particular application.

Whether your problem lies in R&D, production or service measurements, call your nearby Tektronix Field Engineer for assistance. You can depend on him for the kind of help you can use.

Tektronix, Inc.

P.O. Box 500
Beaverton, Oregon
97005

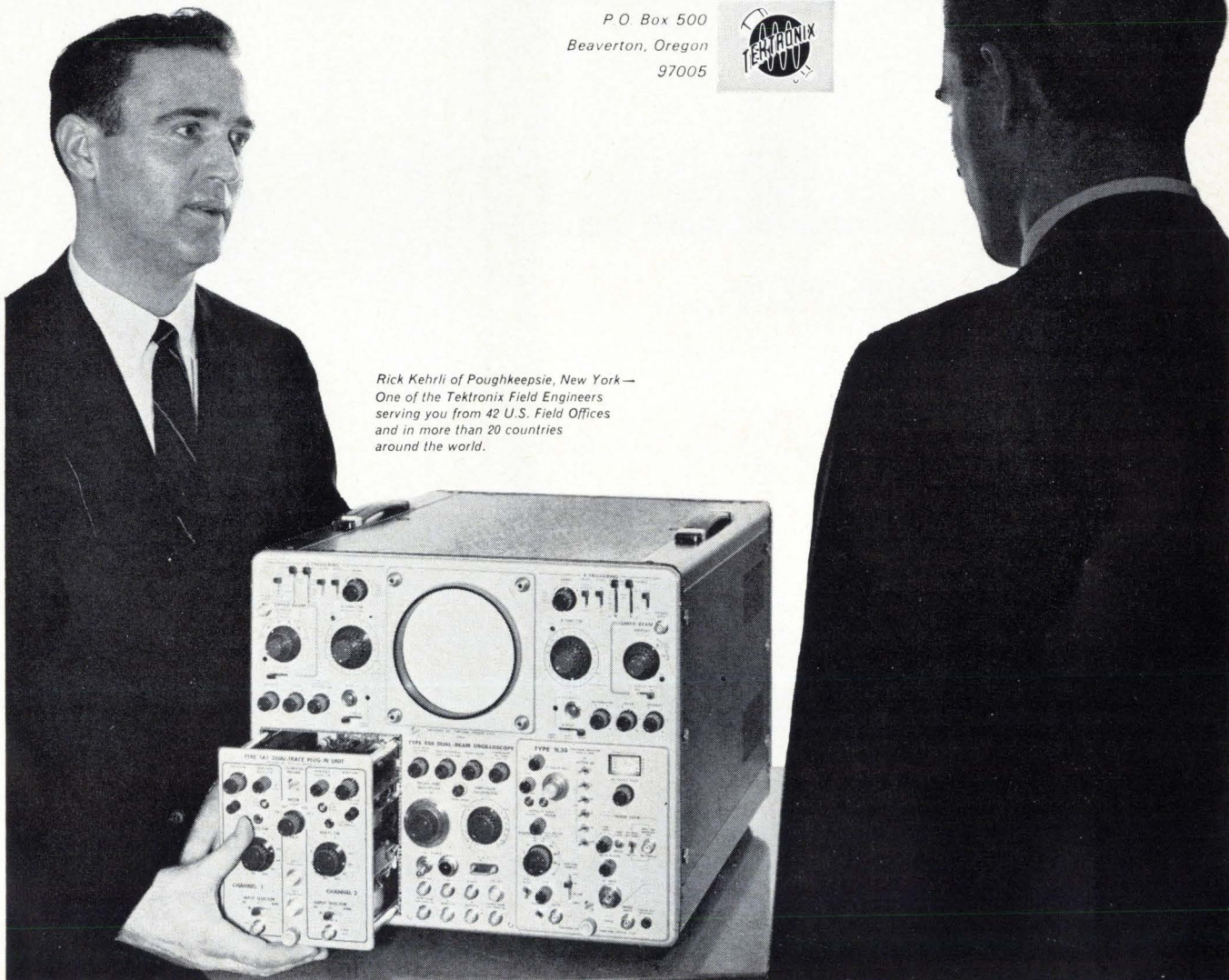

*Rick Kehrl of Poughkeepsie, New York —
One of the Tektronix Field Engineers
serving you from 42 U.S. Field Offices
and in more than 20 countries
around the world.*

"Hello...Acopian...Do you people power supply shipments in

Yes, we do. In fact, we haven't failed to meet this promise in more than five years. Place an order for any of Acopian's 62,000 different AC to DC plug-in power supplies and three days later your order will be on its way to you. To save more time, your buyer can phone your order, then follow with the paperwork. For complete information, contact your local Acopian representative or call us directly at (215) 258-5441.

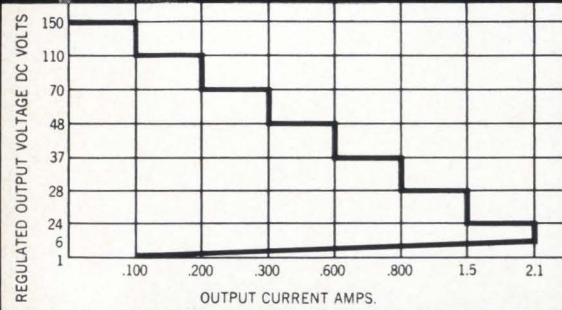

ACOPIAN SINGLE OUTPUT POWER SUPPLIES

Output voltages from 1 to 150 volts available in 1-volt increments. Graph shows range of maximum current ratings. Most models have ± 1 -volt adjustments.

Input voltage: 105-125 volts AC, 50 to 400 cycles, single phase.

Line regulation: Choice of $\pm 0.05\%$ or $\pm 0.5\%$

Load regulation: $\pm 0.05\%$ to $\pm 0.5\%$ depending on model

Polarity: Output is floating; either positive or negative side may be grounded.

Ripple: 1 to 5 mv, depending on model

Size: Housing size varies according to voltage and current rating. Sizes range from 3 $\frac{3}{8}$ " x 3 $\frac{1}{4}$ " x 4-11/16" high to 3-5/16" x 5" x 5-9/16" high.

Features: Short circuit protection. No additional heatsinking required.

Prices: From \$45.00 to \$175.00.

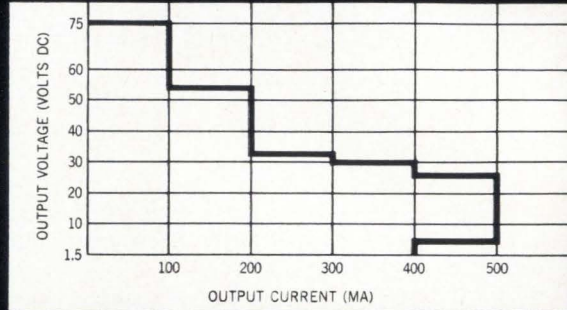

ACOPIAN DUAL OUTPUT POWER SUPPLIES

Two independent power supplies in one housing. Output voltages from 1 to 75 volts per section, available in 1-volt increments. Graph shows range of maximum current ratings per section. Most models have ± 1 -volt adjustments.

Input voltage: 105 to 125 volts AC, 50 to 400 cycles, single phase.

Line regulation: $\pm 0.05\%$

Load regulation: $\pm 0.05\%$ (most models)

Polarity: Outputs are floating. Each power supply may be connected as a separate supply with floating output. Either the negative or positive side of one power supply may be grounded irrespective of the other supply.

Size: 3-5/16" x 4-5/32" x 4 $\frac{3}{4}$ " high.

Features: Short circuit protection. No additional heat sinking required.

Prices: From \$110.00 to \$174.00.



VOLTAGE REGULATED LABORATORY POWER SUPPLY FOR ONLY \$98

Acopian's new K55 laboratory power supply delivers 300 ma over an adjustable range of 1.25 to 30 volts. Load regulation is $\pm 0.5\%$ or 50 mv, whichever is greater. Ripple is 1 mv rms. The K55 contains all-silicon semi-conductors and is short circuit proof. It stands only 5 $\frac{3}{4}$ " high, weighs only 3 pounds, and costs only \$98. Availability ... only 3 days.

Do you have Acopian's new catalog? It contains complete information about 62,000 different power supplies, all available for shipment in 3 days. Included are single and dual regulated supplies, unregulated supplies to 900 volts, supplies for relay and lamp operation, and chassis assemblies for rack mounting. Write or call for your copy.

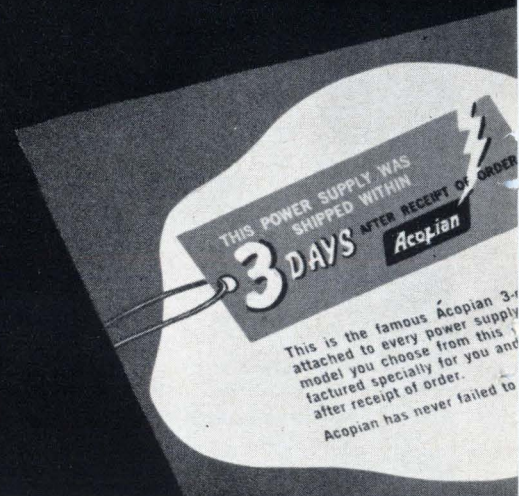

MAINE, N.H., VT., CONN., MASS., R.I.
American Dynamics Corp.
7 Dunster St., Cambridge, Mass. 02138; Tel: (617) 491-6800

NEW YORK STATE (EXCEPT METRO)
-Tron Corp.
P.O. Box 147, Skaneateles, N.Y. 13152; Tel: (315) 685-6172
P.O. Box 114, Latham, N.Y. 12110; Tel: (518) ST 5-5032
5 Thornton Rd., Rochester, N.Y. 14617; Tel: (716) ID 6-4410

METRO N.Y., LONG ISLAND, N.J. (NORTH)
Irane & Egert Corp.
127 Rockaway Ave., Valley Stream, N.Y. 11582
Tel: (516) 561-7791

METRO PHILA., N.J. (SOUTH)
Martin Electric Co.
1741 No. 13th St., Philadelphia, Pa. 19126; Tel: (215) WA 7-5858

PENNA. (EAST)
Beil & Whitaker, Inc.
3623 Jacksonwald Ave., Reading, Pa. 19606; Tel: (215) 779-2610

PENNA. (WEST), OHIO
J. C. Hofstetter Co.
742 Kenbridge Dr., Cleveland, Ohio 44124; Tel: (216) 449-0944
3605 N. Dixie Dr., Dayton, Ohio 45414; Tel: (513) 278-6721

DEL., MD., VA., W.VA., WASH., D.C.
NAECO Associates, Inc.
1925 No. Lynn St., Arlington, Va. 22209; Tel: (703) 524-4551

N.C., S.C., TENN.
Jake Rudisill Associates, Inc.
2009 No. Tryon St., Charlotte, N.C. 28206; Tel: (704) 377-6901

FLA., GA., ALA., MISS.
Gentry Associates, Inc.
2517-B E. Colonial Dr., P.O. Box 11096, Orlando, Fla. 32803
Tel: (305) 424-0730; Tel: (305) 424-4949
P.O. Box 13513, Station K, Atlanta, Ga. 30324
Tel: (404) 233-3816
Rm. 418, 2109 W. Clinton Ave., Huntsville, Ala. 35805
Tel: (205) 534-9771; Tel: (205) 536-5306

IND., ILL. (NORTH), WISC.
Potter-Mac Co.
6027 N. Northwest Hwy., Chicago, Ill. 60631; Tel: (312) 775-6626

MINN., N.D., S.D.
Kirkeby & Associates, Inc.
821 2nd Ave. N., Minneapolis, Minn. 55405; Tel: (612) 377-3239

really guarantee
only 3 days?

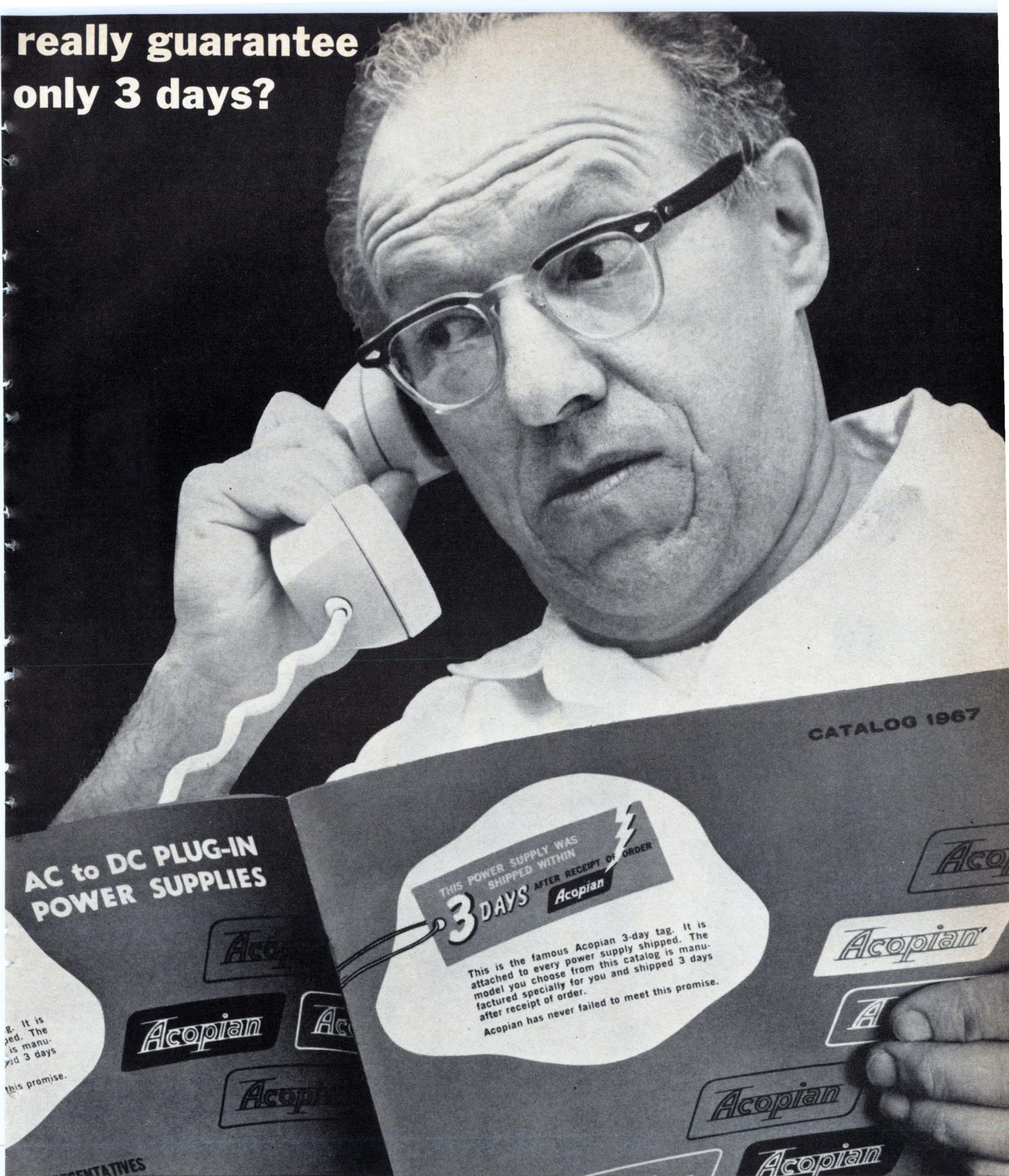

CALIF. (NORTH)

Held & Mollard, Inc.
1494 Oddstad Drive, Redwood City, Calif. 94063
Tel: (415) 369-4871

CALIF. (SOUTH)

Wieler & Co.
10842 So. Paramount Blvd., Downey, Calif. 90241
Tel: (213) 861-9223; Tel: (213) 773-5982
San Diego; Tel: (714) ZE 2-9047

WASH., ORE., MONT. (WEST), IDAHO (WEST), ALASKA

Jud Le Brun Co.
1123 S.W. Yamhill St., Portland, Ore. 97205; Tel. (503) 224-7710

CANADA

Ahearn & Soper, Ltd.
844 Caledonia Rd., Toronto 19, Ont.; Tel:(416) RU 9-4325

COLO., UTAH, N. MEX., ARIZ., IDAHO (SOUTH), MONT. (EAST)

Compar Rocky Mountain
P.O. Box 1607, Scottsdale, Ariz. 85252; Tel: (602) 947-4336
TWX: (602) 949-0182
300 E. Hampden Ave., Suite 315, Englewood, Colo. 80110
Tel: (303) 781-0912; TWX: (303) 789-2418
2125 San Mateo Blvd., N.E., Albuquerque, N. Mex. 87110
Tel: (505) 265-1020; TWX: (505) 243-9570

TEXAS, OKLA., ARK., LA.

Lawrence Sales Co.
P.O. Box 1038, 921 Bowser, Richardson, Texas 75080
Tel: (214) AD 5-5504

NEVADA

Systems Design Corp.
900 W. Bonanza Rd., Suite 1, Las Vegas, Nev. 89106
Tel: (702) DU 2-3037

MO., KANS., IOWA, NEBR., ILL. (SOUTH)

Engineering Services Co.
6717 Vernon Ave., St. Louis, Mo. 63130; Tel: (314) PA 6-2233
TWX: (314) 556-0173
7546 Troost St., Kansas City, Mo. 64131; Tel. (816) EM 3-6000
TWX: (816) 556-2347
1026 Third Ave., S.E., Cedar Rapids, Iowa 52403
Tel: (319) 366-1591



Acopian Corp., Easton, Pennsylvania 18042, (215) 258-5441

Circle 19 on reader service card

5 x 10⁻¹⁰

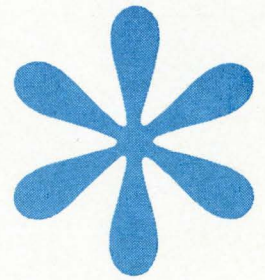

**day stability
and rapid warm-up, too**

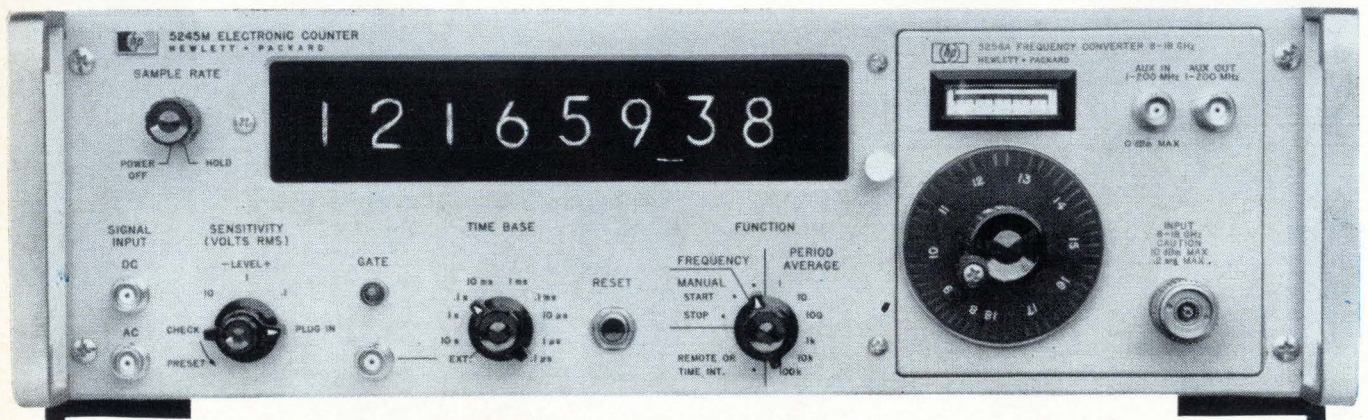

5245M COUNTER WITH NEW 5256A 8 TO 18 GHz FREQUENCY CONVERTER PLUG-IN

* $< 5 \times 10^{-10}$ /day aging rate (long-term stability)

45-minute warm-up

5×10^{-11} /sec short-term stability (rms)

$< \pm 5 \times 10^{-11}$ /°C change with temperature

$< \pm 5 \times 10^{-11}$ change with $\pm 10\%$ line voltage change

$< 2 \times 10^{-11}$ change for load changes on 5 MHz output

Time base output so stable and spectrally pure you can use it as a standard.

The unique specifications on this new Hewlett-Packard plug-in counter belong at the top of the page. They're not mere footnotes, because they combine to offer counter time-base performance never before available.

The new HP 5245M Counter has all the features of the time-proven 50 MHz HP 5245L Plug-in Counter and, in addition, has a time-base with unprecedented accuracy and usefulness as a secondary frequency standard.

The new time-base increases measurement accuracy, particularly when making high-resolution frequency measurements with HP frequency converter plug-ins. There's less frequent need for calibration. The counter's 5 MHz output is present whenever the power cord is plugged in and serves as a secondary frequency standard with excellent stability and spectral purity. For example, spectra less than 1 Hz wide (half-power points) are obtainable when multiplied to X-Band (12.4 GHz). The fast warm-up saves time, too . . . the time-base typically comes to within 1×10^{-8} of its previous frequency within 45 minutes after a 24-hour absence of primary power under lab conditions. The long-term aging rate of 5×10^{-10} /day (max.) is achieved in a fraction of the time normally associated with such performance.

Other features include: the widest variety of high-performance front-panel plug-ins, 8-digit readout, BCD output for recorders, display storage, 1 meg/25 pf input impedance on all ranges.

The new 50 MHz counter is an all-purpose instrument. Use it for measuring frequency, period, multiple period average, ratio, multiples of ratio and for scaling by decades. And increase its versatility with the plug-ins, including the three new ones described below.

HP development of the small ultra-stable time-base for the 5245 Counter is evidence of the continuing engineering commitment that keeps the HP 5245 and 5246 Counter Series the most advanced and versatile in the industry. A steady stream of new high-performance plug-in accessories are compatible with the 5245L, 5245M and 5246L Counters.

NEW 8 TO 18 GHz FREQUENCY CONVERTER With the 5256A plugged into your HP counter you can measure from 8 to 18 GHz. Resolution is up to 1 Hz with only 4 seconds of counter operation, or 10 Hz resolution in 0.4 seconds, etc. Use is rapid and virtually fool-proof. Scheduled availability, October, 1967.

DC TO 12.4 GHz WITH ONLY TWO PLUG-INS Using only two plug-in frequency converters, the HP 5255A and 5254B, your counter measures frequencies DC to 12.4 GHz with 1 Hz resolution. The 5254B covers 200 MHz to 3 GHz, and the 5255A covers 1 to 200 MHz and 3 to 12.4 GHz—without spurious responses.

NEW PRESCALER FOR 1 mV SENSITIVITY The 5258A Prescaler gives you the most sensitive 1 to 200 MHz counting instrument available. It increases counter sensitivity to 1 mV and extends the direct readout range to 200 MHz. No tuning or arithmetic calculations. Combine it with the new 5254B Converter and your counter covers DC to 3 GHz.

For complete information on the advanced counter and plug-ins, call your local HP field engineer or write Hewlett-Packard, Palo Alto, California 94304; Europe: 54 Route des Acacias, Geneva.

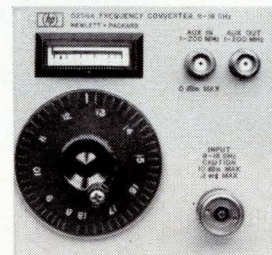

5256A 8-18 GHz CONVERTER

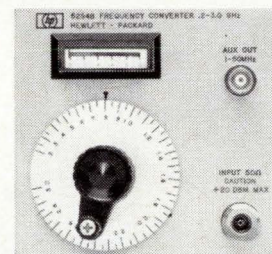

5254B 0.2-3 GHz CONVERTER

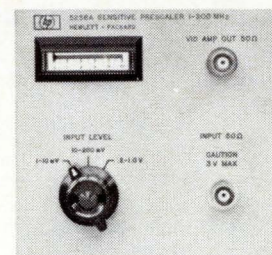

5258A SENSITIVE PRESCALER

5245M and accessories (also compatible with HP 5245L and 5246L Counters)

- HP 5245M Counter without plug-ins, \$3200.
- HP 5255A 3 to 12.4 GHz Converter Plug-in, \$1650.
- HP 5254B 0.2 to 3 GHz Converter Plug-in, \$825.
- HP 5253B 50 to 500 MHz Converter Plug-in, \$500.
- HP 5251A 20 to 100 MHz Converter Plug-in, \$300.
- HP 5252A DC to 350 MHz Prescaler Plug-in, \$685.
- HP 5258A 1 to 200 MHz Prescaler Plug-in, \$825
- HP 5261A Video Amplifier Plug-in, \$325.
- HP 5262A Time Interval Plug-in, \$250.
- HP 5264A Preset Unit Plug-in, \$650.
- HP 5265A DVM Plug-in, \$575.
- HP 5260A 0.3-12.4 GHz Automatic Frequency Divider, \$3450.
- HP 2590B 0.5-15 GHz Transfer Oscillator, \$2150.

PS: There's also a new, faster digital printer, the Model 5050A (20 lines/sec up to 18 columns), \$1750 + \$35/column.



ELECTRONIC COUNTERS

2562

Visit Hewlett-Packard at Wescon '67
San Francisco Cow Palace August 22-25

Circle 21 on reader service card

21

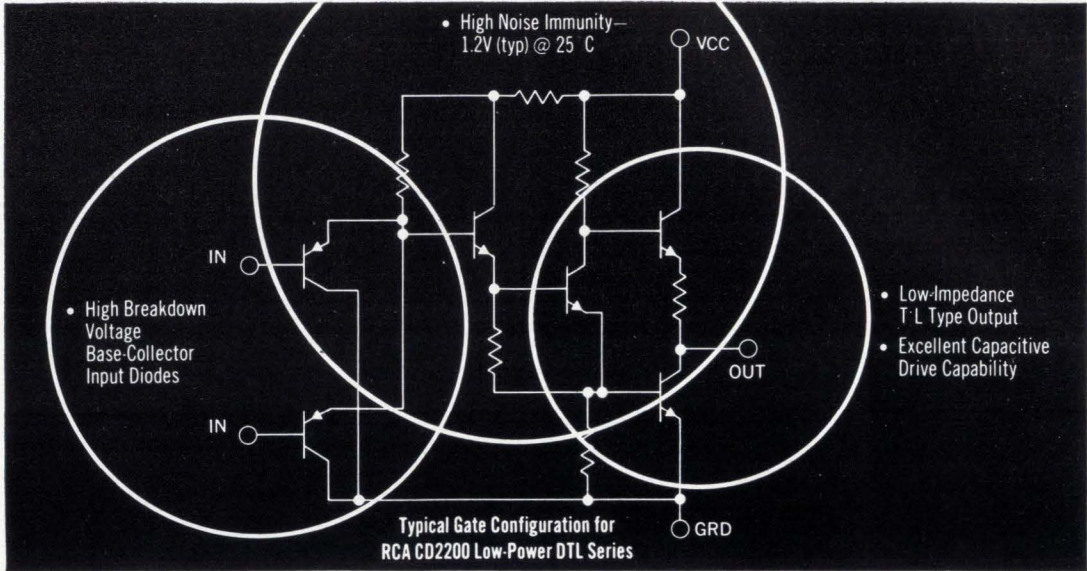

2.3 mW DTL

- Immediate Availability
- -55° to +125°C Operation
- New Buffer Gate (F-0 of 25)
- New AND/OR/NOT Gate
- Improved Characteristics



Now RCA offers an expanded line of Low Power Digital Integrated Circuits—at economy prices. Six versatile logic functions are available—operating at power supply voltages from 3.8V to 6.3V, with a fan-out of 6 over the full voltage and temperature range. New data sheets and an extensive application note are now available on these types. For details, check your RCA Representative or your RCA Distributor.

Family features RCA's unique ultra-reliable hermetic ceramic-to-metal 14-lead flat package

Write for Technical Data on the CD2200 Low-Power DTL series to RCA Commercial Engineering, Section ICN8-1, Harrison, N.J. 07029



TYPE	DESCRIPTION	PRICE (1000+)	TYPE	DESCRIPTION	PRICE (1000+)
CD2200	dual 4-input gate with expander node	\$3.75	CD2203	J-K Flip-Flop dual DC set and DC reset inputs dual J and K clock steering inputs split clock input	\$5.00
CD2201	quadruple 2-input gate	\$3.95	NEW! CD2204	dual 4-input gate expander	\$2.95
NEW! CD2202	dual 4-input buffer gate with expander node	\$3.95	NEW! CD2205	dual 3-input AND/OR/NOT gate ('phantom OR' capability)	\$3.75

RCA DTL TYPES ARE NOW AVAILABLE FROM STOCK-CHECK YOUR RCA DISTRIBUTOR FOR HIS PRICE AND DELIVERY

RCA Electronic Components and Devices



The Most Trusted Name in Electronics

Editorial**Cracked crystal ball**

Among economists and professional managers, it is becoming increasingly popular to believe that the rate of technological progress and change can be predicted accurately. One reason is that planning is becoming increasingly crucial to corporations, particularly large ones whose operations have become bewilderingly complex. Companies forecast market demand based on advertising and marketing outlays and market research; they forecast production abetted by inventory control through computers; and they forecast their supply of money by planning amortization, cash flow, and retained earnings. So it is unnerving to have an unknown like technological progress disrupting all this other "scientific" planning.

Interest in technological forecasting is thus spurred by wishful thinking rather than any record of success. Although the experts in this infant field can produce an overwhelming display of equations, graphs, curves, and memoranda upon which to make and substantiate a prediction, it is far easier to list technological developments that fooled the forecasters—either by exceeding all predictions or missing by a wide mark—than to cite examples of successful forecasting of technical change.

For a long time, technical men have talked of a growth curve that describes the progress of a technical development. Generally the curve has been drawn after a development has reached maturity. Plotted against time as a horizontal variable, it has exactly the same shape as the curve with which biologists chart the growth of living organisms. The biggest problem in using such a curve to predict technology's growth is applying a time scale to it, though putting values on the vertical scale has proven almost as difficult. Too many parameters are unknown and too many others cannot be quantified.

Of course this curve applies only to those technical areas where some success is achieved. The curves are meaningless for developments that look promising but never get off the ground. And it's often impossible to predict the success of technical developments. That companies have had little luck doing this is proven by the high percentage of new products that fail commercially—a percentage estimated by some as high as 90%. New products are only one form of technological advance; because they're so tangible, their progress ought to be the easiest to predict.

The obstacles to technical forecasting are clear. Nobody can predict when an engineer is going to hit on the solution to a knotty problem that has slowed the use of a technology. Nobody knows exactly when social mores will change and thus deflect society's interest—a move that can accelerate the growth of some technologies and wipe out the use of others. Nobody, least of all legislators, can tell when legislation will be passed to produce similar results. And today, changes in inter-

national relations can also stimulate some technologies and hold back others.

Examples are as common as slide rules among engineers. Around 1960, for instance, the laser, the integrated circuit, and the fluidic amplifier were all introduced within a few months of each other. Each was hailed as a major technological advance with great promise. Today, about seven years later, the laser is still primarily a laboratory curiosity, the fluidic amplifier is still a device of great promise—with reports of its promise becoming monotonously repetitive—and the integrated circuit is being used far more widely and in greater volume than anyone could have anticipated at the beginning of the sixties.

No one in 1960 could foresee that the attractive concept of coherent light, which was never possible before the laser, would turn out to be so tantalizingly difficult to use in practical applications. People still talk about the laser in communications, welding, and the fabrication of holograms, but acceptance at any given date is still not predictable. The fluidic amplifier turned out to be far harder to produce in commercial volumes than anyone imagined. Tolerances that looked easy to achieve have turned out to be unattainable.

When President Kennedy decided that NASA should try to put a man on the moon by 1970, that achievement looked impossible. By 1966, scientists impressed by progress—particularly the success of the Gemini flights—were stating confidently that the schedule would be beaten. But in the wake of the fatal fire in the Apollo capsule in February—and the resultant furor in Congress—few scientists are willing to predict that the schedule will be bettered, or even met. And this summer's epidemic of riots in U.S. cities has stirred some Congressional sentiment for a diversion of space funds to housing, education, and jobs for the urban poor.

The defenders of technical forecasting like to tell you that the failures of the past were caused by lack of knowledge, that we are much smarter these days. But even with this added knowledge and experience, who can predict with any assurance when integrated circuits, already far ahead of 1960 schedules, will be used in microwave systems outside the laboratory? When will we have a color television tube that doesn't absorb as many electrons as the shadow mask tube? When will large-scale integration be used in all computer designs?

One answer to each of these questions could be "never." Transmission of electricity by microwave has been a goal of engineers for more than 30 years. Every few years there is another spurt of activity and another tailing-off. Ten years ago, designers of control equipment talked excitedly about adaptive systems that would automatically adjust their performance to changes in their environment; promising aircraft and missile applications were discussed. Today the adaptive concept is almost dead.

Forecasting is attractive because it removes uncertainty from the scene, and uncertainty is bothersome in personal as well as business life. But there simply is no easy way to predict either the rate or direction of technological advance.

What's the biggest problem plaguing RFI filter designers? Well, poor attenuation in available filter components has to be one of the most troublesome. Optimum attenuation leaves a lot to be desired. Our engineers tackled the problem and found we already had a solution. It's a ferrite material we call Ferramic® O-5. This material has established an outstanding reputation for use in chokes, inductors, and transformers operating over a frequency range from audio to the broadcast band. But it does an about face

and its attenuation climbs like a rocket from 10 KHz up through the megacycle range. And it exhibits extremely high permeability and dielectric constant throughout this range.

In short, our O-5 ferrite is about the finest RFI filter material made anywhere and is available as a standard production item. In addition, we have other materials, like H and Q-1 ferrites that do an excellent job for similar applications. This is just one more example of the new uses of ferrites in a widening range of industries.

Because of our demonstrated ability to handle RFI filtering problems we now have various new materials and applications under development for both the military and commercial markets. You'll be hearing about them soon. So if you have an RFI filtering problem, you ought to find out what we've got. Just write Mr. K. S. Talbot, Manager of Sales, Indiana General Corporation, Electronics Division/Ferrites, Keasbey, N.J.

INDIANA GENERAL 

**When it comes to filtering radio frequency interference
Indiana General has what it takes.**



Electronics Newsletter

August 21, 1967

GM builds IC's into regulator for '68 Pontiac

Just when the experts said that integrated circuits and the hot, noisy, and bumpy automotive environment were still incompatible, General Motors shook up its competitors by disclosing that it had produced the industry's first IC voltage regulator. So small that it's built into the alternator—which GM calls a Delcotron generator—the device will be offered in the 1968 Pontiac line: standard equipment on the Grand Prix model, optional on the Catalina, Executive, and Bonneville. Subsequently, it will be installed in all GM cars, trucks, and buses.

The IC's are all hybrid types made at the company's Delco Radio division in Kokomo, Ind. One disadvantage is that the regulator alone can't be replaced because it's built into the alternator housing. But GM says this is no problem since the IC's are virtually indestructible. GM also says the Delcotron will cost a few dollars more at first than the Delcotron generator, but eventually will cost about the same.

Burroughs protest delaying 407L award to TRW

A protest by Burroughs is holding up an Air Force contract to TRW Systems Group for integration, assembly, and checkout of the 407L tactical air control system [Electronics, Feb. 6, p. 26].

Out of the 11 interested companies, the two were chosen for negotiations, which have been going on for several months at Air Force Electronic Systems Division, Hanscom Field, Mass. Industry sources say TRW wasn't low bidder, and that Burroughs is basing its claim on bid-evaluation points.

The contractor will coordinate the \$500 million program, which will upgrade air-transportable communications, radar, and data-processing capabilities for battle areas. Some observers estimate the contract could involve as much as \$10 million a year.

FET's buck trend: five-month sales rise 75% from '66

This year's slump in sales of discrete semiconductors hasn't touched field effect transistors. Dollar sales of FET's spurted 75% in the first five months of 1967 from the year-earlier level, more than double the increase makers expected. But it's still a small market; last year FET volume totaled \$8.7 million—only 1% of the discrete market.

The gain this year is occurring mostly in the instrument and the consumer-entertainment markets, although major suppliers report increased use in military and industrial communications systems as well. Some designers of nonmilitary gear are apparently forsaking bipolar transistors, tubes, and other traditional devices in favor of FET's—mainly plastic-encapsulated units costing less than a dollar.

New TI group to make and market microwave devices

Texas Instruments, in what may be the first in a series of shifts from product-oriented to market-oriented organization, has formed a microwave products branch in its Semiconductor Components division. The new branch will develop, make, and sell a full range of silicon, germanium, and gallium-arsenide products. Developmental efforts will include Gunn and other bulk-effect devices. J. Fred Bucy, vice president and division manager, says TI chose this route rather than its usual product orientation to "concentrate our resources on the major worldwide growth market" in microwave products.

Electronics Newsletter

Data-relay satellites to miss '72 date

Despite earlier optimism by NASA project officials [Electronics, Jan. 23, p. 48] that a data-relay satellite system would be operational by 1972 to support such programs as Apollo Applications, **NASA headquarters is still not convinced there is a requirement for the three-satellite system.** Project officials believe they can demonstrate the need, and expect conceptual design studies will be funded by early 1968. However, that would be too late to ask for funds as a line item in the fiscal 1969 budget. **Program officials' best guess now on an operational date: 1974-1975.**

LBJ forms panel on communications

President Johnson, concerned that the U.S. lacks clearly stated aims or policies in the field of communications, has set up a study panel to consider such diverse matters as **the creation of a secretary of communications**, the role of satellites, use of the available frequency spectrum, and the possibility of merging international communications carriers. **The panel is to report back to the President in a year**—in time for the U.S. to prepare its position for the 1969 meeting of the 58-nation International Telecommunications Satellite Consortium (Intelsat); at that meeting, Intelsat will affirm the interim agreements reached so far on worldwide satellite communications.

General-purpose Lockheed computer

Lockheed Electronics' avionics and industrial products division in Los Angeles is likely to enter the general-purpose computer field. Its small machine, insiders say, could be used for data handling, experimental monitoring, and process control.

The computer would complement Lockheed's current line of ferrite cores, memory stacks, and memory systems.

The first units may be used to control diagnostic test equipment for automobile engines; preliminary discussions with producers of such equipment have already been conducted by Lockheed officials.

AC Electronics likely to get order for Titan guidance

The Air Force will be shopping for a new inertial guidance system for its Titan 3-C launch vehicle's transtage. A spokesman says the Air Force's Space and Missile Systems Organization will request proposals for an all-attitude inertial system in the next few months. **The AC Electronics division of General Motors has the inside track for the award.** It furnishes the inertial guidance unit for the 17 R&D versions of the Titan 3-C and will also supply those for the eight production models ordered late last month.

The Titan product-improvement program prohibits any new R&D, which indicates that AC Electronics' Carousel 4 inertial unit is the only candidate on the horizon now. It's an all-attitude system, and should be flight-proven in the Boeing 747 by the time a source is selected, possibly in a year.

Compatible VTR from Sony

Sony is about to enter the industrial market for color video tape recorders with a machine compatible with NTSC standards—the standards regulating home color television. This means that the recorder will be able to use standard color tv signals and work with any tv monitor. Machines currently on the market have to be hooked up to special monitors to reproduce tv color.

IDEAS

from SYLVANIA Electronic Components Group

DIODES

Now, planar diode arrays that drive cores faster

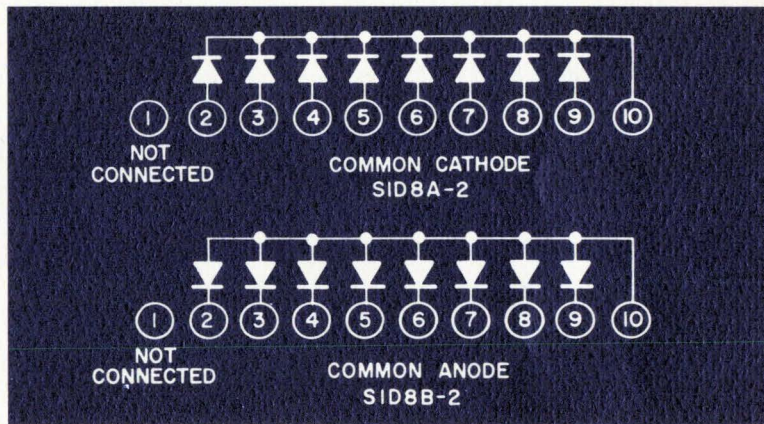
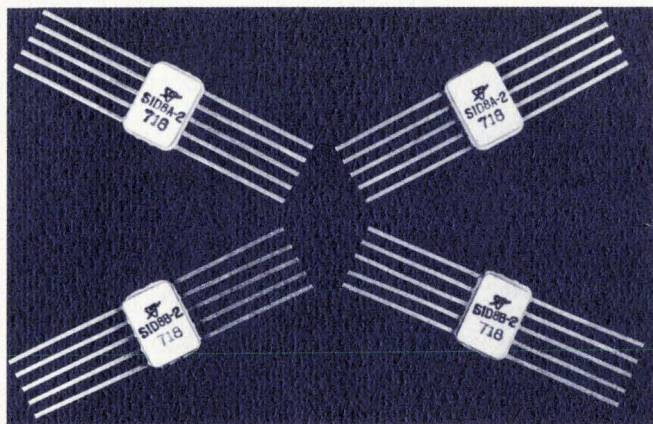

The benefits of packaged diode arrays over a similar number of individual diodes are well known by circuit designers. The user gets reduced costs in the form of lower assembly labor, fewer external wires and less handling of components. There are also the benefits of higher reliability and packaging density which result from the integrated method of manufacture. With Sylvania's new planar core driver arrays you get all these benefits plus ultra-fast switching characteristics in configurations ranging from two to sixteen diodes.

The combination of high forward conductance, fast recovery, low capacitance and tight performance tolerances makes Sylvania's new diode arrays well suited for high speed core driver applications.

Typical of these new units are the

SID8A-2 and SID8B-2, eight diode core drivers with forward current ratings of 300 mA and power ratings of 300 mW per diode. Couple this power drive capability with ultra-fast recovery and designers have diode arrays which meet the demanding requirements for memory drivers in military and aerospace computers as well as commercial computers.

Reverse recovery time of these diodes is a maximum of 60 nsec even at such extreme switching conditions of a forward current of 300 mA and an I_R of 30 mA. Typical values for the recovery time of I_F and I_R switching from 300 mA to 30 mA is 35 nsec.

Sylvania's SID8A-2 and SID8B-2 are monolithic silicon diode arrays assembled in hermetically sealed flat packs (0.250" x 0.175") or dual-in-line plug-in packages. Available in a com-

mon cathode (SID8A-2) or common anode (SID8B-2) configuration, these planar devices feature silicon dioxide passivated construction. They are fabricated on a high resistivity layer which is epitaxially grown on a low resistivity substrate.

The manufacturing process used to produce these arrays results in diodes which have closely matched electrical characteristics over a wide temperature and current range. Passivation insures that performance remains stable over a long operating life. Manufactured to standard MIL quality

(continued)

This issue in capsule

Microwave Components—A diode oscillator that may reduce the cost, size, and complexity of your next X-brand design.

Integrated Circuits—How to build an eight-stage fast adder using only twelve IC packages; also, some special IC problems... with SUHL^(TM) answers.

Photoconductors—Sylvania announces a new generation of PCs, all with 15:1 resistance ratio; also, a new device with high sensitivity and diode isolation.

CRTs—Upgrading your readouts with a two-color one-gun tube.

MAXIMUM RATINGS AT 25°C (each junction):

Reverse Voltage, V_R	40 volts
Forward Current, I_F	300 mA
Peak Forward Current, I_{FP}	1.0 amp (0.1 μ sec, 25% D.C.)
Average Power Dissipation, $P_D(3)$	300 mw (500 mW total package)
Junction Temperature, T_J	-65°C to +150°C
Storage Temperature, T_{159}	-65°C to +300°C

NOTES:

1. Pulse test \leq 300 μ sec, \leq 2% duty cycle.
2. Forward Voltage drop of highest reading diode junction shall be within 200 mv of lowest reading diode.
3. θ_{JC} 0.1°C/mw; θ_{CA} 0.2°C/mw. Linear-derating +25°C to +150°C.

ELECTRICAL CHARACTERISTICS AT 25°C (each junction):

	Conditions	Min	Max	Unit
Forward Voltage Drop, V_F (Note 1.)	$I_F = 300$ ma	—	1.25	V
Forward Voltage Drop, V_F (Note 1.)	$I_F = 500$ ma	—	1.40	V
Forward Voltage Drop, V_F (Note 1.)	$I_F = 800$ ma	—	2.00	V
Reverse Current, I_R	$V_R = 30$ V	—	0.1	μ A
Peak Inverse Voltage, PIV	$I_R = 10$ μ a	40	—	V
Capacitance, C	SID8A-2 SID8B-2 0V, 1 MHz	—	3.0 6.0	pf pf
Reverse Recovery, t_{rr}	$I_F = 300$ ma $I_R = 30$ ma $i_r = 3$ ma $R_L = 100$ ohm $I_F = 500$ ma	—	50	nsec
Forward Voltage Match, ΔV_F	(Notes 1. and 2.)	—	0.2	V

DIODES (continued from page 1)
 assurance requirements, these packaged arrays meet MIL-S-19500.

Other core drive arrays available on request from Sylvania include units with two to sixteen diodes con-

nected common cathode or common anode.

CIRCLE NUMBER 300

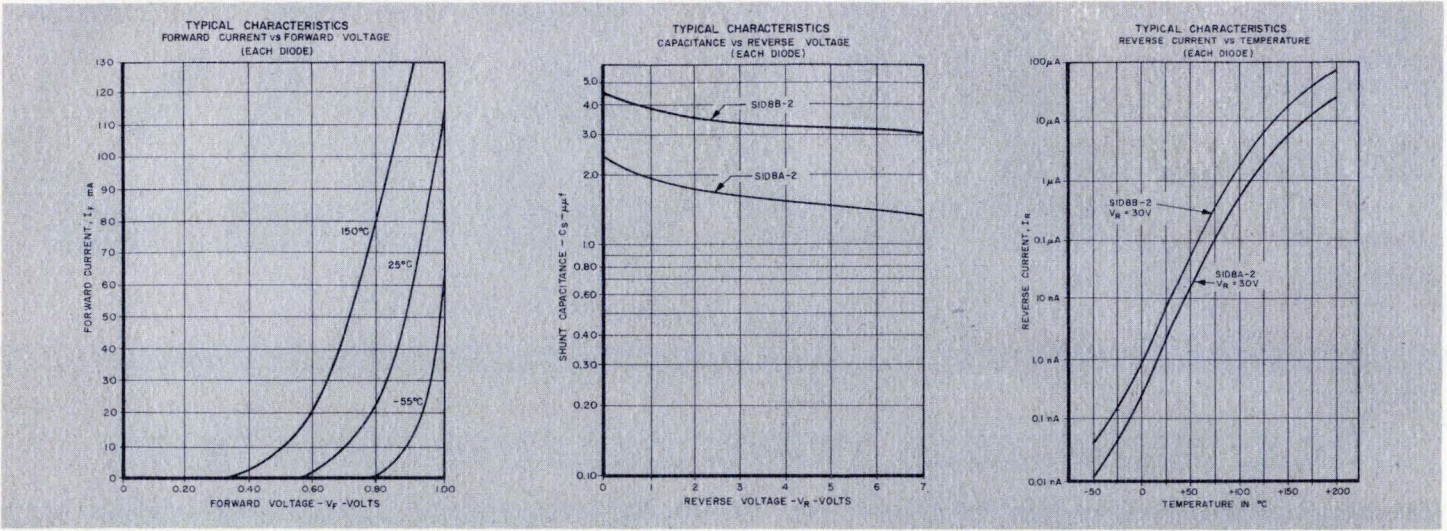

PHOTOCONDUCTORS

Newest PC component gives high sensitivity and diode isolation

If you wonder why we say Sylvania is the logical source for photoconductive devices, just mentally list the different types of devices in Sylvania's PC lines. You'll find power ratings of 50 mW to 500 mW; TO-18, T-2, T-4 and T-33 packages; custom PC matrices; ultraviolet detectors; and photoconductor-lamp (PL) assemblies. Now, with the availability of a TO-18 type Diode Photocell assembly, there's another reason for saying Sylvania has become the logical source for all photoconductive devices.

Any of Sylvania's TO-18 type photocells are now available with a built-in silicon diode. In this integral assembly, a diode chip, mounted on the same rugged ceramic substrate as the photo-sensitive material, is series-connected to the PC. The resulting electrical combination of a diode-PC series circuit is particularly useful in logic circuits where it gives diode iso-

lation without the need for any additional components.

The silicon diodes in these assemblies have peak inverse voltage ratings of up to 50 volts. The PC cells feature very compact construction, improved response time characteristics and 50 mW power dissipation. Resistance values of from 10,000 to 100,000 ohms at 2 footcandles illumination are available. Dark resistance is at least 100 times the 2 FC values.

Improved photosensitive material used in these integral assemblies provides response times approximately twice that of the cadmium sulfide material presently used in T-2 and T-4 types. The fast response time, a dissipation rating of 50 mW, and the diode function are combined in one of the smallest hermetically sealed packages available. Thus, designers gain a product suitable for many circuit uses. They're good for just about

any application where the sensitivity of a photoconductor and the circuit isolation of a diode are required.

With these Diode-PC assemblies, designers gain circuit simplicity, better utilization of space and increased reliability through the use of fewer parts, fewer wires, and fewer soldered junctions and terminals. Typical applications are in card readers, to recognize such functions as configuration and position, and in a host of logic functions.

The reliability and long-life characteristics basic to solid state devices are enhanced in these diode-photocells by the manufacturing process used at Sylvania. The TO-18 devices are manufactured using such proven transistor technology processes as controlled dry box atmosphere, projection welding, and vacuum bake out.

CIRCLE NUMBER 301

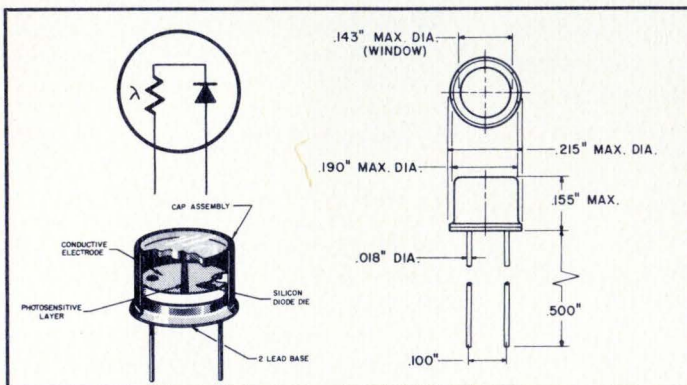

OPTICAL DATA TO-18 DIODE-PC CHARACTERISTICS & RATINGS

Wavelength of Maximum Spectral Response5300 to 6300 Angstroms
 Various Peaks can be Obtained Within the Above Response Range.

RATINGS (Absolute Maximum Rating System)

Breakdown VoltageUp to 200 V
 Dissipation
 T-Amb. = 25°C50 mW
 T-Amb. = 75°C0 mW
 Derate linearly from 25°C to 75°C
 Ambient Temperature Range-40 to +75°C
 Peak Inverse VoltageUp to 50 mV

CHARACTERISTICS

Cell Resistance at 2FCVarious Values Available From 10K to 100K Ohms
 Dark ResistanceIn Megohm Range
 Ratio (2FC to Dark)Minimum Ratio 100: 1
 Average Ratio 1000: 1

SUHL solutions... to some special IC problems

In integrated circuits, it's not enough to provide the designer with just basic logic elements. In the Sylvania SUHL™ integrated circuit line, the NAND/NOR gates, the AND-NOR gates, and the flip-flops are supplemented by devices which overcome the interface and other special problems which IC circuits and systems must overcome if they are to be of practical use. Here are just four of these devices and some of their special applications.

Standard Sylvania IC units can overcome many of the special problems associated with system and subsystem design. When requirements call for wire ORed outputs, the SG-160 series of SUHL devices will solve the problem. The SG-130 series of dual drivers is the answer for high current, high fanout applications. Availability of SUHL AND-OR gates like the SG-280 eases implementation of a host of system functions including up-down counters. Combining a Schmitt trigger and an AND gate into one IC makes Sylvania's SG-80 units useful in many timing circuits. Practical applications of these Sylvania TTL units follow.

The SG-160 series of triple two-input bus drivers can perform logical ORing at its outputs because, in these ICs, the standard SUHL active pull-up output networks are replaced with internal 5K pull-up resistors. These pull-up resistors, which are brought out to separate terminals, can

be externally connected to the collector of the output transistors, allowing the bus driver to function as an integral circuit (Figure 1). Turnoff delay is a function of the RC time constant of the load capacitor and pull-up resistors plus storage time of the device. When a very precise delay time is required, discrete external pull-up resistors can be used to increase or decrease the delay time.

The SG-160 series is ideal for matrices which interface TTL and other logic types including DTL, RTL, CTL, ECL and CML. Key electrical characteristics include: a high logic swing with typical values of 0.26 volts for logic 0 and 5.0 volts for logic 1; a current output of 30 mA minimum for military versions and 15 mA for industrial units; and a high noise immunity rating of 900 mV at 25°C and worst case fanout.

The high fanout dual drivers of the SG-130 series are ideal for applications which require high current drive (Figure 2) to lamps, cables, transformers, relays and similar devices. Capable of a fanout of over 30, these SUHL drivers are designed for 20-MHz systems. They feature a typical propagation delay time of 25 nsec with a 1000 pf load.

Sylvania's SG-280 AND-OR gates and SG-290 input expanders, provide logic designers with an AND-OR system which facilitates system design with other SUHL elements. Each SG-280 package contains two four-

input AND gates with non-inverting amplifiers. Thus, each gate can function as an AND element (in positive logic) or as an OR element (in negative logic). The SG-290 expanders allow single wire feed-in to the SG-280 when performing the wired OR function without degradation of SG-280 fanout, noise immunity or waveform integrity. With the SG-280 and -290, no complex loading rules are needed because input and output are isolated and no buffer or logic level restoration is needed. Figure 3 shows how these units are used with other SUHL devices in an Up-Down counter.

A double Schmitt trigger is the key element in the SG-80 ICs. Combining each Schmitt trigger and its own three-input AND gate with a SUHL output network in one IC makes the SG-80 useful in a host of circuits: one-shot multi-vibrators, wave shapers, threshold detectors, integrators, delay generators, oscillators, pulse generators, pulse restorers, line receivers, and similar subsystem functions. For example, the SG-280 may be easily adapted for a one-shot multi-vibrator capable of producing output pulses of less than 50 nanoseconds to pulses greater than a millisecond. Figure 4 shows a typical logic diagram for this operation.

Another example, the SG-80 may be used as a pulse absence detector, to recognize the absence of a pulse in a train of pulses.

CIRCLE NUMBER 302

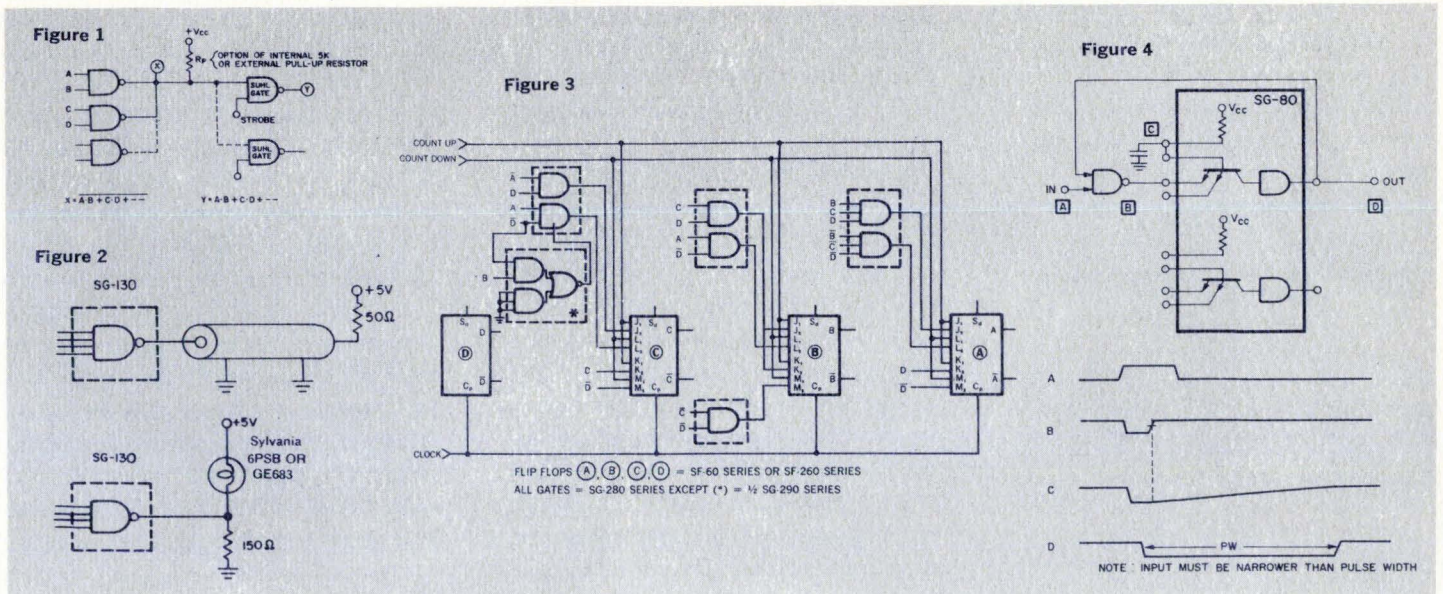

Diode oscillator reduces cost, size and complexity of X-Band designs

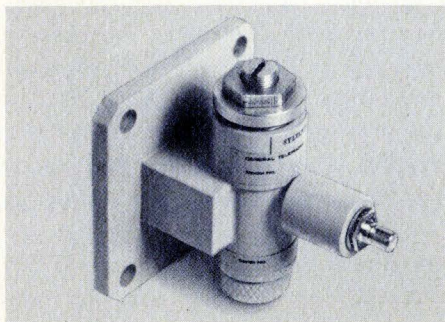

Although introduced only a few months ago, Sylvania's SYA-3200 X-band avalanche diode oscillator is fast becoming a workhorse device adaptable to many circuit functions. Operating at any frequency in X-band (8.2 to 12 GHz), it has use in local oscillators, parametric amplifier pump sources, and also in such equipments as a-m and f-m modulated transmitters and transponders, doppler radar, security systems and PCM microwave relays.

As a parametric amplifier pump source, the avalanche diode oscillator offers significant advantages over the two conventional pump sources, klystrons and varactor multipliers. Klystrons require very large and expensive power supplies, and varactor multipliers usually require many semiconductors and complicated circuitry. The avalanche diode oscillator is much simpler and less expensive than the varactor multiplier. It requires a simple and lightweight power supply and has inherently longer life.

Parametric amplifiers pumped by the SYA-3200 avalanche diode oscillator exhibit performance indistinguishable from that obtained with conventional klystrons. In one application, a parametric amplifier operating in L-band was pumped at 11 GHz by an SYA-3200. The resulting

noise figure of 1.8 db was exactly what was obtained using a klystron. In addition, overall weight and size of the amplifier was reduced by 50 percent and gain, bandwidth and stability were unchanged.

Avalanche diodes can operate as power amplifiers as well as oscillators, and have approximately the same output power in either mode. High level power gain of 10 to 15 db has been obtained at X-band. Figure 1 shows results with a silicon diode amplifier. Here, maximum power

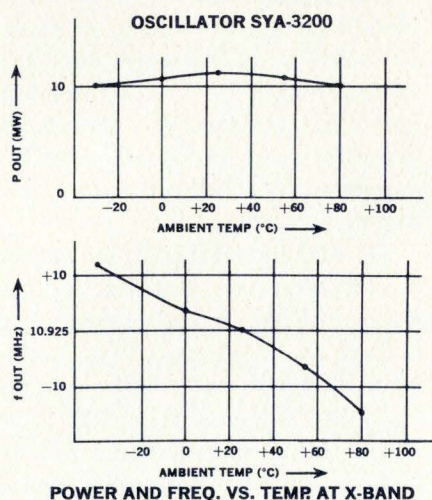

output is 38 mW and instantaneous bandwidth is about 100 MHz with no attempt made to optimize bandwidth. The same diode used as an oscillator at the same frequency and bias level has a 40 mW output.

Short range zero i-f frequency doppler radar systems, including police radar and security surveillance systems, can use the SYA-3200 because avalanche diode oscillators exhibit low noise at frequencies close to the carrier.

Because the avalanche diode oscillator is a current-controlled device whose amplitude of oscillation is nearly a linear function of bias current, it is easily amplitude-modulated by varying bias current. Pulse and video modulation is faithfully reproduced with modulation indices of up to 80 to 90% at modulating rates exceeding 10 MHz. Thus, the oscillator can be used as an amplitude-modulated source for communications or data transmission without adding an

AFC LOOP FOR AVALANCHE OSCILLATOR

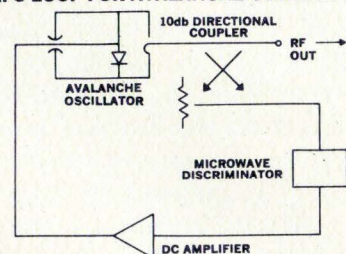

external modulator.

In these applications, there is little variation of performance of the SYA-3200 over wide temperature ranges. Figure 2 gives power output and frequency from -30°C to $+85^{\circ}\text{C}$. Total power change is less than 1 db, and total frequency variation is less than 25 MHz; performance which compares favorably with that of reflex klystrons. Most of the frequency variation in the SYA-3200 is attributable to the thermal coefficients of the metals used in the cavity. The actual diode is extremely stable with temperature. Development of a cavity having metals with lower or better matched coefficients is expected to produce even better frequency stability.

Although the cited figures already show the SYA-3200 to be very stable with temperature, there are ways to provide additional stabilization. Injection and sub-harmonic locking will effectively stabilize the oscillator to the reference source frequency. Tightly coupling an exterior cavity to the oscillator will reflect additional reactance into the oscillator circuit and effectively increase its Q. This reduces frequency fluctuations from variations of diode and external circuit parameters.

Frequency stability of the oscillator can also be increased by an AFC loop which uses a microwave discriminator. The amplified output of the discriminator can be used as a feedback signal to correct the oscillator frequency. A tuning varactor may be used as the control device for this purpose. Electronic tuning of an avalanche oscillator over several hundred MHz has been demonstrated with little change in output power and at very high tuning speeds.

PERFORMANCE OF X-BAND AVALANCHE DIODE POWER AMPLIFIER

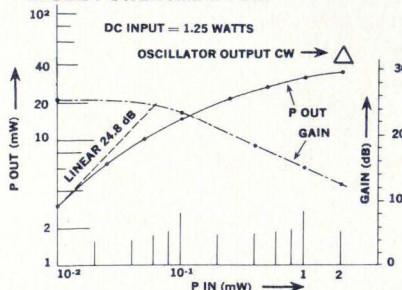

Upgrade your readouts: add 2 colors with a 1-gun tube

With the introduction of Sylvania's new 2-color one-gun CRTs at the Society for Information Display (SID) show in May, designers in the display and oscillography field gained a valuable design tool. Here's why the tube is causing so much interest among designers. But to really be convinced, plan to see our live demonstration at WESCON or ask your local field office to set up one in your plant.

Sylvania's recently introduced one-gun multicolor industrial cathode ray tube has given equipment designers a new tool to meet increasing demands being put on visual displays. Now, there's a practical two-color tube that simplifies the design of new equipment in which the display must provide quick and positive recognition of information from diverse sources. Display system design has been eased because Sylvania has eliminated the need for multiple guns or dot phosphors to get a two-color capability in one CRT. This, in turn, has led to simplified electronic control circuits to accomplish switching from one color to another.

Multilayer phosphors of red and

green produce the two-color output at the face of the new tube. Selection of a red or green output is accomplished by switching the voltage on one of the tube's anodes.

The extra two guns and three-dot phosphor used in conventional color CRTs aren't needed. This eliminates the precise shadow-mask control and alignment procedures normally used in color CRTs. And because dots of three different phosphors are no longer required for each information point, the new tube has very high resolution. This means more information can be displayed in a given area, increasing display space efficiency.

Since, in the improved tube, the colors are changed by placing discrete voltage variations on one of the tube's anodes, color switching is extremely reliable. Elimination of the three-dot phosphors means there's no chance of misalignment which can cause the wrong phosphor to be activated by the wrong gun.

The new tube uses green and red phosphors to provide high contrast and color separation. The result is displays which are both easy to read

and highly accurate. These displays are ideal for those applications requiring discrete-color information—applications which are limited only by the system designer's imagination.

The basic concepts used in the new tubes can be applied to a wide range of CRTs. Custom sizes which supplement Sylvania's standard units can be developed. In addition, the techniques are applicable to other CRT types, such as two-gun tubes, to meet special custom applications.

A specific example of how this new approach is used in a one-gun device is CRT Type SC-4689. This standard unit, available since May, gives excellent color separation from red to green by switching the voltage on anode No. 3 from 6,000 to 12,000 V. The red phosphor used in the tube is the Sylvania-developed europium-activated phosphor. The SC-4689 offers a 5" diameter screen and a high resolution gun. It has spiral post deflection acceleration which minimizes changes in deflection sensitivity and pattern linearity when anode No. 3 is switched.

CIRCLE NUMBER 304

SPECTRAL ENERGY DISTRIBUTION (PHOSPHOR TYPE "PSO")

MAXIMUM RATINGS (Absolute Maximum Values)		TYPICAL OPERATING CONDITIONS	
Anode No. 3 Voltage	13,000 Volts dc	Red Operation	Green Operation
Anode No. 2 Voltage ⁽¹⁾	7,000 Volts dc	6,000	12,000 V. dc
Anode No. 1 Voltage	1,100 Volts dc	3,000	3,000 V. dc
Grid No. 1 Voltage		Anode No. 1 Voltage for Focus	150-400
Negative Bias Value	220 Volts dc	Grid No. 1 Voltage Required for Cutoff ⁽²⁾	-30 to -70 -30 to -70 V. dc
Positive Bias Value	0 Volts dc	Deflection Factor	
Positive Peak Value	2 Volts	Deflecting Plates 1-2 ⁽³⁾	70-90
Peak Heater-Cathode Voltage		Deflecting Plates 3-4 ⁽⁴⁾	65-85
Heater Negative		Line Width "A" @ I _{a3} = 25 μA	.012
with Respect to Cathode	140 Volts dc	Brightness, 2" x 2" raster	
Heater Positive		I _{a3} = 25 μA (approx.)	4
with Respect to Cathode	140 Volts dc	Anode No. 3 Current	35
Peak Voltage Between Anode No. 2 and Any Deflection Plate	550 Volts	@ E _{s1} = cutoff (approx.)	7-30
Post Deflection Spiral Resistance	100-400 Megohms		21-90 μA dc

SC-4689 CHARACTERISTICS		CIRCUIT VALUES	
Focusing Method	Electrostatic	Grid No. 1 Circuit Resistance	1.5 Megohms Max.
Deflect on Method	Electrostatic	Deflection Circuit Resistance ⁽⁵⁾	5 Megohms Max.
Heater Voltage	6.3 Volts		
Heater Current	0.6 Amperes		
Minimum Useful Screen Diameter	4.5 Inches		
Weight (approx.)	2.5 Pounds		
Mounting Position	Any		

NOTES:

1. The product of the Anode No. 2 Voltage and the Average Anode No. 2 Current should be limited to 6 Watts.
2. Visual extinction of undeflected focused spot.
3. Deflecting Plates 1-2 are nearer the screen.
4. Deflecting Plates 3-4 are nearer the base.
5. It is recommended that the deflecting electrode resistances be approximately equal.

Announcing a new generation of PCs, all with 15:1 resistance ratio

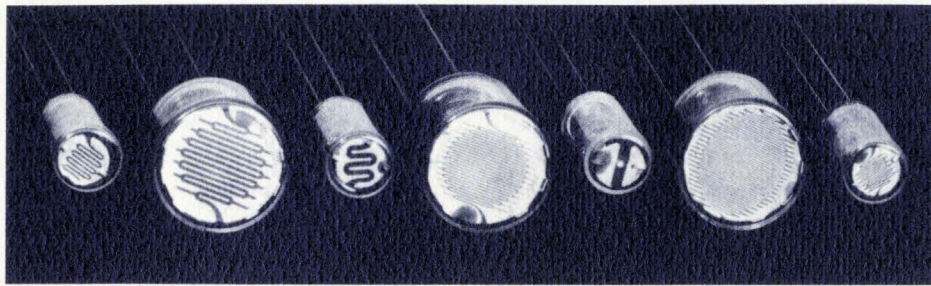

Two months ago we described a new sensitive, low-resistance photoconductor available from Sylvania. We explained that this new device, type 8760, represented the latest advance in cadmium sulfide photoconductors. Now, many of the improvements first used in the 8760 have been incorporated into each unit in Sylvania's broad line of T-2 and T-4 photoconductors. The result is a new generation of extremely sensitive pressed-wafer photocells.

Increased sensitivity of every device in Sylvania's T-2 and T-4 photoconductor line is the result of improvements in materials selection, device design and processing techniques. But increased sensitivity is only one of the superior characteristics of these improved photocells. Sylvania leads the way in other photoconductor advances: increased stability, lower light resistance, higher dark resistance and improved breakdown voltages.

Now circuit designers have a tailored product line which offers a wide cell impedance choice, 75 and 300 milliwatt dissipation ratings, 1/4-inch and 1/2-inch sizes, and socket or solder-in bases. More than ever before, designers can select the cell that is best suited for the particular application.

Increased sensitivity of these improved devices is reflected in the high 15:1 minimum resistance ratio (2 FC to 100 FC) for all units. Typical values range to 30:1. Dark to 2 FC ratio is at least 100:1, with typical values from 500:1 to 1500:1.

Units have light resistance as low as 250 ohms at 2 FC (see table of characteristics and ratings). With these Sylvania units, there's no worry about voltage breakdown. Ratings of 175 to 400 volts comfortably exceed normal application requirements.

Stability of the improved character-

istics has been proven by life tests at above rated dissipation for over 500 hours. Typical units show less than 10 percent resistance change from initial values.

In addition to the controls on materials and manufacturing of the basic cadmium sulfide light-sensitive wafer, physical mounting and sealing also play important roles in the improved electrical and life characteristics.

Each wafer assembly is inserted into a protective glass envelope and the unit back filled with extremely dry gases and then sealed. The all-glass envelopes are strain free and provide a true hermetic seal. To assure hermeticity, each cell incorpo-

rates the famous Sylvania "Blue Dot." This visual indicator changes to pink in as little as 0.02% moisture, warning of impending cell degradation.

A rigid mount structure adds to the cells' ability to take shocks of up to 300 g. An epoxy band between the cadmium sulfide wafer and its metal supporting clip provides solid mounting of the wafer plus a thermal path for better heat dissipation. This means longer life and higher dissipation capability for the cells.

Electrical connections are also epoxied for ruggedness and noise-free operation. Lead wires are welded and brought out of the envelope through a glass-to-metal seal.

The high quality levels of Sylvania's photoconductors are assured by a wide range of acceptance and design tests including accelerated life, voltage breakdown, impact shock, vibration, noise, thermal shock, dark storage, light storage, response time and spectral response.

CIRCLE NUMBER 305

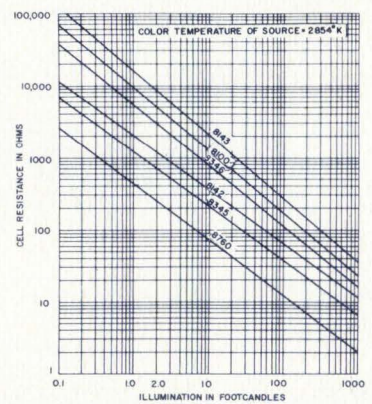
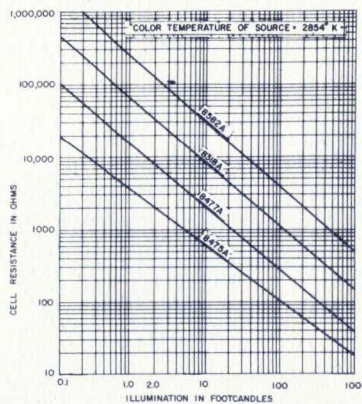

CHARACTERISTICS AND RATINGS								
Sylvania Type Number	Cell Resistance ⁽¹⁾			Resistance Ratio ⁽¹⁾				Max. Cell Voltage ⁽⁴⁾ (volts)
	At 100 FC ⁽²⁾ (ohm)	At 2 FC ⁽²⁾ (ohm)	At Dark ⁽²⁾ (megohm)	Dark to 2 FC		2 FC to 100 FC		
				(min.)	(typ)	(min.)	(typ)	
T-2—75 Milliwatts⁽⁵⁾ 1/4 Inch Diameter								
8475A	100	2000	0.2	100:1	500:1	15:1	20:1	200
8477A	300	8000	0.8	100:1	500:1	15:1	25:1	300
8318A	1000	32,000	10.0	100:1	500:1	15:1	30:1	300
8582A	4000	128,000	13.0	100:1	500:1	15:1	30:1	300
T-4—300 Milliwatts⁽⁵⁾ 1/2 Inch Diameter								
8760	12.5	250	0.1	200:1	500:1	15:1	20:1	175
8345	35	750	0.2	200:1	500:1	15:1	20:1	400
8142	60	1500	0.5	200:1	1500:1	15:1	25:1	400
8346	120	3000	1.0	300:1	1500:1	15:1	30:1	400
8100	165	5000	1.0	200:1	1000:1	15:1	30:1	400
8143	300	9000	1.0	200:1	500:1	15:1	30:1	400

NOTES: 1. Measured after 60 minutes minimum exposure at approximately 50 FC illumination (ambient room light).
 2. Typical Values.
 3. Minimum Value. Measured in complete darkness at least 10 seconds after removal of 2 FC illumination.
 4. Measured in complete darkness at a pulse rate of 120 pps, 50 sec. duration. Voltage in excess of the rated value may damage the cell. Maximum DC voltage is limited by maximum dissipation and minimum dark resistance rating.
 5. -40 to +40°C. (Above +40°C derate per dissipation curve.)

How to build an eight-stage fast adder using only 12 IC packages

Sylvania's basic TTL fast adder digital subsystem, part of a family of monolithic digital functional arrays, makes possible a whole new breed of large-scale, high-performance, general-purpose digital computing systems. These systems not only offer significant speed advances over conventional computers; they will be smaller, more reliable and far less costly than equivalent systems built from standard integrated circuits.

Using only 12 of Sylvania's single-stage fast adder circuits, you can build an 8-stage fast adder with anticipated carry having a total add time of only 50 nanoseconds. Only 96 of the new packages are needed to make a fast anticipated carry adder of 64 bits having a 300-nanosecond total add time. An equivalent 64-bit fast adder using conventional integrated circuits would require at least 320 separate packages.

This new transistor-transistor-logic circuit array represents the first time

that highly complex fast adders with anticipated carry have been integrally formed on a single monolithic silicon chip without compromising system performance characteristics. This Sylvania circuit has a noise margin of ± 1.0 volt, power dissipation of 120 milliwatts, and a fan-out of 6 to 15.

The basic fast adder circuit configuration is interconnected with three standard metalizations to form either a single-stage full adder (SM-10 series), a single-stage dependent carry fast adder (SM-20 series), or a single-stage independent carry fast adder (SM-30 series). To build parallel fast adders larger than 4 bits, the independent and dependent fast adders are used in conjunction with a specifically designed carry decoder package, the SM-40, which extends the anticipated carry operation beyond four stages. Two dependent adders, SM-20 circuits, form the first and last stages to provide for end-around carry operations.

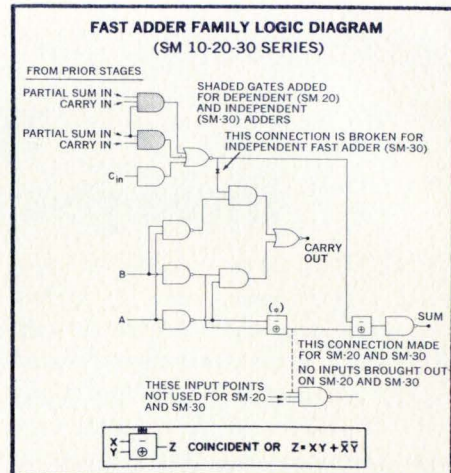

Circuits in the fast adder family are available in Sylvania's standard 14-pin dual-in-line plug-in package as well as in the TO-85 flat pack.

These circuits are completely compatible with all circuits in Sylvania's advanced SUHL™ integrated circuit line. SUHL ICs comprise a total of 120 circuits, by far the biggest TTL line in the industry. In all, these integrated circuits provide superior performance in terms of speed, fan-out, noise immunity, high logic swing, and low power consumption. SUHL circuits offer the fastest saturated logic available for applications down to 5 nanoseconds. CIRCLE NUMBER 306

8-STAGE ANTICIPATED CARRY FAST ADDER MADE FROM SM-20, SM-30 & SM-40 MONOLITHIC DIGITAL FUNCTIONAL ARRAYS

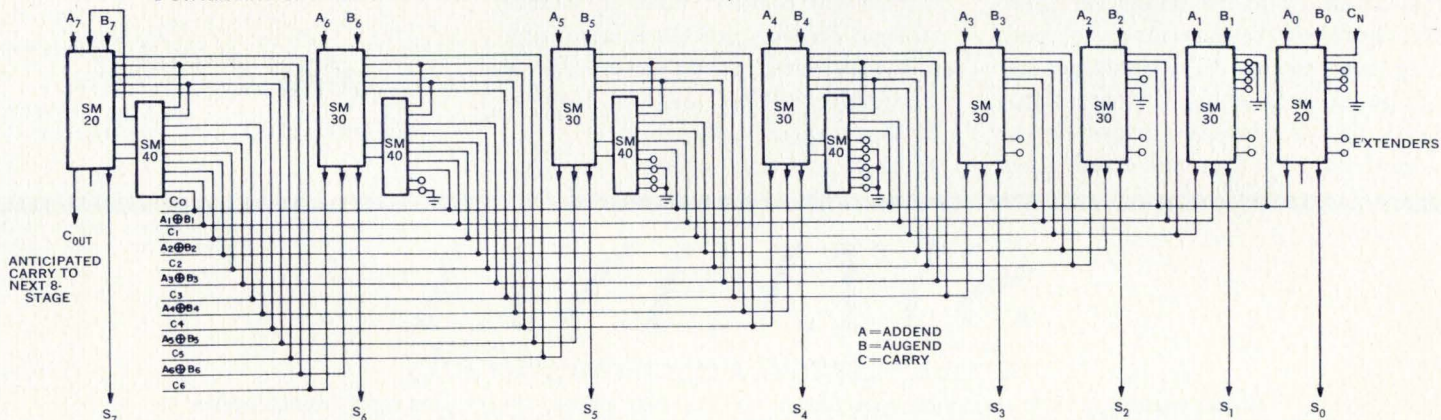

BUSINESS REPLY MAIL
No Postage Stamp Necessary if Mailed in the United States

POSTAGE WILL BE PAID BY
SYLVANIA ELECTRONIC COMPONENTS GROUP
Sylvania Electric Products Inc.
1100 Main Street
Buffalo, New York 14209

Use Sylvania's "Hot Line" inquiry service, especially if you require full particulars on any item in a hurry. It's easy and it's free. Circle the reader service number(s) you're most interested in; then fill in your name, title, company and address. We'll do the rest and see you get further information almost by return mail.

The **color bright 85**® tube:

three years old...and still the one to beat

Virtually all major manufacturers of color picture tubes have completed extensive expansion programs with additional emphasis being directed toward product sophistication. Along with this emphasis, TV receiver manufacturers have recently stepped up their programs for improvement in set performance.

Sylvania foresaw these needs in the early 1960's when we embarked on special color picture tube engineering, production and quality programs. Prime areas considered were uniformity, purity reserve, focus and screen quality. And in June, 1964, the revolutionary new *color bright 85* picture tube was announced, a tube which was some 40% brighter than all previous types.

For ease of setup by both TV receiver manufacturer and servicemen, new beading jigs for gun mounting were designed, built and utilized in production. Sylvania became the first manufacturer to eliminate the color shift between the glass face and aperture mask during tube manufacture.

The glass face panel is pre-stabilized; that is, tempered to pre-determined density. Pre-stabilized glass

means near perfect alignment between phosphor dots and the pin-point holes of the aperture mask. The dimensional stability of each *color bright 85* tube's screen locks screen and mask into tight registry. To put it another way, Sylvania *color bright 85* tube face plates are actually pre-shrunk.

Other improvements were introduced that today are still basic to these tubes. Automatic "Q" spacing machinery is in use at our plants to provide better beam landing and purity reserve. Precise computer measurements taken at five points are then used in a computer to optimize the match of the face panel to mask, assuring tube to tube uniformity in the relationship of the mask to the screen. Also, rigid techniques were established to control phosphor dot size, which also contributes to better quality on purity reserve.

Screen quality is a major factor with color picture tubes. Sylvania's unique dusting process in screening the rare earth europium phosphor eliminates "spokes" and mottling that tend to degrade colors. Inspection criteria of screened panels have been

tightened and improved processing controls have been incorporated into production to provide the best possible color fidelity and brightness.

An engineering analysis program of all brands of tubes is in full swing to make certain that no better tube is available in the industry. Recent engineering evaluation shows that Sylvania's *color bright 85* tube—first with rare earth europium phosphor—is unexcelled by the best competitive product for white brightness and other characteristics. To date, five TV receiver manufacturers have also confirmed this analysis.

No, Virginia, the *color bright 85* tube is not obsolete! With sound, progressive engineering, quality and manufacturing programs in motion, we intend to keep offering the latest improvements under the same, famous *color bright 85* tube name. Believe me, Virginia, you'll never see a finer picture!



ROBERT A. STAREK
PRODUCT MANAGER, ENTERTAINMENT CRTs

SYLVANIA

SUBSIDIARY OF
GENERAL TELEPHONE & ELECTRONICS **GTE**

NEW CAPABILITIES IN: ELECTRONIC TUBES • SEMICONDUCTORS • MICROWAVE DEVICES • SPECIAL COMPONENTS • DISPLAY DEVICES

This information in Sylvania Ideas is furnished without assuming any obligations.

NAME _____
 TITLE _____
 COMPANY _____
 ADDRESS _____
 CITY _____ STATE _____

Circle Numbers Corresponding to Product Item

300	301	302	303	304
305	306			

Please have a Sales Engineer call



HOT LINE INQUIRY SERVICE

Need information in a hurry? Clip the card and mail it. Be sure to fill in all information requested. We'll rush you full particulars on any item indicated.

You can also get information using the publication's card elsewhere in this issue. Use of the card shown here will simplify handling and save time.

**if you could
find a more
stable
polyester film
you'd use
it.**



right?

Users report a measurable stability advantage with Celanar polyester film. In printed circuits Celanese polyester film means less shrinkage—hence a more reliable circuit.

Celanar has other substantial advantages, too. Its tensile (pull) strength is 30% stronger than other films. And Celanar film is the cleanest, freest from contamination, in the industry. We produce Celanar in a "White Room" where air filtration systems effectively trap dirt specks as tiny as 0.3 microns—infinitesimal as the point of a needle.

What's more, we lean over backwards to supply

Celanar film in the roll lengths, widths and gauges most convenient for you. Ship it with temperature recording flags, even impact recorders where necessary, to assure your receiving quality as high as we produce.

Those are reasons why major automotive manufacturers use Celanar film for under-the-dash printed circuitry. And why you should know the full facts about Celanar film. All it takes is a letter to: Celanese Plastics Company, Dept. 133-H, P. O. Box 629, Linden, New Jersey 07036. Celanese® Celanar®



Celanese Plastics Company is a division of Celanese Corporation.

When information buried in noise is periodic, transient, or random, there is a PAR^{T.M.} instrument to recover it

PAR manufactures a complete line of signal processing equipment to measure signals of various types buried in noise. The choice of the most appropriate instrument depends upon the characteristics of the signals. The equipment falls into three general classes:

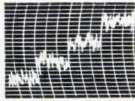

LOCK-IN AMPLIFIERS

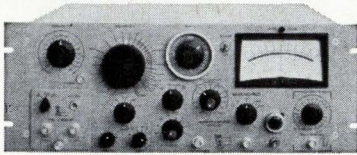

Lock-In Amplifiers have application where the signal of interest is or can be made to appear at a single frequency and where a reference voltage related in frequency and phase to the signal can be obtained. These instruments employ phase-sensitive detection and narrow-band filtering techniques to provide a DC output signal proportional to the amplitude of the fundamental component of the signal being measured. The Lock-In Amplifier can be described as a tuned voltmeter, the response of which is "locked" to that particular frequency and phase at which the signal information has been made to appear. They operate typically in the frequency range of 1.5 Hz to 150 kHz with full scale sensitivities down to 10^{-9} volts.

Waveform Averagers are useful when, after processing, the actual waveform of the signal of interest must be maintained and the signals are repetitive waveforms or transients whose onset can be related to a trigger pulse. The application of a synchronized, repetitive waveform will result in an output that corresponds to the average value at each of the segments of the waveform being studied, whereas any non-repetitive (or un-synchronized) signals such as noise will be suppressed since their average after many occurrences will approach zero. PAR makes two instruments that perform this function; the Boxcar Integrator and the Waveform Eductor^{T.M.} The Boxcar Integrator is a single point averager in which a single slice, as narrow as 1 microsecond, of the input waveform is averaged while the position of the slice is slowly scanned through the waveform. The Waveform Eductor simultaneously averages one hundred points of the waveform which can be distributed over periods varying from 100 microseconds to 10 seconds.

WAVEFORM AVERAGERS

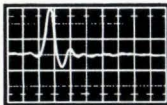
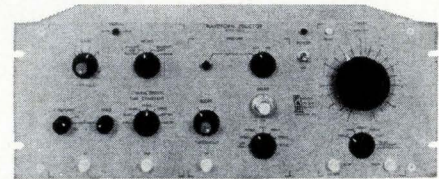
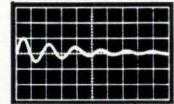

CORRELATION FUNCTION COMPUTERS

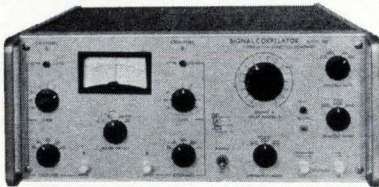

Correlation Function Computers are the most general form of signal processing equipment that can be constructed (Lock-In Amplifiers and Waveform Averagers are actually special cases of correlation equipment). Whereas a reference or synchronization signal is required in the other equipment discussed, autocorrelation analysis allows periodic and random signals to be defined without this restriction. An even more powerful technique is crosscorrelation which has the ability to describe the degree of conformity between two different signals as a function of their mutual delay. The PAR Signal Correlator simultaneously computes in real time 100 points of either the auto- or crosscorrelation function over total delay spans of 100 microseconds to 10 seconds.

A variety of instruments and associated peripheral equipment is available from PAR in each general class. Instrument prices range from \$765 to \$9500. Since PAR has wide experience in applying these systems to many situations in all fields of science and engineering (e.g.: aero- and hydrodynamics, spectroscopy, medical physics, geophysics, etc.), we welcome the opportunity to discuss your specific application. For additional information, or to arrange for a demonstration at your facility, contact Princeton Applied Research Corporation, Dept. D, P.O. Box 565, Princeton, New Jersey 08540. Telephone: (609) 924-6835.



PRINCETON APPLIED RESEARCH CORP.

Electronics Review

Volume 40
Number 17

Communications

The chirp approach

For nearly two decades swept-frequency modulation has been designed into some radars and sonars to boost the on-target energy and improve range resolution by making full use of the transmitter's average power capacity. Next month, the first attempts to apply this technique—commonly called chirp modulation—to digital communications, will be tested.

In chirp modulation, the carrier signal is swept through the available band of frequencies for a set time period. In the receiver, this wide pulse with high average power is compressed into a narrow-pulse signal by delay-line techniques. The desired signal is enhanced in amplitude because its frequency components add up coherently. Unwanted signals do not benefit from the compression, therefore are discriminated against.

Fight multipath. Both the Navy and NASA will try chirp modulation as an antidote to multipath propagation—the arrival of multiple signals, some direct and some reflected. The resultant “smear” is a particularly serious problem in transmission of binary signals.

The basic antidote to multipath is extra bandwidth, and usually this can be justified only if the amount of information transferred is increased, which is the case in multi-access communications. The applications that NASA and the Navy envision are multiple-access systems.

NASA will try the technique for aircraft-to-ground communications via satellite over ocean areas where the water acts like a mirror, producing multiple reflections of signals. And the Navy wants to test chirp modulation of high-frequency

signals telemetered to shore stations from ocean buoys that collect data on wind, currents, and temperature. In both tests, other types of modulation—including frequency-shift keying, phase-shift keying, and conventional morse code—will be simultaneously used for comparison.

Space saver. “The value of chirp modulation is that it makes efficient use of available bandwidth and transmitter power in combatting multipath and other interference,” says David S. Dayton, vice president of the Technical Communications Corp., Lexington, Mass., the company that proposed adaptation of the technique to communications.

Slope-shift keying is built into the chirp modems that the company will deliver to NASA and the Navy. A sweep generator converts the binary data stream into up and down slopes as the carrier signal sweeps through the frequency band. In this swept-f-m waveform, the up slope can be a binary 1 and the down slope a 0. The delay line in the demodulator contains a set of matched filters, also matched to the slopes. The receiver locks onto the wanted signal and tracks it by a sampling technique.

Why it's called chirp

The word chirp is not an acronym. It was first used to describe swept-frequency modulation in an internal memorandum written at the Bell Telephone Laboratories in 1951 by B. M. Oliver. The memo was entitled, “Not with a bang but a chirp,” and contrasted the newly developed technique with high-power pulse-modulation methods. Chirp modulation was a classified technique in the 1950's. It did not appear in the open literature until the July, 1960, issue of the Bell System Technical Journal.

For the satellite relay trial, the Goddard Space Flight Center will install a chirp modulator in a transmitter at a station in the Mojave Desert in California. The synchronous Applications Technology Satellite-1 will relay signals to a commercial jet furnished by the Federal Aviation Administration. The satellite's transponder operates at 150 megahertz and has a bandwidth of 50 kilohertz.

Over 5,000 feet. In this application, the wanted pulse will arrive ahead of reflected signals—providing the aircraft is not flying too low or too near the horizon. “Satellites for midocean navigation and communications will always be directly overhead,” Dayton points out. “As long as the aircraft altitude is over 5,000 feet, the technique should work well.”

For the Navy's h-f tests, two buoys will be anchored in the Gulf of Mexico; shore station equipment in a van will operate at 9 and 15 Mhz, with a 3 to 6 khz bandwidth.

“In h-f,” says Dayton, “we are concerned with more than the multipath problem resulting from multiple ionospheric refractions. H-f is also vulnerable to impulse noise, particularly the ignition noises in cities. Also, the h-f band is crowded, so there is the danger of interference from other nearby signals. These have the character of multipath, they add up incoherently, so do not benefit from compression.”

Avionics

With flying colors

The weakest link in the proposed system to relay voice communications between airliners and ground stations via satellite has been the

aircraft antenna. But several months of tests by an airlines group were capped last month by a week of successful operation by a transceiver antenna from Dorne & Margolin, Bohemia, N.Y. Designs from two other firms so far have failed to make the grade.

The Federal Communications Commission had tried twice—last December and again this May—to relay transmissions from aircraft antennas via Applications Technology Satellite-1, but without success. One of the antennas that flunked was the D&M unit, but improvements have been made since then. Joseph Margolin, a D&M vice president, says proper tuning of the impedance matching network has boosted efficiency from 50% to between 85% and 90% without changing the basic design.

A fifth. The antenna looks like a 2-foot pancake atop a fin-like blade; the pancake radome covers a shaped array of four dipoles and the blade conceals a fifth.

Eight major airlines have been experimenting with ATS-1 since January. The successful tests were made with an antenna aboard a Japan Air Lines jet. Hughes Aircraft, builder of the ATS, monitored the JAL transmissions and pronounced them more than 99% usable, even with untrained operators.

When and if Comsat and the FAA

agree on a price for a satellite system [Electronics, Aug. 7, p. 66], a retrofit market will open for aircraft antennas.

The factor that put the other antennas out of the competition was a lack of suitable gain when the satellite was near the horizon. The D&M model had usable gain whether the craft was overhead or out to the side, and kept circular polarization to within 5 decibels to prevent signal fade.

The antenna on ATS-1 is linearly polarized, and as its signal passes through the ionosphere the plane of polarization rotates unpredictably. A circularly polarized aircraft antenna is therefore needed to receive the signals regardless of their polarization.

Dragged down. Failure to counteract this Faraday effect is what hurt D&M's only serious competitor, the Bendix Corp. Wary of drag and aerodynamic stress, Bendix built an antenna similar to D&M's, but with the dipole array faired into the fuselage. This reduced drag, but when the satellite neared the horizon, the dipoles had to almost peer over the fuselage to "see" it; in the horizontal mode, polarization was off by as much as 20 db. Now, a Bendix spokesman says the company may decide to drop the antenna.

The third antenna tested came from the Nuclear division of Ka-

man Aircraft [Electronics, Feb. 6, p. 47]. When the FAA flew the array of three H-shaped antennas last May, gain reached 10 to 12 db but high standing-wave ratios reduced efficiency. Power-handling capacity also was low—the system could operate at only a quarter of its 500-watt design maximum.

Though Kaman scientists think they can solve their problems, they don't expect to sell the bulky, complex system to the airlines. They are looking to S-band telemetry as a potential market.

Circular reasoning. All the tests have been conducted with a satellite not designed for communicating with aircraft. Any operational satellite would have a circularly polarized antenna that would reduce ionospheric rotation problems and provide twice the effective system power or sensitivity of ATS-1.

Oceanography

Staying put

With the hunt for oil moving farther and farther off shore, oil drillers are grappling with the problem of how to keep a floating rig stationary over the wellhead. A shift in the rig's position by as little as 5% of the sea depth will snap the drillstring. The deeper the water the vessel operates in, the longer the anchor lines; and the longer the lines, the greater the tendency for the rig to drift from the wellhead.

Now Honeywell Inc. has introduced an acoustical control system that allows floating rigs to operate at any ocean depth. The first acoustic position reference system (APRS) will be sent to Oslo in a few weeks for the 23,000-ton Drillship, which will operate off the Norwegian coast. Delivery of a second system to a U.S. oil company is scheduled within 60 days.

Floored. The APRS provides continuous information about the ship's position relative to a beacon placed on the ocean floor. The beacon transmits 40- to 48-kilohertz signal



Winner. Disk-shaped antenna from Dorne & Margolin outperformed its competition in aircraft communications tests with the ATS-1 satellite.

to three hydrophones, fixed to the ship's bottom in an L-shaped pattern. By using phase-comparison techniques, position is determined by measuring the difference in the time it takes the signals to travel from beacon to phones. An extremely narrow bandwidth (0.3 to 0.003 hertz) is used to prevent interference from noisy drilling equipment; actual modulation frequency is 720 hz. Aboard the ship, a vertical gyroscope, acting as a two-axis tilt sensor, detects roll or pitch up to 20° and feeds the data to a computer, which eliminates it from the final reading. The vessel's position is displayed on a cathode-ray tube. Accuracy of the system is ±1% of the depth.

The system can be used on vessels whose position is corrected by winch-driven cables anchored to the ocean bottom. Or it can be combined with a Honeywell automatic station-keeping system, which is essentially two computer-controlled thruster engines, fore and aft.

The cost of the basic APRS is about \$80,000; with station-keeping and other options it can go to \$300,000.

Components

Strengthening a link . . .

Product reliability in the intensely competitive connector industry has long been a vague term with almost as many definitions as there are manufacturers. Tests were either of the makers' own design or those requested by users. The biggest user of all, the military, specified a series of tests—but made no statistical requirement. The connectors tested could have been handmade with tender, loving care in the laboratory. To compound the confusion, some producers insisted that a statistical approach to reliability resulted in a meaningless numbers game; the true gauge, they maintained, was good design and quality control.

Now, a newly issued Air Force spec on one widely used connector—MIL-C-26500C—has been taken by some in the industry as an indication of things to come. The revised spec permits the user to specify that 99% of the devices pass nine of 34 required tests. In the words of one manufacturer,

"You can bet that they didn't put in that option just for show."

In the new optional series, connectors are submitted to vibration, immersion, pressure changes, and mechanical stresses for 7½ hours. Under those conditions, tests are made to determine force and torque needed to couple and uncouple the connector, the breakdown point of insulation and dielectric, and contact resistance.

Who's on first? Interestingly, the Amphenol Connector division of the Amphenol Corp. in Chicago introduced a statistical testing cycle two years ago at a cost of almost \$300,000 that matches the tests in the new spec. And Amphenol's James F. Atkinson, vice president of reliability and quality control, has been a leader in the battle to include statistically established reliability in the specs. In fact, at least one rival insists angrily that Amphenol ghost-wrote the revision and that it puts Amphenol far ahead of everyone else—Pyle-National, Cinch, and Cannon among them—producing the 26500 line.

But Pyle-National's Jack Shearer, vice president and general manager, disagrees. Reliability data, he says, "can be picked up from in-process and acceptance testing that we do anyway." Shearer does note, however, that more testing means added cost.

William D. O'Hirok, manager of military engineering at ITT Cannon Electric, is asking for a delay in the revision until a "services-industry meeting" can be held to iron out disagreements.

At a June meeting of the Society of Automotive Engineers there was considerable disagreement. There was agreement, however, that the revision promises such drastic changes that just about everybody except Amphenol would be forced to requalify as suppliers.

What next? Amphenol's Atkinson believes that the revision, and his test cycle, "set the stage for a new era of connector dependability." But O'Hirok maintains that Cannon, which has a test system that is "somewhat differently oriented" from Amphenol's, has no plans to emulate Amphenol, and

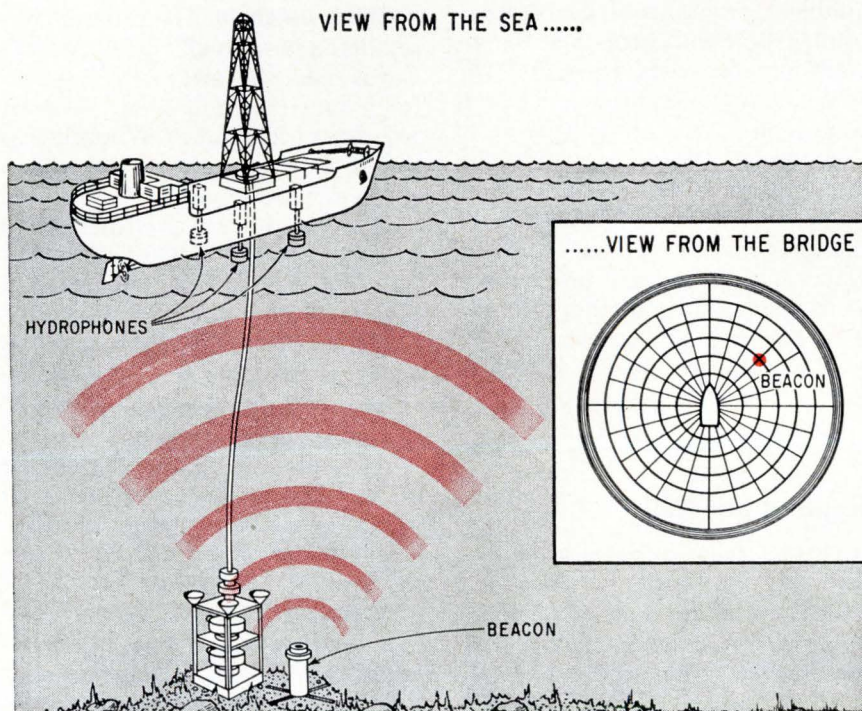

On the mark. Acoustical system developed by Honeywell, keeps a drilling ship over the wellhead so that its drillstring won't snap.

that reliability numbers "aren't worth the powder needed to blow them to hell" because their effectiveness is diluted by too many variables. (For instance, with crimp-removable connectors the supplier doesn't do the final assembly and doesn't have to supply contacts with the connector.)

The spokesman for another competitor even sees a move away from the statistical approach and toward higher design and quality-control standards because "the customer doesn't get his money's worth with statistical data." Not once in the last six months, says the spokesman, has a user requested statistical evidence.

While it's not unusual for connector makers to disagree noisily, the shouting about the revision seems to indicate that Atkinson's prediction might have some merit.

... or replacing it

As if the connector people don't have enough problems, the Naval Air Systems Command and the Radio Corp. of America have devised a way to cut down on the growing maze of wires and multipin connectors. By using frequency- and time-multiplexing techniques, says the Navy, in one system alone—the Project A-New airborne anti-submarine warfare system—could replace 74 miles of conventional interconnecting wire with 34 coaxial broadband cables—with a weight saving of 1,000 pounds. The new concept is called Mincoms (multiplex interior communications system).

Military electronics

Where are (were) we?

Supersonic Air Force jets need more accuracy than ground-based loran provides. The Navy's Transit navigation satellite was tried out and rejected by the Air Force because it needs too much equipment, doesn't provide continuous fixes, and doesn't work in the polar

areas. So the Air Force is moving quickly and quietly to get its own satellite navigation system.

Tight security has been slapped on the program—designated 621B—by the Pentagon's Office of the Director of Defense Research and Engineering, and the Air Force's Space and Missile Systems Organization. However, they're seeking the help of industry experts on how to design such a system. Industry sources, who will vie for the contracts on the expensive system, speculate that 621B will be a highly accurate, secure system that will provide quick fixes anytime and anywhere to U.S. military aircraft only. It will employ several widely separated synchronous satellites to determine position by interferometry, with the contractor to establish the exact techniques and the number of satellites used. The Air Force timetable calls for proposal requests in mid-September, full operation in three years.

We're No. 1. One byproduct of 621B will be accelerated inter-service rivalry. The proposed Air Force system will be more accurate and sophisticated than the Navy's navigation satellite system, and the Navy has long been king of the navigation satellite hill.

The director of navigational and guidance programs of a large electronics firm indicates that the rivalry already exists. He says: "The recent Navy announcement that it would offer use of its system to commercial ships was nothing more than a publicity stunt to show that the Navy is ahead. Because of the high cost of equipment for the Navy system and the infrequency of fixes offered by the doppler system, commercial interests will be hard-pressed to find any reason to use it."

Repairs needed

Red tape seems as much at fault as technical problems in slowing a tri-service program aimed at developing electronic equipment that almost never needs repairs.

Three pieces of gear are getting the ultrareliability treatment, though the experience gained in

this program may be applied to future designs. The Navy is working on the AN/PPS-6 personnel-detection radar for the Marine Corps, the Army on the AN/VRC-12 family of f-m radios, and the Air Force on the AN/ARC-34 ultrahigh-frequency radio. The services were to have let contracts to industry by June 30, but only the Air Force made the deadline—and just barely—with awards to RCA and Electronic Communications Inc. on that date.

Full astern. The Navy is furthest behind schedule; it still hasn't prepared its requests for bids. The unit in charge of the Navy's part of the project, the Marine Electronics and Amphibious branch, claims that it was notified of its assignment four months after the other services, and that the transfer of the branch to another naval command cost it experienced people and two months of paperwork. And atop this snarl of red tape is a backlog of work for the Vietnam war. Requests for proposals should go out to industry by October or November.

The Army has at least issued bid requests and evaluated replies. It's ready to discuss contenders with Pentagon brass this week, and a contract will probably be awarded by Oct. 1.

Clock watchers. The program has set its sights high. The Marine Corps radar was originally designed for a mean time between failures (MTBF) of 225 hours. When it was tested, however, the MTBF was a surprising 800 hours. The model now in production is expected to have a MTBF of 1,800 hours, but the requirement for the planned high-reliability unit is 10,000 hours.

The Army's VRC-12 radio now has an MTBF of 1,000 hours; the new version will shoot for 10,000 hours.

The Air Force radio has an MTBF of from 40 to 350 hours, depending on how bumpy the performance of a particular aircraft happens to be. The new program will strive for an MTBF of 2,000 hours.

Stress on IC's. Whenever possible, solid state and integrated circuitry will be used, and varactor diodes rather than mechanical devices will do the tuning.

If the cost is reasonable enough,

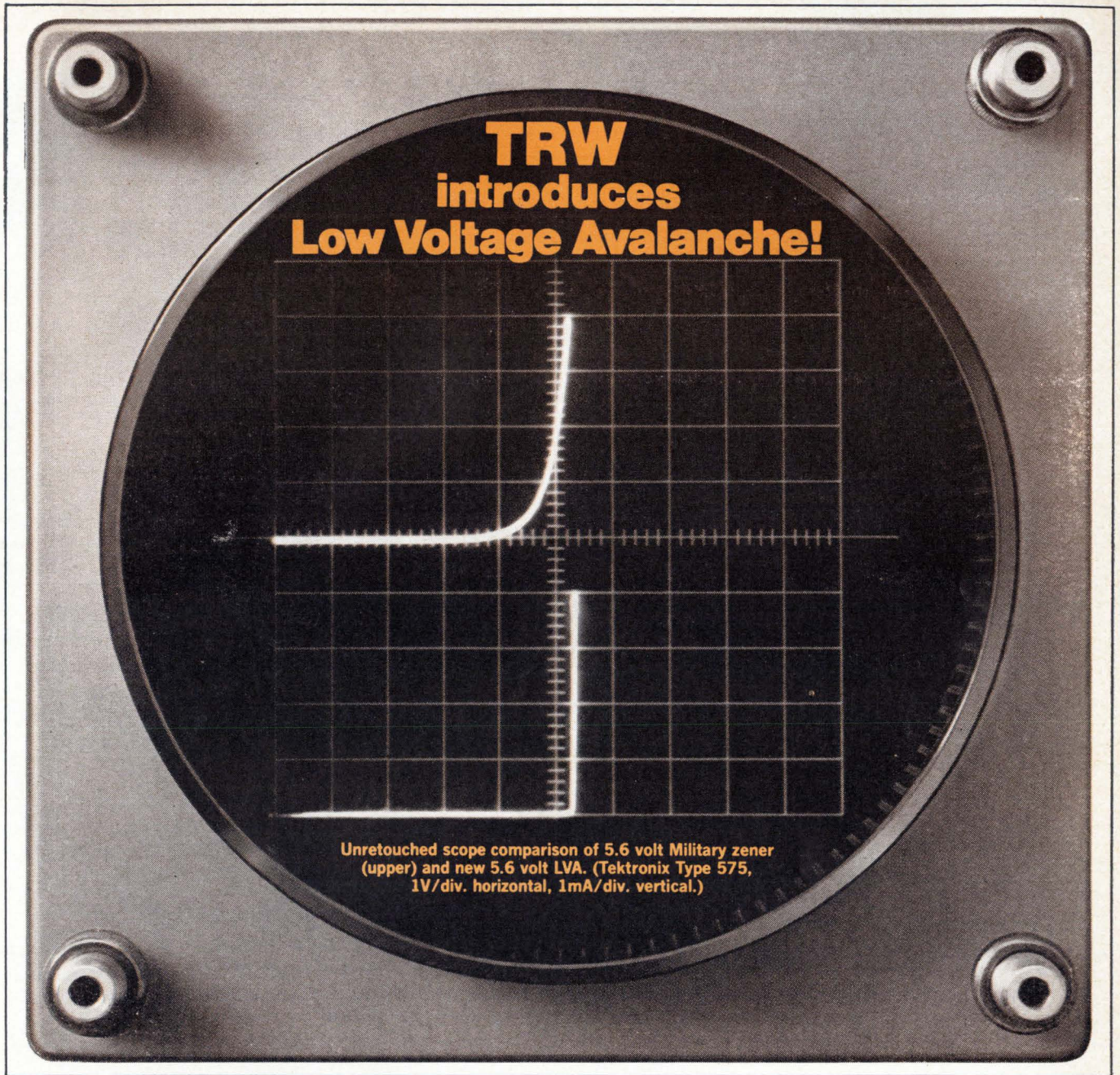

Sharpest Breakdown Below 10 Volts!

The LVA™ is more than just a new diode: it represents a major breakthrough in low voltage regulators (patent pending). Wherever you need a zener below 10 volts, the LVA will significantly improve circuit performance with its avalanche breakdown characteristics.

With the LVA you can design better low current circuits, battery-operated circuits, and operational

amplifier clamping networks. And now for the first time, you can make zero TC reference below 5 volts!

The LVA is available in 10 values from 10 volts down to 4.3 volts. Delivery is off-the-shelf from factory or authorized distributors.

If you'd like to compare, write for test samples and applications data on company letterhead to

TRW Semiconductors, Ray Koch, 14520 Aviation Boulevard, Lawn-dale, California 90260. Phone (213) 679-4561. TWX 910-325-6206. *TRW Semiconductors Inc. is a subsidiary of TRW INC.*

TRW®

plug-in
sampling

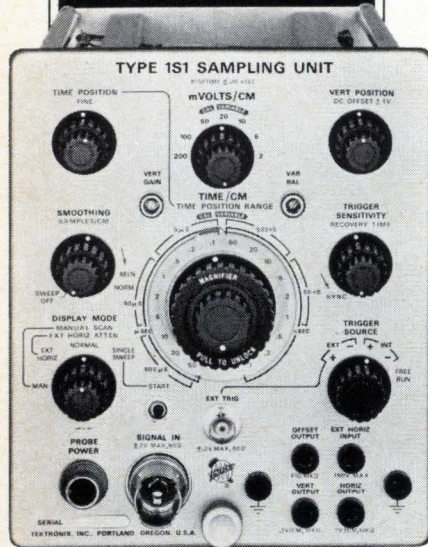

Tektronix
Type 1S1

- DC-to-1 GHz Bandwidth
- 0.35-ns Risetime
- 2 mV/cm Deflection Factor
- Internal Triggering

The Type 1S1 Sampling Plug-in extends the measurement capabilities of any Tektronix 530, 540 or 550-series oscilloscope to 1 GHz. It is a complete, single-channel, 50 μ sampling system featuring internal triggering, 100 ps/cm sweep rate and 0.35-ns risetime.

The vertical is calibrated from 2 mV/cm to 200 mV/cm and has a ± 1 volt DC offset. A complete selection of probes is available for minimum high-frequency loading.

The horizontal features 1 GHz triggering, a direct-reading X100 magnifier and a calibrated time-base extending from 100 ps/cm to 50 μ s/cm. Real-time sampling extends the slowest sweep range to > 2 s/cm (main frame time-base) while maintaining the complete bandwidth capabilities of the Type 1S1 Plug-in.

Type 1S1 Sampling Plug-in \$1100
U. S. Sales Price FOB Beaverton, Oregon



For a demonstration, contact your nearby Tektronix field engineer or write: Tektronix, Inc., P.O. Box 500, Beaverton, Oregon 97005.

the high-reliability models may be mass produced. The Air Force needs between 10,000 and 15,000 improved ARC-34 sets, and would probably ask one or both of its contractors to build them.

Vastly important

Avionics manufacturers reacted with a "ho-hum" six years ago when the Navy started work on a system for automating the maintenance testing of all the electronic gear on carrier aircraft. The companies confidently predicted that they wouldn't be affected by the plan.

Now they are reversing their field. The system, called VAST for versatile avionics shop test, is becoming an operational system and there is a scramble to learn more about it because the Navy says that all avionics equipment bought in the future will have to be compatible with VAST. Three new avionics regulations—AR 8, 9, and 10—describe the compatibility procedures. The Navy directive and regulations have caused a lot of interest and concern, and perhaps even a little apprehension, according to an industry source.

Roadshow. The Electronic Industries Association (EIA) is joining with the Navy in sponsoring one-day briefings on VAST in four cities next month.

What worries manufacturers of avionics is that VAST will impose constraints on the design of equipment.

Equipment designed to be VAST-compatible will have additional test points and these points must be readily accessible. Such a system already has been built into the integrated helicopter avionic system and no major problems have been reported.

Wait and see. Many avionics designers readily admit that their fears of the VAST specifications may be unfounded and say they will wait and see how the Navy implements them.

Everyone concerned agrees that the VAST program, or a similar program, is necessary because even the huge aircraft carriers are running

out of room for avionics test gear. Most planes require a different test system for each of their avionics systems.

VAST will drastically reduce the space required and dramatically increase the speed with which the test can be conducted [Electronics, July 12, 1965, p. 49]. As a measure of VAST's speed, Navy officials say the AN/ARN-52 Tacan can be thoroughly tested in 29 minutes—a procedure that requires 6½ hours using today's manual systems.

Computer-driven VAST systems are being built by PRD Electronics, a subsidiary of Harris-Intertype. Acceptance testing is now going on and deliveries of operational models will begin late next year. All the fleet's carriers will be equipped by the early 1970's and each may cost up to \$2 million.

The Navy and EIA will begin the industry briefings in Beverly Hills, Calif., Sept. 19. Other stops will be: Chicago, Sept. 22; Boston, Sept. 25, and Washington, Sept. 29.

Solid state

So who's worried?

Why should anyone worry about a systems company assigning three salesmen to the job of marketing its hybrid IC rejects—particularly when the semiconductor industry is so murderously competitive?

Yet marketing executives at semiconductor companies turned uneasy earlier this month when IBM announced it would start marketing its solid logic technology (SLT) circuits, which use diode-transistor logic. Said one worried executive, "We learned a long time ago not to underestimate IBM."

But the truth of the matter is that IBM has built up a huge inventory of SLT circuits that don't quite meet its requirements and it would like to sell them. With its three-man marketing staff it can't hope to play a major role in the IC business.

Sales of IBM's System 360 computers have already paid off a lot of the investment in automatic machinery that builds SLT units so IBM

PRECISION MOLDED MONOBLOCS

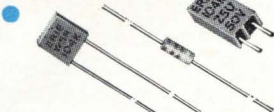

PHENOLIC COATED MONOBLOCS



HERMETICALLY SEALED-IN-GLASS MONOBLOCS

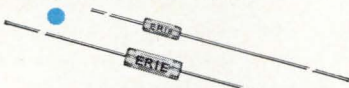

"NEW FLAT-PACK MONOBLOCS"
Five 10,000 pF. capacitors in one package



NEW HIGH VOLTAGE MONOBLOCS
1400 pF. at 3 K Volts ...
in only .003 cu. in.



NEW BUTTON-TYPE MONOBLOC FILTER-CAPACITORS



MONOBLOC CHIPS
Any SIZE and shape available



WORLD'S MOST COMPACT TRIMMER CAPACITOR ...
5 to 25 pF. 100 WVdc



UNMATCHED for VOLUMETRIC EFFICIENCY, STABILITY and RELIABILITY

In today's microcircuitry, Erie's unique MONOBLOC Ceramic Capacitors provide the answer to difficult packaging problems ... particularly where high capacitance, demanding stability, great reliability and severe environmental conditions are deciding factors.

Monobloc Subminiature Capacitors are available now for a wide variety of microcircuit applications. Currently, Monoblocs are used extensively in aerospace and military control equipments, communications computers and other areas requiring the reliability of performance so characteristic of Erie Monoblocs.

You name the capacitance problem and Erie will provide a Monobloc Capacitor with better reliability ... in a smaller package. Write for Monobloc Ceramic Capacitor literature.

Another Series of Components in Erie's Project "ACTIVE"
Advanced Components Through Increased Volumetric Efficiency



IF YOU NEED SMALLER

Quality CAPACITORS... Specify

ERIE MONOBLOCS®

ERIE

TECHNOLOGICAL

PRODUCTS, INC.



Erie, Pennsylvania

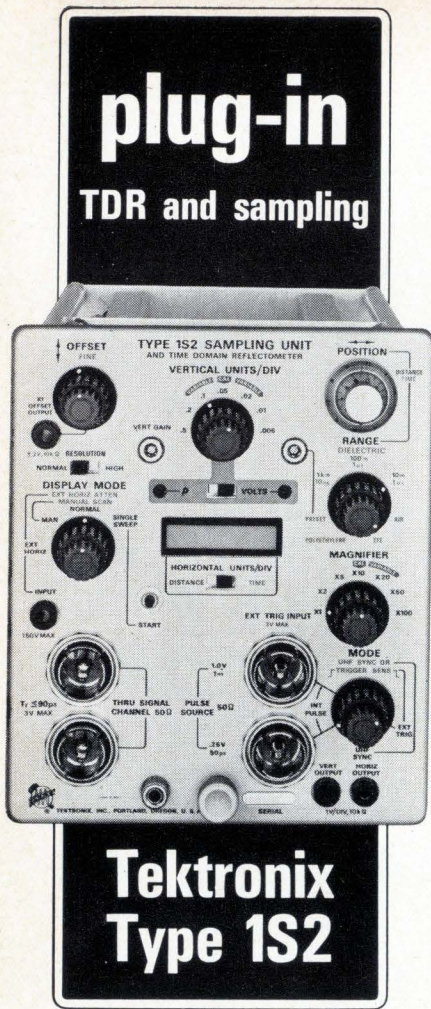

- 140-ps TDR System Risetime
- 90-ps Sampling Risetime
- Rho and Voltage Calibration
- Two Internal Pulse Sources

The Type 1S2 Sampling Plug-in converts any Tektronix 530, 540 or 550-series oscilloscope to a time-domain reflectometry measurement system. It also has the ability to make many general sampling measurements.

As a TDR, the Type 1S2 has a system risetime of 140 ps and is calibrated in rho (ρ) from 0.005 ρ /div to 0.5 ρ /div. The horizontal is calibrated from 1 cm/div to 100 m/div for dielectrics of air, TFE and polyethylene. A 10-turn dial reads directly the one-way distance to the test-line discontinuity. Two pulse outputs provide either 50 ps T_r at 250 mV into 50 Ω or 1 ns T_r at 1 V into 50 Ω .

The 90-ps risetime, 5 mV/div deflection factor, 100 ps/div sweep and built-in triggering capability make the Type 1S2 useful for many other sampling measurements.

Type 1S2 Sampling Plug-in \$1300
U.S. Sales Price FOB Beaverton, Oregon



For a demonstration, contact your nearby Tektronix field engineer or write: Tektronix, Inc., P.O. Box 500, Beaverton, Oregon 97005.

is able to put a low price on its circuits: \$1 to \$1.50 per unit—a price a nervous Sylvania executive was quick to point out is in the same ballpark as high-volume monolithic circuits.

Behind IBM's move is a tale of irony. For years the giant computer maker, unable to produce enough hybrid circuits itself, turned to Texas Instruments and Sprague to fill the gap. Now, IBM will, in effect, be competing with its suppliers.

Advanced technology

Strangest places

Question: Why is a paper on a planar Gunn oscillator for microwave integrated circuits scheduled for presentation at a meeting sponsored by the American Institute of Mining, Metallurgical, and Petroleum Engineers?

Answer: For the same reason field effect transistors are on the program—there is a growing trend in advanced electronics technology toward a materials orientation. And the Metallurgical Society of the group is therefore a natural forum for discussions of semiconductor materials.

The meeting, set for next week in New York, is sponsored by the institute's electronic materials committee, and, like meetings of the Electrochemical Society, it has taken on major importance for semiconductor engineers in recent years.

A GaAs. The planar Gunn oscillator, which will be described by two Texas Instruments engineers, Edward Mehal and Ron Cox, acts as a local oscillator in an integrated 94-gigahertz receiver front end. The Gunn diode delivers a 31.8-GHz signal that is multiplied by gallium-arsenide Schottky-barrier diodes to the 94-GHz range. A balanced mixer using two Schottky diodes completes the circuit.

The Gunn and Schottky diodes are formed by selective epitaxial deposition of gallium arsenide into pockets in a semi-insulating gallium-arsenide substrate that iso-

lates the active devices. The complete integrated front end, which is being developed for the avionics laboratory at Wright-Patterson Air Force Base, Ohio, will be built on a chip measuring about 60 mils by 200 or 250 mils.

Mehal expects the integrated Schottky diodes to outperform discrete diodes. He notes that in discrete form, the diode has an expanded contact that passes over a conductive region, increasing the stray capacitance and reducing the cutoff frequency. In integrated form, he says, the expanded contact will be smaller to begin with, and the portion that does pass over the material will pass over the semi-insulating substrate, reducing capacitance.

Right now, Mehal concedes, the integrated diode's noise figure is about 0.5 decibels away from that of the best discrete types.

Gate of Bell. A way to ease production of insulated-gate field-effect transistors will be described by Bell Telephone Laboratories researchers. J.C. Sarace, R.E. Kerwin, R. Edwards, and D.L. Klein, will tell how they produced a FET with a self-aligning gate structure; this relieves the problem of aligning a gate mask between the source and drain regions after these regions have been diffused in the substrate. The key development, according to Sarace, was the production of high-quality silicon nitride, which acts as a mask against movement of ions through the silicon dioxide layer.

To build the gate insulator a silicon dioxide layer is placed directly on the silicon substrate and is covered by a silicon-nitride layer; this layer is covered in turn by a layer of polycrystalline silicon. During diffusion of the source and drain, the polycrystalline silicon acts as a mask to assure proper alignment of the gate.

No overlap. In the Bell Labs scheme, the gate is already in place when the diffusion is done and the source and drain follow the outline of the two opposite edges of the gate. Except for slight unavoidable diffusion under the gate, there is no overlap to cause stray capacitances.

The polycrystalline silicon also

Amperex

FETS, Zeners & Dual Isolated Diodes, RF & IF Amplifiers and Switches Now Available in



VERY HIGH FREQUENCY RF AMPLIFIER (NPN)

LDA 407
functionally replaces types:
2N2857, 2N5053/4

HIGH GAIN, LOW CAPACITY IF AMPLIFIER (NPN)

LDA 410
functionally replaces type A473

VERY HIGH SPEED SWITCH (NPN)

LDS 205
functionally replaces type 2N709

LOW "ON" RESISTANCE D/A SWITCHES (NPN)

LDS 206
LDS 208

LOW NOISE FETS (N-CHANNEL JUNCTION)

LDF 603/604/605
functionally replace types:
2N5103/4/5

PLANAR ZENER DIODES (4 to 10 Volts, 5%) LDZ 70 SERIES

HIGH SPEED LOGIC/SWITCHING DIODES SINGLE TYPE LDD5 DUAL ISOLATED TYPE LDD15 functionally replaces type 1N914

Other types

HIGH SPEED SWITCHES (NPN)

LDS 200/201
functionally replace types:
2N706, 2N708, 2N743/4,
2N834/5, 2N914, 2N2368/9

GENERAL PURPOSE AMPLIFIERS (NPN)

LDA 402/403
functionally replace
general-purpose amplifiers
operating from
1 to 100 ma, such as:
2N696/7, 2N1613, 2N2218/9,
2N3390/1

MEDIUM CURRENT AMPLIFIER AND SWITCH (NPN)

LDA 404/405
(Complement to LDA 452 and
LDA 453)
functionally replaces types:
2N2217/8/9, 2N2220/1/2, 2N1613,
2N1711, 2N718A, 2N871

HIGH FREQUENCY RF AMPLIFIER (NPN)

LDA 406
functionally replaces type 2N918

GENERAL PURPOSE AMPLIFIER AND SWITCH (PNP)

LDA 450/451
functionally replaces types:
2N2604/5

HIGH GAIN, LOW LEVEL AMPLIFIERS (NPN)

LDA 400/401
functionally replace types:
2N929/30, 2N2483/4

MEDIUM CURRENT AMPLIFIER AND SWITCH (PNP)

LDA 452/453
(Complement to LDA 404 and
LDA 405)
functionally replaces types:
2N2904/5/6/7

DUAL, GENERAL PURPOSE AND HIGH SPEED SWITCHING DIODES COMMON CATHODE TYPE LDD10 COMMON ANODE TYPE LDD50

To meet any hybrid I.C. application

Amperex's expanded line of LID semiconductors now can satisfy all your design requirements for hybrid IC's. First introduced by Amperex early in '66, the LID, an all-ceramic microelectronic package for semiconductors, has proven to be the answer for high yield, low cost production of hybrid integrated circuits.

Evaluation level quantities of LIDS are available now from your local franchised Amperex distributor. Mechanized production techniques now in full swing have resulted in price reductions across the board. For data, write: Amperex Electronic Corp., Semiconductor & Receiving Tube Div., Dept. 371, Slatersville, R. I. 02876.

Amperex
TOMORROW'S THINKING IN TODAY'S PRODUCTS



Circle 45 on reader service card

The Industry Standard Semiconductor Package For Hybrid IC's.

**CORNERED
BY A
FORGOTTEN
RFI FILTER
?**

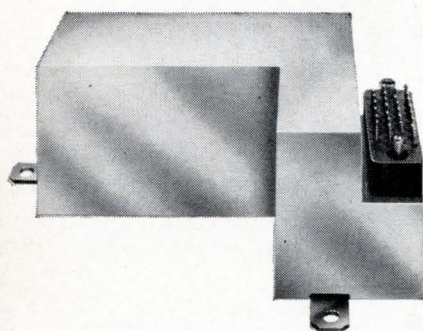
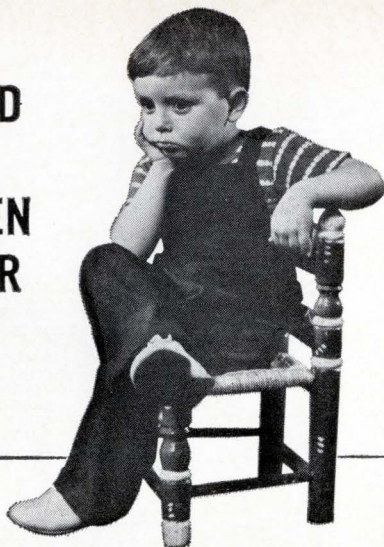

**HOPKINS
WILL
DESIGN
ONE
TO FIT
LEFTOVER SPACE!**

Great package! Everything in place! Now where do you fit the RFI filter? Call Hopkins. Every day we design special filters to fit seemingly impossible leftover spaces.

Figuring for a filter has to wait 'til the circuit is tested. Odd shapes and sizes are common because you don't build an electronic package around a filter. But then why should you? When your project is completed and you're ready to specify a filter, we'll develop one especially to solve your problem—to fit leftover space.

We make special filters any size, shape or value, from postage stamp size to room size. When all you've got left is leftover space we'll design a filter to fit.

Hopkins Filter Specialists are as close as your phone!

Call us to: **ARRANGE A TEST...
DEVELOP A PROTOTYPE...
BID ON A PROJECT...
or just TALK ABOUT FILTERS.**

Telephone: (213) 361-8691



HOPKINS
Engineering Company
A Subsidiary of Maxson Electronics Corporation
P.O. Box 191 • San Fernando, California 91341

Electronics Review

serves as the gate electrode. Its adsorption of impurities during the diffusion steps increases its conductivity and makes it suitable as an electrical contact. One edge is metalized for wire attachment.

Computers

Long and short of it

For over 20 years computer designers have been hounded by some more or less arbitrary design criteria laid down by the late John von Neumann, a mathematician at Princeton University. Although the flexibility and variety of present day computers—still built within those guidelines—are really a tribute to von Neumann, programmers are forced to perform some operations in an artificial and inconvenient way because of them. As a result, organizations that depart from them are often proposed.

No more lumps. One such proposal is being made by A.L. Lucke, of McDonnell Douglas, who will outline his plan in a paper at the National Conference of the Association of Computing Machinery, Aug. 29 to 31. Lucke has laid out the organization of a computer whose word length is variable under program control.

Most computers handle data in uniform lumps that never vary in size. The word length in this design is truly variable—even as small as one bit, whereas the so-called variable-length record machines, like IBM's 360 or 1410, actually use short "words," or characters, of six to eight bits. Their instructions can process "records" of an indefinite number of characters, under control of a record-length count included in the instruction itself or of an extra bit carried by each character.

"Programers have long recognized that storage space is wasted when a whole word is used for a simple on-off switch, or when 12-digit capacity has only 2-digit significance," says Lucke.

Long on words. Lucke's major innovation is a word-length register, which specifies the word length that the computer is using at any

particular instant. One special instruction, load word-length register, must be added to permit the program to specify the word length.

The new register can be quite short; Lucke suggests eight bits. Then it can specify a maximum word length of 256 bits (2⁸)—which is enormous. Current large computers have much shorter word lengths: the Illiac 4, 64 bits; Control Data 6000 series, 60 bits; Burroughs B8500, 48 bits. Large machines can have several word-length registers that do not have to be loaded and unloaded as often.

The capability of processing words of truly arbitrary length affects the design's instruction format, storage organization, arithmetic algorithms, control of input and output operations, and programming.

The instruction format, for example, must be capable of encoding as few as 16 instructions in a small machine with only 2¹⁶ bits of storage, or perhaps many thousands of instructions in a very large machine whose memory holds as much as 2²⁵⁶ bits (about 10⁷⁷).

For the record

Giant killer. Stelma Inc., a Stamford, Conn., firm with annual sales of \$11 million, has burst into the airborne communications field by beating out Sylvania Electronics Systems of Buffalo, N.Y., for a \$12.3 million job building battle-area communications control centers for the 407L system.

Beaten path. Donald T. Valentine has joined National Semiconductor Corp. of Santa Clara, Calif., as marketing manager, a newly created job. Valentine quit as marketing manager of Fairchild Semiconductor in protest against a reorganization of the division's marketing and manufacturing structure along product lines [Electronics, July 24, p. 44]. He rejoins five other ex-Fairchild men who were hired away by National Semiconductor—among them product marketing manager Floyd Evamme, who worked for Valentine at Fairchild.

Flip To The Fets That Fit

(see next page)

... then send the special offer coupon today to one of these

FRANCHISED



MOTOROLA DISTRIBUTORS

EASTERN

- ALABAMA, Huntsville 35805..... Gulf Semiconductors, Inc. 8100 Memorial Parkway, S.W. (205) 881-7737
- CONNECTICUT, Hamden 06514..... Cramer Electronics Inc. 60 Connolly Parkway (203) 288-7771
- D.C., Washington 20001..... Electronic Wholesalers, Inc. 2345 Sherman Ave., N.W. (202) HUDSON 3-5200
- FLORIDA, Miami 33142..... Gulf Semiconductors, Inc. 7495 N.W. 48th Street (305) 887-6541
- GEORGIA, Atlanta 30318..... Jackson Electronic Supply Co., Inc. 1135 Chattahoochee Ave., N.W. (404) 355-2223
- MARYLAND, Baltimore 21230..... Pyttronic Industries Inc. 2035 Worcester St. (301) 539-6525
- MARYLAND, Baltimore 21229..... Electronic Wholesalers, Inc. 3200 Wilkens Ave. (301) 646-3600
- MASSACHUSETTS, Cambridge 02139..... R&D Electronics Supply Co., Inc. 71 Pearl St. (617) 864-0400
- MASSACHUSETTS, Newton 02164..... Cramer Electronics, Inc. 320 Needham St. (617) WOODWARD 9-7700
- NEW JERSEY, Moorestown 08057..... Angus, Inc. P.O. Box 126, Pleasant Valley Avenue (609) 235-1900
- NEW YORK, Binghamton 13902..... Federal Electronics, Inc. P.O. Box 1208 (607) 748-8211
- NEW YORK, Buffalo 14202..... Summit Distributors, Inc. 916 Main St. (716) TT 4-3450
- NEW YORK, Flushing 11369..... Cramer/Esco 96-10 23rd Ave. (212) GR 8-4000
- NEW YORK, New York 10013..... Milgray Electronics, Inc. 160 Varick St. (212) YUKON 9-1600
- NEW YORK, Syracuse 13211..... Cramer/Eastern The Pickard Bldg., E. Molloy Rd. (315) 454-9247
- NEW YORK, Westbury, L.I. 11591..... Schweber Electronics (516) ED-4-7474
- NORTH CAROLINA Winston-Salem 27102..... Electronic Wholesalers Inc. 938 Burke St. (919) Park 5-8711
- PENNSYLVANIA, Philadelphia 19106..... Radio Electric Service Co. of Pa. 701 Arch St. (215) WA 5-6900
- PENNSYLVANIA, Pittsburgh 15218..... Semiconductor Specialists, Inc. 2011 Waverly Street (412) 351-3611

CENTRAL

- ILLINOIS, Chicago 60680..... Allied Electronics Corp. 100 N. Western Ave. (312) HA 1-6800 — TA 9-9100
- ILLINOIS, Chicago 60624..... Newark Electronics Corp. 500 N. Paulaski Rd. (312) 638-4411
- ILLINOIS, Chicago 60666..... Semiconductor Specialists, Inc. P.O. Box 8725, O'Hare International Airport (312) 279-1000
- IOWA, Cedar Rapids 52406..... Deco, Inc. 618 First St., N.W. (319) 365-7551
- KANSAS, Kansas City 66103..... Hall-Mark Electronics Corp. 2707 West 43rd Street (913) AD 6-4343
- LOUISIANA, New Orleans 70112..... Sterling Electronics, Inc. 537 S. Claiborne Avenue (504) 522-8726
- MICHIGAN, Detroit 48240..... Semiconductor Specialists, Inc. 25127 West Six Mile Road (313) 255-0300
- MICHIGAN, Detroit 48227..... Radio Specialties Co., Inc. 12775 Lyndon Ave. (313) BRoadway 2-4212
- MINNESOTA, Minneapolis 55403..... The Low Bonn Co. 1211 LaSalle Ave. (612) 339-9461
- MINNESOTA, Minneapolis 55423..... Semiconductor Specialists, Inc. 7742 Morgan Avenue South (612) 866-3434
- MISSOURI, St. Louis 63134..... Semiconductor Specialists, Inc. 6154 Jefferson Ave. (314) JA 1-8866
- OHIO, Cincinnati 45237..... Sheridan Sales Co. 100 Knollcrest Drive, P.O. Box 37646 (513) 761-5432
- OHIO, Cleveland 44103..... Pioneer-Standard Electronics Inc. 5403 Prospect Ave. (216) 432-0010
- OHIO, Cleveland 44133..... Sheridan Sales Co. P.O. Box 8226 (216) 237-9145
- OKLAHOMA, Tulsa 74115..... Hall-Mark Electronics Corp. 5708 E. Admiral Blvd. (918) TE 5-8458
- TEXAS, Dallas 75220..... Sterling Electronics 2642 Andjon Drive P.O. 20069 (214) FLEETWOOD 7-9131
- TEXAS, El Paso 99903..... Midland Specialty Co. 2235 Wyoming Avenue (915) 533-9555
- TEXAS, Dallas 75231..... Hall-Mark Electronics Corp. 9100 Markville Drive (214) AD 1-6111
- TEXAS, Houston 77042..... Hall-Mark Electronics Corp. 8000 Westglen (713) SU 1-0011
- TEXAS, Houston 77001..... Lenert Co. 1420 Hutchins P.O. Box 2184 (713) CA 5-1465

WESTERN

- ARIZONA, Phoenix 85009..... Hamilton Electro of Phoenix 1741 No. 28th Ave. (602) 272-2601
 - CALIFORNIA, Inglewood 90301..... Liberty Electronics Corp. 339 S. Isis Ave. (213) OREGON 8-8111
 - CALIFORNIA, Los Angeles 90230..... Hamilton Electro Sales 10912 West Washington Blvd. (213) UP 0-7171
 - CALIFORNIA, Los Angeles 90022..... K-Tronics 5645 E. Washington Blvd. (213) OV 5-5888
 - CALIFORNIA, Oakland 94607..... Elmar Electronics 140 11th St. (415) TEMplebar 4-3311
 - CALIFORNIA, Mountain View 94040..... Elmar Electronics 2285 Charleston Road (415) 961-3611
 - CALIFORNIA, Mountain View 94040..... Hamilton Electro Sales-North 340 Middlefield Road (415) 961-7000
 - CALIFORNIA, San Diego 92123..... Kierulff Electronics, Inc. 8797 Balboa Ave. (714) BROWning 8-2112
 - CALIFORNIA, San Diego 92109..... San Delcor, Inc. 4618 Santa Fe (714) 274-3131
 - COLORADO, Denver 80204..... Kierulff Electronics Co., Inc. 1200 Stout St. (303) TABOR 5-7033
 - NEW MEXICO, Albuquerque 87108..... Kierulff Electronics Co., Inc. 6405 Acoma Road, S.E. (505) 268-3901
 - UTAH, Salt Lake City 84110..... W. H. Bintz Company 433 West Third South (801) 363-5821
 - WASHINGTON, Seattle 98121..... Hamilton Electro of the Pacific Northwest 2320 Sixth (206) ATwater 2-3836
- Mailing Address: P.O. Box 9252 / Seattle, Washington 98109

If 1 of These 24 New Motorola FET's Doesn't Fit Your Application...

Let Us Know!*

(We have many others that may)

SPECIAL \$1.00 OFFER ■ FET APPLICATIONS-SAMPLERS

- Send me the Amplifier Kit (Includes 2 MPF157-158 MOSFETs and 2 App Notes).
- Send me the Switching Kit (Includes 2 MPF159-160 MOSFETs and 2 App Notes).
- Send me the data sheets for: 20 New Amplifier/Mixer FETs 4 New Chopper/Switching FETs

NAME _____ TITLE _____

COMPANY _____ DEPT. _____

ADDRESS _____

CITY _____ STATE _____

(See preceding page for the name & address of your nearest franchised Motorola Semiconductor distributor - be sure \$1.00 is enclosed with coupon)

**SPECIAL
OFFER!**
Offer Expires - 10/31/67

E-867

*Just drop us a line, on your company letterhead. Describe your application. Our Applications Engineers will tell you what FET we have that *will* fit! Send to Box 955, Phoenix, Arizona 85001.

-where the priceless ingredient is care!

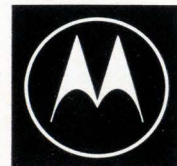

20 New Motorola FETs for Amplifier and Mixer Applications

Device Number	N.F. @ Freq.		G _{ps} (dB)	C _{rss} (pF)	Y _{rs} (μmhos)	Pol.	Type	Pkg.	Price (100-up)
	(dB)	(max)							
2N4416	2.0	100 MHz	18	0.8	7500	N	JFET	TO-72	\$3.35
	4.0	400 MHz	10						
MFE2002	2.5	100 MHz		2.0	6500	P	JFET	TO-72	4.05
MFE2001	2.0	100 MHz	18	1.0	800	N	JFET	TO-72	2.95
	4.0	400 MHz	10						
MFE2000	2.0	100 MHz	18	1.0	6000	N	JFET	TO-72	2.65
	4.0	400 MHz	10						
MPF157	4.5	200 MHz	16	0.2	2000	N	MOS	TO-92	.80
MPF158	4.5	400 MHz	10	0.2	2000	N	MOS	TO-92	1.00
MFE4001	2.5	100 Hz		2.0	4000	P	JFET	TO-72	7.40
MFE4002	2.5	100 Hz		2.0	5000	P	JFET	TO-72	4.30
MFE4003	2.5	100 Hz		2.0	6000	P	JFET	TO-72	5.40
MFE4004	2.5	100 Hz		2.0	4000	P	JFET	TO-72	7.90
MFE4005	2.5	100 Hz		2.0	5000	P	JFET	TO-72	4.80
MFE4006	2.5	100 Hz		2.0	6000	P	JFET	TO-72	5.90
MPF151	2.5	1 KHz		2.0	4000	P	JFET	TO-92	.67
MPF152	2.5	1 KHz		2.0	5000	P	JFET	TO-92	.50
MPF153	2.5	1 KHz		2.0	6000	P	JFET	TO-92	.67
MPF154	2.5	1 KHz		2.0	4000	P	JFET	TO-92	1.00
MPF155	2.5	1 KHz		2.0	5000	P	JFET	TO-92	.80
MPF156	2.5	1 KHz		2.0	5000	P	JFET	TO-92	1.00
MFE3004	4.5	200 MHz	16	0.2	2000	N	MOS	TO-72	4.25
MFE3005	4.5	400 MHz	10	0.2	2000	N	MOS	TO-72	4.50

4 New Motorola FETs for Chopper/Switch Applications

Device Number	r _{ds(on)} (ohms)	C _{rss} (pF)	I _{GSS} (pA _{dc})	Pol.	Type	Pkg.	Price (100-up)
MFE3002	100	1.0	100	N	MOS	TO-72	\$5.40
MFE3003	200	1.0	100	P	MOS	TO-72	5.40
MPF159	300	1.3	100	N	MOS	TO-92	2.75
MPF160	600	1.3	100	P	MOS	TO-92	2.75

in amplifiers: If your primary interest is in amplifier or mixer circuit design, you'll want to order this outstanding applications-sampler. The two application notes parallel papers presented at WESCON; and, the two evaluation units, valued at \$2.00, are the MPF-157-158 MOSFETs. Send \$1 with the completed coupon from the opposite page.

Here's How to
Design with and/or
Evaluate Motorola FETs

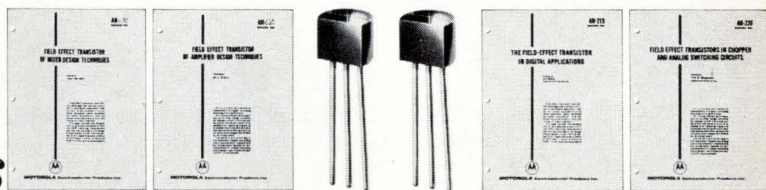

in switching: This comprehensive applications-sampler is designed for the engineer who is primarily interested in chopper or complementary switching circuits. The two application notes cover a wide-range of applications ideas; and, the two evaluation units are the exciting new MPF159 and MPF160 complementary MOSFETs, valued at \$6.00. This package is also available for \$1, with the coupon from the opposite page.

MOTOROLA Semiconductor Products Inc.

P. O. BOX 955 / PHOENIX, ARIZONA 85001

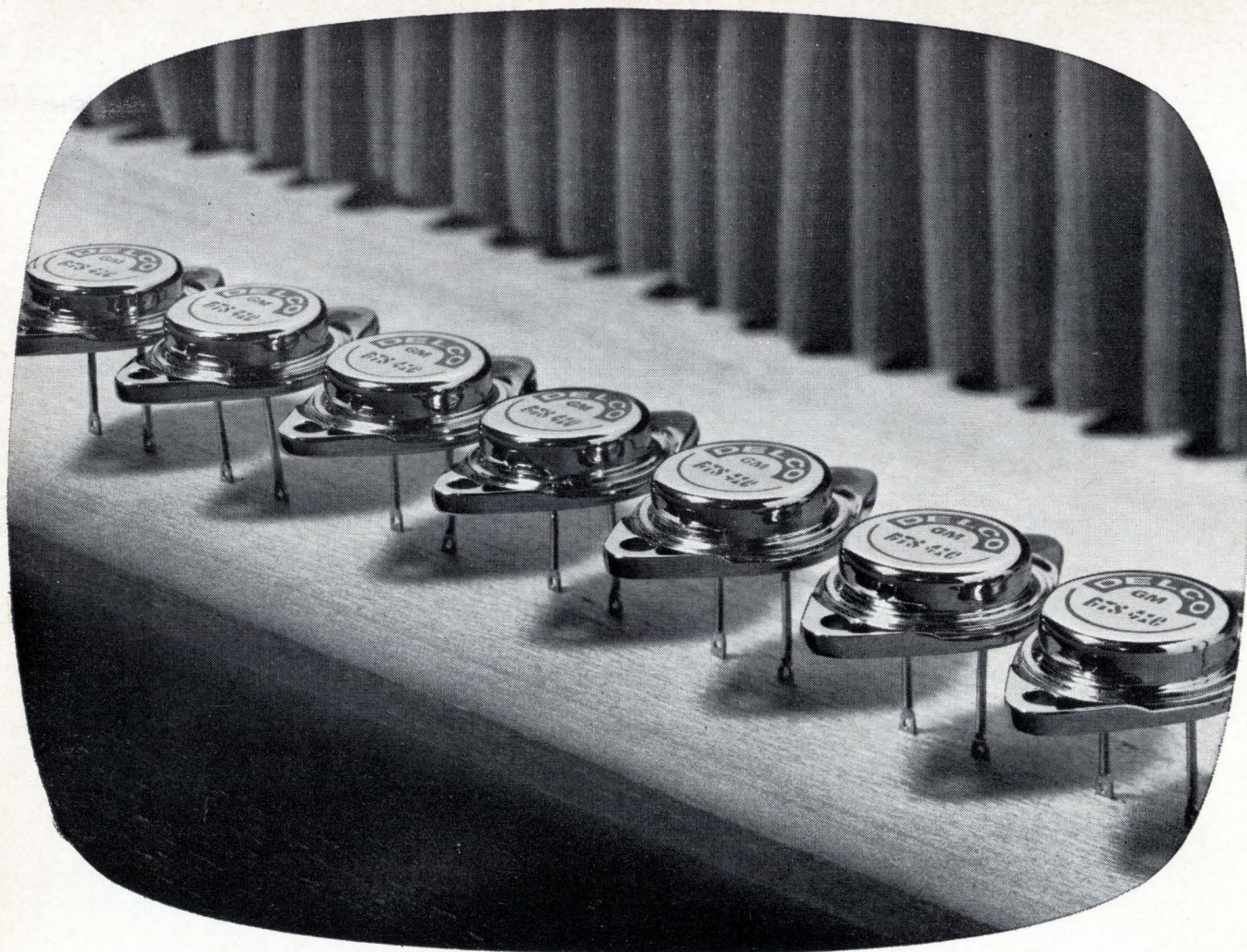

You should see us in living color

Our transistors have carved quite a career in the entertainment world.

First, in our car radios. (We produce all GM car radios and the power transistors for them.)

Then, in television. (We originated the power sweep transistor—for both horizontal and vertical—which helped to make big screen transistorized TV possible and practical.) Several major TV manufacturers are using them.

Today, we have the experience and the capability to supply these transistors in the volume you need for large scale TV set production. For black-and-white or color.

We welcome your order.

DELCO RADIO Division of General Motors
700 E. Firmin St.
Kokomo, Indiana • Phone (317) 459-2175





Proven... better, faster, more economical scribing

THE TEMPRESS AUTOMATIC SCRIBING MACHINE HAS FULFILLED THE PROMISE MADE WHEN INTRODUCED . . . NEW EFFICIENCY FOR SEMICONDUCTOR MANUFACTURE. To restate the advantages: one microscope . . . one group of positioned sequence controls . . . one streamlined package, as small as an office typewriter. A look inside discloses all electronic circuitry on easy-access circuit boards and life-lubricated mechanical components. The price has made it practical for an entire industry to adopt it as the standard scribing device. New refine-

ments include high reliability electronic components, high contrast illumination system, provision for triangular scribing, and a new system for clamping and adjusting scribing tools. The Automatic Scribing Machine is a product of the Tempress Standard of Excellence . . . a proud member of the growing family of Tempress miniature assembly tools and production machines.



TEMPRESS

Tempress Research Co., 566 San Xavier Ave., Sunnyvale, California

Circle 51 on reader service card

Adlake Mercury Wetted Relay – Application Data

Capacitance of Adlake Mercury Wetted Contact Relays Applicable for Low Signal Applications

Typical Capacitance in Picofarads — Graphs illustrate typical capacitance values for Adlake AWCA-16000 series relays. Fig. 1 is for unshielded relays. Fig. 2: Electro-statically shielded switch brought out to a separate pin. Fig. 3: Electro-statically shielded switch with case and shield tied together at a common pin. Interelectrode capacitance across contacts of a bare switch, without external wires, is less than 1.0 picofarad.

Abbreviation COMM. stands for the Combination of the Armature and Normally Closed Contact. N.O. is the abbreviation for Normally Open Contact; whereas the symbol # is the mean average for the 5 relays. Graphs are available on other styles of Adlake Mercury Wetted Contact Relays upon request. (Please state wiring configuration.)

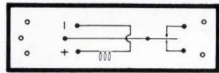

AWCA 16011-S
Fig. 1

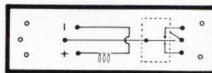
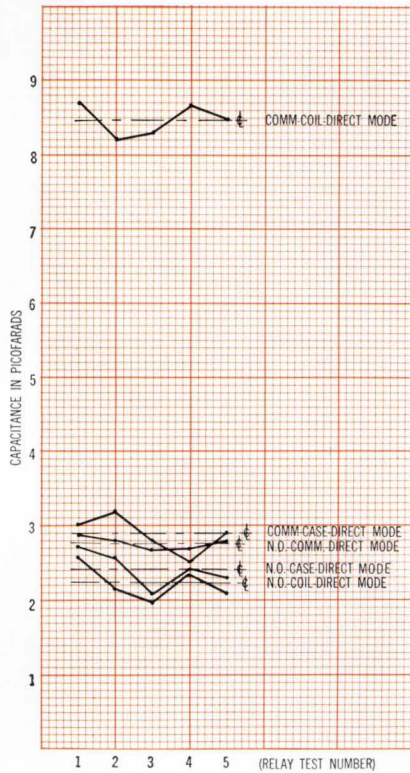

AWCA 16016
Fig. 2

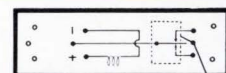
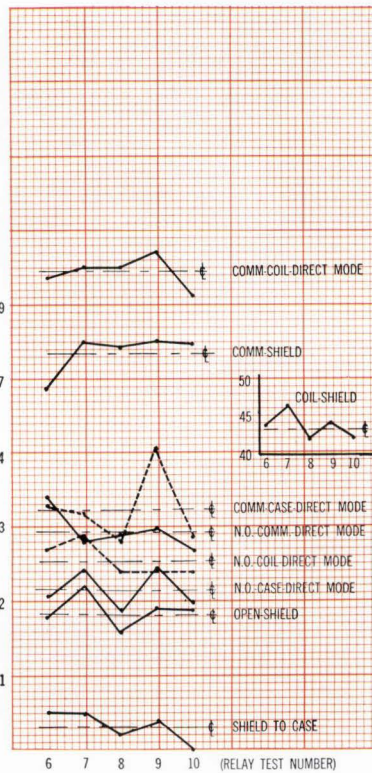

AWCA 16018
Fig. 3

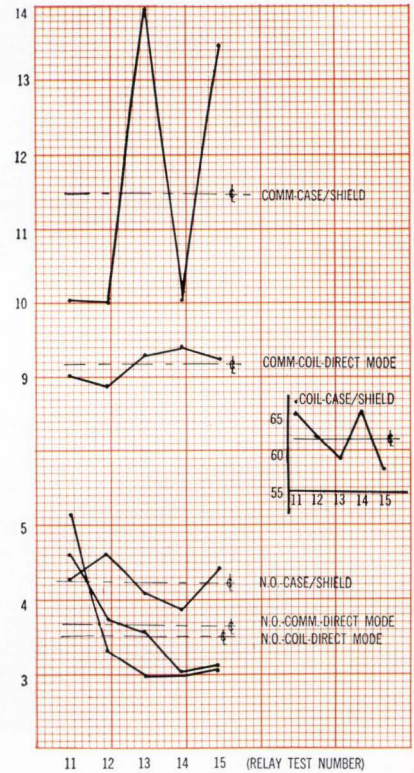

Backed by sound research and disciplined engineering, Adlake applies the industry's broadest line of mercury displacement and mercury wetted relays to the creative solution of design circuit problems. However unique or special your application, Adlake can assist you in

developing it. For prompt, personal and knowledgeable attention to your relay needs, contact the one source that is the complete source in the mercury relay field. Contact Adlake today for catalog and further information.



THE ADAMS & WESTLAKE COMPANY
A SUBSIDIARY OF ALLIED PRODUCTS CORPORATION
ELKHART, INDIANA 46514 • AC 219 • 264-1141

TRANSPORTATION EQUIPMENT • ARCHITECTURAL PRODUCTS • MERCURY RELAYS • DOORS AND ENTRANCES • CONTRACT MANUFACTURING

Some of our work is positively brilliant.



In fact, one of our lasers throws a beam 250 billion times brighter than the sun.

It's the brightest laser in the world.

As leaders in lasers, we've made all kinds, up to giants with 1000 megawatts per pulse. And laser welders. And, of course, a full family of laser accessories.

But lasers are only one of the up-front activities that keep Union Carbide on the frontiers of electronics. We are also leaders in the research, development and production of solid state devices, solid tantalum and foil-film capacitors, fuel cells, and single crystals and related products.

They're reasons to keep Union Carbide in mind before your projects reach the breadboard stage.

UNION CARBIDE Corporation, Electronics Division,
270 Park Avenue,
ELECTRONICS New York 10017.

An Equal Opportunity Employer

100 μ v resolution auto polarity-display storage overrange digit



[\$595]

The new Hewlett-Packard 3430A Digital Voltmeter is a high-performance utility instrument ideal for production line work, repair or inspection stations, in the lab or for quality control. It offers the highest value available today in terms of price and performance.

- 100 μ v sensitivity for low-level measurements
- Auto polarity
- Non-blinking display, ideal for faster, easier, less vulnerable measurements
- 60% overrange with an extra digit
- Floating measurement with 10 Meg input impedance
- Fast (half second) response
- Analog dc output from amplifier, useful as a 100:1 voltage amplifier
- RATIO measurement option

Nowhere else can you get these extra "luxury" features at such a low cost. High-speed measurement, 100 mv-1000 v, accuracy 0.1% of full scale \pm 1 digit, plus the 4th digit for over-ranging. Instrument can be floated to \pm 500 v dc with respect to ground. No worry about circuit loading with the high input impedance. High stability with the voltage accuracy guaranteed to 3 months, one-year warranty on the instrument. The only DVM of its type available with ratio measurement capability, at an accuracy of \pm 0.15% \pm 1 digit. With the ratio option 01 (\$80), you can normalize transducer dc outputs without taking time for recalculation. It offers all polarity combinations. The bonus amplifier output, \pm 0.1% accuracy, increases testing flexibility.

Call your Hewlett-Packard field engineer for complete specifications, or write to Hewlett-Packard, Palo Alto, California 94304, Tel. (415) 326-7000; Europe: 54 Route des Acacias, Geneva.

HEWLETT  PACKARD
An extra measure of quality

For a clear picture of Centralab...

...keep an eye on our ripples

In our years of manufacturing miniature and subminiature components, we've made many ripples, and a few splashes, in the electronics industry:

Centralab designed and produced the world's first carbon composition potentiometer and for more than 40 years has been an industry leader. In 1936 we introduced the first temperature-compensating ceramic capacitor in America. We were first to offer dual controls and to add integral line switches to variable resistors. Our exclusive $\langle \text{PEC} \rangle$ integrated circuits have been key elements in the miniaturization of electronic equipment. During World War II days Centralab developed the ceramic disc capacitor design for military requirements. And our Ultra-Kap[®] ceramic disc capacitor has replaced millions of larger, more costly devices.

Centralab sales have increased substantially every year and our services have grown proportionately. Our products are sold, by separate sales groups and from separate warehouses, to original equipment and distributor markets.

Centralab's tested and proven products include capacitors, packaged circuits, rotary switches, potentiometers and technical ceramics. In October, 1966, we erected a push button switch manufacturing plant and in May, 1967, we acquired solar devices and semiconductor facilities.

Innovation, growth and stirring the waters are nothing new at Centralab; and we don't intend to stop. As technology advances and components become smaller, more complex and more sophisticated, we'll keep our feet wet.

To help keep abreast of Centralab developments, we'll be happy to send you our periodical "This Is Centralab." Write for future issues.



CENTRALAB

Electronics Division
GLOBE-UNION INC.
5757 NORTH GREEN BAY AVENUE
MILWAUKEE, WISCONSIN 53201



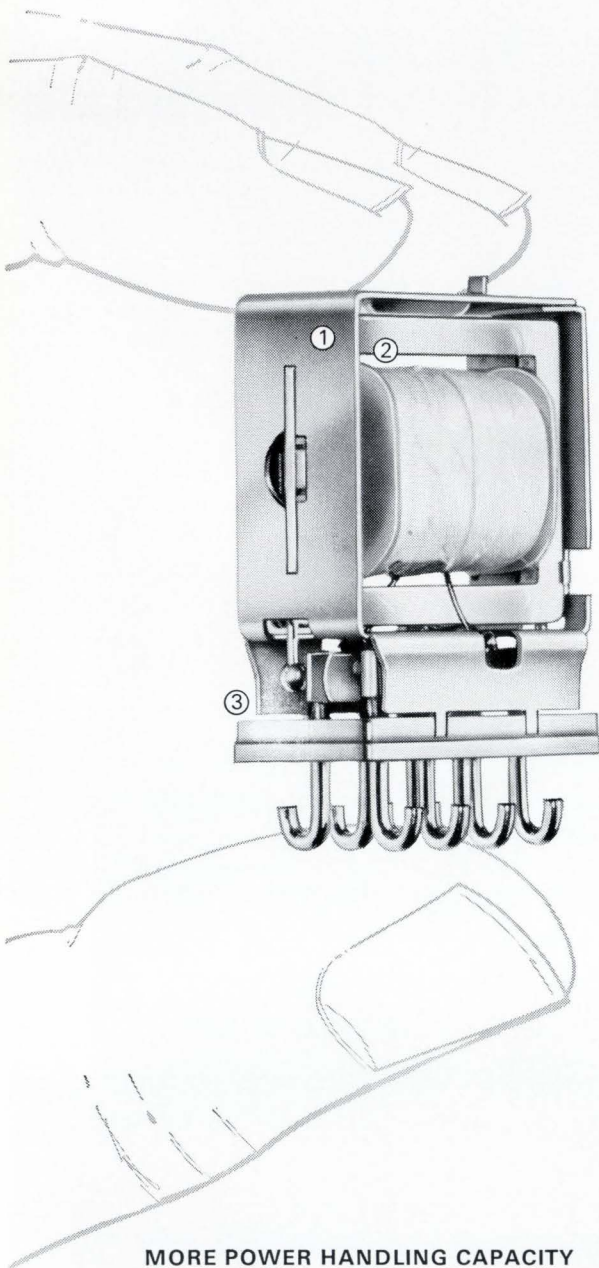

Relay: 2X

**MORE POWER HANDLING CAPACITY
... RUGGED CONSTRUCTION**

- Rigid frame (1) stabilizes all elements ... maintains alignment of pivoted armature (2)
- Optimized magnetic circuit efficiency speeds switching ... provides high contact force, low contact resistance
- Four times the contact area of standard F relay ... spring-tempered silver alloy contacts (3) (2 Form C) ... gold plating available
- Welded cover ... variety of stud and bracket mountings

10 amp titan,

the new Clare PF relay, handles extremes of shock, vibration and temperatures ... delivers proven switching reliability to military and industrial circuits.

Simple, precision construction ... magnetic circuitry of the highest efficiency ... maximum contact reliability—proven performance features of Clare F relays—are basic to the new PF. Design around new tough-job efficiency. Switch up to 10 amperes in less than 7 ms ... with initial circuit resistance of 10 milliohms (max.), 20 milliohms (max.) after more than 100,000 operations at 10 amps, 28 vdc.

Meet advanced power switching requirements with proven Clare performance. Circle reader service number—or ask Clare for Data Sheet 757 ... Write Group 8N7

C. P. Clare & Co., Chicago, Illinois 60645 ... and worldwide

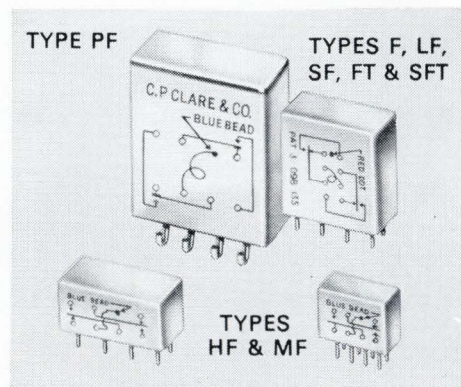

- Clare Military-Type relays include: New 10 amp Type PF, standard size Type F, latching Type LF, sensitive SF, half-size Type HF, one-sixth size Type MF, and Types FT & SFT for noise and thermal voltage problems. All meet appropriate MIL-R-5757D requirements
- Sensitivities from 40 mw
- Versatile contact capabilities ... low level to 10 amp. Gold-plated contact areas, with high contact pressures and positive wiping action. Bifurcated contacts (F, FT, LF, SF, HF)

CLARE MILITARY-TYPE (crystal can) RELAYS

for airborne, aerospace and ground support equipment,
industrial and commercial control systems

From Monsanto:
130,000,000
discrete frequencies
with almost perfect purity.



Computer-aided design and integrated-circuit construction in this new Frequency Synthesizer bring a new level of perfection to signal generation.

The new "4th generation" Model 3100A Digital Frequency Synthesizer obsoletes just about every current concept of general purpose signal sources. Pick your frequency from 0.01 Hz to 1.3 MHz in 0.01 Hz steps. The result—signal purity you can get only from Monsanto, with a stability of 1 part in 10^9 / day. Other refinements include: internally supplied rapid or slow sweep and provision for

external sweep; coupled output permitting internally supplied offset; continuous control of output level over a 90 dB range; provision for amplitude modulation; and, in the remotely programmable version, switching time of less than 20 microseconds. Best of all, you can put this *better way* of signal generation to work for you for only \$3,950. Circle the inquiry number for full technical details, or contact us directly at: Monsanto Electronics Technical Center, 620 Passaic Avenue, West Caldwell, N.J. 07006. Phone (201) 228-3800; TWX 710-734-4334.

Monsanto
ELECTRONICS

Circle 57 on reader service card

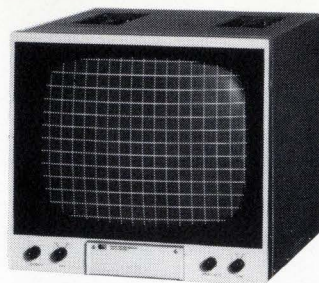

hp VIDEO MONITOR

THE NEW STANDARD OF PERFORMANCE

Advanced Circuit Techniques Achieve Increased Reliability and Improved Picture Quality

MAINTENANCE FREE OPERATION

All Solid State Circuitry • No periodic alignment or adjustment required • Highest quality components and workmanship.

EASE OF OPERATION

Display linearity independent of size adjustment • Unique deflection circuits have feedback active over entire raster • No sync controls — synchronization is automatic on both North American and CCIR Standards.

IMAGE QUALITY

Displays sine² T/2 pulse without distortion (62.5nsec) • Feedback active over full video band • Unity interlace results from novel sync circuitry • Keyed back porch clamp assures less than 1% black level shift for 100% video amplitude change • Less than 1.5% geometric distortion overall.

OTHER IMPORTANT FEATURES

Fully regulated high voltage and low voltage power supplies • Balanced input with loop-through facility • 46 db input common mode rejection.

Model 6946A—Price \$950.

Contact your nearest Hewlett-Packard Sales Office for full specifications.



COMMUNICATION INSTRUMENTS

100 Locust Ave., Berkeley Heights, New Jersey 07922
Telephone 201-464-1234 TWX 710-984-7972

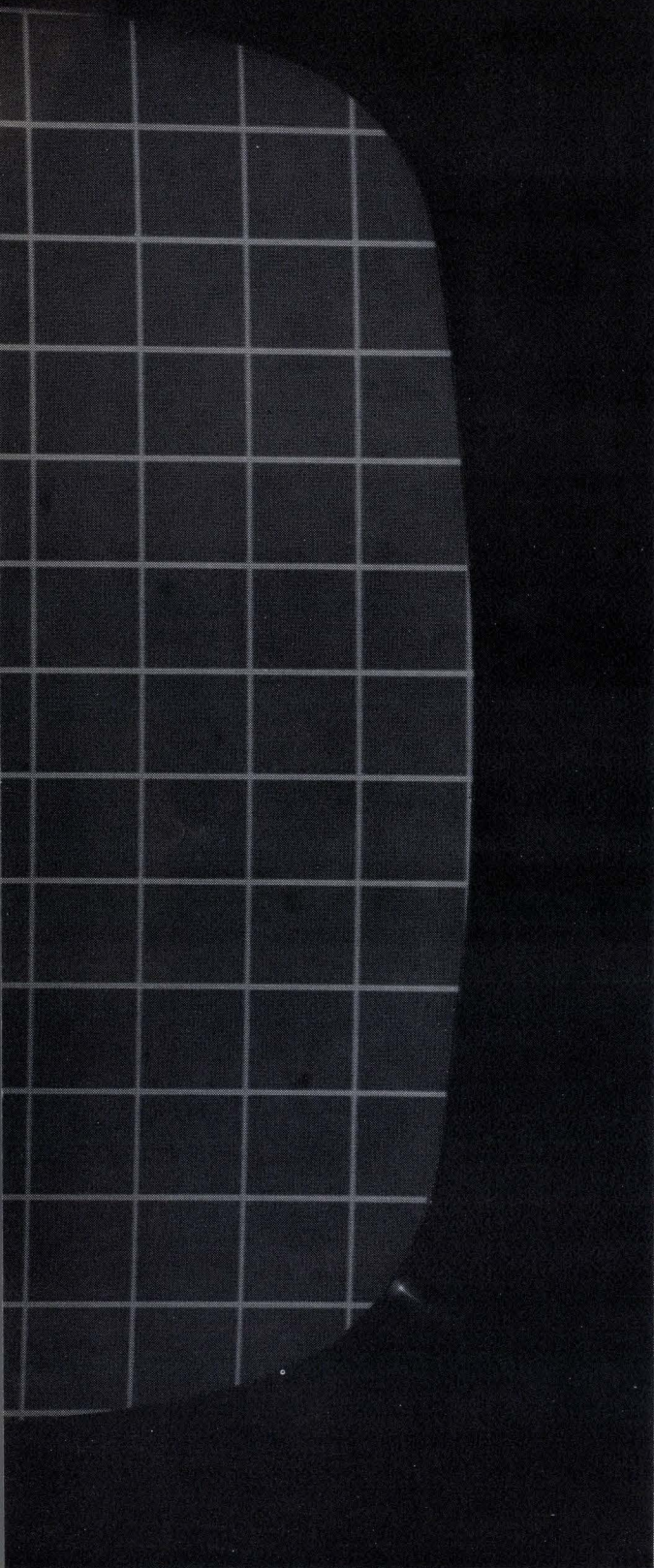

BRIGHTNESS

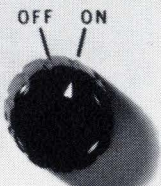

LINE

Washington Newsletter

August 21, 1967

Comsat to ask bids on huge Intelsat 4

The Communications Satellite Corp. has decided to ask for industry proposals early next year to build a 10,000-channel satellite—Intelsat 4. Procurement of four or more of the giant spacecraft must be approved by the international consortium that owns the Intelsat system, but chances of a go-ahead look good. Comsat's plan is based on design studies just completed by Hughes and Lockheed for a high-capacity, multipurpose satellite.

Meanwhile, troubles in the satellites for the first global system—the 1,200-channel Intelsat 3 being built by TRW Systems [Electronics, July 24, p. 49]—have been overcome, Comsat officials say. Comsat now hopes to launch the first of these satellites in mid-1968, at least three months behind schedule. Problems with the Sylvania-built mechanically despun antenna have been solved by replacing the parabolic reflector with a flat plate.

All this doesn't completely rule out the possibility that Comsat will have Hughes build a beefed-up version of its Intelsat 2. Hughes is currently making a \$300,000 design study of such a satellite, and Comsat is expected to decide in October whether to order a \$3 million upgraded Intelsat 2 as insurance.

FAA puts off industry meeting on traffic control

Despite the mounting problems of air traffic control and mounting pressure to do something about them, the Federal Aviation Administration continues to move at its own relaxed pace. The FAA's first conference to brief electronics firms on terminal air traffic control requirements won't be held this month as originally planned [Electronics, July 24, p. 141]. The agency now hopes to hold the Washington meeting in September.

The conference thus could coincide with, or closely follow, hearings on air safety by the House Committee on Interstate and Foreign Commerce. Those hearings, which would include industry representatives if committee members have their way, are expected to result in sharp criticism of the FAA's handling of air traffic control.

No big slash seen in Navy F-111 funds

The Navy will probably get most of the \$287 million it wants for 20 F-111B fighter planes even though the Senate Appropriations committee wants to cut the controversial program to \$115 million and five planes. The reasons: the House Appropriations committee already has approved the full 20-plane program, and the F-111B is needed as the platform for the Navy's costly but successful Phoenix air-to-air missile. Paul H. Nitze, Navy Secretary, told the Senate panel last spring that the plane will never meet original performance specifications.

Eros may miss 1969 launch date

Project officials for the Interior Department's Earth Resources Observation Satellite (Eros) still hope for an initial launch in 1969 [Electronics, Feb. 6, p. 48] but concede it "possibly" will be delayed until 1970. Taking longer than originally expected is the process of deciding what sensors Eros will carry and what jobs will be included. The satellite's design will be settled early in October when an advanced mission study is completed by NASA's Goddard Space Flight Center. The Geological Survey, the Interior bureau in charge of Eros, has been meeting in the meantime with

Washington Newsletter

Interior and Agriculture Department groups ranging from the Bureau of Outdoor Recreation to the Forest Service to make sure no application is overlooked.

Influx of engineers from poor nations alarms Congress

Congress wants to stem a renewed influx of engineering talent from underdeveloped countries into the U.S., but it doesn't know how to go about it. It has scheduled hearings on this "brain drain" for later this year, but must face up to the problem that any legislation limiting immigration from developing nations would smack of discrimination and run contrary to the liberalized immigration act of 1965.

A House subcommittee reports that a new high of 429 electrical engineers—mainly electronic—emigrated from developed countries last year. But what worries legislators more is that the number of electrical engineers leaving developing nations for the U.S. more than doubled last year from 1965, with 150 coming from Asia alone and 100 from Latin America.

'Excess profit' unit may be on last legs

Although the Renegotiations Act is on the books through next June, there is already speculation about its future; some observers say it will be allowed to expire at that time. Rep. Henry B. Gonzalez (D., Tex.), has introduced legislation to extend and strengthen the act—but unless some major scandals occur, the bill doesn't have much chance. Critics of the act and the Renegotiations Board, which reclaims excessive profits on defense contracts, say the costs of administering the law total more than the returns to the Government. The board's high mark came in 1955, when it made "excessive profit determinations" totaling \$167 million. By fiscal 1966, the figure had dropped to \$24 million.

Federal scientist sought for DOT job

Transportation Secretary Alan S. Boyd will probably name a career Government scientist as assistant secretary for science and technology; the appointment is due by mid-September. Boyd refuses to recruit from the transportation industry or the academic world. James D. Densmore, the acting assistant secretary, came to the agency from Lear Siegler, and his industry connections make him an unlikely candidate.

NASA setting up astronomy panel

NASA is placing heavier emphasis on astronomy research. To be established soon will be an astronomy missions board, an advisory panel similar to the recently formed lunar and planetary missions boards. Although no new programs or systems are expected to stem from this move, it's likely that more hardware will. NASA's associate administrator, Homer Newell, will tell the American Institute of Aeronautics and Astronautics in Seattle next week that new discoveries in astronomy will be a major contribution of NASA in the 1970's.

Dominick seeks law on air-crash beacons

Criticizing the FAA's failure to require all aircraft to carry crash locator beacons, Sen. Peter Dominick (R., Colo.) plans to introduce legislation that would make the beacons mandatory. The FAA explains that it doesn't require them because "interest is lukewarm in the general aviation community" and only 10% of all aircraft fly over treacherous terrain. At least eight companies make locators, which cost \$200 and up.

By solving an "unsolvable" cleaning problem, Freon® helped perfect Hamilton's electric watch.

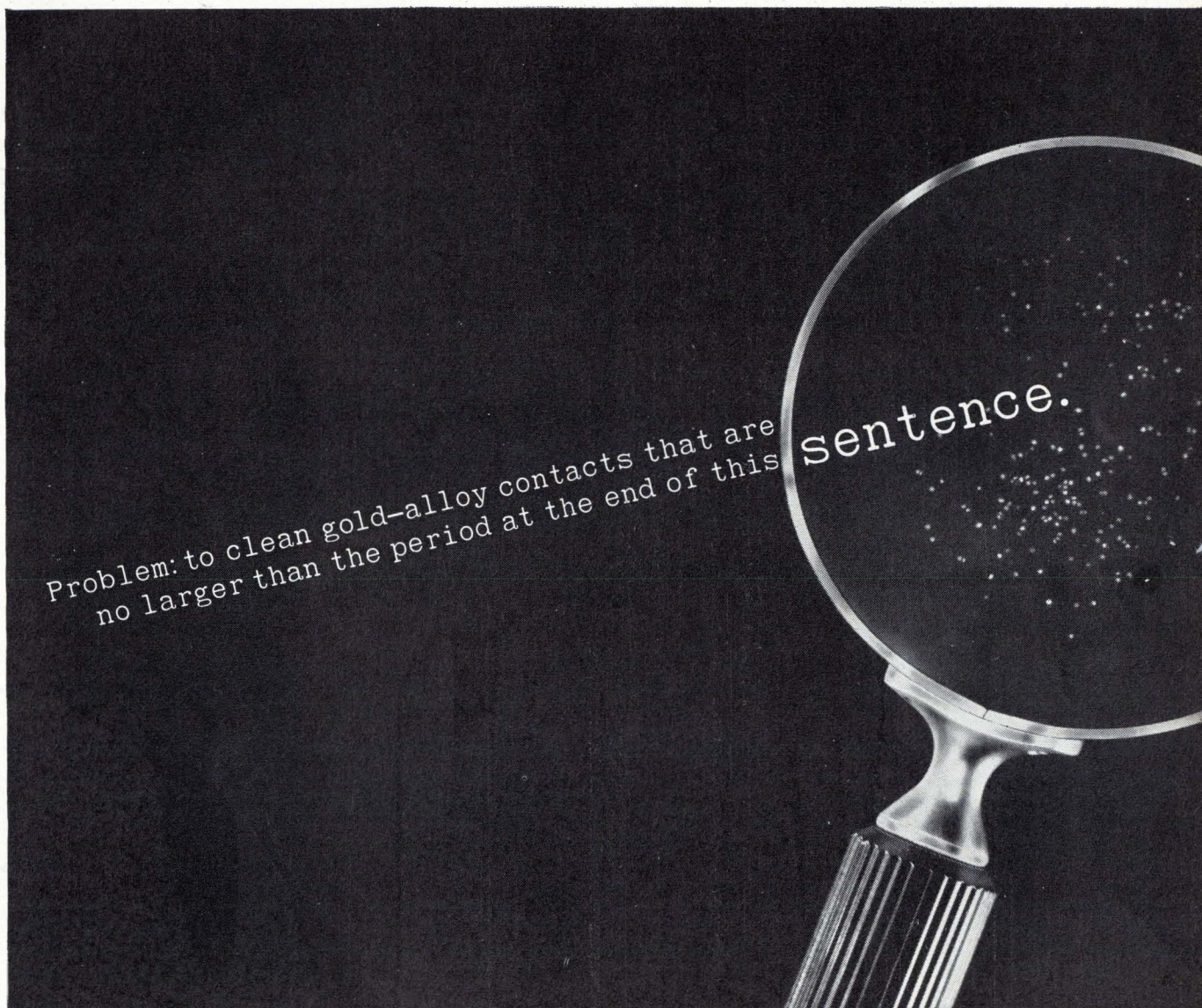

Problem: to clean gold-alloy contacts that are no larger than the period at the end of this

Sentence.

Those specks under the magnifying glass are gold alloys. Each one acts as a contact that transmits power from a tiny battery to the timekeeping mechanism of the Hamilton electric watch... which now ranks with the best of critical timepieces.

Unless these contacts, located in extremely tight assemblies, are *completely free* of soils and stains, however, the watch will malfunction. Or not function at all. And this was precisely the problem that confronted Hamilton engineers during the watch's development in Lancaster, Pa. They simply could not get the contacts clean *enough*. Even the cleaning agents they used left trouble-making stains.

The problem wasn't solved until FREON*, with its unique properties, was introduced into the cleaning operation. FREON has *low* surface tension, which allows it to penetrate the tightest assembly. At the same time, FREON has *high* density. This permits the quick release of all stains left by trapped cleaners. And because it vaporizes at a little above room temperature, FREON dries rapidly, leaving no stains of its own.

Hamilton uses FREON to clean parts ranging from $\frac{1}{16}$ of an inch (the contacts) up to $\frac{1}{4}$ of an inch... including $\frac{1}{8}$ -inch, intricately designed toothed wheels. As many as 3,000 parts are cleaned in an ultrasonic tank simultaneously. So successful was Hamilton's experience with FREON that the company now uses it in its military area.

For instance, FREON is used in a degreaser to remove soils from a gravity-triggered release installed in parachute flares.

Do you have a tough cleaning problem that FREON can solve? Write Du Pont, Room 5297, Wilmington, Del. 19898. (In Europe, write Du Pont de Nemours International S.A., FREON Products Div., 81 route de l'Aire, CH 1211 Geneva 24, Switzerland.)

*DuPont registered trademark for its fluorocarbon cleaning agent.



BETTER THINGS FOR BETTER LIVING...THROUGH CHEMISTRY

Why Astro/348™ won the high contact density design competition

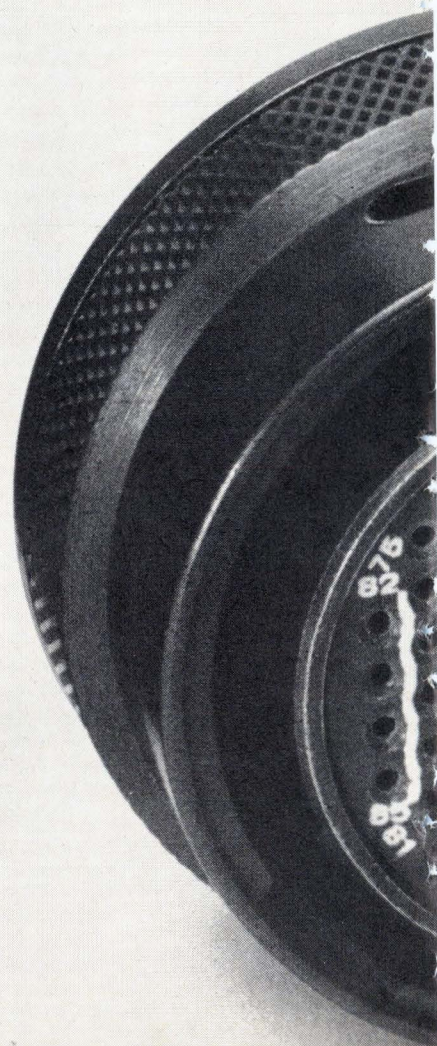
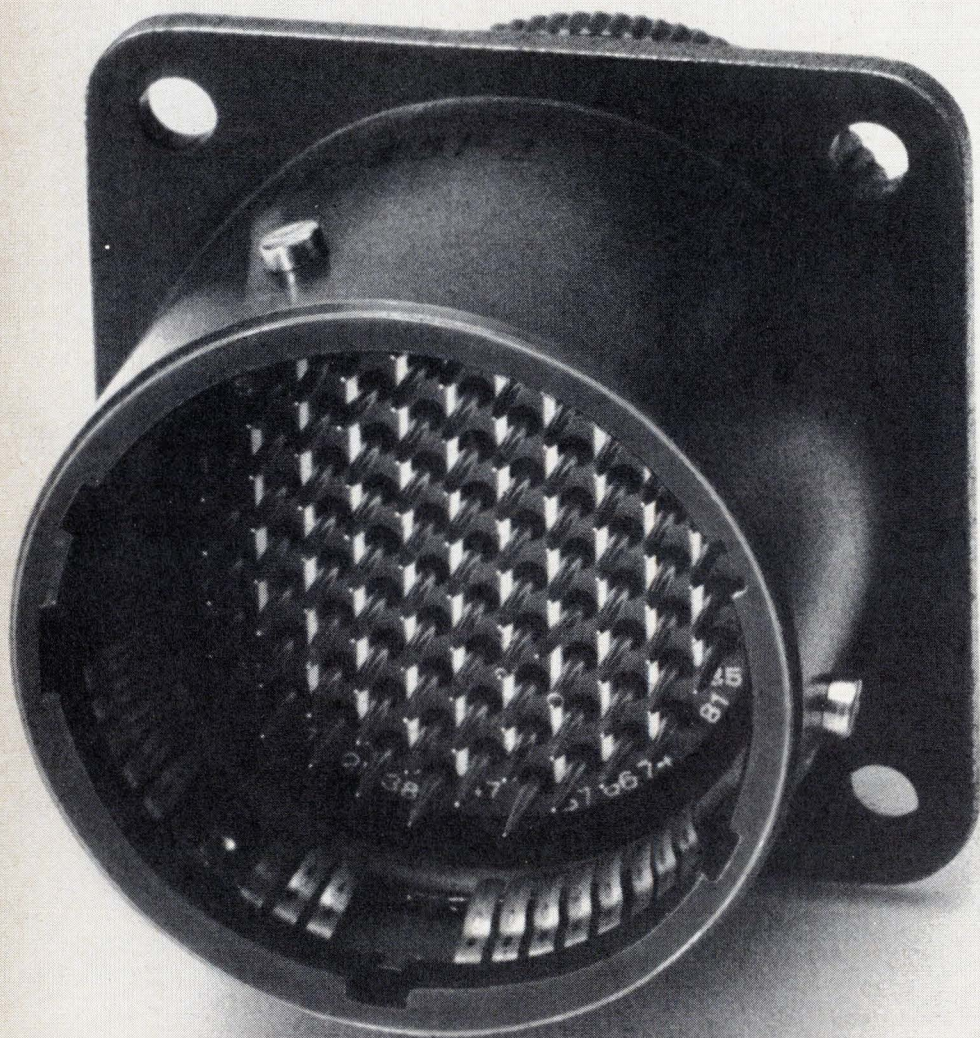

Better features

- One-piece dielectric retention system eliminating metal retention clips.
- Contact dielectric separation of .021 in on .085-in centers, equivalent to existing miniatures with .130-in centers.
- Monoblock construction eliminating air voids between contacts. Wire sealing range of .030 to .054 in.
- Dual environmental mating protection providing interfacial and shell "O" ring seals.
- Damage-proof mating. Pins recessed beyond reach of shells. Closed entry hard socket inserts, prod-proof socket contacts.
- Grounding springs that mate prior to electrical engagement. Shielding for EMI/RFI protection.
- Front release, rear serviceable crimp contacts.
- Front or rear mounted receptacles on 1/8" panels.

A complete family (6 shell styles, 4 to 85 contacts) is now being qualified to MIL-C-81511 (Navy).

Ask an Amphenol sales engineer about Astro/348. Or write Amphenol Connector Division, 1830 S. 54th Ave., Chicago, Ill. 60650.

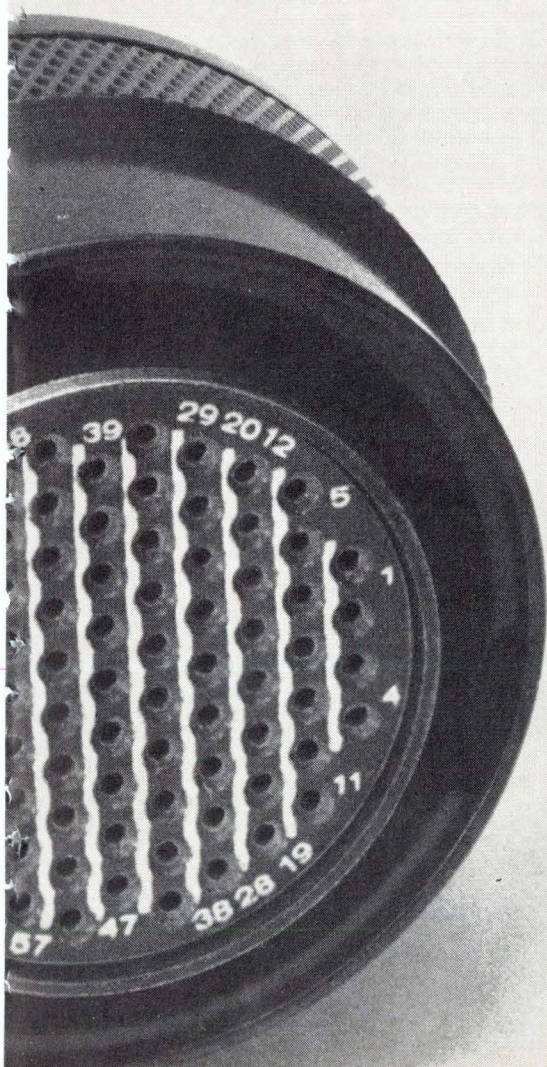
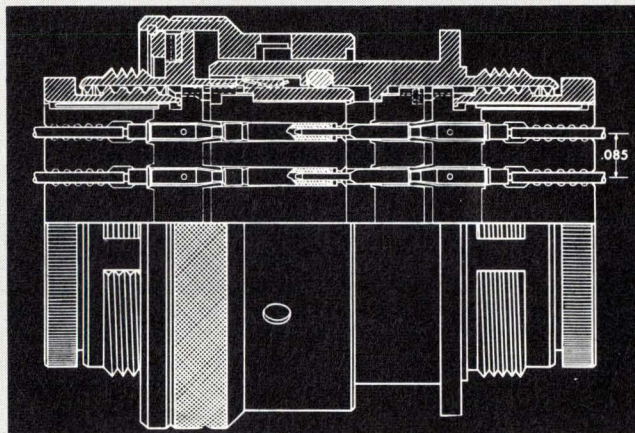

AMPHENOL

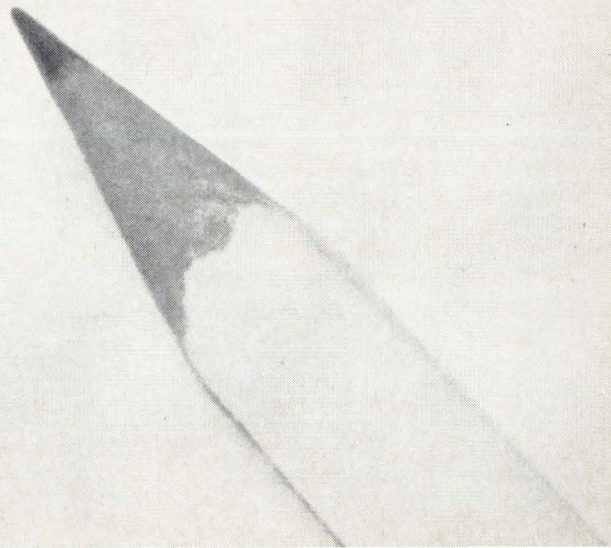

ONE COMPANY

has demonstrated the capability to design, produce and deliver the only broad line of complex **MTOS** arrays (LSI) available today...

MTOS MICROCIRCUIT ARRAYS ($T_A = -55^\circ\text{C}$ to $+85^\circ\text{C}$)

SHIFT REGISTERS		STATIC	DYNAMIC	FREQUENCY	NUMBER OF BITS	INPUT		OUTPUT		NUMBER OF CLOCKS	SUPPLY VOLTAGE (VOLTS)
TYPE	FUNCTION					PARALLEL	SERIES	PARALLEL	SERIES		
MEM 3005PP	5-BIT PARALLEL IN/ PARALLEL OUT	X		dc to 1.0 MHz	5	X	X	X		2	-27V \pm 1V
MEM 3005SP	5-BIT SERIAL IN/ PARALLEL OUT	X		dc to 1.0 MHz	5		X	X		2	-13V \pm 1V -27V \pm 1V
MEM 3008PS	8-BIT 2 ϕ PARALLEL IN/SERIAL OUT	X		dc to 1.0 MHz	8	X	X		X	2	-13V \pm 1V -27V \pm 1V
MEM 3012SP	12-BIT SERIAL IN/ PARALLEL OUT	X		dc to 1.0 MHz	12		X	X		1	-27V \pm 1V
MEM 3016-2	DUAL 16-BIT	X		dc to 1.0 MHz	32(16,16)		X		X	2	-13V \pm 1V -27V \pm 1V
MEM 3016-2D	DUAL 16-BIT		X	10 kHz to 1.0 MHz	32(16,16)		X		X	2	-13V \pm 1V -27V \pm 1V
MEM 3020	20-BIT	X		dc to 1.0 MHz	20		X		X	2	-13V \pm 1V -27V \pm 1V
MEM 3021	21-BIT	X		dc to 500 kHz	21(1,4,16)		X		X	1	-27V \pm 1V
MEM 3021B	21-BIT	X		dc to 250 kHz	21(1,4,16)		X		X	1	-27V \pm 1V
MEM 3032	6-1 ϕ BINARY WEIGHTED	X		dc to 1.0 MHz	32(1,1,2,4,8,16)		X		X	1	-13V \pm 1V -27V \pm 1V
MEM 3050	DUAL 25-BIT		X	10 kHz to 500 kHz	50(25,25)		X		X	2	-27V \pm 1V
MEM 3064	64-BIT SERIAL ACCUMULATOR		X	10 kHz to 5.0 MHz	64		X		X	4	NONE

plus these other exclusive MTOS devices...

MTOS SILICON P-CHANNEL ENHANCEMENT MODE FIELD EFFECT TRANSISTORS ($T_A = 25^\circ\text{C}$, BODY GROUNDED)									
TYPE	V_{EST} (VOLTS TYP)	I_D (ON) (mA TYP)	I_{OSS} (nA TYP)	I_{OSS} (nA TYP)	BV_{OSS} (VOLTS)	BV_{OSS} (VOLTS)	Y_{FS} (μmho TYP)	C_{PD} (pF TYP)	$r_{\text{DS ON}}$ (Ω TYP)
MEM 511	-4.0	-6	-0.5	-0.1	-30	-30	2500	2.0	150
MEM 517	-3.5	-60	-0.8	-0.1	-30	-25	12,000	10	30
MEM 517A	-3.5	-60	-0.8	-0.1	-30	-25	12,000	10	30
MEM 517B	-3.5	-60	-0.8	-0.1	-30	-25	12,000	10	30
MEM 520	-4.0	-6	-0.5	.03	-30	NA	2500	2.0	150
MEM 550	-4.0	-5	-0.1	.01	-30	-25	1400	1.1	250
MEM 551	-4.0	-5	-0.5	.03	-30	NA	1400	1.1	250
2N4353	-4.0	-6	-0.5	-0.1	-30	-30	2500	2.0	150

LOGIC CIRCUITS ($T_A = -55^\circ\text{C}$ to $+85^\circ\text{C}$)		POWER CONSUMPTION (mW)	SUPPLY VOLTAGE (VOLTS)	PROPAGATION DELAY (ns)	CAPACITANCE (pF) (TYP)	FREQUENCY (kHz)
TYPE	FUNCTION					
MEM 1000	DUAL FULL ADDER	< 70 TOTAL	-13V \pm 1V -27V \pm 1V	350 (TYP)	3.0	—
MEM 1002	DUAL 3-INPUT NOR GATE	< 40 (MAX)	-27V \pm 1V	200 (TYP)	3.0	—
MEM 1005	R-S-T FLIP-FLOP	< 80	-27V \pm 1V	950 (MAX)	3.0	dc to 500 kHz
MEM 1008	DUAL EXCLUSIVE OR/NOT GATE	50 (TYP)	-27V \pm 1V	500 (TYP)	3.0	—
MEM 1013	QUAD 2 INPUT NOR GATE	9 mW/circuit	-13V \pm 1V -27V \pm 1V	300 (TYP)	3.0	—
MEM 1014	QUAD 2 INPUT AND GATE	14 [Circ. (1,2,3)] 42 [Circuits 4,5]*	-13V \pm 1V -27V \pm 1V	300 (TYP)	3.0	—
MEM 1015	DUAL J K FLIP-FLOP	60	-13V \pm 1V -27V \pm 1V	—	3.0	dc to 1 MHz
MEM 1022	9-BIT PARALLEL PARITY DETECTOR	50	-27V \pm 1V	500 (TYP)	3.0	dc to 500
MEM 1050	4 STAGE BINARY UP-DOWN COUNTER	300	-27V \pm 1V	—	2.0	—
MEM 1051	BUFFERED D/A CONVERTER	25	-13V \pm 1.5V -25V \pm 3V	—	3.0	dc to 500 kHz

*The MEM 1014 provides Four 2-Input and Gates (Circuits 1, 2, 3, 4) plus One 2-Input N and Gate (Circuit 5)



WESCON BOOTHS 5401-5404

**at prices that reflect the
highest yields in the industry...**

LARGE DIGITAL SUBSYSTEMS		POWER CONSUMPTION	SUPPLY VOLTAGE (VOLTS)	CLOCK RATE	DESCRIPTION
TYPE	FUNCTION				
MEM 5014	A/D-D/A CONVERTER ELEMENT	135 mW	-27V ± 2V	dc to 200 kHz	Complete logic and analog switching for 10-bit successive approximation A/D converter.
MEM 5015	16 CHANNEL RANDOM ACCESS MULTIPLEXER	70 mW	-27V ± 1V	100 kHz	Sixteen Channel Multiplexer with address storage and decoding.
MEM 5021	DDA ELEMENT	100 mW	-13V ± 1V -27V ± 1V	500 kHz	Ternary type DDA performing rectangular integration.
MEM 5031	SERVO ADDER	25 mW	-13V ± 1V -27V ± 1V	dc to 1.0 MHz	Shift Register content decision unit
MEM 5035	SIGMA DELTA "Y" SUMMER	25 mW	-13V ± 1V	10 kHz to 1 MHz	2 Input Delta "Y" Summer used in conjunction with the MEM 5021
S-C-100	MINIATURE A/D CONVERTER SYSTEM	300 mW	-27V ± 2V -15V ± 2V +15V ± 2V REF. VOLT	100 kHz	Complete 10-BIT A/D Converter System

MULTIPLEXER CIRCUITS (T _A = -55°C to +85°C)		OFF RESISTANCE (Ω TYP)	ON RESISTANCE (Ω TYP)	CAPACITANCE (pF) C _{gd}	BV _{oss} (VOLTS)	BV _{oss} (VOLTS)
TYPE	FUNCTION					
MEM 2002	5 CHANNELS (4 Channels —Common Drain)	10 ¹⁰	200	1.1	-30	-30
MEM 2003	4 CHANNELS (Protective Diodes)	10 ¹⁰	200	1.1	-30	-30
MEM 2004	4 CHANNELS (No Diodes)	10 ¹⁰	200	1.1	-30	±60
MEM 2005	4 CHANNELS (Dual 2 Channel)	10 ¹⁰	200	1.1	-30	-30
MEM 2006	3 CHANNELS (2 Channels —Common Drain)	10 ¹⁰	200	1.1	-30	-30
MEM 2009	6 CHANNELS (Protective Diodes)	10 ¹⁰	150	1.9	-30	-30

SERIES SHUNT CHOPPER		OFFSET VOLTAGE	CLOCK φ	FREQUENCY (kHz)	ON RESISTANCE PER UNIT (SERIES OR SHUNT) (Ω TYP)	OFF RESISTANCE PER UNIT (SERIES OR SHUNT) (Ω TYP)	SIGNAL VOLTAGE HANDLING RANGE (TYP)
TYPE	FUNCTION						
MEM 2008	INTEGRATED SERIES SHUNT CHOP. CIRCUIT	0	1	100	6K	10 ¹²	1μV—10V

Contact your authorized General Instrument Distributor for off-the-shelf delivery. In Europe, contact General Instrument Europe, Via Turati 28, Milano, Italy. Write for complete data.

Yesterday in op Today, look:

amps, a nobody.

1 NS7560A — This and the 7560 are the non-monolithics. Output swing is $\pm 5V$ with 100Ω load and $\pm 12V$ supplies. Operating temperature range $-55^{\circ}C$ to $+125^{\circ}C$. Guarantees offset voltage of $3mV$, bias current of $25nA$, and offset current of $2nA$. Gives slew rate of $10V/\mu s$ with 15 MHz bandwidth.

2 NS7560 — Almost identical to 7560A. Offset voltage is 10 mV. Bias current is $100nA$. Offset current is $50nA$.

3 LM709 — The old standby. Built on a single silicon chip, it works with supply voltages from $\pm 9V$ to $\pm 15V$. Has class B output with momentary short circuit protection. Operating temperature range is $-55^{\circ}C$ to $+125^{\circ}C$. Power consumption is less than $170mW$ at $\pm 15V$. Offset voltage is 5.0 mV and offset current is $200nA$. Furnishes a $\pm 10V$ output swing with a $2K\Omega$ load.

4 LM 709C — This is the commercial-industrial version of the 709. It's like the 709 except that it is specified for operation in a temperature range of $0^{\circ}C$ to $70^{\circ}C$.

5 LM 101 — The best Op Amp around. Same pin configuration as the 709. Minimum voltage gain of $50,000$, compensated for unity gain by only one 30 pF capacitor. Class B output with continuous short circuit protection. It provides at least a $\pm 10V$ output swing with a $2K\Omega$ load. The $\pm 30V$ differential input range reduces the chance of burnout from overload. It's specified for operation from $\pm 5V$ to $\pm 20V$, with a power consumption less than 100 mW at $\pm 20V$ supplies. 5 mV offset voltage, $200nA$ offset current and $\pm 12V$ common mode range.

6 LM 201 — Our newest Op Amp. Similar to the 101 but a replacement for the 709C. It costs much less than the 101. Operates in a temperature range of 0° to $70^{\circ}C$. The minimum $15,000$ voltage gain is compensated by only one 30 pF capacitor. Offset voltage is 7.5 mV, offset current is $500nA$, and common mode range is $\pm 12V$.

We have a package put together with all the specs for each of them. Write us.

National Semiconductor Corporation,
2950 San Ysidro Way, Santa Clara,
California 95051 (408) 245-4320.

(to be continued)

Yesterday



Pierre Lamond, Microcircuit Division Manager

Today



Pierre Lamond, Microcircuit Division Manager

Let's take an engineer's look at TTL from TI

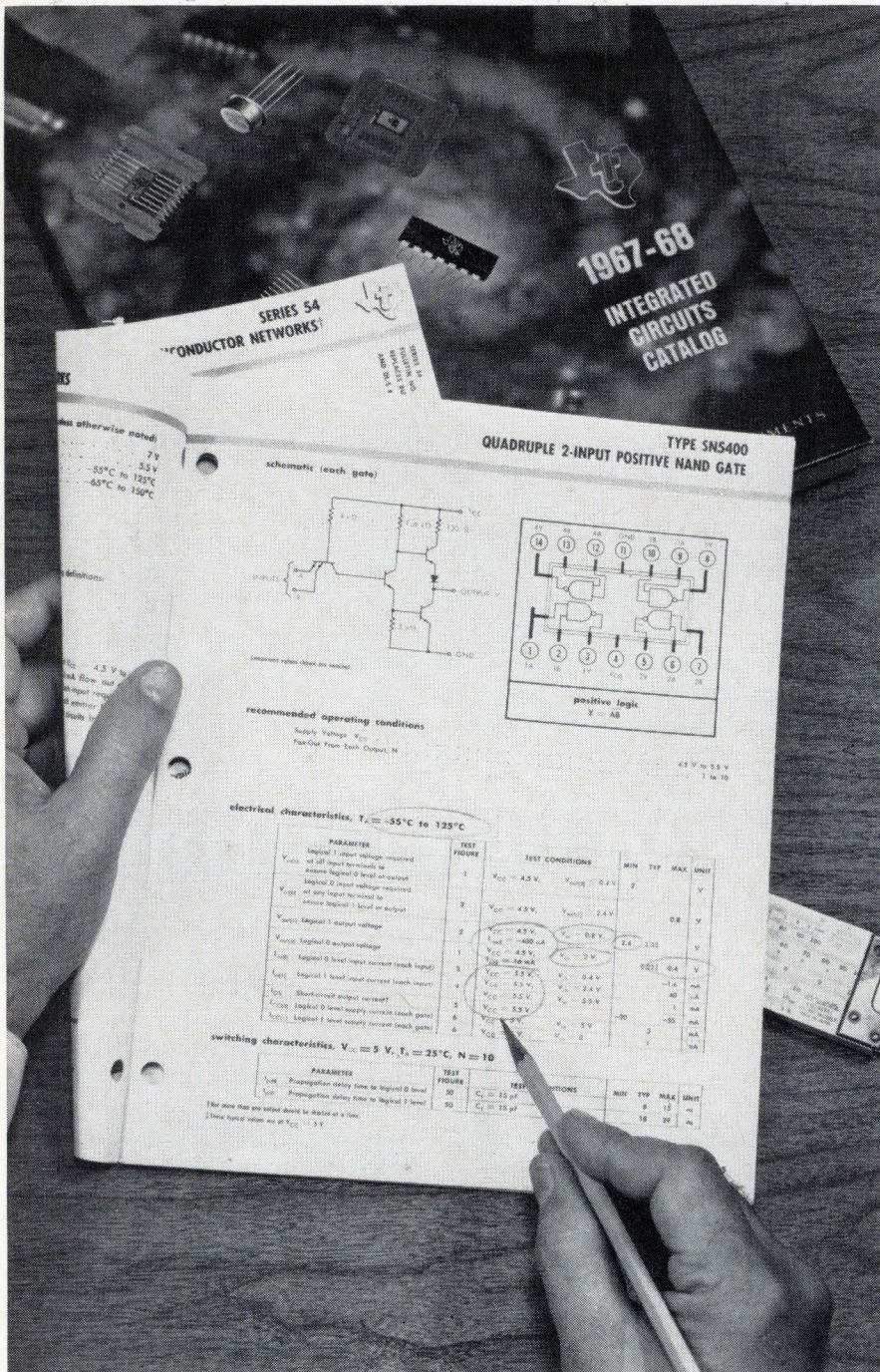

Many key TTL performance characteristics are not readily understood. What do the specifications really mean? How were they determined?

Answers to these questions are important to engineers involved in designing digital systems. Here are some of the reasons why we "spec" Series 54/74 TTL circuits the way we do. It's all part of our efforts to assure reliable, high-performance system operation.

Logical zero DC noise immunity

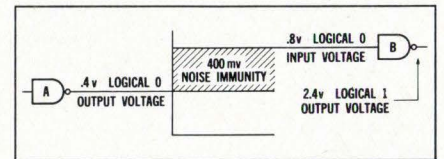

The noise required to false trigger a gate is typically more than one volt. However, TI's guaranteed logical zero noise immunity is 400 mV. Here's how this is determined:

The logical zero input test condition (voltage at which the output does not fall below its 2.4 volt logical one minimum) is 0.8 V. However, guaranteed maximum logical zero output voltage is 0.4 V. Thus, the difference (400 mV) becomes guaranteed noise immunity.

Logical one DC noise immunity

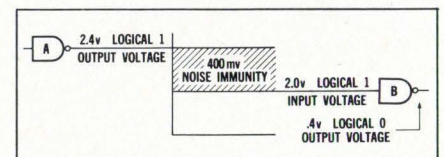

Similarly, guaranteed logical one noise immunity is 400 mV. In this case it's the difference between guaranteed minimum logical one

output voltage (2.4 V) and logical one input test condition of 2.0 V.

Here again, it typically takes more than one volt of noise before a gate actually false triggers.

Low logical one AC noise susceptibility

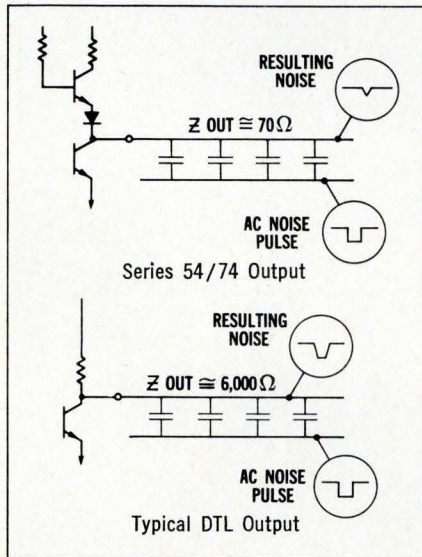

Series 54/74 TTL has a high immunity to signal line noise. It also exhibits a low susceptibility to noise getting there in the first place. Here is an example:

Low output impedance results in a low susceptibility to capacitively-coupled noise... and Series 54/74 logical one output impedance is only 70 ohms. This is far better than for DTL, which typically has a 6000-ohm logical one output impedance.

Worst-case Supply voltage conditions

TI uses the worst-case voltage test condition when testing input current and output voltage. The low supply voltage is critical when

testing output voltage, so the minimum 4.5 volt supply is used. For logical zero, a lower supply voltage reduces the base drive to the lower output transistor... thus creating a worst-case condition.

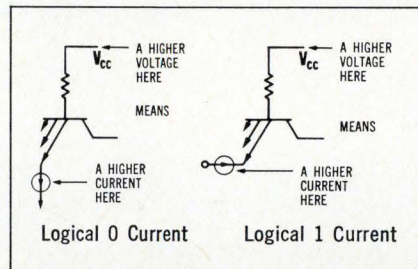
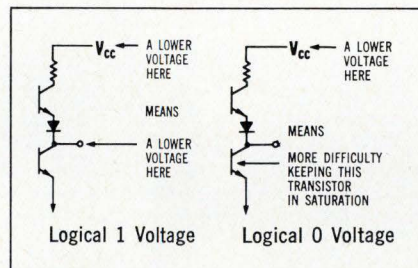

On the other hand, when testing input current, the high supply voltage is critical, since a higher supply voltage means a higher input current. For these measurements, TI uses the worst-case high supply voltage of 5.5 volts.

Worst-case loading conditions

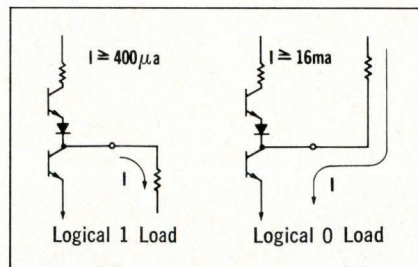

TI measures output voltages while output current is at least the value

required for a fan-out of 10. For logical one, this value is 400 μ A, while for logical zero, it is 16 mA.

Worst-case temperature conditions

Since all circuit parameters vary with temperature, many look better at 25°C than at temperature limits (for example -55°C or +125°C). However, TI guarantees all Series 54/74 DC parameters over the full temperature range.

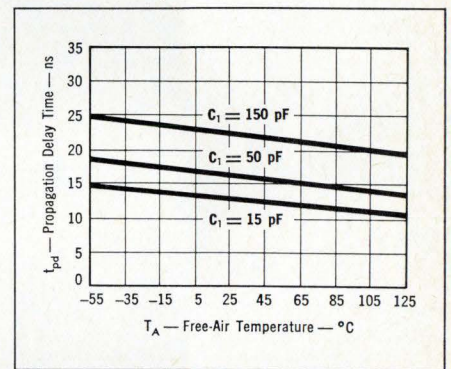

Furthermore, propagation delay of TTL circuits — an important measure of AC performance — is only minimally affected by temperature changes (see chart).

New TTL Brochure

Want to know more about TI's family of TTL circuits? A new 48-page brochure is just off the press and provides in-depth information on all Series 54/74 ICs. For your copy, circle 212 on the Reader Service card or write us directly at P.O. Box 5012, Dallas, Texas 75222.

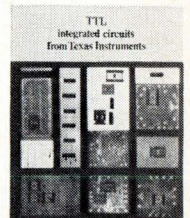

TEXAS INSTRUMENTS INCORPORATED

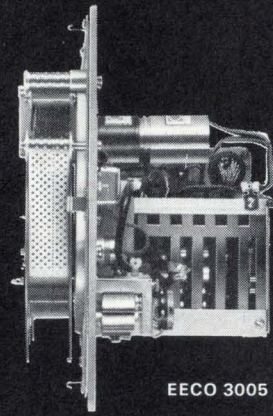
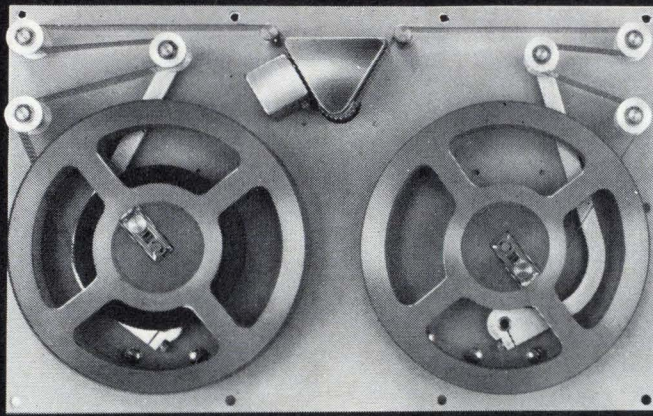

EECO 3005

No matter how you look at it...

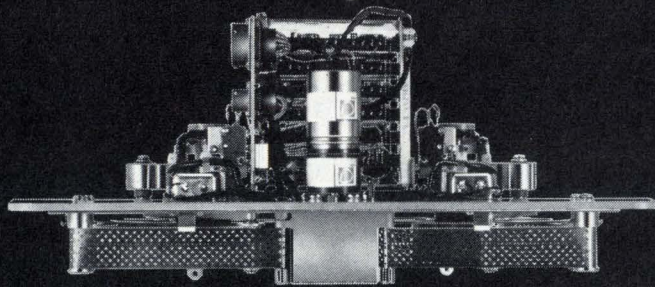

EECO series 3000 military paper tape readers give you less! Less bulk...less weight...less maintenance...all at less cost!

And there's more for you...modular design means *less* difficulty adapting the reader to your specific application...sprocket feed and photoelectric readout mean *less* tape wear... rugged MIL construction means *less* trouble in airborne, shipboard or mobile applications... solid state design—no clutches, brakes, belts or solenoids—means *less* maintenance...all this, and the broadest line of military photoelectric tape readers. Get the full story today—send for the complete EECO catalog of military tape readers.

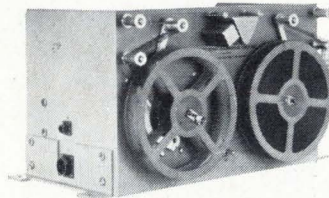

EECO 3004

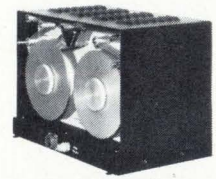

EECO 3002A



ELECTRONIC ENGINEERING CO. OF CALIFORNIA
P. O. Box 58, Santa Ana, Calif. 92702 • (714) 547-5501

Now, isn't that more for your money?

When it's
time for
a change...



Beckman EiD is a quick-change artist.

It's no strain to change to strain. Or pressure. Or displacement. Or temperature. Or anything else that can be transduced into an electrical signal. *Not* when you have Beckman EiD Input Couplers for your signal conditioning.

There are more than 30, to plug directly into the preamplifier in Beckman's Dynograph® Recorder. So you don't have to spend a lot of change to change special amplifier systems.

In short, Beckman makes *you* a quick-change artist; computation, demodulation, rectification; plus the excitation and calibration signals for many types of transducers.

Isn't it time for a change?

Signal your local EiD Sales Representative for all the facts... or write direct to our nearest regional office, listed at right.

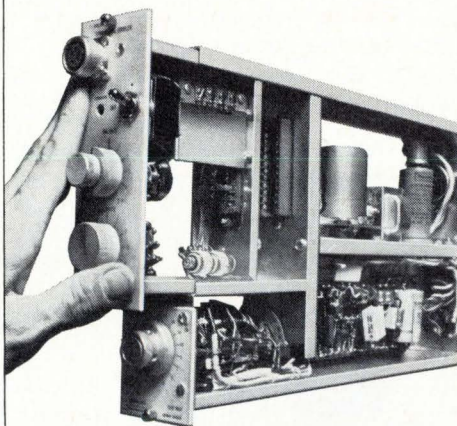

EiD more than
measures up.

Beckman®

INSTRUMENTS, INC.
ELECTRONIC INSTRUMENTS
DIVISION

2400 Harbor Blvd., Fullerton, Calif. 92634,
(213) 691-0841

7360 N. Lincoln Ave., Lincolnwood, Ill.
60646, (312) 583-1020

12051 Tech Rd., Montgomery Ind. Park,
Silver Spring, Md. 20904, (301) 622-2500

International Subsidiaries: Geneva;
Munich; Glenrothes, Scotland; Tokyo; Paris;
Capetown; London; Mexico City

OTHER 2, 4 AND 6 POLE 2 AMP RELAYS MIGHT BE AS GOOD AS THE NEW SIGMA SERIES 62.

If they were built as well.

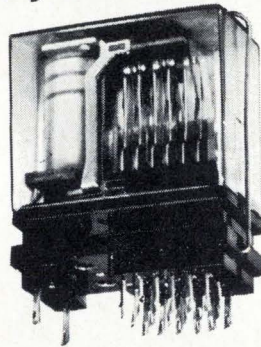

Versatile, miniature Sigma Series 62 general purpose relays outperform their competitive counterparts because they are built better three ways:

Larger Contacts For Longer Life: The larger contacts (.093" & .058" dia.) used in the Series 62 assure superior thermal and electrical conductivity and a life expectancy of 1 million operations at rated load.

Thicker Base For Greater Contact Stability: The Series 62 base, in the terminal area, is twice as thick as competing types. This provides a much higher degree of mechanical support assuring long-term stability of the stationary contact members.

More Durable Lifter For Better Contact Action: The contact actuator of the Series 62 is made of

fabric-filled phenolic rather than paper-based phenolic. It is extremely durable, rigid, and not subject to cracking even after extended use.

We'd like to give you a new Sigma Series 62—or any of our other standard relays. Test and compare it against the brand you may now be using. It's the best way we know to prove what we say about Sigma relay performance. Just circle our reader service number on the reader service card. We'll send you the new Sigma relay catalog and a "free relay" request form. Return the form to us and your Sigma representative will see that you get the relay you need.

Need fast delivery? The Series 62 is available off-the-shelf from your Sigma distributor.

SIGMA DIVISION  SIGMA INSTRUMENTS INC
Assured Reliability With Advanced Design / Braintree, Mass. 02185
Sigma Instruments (Canada) Ltd., P.O. Box 43, Toronto 18

This is the only programmable curve tracer there is.



The Fairchild 6200B/P is the only programmable transistor curve tracer on the market. It has wide range sweeps from 20V at 5 Amps to 1000V at 100mA, and an extended base drive that goes down to 100nA for high-gain devices and up to 35V for FET's. It is all solid state, and costs \$2,350.00. When used with the optional programming unit (\$600 extra), the 6200B/P can subject each device to five separate tests, automatically, at speeds adjustable from 70 to 800msec. per test. High speed handling fixtures are available to facilitate high volume testing in such applications as device classification, quality assurance and receiving inspection. For complete information circle Reader Service Number 72.

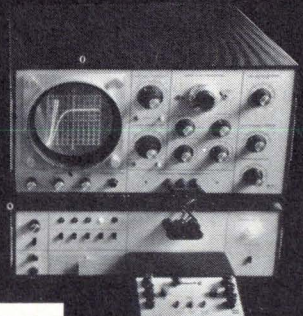

FAIRCHILD
INSTRUMENTATION

this is the freshest relay design approach since 1956.

(or was it '37?)

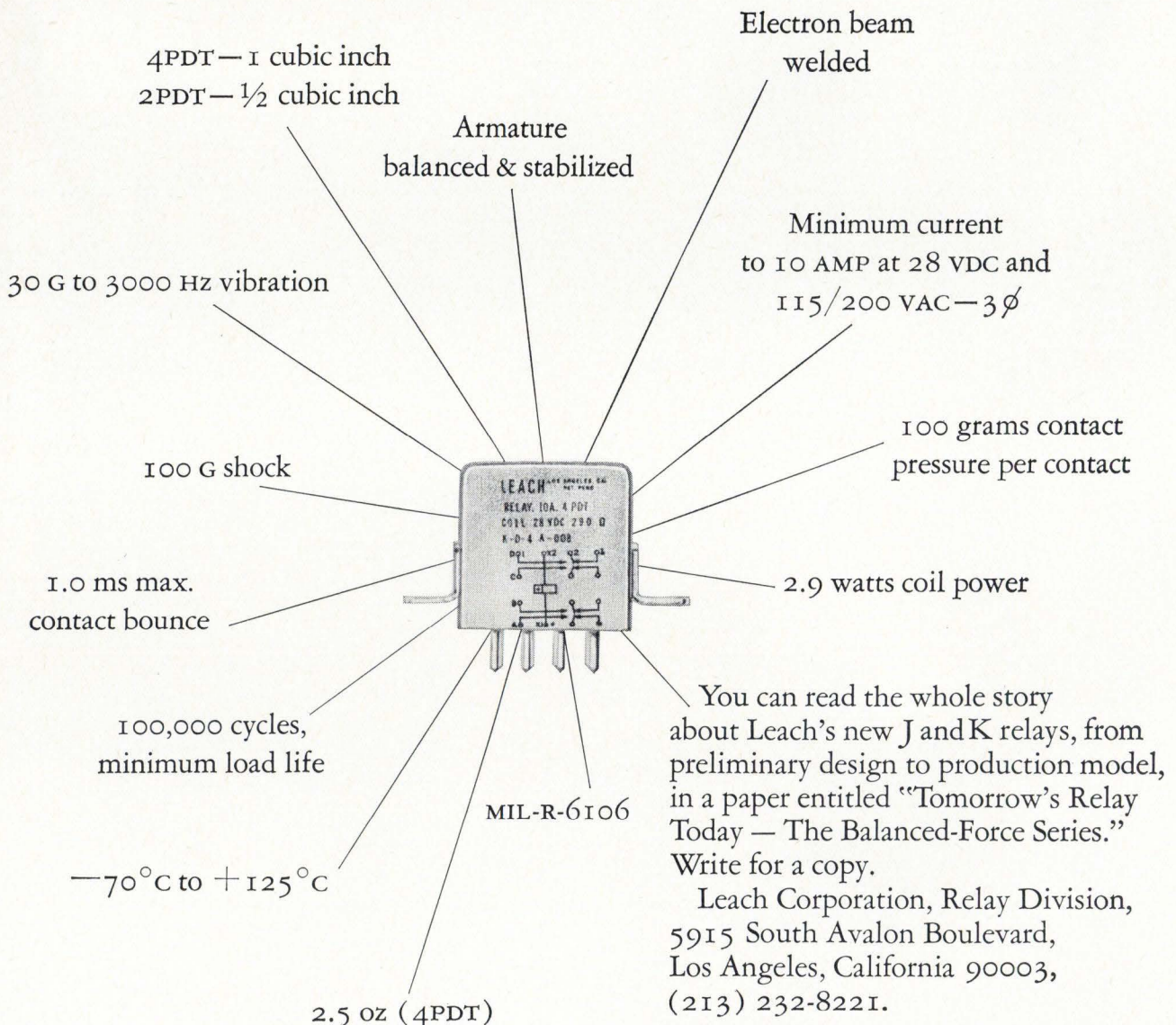

LEACH

SOLDERABILITY

It means easier,
more reliable
electrical connections.

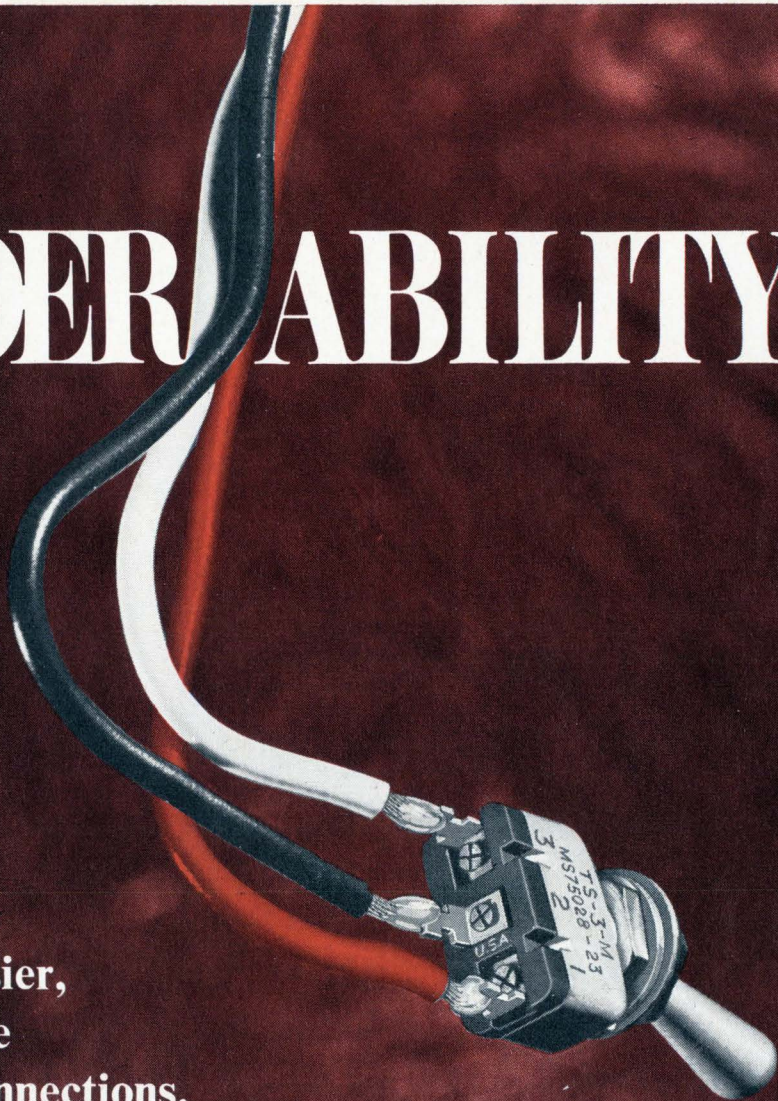

PHOTO TWICE SIZE

Oversized, gold-plated terminals make soldering these Arrow-Hart subminiature switches a snap.

You also get exceptional versatility of installation, because these are combination solder, quick-connect and single-turret terminals.



ACTUAL SIZE

Movable contacts are rhodium plated for long mechanical life. Stationary contacts are gold-plated silver for long shelf life and superior performance on low-energy circuits. Contacts are rated 5 amps at 125

volts AC and 29 volts DC. For design versatility, you get a wide choice of bat and ball levers, including seven colored types. Two or three position. Maintained or momentary contacts. Arrow-Hart subminiature switches are available to meet MIL-S-3950-C, MS-75028 and MS75029 specifications.

It all adds up to the performance, versatility, and installation ease you need for all types of instrumentation and other applications that call for maximum capability in minimum panel space. Write for complete technical information on subminiature toggle and push button switches. The Arrow-Hart & Hegeman Electric Company, 103 Hawthorn Street, Hartford, Connecticut 06106.



QUALITY SINCE 1890

ARROW-HART

The Arrow-Hart & Hegeman Electric Company, Hartford, Connecticut 06106

BUY BETTER ELECTRICALLY • BUY BETTER ELECTRICALLY



Everything's
CUSTOM
 about this
 crystal filter
 except...

production, price, and delivery—they're **STANDARD**

Collins' prototype crystal filters with the response illustrated above are now available in the 100-kHz to 500-kHz region both in upper and lower sideband designs and to the following specifications:

Bandwidth at 1 db:	2780 Hz.
Bandwidth at 60 db:	3300 Hz.
Carrier rejection:	60 db min.
Passband ripple:	1/2 db max.
Differential delay:	500 μ sec. max. over 70% of passband.
Operating temperature range:	- 20° C to + 70° C.
Typical case size:	1.9" X 2.8" X 0.7" max.

Collins' crystal filters meet most narrow band needs (from 5 kHz to 20 MHz) in designs such as Butterworth, Tchebycheff, and Linear Phase. Prototypes to your specifications are

generally available in four to six weeks. Collins' crystal filter capability is expanding rapidly. Send your specifications for design analysis. As one of the largest suppliers, Collins satisfies delivery requirements for all major programs.

Collins' entire filter product line covers the practical spectrum from 1 kHz to 100 MHz, offering LC and mechanical filters for applications where crystal filters are not suitable. If an advantage can be obtained in performance, price, or delivery through LC or mechanical filters, Collins is in a position to recommend these filters rather than crystal filters.

Send or call your performance requirements to Components Division, Collins Radio Company, Newport Beach, California 92663 Phone: (714) 833-0600.

COMMUNICATION / COMPUTATION / CONTROL

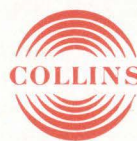

COLLINS RADIO COMPANY / DALLAS, TEXAS • CEDAR RAPIDS, IOWA • NEWPORT BEACH, CALIFORNIA • TORONTO, ONTARIO
 Bangkok • Frankfurt • Hong Kong • Kuala Lumpur • Los Angeles • London • Melbourne • Mexico City • New York • Paris • Rome • Washington • Wellington
 Circle 76 on reader service card

Technical Articles

**Linear IC's, part 2
Heart of the matter
page 78**

The differential amplifier is the keystone circuit for the majority of the linear IC's now on the market, whether simple two-transistor arrangements, operational amplifiers, or communications circuits.

**Power grab by linear IC's
page 81**

The tiny IC becomes the driver that triggers such power behemoths as relays and thyristors controlling large amounts of electrical energy. A new monolithic IC combines linear voltage-detecting and trigger-switching circuitry to do the job.

**Choking up on LC filters
page 93**

When several filtered d-c outputs are desired from a single a-c-to-d-c power supply, the normal practice is to connect separate filters to each rectified output. These filters add to the bulk and weight of the power supply. A better approach is to replace the many filters with a single choke with multiple windings. Applying the design rules described in this article, an engineer can easily create a smaller and lighter power supply.

**Designing for the worst
of worst cases—
nuclear war
page 99**

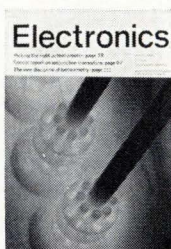

A major concern of military men is the effect of nuclear explosions upon the delicate electronic gear in missile and aircraft guidance systems. Strong radiation at high altitudes can have a catastrophic effect upon semiconductor devices. At lower altitudes, the electromagnetic pulse can wreck equipment. But military—and even civilian—electronic systems can be hardened to

survive such exposure, says this author. On the cover, electronic components in tiny cylindrical cans are being bombarded by radiation from cobalt-60 slugs at Brookhaven National Laboratory, Brookhaven, N.Y., to test their ability to operate in intense radiation. The blue glow is Cerenkov radiation in the shielding water that fills the tank.

**Down-to-earth Army antenna
page 111**

For communications at medium and high frequencies, the Army normally uses long wire antennas. But soldiers in a combat situation would much prefer a small one. Now the Army Limited War Laboratory has developed a vertical loop antenna that stands close to the ground and works as well as the long wire ones.

**Coming
Sept. 4**

- A special report on computer-aided design: Extending the computer to circuit fabrication
- Digitally controlled analog circuits transform graphic patterns into digital signals

Linear IC's: part 2

Heart of the matter

Differential amplifiers continue to be the basic configuration for analog circuits, giving them balance and versatility, and providing compatibility with monolithic processing

By John J. Robertson

Motorola Semiconductor Products Inc., Phoenix, Ariz.

The first monolithic linear integrated circuit and the latest, along with most of those in between and most of those to come, have one thing in common: a differential amplifier configuration. The benefits of this arrangement are balance, versatility, and compatibility with monolithic fabrication.

"Balance" here refers to the matching of the amplifier's elements; as a rule, electrical symmetry exists between each half of the circuit. This balance tends to minimize deleterious electrical effects and enhance tracking, common-mode rejection, gain linearity, and other desirable features.

As for versatility, the differential amplifier can amplify from d-c all the way up to uhf, and can limit, detect, and squelch as well as multiply, modulate, and mix. It can provide temperature compensation and generate signals, and can be used as a gain-control circuit.

The compatibility of the amplifier with monolithic processing is intrinsic. Few, if any, capacitors are needed, and the key to economy in monolithic fabrication is a minimum number of passive components.

As a further advantage, the primary parameters of the differential amplifier are functions of resistor

ratios, which—as in monolithic circuits generally—are good. These ratios eliminate the need for close tolerances in individual resistors and lessen circuit performance variations with temperature.

Finally, the configuration permits close matching of active elements. For one thing, it's relatively easy to fabricate these elements in close proximity to one another—a feature that favors matching.

In the beginning

For all these reasons, the history of linear ic's is largely a record of the evolution of the basic differential amplifier. The first off-the-shelf linears were relatively costly hybrid units. The first to hit the market as differential amplifiers consisted simply of two matched transistors in a metal can; the transistors were probed for matching characteristics, and the two dice were put in one package. Later, both devices were put on the same silicon die, and biasing resistors were added.

The next step was the introduction of a small capacitive element on the chip for biasing. For d-c purposes, the network remained a differential amplifier, though at the time of its introduction it was called an r-f/i-f amplifier. The circuit could be biased without large bypass capacitors, and the biasing circuitry was included in the package. For a-c purposes, the circuit was employed as a common-collector, common-base pair of transistors having a bypass capacitor in the collector circuit of the common-collector stage.

Then a third transistor was put in to serve as a current source—reflecting another advantage of monolithic design. Had a resistor been used instead, common-mode signals applied to the amplifier would have caused voltage changes at the common-

The author



Currently the manager of IC applications at Motorola Semiconductor, John J. Robertson works with both digital and linear devices. He was formerly at Bell Telephone Laboratories, and holds a master's degree in electrical engineering from New York University.

emitter node and thus degraded rejection capability.

The circuit was relatively stable over the temperature range of -55°C to 125°C ; currents in the transistors' collectors varied only 5% with respect to one another over this range. Also, load resistors and transistor characteristics tracked very closely. The linear characteristic was 114 millivolts wide. At present, it's reasonable to expect offset voltages of 2 mv and drifts of $5\mu\text{V}/^{\circ}\text{C}$, with bias currents of 5 microamperes, offset currents of 200 nanoamperes, and drifts of $10\mu\text{A}/^{\circ}\text{C}$.

Operational amplifier

The building of differential amplifiers in multi-stage configurations produced the next advance in the linear IC's evolution: operational amplifiers. The typical present-day operational amplifier consists of two differential amplifier stages followed by an output stage. The first stage provides most of the gain, minimizing any errors stemming from imperfections in the following stages. A current source at the common-emitter node assures high common-mode rejection, and a compensating diode in this area assures constant collector current over the operating temperature range.

To get high input impedance and lower output currents, it's preferable to use a Darlington connection in the first stage. For frequency compensation, the signal transistors in the first stage are accessible through the external pins.

As common-mode rejection is primarily determined by the first stage, it isn't absolutely necessary to use a transistor current source in the second. In fact, the employment of a resistor in the second stage eases the application of feedback to the first stage. Negative feedback helps to stabilize the current sources.

The second stage loads the input stage; a Darlington connection is sometimes used here to minimize this loading. Any form of buffering can be applied to control the combined voltage gain of the first two stages.

The output of the second stage is usually taken single-ended; in some amplifiers, it goes through an emitter-follower buffer before connecting to the output stage. In most linear circuits a positive d-c voltage is present at the point where the single-ended connection is made, and this presents a special problem for the output stage, since the d-c output voltage should nominally be zero.

Besides, the output stage shouldn't load the second stage. Therefore, the output stage is usually driven by a voltage source, and a d-c restorer circuit is put between the last two stages.

The problem of level translation in the output stage is solved by using both npn and pnp devices. In earlier operational amplifiers, npn stages connected upside-down were used to restore d-c levels to zero. Most IC's now employ both lateral and substrate pnp's for this level translation.

Output stages generally use shunt feedback to minimize the effects of such operating character-

Linear IC evolution: the changing differential amplifier

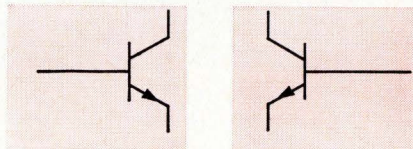

From a hybrid pair of matched transistor chips . . .

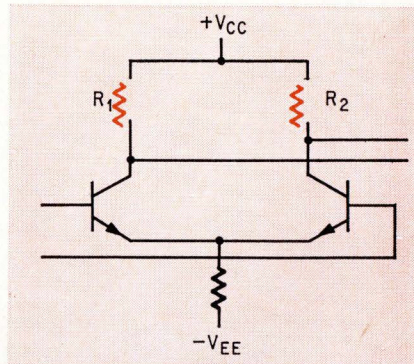

to a simple monolithic IC with resistive elements;

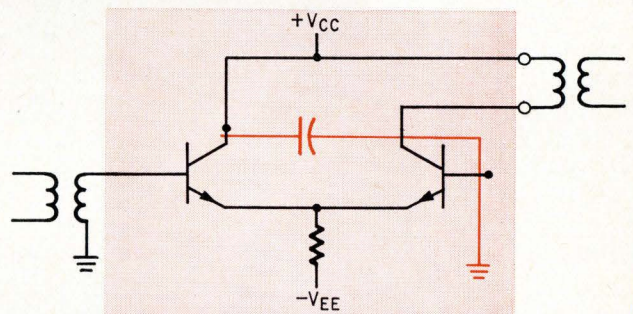

a capacitor added for high-frequency service . . .

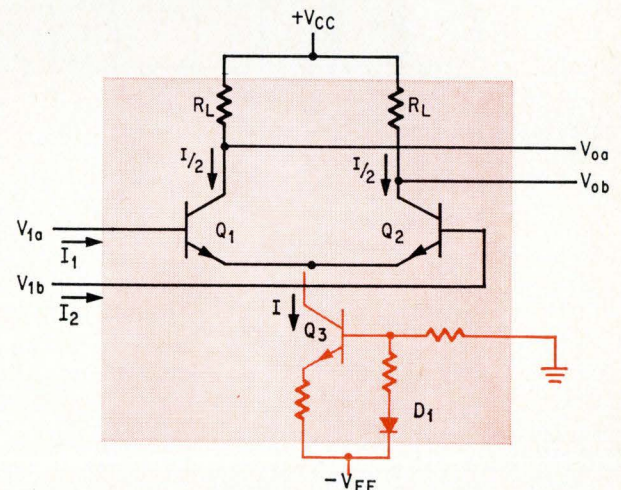

led to a full-fledged differential amplifier.

Growing up. Integrated differential amplifiers went through a series of modifications in the early 1960's. The three-transistor, diode-compensated unit (bottom) became the basic building block in operational amplifiers, communication circuits, and nearly all other linear IC's.

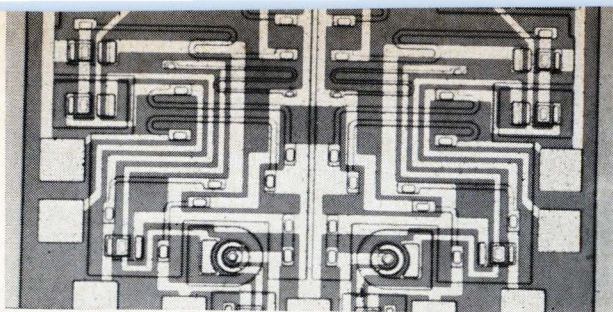

Twoifers. Dual operational amplifiers on a single chip represent the latest step in the evolution of linear IC's. The halves of this Motorola device can be operated independently or in parallel; they have only power-supply connections in common. Price is about 50% more than that of a single-unit chip.

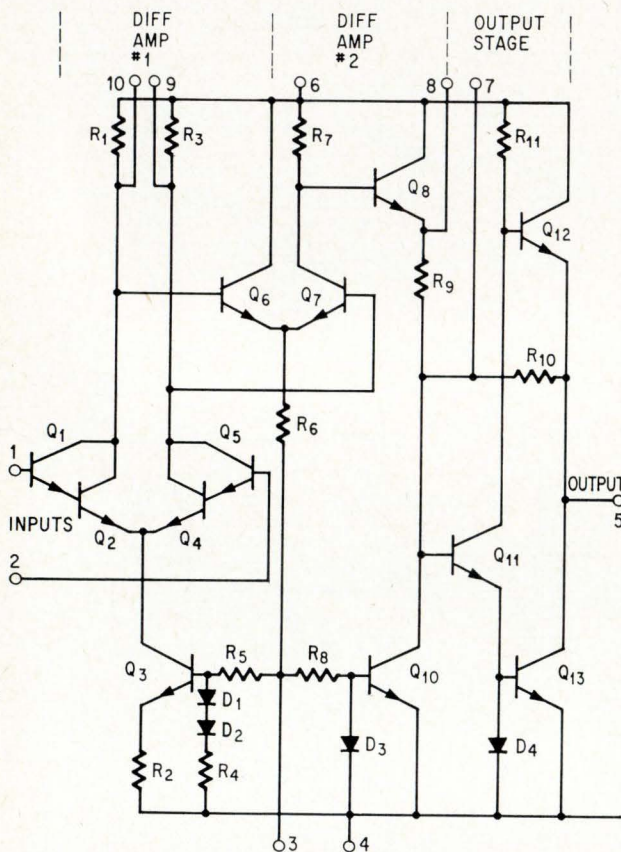

Operational amplifier. Two differential amplifier stages and an output stage make up this early off-the-shelf operational amplifier fabricated in a single chip.

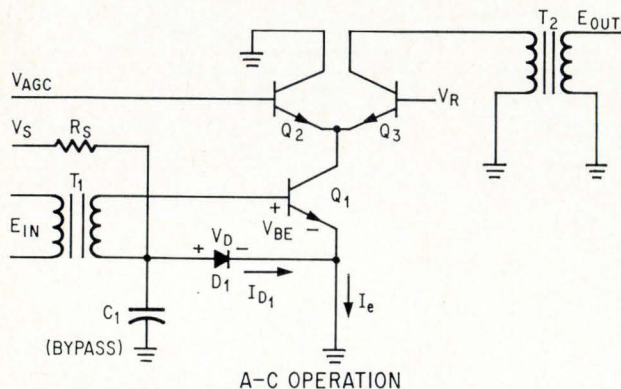

For communications, too. Although considered a d-c network, at uhf communication frequencies the differential amplifier's configuration and impedance levels suit it to i-f amplifier and agc operations.

istics as crossover distortion. In addition, shunt feedback is used to substantially lower over-all output impedance. The output connection is frequently a totem-pole-type circuit, so that the output transistors can drive the load in both positive and negative directions.

In applications where the amplifier is used with external resistors in a negative feedback connection, it isn't necessary to have an extremely high open-loop gain. A divider network can be placed in the emitter of the output stage to vary the open-loop voltage gain, which is made inversely proportional to emitter resistance. If high gain is desired in these applications, users merely short out the resistor by connecting the appropriate pins.

Further refinements in differential amplifier designs are exemplified by the dual, or two-channel, unit at the left. Built on a single monolithic chip, it consists of two amplifiers that can be used individually or in some parallel arrangement.

To achieve extremely low bias currents and offset currents, metal oxide semiconductor field effect transistors will probably be included in future operational amplifiers. Used mostly in the input sections as preamplifiers and resistive elements, the MOS FET's will take up even less space than bipolar transistors.

Communications circuits

The wide bandwidth and impedance characteristics of the differential amplifier make it ideal for high-frequency applications. In one example, the a-c amplifier at lower left, transistors Q_1 , Q_2 , and Q_3 form the familiar differential amplifier.

At the higher frequencies, Q_1 and Q_3 constitute a common-emitter, common-base pair. With the input applied to the base of Q_1 and the output taken from the collector of Q_3 , the configuration becomes the standard cascode connection. The circuit offers very high a-c isolation between output and input because internal feedback is at least three orders of magnitude lower than that in single transistors. In an i-f amplifier, the result is easy tuning and alignment, and high stability.

Besides i-f amplification, the circuit provides an automatic gain control action. In the network, only two resistors are needed to form a voltage divider that controls the agc range. Reference voltage level V_R is established by the divider formed by two other resistors. Because Q_1 and compensating diode D_1 are matched, total emitter current equals diode current.

The current in Q_1 can be shared by Q_2 and Q_3 , or can be made to flow entirely in Q_2 , depending upon the relative adjustment of the agc and reference voltages. When all Q_1 's current flows through Q_2 , transistor Q_3 is cut off, and the gain of the circuit is sharply reduced.

This gain control action is not accompanied by variation in the emitter current of Q_1 ; the input impedance of the input stage remains constant over the entire agc range. Full bandwidth is maintained and no detuning occurs.

Power grab by linear IC's

A monolithic device that operates directly from an a-c source, detects voltage levels, and can drive big power controllers, bids to usurp the role of specialized triggering circuitry

By F. William Gutzwiller and James H. Galloway

Semiconductor Products Group, General Electric Co., Auburn, N.Y.

Conquering new worlds has become a habit with integrated circuits, but their latest incursion—into the world of power control—gives them dominion over giants. The big, brawny relays and thyristors used to handle large amounts of electrical power have been driven until now by costly voltage detectors and specialized triggering circuits. But a recently introduced monolithic linear device—the first ic to operate directly from an alternating-current source—is ready to take over the reins.

Low-cost power semiconductors have been around for some time, but economical discrete circuits to trigger them into conduction according to predetermined time relationships are scarce. Now the new integrated circuit can do the driving—and at a reasonable cost.

The device, the General Electric Co.'s PA424, employs a novel combination of linear voltage-detecting and trigger-switching circuitry. It contains a differential amplifier network that senses imbalance, a converter section that accepts a-c inputs and reshapes them into d-c biasing levels, and a multistage trigger generator. The ic is far more versatile than the circuits traditionally used to trigger power devices; it operates on d-c as well as a-c inputs, and can handle a host of power-control tasks. Moreover, the circuit is but the first of a new breed of linear ic's, units that will perform timing and gating functions for control systems. Upcoming are analog circuits for motor-speed control, for the regulation of lamp dimmers and flashers, and for relay-switching systems.

The PA424 can be called a preengineered package, as it provides functions previously obtained by judiciously combining triggers, such as unijunction transistors, with level-detecting circuitry, power converters, attenuators, and interface components.

The chip contains one pnp and five npn transistor elements, seven resistors, one zener diode,

and three coupling diodes. Aside from firing power devices, the ic can function as a comparator, an ON-OFF switch, a proportional controller, a temperature regulator, and a time-delay network. Its projected systems applications range from hair dryers to spacecraft heat controls.

Zero-voltage switching

The first ic of this type is a plastic-encapsulated unit that produces an output when its input voltage makes a transition through zero.

This feature—called zero-voltage switching—is harnessed in a modular system for the control of a resistive load. Though only one of many applications, this subassembly can serve as an example of the ic unit's operation [see panel, p. 82-83].

Sensing and error detection are accomplished by the bridge formed by resistances R_1 , R_2 , R_3 , and R_4 in connection with the differential amplifier, Q_1 and Q_2 . These transistors sense bridge imbalance and control the pulse output transistor, Q_6 , through amplifiers Q_3 , Q_4 , and Q_5 . Pnp transistor Q_3 in the d-c side of the diode bridge senses the zero-voltage crossover of line voltage by turning off during the 50-microsecond period before and after the line voltage passes zero. The action is contingent upon Q_1 being off, as established by the resistance bridge. With Q_3 and Q_4 not conducting during the zero-crossing interval, the emitter current of Q_2 , amplified by Darlington pair Q_5 and Q_6 , triggers the triac.

By firing the triac only at the zero-voltage crossing point, complete half cycles of a-c voltage are applied to the load, and the fast-rising load currents characteristic of random switching and phase control are avoided. Also, radio frequency interference is minimal though no rfi filters are used.

Diode D_6 rectifies the 10-volt d-c control-circuit power supply, which is limited to less than 10

In the driver's seat

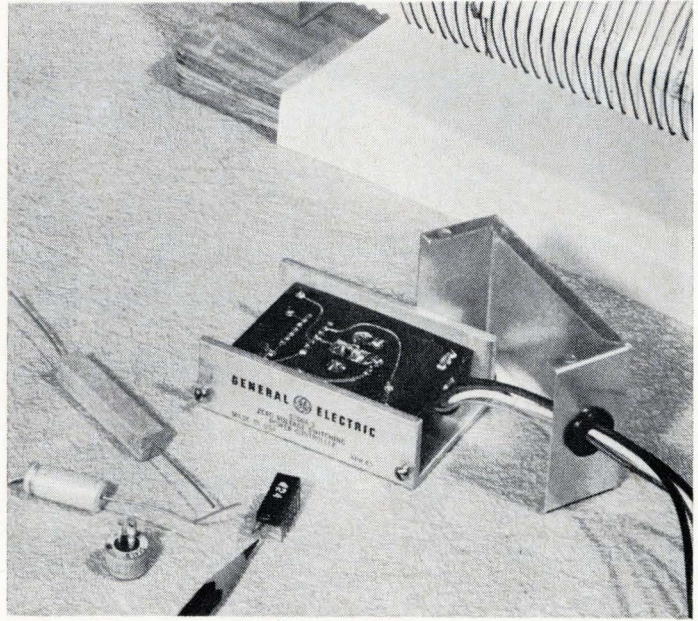
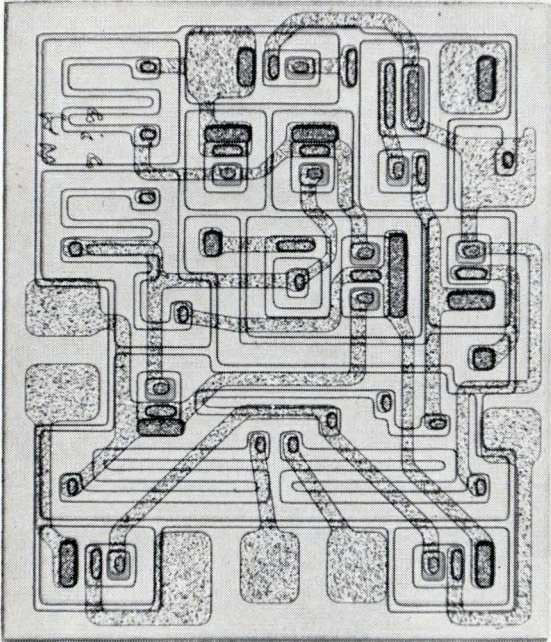

grew into a solid state subassembly . . .

started with a sensing-triggering chip . . .

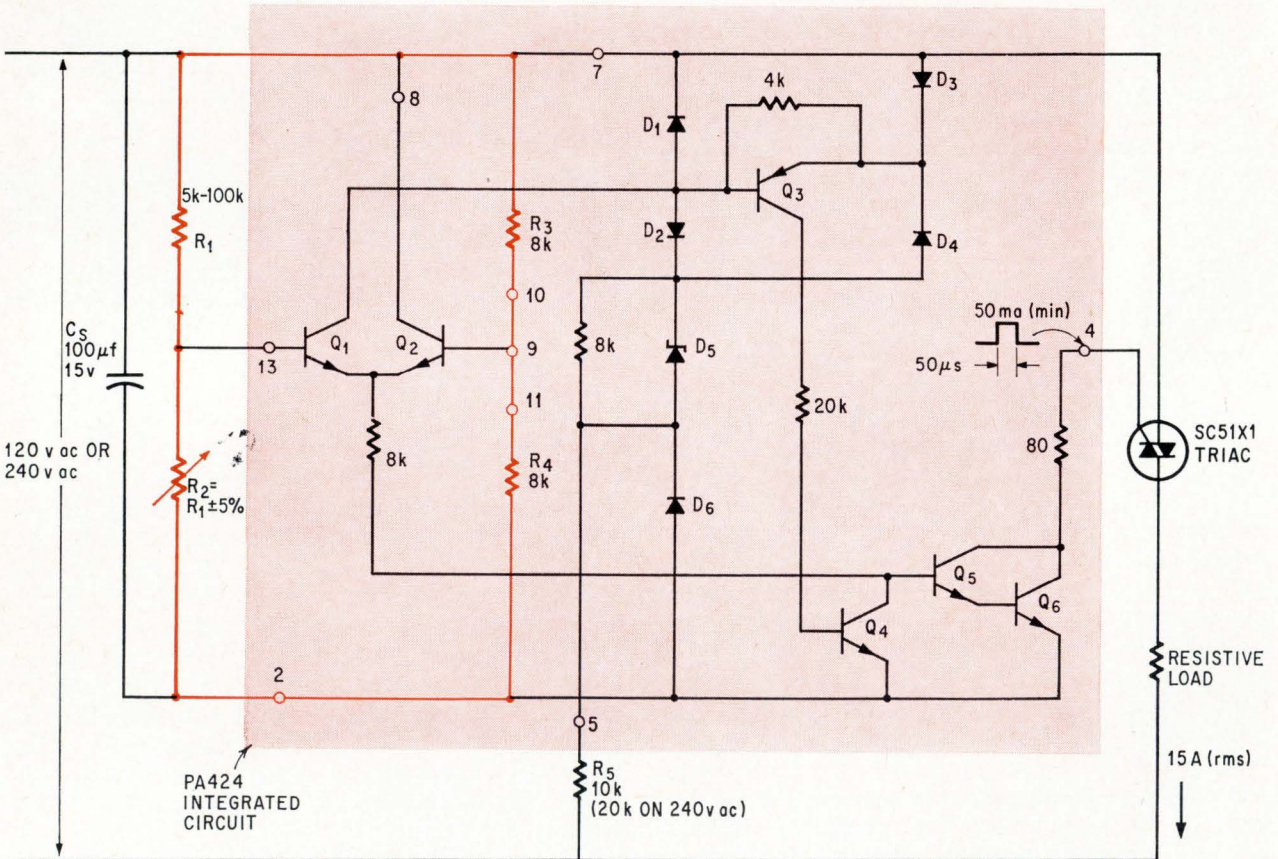

containing just five other components . . .

Chipping up. The development of a linear integrated circuit that senses waveforms and supplies a timed trigger pulse to power semiconductors opens up a new application area for IC's: a-c power control. The chip (above, left), together with three resistors, a capacitor, and a triac, forms a subsystem used to control thousand-watt loads (above, right). Schematic (above) of this zero-voltage switching assembly exhibits another unique quality: operation directly from a-c supplies.

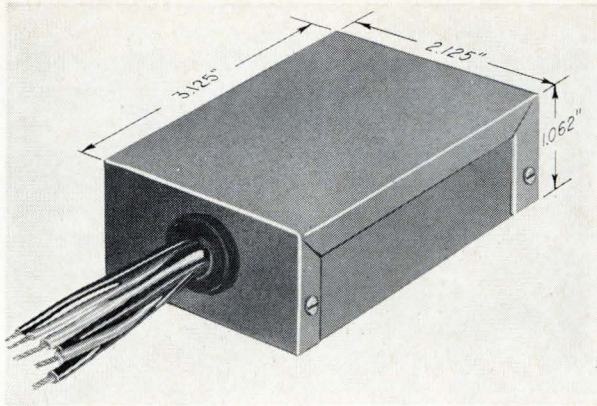

all put into a cigarette-pack-size module . . .

AC LINE VOLTAGE

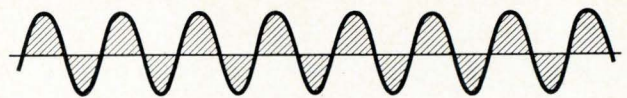

V₇₋₂



V₁₃₋₉ (ERROR VOLTAGE)

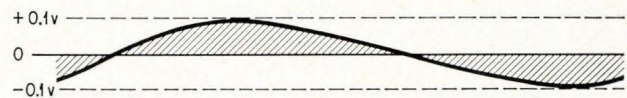

V₄₋₇

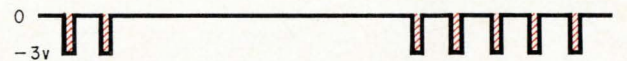

VOLTAGE ACROSS TRIAC

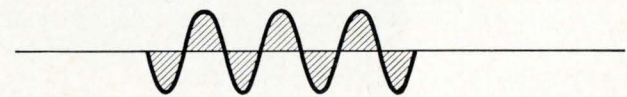

LOAD VOLTAGE

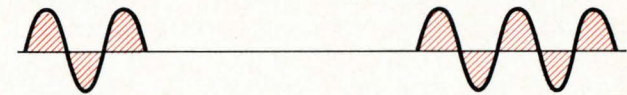

that controls a 4.15-kilowatt system with these signals . . .

Better control. Modularized IC power control subsystem (above) is aimed at industrial users looking for a plug-in-type electronics package that requires little or no further engineering. Functionally, the unit compares to the discrete semiconductor proportional control system (below) containing 40-odd components. Operation of the solid state module is depicted in the waveform diagram (right); voltage potentials referring to pin numbers correlate with the schematic on the preceding page. Power is supplied to the load via the triac switch. The IC, together with a resistor divider formed by R_1 and R_2 , determines when a sufficient input error signal exists, and produces a trigger pulse to fire the triac as the line voltage crosses zero.

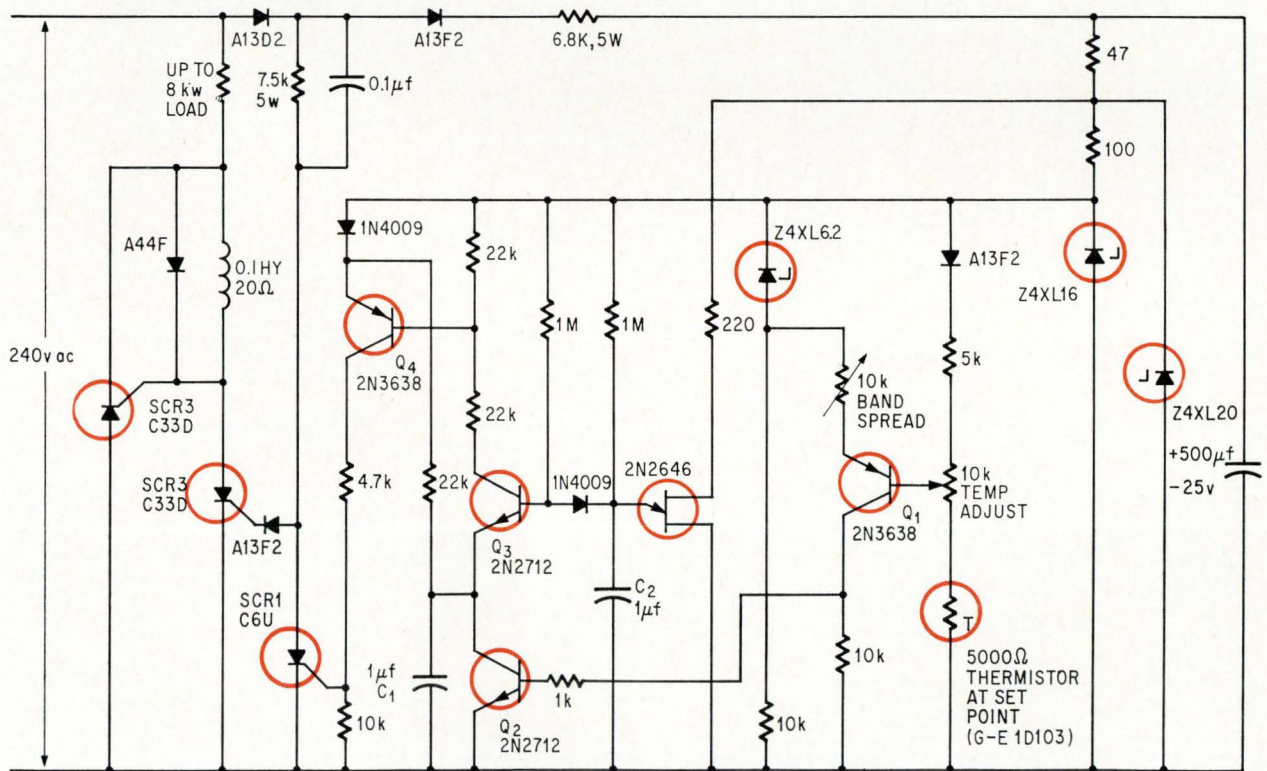

and that compares functionally to this complicated discrete system.

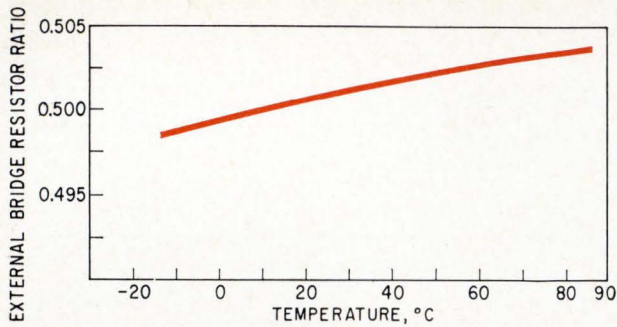

Steady. Variation in the module's inhibit ratio with shifts in temperature is extremely small. A 105°C change produces an input imbalance error of less than 0.5%.

volts by zener diode D_5 and is filtered by the external 100-microfarad capacitor.

The triac load must be resistive so that load current is in phase with supply voltage, assuring proper triggering of the triac. Because the trigger pulse is brief, triac latching can be critical if insufficient current is drawn by the load. The design specifies triacs requiring a minimum load current of 4.2 amperes rms. The simplicity and performance of this zero-voltage switching unit led GE to market it as a module, the S200A, for industrial power control applications.

Temperature control

The subassembly containing the IC is a complete control system with a triac to switch power to a resistive load. To get a 15-amp, 277-volt temperature controller handling 4,150 watts, the user merely adds to the module a resistive load, a variable resistor sensor, and a reference resistor.

In the module diagram on page 82, R_1 is a

thermistor, R_2 is the adjustable resistor to which the thermal resistance is compared, and R_3 is the power supply resistor. Smoothing is provided by filter capacitor C_1 , and the electrically grounded module enclosure serves as a heat sink.

Compared with an electromechanical temperature control containing a line-type hydraulic or bimetallic thermostat, a relay, and a transformer, the module costs 2½ times as much, but is less noisy and more accurate, and can accommodate many more sensors.

The over-all simplicity of the IC control is apparent in the comparison on page 83 of a discrete semiconductor control and the IC unit; there are 40-odd components in the discrete version against six in the IC.

In a typical temperature control application of the PA424, 15 amperes flow through the load, which is 8 ohms when the a-c input is 120 volts, 16 ohms in 240-volt systems, and 18.5 ohms at 277 volts.

The triac switches on heater current when additional heat is called for by the sensor.

The threshold, or control point, occurs when $R_1 = R_2 \pm 5\%$. With typical negative-temperature-coefficient thermistors, this corresponds to $\pm 1.2^\circ\text{C}$, eliminating the need for trimming or calibration in any temperature control applications other than those requiring the highest precision.

Due to some inherent dissymmetry, there will usually be a small range of half-wave operation at the control point, which is sometimes called the inhibit ratio. Circuit temperature also affects the ratio. These combined effects, including supply voltage variations of $\pm 10\%$, amount to less than $\pm 0.5\%$ of sensor resistance change at the control point. With typical thermistors, the resistance change corresponds to a variance of $\pm 0.12^\circ\text{C}$. The

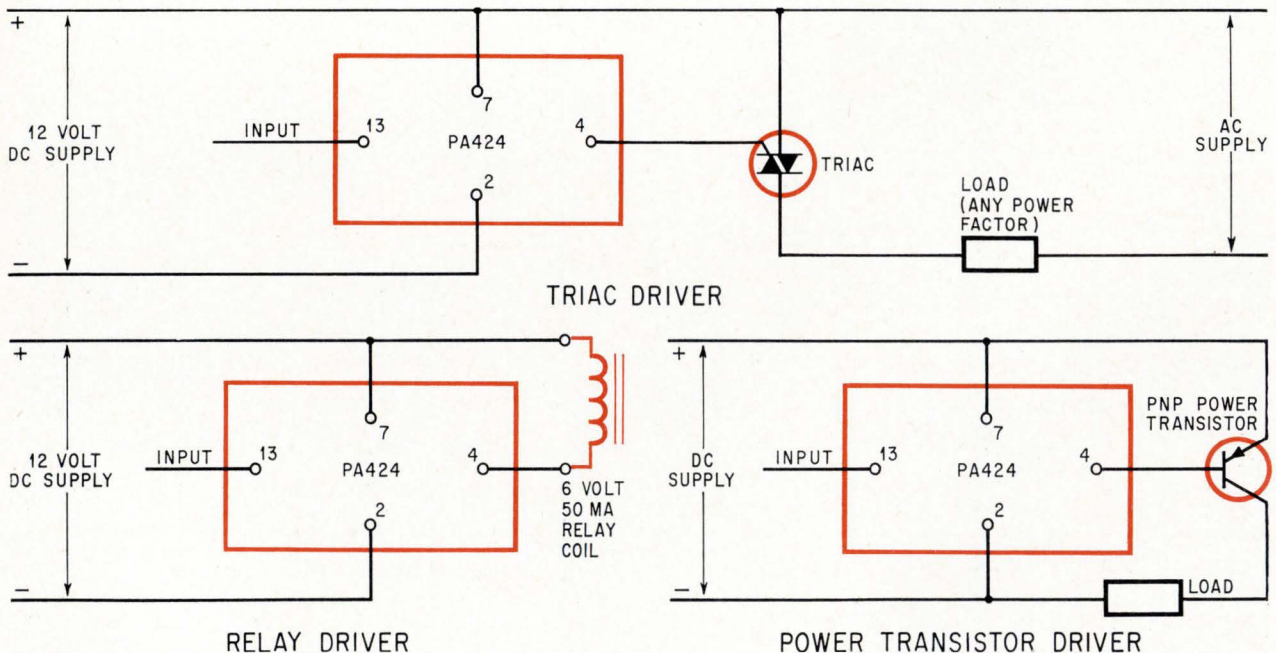

Flexible. With a d-c input, the linear gating IC can handle inductive loads (top), drive relays and other fractional-ampere loads (left), or trigger a power transistor that can handle amperes of current (right).

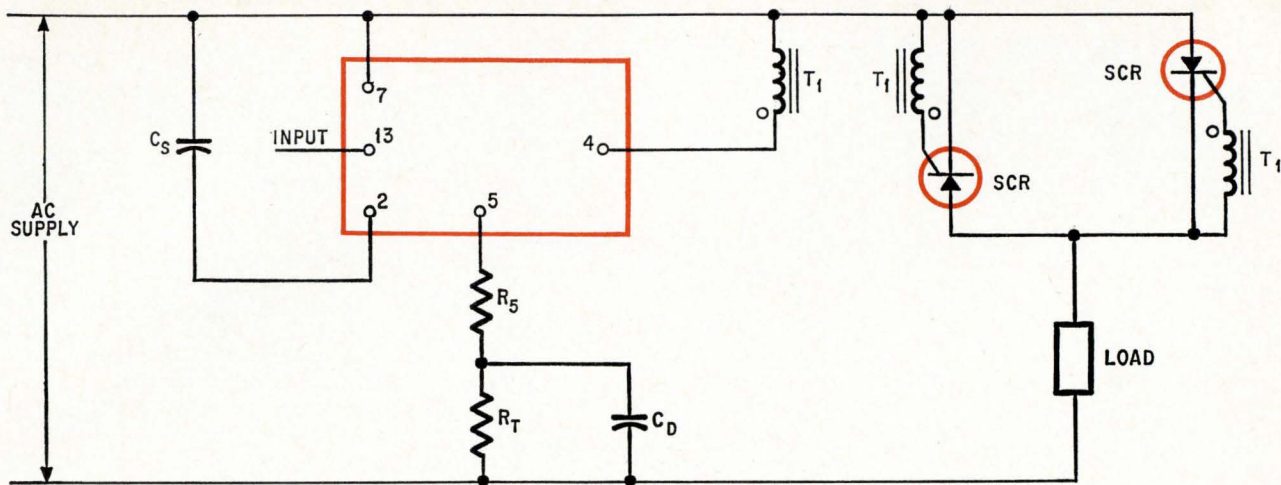

Double play. With a pulse transformer, the IC can drive two SCR's connected directly into an a-c system.

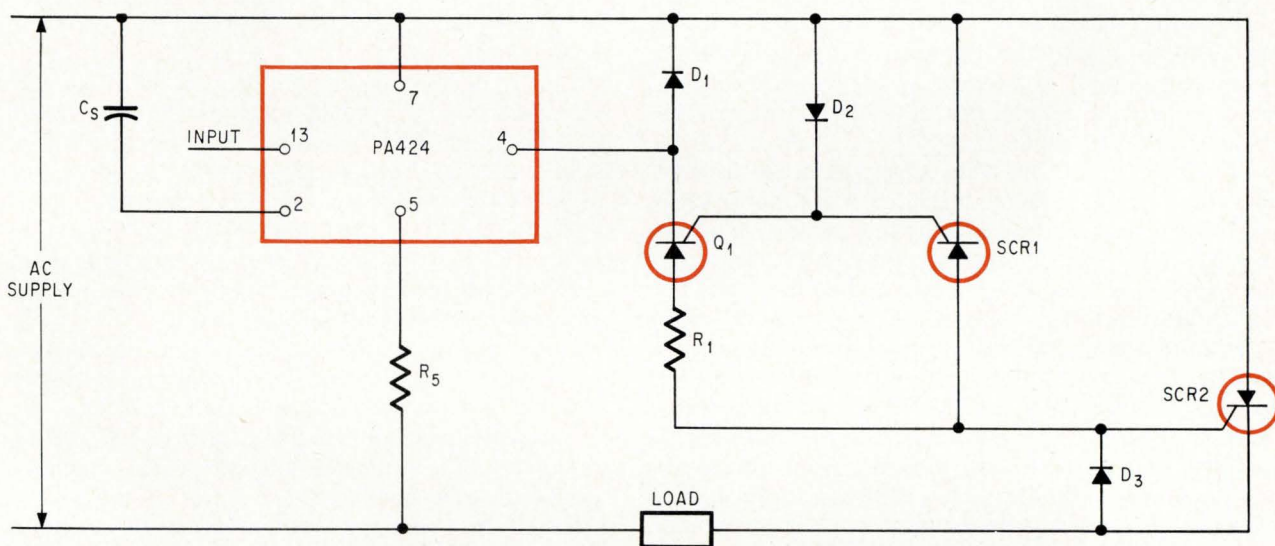

Triple play. The common control arrangement of line-connected SCR's in an inverse-parallel circuit is modified by the addition of third SCR functioning as a transistor and driven by the gating IC to control kilowatts.

narrow variation of inhibit ratio between -20 and $+85^{\circ}\text{C}$ is shown on page 84.

The range of sensor resistance accommodated, 5 to 100 kilohms, is quite wide. Sensors with lower resistance can be used if padding is employed to bring the total to 5,000 ohms, but this sacrifices accuracy. With the use of a single diamond thermistor, a 250°C span of control temperature can be achieved, including operation up to 450°C .

D-c operation

The key to the module's versatility is the integrated circuit itself. In the sampling of input and output connections for the IC, shown on page 84, d-c operation is accomplished by opening pin 5 to allow only the input signal to determine when d-c triggering current is applied to the triac's gate.

This mode is used in cases where it's desirable to turn on an a-c inductive load; the r-f noise associated with the ensuing random triggering time isn't objectionable. In these cases, the triggering

method employed in the temperature controller wouldn't be suitable because pulses at the line voltage's zero crossing would be incompatible with the lagging current of an inductive load. Here the IC operates from a 12-volt d-c supply to furnish a d-c trigger current of 50 milliamperes or more to the triac. With this kind of triggering, the power factor of the a-c load isn't critical.

Use of the IC to drive a small relay, lamp, or other low d-c load is also shown on page 84. To handle larger d-c loads, the IC's output drives a pnp power transistor.

The configuration in the top diagram above can be used to control a pair of SCR's at frequency and power levels higher than possible with commercial triacs. The SCR's are driven by the pulse transformer, T_1 . This unit's output has to be shifted for precise triggering because the IC output pulse is quite long and normally starts before the line voltage crosses zero. The IC pulse is advanced by a lead network formed by C_D , R_S , and R_T . The SCR is

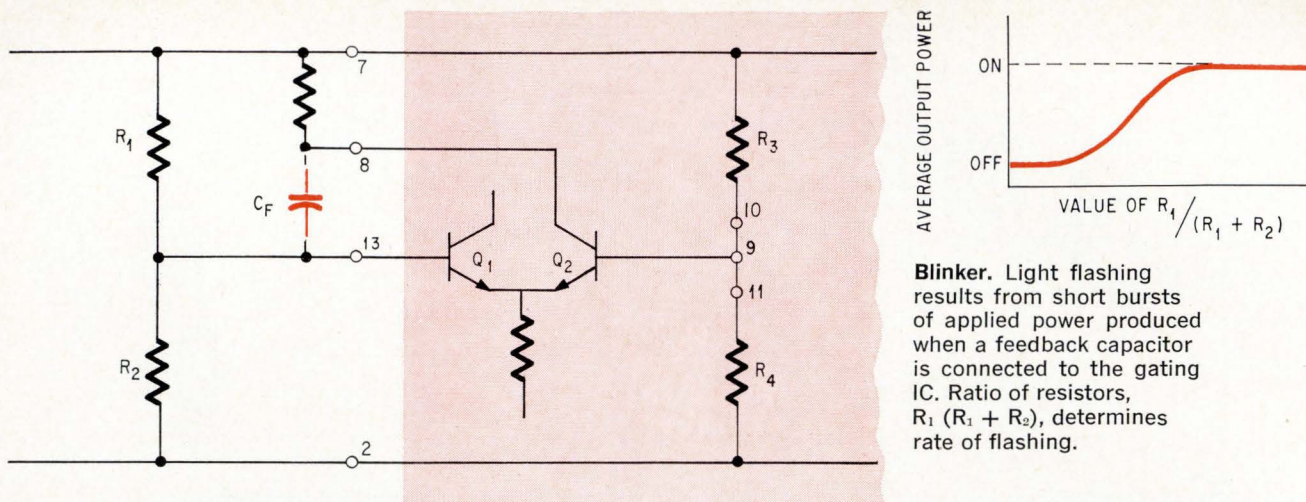

Blinker. Light flashing results from short bursts of applied power produced when a feedback capacitor is connected to the gating IC. Ratio of resistors, $R_1 / (R_1 + R_2)$, determines rate of flashing.

turned on by stored energy in the transformer when the primary drive ends. This arrangement can also be used to isolate the line and the trigger circuit. For completely isolated low-voltage control and sensing, a transformer can be added to supply the trigger circuit's power.

The IC can also fire SCR's arranged in the inverse-parallel configuration common in higher-power systems. Such a network, shown on page 85, contains a third SCR connected as a remote base symmetrical transistor, Q_1 , to trigger the other SCR's. Q_1 is a low-current type—the C106, for instance—with a voltage rating sufficient for the line voltage used.

The IC produces the negative base drive required by Q_1 for both half cycles. Drive current for SCR₁ and SCR₂ flows from either D_2 or D_3 through R_1 and Q_1 to trigger the gate of the appropriate SCR on that half cycle. Diode D_1 protects the IC in case a transient causes Q_1 to fire as a normal SCR.

For comparator functions, the sides of the IC's differential stage can form part of an external bridge, or can be used directly to compare two external d-c levels. These operating modes are achieved by opening pins 9, 10, and 11. The collector of Q_2 (pin 8) generates a signal indicating the state of the input stage. If Q_2 is conducting and drawing full collector current, Q_1 is off and the over-all circuit is supplying energy. The collector current can be sampled by a 2-to-10-kilohm resistor to produce a voltage signal.

Light control

The signal at pin 8 can also provide a positive feedback through a resistor to generate a controlled hysteresis. Very narrow bands of controlled

hysteresis are hard to get in this simple connection, but wider bands—to 10% of sensor resistance or greater—are feasible.

The hysteresis operation for positive ON-OFF switching can be applied to photoelectric control of street lights, for example. But in the flasher circuit shown above, capacitor C_F is connected in place of the feedback resistor so that the circuit oscillates at a rate determined by the time constant of C_F and the input resistance formed by R_1 and R_2 . This arrangement is also suitable to proportional heat controls and the like.

The signal available at pin 8 can be used to slave one IC unit to another. In this arrangement, resistors R_1 and R_2 control circuit 1. When this circuit switches to the ON state with Q_1 off and Q_2 conducting, the collector current of Q_2 causes a voltage drop across R_C .

The drop lowers the voltage at pin 13 of circuit 2 through a divider, R_D - R_E , and this reduction turns off Q_1 of circuit 2, putting that circuit in the ON state. Slaving of this type can be extended to as many circuits as desired.

A time-delay function can be added by generating the d-c supply voltage externally and adding capacitor C_D at the input of circuit 2. Circuit 2 then follows circuit 1 in turning on and off.

A practical use for such a delay arrangement would be in the time-staging of large heating loads in electric heat-control systems.

Further, by the transposing of diametrical legs of the sensing bridge resistors, the integrated circuit can be made to regulate either its own or an ambient temperature, thus saving the cost of a thermistor in certain applications.



The authors

F. William Gutzwiller (left), with GE for 12 years, was one of the team that developed the first commercial SCR, the triac, and other thyristors. James H. Galloway, with GE since 1962, is an applications specialist with a knack for innovative design.

Their present concern: evolving new linear IC's and finding new applications for them. Both men decry what Gutzwiller calls "the infatuation of the electronics industry with digital IC's." They prefer to think in terms of marrying linear and logic IC functions, and predict that analog units will account for 40% of the IC market by the 1970's.

Designer's casebook

Designer's casebook is a regular feature in Electronics. Readers are invited to submit novel circuit ideas, packaging schemes, or other unusual solutions to design problems. Descriptions should be short. We'll pay \$50 for each item published.

Sequential switching enables low-frequency multiplication

By Robert See

Continental Oil Co., Ponca City, Okla.

Multiplication of an input signal's frequency by any even or odd integer is achieved by a sequential switching arrangement of transistors. The switching technique provides an output that is

an exact multiple of the instantaneous input frequency which is not available from conventional heterodyne or synchronizing multiplication techniques. A pulse-train output is filtered to produce a sine wave. The circuits were originally developed for use in the data processing of seismograph records.

Two designs are needed for integral frequency multiplication, one for even valued and the other for odd. Multiplication by an even value requires a sawtooth drive and phase inversion of the pulses, while multiplication by an odd integer needs ramp input and pulse blocking.

In the even-frequency configuration, multipli-

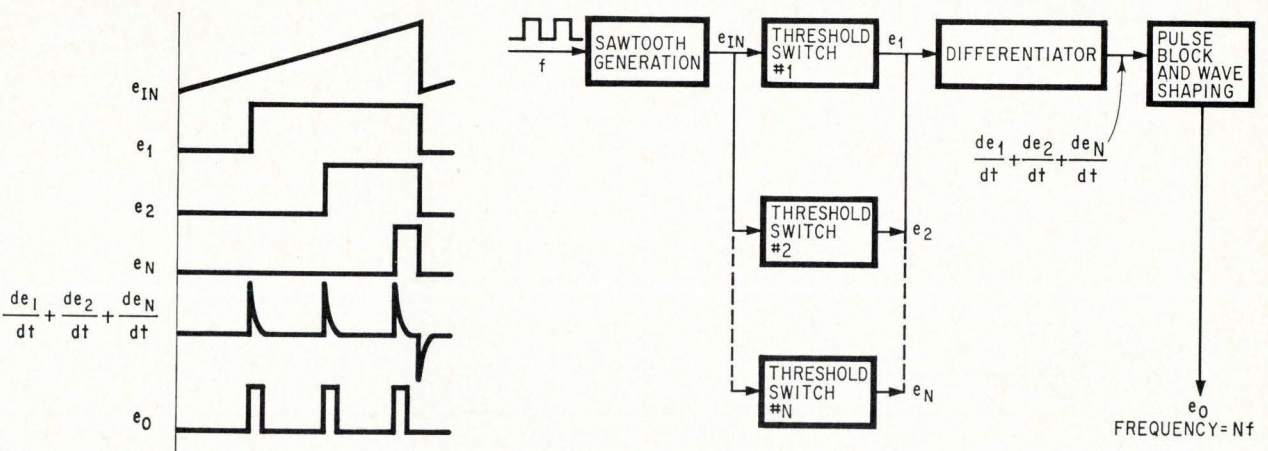
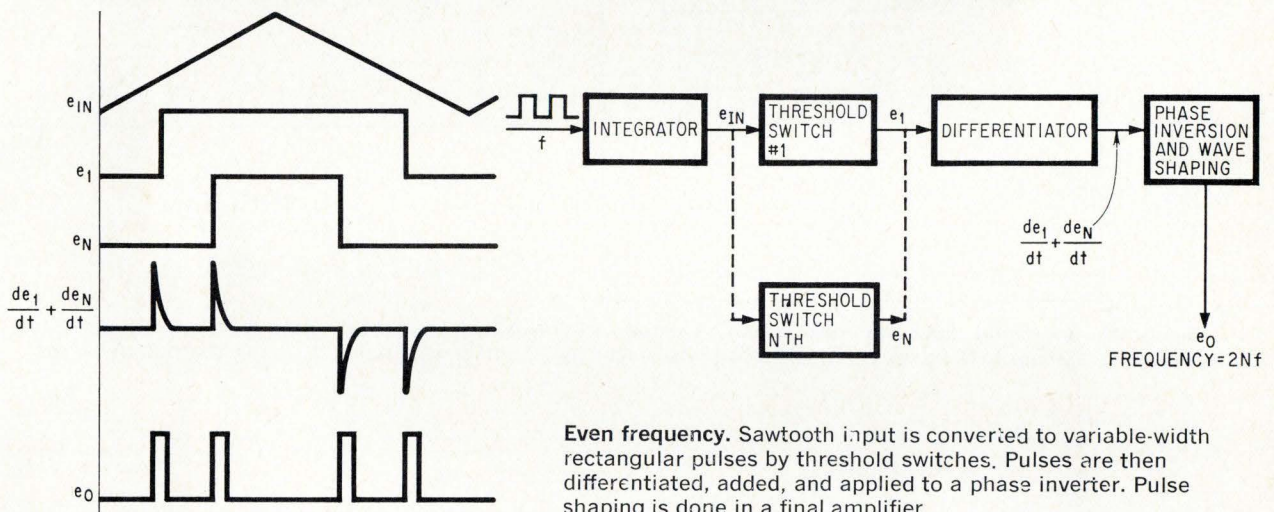

cation of the input by a factor of 10 is achieved. Potentiometer P_1 through P_6 set the triggering voltages of threshold-switching transistors Q_1 to Q_5 . Usually, N threshold switches are needed for frequency multiplication by a factor of $2N$. Here,

for example, multiplication by 10 requires five threshold switches. The output of each switch is a rectangular pulse whose width depends on the voltage at which it is triggered. These pulses are differentiated and summed by resistor R_1 and

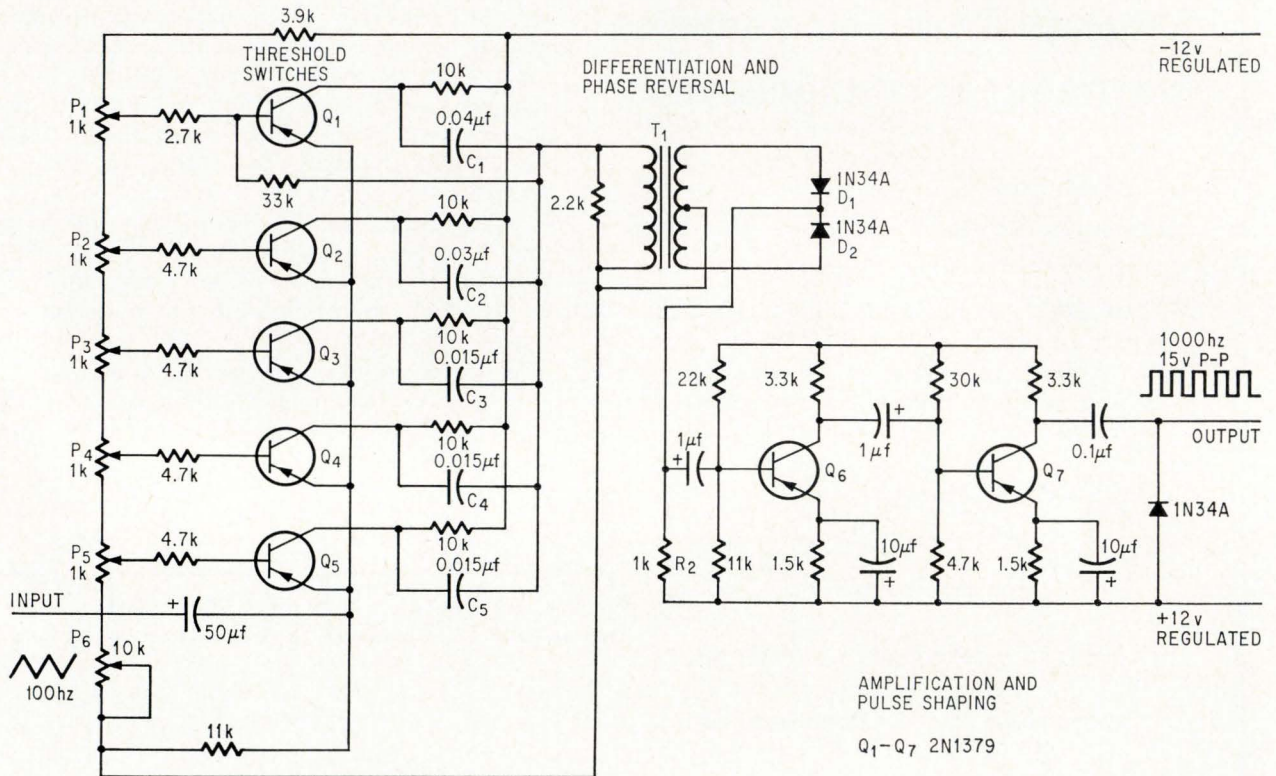

Sequential switching. Even multiplier uses five sequentially switched transistors, Q_1 to Q_5 . Their differentiated output is applied to a full-wave rectifier for phase inversion. Transistors Q_6 and Q_7 shape the output spikes.

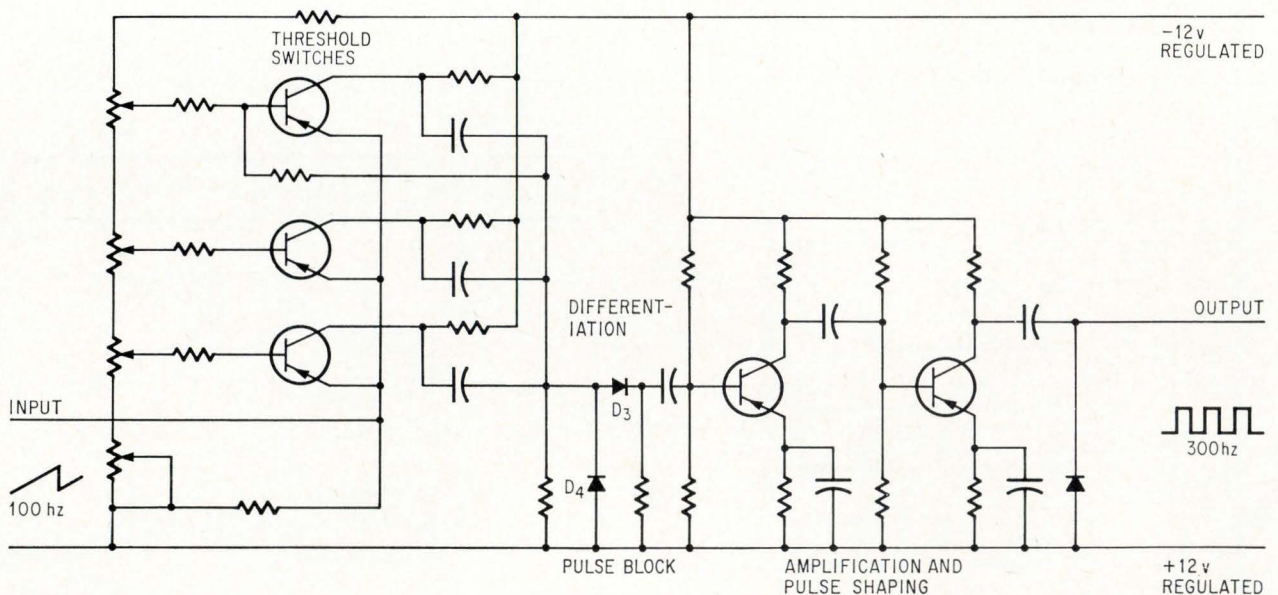

Pulse blocking. For odd multiplication a ramp input is required. Negative-pulse blocking diodes are substituted for the full-wave rectifiers used in the even multiplier. The remainder of the circuit is similar to that of the even multiplier.

capacitors C_1 through C_5 to produce a series of five positive pulses followed by five negative ones.

Transformer T_1 and diodes D_1 and D_2 reverse the phase of the negative spikes, so that the voltage developed across load resistor R_2 is a series of 10 positive pulses for every complete cycle of the 100-hertz triangular input waveform. The 1-kilohertz pulse train is then amplified and shaped by transistors Q_6 and Q_7 . The multiplier also works with a sine-wave input, but it is more difficult to adjust the positive and negative pulses for symmetry.

In the odd-frequency configuration, multiplication by a factor of 3 is accomplished. Here, N threshold switches are needed for multiplication by any odd integer N . Thus, three transistors are required for frequency tripling. A 100-hz sawtooth input is applied to the threshold switching circuitry and the output spikes are fed to diodes D_3 and D_4 , which form a negative-pulse blocking circuit. Since the pulses are not symmetrical, phase reversal by full-wave rectification is not applicable. The 300-hz output is then shaped in the final amplifier.

Bridge circuit cuts contacts in series-parallel network

By George F. Smayling

Conductron-Missouri, Division of the Conductron Corp., St. Charles, Mo.

Synthesizing two-terminal series-parallel switching networks into equivalent bridge circuits minimizes the number of contacts. A Boolean transmission function, which describes all possible paths between the terminals, can be written for any series-parallel circuit. However, most methods for estab-

lishing the bridge equivalent from the transmission function are complex. A simplified method replaces the normal distributive function with its dual, yielding an expression from which the bridge equivalent is obtained by inspection.

To demonstrate the method, consider the accompanying series-parallel configuration in example 1. For this circuit, the Boolean function is:

$$\bar{A}C + \bar{A}B\bar{C} + A\bar{C} \quad (1)$$

The normal distributive function for equation 1 is either of the following:

$$\bar{A}(C + B\bar{C}) + A\bar{C} \text{ or } \bar{A}C + \bar{C}(\bar{A}B + A)$$

Note that \bar{A} appears in the first two terms of equation 1 and C appears in the last two terms. Hence, the normal distributive function can be re-

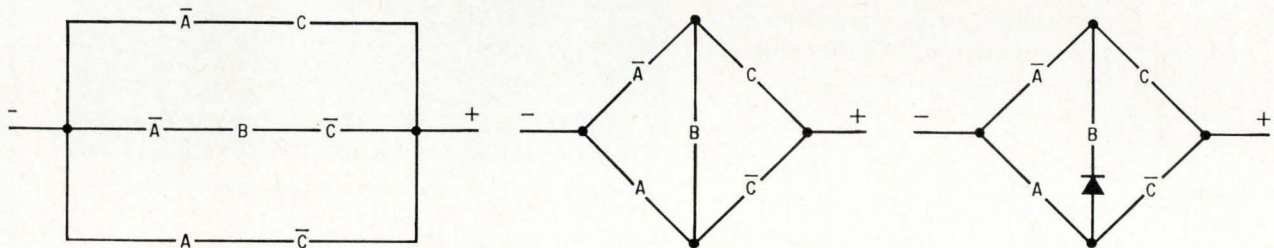

Example 1. Series-parallel configuration (left) is reduced to a bridge circuit arrangement (center). Diode is placed in the shunt leg (right) to keep path ABC open.

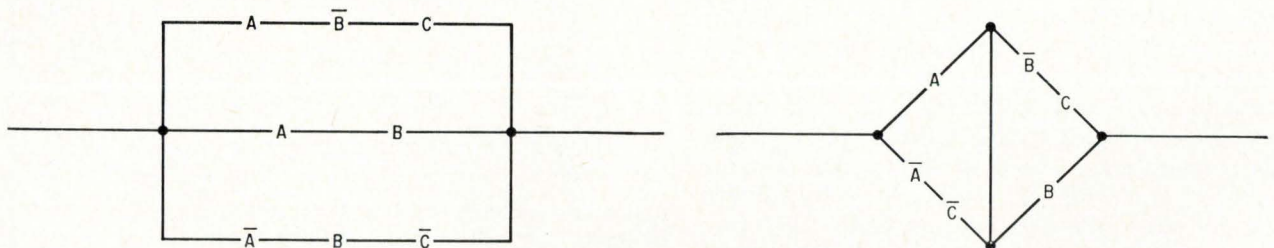

Example 2. Series-parallel configuration (left) is reduced to the equivalent bridge circuit (right). Short circuit in shunt leg indicates that a numerical value of 1 appears in the transmission expression.

placed by a dual distributive function, expressed by

$$\bar{A}(C + [B] + A)\bar{C}$$

In the bridge circuit corresponding to this expression, the double-bracketed B is the shunt leg. To check for equivalence with the original, the four paths through the bridge are traced. The resulting Boolean transmission function is:

$$\bar{A}C + \bar{A}B\bar{C} + ABC + A\bar{C} \quad (2)$$

Equation 2 includes an extra term, ABC, which is not in equation 1. To eliminate this term from equation 2, a diode is placed in the bridge's shunt leg to open the ABC path. With the shunt diode, exact equivalence between the bridge and series-parallel configuration is obtained and the contacts are reduced from seven to five.

In some cases the dual distributive function yields

a 1 in the double brackets. The circuit in example 2, for instance, has a transmission function

$$\bar{A}B\bar{C} + AB + \bar{A}B\bar{C}$$

The dual distributive function is

$$A(\bar{B}C + [1] + \bar{A}C)B$$

The double-bracketed 1 indicates that the shunt leg in the equivalent bridge is a short circuit.

Checking for equivalence, the transmission function for the four paths through the bridge is

$$\bar{A}B\bar{C} + AB + \bar{A}C\bar{B} + \bar{A}C\bar{B}C$$

The term $\bar{A}C\bar{B}C$ is always zero, indicating an open path. Therefore, the bridge is exactly equivalent to the original circuit. If the term representing the fourth path is not zero, a diode is required in the shunt leg to keep that path open.

Low temperature triggers diode relaxation oscillator

By Emanuel Elad

Lawrence Radiation Laboratory, Berkeley, Calif.

Negative resistance needed for proper operation of a relaxation oscillator is available from a low-cost cryogenic diode. Exhibited when the diode is cooled by liquid nitrogen, the resistance resembles that of a more expensive unijunction transistor. In addition, the circuit operates from a 6-volt supply, and can be used in superconductive systems and low-noise varactor amplifiers, both of which work in low-temperature environments.

The general-purpose diode is a 1N116 cooled to a liquid nitrogen temperature of 77° Kelvin. The capacitor C is charged through a 10-kilohm resistor until the avalanche breakdown voltage of the diode is reached. Then C discharges and the recharging cycle is repeated. Thus, relaxation oscillations are produced.

Typical oscillation amplitudes range from 0.4 to 1.5 v, depending on the particular diode chosen. Frequencies available from the circuit range from 30 hertz to 30 kilohertz, depending on the value of the capacitor. However, higher output frequencies are possible with switching-type germanium diodes. For example, with a Q6-100 diode [made by the International Diode Corp.] substituted for the 1N116 and with C removed, 50-megahertz oscillations are obtained. The amplitude and frequency stabilities of the oscillator are very high, because the diode is kept at constant temperature.

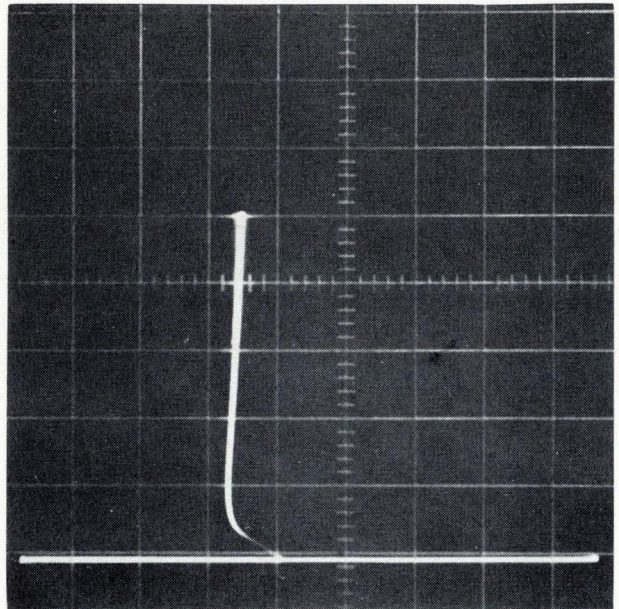

I-v characteristic. Forward bias characteristic of the 1N116 diode at 77°K indicates operating values of current and voltage. Horizontal scale is 0.2v/cm and the vertical scale is 1 ma/cm.

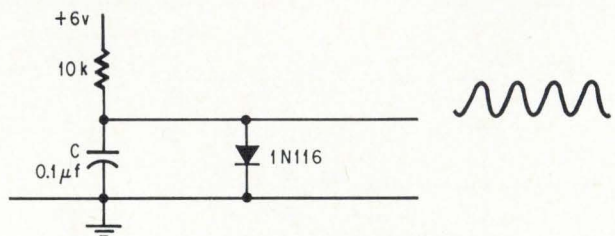

Relaxation oscillator. Negative resistance characteristic of a germanium diode provides circuit with necessary impedance for operation. Output is almost sinusoidal.

**"New I/C Dual Op Amp (Op Amp²)
Provides 36-Million
Voltage Gain!"**

Naturally, you would have no need to use that much gain (right now) . . . yet, the fact remains that with a typical open-loop voltage gain of 6,000 in *each* of the two amplifier sections of the MC1535 (Op Amp²) — the total theoretical voltage gain of the pair in cascade is 36,000,000! Now, for a really large number from the industry's first I/C dual op amp, consider the power gain — where you square the above number . . .

Even more importantly, you can use whatever gain you need in practical applications without having to cascade. Since two operational amplifiers are constructed on a single

monolithic chip and contained within the same package — you can save on component costs — and, on assembly time, too! In addition, you save even more on the low initial cost of the MC1535 Op Amp² — priced at only \$8.50 (100-up) in the TO-100 package.

In addition to excellent gain characteristics, the MC1535 Op Amp² also offers excellent stability, with a minimum of external components; so, it functions well in summing amplifiers, integrators or other amplifiers where operating characteristics are a function of feedback. Some of the specifications that help to make possible the versatile and unusual

performance of the MC1535 Op Amp² are:

CHARACTERISTIC	SYMBOL	TYPICAL RATING	UNIT
Temperature Drift	$T_{C_{V_{io}}}$	10.0	$\mu V/^{\circ}C$
Output Voltage Swing	V_{out}	± 3.6	V
Input Offset Voltage	V_{io}	1.0	mV
Output Impedance	Z_{out}	1.7	$k\Omega$
Input Impedance	Z_{in}	45.0	$k\Omega$
Input Offset Current	I_{io}	0.05	μA
DC Power Dissipation	P_D	100.00	mW

The MC1535 Op Amp² is currently available, from stock, in both the 10-pin metal can and 14-pin ceramic flat pack. For complete details about this exciting, new integrated circuit, write for our data sheet.

where the priceless ingredient is care!



MOTOROLA Semiconductors

Buy this ten dollar Philbrick Operational Amplifier

...and let everyone think
you paid twenty.
They'll believe it,
when they see
its performance.

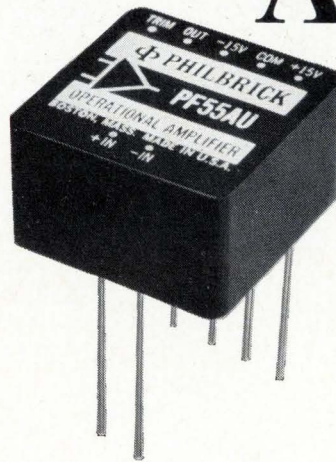

Plain language—our low prices come from volume-production savings and new packaging efficiencies. Others achieve them by cutting corners—thereby making your design job more expensive, more difficult, and more restricted.

Here's what we mean—Economy-Grade Philbricks give you *design resilience* the others don't have. Things like:

Safe, conservative operation at any supply voltage between ± 7.5 V and ± 22 V; a full ± 11 V output swing with a ± 15 V supply (even more at higher supply levels); gain to spare—enough to let you take full advantage of their low offset drifts; remarkably low quiescent power; exceptionally wide stability margins.

We know—that nine times out of ten, you would save money if you paid *twenty* dollars for a resilient Philbrick—but we don't ask you to; just pay what you would for a narrow-margin stiff one. Call us—we've

got what you want, at low prices you'll be surprised to find.

EXAMPLE: This new PF55AU preformed-case epoxy encapsulated miniature has open-loop gain of 40,000 driving $10k\Omega$, 1.5 MHz bandwidth, CMR of at least 1000:1, will slew at 1.5 V/ μ sec, 20 μ V/ $^{\circ}$ C offset limit, and all the resilience described above. It outperforms the cut-spec cheapies, yet it's a genuine Philbrick, through and through. PF55AU price: In lots of 1,000 . . . \$10.00 (even less in larger quantities.)

Send for new Operational Amplifiers price list and 12 page brochure: Bulletin 6111. Philbrick Researches, Inc., 22-G Allied Drive at Rte. 128, Dedham, Mass. 02026.

Phone: (617) 329-1600 TWX: (617) 326-5754.



GOING THE MICROCIRCUIT ROUTE? There's a resilient easy-to-stabilize Philbrick in a modified TO-5 package, too—at only \$6.95 (less in 100-lot quantities or more).

ELECTRONIC ANALOG COMPUTING EQUIPMENT for MODELLING, MEASURING, MANIPULATING and MUCH ELSE



PHILBRICK
A TELEDYNE COMPANY

Choking up on LC filters

A power supply's size and weight is sharply reduced by employing a simply designed multiple-winding choke to replace separate inductors in the filtering circuit

By Allan G. Lloyd

Avion Electronics Inc., Paramus, N.J.

When several filtered d-c outputs are desired from a single a-c to d-c power supply, the normal practice is to connect separate filters to each rectified output. Each filter adds to the system's bulk and weight, and LC choke-input filters are particularly cumbersome.

Size and weight can be reduced significantly by replacing separate filter chokes with one choke containing multiple windings. The major requirement of the design is to assure that the same d-c currents and a-c voltages present in the separate chokes appear in the multiple windings with the proper phasing and turns ratios. The relationships for these parameters are determined by examining a typical multiple-choke circuit.

Circuit analysis

A power supply providing three choke-input-filtered d-c outputs is at the top of page 94. Power transformer T_1 supplies a-c voltages V_1 , V_2 , and V_3 to rectifying diodes D_1 through D_8 . Unfiltered d-c voltages e_1 , e_2 , and e_3 are fed to choke-input filters L_1-C_1 , L_2-C_2 , and L_3-C_3 . Essentially pure d-c voltages E_1 , E_2 , and E_3 are present across the respective filter capacitors.

From the voltage waveforms on page 94, it is seen that e_1 , e_2 , and e_3 have the same shape and frequency, and differ only in amplitude. [The effects of diode conduction voltage and secondary leakage reactance at the zero voltage points are not shown.] The voltages across the chokes are the a-c difference voltages, (e_1-E_1) , (e_2-E_2) , and (e_3-E_3) .

The same power supply circuit, with chokes L_1 through L_3 replaced by multiple-winding choke L_o , is on page 95. To provide d-c outputs identical to the unmodified circuit, the a-c difference voltages must be present across windings N_1 , N_2 , and N_3 . This is done by making the turns ratio of the wind-

ings directly proportional to the a-c difference voltages. Thus, L_o 's turns ratios will duplicate the turns ratios of transformer T_1 's secondary. With the windings polarized as required by the phase of the a-c voltages, the magnetic flux due to currents I_1 through I_3 will add, producing a total d-c flux that is the sum of the individual fluxes. Choke L_o is therefore larger than the individual chokes in the original circuit, and its LI^2 value is the sum of the individual chokes'. Even though the total volt-ampere product is the same for both circuits, there is a net saving in size and weight because only one magnetic component is needed.

Choke loading

In the unmodified circuit each output must be loaded to a minimum current given by¹

$$I_{\min} = E_o / 1,000 L_{\min}$$

where E_o = average output voltage.

This loading maintains the value of average output voltage. For load currents less than I_{\min} , the conduction angle of the rectifying diodes is less than 180° , with no current in the choke during a portion of the a-c input cycle. The interruption in current produces an excess average voltage, represented by area A of the output voltage waveform on page 95. As the load current approaches zero, the diode conduction angle goes to zero, and E_o approaches the peak value of the a-c voltage.

Excess average voltage is indicated by the steep curvature of the filter's voltage regulation characteristic below I_{\min} . Between I_{\min} and I_{fl} (full-load current), $E_o = 0.638e_{ac}$ minus losses, and the regulation characteristic is essentially flat. The ratio $K_1 = I_{\min}/I_{fl}$, is between 0.1 and 0.5 for practical chokes.

In designing the multiple-winding choke, it is more convenient to translate I_{\min} into P_{\min} , where

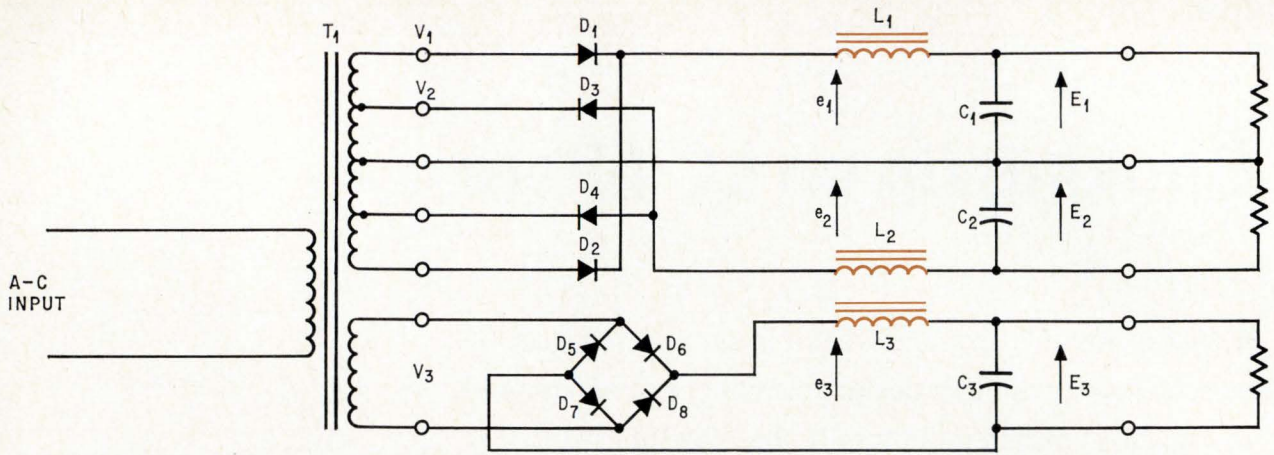

Power supply. Rectified outputs e_1 through e_3 are filtered by individual choke-input filters L_1 - C_1 through L_3 - C_3 . Essentially pure d-c voltages, E_1 through E_3 , are present at the load.

$P_{min} = I_{min} E_o \approx K_1 P_{fl}$. The value of P_{min} is independent of E_{r1}/I_{r1} , and depends only on choke size, flux density, and operating frequency, and is a more fundamental parameter than I_{min} or L_{min} . Loading the multiple-winding choke is accomplished by loading one or all of the windings to a total of P_{min} corresponding to I_{min} for the choke. If the full-load current on one winding doesn't meet the P_{min} requirement, it can be achieved on another. Thus,

one or more windings can be run at no load and still not exceed the theoretical average output voltage.

The multiple-winding choke offers improved ripple performance over the separate choke design. If L_o is wound on standard EI lamination forms, the three windows will have tight coupling, effectively connecting them for a-c ripple current and load voltage transients. All outputs will tend to have the same percentage ripple and transient waveforms under relatively balanced loads. When the loads are heavily unbalanced, the tight coupling causes differences in the ripple of the outputs. However, these differences produce circulating choke currents which act to equalize the output ripple voltages. Thus, a uniform ripple is obtained for a variety of loading conditions.

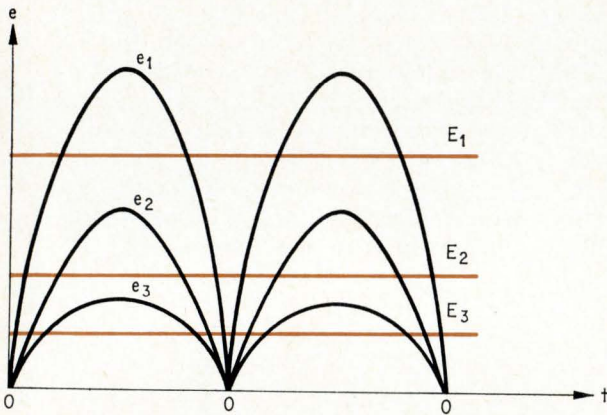

e_1, e_2 AND e_3 = RECTIFIED A-C
 E_1, E_2 AND E_3 = FILTERED D-C

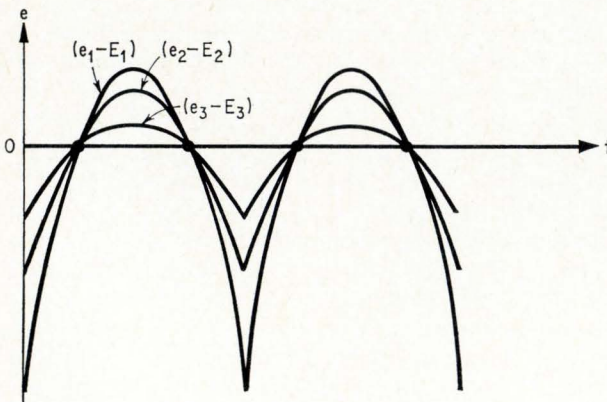

Taking shape. Frequency and shape of rectified a-c voltages are identical. The voltages across the chokes are the rectified voltages displaced by the subtracted filtered d-c outputs.

Design procedure

As an example of how the multiple-winding choke procedure can be applied, consider the case of designing choke L_o for a typical set of desired output voltages and currents. A design table, on page 97, is used as a worksheet to aid computation. As each significant parameter is established, it is entered in the appropriate column. To begin, the engineer enters the output voltages, E_o , currents, I_o , powers, P_o , power ratios, n_p , and voltage ratios, n_v , into the table. He then determines the core shape and wire needed to produce these output values. The design procedure is as follows:

Step 1. Determining a core

- Calculate ΣP_o :

$$\Sigma P_o = \Sigma E_o I_o = (100)(1) + (50)(0.5) + (25)(3) = 200 \text{ watts}$$

- Select $K_1 = 0.3$. This value is arbitrarily chosen and lies midway between the practical limits of K_1 . (This establishes a P_{min} of 60 watts.)

- Calculate 1 choke LI^2 :

$$LI^2 = \frac{K_2 \Sigma P_o}{f_s K_1}$$

where $K_2 = 0.060$ for full-wave single phase;
 $= 0.0017$ for full-wave three phase

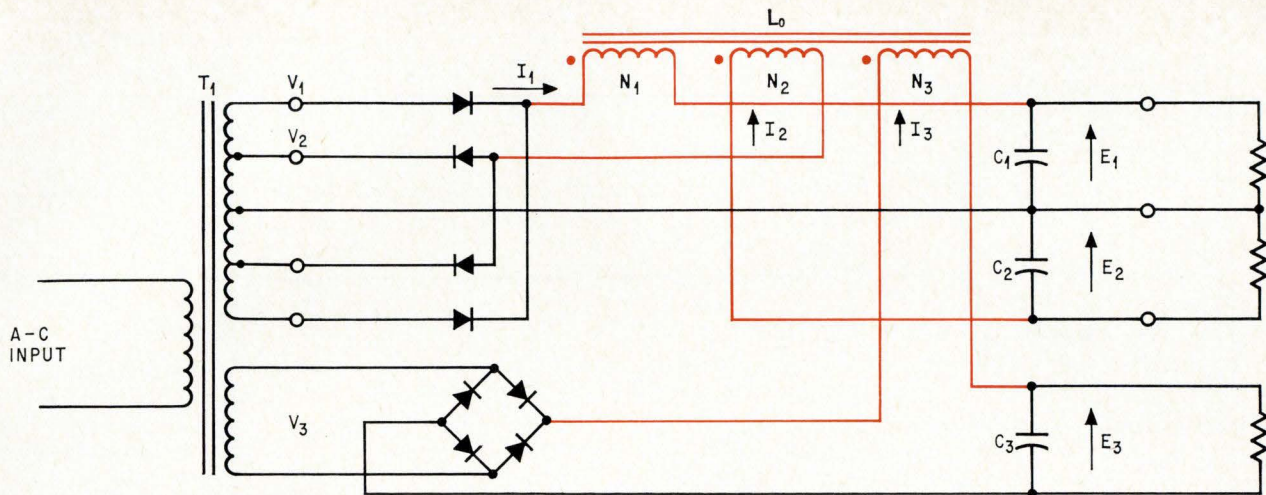

Substitution. Multiple-winding choke L_o provides the inductive portion of the output filtering, replacing chokes L_1 through L_3 in the original circuit.

and f_s = supply frequency. Hence,

$$LI^2 = \frac{(0.060)}{(60)} \times \frac{(200)}{(0.3)} = 0.66 \text{ henrys-amperes}^2$$

■ Translate LI^2 into a choke size. A rule of thumb for 60-cycle operation is

$$WA = 2.5 LI^2$$

where W = core window area, in²
 A = core area, in²

Therefore,

$$WA = (2.5)(0.66) = 1.65 \text{ in.}^4$$

By consulting manufacturer's data sheets for transformer laminations, this WA -value corresponds to a square stack of EI-125 laminations whose WA equals 1.83.

Step 2. Determining winding turns

■ Assume that all of the power of the supply appears at one of the desired outputs. In this example, the 100-volt output is selected for mathematical convenience. Thus,

$$I_o = \frac{\Sigma P_o}{E_o} = \frac{200}{100} = 2 \text{ amps}$$

and

$$L_o = \frac{LI^2}{I_o^2} = \frac{0.66}{(2)^2} = 0.166 \text{ henry}$$

The number of turns, N_o , required for an L_o of 0.166 henry is determined from table 7 of the Richardson² charts (for EI-125 laminations).

Thus,

$$N_o = 330 \sqrt{\frac{0.166}{0.125}} = 374 \text{ turns}$$

■ Calculate the total NA_w (A_w = wire area) from the existing design data for EI-125 laminations in Richardson's table 7:

$$NA_w = (330)(1624) = 535,000 \text{ circular mil (CM)-turns.}$$

■ Calculate the turns for each winding using the relationship $N_n = 374 \frac{E_n}{(100)}$

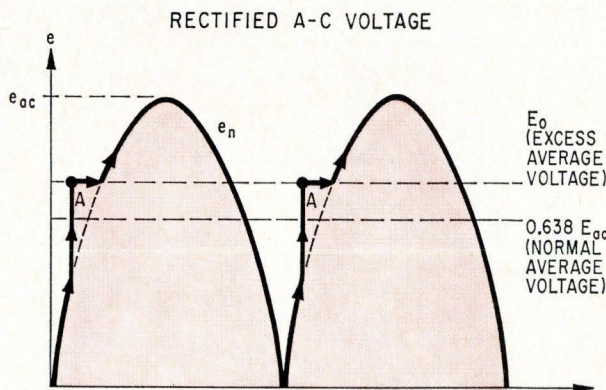

Highs and lows. Load current below I_{min} interrupts conduction of rectifying diodes, producing a notch (area A) in the rectified voltage waveform. The notch produces an excess average output voltage and poor voltage regulation.

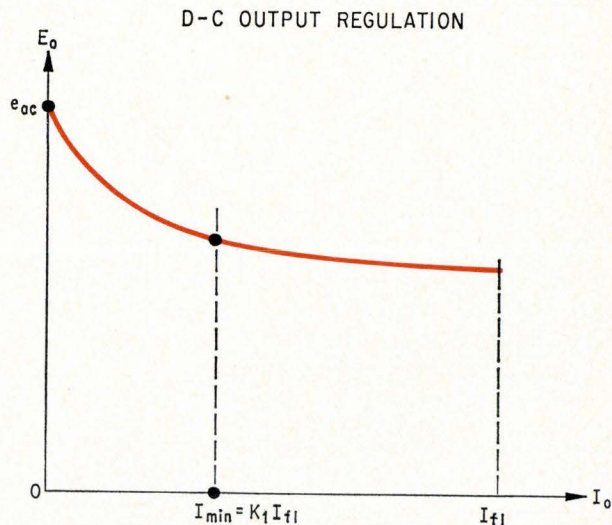

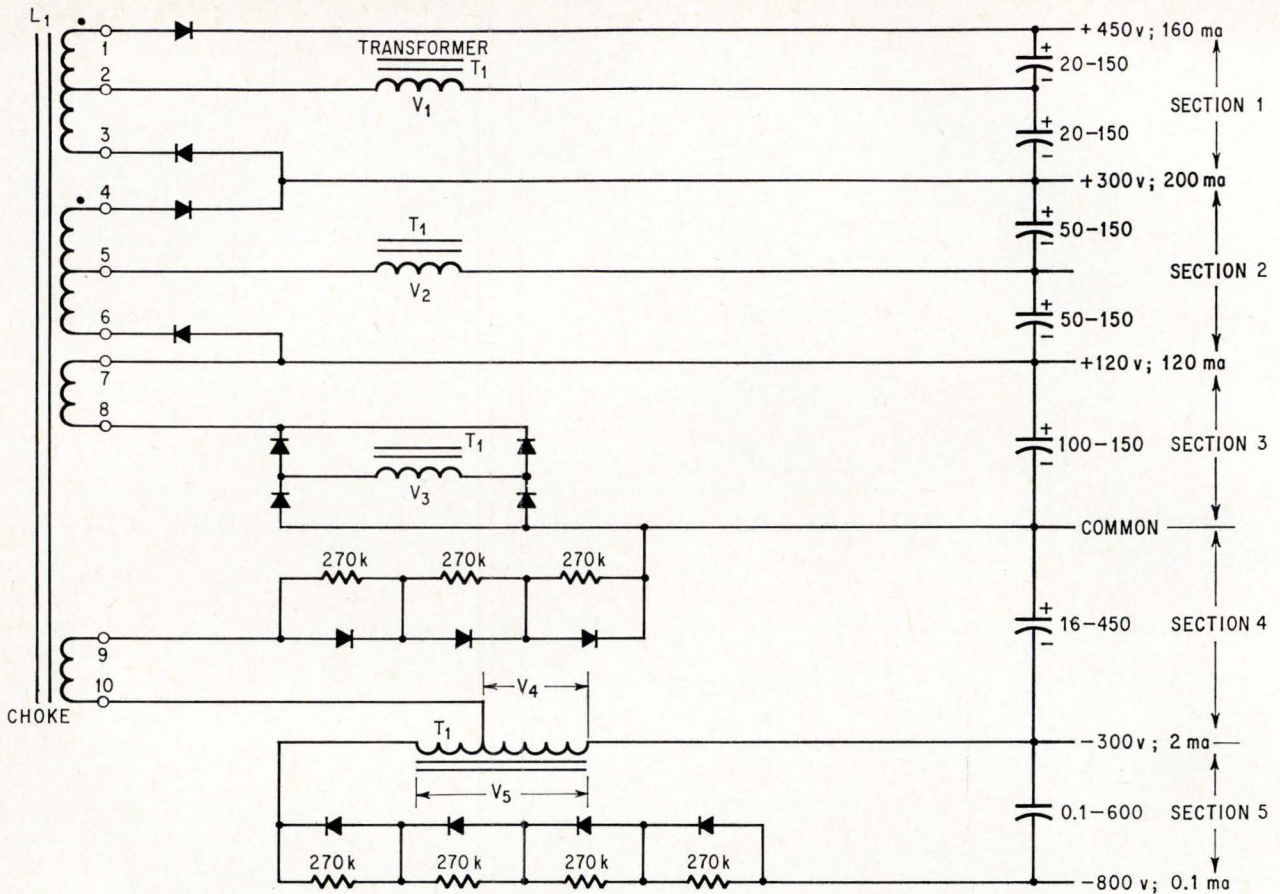

ALL DIODES = 1N1763

Output circuitry. Typical schematic of a filtered d-c to d-c magnetic amplifier inverter in commercial use since 1960. The fixed minimum load on the output of section 3 enables the inverter to have a half-wave choke input filter.

Hence, for $E_1 = 100\text{v}$, $N_1 = 374 \left(\frac{100}{100} \right) = 374$ turns

for $E_2 = 50\text{v}$, $N_2 = 187$ turns
 for $E_3 = 25\text{v}$, $N_3 = 98$ turns

Step 3. Determining winding wire gauge

The NA_w value is divided among the various windings in proportion to the power handled by each output. Therefore, A_w for each winding is calculated from the expression

$$A_{wn} = \frac{535,000 \times n_p}{N_n}$$

Hence,

$$A_{w1} = 268,000/374 = 720 \text{ CM}$$

$$A_{w2} = 67,000/187 = 360 \text{ CM}$$

$$A_{w3} = 200,000/98 = 2040 \text{ CM}$$

From conventional wire tables, the gauges providing wire areas closest to those calculated are now obtained. Thus,

$$\text{winding } N_1 = \text{AWG } 22 = 640 \text{ CM}$$

$$\text{winding } N_2 = \text{AWG } 25 = 320 \text{ CM}$$

$$\text{winding } N_3 = \text{AWG } 17 = 2052 \text{ CM}$$

Step 4. Determining winding build

Turns per layer of winding are obtained from the Richardson chart as 56, 78, and 29, respec-

tively; the number of layers are then calculated:

$$N_1 = \frac{374}{56} = 6.6; N_2 = \frac{187}{78} = 2.4; N_3 = \frac{98}{29} = 3.35$$

Rounding off to the nearest higher integer, the layers for the three windings are 7, 3, and 4, respectively.

Calculate the complete winding build. For each winding, the build is the number of layers times the sum of the wire diameter and wire insulation thickness. The contributions to the complete winding build appear below.

Composite winding	build (inches)
winding tube.....	0.050
winding N_1 : $7 \times (0.037\text{'})$	0.214
interlayer insulation.....	0.010
winding N_2 : $3 \times (0.022\text{'})$	0.066
interlayer insulation.....	0.010
winding N_3 : $4 \times (0.055\text{'})$	0.220
wrap.....	0.025
total:	0.595

To check the design feasibility, it is necessary to calculate the winding space factor, K . This represents the ratio of the winding build to the core

window height. For this case, $K = \frac{0.595}{0.625} = 0.95$,

Multiple-winding choke design

Winding	E_o (volts)	I_o (amps)	P_o (watts)	$n_p = \frac{P_o}{\Sigma P_o}$	$n_r = \frac{E}{E_o}$	N (turns)	NA_w (CM-turns)	A_w (CM)	Wire Gauge (AWG)	Turns/ layer	Number of layers	Wire diameter (in.)	Wire insulation thickness (in.)	Build/ layer (in.)	Total build (in.)	Capacitance (μ f)
N₁	100	1	100	0.5	1.00	374	268,000	720	22	56	6.6	0.0277	0.003	0.0307	0.214	50
N₂	50	0.5	25	0.125	0.50	187	67,000	360	25	78	2.4	0.020	0.002	0.022	0.066	50
N₃	25	3.0	75	0.375	0.25	98	200,000	2040	17	29	3.35	0.048	0.007	0.055	0.220	300
Totals			200	1.00			535,000									
N₃'						98			18	33	3.0	0.043	0.007	0.050	0.150	

which is too high for a practical winding. Therefore, either the wire size or the number of turns must be reduced. In this example, the gauge of winding N_3 is reduced by one size to AWG 18. This results in a new design entry, given in the table at N_3' . The new space factor is

$$K = \frac{0.525}{0.625} = 0.85$$

which is a practical value.

Calculating the filter capacitors

With the design of the choke completed, the values of the output capacitors are now determined. The LC product required to obtain the desired output ripple is calculated.¹ Assume a 5% ripple is required.

$$LC = \frac{K_3}{r} \times \left(\frac{60}{f_s} \right)^2$$

where: r = ripple factor = $\frac{E_{rms}}{E_{dc}} = 0.05$

$$K_3 = 0.83 \text{ for single phase, full wave;} \\ = 0.0079 \text{ for three phase, full wave.}$$

Therefore,

$$LC = \frac{0.83}{0.05} \left(\frac{60}{60} \right)^2 = 16.5 \text{ henry-microfarads}$$

A reference capacitance is calculated:

$$C_o = \frac{LC}{L_o} = \frac{16.5}{0.166} = 100 \mu\text{f}$$

This capacitance is distributed among the various outputs in direct proportion to their power, and inversely as the square of the voltage ratio. Thus,

$$C_m = \frac{C_o n_p}{n_v^2}$$

so that $C_1 = (100) \frac{(0.5)}{(1.00)^2} = 50 \mu\text{f}$

$$C_2 = 50 \mu\text{f} \\ C_3 = 300 \mu\text{f}$$

This completes the filter design. Choke-input filters can be optimized at any given power level by experimentally adjusting the choke gap. The total gaps given in the Richardson table are a

good starting point; however, since there are two gaps, the spacers are one half the total gap length indicated.

Although the foregoing example is for three outputs, any number of outputs can be combined on a given choke. Thus, multiple-output supplies of any complexity can be designed with only one transformer and one choke. Two-stage filters can be devised with two multiple-winding chokes in cascade. The modified circuit operates with any a-c input voltage waveform, so that duty-cycle regulated, multiple-output supplies can be built.

References

1. "Reference Data for Radio Engineers," Fourth edition, International Telephone and Telegraph Corp., 1957, pp. 317-318.
2. I. Richardson, "New procedure for designing linear and swinging chokes," Electrical Manufacturing (now Electro-Technology), December, 1957.

Birth of a notion

Allan Lloyd believes that dissatisfaction always triggers new ideas. He was a designer at the Daven Co. when they were making power supplies and noted that the conventional technique for providing multiple outputs was to use separate chokes to filter each output. Each choke contributed to the size, weight, and cost of the unit.



The thought occurred to him that one multiple-winding choke could easily replace the individual inductors without sacrificing circuit performance. Although this approach seems quite simple, no one had previously used it. Daven Co. immediately applied for a patent. Power supply manufacturers who have recently learned of the technique agree that it shows merit.

With over 15 years of experience in electronics, Lloyd is presently a project engineer at Avion Electronics Inc., designing high-speed signal processors and multiplexers, infrared imaging systems, and radiometers.



Let's make waves!

EiD's Function Generator makes any wave you want a permanent wave.

As a general-purpose signal source, it's designed to make quite a splash: you get sinusoidal, square and triangular waveforms — simultaneously. Frequency is continuously variable from 0.005 Hz to 1 MHz in eight ranges. And you get dc offset controls.

Now, for a few interesting ripples. Selectable, 30-volt output, with continuously-variable level. (How's that for flexibility?) All outputs short-circuit proof. An output sync pulse is provided for precise triggering. Frequency can be externally voltage-controlled over a very linear 20/1 frequency range.

A few more. All silicon, solid-state. Compact. Rugged. Versatile. Easy to operate.

And finally: the price won't curl your hair. Comb your local EiD Sales Representative for all the facts... or write direct to our nearest regional office, listed at right.



EiD more than measures up.



INSTRUMENTS, INC.
ELECTRONIC INSTRUMENTS
DIVISION

2400 Harbor Blvd., Fullerton, Calif. 92634, (213) 691-0841

7360 N. Lincoln Ave., Lincolnwood, Ill. 60646, (312) 583-1020

12051 Tech Rd., Montgomery Ind. Park, Silver Spring, Md. 20904, (301) 622-2500

International Subsidiaries: Geneva; Munich; Glenrothes, Scotland; Tokyo; Paris; Capetown; London; Mexico City

Designing for the worst of worst cases — nuclear war

With the aid of hardening techniques, circuits can be built to withstand the crippling effects of radiation, enabling electronics systems to survive an atomic holocaust

By C.F. Johnson

Buena Park, Calif.

Military theorists have long warned that radiation from nuclear explosions could cripple the electronics of any missile system—but it's not so.

Delicate though they are, transistors and integrated circuits can be designed to withstand the awesome environments of nuclear war. If the circuit designer understands these environments, and their effects, he can harden his circuits to withstand radiation levels that would wreck conventional equipment, and, at the same time, he can protect them from the electric fields of thousands of volts per meter that may be generated as a by-product of nuclear blasts.

The only condition against which there is no defense is an explosion so close that it either melts or permanently degrades the circuitry or the vehicle carrying it. But before the designer can hope to have his equipment withstand the effects of the blast, he must shorten the lethal radiation range by resorting to hardening measures for both systems and devices.

Some of the most effective hardening techniques are surprisingly simple. Originally devised for use in weapons systems, they could be used to improve

the survivability of other systems, such as emergency communications gear and controls vital to the operation of essential civilian services.

Ground systems will be spared much of the radiation faced by weapons systems operating outside the atmosphere. Missiles, for instance, may be subjected to detonations of both attacking and defensive warheads. The lack of air minimizes blast effects such as shock waves, but allows fission fragments, neutrons, gamma rays, and X rays to travel freely. The atmosphere will absorb all the charged particles and soft X rays quickly, and part of the gamma radiation—but absorption of the gamma energy by the air creates a strong electromagnetic pulse (EMP).¹

Natural radiation shielding of the atmosphere can be buttressed, of course, by radiation shielding around the equipment. Weapons system designers usually consider this first, since at high altitudes radiation remains intense at long distances from the explosion. The only buffer up there is square-law attenuation, the normal dispersion of energy emanating from a point source.

First-aid kit

One example of a quick fix is the addition of current-limiting resistors to transistor circuits, since photocurrents strong enough to cause spurious operation of transistors can be generated in semiconductors by small amounts of gamma and X radiation. In IC's, the excess current can be drained off by a substrate bias connection. There is a good chance the circuits will resume near-normal operation after the radiation subsides.

Neutron bombardment, however, reduces transistor gain. But this can be offset in some cases

The author



C.F. Johnson, a veteran aerospace specialist, has coordinated radiation vulnerability and nuclear hardening studies for several large military systems. He recently joined TRW Inc.'s Systems Group, as a member of the technical staff.

by special fabrication techniques that limit the loss in gain. Another possibility is to compensate for the loss with feedback.

The electromagnetic pulse caused by a nuclear blast can attain field strengths as great as 10,000 volts per meter,² inducing severe electrical overloads. The only defense is hardening—highly efficient electrical shielding and circuitry capable of withstanding surges that sneak through.

Even after intensive evaluation, the designer cannot be absolutely sure such measures will work. Hopefully, they will never be put to the acid test. The option of exploding a test warhead is ruled out by the nuclear test ban treaty. He can, however, simulate nuclear radiation and the EMP in the laboratory. One test technique is the use of a laser to induce photocurrents similar to those induced by gammas.

A new design tool that also resolves much of the uncertainty is simulation of a circuit and its radiation environment in a computer. New computer programs assess the radiation effects upon complex circuits and systems [see "Probing the unknowns—in a computer," p. 107].

It must be stressed, however, that an extraordinary degree of control over chemical composition and physical dimensions of solid state devices is critical to accurate predictions of their operation in radiation environments. However, despite improvements in manufacturing quality control, devices available in production quantities don't have uniform electrical characteristics.

First line of defense

Hardening is a defensive military operation that succeeds to the extent that it raises the price of admission—makes an attack on an objective too expensive in terms of warhead size and number. Warhead designers generally strive to increase the lethal range of an explosion and are reluctant to lose even a temporary advantage won by their ingenuity. The cards would be stacked in their favor, except for the fact that the radiation resistance of

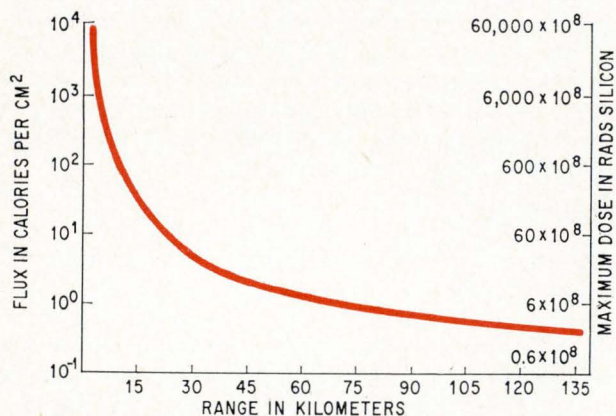

Vacuum range. A 1-megaton explosion at vacuum altitudes releases X rays that can be a hazard at long range. The right-hand scale shows the dose in rads silicon that an unshielded transistor might receive from soft X rays from a fireball with a temperature of about 1 kev or 11 million degrees Kelvin.

hardened components can be made 2 or 3 orders of magnitude better than the resistance of commercial components.

Hardening can reduce a warhead's effective range to the distance at which the explosion's heat would destroy the system carrier. The vacuum range curve below shows that this gives the electronics designer considerable leeway. If the user accepts some degradation in system performance in preference to an aborted mission, he can prevent complete failure.

Fortunately, the vehicle carrying an aerospace weapons system (or other system housing) fends off some of the radiation. Thin layers of material corresponding in density to 1 foot of air at sea level absorb as much as 90% of the soft X-ray energy and produce heat.^{1, 3} Radiation at longer wavelengths is also absorbed or reflected.

Higher energy, hard X rays will penetrate the vehicle skin, causing effects similar to the gamma effects listed on page 101. However, source intensity drops quickly with wavelength.

In principle, the most intense hard X rays can be shielded with a moderate thickness of dense material. Uranium is the best absorber. But, unhappily, it won't absorb much energy having wavelengths shorter than about 0.1 angstrom.

Since shielding alone won't protect semiconductor devices against higher energy, hard X rays, its effectiveness as a hardening measure is inversely proportional to the explosion's temperature.

Spurious transients

The inability of shielding to cope with all radiation means that it is impossible to prevent radiation-induced spurious transients in semiconductor devices. Device operation can be upset temporarily by an extraordinary small amount of penetrating radiation. A significant amount can spell failure.

In the vacuum-range plot, for example, soft X-ray intensity is given in rads silicon⁴ and calories as a function of distance from the explosion. A rad means that 100 ergs of energy is being released in each gram of matter absorbing the X rays. A calorie equals 4.2×10^7 ergs. Thus, at 50 miles from a 1-megaton explosion the dose is 6×10^8 rads silicon⁴—orders of magnitude greater than the energy needed to cause false conduction in a silicon device. The dose from a warhead larger than 1 megaton would be correspondingly larger.

Silicon's band gap is only 1.1 electron volts, or 1.76×10^{-12} ergs (band gap is the energy that will raise an electron from the valence to the conduction band).⁵

In fact, energy at wavelengths longer than a micron affects silicon devices. A neodymium laser produces hole-electron pairs in silicon; this effect was used in 1965 by J.G. Poksheva, of North American Aviation Inc.'s Autonetics division, to simulate closely the effects of gamma radiation. More recently, Donald McWilliams, of TRW Inc.'s TRW Systems, made an extended study of latchup (saturated operation) induced in integrated circuits

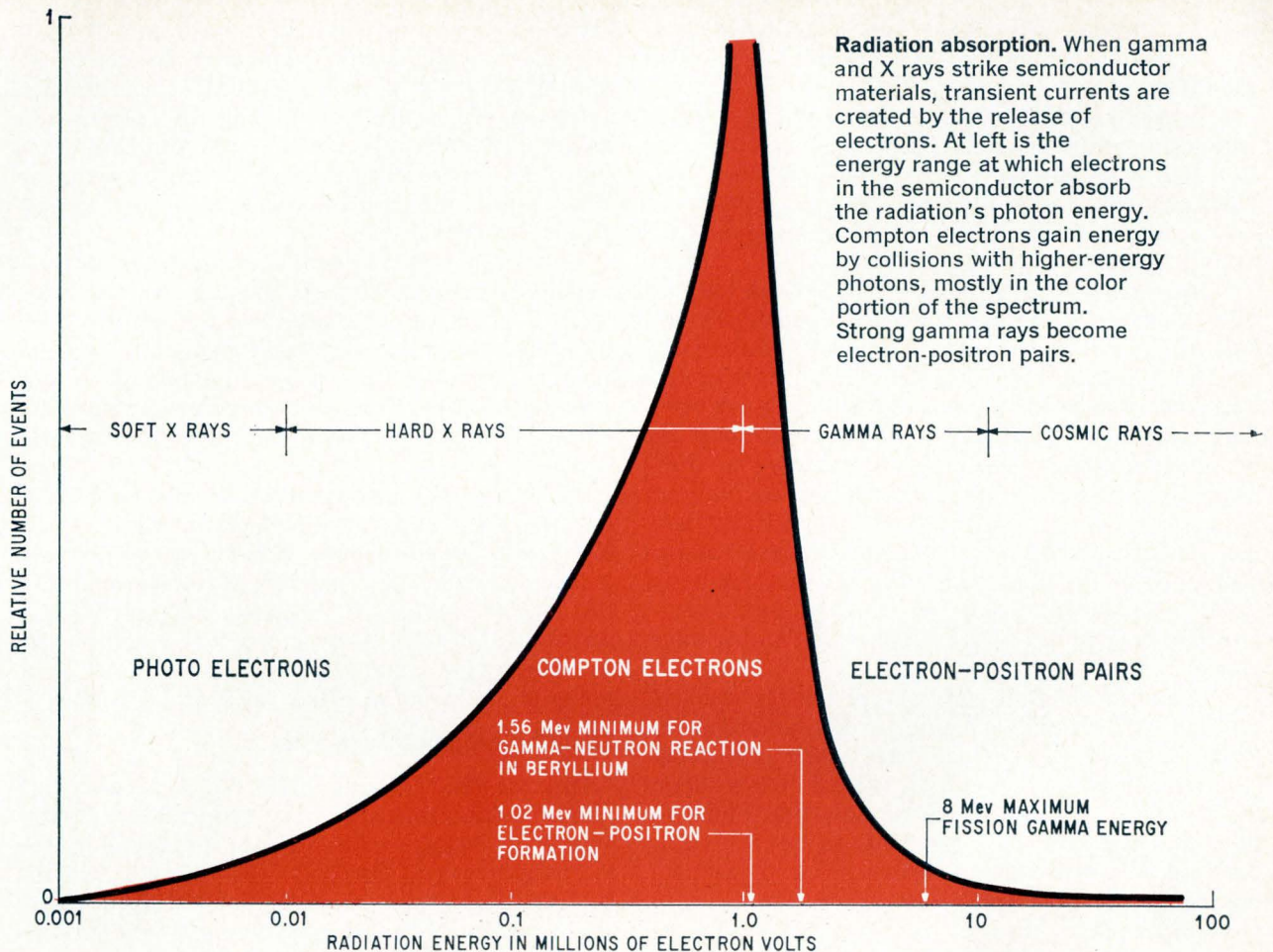

by radiation. His quantitative evaluations were made with a Q-switched neodymium laser.⁶

Radiation-absorption processes

The radiation-absorption processes that do damage in semiconductors are easier to understand if one recognizes that the dividing line between X and gamma rays in the electromagnetic spectrum is arbitrary. It is convenient to discuss the processes as being gamma effects, recognizing that the processes actually overlap the gamma- and X-ray energy ranges, as indicated in the diagram above.

Gamma radiation is absorbed by matter in six different ways. All produce ionization in the absorber to a degree determined by the gamma energy, intensity (total dose), rate of change in intensity with time (dose rate), and the absorber. The six ways are:

- Release of Compton recoil electrons (electrons which pick up additional energy from collisions with gamma or X-ray photons).
- Release of photoelectrons.
- Conversion of gammas to electron-positron pairs (a positron is a positively charged electron), thus destroying the photons.
- Transmutation of the absorber by reactions between gammas and neutrons.
- Heating of the absorber.
- Production of electron-hole pairs in semicon-

ductor materials as a result of the first three effects.

The photoelectric and Compton effects have a nearly equal share in creating excess charges in all materials at energies up to 1.02 Mev. The Compton effect occurs at all energy ranges, but declines once the 1.02-Mev level is reached; the range of interest is outlined in the diagram.

Electron-positron pairs begin forming at gamma energies of 1.02 Mev. This process is the only one able to completely absorb the gamma energy—it reappears as particle energy only at 1.02 Mev. When a positron meets an electron, both disappear and 1.02-Mev gamma radiation, the so-called annihilation radiation, is evolved. The electronics designer has little interest in the electron-positron pairs, since they are created only near the nucleus of a material having a high atomic number. It is the lower energy processes in lower-atomic-number materials that cause trouble.

The generation of excess electron-hole pairs in semiconductors is of paramount concern because the pairs move through the circuit as current. When current is produced near the junctions, which control semiconductor device action, a larger, secondary photocurrent is produced by the current-amplifying mechanism of the device. Momentary saturation of the device occurs, with a fivefold impact on circuit operation:

- The excess charge is drained through the power

supply, producing unwanted voltage and signal transients that may degrade or destroy system operation.

- Amplitude of the voltage transient depends on radiation intensity and circuit impedance; the duration depends on circuit time constants. The transient can cause mischief such as swamping out a digital clock pulse, or spuriously pulsing a digital circuit.

- Current transients may be high enough to drive discrete transistors into the negative-resistance portion of their collector current range, or cause junction breakdown. The transistors may be saturated until collector power is removed (latchup), or they may oscillate if gain and feedback conditions are just right. Latchup hasn't been observed in transistors undergoing nuclear irradiation, but can be induced by intense visible radiation causing thermal runaway, or by making collector-base voltage too high. Transistors, like IC's, will not latch up if the load line does not intersect the negative-resistance portion of the collector current and voltage curve.

- High-current transients can physically damage devices through I^2R heating of the junctions or leads. Neither element can pass much power because each is very small. A typical IC amplifier, for example, has package leads only 0.014 inch in diameter and internal leads 0.001 to 0.002 inch in diameter. Even moderate dose rates can produce damaging photocurrent peaks of several hundred milliamperes.

- Current transients may break down junctions in IC's that depend upon reverse bias for junction

isolation—the conventional technique. Forward biasing of pnpn junction pathways between transistors and resistors in the IC's may cause them to latch up. The pnpn action may also add to the transients' amplitude, melting the thin-film interconnections or the circuit leads. In any case, normal functioning of IC's like linear amplifiers is suspended indefinitely.⁷⁻⁹

Gamma absorption produces neutrons only at gamma energies that are specific in particular materials—at 1.56 Mev in beryllium, for example. Because the intensity of prompt gammas with sufficient energy is relatively low, the amount of neutrons so produced is usually an order of magnitude below the neutron bombardment resulting from the explosion.

The circuit designer need not be concerned with heating of the circuit components by gammas and X rays—if the radiation is intense enough to overheat the components, it would also have degraded the vehicle carrying the circuits beyond hope of recovery.³ This can occur at flux levels of 100 calories per square centimeter. Auto body sheet steel, for example, melts at a flux level of 130 cal/cm².¹

Shunting radiation transients

In transistorized equipment, the gamma-created photocurrent transients can be reduced to tolerable values by placing current-limiting resistors between the transistors and their power supplies. Care must be taken that the resistors do not introduce phase shifts, which could cause oscillation of the circuits even in nonnuclear environments.

Latchup in integrated circuits cannot be pre-

Inside the fireball

The only certainty about the nuclear radiation environment is that the energy spewed out of the fireball is enormous and shouldn't be conservatively estimated.

A 1-megaton explosion—not large by nuclear warfare standards, but equivalent to the detonation of a million tons of TNT—releases about a billion kilowatts of energy in just a fraction of a second. Since the volume of nuclear material in the warhead is small, it quickly reaches thermal equilibrium at temperatures of tens of millions degrees Kelvin. Then the fireball radiates thermal energy.

Warhead designers have many unpleasant tricks for upsetting the estimates of the energy levels of the different kinds of radiation. The bombmaker may increase the neutron flux, for instance, by varying the warhead casing.

Fission or fusion. Although there is a large variety of nuclear ex-

plosive combinations, most have certain common characteristics.

In principle, fusion energy can be produced from all elements having atomic weights of 1 (hydrogen) to 56 (iron). Fission energy is possible from iron to uranium-238, and from the transuranium elements. Californium (atomic number 98) is so prolific a source of neutrons that it fissions spontaneously—only a thimbleful has the explosive force of 10 tons of TNT.²⁶

A typical distribution of energy from fission of uranium and plutonium is given in the accompanying table, adapted from the book written by Samuel Glasstone of the Atomic Energy Commission.¹

Typically, the fission-fragment energy totals 160 million electron volts. Gamma energy averages 1 Mev, and neutron energy averages 2 Mev.

Hotter than the sun. Spectral distribution of the fireball's electro-

magnetic energy can be estimated, but only to a first approximation, with the quantum mechanical concepts embodied in Planck's black-body radiation law. Most of the initial radiant energy is in the form of soft X rays.

If the gamma intensity were actually as low as Planck's law indicates, 28 orders of magnitude less than the X rays, no designer would have to worry about gamma rays.

However, the gamma rays are produced by nuclear reactions in the fireball and proceed directly into space. Called prompt gammas, these rays create a radiation pulse of nanoseconds duration. Even a small fission explosion produces millions of kilowatt hours worth of gamma energy. It is the prompt gammas, not those in the radiant energy, that can be lethal at long range. Like the X rays, the gamma rays are attenuated in space by operation of the inverse-square law.

An important phenomenon at lower altitudes is production of a

vented in this way. Even if it were easy to put the extra resistors into the silicon chip, malfunctions could result simply because of the oscillations produced by the resulting phase shifts. Two other approaches have proven successful for preventing IC latchup.

In 1965, P.H. Ito, of Autonetics, developed a way of draining off the excess photocurrent. To reduce drain resistance, he attached a second substrate bias lead, as in the diagrams on page 104 of a general-purpose amplifier. The shunt in this example prevents forward biasing of the reverse-biased junction between a transistor and an adjacent diffused resistor. If the shunt were not used, forward biasing would occur and establish the potentially destructive pnpn path indicated by the dashed line under the shunt in the cross section.

The use of shunts may not be applicable in other IC's, particularly when circuit complexity permits the formation of many such pnpn paths.⁸⁻⁹ So a dielectric isolation technique may be used. This technique was first developed in 1963 by Donald McWilliams and his associates while he was at Autonetics.¹⁰

Dielectric isolation doesn't depend upon the maintenance of reverse bias during the radiation pulse. It sidesteps a big problem in double-diffused planar IC's—that minute variations in diffusion techniques may greatly increase the chances of junction-bias control being lost in an IC, causing latchup. Although several ways of dielectrically isolating IC elements have been reported,¹¹ only IC's with thermally grown silicon-dioxide dielectric (diagram on page 105) are being made in production quan-

ties. The Norden division of United Aircraft Corp. and Radiation Inc. are among the manufacturers of such IC's.

Excess charges produced by the radiation also produce transients in such components as diodes and resistors. These effects can also be limited by limiting the photocurrents. Capacitors and batteries are relatively unaffected because they already store comparatively large charges. Capacitors usually recover immediately from transient changes in voltage, although series resistances in some circuits may lengthen the duration of the transients.

Even though the circuit design controls the transients, it is still necessary to evaluate the effects of the transients upon overall operation and detailed performance characteristics of the system. This can be done by computer analysis, if suitable device models are available [see "Probing the unknowns—in a computer," p. 107], and by testing the design in flash X ray or linear accelerator facilities.

Neutron bombardment

Ordinary semiconductor devices begin to go awry at dose levels of about 10^{10} to 10^{12} neutrons per square centimeter. In space, this level can be expected about 100 kilometers from the fireball of a fission warhead. A fusion warhead might generate 10 to 100 times that many neutrons—or up to 10^{14} n/cm².

However, it has been estimated that transistors—which are highly susceptible to neutron damage—could be hardened to withstand 10^{14} to 10^{15} n/cm².¹² This would allow the circuitry to operate

secondary pulse of gamma radiation due to reactions between neutrons and nitrogen in the air.¹ Although such inelastic scattering gammas are less intense than prompt gammas, the secondary pulse lasts longer than the first. The circuit designer generally assumes the gamma radiation pulse is short, since dose rate rather than total dose is often of paramount importance in determining an explosion's lethal range.

Extra neutrons. With the exception of He⁴, neutrons react with every known element. Many reactions can take place in an exploding warhead to produce intense gamma radiation that persists for a long time. These increase the total

radiation dose given semiconductor devices and stretch the duration and intensity of the electromagnetic pulse. The use of cobalt 60 in a warhead creates such a dirty bomb.

Copious quantities of neutrons are produced at all altitudes, by fusion and fission bombs. Megaton yields are difficult to attain by fission alone, because of purely mechanical considerations. It is difficult to assemble the subcritical masses rapidly enough, even when the reacting atoms are required to move only through microscopic distances.

However, in the so-called hydrogen bomb the excess neutrons from a fission reaction can be used

to trigger fusion in a variety of light elements. The fusion reaction can be chosen to produce a surplus of fast neutrons. The fast neutrons then react with a third component, like ordinary uranium 238, to cause fission. The greater the mass of U²³⁸ in the warhead, the greater the explosion.

A fission warhead containing about 4 kilograms of uranium or plutonium will emit on the order of 10^{25} neutrons almost instantaneously; a fusion warhead containing the same weight of deuterium, tritium, or both, will spew out perhaps 10^{26} or 10^{27} neutrons.

The megatonnage of the warhead and the intensity of the radiation environment is presumably limited only by the payload capacity of the warhead's booster rocket. The best the electronic system can do, therefore, is to accept the military's estimate of the nuclear environment a given system will face and harden it to that level. That, at least, will make the attacker's job more difficult.

Fission energy breakdown

Kinetic energy of fission fragments	82.5%
Instantaneous gamma ray energy	3.5
Kinetic energy of fission neutrons	2.5
Beta particles from fission products	3.5
Gamma rays from fission products	3.0
Neutrinos from fission products	5.0

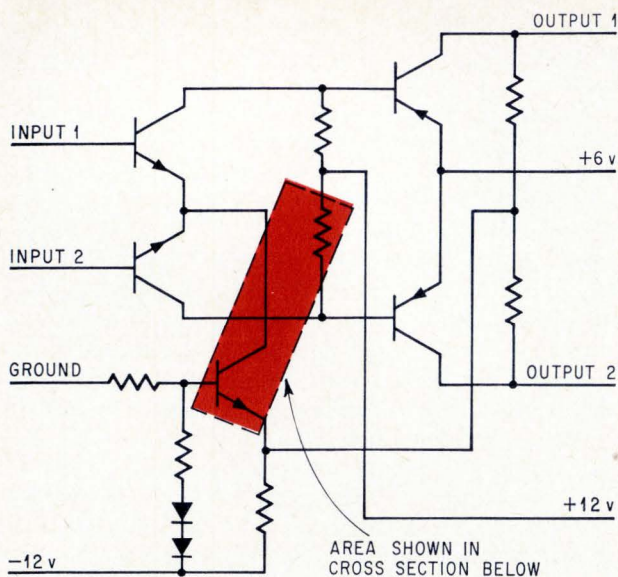

Photocurrent shunt. Radiation can induce photocurrents to travel through pnpn paths in integrated circuits. One such pathway in a general-purpose amplifier is shown in color and by the dashed line in color in the cross section. The extra lead to the -12-volt supply shunts the excess current.

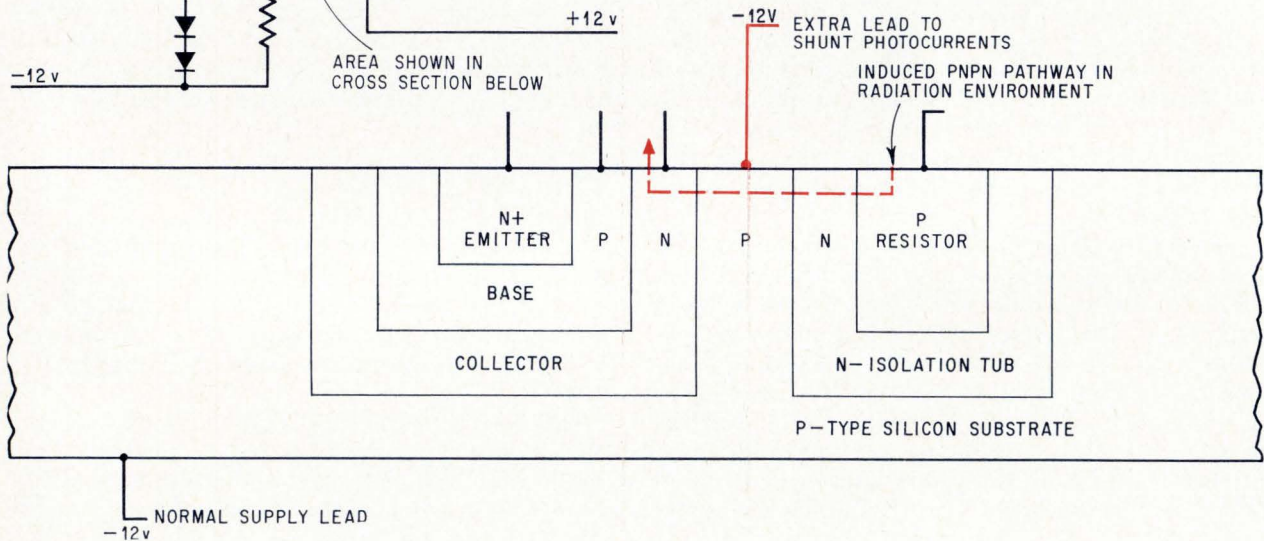

near the edge of a fission fireball's initial radius of 1 km. In the lower atmosphere, at least, where particle flux is quickly attenuated by the air, this is a reasonable target for neutron hardening. Achieving it, of course, would be an idle exercise if the system were not protected from heat and radiation as well.

The reactions between neutrons and matter can, like gamma radiation, cause ionization in the absorbing material. However, the ionization is inconsequential and transitory, compared with the permanent damage that neutrons can cause in semiconductors.

Fast neutrons may be reflected, chiefly by heavy elements, without substantial change in the energy of the neutrons. Practically all newborn fission neutrons are fast—that is, have energies greater than 1 kev—and the average energy of a fission neutron spectrum is typically 2 Mev, and can be as high as 8 Mev.

Reflection by elastic scattering of fast neutron energy results in acceleration of the absorbing nucleus of light elements. This effect can be expected in exposed semiconductors, and it causes heating, ionization, and displacement of the accelerated nucleus from its normal position in the crystal lattice. In transistors, this reduces the gain.

Ionization can be caused by moderation of the neutron's energy by inelastic-scattering reflection. This can generate gamma radiation (or cause fission in nuclear materials such as uranium and plutonium).

In addition, when the neutron energy is moderated to between 100 ev and 0.025 ev, the neutrons are selectively absorbed by all materials except He⁴ through a process known as resonant capture. This also causes fission or gamma emission.

At all energies, there may be nonresonant capture of the neutrons, leading to particle emission. The particles are usually electrons or positrons, but in light elements the particles are likely to be alpha particles, protons, or deuterons.

The probability of these three reactions occurring is usually small unless many of the neutrons are very slow thermal neutrons. These effects could be neglected, except that the warhead designer can increase the proportion of slow neutrons by using a suitable moderator in the material for the warhead casing.

One final effect is the disintegration of the neutron itself into a proton, electron, and neutrino. This isn't too important an effect in the atmosphere, since the neutron will probably react with matter during its 13-minute half life. In space, it can

produce measurable but not damaging ionization at distances of 5,000 miles.¹³ The electrons and protons are trapped by the earth's magnetic field and reach the atmosphere by spiraling around the field lines.

Self-healing transistors

Besides lowering transistor gain, lattice distortions by neutrons cause other mischief in semiconductor circuits. In diodes, they increase forward resistance. The voltage reference point of zener diodes become rounded and shifted.²⁷ Indeed, any characteristic that depends upon crystal structure is altered by the elastic scattering process.

Since proper device operation depends upon concentrations of only a few parts per million of donor and acceptor atoms in the crystal, all that's required to cause abnormal operation is but a few of these atoms to be knocked out of position, especially in transistor base regions.

If the heating that accompanies the displacement isn't high enough to crack the crystal or cause massive dislocations of atoms in the lattice—the thermal-spike effect—the damage may be partially healed by annealing. The displaced atoms may rediffuse in the lattice and resume their original function. The healing, like all neutron effects, is statistical and is known as short-term, or fast, anneal. The loss in transistor gain will not be completely recovered, however.

This effect was first reported by C.S. Roberts and V.H. Grineck at the 1959 Western Electronics Show and Convention.

Pulsed, rather than steady-state, neutron sources should be used to evaluate the effect. The loss in gain immediately after the pulse may be twice as great as the apparent loss measured later, after the healing has occurred. This was observed by H.H. Sander, who used the pulsed reactor facility at the Sandia Corp.,¹⁴ and by G.H. Page and G.B. Nunnally of Autonetics, who used the Triga F reactor at the General Atomic Corp.

If a steady-state neutron flux is used, degradation and annealing will be continuous, so that the degradation is gradual, as illustrated by the neutron-exposure curve, page 106. At a dose of about $5 \times 10^{11} \text{ n/cm}^2$, the transistor's gain has dropped

only a few percent. When this same dose is realistically administered as a massive pulse within milliseconds, the gain is driven down 50% and takes 100 seconds to come back to 75% of the initial value.

When three pulses occur in rapid succession, as shown in the multiple-burst graph, the gain will be driven down further and further since there is insufficient time for the healing to take effect. If the weapons system may be subjected to multiple bursts, the designer must weigh this possibility against mission duration. Full annealing only takes a few minutes, but the mission time itself may be no longer.

The annealing factors are independent of initial transistor gain and the radiation level.¹⁴ If the test is monitored with recorders fast enough to capture the short-term degradation and annealing effects, plots such as the quick-turnaround curve for an ic differential amplifier, page 106, can be obtained. Annealing began restoring the ic's gain after only 3 milliseconds of the 30-ms neutron pulse had elapsed.

Hardening against neutrons

The circuit designer might consider using transistors with an excess of gain, in anticipation of the loss. But in servocircuits, for example, this would cause control errors in a neutron-free environment. He could also use feedback to minimize the influence of transistor gain changes on overall circuit gain. But this technique is not a universal solution; it won't work for all transistors or all circuits.

It is better to harden each transistor or diode. This may be done with junction-fabrication techniques applicable to high-frequency devices. Narrower base regions, increased amounts of donor-acceptance dopants, and dopants that give higher base conductivities can be used. These expedients can offset the reduction in minority-carrier lifetimes, due to displacement of minority-carrier generators in the base region, which is the main cause of gain loss. The percentage of gain loss can thus be limited to acceptable values, provided the neutron flux is not high enough to cause excessive damage to the crystal.

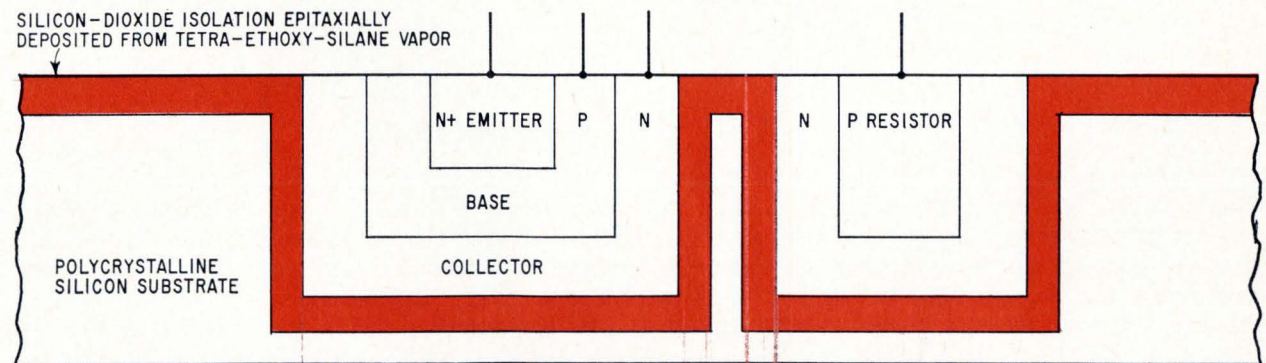

Dielectric isolation. Latchup, or saturation, of integrated circuits can be prevented by dielectric isolation of the IC elements. This eliminates the usual reverse-biased, diffused-junction isolations, so that forward biasing of such junctions by radiation transients is no longer a hazard.

Healing and anti-healing

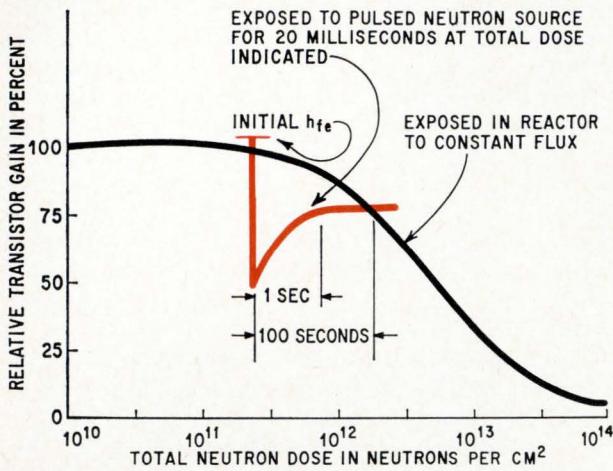

Neutron exposure. A transistor loses gain gradually in a steady neutron flux, as shown by the black curve. However, a quickly administered dose causes the gain to plunge, and only about half the loss is recovered, curve in color. Neutron energy in both cases was above 10 kev.

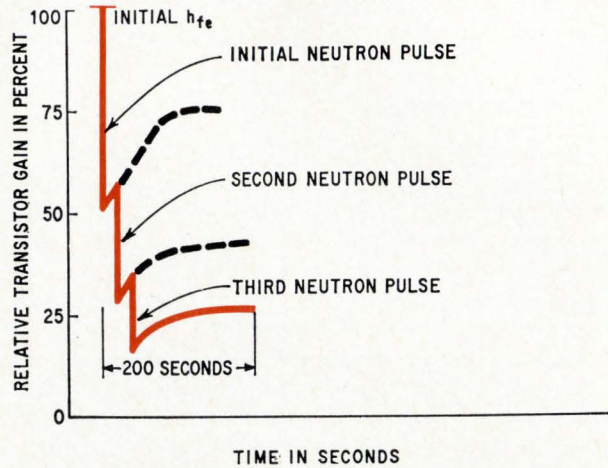

Multiple bursts. When the transistor receives several neutron pulses in succession, before annealing has time to restore much of the gain, the transistor may become useless. The color curve illustrates what might happen if the pulses were only 0.25 second apart.

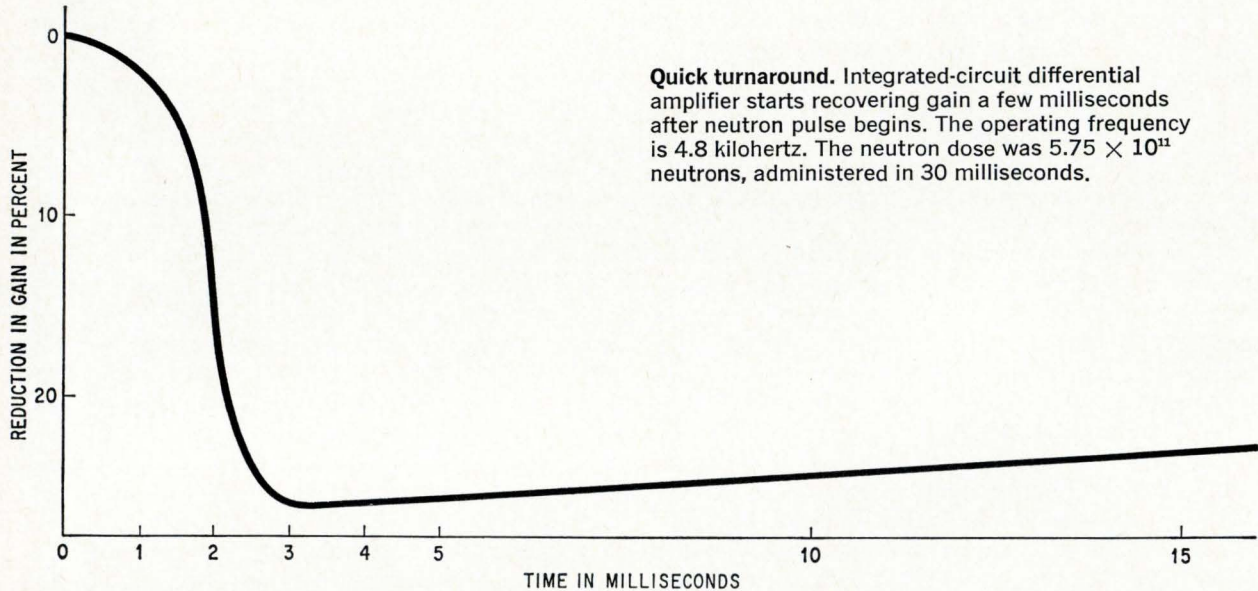

Quick turnaround. Integrated-circuit differential amplifier starts recovering gain a few milliseconds after neutron pulse begins. The operating frequency is 4.8 kilohertz. The neutron dose was 5.75×10^{11} neutrons, administered in 30 milliseconds.

The most serious limitation in this approach to hardening is that the base region of the transistors must be kept thick enough to withstand the punch-through voltage. Sometimes the thickness and gain requirements aren't compatible.

A more direct solution is to build the circuit with field effect transistors, which are less affected than bipolar transistors by displacement effects. Unfortunately, the hardening requirement is often tacked onto a procurement specification after the basic designs are frozen, and cost and schedule limitations make it impractical to redesign the system. One type of transistor cannot simply be substituted for another.

If the system is being built with integrated circuits, IC redesign need not require system redesign. Substitutions can be made as long as the IC's have

similar transfer functions. As was recommended for transistors, hardening can be accomplished by changing dopants, diffusion masks, and diffusion schedules—provided the IC manufacturer can determine which dopant to use.

Electromagnetic pulse

Chief cause of the electromagnetic pulse is apparently the absorption of gamma radiation by air. The high-velocity Compton electrons that are produced become a transient current if they are asymmetrically distributed.

If the explosion occurs in the ionosphere at an altitude of, say, 62.5 miles, the EMP at that height will be weak because of the lack of air and the dispersive effect of the ionosphere.¹⁵ The atmosphere will begin absorbing gamma photons at an alti-

tude of about 19 miles. The Compton electrons formed will be accelerated by the earth's magnetic field, giving rise to an EMP along the line of sight from the explosion to the receiver. Field intensity, it has been estimated, may reach 10,000 volts per meter.²

The lower the altitude of the explosion, the worse the EMP. The ground causes a charge asymmetry, causing a strong EMP with vertical electrical and horizontal magnetic polarization. H.H. Instron and P.A. Siddons have calculated a vertical electric field intensity of some 1,500 volts per meter at a distance of 62.5 miles from a 10-megaton explosion near the ground.¹⁶ The calculated EMP energy spectrum has a peak of about 10^{-6} joules per square meter per hertz at 10 kilohertz and a low of about 10^{-12} j/m²/hz at 20 megahertz.

Instron and Siddons estimated that EMP energy of 10^{-5} to 10^{-3} joules, depending upon the EMP frequency absorbed, is the minimum needed to damage a transistor. Therefore, an EMP pulse can damage solid state circuitry at considerable distances from an explosion unless the receiving area in the system is negligible. Other experimenters have also concluded that unshielded equipment can be severely damaged.¹⁷⁻²⁴

In accordance with Maxwell's field equations,

large differences in potential will be generated in electrically conducting surfaces, such as housings. If the structure is elongated, as a rocket, it will act roughly as a receiving dipole. Large currents will be induced due to the low characteristic impedance of a dipole (78 ohms) at its resonance frequency. The currents can be coupled to the circuitry through discontinuities in the housing, overloading the components with high-voltage pulses.

Shielding against the EMP

Complete electrical shielding of the electronics is the most effective method of hardening against the electromagnetic pulse. In aerospace vehicles, this isn't as simple as it sounds, because the vehicle skin isn't a continuous conductor; it is made up of hundreds of pieces of metal, and sometimes non-conductors as well, fastened together by such diverse methods as welding and cementing. The skins, furthermore, have numerous geometrical discontinuities, such as cable raceways, rocket nozzles, and access openings.

All of these odds and ends can act as antennas receiving some of the frequencies in the EMP. The current transients traverse the vehicle skin or unshielded conductors such as cables between booster rocket stages. Some of the transients will

Probing the unknowns—in a computer

Several automatic computer codes have been developed to simulate circuit or system operation in a nuclear environment. In essence, the designer puts mathematical models of the devices into the computer and has the computer manipulate their characteristics as he assumes they will be affected by radiation.

Two of the best codes have been developed by C.T. Kleiner and his associates at Autonetics. The first—TRAC, for Transient Radiation Analysis by Computer—simulates complex circuits.⁹ A newer version—Secure, for Systems Evaluation Code Under Radiation Environment—simulates entire systems. It has the astonishing ability to handle several thousand unknowns in one computer run.

TRAC, a Fortran-based code, when first released in 1965 was the most economical of all known codes. It is 10 times faster than the slowest codes developed elsewhere and 2½ times faster than the next fastest code. Also, it can simulate more complex circuits—up to 60 nodes. The validity of TRAC has been established by ex-

cellent correlation between its predictions of device behavior and results obtained when devices have been tested in radiation environments.

Like other design codes, these radiation codes allow assessment of a design without the actual construction and testing of circuits. However, these codes have a very special advantage over nuclear environment testing. Very short radiation pulses can be synchronized with any desired interval in a critical circuit waveform—for instance, the rising portion of a sharp square wave, or the brief interval between any two pulses in a long sequence of pulses. Such accurate synchronization is usually impossible in environmental tests using pulsed reactors or flash X-ray machines. Nor could actual explosions be synchronized, even if they were allowed.

Another important advantage is that the codes help the designer focus on important problems, such as whether total dose or dose rate has the greater effect on circuitry.

Generally, the dose rate influences transient behavior, while to-

tal dose determines the amount of permanent damage to devices and the extent of long-term changes in system behavior. One is typified by the nanoseconds duration of prompt gamma exposure and the other by neutron exposure lasting for milliseconds. The modeling techniques employed in TRAC and similar codes make such distinctions.

The use of current-limiting resistors to control current transients may drive a circuit into unwanted oscillation. This hazard can also be evaluated by TRAC. However, some systems are so complex that the code can only be used to examine critical portions one at a time. Then the designer has to compile the individual analyses in conventional ways to estimate overall performance degradation in given environments.

Autonetics' new code, Secure, is designed to overcome this problem by stimulating and analyzing the response of complete systems. It is capable of handling system models containing 5,000 to 10,000 unknowns—the typical number of unknowns in a weapons system that will be exposed to atomic explosions.

get into the circuitry. At a minimum, spurious signals run through the circuits. Integrated circuits may latch up. In extreme cases, the primary currents and the secondary currents (resulting from the effects described for gamma radiation) may cause overload failures.¹⁸

Since the designer cannot trust the skin as a shield, he should shield the electronics, using the devices employed as protection against radio-frequency interference. Outside wiring should also be shielded and access openings made as small as practical. Then, current-limiting impedances should be employed to protect the circuitry against primary overloads.

Heinrich Hertz, revisited

To test these measures, the equipment can be irradiated with r-f energy at the frequencies anticipated in the EMP (the military procurement agency generally specifies the EMP characteristics).

The test field needn't be as high as the anticipated EMP intensity. Attenuation by the shielding can be measured and extrapolated. For example, if a field strength of 10 volts per meter inside the housing would result in damage or spurious signals, the protection against external field strengths of 10 megavolts per meter can be evaluated. However, the field strength used in testing has to be high enough at the specified frequencies to allow the attenuation measurements to be carried down to the 100-decibel level. Otherwise the extrapolation won't be accurate.

Attenuation measurements take much time and, since all possibilities for entry of the transients into the system cannot ordinarily be covered, it is best to irradiate a full-scale mockup of the system with as high a field strength as can be produced. Currents in cables and potentials across terminal points can then be monitored by recorders placed inside the mockup. If the recorders were outside, the currents induced in the lead wires would garble the test results.

It isn't practical to simulate the actual amplitude and frequency characteristics of the EMP. But it can be approximated by a pulsed, variable-frequency microwave generator that gives field strengths of thousands of volts per meter. This can be done exactly as Heinrich Hertz did it, by discharging a capacitance of low inductance (less than 0.01 microhenry) that was charged to say 50 kilovolts. The discharge is across a spark gap located at the inner end of a simple dipole or monopole radiator of adjustable length. Near, or at, induction, field strength as a function of distance from such an antenna can be accurately predicted with a computer program developed by J.C. Shifman of Genistron Inc.²⁵

A 2-microfarad capacitor charged to 50 kv stores 2,500 joules. Discharging this energy in 1 microsecond gives a peak power in the antenna of some 2.5 gigawatts. The field strength in the megacycle range is rather high—remember that Hertz detected microwaves with simple antennas em-

ploying spark gaps that required gradients of some 30 kv (the breakdown gradient of air) to indicate reception.

References

1. Samuel Glasstone, "The Effects of Nuclear Weapons," U.S. Govt. Printing Office, Washington, D.C., 1964.
2. W.J. Karzas and R. Latter, "Electromagnetic radiation from a nuclear explosion in space," *Physical Review*, Vol. 126, June 15, 1962, p. 1919.
3. Rex Pay, "New effort aimed at X-ray protection," *Technology Week*, Jan. 2, 1967.
4. Personal communications from J. McDougal nuclear technology dept., TRW Systems Group, TRW Inc., Redondo Beach, Calif.
5. W.R. Beam, "Electronics of Solids," McGraw-Hill Book Co., New York, 1965.
6. D. McWilliams, et al, "Investigation of Laser Radiation Simulation for Microelectronic Device Hardening," AFCRL-67-0102, TRW Systems Group, TRW Inc., Redondo Beach, Calif., 1967.
7. C.T. Kleiner, G. Kinoshita, and E.D. Johnson, "Simulation and Verification of Transient Nuclear Radiation Effects on Semiconductor Electronics," IEEE Conference on Radiation Effects, Seattle, Wash., 1964.
8. G. Kinoshita, C.T. Kleiner and E.D. Johnson, "Radiation-Induced Regeneration Through the P-N Junction Isolation in Monolithic IC's," IEEE Conference on Nuclear and Space Radiation Effects, University of Michigan, Ann Arbor, 1965.
9. C.T. Kleiner, "Predicting the Effect of an Ionizing Pulse of Radiation on Semiconductor Electronics," National Aeronautical Conference, Dayton, Ohio, 1965.
10. D. McWilliams, C. Fa, G. Larchian, and O. Maxwell, "A New Dielectric Isolation Technique for High Quality Silicon Integrated Circuits," Electrochemical Society, Toronto Meeting, May 1964 (Abstract in *Journal of the Electrochemical Society*, 1964, p. 153C).
11. Donald Christiansen, "A challenge: to integrate and isolate," and A.I. Stoller, J.A. Amick and N.E. Wolff, "Getting the most out of circuits with dielectric isolation," *Electronics*, March 20, 1967, pp. 91-105.
12. TREE (Transient Radiation Effects on Electronics) Handbook, Battelle Memorial Institute, Columbus, Ohio, 1963.
13. J.A. Kuypers and V.W. Vodicka, "Nuclear Electromagnetic Effects on Power, Communication, Command and Control Systems," IEEE National Winter Convention on Military Electronics, Los Angeles, 1964.
14. H.H. Sander, "Room Temperature Annealing of Silicon Transistor Parameters Degraded by a Burst of Neutrons," Sandia Corp., Albuquerque, N.M., Report SC-R-64-192, 1964.
15. Personal communications from P. Malmud, quantum physics department, TRW Systems Group, TRW Inc., Redondo Beach, Calif.
16. H.H. Inston and R.A. Siddons, "Electromagnetic Pulse Research," Final Report No. T-1029-6, IIT Research Institute, Chicago, August 1965.
17. L.J. Johnson, A. Lucic, and D. McGuire, "Electromagnetic Interference Simulations," IEEE 7th Symposium on Electromagnetic Capability, New York, 1965.
18. C.G. Patocka and J.W. Cox Jr., "Voltage Transients for EMP Evaluation," IEEE Region Six Annual Conference, Tucson, Arizona, 1966.
19. J.B. Hays, "Protecting communications systems for EMP effects of nuclear explosions," *IEEE Spectrum*, May 1964.
20. A.S. Kompaneets, "Radio Emission From an Atomic Explosion," *Soviet Physics, JETP*, Vol. 35 (8) No. 6, June 1959.
21. R.L. Waters, G.F. Roberts, and F.J. Morris, "A Broadband Magnetic Impulse Measurement Technique for EMP," IEEE 7th Symposium on Electromagnetic Compatibility, New York, 1965.
22. K. Sittel, "Effects on Radar of Plasma Produced by High Altitude Nuclear Detonations," RCA Missile & Surface Radar Div., Moorestown, N.J., 1966.
23. Seventh International Conference on the Physics of Semiconductors, Paris-Royaumont 1964, 3, "Radiation Damage in Semiconductors," Academic Press, New York, 1965.
24. V.S. Vavilov, "Effects of Radiation on Semiconductors," Consultants Bureau, New York, 1965.
25. J.C. Shifman, "A Simple Method for Predicting Field Intensity Near a Rod Antenna," IEEE 7th Symposium on Electromagnetic Compatibility, New York, 1965.
26. E.K. Hyde, J. Perlman, and G.T. Seaberg, "The Nuclear Properties of the Heavy Elements," Vol. 3, "Fission Phenomena," Prentice Hall, Englewood Cliffs, N.J., 1964.
27. H. Oleson, "Designing against space radiation," *Electronics*, Dec. 28, 1964, p. 61 and Jan. 11, 1965, p. 70.

ANALOGICAL CIRCUIT TECHNIQUE

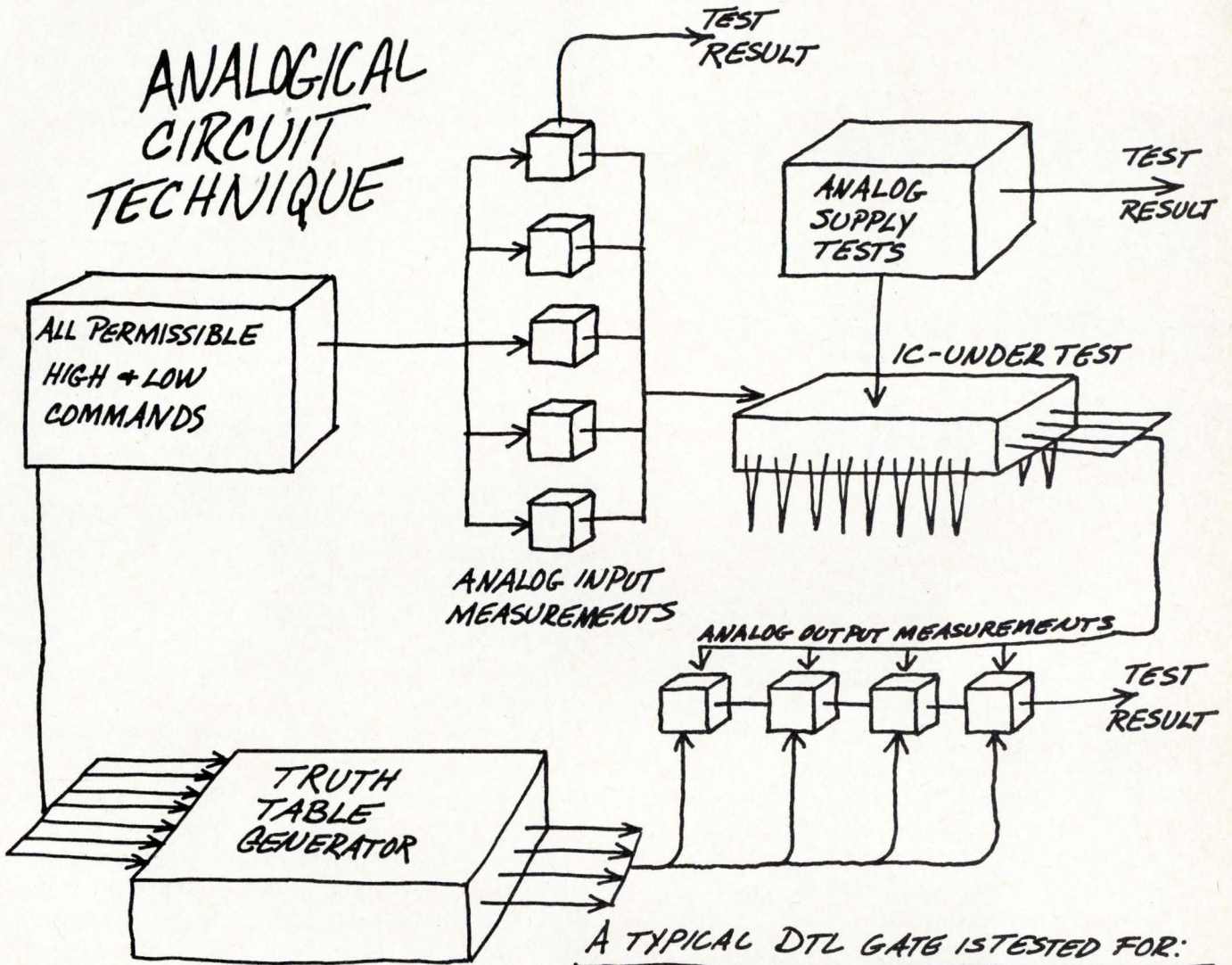

A TYPICAL DTL GATE IS TESTED FOR:

$I_{IN HI}$	5.1 mA MAX @ 4.1 V
$I_{IN LO}$	1.1 mA MAX @ 1.1 V
$V_{OUT HI}$	2.6 V MIN @ 0.12 mA
$V_{OUT LO}$	0.45 V MAX @ 12.0 mA
I_{CC}	16 mA MAX @ 5.0 V

Intriguing, isn't it, this new way of testing digital integrated circuits?

Now you can make sure ALL of your ic's will work — because you can make both parameter and functional tests simultaneously, and for all permissible combinations of inputs. □ It's done by exercising all the LOGICAL inputs on the ic-under-test and selecting the appropriate ANALOG measurements that should be made. 5,000 such measurements are made in 1/100 of a second.



TERADYNE

□ Even more exciting, our Analogical Circuit Technique is available on a little machine that weighs only 25 lbs. It's a cinch to program, and costs only about \$5,000. □ We call it ACT 1 (because of the fortunate acronym). □ To learn more about analogical testing, just write: ACT 1, Teradyne, 183 Essex Street, Boston, Massachusetts 02111. SEE YOU AT WESCON '67, BOOTH 3207

What have you made lately that'll last 1247 years?

Not much? Well, maybe we haven't either. But if you're asking, "What do you mean, *maybe?*" ... the truth is, we couldn't swear our parts *won't* last that long.

You see, 1247 years is 10,924,000 hours, and that's how many diode hours of operating life at full power we've logged without a failure. Everybody knows that doesn't prove our parts will last 1247 years. We know that.

But how can we be *sure?*

We've been using this space for almost a year now to tell you our diodes are virtually guaranteed to never fail. Ever. We can do that because we know how they're made and how they're tested.

We don't say you might not have to pay a little more for this kind of dependability. But then, we knew from the beginning, when we decided we were going to make a demonstrably superior product or nothing, there'd be some applications that just wouldn't need parts as good as ours.

That's alright. We knew we couldn't sell everybody.

But we also knew our parts could be a life-saver to the engineer who really *needs* miniature components that have high power and tremendous surge capacity. That can last almost forever with no change in electrical parameters.

It's on account of how they're made. Altogether different. The metallurgical bond that joins the silicon between the two terminal pins is stronger than the silicon itself. Then we fuse a hard glass sleeve to the entire surface of the silicon, so you have a void-free monolithic structure.

That's why every Unitrode diode can handle as much energy in the avalanche as in the forward direction. That's why you can apply full PIV to a Unitrode at high temperature for weeks at a time with no damage. That's why we can't even find a machine that can fail our diodes in acceleration and shock tests.

Still, there may be new tests we'll find — new conditions we'll learn about. And maybe our diodes won't last 1200 years. Maybe they'll only last 800 years ... or 400 ... or 200 ...

If this is the kind of reliability you're trying to build into what you're making, you might get some comfort from trying our parts. We're at 580 Pleasant St., Watertown, Mass. 02172. Telephone (617) 926-0404. TWX (710) 327-1296.

UNITRODE®



Down-to-earth Army antenna

Built low and compact for field radio operations, a vertical loop is easy to transport and set up. Early square-shaped models got high efficiency ratings, and an octagonal version is even better

By Kenneth H. Patterson

Army Limited War Laboratory, Aberdeen Proving Ground, Md.

Fight fans say a good big man will beat a good little man every time. But Army signalmen setting up radio sites in the jungles of Vietnam would much rather use a small radio antenna with adequate efficiency than a larger, more efficient one that has to be strung on high masts. Mobility and concealment are high-priority features in a guerilla war.

For communications at medium and high frequencies, the Army normally uses various forms of long wires, dipoles, and rhombics. To be reasonably effective, the long wire should be a minimum of about 100 feet (plus a good ground), the dipole should be at least twice as long, and the better rhombics can exceed 600 feet. In addition, all of these antennas should be elevated to a minimum height of about 40 feet, with 80 feet being better. Such space and height requirements are invariably so difficult to meet that compromises are usually made in the field.

But a solution has been developed at the Army Limited War Laboratory at Aberdeen Proving Ground, Md. A vertical loop antenna (in the shape of an equilateral octagon, 5 feet to a side) has been built that doesn't have to be raised above the ground. Despite the inherently low radiation resistance of a loop, the new design usually does as good a job as a full-length dipole 40 feet above the ground, even though the length of the dipole

is about 234 feet at 2 Mhz and 94 feet at 5 Mhz.

One can get an idea of the difference between the low-height performance of vertical loops and horizontal dipoles by visualizing their basic characteristics. The most significant consideration is the effect on the signal of reflection from the ground.

The theory of image antennas tells us that vertically polarized signals are reflected by the earth without a phase shift. Horizontally polarized signals, on the other hand, are phase inverted upon being reflected. The exact amount of inversion depends on orientation, but in most instances it can be expected to approximate the full 180°. It then follows that when the dipole antenna is used at heights lower than about $.12\lambda$, the reflected wave has a cancelling effect on the incident wave. In fact, zero height and a perfectly conducting earth are conditions that cause total cancellation and zero radiation.

Hit the dirt

Under the same circumstances, however, the reflected wave from a vertical loop combines with the incident wave under what is predominantly an in-phase condition. This quite naturally results in an increase in the amount of energy radiated in useful directions. With greater proximity to the earth, therefore, the radiation from the loop may actually improve. It cannot, of course, exceed a limit of twice its radiation in free space.

A close examination of the expressions for the radiation resistance values of the two antenna types, including the height-modifying terms, shows the loop approaching twice its free-space value as a function of decreasing height, while the horizontal antenna goes to zero.

If we wish to operate our antenna at a really low height, therefore, we must use vertical polarization. And if we cannot accept a null in our overhead

The author

Kenneth H. Patterson, who has been developing electronic communications equipment since 1923, designed the loop antenna described in his article. Before joining the Army Limited War Laboratory, he was chief of radio frequency development at the Ballistic Research Laboratories at Aberdeen. There he supervised work on a large portion of the instrumentation used to measure missile performance at the White Sands, N.M., range.

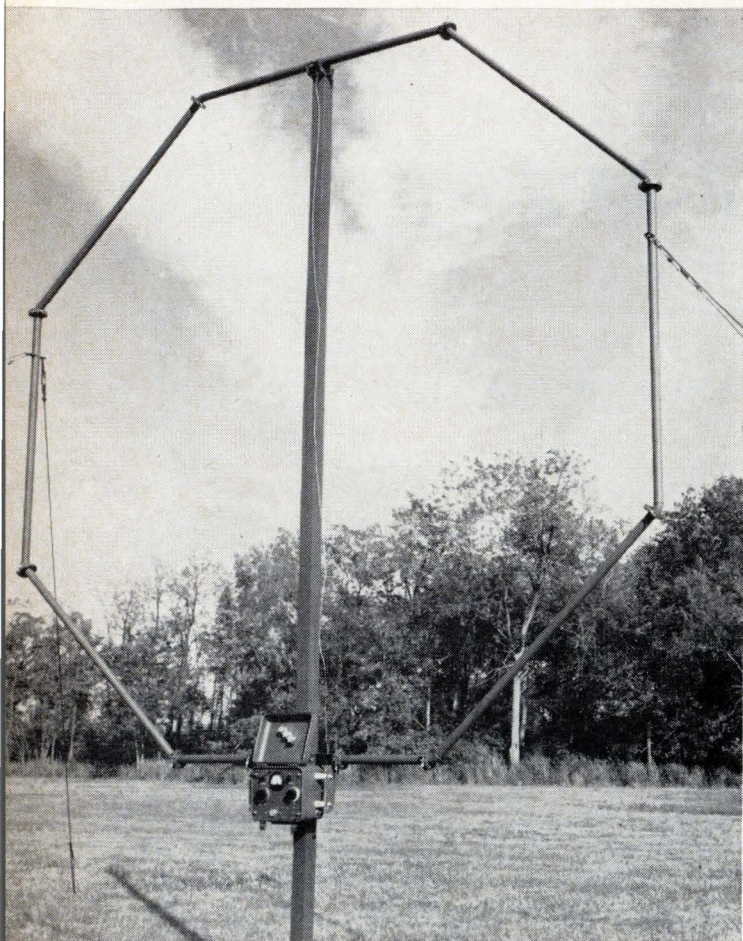

Will travel. Octagonal loop antenna with 5-foot sides is easily set up, dismantled, and transported. Efficiency near the earth matches that of conventional elevated antennas as long as several hundred feet.

pattern, we are restricted to a vertical loop. The problem is to improve the efficiency of the loop antenna.

Besides solving spatial and height problems, the antenna developed at Aberdeen:

- is operational from below 2.5 Mhz to above 5.5 Mhz—although tuning ranges as great as 10:1 are possible;
- offers a pattern factor well suited to both short- and long-range ionospheric propagation with no overhead nulls;
- has a predicted efficiency level of from 20% to 80% throughout the operational band. (Future models will do much better.);
- is self-supporting in use;
- can be transported by a small vehicle when packed;
- can be set up or dismantled by a crew of no more than three men in less than 30 minutes;
- doesn't require an artificial ground plane;
- has sufficient strength to withstand normal wind and rain storms.

The power rating, determined by the voltage breakdown and current ratings of the capacitors used in the matching network, is arbitrary. A 1-kilowatt version has been built.

The loop isn't being suggested as the best design for every antenna application. It won't, for instance, outperform the large rhombic in specific low-angle unidirectional tasks. But the loop can do the job at installations where real estate is limited and a complex of high antenna masts is impractical.

Field tested

Loop antennas, some shaped as squares and others as octagons, have undergone extensive field trials in the U.S. and Vietnam. The results in all cases have been excellent.

Before the loop was selected, other configurations were considered and rejected. Grounded verticals, or whips, were ruled out because of their height and their inherently restricted radiation pattern.

The horizontal series-fed antennas, including dipoles, long wires, V's, and rhombics, were also dismissed because of their height requirements. As noted before, the radiation resistance of these antennas approaches zero as height is reduced. (Radiation resistance is obtained by dividing the total radiated power of an antenna by the square of the effective antenna current measured at the point where power is supplied.)

The vertical loop, being compact and vertically polarized, and having no overhead null in its pattern, got the nod almost by default. The superior low-height performance of a loop antenna was suggested to the Proving Ground by David Sunstein of the General Atomics Corp., Philadelphia.

To improve the loop's efficiency, two problems had to be solved: radiation resistance (R_R) had to be increased, and the sum of all other losses (R_L) had to be reduced. To assess the problems and the expected efficiency (E), the standard efficiency equation was used—efficiency equals radiation resistance divided by the sum of radiation resistance and R_L .

Cutting losses

The two principal sources of loss in a loop antenna are the inherent resistance in the conductor used to form the loop and the resistance in the antenna-matching network.

In considering the losses in the matching network, it was decided the antenna would be driven from a 50-ohm or 70-ohm coaxial line, thus requiring the input portion of the matching network to handle the comparatively high currents characteristic of low impedance levels. Particular care was taken in the design of the input part of the network to reduce the normal resistive power losses to a practical minimum.

To do this, the customary taps or links, with their inherent resistive losses, were discarded in favor of variable air-dielectric and fixed mica capacitors, both of which have low loss characteristics. The schematic diagram of this matching network on page 113 is conventional except that the low-value, high-impedance capacitor is divided into two equal sections to provide a close—though not pre-

cise—balance with respect to ground, and to permit higher voltages. For low-power applications where the emphasis is on portability, the second tuning capacitor is omitted.

In either balanced or unbalanced form, the capacitive matching network is practical, versatile, and efficient. Matching losses can be cut to the point where they can be ignored in many instances. If a loop with a high ratio of inductance to capacitance (L/C ratio) is attempted, however, a significant portion of the circulating current flows through the stray (shunt) capacitance and a poor match and an inefficient coupling condition results. This could occur, for example, if the operating frequency is raised to a level closely approaching the self-resonant frequency formed by the loop inductor and the stray shunting capacitance.

In using the matching network, the transmitter is turned on. With the arrow on the pick-up probe in the "REFL" direction the meter reads the reverse power level. The controls are adjusted to the deepest null until the meter reads zero, indicating a perfect match. The transmitter power can then be advanced to a maximum level and the pick-up probe rotated to "FOR" to read the forward power level.

The method selected to reduce loss in the loop

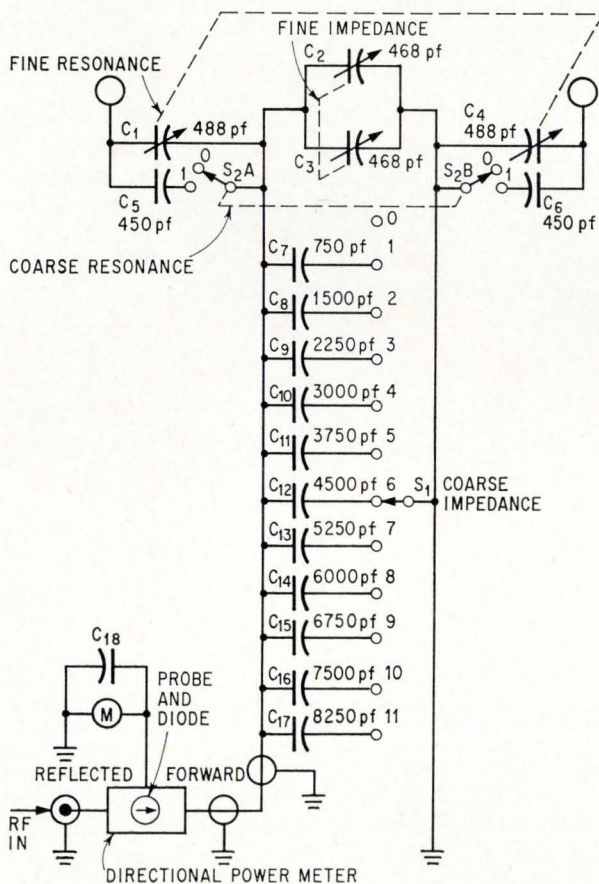

Indicator. The arrow on the front of the probe assembly indicates whether forward or reflected power is being provided by the pickup link. The link applies this energy to an r-f rectifier whose d-c output drives the power meter movement.

itself is a straightforward brute-force technique using conductors with an exceptionally large surface area. In the majority of the models built to date, the loop conductors are composed of 1½-inch tubing. With such large conductors, the r-f losses due primarily to skin effect are sharply pared.

Radiation resistance

The next step in improving efficiency is to obtain the greatest practical radiation resistance. This involves another classic equation:

$$R_R = 3.12 \times 10^4 [NA^2/\lambda^2]^2$$

where R_R = the approximate radiation resistance of a small loop.

N = the number of turns in the loop.

A = the area enclosed.

λ = the wavelength of the frequency being used.

The dimensional terms are expressed in the same units, squared or lineal.

The equation shows that two parameters, N and A , may be controlled to possible advantage. In the case of N , imagine a small loop antenna composed of a single turn shaped to form a square 3 feet on a side. Further assume that in all cases a very short drive cable is used, a low-to-moderate L/C ratio is employed, and losses in the capacitive matching network are negligible. In other words, essentially all the losses in this antenna stem from resistance in the wire conductor. Under these circumstances, the losses (R_L) are, to a great extent, directly proportional to the total length of the conductor.

As one would expect, the efficiency of this imaginary reference antenna is extremely low. In fact, if it were made of 18-gauge copper wire, the computed free-space efficiency at 3 Mhz would be a mere 0.0457%.

If the number of turns in a 3-foot-square loop were increased to three, the radiation resistance would be increased by a factor of nine. Unfortunately, the extra turns in this example also increase the loss resistance by a factor of three. Consequently, the efficiency improvement is reduced to a net factor of three; this is a reasonably significant improvement, but efficiency is still intolerably low.

The same conductor used for the three-turn loop can be reshaped to form a single-turn square loop with 9-foot sides, increasing its area by a factor of nine. Since R_R is proportional to A^2 , the radiation resistance is now greater by a factor of 81. Here again, however, the losses are three times greater, resulting in a net efficiency improvement factor of 27. Using 18-gauge copper wire, the free-space calculated efficiency of this antenna is 1.23% at 3 Mhz and 13.1% at 6 Mhz.

Unless extremely severe restrictions are imposed on space, therefore, the largest practical single-turn loop is preferable to a smaller multiturn unit.

Shaping up

The final consideration is form. Efficiency has been shown to be highest when a fixed-length peri-

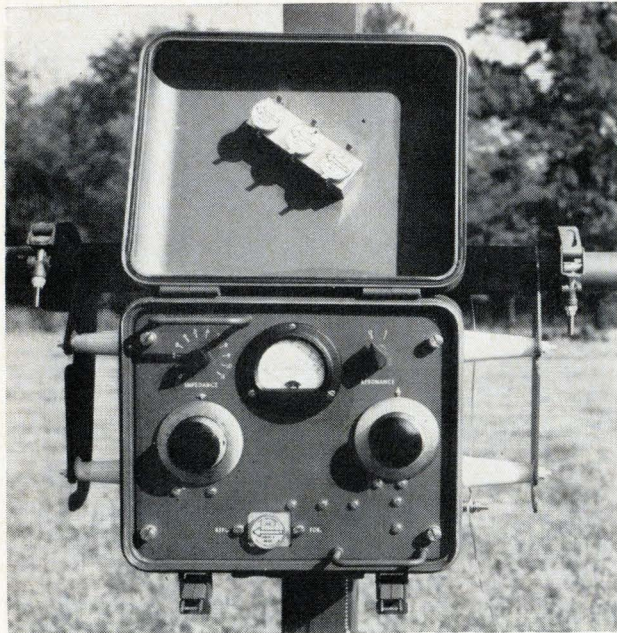

Precise tuning. Reflected power meter permits fine tuning and exact matching, and monitors forward output power level. The coarse adjustments make discrete, step-by-step changes, while the fine controls provide continuous variations overlapping the coarse steps.

meter encloses the greatest possible area. A circular configuration is best from a performance standpoint, but practical factors, such as the types of commercial tubing available, must be considered. This is especially true of developmental models, which are most economically built with straight tubing and "els."

Comparisons were made between a square, an equilateral octagon, and a circle, all of the same total perimeter. The octagon encloses 20% more space than the square, and the circle 29% more. Since radiation resistance is proportional to the square of the area, the radiation efficiency of the small octagon loop exceeds that of the square by about 45%, while the circular loop outperforms its square counterpart by about 65%. But because straight tubing packs more compactly, is more readily available, and is much cheaper than the circular kind, the octagon shape was chosen. The size—5 feet is the maximum length for any part—was held down so the antenna could be easily disassembled and carried in a small motor vehicle.

With the loss reduction achieved, the loop antennas that have been built provide a calculated free-space efficiency of about 22% at 2.5 Mhz and about 77% at 5 Mhz.

In the final analysis, however, an antenna's efficiency, or, perhaps more important, its effectiveness, must be proven in field tests.

As noted before, preliminary tests in the U.S. were followed by several hundred more conducted by the Army in Vietnam. Numerous frequencies and different ranges were used at various times of day in the later trials. Also, the tests were at all times confined to relatively low power levels, usu-

ally on the order of a few watts.

Nevertheless, all contacts attempted in Vietnam were not only 100% successful, but, with few exceptions, were rated "perfect." These few exceptions were never ranked lower than "good."

Competitive trials

The earlier U.S. tests, however, were perhaps more informative in providing direct comparisons between the loop and other antennas. As a matter of fact, the octagonal loop made of 1½-inch tubing is actually a second-generation model. For convenient construction, the earlier developmental models were constructed in a square shape and formed from ¾-inch tubing. Later tests have revealed a very significant 8-decibel superiority for the octagon version over the square.

Despite this, however, the square models showed themselves to be effective radiators in the early trials. In numerous ionospheric field tests conducted between Aberdeen Proving Ground and two widely separated mountain valleys in the Alleghenies, the square loop proved, in almost all instances, as effective as a full-sized dipole, and actually surpassed the dipole in most matchups. Several frequencies between 2.5 Mhz and 5.5 Mhz were used, and in each instance the dipole was cut to the optimum length. Furthermore, the dipole was strung in a cleared area at a height of 40 feet, while the bottom of the loop was only 4 feet above the ground.

In one field test to determine ground-wave propagation over a distance of two miles, a dipole supported at a height of 6 feet delivered a measured field strength of about 68 microvolts on a transmitter power of 6 watts. The square loop gave about 600 microvolts on the same power, and the octagon produced approximately 1,500 microvolts. The frequency used was 3.275 Mhz—not the best for the small loops.

It's true that the dipole's propagation in this particular test suffered from a less favorable polarization. But polarization characteristics are basically inherent and have to be considered in choosing antennas for operation at low heights.

Modifications

Though the octagon loop is a second-generation version, further improvements are being made. With the fiberglass mast used in some recent models, a single soldier can set up the antenna. For some applications, the diameter of the tubing can perhaps be advantageously increased from the present 1½ inches to 3, 4, or even to 6 inches. For other applications, the usual output tank circuit and matching network can be eliminated if the final amplifier is located close to the loop. The loop then can serve as both the radiation element and the final tank circuit, a technique especially useful where power is low and portability a prime requisite. Models of such long-range, highly portable antennas have been successfully tested at the Limited War Laboratory.

Leadership

15 ohms ON resistance with only 8.0 pf drain to gate capacitance solved critical FET switch applications



SPECIFICATIONS—TYPE 2N4977

- ON Resistance: 15 ohms max
- Drain to Gate Capacitance: 8.0 pf max
- Input Capacitance: 35 pf max
- Reverse Transfer Capacitance: 8.0 pf max
- Temperature Range:
Operating -55°C to 150°C
Storage -55°C to 200°C
- Breakdown Voltage Drain to Gate: 30v min
- Drain Current, Zero Gate Voltage: 50mA min
- Pinch-off Voltage: 10v max
- Gate Leakage Current: 0.5 nA max

Price:	1-99	100-999
	21.50	14.00

Available from stock in TO-18 package

AMELCO SEMICONDUCTOR

DIVISION OF TELEDYNE, INC. • 1300 TERRA BELLA AVENUE • MOUNTAIN VIEW, CALIFORNIA • Mail Address: P. O. Box 1030, Mountain View, California • Phone: (415) 968-9241 • REGIONAL OFFICES: East—Westwood, Mass., 805 High Street, (617) 326-6600; Melville, L. I., N. Y., (516) 692-4070; Syracuse, N. Y., (315) 437-8343; Paterson, N. J., (201) 696-4747; Glenside, Pa., (215) 887-0550; Towson, Md., (301) 825-3330; Orlando, Fla., (305) 423-5833 • Midwest—Des Plaines, Ill., 650 W. Algonquin Rd., (312) 439-3250; Cedar Rapids, Iowa, (319) 366-0635; St. Louis, Mo., (314) 427-7200; Farmington, Mich., (313) 474-0661; St. Paul, Minn., (612) 488-6634; Columbus, Ohio, (614) 299-4161; Dallas, Texas, (214) 631-6270 • Northwest—Home Office, Mountain View, Calif.; Los Altos, Calif., (415) 941-0336; Seattle, Washington, (206) 323-5100 • Southwest—Los Angeles, Calif., Suite 213, 8621 Bellanca Ave., (213) 678-3146; Los Angeles, Calif., (213) 870-9191; San Diego, Calif., (714) 298-4711; Phoenix, Ariz., (602) 277-9739; Albuquerque, N.M., (505) 268-0928; Littleton, Colo., (303) 798-8439 • Canada—Montreal, P.Q., (514) 384-1420.

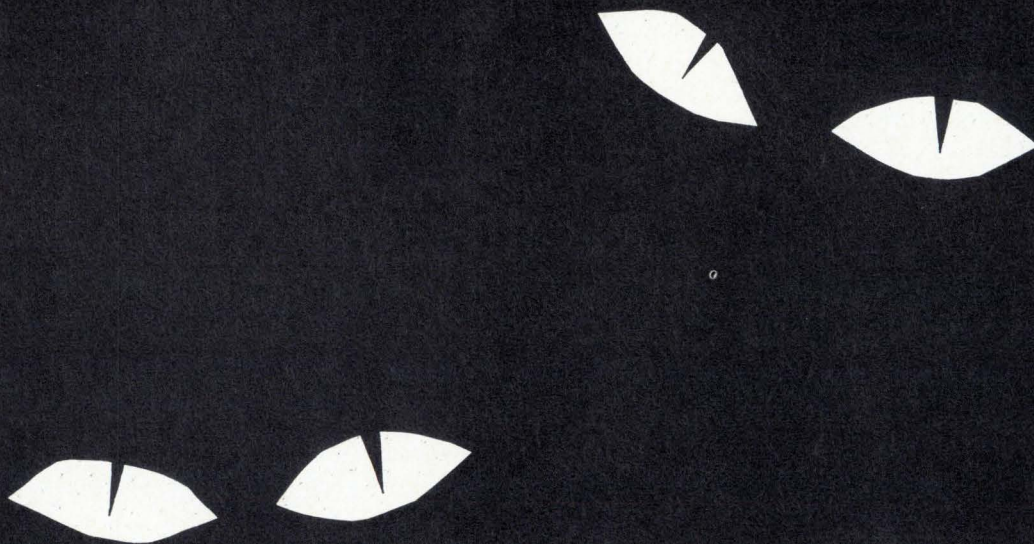

**If you want to see
as well as these eyes,
use the MTI Image Orth**

Nocturnal animals see well in the dark. MTI Image Orthicon television cameras see almost as well. We're specialists in low light level television equipment. In fact, the largest manufacturer in the world. And our equipment will pick up an

image in near total darkness. A pin hole of light is more than enough. Or more specifically, at 1×10^{-5} foot candles of ambient light (approaching total darkness).

This is but one research application. The possibilities in all fields

are endless, as research is discovering every day. If you have need — call us. We'll be there to help . . . quickly with quality.

mti MARYLAND TELECOMMUNICATIONS, INC.
York & Video Roads, Cockeysville, Md. 301-666-2727 World's largest manufacturer of low light level television cameras.



you get a choice,



not a challenge

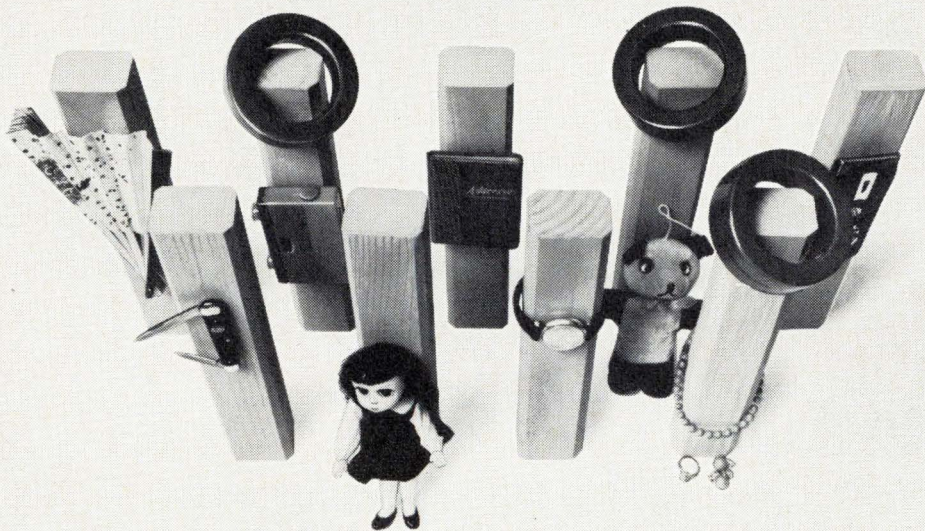

Industry's widest selection of powder cores gives you greater design flexibility

The trend toward smaller circuits and higher density packaging has posed a compaction problem for electrical design engineers—finding quality components small enough to do the job. Magnetics gives the designer more “elbow room” by providing the industry's most complete line of moly-permalloy powder cores—sizes as small

as 0.110" I.D. in the widest range of permeabilities and stabilizations.

We also give the designer involved with highly critical inductor stability factors more latitude with guaranteed temperature stabilization in miniature powder cores. All of these types are designed so they can be wound on present miniature toroidal winding equipment. The “M” type limits the change in inductance to $\pm 0.25\%$ from -65 to $+125^\circ\text{C}$. The “D” type limits the

change to $\pm 0.1\%$ from 0 to 55°C . The “W” type limits the change to $\pm 0.25\%$ from -55 to $+85^\circ\text{C}$. These stabilizations are available in all sizes and permeabilities.

If condensing a circuit design is your bugaboo, check Magnetics' powder core line—the one that gives you a choice, not a challenge. For the complete story, write Magnetics Inc., Butler, Pa. 16001

MAGNETICS inc.
®

Guard water purity...
Produce chemicals...
Run steam power plants...

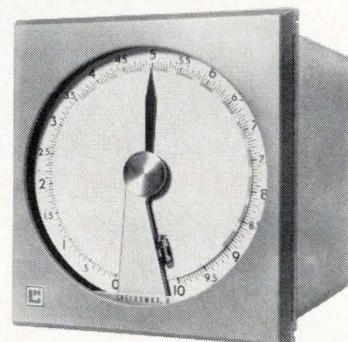
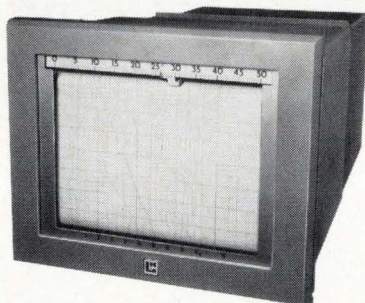
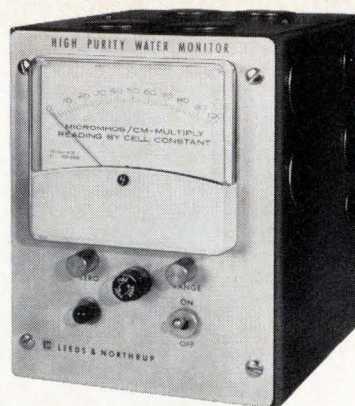

with help from
LEEDS & NORTHRUP

and Keystone
Thermistors

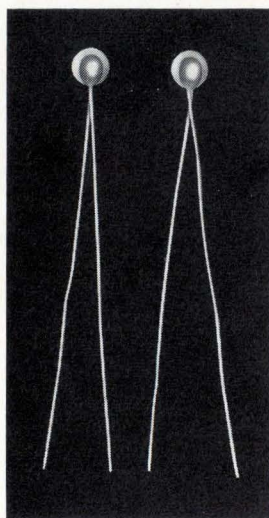

These tiny Keystone Thermistors are components of temperature compensators in a number of Leeds & Northrup Company electrolytic conductivity instruments—serving such applications as water purification, chemicals production, steam power generation and many other processes involving operation throughout a wide range of ambient temperatures. Let us consult with you on your thermistor requirements. KEYSTONE CARBON COMPANY, St. Marys, Pa. 15857.

Keystone
leads

in creative thermistor technology

"Alpac Sr." New High Current Rectifier Circuits

Capable of handling the highest currents in the smallest overall package, the "ALPAC SR." rectifiers are designed to replace multiple stud rectifier and multiple isolated heat sink usage. These low cost rectifier circuits have completely insulated terminals, thermally joined to a large area aluminum base.

Internally, "ALPAC SR." utilizes double tungstaloid pin rectifiers electrically and thermally bonded to large copper buss bars, which also serve as terminals.

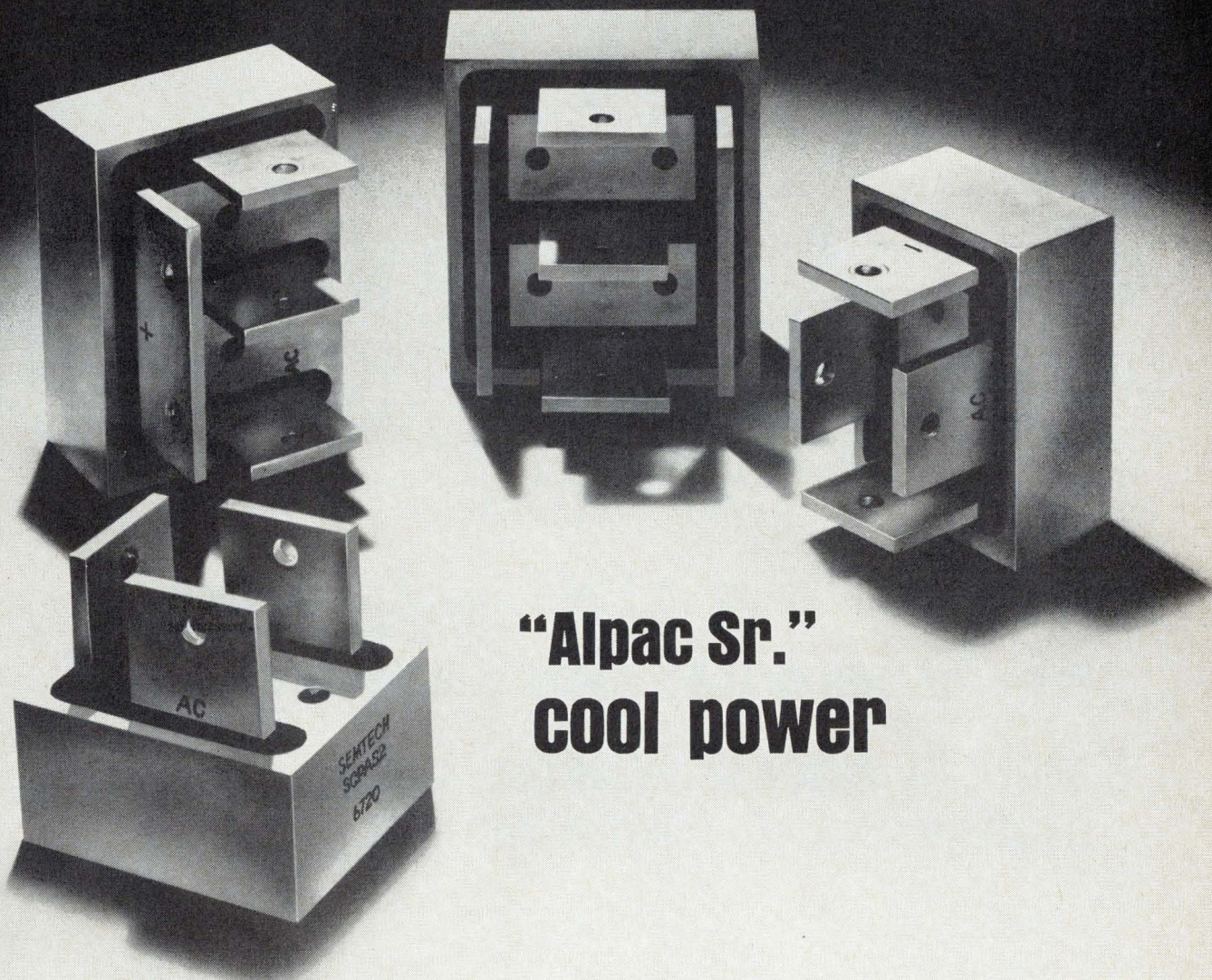

"Alpac Sr." cool power

With PIV ratings of 50-600 volts per leg, ALPAC is available in four basic rectifier circuits:

Rectifier Circuits	Current Rating	Case Dimensions
Doublers & Center Taps	200 amps at 55°C	1"H x 1.75"W x 2.125"L
Single phase Full Wave Bridge	150 amps at 55°C	1"H x 1.75"W x 2.50"L
Three phase Half Wave Bridge	250 amps at 55°C	1"H x 2.125"W x 2.875"L
Three phase Full Wave Bridge	190 amps at 55°C	1"H x 2.50"W x 2.875"L

Available for immediate delivery.



Western Offices: 652 Mitchell Rd., Newbury Park, California. 91320 (805) 498-2111/ from L.A. (213) 628-5392 TWX: 910-336-1264

Central: 140 No. La Grange Rd., La Grange, Illinois, 60525 (312) 352-3227 TWX: 910-683-1896

Eastern: 116-55 Queens Blvd., Forest Hills, N.Y., N.Y. 11375 (212) 263-3115 TWX: 7 10-582-2959

European Sales: Bournes AG, Alpenstrasse 1, Zug, Switzerland (042) 4 82 72/73

**Transistor
Mounting
Pads?
Clips?
Heat Sink
Adapters?**

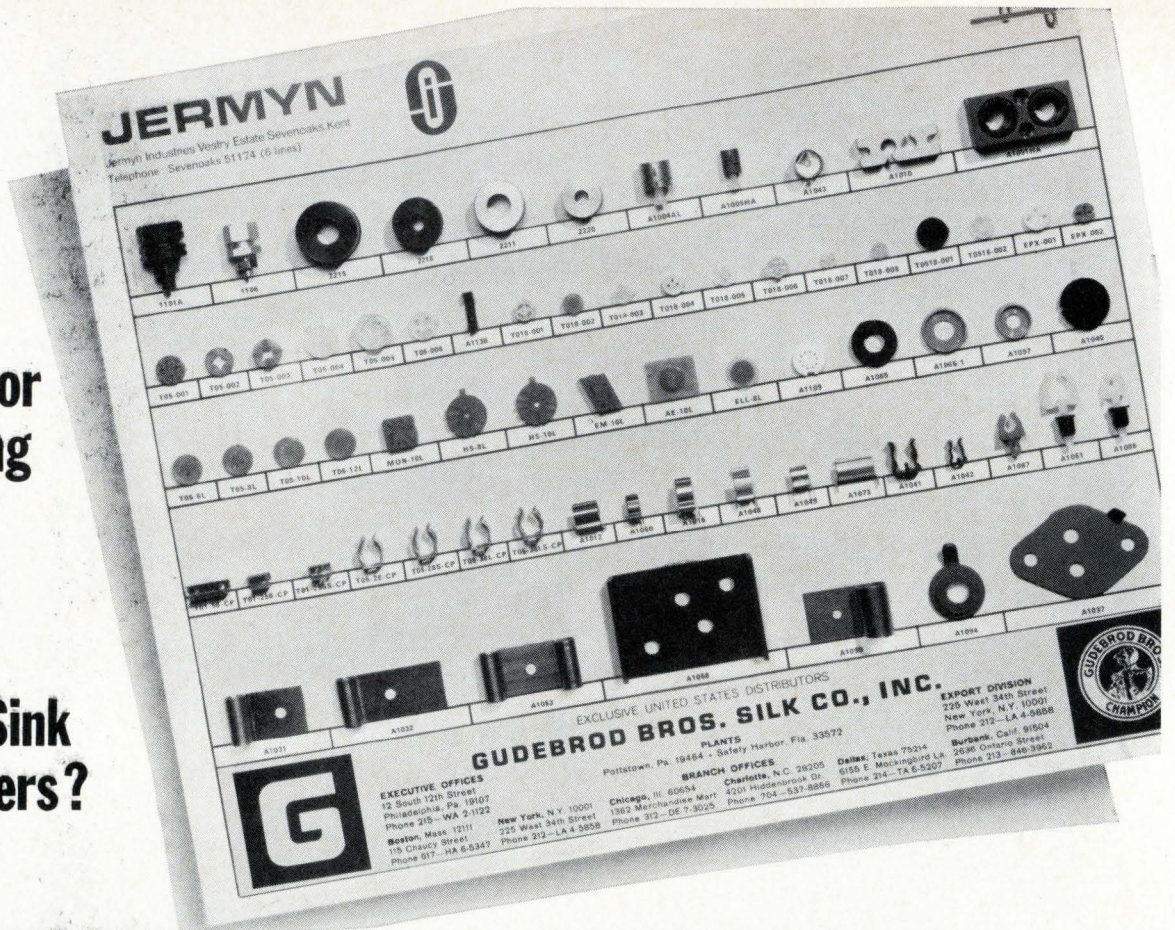

GUDEBROD is your new, reliable source for this important circuit hardware.

Precision made with traditional English craftsmanship—by JERMYN Industries.

Stocked and sold exclusively in the United States by GUDEBROD.

You ought to know more about these products!

Send for catalog now!

Gudebrod is now exclusive U.S. distributor for the electronic products manufactured by Jermyn Industries of Kent, England. Gudebrod feels it will be providing the industry with electronic hardware consistent with the high quality products manufactured by Gudebrod for nearly 100 years. Gudebrod will extend the same quality and depth of service it has become known for in lacing tapes. Write for the Catalog GJ100.



GUDEBROD BROS. SILK CO., INC.

FOUNDED IN 1870

Electronics Division

12 SOUTH 12th STREET, PHILADELPHIA, PENNSYLVANIA 19107

Area Code 215, WA 2-1122

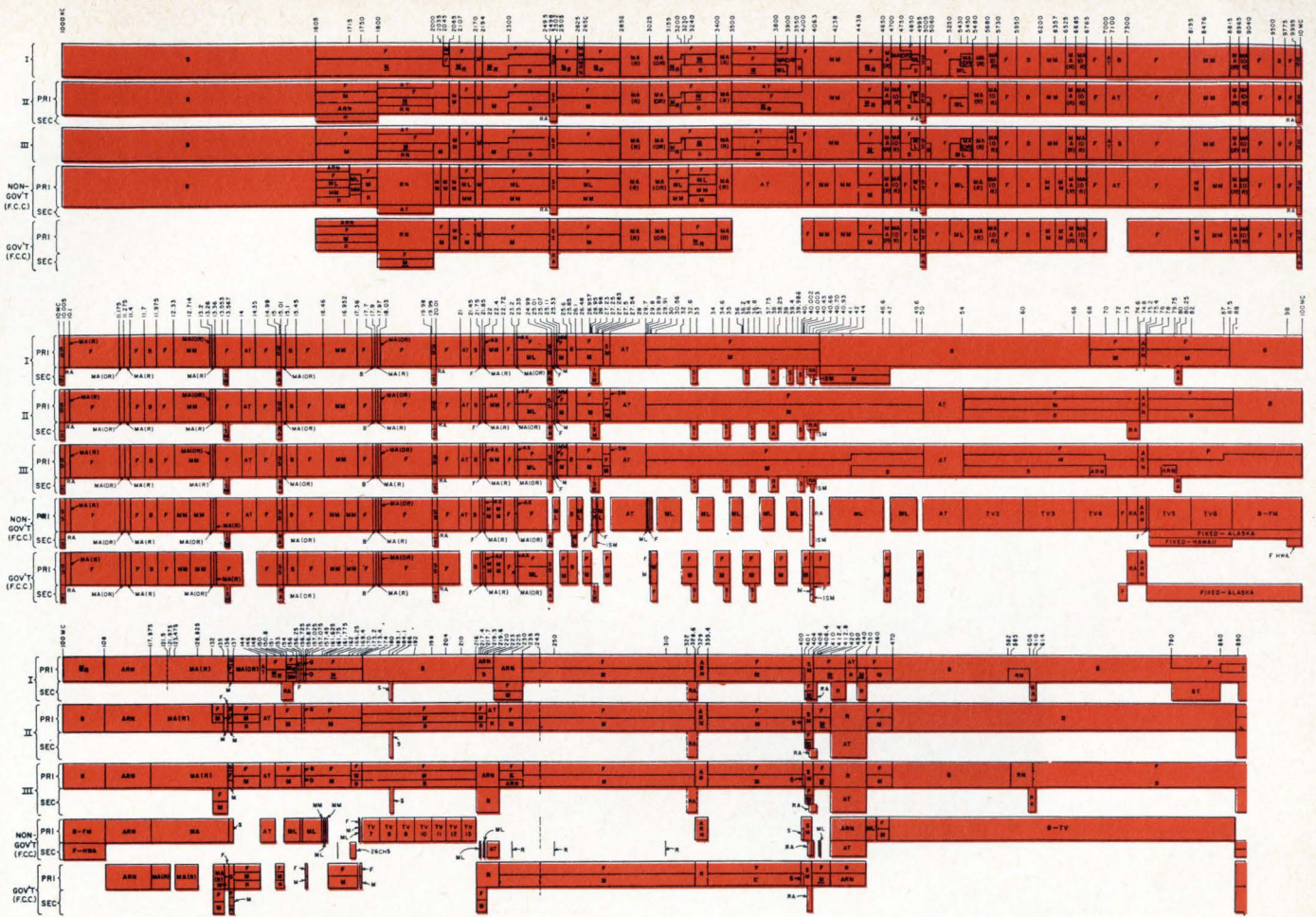

The HD-1A sweeps this entire spectrum 1000 kHz to 900 MHz

Significant? Yes, because the HD-1A Sweep Generator can thereby replace a half dozen or more instruments at a cost less than most any one of them. It will do the work of a number of signal generators and provide a swept output instead of a single frequency. Its wide range includes an area of the spectrum normally covered by several ordinary sweep generators.

The HD-1A can also be used as a frequency analyzer providing data for frequency identification and stability, signal purity, and signal strength.

And it does all this at a cost of only \$995.00

SPECIFICATIONS

Center Frequency 1-910 MHz
Sweep Width . . .200 kHz-10%
Output3-1.0v P-P

Source VSWRBelow 1.3:1
Impedance50 ohms
Flatness±5%

Catalog #70 includes complete data on the HD-1A, 30 other Telonic Sweep Generators and accessories as well as a complete section on Applications. Write for your copy today.

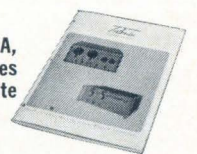

Telonic INSTRUMENTS

A DIVISION OF TELONIC INDUSTRIES, INC.

60 N. First Ave., Beech Grove, Indiana 46107 Tel: (317) 787-3231 TWX: 810-341-3202

See Telonic Industries, Inc. at WESCON, Booths 3124-3128.

Reader's Choice

IEE bright, legible, wide-angle readouts:

Any characters desired
Any colors or combinations
Any input, BCD or decimal
Any input signal level
Any mounting, vertical or horizontal

Many sizes
Many configurations
Many lamp lives (to 100,000 hours)
Many brightness choices
Many options and accessories



Standard Readouts: Rear projection principle, like all IEE readouts. A lamp in the rear of the unit illuminates one of the 12 film messages, and projects it to the front viewing screen. Unbeatable readability and versatility.

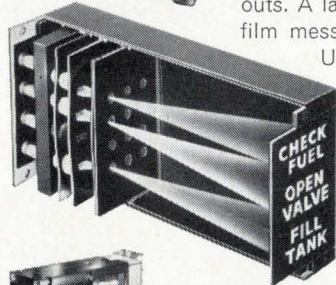

Large Screen Readouts: For reading distances up to 100 feet. Maximum character size $3\frac{3}{8}$ ".

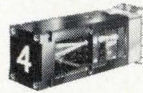

Miniature Readouts: Only 1" wide x $1\frac{5}{16}$ " high, yet can be read at 30 feet because of clarity of one-plane projection. Character size: $\frac{5}{8}$ ".



Micro-Miniature Readouts: Only $\frac{1}{2}$ " wide x $\frac{3}{4}$ " high, but 20 foot viewing distance and maximum 175° viewing angle because of front-plane display. Character size: $\frac{3}{8}$ ".



Hi-Brite Readouts: Special lens system increases character brightness 50%. Particularly good when high ambient light conditions exist.

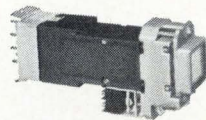

Cue-Switch Readouts: Rear projection readout with push-button viewing screen. Combination switch and display device.



Bina-View Readout: Accepts binary or teletype code, decodes, and displays the proper character.



Status Indicator Readout: Displays up to 12 different messages, individually or in combination. Viewing screen only 3 sq. in.



Indicator Assemblies: Available with up to 11 rear projection readouts, for indicating seconds, minutes, hours, days, etc.

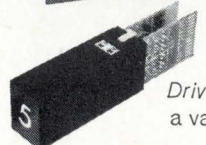

Driver/Decoder Module: Designed to work with IEE Readouts. Accepts a variety of binary codes for decimal conversion.

The new IEE Display Devices catalog gives complete information and specifications on these products, and their accessories. Ask for it.



"I-double-E", the world's largest manufacturer of rear projection readouts.
Industrial Electronic Engineers, Inc. 7720 Lemona Avenue, Van Nuys, California



If your target is precision, why not start with it?

Durez[®] phenolic, diallyl phthalate, and alkyd molding compounds

Start by specifying the precision compounds from Durez for the molding of your electrical components.

The precision compounds deliver, in the mold and on the job. They'll give you the precision results your specs call for, every time. They solve the tough problems, like wall thicknesses of .050" or superior corrosion resistance.

The wide line of Durez phenolic, diallyl phthalate, and alkyd molding compounds offers the balance you want from these key design requirements: good electrical and thermal properties, impact strength,

durability; relatively low cost; heat, corrosion, and chemical resistance; flame retardance; dimensional stability; and retention of electrical properties after long periods at high humidity.

Durez sales engineers and technical service men are standing by to help you get the precision compound that can best handle your specific application.

For complete information, write Durez Division, Hooker Chemical Corporation, 9008 Walck Road, North Tonawanda, N. Y. 14120

 **hooker**
DUREZ DIVISION

Why the big swing to silicone molded devices?

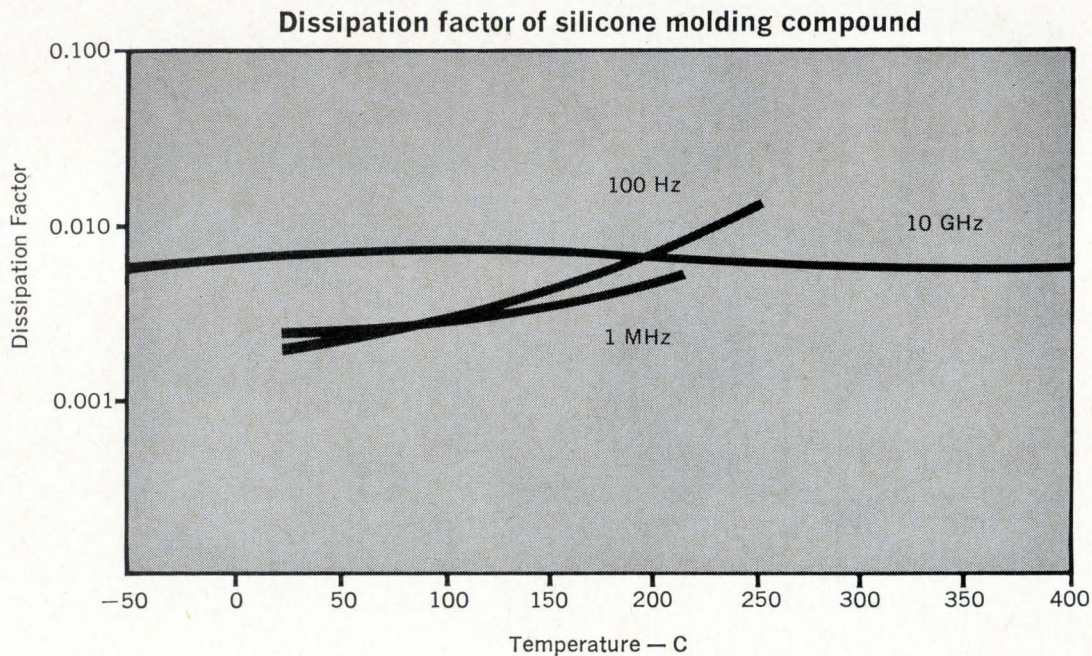

Why the big swing to silicone molded devices? . . . Electrically stable materials over a wide range of temperatures from low to high frequencies—as shown graphically above. Silicone molded packages do not limit the design or performance of high frequency semiconductor devices. Design characteristics will not drift due to changing electrical properties of the molded package.

That's why the rapid growth in the number of devices—from simple diodes to integrated circuits—packaged in silicone molding compound. Of course, there are other important reasons.

No derating necessary. Devices packaged in silicone molding compounds can be operated at their full power potential. This enables designs with a higher device density per given volume. For example, one manufacturer reduced the size of a power diode to 1/30th of its glass packaged counterpart. Compared to other plastic materials, the package size is from 1/5th to 1/3rd smaller, since derating due to package stability is not required.

No cracking — Dow Corning silicone molding compounds—unlike other organic thermal setting plastics—are virtually unaffected by heat and thermal shock. For example, a power resistor molded in Dow Corning® 307 molding compound was subjected to repeated cycling from -65 C to 350 C without damage to the packaging material or the device. Dow Corning® brand molding

compounds subjected to 1000 hours at 300 C (572 F) show no significant change in physical and electrical properties.

Will not burn. Silicone molding compound is inherently non-burning. Thus components packaged in silicone molding compound will not constitute a fire hazard. No flame snuffers are needed . . . a source of ionic contamination for devices packaged in organic plastic materials. With silicone molding compound there are no ionic or polar constituents when properly used, to affect junction performance.

Low water absorption—Dow Corning silicone molding compounds have low water absorption even after long aging at maximum operating temperatures.

Competitive Price. Silicone molding compound costs only a fraction of a cent per device. Thus, it enjoys a substantial price advantage over metal cans and glass packages.

Manufacturing Economies. Transfer molding enables devices to be packaged with minimum of manual labor and supervision. Good mold release and minimum flash assure high production rates and reduced de-flashing costs.

For technical data on why the swing to Dow Corning silicone molding compounds in device packaging, write Dept. 3720, Electronic Materials Division, Dow Corning Corporation, Midland, Michigan 48640.

"we have used many millions of Allen-Bradley hot molded resistors. The uniformity of quality from one shipment to the next is truly astounding. There can be no question about the reliability of these resistors."

Wang Laboratories

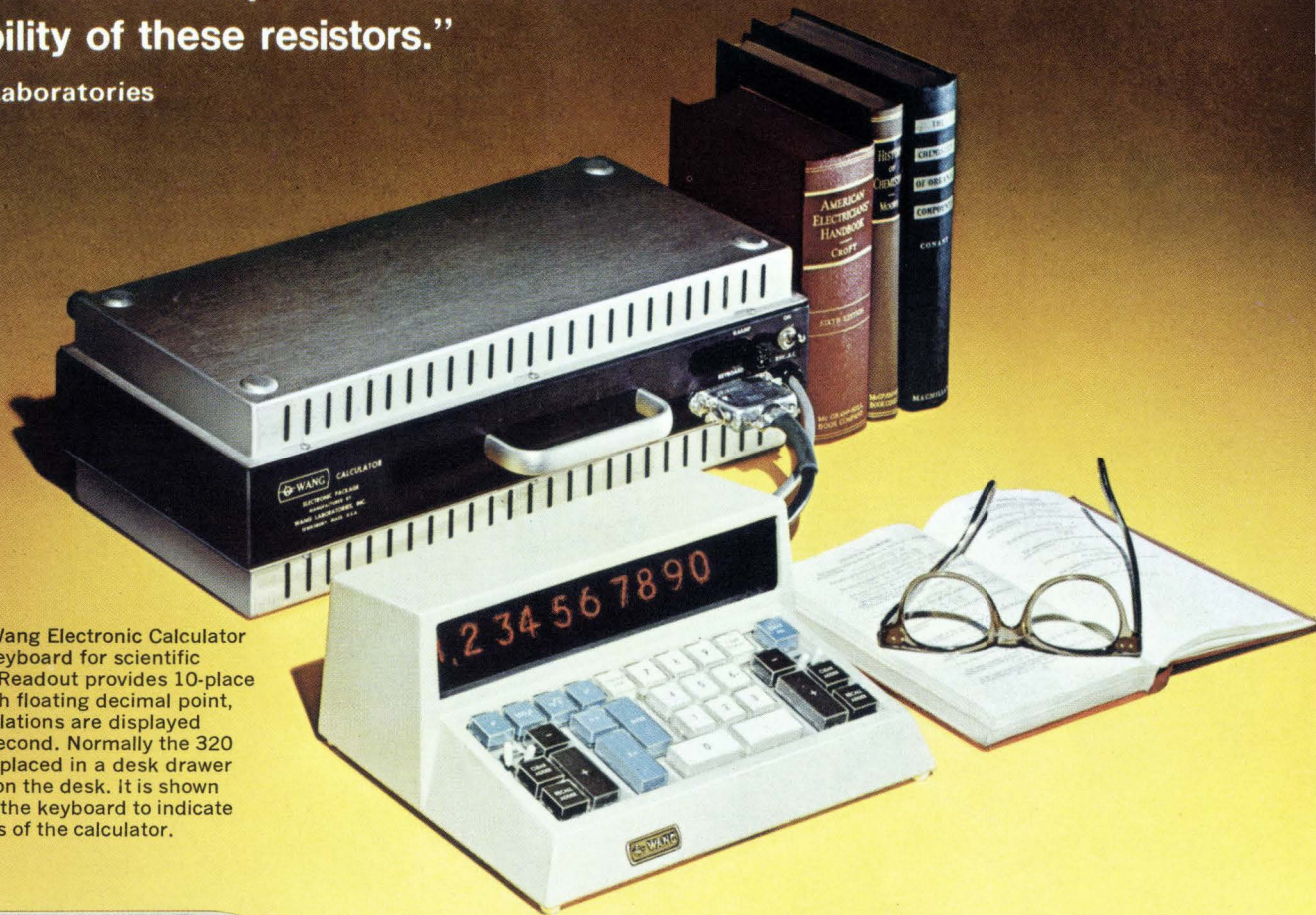

Model 320 Wang Electronic Calculator with 320K keyboard for scientific application. Readout provides 10-place accuracy with floating decimal point, and all calculations are displayed in one millisecond. Normally the 320 calculator is placed in a desk drawer rather than on the desk. It is shown here next to the keyboard to indicate compactness of the calculator.

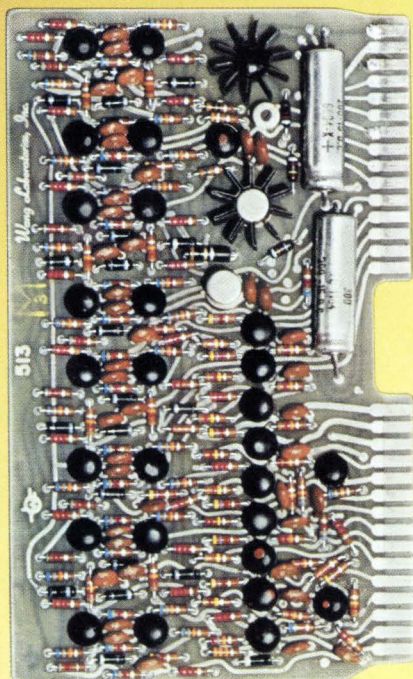

One of the printed circuit cards from the Model 320 calculator. All resistors on this card are Allen-Bradley Type CB 1/4 watt hot molded resistors.

To insure the extremely accurate and high speed operation of the 300 Series Wang Electronic Calculators, all components are selected with utmost care. Thus, it was only natural that Allen-Bradley hot molded resistors were chosen for this most exacting application.

Composition resistors, not produced by the technique of hot molding used by Allen-Bradley—using completely automatic machines—cannot equal the quality and uniformity of production for which the hot molded Allen-Bradley resistors have a worldwide reputation. The precise control during manufacture results in such uniformity of one A-B resistor to the next—million after million—that long term resistor performance can be accurately predicted. There is no record of any Allen-Bradley hot molded resistor having failed catastrophically.

Let the experience of the engineers at Wang Laboratories become your

own experience. Allen-Bradley fixed and variable hot molded resistors will do exactly as well for you as they have done for all other users. For complete specifications, please write for Technical Bulletin 5000: Allen-Bradley Co., 222 W. Greenfield Ave., Milwaukee, Wis. 53204. In Canada: Allen-Bradley Canada Limited. Export Office: 630 Third Ave., New York, N. Y., U.S.A. 10017.

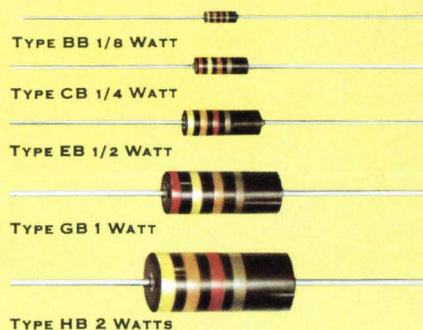

TYPE BB 1/8 WATT

TYPE CB 1/4 WATT

TYPE EB 1/2 WATT

TYPE GB 1 WATT

TYPE HB 2 WATTS

HOT MOLDED FIXED RESISTORS are available in all standard resistance values and tolerances, plus values above and below standard limits. Shown actual size.



ALLEN-BRADLEY
QUALITY ELECTRONIC COMPONENTS

Miniature A-B Type BB hot molded resistors provide over 1,300,000 units per cu. ft.*



...your answer to high packaging density with discrete components

Faced with a severe space limitation for your electronics equipment, the miniature Allen-Bradley Type BB is just the "ticket." Its extremely high packaging density (over 1,300,000 per cu. ft. *) enables a drastic size reduction—with no sacrifice in reliability!

These tiny Type BB resistors are made by the identical exclusive hot molding process as the larger Allen-Bradley resistor. Using precision automatic machines—developed and perfected by Allen-Bradley—the human element is completely eliminated. The resulting uniformity from one resistor to the next—million after million and year after year—is so exact that long term resistor performance can be accurately predicted. And during the twenty-five years this exclusive hot molding process has been in operation, no Allen-Bradley resistor is known to have failed catastrophically.

Allen-Bradley Type BB resistors are available in standard resistance values from 2.7 ohms to 100 megohms with tolerances of $\pm 5\%$, $\pm 10\%$, and $\pm 20\%$. Maximum rated wattage is $\frac{1}{8}$ watt at 70°C and can be derated linearly to zero watts at 130°C. The maximum continuous rated voltage is 150 volts RMS or DC. For complete specifications on the Type BB resistor, please write for Technical Bulletin B-5005. Allen-Bradley Co., 222 W. Greenfield Ave., Milwaukee, Wis. 53204. In Canada: Allen-Bradley Canada Limited. Export Office: 630 Third Ave., New York, N.Y., U.S.A. 10017.

**Theoretical packaging in cordwood arrangement.*

actual size

of Allen-Bradley Type BB hot molded resistors

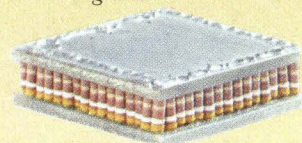

ALLEN-BRADLEY

QUALITY ELECTRONIC COMPONENTS

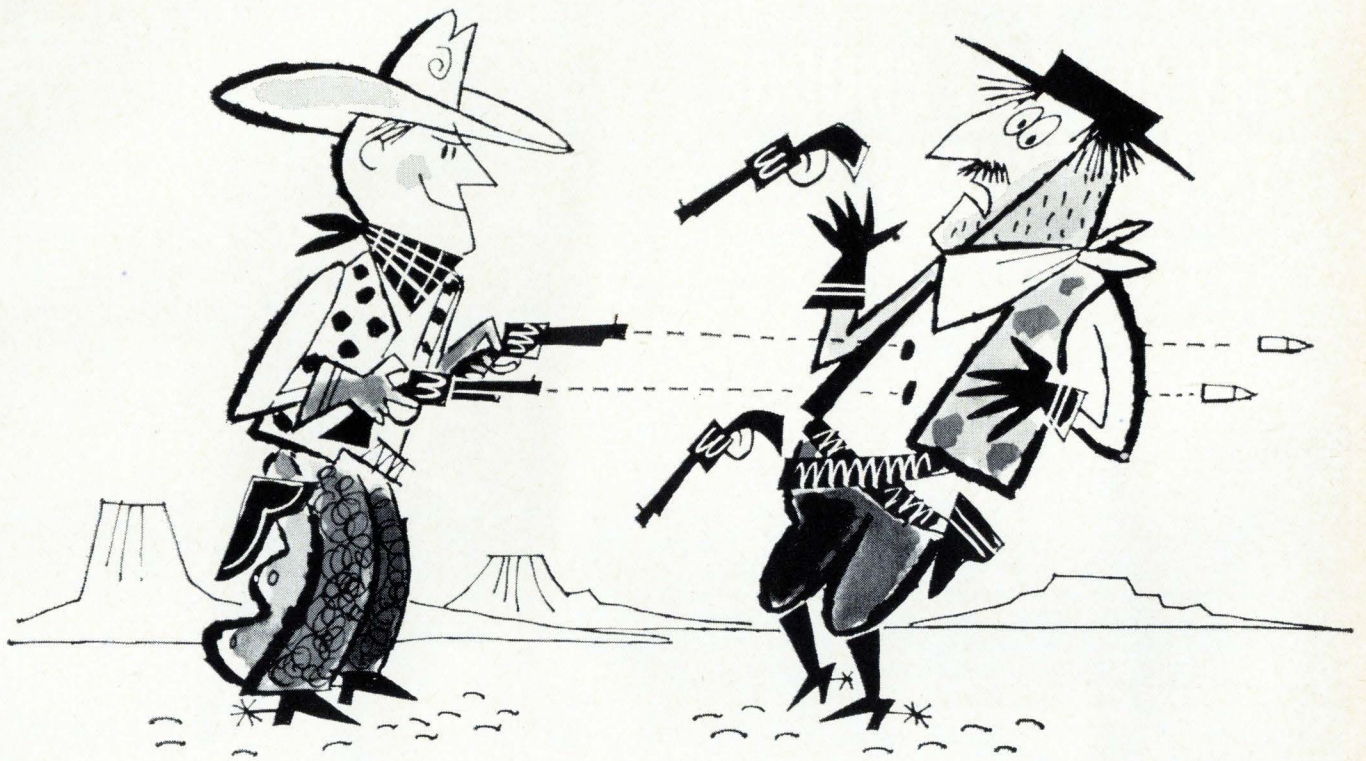

The Fastest S/D Converter in the West...or East!

Continuous Synchro-to-Digital Conversion

Tracks Data Up to 2000°/second.

The NEW solid-state North Atlantic 545 is a good deal faster than Black Bart...and more accurate too! Featuring .01° resolution and accuracy, it continuously converts 400 Hz synchro (or resolver) data to digital form — eliminates variable errors due to data staleness associated with previous conversion techniques.

In addition to the basic tracking mode, track/hold modes are provided to permit observation of slowly changing or jittery data. Drift-free performance is guaranteed through the use of solid-state switched precision transformers. Optional features include 50 Hz to 5 KHz data signals, .001° resolution, 2-speed inputs, and many other system-oriented options.



See it at Wescon!

Booth 3215-3216



NORTH ATLANTIC industries, inc. TERMINAL DRIVE, PLAINVIEW, NEW YORK • (516) 681-8600

We asked 20 of your fellow engineers

“WHY DO YOU CHOOSE CTS SWITCHES?”

HERE ARE THEIR REASONS:

“NO BREAKAGE”

They don't break on production lines or on finished equipment if dropped or jarred . . . CTS glass alkyd wafers are not brittle like phenolic . . . easy to handle.

“NO SHIFTING”

Precision molded construction eliminates mechanical shifting of stator circuitry and terminals.

“MORE COMPACT”

No spacers needed when stacking wafers . . . Maximum switching capability with minimum depth . . . Smaller diameter—only 1-1/8" (Series 212 wafers)

“VERSATILITY OF CIRCUITS”

Many circuit variations available due to varied rotor contact configurations. External jumpers eliminated by CTS internal connections between positions.

“AVAILABILITY OF POWER SWITCHES”:

Available with 4 types of power switches and/or numerous potentiometers.



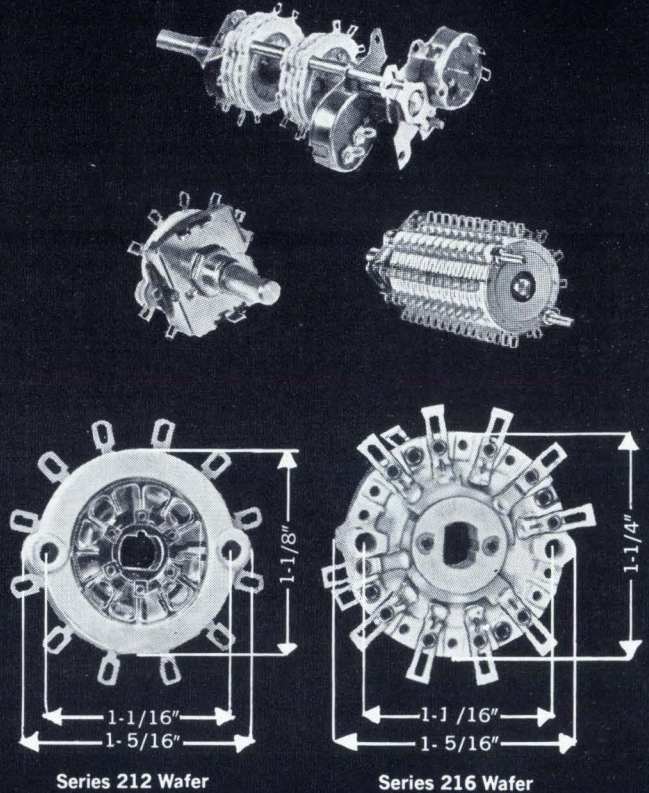

“SUPERIOR INSULATION”

Glass alkyd is superior to phenolic insulation.

- Soldering heat can't loosen terminals.
- Meet MIL-S-3786 A&B, Style SR03 (Series 211 and 212.)
- Balanced contact spring.
- Natural solder barrier provided by glass alkyd insulation.

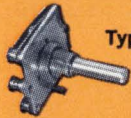

DETENTS

-  **Type 211—STAR WHEEL DETENT**
HIGHEST QUALITY • POSITIVE FEEL
• 250,000 CYCLE LIFE • FREE FROM
END AND SIDE THRUST • HIGH
SWITCHING TORQUE 15–60" OZ.
-  **Type 212—HILL AND VALLEY DETENT**
LOW COST • DESIGNED FOR HOME
ENTERTAINMENT AND LOW COST IN-
STRUMENT APPLICATIONS • 25,000
CYCLE LIFE • SWITCHING TORQUE
20–48" OZ.
-  **Type 212 ND—DIE CAST DETENT**
LOWEST COST OF ALL DETENTS
• LOW COST STAKED CONSTRU-
CTION • AVAILABLE FOR 1 AND 2
WAFER SWITCHES • 20,000 CYCLE
LIFE • SWITCHING TORQUE 18–
40" OZ.
-  **Type 215—DOUBLE BALL DETENT**
DESIGNED PRIMARILY FOR INSTRU-
MENT MARKET • HIGH QUALITY
• CRISP FEEL • 100,000 CYCLE LIFE
• SWITCHING TORQUE 6–35" OZ.



Discover for yourself the advantages of working with CTS for your switch requirements. Switches produced in Elkhart, California and Canada. Request Catalog 4000 containing the full CTS Switch line.



Founded 1896

CTS
CORPORATION
Elkhart, Indiana

Sales Offices and Representatives conveniently located throughout the world

Principal Products

- Variable Resistors
- Selector Switches
- Loudspeakers
- Trimming Potentiometers
- Microminiature Components & Circuit Packages
- Crystals, Filters, Oscillators & Ovens

Subsidiaries:

- CTS of Asheville, Inc., Skyland, N. C.
- CTS of Berne, Inc., Berne, Indiana
- CTS of Paducah, Inc., Paducah, Kentucky
- Chicago Telephone of California, Inc., South Pasadena, California
- CTS of Canada, Ltd., Streetsville, Ontario
- CTS Microelectronics, Inc., Lafayette, Ind.
- CTS Research, Inc., Lafayette, Indiana
- CTS Knights, Inc., Sandwich, Illinois

Probing the News

Regions

China's three-way stretch

Communist regime seeks to integrate electronics and priority atomic projects while producing broadcast gear for propaganda and goods for foreign markets

By Don Kirk

Hong Kong news bureau

An assessment of mainland China's capabilities in electronics—or any other industrial field, for that matter—is, at best, an educated guess. But by reading between the lines of such party-line bombast as reaches the West, stitching together the data available from outside sources, and watching "China 'cross the bay" from Hong Kong it's possible to conclude that slow, steady progress has been made—at least until the advent of the so-called Cultural Revolution early this year.

Since the Communists seized political control of the country in 1949, there has been a paucity of information on technology. Periodic social and economic upheavals only compound the uncertainty. And, in contrast to previous years, there have been during 1967 even fewer reports and less commentary in the Chinese press on developments in electronics.

This latter situation has led some observers to speculate that China has continued, but not advanced in, the production of civilian radios and has concentrated its resources on nuclear projects. While there have been no reports of fighting between Red Guards and workers in electronics factories—as there have been in other key fields—many believe the industry's development has been arrested by the Cultural Revolution.

Despite continuing disorders, it is still possible to glimpse Red China's three-part goals. At the same time Chairman Mao Tse-

tung's regime is seeking to make electronics the handmaiden of strategic nuclear projects, there is an obvious national drive to expose prestige wares and consumer goods to Western eyes. Meanwhile, there is a continuing push to produce broadcast communications equipment that serves the internal propaganda ends of the government.

Bombshell. Earlier this month, Congress's Joint Committee on Atomic Energy issued a brief, unclassified report on Communist China's nuclear potential. Among other things, the committee concluded that the Chinese would have an operational intercontinental ballistic missile with a thermonuclear warhead before 1972—a target date considerably ahead of previous official estimates. The Pentagon is typically close-mouthed on the subject. But given the complex command, control, guidance, and instrumentation requirements of ICBM systems, it can safely be inferred from the new timetable that China is developing a formidable electronics capability.

I. Red sales

At the same time, save for an occasional riot, it's business as usual in the teeming bazaars of Hong Kong, that British outpost of empire off China's southern coast. Here, the strains of propaganda songs fill the air and portraits of Chairman Mao bedeck the walls of the half dozen or so Communist-owned department stores. But the salesmen behind the electronic-

Eastfoto



End of the line. Assemblers at plant in Shanghai put the finishing touches on transistor radios. Annual capacity is estimated to be 100,000 receivers.

... most complex wares are show pieces displayed for propaganda purposes ...

wares counters are strictly business as they push merchandise ranging from voltmeters to transistor radios, carrying such Westernized labels as Swan, Bestone, 555, or Aviation.

Price is the big selling point of Chinese electronic products in Hong Kong. Radios with medium-, long-, and short-wave bands cost from \$10 American to \$90—substantially less than equivalent Japanese, European, or U.S. models. The counters of such Communist stores as the Chinese Merchandise Emporium Ltd. and China Products Ltd. also display electric clocks, optical lenses, variable tube voltmeters, loudspeakers, coils for crystal sets, variable capacitors, and output transformers, as well as workaday goods ranging from fluorescent lights to hair dryers.

Short lines. The variety may be somewhat limited by Western standards, but such goods represent the best of China's workaday electronics products for sale on a retail basis. A Communist newspaper, bragging about electronic goods on display at the Canton Trade Fair last spring, said China "has developed a full-grown modern electronics industry in a little over 10 years."

Another Communist publication said factories in China, besides producing radios and other household items, were also capable of making "high-grade precision elec-

tronic instruments for modern scientific research." It claimed that China had "successfully turned out direction-guiding equipment for missiles, as well as various kinds of remote-control devices."

II. Strictly for show

Products displayed at the Canton fair included vacuum-tube voltmeters, millivoltmeters, high-frequency voltmeters, multipurpose electric bridges, signal generators, oscillographs, and apparatus for testing high-frequency characteristics. Observers doubted, however, that China's more complex electronic creations were much more than show pieces for propaganda purposes. Western businessmen returning from the fair reported that virtually no business was done. One, in fact, said: "When I asked about the price of an oscillograph, no one seemed to know. And then I learned you couldn't really buy it." China did a limited business in radios and clocks, but mostly through overseas Chinese businessmen distributing China-made products in Asia—notable Hong Kong, Singapore, and Malaysia.

Top of the line. At the same time, propaganda media continued to take pride in exotic electronic developments. For example, China recently claimed to have developed an automatic electron trajectory simulator for use in the study and

design of electron guns and other devices. The Research Institute of Electronics of the Chinese Academy of Sciences reported that "the new apparatus was automatically controlled and used to trace out on paper the electron path in electrostatic fields." The institute called it "a valuable component in the equipment of electron optic laboratories."

Leadership. As in every other phase of Chinese life, Chairman Mao generally gets the credit for China's "progress" in electronics. A Communist newspaper in Hong Kong reports that the Shanghai Electric Furnace plant had trial-produced its first electron bombardment unit "in observance of Chairman Mao's teachings and with full liberation of ideas and breaking down of superstition." The newspaper claims the trial showed the furnace "reaches the technical level of the 1960's." The same newspaper has reported the production of: China's first home-made X-ray machine, an electronic microscope capable of magnifying 200,000 times, and a digital computer.

Calculating. China Reconstructs, a handsomely produced propaganda magazine distributed abroad, said in April 1964 that computers were constantly used in China for jobs ranging from weather-forecasting to agriculture and engineering. "Shortly after they have fed coded high-altitude weather data into the machines," said the magazine, "meteorologists can use the results to forecast weather throughout China for the coming 48 hours." The article credited computers with having devised "a master plan for routing the shipment of fertilizer, saving millions of miles of transport," and said that China-made computers had also done "enormous calculations for more than a dozen huge dams."

Some observers, including T.C. Tsao, senior research engineer at Columbia University's Electronics Research Laboratories, doubt that China has made any real advances in computer technology in recent years. Tsao assumes that progress came to a halt after 1959 since little has been heard of late from the Institute of Computing Technology, which was highly touted for the first three years after its 1956 founding. He concludes that

Eastfoto



Up for sale. Transistor radios, like these Panda brand receivers from Nanking, are merchandised through Communist-owned department stores in Hong Kong.

China is technically about five years behind the U.S. in the field.

III. Means to an end

China is perhaps proudest, however, of its work relating to nuclear development. Informed sources report that factories have opened in Kunming, capital of Yunnan province in southern China, and Chengtu, capital of Szechuan in central China, capable of making electronic instruments and computers for defense applications. One newspaper reported that a factory in Shanghai was producing electron static accelerators, which it described as a "new-type device for nuclear research." The accelerator was called the "combined product of various science departments, including electric machines, machine-building, nuclear physics, electronics, metallurgy, high-vacuum studies, welding, and chemistry."

Little is known of Red China's nuclear efforts, but the best guess is that a huge amount of time and effort are expended in such activities. Columbia's Tsao estimates annual outlays at \$1.5 billion—an enormous drain on China's estimated gross national product of \$70 billion. A number of experts, including John B. Tsu, who heads the Institute of Far Eastern Studies at Seton Hall University, South Orange, N.J., agree that the value of factory shipments of Chinese electronic goods of all kinds was only in the \$70 million range last year. However, Tsu notes, nuclear-oriented electronics are getting top priority from state planners in their zeal to develop an ICBM. Anything that furthers this goal, says Tsu, comes first these days.

The status sphere. China has also concentrated, for reasons of power and prestige, in the past few years on increasing production of radio equipment. A number of China's 80 technical universities now have radio and electronic colleges with four or five departments. Some universities also provide correspondence courses.

Taiyuen, the capital of northern Shansi province, has a work-study high school for television technology established in 1964 by the local television station and education department. The school offered 26 classes in the first year and ex-

Comes the revolution . . .

Eastfoto



By the numbers. China's first digital voltmeter was developed in Shanghai at the Electric Instruments and Meters Research Institute two years ago.

. . . then the evolution

Eastfoto

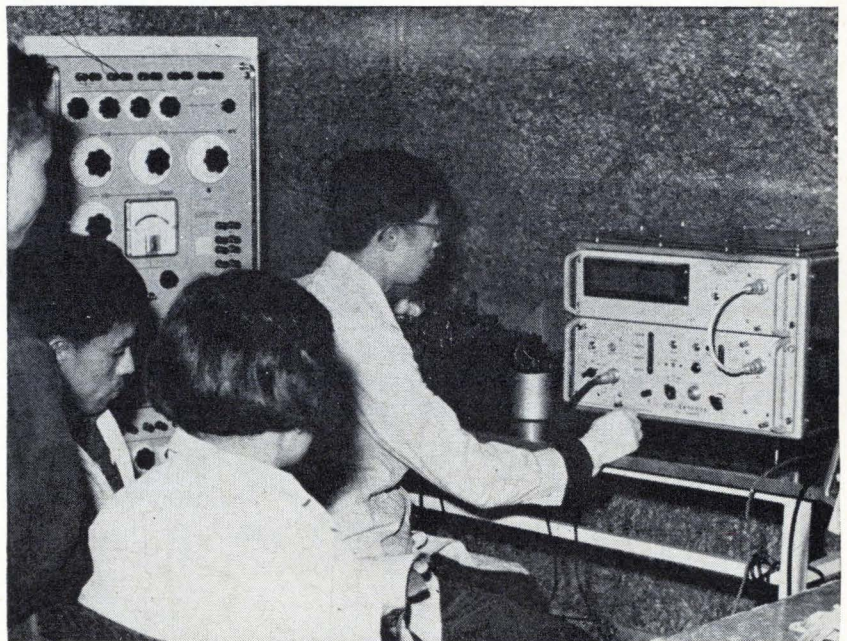

Second generation. New precision voltmeter was unveiled this spring at Peking Wireless Research Institute; instrument is transistorized.

panded to 45 classes with more than 2,000 students and 90 teachers by the second year. Students were assigned to work in electronics factories for the dual purpose of learning the business and making enough money to pay their tuition and board fees.

The big reason for the emphasis on radio and electronics, according

to an editorial, is that they "played a great role in national reconstruction and defense."

IV. No fallout

Strangely, the military didn't benefit greatly from this concentrated effort until an inspection tour several years ago by Lo Jui-ching, then secretary-general for



Styrafil® provides impact resistant cabinet for Westinghouse portable phonographs

Consumers will get long use from six new Westinghouse portable phonograph models, thanks to their tough, scuff resistant and lightweight reinforced thermoplastic cabinet housing.

Westinghouse design engineers found that the high impact strength of Styrafil would be ideal for the cabinet shell. The ability to withstand scuffs and kicks is a valuable asset for the attractive appliances.

Styrafil also offers extra stiffness which aids in sound reproduction and dimensional accuracy, an important factor in obtaining a neat fit of all parts.

The parts were formerly made from molded wood. Other materials considered for the new injection molded parts were rejected because of deficiencies in stiffness and dimensional stability.

Westinghouse is achieving excellent surface finish through good molding techniques.

The extra performance of the FRTP's can improve your product. Check the facts.

Compare physical properties

	Unit	Unreinforced polystyrene	Styrafil G-30/30
Tensile Strength @ 73°F	PSI	5,500	14,000
Izod Impact Strength @ 73°F	Ft./lb./in.	0.25	2.5
Flexural Strength	PSI	8,000	17,000
Compressive Strength	PSI	11,500	19,000
Coefficient Linear Thermal Expansion	°F/in./in.	4.4×10^{-5}	1.8×10^{-5}
Deflection Temp. Under Load @ 264 PSI	°F	165	220

Fiberfil offers the most complete line of FRTP's. Only Fiberfil can give you complete technical data and widest practical experience on all the fiberglass reinforced thermoplastics.

Send for your free copy of the Fiberfil engineering manual, 32 pages of detailed information. Write Fiberfil Div., Rexall Chemical Company, Evansville, Indiana 47717



... radio plays an important role in China's national defense ...

the military committee of the Communist party's Central Committee. Lo found the armed services' communications in a sad state of repair. He reported that some units could not make radio contact clearly, took too long to make contact—or couldn't operate at all.

Since then, China's armed forces have concentrated to some extent on improving electronic communications as one part of China's program for expanding its communications industry as a whole. Ironically, however, some of those responsible for this program have been attacked by Maoist Red Guards in wall posters in Peking and are believed to have lost power.

communications apparatus. The report claimed that China already had 94 radio broadcasting stations and 20 million tv sets when an earlier team visited Japan in November 1964. Although China had no national tv network, said the article, 10 different stations were on the air.

V. Aye witness

One of Tokyo's leading newspapers, Asahi Shimbun, last year published an article by a Japanese professor reporting on his visit to China at the invitation of the electronics institutes of Peking and Shanghai. The article, reprinted in one of Hong Kong's Communist

Eastfoto



Master's voice. Regime has long used radio for indoctrination purposes; Shanghai's plant was manufacturing vacuum-tube sets as long ago as 1956.

Making it. Over-all, China's electronics industry, at least until the advent of Chairman Mao's disruptive Cultural Revolution a year ago, was doing quite well, in the opinion of knowledgeable Hong Kong observers. The business is heavily influenced by Japanese techniques. In the spring of last year, according to a press report, China sent a mission to Japan to study the production of radio sets and spare parts and to look into long-distance

newspapers, said that transistor radios were made "in large quantities in China," that Chinese plants were capable of mass production of wireless equipment and radios, and that transistors for long- and short-wave reception were "turned out unceasingly and in automatic fashion on conveyor belts." The professor added that Chinese tv sets were "seen transmitting clear pictures" and that "transistorized tv cameras were used on many oc-

casions.”

The professor added, however, that China's electronics industry was “still behind Japan's on many levels.” He noted, for instance, that China produced only a “limited variety of products” and that they couldn't match Japanese makes in “beauty and appearance.”

Growth rate. The professor said that the Peking Wireless Plant had 900 workers and made 50,000 transistor radio sets a year. Shanghai's Number 3 Wireless Plant, he said, employed 2,400 workers—against only 250 in 1958—and produced 100,000 transistor radios a year. The workers made most of the parts for each set, he said, and built 150 other different sets of special equipment, as well as 90 sets of measurement tools.

As elsewhere in the world, the popularity of transistor radios has skyrocketed in China. Only 4% of the radios made in China in 1963 were transistor models, according to the Japanese professor, compared with 40% in 1964 and 72% in 1965. One of Hong Kong's Communist newspapers, also published simultaneously on the mainland, boasted that China's radio products “have grown from general to higher grades,” and said, “it's now an integrated industry, deriving raw materials entirely from inside the country.” The newspaper said China in 1965 produced 40 different kinds of transistors, and concluded, “this year the variety of products and production has increased 100%.”

Component parts. The production of transistors in China was first reported in Shanghai in June 1963, and later in such industrial centers as Nanking, Wuhan, and Peking. The coastal cities of Tientsin and Canton also have electronics factories, some of them producing electronic tubes. Other large factories are in Chungking; Sian, the capital of Shensi province in northern China; and Harbin, a Manchurian industrial center. The largest plants are the Wah Pei (North China) Radio Equipment Factory, the Peking Electronic Factory, and the Sze Nam (Southwest) Radio Equipment Factory, built with Russian aid before the withdrawal of Soviet technicians in 1960. China claims the Sze Nam Factory, completely designed

Moonstruck

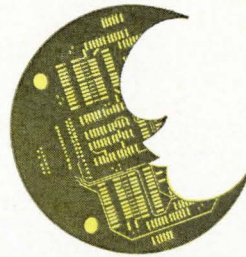

Each of the Ranger spacecraft which bit the lunar dust utilized ultra-precise multilayer circuitry by Cinch-Graphik. To meet the exacting demands of NASA, Military, or *your own* special requirements, there are no more reliable circuits on earth... or the moon. Write for a sample section of our lunar type circuitry.

CINCH-GRAPHIK

DIVISION OF UNITED-CARR



200 South Turnbull Canyon Road, City of Industry (Los Angeles), Calif. 91744 • Phone (213) ED 3-1201. Sales offices in 33 principal cities throughout the United States, Great Britain, Canada, Australia and West Germany.

CONSISTING OF CINCH MANUFACTURING COMPANY, CINCH-GRAPHIK, CINCH-MONADNOCK, CINCH-NULINE, UOINITE (ELECTRONICS) AND PLAXIAL CABLE DEPT.

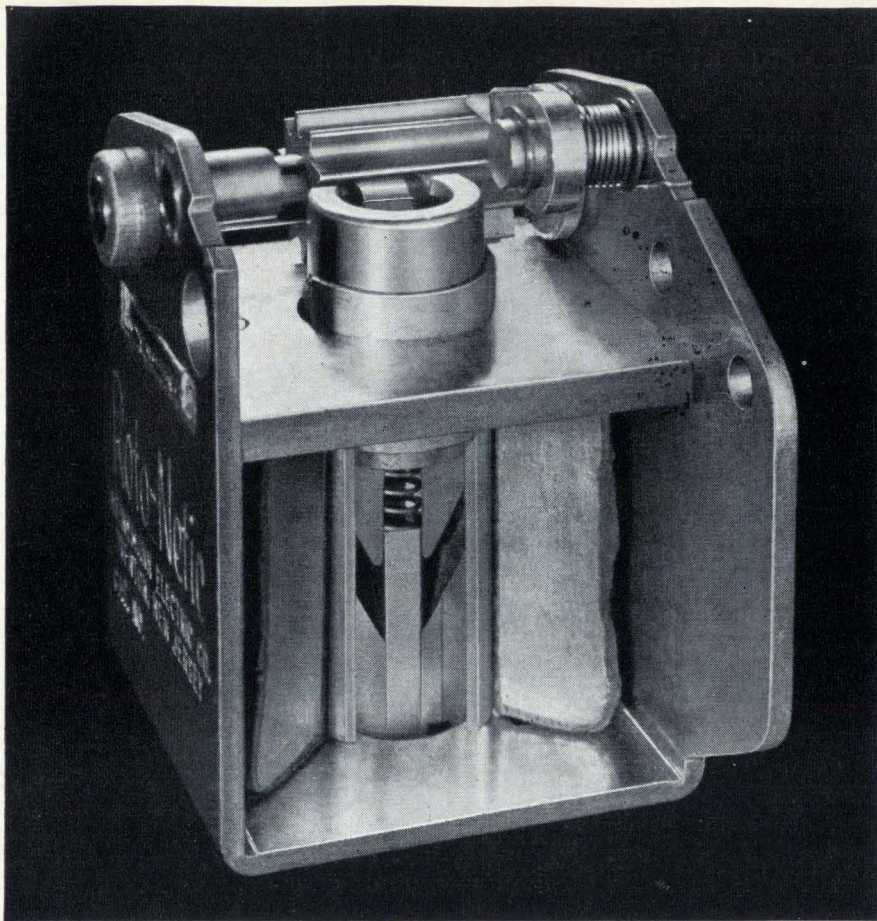

Nobody ever built a stepping motor this way before.

Or sold one for so little.*

A stepping motor has always been a rotary motor that steps. With all the design and manufacturing difficulties that implies. Precision bearings, dynamic balance, and the like. Incremental rotation calls for detents, springs, balls. Or magnetic braking. Then there's the axial thrust problem. Not surprisingly, you pay a lot of money for a rotary motor that steps.

Our picture shows a stepping motor that is not a rotary motor. It's a solenoid in disguise. A spring-loaded armature actuates a ratchet and pawl mechanism. Mechanically, that's all there is to it.

But functionally, there's a great deal more. For example, there's a double-ended shaft that lets you choose the direction of output rotation. An output torque of 0.1 inch-pounds. A ten-step star wheel (very handy for decade functions). A standard stepping speed of 600 steps/min.

There's still more, but we'll save it until you ask—either for Bulletin 701, which is free, or for a sample motor, which costs ten dollars. If you'd like the sample, please let us know whether you want the 12 VDC or 115 VAC model. Heinemann Electric Company, 2600 Brunswick Pike, Trenton, N.J. 08602.



*\$8, to OEM's, in quantities of 100 to 499.



HEINEMANN

by Russian experts, has the latest machines.

Captive audience. The New China News Agency, indicating the internal propaganda importance that China's leaders attach to radios, claimed in 1964 that 95% of all the provinces and cities in the country had their own radio stations and that 80% of the people's communes, 60% of the production brigades, and 40% of the production teams also had broadcast services of one kind or another. "Radio listeners' centers provide radios or transistors for people in remote mountain and livestock-breeding regions and for fishermen in the coastal areas," said the NCNA dispatch. "The number of loud-speaker outlets in rural areas totals 6 million." Most of the broadcast time is devoted to "revolutionary education," interspersed by such songs as "Sailing the High Seas Depends on the Helmsman (Chairman Mao)," "Our Great Leader, Chairman Mao," not to mention that all-time Communist Chinese favorite, "The East is Red."

VI. Looking backward

"Old China left behind only a small number of wireless-parts-assembling plants, capable of using only imported electronic tubes, resistors, and condensers to assemble relatively simple wireless apparatus and telephones," reports an Oct. 11, 1964, article in *Wireless Technology* magazine. "The reactionary government had ordered special equipment from the U.S. for making tubes but it was allowed to lie idle in warehouses."

The article credited the Korean war with giving the initial boost to China's electronics industry. "Certain kinds of wireless parts and electronic tubes began to be produced," it said. "This marked a transition from the pure assembling stage to the stage of assembling and production." The real turning point, however, was 1958, the first year of China's ill-fated "Great Leap Forward." It was then that China began to build most of its electronics factories, to encourage scientific research in the industry, and to build up a staff of technical personnel, workers, and administrators who, in the words of *Wireless Technology*, "are forever arming themselves with the

... China is still behind
world's advanced level ...

ideologies of Mao Tse-tung."

Cooler head. Seton Hall's Tsu agrees in general with this chronology. But, he points out, the top-flight scientists were largely educated at U.S., British, or French universities. The next level, men in their mid-30's, were trained largely in Russia around 1950. The backbone of the technician corps are Japanese who remained in China after 1945. Finally, says Tsu, the withdrawal of Russian technical aid in 1960 cost the Chinese electronics industry about two years of progress. An estimated 25% of the industry was idled; the Soviets had shipped in a lot of gear with the intention of installing it themselves. After the walk-out, this equipment simply sat either because the Chinese couldn't figure out what to do with it or because it was assigned a low priority in nuclear-oriented programs.

Introspection. Reviewing the progress of the past 15 years, Wireless Technology said electronic tube production has entered "the microwave, large-size, wide-span, and high-reliability fields," that the industry is approaching "complete systematization," and that it has begun making products "of a high-precision, moisture-resisting, and heat-resisting nature." The article claimed "solid growth" for transistor products, "a newcomer in the field of electronics," and cited "advancement in the direction of high-frequency tubes and power tubes." The magazine asserted that China's factories had taken only six or seven years to build electronic measurement tools "on which other countries spent several decades."

Wireless Technology noted that China was already making inroads on the market for transistors overseas, particularly in Hong Kong and Southeast Asia. It thanked China's "raw-materials industries for their strong support" in making electronic production almost entirely self-sufficient, (largely because it has to be). But it concluded by admitting that China was "still considerably behind in comparison with the world's advanced level."



μWATT 'TIME SINK' CIRCUIT GIVES SUBTOTALS AND TOTALS

Problem: measure the operating time of major components of a system, while also summing the operating time of the system. The old way: use two parallel meters, with their readout gears. The new way: use the Bissett-Berman E-CELL* "time sink" circuit below for a total up to 1000 hours (which can be read out in 30 minutes), in a matchbox-size package that: uses only 1/100 watt-hour; has no moving parts; withstands mil spec shock and vibration; and is directly compatible with solid-state circuitry. Cost? a fraction of just one of the meters. Try it yourself!

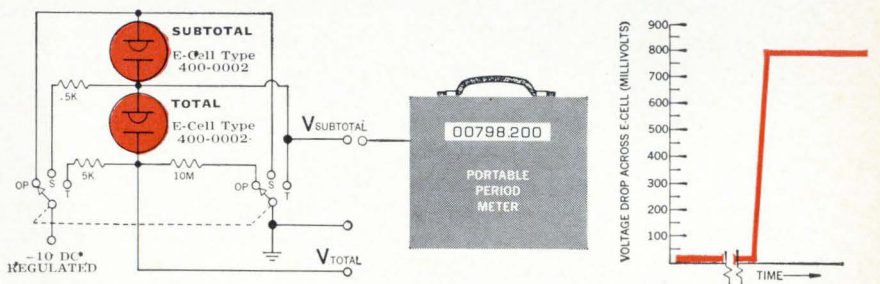

* The Bissett-Berman E-CELL™ is a unique "liquid state" electrochemical timing and integrating component now being manufactured in high volume on fully automatic production lines. E-CELLs are designed for single use or re-cycling, can be set or re-set in the field, and are furnished in wire-lead or plug-in versions. A multiple-electrode E-CELL enables complex functions such as two-phase timing — or subtotaling and totaling — with



Actual size

signal outputs at each step. E-CELLs can generate accurate time delays ranging from a fraction of one second to months; can integrate events from one to infinity; and can operate in the **nanowatt** range. Operating/storage temperature is -55°C to 75°C . E-CELLs have been tested and approved by users for severe shock and vibration tolerance in accordance with military specifications. Patents applied for.

For technical information and application notes, contact: Components Division. The Bissett-Berman Corporation, 3860 Centinela Avenue, Los Angeles, California 90066; Telephone: Area Code 213, 390-3585.

**BISSETT
BERMAN**

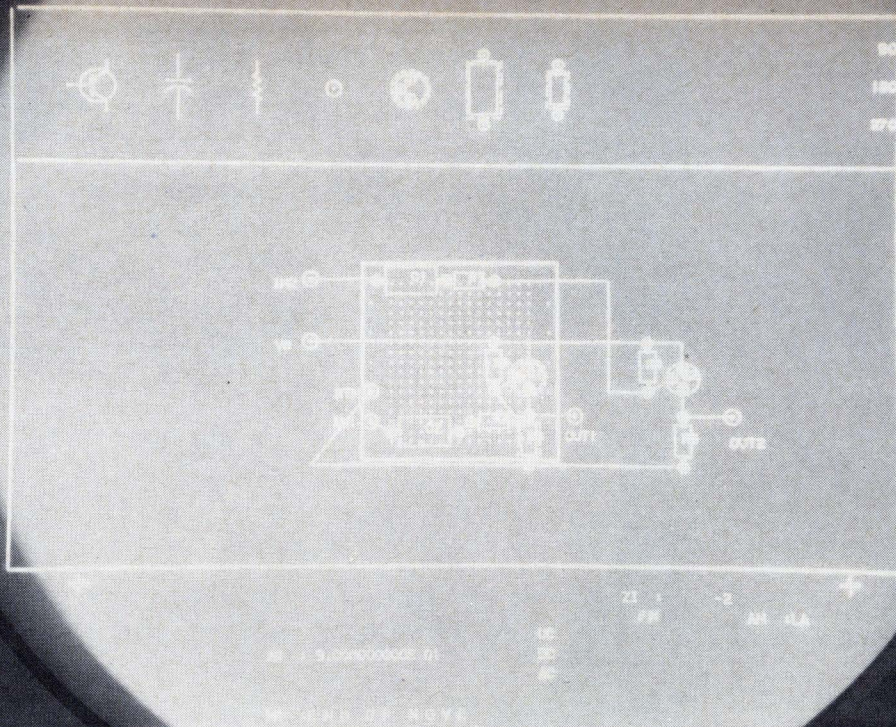

Readouts clear up problems.

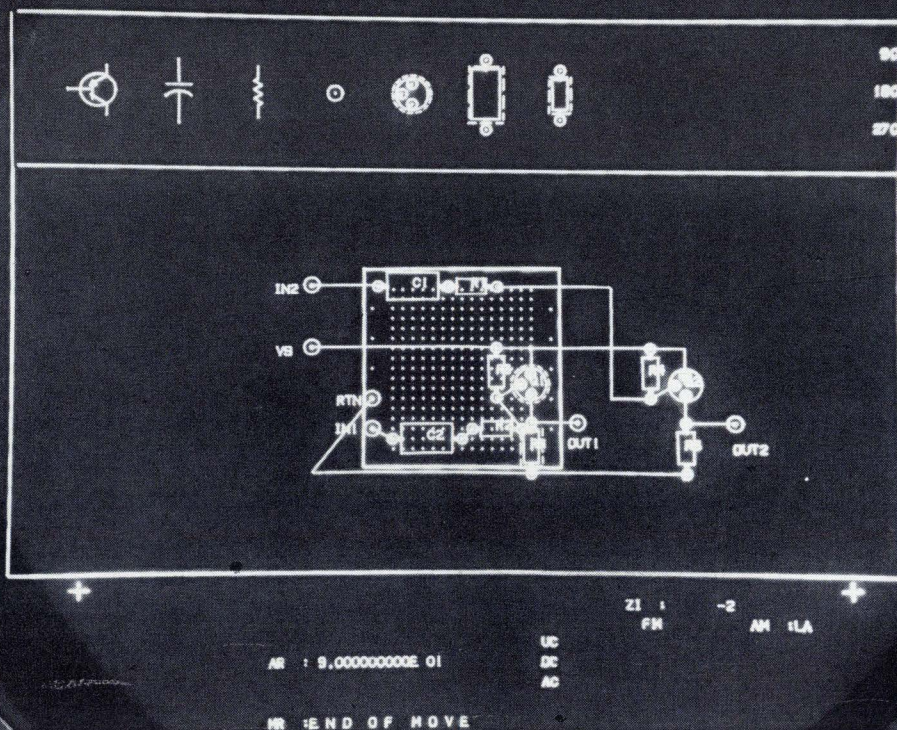

Polaroid circular polarizers clear up readouts.

It's never a problem to read readouts if they're equipped with Polaroid circular polarizers. Our polarizers improve readability from every angle by increasing contrast. In daylight. Or even in brightly lighted rooms.

But now you don't have to take our word for it. Send for our new brochure, and we'll include 3 samples of our circular polarizers (amber, neutral, and green). They'll help you see very clearly why many major display and

instrument manufacturers are now using Polaroid circular polarizers.

Write Polaroid Corporation, Polarizer Sales, Department 59, Cambridge, Massachusetts 02139.
Polaroid Circular Polarizers.

Brokers put stock in electronics

As new systems help to swell trading volume in securities and commodities, investment firms and exchanges struggle to break the back-room bottlenecks

By Alfred Rosenblatt

Industrial electronics editor

Perhaps no other sector of American business can use the help of the electronics industry to better advantage than the financial community. Electronic systems have already played a leading role in the industry's booming business. But the sustained high volume of trading in securities and commodities from Wall Street in New York to La Salle Street in Chicago and Montgomery Street in San Francisco has buried brokerage firms and exchanges in a mountainous backlog of paperwork. Two weeks ago, both the New York Stock Exchange and the American Stock Exchange, among others, were forced to shorten their trading days by 1½ hours to give member firms extra time to catch up on their bookkeeping chores. Meanwhile, brokers are turning to data-processing systems to handle orders in a more orderly fashion.

Rush hours. Ironically, electronics represents both the cause and cure here. "Electronics has speeded our ways of doing business fantastically," says an officer of the investment firm of Paine, Webber, Jackson & Curtis. "The methods we employed as little as five years ago couldn't possibly have accommodated the volume of trading we're handling now." But while the financiers have caught on to the benefits of electronics on the retail side, most have not—despite repeated proddings by the Securities and Exchange Commission—caught up on automating their back-room procedures to deal with the swelling influx of orders.

Since 1960, the average daily trading volume on the Big Board has soared from 3 million shares to 9.8 million during the first half of this year. The number of transac-

tions at most other exchanges and commodity marts, like the Board of Trade in Chicago, has climbed just as dramatically.

I. Brave bulls

Already, annual revenues from the rental and sale of electronic equipment and information services to financial outlets top \$20 million. And the outlook is bullish: such outlays may reach \$100 million by 1975. Thus far, the electronics industry has played a two-part role in the boom in financial markets:

- At brokers' offices, electronic inquiry and display devices provide almost instantaneous information on prices and related subjects. Customers' men in the hinterlands need no longer place time-consuming phone calls to get quotations on securities or commodities. They have only to punch a few buttons.
- At the exchanges and com-

modity marts, electronic gear is reducing the time it takes to get the news of transactions on the tickers and flashed throughout the world.

Suppliers three. The market for inquiry and display devices is the private preserve of just three companies: The Bunker-Ramo Corp., Stamford, Conn.; Scantlin Electronics Inc., Los Angeles; and Ultronic Systems, Mount Laurel, N.J., a division of Sylvania Electric Products Inc., which is, in turn, a subsidiary of the General Telephone & Electronics Corp. In all, these firms have made about 18,000 installations since the first unit was introduced by Scantlin in 1960.

New deal. "The whole concept of supplying information to brokers' offices changed when inquiry devices were introduced," says W. Frederick Goodyear, vice president of engineering at Bunker-Ramo. Although methods of displaying

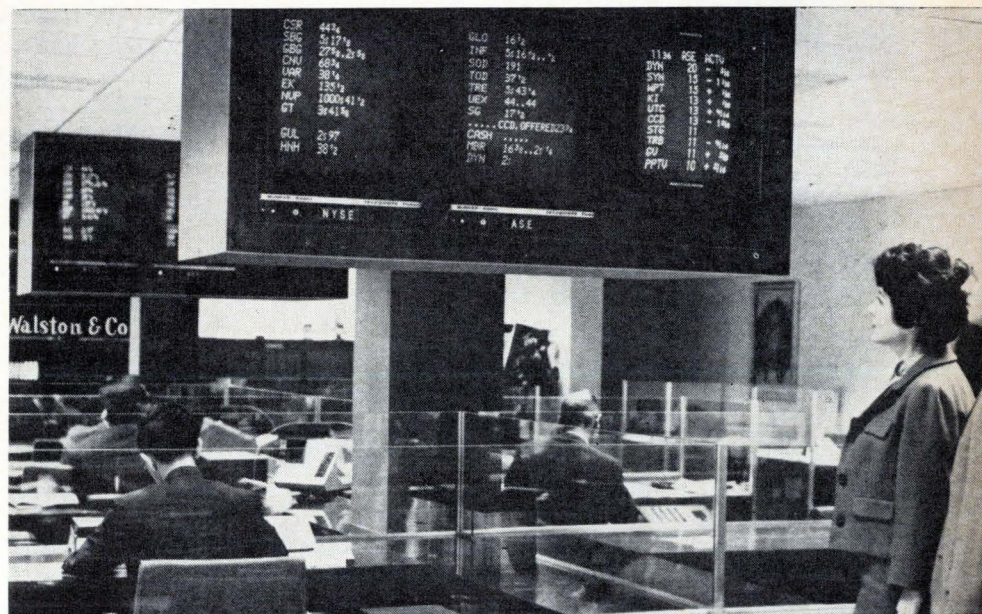

Taking a leaf. Bunker-Ramo's Telequote ticker system displays market data in book-page format instead of a conventional horizontal tape presentation.



this
DIMCO
snapslide
fastener...

holds assemblies
securely...

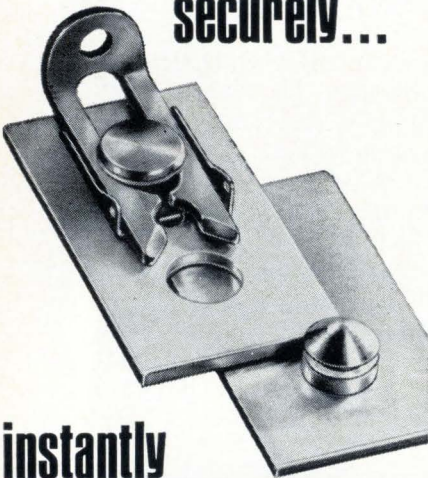

instantly
engages/releases...



write for
new
handbook

Dimco-Gray Snapslide Fasteners hold assemblies firmly despite shock or vibration... never need adjustment, even with repeated use. Instant snap action engages or releases fastener... no tools required. Approved under Military Standards. Handbook illustrates typical applications, stimulates design ideas, describes attachment methods. Write for free copy today.

DIMCO-GRAY CO., 204 E. SIXTH ST., DAYTON, OHIO 45402

Three of a kind



See it now. Inquiry and display units like this one made by Ultronic reduce brokers' dependence upon ticker data.



Pushbutton. Customers' men need only punch a few buttons on Bunker-Ramo device to get immediate stock data.

replies vary among the three manufacturers, the questions are generally posed in the same way. Using an alphanumeric keyboard, a stock broker can ask at what price any listed issue closed on the previous day, the daily high and low, or at what price the security last traded. In addition, a broker can check on a particular company's earnings and indicated dividend, the markets' current trading volume, or the trend of the market averages.

Readout. At present, only Bunker-Ramo's Telequote III desk inquiry unit uses a cathode ray tube to display information. The 3-inch tube, displaying alphanumeric characters made up of a 5-by-7 dot matrix, presents more information at one time than either of its rivals. Using the dot matrix rather than a conventional scanning raster made the circuitry simpler, according to Bunker-Ramo.

Scantlin's Quotron II and Ultronic's Stockmaster have digital readouts, but both are said to be developing crt's. This month Scantlin announced that it was supplying the electronics for a new market-information broadcasting service begun by Dow Jones & Co. Scantlin is modifying 23-inch monitors from the Conrac Corp. and 7-inch receivers from the Sony Corp. to accept data in digital form.

And last month, Ultronic began testing 14- and 23-inch television-type monitors at Bache & Co. offices in San Francisco. These units display both the NYSE and Amex tickers at the top half of their screens, and the Dow Jones finan-

cial news wire at the bottom. Robert Sinn, Ultronic's president, says this equipment presages a family of displays that will include 9- and 27-inch units. The 9-inch displays will be fitted with keyboards for use as desk inquiry devices.

Ultronic's monitors are similar to conventional television sets but they don't have a radio-frequency front end, says design engineer Eugene Gertler. Digital data is fed to the sets over 10 different data channels. The channels feed through a control, or interface, unit that drives the monitors. The control unit—at least one in every office—stores and formats the data and prepares the video and composite sync signals for display at the standard 525-line tv scanning rate.

II. Off the ticker

The familiar ticker-tape display is a potential casualty of the electronic invasion of financial markets. Developed by the Trans-Lux Corp., New York, in the mid-1920's, the ticker system prints the last-sale prices coming from the NYSE and Amex on a moving transparent tape and optically projects the alphanumeric symbols onto a translucent screen.

New display systems do away with the fragile tape, which has to be frequently replenished, and with the cumbersome projection system. For example, Ultronic's solid state Lectrascan has large Nixie-like tubes whose segments can be lighted to form alphanumeric symbols; stock prices move across the



Tab. Brokers pay about \$400 a month per office plus \$35 a unit for devices like this from Scantlin.

length of a horizontal display as they're received from the exchanges' communications networks.

Bunker-Ramo's Telequote ticker represents perhaps the sharpest departure from traditional displays. It presents prices like a page from a book on a 27-inch tv monitor, instead of on a horizontally moving sign. The system displays up to 11 prices printed a line at a time. The same data can also be presented on a 3-inch desk inquiry unit or on display monitors.

Far flung. To back up the equipment in the brokers' offices, each of the three top suppliers has developed a base of computerized market information that is continually updated as stocks and commodities are traded. Typical is the Ultronic system, which feeds in sales-price data from the NYSE, Amex, and 10 different commodity exchanges, as well as information on over-the-counter issues. Information on corporate dividends and earnings can also be entered.

Information is stored against the time that brokers request it and also is processed to provide a variety of special services. For example, Bunker-Ramo's Telequote III Trends furnishes a continuously updated series of reports on such things as: the 10 stocks registering the greatest price gains; the 10 suffering the greatest losses; the 10 most active; as well as the Dow Jones and Standard & Poor's market averages and the number of stocks that have advanced, declined, or remained the same. It even supplies some of this data for use by the

Versatility and simplicity in variable, regulated power supplies

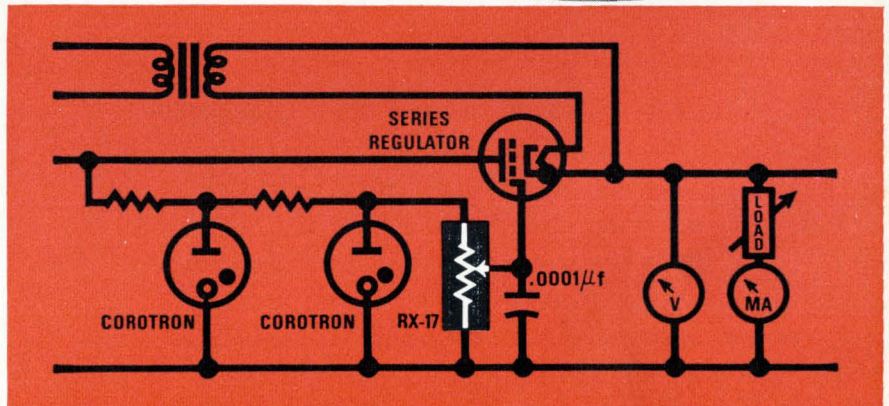
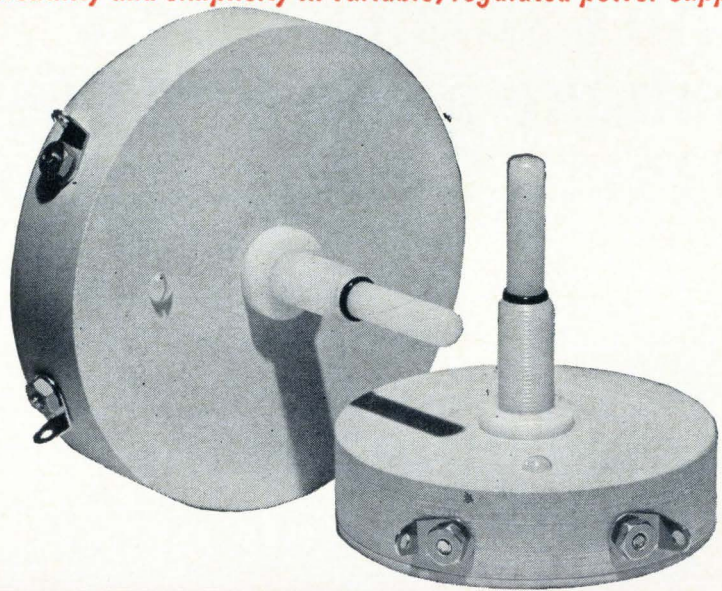

POTENTIOMETERS TO 10 KV

New Victoreen RX-17 series ceramic potentiometers, when used across a well-regulated high-voltage source, provide reference adjustment with a degree of simplicity never before available to circuit designers.

Long life, resistance stability and panel insulation capability to 20 kv make Victoreen RX-17 series potentiometers ideal for reference adjustment for variable, regulated HV supplies in CRT's, TWT's, Klystrons, GM tubes, proportional counters, etc.

Two RX-17 series are available: One for operation to 5 kv rated at 3 w, the other for 10 kv rated at 5 w. RX-17 series ceramic potentiometers are normally supplied with nominal resistance range of 1 Meg to 5000 Meg, with a linearity of $\pm 2\%$. Full technical details on request to Applications Engineering Department.

6976-A

VICTOREEN INSTRUMENT DIVISION
10101 WOODLAND AVENUE · CLEVELAND, OHIO 44104
IN EUROPE: GROVE HOUSE, LONDON RD., ISLEWORTH, MIDDLESEX, ENGLAND



Who's small enough to make a slip ring big enough to test a C-5A jet engine?

Some company called Poly-Scientific.

Being small has its advantages. We're a man-to-man outfit. That makes it easy for us to cut red tape. Juggle schedules around. Accommodate your project with speed and efficiency.

And it makes it easy for us to tackle new things, too. Like our 110-inch diameter slip rings for testing C-5A jet engines. Or slip rings for two-ton, 15-foot-high space simulator centrifuges. Or medium-size units for helicopter rotors, wind tunnels, radar rotary joints. Sometimes projects like these require special equipment, materials and processes. So we often design and develop our own.

And we have the help of our Scientific Advisory Board to tell us how to do it—a professional group made up of some of the best qualified chemical, electronics, and mechanical engineering professors of nearby Virginia Tech.

An advanced approach for a small company located in Blacksburg, Va.? Not so surprising when you consider we've been here since 1953 developing this way of doing things.

Care to try us on for size?

POLY-SCIENTIFIC 
A DIVISION OF LITTON INDUSTRIES



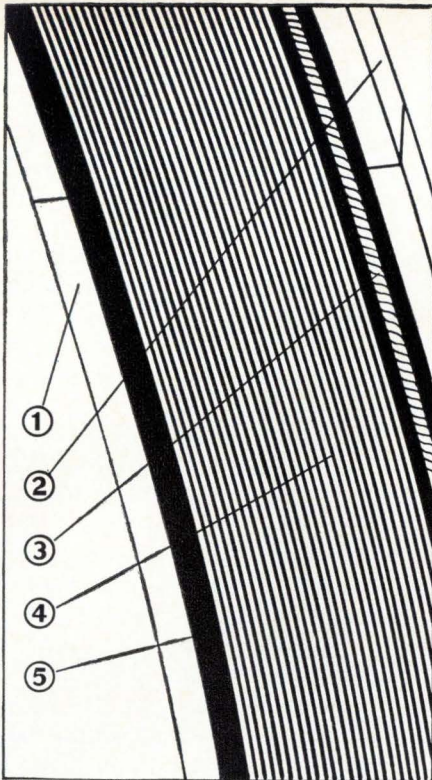

SLIP-RING SPECIALIZATION isn't new to Poly-Sci. Our giant 110"-dia., 4½"-wide unit, for example, was designed to meet rigid performance specs within minimum physical dimensions.

- ① Outside backplates are divided into ten 30° and two 13° segments with a 34° "open" joint.
- ② Plate thickness: 0.34"
- ③ Mandrel dia. of continuous slide-wire position indicator: 0.128"
- ④ 27 continuous signal pick-up channels grooved for mating brush alignment.
- ⑤ Thickness of dielectric base: 0.090"

Send us your requirements—regardless of slip-ring size. Mail coupon or call Robert Gardner at 703/552-3011. Or TWX 710-875-3692. On the West Coast, call Jim Swallow at 213/887-3361.

Poly-Scientific Division ★ ★
 Litton Industries
 1111 N. Main St., Blacksburg, Va.
 Tell me more about your
 slip-ring capabilities.

Name _____

Title _____

Company _____

Address _____

City _____ State _____ Zip _____

... suppliers have computerized data on securities and commodities ...

American exchange. Bunker-Ramo is readying a similar service dubbed TOPS, for Teleregister Omni Processing and Switching, for introduction [Electronics, March 6, p. 221].

To make data available almost instantly, the companies maintain satellite computers in major metropolitan centers, each with memories identical to the master unit. Ultronic, for example, has 21 satellite machines in the U.S. and nine overseas. The company keeps track of 8,000 stocks and commodities with data stored on magnetic disks at its main computer center.

III. On the floor

While the brokers speed up operations in their front offices with electronics gear, the exchanges are following suit. Not only are they using electronic data processing to handle orders and keep track of accounts but they are also automating operations on the trading floor. In 1964, the NYSE installed high-speed tickers, operating at up to 900 characters per minute, to replace 500-cpm machines in use since 1930. This speed should theoretically be able to accommodate trading volumes of 16 million shares a day, according to the exchange.

Early next year, the Amex will

also convert its transmissions from 500 to 900 characters per minute. Information for the ticker lines is fed from the Amex floor through 48 electronic input devices—two at each of the 24 trading areas—made by Bunker-Ramo. The units, which resemble the company's Telequote III equipment, have a crt and special keyboard. As sales are made, the information for the ticker is keyed in and displayed. The operator checks the display data against the sales slip and then transmits it to the exchange's data center.

The information goes into Bunker-Ramo control units where it's formatted for transmission over the ticker lines; it is then switched onto the lines by a Datanet 30 terminal made by the General Electric Co. The GE system—two terminals operate in parallel—replaced electromechanical switching gear late in June. The complete system, with three Bunker-Ramo control units, will be able to handle 9 to 12 million shares a day.

The NYSE has also automated the reporting of transactions, but its system uses a coded data card marked in pencil by a floor reporter. The card is then read by an automatic optical card reader that transmits the information directly to the

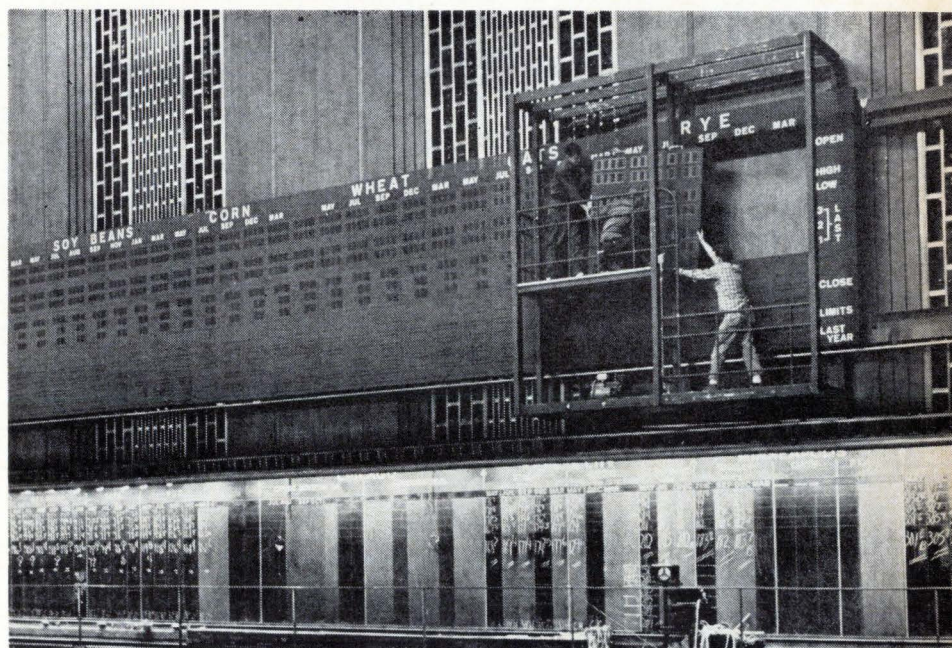

After the fall. Board of Trade's computer-based system to report commodity transactions will be installed by autumn; equipment replaces manual postings.

NEW! Push-Button Bridge

Measures Impedance to 0.1% Accuracy

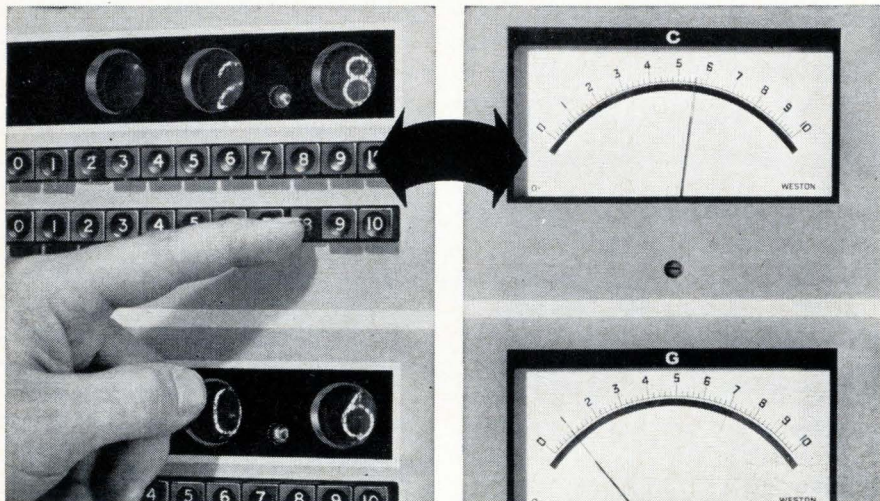

Once the Bridge is trimmed, a series of front-panel range push-buttons are suppressed in sequence until a reading is obtained on the meter. Setting up the first one or two digits of this reading on push-button decade controls gives the final reading.

No Manual Balancing with New Wayne Kerr B641 Universal Impedance Bridge

Now, batch testing of components or the observation of changing values under laboratory conditions are made simpler and faster by the new Wayne Kerr B641 Universal Impedance Bridge.

Designed for the continuous measurement of any type of impedance or admittance, at audio frequencies, as low as 1 picofarad — to an accuracy of 0.1% — the B641 eliminates manual balancing, makes readout virtually automatic.

Operation is simple: once the Bridge is trimmed, it is necessary only to depress a series of front-panel range push-buttons in sequence until a reading is obtained on the electronically-balanced meters. Setting up the first one or two digits of this reading on push-button decade controls makes the balancing automatic; the meters can read the first, second, third or fourth digits.

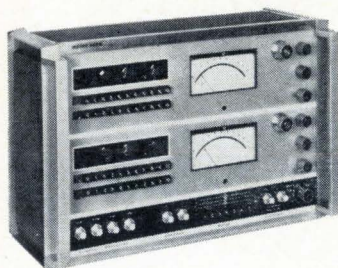

The Bridge produces analog voltage proportional to the meter readings and BCD (in a 1248 code), for the nixie readout.

The B641 is based on the transformer-ratio-arm principle, giving stable performance even when components under test form part of a sub-assembly (such as a printed board or an encapsulated unit) or when long measurement leads must be used.

SPECIFICATIONS

Overall Ranges: 0.002pF — 50,000μF	Accuracy: 0.1% from 1pF to 10μF
20pF — 500Ω	10nΩ to 100mΩ
200nH — 5MH	1mH to 10kH
2nΩ — 50,000MΩ	10Ω to 100MΩ
Discrimination: 0.01% of max. on all ranges	Price: \$1,700 FOB Montclair, New Jersey

For literature and detailed specifications, write:



Wayne Kerr CORPORATION

18B Frink Street, Montclair, N.J. 07042 • Phone 201 746-2438

INNOVATIONS IN INSTRUMENTATION

central computer driving the Big Board's ticker network.

Bid and asked. The Chicago Board of Trade's new computer-based system, which replaces manual posting of quotes on commodities, uses a different breed of electronic equipment. The system, slated for operation this fall, not only has to get the last-sale prices and quotes onto the Board's ticker lines but must also continuously display them for the benefit of traders on the floor.

The latter chore is being done with information display panels built by Ferranti-Packard Electric Ltd. of Toronto. The panels consist of an array of disks, each controlled by an attached permanent magnet that applies a pulse of current to two field coils. Up to 5,000 changes can be made a second.

Information from the Board of Trade floor is keyed into Mimo data terminals, built by Data Trends Inc., Parsippany, N.J., and fed into two computers. Data Trends is also supplying interface equipment to integrate the whole system.

The computers also drive Divcon digital-to-video converters supplied by a Canadian subsidiary of the Radio Corp. of America. Models with both 12- and 23-inch television screens will be available at locations away from the trading floor.

IV. Backstop

Programming the computers already in place in brokerage houses and exchanges to perform additional tasks will be a top-priority job in the years ahead. Switching buy or sell orders automatically from branch offices to the floor of the appropriate exchange for execution is one such task. Several large brokerage houses, including E.F. Hutton & Co. and Bache & Co., have begun doing this.

"A simple computer could have been used a long time ago if all it had to do was switch messages," says Norman M. Epstein, vice president for data processing and communications at E.F. Hutton. "It's only with the present-day high-speed computers in the IBM 360 and RCA Spectra 70 class that we can do the data processing associated with the orders." This processing includes bookkeeping and billing, address updating, and portfolio analysis.

**It's easy to buy from a national distributor.
Just call our local warehouse.**

ARCO ELECTRONICS

- Elmenco Capacitors
- Deutsch Connectors
- Edison Thermostats
- Fairchild Semiconductors
- Speer Resistors
- Jeffer's Inductors
- Dale Potentiometers
- General Instrument Capacitors and Semiconductors
- Arco Capacitors
- Allied Control Relays
- General Electric Semiconductors and Capacitors
- Bendix Semiconductors
- Philco and ITT Semiconductors
- General Radio Variacs



"FOR INFORMATION CALL"

ARCO ELECTRONICS INC
1610 Industrial Ct Arlington...TA 1-1120

DALLAS

ARCO ELECTRONICS

- Elmenco Capacitors
- Deutsch Connectors
- Edison Thermostats
- Fairchild Controls
- Speer Resistors
- Jeffer's Inductors
- Torotol Transformers
- General Instrument Capacitors
- Arco Capacitors
- Allied Control Relays
- Philco Semiconductors
- Solid State Products Semiconductors
- General Radio Variacs



"FOR INFORMATION CALL"

ARCO ELECTRONICS INC
Community Dr Great Neck...516 HU 7-0500

NEW YORK

ARCO PACIFIC

- Elmenco Capacitors
- Deutsch Connectors
- Edison Thermostats
- Fairchild Controls
- Speer Resistors
- Jeffer's Inductors
- Torotol Transformers
- General Instrument Capacitors
- Arco Capacitors
- Allied Control Relays



"FOR INFORMATION CALL"

ARCO PAC INC
2707 E Foothill Pas 684-1510

LOS ANGELES

ARCO PACIFIC

- Elmenco Capacitors
- Deutsch Connectors
- Edison Thermostats
- Fairchild Controls
- Speer Resistors
- Jeffer's Inductors
- Torotol Transformers
- General Instrument Capacitors
- Arco Capacitors
- Allied Control Relays



"FOR INFORMATION CALL"

ARCO PAC INC
3945 Bohannon Dr Menlo Park...324-1356

SAN FRANCISCO

ARCO ELECTRONICS

- Elmenco Capacitors
- Deutsch Connectors
- Edison Thermostats
- Fairchild Controls
- Speer Resistors
- Jeffer's Inductors
- Torotol Transformers
- General Instrument Capacitors and Semiconductors
- Arco Capacitors
- National Semiconductor
- Philco Semiconductors
- Union Carbide Semiconductors
- General Radio Variacs



"FOR INFORMATION CALL"

ARCO ELECTRONICS INC
75 Gaylord St Elk Grove Village...439-8100

CHICAGO

You can get the electronic parts you want, when and where you want them, from Arco.

It's not always that easy with a local distributor. Sometimes they just don't have the parts you want.

It could be they don't have enough shelf space to stock them. Or enough volume to buy them in large amounts.

Arco, being a national distributor, has both. We have five warehouses around the country. So we have plenty of shelf space. And enough volume to keep it filled with the best product lines in the business.

We also have more people working for you. Not just order-takers. But people who know enough about electronics to help you with application problems.

And people who'll fill your order, whether it's for one piece or one thousand. And see that it's delivered. Fast.

So if you don't happen to have a copy of the New York, Los Angeles, Chicago, Dallas and San Francisco Yellow Pages handy, it might be a good idea to tear out this ad and save it.

It'll make it that much easier for you to buy from Arco, your local national distributor.

Arco Electronics: Coast to coast.

High performance attenuators at "PAD" prices?

Precisely.

The unique combination of exceptional performance at attractively low prices makes Hewlett-Packard coaxial attenuators ideal for your full range of applications: as measurement standards, in lab and production setups and as systems components. Use them to measure and compare attenuation, to reduce power, to improve impedance match and to achieve circuit isolation. High accuracy, low VSWR and flat frequency response—all these at "pad" prices.

Carefully engineered fabrication methods make it possible to guarantee the precision performance from volume-production attenuators. New semi-automated thin film deposition techniques, for example, provide unprecedented uniformity. In addition, each unit is individually

swept frequency tested during manufacture to guarantee that these precision attenuators will out-perform specified accuracy over their complete frequency range.

Three versions of the HP precision attenuators are available right now in attenuation values of 3, 6, 10 and 20 dB. Sets containing the four attenuator values are also offered. For more information, call your local HP field engineer or write Hewlett-Packard, Palo Alto, California 94304. Europe: 54 Route des Acacias, Geneva.

HEWLETT  PACKARD

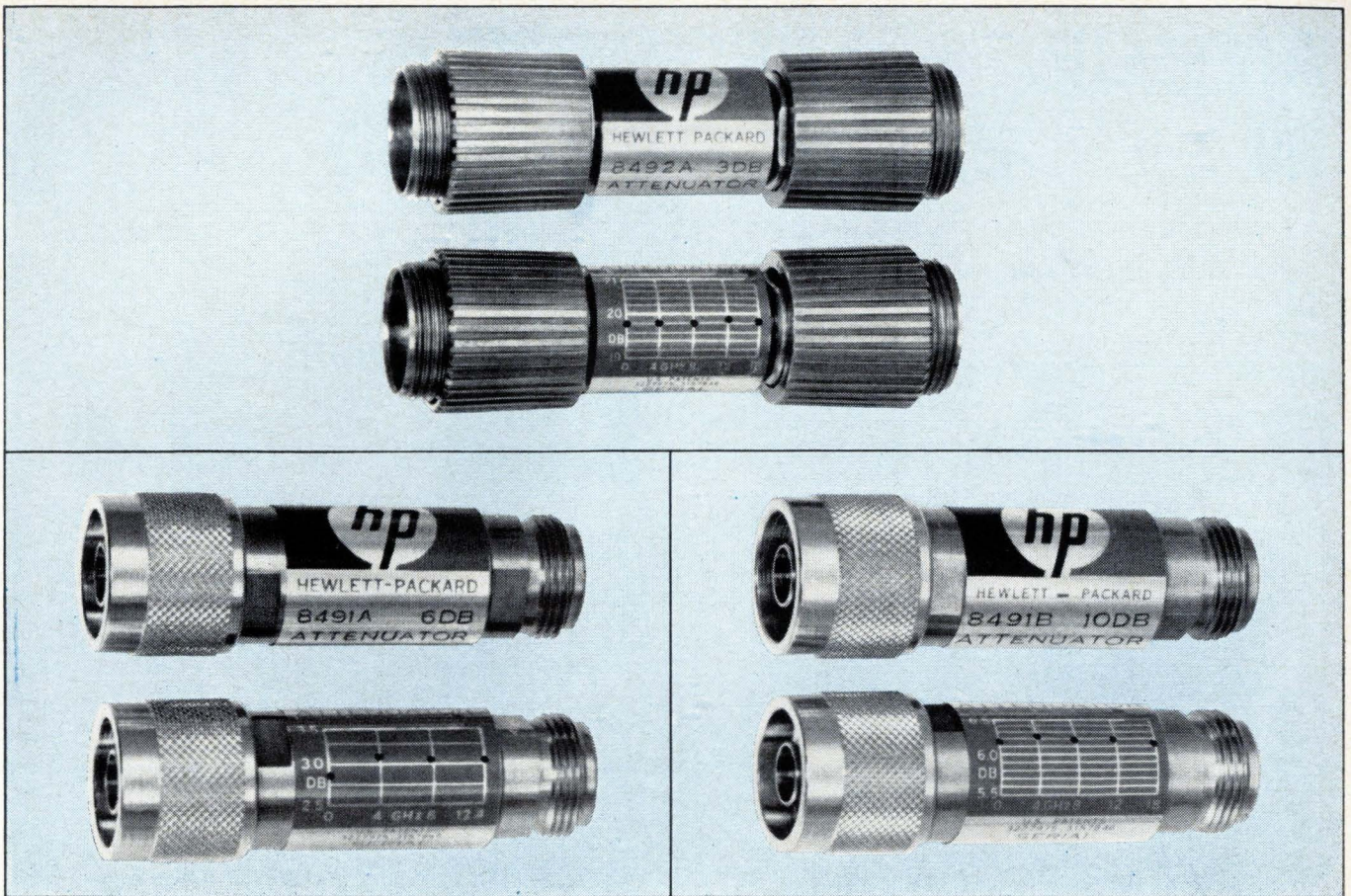

MAXIMUM VARIATION IN ATTENUATION—DC to 12.4 GHz for 463 production-run 8491A Attenuators (263 10-dB units, 200 20-dB units)

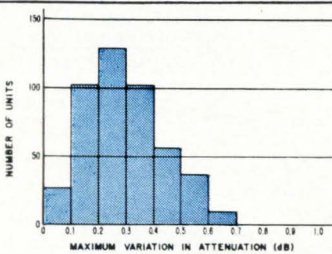

The consistency with which Hewlett-Packard coaxial attenuators achieve flat frequency response is illustrated here, your guarantee that your unit will out-perform specified accuracy.

	8491A DC to 12.4 GHz	8491B DC to 18.0 GHz	8492A DC to 18.0 GHz
Accuracy	±0.3 dB to ±1.0 dB depending upon attenuation		
SWR	1.15 to 1.5, depending upon attenuation		
Connectors	Type N	Type N	APC-7
Price	\$50 each	\$65 each	\$125 each
Attenuator Set (1 @ 3, 6, 10, 20 dB)	HP 11581A \$225	HP 11582A \$285	HP 11583A \$525



Sets of 4 attenuators, complete with full calibration reports, are available. Each set includes convenient storage case.

ANY OF FIVE PROTECTIVE CIRCUITS IN ONE EASILY OPERATED SWITCH

APL CIRCUIT PROTECTORS

SERIES TRIP

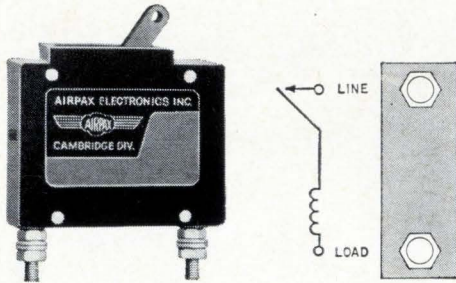

Airpax APL circuit protectors are manufactured in five circuit configurations. Each is available in any of 10 time delays, in any of 16 standard trip levels, and rated for a maximum of either 50 vdc, 250 vrms at 60 Hz, or 250 vrms at 400 Hz.

REMOTE INDICATION

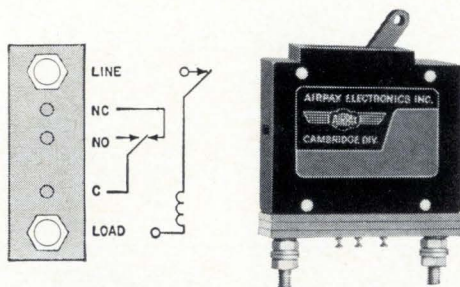

A switch built into Type APL-RE protector transfers up to 5 amperes in a separate signalling circuit.

*To the operator it's an ON-OFF switch.
To you it's a design simplifier.*

SHUNT TRIP

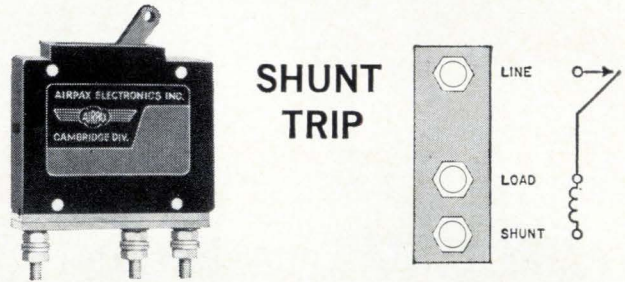

Shunt trip provides you with several possibilities. You can program an external shunt across the coil to change trip level for different operating modes of your equipment.

RELAY TRIP

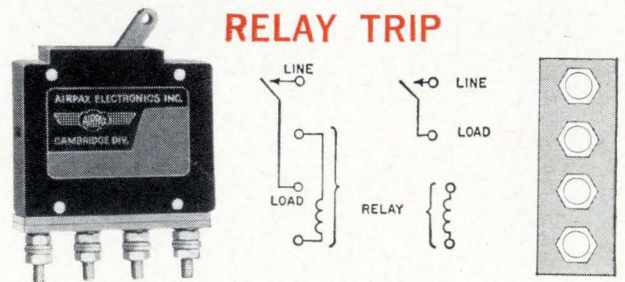

In protector Types APL-4 and -5, coil and contacts terminate at separate pairs of terminals. With this configuration, you can control current in one circuit by a different current in a separate circuit.

REMOTE OPERATE

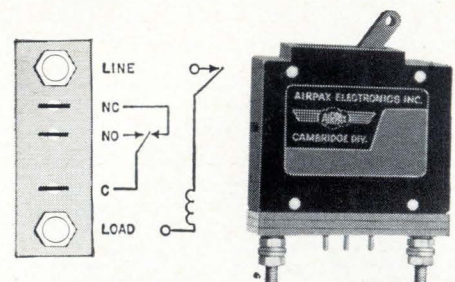

Auxiliary contacts built into Types-RO and -RO1 handle up to 10 amperes. This spdt switch operates simultaneously with the main contacts. Used to switch a remote load, this feature provides means for interlocking and protecting related loads.

AIRPAX ELECTRONICS

CAMBRIDGE DIVISION • CAMBRIDGE, MARYLAND
Phone 301-228-4600

New Products

New semiconductors

Low threshold voltages switch MOS registers

Four new circuits can be used in airborne instruments, for radar signal processing, or as variable delay lines

Ever since last February, when Charles E. Sporck and four colleagues left the gaint Fairchild Camera & Instrument Corp. to join the tiny National Semiconductor Corp., integrated-circuit makers—and customers—have been waiting to see what direction National would take. This month they got their answer. The company, which already offers a small linear IC line, introduced a family of four metal oxide semiconductor shift registers. "We are going to be a linear and mos house," says Floyd Kvamme, product marketing manager.

National's MOS family is made up of a pair of dual registers, the 25-bit MM400 and 50-bit MM402, and two single registers, the 25-bit MM501 and 50-bit MM503. All but the last are now available off the shelf. The MM503 won't be available until next month.

The MM400, a dynamic shift register built on a single silicon chip, utilizes MOS p-channel enhancement mode transistors. It is designed to operate over a wide frequency spectrum and can be used in any sequential digital equipment that employs a two-phase clocking system.

The four circuits share a characteristic that National considers extremely important: the threshold voltage for switching any device on the chip is only 2.2 volts, as against 5.5 volts for competitive devices. As a result, the registers

are operated with lower clock and input voltages, and have less power dissipation.

Low road. The saturation voltage required to change the field under

an MOS gate and enable current to flow between source and drain must be two to three times the threshold voltage, Kvamme explains. With an input voltage of -10 v, the circuits' clock voltage of -16 v is the lowest in the industry, he adds. The significance is:

- In airborne instruments, MOS devices must work off a 28-v supply, which can drift down to 26 v. The best regulated voltage users can hope for is 22 to 24 v. This level is high enough to supply a -16 -v clock, but it can spell trouble for devices requiring -27 v—the MOS industry norm. Devices with 5.5-v threshold voltages require about 15 v for saturation.

- Impedance is independent of

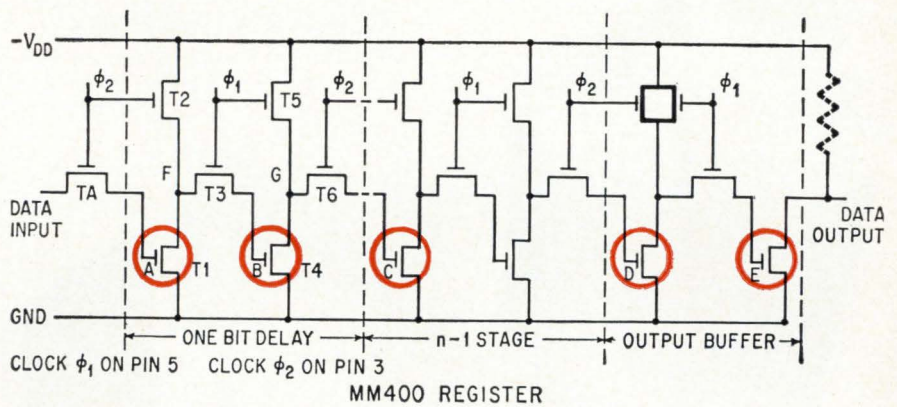

By the numbers. National Semiconductor's MM400 is a dual 25-bit dynamic shift register. Each bit of delay shown in the schematic above consists of two inverters, T1 and T4, together with clocked load resistors, T2 and T5, and two coupling devices, T3 and T6.

Countdown. The timing diagram at right shows how the MM400 generates a multiple-bit delay. When ϕ_2 goes negative, the coupling unit, TA, and load resistor T2 are clocked on, transferring data at the input to node A. Depending on the stage of the input, this turns T1 on or off.

TIMING DIAGRAM

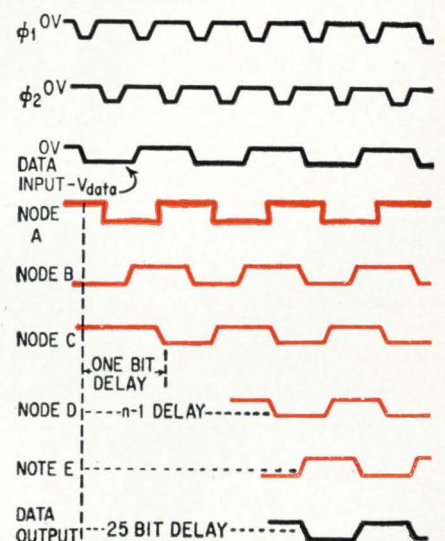

Barnstead elephant-sized demineralizers work for peanuts

Barnstead industrial demineralizers give you large quantities of process water at unusually low cost. Take this Barnstead Two-Bed model used by a major metals producer.

It removes heavy concentrations of calcium and other troublesome impurities from 2,000 gallons of water per hour — at an operating cost of only a fraction of a cent per gallon. (Excluding initial demineralizer cost.)

Operation, particularly regeneration, is easy and economical. A simple one-handle valve for all steps and a visible waste trough help prevent resin-wasting mistakes. An automatic purity controller assures water quality and tells when it's time to regenerate.

Do you have a big demineralizing job to do? Write for the Barnstead Catalog 160 describing demineralizers from 5 to 3,000 gph.

Barnstead

A subsidiary of Ritter Pfaudler Corporation
472 Lanesville Terrace
Boston, Massachusetts

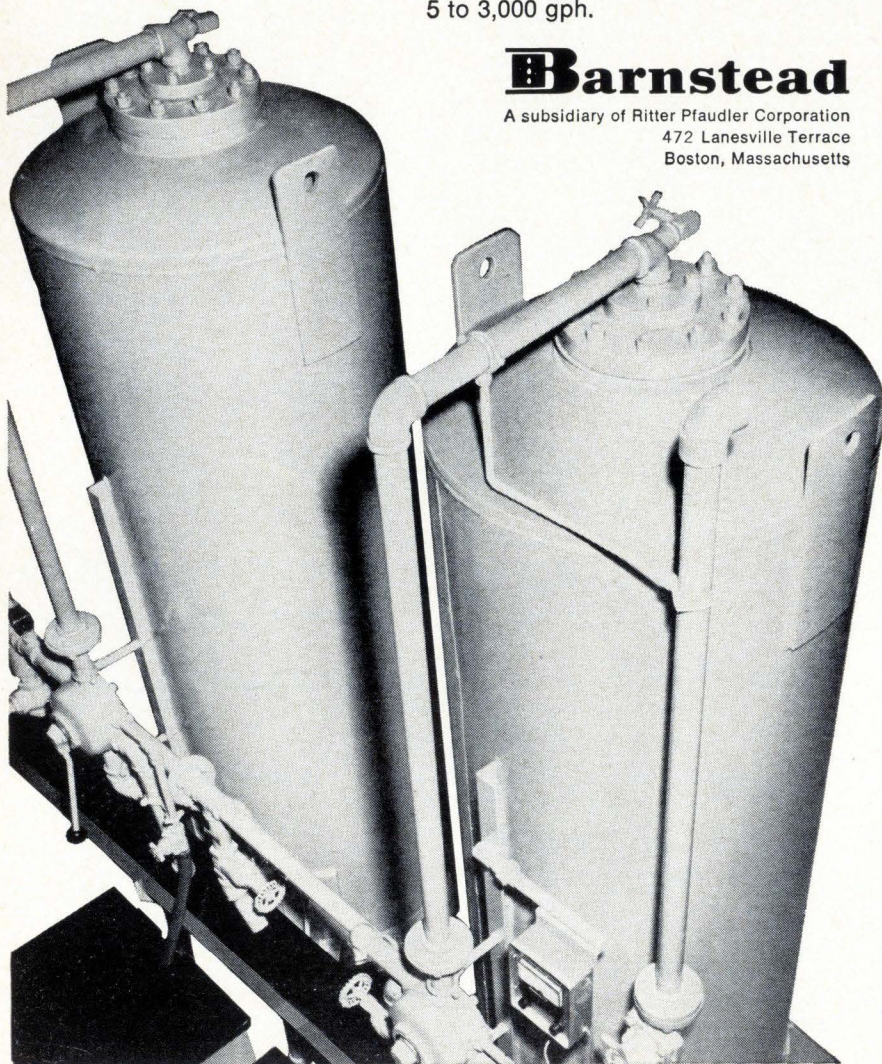

... new registers vie with DTL circuits ...

these voltages. Since power equals v^2/R , the lower voltage means that the device's power dissipation is inherently less.

National gets the lower threshold voltage by using a silicon wafer that is sliced from the crystal in the 100-oriented plane, rather than in the conventional 111-oriented plane. The lower resistivity of these slices offers two fringe benefits: the zener protection at the input is better and the devices can be packed closer on the chip. The MM400 is on a 49-by-67-mil chip; the MM402, with twice as many devices, is on a 62x67-mil chip. In choosing the 100-oriented silicon, National indicates that it doesn't believe that 111-oriented silicon is more stable.

Outlets. Kvamme points out that with a threshold voltage of only 2.2 v, the devices are almost directly compatible with diode-transistor-logic bipolar circuits driven by voltages of 0.8 to 2 v. He believes the devices have applications in radar signal processing, serial information processing, and as variable digital delay lines. Halving the clock frequency doubles delay, Kvamme points out. In this latter area, mos devices will probably collide with the magnetostrictive devices now being perfected by a number of companies. The mos makers argue that their units are more compact, and assert that they do not require signal processing on either end.

Specifications

Model MM400	
High frequency operation	1 Mhz
Low power consumption	1.2 mw/bit at 1 Mhz
Temperature range	-55° to +125°C
Clock input level	
Logic 0	-0.5 v
Logic 1	-16.0 v
Data input voltage	
Logic 0	-1.5 v max.
Logic 1	-7.0 v min.
Clock repetition rate	0.01 Mhz min.
Data output voltage	
Logic 0	-1.5 v max.
Logic 1	-7.0 v min.
Output impedance	2.0 kilohms
Breakdown voltage	28 v max.

Prices

Quantities:	1-25	25-99	100-999
MM400	\$45	\$36	\$30
MM402	\$50	\$48	\$40
MM501	\$14.80	\$11.80	\$ 9.85
MM503	\$22.20	\$17.75	\$14.80

National Semiconductor Corp., 2950 San Ysidro Way, Santa Clara, Calif. [338]

24 hours after we hear from you, you'll hear from us.

Name _____

Address _____

City _____ State _____ Zip _____

College _____

Degree _____ Year _____

I am interested in the following type of assignment:

I have had professional experience in the following area(s):

I have had a total of _____ years' experience.

AIRMAIL COUPON NOW TO:
Mr. Robert A. Martin
Head of Employment, Dept. 53
Hughes Aerospace Divisions,
11940 W. Jefferson Blvd.,
Culver City, California 90230

Hughes — where the hiring action is

300 aerospace engineers needed.
Electro-Optical Engineers
Aeronautical System Engineers
High-Frequency Design Engineers
Space Systems Engineers
Guidance and Control Engineers
Missile Systems Engineers
Component Engineers and
many other disciplines.

Current projects include:

PHOENIX, TOW,
AIM-47A / AIM-4E Missile
Systems • VATE
Automatic Checkout Equipment
• CORDS • COMMUNICA-
TIONS SATELLITES like Lani
Bird • APPLICATIONS
TECHNOLOGY SATELLITES
• and dozens of other important
programs and projects.

HUGHES

HUGHES AIRCRAFT COMPANY
AEROSPACE DIVISIONS

An equal-opportunity employer
(U.S. citizenship required)

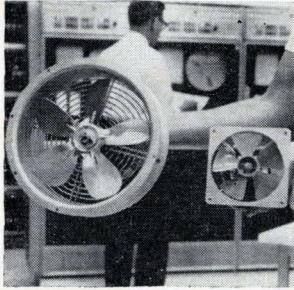

Blower units designed for spot cooling can fit in an opening less than 4¾ in. sq. They are rated 100 or 90 cfm at approximately 3,000 rpm and operate at 115 v or 230 v, 60 hz. Assemblies feature a shaded-pole, unitized motor with a hydrodynamic oil-film lubrication system. They operate at any angle. General Electric Co., 1635 Broadway, Fort Wayne, Ind. 46804. [341]

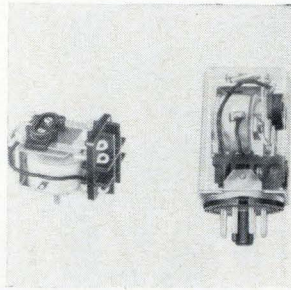

An industrial relay has double-pole, double-throw contacts with 10-amp (1/6 hp) at 120 v a-c and 5-amp (1/3 hp) at 240 v a-c ratings. The open-type 314-XBX has a single-stud mounting. The enclosed, plug-in 314XBX-48P has a dust and flame resistant polycarbonate cover and standard octal plug. Prices are \$3.90 and \$6. Struthers-Dunn Pitman, N.J. [342]

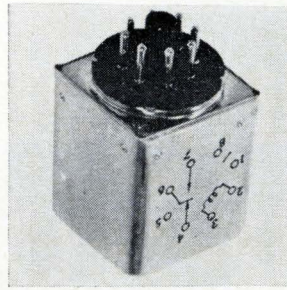

Designed for industrial and military use, the series 12FP sensitive relay comes in an aluminum enclosure with octal plug-in base. Contacts are adjustable up to 80% of operate and release values. Sensitivity starts as low as 5 mw. Coil resistance is from 0.100 ohm to 22,000 ohms. General Automatic Corp., 235 W. First St., Bayonne, N.J. 07002. [343]

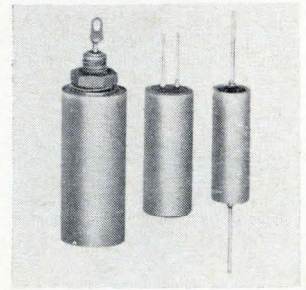

Metalized mylar capacitors are offered in tubular construction with glass-to-metal end seals. Miniature series 17E are available from stock in 100- to 600-v sizes in capacitance ratings from 0.001 to 20 µf with 20% to 1% tolerances. Operating temperature is from -55° to +125°C. Units meet MIL-C-18312. SEI Manufacturing Co., 18800 Parathenia St., Northridge, Calif. [344]

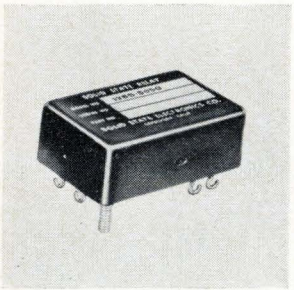

Silicon transistorized, switching relay SSR-1285-5050 is a contactless device capable of over a trillion operations. Actuation time is 2 µsec; dropout time, 5 µsec. Actuation frequency can be as high as 50 khz. Epoxy encapsulation assures protection against shock and vibration. The devices occupy 1 cu in. Solid State Electronics Co., 15321 Rayen St., Sepulveda, Calif. [345]

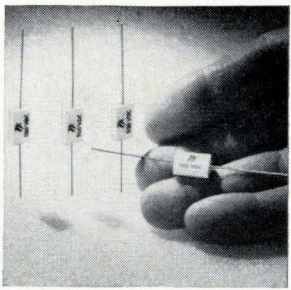

Porcelain capacitors in the VY14 series have capacitance values of 0.24 pf to 0.91 pf, temperature coefficient of 0 ± 25 ppm/°C, and a rating of 500 v d-c. Operating from -55° to +125°C, the units show a dissipation factor of less than 0.001 and insulation resistance of more than 100,000 megohms at room temperature. Vitramon Inc., Box 544, Bridgeport, Conn. [346]



Miniature, transistorized telegraph relay 538-2 is designed for continuous duty and minimum distortion, with a life of 5 years at 200 bits/sec. It can be used as a replacement for octal-based, electromechanical relays for teletypewriters in data-processing applications. Output contacts handle up to 140 v each. Trepac Corp. of America, 30 W. Hamilton Ave., Englewood, N.J. [347]

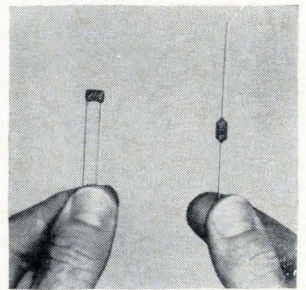

Subminiature series ML02 and ML03 capacitors are designed for use in computers as well as for by-pass and coupling applications in any circuitry. Rated at 25 v d-c across the temperature range of -55° to +85°C, both are available in capacitance values from 0.01 to 0.15 µf and meet or exceed MIL-C-11015. Gulton Industries Inc., 212 Durham Ave., Metuchen, N.J. [348]

New components

Power transistors: the jump to 50 watts

TRW further plans a device producing 100 watts at 500 Mhz, a product that should be on the market within a year

Power transistors' first big break came in 1963 when the overlay technique pushed the devices to outputs of from 2 or 3 watts at 200 megahertz to several watts at 400 Mhz. Since then, the gains in both power and frequency have occurred slowly, watt by watt and

hertz by hertz, until last year when the state of the art leveled off at about 20 watts at 400 Mhz. Now, TRW Semiconductors Inc. has made a giant jump: it's about to introduce a transistor that generates 50 watts at 500 Mhz. A complementary device, generating 25

watts at 500 Mhz, also will be offered.

TRW isn't stopping there. Within six months, says Mike Preletz, manager of the company's advanced technology plant, the firm will have a device that produces 10 watts at 2 gigahertz. And within a year, he adds, "we'll have a transistor that generates 100 watts at 500 Mhz."

The 50-watt, 500-Mhz device, is called the 2N5178, and it will sell for \$110 each in quantities of 100. The 25-watt model, called the 2N5177, will sell for \$55 each in 100-lot orders.

On the chip. In the 25-watt model, eight cells are deposited

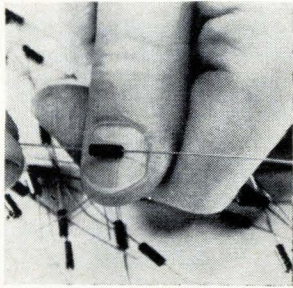

Solid tantalum capacitors measuring 0.100 x 0.290 in. are designed for use in computers, data-processing, and communications equipment. Series D units are available in working voltages of 6 (12 μ f max), 10, 15, 20, and 35 (1.2 μ f max) v. Impedance of the 12 μ f-rated device is less than 1 ohm at 10 Mhz. Union Carbide Corp., Box 5928, Greenville, S.C. [349]



Aircraft and military limit switches, designated HE, use glass-to-metal and metal-to-metal seals throughout. The 1HE-6 is interchangeable with the company's other environment-proof switches; major difference is its hermetic seal at the actuator. Mechanical life is 100,000 operations. MicroSwitch division, Honeywell Inc., 11 W. Spring St., Freeport, Ill. [350]

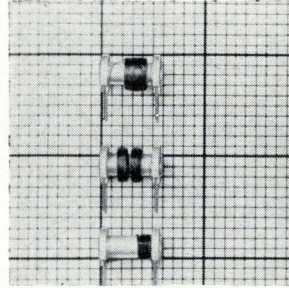

Three horizontally-mounted coils in the 7120 series are for use with printed circuits. They provide overlapping inductances from 0.095 μ h to 11 millihenrys. Units measure 0.378 x 0.375 x 0.562 in., have 4 mounting pins of 0.025-in. diameter, and fit mounting holes with 0.250- x 0.500-in. spacing. Cambridge Thermionic Corp., 445 Concord Ave., Cambridge, Mass. [351]

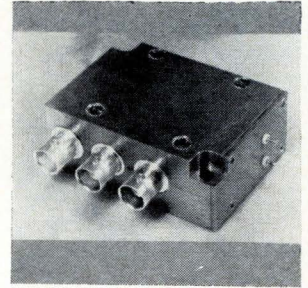

Taking up an area of less than 3 cu. in., type RC60A coaxial relay is rated 0.5 kw c-w at 30 Mhz. Vacuum construction eliminates noise generation. Vswr is 1.1:1 max across 0 to 200 Mhz. Switching speed is 10 msec max. Applications include transmitter switching, and sonar and radar transducer circuits. Jennings division, ITT Corp., Box 1278, San Jose, Calif. [352]

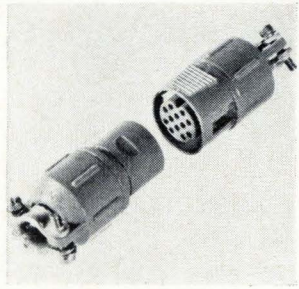

Rugged, circular ThorKom connectors have crimp, removable, high-density contacts. Plug/receptacle housing and insulators are molded in a single unit. The closed-entry designed contacts accept No. 22 Awg wire and are crimped with standard tools. Connectors are available with 7, 12, and 24 contacts. Viking Industries Inc., 21001 Nordhoff St., Chatsworth, Calif. 91311. [353]

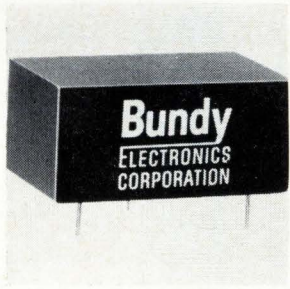

Active filters are available with 20-hz spacing from 385 to 3,495 hz, and 24-hz spacing from 353 to 3,503 hz. The 20-hz filters produce 155 channels, with a bandwidth of 5 hz and crossover attenuation of 12 db. The 24-hz unit produces 131 channels with a bandwidth of 10 hz and crossover attenuation of 18 db. Bundy Electronics Corp., Fadem Rd., Springfield, N.J. [354]

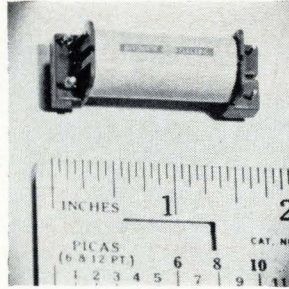

Designated IPC, a printed circuit dry reed switch is a miniature reed capsule within a relatively large bobbin, which provides greater sensitivity. Due to its low self-inductance and high-speed operation, it offers complete isolation between coil drive and output contacts. This assures high open- and low closed-circuit resistance. Automatic Electric Co., Northlake, Ill. [355]

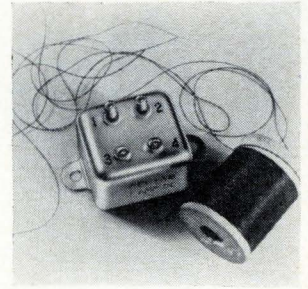

D-c, transient-free switches for 28 v d-c service are available in 1-amp and 5-amp configurations. They measure 0.875 x 1.12 x 1 in. and 1 x 1.75 x 1.25 in., respectively. Both exceed requirements of MIL-STD-826A when switching full-rated load or less. Prices in quantities of 1,000 are \$4.94 and \$6.75. Genisco Technology Corp., 19435 Susana Rd., Compton, Calif. [356]

on one chip; in the 50-watt model, two chips (for a total of 16 cells) are used.

Pilot production for the transistors is already under way and deliveries will begin Oct. 1.

Rumors of TRW's development have spread swiftly throughout the industry. One marketing man at the Radio Corp. of America said with marked understatement: "We're waiting rather anxiously to see the transistor."

RCA has a 20-watt, 400-Mhz device on the market.

TRW will display a breadboard of a transmitter using the 50-watt transistor at the Western Electronic

Show and Convention in San Francisco this month. The transmitter, designed to put out 100 watts at 500 Mhz, will use two of the transistors in parallel.

I. How it was achieved

The leap to 50 watts was not totally unexpected. TRW has maintained its research into high-power transistors at a high-priority level for years. It was two technical steps that pushed power up. One was the company's technique for producing transistors with a interdigitated cell structure, a process that TRW patented several years ago. And the other was the method

of packaging, which boosts the device's heat-dissipating ability.

Aside from this, TRW added four improvements. In one, the firm that makes its masks, Electro Mask Inc.

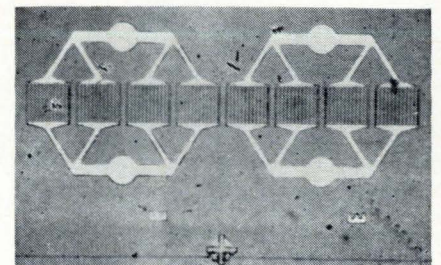

50 watts at 500 Mhz. Interdigitated transistor contains eight cells on each of two chips.

RMC

DISCAPS

*the complete
Ceramic Disc
line*

Over the years Radio Materials Company has maintained its leadership in the production of ceramic disc capacitors. A complete line offering outstanding quality has been the key to continuing growth.

STANDARD

Type C, B, BA, JF, JL and JE

SUBMINIATURE

Type SM, BT, TA and Magnacaps

GREENCAPS

Type CG, JG, and BG

SPECIAL

U.L. Listed Discaps, T.C. High Voltage, High K High Voltage and Dual Section By-Pass



*Send for
Your
Catalog Today!*

Write on your letterhead for a copy of the RMC catalog that lists the complete line of RMC DISCAPS.

DISCAP
CERAMIC
CAPACITORS

RMC

RADIO MATERIALS COMPANY

A DIVISION OF P. R. MALLORY & CO., INC.
GENERAL OFFICE: 4242 W. Bryn Mawr Ave., Chicago 46, Ill.
Two RMC Plants Devoted Exclusively to Ceramic Capacitors
FACTORIES AT CHICAGO, ILL. AND ATTICA, IND.

**... comb structure
boosts power capacity ...**

of Van Nuys, Calif., uses a laser source for transferring the pattern; the laser beam, being parallel, enables the engineers to transfer a dimension as small as 0.1 mil, compared with about 0.2 mil a few years ago. The result is sharply higher emitter peripheries. Also, because the internal emitter bond is kept short, emitter inductance is held to a minimum—about 0.5-ohm reactance at 500 Mhz. In another improvement, diffusion depths are kept very shallow—on the order of a micron. Finally, parasitic base resistance was reduced by about 40% by using a p⁺ diffusion on the base contact.

The transistor is encased in a package design similar to a TO-37 can, except that in this case the can has stripline radial leads. The emitter is integrally connected to the heat sink, which, as a result, can dissipate more than 100 watts. The package is encapsulated in a silicon polymer.

Maximum length. The interdigitated cell-structure technique ("Like two combs," explains Pretz, who helped develop it) allows the maximum emitter length for a particular fixed-base region, thus providing the maximum frequency for that cell. Several cells are optimized at a certain frequency, then are connected in parallel to produce the required power output. Trw has already used this technique for devices producing lower frequencies and lower powers.

The company calculates the 50-watt transistor's gain at 5 decibels minimum, and its efficiency at 60% minimum; to generate the 50 watts at 500 Mhz, a 28-volt source is necessary.

The firm sees an immediate market for the device in military and space communications equipment.

Other potential applications, it says, are in airborne electronic countermeasure systems and high-powered radars operating at about 450 Mhz.

Looking still farther ahead, TRW sees a very large-volume market in the industrial two-way mobile communications field.

TRW Semiconductors Inc., 14520 S. Aviation Blvd., Lawndale, Calif. [357]

Beckman EiD uncoils new flexibility in IC counter-timers.

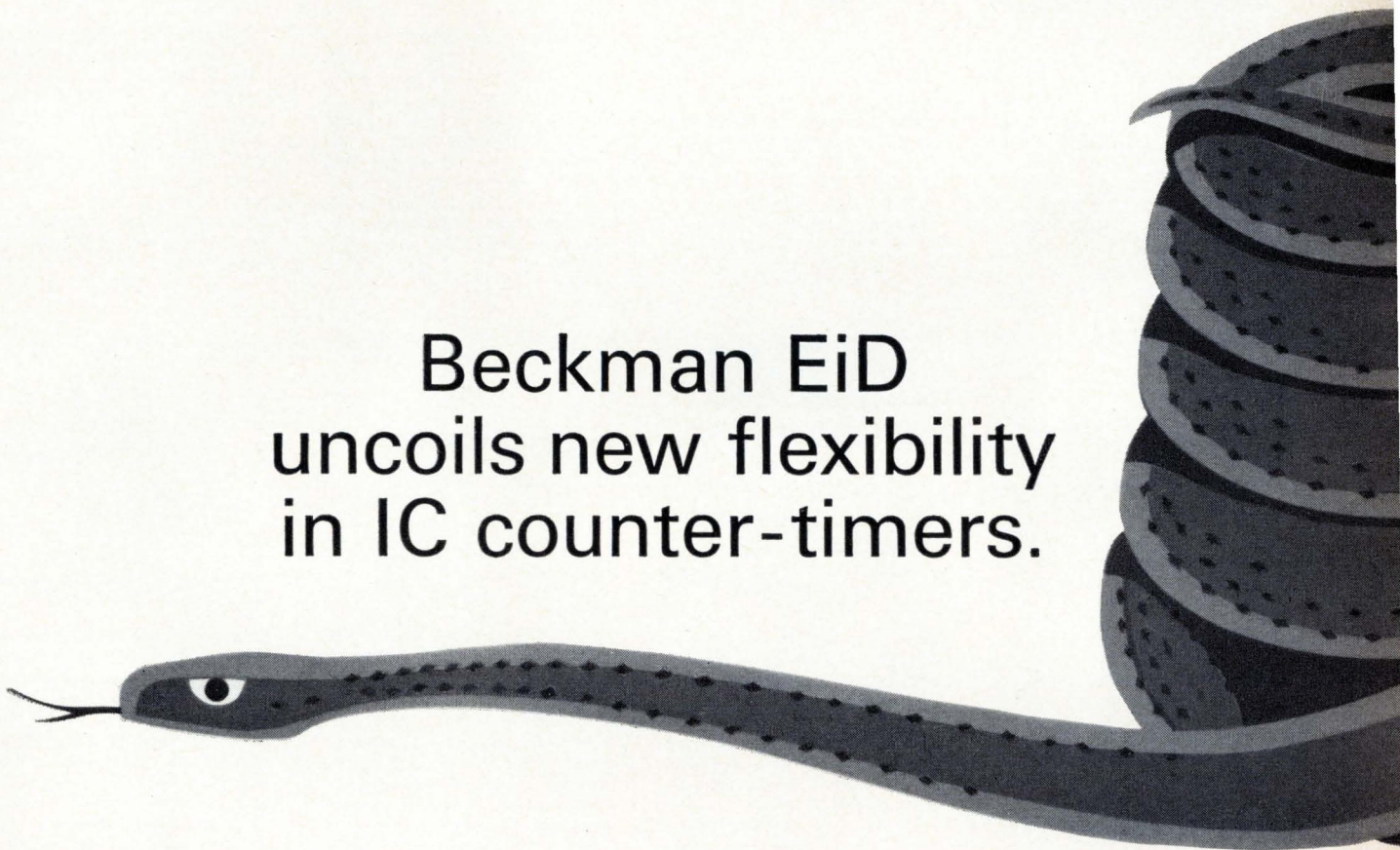

This one's non-constricting. It's designed with multiple plug-in options that unlimber your measuring capabilities.

It's an all-new, 50 MHz EPUT® & Timer, built with integrated circuits. *Without* plug-ins, it measures frequency, time intervals, period, multiple period, ratio, multiple ratio, and counts random events.

With plug-in extenders (from our 600 Series), you can measure frequencies to 12.4 GHz. Measure voltages to 1000 volts.

Stability? Better than ± 3 parts in 10^7 per 24 hours. Visual measurement? An 8-digit, in-line numerical display utilizing glow tubes. (9th digit optional.) Output



data? An 8-digit, 4-line, 1-2-4-8 BCD code, at a rear panel connector.

The *future?* Unlimited. With provisions for new plug-ins, there's only one thing hard to measure: just how many years this instrument will meet your most advanced measurement needs. Squeeze all the details out of your local EiD Sales Representative... or write direct to our nearest regional office, listed at right.

EiD more than
measures up.

Beckman®

INSTRUMENTS, INC.
ELECTRONIC INSTRUMENTS
DIVISION

2400 Harbor Blvd., Fullerton, Calif. 92634,
(213) 691-0841

7360 N. Lincoln Ave., Lincolnwood, Ill.
60646, (312) 583-1020

12051 Tech Rd., Montgomery Ind. Park,
Silver Spring, Md. 20904, (301) 622-2500

International Subsidiaries: Geneva;
Munich; Glenrothes, Scotland; Tokyo; Paris;
Capetown; London; Mexico City

New Instruments Review

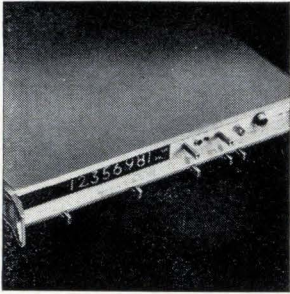

Fabricated principally with IC's, model 6316 counter automatically measures from 0.3 to 12.4 Ghz, and has a direct 100-Mhz counting range. A built-in automatic computing transfer oscillator performs phase lock and selection of the proper harmonic. Measurements are read out in 8 digits. Price is \$4,650. Systron-Donner Corp., 888 Galindo St., Concord, Calif. [361]



A millivolt or thermocouple-to-current transducer uses only 2 wires for transmission of the current signal. No a-c or d-c power supply is required; power is derived from the receiving instrument. When used with thermocouples, the units have junction compensation, eliminating compensating lead wires. Fischer & Porter Co., 333 Jacksonville Rd., Warminster, Pa. [362]

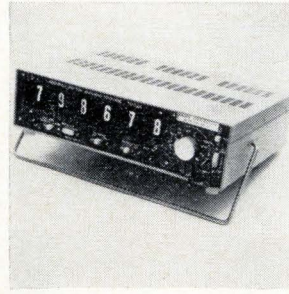

Frequency and period counters operate from a 12-v d-c source and are suitable for field service. The TSA3334, with a 4-digit readout, covers 15 hz to 1.2 Mhz; and the TSA3436, with 6-digit readout, spans d-c to 1.2 Mhz. Inputs range from 100 mv to 250 v. Accuracy is ± 1 count plus crystal stability. Amark Corp., 31 Commercial St., Plainview, N.Y. [363]

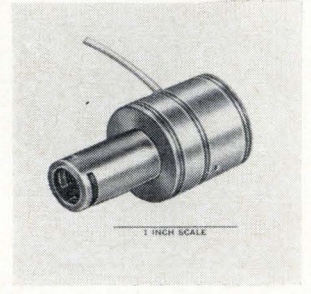

Transducers in the 900 series are for precision pressure measurement in laboratory, industrial, or space applications. They measure $1\frac{1}{2} \times \frac{7}{8}$ in. Powered by 24 ± 4 v d-c from a separate module, output is 0 to 5 v d-c for a full-scale range of 1 to 20 psi with an accuracy of $\pm 1\%$ static error band. Price is \$950. Lion Research Corp., 60 Bridge St., Newton, Mass. [364]

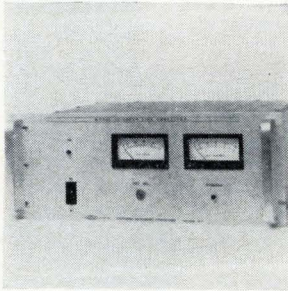

A-c line corrector LC-1000B supplies 1,000 v-a with less than 0.25% total harmonic distortion. Fast regulation and r-f filtration eliminate incoming transients that adversely affect the operation of digital, counter, and timing systems. Output voltage is 0.1% regulated. Price is \$1,425. Elin Division, California Instruments Corp., 3511 Midway Dr., San Diego, Calif. [365]

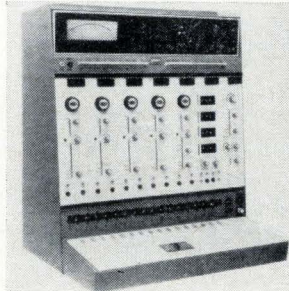

Pulse, d-c, and function tests are performed by the model 990 IC test system. Test programing is accomplished with a digit switch register that selects matrix connections and a series of programmable pushbuttons. Most tests require less than 60 sec. Measurement accuracy is 1%. Price is under \$5,000. Redcor Corp., 7800 Deering Ave., Canoga Park, Calif. [366]



Both magnitude and sign are considered by the 1020A algebraic comparator in comparing data input signals against preselected high and low limits. High, in, or low indication follows algebraic rules where the more negative number is considered lower. Four digits are standard, with up to 8 available as options. Price is \$930. ATEC Inc., Box 19426, Houston, Texas 77024. [367]

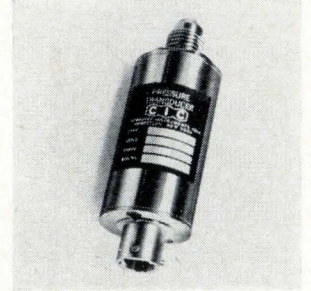

Ruggedness and reliability are featured in model 1200 miniature pressure transducer. A pre-stressed helical bourdon tube is incorporated as the sensing element. Eliminating intermediate linkages and using oil damping enables the unit to withstand a 100-g, 11-msec shock without calibration shift. Computer Instruments Corp., 92 Madison Ave., Hempstead, N.Y. [368]

New instruments

Off-the-shelf IC's in new counter

General Radio opts for commercially available semiconductors instead of designing its own

Last March, Hewlett-Packard, the big West Coast instrument maker, told the world that it would design and make its own integrated circuits—even digital devices for computers. This month, General Radio Co., the big East Coast instrument maker, announced that

it is taking the opposite route for the time being: it will introduce counters with integrated circuits that are bought off the shelf from semiconductor companies.

Although General Radio is not yet ready to commit itself entirely to IC technology, it has a contract

with the Transitron Electronic Corp. to develop special-purpose IC's. It wants a product to compete with Hewlett-Packard's 5216A and Fairchild's 8200, which contain IC's; its answer is the model 1191, which is 80% IC. Discrete components are used in the crystal oscillator, the power supply, and the drivers for the readout tubes.

Remote control. General's unit is an eight-digit counter-timer. All functions can be externally programmed with a contact closure to ground except display time, threshold, and time base; these require additional passive components.

Frequency response of the

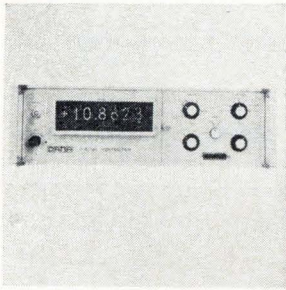

Remote-programming dvm 5703 is for high-performance instrumentation and data-acquisition systems. D-c accuracy is $\pm 0.004\%$ of reading, $\pm 0.001\%$ of full scale. All functions, ranges, and reading modes may be remotely controlled by contact closures. Automatic-ranging, d-c measurement is from $\pm 10 \mu\text{v}$ to $\pm 1,100 \text{ v}$. Dana Laboratories Inc., 2401 Campus Dr., Irvine, Calif. [369]

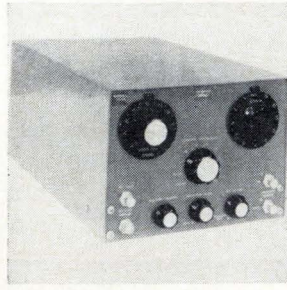

Tv tuner alignment and attenuator measurements are among the uses for the 1006 uhf sweep generator. It spans 450 to 910 Mhz with continuously variable tuning. Sweep width is also variable from 5 to 50 Mhz. Auto-track tuning system permits changing frequency without changing generator setting. Telonic Instruments, 60 N. First Ave., Beech Grove, Ind. [370]

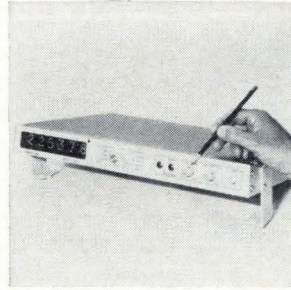

Counter-timer CF-500R can measure frequency, period and multiple period average, and time interval, or totalize the number of input cycles or events. It is designed for either rack or bench mounting. The internal time base is generated by decade-divider circuits from a 100-khz stable crystal oscillator. Anadex Instruments Inc., 7833 Haskell Ave., Van Nuys, Calif. [371]

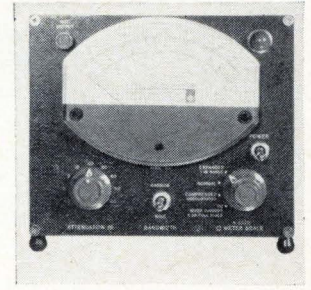

Solid state, 30-Mhz, lab i-f amplifier type 1236 features 2 bandwidths (0.5 and 4 Mhz) and a noise figure of 2 db. The 6-in. meter has an expanded range of 1-db full scale and a 50-db compressed scale. Also featured are continuously adjustable gain control, video, and i-f outputs. Attenuator range is 70 db in 10-db steps. General Radio Co., West Concord, Mass. [372]

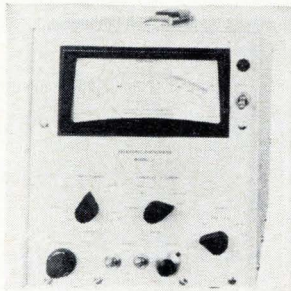

Recording photometer model 17 is for use with photomultiplier tubes in low light-level experiments. It covers 100 μa to 100 pa full scale and resolves 10^{-18} amps when connected to a 3-digit dvm. Dark current cancellation is featured. Absolute accuracy varies from 0.1% to 1% with range setting. Pacific Photometric Instruments, 3024 Ashby Ave., Berkeley, Calif. [373]

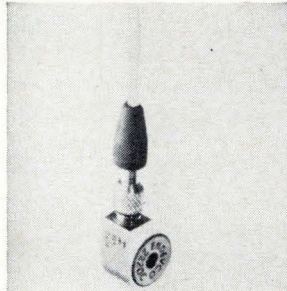

Dynamic testing of small components is performed by the 2220 C shear accelerometer. Flat-charge temperature response is $\pm 10\%$ from -65° to $+350^\circ\text{F}$. It weighs 2.2 grams, has a frequency response from 2 to 10,000 hz, and center-hole construction allowing 360° positioning of connector and cable. Endevco Corp., 801 So. Arroyo Parkway, Pasadena, Calif. [374]

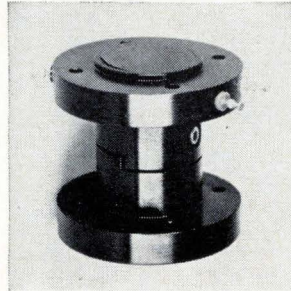

Torque transducers in the LT series span the range of 2.5 to 200 oz-in. Nonlinearity is less than 0.15% and repeatability is within 0.1%. Output at rated torque is 150 mv. Full temperature compensation from 15° to 115°F is provided. Applications include testing of small motors, and measuring viscosity of fluids. Schaevitz-Bytrex Inc., 223 Crescent St., Waltham, Mass. [375]

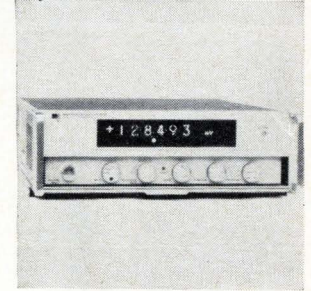

Integrating digital voltmeter model 2402A makes up to 40 readings per sec with 5-digit resolution and with high rejection of unwanted noise superimposed on the signal. Insensitivity to noise is achieved without input filters, which slow the reading rate. Accuracy is 0.01%. Price is \$4,800. Hewlett-Packard Co., 1501 Page Mill Rd., Palo Alto, Calif. 94304. [376]

counter is d-c to 20 megahertz, ± 1 count, \pm time base accuracy—and two time bases are available. The standard time base is a room-temperature crystal oscillator with a drift of ± 2 parts in 10^6 per month. For \$150 more over the basic price of \$1,340, a high-precision oscillator is available with a

drift of only ± 1 part in 10^9 per day.

Featuring high-speed storage for a nonflickering display, the 1191 has a 100-usec display time and automatic positioning of the decimal point. The input circuit uses FET's for low noise and has an impedance of 1 megohm with a sen-

sitivity of 10 millivolts.

Additional equipment includes a fully buffered data output for \$50. Measuring $19 \times 3\frac{7}{8} \times 12\frac{3}{4}$ inches, the counter weighs 22 pounds and consumes 32 watts.

Specifications

Input impedance	1 meg
Frequency range	d-c to 20 Mhz
Single period	1 to 10^6 sec
Multiple period	1 to 10^8 periods
Time interval	0.1 μs to 10^6 sec
Sensitivity	10 mv rms sine wave, 30 mv p-p pulse
Display	8-digit
Display time	100 μs to 10 sec
Operating range	0 to 50°C
Price	\$1,340

General Radio Co., 22 Baker Ave., West Concord, Mass. [377]

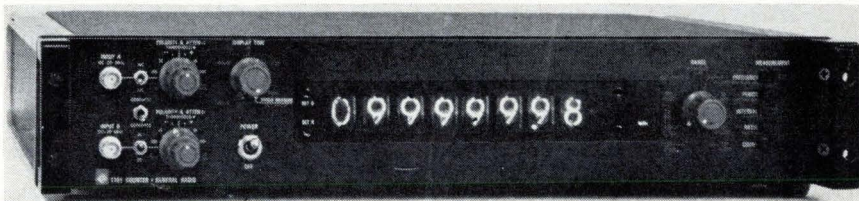

Slim lines, IC's thinned-down counter.

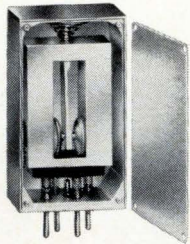

Actual Size

MODEL RF20
 contactless resonant
 reed encoder/decoder
 .395 x .620 x 1.100

REMOTE CONTROL SWITCHING WITH AUDIO SIGNALS

An audio tone can be generated by an electronic oscillator or resonant reed encoder circuit, then transmitted by wire or radio. The tone activates a resonant reed relay to perform a control function.

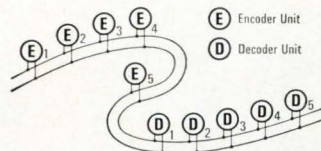

A single pair of wires, or a leased telephone line, can carry the audio signals for a complete control system.



For inaccessible areas or mobile installations, a radio transmitter and receiver system can carry the signals.

Bramco reeds permit over 50 selective control frequencies within the 67 to 1600 cps spectrum. This is assured by: (1) the narrow response bandwidth of about 1% for decoders and (2) the high accuracy of Bramco reed encoders (1/10 of 1% of design frequency).

A big advantage of reeds in control switching is that they are ideally suited for simultaneous and sequential coded tone systems. The actual number of control functions possible in such a system is virtually unlimited. For example, over 3300 individual control functions are possible with only 16 frequencies coded sequentially in groups of three.

Compared to other types of tone filters, resonant reeds are small and inexpensive. They give more control functions per spectrum, per size, per dollar.

If you work with controls that select, command, regulate, or indicate, you should know about how it can be done with audio signals. We custom design and stock a broad line of encoder/decoder components and modules.

For literature write Bramco Controls Division, Ledex Inc., College and South Streets, Piqua, Ohio, or call 513-773-8271.

SEE THESE AND OTHER PRODUCTS AT
 WESCON SHOW, BOOTHS #5216-18



BRAMCO CONTROLS DIVISION, LEDEX INC.
 College and South Streets, Piqua, Ohio 45356

New instruments

Tiny power supply puts out 17.5 kv

Squeezed into cigarette-pack size, solid state supply is also more stable

In the design of a cathode-ray tube display for a military or air traffic control application, space is often at a premium. In some displays, use of integrated circuits has slimmed some of the circuitry, but power supplies capable of high voltage still required a lot of room. Now Britain's Marconi Co. has squeezed almost 18 kilovolts of power supply into a package no bigger than a transistor radio.

Its solid state circuitry not only saves space, but also makes the output—up to 17,500 volts—more stable and more reliable than the vacuum-tube supplies previously used. The unit is particularly resistant to shock. In an impact test, the power supply withstood 4,000 shocks at accelerations of 40 g.

For even better protection, the power supply is built into a molded plastic box that forms a self contained package. A web, impregnated with a silicone elastomer, insulates the high voltage circuitry and protects it from moisture. Even short circuits lasting several seconds won't damage the unit if the input current is under 0.7 amp.

Inside operation. The buildup of voltage starts with an input of 15.5 volts d-c that drives a push-pull oscillator to produce a sinusoidal output. This ultrasonic signal is coupled through a transformer to a conventional diode voltage multiplier bank. The bank has 10 stages, with a maximum no-load rating of 2 kv per stage.

Different terminal positions determine the range of voltage outputs. For example, one arrangement produces a single output of 17.5 kv or any voltage down to 8 kv. Another offers a positive 15.5 kv and a negative 2 kv. Price: under \$300.

The Marconi Co.,
 Chelmsford, England [378]

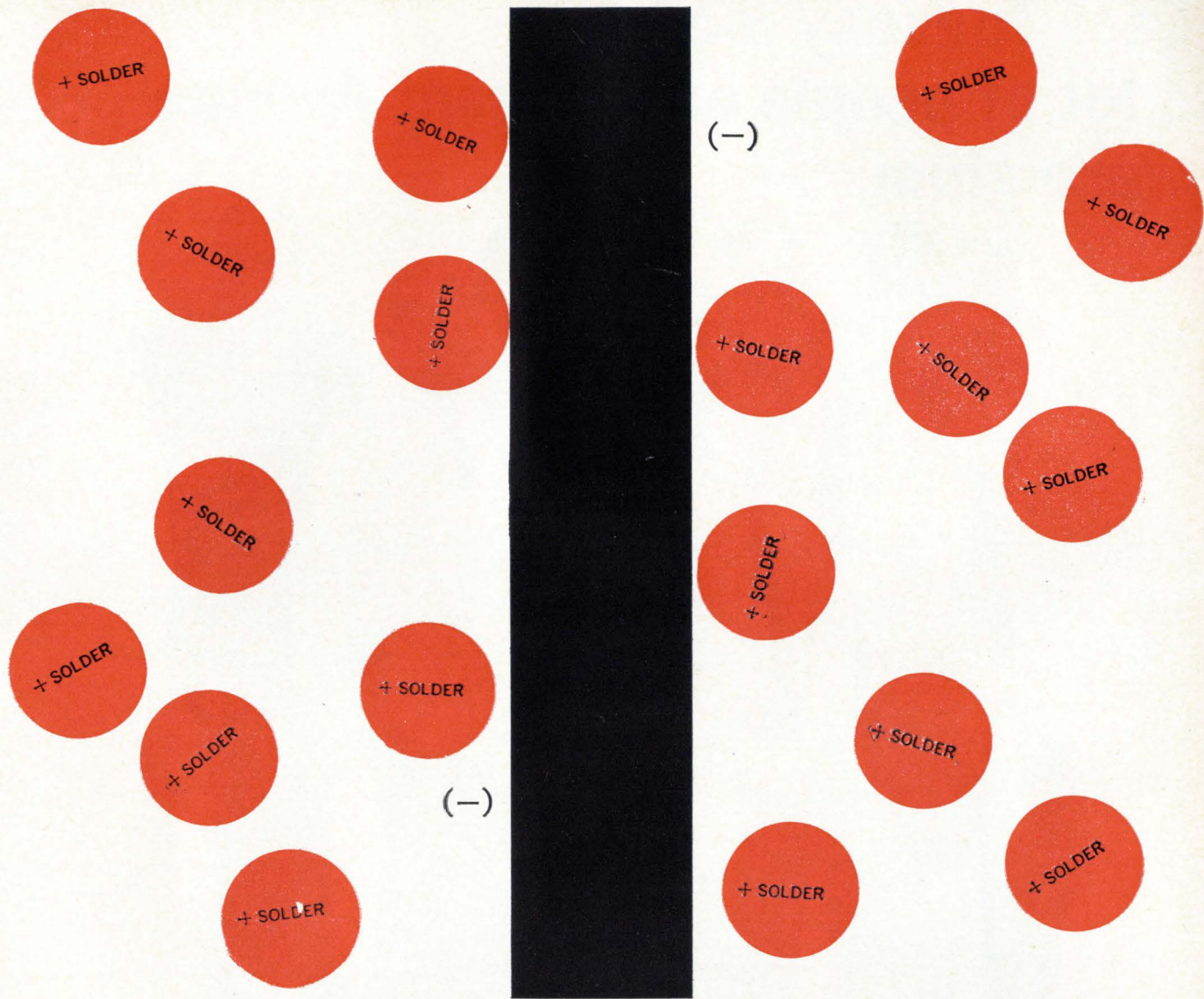

We could solder-plate 100,000,000,000,000 miles of wire
and not vary .0002"

(Hot-dipped wire could never be that precise.)

Up till now all known solder-coated wire was hot-dipped.

That meant lack of uniformity. And plenty of waste. But we've developed a way to solder-plate wire that will hold coating thickness to minimums. We can solder-plate (in a variety of baths) or tin-plate any diameter wire from .010" through .060". We can solder-plate or tin-plate ribbon from .005" x .020" through .050" x .080".

And we can hold a plating thickness range of .0002" on plate thickness up to .0005" minimum (for example: .00025"-.00045" or .0005"-.0007").

There are no more thin areas that become unsolder-

able due to "non-wetting." Coatings on pigtailed can now retain their solderability even after extended baking or curing times. And solderability is retained even after an extended "shelf-life" when hot-dipped wire normally goes bad.

What else? Well, we think that many faults you've ever found with hot-dipped wire, our solder-plated wire will correct.

Give us a call, and we'll send you some.

Sylvania Electric Products Inc., Parts Division, Warren, Pennsylvania 16365. Phone 814-723-2000.

SYLVANIA
SUBSIDIARY OF
GENERAL TELEPHONE & ELECTRONICS **GTE**

Last Tuesday morning a lot of people on Pleasant Avenue were glum.



But not "Smiling" Sam Price. He's one of the Twelve Cranks on Pleasant Avenue. And last Tuesday he found a lousy connection in a Trygon Liberator Power Supply that was coming off the line! It made his day!

The point is, of course, that loused-up Liberators never leave Trygon. Not with Sam Price and his un-merry men around. Their job is finding problems for us; so you don't get any problems from us.

Sam's pet, the Liberator, gives you the ultimate in IC and transistor system power in minimum size at lowest possible cost. Wide slot adjustment ranges with voltages up to 160v. Output current levels up to 40 Amp (3½") and 70 Amp (5¼").

.005% regulation/.5 mv ripple/3mv P-P noise/.01% stability/extremely low output impedance/MIL Spec. performance/integral slide mounting/automatic load share paralleling/overvoltage protection.

And you can be sure of this. Every Trygon Liberator Power Supply comes off the line under Sam's baleful eye. Order one and see.

Trygon Power Supplies

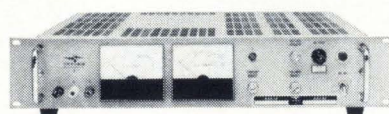

TRYGON LIBERATOR SERIES SYSTEM POWER SUPPLIES						
Model	Volts	Amps 60°C.	Height	Overvoltage Protection	Price w/Meters	
L3R4-40 L5R4-70	2.5-4.5	40	3½	\$90	\$445	
	2.5-4.5	70	5¼	90	550	
L3R6-40 L5R6-70	4.8-6.8	40	3½	90	445	
	4.8-6.8	70	5¼	90	550	
L3R8-25 L5R8-50	6.5-9.5	25	3½	90	445	
	6.5-9.5	50	5¼	90	550	
L3R10-25 L5R10-50	8.5-11.5	25	3½	90	445	
	8.5-11.5	50	5¼	90	550	
L3R12-25 L5R12-50	11 -14	25	3½	90	445	
	11 -14	50	5¼	90	550	
L3R18-20 L5R18-40	13.5-19.5	20	3½	90	420	
	13.5-19.5	40	5¼	90	550	
L3R24-15 L5R24-30	18.5-26.5	15	3½	90	420	
	18.5-26.5	30	5¼	90	535	
L3R28-15 L5R28-30	24 -32	15	3½	90	420	
	24 -32	30	5¼	90	535	
L3R48-8.5 L5R48-17	32 -52	8.5	3½	90	445	
	32 -52	17	5¼	90	560	
L3R65-6 L5R65-12	50 -82	6	3½	90	465	
	50 -82	12	5¼	90	585	
L3R100-4 L5R100-8	80 -125	4	3½	90	510	
	80 -125	8	5¼	90	630	
L3R150-3 L5R150-6	115 -160	3	3½	90	510	
	115 -160	6	5¼	90	630	

Most models slightly higher priced in Europe.

TRYGON ELECTRONICS, INC., 111 PLEASANT AVENUE, ROOSEVELT, LONG ISLAND NEW YORK 11575, TRYGON GMBH 8 MUNCHEN 60 HAIDELWEG 20, GERMANY

New Subassemblies Review

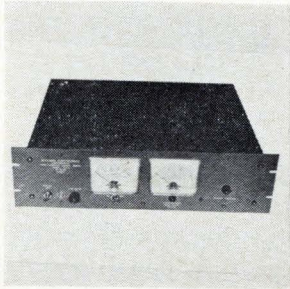

Regulation of 0.01% on an output adjustable from 10 kv to 30 kv is featured in the model 545A power supply. Stability is $\pm 0.01\%$ in 8 hours (within a 10° to 40°C range). The solid state unit is available with either 50- or 500- μa output current. Both overload and overvoltage protection are provided. Walden Electronics Corp., 223 Crescent St., Waltham, Mass. [381]

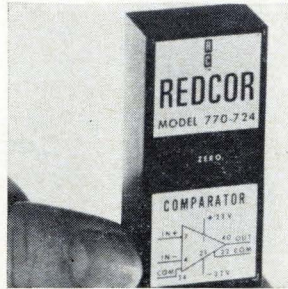

Comparator module 770-724 features a typical resolution-speed product of $2\text{ mv}/2\ \mu\text{sec}$. It offers fast overload recovery guaranteed over a full 10-v input range. Input impedance is 100 kilohms minimum differential, 10 megohms minimum common mode. Accuracy is provided by 100 db of open-loop gain at d-c. Redcor Corp., 7800 Deering Ave., Canoga Park, Calif. [382]

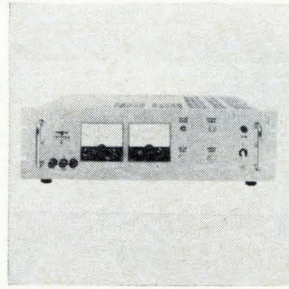

Constant-voltage, constant-current power supplies are for lab and systems use. Ratings of the Super-Mercury series are from 0 to 160 v, and up to 100 amps. Regulation is 0.005%, stability 0.015%. Also featured is full power to 60°C without derating. Ripple is less than 1 mv rms, 10 mv peak-to-peak. Trygon Electronics Inc., 111 Pleasant Ave., Roosevelt, N.Y. 11575. [383]

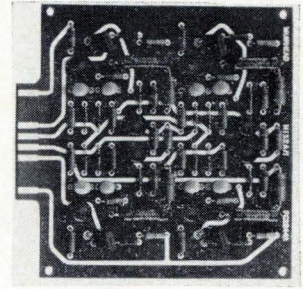

Logic controller H132A/1 operates 4-phase stepper motors. It consists of a transistor circuit mounted on a plug-in, 4-in.-sq. p-c board. It requires a 28-v d-c supply and must have stepping pulses from an external source, such as computer, tape, pulse generator, or other programmer. Ambient operating range is -40° to $+85^\circ\text{C}$. Muirhead Instruments Ltd., Stratford, Ontario [384]



Dual tracking power supplies are suited for operational amplifier applications as well as other compatible operational elements. Two models feature $\pm 15\text{ v}$ and $\pm 20\text{ v}$ at 100 ma. Noise and ripple are less than $\frac{1}{2}\text{ mv rms}$. Operating temperature is -25° to $+65^\circ\text{C}$. Both measure approximately $3 \times 2\frac{1}{2} \times \frac{3}{4}\text{ in}$. GPS Instrument Co., 188 Needham St., Newton, Mass. 02164. [385]

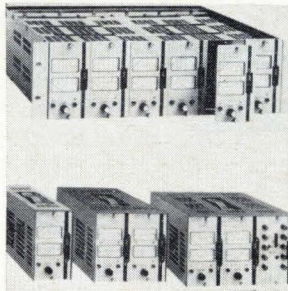

Laboratory-style, metered power supplies in a plug-in package have 10-turn voltage control and are 0.01% regulated. Temperature coefficient for the PBX-MAT series is 0.01% per $^\circ\text{C}$; ripple is 0.1 mv. D-c output ranges are 0-7 to 0-100 v, 0-2 to 0-0.02 amps. A choice of mounting accessories is available. Price is \$160. Kepeco Inc., 131-38 Sanford Ave., Flushing, N.Y. [386]

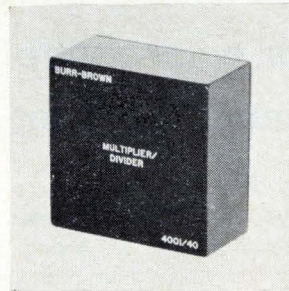

Static accuracies of 0.25% of full scale and bandwidths of 1 Mhz are offered by the 4001/40 encapsulated multiplier. Phase shift is under 0.5° at 50 khz. Quadrant multiplication is achieved by using bipolar-diode squaring circuits driven by external high-speed inverters. Price is \$675. Burr-Brown Research Corp., International Airport Industrial Park, Tucson, Ariz. [387]



Grafacon model 1010A is a graphic data processor for reducing and manipulating graphic information. The system can digitize oscillographs, slides, and arbitrary graphic forms, mathematically scale and operate on digitized curves, and display or record resulting forms on an associated crt or x-y plotter. Bolt Beranek & Newman Inc., 2126 S. Lyon St., Santa Ana, Calif. [388]

New subassemblies

Increasing accuracy of telemetry data

New formatter has unique integrator that improves accuracy four times that of available units

As more men venture into space, as more probes are launched to explore planets, and as more tests are run outside the earth's atmosphere, the need for more accurate telemetry equipment grows increasingly urgent. A major improvement in accuracy is made

possible by a new data formatter developed by Stellarmetrics Inc., a small company in Santa Barbara, Calif. The new device, called the DDF-12, has an accuracy of 0.025%—four times better than other decommutation formatters. It converts incoming analog data into

12-bit digital words instead of the 10-bit words generally used, so that accuracy is improved throughout the system.

Mainly responsible for the improvement is a new integrator that

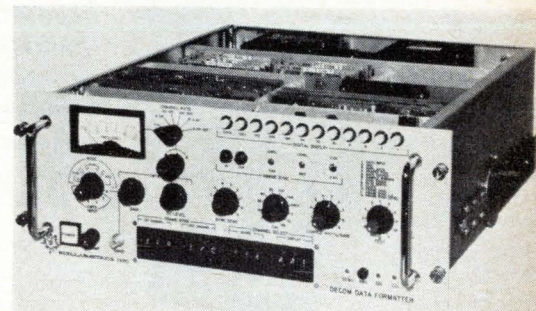

Rack-mounted. Formatter is rugged, too.

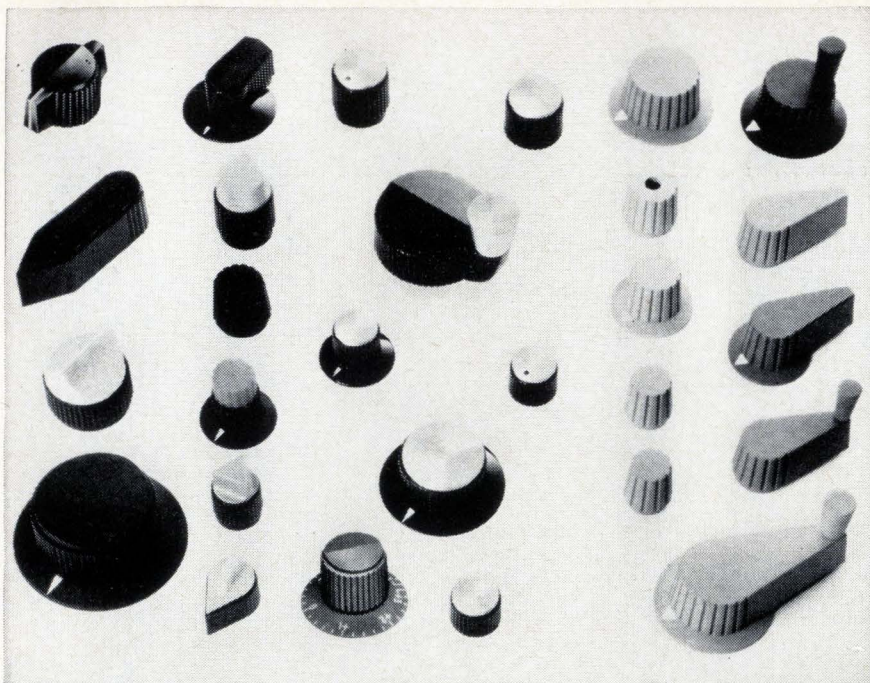

**Standard and custom military knobs,
aluminum cap knobs, color control knobs for
every panel requirement. Send for data kit.**

With Raytheon control knobs, you can meet military specifications—or select styles and colors that harmonize or contrast with any commercial panel decor. And you can get these knobs immediately—through Raytheon distributors from coast to coast.

Meet MS91528C Military Specifications from the more than 300 standard types and the 2,000 "specials" Raytheon has designed. All knobs are functionally designed. All styles have an integrated design to give uniformity to your panel. And all knobs meet specifications for resistance to flame, torque, temperature and humidity extremes, salt spray, and ultraviolet radiation.

Handsome aluminum cap knobs are made of strong plastic with satin finish aluminum caps that are treated with an epoxy coating for corrosion resistance.

Commercial color knobs—available in nine colors and ten styles—harmonize or contrast with commercial equipment design. Raytheon makes these 400 Series knobs of durable, high-impact ABS.

Custom-made control knobs. Raytheon also designs and manufactures control knobs to meet special requirements for color, shape, size, finish. Call your nearest Raytheon regional sales office or write to us. *Raytheon Company, Components Division, Quincy, Mass., 02169.*



Send for Raytheon Control Knob Data Kit
—contains complete specifications on all standard and custom knobs. Just send the reader service card.



**... grounded capacitor
cuts noise sharply ...**

contains a differential amplifier to convert the voltage of the telemetered signal into a constant current whose magnitude is proportional to the input voltage.

Constant input. This current charges a grounded capacitor during a fixed gate time, so that when the gate closes the voltage on the capacitor is proportional to the current. The capacitor voltage corresponds to the input voltage except in magnitude and in its freedom from noise. With the gate closed, the voltage on the capacitor, through a sample-and-hold amplifier, provides a constant input to an analog-to-digital converter, to which the formatter would normally be connected.

After a suitable time interval for conversion, the capacitor is discharged and the formatter prepares to receive the next pulse from the telemetry channel. The output is a pulse of constant width.

Previously, a formatter depended on a standard analog integrator, made of an operational amplifier with a capacitor connected between the output and the input. Because the capacitor is not connected to ground, it may retain residual signals or noise between input pulses, limiting the accuracy of the entire circuit to about 0.1%.

Pulses and signals. The DDE-12 can receive from one to 10,000 pulses per second from an orbiting spacecraft or from a remote location in an industrial application. Each pulse represents a measured quantity, which can be in any of three modes. These modes—pulse-duration-modulation, and pulse-amplitude-modulation, with or without a return to base line between pulses—are controlled by a switch on the front panel.

In most systems, one frame consists of 90 to 100 different signals in a prescribed order, followed by two or three synchronizing pulses; the new unit accepts up to 999 signals in a single frame. A phase-lock servo maintains the synchronization for a brief interval even if some of the input pulses—up to 50—are missing.

Stellarmetrics Inc., 416 Cota St., Santa Barbara, Calif. [389]

RG



Metal Glaze resistors offer .02% reliability and low cost

IRC Metal Glaze resistors now offer you a combination of proved reliability and economy that just can't be matched. You can upgrade your circuit designs and still keep the lid on costs.



- **RELIABILITY PROVEN DESIGN.** A design so conservatively rated that even at *twice rated load*, performance still far exceeds applicable MIL requirements.
- **RELIABILITY PROVEN BY TESTS.** After more than 4 million unit hours of testing, estimated maximum failure rate is .02%/1000 hours, full load @ 70°C, at 60% confidence. Failure is defined as $\Delta R > \pm 4\%$.
- **RELIABILITY PROVEN IN USE.** Millions used in a wide range of applications. No in-circuit failure—*catastrophic or otherwise*—has ever been reported.

Metal Glaze resistors offer other benefits, too: indestructible thick-film resistance element, plated-on copper

end cap, high-temperature soldered termination and a smooth, tough molded body that resists solvents, corrosion, and mechanical abuse.

For top resistor performance without any cost penalty, specify IRC Type RG. Write for data, prices, and sample. IRC, Inc., 401 N. Broad St., Phila., Pa. 19108.

CAPSULE SPECIFICATION

		
WATTAGE:	¼ W @ 70°C	½ W @ 70°C
RESISTANCE:	51Ω thru 150K	10Ω thru 470K
TOLERANCES:	± 2%, ± 5%	± 2%, ± 5%
TEMP. COEF.	± 200ppm/°C	± 200ppm/°C
IRC TYPE:	RG07	RG20



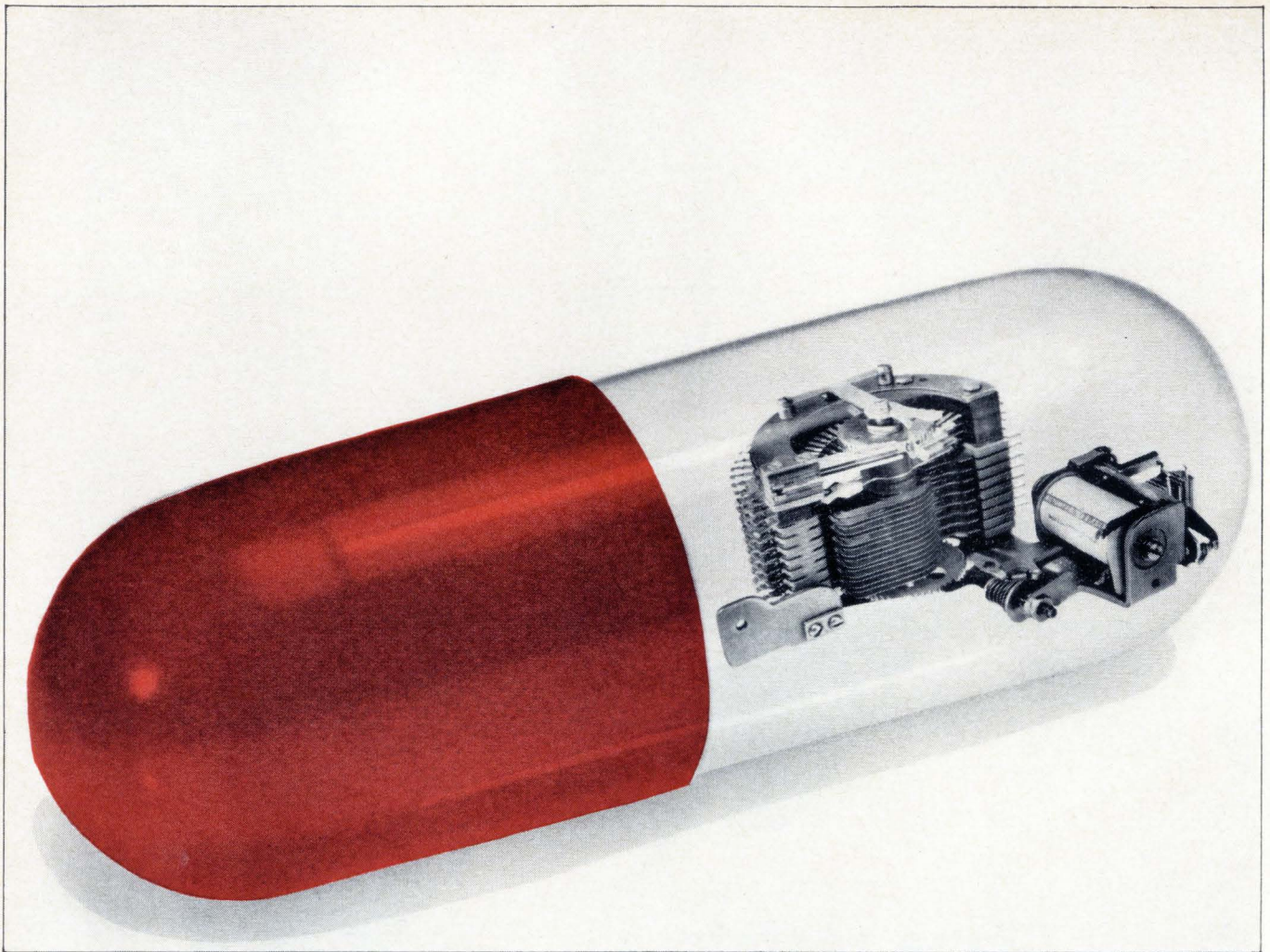

Remedy for nightmares: AE's Type 45NC stepping switch with "shorting" levels.

Many of today's complex switching circuits look like an engineer's nightmare. Why not simplify them? You can replace whole groups of components with an AE Type 45NC "stepper."

This switch has normally closed ("shorting") levels. It's designed so that pairs of contacts *open* successively when the rotor is stepped.

The Type 45NC can solve almost any circuit-transfer or testing problem.

It's ideal for self-interrupted hunting, and you don't need auxiliary relays.

You get one or two electrical levels of either 26 or 52 point normally-closed contacts. For extra versatility, you can specify addi-

tional levels of *normally-open* contacts—on the same switch.

Contacts are gold-plated phosphor bronze. Contact resistance: a maximum of 50 to 100 milliohms, measured at 6 volts 100 milliamperes.

When you specify AE rotary stepping switches, you get the benefit of our continuous research—in design, in metals and insulating materials. All this plus *positive positioning* — a unique AE design

feature that locks the rotor and makes overthrow impossible.

Find out more about AE rotary stepping switches—an economical, rugged and reliable way to simplify switching circuits. There's a lot of helpful application information in our new reference circular 1698-L. To get your copy, just ask your AE representative. Or write to the

Director,
Relay Control Equipment Sales,
Automatic Electric,
Northlake, Illinois
60164.

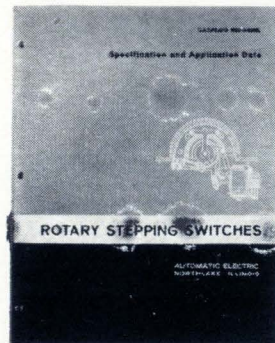

AUTOMATIC ELECTRIC
SUBSIDIARY OF
GENERAL TELEPHONE & ELECTRONICS **GTE**

New Microwave Review

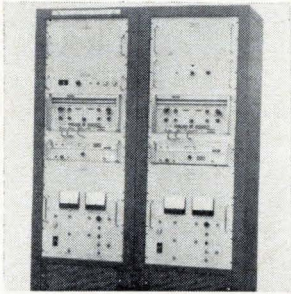

Sweeping transmitter T-23 provides 500-w peak pulse leveled power at duty cycles to 0.01 across the range of 2 to 8 Ghz. Sweep rates are adjustable from 10 to 100 sec for full 2-octave sweep. Second harmonic and spurious content are each a minimum of 30 db below the carrier level at any r-f frequency. Alto Scientific Co.; 4083 Transport St., Palo Alto, Calif. 94303. [401]

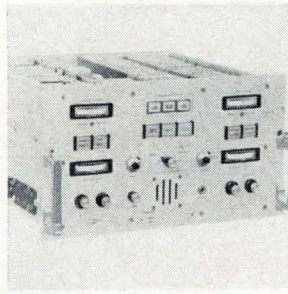

Monopulse tracking receivers handle the standard bands including 225 to 260 Mhz, 1.7 to 1.8 Ghz, and 2.2 to 2.3 Ghz. They have solid state circuitry, 2 and 3 channels, modular construction, switchable bandwidths, phase-lock and cross-correlation detection, and IRIG-frequency tracking. Canoga Electronics Corp., 8966 Comanche Ave., Chatsworth, Calif. 01311. [402]

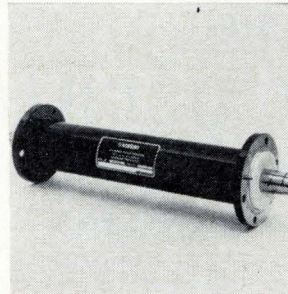

Coaxial, low-pass, reactive filter FC3JA1 attenuates the harmonic outputs of a high-power transmitter operating in the range of 820 to 890 Mhz. It consists of alternating high- and low-impedance coaxial-line segments in series, which permits transmission of the operating band power while reflecting its harmonics. Varian Associates, 611 Hansen Way, Palo Alto, Calif. [403]



Radar transponder CSC-510-C is for missile or aircraft use demanding ultraprecise velocity measurements. Receiver sensitivity is -65 dbm minimum, with the 100-w-peak minimum retransmitted pulse identical in frequency to, and coherent with, the received signal. Operating frequency is 5.4 to 5.9 Ghz. Control Science Corp., 4810 Beauregard St., Alexandria, Va. [404]

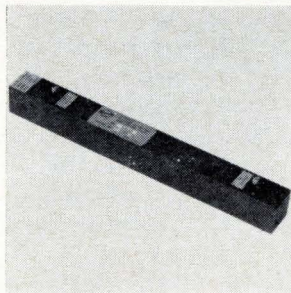

Traveling-wave tube EM-1600 produces 1-w minimum output at 1 to 2 Ghz. It is 8 in. long, and weighs 1 lb. The gridded unit has 30-db minimum gain, is periodic-permanent-magnet focused, and meets MIL-E-5400 environmental specifications. The tube is suitable for phase modulation. Eimac Division of Varian Associates, 301 Industrial Way, San Carlos, Calif. [405]

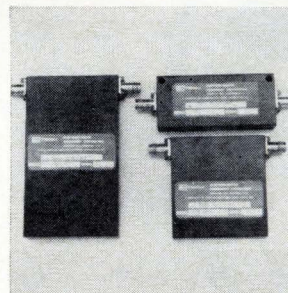

Gain equalizer EMT4000 is a passive, self-contained device for removing undesirable gain variations often found in broadband twt amplifiers. Either terminal can serve as input, and band-edge loss can be limited to 1/2 db. Units are available in ranges of 1 through 5 Ghz to accommodate power levels up to 10 w. American Electronic Laboratories Inc., Box 572 Lansdale, Pa. [406]

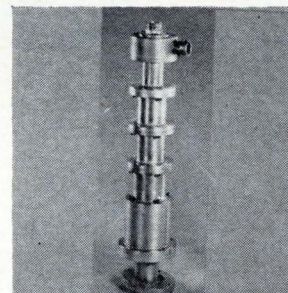

The Omegaline model 5725 dummy load terminates 50-ohm coaxial lines in the 25-kw power range and in the frequency range from 60 hz to 2.2 Ghz. Maximum vswr is 1.10 to 1 Ghz; 1.15 to 1.5 Ghz; and 1.2 to 2.2 Ghz. The unit uses water as a dielectric and as a coolant. It measures 17 x 3 3/4 in. Altronic Research Corp., 13710 Aspinwall Ave., Cleveland, 44110. [407]

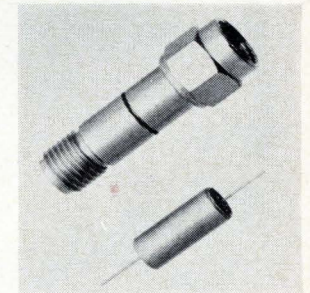

Broadband passive limiters reflect excess microwave power on coaxial transmission lines. They protect detectors and other sensitive elements by attenuating power at levels above 10 mw. Frequency range of the limiters is 0.4 to 12.4 Ghz. Max input can be 1 w. Type 3701 costs \$100; the 3711, \$125. Hewlett Packard Co., 1501 Page Mill Rd., Palo Alto, Calif. [408]

New microwaves

Mesa structure quiets Impatt

Oscillators that deliver 40 milliwatts at 10.5 Ghz. are fabricated for low-noise operation

In the new wave of semiconductor microwave oscillators—impact avalanche transit time (Impatt) and Gunn diodes—the highest powers so far have been produced by the Impatt. Impatt's, though, have gained a reputation for being noisy and thus unsuitable for supplying

the primary microwave power for a quality communications system. But engineers at Varian Associates' Bomac division say that the noise can be brought under control with better diode and circuit design. To back up their claim, they now are offering an Impatt oscillator that

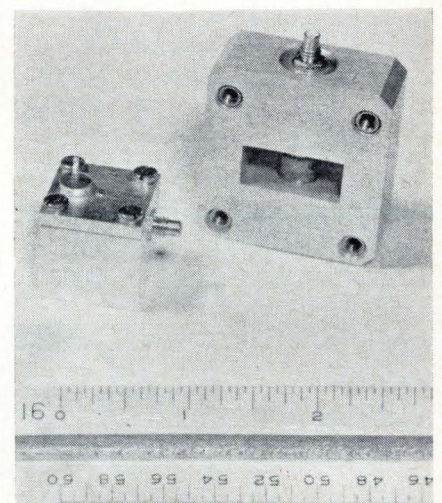

Shhh. Oscillator fits in low-power radar.

2

ALIGNMENT OSCILLATORS

DESIGNED TO MAKE SERVICING EASIER

BOTH NEW FROM INTERNATIONAL



MODEL 812

(70 KHz — 20 MHz)

The Model 812 is a crystal controlled oscillator for generating standard signals in the alignment of IF and RF circuits. The portable design is ideal for servicing two-way radios, TV color sets, etc. This model can be zeroed and certified for frequency comparison on special order. Individual trimmers are provided for each crystal. Tolerance .001%. Output attenuators provided. Battery operated. Bench mount available.

Complete (less crystals) **\$125.00**

MODEL 814

(70 KHz — 20 MHz)

The Model 814 is identical in size to the 812. It does not have individual trimmers for crystals. Tolerance is .01%. Battery operated. Bench mount available.

Complete (less crystals) **\$95.00**

Both the Model 812 and Model 814 have positions for 12 crystals and the entire frequency range is covered in four steps.

Write for catalog



CRYSTAL MFG. CO., INC.
10 NO. LEE • OKLA. CITY, OKLA. 73102

... a-m noise is so reduced,
device has low-power uses ...

delivers a minimum of 40 milliwatts at 10.525 gigahertz. The oscillator, comprising a silicon Impatt diode and a resonant cavity, will initially cost \$450 in small quantities. It's aimed at the low-power doppler radar market.

Inside the cavity. In operation, the diode is reverse-biased into breakdown, where it exhibits a negative resistance at microwave frequencies because of the delay caused by the transit time of charge carriers through the semiconductor material. When placed in a resonant cavity, the diode can deliver useful microwave power. The diodes typically have efficiencies in the 6% to 8% range, and the cavities are usually about 50% efficient, so over-all efficiencies are usually in the 3% to 4% range.

With the first commercial unit, however, Bomac engineers are a little more conservative—working from 60-to-80-volt d-c source and drawing 30 to 50 milliamps, the oscillator is rated at a minimum of 40 milliwatts. This corresponds to about a 2% efficiency.

Upside down. The diodes have a mesa configuration and are mounted in metal-ceramic packages similar to those used with varactors and other microwave diodes. Internally, however, the diodes are mounted just the opposite from a varactor.

The noise caused by the avalanche breakdown takes the form of both amplitude and frequency modulation. The a-m noise, Bomac engineers say, has been decreased enough in the new diode to make it useful for many low-power transmitter and local-oscillator uses. The f-m noise, though, is still marginal, they say.

When Bomac engineers compared the noise figure of a receiver that used the diode with the noise figure of the same receiver with a low-noise klystron or backward-wave oscillator (bwo). They found that the diode and the bwo gave virtually identical performance.

The Impatt, they feel, is ready now for use as a solid state local oscillator.

Bomac division, Varian Associates, Salem Rd., Beverly, Mass. [409]



A COMPUTER DESIGNED FILTER CAN MAKE YOUR ENGINEERING EASIER

Telonic RF and Microwave Filters cover such a wide range of frequencies, types, and performance characteristics that you don't have to design "around" them. Your specific requirements are programmed into an engineering computer, the filter designed and then produced to these precise parameters.

Basically modular, Telonic filters can be manufactured from elements in stock, providing another benefit in fast delivery*. With over 100,000 filter designs already produced, even so-called special types may already be standard. Here is the broad selection you have in designing —
Frequencies from 30 MHz to 12 GHz • Lowpass • Bandpass • Tubular
• Miniature • Cavity • Interdigital • Tunable

With that variety, quick delivery, and high performance, do you even need a second source?

*Three-day, Jet Order Service available

Telonic ENGINEERING CO. A Division of
Telonic Industries, Inc.

Box 277 • Laguna Beach, Calif. 92652 • Tel.: 714-494-9401 • TWX: 910-596-1320

Representatives throughout the U.S. and foreign countries. Factory
offices in Maidenhead, England, Frankfurt, Germany, and Milan, Italy.

- 52 page Filter Textbook •

Telonic's new catalog contains never before published data on filter-insertion loss, attenuation, physical size, frequency and bandwidth tolerances, and pass band relationships. Send for your copy.

Circle 165 on reader service card

See Telonic Industries, Inc. at WESCON,
Booths 3124-3128.

CERMET

10Ω TO 1 MEG

POTENTIOMETERS

IMMEDIATE DELIVERY FROM FACTORY OR DISTRIBUTOR STOCKS!

Complete stocks are now available of TRIMPOT® cermet element potentiometers in the full range of 10Ω to 1 Megohm.

Models 3012 and 3052 are in the familiar rectangular configurations, while the Model 3282 is a 3/8" square unit available in five mounting configurations . . . all three units are rated at 1 watt. All PALIRIUM® cermet potentiometers are designed and built to the usual Bourns high quality standards. They meet all the requirements of MIL-R-22097 and are ideal for applications requiring top performance under the most stringent environmental conditions.

Remember, Bourns is your best single source for the industry's widest selection of wirewound, cermet and carbon potentiometers. For detailed technical data sheets on these cermet units, contact your nearest Bourns office, representative or write the factory direct.

These units are stocked in depth, in all resistances and mounting configurations at the factory and by your local Bourns authorized distributor!

Circle 166 on reader service card

SPECIFICATIONS	3012	3052	3282
Size	1 1/4 x 3/2 x 3/16"	1 1/4 x 3/16 x 3/16"	3/8 x 3/8 x 1 3/4"
Mechanical Adjustment	22 Turns	22 Turns	25 Turns
Resistance Range		10Ω to 1 Megohm	
Resistance Tolerance		±10% Standard	
End Settings		10Ω to 200Ω, 0.5% 500Ω to 1 Megohm, 0.1%	
Temperature Range		-65°C to +175°C	
Power Rating		1.0 watt at 70°C	
Temperature Coefficient		+25°C to +175°C { 10Ω to 200Ω, 0 to +500 PPM/°C 500Ω to 1 Meg, ±100 PPM/°C	
		+25°C to -65°C { 10Ω to 200Ω, +500 to -100 PPM/°C 500Ω to 1 Meg, +100 to -250 PPM/°C	
Humidity		100 Megohms minimum insulation resistance after removal from chamber	



BOURNS, INC., TRIMPOT DIVISION • 1200 COLUMBIA AVE., RIVERSIDE, CALIF.
TELEPHONE 714 684-1700 • TWX: 910 332-1252 • CABLE: BOURNSINC.

TRIMPOT® and Precision Potentiometers • Miniature Relays • Electronic Modules • Microcomponents.

New Semiconductor Review

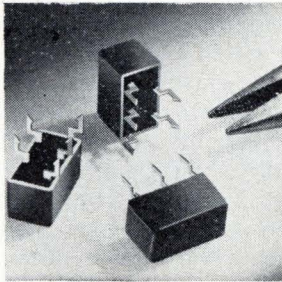

Plastic-cased silicon bridge rectifiers in the XP-188 series measure $\frac{3}{8} \times \frac{3}{4} \times \frac{1}{2}$ in., and have push-in terminals for p-c boards. Avalanche characteristics protect against transients. Units are rated 0.5 amp and are available from 200 to 800 piv. Production quantity prices range from 81 cents to \$1.09. Sarkes Tarzian Inc., 415 N. College Ave., Bloomington, Ind. [436]

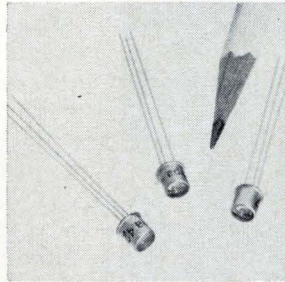

Photodiode light detector type 4207 has a sensitive area 0.040 in. in diameter. Dark current is 1 nanoamp at 10 v reverse bias and 25°C. Typical response is 0.5 $\mu\text{a}/\mu\text{w}$ into a 1-megohm load at a wavelength of 0.77 micron. Noise equivalent power resulting from dark current is less than 3.6×10^{-14} w per root cycle. Hewlett-Packard Co., 1501 Page Mill Rd., Palo Alto, Calif. [437]

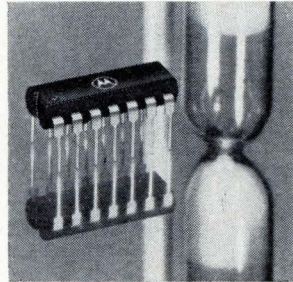

Designed for high-frequency counters, frequency synthesizers, and high-speed registers, J-K flip-flop MC1027P features a typical toggle frequency of 120 Mhz. For maximum speed, it should be driven by the MC1023P clock driver, which provides a 2-nsec risetime pulse with a 2-nsec propagation delay. Motorola Semiconductor Products Inc., Box 955, Phoenix, Ariz. [438]

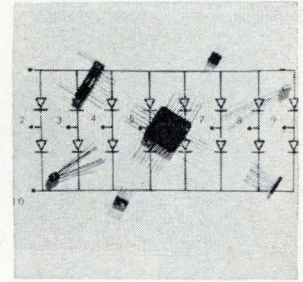

Silicon core driver assemblies and individual core driver microdiodes are available. Diode matrices (1 x 4, 2 x 4, 1 x 8 and 2 x 8) are produced on 0.25-in. design centers or smaller in T0-5 and T0-18, flatpack, and dual in-line mechanical packages. MIL-S 19500 specification is standard. MicroSemiconductor Corp., 11250 Playa Court, Culver City, Calif. [439]

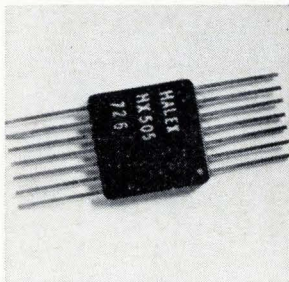

Ladder network model HX505, for use in d-a and a-d conversion, is packaged in a $\frac{3}{8} \times \frac{3}{8} \times 0.080$ in. flatpack. Basic circuit is made from thin films vacuum deposited on a ceramic substrate. The device has a 5-bit capacity in a voltage mode and 6-bit in a current mode. Accuracy is $\frac{1}{2}$ bit. Price is \$40 each for 100 units. Hallex Inc., 139 Maryland St., El Segundo, Calif. [440]

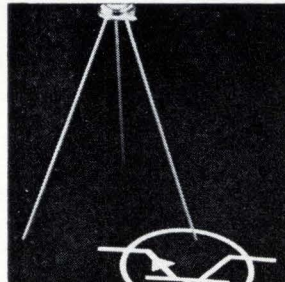

Silicon switching transistors of the npn type offer an emitter-to-base voltage of 30 v max. Offset voltage of the 2N5066 is 1 mv max and saturation resistance is 8 ohms max. The 2N5066 complements the 2N3677 and can be used with it in high accuracy a-c switching. Unit price is \$10.80 for 1 to 99. Crystalonics Div., Teledyne Inc., 147 Sherman St., Cambridge, Mass. [441]

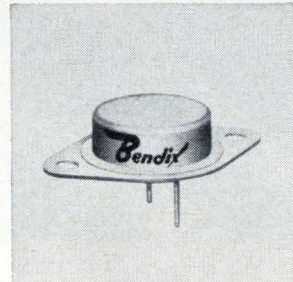

Twenty-two silicon npn transistors are included in the B-176,000 series. The 650-v units are for use in high-voltage inverters, regulators, converters and deflection circuits. All are SOAR (safe operating area) specified for second-breakdown protection. Prices range from \$2.95 to \$26 each in lots of 100 to 999. Semiconductor Div., Bendix Corp., Holmdel, N.J. [442]

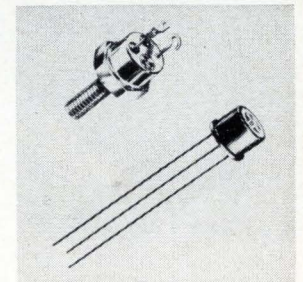

Series 2N5110 is a line of npn, silicon, single-diffused power transistors with sustaining voltages of 40 v and 80 v in T0-5 and T0-59 packages. All types are designed with a 1-amp collector current. The T0-5's have a 5-w dissipation at 25°C, and the T0-59's, 34 w. Price range is \$8 to \$16 in lots of 100. Silicon Transistor Corp., East Gate Blvd., Garden City, N.Y. [443]

New semiconductors

Integrating a silicon controlled rectifier

Small scr, integrated with amplifier, triggers a large discrete scr

Among designers of integrated circuits, one question sure to start an argument is: should silicon controlled rectifiers be built into ic's on a monolithic chip? Those in opposition to it base their argument on the fact that in most applications, scr's have to switch

power, which monolithic chips cannot withstand. But those in favor point out that the scr is such a useful device that it eventually will have to be included in the ic family. The time to start is now, they contend.

Engineers at the Westinghouse

Electric Corp.'s Molecular Electronics division have broken the ice by integrating a small scr into a circuit that is applied to trigger a larger scr. Called the WC185, the ic is a monolithic chip on which a differential amplifier drives a small scr. When used to trigger a larger scr, it serves as a millivolt-to-megawatt control package.

New grounds. Not only does the WC185 break some new processing ground for ic's, it also solves a problem in industrial control that had plagued both users and makers of scr's—reducing the high cost of controlling a high-current scr. To do it right, a hard, initial spurt of

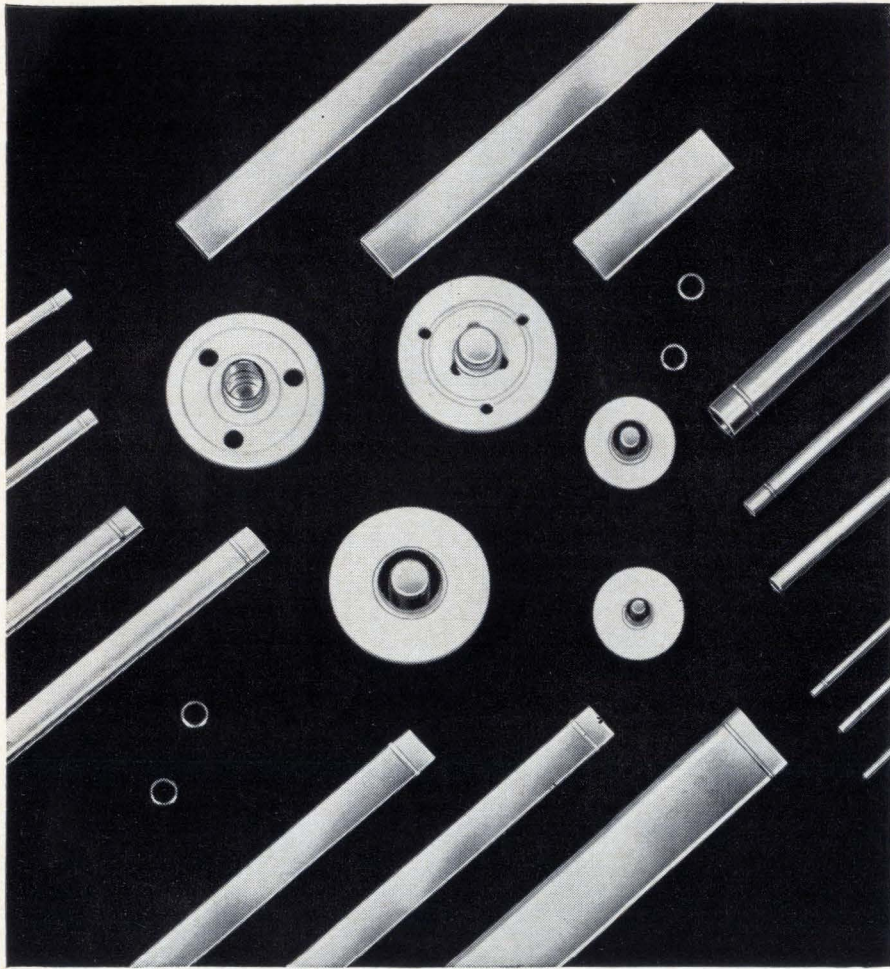

NEED CATHODES? WANT ON-TIME DELIVERY?

It's a reasonable request. And Superior gives you tangible assurances. First, every cathode we make is for our customers—none for ourselves. Second, we have two large, modern plants, located about 600 miles apart, with identical facilities to protect you against delays. And you can choose from the widest variety of cathode types and materials in the field. So why do you suppose we are the world's leading independent cathode supplier? Send for our Catalog 51. Dept. 2500.

Superior Tube 

The big name in small tubing
NORRISTOWN, PA. 19404

West Coast: Pacific Tube Company, Los Angeles, California

Johnson & Hoffman Mfg. Corp., Carle Place, N. Y.—an affiliated company making precision metal stampings and deep-drawn parts

... the IC is far cheaper
than magnetic amplifiers ...

current is required, or small areas around the gate will carry large currents that cause burnout and failure of the device.

Such components as magnetic amplifiers and solid state controls can produce this hard firing, but at a cost of about \$75. The new IC will perform the same function and costs only \$3. It supplies a sharp, full-amplitude drive pulse that turns on any large scr despite such power-circuit hazards as in-

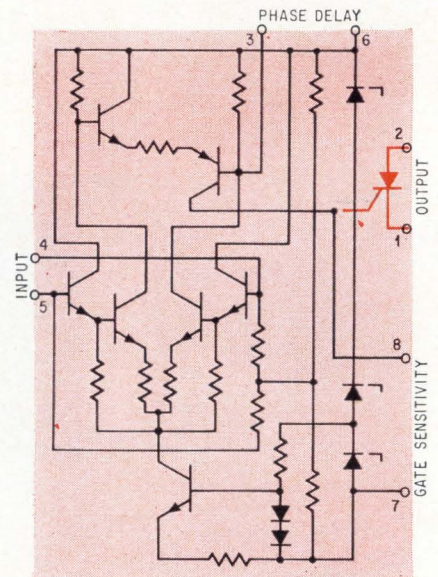

Crowded chip. IC contains seven transistors, five diodes, and one scr.

ductive loads or high inrush currents.

The new circuit illustrates, Westinghouse believes, the future trend in industrial control: low-level circuits in integrated form and high-power parts made of discrete components.

The chip contains seven transistors, five diodes, one scr, and 12 resistors. Six of the transistors are npn and make up the Darlington differential-amplifier stage. A pnp transistor drops the amplifier output to the level required by the scr, and three zener diodes serve as a voltage regulator for the differential-amplifier power supply. Thus, there are two pnp devices.

Reducing steps. By its nature, the scr must be an npnp device. To build such four-layer devices economically on an npn monolithic

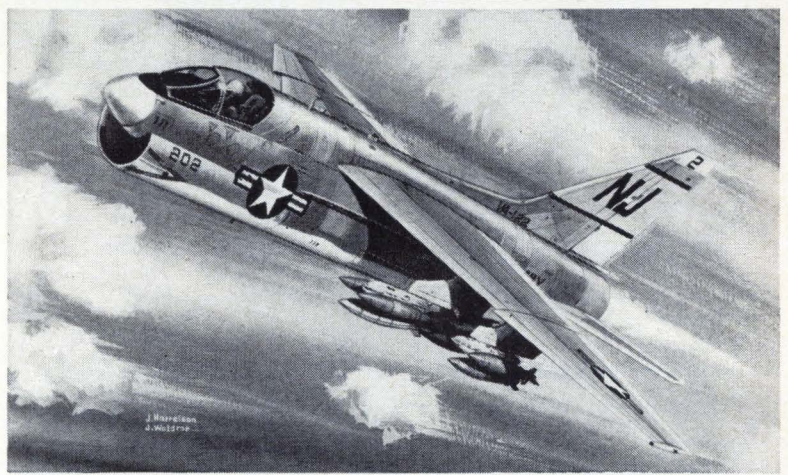
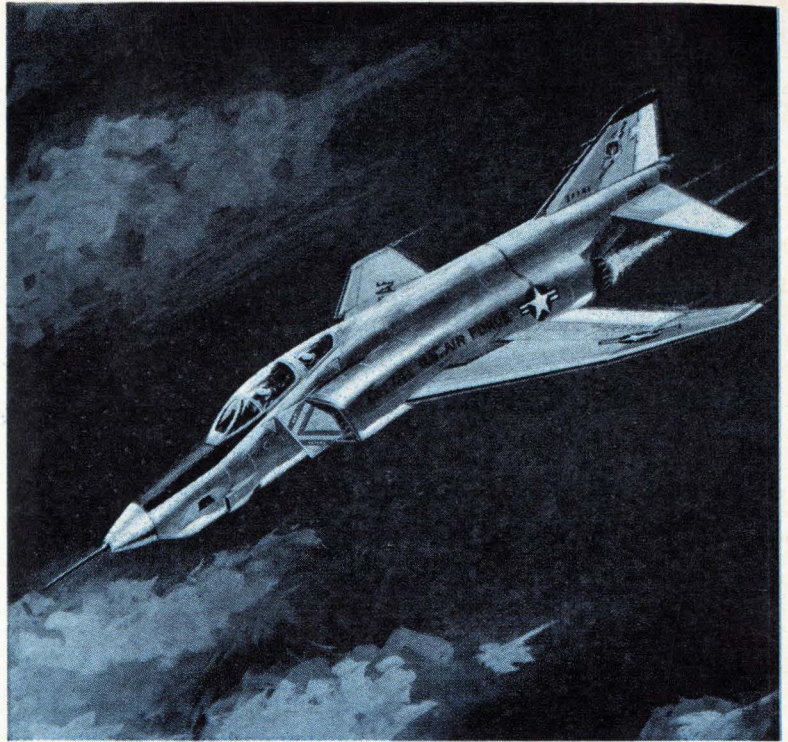

Sperry Rand Corporation has solved a unique oscillator application problem for multi-mode radars on the RF-4C and the A-7A. Texas Instruments Incorporated, prime contractor for both radar systems, needed a dual function tube — one which could serve as local oscillator in the radar, and would also work in the test and check-out circuit.

Sperry suggested the SRU-2161, and tests proved they were right. Today every AN/APQ-99 (for the RF-4C) and AN/APQ-116 (for the A-7A) system carries two of these Sperry reflex klystron oscillators.

The SRU-2161 delivers 50 mW at Ku band, while operating from a 300 V power supply. Since the oscillator has Sperry's unique adjustable reflector voltage, both tubes in the system can be driven from a single power supply. Mode shapes can be controlled to comply with the exacting tolerances of both systems.

If you need unusual performance from klystron oscillators, Sperry is the place to look. Contact your Cain & Co. representative, or write Sperry Electronic Tube Division, Sperry Rand Corporation, Gainesville, Florida 32601.

SPERRY
MICROWAVE ELECTRONICS AND
ELECTRONIC TUBE DIVISIONS
CLEARWATER AND GAINESVILLE, FLORIDA



Why multi-mode radars for RF-4C and A-7A depend on dual-purpose oscillators from Sperry... the first name in microwaves.

KEITHLEY UNWRAPS *FIRST* MOS FET ALL SOLID-STATE ELECTROMETER



New Model 602 eliminates the need for frequent zero adjustment

Using Mos Fets at the input, this new Keithley solid state electrometer measures voltage, current, resistance and charge over 73 ranges. It is so stable the only discernible drift is with temperature. And only at a rate less than $300 \mu\text{V}/^\circ\text{F}$.

The 602 exhibits minimum zero shift from shock, vibration or voltage overloads up to 500 volts. Battery-operated, this versatile giant operates up to 1500 volts off ground and has battery life of 1000 hours, even when recording! Fast warm-up time, low 5×10^{-15} ampere offset current and freedom from microphonics make it truly unique!

Call your Keithley man for our technical engineering note. Ask for a free in-plant demonstration, too.

Model 602

- 1 mv f.s. to 10v, with 10^{14} ohms input resistance
- 100 ohms f.s. to 10^{13} ohms
- 10^{-13} to 10^{-6} coulomb
- 10^{-14} ampere f.s. to 0.3 amp.
- 500-volt overload protection

\$675, with input leads

K

**KEITHLEY
INSTRUMENTS**

28775 Aurora Road • Cleveland, Ohio 44139
EUROPE: 14 Ave. Villardin, 1009 Pully, Suisse

processing line, the pnp portion is made laterally by photomasking rather than vertically by additional diffusions. In this way, additional processing steps aren't needed to fabricate the scr's.

Although the circuit is designed to control a large scr, it can regulate any load up to 250 milliamps.

Packaged in a TO-5 can, the unit is priced at \$7 in single orders and \$3 in large quantities.

Specifications

Differential gain at 1 khz	33 db
Common-mode rejection ratio	80 db
Frequency response	15 khz
Input impedance	80 kilohms
Trigger level	40 mv rms
Scr steady-state anode current	250 ma
Scr pulse current	3 amp max
Scr forward blocking voltage	80 v
Scr holding current	1.7 ma
Scr forward voltage drop	2 v
Operating temperature range	-40 to +75°

Molecular Electronics Division, Westinghouse Electric Corp., Elkridge, Md. [444]

New semiconductors

Fine tuner for TV fits on a chip

Monolithic processing makes circuit that is easy to align, the hardest job with a tuner

The fine tuner on a television set is the control that is handled most often by the viewer. That's because for really sharp pictures—particularly in color receivers—and high quality sound, the set must be adjusted to keep it accurately on channel. One way to eliminate manual regulation is to install an automatic fine tuning (AFT) circuit. But such circuits are expensive because they have to be carefully aligned.

Recognizing that monolithic integrated circuits have high stability and can be aligned easily, Radio Corp. of America engineers are using them in a new wideband AFT amplifier circuit. Although the amplifier is intended for use in an automatic fine tuning circuit for a tv or f-m receiver, it is suited for any circuit that needs a correction

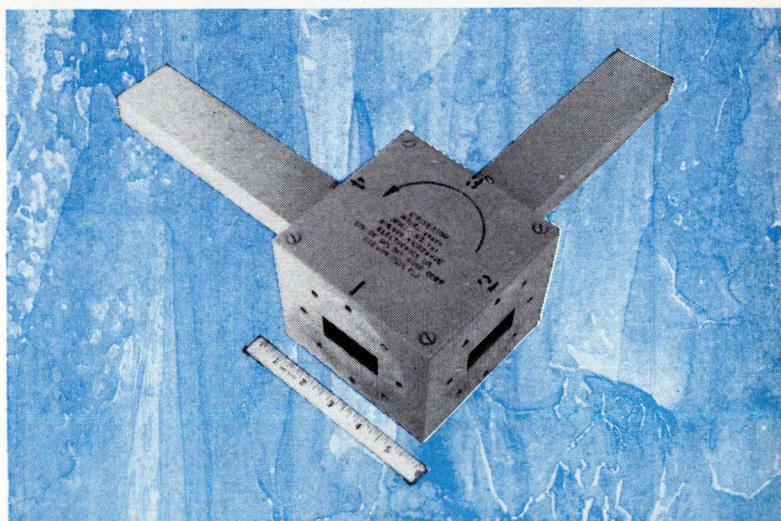
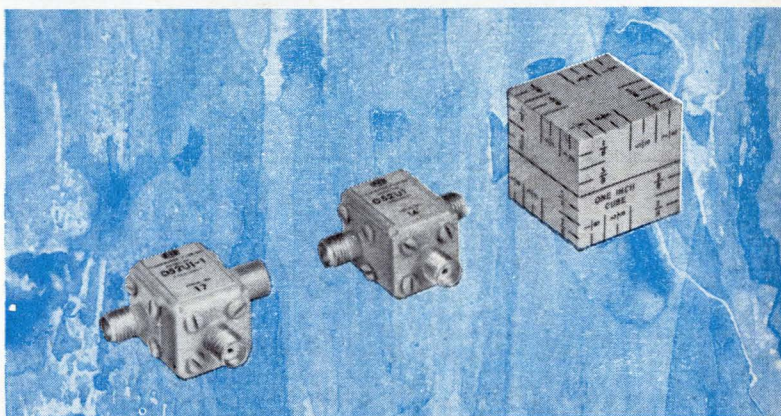
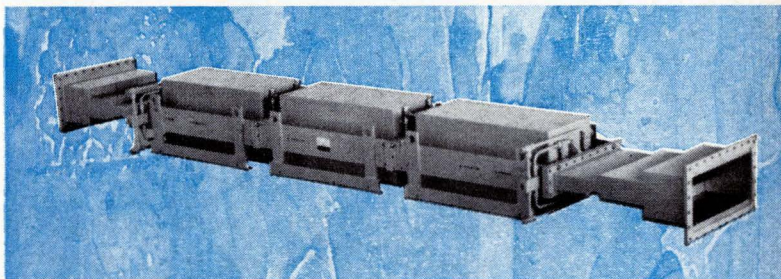
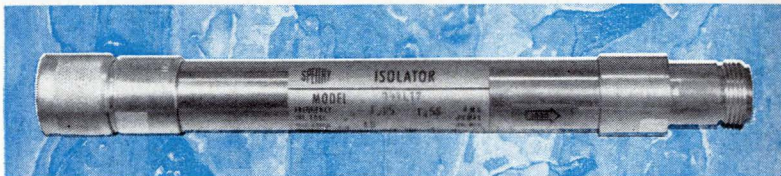
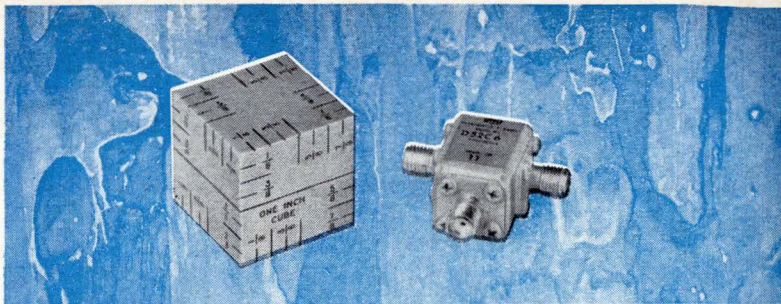

How much isolation does your microwave system need? How low must isolator insertion losses be?

Regardless of your answers, the right isolator or circulator is most likely to come from Sperry, no matter what frequency range you're working in.

After all, the coaxial isolator was invented at Sperry, and Sperry has set the pace in its development. Today the Sperry line is unquestionably the industry's most comprehensive.

You can get 217 models of standard Sperry isolators and circulators. Frequencies range from 0.1 to 40 GHz. Isolation can be as high as 40 db; insertion loss as low as 0.3 db. Remarkable custom development capability is also available.

Write for our new catalog and look over the line. Then, if you don't see exactly what you want, ask for it. Ask your Cain & Co. man or write Sperry Microwave Electronics Division, Sperry Rand Corporation, Box 4648, Clearwater, Florida 33518.

SPERRY
MICROWAVE ELECTRONICS AND
ELECTRONIC TUBE DIVISIONS
CLEARWATER AND GAINESVILLE, FLORIDA

The world's most comprehensive line of microwave isolators/circulators comes from Sperry... the first name in microwaves.

it costs you nothing to call on experience:

Reeves-Hoffman design and manufacture is 100% custom . . .
let us quote your needs!

- ★ quartz crystals
- ★ crystal filters
- ★ oscillators
- ★ discriminators
- ★ standards
- ★ ovens



400 WEST NORTH STREET, CARLISLE, PENNSYLVANIA 17013
Telephone 717-243-5929

- Md., Del., D.C., Va., W.Va., N.C.**
Valley Electronics, Inc.
Baltimore, Maryland
(301)668-4900; (202)659-1760
- New England**
Howard Jappe Company
Wakefield, Mass.
(617)245-9359
- Pa. (except Pittsburgh), So.N.J.**
Eastern Components, Inc.
Philadelphia, Pa.
(215)927-6262
- New York (except N.Y.C.)**
Midstate Research Sales Co.
Syracuse, New York
(315)478-8314; (315)478-0715
- New York City, No.N.J.**
G. M. Moch Company
Ridgefield, New Jersey
(201)945-0080; (212)279-6758
- So. California**
Ash M. Wood Company
Arcadia, California
(213)283-1201; (213)287-0449
- No. California**
L & M Engineering
Santa Clara, Cal.
(408)243-6661
- Ill., Ind., Wisc., Minn.**
PGM Sales, Inc.
Chicago, Illinois
(312)622-8183
- Ohio, W.Pa., Mich., Ky.**
Tri-State Marketing, Inc.
Cincinnati, Ohio
(513)631-5060
- Texas, Okla., Ark.**
Carter Associates, Inc.
Garland, Texas
(214)276-7151
- Ariz., N.M., Las Vegas**
Carter Associates, Inc.
Scottsdale, Arizona
(602)947-4355

Circle 172 on reader service card

This is the symbol and
"digilog" is



the name of a reliable new source of
precision
potentiometers

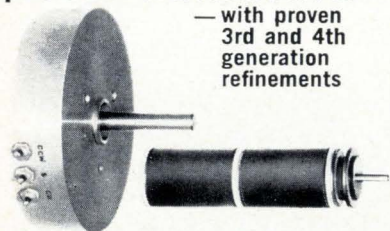

— with proven
3rd and 4th
generation
refinements

SPECIAL FEATURES: Choice of servo, screw or bushing mounting • Up to 6 (and more) sections ganged • Non-linear functions wound to your specs • Simplified phasing — loosen only one screw • "Zero-width" taps • Reliable, simple designs • Close linearities • Performance to MIL-R-12934E and beyond.

SINGLE-TURN: nine sizes, from 8 to 30; continuous rotation or stops; electrical travel up to 358°, or closed loop elements.
MULTI-TURN: two sizes, 9 and 20; standard models, 3, 5, and 10 turn; any comb. of electrical and mechanical travel up to 10 turns (or more).

AVAILABLE PROMPTLY, stock or custom designed, produced by engineer-specialists oriented to your requirements. For full line of Digilog precision and trimmer pots, see Page 2207, 1967 EEM, or contact

digilog electronics corp.

701 3rd Ave. North, Seattle, Wash. 98109
Phone (206) 284-6811 TWX (206) 998-0946

172 Circle 311 on reader service card

New! From MESON! New!

ELECTRONIC TIME DELAY RELAY



- High Accuracy, $\pm 10\%$
- Repeatability, $\pm 3\%$
- Fast recycling time — .05 sec. max.
- Input — 115 VAC
- Up to 180 sec. delay, fixed or variable with external variable resistor.

\$6⁹¹
Only **6** in 100 lots

IMMEDIATE DELIVERY!

Order one for test at \$8.80. Your
MONEY BACK if not satisfied!

MESON
ELECTRONICS CO. INC.
380 Cottage St., Rochester, N.Y. 14611
Phone (716) 235-7070

Circle 312 on reader service card

... corrects voltage
as a function of frequency ...

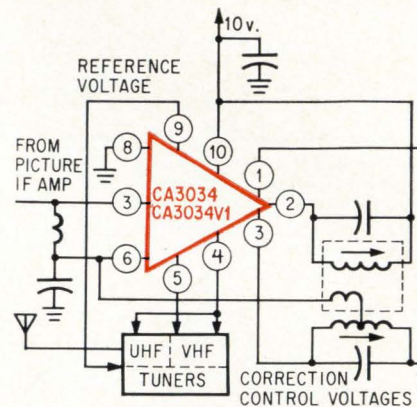

Fine-tuning IC. Automatic tuning circuit requires a minimum of peripheral components. The integrated circuit has 10 leads and can be used with uhf and vhf tuners.

voltage as a function of frequency.

On the chip. The silicon chip contains nine transistors and 11 diodes distributed among an amplifier-limiter, a dual phase detector, a differential output amplifier, and a temperature-compensated bias and voltage reference supply.

The amplifier samples the intermediate frequency and develops a correcting voltage when the i-f is off center. This signal feeds into a varicap diode in the local oscillator to change the injection frequency and retune the receiver.

The circuit is available in two different metal TO-5 packages: type CA3034 has straight leads; type CA3034V1 has offset-formed leads so it can be inserted easily into a printed-circuit board. Both packages are hermetically sealed, with all-welded construction.

Sample quantities are now available for evaluation and production quantities will be available in the fall. Price is \$1.75 each in quantities of 1,000.

Specifications

Input voltage	15 v
Operating temperature range	-55 to +125°C
Device dissipation	300 mw
Current drain	9 ma
Input impedance	2 kilohms
Output offset voltage	1.5 v
Quiescent operating current	1.9 ma
Quiescent operating voltage	5.5 v

Electronic Components and Devices Division, Radio Corp. of America, Harrison, N.J. [445]

Circle 173 on reader service card

Only new Lambda LP Series lab power supplies provide all these big system features in a small, low-cost package.



Starting at only \$114.

- High power output—up to 28 watts.
- Wide voltage range versatility—0-10 VDC up to 0-250 VDC.
- Bench or rack use—without adapters.
- Unusually wide automatic current limiting—from 1% (or 5 MA) to 105% of rated output current.
- Two meters for voltage and current.
- Both coarse and fine adjustment of voltage and current.
- Over-temperature protection by thermal relay—prevents overheating.
- Convection cooled—no blower failures.

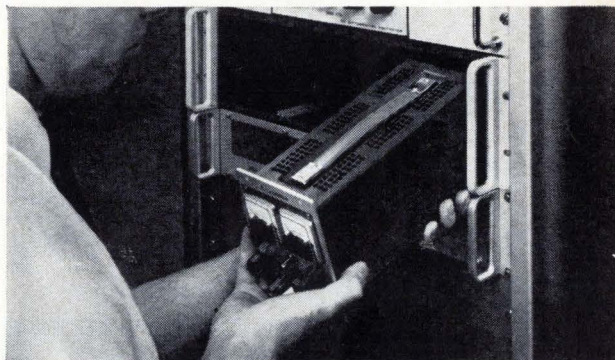

You can mount up to 4 units in a standard LRA-1 or LRA-2 rack adapter.

Other features

- Regulation (line or load): .01% + 1 MV.
- Ripple: 500 μ V RMS, 1.5 MV p-p
- Temperature coefficient: .015% + .5 MV/°C.
- CV/CC with automatic crossover.
- A-C input: 105-132 VAC 45-440 Hz (ratings based on 57-63 Hz operation).
- All Lambda power supplies are guaranteed for 5 years.

Select from six models

Model	Voltage Range	MAX. CURRENT AT AMBIENT OF:				Price ¹
		30°C	40°C	50°C	60°C	
LP 410	0-10 VDC ^o	2A	1.8A	1.6A	1.4A	\$129
LP 411	0-20 VDC ^o	1.2A	1.1A	1.0A	0.8A	119
LP 412	0-40 VDC ^o	0.70A	0.65A	0.60A	0.50A	114
LP 413	0-60 VDC ^o	0.45A	0.41A	0.37A	0.33A	129
LP 414	0-120 VDC	0.20A	0.18A	0.16A	0.12A	149
LP 415	0-250 VDC	80MA	72MA	65MA	60MA	164

^o Overvoltage Protection available as an accessory — \$40.00 each.

¹ Prices are for non-metered models. For metered models, add suffix (FM) and add \$10.00 to price.

 **LAMBDA**
ELECTRONICS CORP.
615 BROAD HOLLOW ROAD • MELVILLE, L.I., NEW YORK 11746 • (516) 694-4200

A VEECO SUBSIDIARY

VEECO HIGH VACUUM EQUIPMENT/LAMBDA POWER SUPPLIES

New Books

More GaAs mileage

Gallium Arsenide
Conference Series No. 3, Institute of
Physics and Physical Society
London, 247 pp., \$12

Though not a comprehensive summary of the present state of the gallium arsenide art, this volume is one of the few single sources of information on the many aspects of this unusual material. It is a collection of papers presented at a 1966 international symposium on GaAs, sponsored by the Institute of Physics and The Physical Society (of England) and the Avionics Laboratory at Wright-Patterson Air Force Base, Ohio. Much of the experimental device performance reported has since been surpassed, but the background material and processing information will be of real value for several years.

Under four major headings—ma-

terials preparation, optical effects, microwave devices, and junction devices—35 papers were presented, with British and American authors contributing equally. A few papers came from French and German researchers. Transcripts of discussion sessions are included.

The portion on materials preparation is particularly significant, since the key to the eventual success of many GaAs devices will be the economical production of high-quality material. Five papers on epitaxial methods are included, and three on growth of GaAs from the melt.

The section on optical effects contains papers on lasers, radiation efficiency, and photoluminescence. The portion on microwave devices covers Schottky-barrier mixer diodes and varactors, as well as seven papers on Gunn-effect de-

vices. The papers from British researchers on the Gunn diode illustrate the advanced state of development of these devices in England. A final section covers bipolar and field effect transistors and diodes.

The art of the state

Analysis of Discrete Physical Systems
H.E. Koenig, V. Tokad, and
H.K. Kesaven
McGraw-Hill Book Co., 447 pp., \$13.75

For many years the most widely used methods for analyzing lumped systems were based on Fourier and Laplace transforms. Now, with the renewed interest in both time-varying and nonlinear systems, these approaches are being supplanted by the differential equation, or state-space technique. In this method, the system is described by a number of variables related to one another by differential equations.

This volume is recommended as a well-illustrated, thorough intro-

PROBLEM SOLVED / Formica know-

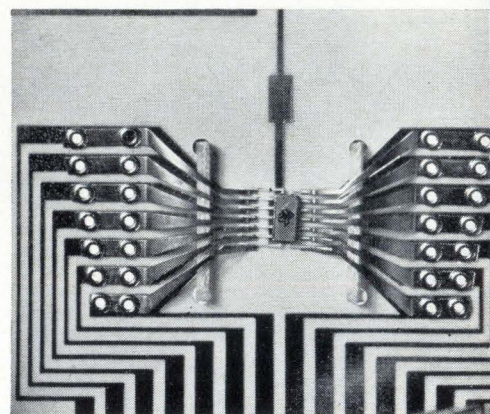

Case #1695-Problem: 4 different copper clad grades were purchased and inventoried, creating multiple paper work, record-keeping. Idea activated: One FORMICA® FR-45 laminate, created to meet NEMA G-10, G-11, FR-4, FR-5.

Case #6520-A-Problem: Pad slippage causing poor registration in production of multi-layer circuitry boards. Idea activated: FORMICA® laminate MLC system created a sandwich with better copper bond strength and registration control at elevated temperatures.

duction to the use of this technique. The authors have done a commendable job of introducing its essential features, although, presumably for simplicity, they have restricted their discussion to linear time-invariant lumped systems. This limited coverage means that many difficulties involved in analyzing more general systems won't be appreciated by the reader.

The state-space approach is complemented by a discussion of transform methods and the associated system transfer functions. Although adequate, the treatment of these topics is somewhat superficial in comparison with previous books on the subject. The representation of a system as a mapping between input and output is not forcefully presented, and thus concepts like linearity, time-invariance, and causality are treated as properties of components rather than systems. This viewpoint is undesirable, especially when at-

tacking problems in distributed systems.

Three chapters are devoted to the problem of modeling physical systems; the selection of independent and dependent, input-output, variables are described in detail. To illustrate the method, examples go beyond electronic circuits, and are drawn from electrical and mechanical engineering.

The authors see the problem of large-scale system analysis in terms of linear graph theory, leading to a discussion of the state model of a system. Particular consideration is given the state transition matrix as the primary means for numerical analysis.

The theorems and proofs included in certain chapters seem to be best suited for graduate study, although the authors contend that the material is written for advanced undergraduates. In any case, the fully discussed, excellent examples make the text well suited for self-

study and for reference by the systems engineer.

M.R. Wohlers
Grumman Aircraft Engineering Corp.
Bethpage, N.Y.

Recently published

Unified Circuit Theory in Electronics and Engineering Analysis, J.W. Head and C.G. Mayo, Iliffe Books Ltd., London, 174 pp., \$2.75

Unlike most recent circuit theory texts, this book uses Heaviside's operational calculus in preference to the Laplace transform as a more practical method for circuit analysis. Circuits with lumped and distributed elements are analyzed, along with two- and four-port networks.

Radar Signals, Charles E. Cook and Marvin Bernfeld, Academic Press, 531 pp., \$19.50

This book can provide both the radar systems engineer and the nonspecialist with the necessary background in radar signals and modulation theory. Pulse compression and optical matched-filter techniques are discussed in detail.

Modern Communication Principles, Seymour Stein and J. Jay Jones, McGraw-Hill Book Co., 377 pp., \$15.00

Designed for self-study, this volume covers the communications field with special attention to digital radio communication. Latest aspects of system design, such as information theory and circuit noise, are emphasized, with appropriate theoretical discussions.

how activates ideas!

If your problem is printed circuit boards, call us. Continuing innovations at Formica Corporation have created a wide variety of copper clads. One of these could help you!

Small problems in copper clad circuit boards can become big problems in product dependability. Turn those problems into profit and reliability. Call Formica. No one offers as much experience in laminates . . . backed by the research resources of Cyanamid. We make a variety of copper clad grades to solve a variety of problems. Ideas solve problems. Formica know-how activates ideas.

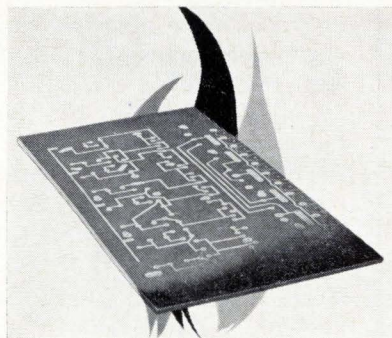

Case #5266-Problem: Flame retardant version of XXXPN-36 required, at no premium price. Idea activated: Flame retardant FORMICA® laminate FR-200 engineered to meet MIL specs, offers high flexural strength, excellent electrical properties.

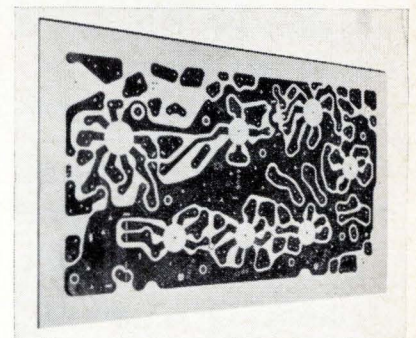

Case #J-9291-Problem: Utility-priced copper clad with quick local delivery required, due to limited inventory space. Idea activated: FORMICA® laminate FF-91 (meets G-10 specs) produced, maintained in Formica regional warehouses for phone-call delivery.

There are other brands of industrial plastics but only one



FORMICA CORPORATION • Cincinnati, Ohio 45232, Dept. EL 8-7
subsidiary of



WHY SETTLE FOR LESS? GET TOP PERFORMANCE WITH DELTA'S FABULOUS MARK® TEN

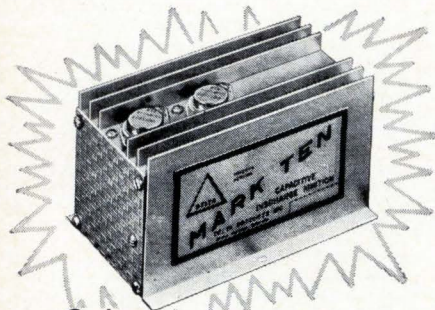

Only
\$44.95 CAPACITIVE
ppd. DISCHARGE
Deltakit — Only
\$29.95 ppd. IGNITION SYSTEM

You read about the Mark Ten in the April issue of Popular Mechanics!

Now discover why even Detroit has finally come around. In 4 years of proven performance and reliability, the Mark Ten has set new records of ignition benefits. No wiring. And works on literally any type of gasoline engine. Buy the original, the genuine, the real McCoy — Mark Ten. From Delta. The true electronic solution to a major problem of engine operation.

READY FOR THESE BENEFITS?

- ▲ Dramatic Increase in Performance and in Fast Acceleration
- ▲ Promotes more Complete Combustion
- ▲ Points and Plugs last 3 to 10 Times Longer
- ▲ Up to 20% Mileage Increase (saves gas)

LITERATURE SENT BY RETURN MAIL
BETTER YET — ORDER TODAY!



DELTA PRODUCTS, INC.

P.O. Box 1147 E • Grand Junction, Colo. 81501

Enclosed is \$_____ Ship prepaid.

Please send: Ship C.O.D.

Mark Tens (Assembled) @ \$44.95

Mark Tens (Delta Kit) @ \$29.95

(12 VOLT POSITIVE OR NEGATIVE GROUND ONLY)

6 Volt: Negative Ground only.

12 Volt: Specify Positive Ground

Negative Ground

Car Year _____ Make _____

Name _____

Address _____

City/State _____ Zip _____

Technical Abstracts

Underwater view

A review of laser applications to underwater illumination
Ivor P. Lemaire
U.S. Naval Ordnance Test Station,
Pasadena, Calif.,
and Henri Hodara
Tetra Tech Inc., Pasadena

The best way to identify an object underwater is to illuminate it and then examine it. The laser, with its high peak power, narrow bandwidth and beamwidth, and high scanning rate, provides a considerable increase in viewing range.

Recent experiments point the way to an extended range electro-optical underwater target-recognition system. Such a system would include high-power laser sources, scanning capabilities, and a means of reducing backscatter.

Although water severely attenuates a light beam and limits target recognition and viewing range, the light reflected back from particles in the water presents greater problems. This backscattered light washes out target contrast and saturates the receiver.

To reduce backscatter without reducing the viewing range, specialized techniques such as range gating and polarization discrimination are employed.

In range gating, used where the distance to the object is known, a narrow light pulse is emitted with the receiver off. The receiver opens up only long enough to receive the reflected pulse from the target; thus, the narrower the pulse, the smaller the backscatter. However, narrowing this pulse means increasing peak power if the same received threshold energy is to be maintained.

Here lies the advantage of the laser over incoherent sources—its ability to pack extremely high powers within narrow pulses.

The second backscatter reduction method, polarization discrimination, is based on water particles scattering light differently than a diffuse target. If the source is circularly polarized, say right handed (RH), it changes to left handed (LH) after scattering from the water. The target, however, divides the power equally between RH and LH. A polarizer that accepts

only RH light and is placed over the receiver, rejects the backscattered light.

Presented at the First International Conference on Laser Applications, Paris, July 18-23.

Screening the memory

Electrophoretic deposition of ferrite for computer stores
M. Barraclough and N.E. Bolton,
Royal Radar Establishment,
Malvern, England, and
A.H. Collins and J. Andrews,
Scientific Instrument Research
Association, Chislehurst, England

Computer memories made by depositing thin, uniform layers of ferrite around tiny conductors provide high reliability at low cost. The memories lend themselves to batch fabrication, and are produced with a minimum of manufacturing effort. In addition, the magnetic storage elements are driven with low currents and reduce the need for peripheral electronics.

Electrophoresis is used to deposit the ferrite layers on a wire grid made up of conductors as small as 5 mils in diameter. In this process, a suspension of ferrite particles is prepared and a small amount of iodine added. The mixture is stirred for a day so the ferrite particles will absorb the iodine and acquire a positive charge. The suspension is then circulated through a deposition chamber with a cylindrical wire mesh anode; the wire memory grid serves as cathode.

An intense electric field between anode and cathode attracts the ferrite to the cathode, where it plates out. Since the particles have a high resistivity compared with the suspension medium, the field pattern is modified at the point of deposition and next particle has a tendency to plate out at another point. This self-regulating property of electrophoresis accounts for the great uniformity of thickness.

The coated array is fired at high temperature, sintering the ferrite and giving it the proper crystal structure. Keeping the grid at 1,400°C for 20 minutes and cooling in air yields a ferrite coating with square-loop hysteresis characteris-



Packs a wide frequency range in small space

The Hewlett-Packard 3200B VHF Oscillator offers continuous coverage of frequencies from 10 to 500 MHz, yet takes up little space on the bench or in the rack. The 3200B provides $\pm 0.002\%$ frequency stability over a 5-minute period, a high RF output level, and an output attenuator. It is ideal as a general purpose source of CW signals and will also accept external pulse or amplitude modulation. The 3200B may be used with an accessory doubler probe to extend the frequency coverage to 1000 MHz. Size: $7\frac{1}{8}$ " wide, $6\frac{1}{2}$ " high and $13\frac{1}{8}$ " deep. Price \$525. For more complete information, contact your local Hewlett-Packard field engineer or write: Hewlett-Packard, Green Pond Road, Rockaway, New Jersey 07866.

HEWLETT  PACKARD
SIGNAL SOURCES

1074B

Circle 316 on reader service card



NEW from Cramer



ADJUST-A-LOK STOOLS

Adjust to every worker like fine tools!

Cramer Adjust-A-Lok is immediately adjustable to any workers height. Just release the safety stop, and lift or lower. It can be done just that quick. Since fatigue is a critical factor in efficiency of seated workers, it's just good economics to provide tools that minimize fatigue. With Adjust-A-Lok every worker can find his own most comfortable and efficient level. 6 seat styles and 5 base types provide 30 available models. For more information: write V. P. Sales, Cramer Industries, Inc., 625 Adams, Kansas City, Kansas 66105.

Industrial supplier
inquiries invited

CRAMER
CRAMER INDUSTRIES INC. • KANSAS CITY, KANSAS
A Subsidiary of U.S.M Oil Co.

Cramer—The leader in style and quality.

Circle 317 on reader service card

TUNG-SOL MOLDED BASE LAMPS —A GOOD IDEA FOR HIGH SPEED CHECK SORTERS

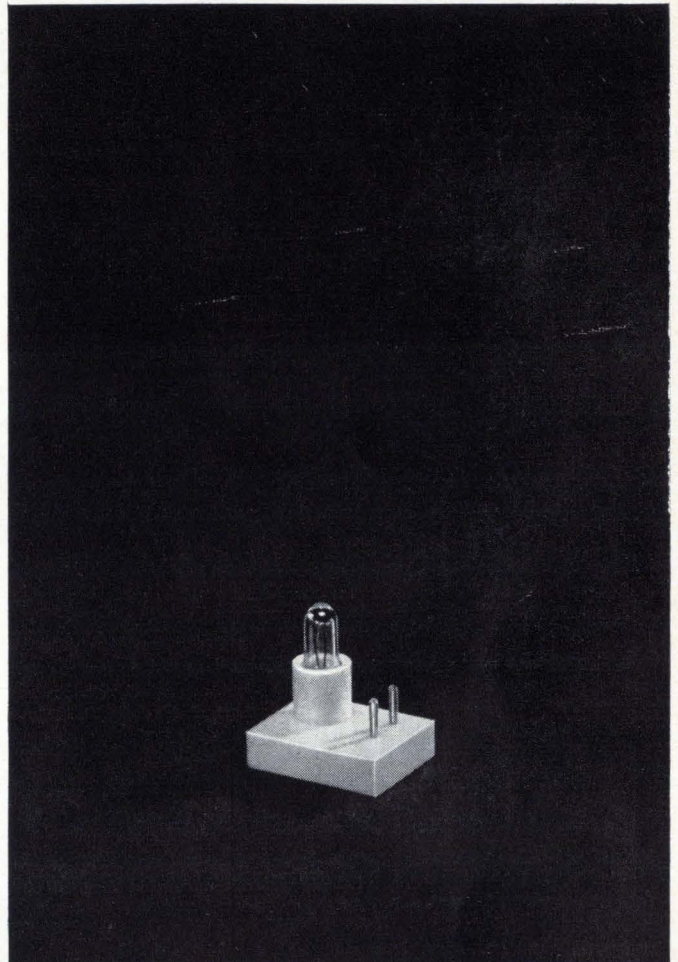

This lamp module is used to activate the photo-electric sensor in a high speed check sorter. It is Tung-Sol's version of another design.

The original involved separate purchasing of molded plastic blanks, lamp pins and bulb with lead wires. Contact pins were inserted manually and the lamp was inserted. The lamp leads were wired to pins in a recess in the correct position and the recess was sealed with epoxy. *Shrinkage in finished units was absorbed by the customer.*

The Tung-Sol idea consists of pre-assembled lamp and pins molded into a single integral unit. *Yield to the customer in usable units is 100 percent, with a bonus in the form of added reliability.*

Tung-Sol can mold bases to almost any requirement. Why not get a Tung-Sol idea for your small lamp application? Tung-Sol Division, Wagner Electric Corporation, One Summer Ave., Newark, N.J. 07104.

TUNG-SOL®

WHERE BIG THINGS ARE DONE
WITH SMALL LAMPS

© REGISTERED TRADEMARK WAGNER ELECTRIC CORPORATION

Circle 177 on reader service card

177

tics. The process forms small magnetic elements at each crossover whose dimensions are determined by the diameter of the array wire and the thickness of deposited ferrite. By using one set of wires as digit conductors and the other as word conductors, the magnetic elements can be operated as storage devices.

Presented at the Conference on Computer Technology, Manchester, England, July 18-20.

Acting on impulses

A wideband magnetic field intensity meter
M.T. Buchanan and F.J. Morris
Electro-Mechanics Co., Austin, Texas

Much of the magnetic interference associated with sensitive electronic systems occurs as impulses, and therefore contains a wide spectrum of frequencies. To reduce the interference, the magnetic fields must first be measured and their sources identified. But most conventional low-frequency magnetometers are unsuitable for high-frequency, large-amplitude magnetic pulses.

A variable- μ magnetometer has therefore been designed with a flat response from 10 hertz to 10 megahertz and a 100-decibel dynamic range, and then built into a 1/2-cubic-inch package.

The key element in the variable- μ magnetometer is a ferrite sensor rod. Ferrites not only maintain high permeabilities and Q's at high frequencies, but have nonlinear magnetic properties that enable detection of variations in magnetic fields. The ferrite rod is used as an inductor core in the tuned circuit of an oscillator. Changes in the magnetic field intensity cause the a-c permeability of the core to vary, changing the coil inductance and the oscillator frequency.

Magnetic field intensity excursions thus frequency-modulate the oscillator. The f-m signal is amplified, limited, and discriminated to convert the deviations in frequency into an analog signal. This signal is amplified to drive a display oscilloscope at the magnetometer output.

Presented at the Electromagnetic Compatibility Symposium, Washington, D.C., July 18-20.

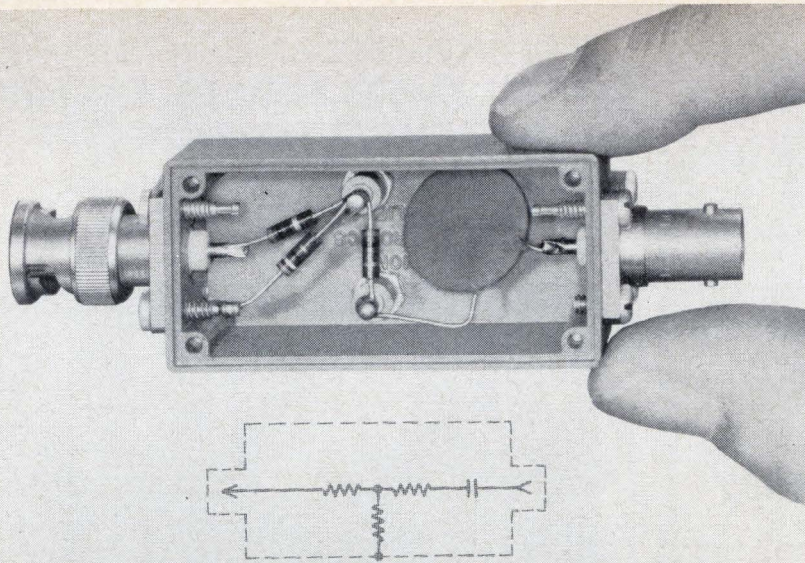

HERE'S A BETTER WAY TO PACKAGE, PROTECT, AND SHIELD CUSTOM TEST CIRCUITS

Use Shielded "Black Boxes," manufactured exclusively by Pomona Electronics, to package voltage dividers, attenuators, active, passive, isolation, impedance, and matching networks, or other specific test circuits. They're compact, rugged die-cast aluminum containers, supplied with aluminum covers secured by self-tapping screws for effective RF shielding. Available in 16 different connector combinations to match existing test equipment. Solder turret terminals provide permanent noise-free connections. Write for catalog.

POMONA ELECTRONICS CO. INC.

1500 East Ninth St. / Pomona, California 91766 / Phone: (714) 623-3463

Circle 313 on reader service card



INTEGRATED CIRCUIT POWER SUPPLIES

Write today for the IC Brochure



Designed Specifically for Original Equipment Applications.

THE IC PRODUCT LINE

After a careful analysis of existing power supply product lines, Wanlass Electric concluded that there was an important omission in these lines, namely, the low-cost quality supply for use by OEM's with their integrated circuits. The Wanlass IC line is aimed specifically at this market. This line features a quality series regulator but no frills... no expensive package, no unnecessary precision components, 0.25% regulation not 0.05%, 5 millivolts ripple not 1 millivolt, overvoltage protection is available as an option.

7.5 Amp Model \$105.00
15 Amp Model \$150.00

WANLASS ELECTRIC CO.



A Subsidiary of American Bosch Arma Corporation
2175 South Grand Avenue/Santa Ana, California 92705

178 Circle 178 on reader service card

THIS SPACE CONTRIBUTED BY THE PUBLISHER



The Voice. Anybody's voice. Your voice. It has a special quality and timbre all its own. But.

If it should become hoarse or if a cough should persist, find out what the reason is. Promptly. It could be a warning signal of cancer. And cancer is easier to cure when it's detected early.

Frank Sinatra knows the seven warning signals of cancer. Do you? 1. Unusual bleeding or discharge. 2. A lump or thickening in the breast or elsewhere. 3. A sore that does not heal. 4. Change in bowel or bladder habits. 5. Hoarseness or cough. 6. Indigestion or difficulty in swallowing. 7. Change in a wart or mole.

If a signal lasts longer than two weeks, see your doctor without delay.

It makes sense to know the seven warning signals of cancer.

It makes sense to give to the American Cancer Society.



NEW Ultrasonic Soldering Systems

I/C PACKS
COMPONENTS
SUBASSEMBLIES

- Fluxless
- Increase throughput
- Reduce rejects

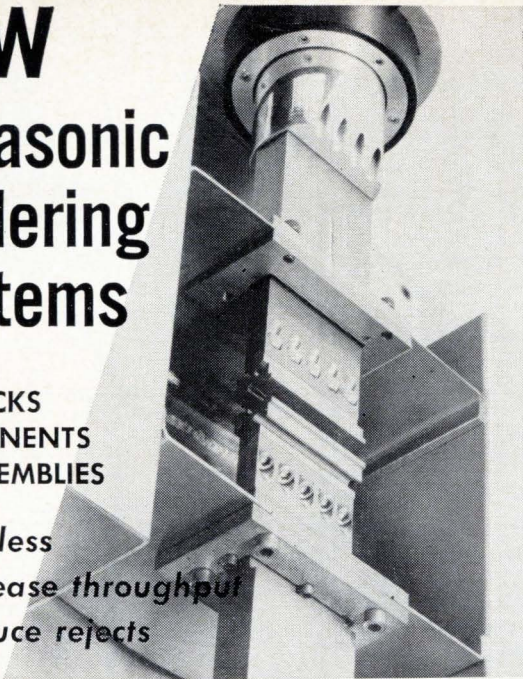

Redford has a broad range of fully automated, semi-automated, and manual systems. With ultrasonic soldering there is no worry about corrosion caused by residual flux because no flux is used. Pre-cleaning and post-cleaning eliminated. Send our application engineers a sample of your 'problem'—or call and tell them about it... even between noon and 1 pm.

968 Albany-Shaker Road
Latham, New York 12110
Phone (518) 785-2345

REDFORD
CORPORATION

Circle 314 on reader service card

How many ways can the all-electric **ELECTRO**TABLE increase your production?

Illustration includes
ELECTROPUNCH HEAD

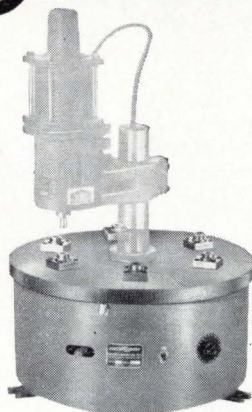

1. automatically positions work within $\pm .001"$
2. triggers other tools to swage, stake, rivet, punch, etc. as desired.
3. available in 6, 8 and 12 stations at speeds to 48 indices per minute (higher indexing rate available)
4. plugs into any 115V or 230V outlet
5. has no complicated connections or piping of any kind
6. adapts easily to automatic feeds
7. cuts costs, time, and labor

For further information, write:

BLACK & WEBSTER, INC.

297 WINTER STREET, WALTHAM, MASS. 02154 • TEL: (617) 891-8100

Good News for Packaging Engineers

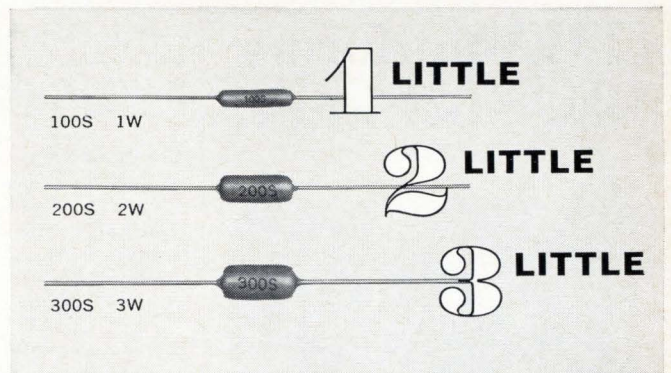

Sage delivers the smallest 1, 2 and 3 watt resistors available—Specially designed for uniform length fit in .4 inch "Cordwood" circuit modules.

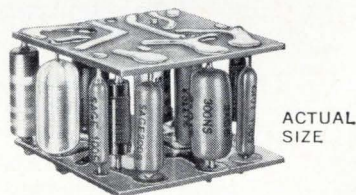

Check these outstanding features

Resistance Range:	(1W)	(2W)	(3W)
Regularly wound05 Ω to 13K Ω	18K Ω	23K Ω
Non-inductively wound . .	.5 Ω to 3.0K Ω	3.9K Ω	5.3K Ω

Tolerance: 5% to .05%.

Standard TC: As close as 10 ppm/ $^{\circ}$ C.

Construction: All welded, silicone coated for temperature endurance beyond 275 $^{\circ}$ C. Solderable or weldable leads.

SAGE backs up its resistor products with far more design and performance data than you customarily see from other manufacturers. Make us prove it by asking now for your copy of Catalog R-66.



SAGE ELECTRONICS CORP.

BOX 3926

ROCHESTER, N. Y. 14610

Phone 716:586-8010



Minutes approved!

TWA performs like clockwork.

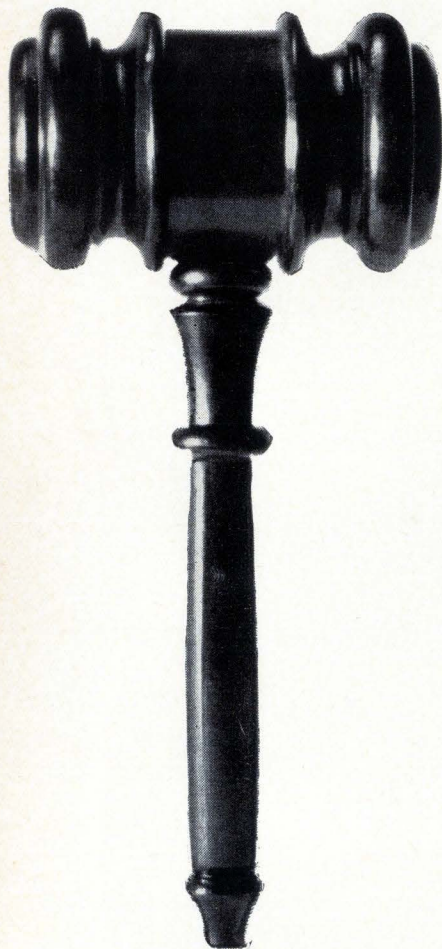

Wescon 67

San Francisco, August 22-25

A TWA timetable performs as read. No omissions, no corrections. A jet just when we promise. Smooth service on the ground, too. You're out of the terminal and on your way... fast! If you're making the convention, make time with TWA. We cover the convention circuit... like clockwork. Call TWA and ask for our convention specialist, or see your travel agent.

Welcome
to the world of
Trans World Airlines*



*Service mark owned exclusively by Trans World Airlines, Inc.

New Literature

Memory test system. Computer Test Corp., 3 Computer Drive, Cherry Hill, N.J. 08034. A memory test system, which utilizes the memory of an associated control computer to program both test conditions and grading criteria, is presented in technical brochure 67-K. Circle **446** on reader service card.

Rear-projection readouts. Industrial Electronic Engineers Inc., 7720 Lemona Ave., Van Nuys, Calif. 91405. Catalog 202, aimed at anyone interested in the design, manufacture and use of visual displays, covers single-plane, rear-projection readouts, and accessories. [447]

Digital voltmeter. Dana Laboratories Inc., 2401 Campus Drive, Irvine, Calif. 92664, offers catalog 705, an eight-page brochure describing the Model 5500/130 digital voltmeter that features 1- μ v resolution. [448]

Zero speed switch. Airpax Electronics Inc., P.O. Box 8488, Fort Lauderdale, Fla. 33310. Bulletin F-99 illustrates and describes a switch that is used for alarm switching or equipment shutdown as a rotating shaft's speed approaches zero. [449]

Microwave mixers. Sage Laboratories Inc., 3 Huron Drive, East Natick, Mass., has prepared a 36-page technical discussion focusing on mixers utilizing the point contact resistive microwave diode as the nonlinear element. [450]

Brazing and soldering manual. All-State Welding Alloys Co., P.O. Box 350, White Plains, N.Y. 10602, has available a 36-page manual treating principles and techniques for brazing and soldering ferrous and nonferrous metals. [451]

Modular core memories. Ampex Corp., 401 Broadway, Redwood City, Calif. 94063. Performance, operation, and interface of the Model RF family of modular core memories for computers are discussed in brochure C030. [452]

Analog computer. GPS Instrument Co., 188 Needham St., Newton, Mass. 02164. The solid state, high-speed model 200T computer is described in a 16-page illustrated brochure. [453]

Power supplies. NJE Corp., 20 Boright Ave., Kenilworth, N.J. 07033. A compact catalog offers information about the company's expanded line of power supplies, frequency converters, and multiphase adapters. [454]

Spectrum analyzers. Spectran Electronics division, Novatronics Inc., P.O. Box 878, Pompano Beach, Fla., covers 44 standard spectrum analyzers that use magnetostrictive filters to provide a filter skirt slope of 18 db per octave. [455]

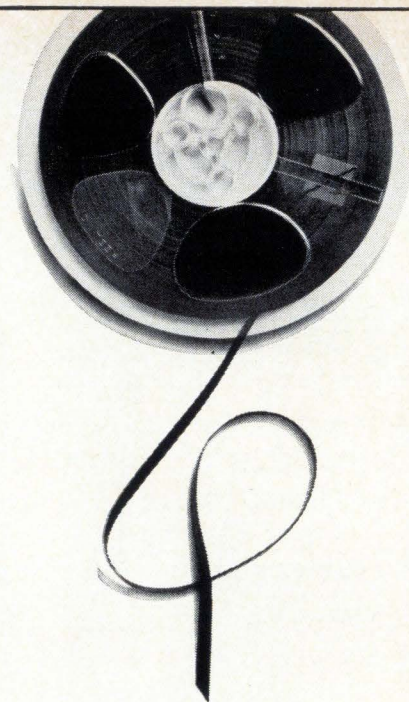

GREATER TAPE SENSITIVITY

with Pfizer
magnetic iron oxides

Whenever there's a need for a more sensitive magnetic tape of any kind, chances are Pfizer has the magnetic oxide for you to produce it. Significant advances in magnetic tape technology have coincided with Pfizer's continuing development of high quality oxides. Available are IRN[®] magnetic oxides of high density which facilitate more magnetic action in a given volume, providing greater sensitivity in a wide variety of uses:

- Audio, video, computer and instrumentation tapes;
- Memory drums and discs;
- Cinema film stripings;
- Magnetic inks;
- Transfer tapes;
- Ribbons.

Pfizer's continuing research & technical service programs are ready to help you on any specific problem you may have in this growing field. Complete technical data on request.

Pioneering in Physical Chemicals

Pfizer

MINERALS PIGMENTS & METALS DIVISION

Dept., 75, 235 East 42nd Street
New York, New York 10017



NEW! DYNAMIC IC TESTER
 simulates actual in-circuit conditions

The MONITOR Model 851 dynamically tests all commonly used integrated circuit types and package configurations. It makes a full operational check on an IC in less than 15 seconds, at the actual in-circuit pulse rates, logic levels, and voltages called for by your system. The Model 851 is a complete, portable package (even includes a vacuum pickup for flatpack handling). All you need is a scope. It is obsolescence-proof, via interchangeable IC adapter sockets and test program plugs.

But the real clincher is the price: \$1,920.
 Descriptive literature? Get in touch with us.



MONITOR
 SYSTEMS INC. A subsidiary of Epsco, Inc.

Fort Washington, Pa. 19034 □ Phone 215-646-8100
 3597

TWX 510-661-1520

Circle 319 on reader service card

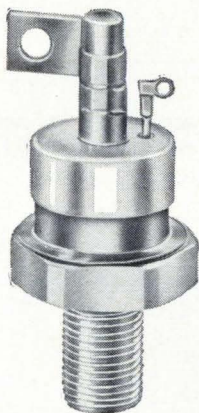

**dv/dt 500 volts
 per microsecond**

SCR's

manufactured
 by

NATIONAL®

- ⊕ 12 to 20 microseconds turn-off time available.
- ⊕ 16 amp thru 110 amp.
- ⊕ Immediate delivery.

NATIONAL

*Request
 bulletin*

ELECTRONICS, INC.
 a varian subsidiary

PHONE: (312) 232-4300 • GENEVA, ILLINOIS 60134

Visit Us At WESCON Booths 2309-2317

Circle 320 on reader service card

Our ultrasonic waves have made quite a stir.

Take these three Blackstone cleaning systems for example.

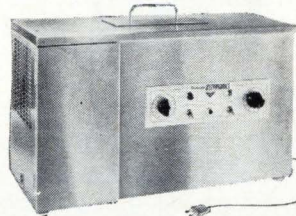

Blackstone VR-O.7

Makes it easy to put vapor rinse and ultrasonic cleaning at every work station. Requiring no water drains or hood because of its built-in refrigeration system, the VR-O.7 runs on 110 volts, delivers 21,000 cycles (nominal), has a filter spray which controls

particulate matter to 5 microns (nominal) and provides solvent vapor rinsing. To assure long, trouble-free life, the lead zirconate titanate transducer is mechanically held by a retainer which is silver brazed to the bottom of the 6"x6"x4½" stainless steel tank.

**Blackstone Small Tank
 Ultrasonic Cleaners**

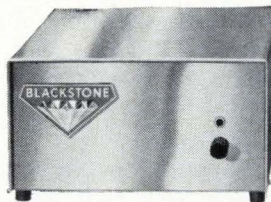

Enables precision scrubbing of a variety of small parts including . . . electronic components, printed circuit boards, sub-assemblies, optical equipment and assembled instruments or parts at strategically located cleaning stations. Available with two tank capacities — .5 gallon (Model SOBCT.5) and 1 gallon (Model SIBCT1). Tanks removable from assembly for emptying. High efficiency lead zirconate titanate transducer. Solid state, automatically-tuned generator.

**Blackstone
 2-Solvent
 Cleaners**

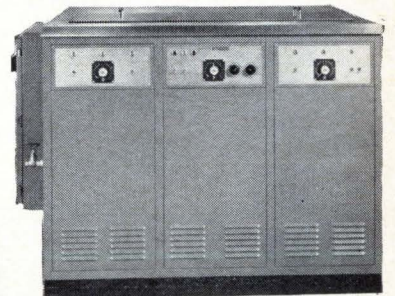

Gives you a combination of solvents, time, power control and unlimited processing sequences to handle both oil and mineral salt cleaning problems. Available with two ultrasonic cleaning tanks (of 5, 10 or 20 gallon capacities) and a vapor rinse tank. 0 to 100% power control with 0 to 15 minute timers on each of the generators.

Let us solve your problem. Special ultrasonic processes and recommendations can be developed for you. Write and tell us about your cleaning problem.



BLACKSTONE ULTRASONICS, INC.

1400 Howard Street • Sheffield, Pa.

Circle 181 on reader service card

181

RF CIRCUIT ENGINEERS
 SYSTEMS ANALYSIS ENGINEERS
 SYSTEMS INTEGRATION ENGINEERS
 INDUSTRIAL ENGINEERS
 DIGITAL ENGINEERS

SEARCHING FOR

OPPORTUNITY instead of promises?

We can't promise you'll realize all your career objectives at ECI, but we will give you every opportunity. And we'll help you every way we can. The rest is up to you.

CHALLENGE instead of a chance?

Challenges lead to accomplishments. Chances don't necessarily lead to anything. If you like the satisfaction of accomplishing things, you'll like working at ECI. We're objective oriented.

GROWTH instead of a groove?

In our business you can't afford to stop learning ... to stop growing. At ECI you'll be pushing the state-of-the-art. There are few confining grooves when you explore the unknown.

And LOCATION too?

If you're going to like your job, you might as well like where you're living. We'll pit the St. Petersburg area against anyplace in the U.S. for stimulating, comfortable living.

INVESTIGATE ECI!

We have immediate openings in design and supervision. You'll work on systems and equipment in satellite communications, multiplexing, electronic switchboards, and advanced VHF/UHF communications using microcircuitry and state-of-the-art techniques.

Send your resume, in confidence, to K. S. Nipper, Supervisor of Professional Placement, Electronic Communications, Inc., Box 12248E, St. Petersburg, Florida 33733. (An equal opportunity employer.)



St. Petersburg Division
 Electronic Communications, Inc.



EMPLOYMENT OPPORTUNITIES



E.E.'s
 For FEE PAID positions
 throughout U.S.

SEND RESUME TODAY
 (if none, send coupon for
 confidential application.)

ATOMIC PERSONNEL, INC.
 Suite L, 1518 Walnut St., Phila., Pa.
 Experienced Engineers
 Working Full Time for You!

Name _____
 Address _____
 City _____ State _____

AN EMPLOYMENT AGENCY FOR ALL TECHNICAL FIELDS

We are offering a proprietary line of
 Microwave & Professional Cathode
 Ray Tubes.

**WE ARE LOOKING FOR
 EFFECTIVE & EXPERIENCED
 OEM REPS.**

Many territories open.

Write for full details to the
M-O VALVE CO., LTD.

a subsidiary of the
 British General Electric Co., Ltd.

468 Park Avenue South
 N.Y., N.Y. 10016 • Tel. (212) MU 6-2120

SELLING OPPORTUNITY WANTED

French Engineer experienced in & familiar
 with French electronic market wishes to con-
 tact stateside firms to establish U.S. repre-
 sentation for electronic exports to France.
 Reply to A. Rose, 6 Rue De Babylone, Paris
 7E France.

CLASSIFIED ADVERTISING



SEARCHLIGHT SECTION

BUSINESS OPPORTUNITIES
 USED OR SURPLUS EQUIPMENT

free catalog
POTTING APPLICATORS
MANUAL AND DISPOSABLE

6cc 12cc 30cc
 FOR POTTING, ENCAPSULATING, AND
 SEALING OF MINIATURE COMPONENTS

PHILIP FISHMAN COMPANY
 7 CAMERON ST. WELLESLEY 81, MASSACHUSETTS

CIRCLE 966 ON READER SERVICE CARD

RADAR AUTO-TRACK & TELEMETRY ANTENNA PEDESTALS
 3 & 10 CM. SCR 584 AUTOTRACK RADARS. M-33 RADAR
 TPS-1D SEARCH. APS-45 TPS-10D HT. FINDERS. WX RADARS.
 FPN-32GCA. APS-10 APS-15B APS-27 (AMT) SEARCH. ■ ■
 APN-102 DOPPLER. DOZENS MORE. CARCINOTRONS. PFN'S.
 25-5-1-2-3-6 MEGAWATT PULSE MODULATORS. CAVITIES.
 PULSE TRANSFORMERS. IF STRIPS. WAVEGUIDE. BENDS
 200 MC. 1 KMC. 3 KMC. 6 KMC. 9 KMC. 24 KMC. RF PKGS.

RADIO RESEARCH INSTRUMENT CO.
 550 5TH AVE., NEW YORK 36, N. Y. JU 6-4691

CIRCLE 967 ON READER SERVICE CARD

PROFESSIONAL SERVICES

Donald C. Harder., Inc.

Magnetic Component Engineers

Reactors—Transformers—Filters

Serving the Research Laboratory

2580 K Street, San Diego, Calif. 92102

Phone (714) 239-8021

An outlined guide to testing IC's

cheap

start here

8.

7.
1.

BRILLIANT PERFORMANCE

The 990 stimulates and measures all dc parameters without additional equipment. In combination with an oscilloscope it measures ac parameters.

6.

FETCHING MODULARITY

The standard complement of modules is three voltage supplies, one current supply, one swept voltage supply, one dual loads module, and one dual output pulse generator. All modules are individually powered from ac line and are floating. Current and voltage are continuously variable with indication when limits are reached.

STUNNING ACCURACY

The 990's metering capability is comparable to that of testers ten times its cost. With the optional DRO, accuracy is $0.1\% \pm 1$ mv. Kelvin referencing means that the actual voltage or current at the lead is just what it should be. (Greater accuracy in low-level current measurements.)

RATHER SWIFT PROGRAMMING

Test programming for any available device can be set up in less than sixty seconds. Thumbwheel/pushbutton programming gives instantaneous verification of testing conditions. A complete line of device adaptors is available.

CRASHINGLY SIMPLE OPERATION

From the programming to the actual testing, the model 990 can be operated by nearly anyone (even salesmen). Why don't you call one of ours and see.

5.

9.

DELIVERY
Immediate.

4.
12.

3. FURTHER INFORMATION

Call collect to Dick Barr, our sales manager for this product.

11.

10.

It tests all digital integrated circuits & costs only \$60,000

per dozen.

1. REDCOR's new IC tester does everything \$50,000 testers do. Except cost \$50,000. True, it's somewhat slower than expensive units, but as it costs only one-tenth as much, perhaps you could manage with less than overwhelming speed.

2. The 990 IC tester *has* to be the perfect tester for small run production, incoming inspection, and laboratory analysis. It performs both pulse and dc parameter tests as well as functional tests without external equipment. Measurement accuracy is 1%. (For an extra thousand bucks we build in a digital readout that gives an accuracy of 0.1% on all ranges.)

3. The 990 is easy to operate. You can train a bright girl to be a proficient operator in half a day. Test programming is accomplished with thumbwheels and requires less than 60 seconds for most IC's.

4. Power supply accuracy is 0.1% ± 1 mv. All supplies have adjustable current or voltage limiting and will both source and sink. Kelvin connections are provided to the device under test.

5. For more information on the 990, flip the page.

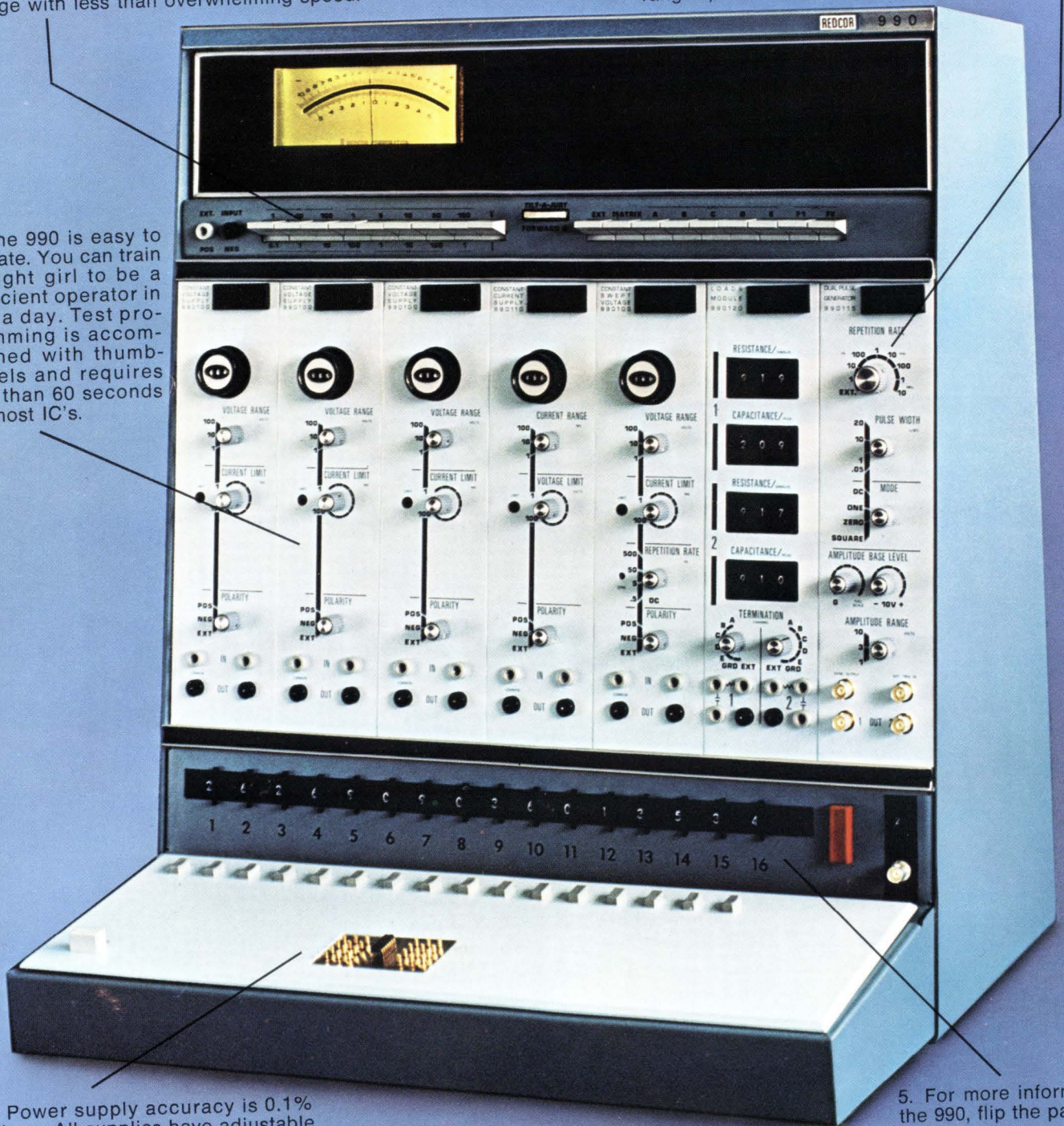

Newsletter from Abroad

August 21, 1967

French merger could give GE bigger Bull share

The de Gaulle government's drive to set up strong French computer and semiconductor companies apparently will force substantial changes in General Electric's holdings in France.

Insiders say GE probably will have to sell its 49% share in the Societe Europeenne des Semiconducteurs (Sesco) to the French government. This would clear the way for a merger this fall of Sesco, the Compagnie Generale des Semiconducteurs (Cosem), and the Societe Industrielle de Liaisons Electriques (Silec). Cosem, an affiliate of CSF, and Silec already have a joint marketing company. Sesco, whose French partner is Compagnie Francaise Thomson Houston-Hotchkiss Brandt, and Cosem have made a small start toward coordinating their research.

The merged, all-French company would get strong backing from the government under the "Plan Composants", the de Gaulle scheme to make France strong in integrated circuits. The other company in line for help under the plan is RTC-La Radiotechnique-Compelec, formed this summer by a merger of the components-producing subsidiaries of the Compagnie Generale d'Electricite and La Radiotechnique, a Philips Gloeilampenfabrieken subsidiary.

GE most likely will come out of the deal with the right to increase its interest in its French computer venture, Bull-GE. Originally, the de Gaulle government set a 50% ceiling on GE's interest in Bull. However, the holding now is 66%—temporarily—since GE put up Bull's share of a \$30-million capital increase last month. The Sesco deal also should help Bull-GE's relations with the biggest French computer buyer—the government.

Israel may trade captured war gear for Western arms

Israel is keeping tight security wraps on advanced Soviet arms captured from Arab countries this summer. The reason, Tel Aviv officials hint, is that the Israelis hope to get modern Western war equipment in exchange for information on the Soviet weapons. Also, Israeli experts are examining captured electronics gear for innovations that can be put to use.

The Israelis hold some \$2 billion worth of captured equipment, most of it Russian. For barter purposes, the most valuable booty is an improved version of the Soviet SA-2 antiaircraft guided missile, a mainstay in North Vietnam for defense against U.S. aircraft. The Israelis have more than a dozen of the missiles, plus complete ground equipment from three launching bases.

British space effort due for overhaul

A new look seems to be in the offing for Britain's piecemeal space effort, currently oriented toward international projects and split up among eight ministries and a trio of lesser government organizations.

Insiders think that nearly all space projects will be put under the wing of the Ministry of Technology. The outlook is for tighter control over space activities, and for a national program. Much of Britain's \$85-million annual outlay for space is earmarked for the country's share of the budgets of international groups like the European Launcher Development Organization and the European Space Research Organization.

Catalyst for the almost-certain reorganization is a stinging report on space released this month by the estimates committee of the House of Commons. The committee, the Parliament's watchdog on public spend-

Newsletter from Abroad

ing, slammed Britain's effort as incoherent and wasteful. The report plumps for a British telecommunications satellite program and a cut-back in expenditures for international projects.

There's little chance that the Wilson government will push its reforms as far as the committee wants. But substantial changes in Britain's space picture now seem inevitable.

Key test shot next for Europa rocket

West European space officials regard this fall's test launch of the Europa-1 launch vehicle as crucial. **Failure of the shot—with the first two stages live—could jeopardize Europe's bid to counter U.S. domination of the International Telecommunications Satellite Consortium.**

France and West Germany, which are leading this bid, are counting on a Europa rocket with apogee and perigee motors added to put their "Symphonie" communications satellite into orbit. They see Symphonie, slated for an early-1970 launching, as the backbone of Europe's bargaining position when the Intelsat agreement comes up for review in late 1969. **But Europa's developers, the seven-nation European Launcher Development Organization, won't be able to hold to the rocket's timetable if it runs into serious troubles in the upcoming shot. The schedule calls for a May 1968 flight of Europa-1 with all three stages live.**

So far, only the British-built first stage has flown successfully. The first test with a live second stage flopped earlier this month when the French "Coralie" failed to separate and ignite. But ELDO officials say this won't upset their schedule. **They suspect the trouble lay in repeated loadings and unloadings of the Coralie's fuel, necessitated by 10 postponements of the test flight.**

Fujitsu and Siemens team for NC sales in Western Europe

Fujitsu Ltd. has lined up a powerful partner, West Germany's Siemens AG, to market its Fanuc-260 integrated-circuit numerical-control system in Western Europe.

Siemens will launch the European sales campaign next month at the big Hanover machine-tool show. If the IC control system catches on, Siemens plans to import large numbers and fit them to the machine tools of European producers.

To avoid patent problems, Fujitsu is using Texas Instruments IC packages in its exported controls. For domestic models, Fujitsu uses IC's it builds in-house as well as TI packages.

Airbus deal bothers U.K. avionics firms

British avionics companies are pressing the Ministry of Technology for tighter controls over electronics contracts awards for the European airbus. **They feel French companies will benefit at their expense unless the management setup for the mammoth jet transport project is revised.**

Last month's agreement covering the airbus feasibility study calls for Britain and France to split 75% of the electronics work, with the balance earmarked for West Germany. The deal makes Rolls-Royce the team leader for the engines and France's Sud-Aviation team leader for the airframe. **Sud will have the key say-so on who gets avionics contracts, and this has U.K. companies on edge. They maintain Sud steered some avionics contracts for the Concorde supersonic jet transport to French companies that needed help from U.S. partners to do the work. The British want no "unnecessary" U.S. participation in the airbus.**

International

Economic slowdown

No matter how the wines turn out, 1967 will definitely not go down in the books as a vintage year for business in Western Europe.

Expansion of the kingpin economies, Britain's and West Germany's, petered out last year and they remain tinged with recession. Inevitably, the slowdown in Germany has braked business in the other Common Market countries. Italy excepted, all the members of the six-nation community are suffering slowdowns in growth rates. And much the same process is showing up in the European Free Trade Association, the seven-nation bloc bellwethered by Britain.

So far, West Europe's electronics industry has weathered the slowdown reasonably well. To be sure, producers of consumer electronics equipment are fretting over sliding sales. But makers of telecommunications hardware, industrial controls, and military equipment have been only slightly affected so far. Says an executive of a leading French firm, "The electronics industry has a long response time, so we haven't felt any direct effects yet."

Some of the measures taken by European governments to help get their economies back on the track of growth, in fact, figure to fatten the order books of electronics companies. But until there's a sign of a real turnaround in Britain and Germany—and none is in sight right now—a mood of apprehension about long-term prospects will prevail in the industry.

Great Britain. Most sickly of the West European economies is Britain's, stagnant now for two years and constantly threatened by a sterling crisis. The stern deflationary medicine prescribed by the Wilson government last year to

strengthen the pound slowed economic growth to about 1%. In the good years of the early 1960's, annual expansion ran about 3.5%.

The deflation has consumer electronics people singing the blues. Set makers' sales of monochrome television receivers slumped to 1.3 million last year from the 1965 level of 1.7 million. Sales so far



Stalled economy plagues Harold Wilson.

this year (mostly to companies that rent sets to users) are off 17%. And although color television broadcasts started in July, no one expects much of a lift from sales of color sets until next year.

Other sectors of the British electronics industry have yet to be hit by the slowdown, however. The backlog of orders for business computer systems climbed sharply during this year's first quarter to \$373 million from \$234 million at yearend. Much of this business, of course, is going to subsidiaries of U.S. companies, but British firms have shared in the spurt.

Similarly, producers of telecommunications equipment are in for gains. The British Post Office plans to order \$670 million of hardware this year to modernize the country's communications network.

Then there's some \$135 million going for new television broadcast equipment. And the pace of export orders has held steady.

The government's drive to increase the efficiency of British industry has been a boon to controls makers, whose orders also are on the rise.

West Germany. As in Britain, the recession in Germany has hit consumer electronics hard. And largely because of a sag in tv receiver sales and cutbacks in the defense budget, the over-all growth of the electronics industry this year will drop to an estimated 3% from the 6% of last year.

Even so, the industry's growth rate is running well ahead of the economy as a whole. This year, Germany's gross national product figures to edge up barely 1% at best. Some forecasters are even predicting no growth at all from last year's \$119.5 billion, and possibly a drop.

The Kiesinger government's efforts to spur the economy have helped cushion the impact of the recession on the electronics industry. In the spring, the government managed to add \$625 million to its budget for internal improvements. Half went to the post office and to the state-run railroad system, both big buyers of telecommunications equipment.

Now the government is putting together a plan to prime the pump again with \$1.3 billion in federal, state, and local funds. Some of the spending is sure to go for electronics. But there's no chance of an over-all upturn before 1968.

Meanwhile, some big electronics companies are concentrating on streamlining their operations, which they couldn't do when overloaded with business during the past few years of fast-paced growth. For example, a spokesman for Siemens AG, the country's largest electronics firm, reports: "Our investment plans are unchanged. We are

arming now for the next boom.”

The recent belt-tightening by the federal government—much of it in the defense budget—will hit military hardware producers. Despite austerity, though, Bonn plans to boost its spending for nonmilitary research and development. Just this month, the science ministry released details of a program that will increase government research outlays this year to \$420 million, up 25% from 1966. Even more R&D money will be forthcoming every year through 1971; the program calls for a rise of between 15% and 20% every year until then, and earmarks \$75 million to strengthen the domestic computer industry during that period.

France. Compared to Britain and West Germany, France will show solid economic growth this year, something like 4%. All the same, the expansion won't match last year's 4.5%, and it falls short of the 5% that the de Gaulle government planned.

The French tend to put much of the blame for their slower growth on their neighbors. But the decline in French exports has been paralleled by a falloff in domestic demand. The de Gaulle government's stabilization plan, put into force nearly four years ago to ward off inflation, squeezed the economy a little too hard.

Still, the electronics industry has found little to complain about except a lackluster receiver market. “We're not touched immediately by the waves of recession,” says Pierre Braillard, secretary general of CSF-Compagnie Générale de Télégraphie sans Fil.

There's been a mild drop in domestic and foreign sales of military electronics. But this drop seems to be offset by additional government spending for electronics telephone equipment, according to Edouard Guignonis, head of the electronics division of Compagnie Française Thomson Houston-Hotchkiss Brandt. The outlook for computers and process controls is also favorable, Guignonis adds.

Along with radio and tv makers, the components sector is faring poorly. “Sales are off from last year,” says an official of the elec-

trical industries trade association. The main reason, though, isn't the slowdown of West European economies, according to this official. The French components producers say their real problem is the competition from plants set up in the country by U.S. firms.

Italy. While her northern neighbors basked in boom times during 1964 and 1965, Italy was wrestling with a recession. Now it's the other way around; the Italian economy is on a strong upswing, with a growth rate of 5.5% in sight for this year.

And the electronics industry figures to grow even faster than the economy generally. Telecommunications equipment makers see a 12% rise from last year, and producers of computers, controls, and test instruments, expect a surge of 15% or more. Consumer electronics won't do quite as well as the other sectors, but should post a respectable 10% gain.

West Germany

The right type

A West German doctor with a flair for electronics has hit upon an instrument to determine a patient's blood group in about a minute. Conventional blood-typing, done by examining a sample under a microscope, usually takes from 10 to 20 minutes.

Moreover, human error occasionally occurs in visual blood-typing and the results can be fatal. The electronic blood-typing is virtually foolproof.

Dr. H.G. Noeller, the Heidelberg pediatrician who conceived the instrument, already has used it successfully for blood tests on some 1,500 people. Werner Wolz, general manager of Gulde Regelarmaturen KG, the firm that will produce Noeller's “agglutinator,” says hospitals and doctors are already clamoring for it. Wolz, however, doesn't plan to put the agglutinator on the market before a year or more; he wants to run further environmental and reliability tests on it first. Once in

production, the instrument will sell for between \$400 and \$500.

Togetherness. Like all blood-group identification methods, Noeller's is based on the fact that red corpuscles lump together—or agglutinate—when the serum of an incompatible group is added. This makes it possible to identify a blood group by the way it reacts to known test serums. Noeller's technique is also based on the fact that red corpuscles won't conduct currents at low frequencies, whereas blood plasma will.

Blood samples to be typed by the instrument are put into test tubes with three equally spaced electrodes. Normally, the blood particles are dispersed throughout the plasma, and resistance between the center and lower electrodes is thus the same as that between the center and upper electrodes. But, when an incompatible test serum is put into the tube, the red particles group together and sink to the bottom of the tube. The resistance in the lower half of the tube then rises sharply and that of the upper half falls.

Checks and imbalances. The three electrodes are connected into a Wheatstone bridge that unbalances when the test sample agglutinates. When the imbalance is significant, the output signal from the bridge is amplified to light a lamp on the instrument's panel. The amplifier won't react to the slight agglutinations that sometimes occur with a serum compatible with a blood sample. To prevent polarization of the electrodes, the bridge is fed by a 10-kilohertz a-c square wave.

Japan

Fit to print

It's still anybody's guess who will eventually get the right to broadcast news by facsimile in Japan. The country's big newspapers think they're best qualified to provide the service. But the government-run broadcasting firm, Nippon Hoso Kyokai, thinks it is.

No matter who wins, it's a good bet that the facsimile receivers will be built around a special picture tube developed at NHK's research laboratories. NHK, in fact, has readied two versions of the tube. One, based on fiber optics, is in production at the Matsushita Electronics Corp. The second, with a faceplate carrying a row of tiny pins, is about to go into pilot production at Matsushita.

Hitachi Ltd. and the Tokyo Shibaura Co. also plan to tap NHK's facsimile technology, but neither is as far along as Matsushita Electronics, a joint venture of the Matsushita Electric Industrial Co. and Philips of the Netherlands.

Squashed. Both versions of the facsimile tube have the same bulb, which looks like a long, flattened oscilloscope cathode-ray tube. The bulb measures about 20 inches long and its faceplate is fitted with a window about 7¼ inches wide by 5/32-inch high. With a window this size, the tube's span is just enough to handle the three columns printed on this page.

Also common to the fiber-optic and pin versions of the tube is a magnetically focused electron gun originally developed at NHK for kinescope recording. The gun puts out a beam 100 microns in diameter. This gives the tube a maximum resolution of 10 lines per millimeter, much higher than that of an ordinary television receiver.

Fibers. The faceplate fitted over the bulb window in the fiber-optic tube is made up of bundles of fibers 25 millimeters in diameter.

Individual fibers are coated to prevent a scattering of light from one fiber to another. The bundles are shaped into bars and then sliced into sheets about 5 mm thick to form the faceplate. The inner surface of the faceplate sheet is coated with aluminum-backed phosphors.

In a receiver, paper with a photoconductive coating is driven past the fiber-optic faceplate; it is charged by a corona unit just before reaching the faceplate. A latent image of dark and light spots for each horizontal line is laid down as the electron gun illuminates the faceplate fibers. A wet-toner process develops the image.

Pinned. In the pin tube, the faceplate is a 1-mm-thick sheet of glass with one row of 2,600 pins spaced 70 microns apart embedded in it. This tube works with electrostatic paper, which is charged selectively by the pins as it passes the faceplate while the electron beam moves across the row of pins. Again, a wet-toner process is used to develop the latent image.

Although the fiber-optic tube has slightly better resolution than the pin tubes developed so far, the pin version looks like the best candidate for the long run. Considerable improvement is in sight for the electroforming technique used to make the pin-embedded faceplates, and they should eventually be much cheaper to produce than the fiber-optic versions. NHK expects the facsimile tubes, turned out in quantity, to cost less than a color-tv picture tube.

IC's where it counts

Among Japanese desk-calculator makers, none can match the diverse approach to integrated circuits of the Hayakawa Electric Co.—the industry leader.

In February, Hayakawa started selling a 14-digit calculator with bipolar ic memory registers. In March, the company unveiled prototypes of a 12-digit calculator built of metal oxide semiconductor ic's. Last week, Hayakawa put on the market a 16-digit model with bipolar ic control circuits paired with ferrite-core registers.

At first glance, it would seem that Hayakawa has darted every which way in its development of ic calculators. Actually, the company has been moving steadily towards twin objectives—getting mos circuits in its low-priced models, and monolithic bipolar circuits in its higher-priced, more sophisticated units.

Repeaters. The ic packages in the new 16-digit model, in fact, are the same quadruple dual-input, transistor-transistor-logic gates used in the memory register of the earlier 14-digit model [Electronics, Feb. 20, p. 295]. After its experience with the packages in memories, Hayakawa decided they would be suitable for the crucial control circuits of the new model. But rather than stick with the ic's for the registers, the company switched to ferrite cores because they offered the same performance but cost less.

Along with the core registers and 23 ic packages for the control circuits, the 16-digit calculator has some 200 discrete silicon transistors serving as inverters for the control circuits and drivers for the display tubes and core registers. There are also about 500 diodes, used mainly in wired programs for such routines as finding square roots and rounding off results.

On display. Hayakawa has come up with a spate of innovations for its 16-digit calculator, most of them aimed at holding the line on costs. The machine sells in Japan for \$972. In the register circuitry, the example, the complement of core-driving transistors is half the num-



Checking fax. Engineer examines alignment of fiber-optic faceplate on facsimile receiver tube.

Clean Safe-
Clean Quick-
Clean Clean

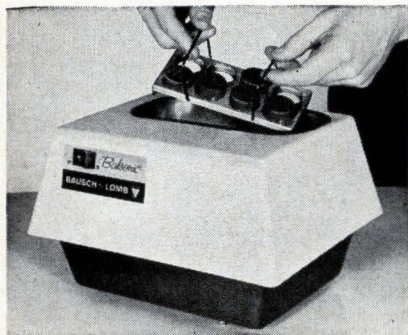

Bausch & Lomb BALSONIC ULTRASONIC CLEANERS

Different size bubbles blast
away dirt of all sizes.

Remove soils of oil, dust, dirt, grease, fingerprints, lint, jeweler's rouge, abrasive, polishing and grinding compounds, plastic residues, metal chips, tarnish, corrosion from metal, glass, plastics.

Thorough cleansing action is assured by simultaneous multi-frequency output—(the only small size ultrasonic cleaner to have this feature).

Choose Balsonic wherever small part cleaning is important. Conveniently packaged with proper solvent for either Metallurgical, Precision Parts, Surgical or Contamination Control applications.

Two sizes: Balsonic I. $7\frac{5}{8} \times 3\frac{1}{2} \times 2\frac{1}{2}$ in. tank. Balsonic II. $9\frac{1}{8} \times 7\frac{1}{4} \times 3\frac{7}{8}$ in. tank.

Use the coupon for a free demonstration and our new catalog 42-2221. Bausch & Lomb, 61444 Bausch St., Rochester, N.Y. 14602.

BAUSCH & LOMB 

Bausch & Lomb
61444 Bausch St., Rochester, N. Y. 14602

- Please send me your catalog No. 42-2221 with complete information on your new Balsonic Cleaners.
- I would like a free demonstration of Balsonic Cleaners.

Name.....

Please Print

Title.....

Firm or Institution

Address.....

Zip.....

Electronics Abroad

ber that normally would be used. Instead of a pair of back-to-back transistors to feed read and write currents of opposite polarity into each drive line, there is a bidirectional switching circuit with a single transistor.

Doubled. Like the 12-digit mos calculator, the 16-digit bipolar ic model saves on display-tube drive circuits by a sequential lighting scheme that permits common cathode connections [Electronics, March 20, p. 241]. The tubes need a bias of 180 volts for operation, but Hayakawa has designed a voltage-doubling switching circuit so that the driver transistors can work off a 90-volt supply.

Great Britain

High on ions

Semiconductor specialists generally agree that there's much to be said for ion implantation—bombarding semiconductor materials with impurity ions to form junctions.

Most researchers working on the technique, though, see commercial devices—other than solar cells—as a long way off [Electronics, Aug. 7, p. 162]. But not John A. Kerr of Associated Semiconductor Manufacturers Ltd. Kerr maintains that high-frequency bipolar transistors with ion-implanted junctions will start turning up on the British market within the next year or two. He will make his case next month at a conference on solid state devices at Manchester, England. Backing him up will be Leslie N. Large of the Services Electronics Research Laboratory (SERL), the government facility working with Associated Semiconductor to develop ion-implantation techniques.

Base first. In the early stages of their work, SERL and Associated tried implanting emitters in diffused bases to make pnp transistors. The impurity used for the base region was phosphorous with a surface concentration of about 10^{18} atoms per cubic centimeter and a junction depth of around 0.5 micron.

After the base diffusion, a layer of oxide 1,000 angstroms (0.1 micron) thick was grown, and the emitter impurities were bombarded through the oxide.

The pnp transistors made this way had excellent frequency response, but for adequate current gain the emitter impurity concentration must be at least two orders of magnitude higher than that of the base. Npn transistors made by implanting the emitter in a diffused base, however, had poor frequency characteristics, the result of "push out" of the base region under the emitter. Instead of the 0.5 micron intended, the width of the base was 0.9 micron.

Emitter first. Large and Kerr say the push out was caused by the high annealing temperature—about 900°C —needed to recrystallize the silicon after implantation. The atomic structure is thrown into disarray by the heavy ion bombardment required for the high impurity concentration of the emitter. The answer, they say, is to implant the emitter first, anneal at high temperature, then implant the base and anneal a second time at about 600°C .

Implanted npn transistors made by the emitter-first technique have shown base resistances as low as 6 ohms at a 1-millamp base current. And the structures have high-frequency dimensions—base widths of 0.3 microns and rectangular emitters with perimeters of 200 microns.

Under the window. The British pair think the first commercial implanted transistors will be hybrids with diffused emitters and implanted bases. Implanting the base impurities is a relatively easy way of stepping up the number of carriers in the base and thus decreasing its resistance. And although there's no push out with an emitter implanted before the base, there is an emitter-contact problem. Unlike diffused impurities, implanted ones do not spread out under the emitter window cut into the oxide layer. Thus, special precautions are needed to prevent shorts between the emitter contact material and the base, and this drawback gives diffused emitters the edge.

France

Fast film

Great Britain has started a massive switch to electronics telephone exchanges and other European countries seem ready to follow suit. It adds up to a very lucrative market and one company that's ready to cash in is Laboratoire Central de Télécommunications.

LCT, one of the French firms in the stable of the International Telephone & Telegraph Corp., has developed a very fast thin-film memory tailored for computer-controlled electronic switching centers. The company already has put together three prototypes with thin-film memory plates paired with discrete transistor circuitry. By next month, LCT expects to have a fourth prototype ready, this one with about two-thirds of its circuitry built of integrated circuits.

Plates. What makes the LCT memory memorable are its thin-film plates. They are made up of optically lapped copper substrates coated with a continuous film of Permalloy. The square plates are 4 millimeters thick and measure about 2 inches on a side. The film is 400 angstroms thick.

André Judeinstein, chief of LCT's physics research division, thinks the memory is the first thin-film type to use a straight nickel-iron alloy. Other manufacturers have been working with nickel-iron-cobalt films. Alloys with cobalt make it easier to control changes in the magnetostriction coefficient of the film caused by slight variations in its composition. The cobalt, though, makes the film magnetically "harder" and requires a higher driving current.

Judeinstein says the LCT plates need a driving current of only 200 milliamps, less than half that required for films with cobalt. The low current, he adds, makes the plates admirably suited for pairing with IC control circuitry.

The discrete-component third prototype currently under test has a capacity of 1,024 words of 36 bits. Its read-write cycle time is 170 nanoseconds.

wanted: "big" insulator problems

Solving "big" insulator problems is Lapp's specialty. Wherever insulator requirements call for high strength, special electrical specifications, maximum dependability and long service . . . Lapp is the company to contact.

Lapp has been designing, testing and making insulators for communications installations for almost a half century. On many special jobs, our experience provides the basic engineering and design, which enables us to deliver the job quicker, *and* save you money.

How "big" are the jobs we've done? How about tower base insulators to 9 million lbs. ultimate strength with 500 kv peak wet flashover. Or, compression cone guy insulators to 620 thousand lbs. strength and in strings with grading rings giving wet flashover to 700 kv peak.

Lapp also made 3 of the world's largest RF feed through bushings with wet flashover of 600 kv peak, for continuous operation at 2545 amperes at 140 kv rms at 14-30 kc. Our double-yoked strain insulators have been made to 240 thousand lbs. ultimate strength with a wet flashover rating of 700 kv peak.

From drawing board to delivery, you can count on Lapp when it comes to "big" insulator problems. Write for additional information, Lapp Insulator Co., Inc., LeRoy, N.Y. 14482.

Lapp 50 YEARS

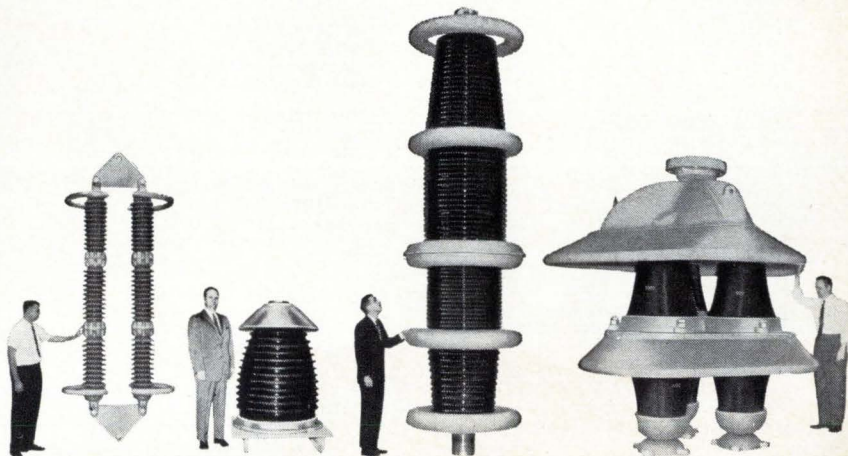

Electronics advertisers

August 21, 1967

■ Acopian Corp. Mort Barish Assoc.	18, 19	Electro Scientific Industries Nadler & Larimer, Inc.	14	Litton Industries, Inc. Poly-Scientific Div. West, Weir & Bartel, Inc.	140, 141
Adams & Westlake Co. Kasper & Assoc., Inc.	52	□ English Electric Valve Co., Ltd. Allardyce Palmer, Ltd.	OAS 1	□ L T T Promotion Vente Publicite	OAS 6
Airpax Electronics, Inc. Welch, Mirabile & Co., Inc.	146	Erie Technological Products Co., Inc. Altman-Hall Associates	43	■ Machlett Laboratories, Div. of Raytheon Co. Fuller & Smith & Ross, Inc.	11
Allen-Bradley Co. Fensholt Adv. Agcy.	125, 126	Fairchild Instrumentation Faust/Day, Inc.	73	Magnetics, Inc. Lando Adv. Agcy., Inc.	117
Amco Engineering Co. Buti-Roberts Adv.	16	Fiberfil Co., Div. Rexall Chemical Co. Tri-State Adv. Co.	132	■ Mallory & Co., P.R., Mfg. Div. Aitkin-Kynett Co.	8
■ Amelco Semiconductor, Teledyne Inc. Div. Sturges Advertising	115	■ Formica Corporation, Div. of American Cyanamid Co. Clinton E. Frank, Inc.	174, 175	□ Marconi Company, Ltd. Hampshire House, Ltd.	OAS 8
■ Amperex Electronics Corp., North American Philips Co. Div. Sam Groden, Inc.	45	Garrett Corporation, Airesearch Mfg. Div. J. Walter Thompson Co.	193	Maryland Telecommunications, Inc. Ray E. Finn Adv.	116
■ Amphenol Corporation, Connector Div. Marsteller, Inc.	62, 63	General Instrument Corp., Semiconductor Products Div. Norman Allen Assoc.	64, 65	Meson Electronics Co., Inc. Wolff Associates, Inc.	172
Arco Electronics, Div. of Loral Corp. Campbell Ewald Co.	143	General Radio Co. Horton, Church & Goff, Inc.	6	■ Monitor Systems, Inc. Thomas R. Sundheim, Inc.	181
Arrow Hart & Hegeman Electric Co. Chirurg & Cairns, Inc.	75	■ Gudebrod Brothers Silk Co., Electronics Div. Ramsdell-Buckley & Co.	120	■ Monsanto Co. Foote, Cone & Belding	57
□ Ates Componenti Elettronici S.P.A.	OAS 10	Heinemann Electric Co. Thomas R. Sundheim, Inc.	134	Motorola Semiconductor Products, Inc. Lane & Bird Adv., Inc.	47, 48, 49, 91
Automatic Electric Co., Sub. of Gen. Tel. & Electronics Corp. Tatham-Laird & Kudner, Inc.	162	■ Hewlett Packard, Frequency & Time Div. Lennen & Newell, Inc.	20, 21	National Electronics, Inc. Connor-Sager Assoc.	181
■ Barnstead, Sub. of Ritter Pfaudler Corp. Creamer Trowbridge & Case, Inc.	148	■ Hewlett Packard, Harrison Div. Healy Adv. Agcy.	58	National Semiconductor Corp. Jay Chiat & Assoc.	66, 67
■ Bausch & Lomb, Inc. Wolff Assoc., Inc.	190	■ Hewlett Packard, Loveland Div. Tallant/Yates Adv., Inc.	1, 54	North Atlantic Industries, Inc. Murray Heyert Assoc.	127
Beckman Instruments, Inc., Electronic Instrument Div. Hixson & Jorgensen, Inc.	71, 98, 153	■ Hewlett Packard, Microwave Div. Lennen & Newell, Inc.	144, 145	■ Pfizer & Company Chas., MPM Div. Newmark, Posner & Mitchell, Inc.	180
Bissett-Berman Corp. S. F. Associates	135	■ Hewlett Packard, Rockaway Div. Culver Adv., Inc.	177	■ Philbrick Researches, Inc. Culver Adv., Inc.	92
Blackstone Corp., Ultrasonics Div. Carr Liggett Adv., Inc.	181	■ Hewlett Packard, Sanborn Div. Culver Adv., Inc.	2	Polaroid Corp. Doyle Dane Bernbach, Inc.	136
Black & Webster, Inc. Larcom Randall Adv., Inc.	179	Hooker Chemical Corp., Durez Div. Rumrill-Hoyt, Inc.	123	Pomona Electronics Co. Buxton Adv. Agcy.	178
Bourns, Inc., Trimpot Div. Lester Company, The	166	Hopkins Engineering Co. Ray Gage, Inc.	46	Princeton Applied Research Corp. Mort Barish Assoc., Inc.	36
Burroughs Corp., Electronic Components Div. Conti Adv. Agcy., Inc.	12, 13	Hughes Aircraft Co. Foote, Cone & Belding	149	Radio Corporation of America 4th Cover, 22 Al Paul Lefton Co.	
Celanese Corporation of America, Celanese Plastics Div. West, Weir & Bartel, Inc.	35	Indiana General Corp., Ferrites Div. Griswold & Eshleman	24	■ Radio Materials Co., Div. of P. R. Mallory & Co. Gallay Adv., Inc.	152
Centralab, Div. of Globe-Union, Inc. The Brady Company	55	Industrial Electronic Engineers Gumpertz, Bentley & Dolan, Inc.	122	Raytheon Co., Components Div. Fuller & Smith & Ross, Inc.	160
■ Cinch Graphik, Div. of United Carr Fastener Co. Reach, McClintock & Co.	133	Information Retrieval, Inc. Wank, Williams & Neylan, Inc.	9	Raytheon Computer Co. Martin Wolfson Adv.	15
Clare & Company, C.P. Reincke, Meyer & Finn Adv., Inc.	56	International Crystal Mfg. Co. Robert V. Freeland & Assoc.	164	RCL Electronics, Inc. Morvay Adv. Agcy.	7
Collins Radio Co. John G. Barnett Adv. Agcy.	76	I R C, Incorporated Gray & Rogers, Inc.	161	Redcor Corporation Smith-Klitten, Inc.	183, 184
Cramer Industries, Inc. Bryan/Donald Adv., Inc.	177	ITT Semiconductors Div. Neals & Hickok, Inc.	194	Redford Corp. Communications Associates	179
□ C.S.F. SPI Agency	OAS 7	Keithley Instruments, Inc. Bayless-Kerr Co.	170	■ Reeves Hoffman, Div. of Dynamics Corp. of America Adams Assoc., Inc.	172
■ CTS Corporation Burton Browne Adv.	128	Keystone Carbon Co. Downing Industrial Adv., Inc.	118	Sage Electronics Corp. Mathison Adv., Inc.	179
■ Delco Radio, Div. of General Motors Corp. Campbell-Ewald Co.	50	■ Lambda Electronics Corp. Michel Cather, Inc.	173	Semtech Corporation Burruss Advertising	119
■ Delta Products, Inc. Noble De Roin & Assoc.	176	■ Lapp Insulator Co. Wolff Associates	191	Sigma Instruments, Inc. Marschalk Co., Inc.	72
Digilog Electronics Corp. Pollock & Loth, Inc.	172	■ Leach Corporation Jay Chiat & Assoc.	74	□ S. P. Electronica	OAS 9
■ Dimco Gray Co. Weber, Geiger & Kalat, Inc.	138	Lexed, Inc., Bramco Controls Div. Yeck & Yeck, Inc.	156	Sperry Rand Corp., Microwave Components Neals & Hickok, Inc.	169, 171
Dow Corning Corp., Silicone Div. Church & Guisewite Adv.	124			The Sprague Electric Co. Harry P. Bridge Co., The	5, 10
DuPont de Nemours & Co., Freon Div. Batten, Barton, Durstine & Osborn, Inc.	61			■ Stackpole Carbon Co., Electro-Mechanical Div. Meek & Thomas, Inc.	3rd Cover
Electronic Engineering Co. of California Jansen Associates	70				
□ Ellectronica Metallux Jachini Pietro Agcy.	OAS 2, 3				



Advertising sales staff

Superior Tube Co. Gray & Rogers, Adv., Inc.	168
Sylvania Electric Products, Inc., Electronic Tube Div. Doyle, Dane, Bernbach, Inc.	27, 34
Sylvania Electric Products, Inc., Parts Div. Doyle, Dane, Bernbach, Inc.	157
■ Tektronix, Inc. Hugh Dwight Adv., Inc.	17, 42, 44
Telonic Engineering Co. Jansen Associates, Inc.	165
Telonic Instruments Jansen Associates, Inc.	121
Tempress Research Co., Inc. Hal Lawrence, Inc.	51
Teradyne, Inc. Quinn & Johnson Adv., Inc.	109
Texas Instruments Incorporated Semiconductor/Components Division Don L. Baxter Incorporated	68, 69
□ Thermionic Products, Ltd. Southern Advertising, Ltd.	OAS 4, 5
Trans World Airlines, Inc. Foote, Cone & Belding	180
TRW Semiconductors Fuller & Smith & Ross, Inc.	41
Trygon Electronics, Inc. Solow/Wexton Co., Inc.	158
■ Tung Sol Division, Wagner Electric Corp. E.M. Freystadt Assoc.	177
Union Carbide Corp., Electronics Div. J.M. Mathes, Inc.	53
■ United Transformer Co. Philip Stogel Co.	2nd Cover
■ Unitrode Corp. Silton Brothers, Inc.	110
Victoreen Instrument Co., The Palm & Peterson, Inc.	139
Wanlass Electric Co. Leland Oliver Co., Inc.	178
Wayne Kerr Corp. Josephson, Cuffari Co.	142

Classified Advertising

F.J. Eberle, Manager

PROFESSIONAL SERVICES	182
EMPLOYMENT OPPORTUNITIES	182
EQUIPMENT (Used or Surplus New) For Sale	182
ADVERTISERS INDEX	
Atomic Personnel, Inc.	182
Electronic Communications Inc.	182
Fishman, Philip Co.	182
M. O. Valve Ltd.	182
Radio Research Instrument Co.	182

■ For more information on complete product line see advertisement in the latest Electronics Buyers' Guide

□ Advertising in Overseas Section following Newsletter from Abroad

Frank E. LeBeau [212] 971-6464

Advertising sales manager

Wallis Clarke [212] 971-2187

Assistant to sales manager

Donald J. Austermann [212] 971-3139

Promotion Manager

Atlanta, Ga. 30309: Michael H. Miller, 1375

Peachtree St., N.E.

[404] TR 5-0523

Boston, Mass. 02116: William S. Hodgkinson

McGraw-Hill Building, Copley Square

[617] CO 2-1160

Chicago, Ill. 60611: Robert M. Denmead,

J. Bradley MacKimm, Ralph Hanning,

645 North Michigan Avenue,

[312] MO 4-5800

Cleveland, Ohio 44113: William J. Boyle, 55

Public Square, [216] SU 1-7000

Dallas, Texas 75201: Richard P. Poole, 1800

Republic National Bank Tower,

[214] RI 7-9721

Denver, Colo. 80202: Joseph C. Page, David

M. Watson, Tower Bldg., 1700 Broadway,

[303] 255-5484

Detroit, Michigan 48226: Ralph Hanning

856 Penobscot Building

[313] 962-1793

Houston, Texas 77002: Kenneth George,

2270 Humble Bldg., [713] CA 4-8381

Los Angeles, Calif. 90017: Ian C. Hill,

John G. Zisch, 1125 W. 6th St.,

[213] HU 2-5450

Minneapolis, Minn. 55402: J. Bradley

MacKimm, 1104 Northstar Center

[612] 332-7425

New York, N.Y. 10036

500 Fifth Avenue

Donald R. Furth [212] 971-3615

James R. Pierce [212] 971-3616

Jeffrey M. Preston [212] 971-3617

Philadelphia, Pa. 19103:

Warren H. Gardner, Jeffrey M. Preston,

6 Penn Center Plaza,

[215] LO 8-6161

Pittsburgh, Pa. 15222: Warren H. Gardner,

4 Gateway Center, [412] 391-1314

Portland, Ore. 97204: James T. Hauptli,

218 Mohawk Building, 222 S.W. Morrison

Street, Phone [503] 223-5118

Rochester, N.Y. 14534: William J. Boyle,

9 Greylock Ridge, Pittsford, N.Y.

[716] 586-5040

St. Louis, Mo. 63105: Robert M. Denmead

The Clayton Tower, 7751 Carondelet Ave.

[314] PA 5-7285

San Francisco, Calif. 94111:

James T. Hauptli, 255 California Street,

[415] DO 2-4600

London W1: John W. Patten, Edwin S.

Murphy Jr., 34 Dover Street,

Hyde Park 1451

Milan: Pierre Braude,

1 via Baracchini Phone: 86-90-656

Frankfurt/Main: Pierre Braude,

Elsa-Brandstroem Str. 2

Phone: 72 01 81

Geneva: Pierre Braude,

1, rue du Temple Phone: 31 95 60

Paris VIII: Pierre Braude,

17 Avenue Matignon Phone: 359 6637

Tokyo: Nobuyuki Sato, 1, Kotohiracho

Shiba, Minato-Ku [502] 0656

Osaka: Ryoji Kobayashi 163, Umegae-cho

Kita-ku [362] 8771

Business department

Wallace C. Carmichael, Manager

[212] 971-3191

Stephen R. Weiss, Production Manager

[212] 971-2044

Thomas M. Egan,

Assistant Production Manager [212] 971-3140

Dorothy Carmesin, Contracts and Billings

[212] 971-2908

Circulation and research

Milton Drake, Manager [212] 971-3485

Isaaca Siegel, Assistant Circulation Manager

[212] 971-6057

David Strassler, Assistant Research Manager

[212] 971-6058

Chloe D. Glover, Research Associate

[212] 971-6057

Electronics buyers' guide

George F. Werner, General Manager

[212] 971-2310

Ray Smyth, Eastern Regional Manager

[212] 971-6538

Regina Hera, Directory Manager

[212] 971-2544

Thomas M. Egan, Production Manager

[212] 971-3140

Compact electronics package?

COOL IT...

...with a small size, long life, high output AiResearch fan.

Garrett-AiResearch special purpose fans are individually designed and custom built to deliver more flow and greater pressure rise with a minimum envelope size.

Take a typical AiResearch small size fan: computer-optimized for required performance under all operating environments; our own motor, engineered and manufactured for a perfect match to its fan; and up to 40 percent more airflow than any other ventilating fan of similar input, size, and weight.

Next time you need a ventilating fan for a very special airborne or ground electronics enclosure specify AiResearch. Available for high temperature and cryogenic applications, with flow rates and power requirements as specified. AiResearch Manufacturing Division, Torrance Facility, 2525 190th Street, Torrance, California 90509.

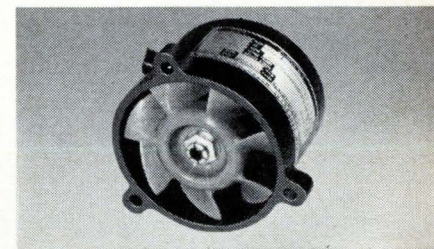
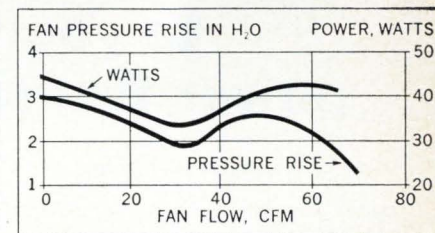

AIRESEARCH SPECIAL PURPOSE FANS



**ITT has eight instant solutions
to your VHF/UHF
power transistor procurement problems.**

Is there something missing from your procurement cycle for RF power transistors? Is it predictable delivery? Better-than-competitive pricing? Superior performance?

Let ITT "crack" your RF power vacuum. The eight popular part numbers listed above are in stock and

ready to go — at the ITT factory and at every one of ITT's distributors. Next time you send out an RFQ, send it to The Predictables, and fill your power vacuum.

ITT Semiconductors is a Division of International Telephone and Telegraph Corporation, 3301 Electronics Way, West Palm Beach, Florida.

*New state-of-the-art devices, exclusive from ITT, 1 to 50 W, 30 to 70 MHz.

semiconductors ITT

FACTORIES IN WEST PALM BEACH, FLORIDA • PALO ALTO, CALIFORNIA • LAWRENCE, MASSACHUSETTS • ENGLAND • GERMANY • PORTUGAL • AUSTRALIA