

Electronics[®]

More on fast Fourier: page 92

Solid state sweep circuit: page 104

Specifying power-line filters: page 112

June 24, 1968

\$1.00

A McGraw-Hill Publication

Below: Liquid crystals help
map electric fields, page 118

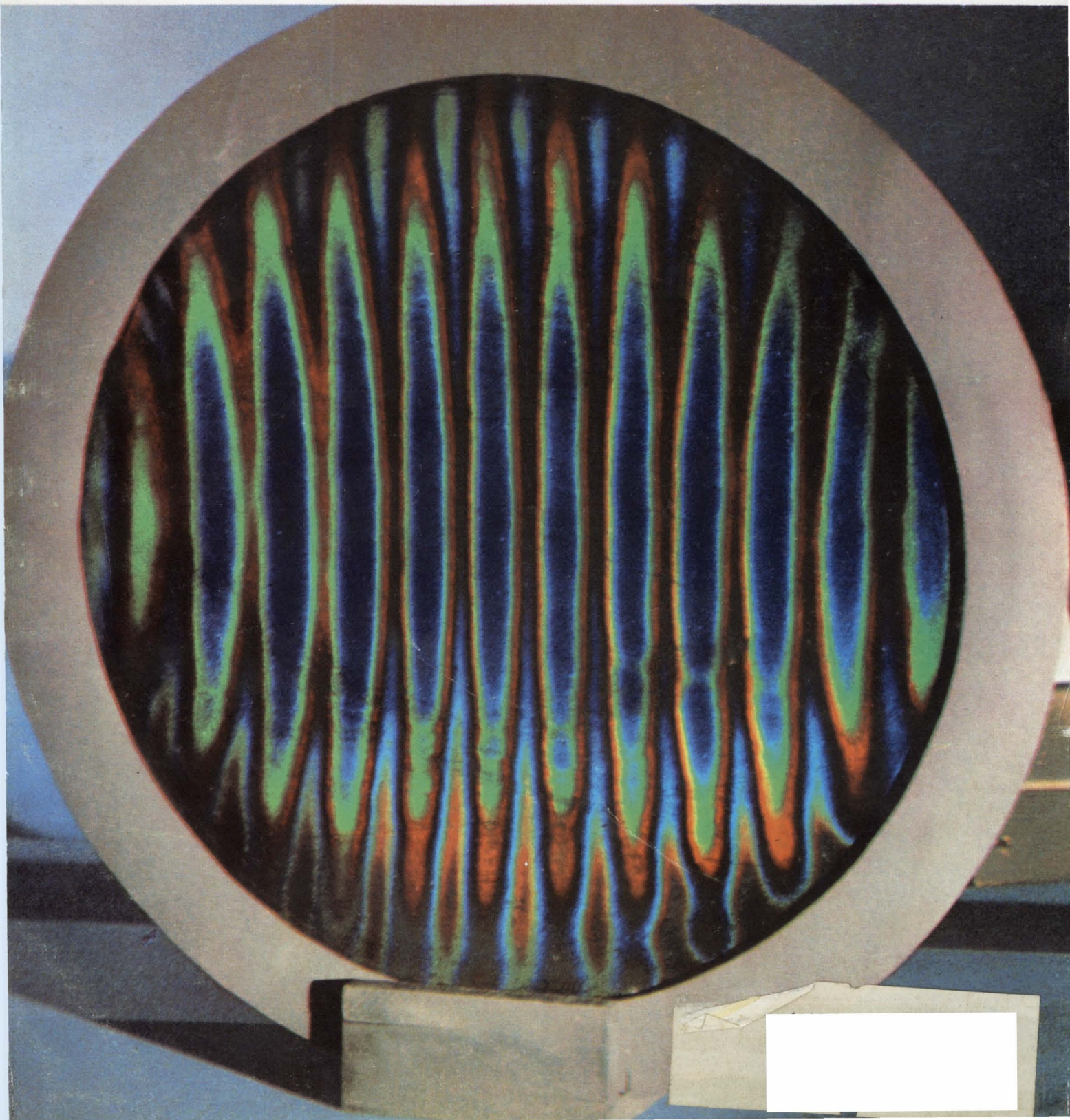



NEW "MS"TM LINE OF TOROIDAL INDUCTORS



- **ULTRAMINIATURE**
(Less than 1/4" high)
- **HIGH Q**
- **PRECISION ADJUSTED WITH EXCELLENT TEMPERATURE CHARACTERISTICS**

DESIGNED & SUCCESSFULLY TESTED TO COMPLETE MIL-T-27B ENVIRONMENTAL REQUIREMENTS

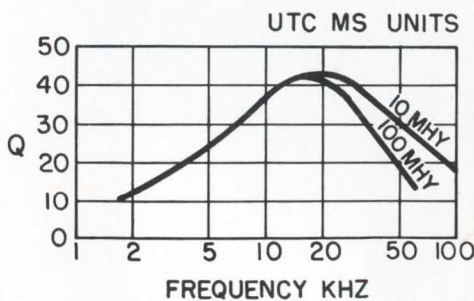

Stock Type No.	Ind. Mhy (0 DC)	ma DC Max.*	DCR Ω Max.
MS-1	1	60	1.4
MS-5	5	28	7
MS-10	10	20	11
MS-25	25	13	38
MS-50	50	9	75
MS-100	100	6	132

*The maDC shown is for approximately 5% drop in inductance.

The new "MS" toroidal high Q coils provide unique packaging flexibility: only .23" high x .35" diameter (conforms to TO-5 base and terminal dimensions) with solderable and weldable leads which make them ideal for hybrid Flat Pack and IC applications. These units have excellent Q in the 10 kHz to 50 kHz range and are designed for usage from 1 kHz to 100 kHz (see curve).

They are precision adjusted $\pm 2\%$ at 0.1V RMS at 1 kHz. Inductance variation is less than 2% from -55° to $+105^\circ$ C. MIL type TF5RX20ZZ.

Stock items shown are available for immediate delivery. Special values will be designed to your requirements.

Write for brochure
for complete data

UNITED[®] TRANSFORMER CO. TRW
DIVISION OF TRW INC. • 150 VARICK STREET, NEW YORK, N. Y. 10013

Circle 900 on reader service card

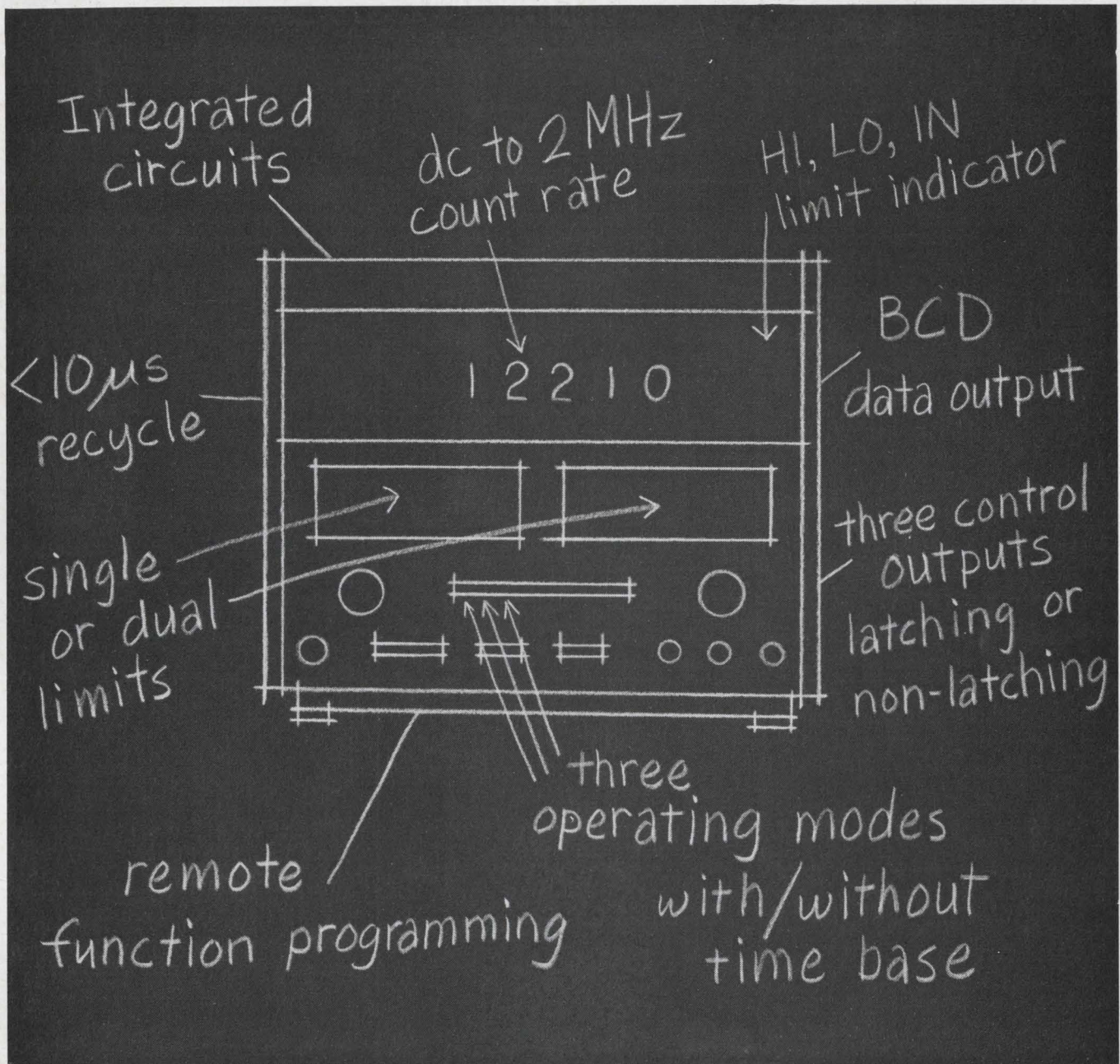

What more could you want in a Preset Controller/Counter?

One of four new Hewlett-Packard Preset Controller/Counters is sure to have what you need for your control or instrumentation system. In fact, if you buy a really versatile counter now, you won't have to worry about counter obsolescence even if you change your setup later.

"A" models have single limits; "B" models have dual limits. The 5331 models will display and limit-detect totalized input counts. The 5332 models, which have quartz crystal-controlled time bases, will not only limit-detect input counts, but will also measure and limit-detect frequency and rate (to 2 MHz), frequency ratio and pulse duration. They make good digital delay generators, too. Input impedance is 1 M Ω /30 pF, and input trigger is adjustable from 100 mV to 100 V, + or - slope, ac or dc coupling.

A wide variety of optional features is available to meet special requirements, including remote control of limit settings, one more digit or one less, and contact-closure control outputs. All this in a medium-priced, IC-construction preset counter. Prices: 5331A, \$850; 5331B, \$950; 5332A, \$1000 and 5332B, \$1100.

Think about what it would cost you to expand the capabilities of a lower-priced counter, or think about the problem of complicating your measurement or control system to make up for counter features you may need later. Now you can see the value of the extra versatility built into these four models.

Call your HP field engineer for more details. Or write Hewlett-Packard, Palo Alto, California 94304; Europe: 54 Route des Acacias, Geneva.



HEWLETT  PACKARD

ELECTRONIC COUNTERS

02809

Looking for an All-Around Voltmeter?

Hewlett-Packard gives you a broad choice of multi-function meters that do not have to be pampered. Choose the versatility that fits your needs for ac volts, dc volts, current and resistance measurements. The exclusive individually calibrated taut-band meter used in these voltmeters gives you reliability, repeatability and high accuracy.

Make 90% of your day-to-day ac/dc measurements with laboratory precision using the hp model 410C Voltmeter. Measure dc from 15 mV to 1500 V full scale, current from 1.5 μ A full scale, resistances from 10 Ω to 10 M Ω , and ac volts to 700 MHz. The hp-developed photoconductor chopper amplifier gives the 410C high sensitivity, low drift, and low noise. Price of hp 410C is \$475. Vacuum tube version, hp 410B is \$275.

Low cost fully-portable multi-function meter—that's the all-solid-state, battery-operated hp model 427A Voltmeter. It costs only \$225. Option 01 gives both battery and line operation for an additional \$25. Measure dc voltages from 100 mV to 1 kV full scale; ac voltages from 10 mV to 300 V full scale at frequencies to 1 MHz (to 500 MHz with the 11096A High Frequency Probe, price \$45); resistance from 10 Ω to 10 M Ω . Ac and dc accuracy is \pm 2%. FET's in the input circuit give you 10 M Ω input impedance—minimal circuit loading.

Highly sensitive dc and resistance measurements are made with hp 412A DC Vacuum Tube Voltmeter. With its 1 mV full scale dc voltage sensitivity and 1 Ω midscale ohms sensitivity, and its simplicity of

operation, the 412A is ideal for production line testing. Measure dc with 1% full scale accuracy. Price of 412A is \$450.

Extreme accuracy and hands-free operation distinguish the "Touch and Read" 414A DC Autovoltmeter. Automatic ranging and polarity indication occurs in less than 300 ms. Measuring accuracy for dc voltage is \pm (0.5% of reading +0.5% of full scale)—the best available in any analog voltmeter. Resistance accuracy is \pm (1% of reading +0.5% of full scale) on an easy-to-read linear scale. Price is \$690.

For full details on these and other Hewlett-Packard Voltmeters, see your hp catalog or contact your nearest hp field engineer. Or, write to Hewlett-Packard, Palo Alto, California 94304. Europe: 54 Route des Acacias, Geneva.

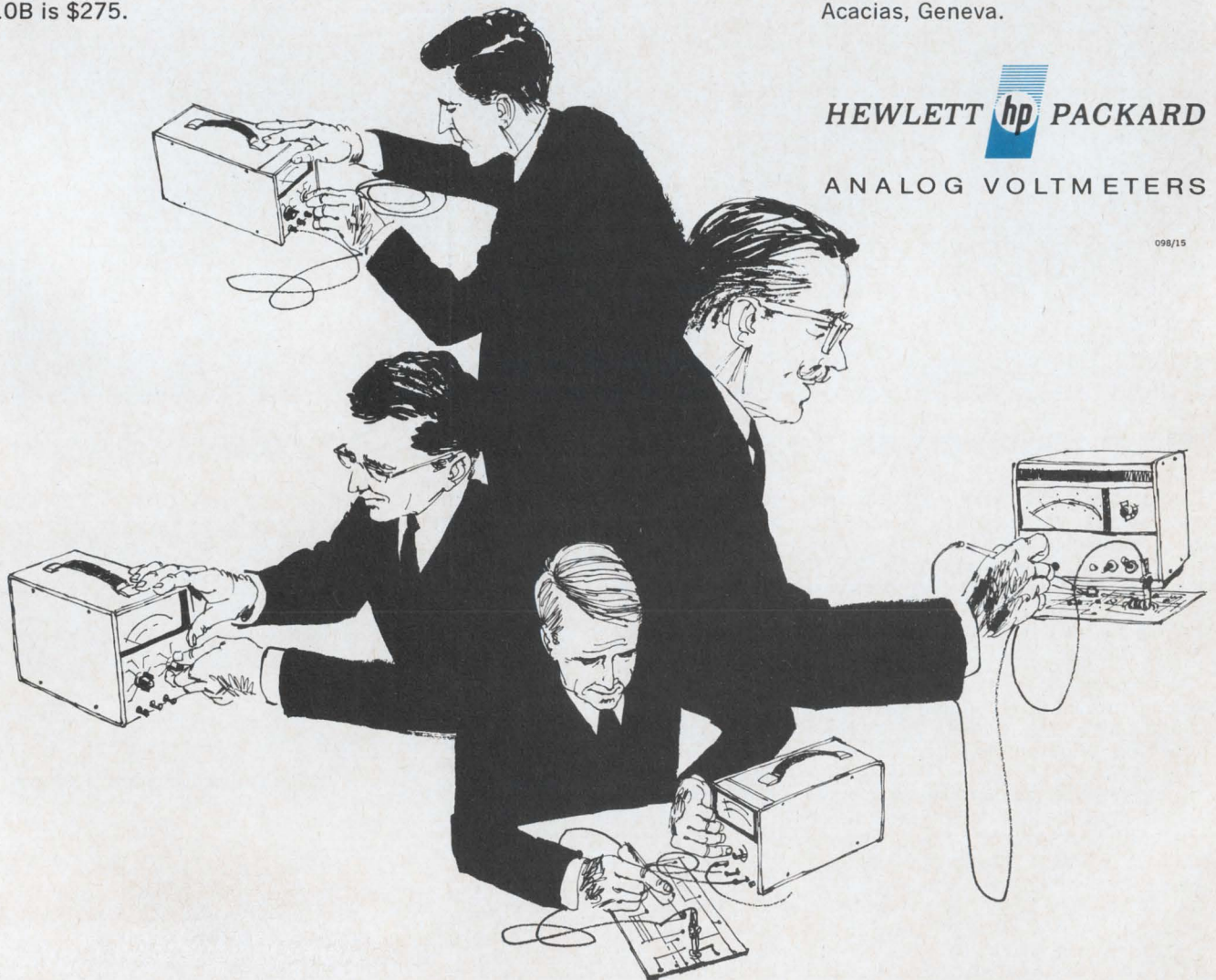

HEWLETT  PACKARD
ANALOG VOLTMETERS

098/15

News Features

Probing the News

- 139 **Space electronics:** Intelsat countdown nears zero
145 **Companies:** Federal Center broadens IBM's horizons
151 **Avionics:** Air Force plans new weather monitor

Electronics Review

- 47 **Avionics:** Discretionary LSI; Outside wiring; Helicopter landing system
48 **Computers:** Circular data layout; Hybrid LSI memory
50 **Oceanography:** Sea readings
52 **Government:** Defense budget cuts; Less cash for space
54 **Military electronics:** Awacs on its mark
58 **Consumer electronics:** Schottky problems
58 **For the Record**

Electronics Abroad

- 205 **Czechoslovakia:** Teaching machine takes any right answer
205 **Japan:** Competition keen for giant computer job; Watt converter accurate to 0.02%
207 **Great Britain:** Integrated circuits to change college curricula; Plessey pushes custom-designed IC's
208 **France:** "Hearing" with hands
208 **West Germany:** Portable facsimile for photographers
209 **Spain:** Small companies band together for export drive

New Products

- 157 **Large firms ready Gunn-effect devices**
163 **Components review**
163 Photocell measures ultraviolet
169 **Subassemblies review**
169 Printer outpaces teletypewriter
173 Tape handler/reader is under \$1,000
177 **Semiconductors review**
177 Monolithic op amp has high slew rate, short settling time
183 **Production equipment review**
183 Photoresist sprayer coats 5,000 wafers an hour
187 **Microwave review**
187 Raytheon offers quick delivery of custom microwave IC's
191 **Instruments review**
191 Panel voltmeter has five digits

Title R registered U.S. Patent Office; © copyright 1968 by McGraw-Hill Inc. All rights reserved, including the right to reproduce the contents of this publication, in whole or in part.

Technical Articles

I. Design

- Computers** 92 **The time-saver: FFT hardware**
Special-purpose processor calculates Fourier coefficients 20 times faster than can programmed, general-purpose computers
Richard Klahn, Richard R. Shively, Ernest Gomez, and Michael J. Gilmartin, Bell Telephone Laboratories
- Circuit design** 98 **Designer's casebook**
■ Curve tracer tests logic IC quickly
■ Bridge and amplifier monitor d-c level
■ Putting electronic organs in tune with natural sound
■ Transistor and zener monitor calibration
- Consumer electronics** 104 **All-solid state design overtakes large-screen monochrome tv sets**
High-voltage transistors can be used in the horizontal deflection circuit if they're protected from picture-tube flashovers and oscillator or driver failure
Wim Hetterscheid, Phillips' Gloeilampenfabrieken

II. Application

- Industrial electronics** 112 **Power-line filters need specific specs**
Filters guard equipment from electromagnetic interference, but—under actual operating loads—they can also cause wide swings in voltage
Robert B. Cowdell, Genisco Technology Corp.
- Instrumentation** 118 **Field detector works in real time**
Liquid crystals provide instant display of microwave intensity—and in color
Carl F. Augustine, Bendix Corp.
- Instrumentation** 127 **Finding leaky IC's on p-c boards**
Experimental test method uses a high-dielectric gas and capacitance measurements to single out faulty devices
Frank L. Girard, Hughes Aircraft Co.

Departments

- | | | | |
|----|------------------------|-----|-------------------------|
| 4 | Readers Comment | 69 | Washington Newsletter |
| 8 | People | 88 | Who's who in this issue |
| 14 | Meetings | 194 | New Books |
| 23 | Editorial Comment | 196 | Technical Abstracts |
| 25 | Electronics Newsletter | 198 | New literature |
| | | 203 | Newsletter from Abroad |

Electronics

Editor-in-Chief: Donald Christiansen

Associate managing editors

Technical: Stephen E. Scrupski
News: Robert Henkel
Copy: Sally Powell

Senior associate editors

Joseph Mittleman, Harry R. Karp

Department editors

Avionics & Space: Alfred Rosenblatt
Computers: Wallace B. Riley
Communications: William Buccu
Components: George Watson
Consumer electronics: John D. Drummond
Design theory: Joseph Mittleman
Industrial electronics: Harry R. Karp
Instrumentation: Carl Moskowitz
Military electronics: Richard Gundlach

Domestic bureaus

Boston: James Brinton, manager
Chicago: Frederick Corey, manager
Los Angeles: Lawrence Curran, manager; Burton Bell
New York: Howard Wolff, manager
San Francisco: Walter Barney, manager; Peter Vogel
Washington: Robert Skole, manager; Paul Dickson, William F. Arnold

Foreign bureaus

Bonn: John Gosch
London: Michael Payne
Tokyo: Charles Cohen

Copy editors

James Chang, Larry Miller

Graphic design

Art director: Saul Sussman
Assistant art directors: Ann Mella, Valerie Betz
Production editor: Arthur C. Miller

Editorial research:

 Kay Fontana

Editorial secretaries: Lorraine Longo, Claire Benell, Lynn Emery,
Patricia Gardner, Barbara Razulis, Frances Vacca

McGraw-Hill News Service

Director: Arthur L. Moore; **Atlanta:** Fran Ridgway; **Chicago:** Robert E. Lee
Cleveland: Arthur Zimmerman; **Dallas:** Marvin Reid;
Detroit: James Wargo; **Los Angeles:** Michael Murphy
Pittsburgh: Louis Gomolak
San Francisco: Margaret Drossel
Seattle: Ray Bloomberg; **Washington:** Charles Gardner, Daniel B. Moskowitz,
Herbert W. Cheshire, Seth Payne, Warren Burkett, William Small, William D. Hickman

McGraw-Hill World News Service

Bonn: Robert Dorang; **Brussels:** George Williamson; **Hong Kong:** Wes Perry;
London: John Shinn; **Mexico City:** Gerald Parkinson; **Milan:** Ronald Taggiasco, Jack Star;
Moscow: Howard Rausch; **Paris:** Robert E. Farrell, Peter Kilborn;
Rio de Janeiro: Leslie Warren; **Tokyo:** Marvin Petal

Reprints:

 Susan Nugent

Circulation: Isaaca Siegel

Publisher:

 Gordon Jones

Electronics: June 24, 1968, Vol. 41, No. 13

Published every other Monday by McGraw-Hill, Inc. Founder: James H. McGraw 1860-1948.

Printed at 99 North Broadway, Albany, N.Y. 12207; second class postage paid at Albany, N.Y.

Executive, editorial, circulation and advertising addresses: McGraw-Hill Building, 330 W. 42nd Street
New York, N. Y. 10036. Telephone (212) 971-3333. Teletype TWX N.Y. 710-581-4235. Cable address:
MCGRAWHILL N.Y.

Subscriptions solicited only from those professionally engaged in electronics technology. Subscription rates:
qualified subscribers in the United States and possessions and Canada, \$8.00 one year, \$12.00 two years,
\$16.00 three years; all other countries \$25.00 one year. Non-qualified subscribers in the U. S. and
possessions and Canada, \$25.00 one year; all other countries \$50.00. Air freight service to Japan \$50.00
one year. Single copies: United States and possessions and Canada, \$1.00; all other countries, \$1.75.

Officers of McGraw-Hill Publications: Joseph H. Allen, President; Bayard E. Sawyer, Executive Vice President;
J. Elton Touchig, Senior Vice President-Operations; Vice Presidents: John R. Callahan, Editorial;
John M. Holden, Marketing; Paul F. Cowie, Circulation; Jerome D. Luntz, Planning & Development;
Robert M. Wilhelmy, Controller.

Officers of the Corporation: Shelton Fisher, President and Chief Executive Officer; John L. McGraw, Chairman;
Daniel F. Crowley, Donald C. McGraw, Jr., R. E. Slaughter, Senior Vice Presidents; John J. Cooke,
Vice President & Secretary; Gordon W. McKinley, Vice President & Treasurer.

Title © registered in U.S. Patent Office; © Copyright 1968 by McGraw-Hill, Inc. All rights reserved. The contents
of this publication may not be reproduced either in whole or in part without the consent of copyright owner.

Subscribers: The publisher, upon written request to our New York office from any subscriber,
agrees to refund that part of the subscription price applying to copies not yet mailed.
Please send change of address notices or complaints to Fulfillment Manager; subscription
orders to Circulation Manager, Electronics at address below. Change of address notices
should provide old as well as new address, including postal zip code number. If possible,
attach address label from recent issue. Allow one month for change to become effective.

Postmaster: Please send form 3579 to Fulfillment Manager, Electronics,
P.O. Box 430, Hightstown, New Jersey 08520

Readers Comment

Prime concern

To the Editor:

Concerning the article on industrial control computers [May 27, p. 129], one would suspect that the people who build these machines fail to realize that their equipment may be used to control the manufacture of a part upon which their very lives may depend.

The process-control computer isn't the only problem area. Other mechanical and electronic equipment reflects the same thoughtlessness and yields the same end result—failure in a critical application. The manufactured product is no better than the design from which it was derived, and in most cases a company that permits marginal design will not improve in the production phase.

The wisest advice for the engineer, then, is to make the end usage his primary concern.

Bernard J. Barr
Hallicrafters Co.
Rolling Meadows, Ill.

More on mobile f-m

To the Editor:

The letter from Kerim Onder [April 29, p. 4] regarding the mobile f-m receiver design on which he holds a patent aroused my interest, but for reasons different from the subject of his letter.

My experience over the past 10 years has been that two problems continue to hurt mobile f-m reception and thus the market for receivers. The first is multipath distortion from hills, tall buildings, and vehicles. The second, recognized but little publicized, is the cross-polarization problem with the commonly used vertical whip.

One solution to the latter is the use of circular or multiple (horizontal and vertical) polarization by commercial f-m transmitters. This practice is not yet widespread. A second solution is the design of a horizontally polarized antenna having the esthetic and economic advantages of the popular vertical whip antenna.

Still experimental but promising is the use of a simpler form of space

**Stability, Reliability
Under Adverse Conditions
Achieved with Acrasil®
Silicone-Encapsulated
Precision/Power Resistors**

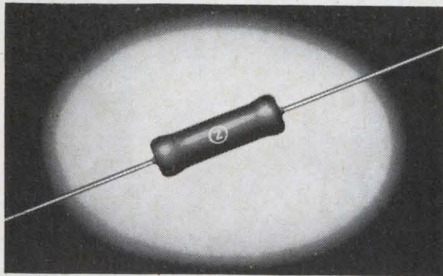

Excellent stability and reliability under extended load life and other adverse operating conditions are the outstanding design features of Acrasil precision/power wire-wound resistors.

Developed by the Sprague Electric Company, these miniature silicone-coated resistors fit neatly in high density circuitry, which demands far greater stability than that offered by composition and film resistors. The small size of Acrasils makes them ideal for printed circuit and point-to-point wiring applications.

The 1-watt Type 219E Acrasil Resistor is extremely small, therefore it is of particular interest to designers of military and industrial digital equipment where cordwood packaging is a factor. Only .098" D. x .250" L., it is compatible with other "cordwood" components.

The expansion coefficient of the silicone coating is closely matched to that of the ceramic base in order to insure positive protection of the resistance winding. This silicone coating seals the wire and provides exceptional protection against the effects of moisture, shock, vibration, fungus, and salt sprays.

Acrasil Resistors fully meet electrical performance requirements of MIL-R-26, as well as individual customer high reliability specifications. These miniature resistors, manufactured with both standard solenoid-type windings and non-inductive windings, are available in close resistance tolerances to $\pm 0.05\%$ and in a wide range of ratings from $\frac{1}{4}$ to 10 watts in resistance values from $.05\Omega$ to 250K Ω .

For complete technical data, write for Engineering Bulletin 7450A to Technical Literature Service, Sprague Electric Co., 35 Marshall St., North Adams, Mass. 01247.

Your custom pulse transformer is a standard DST* transformer

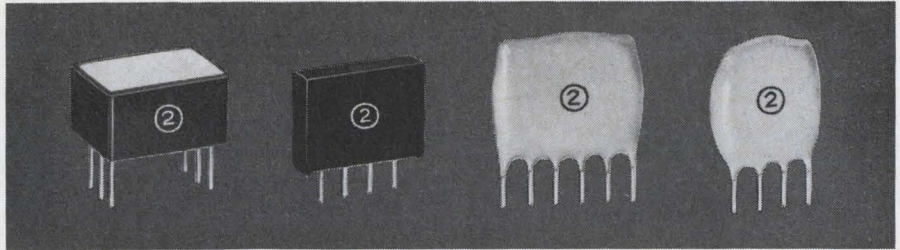

Some of the case styles in which Sprague DST Pulse Transformers are available. Note the in-line leads.

You can select the transformer design you need from the new Sprague DST Family, a fully-characterized series of Designer Specified Transformers which Sprague Electric has pioneered. It's easy. Start with the two basic parameters dictated by your circuit requirements: primary (magnetizing) inductance and volt-second capacity.

New Sprague engineering data gives basic information from which all nominal sine wave parameters are derived. This data allows you to specify the one transformer from thousands of possibilities which will optimize performance in your application.

Design Style A minimizes magnetizing inductance change as a function of temperature. Typically it's $< \pm 10\%$ change from 0 to 60 C; $< \pm 30\%$ from -55 to $+85$ C.

Design Style B and C give you broad bandpass characteristics, and still keep magnetizing inductance change $< \pm 15\%$ from 0 to 60 C.

Design Style D is *fast*. Associated leakage inductance and coupling capacitance are kept at a minimum. This style is just what you need for interstage and coupling devices in computer drive circuits.

The Sprague DST Series packs a lot of transformer into minimum volume packages — epoxy dipped for minimum cost, or pre-molded. The 100 mil in-line lead spacing is compatible with integrated circuit mounting dimensions on printed wiring boards.

To solve your pulse transformer design, start now. Write for Engineering Bulletin 40,350 to the Technical Literature Service, Sprague Electric Company, 35 Marshall St., North Adams, Mass. 01247.

*Trademark

SPRAGUE COMPONENTS

PULSE TRANSFORMERS
CAPACITORS
TRANSISTORS
RESISTORS
THIN-FILM MICROCIRCUITS
INTEGRATED CIRCUITS

INTERFERENCE FILTERS
PACKAGED COMPONENT ASSEMBLIES
FUNCTIONAL DIGITAL CIRCUITS
MAGNETIC COMPONENTS
CERAMIC-BASE PRINTED NETWORKS
PULSE-FORMING NETWORKS



Sprague and '®' are registered trademarks of the Sprague Electric Co.

LF

MF

HF

VHF

UHF

SHF

First counters to operate automatically across the VHF gap.

Until now you couldn't make simple, automatic frequency measurements from 100 to 300 MHz without a special VHF plug-in. The extra plug-in was clumsy in the lab. And when switching plug-ins was impossible—as in automatic console systems—the VHF gap was unavoidable. Now two self-contained Systron-Donner counters span the VHF gap, operating automatically from DC to the microwave region.

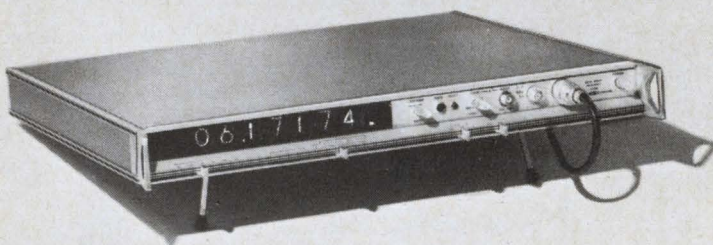

Non-stop DC to 12.4 GHz. The VHF gap is filled by a built-in prescaler in this new Thin Line counter. The instrument operates just like a simple frequency counter across the board from DC to 12.4 GHz. You merely connect the signal and read the final answer on the display. Built with IC's to take only 1-3/4" of rack space and operable by remote control, it is the ideal instrument for automatic systems.



Non-stop DC to 3 GHz. New ACTO® plug-in with built-in prescaler carries this counter across the VHF gap to 3 GHz with fully-automatic operation. The new broadband plug-in can be replaced by others to raise the frequency range to 40 GHz, to measure very noisy signals, to measure FM and pulsed RF, to read time interval, etc. This is the best available wide-range laboratory counter—the root of a system that can accomplish nearly everything possible with counter instrumentation.

**...two more reasons
to check with
Systron-Donner
before you buy.**



Send for Catalog.

Circle 6 on reader service card

SYSTRON  DONNER

888 Galindo Street, Concord, California 94520.

diversity, with a vertical whip on either side of the vehicle and the coax feeds paralleled at the receiver input. This arrangement significantly reduces the depth of fading encountered when probing the horizontal field with a vertical whip. The output is the vector sum of the radio-frequency voltages from the two whips.

Note that to get a null, the two signals would have to be equal in magnitude and out of phase, something that seldom happens. Of course, this method introduces some directivity into the antenna, but my experience is that any slight undesired effects of directivity are more than offset by the improvement in reception.

James R. Kaness
Pacific Missile Range
Point Mugu, Calif.

Rebutting a rumor

To the Editor:

The May 27 issue of Electronics [p. 26] reported a rumor about the IBM 1800 data acquisition and control system that is misleading. The facts are:

There is no plan to discontinue the IBM 1800.

IBM 1800 production and product engineering is not being transferred to Boca Raton, Fla. These activities remain at IBM's San Jose, Calif., facilities.

The Boca Raton laboratory will be responsible for development of small scientific systems and new process-control systems, as covered in IBM's press release announcing the establishment of the laboratory on March 18.

A time-shared operating system

for the 1800 called the multiprogramming executive will be delivered this summer.

Robert F. Sposito
International Business Machines Corp.
White Plains, N.Y.

Solid state standards

To the Editor:

Many new solid state devices have been announced as breakthroughs in recent times, but local officials around the country have indicated that they will not permit the use of these devices in public places unless they're listed by Underwriters Labs or some other organization of equal stature.

At the present time, UL doesn't have standards for solid state components. Further, it is likely that the old, old standards for industrial controls will be applied. If this happens, few of the present devices will have the required lead spacing to pass a UL test, and present methods of heat-sinking won't provide the required insulation between "live" and "dead" parts.

I suggest that the major suppliers of solid state components begin working with UL immediately to resolve some of these problems. If UL is not able to respond to the rapid growth expected in solid state home and industry controls, I suggest that a nonprofit, industrywide testing laboratory be set up to pass on solid state components and assemblies.

William Brooks
Brooks Optronics
Santa Clara, Calif.

Application For

LAMP DRIVERS

PROBLEM: Find integrated circuit to drive two lamps... must be dual.

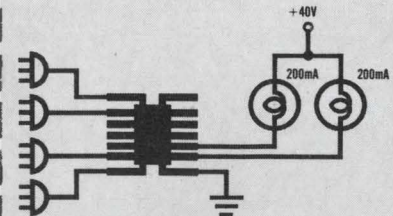

REQUIRED: Drivers must be controlled by 5 volt logic... and must latch.

GIVEN:

Input swing ...

Logic 0 ... +0.5 V

Logic 1 ... +4 V

Lamp rating ... 40 V; 200 mA

Available power supplies ... +5;

+40 V

Both lamps are never ON at same time (exclusive OR)

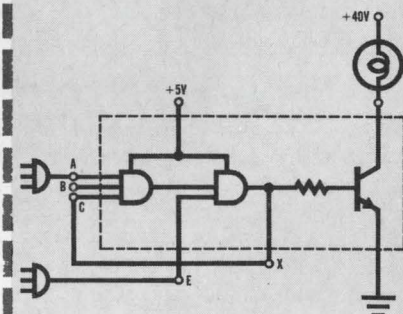

SOLUTION: SI 4002... Integrated dual lamp driver with 3 logic inputs... and latching capability (one of a series of 3 drivers).

Max output current ... 250 mA

(can withstand surges up to 1 amp)

Max output voltage ... 42 V

Power Dissipation ... 600 mW

Lamp drivers keeping you in the dark? Contact us for applications help and data sheets.



Siliconix incorporated

1140 W. Evelyn Ave. • Sunnyvale, CA 94086
Phone (408) 245-1000 • TWX: 910-339-9216

SUBSCRIPTION SERVICE

Please include an Electronics Magazine address label to insure prompt service whenever you write us about your subscription.

Mail to: Fulfillment Manager
Electronics
P.O. Box 430
Hightstown, N.J. 08520

To subscribe mail this form with your payment and check new subscription renew my present subscription

Subscription rates: qualified subscribers in the U.S.: 1 year \$8; two years, \$12; three years, \$16. Non-qualified: 1 year \$25. Subscription rates for foreign countries available on request.

CHANGE OF ADDRESS

ATTACH LABEL HERE

If you are moving, please let us know five weeks before changing your address. Place magazine address label here, print your new address below.

name _____

address _____

city _____

state _____

zip code _____

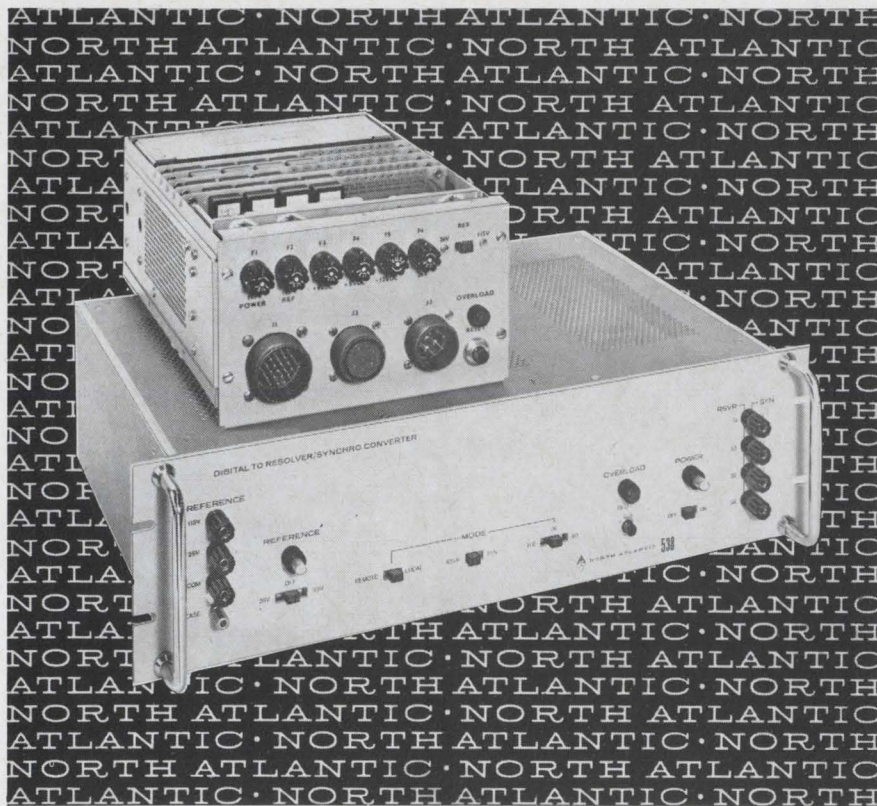

digital to resolver/synchro converters...here's the next generation!

North Atlantic now brings you a new generation of solid-state digital-to-analog converters. They offer major advances in resolver/synchro conversion accuracy along with drift-free and stable performance unobtainable with currently available resistor/amplifier devices.

Typical of these new instruments are the Model 536 D/R and Model 537 D/S "shoebox" converters (11-13 bit) and the Model 538 D/R-S converter (14-17 bit). Both models use solid-state switched trigonometric transformers and feature input data storage registers thereby saving computer time. Conversion speed exceeds 10 microseconds. Built-in overload and short circuit protection assures trouble-free system integration and reliable on-line performance.

Your North Atlantic representative (see EEM) has complete specifications and application information. He'll be glad to show you how these new converters can be the answer to critical interface problems.



NORTH ATLANTIC industries, inc.
TERMINAL DRIVE, PLAINVIEW, NEW YORK 11803 • 516-681-8600

People

The Columbia Broadcasting System is now poised to put its much-heralded Electronic Video Recording equipment on the market. And the man who'll lead the drive is Robert E. Brockway.



Brockway

CBS brass is so optimistic about the recorder's money-making possibilities that Brockway has been tapped to head a separate division. Called, aptly enough, CBS-EVR, the new division ranks with CBS Laboratories and CBS Services on the organization chart of its parent, CBS/Comtec Group. Brockway thus becomes a peer of Peter C. Goldmark, CBS Labs' president and chief developer of the EVR. Both have as their immediate boss Felix A. Kalinski, president of CBS/Comtec.

Head start. Mid-June found Brockway in Europe, witnessing the realization of Goldmark's prediction last fall that the British and Swiss partners in the development of the recorder would get on the market before CBS. The two, Ciba in Switzerland and Imperial Chemical Industries in Britain, initially plan to push the educational side of the recording technique rather than its entertainment side. In EVR, television signals stored on a special film are played back through an ordinary tv receiver.

Brockway, too, sees educational tv as the initial mainstay for CBS' marketing effort in the U.S. Along with the EVR system itself—and the production of educational and entertainment films—he'll have an impressive item of studio equipment to sell, a tv camera called broadcast EVR. With the camera, color-tv programs can be recorded on black-and-white EVR film. And CBS-EVR will get a stem-to-stern coverage of the market by setting up EVR-film processing centers.

Brockway comes to CBS from the Manhattan Cable Television division of Sterling Information Services, a major producer of business movies. Brockway was vice pres-

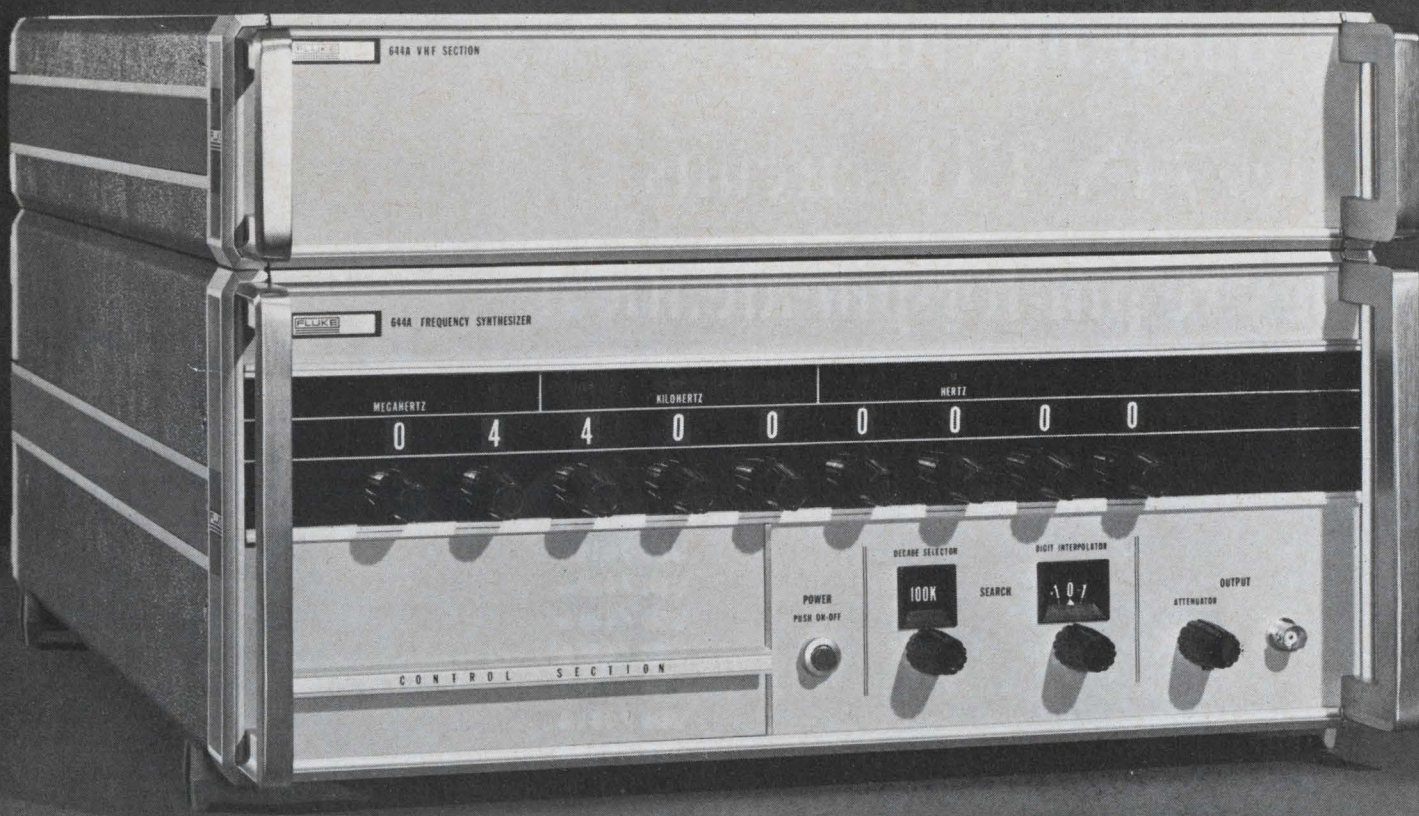

The New Family of Synthesizers with the High Figure of Merit.

Up above, you see just one member of Fluke's exciting new family of frequency synthesizers, the Model 644 which covers the DC to 40 MHz range. Model 633 covers the DC to 11 MHz range. Model 622 covers DC to 1.1 MHz range.

All three units feature exceptionally low spurious content, low signal to phase noise ratio, modern packaging in minimum panel height, in-line, in-plane digital presentation and remote programming to give you synthesizers with the right figure of merit.

Want a demonstration. Your full service Fluke sales engineer will be glad to arrange a demonstration of any or all of these high performance new synthesizers. Or write or call us here at the factory for more information.

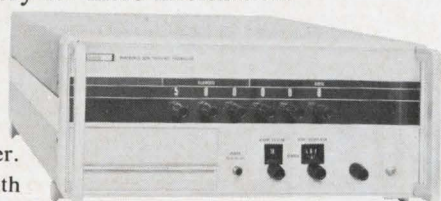

Model 622 Synthesizer.
Model 633 similar with one more decade.

Brief Specifications

Model	622	633	644
Frequency Range	DC to 1.1 MHz	DC to 11 MHz	DC to 40 MHz
Frequency Stability and Accuracy	1 pt in 10 ⁸ /day	Same	Same
Spurious Content	At least 90 db below fundamental	Minus 90 db to 6 MHz Minus 60 db to 11 MHz	At least 90 db below fundamental
Harmonics	At least 30 db below fundamental	Same	Same
Power	115 or 230 VAC ±10%, 50-400 Hz, 50 watts	Same	Same except 75 watts
Size	7"H x 17"W x 22"D	Same	Two chassis, 10½"H x 17"W x 22"D Total
Mounting ears fit standard 19" rack.			
Price	\$6,500	\$7,100	\$10,500

Fluke, Box 7428, Seattle, Washington 98133. Phone: (206) 774-2211. TWX: (910) 449-2850.
In Europe, address Fluke International Corporation, P. O. Box 5053, Ledeborstraat 27,
Tilburg, Holland. Telex: 844-50237. In U. K., address Fluke International Corporation,
P. O. Box 102, Watford Herts, England.



Add Sprague Series 7400A to your prints for Series 74N TTL circuits. They're pin-for-pin identical.

SERIES 74N	FUNCTION	SPRAGUE PART NO.
SN7400N	Quad 2-Input NAND	USN-7400A
SN7401N	Quad 2-Input NAND (No Collector Load)	USN-7401A
SN7402N	Quad 2-Input NOR	USN-7402A
SN7410N	Triple 3-Input NAND	USN-7410A
SN7420N	Dual 4-Input NAND	USN-7420A
SN7430N	Single 8-Input NAND	USN-7430A
SN7440N	Dual 4-Input NAND Buffer	USN-7440A
SN7450N	2-Wide 2-Input Expandable AND-OR-INVERT	USN-7450A
SN7451N	2-Wide 2-Input AND-OR-INVERT	USN-7451A
SN7453N	4-Wide 2-Input Expandable AND-OR-INVERT	USN-7453A
SN7454N	4-Wide 2-Input AND-OR-INVERT	USN-7454A
SN7460N	Dual 4-Input Expander	USN-7460A
SN7470N	D-C Clocked J-K Flip Flop	USN-7470A
SN7472N	J-K Master Slave Flip Flop	USN-7472A
	Dual J-K Master Slave Flip Flop:	
SN7473N	Single chip, pin 11 GND	USN-7473A
—	Single chip, pin 7 GND	USN-74107A
SN7474N	Dual D-Type Edge-Triggered Flip Flop	USN-7474A
—	Dual AC Clocked J-K Flip Flop	USN-7479A

Series 5400, full-temperature-range equivalents in 14 pin flat-packs, are also available for rapid delivery from Sprague.

Don't spend another week without calling Sprague.

For complete technical data on Series 5400 and 7400A circuits, write to Technical Literature Service, Sprague Electric Co., 35 Marshall St., North Adams, Mass. 01247

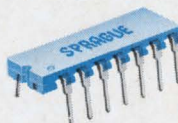

SPRAGUE COMPONENTS

INTEGRATED CIRCUITS
CAPACITORS
TRANSISTORS
RESISTORS
THIN-FILM MICROCIRCUITS
PULSE TRANSFORMERS

INTERFERENCE FILTERS
PACKAGED COMPONENT ASSEMBLIES
FUNCTIONAL DIGITAL CIRCUITS
MAGNETIC COMPONENTS
CERAMIC-BASE PRINTED NETWORKS
PULSE-FORMING NETWORKS



'Sprague' and '®' are registered trademarks of the Sprague Electric Co.

People

ident and general manager of the New York community antenna tv outfit.

Instead of chasing after new business at high speed, Litton Industries Inc.'s Data Systems division is shifting gears.

As George Romano puts it, the company is putting greater emphasis on "profitable execution of work now on the books." The reason:



Romano

the Van Nuys, Calif., division has the largest backlog of its history. And Romano, newly appointed director of advanced programs, had a great deal to do with it. Before his promotion, he was program director for the Tactical Fire Direction System (Tacfire) for which Litton was selected as the Army's prime contractor [Electronics, March 4, p. 171].

Not that the division is giving up its quest for new business. "What we are doing," says Romano, "is tailoring our new business to our backlog."

Timing. The big problem in seeking new business, notes Romano, is deciding when to get into a program. "You always invest quite a bit of your own money, even on supported studies. When you get in too early, the concept is vague; when you get in too late, you operate in a panic, and you spend money inefficiently.

The Air Force's Airborne Warning and Control System (Awacs), says Romano, is a good example of a program for which Litton had to decide whether to enter the conceptual phase or wait until the contract-definition phase. The company chose the former and won a study contract for Awacs' command and control, and communications portions. (The International Business Machines Corp. won a second study contract.) Romano believes the award puts Litton in a strong position for the crucial contract-definition phase.



With Varian vacuum systems, Schick is processing superior Krona-Chrome razor blades. A sputtered thin film of chromium is deposited on stainless steel for "the ultimate in a durable edge."

Like Schick, you can draw on Varian's technological leadership for a reliable vacuum coating system — one that will stand the rigors of high-volume production with low unit-cost.

Investigate our comprehensive line of deposition equipment, e-Gun™ evaporation sources, sputtering modules, and vacuum instrumentation. We'll combine standard subsystems, design any custom tooling required, and sequence operation to suit your work.

You'll get guaranteed performance, a quality automatic vacuum system, skilled service back-up. All of which is hard to beat. Or equal. Want to sharpen your vacuum processing? Write for our data. Varian Vacuum Division, Palo Alto, California; Zug, Switzerland; Georgetown, Ontario.



varian
vacuum division

**Varian
helped
Schick get an
edge on the
competition.**

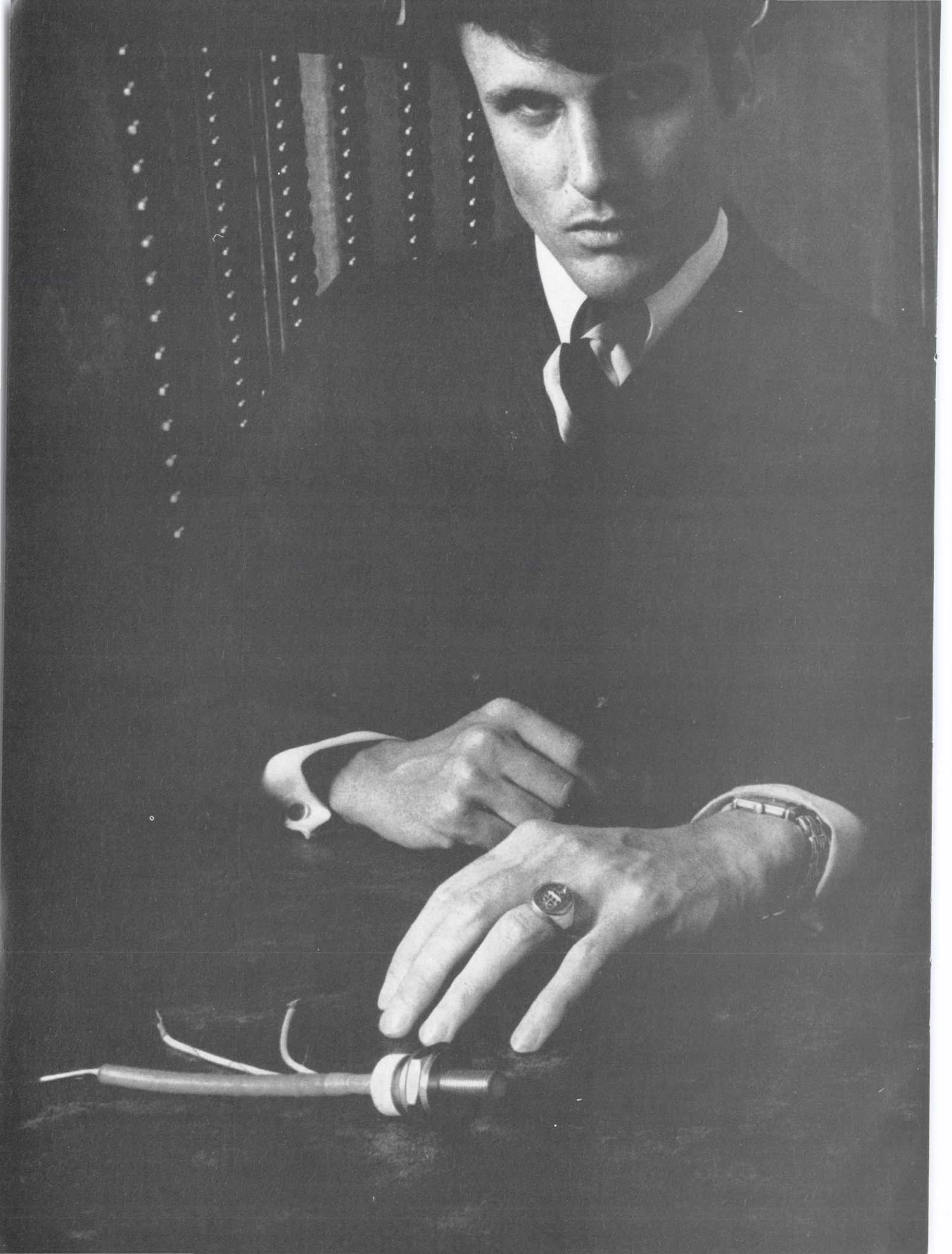

This is an ad for power-hungry engineers

Here's something that will whet your appetite for design innovations: switch to Westinghouse Full Capacity Thyristors that give you 14% more power for your dollar.

That's right. The extra amps in these Westinghouse thyristors are on us.

You might just call it a breakthrough. These thyristors (Types 250 and 251) are rated at 80 and 40 amps AVE. With them, you can uprate existing SCR circuits without raising their cost.

And in new circuits, they'll help you even more, by allowing you to achieve simpler, lower-cost designs.

Our breakthrough was in bringing out the full inherent capacity of these thyristors. New diffusion techniques were used. And critical thermal stresses were eliminated through our exclusive CBE construction.

Design Opportunities—Look at this characteristics comparison chart. Then grasp the opportunities. For example, if you make a 1½ hp. motor control, you could uprate it to 2 hp. with a simple thyristor switch from "Brand X" to Westinghouse.

Here's another cost-cutter: simplify

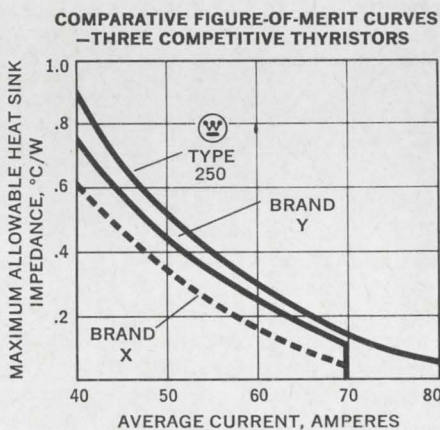

You can be sure... if its

Circle 13 on reader service card

circuits by reducing dv/dt protection networks. Until now, dv/dt on standard thyristors has been limited to 200 V/ μ sec. Westinghouse offers a minimum of 300 V/ μ sec. (typically 600V/ μ sec.) to full V_{FB} .

Maybe you're working with a 550 volt power supply. Then here's the first positive control thyristors that block 1800 volt transients, 1500 volts steady-state.

Designing drive circuits? Our maximum I_{GT} of 100 ma. is an optimum figure. Low enough to achieve low-cost circuitry, high enough to minimize false triggering.

Ready to seize power?

We'll shoot you all the data you need. Just call your local Westinghouse salesman. Or phone us at (412) 925-7272. Or write Westinghouse Semiconductor Division, Youngwood, Pa. 15697.

Westinghouse



SC-2113

The Best Direct Drive For Computer Peripheral Equipment

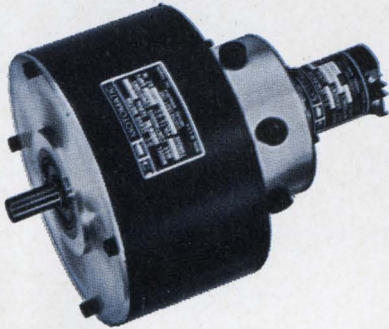

Moving Coil Motors

■ Electro-Craft offers a wide choice of MOTOMATIC® MCM low inertia, ultra high performance, dc servo motors and compatible driving amplifiers, available either as a complete package or as separate modules.

■ MOTOMATIC® MCM units are ideally suited for direct drive applications in computer printers, card readers, punch equipment, disc memory, magnetic and paper tape capstan drives, analog and digital positioning, recorders and XY plotters, machine tool positioning, film drives, incremental motion velocity and phase lock servos, and precision tensioning.

■ MOTOMATIC® MCM, moving coil motors feature; acceleration in excess of 10^5 rad/sec.², time constant of 2m-sec., high pulse torque, extremely low inductance, high efficiency, long-life and integral feedback tach-generator.

For the best in direct drive servo systems... write or call today.

**ELECTRO-CRAFT
CORPORATION**
1600 Second Street South
Hopkins, Minn. 55343
Tel. (612) 935-8226

Meetings

Two approaches to airborne computer systems

For all the promise held out by the introduction of large-scale integration into designs for airborne computer systems, debate still rages over how the equipment should be arranged. This controversy—dispersed computers versus a central-processor complex—will get a full airing at the Guidance, Control, and Flight Dynamics Conference in Pasadena, Calif., Aug. 12-14.

The meeting, sponsored by the American Institute of Aeronautics and Astronautics, will feature an "organized bull session" on the subject headed by Gordon Smith, an Autonetics engineer. Smith says the argument comes down basically to a question of whether the expense of dispersing the computational functions is worth the gain in reliability. "Certainly a single arithmetic unit is less costly than a number of units," he says, "but do you sacrifice reliability, speed, or capability by taking this approach?"

Moot point. That question won't be answered at the meeting. Several avionics systems with central processors are under development, but Smith notes that until dispersed computers are built into a system, "It's only speculation as to how well they'd perform in comparison."

One example of the central-processor approach is the F-111D integrated avionics system (Mark 2) now being developed. Design objectives and their implementation in this computer complex, which consists of two IBM 4-pi digital processors and a Kearfott converter

being integrated into the system by Autonetics, will be detailed in a paper presented by D.H. Daggett, a design specialist, and R.W. Lee, a group engineer, both from General Dynamics' systems technology department at Fort Worth, Texas.

Forecast. The question will be tackled from the aerospace angle when S.R. Hurst, R.J. Shuck, and J.S. Tanguy, engineers with General Electric's Missile and Space division, King of Prussia, Pa., report on a study comparing the central-computer and decentralized approaches for interplanetary spacecraft. Their results suggest that separate-subsystem designs will be used for the early missions of the 1970's, but that the question will be reopened for later flights.

On another topic, J.A. Hand, a systems engineer working on the Apollo project at MIT's instrumentation laboratory, will describe a computer-aided technique for automatically realigning an inertial platform during long-term manned space flights. The system is being considered for an Apollo Applications Program experiment.

In a session on aircraft flight control, V.R. Jackson and D.E. Patch, systems engineers at GE's avionics control department, will discuss the advantages of fly-by-wire control for the XV-4B vertical-takeoff-and-landing craft, and will propose that this method be used in other applications in this area.

For more information write Al Kildow, meetings department, AIAA, 1290 Avenue of the Americas, New York, N.Y., 10019.

Calendar

Conference on Precision Electromagnetic Measurements, IEEE; National Bureau of Standards Laboratories, Boulder, Colo., June 25-28.

Computer Conference, IEEE; International Hotel, Los Angeles, June 25-27.

Automatic Control Conference, Instrument Society of America and

IEEE; University of Michigan, Ann Arbor, June 26-28.

Management in the Fields of Aerospace Meeting, American Institute of Aeronautics and Astronautics; Montreal, July 8-9.

Conference and Exhibit of the Marine Technology Society; Sheraton Park Hotel, Washington, July 8-10.

(Continued on p. 16)

THE CONNECTOR Thing

A periodical periodical designed, quite frankly, to further the sales of Microdot connectors and cables. Published entirely in the interest of profit.

A new coaxial mystery PART 3

IN ONLY THREE PARTS

PART 1 I was biting off the cap of a bottle of near beer when the phone suddenly rang. I pulled it from the wall. Silence.

Later there was a knock on my door. It was a messenger. "Your phone's dead." "It was self defense." "We thought so. Just checking." He handed me a telegram. I read it.

"THE STANDARD 50 OHM COAX CONNECTORS ARE IN TROUBLE. STOP. THERE'S A RUMOR THERE'S A NEW LIGHTWEIGHT IN TOWN THAT MAY TURN INTO A HEAVYWEIGHT. STOP. IT'S CALLED A 3-PIECE GOLDEN CRIMP*. IF ALL WE HEAR IS TRUE. STOP. PLEASE."

The messenger smiled. I gave him a tip. "Stay out of pool halls until you're twenty-one."

I took the stairs down and climbed into my 5 litre Munchausen.

Fortunately I knew where to go. People have been telling me for a long time.

I headed straight for a big brick building in South Pasadena. It was rumored that in the back they were testing a black box. I worked my way in. Disguising myself as a test bench with a trenchcoat thrown over it, I edged toward the device. Suddenly, something pulled at me from behind.

PART 2 Extricating the belt buckle from a lurking ventilator, I clumped and banged toward the device.

Plugged in to the box was the most compact 50 ohm connector I'd ever seen. The specs were on the floor. I picked them up and slipped them on.

They were right. The MARC 131 was fantastic.

It weighs just 1.693 grams as compared to slightly over two grams for conventional 50 ohmers. And it has shaved off a rather respectable .163" off the length. The new connector measures in at .620" by .242" diameter by .250" hex. And all the units mate with standard 10-32 50 ohm coax connectors.

I was getting ready to leave and make my report, but suddenly, the door opened.

Two guys came in. I held my breath. One of 'em spoke. "Let's put a MARC 131 together."

"There it is, babe. One. Two. Three. Complete."

I was stunned. A contact assembly, an inner crimp sleeve and a housing. That was all. Other conventional coaxes have sealing sleeves, two or three pieces of Teflon dielectric insulators, jerk rings and retaining rings to mess with. Did I know what this meant?

Did I! Ever try to put a puzzle together fast? Same size? Seven parts, five parts or three parts, which would be easier? Phenomenal! If those engineers could do it that fast, real people could reduce assembly time by 20% or more. A unit could be assembled in less than one-and-a-half minutes which meant... I calculated rapidly... but one of those guys broke in on my thoughts...

"About a thousand assemblies in twenty-four hours."

I'd like to have those connectors,

I thought.

"I'd like to have that durable an assembler," he said.

"Well, think it'll sell?"

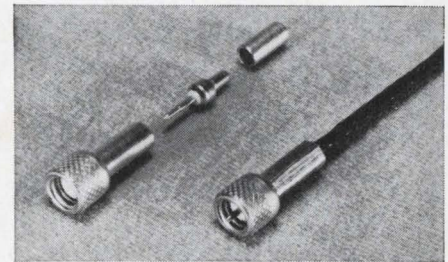

"It can't miss. Let's go. And, say, make a note to get rid of that crummy bench."

They left. But I was stunned. They were in production. Had it licked. I was too late.

EPILOGUE

(dum da dum dum)

The MARC 131 3-piece Golden Crimp 50 ohm connector is now wanted nationwide. It is known it is competitively priced with standard coaxial connectors.

These units are capable of operating at 200°C, have contact resistance of 4 milliohms max and insulation resistance of 5K Megohms min.

The unit has been identified in three plug-in types: jack, bulkhead jack and bulkhead receptacle; straight or right angle.

It is, engineering-wise, diabolical. In the past, 5 to 7 pieces have been needed to put a coax connector together before.

Easy? Well, to illustrate our point, we're offering a set of three jim dandy puzzles. In three, five and seven pieces. Send for 'em.

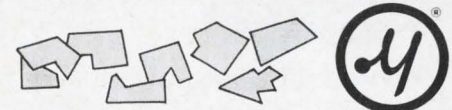

MICRODOT INC.

Okay, you guys. Send me your three puzzles. Also send me all the goods on that neat new 3-piece Golden Crimp. 50 ohm mates-with-all-standard - 10 - 32 - types connector. Understand you call it the MARC 131.

Name _____

Company _____

Title _____ Phone _____

Address _____

City _____

State _____ Zip _____

*Golden Crimp Registered Trademark of Microdot Inc.

MICRODOT INC., 220 Pasadena Avenue, South Pasadena, California 91030

STANDARDS LABORATORY

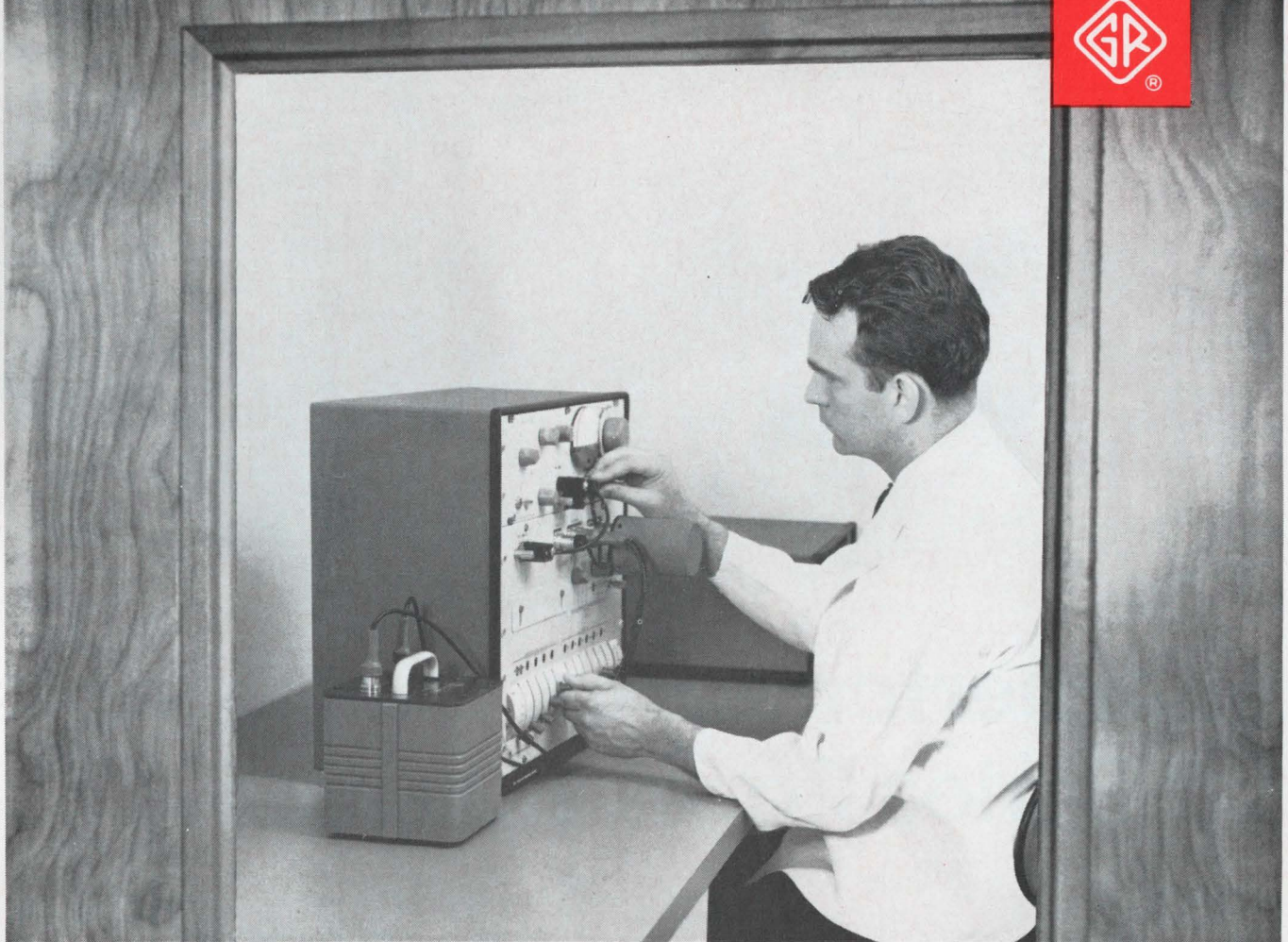

Why do so many standards labs use this capacitance bridge?

Because it has:

- 6-figure resolution.
- 0.01% accuracy.
- 10^{-5} pF-to-1.11110 μ F range (to 11.1 μ F with range-extension capacitor).
- D range of 0.000001 to 1.0 (at 1 kHz) and a G range of $10^{-12}\Omega$ to $10^{-4}\Omega$.
- frequency range of 50 Hz to 10 kHz with proper detector (useful with reduced accuracy to 100 kHz).
- two- or three-terminal measurement capability.
- easy-to-use, easy-to-read, lever-type balance controls (automatically positioned decimal point, too!).
- excellent internal standards and connection for external standards.

The 1615 Capacitance Bridge is a standards-lab's standard. It is THE bridge for the precision measurement of capacitance and loss, for dielectric measurements, and for intercomparison

of capacitance standards differing by as much as 1000:1. It is also used extensively in design and production applications that require precision measurements.

Price of the bridge alone is \$1675*. With an appropriate null detector and oscillator, as shown above, the three instruments form the 1620-A Capacitance-Measuring Assembly (\$2380*).

For complete information or a demonstration, call your nearest GR office or write General Radio Company, W. Concord, Massachusetts 01781; telephone (617) 369-4400. In Europe: Postfach 124, CH 8034 Zurich 34, Switzerland.

*Prices apply only in USA.

GENERAL RADIO

Another new line of instruments from Lambda...



The high performance LR Series Power Supplies

0-20, 0-40, 0-120, 0-250 VDC
Up to 1.8 amps
Regulation: 0.0005% plus 100 μ V
Ripple: 35 μ V rms
AC Input: 105-132 VAC, 47-440 Hz
(Ratings based on 55-65 Hz)

With Remote Programming:
Accuracy—0.01%+1mV
Stability—0.001%+100 μ V for 8 hours
Temp. Coeff.—0.001% plus 10 μ V/ $^{\circ}$ C

Constant current/constant voltage by automatic crossover
For rack or bench use
Guaranteed five years
Prices start at \$285

Model	Voltage Range	MAX. AMPS AT AMBIENT OF ¹				Price ²
		30 $^{\circ}$ C	40 $^{\circ}$ C	50 $^{\circ}$ C	60 $^{\circ}$ C	
LR-612-FM	0-20 VDC	1.8A	1.6A	1.3A	1.1A	\$285
LR-613-FM	0-40 VDC	1.0A	0.9A	0.75A	0.6A	285
LR-615-FM	0-120 VDC	0.33A	0.29A	0.25A	0.21A	285
LR-616-FM	0-250 VDC	0.1A	0.09A	0.08A	0.07A	325

¹ Current rating applies over entire voltage range. Ratings based on 55-65 Hz operation.

² Prices are for metered models. LR Series models are not available without meters.

OVERVOLTAGE PROTECTION For Use With	Model	Adj. Volt. Range	Price
LR-612-FM (0-20VDC)	LH-OV-4	3-24 V	\$35
LR-613-FM (0-40VDC)	LH-OV-5	3-47 V	\$35

Rack Adapter LRA-1 5 1/4" Height x 16 1/2" Depth (For use with chassis slides) Price \$60.00		Rack Adapter LRA-2 5 1/4" Height. Price \$35.00		Blank Front Panels Model LBP-10 (1/4 rack size) Price \$5.00 Model LBP-20 (1/2 rack size) Price \$10.00
CHASSIS SLIDES: To order LRA-1 with chassis slides order LRA-1-CS, and add \$50.00 to price.				

OR choose from these other Lambda power supplies

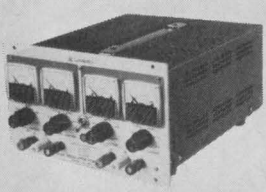

LPD

LP-LPD Series

A-C Input: 105-132 VAC, 47-440 Hz
Regulation: (line or load) 0.01%+1mV
Ripple: 500 μ V rms, 1.5mV p. to p.



LP

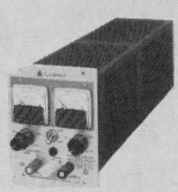

LH



LH, LK

LH-LK Series

Regulation: (line or load) 0.015% or 1 mV
Ripple: LH models — 250 μ V rms, 1 mV p. to p.
LK models — 500 μ V rms

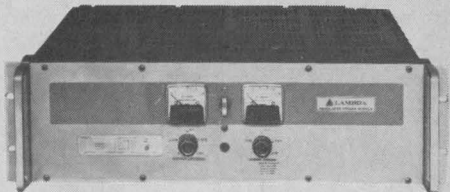

LK 5 1/2" (7" model also)

AC Input:

LH models — 105-135 VAC, 47-480 Hz
LK models — 105-132 VAC, 47-63 Hz
(LK 7" package available in 188-238 V and 205-265 V only)

Size 5 1/8" x 8 3/4" x 10 1/2" 1/2 Rack • LPD Series

Model ²	Voltage Range Per output/ Outputs in series	I MAX AMPS AT AMBIENT OF: ¹ Per output/Outputs in parallel				Price ³ US and Canada
		30°C	40°C	50°C	60°C	
LPD-421-FM	0-20/0-40	1.7A/3.4A	1.5A/3.0A	1.3A/2.6A	0.9A/1.8A	\$325
LPD-422-FM	0-40/0-80	1.0A/2.0A	0.85A/1.7A	0.7A/1.4A	0.55A/1.1A	260
LPD-423-FM	0-60/0-120	0.7A/1.4A	0.6A/1.2A	0.5A/1.0A	0.4A/0.8A	325
LPD-424-FM	0-120/0-240	0.38A/0.76A	0.32A/0.64A	0.26A/0.52A	0.20A/0.40A	325
LPD-425-FM	0-250/0-500	0.13A/0.26A	0.12A/0.24A	0.11A/0.22A	0.10A/0.20A	350

Size 5 1/4" x 19" x 16 1/2" Full Rack • LK Series

Model ²	Voltage Range	CURRENT RANGE AT AMBIENT OF: ¹				Price ²
		40°C	50°C	60°C	71°C	
LK-350	0-20VDC	0-35A	0-31A	0-26A	0-20A	\$675
LK-351	0-36VDC	0-25A	0-23A	0-20A	0-15A	640
LK-352	0-60VDC	0-15A	0-14A	0-12.5A	0-10A	650

Size 7" x 19" x 18 1/2" Full Rack • LK Series

Model ²	Voltage Range	CURRENT RANGE AT AMBIENT OF: ¹				Price ³
		40°C	50°C	60°C	71°C	
LK-360-FM	0-20VDC	0-66A	0-59A	0-50A	0-40A	\$995
LK-361-FM	0-36VDC	0-48A	0-43A	0-36A	0-30A	950
LK-362-FM	0-60VDC	0-25A	0-24A	0-22A	0-19A	995

Size 5 3/8" x 4 3/8" x 10" 1/4 Rack • LP Series

Model ²	Voltage Range	CURRENT RANGE AT AMBIENT OF: ¹				Price ²
		30°C	40°C	50°C	60°C	
LP-410	0-10 VDC	0-2A	0-1.8A	0-1.6A	0-1.4A	\$129
LP-411	0-20 VDC	0-1.2A	0-1.1A	0-1.0A	0-0.8A	119
LP-412	0-40 VDC	0-0.70A	0-0.65A	0-0.60A	0-0.50A	114
LP-413	0-60 VDC	0-0.45A	0-0.41A	0-0.37A	0-0.33A	129
LP-414	0-120 VDC	0-0.20A	0-0.18A	0-0.16A	0-0.12A	149
LP-415	0-250 VDC	0-80mA	0-72mA	0-65mA	0-60mA	164

Size 5 3/8" x 4 3/8" x 15 1/2" 1/4 Rack • LH Series

Model ²	Voltage Range	CURRENT RANGE AT AMBIENT OF: ¹				Price ²
		30°C	50°C	60°C	71°C	
LH-118A	0-10VDC	0-4.0A	0-3.5A	0-2.9A	0-2.3A	\$180
LH-121A	0-20VDC	0-2.4A	0-2.2A	0-1.8A	0-1.5A	170
LH-124A	0-40VDC	0-1.3A	0-1.1A	0-0.9A	0-0.7A	170
LH-127A	0-60VDC	0-0.9A	0-0.7A	0-0.6A	0-0.5A	185
LH-130A	0-120VDC	0-0.50A	0-0.40A	0-0.35A	0-0.25A	240

Size 5 3/8" x 8 3/8" x 15 1/2" 1/2 Rack • LH Series

Model ²	Voltage Range	CURRENT RANGE AT AMBIENT OF: ¹				Price ²
		30°C	50°C	60°C	71°C	
LH-119A	0-10VDC	0- 9.0A	0- 8.0A	0- 6.9A	0-5.8A	\$289
LH-122A	0-20VDC	0- 5.7A	0- 4.7A	0- 4.0A	0-3.3A	260
LH-125A	0-40VDC	0- 3.0A	0- 2.7A	0- 2.3A	0-1.9A	269
LH-128A	0-60VDC	0- 2.4A	0- 2.1A	0- 1.8A	0-1.5A	315
LH-131A	0-120VDC	0- 1.2A	0- 0.9A	0- 0.8A	0-0.6A	320

Size 5 3/8" x 8 3/8" x 15 1/2" 1/2 Rack • LK Series

Model ²	Voltage Range	CURRENT RANGE AT AMBIENT OF: ¹				Price ²
		40°C	50°C	60°C	71°C	
LK-340A	0-20VDC	0- 8.0A	0- 7.0A	0- 6.1A	0-4.9A	\$330
LK-341A	0-20VDC	0-13.5A	0-11.0A	0-10.0A	0-7.7A	385
LK-342A	0-36VDC	0- 5.2A	0- 5.0A	0- 4.5A	0-3.7A	335
LK-343A	0-36VDC	0- 9.0A	0- 8.5A	0- 7.6A	0-6.1A	395
LK-344A	0-60VDC	0- 4.0A	0- 3.5A	0- 3.0A	0-2.5A	340
LK-345A	0-60VDC	0- 6.0A	0- 5.2A	0- 4.5A	0-4.0A	395

Overvoltage Protection

Overvoltage protection up to 70VDC is available as a plug-in accessory with all LR, LP and LPD models and for LH and LK models with Suffix "A".

For models with this VDC	Specify this OV Accessory	Adj. Volt Range	Price
0-10, 0-20	LH-OV-4	3-24V	\$35
0-36, 0-40	LH-OV-5	3-47VDC	35
0-60	LH-OV-6	3-70VDC	35

Overvoltage protection up to 70 VDC as a built-in option for full rack LK models. To order, add suffix (-OV) and add \$90.00 to price of models LK-350-352; add \$120.00 for models LK-360-FM-362-FM.

NOTES:

- 1 Current rating applies over entire range. Ratings based on 57-63 Hz operation.
- 2 Prices are for non-metered models. For metered models, add suffix "-FM" and add \$10 to price for LP, \$30 for LH and LK.
- 3 Available metered only.
- 4 For chassis slides for full-rack models, add suffix "-CS" and add \$60 to price for 5 1/4" LK models, \$100 for 7" LK models.
- 5 All subrack models in this ad fit rack adapters described on previous page.

All specifications and prices subject to change without notice.

Write, wire, or call to order direct, for information, or for new Lambda Power Instruments catalog. LAMBDA Electronics Corp., 515 Broad Hollow Road, Melville, L. I., New York 11746, TEL. 516-694-4200, TWX 510-221-1897.

LAMBDA



NOW! NEW VSMF SYSTEM BRINGS

- RIGHT AT THE DESK ■ MORE CATALOG DATA FROM MORE VENDORS ■ MORE COMPLETE PRODUCT DATA FROM EACH VENDOR
- AVERAGE COST: LESS THAN \$60 PER YEAR PER MAN

A design breakthrough in microfilm technology – the VSMF Satellite™ Reader – now brings all the advantages of the VSMF (Visual Search Microfilm File) System right to the engineer's desk for instant use!

The VSMF System, already providing up-to-date, indexed, microfilmed catalog and technical data in more than 500 U. S. industrial installations, now achieves the ultimate in ACCESSIBILITY – individualized data systems, an arm's length away.

The new 8mm Satellite Data System provides:

- all the data and the same indexes as the VSMF 16mm Data Center at a much lower cost, and
- a section or sections of the file applicable to a specific design specialty for as little as \$348/year.

ECONOMICAL VSMF EXPANSION

In companies with large engineering staffs, where VSMF 16mm Data Centers already are located, the Satellite System will offer a more economical means of expanding the use of VSMF to additional plant locations.

In companies with smaller engineering staffs, the new

Satellite Reader System offers the increased data searching efficiency of VSMF at a much lower cost than previously available.

ONLY 11 POUNDS

The new Satellite Reader:

- weighs 11 pounds ■ has screen dimensions of 8 x 10½"
- utilizes a simple hand control for page scanning
- utilizes a no-threading film cartridge that holds 4,400 pages of data.

COMPLETE DATA!

The Satellite Reader not only is bringing a new look to engineering and design departments, but also has brought a new look within the total VSMF System itself. The immediate and enthusiastic acceptance of the Satellite Reader in field tests has resulted in the following system improvements:

- VSMF data on each vendor now will be COMPLETE, due to a new policy of including all of each vendor's catalog data at NO CHARGE to the vendor
- individual VSMF files have been broadened to better serve the needs of different specializations within the engineering field. The following files now are available:

VSMF Design Engineering File
 VSMF Plant Engineering Catalog File
 VSMF Documentation File
 VSMFMilitary Specifications File
 VSMFMilitary Standards File
 VSMF COMM-PAK Files, tailor-made to data storage and retrieval systems for an individual company's needs



ALL ENGINEERS A CLOSER LOOK

FOR ENGINEERING SPECIALISTS

Specialized sections of the above files also may be obtained separately, in the following categories:

■ **DESIGN ENGINEERING** . . . Electrical / Electronic / Fluid Systems / Instruments / Materials & Fasteners / Power Transmissions and Hardware / Production Equipment and Services

■ **PLANT ENGINEERING** . . . Electrical / Process Piping / Instrumentation & Control / Mechanical / Architectural & Structural / Materials Handling / Plant Operating Equipment & Materials

The VSMF System of Data Centers and Satellites saves time, space and money. More importantly, it helps improve engineering performance by providing vendor product information that is **ACCESSIBLE, UP-TO-DATE and COMPLETE.**

For more information on the all new VSMF System, including the exciting Satellite Reader, please call your VSMF representative, or write Information Handling Services, Inc., Denver Technological Center, Englewood, Colorado 80110. . . Dept. E624



Information

HANDLING SERVICES, INC.

DIVISION OF INDIAN HEAD INC.

“80 dB voltage gain in a 10.7 MHz FM IF Amplifier System from just this?”

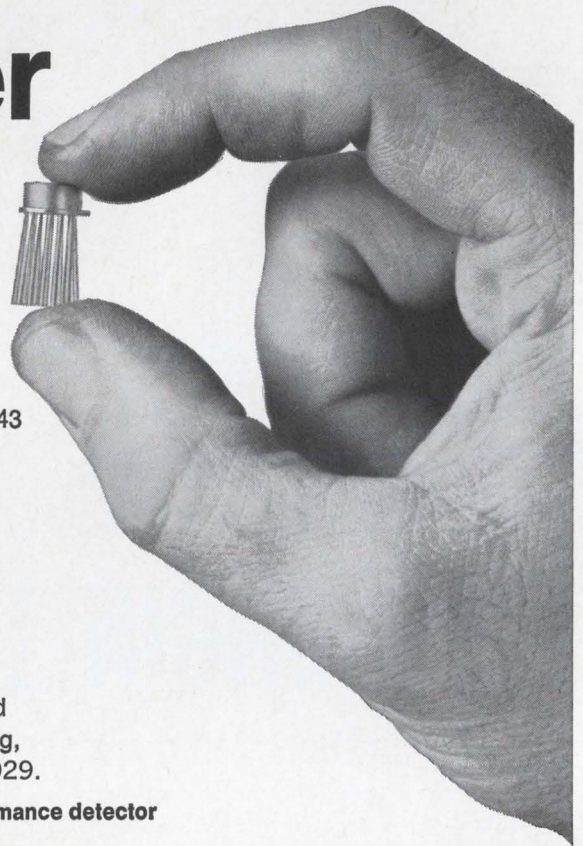

Yes—and an FM detector and audio pre-amp, too! It's the RCA-CA3043 for FM IF systems—a superb package that gives you 80 dB of IF voltage gain plus audio current gain in the audio pre-amp stage. All this—with an exceptionally low limiting (knee) of $50 \mu\text{V}$ and an internal AFC reference voltage. Detector efficiency is enhanced by the use of forward-biased diodes. The CA3043 is packaged in a standard TO-5 configuration for operation at full military temperature range of -55°C to $+125^\circ\text{C}$ —ready to go into your equipment for only \$1.60 per unit (1,000 units). Ask your RCA Representative for details. See your RCA Distributor for his price and delivery. For full technical information, write Commercial Engineering, Section ICN-6-2, RCA Electronic Components, Harrison, N.J. 07029.

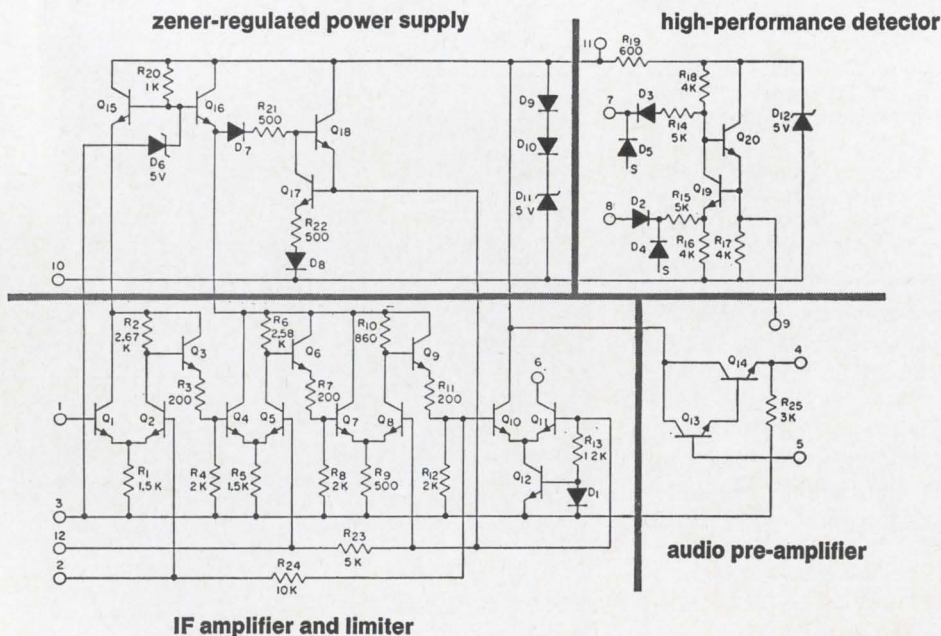

RCA Integrated Circuits

Editorial comment

NASA at the crossroads

Despite the unclear role the National Aeronautics and Space Administration will play over the next several years in meeting national goals, the agency's Electronics Research Center holds some definite ideas about its own directions.

Recently, Edward C. Welsh, executive secretary of the National Aeronautics and Space Council, warned that the Soviets have an orderly, persistent, and well-planned space program, including a "vigorous" project for a manned landing on the moon's surface. "They don't seem to be handicapped by fluctuations in their budgetary thermometer, as we sometimes are," Welsh noted.

The U.S. space agency, still reeling from budget cuts, faces additional attrition in its personnel. Added to that, a survey by the House Subcommittee on NASA Oversight did not paint a rosy picture of support for NASA programs.

Of 750 top industrial executives who received a questionnaire sent by the committee, 300 did not bother to reply. Among those who did, 35% thought the annual NASA budget too high, 27.4% thought the manned lunar landing project should be changed, and 9.8% thought it should be eliminated. When it came to ranking programs as to their importance in relation to national goals, space did not score well; national defense, for instance, and poverty and other social programs ranked higher.

On the other hand, a significant portion (75.3%) thought the contributions of the space program to technological progress in our industries were worthwhile.

NASA executives are in a dilemma. Should they emphasize mission-oriented programs or broader-based programs that utilize NASA-generated technology? Would trying to do both spread the agency's limited resources too thin?

An inkling of NASA's approach as far as electronics is concerned is gleaned from a sampling of the programs contemplated in the agency's Electronics Research Center for fiscal 1969 and beyond. Among the major ones are several in each of these areas: testing and diagnostics,

process control and simulation, standardization of software, time reference systems, and the development of circuit designers' manuals. Specific projects include the study of reflectometry techniques for testing IC's, combinatorial techniques for fault diagnosis of circuit arrays, and fault isolation and diagnosis in multiterminal electronic components.

In the area of process control, one work proposal concerns the modeling of a production line for IC's as a stochastic network; the model could be analyzed to help answer questions about the number of wafer starts required for a given production level, the optimum flow of wafers through each process step, and rework on rejected material. The research center is continuing its search for reasons why electronic components, particularly IC's, fail, and hopes to define the processes required to fabricate high-reliability semiconductor devices.

The proliferation of computer-aided circuit design programs—called the "software Babel" by NASA—now devours about \$100 million a year. NASA thinks the answer could be standardization and qualification of CAD programs. The construction of a network compiler could help here.

An example of NASA's leanings toward earth-oriented applications is a plan to study automatic in-flight identification of impending component failures in supersonic aircraft. The idea is to simulate on-board failures and corrective procedures. From such a study might come a recommendation to extend on-board computers or, alternatively, to use a ground-based system to do the job.

In still another project, the techniques already developed for Apollo countdown and performance optimization might be applied to automatic test, navigation, and air traffic control for manned aircraft, including V/STOL and supersonic types.

The NASA center is also concerned with developing prototype models of advanced clocks for use in standard time reference systems. Accurate time measurements are vital for telemetry, guidance, the clocking of instruments, collision avoidance, delay switches, and on-board experiments involving relativity.

If NASA is able to summon the money and manpower to carry out these ambitious studies, and others like them, the results could be of value not only in the short term to NASA itself but in the longer run to industry generally.



Toroid selection for pulse transformers used to be a nightmare.

But our ferrites have changed all that.

They're Pulse-Rated. A first for the industry.

The only toroids with specified characteristics for pulse transformer applications. Not just the usual irrelevant magnetic properties. Each part is designated as a pulse component, and listed by its pulse inductance, pulse magnetizing current and ET

product, according to ASTM methods.

We also guarantee all parameters. Every pulse transformer toroid we make is 100% tested. Performance reliability is assured from samples to production quantities. We make use of automatic high speed testers to guarantee these parameters.

It marks the end of trial and error spec'ing.

Especially for computer applications. The 230 mil diameter core is just the first in our series of PR toroids.

For literature or samples of our new PR toroids, write Indiana General Corporation, Electronics Division/Ferrites, Keasbey, N. J. Pleasant dreams.



INDIANA GENERAL

Making Magnetism Work

Electronics Newsletter

June 24, 1968

Philco giving up on MOS calculator

Philco-Ford's Microelectronics division seems ready to call it quits on the Victor 3900 calculator, the MOS machine that the company has been building for Victor Comptometer of Chicago [Electronics, March 6, 1967, p. 231].

Introduced with great fanfare as the first true desk-top calculator in late 1965, the 3900 has been the hope and despair of the old General Micro-electronics Inc. and the Philco-Ford Corp. that acquired it early in 1966. Engineers at first experienced great difficulty in making the extremely complex IC's, and after many false starts, the calculator went into production last fall. But Victor has complained lately that production problems have kept shipments below its requirements.

A Victor spokesman said that neither he nor anyone else in the company had been informed of Philco's move. However, it's known that the two companies are negotiating to end the contract, and Philco has already shut down its production line.

The plant, part of Philco's Santa Clara, Calif., complex, will reportedly be used for the production of diodes and rectifiers for the automotive market. The new divisional plan that Microelectronics boss John R. Welty will present to Philco-Ford next month will emphasize penetration of the auto market as well as stress in bipolar IC's.

Reports that Philco will get out of MOS entirely were denied by the firm. The Microelectronics division will concentrate on a standard line of MOS products to be manufactured at Santa Clara. Philco's MOS R&D work has been transferred from Santa Clara to Blue Bell, Pa.

Reconnaissance job seen for big vidicon

A vidicon with a sensitive area, or "target," 70 millimeters in diameter may form the core of an advanced television sensor system for air reconnaissance. Under a partially classified, \$1.2 million Air Force research contract, RCA will develop a flight version of a tube already demonstrated in the laboratories.

The target, perhaps the largest of its kind, suits the tube to ultra-high-resolution operations. A source at RCA's Aerospace division in Burlington, Mass., expects a level of 6,000 lines and describes this as "competitive with photography."

Since resolution may be two or three times higher than that of present military systems, RCA is expected to develop complementary displays capable of reproducing images as sharply as its vidicon can record them.

Litton seen tapped for prototype of guidance system

Chances are slim that the Air Force will be able to fund two contractors to develop flight-prototype systems for the doppler inertial loran (DIL) program. Project officials concede they lack the money to contract with a second source.

A contract to build the prototype and fly it on an F-106 in a 30-month program is expected to go to Litton's Guidance and Control Systems division, which was low bidder in the final go-round. Two competing companies, funded by the Avionics Laboratory, Holloman Air Force Base, N.M., to do feasibility studies, were Teledyne Systems and Kearfott.

The multisensor system, aimed at improving navigational and weapon delivery accuracy, would be a candidate for incorporation into new tactical aircraft—the FX, for example.

Electronics Newsletter

New Raytheon crt is small but bright

A new projection cathode-ray tube that's about a fifth the diameter of the brightest tubes now available but is nearly as brilliant has been developed in-house by Raytheon's industrial components operation in Quincy, Mass. The five-inch-diameter tube might replace the present 24-inchers that have to use costly and complex Schmidt optics—lens-reflectors much like those used in some astronomical telescopes.

The big tubes with their complex optics are capable of outputs of 15,000 to 20,000 foot-lamberts, but Raytheon's tube has already achieved 10,000 to 12,000 foot-lamberts without mirrors or lenses. The secret lies in the new tube's faceplate material; heat is quickly conducted away from the phosphor, and this allows the generation of more light by powerful electron beams without over-heating and destroying the phosphor.

Raytheon is aiming the tube at such applications as the Naval Tactical Data System and computer displays.

Defense firms hope antitrust probers will tread softly

Defense contractors are becoming increasingly uneasy about the current Congressional inquiry into the antitrust implications of military procurement. Particularly under scrutiny are the 100 companies and their sub-contractors that account for 65% of the \$40 billion in defense orders awarded each year.

The chairman of the Senate antitrust and monopoly subcommittee, Phillip A. Hart (D., Mich.), says the hearings are aimed at determining whether more competition would cut defense costs. More than 50% of defense contracts are let without competition.

Industry spokesmen note that what the Senators may fail to realize is that the choice of suppliers is limited in the case of sophisticated weapons, and that competition in this area exists more in technology than in price.

New copyright bill is next for CATV

Cable-television operators, buoyed by the Supreme Court's ruling that they needn't pay fees for copyrighted programs, still have another hurdle to clear. CATV interests, film producers, and broadcasters must hammer out an agreement that can be used in the formulation of a new copyright bill to cover CATV. This move was asked by Sen. John L. McClellan (D., Ark.), chairman of the Senate patents subcommittee. It is doubtful that Congress will take up the issue this year, but broadcasters and film producers will undoubtedly be clamoring for action in the next session of Congress.

Pentagon to keep closer tabs on contract efficiency

The Pentagon may start running efficiency checks on contractors whose design and engineering prices seem out of line. The decision stemmed from a Navy efficiency team's discoveries at the Pratt & Whitney division of United Aircraft. Pratt & Whitney originally estimated the costs for F-111 jet engines at \$273,000 each, but after production started the figure soared to \$700,000.

Navy inspectors, ordered in by the Pentagon, found inefficient use of manpower and machines and poor managerial decisions on whether to make or buy parts. This inspection marked the first time the military insisted on going beyond costs to check efficiency. Usually in a negotiated fixed-priced incentive contract, the Pentagon is concerned only with the accuracy and completeness of cost estimates and with striking a bargain on fair profits.

SEMICONDUCTOR NEWSBRIEFS

PUBLISHED BY MOTOROLA SEMICONDUCTOR PRODUCTS INC.

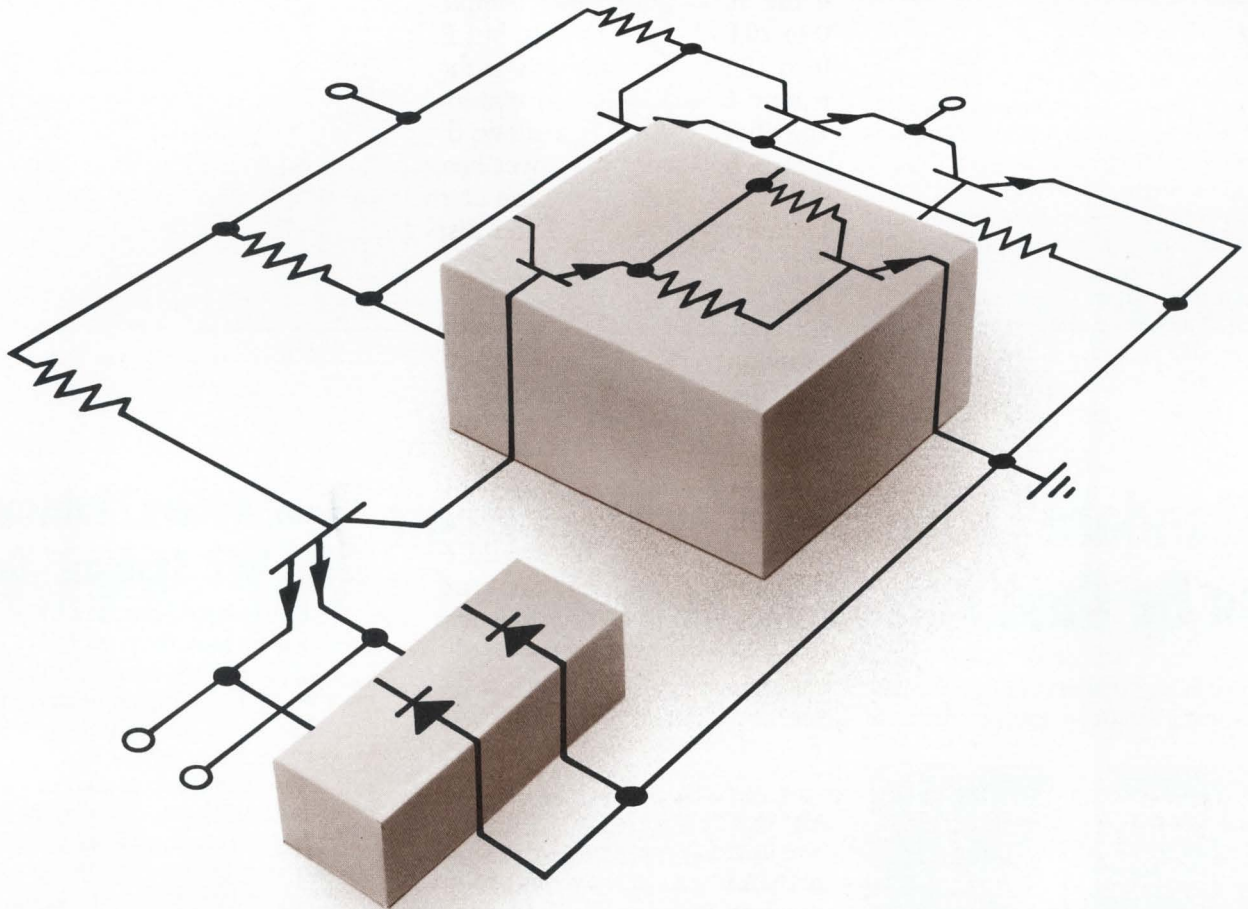

3rd GENERATION TTL SOLVES TRANSFER, "RINGING" PROBLEMS!

The MTTL III line of integrated circuits provides a "whole new ball game" for the logic designer who likes the speed and capacitance drive features of TTL, but can't live with some of its inherent

problems — namely, a less than optimum voltage transfer characteristic and a tendency for "ringing." MTTL III circuits employ an internal bypass network, which eliminates the extra breakpoint in

the transfer characteristic of conventional TTL. Diodes have also been added to the input to limit ringing.

The MC3000 MTTL III series consists of 18 functions in the 14-pin Uni-bloc plastic package and TO-86 flat-pack (0° to 75°C). Included are AND, NOR, OR, series-terminated line driver and power gates, as well as five flip-flops, consisting of a dual "D" and single and dual J-K types — one of these being a master-slave unit similar to those found in DTL. The flip-flops are edge-triggering rather than storage devices as in standard TTL, eliminating the need for minimum-width clock pulses.

All the gates are pin compatible with 74HN types, except for the single 8-input gate. Prices range from \$1.85 for the MC3000P to \$2.95 for the MC3052 and \$4.70 for the MC3060/61/62 (1000-up).

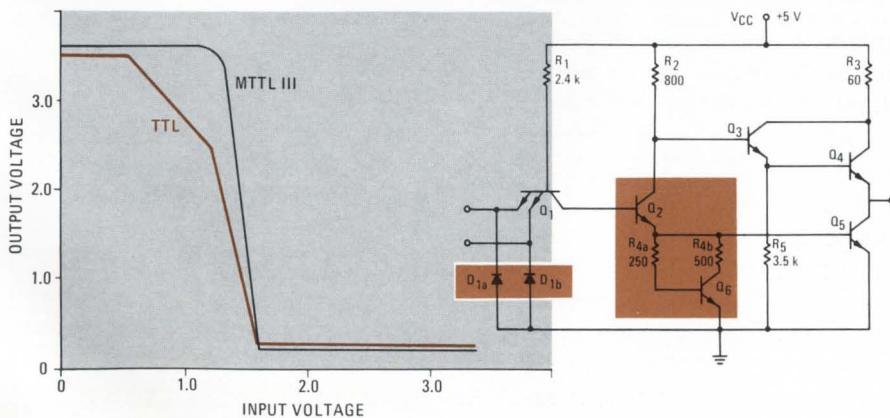

For details circle Reader Service No. 316

New Dual Diff-Comparators Double Design Dexterity

Two new dual differential-voltage comparators, the MC1711 and MC1711C, are now available to simplify level detection, low-level sensing and memory applications.

Both types provide typical input offset voltages of only 1.0 mV and offset voltage drift is a low $5\mu\text{V}/^\circ\text{C}$ (typ). Their low-level differential input characteristics, coupled with a typical fast response time of 40 ns, make them ideal for functions such as voltage comparators, variable threshold Schmitt triggers and pulse height discriminators.

Their outputs are compatible with all saturated logic forms — as indicated by a typical V_{out} range of +4.5 V to -0.5 V. In addition, output impedance is specified at 200 ohms; and, their unusually high voltage gain (for a differential com-

parator) is 1,500 typ. The MC1711 operates over the full -55 to $+125^\circ\text{C}$ range, while the MC1711C is spec'd for 0 to $+75^\circ\text{C}$ operation.

Package Types	Prices (100-up)	
	MC1711	MC1711C
TO-100 ("G" suffix)	\$13.50	\$7.00
TO-86 ("F" suffix)	13.50	7.00
Unibloc ("P" suffix)	N.A.	6.50

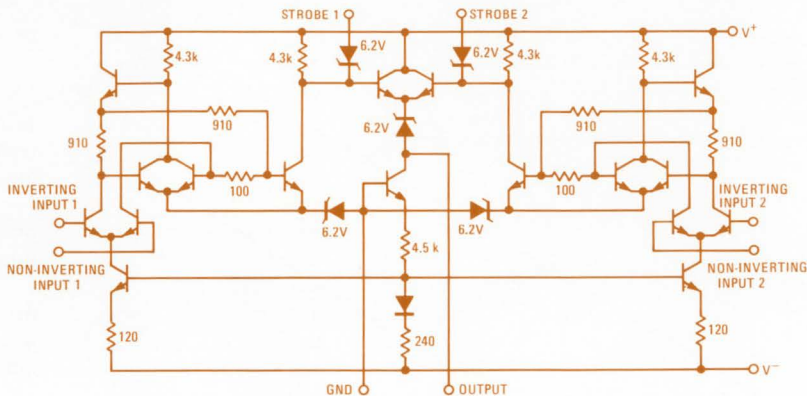

For details circle Reader Service No. 317

"Standard" 12-Gate Array MSI Circuit Can Be Customized To Your Specs!

You can now design your own second-layer metallization using the new

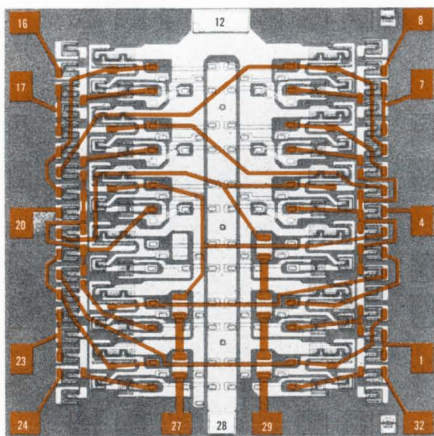

Design your own interconnect pattern as illustrated in this 4-channel clocked latch.

Motorola XC157 12-gate array to form complex monolithic integrated circuit functions such as a 4-bit compare circuit, a quad exclusive OR, a 4-channel clocked latch or a dual "D" flip-flop, to name just a few.

The XC157 is a form of MSI in which the first metallization layer provides intraconnection of each gate leaving the

logic input diodes and output load resistors uncommitted. You design the second layer of metallization to complete the diode resistor intraconnections along with gate-to-gate interconnections. In all, the XC157 array represents a significant and necessary step toward the accomplishment of *economically feasible large scale integration!*

This array is designed for medium-speed computer applications with propagation delays on the order of 20 to 30 ns per gate. The second layer of metallization may also be used to connect two or four adjacent arrays to form larger monolithic circuits encompassing up to 48 gates. These large-scale arrays may be supplied in the same 32-pin flat-pack used to house the basic 12-gate array.

To simplify second-layer metallization design, the comprehensive data sheet for the XC157 includes the array schematic, a diagram showing available "nodes" and a list of design rules — all that's needed to develop complete interconnection patterns.

Costs range from \$25 to \$40/unit with a "first lot charge" of \$2,000 to \$5,000 for masking and test set-up, depending on the complexity and type of requirement. Delivery time is about eight weeks.

For details circle Reader Service No. 318

Dual Adders/Subtractors Cut RTL Systems' Costs

Two complex-function I/Cs have been added to Motorola's MRTL line which offer a very low power dissipation of 70 mW (typ). They provide for greater design flexibility as well as lower your systems' fabrication costs.

The MC996 series dual full adder is a 18-gate array that provides the SUM and CARRY functions while requiring only (A) and (B) inputs with CARRY IN.

The dual full subtractors (MC997 series) provide the DIFFERENCE and BORROW functions while requiring only (X) and (Y) inputs with BORROW IN.

These MRTL circuits are available in four full operating temperature ranges (-55 to $+125^\circ\text{C}$; 0 to $+100^\circ\text{C}$; 0 to $+75^\circ\text{C}$ and $+15$ to $+55^\circ\text{C}$). The MC996/997, MC896/897 and MC796/797 come in the TO-86 flat-pack and operate at -55 to 125°C (MC996/7), 0 to $+100^\circ\text{C}$ (MC896/7) and $+15$ to $+55^\circ\text{C}$ (MC796/7). The MC896/897 and the MC796/797 also come in the Unibloc package (0 to $+75^\circ\text{C}$ and $+15$ to $+55^\circ\text{C}$).

MRTL TYPES	TO-86 (100-up)	Unibloc (1000-up)
MC796/797	\$ 8.00	\$3.75
MC896/897	8.75	4.20
MC996/997	13.00	N.A.

For details circle Reader Service No. 319

1/2 μ s Memories With Dual I/C Sense Amps = MC1541F

Two channels on the input of the new MC1541F make it possible to reduce by as much as one-half the number of I/C sense amp packages required for 0.5 μ s core memory applications. Either input can be gated "on" to provide immediate signal detection without interference from unwanted warm-up signals.

Basically a dual-gated sense amplifier (with differential input amplifiers), the MC1541F, also features adjustable threshold, saturated logic output levels, and a strobe input that accommodates saturated logic levels.

In addition, a built-in reference voltage and separate threshold adjustment make it possible to easily check voltage levels so that the threshold setting can be less sensitive to power supply variations. Further, it exhibits a 6 mV threshold range, for greater accuracy.

Packaged in the TO-86 flat-pack (-55 to $+125^\circ\text{C}$) it is priced at \$18.00 in 100-up quantities.

ELECTRICAL CHARACTERISTICS	Min	Typ	Max
Input Threshold Volt. (mV) $T_A = +25^\circ\text{C}$ $T_A = -55^\circ\text{C}, +125^\circ\text{C}$	14 12	17 17	20 22
Input Offset Voltage (mV)	—	1.0	6.0
Propagation Delay (ns)			
Input to Ampl. Output	—	10	15
Input to Output	—	20	30
Strobe to Output	—	15	20
Gate Input to Ampl. Input	—	10	15
Gate Input to Ampl. Out	—	30	35
Common Mode Range (V)			
Input Gate High/Low	—	1.5	—
Differential Mode Range (V)			
Input Gate High	—	± 0.6	—
Input Gate Low	—	± 1.5	—
Power Dissipation (mW)	—	140	180

For details circle Reader Service No. 320

MC1539 ... THE BEST I/C OP AMP YET!

Motorola's MC1539 integrated circuit operational amplifier (and MC1439) set a new industry standard of performance — out-distancing both the popular MC1709 type as well as the more recently announced 101 Op Amp.

These state-of-the-art Op Amps offer six distinct advantages:

1. Input Offset Voltage 2.0 mV lower, requiring less bias compensation.
2. Input Offset Current is almost an order of magnitude better, for high input impedance designs.
3. Large Power Bandwidth—allows full output swing at high frequencies (see illustration).
4. Built-in Output Short-circuit Protection (reduces human-error), and Input Over-voltage Protection, for higher transient suppression.
5. Twice the minimum Gain over the full operating temperature range, for high performance with optimum stability.
6. Fast Slew Rate — typically $34 \text{ V}/\mu\text{s}$ at $A_V = 100$ (twice as high as the MC1709 and 101 types) makes the MC1539/1439 ideal for comparator applications which require extremely fast "slew rates."

As added frosting on the cake, the MC1539/1439 employ the same pin configuration as the MC1709 and 101 types. And, you don't have to pay premium prices for this top-performance Op Amp!

Both units come in the 8-pin, TO-99 metal case. 100-up prices: MC1539G—\$12.00; MC1439G—\$7.50.

Key Parameters	MC1709 Type	101 Type	MC1539
Power Bandwidth (@ $V_{OUT} = 20V_{P-P}$)	4kHz (typ)	10kHz (typ)	50kHz (typ) 20kHz (min)
Minimum Open Loop Voltage Gain (A_{VOL}) (-55 to $+125^\circ\text{C}$)	25,000	25,000	50,000
Input Offset Voltage (V_{IO})	5mV (max)	5mV (max)	3mV (max)
Input Offset Current (I_{IO})	200nA (max)	200nA (max)	60nA (max)
Input Bias Current (I_{IB}) (-55 to $+125^\circ\text{C}$)	1500nA (max)	1500nA (max)	700nA (max)

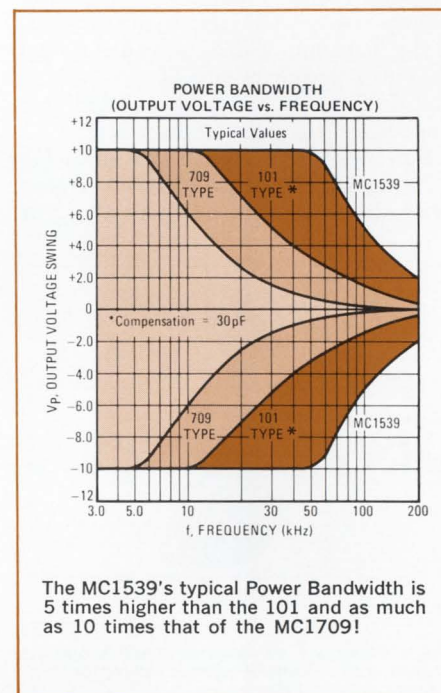

The MC1539's typical Power Bandwidth is 5 times higher than the 101 and as much as 10 times that of the MC1709!

For details circle Reader Service No. 321

Complex-Function MECL II I/Cs Reduce System Costs Up To 30%!

Recent price reductions for all MECL II circuits plus the minimizing of "package-count" (made possible by their complementary outputs and high fan-out) and the introduction of new complex-function types, now provide for a substantial lowering of total system costs. It is conservatively estimated that the system designer can now save 30%, or more, and still enjoy the benefits of the world's fastest, most advanced I/C logic form.

Use MC1029/1229 to Cut Down Wiring and Package-Count!

This data distributor, a 2-by-3 array of 2-input OR gates, utilizes negative logic. (That is, the positive OR function becomes the negative AND.) Its typical propagation delay is just 5.0 ns, permitting rapid data transfer. The accompany-

ing diagram illustrates one manner in which the MC1029 can be used to reduce wiring requirements and package-count.

Quad Exclusive OR and NOR Gates.

MC1030/MC1230 quad Exclusive OR gates are high-speed circuits that employ

Register data transfer system — using two MC1029/1229 MECL II I/C's

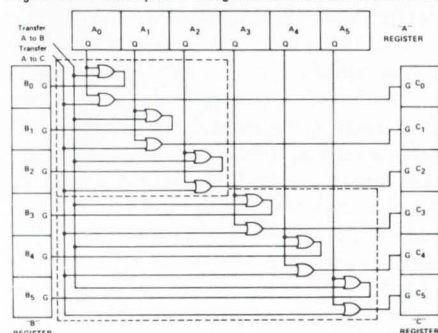

For details circle Reader Service No. 322

the series gating technique, while the MC1031/MC1231 are their NOR gate counterparts. These devices are generally useful for data comparison, parity generation and checking, decision circuitry and frequency mixing.

MECL II TYPES	P_D (Typ)	Prices	
		"P" (1000-up)	"F" (100-up)
MC1029P MC1229F	160 mW	\$2.60	— \$5.50
MC1030P/31P MC1230F/31F	130 mW	\$3.95	— \$7.75

They are available in the Unibloc plastic case (0 to $+75^\circ\text{C}$), and the TO-86 ceramic flat-pack (-55 to $+125^\circ\text{C}$).

30 Amp NPN Silicon Power Transistors Now Pair-Up With Popular PNP Counterparts!

30 amp, 200 watt silicon power NPN/PNP complements — yesterday just a hope . . . today an “off-the-shelf” reality!

With the advent of the 2N5301/02/03 NPN series, designers can realize substantial savings by utilizing complementary symmetry in their high power circuitry. In addition to reducing component costs and simplifying designs, these 30 amp devices provide a high degree of frequency stability for both ac and dc driven loads, without additional impedance-matching transformers.

The new NPN 2N5301-03 series (as well as the PNP 2N4398/99 types) dissipate up to 200 watts with V_{CEOS} of

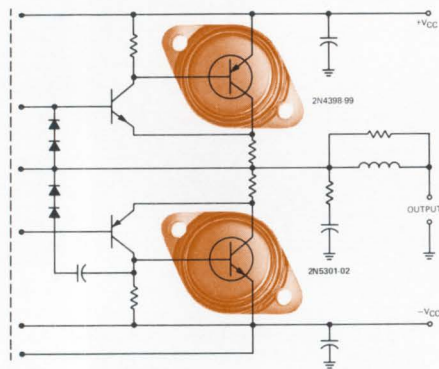

Complementary silicon power-pairs obviate “totem pole” output stages, complex bias adjustments and circuitry.

40, 60 and 80 volts, enabling direct, plug-replacement of germanium types in “extra tough” amplifier, voltage regulator and modulator designs. There’s also no need to sacrifice speed for power in switching applications, due to 400 ns typ. delay and rise-time (@ 10 A, 30 V). And, efficient, low-power-loss, low distortion performance is ensured by a low saturation voltage at high current levels.

Add excellent gain linearity over an I_C range of 5-20 A, peak surge current of 50 A, 200 W power dissipation @ $T_C = 25^\circ\text{C}$, a typical f_T of 4 MHz, rugged TO-3 cases — and you’ve got the right combination of parameters to assure that your power amplifier designs are tops in performance and reliability.

Types		V_{CE0} (sus)	f_{FE}	$V_{CE(sat)}$ (max)	Prices (100-up)	
NPN	PNP				NPN	PNP
2N5301	2N4398	40 V	15/60 @ 15 A	1.0 V @ 15 A	\$ 4.60	\$7.50
2N5302	2N4399	60 V	15/60 @ 10 A	1.0 V @ 10 A	5.10	9.05
2N5303	—	80 V	—	—	12.00	—

For details circle Reader Service No. 323

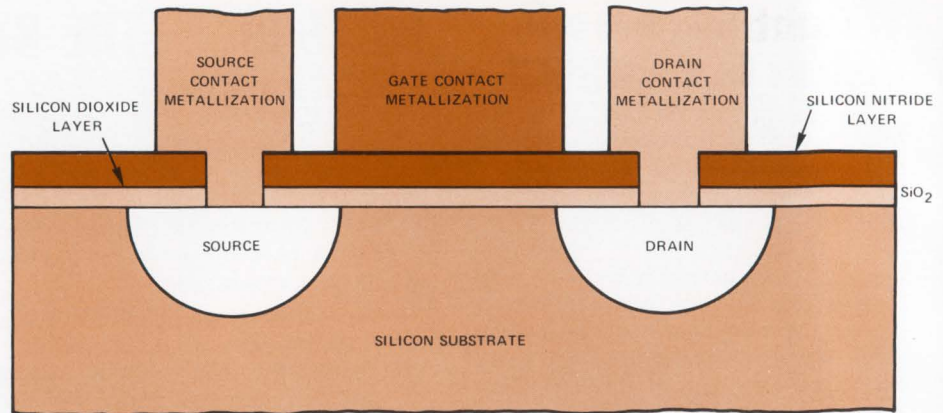

Temperature-Stable Silicon Nitride MOSFETs Now a Volume Production Reality

Motorola has developed a reliable and repeatable production technique for silicon nitride passivation which it is now using in the volume fabrication of MOS field-effect transistors — to assure parameter stability even under high temperature and reverse bias conditions.

Although silicon nitride has been used in the laboratory for some time to reduce sodium ion contamination problems inherent in MOS devices, it has been difficult to employ on a volume production basis. Now, through a Motorola processing breakthrough, silicon nitride passivation is being applied to mass-produced MOSFETs.

Sample lot testing has indicated that even when subjected to *reverse bias at 200°C for 1,000 hours*, the silicon nitride passivated MOSFETs’ parameters re-

mained stable (standard MOS devices using only SiO_2 passivation have exhibited shifts in their operating points when subjected to this stringent test). The severity of this test is so great it has been said to present to the device, a challenge similar to “a man going over Niagara Falls in a rowboat!”

The new and proprietary silicon nitride passivation process has now been incorporated in all Motorola’s MOSFET lines including:

- 2N4351/52; 2N3796/97
- 3N155/56/57/58
- MFE3001/02/03/04/05

Motorola distributors have been stocked with silicon nitride MOSFET units, and “volume requirements” are immediately available from the factory.

For details circle Reader Service No. 324

HV Ge. Power Units Up Inverter, Switching Circuits’ Performance

Designers of power switching, inverter, deflection and power supply circuits will find that the new 2N5324-25 epitaxial-base, high-voltage germanium power transistor series will give them more of what they’ve been looking for in peak performance parameters!

For example, they feature a low-collector cutoff current — only 7.0 mA max. — at very high voltages, along with low saturation voltages at $I_C = 10$ amps and fast switching speeds, also at high-current levels . . . And, that’s only a starter! They also deliver a minimum dc current gain of 20 at 5.0 amps and can dissipate a full 56 watts of power at $T_C = 25^\circ\text{C}$.

Talk about safe operating areas . . . their high sustaining voltages — $V_{CER(SUS)}$

— is pegged at both 3 and 10 amps, spec’d where you really need it for most critical power designs!

Factor in a current-gain-bandwidth product of 2.0 MHz min. and feather-light all-aluminum TO-3 package — plus the fact that *every unit* has undergone an elevated 125°C “bakeout” for 100 hours (to assure stable, drift-free performance) and you’ll find that these new germanium power devices can supply a parameter mix that’s hard to come by, at any price.

Key Parameters	2N5324	2N5325
High V_{CB} Ratings (min)	250V	325V
Low I_{CEX} @ High V_{CEX} (max)	7.0mA @ 250V	7.0mA @ 325V
High h_{FE} @ High I_C	20-60 @ 5.0A	
Low $V_{CE(sat)}$ @ $I_C = 10A$	0.5V (max)	
Low $V_{BE(sat)}$	0.75V (max)	
High P_D @ $T_C = 25^\circ\text{C}$	56W	
Fast Switching Speeds @ High I_C (5.0A) (max)	$t_r = 15\mu\text{s}$ $t_s = 10\mu\text{s}$ $t_f = 7.0\mu\text{s}$	
Low Prices (100-up)	\$3.00	\$4.00

For details circle Reader Service No. 325

Tightly-spec'd 2:1 I_{DSS} Ratio JFETs Eliminate Guesswork Design

Now, for the first time, engineers can utilize the inherent performance benefits to be derived from field-effect transistors yet, take the guesswork out of their amplifier designs. A new JFET series, types 2N5265-70, which is closely characterized by a Designers Data Sheet, provides guaranteed 2-to-1 I_{DSS} ranges. Presently,

most comparable devices carry at least a 3-to-1 and some as high as a 5-to-1 ratio, in this key parameter.

Gain being a function of I_{DSS} , these new FETs also operate at comparably high Y_{fs} ranges, an assurance of high bias stability. In addition, their high breakdown voltages ($BV_{GSS} = 60\text{ V}$) allow them to be used over a broad range of operating conditions with less chance of failure due to surges.

The Designers Data Sheet, describing the 2N5265-70 series, contains a full complement of minimum, maximum and typical design curves. You can now stop worrying about the performance of any of these devices even when operating under conditions other than major test-

For details circle Reader Service No. 326

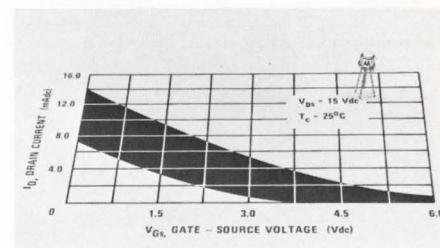

This curve for the 2N5270 illustrates the tight 2-to-1 I_{DSS} ratio offered by the new 2N5265-70 JFET series.

points.

Characterized as general purpose amplifiers, these p-channel devices also serve in many switching applications. All are available in the TO-72 package.

Type No.	$V_{GS(off)}$ (V) Max.	$I_{DSS}(mA)$ Min.-Max.	$Y_{fs}(\mu mhos)$ Min.-Max.	Prices (100-up)
2N5265	3.0	0.5-1.0	900-2700	\$5.40
2N5266	3.0	0.8-1.6	1000-3000	5.10
2N5267	6.0	1.5-3.0	1500-3500	4.80
2N5268	6.0	2.5-5.0	2000-4000	4.50
2N5269	8.0	4.0-8.0	2200-4500	4.80
2N5270	8.0	7.0-14.0	2500-5000	5.10

Plastic NPN/PNP Ampl. High In Low-Level Performance!

How low can an amplifier go and still be a high gainer? Try Motorola's NPN 2N5209/10 and PNP 2N5086/87 complementary silicon Annular plastic transistors the next time you have a low-noise, low-current high-beta application and see for yourself just how high performing a low-level amplifier can get!

And, they're low in price — housed in the TO-92 Unibloc plastic package — yet so rugged and dependable.

Useful in most any high-gain low-noise pre-amplifier and predriver application, these versatile transistors take the high-cost out of low-level amplifier designs without sacrificing performance and reliability. And, as they can be used in complementary schemes, you can simplify circuitry and reduce component count. Compare these highlights:

• Low 1.0 kHz Noise Figures (max)

NPN	PNP
2N5209 — 4 dB	2N5086 — 3 dB
2N5210 — 3 dB	2N5087 — 2 dB

• Low I_{CBO} — 10 nA (max) @ 10 V

• Low C_{ob} — 4.0 pF @ 5 V/100 kHz

• Low f_T (typ) —

2N5209/10 — 80 MHz | 2N5086/87 — 130 MHz

• High h_{FE} @ Low I_C (100 μA)

2N5209 — 100/300	2N5086 — 150/500
2N5210 — 200/600	2N5087 — 250/800

• High BV_{CEO} — 50 V (min)

• Prices (5,000-up)

2N5209 — 31¢	2N5086 — 35¢
2N5210 — 34¢	2N5087 — 38¢

But don't take our word for it. Try them yourself. Your distributor has both the PNP and NPN versions in stock and we can deliver large quantities in "quick-time" from the factory.

For details circle Reader Service No. 327

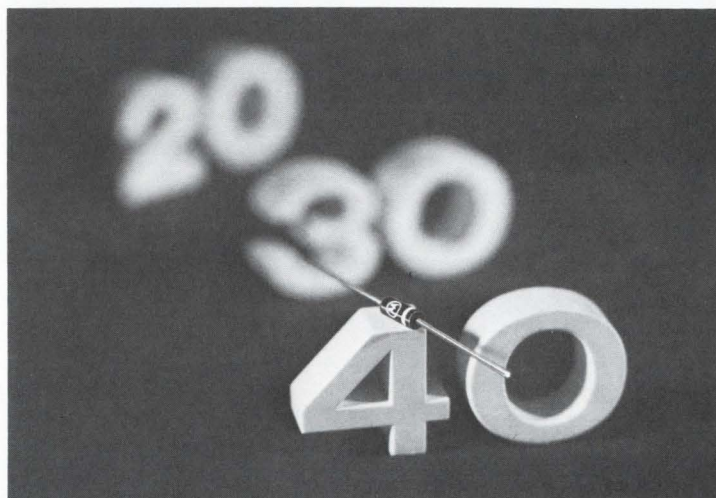

40-mil lead Surmetic zener diodes now join the popular Surmetic 20 (500 mW) and Surmetic 30 (1.0 W) series, upping power handling capabilities to 5 watts — to serve a wide range of economy applications.

Move Over, Costly Stud Units... Here Come Surmetic '40' Zeners!

You've got an application need for a $\pm 5\%$, 5-watt zener diode that will handle non-repetitive square wave surges to 180-watts maximum. It has to be rugged, reliable, and reasonably within your budget. You'd like it to have low leakage. You specify a 10-watt stud zener diode, right?

Wrong!

The new 1N5333-88 plastic, axial-lead Surmetic '40' zener diode will do *everything* a stud device could do in an application like this, plus give you these impressive advantages:

- **Low-cost** — 100-up prices are *one-half* comparable-performing stud devices! (Only \$1.85 for voltages up to 100 V, $\pm 5\%$ tolerances.)
- **Superior surge capability** — up to 300% better than published ratings

for comparable plastic units and up to 4 times greater than the Mil-spec for metal 10-watt units!

- **Oxide-passivated junctions** — only from Motorola!
- **Mounting freedom** — you can choose any position or mounting arrangement without special clips or terminals. In accordance with the proposed new JEDEC method of rating power capability in terms of lead length/temperature, the Surmetic '40' will easily dissipate 5-watts @ $T_L = 75^\circ C$ (measured $\frac{3}{8}$ " away from body).

The new series has over 40% greater power capability than similar plastic units, under equal conditions... and leakage is up to 20 times (50 nanoamps) less!

For details circle Reader Service No. 328

DUAL MONOLITHIC PREAMPLIFIER INTEGRATED CIRCUIT

— Provides 2-in-1 Package Convenience And Cost Savings!

The new MC1303P, consisting of **two** amplifier circuits on a single monolithic chip, is designed primarily for compact, low-signal-level applications. Its dual circuitry makes it readily adaptable to multiple function use (as illustrated), to afford savings in space, parts, and assembly time, as well as increasing efficiency.

Some of the outstanding specifications that contribute to the performance of this unusual dual linear I/C are (per each amplifier):

- Low Noise Input Voltage — 0.5 μ V (typ)
- High Open-Loop Voltage Gain = 8,000 (min)
- Large Output Voltage Swing — 4.5 V_{rms} (min)
- Wide Channel Separation = 60 dB (min) at 10 kHz

The MC1303P comes in the 14-lead dual in-line Unibloc plastic package; and, is priced at only \$3.50 (100-up) — just \$1.75 per amplifier circuit!

For details circle Reader Service No. 329

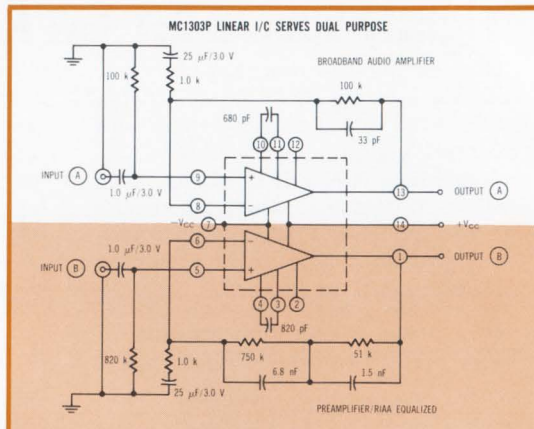

LOW-VOLTAGE MPT20 SILICON BILATERAL TRIGGER

— For High Turn-On Stability, Low Power Consumption And Economy!

Motorola's MPT20 silicon bilateral trigger sets a new level in state-of-the-art solid-state power control designs.

This unique bi-directional switching device, although priced at just 45¢ (100-up), triggers at breakover voltages of only 20 volts \pm 4 V, allowing "firing" of thyristors early in their conduction cycle — reducing their power consumption and assuring reliable performance by minimizing internal heating conditions. And, the MPT20's high bilateral breakover current of 35 μ A (typ.) ensures stable turn-on with less "jitter" (oscillation at switching point). It also provides lower sensitivity to transients and improved ability to remain stable even when operating under high ambient temperature conditions.

The MPT20 can handle peak current pulses of up to 2 amps. Its Annular die structure and rugged Unibloc plastic package assures reliable, long-term performance over a wide temperature range of -40 to +100°C.

For details circle Reader Service No. 330

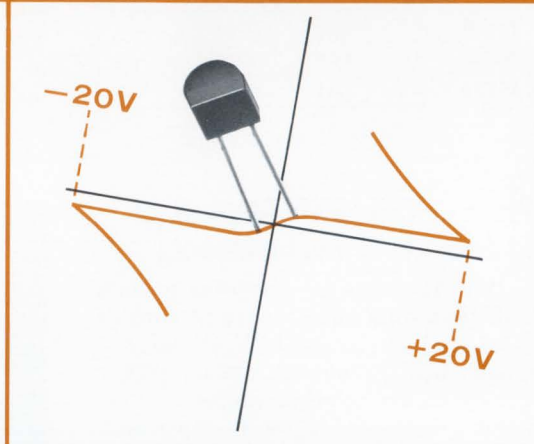

MULTI-CELL II POWER RECTIFIER BRIDGES

— Offer High-Current, Heavy-Duty "Plug-In" Convenience

Six new Multi-Cell II power rectifier bridges — extensions of the unique, Motorola-originated, power-device-paralleling concept — completely eliminate guesswork in the troublesome diode-to-heat-sink engineering interface. Each unit is bus-bar-ready without intermediate heat sinking and/or assembly steps. V_{RM} range: 50 to 400 V.

	1 ϕ Half Wave Bridge		1 ϕ Full Wave Bridge		3 ϕ Full Wave Bridge	
Type Number	MR2080HA	MR2100HA	MRA130	MRA160	MRA330	MRA360
Avg. Output Current (I _o)	750 A	1,000 A	300 A	600 A	300 A	650 A

For details circle Reader Service No. 331

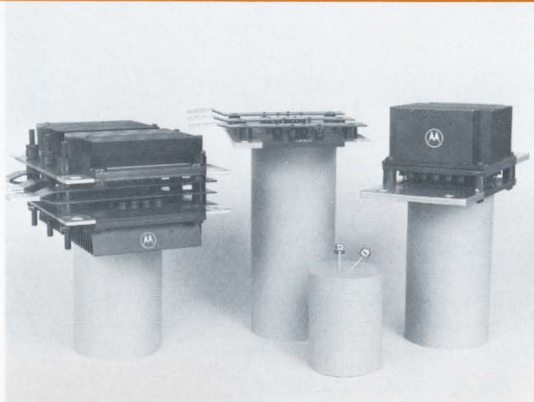

NPN/PNP SILICON DUAL AND QUAD CORE DRIVERS

— Cut Space Requirements In Fast Switching and Driver Circuits

Need maximum component density and minimum lead inductance in your medium-current high-speed switching and core driver designs? Then, evaluate Motorola's latest dual and quad NPN/PNP silicon Annular transistor offerings. They're available in three case styles: a 6-lead low-profile metal can and the TO-89, 6-lead ceramic flat pack for the dual types — and, the TO-86, 14-lead flat pack for the quad devices.

The individual transistors feature exceptionally fast switching characteristics — even at collector-currents of 500 mA — with high breakdown and low saturation voltages.

Type Nos.		P _D	BV _{CEO} (min)	t _{on} (typ)	t _{off} (typ)	f _T (typ)	C _{ob} (max)	V _{CE(sat)} (max)
NPN	PNP	@ T _A = 25°C	@ 10 mA	@ 500 mA		@ 50 mA/10 V	@ 10 V/100 kHz	@ 500 mA
MD3725 (Dual)	MD3467 (Dual)	600 mW (both sides)	40 V	25ns	50ns	300 MHz (NPN)	10 pF (NPN)	0.52 V (NPN)
MD3725F (Dual)	MD3467F (Dual)	350 mW (both sides)				250 MHz (PNP)	20 pF (PNP)	0.50 V (PNP)
MQ3725 (Quad)	MQ3467 (Quad)	500 mW (4 devices)						

For details circle Reader Service No. 332

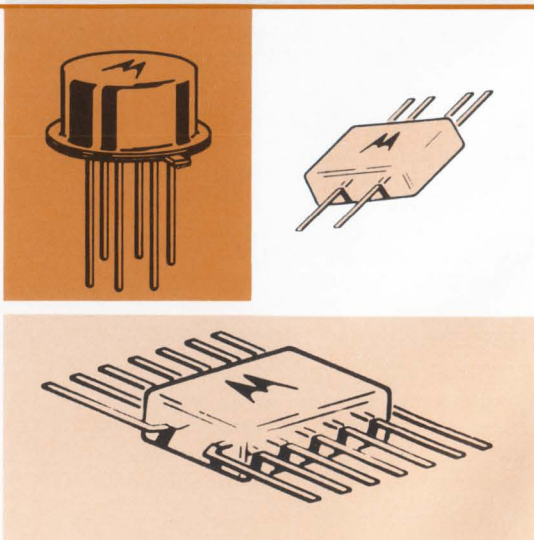



- MEG-A-LIFE
- JAN
- JAN-TX
- S1N

HI-REL RamRod ZENER AND TC REFERENCE DIODES

— Now Supplied To Meg-A-Life, JAN, JAN-TX or S1N Specs

There are now *four* ways to specify 400 mW RamRod glass zener diodes for your hi-rel applications, among them the advanced Meg-A-Life program that offers you a choice of three ascending levels of reliability. Initial reliability and test procedures are standard — 100% processing and electrical tests plus sample-life and environmental tests. And, fast delivery is virtually guaranteed from inventory! Units can also be supplied to standard JAN, JAN-TX, S1N specifications, or other special hi-rel requirements.

Hi-Rel Spec	IN4370-72A	IN746-59A	IN761-69A	IN962-92A	IN821-29	IN3154-57	IN935B-39B	IN941B-44B
M-L (Level III)*	X	X		X	X	X	X	X
JAN*	X	X		X	X	X	X	X
JAN-TX*	X	X		X	X	X	X	X
S1N†		X	X					

*MIL-S-19500/127D/117C/156D/157E/158E/159C

†85M01308 or 85M01646

For details circle Reader Service No. 333

MOTOROLA PNP GERMANIUM HIGH-FREQUENCY AMPLIFIER

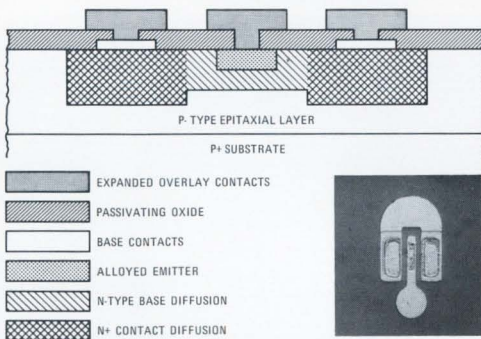

GERMANIUM HIGH-FREQUENCY AMPLIFIER TRANSISTORS

— Feature Both Low Noise and High Power Gain At 450 MHz!

Capitalize on the advantages of low noise figures (2.5 dB) and high power gain (20 dB), at very high frequencies offered by the MM5043/44 series.

The use of an advanced "passivated overlay process" — a Motorola breakthrough in germanium transistor fabrication — now makes possible smaller geometries and extends this material's inherent ability to operate at lower-than-ever noise figures and higher frequencies. The comprehensive data sheet includes NF and G_{PE} specs out to 1.0 GHz. Maximum C_{cb} is only 1.0 pF on both units. They are packaged in TO-72 (shielded package).

Type	G_{PE} @ 450 MHz (min)	NF @ 450 MHz (max)	$r_b \cdot C_c$ (max)	f_T @ 3 mA (max)	Price (100-up)
MM5043	20 dB	2.5 dB	6 ps	3000 MHz	\$6.50
MM5044	16 dB	3.5 dB	10 ps	2600 MHz	4.00

For details circle Reader Service No. 334

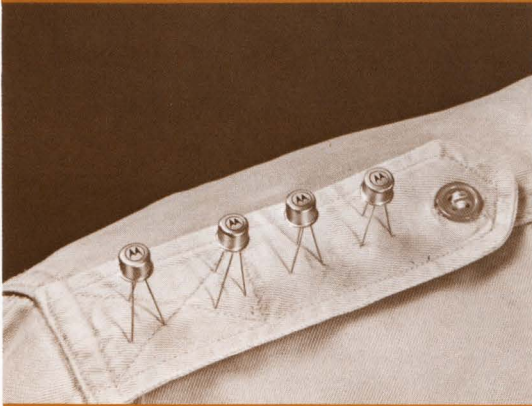

JAN2N3506/7, JAN2N3253, JAN2N3444 NPN SILICON SWITCHES

— Now On QPL To MIL-S-19500/347/349 (Navy)

Fast switching at high current levels — low C_{ob} and $V_{CE(sat)}$ — high f_T and V_{CEO} — all this with fast-delivery assured and MIL qualification too!

These popular NPN silicon Annular transistors can now fulfill high-rel requirements in the most stringent high-current, high-speed, saturated switching and core driver applications. Packaged in the TO-5 solid-header metal case, they dissipate a full 5 watts at 25°C case, and 1.0 watt at 25°C ambient.

Check your local Motorola field representative for prices and delivery schedules.

For details circle Reader Service No. 335



FIRST CLASS
Permit No. 2565
PHOENIX
ARIZONA

For Fast Action!

... on delivery of literature for items described in this publication — fill out this coupon, fold as indicated and drop in the mail.

(NO POSTAGE IS REQUIRED)

FOLD HERE

BUSINESS REPLY MAIL
No postage stamp necessary if mailed in the United States

POSTAGE WILL BE PAID BY

Semiconductor NEWSBRIEFS
Motorola Semiconductor Products Inc.
P. O. Box 20924
Phoenix, Arizona 85036

NPN SILICON POWER SWITCHING TRANSISTORS

— Provide An Optimum High-Speed, High-Current Combination

Designers of industrial and military power switching circuits, such as computer hammer drivers, will find this new NPN series of silicon power transistors a letter-perfect choice for critical high-voltage, high-current, fast switching requirements. The units operate at up to 80 and 100-volts while delivering high betas with low saturation voltages at high operating current levels. All this and yet they are specified with maximum rise and fall times of just 100 ns and 200 ns, respectively, at $I_C = 2.0$ -Amps.

And, you have a choice of the space saving TO-39 case ($P_D = 6$ -watts) or the 35-watt TO-66 package.

TO-39 Type	TO-66 Type	$h_{FE} @ I_C$	V_{CE0} (sus)	$I_{CEX} @ 25^\circ C$ (max)	$V_{CE(sat)} @ I_C$ (max)	t_{on} (max)	Prices (100-up)	
							TO-39	TO-66
2N5336	2N5427	30-120 @ 2 A	80 V	10 μA @ 75 V	0.7 V @ 2 A	200 ns @ 2A	\$ 8.50	\$ 8.95
2N5337	2N5428	60-240 @ 2 A					9.60	10.15
2N5338	2N5429	30-120 @ 2 A	100 V	10 μA @ 90 V			10.20	10.95
2N5339	2N5430	60-240 @ 2 A					11.90	12.50

For details circle Reader Service No. 336

HIGH-VOLTAGE, 150-AMP GERMANIUM POWER TRANSISTOR PACKS

— Deliver Up To 120 Volts And Eliminate Paralleling Problems

They're paralleled for high power! That's what makes these new 60, 90 and 120 V, 150 A germanium power transistor packs champion heavyweight performers in such applications as inverters, motor speed controls, high wattage switching circuits and power supplies operating up to 2 kW.

Consisting of three, 60 amp, TO-3 packaged ADE transistors (Motorola alloy-diffused epitaxial process) which have been closely matched and mounted on an integral heat-sink, the MP900 series offers a powerhouse of advantages — such as high beta and low saturation voltage at high current levels, safe operating areas spec'd at both 50 and 150 amps and fast switching speeds.

Type No.	V_{CE0} (sus)	I_C (cont)	$h_{FE} @ 70A$ (min)	$V_{CE(sat)} @ 150A$ (max)	Switching @ 75A (typ)			$P_D @$ $T_C = 25^\circ C$
					t_r	t_f	t_r	
MP900	60V	150A	20	0.5V	25 μs	5 μs	15 μs	250W
MP901	90V							
MP902	120V							

For details circle Reader Service No. 337

Published by Motorola Semiconductor Products Inc., P. O. Box 20912 • Phoenix, Arizona 85036
The circuitry shown external to Motorola products is for illustrative purposes only, and Motorola does not assume any responsibility for its use or warrant its performance or that it is free from patent infringement.

MTTL III, MRTL, MDTL, MECL II, Unibloc, RamRod, Surmetic, Designers, ADE and Multi-Cell used in this publication are trademarks of Motorola Inc. Annular semiconductors are patented by Motorola Inc.

NOTE: If coupon is missing use magazine's Reader Service numbers to order literature on items described in NEWSBRIEFS.

Tear Along Perforated Line and Drop in Mail (No Postage Required)

To expedite the delivery of the literature you have requested, please CLEARLY PRINT your name and mailing address below:

NAME, TITLE _____

COMPANY (DIV.) _____

ADDRESS _____

CITY _____

STATE (ZIP) _____

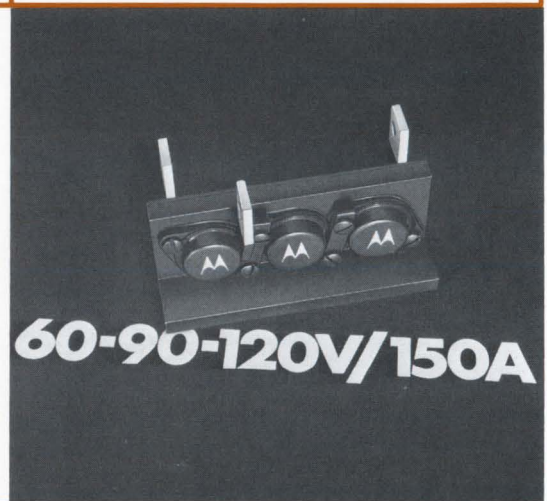
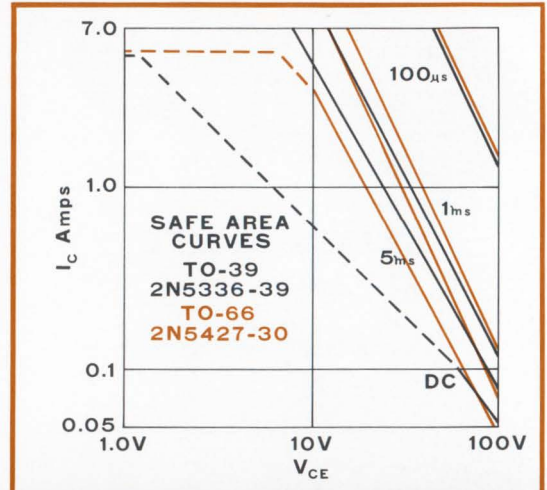

SEMICONDUCTOR
NEWSBRIEFS

©Motorola Inc. 1968

Please circle the Reader Service number of item(s) you are interested in receiving.

E					
316	317	318	319	320	321
322	323	324	325	326	327
328	329	330	331	332	333
334	335	336	337		

Do you wish a Motorola Field Representative to contact you? VISIT PHONE

Phone No. _____ Area Code _____

NOTICE: Requests for literature on items described in this issue cannot be honored after **October 1, 1968**.

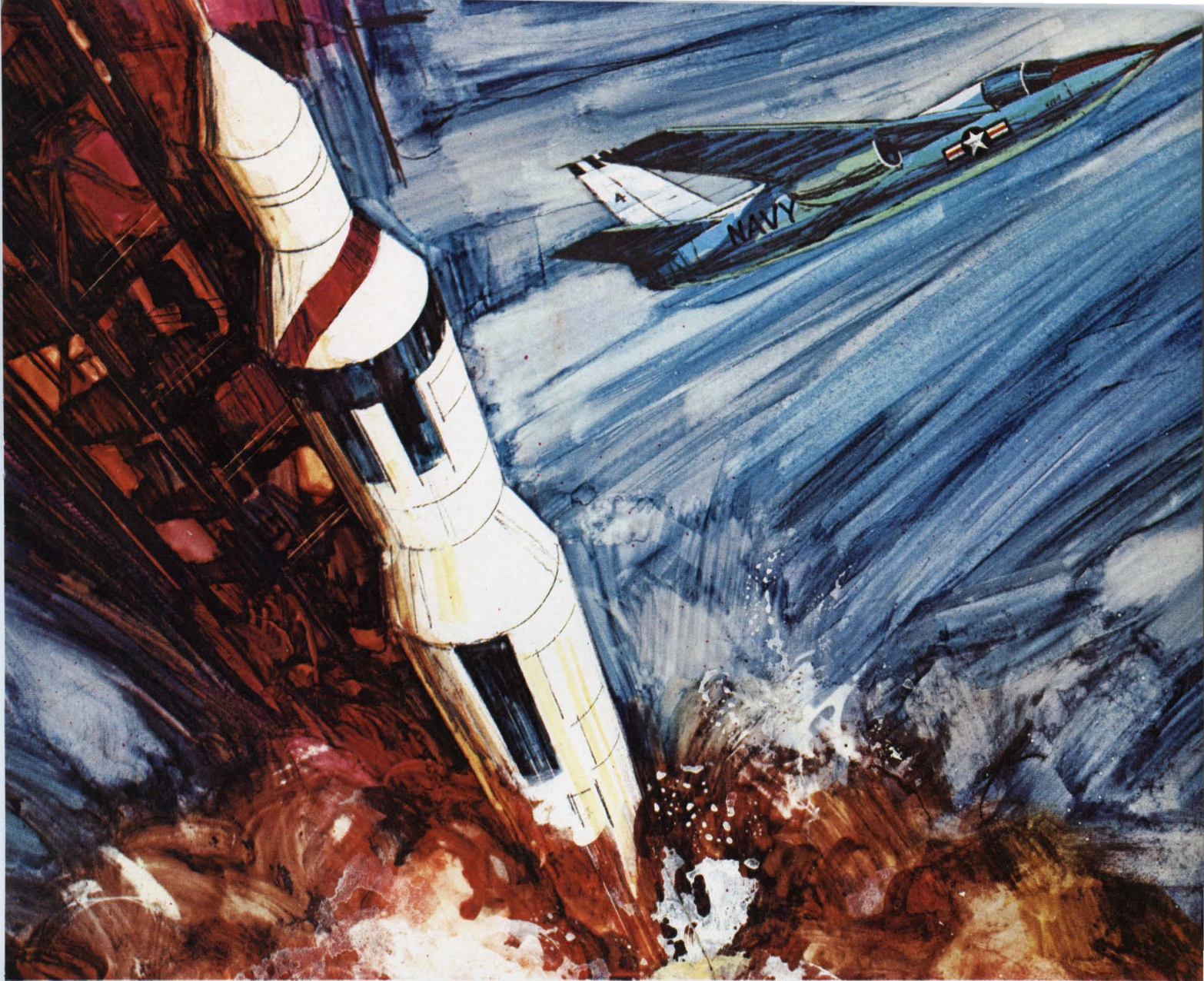

MIL-C-81511 SUBMINIATURE CONNECTORS CINCH-NULINE DELIVERS THEM NOW!

The MIL-C-81511 Astro/348 represent the highest state-of-the-art in round connectors. They have .085" contact centers with dielectric separation of .021" (equal to other connectors with .130" centers). The dielectric has a one-piece retention system that eliminates metal construction. Other important features include scoop-proof mating, grounding prior to electrical contact, removable crimp contacts and extreme environmental stability.

The complete line includes shell sizes for contact configurations of 4, 12, 37, 55, and 85 contacts, five receptacle styles and standardized accessories.

For additional information contact any Cinch Electronics Group Sales Office or write to Cinch-NuLine, 1015 S. Sixth Street, Minneapolis, Minnesota, 55415.

MIL-C-26500 Omega Connectors are also available from Cinch-NuLine on short delivery cycles (generally 6-8 weeks) for any shell style, contact size and insert configuration.



CINCH-NULINE
DIVISION OF UNITED-CARR

CONSISTING OF CINCH MANUFACTURING COMPANY; CINCH-GRAFIK, CINCH-MONADNOCK, CINCH-NULINE, UCINITE (ELECTRONICS) AND PLAXIAL CABLE DEPT.



Circle 35 on reader service card

CN-6870

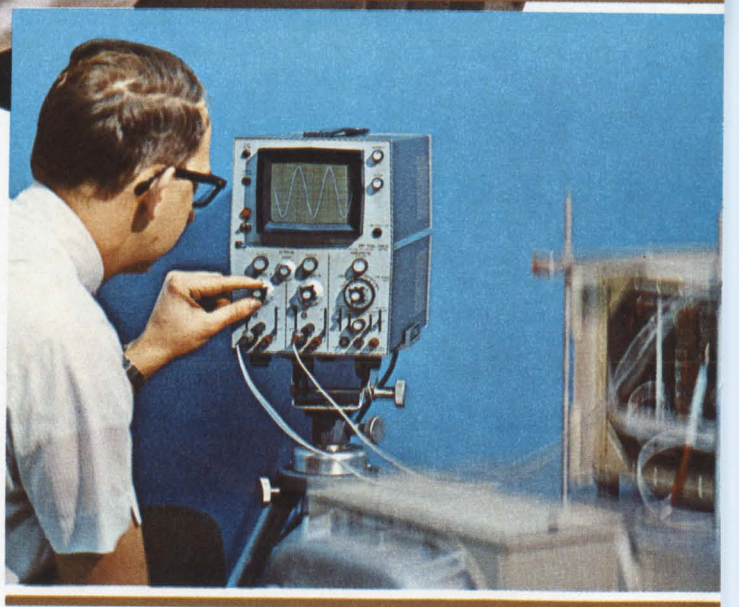

Now... There is a New dc-500 kHz Oscilloscope with all the step-ahead features of a high frequency instrument!

Hewlett-Packard puts you in the measurement forefront with this new all-solid-state oscilloscope family—the new hp 1200 Series Oscilloscope. The 1200 Series Scopes are new from the inside out—specifically designed so you get step ahead measurement capabilities in the dc to 500 kHz frequency range. When you turn one on, you'll know you are operating a state-of-the-art instrument.

In developing scopes for use in the higher frequencies, Hewlett-Packard found many features that could be economically applied to other scopes. These hp 1200 Series Scopes are a direct result of the experience gained in design and development of the high frequency hp 180 Series Scopes and plug-ins. Essentially, the 1200 series is designed with the features normally found in higher frequency scopes—only the bandwidth is reduced. The result is the first all-new design in a lower frequency scope in the past decade!

The hp 1200 Scopes are the first to provide all-solid-state reliability and stability in the dc to 500 kHz range. Drift has essentially been eliminated by using input FET's (another first in 500 kHz scopes) to give you accurate measurements—even in the 100 μ V dc area. A new, specially-designed hp CRT gives you a large 8 x 10 cm internal graticule CRT for the first time in a low frequency scope. The compact package (resulting largely from the shorter tube) and the new modular construction concept reduce manufacturing costs—the savings are passed on to you.

Other important, step ahead features include single-ended or differential input on all ranges, complete triggering versatility, external horizontal input, dc-coupled Z-axis, beam finder—all features you normally find only on high-frequency scopes!

Choose from four models to get single or dual trace 100 μ V/cm sensitivity, or single or dual trace 5 mV/cm sensitivity. The 100 μ V scopes have 17 calibrated ranges

in 1-2-5 sequence with vernier for continual adjustment between ranges. The 5 mV scopes have 12 calibrated ranges. Here is a complete family of instruments that match your measurements in the low-cost, high-performance scope area.

Increase Your Measurement Confidence. In addition to the reliability you get from all-solid-state components, you get the reliability and accuracy from direct reading and interlocking controls on the 1200 series scopes. These controls have been human engineered so they are easy to operate, grouped according to function and interlocked so they can't let you make an "impossible" measurement. You know the measurement you're making is accurate and true!

Speed Your Measurements. The 1200 scopes are easy to use—they'll help you make your measurements in less time. You simply connect to the single-ended or differential inputs; locate elusive, off-the-screen traces with the convenient beam-finder (the scope's automatic triggering displays a baseline starting point—even when no input signal is present); select the sensitivity setting you need. Your results are displayed without annoying flicker or trace jump on the easy-to-read, parallax-free CRT.

Available as Cabinet or Rack-Mount. Each of the four models is available as a lightweight (<25 pounds) cabinet or 5¼" high rack mounts. Power consumption is a cool 33 watts—no noisy fans are needed.

For full specifications on these new dc to 500 kHz scopes and how they can increase your measurement confidence and your measurement accuracy, contact your nearest hp field engineer. Or, write to Hewlett-Packard, Palo Alto, California 94304. Europe: 54 Route des Acacias, Geneva.

	1200A/AR*	1202A/AR*	1205A/AR*	1206A/AR*
Number of Channels	2	1	2	1
Maximum Vertical Sensitivity	100 μ V/cm	100 μ V/cm	5 mV/cm	5 mV/cm
Common Mode Rejection (Differential)	100 dB	100 dB	50 dB	50 dB
X-Y Capability	Identical Amplifiers (17 ranges)	17 vertical vs. 4 horizontal ranges	Identical Amplifiers (12 ranges)	12 vertical vs. 4 horizontal ranges
Price	\$990	\$790	\$875	\$715

* AR indicates 5¼" rack mount model

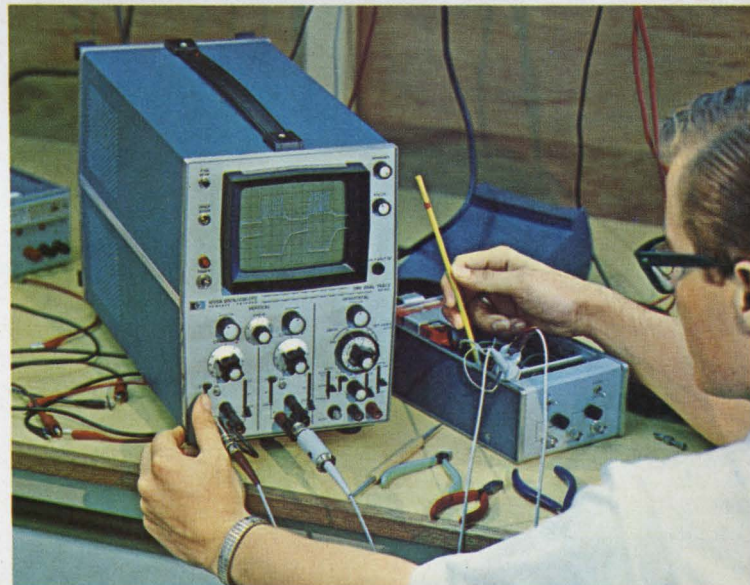

HEWLETT  PACKARD

OSCILLOSCOPE SYSTEMS

automate



**Unique Gardner-Denver Grid-Drill™
drills electronic circuit boards
at a rate of 130 cycles per minute—at total
positioning accuracies of less than $\pm .0006$ "**

No other production machine drills so many holes so accurately in so short a time as this new n/c Gardner-Denver Grid-Drill. Perfect for multi-layer and through-hole plating, for computers of this generation—and the next.

Handles as many as four stacks of panels as large as 15" x 20" each. Drills hole sizes from .010" to .125". Fingertip control adjusts spindle speed from 10,000 to 50,000 rpm. Each spindle is programmed for "use" or "not use," allowing the use of one, all, or any combination of spindles for each cycle. Individual spindles are located in "packages," the spacing and number of which are dependent on the type and volume of work. Packages are customized to your application.

How's this for accuracy? Table location, over a 20" travel, is accurate within $\pm .0006$ ". Repeatability of positioning—within .0003". Spindle runout—within .0005" TIR.

Production rate, including table movement, spindle programming and drilling, is as high as 130 cycles with each spindle per minute.

Gardner-Denver is also the maker of the famous automatic Wire-Wrap® machine. Both machines spectacularly increase production—and lower the cost—of electronic equipment. Call for further information, or write for Bulletins 14-121 and 15-1.



GARDNER-DENVER

Gardner-Denver Company, Quincy, Illinois 62301



Circle 39 on reader service card

How to select the best DVM in the medium price range:

	HP 3440 SERIES	FAIRCHILD 7000 SERIES
TO MEASURE DC VOLTS		
price	\$1295	\$1275
ranges	3	4
overranging	5%	20%
accuracy—		
24 hours	.05% r. ± .01% f.s.	.01% r. ± .01% f.s.
3-month stability	.05%	not specified
noise rejection		
common mode, 60 Hz	30 - 70 dB	not specified
normal mode, 60 Hz	30 db	30 dB
input resistance—10-volt range	10.2 megohms	1000 megohms
TO MEASURE MILLIVOLTS		
price	\$1610	—
accuracy—100 mV	.10% r. ± .05% f.s.	—
3-month stability	.05%	—
input resistance	10.2 megohms	—
common mode noise rejection	100dB	—
autoranging—100 mV to 1000 V	yes	—
TO MEASURE AC VOLTS (100 kHz)		
price	\$1775	\$1725
ranges	3	4
basic accuracy	.10% r. ± .02% f.s.	.10% r. ± .02% f.s.
auto ranging	no	yes
common mode noise rejection	not specified	not specified
TO MEASURE OHMS		
price	\$1525 (incl. mV and current)	\$1385
ranges	5	5
basic accuracy	.30% r. ± .01% f.s.	.05% r. ± .02% f.s.
max. voltage across unknown	1.0v	1.2v
MULTIMETER CAPABILITY		
price	—	\$1895
functions	—	dc, ac, mV, ohms, current
source of data	catalog—1968	#7000 - 8/67

NLS X2 SERIES

DANA 4400 SERIES

\$1180

3

20%

.02% r. \pm .01% f.s.
not specified

100 dB

30 dB

10 megohms

\$1150

4

20%

.01% r. \pm .01% f.s.

.01%

100 dB

60 dB

1000 megohms

\$1630 (incl. ohms)

.06% r. \pm .05% f.s.
not specified

100 megohms

not specified

no

\$1395

.01% r. \pm .01% f.s.

.01%

100 megohms

100 dB

yes

\$1480

4

.05% r. \pm .02% f.s.

yes

not specified

\$1450

4

.10% r. \pm .02% f.s.

yes

60 dB

\$1630 (incl. mV)

5

.02% r. \pm .06% f.s.

16v

\$1795 (incl. mV and ac)

5

.01% r. \pm .02% f.s.

1.2v

\$2230

dc, ac, mV, ohms,
current, ratio

#002 - 6/67

\$1795

dc, ac, mV, ohms

catalog - 1968



The rest of the series 4400 specs are in our new brochure along with those on all the Dana DVM's. A letterhead request will get you a copy.

Dana Laboratories, Inc., 2401 Campus Drive, Irvine, California 92664.

DANA

Circle 41 on reader service card

TWO NEW CERAMAG® 90° COLOR YOKE CORES FROM STACKPOLE

THE COMPACT

(Part No's 52-437, 52-506)



THE MINI

(Part No's 52-488, 52-489)

With deflection yoke cores that are 25% smaller, consider the savings in copper, hardware, labor and shipping costs, too. Both the Compact and Mini yoke cores are moulded from Stackpole's standard 7B ferrite material. Even though you benefit from smaller, more compact yoke size and appreciably lower prices, there is no sacrifice of nickel content with Ceramag® 7B. Curie is 160°C. ± 10°C. For specifications, samples, prices and delivery, call: D. L. Almquist, Electronic Components Division, Stackpole Carbon Company, St. Marys, Pa. 15857. Phone: 814-781-8521. TWX: 510-693-4511.



STACKPOLE
ELECTRONIC COMPONENTS DIVISION

ALSO A LEADER IN THE MANUFACTURE OF QUALITY FIXED COMPOSITION RESISTORS



Is your carbon comp resistor supplier ho-hum about your business?

You'll like the way we document our interest. We're one of the few manufacturers who will furnish you with written data to prove how our resistors meet the requirements of MIL-R-39008. We've also insured that our documentation is fallibility-free, by developing the world's only on-line computerized resistor quality control system. Is the reliability of your present military, aerospace, or industrial resistors something you have to take on faith? Get in touch with us. We can prove what we say, and we also have bright flexible ideas that will keep pace with your requirements. So....

Call the passive innovators at Airco Speer.



AIRCO Speer Electronic Components include Speer resistors, Jeffers JC precision resistors, Jeffers JXP precision resistors and networks, Jeffers inductors and capacitors and PEC variable resistors and trimmer potentiometers.
St. Marys, Pa. 15857 • Bradford, Pa. 16701 • DuBois, Pa. 15801 • Toronto 15, Ontario.

930 DTL Problems? Get 120 Solutions from DEECO

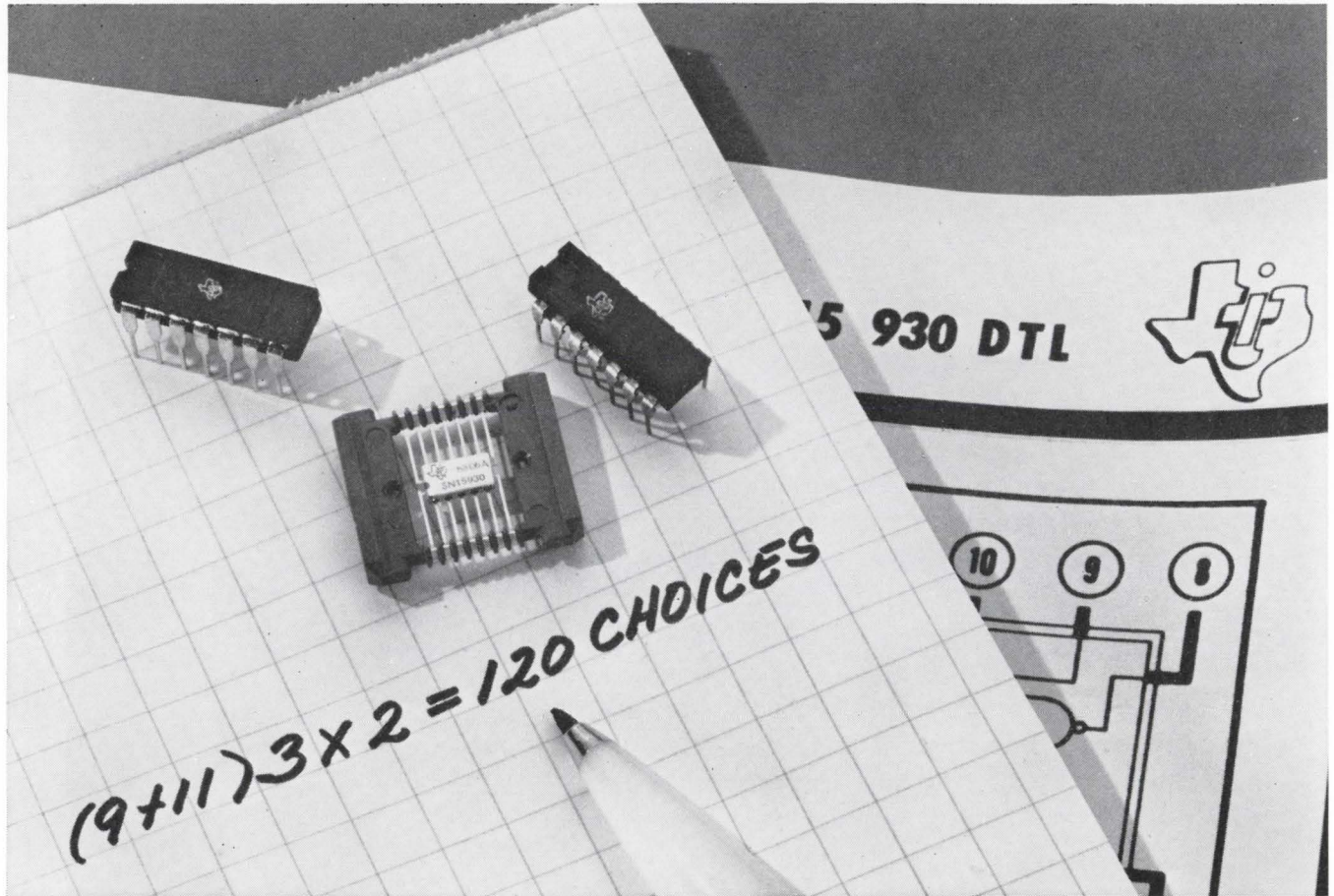

Figure it out for yourself.

Nine new 930 DTL circuits added to the 11 already available. Three package types. Two temperature ranges. Total it up and you've got 120 different versions of Texas Instruments' 930 DTL—industry's widest selection.

The nine new circuits include four dual flip-flops, two hex inverters and three fast-rise-time gates. These are

combined with eleven Series 15 930/15 830 circuits previously in the TI line for a total of 20 device types available. All are offered in any of three 14-lead packages: flat pack, dual-in-line plastic and the new dual-in-line hermetic ceramic. Finally, you have a choice of two temperature ranges—military or industrial—for each circuit. All circuits are pin-for-pin and spec-for-spec,

replacements for other 930 DTL series.

Why shop around for the numbers you need? Call us for fast delivery of 120 solutions to your DTL circuit problems.

For your copy of a new specifying guide and interchangeability chart, circle 290 on the Reader Service card.

DEECO  **Inc.**

DISTRIBUTORS — SERVING INDUSTRIALS EXCLUSIVELY

618 FIRST STREET N. W. • CEDAR RAPIDS, IOWA • PHONE 319 365-7751

AUTHORIZED
DISTRIBUTOR 

Zener LIDs

New! from Semcor...

Silicon Zener Diodes, that
work like chips but handle
and mount with ease.

the 400 mW LID – 6.8 to 33 volts

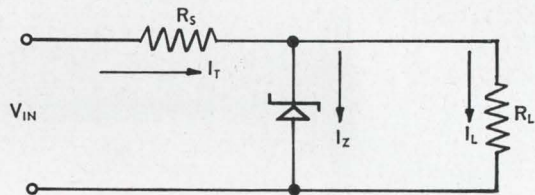

General Electrical Characteristics (@ 25°C):
 Maximum Power Dissipation . P_z 400 mW
 Zener Voltage V_z 6.8 to 33 Volts

Mechanical Characteristics:

Case: 95% Alumina filled ceramic substrate
 with epoxy encapsulation
 Contacts: 200 μ inches of gold
 Polarity Marking: Dot on cathode end of package
 Device may be mounted in any position

Thermal Characteristics:

Storage Temperature T_{stg} -65°C to +150°C
 Operating Temperature T_a -65°C to +150°C
 Thermal Resistance θ_{Jc} 200° C/W
 Derating 5 mW/°C

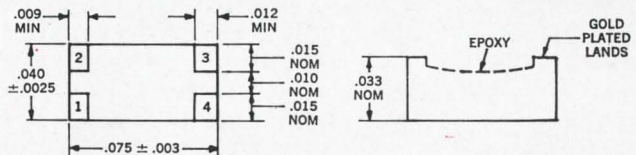

3540 W. OSBORN RD. / PHOENIX, ARIZONA 85019
 PHONE 602-272-7671 / TWX 910-951-1381

Resolve 10 Nanosecond Signals Buried In Noise

Complex repetitive waveforms are accurately resolved to 10 nanoseconds and recovered from noise in the new PARTM High Resolution Boxcar Integrator. The Model 160 achieves signal recovery by time averaging a small portion of a coherent waveform over a large number of repetitions. Because the mean value of the noise approaches zero when averaged over many repetitions, the averaged output results only from the coherent content of the sampled portion of the waveform. To recover the entire waveform, the incremental portion being sampled and averaged is either manually or automatically scanned over the period of interest.

An optional digital storage module is available for maintenance of averaging accuracy in situations where the repetition rate of the investigated phenomenon is extremely low or to serve as an interface to peripheral data processing equipment.

Price of the Model 160 Boxcar Integrator is \$3,250. For more information or to arrange a demonstration write Princeton Applied Research Corporation, P. O. Box 565, Princeton, New Jersey 08540 or call 609-924-6835.

**P
A
R**

PRINCETON APPLIED RESEARCH CORPORATION

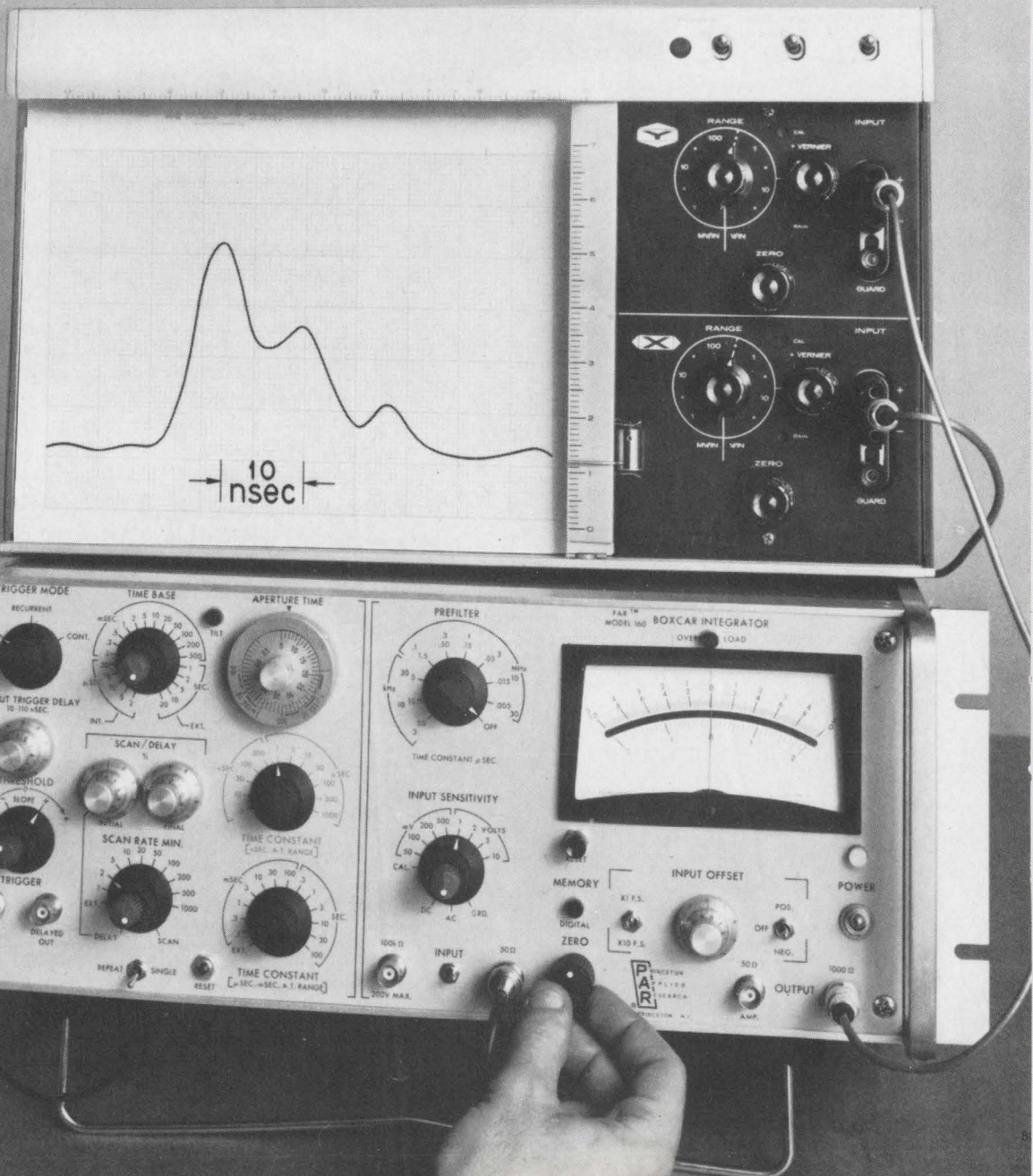

Electronics Review

Volume 41

Number 13

Avionics

Discretionary LSI . . .

Texas Instruments expects to deliver to the Air Force later this year the first general-purpose airborne digital computer using discretionary-wired large-scale integrated arrays.

TI's Government Products division believes the computer will represent "the first application of 'true' LSI arrays," besides being the first to use discretionary wiring.

Called the LSI 2502, the machine uses 34 transistor-transistor logic bipolar arrays averaging 200 gates a chip to perform all logic functions. It is a reconfigured version of a similar TI computer that uses TTL IC's. The IC model averages three gates per package; discretionary wiring makes possible the 200-gate array.

Pick a route. While many in the industry say discretionary wiring to tie LSI chips together can't be used economically, TI is convinced that this is the best way to go. The company believes that discretionary wiring gives greater flexibility in design, and that computer programming makes it all possible.

The computer is being designed under a developmental Air Force contract. TI intends to use some models, however, along with LSI memory and LSI interfaces, for computation and processing functions in its solid state MERA (Molecular Electronics for Radar Application) radar system now under development. The two projects are separate; only by fortunate coincidence can MERA make use of the computer.

The LSI computer will be composed of a central processing unit, an input/output unit, and a power supply. Its main memory outside

the computer is a conventional ferrite-core unit.

CAD. Richard C. Jennings, head of the TI project, says maximum use has been made of computer-aided logic design. This has included logic design verification, logic implementation, and partitioning (deciding what was to be put on each chip). "It has been by far the most automatic design that we know of," says Jennings, who will detail the TI work at the IEEE

savings in volume.

What goes where? The most difficult task in designing the LSI 2502 has involved partitioning, says Jennings. The goal was to average a gate-to-pin ratio of 2:1. Each array has 100 input/output pins for logic signals. Ground rules for partitioning were based on the characteristics of the arrays.

In packaging, each array is on a round chip 1¼ inches in diameter. Each chip, in a 2-inch-square-

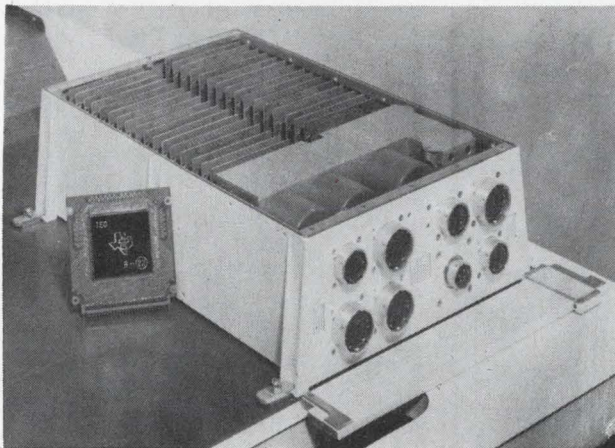

Complex thought. Texas Instruments' new LSI computer will be delivered to the Air Force this year. It's the first general-purpose airborne machine to use discretionary-wide LSI arrays.

Computer Conference this week in Los Angeles.

The LSI computer will weigh 35 pounds and be 0.37 cubic feet in size. It will be fast; execution times for typical instruction are the same as in the present machine—a few microseconds. Over-all capabilities of the LSI 2502 will be basically the same as the IC 2502, because the effort has been aimed mainly at reconfiguring the IC model to LSI arrays. "We took a known computer design because we wanted to avoid mistakes inherent in new designs," explains Jennings.

The LSI approach does improve reliability, says Jennings, and he adds that theoretically the design should be simplified. Also, he points out, there can be sizeable

module, is soldered to a multilayer card that mates to a connector in an interconnecting mother board. Etched planes on the mother board provide low impedance distribution of +5 volts. Ground components are cooled by three finned cold plates.

. . . from the outside

A new approach to discretionary wiring is being tried in a highly parallel computer. Litton Industries' Guidance and Control Systems division is making the machine for the Air Force Avionics Laboratory at Wright-Patterson Air Force Base.

Litton's discretionary wiring,

unlike that of Texas Instruments [see story above], is outside the large-scale integration wafer. Each wafer—with 36 arithmetic units, eight control units, and as many as 100,000 metal-oxide-semiconductor transistors—is tested through contact pads around its perimeter; the transistors aren't tested individually. A functional unit that fails is left out of the wiring scheme.

The unpackaged wafers are mounted on one side of an ordinary printed-circuit board. Holes are drilled through the board to the pads connected to the good circuits, which are interconnected on the wiring side of the board.

Less redundancy. The computer is designed to perform guidance and control operations for a missile. It will sell for less than \$2,000 and will be expendable—as all hardware on a missile must be.

Possibly only 90% of the good cells are in use at a given time. Joseph Campeau, a Litton research head, says the division plans only 1% to 10% redundancy, instead of the 100% in such programs as Apollo and the C-5A, in which there is a complete standby unit. And Litton's cellular redundancy is in the basic computer package; an entire standby isn't needed.

Litton is paying the General Instrument Corp. and American Microsystems Inc., about \$200 for each MOS LSI wafer now, but \$20 per wafer is the expected cost in volume production. A 25% yield has been projected for the wafers in the next year. At that level, Campeau says, the memory will have 2,000 32-bit words. "But with our organization," he says, "we could get well over 25 million words before we exceed the logical capacity of the design."

Campeau will discuss details of the low-cost computer at this week's IEEE Computer Conference in Los Angeles.

Touching down

If the helicopter is to become a successful means of mass transportation, it will have to be capable of landing in all kinds of

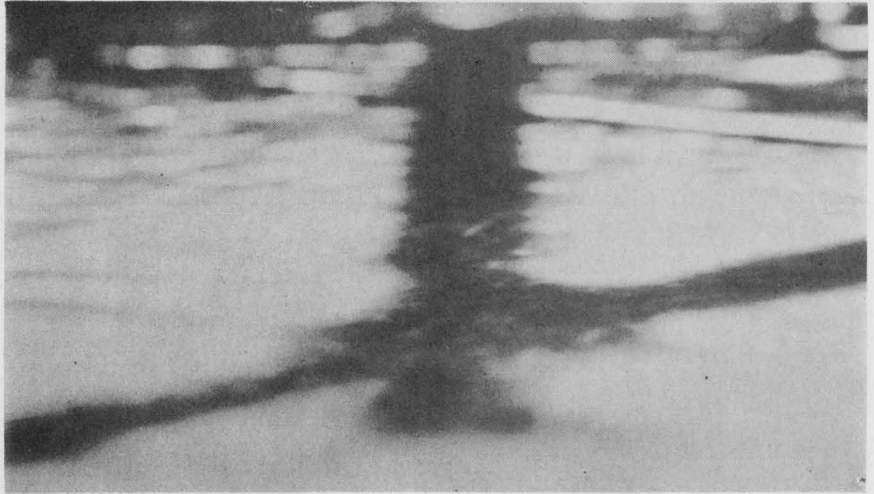

On target. Terminal landing radar for VTOL craft will present the pilot with a head-up display projected from a radar scope. Shown are the runways at Mercer County Airport, Trenton, N.J., as they appear on the scope.

weather. Bringing this capability a step closer to reality is the Lockheed Electronics Co., which has developed a terminal-landing system that can operate with a 100-foot ceiling and a 400-foot visual slant range.

Called Sparr, for self-contained perspective approach rotor-blade radar, the system is based on the rotor-blade radar antenna that the Plainfield, N.J., firm—a division of Lockheed Aircraft—has had under development for the last two years. Sparr presents a head-up, perspective display of a landing area, and enables the pilot to bring down the copter safely to an altitude of 100 feet. At this level, the pilot can complete the landing visually.

Teamwork. Lockheed envisions Sparr as a backup to such microwave-type instrument landing systems as Honeywell's C-band, 5 gigahertz simplified tactical approach and terminal equipment (State) or Airborne Instruments Laboratories' Ku-band, 15-Ghz Advanced Integrated Landing System (Ails). Both State and Ails are cooperative systems that rely on signals beamed from the ground.

"Sparr, combined with either of these two, would be independent," says David W. Young, Lockheed's program manager. "But Sparr requires only corner reflectors to be set up in the landing area."

Whirlymap. Sparr combines the beams from Ku-band antennas in

the rotor blades—each up to 15 feet long—with that of a vertical-slot antenna on the front of the craft. The rotor antennas produce a radar map of the area; the slot antenna—about 1 inch in diameter and 40 inches long—provides information for glide slope. A horizontal antenna could also be included for precise heading data.

Attitude and altitude information are combined with range and azimuth to present a perspective display on a 5-inch cathode-ray tube in the cockpit. For the head-up display, this data is projected on optical glass.

Lockheed has tested the system aboard its own Enstrom F-28 and is currently outfitting a Fairchild-Hiller helicopter. Eventually, probably in the 1970's, the system will be improved to the point that it can be used in zero-zero landings, says Young. But for now, he points out, Sparr could be used with fog-dispersal equipment at the landing point to give the 100-foot breakout.

Computers

Circular words

A new computer that processes trainloads of data in many synchronized streams, yet requires a minimum of preparatory effort by the

programer, is being designed at Bell Telephone Laboratories in Whippany, N.J., for radar signal processing.

The machine has up to several thousand identical computing elements, all executing the same instruction sequence in parallel under the direction of a single control unit. The data layout is circular—the most significant bit position is specified when the data is addressed—so that data words of different lengths can be packed into a single computer word and aligned with one another only when they are needed for actual computations. Richard R. Shively and J.H. Huttenhoff will describe the machine at the IEEE Computer Conference in Los Angeles, June 25-27.

Programers have always had to waste time and memory getting data words properly lined up with one another for arithmetic operations. The development of floating-point arithmetic for computing machines was one of the early breakthroughs in reducing this "house-keeping" effort. Circular words reduce it further; when a word is needed from memory, the word address, location of the most significant bit, and the number of bits in the word must be specified. The computer automatically masks and scales the data so that only the desired word is obtained from the memory.

Fetching a word. In the diagram on the right, nine data words are shown stored in only four memory words. The data words are all different lengths, and take up far less space than if each data word had a whole memory word all to itself. The three steps in fetching a word from the memory to be added to a previous result are also shown in the diagram.

First, word X_6 is taken from the memory and placed in register B. Then the previous result, X_0 , in register A, is moved to the left until the binary points in the two registers are aligned. Finally, the representation of X_0 , in register A, is altered to align the most significant bits of the two numbers, after which the addition can take place in the usual fashion. All this happens

automatically, with no effort by the programer. Likewise, data stored in the memory is placed with the most significant bit in any position that permits the entire data word to fit in one memory word.

Besides saving memory space and reducing programing effort, the circular words permit two or more smallish words to be processed simultaneously. This is done by specifying two or more positions as being most significant for a given operation. For example, both the real and imaginary parts of a complex number can be processed at the same time.

Single pulse. Each computing element in the array of thousands contains an arithmetic unit, a small circular-word memory, some local control circuitry, and data-input logic. The arithmetic unit contains three 32-bit registers, a stored-carry register that permits high-speed multiplication, and a logic configura-

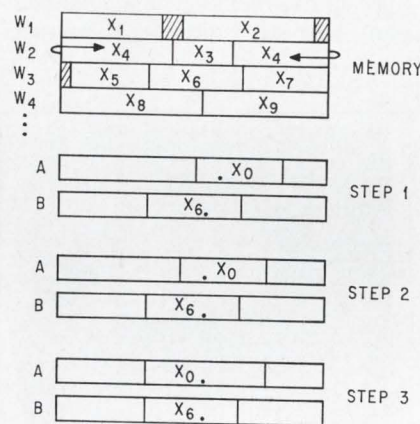

ration that, with a single pulse, gates an old number out of a register position and gates a new number in. This logic configuration works because it's fabricated on a single monolithic chip; the signal-propagation variations of discrete components would, however, reduce reliability.

In its ability to execute an operation on two or more numbers simultaneously, as a result of the circular data layout and its use of a stored-carry register for high-speed multiplication, the machine slightly resembles Shively's fast Fourier transform processor, which he

described at last year's IEEE Computer Conference [Electronics, Sept. 4, 1967, p. 40].

All the logic that processes a single bit in one arithmetic unit fits on two silicon chips 70 mils square. Thus the entire 32-bit unit uses 64 of these chips; the local control fits on four more. The memory is made of insulated-gate field-effect transistors with 128 bits on a single chip; 32 chips make up the memory associated with a single arithmetic unit. The input logic takes another 64 chips. All 160 chips and their connections fit on a 3¾-by-4 inch ceramic substrate.

Core assault

Random-access memories made of semiconductors require less power and are in some ways more convenient to use in computer systems than ferrite cores. However, integrated-circuit makers admit freely that cores will never be displaced until the IC version can compete in price. With some large core systems costing only a few cents a bit, that day is still years away. Yet one large IC maker will unveil a system built around metal-oxide-semiconductor devices this week, and a small systems house is already offering an active MOS memory.

At the IEEE computer conference in Los Angeles this week, Fairchild Semiconductor will reveal details of what it calls a "hybrid LSI memory" made of stacked ceramic substrates, each bearing 16 MOS 64-bit memory cells. The memory will be described in a paper by T. Asai, Jack D. Schmidt, and Joseph H. Friedrich; the hardware itself won't be available until the end of the year, and then only in prototype form.

By twos. Fairchild has actually been beaten to the marketplace by American Astrionics Inc., a Palo Alto, Calif., company that was formed only last fall. It offers a whole family of MOS memories, both active and read-only, but at a price per bit that makes them attractive only for special purposes.

There is a tradeoff, a function of yield, in speed and cost, but AAI

charges about 90 cents a bit for a 250,000-bit memory operating with microsecond cycle times. Its thousand-bit memory, operating with 200-nanosecond cycle times, costs \$2.50 per bit. Even at that price AAI will deliver one of its memories for use in the F-111 simulation program. The Fairchild memory, which was designed to use off-the-shelf components, with low cost the prime design constraint, will probably cost about 30 cents a bit.

Still, Benn Anixter, Fairchild's IC marketing manager, says that in two years memories will be the company's fastest-growing product line. Within five years, he says, the cost of the memory systems should drop to less than a penny a bit.

All in one. Even now AAI matches, and Fairchild will undoubtedly beat, the cost of the MOS memory built by the Defense Systems division of the Bunker-Ramo Corp. [Electronics, Nov. 13, 1967, p. 138] Organizationally, the two hybrid systems resemble the Bunker-Ramo suitcase memory; the difference is that where Bunker-Ramo used individually packaged chips, Fairchild and AAI are putting many chips in a package.

Structurally, the AAI and Fairchild systems are much alike. Both use 64-bit memory cells, and some associated circuitry, on ceramic substrates. The more substrates, the larger the memory. The number of chips per substrate determines the word length. Fairchild puts 16 chips on a substrate and packages 16 storage substrates and two driver substrates in a 1,024-word, 16-bit-per-word module that measures only 1.5 by 1.5 by 2.5 inches. AAI will put any number of chips on a substrate, depending on the word length required by the customer. Like Fairchild, it stacks substrates to increase memory size.

Both memories use face-down bonding to cut costs. Fairchild uses flip-chip dice; AAI gets beam-lead dice from the General Instrument Corp. (AAI does its own design work and cuts its own artwork to make masks. It sends these to GI for wafer fabrication.)

Cost vs. work. It is in cost and

performance—as well as availability—that the memories differ. AAI's memories stem from its work on a classified contract that required high data rates and a means of buffering the data into a computer. Fairchild's design was the result of the company's SAM (Semiconductor Active Memory) project, and cost was far more important than performance.

The AAI memory has an extremely short access time of 20 nanoseconds and a cycle time of 200 nsec. Fairchild's system has a cycle time of 300 nsec. In addition to the MOS chips, Fairchild uses bipolar x and y selection drivers to achieve large fanout and to supply the 18-volt voltage swings necessary to switch the MOS devices rapidly. The output of the memory cells is sensed with an off-the-shelf 710 differential amplifier.

Splinter. Anixter says that the memory to be described in Los Angeles will be the first of many products that Fairchild will introduce in the memory area. The company recently sold off its memory

products department, but the IC memory is the achievement of a task force that was split off from memory products and moved to Fairchild's R&D laboratory some time ago.

The packaging technique is a new direction for Fairchild. In some respects, the ceramic package resembles the Microelectronic Modular Assembly (MEMA) developed by the Amelco Semiconductor division of Teledyne Inc. MEMA's are now made with two-layer metalization, but the Fairchild package has a single layer—a much simpler approach as far as production is concerned, but one that made design very tricky.

Oceanography

Going overboard

Scientists, anxious to find out what goes on under water, and how these activities are influenced by salinity, temperature, and pressure, are bedeviled by the inaccuracy of present systems of measuring such variables as the depth of deep currents or underwater waves. Not only that, but the acquisition and processing of the data is a slow, painstaking process.

The depths may lose some of their murk soon, though. Engineers at the Electronic Systems division of Sylvania Electric Products Inc., Waltham, Mass., have devised a computerized setup that not only upgrades the accuracy of probe measurements to within less than a meter, but speeds the processing of the data.

As part of the Sound Velocity Profiler System of the Woods Hole Oceanographic Institute, Woods Hole, Mass., Sylvania has designed multiplexing electronics to get data from up to eight sensors through a cable to the surface and has placed a magnetic tape recorder and a Hewlett-Packard 2116A general-purpose digital computer at the topside end.

Hawaiian test. A version of this system made almost wholly of in-



Teacher. CBS Laboratories and the Reading Institute of Washington, D.C., have developed this \$350 programmed learning system, the AVS-10. Video—152 transparencies—line the outer edge of record; record has 600 lines per inch, plays at 22½ rpm. Response is 100 to 7,500 hertz. Slots on the cartridge operate microswitches to provide answers to questions.

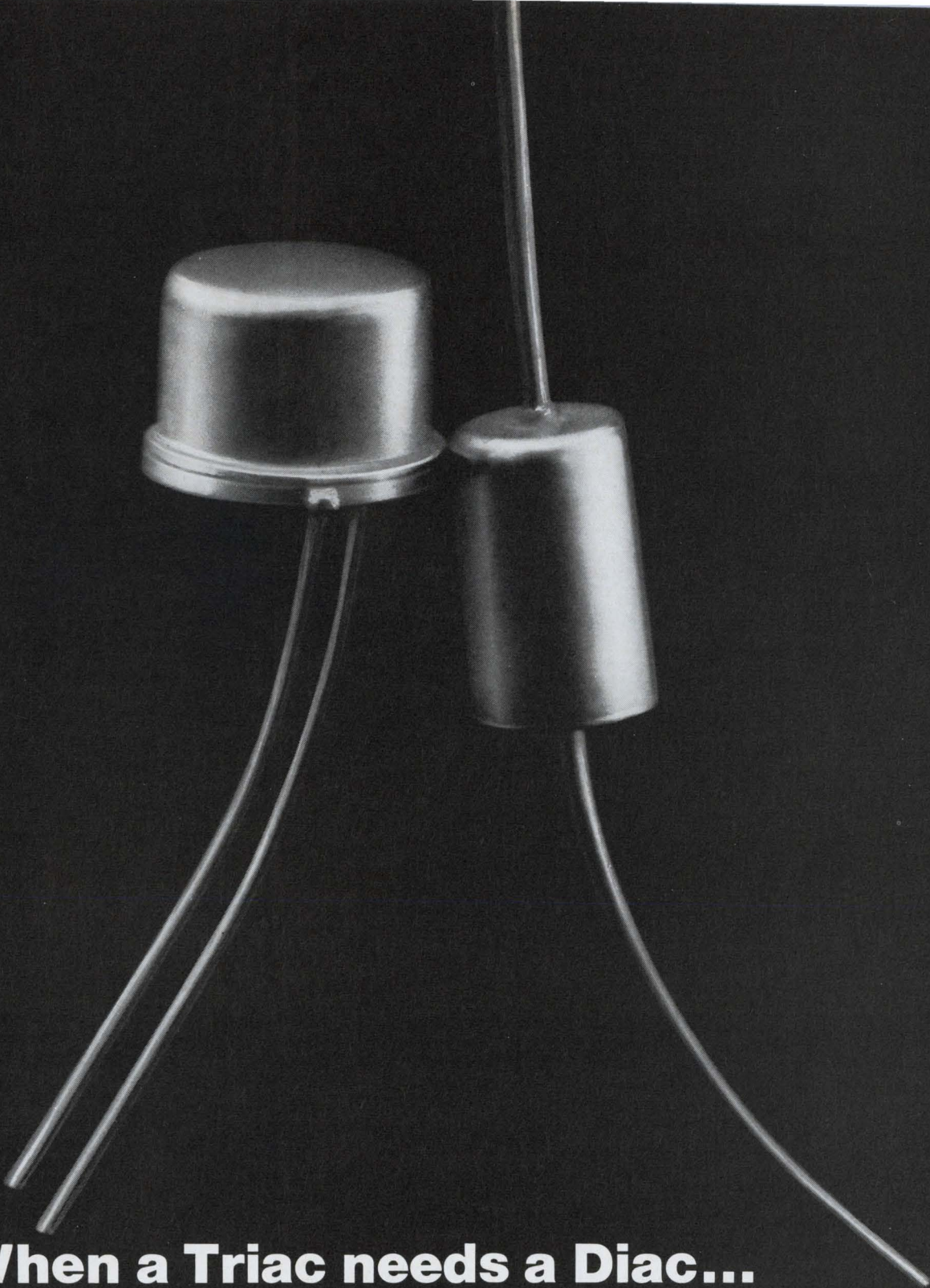

When a Triac needs a Diac...

Try your Triac Leader! You've asked for it... and we have it. To complement the largest Triac line in the industry, we've added the trigger diode. RCA's new silicon Diac (1N5411) is packaged in a hermetic DO-26 case. It has a typical break-over voltage of 32 volts, with a symmetry of ± 3 volts.

Manufactured by the same RCA assembly line that has produced millions of lead-mount rectifiers, our Diac is available right now in production quantities at attractive low prices. We think so much of the new 1N5411, we would like you to try one free in your AC-control circuits. Just mail in the coupon for your sample. Of course, there's no obligation.

RCA Electronic Components
Commercial Engineering Department
Section RN6-2
Harrison, N. J. 07029

FREE

Gentlemen:

I'd like to use an RCA Diac with my Triac. Please send me my free sample.

Name _____

Title _____

Application _____

Company _____

City _____ State _____ Zip _____

Circle 51 on reader service card

RCA

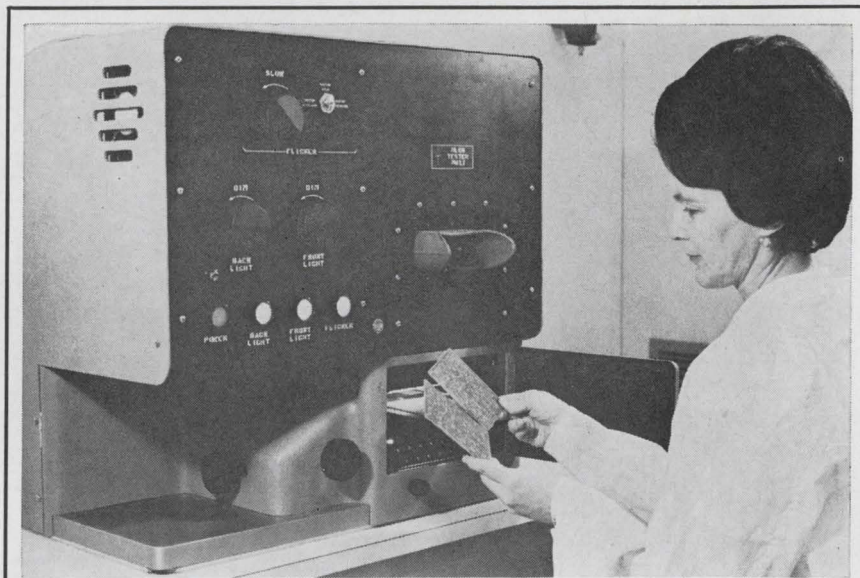

Done with mirrors. RCA's new printed-circuit board tester borrows a technique used by astronomers to chart the movement of stars. Stationary and rotating mirrors superimpose the image of a new board upon the image of a board of known quality; a defect in the new board appears as a flicker. The device can inspect every part of the board—holes, wiring, and components—at each production stage. Used for checking the number and alignment of holes, the prototype has reduced the time for this operation by 50%.

tegrated circuitry will be tested in August during a cruise off Hawaii. The tests will cap almost four years of work on oceanographic problems at Sylvania, during which the company invested about \$140,000 of its own and won an \$80,000 contract from Woods Hole.

Using data from the probe, the Sylvania system recalibrates an inverted echo sounder each time it pings. One of the sensors, a sound velocimeter from the NUS Corp., pings frequently and times the round trip of these pings from a reflector about a foot away from its transducer. The velocimeter's output is an f-m signal whose frequency is proportional to the sound's velocity; this signal is sampled and placed in a time slot along with other multiplexed sensor readings and then it is relayed to the surface.

After it's demultiplexed and digitized, the sound-velocity data is used by the computer to correct the coarse readings of package depth given by the echo sounder.

Choosing sides. According to Donald E. Meyers, a Sylvania research engineer, "The system can use a plotter to yield a graph of

sound velocity versus depth, or temperature versus depth, or a graph of depth calculated from pressure sensors versus depth as calculated from the corrected echo-sounder measurements." With accurate data of this type, calculations become less of a black art and more of a repeatable process, Meyers says.

One remaining hurdle is that the computer can take data faster than the probe can generate it. Many parties, including the Navy, would like a faster-working probe; a speeding of the sound-velocity profiling process could be a help in antisubmarine warfare. If a sub skipper tried to take advantage of a cold-water layer to refract sonar pulses, a sound-velocity profiling system might be able to compensate for the refraction.

Splash. "Right now, the speed limit is imposed by sensor and package design," says Robert N. Joel, a senior Sylvania engineer. "Hydrodynamic effects cause such packages to drag water with them unless they're lowered slowly." Thus it's possible to measure the same volume of water several times over again and to miss parameter changes.

With its feet now wet, Sylvania plans to undertake experiments in acoustic oceanographic communications. An example would be teletypewriter or data communications between underwater stations, a necessity as men press the exploration of inner space.

Government

Painful surgery . . .

To the distress of the generals—and the aerospace and electronics industries—the Government's economy drive will mean a defense-spending reduction of close to \$3 billion in fiscal 1969. The cuts will result from President Johnson's agreement to a \$6 billion slash in over-all expenditures in return for enactment of his 10% income tax surcharge.

The only thing definite about the cuts is that they're certain to come; Congress must act first on the fiscal 1969 appropriation bill—probably next month. But you can bet that defense cuts will occur in programs not related directly to Vietnam. The programs most vulnerable to the budget squeeze are:

- The Sentinel antimissile system
- The Manned Orbiting Laboratory (MOL)
- The FB-111
- The Fast Deployment logistics Ship (FDL) program
- Additional nuclear-powered aircraft carriers
- Military research and development

Other targets for cutting or stretching out include the Raytheon Sam-D Army anti-aircraft missile and the Air Force Maverick air-to-ground missile, now being competed for by the Hughes Aircraft Co. and the North American Rockwell Corp.

Iffy. The biggest program is Sentinel, for which Western Electric is the prime contractor. As a start on this controversial \$5 billion program, the Pentagon originally asked for \$227 million in fiscal '69 for construction, \$313 million for pro-

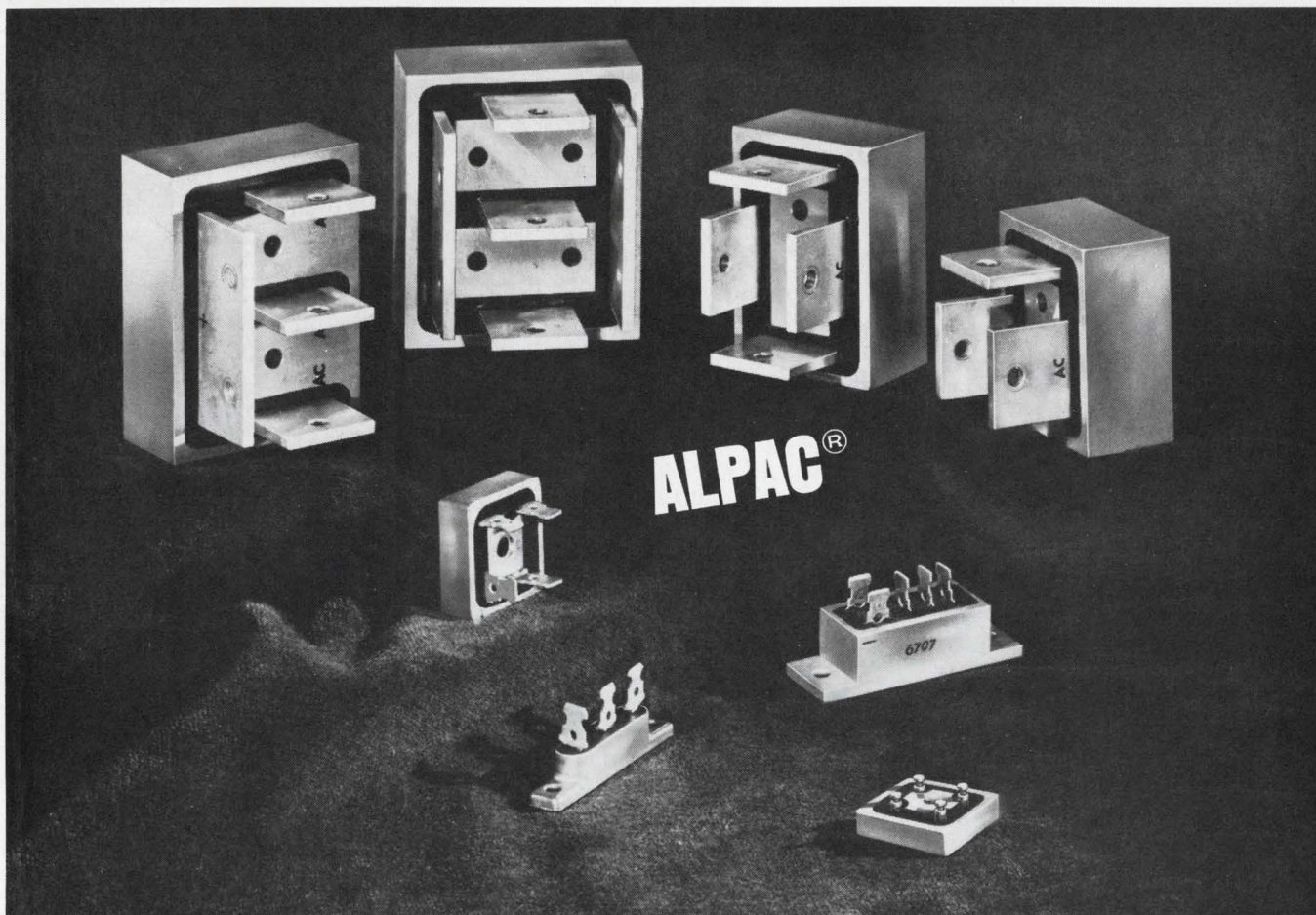

"Cool" Power Rectifiers

A Family of Bridges, Doublers and Center Taps.

The ALPAC Family is a complete line of silicon bridges, doublers and center taps. These power rectifiers offer PIV ratings from 50 to 600 volts, with an average output current from 5 to 250 amps.

All ALPAC devices offer the superior thermal characteristics of aluminum cases. TERMINALS ARE COMPLETELY INSULATED.

Internally, all ALPAC units utilize double Tungstaloïd pin rectifiers electrically and thermally bonded to the terminals.

ALPAC Family is economical, small and easy to mount.

The entire ALPAC Family is field tested and available for immediate delivery.

Introducing ALPAC "Jr."

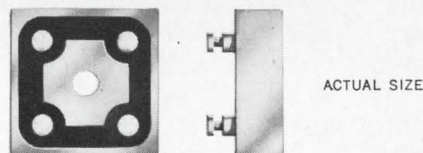

The smallest silicon bridge rectifier in the family. Measuring only .750" square and .225" high. These devices are ideally suited to control circuits, converters, power supplies, etc.

ALPAC Jr. offers PIV ratings of 50 to 600 volts with an average output current of 5 amps. Thermal resistance is 5°C/watt, maximum.

San Francisco—941 E. Charleston, Suite 10, Palo Alto, California 94303
(415) 328-8025
Chicago — 140 N. La Grange Road, La Grange, Illinois 60525
(312) 352-3227 / TWX: 910-683-1896
Dallas — 402 Irving Bank Tower, Irving, Texas 75060 / (214) 253-7644
New York — 116-55 Queens Blvd., Forest Hills, New York 11375
(212) 263-3115 / TWX: 710-582-2959
Boston — P.O. Box 264, Woburn, Massachusetts 01801
(617) 935-5595
European Sales — Bourns A. G. Alpenstrass 1, Zug, Switzerland
(042) 4 82 72/73

SEMTECHTM
CORPORATION

652 Mitchell Road, Newbury Park, California 91320
(805) 498-2111, (213) 628-5392 / TWX: 910-336-1264

curement, and \$313 million for further development. Defense officials now are considering a stretchout, but some Congressmen will try to cancel the program altogether.

But even if Sentinel funding survives Congressional opposition, the Pentagon is prepared to delay the program on its own for economy's sake. One argument for doing so: the Chinese intercontinental missile program to which Sentinel is keyed has fallen behind the schedule predicted by U.S. intelligence agencies.

The MOL program, on which General Electric, McDonnell Douglas, and Martin Marietta are major contractors, is also sure to feel the ax. This \$2.2 billion program to explore military applications of manned spaceflight would get \$600 million in fiscal '69. Again, the Pentagon is considering a stretch-out only, but many Congressmen are asking the old question: Doesn't MOL duplicate the Apollo program? They feel the two should at least be consolidated.

By the wayside. The General Dynamics FB-111 long-range strategic-bomber version of the controversial F-111 fighter-bomber is ticketed for \$18 million in fiscal '69, with growing amounts later. But there is some feeling that the whole FB-111 project, conceived as a transition from the B-52 to the proposed Advanced Manned Strategic Aircraft, might be skipped entirely.

The first four of Litton Industries' FDL ships were set for \$184 million in the original '69 budget. Eventually, this would be a \$1.4 billion program. Like last year—when Congress eliminated the program—there is strong opposition in Congress, so that the program may be knocked out even before the Pentagon decides whether to move more slowly. However, Litton is going ahead with what it calls an automated shipyard in Mississippi, where the FDL ships would be built.

Handy. Critics of new American military adventures abroad say the FDL, a kind of floating warehouse loaded with Army equipment, would increase the probability of U.S. intervention in future trouble spots. But the Pentagon says the

FDL, used with the giant new Lockheed C-5A transport, would so improve strategic mobility that many American troops now stationed abroad could be brought home.

Two nuclear-powered aircraft carriers are being built. The '69 budget contains \$83 million toward two additional ships, with a big bulge in funding to come in fiscal 1970.

Second thought. There is also a strong possibility that Congress will reduce the \$300 million it planned to spend at nonprofit "think tanks." Probably due for cutting are "social sciences" contracts, which have come under criticism by Sen. J.W. Fulbright (D., Ark.), and research carried out at foreign universities. There has been sharp criticism of such Pentagon-financed research in Japan and Sweden, which, the critics say, is supposed to be non-aligned.

The economy wave won't affect the \$3.9 billion supplemental budget for Vietnam that was recently submitted to Congress. Most of the spending impact of that will come in fiscal '69, principally for procurement of helicopters and equipment for modernizing the South Vietnamese Army.

... means less space

There was a time when astronauts dined at the White House and the eyes of the nation scanned the evening sky for satellites. It was also a time when Congress gave NASA sums as much as \$6 billion or more a year to get the nation into space.

As with other national moods, the one that got the U. S. into space is changing, and nowhere was that more evident than on the floor of the Senate earlier this month. An already austere Administration fiscal 1969 budget request came within a hairbreadth of being trimmed by a billion dollars—the vote was 36-33. There have been major assaults on the NASA budget before, but never has one come so close to a massive slice or rallied such an army of Senators behind it. Several of those favoring the cut came from states rich in space con-

tracts, and others, such as Sen. Dirksen (R., Ill.) and Russell (D., Ga.), a member of the Committee on Aeronautical and Space Sciences and chairman of the Armed Services Committee, were also surprise backers of the budget cut.

War goes on. The amendment that would have cut so severely was introduced and engineered by long-time space critic William Proxmire (D., Wis.), who is not yet through with the fiscal 1969 space budget. Proxmire, who will lead the fight again when the budget comes up for appropriation, serves on the Senate Appropriations Committee. He will try again there and continue trying, if necessary, when the appropriation goes to the Senate floor. One of Proxmire's aides points out that even if the Senator isn't successful, both houses are expected to take a much closer look at NASA requests in the appropriation round.

As it stands now, the Senate authorization rests at \$4.013 billion and the House authorization at \$4.031 billion; the President asked for \$4.370 billion. In all cases but one the Senate has authorized line items equal to or less than the House action; at the last moment, the Senate decided to authorize \$55 million for the nuclear rockets line item.

Speculators. The only thing left to decide in House-Senate conference, then, is whether to go ahead with the Nerva nuclear engine program, which the House just about eliminated. Both houses are agreed upon a figure of \$253.2 million for Apollo Applications Programs, a far cry from the \$439.6 million requested by the Administration.

Military electronics

On the flight line, but . . .

Although the word out of Washington is that the long-delayed 411L airborne warning and control system (Awacs) will move to the contract-definition stage this summer,

NEW Tektronix 50-ps Sampling Oscilloscope



The Tektronix Type 561A Oscilloscope with the Type 3T2 Random Sampling Sweep and Type 3S2 Dual-Trace Sampling Unit provides new convenience when making fast pulse measurements. Random sampling permits triggering before or after the displayed pulse, eliminating the need for delay lines or a pretrigger.

The new Type 3S2 Dual-Trace Sampling Unit with plug-in Sampling Heads lets you change your measurement capabilities to meet your changing measurement needs. Two sampling heads are presently available: the Type S-2 features a 50-ps risetime and the Type S-1 features lower noise with a 350-ps risetime. Any combination of two Sampling Heads provides dual-channel operation in the Type 3S2. The Sampling Heads have a 50-Ω input with an internal trigger pick-off and a 2 mV/div to 200 mV/div calibrated deflection factor. Sampling Heads can be plugged into the Type 3S2 or attached by a 3 foot or 6 foot cable for remote use. An interchannel delay control compensates for signal cables or other external delays.

The Type 3T2 Random Sampling Sweep provides all the measurement capabilities of a conventional (sequential) sampling sweep, plus it features the added

advantage of random sampling operation. When used in the random sampling mode, the triggering event may be displayed on screen without the use of delay lines or a pretrigger. The Type 3T2 has a calibrated sweep range from 100 μs/div to 200 ps/div extending to 20 ps/div with the X10 magnifier.

The Type 561A Oscilloscope has an 8 by 10 cm CRT with an illuminated internal graticule. In addition to the sampling plug-in units described, the Type 561A offers a wide range of measurement capabilities with 10 MHz Multi-Trace Plug-ins, 10 μV/div Differential Plug-ins and Spectrum Analyzer Plug-ins covering the spectrum from 50 Hz to 36 MHz. The Type 564 Storage Oscilloscope uses the same plug-in units and offers the added advantage of split-screen storage.

Type 561A Oscilloscope	\$ 530
Type 564 Split-Screen Storage Oscilloscope	\$ 925
Type 3T2 Random Sampling Sweep	\$ 990
Type 3S2 Dual-Trace Sampling Unit	\$ 800
Type S-1 350-ps Sampling Head	\$ 250
Type S-2 50-ps Sampling Head	\$ 300
Scope-Mobile® Cart, Model 201-2	\$ 135

U.S. Sales Prices FOB Beaverton, Oregon



Tektronix, Inc.



For a demonstration, contact your nearby Tektronix field engineer or write: Tektronix, Inc., P. O. Box 500, Beaverton, Oregon 97005

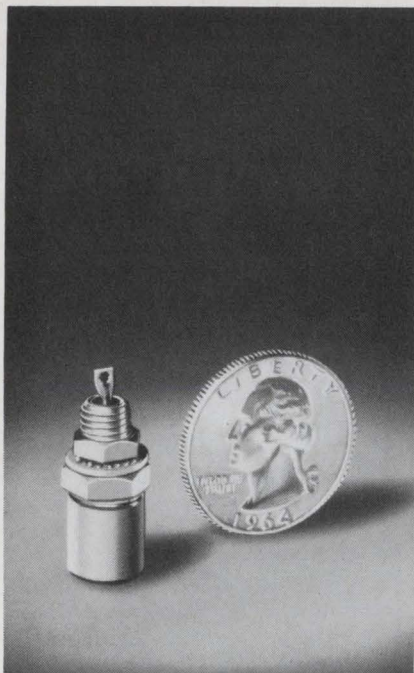

By George... Captor sure makes small EMC Filters!

Captor subminiature EMC filters are the industry's smallest . . . 25% to 37% more compact than other popular miniatures. Volumes and weights are correspondingly reduced . . . as light as 4.9 grams for many units. Captor EMC filters maintain high published performance over full temperature range to 125° C. Their performance is equal to or better than the competition's, yet they truthfully cost less! Let Captor bid on your next EMC filter or filter assembly requirement, by George! Write for Catalog F-104 and prices today.

Captor Corporation manufactures miniature filters . . . communications and security filters . . . custom-design filters, and other electronic components.

CAPTOR
CORPORATION

APPLICATION ENGINEERING DEPT.
5040 Dixie Highway, Tipp City, Ohio 45371

there is a growing concern among electronics firms as to whether the program is ready for this phase.

Part of the problem stems from the controversy over who should integrate an aircraft system that has a major electronics subsystem—airframe makers or electronics companies? Electronics will account for at least 80% of the \$25 million cost of each Awacs craft.

At least one company would use the extra time and money to test additional functions for the radar. The company wants more data for verification and confidence in the new radar.

One major part of a new test would be to try to get as much of a "single-thread system" together as possible; the radar, a computer, and displays would be an integral subsystem. The overland radar tests proved that aircraft could be detected in a high-clutter environment. But they weren't real systems tests: a 20-year-old plan-position-indicator scope was used in one test for the display, for example.

Difficult task. "It's a real problem—and a touchy one—of whether Awacs is ready to go to contract definition," says one engineer close to the program. "It's a very difficult interface problem," he adds, in marrying the hardware and software for the radar, communications, and command and control.

Though an electronics company won't be the Awacs prime, one top company official says "at least major subsystems should be procured as group rather than collect them as separate black boxes." But he's not even sure this will happen. He predicts major problems if an airframe company integrates the electronics subsystems. These are things that should be decided now, he insists, "rather than have us just stumble through the program like we have with earlier systems."

Competing to build the communications, and the command and control subsystems are two company teams, one headed by Litton Industries Inc., and the other by the International Business Machines Corp. McDonnell Douglas is understood to be working with Litton as a possible systems inte-

grator. Boeing, however, apparently is still undecided.

Shares. But when a go-ahead to contract definition is given, probably in early September, the money will then go to both the Boeing Co. and to McDonnell Douglas. If the Pentagon can persuade Congress to take the next step—developing a prototype aircraft system—then one of two airframe manufacturers will probably get the job. The winner will also select the firm to build the overland radar, the key to the entire mission.

Following overland radar tests carried out over the last year or so, the Pentagon said that two of the systems—believed to be those of Hughes Aircraft Co. and the Westinghouse Electric Corp.—"look extremely promising." Hughes is working with a C-band doppler radar operating with a medium-pulse repetition frequency. Westinghouse's system is an S-band doppler radar with a high-pulse repetition frequency.

There is some controversy—within both industry and the military—over whether additional radar testing is necessary, and additional funding is yet to be authorized. But if it is, all three radar contractors (the Raytheon Co. has an S-band set with a low-pulse repetition frequency) would get more money. Chances appear good that more money is in the offing.

Cloudy skies. Even with Pentagon approval of contract definition, Awacs still has another hurdle to clear. The Senate Armed Services Committee has serious doubts about the need for defense against enemy bombers. In a report authorizing appropriations for fiscal 1969, the committee said bluntly: "Until there is some indication of an added threat to the U.S. from bombers, the committee is unconvinced that the U.S. should embark on a new bomber-defense system."

The Awacs program also would include interceptors. Originally, the interceptors were slated to be modified F-106's. But the Senate committee questioned the use of an aircraft "as old as the F-106" and turned down the Air Force request for \$28 million for research and development work on this modifica-

**The world's smallest 10 watt zener
has a 350 watt surge capacity...**

**600% more than an ordinary one,
35% more than a 50 watt.**

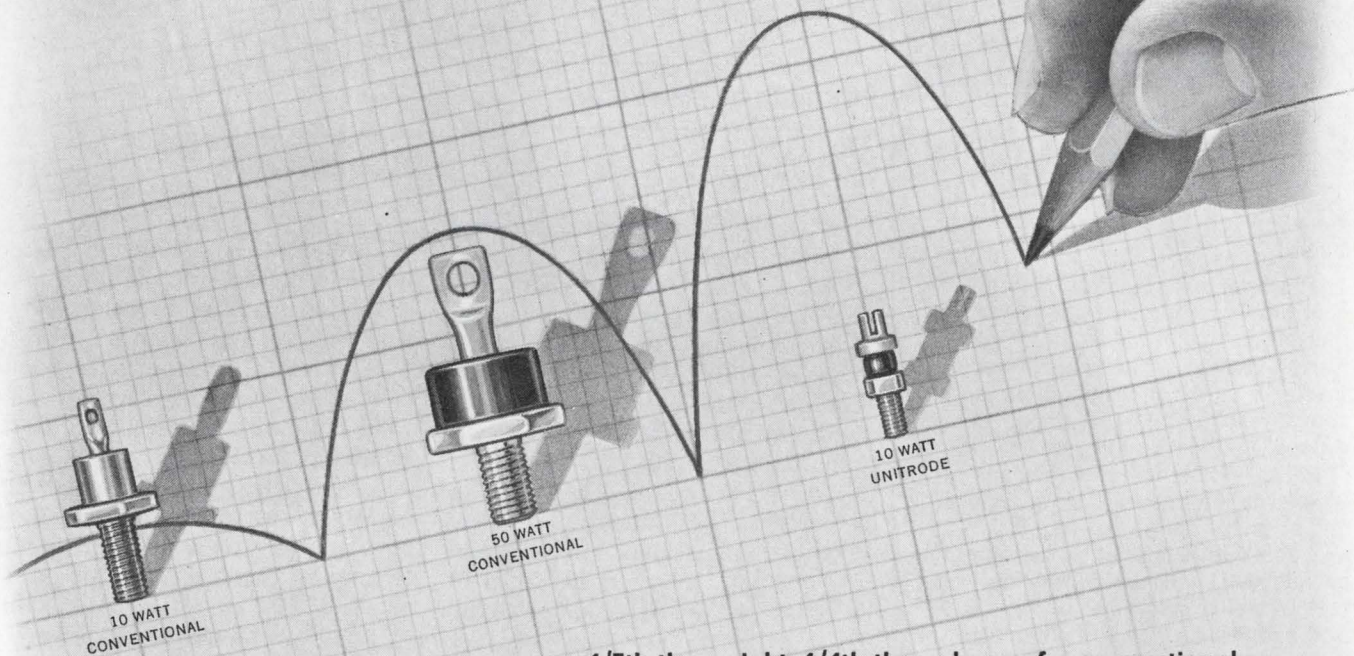

- 1/5th the weight, 1/4th the volume of a conventional 10 watt (smaller than an ordinary 400 milliwatt).
- 1/10th the weight, 1/20th the volume of a conventional 50 watt
- 10 watt continuous rating — stud mounting
- 6 watt leaded version for mounting on circuit boards, has same high surge capacity
- 6.8 to 100 volt range
- Low leakage current
- Electrical characteristics remain stable throughout life, exceeding the environmental requirements of MIL-S-19500

580 Pleasant St., Watertown, Mass. 02172, (617) 926-0404

UNITRODE 

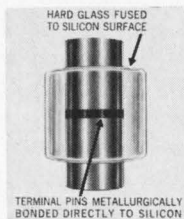

THE UNIQUE UNITRODE CONSTRUCTION

With the silicon die metallurgically bonded between terminal pins of the same thermal coefficient, the hard glass sleeve is fused to the entire outer silicon surface. Result — a voidless, monolithic structure.

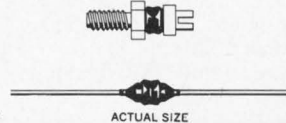

Get yourself a complete set of specs that give you all kinds of detailed information. Circle the reply card number now.



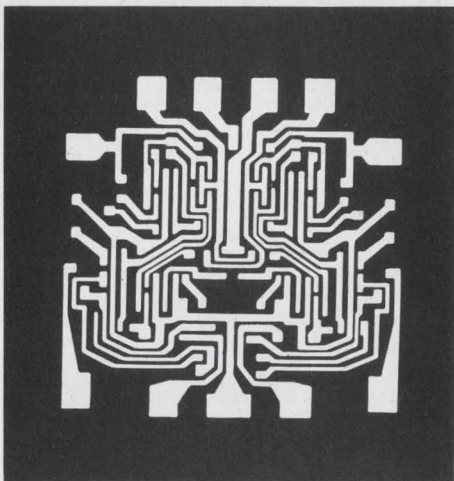

Precision plotting.

That's what our new Micro/Plotter coordinatograph offers you — precision plotting to $\pm .001$ inch.

Now you can produce highly accurate master layouts for printed circuits, optical resolution targets, maps, charts, graphs, and tool templates.

Micro/Plotter features rack and pinion motion, ultra-flat work surface, and abscissa rail pivots. And it's available with a special hardwood or backlighted translucent glass top — rectangular or rotary. An optical electronic digital display unit eliminates scale dials and tapes, increases operating speed and efficiency. And a new electrostatic top prevents movement of drafting films, minimizes air pockets, and improves accuracy.

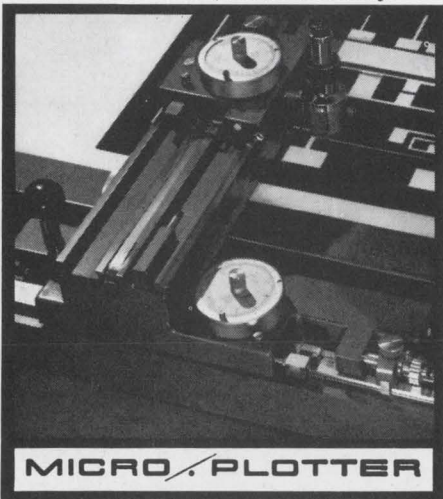

MICRO PLOTTER

Write today for complete information.
 Consul & Mutoh, Ltd., 519 Davis St.,
 Evanston, Illinois 60201
 Eastern Regional Office: 7601 Castor Ave.
 Philadelphia, Pa. 19152

MUTOH
 MICRO PLOTTER

tion. This action has dimmed the prospects for Awacs.

There is about \$70 million earmarked in the fiscal 1969 budget to get the program under way, but this was based on going ahead with the prototype aircraft. But now, there will be a big cut in Awacs money.

Consumer electronics

Sour notes

Shottky-barrier diode mixers have a high dynamic range and low noise figures. Over the years, hi-fi makers have considered them for the front ends of f-m stereo receivers. However, most have been content with metal-oxide-silicon field-effect transistors; they generally discontinued their work on diode mixer circuits. There was an exception: the Marantz Co. [Electronics, June 26, 1967, p. 47]. When the company unveiled its Model 18 receiver at the High Fidelity Show in New York last year rival set producers as well as hi-fi buffs sat up and noticed.

But something happened. Sales fell off as hi-fi critics zeroed in on performance features. Last week, Marantz was producing only 10 sets a day, down from the 40-a-day pace maintained for several months. And, as is customary, rival producers bought units for laboratory examination. "We were disappointed in the performance figures we got," says the chief engineer of one.

Disagreement. A former Marantz engineer who worked on the Model 18 says the problems are essentially those of production, not engineering. Most of the sets being produced are reworks from field rejects. But another engineer, who left Marantz within recent weeks, disagrees. He attributes the problems to poor design. Whatever the reason, there's general agreement that the Model 18 suffers from drifts due to poor temperature compensation, spurious responses in the front end, poor sensitivity—measured sensitivity is said to

be 3.5 microvolts—and a high capture ratio: about 6 decibels.

It's known that the Model 18 has undergone several design changes since its introduction. The latest has been by a team of engineers brought in from the Pilot Radio Corp. within the last three months. But Flavio Branco, Marantz's general manager, denies there's anything wrong with the Model 18. "It's all rumor," he says.

For the record

Shrinkage. A 1,400-volt silicon power transistor for the horizontal deflection circuitry in color television sets, one of seven new products unveiled by Motorola's Semiconductor Products division last week, promises to eliminate, or greatly reduce the size of power-supply transformers in the receivers. Most solid state color sets now use two 700-volt transistors in this application. The plastic-packaged device is designated the MJE8401. Thus Motorola joins AmpereX, Delco, Matsushita, and Toshiba in this new market. [For more information about this area, see page 104.]

SST multiplexing. As expected, the Autonetics division of the North American Rockwell Corp. and the Hamilton Standard division of the United Aircraft Corp. have been awarded parallel \$250,000 contracts to study and define a general-purpose multiplexing system for the supersonic transport to be built by the Boeing Co. [Electronics, June 10, p. 25]. The companies will define system requirements, evaluate components through the fabrication and test stages, and do initial designs to estimate system weight and performance. Four independent multiplexing systems—eliminating the need for 1,000 to 1,500 pounds of hard wiring—will each monitor about 600 subsystem channels of information.

Hitting the road. Last month, IBM delivered to Ft. Hood, Texas, the first of five Combat Service

The PINpickings are good

Microwave Associates offers the broadest line of PIN diodes in the industry, not only for high power, and not only at microwave frequencies, but right across the spectrum. The diodes are offered in a wide choice of case configurations, backed by production capacity second to none.

For control, switching; limiting, duplexing, phase-shifting, attenuating, modulating and pulse-forming.

Save this chart. It isn't complete, of course. A full catalog and application data sheets are available on request. But if your applications are low or medium power at any frequency, the chart covers many typical diodes that are immediately available.

Model Number	Case Style	Max. Total Capac. ¹ pF	Max. Series Resist. ²	Max. Therm Resist. °C/W	Min. Break-down Volt V ⁶	Peak Power W	Switching Time ns	Unit Price 1-9
MA-47027	30	0.4 @ -50V	1.2 ³	25	300	1000	50 to 200	\$30.00
MA-47028	30	0.6 @ -50V	1.0 ³	20	300	1000	50 to 200	30.00
MA-47030	30	0.6 @ -50V	1.0 ³	20	200	1000	50 to 200	25.00
MA-47032	30	0.4 @ -50V	0.8 ³	25	300	300	30 to 100	35.00
MA-47033	30	0.45 @ -50V	0.7 ³	20	300	300	30 to 100	35.00
MA-47034	30	0.35 @ -50V	1.0 ³	30	150	300	30 to 100	30.00
MA-47036	30	0.45 @ -50V	0.7 ³	20	150	300	30 to 100	30.00
MA-47037	30	0.3 @ -30V	2.5 ⁴	80	150	60	10 to 30	22.00
MA-47038	30	0.4 @ -30V	2.0 ⁴	60	150	60	10 to 30	22.00
MA-47039	30	0.3 @ -30V	2.5 ⁴	80	75	60	10 to 30	19.00
MA-47040	30	0.4 @ -30V	2.0 ⁴	60	75	60	10 to 30	19.00
MA-47041	54	0.1 @ -30V	2.5 ⁴	500	150	10	10	17.00
MA-47042	54	0.2 @ -30V	2.0 ⁴	500	150	10	10	15.50
MA-47043	54	0.3 @ -30V	1.5 ⁴	500	150	10	10	14.25
MA-47044	54	0.1 @ -30V	2.5 ⁴	500	75	10	10	15.50
MA-47045	54	0.2 @ -30V	2.0 ⁴	500	75	10	10	14.25
MA-47046	54	0.3 @ -30V	1.5 ⁴	500	75	10	10	13.00
MA-47047	54	0.3 @ -50V	1.5 ⁵	500	100	10	200	5.50

1 f = 1MHz 2 f = 500MHz 3 If = 100mA
 4 If = 30mA 5 If = 50mA 6 Breakdown voltage at I_z = 10μA



MICROWAVE ASSOCIATES

Burlington, Massachusetts

Offices: Northwest Industrial Park, Burlington, Mass.

3605 Long Beach Blvd., Long Beach, Cal.

Subsidiaries: Microwave Associates (West) Inc., Sunnyvale, Cal.

Microwave Associates, Ltd., Luton, Beds, England.



We're Turning The Pot Industry On Its Ear!



Now, a 10-Turn, Precision Wirewound

"PIXIEPOT"

T.M. (PAT. PEND.)

FOR AS LOW AS

\$3.97 EACH

That's right! The Duncan Model 3253 "PIXIEPOT" potentiometer is yours for as low as \$3.97 each in production quantities and only \$5.95 each for 1-24 units. Match the following "PIXIEPOT" features with any other similar pot on the market.

- Length: ONLY 3/4"
- Diameter: ONLY 7/8"
- Linearity: ±0.25%
- Resistance Range: 100 ohms to 100K ohms
- Power Rating: 2 watts @ +20°C
- Temperature Range: -25°C to +85°C
- Resolution: Better than ANY wirewound pot TWICE its size!
- Slotted Stainless Steel Shaft



SHOWN ACTUAL SIZE

A Duncan "PIXIEPOT" can save you dollars on your instrument and system requirements. If you want to know just how many, call or write us today. The full story on the "PIXIEPOT" will be in the mail to you within 24 hours.



DUNCAN electronics, inc.

A DIVISION OF SYSTRON-DONNER CORPORATION
2865 FAIRVIEW ROAD, COSTA MESA, CALIFORNIA 92626
Phone: (714) 545-8261

Electronics Review

Support Systems it is building for the Army. The gear, installed in trucks, is designed to give field commanders instant access to such data as troop strength, spare parts availability, and equipment status. The CS3 is the first operational portion of the Adsaf—Automatic Data Systems within the Army in the Field—program. IBM's initial contract is worth \$5 million, but some observers think the company may eventually win as much as \$100 million worth of orders for CS3.

Phase two. The National Library of Medicine's already advanced automated information and retrieval system, called Medlars for medical literature analysis and retrieval, will be upgraded and expanded to integrate and automate all the functions of the library [Electronics, March 18, p. 70]. The new system, Medlars 2, will use an IBM 360/50 computer. The Computer Sciences Corp. has been awarded a \$2 million contract to integrate and provide software for the new system. The job is expected to be completed in 1971.

FCC gets CATV. The Supreme Court has cleared the air once and for all and decided that the FCC does indeed have jurisdiction over community antenna television systems. In a unanimous—and expected—decision, the court agreed with the FCC's contention that CATV, rather than being a means of improving tv reception, is an integral part of the entire broadcasting picture.

Fix it fast. Sylvania Electric Products Inc. has developed a module tester—designated the MK-994—that will help speed repairs on aircraft navigation and radio equipment. The Army Electronics Command has ordered 400 as part of a \$25 million contract, awarded in 1966 as the Army's first total package procurement. Also called for by the contract, and already in production, are 2,737 vhf a-m radios; 2,367 vhf f-m radios, uhf a-m radios, and automatic direction finders; 4,374 communications controls; and 1,967 f-m communications antennas and homing antennas.

Most important advancement in stereo-zoom microscopy in a decade.

ALL NEW Bausch & Lomb **STEREOZOOM[®] 7**

*Courtesy Electronic Tube Division
Westinghouse Electric Corporation*

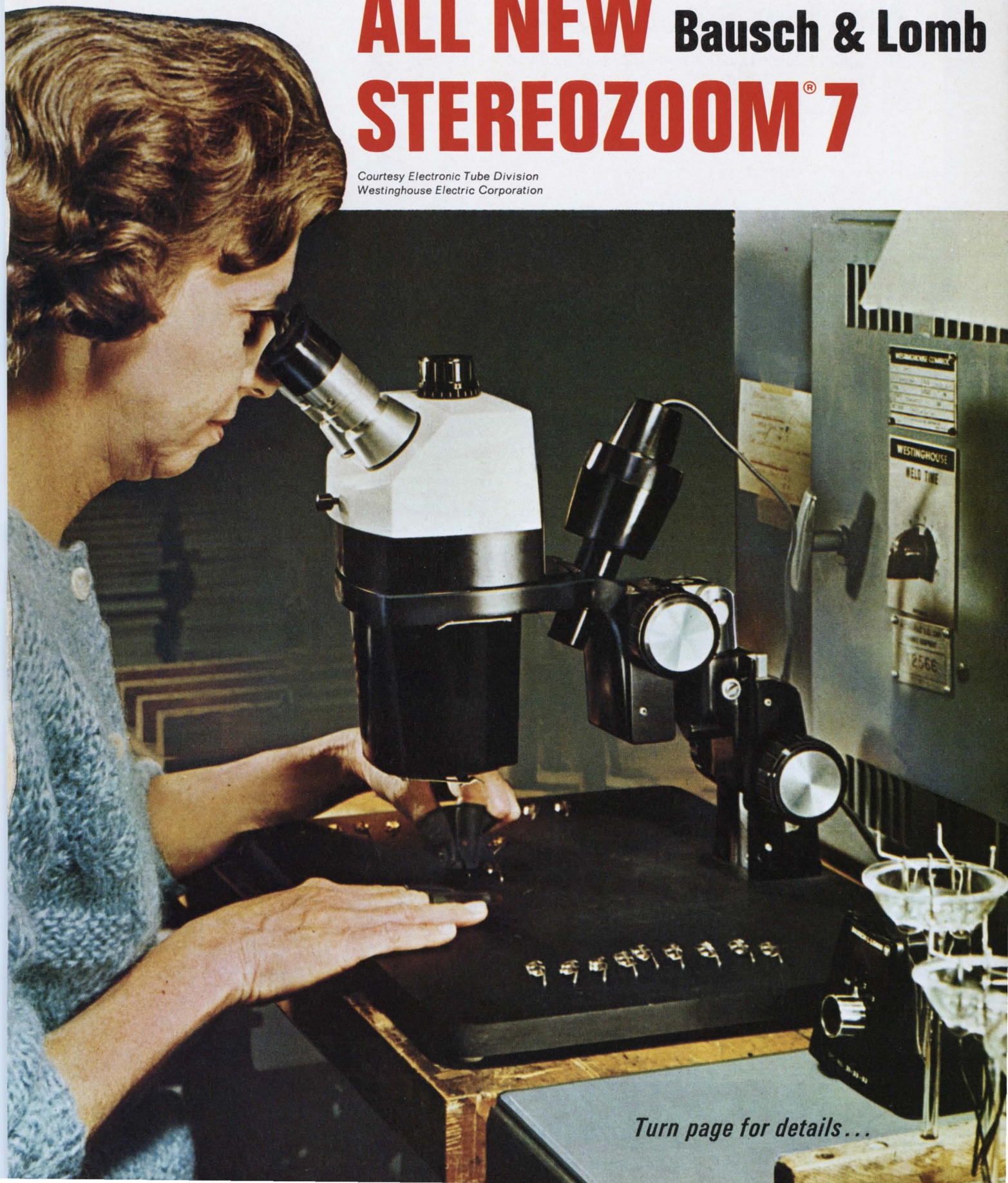

Turn page for details...

STEREOZOOM 7

New from Bausch & Lomb

The world's acknowledged originator and leader in stereo-zoom microscopy brings you a powerhouse of unequalled performance . . . StereoZoom 7, just added to the already successful line of Bausch & Lomb stereos.

LET US DEMONSTRATE THESE LEADING FACTORS IN NEW SEE-POWER

- Widest zoom range
- Clearest viewing
- Highest magnification
- Proven reliability . . .
designed by the 10-year
innovator and leader
in stereomicroscopes

Zoom Range—1X to 7X, infinitely variable, choose the just right power to see your work best.

Magnification Range—5X to 280X, all you need for viewing of micro-size detail.

Resolution—Up to 80% more numerical aperture (N.A.) gives you the highest resolving power over this wide range of magnification with maximum depth of field.

Working Distance—3" (without attachment lenses) optimum for macro to micro objects.

Image Brightness—High level brilliance at all powers, even at the upper limits of the zoom range.

Photomicrography—Simultaneous viewing and exposure with integral camera attachment for 35mm, 4" x 5", Polaroid* Cameras, and standard eyepiece cameras.

Versatility—Fits any standard StereoZoom stand and accepts all StereoZoom illuminators.

Why not let us bring you a StereoZoom 7 to try out. That's the only way to judge its performance. Write for catalog 31-2185 and our free demonstration offer. Bausch & Lomb, Scientific Instrument Division, 61404 Bausch Street, Rochester, New York 14602.

*Trademark, Polaroid Corporation



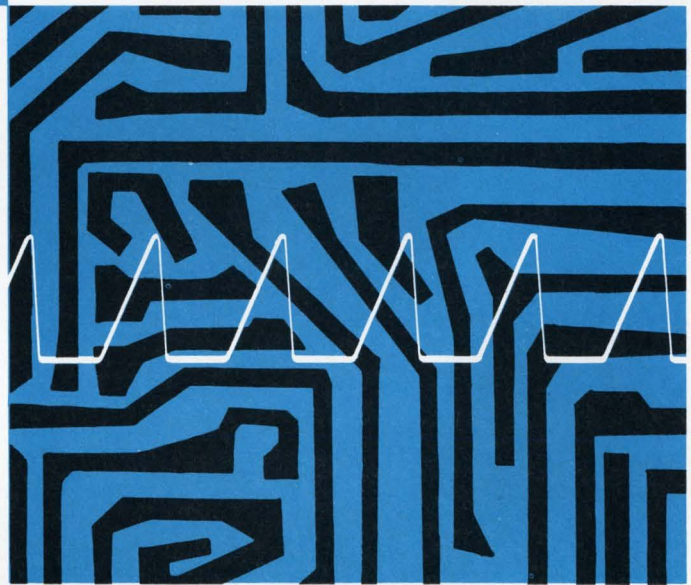
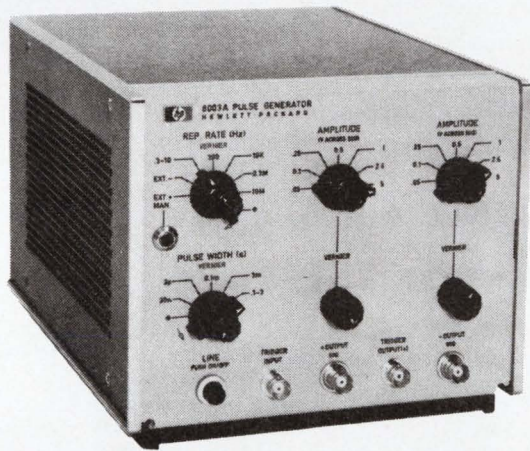
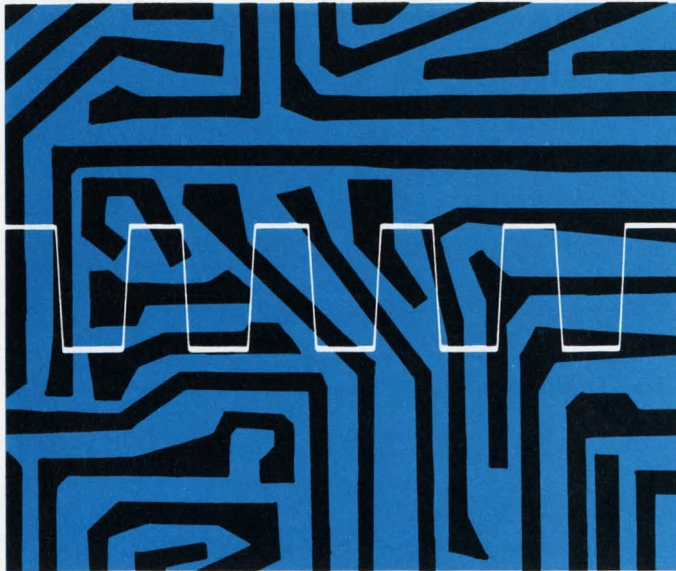

Better circuit testing requires better pulse generators.

Better check these out.

The Hewlett-Packard 8002A and the Model 8003A Pulse Generators offer you new and improved control over your input pulses for testing circuits under actual operating conditions. With clean, well-controlled and clear geometry pulses, you now have a versatile way to analyze circuit outputs without being restricted by the limitations of the pulse generator itself.

The 8002A Pulse Generator gives you excellent control of your

pulses, with rise and fall independently controllable by means of a vernier. Variable rise and fall times, 10 nsec to 2 sec, and rise/fall, fall/rise ratios up to 30:1. Repetition rate is 0.3 Hz to 10 MHz. 50 ohm source impedance, even during transitions; reflections are minimized. Price: \$700.

For the best pulses and greatest versatility for your money, the 8003A Programmable Pulse Generator is your best buy. Here you get simultaneous positive and negative outputs, 5 nsec rise time, pulse width of 30 nsec to 3 sec

and a 10 MHz repetition rate. Great for fast switching applications, wide frequency testing capability of the 8003A also makes it ideal for testing analog devices such as wideband amplifiers, filters and other linear circuits. Price: \$470.

If you've been searching for a better way to test circuits, a way to get better, more accurate results, get complete details on these two pulsers by calling your local HP field engineer. Or write Hewlett-Packard, Palo Alto, Calif. 94304; Europe: 54 Route des Acacias, Geneva.

HEWLETT  PACKARD

PULSE GENERATORS

18804

FAST MEMORY TESTING PICOSECOND TIMING TRANSIENT ANALYSIS

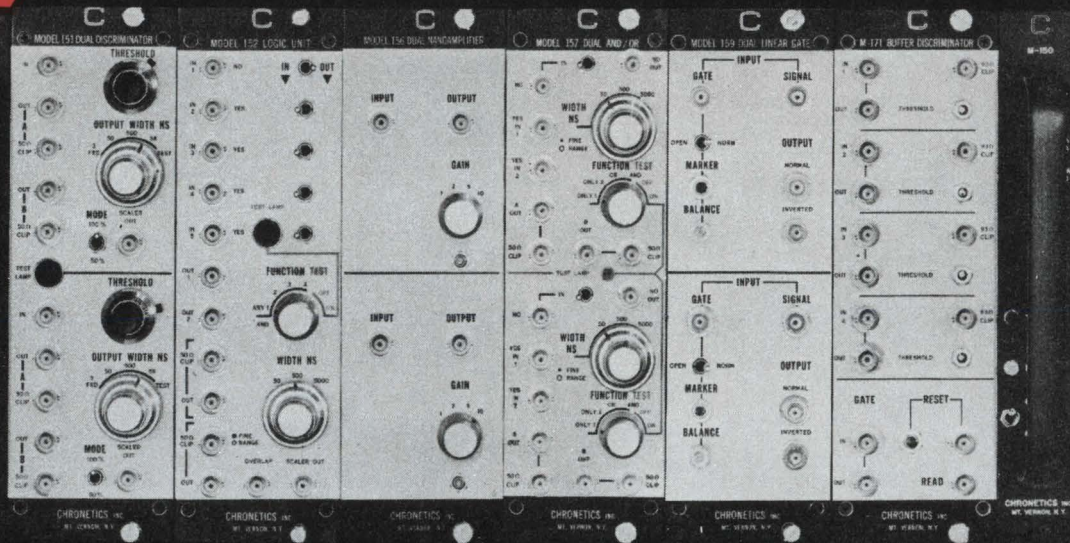

Voltage Discriminators Settable To ± 1 mV in 1000 mV
Timing Resolution Better Than 50 Picoseconds
Time To Amplitude Conversion In The Picosecond Resolution Region
Decade Amplifiers DC to 200 MHz
System Stability: 100 Psec/24 Hours
Outputs Compatible With Computers And ADC's

The Nanologic 150 System makes possible automatic measurement and analysis of transient or recurring signals. These measurements and analyses can be made at input rates to 200 MHz, with input pulse widths as narrow as 2 ns, signal amplitudes in the millivolt region and rise times of less than 1 ns. Such measurements were previously possible only through painstaking, expensive and less accurate visual techniques.

The System's modular form permits exactly the operational configuration required for such applications as thin film or plated wire sense analysis, semi-conductor switching time measurements and transient pulse identification and analysis. Modules presently available include voltage sensitive discriminators, logic units, amplifiers, linear gates,

sample and hold units, time to amplitude converters and input/output interconnecting interfaces.

And Nanologic 150 is a proven system. In varied configurations it is in use at most major accelerators conducting experiments in high energy physics; Chronetics has long been the leader in such nuclear instrumentation.

Nanologic is supported by a world-wide network of Sales/Engineering offices. An exceptionally competent Applications Engineering Staff is available to assist you in determining the optimum Nanologic 150 System for your application. For assistance, technical data and/or a prompt demonstration, please write or call.



U.S.A.: 500 Nuber Avenue, Mt. Vernon, New York (914) 699-4400 TWX 710 560 0014
Europe: 39 Rue Rothschild, Geneva, Switzerland (022) 31 81 80 TELEX 22266

whatever direction
your design takes...

Allen-Bradley thick film networks will put you out front in...

Packaging—Advanced manufacturing capability covers virtually every type and every configuration of resistive and/or capacitive networks—single or dual in-line, as well as flat-packs, with or without hermetic sealing.

Characteristics—Exclusive and patented formulations enable A-B to provide resistance values from 1 ohm to 5.0 megohm. Ratings to 20 watts/in² at 85°C. Capacitance values from 10 pfd to 0.5 mfd with voltage ratings to 50 volts. Applications include precision tuned circuits.

Performance—Standard resistance tolerance $\pm 10\%$. For critical circuitry, tolerances to $\pm 0.1\%$ can be furnished—with resistances and TC's matched. Temperature coefficient less than 250 ppm in all cases. Special units to 100 ppm or less. Load life stability of 1% in 10,000 hours can be achieved.

Reliability—Allen-Bradley has precise control over all raw materials and manufactures all basic components—glasses, organic materials, and substrates. Special machines—designed and built by A-B—assure uniform product quality—at a competitive price.

Timing—Allen-Bradley has unique in-plant ceramic facilities. Prototype networks—with or without holes—can be prepared to meet your specific needs. Quickly. Economically.

For more details, write Henry G. Rosenkranz, Allen-Bradley Co., 1315 S. First St., Milwaukee, Wis. 53204. In Canada: Allen-Bradley Canada Ltd. Export Office: 630 Third Ave., New York, N. Y., U.S.A. 10017.

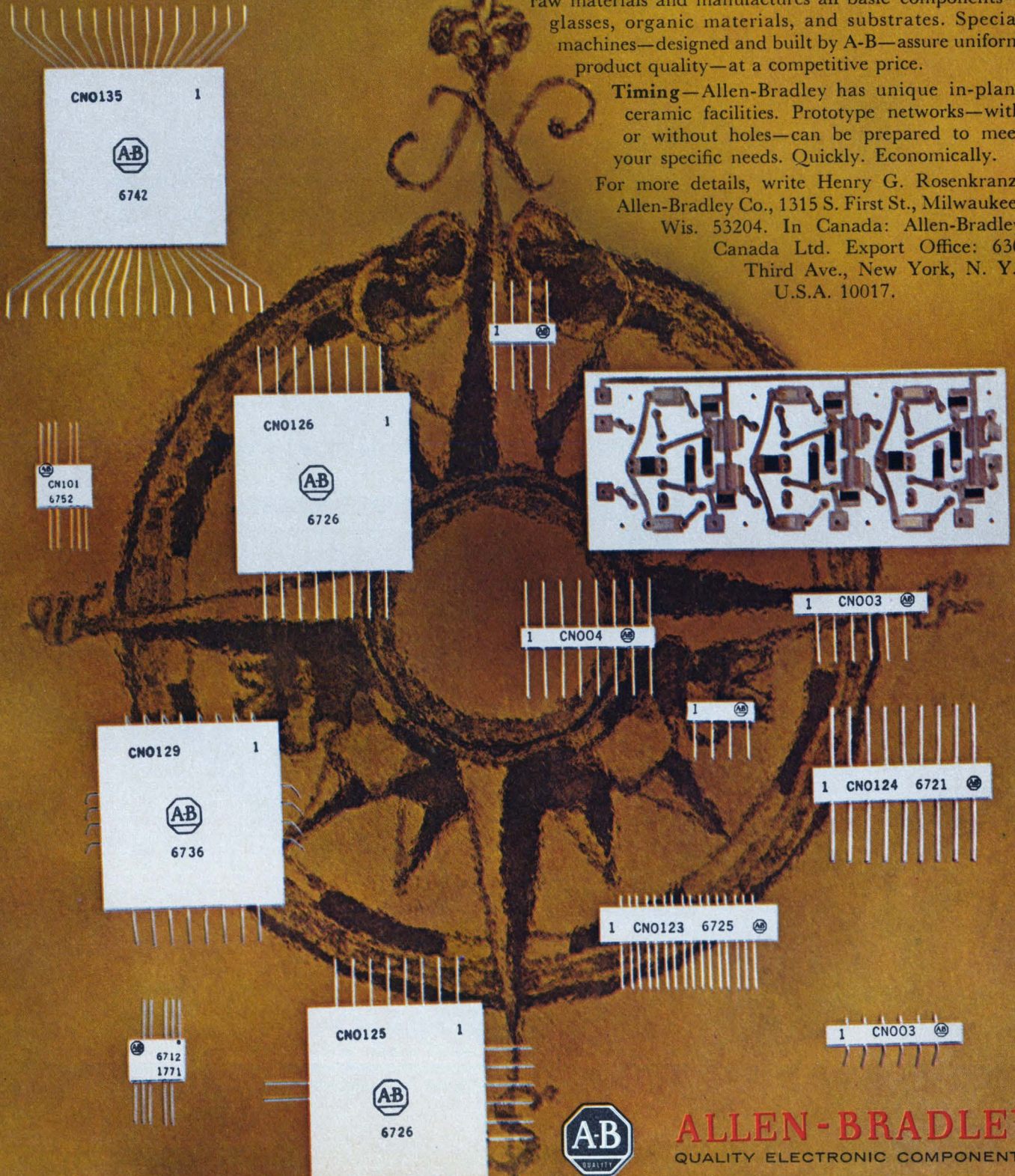

ALLEN-BRADLEY
QUALITY ELECTRONIC COMPONENTS

FET hybrid test: 500,000 hours without a failure and still going strong

Philbrick/Nexus mounted fifty Q25AH op amps on a long-term test rack a year ago. Since that time, at 25°C, not a *single* operational amplifier failed or drifted as much as $\pm 1/2$ MV.

The Q25AH FET hybrid exhibits in its microminiature size: high-speed operation, very high input impedance, extremely small current offset, low noise and wide-range operating voltages on both input and output signals. It is completely immune to all forms and combinations of external circuit or signal stresses. Available in a low-profile TO-8 can. For higher output current, voltage and power than you get from monolithics, design the Q25AH into your circuits for trouble-free operation. For performance requiring the addition of high common mode rejection, specify the Philbrick/Nexus Q85AH. Contact your Philbrick/Nexus sales representative for complete details and specifications. Or write, Philbrick/Nexus Research, 22 Allied Drive at Route 128, Dedham, Mass. 02026.

Philbrick/Nexus welcomes technical employment inquiries.



PHILBRICK/NEXUS RESEARCH

A TELEDYNE COMPANY

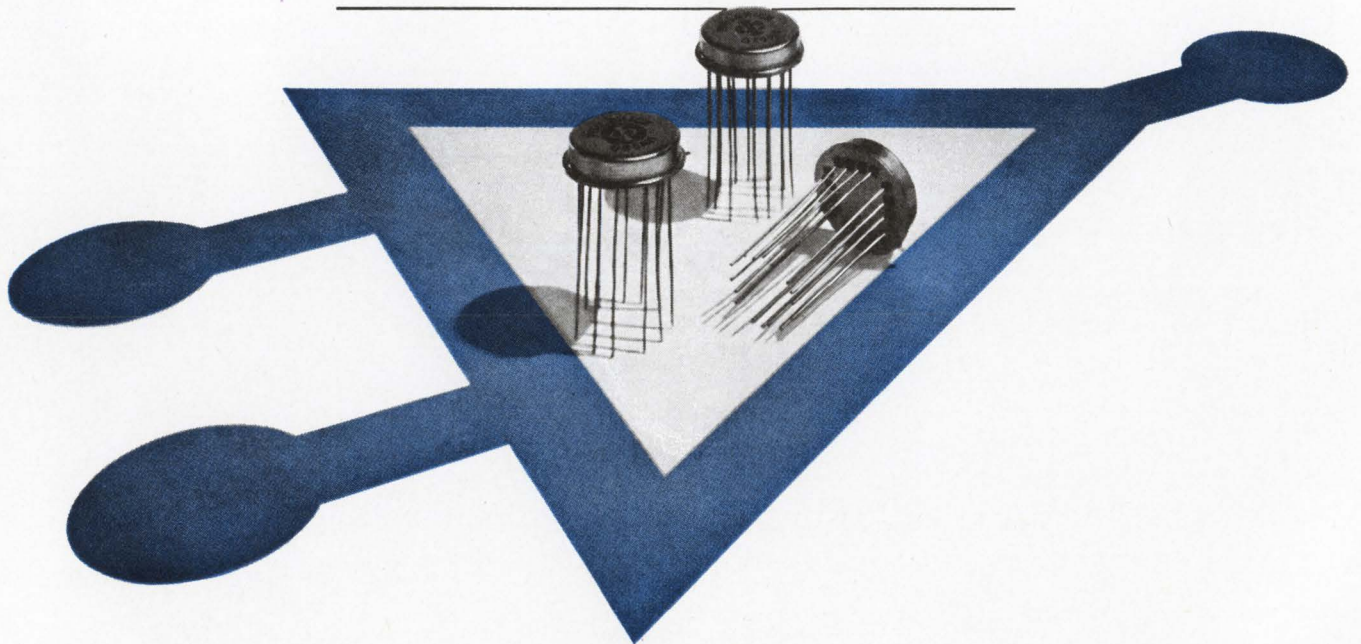

ALLEN-BRADLEY
Metal-Grid resistor networks
combine a new measure of

precision, stability and performance in a sealed, compact package



Precision Metal-Grid resistor network shown
approximately 1½ times actual size

The advanced capabilities—developed from years of manufacturing Allen-Bradley Metal-Grid resistors—are now applied to a new line of resistor networks. This technology enables the production of complex resistive networks on a single substrate.

Allen-Bradley's exclusive simultaneous deposition method is used to obtain the best resistance tolerance and temperature coefficient matching. The reliability of interconnections on the common resistance plane is incomparable. Uniformity and quality are inherent in A-B networks. To illustrate, 2 PPM temperature tracking is normal.

A-B Metal-Grid networks offer a wide range of values—with individual resistances as low as 25 ohms and as high as 2.0 megohms. Both the inductance and capacitance are low, permitting efficient operation at high frequencies.

A-B engineers will be pleased to cooperate in developing networks for your specific need. For additional details, please write to Henry G. Rosenkranz, Allen-Bradley Co., 1315 S. First Street, Milwaukee, Wisconsin 53204. In Canada: Allen-Bradley Canada Ltd. Export Office: 630 Third Avenue, New York, N. Y., U.S.A. 10017.

BRIEF SPECIFICATIONS

Resistor Networks

Tolerances: $\pm 1.0\%$ to $\pm 0.01\%$
Resistance Matching: to 0.005%
Temperature Range: -65°C to $+175^{\circ}\text{C}$
Temp. Coef.: to ± 5 ppm/ $^{\circ}\text{C}$
Load Life (Full load for 1000 hr @ 125°C): 0.2% maximum change

Ladder Networks

Full Scale Accuracy: 10 bits or less, better than $\pm \frac{1}{4}$ least significant bit. More than 10 bits, better than $\pm \frac{1}{2}$ least significant bit.
Frequency Response: Less than 100 nanosecond rise time or settling time
Temp. Coef.: Less than 10 ppm/ $^{\circ}\text{C}$
Temperature Range: -65°C to $+175^{\circ}\text{C}$

ALLEN-BRADLEY
QUALITY ELECTRONIC COMPONENTS



MICROWAVE IC PROGRESS REPORT #2

PACT program circulators prove power handling ability up to 8.5 kW

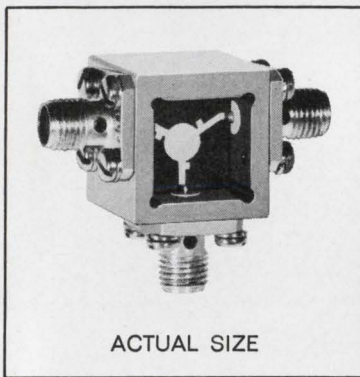

Sperry's PACT (Progress in Advanced Component Technology) program has achieved outstanding results in the development of microstrip ferrite circulators. PACT engineers report considerable progress in loss reduction, bandwidth, and power handling capability.

In the power area, laboratory work has already demonstrated Sperry circulators' ability to handle as much as 8.5 kW at X band. Improved power levels are achieved by doping the YIG substrate with small quantities (2%-5%) of dysprosium. While the higher power levels are achieved at the expense of somewhat higher insertion loss, PACT engineers feel that dysprosium doping offers great promise for high power applications.

Improvement in bandwidth/loss relationships has been equally gratify-

ing. Isolation of 20 db or better with insertion loss of .5 db or less has been achieved with a single device across a 40% (6.5-9.5 GHz) bandwidth.

PACT engineers feel that the reasons for such improvement are about

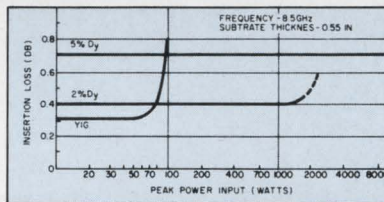

POWER CURVE

equally divided between selection and handling of substrate material and improved design of the microstrip conductors.

Substrate selection has been approached on a lowest possible loss basis; no other circuit parameters are considered at that stage. As a result, Sperry has learned that a thicker substrate is useful. Instead of the 25 mil substrate common in earlier microstrip work, PACT designers have gone to a 55 mil substrate and the added thickness contributes to demonstrably lower insertion loss.

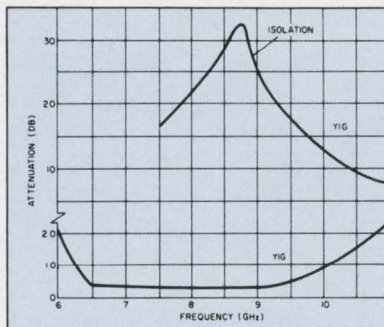

BANDWIDTH CURVE

Bandwidth has been substantially increased by the addition of matching

stubs to the deposited microstrip structure. Considerable work has gone into determination of optimum size and location for the stubs, and these efforts have been extremely rewarding.

PACT efforts have resulted in a number of microstrip circulator designs which cover a combined frequency range from 1.5 to 13.0 GHz. All circulators in the group share the desirable bandwidth and low loss

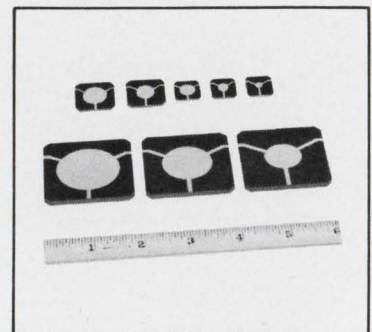

VARIOUS CIRCULATOR SIZES AND DESIGNS COVER 1.5 TO 13.0 GHz

characteristics described above. To date, PACT has concerned itself primarily with fixed bias devices, but recent technical evidence indicates that the program will shortly produce latching circulators with comparable capabilities.

If you would like more information about progress in microwave integrated circuit modules, contact your Cain & Co. representative or write Sperry Microwave Electronics Division, Sperry Rand Corporation, Clearwater, Florida.

*For faster microwave progress,
make a PACT with people
who know microwaves.*

SPERRY
MICROWAVE ELECTRONICS DIVISION
CLEARWATER, FLORIDA

Washington Newsletter

June 24, 1968

Requests for bids on computers . . .

Requests for proposals on the Air Force's Worldwide Command and Control System will be mailed in August, signaling the start of a computer procurement that is expected to run between \$300 million and \$400 million.

The Air Force will equip more than 100 installations with the general- and special-purpose machines. Proposals will be due at the Electronic Systems Division at Hanscom Field, Mass., in September. Award of the contract is scheduled for next April.

Although there will be four types of computers in the system, only two bench-mark tests are contemplated—one for general-purpose or business-type computers, and the other for special-purpose or scientific- and control-type processors.

. . . finds Pentagon under fire over purchase policy

Congressional pressure is again being exerted on the Pentagon to reverse its policy of ordering computers in large lots from a single manufacturer. At issue is the computer buy for the Worldwide Command and Control System. Applying the pressure is the House subcommittee on Government activities, headed by Texas Democrat Jack Brooks.

The panel has charged the Pentagon with being oriented to a single computer vendor when a mix of manufacturers can fill the bill. The subcommittee is contending that Jovial, the system's compiler language, can be standardized—as the Navy's Cobol language was—to make software independent of the hardware of a select few manufacturers. Thus, the computers for the worldwide system could be ordered from several companies.

Lockheed in lead for Awads order

Lockheed-Georgia is favored to win the prime contract for the Air Force's on-again, off-again Adverse Weather Aerial Delivery System (Awads) scheduled for award this week. Four firms reportedly bid for the order, but Texas Instruments is Lockheed's only competition now.

The contract was originally estimated at around \$300 million, but the project has been cut back considerably. The Air Force initially intended to equip 448 transport planes—C-130E's, C-141's, and the giant C-5A's—with new station-keeping gear, multimode radars, and computers. Plans now call for the outfitting of only 156 aircraft—all C-130E's—and the use of computers already owned by the Government. These machines are believed to be ASN-24's made by General Precision.

NASA seen getting another Nimbus B

Chances are excellent that NASA will be able to start an extra Nimbus satellite within the next month to replace the Nimbus B that was lost when its booster was destroyed just after liftoff last month. Backers of the replacement satellite—including John E. Naugle, head of the Office of Space Science and Applications—would like to sign a contract for the craft, dubbed Nimbus B', next month. General Electric would again be prime contractor. Total cost for the satellite, launch vehicle, and launch: between \$18 and \$20 million. Nimbus B cost \$50 million.

All instruments needed for the complex experiment package are available, as are such satellite components as solar cell paddles. With a

Washington Newsletter

go-ahead in the next few weeks, NASA feels it could have the B' ready for launch by next May.

The B', which would be identical to its predecessor, would perform such first-time feats for satellites as determining air pressures and temperatures. Through sensor-equipped buoys and balloons, it would also check wind velocity.

Land mobile likely for freed spectrum

The FCC, which has just gotten a windfall of 26 megahertz of frequency space previously reserved by the Government, will probably make this space available for land mobile use. One catch, though: the commission may leave it up to prospective users and their suppliers to develop the hardware needed to exploit this range. None exists at present.

The frequency space—half of the 890-to-942-Mhz band—was released by the Office of Telecommunications Management. Land mobile users would rather get frequencies in the lower portion of the uhf spectrum—now reserved for television—a range for which equipment is already available.

Airline user tax makes headway

The Administration's proposed user tax for the air transport industry has gotten farther along in Congress than many had expected, and some on Capitol Hill are now betting that a compromise will be hammered out next session. The tax—which would boost the levy on passenger tickets from 5% to 8%, establish a similar tax on freight waybills, and raise gasoline taxes—would be used to finance airport and air traffic control improvements. Originally it was not expected to be taken up by committee this session, but the Senate aviation subcommittee surprised many opponents of the tax by scheduling hearings last week.

The FAA proposed that \$121 million raised by the tax rise in fiscal 1969 be spent on facilities and equipment, mostly terminal and en route radars and instrument landing systems. Another \$23 million would go for research and development, under the agency's plan.

Addenda

With most Government agencies reeling from heavy budget cutbacks, Edward Reilly, who directs the Post Office's research and development work, is counting his blessings. His request for \$36 million—much of it earmarked for electronics—emerged from Congress in comparatively good shape. The House shaved only \$2 million, while the Senate pared \$1 million. And the betting is that no further cuts will be made when the Joint House-Senate Committee irons out a final version . . . NASA's Application Technology Satellite office pushed it and the Goddard Space Flight Center wanted it, but the proposed ATS-B' satellite [Electronics, May 27, p. 74] has been scrubbed by NASA headquarters—a victim of the agency's budget woes. Meanwhile, the gravity-gradient-stabilized ATS-D satellite arrived at Cape Kennedy last week in preparation for a planned July 24 launch . . . The FCC decision on the long-running Carterphone case, expected momentarily, may force the Bell system to completely reevaluate its rate structures. The ruling on whether equipment not made by Bell can be attached to its lines [Electronics, June 10, p. 80] is expected to make it clear that though Bell can set standards for such attachments, it will be up to the phone company to prove that a piece of equipment does not fall within these specifications.

**All the Volts: 6kV
All the Watts: 1.5kW
All the Time!**

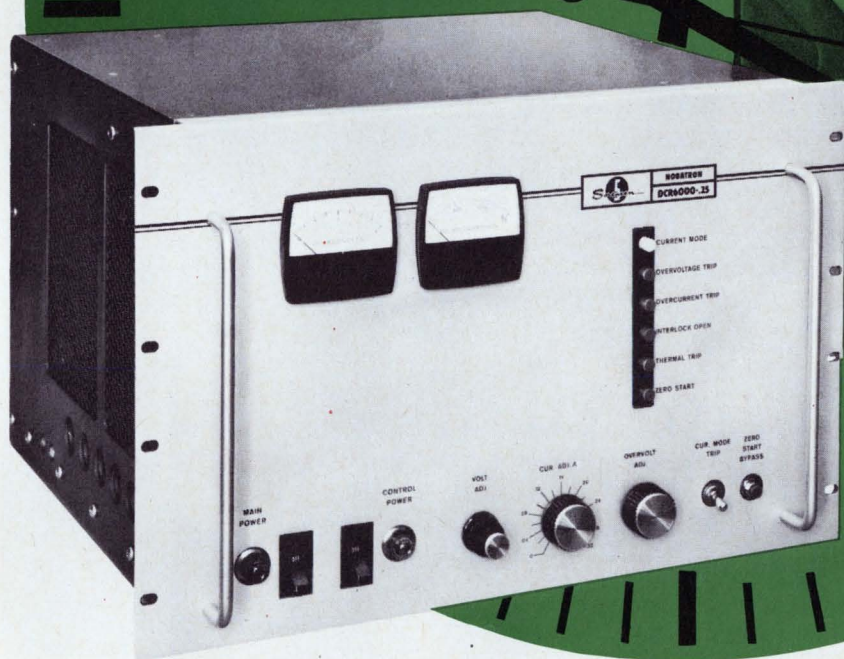

Dollar for dollar—
spec for spec—6000 Vdc
/ 1500 W/ $\pm 0.075\%$ Regulation—
dependability when and where
it counts!

New Sorensen DCR-HV:

- Voltage/Current Regulation with Automatic Crossover
- $\pm 0.075\%$ Voltage Regulation for Maximum Line and Load Changes Combined
- All Solid State Design Featuring Reversible Polarity

Model Number	Output Voltage Range	Output Current Range @ Ambient			Sizes (inches)			Price
		@ 30°C	@ 55°C	@ 71°C	h	w	d	
DCR600-2.5A	6-600 Vdc	0-2.87A	0-2.50A	0-1.65A	10½	19	18	\$ 875.
DCR1500-1.0A	15-1500	0-1.15	0-1.00	0-0.66	12¼	19	18	995.
DCR3000-0.5A	30-3000	0-0.58	0-0.50	0-0.33	12¼	19	18	1250.
DCR6000-0.25A	60-6000	0-0.29	0-0.25	0-0.17	12¼	19	18	1495.

Contact your local
Sorensen representative
or: Raytheon Company,
Sorensen Operation,
Richards Ave., Norwalk,
Conn. 06856.
TWX 710-68-2940.



for more data on this versatile instrument ... **Call Sorensen: 203-838-6571**

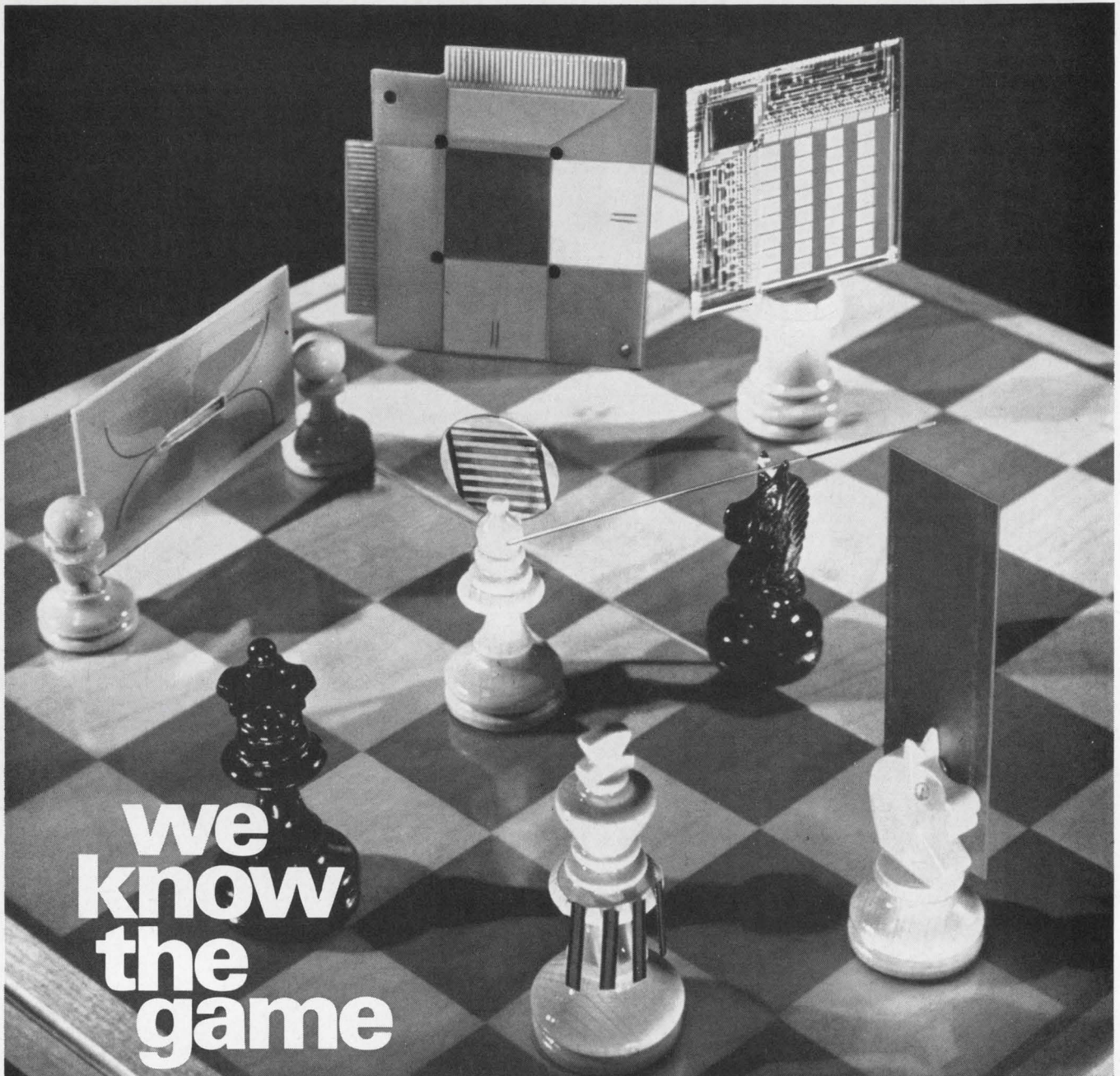

**we
know
the
game**

The Electronics Group of The Bank of New York has only full time industry specialists.

If your needs involve financing working capital, corporate or product development, mergers, acquisitions, stockholder relations, options, pensions or other considerations, no one is better equipped than our full time "electronics bankers" to assist you in finding the solutions for continued growth and increasing profits.

On a comprehensive, first-hand level, the officers in our Electronics Group, Special Industry Banking Division, have a unique ability to give your company the most experienced attention in the field.

Ask yourself if you can afford to have your financial needs handled by other than a banker who concentrates exclusively in Electronics.

... a specialist from The Bank of New York

Write for our new Electronics Group booklet.

**THE
BANK
OF
NEW YORK**

ELECTRONICS GROUP

Special Industry Banking Division

48 Wall Street • New York, New York



Automated testing...

**...helps make μ -PACS
the most reliable
I/C modules in the
industry**

μ -PACS are 100% tested. We test the components, test the circuit boards, and test every finished PAC against stringent QC standards. In fact, we designed our own automatic PAC test system to perform more tests faster . . . like 85 static and dynamic electrical tests in less than 20 seconds. All to make sure the reliability we achieve in design is passed on to you in production.

Whether you face design of a one-shot black box, or an entire product line, why not rely on μ -PACS. You'll never have to worry about reliability. They've been proven in hundreds of systems — and in test after test. And you get the best price/performance ratio available today. Write for our new brochure. It sums up all the facts. Honeywell, Computer Control Division, Old Connecticut Path, Framingham, Massachusetts 01701.

Honeywell

 **COMPUTER CONTROL**
DIVISION

Circle 73 on reader service card

Sealing diodes, ICs, thick or thin film packages?

GTI can help you:

Seal 675 diodes in less than ten minutes with the DAP-500 infrared multispeed sealer. Leads, envelopes and dice are loaded in fifteen minutes; automatic sealing takes less than ten. Adaptable for soldering and brazing; handles glass kovar or ceramic.

Totally control entire sealing cycle when sealing "Flat-Packs" in the FP-VP-1 bench-type single head perimeter sealer. Designed especially for lab and pilot line work, it allows complete variation of all sealing parameters—atmosphere, heat and heat location, time at temperature and slope of heating and annealing curves.

Automatically seal 3, 5, or 10 "Flat-Packs" at once in FP-VP-103, 10 or 210 perimeter sealers. Cycling from 30 to 120 seconds, these production sealers load semi-automatically, insure perfect hermetic seals on glass, kovar or ceramic packages. Plug-in elements adapt sealers to different types and sizes. Sealing yields of 98% are possible when GTI Providence glass/ceramic packages are used.

Seal high reliability diodes semi-automatically in the DE618-5 (standard) and DE618-10 (vacuum) sealers with a seven stage timer for split second control of all sealing stages.

Completely control pre-bake and seal atmospheres. FP-DB-103 and 10 add hermetic dry boxes to the "Flat-Pack" sealers described above. DE618-55 adds a dry box to two DE618-5 sealers for producing up to 5,000 diodes per day with less than 10 ppm moisture.

Develop reliable procedures for your hermetic sealing process with the help of GTI packaging specialists. As suppliers of the Dix Division sealing equipment described, "Flat-Packs" for integrated circuits (Providence Division) and diode glassware and leads (Saegertown Components Division), GTI is uniquely qualified to assist you in all phases of your packaging operations.

Find out more about sealing diodes, ICs, thick or thin film packages with our new Dix applications brochure. Just write for your free copy. GTI Corporation, 310 Chestnut Street, Meadville, Pa. 16335.



Let us throw you a curve

If you've problems with LC circuits, Magnetics' new Iso-Q contour curves speed ferrite pot core selection.

No more squinting at tangles of curves on log paper to find the ferrite pot core size you need. Magnetics' new Iso-Q contour curves let you zero in on your target size in seconds. We've plotted over 100 of these time-savers to handle more than 90% of normal design

requirements. They're all contained in our new Ferrite Cores Catalog, first of its kind in the industry.

Magnetics' high purity ferrites cover frequencies up to 2 megahertz. Linear temperature coefficients on 750, 1400 and 2000 permeability materials are guaranteed from -30° to $+70^{\circ}\text{C}$. Flat temperature coefficient on 2300 perm material is guaranteed from $+20^{\circ}$ to $+70^{\circ}\text{C}$.

Magnetics' wide selection of ferrites comprises eight international standard sizes and five additional sizes—175 part numbers for design freedom. We can give you quick

delivery from our large inventory that includes both gapped and ungapped cores in your most asked-for sizes. Of course, we provide one-piece clamping hardware for most sizes. Finally, we offer you a complete choice of tuning assemblies, bobbins and shapes—toroid, E, U and I.

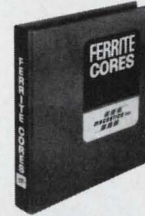

Get your set of our new Iso-Q Curves. You'll like their curvilinearity. Write on your letterhead to Magnetics Inc., Dept. EL-101, Butler, Pa. 16001. Please include your title and/or job function.

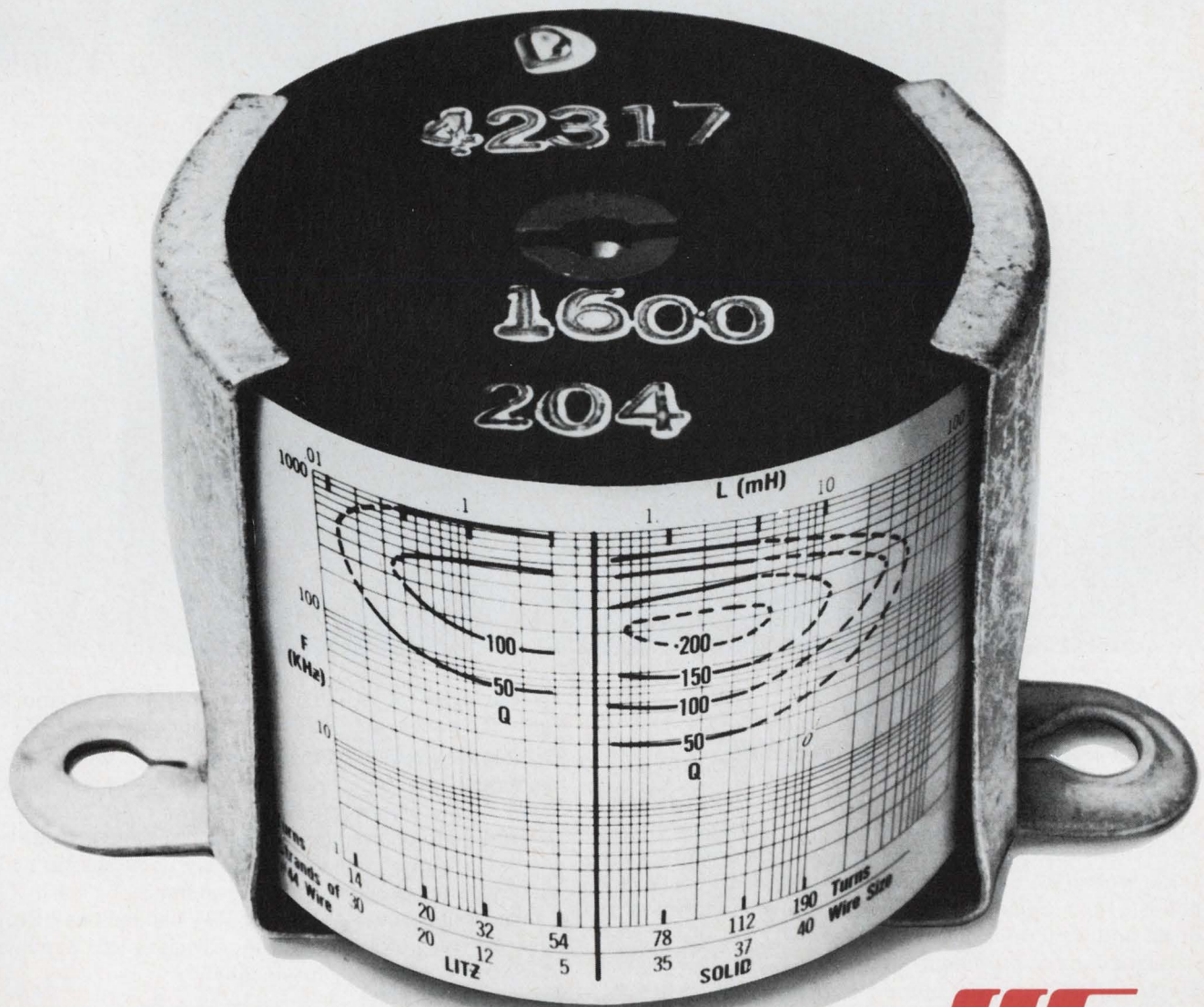

MAGNETICS inc.
®

Tape, Powder, Bobbin, Ferrite Cores • Laminations • Photo-etched Parts • Specialty Metals • Engineered Control Systems



Quick response on Ram Air Turbine Systems.

Garrett now has 30 types of RATS (Ram Air Turbine Systems) to choose from, and more standard designs are on the way. That's how we can promise quick response.

But what if we don't have a model that meets your exact needs? No problem—we can design and build one that does, and we'll do it quickly.

Take a look at our lineup:

Electrical RATS—power outputs from 500 watts to 40 KW.

Mechanical RATS—ratings up to 60 shaft hp at speeds from 600 to 60,000 rpm.

Hydraulic RATS—reliable power at pressures and flow rates compatible with current hydraulic designs.

Combination RATS—versatile performance with any combination of electrical, mechanical, or hydraulic outputs.

We supply more than 90% of all Ram Air Turbines for externally-stored systems—applications that provide military aircraft with a mission flexibility unsurpassed by any other type of secondary power system.

Like to hear more about our RAT capabilities? Drop a line to AiResearch Manufacturing Division, 9851 Sepulveda Blvd., Los Angeles, California 90009.

 **AiResearch**
Ram Air Turbine Systems

one of The Signal Companies 



Meet Your Components Sources in Tokyo — Visit

JAPAN ELECTRONICS SHOW '68

Tokyo
Sept. 17-23



'68 JAPAN ELECTRONICS SHOW

Sept. 17-23, Tokyo

Here is an excellent opportunity to meet with select members of sales and industry. We will have a record number of exhibitors from abroad this year. In fact, upwards to 400 foreign and domestic manufacturers will be displaying their latest state-of-arts electronic products to an anticipated daily attendance of 20,000

visitors. Exhibits will include radios, televisions, stereos, tape recorders, transceivers, communications and measuring equipment and a host of parts and devices of current interest.

Open daily from 10 a.m. to 5 p.m. at the Tokyo International Trade Center pavilions.

ELECTRONIC INDUSTRIES ASSOCIATION OF JAPAN

Tosho Building, 3-14, Marunouchi, Chiyoda-ku, Tokyo

Overseas Affiliates:
Electronic Section,

Japan Light Machinery Information Center, JETRO

□ 437 Fifth Avenue, New York, U.S.A. □ Duesseldorf, Berliner Allee 32, West Germany



Meet Your Components Sources in Tokyo — Visit

JAPAN ELECTRONICS SHOW '68

Tokyo
Sept. 17-23

so small yet
so

BIG



CS-32A
World's first solid state electronic desk-top calculator using ICs.
*16 digits, 8 decimal places *2 memory registers *Rounding off device *Overflow error check lamp *Power consumption: 20W *6.6 kg (14.5 lbs)



Now—two new models to work for you. Both with **IC**

Always looking for a better way... We made the world's first solid state electronic desk-top calculator. Then we announced the world's first calculator using revolutionary ICs. Now we bring you two new dyna-compact calculators that work harder, take up less space, and save you time and money.

Take our CS-32A. Super-streamlined, yet big on performance. Complex calculations up to 16 digits and eight decimal places. Even has two memory registers that store intermediate answers for continued calculations. A truly ideal calculator at realistic prices.

Our CS-17B with superior ICs is more compact, has a hide-away handle for perfect portability. Big on performance, too. Calculations up to 12 digits and six decimal places. Just right for modern business use.



CS-17B
Dyna-compact, big on performance.
*12 digits, 6 decimal places *Panel hood *Hide-away carrying handle *Power consumption: 11W *4kg (8.8 lbs)

Why not put us to work for you? Our lightning fast dyna-compact IC calculators look smarter, last longer and work harder.

SHARP
HAYAKAWA ELECTRIC CO., LTD. Osaka, Japan

U.S. Subsidiary: SHARP ELECTRONICS CORP. 178 Commerce Road Carlstadt, New Jersey

NEW EFFICIENCY FOR ULTRASONIC TRANSDUCERS

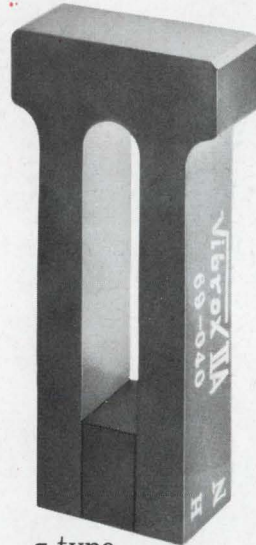

π type

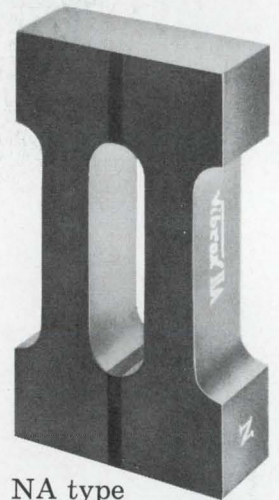

NA type

Now, adding new efficiency to ultrasonic propagation, **Token** introduces VIBROX—unique ferrite magnetostrictive vibrators. VIBROX has minimum eddy current loss and a far greater electro-mechanical transduction efficiency than conventional vibrators. A wide range of application embraces ultrasonic cleaning and degreasing; metal, textile, and chemical processing; and echo-sounding and navigation devices such as depth-sounder, fish-finders, etc.

Token VIBROX is supplied in two shape-types with nominal frequencies ranging from 15 to 100 kHz. Termed NA and π respectively, both make use of associated permanent magnets to totally eliminate the need for DC bias—despite the fact that VIBROX is magnetostrictive.

For further information and brochures, write to:

Token

Tohoku Metal Industries, Ltd.

4, 7-chome, Ginza-Higashi, Chuo-ku, Tokyo, Japan
Telephone: Tokyo 542-6171 Cable Address: TOHOKUMETAL TOKYO

Main Products: Permanent Magnets (Cast, Ferrite), Tape Wound Cores, Bobbin Cores, Magnetic Laminations, Fe-Co Alloys, Sendust Cores, Ferrite Cores, Memory Cores, Memory Matrices, Pulse Transformers



Meet Your Components Sources in Tokyo — Visit

JAPAN ELECTRONICS SHOW '68

Tokyo
Sept. 17-23

in the land of the "Risen Sun"
engineers in the know
select **OMRON**

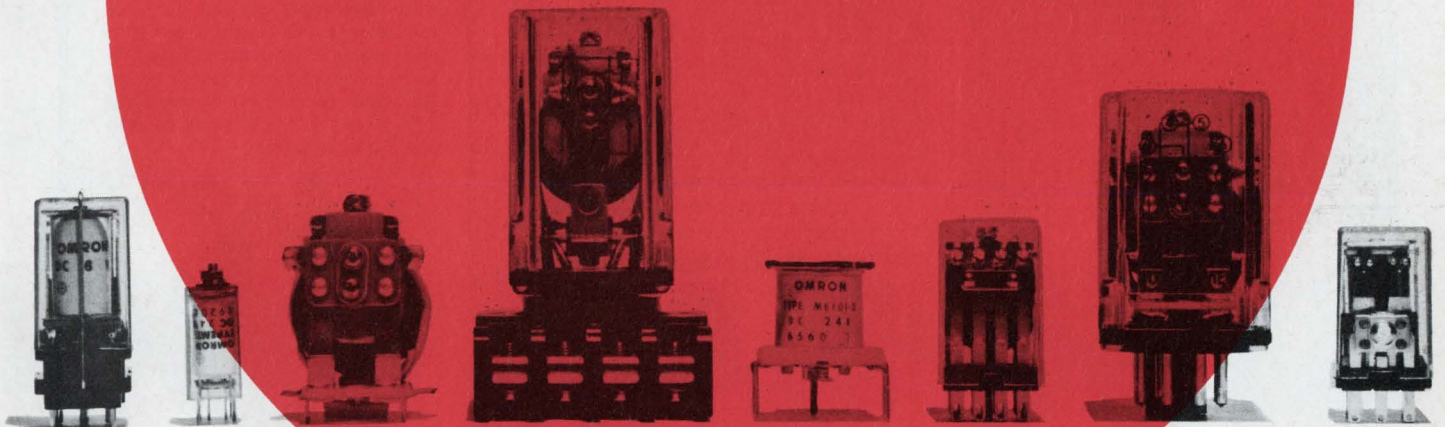

"The Economist" recently called Japan "The Risen Sun". This is particularly apt with respect to the Electronics Industry, to which OMRON makes a vital, though hidden, contribution. In the field of automation and electronic controlling OMRON is outstanding. Our range of products is unsurpassed in breadth; including switches, relays, level controllers and timing relays. Also, each product has great application potential—what might be termed "product depth". For example, let us examine relays. We can supply a relay for practically any purpose, from 1 amp to 25 amp

maximum-permissible load. One line, miniature relays, consists of 10 different models. One model, the MK type, has 8 variants, including twin contact, hermetically sealed, high capacity, multi-polar and UL-Standard types.

Top engineers with exacting standards the world over, as in Japan, specify OMRON products, knowing they will get versatility, quality and economy.



MAIN SALES OFFICE Tokyo, Japan NEW YORK OFFICE New York N.Y., U.S.A. OVERSEAS AGENCIES Italy/Carlo Gavazzi S.P.A. Holland/Carlo Gavazzi N.V. West Germany/Carlo Gavazzi Austria/Carlo Gavazzi-GMBH Switzerland/Carlo Gavazzi AG France/Carlo Gavazzi S.A.R.L. Sweden/Billman Regulator AB England/Keyswitch Relays Ltd. Australia/H. Rowe & Co. Pty. Ltd. South Africa/P.J. Yelland & Co. (pty) Ltd. _____ OMRON RELAY DIVISION



Meet Your Components Sources in Tokyo — Visit

JAPAN ELECTRONICS SHOW '68

Tokyo
Sept. 17-23

MATSUO

Highly Reliable Capacitors

POLYESTER FILM CAPACITORS.

Type MXT
Type MFK
Type MFL
Type SW

Type MXT In plastic tube.
Capacitance Range: .001 MFD to .47 MFD.
Voltages: 100v, 200v, 400v, 600v DC.

Type MFK Dipped flat shape, non-inductive construction.
Capacitance Range: .01 MFD to .47 MFD.
Voltages: 100v, 200v, 400v, 600v DC.

Type MFL Dipped flat shape.
Capacitance Range: .001 MFD to .22 MFD.
Voltages: 50v, 100v, 200v DC.

Type SW Super Wrap With epoxy endfill.
Capacitance Range: .01 MFD to .47 MFD.
Voltages: 100v, 200v, 400v, 600v DC.

METALLIZED POLYESTER FILM CAPACITORS.

Type FNX-H Mylar Wrapped semioval with epoxy end seal.
Capacitance Range: 1 MFD to 10 MFD
Voltages: 100v, 200v, 400v, 600v DC.

SOLID TANTALUM CAPACITORS.

Type TAX
Type TSX
Type TSL

Type TAX MIL-C-26655A hermetically sealed.
Type TSX · TSL Sealed With epoxy resin.
Capacitance Range: .22MFD to 330 MFD.
Voltages: 6v, 10v, 15v, 20v, 25v, 35v, 50v DC.

for further details, contact:

MATSUO ELECTRIC CO., LTD.

3-chome, Sennari-cho, Toyonaka-shi, Osaka, Japan
Cable Address **NCC MATSUO OSAKA**
TWX-523 4164 OSA.



*High Quality!
Low Cost!
Quick Delivery!*

HRS is the leading manufacturer of printed circuit connectors.....



For detailed information, Please contact to.

HIROSE ELECTRIC CO., LTD.

23, 5-5 Chome, Osaki, Shinagawa-Ku, Tokyo, Japan Cable: BESELECONHIROSE

OR OUR DEALERS:
Kimates S.P.A./Milano via Turati 28, Italy.
Seyffer & Company, Inc./
Badenerstrasse 265, Zurich 40, Switzerland.

Circle 216 on reader service card

For audio use
For industrial measuring instruments use

Printed Circuit Boards!

Provides at low cost by mass-production.

For Tr. Radios, Industrial Measuring Instruments & Communication Equipments....

Also, for special use;

- Smooth Printing
- Flexible Printing
- Front-Back Through-Hole Processing
- Multi-Layer Printing

(UL Standard Approved No.E-41166)

* For further information please write to



SHIN-EI INDUSTRIAL CO., LTD.

9-7, Megurohon-cho 4-chome, Meguro-ku, Tokyo, Japan Tel. Tokyo 714-1651~9



11 experts at work on every printed board

High Quality Printed Circuit Boards!

Through the strictest quality control system, Tokyo Print have won the fullest confidence, as top printed circuit board manufacturers in the field. Indeed, all the manufacturing processes are so systematically installed and organized that all engineers can keep watch on every part and every process.

For computer use

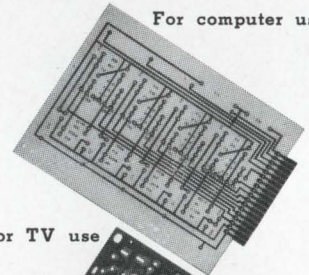

For TV use

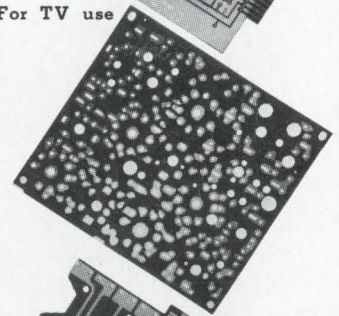

For TR. Radio use

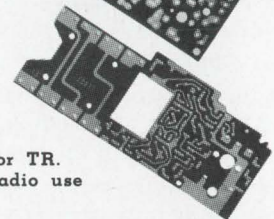

(UL Standard Approved: E-38255)



We can supply in 3 or 4 weeks upon receipt of your order.

Tokyo Print Industrial Co., Ltd.

No. 782, Shimoishihara, Chofu-shi, Tokyo, Japan
Tel. 0424 (83) 5711



Meet Your Components Sources in Tokyo — Visit

JAPAN ELECTRONICS SHOW '68

Tokyo
Sept. 17-23



120LB31(DC-50 MC)

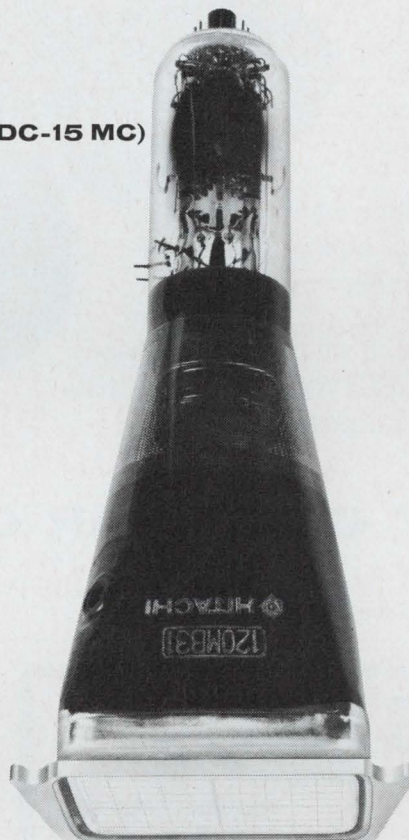

120MB31(DC-15 MC)

NEW OSCILLOGRAPH TUBES FROM HITACHI

WHAT THEY HAVE IN COMMON:

These Hitachi tubes are rectangular cathode ray tubes for precision instruments, with electrostatic focus and deflection.

They all use a mesh grid and inside scale, giving them high deflection sensitivity and non-parallax observation.

They're all made by Hitachi — so you know they're good. These two, the 120LB31(DC-50 MC) and the 120MB31(DC-15 MC) are particularly apt for portable equipment.

ONE MAY BE RIGHT FOR YOUR OPERATION:

Item	120LB31	120MB31	140LB31	Unit
Overall Length	423±7	318±7	466±10	mm
Heater Voltage	6.3	12.6	6.3	V
Heater Current	0.3	0.15	0.3	A
Post Accelerator Voltage	10,000	6,000	15,000	Vdc
Accelerator Voltage	2,000	1,400	2,400	Vdc
Useful Scan	80×48	80×64	100×60	mm ²
Deflection Factors				
Horizontal	12—16	11—16	12—18	V/cm
Vertical	4—7.5	6—10	3—5.5	V/cm

And if these aren't exactly what you're looking for, see the others —including our vidicon tubes and our cathode ray tubes for industry—from Hitachi, the people who make exacting quality available for less.



HITACHI
Hitachi, Ltd. Tokyo Japan

HITACHI SALES CORPORATION: 333 N. Michigan Ave., Chicago, Ill. 60601, U.S.A. Tel: 726-4572/4; 48-50 34th St., Long Island, N.Y. 11101, U.S.A. Tel: 361-3090; HITACHI, LTD., DUESSELDORF OFFICE: 4 Duesseldorf, Graf Adolf Strasse 37, West Germany Tel: 10846



Meet Your Components Sources in Tokyo — Visit

JAPAN ELECTRONICS SHOW '68

Tokyo
Sept. 17-23

SPECIAL COSMICAR[®] LENSES

FOR YOUR SPECIAL CCTV CAMERAS



COSMICAR lenses have improved in quality as CCTV cameras have improved.

There is no problem whether your cameras are with a built-in EE mechanism or a viewfinder mechanism.

COSMICAR will make whatever new lenses you need for your CCTV cameras to satisfy your every CCTV purpose.

For example, COSMICAR lenses can be adopted to automatic or rear control system by one hand.

Superb lenses of proven ability from 12.5mm to 1,000mm and Zoom lenses are on sale.

For further details, write to:



COSMICAR OPTICAL CO., LTD.

(Former name: ICHIZUKA OPTICAL CO., LTD.)

568, Shimoochiai, 2-chome, Shinjuku-ku, Tokyo Cable Address: "MOVIEKINO TOKYO"

Circle 219 on reader service card

NOBLE

● SLIDE VARIABLE RESISTORS

- Effective Shaft Travel : 30mm (1.19")

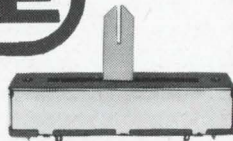

● VARIABLE RESISTORS

- 24mm (15/16") dia.
- Und. Lab. Listed Snap Switches are available



● METAL OXIDE FIXED RESISTORS

- 1 ~ 5 watts
- 10Ω ~ 300KΩ



● ROTARY SWITCHES

- New Molded Wafer
- 26mm (1.02") dia.

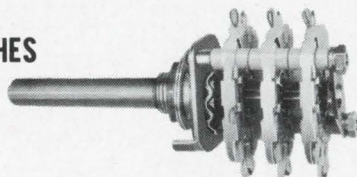

MAIN PRODUCTS / Variable Resistor ● Electronic Switch ● Capacitor
● CR Composite Parts ● Fixed Resistor ● Coil & IFT ● Power Resistor

TEIKOKU TSUSHIN KOGYO CO., LTD. 335, Nishinaka-machi,
Kariyado, Kawasaki, Japan
TEL: NAKAHARA (044) 42-3171 TELEX: 3842-155 CABLE: KAWASAKI-TEITSU

82 Circle 82 on reader service card

TDK CORE

The high-performance ferrite cores that made possible many breakthroughs in Japan's electronics technology.

● FERRITE CORES FOR COMMUNICATIONS EQUIPMENT

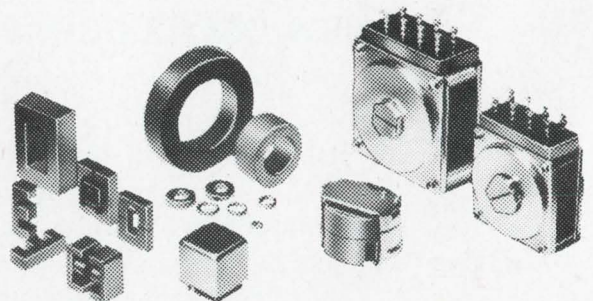

Write to M H & W for full technical data and information on applications

Representative in U.S.A & Canada for Ferrite Core for communications



MH & W INTERNATIONAL CORPORATION

280 Midland Avenue Saddle Brook, N. J. 07662
phone: N. J. :201-791-6277 N. Y.:212-244-0695



TDK

TDK ELECTRONICS CO., LTD.
2-14-6 Uchikanda, Chiyodaku, Tokyo, Japan

Circle 220 on reader service card



Meet Your Components Sources in Tokyo — Visit JAPAN ELECTRONICS SHOW '68

Tokyo
Sept. 17-23

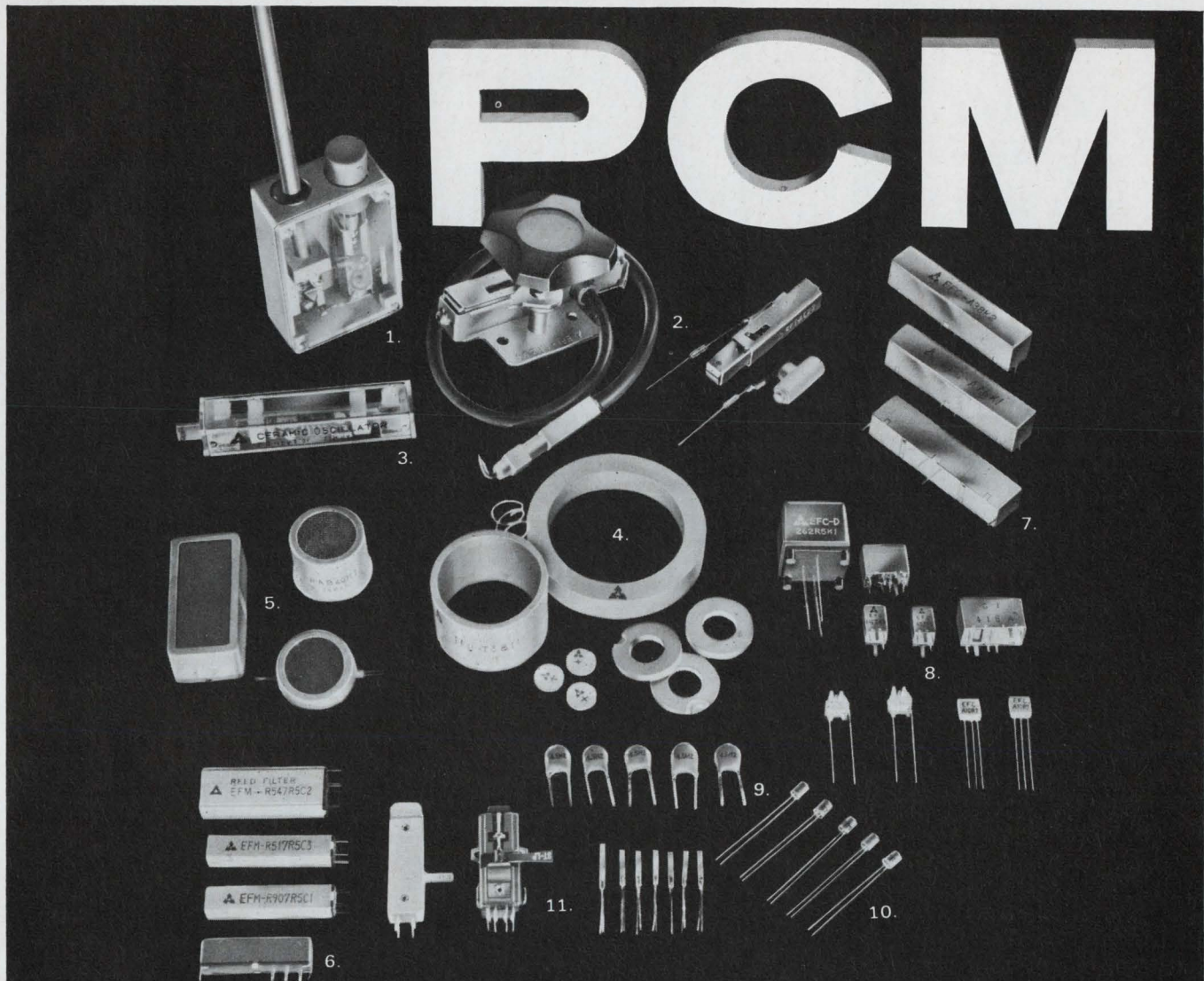

PCM Ceramics provide you with the most in dielectric constant (from 300 to 5,300), the most in electro-mechanical coupling coefficient (more than 40%), the most in mechanical quality factor Q_m (over 1,000), and the most in uniformity over a wide temperature range.

Matsushita makes a variety of PCM Ceramics to suit your particular needs. We have PCM with the mechanical strength and hardness to generate high voltage under sudden stress, and others with delicate acoustic sensitivity for use in microphones and cartridges.

1. **Remote Controller**—Utilizes noise wave from the sparking of the piezoelectric element to activate a receiver.
2. **Piezo Arc®**—Gas igniter—Ignition device for gas appliances and cigarette lighters. Generates up to 15KV, and features supreme reliability and durability.
3. **Ceramic Oscillator**—Compact transistor oscillator with divided electrode piezoelectric resonator. Useful as standard signal generator. 30-100kHz available.
4. **Transducer**—Various sizes and shapes are available for a multitude of different functions including detonators, etc.
5. **Ultrasonic Ceramic Microphone**—Can transmit as well as receive. Useful in ultrasonic controller devices, alarm systems, etc.
6. **Reed Filter**—Frequency Resonant Filter—Contains tuning fork and two piezoelectric transducers. Applicable as sharp selectivity audio-frequency filter or as audio tone generator replacing con-

- ventional LC filter. High Q, high selectivity, compact.
7. **FM Multiplex Ceramic Filter**—Stable, compact, preset—no tuning required. Eliminates need for conventional L-C parts and allows simpler circuit design.
8. **Ceramic Filter**—For IF stage of AM/FM radios. Hybrid type (a combination of filter and coil) and composite disc type available. 262.5kHz, 455kHz, 10.7MHz.
9. **Ceramic Trap "CERAP®"**—Preset, low loss. Sound frequency rejection element in TV video amplifier circuit. 4.5MHz, 5.5MHz, 6.5MHz and others available.
10. **FM Discriminating Element "CERAMINATOR®"**—Stable, preset, small. FM demodulation element for TV/radio receivers. 4.5MHz, 5.5MHz, 6.5MHz, 10.7MHz and others available.
11. **Ceramic Cartridge**—High electrostatic capacitance and fidelity characteristics.

MATSUSHITA ELECTRIC

ELECTRONIC COMPONENTS DIV. Kadoma, Osaka, Japan



Meet Your Components Sources in Tokyo — Visit JAPAN ELECTRONICS SHOW '68

Tokyo
Sept. 17-23

Anritsu's
SSG MG56A
reads down to
0.5kHz,
and reduces
warm up time
to **15 minutes.**

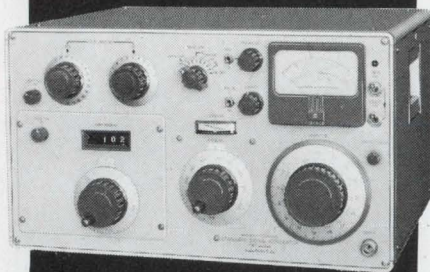

Forty five minutes a day, six days a week, 30 days a month. Whichever way you look at it, 22 hrs. per month are spent waiting for most conventional signal generators to warm up. And this time represents profits down the drain.

Now Anritsu's MG56A SSG incorporates a transistor oscillator which reduces warm up time to 15 minutes thereby enhancing your profits. A frequency synthesis technique is built in and provides highly stable output frequency and extremely high spectral purity. The MG56A is designed for testing 400MHz band mobile radios and need not employ a frequency counter. Conventional signal generators can't come close to the high degree of topflight measurements this unit is capable of providing. Would you like more complete information? We'll have our technical bulletin in the mail as soon as we hear from you.

Anritsu Electric Co., Ltd.

4-12-20, Minamiazabu, Minato-ku, Tokyo
Phone: Tokyo 442-8171/Telex: 0242-2353
cable address ANRITDENKI TOKYO

CAPACITORS

ALL-WELDED CONSTRUCTION

Miniature Aluminum
Electrolytic Capacitors
S (Radial Type) &
W (Axial Lead Type)

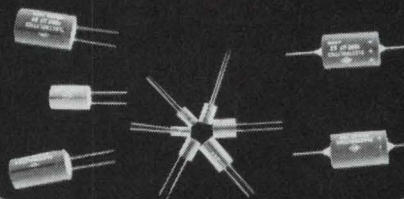

**SMALLER IN
SIZE, HIGH PERFORMANCE!**

Temperature Range: — 40°C to + 85°C (Characteristic T)
— 25°C to + 85°C (Characteristic K)
— 25°C to + 70°C (General Application)



Nitsuko Ltd.

(Formerly NIPPON COMMUNICATION INDUSTRIAL CO., LTD.)
260 Kitamikata, Kawasaki, Japan Tel. 044-82-5131
Cable: NITSUKO KAWASAKI Telex: 3842-177 NITSUKO KAW
SEE US AT OUR BOOTH IN JES 1968

Circle 221 on reader service card

KCK—

SPECIALISTS in CERAMIC CAPACITORS

Provides the highest stability, reliability and prompt delivery.

HIGH QUALITY CERAMIC CAPACITORS FOR TV & RADIO

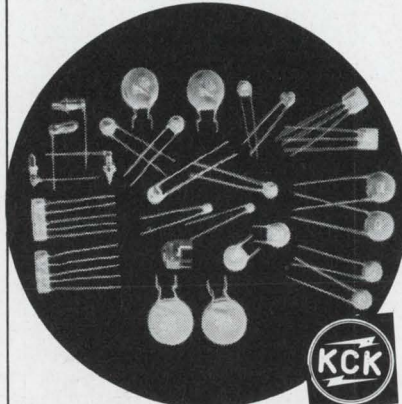

By the automated and quality-controlled mass production, the various lengths of lead wire available for automation of your sets assembling.

Working Voltage(DC): 12V, 25V, 50V, 250V & 500V
Capacitance Range: 0.05pF ~ 100,000pF

* For any other information, T.C. and dimension etc., ask for

KCK CO., LTD.

HEAD OFFICE:
16-1, 5-chome, Takingawa, Kita-ku, Tokyo, Japan
Tel. (916)3521

CHICAGO OFFICE:
528 West Wellington Ave., Chicago, Illinois 60657
Tel. (312)327-8392 Tlx: 25-4247 KAWACERA CGO

ECONOMICAL Thin Film!



Managers of Engineering Div. say
"SUSUMU's thin film components are most reliable ever used."

Managers of Material praise
"SUSUMU's prices are quite reasonable."



Factory Managers affirm
"SUSUMU's products are indispensable to keep up our good reputations."

- Plate-ohm: evaporated metal film resistor
- Pla-module: thin film modulated C-R circuit
- Pla-con: organic thin film capacitor by plasma reaction

SUSUMU INDUSTRIAL CO., LTD.

Minami Bldg. 1-12 Ebisuminami
Shibuya-ku, Tokyo, Japan

TEL: Tokyo (03) 712-5990
TELEX: No. 246-6270



Meet Your Components Sources in Tokyo — Visit JAPAN ELECTRONICS SHOW '68

Tokyo
Sept. 17-23

MITSUMI «UHF» TV TUNER

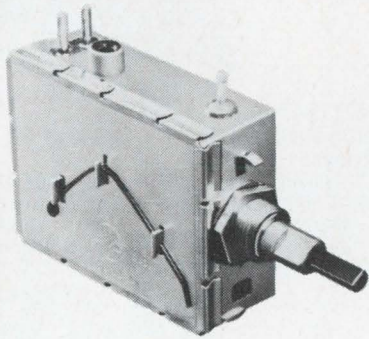

Far outrating the FCC and VDE specifications, which are widely prevailing in the World as telecommunication standards, the MITSUMI UHF tuner only radiates spurious signals less than 33.5 dB below the reference field strength. Material, plating, soldering, as well as the proprietary circuit design are the technical achievements by MITSUMI based on a long-term fundamental research.

By virtue of high compactness, light-weight, outstanding durability and overall use of silicon transistors, the MITSUMI TV-tuner has made possible of minimum frequency drift due to temperature variation. And also, the MITSUMI TV-tuner is made available to tube-type TV sets.

Specifications	Model	UHF TV tuner UKA32
Transistor		2SC 684
Diode		IS 750
Source voltage (V)		11
Current consumption (mA)		12 max
Frequency range (MHZ)		470 - 890
Intermediate Frequency (MHZ)		43.5
Gain (dB)		-10 min
Noise figure (dB) (VIF - 45dB)		14 max
Image ratio (dB)		30 min
IF rejection (dB)		60 min
Voltage standing wave ratio		3 max
Spurious radiation (dB/m)		54 min (FCC)
RF band characteristics (MHZ)		4.5 min at -3dB
		Temperature Stability:
Frequency stability		+300 (25 + 40°C)
		-700
Outer dimensions (mm)		51 x 62.5 x 24.6

MAIN PRODUCTS

- Polyethylene variable capacitors
- IF Transformers
- Micromotors
- Synchronous motors
- Front-end FM tuners
- UHF & VHF TV tuners
- Car tuners
- CdS photoconductive cells
- Hybrid IC
- Trimming potentiometers
- Various types of coils
- Micro switches
- Various types of sockets
- Trimmer capacitors
- Various types of terminals
- Fuse holders



MITSUMI

MITSUMI ELECTRIC COMPANY LIMITED
1056 Koadachi, Komae-machi, Kitatama-gun, Tokyo, Tel: 489-5333
Marienstrasse 12, Düsseldorf, W. Germany, Tel: 352701
MITSUMI ELECTRONICS CORPORATION
11 Broadway, New York 4, N.Y. 10004, Tel: HA-5-3085

meguro

HIGH RELIABILITY INSTRUMENTS



MAK-659

Dist. meter

— FOR AUDIO LABS AND PRODUCTION —

Measurement Ranges

■ **Distortion** Range: 0.1 to 30%, 5 steps; frequency: 20Hz-200kHz; input impedance: 600, 10k, 20k ohms; automatic control range: 40dBm or 100X in voltage; fundamental suppression: over 60dB.

■ **Level** Range: -70 to +40dBm, 600 ohms, and -70 to +20dB (0.3mV-10V), 10k and 20k ohms; frequency: 20Hz to 600kHz.

■ **S/N**
(signal/noise)

Range	Input
0 to 70dB	-22 to 0dBm
0 to 90dB	0 to +38dBm

frequency: 20Hz to 60kHz

● Catalog sheet on request.



MEGURO DENPA SOKKI K.K.

(Meguro Electronic Instrument Co., Ltd.)
No. 5, 1-2-chome, Chuo-cho, Meguro-ku, Tokyo, Japan
TEL: 711-7191-7 Cables: MEGURODENPA TOKYO

Circle 225 on reader service card

Ultra-small Lamps!

Long life and reliability.

● Sub-miniature

● Miniature

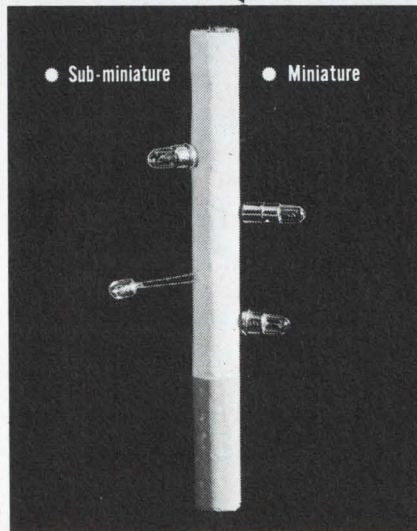

OKAYA ELECTRIC INDUSTRIES CO., LTD.

Yasuda Bldg., 8-3, 1-chome, Shibuya
Shibuya-ku, Tokyo, Japan

Circle 226 on reader service card

VARISTORS PROTECT YOUR CIRCUITS

Silicon Varistors

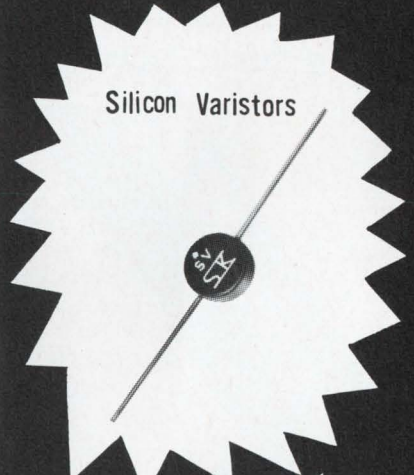

SiC Varistors



Si diodes, Si rectifiers,
Si transistors, Se rectifiers,
CdS photo cells, Power supplies.

SanKen®

CABLE: SANKELE TOKYO Phone: 986 6151

1-22-8 NISHI-IKEBUKURO,
TOSHIMA-KU, TOKYO

SANKEN ELECTRIC CO., LTD.

Circle 85 on reader service card

Circle 224 on reader service card



Meet Your Components Sources in Tokyo — Visit JAPAN ELECTRONICS SHOW '68

Tokyo
Sept. 17-23

Low frequency filter ?

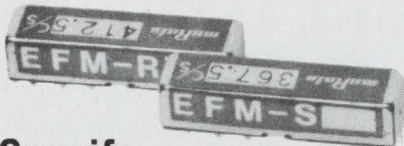

**Specify
Murata microfork, a
unique piezoelectric
tuning fork.**

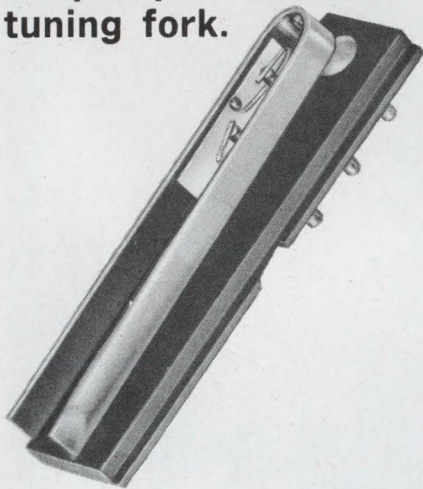

Murata pasted a tiny piezo ceramic on the fork to drive it piezoelectrically. As a result the Microfork provides stability in the face of bumps, jars, and changes of temperature and humidity.

Microfork Model EFM is highly accurate, compact and durable in such applications as selective calling apparatus, precise control instruments and audio frequency standards.

Nickel plated brass case is mounted on a plastic base designed for printed circuitry.

Frequency range : 360 to 2900Hz
Accuracy : $\pm 0.3\text{Hz}$ (360~999Hz)
 $\pm 0.7\text{Hz}$ (1000~2900Hz)

Temperature range : -20°C to 60°C .

For specifications on Murata's complete line of piezoelectric tuning forks request new catalog 864-E.

muRata

MURATA MANUFACTURING CO.

Nagaokacho, Kyoto, Japan
Cable: MURATA KYOTO
TELEX 5422-317-KYO

MURATA CORP. OF AMERICA

160 Broadway, New York, N.Y. 10038
Phone : (Area 212) 686-2510



ASSURES...

**High Quality!
Excellent Technique!
Fast Delivery!**

**PRECISION
TRIMMER POTENTIOMETER**

● Wire-wound type

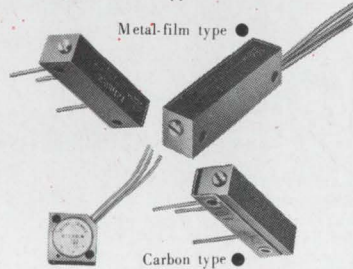

● Square-Trimmer (Wire-wound type)

— MAIN PRODUCTS: —

- Variable Resistors
- Trimmer Potentiometers

* For catalog write to

Tokyo Cosmos Electric Co., Ltd.

No. 303, 1-chome, Horinouchi, Suginami-ku, Tokyo, Japan
Tel. Tokyo 313-1111 Cable: "COSMOSDENKI" TOKYO

Circle 227 on reader service card

Primo

**UNI-DIRECTIONAL
MICROPHONE
(with tone control)**



UD-900

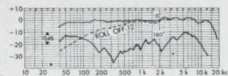

SPECIFICATIONS:

- Cartridge: DM-49
- Impedance: 600 ohms
- Sensitivity: $-73\text{db} \pm 2\text{db}/\mu\text{bar}$
- Frequency Response: 50 to $15000\text{Hz} \pm 5\text{db}$
- Dimensions: 50mm dia, 250 Length

* For further information please write to:

PRIMO COMPANY LTD.

Head Office: 25-1, 6-chome, Mure, Mitakashi, Tokyo, Japan
Tel. 0422-43-3121 ~ 7 Cable: "Primo Musashino Mitaka"
Telex: 2822-326 PRIMO MUS
Chicago Illinois Office: A.P.T. No. 204, 530 W. Surf, St.,
Chicago Illinois 60657, U.S.A. Tel. 312-472-61421
Telex: 25-4225 PRIMO MUS CGOILLUSA

Circle 228 on reader service card

Takamisawa — Assurance of Relay Reliability

It's superior know-how acquired through years of experience that makes Takamisawa a stand-out in dependable relay performance.

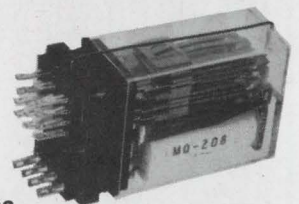

**MQ Series
Ultra-Miniature, High Performance DC
Relays**

- Contact current 0.7 Amp. at 100V DC
- DPDT, 4PDT combination
- 6mS operating time
- Mechanical life of over 50 million operations
- Superb anti-shock (5G), anti-vibration capacity
- Measures only $39.5 \times 29.7 \times 18.8\text{mm}$

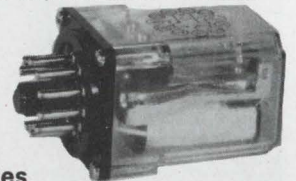

**MA-R Series
Compact DC/AC Relays with Extra-Large
Contact Load Capacity**

- Normal contact current 5 Amp. at 100V AC
- 2T or 3T combination
- 20mS operating time
- Mechanical life of over 10 million operations
- 50 milliohm insulation resistance at 500V DC
- Plug-in type

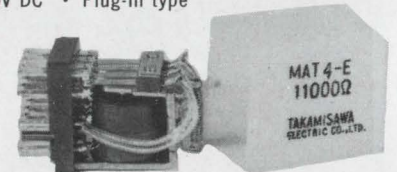

**MAT4 Series
Miniature Electromagnetic DC/AC Relays**

- Contact current 0.5 Amp. at 100V DC
- 4PDT contact combination
- 14mS operating time
- Mechanical life of 30 million operations
- 50 megohm insulation resistance at 500V DC
- Weighs only 40 grams

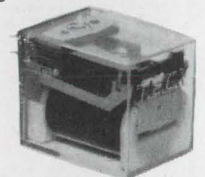

**TECK Series
Revolutionary DC Relays for All Types of
Automatic Controls**

- Contact current 0.5 Amp. at 100V DC
- 1M, 2M, 1B, 2B, 1T, 2T combination
- Mechanical life of 50 million operations
- Over 50 milliohm insulation resistance at 250V DC
- Weighs only 20 grams

For catalogs, please write to Planning Dept.



**TAKAMISAWA
ELECTRIC CO., LTD.**

35-4, 1-chome, Koyama, Shinagawa-ku, Tokyo, Japan

Circle 229 on reader service card



Meet Your Components Sources in Tokyo — Visit

JAPAN ELECTRONICS SHOW '68

Tokyo
Sept. 17-23

**DX ANTENNA - WITH
ITS SUPERB TECHNOLOGY
AND IDEAS RECOGNIZED
THE WORLD OVER**



**DX
ANTENNA**

DX ANTENNA CO., LTD.

MANUFACTURERS, EXPORTERS CABLE DXANTENNA KOBE, JAPAN

DX ANTENNA

Circle 230 on reader service card



**One Gift Works Many Wonders
THE UNITED WAY**



**HIGH RELIABILITY
Electronic Components
AVAILABLE TODAY!
CIRCUIT BREAKER**

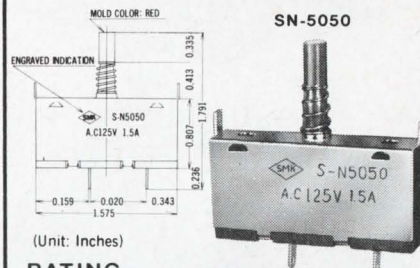

(Unit: Inches)

RATING

- * Potential rating: AC 125V
- * Current rating: 0.5, 1, 1.5, 2.0, 3.0 (Amperes)

45P CONNECTOR PLUG & SOCKET

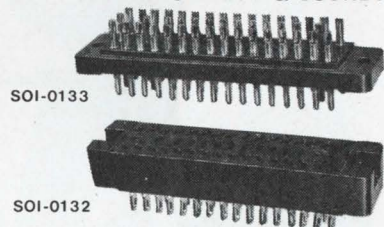

SOI-0133

SOI-0132

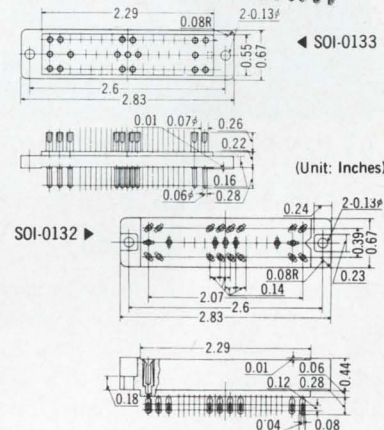

(Unit: Inches)

SPECIFICATIONS:

- Contact Resistance: 10mΩ or less when measured by microscopic ohm instrument. (Between Mating Plug Pins)
- Insulation Resistance: DC 500V 1000MΩ or more.
- Withstand Voltage: AC 1000V for 1 minute.

Besides the above, varied type of electronic components available on your request.

MAIN PRODUCTS:

- Plugs
- Jacks
- Sockets
- Switches
- Connectors
- Fuse Holders
- Lamp Holders
- Terminal Boards
- Binding Posts
- Other Components

● For further, please write to:

SHOWA MUSEN KOGYO CO., LTD.

No. 5-5, 6-chome, Togoshi, Shinagawa-ku, Tokyo, Japan
Phone: 783-1171 Cables: "SHOWAMUSEN" Tokyo

X-Y RECORDER
VOLUME PRODUCTION
MEANS LOWER COST

PRICES
DOWN

Model HR-100-1

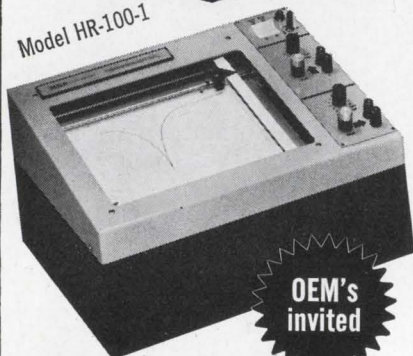

NOW
\$595
was \$845

AT LAST! TRULY LOW PRICE
FOR SCHOOLS, OEM's,
VOLUME BUYERS

In this age of inflation it's refreshing to see the price of a product go down — especially when it's a well-known and accepted unit that's been selling at a higher price since 1961. So while others go up, the Houston Instrument HR-100-1 goes down in price to a new low, \$595. (almost 1/3 reduction). OEM accounts: Can't you find a way of working this into your system and take advantage of the lowest priced X-Y recorder on the market?

check these features

- .2% accuracy Full Scale
- Sensitivity continuously adjustable from 1 mV
- 100 K input impedance
- Independent X and Y axes
- Zener reference voltage
- HR-200-1 (transistorized version) \$745.

houston instrument | DIVISION OF BAUSCH & LOMB
4950 Terminal Avenue, Bellaire, Texas 77401
(713) 667 7403 Cable HOINCO

Who's who in this issue

Extracting data from an audio-frequency waveform was the problem faced by engineers at Bell Labs' Whippany, N.J., facility when the first articles on the fast Fourier transform algorithm were published. The value of the technique with regard to the project was immediately recognized, and a task force was set up to build a digital processor that would compute Fourier coefficients and nothing else.

The team that designed the processor was headed by Richard Klahn, one of the authors of the story on the computer on page 92. Klahn, who's now at Bell Labs' installation in Winston-Salem, N.C., had previously worked on several computer-organization problems and on antenna-steering projects at Whippany.

Much of the primary designing was done by Richard R. Shively, a member of the technical staff who had been working on radar-signal processing and the Nike X computer since 1963. Shively has a doctorate from the University of Illinois, and was employed by the International Business Machines Corp. before joining Bell Labs.

Ernest Gomez and Michael Gilmartin were responsible for the detailed design of the FFTP computer. Gomez, who has been at Bell Labs since 1953, previously worked on the Telstar antenna-control system and the Nike X computer.

Gilmartin, at Bell Labs since 1955, developed the indexing unit for the FFTP. He, like Gomez, earlier worked on the Telstar antenna control.



Klahn



Shively



Gilmartin



Gomez

Start talking semiconductors and you have an attentive listener in Wim Hettterscheid, author of the article on solid state tv receivers on page 104. He has been with Philips' semiconductor applications lab since getting his bachelor's degree in electrical engineering from the Arnhem Technical School in Holland in 1957. While working for Philips, Hettterscheid shuttled back and forth across the channel to pick up his master's degree in electrical engineering from the British Institute for Engineering Technology in London.

Now 35, Hettterscheid is an engineering group leader at the lab. He has also found time to write two books on transistor amplifiers.

"The parameters in the design and application of power-line filters often work against each other," states Robert B. Cowdell. "The engineer has to know just what will happen to line voltage when he specifies a filter so he can choose the best of several alternatives." Cowdell, author of the article on often-overlooked problems with filters used to suppress rfi [p. 112] has had extensive experience in controlling rfi in such military applications as the Skybolt missile and the XB70 weapons system, and the Minuteman ground-support system.

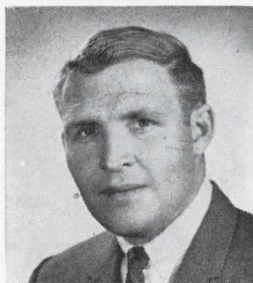

Cowdell

Cowdell holds bachelor's and master's degrees in electrical engineering from the University of Southern California, and is now manager of systems engineering for the Genisco Technology Corp.'s consulting and research operation.

Unusual microwave instrumentation problems have been one of the specialties of Carl F. Augustine, author of the article on real-time microwave field patterns on page 118. A staff engineer at the Bendix Corp.'s Research Laboratory division, Augustine has bachelor's and



Augustine

master's degrees in physics from Michigan State University.

The lack of large-area detectors for microwaves was a problem Augustine first tackled when he came to Bendix from Bell Telephone Laboratories in 1957. "My initial job was to design a fuse antenna for the Bomarc missile," he recalls. "An area detector would have simplified the job."

The concept of using liquid crystals for area detection actually came to Augustine while reading an article about the hybrid materials in the Jan. 12 issue of *Life*.



Girard

"The problem of leaks in an integrated circuit's supposedly hermetic package doesn't stop once the devices are assembled into equipment," says Frank L. Girard, author of the article on IC testing on page 127. Girard speaks from experience in the fields of optics, electro-optics, aerospace, radiation safety, and electronic component evaluation.

As a member of the Hughes Aircraft Co.'s technical staff since 1967, he has devised a number of approaches to leak testing.

Now You Have a Choice

\$1293

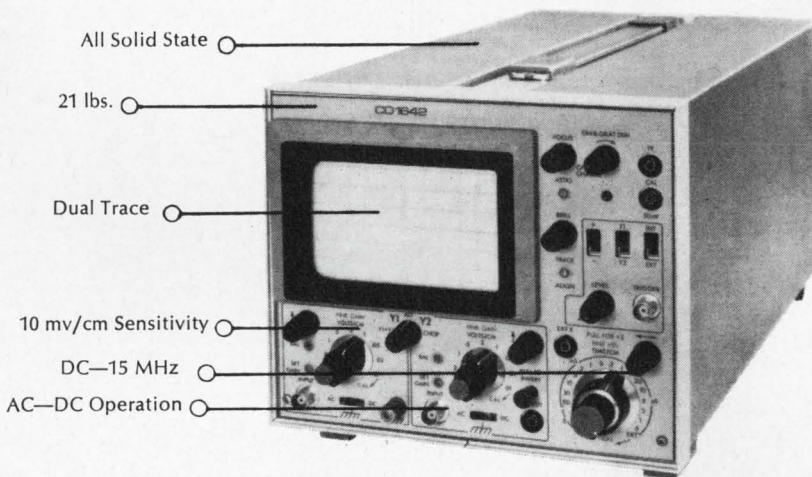

No longer is there just one ultimate performance, AC/battery powered scope available. Now you have a choice—Data Instruments CD 1642. Of course, we don't think that "choice" is exactly the right word. Because, as a basic oscilloscope, the CD 1642 offers so much more. 20% greater display area, for instance, and full centimeter divisions. Sensitivity, also, is better by 20% and the sweep is faster by the same amount. Moreover, the CRT has far superior focus and contrast so a better display is possible. The rise time is somewhat faster and the instrument will trigger well in excess of its rated 15MHz. And finally both AC and internal as well as external battery operation are included in the basic instrument.

On the other hand, there is the Status Symbol Factor. The CD 1642 has not yet achieved this. That other great scope has, and perhaps there is significant psychological value attached to it. The question is—is it worth paying 40% more to own a status symbol? We don't know. We can only point to the specs.

VERTICAL AMPLIFIER (2 channels Y1, Y2)					
BANDWIDTH	SENSITIVITY/CM	RISE TIME	ACCURACY	IMPEDANCE	AUX. AMP. Y2
DC-15MHz (DC) 2Hz-15MHz (AC)	10mv to 5v 9 ranges	20ns.	± 5%	1MΩ + 40pf	× 10 Gain 40Hz-5MHz
TIME BASE		CRT		POWER	PHYSICAL
SWEEP/CM	TRIGGER	HOR. AMP.	DUAL TRACE	AC & DC	WT. & DIM.
0.5μs-200ms 18 ranges	Int., Ext., +, - Normal and Automatic	Exp. X5 1v/CM DC-500KHz	6 x 10CM 4kv	AC 44-440Hz 117-220v DC Bat. 12-30v 25w	7¼" x 8¾" x 19" 21 lbs.

Why take our word for it? Compare Data Instruments CD 1642 with that other scope and make your choice. True, we can't offer you a Status Symbol, but we can improve your image.

Data Instruments Division • 7300 Crescent Blvd. • Pennsauken, N. J. 08110



Small Wonder the

Burroughs miniature rectangular NIXIE® tube is so well accepted! It is the smallest electronic readout available. For space-saving applications, excellent readability, greatest reliability and long life, the Burroughs Type B-4998 is the only answer. Now, because of its great popularity, Burroughs has effected production economies to reduce the price in quantities of 1000 to only \$13.95. For more detailed information on this NIXIE tube, associated driver modules and assemblies, contact Burroughs Corporation, Electronic Components Division, P.O. Box 1226, Department N5, Plainfield, New Jersey 07061 Telephone (201) 757-5000.

Tube photograph is actual size.

 **Burroughs Corporation**

Only Burroughs manufactures NIXIE Tubes.

Circle 90 on reader service card

Technical Articles

Finding Fourier transforms in real time
page 92

A special-purpose computer based on a fast Fourier transform algorithm carries out—in real time—the thousands of transformations required to extract data, for example, from seismic waves and electroencephalograms. The processor executes the algorithm 20 times faster than FFT-programmed general-purpose computers.

Designing transistor deflection circuits
page 104

Though no tv set makers are now marketing large-screen all-transistor black-and-white receivers—because of the high costs that would be involved—new high-voltage transistors for use in the horizontal deflection system may soon change things. This article discusses the design of the deflection circuit and tells how to protect the transistor from circuit failures and high-voltage flashovers.

Line filters need realistic specs
page 112

Many users of power-line filters aren't aware that specifications for these devices often don't relate to actual operating conditions. The filters usually aren't used at their specified source and load impedances; the actual impedances are likely to be much lower. Because of the mismatch, the filter's output voltage can vary significantly.

Using liquid crystals to detect microwaves
page 118



A thin Mylar membrane coated with liquid crystals can instantly produce a color picture of the electric field pattern of microwaves. One use would be to produce three-dimensional microwave images in space. There are also such applications as delineating the radiation patterns of antennas and the mode patterns in complex waveguides and resonators, and finding internal

flaws in materials translucent to microwaves. The cover photograph, by Robert R. Grenier, shows the interference pattern between two radiating horns.

Capacitance tests identify leaky IC's
page 127

Once integrated-circuit modules are assembled onto printed-circuit boards, it's hard to single out the IC's that have faulty hermetic seals. Conventional bubble tests aren't adequate, because the p-c board itself contains entrapped air and emits bubbles. However, the leakers can be identified by exposing all the modules on the board to a high-dielectric gas and measuring the IC's capacitance; the gas entering a leaky device changes its capacitance.

Coming

In the next issue: crystals that store light and give it off when tapped.

The time-saver: FFT hardware

Peripheral special-purpose processor calculates Fourier coefficients of signals 20 times faster than programmed, general-purpose computers

By Richard Klahn, Richard R. Shively, Ernest Gomez and Michael J. Gilmartin

Bell Telephone Laboratories, Whippany, N.J.

Real-time calculation of the spectral components of a waveform containing many frequencies is easily achieved with a special-purpose computer that employs the fast Fourier transform (FFT) technique in its hardware. The computer finds the Fourier coefficients 20 times faster than an FFT-programmed general-purpose computer—itsself several hundred times faster than older methods—and as a result can provide improved frequency resolution in real time.

Developed by the Bell Telephone Laboratories, the computer combines the inherent speed of the FFT, which eliminates unnecessary computations, with a wired-in program that capitalizes on certain characteristics of the FFT. These characteristics include a fixed arithmetic sequence, real and imaginary parts of complex computations that can be handled in parallel, and a regular but unusual pattern of memory addresses that can be generated by specialized counters. Called, appropriately enough, the Fast Fourier Transform Processor (FFTP), the machine is limited to processing signals in the audio-frequency range.

Since Fourier transforms are a useful tool in extracting the information contained in many kinds of waveforms—such as seismic waves, electroencephalograms, and data signals telemetered from deep space—Bell Labs' processor isn't lacking in applications.

The processor is based on the FFT algorithm developed a few years ago by mathematicians James W. Cooley of the International Business Machines Corp. and John W. Tukey of Bell Labs [Electronics, April 15, p. 124]. It is intended to carry out in real time the thousands of transformations that many signal-processing applications require. For such applications, special-purpose processors organized to execute the algorithm are far better than general-purpose computers running FFT programs.

Bell Labs' FFT processor was designed as a peripheral unit in a general-purpose computer system. As such, the FFT processor greatly extends the pro-

cessing capacity of computers for Fourier analysis applications.

Actually, the peripheral-unit approach was quite natural for Bell Labs' engineers. Running signal-processing experiments on Bell's large general-purpose machine would have consumed thousands of hours of computer time. The engineers found that the same experiments could be completed in a single day on an IBM 1800, a medium-size computer, if it were linked to the fast Fourier transform processor.

What it can do

With a set of input numbers representing sampled values of a continuous waveform, the processor can compute Fourier coefficients. Or if the input represents the coefficients, the processor can compute successive amplitudes of the waveform. Thus, the processor is capable of obtaining either direct or inverse transforms. Either way, the processing is in real time.

From a computer designer's standpoint, FFT holds out the promise of execution times much shorter than those possible on a general-purpose machine. The fixed nature of the computation's arithmetic sequence permits matching the speed of the arithmetic section to that of the memory, allowing an overlap of arithmetic operations and memory transfers. Moreover, both units can handle the real and imaginary portions of complex values in parallel, thereby saving processing and transfer time.

Since the FFT requires a sequence of memory addresses and trigonometric values for its regular but unusual pattern of combining data, the software approach necessitates testing of several index values. This is time consuming. The hardware approach is far simpler and much faster—the values are easily generated by specialized counters.

This is just one example of where hardware proves superior to software. Except for table look-up, which takes a lot of memory space, no single

software routine can perform this conceptually simple operation in real time.

Putting it in hardware

The FFTP's major components, shown in the block diagram below, include a table memory that holds trigonometric coefficients, a record memory for both the sample records and computed results, an indexing unit to generate memory addresses, and a complex arithmetic unit. Besides sequencing the algorithm, the logic in the FFTP controls both data transfers and execution of a small set of instructions. Input-output format conversions and recording of results as part of the transfers are also possible.

Within the complex arithmetic unit, the four real multiplications and two additions required for a complex multiplication are performed as a single operation. The multipliers are recoded to base 4 so that only one adder pass is required per pair of bits. Carry-save adders reduce the time delay for the parallel addition of two numbers during multiplications to that of a single adder stage. Fixed-point arithmetic contributes to speed. The automatic re-scaling that the slower floating-point arithmetic would provide is made available by special hardware that takes over when overflow is threatened.

Indexing unit

Two binary counters, a shift register, and a small amount of combinational logic make up the FFTP's indexing unit. One counter addresses the data in the record memory and the other addresses the trigonometric coefficients in the table memory. When the completed results are being transferred out of the FFTP, the second counter generates addresses for the record memory. During this operation, the order of bits is reversed, thus the coefficients are unscrambled.

The pattern of operand addressing appears in the panel, "An eight-bit example," on page 94. In that example, the memory addresses of interacting operand pairs are separated by 4 during the first iteration, 2 during the second, and 1 during the third. In general, for N samples, N being a power of 2, the

operand addresses differ by $N/2$, $N/4$, $N/8$, and so on down to 4, 2, and 1, respectively, in successive iterations. In binary notation, the sequence of address pairs during the first iteration of the example is: 000 and 100; 001 and 101; 010 and 110; and 011 and 111.

In each pair the addresses differ in only one bit position—the first position—and may therefore be generated in a binary counter whose bits can be individually complemented. During the second iteration the address pairs are: 000 and 010; 001 and 011; 100 and 110; and 101 and 111. Here the second bit is complemented, but the sequence shows that in proceeding from the second to third pair of addresses, the counter must be incremented before recomplementing the second bit—not after. Thus, an overflow—a carry out of the most significant digit of the counter—always signals the end of an iteration.

These operations are controlled by the iteration shift register and the address counter, top of page 95, both of which are 13 bits long. Initially, the most significant bit is set to 1 in the shift register; all other bits remain 0. As the address counter is advanced, this single bit in the shift register controls the selective complementing of the corresponding bit in the address register. When the address register overflows, the first iteration is finished; the overflow automatically shifts the lonely bit one position to the right. The overflow also implies that all remaining bits in the address register are 0, so that both the register and the counter are ready to begin the next iteration. The end of the algorithm is signaled when the single 1 in the shift register is shifted out of the low-order bit position.

Weight-watching

Only one complex weight is required during the first iteration, two during the second, four during the third, eight during the fourth, and so on. These weights are always required in the same order. In the eight-sample example, the complex weights are $W^{0/8}$ in the first iteration, $W^{0/8}$ and $W^{2/8}$ in the second iteration, and $W^{0/8}$, $W^{2/8}$, $W^{4/8}$, and $W^{6/8}$ in the third iteration.

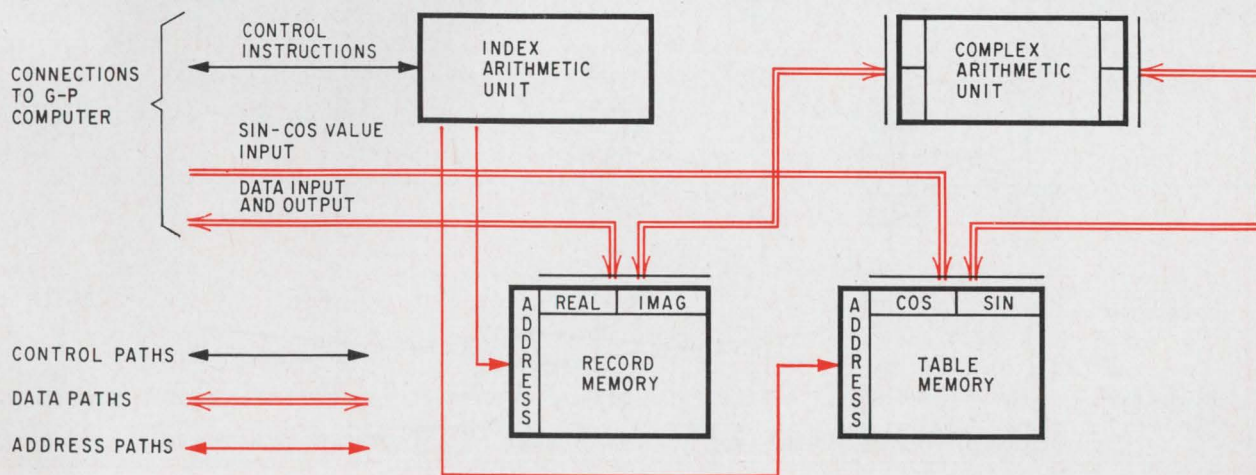

Computer components. Sample records are stored in the record memory, coefficients in the table memory. Indexing unit generates memory addresses, and the arithmetic unit computes the coefficients.

in that order in the third iteration. The same ordering of complex weights applies regardless of iteration number or array size; only the number of weights used changes with each iteration. The sequence of exponent values is a consequence of the reversed-digit ordering.

During each iteration, groups of samples or intermediate results are paired in operations similar to those shown in the panel. The complex weight is

the same for all numbers in the group, and changes whenever the processing of a new pair of segments begins. Since the iterations in the example involve one, two, and four segment pairs respectively, the complex weights change zero, one, and three times. When all operations on a segment pair are finished, and a new complex weight is needed, a carry occurs in the record-memory address counter into the bit positions controlled by the single bit in the itera-

An eight-bit example

A rather short record of only eight samples, as diagramed below, illustrates the principles of the FFT and their implementation in Bell Labs' FFTP. The symbol W represents the complex exponential,

$$W = \exp(-j2\pi);$$

therefore appropriate powers of W represent multiples of $+1$ or -1 :

$$W^{0/8} = +1$$

$$W^{4/8} = -1$$

and for any integer value of M ,

$$W^{(8M + a)/8} = W^{a/8}$$

The FFT computational proce-

dures first uses pairs of the original samples to obtain simple two-point transforms based on two of the original samples. For example, samples $X(0)$ and $X(4)$ are combined to get $A_1(0)$ and $A_1(4)$:

$$A_1(0) = X(0) + X(4)W^{0/8}$$

$$= X(0) + X(4)$$

$$A_1(4) = X(0) - X(4)W^{0/8}$$

$$= X(0) - X(4)$$

The quantities $A_1(0)$ and $A_1(4)$ represent estimates of the d-c term and first harmonic. The same mathematical procedure makes other estimates of the d-c and first

harmonic from each pair of original samples, obtaining the four two-point transforms $A_1(0)$ through $A_1(7)$.

Pairs of two-point transforms are then combined to obtain four-point transforms $A_2(0)$ through $A_2(7)$. Again, the arithmetic operations are similar, except that the spacing between pairs is halved, and different powers of W are used in the complex multiplication. The final step for an eight-bit eight-point record determines the A_3 terms that are the desired complex Fourier coefficients within a scale factor of $1/8$.

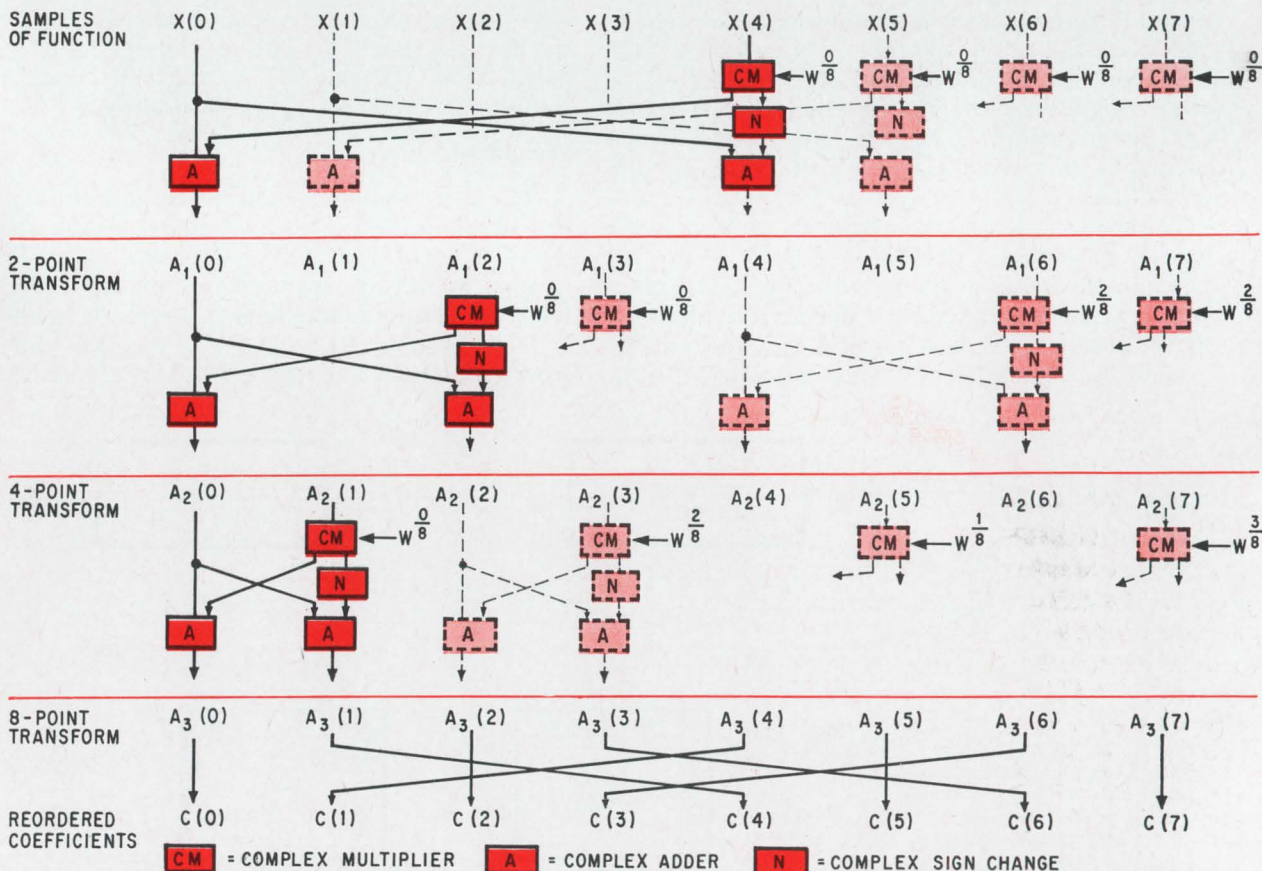

Transform procedure. The FFT algorithm combines sample pairs into two-point transforms, four-point transforms, eight-point transforms, and so on, until it obtains a single transform based on all the original samples.

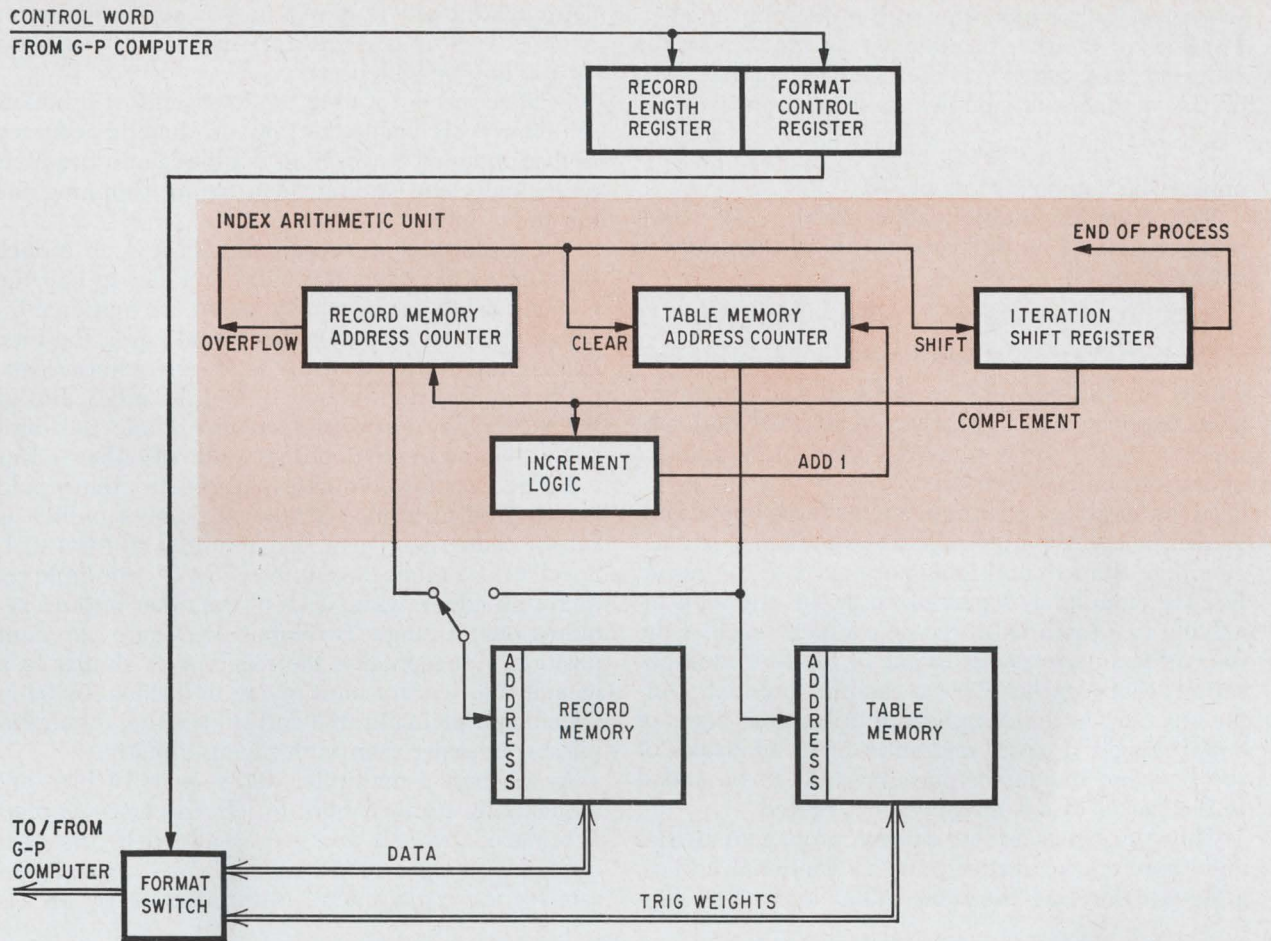

Computational key. Without the indexing unit, which controls the sequence of memory addresses, the fast Fourier transform processor would be much more complicated.

tion shift register. The increment logic in the diagram shown above detects this unique carry condition, and causes three things to happen:

- Transfers the contents of the table memory data register to the complex arithmetic unit,
- Increments the table memory address counter in the indexing unit,
- Refers to the table memory for the next complex weight.

Since the next complex weight is always anticipated, table-memory references do not delay the process. When each iteration begins, the starting value, $W^0 = 1 + j0$, is already in the complex arithmetic unit, and the second value is in the table-memory data register. Table-memory cycles are therefore always one step ahead of the segment pair being processed.

An overflow from the record-memory address register, which signals the start of a new iteration, clears the table-memory address counter to its starting value so that each iteration starts at the beginning of the list of weights.

End of the line

Results in the record memory are stored in an unusual order. In addition to reducing the number of arithmetic operations, the FFTP conserves mem-

ory space by overwriting each new pair of results on the two operands used to compute it. In this way, intermediate and final results require no memory beyond that which held the initial data. However, if the initial data is in its normal order, an inherent consequence of this overwriting is a scrambled order of final results. When the results are labeled with the numbers 0 to $N - 1$, the location of any particular result is represented by reversing the order of bits in the binary representation of its label.

For example, in the eight-sample diagram, the coefficient for result No. 1 (binary representation 001) appears in location 4, or 100 in binary. The indexing unit achieves this reordering by switching the table-memory address counter, with digits reversed, to furnish addresses to the record memory while completed results are being transferred to the general-purpose computer.

Complex arithmetic unit

The two operations to be iteratively performed on the data are:

$$\begin{aligned}
 A_{i+1}(j) &= A_i(j) + A_i(k) \cdot W' \\
 A_{i+1}(k) &= A_i(j) - A_i(k) \cdot W' \\
 &= 2A_i(j) - A_{i+1}(j)
 \end{aligned}$$

where the subscripts refer to the iteration number; j and k are the pair of addresses generated by the indexing unit; and W' is the complex weight. Each of the numbers is complex, and W' represents

$$W' = W^{j2\pi/N} = \cos \theta + j \sin \theta$$

one of the complex roots of $+1$.

The complex multiplication $A_i(k) \cdot W'$ comprises four real multiplications, an addition, and a subtraction:

$$\text{Re}[A_i(k) \cdot W'] = \text{Re}[A_i(k)] \cos \theta - \text{Im}[A_i(k)] \sin \theta$$

$$\text{Im}[A_i(k) \cdot W'] = \text{Im}[A_i(k)] \cos \theta + \text{Re}[A_i(k)] \sin \theta$$

where Re and Im refer to the real and imaginary parts, respectively. Similarly, the addition and subtraction in the same equations also imply pairs of operations on real numbers.

In the hardware that implements these operations, shown below, separate registers simultaneously accumulate the real and imaginary parts of the result. Each accumulator is part of an arithmetic loop involving two cascaded carry-save adders; each of the four adders corresponds to one of the four multiplications that together yield a complex product. During any step in the complex multiplication, digits of equal weight in $\cos \theta$ and $\sin \theta$ select multiples of the real and imaginary parts of $A_i(k)$ to be added to the partial result already accumulated.

The carry-save adders do not propagate carries and therefore are faster than conventional adders, although they use the same adder logic. Two flip-

flops per bit are required in the accumulator for intermediate results—one for the sum bit and one for the unpropagated carry.

Besides speed, forming the four sums of products simultaneously yields the same arithmetic accuracy as that obtained by forming double-length products individually and adding them before dropping the low-order bits.

The multipliers are recoded in base 4, to reduce the number of passes through the adder to half the number of bits in the multiplier. In conventional binary form, base 2, the passes would equal the bits. Pairs of bits form base-4 digits. Base-4 notation normally requires digit values of 0, 1, 2, and 3. But in the FFTP, they are expressed to exclude the digit value $+3$ and to admit a digit value of either -1 or -2 . The recoding eliminates the circuitry that would be required to form $+3$ times a number, which is substantially more than that required to form 0, 1, 2, -1 , or -2 times the number. The $3 \times$ multiple requires an adder, while each of the other options requires only a single two-input AND gate per digit position. Conceptually, the recoding is similar to a mental short-cut for multiplying in decimal by 99 in which multiplying by 100 and subtracting the multiplicand is easier than multiplying directly.

As the base-4 multiplier digits—pairs of bits—are sequentially scanned right to left, the first $+3$ digit is replaced by -1 , and $+1$ is added to the next digit, which has a relative weight of 4, to compensate for the replacement. Multiplication by an 11-

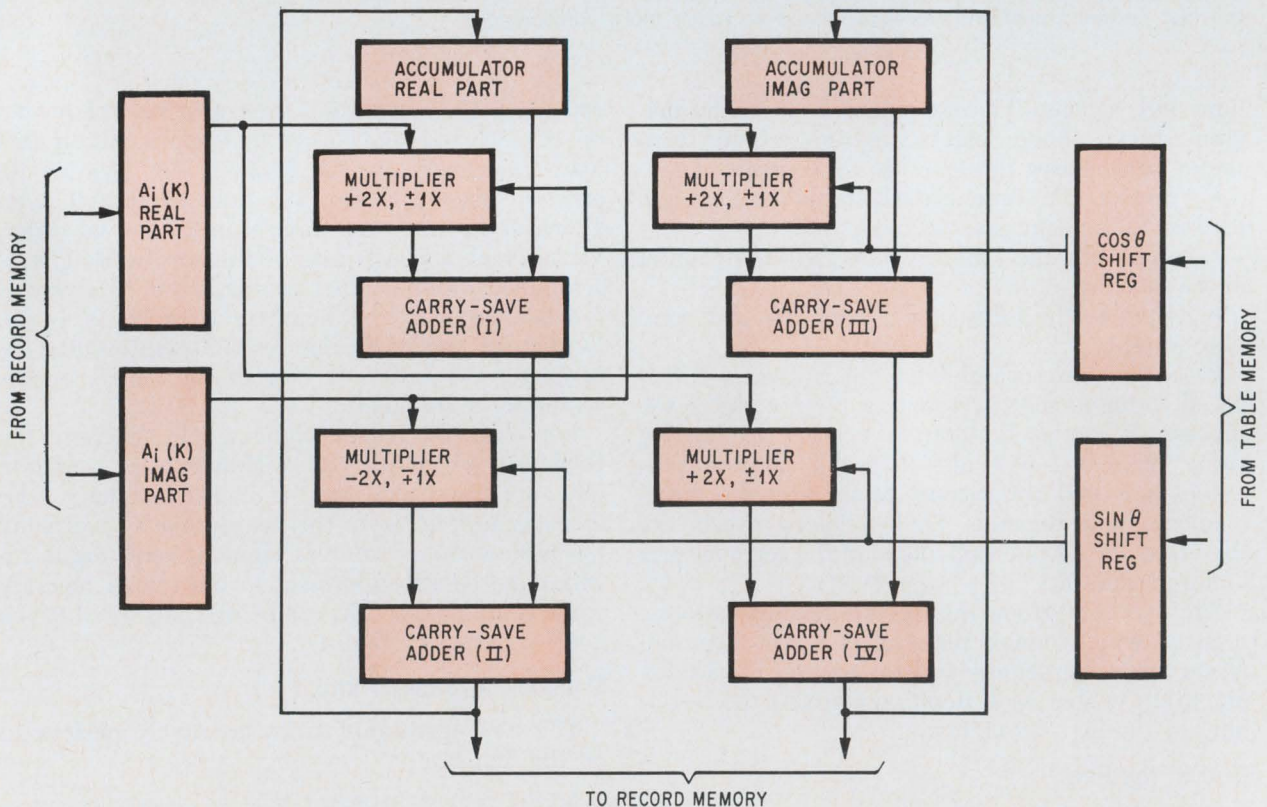

Complex arithmetic unit. Four multiplications, an addition, and a subtraction all occur simultaneously in this unit, which generates the real and imaginary parts of each complex result in parallel. Inputs to the lower left multiplier are the negative of the others to obtain the subtraction.

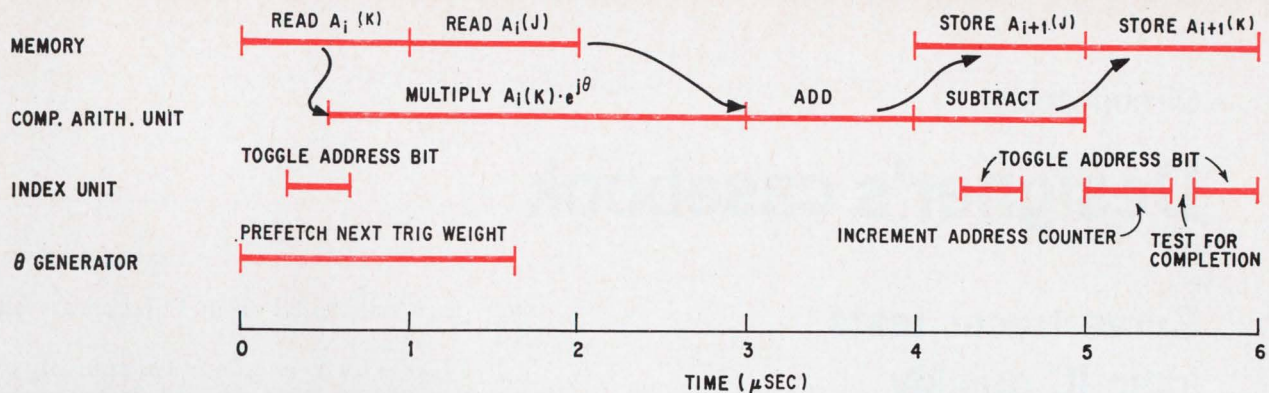

Real-time results. Six-microsecond timing cycle of the FFTP produces answers 20 times as fast as general-purpose software.

bit number, therefore, requires only six steps. The multipliers in the complex-arithmetic unit diagram indicate the multiples that achieve this reduction.

The FFTP's timing diagram, shown above, indicates that one pair of results is obtained in 6 microseconds. The total time required to transform a record of N samples is therefore $(N/2) \log_2 N \times 6 \mu\text{sec}$. Matching the arithmetic and memory speeds could be improved, but this would be costly. Thus far, 6 μsec has proved more than adequate for present needs.

Besides the FFTP and the IBM 1800 computer, Bell Labs' signal processing facility includes a magnetic tape unit and a multiplexed analog-digital converter. All of these elements are linked by independent data channels to the computer, so that it can direct the flow of data through the system without seriously degrading its internal computational capacity. This arrangement retains the inherent flexibility of conventional stored-program control over the system's functions, and at the same time exploits the significant efficiencies of the FFTP in executing the Fourier series calculations.

Carrying out the job

The system's operation is illustrated by a real-time analysis and display of the power spectral density of an analog signal. Sampling the signal, transforming the samples into spectral density estimates, and displaying the results are all under control of an operating program in the IBM 1800. This program loads the FFTP table memory with a list of sine and cosine values, and selects analog-to-digital and digital-to-analog converter sampling from a timing generator unit in the FFTP. The computer transmits instructions to the control section of the FFTP, which carries out these operations.

To bring sample values into the system, the computer commands a data channel to sample the desired number of points, and waits for an interrupt from the data channel that indicates when the samples have been taken. As the voltage waveform is encoded, the sample values are stored in one of two buffer areas in the computer's memory. When the first set of points has been sampled, the central processor resets the data channel, and directs sub-

sequent samples to the alternate buffer area. The computer also transfers the first record to the FFTP, along with a command to start the FFT process. When the transformation is completed the FFTP signals the computer, which transfers the resulting complex Fourier coefficients to its own memory. From this data, the computer obtains the power spectral density function and sends it to the output data channel, where it is converted to an analog deflection voltage and displayed.

While all this is in progress, the analog input channel is concurrently storing the samples for the next record. When these are available, the computer is again interrupted, and the entire sequence is repeated. This operation is maintained until the test is completed.

In this example, the entire set of operations performed on the input data is under control of the operating program. By changing appropriate software, the experimenter can vary the sampling rate, the length of record processed, or the sequence in which data is manipulated. This flexibility permits experiments with a number of processes based on Fourier transform techniques. Many of these experiments may now for the first time be performed in real time because of the high speed of the FFTP. Thus test results can be interpreted instantly without large amounts of input or output storage, required in nonreal-time systems.

Bibliography

- R.B. Blackman and John W. Tukey, "The Measurement of Power Spectra," New York, Dover Publications, 1959.
- J.E. Robertson, "Theory of computer arithmetic employed in the design of the new computer at the University of Illinois," University of Michigan Summer Conference, Theory of Computing Machine Design, June 13-17, 1960.
- James W. Cooley and John W. Tukey, "An algorithm for the machine computation of complex Fourier series," Mathematics of Computation, April 1965, p. 297.
- W.M. Gentleman and G. Sande, "Fast Fourier transform for fun and profit," AFIPS Conference Proceedings, vol. 29 (FJCC 1966), p. 563.
- G.D. Berglund and H.W. Hale, "Digital real-time spectral analysis," IEEE Transactions on Electronic Computers, April 1967, p. 180.
- R.R. Shively, "A digital processor to generate spectra in real time," Digest, First Annual IEEE Computer Conference, Sept. 6-8, 1967, p. 21.
- David Slepian, "Restoration of photographs blurred by image motion," Bell System Technical Journal, December 1967, p. 2,353.

Designer's casebook

Curve tracer tests logic IC quickly

By G. Donald Wagner

The Johns Hopkins University, Silver Spring, Md.

Curve tracers, generally used in the laboratory to observe transistor characteristics, can quickly test integrated logic circuits. An external power supply for the logic circuit and two resistors to simulate load and input impedances are the only extra equipment necessary.

The rectified 120-hertz voltage that supplies the discrete transistor's collector during normal testing becomes the input signal to the logic circuit. In each half-cycle, this signal moves the base-emitter junction of an internal transistor from cutoff into saturation and then back to cutoff. The movable contact on the switch determines which of the three base-emitter junctions is controlled by the 120-hertz signal.

Because the waveform across the emitter-base terminals is the same frequency as the collector-to-emitter signal, the scope plates are synchronized. Consequently, a fixed display showing the collector

voltage as it falls to 0.1 from 1.61 appears on the scope.

A leaky collector-to-emitter junction in any of the transistors will be indicated by a collector-to-emitter voltage of less than 1.61. A fairly accurate determination of the leakage current is possible if R_1 is removed during testing. Knowing the collector voltage, the supply voltage, and the internal collector resistance, the engineer can then calculate leakage current.

High saturation voltages indicate the presence of defective junctions in the transistor. If an ohmic contact that was inadvertently developed during manufacturing is present in either the base-emitter or base-collector junction, saturation voltage in the transistor will be higher than the 0.1 volt shown.

In the transition from cutoff into saturation, the transistor operates for a short time in its active region. Thus the transistor's d-c gain can be calculated by measuring voltages on the horizontal and vertical axes near the midpoint of the transition region. Again, any defect in the transistor will reduce the ratio of collector voltage to base voltage.

The difference between collector voltage at saturation and cutoff is called noise margin. It's the voltage level a transient must have to turn the logic transistor on or off. For example, a positive 1.8-volt spike that appears while the transistor is in satura-

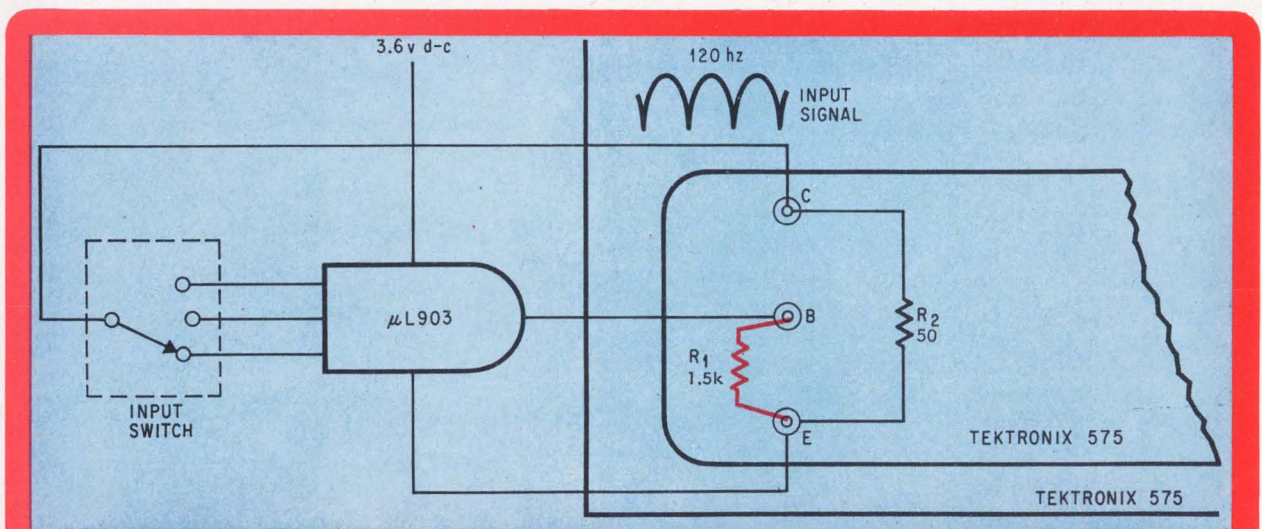

Internal diagnosis. Any flaws in the logic circuit will be displayed on the curve tracer as either high saturation voltage, low cutoff collector voltage, or low gain in the active region. The collector voltage in the integrated circuit appears on the vertical axis of the scope face.

tion will raise collector voltage from 0.1 to 1.61 and place erroneous information in the computer. Obviously, noise margin in the logic circuit shown can be easily measured on the scope face; it is 1.51 volts for the μ L901.

To test the μ L910 logic circuit, the base generator panel on the face of the curve tracer is turned off. To avoid loading the output of the circuit under test, however, the step voltage switch in the base panel must be set at 0.001 milliamp/step. This places a high resistance between the collector of the logic circuit and the base measuring circuit. Although the base circuit isn't supplying voltage for use in the testing, it is still coupling the output signal into the scope plates.

The horizontal panel on the curve tracer is switched into the collector voltage section and set at 0.2 volt/centimeter; the vertical panel was set in the base voltage section at 0.2 volt/cm.

If it is necessary to measure the current sinking capabilities of a circuit, R_1 must be placed between the collector and base terminals and a diode placed in series with the resistor.

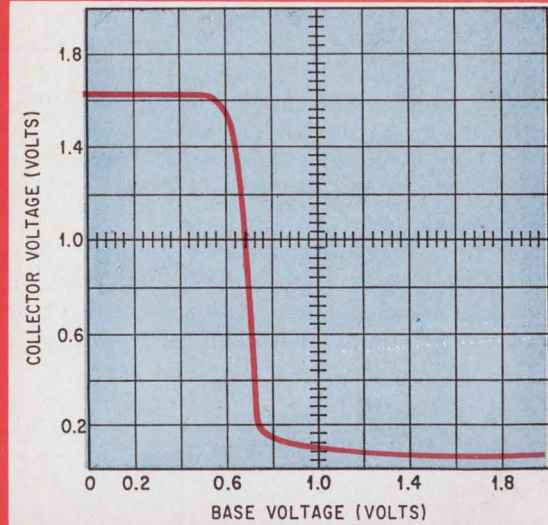

Caught in the act. Input and output signals synchronize the curve tracer into a stable display of the logic circuit's switching.

Bridge and amplifier monitor d-c level

By John P. Budlong

Bedford Institute of Oceanography,
Dartmouth, Nova Scotia

Small variations from an established d-c level are difficult to measure because of the high input impedance in monitoring equipment. Only nanoamperes are drawn by the monitor when the voltage is at its established level. Consequently, the change in input current is an infinitesimally small part of an already small current.

A voltage monitor consisting of an operational amplifier, ammeter, and bridge rectifier provides both high input impedance and the ability to measure small voltages. Because of the feedback loop added to the operational amplifier, its gain and input impedance are high. The bridge rectifier keeps current through the meter going in only one direction despite the polarity of the variation.

A positive 1 volt at the input forces the operational amplifier into generating a 10.5-volt output, because in the noninverting configuration shown, the amplifier tries to keep the two input voltages equal. With 10.5 volts sitting above the bridge

rectifier, 1 milliamperes flows through the meter, diodes D_1 and D_2 , and the resistors R_1 and R_2 . This current causes a full-scale deflection in the meter and develops a 1-volt drop across R_2 . The resistor's 1-volt drop is coupled back into the am-

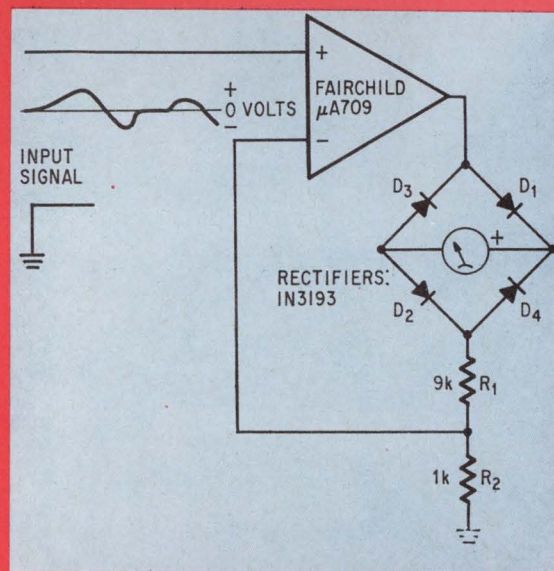

Accurate both ways. Variations in a voltage level are given meter-driving capability by the operational amplifier.

plifier's other input, where it stabilizes circuit operation.

Negative voltage deviations cause essentially the same circuit operation. The only difference is that D_2 and D_3 conduct, so that the meter deflects upward. And, of course, a negative feedback voltage is developed across R_2 , which, when coupled back to the negative input of the operational amplifier, stabilizes circuit operation.

If millivolt deviations must be read accurately, the resistors R_1 and R_2 should be reduced in value so that the current through these resistors is capable of driving the milliammeter. Offset voltage—the

small difference between the two input voltages that can't be removed—should be taken into account at the low input levels, because it might introduce large errors. A 1-millivolt offset voltage makes the meter voltage 4.5 mv when the input is 5 mv.

The circuit can be used to read a-c currents if the current-limiting resistor R_2 is reduced by 11%. This allows higher peak currents to flow through the meter. Instead of presenting an average of the a-c current, the meter will then indicate peak variations.

When used with an EEG, this circuit makes it possible for a researcher to observe brain reactions to external stimuli.

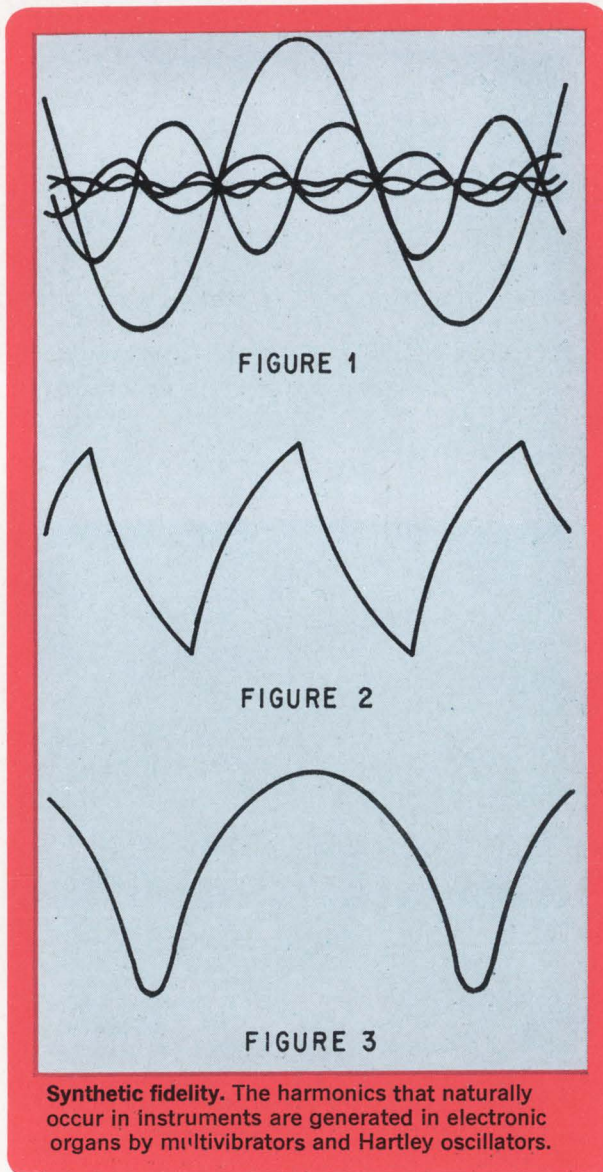

Synthetic fidelity. The harmonics that naturally occur in instruments are generated in electronic organs by multivibrators and Hartley oscillators.

Putting electronic organs in tune with natural sound

By Robert F. Woody Jr.

Christiansburg, Va.

Perceptible richness is added to the music in an electronic organ when all the audio harmonics are generated along with each fundamental note. Because they contain both a fundamental frequency and all the higher harmonics, sawtooth voltages are generated in the organ's tone oscillators. Unfortunately, the multivibrators and Hartley oscillators currently in use generate a sawtooth voltage whose flyback time is fast. The buzzing sound heard in the organ because of this flyback can be eliminated by adding a capacitor to the multivibrators and modifying the Hartley oscillators.

In addition to removing the buzz sound, the redesigned multivibrators add versatility to the organ circuitry. By changing a few components the designer can make the output of the tone generators either a sawtooth or nearly sinusoidal waveform.

A nearly sinusoidal waveform contains the fundamental note and highly attenuated harmonics; when heard in the organ's speaker it sounds like the note in a wood flute pipe organ. Because these nearly sinusoidal voltages are used as harmonics, this mixing with the fundamental gives a strikingly rich voicing to the electronic organ.

Twelve banks of multivibrators and their synchronizing oscillators generate all the A, B, C, D, E, F, and G notes and their respective sharps. The seven A notes in an electronic organ are generated by a bank of six multivibrators and a synchronizing Hartley oscillator. Tapping the oscillator coil so that the feedback signal overdrives the base of transistor

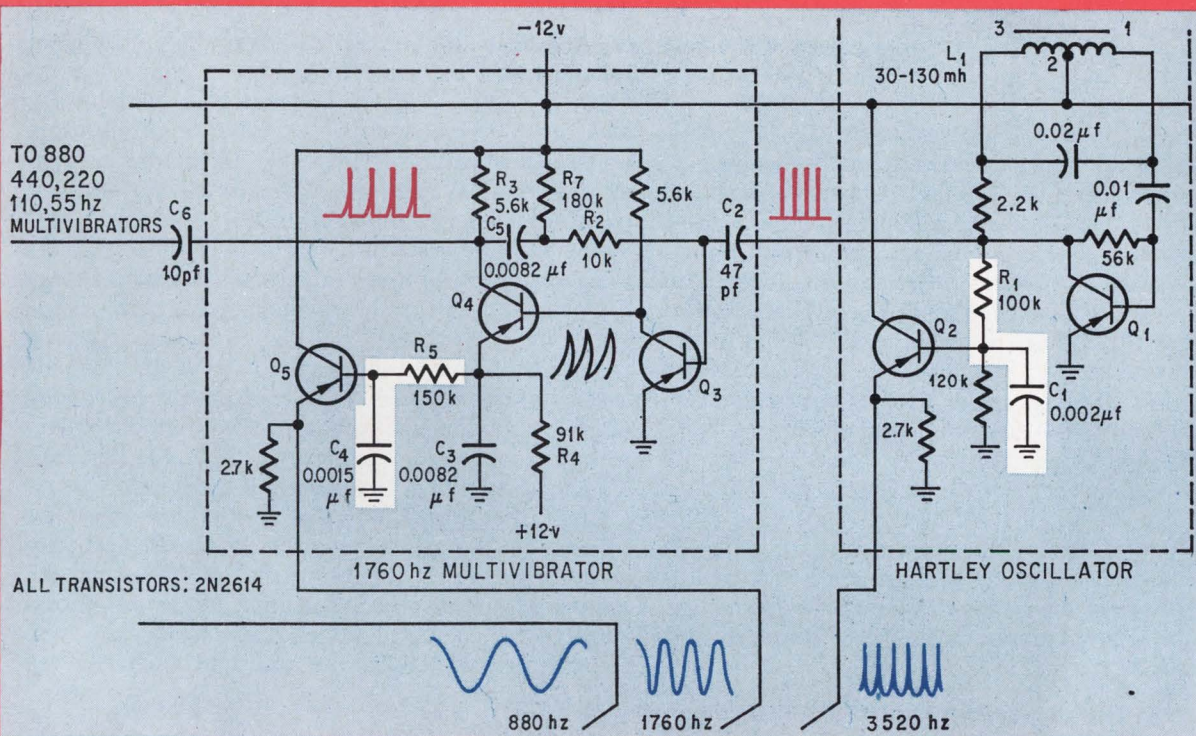

Music maker. The Hartley oscillator generates a very stable audio frequency that is used as both a note for the electronic organ and a synchronizing signal.

Q₁ causes the transistor to operate in the nonlinear portion of its base current/collective current curve. A sawtooth waveform results, which, when filtered by resistor R₁ and capacitor C₁, changes into a distorted sine wave. When a note is pressed, closing a key contact, further filtering by the 15-kilohm key resistor and C₅ makes the waveform at the emitter of Q₂ nearly sinusoidal.

Capacitor C₂ is coupled to the Hartley oscillator, whose collector signal triggers a 1,760-hertz multivibrator. After C₂ and R₂ differentiate the oscillator's signal, it becomes a positive spike that turns Q₃ off. The negative 12 volts of the supply then appear at the base of Q₄ and drive it into conduction. While Q₄ is on, C₃ charges through R₃. When the spike is removed from the base of Q₃, its collector and Q₄'s base are returned to ground.

With Q₄ off, C₃ discharges through R₄, thus completing one cycle of a 1,760-hz sawtooth signal. Midway through this discharge another spike appears at the base of Q₃, turns it on, and again places the supply voltage at the base of Q₄. This time, however, Q₄ doesn't conduct because the charge on C₃ prevents the flow of base current.

The sawtooth wave developed across C₃ has all its component harmonics attenuated because it is connected to the R₅ C₄ filter. The smooth sawtooth that results at the emitter is changed again by the

filtering of the key resistor and C₅. A waveform resembling the output of a full-wave rectifier is therefore available to the organ bus. The waveform is inverted with respect to the output of the Hartley oscillator. This inversion is undetectable by the human ear since the harmonic content in each signal is almost the same.

The voltage spike developed across R₃ when C₃ was charging is coupled to C₆ and triggers the 880-hz multivibrator. The same sequence of events occurs in this multivibrator; a nearly sinusoidal wave is generated for the organ and a synchronizing pulse, half the frequency of that supplied, is coupled to the 440-hz multivibrator.

Four of the component values in the multivibrator, C₃, C₄, C₅, and R₄, are determined by the frequency of oscillation.

Capacitors C₅ and C₃ are made equal to simplify the design. Because of this equality the period of oscillation of the multivibrator is $0.693 R_4 C_3$. Since R₄ is approximately 0.1 megohm, C₃ is related to the frequency by

$$f = \frac{1}{0.693 \times 0.1 \times 10^6 \times C_3}$$

where f = frequency of oscillation in hertz

C = capacitance of C₃ in microfarads

Performing the arithmetic with C₅ and C₃ equal

results in the following equation:

$$C_3 = C_5 = \frac{14}{f}$$

After these capacitors are placed in the circuit, a value of 91 kilohms is selected for R_4 because it synchronizes the following multivibrator at half the frequency of 1,760 hz. The value of the respective capacitors and resistors in the following multivibrators are determined in the same manner.

The low-pass filter capacitor C_4 —0.0015 μ f in the 1,760-hz multivibrator—has double this value in the 880-hz multivibrator. The value is doubled in the following multivibrators and, because organs usually operate in stable environmental conditions, 20% capacitors can be used.

The coupling capacitors between the multivibrators are all 10 pf.

Instead of blending fundamental frequencies to form a musical voice, most designers begin with a sawtooth wave and remove harmonics with a tone filter. The desired harmonics stay in the note and a voice similar to that of the blending system is produced.

In converting this circuit into a sawtooth generator, all the 0.22 μ f capacitors are removed from the buses. In the Hartley oscillator, R_1 and C_1 are removed and the collector of Q_1 is connected directly to the base of Q_2 . Capacitor C_4 , resistor R_5 , and their equivalents in the other multivibrators must be removed. The bases on all the driver transistors are then connected directly to the emitters of the transistors equivalent to Q_4 .

Sawtooth waveforms generated in these circuits have longer return times—the time it takes to charge C_3 —than the sawtooth waveforms in conventional organ multivibrators. This desirable characteristic is the result of C_2 's charge holding Q_4 on after the bias is removed from that transistor's base. The almost instantaneous return of the sawtooth waveforms in conventional electronic organs is heard as a buzzing sound in the system's speakers.

Since the third, fifth, and sixth harmonics are present in the waveform, the buses that supply these frequencies are not used in the sawtooth system. If one or all of these harmonics are necessary in the generation of an organ voice, the tone filtering is selected so that these frequencies are not attenuated.

Transistor and zener monitor calibration

By Edwin R. DeLoach

Astro-Dynamics Electronics, New Orleans

Portable measuring equipment whose calibration depends on a battery power supply should become inoperative when the battery discharges to a low voltage level. This can be arranged by placing a transistor and zener diode in the line between the battery and the instrument's circuitry.

As long as battery voltage remains above 19 volts in this scheme, transistor Q_1 is biased into saturation and current flows into the instrument. When the battery supply approaches 18 volts—the zener voltage of D_1 —the transistor starts operating in its active region. Collector-to-emitter resistance increases, and an appreciable part of the battery voltage is dropped across Q_1 . Eventually the cutoff point of the transistor is reached, and a resistance in the megohm range appears between Q_1 's collector and emitter. The line between the battery and the instrument's circuitry is then opened.

The gear can't be operated until the batteries in

the supply are recharged or replaced. If the batteries are nickel-cadmium, their life is prolonged by this arrangement, since discharge below the 30% of full capacity either destroys or endangers such batteries.

And this handy addition to the circuitry requires only 2% of total battery power.

An external indicator can be added to the equipment if a 24-volt bulb is connected across the emitter and collector of Q_1 . When Q_1 is turned off the voltage across it turns on the bulb.

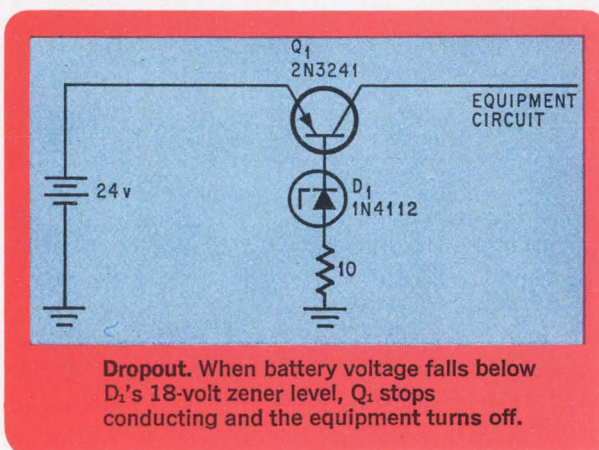

bench accuracy at system speed

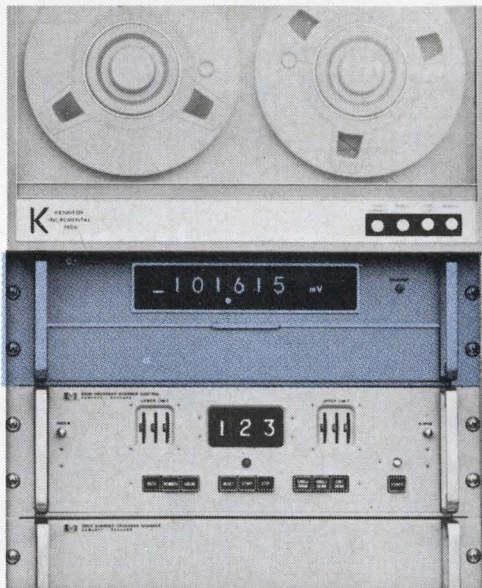

Cover protects 2402A controls for systems use.

Both in an
integrating DVM
with 1 microvolt
resolution.

Take 40 readings per second, integrate and resolve the answers to a microvolt with the new Hewlett-Packard 2402A IDVM...get resolution never before available in this speed range. With the accuracy of a lab instrument (0.01% of reading $\pm 0.003\%$ of full scale), the 2402A is excellent for system applications...with full programmability and all the features you'd expect from a systems voltmeter. (Of course, it's an excellent lab instrument, too.)

Guarding and integration permit accurate measurement of low-level signals in the presence of common mode and superimposed noise—over 120 dB effective common mode rejection...even at 40 readings per second. Designed for low-cost multimeter expandability: AC, resistance and frequency measurement capabilities can be added easily with optional plug-in circuit cards. Five ranges

to ± 1000 Volts, including a 0.1 Volt range for high-accuracy millivolt measurements.

The 2402A: \$4800. Plug-in options are reasonably priced—AC, for example, only \$450.

For more information, call your local HP field engineer or write Hewlett-Packard, Palo Alto, California 94304; Europe: 54 Route des Acacias, Geneva.

HEWLETT  **PACKARD**
DIGITAL VOLTMETERS

All-solid state design overtakes large-screen monochrome tv sets

High-voltage transistors can be used in the horizontal deflection system of these receivers if the devices have special circuitry to protect them from picture-tube flashovers and from failure of the oscillator or driver

By Wim Hetterscheid

Semiconductor Applications Laboratory, Philips, Gloellampenfabrieken, Nijmegen, the Netherlands

Large-screen monochrome television receivers are the home-entertainment industry's last holdouts against full transistorization. It's just been less expensive to produce a 23-inch set with transistors in the low-power signal circuits and vacuum tubes in the power output stages and deflection system.

The higher cost of the all-transistor sets is attributable primarily to the elaborate transformer-driven regulated power supply that would be needed to provide the low-level voltages—40 volts and under—for the transistors. A more economical all-transistor receiver could be made if the horizontal deflection system were designed with high-voltage transistors operated directly from rectified line voltage.

But there's a lot more to designing solid state deflection circuitry than simply getting suitable high-voltage transistors. Even devices meeting the most stringent specifications can be ruined if they aren't protected by special circuitry. Also, precautions must be taken against excessive radiation.

First step

To design a horizontal deflection circuit for an all-transistor black-and-white set operating from an unregulated rectified d-c line voltage of 130 volts, it's first necessary to determine the deflection energy the yoke will have to handle. This will indicate the scanning voltage involved, as well as the operating parameters of the output stage, driver stage, and oscillator timing circuits.

The magnetic energy required to scan a 23-inch, 110° deflection picture tube can be calculated from the specifications for the yoke's horizontal coil. With the coil operating at an acceleration voltage of 18 kilovolts, the specs would be:

Inductance	2.1 millihenrys
Resistance (d-c)	3.8 ohms
Deflection current	2.82 amps peak to peak

In this example, the deflection current must move the picture tube's electron beam over a distance of 495 millimeters—approximately 19.5 inches—with the aid of an 18-kv accelerating voltage. In practice, engineers shoot for an overscan of 9% to ensure adequate picture width, and they achieve it by increasing the deflection current by 6% over the nominal requirements. The energy required can be determined from the following equation:

$$W_m = \frac{1}{8} LI_y^2$$

where L = inductance in henrys and I_y = yoke current. Thus:

$$W_m = \frac{1}{8} \times 2.1 \times 10^{-3} \times (1.06)^2 \times (2.82)^2 = 2.32 \text{ mj}$$

where the 1.06 factor accounts for the 6% overscan current.

For a 20-kv accelerating voltage, the required magnetic energy is

$$W_m = \frac{20}{18} \times 2.32 \text{ mj} = 2.58 \text{ mj}$$

In the diagram at the right, the voltage, V_{Ly} , across the deflection coil can be determined from the equation

$$V_{Ly} = L_y \frac{I_y}{(1-p)T}$$

where

$$I_y = \frac{8 W_m}{L}$$

Substituting 2.1 mh for L, 0.18 for p (flyback ratio), 64 microseconds for T (flyback period), and 2.58 mj for W_m , we obtain

$$I_y = \frac{8 \times 2.58 \times 10^3}{2.1 \times 10^{-3}} = 3.15 \text{ amps}$$

The peak-to-peak deflection current, then, including overscan, is 3.15 amperes. The voltage across the coil can now be determined by:

$$V_{Ly} = 2.1 \times 10^{-3} \frac{3.15}{0.82 \times 64 \times 10^{-6}} = 126\text{v}$$

The calculated value of V_{Ly} is thus well within the range available from the 130-volt d-c supply.

The usual practice is to put a low-value resistance in series with the primary of the flyback transformer for flashover protection. The sawtooth voltage drop produced by the resistor, coupled to other circuit resistances, produces linearity errors that have to be neutralized by a linearity coil.

Assuming a combined drop of 8 volts in the circuit, the voltage, V_y , across the linearity coil, S-correction capacitor, and deflection coil—all in series—is reduced to 122 volts. Experience has shown that for linear deflection across a 23-inch picture tube, V_y always comes to about 97% of the voltage across the deflection yoke. And this observation checks out precisely with the calculated voltage (122 volts.)

Collector-emitter voltage

As shown earlier, the deflection coil and linearity correction circuitry are connected to a tap on the primary of the flyback transformer. In this specific transformer, the tap is at the 90% point of the total transformer winding. Thus the voltage across

the effective inductance in the collector circuit of the output transistor becomes, during the scanning period,

$$V_o = \frac{122}{0.9} = 136\text{v}$$

The peak value of the collector-emitter voltage, V_{CE} , during the flyback period can be calculated from the formula

$$V_{CE} = (1 + F_p) (1 - a) V_o$$

F_p is a constant that depends on the flyback ratio, p; its value is derived from the equation

$$F_p = \frac{1 - p}{p} \frac{\pi}{2} + \frac{2}{\pi}$$

For a ratio of 18%, $p = 0.18$ and $F_p = 7.8$. The factor "a" is a reduction coefficient of the collector-emitter voltage reflecting the reduction of collector peak voltage due to third harmonic tuning of the flyback transformer. From experience, a practical value for "a" is 0.15. Inserting these figures in the formula for collector-emitter voltage yields:

$$V_{CE} = (1 + 7.8) (1 - 0.15) 136 = 1,010\text{v}$$

In specifying the V_{CE} rating of the horizontal output transistor, the designer must consider the worst case and allow for a possible voltage increase of up to 10% above nominal value due to line-voltage variations, and another 15% increase that could be caused by out-of-tolerance components and out-of-sync circuit conditions. From a practical standpoint, therefore, the transistor peak rating is

$$V_{CE \text{ max}} = 1.10 \times 1.15 \times 1,010 = 1,278\text{v}$$

The deflection coil current, as previously determined, is 3.15 amps; this is reduced at the flyback transformer collector tap—which is at 90% of the

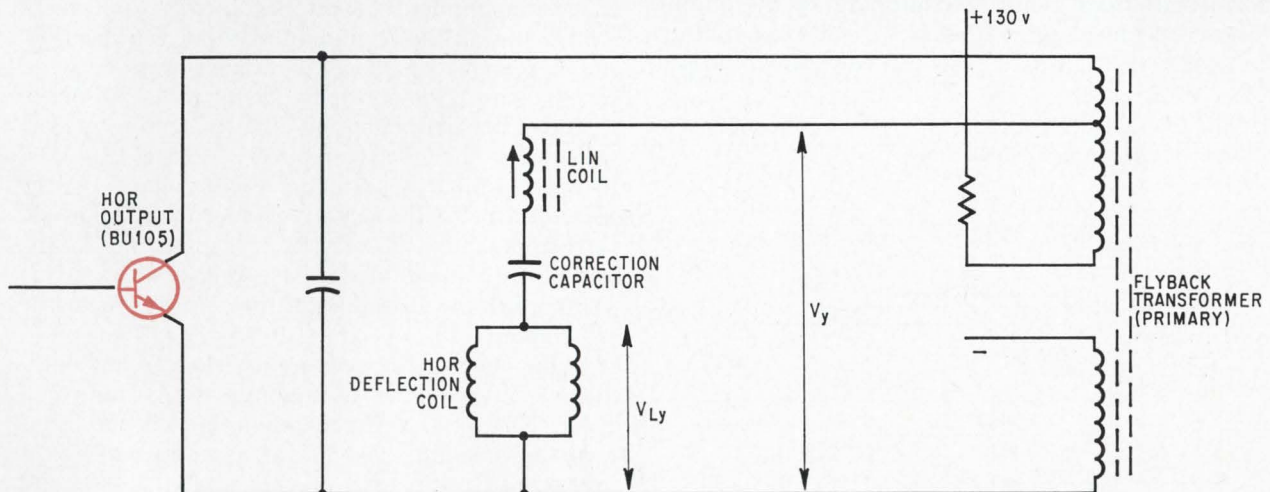

Horizontal output stage. The deflection coil and horizontal linearity correction circuitry are hooked up to a tap on the primary of the flyback transformer. The coil compensates for linearity errors, while the capacitor provides tangent (S) correction. Supply voltage is applied between the primary split terminals.

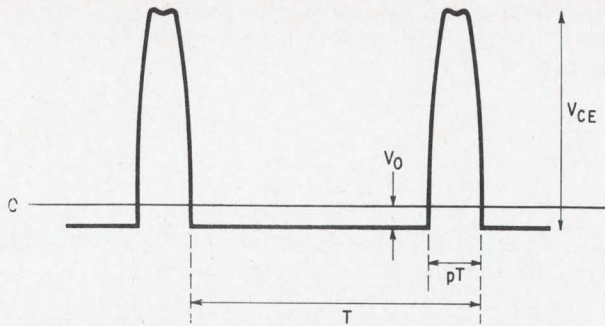

Waveform. Peak collector-emitter voltage value during the flyback period is a function of the flyback ratio and third harmonic tuning of the flyback transformer. Voltage V_0 appears across the inductance during the scanning period.

primary winding—by 10% to a value of 2.84 amps. In practice, the magnetizing current through the transformer is assumed to be 15% of this value, or

$$I_T = 0.15 I_y$$

Thus, the total peak-to-peak value of the current delivered by the transistor becomes

$$I_{y \text{ tot}} = 1.15 \times 2.84 = 3.2 \text{ amps}$$

The peak value of the collector current, as shown below, can now be determined from the equation

$$I_C = \frac{I_{y \text{ tot}}}{2} + \frac{I_{DC}}{1-p}$$

where I_{DC} is the current drain from the power supply, and the factor $(1-p)$ is the ratio of scanning time to the period time of a complete cycle.

In a practical horizontal deflection circuit operating with an acceleration voltage of 20 kv, power consumption is approximately 17 watts under conditions of no beam current. With a 10-watt load across the auxiliary windings of the flyback transformer, the total power consumption of the output circuit becomes approximately 27 watts, amounting to a current drain from the 130-volt power supply of

$$I_{DC} = \frac{27}{130} = 206 \text{ ma}$$

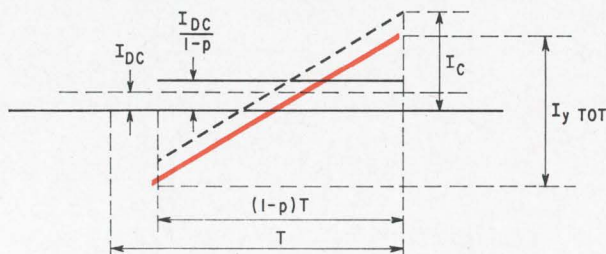

Collector current derivation. Peak value of I_C depends on the total sawtooth current of the system and on the current drain on the power supply. For an acceleration voltage of 20 kv, power consumption is about 17 watts.

Under nominal conditions for a flyback ratio of 18%, the peak collector current is

$$I_C = \frac{3.2}{2} + \frac{0.21}{0.82} = 1.85 \text{ amps}$$

The computed collector current corresponds, under normal operating conditions, to the current of the deflection output stage when component values are normal and when there's a 10-watt load across the transformer auxiliary windings but no load across the accelerating potential.

Outer limits

Computed collector-emitter voltage and collector current are considered nominal values for a well-designed circuit containing high-grade components. In practice, however, abnormal conditions can readily change these values. For example, the over-all effect of component tolerances, differences in the sensitivity of the deflection coils supplied by different makers, and variations in picture tubes and beam currents can boost collector-emitter voltage and collector current by as much as 25% from their nominal values.

Having determined the operating parameters of the horizontal deflection system with these hazards in mind, the designer can specify the characteristics of the various components involved and proceed with the circuit layout.

The use of a horizontal output transistor such as Philips' BU105 eliminates the need for the usual damper diode; the damper function is achieved with the collector-base junction of the transistor and its inverse operation.

During the flyback retrace time, a positive pulse is present between collector and emitter. At the end of the retrace period, this voltage passes through zero and increases negatively until it exceeds the value of both the base reverse-bias voltage and the forward voltage of the collector-base diode, at which point, that diode conducts. The base-reverse bias voltage is applied through the driver transformer as soon as the collector current switches off at the beginning of the flyback period, and it remains on until the transistor is forward biased again. This normally occurs about 10 microseconds after the beginning of the scanning period.

Consider the energy recovery during this first 10 μsec . With a base reverse-bias voltage on the order of 4 volts, the negative collector voltage will vary from about 5 volts to a level equal to the breakdown voltage of the base-emitter diode. This voltage, in turn, depends on the impedance in the base circuit.

At the start of the scanning period, a sawtooth-shaped current flows through the transistor's collector. Part flows through the base and serves as a normal forward bias. As far as collector-emitter voltage and base drive are concerned, the circuit parameters cause the transistor to operate in an inverse mode—the collector acts as emitter and the emitter as collector. The current gain of a BU105

Doing it in color

There are no large-screen, all-solid state black-and-white tv sets on the market now, but two companies—Motorola and RCA—will be offering all-solid state color models with 23-inch screens this summer. Motorola introduced the industry's first all-transistor color receiver at last year's Consumer Electronics Show. RCA will introduce its line this week at the show.

Solid state sets cost a lot more to produce than do vacuum-tube units. And these higher costs can be absorbed more readily in the higher-priced color-tv sector than in the sharply competitive black-and-white market. For example, RCA's solid state monochrome set with an 8-inch screen is priced at \$125, while Admiral's tube-operated monochrome set with a 9-inch screen has a \$69.95 price tag.

Hold that line. Engineers attending last year's

the other solid state devices to provide instant picture and sound when the set is turned on.

Whether Motorola or RCA is right about the rectifier, the rest of the tv industry will surely not be long in going to transistorized designs for the other circuitry.

No secrets. Despite all the precautions taken in the consumer electronics industry to safeguard secrets, companies are usually able to find out what rivals are doing, and the word in industry circles is that Zenith Radio will be next with an all-solid state color set.

"Our information is that they are readying a solid state line," says an RCA spokesman. "We're surprised that they haven't announced it yet."

It should be noted that the solid-state deflection circuit being developed at Philips cannot be used in

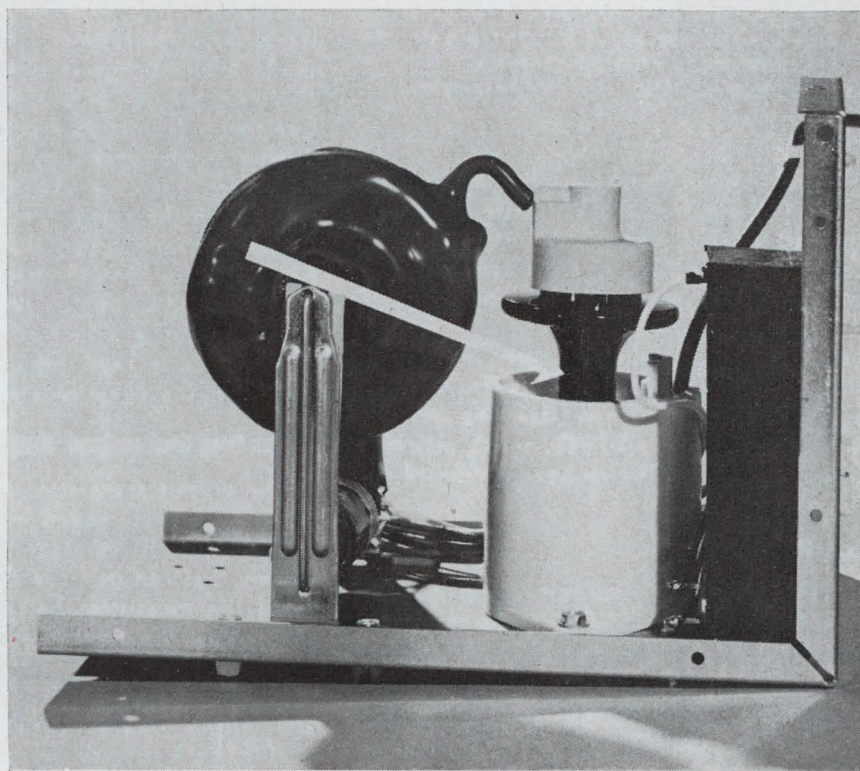

High-voltage module. Motorola's solid state high-voltage module replaces vacuum-tube rectifier with a silicon unit that's shown mounted in position.

Spring Conference on Broadcast and Television Receivers in Chicago were openly skeptical that Motorola could continue to market its solid state color set at a price only about \$90 above those on comparable tube-type sets. But the firm has held the price line, and according to Dick Kraft, Motorola's director of color tv engineering, people are willing to spend the extra money to get solid state reliability.

Motorola's first solid state color sets used a high-voltage rectifier tube, but that has now been replaced by a solid state silicon rectifier that plugs into a socket.

RCA's solid state color line still features a tube-type high voltage rectifier. An RCA spokesman claims that the solid state devices now available for this application aren't yet cost-competitive with vacuum tubes. The one undeniable advantage of the solid state rectifier is that it provides instant warmup. This feature complements those yielded by

color sets, which consume considerably more power than their black-and-white counterparts. Solid state color sets employ several voltage multiplier stages to develop the needed accelerating voltages, which approach 30 kilovolts in some sets.

The color receivers also require a well-regulated transformer power supply to provide low-level voltages for the transistors. Typically, the B+ is held at an average of 80 volts d-c during modulation. The power supply for the color set thus adds appreciably to the over-all cost of the unit.

This is essentially the point made by Philips' Hettterscheid: it's cheaper to build black-and-white all-transistor sets that can operate with a simple line-voltage rectifier and filter than one requiring a well filtered and regulated low-voltage d-c power supply.

J.D. Drummond, Consumer electronics editor

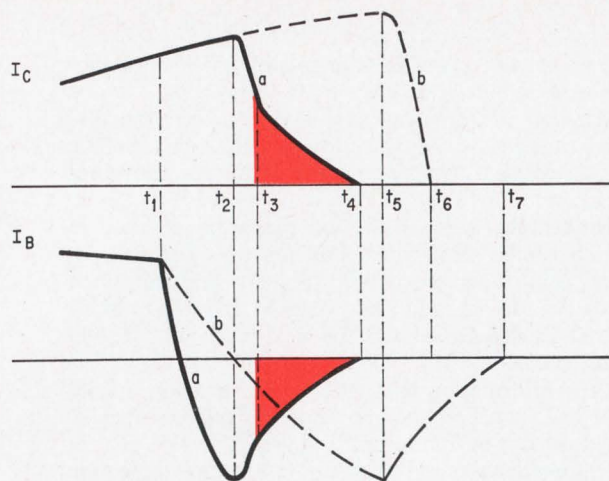

Quick change. Turn-off waveform "a" shows what happens when fast-charging base current is applied. In waveform "b," the base current's rate of change is slowed by the switching speed of the BU105 transistor. As indicated in the tinted areas, collector charge is removed by recombination in the collector-base diode.

in the inverse mode is about 0.8, the ratio of collector current to base current. The base and emitter currents are on the same order of magnitude and make up about half the total current flowing in the collector circuit, excluding second-order effects.

Therefore, the parallel-efficiency recovery of energy in the output circuit takes place by inverted transistor operation in a common-base arrangement. And parallel-damper (parallel-efficiency) action is thus provided by the collector-base diode of the output transistor.

Turning off the drive

If collector current is to be turned off quickly, it has to be controlled by the base current. The transistor collector-base junction must therefore become nonconductive before the emitter-base junction—a precaution that's of special importance in circuits using the BU105. During scanning periods, large amounts of charge carriers are stored near the collector junction because of the large base current needed to get a sufficiently low saturation voltage at

the end of the scans. So it takes a considerable time to remove the excess charge carriers from the collector region when applying a turn-off drive to the base. Only after all of the carriers have been removed will the actual turn-off of the collector current begin to take place.

It's essential, however, that the base-emitter region not discharge at a faster rate than the collector is able to follow. Otherwise, the emitter junction will be reverse biased at a time the collector junction is still storing carriers. In that case, the charge from the collector region could be removed only by the recombining of charged carriers in the transistor's collector-base diode.

In the chart at left, curve "a" shows the result of a too rapidly changing turn-off current at the base. The spike in the collector current's turn-off characteristic could lead to excessive turn-off dissipation. In curve "b," full use is made of the transistor's switching speed. With the slowing of the turn-off base current's rate of change, the emitter junction cannot become nonconductive before the collector current is turned off. Since there is no recombination spike in the collector current waveform, there can be no excessive turn-off dissipation in the transistor.

The rate of change of the reverse base current has been slowed in the practical circuit by an extra inductance, L_B , put in series with the base lead. This inductance, which is shown below, and which includes the leakage inductance of the driver transformer, has a value of about 25 microhenrys.

Protecting the output stage

The output transistor in a horizontal deflection circuit can be damaged by a sudden failure of the oscillator or driver stage. To understand the conditions that can occur with faulty driver operation—and the measures that can be taken to prevent damage to the output transistor—consider the situation prevailing under normal operation.

In the horizontal deflection circuit, the driver and output stages operate in a nonsimultaneous mode. That is, the driver transistor conducts during the time required for the output transistor to switch off. All this happens in the flyback period, during which a high collector voltage is present and energy is recovered.

The output transistor is forward driven when the driver transistor doesn't conduct. This forward drive draws energy from that stored in the inductance of the driver transformer during the preceding conduction period of the driver stage.

Driver and output stages are designed to ensure that the output transistor sees a relatively low impedance at its base during the conduction time of the driver transistor. The protective impedance in the base circuit under these conditions is, as indicated before, formed by coil inductance and resistance, plus the driver transformer's leakage inductance.

Failure on the part of the driver transistor to deliver a pulse alters the operation of the output

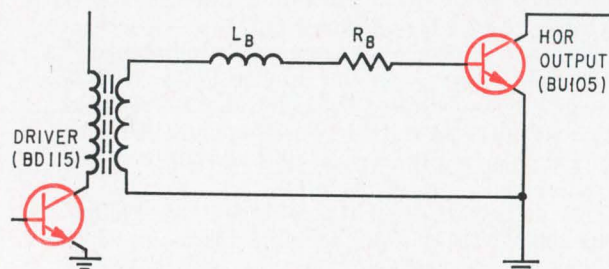

Base circuit inductance. Leakage inductance of the driver transformer can be boosted by the addition of an inductor, L_B , to the output transistor base lead. The added inductance helps slow the rate of change of the turn-off base current, but at the expense of an increase in the storage time.

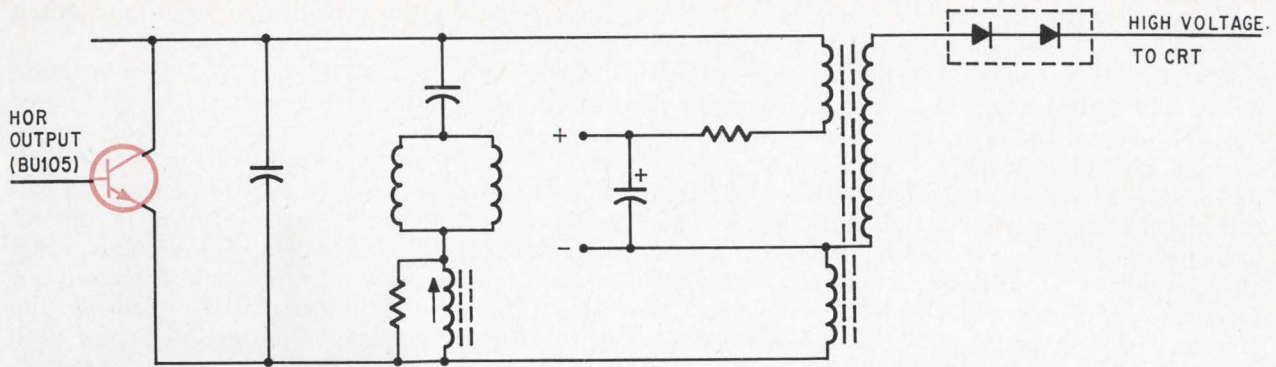

Built-in protection. The output stage can be effectively protected from picture-tube flashovers by a resistor in series with the power supply and primary of the flyback transformer. For circuits using the BU105, a resistance value of 27 ohms is adequate. The resistor should not be decoupled, however.

transistor. When faulty driver conditions occur suddenly, the output stage can easily become self-oscillating. Experiments with practical circuits show that the frequency of self-oscillation and the number of cycles affected depend on the transistor type involved and on the circuit parameters.

To understand how the horizontal deflection output stage can become self-oscillating during failure of the driver system, suppose that for some reason a current flowing in the base circuit of the output stage is of the same polarity as the "parallel-efficiency" current that flows under normal operating conditions. The base current would then cause magnetic energy to be stored in the inductance of the driver transformer secondary. And the amount of this energy could be large enough to apply a forward drive of the output transistor.

When no more energy is available in the driver transformer inductance, some collector current turn-off mechanism will occur in the circuit. After this, there may be a further period of energy recovery from the output circuit and subsequent energy storage in the transformer inductance.

It should be noted that the circuit of the output stage under faulty driver conditions takes on the basic form of a Hartley-type oscillator. The main components are the inductance of the driver transformer, the collector-base capacitance of the transistor, and the inductance in the collector circuit. There is also, of course, the amplifying action of the transistor.

Self-oscillation of the output stage can destroy the transistor. First of all, forward base drive produced by the magnetic energy stored in the secondary inductance of the driver transformer may not be adequate to control the collector current drawn by the output circuit. The transistor comes out bottoming and a large amount of power is dissipated. Also, the collector current takes a long time to turn off under these conditions, resulting in another large waste of power. And these forward and turn-off dissipations can damage the transistor.

Further, under faulty driver conditions, a large voltage pulse may still appear during turn-off. The combination of a large collector-emitter voltage and the turn-off collector current, plus the rela-

tively large impedance of the base circuit, may lead to a "pinch-in" effect that shows up in the output transistor as a short-circuit between collector and emitter.

During normal operation of the circuit, the inductance in the base consists of the "speeding-up" inductance, I_B , and the leakage inductance of the driver transformer. This inductance is small in comparison with the secondary inductance of the driver transformer (measured with open primary). The amount of energy stored in the base inductance during "parallel-efficiency" action of the transistor is thus far smaller than that occurring under faulty driver conditions. There is no risk, therefore, that the circuit with a BU105 can become self-oscillating during normal operation.

To protect the output transistor against the effects of driver failure, a large-value capacitor should be connected across the secondary of the driver transformer to ensure that the base output of the transistor always sees a low impedance. The capacitor also prevents the output stage from becoming self-oscillating during periods of faulty driver operation. The capacitor shouldn't be connected directly between the base and emitter of the output transistor, however, because this would upset the effect of the inductance, L_B , and lead to long spikes in the collector current's turn-off characteristic. In a practical circuit employing the BU105, safe operation under all drive conditions is ensured when the capacitor has a value of 0.47 microfarad.

Base drive pulse

The base drive pulse should be timed so that forward bias isn't applied to the output transistor before the end of the flyback period.

In determining the proper pulse width for the BU105 reverse-bias base voltage, one must take into account the 10- μ sec turn-off delay and the approximately 12- μ sec duration of the flyback period. Counting spreads in turn-off delay and tolerances in the duty cycle of the drive pulse, though, the actual reverse-bias pulse width should be considerably larger than that 22- μ sec minimum. In general, a circuit can be considered safe if the pulse

has a width of 34 μsec .

Because the deflection coil used in a BU105 circuit has a relatively high impedance, large voltage pulses will appear across it during the flyback period. To keep X radiation as low as possible, the circuit's ground connection should be at a point that keeps the pulses at the ends of the deflection coil equal and opposite in polarity. This is done by connecting the power source to the two halves of the flyback transformer's primary winding. Neither side of the coil should be connected to ground, however, as this could set up X radiation exceeding official limits.

To protect the output transistor from possible damage from picture-tube flashovers, a current limiting resistor is connected in series with the primary of the flyback transformer. A 27-ohm resistor serves for the BU105 circuits. Further protection can be achieved by putting a diode in the collector circuit to act as a clamp.

Countering the arc

Use of a vacuum-tube high-voltage rectifier in the circuit raises the threat of damage to the output transistor from arcing. One of the ways to beat this problem is to limit the discharge current of the picture-tube capacitance by connecting a resistor in series with the cathode lead of the rectifier tube. Good results are obtained only when the resistor is so installed that the tube's cathode capacitance—as well as the capacitance of the socket—is minimized. The resistor must also be large enough, physically, to prevent arcing across itself.

In another solution, a reverse bias is maintained at the base of the transistor during rectifier arcing by means of a feedback-circuit arrangement. Arcing is thus initiated at the start of the scan period only.

A combination of these two techniques affords more effective protection than either one singly.

In the schematic of driver and oscillator stages on the next page, the stages are operating in a non-simultaneous mode with respect to each other. The driver transistor is therefore off when forward drive is applied to the output transistor—a period during which a relatively large voltage pulse appears across the primary of the driver transformer and, hence, at the collector of the driver transistor. Considerable ringing will be present in this voltage pulses due to the transformer leakage inductance and the coil in series with the base of the output transistor.

With a BD115 transistor in the driver stage, a damper circuit is employed to remove the ringing and thus prevent a surge above the transistor's voltage rating of 225 volts with low-impedance base termination. The damper, which is connected across the primary of the driver transformer, is nothing more than a 5.6-nanofarad capacitor and a 1,200-ohm resistor in series.

The collector voltage can be further reduced by a network composed of a 1,000-ohm resistor and a 100-nf capacitor in series with the power supply.

This network also provides a ripple-smoothing function.

Taking into account the fact that the maximum voltage rating of the driver transistor should never be exceeded, the designer must make allowances for a 10% increase in supply voltage due to line-voltage variations, and for a 10% increase in collector peak voltage due to tolerances in the resistance-capacitance networks. The nominal value of the collector peak voltage should therefore not exceed 180 volts. Since, as stated previously, the driver must be conductive during 34 μsec of each period—with a period time of 64 μsec —the operating duty cycle is 53%.

The effective value of the voltage across the driver transformer's primary during the driver transistor's conduction period then becomes:

$$(1 - 0.53) 180 = 85\text{v}$$

The reverse-bias voltage for the output transistor should be in the order of 4 volts, giving a tuner ratio for the driver transformer of $n = 22$.

Oscillator stage

To deliver sufficient base current for the driver transistor, the oscillator circuit must provide a relatively low output impedance. Capacitive coupling between oscillator and driver stages prevent damage to the driver transistor in case of oscillator failure.

The oscillator's voltage comes from a potentiometer across the 130-volt supply provided for the output and driver stages. The circuit is protected from spikes by the resistor in series with the transformer primary lead.

The relatively large impedance in the base circuit of the horizontal output transistor results in a long storage time—on the order of 5 μsec for a low impedance and up to 12 μsec for a higher impedance. Thus the timing of the oscillator and driver should be such that the output transistor is not forward biased before the flyback period is finished. Assuming, for design purposes, a worst-case condition of a 12- μsec storage time, the period the driver transistor is on should be about 34 μsec , as mentioned earlier. This allows an extra margin for possible timing errors.

The power required by the low-voltage circuits of the television receiver can be supplied by auxiliary windings on the flyback transformer. Typical low voltages of -24 and $+12$ volts are obtained by rectifying the pulse voltage during the scanning period by means of suitable diodes. This type of rectification ensures that the internal impedance of the voltage source is kept relatively low.

To prevent interference in the r-f and i-f circuits due to the inherently fast reverse-recovery phenomena of rectifier diodes, bypass capacitors must be connected across these diodes. In some cases, however, a resistance in series with the diode yields even better results. Here again, the surest course is to employ both methods.

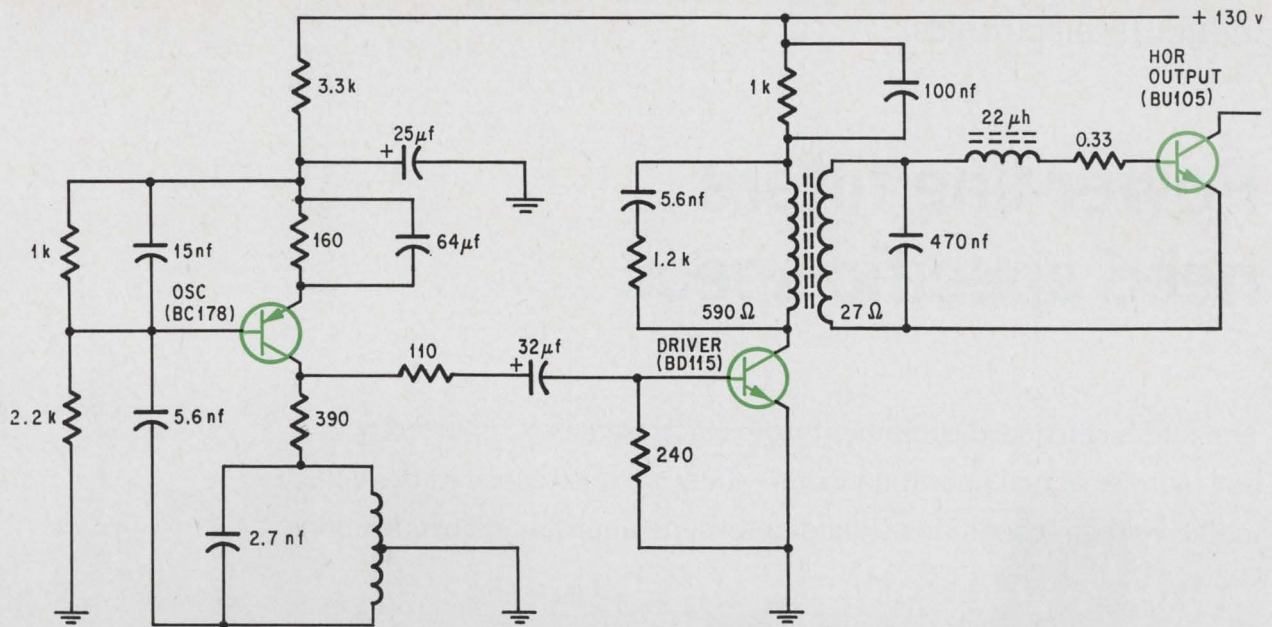

Oscillator and drive stages. The values shown for the circuit components are suited to the transistor types employed in this deflection system. The use of transistors with different characteristics might require some changes in these values, therefore. The oscillator must include provisions for frequency adjustment.

The use of the BU105 transistor in the horizontal deflection circuit of a large-screen tv set requires that full use be made of the device's maximum rating. The total dissipation is approximately 6 watts. However, the dissipation can rise to 8 watts or more under abnormal drive conditions.

If the specified maximum temperature of the transistor's mounting base is 95°C, the size of the heat sink should permit dissipation of 8 watts without an increase in temperature beyond that level under maximum ambient temperature conditions. However, if the engineer determines that the power rating of the transistor isn't likely to be exceeded, he may elect to use a smaller heat sink.

Rectifier

The use of a tube-type rectifier in the horizontal output circuit, creates an additional design requirement for the flyback transformer: it must have a separate winding for the rectifier.

The flyback transformer should be designed to provide proper third harmonic tuning with a silicon or selenium rectifier stack, as well as with a tube rectifier. The capacitance of the solid state rectifier when reverse biased should be about 1 pf, and the anode capacitance of the rectifier tube should be of approximately the same value.

In some flyback designs, it's necessary to add stray capacitance when driving a solid state rectifier. As is customary, the flyback also provides the first anode and focus voltages for the picture tube. The focus voltage is obtained from a tap by diode rectification. The diode circuit also serves to clamp the horizontal output transistor's collector voltage peaks during periods of picture-tube flashover. During flashover, the load current will be relatively large—up to 1 ma. A charge capacitor of 1 µf is

therefore needed to safeguard the circuit.

The horizontal output circuit described here has been used in a number of prototype tv sets that have been built to determine the feasibility of solid state sets operating from a rectified 120-volt power line. The flyback transformer used has auxiliary windings that supply peak-to-peak voltages of +25, -125, +250, and -250 volts. The maximum load on the auxiliary windings is 10 watts. The accelerating voltage for the picture tube is 20 kv with a load current of 35 µa.

Coil windings for the driver transformer are 590 turns of 0.1-millimeter enamelled copper wire for the primary and 27 turns of 0.28-mm enamelled copper wire for the secondary. Insulation between primary and secondary is 0.5 mm thick.

The horizontal oscillator coil has two sections, one made up of 1,195 turns of 0.10-mm enameled wire, and the other of 384 turns of 0.05-mm enameled copper wire. The coils are on a form with an adjustable Ferroxcube core and screen can. Four Ferroxcube slugs are used to vary the inductance for precise frequency tuning of the oscillator.

Other high-voltage transistors will undoubtedly appear on the market and the engineer will wish to compare operating characteristics before consolidating his circuit design. One warning, however: most designers are used to working with low-voltage horizontal deflection circuits with transistors having a slower turn-off than the BU105's time of less than 1 µsec. Because the BU105 has a very high collector breakdown voltage, it has been designed with a very thick collector made of high-resistivity material, and this can reduce current gain and lengthen the turn-off time if an incorrect turn-off drive is applied.

Power-line filters need specific specs

The filters can guard equipment from electromagnetic interference, but—under actual operating loads—they can also cause wide swings in line voltage; conditions should determine application specifications

By Robert B. Cowdell

Genisco Technology Corp., Compton, Calif.

Standard installation of a low-pass filter in a power line to keep electromagnetic interference from entering a shielded room can create more serious problems than it solves. As a recent case in point, an engineer used a standard, 400-hertz, off-the-shelf filter, rated at 100-decibel insertion loss at a cutoff frequency of 14 kilohertz, only to discover that though the generator produced the correct supply of 208 volts, the voltage at the load inside the room was 240 volts!

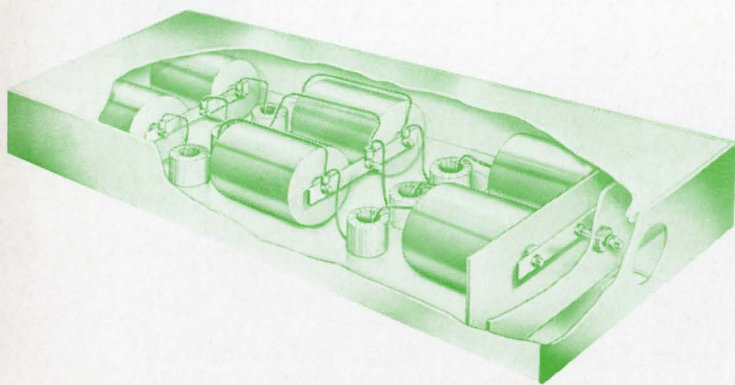

Checking the filter under resistive load, he found the voltage drop at rated current to be 2.6 volts, well within the filter's specifications. The power generator also turned out to be operating satisfactorily. In this case, the equipment inside the shielded room was the generator's only load, so the problem was solved by reducing the generator's voltage from 208 to 180 volts, thus bringing the inside voltage to the desired 208 volts. But why had the voltage increased?

Further investigation revealed the essential cause of the problem: people who specify filters may not be aware of actual operating conditions. Power-line filters are specified to have 50-ohm resistive source and load impedances, but more often these impedances will be complex and have values of 2 to 10 ohms. Thus, power-line filters are sensitive to the magnitude of load current and the power factor. Sometimes, then, the load makes the filter resonate rather than attenuate.

Rolloff

An ideal filter would have zero attenuation for frequencies slightly higher than the power-line frequency, and a specified insertion loss for all higher frequencies. That is, it would have a steep rolloff characteristic.

But practical passive power-line filters, made of capacitive and inductive elements, actually have a rolloff characteristic whose slope depends on how many elements are used and how far above the power frequency the cutoff frequency is set. With a resistor-capacitor load, the rolloff may peak near power frequencies and cause a gain instead of a voltage drop.

Some of the latest specifications call for a 100-db insertion loss at 14 khz. This low cutoff frequency, compared with the 50 khz and higher specified earlier, means that insertion loss of a few tenths to several decibels may occur at 60- and 400-hz frequencies. This small insertion loss may seem insignificant in relation to the specified 100 db, but at power-line frequencies it means substantial line-voltage drops or gains.

One standard five-element filter, rated at a 100-db insertion loss and a 12.5-khz cutoff frequency, uses

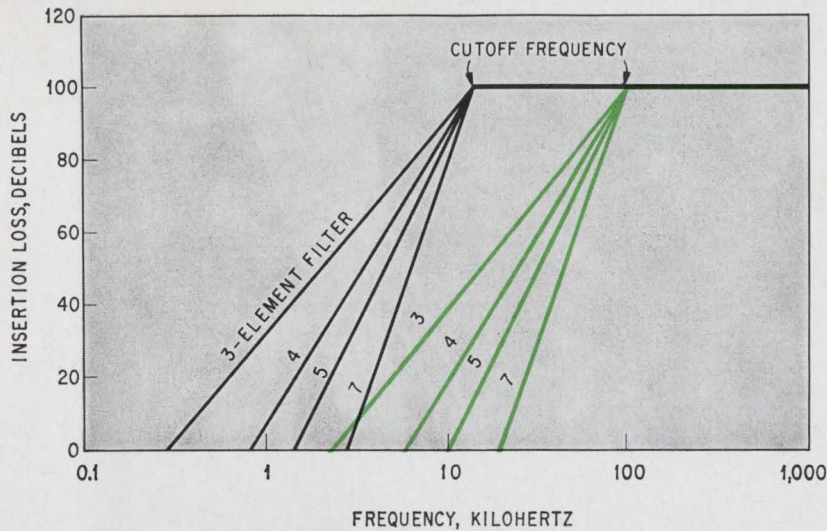

Big loss. Ideal passive power-line filters have high insertion loss for electromagnetic interference above the cutoff frequency (14 or 100 khz), and no loss at power-line frequencies. But filters with five or less inductive and capacitive elements can cause a variation in line voltage at 60 hz. Seven-element filters may be needed for 400-hz line frequencies.

three capacitors and two inductors. Another filter, a seven-element unit with four capacitors and three inductors, also has a 100-db insertion loss but cuts off above 16 khz. The insertion-loss characteristic of these two filters strongly depends on the values of source and load resistances. The lower these resistances, the less the insertion loss at power frequencies.

Computer evaluation

Rarely is the filter's load purely resistive, however, and there's usually little or no source impedance. To find out what voltage drops or gains are caused by variations in load current and in capacitive and inductive impedance loads (power factor), the two standard 50-ampere filters were simulated in a digital computer. Curves of voltage drop or the gain-versus-power factor were plotted at different load currents at both 60 and 400 hz.

In the tests, the source impedance was set at zero—realistic for most 60- and 400-hz sources. The computer simulated series resistor-inductor, series resistor-capacitor, and single resistor loads to yield impedances of 230, 11.5, 4.6, and 2.3 ohms—equivalent to load currents of 0.5, 10, 25, and 50 amps.

The values of the R's and C's in the load impedances were calculated and simulated in the computer by the application of some simple and basic

relationships:

$$Z = V/I$$

$$\text{Power factor} = R/Z$$

$$\text{where } Z^2 = R^2 + X^2$$

Thus, for a load current of 10 amps, a power factor of 0.6, and a 115-volt, 60-hz source,

$$Z = 115/10 = 11.5 \text{ ohms}$$

$$R = 6.9 \text{ ohms}$$

$$X = 9.2 \text{ ohms}$$

$$C = 1/(2\pi fX) = 288 \text{ microfarads}$$

$$L = X/2\pi f = 24.4 \text{ millihenries}$$

To get realistic results, the simulated filter model was also fed information about how its elements' values varied under different operating conditions. In particular, the Q of an inductor drops when higher currents are applied because of increasing power losses and because the inductance itself decreases as the inductor saturates.

The computer-plotted results show the magnitude of the line-voltage drops or gains introduced by the filters under different conditions. At 60 hz, the seven-element filter is affected less by the load power factor than is the five-element filter. For light load currents, however, the voltage drop of both filters is small for all load impedances. Further, for a power factor of about 0.9 capacitive, there is a

FIVE-ELEMENT FILTER

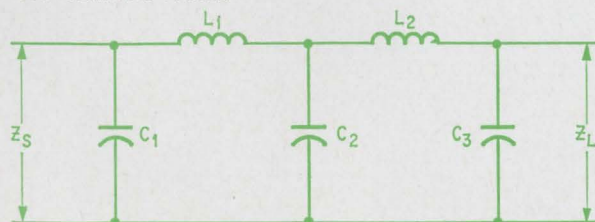

$$L_1 = L_2 = 200 \text{ MILLIHENRIES}$$

$$C_1 = C_2 = C_3 = 30 \text{ MICROFARADS}$$

$$Q_{\text{ind}} = 3$$

$$R_{\text{ind}} = 0.005 \text{ OHMS}$$

SEVEN-ELEMENT FILTER

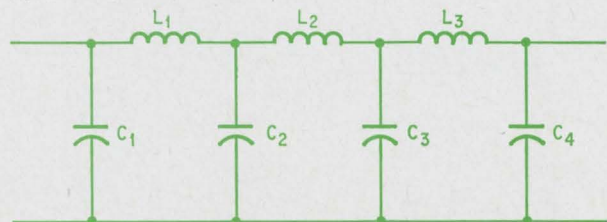

$$L_1 = L_2 = L_3 = 25 \text{ MICROHENRIES}$$

$$C_1 = 60 \text{ MICROFARADS}$$

$$C_2 = C_3 = C_4 = 34 \text{ MICROFARADS}$$

$$Q_{\text{ind}} = 3$$

$$R_{\text{ind}} = 0.005 \text{ OHMS}$$

Elemental. These standard power-line filters contain five inductors and capacitors (left) or seven. In general, the more elements, the less line-voltage loss there is at line frequencies. Filter efficiencies depend on the inductors' Q, which varies with load current.

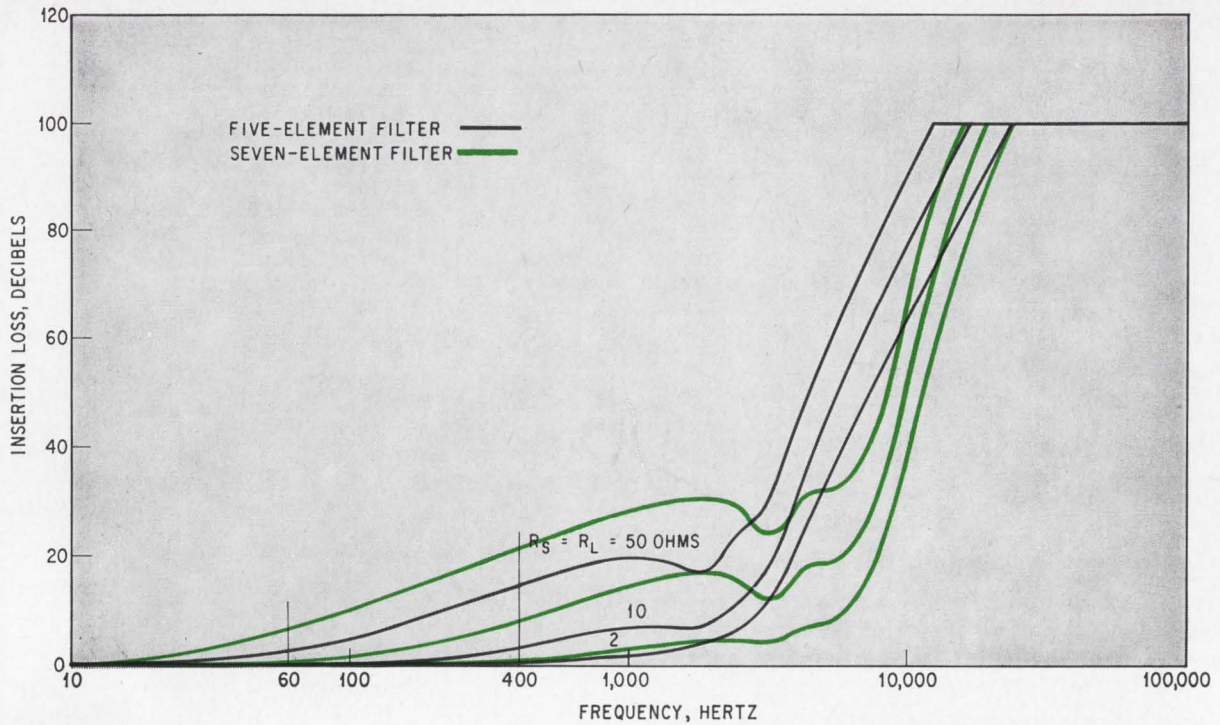

Hidden. These insertion-loss characteristics indicate that even with pure resistance loads there is substantial line-voltage drop at the 60- and 400-hz power frequencies. However, the decibel scale used here masks the real impact of line-voltage variations. With complex (resistor-inductor, resistor-capacitor) impedance loads the line-voltage gain or drop caused by the filter can degrade the operation of equipment.

slight voltage gain that remains substantially independent of load current and impedance.

The extent of these variations in supply-line voltage would be masked if the filter's insertion-loss characteristic were plotted in the normal way—on a

decibel scale. For example, at 60 hz and with a 2.3-ohm resistive load, the five-element filter reduces the generator voltage from 115 volts to 112; yet these 3 volts represent an insertion loss of only 0.22 db. At a 0.4 inductive power factor and 2.3-ohm

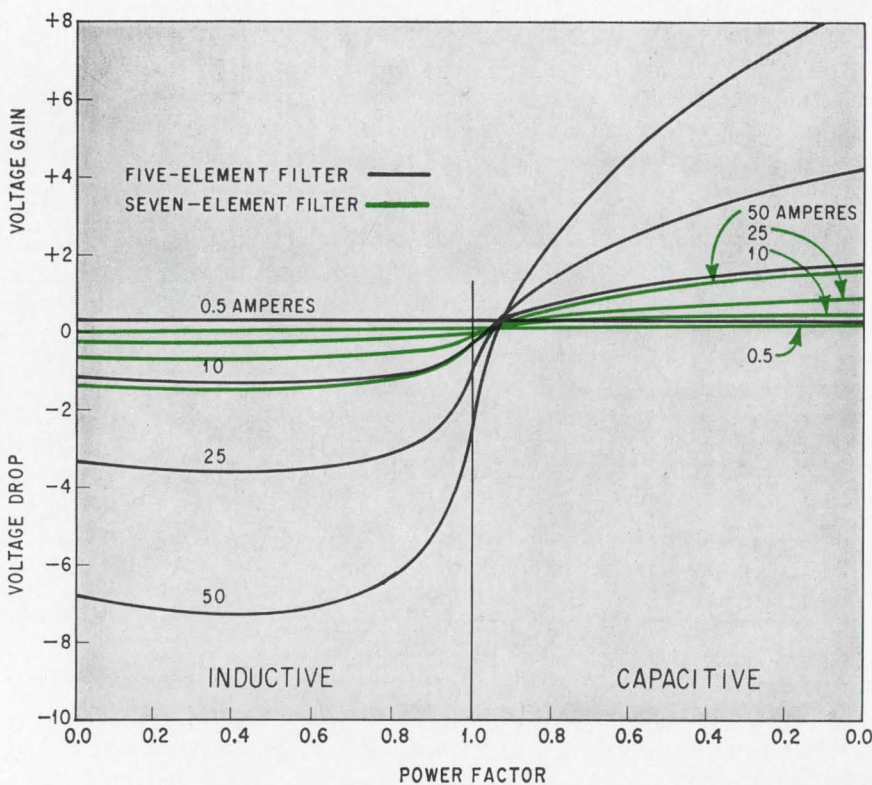

Less for more. At 60 hz, the seven-element filter's voltage gain and drop, in color, vary less with changes in load current and power factor than do those of the five-element filter, shown in black. Note that the voltage gain for both filters is independent of current at about 0.9 capacitive power factor.

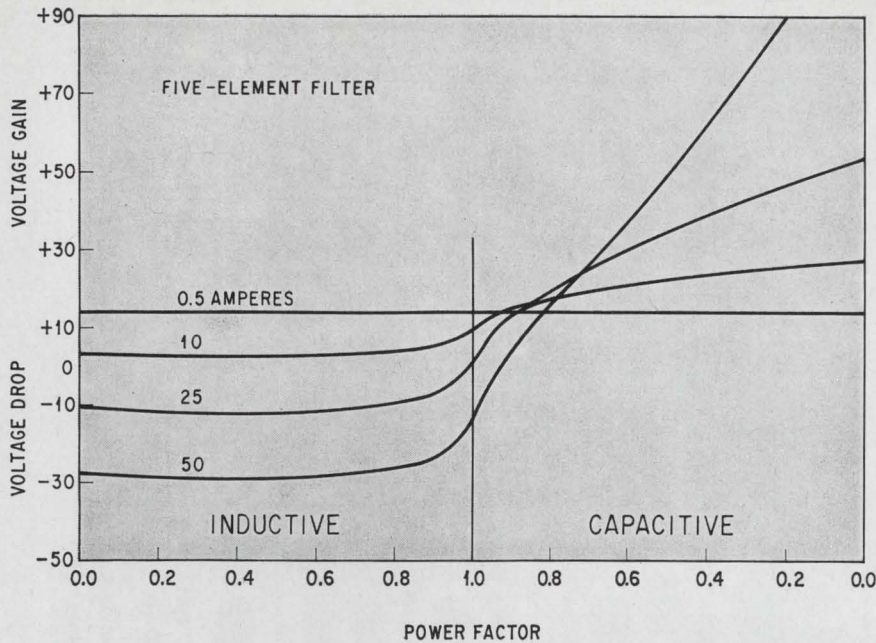

Closer to cutoff. The five-element filter has much greater voltage drop or gain at a 400-hz power frequency than it does at 60 hz. Raising the cutoff frequency or adding more filter elements would improve the characteristics.

More and better. The characteristics of the seven-element filter at 400 hz are. Again, line-voltage variations can be reduced by adding even more elements or by raising the cutoff frequency.

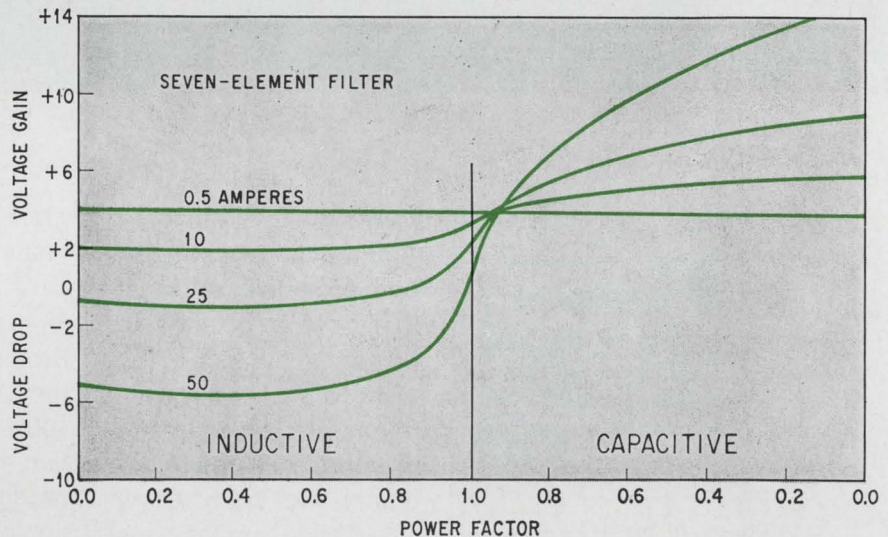

load, the line voltage drops to 107.7 volts, the equivalent of a 0.57-db insertion loss.

The characteristics of the two filters at 400 hz were plotted separately because of the change in scale, a situation that further emphasizes the fact that the seven-element filter is much less susceptible to changes in load current and power factor than is the five-element one.

No one answer

The engineer wanting to get rid of electromagnetic interference on power lines, but without wide swings in line voltage, is faced with several alternatives, none of which may be completely satisfactory. For example, he can arrange for an isolated line to run from the generator (autotransformer) to the load inside the shielded enclosure, and can adjust the source voltage up and down as the load current and power factor change with different loads. If he manages to compensate for voltage drop or gain in

this manner, the insertion loss at power frequencies due to having a 14-khz cutoff frequency can be tolerated, and the filter can serve its main purpose of attenuating even low-frequency electromagnetic interference.

Adding more elements to the filter makes the insertion loss characteristic below the cutoff frequency steeper and also reduces the insertion loss and power-line frequencies. But it also boosts the cost of the filter. For example, a five-element filter rated at 50 amps and 12.5 khz, and having a 100-db insertion loss, costs about \$150; a seven-element filter with similar specs costs about \$30 more.

Probably the easiest way to handle the problem is to investigate the spectrum of the electromagnetic interference. The higher the frequency of the low end of this spectrum, the higher the cutoff frequency of the filter can be. And the higher the cutoff frequency, the lower the insertion loss at power frequencies.

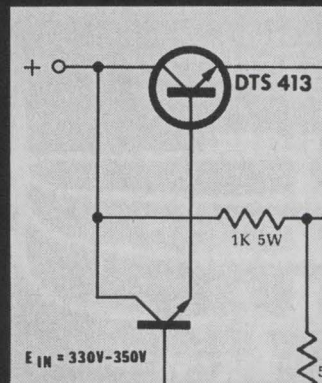

The Kokomoans'



Power semiconductors. And that knowledge can help you solve your most intricate problems in power. Our applications experience began the moment the power industry was born. Grew with it. And comes to you in Delco applications engineers stationed in nearby offices throughout the country. Engineers who've worked with people in everything from TV to space technology. Engineers who'll work with you to help take your pro-

gram from concept into production. Help you simplify circuits, lower costs or take care of most anything that might be short-circuiting your operation.

Prompt delivery's no problem because the Delco Radio organization is keyed 100% to mass production: mass production of components to meet customer production schedules. And mass production of our own end products—car radios and automatic temperature control systems. StereoTape systems. Portable military communications equipment.

When a company is geared like this, you know you'll get your parts on time.

You'll find that Delco devices come with conservative specs. Plus the uniform high quality and reliability gained through our precision high-volume production. So you can design with confidence.

SEMICONDUCTOR DISTRIBUTORS: EAST—BALTIMORE, MD. 21201, Radio Electric Service Co., 5 North Howard Street, (301)-539-3835 BINGHAMTON, N.Y. 13902, Federal Electronics, Inc., P. O. Box 1208, (607)-748-8211 CLIFTON, N.J. 07015, Eastern Radio Corporation, 312 Clifton Avenue, (201)-471-6600 NEWTON, MASS. 02195, The Greene Shaw Co., Inc., 341-347 Watertown St., (617)-969-8900 NEW YORK, NEW YORK 10036, Harvey Radio Co., Inc., 2 West 45th St., (212)-582-2590 PHILADELPHIA, PENN. 19123, Almo Industrial Electronics, Inc., 412 North 6th Street, (215)-922-5918 PITTSBURGH, PENN. 15206, Radio Parts Company, Inc., 6401 Penn Ave., (412)-361-4600 WOODBURY, L. I., N.Y. 11797, Harvey Radio Company, Inc., 60 Crossways Park West, (516)-921-8700 **SOUTH**—BIRMINGHAM, ALA. 35233, Forbes Distributing Company, Inc., 1416 Fourth Ave., South, (205)-251-4104 MIAMI, FLORIDA 33142, Mountain Electronics, Division of Mountain National Co., 3730 Northwest 36th St., (305)-634-4556 RICHMOND, VA. 23220, Meridian Electronics, Inc., 1001 West Broad Street, (703)-353-6648 WEST PALM BEACH, FLA. 33402, Mountain Electronics, Division of Mountain National Co., 1000 N. Dixie Highway, (305)-833-5701 **MIDWEST**—CINCINNATI, OHIO 45237, United Radio, Inc., 7713 Reinhold Drive, (513)-761-4030 CLEVELAND, OHIO 44125, The W. M. Pattison Supply Co., Industrial Electronics Division, 4550 Willow Parkway, (216)-441-3000 INDIANAPOLIS, IND. 46225, Graham Electronics Supply, Inc., 122 South Senate Avenue, (317)-634-8486 KALAMAZOO, MICH. 49005, Electronic Supply Corp., P. O. Box 831, (616)-381-4626 KANSAS CITY, MO. 64111, Walters Radio Supply, Inc., 3635 Main

knowledge is power.

You'll find that detailed Delco data sheets and applications notes are written especially for engineers in a standard, easy-to-analyze form.

And you'll find that often we can recommend suitable devices at a lower cost than those originally applicable. Once you get what you need, you get follow-up service to make sure each device works where it's supposed to.

For more information on what's in Delco power semiconductors for you, contact your local Delco distributor or Delco sales office. See why the Kokomoans' power is knowledge.

FIELD SALES OFFICES

Union, New Jersey* 07083 Box 1018 Chestnut Station (201) 687-3770	Syracuse, New York 13203 1054 James Street (315) 472-2668	Detroit, Michigan 48202 57 Harper Avenue (313) 873-6560
Chicago, Illinois* 60656 5151 N. Harlem Avenue (312) 775-5411	Santa Monica, Calif.* 90401 726 Santa Monica Blvd. (213) 870-8807	Kokomo, Ind. 46901 700 E. Firmin (317) 459-2175 Home Office

*Office includes field lab and resident engineer for application assistance.



MARK OF EXCELLENCE

DELCO RADIO
DIVISION OF GENERAL MOTORS
KOKOMO, INDIANA

Street, (816)-531-7015 MINNEAPOLIS, MINNESOTA 55401, Stark Electronics Supply Co., 112 3rd Ave., North, (612)-332-1325 SKOKIE, ILL. 60076, Merquip Electronics, Inc. 7701 N. Austin Ave., (312)-282-5400 ST. LOUIS, MO. 63144, Electronic Components for Industry Co., 2605 South Hanley Road, (314)-647-5505 WEST—ALBUQUERQUE N. M. 87103, Sterling Electronics, Inc., 1712 Lomas Blvd., N. E., (505)-247-2486 DALLAS, TEXAS 75201, Adleta Electronics Company, 1907 McKinney Ave., (214)-742-8257 DENVER, COLO. 80219, L. B. Walker Radio Company, 300 Bryant Street, (303)-935-2406 HOUSTON, TEXAS 77001, Harrison Equipment Co., Inc., 1422 San Jacinto Street, (713) 224-9131 LOS ANGELES, CAL. 90015, Radio Products Sales, Inc., 1501 South Hill Street, (213)-748-1271 LOS ANGELES, CAL. 90022, Kierulff Electronics, Inc., 2585 Commerce Way, (213)-685-5511 OKLAHOMA CITY, OKLAHOMA 73102, Radio, Inc., 903 North Hudson, (405)-235-1551 PALO ALTO, CAL. 94303, Kierulff Electronics, Inc., 3969 East Bayshore Road, (415)-968-6292 PHOENIX, ARIZ. 85005, Sterling Electronics, Inc., 1930 North 22nd Ave., (602)-258-4531 SAN DIEGO, CAL. 92101, Milo of California, Inc., 2060 India Street, Box 2710, (714)-232-8951 SEATTLE, WASH. 98108, Kierulff Electronics, Inc., 5940 6th Ave., South, (206)-763-1550 TACOMA, WASH. 98402, C & G Electronics Company, 2502 Jefferson Ave., (206)-272-3181 TULSA, OKLAHOMA 74119, Radio, Inc., 1000 South Main Street, (918)-587-9124 CANADA—SCARBOROUGH, ONTARIO, Lake Engineering Co., Ltd., 123 Manville Rd., (416)-751-5980

Field detector works in real time

Liquid crystals provide instant display of microwave intensity, in color

By Carl F. Augustine
Bendix Corp., Southfield, Mich.

Liquid crystals are bringing the advantages of real time to the mapping of electric-field intensities.

The conventional way to map a field has been to scan it point-by-point with a small probe. This is not only laborious and time-consuming but also often inaccurate, because the probe disturbs the original field. And information is lost, because the scans aren't continuous. A newer method, described on page 122, that automatically maps fields on sensitized Polaroid film [Electronics, April 15, p. 130] is simple and accurate, but isn't a continuous process. The photos represent discrete moments in time.

The real-time technique developed by the Bendix Corp. uses liquid crystals as sensing elements in a very broadband microwave detector that instantly produces color displays of field intensity. The detector is efficient and has good resolution. It can be used to plot near-field antenna patterns and mode patterns in complex waveguides and resonators, and to measure impedance and power by detecting standing waves and power-density patterns in open transmission lines. In fact, such a real-time detector may be the key element in microwave holography, or for producing three-dimensional images of microwave patterns.

The device consists of a support structure made from a very thin Mylar membrane. The membrane's size depends on the experiment. With a small rectangular waveguide, for example, a 6-inch-diameter membrane suffices. A thin metalized film deposited on one side of the membrane then is coated with the liquid crystals.

A concentrated microwave beam passing through the membrane sets up currents in the metalized film. Energy transferred to the film heats up various segments in proportion to the amount of energy that is absorbed. Because the color of light scattered from the liquid crystals varies with temperature, distinct color lines surround the area through which

energy was transmitted. These lines form a two-dimensional plot of the microwave field intensity.

Neither liquid nor crystal

Liquid crystals are neither liquid nor crystal, but exhibit some properties of both states. At the proper temperatures, the chemicals are somewhat fluid but display the cloudiness characteristic of crystals. They can scatter light of various colors, usually within any range of about 3°C from 0°C to 100°C. The process is reversible, and the crystals are very sensitive to small temperature changes. Changes as small as 0.1°C can be detected if a narrow range is used. Thus, the crystals can be painted on surfaces to serve as a precise temperature indicator [Electronics, Oct. 18, 1965, p. 46].

Liquid crystals are usually applied as a thin coating. The usual procedure is to apply a 10% solution in a fast-evaporating solvent by brushing, flowing, dipping, or dripping. The solvent usually evaporates in about two or three minutes and leaves behind a coating of waxy liquid crystals. As soon as the coating is dry, it displays the colors indicative of temperature.

The sequence of colors within the 3°C range is blue, green, yellow, orange, red, and then back to colorless. Blue indicates the highest temperature of the response range and red the lowest.

The first model of the crystal detector consisted of a 6-inch-diameter Mylar membrane stretched over a plastic holder. The membrane was about 0.002 inch thick and had applied to it a thin metalized film that gave the material a resistivity of approximately 400 ohms per square. The liquid crystal solution was sprayed onto the membrane.

Concentric bands

The membrane was placed about one inch in front of a radiating X-band waveguide. When the

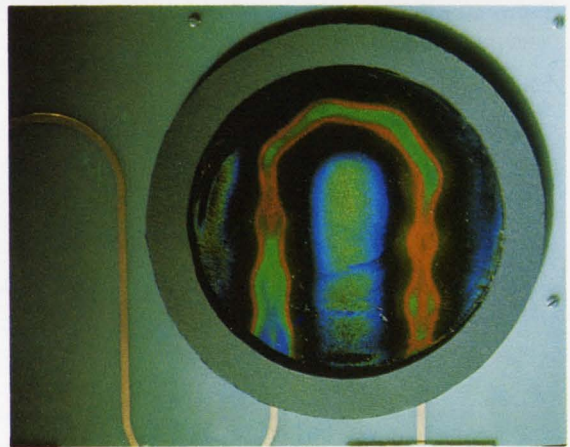
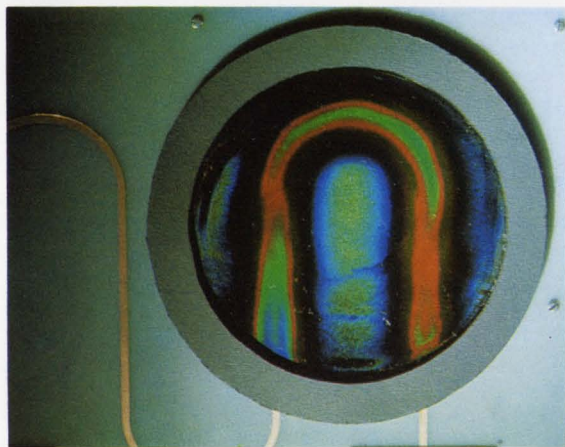
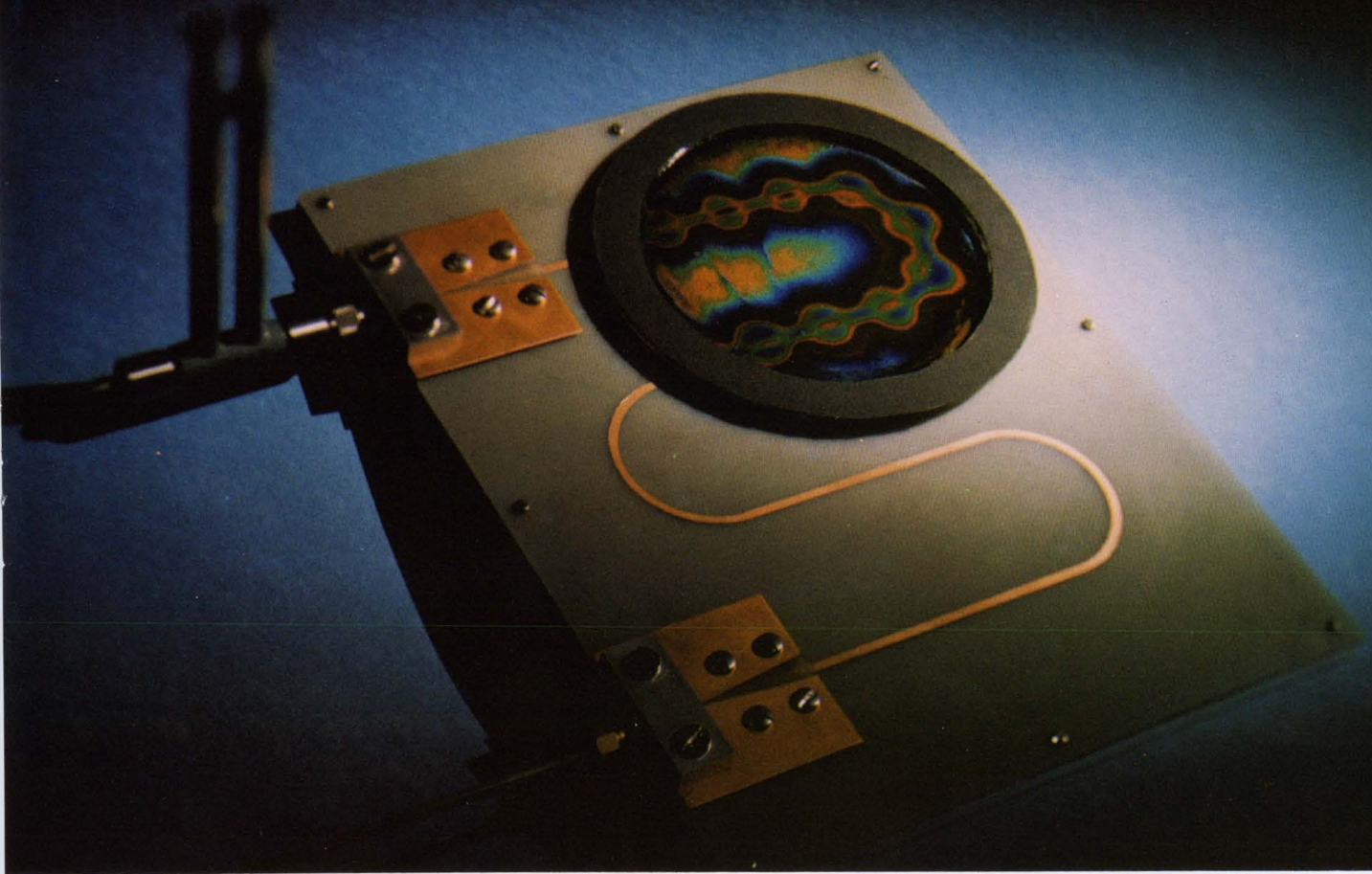

Balancing act. Liquid crystals delineate standing waves along a transmission line. Real-time display enables line's load to be adjusted for proper match. The standing wave smoothes out as the load is balanced.

energy radiating from the waveguide was increased to about 20 milliwatts, distinct oval concentric bands of color appeared on the membrane. The temperature range represented by the transition from blue to red is equivalent to a power spread of 7 decibels. The shape of the beam's cross section was quite well-defined. The concentric bands could be expanded or contracted by adjusting the amount of power from the waveguide. The energy density of the beam's cross section was calibrated by comparing the difference in radiated power to the change in position of a particular color.

Tests using an X-band focusing antenna from an-

other project further proved that useful information on the shape and position of the beam could be obtained.

The membrane's efficiency can be increased by impedance matching. For essentially plane-wave incidence, the impedances can be matched exactly by using a metal film with a resistivity of 377 ohms per square backed by a plane metal surface placed one-quarter wavelength from the film. This converts all the incident energy to heat. Otherwise, the amount of energy absorbed must be calculated.

Each color is the result of a specific power density. Calibration can, therefore, be achieved by making

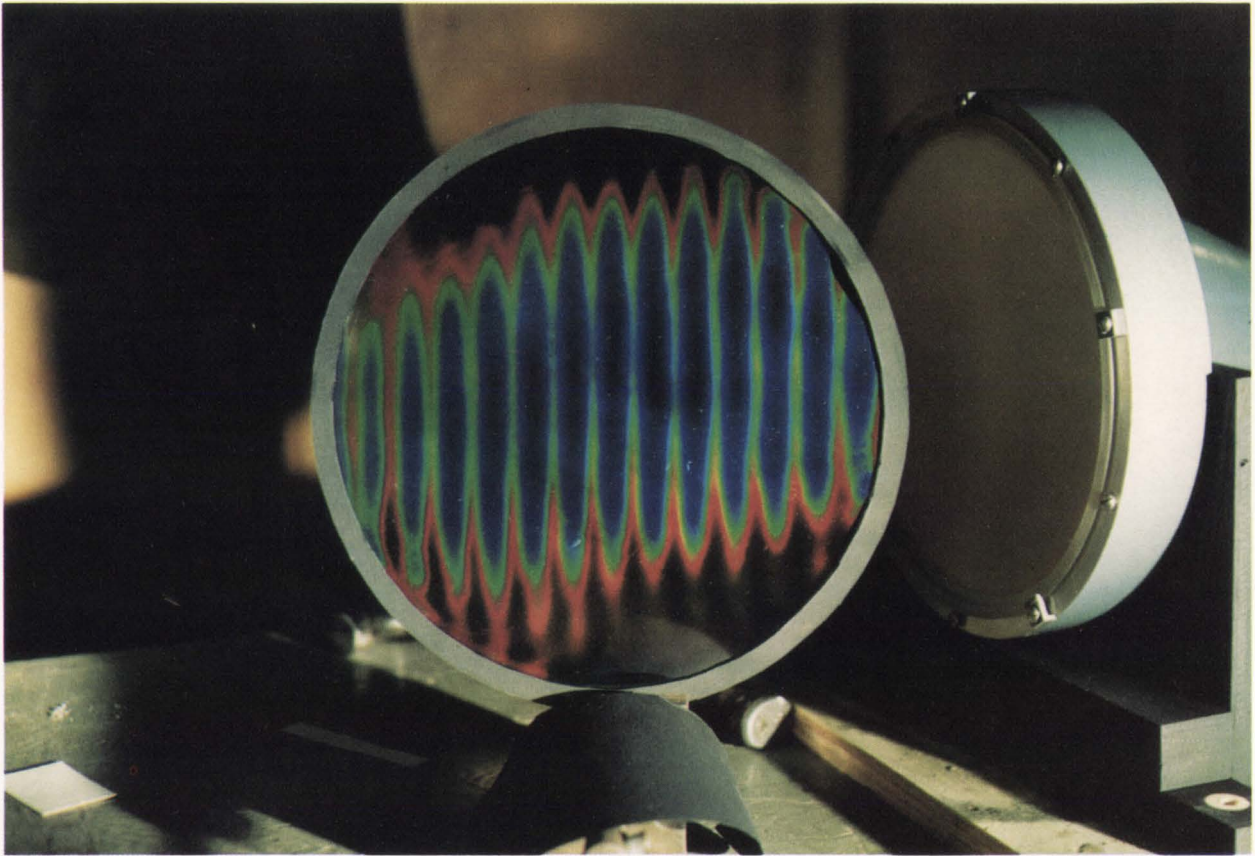

Colorful reflections. Area detector displays fringes set up by standing waves between antenna and reflector.

incremental changes in the power density and observing the color transitions.

Microwave fluoroscope

The liquid-crystal membrane could also serve as the basic element in a microwave fluoroscope, which could be used to find internal flaws or changes in density or thickness of materials that are translucent

to microwave radiation. The instrument would be simple to make.

The only active component would be the microwave signal source. This source should be at X band or above and be capable of delivering several watts of average power to the power divider. Two lengths of waveguide would feed two collimating antennas opposite each other and a foot or so apart. Typically,

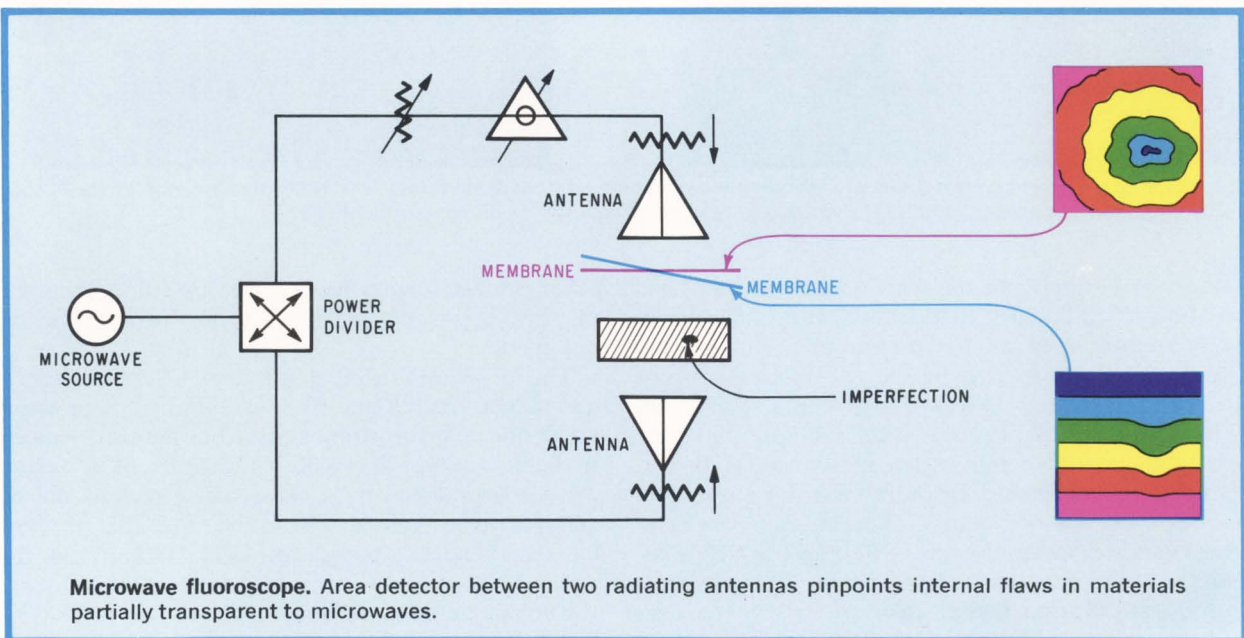

Microwave fluoroscope. Area detector between two radiating antennas pinpoints internal flaws in materials partially transparent to microwaves.

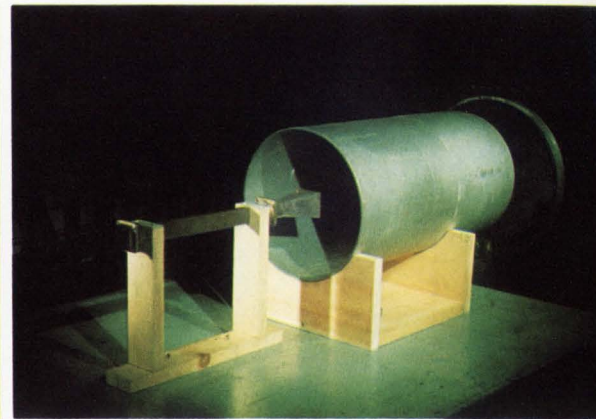

Radiation modes. The mode pattern appears on Mylar film coated with liquid crystals and placed in front of a radiating circular waveguide.

they would be lens-compensated horns with several hundred square inches of radiating surface. Because of the collimating effect, they radiate essentially plane waves in the near field.

The plane waves, traveling in opposite directions, create a standing wave between the antennas. Ideally, standing waves have troughs and peaks in planes perpendicular to the direction of propagation. Now, if a liquid-crystal membrane is placed completely in the plane of a standing-wave trough, minimum energy would be absorbed and the membrane color would correspond to a minimum temperature.

Seeing in depth

As the membrane is moved from a trough toward a peak, the color changes as a result of the higher temperatures. The membrane would have a uniform color as long as it was kept in a plane perpendicular to the radiation. Similarly, if a sheet of a uniform dielectric material were inserted between one antenna and the membrane, the membrane color would change because of the added phase shift, but remain uniform. However, if the dielectric material weren't uniform, the membrane would display contours of color caused by areas on the material having significant deviations in phase or loss. Absolute differences in loss or phase can be determined with a calibrated waveguide phase shifter or attenuator inserted ahead of one antenna.

For some measurements, it may be desirable to place the membrane at an angle to the direction of propagation. This would cause a series of identi-

cal color bars to appear across the sheet. The number of bars depends on the angle of the sheet and the microwave frequency. Now any nonuniformities cause irregularities to appear in the color bars. This presentation gives some indication of depth as well as cross section. Furthermore, a number of membranes placed at right angles to each other could be used to construct three-dimensional images in space.

Using only one collimating antenna would have advantages for certain applications. A standing wave in space is obtained by placing a uniform-plane metal reflector a short distance in front of the antenna. The membrane and the material to be tested are placed between the antenna and the metal plate. Variations from a plane surface or just the reflector can be detected, as well as variations in such materials coated on metals as rubber, cork, and plastic paint.

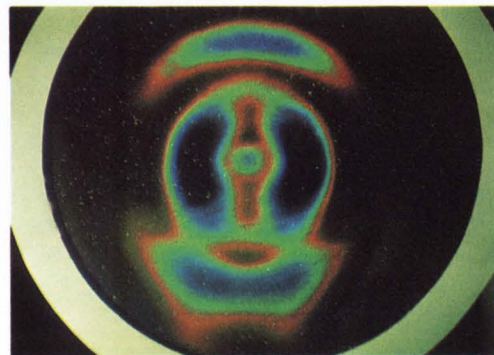

Another approach

This article is the second one published in *Electronics* in recent months on the subject of mapping electric fields. In the April 15 issue, Keigo Iizuka of Harvard University's Gordon MacKay Laboratory described a method using Polaroid film.

Iizuka exposes standard color-pack film to white light and then pulls it through the camera rollers to start the development process. He then quickly places the film, covered with its black paper, in the microwave beam. The areas of high field intensity heat the silver-halide grains and change their developing speed by changing the rate at which the developing agent diffuses to the grain sites. This produces variations in the color corresponding to different levels of field intensity.

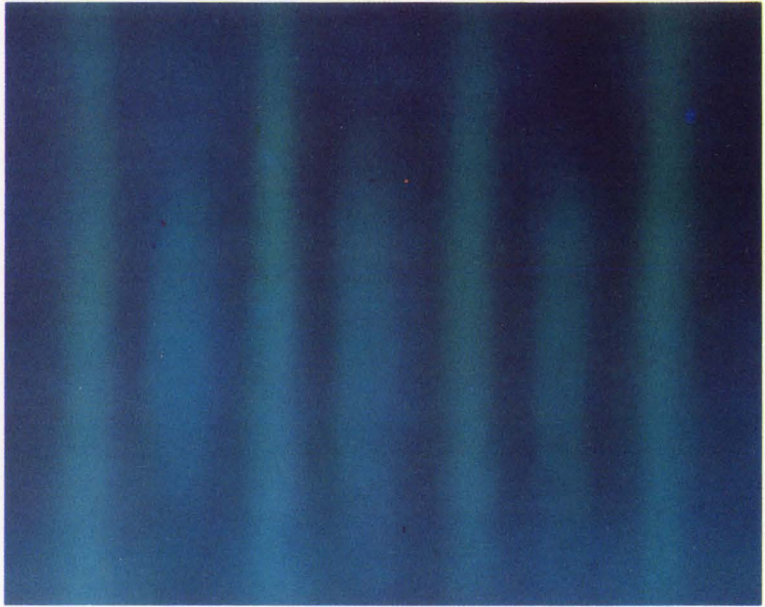

On the fringe. Young's fringe pattern was produced here by putting a film packet at the convergence point of beams from two X-band horns set at a 90° angle to each other.



Hot tip. Picture of the heat distribution around and in a candle's flame indicates that the technique is based on temperature dependence.

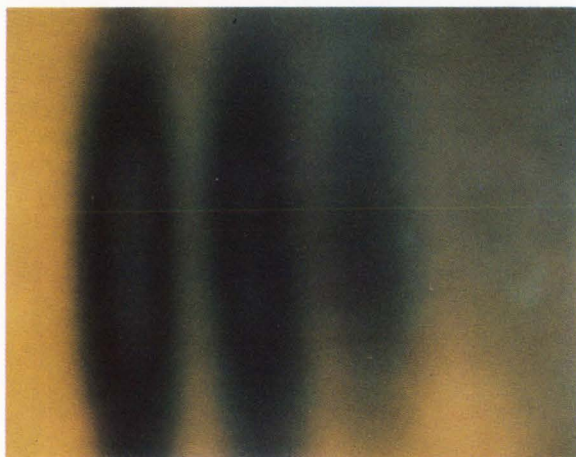

Scattering rod. Polaroid film depicts the electric field scattered by a metal cylinder 17 millimeters in diameter.

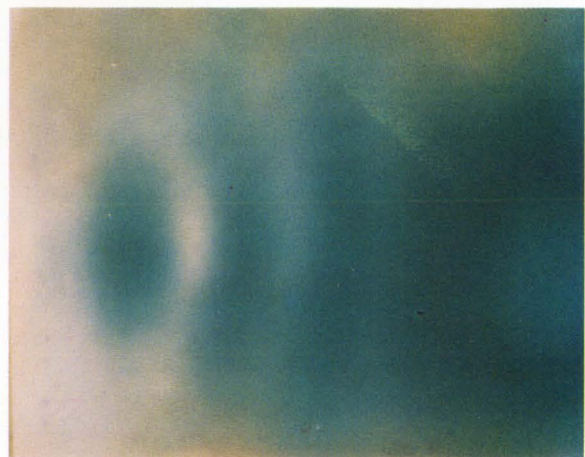

Mapped out. This 8.9-gigahertz incident field was scattered by a metal sphere of 11.1 millimeters diameter.

Transitron MSI off the shelf!

High-speed, complex
monolithic arrays—
HLTTL-compatible.

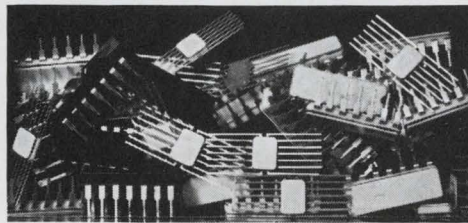

AVAILABLE NOW! AVAILABLE NOW! OVER 30 MILLION BITS OF MEMORY SHIPPED!

SCRATCH-PAD 16-BIT MEMORY CELL

- Non-destructive readout
- High speed — less than 25ns for interrogation or writing
- Write-over capability — need not be cleared before writing
- High fan-out — available with 20 or 40 milliamps Sense Amplifier output
- High noise immunity — typically over 1V
- Full HLTTL compatibility
- Available in ceramic Dual In-line package or Flat Pack (TMC3162, 3163 and 3164)
- Available in plastic Dual In-line package (TMC3162E, TMC3164E)
- Wired OR capability on sense amplifier outputs
- Interrogation — coincident matrix addressing
- Writing — coincident matrix addressing and raising input of write amplifier to a logic "1"

35MHz 4-BIT SHIFT REGISTER

- High speed — shifting frequency typically 35MHz
- Versatile — 4 operating modes

serial in	}	serial out or parallel out	parallel in	}	parallel out or serial out
-----------	---	----------------------------------	-------------	---	----------------------------------
- Shift-left/shift-right capability (without external gating)
- High output drive capability — 20ma
- Low input current loading
- Full HLTTL compatibility
- Two pin configurations — 7/14 (TSR2511 - 2514)
4/10 (TSR2515 - 2518)
- Resettable version available — same packages and configurations as standard device —
7/14 (TSR2521 - 2524)
4/10 (TSR2525 - 2528)
- All units available in 14 lead Dual In-line package (suffix "P"), Flat Pack (suffix "F"), or Dual In-line plastic package for 0-75°C use (suffix "E")

OTHER NEW IC DEVICES AVAILABLE

TFF 3221-24 Dual 35MHz JK flip flop (separate clock)
TFF 3225-28 Dual 35MHz JK flip flop (common clock)
TFF 3251-54 Dual 50MHz JK flip flop (separate clock)
TFF 3255-58 Dual 50MHz JK flip flop (common clock)
TNG 8011-8014 Dual pulse shaper/delay AND gate
Packaging: Flat Pack (suffix "F") or
Dual In-line package (suffix "P")

TDD 1100 BCD-to-Decimal decoder driver
TDD 1101 High-Current BCD-to-Decimal
decoder driver

Packaging: 16-pin Epoxy Dual In-line
package (suffix "E") hermetic Dual
In-line package (suffix "P") or
hermetic Flat Pack (suffix "F")

Transitron
electronic corporation
168 Albion St., Wakefield, Massachusetts 01881

IBM Circuit Design and Packaging Topics

- Police communications rely on high reliability switches
- Numerical control demands high-speed switching

□ Police communications rely on high reliability switches

The Fort Worth, Texas police department communications center confirms virtually trouble-free performance with its new electronic switchboard console system, a network relying on IBM logic switching components.

Designed and installed by Fort Worth's Thomas Electronics, Inc., a commercial sound contracting firm, the police nerve center takes all incoming citizens' telephone calls, displays patrol car deployment, then handles dispatching of cruiser assistance by radio.

Basic elements of the Thomas Electronics' system are IBM wire contact relays, selected specifically for their long life, fast operation time, plug-in construction and simplified serviceability.

In round-the-clock operation since start-up more than 14 months ago, the police system shows no internal failures of IBM relays in a total of more than 10,000 hours of continuous duty or approximately 1,530,000 operations.

This endurance is fully predicted and expected, however, since IBM specifies wire contact relay longevity of 200 million-plus operations.

Fort Worth's police communications system utilizes more than 130 multipole IBM wire contact relays. They are emplaced in critical circuits for both audio and control functions where overall operation of the system is affected.

View of Ft. Worth police communication center with dispatchers at console stations and city patrol car deployment screen in background.

Tim L. Thomas, who heads the sound contracting firm responsible for the project, says about the use of IBM products: "I can say without doubt that IBM wire contact relays will handle audio levels from a -30 db. to a $+10$ db. with no problems whatsoever." ($0 = 1$ mw 600 Ohm: standard db. reference). Thomas Electronics also plans to subject the relays to tests for levels down to -55 db. for incorporation in extremely low level circuits.

Thomas further adds, "We also found that IBM is rather conservative in their specification data as to temperature rise

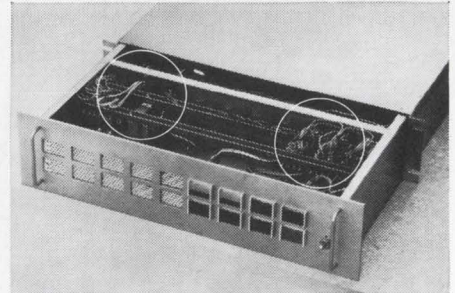

Circles show where IBM wire contact relays are mounted in the circuit control panels of the police communication system console.

as several relays in the system stay picked up to eight hours continuously with the heat rise less than that specified."

IBM's compactly mounted relays and associated hardware deliver a highly efficient use of console space for the Thomas-engineered project.

Each dispatcher station at the console has its own drawer-like wired panel unit containing the pluggable IBM components which allows design freedom to

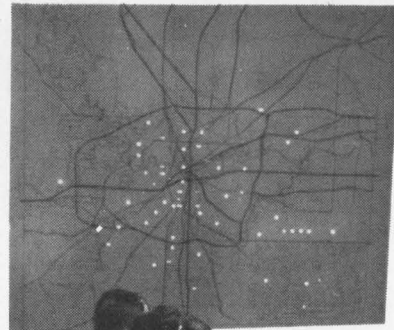

alter or add to the switch configuration.

Since the same IBM relay frequently handles both an audio function and a control (DC) mode circuit design and service are simplified. The dual-purpose single component also speeds access for any diagnostic analysis required.

The Thomas-designed communications system demonstrates how IBM's standard modular system (SMS) gives engineers numerous packaging options. Most significant, however, is the proven, dependable performance of IBM components working successfully to protect the public.

IBM also offers a wide range of other componentry, for many other types of switching applications, from circuit cards and relay elements to industrial hybrid integrated circuit modules.

Time-tested, you will find that IBM components deliver the exacting reliability demanded for a broad spectrum of design and packaging needs.

Numerical control demands high-speed switching

IBM wire contact relays were originally designed for data processing use. Now they are also being used extensively in machine tool and assembly applications. One of these assembly applications is a numerically-controlled component insertion machine. It sequentially inserts random combinations of up to 24 different types of axial lead resistors and diodes into printed circuit

boards. Such machines have been widely used, often on a round-the-clock, three-shift basis, in IBM's electronic assembly operations.

Insertion rates range from 3,000 to 4,500 components per hour, depending upon the type of components being inserted.

Instructions from an 8-channel punched paper tape provide the logic input to the relay gate. The gate employs three rows of 6- and 12-pole IBM wire contact relays. These relays control the movement of each printed circuit board through the X and Y axis positioning of the board for each component insertion. They also control the component feed, component insert, and cut-and-clinch cycles for each insertion operation.

IBM wire contact relays can perform in excess of 200 million operations with an operate speed as fast as 4.5 ms, a release time of 5 ms maximum. The product line includes 4-, 6-, and 12-pole Form C relays, 4- and 6-pole latch models, all with compact, solderless, pluggable mountings—with coil-voltages up to 100 VDC.

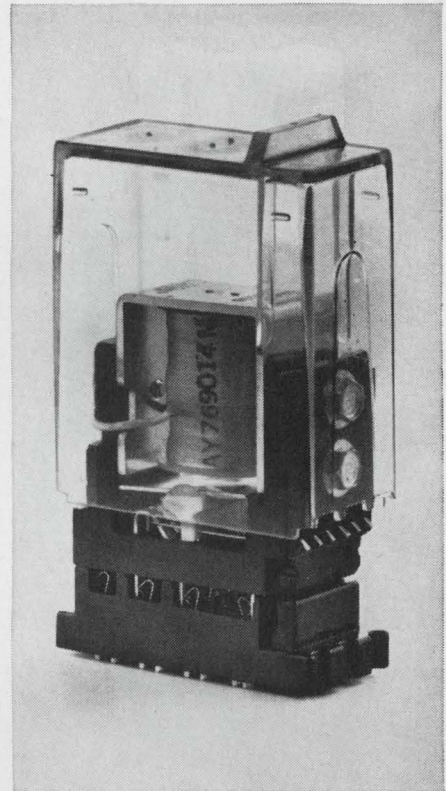

Dust covers are available for various types of IBM wire contact relays. The six-pole model above is shown with cover partially removed.

**IBM Industrial Products Marketing Dept. E624
1271 Avenue of the Americas
New York, New York 10020**

IBM®
INDUSTRIAL
PRODUCTS

I am interested in further information on:

- IBM wire contact relays
- IBM standard modular packaging system

name _____
position _____
company _____
address _____
city _____ state _____ zip _____

di/dt capability 10 times industry's best

EVEN WITH LOW POWER GATE DRIVE

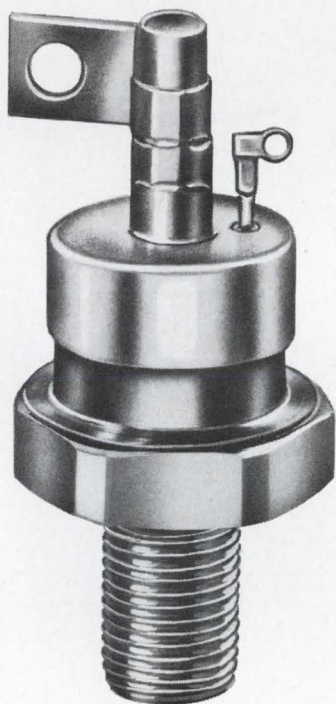

NATIONAL[®] INVENTS THE REGENERATIVE GATE^{*} SCR

NATIONAL ELECTRONICS, INC. regenerative gate SCR is the only SCR that will give 600 amps/ μ sec. when tested according to JEDEC SUGGESTED STANDARD NO. 7 Section 5.1.2.4. This is a di/dt rating at three times the peak on-state current and $\frac{1}{2}$ the switching loss of any SCR now on the market. No sacrifice is required in gate drive, turn-on time, turn-off time or any other characteristic. Presently available in 55 amp and 110 amp SCRs.

NATIONAL[®] manufactures SCRs from 16 amp to 470 amp.

**Patent Pending*

REQUEST BULLETIN

NATIONAL
ELECTRONICS, INC.

a varian subsidiary

PHONE: (312) 232-4300 • GENEVA, ILLINOIS 60134

Finding leaky IC's on p-c boards

Experimental test method uses a high-dielectric gas and capacitance measurements to single out faulty devices

By Frank L. Girard

Hughes Aircraft Co., Culver City, Calif.

Glee club directors face a dilemma of detection when they hear the harmony breaking down. It's hard to single out the off-key culprit while everybody's singing, and listening to each man individually would take too much time.

The same dilemma is encountered by users of hermetically sealed integrated circuits. It's hard to single out the leakers from among many devices assembled onto printed-circuit boards, and leak-testing each IC before assembly is often totally impractical. And when a leaky device is suspected, removing it from a p-c board is no help, because this process itself may damage the seal.

Although manufacturers leak-test their IC's, some users find they must also do their own testing. Users may have to test the devices after they're built into equipment because the maker may have checked only a sample of the shipment or the IC's may have been damaged during handling.

Soon, however, the user's dilemma may be resolved by a gas-capacitance leak test developed and used experimentally by the Hughes Aircraft Co. This new technique can find leaky IC's already assembled onto p-c boards. And it can be implemented with equipment already on hand.

The new method's basic approach is simplicity itself. IC's or IC assemblies are exposed to a gas with a high dielectric constant, and each module's capacitance is measured. If an IC leaks, its capacitance changes as the gas enters and leaves the package. The method takes several hours in its present stage, but would be made quick enough with instrumentation that could detect, say, 10^{-5} picofarads instead of 10^{-3} pf currently.

Present procedures

Conventional leak testing is divided into two categories: fine and gross. In fine-leak detection, the modules are exposed to helium or radioactive krypton. Leaky modules absorb these gases; mass spectroscopy or Geiger-counter techniques indicate leaks

by detecting any gas escaping from these modules. Because a number of modules are tested in a chamber at the same time, individual leaky modules can be identified only by subdividing the sample for more testing. This problem can be alleviated by using a separate enclosure and gas line for each module. Fine-leak detection methods are relatively slow, requiring at least four hours.

For gross leaks—greater than 10^{-5} atmosphere-cc/sec—entirely different procedures are used. In one method, for example, the suspect modules are immersed in a hot liquid and an observer looks for gas bubbles from leaks.

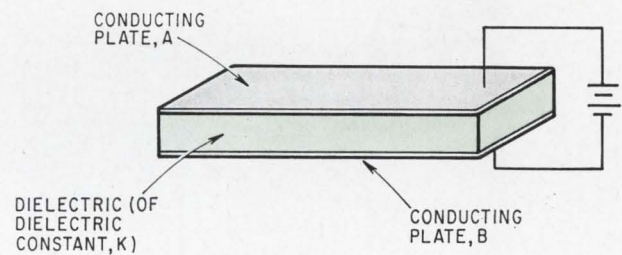

Basis. Leak-testing method considers integrated-circuit module equivalent to a parallel-plate capacitor.

Both these conventional approaches are of questionable value for detecting leaky modules already attached to circuit boards. The boards themselves may entrap relatively large quantities of the testing gas, masking the existence of leaky modules.

Theory of detection

Such modules as dual in-line IC packages can be readily leak-tested with the gas-capacitance method. This is done by considering the conducting elements of the IC package as a parallel-plate capacitor. The module's internal volume of about 0.15 cubic centimeter is formed by the circuit itself, with its associated leads on the bottom and a metal cover on top. An insulating ceramic separates the

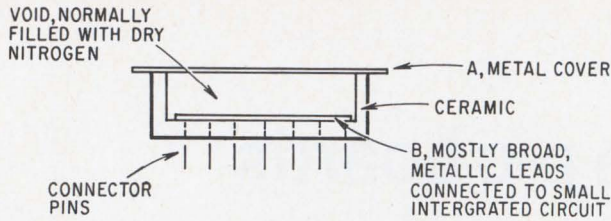

Void. High-dielectric gas increases dielectric constant of dry nitrogen that normally fills IC's void.

top and bottom. The void, normally filled with dry nitrogen, corresponds to a material with dielectric constant k . Thus, capacitance exists in the module, as shown above.

The capacitance of a parallel-plate capacitor is directly proportional to the product of the area, a , of the conducting plates and the dielectric constant of the material between the plates, divided by the separation, s , of the plates.

$$C \propto \frac{ka}{s}$$

Since capacitance is directly proportional to the dielectric constant, a fractional change in k , area and separation remaining constant, causes the same fractional change in C . The dielectric constant of dry nitrogen under standard conditions is nearly 1. If this dry nitrogen was replaced by or mixed with a gas that raises the dielectric constant 1% or 2%, the capacitance of the module also increases 1% or 2%. Based on the simple parallel-plate concept, calculations of the capacitance of a dual in-line package put it at about 1 pf, and actual capacitance measurements correlate closely.

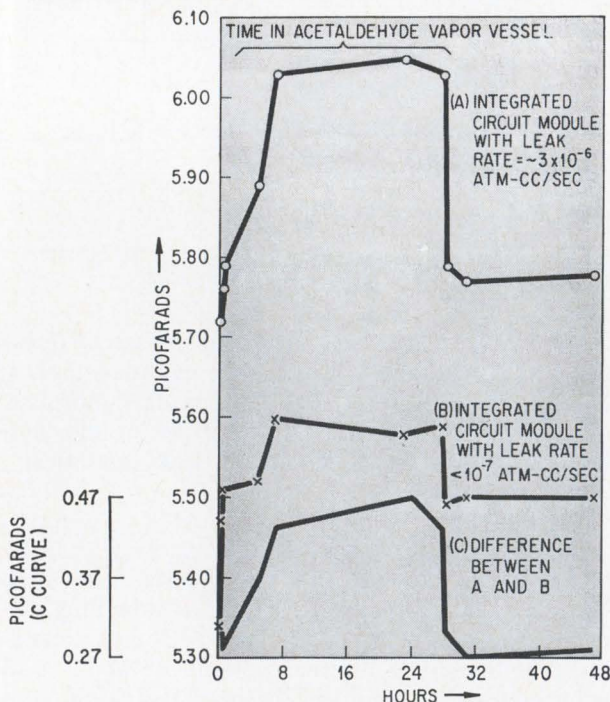

Buildup. Leaky IC's capacitance increases as gas enters module and decreases when gas exits.

Several gases have dielectric constants 1% or 2% higher under standard conditions than dry nitrogen or air. If such a gas is introduced into an IC module, with a partial pressure approaching one atmosphere, the capacitance of the module can be expected to increase a maximum of 1% or 2%. Experiments using acetaldehyde (dielectric constant 1.02, vapor pressure 750 millimeters of mercury at 21°C) indicate that this does indeed happen. The module under test was placed over an open reservoir of liquid acetaldehyde in an airtight vessel. The graph below shows results of one experiment.

Pressure problems

Because pressure in the chamber may be greater than that in the module, the plates may be pushed closer together—changing the capacitance—even if the seal is perfect. These capacitance changes that result from pressure must, of course, be separated from those that result from leaks. This separation is accomplished by varying the chamber pressure before the gas is introduced; capacitance changes that result from pressure can then be measured and calibration curves established.

Improving measurement sensitivity to speed the process needn't necessarily await development of instruments to detect 10^{-5} pf. Operating at higher pressures—if the effects on geometry could still be controlled at these pressures—would increase the dielectric constant of the gas and make it penetrate a leaky module faster.

Another way

The gas-capacitance leak test isn't suitable for IC packages that don't have metal caps and are enclosed almost completely by ceramic or other insulating material. However, a testing method suitable for these packages is also being considered at Hughes. It's still in the theoretical stage.

In this procedure, called condensable-vapor conduction, a layer of material whose conduction can be easily measured is deposited over and between the internal circuit elements and leads of a module. This changes the device's electrical characteristics, presumably by shorting, in an easily determined manner.

The specifications of most, if not all, modules require that they tolerate temperatures from -55°C to 175°C . More than 80 stable inorganic compounds have been selected that have vapor pressures of at least an atmosphere but condense in this temperature range under vapor pressure of less than 0.1 atmosphere. Within these temperatures, then, one of these compounds would fill a leaky module with its vapor.

The temperature of the module would then be lowered to a point in the given temperature range where the compound would condense, forming a coating about 100 layers thick on the inside surface of the module's cavity. Because the condensable compound conducts, its presence inside the module could be determined. Time-temperature vs. current curves would indicate the leak rate.

"The difficulties of speaking foreign languages are no barrier to selling integrated circuits overseas. You have to know how to listen, not talk, to meet a customer's needs."

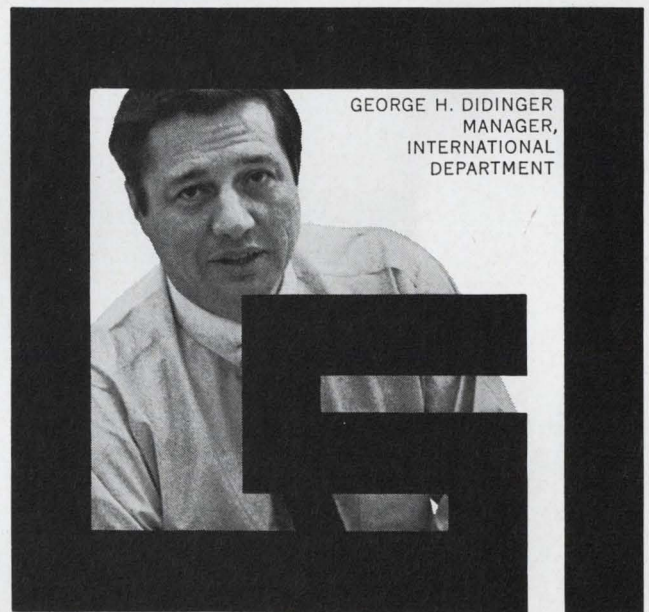

SIGNETICS INTEGRATED CIRCUITS

SIGNETICS CORPORATION
THE RESPONSE/ABILITY COMPANY

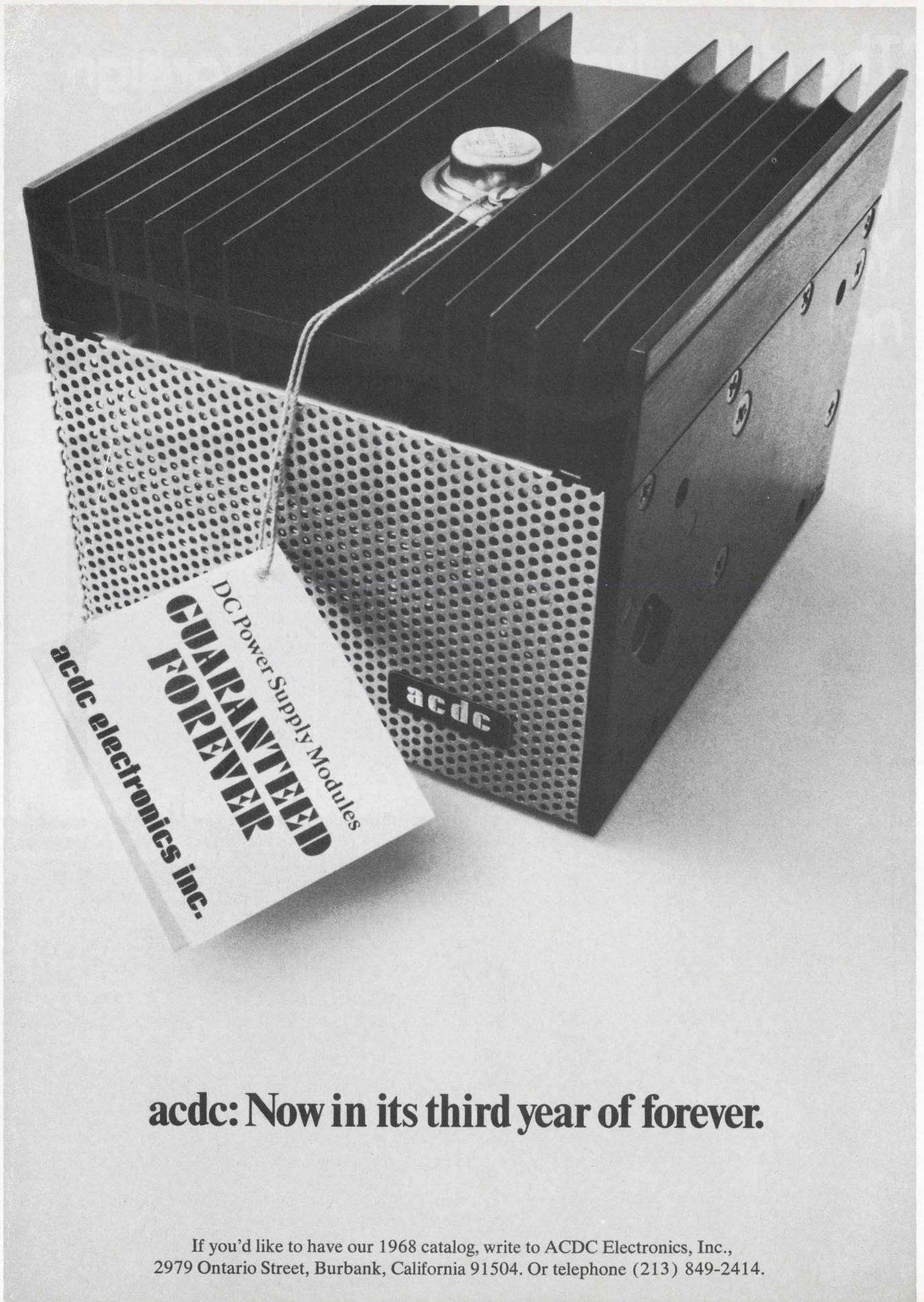

acdc: Now in its third year of forever.

If you'd like to have our 1968 catalog, write to ACDC Electronics, Inc.,
2979 Ontario Street, Burbank, California 91504. Or telephone (213) 849-2414.

At ECI in St. Petersburg, Florida...
RF Communications Opportunities

For a special breed of engineer

If you're one of that special breed of communication engineers who finds a challenge in projects beginning with applied research and advanced development and continuing through prototype and product design, you may well be the kind of person we're looking for.

Check this partial list of RF engineering activities at ECI. If you'd like to help push the state-of-the-art in any of these or other areas in communications, send us your resume. You'll design systems and equipment for satellite communications, multiplexing, electronic switching, command and control and advanced radio communications for some of the nation's major defense and space programs.

RF Communication Engineering Activities:

- Modulation and Demodulation
- Frequency Synthesis
- Solid State Power Amplification
- Hi Power Amplification
- Power Supply Technology
- Receiver Front End Design
- Packaging and Cooling
- Microelectronic Applications
- Reliability Techniques

CHALLENGE, GROWTH . . . and LOCATION TOO!

At ECI your job will be challenging. At ECI you'll find real opportunity for growth instead of just another confining groove — two-thirds of all advanced development is done in regular engineering development areas. And, at ECI you'll like where you're living just as much as you'll like your job. We'll match subtropical, sunny St. Petersburg against any location in the U. S. for stimulating, comfortable living.

SEND YOUR RESUME TODAY — in confidence — to K. E. Nipper, Supervisor of Professional Placement, Electronic Communications, Inc., P. O. Box 12248, St. Petersburg, Florida 33733.
(An equal opportunity employer, M & F.)



ELECTRONIC COMMUNICATIONS, INC.
ST. PETERSBURG DIVISION

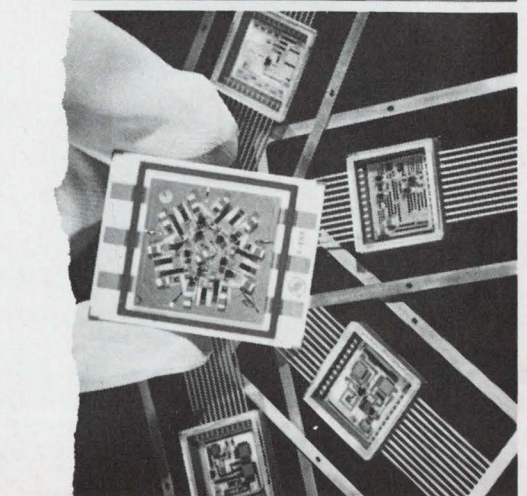

How to use the Singer model SSB-50-1 Spectrum Analyzer to monitor tone level in a multiplexed communications system

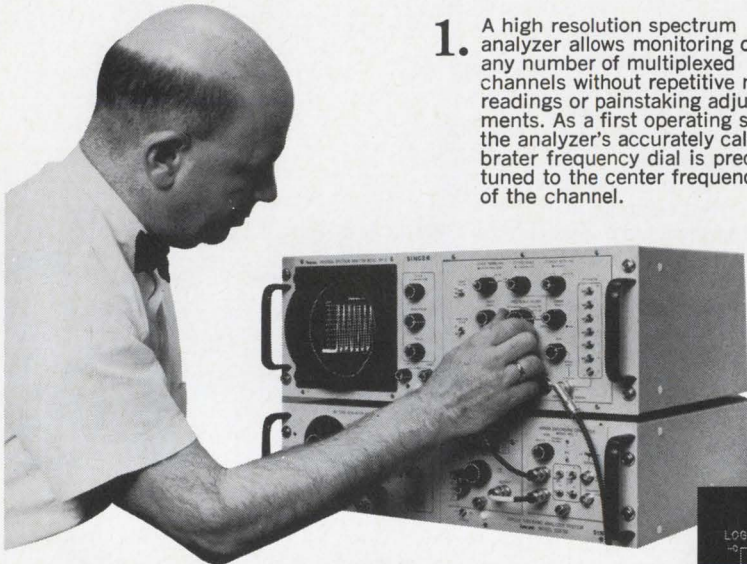

1. A high resolution spectrum analyzer allows monitoring of any number of multiplexed channels without repetitive meter readings or painstaking adjustments. As a first operating step, the analyzer's accurately calibrated frequency dial is precisely tuned to the center frequency of the channel.

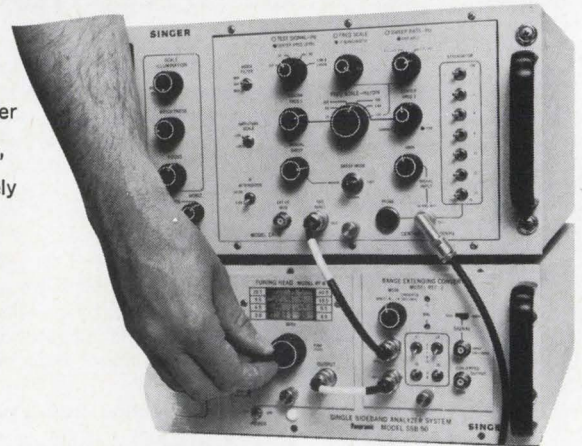

2. A selector knob sets the frequency scale in one of five settings from 15Hz/division to 1.4KHz/division. Interlocked circuit functions in the analyzer automatically optimize the display for any setting of the frequency scale.

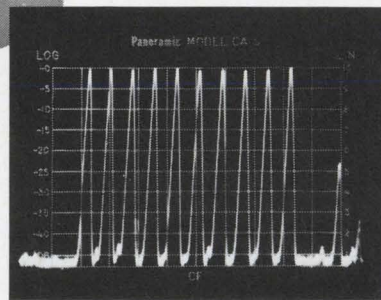

3. The high resolution of the Singer Model SSB-50-1 provides this clear display of the multiplexed channel. The amplitude of each subcarrier is shown as a function of frequency. The display demonstrates complete operational readiness at a glance . . .

4. . . . but often a subcarrier level changes with a resulting communications malfunction. This display on the CRT shows that one subcarrier's level is down 12 db. Another is over the predetermined acceptable level.

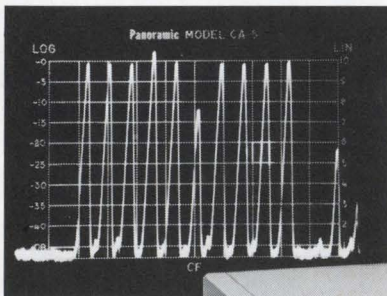

5.

Because the entire spectrum is continuously visible on the display, a lost channel shows up instantly . . . A frequency range of 10Hz to 40 MHz makes the Model SSB-50-1 an invaluable tool for this application and for general laboratory or field use.

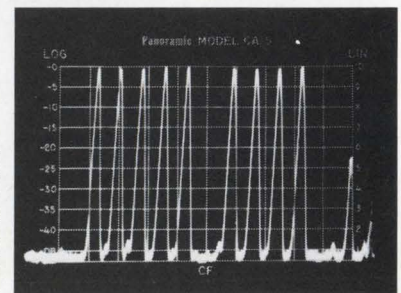

Model MF-5/CA-5-1 Spectrum Analyzer display section (features high resolution/low distortion and 70 db dynamic range)

Model TTG-3 Two-Tone Audio Generator 20-20,000 Hz frequency range and IM distortion of less than 70 db for testing single sideband transmitters

Model REC-2 Range Extending Converter (extends the tuning range down to 10 Hz)



Model RF-8 Tuning Head (highly stable LO with coarse and vernier two speed tuning from 2 MHz to 40 MHz . . . usable to 200 MHz)



SINGER
INSTRUMENTATION

The Singer Company, Metrics Div.,

915 Pembroke Street, Bridgeport, Conn. 06608 (203) 366-3201

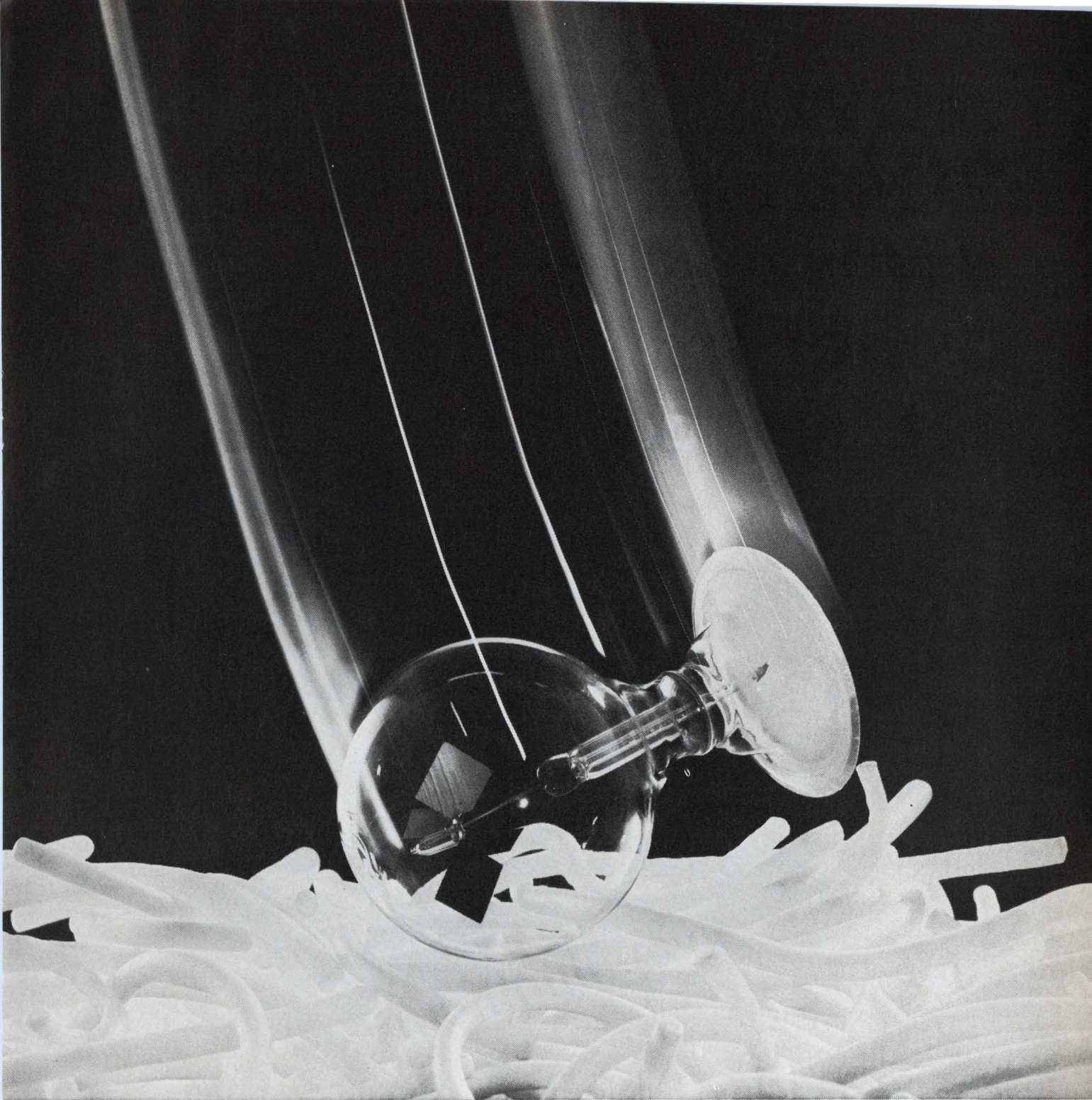

Packaging Sales, The Dow Chemical Company, Midland, Michigan 48640.

Try this on your fragile parts.

Pelaspac[®] loose fill packing. It weighs 3 to 6 times less than most other dunnage. It won't absorb water. It cuts shipping losses. Because it's highly shock-resistant, and it interlocks to prevent settling. It cuts cleanup, too. Because it's clean, nondusting and noncorrosive. Write for details.



NOW plug in up to
2048 bits, at a speed of
8 MHz for less than
5¢ per bit, with built-in
TTL interface.

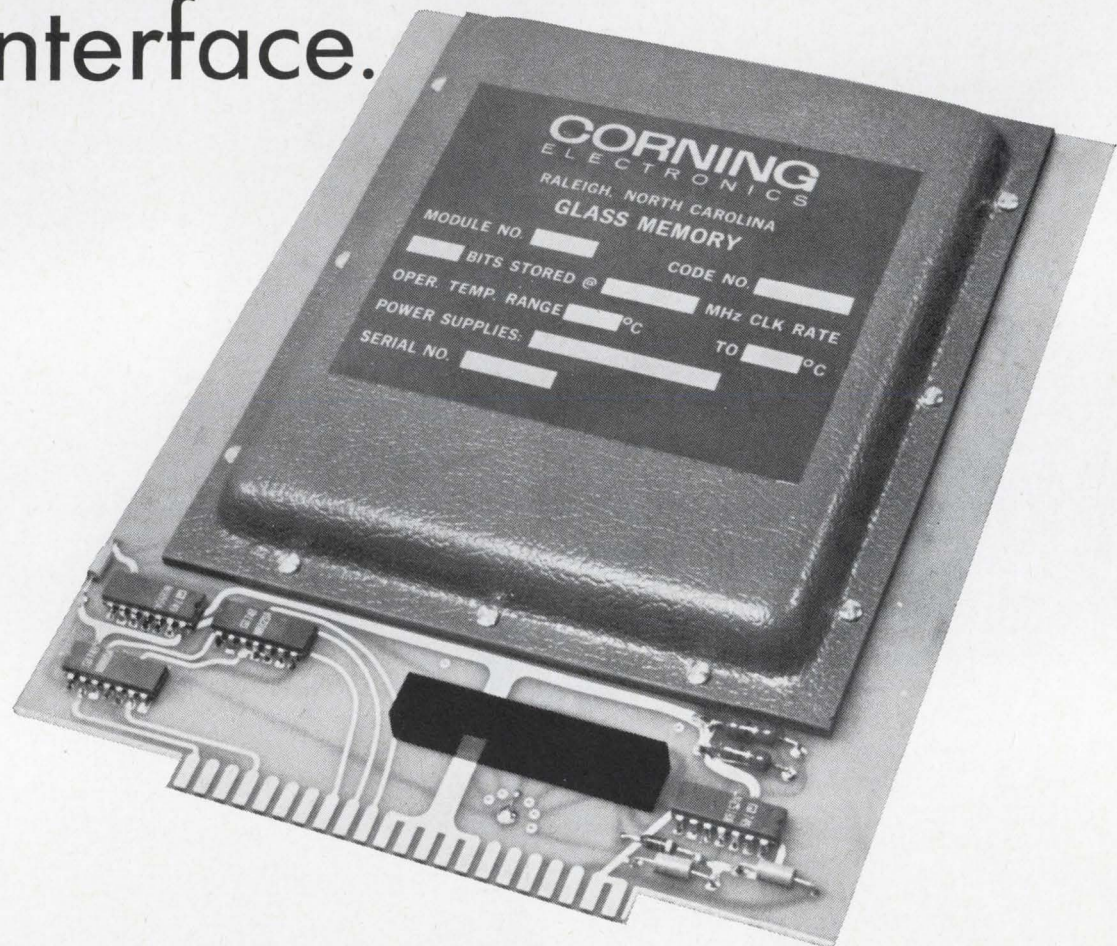

New Low Cost CORNING® Digital Memory Modules.

Fast Available Frequencies	Available Delay Time		
	64 μ sec.	128 μ sec.	256 μ sec.
4 MHz	256 Bits	512 Bits	1024 Bits
8 MHz	512 Bits	1024 Bits	2048 Bits

These are standard. Custom modules available up to 4096 bits and up to 16 MHz.

Easy. Just plug one in and you have serial storage. All the circuitry to interface with TT Logic is built in. You need no special power supplies, no voltage level shifters.

Low Cost. In the 1000 module bracket, for 2048 @ 8 MHz,

each bit costs less than a nickel. More modules—less cost. Even in 100 piece quantity, each bit costs less than a dime. And it's your only cost.

Stable. The medium is proven CORNING® Zero-TC glass.

Here now. These are performing products, not promised potential. Write for full data sheets, or to see our man with samples. Corning Glass Works, Electronic Products Div., Advanced Products Dept., Raleigh, N.C. 27602. Telephone (919) 828-0511, Ext. 262.

CORNING
 ELECTRONICS

GOOD

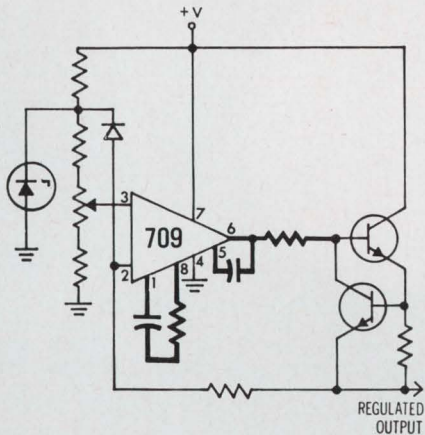

This good regulator circuit . . .

BETTER

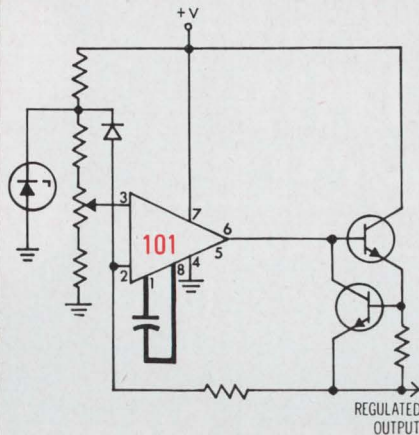

can just be improved . . .

BEST

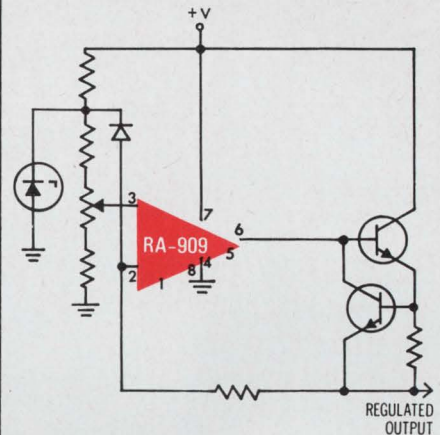

or it can be optimized!

Now optimize all 709 circuits by using the NEW compensationless RA-909.

*It's a pin-for-pin replacement offering a faster slew rate,
lower power dissipation, better transient response, greater D. C. gain stability,
and a noise level so low that we'll even publish it (see below)!*

The regulator circuit above is only one example of how you can optimize your present designs by using the RA-909. Design it into any circuit where you would use a 709 or use it as a replacement in equipment already in use. It's in an eight pin TO-5 and a TO-86 flatpack configuration. Both have blank leads where the 709 and 101 require compensation. This permits you to use the RA-909 even though compensation networks are already on the circuit board. And you'll find that the cost is competitive.

The new RA-909 is dielectrically isolated and incorporates vertical PNP and NPN transistors in the same monolithic structure. These processes eliminate the need for external compensation and insure a slew rate of 5 volts per microsecond; power dissipation of 52 milliwatts; transient response of 40 nanoseconds (10 to 90% points) with a 200 millivolt output into a 2K Ω , 100 pF load in the worst-case unity gain configuration; and a maximum equivalent input noise of 5 microvolts rms. For complete information contact our nearest sales office.

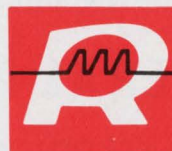

RADIATION
INCORPORATED
SUBSIDIARY OF HARRIS-INTERTYPE CORPORATION
MICROELECTRONICS DIVISION

Sales Offices: 600 Old Country Road, Garden City, N.Y. 11530, (516) 747-3730 — 2600 Virginia Avenue, N.W., Washington, D.C. 20037, (202) 337-4914 — 6151 W. Century Boulevard, Los Angeles, Calif. 90245, (213) 670-5432 — P.O. Box 37, Melbourne, Florida 32901, (305) 727-5430 — International Sales: Marketing Department, P.O. Box 37, Melbourne, Florida 32901, (305) 727-5412



**SEE THIS
PINHOLE?**

**General Electric's
Helium Leak Detector
will find a leak
one ten-thousandth its size.**

Our Helium Mass Spectrometer Leak Detector's sensitivity is like horsepower in a big car. Most of the time you have more than you really need; but when you *do* need it, it's there.

Specifically, our units are sensitive to at least 2×10^{-11} std. cc/sec. Put another way, GE equipment will—in less than one second—detect leakage that's at a rate of an ounce of helium in *ten* years.

But sensitivity is only part of our story. We'd

like the chance to tell you about our two-years-guaranteed spectrometer tube filament; our reliable, long-life, solid-state circuitry; our models' ease of operation and servicing; our constant sensitivity; our all-welded, stainless steel high-vacuum system.

And then some. Check the reader service card, or write us direct for full particulars on manual model LC-10 or automatic model LC-20. We have a product we're proud of.

VACUUM PRODUCTS BUSINESS SECTION

GENERAL  ELECTRIC

SCHENECTADY, N.Y. 12305

LC-2

Coors Strate-Breaks™

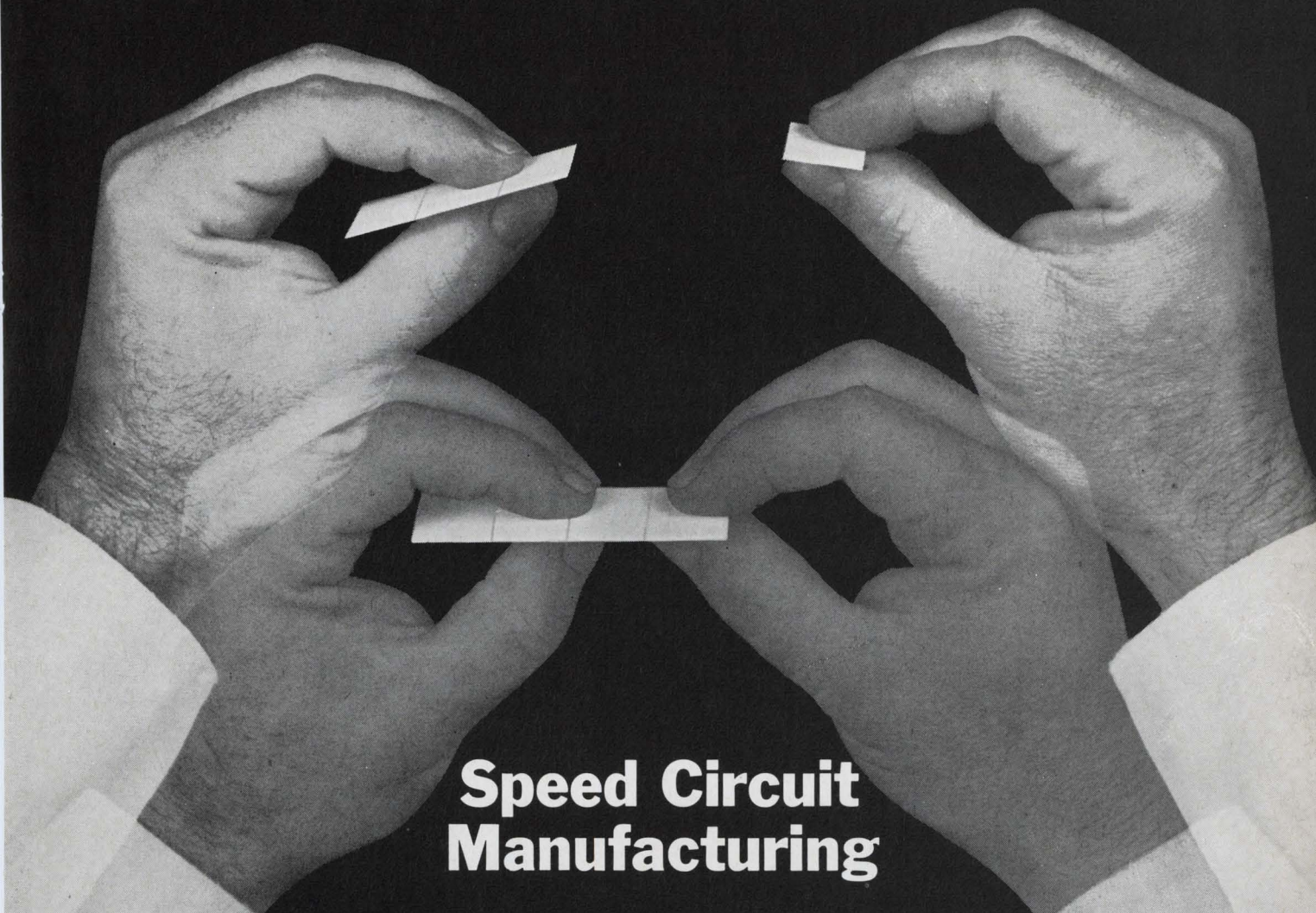

Speed Circuit Manufacturing

High quantity production of integrated circuits with uniform quality, increased precision tolerances, greater economy in the production of micro-ceramic components—all these are yours by gang printing your circuits on Coors *Strate-Breaks*. No cutting apart, no multiple handling before assembly. Just SNAP!...and there are your individual components with a straight, smooth, precision edge.

Coors *Strate-Breaks* are made to your specifications in sizes from $\frac{1}{2}'' \times \frac{1}{2}''$ to $4'' \times 4''$. They are available unglazed for thick-film circuits, and glazed or unglazed for thin-film circuits. Get on-the-spot answers. Dial Coors—303/279-6565, Ext. 361. For complete design criteria, write for Coors Alumina and Beryllia Properties Handbook No. 952.

Patent
Pending

*consider
Coors
ceramics*

Coors

CERAMICS

ALUMINAS • BERYLLIAS • MAGNESIAS • SPECIAL OXIDES
Coors Porcelain Co., Golden, Colo.

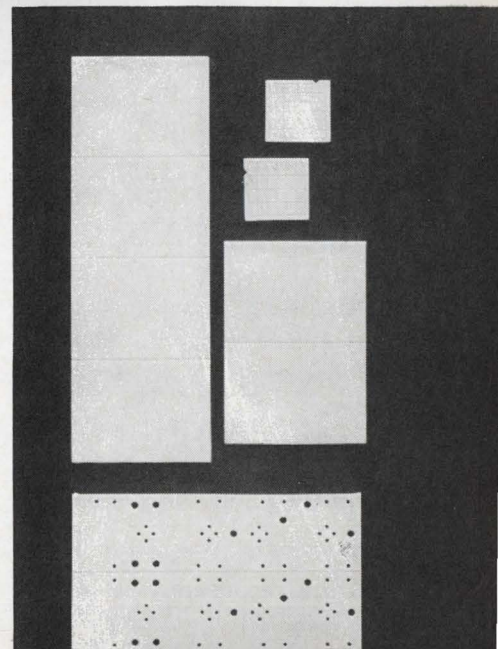

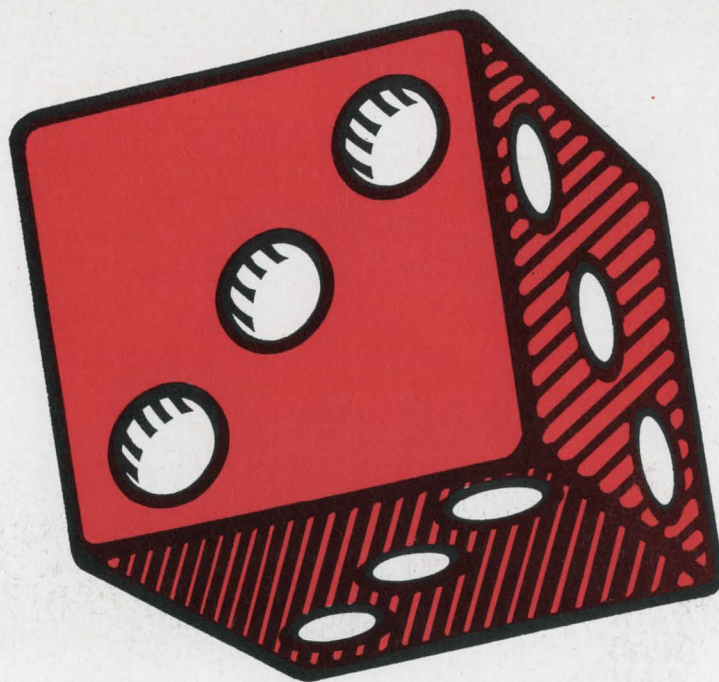

LIKE A SURE THING?

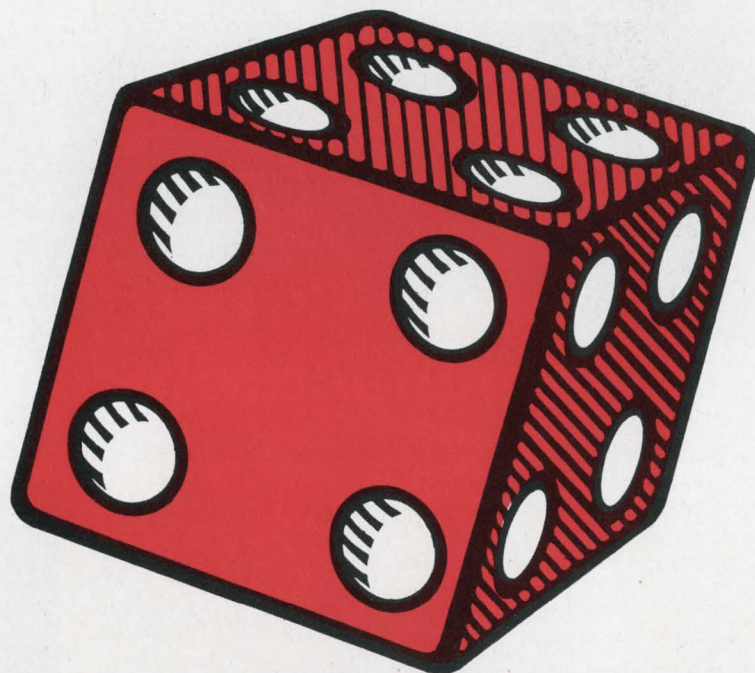

THE ODDS ARE 36,000 TO ONE COHU HAS THE RIGHT TV SYSTEM FOR YOU! A pioneer in TV, Cohu today is the largest producer of standard, off-the-shelf TV systems in the industry. Take the standard lenses, camera controls, pick-up tubes (both vidicons and Plumbicons®) and video monitors—put these together with Cohu's various camera housings, remote controls and lens drives and you have over 36,000 possible TV system combinations. And this does not include Cohu's wide variety of quality TV accessories and switching systems.

ONE IS RIGHT FOR YOU! Whether your needs be industrial, educational or military, one of Cohu's TV combinations is right for you. Let Cohu engineering know-how design for you a custom TV system from standard, off-the-shelf components.

For details on the industry's most complete TV line, contact your nearest Cohu representative or call Bob Boulio direct at 714-277-6700 in San Diego. The odds are in your favor.

® Reg. TM N. V. Philips Co. Holland

Box 623, San Diego, California 92112. TWX 910-335-1244.

138 Circle 138 on reader service card



Electronics | June 24, 1968

Probing the News

Space electronics

Intelsat 4 countdown nears zero

Groups led by TRW, Hughes, and Lockheed await a decision on their proposals for spin-stabilized or three-axis communications satellite with 6,000 channels

By Robert W. Henkel

Associate managing editor

Anxious callers will be ringing phones in the Washington office of Comsat's Fred Esch these next two weeks, but he probably won't be answering. Esch, the manager of the Communications Satellite Corp.'s Intelsat 4 program, spent most of last week in Geneva meeting with the technical section of the International Telecommunications Satellite Consortium's interim committee, and he has returned with the name of a recommended contractor for the giant, next-generation communications satellite.

But Esch won't be talking until the July 10 meeting of Intelsat's interim committee in Washington [Electronics, June 10, p. 25]. This group, as consortium manager, will hear the Geneva meeting's recommendations, and Esch feels there's a good chance the winner will be chosen at that time. Bidders see August as the earliest the contract can be signed, and one says October is more likely.

Trio and quartet. Sweating it out will be three groups of bidders led by TRW Systems Group, the Hughes Aircraft Co., and the Lockheed Missiles & Space Co. Lockheed bid on two different satellite types, so Comsat has had four proposals and four prices to consider. Ever since turning in their bids last April, the companies have been changing their proposals. Some shifts have been technical, but several are understood to be price adjustments—downward. Three of the original bids were fairly close in price, but the fourth—reportedly TRW's—was

way above the others.

The number of second—and third—thoughts on these proposals indicates the importance of this satellite program to the bidders. With the current paucity of space hardware contracts resulting from NASA's well-publicized budget problems, the Intelsat 4 job looms large; loss of the contract might well mean layoffs at any of these companies, while winning it could keep skilled engineering teams together.

The estimated cost of Intelsat 4, excluding the Titan 3B Agena launch vehicles, is \$80 million. This covers development work, one prototype, an engineering model, and four operational craft. The price tag for each production model is expected to be about \$8 million.

Eye on the competition

Comsat would like to start launching Intelsat 4's in mid-1970, though it may face some delaying action by other members of the 61-nation consortium. The company's timetable coincides with that for the new transistorized transatlantic cable—the 720-circuit TAT-5—slated to go into service in 1970. Certain interests would like to have all the cable circuits busy before the big satellite comes along with its 6,000-channel capacity.

An interim satellite, the Intelsat 3.5, had been under consideration for launching in 1969, between the 1,200-channel Intelsat 3 now being built by TRW for launch this year and the Intelsat 4. An outgrowth of the Intelsat 3 design, the 3.5 most

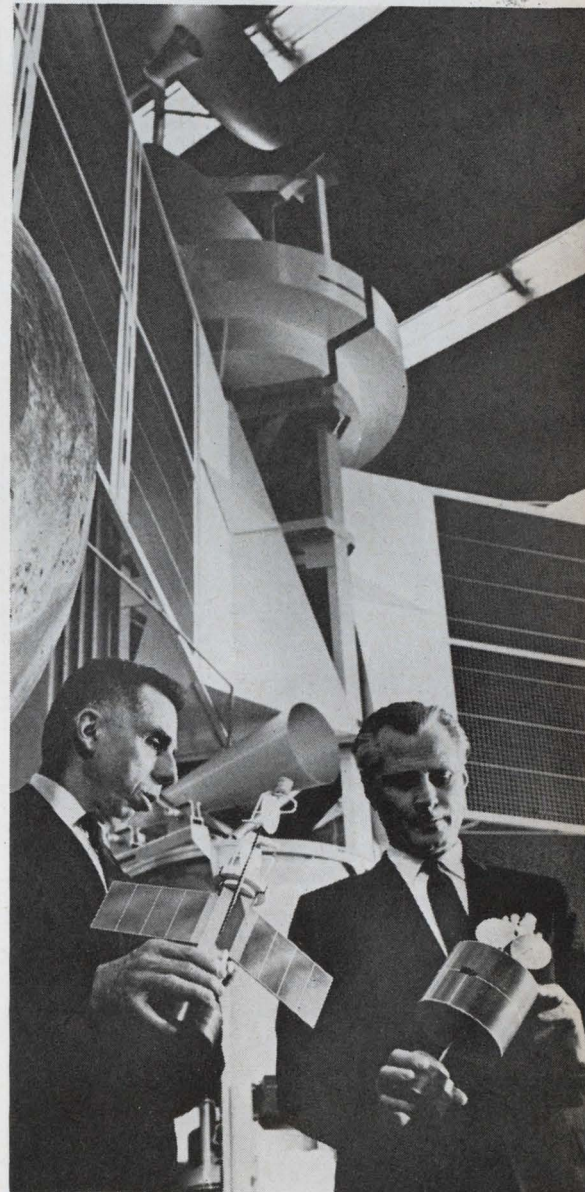

Choice. Lockheed officials check models of the three-axis and spin-stabilized designs proposed for Intelsat 4.

Size 13 DC Motor State-of-the-Art



is off the shelf at AEI

The size 13 DC Permanent Magnet Motor, 1.25 in. dia x 1.750 in. length, is available open with Terminals or closed with Leads or Terminals.

Frame is Aluminum, finish Alodine per MIL-C-5541, with Armature supported in Ball Bearings.

Mounting either by Servo Clamps or Face Mounting by screws. Performance speeds are available from 5000 RPM to 20,000 RPM, at a continuous running torque of .8 in. oz. with an operating voltage of 6-50 VDC.

The Size 13 will meet all of the requirements of MIL-M-8609. Available accessories include Planetary Gearheads, RF Filter and Speed Governor.

Complete literature is available by writing Electro-Mechanical Group, American Electronics, Inc., 1600 East Valencia Drive, Fullerton, Calif. 92634, (714) 871-3020, TWX 910-592-1256

Electro-Mechanical Group **AEI**
AMERICAN ELECTRONICS INC.

- Please rush checked item(s)
 DC Motor Design Manual
 DC Motor Technical Catalog

NAME _____

TITLE _____

COMPANY _____

ADDRESS _____

CITY _____ STATE _____ ZIP _____

... Comsat won't say the Intelsat 3.5 program is officially dead ...

likely would have been built by TRW and featured a new mechanically despun antenna system furnished by the Philco-Ford Corp.'s Space and Reentry division. The Philco antenna package, with its two 6° spot beams, would have replaced the Intelsat 3's mechanically despun horn developed by Sylvania Electric Products Inc. [Electronics, April 1, p. 71]. With its highly directional antennas, the 3.5 would have provided 1,900 two-way voice channels, 700 more than the Intelsat 3.

Philco has also joined the TRW team bidding for Intelsat 4. Again it would provide the communications and antenna systems, and this partnership certainly strengthens the TRW proposal technically.

Hedged bet. Though Comsat won't declare the 3.5 program officially dead—presumably in case its Intelsat 4 plans go awry—the interim craft most likely won't be heard of again. Says a TRW official, who claims his firm invested only a small amount of money in the project: "It was only a gap filler over the Atlantic with a limited application for a period of time."

The main reason Comsat is pushing the Intelsat 4 so hard is that it foresees a huge increase in global communications traffic, particularly over the Atlantic. The company has taken great pains to develop "refined" traffic forecasts, but it's keeping the growth projections to itself. These rapidly rising forecasts really "caused the panic" (about the number of channels needed), according to a satellite engineer for one company.

Comsat back in 1966 fought Federal Communications Commission efforts to get it to build a satellite bigger than the Intelsat 3; the company declared at the time that the state of the art wasn't sufficiently advanced to produce a larger-capacity craft. However, the position of Hughes, a pioneer in stationary-orbit satellites, was that a communications satellite the size of the Intelsat 4 could have been designed and built in two years—for a launch in line with the Intelsat 3 timetable [Electronics, May 30, 1966, p. 109].

Foreign affairs

Of the members of the Intelsat interim committee meeting next month, France is the only one opposed to Intelsat 4. Comsat is trying to change the French position, but it doesn't really need France's vote to get the satellite going. Comsat holds half of the voting shares in Intelsat, and with support from its allies on the committee it can push through the Intelsat 4 plan whenever it wants. (Any "substantive issues" like this must be approved by 62.5% of the voting shares.) But with the Intelsat interim agreement up for review by members next year, the firm doesn't want to have to strong-arm the program through the committee.

Two ways to turn. Studies had been made for Comsat earlier on multipurpose satellites comparable in size to Intelsat 4; these were a spin-stabilized design from Hughes and a craft stabilized by a spinning flywheel from Lockheed. The spinning satellite was specified in the request for Intelsat 4 proposals, but the Lockheed three-axis design was not ruled out. Hughes and TRW bid on the spinning version, while Lockheed bid on both. All four bids met or exceeded Comsat requirements for circuit capacity; the company wants 6,000 channels and the bidders are proposing from 6,000 to 6,400.

Lockheed's alternate version incorporates a variable-speed, 40-pound flywheel that runs at high rpm to provide gyroscopic action, according to Charles O. Wallin, staff engineer for commercial satellite projects at the Sunnyvale, Calif., firm. The approach is similar to that applied by Lockheed to military reconnaissance satellites. "Practically everything we've put into the design has been flown, or will be flown before Intelsat 4," Wallin says.

Lockheed was surprised at the design details in the Comsat request for proposals. "It was very conservative; they want flight-proven hardware," Wallin says. It's this attitude that may doom the flywheel approach. Sources close to

Comsat say its engineers are wary of this kind of stabilization because they've never worked with it before.

Split. Unlike previous Comsat craft with their single communications antenna, the Intelsat 4 will carry two 17° circular beams to cover the entire earth disk from the satellite's 22,300-mile stationary altitude. Two 4.5° spot beams will concentrate their power in areas of heaviest communications traffic. For instance, one beam could be pointed at the eastern U.S. and the other at West Europe. The effective radiated power specified for the wider-beam antennas is 23 dbw, while that for the spot beams is 34.7 dbw. Twelve communications repeaters are to be carried by the satellite, each having a 36 megahertz r-f bandwidth and the capability of handling a color-television relay.

Logjam at home

Outside the realm of Intelsat but figuring very heavily in Comsat plans for the Intelsat 4 spacecraft is the U.S. domestic satellite program. The consensus among observers is that a high-priority need already exists for such a U.S. communications satellite. However, the project has been held up for years

in the FCC by a controversy over ownership. To get moving in this area, Comsat in March 1967 proposed a pilot program under which it would finance, build, and operate a satellite system on a stewardship basis. It looked as if Comsat was going to get its way last year [Electronics, June 26, 1967, p. 597], but the go-ahead still hasn't been given.

Foot in the door. An engineer at one satellite builder says that "Comsat's plans are to have the contractor for Intelsat 4 build the domestic craft." Says another, "Intelsat 4 is a logical vehicle for the domestic program, but because the pilot satellite would be a demonstration craft, it would be different." The pilot craft would carry out such experiments as millimeter-wave propagation tests, this engineer says, the sort of thing the American Telephone & Telegraph Co. proposed in submitting its domestic-satellite plan to the FCC.

Comsat isn't ready to say what it wants to do on the domestic-satellite question. Esch does observe that "there would obviously be similarities to the Intelsat 4, and there's a possibility that certain development costs could be shared." But he believes the domestic craft will be procured separately, and

Meanwhile, back at TRW . . .

A visitor at TRW Systems' Redondo Beach, Calif., production plant is bound to be impressed by the way work on the first flight model of the Intelsat 3 satellite is now progressing after a slow start. Going all out to meet the present timetable, TRW is trying to erase any doubts about its ability to build the 1,200-channel craft. The company is, of course, also looking ahead to the award of the Intelsat 4 contract.

TRW has had its problems with Intelsat 3 [Electronics, Dec. 11, 1967, p. 155]; the list of woes includes such items as the mechanically despun antenna from Sylvania, the communications subsystem, power supplies, and foreign subcontractors. But all subsystems in the first flight model in the six-satellite order have been accepted, all systems tests have been started on the fully integrated craft, and TRW is sure it can deliver the satellite in the first week of August.

The second flight craft will be shipped a month later, the next two are being built, and TRW is currently receiving European-built subsystems for the final pair.

But the company still isn't out of the woods. The verdict won't be in until the first Intelsat 3 starts relaying signals in September. Sylvania, which has been plagued by gain problems on the beam edges of its antenna, has added an unspecified new material to the radiating element and claims to be "very excited about it." In tests with the Intelsat 3 engineering model in TRW's anechoic chamber, gains about 2 decibels higher than expected were measured. But Comsat has decided to permit rolloff at the antenna beam edge in the case of the first two satellites.

Chances of follow-on orders for as many as 18 more Intelsat 3's have long since disappeared. The current Comsat order is the end of the line.

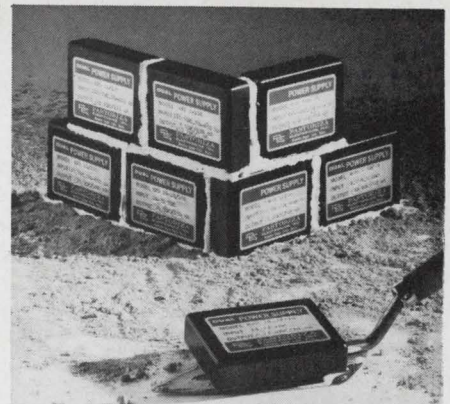

3.19" × 2.50" × .750"

Power Supply "Cornerstones"

provide a solid foundation for system performance.

The industry's first and still finest miniature, precision dual power supply is now offered in a variety of voltage ranges and high performance specifications.

NEW SPECIFICATIONS

- Tracking Outputs
- .02% Regulation
- Sustained Short-Circuit Protection
- Temp. Ranges -55°C to +71°C
- 5 μsec. Response Time
- No Output Spiking
- Noiseless
- RFI Free
- Over 40,000 Hrs. MTBF

NEW MODELS

- 105 to 125 VAC Input
- ± 15 VDC Output—For Op Amp Supply
 - ± 18 VDC Output or ± 12 VDC—For MIL Application
 - ± 22 VDC Output—For FET Amplifiers
 - ± 30 VDC Output—For Wide Swing Amps
 - 180 VDC Output—For Neon, Nixie, and High-Voltage Amplifier Supplies
- Models available with 28 VDC, or 5 VDC Inputs.

NEW PRICES

\$100 in quantity.

Wire or call for more information.

PASTORIZA
ELECTRONICS, INC.

385 Elliot St., Newton, Mass. 02164 • 617-332-2131

... Intelsat members outside the U.S. want a fair share of contract awards ...

maintains that domestic considerations won't figure in the Intelsat 4 purchase. Insiders at two of the companies that would bid on the domestic satellite assert that no one company could handle both projects at the same time, anyway.

Politics

One of the most important factors in the selection of the Intelsat 4 contractor—a factor the technical group of the Intelsat interim committee pondered at length in Geneva last week—has nothing to do with price or technical advantages. It concerns the number of foreign companies that would participate in the work proposed by the three bidders. Intelsat members outside the U.S. have long demanded that their share of consortium expenses be returned in the form of contracts for their aerospace-electronics industries.

TRW started such subcontracting with its Intelsat 3, and all three bidders for Intelsat 4 have made a major effort to set up foreign teams

and to tell the world about them.

There are several ways to calculate foreign participation, but the one Comsat has adopted puts TRW on top with 46% foreign participation and Hughes at the bottom with 20%. The figures are based on a formula reflecting dollar value and share of work.

Each of the bidders has taken a different approach to bringing in foreign partners. For example, companies from 10 nations are listed as major subcontractors in the Hughes proposal, but all would be working from Hughes blueprints.

Hughes traditionally does its own research and development work on designs and systems tradeoffs, Subbotin comments, because this is its strength. "This is the Hughes way," he adds, "but it isn't necessarily the best approach for other companies."

Melding. TRW, on the other hand, is a systems manager with less expertise in the subsystems area. The firm's foreign partners would therefore build subsystems right from the outset under TRW's proposal, while the U.S. concern would concentrate on integration.

"We feel the integration job takes a heavyweight, and that's the job we'll tackle," says Joseph Freitag Jr., applications manager for commercial communications satellites at TRW's Space Vehicle division in Redondo Beach, Calif. Unlike the Hughes and Lockheed plans, in which overseas participation would increase with each successive satellite, the TRW proposal maintains the foreign share at about the same level throughout the life of the contract.

Lockheed's Wallin says his company's bid includes 22 hardware items from 14 subcontractors in nine foreign countries. Foreign procurement for the first four satellites would come to about 38%, the company estimates, with components and minor subsystems making up almost all of it. In fact, the largest subsystem that would be built overseas under either Lockheed proposal would be the solar-cell-array structure, slated for Hawker Siddeley Dynamics of Britain.

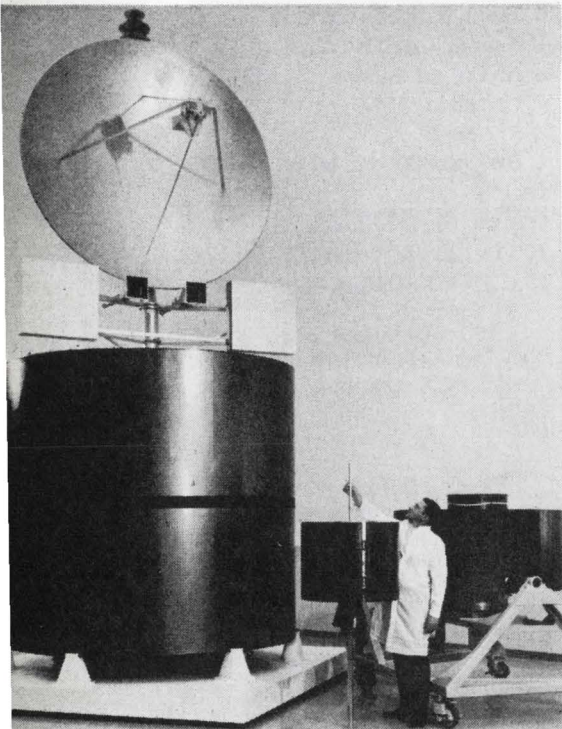

Big brother. Hughes' proposed version of Intelsat 4 towers over Early Bird and Intelsat 2; dish can transmit two spotlight beams to heavy-traffic areas.

Hughes Sales Representatives

CALIFORNIA (Northern) Also Nevada
Deere Electronics, Inc.
Suite D, 20440 Town Center Lane
Cupertino, California 95014 • 408 257-3040
CALIFORNIA (Southern) Also Arizona
W.E.S.T., Inc.
3825 Birch Street
Newport Beach, California 92660 • 714 540-9040
COLORADO Also Montana, Wyoming,
Utah and Southern Idaho
Williams Associates
4971 Jackson Street
Denver, Colorado 80216 • 303 388-4391
CONNECTICUT Also New Hampshire, Maine,
Vermont and Rhode Island
The William McCoy Company
896 Main Street
Branford, Connecticut 06406 • 203 488-2012
FLORIDA Also Alabama, North Carolina,
South Carolina, Georgia, Tennessee
Spectec Engineering Representatives
Division of W. A. Brown & Associates, Inc.
222 Weber Avenue
Orlando, Florida 32803 • 305 425-5505
ILLINOIS (Northern) Also Eastern Wisconsin,
Northern Indiana and Eastern Iowa
Technical Devices, Inc.
6416 North Central Avenue
Chicago, Illinois 60646 • 312 774-8252
MARYLAND Also Virginia, West Virginia, Delaware,
District of Columbia
Kraft Electronic Sales, Inc.
510 Woodbine Avenue
Towson, Maryland 21202 • 301 828-5838
MASSACHUSETTS
The William McCoy Co.
55 Prospect Street
Holliston, Massachusetts 01746 • 617 429-2369
MINNESOTA Also North Dakota, South Dakota,
Western Wisconsin
Fred B. Hill Company
6110 Excelsior Boulevard
Minneapolis, Minnesota 55416 • 612 929-6727
MISSOURI Also Kansas, Nebraska, Western Kentucky,
Western Tennessee, Southern Illinois and
Western Iowa
Ridgewood Sales Company
8754 Big Bend Boulevard
St. Louis, Missouri 63119 • 314 966-6878
NEW JERSEY (Southern) Also Eastern Pennsylvania
Thomas M. Mills Company
13 B Tanner Street
Haddonfield, New Jersey • 609 429-1005
NEW MEXICO
Williams Associates
3221 Silver Avenue, S.E.
Albuquerque, New Mexico • 910 989-0622
NEW YORK (Metropolitan) Also Northern New Jersey
Robert Horne Associates
P. O. Box 31
Pompton Lakes, New Jersey 07442 • 201 835-7400
NEW YORK (Except Metropolitan area)
C. W. Floring & H. R. Murray, Inc.
6585 Kinne Road
Syracuse, New York 13214 • 315 446-5555
OHIO Also Michigan, Southern Indiana,
Eastern Kentucky, Eastern Tennessee
Luebke Sales Company, Inc.
2549 Erie Avenue
Cincinnati, Ohio 45208 • 513 871-4211
PENNSYLVANIA (Western)
Anderson Connector Corporation
P. O. Box 237
Wexford, Pennsylvania 15090 • 412 776-3211
TEXAS Also Oklahoma, Arkansas, Louisiana,
Mississippi
Space Electronics Corporation
Suite 409, Irving Bank Towers
Irving, Texas 75060 • 214 631-0905

Maybe we should have called it The Polar-Sex.

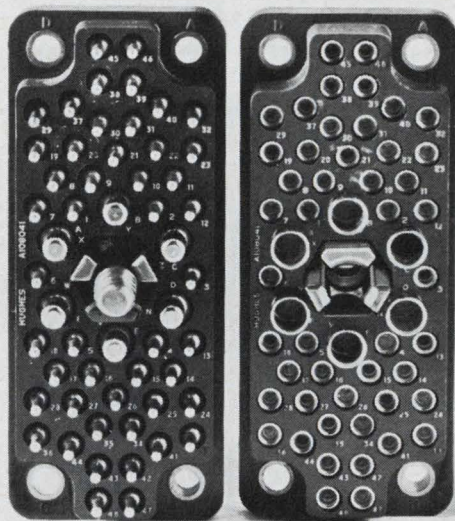

For a foolproof interlocking device, it's a more descriptive name than PolarHex.

We would have gotten more publicity too.

But even with a handle like PolarHex, Hughes got plenty of notice. There has never been a coupling method like it for connectors.

Instead of conventional coupling nuts, we use a center jack-screw and boss. There's only one way they can fit together.

So they polarize every time.

The contacts are perfectly aligned every time.

By designing the PolarHex we were also able to design a circular subminiature with the highest contact density ever.

You'll find the PolarHex on all Hughes MS rectangulars and high-density subminiatures. Including our new BULLS-EYE line of circular subminiatures.

That's PolarHex. The name may not fit. But the contacts do.

Write Hughes Aircraft Co., Connecting Devices, 500 Superior Avenue, Newport Beach, Calif. 92663. Phone (714) 548-0671. TWX 714-642-1353.

 Connecting Devices, part of Hughes Circuit Technologies. Including: Contour™ Cable; Semiconductors; Flip Chips/Equipment; Frequency Control Devices; Microelectronic Circuits; MOSFETs.

HUGHES

HUGHES AIRCRAFT COMPANY

If it's happening in connectors,
it probably started at Hughes.

Now there are 3 low-noise UHF transistors with f_T above 1GHz...

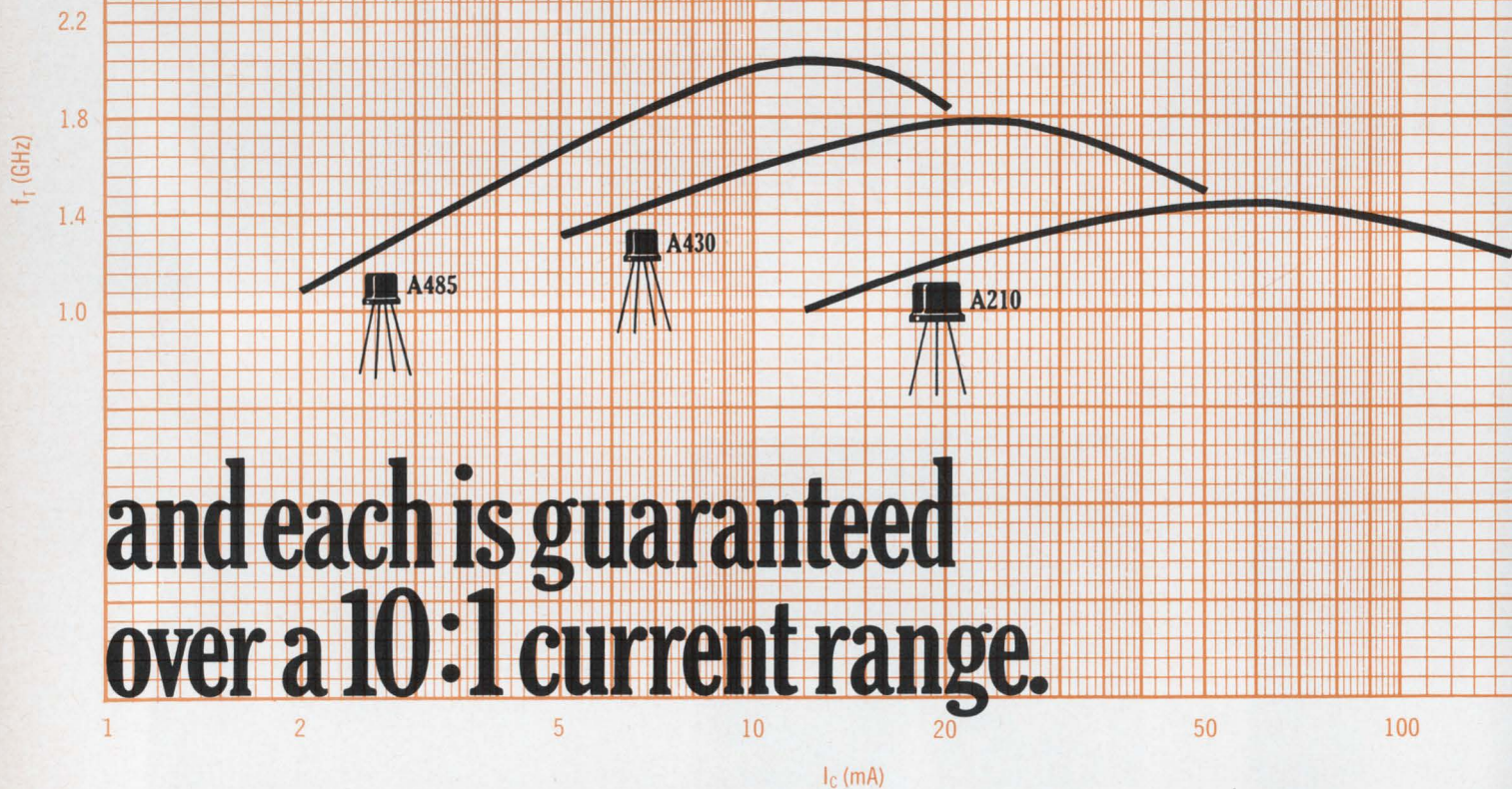

and each is guaranteed over a 10:1 current range.

**AmpereX A485,
AmpereX A430,
AmpereX A210.**

The rousing success of our A485, which has linear f_T above 1GHz for collector currents from 2 to 25mA, has led us to develop the A430 (f_T above 1.2GHz from 5 to 50mA) and the A210 (f_T above 1GHz from 15 to 150mA). And now there are three AmpereX low-noise UHF transistors with linear, high f_T and with overlapping collector current ranges in steps of 10:1.

With these transistors you can now optimize broadband, high gain UHF amplifiers to operate at any collector current from 2 to 75mA— with extremely low intermodulation distortion and low, low noise. Until now, it simply couldn't be done.

Typical applications include broadband test instruments, (e.g., RF oscilloscopes), telemetry equipment, antenna amplifiers (say, from 40 to 860MHz), CATV distribution amplifiers and high performance communications receivers.

If you need high gain, low noise and low intermodulation distortion anywhere in the UHF spectrum, the AmpereX A485, A430 and A210 may be your answer.

For data and applications information, write: AmpereX Electronic Corporation, Semiconductor and Microcircuits Division, Slatersville, Rhode Island 02876.

AmpereX
TOMORROW'S THINKING IN TODAY'S PRODUCTS



Companies

Federal Center broadens IBM's horizons

Facility, organized to get systems orders from the Government, has led company into new areas like management of the FAA air-traffic-control setup shown above

By Paul A. Dickson

Washington regional editor

"We are trying to pursue the unknown on a business basis," says an executive at IBM's Federal Systems Center—a sort of giant workshop near Washington that attends to the company's Government activities. While this might be an overstatement, his organization has acquired an assortment of exotic skills in advanced technologies and become an excellent example of how to sell electronic systems and services to Uncle Sam not only today but also five and 10 years hence. The center, which takes particular pride in its advanced studies efforts, is now bent on branching out into the uncharted realms of systems engineering as applied to civil and urban problems.

Established in 1962 to go after

the Government's real-time information and communications business, the center now has 3,700 employees working on 100 or so contracts, in-house projects, and basic research programs. The facility, located in Gaithersburg, Md., is one of several managed by the Federal Systems division of the International Business Machines Corp. What's special about the center is that it not only acts as a vehicle for substantial hardware sales but also gives IBM a Government-underwritten opportunity to sharpen its skills in a wide variety of scientific disciplines.

Breakdown. The center has five semiautonomous directorates—the engineering laboratory, a civil programs group, and units working on

command, operational-control, and special systems. Each department administers contracts and goes after new business on its own, but there's a continuing and fruitful interchange among the various groups. For example, Tom Bianco, manager of advanced programs at the engineering lab, is currently assisting the civil programs department and doing odd jobs for the IBM World Trade Corp., which is in the midst of a project to automate the Japan Broadcasting Corp.'s television facilities with a real-time computer-controlled switching setup.

Integrator

The engineering laboratory is possibly the most diverse operation

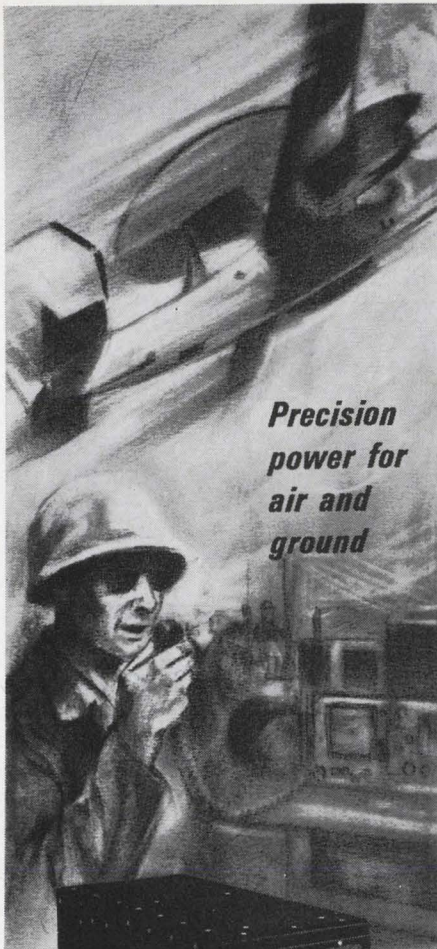

**Precision
power for
air and
ground**



Model
PS62-66D
3.5KVA

UNITRON FREQUENCY CONVERTERS 400 Hz to 60 Hz

3.5 and 8 KVA Sine Wave Outputs

• Complete input and output loading protection • Wide input voltage and frequency variations • Tested to Applicable Environment & RFI Specifications

From Unitron, two all-silicon solid state frequency converters with fourth-generation proven reliability and efficiency.

The design of these units gives an operational flexibility for a wide variety of environments.

Typical applications: Air-transportable equipment requiring precision 60 Hz power, and ground systems where input power is 400 Hz.

Write for complete information.

UNITRON

Division of Electric Machinery Mfg. Company

1624 N. FIRST ST.

GARLAND, TEXAS 75040 (214) 276-8591

... the engineering lab is looking at systems as much as five years away ...

at the Federal Systems Center. Established three years ago, the lab has the job of supplying the "glue" needed to get systems into working order. In other words, the staff seeks to develop the best blend of IBM computers, programs, off-the-shelf electronics hardware, and, when needed, specialty items to meet specifications for ground-support equipment and communications and data-handling systems.

The lab is currently involved in more than 40 contracts, most of them in the R&D category. However, the lab is turning out a lot of useful gear, too. For example, it's building Dacor, a system that automatically corrects errors in digital transmissions, and the Adaptive Microprogramed Control System, which allows quick changes in computer-controlled communications systems by manipulation of Mylar strips rather than wired logic. Other hardware coming from the lab includes high-speed digital modems, an f-m feedback demodulator, and an adaptive multiplexer.

Says Bianco: "The development of a system like Dacor is important to us because it gives more credence to systems and our ability to produce them." He adds that the lab will continue to develop hardware that enhances IBM's

communications abilities.

Over the rainbow. About half the lab's 500 employees work in what Bianco calls "a very advanced think shop" that serves both the center and the rest of the company. "We're looking at problems and systems that are as much as five or six years away and trying to determine what we should be doing now," he says.

Automated telemetry systems, self-repairing computers, terminals, and new data-filing techniques for computers are now being studied. In addition, the lab is undertaking basic investigation of the techniques and materials involved in large-scale integration. Bianco says the lab is checking unanswered questions and theories as well.

One question cited: "Can you use a communications system as its own data collection system and, in effect, just keep the data in the system?" Another is posed this way: "Everyone is looking at electronic management information systems; should we be looking instead towards worker information systems?"

The lab's open-ended mandate will pay off in several ways, says Bianco. The center can be zeroing in on requirements before the Government even knows what systems it needs and can thus pace the

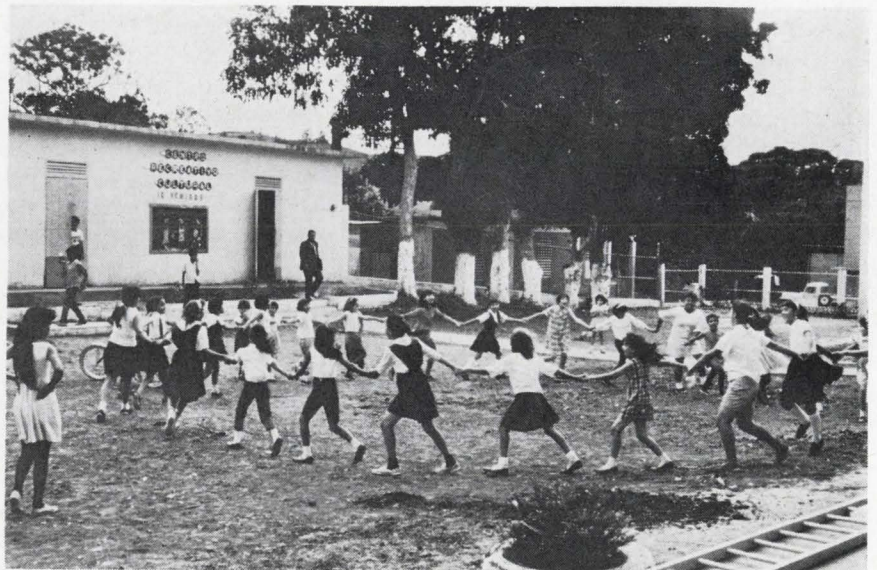

School days. Among other projects, the Federal Center's civil programs group is evaluating the state of the educational system in Puerto Rico.



Road show. IBM's Combat Service Support System, built around 360 computers, gets a rugged work-out over bumpy test course before delivery to the Army.

commercial divisions. "We may find that we're in a position to look ahead and will begin needling the commercial operation to get into new markets," he explains.

Civil servant. While most of the activity at the center is concerned with Federal military and space systems, one department is directed towards the systems needs of state and municipal governments. Slightly over a year old, the civil programs department is currently involved in a score of funded programs. The list includes two big projects—the Spring (special radio inquiry network) command-and-control system now being developed under a \$4.8 million contract for New York City's police department, and Press (Puerto Rican educational statistic system), which is being built under a \$2.8 million contract. Among others, the cities of Memphis, Nashville, and Honolulu as well as the states of Illinois, Wisconsin, and Michigan have awarded the center contracts for systems aimed at everything from paying employment benefits to storing data on highway projects.

Robert P. Crago, the center's director of civil programs, has a staff of 230. He's now trying to get into as many programs as possible to secure a "substantial contract base," and he cites four areas of principal interest: public administration, education information, medical information, and law enforcement.

In addition, many members of his staff are looking into ideas and techniques that might be applicable to the civil market. "We are checking the possibilities of looking at data in new ways, like computer-generated graphics to take information and transfer it to charts and maps," Crago says. He feels, for instance, that census data geographically displayed on maps could make for more meaningful population studies.

Sophisticates. Crago describes the center's move into the civil sphere as an attempt to make wider use of the experience gained in supplying the Federal Government with sophisticated systems. In the past, the smaller systems ordered by local governments were the province of the company's Data Processing department. "The nature of the market is changing, though," Crago says, "and the needs of local authorities are becoming much more sophisticated; we entered the picture to serve that kind of market."

Many masters

The largest directorate at the center works on operational-control systems. It's providing services and systems to various Federal agencies as well as doing advanced development work under contract or in-house.

At the moment, the center is running two major real-time computer systems for the National Aeronautics and Space Adminis-

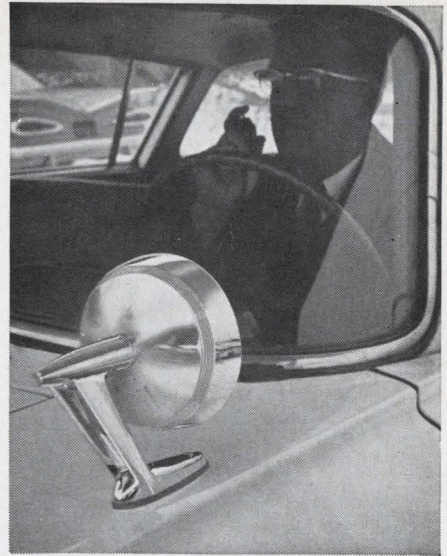

this is an antenna!

That's right! Concealed within this rugged rear view mirror is an omnidirectional V.H.F. antenna for the 148-174 Mc band. The Sinclair Mobile Mirror Antenna defies detection... prevents vandalism... eliminates special antenna mounting. Independent tests prove efficiency equal to — or better than a 1/4 wave whip. V.S.W.R. is less than 1.5 to 1 at design frequency. Clip the coupon for FREE literature, including test data and prices.

so's this

It looks — and mounts — like a standard car radio antenna. Yet it conceals a rugged V.H.F. two-way radio antenna for the 148-174 Mc band. Each Sinclair Disguised Whip Antenna is perfectly "matched" to your specific frequency. This exact matching, combined with a 2.5 db gain, insures greater efficiency than any other disguised antenna now on the market. Clip the coupon for FREE literature, test data and prices.



SINCLAIR RADIO LABORATORIES

FREE LITERATURE

TO: SINCLAIR RADIO LABORATORIES, INC.
676 Ensminger Rd., P.O. Box 23
Tonawanda, New York 14150

Name: _____
Title: _____
Company: _____
Address: _____
City: _____
State: _____ Zip: _____

All you need to know about relay rack panels is that BUD makes 141 different types and sizes in a choice of 7 finishes all delivered from stock. They are typical examples of a family of fine products and are available at your nearest

BUD

Distributor.

Write for Bulletin PA. 67



BUD RADIO, INC.
Willoughby, Ohio 44094

your product
Belongs in a BUD cabinet

... an advanced programs group checks computer-aided instruction systems ...

tration—a \$142 million complex at the Manned Spacecraft Center in Houston and an \$18 million setup at the Goddard Space Flight center. The Houston system collects, processes, and forwards to mission control all the information needed to direct Apollo flights. The Goddard system checks tracking and communications equipment in NASA's manned space flight network.

Another control system now in the testing stage is the Seismic Array Analysis Center in Washington. This center, built for the Pentagon's Advanced Research Projects Agency, uses IBM 360/40 computers to locate and classify natural and man-made seismic events. The computers receive their data from the Large Aperture Seismic Array system of 525 seismometers in Montana. By year's end, the SAAC system will be operating round the clock.

In another area, the Federal Aviation Administration is using the center to develop, integrate, and check out its near-real-time air traffic control system for installations at Atlantic City, N.J., and Jacksonville, Fla.

Added attraction

Larry Sarahan, who heads the operational-control systems group, sees many benefits in working in so many different areas. He says the SAAC job has refined IBM's knowledge of sensors and how they can be linked to computers for analysis, knowledge that might lead to applications in oceanology and geology. For NASA, Sarahan says, "we wrote the longest computer program ever for the lunar landing, and that extended our abilities in this area." He also points to experience being gained in ground-based operational control while evaluating an air-to-ground telemetry system for the General Dynamics Corp.

Educational. Sarahan also directs other activities, including an advanced programs group that's looking into computer-aided instruction and phased-array-radar programing. Sarahan would like to build up a fund of experience

in CAI; he estimates that such techniques will come into their own in eight to 10 years. The advanced programs unit has already sold CAI systems to the Naval Academy and the Army Signal Corps, and it's now negotiating an expansion of the Signal Corps contract.

Another element of the operational-control systems unit is the programing laboratory operating out of the Gaithersburg headquarters and Boston. This lab does the programing for the center and much of the advanced software work for the entire corporation. Sarahan says a good part of the lab's efforts are devoted to "the intriguing area of time-sharing," and that staff members are now looking at such advanced aspects as conversational modes. He adds facetiously: "If things continue the way they're going, the time will come when everybody in the world is a computer programmer. We're developing new ways to prevent that."

One unique aspect of the operational-control directorate is that it runs its own open technical symposiums. It has already sponsored a real-time systems seminar in Houston, and in September it will hold an information systems sym-

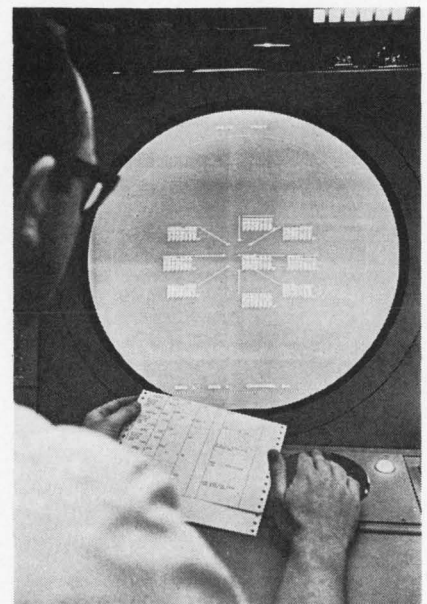

In the round. Federal Center prepares test programs and procedures for FAA systems; this display provides data on in-flight aircraft within control area.

posium in Washington to review, among other things, graphics, file processing, educational applications, and text processing.

Pentagon procurement

The command systems directorate, headed by Dan Ross, works in three areas: military information, tactical ground systems, and advanced systems. Among its bigger custom jobs for the military are: the Army's Combat Service Support System (CS3), the Defense Communications Agency's National Information Processing System (Nips), and the Joint Chiefs of Staff's Transportation Movement Planning System (Tramps).

The Tramps system keeps track of the transportation resources of all branches of the Armed Forces, while Nips is a key part of the National Military Command System, which gives users batch and real-time access to a number of files.

On the road. The CS3 is a data processing and communications system installed in trailer vans. Each CS3 unit is carried in four vans, and includes a 360/40 computer, an IBM 2314 direct-access storage unit, digital transmitting equipment, and maintenance support gear. The system keeps tabs on such tactically important facts as troops, equipment, and spare parts.

IBM is delivering its first CS3 units to the Army under an initial \$5 million contract, but sources estimate that the total purchase may eventually reach \$100 million.

Ross's group is also involved in classified command-and-control and intelligence systems for various Government agencies. Another directorate, the special systems department, is involved solely in projects for highly classified intelligence work.

Selective service. While all of the directorates are doing work under contract, none is seeking contracts for their own sake. Sarahan puts the center's philosophy this way: "We are primarily interested in doing work at the frontier of technology. If we just wanted to do jobs for people, we could be making a lot more money, but we are selective in the contracts we pursue and we leave the routine work to other companies."

BUD SERIES SIXTY

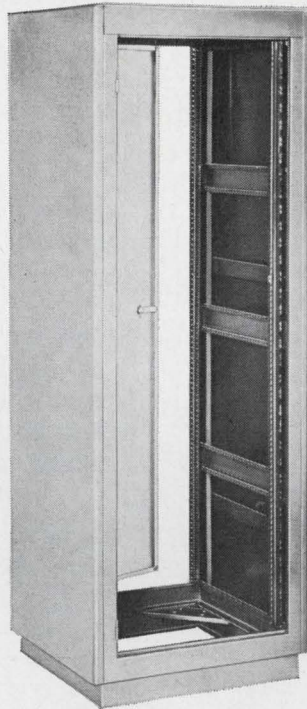

gives you

Reliability where it counts!

...and when*

I

CONSTRUCTION features all-welded steel frame with elements designed to provide a most rugged structure with exceptional load bearing capabilities. Each of sixty-eight sizes and types, completely factory assembled to allow for use immediately upon delivery.

II

DESIGN both durable in appearance, yet most practical and economical for housing electronic equipment or instrumentation systems. Affords utmost access for installation and service.

III

DELIVERY "off-the-shelf" from both BUD distributors' stock in your area and from the BUD plant. Buy when you need and get the delivery you want.

Doesn't this sound like Series Sixty Cabinets are the answer to many of your housing needs? We're anxious to tell you more about them or to have a BUD Distributor show them to you. Just ask us!



BUD RADIO, INC.

WILLOUGHBY, OHIO 44094

your product *Belongs* in a BUD cabinet.

Are you going to do something now about your identification problem?

If you're in the business of making things, you can't escape the business of marking things. And the business of identifying electrical and electronic components can be a messy (and costly) problem. But it doesn't have to be, with the right kind of help.

Markem can help by supplying the best machines, specialty inks, printing elements and other supplies you need. We can help by being there whenever you need service, whenever an operator needs training. But mostly we can help by coming up with new ways to give you better identification for less money. For example, we recently introduced an Instant Type Former which lets you make metal type in-plant, as needed. No waiting for delivery . . . you can form new type inserts in less than a minute by simply "dialing" the legend.

We can also show you how to combine sequential numbering with identification . . . how to print 14 characters plus trademark in an 0.125" diameter area . . . how to produce clear imprints on recessed, irregularly-curved and other difficult surfaces . . . how to safely mark flat-pack ceramic I.C.'s either in or out of carriers . . . how to color-band axial-lead components with up to 6 different bands at high rates of speed.

It doesn't cost a dime to have one of our analysts come to your plant to discuss your particular identification problems. His ideas could save you a lot of headaches. And a lot of money. Call your local Markem Sales office or Bernie Toomey at 603-352-1130. Write for our new "Problem Solver" booklet.

Markem, 305 Congress St.,
Keene, New Hampshire 03431.

MARKEM®

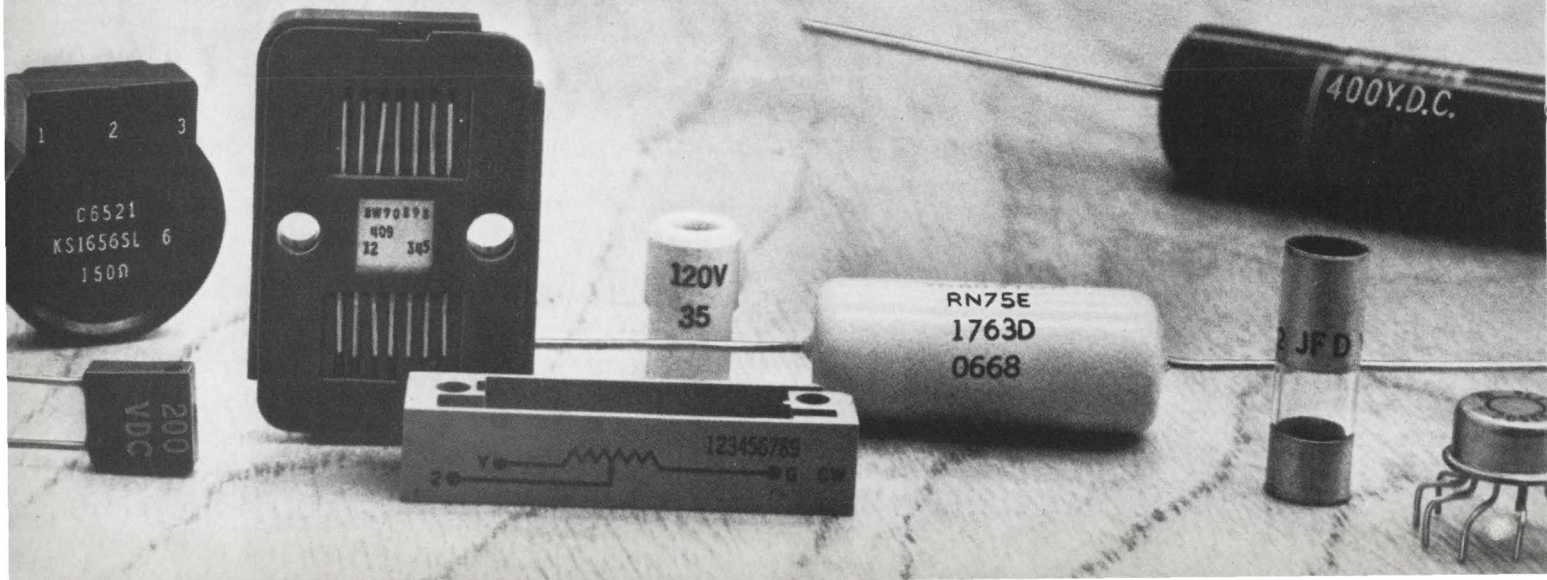

Air Force plans new weather monitor

Service will soon award definition contracts for airborne reconnaissance system that will collect and process twice as much information as present equipment

By James Brinton
Boston bureau manager

Air Force meteorologists are flying in the face of that old saw about the weather. They're planning to do twice as much about it as they're doing now. The service is laying the groundwork for a new Airborne Weather Reconnaissance System (Awars) that will collect and process data on about two times as many parameters as the equipment it will replace. Besides adding such prosaic measurements as dew point to the list of capabilities, Awars will probably be equipped to track clear-air turbulence and ionospheric disturbances. Data will be processed on-board with a general-purpose digital computer and relayed to ground stations, via satellites or high-frequency radio teletypewriter channels.

At the moment, the Electronic Systems Division (ESD) at Hanscom Field in Bedford, Mass., is poring over letters of interest from such prospective contractors as Bendix, Burroughs, Fairchild-Hiller, General Dynamics, Honeywell, IBM, Lockheed, LTV Electrosystems, TRW Systems, Sperry Rand, Martin-Marietta, and Motorola. After sending out requests for proposals, ESD will award two four-month systems definition contracts, which will begin in December. With definition completed by next spring, a purchase order for 24 systems could be signed in August; Awars would become operational in 1971.

Ante. Despite a general paucity of cash for military projects unrelated to Southeast Asia, Awars funding appears secure, according to an ESD source. Over-all, the program will cost \$44 million, and a good chunk of this is earmarked for electronics.

The money is available, says an ESD officer, because better flight

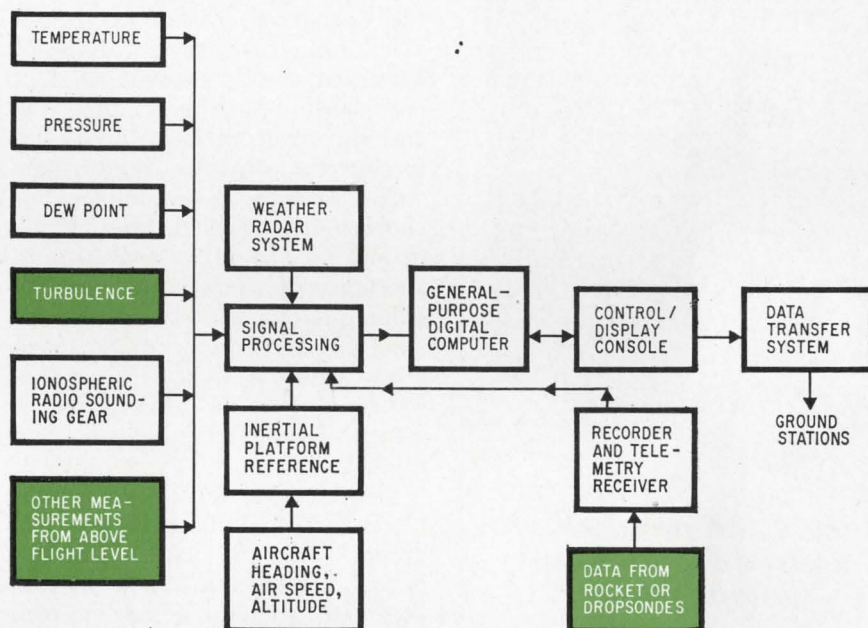

Best guess. Preliminary block diagram of airborne weather reconnaissance system shows potential growth items in color. Improved sensor techniques will permit system to monitor twice as many parameters as present gear.

forecasts are needed for the polar routes from the Far East to North America and Europe. In addition, the Atlantic hurricane-hunting effort needs to be upgraded. Finally, both the Air Force and the Pentagon are impressed by recent developments in the sensor field and are becoming more than a little impatient with the performance of the superannated AMQ-25 gear that's now flying. This system, carried aboard a fleet of WC-130's and WC-135's, uses some sensors that are 10 years old; information is processed in a modified version of the Air Force's Tactical Data Processing System (TDPS) —an IBM setup that dates back to the Eisenhower Administration. And the AMQ-25 is a minimum-cost retread of an even older system, the AMQ-19, which was carried by RB-47 weather reconnaissance aircraft

15 years and more ago.

Straw man. Satellites are available for monitoring, but weathermen have found that such spacecraft can't supply the kind of precise data needed for flight forecasts. "They can't spot pressure, temperature, and wind-velocity gradients in storms," says Capt. John F. Shunk, the Awars project manager at ESD. "We need this sort of information to determine whether a disturbance is growing or blowing itself out. Aircraft can go where the weather is, flying through it, above it, and below it to collect data that's valuable to meteorologists."

An official at NASA's Goddard Space Flight Center, which oversees a number of weather satellite programs, points out that it's probably unfair to compare the performance of reconnaissance planes

Buying Power?

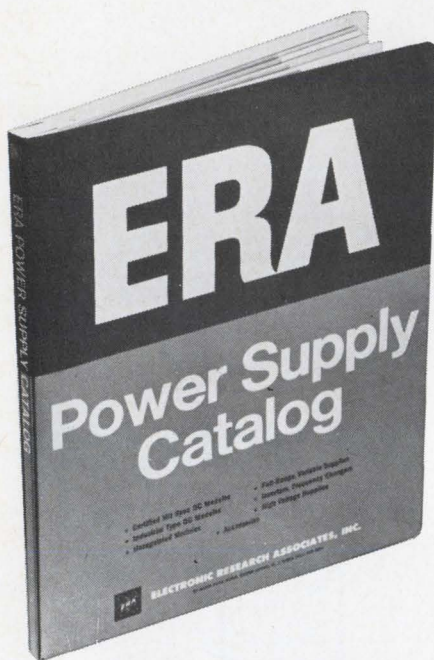

Here's the new, single source for all your power needs.

- Certified Mil Spec Transpac® DC Modules
- New Low-Cost Silicon Transpac DC Modules
- Full-Range Variable Supplies
- Inverters, Frequency Changers
- High-Voltage Supplies

**AC to DC • DC to AC
AC to AC • DC to DC**

Send for Your Free Copy TODAY!



ELECTRONIC RESEARCH ASSOCIATES, INC.

Dept. E-6-8, 67 Sand Park Road
Cedar Grove, N. J. 07009 • (201) 239-3000

Subsidiaries: ERA Electric Co. • ERA Acoustics Corp.
ERA Dynamics Corp. • ERA Pacific, Inc.

... ESD anticipates little trouble finding a computer for Awars ...

with that of such frankly experimental scientific spacecraft as Nimbus. Satellites, he says, are global systems designed to cover large geographic areas from points up to 620 miles above the earth.

Computer costs

Modernizing an aged system that had already been modified once held little appeal for the Air Force. For one thing, the not-too-bright TDPS limited the rate and type of data that could be assimilated; if new sensors had been added, the cost of converting their outputs into formats the computer could handle would have been prohibitive. For another, IBM showed little interest in making any more systems, and shortages of spare parts were becoming an acute problem. As a result, the Air Force decided to go ahead with the Awars idea, spending three years on studies at ESD's weather engineering division and other installations.

Shunk expects to have little trouble finding a computer for the program. "There are enough military-grade machines available so the contractor should only have to pick one off the shelf," he says. "Then we'll make decisions about memory size, the best means of analog-to-digital conversion, and so on. But none of this should push the state of the art or be costly. Sensor technology is an area where we hope industry will open a few doors," he says.

Storm center. One of Awars' more glamorous missions will be the detection and profiling of clear-air turbulence. Almost sure to fly aboard the first Awars-equipped aircraft is a simple real-time turbulence-measuring device developed, partly with NASA funds, by Meteorological Research Inc., Altadena, Calif. An ordinary pitot tube makes a quantitative measurement of turbulence—said to be a first—with an accuracy independent of airspeed. The system notes the output of the pitot tube's pressure transducer and filters out all frequencies except those between 2 and 50 hertz; amplitude at these frequencies gives a gage of turbulence.

"With a device of this type, we hope to develop a magnitude scale for turbulence cells," Shunk says. And since these cells retain their shape and strength for up to three or four days, moving with the wind, it could be possible to track or avoid them just like thunderstorms, he says.

Laser and infrared CAT detectors are also planned for Awars, but they will probably be later additions. ESD feels that about five times more range capability is needed to make them practical.

Another glamor mission involves ionospheric radio-frequency sounding. This would support the Eastern and Western Missile Test Ranges, providing sneak previews of down-range conditions so the best possible communications setups could be arranged.

Shunk says this sensor would be similar to those used at Cape Kennedy and Vandenberg Air Force Base. It would sweep a radio-frequency signal through bands of interest and note the amount of returned energy. The Institute for Telecommunications Sciences at Boulder, Colo., has the only sounder now able to furnish data in real time; it uses a Digital Equipment Corp. PDP-8S computer. Awars would use its on-board processor to yield an "ionogram" for relay to the ground.

Avoiding trouble

Awars may mean development of a new weather radar system, or at least a modification of the standard APN-59. Shunk says: "Conventional weather radars are designed to spot storms so they can be avoided, but we want to fly right in there. What we need is radar operating at wavelengths unattenuated by severe rainfall. At X band, the attenuation wipes us out."

ESD is investigating modified APN-59's that might use longer C- or S-band wavelengths to penetrate storms and spot centers of precipitation. But there's a tradeoff here, because information on the precise altitude of cloud tops and bottoms is needed by the Strategic Air Command and other agencies. SAC, for

example, often schedules in-flight refueling operations between two layers of cloud. To find this kind of "deck area," Shunk thinks, a Ka-band radar may be needed. With its short, centimeter wavelengths, it could be sensitive to the finest clouds.

"The ultimate radar might require as many as three wavelengths, retaining X band for long-distance work. But it would also be the ultimate in high price," says Shunk. "So we are telling the contractors to make tradeoffs using as much off-the-shelf gear as possible in their proposed designs."

At sea. Accurate determinations of wind at flight altitude are as valuable as they are hard to get. "Over land," says Shunk, "it's easy to compute your drift, and thus wind, by watching landmarks and navigational aids. But many air-weather missions are flown over water, where such precise navigation isn't possible."

ESD doesn't suggest any single sensor for this application; it would prefer a combination of the aircraft's doppler navigation system and instrument readings of heading, indicated air speed, and altitude. Also in the package would be an

inertial platform reference and the computer.

Shunk says the inertial platform could be very cheap, since the Air Force would be less interested in using it as a navigational aid than in picking its brain to spot such disturbing forces as wind. Precession caused by the push of the wind could be measured by an accelerometer and fed to the on-board computer. This reading, along with other navigational data, would give more accurate wind measurement than previously possible, he says.

All wet. Accurate measurements of so-called simple parameters like humidity are also difficult; for example, although temperature sensors are quick to respond, they can be inaccurate. As a case in point, Shunk cites humidity units. The 20-year-old standard is a sheet of glass, coated with carbon black. As humidity increases, the carbon absorbs moisture and its resistance changes; weathermen catch increases in humidity by noting a reduced voltage drop across the sensor. The trick, however, is getting the sheet to show reductions in humidity. "These things work so long as humidity rises, but if it's the other way around, you'll never know," says Shunk. "The carbon takes so long to dry that readings are meaningless."

"The response time is slow, too. It doesn't work with electronic speed. We want a new generation of parachute dropsondes that can relay data back to the plane every second rather than every 12 seconds like those used today."

Awars will mark the first time a dew-point sensor has been flown in an operational weather aircraft or dropsonde, says Shunk. This technology should be pretty well in hand—ESD is getting, from the Air Force Cambridge Research Laboratories, dew-point sensors with quick response times and good accuracy. The typical response is 100° per minute for dew points between 15° and 30°.

Soundings

The parachute sonde is also a problem for Air Force meteorologists. "Drop one into a storm cloud, an area from which you want information badly, and usually the telemetry shorts out," gripes Shunk. He notes that this is true only



Critic. Capt. John F. Shunk, Awars project manager, is dissatisfied with state-of-the-art dropsondes

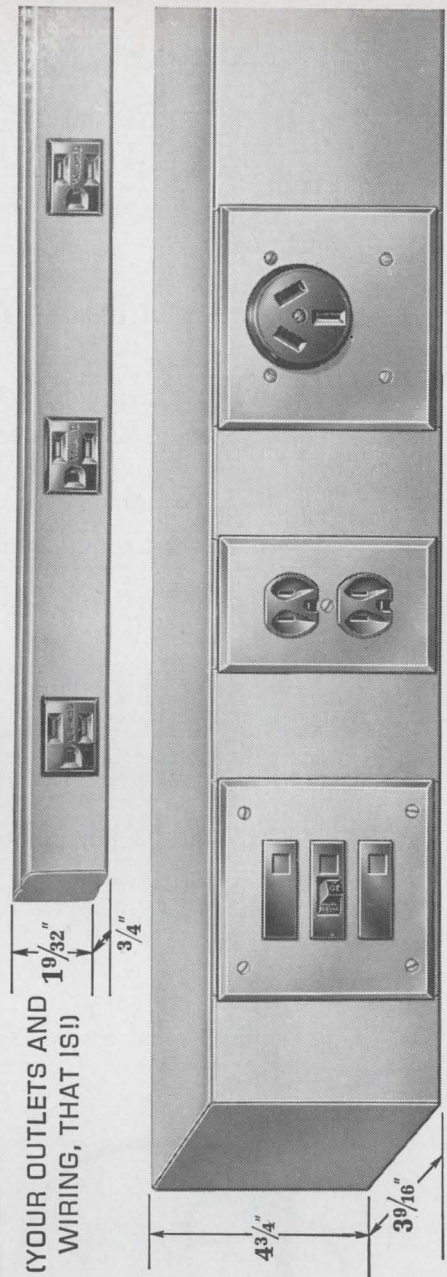

ORGANIZE!

PLUGMOLD® MULTIOUSET SYSTEMS offer a versatile efficient way to organize electrical wiring and devices of all kinds. Build Plugmold into the products you design. Use it in lab and production areas.

Rugged, attractive Plugmold—in a variety of sizes—accommodates 14 to 2/0 AWG wire, devices to 60A, circuit breakers to 100A. U.L. listed. Send for bulletin.



THE WIREMOLD COMPANY / HARTFORD, CONNECTICUT 06110

CRYSTAL Quips

Wow! Topless! Who's the sexy new crystal?

Shhh. She's very sensitive—heart of an incredibly accurate electronic microbalance.

She holds tiny samples and measures changes in weight as oxygen and light attack them.

So?

She helps determine aging effects in a matter of hours instead of months.

Always knew a naked crystal could do a lot for this business!

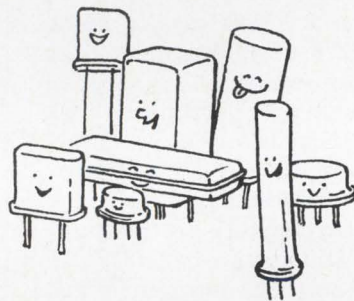

Why don't
you call up
and **SPEC** me
sometime?

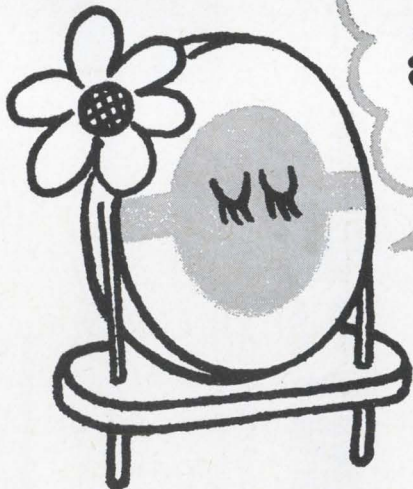

*Topless... solderseal... coldweld—you spec it,
Reeves-Hoffman makes it for you. Crystals...
filters... oscillators. Let us quote.*



REEVES-HOFFMAN

DIVISION, DYNAMICS CORPORATION OF AMERICA
400 WEST NORTH ST., CARLISLE, PENNSYLVANIA 17013, 717/243-5929

when you can get the sonde to drop in the first place. All too often, a sonde gets stuck in the dispenser and can't be dislodged. "Awards should include a manual loading and dropping facility for sondes," Shunk says, "one located within the cabin, where such tiny mechanical problems can't plague us."

Another type of sonde, the high-altitude probe, is also a big part of the Awards growth plan, although its design is being left to contractors. "We want to measure the temperature of the atmosphere to 200,000 feet and try for a profile of atmospheric densities and temperatures between 200,000 and 400,000 feet," says Shunk. Missile ranges need data, he notes, to determine ballistic coefficients during tests of re-entry vehicles and to calibrate for ablation studies.

Shunk calls this a high-risk part of the program, meaning that the ionospheric probe is a possible dropout if it proves too costly or impractical. "We've tried suspending rockets from balloon, ejecting the rocket from the plane," he says. "But so far we've had trouble reaching altitude. Balloons themselves are out of the question; they're good for only about 100,000 to 120,000 feet."

There's also the question whether the instruments in the rocket would respond quickly enough to take the readings, especially temperature. But getting the instruments up there in the first place is Shunk's prime worry; he won't even rule out small cannon to fire projectiles out the top of the fuselage. The WC-135 is a tough aircraft, he says.

Down to earth. Communications satellite channels should be available by the time Awards is operational, but whether Awards priority will be high enough to get them is an open question. Thus, ESD is asking potential contractors to evaluate both conventional high-frequency radio and microwave-frequency satellite communications systems.

"We might have to take a back seat to almost everything else," says Shunk, "but once we wondered if we would even get the money to fund Awards to this point. So far, ESD has been more conservative about the importance of Awards than the air staff, so we might just get satellite channels too."

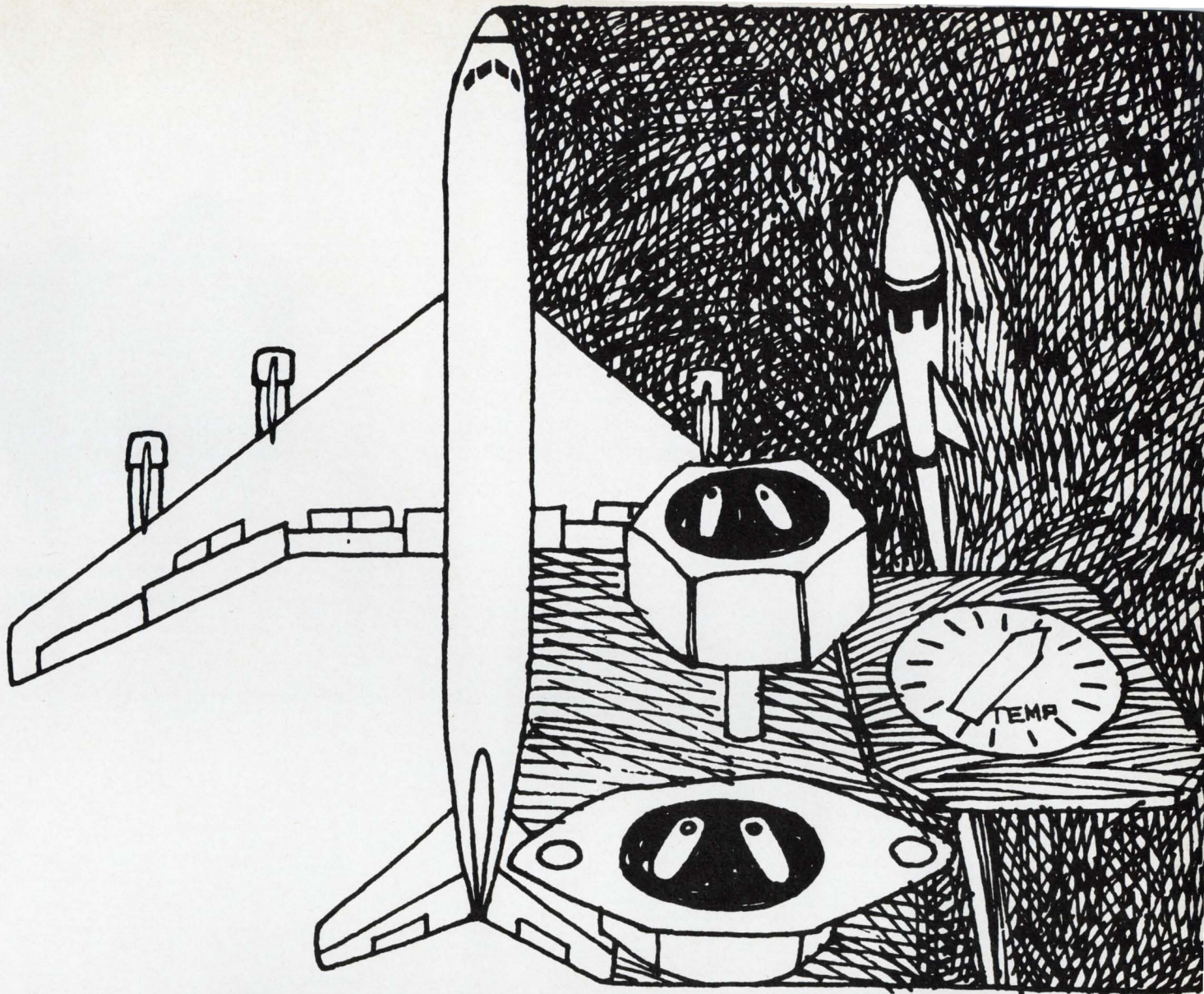

protect

Protect your critical functional systems against damage from temperature changes—whether in aircraft, missiles, space vehicles, military ordnance, aerospace ground equipment or industrial equipment. It's a snap, with United Control's inherently simple, snap-acting, bimetallic disc thermal switches. Refined and perfected to put maximum emphasis on precision, reliability and flexibility of application. For more information, call or write United Control.



UNITED CONTROL

A SUBSIDIARY OF SUNDSTRAND CORPORATION
REDMOND, WASHINGTON 98052 · PHONE (206) 885-3711

DOUBLE THRESHOLD TIME DELAY

Magnetic circuit breakers permit accurate and reliable control circuits. The circuit shown allows an adjustable time delay responding to the average, (average, not rms) value of an overload, no trip below rated current, a time delay between 100% and 200% of rating, essentially zero delay above the adjustable limit. A 1/2 volt input corresponds to 100%. 1 volt input corresponds to about 200%. Between these limits time delay is furnished by C1-R2. R1 adjusts the first threshold, the 100% point.

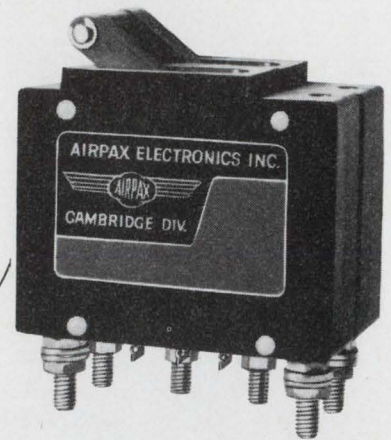

Double Pole Breaker
Type APL 14-R

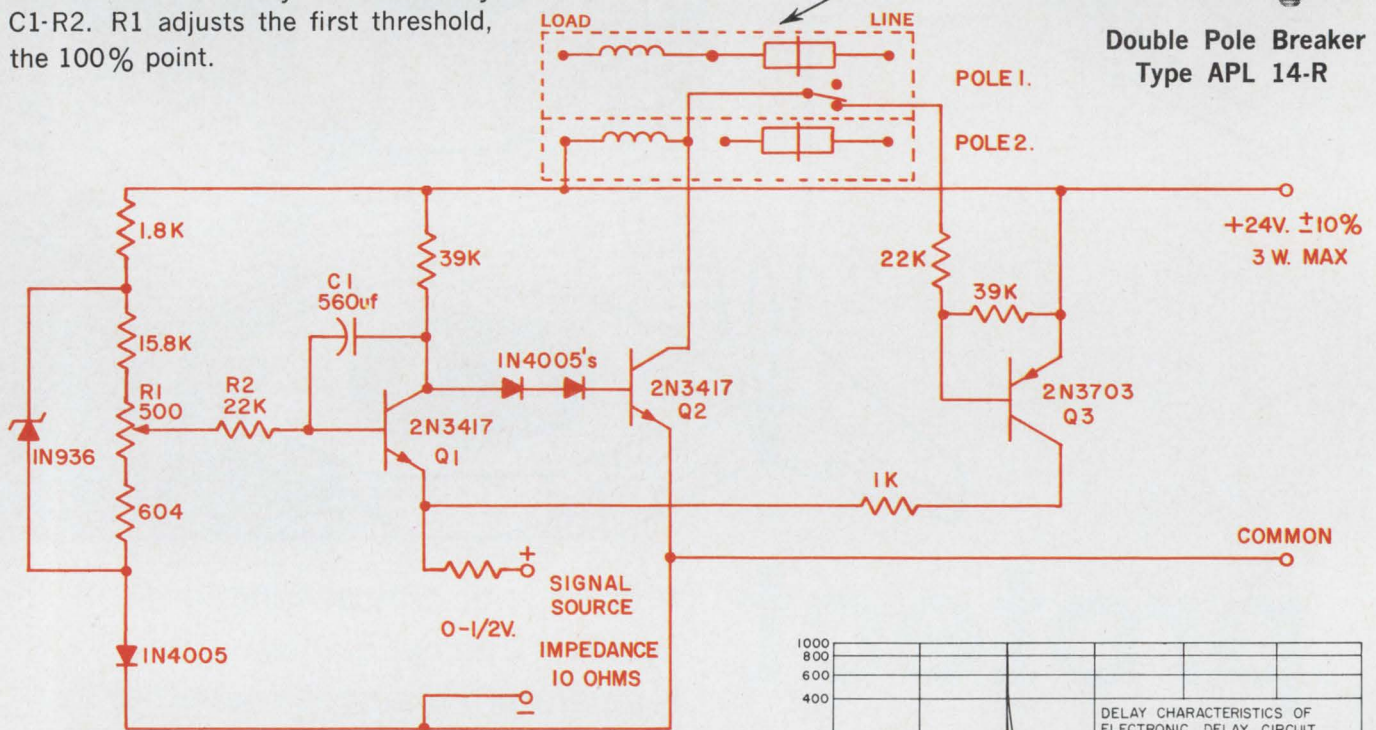

Electronic time delay circuit

Double threshold characteristic curve

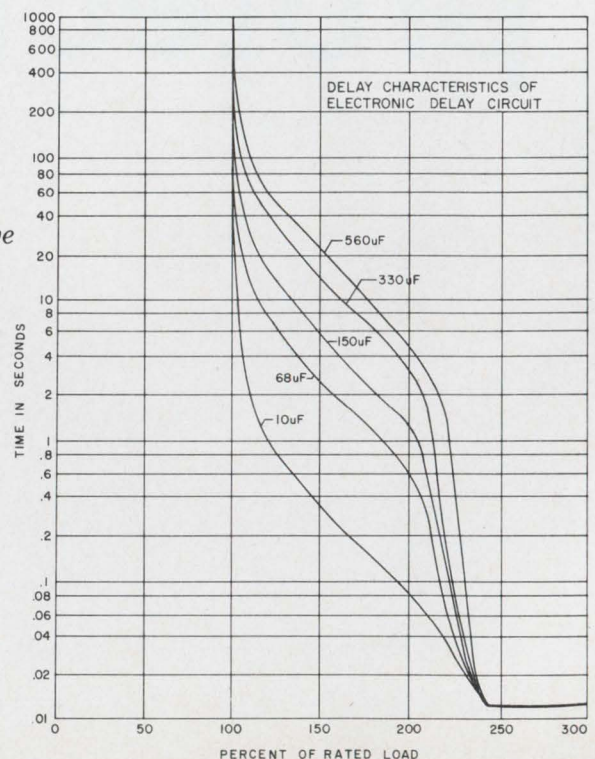

For further information on Airpax breakers, contact

**AIRPAX
ELECTRONICS**

Cambridge Division, Cambridge, Maryland 21613

Phone (301) 228-4600

TWX 710 865-9655

TELEX 8-7715

New Products

Microwave

Gunn-effect oscillators aim at klystron markets

Three companies are readying continuous-wave, gallium-arsenide devices for autumn introduction, but some observers believe the move is premature

By autumn, solid state, continuous-wave Gunn-effect oscillators will be available off the shelf from at least three U.S. sources—Varian Associates, Texas Instruments, and RCA. Touted as potentially economical and reliable replacements for klystrons, the devices are designed for use in electronic counter-measures gear, radar and low-power transmitters, police communications equipment, and even burglar-alarm systems. However, largely because of the difficulties involved in working with gallium arsenide, some observers feel the sales push may be premature.

Undaunted, the three are going ahead with plans to develop volume outlets for their wares. Varian, for example, is introducing four mechanically tunable Gunn-effect oscillators operating in the X, Ku, and K bands [Electronics, March 18, p. 54]. The X-band device, called the VSX-9001, has a frequency range from 9 to 12.4 gigahertz and a maximum power output of 25 milliwatts; it operates on 8 volts at 350 milliamps. In the Ku-band series, the VSU-9002 has a range of 12.4 to 15 GHz, a minimum power output of 20 mw, and a typical voltage of 7 volts; the VSU-9003, with a 15-to-18-GHz range, has a minimum output of 15 mw at a typical voltage of 6 volts. Finally, the K-band (VSK-9004) assembly operates at 18 to 26.5 GHz with 10 mw minimum output at a typical voltage of 4.5 volts.

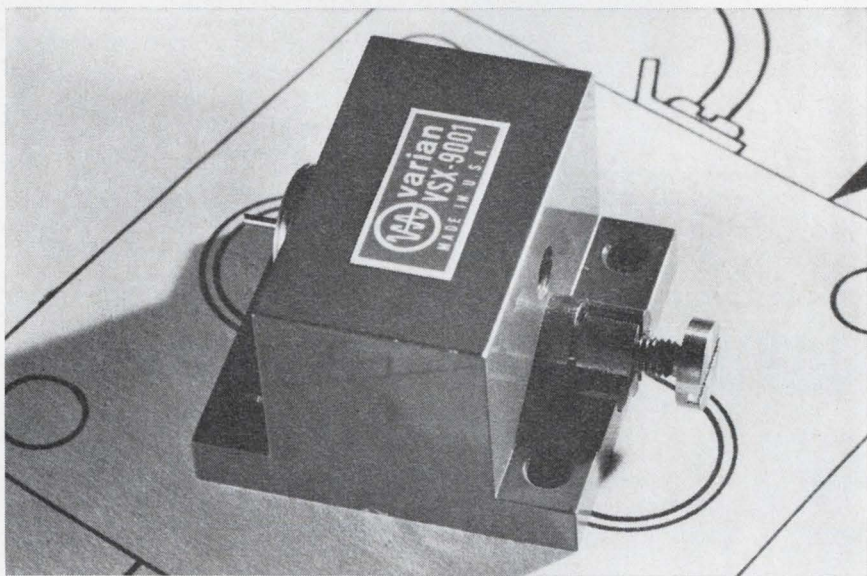

By design. This X-band continuous-wave local oscillator is one of four mechanically tunable gallium-arsenide units made by Varian Associates.

The Ku-band and K-band devices have a typical current of 300 ma; all of the units have a mechanical tunability of 1,000 megahertz.

Samples. For some months now, Varian has been distributing pre-production versions of these oscillators in small lots for experimental use and evaluation by customers. The decision to go into full-scale production is a recent one.

Likewise, TI has been quietly making and selling small lots of a series of Gunn-effect oscillators, operating in the 4-to-18-GHz range, for the past eight months. Prelim-

inary performance specifications, says A.C. Rowe, TI's marketing manager for microwave products, include up to 100 mw of c-w power and a tuning range of more than 10%. The company expects to be tooled up for volume production some time in September, and is now writing firm performance spec sheets.

RCA prefers to call its X-band unit, which was announced this spring, a transferred-electron oscillator. Chester Gurwacz, market planning manager for the company's microwave solid state de-

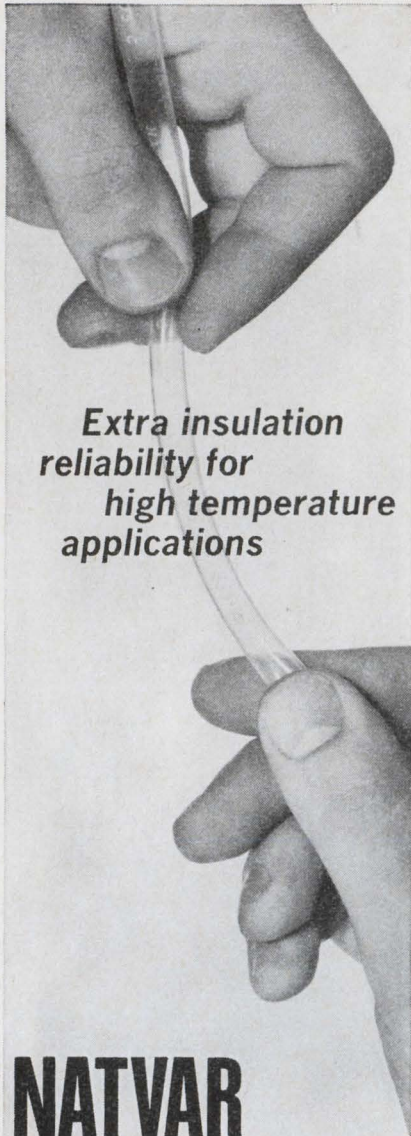

**Extra insulation
reliability for
high temperature
applications**

NATVAR 400 Vinyl Tubing

Here's an insulation you can rely on when the heat's on. Because Natvar 400 vinyl tubing has excellent thermal life. In fact, it's U.L. recognized for 105°C continuous operation. Besides that, it has exceptional resistance to oils.

Use Natvar 400 high temperature vinyl tubing to insulate leads... terminations... wiring... electronic equipment... oil filled transformers... harnesses.

Available in a wide range of sizes and colors—in continuous lengths or cut pieces. Send for FREE samples and complete technical data.

NATVAR CORPORATION
P. O. Box 67, Rahway, New Jersey 07065

... avalanche diodes are superior to Gunn-effect devices in certain cases ...

vices group, says the RCA designation is less limiting than the Gunn effect tag. "As new types of microwave oscillators are readied for commercial applications, we can bring them to market under the TEO banner," he explains.

Unlike the tunable Varian and TI devices, RCA's oscillator is a fixed-frequency unit. Gurwacz dismisses the difference as simply a matter of packaging. The RCA devices operate at 9 to 10 Ghz, but according to Fred Sterzer, director of the firm's microwave applied research lab, devices have operated as high as 15 Ghz in the lab.

Where it's at

"Diode preparation is the key to producing GaAs Gunn-effect c-w oscillators," says Berin Fank, manager of Varian's solid state microwave operation. He believes his company has opened a lead over the opposition because of a proprietary method of bonding the 4-mil-square GaAs chip to its heat sink. Such technology is a prerequisite for devices that will operate over a wide range of temperatures with high-power—2 to 3 watts—inputs.

Both RCA and TI use mesa bonding techniques, which Fank claims significantly reduce the bond area between chip and stud, and permit operation only at relatively low-power levels where little heat is expected.

RCA's Sterzer dismisses such criticism out of hand, noting that on a single chip there may be as many as 1,000 mesas. Since each mesa has its own surface area, more heat can be dissipated by a device made this way than from one processed with solid bonding techniques, he says.

TI's assemblies are similarly fabricated from an epitaxially grown GaAs $n^+ n^- n^+$ sandwich. According to Rowe, the company went to mesa bonding to minimize noise fluctuation. High-temperature, tinless alloy contacts are used to assure long device life.

Dissent. James Cauger, manager of semiconductor marketing at Microwave Associates Inc., takes a go-slow attitude toward off-the-

shelf Gunn-effect programs though he expects his company to be producing evaluation lots of such devices within six months. "Selling these things on a true commercial basis can be dangerous," he says. "Evaluation quantity orders are relatively safe, but if the engineering sample you sold last month gets designed into a system requiring thousands of devices, you're in trouble. There just isn't enough good gallium arsenide to meet such demands, and that's true regardless of the company selling the diodes."

Vested interest. Nor, for somewhat different reasons, is the Raytheon Co.'s Micro State Electronics Co. subsidiary convinced of the viability of GaAs Gunn-effect devices. Wesley Matthei, research and development manager, says pure GaAs crystals are too difficult to work with in terms of yield. Micro State is pinning its hopes on GaAs avalanche diodes operating in the 8-to-12-Ghz range and already in production. "These devices have transit times comparable to those of Gunn-effect assemblies, but they can operate in higher-power applications," Matthei asserts.

RCA's Sterzer agrees with Matthei in this respect. "For certain lower-frequency applications, the avalanche diode is superior to the Gunn-effect device," he says. "They're easier to work with and generate more power. But they don't perform as well in the higher frequency ranges."

However, TI believes Gunn-effect devices have great potential, right now, as low-power local oscillators. Rowe says that up to 30 mw, Gunn devices beat out the avalanche types because they feature noise ratios 10 to 20 decibels lower. "Somewhere between 30 and 50 mw, however, they cease to become practical," he concedes.

A joyful noise

Varian describes the output of its Gunn-effect devices as exceptionally noise free. The frequency-modulation figure, though not quite as good as that of a reflex klystron, is acceptable for most applications; the amplitude-modulation level is



Brass 70-30; 12" diameter, .35" blank
One draw • 12,000 psi



Aluminum 5257-0;
12" diameter, .035" blank
One draw • 5,000 psi



Stainless Steel 304;
12" diameter, .030" blank
Two draws • 14,000 psi



Cold Rolled Steel; 22" diameter, .024" blank
One draw • 7,000 psi



Aluminum 6061-0;
12" x 6 1/2", .062" blank
One draw • 10,000 psi



Stainless Steel 302;
7" diameter, .020" blank
One draw • 10,000 psi

PROFIT MINDED?

Perfection Mica's Hydroforming Service will economically and accurately form your metal parts to any size or shape . . . with minimum scrap and low tooling and finishing costs. Even difficult shapes of metal are formed easily. (A few typical examples are illustrated above). Equally efficient for high or low volume production runs . . . plus the quick changeover and low set-up charges traditional with hydroforming. Centrally located in the midwest for rapid delivery and low shipping costs.

If hydroforming fits your needs, send us your drawing and we'll fabricate to your requirements.

PERFECTION MICA COMPANY

1322 N. Elston Avenue, Chicago, Illinois 60622
Phone 312, EV 4-2122. TWX 910 221-0105.

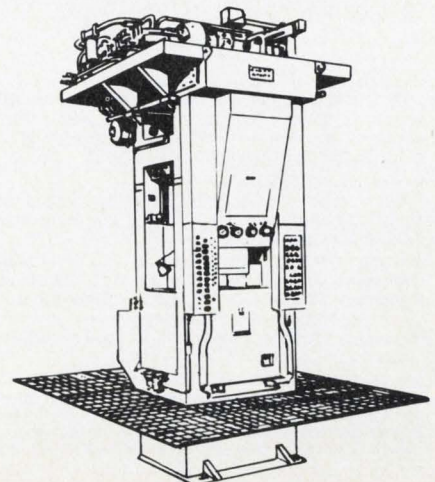

Something new under the sun!
Bissett-Berman E-CELL® Timers

UNDETECTABLE E-CELL* TIMER WON'T TICK, HUM OR RADIATE

Problem: Arm or safe an ordnance device using self-destruct or self-sterilize methods with precision components that emit no sounds or electromagnetic energy. **Solution:** Use an E-CELL timing component in an all solid-state circuit (see schematic) and your timer will have no moving parts, mechanical functions, or energy radiation. When the pre-set interval has elapsed (it could be anywhere from seconds to months), the E-CELL will deliver an output signal in the 1-volt range. Your complete timer will occupy less than one-half cubic inch of space, will consume only microwatts of power, will work in hostile environments, and will work every time!

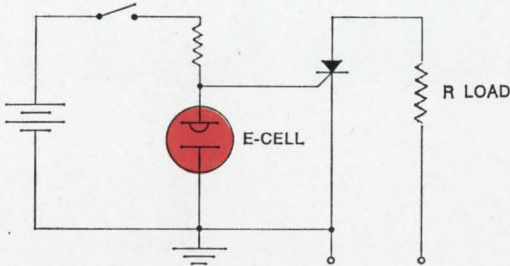

* E-CELL timers are used in many of today's advanced ordnance weapon systems. E-CELL timers are also ideally suited for scuttling sonobuoy transmission, in addition to many industrial control applications. Patents applied for.

Environmental Tolerance

E-CELL devices have been tested and approved by users for severe shock and vibration tolerance, and are designed to meet or exceed the following requirements:

Altitude: MIL-STD-202C, Method 105C Test Condition B.

Ordnance: MIL-STD-303A, 304, 306, 314, 358, 828, etc.

Airborne: MIL-E-5400, MIL-E-5272, Procedures I, II, VIB, etc. and air drop, hi-shock service.

Marine: Requirements for air-dropped sonobuoy use.

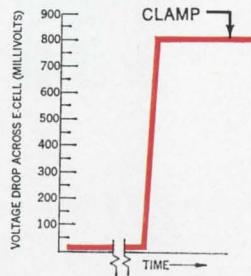

Actual size

on a par with that of the tubes. For example, with a separation of 100 khz from the carrier and with a 1-khz bandwidth, f-m noise is 20 hertz and a-m noise is 120 to 130 db down from the carrier. On a comparable basis, the f-m noise in a klystron is 1 to 10 hertz.

Gurwacz says RCA's transferred-electron oscillator appears to have better f-m and a-m noise characteristics than klystrons "on the basis of limited test data." TI's preliminary specs for its preproduction models show less than 10 hertz f-m noise at 10 khz from the carrier with a 1-hz bandwidth; a-m noise is 130 db below the carrier at 10 khz with a 1-khz bandwidth.

Proving ground. While the early returns are encouraging, the makers of Gunn-effect devices are wary in their assessments. "We have to show our customers that the life expectancy and reliability of these assemblies is equivalent to that of klystrons in quantities of 1,000 to 10,000 before we get them into sockets," says Varian's Fank. "Users are reaching for these features along with lower voltages, smaller packages, and attractive prices." Klystrons have been life-tested up to 20,000 hours.

TI agrees that the lack of reliability data has been a limiting factor in the marketing of its GaAs units, but it says it recently completed a 1,000-hour life test of more than 100 devices. At RCA, 3,000-hour checks have been run on devices mounted in a standard varactor package. "However, it's far too early to start talking about guarantees," says Gurwacz. "The only thing we'll warrant is that the device will work."

Pretty penny. The prices on the GaAs c-w oscillators are still way out of line with the \$125-to-\$175 going rate for klystrons. In quantities of one to four, for example, Varian's "complete-package-source" devices will sell for \$500 to \$800. RCA is pricing its preproduction transferred-electron oscillators at around \$1,000 a piece. Eventually, however, as vendors increase production runs and outlets expand, price tags will come down. Varian expects to get its prices below those of klystrons within two or three years, and TI is shooting at a unit price of \$75 to \$100 for 10mw X-band devices.

For technical information and application notes, contact: Component Division, The Bissett-Berman Corporation, 3860 Centinela Avenue, Los Angeles, California 90066; Phone (213) 390-3585.

**BISSETT
BERMAN**

Moving air is easy . . . controlling it takes an expert



Clearing a path in traffic is seldom a problem for the trucker who has mastered the dock-walloper's whistle. Ear-splitting in its audibility, that shrill, sharp blast says "Move it Mac" with an authority few mortals would care to dispute. It figures. Anyone capable of channeling air with such finesse has little trouble communicating with even the most literal-minded audience. Take Torrington's team of engineers. When it comes to controlling the movement of air, they're experts at making themselves understood. The language they talk is pure CrossfloTM, centrifugal, vane- or tube-axial. Got a big or small air flow problem requiring straight interpretation? We've got the specialists to help you. The Torrington Manufacturing Company.

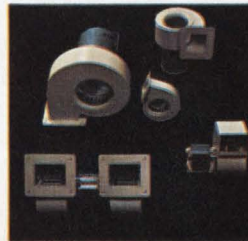

TORRINGTON

United States: Torrington, Conn./Van Nuys, Calif./Rochester, Ind. **Canada:** Oakville, Ont. **England:** Swindon, Wilts. **Belgium:** Nivelles **Australia:** Sydney

Circle 161 on reader service card

from dc to 3 GHz
with only
one plug-in

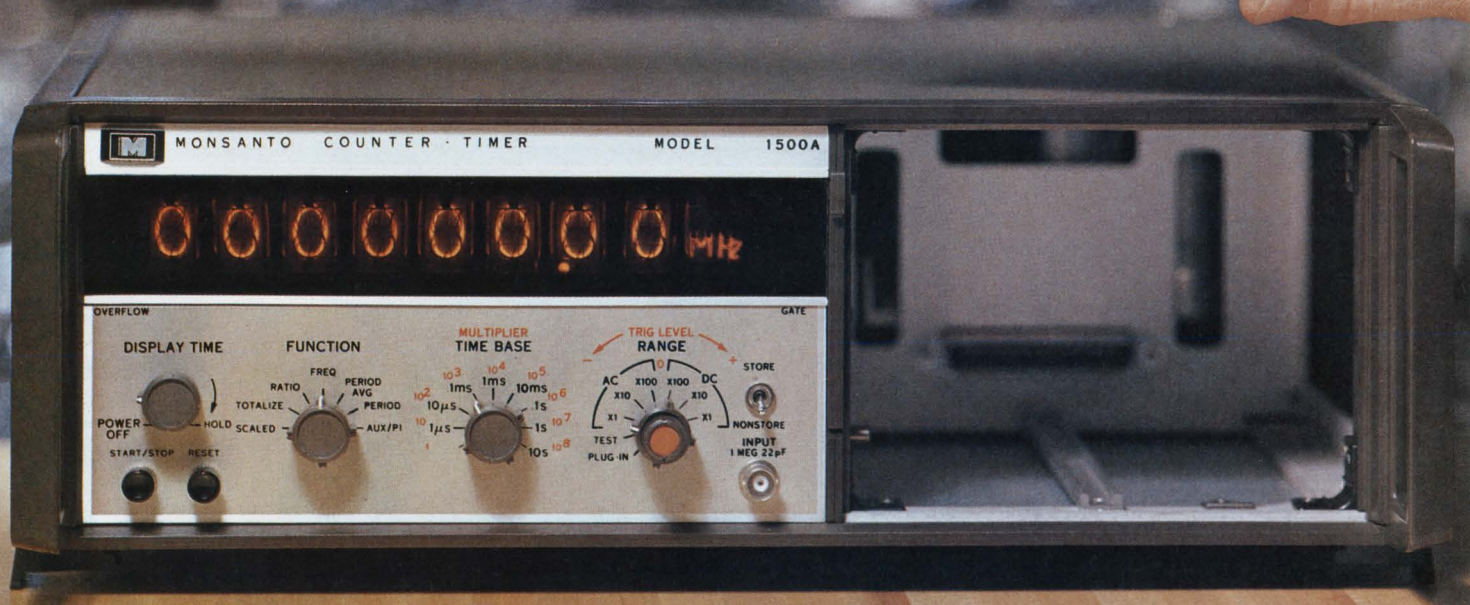

Shown above: Model 1104B 3 GHz frequency converter plug-in. Also available: Model 1100A uncommitted plug-in; Model 1102A 6-digit preset plug-in; Model 1103A 500 MHz frequency converter plug-in; Model 1107A time interval plug-in.

This New "4th Generation" I.C. Plug-In Counter/Timer Outperforms All Others ... And Will For Years To Come!

Why compromise for less . . . the Model 1500A has a main frame counting range from dc to 125 MHz (to 3 GHz with a single plug-in) . . . full programmability as a standard feature . . . well recognized advantages of Monsanto's "4th generation" 90% integrated circuit design . . . provision for external time base up to 10 MHz . . . plus a number of other significant features. Unparalleled performance plus award winning design make the Model 1500A the ultimate counter for the no-compromise

engineer. Price \$2850. Other models of the 1500 Series offering a wide selection of features and capabilities begin at \$1695.

Most engineers take Monsanto's reliability for granted because of our 2 year warranty. But, just in case, we maintain 36 Service Centers located strategically throughout the United States and overseas.

Call your local Monsanto field engineering representative for full technical details, or contact us directly at: Monsanto Electronics Technical Center, 620 Passaic Avenue, West Caldwell, New Jersey 07006. Phone: (201) 228-3800; TWX 710-734-4334.

Price for main frame only, in U.S. dollars, f.o.b. West Caldwell, New Jersey.



ELECTRONICS

Circle 162 on reader service card

New Components Review

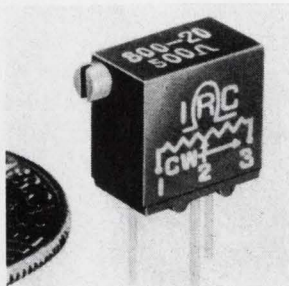

P-c wirewound trimmer type 800 incorporates a diallyl phthalate housing that minimizes the moisture seal length to assure protection from common industrial cleaners and solvents. Resistance values range from 10 ohms to 20 kilohms, $\pm 5\%$ tolerance. Rated 0.6 w at 70°C, the trimmer operates from -65° to $+150^\circ\text{C}$. IRC, Div. of TRW Inc., 401 N. Broad St., Philadelphia. [341]

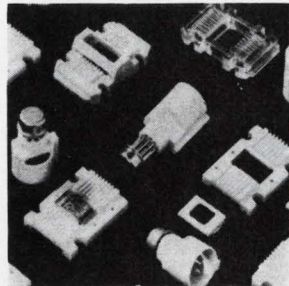

IC carriers for flatpacks and TO-5's are molded of polysulfone material. They can be used in shipping and testing of IC's over a temperature range of -65° to $+150^\circ\text{C}$. The flatpack carriers accommodate 14-lead units of various standard sized packages. The 8 and 10 lead TO-5 carriers are socket-type units. Gibson-Egan Co., 34 LaPorte St., Arcadia, Calif. 91006. [342]

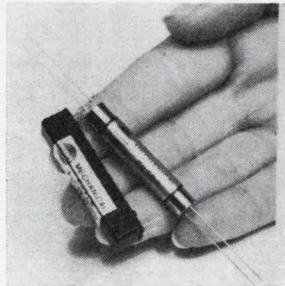

Mechanical filter, called minifilter, comes in 2 packages: cylindrical brass (F455T-150), measuring approximately 0.08 cu. in.; and rectangular plastic (F455W-150), measuring 0.15 cu. in. Center frequency is 455 khz. Bandwidth is 15 khz at 6 db and less than 30 khz at 60 db. Passband ripple is 2 db max. Collins Radio Co., 19700 Jamboree Rd., Newport Beach, Calif. 92663. [343]

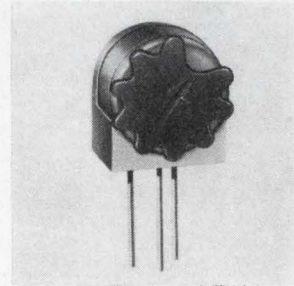

Single-turn industrial wirewound adjustment pot model 3365W-1 (RC)T comes in a thumbwheel configuration. It measures $\frac{1}{2}$ in. diameter by less than $\frac{1}{4}$ in. It has a standard resistance range of 10 ohms to 50 kilohms, a power rating of 1 w at 25°C, and an operating temperature range of -55° to $+125^\circ\text{C}$. Bourns Inc., 1200 Columbia Ave., Riverside, Calif. 92507. [344]

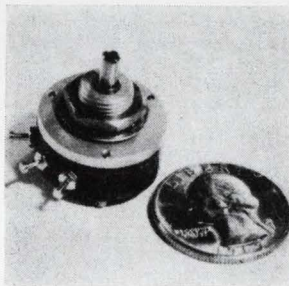

Precision potentiometers have a maximum starting torque of 0.01 in.-oz and are available in resistance values ranging from 500 to 5,000 ohms. They feature precision ball bearings and a dual wiper. Power rating is 1 watt at 70°C. Price is \$29, with quantity discounts available. Delivery is 30 days. Engineering Measurements Co., P.O. Box 346, Boulder, Colo. 80302. [345]

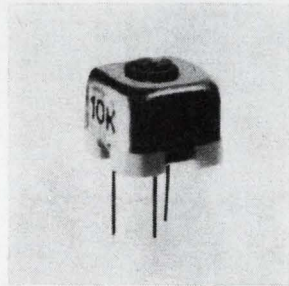

Single-turn, rotary cermet trimmer series 340 measures $\frac{1}{4} \times \frac{1}{4} \times 0.220$ in. It has top adjustment and resistance range of 50 ohms to 500 kilohms with $\pm 20\%$ standard resistance tolerance. Power rating is $\frac{3}{4}$ w at 25°C or $\frac{1}{2}$ w at 85°C. Applications are in industrial and military fields. Price is \$1.25 each in 1,000 quantity; 93 cents in 50,000 lots. CTS of Berne Inc., Berne, Ind. [346]

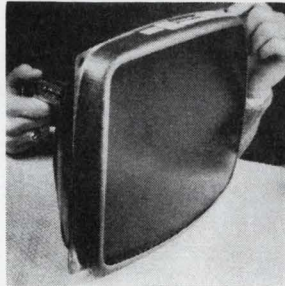

Twelve-in. rectangular crt WX-30886, with laminated panel implosion protection and integral mounting shell, is for computer displays and monitor applications. It features 110° magnetic deflection and low-voltage electrostatic focus. Maximum line width is about 0.015 in. The tube can be mounted in any position. Westinghouse Electric Corp., P.O. Box 284, Elmira, N.Y. 14902. [347]

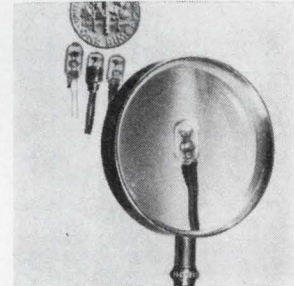

Subminiature T-1 $\frac{3}{8}$ neon lamps feature a tiny envelope size and ring-electrode construction allowing maximum brightness when viewed from the end. Starting voltage is 90 v ± 10 v; operating voltage, 7 v ± 5 v; cathode current, 1 ma max.; light-intensity, 60 lux; life expectancy, 10,000 hours; 110 v series resistance, 47 kilohms. Alco Electronic Products Inc., Lawrence, Mass. [348]

New components

Photocell sensitive to ultraviolet

Two-terminal device is made by depositing thin film of zinc sulfide; resistance peaks at 3,700 angstroms

Besides lotions, lunches, blankets, and radios, the beach-bound sunbather of the future may also tote along a sunburn meter to measure the sun's ultraviolet rays and tell him when to roll over or cover up. Designers have been thinking about this type of meter for years, but no

one has ever marketed an inexpensive ultraviolet detector. Now, though, the Clairex Corp. is doing just that.

Keeping watch on the summer sun is just one use that's been suggested for a new photocell that Clairex says is the first cell directly

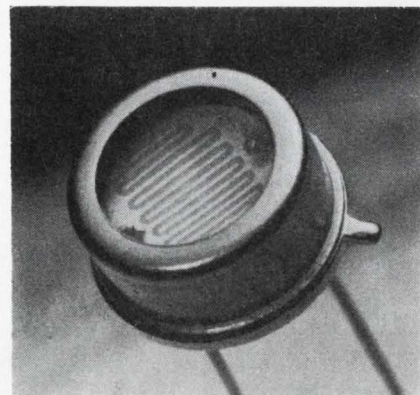

Eye for ultraviolet. Incident light can raise cell resistance a thousand fold.



KROHN-HITE

0.001 Hz to 100 kHz

1966
\$850

Model 4000



0.01 Hz to 1 MHz

1967
\$550

Model 4100

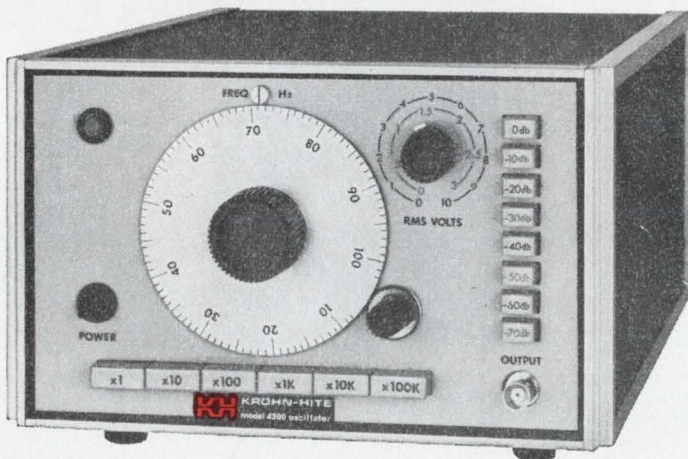
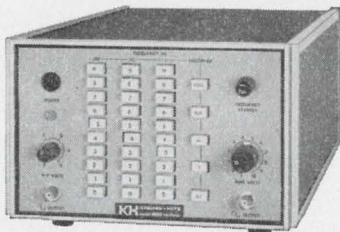

10 Hz to 10 MHz

1968
\$350

Model 4200: The newest addition to the family of K-H Quality Oscillators.

The 10 Hz to 10 MHz Model 4200, the newest (and lowest cost) member of the new family of Krohn-Hite all solid-state oscillators, performs as well as or better than competitive units costing as much as \$250 more! This proves that Krohn-Hite quality instruments do not necessarily have a high price tag.

Here's a general purpose oscillator that spans 10 Hz to 10 MHz with a frequency response so flat that a panel meter isn't necessary. Add to that — the half-watt output is available all the way to 10 MHz! That's not all — the amplitude stability is better than 0.1%/20 hours, the distortion is less than 0.1%, and the frequency response is within 0.025 db.

Pushbuttons provide 10-db attenuation steps for rapid, easily resettable control of output level. A vernier is provided for levels within the 10-db steps.

Write for Model 4200 data.



580 Massachusetts Ave., Cambridge, Mass. 02139, U.S.A.
Phone: (617) 491-3211 TWX: 710-320-6583

Oscillators / Filters / AC Power Sources / DC Power Supplies / Amplifiers

... ultraviolet changes zinc-sulfide resistance ...

responsive to ultraviolet light. "Before, if you wanted to sense the rays, you had to use some kind of optical filter with a standard photocell," says Joseph Malgiolo, the chief engineer at Clairex. "Now you can plug in a two-terminal cell and measure or just detect with no additional gear."

Zinc deposits. To make the cell, Clairex engineers deposit a thin film of zinc sulfide in an interdigitated pattern on a ceramic substrate. Two metallic electrodes are then deposited—not at the ends of the snaking sulfide, but along the two borders.

Because of zinc sulfide's physical properties, there was never any question at Clairex that this compound was the material needed for the cell. The problem Clairex faced was learning how to handle the compound. In fact, the new cell represents the first commercial use of zinc-sulfide films, according to Malgiolo.

Altering the length and width of the sulfide path would change the properties of the cell, but Malgiolo says he prefers to make these changes by controlling doping levels.

Clairex isn't sure what engineers will do with the cell or what kind of properties they'll want, so final specifications for a product line haven't been established. Units now being tested have a resistance of 1,000 megohms when exposed to 3,700-angstrom radiation, 500 megohms at 3,500 Å or 3,900 Å, and 1 megohm at room illumination. The company is still awaiting delivery of the test equipment needed to describe cell resistance as a function of radiation intensity. But Malgiolo says resistance is linear around 5 milliwatts per square centimeter.

Slow but steady. Because of the molecular properties of zinc sulfide, the new cell has a higher response time—in the millisecond range—than does a visible-light cell, so it's not as useful in high-speed applications. However, its temperature stability is better. "We haven't run any lifetime tests, but units have run for five months with no trou-

EMI FILTER *BREAKTHROUGH*

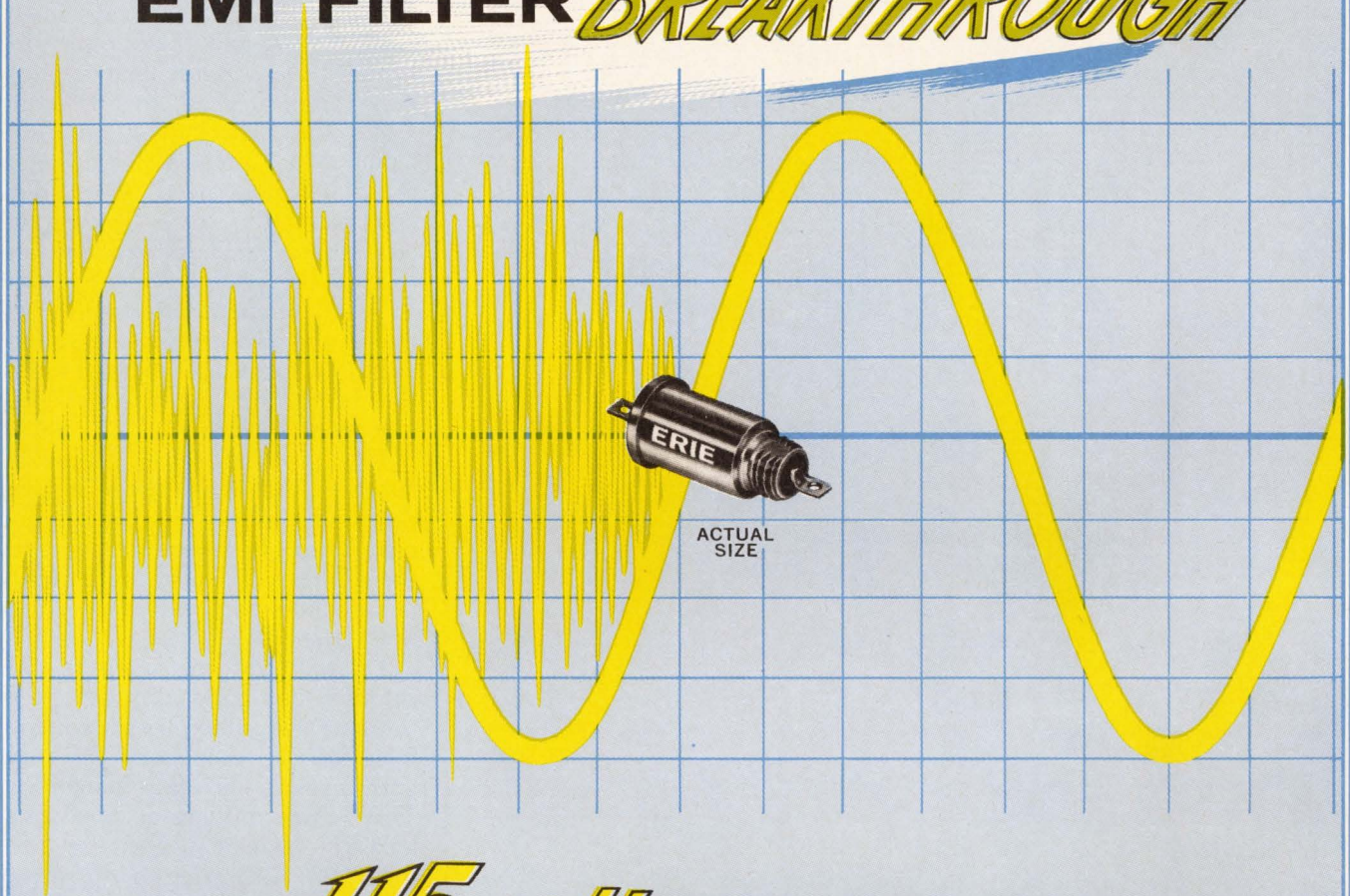

ERIE *115 volt ac* LINE FILTERS

**SMALLER and LIGHTER THAN ANY OTHER
LINE FILTER AVAILABLE!**

- **DESIGNED FOR OPERATION IN . . .**
400 Hz lines @ 85°C
60 Hz lines @ 125°C
- **INSERTION LOSS GUARANTEED FROM . . .**
-55°C to +125°C @ rated current
- **TYPICAL INSERTION LOSS . . .**
30 db @ 150 kHz
80 db @ 1 MHz and up



These hermetically sealed ERIE EMI Power Line Filters represent a substantial reduction in size and weight without sacrifice in performance through the use of a sophisticated state of the art dielectric. Most measure less than 1 inch long and weigh less than 10 grams, making these tiny Filters perfect for power supply applications where reliability, size, and weight are design considerations.

The broad line of ERIE EMI Filters economically provides optimum performance for virtually any environment. For detailed specs see your local ERIE applications engineer or write for Catalog 9000.

ERIE

TECHNOLOGICAL

PRODUCTS, INC.



Erie, Pennsylvania



New Victoreen MOX Resistors Now values to 2500 megohms in a compact package only 1/4" OD x 5" long

Now — by specifying new Victoreen metal oxide glaze resistors — you can buy resistance by the inch.

Based on our standard 1/4" OD size, Victoreen Series MOX resistors, per inch of lineal length, give up to 7.5 kv ratings . . . 500 megohms resistance . . . 2.5 watts power dissipation. Tolerances are $\pm 2\%$ or $\pm 5\%$ right across the board up to the 5" size . . . $\pm 1\%$ and $\pm 0.5\%$ in some sizes. Stability is exceptional, too — less than 1% full-load drift in 2000 hours . . . shelf life drift less than 0.1% per year.

Victoreen MOX Resistors are available right now in sizes and ratings that make them near-perfect — for HV probes with DVMs, meter multipliers, HV plate load resistors and similar circuits. And still more new sizes and ratings are on the way, too.

A-1962

VICTOREEN INSTRUMENT DIVISION
10101 WOODLAND AVENUE • CLEVELAND, OHIO 44104
IN EUROPE: GROVE HOUSE, LONDON RD., ISLEWORTH, MIDDLESEX, ENGLAND



... a flame detector that
isn't easily fooled . . .

ble," say Malgiolo. "There's no reason to believe they won't last as long as any other photocell."

The device should be useful anywhere ultraviolet is present—in mask making and photography, for instance. Two immediate applications Clairex sees are detecting fires and checking germicidal lamps. Since present photoelectric flame detectors need filters, they can't match the new cell's cost and sensitivity. An additional advantage of the photocell here is that its good temperature stability reduces the chance that an alarm will be triggered by thermal radiation from a furnace or some other innocuous source.

The problem with germicidal lamps is that the ultraviolet level drops off before the lamp burns out. A built-in detector made with the Clairex cell could continuously monitor the lamp and warn of deterioration.

There's only one hitch to this solution. Normally, Clairex covers the sensitive sulfide with a window made of the same glass the company uses in its other photocells. This is fine as long as the wavelength of the incident light is greater than 3,000 Å. But for shorter wavelengths, the transmittivity of the glass drops off.

The wavelength of the ultraviolet light from a germicidal lamp is about 2,800 Å. So, to take full advantage of the cell's sensitivity, Clairex uses a window of quartz or sapphire in cells designed for the lamp because these materials pass light completely down to about 2,000 Å.

The cells now come in TO cans, but Clairex says it can put them in any package that doesn't deteriorate when exposed to ultraviolet rays, a limitation that rules out a lot of plastics.

Sample quantities of the cell are available from stock. The price is now between \$10 and \$20, but Malgiolo says this will probably drop as demand increases. Replacing the glass window with one made of sapphire or quartz adds another \$10 to the cost.

Clairex Corp., 1239 Broadway, New York, N.Y. 10001 [349]



CINCH PRECISION MINIATURE SOCKETS

INSURE EQUIPMENT DEPENDABILITY

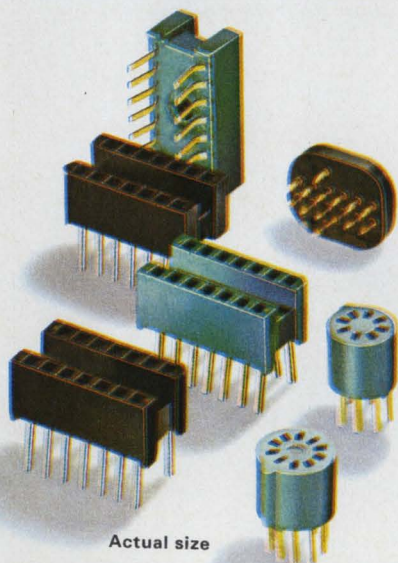

Actual size

Equipment design frequently involves problems of field maintenance or circuit updating. Cinch component sockets provide inexpensive and effective solutions without compromising reliability.

DIP sockets for 14 and 16 lead DIP's are typical of Cinch specialized miniature sockets. Available in GP black phenolic or SDGF diallyl phthalate, they have extremely high resistance to shock, vibration, humidity and corrosive atmospheres. Contacts are gold or cadmium plated beryllium copper with low contact resistance.

IC sockets for 6, 8 and 10 pin TO-5 cased devices, miniature *NIXIE Tube* sockets and *Subminiature relay* sockets are just a few of the other component sockets Cinch manufactures.

For information on DIP sockets and other Cinch interconnection devices, write to Cinch Manufacturing Company, 1501 Morse Avenue, Elk Grove Village, Illinois 60007.

C-6818

CINCH
DIVISION OF UNITED-CARR

MEMBER



CONSISTING OF CINCH MANUFACTURING COMPANY, CINCH-GRAPHIK, CINCH-MONADNOCK, CINCH-NULINE, UCINITE (ELECTRONICS) AND PLAXIAL CABLE DEPT.

Circle 167 on reader service card

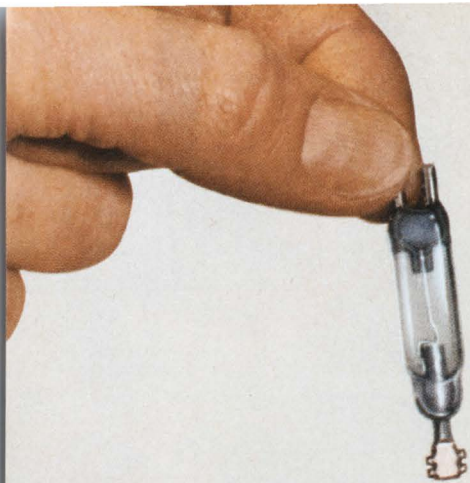

When you want a relay that...

*delivers billions of high speed
bounce-free operations;
has low profile for p.c. board mounting
and is compatible with solid state circuits*

mercury's the answer

In order of importance, how would you rate these advantages of P&B's mercury-wetted contact relays?

- no bounce
- constant low contact resistance
- long life (billions of operations)
- low profile for p.c. board mounting
- 1 ms operating speed
- contact isolation
- compatibility with solid state circuitry

You will find our JMF Series relays useful in computer logic circuits, high speed processing equipment, in sophisticated instrumentation . . . wherever you need crisp switching action, long life, solid state compatibility, and immunity from transient voltages.

Housed in a pressurized glass capsule, the contacts are renewed on every cycle through capillary action of the mercury. Hence, contact resistance remains constant and extremely long, maintenance-free life is assured.

P&B mercury-wetted relays are available in contact Forms C and D, as well as polarized and sensitive models. Up to four capsules in a single case are available. Call your P&B representative for full information today.

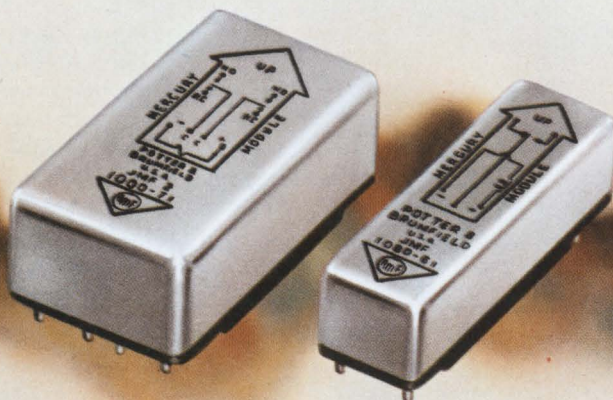

POTTER & BRUMFIELD

Division of American Machine & Foundry Company, Princeton, Ind. 47570
Export: AMF International, 261 Madison Avenue, New York, N. Y. 10016

New Subassemblies Review

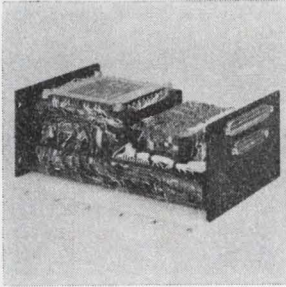

Core memory systems series SM are suited for aerospace, oceanographic and portable applications. Standard models SM-128 and SM-1216 store 4,096 words of 8 and 16 bits per word, respectively. The SM-128 (illustrated) measures 6 x 4 x 2½ in. Access time is 1 μsec; full cycle time, 4.7 μsec. Space and Tactical Systems Corp., 1 Garfield Circle, Burlington, Mass. [381]

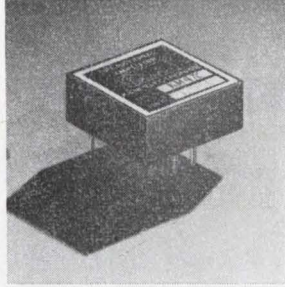

Differential operational amplifier KM47C, made with field-effect transistors, is useful for integrators and buffers in instrumentation, control and computer applications. It has an input impedance of 10¹² ohms (typical) and 10¹¹ ohms (min.). Bias current is 10 picoamps max. Price is \$14.50 in small quantities. K&M Electronics Corp., 102 Hobart St., Hackensack, N.J. 07601. [382]



General purpose computer designated the Decade 70 has a 4,096 word memory, expandable to 16,384 words. Speed is 1 μsec for full cycle time. The processor, which includes power supply and up to 16 K memory, is contained in a 19-in. cube. Decimal arithmetic and variable word length are available on all models. Decade Computer Corp., 7457 Lorge Circle, Huntington Beach, Calif. [383]

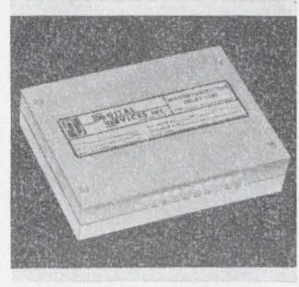

Digital refresh memory type 457E stores up to 512 bits of digital data to refresh a single horizontal television line, or for use as a high speed scratch pad memory. The unit uses a glass delay line as the storage element. Package size is 4½ x 5 x 1¼ in. Cost in production quantities is under \$250; availability, 4 to 6 weeks. Digital Devices Inc., 200 Michael Dr., Syosset, N.Y. 11791. [384]

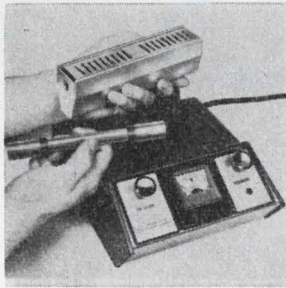

Neodymium doped glass laser system, the Uni-Laser, is ¾ in. in diameter and 6¾ in. long. It is capable of an output energy of more than 1 joule in a 3-mm beam at 1.06 microns. The unit's operating life is more than 100,000 firings. Price is \$440. Power supplies are available for \$540. American Optical Co., Laser Products Dept., Southbridge, Mass. 01550. [385]

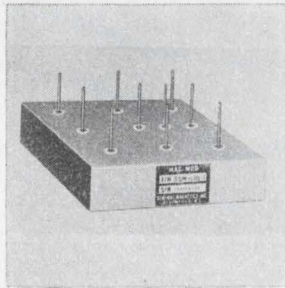

Solid state, magnetic analog d-c/d-c voltage multiplier measures 1.5 x 1.9 x 0.5 in. Accuracy is within 0.5% of full scale output amplitude, with d-c offset of less than 2 mv and total null offset of less than 10 mv over a temperature range of -55° to +100°C. Frequency response is 0 to 100 hz. General Magnetics Inc., 135 Bloomfield Ave., Bloomfield, N.J. 07003. [386]

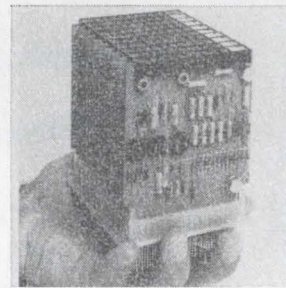

Data acquisition system, the 12-bit Miniverter, includes a 16-channel multiplexer, a sample and hold amplifier, a 12-bit analog-to-digital converter plus power supply and control logic. It operates at 35-khz throughput rate with over-all accuracy of 0.05%. Price is \$1,950 and deliveries are scheduled for August 1. Raytheon Co., 2700 S. Fairview St., Santa Ana, Calif. [387]

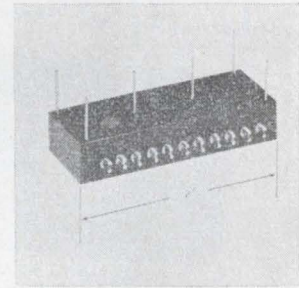

Printed-circuit, multitap delay lines offer up to 6 separate delay lines with 6 separate programmable tapped sections in less than 0.6 in.³. Delay times range from 3 nsec to 300 nsec with delay tolerances of ±2% or less. Rise times are as low as 1 nsec. Impedance ranges from 50 to 2,000 ohms. Daven Div., Thomas A. Edison Industries, McGraw-Edison, Grenier Field, Manchester, N.H. [388]

New subassemblies

Printer types 60 characters a second

It's several times faster than other serial devices and costs only about half as much as line units

If a computer user isn't satisfied with the printing speed of a teletypewriter, his only alternative is a high-speed line printer whose price is also high—at least \$10,000. There are serial printers that are faster than standard teletypewriters, but they're made for

specific Government applications.

So Tally Corp., seeing a big market gap between teletypewriters and line printers, built a serial printer that goes 60 characters a second, several times faster than typical teletypewriters, and costs \$4,000 to \$6,000.

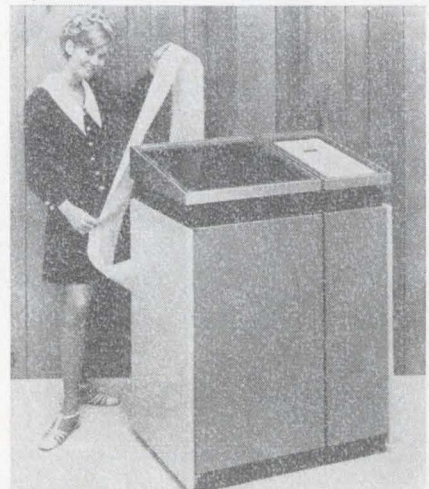

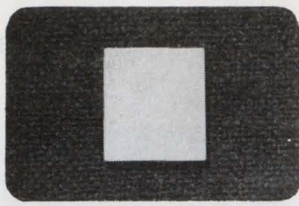

Substrates

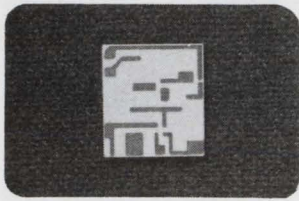

Metallized Substrates

ACTION IN MICROCIRCUITRY



there's
no end to
Centralab's

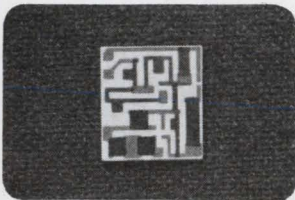

Metallized Substrates
with resistors

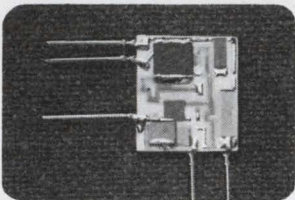

Metallized Substrates with
resistors and capacitors

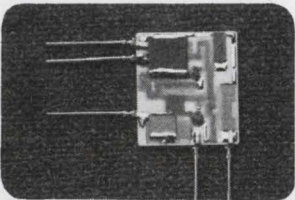

Metallized Substrates with
resistors, capacitors and
active components

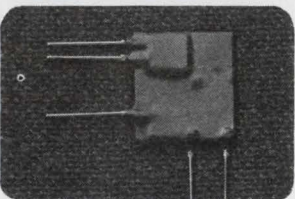

Metallized Substrates with
resistors, capacitors, active
components, sealed



(No matter how you cut it)

When you AIM with Centralab, you'll soon discover there's no end to the thick film microcircuits we can produce for you. Our experience and craftsmanship have contributed to the manufacture of more than 459,700,000 microcircuits, which is more than any other manufacturer has made. Our skilled designers have produced more than 5,000 different designs. They can tailor a special substrate, ceramic package, or a microcircuit to your requirements, deliver a sample in two weeks and ship production quantities 6-10 weeks later, depending on complexity of the unit. Centralab is an established leader in the microcircuit field, from substrates to complete packages. We're actually one-sided (like a möbius strip) where microcircuitry is concerned — point us in the right direction and we'll zero-in on the product you require. For immediate design assistance, write Centralab Application Engineering Department today.

AIM with **Centralab**

CENTRALAB PRODUCTS ARE MARKETED THROUGH CENTRALAB INDUSTRIAL DISTRIBUTORS
AND INTERNATIONALLY THROUGH GLOBE-UNION INC.—INTERNATIONAL DIVISION.



CENTRALAB

Electronics Division
GLOBE-UNION INC.
5757 NORTH GREEN BAY AVENUE
MILWAUKEE, WISCONSIN 53201

Encoding and buffering circuits can be built into the unit to meet a customer's requirements; the printer can be adapted to accept input from magnetic or paper tape decks, card readers, data phones, or the computer itself. The basic model has been designed to accept six-bit Ascii (American Standard Code for Information Interchange) without additional circuitry.

One in use. Printing is done on pin-fed paper of any width up to 15 inches, and up to six copies can be made.

Tally expects to sell the printer to both computer users and makers. The faster printouts can result in more efficient use of transmission lines. Tally notes that one printer is already being used by IBM in a 360 in Poughkeepsie, N.Y.

The printing is done by a metallic bar, 1 inch long and 1/4 inch in diameter, that has 64 raised symbols distributed evenly in eight parallel columns. The bar is mounted in a carriage that is moved across the paper by a stepping motor. When the signal for a symbol arrives at the printer, the signal is encoded and fed to two assemblies that have spring clutches. Each assembly drives a mechanical binary adder. A metal rod protrudes from each adder; one rod rotates the bar and the other raises or lowers it. This mechanism positions the bar so the proper symbol is presented to a magnetic print hammer.

The stepping motor can drive the carriage at speeds equivalent to printing rates of 120 characters per second. According to Richard Wagner, the project engineer, speed is limited by the compliance of the spring clutches. At 90 characters per second, the bar oscillates, so Tally rates the unit at 60.

Company coming. Wagner says the big problem in the development was designing drive belts that could take high speeds, shock, and continual use without stretching or breaking. Tally finally devised a toothed belt that's made of polyurethane molded around eight thin parallel wires that run horizontally. The belts are rated at 1,000 hours and can be easily replaced by a repairman. The hammer lasts for more than 500 hours; the bar, which costs \$5, will last from 250 to 500 hours.

Test The Total Digital IC Family for \$595

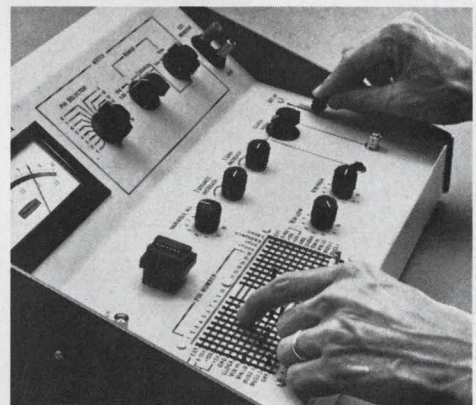
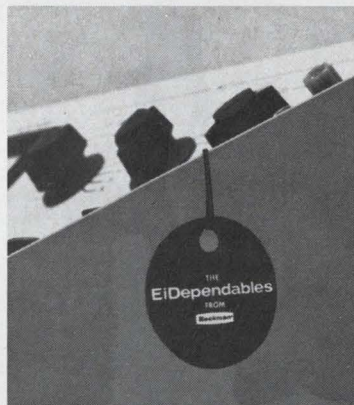
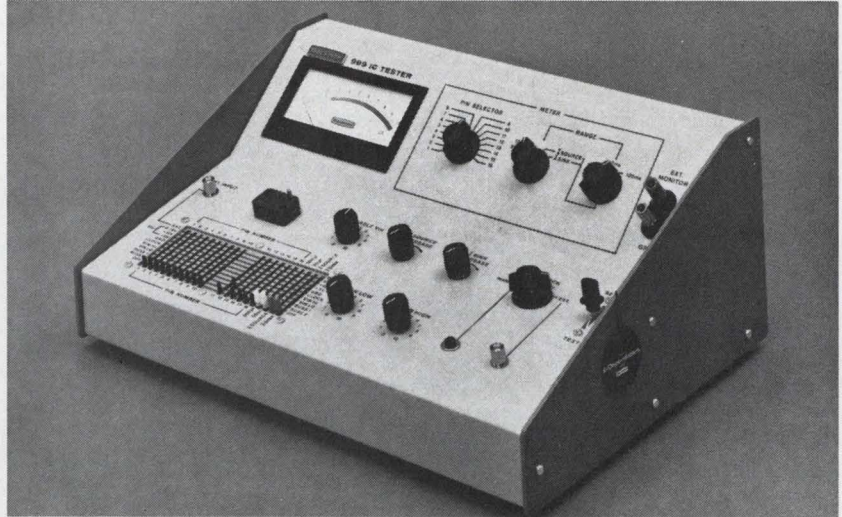
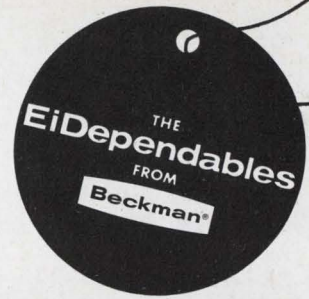

Another EiDependable—The Beckman Model 999 Digital Integrated Circuit Tester is designed to evaluate all dc parameters of RTL, RCTL, DTL, TTL, LPDTL, and ECL devices. In the engineering laboratory, the Model 999 saves design time checking circuit parameters. Quality assurance can verify manufacturers' exact specifications and test for source of IC failures. Educators find the Model 999 ideal for demonstrating IC logic theory. • Compare these Model 999 features with other IC test equipment costing up to ten times more: checks the total digital IC family; has panel board legends matched to IC manufacturers' specifications for fast, easy-to-learn operation; tests all important dc parameters giving exact values; and, gives you Beckman quality in every instrument. • Place your order now... immediate delivery through your local Beckman office, sales representative, or distributor. Prove to yourself that the Model 999 will satisfy all your IC evaluation requirements. • The Model 999 is just one of a team of IC testers that include the Model 998 Linear IC Tester for amplifier evaluation, and the Model 997 Automatic Digital IC Tester for production IC inspection. • Specifications (Model 999): Vcc: +5V ±2%, 0-200 mA; +12V ±2%, 0-200 mA; 0 to 10V, 0-200 mA. Current Source & Current Sink: 50 μA to 100 mA in 3 ranges. Clock: 100 kHz (internal), Manual (internal), or dc to 1 MHz (external). Vin High & Vin Low: 0 to 10V adjustable, 0 to 50 mA. The Electronic Instruments Division develops and manufactures precision electronic measurement and test instrumentation for science and industry. Major product lines include: electronic counters, IC testers, oscillographic recorders, panel meters, system components, signal sources, time standards, and data acquisition systems.



INSTRUMENTS, INC.
ELECTRONIC INSTRUMENTS DIVISION
RICHMOND, CALIFORNIA • 94804

International subsidiaries: Geneva; Munich; Glenrothes, Scotland; Tokyo; Paris; Capetown; London; Mexico City.

EIMAC

new 3-500Z offers
high power gain,
less circuitry.

EIMAC's new 3-500Z is a compact, heavy-duty power triode with 500 W plate dissipation, designed for operation in zero-bias Class B r-f or audio amplifiers. The tube can be used as a cathode driven (grounded grid) linear amplifier where low distortion, high plate dissipation, and great thermal anode reserve are desired. The 3-500Z may be operated at plate potentials up to 3000 Vdc, and eliminates expensive, bulky screen and bias supplies. The 3-500Z will replace EIMAC's 3-400Z where additional plate dissipation or greater reserve is desired. Forced-air requirement is approximately equal to that of the 3-400Z, and a blower capacity of only 13 cfm at a back pressure of 0.2 inch is satisfactory for a single tube. The 3-500Z's zero-signal plate current is somewhat higher than that of the 3-400Z. When used as a replacement for the latter tube, the 3-500Z's zero-signal plate current can be reduced by addition of a simple zener diode in the cathode return. This technique is particularly suggested if plate potentials over 3000 Vdc are contemplated, or if the tube is used in equipment that is power supply limited. Contact your nearest distributor or Varian Field Office for further information. Offices are located in 16 major cities. Ask information for Varian Electron Tube and Device Group.

3-500Z TYPICAL OPERATION*

(Minimum Distortion Products at 1 kW PEP Input)

DC Plate Voltage	2500 V
Zero-Sig DC Plate Current**	130 mA
Single-Tone DC Plate Current	400 mA
Single-Tone DC Grid Current	120 mA
Two-Tone DC Plate Current	280 mA
Two-Tone DC Grid Current	70 mA
Peak Envelope Useful Output Power	500 W
Resonant Load Impedance3450 ohms
Intermodulation Distortion Products	-33 dB

*Measured data from a single tube

**Approximate

EIMAC

Division of Varian

San Carlos, California 94070

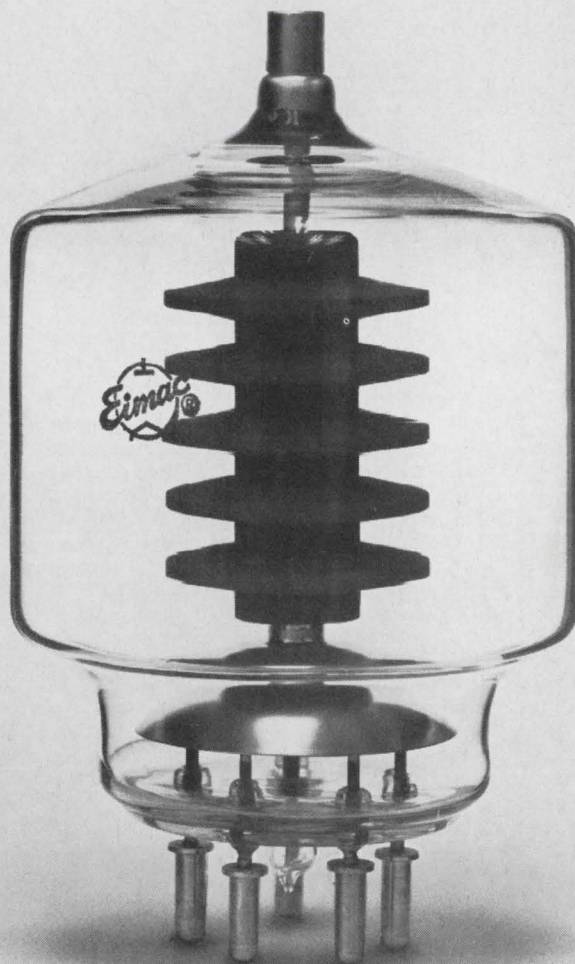

Although Tally says it's first on the market with a printer of this speed and price, it doesn't expect to be alone for long. Many firms, big and small, are working on similar units, but Tally is hoping that bigger companies will find it more economical to use Tally's printer.

The printer is 34 by 46 by 23 inches and weighs about 450 pounds. Although first deliveries won't be made until January 1969, Tally is taking orders now.

Tally Corp., 1310 Mercer St., Seattle, 98109 [389]

New subassemblies

Handler / reader at under \$1,000

Photoelectric system
for punched tape reads
625 characters a second

The high cost of photoelectric systems that read punched tape stems partly from the price of the tape-handling devices. Now, Chalco Engineering Corp. says it has built the first handler/reader selling for less than \$1,000.

Chalco built a new handler, the TH145, which sells for \$245, and joined it to the 5101 tape reader to form the 5301 system. James Cox, marketing manager, says equivalent handlers cost at least twice as much as the TH145.

The 5301 is bidirectional—it reads whether the tape moves forward or backward. It handles standard 5¼-inch tape reels, reading 625 characters a second when operated continuously and a maximum of 150 characters a second in a command or pulse-reading mode. According to Cox, the 5301's nearest competitor is only half as fast, costs \$200 more, and is unidirectional.

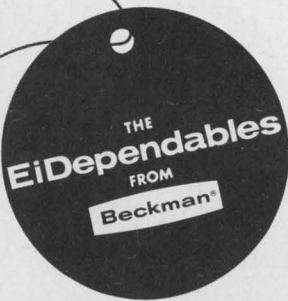
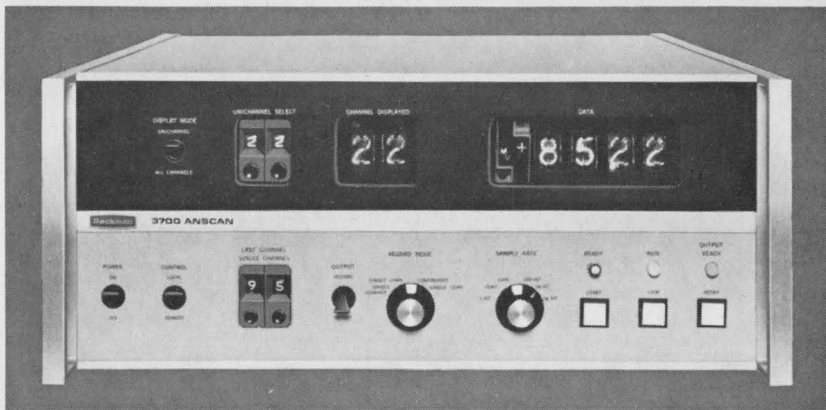
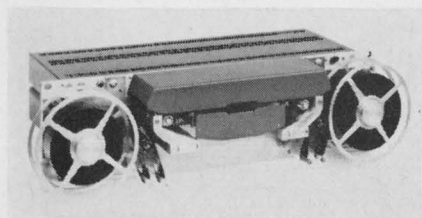

New Data Acquisition Recorders

The new Beckman 3700 Series Data Acquisition Recorders provide rapid and accurate collection of analog and digital data for processing or recording by a variety of output devices. Consisting of the Model 3700 ANSCAN Subsystem, the Model 3701 Universal Output Coupler and the output devices, these low cost, high performance, self-contained systems accept up to 100 analog signals, measure and convert them at rates up to 5000 samples per second, and accurately record or process the data. • Now, for the first time, a selectable scan rate, modular concept, and economical pricing permit the 3700 Series to be used in application areas where digital data systems were previously not considered. Research labs, universities, rocket test facilities, petrochemical plants, and many others can now afford to acquire computer compatible data utilizing dependable systems built by experienced Beckman data systems engineers. • Compare these features with higher priced data systems and prove that inexpensive accurate data collection is possible for your facility: Accepts up to 100 analog data sources with other digital data sources; provides an analog and digital multiplexing rate up to 5000 samples per second; is completely computer controlled or self sequencing; provides a unique automatic gain ranging capability which eliminates the need for individual channel programming; and measures low level signals without preamplification down to 10 mV full scale. • For complete details on these outstanding systems, contact your local Beckman office, sales representative or the factory direct. The Electronic Instruments Division develops and manufactures precision electronic measurement and test instrumentation for science and industry. Major product lines include: electronic counters, IC testers, oscillographic recorders, panel meters, system components, signal sources, time standards, and data acquisition systems.

Beckman

INSTRUMENTS, INC.

ELECTRONIC INSTRUMENTS DIVISION

FULLERTON, CALIFORNIA • 92634

International subsidiaries: Geneva; Munich; Glenrothes, Scotland; Tokyo; Paris; Capetown; London; Mexico City.

FILL IN YOUR APPLICATION

Whatever it is, Olympus has a microscope to fit it. And your budget. With quality you can see even before you look through the precision optics.

Cases in point, the four new inverted metallographs illustrated here. Send for information on the model(s) that suit your needs. Or fill in your applications, and we'll send you information on the Olympus model we think suits them.

My applications for inverted metallographs include:

Olympus metallographs:	MGK	MG	PMD	PME
Price (less optional camera body)	From \$550	From \$850	From \$1700	From \$2100
Total magnification range available:	13-1000X	13-1000X	13-1250X	13-1250X
Camera facilities:				
35mm	—	optional	optional	optional
Polaroid 3¼" x 4¼" pack	—	optional	optional	optional
Polaroid 4" x 5" sheet	—	—	optional	optional
Exposure meter type	—	optional	semi-auto	automatic
Illuminators:				
Bright-field axial	standard	standard	standard	standard
Built-in variable transformer	unmetered	unmetered	metered	metered
Transmitted light	optional	optional	optional	optional
Oblique light	optional	optional	optional	optional
Dark-field	optional	optional	optional	optional
Xenon	—	—	optional	optional
High-pressure mercury	—	—	optional	optional
High-temperature vacuum stage	—	—	optional	optional

Please send information on: () MGK; () MG; () PMD; () PME; () The model you think best fits my applications.

Name

Title

Organization

Address

City State Zip

OLYMPUS CORPORATION OF AMERICA

Precision Instrument Div., Dept. E
1190 Brooks Ave., Rochester, N.Y. 14624



Prices and specifications subject to change without notice

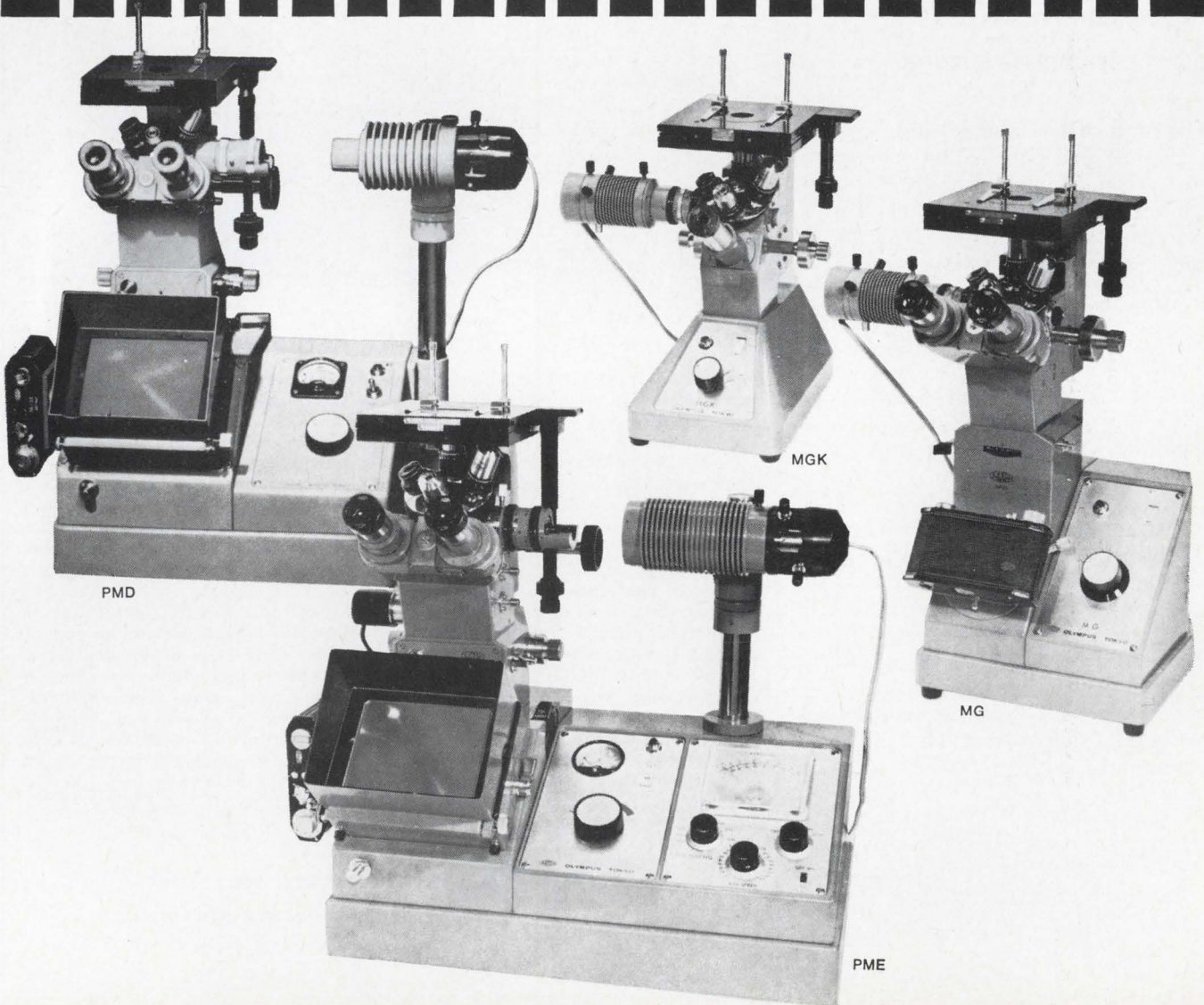

No noise. Besides lowering cost, Chalco wanted to eliminate the radio noise generated when the handler's motor control switches.

Cox says one Chalco customer wants to scrap a competitor's reader/handler because of the noise problem, caused by arcing in the switch stack when the a-c input is switched to the motor. Chalco reduced this type of noise by eliminating independent handler motor drives. The reader motors continuously drive the handler reels.

The 5301 also has shielded transformers to reduce noise.

The 5301's electronics is mounted on a printed-circuit board. Only discrete components are used, but Cox says the system interfaces easily with integrated circuits because its output is 50 milliamperes at 6 volts. He points out that this is far more than the 5 to 15 ma typical of competitive readers, and more than enough to drive an IC. When the IC is off, Cox says, a resistor in parallel with the reader's output dissipates enough power to protect the IC. "We can operate into resistors in the 47- to 50-ohm range, so there's no problem matching discrettes with IC's," he says.

A special high-speed brake allows the 5301 to stop on character—that is, on the line being read—even at the 625-character-per-second rate.

Light approach. The 5301's light sensor is used in a special way, says Cox. He says Chalco reverse-biases it and uses it as a photodiode rather than as a photovoltaic generator. This eliminates the "sleeping sickness" often associated with photovoltaic cell aging. There are nine electrically independent photodiodes in the sensor, and their output is fed to the amplifier part of the p-c card, which consists of 27 transistors.

A light-regulating circuit in the 5301 controls the lamp's intensity, increasing lamp life.

When lamps do burn out, new ones can be snapped in without electrical or mechanical adjustments. Cox says that some competitive tape readers use a lens to focus the light on the sensor and that the lamp must be aligned carefully in its holder to get the proper focus.

Chalco Engineering Corp., 15126 S. Broadway, Gardena, Calif. 90247 [390]

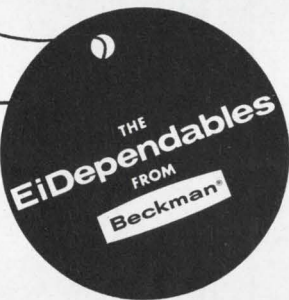
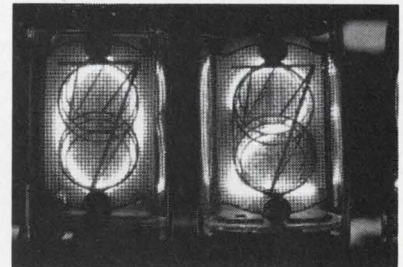
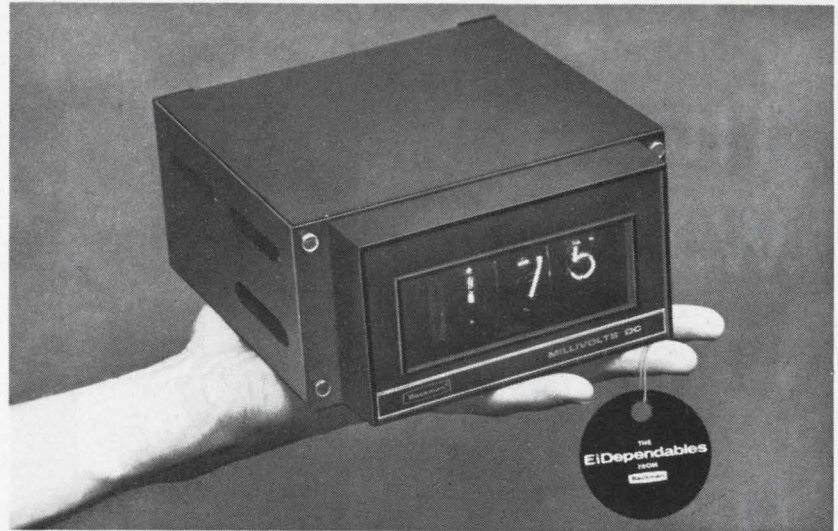

Eight New Digital Panel Mounted Instruments

Now you can economically select Beckman digital panel mounted instruments from a complete family of EiDependables. These instruments offer OEM, power companies, display console manufacturers and others compact size, integrated-circuit design, easy-to-read display, and digital accuracy not possible in analog meters. In addition, all instruments provide useful digital output data for further data processing or recording. Here is a brief description of the line: The *Model 4025 Voltage and Current Meter* (\$345) converts an analog voltage or current to an equivalent digital number; the *Model 4026 Voltage and Current Meter* (\$395) performs the same function as the Model 4025 but also features a fully buffered output and completely floating input circuit; the *Analog to Binary Converter Model 4027* (\$450) translates analog data to directly computer compatible binary information; the *Model 4034 EPUT Meter* (\$450) provides an events per unit time display with programmable time base; the *Beckman Accumulator Model 4038* (\$425) counts events and periodic functions up to 1MHz; the *Model 4050 Time of Day Clock* (\$375) provides real time information in 6-digit in-line display representing hours, minutes, and seconds; the *Model 4060 Binary to Decimal Converter* (\$495) provides a 13 bit binary word to a BCD number conversion and display in less than 17 μ s; and the *Model 4070 Limit Comparator* (\$475) compares incoming information with preset data, and provides output control commands based on this comparison. For complete detailed information on the panel mounted instrument to meet your application, contact your local Beckman office, sales representative, distributor or the factory direct.

The Electronic Instruments Division develops and manufactures precision electronic measurement and test instrumentation for science and industry. Major product lines include: electronic counters, IC testers, oscillographic recorders, panel meters, system components, signal sources, time standards, and data acquisition systems.

Beckman

INSTRUMENTS, INC.

ELECTRONIC INSTRUMENTS DIVISION

FULLERTON, CALIFORNIA • 92634

International subsidiaries: Geneva; Munich; Glenrothes, Scotland; Tokyo; Paris; Capetown; London; Mexico City.

The Wait Reducers! New Active Filters from BURR-BROWN



At Burr-Brown, computer-aided design and new modular assembly techniques combine to give you faster delivery of active filters . . . in most cases within two weeks of your order. And, you specify the exact performance you want from Burr-Brown's new line of 5 Hz to 20 kHz units. Custom units are available with frequencies as low as 0.1 Hz and as high as 100 kHz.

A variety of active filter types and response characteristics are available including:

- | TYPES | CHARACTERISTICS |
|---|--|
| <input type="checkbox"/> low-pass | <input type="checkbox"/> Butterworth |
| <input type="checkbox"/> high-pass | <input type="checkbox"/> Tchebyscheff |
| <input type="checkbox"/> band-pass | <input type="checkbox"/> Bessel (linear phase) |
| <input type="checkbox"/> band-rejection | |

Since the heart of the filter is the amplifier, Burr-Brown has the very finest building blocks, including its own IC op amp (patent pending). Because of the outstanding performance of Burr-Brown op amps you get active filters with superior characteristics at the lowest possible prices.

You also benefit from Burr-Brown's industry-leading technical staff. For the same experts who authored the Active RC Network Handbook, the basic industry reference on the use of operational amplifiers in filtering applications, supervise Burr-Brown's active filter facilities.

So, if you use active filters and you want a fast, dependable source of supply, call on Burr-Brown. You'll find Burr-Brown knows a little more and does a little more, because Burr-Brown has more to work with.

NEW 12-PAGE ACTIVE FILTER CATALOG

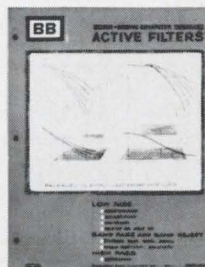

For your copy of the new applications-oriented Burr-Brown Active Filter Product Bulletin, contact your local Engineering Representative or use this publication's reader-service card. For Immediate Applications Assistance: simply phone (602) 294-1431 and ask to talk to your Burr-Brown Applications Engineer.

BURR-BROWN RESEARCH CORPORATION

International Airport Industrial Park • Tucson, Arizona 85706
TELEPHONE: 602-294-1431 • TWX: 910-952-1111 • CABLE: BBRCORP



Operational Amplifiers
Instrumentation Amplifiers
Function Modules
Active Filters
Analog Simulators
Geophysical Instruments

ENGINEERING REPRESENTATIVES: ALABAMA, HUNTSVILLE (205) 534-1648 / ARIZONA, PHOENIX (602) 254-6085 / CALIF., LOS ANGELES (213) 665-5181, SAN FRANCISCO (408) 244-1505 / COLO., DENVER (303) 388-4391 / CONN., EAST HARTFORD (203) 874-9222 / D.C., WASHINGTON (SEE MARYLAND) / FLORIDA, ORLANDO (305) 425-2764 / ILLINOIS, CHICAGO (312) 286-6824 / LA., NEW ORLEANS (504) 888-2266 / MD., SILVER SPRING (301) 588-8134 / MASS., BOSTON (617) 245-4870 / MICH., DETROIT (313) 358-3333 / MINN., MINNEAPOLIS (612) 781-1611 / MO., ST. LOUIS (314) 524-4800 / N.C., GREENSBORO (919) 273-1918 / N.J., CAMDEN (215) 925-8711

/ N.M., ALBUQUERQUE (505) 255-1638 / N.Y., ALBANY (518) 436-9649, BINGHAMTON (607) 723-9661, MT. VERNON (914) 968-2200, NEW HARTFORD (315) 732-3775, ROCHESTER (716) 473-2115 / OHIO, CINCINNATI (513) 761-5432, CLEVELAND (216) 237-9145, DAYTON (513) 277-8911 / PENN., PHILADELPHIA (SEE CAMDEN, N.J.), PITTSBURGH (412) 243-6655 / TEXAS, DALLAS (214) 357-6451, HOUSTON (713) 774-2568 / UTAH, SALT LAKE CITY (801) 466-8709 / VIRGINIA, (SEE MARYLAND) / WASH., SEATTLE (206) 767-4260 / CANADA, DOWNSVIEW, ONT., (416) 636-4910 — MONTREAL, QUE., (514) 739-6776 — OTTAWA, ONT., (613) 725-1288 — VANCOUVER, B.C., (604) 298-6242

New Semiconductors Review

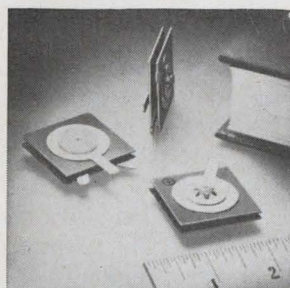

Super-Sel rectifier S-797 is a 3-amp, center-tapped device for battery charging circuits in appliances and electronic equipment that use rechargeable batteries. It measures 1.3 in. square by $\frac{3}{8}$ in. high. Battery load output is 15.8 v d-c, resistive-conductive load output is 13.5 v d-c. Maximum input is 33 v rms. Sarks Tarzian Inc., 415 N. College Ave., Bloomington, Ind. [436]

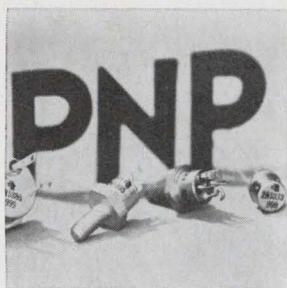

Four pnp epitaxial planar silicon power transistors, designated 2N5333, 5384, 5385 and 5386, have breakdown voltages of 80 v and complement the company's line having current ranges from 2 to 12 amps. Power dissipation is 15 w at 100° C case for the TO-5 package to 50 w for the 11/16 in. stud. Texas Instruments Inc., 13500 North Central Expressway, Dallas 79222. [437]

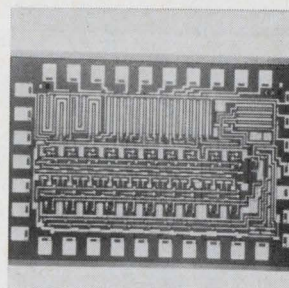

Monolithic MOS circuit 3750, which uses P-channel enhancement mode technology, is a complete 10-bit digital-to-analog converter subsystem. Three blocks of logic components are contained in the chip—a 10-bit d-c stable shift register, a holding register, and 10 spdt analog switches. The device has 36 leads. Fairchild Semiconductor, 313 Fairchild Dr., Mtn. View, Calif. [438]

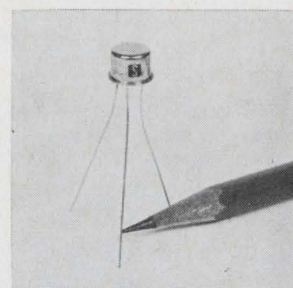

Silicon power transistors 2N5237 and 2N5238 are 10 amp units packaged in TO-5 cases. They have sustaining voltages of 120 v and 170 v respectively. Power ratings are 5 w at 100° C. Gains are 40 to 120 at 5 amps and 10 minimum at 10 amps. Total switching speed at 5 amps is less than 2 μ sec. Solitron Devices Inc., 1177 Blue Heron Blvd., Riviera Beach, Fla. 33404. [439]

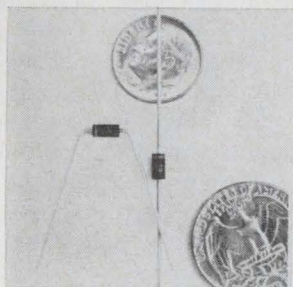

One watt of zener power in a sub-miniature molded plastic package is offered by the 1N4728, A-1N4764, A series of voltage regulators. A full watt of power dissipation is available from 3.3 v to 100 v. Maximum operating temperature is 200° C. Units are offered in both 5% and 10% tolerances off-the-shelf. International Rectifier, 233 Kansas St., El Segundo, Calif. 90245. [440]



Gallium arsenide p-n diode M120C1 is an infrared-emitting device that radiates 1.5 mw power at an input current of 100 ma, when forward biased above 1 v. The output radiation peaks sharply at 9000 angstroms. The III-V semiconductor chip in the diode is protected by an epoxy lens, which also collimates the beam. Monsanto Co., 800 N. Lindbergh Blvd., St. Louis, Mo. 63166. [441]

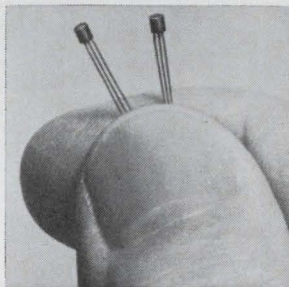

Silicon epitaxial audio transistors models A141, -2 and -3 are micro-miniature devices for high-density packaging. Noise figure for the group is typically 1.5 to 2 db from 30 to 15,000 hz with minimum gain of 80 for the A141, 140 for the A142, and 280 for the A143. Leakage current is 10 na and the collector saturates at 0.1 v. Amperex Electronic Corp., Slatersville, R.I. 02876. [442]



Thick film silicon bridge rectifier BHC0001-0005 has an average output current of 10 amps, peak reverse voltage/leg of 100 to 600 v, and a surge current of 100 amps. It provides the mounting versatility of a TO-3 with the savings of a plastic encapsulant. Applications include power supplies, a-c/d-c converters, and motor controls. Bendix Corp., South St., Holmdel, N.J. [443]

New semiconductors

The 709 gets a high-speed successor

Fairchild is ready to unveil the 715, a monolithic op amp with a very high slew rate and fast settling time

One of the lines of new devices Fairchild Semiconductor has been introducing in its "product-of-the-week" campaign is a series of fast-stepping operational amplifiers it bills as second-generation descendants of the fabled 709.

Among the complex linear inte-

grated circuits already unveiled are the 741, a fully compensated replacement for the 709 [Electronics, May 27, p. 184]; the 737, a color-television demodulator [Electronics, June 10, p. 221], and the 722, a digital-to-analog device.

Soon to move to center stage is

the star of the show, the 715, a high-speed monolithic op amp with breathtaking parameters. It features a very high slew rate of 20 volts per microsecond—allowing high output voltage swings of up to 12 megahertz—and a settling time of 200 nanoseconds with 0.1% accuracy. For comparison's sake, the 709 and most of its competitors have slew rates of 0.3 volt per μ sec.

High hopes. "It's the most significant thing we'll do all year," says Jack Gifford, linear-circuit marketing manager. "This circuit will have far-reaching effects on the industry." Fairchild hopes to

The only thing this discriminator lacks is serious price competition

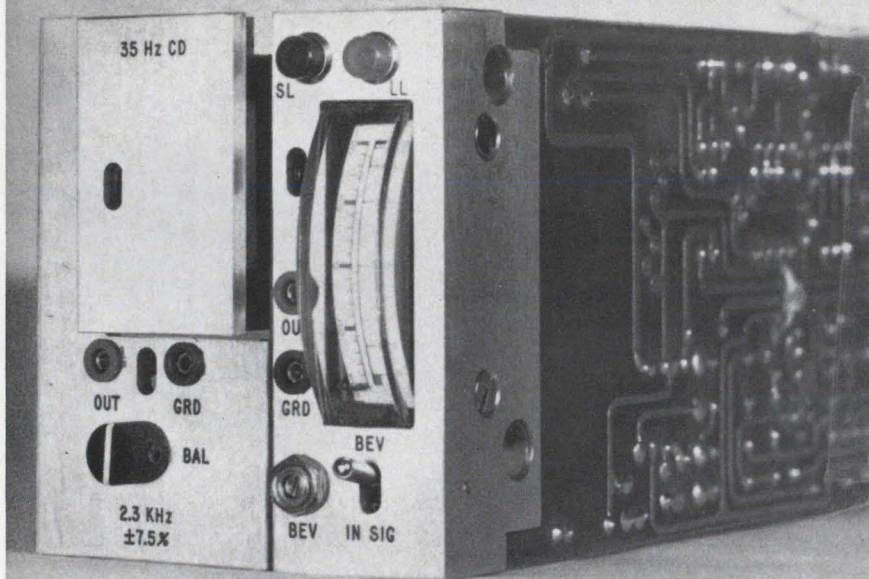

The SCD-5 phase lock loop discriminator represents the latest addition to the DEI F/M product line. Switchable loop filter bandwidths for operation within MI's of one and five are supplied as standard filters. Constant time delay input filter provides data distortion less than 0.3% at DR = 5.

The small size of the modules permits five discriminators to be installed in a standard 19-inch housing assembly with a panel height of only 3½ inches. Over 50 discriminators can be accommodated in a standard 72-inch rack.

Using all silicon transistor and IC circuitry, the SCD-5 is available with digital output and is priced under \$850.

For further information on what the SCD-5 has to offer, contact the DEI sales office nearest you.

Defense Electronics, Inc.

PRODUCERS OF
DEI AND NEMS-CLARKE
EQUIPMENT



DEI
RESEARCH
DEVELOPMENT
MANUFACTURING

ROCKVILLE, MARYLAND (301) 762-5700; TWX: 710-828-9783; TELEX: 089602 • LOS ANGELES, CALIFORNIA (213) 670-4815 • INTERNATIONAL: ROCKVILLE, MARYLAND • CABLE: DEIUSA; INTELEX: 64102 • Sales Representatives: Rome, Italy • London, England • Madrid, Spain • Tel Aviv, Israel • Bromma, Sweden • Rijswijk, Holland • Koln, Germany • Paris, France • Zurich, Switzerland • Oslo, Norway

get the 715 in the growing communications and guidance and controls systems markets, where the quick op amp can also function as an a-d converter, amplifier, oscillator, integrator, or comparator.

Slated for mass production, the 715 is supposed to compete, Gifford says, with the modularized "chip and wire" assemblies containing up to 14 transistorized units collected and hand-adjusted into 2-by-2-by-½-inch packages. To get that much circuitry into a TO-5 can took 20 Fairchild staffers, paying meticulous attention to layout problems, more than two years.

Besides difficulties with high-frequency feedback and pin configuration, Fairchild faced the problem of coupling high slew rate with high settling time; the two tend to work at cross purposes. A lot of resistors are required to compensate a high slew rate—the time it takes for the output signal to reach the level of the input signal. And this feature typically involves a rather langorous settling time—the time it takes the output signal to settle to a defined accuracy.

By carefully combining its tried-and-true planar processing with a few new techniques, Fairchild gets both high parameters. For example, the company has growing confidence in metal-oxide semiconductor technology. "We have MOS capacitors in production," Gifford says, "that no one else will be able to make for some time."

Even so, actual production proved tough. Fairchild first claimed 25 volts per microsecond slew rate when it talked about the 715 three months ago [Electronics, March 18, p. 47]. Profitable production lowered the figure to 20 typically and 15 minimally.

Quick charge. The problem here is that Fairchild couldn't use pnp transistors in the level-shifting stage of the circuitry because they have low bandwidth. Zener diodes, the other common alternative, are too noisy. So the designers used a resistor and current source combination to give the required level shift. Since this combination has poor frequency characteristics, they added 15-picofarad MOS capacitors across the resistors.

And Fairchild came up with still another way to achieve high-fre-

Unkluged Squelcher



The one & only

Before you kluge up another complicated squelch circuit, check out our new general purpose AGC/squelch gain module—the LM 170.

Squelch and AGC are built-in with threshold set externally by a single resistor or potentiometer. Two gain control inputs allow automatic gain control using manual or remote override. Supply voltage can range from +4.5 to +24 VDC with supply drain being 18 mw at +4.5V. Our typical gain reduction range is a fantastic 80db, which we achieve with direct coupling, and without inducing output switching transients at fast squelch rates.

Besides routine squelch and AGC, the LM 170 is useful as constant-amplitude audio oscillator, transmitter or tape-recorder VOX, single-sideband ALC system, and a variable-gain DC amplifier in analog computation.

It's all in a single TO-5 can, perfect for airborne or mobile communications systems. Price is \$12.95 for 100-999 quantities. A reduced temperature military unit, the LM 270, is available at \$4.95.

Write for details. National Semiconductor Corporation, 2975 San Ysidro Way, Santa Clara, California 95051.

National Semiconductor

Lapp Gas-filled Capacitors



Specially designed for a broad range
of high voltage operating conditions.

High voltages, as well as high current and capacitance applications, are easily handled by Lapp Gas Filled Capacitors. For this type of service Lapp Capacitors offer small size and low cost.

Lapp precision-builds these capacitors to give years and years of accurate trouble-free operation. They are made in either fixed or variable models. All are equipped with external safety gap to protect against internal flashover.

Current ratings are available up to 400 amps at 1 mc., capacitance to 30,000 mmf, and safety gap settings to 85 kv peak. These characteristics fill a broad range of needs. May we send you more information? Ask for Bulletin 302. Lapp Insulator Co., Inc., LeRoy, N.Y. 14482.

Lapp

quency response in the 715: all capacitors in the circuit, parasitic or not, are driven by current sources. "With no resistors to charge capacitors, you can charge a capacitor in no time," Gifford explains.

The input stage is basically a current-source-fed differential cascade with a Darlington input stage followed by a simple differential gain stage. This set-up, with the input stage current sources, together with feedback from the gain stage, gives good common-mode rejection over a wide common-mode input voltage range, low input bias and offset currents—500 nanoamps and 50 na respectively—as well as low input offset voltage—2 millivolts.

The 715 improves the a-c performance without compromising the d-c performance. The d-c characteristics can be reached by operating the input stage at low current, while the a-c characteristics of high input resistance, low input capacitance, wide bandwidth, and high slewing rate can be achieved by operating it at high current.

Features. The 715 operates over a frequency range from d-c to 65 Mhz, a common-mode range of ± 13 volts, and a high input resistance of 10 megohms. The device also has a high output swing of ± 12 volts and a provision for nulling the offset voltage with a 10-kilohm potentiometer, an important feature for analog computation applications. Open-loop voltage gain is 92 decibels.

As a fast high-gain op amp with high circuit impedances, the 715 requires careful mounting. Short lead lengths, ceramic disk capacitor decoupling, and common grounds are required. Gifford won't quote a price on the 715, but says it'll be about one-quarter that of modular op amps.

Having designed the circuit, Fairchild is being cautious about introducing it. "We have a tremendous customer education problem in getting people used to the circuit," Gifford says. Consequently, he's delaying the introduction of the 715 until August 15 so his engineers can write appropriate applications notes.

Fairchild Semiconductor Corp., Mountain View, Calif. 94040 [444]

The follower leader.

The great thing about our new LM102 voltage follower is that it's the first monolithic amplifier that has combined low input current with high speed. A slew rate of $10V/\mu s$ means fast operation. Yet, the maximum input current is an incredible 10 nA.

The circuit is designed so that leakage isn't a problem. Input currents better than 10 nA at $125^{\circ}C$ can be guaranteed. Considering high temperatures, it even gives better performance than FET amplifiers.

The LM102 has an offset voltage less than 5 mV, a guaranteed accuracy of 0.1%, needs no external compensation and is short circuit protected. Plus, it's a plug-in replacement for both the LM101 and the 709 in voltage follower applications.

Although it's really not a complete operational amplifier, it's a dream in low drift sample and hold circuits. And it's a wonder as a buffer amplifier for high speed analog commutators, in active filters or as an impedance buffer in analog computation circuits.

The LM102 will cost you \$30.00 each for 100 or more pieces. For \$12.00 we'll give you an LM202, which works from $-25^{\circ}C$ to $+85^{\circ}C$. If you're really pinched, the LM302 does it on a $0^{\circ}C$ to $70^{\circ}C$ temperature range for \$5.50. And you can get them all today.

National Semiconductor Corporation, 2975 San Ysidro Way, Santa Clara, California, (408) 245-4320.

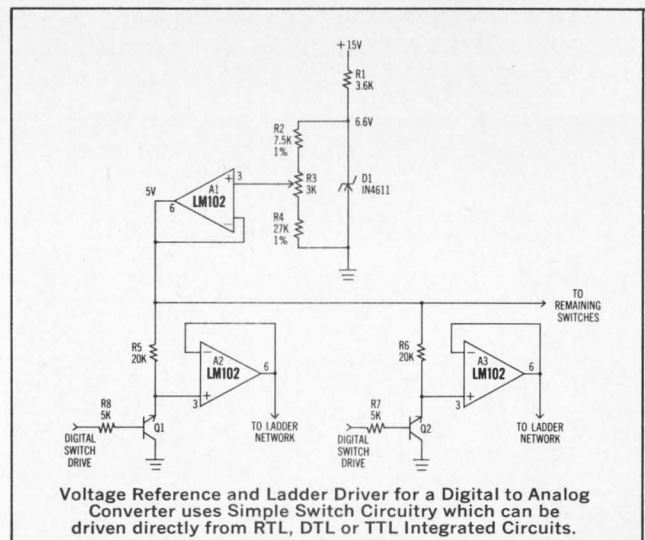

National Semiconductor

Two ways to obtain a permanent graphic record of transient phenomena:

1. Record the signal on magnetic tape.
2. Display the recorded signal on an oscilloscope.
3. Photograph the display with an oscilloscope camera (after you've replayed the taped record enough times to allow for test shots, etc.).
4. Develop the photograph.
5. You now have a single 4" x 5" record.

or

1. Display and record the signal simultaneously on the Honeywell 1806 CRT Recording Oscilloscope (one-shot or continuous permanent records on 6" wide direct-write paper)!

A breakthrough in direct-recording technique, our Model 1806 fiber-optics CRT Recording Oscilloscope brings new convenience to data recording. With the flexibility of X-Y-Y'-Z axes and a frequency response of DC to 1MHz—100 times greater than any oscillographic recorder—the applications of this remarkable instrument are virtually unlimited.

Check the graphic examples of the 1806's capability we've shown here—you're bound to think of applications of your

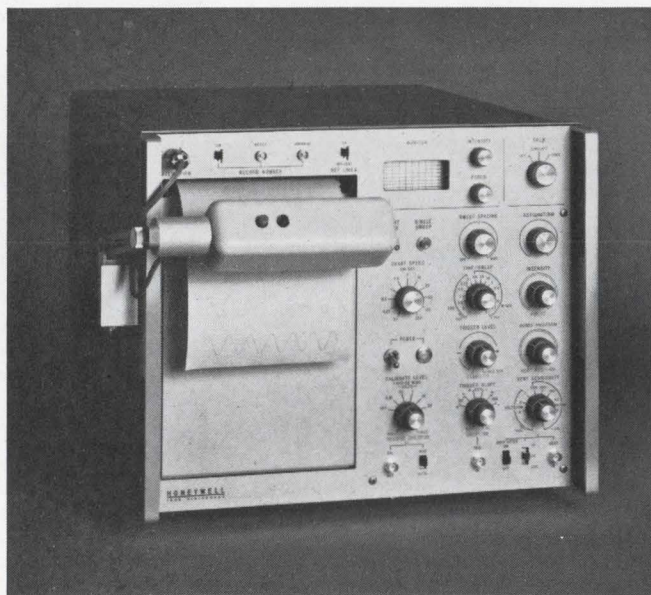

As easy to use as an ordinary oscilloscope, the 1806 CRT Recording Oscilloscope is the greatest direct-recording advance in years!

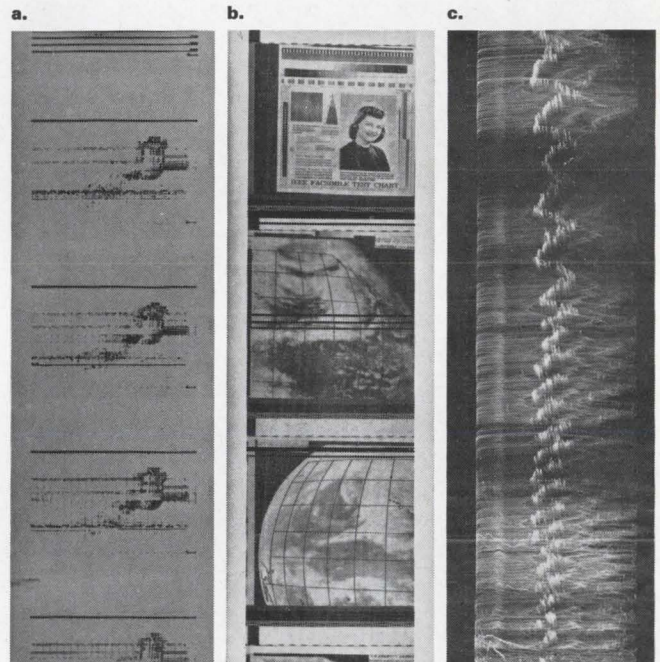

a. RTI Recording (XY'Z axes)—A range, time, and intensity recording indicating receiver signal strength on a long distance radio transmission. Used to determine the best transmission frequency to use at a specific time-of-day, this record is one of the few nonclassified examples of this art available.

b. Slow Scan Video Recording (XY'Z axes)—A pictorial presentation of cloud formations and a test pattern. Similar applications include infrared scanning and sonar work.

c. Contourogram Recording (XYY'Z axes)—Electrocardiogram of a female in labor, recorded over a long period of time in the transverse mode. (Courtesy Mr. Dennis Upright, Mt. Sinai Hospital, Baltimore, Md.)

own! Right now, the 1806 is being used in all fields of instrumentation, from component testing through shock and vibration, recording electrocardiograms and other medical phenomena, servo analysis, computer qualification, and a wide variety of classified applications in the security and surveillance field. It's another example of how Honeywell's broad line, backed by local sales and service, can provide the precise solution to your instrumentation problems.

For a demonstration of the 1806, call your local Honeywell Sales Engineer. For technical literature, write: Honeywell Inc., Test Instruments Division, P.O. Box 5227, 4800 E. Dry Creek Rd., Denver, Colorado 80217.

Honeywell

Honeywell engineers sell solutions

New Production Equipment Review

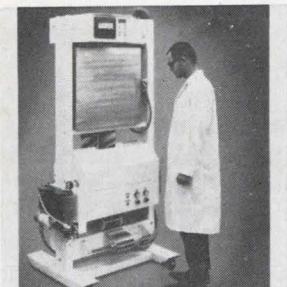

Coil coater model 765 applies uniform, controllable, and continuous coatings of photoresist to both sides of coiled stock. Coating thickness is uniform, adjustable, and automatically regulated. Capacity is 1 to 5 mil coiled materials up to 18 in. wide, or multiple smaller coils. Gyrex Products, Varo Inc., 402 E Gutierrez St., Santa Barbara, Calif. 93101. [421]

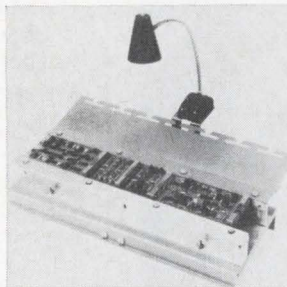

An adjustable soldering and assembly aid adapts to a wide variety of connectors and p-c boards and can also be used for any small assembly operation. Adjustments of height and width allow easy holding of workpieces of different sizes and shapes and keeps them properly aligned at a convenient working location and angle. Henry Mann Co., Box 37, Cornwells Heights, Pa. [422]

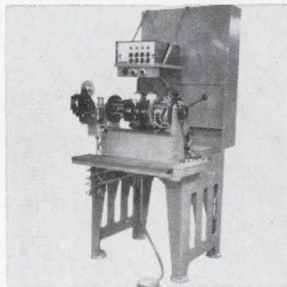

Field coil winder STW-100 operates at speeds to 3,500 rpm, providing up to 9,999 turns per level-wound coil, determined by a precision solid state electronic control. It will produce windings in sizes up to 8x12 in. The design includes a pushbutton operated tape dispenser that tapes one coil while another is being wound. Industra Products Inc., Box 626, Ft. Wayne, Ind. [423]

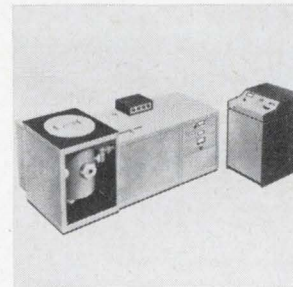

Continuous automatic processing of semiconductor components is possible with two new deposition systems. Specific coating processes can be experimented with and then scaled up to high-throughput production. Systems are: (1) in-line with separate entry and exit air locks; (2) rapid-cycling, with single lock. Varian Associates, 611 Hansen Way, Palo Alto, Calif. [424]



Belt-type fracturer 1180b handles a wide variety of material. Semiconductor wafers up to 2½ in. diameter with die as small as 0.010 in. and up to 0.200 in. as well as ceramic substrates from 0.050 in. to 1.00 in. have been successfully fractured. Bending radius and pressure are variable. Mechanization Associates, 2622 Frontage Rd., Mtn. View, Calif. [425]

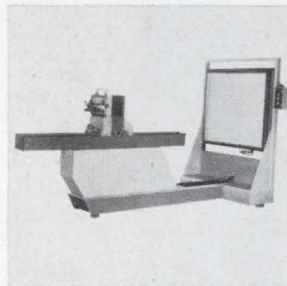

High-resolution microphotography camera system Dekacon III is designed for the production of integrated circuit and other high-accuracy photomasks. It accepts artwork up to 40 x 40 in. and produces photomasks as large as 8 x 10 in. The standard system provides reductions in any ratio from 3.5:1 to 13:1 (continuous). HCL Manufacturing Co., Oreland, Pa. 19075. [426]

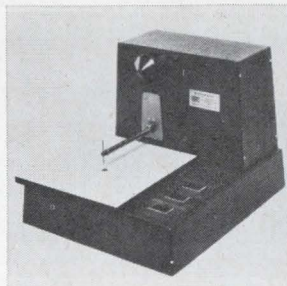

Packaging densities of 15 IC's per cu in. are attainable with the Micropoint welding system without costly artwork. A Teflon-insulated, solid nickel alloy magnet wire passes through a hollow welding electrode. This wire is resistance welded to designated circuit points by a completely machine-controlled process. Micro Technology, 21525 Parthenia St., Canoga Park, Calif. [427]

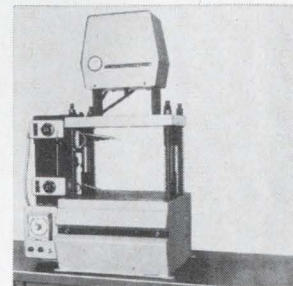

Bench-type semiautomatic transfer molding machine model E5 is for encapsulating electronic components and molding small parts with epoxies, silicones, and other soft flow thermosets. The unit is air powered. Platen size is 11¼ x 10 in. Transfer ram force is 2,000 lbs at 100 psi air pressure and is variable down to zero. Gluco, Box 315, Monroeville, Pa. 15146. [428]

New production equipment

Applying photoresist automatically

Sprayer handles thousands of silicon wafers an hour, outpaces other equipment used in IC production

One of the bottlenecks in integrated-circuit production—application of photoresist—can be eliminated with an in-line sprayer that automatically coats silicon wafers. The Zicon Corp.'s series 9500 Auto-coater can process 1½-inch-diameter wafers at the rate of 5,000 an

hour (or 2-inch-diameter wafers at 2,000 an hour).

The manufacturer says the spraying equipment is several times faster than conventional spinning equipment, in which a drop of photoresist is placed at the center of the wafer and spreads over the

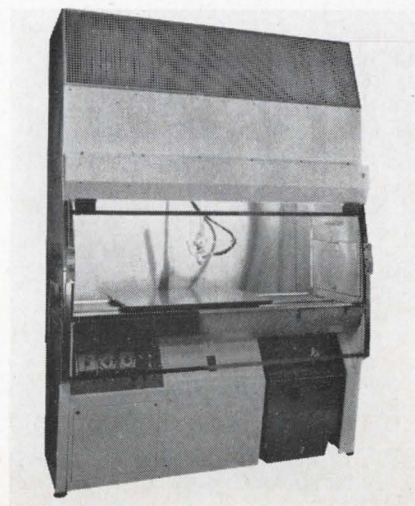

Sweep



IF FREQUENCIES
2-WAY RADIO
VHF-TV
TELEMETRY BANDS
COMMUNICATION BANDS
COMMAND CHANNELS



Designed for Telonic's SM-2000 Sweep Generator, this new Model 3003-1 plug-in oscillator provides frequency coverage from 5 to 500 MHz, sweeping this entire range in one pass or any portion of it down to 500 kHz wide.

Using electronic tuning and all solid state circuits, the 3003-1 virtually doubles the capabilities of the SM-2000 Sweep Generator. In addition to wide range and sweep width, it also features variable rate for permanent recording applications and a variable birdy-type marker, providing frequency identification from 5 - 500 MHz.

SPECIFICATIONS

Frequency Range	5 MHz - 500 MHz
Sweep Width	500 kHz - 500 MHz
Output	.5 v RMS
Sweep Rate	.01 to 100 Hz, variable
Vernier Attenuation Range	6 dB min.
Linearity	1.5:1
Flatness @ max. sweep	±0.75 dB
@ 10% max. sweep	±0.5 dB

Full details plus Application Data in Catalog 70-A. Send for your copy.

Telonic INSTRUMENTS Division of
Telonic Industries, Inc.

60 N. First Avenue • Beech Grove, Indiana 46107 • Tel.: (317) 787-3231 • TWX - 810-341-3202

surface as the wafer is spun. Spraying is so much faster, in fact, that present exposing and developing equipment can't take advantage of the speed of the Autocoater.

Photoresist is the material used to delineate the geometry of an IC through a series of exposures, etches, diffusions, and depositions.

Other automatic equipment is available, but these use spinning rather than spraying. The Electroglas model 1000, for example, can process 2500 wafers in a 7-hour shift. Cost is \$7950. Another spin system being developed by LTB Associates, Inc., produces 1200 wafers an hour; cost will be about \$10,000. Zicon's Autocoater spray system costs about \$18,000.

Gentle touch. The Autocoater uses Freon as a propellant to spray the photoresist.

The spray gun moves back and forth over the wafers as the table moves them from right to left. Each point on the wafers gets five to six passes as the table indexes. In effect, the photoresist is sprayed on in several thin coats rather than a single thick one. This practice helps control thickness and uniformity.

Layers as thin as 3,500 angstroms and as thick as 10 microns can be deposited within ±5%. Thickness is varied by adjusting the size of the nozzle orifice, the propellant pressure, the height of the nozzle, and the indexing speed of the table.

Besides a high production rate, the spray method has these advantages over the conventional spin method, according to Zicon:

- Low down time. Spin equipment is somewhat complicated mechanically, and may be shut down frequently for maintenance and repair. In production runs of the Autocoater, breakdowns are rare.

- No edge buildup. The photoresist layer tends to become much thicker at the edge of a spun wafer.

- Variable shape. Spin coating is more or less limited to round wafers, but spray coating can be used with the oval wafers currently favored in IC manufacture.

- Economy. Spraying uses only about 10% the photoresist that spinning does, because photoresist isn't wasted by being spun off the wafer.

Zicon Corp., 63 E. Sandford Blvd., Mount Vernon, N.Y. 10550 [429]

Acopian will ship this power supply in only 3 DAYS and any of the other 61,999 too.

Next time you need power supplies in a hurry, contact Acopian and request a copy of our latest catalog. It lists 62,000 different AC to DC plug-in power supplies, any of which will be shipped to you in **just three days!** Choose the exact DC output you need. Singles or duals. Regulated or unregulated. Whether you need one power supply or several, your order will be shipped in just three days! That's our promise. For particulars, contact your local Acopian rep, call us at (215) 258-5441, or write to Acopian Corp., Easton, Penna. 18042.

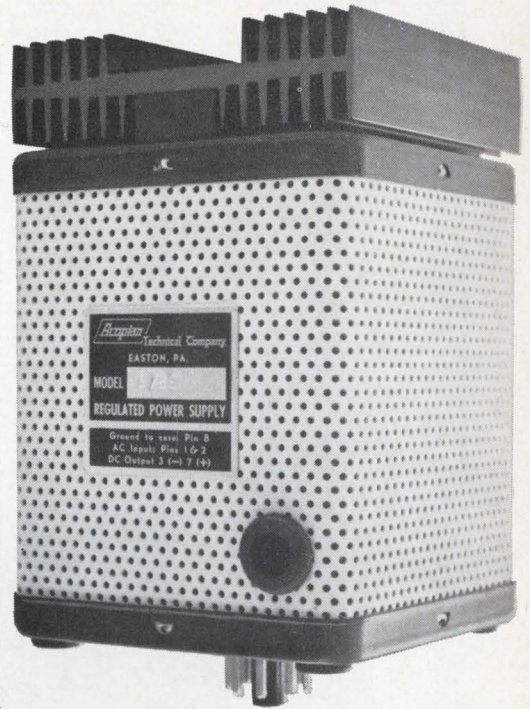

Acopian SINGLE OUTPUT SOLID STATE REGULATED POWER SUPPLIES Ambient temperature rating 0 to 55° C.

Nominal Output Voltage	Adjustment - Volts	Output Current Amps	REGULATION			Ripple RMS	Price	Model	Size	Nominal Output Voltage	Adjustment - Volts	Output Current Amps	REGULATION			Ripple RMS	Price	Model	Size
			Load - %	Line - %	RIIS								Load - %	Line - %	RIIS				
34	1	100	.5	.5	5	\$ 60	14A10	A	55	1	100	.5	.5	5	\$ 65	14B10	A	A	
34	1	100	.05	.05	1	70	14B10	A	55	1	100	.05	.05	1	70	14B10	A	A	
34	1	200	.05	.05	1	70	14B20	A	55	1	200	.05	.05	1	70	14B20	A	A	
34	1	300	.05	.05	1	75	14D30	A	55	1	300	.05	.05	1	75	14D30	A	A	
34	1	500	.1	.05	1	85	14D50	A	55	1	500	.1	.05	1	85	14D50	A	A	
34	1	600	.1	.05	1	95	14D60	A	55	1	600	.1	.05	1	95	14D60	A	A	
34	1	800	.15	.05	1	105	14D80	C	55	1	800	.15	.05	1	105	14D80	C	U	
34	1	1,500	.3	.05	1	175	14B150	U	55	1	1,500	.3	.05	1	175	14B150	U	W	
35	1	100	.5	.5	5	60	35A10	A	60	1	100	.5	.5	5	60	35A10	A	A	
35	1	100	.05	.05	1	65	35B10	A	60	1	100	.05	.05	1	65	35B10	A	A	
35	1	200	.05	.05	1	70	35B20	A	60	1	200	.05	.05	1	70	35B20	A	A	
35	1	300	.05	.05	1	75	35D30	A	60	1	300	.05	.05	1	75	35D30	A	A	
35	1	500	.1	.05	1	85	35D50	A	60	1	500	.1	.05	1	85	35D50	A	A	
35	1	600	.1	.05	1	95	35D60	A	60	1	600	.1	.05	1	95	35D60	A	A	
35	1	800	.15	.05	1	105	35D80	C	60	1	800	.15	.05	1	105	35D80	C	U	
36	1	100	.5	.5	5	60	36A10	A	65	1	100	.5	.5	5	60	36A10	A	A	
36	1	100	.05	.05	1	65	36B10	A	65	1	100	.05	.05	1	65	36B10	A	A	
36	1	200	.05	.05	1	70	36B20	A	65	1	200	.05	.05	1	70	36B20	A	A	
36	1	300	.05	.05	1	75	36D30	A	65	1	300	.05	.05	1	75	36D30	A	A	
36	1	500	.1	.05	1	85	36D50	A	65	1	500	.1	.05	1	85	36D50	A	A	
36	1	600	.1	.05	1	95	36D60	A	65	1	600	.1	.05	1	95	36D60	A	A	
36	1	800	.15	.05	1	105	36D80	C	65	1	800	.15	.05	1	105	36D80	C	U	
36	1	1,500	.3	.05	1	175	36B150	U	65	1	1,500	.3	.05	1	175	36B150	U	W	
37	1	100	.5	.5	5	60	37F10	A	70	1	100	.5	.5	5	60	37F10	A	A	
37	1	100	.05	.05	1	65	37D10	A	70	1	100	.05	.05	1	65	37D10	A	A	
37	1	200	.05	.05	1	70	37D20	A	70	1	200	.05	.05	1	70	37D20	A	A	
37	1	300	.05	.05	1	75	37D30	A	70	1	300	.05	.05	1	75	37D30	A	A	
37	1	500	.1	.05	1	85	37D50	A	70	1	500	.1	.05	1	85	37D50	A	A	
37	1	600	.1	.05	1	95	37D60	A	70	1	600	.1	.05	1	95	37D60	A	A	
37	1	800	.15	.05	1	105	37D80	C	70	1	800	.15	.05	1	105	37D80	C	U	
38	1	100	.5	.5	5	60	38F10	A	75	1	100	.5	.5	5	60	38F10	A	A	
38	1	100	.05	.05	1	65	38D10	A	75	1	100	.05	.05	1	65	38D10	A	A	
38	1	200	.05	.05	1	70	38D20	A	75	1	200	.05	.05	1	70	38D20	A	A	
38	1	300	.05	.05	1	75	38D30	A	75	1	300	.05	.05	1	75	38D30	A	A	
38	1	500	.1	.05	1	85	38D50	A	75	1	500	.1	.05	1	85	38D50	A	A	
38	1	600	.1	.05	1	95	38D60	A	75	1	600	.1	.05	1	95	38D60	A	A	
38	1	800	.15	.05	1	105	38D80	C	75	1	800	.15	.05	1	105	38D80	C	U	
39	1	100	.5	.5	5	60	39F10	A	80	1	100	.5	.5	5	60	39F10	A	A	
39	1	100	.05	.05	1	65	39D10	A	80	1	100	.05	.05	1	65	39D10	A	A	
39	1	200	.05	.05	1	70	39D20	A	80	1	200	.05	.05	1	70	39D20	A	A	
39	1	300	.05	.05	1	75	39D30	A	80	1	300	.05	.05	1	75	39D30	A	A	
39	1	500	.1	.05	1	85	39D50	A	80	1	500	.1	.05	1	85	39D50	A	A	
39	1	600	.1	.05	1	95	39D60	A	80	1	600	.1	.05	1	95	39D60	A	A	
39	1	800	.15	.05	1	105	39D80	C	80	1	800	.15	.05	1	105	39D80	C	U	
40	1	100	.5	.5	5	60	40F10	A	85	1	100	.5	.5	5	60	40F10	A	A	
40	1	100	.05	.05	1	65	40D10	A	85	1	100	.05	.05	1	65	40D10	A	A	
40	1	200	.05	.05	1	70	40D20	A	85	1	200	.05	.05	1	70	40D20	A	A	
40	1	300	.05	.05	1	75	40D30	A	85	1	300	.05	.05	1	75	40D30	A	A	
40	1	500	.1	.05	1	85	40D50	A	85	1	500	.1	.05	1	85	40D50	A	A	
40	1	600	.1	.05	1	95	40D60	A	85	1	600	.1	.05	1	95	40D60	A	A	
41	1	100	.5	.5	5	60	41F10	A	90	1	100	.5	.5	5	60	41F10	A	A	
41	1	100	.05	.05	1	65	41D10	A	90	1	100	.05	.05	1	65	41D10	A	A	
41	1	200	.05	.05	1	70	41D20	A	90	1	200	.05	.05	1	70	41D20	A	A	
41	1	300	.05	.05	1	75	41D30	A	90	1	300	.05	.05	1	75	41D30	A	A	
41	1	400	.1	.05	1	85	41D40	A	90	1	400	.1	.05	1	85	41D40	A	A	
41	1	600	.15	.05	1	105	41D60	C	90	1	600	.15	.05	1	105	41D60	C	U	
42	1	100	.5	.5	5	60	42F10	A	95	1	100	.5	.5	5	60	42F10	A	A	
42	1	100	.05	.05	1	65	42D10	A	95	1	100	.05	.05	1	65	42D10	A	A	
42	1	200	.05	.05	1	70	42D20	A	95	1	200	.05	.05	1	70	42D20	A	A	
42	1	300	.05	.05	1	75	42D30	A	95	1	300	.05	.05	1	75	42D30	A	A	
42	1	400	.1	.05	1	85	42D40	A	95	1	400	.1	.05	1	85	42D40	A	A	
42	1	600	.15	.05	1	105	42D60	C	95	1	600	.15	.05	1	105	42D60	C	U	
43	1	100	.5	.5	5	60	43F10	A	100	1	100	.5	.5	5	60	43F10	A	A	
43	1	100	.05	.05	1	65	43D10	A	100	1	100	.05	.05	1	65	43D10	A	A	
43	1	200	.05	.05	1	70	43D20	A	100	1	200	.05	.05	1	70	43D20	A	A	
43	1	300	.05	.05	1	75	43D30	A	100	1	300	.05	.05	1	75	43D30	A	A	
43	1	500	.1	.05	1	85	43D50	A	100	1	500	.1	.05	1	85	43D50	A	A	
43	1	600	.1	.05	1	95	43D60	A	100	1	600	.1	.05	1	95	43D60	A	A	
44	1	100	.5	.5	5	60	44F10	A	110	1	100	.5	.5	5	60	44F10	A	A	
44	1	100	.05	.05	1	65	44D10	A	110	1	100	.05	.05	1	65	44D10	A	A	
44	1	200	.05	.05	1	70	44D20	A	110	1	200	.05	.05	1	70	44D20	A	A	
44	1	300	.05	.05	1	75	44D30	A	110	1	300	.05	.05	1	75	44D30	A	A	
44	1	500	.1	.05	1	85	44D50	A	110	1	500	.1	.05	1	85	44D50	A	A	
44	1	600	.1	.05	1	95	44D60	A	110	1	600	.1	.05	1	95	44D60	A	A	

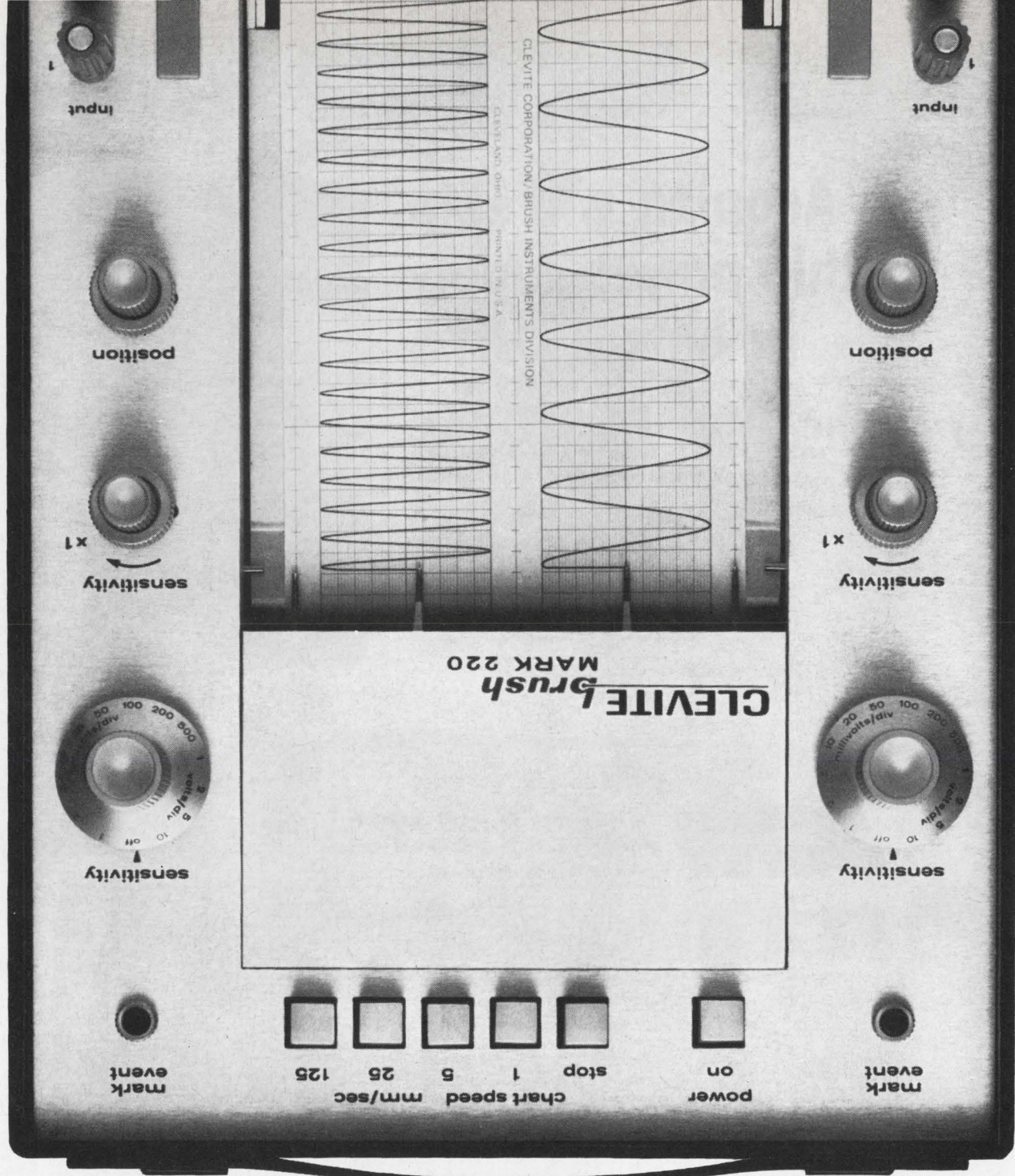

Write-side up?

Why not? New Mark 220 by Brush features pressurized-ink writing. Puts trace into the paper . . . not just on it. And you can see you don't have to pamper it! Now, anyone can take this remarkable new 25 lb. portable *anyplace*, plug it in . . . and put it in writing. And what writing! Fine, sharp traces you can read at a distance—99½% accurate! Rectilinear writing, of course, on two easy-to-read 40mm analog channels plus left and right-hand event markers. And there's enough ink in the throw-

away ink cartridge to last for about a thousand miles. There's more. Rugged, reliable solid state electronics to give you position feedback pen control . . . no springs, no strings. Pushbutton choice of chart speeds. Frequency response that's flat ($\pm 2\%$) from d-c to 40 cps at 50 div, or from d-c to 100 cps at 10 divisions. The price? Less than \$1700. For a portable chart recorder the likes of which you've never seen! Bulletin 942-1 has all the details. Call or write: Clevite Corporation, Brush Instruments Division, 37th & Perkins, Cleveland, Ohio 44114.

Circle 186 on reader service card

brush CLEVITE
INSTRUMENTS DIVISION



New Microwave Review



Five basic models of crystal stabilized frequency sources cover the range of 0.6 to 18.0 Ghz. Power levels from 2 w in L-band to 25 mw in Ku-band are available as standard items. Spurious signal suppression is -40 db minimum, and the d-c power required is less than 40 v with 400 ma max. current. Frequency Sources Inc., Kennedy Drive, Box 159, North Chelmsford, Mass. 01863. [401]

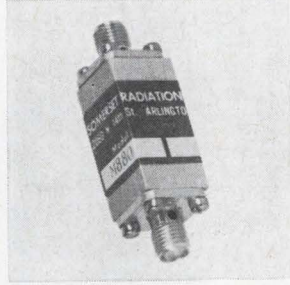

Comb generator M880 accepts an input level of only 5 mw from 10 Mhz to 250 Mhz with output up to 2 Ghz without zeros in the sin X/Y output pattern. It is suited for operation directly from high-stability, low-level crystal oscillators for producing accurate frequency markers in precision measuring systems. Somerset Radiation Laboratory Inc., 2060 N. 14th St., Arlington, Va. [402]

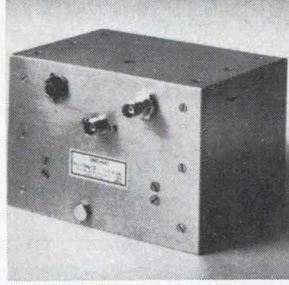

Solid state, phase locked multipliers are available for system applications. The unit shown, PLM-5/1545, provides 20 mw output at 1,545 Mhz, operates from -30° to +55° C, and occupies less than 100 cu in. Residual f-m is less than 5 hz rms when referenced to a 5 Mhz crystal oscillator. Curry, McLaughlin & Len Inc., East Molloy Rd., Syracuse, N.Y. [403]

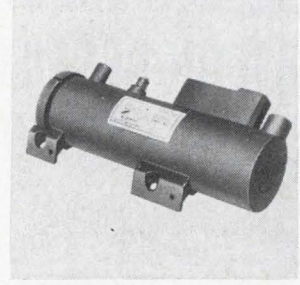

C-w varactor modulated oscillators are for high altitude and space electronics use in L band. They include model 6012, operating from 590 to 620 Mhz with 20 w minimum output; 6013, covering 945 to 975 Mhz with 20 w output; and 6014, spanning 1482 to 1507 Mhz with 15 w output. Microwave Cavity Laboratories Inc., 10 N. Beach Ave., LaGrange, Ill. [404]

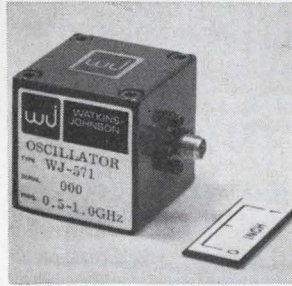

Electronically-tuned transistor oscillators are for use as microwave signal sources. The WJ-569 covers 1 to 2 Ghz and the WJ-571 operates between 0.5 and 1 Ghz. YIG tuning provides excellent linearity over the specified ranges, and the use of high Q YIG spheres for frequency control provides clean output spectrums. Watkins-Johnson Co., 3333 Hillview Ave., Palo Alto, Calif. [405]

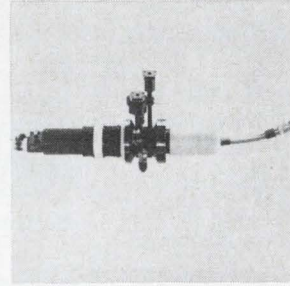

C-w klystron amplifier VA-928, for use in millimeter-wavelength research, space-probe and communications applications, produces 1 kw at 35 Ghz with a drive power of only 10 mw. Load vswr is 1.05:1; beam voltage, 12 kv d-c; and beam current, 1.0 amp d-c. The unit is electromagnetically focused and liquid cooled. Varian Associates, 611 Hansen Way, Palo Alto, Calif. [406]

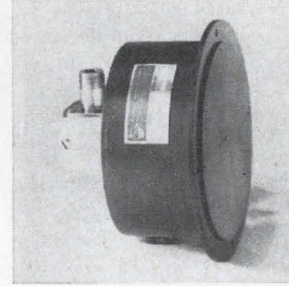

Cavity backed Archimedes spiral antennas are circularly polarized, broadband with essentially constant impedance and radiation characteristics. They are suited for many ECM, telemetry and surveillance applications. Model S6510 has a frequency of 2 to 11 Ghz, vswr of 2:1, axial ratio of 2 db, and gain of 5 db. Eastern Microwave Corp., 139 Swanton St., Winchester, Mass. [407]

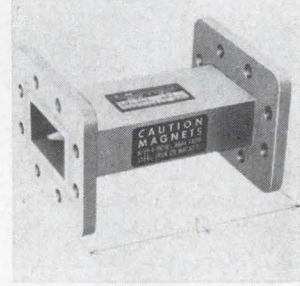

Waveguide isolators incorporate a lightweight magnetic structure, eliminating the old style bulky C-magnet. Seven models are available covering 5.800 to 6.875 Ghz. Typical characteristics are found in model CB24L, with a frequency range of 5.925 to 6.425 Ghz; isolation, 30 db min.; insertion loss, 0.7 db max. E&M Laboratories, 7419 Greenbush Ave., N. Hollywood, Calif. [408]

New microwave

Fast service on custom IC's

Raytheon unit is ready to take commercial orders for subassemblies and deliver the goods in 60 to 90 days

Microwave integrated circuits are usually designed and built to fill large research contracts with long lead times, and makers generally aim their sales efforts at acquiring such orders. Not so the Micro State Electronics operation of the Raytheon Co. The unit,

which already produces a line of microminiaturized local oscillators, limiters, mixers, phase shifters, and other components, is now organized to turn out simple, custom MIC's in as little as one month and to deliver large-scale subassemblies in from 60 to 90 days.

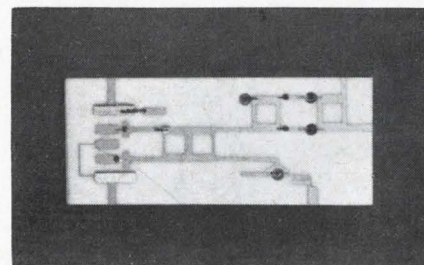

Demonstrator. Hybrid circuit has beam-lead Shottky mixer, other GaAs devices.

Thomas Warren, head of the MIC department at Micro State, expresses less interest in headline-making R&D awards than in commercial orders for "producible" components and subassemblies.

WE MAY ALREADY HAVE DESIGNED THE SILICON RECTIFIER ASSEMBLY YOU WANT

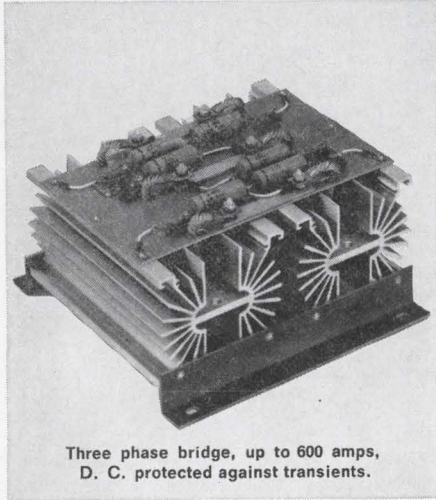

Three phase bridge, up to 600 amps,
D. C. protected against transients.

Tung-Sol packages a lot of performance into silicon rectifier stacks. Thorough experience in heat sink configuration, control of transients and the manufacture of solid state devices, assures highest efficiency in units that require only minimum space. Power capability is extremely broad.

Write for descriptive literature. Describe your requirements and we will offer specific suggestions. Tung-Sol Division, Wagner Electric Corporation, One Summer Ave., Newark, N.J. 07104.

Controlled avalanche assembly, to 150KV at 12 amps, single phase, half-wave rating.

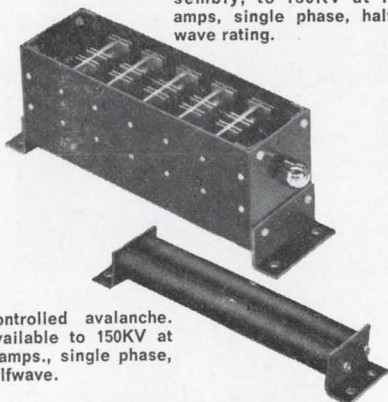

Controlled avalanche. Available to 150KV at 3 amps., single phase, halfwave.

TUNG-SOL® SILICON RECTIFIER ASSEMBLIES

© REG. T.M. WAGNER ELECTRIC CORPORATION

And he includes in this category assemblies as large as or larger than receiver front ends.

"Though we quote 60-to-90-day delivery, the extra time often isn't needed," Warren says. "But gearing up for a brand-new or more complex MIC could take a few weeks more."

Show me. "We'd rather build MIC's and subassemblies for off-the-shelf sales," he concedes. "But this is going to be a custom business for some time. Thus, we're demonstrating our capabilities rather than working up a fictitious product line."

Warren's demonstrator is a receiver front end of hybrid IC design on a 1.6-by-0.6-inch alumina substrate. A catalog of its active components reads like a microwave engineer's dictionary, with most of the glamor items in microwave semiconductor work appearing somewhere on the ceramic substrate.

For example, the front end has a double balanced mixer that uses twin gallium-arsenide, Schottky-barrier, beam-lead diodes. The local oscillator is a GaAs avalanche diode, and the limiter/duplexer uses high-power beam-lead p-i-n diodes.

Since Micro State epitaxially grows its own single-crystal gallium arsenide, it's able to select material to assure performance. In this 8.5-to-9.6-gigahertz front end, for example, the noise figure for the mixer is about 8.5 decibels—including 1.5 db of intermediate-frequency amplifier noise.

The duplexer handles pulses as powerful as 1 kilowatt on a 0.001 duty cycle, and thus could easily take spillover from a radar transmitter in phased-array applications.

More to come. Warren doesn't expect capabilities to stop there. The department's R&D staff is intent on adding avalanche-diode oscillators of "respectable power" to Micro State's arsenal sometime this year.

And with an in-house source of high-quality gallium arsenide, the researchers may soon be able to add a capability for limited space-charge accumulation (LSA) signal sources for MIC's.

Micro State Electronics, Raytheon Co.,
152 Floral Ave., Murray Hill, N.J.
07974 [409]

SOLID STATE STANDARD SIGNAL GENERATOR Model SG-83B

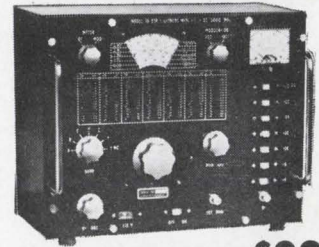

MADE IN U.S.A.

\$295⁰⁰

- ✓ 50 Kc. to 54 Mc.; 1% accuracy; plus 1 Mc. crystal
- ✓ Calibrated output 0.6 to 160,000 microvolts
- ✓ Operates from 115 volts or internal battery
- ✓ Modulation 0-50%, read on meter. No FM!
- ✓ Send for complimentary copy of Instruction Book with Schematic and all details.

Immediate Delivery f.o.b. St. Louis



CLEMENS MANUFACTURING CO.
630 South Berry Road
St. Louis, Missouri 63122
Area Code (314) WO 1-7228

Circle 233 on reader service card

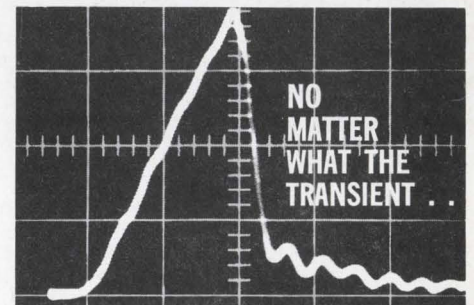

JOSLYN STOPS IT!

Joslyn Precision Spark Gaps act fast operate precisely at voltage breakdown specified every time no matter how long between transients will last virtually for the life of your product arresting capability spans wide current and voltage range complete protection . . . from stock or custom design. Just one of many surge arrester lines.

Write or call today for full information on these and other electronic surge protectors.



JOSLYN
ELECTRONIC SYSTEMS

Division of Joslyn Mfg. and Supply Co.

SANTA BARBARA RESEARCH PARK
P.O. BOX 817 • GOLETA, CALIFORNIA 93017
TELEPHONE (805) 968-3551 44

evening classes won't fit your schedule?

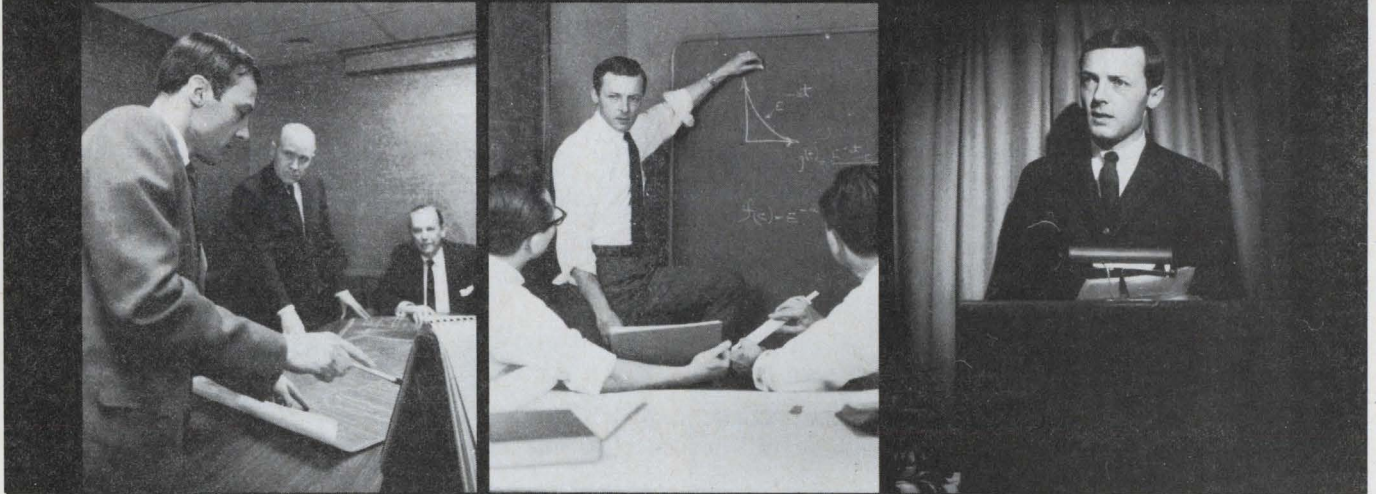

here's a practical way to keep up with new developments

Are irregular hours, travel and family obligations keeping you from attending classes—even though you worry about becoming technically obsolescent? Check into the Special Programs in Electronics for Engineers developed by CREI, the Home Study Division of the McGraw-Hill Book Company.

These are not simply courses, but comprehensive programs in advanced electronics offering major electives in such fields as:

Communications Engineering, Aeronautical and Navigational, Television Engineering, Automatic Control Engineering, Missile and Spacecraft Guidance, Radar and Sonar Engineering, Nuclear Instrumentation and Control, Computers.

Industry-recognized CREI Programs make it possible for you to catch up on new developments in electronics through study in your own home, at your own pace,

your own schedule. Free book gives complete information and details of technical material covered. For your copy, mail coupon below or write: CREI, Home Study Division, McGraw-Hill Book Company, Dept. 1826-G, 3224 Sixteenth St., N.W., Washington, D.C. 20010.

Founded 1927



Accredited Member of the National Home Study Council



CREI, Home Study Division, McGraw-Hill Book Company
Dept. 1826-G, 3224 Sixteenth St., N.W.
Washington, D.C. 20010

Send me free brochure describing CREI Programs in Electronics for Engineers.

NAME _____ AGE _____
ADDRESS _____
CITY _____ STATE _____ ZIP CODE _____
COMPANY _____
TITLE _____

How AO fiber optic light guides solve illumination problems.

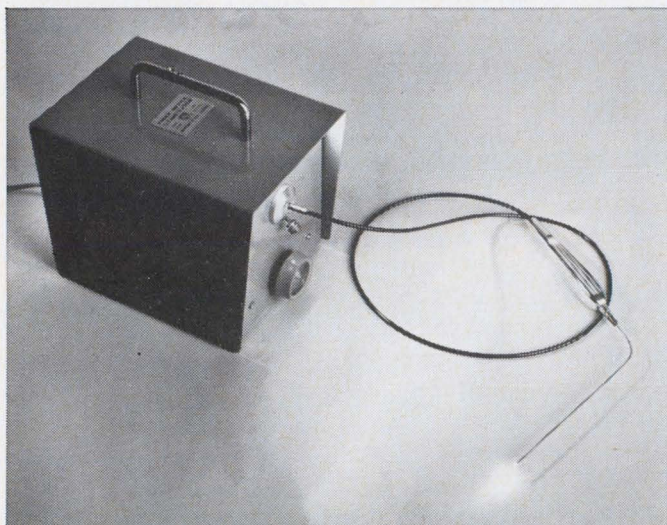

Transmit "cold" light like other forms of energy—by flexible routing to remote or inaccessible locations, hazardous areas, or any abnormal environment.

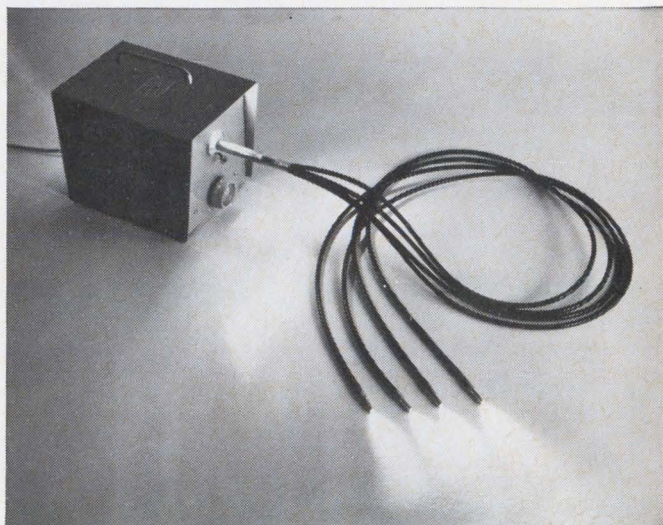

Supply multiple illumination from a single light source, with multi-branched light guides.

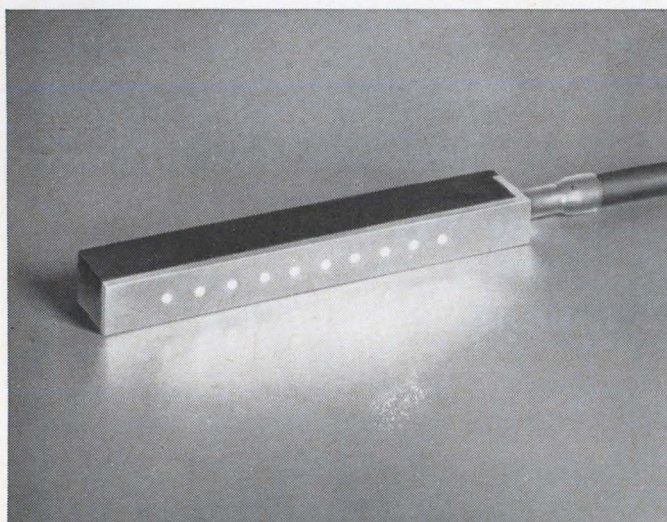

Simplify lighting problems by eliminating lens systems, multiple lamps, complex electrical circuitry.

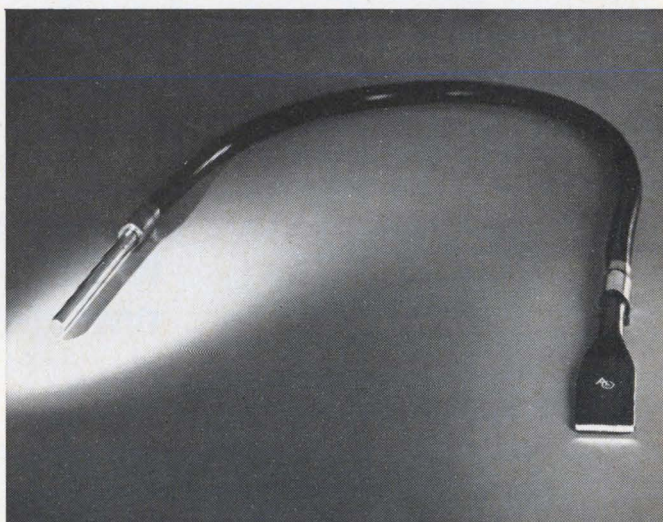

Provide input-output geometry conversions such as round-to-square, round-to-slit, etc.

These are only a few of the ways in which American Optical fiber optic light guides are used to help solve illumination problems. Specific applications range from mark sense readout to electro-optical sensing in data processing, circuit verification, fire control, null detection, light pens, spot illumination, and many others.

Simple, reliable, economical. AO fiber optic light guides are simple, passive elements which remain extremely reliable under normal vibration, temperature or humidity changes, or other environmental fluctuations. This results in long service life with minimum maintenance.

Standard and custom light guides from American Optical have light transmission ranges from 400 to 1500 millimicrons. Standard light guides are

available in bundle sizes from .020" to 1/4", with 30 to 6000 fibers, lengths up to 72", plastic or stainless steel tips, and PVC sheaths. Custom light guides can be supplied in any length desired, with special end tips, sheaths, diameters, input-output face configurations, and branchings.

A leader in optics since 1833, American Optical Company brings a great breadth of related experience to the technology of fiber optics. Our versatility in fiber optics is unmatched by any other manufacturer. In fact, AO scientists already hold more than 200 important patents or patents pending in this relatively new field.

For Fiber Optics Data Kit, send reader service card, or write to Fiber Optics Department:



AMERICAN OPTICAL COMPANY

Space-Defense Division • Southbridge, Mass. 01550

New Instruments Review

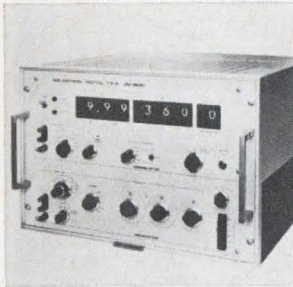

Transfer function analyzer JM-1600 contains a digital oscillator and digital correlator covering 0.00001 hz to 159.9 hz, and provides direct reading outputs in Cartesian, polar or log polar coordinates. Resolution and accuracy are typically $\pm 0.5\%$ of reading $\pm 0.1\%$ full scale on amplitude at ± 10 minutes of arc at full scale phase. Marconi Instruments, Englewood, N.J. [361]

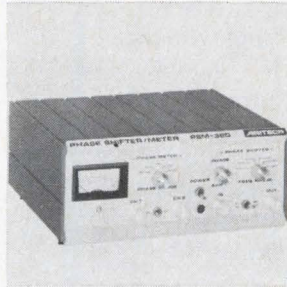

Phase shifter/meter model PSM-360 consists of a complete 5-range, linear, 0 to 360° phase meter as well as complete phase shifter-generator. It has an overall absolute accuracy of less than 2° (worst case). It is housed in an aluminum cabinet 3½ x 8¾ x 7½ in. Price is \$425; availability, from stock. Aritech Corp., 130 Lincoln St., Brighton, Mass. 02135. [362]

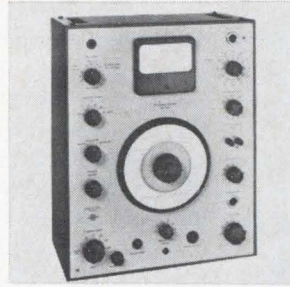

Sine-random generator model 1024 is for electrical, electro-acoustical and acoustical measurements. The signal source covers the frequency range from 20 hz to 20 khz. It consists of a wide-band noise generator, beat frequency type oscillator, filters, amplifiers and an automatic output regulator. B&K Instruments Inc., 5111 W. 164th St., Cleveland. 44142. [363]



Voltage-controlled waveform generator model F210A provides sine, square, triangle, ramp and sync pulse outputs from 0.005 hz to 3 Mhz. Frequency can be modulated by an external d-c wideband (100 khz bandwidth) analog signal. A step output attenuator with 20 db vernier provides excellent low-level operation. Data Royal Corp., 8014 Armour St., San Diego, Calif. [364]



Digital ratio/voltmeter DS-100-K6C is suited for testing low-level d-c parameters of semiconductors. Performance factors include μv sensitivity, differential input with 10 gigohm common mode impedance, and low exit current in the picoamp region. Accuracy is 0.01%. Price is in the \$1,000 to \$1,500 range. Doric Scientific Corp., 7969 Engineer Rd., San Diego, Calif. [365]

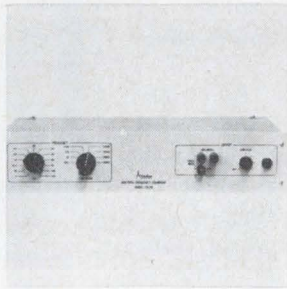

Crystal-controlled, multiple frequency standard CU-2R provides frequencies ranging from 0.5 hz to 600 khz. It features an accuracy of 0.0005%. Applications include calibration of lab frequency measuring instruments, timing circuits, tachometers and flow meter instrumentation. Price is \$595. Anadex Instruments Inc., 7833 Haskell Ave., Van Nuys, Calif. 91406. [366]

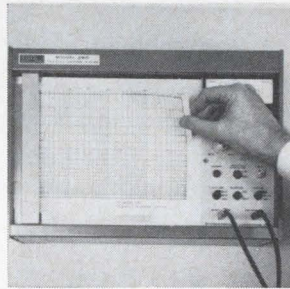

Frequency response plotter model 260 provides a continuous sweep signal from 10 hz to 100 khz to the device under test. In 45 seconds or less, it produces an 8½ x 11 in. hard copy plot in volts or decibels versus frequency. The self-contained voltmeter also permits visual monitoring. Price is \$3,500. Systems Research Laboratories Inc., 500 Woods Drive, Dayton, Ohio 45432. [367]

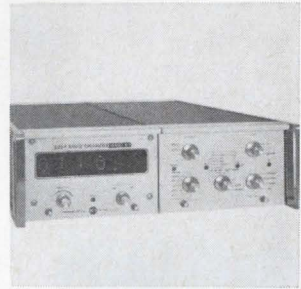

Fast, accurate resistance measurements are presented on a 6-window display when using the model X-1 digital ohmmeter/voltmeter. Eight full scale resistance ranges of 12/120 ohms, 1.2/12/120 kilohms, 1.2/12 and 120 megohms and 5 voltage ranges of 120 mv and 1.2/12/120 and 1,000 v are available. Non-Linear Systems Inc., Box N, Del Mar, Calif. 92014. [368]

New instruments

Measuring becomes five-digit exercise

Separate IC's do counting and storage to give improved reliability to new panel meter

Getting one digit ahead of the Fairchild Camera & Instrument Corp. and the Data Technology Corp., a small firm in Sunnyvale, Calif., has begun its career with the production of a panel meter with a five-digit readout.

The Electro-Numerics Corp.'s

model 3410 automatic polarity panel meter has four full digits and an overrange digit, plus polarity readout tubes that give $\pm 19,999$ volts full scale. Resolution in the least significant digit is 100 microvolts, but a 10-microvolt resolution is available as an option.

Russell Walton, an applications engineer, puts accuracy at 0.05%, but adds that higher accuracy is available on special order. Measurement speed is externally adjustable from one to 20 readings a second. Data outputs are at either the 24-v or micrologic level.

Specialization. The design of the new panel meter, which involves a dual slope integration technique, differs significantly from present designs in that counting and storage functions are performed by separate banks of IC's; the readout tubes are driven by discrete transistors. Says Walton, "By staying away from a single-chip circuit



... splitting functions gives extra options ...

for both counting and storage, we've done much to improve reliability."

He also notes that the hybrid design permits the model 3410 many optional functions not available with single-chip panel meters without added external circuitry. For example, when input exceeds the unit's 19,999-volt ceiling, the entire display blinks to indicate overload. Or the display can be set to blink above or below any selected reading by a "digital-limits" option that's analogous to the set points on an analog meter; either two or four limits are available. Digital limits are programmed by selecting five decimal digits and a polarity sign. They may be permanently fixed or externally adjusted by rotary or thumb-wheel switches.

With digital limits, the meter can be used in a variety of industrial situations where variables must be kept within specified limits. It can act as a safety device. For example, if the preset limits are exceeded, the panel meter can trip a relay to shut down external equipment or to activate a buzzer or other alarm.

Options. Also optional are fully buffered binary coded data or 10-line outputs for data logging. The choice of outputs, says Walton, is possible because the meter's flip-flop counter circuits use biquinary code rather than BCD. The biquinary code is decoded directly to 10-line output in the readout-tube drivers. And for data logging, Walton says, it's a relatively simple matter to decode to BCD from biquinary. Both the digital limits and digital outputs are available as plug-in printed cards. Remote readout capability is also available as an option.

In single-unit quantities, the standard panel meter will sell for \$550; optional functions can run the price up to \$600. Without options, the instrument is 2¾ inches high, 6 inches wide, and 7½ inches deep. The unit is designed for behind-the-panel mounting.

Electro-Numerics Corp., 865 Carlisle Way, Suite 46, Sunnyvale, Calif. 94087 [369]

switch wiring a hangup?

Many of our cost conscious customers have found that we can wire a switch before assembly at a considerable savings.

With your next switch order, send along a harness diagram and let us show you what your *fixed* cost would be.

Remember, we build (and wire) switches like no one else can!



DIVISION OF THOMAS A. EDISON INDUSTRIES
GRENIER FIELD, MANCHESTER, N.H. 03103
(603) 669-0940 • TWX 710-220-1747

PROFIT from iron core research by PERMACOR® Iron Core Engineers

Countless years in the research, development and production of quality iron cores for various applications enable us to more efficiently serve your needs in the following ways:

- In the development of specialized iron cores for unique product applications.
- In providing qualified research personnel familiar with your product and production problems including circuitry and coil winding.
- In supplying iron cores, based on experience, that perform better, lower product and production costs.

Whether your problems involve military, commercial, miniaturization, micromodular, or special applications, let us show you why PERMACOR "Engineered Economy" has made us the largest iron core manufacturer.

We invite your inquiry at any time
... no obligation, of course!

PERMACOR®
A Division of Radio Cores, Inc.
9540 Tulley Ave., Oak Lawn, Ill.
Phone: 312/GA 2-3353

Circle 235 on reader service card

Cartoon by Whitney Darrow, Jr.



Be a buddy!

One gift works many wonders
THE UNITED WAY

Darcy Tried Harder! The DM440 is Now the Best Value in DVM's.

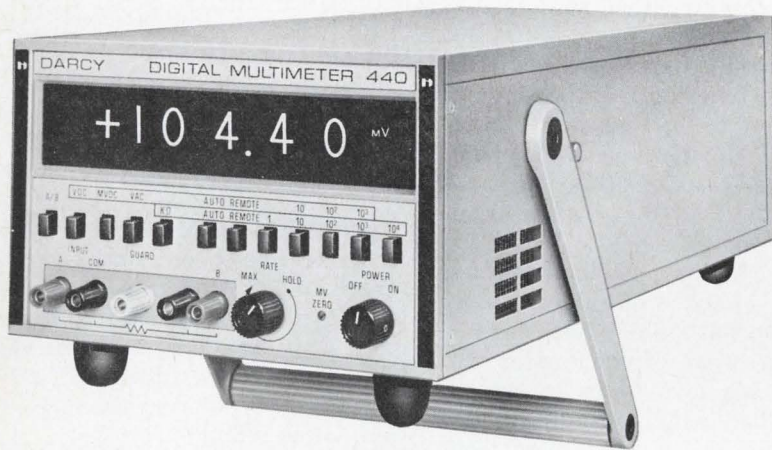

COMPARISON OF PERFORMANCE vs \$s Tells the Story in DVM Values. Just a few of the DM 440 specifications and features are:

EXTREMELY STABLE — accuracy will remain as specified for not less than 90 days from calibration over the temperature range of 15°C to 35°C.

HIGHLY ACCURATE — $\pm 0.01\%$ of reading ± 1 digit.

HIGH COMMON MODE REJECTION — infinite at DC; 140 dB at all frequencies up to 1 KHz with up to 1 K Ω source imbalance in either input lead. Common mode voltage up to 1000 VAC peak.

SYSTEM ORIENTED ACCESSORIES AND OPTIONS — DCmV, K Ohms, AC, and DC accessories and over 13 options (as many or as few as you like).

COSTS ONLY \$995! Sound like a big value? It should, it's from DARCY. Write for the whole DM 440 story today and compare for yourself. Darcy Industries Inc. 1723 Cloverfield Blvd., Santa Monica, Calif. 90404. Phone (213) EX 3-9611 or TWX (910) 343-6963.

DARCY INDUSTRIES

- AC and DC Power Supplies
- Electronic Counters and Nuclear Scalers

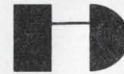

- Digital Voltmeters
- Instrumentation Systems for Industry

Representatives in principal cities throughout the world.
1723 CLOVERFIELD BLVD. • SANTA MONICA, CALIF. 90404
Phone (213) EX 3-9611 TWX (910) 343-6963

Circle 238 on reader service card

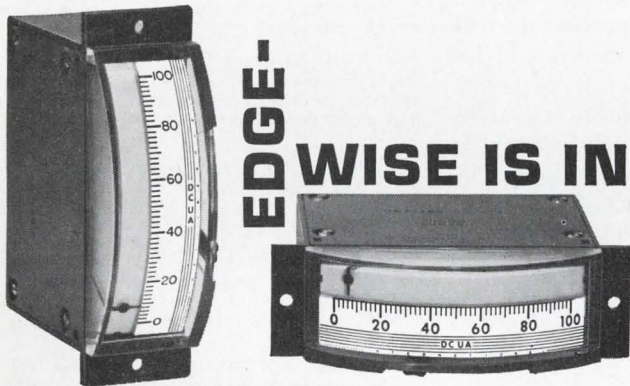

Panel space savings and increased readability have made edgewise panel meters the choice in many critical applications. International, who pioneered the idea of the edgewise panel meter many years ago, offers you the industry's longest experience and widest choice of models and options:

Vertical and horizontal reading. Military and commercial. Interchangeable scales. Scale lengths from 1 1/4 to 5 in. Magnetic and rf shielding. Diode overload protection to 25 times full scale. Glass-and-metal or plastic cases. Illuminated scales. More.

Bulletin 391 tells the whole story. Write for a copy. Also in VSMF Microfilm File.

 **international instruments inc.**
8703 Marsh Hill Road, Orange, Connecticut 06477

4070

The \$12.00 C.P. pot.

Helipot's new Model 3351
conductive plastic potentiometer

is your twelve-dollar solution to applications requiring high precision and long, trouble-free life at minimum cost.

Here are just a few of the specs:

- Resistance range: 1K to 75K ohms
- Linearity: $\pm 0.5\%$
- Power rating: 0.75 watts at 70°C
- Bushing mounted

If you like the specs *and* the price, get in touch with any

Helipot Sales Rep. He'll give you the complete non-wire-wound pot story — about both cermet and conductive plastic models.

Beckman®

INSTRUMENTS, INC.
HELIPOT DIVISION
FULLERTON, CALIFORNIA • 92634

INTERNATIONAL SUBSIDIARIES: GENEVA, MUNICH, GLENROTHES, SCOTLAND; TOKYO, PARIS, CAPE TOWN, LONDON; MELBOURNE

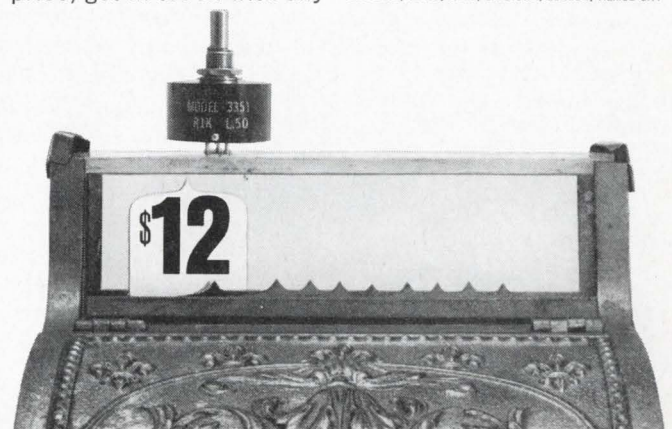

Circle 239 on reader service card

Circle 193 on reader service card

193

have you any idea
how many ways
you can use this
handle?



as a screwdriver...



for slotted, Allen hex, Phillips, Frearson, Bristol, Clutch Head, ScruLox® screws

as a nutdriver...



for hex nuts, screws, and bolts

as an awl/scraper and reamer

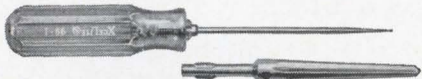

It accommodates 49 interchangeable blades of various types and sizes.

Its patented spring device permits quick blade insertion and removal.

It's shockproof, breakproof (UL) plastic. Comes in three sizes—regular, junior, stubby—also Tee type.

It's available in a great variety of sets from 39-piece roll kits to compact, pocket cases.

For information on time-saving, space-saving Xcelite "99" tool kits and sets, request Catalog 166.



XCELITE®

XCELITE, INC., 130 Bank St., Orchard Park, N. Y. 14127
In Canada contact Charles W. Pointon, Ltd.

New Books

Learning by rote

Electronic Digital Techniques
Paul M. Kintner
McGraw-Hill Book Co.
315 pp., \$11.95

Dr. Kintner has the mistaken idea that those without a technical background should learn technical material only in terms of "what," because the "why" is beyond them. On the contrary, the "why," stated in terms a nontechnical person can understand, would strongly reinforce his knowledge of the material and possibly lead him on to other material—in the long run giving him nearly as good a technical background as the man with an engineering degree.

Because this "why" is lacking, Kintner's book is of dubious value.

And to this sin of omission Kintner adds a sin of commission. He invents his own terms to explain established ideas, so that the reader who goes on to learn more from other books is likely to be baffled by the different terminology. For example, what every logic designer calls a truth table, Kintner calls a logic list. And he compounds this by putting the combinations of input values across the top of the list, or table, and the output values below them; the usual truth table puts input combinations on the left and outputs on the right.

Kintner also introduces the familiar Karnaugh map—under the name logic map—but juggles the rows and columns from their usual arrangement, for no particular reason. Of course, that this juggling is possible is one of the beauties of the Karnaugh representation of a logic function, but Kintner doesn't say a word about this or about why the cells in the map are numbered nonconsecutively—a key idea. Instead, he introduces an arbitrary and somewhat confusing spiral pattern as a rule of thumb for labeling the cells, and lets it go at that.

In chapter two, various kinds of switching circuits are discussed. Here, perhaps, omitting the "why" can be partially justified; some readers may want to know only how logic design on paper can be translated into hardware. However, even these readers are entitled to

know, if only for their leisure moments, that a transistor's terminals aren't arbitrarily named collector, base, and emitter, for example. As far as Kintner's book is concerned, these details are arbitrary.

Beginning with chapter three, Kintner has a good step-by-step sequence from number systems, through decoding and encoding, parity generation, and parallel arithmetic, to flip-flops, registers, and counters. However, with the somewhat shaky basis of the first two chapters—especially with those logic lists that keep cropping up—even these chapters leave something to be desired.

The book concludes with chapters on time-based signals, rate scalars, digital system control, and ways to translate push-button signals, shaft positions, and the like, into logic signals, and back again.

Wallace B. Riley

Computers editor

Recently published

Microelectronic Packaging, George Sideris, McGraw-Hill Book Co., 299 pp., \$12.50

Covers special design and production methods used today in industry. Aimed at design engineers, it describes new packaging and assembly techniques developed for IE's.

Gas Lasers, Arnold L. Bloom, John Wiley & Sons, Inc., 172 pp., \$8.50

For those using lasers for industrial applications who want a basic understanding of their operation. Topics covered include laser physics, laser types, resonator properties, optical properties of laser beams, and most important laser applications.

Introduction to Distributed-Parameter Networks with Application to Integrated Circuits, Mohammed S. Ghausi and John J. Kelly, Holt, Rinehart and Winston, Inc. 331 pp., \$11.95

Presents unified picture of distributed-parameter (microelectronic and transmission-line) theory, discusses lossy and lossless transmission lines and the properties and solutions of distributed LC and RC networks. Gives practicing engineers enough information to efficiently design linear IC's.

Electronic Circuit Design Handbook—Second edition, Tab Books, 318 pp., \$14.95

A reference source of over 500 circuits originally published in EEE magazine. Includes both basic and advanced designs for control, filter, power-supply, detection, sensing, gating, and logic circuits.

High-Frequency Communications, J.A. Betts, American Elsevier Publishing Co., 94 pp., \$5.

An introduction to current trends in h-f communications systems. Frequency synthesis, single sideband, wideband amplifiers, and aerials are covered.



EVER SEE THIS COLLECTION OF POWER RESISTORS BEFORE?

Don't feel left out because no one else has either. Each resistor or network illustrated is designed for custom fit and performance in some customer's special application.

If provided a few details of your extraordinary resistor needs perhaps SAGE can help you out too. Write or call industry's leading producer of miniature precision wire-wound resistors.



SAGE ELECTRONICS CORP.
 Subsidiary of Gulton Industries, Inc.
 BOX 3926 ROCHESTER, N. Y. 14610
 Phone: (716) 586-8010

WHAT'S NEW in

Printed Circuitry?

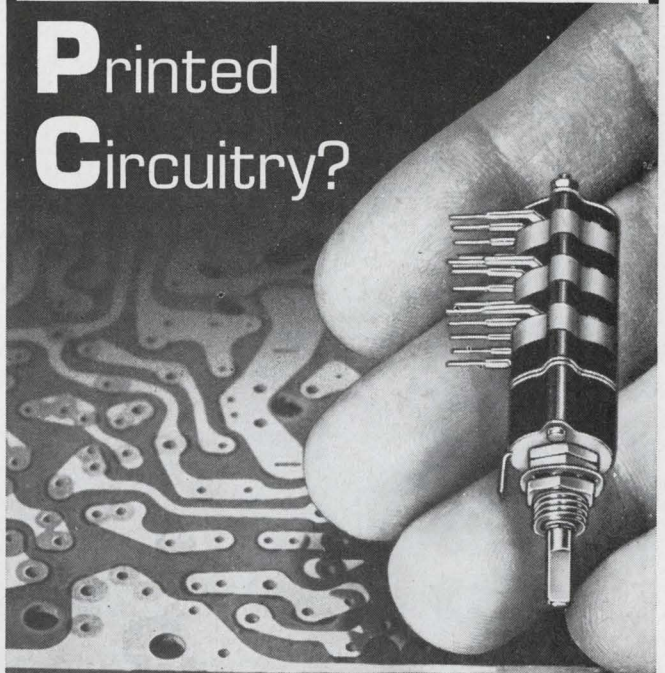

Push Button

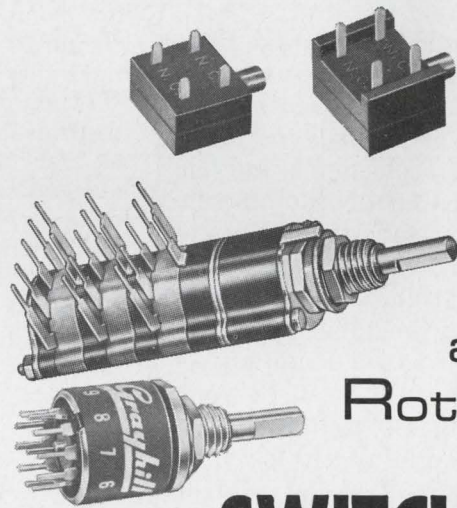

and
 Rotary

SWITCHES

Grayhill Excellence in Switches fits directly into your PC Boards. For complete Dimensional and Electrical Data available —

Phone or Write Direct To



523 Hillgrove Avenue
 LaGrange, Illinois 60625
 Area Code 312, Phone 345-1040

... the Difference Between Excellent and Adequate

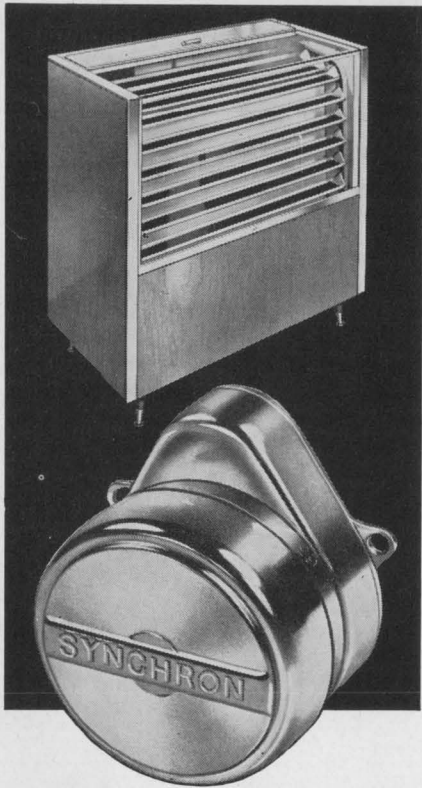

HOW SYNCHRON® MOTORS time MOTION DISPLAY CASES

In revolving showcases like this, a SYNCHRON Motor controls the shaded pole motor that starts, stops, runs or reverses the moving trays, in a selection of motion speeds. SYNCHRON Motors can perform thousands of similar timing, control, switching and cycling operations. One of these motors may be ideal for your application, too. Find out—write or phone Hansen or your SYNCHRON representative, for brochure and all the facts.

SYNCHRON timing and control motors; 168 different speeds. Right, left or reversible rotations. 8, 20 or 30 oz.-in. torques; 220, 110 or 24 volts; 60, 50 or 25 cycles.

HANSEN

Manufacturing Co., Inc., Princeton, Ind. 47570

HANSEN REPRESENTATIVES: CAREY & ASSOCIATES, Houston and Dallas, Texas; R. S. HOPKINS CO., Sherman Oaks, Calif.; MELCHIOR ASSOCIATES, INC., San Carlos, Calif.; THE FROMM CO., Elmwood Park, Ill.; JOHN ORR ASSOCIATES, Grand Rapids, Mich.; H. C. JOHNSON AGENCY, INC., Rochester, N.Y.; WINSLOW ELECTRIC CO., Essex, Conn., Narberth, Pa., and New York, N.Y.
EXPORT DEPARTMENT: 64-14 Woodside Ave., Woodside, N.Y.

Technical Abstracts

LSI overview

System considerations in large-scale integration design
W.T. Rhoades
Hughes Aircraft Co.
Fullerton, Calif.

The single most important aspect of large-scale integration is the prospect for lower costs than with more common methods of making and wiring circuits.

LSI is defined as the placement of about 100 or more circuits (gates) in one package. This means that such functional blocks as arithmetic units, decoders, digital differential analyzers, and small memories can or will be built with LSI methods.

Enough experience has been gained in LSI to project semiconductor technology, packaging alternatives, and array complexity to see what kinds of constraints and tradeoffs will be involved in minimizing over-all functional cost.

By 1970, the number of devices per chip is expected to be 500, compared with 25 in 1967. Similarly, the number of circuits per chip should go to 80 from 4.2. However, there may not be a corresponding cost improvement, because LSI cost depends on such design constraints as yield of circuits and interconnections, a finite number of package pins, high heat densities, high tooling costs, and long turn-around time to modify a specific LSI configuration.

One way to evaluate the worth of LSI is by cost per gate, and this depends on the sum of chip, enclosure, packaging, and tooling costs. Chip cost per gate is a direct function of silicon cost and chip area, and an inverse function of chip and enclosure yields and the number of gates.

The enclosure cost per gate is the sum of package cost and a complexity factor times the number of gates raised to the one-half power, all divided by enclosure yield times the number of gates. For high-performance LSI, package costs dominate when the number of gates is less than 100; complexity costs mean little until the gates per package exceed 100; the enclosure cost is a strong function of

yield, and—when there are many gates in a package—the cost of the package per gate is small.

There is no universal rule about the optimum number of pins per package, but, as an estimate, the number of pins depends on the number of gates raised to the 0.6 power.

Packaging cost per gate is a fairly complex function, depending on handling cost per package, testing and interconnection (T&I) cost per pin, the number of pins, and the board cost per package. Four conclusions can be reached from analyzing packaging cost: handling cost can be neglected for LSI; board cost dominates when T&I requirements are low; a high T&I makes packages with many pins very expensive, and packaging cost per gate goes down as the number of gates per package increases.

The tooling cost for LSI ranges from \$500 to \$50,000. A few design iterations—the usual case—makes this cost go even higher. Tooling cost is directly proportional to the number of different types of chips, not circuits or devices. Within the constraint of yield efficiency, it is therefore better to use more devices or circuits per chip—with the added advantage that the number of pins decreases.

Presented at the National Electronics Packaging Conference, New York, June 3-6.

Tuning up

Adjustable reactive components for direct-mounting on thick-film substrates
Roger L. Weber
Texas Instruments Incorporated
Dallas

After deposition, subminiature inductors can now be tuned to a 1% tolerance in production runs. The conductive winding of a toroid covers no more than three-fourths of the core. A portion of the remaining core is then removed by air-abrasive techniques until the inductance reaches the desired value. Hybrid circuits made this way serve as frequency-selective elements in commercial broadcast receivers.

Presented at the IEEE-EIA 1968 Electronics Components Conference, Washington, May 8-10.

Free control knob catalog

Broadest selection of commercial and military knobs: colorful new PANELRAMA series, self-locking types, aluminum-cap and designer series, MIL-spec, custom knobs of all shapes and colors. Send reader service card or write: Raytheon Company, Components Division, Fourth Avenue, Burlington, Mass. 01803.

RAYTHEON

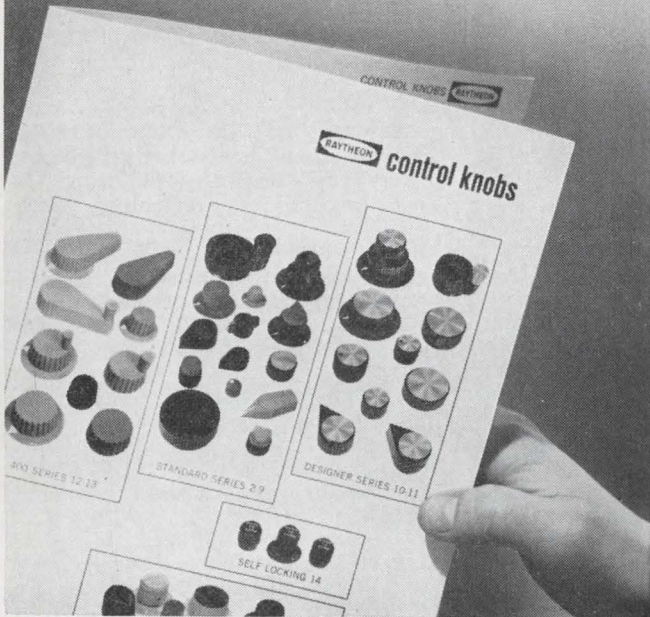

Circle 241 on reader service card

Our little black book has over 100,000 phone numbers.

You never had a black book like it. Over 1,500 pages. And those phone numbers! More than 100,000 telling you who to call/where to go, for the over 4,000 different product categories listed and advertised in the yellow pages of the Electronics Buyers' Guide.

It's the industry's one-stop shopping center that lets you find the products and services you need quickly. You can depend on EBG.

Electronics Buyers' Guide

A McGraw-Hill Market Directed Publication, 330 West 42nd Street, New York, N.Y. 10036

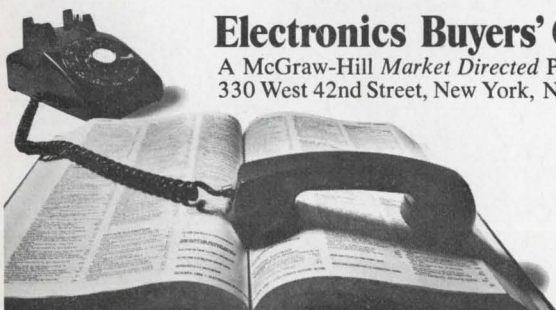

NEW. Low Frequency Ceramic Band Pass Filter.

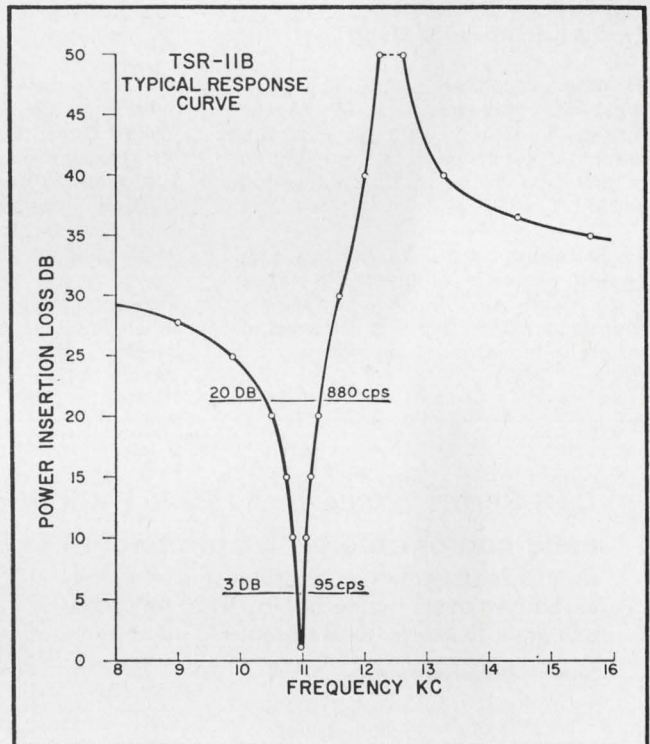
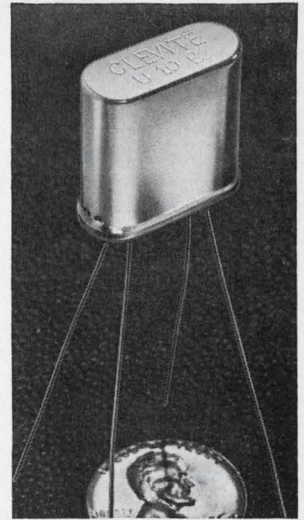

Big performance in a quarter ounce package.

Looking for something better in a low frequency filter? Look no more. Clevite's new generation of fixed-tuned ceramic band pass filters combine narrow bandwidths and high performance with surprisingly small size and low weight.

Check the specs and see for yourself:

Center Frequency — from 9kc to 50kc

Bandwidth (% fo) — @ 3db-1%; @ 20db-13%

Stability — Within 0.2% for 5 years

Within 0.2% from -40°C to +85°C

Dimensions—HC-6/U case 3/4" x 3/4" x .34" (hermetically sealed)

Shock — 20g any axis 20-2000 cps per mil std. 202B.

As we said, look no more for a high performance, low frequency filter. This new one from Clevite is the perfect choice. Write for free Technical Bulletin 94023. Clevite Corporation, Piezoelectric Division, 232 Forbes Road, Bedford, Ohio 44014.

CLEVITE

New Literature

Thumbwheel switches. General Electric Co., Schenectady, N.Y. 12305. Bulletin GEA-8124 contains descriptions, ratings, outline drawings with dimensions, circuit board connection table, and complete ordering information on the CR103F line of thumbwheel switches. Circle **446** on reader service card.

Toroidal inductors. Allen Electronics division, Allen Organ Co., Macungie, Pa. 18062, offers a catalog sheet listing more than 150 sizes of toroidal inductors. [447]

Heat sinks. Thermalloy Co., 8717 Diplomacy Row, Dallas 75247. Catalog 68-B-2 covers a line of heat sinks for TO-5 transistors. [448]

Trimmer capacitors. Voltronics Corp., West St., Hanover, N.J. 07936, has issued a revised 16-page illustrated catalog 766A covering its complete line of precision piston trimmer capacitors. [449]

Temperature controllers. Barnes Engineering Co., 30 Commerce Rd., Stamford, Conn. 06904, has available a four-page data sheet and price list on infrared industrial temperature controllers. [450]

Panel meters. Honeywell Precision Meter division, Honeywell Inc., Manchester, N.H. 03105. A 16-page booklet presents ranges, prices, resistances, photographs, diagrams and mounting specifications for d-c and a-c panel meters. [451]

Semiconductor mica isolators. Perfection Mica Co., 1322 N. Elston Ave., Chicago 60622, has released catalog K-11 picturing and describing a line of semiconductor mica isolators. [452]

P-c connectors. Viking Industries Inc., 21001 Nordhoff St., Chatsworth, Calif. 91311, has published a 20-page catalog showing details of all its standard p-c connectors. [453]

IC photomask system. HLC Manufacturing Co., 724 Davisville Rd., Willow Grove, Pa. 19090. Watson Mark III step-and-repeat photomask system, designed for research and custom production of IC's and other complex microcircuits, is described in a technical bulletin. [454]

Potentiometry. James G. Biddle Co., Township Line & Jolly Rds., Plymouth Meeting, Pa. 19462. Bulletin 71-6 covers Veritor systems, which are inte-

grated, wide-range potentiometric and bridge consoles for the measurement and generation of the fundamental electrical parameters. [455]

Constant voltage transformers. Acme Electric Corp., Cuba, N.Y. 14727. Bulletin 09 gives technical data for the Voltrol sinusoidal-type constant voltage transformers. [456]

Magnetic circuit protectors. Airpax Electronics Inc., Cambridge, Md. 21613. Bulletin 16E-10 illustrates and describes the series APG magnetic circuit protectors. [457]

D-c voltage regulators. Beckman Instruments Inc., 2500 Harbor Blvd., Fullerton, Calif. 92634, has issued data sheet 68665 describing the series 851 negative d-c voltage regulators. [458]

Bridge rectifier. Bendix Corp., Semiconductor division, South St., Holmdel, N.J. 07733, has released an engineering data sheet on its 10-amp, full-wave, thick-film bridge rectifier. [459]

Circuit-board laminate. Westinghouse Electric Corp., Micarta division, Hampton, S.C. A four-page illustrated folder describes the properties of 65M27 glass-epoxy circuit-board laminate. [460]

D-c servo motor. Servo-Tek Products Co., 1086 Goffle Rd., Hawthorne, N.J. 07506. A two-page bulletin describes

CTS Series 760 cermet resistor network or thick film hybrid circuit is mechanically compatible with standard 14 lead dual-in-line package. . .

simplifying automatic insertion and reducing assembly costs accordingly. The networks can also be easily hand mounted.

Series 760 provides:

- Up to 13 resistors per module with an infinite number of circuit combinations.
- Extremely good environmental specifications.
- 5 lbs. pull strength on leads.

Delivery: 2 weeks for prototypes; 4-6 weeks for production quantities.

Order from: CTS of Berne, Inc., Berne, Indiana 46711. (219) 389-3111.

CTS CORPORATION/Founded 1896

Series 760	9 resistors	11 resistors	13 resistors
1,000 piece price	82c ea.	86c ea.	90c ea.
10,000 piece price	41c ea. (4.5c/resistor)	43c ea. (4c/resistor)	45c ea. (3.5c/resistor)

Prices shown are based on $\pm 5\%$ tolerance, $\pm 300\text{ppm}/^\circ\text{C}$ standard TC, and 50 ohms through 100K ohms resistance range with all resistance values within a 5:1 ratio per side.

CERMET RESISTOR



the SU-680D-29 permanent-magnet d-c servo motor, which delivers 12.7 watts of continuous power output at 8,600 rpm. [461]

Polystyrene capacitors. Southern Electronics Corp., 150 W. Cypress St., Burbank, Calif. 91502, has available five data sheets on polystyrene capacitors. Case styles and dimensions are illustrated. [462]

Single component sealants. Diamond Shamrock Corp., 300 Union Commerce Building, Cleveland 44115. A technical bulletin describes polymercaptan resin-based single component sealants. [463]

Silicon zeners. Solitron Devices Inc., 256 Oak Tree Rd., Tappan, N.Y. 10983, offers a preliminary catalog sheet on the 1/2R series of silicon 500 mw zener diodes. [464]

Porcelain capacitors. Vitramon Inc., Box 544, Bridgeport, Conn. 06601. A breadboarder's kit of "VY"03 porcelain capacitors, which can save engineers more than \$500, is described in data sheet P30. [465]

Military connectors. Star-Tronics Inc., Moulton St., Georgetown, Mass. 01830. Two engineering data sheets describe series N and BNC connectors designed to meet requirements of MIL-C-39012. [466]

Digital computer system. Leeds & Northrup Co., 4901 Stenton Ave., Philadelphia 19144. The LN5000 digital computer system for process control is introduced in 16-page brochure F1-3201. [467]

Cans and covers. Russell Industries Inc., 96 Station Plaza, Lynbrook, N.Y. 11563, offers a bulletin on a line of MIL-T-27 cans and covers made from high nickel-iron alloy for use with components where electromagnetic interference is in evidence. [468]

Wire and cable. Tensolite Insulated Wire Co., West Main St., Tarrytown, N.Y. 10591. Bulletin 108B covers the Tufflite line of insulated wire and cable for the electronic and aerospace industries. [469]

Magnetic voltage multiplier. General Magnetics Inc., 135 Bloomfield Ave., Bloomfield, N.J. 07003. A new analog d-c x d-c voltage multiplier is described in bulletin MM112. [470]

Antenna systems. Technical Appliance Corp., 1 Taco St., Sherburne, N.Y. 13460, has published a four-page brochure dealing with transportable and tactical antenna systems. [471]

Angle measurement. Micro Metrics Inc., 165 Pennsylvania Ave., Paterson, N.J. 07503. Bulletin AMI-1 describes 15 models of high-precision angle measur-

ing instruments used in the production testing of gyros, servos, or any device using synchros or resolvers. [472]

Transmitters and alarms. Deltron Inc., Wissahickon Ave., North Wales, Pa. 19454, has released bulletin 602A describing its instrument line of transmitters and alarms. [473]

Servo chart drive. B&K Instruments Inc., 5111 W. 164th St., Cleveland 44142, has issued a two-page bulletin on the model 130 servo chart drive, a new accessory for its model 2305 graphic level recorder. [474]

Tungsten-rhenium alloy wire. General Electric Co., 21800 Tungsten Rd., Cleveland 44117. Product data sheet 1300-c describes the properties of 3D tungsten-rhenium alloy wire for use in critical lamp and electronic tube applications. [475]

Operational amplifiers. Analog Devices Inc., 221 Fifth St., Cambridge, Mass. 02142. Latest issue of Analog Dialogue combines analytical articles with circuit suggestions and practical techniques for mounting operational amplifiers onto circuit boards. [476]

Reed relays. Elec-Trol Inc., 21018 Soledad Canyon Rd., Saugus, Calif. 91350, has published a 40-page catalog on magnetic reed relays, electronic components, and systems. [477]

NETWORKS

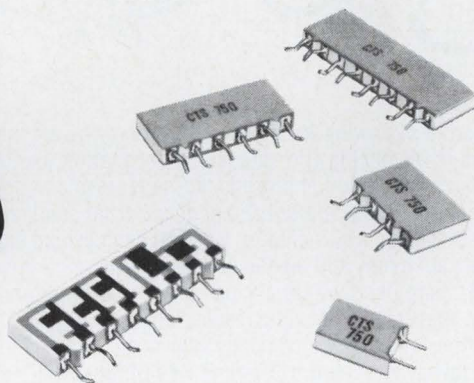

CTS series 750 cermet resistor networks with snap-in formed leads . . . for either automatic insertion or hand mounting.

- Available in 4 sizes and an infinite number of circuit combinations.
- Extremely good environmental specifications.
- 5 lbs. pull strength on leads.
- Available with or without active devices.

Delivery: 2 weeks for prototypes; 4-6 weeks for production quantities.

Order from: CTS of Berne, Inc., Berne, Indiana 46711. (219) 389-3111.

Series 750	2-pin 1 resistor	4-pin 3 resistors	6-pin 5 resistors	8-pin 7 resistors
1,000 piece price	31.6c ea.	29.6c ea.	40.6c ea.	50.9c ea.
10,000 piece price	15.8c ea.	15.5c ea. (5.2c/ resistor)	21.0c ea. (4.2c/ resistor)	26.1c ea. (3.7c/ resistor)

These prices are based on $\pm 5\%$ tolerance. $\pm 300\text{ppm}/^\circ\text{C}$ standard TC, and 50 ohms thru 100K ohms resistance range with all resistance values being within a 10:1 ratio per side.

CTS CORPORATION



THINK SHRINK!



Motorola's growing leadership in state-of-the-art miniaturization of electronic fuzes is advancing the science of detonating explosives.

Fuzes designed and produced by Motorola — for the U.S. Army, Navy and Air Force — span the entire spectrum from small explosive packages to large missile systems — including free-fall devices and highly sophisticated surface-to-air, air-to-air, and air-to-surface systems.

To help us maintain our pace-setting competence in this vitally important field, Motorola needs Electronics Engineers with fuze experience. Ours is an engineering-oriented company where you'll be given freedom to exercise your own initiative — and by helping us "think shrink" about fuzes, you can make it big professionally. Send us your resume.

Opportunities in Fuzing & Guidance:

Electronics & Mechanical Design ■ Integrated Electronics ■ Advanced RF & Microwave Techniques ■ Antennas & Propagation ■ Fuzing ■ Missile Guidance ■ Checkout Systems ■ Reliability & Components ■ **OTHER OPPORTUNITIES:** Space Communications ■ Radar Systems ■ Tracking & Telemetry ■ Digital Data Transmission ■ ECM & Elint ■ Coherent Transponders ■ Radar Transponders

in PHOENIX  **MOTOROLA**

Government Electronics Division · Aerospace Center

Write: Paul Ahler, Recruitment Mgr., Dept. 65, Box 1417, Scottsdale, Arizona

MOTOROLA ALSO OFFERS OPPORTUNITIES AT CHICAGO, ILLINOIS — AN EQUAL OPPORTUNITY EMPLOYER

CLASSIFIED ADVERTISING
 **SEARCHLIGHT SECTION**
 BUSINESS OPPORTUNITIES
 USED OR SURPLUS EQUIPMENT

We manufacture
**SPECIAL PURPOSE
 CATHODE RAY TUBES**
Send us your requirements.
MAJOR ELECTRONICS, INC.
 14745-A Keswick St.
 Van Nuys, Calif. 91405
 (213) 873-6061

CIRCLE 968 ON READER SERVICE CARD
 RADAR SYSTEMS GROUND AND AIRBORNE AUTOMATIC TRACKING ANTENNA SYSTEMS, NIKE AJAX, NIKE HERCULES M-33, M O-1A, MP5-19, MP5-9, SCR 584, TPS-1D, TPS-28, FAA-ASR-2, AIRBORNE SYSTEMS, APN-84, APN-102, APS-20, APS-27, APS-45, DPN-19, DIGITAL COMPUTERS, IBM 650, IBM 704
 LARGEST INVENTORY OF RADAR AND MICROWAVE EQUIPMENT IN THE WORLD.
 **RADIO RESEARCH INSTRUMENT CO.**
 45 WEST 45TH ST. N. Y. 10036 212-JU 6-4691

CIRCLE 969 ON READER SERVICE CARD
VOLT SENSOR
 VOLTAGE SENSITIVE RELAY DRIVER

 • 100 K Input Impedance
 • 25 Microsecond Response
 • +/-20 Volt Trip Range
 • \$38 ea., \$26.60 at 100 pcs.
 • Accuracy 0.01%
 Send today for full specifications
 CALIF. ELECTRONIC MFG. CO.
 P.O. Box 555, Alamo, Calif. 94507

CIRCLE 970 ON READER SERVICE CARD

*Somebody—
 Somewhere,*

needs your idle equipment!
 Reach that buyer quickly and economically thru the

“SEARCHLIGHT SECTION”

*The meeting place of Used
 Equipment Buyers and Sellers*



The day the coffee break produced the breakthrough in communications

Maybe it was the way the napkin came folded. Or how Norm Taylor crumbled his coffee container. Whatever it was, the breakthrough came at 10:47 A.M.

"Norm, I've got it," said Jack Jones. "We know high-power semiconductors have poor linearity at high output levels and destroy themselves when a mismatch occurs. That's been our problem. Why don't we go the low-power route? We'll couple enough low-power transistors to get high output and good VSWR. And I know how to do it."

So Jack had the answer to the problem Norm and he had been stewing over for more than two months. How to design a viable solid-state broadband amplifier with high output and good match over the full 2-30 MHz range.

"We can use a special transformer to isolate the low-power transistors."

It proved out theoretically. Designing the special transformer came next. When nobody around could build it, they built their own. All in all it took two years from insight to final operation.

That's the way we do things in Communications. Involving engineers in high-grade problems. And giving them the opportunity—and all the support they need—to come up with elegant solutions.

Like the continuously-tuned receiver for 2-30 MHz operation: as stable as a digitally-synthesized receiver's...yet with full VFO versatility. Or our antenna range: a 135'-diameter wire mesh ground plane used in the 90-1500 MHz range—level to $\pm 1/4''$ over its entire surface and with a 65-foot constant-radius arch that makes vertical angle measurements possible. (Azimuthal ones are facilitated by means of a 20-diameter turntable.) It's what you'd expect from a communications laboratory that does the bulk of its own R&D.

Current need is for Engineers experienced in frequency synthesizer design;

UHF/VHF phase-lock loop analysis and design; HF thru UHF RF transmitter, receiver and circuit design (including SSB); multiplex equipment; phase-lock tracking receivers; AGC wideband IF amplifier design.

However, if you find other electronic fields more fertile, we have them, too. ASW, navigation aids, data equipment, tracking, countermeasures and AGE. The opportunities are as broad as your abilities.

To see what we mean, direct your resume, in confidence, to Mr. J. P. O'Reilly, Dept. 184

GENERAL DYNAMICS

Electronics Division

1400 N. Goodman Street, Rochester,
New York 14601

— We are an equal opportunity employer in deed, not only an equal opportunity employer in words.

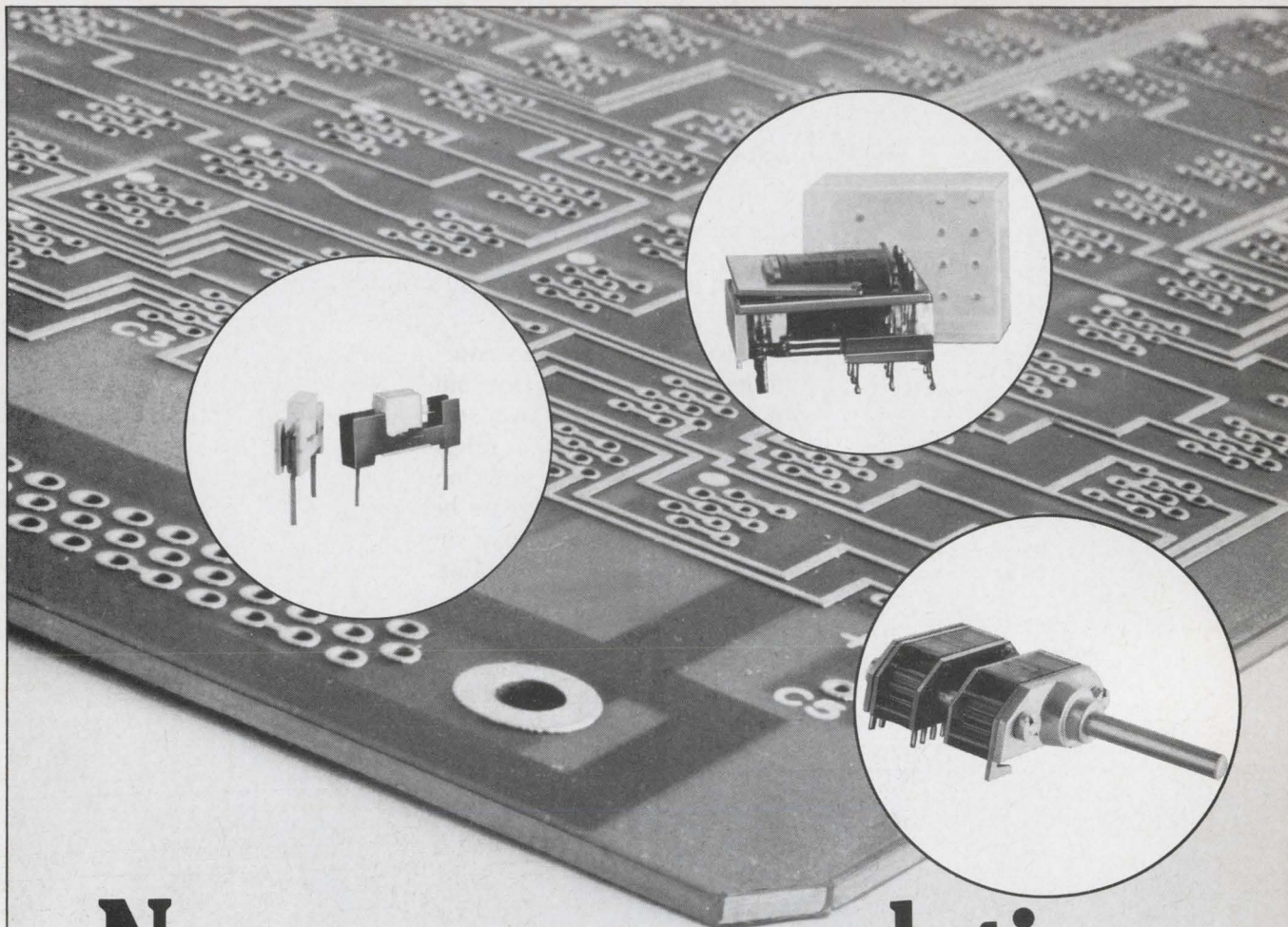

Now, some new solutions to printed circuit problems.

Here are three new products to solve your printed circuit "bottlenecks"

The Smaller Relay. (JAE Series) The first true miniature industrial relay for PC applications, and life of 100,000,000 operations prove its value. Less than 1 cubic inch. Weighs only $\frac{3}{4}$ ounce. Mounts on 0.1 inch PC grid and saves space. Twin contacts per pole insure less than 120 milliohms contact resistance. 4 and 6 Form C arrangements available. Technical breakthroughs and automated production eliminate costly adjustments and raise reliability to the nth degree. Pole for pole, inch for inch, it's the most economical relay buy available for PC boards.

The Thinner Switch. (JRT Series) Width only 0.16 inches. Height only 0.43 inches. Dimensions fit 0.1 inch PC grid spacing; can be mounted side by side on 0.2 inch spacing. The JRT Series miniature track switch fits directly into the conductive track, eliminating special track layouts. Bifurcated contacts insure low contact resistance in the range of 10 milliohms. And — it gives you 10,000 operations at a maximum

switched power rating of 25W. It's a winner across the board.

The Flatter Rotary Switch. (JSR 325 Series) A unique, miniaturized rotary flat switch which provides exceptional design flexibility. Low height of .44 inches and parallel position of the shaft make it ideal for sub rack technique. Can be directly soldered to PC board. Sections slide along shaft, accommodating other components in between. Assembled switches include a detent section plus up to a maximum of 5 switching sections. Detent angle 30°, 1 to 6 poles, shorting or non-shorting operation, 1 to 12 positions. Sections are tightly enclosed to give protection against dust, insuring uniform low contact resistance. Also available with a dual concentric shaft.

For complete information, write ITT Jennings, a division of International Telephone and Telegraph Corporation, 275 Meridian Road, Salinas, California 93901. Telephone: (408) 663-2501

JENNINGS **ITT**

Newsletter from Abroad

June 24, 1968

Strikes force delay in French 'strike force'

The big wage increases won by workers during the recent rash of strikes in France are a serious setback to the "force de frappe," the nuclear strike force that's President de Gaulle's most cherished—and expensive—prestige symbol.

Foreign Minister Michel Debre now concedes that the tightly scheduled drive to get a quartet of nuclear submarines at sea will be stretched out by both higher hardware costs stemming from the wage rises and by higher military pay scales. Plans originally called for three operational, missile-armed subs by 1974; it now looks as if the program will wind up anywhere from one to four years behind schedule. And nonnuclear arms projects now in the works may simply be dropped.

The slowdown in military contracting will be soon felt by electronics producers. About 60% of their nonconsumer business comes from the armed forces, whose budget has been climbing 5% or 6% annually over the past few years. The budget rise, if any, will be slight in 1969 and will only partly offset the increase in wages and salaries paid by the military establishment. Defense contractors thus have dismal short-term growth prospects.

British government keeps a loose rein on computer firm ...

Managers at International Computers Ltd. should have little trouble with the company's most powerful stockholder—the Ministry of Technology. The government, which holds a 10.5% share of the "national" computer firm, has issued a policy paper making it clear that it will not "intervene in the day-to-day management" of the company.

The government has instructed International Computers, however, not to enter into pacts with foreign companies—except for such ordinary business matters as licensing arrangements—without the ministry's approval. And the ministry will have a say in research policy through September 1971, when the government's \$22 million of research grants runs out.

In a move sought by the government, International Computers was formed in mid-March by the consolidation of the English Electric Co.'s and the Plessey Co.'s computer operations with International Computers & Tabulators Ltd. [Electronics, April 1, p. 146]. The government purchased its holding when the merger was arranged.

... but alarms industry by role in merger fight

The British business community is nervously awaiting the next move of the Industrial Reorganisation Corp., a government agency set up to foster mergers.

IRC threw its weight decisively into the battle for control of the Cambridge Instrument Co., a small but technically sophisticated firm best known for its scanning electron microscope. The agency bought \$10 million of Cambridge stock and voted it for the merger partner it favored, George Kent Ltd. Kent, a process-control maker, was jousting with the giant Rank Organisation Ltd. when IRC decided the consolidation of Kent and Cambridge would be best for Britain. Rank, the agency reasoned, already has in one of its instrument subsidiaries most of the know-how that Cambridge would have brought it. Kent, on the other hand, will broaden its technological base considerably.

Rank is now seeking to take over Hilger & Watts Ltd., an optical-

Newsletter from Abroad

instrument maker. So far, no rival has appeared; but if one does, and IRC once again buys shares to swing the deal its way, there'll be heavy pressure on the government to curb the agency's influence.

Fairchild slates voltmeter output with Tokyo firm

The Fairchild Instrumentation division, which already holds a large share of the Japanese digital-voltmeter market with its imported model 7050, is challenging for an even bigger slice. The U.S. firm has joined with the Tokyo Electron Laboratory in proposing an equally owned joint venture to produce the low-priced voltmeters in Japan.

If the plan is approved by the Ministry of International Trade and Industry, the new firm, called the Tel-Fairchild Corp., would begin assembling 100 to 200 of the instruments a month. Only U.S.-made parts would be used initially, but there's a chance that Japanese components—including integrated circuits—might be incorporated later.

Light pen to trace refinery blends

The Lago Petroleum Corp. plans to run its blending terminal on the Dutch Caribbean island of Aruba from a cathode-ray-tube display. The company, an affiliate of the Standard Oil Co. (New Jersey), expects to have the control system—based on a GE 4000 series computer—on-stream in from six months to a year.

Jersey Standard engineers believe this will be the first such application of a crt display to a process-control installation of this size. Operators will direct oil transfers between tanks and tankers simply by tracing the flow on the display with a light pen.

Latin trade bloc to lower tariffs

Electronics companies producing hardware in the Latin American Free Trade Association stand to get an added edge over outsiders starting next year.

Nine of the 11 LAFTA member countries cleared the way this month for a round of tariff reductions on a long list of electrical equipment and a sprinkling of electronic products. Chief among them: telegraph-terminal receivers, transmission tubes, and traffic-signal controllers. The new tariffs—applying to sales within the bloc—will range up to 5%. LAFTA's general conference is expected to make the cuts official this fall, and the new rates should go into effect next January.

Meanwhile, the trade bloc will try to get together on tariff cuts for an even longer list of electronic products. Colombia, Peru, Chile, and Uruguay have suggested 68 items on which barriers could be lowered. Brazil and Mexico, the area's leaders in electronics, have countered with a list of 174 products. LAFTA will attempt to work out a compromise between these two proposals at a special meeting next month.

Siemens eyes share of aerospace firm

Siemens AG is out to bolster its already strong position in European aerospace electronics.

The company, West Germany's largest electronics producer, may buy up the Bavarian state government's minority holding in Messerschmitt-Boelkow GmbH, formed by merger earlier this month and the country's biggest aerospace concern. The merger agreement gave Messerschmitt's owners a one-third share of the new company and split the other two-thirds equally among the Bavarian government and Boelkow's shareholders—the Boeing Co., France's Nord Aviation, and Ludwig Boelkow.

Czechoslovakia

Head of the class

Many educators have grave doubts about the multiple-choice tests used in most noncomputerized teaching machines. They feel that such tests make the course material stereotyped and curb student creativity. And a student who doesn't really understand the material can sometimes get the right answer by pure chance or a process of elimination.

These misgivings led Vladimir Stepan and two of his colleagues at the Prague School of Economics to devise a low-cost machine that provides for free-choice responses in addition to multiple choices. Faced with a mathematical problem, for example, a student must figure out his own answer and feed it into the machine.

Western market. Stepan's machine, called the Unitutor, may quickly move to the head of its class. At the Didacta teaching-aid fair this month at Hanover, West Germany, Unitutor was a standout. Tesla, the Czech electrical-electronics combine, has made eight prototypes and plans to start large-scale production toward the end of the year. The machine will sell for about \$2,500.

As for programs, the Prague School has already turned out courses in mathematics, bookkeeping, automobile driving, mechanics, and foreign languages. Stepan plans to set up a school for programmers in West Europe so Unitutor can find a market there.

Framed. The programs combine pictures projected from 35-millimeter film and sound recorded on four-track magnetic tape. The tape system handles up to two hours of audio, and the film can have as many as 1,200 frames, or lesson segments.

Branching—backtracking when a student hasn't understood or moving him ahead when he has—is provided in both audio and visual channels. In the Unitutor, a 30-bit optical code is used to signal the film-frame information to the control circuitry. For audio, two of the tracks on the tape are assigned to control markings, with one track for each direction.

After each lesson segment, a Unitutor student punches into a keyboard his answers to the quiz. These inputs are compared to the signals generated by the optical code for the frame. Essentially, coincidence circuits determine whether the inputs match and develop logic zero or logic one outputs. They are the source of command signals that step the film and the tape drives forward or backward. If the response is incorrect, a red light flashes to show the student he's made a mistake. For free-choice responses, the tests are designed so that the first two or three symbols punched into the keyboard will indicate whether the answer is correct.

Baffled. Along with "A" to "Z" and "0" to "9" keys, there's a row

of unmarked ones along the top. The inputs of these keys vary from frame to frame, and their functions are shown by symbols carried on the lesson-segment frame. In a driving lesson, for example, these keys might indicate trucks, cars, or buses. And for mathematics instruction they could stand for such operations as taking integrals, squaring a number, or multiplying.

There's even a key for particularly slow learners. It's marked "P" and when it's pressed the machine backtracks to a spot where basics are introduced and takes the student through the lesson again.

Japan

Giant chasers

The anxiety level of Japanese computer-company executives is on the rise—and with good reason. The Ministry of International Trade and Industry is on the verge of letting the key contract for a giant computer that the government is back-

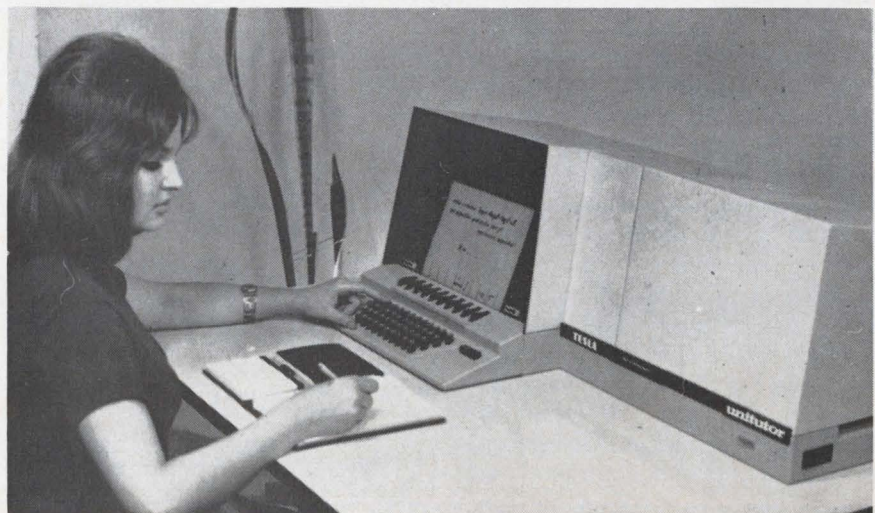

Adult's play. Student works out logarithmic function on Unitutor. Machine will check the work to decide what student should do next.

ing to bolster Japanese technology.

The contract will be a prize—both in prestige and money—for the company that gets it. Some \$32.5 million has been earmarked by the government to get the prototype of the computer built by 1971. The specifications call for an addition speed of 50 nanoseconds and a cycle time of 200 nanoseconds for an internal memory of 128,000 words of 50 bits each. Presumably, this would put the machine in about the same class of the CDC 7600 computer that the Control Data Corp. expects to have on the market within a year. Both will be much larger and faster than the CDC 6600, which at present tops the list of commercially available computers in capacity and speed.

In the act. To be sure, all six Japanese computer makers will get a lift from the project, a national one that began two years ago. Thus far, the work has been limited mainly to development of peripherals and memories. The central-processor contract that's about to come, though, will give the winning company the edge; it will be project leader and the other five just team members.

The government and the industry decided on a prime-contractor arrangement after considerable soul searching. Three companies that have worked on the project so far—Fujitsu Ltd., Hitachi Ltd., and the Nippon Electric Co.—wanted to split the processor contract among themselves. The government turned this down on the grounds there'd be no strong leadership. Moreover, such an arrangement would have brought howls from the other three contenders—the Mitsubishi Electric Corp., the Tokyo Shibaura Electric Co., and the Oki Electric Industry Co.

Sharing. Another formula the government rejected was that of a jointly-owned company to develop the prototype and then produce commercial models. But Japanese law bars a heavily subsidized company from competing commercially with unsubsidized firms. Although the prime contractor will get subsidies to develop the processor, there will be sharing of the work and all six companies will

get access to the know-how.

The organization most likely to pass the know-how around is the Electrotechnical Laboratory, which has been government's agency active in computer technological development. The laboratory has generated most of the technical ideas for the giant computer, and will work them out in conjunction with the computer makers. This is how the peripherals and the prototype 200-nsec memory were developed [Electronics, Jan. 8, p. 245]. And this is the tack that will be taken with the large-scale integrated circuit arrays for the central processor.

Accurate on the draw

Calibrating a wattmeter usually calls for a precision dynamometer, an instrument that can check a-c power with an accuracy considerably better than 0.1%. But these dynamometers tend to be as delicate as they are accurate.

Yokogawa Electric Works Ltd., for example, makes one that strays no more than 0.02% from the true value in its power measurements [Electronics, April 15, p. 228]. But the company won't entrust shipment to a common carrier. In Japan, the dynamometers are delivered by messenger to reduce the chance of shocks—however slight—that might affect precision.

This legwork is on the way out at Yokogawa, though. The firm says it's ready to take orders for a watt converter that matches the dynamometer in accuracy and needs no special handling. What's more, the electronic instrument

will sell for something like \$3,300, much less than its electromechanical predecessor.

Transformation. Yokogawa engineers will describe the watt converter in detail later this week at the Conference on Precision Electromagnetic Measurements at Boulder, Colo. The instrument's name gives a clue to its mode of operation—current and voltage drawn by the load being checked are transformed into analog voltages. These are multiplied by pulse-width modulation, and the output voltage is converted by a digital voltmeter to a reading in watts.

The input voltages fed to the multiplier come from a ratio transformer—for the voltage fed to the load—and a 0.2-ohm shunt resistor across a current transformer—for the current drawn by the load. In each case, the analog potential is 1 volt at full load rating—110 volts and 5 amperes.

One of the unknown analog voltages is applied to the x input of the multiplier, the other to the y input. The x-input voltage and an 8.5-volt standard reference voltage are summed and integrated in an operational amplifier and then passed to a Schmitt comparator, which also gets a triangular-wave input from a 200-kilohertz clock. The comparator output is thus a waveform proportional to the analog input voltage.

Switched. The comparator drives a transistor switching circuit that simultaneously changes the polarity of both the reference voltage and the y input. In this way, the y input in effect is modulated—indirectly—by the x input. Passed

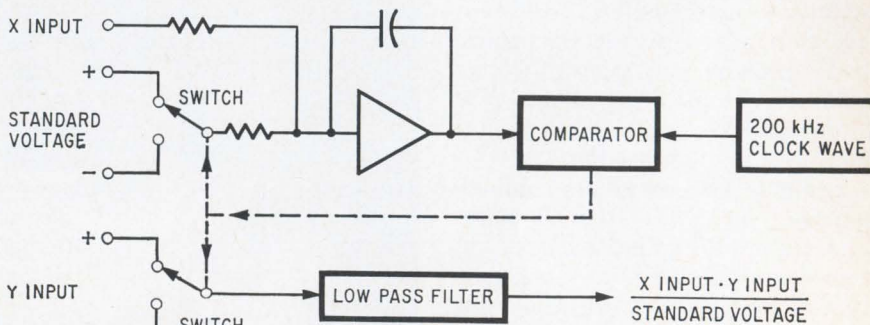

Power is the product. Analog multiplier is the key to the highly accurate power measurements made by Yokogawa's watt converter.

through a filter that blocks out the 200-khz clock component, the resulting voltage is proportional to the product of the two unknown input voltages and the reference.

Great Britain

Broader view

Electronics generalists are a disappearing breed. The technology is so complex and fast-changing that engineers are hard pressed to keep up in their special fields, let alone branch out into others. All too often, developments in sonar, say, are as far removed from the ken of a space-communications man as Chinese history.

Aware that these information gaps are widening, Britain's Institution of Electronic and Radio Engineers has slated an early-July state-of-the-art convention at Cambridge University. There, British experts in a dozen fields, from under-water communications to space technology, will spread as much mutual understanding as possible. And from present trends they'll extrapolate prospects for the next decade.

New courses. A prime topic at the Cambridge gathering will be the impact of integrated circuits. In this regard, one educator, Bryan Venning of Brighton College, will chart the curriculum changes that IC's will force on engineering schools.

In Venning's view, most of today's electronics engineering students will never design a circuit during their professional careers; instead, they'll work entirely with linear or digital IC modules. So they'll need a different kind of schooling from the relatively few engineers who will be designing IC's.

Mathematics curricula, particularly, need sweeping revision, Venning feels. Much of the math engineering students learn today involves analytical techniques that computers will handle automatically in the 1970's. Instead of studying classic mathematics in de-

tail, he says, students should spend the time learning logic design and "digital thinking."

Three degrees. Venning thinks educators should reshape courses of study to suit three categories of students. For engineers who will do little more than use existing devices, the course material should be qualitative only. The men who intend to design with modules should get a semiquantitative understanding of circuits. But under Venning's plan, only those training to become IC designers would get the full grounding in circuitry that's required for nearly all undergraduates now.

Masked marvels

British integrated-circuit producers have fared poorly over-all in their effort to contain the invasion of their home market by U.S.-controlled companies. Hard figures are hard to come by, but it's doubtful that the native companies have as much as 20% of a market estimated at \$20 million this year.

One way to counter the domination of the U.S. affiliates, whose large production runs make them hard to beat on standard circuits, is to specialize in custom circuits. And that's the direction that the Plessey Co. has taken.

Plessey probably already leads the British IC producers in custom designs. Derek Roberts, the 36-year-old physicist who heads the company's semiconductor division, says orders for specials are coming in at the rate of two designs a week. Plessey, one of the top trio of all-British producers, gets about 20% of its IC income from specials, and Roberts expects this share to double in the next two years.

Cut to size. This happy prospect, Roberts maintains, stems largely from the evolving technology of IC's. Hardware designers nearly always sacrifice some performance if they build their equipment around standard IC's. At the same time, the number of components that can be put on a chip economically is climbing, thus making standard circuits less flexible. Roberts says the answer is standardized production



Customer's man. Derek Roberts is stepping up custom-design efforts at Plessey's semiconductor division.

processes along with special masks to tailor circuits for specific applications.

In Roberts' view, all classes of equipment can use custom circuits. The added cost of a custom design—\$10,000 to \$25,000—becomes almost insignificant for such large-run applications as computer logic packages. At the other end of the scale, Roberts points out, the added cost sometimes can be justified even when only a half-dozen chips are produced. Plessey has built an IC optical reader, for example, in which each chip does the work of a system that costs about \$4,000.

Two lines. As for types of circuits, Plessey custom-designs emitter-coupled logic, resistor-transistor logic, operational amplifiers, logarithmic amplifiers, and communications linear circuits in bipolar versions. There's also a range of metal-oxide-semiconductor circuits.

Roberts left transistor-transistor logic and diode-transistor logic off the list for two reasons. He believes that logic circuits will eventually

be either bipolar emitter-coupled (where speed is the prime consideration) or MOS (where cost is of more concern than speed). Adding resistor-transistor logic and diode-transistor logic to the custom line would have made it harder to standardize the process that Plessey uses for bipolars. Thus the addition would have raised costs for all bipolar circuits.

In the bank. All the custom IC's come off two lines—one for MOS and one for everything else. Roberts says switching masks is the only change needed to tailor circuits. The company has built up a data bank that gives it "total knowledge" of how variations in component size and location affect circuit characteristics. It was the data on breakdown voltages, Roberts says, that made possible an MOS driver circuit with a 30-volt rating. Saturation, he goes on, is the key to high-speed emitter-coupled logic and to high-power audio amplifiers, one of which delivers 5 watts. And the bank's information on transistor equivalent circuits and parasitic capacitances was crucial for designing a logarithmic amplifier with a bandwidth of 170 megahertz.

Roberts expects the data bank to lure a lot of customers. Eventually, he expects regular customers to send their circuit engineers to Plessey for a three-month design course. After that, he says, all they'll need to do is send the mask dimensions for their specials. Roberts figures that about half the customers will let Plessey add their designs to the bank in exchange for lower circuit costs.

France

Handling words

Two French inventors have high hopes that they'll be able to help deaf mutes "hear" through their hands.

The pair have put together experimental versions of a system that transforms the sounds of speech into a pattern of "tickles" on the palm of the hand. The inventors,

Jean-Louis Monzat de Saint-Julien and Louis Jean Coussot of the education department at the Paris Chamber of Commerce, say they've trained a test group of normal people to recognize unheard sounds with the equipment. After three hours' practice, the group had learned 17 words and could identify them—at least partially—about three times out of five when read at random. Coussot and Monzat de Saint-Julien see no reason why the technique couldn't be used with deaf mutes.

Pinned. The two were working on a new language-training aid when they discovered they had a promising touch-hearing system as well. The central element is a fist-size box that straps onto the user's hand and has 49 piezoelectric ceramic pins, laid out in a seven-by-seven array, extending from it. The vibration of these pins transmits tactile "speech" patterns to the especially sensitive skin on the palm.

Each pin corresponds to a narrow frequency band—about 3% of the 640-to-3,445-hertz sound range covered by the equipment. All the pins vibrate at the same frequency, though—usually set at 250 hz—so each has paired with it a four-transistor selector circuit that switches it onto the pin-drive supply when it's part of the sound pattern. The pins have an oval cross-section 1 by 2 millimeters, and they are mounted so that they fall freely until they hit the palm.

Selective. Anywhere from one pin to all 49 can vibrate at the same time, depending on the volume and frequency range of the sound picked up by the system's microphone. This microphone signal is first amplified conventionally and then compressed in amplitude to enhance the frequency contrasts that characterize sounds.

The compressed signal is fed in parallel to all 49 selector circuits, which also get an input from the 250-hz generator that drives the pins. If its frequency band covers part of the compressed audio signal, the selector circuit then switches the 250-hz drive frequency onto the associated pin. The amplitude of the vibration depends on

the amplitude of the frequency band applied to the selector circuit.

Perfections. Coussot and Saint-Julien aren't the only ones to hit on the idea of tactile sensing patterns. Two research groups in California have been trying a similar approach with instruments that could transmit images to the blind through their skins [Electronics, July 10, 1967, p. 44].

Like the others working in the field, the French pair see a lot of improvements that could be made. For instance, they would like to try air jets in the place of pins. Another possibility they're thinking of is a dynamic selector circuit to replace the 49 static ones now used. But they feel their present system will be suitable for classroom and home use. Coussot estimates the equipment's cost at between \$200 and \$300 in a limited production run.

West Germany

Fax afield

Deadline-harried photographers on assignment for Europe's picture-packed tabloids often have the hard part of their job ahead of them once they've got the right shots. Getting the pictures back to the office in time to beat the competition can be the trickiest side of handling a story.

This competition augurs a good market for Dr.-Ing. Rudolf Hell, a German firm specializing in facsimile-transmission equipment and electronic typesetting machines. Hell is now testing a typewriter-size, portable telephoto unit that may one day be part of the standard kit for press photographers. Plugged into a "picture" line at one of the Post Office telegraph offices that dot the country, the telephoto unit transmits photos—black-and-white or color—back to the home-office receiver in minutes.

Hell believes the unit will be used most often with Polaroid cameras and has designed the prototype unit to send 4¼-by-3¼-inch pictures. But before

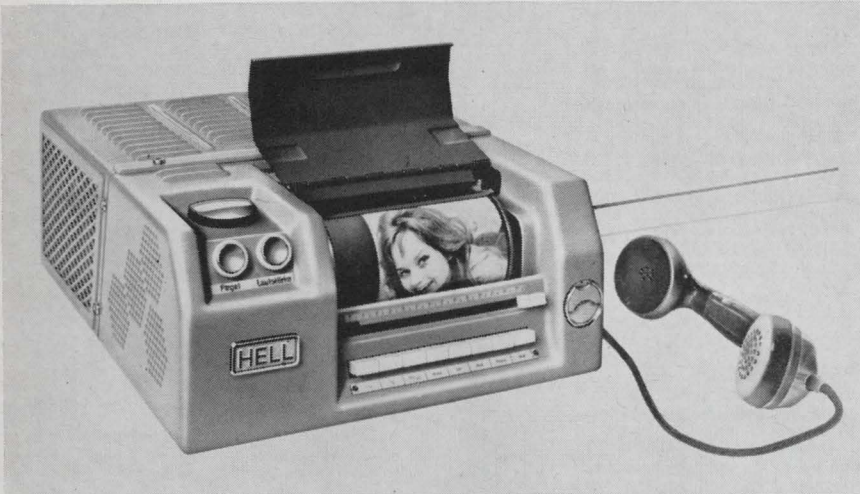

New for newsmen. Portable facsimile transmitter helps press photographers meet deadlines by speeding pictures back to their editors.

settling on the format for production versions, the firm's facsimile men say they want to see if this is the size photographers want. With 4¼-by-3¼-inch capacity, the unit would sell for about \$2,500. A larger format would result in a higher cost.

Drummed up. Hell uses a helical scan with a pitch of about 0.1 millimeter to achieve a reproduction-quality telephoto transmitter in a 45-pound package. The drum spins at either 60 or 120 revolutions per minute, its speed regulated by a 480-hertz tuning fork generator. Optics, including the scanning light and photomultiplier tube, ride on a carriage that slides alongside the drum.

The photomultiplier output amplitude-modulates a 1,900-hz carrier. A filter, an amplifier, and a line-matching element process the picture signal before it is fed onto the picture line. Like ordinary telephone lines, the picture lines have a 3,000-hz bandwidth; their attenuation characteristics, however, are better than those for voice lines.

When editors want color photos, the scan must be made three times, each time with an appropriate filter. This gives three color separations at the receiving end. The sending unit carries the filters.

To send captions along with photos, there's a regular telephone handset included with the telephoto unit.

Fine print. Even closer to mar-

ket is a unit—using a similar scan technique—Hell developed for police work. Like the newsman's unit, the detective's is portable and transmits graphics over phone lines. But because of the resolution needed for fingerprints, the scan is half again as fine. And the document size is larger—8 by 8 inches, sufficient to handle the standard identification cards used by Interpol, the organization that links the police forces of 98 countries. The machine will sell for \$2,750; it handles black-and-white only.

Spain

Brave new band

Olives and wine have traditionally been Spain's leading export items, but industrial goods topped agricultural products in the country's foreign-trade statistics last year for the first time.

This state of affairs figures to continue and the country's small domestically-owned electronics producers plan to contribute—albeit modestly—to the trend. Thirty of them have banded together to improve their position in foreign markets. Although exports of electronics nearly tripled last year, the level is still low—just under \$1 million.

Quota quest. The new organization, Grupo Nacional de Componentes y Aparatos Radio-Tv y Sonido, has elected as its first president Ramon Rosello Olive, chairman of Acustica Electronica Roselson S.A. Rosello says the group will enhance the local industry's international status and give it a voice in future bilateral trade agreements between Spain and East European countries. So far, there've been no official quotas for electronics hardware in these trade agreements. But Spanish electronics wheeler-dealers in some cases have managed to pick up quotas originally allotted for other products.

Along with its push to find new outlets in East Europe, the group will try for sales in Scandinavia and the Arab countries. And there'll be moves to expand footholds in such existing markets as the U.S. and Latin America. Piher S.A., the export leader among Spanish-owned electronics firms, sold \$100,000 worth of components to U.S. companies last year and plans to set up a sales office in Chicago this summer.

Open door. So far, only Spanish-owned companies have joined the association, but Rosello says the membership rolls are open to Spanish affiliates of such big foreign companies as Philips' Gloeilampenfabrieken and the International Telephone & Telegraph Corp. Although they're dwarfed by ITT's Standard Electrica, for example, the smaller firms feel they would benefit over-all from the marketing know-how the giants would bring to the group.

If they do decide to join, the ITT companies in Spain may need U.S. State Department clearance. The group will be active in Soviet-bloc countries and some of the telecommunications hardware likely to be peddled there comes under the U.S. embargo on strategic materials.

Rosello, though, intends to keep the rolls open until Sept. 30 for founding members. After that, its initial roster complete, the group will probably set some short-range goals for itself in the markets it plans to tackle.

Electronics advertisers

June 24, 1968

A C D C Electronics Faust/Day, Inc. Adv.	130	Daven Inc. Weston Associates, Inc.	192	Indiana General Corp., Ferrites Div. Griswold & Eshleman	24
Acopian Corp. Mort Barish Associates	185	Defense Electronics, Inc. Harry I. Clarkson Associates	178	Information Handling Service Martz & Associates	20, 21
Airco Speer Electronics Components Hazard Adv. Co., Inc.	43	Delco Radio Div. of General Motors Corp. Campbell-Ewald Co.	116, 117	Int'l. Instr. Inc. Thomas R Sundheim, Inc.	193
Airpax Electronics, Inc. Welch, Mirabile & Co., Inc.	156	Dow Chemical Co., The MacManus, John, & Adams, Inc.	133	ITT Jennings Mfg. Co. MacManus, John & Adams, Inc.	202
Allen-Bradley Co. Fensholt Adv. Agcy.	65, 67	Duncan Electronics Inc., Sub of Systron Donner Corp. Helme Associates, Inc.	60	Joslyn, Inc. Chace Co.	188
American Electronics, Inc. Alden Adv. of California, Inc.	140	DX Antenna Co., Ltd. Sanko Sha Adv. Agcy. Co., Ltd.	87	KCK Co., Ltd. General Adv. Agcy., Inc.	84
American Optical Co., Space Defense Group Fuller & Smith & Ross, Inc.	190	Electro Craft Corp. Inter-Ad, Inc.	14	Krohn-Hite Corp. L.K. Frank Co., Inc.	164
Amperex Electronics Corp., Div. of North American Philips Co. Sam Groden, Inc.	144	Electronic Industries Association of Japan Asian Advertisers, Inc.	77	Lambda Electronics Corp. Michel Cather, Inc.	18, 19
Anritsu Electric Co., Ltd. Diamond Agcy. Co., Ltd.	84	Electronic Communications Inc. Neals & Hickok, Inc.	131	Lapp Insulator Co. Wolff Associates	180
Bank of New York, The, Special Industries Group Evans Marketing Communications, Inc.	72	Electronic Research Associates Inc. Josephson Cuffari & Co.	152	Magnetics, Inc. Lando Adv. Agcy., Inc.	75
Bausch & Lomb, Inc. Wolff Assoc., Inc.	61, 62	Erie Technological Products Co., Inc. Altman-Hall Associates	165	Magnetic Shield Div., Perfection Mica Co. Burton Browne Adv.	159
Beckman Instruments, Inc., Electronic Instrument Div. Hixson & Jorgensen, Inc.	171, 173, 175	Fluke Mfg. Co., John Bonfield Associates	9	Markem Corp. Creamer Trowbridge Case & Basford, Inc.	150
Beckman Instruments, Inc., Helipot Div. Hixson & Jorgensen, Inc.	193	Gardner-Denver Co. Buchen Adv., Inc.	38, 39	Matsuo Electric Co., Ltd. Daiyusha, Inc. Adv.	80
Bissett-Berman Corp. S F Associates	160	Garrett Corp., AiResearch Mfg. Div. J. Walter Thompson Co.	76	Matsushita Electric Dentsu Adv., Ltd.	83
Brush Instruments, Div. of Clevite Corp. Carr Liggett Adv., Inc.	186	General Electric Co., Vacuum Products Business Section Doe-Anderson Adv. Agcy., Inc.	136	Meguro Electronic Instrument General Adv. Agcy., Inc.	85
Bud Radio, Inc. Allied Adv. Agcy., Inc.	148, 149	General Radio Co. Horton, Church & Goff, Inc.	17	Metal Removal Co., The Advertising Producers Assoc.	16
Burr Brown Research Corp. N.A. Winter Adv. Agcy.	176	Grayhill Inc. Merchandising Adv., Inc.	195	Microdot, Inc. Gumpertz, Bentley & Dolan Advertising	15
Burroughs Corp., Electronic Components Div. Conti Adv. Agcy., Inc.	90	G.T.I. Corp. Meek and Thomas, Inc.	74	Microwave Assoc., Inc. Kalb & Schneider, Inc.	59
Captor Corp. Weber, Geiger & Kalat, Inc.	56	Hansen Mfg. Co. Keller-Crescent Co.	196	Mitsumi Electric Co., Ltd. Sanko Tsushinsha, Ltd.	85
Centralab Div. of Globe-Union, Inc. The Brady Co.	170	Hayakawa Electronics Co., Ltd. Dai-Ichi Int'l., Inc.	78	Monsanto Co. Foote, Cone & Belding	162
Chronetics, Inc. J.S. Lanza & Associates	64	Hewlett-Packard, H-P Associates Lennen & Newell, Inc.	212	Motorola Semiconductor Products, Inc. Lane & Bird Adv., Inc.	27 to 34
Cinch Mfg. Co. Stral Adv. Co., Inc.	167	Hewlett-Packard, Colorado Springs Div. Tallant/Yates Adv., Inc.	36, 37	Murata Mfg. Co., Ltd. Dentsu Adv., Ltd.	86
Cinch Electronics Group, The, Cinch-Nuline Div. Stral Adv. Co., Inc.	35	Hewlett-Packard, F&T Div. Lennen & Newell, Inc.	1	National Electronics, Inc. Connor-Sager Associates	126
Clemens Mfg. Co.	188	Hewlett-Packard, Int'l Div. Lennen & Newell, Inc.	63	National Semiconductor Corp. Jay Chiat & Associates	179, 181
Clevite Corp., Piezoelectric Div. Carr Liggett Advertising, Inc.	197	Hewlett-Packard, Loveland Div. Tallant/Yates Adv., Inc.	2	Natvar Corp. Sanger-Funnell, Inc.	158
Cohu Electronics, Inc. Erwin Wasey, Inc.	138	Hewlett-Packard, Palo Alto Div. Lennen & Newell, Inc.	103	Nitsuko, Ltd. General Adv. Agcy., Inc.	84
Consul & Mutoh, Ltd. Drew & Carr, Inc.	58	Hirose Electric Co., Ltd. Diamond Agcy. Co., Ltd.	80	North Atlantic Industries, Inc. Murray Heyert Associates	8
Coors Porcelain Co. Tallant/Yates Adv., Inc.	137	Hitachi, Ltd. Dentsu Adv.	81	Okaya Electric Industry Co., Ltd. Diamond Agcy. Co., Ltd.	85
Corning Glass Works Electronic Div.- Glass Memories Rumrill-Hoyt, Inc.	134	Honeywell, Computer Control Division Franklin P. Folts, Inc.	73	Olympus Corp. Kameny Assoc., Inc.	174
Cosmicar Optical Co., Ltd. Matsushita, Inc.	82	Honeywell, Test Instr. Div. Campbell Mithun, Inc.	182	Pastoriza Electronics Co. L.K. Frank Co., Inc.	141
CREI, Home Study Div. of the McGraw-Hill Book, Co. Henry J. Kaufman & Associates	189	Houston Instr., Div. of Bausch & Lomb Ray Cooley & Associates, Inc.	88		
CTS Corporation Burton Browne Adv.	198, 199	Hughes Aircraft Co. Foote, Cone & Belding	142, 143		
Dale Electronics Inc., Sub. of Lionel Corp. Swanson, Sinkey, Ellis Inc.	3rd Cover	I B M Corp., Systems Development Div. Marsteller, Inc.	124, 125		
Dana Laboratories, Inc. Jay Chiat & Associates, Inc.	40, 41				
Darcy Industries Hobco Arts, Inc.	193				
Data Instruments Div. Technical Marketing	89				

- Philbrick/Nexus Research 66
Culver Adv., Inc.
- Potter & Brumfield Division, American 168
Machine & Foundry Corp.
Grant, Schwenck & Baker, Inc.
- Primo Company, Ltd. 86
General Adv. Agcy., Inc.
- Princeton Applied Research Corp. 46
Mort Barish Assoc., Inc.



- Radiation, Inc. 135
W.M. Zemp & Associates
- Radio Cores, Inc. 192
Sander Rodkin Adv. Agcy., Ltd.
- Radio Corp. of America 4th Cover, 22, 51
Al Paul Lefton Co.
- Raytheon Co., Industrial Components Div. 197
Fuller & Smith & Ross, Inc.
- Reeves Hoffman, Div. of Dynamics 154
Corp. of America
Adams Associates, Inc.

- Sage Electronics Corp. 195
Mathison Adv., Inc.
- Sanken Electric Co., Ltd. 85
Seikosha Adv., Inc.
- Semcor Div. Components, Inc. 45
Marketing & Corporate
Communications, Inc.
- Semtech Corp. 53
Burruss Adv.
- Shinei Industrial Co., Ltd. 80
General Adv. Agcy., Inc.
- Showa Musen Kogyo Co., Ltd. 87
General Adv. Agcy., Inc.
- Signetics Corp., Sub. Corning Glass 129
Works
Cunningham & Walsh, Inc.
- Siliconix, Inc. 7
Graphics West
- Sinclair Radio Labs., Inc. 147
John E. Hayes Co., Inc.
- Singer Company, The, Metrics Div. 132
The Stanley Schwartz Company
- Sorensen Operation, Raytheon Co. 71
Urrutia & Hayes Inc.
- Sperry Rand Corp., Sperry Microwave 68
Electronics Div.
Neals & Hickok, Inc.
- Sprague Electric Co., The 5, 10
Harry P. Bridge Co.
- Stackpole Carbon Co., Electronic 42
Components Div.
Meek & Thomas, Inc.
- Susumu Industrial Co., Ltd. 84
Sanko Sha Adv. Agcy. Co., Ltd.
- Systron-Donner Corp. 6
Bonfield Associates

- Takamisawa Electric Co., Ltd. 86
New Asia Trading News Agcy., Ltd.
- Tateisi Electronics Co., Ltd. 79
Dai-ichi Int'l, Inc.
- TDK Electronics Co., Ltd. 82
Fuji Agency
- Teikoku Tsushin Kogyo Co., Ltd. 82
Diamond Agcy. Co., Ltd.
- Tektronix, Inc. 55
Hugh Dwight Adv., Inc.
- Telonic Instruments 184
Jansen Associates, Inc.
- Texas Instruments Incorporated, 44
Components Group
Don L. Baxter, Div. of Albert Frank-
Guenther Law, Inc.
- Tohoku Metal Industries, Ltd. 78
Hakuhodo, Inc.
- Tokyo Cosmos Electric Co., Ltd. 86
General Adv. Agcy., Inc.
- Tokyo Print Industrial Co., Ltd. 80
General Adv. Agcy., Inc.
- Torrington Mfg. Co., Air Moving Div. 161
Wilson, Haight & Welch, Inc.
- Transitron Electronic Corp. 123
Larcom Randall Adv., Inc.
- Tung-Sol Div. Wagner Electric Corp. 188
Feeley & Wheeler, Inc.

- United Control Corp. 155
Botsford, Constantine & McCarty, Inc.
- United Transformer Co., Div. of 2nd Cover
TRW, Inc.
Fuller & Smith & Ross, Inc.
- Unitrode Corp. 57
Silton Div., Inc.
- Unitron, Div. of Electric Machinery Mfg. Co. 146
Warren Associates
- Varian Associates, Eimac Div. 172
Botsford, Constantine & McCarty, Inc.
- Varian Associates, Vacuum Div. 11
Botsford, Constantine & McCarty, Inc.
- Victoreen Instr. Co., The 166
Palm & Peterson, Inc.
- Westinghouse Semiconductor Div. 12, 13
McCann/ITSM
- Wiremold Co., The 153
The Charles Brunelle Co.
- Xcelite, Inc. 194
Harold Warner Adv. Inc.

Classified Advertising

F.J. Eberle, Manager

- EMPLOYMENT OPPORTUNITIES 200-201
- General Dynamics Electronics Div. 201
- Motorola 200
- EQUIPMENT 201
(Used or Surplus New)
For Sale
- Calif. Electronic Mfg. Co. 200
- Major Electronics 200
- Radio Research Instrument Co. 200

Electronics Buyers' Guide

- George F. Werner, General Manager [212] 971-2310
- Ray Smyth, Eastern Regional Manager [212] 971-6538
- Regina Hera, Directory Manager [212] 971-2544
- Thomas M. Egan, Production Manager [212] 971-3140

Circulation Department

Isaaca Siegel, Manager [212] 971-6057

Research Department

- David Strassler, Manager [212] 971-6058
- Chloe D. Glover, Research Associate [212] 971-6057

Advertising Sales Staff

Frank E. LeBeau [212] 971-6464
Advertising Sales Manager

Wallis Clarke [212] 971-2187
Assistant to sales manager
Donald J. Austermann [212] 971-3139
Promotion Manager

Warren H. Gardner [215] LO 8-6161
Eastern Advertising Sales Manager

Atlanta, Ga. 30309: Michael H. Miller, 1375
Peachtree St., N.E.
[404] 892-2868

Boston, Mass. 02116: William S. Hodgkinson
McGraw-Hill Building, Copley Square
[617] CO 2-1160

Cleveland, Ohio 44113: William J. Boyle, 55
Public Square, [216] SU 1-7000

New York, N.Y. 10036
500 Fifth Avenue
Donald R. Furth [212] 971-3615
James R. Pierce [212] 971-3616
John A. Garland [212] 971-3617

Philadelphia, Pa. 19103:
Jeffrey M. Preston
Warren H. Gardner,
6 Penn Center Plaza,
[215] LO 8-6161

Pittsburgh, Pa. 15222: Warren H. Gardner,
4 Gateway Center, [412] 391-1314

Rochester, N.Y. 14534: William J. Boyle,
9 Greylock Ridge, Pittsford, N.Y.
[716] 586-5040

J. Bradley MacKimm [312] MO 4-5800
Midwest Advertising Sales Manager

Chicago, Ill. 60611: Robert M. Denmead,
J. Bradley MacKimm, Ralph Hanning,
645 North Michigan Avenue,
[312] MO 4-5800

Dallas, Texas 75201: Richard P. Poole, 1800
Republic National Bank Tower,
[214] RI 7-9721

Houston, Texas 77002: Kenneth George,
2270 Humble Bldg., [713] CA 4-8381
Detroit, Michigan 48226: Ralph Hanning
856 Penobscot Building
[313] 962-1793

Minneapolis, Minn. 55402: J. Bradley
MacKimm, 1104 Northstar Center
[612] 332-7425

St. Louis, Mo. 63105: Robert M. Denmead
The Clayton Tower, 7751 Carondelet Ave.
[314] PA 5-7285

James T. Hauptli [415] DO 2-4600
Western Advertising Sales Manager

Denver, Colo. 80202: Joseph C. Page, David
M. Watson, Tower Bldg., 1700 Broadway
[303] 255-5484

Los Angeles, Calif. 90017: Ian C. Hill,
John G. Zisch, 1125 W. 6th St.,
[213] HU 2-5450

Portland, Ore. 97204: James T. Hauptli,
218 Mohawk Building, 222 S.W. Morrison
Street, Phone [503] 223-5118

San Francisco, Calif. 94111:
James T. Hauptli, 255 California Street,
[415] DO 2-4600

Pierre Braude Tel: 225 85 88: Paris
European Director

Paris: Ken Davey
88-90 Avenue Des Champs-Elysees, Paris 8

United Kingdom and Scandinavia
Brian Bowes Tel. Hyde Park 1451
34 Dover Street,
London W1

Milan: Robert Saidel
1 via Baracchini Phone: 86-90-656

Brussels: F.I.H. Huntjens
27 Rue Ducale Tel: 136503

Frankfurt/Main: Hans Haller
Elsa-Brandstroem Str. 2
Phone: 72 01 81

Geneva: Ken Davey
1, rue du Temple Phone: 31 95 60

Tokyo: George E. Olcott, 1, Kotohiracho
Shiba, Minato-Ku [502] 0656

Osaka: Ryoji Kobayashi 163, Umegae-cho
Kita-ku [362] 8771

Business Department

Wallace C. Carmichael, Manager

[212] 971-3191
Stephen R. Weiss, Production Manager
[212] 971-2044

Thomas M. Egan,
Assistant Production Manager [212] 971-3140

Dorothy Carmesin, Contracts and Billings
[212] 971-2908

Frances Vallone, Reader Service Manager
[212] 971-2865

What's Hewlett-Packard doing in the volume components business?

Lowering the price of
Hot Carrier Diodes to...

55¢

Because we found a new way to build them: combining the superior performance of a hot carrier diode with the best features of PN junction diodes, eliminating the cat whisker of earlier designs, and using low-cost assembly techniques. The result is the HP 2800 Hot Carrier Diode with silicon temperature capabilities and turn-on equal to germanium. You get 100 picosecond switching speeds, 70 volt breakdown, low turn-on voltage at 410 mV at 1 mA, and operating/storage temperature of -65°C to 200°C . Ideal for RF and digital applications, or for mixing, detecting and sampling. Prices: 1000-4999, 55¢; 100-999, 75¢; 1-99, 99¢. Get the specs from your local HP field engineer, or write Hewlett-Packard, Palo Alto, Calif. 94304; Europe: 54 Route des Acacias, Geneva.



SOLID STATE DEVICES

Figure on faster rise time!



New FREE* SLIDE RULE proves you can do more with DALE bobbin resistors!

Dale Bobbin Wirewounds have the performance you need plus good delivery at competitive prices. Prove it with our new free* slide rule. It puts at your finger tips valuable design information on rise time plus inductance/capacitance readings from .5 to 50 MHz. Choose from 14 Dale bobbins from .1 to 1 watt with fast, non-ringing rise times as low as .003 microseconds (10%-90% - 100 KC pulse). All are available with the accuracies and/or matching you need for switching in digital to analog converters and other high frequency, low reactance applications.

*To Get Your Free Bobbin Slide Rule, write us on your company letterhead, including your job title or function.



DALE BOBBIN SPECIFICATIONS

Power Rating: .1 watt to 1 watt in 14 sizes. Power may be doubled for commercial applications.

Resistance Range: .1 ohm to 23 Megohms

Tolerances: 1%, .5%, .25%, .10%, .05%

Mil. Spec.: Meet applicable requirements of MIL-R-93 and MIL-R-39005

Construction: Molded. Pass salt water immersion test

Load Life: .5% Max. ΔR in 1500 hours at MIL-R-93 conditions

Operating Temperature: -55° C to +145° C

Reactance & Rise Time: Write for slide rule or consult factory.

Special Modifications Available: Tolerances to .005%; Tolerance Matching to .001%; Special T.C.'s to ± 2 PPM/° C; Matched T.C.'s to 1 PPM/° C accuracy.

For complete information, write Dale Electronics or phone 402-564-3131.

For Catalog A, Circle No. 181



DALE ELECTRONICS, INC.

1300 28th Ave., Columbus, Nebraska 68601

In Canada: Dale Electronics Canada, Ltd.



It's what's in these RCA "overlay" transistors that gives you better watts out

Plastic Package for SSB Communications (TA2758)
75 Watts PEP Output (Min.) @ 30 MHz. Intended for 2- to 30-MHz SSB power amplifiers operating from a 28-volt supply, this high gain transistor is encased in RCA's plastic package with isolated pin-pad terminals.



High Power Performance up to 700 MHz (2N5016, TA7036) The 2N5016 is designed for Class-B and Class-C RF amplifier applications and provides 15 watts (min.) at 400 MHz. The TA7036 provides 20 watts (min.) at the same frequency.

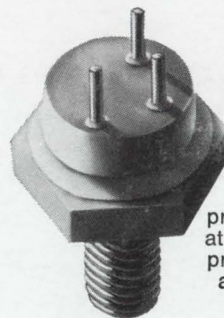

For HF/VHF Communications Applications (2N5070, 2N5071)
2N5070—25 Watts PEP Output (min.) with 13 dB gain (min.) @ 30 MHz and 28 V.

2N5071—24 Watts Output (min.) with 9 dB Gain (min.) @ 76 MHz and 24 V. The 2N5070 is designed for single-sideband power amplifier service in military and amateur-radio transmitters. The 2N5071 is intended as a Class-B and Class-C RF amplifier for FM communications.



Load Mismatch Protection for Aircraft Transmitters (2N5102) 15 Watts Output (min.) @ 136 MHz.

RCA-2N5102 is intended as a high power device for Class C, AM amplifier service (for aircraft VHF) in the 108- to 150-MHz range.



VHF/UHF Type with Higher Dissipation (2N5090) P_{out} —1.2 Watts (min.) @ 400 MHz. This new type offers famous "2N3866" performance in a TO-60 package. The stud-type package allows you to design circuits with better reliability for CATV and other general-purpose VHF/UHF equipments.



Microwave Coaxial Package (TA7003) 1 Watt Output with 5 dB Gain (min.) @ 2 GHz. 2 Watts Output (typ.) with 10 dB Gain @ 1 GHz. Low-inductance package for UHF and microwave oscillator, frequency-multiplier, and RF-amplifier service.



For more information on these and other RCA "overlay" transistors, see your RCA Representative or your RCA Distributor. For technical data on specific types, write: RCA Electronic Components, Commercial Engineering, Section PN6-2, Harrison, N. J. 07029.