

Electronics[®]

Dynamic testing of IC's: page 74
Regenerative-gate SCR's: page 96
Prospects for home vtr's: page 102

September 30, 1968
\$1.00
A McGraw-Hill Publication

Below: Engineer 'talks'
to hybrid system, page 86

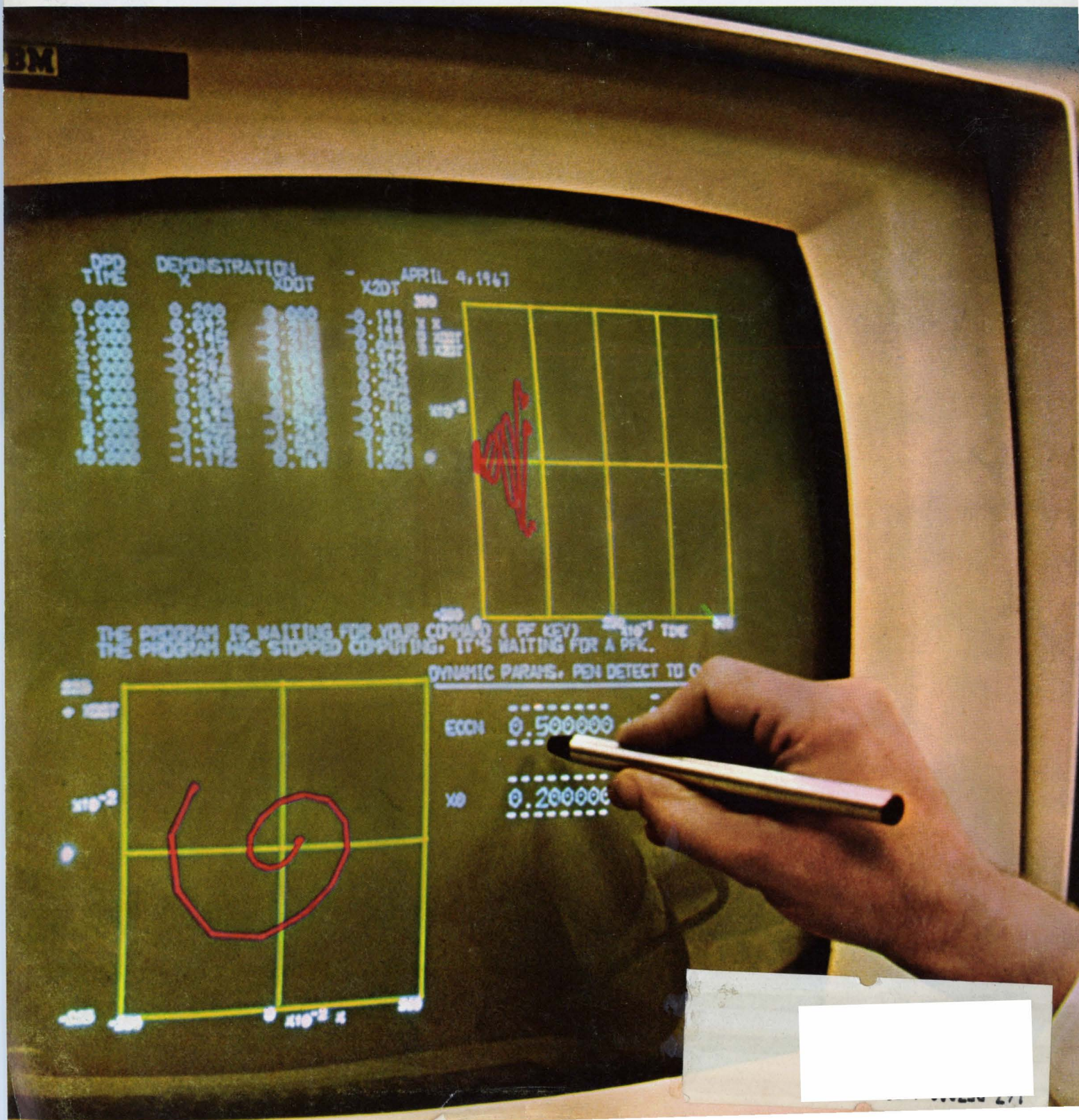



New! Type 1681 Automatic Impedance Comparator — \$4975



Type 1680 Automatic Capacitance Bridge — \$4975

We've made life more difficult

Now you must choose between TWO automatic bridges

With the introduction of the 1681 Automatic Impedance Comparator, you are forced to decide whether it or the 1680 Automatic Capacitance Bridge is better suited to handle your measurement problems. You'll thank us, though, because we've made life easier for you in the long run.

Whichever instrument you choose — 1680 or 1681 — you get a true three-terminal bridge, with all the inherent accuracy and stability of a bridge. You also get BCD output data, 1/2-second (or less) automatic balance, and a choice of frequencies (120, 400, or 1000 Hz).

Like the 1680, the 1681 can be used by itself or it can form the nucleus of an automatic measuring system. Systems typically include devices such as scanners, recorders, card- or tape-punches, and even on-line computers. Call your nearest General Radio Office, or write General Radio, W. Concord, Massachusetts 01781; telephone (617) 369-4400. In Europe Postfach 124, Ch 8034 Zurich 34, Switzerland.

The 1681 is direct reading in impedance-magnitude and phase angle differences, and it can measure R, L, or C from 2Ω to 20 MΩ.

The 1681 achieves its flexibility through the use of external standards — precision laboratory standards or your production samples.

The 1681 can read $\Delta|Z|$ to within 10 ppm of your standard and $\Delta\theta$ to within 0.00001 radian. Comparison accuracy is as good as 0.005%.

The 1681 is best suited for comparison measurements or for measurements requiring extreme resolution. Typical applications are component evaluation such as temperature-coefficient measurements, receiving inspection, production testing, sorting, and precise measurement of small and low-loss capacitors.

The 1680 is direct reading in capacitance and dissipation factor (or conductance) over a 0.01-pF-to-1000-μF range.

The 1680 contains its own highly stable internal standards.

The 1680 reads absolute value of capacitance and loss factor to five-figure resolution at 0.1% basic accuracy.

The 1680 is best suited for general capacitance measurements where wide range, ease of use, and direct readout are desired. Capacitor sorting, process control, and quality control are typical applications.

A better V-F Converter? Look no farther.

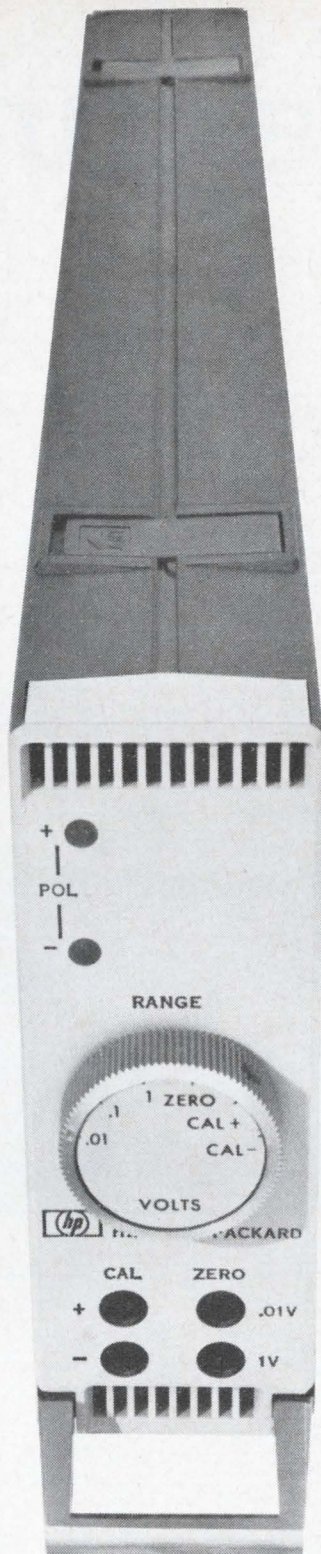

Take this voltage-to-frequency converter, couple it with your electronic counter—and you have a highly accurate low-level integrating digital voltmeter with high rejection of superimposed and common mode noise. Use it with counter remote start-stop signals to measure long term integrals. Use it with a preset counter and you can scale or normalize analog signals. Or integrate signals crossing zero with a reversible counter. Use two converters for ratio.

The Hewlett-Packard 2212A is more accurate, stable and linear, faster responding, smaller than any other V-F converter on the market. Input ranges down to 10 mV for 100 kHz output. Bipolar response with polarity output. 114 dB common mode rejection at 60 Hz. Internal calibration reference included. Use on the bench or install in combining cases; cases available to hold two or ten converters. Price, \$1100. Call your local HP field engineer for complete specifications, or write Hewlett-Packard, Palo Alto, California 94304; Europe: 54 Route des Acacias, Geneva.

HEWLETT  PACKARD

06824

COUNTER RESOLUTION

RESOLVED:

get dc to 135 MHz in a general purpose counter

RESOLVED:

get 10 ns time-interval resolution

RESOLVED:

get both in this new team from Hewlett-Packard

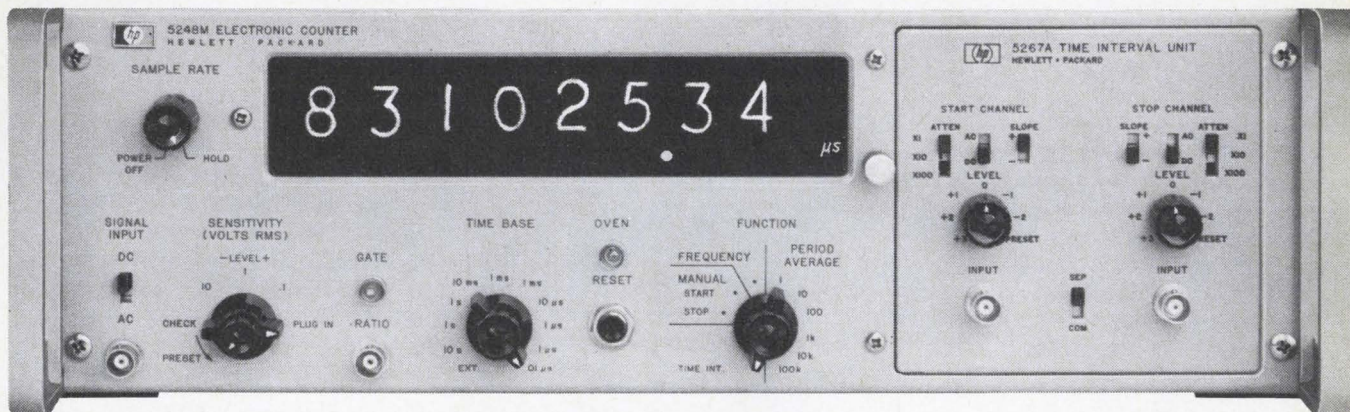

You get more and more from HP counters. Now we've extended the basic frequency-counting range to 135 MHz with a new general-purpose HP 5248L/M Counter. And increased time-interval resolution to 10 ns with the new HP 5267A Time Interval plug-in.

This new team offers the best price/performance combination available to measure period or interval in such high-speed areas as wind-tunnel testing, shock wave propagation, computer switching, pulse generation, pulse delay, and similar investigations. Moreover, you're getting the most versatile, general-purpose counter available.

The 5248L Counter is based on the same technology as the widely used HP 5245 series. Besides extending the frequency range to 135 MHz, the 5248L increases period measurement resolution to 10 nsec, too. Time base aging rate is less than 3×10^{-9} per day. (The 5248M version gives you fast warm-up and greater time-base stability, $< 5 \times 10^{-10}$ /day). And you can use all 12 plug-ins and other accessories for the 5245's, like the transfer oscillator and heterodyne converters that go up to 18 GHz.

For the first time, the 5267A Time Interval plug-in combines all these features in one unit: 10 ns resolution above 100 ns, dual trigger level controls, marker outputs to identify the measured interval on an oscilloscope, 100 mV sensitivity, ac or dc input coupling, and $1 M\Omega/35 \text{ pF}$ input impedance that doesn't change with multiplier settings. Together the 5248 and 5267 make a universal counter team the exceeds all previous limits. (The new plug-in will also add these features to the 5245 series counters, except time interval resolution will be only 100 ns.) Price: 5248L Counter, \$2900; 5248M Counter, \$3300; 5267A Time Interval plug-in, \$400.

Your HP field engineer can help you attack any counting problem. Or write Hewlett-Packard, Palo Alto, Calif. 94304; Europe: 54 Route des Acacias, Geneva.

02817

HEWLETT  PACKARD
ELECTRONIC COUNTERS

News Features

Probing the News

- 119 **Management:** Hogan takes hold at Fairchild
125 **Industrial electronics:** Utilities go slow on automation
131 **Computers:** ARPA network will represent integration on a large scale

Electronics Review

- 43 **Consumer electronics:** Danger from microwave; Sophisticated hi-fi
44 **Components:** Tuning Gunn diodes; Filter on a slice
46 **Computers:** Emphasizing MOS
48 **Avionics:** RCA aims for navigation market
50 **Space electronics:** NASA's unhappy birthday; Lincoln Lab satellite
54 **Military electronics:** Awacs wins approval
54 **Displays:** New line from Univac
56 **For the record**

Electronics International

- 209 **Japan:** Polycrystalline isolation process cuts IC fabrication step; Millimeter-wave phone experiment a success; New diodes developed for phone test
210 **Mexico:** First nationwide air-traffic control system
211 **Great Britain:** Line flyback period used for audio; Race is on for big transponder market

New Products

- 147 Third-generation small computer to make its debut in December
151 **Components review**
151 MOS FET electrometer marketed
154 Pressure transducer is washable
159 **Instruments review**
159 Components measured in-circuit
160 Nanovoltmeter output is binary
165 **Subassemblies review**
165 Comparator gives linear output
168 2 hi/lo's = 1 bandpass filter
172 Infrared detector spots intruders
176 Phase detected automatically
179 **Microwave review**
179 Circulator silences 4-GHz echoes
183 **Production equipment review**
183 Laser moves onto assembly line
184 Tester checks most components
189 **Semiconductor review**
189 MOS memory costs a dime a bit
192 Converter built on one substrate

Technical Articles

- Instrumentation** 74 **Dynamic IC testing made easy**
New techniques and equipment check out IC's at speeds at which they're intended to operate
Gordon C. Padwick
Fairchild Instrumentation
- Circuit design** 81 **Designer's casebook**
▪ Collector clamping improves threshold detector
▪ Circuit divides pulses without binary counters
▪ Voltage adjustment extends multivibrator's pulse width
▪ Bridge amplifier provides isolation
- Hybrid computers I** 86 **Three-way dialogue yields solutions in depth**
Hybrid computers bring both analog and digital methods to bear on solving problems that are difficult for either method alone
George R. Marr Jr., consultant,
and Leo G. Noronha
Electronic Associates Inc.
- Hybrid computers II** 91 **Choosing a simulation system**
The hybrid computer takes on big simulations, but analog and digital computers still have their place
Saul Shapiro
IBM Data Processing Division
- Solid state** 96 **This SCR is not for burning**
Regenerative-gate concept helps an SCR withstand sudden inrushes of current
Donald I. Gray
National Electronics Inc.
- Consumer electronics** 102 **Waiting for a home vtr? Don't hold your breath**
High tape consumption, limited bandwidth, and the lack of standards cloud the picture for the home video tape recorder
John D. Drummond
Consumer electronics editor
- ### Departments
- | | | | |
|----|--------------------------|--------------------------|------------------------|
| 4 | Readers Comment | 33 | Electronics Newsletter |
| 8 | Who's who in this issue | 63 | Washington Newsletter |
| 14 | Who's who in electronics | 197 | New Books |
| 22 | Meetings | 198 | Technical Abstracts |
| 31 | Editorial Comment | 200 | New Literature |
| | 207 | International Newsletter | |

Electronics

Editor-in-Chief: Donald Christiansen

Associate managing editors

Technical: Stephen E. Scrupski
News: Robert Henkel
Copy: Sally Powell

Senior associate editors

Joseph Mittleman, Harry R. Karp

Department editors

Avionics & Space: Alfred Rosenblatt
Computers: Wallace B. Riley
Communications: William Bucci
Components: George Watson
Consumer electronics: John D. Drummond
Design theory: Joseph Mittleman
Industrial electronics: Harry R. Karp
Military electronics: Richard Gundlach

Domestic bureaus

Boston: James Brinton, manager
Chicago: Frederick Corey, manager
Los Angeles: Lawrence Curran, manager; Burton Bell
New York: Howard Wolff, manager
San Francisco: Walter Barney, manager; Peter Vogel
Washington: Robert Skole, manager; Paul Dickson, William F. Arnold

Foreign bureaus

Bonn: John Gosch
London: Michael Payne
Tokyo: Charles Cohen

Copy editors

James Chang, Larry Miller

Graphic design

Art director: Gerald Ferguson
Assistant art directors: Valerie Betz, Susan Hurlburt
Production editor: Arthur C. Miller

Editorial research: Kay Fontana

Editorial secretaries: Lorraine Longo, Claire Goodlin, Patricia Gardner, Barbara Razulis, Stina Colombo

McGraw-Hill News Service

Director: Arthur L. Moore; **Atlanta:** Fran Ridgway; **Chicago:** Robert E. Lee
Cleveland: Arthur Zimmerman; **Dallas:** Marvin Reid
Detroit: James Wargo; **Los Angeles:** Michael Murphy
Pittsburgh: Louis Gomolak
San Francisco: Margaret Drossel
Seattle: Ray Bloomberg; **Washington:** Charles Gardner, Daniel B. Moskowitz, Herbert W. Cheshire, Seth Payne, Warren Burkett, William Small, William D. Hickman

McGraw-Hill World News Service

Bonn: Robert Dorang; **Brussels:** James Smith; **Hong Kong:** Wes Perry;
London: John Shinn; **Mexico City:** Gerald Parkinson; **Milan:** Ronald Taggiasco, Jack Star;
Moscow: Jack Winkler; **Paris:** Robert E. Farrell, Stewart Toy
Rio de Janeiro: Leslie Warren; **Tokyo:** Marvin Petal

Reprints: Susan Nugent

Circulation: Isaaca Siegel

Publisher: Gordon Jones

Electronics: September 30, 1968, Vol. 41, No. 20

Published every other Monday by McGraw-Hill, Inc. Founder: James H. McGraw 1860-1948.

Publication office 99 North Broadway, Albany, N.Y. 12202; second class postage paid at Albany, N.Y.

Executive, editorial, circulation and advertising addresses: McGraw-Hill Building, 330 W. 42nd Street New York, N.Y. 10036. Telephone (212) 971-3333. Teletype TWX N.Y. 710-581-4235. Cable address: MCGRAWHILL N.Y.

Subscriptions solicited only from those professionally engaged in electronics technology. Subscription rates: qualified subscribers in the United States and possessions and Canada, \$8.00 one year, \$12.00 two years, \$16.00 three years; all other countries \$25.00 one year. Non-qualified subscribers in the U.S. and possessions and Canada, \$25.00 one year; all other countries \$50.00. Air freight service to Japan \$50.00 one year. Single copies: United States and possessions and Canada, \$1.00; all other countries, \$1.75.

Officers of McGraw-Hill Publications: Joseph H. Allen, President; J. Elton Tuohig, Executive Vice President; David J. McGrath, Senior Vice President-Operations; Vice Presidents: John R. Callahan, Editorial; Paul F. Cowie, Circulation; John R. Emery, Administration; John M. Holden, Marketing; David G. Jensen, Manufacturing; Jerome D. Luntz, Planning & Development; Robert M. Wilhelmy, Controller.

Officers of the Corporation: Shelton Fisher, President and Chief Executive Officer; John L. McGraw, Chairman; Robert E. Slaughter, Executive Vice President; Daniel F. Crowley, Donald C. McGraw, Jr., Bayard E. Sawyer, Senior Vice Presidents; John J. Cooke, Vice President & Secretary; Gordon W. McKinley, Vice President & Treasurer.

Title © registered in U.S. Patent Office; © Copyright 1968 by McGraw-Hill, Inc. All rights reserved. The contents of this publication may not be reproduced either in whole or in part without the consent of copyright owner.

Subscribers: The publisher, upon written request to our New York office from any subscriber, agrees to refund that part of the subscription price applying to copies not yet mailed. Please send change of address notices or complaints to Fulfillment Manager; subscription orders to Circulation Manager, Electronics at address below. Change of address notices should provide old as well as new address, including postal zip code number. If possible, attach address label from recent issue. Allow one month for change to become effective.

Postmaster: Please send form 3579 to Fulfillment Manager, Electronics, P.O. Box 430, Hightstown, New Jersey 08520

Readers Comment

ABC votes nay

To the Editor:

Many of the technical comments in the article "CBS nominates a convention hopeful" [Aug. 19, p. 74] missed the point entirely concerning characteristics for a successful r-f camera operated in a convention hall.

In addition, a major focus of the article is on construction of the camera around three lightweight hybrid lead-oxide tubes which are claimed to approach the performance of the standard magnetic focus and deflection 30 mm Plumbicon. The performance is actually far from that of the Plumbicon and it took ABC to develop a lightweight camera which has the low lag and long life of the standard Plumbicon by using it in a unique two-tube configuration.

In the article much was made of the reduction in color error due to multipath resulting from transmission of NTSC encoded video. ABC utilized a system of Secam-type encoded video which completely eliminated error due to multipath, and actually made the r-f connection as solid as that of the cabled cameras.

At the Miami convention, the CBS cameras made pictures that fluttered in hue and saturation, as contrasted with the solid ABC pictures, which benefited from the f-m chroma transmission standard of Secam. This latter feature also adds to the ability to tape record distortion-free pictures directly from the camera.

The article made a point of the well-planned r-f system that included an omni antenna at the backpack. Unfortunately, it is common knowledge that this would be anathema in a crowded convention hall. ABC anticipated this and designed a 75° horn mounted on a radio-controlled platform. CBS muddled through by adding a second man to the camera team to carry a pole with a horn attached.

As far as remote controls are concerned, ABC was right there with not only the remote controlled antenna but also tally, horizontal sync, vertical sync, color lock and

Add Sprague Series 7400A to your prints for Series 74N TTL circuits. They're pin-for-pin identical.

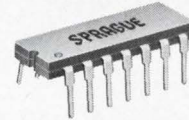

SERIES 74N	FUNCTION	SPRAGUE PART NO.
SN7400N	Quad 2-Input NAND	USN-7400A
SN7401N	Quad 2-Input NAND (No Collector Load)	USN-7401A
SN7402N	Quad 2-Input NOR	USN-7402A
SN7410N	Triple 3-Input NAND	USN-7410A
SN7420N	Dual 4-Input NAND	USN-7420A
SN7430N	Single 8-Input NAND	USN-7430A
SN7440N	Dual 4-Input NAND Buffer	USN-7440A
SN7450N	2-Wide 2-Input Expandable AND-OR-INVERT	USN-7450A
SN7451N	2-Wide 2-Input AND-OR-INVERT	USN-7451A
SN7453N	4-Wide 2-Input Expandable AND-OR-INVERT	USN-7453A
SN7454N	4-Wide 2-Input AND-OR-INVERT	USN-7454A
SN7460N	Dual 4-Input Expander	USN-7460A
SN7470N	D-C Clocked J-K Flip Flop	USN-7470A
SN7472N	J-K Master Slave Flip Flop	USN-7472A
SN7473N	Dual J-K Master Slave Flip Flop:	
—	Single chip, pin 11 GND	USN-7473A
—	Single chip, pin 7 GND	USN-74107A
SN7474N	Dual D-Type Edge-Triggered Flip Flop	USN-7474A
—	Dual AC Clocked J-K Flip Flop	USN-7479A
COMPLEX ARRAYS		
SN7441N	BCD-To-Decimal Decoder/Driver	USN-7441B
SN7475N	Quadruple Bistable Latch	USN-7475B
SN7480N	Gated Full Adder	USN-7480A
SN7482N	2-Bit Binary Adder	USN-7482A
SN7483N	4-Bit Binary Adder	USN-7483B
SN7490N	Decade Counter	USN-7490A
SN7491AN	8-Bit Shift Register	USN-7491A
SN7492N	Divide-By-Twelve Counter	USN-7492A
SN7493N	4-Bit Binary Counter	USN-7493A

For complete technical data on Series 5400 and 7400A circuits, write to Technical Literature Service, Sprague Electric Co., 35 Marshall St., North Adams, Mass. 01247



'Sprague' and '®' are registered trademarks of the Sprague Electric Co.

SPRAGUE WORCESTER...the world's finest microcircuit facility



Some people will buy a Sierra High-Power Signal Generator

You can change the output tube in a Sierra Model 470A in as little as 30 seconds. With other signal generators, the job eats up precious hours. So you can't really fault a man who goes overboard on this quick-change act, even though he may be overlooking some of the more important advantages of owning a 470A.

For example, consider the low cost of high-power output, as depicted by this table:

Frequency Range (MHz)	50-200	200-500	500-1000	1000-1800	1800-2500
Maximum Power (W)	50+	65+	60+	40+	20+
Price	\$2,650	\$2,555	\$2,555	\$2,835	\$3,360

Each of the five models puts out more than enough power to comply with field-strength requirements of currently effective EMI specifications.

Consider such conveniences as: Direct-reading, front-panel meters that keep you posted on power output plus grid and cathode current; an output monitor jack that gives you power samples 35 db down from the main output, ideal for waveform analysis and frequency calibrations; automatic protection against no-load or underload conditions.

Weigh the specs. A magnificent body of technical literature awaits your pleasure. Write Sierra/Philco-Ford, 3885 Bohannon Drive, Menlo Park, California 94025.

...for the pure pleasure of changing the only tube in its magnificent solid-state body



PHILCO-FORD CORPORATION
Sierra Electronic Operation
Menlo Park, California • 94025

Readers Comment

iris which permitted its three cameras to be operated via r-f for the entire convention period within the highest broadcast standards.

If the CBS camera was nominated I can safely say that ABC's Scrambler was elected.

Max Berry

Manager
Audio/Video Systems
American Broadcasting Co.
New York

research scientist. Then, credit is payment enough to negotiate for higher paying positions in his career development. On the other hand, if he were just a creative engineer—as is often the case in a small company—not being paid as a researcher, I am sure Mr. Dresler's ill-chosen words will cause his own technical staff as well as many others to reflect more than a little on the expressed creative incentive of "He'll get nothing."

W.D. Summers

TRW Inc.
Loveland, Colo.

Creating incentive

To the Editor:

The article on CO₂ laser systems [Aug. 5, p. 51] though interesting in itself points out three more significant points or, if you prefer, electronics industry maladies.

The first of these is the fallacy in the industry belief that all advance technology flows forth only from Bell Labs, and secondarily that only well-known scientists such as C. Kumar N. Patel deserve credit for advancements in their fields.

Although I respect Mr. Patel's reputation and admire his contributions to the science, I for one am pleased that, within our crippled and sadly ailing patent system, the man there "first with the most" gets the credit.

The third and perhaps most significant point is the "He'll get nothing" statement uttered by Robert Dressler, president of Riker Video concerning inventor R. C. Vickery.

I am sure this attitude is warranted if Vickery was a full-time

Television in India

To the Editor:

"India bids for self-sufficiency" [Sept. 2, p. 117] reflects an informative image of the nation today and tomorrow. The various statistics are quite accurate. However, the article may develop a misleading impression for a reader not familiar with living standards, income, etc. of the different masses in India.

For example, a price of \$250 for a 23" tv set may sound reasonable by American standards but the median income of a salaried person from a middle class family is between \$400 and \$533 (approximately 3,000 to 4,000 rupees). That means he will have to save at least half a year's salary to enjoy television entertainment.

Ramakant Dhond

Bendix Semiconductor
Holmdel, N.J.

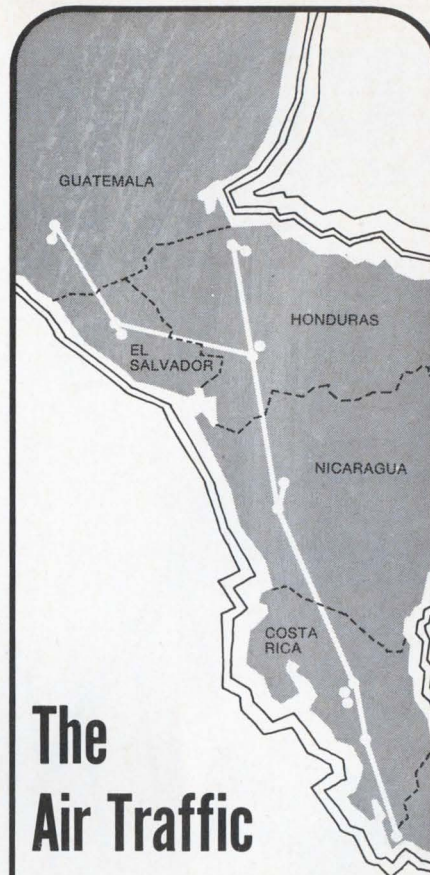

The Air Traffic Control System Of Central America

uses Farinon radio and multiplex systems for reliable telephone circuits.

So do 16 US government agencies, 45 US telephone companies of all sizes, 36 communications agencies of other governments, and the Volta Aluminum Company of Ghana . . . among 223 others.

Farinon has won a world-wide reputation for performance, reliability, economy and all-around engineering judgment.

Write for our catalog of radio, microwave and multiplex equipment, accessories and services.

Farinon

Farinon Electric, 935 Washington St., San Carlos, Cal. 94070

SUBSCRIPTION SERVICE

Please include an Electronics Magazine address label to insure prompt service whenever you write us about your subscription.

Mail to: Fulfillment Manager
Electronics
P.O. Box 430
Hightstown, N.J. 08520

To subscribe mail this form with your payment and check new subscription renew my present subscription

Subscription rates: qualified subscribers in the U.S.: 1 year \$8; two years, \$12; three years, \$16. Non-qualified: 1 year \$25. Subscription rates for foreign countries available on request.

CHANGE OF ADDRESS

ATTACH LABEL HERE

If you are moving, please let us know five weeks before changing your address. Place magazine address label here, print your new address below.

name _____

address _____

city _____

state _____

zip code _____

Who's Who in this issue



Padwick

Matching test equipment to the requirements of customers is Gordon D. Padwick's job. As applications manager in the systems group at the Fairchild Instrumentation division, the author of the article on the dynamic testing of integrated circuits (page 74) is strongly aware of the importance of dynamic parameters as well as the problems of measuring them. Padwick is a native of Birmingham, England, and holds a BSEE from the University of London.

Now a consultant on computer applications in processing industries, George Marr, co-author with Leo Noronha of the article on hybrid computers on page 86, studied chemical engineering at Yale, received a Ph.D. from Princeton, and taught at Yale. He left Electronic Associates Inc. this year, having worked at that company since 1961. Noronha is manager of computer systems applications at Electronics Associates. He received his BSEE from the University of Birmingham, England, in 1958, and has worked in Mexico, England, and Belgium. He is a member of the British Computer Society and of the British IEE.

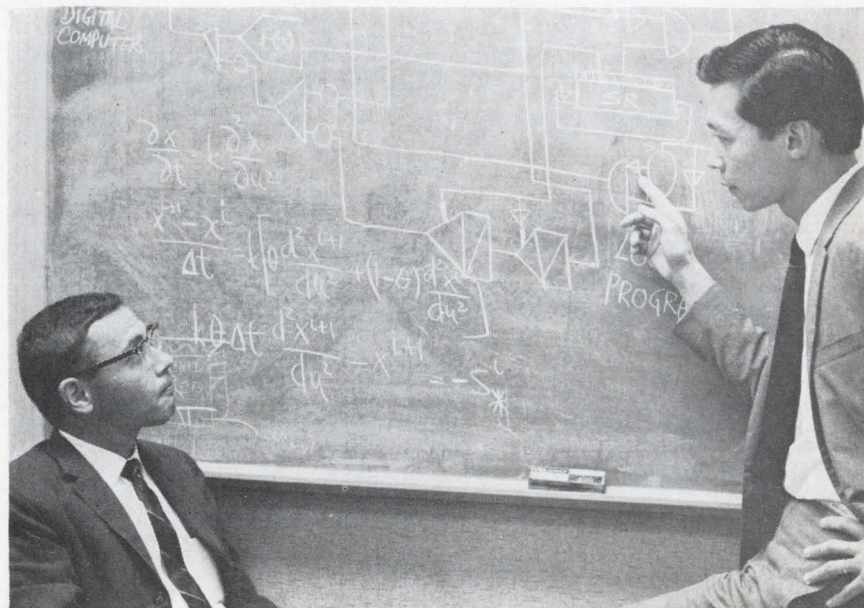

Marr

Noronha

SINCLAIR'S YAGI ANTENNAS

RUGGED RELIABILITY... WHEN IT COUNTS!

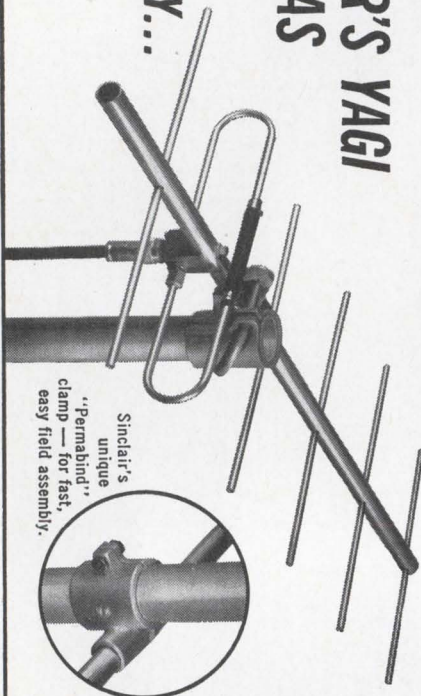

Sinclair's unique "Permabind" clamp — for fast, easy field assembly.

Sure, most UHF-VHF yagi antennas function effectively — when the weather's good! It's when the wind starts to howl and the weather turns from bad to worse that the unmatched rugged reliability of a Sinclair yagi really counts. Every standard Sinclair yagi is designed to withstand 110 mph winds with a 1/2" radial ice coating. An integral part of this rugged construction is Sinclair's unique "Permabind" clamp that makes for fast, permanent field assembly.

Standard Sinclair yagis are available in a wide frequency range from 30Mc. to 470Mc. . . . gains from 6.5db to 17.0db . . . power ratings up to one KW. Send coupon today for complete FREE literature and prices.

676 ENSMINGER RD.

SINCLAIR RADIO LABORATORIES, INC.
P. O. BOX 23
TONAWANDA, NEW YORK

FREE LITERATURE

TO: SINCLAIR RADIO LABORATORIES, INC.
676 Ensminger Rd. P.O. Box 23
Tonawanda, New York 14150

Name: _____
 Title: _____
 Company: _____
 Address: _____
 City: _____
 State: _____ Zip: _____

Do you have this new capacitor data?



Shapiro

Computers need programs to make them work, and planning the worldwide distribution of these programs is the job of Saul Shapiro, author of the article about choosing a simulation system on page 91. Shapiro is an advisory systems analyst in the program information department of IBM's Data Processing division. He has been with the company since 1959. Like most computer applications people, Shapiro relies on a mixed bag of skills. He holds a bachelor's degree in chemical engineering from Cooper Union, and a MSEE and Ph.D. in mathematical statistics from Columbia.

After receiving his bachelor's degree in industrial engineering from the University of Minnesota in 1955, Donald Gray joined the Westinghouse Electric Corp.'s Electronic Tube division. In 1960, when solid state devices began to replace vacuum tubes, Gray moved on to National Electronics, where he has worked on rectifier design, development, and production engineering. Since 1963 he has been doing development work on SCR's, work that has helped produce the regenerative-gate device described in the article on page 96.



Gray

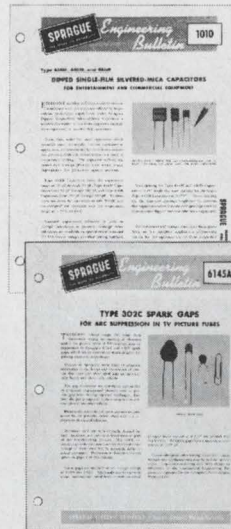

DIPPED MICAS . . . for entertainment and commercial equipment

Single-film silvered-mica capacitors cost less than stacked mica or ceramic types. These capacitors are rated at 300 WVDC and have good stability and retrace characteristics over their operating temperature range of -55°C to $+85^{\circ}\text{C}$. Capacitance values from 10 to 360 pF, $\pm 5\%$ are available. Put this quality and performance into your next design. Ask for Engineering Bulletin 1010.

CIRCLE READER SERVICE NUMBER 220

SPARK GAPS . . . for TV tube protection

Sprague spark gaps suppress transient voltage surges and protect your expensive picture tube and allied circuitry. They are available in 1.5 kV and 2.5 kV ratings, and have a maximum capacitance of 0.75pF, providing an economical means of safely bypassing transient overvoltages. All Sprague spark gaps are 100% tested to insure your circuitry. Use them to protect your picture tube warranty. Ask for Engineering Bulletin 6145A.

CIRCLE READER SERVICE NUMBER 221

DISC CERAMICS . . . for general, temperature-compensating, and low-voltage applications in industrial, commercial, and consumer equipment



Cera-mite® general application discs for bypass and coupling at low cost. Nine disc sizes from .300 to .875 inches have 100, 250, 500, and 1000 WVDC ratings, in standard or temperature-stable formulations. Dual-section discs have up to $.022\mu\text{F}$ @ 1000 V. Ask for Engineering Bulletin 6101D.

CIRCLE READER SERVICE NUMBER 222

Cera-mite temperature-compensating discs for controlled capacitance change with temperature in R-F oscillators, precision amplifiers, timing circuits, other critical applications. Select from ten linear temperature coefficients from NPO to N2200. Capacitance values from 1 to 2200 pF with 1000 WVDC ratings are available, plus popular values at 3000, 4000, and 5000 WVDC for TV yoke circuits. Mini-fied units in 250 WVDC ratings may be obtained with capacitance values ranging from 22 to 990 pF. Ask for Engineering Bulletin 6102B.

CIRCLE READER SERVICE NUMBER 223

Hypercon® ultra-high capacitance discs for low-voltage circuits. Replace electrolytics with non-polar Hypercon capacitors only a fraction as large. The $2.2\mu\text{F}$, 3 volt disc has a diameter of .875 inches; the $0.1\mu\text{F}$, 25 volt unit measures .750 inches. Ask for Engineering Bulletin 6141F.

CIRCLE READER SERVICE NUMBER 224

For bulletins in which you are interested, write
Technical Literature Service, Sprague Electric Co.,
35 Marshall St., North Adams, Mass. 01247

SPRAGUE COMPONENTS

CAPACITORS
TRANSISTORS
RESISTORS
INTEGRATED CIRCUITS
THIN-FILM MICROCIRCUITS
INTERFERENCE FILTERS

PACKAGED COMPONENT ASSEMBLIES
FUNCTIONAL DIGITAL CIRCUITS
MAGNETIC COMPONENTS
PULSE TRANSFORMERS
CERAMIC-BASE PRINTED NETWORKS
PULSE-FORMING NETWORKS



*Sprague and ® are registered trademarks of the Sprague Electric Co.

5 things you should know

3. More than a switch:

Most double-diffused power transistors can only be used for switching applications. But, Fairchild power transistors have extremely high power dissipation. That means they can also be used as amplifiers. (Servo-amps, power amps, class B push-pull amps, etc.) They also make good switches.

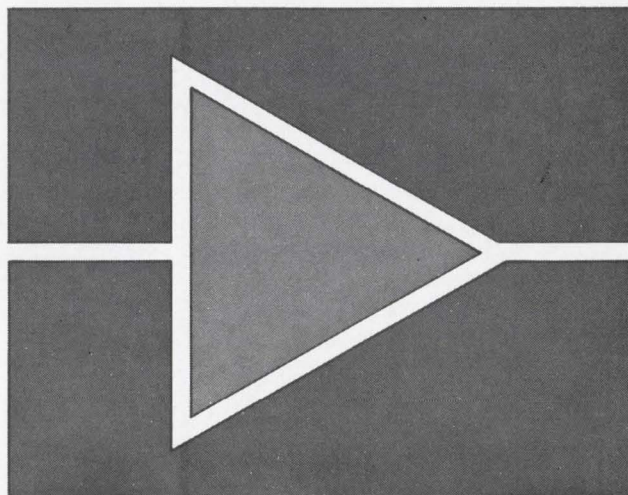

1. The discrete emitter:

Fairchild has improved beta linearity characteristics of power transistors. We chopped the emitter into many small discrete emitters connected in parallel by buss bar metalization. As a result, the increased emitter-base peripheral area raises emitter injection efficiency.

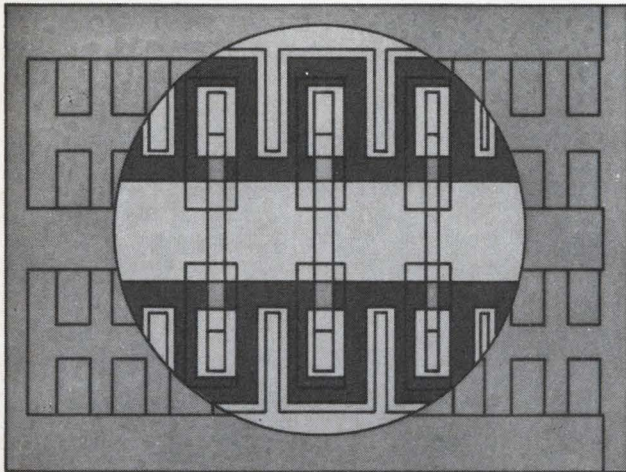

2. Integrated feedback resistors:

We also increased the safe area of operation. With a built-in safety fuse. Each discrete emitter is connected to the buss bar through a deposited thin film nickel-chromium resistor. That keeps the current flow under control and increases the device's second breakdown capability. If any emitter overheats, its resistor will open. Fairchild power transistors will perform without detectable degradation with up to 10% of the emitter sites opened.

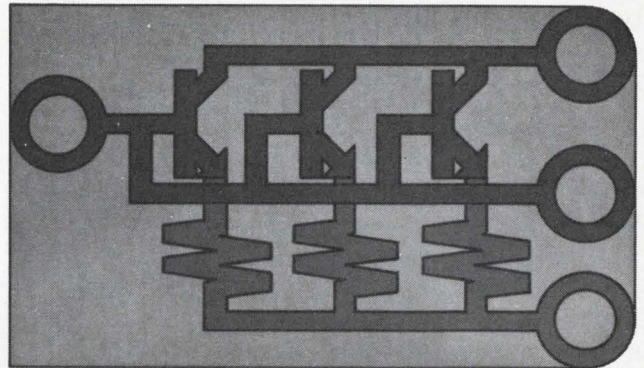

about silicon power transistors:

4. Planar II:

Several manufacturers use the Planar* process to make power transistors. But, not the way we do. (That's why other power transistors are limited to switching functions.) So, if you're a circuit designer, you don't have to put up with the low reliability and poor frequency response of Mesa designs. Fairchild offers reliable, 100%-tested epitaxial Planar power transistors with high frequency response. And, with all the advantages Fairchild power transistors offer, they cost only a little more than Mesa.

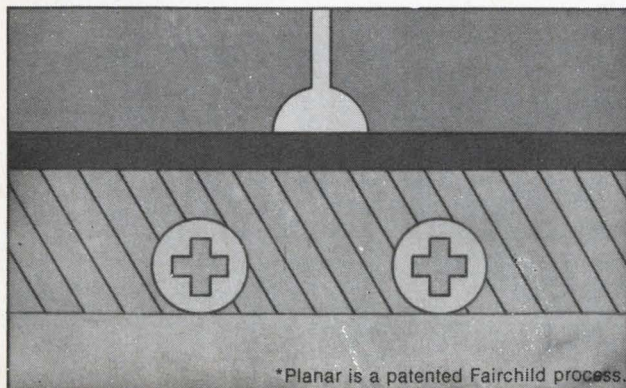

*Planar is a patented Fairchild process.

5. Power source:

You can get power transistors from your local Fairchild distributor. He's got NPNs and PNPs. Amplifiers and switches. Simply circle the Reader Service Number below for complete specifications and applications information.

Fairchild Semiconductor, A Division of Fairchild Camera and Instrument Corporation, 313 Fairchild Drive, Mountain View, California 94040 (415) 962-5011 TWX: 910-379-6435

FAIRCHILD
SEMICONDUCTOR

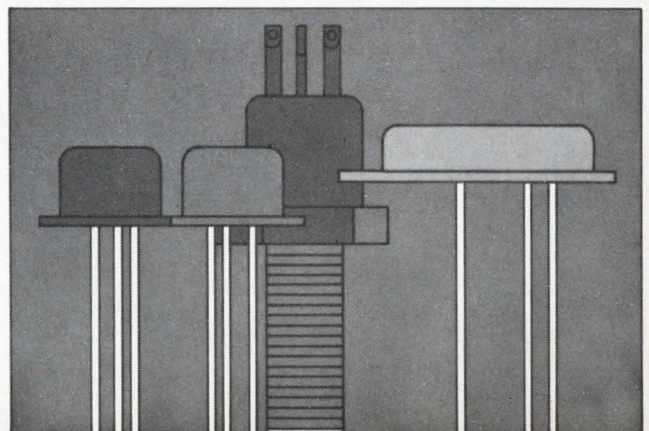

The New Emancipator

63 KEYS TO COMPUTING FREEDOM ARE NOW WITHIN YOUR REACH!

Freedom from waiting to get on the BIG computer;

Freedom from translating your problems into foreign computer languages;

Freedom from starvation-level computing with under-developed calculators;

Freedom from the drudgery of manual computation.

The new hp 9100A puts heroic computing power responsively at your fingertips...

for the unheroic, one-time-cost of \$4900.

Fast core memory delivers answers

to log, trig and other keystroke functions in milliseconds.

And... in seconds you get answers to more complex computations such as roots of a fifth degree polynomial...

Fourier analysis... elliptic integrals... Fresnel integrals...

real and complex polynomial evaluation...

coordinate geometry... regression analysis...

three dimensional vectors... numerical integration

and many, many, more!

This major computing capability is compressed into one 40 pound package.

Its only moving parts are the keys, the switches and one decimal wheel.

No noise!

The 9100A is being delivered now

along with an extensive—and growing—program library that puts you in control.

Examine the keyboard. Question every key and switch.

Then join the participators!

A telephone call or purchase order directed to any Hewlett-Packard sales and service office

(located in principal cities throughout the world)

will start your liberation from the tyranny and

tradition of too BIG, too slow and too weak.

If you are still skeptical or of faint heart,

ask for a demonstration.

It will affirm, assure

and delay—but only slightly

—your entry into the solid-state

of personal computing freedom. Hurry.

Being a leader has its advantages.

Hewlett-Packard, P.O. Box 301,

Loveland, Colorado 80537.

Europe: 54 Route des Acacias,

Geneva.

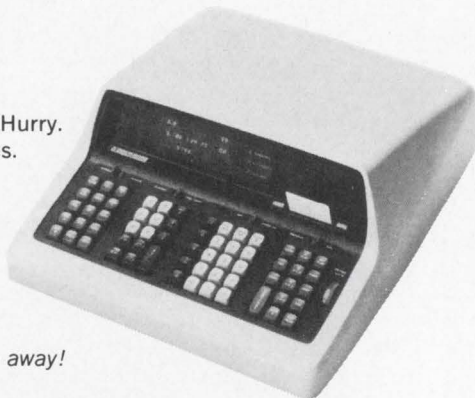

9100A puts answers just a touch away!

HEWLETT  **PACKARD**

Circle 12 on reader service card

754.8387	z temporary
5.326 845 815 05	y accumulate
33.50	x keyboard

Dynamic range 10^{-98} to

10^{99} , nearly 200 decades.

Observation of math operations on 3 displayed registers. Up to 16 more registers for data storage.

TO
POLAR

Complex and vector arithmetic

simplified with coordinate transformation keys, rectangular-to-polar and vice-versa, in milliseconds.

$\tan x$

Trig functions covering all quadrants and any size angle in degrees or radians.



IF $x < y$ Up to 196 program steps, each a simple key stroke. "IF" keys permit looping and branching flexibility found only on large computers.

STEP PRGM Edit programs easily. Single-step through programs to check and de-bug. Address an individual step and make corrections without re-entering the entire program.

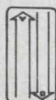

Program from the keyboard. Record and store programs on credit-card-size magnetic cards for repeated use.

Designed for expansion. Printer, plotter, electrical data input/output will become available.

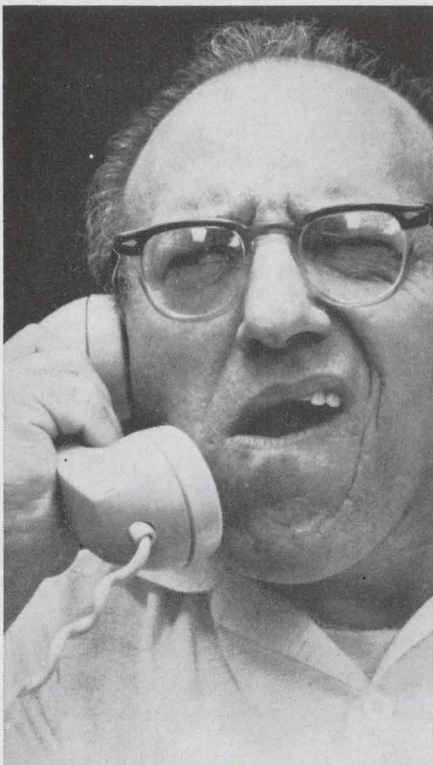

“Four to six weeks for power supply delivery?

Forget it!

Acopian will ship any of their 62,000 different AC to DC plug-in power supplies in just 3 days!”

This catalog lists 62,000 models of AC to DC plug-in power supplies available for shipment in just three days. Choose the exact outputs you need. Singles or duals, regulated or unregulated. Write or phone for your free copy.

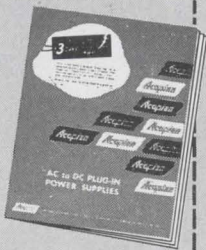

Name _____
 Title _____
 Company _____
 City _____
 State _____ Zip _____



Acopian Corp., Easton, Penna. 18042
 Phone: (215) 258-5441

Who's who in electronics

“Demand for small general-purpose computers is simply outstripping the industry's ability to fulfill it,” according to Edson D. de Castro, who's generally recognized as the father of such computers.

The company de Castro and two other former Digital Equipment Corp. officials formed to make help meet this demand has already produced a new breed of small machine, the Nova (see “Third-generation small computer to make its debut in December,” page 147).

Now, as president of the new firm, Data General Corp. in Hudson, Mass. [Electronics, Sept. 16, p. 34], de Castro will be competing

pany's profits. And though the Nova will compete aggressively with the various PDP-8's, the three men expect a fast-expanding market to provide room for both firms.

The Nova has more architectural characteristics in common with an IBM 360 than with a PDP-8, says de Castro. “And we're taking more advantage of large integrated-circuit arrays than other builders of small general-purpose computers.” Adds Sogge, “We'll use anything we don't have to buy on a purely custom basis.”

The firm also stresses logic at the expense of hardware in an attempt to cut parts costs. This com-

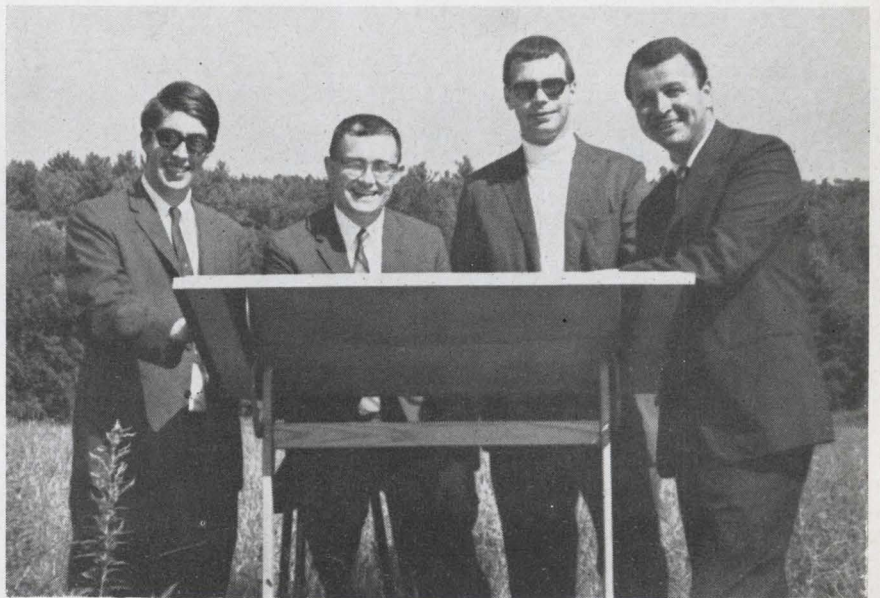

Burkhardt de Castro Sogge Richman

with his past. He left DEC as head of small-computer design, having created since 1962 the PDP-5, PDP-8, PDP-8I, and PDP-8S.

His cofounders and vice presidents at Data General are Henry Burkhardt, who was head of small-computer applications programming at DEC, and Richard G. Sogge, head of memory and circuit development.

Lebensraum. When the three left last April, the PDP-8 series accounted for the lion's share of DEC's unit volume and, it is said, for as much as half of the com-

bination of high power and low price is expected to spur quick sales to original-equipment manufacturers. According to Data General's director of marketing, Allen Z. Kluchman, also a former DEC employee, a 16-bit Nova with four kilobits of memory will sell for \$8,000—but an order for 200 Novas will give OEM's a 40% discount, to \$4,800.

Burkhardt says Data General's software package will also be aimed at the OEM's. Burkhardt, who wrote all DEC's pulse-height-analysis programs, as well as its typesetting



DC to 40 MHz in Seven Inches! 90 db Clean.

Up above, you see just one member of Fluke's exciting new family of frequency synthesizers. Model 644 covers DC to 40 MHz. Model 633 covers DC to 11 MHz. Model 622 covers DC to 2 MHz range.

All three units feature exceptionally low spurious content, high signal to phase noise ratio, modern packaging in minimum panel height, in-line, in-plane frequency readout and fast remote programming to give you synthesizers with the right figure of merit.

Want a demonstration? Your full service Fluke sales engineer will be glad to arrange a demonstration of any or all of these high performance new synthesizers. Or write or call us here at the factory for more information.

Brief Specifications

Model	644	633	622
Frequency Range	DC - 40 MHz 0.1 Hz Steps	DC - 11 MHz 0.1 Hz Steps	DC - 2 MHz 0.1 Hz Steps
Non-Harmonic Spurious	At least 90 DB Below the Fundamental	-90 DB to 5.5 MHz -80 DB to 6.5 MHz -60 DB to 11 MHz	-90 DB
Harmonics	At least 30 DB Below the Fundamental	-35 DB	-35 DB
Internal Standard	1 part in 10 to the 8th per day stability Higher stabilities optional		
Size	7" high, 17" wide, 23" deep Mounting ears fit standard 19" rack		
Power	100/115/200/230 VAC plus or minus 10% 50 - 400 Hz 75 watts max.		
Price	\$10,490	\$7,090	\$6,490



Fluke, Box 7428, Seattle, Washington 98133. Phone: (206) 774-2211. TWX: 910-449-2850. In Europe, address Fluke Nederland (N.V.), P.O. Box 5053, Tilburg, Holland. Telex: 844-50237. In the U.K., address Fluke International Corp., P.O. Box 102, Watford Herts, England, Telex: 851-934-583.

Circle 15 on reader service card

**if you're using
any other
miniature fan
in your equipment,
you're getting
less efficient cooling...
and paying more dollars to do it!**

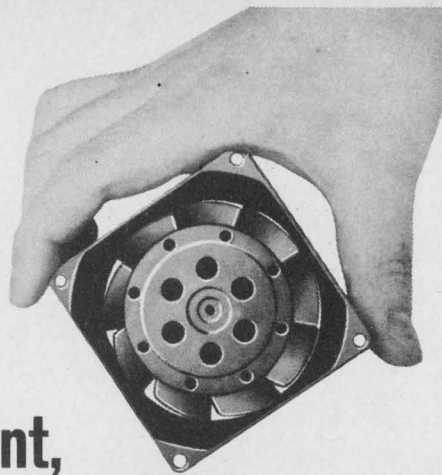

THE NEW ALL-METAL MODEL 8500 IS...

THE QUIETEST...

(Unmatched low noise level of 28.8 dB SIL.)

THE MOST COMPACT...

($\frac{1}{8}$ " thinner than conventional $3\frac{1}{8}$ " fans. Standard mounting dimensions for EIA $3\frac{1}{2}$ " rack panels.)

THE MOST EFFICIENT...

(Delivers 45 cfm at zero static pressure... up to 50% more air than other $3\frac{1}{8}$ " fans.)

$3\frac{1}{8}$ " FAN YOU CAN GET YOUR HANDS ON

(Immediate delivery through leading electronic distributors or directly from factory stock.)

**IF THIS SEEMS TOO GOOD TO BE TRUE,
FILL IN THE COUPON AND WE'LL MAKE YOU A BELIEVER!**

OK, so prove to me that the new Model 8500 offers better performance at a lower cost than *any other* $3\frac{1}{8}$ " fan.

Have sales representative call Send me complete data

Name.....Title.....

Company.....Phone.....Ext.....

Address.....City.....State.....Zip.....

PAMOTOR, INC.
312 Seventh Street, San Francisco, Cal. 94103

Who's who in electronics

software, estimates that 150 to 200 of DEC's typesetting computers are now in the field. With his experience in these and other applications, Burkhardt says he has a feel for new OEM applications that have yet to surface. In fact, he says some of the Nova's powerful multiaccumulator architecture was developed with such new applications in mind.

Basic scheme. The hardware in Nova was largely selected by Sogge, who is said to have picked all DEC's IC's. Sogge also played a key role in developing the special core memories for DEC computers. He had worked for Raytheon, where he developed the basic scheme used in the read-only memory of the Apollo guidance and navigation computer, as well as one of the first IC sense amplifiers. Nova makes heavy use of very similar read-only memories.

Heading the sales effort, with the title of vice president, will be the outlander among the founding four. Herbert J. Richman came not from DEC but from Fairchild Semiconductor, where he was Eastern sales manager. Fairchild will supply transistor-transistor logic IC's for most of Data General's output; Signetics is to be the second source for the circuits.

And, unlike many new ventures, Data General plans to buy vast numbers of parts almost from the outset. Next year, the company is planning to build at least 200 Novas—possibly more—according to Kluchman.

Anything but undercapitalized, the company has leased a 15-acre site in Southboro, Mass., and is readying a 10,000-square-foot-plant it hopes to move into before Christmas.

The money to make such a fast start possible has come from a group of about 15 investors, (de Castro & Co. retain control), many of whom are in the electronics industry. Running financial interference with Wall Street and with industry personalities was Richman's job, and, judging by de Castro's smile when he mentions the till, Richman succeeded.

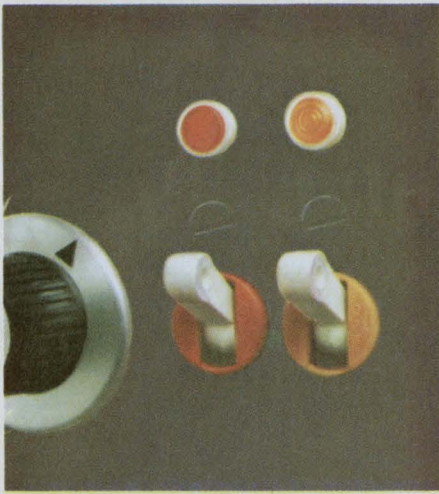

The Heinemann Series JA circuit breaker

Legend has it that the equipment that wears one is forever safe from harm. (Although our claims for it are considerably more modest.)

We do believe, however, that a bouquet of color-coded JA's on your equipment panel will give you a distinct feeling of well-being.

For one thing, those bright JA color caps make your panel look better. (They also make faults easier to find and correct.) There are nine happy colors to choose from.

For another, you have all the advantages of Heinemann's kind of hydraulic-magnetic protection working for you.

What advantages?

Ultra-precise current ratings, from 0.020 to 30 amps, in fractional increments. Absolutely temperature-stable current ratings and trip-points. Job-matched overload response curves. Special function internal circuits like relay-trip, auxiliary-switch, and so forth. Multipole models for multiple protection requirements.

And a five-year warranty.

We think maybe the warranty was the beginning of the legend.

For more information on our colorful JA breakers, write for Bulletin 3350, Heinemann Electric Company, 2700 Brunswick Pike, Trenton, N. J. 08602.



HEINEMANN

4056

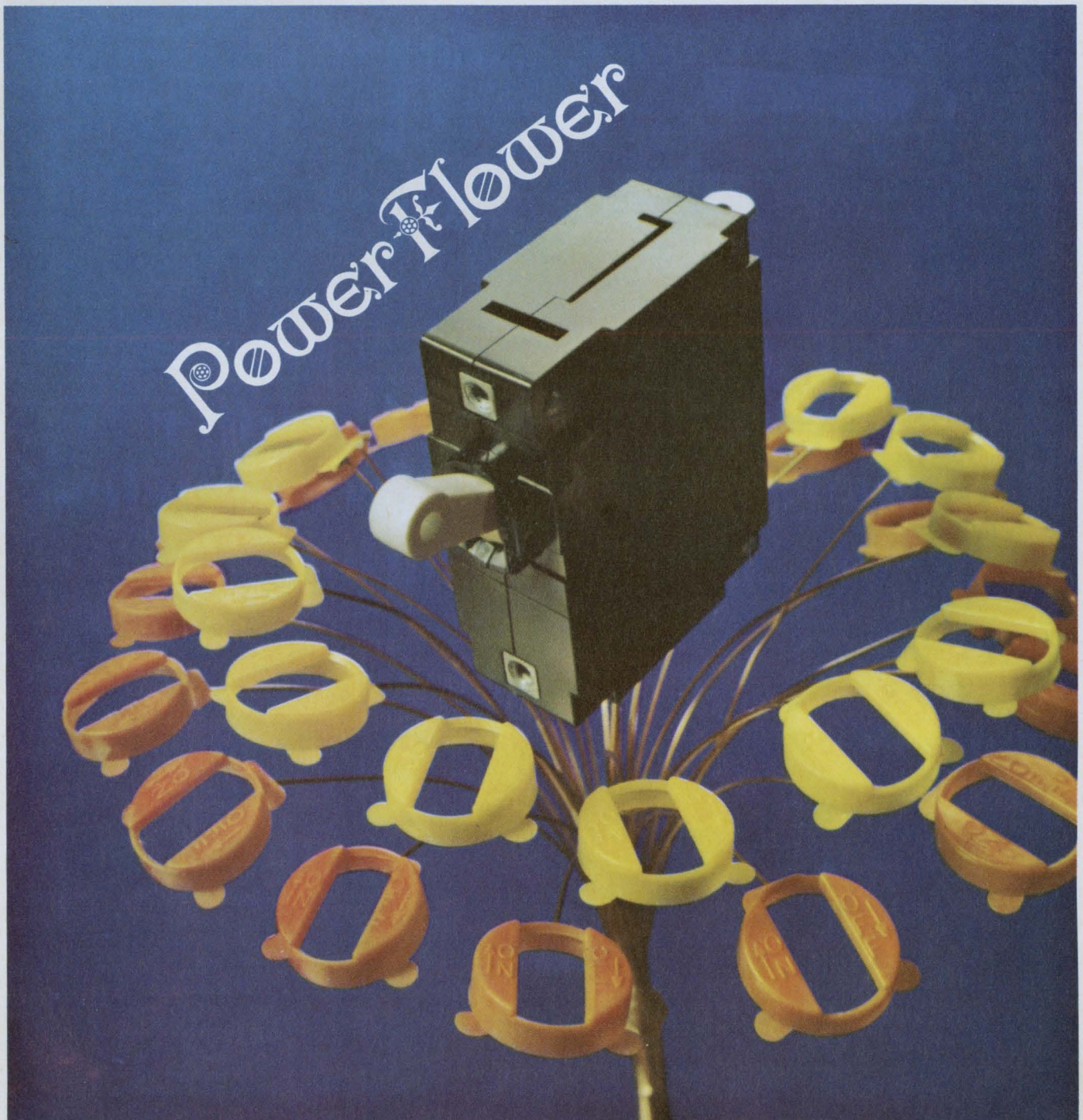

7 digit Universal Counter \$995

30-day delivery 2 year warranty



0 to 20 MHz
Integrated circuits
10 mv sensitivity
2 input amplifiers
Pushbutton controls
100 μ sec minimum display time
Simplified programming
8-digit readout (optional)

How come such a whale of a buy for a true universal counter? Because of its superb design! Roundabout circuitry has been simplified, interconnections reduced, and logic minimized. Also, normally unused extras have been made available as options. Model 300 shows the conceptual, design, and manufacturing skill you'll get used to expecting from Time Systems. Circle the reader service card, write or telephone for complete specs.

New Computing Counter measures very low frequencies with 7 digit resolution \$1995



7-digit resolution
0.1 Hz to 20 MHz
Autoranging
Autofiltering*
Autoreset
10 mv sensitivity
Pre-set trigger level

Why is this counter like no other? Because it gives you direct frequency reading as low as 0.1000000 Hz! Never again will you need to read period and convert to frequency. Our unique, low-cost digital computing circuit does it for you. Makes period reading obsolete, doesn't it? Model 210 is another in a new class of computing counters from Time Systems. Circle the reader service card, write or phone for complete data.

* patent pending

Exclusive new lite needle* adds fast-glance analog readout to digital panel meters

MODEL 700

Lite needle
Autopolarity
0.1% accuracy (10 to 40° C)
>1000 megohms/volt
100 μ v resolution

\$245.

MODEL 710

Lite needle
Autopolarity
Floating analog ground
Floating BCD output
0.1% accuracy (10 to 40° C)
>1000 megohms/volt
100 μ v resolution

\$320.

What makes these panel meters unique? Time Systems' exclusive lite needle simulates the left-to-right action of an ordinary deflection type meter. You get simulated analog readout for quick-look trend information, plus digital readout for high accuracy. Complete voltage and current ranges are available.

Stack them in banks — ask for quantity discounts. For complete information, check the reader service card, write or telephone.

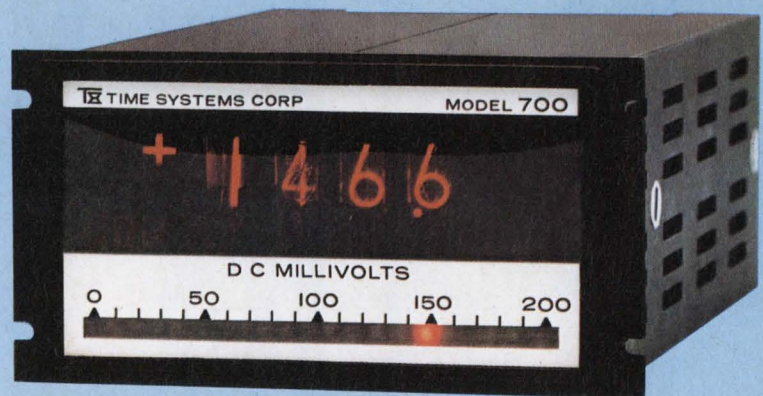

* patent pending



TIME SYSTEMS CORPORATION

265 Whisman Road • Mountain View, California 94040 • Telephone (415) 961-9321

MAGNETICS

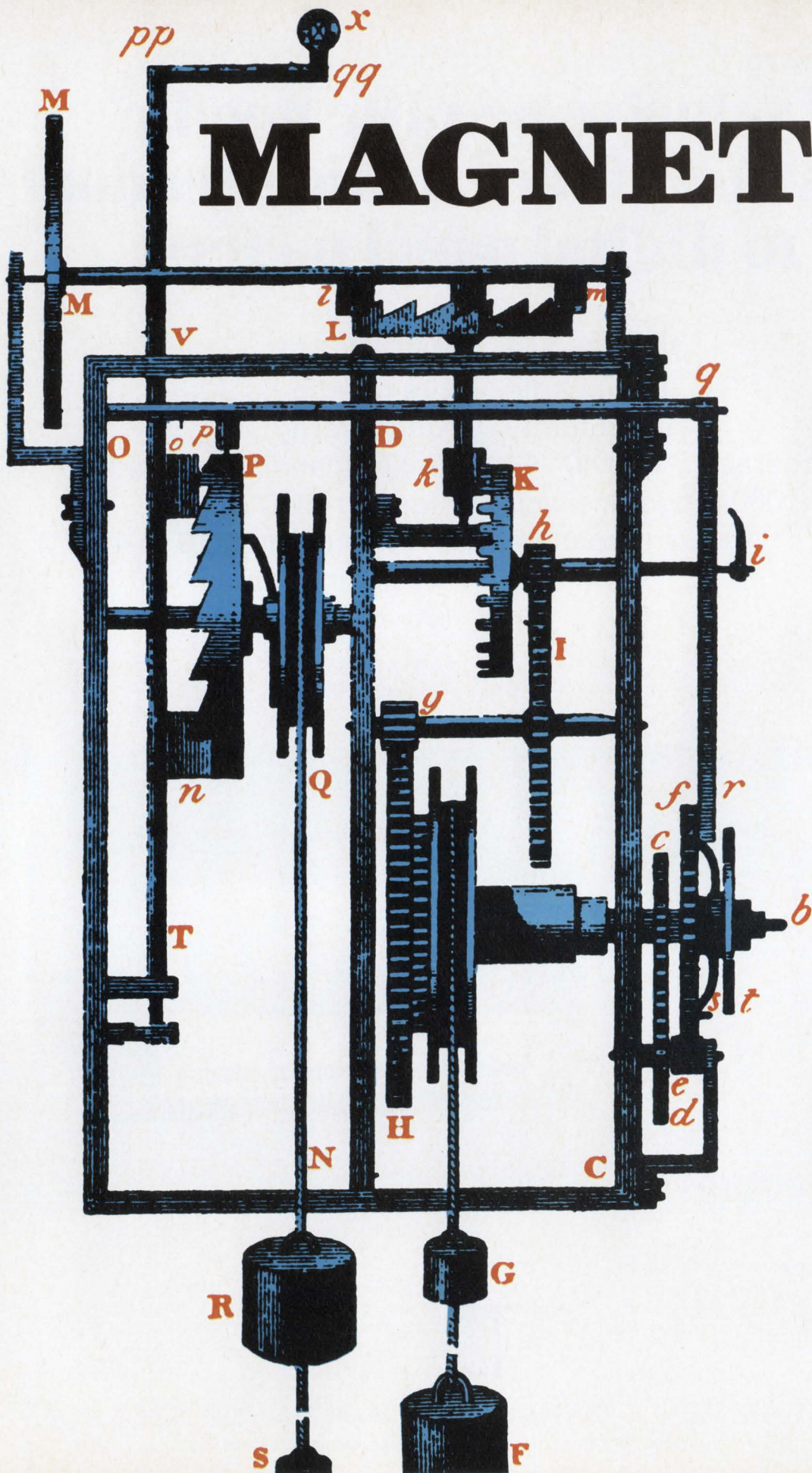

BY ARNOLD

speed time in new dimensions

The "tick-tock" of the pendulum clock is quaint, but passé in today's world of precision. Modern and inexpensive timing devices rely on permanent magnets which won't lose their power, hence maintain accuracy. Clocks, timers and pinwheel motors requiring low torque and constant speed use rotors of Arnox 3 impregnated into a resin. When time is a design parameter, forward-looking manufacturers look to Arnold for high-quality magnetic materials, design, technology, components. Magnetic cores. Powder cores. Laminations. Permanent magnets. You ask. We'll supply. The best in magnetic materials.



Write for free guide to the only complete line of magnetic materials.

In other areas where time is a factor you'll find Arnold magnetic materials: soft ferrites in pushbutton phones • MPP cores in high frequency selection or control • powdered iron cores and toroids in electronics, radio and communication equipment • tape cores in NC machine tools • bobbin cores in telemetering and delayed action fuses • Supermendur "C" cores in transformers.



ARNOLD
SPECIALISTS IN MAGNETIC MATERIALS

The Arnold Engineering Company, Main Office: Marengo, Ill.
Branch Offices and Representatives in Principal Cities

The more you need from crystal filters, the more you need Bulova!

Today's sophisticated systems call for filters with "difficult" characteristics. Difficult, that is, for everyone but Bulova! Bulova has had so much experience with crystal filters, there's hardly anything we don't know about them.

Take single side-band filters, for example: Attenuation figures alone are not enough to adequately describe today's military communication filters. More and more filters require limitations on envelope time delay, while others must follow a precise time-delay envelope curve.

Bulova has been testing for these parameters — providing measurements both in terms of phase linearity and, in many cases, directly in envelope time-delay readings. As a result,

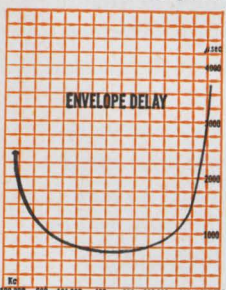

Bulova can engineer and produce to the exact measurements you specify. And at a realistic price!

Proof: Here are the actual curves and specs for just one Bulova filter, Model 562.

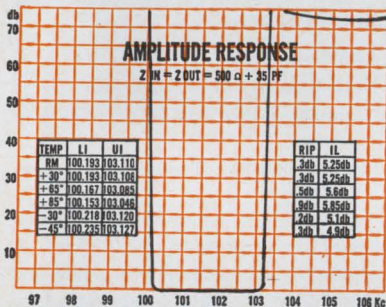

- Bandwidth (1db) 100.255 to 103.035 Kc
- Bandwidth (60 db) 99.990 to 103.260 Kc
- Carrier frequency — is 100 Kc
- Loss at carrier — 55 db min.
- Ultimate attenuation — 70 db
- Max. insertion loss — 6 db
- Max. ripple — 1 db max.
- Operating temperature— -40° to +65°C
- Impedance — 500Ω (in and out)
- Differential envelope time delay — 500 μsec max. over 80% of pass band

With specs like these you can see why we say — the more you need from a filter, the more you need Bulova! Call or write Dept. E-21.

Try Bulova first!

FREQUENCY CONTROL PRODUCTS

ELECTRONICS DIVISION
OF BULOVA WATCH COMPANY, INC.

61-20 WOODSIDE AVENUE
WOODSIDE, N.Y. 11377, (212) DE 5-6000

Meetings

Hybrid microelectronics: still thriving

Despite the increasing importance of monolithic integrated circuitry, hybrid microelectronics technology appears to have a secure hold in the solid state world, as evidenced by the caliber of papers that will be presented at the third Hybrid Microelectronics Symposium.

This year's meeting, in Chicago Oct. 28-30, comprises 50 papers divided into eight sessions and will concentrate on advances in beam-lead techniques, stable resistor pastes, and thin-film capacitors, and on recent experimental work in hybrid microwave IC's.

In a session on component design, Roger D. Quick, of the Friden Research Center's technical staff, will describe a computer-aided system for designing hybrid circuit masks. The program is run on an IBM 360/30 and uses a Calcomp plotter. Patterns are inked first on frosted Mylar and then replotted over the first inking to provide enough opacity for direct photographic reduction.

Colorful. In the area of applications, five engineers from the

Zenith Radio Corp.'s research laboratories will present a paper on a hybrid thick-film chroma-demodulation and color-difference amplifier in which three circuit sections are combined on a single 1-by-2-inch ceramic substrate. The first section is made up of two dual-diode color demodulators; the second is the color-difference amplifier. The final section is a four-diode d-c restoration circuit that clamps all three color signals.

The amplifier consumes 9 watts. It's still experimental, but could replace 50 to 65 discrete components in a color tv set.

Other papers will cover a technique for testing circuit components before incorporating them on the substrate, a room-temperature nickel metalizing process for alumina ceramics, and a digital process control system for tuning thin-film devices designed for the RC audio oscillator in Western Electric's Trimline Touch-Tone dial.

For further information write Joseph English, c/o Cozzens and Cudahy, 9501 W. Devon Ave., Rosemont, Ill. 60018.

Calendar

Allerton Conference on Circuit and System Theory, IEEE; Allerton House, Monticello, Ill., Oct. 2-4.

International Telemetry Conference, International Foundation for Telemetry; Ambassador Hotel, Los Angeles, Oct. 8-11.

Symposium on Multivariable Control Systems, International Federation of Automatic Control; Duesseldorf, West Germany, Oct. 7-8.

Fall Meeting of the Society of Automotive Engineers, Committee on Electromagnetic Compatibility; Cabana Motor Hotel, Atlanta, Ga., Oct. 8-9.

International Telemetry Conference, Foundation for Telemetry; Ambassador Hotel, Los Angeles, Oct. 8-11.

Symposium on Applications of Ferroelectrics, IEEE; Catholic University of America, Washington, Oct. 10-11.

German Society for Medical and Biological Electronics, Munich, Oct. 10-11.

Conference on Analytical Chemistry in Nuclear Technology; Mountain View Hotel, Gatlinburg, Tenn., Oct. 10-12.

Metallurgical Society of the American Institute of Mining, Metallurgical, and Petroleum Engineers; Detroit, Oct. 13-17.

International Astronautical Congress; Waldorf-Astoria Hotel, New York, Oct. 13-19.

Systems Sciences & Cybernetics Conference, IEEE; Towne House, San Francisco, Oct. 14-15.

(Continued on page 24)

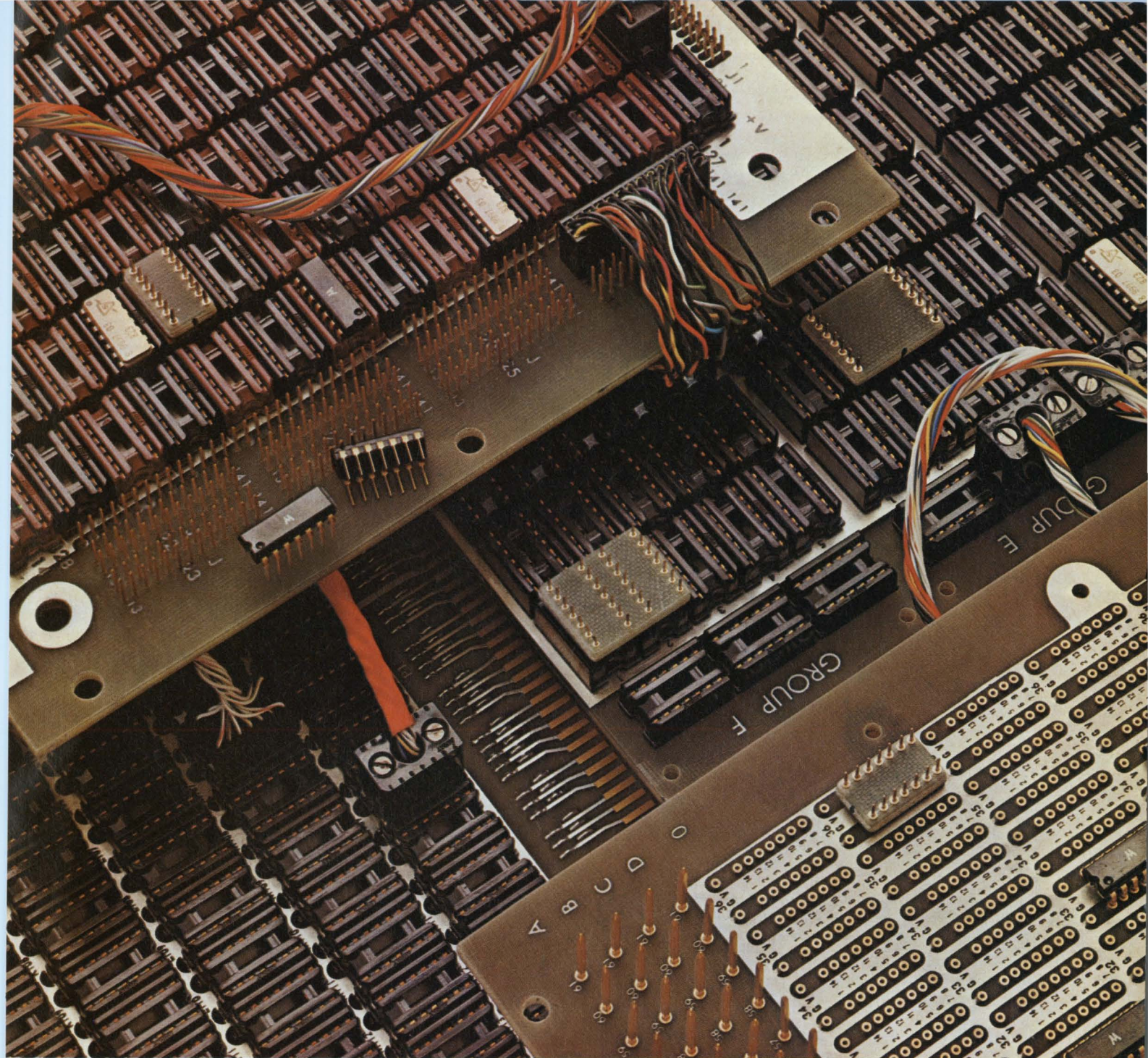

Innovation in IC packaging panels

Let Augat provide flexibility, reliability and fast turn around time you need

You can have increased flexibility — and save time, space and money — with Augat's unique 2-dimensional approach of packaging IC's on a point-to-point basis. And regardless of the size of package, Augat can design and produce the panels and peripheral hardware to solve your most difficult packaging problem. In addition to standard panels, modifications can be made to your specification without premium charge: Standard sockets and connectors, providing excellent lead retention, low contact resistance, and long life reliability are used on all panels.

Illustrated are four methods of input-output connections. These are available on virtually any size or shape panel required to fit your existing cabinets, racks and drawers. Variations in contacts and materials permit unusual pricing flexibility. Why wait. Call Augat for fast proposal and delivery. Tel: 617/222-2202 or write for our complete IC folder. Augat, Inc., 30 Perry Ave., Attleboro, Mass. 02703.

AUGAT^{INC.}

**Penny
wise,
printed
circuit board
foolish**

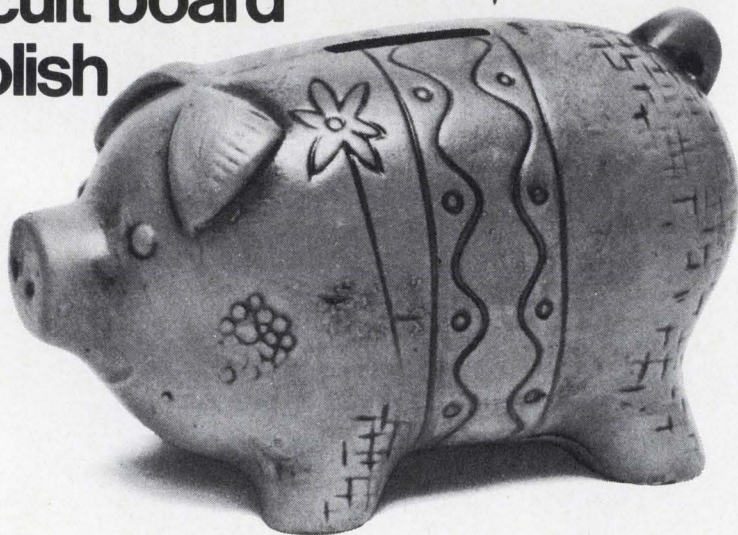

Our printed circuits often appear to cost a bit more. But when quality counts and your final assembly costs are checked, the cost turns into savings. WHY? These parameters tell the story: dimensional stability, solderability, shelf life, repeatability, reliability, and assurance from the largest printed circuit supplier in the world that your requirements have been maintained.

Consider the other savings. Inspection time saved. MRB time saved. Extra paperwork and bookkeeping on rejects avoided. You might say it sometimes takes a dollar to save two.

Our boards are built to pioneer the moon, explore Mars, power the finest hi fi system, are used in computers that add to our very existence. We've had to build some of our own machinery and develop special processes in order to give you this kind of reliability. Is it the kind you're looking for? Write us, visit us, we'll meet your exact needs.

CINCH-GRAFIK

D I V I S I O N O F U N I T E D - C A R R



200 South Turnbull Canyon Road, City of Industry (Los Angeles), Calif. 91744 • Phone (213) ED 3-1201. Sales offices in 33 principal cities throughout the United States, Great Britain, Canada, Australia and West Germany.

MEMBER

CONSISTING OF CINCH MANUFACTURING COMPANY, CINCH-GRAFIK, CINCH-MONADNOCK, CINCH-NULINE, UCONITE (ELECTRONICS) AND PLAXIAL CABLE DEPT.

Meetings

(Continued from p. 22)

Symposium on Switching and Automata Theory, IEEE; Schenectady, N.Y., Oct. 15-18.

Symposium of Reliability in Electronics, Hungarian Academy of Sciences; Budapest, Oct. 15-18.

Conference on Electrical Insulation and Dielectric Phenomena, National Academy of Sciences—National Research Council; The Inn, Buck Hill Falls, Pa., Oct. 20-23.

Meeting and Technical Display, American Institute of Aeronautics and Astronautics; Philadelphia Civic Center, Philadelphia, Oct. 21-25.

Shock and Vibration Symposium, Naval Research Laboratory; Asilomar Conference Grounds, Pacific Grove, Calif., Oct. 22-24.

International Electron Devices Meeting, IEEE; Sheraton Park Hotel, Washington, Oct. 23-25.

Nuclear Science Symposium, IEEE and United States Atomic Energy Commission and Atomic Energy Commission of Canada; Bonaventure Hotel, Montreal, Canada, Oct. 23-25.

Seminar in Depth—Image Information Recovery, Society of Photo-Optical Instrumentation Engineers; Benjamin Franklin Hotel, Philadelphia, Oct. 24-25.

Instrument Automation Conference and Exhibition, Instrument Society of America, Hilton Hotel; New York Coliseum, N.Y., Oct. 28-31.

Machine Tools Industry Technical Conference, IEEE; Wagon Wheel Lodge, Rockford, Ill., Oct. 28-30.

Applied Superconductivity Conference and Exhibition, Oak Ridge National Laboratory; IEEE and American Physical Society, Gatlinburg, Tenn., Oct. 28-30.

Symposium of the American Vacuum Society; Pittsburgh Hilton Hotel, Oct. 30-Nov. 1.

Product Assurance Conference and Technical Exhibit on Reliability, Standard Maintainability and Parts-Materials Packaging, IEEE & Standards Engineers Society; Waldorf-Astoria Hotel, New York, Nov. 2-3

American Institute of Ultrasonics in Medicine; Monteleone Hotel, New Orleans, Nov. 4-7.

West Coast Conference on Broadcasting, IEEE; Ambassador Hotel, Los Angeles, Nov. 6-8.

(Continued on p. 26)

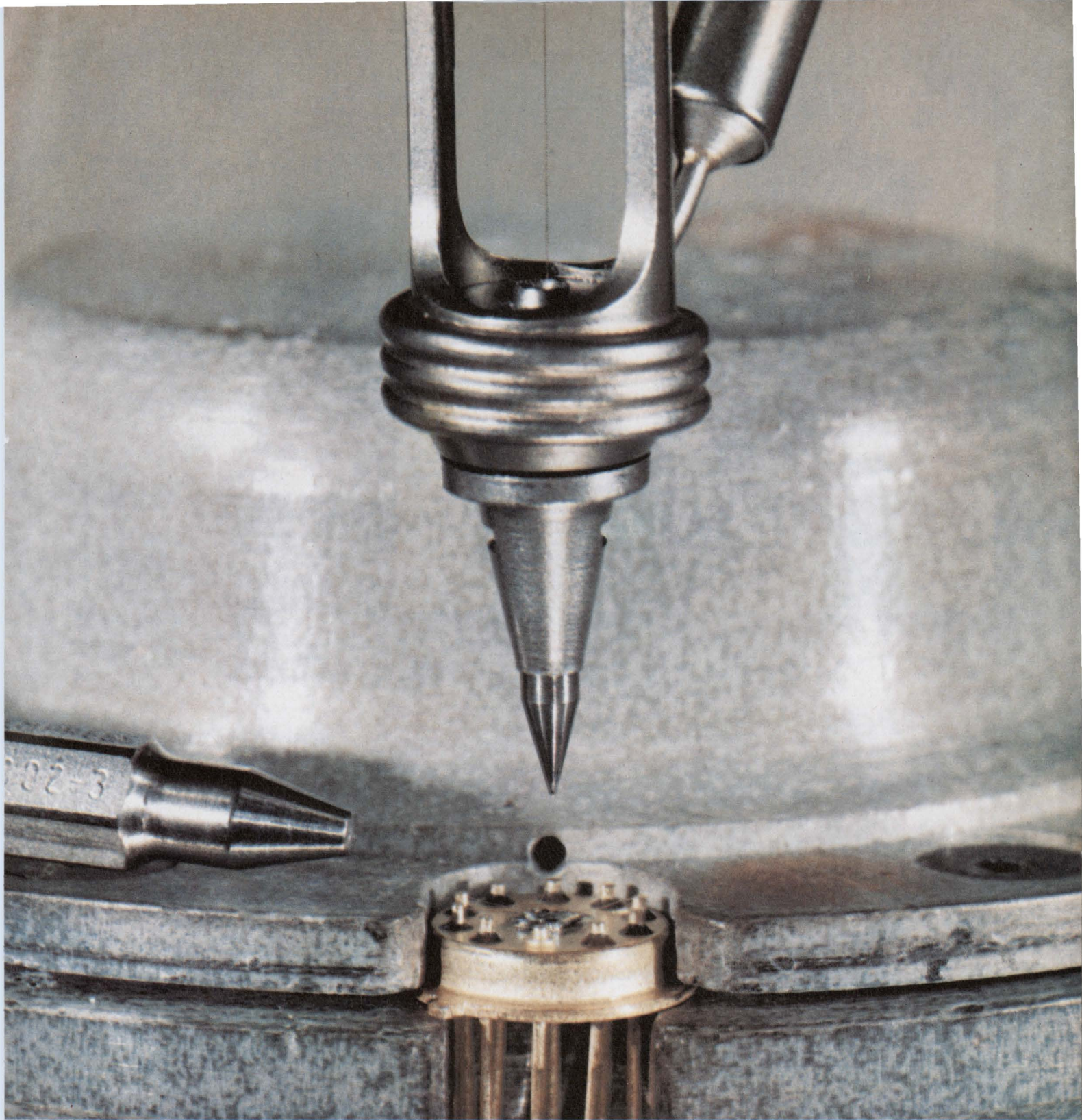

At .0008" Dia. . . . there is no second source

The tungsten carbide capillary tip and its complete family of accessories for thermal compression nailhead bonding was created and introduced by Tempress in 1963. . . . Only from this pioneering source can you purchase the entire system, designed from the beginning to give maximum efficiency: tungsten carbide capillary tip, heated shank and power supply that provides constant capillary temperature from 0° to 350°C, testing pyrometer for the tungsten carbide tip, capillary unplugging fixture and punches, and flame-off torch with sap-

phire orifice insert. Tempress also created and supplied the tungsten carbide ultrasonic bonding tool and pioneered its technology. . . . When you purchase Tempress miniature assembly tools and production equipment, you tap the ultimate source of high precision . . . the Tempress Standard of Excellence. In fields demanding high precision, such as semi-

conductor manufacturing, there is no second source.



TEMPRESS

Tempress Research Co., 566 San Xavier Ave., Sunnyvale, Calif. 94086

Circle 25 on reader service card



digital to resolver/synchro converters ... here's the next generation!

North Atlantic now brings you a new generation of solid-state digital-to-analog converters. They offer major advances in resolver/synchro conversion accuracy along with drift-free and stable performance unobtainable with currently available resistor/amplifier devices.

Typical of these new instruments are the Model 536 D/R and Model 537 D/S "shoebox" converters (11-13 bit) and the Model 538 D/R-S converter (14-17 bit). Both models use solid-state switched trigonometric transformers and feature input data storage registers thereby saving computer time. Conversion speed exceeds 10 microseconds. Built-in overload and short circuit protection assures trouble-free system integration and reliable on-line performance.

Your North Atlantic representative (see EEM) has complete specifications and application information. He'll be glad to show you how these new converters can be the answer to critical interface problems.



NORTH ATLANTIC industries, inc.
TERMINAL DRIVE, PLAINVIEW, NEW YORK 11803 • 516-681-8600

Meetings

(Continued from p. 24)

Northeast Electronics Research and Engineering Meeting (NEREM), IEEE; Sheraton Boston Hotel, Boston, **Nov. 6-8.**

Applied Superconductivity Conference and Exhibition, Atomic Energy Commission and University of Texas; **Nov. 6-8.**

Reliability Physics Symposium, IEEE; Statler Hilton Hotel, Los Angeles, **Nov. 6-8.**

Conference on Speech Communication and Processing, IEEE; Massachusetts Institute of Technology, Cambridge, Mass., **Nov. 6-8.**

Symposium on Automatic Support Systems for Advanced Maintainability, IEEE; Colony Motor Hotel, Clayton Mo., **Nov. 7-9.**

Engineering in Medicine and Biology Conference, IEEE; Statler Hilton Hotel, Boston, **Nov. 13-16.**

Short courses

Systems Engineering, Georgia Institute of Technology, Atlanta, Oct. 24-25; no fee.

Low-Frequency Standards, Department of Commerce, National Bureau of Standards, Washington, Dec. 11-13; \$90 fee.

Process Control, University of Wisconsin's Department of Engineering, Madison, Dec. 13-15; \$70 fee.

Call for papers

International Congress of Instrumentation in Aerospace Simulation Facilities, IEEE; Polytechnic Institute of Brooklyn Graduate Center, Farmingdale, N.Y., **May 5-8. Nov. 13** is deadline for submission of synopses to Cary R. Spitzer, MS-236, NASA Langley Research Center, Hampton, Va. 23365

International Solid State Circuits Conference, IEEE; Philadelphia, **Feb. 19-21. Oct. 18** is deadline for submission of abstracts to J.H. Wuorinen, Bell Telephone Laboratories, Murray Hill, N.J. 07971

Nuclear Electronics Symposium, IEEE; Ispra, Italy, **May 6-8, Jan. 10** is deadline for submission of abstracts to Prof. Luciano Stanchi, C.C.R. Euratom, 21020, Ispra, Italy

If you don't find the control you need in this ad, then refer to your A-B handy catalog—where you surely will find it listed.

control relays

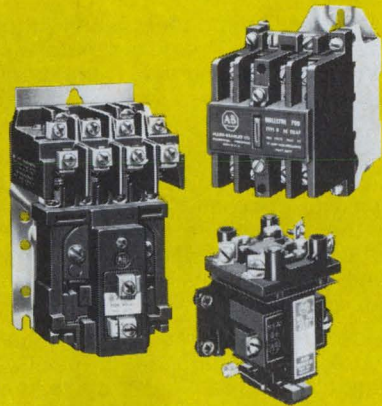

A-B control relays feature a solenoid design having but a single moving part. This design simplicity assures many millions of trouble free operations. The pressure molded coils are impervious to corrosive atmospheres. A wide variety of relays available for 300-volt or 600-volt a. c. operation.

dry reed devices

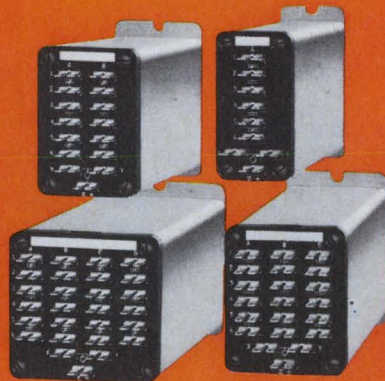

The individual contacts in A-B dry reed switching units are hermetically sealed within an inert gas-filled glass tube. Contact contamination can never occur. They are good for hundreds of millions of faultless operations. Electrically held relays, latching relays, shift registers, flip-flops, logic units, and accessories are available.

terminal blocks

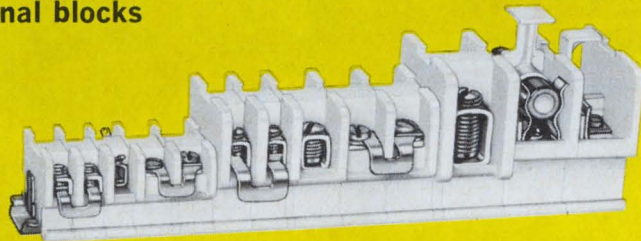

Both the Style C, 600-volt, and Style F, 300-volt terminal blocks mount on the same channel. Meet needs for both industrial and electronic control. Available in time-saving factory assembled 6-foot lengths. Just count off the number of

blocks required and "snap off" such section. Channel breaks cleanly—sawing and filing are unnecessary. A variety of terminals are available for handling wire up to Size 1/0, plus fuse blocks and switches.

control stations



This broad line includes standard duty, heavy duty, and heavy duty oiltight stations. A-B standard duty stations are so designed as to cut wiring time in half. Selector switches can be changed from two to three positions—or vice versa—in seconds. Heavy duty stations are for the toughest jobs. A large variety of contact variations. Also special purpose enclosures. Oiltight stations are really oiltight.

limit switches

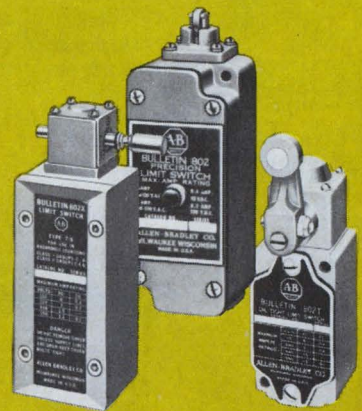

There's virtually no limit switch problem that cannot be solved with the A-B line. There are units with slow action or snap action; contacts with light, standard, and heavy duty ratings in a wide variety of contact arrangements. Can be supplied with many different actuating means, and mountings, including plug-in. Environmental conditions offer no problems, because there are units for general purpose, industrial, moist, and hazardous applications. This line of Allen-Bradley limit switches is complete.

There's almost an endless number of pilot controls in the Allen-Bradley line. All built to deliver long, trouble free life. All A-B contacts are of silver or silver alloy—they never need a moment's service attention. Let us send you our Handy

Catalog—182 pages of answers to your control problems. Allen-Bradley Co., 1201 S. Second St., Milwaukee, Wis. 53204. Export Office: 630 Third Ave., New York, N. Y., U.S.A. 10017. In Canada: Allen-Bradley Canada Limited.



ALLEN - BRADLEY
QUALITY MOTOR CONTROL

Capacitor problems?

General Electric has 1844 application-designed solutions

General Electric's application-designed capacitors are made to solve your problems. Whether you need aluminum, tantalum, or film units, GE has the right answer.

Circuit design problems? Many General Electric capacitors are designed by computer to optimize their electrical and mechanical characteristics. You get the highest capacitance in the least volume with electrical properties consistent to your own circuit designs. For example, if you know your installed capacitance requirements in a new power supply, our computers can quickly tell you the best capacitor combination and its electrical characteristics in your circuit.

Product application problems? General Electric has experienced capacitor application en-

gineers in Electronic Components Sales Offices throughout the country. These technical specialists are ready to help you select the capacitors you need and to provide specialized information about them.

Ordering or delivery problems? Your local Electronic Components Sales Office will be glad to furnish you price and delivery data for General Electric capacitors. We also have stocking distributors who can meet many of your immediate requirements for limited quantities of standard units.

You supply the capacitor problems. General Electric can supply 1844 application-designed solutions. Contact your local sales office, franchised distributor or **Capacitor Department, Irmo, South Carolina 29063.**

430-32

GENERAL  ELECTRIC



Aluminum High-performance Computer-grade Capacitors
236 standard ratings. 5 to 450 volts,
75 to 480,000 μf , -40
to 85C ambient temperature



Aluminum Miniature Tubular Capacitors
151 standard ratings. 3 to 150 volts, 1 to
790 μf , -40 to 85C ambient temperature



Aluminum Industrial Tubular Capacitors
102 standard ratings. 3 to 450 volts, 2 to
3500 μf , -20 to 85C ambient temperature



Tantalum Sub-miniature Wet-slug Capacitors
59 standard ratings. 6 to 60 volts,
0.01 to 450 μf , -40 to 85C ambient temperature



Metallized Film Flattened Oval Capacitors
102 standard ratings. 100 and 200 volts d-c, 0.01 to 10.0 μf , -55 to 85C



Metallized Polycarbonate Tubular Capacitors
57 standard ratings. 200 volts d-c, 0.010 to 10.0 μf , -55 to 125C



Micro-flat Polyester Capacitors
78 standard ratings. 50 volts d-c, 0.0010 to 1.50 μf , -55 to 85C



Polyester Tubular Capacitors (left)
296 standard ratings. 100 and 200 volts d-c, 0.0010 to 2.00 μf , -55 to 85C

Black Hawk Capacitors
483 standard ratings. 50 to 600 volts, 0.0010 to 1.00 μf , at 85C

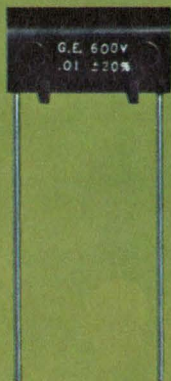

Polycarbonate Tubular Capacitors (left)
64 standard ratings. 100 and 200 volts d-c, 0.001 to 1.0 μf , -55 to 85C

Blue Jay Capacitors
50 standard ratings. 100 and 200 volts d-c, 0.001 to 0.47 μf



Aluminum Can-style Capacitors
43 case size and terminal combinations—thousands of ratings. 5 to 450 volts, 5 to 500 μf , 1, 2, 3, or 4 sections



Aluminum A-c Motor Start Capacitors
123 standard ratings. 110 to 330 volts a-c, 21 to 850 μf , -20 to 65C ambient temperature



Cimron's environmental multimeter is a pretty insensitive brute

To abuse, that is! Not that we actually took a club to it, but no ordinary multimeter could take the punishment it has and still run, let alone provide accurate measurements. Built to meet Mil Spec T-21200F, Class 3, this instrument is rugged enough to give you lab precision anywhere from the arctic to the jungle. And it's the second generation design. Over 300 first generation models are now in use in harsh environments around the world. Certified test data show it has an accuracy

of .001% F.S. + .005% of reading, can take a 15g shock, vibration up to 55 Hz, and run through extremes of temperature and humidity. 6 digits, including 10% overrange. Solid state logic tracks as fast as the voltage changes; response time is faster than 100 milliseconds. And with it goes all of Cimron's customer concern — the technical support that helps you get all the performance it can give. For details on Model E4600, write to Cimron®, Dept. B-123, 1152 Morena, San Diego, California 92110.



LEAR SIEGLER, INC.

CIMRON DIVISION

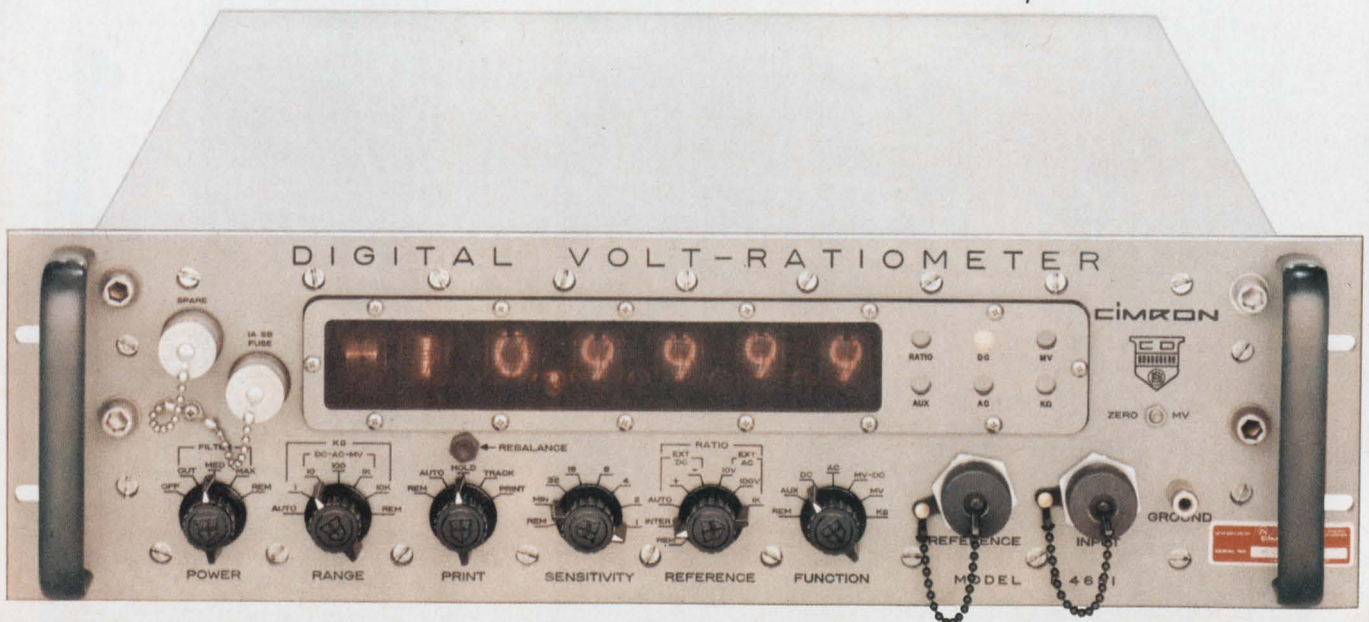

Editorial comment

International outlook

Less than a decade ago Hewlett-Packard, with some trepidation, decided to enter the European market. Today the company's overseas sales alone are 1.5 times its total sales at the time of that significant decision. In spite of the success of companies like Hewlett-Packard in the international marketplace, none has been able to write a sure formula for success. Most firms that started early learned the hard way; many of them, with the benefit of hindsight, would attack the task differently.

Several paths are open to the company with ambitions to crack the international market. It can establish its own sales force as did Hewlett-Packard, which originally felt that local representatives were not capable of handling its products. Alternatively it can use representatives, or establish licensees to manufacture and distribute its products, or set up its own plants abroad.

Each approach has its attendant hazards. For one thing, it's not easy for any firm to develop a competent sales staff. With the difficulties of selling abroad compounded by thriving nationalism, most businessmen agree that the best sales engineer will be a national. Hewlett-Packard has been recruiting good foreign engineers while they're still attending school in the U.S., training them and then sending them back to their native countries to use the American sales techniques best suited to the individual market.

Companies that elect to go the sales representative route are advised by the veterans to do so on a country-by-country basis with each rep or group of reps covering its own country only. Not surprisingly, representatives have much in common the world over. It makes good sense—in Boston or in Bonn—that salesmen will do a better job if they visit the headquarters manufacturing plant periodically and study the competition carefully.

Pierre Simon, who heads his own U.S.-based export sales organization, asserts that high-quality technical support is a must for the successful use of electronics representatives in Europe. He suggests publishing promotional technical literature in the native language, although detailed technical manuals and data sheets can be in English.

The case for a U.S. firm licensing an overseas manufacturer to produce its wares hinges on the possibility of establishing the product simultaneously here and abroad—or even getting it started overseas well before it's under way in the U.S. One licensee is probably adequate for all Europe excepting for defense products that are sold to local

governments. Advice from the experts in choosing a licensee includes picking one your own size. Too big a firm may take on a line mainly to supply its in-house needs. Since American techniques are way ahead of the rest of the world a licensee should be "technically savvy and catch on fast," Simon cautions. Another warning: Europeans are behind in the art of subcontracting so the firm chosen should not be too small to produce the product itself.

There's a temptation for a U.S. firm to produce a small part of its output overseas—in France, say, to impart a "French image" to its entire line. For some, the strategy has worked, and it's almost mandatory if one expects to sell to local governments. Ironically, those companies that began manufacturing overseas to exploit low-cost labor may have a head start as local markets for their products begin to develop.

One point is universally agreed upon by the experts: the international electronics market is virtually untapped, and there are ways of developing it that can benefit manufacturer and customer alike.

The best salesman

American electronics firms that have built plants in Europe or the Far East tend to feel self-conscious when the subject of low labor rates comes up. Even though most will admit that it was the threat posed by Japan's labor market that first sent them abroad, they are likely to react by sprinkling the conversation with euphemistic generalities—"competing on an international basis," for example.

But Americans needn't be defensive. We tend to discount the free or largely subsidized lunches provided by U.S. firms to their workers overseas as simple fringe benefits—the kind taken for granted in a country with the highest standard of living. Yet without them, workers in the less affluent countries would subsist on a scanty diet or miss meals completely. We forget that teenage girls in underdeveloped countries would be working in the fields or even hauling fishing nets if they were not doing light assembly work in pleasant surroundings. The flow of U.S. technology to "off shore" enterprises represents a modern industrial revolution—but without the sweatshops of Samuel Gompers' time.

Even the cynic would agree that economic success breeds corporate altruism if only because it provides an advantageous position to protect. In fact, economic success moves events in the direction of synergism rather than exploitation.

American productivity abroad could be the best salesman yet for democracy and the free enterprise system. By setting an example for underdeveloped countries it could encourage them to bootstrap themselves to a higher standard of living.



*a leading memory system manufacturer and
some pleasant memories of an expansion*

Ferroxcube Corporation of America is the nation's leading independent manufacturer of ferrite recording devices and memory systems for data processing equipment.

On January 3, 1966, less than three weeks after the decision to make its first expansion outside New York State, Ferroxcube was in operation in a 26,000 square foot plant in Denver Technological Center. Ferroxcube has since purchased this plant and acquired additional acreage for major expansion in the near future.

Because its overall experience was so favorable, Ferroxcube made the Denver plant a full division, with autonomous operations for production, product development, applications engineering, sales, and customer service.

Here's what Ferroxcube found in Denver: *John J. Doherty*, Vice President and General Manager: "People are the most important thing in our business. We didn't want location to be a detriment to finding them, so we looked for an ideal place to live. Denver

impressed us as one of the better places in the country. Our history to date has verified this."

Robert C. Derschang, Vice President of Marketing: "Communications and transportation that are fast, convenient and economical are sales essentials. Denver transportation is quick to every part of the country, and we're central and accessible to customers in any direction."

Hugh DeVries, Chief Engineer: "Denver has first-rank universities and a great deal of science-based industry. Consequently, there is a broad scientific community which results in excellent vendor service. It also means a good pipe-line for ideas, and a considerable reservoir to draw on for either trained manpower or consulting talent."

Lowell H. Mau, Manager of Industrial Relations: "Our success in transferring 20 key personnel was 100%. We provided a pre-transfer trip for the families, and the community won them over."

This is Ferroxcube's experience in Denver.

It's part of the experience of other industry leaders who have moved here, too: IBM, Honeywell, Ampex, Amphenol, Litton, Dahlstrom, Martin, Beech Aircraft, Ball Brothers Research, Bendix.

It's the reason why firms that began here have become industry leaders: Gates Rubber, Samsonite, Coors, C. A. Norgren, Ideal Cement.

SEND TODAY—If you're interested in a new plant site, research facility, administrative headquarters or distribution center, ask for this new brochure which gives you a broad review of Metro Denver and Colorado's Front Range of Science and Technology. All inquiries confidential. Write Manager, Forward Metro Denver, Dept. 223, 1301 Welton St., Denver, Colo., 80204. Telephone (303) 534-3211.



Electronics Newsletter

September 30, 1968

Prototype tests MOS, bipolar LSI 50 times faster

A tester for MOS and bipolar large-scale integrated circuits that's 1,000 times faster than present systems is being developed for in-house use by Motorola Semiconductor Products. The division plans to use a prototype of its EC-34 before the year is out.

The unit will accommodate 60 pins at first, but will ultimately do functional (go/no-go) tests on packages with up to 120 pins in 8 microseconds per functional pattern. While it's making these checks—driving all inputs and sensing all outputs simultaneously—it can also measure a-c parameters, because output strobing can be delayed to a resolution of 2 nanoseconds for up to 8 μ sec. Other testing gear generally can't do a-c and functional tests simultaneously.

The high speed is attained by using programmable pulse generators instead of the usual relay matrixes, most of which run at 5 to 8 milliseconds, limiting testing speed. The EC-34 can measure a parameter in 96 μ sec; most available machines take about 5 milliseconds.

Motorola developed its own computer for the tester, using a memory with 8,192 words of 24 bits each and 2- μ sec cycle time.

BARTD stalled for lack of cash

The Bay Area Rapid Transit District (BARTD) is once more in distress. Inflation has increased the cost of San Francisco's billion-dollar automatic high-speed train system by \$144 million and the California State Legislature adjourned without agreeing on how to raise the money; BARTD will let no new contracts until it does. The BARTD leadership has made it clear that without the additional \$144 million, no trains will run.

Contracts for the automatic control and communications system and the automatic fare-collection system have already been let to Westinghouse Electric and IBM, respectively.

Small computer from Motorola

Motorola is the latest to join the growing parade of firms entering the small computer business. At the Fall Joint Computer Conference, Dec. 9 to 11, the company's Instrumentation and Control division will introduce its MDP-1000, developed to replace the Varian 620A and the 620I machines Motorola formerly used in process-control systems. The division explains that it doesn't need the 1,000 i/o channels typical of the Varian machines; the MDP-1000 may have as few as 50 to 100 digital input-output channels and 20 to 80 analog. The processor has been included in at least two process-control systems sold so far. A version of the MDP-1000 with 4,096 words of memory will cost about \$8,500, not including a teletypewriter.

RCA unit quits a Tacfire contract

The Data Systems division of Litton Industries will develop and build the data terminals for the Army Tactical Fire Direction System (Tacfire) because a Litton team member in the contract-definition phase—RCA's Defense Electronic Products division—balked at the task. **RCA made its decision after learning Litton's terms in limiting its liability in major subcontracts.** The Litton division is prime contractor for Tacfire [Electronics, March 4, p. 171] in a total-package procurement.

In negotiating with potential subcontractors, Litton protected itself

Electronics Newsletter

by passing on liability limitations similar to those the Army imposed on Litton. A Litton official used this hypothetical example to illustrate the problem:

In letting a 10-month, \$1-million subcontract, Litton may have negotiated so that it would be liable for \$600,000 after six months if the program were canceled—a very remote possibility, but one that must be considered. RCA contested the terms, and passed up the multimillion-dollar subcontract for the terminals, which process long-line and radio data to be fed to Tacfire computers.

Control Data plans two new machines

Control Data is quietly readying two new computers: one for nuclear research and the other for airborne systems. In November, CDC will deliver its first model 7600 to the Atomic Energy Commission's Lawrence Radiation Laboratories. This will be in addition to Lawrence's CDC 6600, now the world's most powerful. The 7600 was once known as the 6800; the model number was changed because 6800 suggested that the machine was a bigger and better 6600. The 7600 is indeed more powerful, but it's an entirely different machine. However, the 7600 will run most programs written for the 6600.

Unlike most machines of its general size and speed, the 7600 is built entirely from discrete components. This implies that the machine has an extensive set of instructions and some unusual algorithms—processes to execute instruction—to perform well with discretely. Seymour Cray, one of CDC's founders and designer of most of the company's large computers over the past 10 years, is said to distrust IC's, believing that they haven't quite reached the level of reliability and cost he wants in his machines.

Cray to the contrary, CDC does use medium-scale integration in its new digital airborne computer, scheduled to be completed by the first of the year. Although reluctant to talk, company executives are obviously excited about the computer. One CDC executive said it "makes every other one obsolete." This presumably includes IBM's 4 Pi computer.

The airborne computer, like the 7600, owes its increased capability to an improved instruction set, which reduces problems of speed and memory. The machine, using four or five types of circuits of 50 to 70 gates, is being developed with company funds for aerospace applications.

GE gives Haanstra a vice presidency

John W. Haanstra, who only last spring was named general manager of General Electric's Information Systems Equipment division [Electronics, April 29, p. 38], is making his weight felt in the company. In a move that GE said reflected its increased emphasis on computer operations, Haanstra was appointed a corporate vice president. Previously he was a top executive at IBM. As vice president, Haanstra will continue his responsibilities in overseeing all GE's domestic computer manufacturing and marketing activities.

Stretchout likely for A-7D Corsair

There's a strong possibility that the Air Force's A-7D Corsair 2 program will be stretched out. First deliveries on the initial 300-plane order were due to start next year. The speculation now is that any stretchout would be an initial move by the Air Force to cut back the program permanently. The Air Force, not too happy with the Navy-designed aircraft, would rather use the money to develop its own planes.

**Announcing the
newest,
easiest
and fastest
way to make
accurate
frequency
domain
measurements**

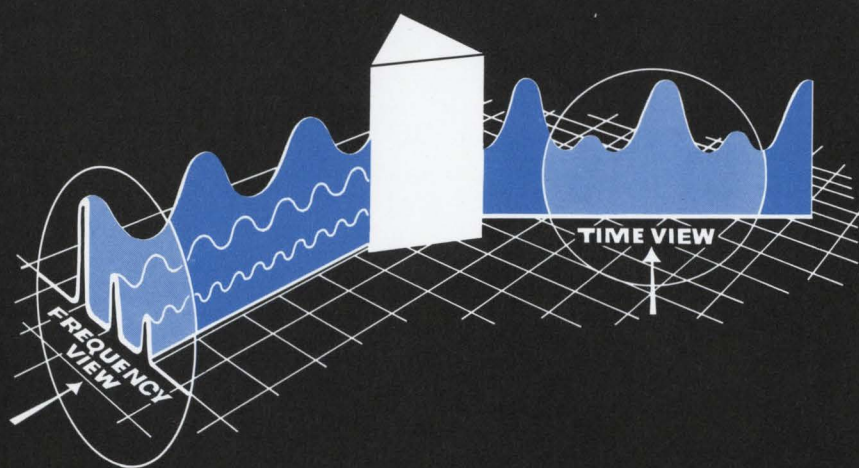

That's why this Spectrum Analyzer belongs on every engineer's

Internal graticule, variable persistence CRT. This 141S display also provides storage for side-by-side comparisons of changing signals.

Display calibration absolute in log (dB) and linear (voltage); LOG REF line at top establishes absolute power levels.

Persistence control (0.2 second to more than a minute) and viewing mode selector for matching trace to requirements of any signal. Gives flicker-free trace, even on slow sweeps.

1 kHz to 110 MHz frequency range with dial indicator accurate to ± 1 MHz.

Nine bands from 500 Hz to 110 MHz wide for spectrum analysis.

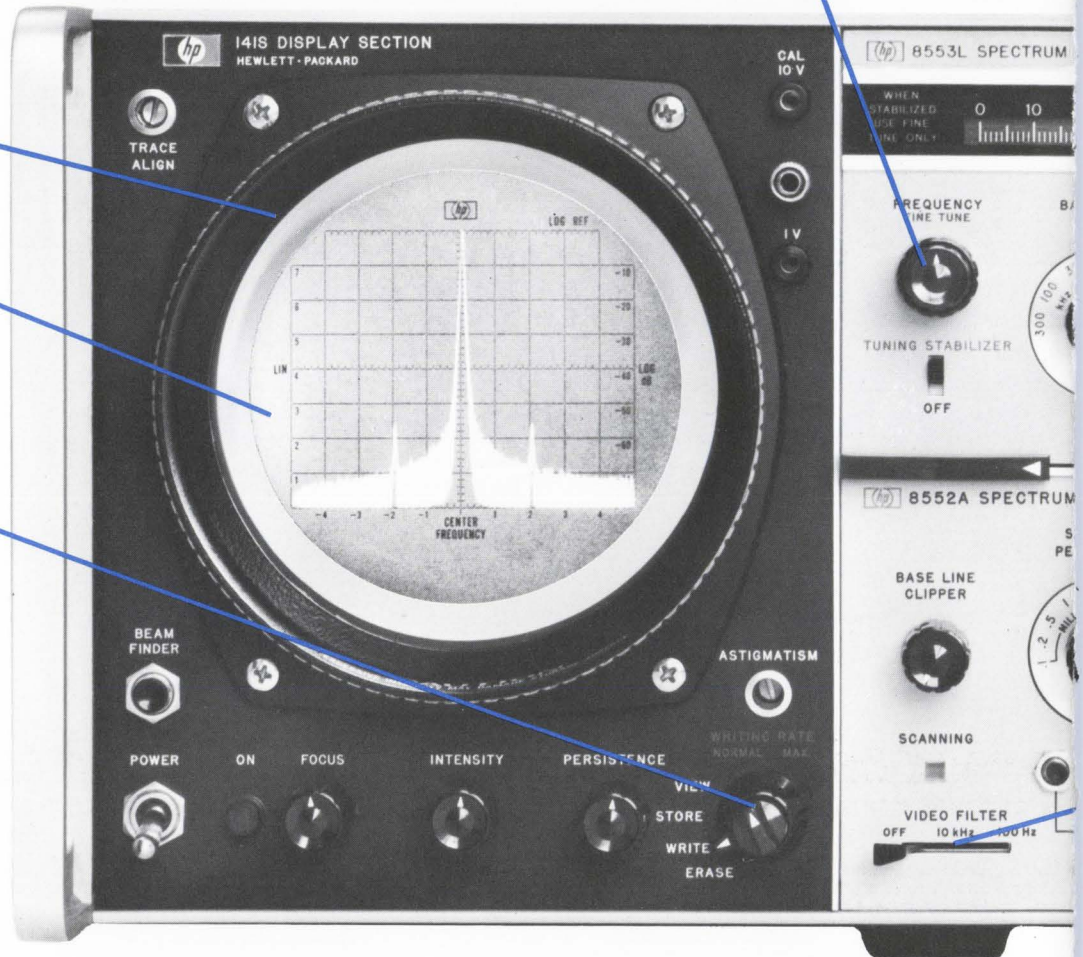

Signal analysis in the frequency domain is one of the most powerful techniques available for evaluating circuit performance. It's the most logical technique because you usually start thinking about a circuit in terms of its frequency domain characteristics.

But up to now actual measurements in the frequency domain have been plagued by equipment limitations. Older instruments were either too complex or uncalibrated.

Now the HP 8552A/8553L Spectrum Analyzer lets you make measurements in the frequency domain rapidly, easily and dependably. For the first time, absolute amplitude calibration is combined with broad sweep capabilities, high sensitivity, low distortion, wide dy-

namic range, and flat frequency purpose frequency domain inst. The Spectrum Analyzer is invaluable but also in systems evaluation. to 110 MHz, combined with absolute MHz scan, and ± 0.5 dB flatness of IF amplifiers, navigation aids, systems.

Other major advantages of this range free of distortion; sensitivity resolution to separate closely s

analyzer bench

Selects full 0-100 MHz scan, symmetrical scan or zero scan (analyzer then becomes tuned receiver); in full scan, dial pointer generates a frequency marker on the CRT to identify important display points.

Bandwidth choices: 50 Hz-300 kHz; or fast view of total spectrum, narrow for high resolution.

2 kHz to 100 MHz scan width choices, symmetrical about dial pointer (automatic phase lock below 20 kHz/division for maximum stability).

Warning light if scan too wide or too fast for bandwidth selected

Adjusts input signal level to prevent overdriving input mixer; the circuit is logic coupled to the LOG REF LEVEL indicator and automatically maintains absolute amplitude calibration.

Wide range of calibrated scan times; slow scan for highest resolution, aided by variable persistence display.

LOG REF LEVEL and vernier set calibration factors for log and linear scales.

Video filter aids in discriminating low-level signals from noise.

Selectable scan modes and trigger controls for all applications.

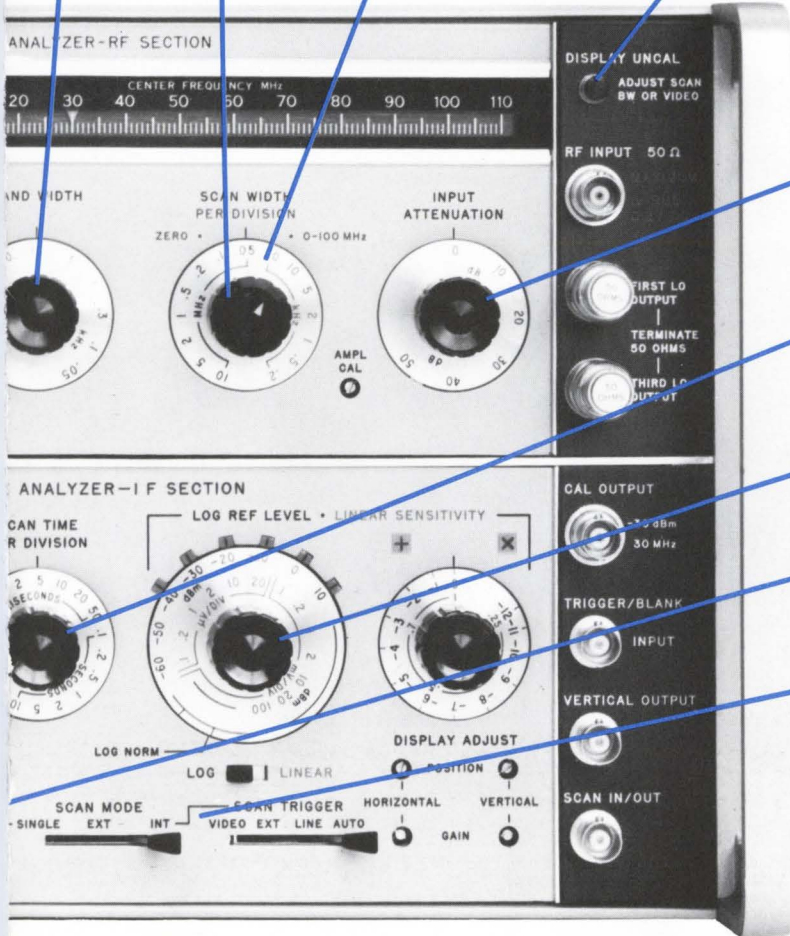

response, to produce a truly general instrument.

able, not only in basic circuit design, The broad frequency range, 1 kHz to 100 MHz, absolute amplitude calibration, full 100 MHz resolution, is exactly suited to the evaluation of telemetry and most communications

new instrument are: 70 dB dynamic range, sensitivity to -130 dBm ($0.07 \mu\text{V}$); 50 Hz spaced signals; residual FM less than

20 Hz; automatic phase lock in narrow scan widths; and variable persistence, a necessity for slow scan, high resolution display, free from disturbing flicker.

The 8552A/8553L Spectrum Analyzer, with its broad capabilities and general usefulness, makes the frequency domain accessible for virtually all measurements.

AMPLIFIERS

FREQUENCY RESPONSE. The broad frequency coverage and flat response of the Spectrum Analyzer are ideal for observing an amplifier's performance. This amplifier's frequency response from 2 MHz to 100 MHz was held on the variable persistence display. The top of the trace shows there is only 2 dB gain variation across the range.

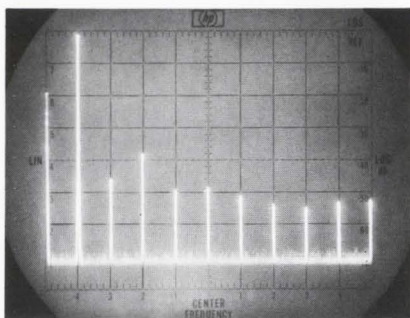
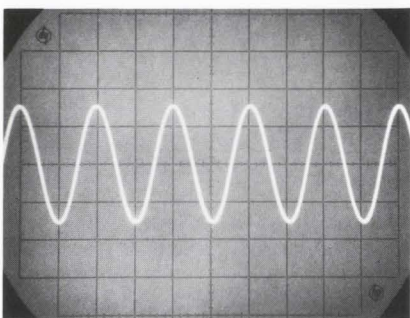
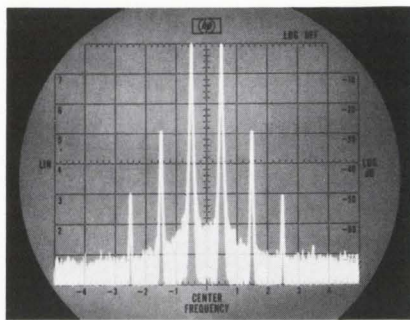
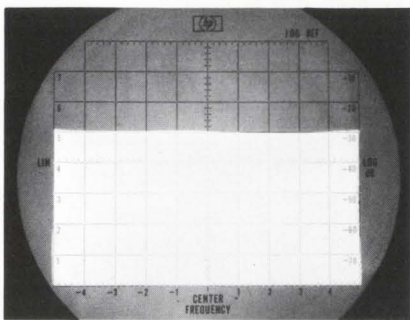

HARMONIC DISTORTION. In the time domain display (left), harmonic distortions are scarcely observed. But in the frequency domain presentation (right), harmonics in this same amplified 10 MHz signal are readily apparent. Scan width 10 MHz per division centered at 50 MHz. With absolute amplitude calibration, you can quantitatively measure harmonic content as a function of output signal level.

INTERMODULATION DISTORTION. You can readily measure distortion products close to the carrier with the Spectrum Analyzer's 50 Hz bandwidth and distortion-free 70 dB dynamic range. This two-tone intermodulation test is performed with signals of 9.95 MHz and 10.05 MHz. The analyzer is set at 0.1 MHz per division centered at 10 MHz. Third order and even higher odd order IM distortion products are easily noted.

FILTERS

FREQUENCY RESPONSE. With long CRT persistence, you can use a signal generator to measure frequency response of a filter in both passband and stop bands. Stop band rejection in this filter is greater than 70 dB throughout most of the frequency range, but at 90 MHz the stop band is only 66 dB down.

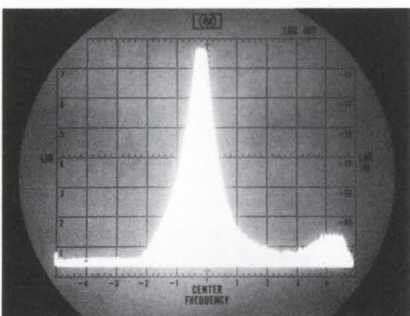

EMI/RFI

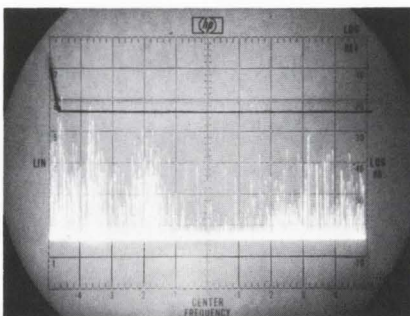

INTERFERENCE LIMITS. The broad range, high sensitivity and absolute calibration make the analyzer useful in electromagnetic compatibility tests. The effectiveness of this EMI line filter is being evaluated. The dark line drawn on the CRT face is the specification limit. The filter has not reduced all conducted interference to specifications.

SYSTEMS

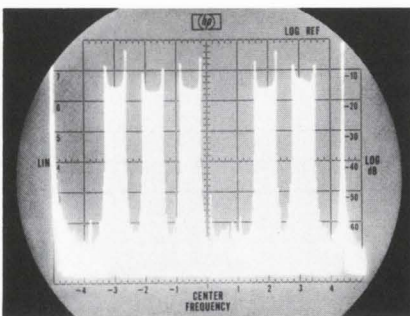
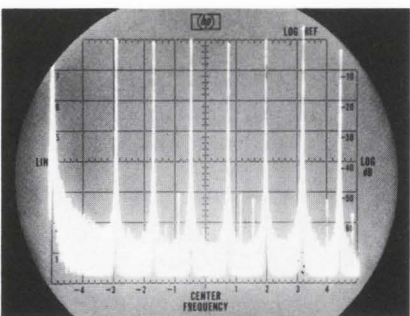

FM TELEMETRY MODULATION. In left photo, absolute amplitude calibration of the Spectrum Analyzer is used to set carrier and pilot output levels. Spurious IM distortion products can also be measured. In right photo, Channel 4 of the modulator has been removed to measure the "slot" signal-to-noise ratio. All remaining channels except the pilot are fully modulated (16 kHz peak deviation) and the residual noise and IM products are measured. Scan width is 50 kHz/division, centered at 250 kHz. LOG REF LEVEL is -10 dBm.

Now you can make direct and absolute measurements in all these critical design areas:

OSCILLATORS

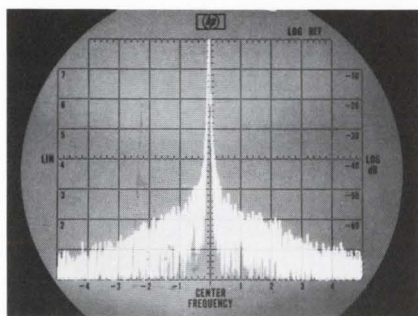

SPECTRAL PURITY. Low level AM or FM signal noise, easily seen in the frequency domain, produces sidebands around the oscillator's center frequency. The level of these sidebands indicates the magnitude of the noise. Major noise sidebands above are about 55 dB below the carrier.

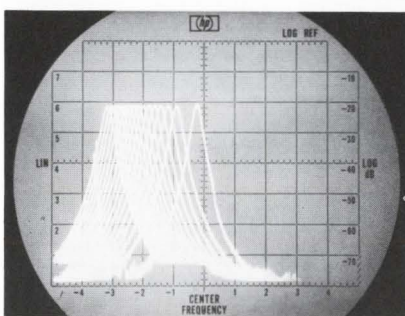

FREQUENCY DRIFT. This frequency domain display shows the drift of an oscillator during warm-up. Scans are independently triggered 5 seconds apart and stored on the display CRT. Since the Spectrum Analyzer's own drift is less than 500 Hz in 10 minutes, it's also useful for measuring the long-term stability of oscillators.

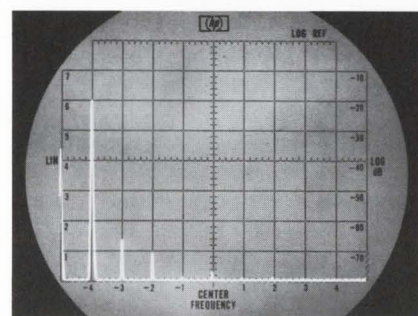

HARMONIC OUTPUT. With the Spectrum Analyzer sweeping a wide frequency range, you can observe the harmonics while you adjust oscillator parameters to minimize them. Here, the frequency scale is 10 MHz/division centered at 50 MHz, with reference level (top line) set at +10 dBm. The second harmonic of this 10 MHz signal is 45 dB down.

MIXERS

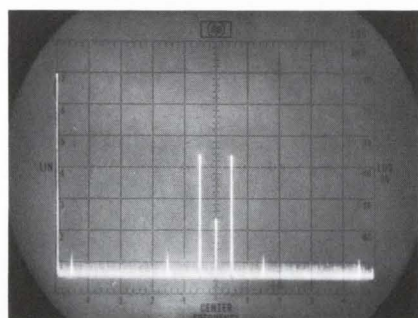

CONVERSION EFFICIENCY. Absolute calibration is a great convenience in measuring conversion loss. In this display a double balanced mixer combines 50 MHz at 0 dBm with 5 MHz at -30 dBm. With a reference level of 0 dBm, the sidebands at 45 MHz and 55 MHz read -36 dBm, indicating a conversion loss of 6 dB. The 5 MHz leak is shown at -65 dBm.

MODULATORS

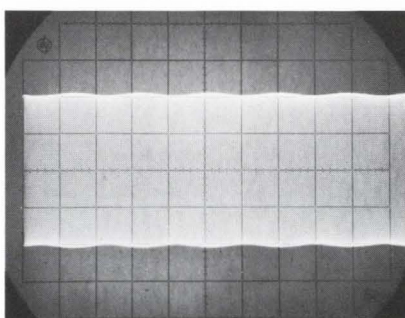

MODULATION INDEX. Viewed in the time domain, a 2% modulation index is barely discernible. These pictures compare 2% AM shown in the time domain (left) and the frequency domain (right). The sidebands are 40 dB down from the carrier. With the 70 dB dynamic range of the Spectrum Analyzer, you can measure modulation levels as low as 0.06%.

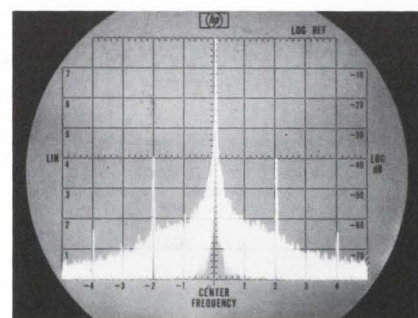

Definitive Information on the HP 8552A/8553L Spectrum Analyzer

RF INPUT AND TUNING CHARACTERISTICS

Frequency Range: 1 kHz to 110 MHz.

Frequency Response: ± 0.5 dB, 1 kHz to 110 MHz (for attenuator settings ≥ 10 dB).

Input Impedance: 50 Ω nominal. SWR < 1.3 for input attenuator settings ≥ 10 dB, < 2.6 at 0 dB.

Maximum Input Level: Peak or average power to input mixer $< +13$ dBm (1.4 Vac peak; ± 0.2 Vdc).

Sensitivity: $\left(\frac{\text{Signal Power} + \text{Noise Power}}{\text{Noise Power}} \right) = 2$

IF Bandwidth (kHz)	Sensitivity (dBm)
1	-120
10	-110
100	-100

Tuning Dial Accuracy: Display center frequency is within ± 1 MHz of indicated dial frequency.

SCAN CHARACTERISTICS

Scan Width: 15 calibrated scan widths from 200 Hz/div to 10 MHz/div in a 1, 2, 5, 10 sequence.

Scan Width Accuracy: Scan widths 10 MHz/div to 1 MHz/div and 20 kHz/div to 200 Hz/div: Frequency error between two points on the display is less than $\pm 3\%$ of the indicated frequency separation between the two points. Scan widths 500 kHz/div to 50 kHz/div: Frequency error between two points on the display is less than $\pm 10\%$ of the indicated frequency separation.

Scan Time: 16 rates from 0.1 ms/div to 10 s/div in a 1, 2, 5, 10 sequence, INTERNAL and SINGLE SCAN modes only.

Scan Time Accuracy: 0.1 ms/div to 20 ms/div, $\pm 10\%$. 50 ms/div to 10 s/div, $\pm 20\%$.

Scan Mode:

INTERNAL: Analyzer repetitively scanned by internally generated ramp; synchronization selected by SCAN TRIGGER. SCANNING lamp indicates duration of scan.

SINGLE: Single scan actuated by front panel pushbutton. SCANNING lamp indicates duration of scan.

EXTERNAL: Scan determined by 0 to +8 volt external signal; analyzer input impedance > 10 k Ω . Blanking: -1.5 V external blanking signal required.

Scan Trigger: Required only when INTERNAL SCAN MODE selected. AUTO: Scan free runs. LINE: Scan synchronized with power line frequency. EXTERNAL: Scan synchronized with external 2-to-20-volt signal (polarity selected by internally located switch of Model 8552A IF Section). VIDEO: Scan internally synchronized to envelope of RF input signal (signal amplitude of 1.5 major divisions peak-to-peak required on display section CRT).

SPECTRAL RESOLUTION

IF Bandwidth: 3 dB bandwidths of 50, 100, 300 Hz, and 1, 3, 10, 30, 100, and 300 kHz can be selected.

IF Bandwidth Accuracy: Individual bandwidths calibrated within $\pm 20\%$; 10 kHz IF bandwidth calibrated within $\pm 5\%$.

IF Bandwidth Selectivity: 60 dB/3 dB bandwidth ratio less than 20:1 for IF bandwidths from 1 kHz to 300 kHz.

60 dB/3 dB bandwidth ratio less than 25:1 for IF bandwidths from 50 Hz to 300 Hz.

Video Filter Bandwidth: Two post-detection bandwidths: 10 kHz and 100 Hz.

Video Filter Bandwidth Accuracy: Individual video bandwidths calibrated within $\pm 20\%$.

AMPLITUDE CHARACTERISTICS

Vertical Display Calibration (8 divisions full scale deflection):

Logarithmic: Calibrated directly in dBm over 140 dB range from -130 dBm to +10 dBm, 10 dB/div on 0 to -70 dB CRT Display. LOG REFERENCE LEVEL control provides 90 dB range in 10 dB steps; log reference vernier provides calibrated continuous adjustment over 0-12 dB range. LOG REFERENCE LEVEL control and log reference vernier establish absolute power reference level in dBm for CRT display.

Linear: Calibrated directly in V/div from 0.1 μ V/div to 100 mV/div in a 1, 2, 10 sequence. LINEAR SENSITIVITY and vernier controls establish absolute voltage calibration (deflection factor).

Calibrator: 30 MHz signal provided as operating standard for absolute vertical calibration of display. Frequency Accuracy: ± 0.3 MHz. Amplitude: -30 dBm ± 0.3 dB.

Vertical Display Accuracy:

	LOGARITHMIC dBm	LINEAR volts
Calibrator	± 0.3 dB	$\pm 3.5\%$
Log Reference Level (Linear Sensitivity)	± 0.2 dB	$\pm 2.3\%$
Log Reference Vernier (Linear Sensitivity Vernier)	± 0.1 dB*	$\pm 1.2\%*$
RF Input Attenuator Accuracy (excluding flatness)	± 0.2 dB	$\pm 2.3\%$
Analyzer Frequency Response (flatness)	± 0.5 dB	$\pm 5.8\%$
Switching between Bandwidths (at 20°C)	± 0.3 dB	$\pm 3.5\%$
Amplitude Stability:		
100 Hz-300 kHz bandwidth	± 0.05 dB/°C	$\pm 0.6\%$ / °C
50 Hz bandwidth	± 0.1 dB/°C	$\pm 1.2\%$ / °C
CRT Display	± 0.25 dB/div	$\pm 2.8\%$ of full 8 div deflection.
	but not more than ± 1.5 dB over the full 70 dB display range.	

*Vernier accuracy at 0, 6, and 12 dB; otherwise ± 0.25 dB ($\pm 2.8\%$).

SPECTRAL PURITY

Automatic Stabilization: First local oscillator automatically stabilized (phase-locked) to internal reference for scans of 20 kHz/div or less.

Long Term Stability (after approximately one hour warmup):

Stabilized: 100 Hz/min; 500 Hz/10 min.

Unstabilized: 5 kHz/min; 20 kHz/10 min.

Residual FM:

Stabilized: Less than 20 Hz peak-to-peak.

Unstabilized: Less than 1 kHz peak-to-peak.

Noise Sidebands: More than 70 dB below CW signal 50 kHz or more away from signal, with a 1 kHz IF BANDWIDTH setting.

Spurious Responses: For -40 dBm signal level to input mixer: image responses, out-of-band mixing responses, harmonic and intermodulation distortion products, and IF feedthrough responses all more than 70 dB below the input signal level.

Residual Responses: 200 kHz to 110 MHz: < -110 dBm; 20 kHz to 200 kHz: < -95 dBm.

Display Section: The 141S Display Section has variable persistence and storage. Also available is 140S Display Section with normal persistence.

Price: Model 8552A IF Section, \$1,900.00.

Model 8553L RF Section, \$1,800.00.

Model 140S Display Section, \$725.00.

Model 141S Variable Persistence Display Section, \$1,525.00.

For additional information, call your HP field engineer, or write Hewlett-Packard, Palo Alto, California 94304; Europe: 54 Route des Acacias, Geneva.



SPECTRUM ANALYZERS



How to Use E-CELL™ Timing and Integrating Components

The Bissett-Berman Components Division engineering staff answers four basic questions often asked about E-CELL* devices



$$\int_{t_i}^{t_f} \frac{dq}{dt} = t$$

I

1. What is an E-CELL device?

An E-CELL device is a new kind of circuit element that looks like a discrete electronic component but does the work of a complex assembly. Its main functional part is a center electrode, which is surrounded by an electrolyte; the metallic container also serves as the second electrode. In terms of its physical operation, an E-CELL unit is a reversible micro-coulometer, i.e., it converts the current-time integral of an electrical function into an equivalent mass integral (or the converse operation) up to a maximum of several thousand microampere-hours. Exactly one atom is transferred for each electron impressed on the E-CELL unit. Power drain is normally in the microwatt region. The mass integral can be read out at a known current, the time to read it out being proportional to the original integral. When a mass is given as part of the initial condition, this same process generates a precise time interval.

2. What does an E-CELL device do?

For timing applications a constant current is applied to a pre-charged E-CELL unit. The selected time delay is determined by a combination of the E-CELL type and the specific constant current being used. The range of timing is from seconds to months. The output voltage swing that occurs when the mass has been completely transferred is normally used as a bias transition with semiconductor devices.

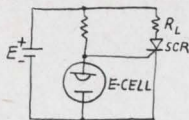
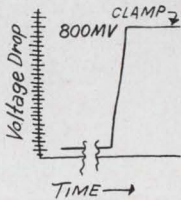

For integration applications, an uncharged E-CELL unit accepts d-c, periodic, or random inputs in any wave-shape and stores these as the mass equivalent of a current-time integral. Readout is handled in essentially the same manner that the timing function is handled for a pre-charged E-CELL unit, i.e. the measured time required to reach the point of the abrupt voltage swing, multiplied by the readout current, will be the accumulated charge integral. This could represent the total "count" of a series of events analogous to the input pulses.

3. When should I consider using an E-CELL device?

The scope of applications is as broad as timing and counting functions themselves. New uses are continually being devised. Here are two prime applications areas:

Control: You can use E-CELL devices in circuits for timing, gating, starting, stopping, delaying, relaying, monitoring, actuating, sequencing, measuring—wherever the control condition can be represented by an electronic signal.

Information Handling: You can use E-CELL devices in circuits for data capture, totaling and subtotaling time periods or discrete events, elapsed time logging, running time monitoring, out-of-limits logging, maintenance status reporting, real-time analog computing—wherever the input data can be represented by an electronic signal. Readout can be formatted as either analog or digital data.

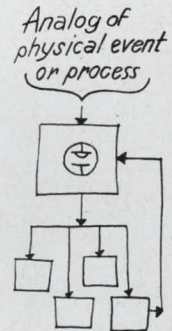

4. What are some present production uses of E-CELL devices?

Fuzing and arming; battery charging; cardiac output integration; sonobuoy scuttling; high-power tube protection; engine maintenance scheduling; warranty monitoring; time delay relays; transistor aging racks; program timer; r-f level monitoring.

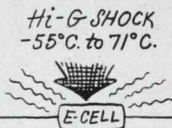

5. Want more information?

For technical information and application notes, please send in the coupon below.

*Patents applied for.

BISSETT
BERMAN COMPONENTS DIVISION
Los Angeles, California

The Bissett-Berman Corporation, Components Division
3860 Centinela Ave., Los Angeles, Calif. 90066

LITERATURE ONLY HAVE REPRESENTATIVE CALL

APPLICATION _____

NAME _____

COMPANY _____ DEPT. _____

STREET _____

CITY _____ STATE _____ ZIP _____

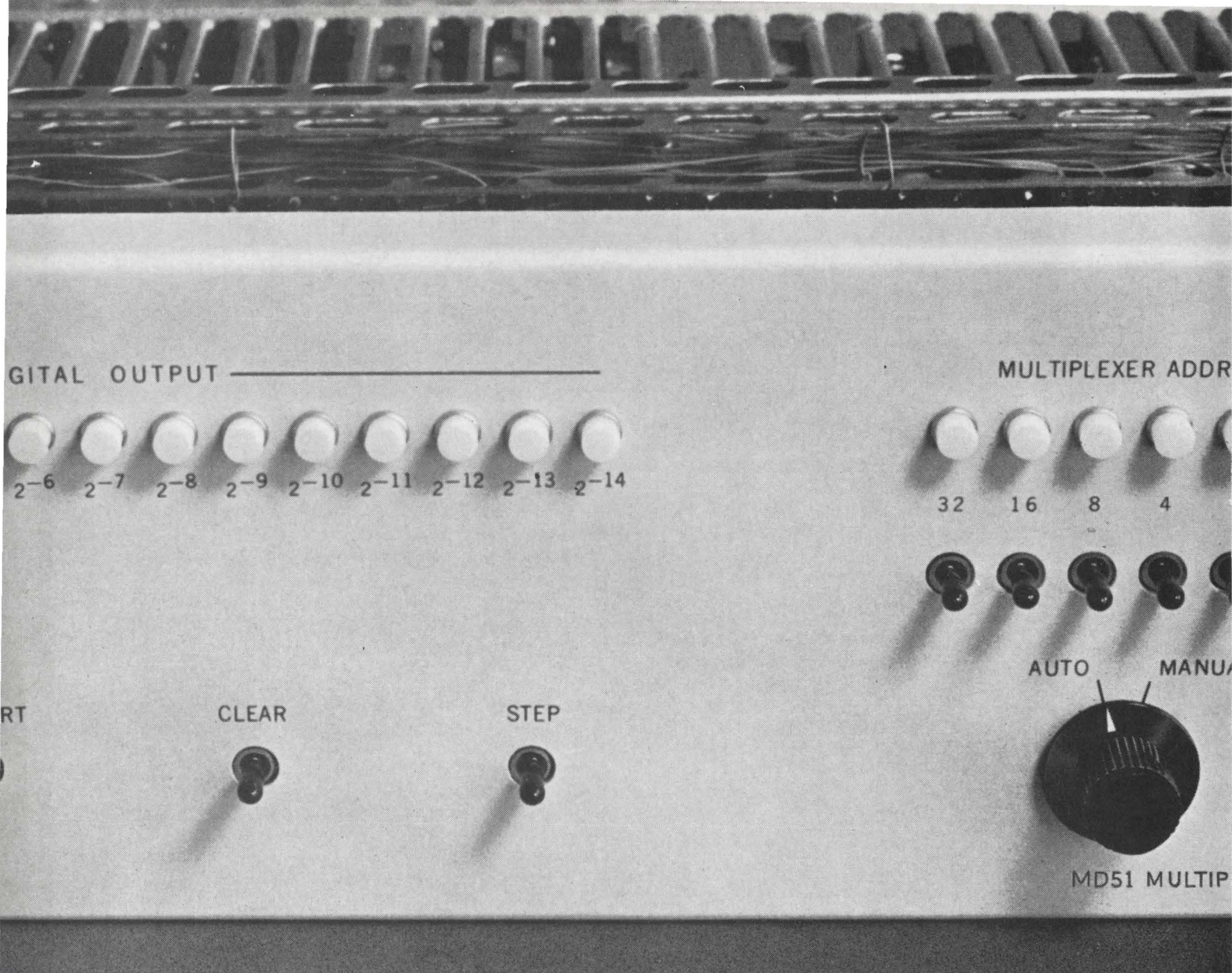

It's the fastest. It's the most accurate.

The MD51 is a high-level 64 channel multiplexer, a sample and hold amplifier and a 15-bit A to D converter, all in a single chassis. It has a total sample and conversion time of 10 microsec-

onds max. and an accuracy of 0.01%. And it sells for under \$10,000. If that doesn't say it all, write for the rest.

SDS
Scientific Data Systems,
Santa Monica, California

Consumer electronics

Kitchen danger

Congressional hearings on radiation safety have covered the broad range of potential hazards—from medical X-ray equipment to military radars. But color tv receivers—for obvious reasons—received most attention, particularly in connection with the 90,000-set recall by General Electric and in surveys showing considerable leakage by other brands [Electronics, April 15, p. 56].

Now, however, the National Center for Radiological Health is focusing on microwave ovens. The reason is that household use of these ovens is expected to rise from about 20,000 now to 40,000 by the end of next year and 1.8 million by the mid-70's. Prices of these ovens are rapidly tumbling [Electronics, April 29, p. 39], and some homebuilders are even installing them in kitchens as a sales lure.

Set standards. The center, using the same laboratory and technicians it used for the color-tv studies, is first trying to establish testing techniques and equipment to use in the field for checking leakage. The two standard instruments available now, say center officials, must be oriented differently for different ovens. Officials don't think the instruments could be used for any large-scale surveys.

"We'd like to come up with a simple portable unit like the one we developed for testing color-tv receivers," says D.J. Nelson, who's in charge of the project. "We want to learn the power density, which we hope to translate to the absorbed energy in a tissue of the body—particularly for the eye."

The five domestic oven makers

have cooperated with the center by offering samples for laboratory study. One major problem facing the center—as well as the manufacturers—is that there is no single nationally recognized standard for microwave exposure in the home. The Defense Department and NASA have standards, but they've been criticized for being so much more liberal than those in some other nations, particularly the Soviet Union.

The Russians will allow only 1 milliwatt per square centimeter for only 15 to 20 minutes of exposure daily, while the U.S. Army and the Air Force will allow continuous exposure of 10 milliwatts per square centimeter. (These exposures are in the frequency range of 300 to 30,000 megahertz for the Soviets and from 30 to 30,000 Mhz for the Americans.)

Eye watch. Experts generally agree that the eye is the most vulnerable part of the body. They also agree, however, that not enough research has been done on the hazards. Only within the past month has a booklet on the biological aspects been put out by the center.

Although most research in the U.S. leaves some question about the real danger posed by microwaves, Russian studies present a frightening picture.

The general effects of chronic exposure, according to Russian researchers, include bradycardia (slow heart rate), hypotension (low blood pressure), hyperthyroidism, central nervous system exhaustion, decrease in the sense of smell, increased histamine level in the blood (the same reaction as in an allergy), changes in the lenticular

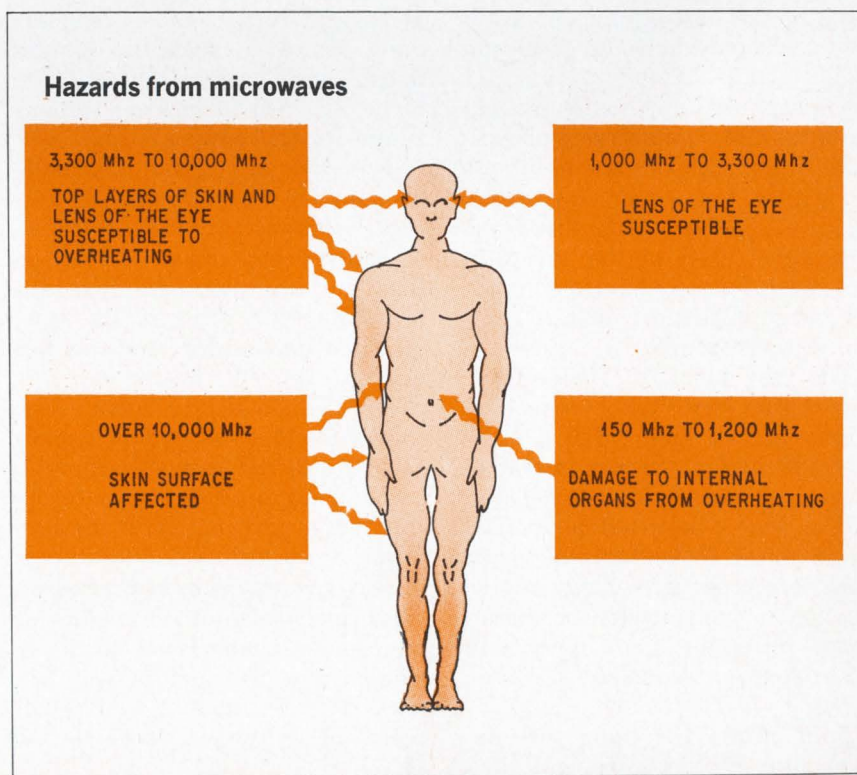

nucleus of the brain, and changes in intraocular pressure.

The big question is the effect of the heat microwave penetration produces in tissues and organs. Some studies in the U. S. have suggested an increased incidence of mongolism in children of fathers who have had prior exposure to radar.

The booklet concludes by saying that "microwave systems have become a part of our way of life . . . although the biological effects of microwaves have been studied, certain areas, such as the possibility of cumulative effects from subthreshold exposures, functional changes from low-intensity irradiation as reported by the Russians, and possible nonthermal changes need further clarification. Large gaps also exist in the current knowledge of possible genetic implications and the actual long-term effects, if any, of microwave radiation on humans."

Interesting, but expensive

What's a young hi-fi firm that's trying to break into the f-m stereo tuner market doing with a model that carries a \$1,050 price tag when some of the best equipment available costs only between \$500 and \$700?

The answer, apparently, is that the firm, CM Laboratories of Norwalk, Conn., thinks some hi-fi buffs are eager for some very exotic electronics; some of the electronic techniques used in the tuner, in fact, were borrowed from computers and sophisticated military communications gear.

The new tuner, the model 804, uses digital Nixie tubes instead of a conventional tuning dial, a crystal frequency synthesizer instead of a variable-tuned local oscillator, and a double-balanced hot-carrier diode mixer instead of the usual transistor type. It employs double frequency conversion for better image rejection, and a new elliptical detector circuit that needs no tuning.

Joint effort. The tuner was designed by Wayne Chou and Nick

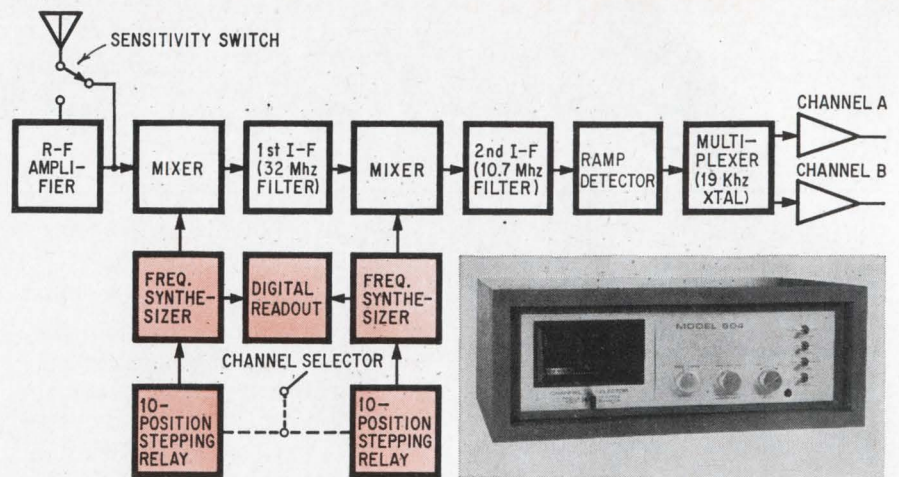

Digital dial. F-m stereo tuner, priced at \$1,050, borrows from computer and military communications technology.

Morris, who together formed CM Laboratories five years ago. The stereo units will start rolling off the production line some time in November.

The 804 is simple to operate despite its internal complexity. Stations are tuned in by moving a lever to advance the readout counter to the desired frequency. Depressing the level causes two 10-position stepping relays to advance the counter a step at a time from station to station.

The equipment can also be operated semiautomatically to sweep across the entire band in five seconds. However, since the counter doesn't read down, the unit has to be recycled to pick up stations below its last setting.

The channel selector is actually pretuned to each of the 100 discrete stations in the 88-to-108-megahertz f-m band. Thus, although the stations are spaced a mere 0.2 Mhz apart in the most crowded part of the band, the frequency cannot be mistuned.

The 804 can also be operated remotely. In that mode, the channels can be selected manually through a companion unit or automatically through a preprogrammed memory drum.

The memory drum is driven by a clock mechanism that enables it to change channels at a preselected time and as often as desired, a useful feature when tape-recording radio programs off the air.

Two paths. In strong signal areas, the signal picked up by the antenna is fed directly to the mixer; this results in very low noise figures and excellent image rejection. In fringe reception areas, a dual-gate MOS FET amplifier in a cascade configuration is switched in to achieve infinite dynamic range.

The mixer is fed by the frequency synthesizer, which makes possible the individual frequency selection. A double conversion intermediate frequency is used to provide maximum image rejection. The first i-f stage employs a new type of elliptical 32-Mhz filter designed specifically to eliminate phase distortion. The second filter for the 10.7-Mhz bandpass is of standard IC design.

To avoid using a limiter and standard f-m discriminator, CM has developed a new detector, a pulse-counting type that needs no tuning. The output is fed to the multiplex circuit, which uses a 19-kilohertz crystal to select the pilot signal.

Components

Tuning Gunn diodes

Within a year, Varian Associates expects to be marketing an electronically tunable Gunn diode that

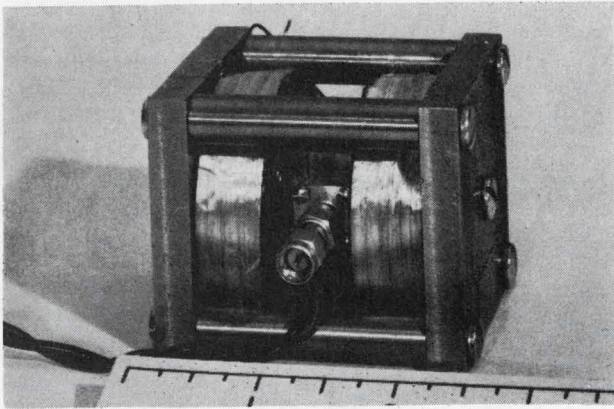

Progenitor. Competition for building an electronically tunable Gunn diode that can replace a backward-wave oscillator is heating up. This is a prototype developed by Varian.

will function as a direct replacement for a backward-wave oscillator (bwo).

The tuning mechanism is a familiar one for microwave devices—a yttrium iron garnet sphere in a magnetic field. In such an arrangement, frequency and power vary with the strength of the field, and are thus voltage-controllable. Even with the rather crude circuits built so far, Varian researchers Masahiro Omori and Gene F. Day have obtained octave tuning at X band (6 to 12 gigahertz), with peak power of 115 milliwatts, continuous wave, at 7.8 gigahertz.

If it can make the devices more efficient, Varian will have a product certain to interest its Palo Alto, Calif., neighbor, the Hewlett-Packard Co. H-P uses a bwo in every microwave sweep generator, but wishes it didn't have to. "If the tuning principle works, it would offer a promising way to replace a big, cumbersome, noisy component with a small, convenient solid state equivalent," says one H-P spokesman cautiously.

H-P first? He is probably being disingenuous. Hewlett-Packard has a strong gallium arsenide effort, and at least one researcher familiar with the field says the first solid state bwo replacement will probably be made by H-P itself. "Their circuits are far more advanced, they're designed as part of the waveguide, but Varian's are modified klystron mounts," this researcher says. H-P itself flatly refuses to comment on whether it's even investigating tunable Gunn devices. The company did introduce a line of experimental Gunn oscillators at the Western

Electronic Show and Convention this summer.

Varian's Day concedes that the main problems in building a practical device are with the microwave circuits. "We have made enough progress in materials so that is no longer a real difficulty," he says. "But we have to make the magnet gap as small as possible to cut down on the power requirements, and since the Gunn diode, the sphere, and the connecting circuitry must all be in the gap, there's some difficulty in shrinking the circuitry and then coupling out of the device."

The circuits built by Day and Omori were in a magnet gap of 0.2 inch. The entire 10-cubic-inch oscillator weighs 1.8 pounds. By narrowing the gap even further and using permanent magnet materials to produce part of the field, Omori and Day expect to shrink the oscillator to a 5-cubic-inch package weighing less than a pound for C- or X-band devices. Day says that outputs of 20 mw over 4 to 8 Ghz, 7 to 13 Ghz, or 12 to 18 Ghz range are possible with outputs of more than 50 mw over any 3-Ghz range, greater than 100 mw over any 1-Ghz range, and about 200 mw peak.

Power is limited not by the Gunn diode but by the size of the sphere; enlarging the sphere would keep the magnet gap large. Day and Omori are secretive about the size of their present sphere, saying only that it is between 20 to 60 mils in diameter.

A la mode. The Varian oscillator is made with a true Gunn device, operating in the transit-time mode. "There are no practical devices

made using the limited space-charge accumulation mode (LSA)," Day says. But the other major manufacturer of bwo's, the Watkins-Johnson Co. has hired W. Keith Kennedy, who achieved high-power outputs in Gunn work at Cornell University, and plans strong efforts in building Gunn oscillators and growing gallium arsenide.

Leopoldo B. Valdes, manager of semiconductor and integrated-circuit research and development at Watkins-Johnson, says the company is working on tuned avalanche oscillators and will have a product within six months. At the lower microwave frequencies, around C band, doping is still too critical for the manufacture of reproducible Gunn devices, Kennedy says. (The frequency of a Gunn device depends up the nL product, where n is the doping level and L the length of the diode. Low doping levels are very tricky, Kennedy says; temperature changes alter the effective doping level, and the devices aren't temperature-stable.)

Three for the bwo. At high frequencies, however, the avalanche diodes become unmanageably small; here, above Ku band, Watkins-Johnson will build LSA oscillators. "Gunn devices are still fighting materials technology," says Valdes. Watkins-Johnson feels that only at the high-frequencies, where doping levels can be as much as 10 times those of C-band oscillators, are Gunn diodes practical now.

Still, Valdes leaves no doubt that Watkins-Johnson expects to match Varian in making the bwo obsolete. The goal—a device equal in power and bandwidth to the bwo, but with noise figures comparable to those of a good klystron—is attractive enough for both companies to feel that special efforts are justified. The question now seems to be not whether they can attain the goal, but whether they can outperform their customer, Hewlett-Packard.

Filter on a slice

A couple of years ago, Bell Labs announced the monolithic crystal filter. Suddenly a sliver of quartz

with a few electrodes could replace the fistful of coils, capacitors, and other discrete components used for bandpass filters.

By converting electrical signals piezoelectrically to acoustic ones and propagating them through the quartz to another set of output resonator electrodes, very narrow-band filters could be made. By adding resonator electrodes between input and output, and by changing the spacing between them, engineers could obtain wide varieties of filter characteristics: equal ripple, equal phase, sharp or softly sloping cutoffs, and others.

Quartz is cheap, and the new filters seemed easy to make; observers might have expected the industry to lunge into commercial production of the devices, but instead it has taken nearly two years. Now Damon Engineering Inc., Needham Heights, Mass., will offer 3- to 30-megahertz center-frequency filters for as little as \$20, delivering prototypes within two to four weeks.

But what took so long in the first place?

"An information gap," suggests Damon's engineering manager,

Robert N. Kent. "We knew crystals but not much about thin-film technology—seemingly it's just taken the crystal business two years to see the market and find out how easy these things are to make."

"We hadn't forgotten about monolithic filters," he says, "but it wasn't until the interest shown at last April's Frequency Control Symposium that we saw real markets and the possibility of expanding numbers of applications as the monolithics took hold. So we sat down to do some constructive kaffeeklatsching with semiconductor people, and traded a little information in exchange for data on thin films, mask alignment, and other manufacturing problems we expected."

Quick and easy. But there weren't any problems. "Nothing has ever gone together so quickly or cleanly," says Kent.

All that was necessary to duplicate Bell Labs' work was careful lapping to produce extra-smooth surfaces on the quartz crystals. Vapor deposition of the resonator electrodes proved no problem at all, and within two months of the symposium, Damon's engineers

had built nearly 100 prototypes of the device.

Then they added improvements. Damon used circular rather than square resonator contacts, allowing more effective use of the crystal lattice. This, combined with a proprietary coupling scheme, enabled the company to get more resonators on a sliver of quartz and thus make filters smaller than those produced by the Bell Labs method.

Already-developed techniques for clean rooms about 10 times cleaner than those needed for integrated-circuit work, Kent says, made it possible to ward off contaminants that might have made the crystal's resonant frequency change with age. Such contamination would have not only shifted the center frequency of the pass-band but also changed its shape. The ultraclean rooms had been developed for production of low-drift oscillator crystals.

Although its capability is only now being publicly announced, Damon has already sold filters to Raytheon for the Army SAM-D missile and to an unidentified firm making miniature radios and paging systems for Government security agencies.

"This is where the markets are," says Kent, "in miniaturized or mobile communications and radar gear, and in military and space vehicles where ruggedness and performance over broad temperature ranges are needed."

Now to space. Kent is particularly interested in space and radar. Damon's discrete-component filters flew aboard Ranger spacecraft, giving Kent a feeling for NASA's reliability requirements. "Monolithics are tiny, light, and far, far more reliable than discrete-component filters. They are naturals for deep-space and satellite communications," he says.

As for radar, "Such filters would work well in miniaturized doppler systems, making possible far smaller range-rate bins than possible with today's other techniques."

But by the time users awaken to all the possibilities of monolithic filters, Damon may have competition; Collins Radio and

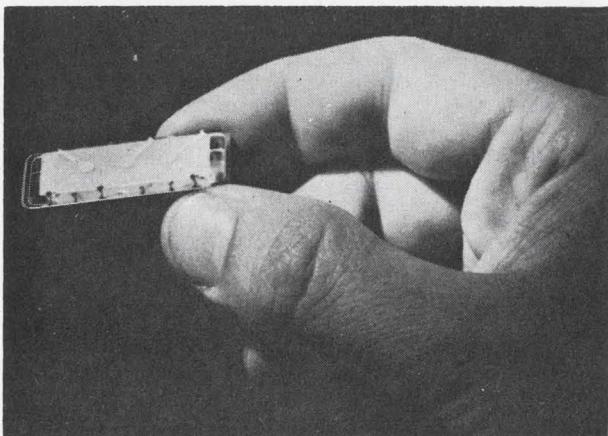
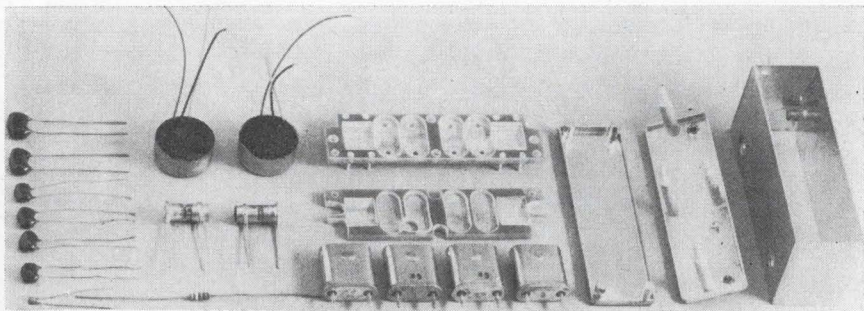

Thin-film filter.

Commercial model of monolithic crystal filters, left, replaces all the coils, capacitors, and other discrete components shown above.

Piggy Bank Pac



μ -PAC logic module prices have been reduced. Again. It brings us close to our objective: to provide the most comprehensive and economical digital logic offering in the industry. First, take a look at some typical prices:

Model	Description	Unit Price		New Price per Function
		Old	New	
DI-320	10, two input NAND gates	\$25.00	\$20.00	\$2.00/gate
DN-320	6, three input NAND gates	21.00	16.00	2.66/gate
DF-320	8, three input NAND gates	New	20.00	2.50/gate
FF/320	8 basic flip-flops	New	31.00	3.87/flip-flop
FA/320	4 clocked flip-flops	31.75	25.00	6.25/flip-flop
BC-320	6 stage binary counter	46.50	38.00	6.33/stage
SR-321	8 stage shift register	New	54.00	6.75/stage
AP-335	8 half adders	168.00	129.00	16.12/half adder

We'll give you 102 more price comparisons on request.

Now, focus on those factors most often neglected in a make-or-buy go 'round. μ -PAC modules offer the lowest total system cost because they are more than "a flip-flop mounted on a card." μ -PAC modules are an

integrated system of digital logic electronics with fully compatible mounting hardware and power supplies. I/O circuits and analog circuits. Wire wrap tools and other accessories. The works. Plus support. Like in-depth documentation. Logic design aids. 100% circuit testing. 72-hour Certified Fast Shipment. Even custom designs for your special needs.

Whether your logic needs are large or small, ask your Honeywell PAC man to give you the full story. He'll help you "bank" a nice piece of change. Honeywell, Computer Control Division, Old Connecticut Path, Framingham, Massachusetts 01701.

Honeywell
COMPUTER CONTROL
DIVISION

Reeves-Hoffman are both near commercial lines, and the latter is already producing such filters for Western Electric.

Computers

Calculating on MOS

Computer designers talk a lot about metal oxide semiconductors and how they'd like to take advantage of their high packing density and low current drain, but so far it's been all talk—except at a small new firm in Burlington, Mass.

The company, Viatron Computer Systems Corp., will be introducing its first products—off-line peripherals for clerical functions—in the next couple of weeks. These introductions, says president and co-founder Edward M. Bennett, will be the first step toward a "Sears Roebuck catalog of electronic data processing equipment."

All the equipment will have a low price (rentals are far less than \$100 a month) stemming from maximum use of large MOS arrays. The peripherals include formatting systems, data storage and retrieval systems, and tape store and forward systems.

Says Bennett, "We will buy the largest arrays the industry can support, and we think it can support some big ones." One Viatron employee mentions 700-gate MOS arrays, while Bennett himself talks about the possibility of "low thousands of kilobits of memory in one integrated-circuit package."

Hot competition. But such arrays almost certainly must be custom devices, and thus supposedly expensive ones. Bennett has a ready answer to this problem. He reasons that IC houses, try as they might, won't be able to capture the whole spectrum of custom MOS applications. "And right now it looks as if there will be more MOS producers than users," he says. The anticipated results are hot competition for array business and rock-bottom prices, perhaps lower than average in Viatron's case, because Bennett's

engineers may supply their vendors with masks that are developed in-house.

Finally, in Viatron's initial products, clock rates will be very low—down in the kilohertz range. "Since we'll be interfacing with humans rather than machines in our early off-line products, we won't need high speed. This in turn is going to make the kind of arrays we want easier to make," says the Viatron executive.

Software will also be inexpensive. "With large MOS read-only memories, we'll use a matrix programming approach," Bennett says. "The programs are to be general ones; a conditional retrieval program would operate in a broad sense to make possible inventory control, literature search, executive information services, and so on."

Avionics

New directions

Probably best known in avionics circles for its weather radars, the

aviation equipment department of RCA has decided to start tangling with such suppliers of airborne navigation equipment as Bendix, Collins Radio, and King Radio. Officials at the West Los Angeles, Calif., department believe they've stolen a march on the competition with their AVN-210 integrated very-high-frequency omnirange/instrument landing system (VOR/ILS) for general aviation planes.

The system, in development about two years, was shown for the first time last week at the Aircraft Owners and Pilots Association meeting in Las Vegas. It incorporates in one 3.19-by-3.19-by-10.6-inch package what competitive systems have to carry in up to six bulky remote boxes housed in various parts of the aircraft. RCA is shooting for the heavy single-engine and light- and medium-weight twin-engine aircraft market, including such planes as the Beechcraft Bonanza and the Cessna 210.

Weight trimming. The AVN-210 weighs but 4 pounds; its two closest competitors, RCA spokesmen say, weigh 16.2 pounds (in six boxes) and 14.5 pounds (in three boxes) although both designs employ solid

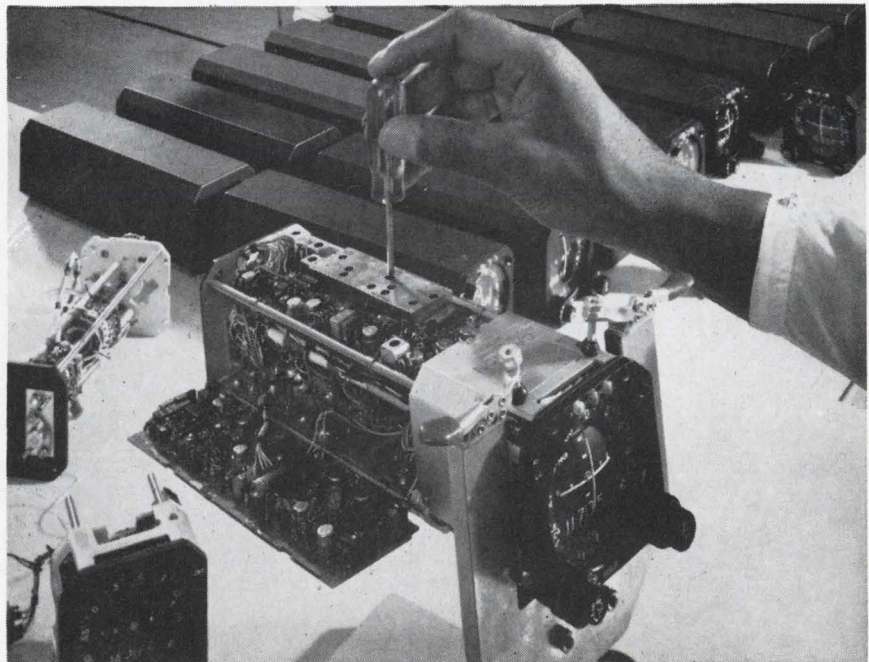

Changing course. RCA enters the avionics navigation field with this integrated very-high-frequency omnirange and instrument landing system. The entire unit fits in a single black box.

Pick the
BEST IC
for the job

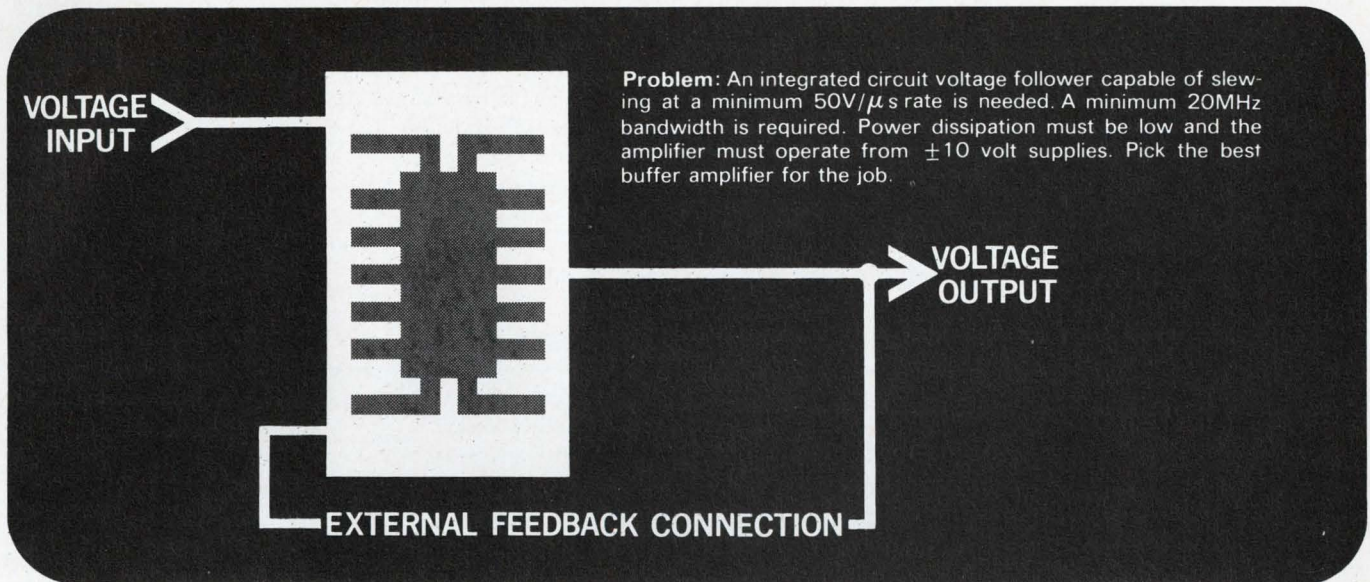

the **BEST** Solution:

THE NEW RA-244 COMPENSATIONLESS BUFFER AMPLIFIER

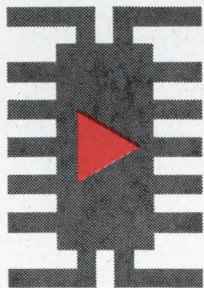

Solve the problem with Radiation's dielectrically isolated RA-244 buffer amplifier. Operating in Mode #2 of its dual-mode capability, a guaranteed minimum slew rate of $50V/\mu s$ is yours! And the bandwidth is 20MHz. Maximum power dissipation is only 170mW. Low enough for the most demanding design criteria. Another plus... like Radiation's RA-909 operational amplifier, no compensation networks are needed. Obviously, the Best IC for the job.

Switch to the $15V/\mu s$ (guaranteed minimum) Mode #1 simply by using externally available resistor trim points. And, also, the feedback loop is accessible, making the RA-244 extremely versatile. Use it as a voltage follower, wideband video amplifier, or general purpose operational amplifier.

Contact your nearest Radiation sales office for further information. We'll help you pick the Best IC for the job.

WE MAKE THE **BEST** IC FOR THE JOB



RADIATION
INCORPORATED

SUBSIDIARY OF HARRIS-INTERTYPE CORPORATION
MICROELECTRONICS DIVISION

RADIATION SALES OFFICES: P.O. Box 476, Lexington, Mass. 02173, (617) 682-1055 • 600 Old Country Road, Garden City, N.Y. 11530, (516) 747-3730 • 2600 Virginia Avenue N.W., Washington, D.C. 20037, (202) 337-4914 • 6151 W. Century Boulevard, Los Angeles, California 90045, (213) 670-5432 • P.O. Box 37, Melbourne, Florida 32901, (305) 727-5430 • International Sales: Marketing Department, P.O. Box 37, Melbourne, Florida 32901, (305) 727-5412

state components.

But the clincher may be price. The AVN-210 sells for \$3,995, and RCA officials estimate that it will cost \$200 to install. The rival six-box system sells for \$4,648 and costs an estimated \$900 to install. The three-box competitor costs roughly \$4,500, plus an estimated \$830 for installation.

RCA was able to shrink its system by eliminating separate power supplies (required in the competing gear because it isn't in a single package) and by using integrated circuits extensively.

The front of the AVN-210, with the instrumentation and operating controls, is mounted flush with the cockpit instrument panel and requires a 3.19-by-3.19-inch space. Behind the instrumentation are three complete receivers plus the VOR/localizer (LOC), each on a separate printed-circuit board. The top of the box contains the 108-to-117.95-megahertz navigation receiver, which contains three types of RCA transistors, plus other discrete components. Channel spacing

is 50 kilohertz.

Folded into the right side of the box are the runway-marker receiver and light-amplifier circuitry. The cards contain RCA discrete transistors and Motorola linear IC amplifiers, and are hinged to the bottom of the box, swinging down for maintenance. On the left side of the box, hinged in similar fashion to the marker receiver, is the card containing the VOR/LOC converter, which uses both RCA and Motorola linear IC's.

Face the elements. Beneath the navigation receiver and nested between the marker receiver and VOR/LOC converter is a 20-channel glideslope receiver and converter, which also uses RCA transistors and Motorola IC's. Because the entire integrated system fits behind the instrument panel in a heated and pressurized cabin, it doesn't have to stand up to the temperature and pressure extremes and changes encountered by the traditional remote black boxes. Nor does it need the wiring required by gear situated in remote parts of the plane. It will,

however, operate from -46°C to $+55^{\circ}\text{C}$ and at up to 55,000 feet.

The AVN-210's current drain of 300 milliamperes is 1.5 to 2 amps less than that of competitive systems. The unit operates on either a 14- or 28-volt power source and meets the Federal Aviation Administration's Technical Standard Order requirements covering such things as vibration, temperature, and humidity.

RCA expects to begin deliveries in November.

Space electronics

Happy birthday?

The National Aeronautics and Space Administration is 10 years old tomorrow, but expressions of sympathy are as much in order as congratulations. For all its past triumphs, the agency faces a doubtful future.

The weeks preceding its anniversary have been marked by the resignation of James Webb, NASA's administrator for eight years, continued paring of the agency's already slim fiscal 1969 budget, and hints that the Apollo lunar landing scheduled for next year may be deferred.

In taking leave of his post, Webb bitterly criticized Congress for budget cuts he said have cost the nation its lead in the space race. The cuts he referred to have forced NASA to shift funds away from long-range programs to more immediate ones, and have caused layoffs at the agency and at contractors.

As for the Apollo program, the first manned flight is scheduled for launch in less than two weeks, and plans call for a manned lunar fly-by in December. But some NASA officials fear that this program may signal the end of an era of heavily funded projects and the beginning of lean years. Recent budget reductions have already severely limited the scope of the follow-on Apollo Applications Program and the unmanned Mariner Mars mis-

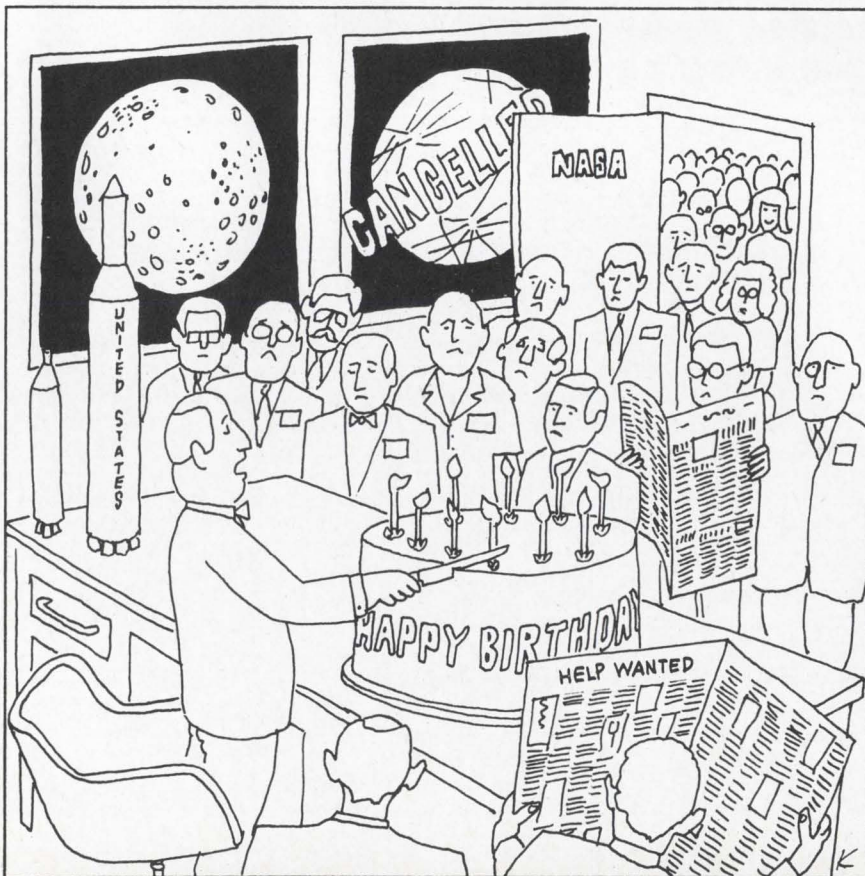

The Readable Little Meter

Hold the ad at arm's length and see just how readable it is.

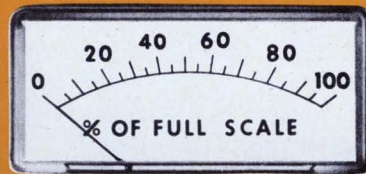

(Actual size)

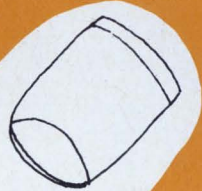

Put your left thumb here.

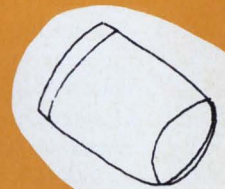

Put your right thumb here.

Honeywell's new 81T Panel Meter takes up about half the panel space of a full-scale meter.

But hold this ad out at arm's length and see how easy the meter is to read. (How we ever got such a large scale on such a small face without cluttering it, only our designers know.) And we've set the dial up front, so you can see it clearly, even from an oblique angle.

The small mechanism behind the small face is Honeywell's Auto-Torque taut-band mechanism.

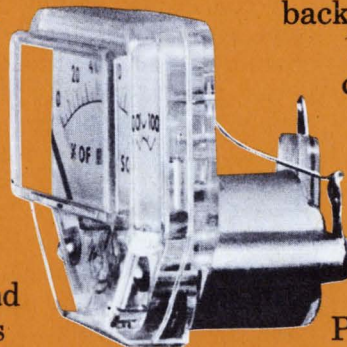

It has about 50% fewer parts than a pivot-and-jewel.

(One of the parts that's missing is the old space-consuming plastic barrel on the back of the meter.)

Honeywell 81T Panel Meters come in 33 standard ranges.

And they cost no more than pivot-and-jewel meters.

So you don't have to pay a lot to get a little.

(We'd like to send you a catalog. Write Honeywell Precision Meter Division, Manchester, N.H. 03105.)

It takes all kinds of meters to make the Honeywell line.

Honeywell

Circle 51 on reader service card

sions slated for 1973.

Tall order. The agency feels that if its first decade is not to be followed by decadence it must find new goals to sell to Congress, a new Administration, and the public. And as things stand now, this job will fall to NASA's acting administrator, Thomas O. Paine. It's too early to say what his strategy will be, but some ideas kicking around Washington may serve as indicators.

For one thing, Paine may stress the benefits of "technological fallout." Since becoming Webb's assistant, he has often urged that the agency increase efforts to apply itself to earthly problems.

Reusable spacecraft may be another selling point. The idea, discussed in the aerospace industry for years, is now being regularly cited in speeches by NASA officials, who see the craft as a future alternative to costly one-shot vehicles.

Finally, the agency is going to have to find a new way to sell its schemes for planetary exploration. Congressional resistance to these plans is strong, and less than 2% of NASA's budget is currently allocated to this area.

Cheap shots. One approach that's attracting interest at the agency is outlined in a report recently released by the space science board of the National Academy of Sciences. The report, a blueprint for economic exploration, urges that costly manned missions be replaced by unmanned instrument flights, and suggests that more use be made of the relatively inexpensive Pioneer-type spacecraft. It even spells out a comprehensive flight plan for exploration and insists on an end to duplication and triplication of missions.

These ideas are less glamorous than the ones NASA has been pushing for a long time, but their adoption would mean cost savings and could give planetary exploration a new lease on life.

More of LES

The 360-pound LES-6 communications satellite—which was to be

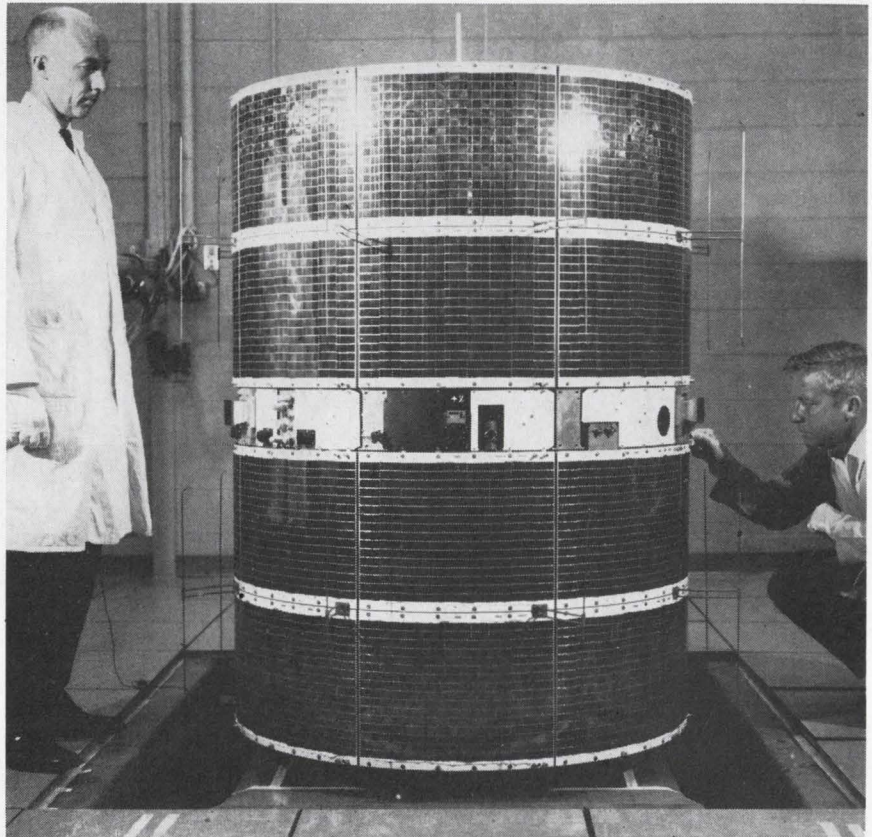

Test bird. Lincoln Lab's LES-6 communications satellite has electronic features that may be included in the military's Tacsatcom.

launched from Cape Kennedy on Sept. 26—has some technological features never before orbited.

The craft, designed by Lincoln Laboratory for the Air Force, carries the first automatic self-contained station-keeping system, a setup that allows the satellite to sense its position above the earth and to direct itself to its proper station.

It can change station upon receipt of a single signal from the ground. Continual control and monitoring aren't needed. Its power supply and transmitter are designed to use solar-cell-generated power more efficiently than previously orbited gear. Radio-frequency output is thus improved. It's the first communications satellite to combine circular polarization with an electronically despun antenna.

These features being tested in the Lincoln Experimental Satellite series are slated for incorporation in the Tactical Satellite Communications system (Tacsatcom). And

if they prove practical in this Air Force experimental system, they may be included in the military communications satellites of the 1970's. LES-6 itself is certain to be used in the hardware-checkout phase of the Tacsatcom program, expected to begin early next year at the latest.

Staying put. The automatic station-keeping system uses two optical sun sensors on opposite sides of the satellite, an optical earth sensor at a 45° angle from one of the sun sensors, and an electronic clock that keeps track of solar time.

As the satellite spins on its axis at about 10 revolutions per minute, the earth sensor and sun sensors transmit pulses to an on-board digital computer. From the relative position of the earth and the sun, the computer calculates the position of the craft. If the satellite is off station, the computer figures out how to get it back in place with the least expenditure of ammonia-gas propellant.

An alternative station-keeping

POUF....**THAT'S ALL IT TAKES
TO ACTUATE THIS
NEW SWITCH.**



SKEPTICAL? TRY IT.

(we'll send you a free sample)



Just a gentle whisper of force ($1\frac{1}{4}$ grams) actuates this new Cherry E22 miniature switch. As easy as blowing fluff off a dandelion. It's so sensitive, we had to make the actuator of aluminum (to permit re-setting of the switch). Dependability? This 3 amp., 125 VAC switch features Cherry's exclusive long-life coil-spring mechanism that insures positive snap action...proven in over 100 million product applications.

But, see for yourself. Send for a free sample and complete specifications.

CHERRY 

Cherry Electrical Products Corporation • 1656 Old Deerfield Road • Highland Park, Illinois 60035

Circle 53 on reader service card

system that operates on commands from earth will be used to initially move the satellite after synchronous altitude is attained.

LES-6's power supply has been designed to improve the transmitter's operation. Rather than designing the transmitter to operate at a single specified input power, Lincoln Lab broadened its d-c input capabilities. So when the satellite first goes aloft with its fresh solar cells supplying more power than required, the transmitter can slough off the overload. Even after degradation of the cells causes power to fall off, the transmitter is still operating within specifications, and its ratio output doesn't drop. Doing away with the conventional power supply regulators and converters, says a lab spokesman, makes possible nearly twice as much r-f power output at takeoff.

Dumping donuts. LES-5 was the first Lincoln satellite to use circular polarization, which enables a radio beam to penetrate the ionosphere with minimal fading and without signal loss due to polarization rotation. LES-5's antenna pattern was shaped like a donut, surrounding the satellite. However, the pattern intersected the earth for only about 17°, so most of the craft's power was wasted.

LES-6 retains the basic LES-5 method of obtaining circular polarization: pairs of dipoles and slot antennas are excited in quadrature (each half dipole is 90° out of phase with the slot behind it in the body of the satellite). But instead of exciting all antennas simultaneously, LES-6 uses a system of p-i-n diodes to switch power only to those antennas facing the earth.

Thus, while the transmitter generates only about 120 watts of uhf, the concentration of power in one beam produces 600 watts effective radiated power toward the earth.

Also flying on LES-6 are experiments to measure radiation levels at synchronous altitudes and to measure uhf radiation from the earth between 290 and 315 megahertz. The latter experiment is designed to uncover possible uplink interference; LES-5 carried a similar package to investigate frequen-

cies between 255 to 280 Mhz, bands that Tacsatcom might use.

Military electronics

Crisis of identity

The Airborne Warning and Control System (Awacs) has now been cleared for takeoff into the contract-definition stage, but what direction it will take once aloft is still a question.

For one thing, there's a difference of opinion in defense circles over how elaborate an electronics system the flying command post will need. Sources close to the program are reluctant to talk, but they do indicate that one faction wants a system that would include redundancies to handle emergencies while the other maintains that an austere version could do the job.

Internal squabbles. Not only have there been conflicts between the cost-conscious Defense Department and the Air Force on this score, but there are opposing camps within both agencies. There is some disagreement between the Tactical Air Command and the Air Defense Command, for example, according to one source.

Differences between the Pentagon and the Air Force on testing procedures have helped to hold up issuance of requests for contract-definition proposals to Boeing and McDonnell Douglas for almost a year [Electronics, Sept. 16, p. 67].

Boeing prefers an austere version of Awacs, but McDonnell Douglas is pushing for a system with all the trimmings.

According to one Boeing engineer, "The Air Force is asking too, too much. They're not going to get the capability they want with that system. It's more than they need."

He figures the system the Air Force wants will cost \$300 million more to test and evaluate than would the equipment they could really use, or about \$2 million more per production unit. Among the items he cites as "gold plate" are: a crew twice as large as needed, military jet engines instead of less

expensive commercial types, and excessively large computers.

Muddy prose. Another complicating factor, according to industry sources, is that the Air Force hasn't been all that precise about what it wants. A Boeing executive comments that the service's contract-definition paper sounds "like a bunch of kids wrote it; I could have done better." A McDonnell Douglas representative asserts that the document had to be rewritten more than 35 times before the Defense Department would okay it.

A further problem is that the delay in issuing the requests for proposals has caused the companies to cut back the project teams they've had to support on house money for so long. Boeing says it has less than 100 employees on the program right now, down from about 800 at one time. And McDonnell Douglas concedes that it no longer has its 300-man team assembled. It will take time to rebuild and recoordinate these groups.

In view of the conflicting opinions both in and out of the military, one source close to the program guesses that each company will play it safe and submit two contract-definition proposals, one plush and the other austere.

Displays

Deflected by digits

The days of pot-twiddling in graphic displays are numbered. Their end became inevitable when the Univac division of the Sperry Rand Corp. announced a new line of cathode-ray tube display systems using a digital deflection technique.

This technique eliminates the need for low-level digital-to-analog conversion and reamplification, which require circuits that tend to drift and so have potentiometers that have to be readjusted every few days.

Univac's new approach converts the digital data into analog deflection signals directly at high levels, using a constant rise-and-fall cir-

Very few capital equipment requests can be accompanied with a 1½ year payback expectation. If your firm constantly strives to reduce its overhead and increase the quality and efficiency of its operation, be sure your drafting department has evaluated the Mergenthaler DIAGRAMMER—an automated push-button drafting system. Users have experienced increased output of better than 4 to 1 over manual methods—30 to 1 when drawing data is furnished in digitized form—plus receiving superior, “better-than-inked” quality that is geared to the requirements of today and tomorrow’s information storage, retrieval and data transmission systems. For DIAGRAMMER details and user payback testimonials, contact Automated Drafting Systems, Mergenthaler Linotype Co., a Division of ELTRA Corporation, 300 East 42 Street, New York, N.Y. 10017. Tel.: 212-661-5615; TWX 710-581-3385.

AUTO- MATED

DRAFTING

PAYBACK

.....

Please send me DIAGRAMMER details ()
Please call me soon () Phone No. _____
Name _____ Title _____
Firm _____
Address _____
City/State/Zip _____
Mergenthaler Linotype Co., 300 East 42 Street, New York, N.Y. 10017

.....

IN

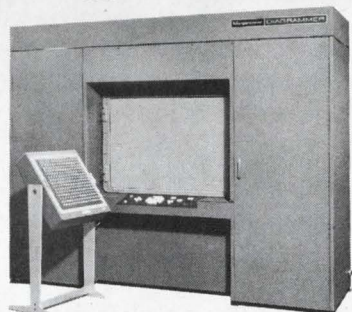

1½ YEARS

THE DIAGRAMMER by

Mergenthaler

the
total
graphic arts
company

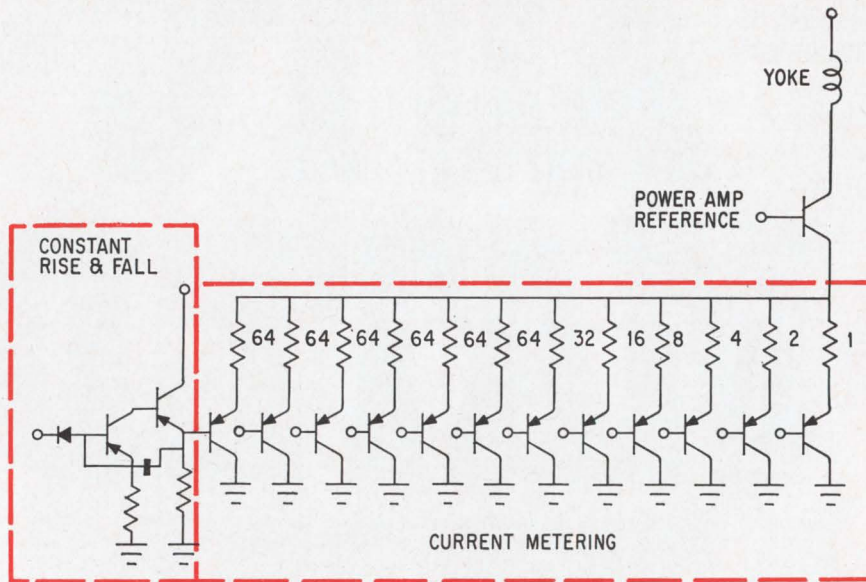

Smoothing the way. Abrupt voltage steps at outputs of flip-flop register are turned into smooth transitions by constant-rise-and-fall circuits connected to each transistor switch. Circuits replace servoloop in new display system from Univac.

cuit that translates the little jumps generated by the digital input into a smoothly varying signal. Its deflection signal, furthermore, is electromagnetic, so it attains high precision and reliability without the high voltages and attendant voltage step-up and insulation problems that electrostatic deflection would entail.

No loop. As in all digitally driven displays, a digital code addresses a read-only memory that establishes a sequence of coordinates corre-

sponding to the input code. Univac uses the 7-bit ASCII code; its read-only memory is a diode matrix. Each coordinate is stored in a flip-flop register as a binary number.

Conventional displays convert the binary number into analog form at low voltage levels, then amplify the analog signal into high-voltage (for electrostatic) or high-current (for electromagnetic) form to drive the deflection yoke on the crt. Feedback signals from the yoke to the amplifiers establish a servo loop

that can easily get out of adjustment. Univac's approach, however, drives a high-level d-a converter; current through the resistor network in the converter goes directly to the yoke.

The converter is a conventional d-a circuit in most respects. The resistors that control the smaller output changes are binary-weighted in the usual way—1, 2, 4, and so on up to 64. The larger changes are all controlled by switching in multiples of 64; as a result, precision resistors with larger ratios to one another aren't needed, and large currents don't have to be switched rapidly on and off.

For the record

Buying in. RCA, which in 1966 signed an agreement with Hoffmann-La Roche to collaborate on the development, production, and marketing of medical electronics products, has now sold the activity to the drug and chemical firm for approximately \$1 million.

Selling off. Cornell University will sell its Aeronautical Laboratory to EDP Technology Inc. of Washington for about \$25 million. The lab, a university subsidiary since 1946, does applied research for Government and industry in aeronautics, electronics, and allied technologies. Last year its contracts totaled \$32 million. EDP, which was founded early this year, has moved into many areas of computer software.

Double-teaming. NASA's Goddard Space Flight Center has selected General Electric and Fairchild Hiller to carry out parallel design studies for Applications Technology Satellites F and G. Each firm will receive \$4.6 million for studies to be done over the next two years. One of the companies will get the final contract for the two satellites in early 1970. Meanwhile, NASA is working on its final list of experiments for the two satellites, which are to be launched in 1972 and 1973.



Representational art. Univac's new display unit produces multi-layer-board artwork with a tolerance of ± 2 mils in 15 inches.



New flame resistant **GLASKYD[®]** **7100 FR**

Alkyd Molding Compound

for economical high performance connectors

This card-edge printed circuit connector won't singe your reputation.

Made with GLASKYD 7100 FR, it's replacing DAP for some mighty good reasons. Point 1—it provides comparable wet electrical properties at a much lower material cost. Point 2—it's economical in other ways, too. In slug form, its fast molding cycle increases production significantly. Point 3—it has low weight loss at elevated temperatures and permanent flame resistance exceeding normally accepted requirements. So specify New

GLASKYD 7100 FR alkyd molding compound over DAP for savings and quality right down the line.

Among the many types of GLASKYD available, chances are there's a GLASKYD molding compound that will meet your needs . . . for flexural strength, impact strength, arc resistance, low water absorption, flame resistance, heat resistance, dimensional stability, and many more advantages. Write today for technical brochure to American Cyanamid Company, Plastics Division, Wallingford, Connecticut 06492.

CYANAMID

SALES OFFICES IN: CHARLOTTE • CHICAGO • CLEVELAND • DALLAS • DETROIT • LOS ANGELES • MINNEAPOLIS
OAKLAND • PHILADELPHIA • TUKWILA, WASHINGTON • WOODBRIDGE, CONNECTICUT • ALSO AVAILABLE IN CANADA.

Circle 56 on reader service card

Electron gains > 10^8 with background counts < 1 in 10s



... obtained from the Mullard range of 14 standard Channel Electron Multipliers. Specials built to order.

Response All these Multipliers respond to electrons, ions, short-wavelength ultraviolet radiation, and both soft and diagnostic-quality X-radiation.

Ideal for rocket and satellite payloads Because they are small and rugged, have a high electron gain, and require only minute operating power. Earth bound applications are in the fields of mass and ultraviolet spectroscopy.

Important properties * windowless input * high electron gain * low background count rate * narrow pulse-height distribution * low power consumption.

Features that count * performance independent of ambient pressure over a wide range * compact, rugged and light * freedom from contamination after long-term exposure to normal atmospheres * simplicity of use.

Two series are available—high-resistance, with a particularly low power consumption, and low-resistance for high pulse-counting rates. There are open or closed output versions of all types for dc or pulse-counting operations.

The Mullard range of Channel Electron Multipliers has been developed from a specialised series of Electron Optical devices. These include channel plates, infrared image converters and cascade image intensifiers—all from Europe's largest image-device facility.

Every designer should have a copy of the Mullard book on C.E.Ms. It gives full information on their characteristics and principles of operation. Also ask to be put on the mailing list of the Mullard Bulletin—a regular publication which gives details of new components and applications . . . the result of extensive research and development programs in the Mullard laboratories in England. Mullard employ 1000 qualified scientists and engineers and have six major plants, with over 3 million square feet of floor space.

Write today for information on Mullard Channel Electron Multipliers, and the name of your local Distributor. Mullard Limited, Mullard House, Torrington Place, London WC1, England.

U.S.A. enquiries to Mullard Inc., 100 Finn Court, Farmingdale, Long Island, New York. 11735 U.S.A. Telephone: (516) 694-8989 Telex: 961455.

Mullard

MOL50



MOS 100-BIT WORD GENERATOR

As the size and complexity of a digital system grows, checkout or test hardware becomes more and more significant. This is particularly true for integrated circuits, with the growing complexity of monolithic functions making testing time consuming and expensive. A partial solution to the problem is automation of as much of the testing as possible. The format of digital information required to test today's systems, however, is often beyond the capabilities of pulse generators, while complex computer-controlled test systems are costly. Presently-available IC's can be used to fill the gap.

SYSTEM OPERATION

Figure 1 shows a versatile, programmable word generator implemented using off-the-shelf MOS IC's. Any 100-bit serial combination of digital information in the accumulators is available to the system under test at a 1 MHz rate. All outputs are synchronous and bit number 1 of all channels appears simultaneously. To load the accumulators, the clock is switched to the load rate of 100 kHz (determined by the operating speed of the serializer), and the channel selector (a 2 gang rotary switch) is set to the appropriate channel. The desired bit pattern is programmed by toggle switches, then stored in the selected channel accumulator by depressing the "load command" push-button. The pattern appears immediately on the channel output. Additional channels are programmed by simply selecting a new channel on the channel selector switch and repeating the procedure.

Because of the centralized programming and loading scheme, the system is easily expandable to more channels by adding a buffer, an accumulator, and one rotary switch position on the channel selector for each additional output channel re-

quired. The bit pattern can be made longer or shorter by choosing a different length for the shift register in the accumulator.

SYSTEM MECHANIZATION

The complete system is implemented using MOS IC's and hardware, except for the clock and buffers.

The two-speed clock shown in Figure 2 is basically a collector-coupled astable multivibrator. Variations in the current from the bias supply change the charging current to the timing capacitor C1 and therefore the clock frequency proportionately. When the "repetition rate control" switch is closed, the current increases by an order of magnitude and the frequency increases from the load rate of 100 kHz to the test rate of 1 MHz.

The accumulators require two clock phases, so both the "clock" and the "clock" outputs are used. They cannot, however, drive large capacitive loads directly, so buffers are needed. The buffer circuits shown, also used on the accumulator outputs, sink up to 200 mA and can drive large capacitive loads at 1 MHz. To conserve power, the duration of the clock phase pulses is reduced by the phase generator, as shown in the timing diagram.

Since T9, the current source for capacitor C2, is biased by the clock supply, the duration of the phase pulses will always be a fixed percentage of the clock periods (20% in this circuit).

The counter/decoder consists of two identical decades (Figure 3) to allow two levels of control in the serializer. Each section contains a decade counter and decimal decoding. The input to the second section is the clock frequency divided by

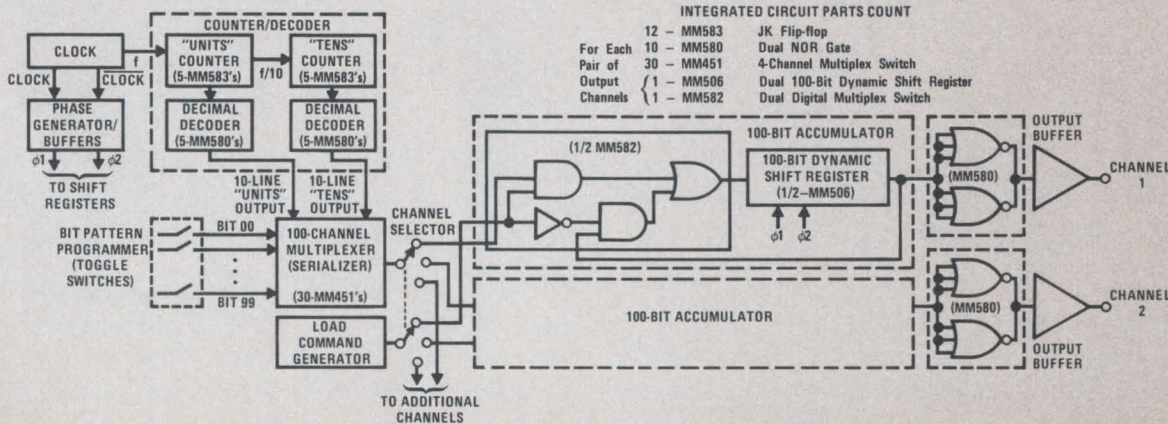

FIGURE 1. Programmable MOS 100-Bit Word Generator

MOS 100-bit word generator
MOS BRIEF I

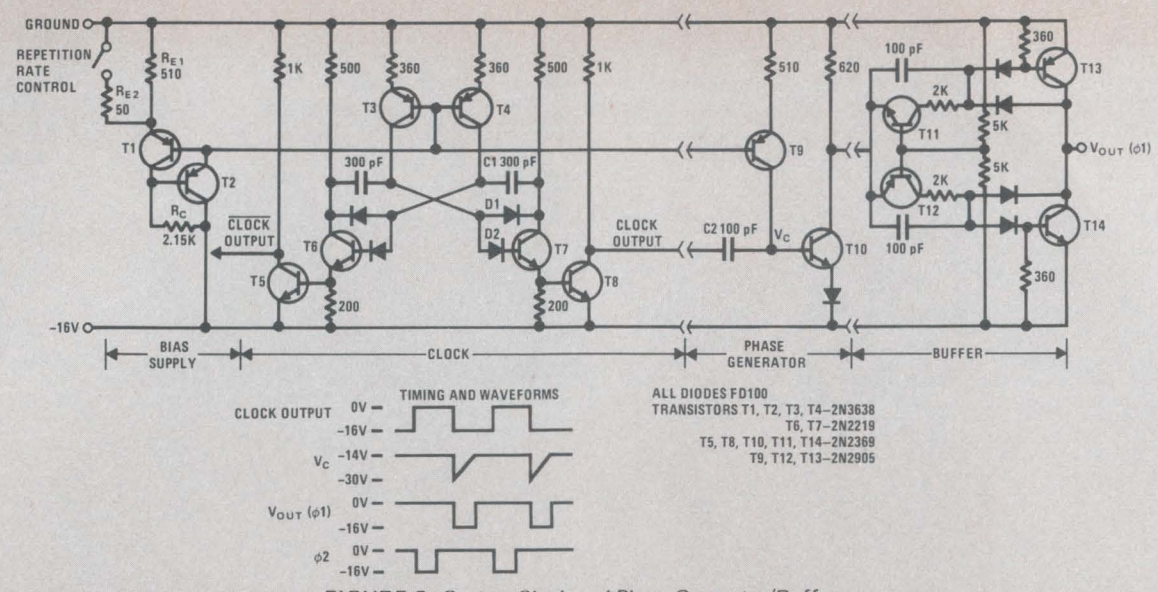

FIGURE 2. System Clock and Phase Generator/Buffer

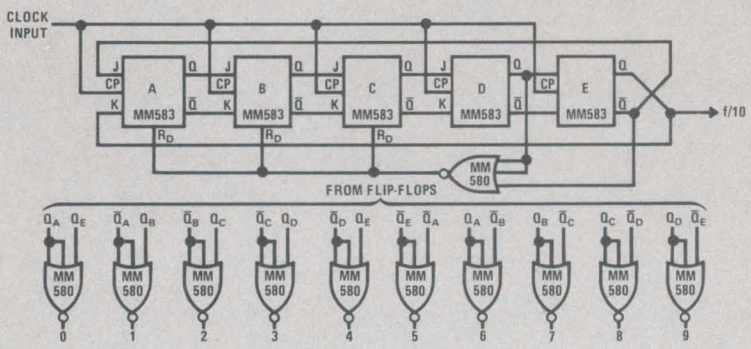
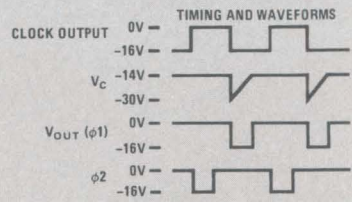

FIGURE 3. Counter/Decoder

ten. A shift counter was used (rather than a ripple counter) because it requires no feedback, any state can be decoded by a single two-input NOR gate, and operation is more reliable since it is synchronous, with all outputs changing at the same time.

The serializer converts the pattern set by the toggle switches into a serial bit stream that is then stored in the accumulators at the 100 kHz load rate. Using two levels of multiplexing as shown in Figure 4, only 20 rather than 100 decoder outputs (and therefore decoding gates) are required.

The accumulator recirculates a bit pattern until the load command becomes a logic "1," at which time it accepts a new bit pattern. (The MM582 steering circuit functions like a single-pole, double-throw switch.) The "load command" must remain true for at least 100 clock pulses to ensure complete loading, and the circuit of Figure 5 uses any one of the "tens" signals to achieve this. To load a new pattern, the switch is closed to clear the flip-flops. The "B" flip-flops will output a "load command" until two pulses have been re-

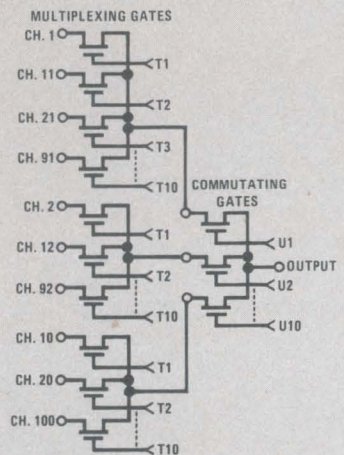

FIGURE 4 100 Channel Multiplexer Using Two Levels of Switching All MOS Gates Are MM451

ceived. The second pulse switches the B output, disabling the "load command" and inhibiting any further state changes in the registers. Loading is accurate regardless of switch noise or bounce or the length of time the switch is depressed.

Any of the subsystems may be used in other applications, and complete data sheets on all the MOS elements are available.

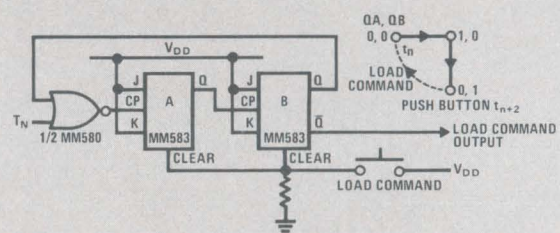
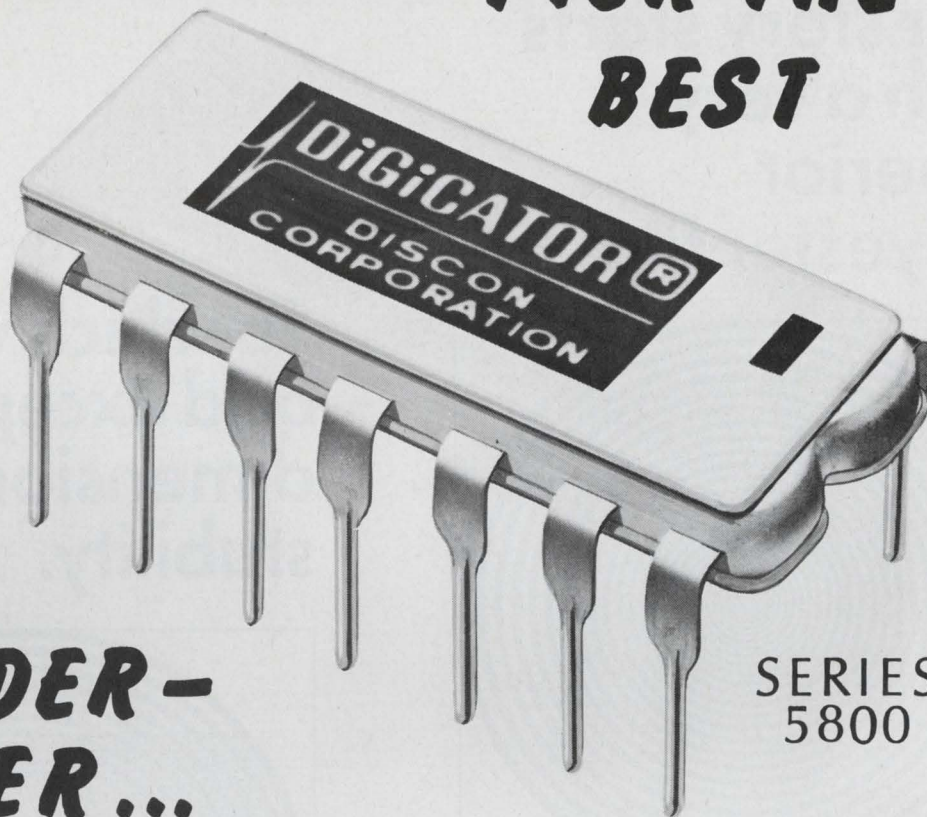

FIGURE 5. Load Command Generator

National Semiconductor Corporation
 2975 San Ysidro Way, Santa Clara, California 95051
 (408) 245-4320/TWX (910) 339-9240



**PICK THE
BEST**



**DECODER-
DRIVER...**

**SERIES
5800**

**HIGH CURRENT LAMP DRIVER - UP TO
80MA PER LAMP**

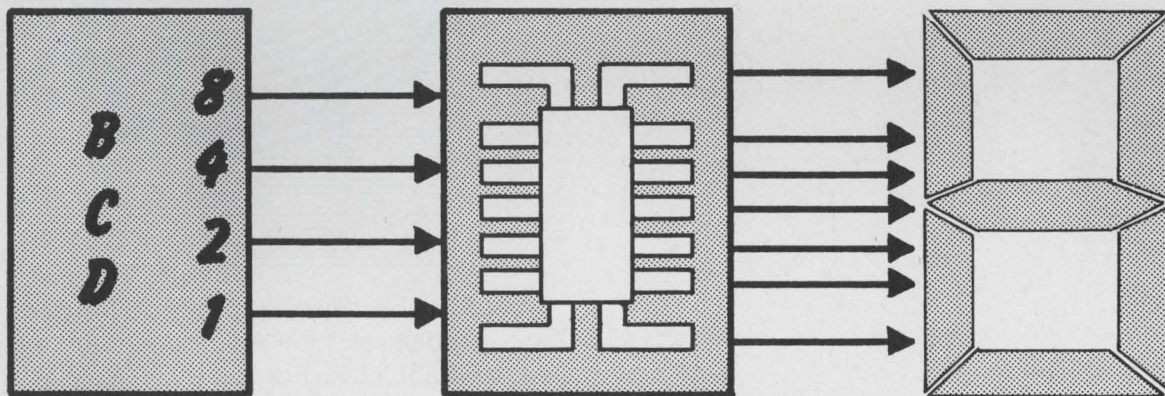

DiGiGATOR® REGISTERED TRADE MARK

A complete line of display readouts and decoder/drivers

DISCON CORPORATION

P.O. BOX 9355 * FORT LAUDERDALE, FLORIDA 33310

PHONE: (AREA CODE 305) 565-5511

**Our story starts
with a very
superior
polyester film.**

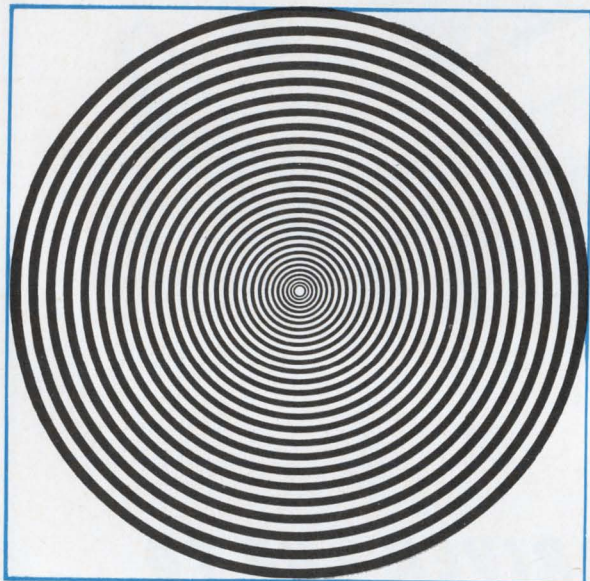

**To which we
add exceptional
dimensional
stability.**

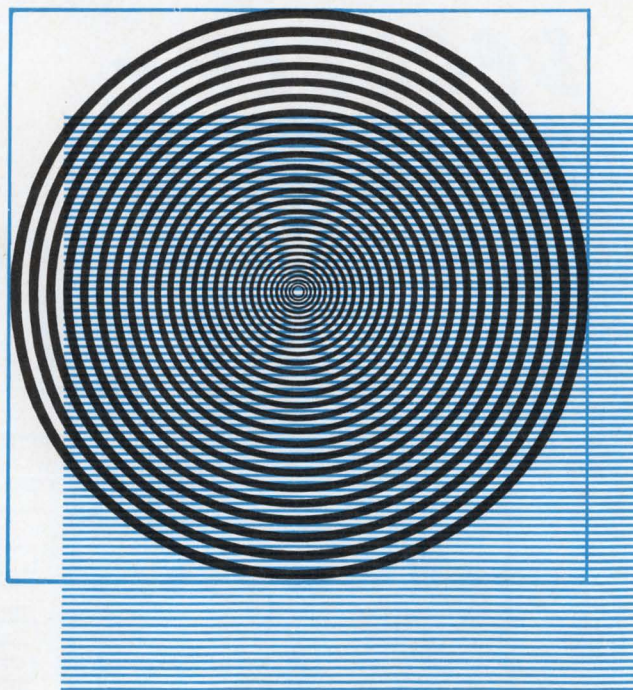

The best dimensional stability of any polyester film. An independent testing lab, DeBell & Richardson, Inc., tested calibrated lengths of Celanar and other polyester films at temperatures from 73F to 120F for over 24 hours. When measured, other films showed up to 77% greater thermal expansion than Celanar film.

And greater strength.

Celanar is the strongest balanced biaxially oriented plastic film commercially available.

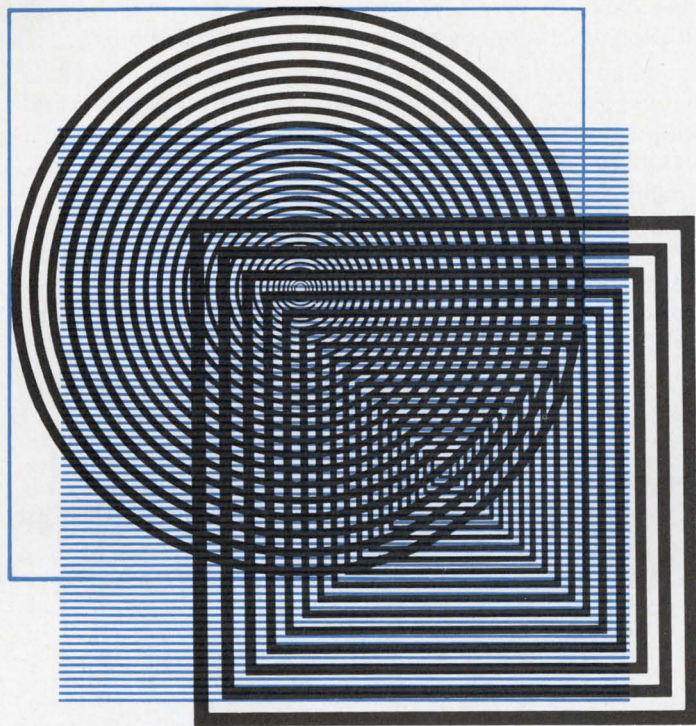

And insulation resistance.

An outstanding property of Celanar film is its high insulation resistance over a wide range of temperatures. Celanar has superior electrical properties, including excellent dielectric strength, dielectric constant and dissipation factor. Good reasons why Celanar is widely used as an insulating material in electrical insulation applications.

To bring you Celanar Film with a combination of properties unsurpassed for electrical uses.

Celanar polyester film offers a balance of electrical, mechanical, thermal and chemical properties that make it your best choice for applications from flexible circuits to wire-wrap. Want proof? Just mail the coupon.

Celanese Plastics Company
Dept. 133-S, P.O. Box 629
Linden, N.J. 07036

Yes, I want all the facts about Celanar film for electrical applications. And send me a FREE set of gratings printed on Celanar. (Laying one on top of the other produces Moiré patterns that confound the eye.)

Name _____ Title _____

Company _____

Address _____

City _____ State _____ Zip _____



CELANESE
PLASTICS COMPANY

Celanese®
Celanar®

Celanese Plastics Company is a division of Celanese Corporation.



**lower
attenuation...**

**higher
power**

8" diameter flexible HELIAX® coaxial cable

8" Air dielectric HELIAX coax extends the advantages of flexible cable to very low attenuation or very high power applications that formerly required rigid transmission line.

Corrugated inner and outer copper conductors accommodate thermal expansion without the need for sliding contacts. End connectors mate with 6 1/8" EIA flanges and lock inner and outer conductors together to eliminate differential expansion.

The continuous, connector free cable assures freedom from the VSWR "spikes" associated with the periodic inner connectors of rigid line in a long feeder. Cable assemblies can easily be electrically tested on the reel to assure your exact system performance. For complete details write Andrew Corporation, 10500 West 153rd Street, Orland Park, Illinois 60462.

HJ 10-50 HELIAX COAXIAL CABLE

	At 30 MHz	At 600 MHz
Attenuation	.027 dB/100 ft	.15 dB/100 ft
Average Power	300 kW	58 kW
Other Power Ratings	For SSB, 200 kW PEP with antenna VSWR of 3:1 2 Megawatts Peak	TV transmitter power ratings, 223 kW at Channel 4 and 70 kW at Channel 35



2-68

Washington Newsletter

September 30, 1968

Navy sets last talks with Cains bidders

The final bidders' conference for the eight companies competing for the Carrier Aircraft Inertial Navigation System (Cains) will be held next month in Washington by the Naval Air Systems Command. **The contract will be to build six prototypes of a system aligned through a radio-frequency data link between an aircraft carrier's inertial navigator and an aircraft** [Electronics, Oct. 30, 1967, p. 44]. The Navy wants to reduce the long warmup and alignment times needed for present systems and to eliminate the umbilical cables now cluttering flight decks.

The contract will be for the inertial systems only, since the Naval Air Development Center has found a way of modifying existing r-f gear aboard an aircraft. This modification will probably be done by the manufacturer, Radiation Inc., in a separate contract. The pact for Cains, which includes an option for 11 more, should be signed by the end of the year; a production contract is expected to follow six months later. **The Navy hopes to make Cains the fleet standard by 1975.**

The eight bidders are: Autonetics, the AC division of General Motors, General Precision, Honeywell, Lear Siegler, Litton, Northrop's Nortronics division, and Teledyne.

NASA cuts back spinoff program

NASA's office of technology utilization, caught between a lack of Federal funds and a lack of interest on the part of most industry, is dropping two of its eight Regional Experimental Dissemination Centers. The office, whose job is to oversee space technology spinoffs, now plans to vigorously promote the centers still operating in the hope of spurring industry to use them more.

The regional center at Wayne State University in Detroit has been cut back to a library operation, and the center at Midwest Research Institute in Kansas City will cease operations altogether next month.

Space agency officials are still optimistic about the program, but one says, "Industry hasn't scratched the surface of what we have to offer." Computers at the centers search through hundreds of thousands of technical documents from Government agencies to provide tailored packages of information for companies that pay a fee to defray expenses [Electronics, Jan. 22, p. 111].

Air Force to seek bids on transport and fighter Aids

The Air Force Systems Command will start the ball rolling later this year on two more Airborne Integrated Data Systems (Aids), one for the C-141 transport and the other for the A-7D fighter. **But a lack of money still hinders the entire effort.**

A bomber version of Aids, which monitors all subsystems in an aircraft to detect malfunctions, is now being assembled by Garrett under a \$1.93 million Air Force contract awarded earlier this year after several years of study [Electronics, May 27, p. 50].

A request for proposals will be issued in the next month or two for the integration and testing of the Aids for the C-141. This will be a computer-based system and much more extensive than the versions tried out in two earlier C-141 programs. **The new test project could lead to a contract to install Aids throughout the entire C-141 fleet.**

Industry proposals for the A-7D version will be asked toward the end

Washington Newsletter

of the year. But a lack of funds will probably force the Air Force to specify only propulsion tests and to exclude on-board computers.

Companies expected to bid on one or both of the contracts include Bendix, Garrett, GE, Honeywell, IBM, Lockheed, and Teledyne.

Next Intelsat 3 try seen 3 months away

Comsat will have to wait at least three more months to find out how the Intelsat 3 satellite does its job. **The second model isn't scheduled to be delivered by TRW Systems, the prime contractor, until late November, and it doesn't now look as if it can be launched until January at the earliest.**

Comsat was counting on the first Intelsat 3, destroyed at launch Sept. 18 by a malfunctioning booster, to relay televised accounts of the Olympic Games in Mexico City next month. Now the Intelsat manager will have to use existing circuits on the Early Bird and Intelsat 2 craft, plus circuits leased from NASA on the ATS 3.

Making even January look chancy for the next launch is the tight Apollo schedule at Cape Kennedy and the more-than-usual testing that will have to be done on the long-tank Thor Delta booster, which failed in its maiden flight for Comsat. **Comsat is anxious to get its first world-wide satellite system—made up of Intelsat 3 craft—operating before Intelsat members meet next year to renegotiate the agreement governing the 61-nation consortium.**

AT&T plan gains, but objections rise

There definitely won't be clear sailing for AT&T's effort to require a \$2-a-month black box between "foreign attachments" and Bell lines. The FCC, which this month rejected AT&T's appeal to reconsider the landmark Carterphone decision, is allowing AT&T to file the new tariff, effective Nov. 1. But this does not mean the commission will accept it as final [Electronics, Sept. 16, p. 33].

Opposition to the tariff is building up, and there's a good chance the FCC will modify it or even throw it out altogether. The National Retail Merchants Association has filed a vigorous objection to Ma Bell's proposal. Other groups of companies seeking to hook computers and other foreign devices to telephone lines are expected to join in. Their arguments will stress that the black-box proposal isn't in line with the FCC position, expressed in the Carterphone decision, that Bell has no monopoly on interface technology.

Army plans to buy light mine detector

Procurement of a new lightweight mine detector—the first major improvement in such gear since World War II—will begin next year. The AN/PRSA detector will weigh only about eight pounds, compared with the 56 pounds of the current model. **The Army Mobility Equipment Command is expected to ask for bids early in 1969 on the first production units.**

Litton's Amecom division, working under a \$100,000 development contract, designed and built the prototype. **Made with integrated circuits, the new model can distinguish better between false and true targets.** Details are classified, but the Litton unit, like the old one, uses an inductive-bridge technique and is expected to cost a little less than the existing unit, now priced at about \$600 in production quantities.

Another advantage: the mercury battery in the new detector will operate for about 20 hours; the carbon battery in the current unit lasts only about eight hours.



The QRC solves the size / power / regulation problem by combining all silicon, low-voltage series regulator circuitry with high-speed transistor switching techniques.

Sorensen High Performance QRC Series:

The QRC Series covers a wide target area without performance trade offs. Standard features include excellent regulation for voltage and current, fast response time ($\leq 25\mu\text{sec.}$), and surprisingly small size for power outputs to 1200 watts at ambient temperatures to 71°C .

Some laboratory power sources offer high power levels, but are bulky and, by today's standards, are unregulated. Others offer excellent regulation specifications, but are inefficient and, if high-power levels are desired, become large heat sinks. Sorensen QRC's are high efficiency, compact power sources which have excellent performance characteristics with prices

starting at \$325. Seven models are available from stock, covering the range of 0-40Vdc at currents to 30 amperes.

Additional features resulting from the utilization of sophisticated regulation techniques include low ripple ($\leq 1\text{mV r.m.s.}$); output voltage and current resolutions of 0.01% and 0.05%, respectively; remote programming in both the voltage and current modes; remote-sensing and a solid state automatic-crossover indicator.

Contact your local Sorensen representative or: Raytheon Company, Sorensen Operation, Richards Avenue, Norwalk, Connecticut 06856, TWX 710-468-2940.



for more data on this versatile instrument . . . **Call Sorensen: 203-838-6571**



COMPONENT CAPSULES

New 3 amp hermetic A15 replaces costlier A14 rectifier diodes

GE now offers a higher rated companion to its field-proved, 1 amp A14 rectifier at a significantly lower cost than other stud or lead mounted units (depending upon configuration). The A15 is rated 3 amps at 70°C and the 200 to 800 volt models are

Microwave Circuit Modules reduce design cycles and improve system performance

While producing lower overall costs, these design benefits result from:

- Optimum integration of active devices in package form
- Over two decades of microwave circuit development
- The industry's most

New benefits from GE's hermetically sealed reed relays

Glass to metal seals and steel housing now provide true hermetic enclosure for reed relays. The GE 3SBN reed relay has:

- Increased sensitivity
- Immunity to magnetic interference effect
- Very low thermal

New low-cost miniature indicating lights ideal for limited space applications

GE's new, low-cost CR-103HE indicating lights are only 1 1/8 inches long and mount with a speed nut in a 3/8 inch diameter hole — perfect for applications where space is at a premium.

Flush and cylindrical lens types are available. The cylindrical lens pro-

GE computer-grade capacitors offer over 1/2 farad at 5 volts

New GE 86F500 High-Capacitance computer-grade capacitors now provide up to 540,000 µf at five volts (34,000 µf at 100 volts) in a single case.

These enlarged-capacity units are excellent choices where large blocks of capacitance

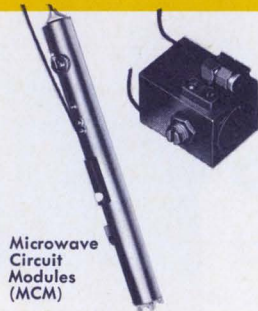
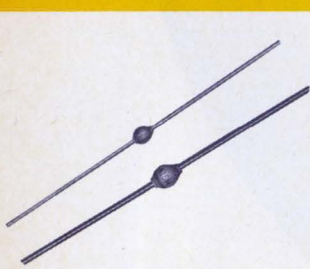

Microwave Circuit Modules (MCM)



New 3S BN



CR103HE



86F500's

transient voltage protected up to 1000 W for 20 µs in reverse direction.

A15's dual heat sink design means low thermal impedance. Easy adaptation of axial leads to PC boards reduces installation cost below stud mounted units.

Both the A15/A14 are hermetically sealed in an all-diffused, glass passivated junction structure. No internal cavity means more resistance to environmental stresses... thus increased reliability.

High-power A15 is now available through GE distributors for applications including power supplies, battery chargers, TV damper diodes, communication equipment and small portable appliances. Circle Number 231.

advanced tube technology

MCM's used as: oscillators, amplifiers, multipliers, detectors, mixers, etc. Available in a variety of individually designed configurations.

Compare MCM features:

- * Stable frequency performance in severe adverse environments
- * Small size and lightweights—as low as 1 cubic inch and 2 ounces with high power to volume ratio
- * Fast warm-up—3 seconds or less capability
- * High performance from a single active device

GE is your one source for full R&D backup, critical testing experience and facilities and an unequalled output of highest performance active components including coaxial and planar gridded tubes. Circle Number 232.

emf's in contact circuits

- Protection of contact capsules and coils, because of rugged construction
- A lower weight than plastic encapsulation

This new relay comes in Form A, 1-6 poles and Form C, 1-5 poles and is only 0.350 inches high. The relay is available in a wide range of system voltages and is ideally suited for printed circuit board applications.

For more information Circle Number 233.

trudes only 3/8 inch, and is ultrasonically welded for maximum strength. Both are available in four lens colors: clear, amber, red and white. Four body colors are available: gray, white, beige and black.

The standard light has a 6 inch lead stripped 1/2 inch, but special lengths are available. Leads are staked into the body of the unit to insure that no movement takes place inside the light.

The CR103HE is UL listed for 120V, 240V, and 460V, and is ideally suited for applications where visual display and appearance is important. For more information Circle Number 234.

are required—as in power supply filters, for example. 86F500 units are rated for continuous operation at 65C or at 85C with proper voltage derating.

GE's new computer-grade capacitors provide highest capacitance per case size, high ripple current capability, low ESR, long shelf and operating life.

Units are available in nine case sizes—diameters 1 3/8" to 3", with lengths up to 8 5/8"—for operation up to 100 VDC. Circle Number 235 on your reader service card.

A TECHNICAL DIGEST FOR INNOVATORS OF ELECTRONIC EQUIPMENT

Versatile GE meter relays are ideal for hundreds of applications

Including: temperature control, equipment overload protection, "go—no go" production line testing, and alarm sounding for a pre-selected value.

Accurate, repeatable control action over the entire scale is possible because there are no contacts on the unit's



Big Look® Meter Relay

Computer tape reel drives—one of many applications for these motors

The excellent commutating ability, fast response, and long insulation life of GE 3 $\frac{1}{4}$ %, 4%, and 6% diameter fhp motors meet computer tape reel demands for continuous duty, low maintenance, and reliability. And, applications don't end here.



D-C Reel Drive Motor

Here's your key to low cost voltage stabilization

Every GE voltage stabilizer supplies constant output voltage to within $\pm 1\%$, even with input fluctuations up to 15%. For special economy, core-and-coil units provide the lowest cost voltage regulation obtainable. They help meet tight space require-

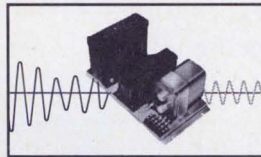

AC Voltage Stabilizer

Fill your needs for sensitive temperature control with GE thermistors

Want extreme sensitivity to relatively minute temperature changes? You get it with GE thermistors (temperature-sensitive resistors). These devices also have temperature-compensating capability.

High sensitivity and small size make GE

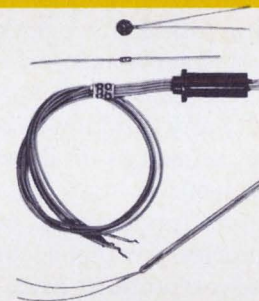

New circuitry combines TVG's in pairs for easy HV crowbaring

New developments in firing circuitry now make it convenient to crowbar high-voltage power supplies by utilizing GE's companion Triggered Vacuum Gaps in tandem.

And what's more—at-taché-case size sensing and firing circuitry is now possible. A unique

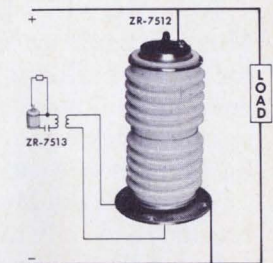

indicating pointer to cause mechanical interference. All units feature automatic ON-OFF reset control action. They easily adopt to manual reset.

No amplifier necessary. The unit's solid-state switch is connected in series with the coil of the load relay which operates it directly. Standard 120-volt a-c operation means no special power supply is needed.

The unit's "piggyback" control plug-in module design saves installation time, and eliminates the need for separate mounting.

For complete information about this meter relay and GE's full line of panel meters Circle Number 236.

Stall torque ratings from 3 to 120 ounce-feet and higher and various motor voltages span many application needs. This means these d-c motors can be custom tailored for almost all peripheral equipment needs.

Special mounting flanges, brake mounting arrangements on the commutator end, and shaft extensions can be furnished to your requirements. Also available: cooling air duct inlets at convenient locations. For more data, Circle Number 237.

ments, make wiring connections easier, and provide all the mounting flexibility you can ask for.

Voltage stabilizers are available in rating from 15 to 15000 volt-amperes in both standard and custom-designed models. Ask your GE sales engineer for publication GEA-7376 or circle magazine inquiry card Number 238 for details.

thermistors ideal sensors for SCR and transistorized controllers.

Operation over a wide temperature range permits thermistors to compensate the combined effects of copper windings and temperature-sensitive electromagnetic core materials.

GE thermistors are available as elements or in a wide variety of probe assemblies to suit your applications. Circle Number 239 for more facts.

pulse transformer allows fault sensing at ground potential, even where the TVG trigger is at high negative voltage.

Use General Electric's ZR-7512/13 TVG combination shown in the sketch for protection at 45-KV, or other combinations covering from 300 volts to over 75 KV. For more information Circle Number 240.

FOR THE NEW IDEAS IN ELECTRONICS, look to General Electric—your best single source for electronic components.

ELECTRONIC COMPONENTS SALES OPERATION

GENERAL  ELECTRIC

Three-quarters of your next digital system is on our shelf.

Fairchild has enough MSI and LSI building blocks on the shelf to produce 60 to 80 percent of any digital logic system you have on the drawing board.

Since last October, we've introduced nine versatile MSIs and nine unbelievable LSIs. Designed specifically to work together. And, together, they do more jobs than a hundred ICs.

Our MSI fundamental building blocks do the work of shift registers, counters, decoders, latching circuits, storage elements, digital multiplexers, etc. The LSI building blocks serve as comparators, function generators and dozens of other complex functions.

To tie the whole thing together, we make Micromatrix™ arrays that serve as interface circuitry for all our building blocks. The arrays can be customized for virtually any function in any digital system. They can even be used as fundamental building blocks themselves.

We also make MOS LSI fundamental building blocks: read-only memories, parallel accumulators, A/D converters, you name it. And, we have the interface devices that make our MOS devices compatible with CCSL.

Fairchild MSI and LSI building blocks are available in both military and industrial temperature ranges; in hermetic DIPs and Flatpaks. You can buy them from any Fairchild distributor.

MSI BUILDING BLOCKS*

- 9033 Sixteen-Bit Random Access Memory
- 9034 Two Hundred Fifty Six-Bit Read-Only Memory
- 9300 Four-Bit Universal Register
- 9301 One-of-Ten Decoder
- 9304 Dual Full Adder
- 9306 Up/Down Counter
- 9307 BCD to Seven-Segment Decoder
- 9308 Dual Four-Bit Latch
- 9309 Dual Four-Input Digital Multiplexer
- 9312 Eight-Input Digital Multiplexer
- 9328 Dual Eight-Bit Shift Register

LSI BUILDING BLOCKS*

Bipolar

- 4510 Dual Four-Bit Comparator
- 4610 Dual Two-Variable Function Generator

MOS

- 3501 1024-Bit Read-Only Memory
- 3750 Ten-Bit D/A Converter
- 3751 Twelve-Bit A/D Converter
- 3800 Eight-Bit Parallel Accumulator
- 3801 Ten-Bit Serial/Parallel-Parallel/Serial Converter

LSI CUSTOM ARRAYS*

- 4500 DTL Micromatrix Array
- 4600 TT μ L Micromatrix Array

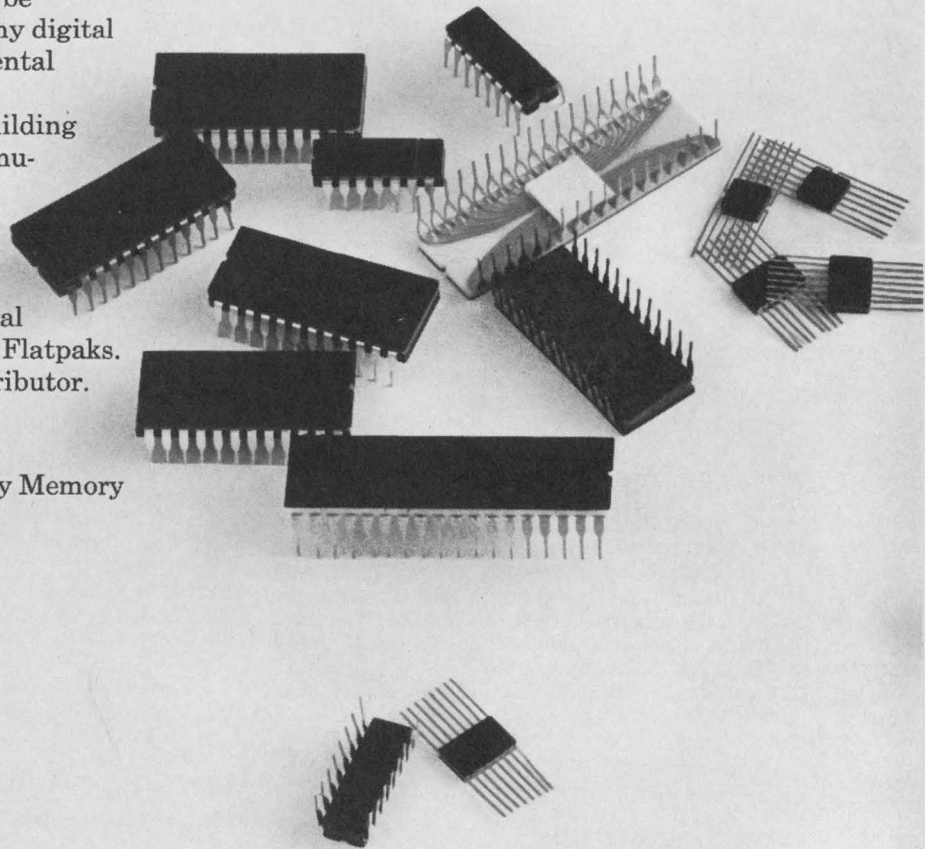

O.K. What about Linear?

We don't know how much of your linear system we have on the shelf. It depends on your design. Our Second Generation linears are so versatile, they may be all you need to build a whole system. Or, at least half.

We have a family of Second Generation linear ICs that will serve as fundamental building blocks in any linear application. We have a temperature-controlled differential preamp that replaces chopper-stabilized and FET input amplifiers. We've developed a frequency compensated operational amplifier that doesn't

require external stabilization components. We've introduced the first MSI

linear. And the first linear with an N-channel FET directly on the chip. And many other devices designed to take circuit designing out of systems designing.

See your Fairchild salesman or distributor. He'll give you the whole story. Digital and linear.

LINEAR BUILDING BLOCKS*

μ A722 Programmable D/A-

A/D Converter Current Source

μ A723 Precision Voltage Regulator

μ A727 Temperature-Controlled Differential Preamp

μ A741 Frequency Compensated Operational Amplifier

*The devices listed here are those introduced by Fairchild as of Aug. 15, 1968. More are on the way. Keep watching the trade press. We're introducing a new IC every week for 52 weeks.

Fairchild Semiconductor, A Division of Fairchild Camera and Instrument Corporation,
313 Fairchild Drive, Mountain View, California 94040

FAIRCHILD
SEMICONDUCTOR

(415) 962-5011/TWX: 910-379-6435



BELDEN...new ideas for moving electrical energy

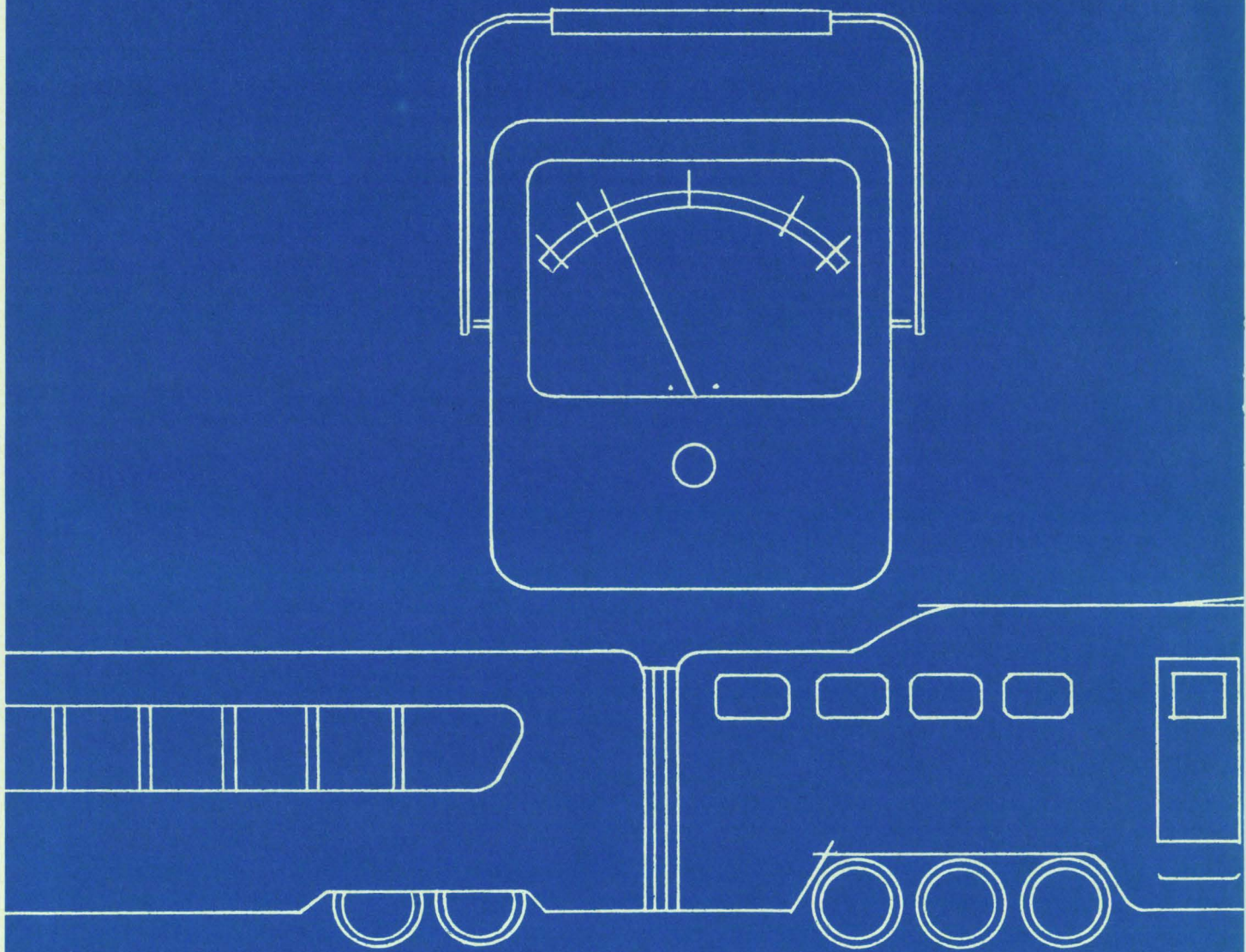

Belden's systems savvy is

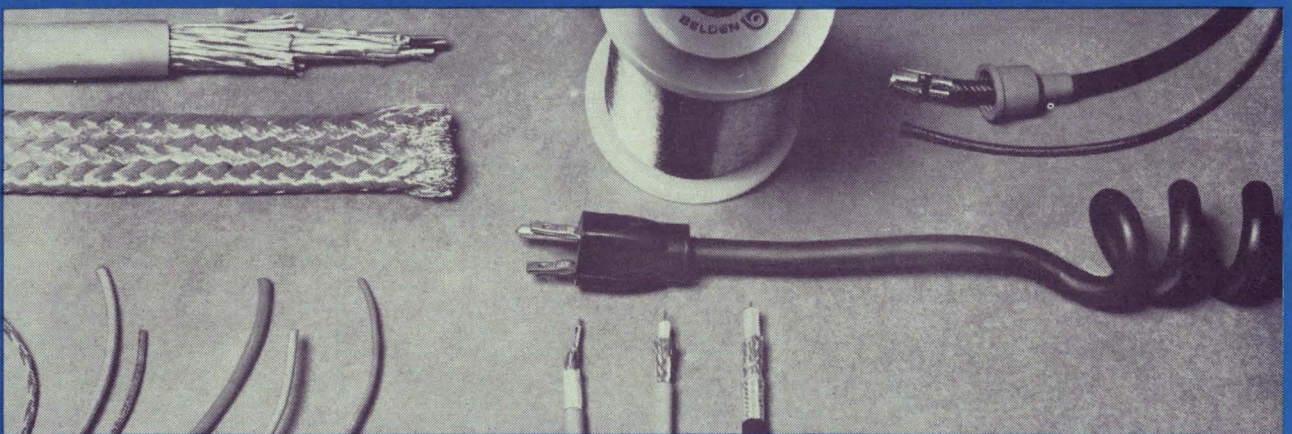

BELDEN

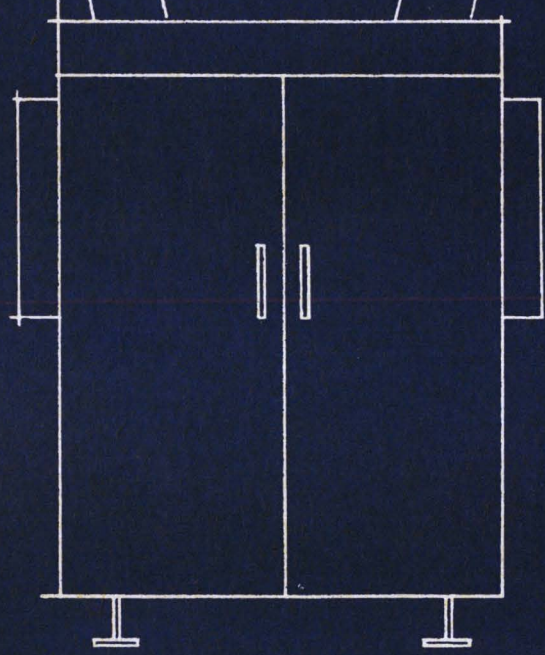
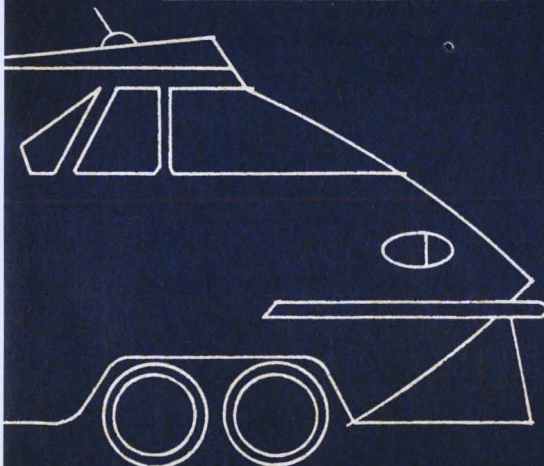
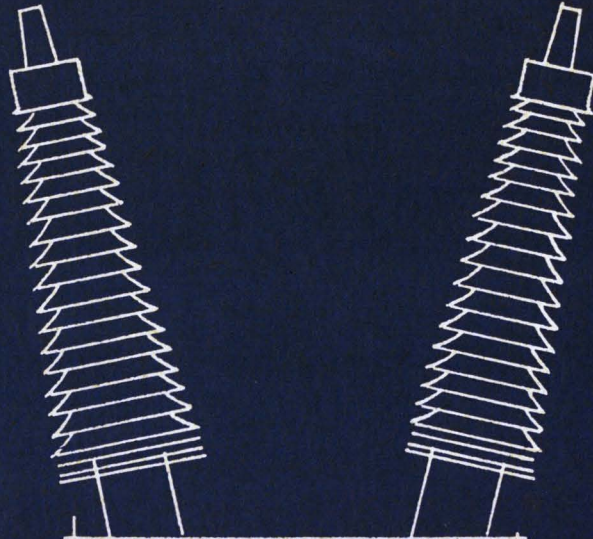
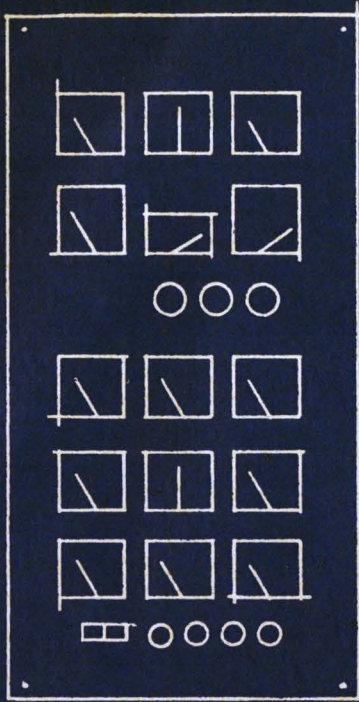

no big deal

It's a lot of little deals, that add up to something big. Like lower costs. Fewer production headaches. Enhanced product reliability. By poking and probing into your product's electrical system and the way it's manufactured and used, Belden Wire Systems Specialists may be able to suggest a wire or cable that costs less. Or that lasts longer, or that takes up less space*. Or maybe they'll suggest a different put-up that saves you assembly time. Or a solution to a stripping problem. They'll also offer you one responsible source for all your wire needs. Because we're the

people who make all kinds of wire for all kinds of systems. So if you're making plans or having problems, get yourself a good deal. Call or write: Belden Corporation, P.O. Box 5070-A, Chicago, Illinois 60680. And ask for our catalog, and the reprint article, "Key Questions and Answers on Specifying Electronic Cable."

*For example: Beldfoil® shielding in Belden cable. It isolates conductors better than anything yet. And it's thinner. You can pack more conductors into a conduit . . . hold down size and weight.

G-2-8

The endless line

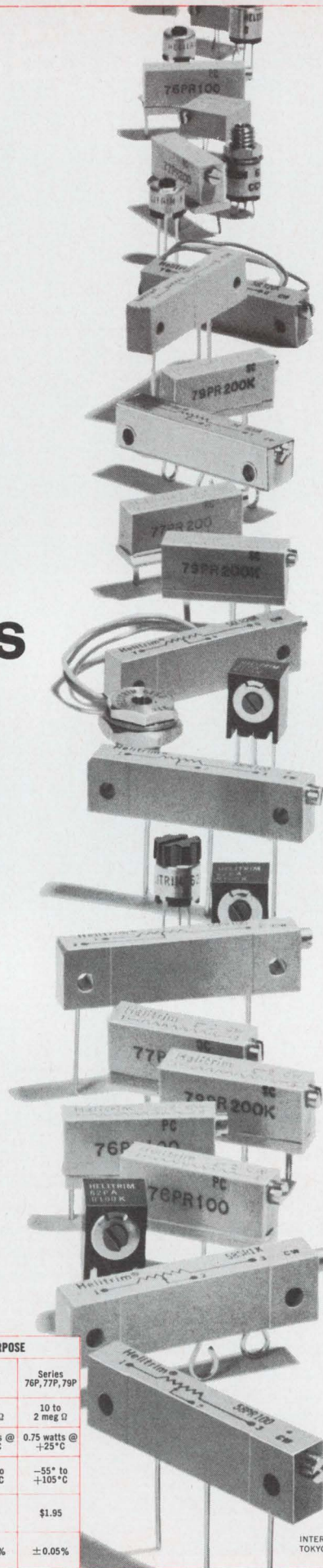

It's a complete line – an endless line of Helipot® cermet trimming potentiometers with a current field failure rate of only 0.08%.

And all have essentially infinite resolution. Plus a wide range of standard resistance values. And excellent setting and total resistance stability under a wide range of environmental extremes. Helipot stocks almost 2 million trimmers in a wide range of models and values at 13 stocking locations. All to fit your every need—whatever it is. To fit your budget—list prices from \$1.75. And to assure you immediate delivery—anywhere in the U.S. and in Canada.

For more details on “the endless line” of cermet trimmers, contact your local Helipot sales representative. He'll tell you all about cermet reliability, fill you in with all available test data and personally handle your Helipot orders.

	MILITARY			HIGH TEMP.	GENERAL PURPOSE		
	Series 55, 56, 58 (RJ11 & RJ12)	Series 61 (RJ22)	Series 63 (RJ24)	Series 50	Series 62	Series 78	Series 76P, 77P, 79P
Resistance Range	10 to 2 meg Ω	10 to 1 meg Ω	10 to 2 meg Ω	10 to 2 meg Ω	10 to 1 meg Ω	10 to 2 meg Ω	10 to 2 meg Ω
Power Rating	1 watt @ +85°C	0.5 watts @ +85°C	0.5 watts @ +85°C	1.5 watts @ +125°C	0.5 watts @ +70°C	0.75 watts @ +70°C	0.75 watts @ +25°C
Operating Temperature Range	-65° to +175°C	-65° to +150°C	-65° to +150°C	-65° to +200°C	-25° to +125°C	-25° to +125°C	-55° to +105°C
Price (List 1 to 9)	\$5.50	\$5.50 (61P) \$6.50 (all others)	\$6.50	\$8.00 (50) \$7.50 (53, 54)	\$1.75 (62P) \$2.00 (62PF) \$2.50 (all others)	\$3.00	\$1.95
Typical Setting Ability	±0.01%	±0.05%	±0.01%	±0.01%	±0.05%	±0.05%	±0.05%

Beckman®

INSTRUMENTS, INC.
HELIPOT DIVISION
FULLERTON, CALIFORNIA • 92634

INTERNATIONAL SUBSIDIARIES: GENEVA; MUNICH; GLENROTHES, SCOTLAND; TOKYO, PARIS; CAPE TOWN; LONDON; MEXICO CITY; STOCKHOLM; VIENNA

Technical Articles

**Dynamic IC parameters
needn't be ignored**
page 74

Designers of digital systems need no longer make do with static tests of integrated circuits. The inadequacy and high cost of dynamic testing gear have kept most time-dependent parameters beyond reach of inspection. But new techniques and equipment are making it easier for the designer to ensure that IC's in a fast, complex system will live up to their specs.

**Hybrid computers I
For the tough ones**
page 86

Doing simulations piece by piece is like looking through the slits in a fence: you can't see all the action. The hybrid computer puts you right on the playing field; it can take on the whole project at one time, yielding a stream of answers. Hybrid machines thrive on tough engineering problems that require more speed, capacity, and accuracy than analog and digital machines can supply alone.

**Hybrid computers II
Choosing a system**
page 91

Electronics



The hybrid machine's ability to display an entire situation—as shown on the cover—makes it ideal for some simulations but doesn't by any means put analog or digital computers out of the running. Deciding which type of system to use requires study of many criteria, including the size of the problem, the amount of speed and memory needed, programing costs, first cost, and

ease of modification. Hybrid systems can enhance most of the advantages of the other types—such as the analog's speed and the digital's memory—but they also negate some.

**SCR's with
regenerative gates**
page 96

SCR's do a fast burn when too much current is applied too fast. But a new kind of SCR can take up to 600 amps per microsecond by using a voltage drop generated at its emitter lip to turn on more of the chip sooner. And this regenerative-gate process can be triggered by a simple, low-cost circuit.

**Home video
tape recorders**
page 102

Looking for a low-cost vtr? Forget it! Fixed-head home video tape recorders, perennially just around the corner, will never turn that corner until the problems of limited bandwidth and high tape consumption are licked. Even then, it will be hard to sell these machines without standardized tapes and inexpensive companion color cameras that consumers can use to record something besides tv broadcasts.

Coming

Microwave ferrites

The world of ferrites is explored in a new Electronics series covering how the materials are grown, their unique properties, and their many uses in today's microwave systems.

Dynamic IC testing made easy

Checks of fast, complex digital circuits have too often been limited to static parameters, but needn't be with new techniques and equipment

By Gordon C. Padwick

Fairchild Instrumentation, Sunnyvale, Calif.

From one nanosecond to the next, the internal state of a digital system is constantly changing as its integrated circuits interact in a complex pattern of on and off states. It is, in other words, a dynamic system. And the faster the changes happen, the greater the system designer's need for adequate data on the dynamic behavior of the IC's.

Such data hasn't been easy to come by. Until recently, the designer had to rely on static data almost exclusively, inferring whenever possible what the dynamic behavior would be.

Static tests of IC's are fairly simple and straightforward: steady-state voltages and currents are applied to certain terminals of the IC, and at the same time, the resulting voltages and currents at the other terminals are measured. For digital IC's, static tests ensure that steady-state fan-out, noise immunity, and power dissipation meet the specifications.

Dynamic tests, on the other hand, measure the time-dependent parameters—propagation and transition times in a gate and setup and release times in a flip-flop, for example.

There may be some correlation between static and dynamic parameters in such simple IC's as diode-transistor and resistor-transistor logic gates. In DTL, propagation delay is largely a function of the output pull-up resistor in the IC and the external capacitive loading. By statically measuring the pull-up resistance for a given load, the propagation delay can be qualitatively predicted; if the resistance is high, the delay will be high, and vice versa. No such simple correlation exists for the more complex transistor-transistor and current-mode logic, however.

Knowledge of dynamic values remains essential to the system designer even in a system that operates at a repetition rate several orders lower than the capability of its component IC's. Malfunctions can occur if the dynamic parameters aren't what they should be. Excessive propagation delay in a

gate can cause race conditions, in which even the simplest logic function can get out of synchronism with the system. Incorrect setup and release times in a flip-flop can prevent a shift register from operating correctly.

If dynamic tests are so important, why aren't they used more? Why have manufacturers (in their data sheets) and users (in their incoming inspection specifications) emphasized static parameters so strongly? And when a dynamic parameter is mentioned, why is it specified at 25°C only? The main reason is that dynamic testing equipment—especially that for checking at the high and low temperatures essential for complete characterization—has been expensive and inadequate.

For example, patch-panel wiring was required for each test; when the test was changed, the wiring had to be changed too. And the long leads needed to contact IC's in environmental chambers added error to high-speed measurements.

Fortunately, programable dynamic measurement systems and improved environmental chambers have recently become available from several sources, so dynamic parameters need no longer be ignored. The important dynamic parameters of digital IC's are described here, and are related to system functions. Although the examples deal specifically with TTL circuits, most of them are equally applicable to DTL, RTL, and CML. The gate and the flip-flop will be considered separately.

Two delays

The most important dynamic parameters of a gate are its two propagation delays. One is the delay t_{pd+} between a falling input and a rising output, the other delay t_{pd-} between a rising input and a falling output (the polarity sign in the subscript indicates the direction of change of the output).

The system designer needs both minimum and maximum values of propagation delay. The max-

imum value determines the number of gates that can be connected in series between two clocked states. Both minimum values are needed to avoid race conditions in the design of the logic system.

(Race conditions exist when a pulse arrives too early or too late relative to another pulse. For example, when two pulses from two sources go to an AND gate, they don't arrive simultaneously because their paths have different propagation delays. If one pulse is delayed by the excessive propagation delay of a gate it passes through, the AND gate doesn't reach its desired state by the time it's used. Similarly, if one input arrives too soon because the propagation delay in its path is too short, it can change the gate's output too soon.)

Whether it's minimum or maximum, or whether the output is rising or falling, propagation delay can be specified in two ways, shown on page 76, and the values yielded by each are not necessarily the same. It can be defined in terms of a percentage—that is, as the interval from the time the input to the gate is, say, 50% between its high and low levels to the time the output is at a certain percentage between its high and low levels. Or it can be defined in terms of voltage—that is, the interval from the time the input passes through a certain voltage to the time the output passes a certain voltage. The second definition is preferred, because when the typical threshold voltage is used as the reference, the measured propagation delays are

more representative of operation in a system.

For meaningful and repeatable measurement, all the factors that affect propagation delay must be specified and reproduced. The principal factors are:

- Input high and low levels
- Input transition time
- Output load (does it have resistive, capacitive, inductive, and nonlinear components?)
- Temperature
- State of unused inputs

Some older IC specifications have avoided defining the high and low inputs and the input transition time by having the device under test driven by another "typical" device of the same type. Such measurements always depend to some extent on how typical the driving circuit is; they do ensure that the conditions represent the system, but correlation of measurements in different locations is difficult. In fact, this type of measurement causes significant differences between measurements by the manufacturer and the user.

The current trend is to define the conditions—the input high and low levels in volts and the transition time in nanoseconds. The disadvantage of this method is that the IC is driven from a constant low-impedance source, even though in a system the source impedance changes—sometimes drastically—during the transition.

Probably, then, both types of test are needed. For specification, when reproducibility is essential, the

Dynamic parameters in a system

A typical system configuration can show how an important system parameter, the clock frequency, depends on dynamic parameters of the IC's.

A flip-flop releases information through a number of gates in series to the input of the second flip-flop. As the clock input C_1 to the first stage changes from the high to the low state, information begins to propagate from the master stage to the output of the slave. This information is then propagated through the chain of gates and eventually arrives at the input of the second flip-flop, where it must be present for at least the setup time before the clock input C_2 changes state to allow information to enter.

Thus the minimum allowable time between the two clock pulses is the sum of the minimum clock pulse width t_{wc} , the maximum propagation delay of the flip-flops t_{pdf} , the maximum propagation delay of the chain of gates t_{pdg} , and the setup time t_{su} of the second flip-flop.

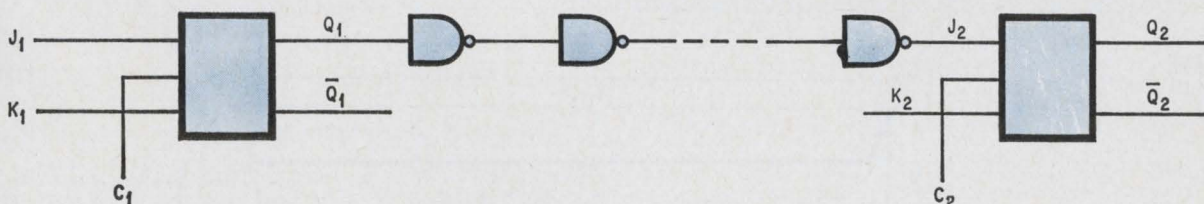
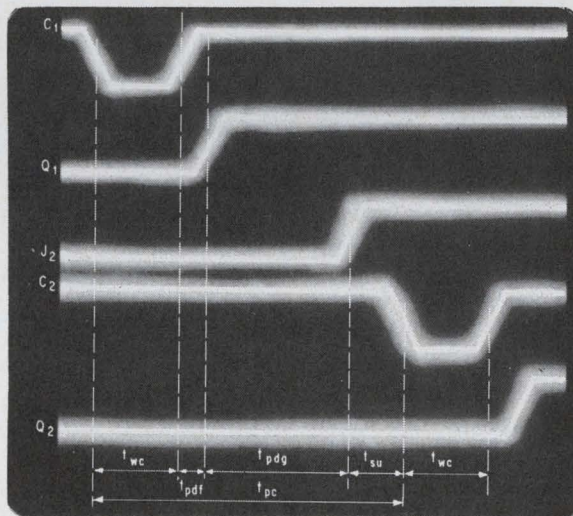

input should be driven by a known voltage source. But when the user wants a detailed understanding of the IC's performance in the system, it's more meaningful to drive with the same type device.

The same problem and the same criteria apply to the output load. To represent system performance, the propagation delay should be measured under both minimum and maximum load. And the capacitance of the interconnection wiring should be accounted for as part of the load.

Unused leads

Input leads not needed for the test can strongly influence the propagation delay measurement, particularly in fast devices such as TTL gates. The condition of unused inputs—left open, connected to a used input, or, in the case of DTL and TTL, connected to a high voltage—should be stated in the IC specification, because each condition will give different propagation delay values. Unless there is a good reason for doing otherwise, connecting the unused inputs to a defined high voltage is recom-

mended, because this is how the IC is used in the system. For TTL, this voltage should represent the high logic level of the IC's interconnected in the system—3 volts, for example.

External leads that connect to an internal node of the IC must also be considered. Examples are the DTL 930 dual four-input gate and such TTL circuits as Motorola's MC2013 dual AND/NOR gate; these circuits have fan-in extension terminals that must remain open unless, of course, they are used for extending the number of inputs.

These extension terminals are connected to high-impedance points in the circuit, where any capacitive loading affects the propagation delay. Even if the leads are just soldered to a printed-circuit board, they will add capacitance to the circuit. Similarly, inserting the IC into a test socket for measurement adds capacitance. So, to obtain reproducible measurements, the capacitance at these fan-in extension terminals should be defined in the test system. This is particularly important in high-speed TTL circuits, less so for the slower DTL.

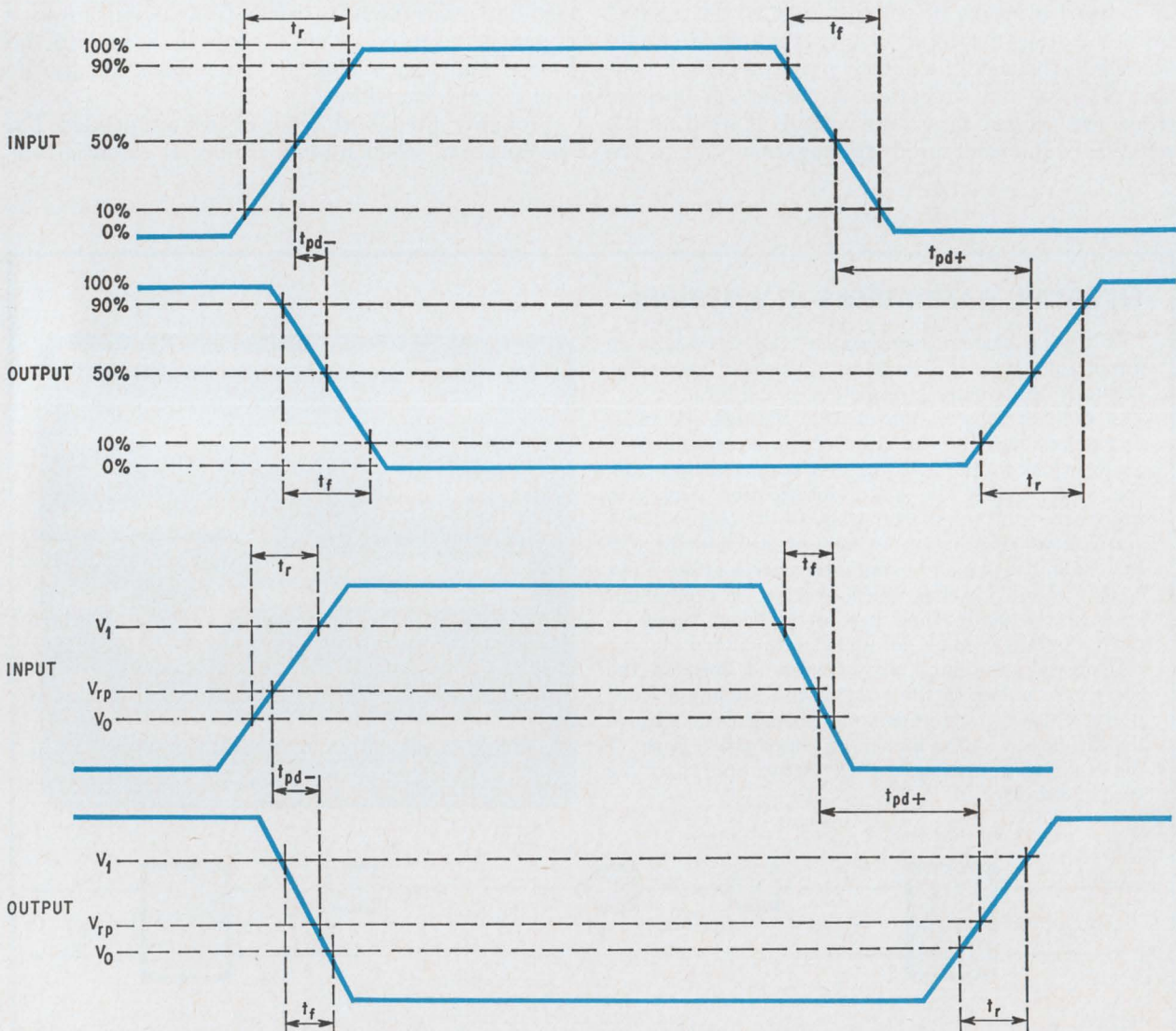

Two ways. Propagation delay can be defined in terms of percentages (top) or voltage levels (bottom).

Master and slave

A typical flip-flop contains two bistable circuits; a "master" and a "slave." Both can be set to the 1 state by an input to the preset terminal of the IC and to the 0 state by an input to the preclear terminal. For TTL circuits, PS and PC are normally either at a high level or open. Setting the flip-flop to 1 or 0 requires a low input to either PS or PC.

In normal operation, the information is presented to the flip-flop at the J and K terminals. This information is set in the master bistable circuit and transferred to the slave bistable circuit by a pulse at the clock (C) input. In the circuit shown at bottom, the input information is accepted by the master bistable stage when the clock input is low and transferred to the slave stage when the clock input is high.

Toggling. Usually, there is feedback from the output of the slave stage to the input of the master stage. This allows the flip-flop to toggle (change state once for every cycle of the clock input). With feedback, the flip-flop acts as a binary frequency divider, since the output frequency is half the clock-input frequency.

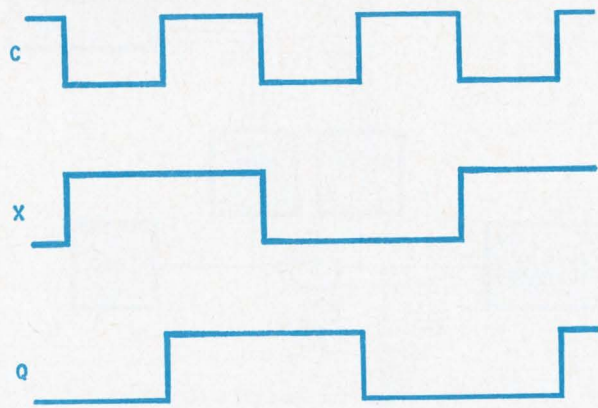

The waveform represents toggling; it shows how the output of the slave stage causes the master to change state as the clock input changes from high to low, and how the output of the master causes the slave to change state as the clock input changes from low to high. This toggling action can be modified if information from an external source is presented to the J and K terminals.

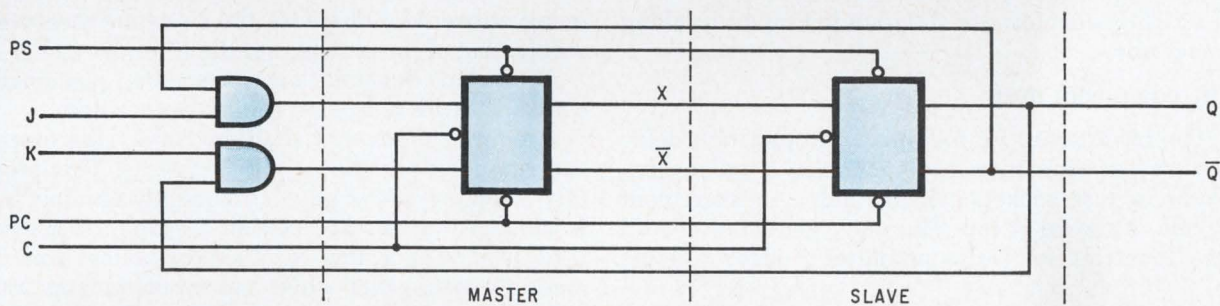

All parameters of an IC depend on the temperature of the silicon chip, and propagation delay is no exception. This temperature is determined partly by the ambient temperature and partly by the amount of power dissipated in the chip and the thermal resistance between the package and the environment. The difference between the temperature of the chip and that of the surrounding air may be insignificant for low dissipation devices such as DTL, but it can be considerable for higher-dissipation TTL. And it's significant indeed for very fast CML circuits, some of which have an extremely high dissipation. The best way to establish temperature for testing is to define the ambient temperature and apply power to the IC briefly before making the measurement. This procedure allows the internal temperature of the integrated circuit to reach equilibrium.

Power dissipation is also important from another viewpoint. Most IC specs define the power dissipation under static conditions, but dynamic dissipation, which can be much higher, is rarely specified. Yet the system designer has to provide a power supply adequate for the devices. Power dissipation

should therefore be measured with the IC switching at the system rate.

Rise and fall

The system designer arranges the connections between IC's in such a way that the output pulse edges are transmitted without ringing or oscillation. The faster the rise and fall times of the IC's, the greater the precautions the designer must take, so the minimum rise and fall time should be specified.

Like propagation delay, t_r and t_f can be defined in terms of either percentages or voltages. Most specifications use percentages (that is, the time required to pass through the 10% and 90% levels). This is an unfortunate choice, because such a definition doesn't represent the system conditions and makes it unnecessarily difficult to get reproducible measurements. Usually, it's better to define t_r and t_f as the time needed to pass between the high and low threshold voltages.

When percentages are preferred, however, the specification writer should let the type of IC being tested determine the reference points rather than automatically choosing 10% and 90%. With CML,

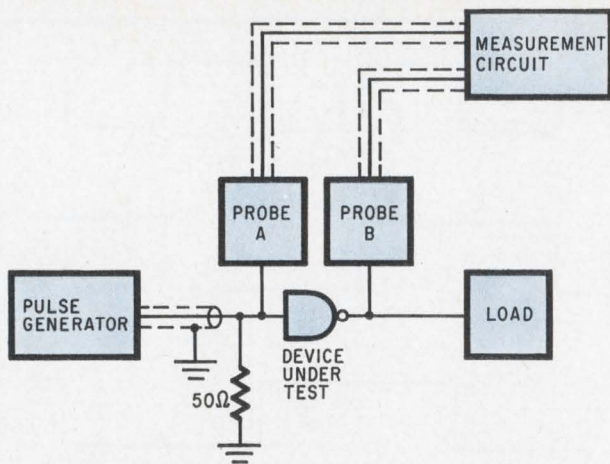

No errors. The measurement system should not introduce more capacitance than specified and its rise time should be shorter than that of the IC's.

which has only a small difference between the high and low logic levels, using 20% and 80% prevents errors that might result from the rounded bottom of a rising waveform or the rounded top of a falling waveform.

The equipment itself

The basic setup for measuring propagation delay and output transition time includes a pulse generator, a test socket, a load, and a measurement circuit as shown at top. The pulse generator should have controls for pulse amplitude, offset voltage,

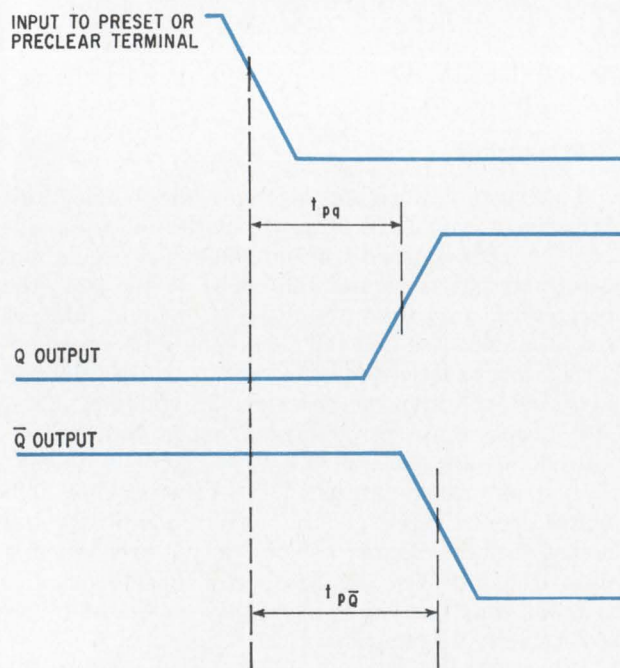

Preset and preclear. The propagation delays from PS to Q, PS to \bar{Q} , PC to Q, and PC to \bar{Q} are measured independently.

rise time, and fall time, in addition to the usual ones for frequency, pulse width, and delay. The measurement circuit is usually a sampling oscilloscope or a digital instrument using the sampling principle.

The test socket deserves special attention. It should provide connections to the input and output terminals of the device without introducing measurement errors. For high-speed IC's, it must allow the pulse generator's output to be terminated close to the IC's input terminal and at the correct output impedance, usually 50 ohms. And the capacitance the test socket introduces at each terminal of the circuit must be exactly as stated in the specification.

The measurement probe, too, must be very close to the terminals of the circuit. CML circuits are often specified for a 50- or 100-ohm load and therefore don't require a high-impedance probe, but TTL and DTL do. Ideally, the probe should have no offset voltage and no offset-voltage drift; alternatively, there should be some means of compensation.

The over-all rise time of the measurement system—from the pulse generator, through any relays to the test socket, and back through the relays to the measurement circuit—should be less than the times being measured. Otherwise the rise time measured will be that of the system, not the IC under test.

Additional dynamic measurements, principally concerned with noise, are sometimes wanted:

- Input changes that shouldn't affect the output can cause undesirable output transients. This property of some types of gate is frequently ignored, but it can cause noise problems in a system if it's not controlled. For a TTL NAND gate, a test can be made to ensure that while one input remains low, changing another input from low to high doesn't cause the gate's high output voltage to fall momentarily by more than a specified amount.

- Multiple gates on the same chip can interact if the voltage-supply or ground metalization is improperly designed. A test can be made to ensure that no transients occur on the output of one gate when another switches.

One of the undesirable features of TTL is the current spike that occurs in the positive supply as the device switches. This is a major source of noise in a system. Devices should be checked—at least during evaluation of a design—to make sure that the current spikes are within manageable limits.

Flip-flop tests

Despite the variety of IC flip-flops, the dynamic tests on all of them are similar. The tests measure propagation delay, output transition time, synchronous timing, and such parameters as noise immunity, noise generation, and power dissipation.

For DTL systems, the 945 flip-flop, widely available, has become an industry standard. There is no standard TTL flip-flop, however, so the system designer and the spec writer must thoroughly understand the device they're working with. But since the Fairchild $TT\mu L$ 9000 J-K flip-flop is as representative a TTL as any, it can serve as an example.

(The 9000 behaves like the basic flip-flop described in "Master and slave" [p. 77], but it has three J inputs, three K inputs, and a J-K input, and the clock input is inverted.)

Two types of propagation delay are specified for a flip-flop: that from the clock terminal to the resulting output at the Q or \bar{Q} terminals, and that from the preset and preclear inputs to the outputs.

To characterize preset and preclear delay, four measurements are required: PS to Q and \bar{Q} , and PC to Q and \bar{Q} , as shown on page 78, bottom. All the factors that affect propagation delay in gates also apply here.

In most types of TTL (Sylvania universal high-level logic, SUHL, is an exception), the preset and preclear inputs control both the master and slave bistable stages. Only the propagation delay to the output of the slave stage can be measured, however, since no output terminals are available from the master stage.

When the delay from the preset or preclear terminals to the output is measured, the clock input must be in a state that does not interfere with the PS and PC inputs (for the 9000, this means that the input to the clock terminal should be low).

Measuring the recovery time of the PS and PC inputs will indicate how soon after PS or PC has returned to a high level the flip-flop can be reliably toggled—made to change state once every cycle—by an input to the clock terminal. Two pulse generators are needed for this test: one to provide an input to the PS or PC terminal, the other to introduce a clock pulse at a specified time after PS or PC returns to the high level. The output of the flip-flop is examined to see if the device has switched correctly.

The clock's edge

In normal operation, of course, the flip-flop is driven by clock pulses, not by PS or PC pulses. Whether it changes state depends on its previous state and the state of the J and K inputs before

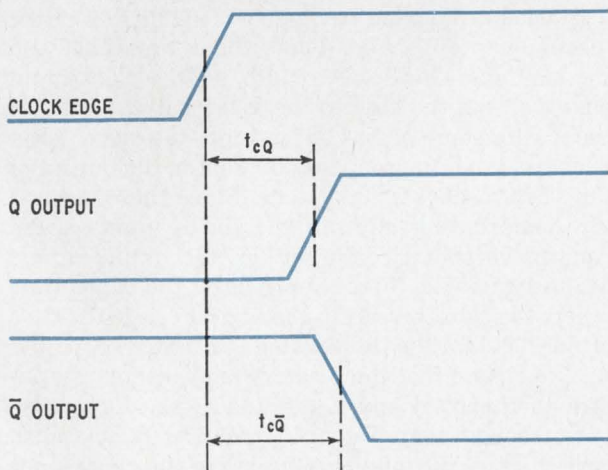

Clock delay. The propagation delay from the clock edge input to the Q and \bar{Q} outputs should be measured as the flip-flop switches from 0 to 1 and 1 to 0.

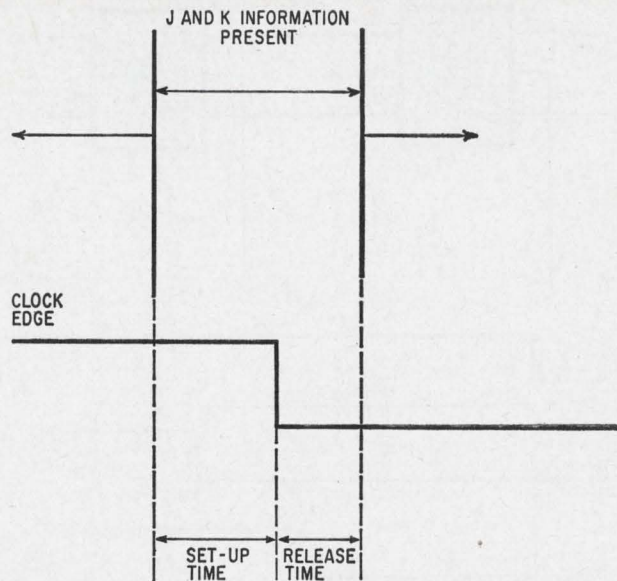

Before and after. The setup and release times indicate by how long the J and K information must precede and follow the clock edge.

and during the transition part of the clock pulse. In the 9000, the master bistable stage changes state when the clock input changes from a low to a high level. Subsequently, as the clock changes from a high to a low level, the state of the master stage is transmitted to the slave. In certain other flip-flops, the functions of the high and low clock levels are reversed. As with the PS and PC delays, regardless of the IC, only the delay through the slave stage can be measured, since no outputs from the master stage are available.

At least four measurements are needed to characterize the clock-to-output delay, as shown at bottom of this page. As the flip-flop switches from 0 to 1, the propagation delay between the clock input and the Q and \bar{Q} outputs should be measured, and these two measurements should be repeated as the flip-flop switches from 1 to 0. Ordinarily, this is done for both light and heavy loads, for a total of eight measurements.

Even though propagation delay through the master stage can't be measured directly, it's easy to make sure that the delay is not too long by simply seeing that the flip-flop operates correctly at the minimum specified pulse width. To make this test, first set the flip-flop at a known state by the PS or PC input. Set the J and K inputs at the state that will make the flip-flop switch when a clock pulse is applied. While these conditions are being set, hold the clock input at a level that prevents information from being transferred into the master stage; for the 9000, this means holding the clock in the low state. If the flip-flop operates correctly when the minimum-width pulse is applied, information will be transferred into the master stage as the clock pulse goes from low to high, then transferred to the slave stage as the clock returns to the low level. Therefore, if there is an output, it's

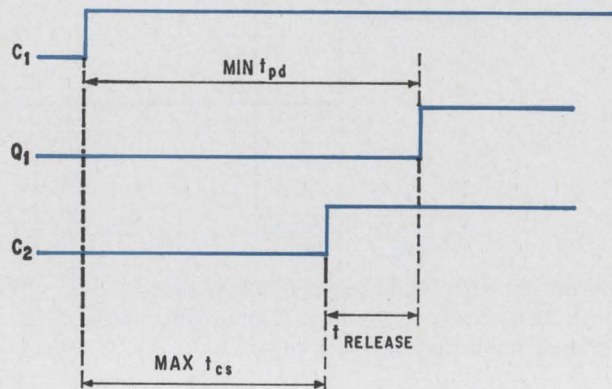
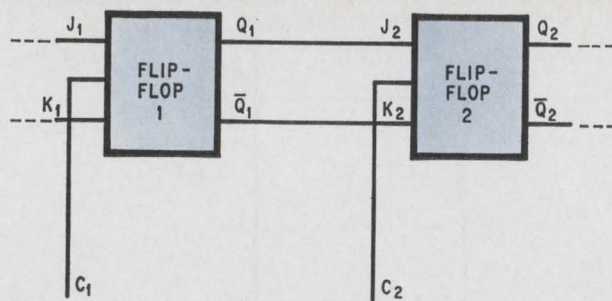

Askew. The time separation between clock edges at two adjacent flip-flops should not be greater than the propagation delay minus the release time.

safe to assume that the propagation delay through the master stage is less than the width of the clock pulse.

Repeating this procedure for decreasing pulse widths shows what minimum pulse width will permit information to be set in the master stage; this measurement indicates the minimum noise pulse width that the circuit is susceptible to.

Setup and release

Descriptions of flip-flop operation often say that the state of the J and K inputs determines whether the device switches during the clock-pulse transition. This description is somewhat oversimplified, because it doesn't take into account that the J and K inputs change. So it's necessary to ask how long before and how long after the clock-pulse transition the J and K inputs must remain constant. The setup and release times, as shown on page 79, provide the answer.

The setup time is the interval that the J and K information must be present before the clock transition. The release time is the interval after the transition that the information must be present. Release time can be either positive or negative; a negative value means that the J and K information can be released before the clock transition.

The actual values of the setup and release times can't be measured directly; tests are made on a pass-or-fail basis. The J and K information is presented to the flip-flop in the form of pulses suitably timed with respect to the clock edge; that is, present for a period equal to the setup time before

the clock edge and for a period equal to the release time after the clock edge. If the device operates correctly—if it switches to the state defined by the J-K inputs—it meets its setup and release time specifications. Precise values, if needed, can be determined by reducing the time difference between the J-K pulse and the clock pulse incrementally, until the IC just operates.

Since setup and release times affect the master stage only, there's no need to load the outputs of the flip-flop during the tests.

System parameters

In addition to the basic flip-flop parameters, related system-oriented parameters are sometimes specified. Depending on how the flip-flop will be used, it may be better to measure system-oriented parameters and omit the basic ones.

One such system parameter is clock skew. When only a few flip-flops are connected as a shift register, their clock inputs can usually all come from the same source, and the clock transitions at two adjacent flip-flops occur simultaneously, for all practical purposes. But with a shift register containing more flip-flops, more than one clock source may be needed, so there'll be a time difference between the clock edges at some adjacent stages. This time difference is the clock skew.

The maximum allowable clock skew is the minimum propagation delay less the release time of the IC, as shown above. If the skew exceeds this maximum, the driven flip-flop, when the clock edge arrives, may change its state to the post-clock rather than pre-clock state of the driving flip-flop. If this happens, the information will pass through two or more stages of the shift register instead of just one stage for each clock pulse.

Another system-oriented parameter is the maximum toggling frequency of a frequency divider, which is a flip-flop with its outputs cross-coupled to its J and K inputs, either internally or externally. The maximum toggling frequency is the maximum clock frequency that will allow the divider to switch reliably, once for each cycle of the clock input.

Maximum toggling frequency is a function of the maximum propagation delay, the setup time, and the minimum clock-pulse width. As the clock input changes from the high to the low level, the state of the master stage begins to pass into the slave. After a certain time (the propagation delay), the output of the slave reaches its final state. Since these outputs are connected directly to the J and K inputs in the frequency-divided configuration, the outputs must be present at the inputs for at least the setup time before the clock reverts to the high level (in the case of the 9000) for the master stage to switch correctly. And to ensure that the master stage accepts the information at its J and K terminals, the clock pulse must remain high for the minimum clock-pulse period. Thus, the minimum period of the clock input wave-form is the sum of the maximum propagation delay, the setup time, and the minimum clock-pulse width.

Designer's casebook

Collector clamping improves threshold detector

By Brian Fugit

Westinghouse Electric Corp., Baltimore

Fast rise and fall times, low hysteresis, and a stable reference voltage are possible in a threshold detector when the zener diodes used for reference voltage can also act as the anti-saturation elements of a switching transistor.

When the threshold level of D_3 is exceeded, diode D_1 and zener diode D_2 conduct and clamp the collector of Q_1 at a voltage determined by the relation

$$V_c = V_3 - (V_1 + V_2)$$

where V_c = collector voltage of Q_1

V_3 = zener voltage of D_3 (6.8v)

V_1 = forward drop of D_1 (0.7v)

V_2 = zener voltage of D_2 (5.6v)

For the values shown, the clamp point is 0.5 volts.

This clamping level is solely a function of the two zeners and one diode. By choosing zener values which set the voltage level just outside the transistor's saturation region, the turn-off delay, associated with charge accumulation in the base region, is eliminated.

The mechanism by which the collector is clamped out of saturation is based on the constant voltage characteristic of diodes and zeners. Excess base current is bled off by D_1 and D_2 to maintain the V_{CE} of Q_1 above the preset level. At the clamp-voltage level, D_1 and D_2 are on the verge of conduction.

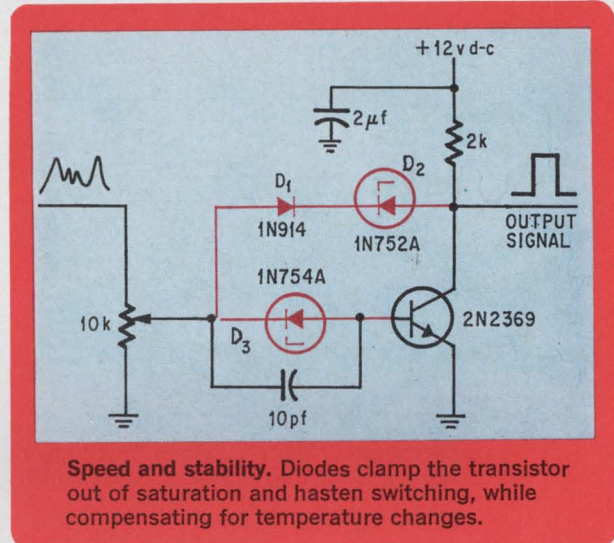

Speed and stability. Diodes clamp the transistor out of saturation and hasten switching, while compensating for temperature changes.

Since dense current accumulations are not swept in and out of the transistor, rise times of 30 nanoseconds and fall times of 35 nsec are possible.

The circuit is also temperature-stable by proper selection of components. Zener D_3 is matched to the base-emitter junction of Q_1 for a near-zero temperature coefficient; D_1 and D_2 are matched to each other. The result is a circuit whose threshold is insensitive to temperature variations. Since it is in the base-collector circuit, D_1 prevents collector current from flowing back into the base during the turn-off time. Potentiometer R_1 was placed at the input to establish the threshold level. The small capacitor across D_3 assists in sweeping any residual charge out of Q_1 's base region.

Circuit divides pulses without binary counters

By Stanley Domanski

Burroughs Corp.,* Plainfield, N.J.

A divider or counter can be adjusted to give a single output pulse for any number of input pulses—from 2 to 90. The adjustment eliminates a binary

* Now with RCA, Somerville, N.J.

counter and a decoder.

Input pulses trigger a one-shot multivibrator made up of Q_1 and Q_2 which generates a 150-microsecond pulse. The pulse amplitude is clamped at 6 volts by D_1 and applied to the base of Q_3 , which acts as a constant current source charging C_1 . As long as the collector of Q_2 is high—above 6 volts— Q_3 conducts and C_1 charges. When the collector of Q_2 is low, the charge is prevented from leaking off C_1 by D_2 . Eventually, the charge on C_1 reaches the firing voltage of Q_4 and an output pulse occurs.

The number of pulses put into the circuit that

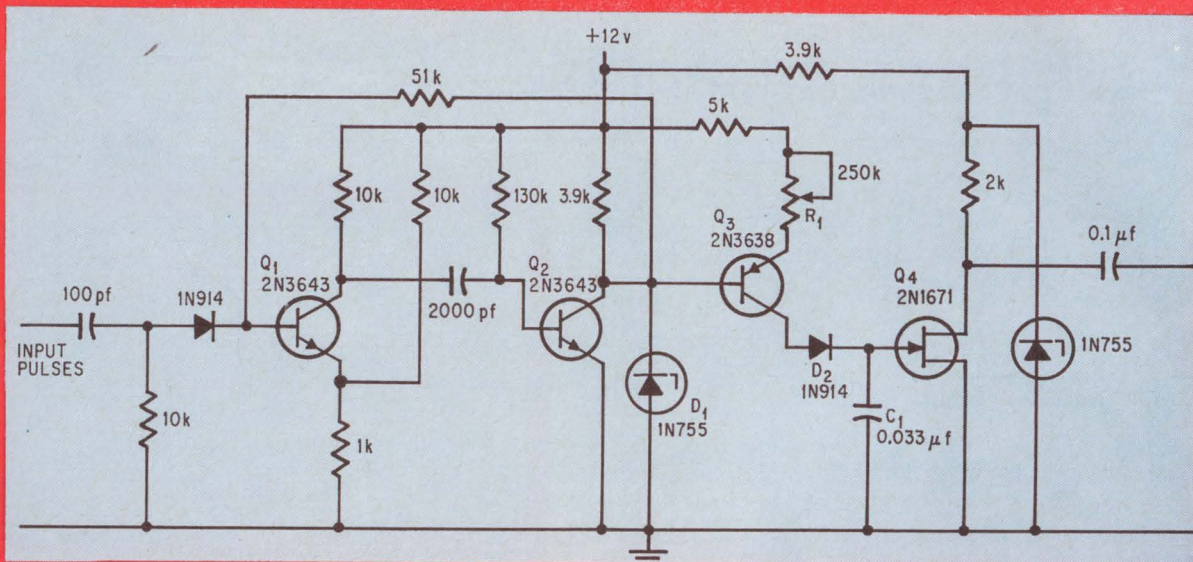

Dividing. Input pulses trigger a multivibrator whose output charges a capacitor. When the charge reaches a preset level, unijunction Q_4 is triggered, producing one pulse. The number of pulses from the multivibrator needed to charge C_1 is determined by the setting of R_1 , a 10-turn potentiometer.

are needed to produce an output pulse is determined by how fast C_1 charges through Q_3 . The rate at which C_1 charges depends on the width of the pulse from the one-shot multivibrator and the mag-

nitude of the current supplied by the constant current source.

To achieve high resolution of the number of pulses to be divided, R_1 should be a 10-turn pot.

Voltage adjustment extends multivibrator's pulse width

by Peter Schiff

RCA Electronic Components & Devices, Somerville, N.J.

Decreasing the capacitor charging voltage instead of adjusting the RC time constant greatly extends the range of possible variation in the output pulse width of a monostable multivibrator. This avoids the problems of maintaining constant collector current while varying the resistance of the RC timing circuit in conventional monostable multivibrators.

The charging voltage of timing capacitor C_1 is adjusted with R_1 , a potentiometer in the collector circuit of Q_1 . The width of the output pulse can be calculated by equating the current in C_1 at the end of the unstable mode, (V_{cc}/R_2) , to the current in C_1 at the beginning of the unstable mode, $(V_{cc}/R_2)(1 + \alpha)$, where α is the potentiometer factor, $R_{1a}/(R_{1z} + R_{1b})$, multiplied times the exponential

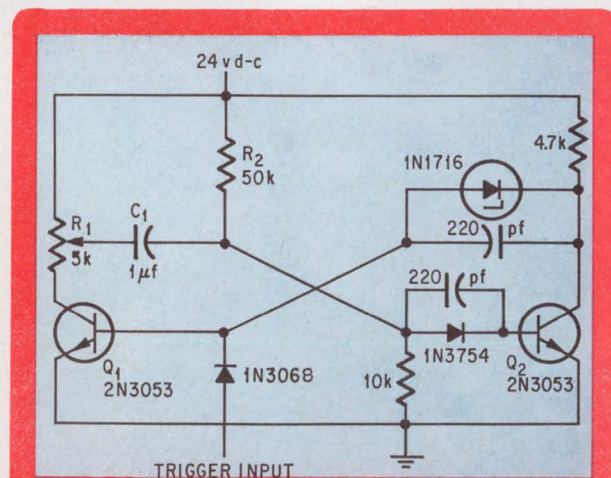

Voltage setter: Potentiometer R_1 can be used to adjust the voltage for the timing capacitor C_1 , producing a broad range of pulse widths.

decay factor, $\exp(-T/R_2 C_1)$. This equation holds under the assumption that resistor R_2 is much larger than the parallel combination of the two sides

of the potentiometer, R_{1a} and R_{1b} . The period then is $R_2 C_1 \ln(1 + \alpha)$.

The resulting monostable multivibrator has an adjustable range greater than 100:1. If both R_1 and R_2 are varied, ratios greater than 1,000:1 can be attained. The zener diode helps obtain a sharp,

consistent switching action for large ranges.

The circuit offers several advantages in addition to greater range: adjustment of the pulse width has little effect on the collector current of Q_1 ; R_2 affects the low and high end equally, and provides a suitable calibration control.

Bridge amplifier provides isolation

By M.A. Hassan and T.A. Greinevitch

Atomic Energy Establishment, Cairo, Egypt

Two low-power transistors added to a bridge amplifier, separate input current circuits and insure class B operation. The transistors, Q_5 and Q_6 are of opposite polarity to the bridge transistors.

When the potential of point A is positive with respect to point B, transistor Q_6 conducts and provides base current to power transistors Q_1 and Q_4 . The magnitude of this current depends on the potential difference between points A and B, and on the value of R_1 , R_3 , and R_4 . Thus the load current will not directly depend on the value of the load resistance—unlike the normal situation in a bridge amplifier where the load resistance is an important factor. Transistors Q_2 and Q_3 don't conduct because

transistor Q_5 has a reverse-biased emitter.

When the potential of point B becomes positive with respect to point A, Q_5 will conduct and supply base current to transistors Q_2 and Q_3 while Q_6 will have a reverse-biased emitter junction, keeping Q_1 and Q_4 from conducting.

The load current is approximately proportional to the difference between the potentials of points A and B. The amplifier is phase sensitive and will retain its class B mode of operation no matter what the common mode potential. However, an upper limit has to be imposed on load resistance R_5 —the voltage across R_5 must not be greater than the voltage difference between points A and B. If this restriction were not placed on the amplifier, the circuit would be driven out of the class B mode.

The amplifier, shown schematically, was developed to control a 100-watt direct-current motor which positions control rods in a nuclear reactor. The bridge circuit was used as the output stage of a direct-coupled amplifier where isolation between the amplifier's input and output were required, and high efficiency was necessary.

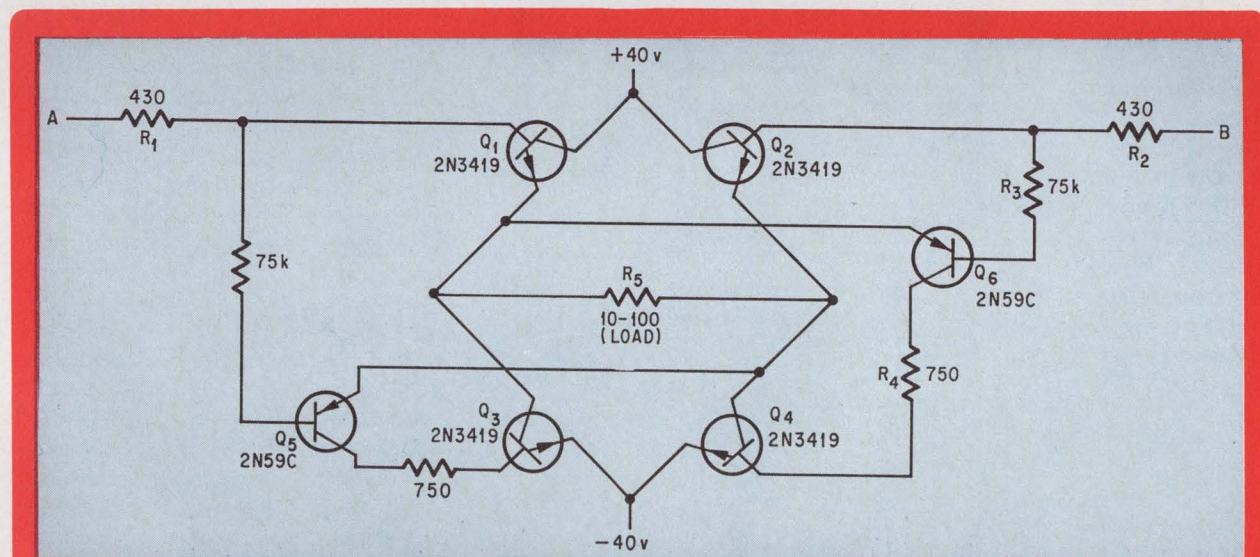

Amplifier with class. Bridge amplifier, which operates class B, is used when isolation is needed between the input and output. When point A is positive with respect to point B, Q_1 turns on, and Q_6 turns on Q_4 . When B is positive, Q_2 conducts, and Q_5 is turned on by Q_5 . The amplifier isn't dependent on the load resistance.

Now that you're going to buy
an ac voltmeter,
get hp's
extra measure of

Performance

Sonar, acoustics, audio response, servo, communications measurements – or ac to dc conversion and amplification – these and many more are yours with a Hewlett-Packard 400-Series AC Voltmeter!

The 400-Series Voltmeters are wide bandwidth, average-responding, rms calibrated instruments. They are solid state, externally battery operable, equipped with the exclusive hp taut-band meter.

Each of the instruments in the 400-Series is outstanding in frequency, or sensitivity or dB range. The 400E/EL voltmeters, for example, have a broad frequency range of 10 Hz to 10 MHz. The 400F/FL meters have 100 μ V full-scale sensitivity. They also have a low-pass filter to take out unwanted high frequencies for low-level audio measurements. The 400GL measures -100 to +60 dB for the greatest range available in a voltmeter.

How to choose the right ac voltmeter that exactly matches your requirements? Call your hp field engineer, he can show you the widest range of these instruments now available. Get that hp extra measure of performance in your ac voltage measurements!

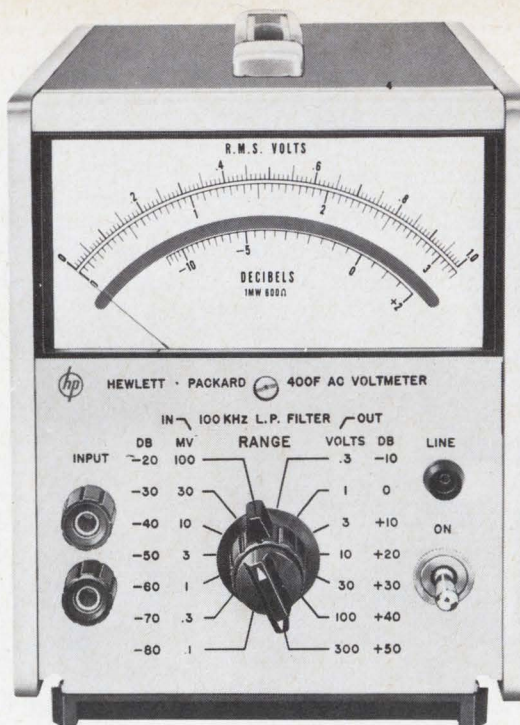

hp Model 400E|EL
for Broad-Frequency

Performance

The hp 400E/EL solid-state simple-to-operate ac voltmeters give a wider

frequency coverage than any other comparable instrument! They cover a frequency range from 10 Hz to 10 MHz and have a constant 10 M Ω input impedance on all ranges.

These voltmeters give exceptionally long-term stability. Calibration is not dependent on components subject to aging.

Either Model 400E or 400EL can be used as a wide-band ac voltmeter, high-gain ac amplifier or as an ac to dc converter.

The 400E has full scale accuracy of 1% on the linear voltage (upper) scale. Lower scale is log dB. The 400EL has 1% full scale accuracy on the linear dB (upper) scale. Lower scale is log volts.

Option 02, available on both 400E and 400EL, provides a front panel relative control for a variable 3 dB change in sensitivity on each calibrated range. This gives a convenient level, such as 0 dB, for relative voltage measurements. The control has a detented position to insure calibration accuracy.

AC-DC Converter:—The 400E/EL Voltmeters provide a linear dc output (1 Vdc for full scale meter deflection) proportional to meter deflection which can be used as a 10 Hz to 10 MHz ac to dc converter, with an accuracy of $\pm 0.5\%$.

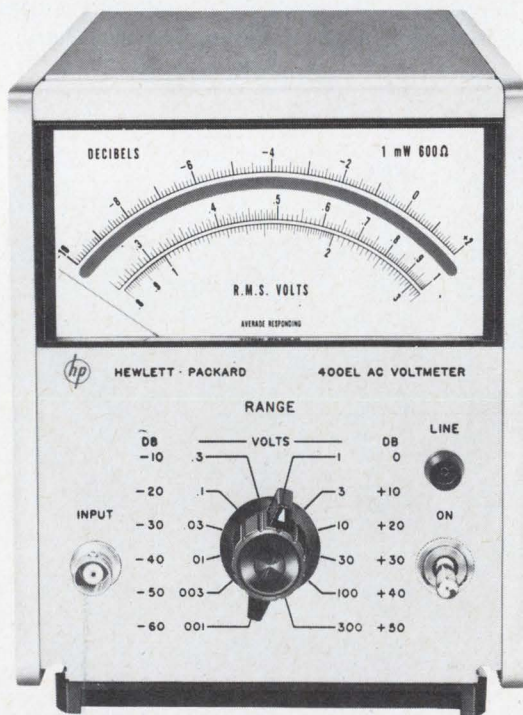

PREPARE

Pick the 400E or 400EL when you need broad frequency range performance. See table for comparative specifications.

*hp Model 400F/FL
for High Sensitivity*

Performance

In addition to the 100 μ V full-scale sensitivity, the 400F/FL AC Voltmeters contain a low-pass 100 kHz filter for controlling the bandwidth of noise—reduces the effects of unwanted high frequencies to give you more accurate low-level audio measurements.

You get fast response with these instruments—a reading in less than two seconds after turn-on—and <2 seconds overload recovery, too!

The 400F has 0.5% full scale accuracy on the linear voltage (upper) scale. Lower scale is log dB. The 400FL has 1% accuracy full scale on the linear 12 dB (upper) scale. Lower scale is log volts.

Amplifier:—Models 400F/FL are stable, low distortion, wideband ac amplifiers, with a maximum open circuit gain of 80 dB. AC output is 1V rms (full scale) open circuit, or 0.5 V rms into 600 Ω and is proportional to meter indication on voltage scale. Frequency response: 20 Hz to 4 MHz. Noise level <5 μ V referred to input.

For general purpose low level audio, servo, communications or sonar measurements with low noise, choose the hp Model 400F or 400FL AC Voltmeter. Check the comparative specifications in the table.

*hp Model 400GL
for Broad dB Range*

Performance

With the -100 to +60 dB measurements range (100 μ V to 1000 V full scale), the hp Model 400GL AC Voltmeter is the instrument with the greatest dB range—20 dB linear log scale!

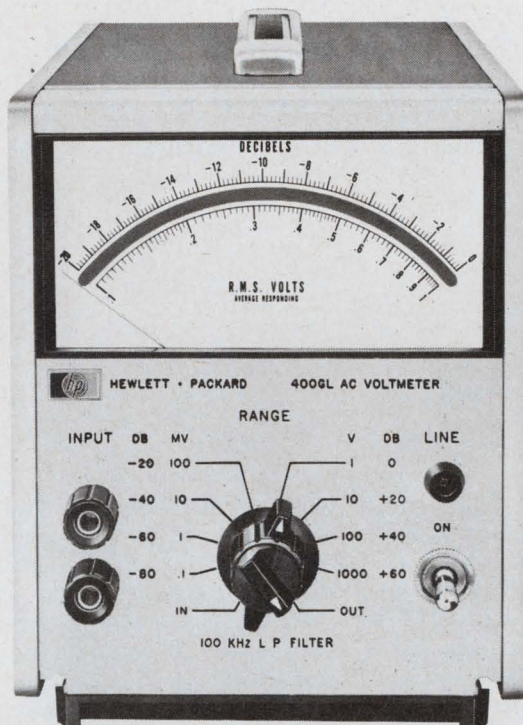

This voltmeter was especially designed to increase efficiency and speed of acoustic and sonar measurements. It can be used in calibration laboratories because of its speed of response, accuracy, high sensitivity and low noise.

The 400GL also can be used as a high-gain ac amplifier with 80 dB amplification.

When you need a ruggedly-built ± 0.2 dB accurate voltmeter for broad-range dB measurements, hp Model 400GL is your best choice! See table for more specifications.

hp Model 11074A Probe

The hp Model 11074A Voltage Divider Probe (10:1 division ratio) provides constant 10 pF with 10 M Ω input impedance at the point of measurement. Probe and suitable adapter are usable with all the 400-Series AC Meters. Price: hp Model 11074A Probe, \$45.00, plus adapter.

Pick Your

Performance

	400E/EL	400F/FL	400GL
Frequency Range	10 Hz to 10 MHz	20 Hz to 4 MHz	20 Hz to 4 MHz
Sensitivity	1 mV-300 V	100 μ V-300 V	100 μ V-1000 V
dB Range	-72 to +52	-92 to +52	-100 to +60
Low Pass Filter	No	100 kHz	100 kHz
AC-DC Converter	1 V at 1 mA	No	No
AC Amplifier	150 mV/50 Ω	1 V/600 Ω	1 V/600 Ω
Price	400E: \$310.00 400EL: \$320.00	400F: \$300.00 400FL: \$310.00	400GL: \$290.00

Option 01: Available on 400E and 400F, puts log scale uppermost for greater resolution in dB measurements. Other scale options available on request.

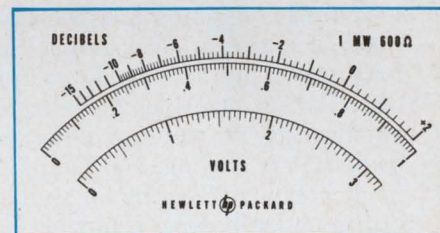

For assistance in selecting the ac voltmeter that best fills your needs, contact your nearest hp field engineer—he has full specifications. Or, write to Hewlett-Packard, Palo Alto, California 94304. Europe: 54 Route des Acacias, Geneva.

HEWLETT  **PACKARD**
An extra measure of performance

Circle 85 on reader service card

INFORMATION RETRIEVAL NUMBER 7

097/7R

MANAGE

Three-way dialogue yields solutions in depth

With analog and digital processors communicating with each other and with him, an engineer can simulate all aspects of a problem, change the variables at will, and receive a stream of answers

By George R. Marr Jr.

Consultant, Little Silver, N.J.

and Leo G. Noronha

Electronics Associates Inc., West Long Branch, N.J.

Hybrid computers thrive on the tough engineering and scientific simulations that require more speed, capacity, and accuracy than analog or digital machines can supply alone. The art of hybrid computing—the mating and programing of analog and digital equipment—has grown to the point where it's now applied routinely in these simulations. And it's also starting to find on-line applications in industrial processes requiring continuous control by an analog computer and programed control by a digital machine.

Hybrid computing is especially suited to simulations of entire projects rather than fragments and to those requiring timely man-machines interaction. Hybrid machines have been used in electrical engineering for studies of antenna patterns, ionospheric-ray tracing, and learning and recognition; in chemical engineering for studies of kinetic curve-fitting and tubular reactors; in aerospace and mechanical engineering, of vehicle launch paths, aircraft adaptive control, and aerospace vehicle re-entry; in nuclear engineering, of reactor design and operational start-up; and in biomedical engineering, of human body functions and heart and brain wave patterns.

Dynamic differentials

Many applications have common requirements, among them the solution of ordinary and partial differential equations and the processing of data.

Ordinary differential equations can be divided into initial-value and boundary-value problems. For initial-value problems hybrid computation offers two advantages. The analog part provides exact,

fast, and simultaneous solution of sets of differential equations. And for highly nonlinear differential equations, the digital portion provides high-accuracy multiplication and function generation.

A common technique for solving boundary-value problems is to guess at the initial value, solve the equations as an initial-value problem, compare the given boundary condition with the computed value, and then revise the initial guess. This procedure is repeated until the solution is found. Because the analog part of the hybrid can solve different segments of the same problem at different speeds, the iterative boundary-value technique can be implemented in fast time, while the rest of the system simulation is carried out in real or slow time. The high-speed parallel logic in the hybrid can be used to control the iterative procedure.

One approach to the solution of partial differential equations is to reduce them to a set of simultaneous differential-difference equations. All of the equations are functionally identical, the only distinction being that the subscripts of the dependent variable differ in each equation. This simply means, of course, that each equation corresponds to a different segment in time or space, depending upon which variable has been retained as a continuous variable.

If the equations are differenced with respect to time, they can be solved in an iterative fashion on a hybrid computer by time-sharing an analog circuit representing a single differential equation. The iterative procedure would update the subscripts from run to run, store the appropriate variables in the digital computer, and seek interpolated

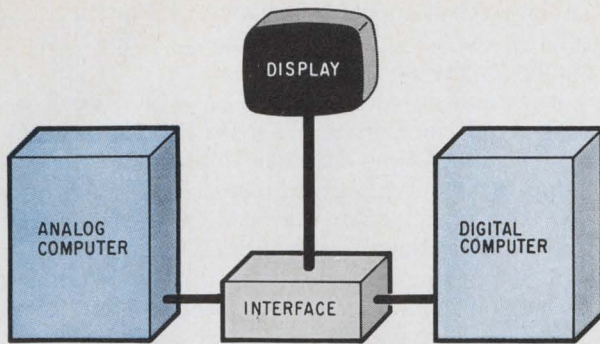

Essentials. A hybrid computer has four main elements, whose characteristics depend on system application.

values of the dependent variable from the digital computer. This is called the serial method.

In the parallel method, the entire set of equations is solved simultaneously, so a separate analog circuit is required for each differential equation. The parallel method may thus require 20 to 100 times more hardware than the serial method. With a large-sized, balanced hybrid system the parallel method becomes practical for moderate-sized sets of partial differential equations. Thus, with hybrid computation, one can solve them in real time by either the serial or the parallel technique.

Many research and development projects require experimental measurements of continuously varying quantities, followed by statistical correlation of the measurements. Often, as in studies of chemical process equipment, a considerable amount of time is required for the experimental system to be brought to a prescribed state. A hybrid computer is ideally suited for data reduction in this type of work. Data can be correlated on-line, and unusual effects or possible errors in the operating state of the equipment can be detected and corrected immediately, so a run never has to be repeated. In sum, hybrid computers used in a data processing mode can accumulate good data rapidly.

Best of both

The analog and digital parts of the hybrid computer complement each other. The analog part lends its greater speed to the solving of problems in a time frame set by factors outside the computer; for example, it can provide solutions fast enough to keep up with human response time. The digital part provides a larger memory and more precise arithmetic and permits reproducible sequential operation of itself, the analog computer, and the interface.

It was argued and predicted for years that the analog computer would be replaced by the digital computer for scientific and engineering problems. These discussions were meaningless. They missed the point that analog computing provides two important and extremely fundamental computing capabilities: continuous integration and parallel (or simultaneous) signal processing.

A single ordinary differential equation is solved with one analog integrating amplifier, plus whatever algebraic components are needed to complete the equation; a set of N differential equations requires N integrators. The second problem will require a larger computer than the first, but the really significant point is that on the analog computer the two solutions are obtained in the same computing time. What's more, the computing time is selectable, in the range of 0.001 to 1,000 seconds, so the analog timing can be matched to either the time frame required for data acquisition or the time frame acceptable to an engineer interacting with a simulation.

Hybrid with logic

Analog computers have always used logical elements as programing aids. In early analog computers, diodes and relays performed parallel rather than sequential logic. Relays proved too slow when analog time constants reached the microsecond range. Further, a new class of problems requiring sequential (or timed-by-logic) operation of whole parallel circuits began to demand attention. Thus, flip-flops, shift registers, monostables, and counters were added to the AND, OR, and comparator logic of the analog computer.

In commercial computers, the electronic aspects of the analog-to-logic interface are all taken care of. The programmer or engineer need only set up the problem. For example, the amplitude of two analog voltages can be compared to generate a logic level that is differentiated, counted, and eventually used to set an analog (diode bridge) switch.

In the semantic sense, one could challenge whether the analog-plus-logic is a hybrid computer. In the practical sense, this type of machine should be considered a hybrid because it was a forerunner of and has many attributes of the larger hybrid systems. Many problems have been and are still being solved on the analog-plus-logic computer.

In one case, the logic simply operated differential equation circuits seven times to ensure satisfaction of a split-boundary condition. In a second example, the logic implemented a complete multivariable

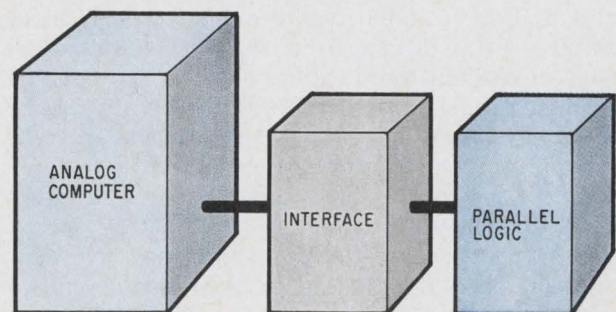

Semihybrid. An analog computer paced by parallel logic is a minimal hybrid system, but it can still solve dynamic and optimization problems.

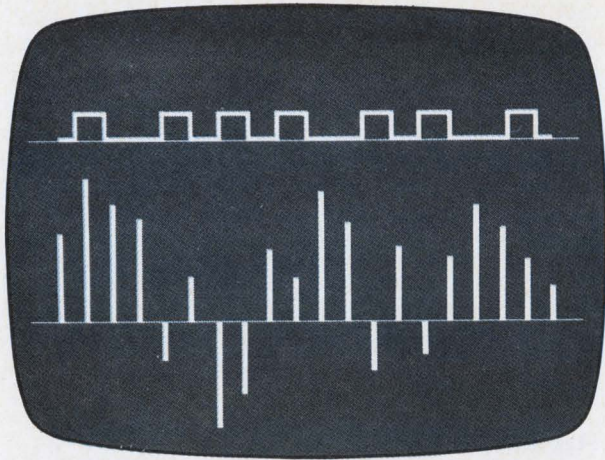

Eavesdropping. A small analog computer can drive a display showing a digital computer's real-time status.

optimization algorithm. In a third case, the same optimization algorithm and associated analog circuits were immersed, as a subroutine, in a large study of aircraft adaptive control.

Sizing up the hybrid

There are three distinct types of hybrid computer systems, classified by whether the digital computer is "smaller," "equal to" or "larger" in bandwidth than the analog computer. That is, relative to solution time, a "small" digital computer has a cut-off frequency below that of the analog computer.

This point can be clarified by imagining an analog computer solving the equation for the temperature across a flat plate, with boundary values varying increment-by-increment as the investigation proceeds. Each time the boundary and other parameter values are changed the analog computer produces a new temperature profile.

During each of the analog's solution periods, the associated (small) digital computer reads and converts 10 measurements of the profile.

Suppose, as is often the case, that the maximum "frequency" of the digital computer is determined by the speed of its input sampling and conversion equipment. Say this maximum input speed is 200 measurements and conversions a second. Suppose also that the solution period of the analog can be set at 1, 0.1, 0.01, and 0.001 seconds. Ten readings and conversions must still be made in each period.

During the 1-second period, the readings can be taken as slowly as 10 per second. Under these conditions, the 200-conversions-per-second capability makes the digital computer larger in bandwidth than the analog.

However, because the problem under investigation may need literally tens of thousands of runs to make a complete evaluation, the analog would probably be run as fast as possible. Thus, during a solution period of 0.001 second, the digital computer system would have to read and convert 10,000

analog measurements in one second. For these conditions, the digital computer is much too slow—or small—for the analog.

In general, it can be said that small digital computers yield medium-speed hybrid simulations. But medium speed is no deterrent to the adequate simulation of many types of problems. The small digital computer brings other assets to the hybrid system besides its arithmetic capabilities. Its logic, tied in with the analog computer, can provide signal pre-processing in data acquisition. And the small computer can take over the previously time-consuming problem setup and check-out.

The second type of hybrid computer is composed of computers whose bandwidth is approximately equal. The digital computer must then have such versatile features as floating-point hardware and automatic data channels.

The resulting balanced hybrid machine is powerful. Consider a simulation involving a set of nonlinear ordinary or partial differential equations that must be solved to find a set of parameter values yielding the best system performance. For a large set of equations, as in a 12-variable control system with 24 controller settings to be optimized: the over-all solution may require 100,000 or a million runs. The balanced hybrid system is the fastest way to get the answers; it is typically 100 times faster than the best available digital computer, which might by itself take 600 to 2,400 hours to complete the project.

The third type of hybrid system has a relatively small and limited-capability analog computer. The value of this small analog increment to the digital computer is the same as that for analog computers in general: a problem must be solved in the time frame of a real-time digital computer and, for large, fast digital computers, this time frame can be quite short and demanding.

Typical of this situation is the check-out of a real-time digital computer program servicing random interrupts and tied to sources of relatively nonreproducible input data. There comes a time in the check-out when piecemeal verifications of the program and system no longer have meaning.

The whole system must run in real time, with real data and real interrupts. Trying to find out what's happening by using the console of the digital computer and other peripherals is like trying to watch a football game through a slit in a fence. There is a pressing need for a fuller view of the actions of the core memory and registers.

For such an application, the analog computer would be part of an information display that would also require a digital-to-analog converter, one set of digital control lines, and an oscilloscope.

The analog computer would permit the display of digital-computer words or the status of interrupts or of any other condition. It would also display an analog bar graph of selected variables in the digital computer. For example, the status word and one of the variables could be brought up to date every 10 milliseconds.

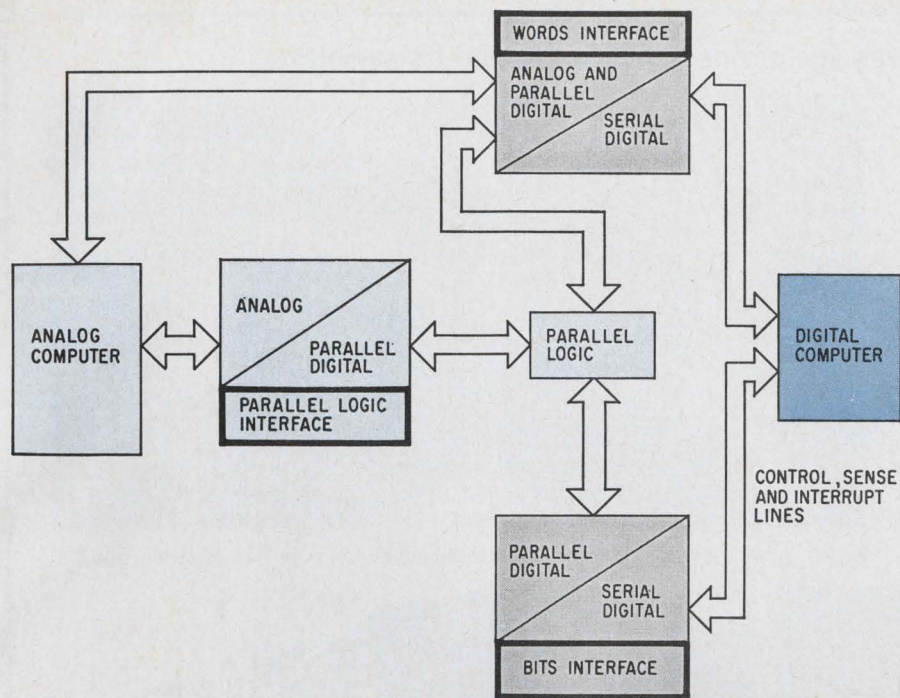

Traffic managers. Interface equipment and cables keep bits and words moving between the analog and digital computers.

Modern hybrid computing systems have at least one of four types of interface elements or information routes. They are the parallel-bit interface, the low-speed-word interface, the high-speed-word interface, and the special interface such as the digital coefficient attenuator.

Communications between computers

The parallel-bit interface consists of control lines, sense lines, and interrupt lines of the digital computer and the parallel logic of the analog computer. Bits, transmitted in parallel, represent such information as operating commands and status conditions. The interfaces are connected to effect control of one computer over the other. The interface consists primarily of a cable, a part of which is terminated on the programmer's logic patch panel of the analog computer.

All terminations on the digital side are physically fixed but can be manipulated to a desired information route by software. Analog-side terminations—which might be fixed—sense the analog-console mode (initial condition or operate) and perform similar functions. The programable (patchable) analog terminations would be used, for example, to signal an AND condition (high voltage and a positive slope) and initiate an interrupt of the digital computer for automatic rescaling.

The low-speed-word interface routes information through the operator's console of the analog computer. The functions of the interface include digital-computer-actuated settings of potentiometers and readout of all addressable analog signals.

Together with the fixed part of the parallel-bit interface, digital computer software can then substitute for manual operation of the analog computer in setup, check-out, operation, result-logging,

and maintenance. Sophisticated software also allows the symbolic addressing of the analog: the single parameter change from $A = 0.70$ to $A = 0.75$ might lead to the automatic resetting of 10 potentiometers.

The high-speed-word interface is built around a fast (30,000 conversions a second) and converter, a scanner, and several d-a converters. This speed is necessary to match the repetitive operation rates possible in the analog realm where, say, 100 values of 10 variables must be converted 10 times a second, for a total of 10,000 conversions a second.

Time skew between variables during the fast conversion cycle can be avoided by using programable logic and track-and-hold elements. All variables (voltages) are sensed and tracked. At a given instant a HOLD command sent in parallel to all track-and-hold elements freezes the voltages. Then each variable is converted in sequence. Thus, the logic and bit interface directs parallel-serial and serial-parallel conversion, and the word converters carry out the voltage-to-word and word-to-voltage conversions. Both bit and word links have been found necessary for efficient operation of the hybrid system.

Special forms of analog-digital interface connections are important in certain applications. Among these interface elements are the digital-analog multiplier, the digitally controlled limiter, and the digital coefficient attenuator.

In the multiplier, one side of an analog multiplier is driven from the digital computer; the product is an analog voltage. Performance is similar to that of a d-a converter. In the limiter, an analog limit circuit is controlled by a high-speed digital-word converter. The attenuator is the functional equivalent of a digitally set potentiometer, but it can be set

Hybrid computer behaves like airborne helicopter and its avionics

At Ft. Monmouth, N.J., military pilots aid avionics design by "flying" a mock helicopter driven by a hybrid computer. The digital part models the aerodynamics, the analog part the avionics. The facility includes six-degree-of-freedom terrain cues. A television camera moves toward and away from a map of the terrain, which rolls past the camera to simulate changes in altitude and speed.

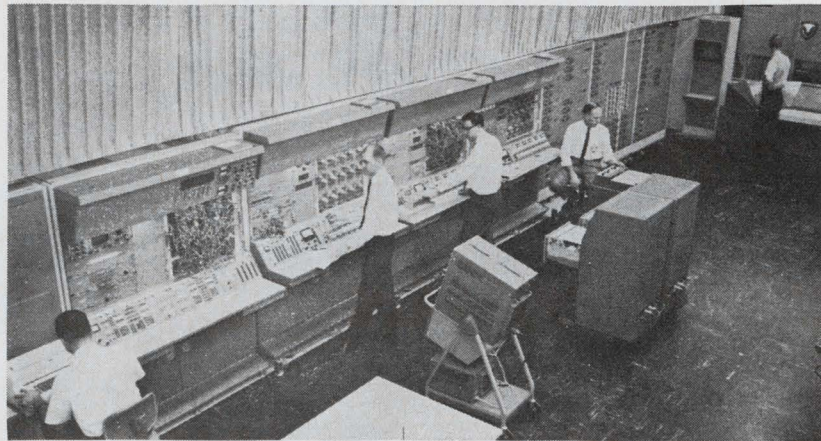

Power. Analog computer solves big problems; digital part is in another room.



Terrain. Realism for flights.

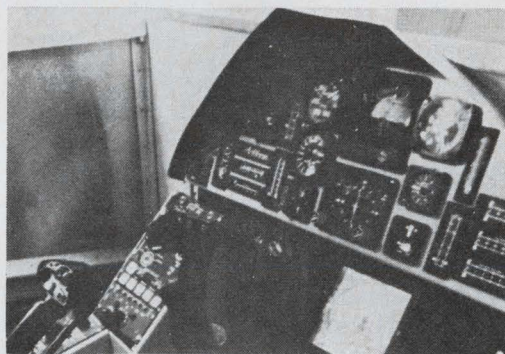

Cockpit. Pilot flies blind, following instruments hooked to hybrid system.

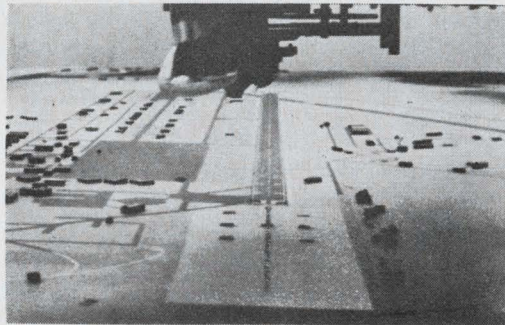

Coming in. Simulated helicopter approaches simulated airport.

up much faster because it's completely electronic.

What about the future? The distinction between analog and digital equipment is already starting to disappear, in hybrid systems and even in separate analog and digital computers. Analog circuit elements are much like digital elements in the sense that analog-circuit time frames and physical dimensions are compressing just as much as digital-circuit time frames and physical dimensions.

Moreover, basic advances in electronics, such as integrated circuits, will have their impact on hybrid computers. Thus, multiple analog elements in one package will replace the present single-analog-circuit packages, resulting in higher performance and

"compiler-level" patching of the analog computer.

It's virtually certain that the large-sized analog-plus-logic computer of the future will include a small digital computer. This should simplify analog programming, which, except for patching, will be done through a typewriter or card decks. The small digital computer in the analog system will also serve as the entire interface to a larger digital computer to make up a balanced hybrid computing system.

Coming from the other end of the hybrid spectrum, the large digital computer of the future will contain a small analog computer that will provide efficient man-machine interaction.

Choosing a simulation system

Deciding whether to use a hybrid, analog, or digital computer requires study of problem size, speed and memory requirements, and many other criteria

By Saul Shapiro

IBM Data Processing Division, Hawthorne, N.Y.

When it comes to simulation, analog and digital computers can compete with each other. And the hybrid computer, containing both analog and digital machines, can compete with either type alone. No one type is ideal for all needs. Hybrid systems enhance most of the distinctive virtues of analog and digital computers but negate some.

Dynamic physical systems described by differential-equation models are typical of problems simulated on early analog computers. Analog-computer technology and equipment were gradually expanded to enable them to simulate complex problems, such as those represented by simultaneous partial differential equations and by mathematical expressions related to optimization of continuous processes.

Some complex simulations require extensive memory capacity to store interim solutions, and to get this capability, and others as well, the digital computer was used to augment the analog machine.

Paralleling the early efforts in hybrid computing was the development of special programs that made possible the simulation of continuous processes—originally a monopoly of the analog computer—on the digital computer. Digital simulation has found great acceptance because it permits greater use of a computer already available for other research and business reasons.

Broadly speaking, any type of electronic computing system can be designed and programmed to give the same answer to a continuous simulation problem. But there can be significant differences in first cost, programming cost, execution time, and the ease with which the system can be modified for other problems.

Analog and digital computers are organized differently and handle mathematical variables differently. Analog machines are made from individual computational elements that operate in parallel during solution. The digital computer has fewer functions, but they're used over and over again during

solution. That is, the digital computer operates in discrete, sequential steps. The hybrid system, then, can perform simultaneously in parallel and sequential modes.

The complexity or size of problems that can be solved on an analog computer is determined, basically, by the number of components available in the system. The more analog components, the larger the problem that can be solved. The digital computer, however, is limited by the time available for solution. Roughly speaking, for a digital computer of a given size, the more complex the problem, the longer the solution time.

Machine organization also plays an important part in how the two types of computers are programmed. Analog computers are programmed by connecting or "patching" components needed for solution. In the digital computer, all necessary programs for solving problems are stored in the machine, and the programs are called into operation in sequence as the solution progresses.

Mathematical variables on the analog computer are continuous in time and represented by voltages that permit, for example, integration based on the electronic operational amplifier. Electronic integration poses no special problems.

Digital computers, operating in discrete time intervals on quantized values, integrate numerically—that is, they perform summation in successive intervals. Because the time for solution is inversely proportional to the integration interval, this interval should be as large as possible, but not so long that it will impair the accuracy of the solution to the differential equation.

Numerical analysis is useful in determining the integration procedure as well as the optimum integration interval. An empirical method, which usually works, is to start with a large integration interval and halve it on successive runs of the problem until no change is observed in the solution.

Working together

Timely interaction between the user and his problem is one of the main advantages of simulating a project on a hybrid computer. New techniques and programs are being developed to make it easier for the user to see the answers and to add new information to the simulation in real time, see cover.

At the International Business Machines Corp., the author, Saul Shapiro, heads a software team that has developed an experimental graphic continuous systems modeling program (CSMP) for an on-line interactive solution of differential equations. The program incorporates both analog and digital displays individually or simultaneously on an IBM 2250 input-output terminal.

On the screen are four displays available during solutions to the Van der Pol equation—a nonlinear

second-order differential equation that can, for example, represent the output of a vacuum-tube oscillator with constant inductance and capacitance but nonlinear resistance.

The problem variables—time, X , \dot{X} , and \ddot{X} —are tabulated in digital form in the upper left quadrant. The upper right quadrant simultaneously carries continuous displays of time versus the first derivative of X and time versus the second derivative of X .

The lower left presents a continuous plot of X and its first derivative.

The lower right quadrant displays two parameters. Above and below each parameter value is a line of dashes. Touching the light pen to a dash over the word raises the corresponding digit incrementally; touching under the line reduces the digit.

In any event, there is no question that digital simulation requires special attention to integration, whereas analog simulation does not.

The analog computer is faster than the digital machine mainly because the analog integration is continuous and partly because its operation is parallel.

Analog computers operate within a relatively small range, usually ± 100 volts, so problem variables must be scaled to within these limits. This task is complicated by the fact that the exact range of the variables is unknown until solution time, and scaling must be done beforehand. Often a trial-and-error procedure, scaling is one of the most time-consuming parts of analog-computer programming.

However, the digital computer, with a problem-variable range of about $\pm 10^{50}$, offers high-precision solutions and doesn't suffer from scaling problems.

Payoffs and penalties

Judicious programming of a hybrid system can take advantage of many of the desirable features of both the analog and digital computer. Basically, the hybrid computer can handle problems of much greater complexity than either the analog or digital computer alone. In a superficial way, the hybrid system can be thought of as combining the analog's speed of integration with the digital's logical, memory, and arithmetic-subroutine capabilities. Nevertheless, as noted earlier, hybrid systems do negate some of the desirable individual features of both types of computers.

The hybrid's over-all precision is that of the analog computer (about one part in 10,000), not the digital. And scaling of problems is necessary for those parts of the problem run on the analog part of the hybrid system.

Finally, certain types of errors peculiar to the hybrid system result from the two-way conversion—between the analog's continuous variables and the digital's discrete variables—performed by ana-

log-to-digital and digital-to-analog converters that link the two computers. The principal errors are those due to quantization in conversion from continuous to discrete variables and to small, finite time delays during this conversion.

Setting up and solving

The user of any kind of computational system for simulation is concerned with two distinct phases: a problem setup-debug phase and a problem execution phase that provides answers. The setup-debug phase includes problem conception, translation of the problem into computer language, creation of computer-usable input, and the debugging of test runs until a working model is achieved. Even after the model is obtained, more insight into the problem will probably call its modification.

The analog-computer block language, tailored around analog components, has proven to be a powerful programming tool for simulation of continuous physical, chemical, and engineering problems represented by differential equations. Such equations can be translated into this block language with a minimum of training.

Digital-computer languages have traditionally been harder to learn and use than the analog block language, perhaps partly because it's difficult to program a continuous simulation problem in a sequential language. In the past few years, special nonsequential digital computer languages have been developed for simulation and have been generally well received. Some are patterned after the analog computer block language; others resemble conventional digital computer languages such as Fortran.

On the analog computer, the creation of computer-usable input calls for the patching of boards to connect the components needed for the solution and for the setting of attenuators to scale the variables. All this is done according to the problem's block diagram. On the digital computer, creation of the input requires the punching of cards accord-

ing to a program list.

Modern analog computers can have a feature called automatic potentiometer setting. Automatic pot setting means that digitally coded data on punched cards or tape drives a motor that sets a pot to its properly scaled value. Manual pot setting was time-consuming and tedious, but setting up the digital computer required only a deck of punched cards. But now that analog machines can have the automatic pot setting, about all that can be said in favor of the digital procedure is that cards are cheaper and more convenient than wired boards for program storage. If a technician is available to help set up the program, there is now substantially no difference to the engineer whether a program is prepared on a patch bay (wired board) for the analog computer or a deck of cards for the digital computer. But engineers who must do their own program preparation seem to prefer the wired-board method, because it directly relates programming action to problem mathematics. However, a program can be modified far more easily with a card deck than with a wired board.

Programming errors—which have to be debugged—can occur during the translation of the problem into computer language and the creation of computer-usable input for this language. Program debugging is usually a major task in any kind of system.

Most digital systems have an on-line printer, so an advantage of digital simulation is the machine-produced documentation, which serves as a valuable debugging tool. Such documentation is especially useful when errors have been made in converting from problem language to machine-usable input.

Patching, attenuator setting, and card punching are all necessary for a hybrid system. The debugging of a hybrid computer is much more complicated than that of either of the other systems alone, because it's often hard to tell whether the bug is in the analog or digital system, or in the data-conversion links between them. Most of the programming problems of analog and digital computers, then, become even more formidable in hybrid computer systems.

Getting the answers

Problem execution includes obtaining the computer solutions and presenting them on output equipment. The analog computer can be about 10 to 100 times faster than the fastest digital computer system for solving problems of any complexity. The speed of the hybrid lies between that of the analog and of the digital, the exact value depending on the characteristics of each computer and how they're matched to form the hybrid system.

When accuracy is considered, however, it's not so obvious which system is superior. By using extensive numerical analysis, the digital computer can provide an answer that's not only more accurate but also fully repeatable. But numerical analy-

Analog and digital programming

Problem: Find the dependent variable X of the differential equation as a function of time

$$\ddot{X} + 3\dot{X} + 2X = 5$$

$$\dot{X}(0) = 10 \quad X(0) = 0$$

Analog block language

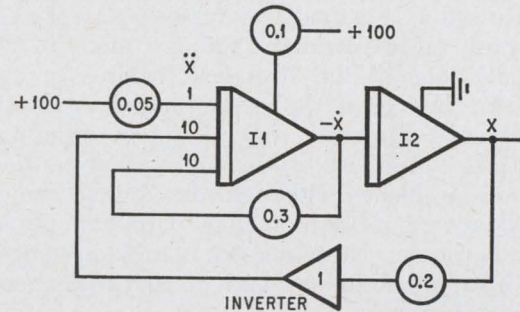

Digital simulation languages

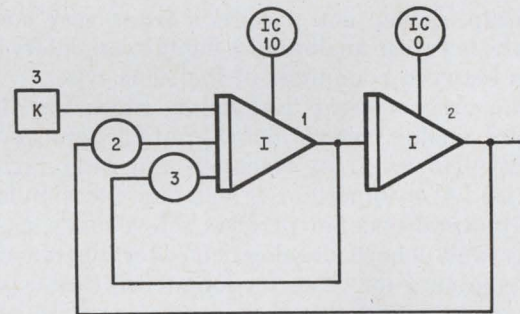

1130 Continuous systems modeling program

Configuration cards

Block number	Type	INP1	INP2	INP3
1	I	3	1	2
2	I	1		
3	K			

Parameter cards

Block number	IC/PAR1	PAR2	PAR3
1	10.	-2.	-3.
2	0.		
3	+5.		

S/360 Continuous systems modeling program

```

X = INTGRL (X0, XDOT)
XDOT = INTGRL (XDOT0, X2DOT)
X2DOT = 5. - 3.*XDOT - 2.*X
X0 = 0.
XDOT0 = 10.
    
```

sis can be expensive.

The analog computer's accuracy depends on the fixed accuracy of its components and the small range of its variables. Accuracy of $\pm 0.01\%$ is possible, but only if the variables never vary much from their maximum value, usually 100 volts. If, however, the variables range close to zero during solution, the accuracy may drop to 10% or worse.

Computer-solution output can take several forms: tables and graphs are most common. These may be viewed as a cathode-ray-tube display or as hard copy on on-line printers and x-y plotters. Traditionally, one of the strongest features of analog systems has been the user-oriented input-output equipment. Formerly, digital-system input-output was less convenient for displaying answers to simulation problems, although the digital computer could always produce tabular output on its high-speed printers. Now, makers of digital computers are also providing crt and plotter equipment as input-output gear.

Tradeoffs

Setup, debug, and execution times vary considerably between analog and digital computers, and even between computers of the same type.

The ratio of setup and debug times for digital versus analog versus hybrid might typically be 1:5:100. However, the execution-time ratio might be 100:1:5. Also important is whether the simulation will be used once, or perhaps a few times, as in a fairly well-defined development effort, or remain in the computer for years for long-term, ever-expanding investigations. And of course, each re-execution of the simulation will reduce the setup-debug cost per solution.

Another criterion in choosing the type of computer is whether real-time solution or outputs are needed. Hybrid and analog simulations will often yield real-time operation—performing calculations and displaying them to, for example, a helicopter pilot in an investigation of optimum landing procedures. The digital computer alone would be too slow.

The simulation of a fixed-bed catalytic chemical reactor on analog, digital, or hybrid systems can serve as a good example of the factors involved in the choice.

The reactor converts feed stocks to a product with a more valuable chemical composition. The true model of such a reactor is a set of partial differential equations. The computation can be simplified with little loss of accuracy by representing the reactor with an N-by-M array of continuous stirred-tank reactors, which are simpler to model.

The more stirred-tank reactors used to represent the fixed-bed reactor, the better the approximation and the solution. That is, the larger M and N are made, the better the simulation. During the simulation solution, the output of one stirred-tank reactor becomes the input of the following one.

The model of the stirred-tank reactor—that is, of each element in the array—requires only two inte-

gral equation, one solved for outlet composition, the other for outlet temperature.

$$C_{i,j} = \int \{ \phi_{i-1,j} - C_{i,j} [1 + k \exp(E/T_{i,j})] \} dt$$

$$T_{i,j} = \frac{1}{B} \int \{ \psi_{i-1,j} - T_{i,j} + \lambda C_{i,j} k \exp(-E/T_{i,j}) \} dt$$

where C is concentration, T temperature, ϕ inlet concentration, ψ inlet temperature, and E, λ , B, and k are reaction coefficients. Each stirred-tank reactor involves two integrations.

The analog-computer simulation requires a total of 2MN integrators, all operating at the same time. A fine-grid approximation would require over 1,000 integrators, more than are available on even the largest analog-computer installations. For this evaluation an array of only 20 stirred-tank reactors (40 integrators) was simulated.

The hybrid simulation solves the same model, but in a different way. Only one stirred-tank reactor is simulated, by two integrators, in the analog computer. The digital computer—connected to the analog through two a-d and two d-a conversion channels—programs the shared use of the two integrators through each element in the array and calculates new initial conditions for the elements.

The hybrid method of solution of the M-by-N array is to start with row 1, that is $i = 1$. Using the known feed to the reactor, solve the two equations for $j = 1$, then $j = 2$, and so forth through $j = M$. Once the response for each stirred-tank reactor in row 1 is calculated, this value is used as feed to the reactors in row 2, and the run is made again. The entire procedure is repeated until $i = N$, when the temperature and composition of the material flowing out of the fixed-bed reactor are known.

The digital simulation of the fixed-bed reactor used the same model and procedure as the hybrid simulation. To do this, the entire problem, including the continuous integrations, was translated into a digital computer input language [see "Working together," p. 92].

The analog computer took several days to set up and debug, and the solution, of course, was available in several seconds. The best model couldn't be simulated, however, because only 40 integrators were available.

The hybrid solution, reached on an IBM 704/EAI 131-R system, took several weeks to set up and debug, and the answer was available in five minutes. The setup-debug time can be justified for a long-term study, and a five-minute solution time may be just long enough for the investigator to assimilate the results and arrange for a new run with improved parameters.

The digital simulation on an IBM 360/40 took several hours to set up and debug and—at best—several hours to get one answer. Repeated executions could be too expensive.

SPST, DPDT, SPDT, DPST, 4PST...

What type of *Analog Switch* do you need?

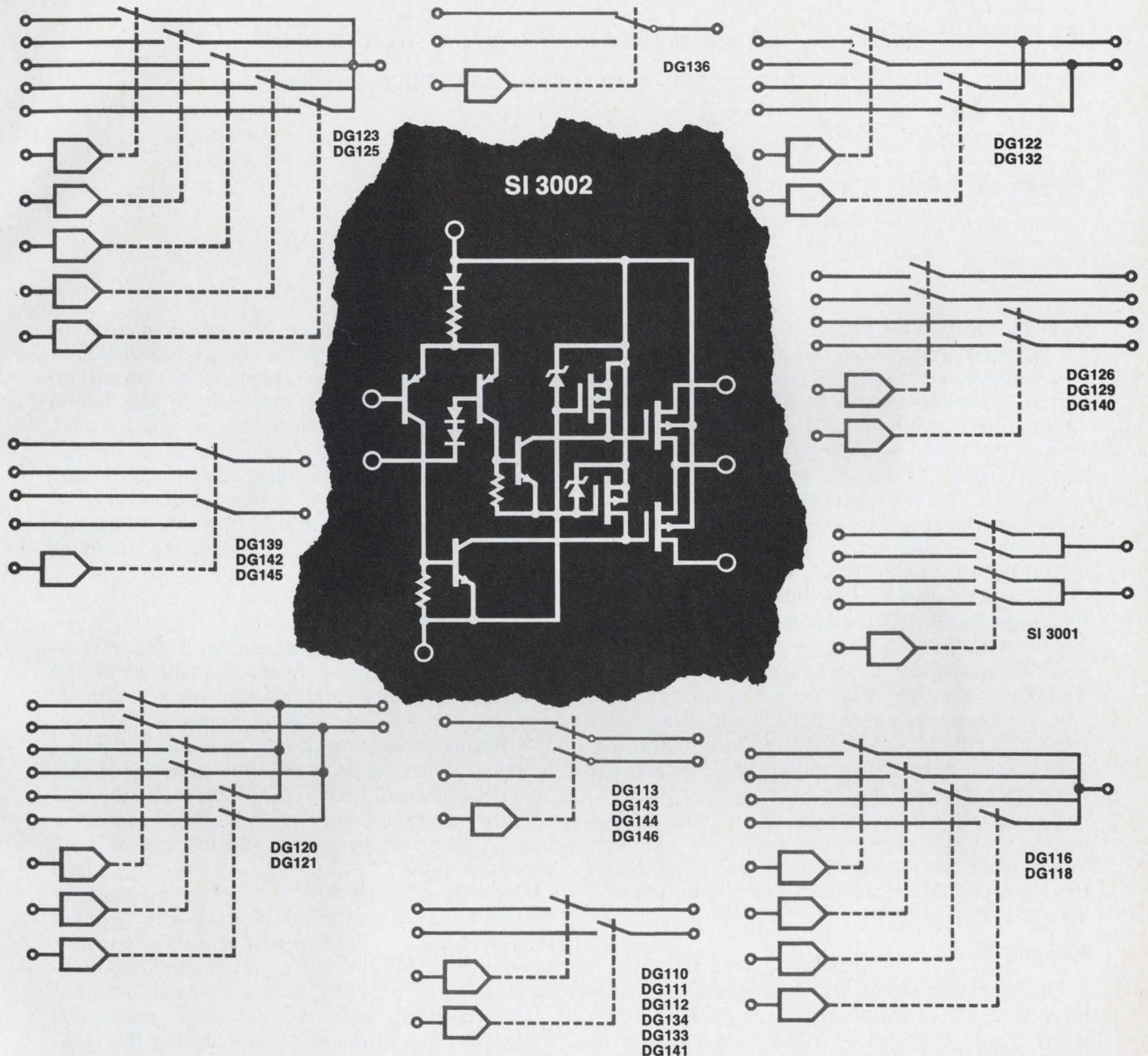

We offer 27 different integrated circuits to satisfy known driver-FET switch needs. Features include:

- MOS or junction FETs
- r_{ds} as low as 10 ohms max
- Switch analog signals up to 20V
- Drive from standard 5V logic
- Up to 5 channels per package
- TO-86 or TO-100

Write for our FET Switch Data Packet or tell us your design problem.



Siliconix incorporated

1140 W. Evelyn Ave. • Sunnyvale, CA 94086
Phone (408) 245-1000 • TWX: 910-339-9216

This SCR is not for burning

It protects itself from inrush currents of 600 amps per microsecond by using a self-generated voltage drop to spread conduction rapidly

By Donald I. Gray

National Electronics Inc., Geneva, Ill.

Voltage and current ratings for silicon controlled rectifiers have been on the rise, but until now there's been no answer to the problem of inrush current. The devices will burn up if the current is applied too rapidly, and this characteristic has limited the speed of high-power SCR's and made them incapable of high-frequency operation.

No more. The development of a regenerative-gate technique has resulted in an SCR capable of high-frequency operation, with the upper limit increased to 30 kilohertz from 10 khz.

The regenerative-gate method takes advantage of the power losses that are inherent in SCR's. Through a contact on the cathode layer of the chip, a voltage is picked off and fed to other areas to speed turn-on throughout the chip. The technique eliminates the need for expensive current limiters and complicated trigger circuits to protect the SCR; the simplest low-power firing circuits can initiate the process, and the device protects itself.

It's important to understand that an SCR, unlike a diode, turns on slowly and has high switching losses. Only one junction is in series with the load in a diode, but three junctions must be turned on if an SCR is to conduct.

Anatomy lesson

The normal side-fired SCR atop page 97 is a four-layer device. The anode contact is connected to a p-type layer (designated P_2) above which is an n-type layer (N_2) and another p-type layer (P_1). The gate lead is connected to this top p layer towards the outside of the chip, and there's an n-type diffusion (N_1) in the center of the layer with the cathode contact at its center. Thus the device has three junctions: J_1 between the N_1 and P_1 layers, J_2 between the P_1 and N_2 layers, and J_3 between the N_2 and P_2 layers.

At the instant of turn-on, the charge at the forward blocking junction, J_1 , is redistributed from reverse bias to forward bias at the spot where con-

duction starts.¹ The other two junctions become reversed biased because of a charge redistribution (lateral current) flowing through the lateral resistances of the device. Increases in the lateral resistances in an SCR reduce the switching speed.

Full area conduction—conduction of all of the junctions across their surface areas—can't occur until each of the junctions is forward biased across its whole area. In other words, to prevent burnout, current can't be applied faster than the junctions turn on.

Complications

When a normal SCR is turned on, it will tolerate an inrush of current—a di/dt —of about 30 to 100 amperes per microsecond, whether it's a 15-amp or 400-amp device. The limiting factor is that any SCR begins conducting at only one spot on the J_1 junction. When the di/dt rating is exceeded at this spot, local burnout occurs. And even at di/dt levels slightly below the failure point, localized switching heat reduces device rating, particularly at high repetition rates.

One way to handle di/dt is to add components to the anode circuit. Saturable and air-core reactors have been used to limit current after turn-on; they provide time for the SCR's conducting region to increase in area before a steep current occurs.²

One problem with the saturable reactor is that if the current density is low during the reactor's delay period, the conducting region won't spread and all the current will still flow through one small area.³ Therefore, an engineer designing this type of circuit must consider the current during the reactor delay period and the delay characteristics of the reactor.

The added circuit elements thus complicate the designer's job and don't improve the actual SCR; they simply represent a tradeoff between circuit and device performance.

To solve the di/dt problem rather than circum-

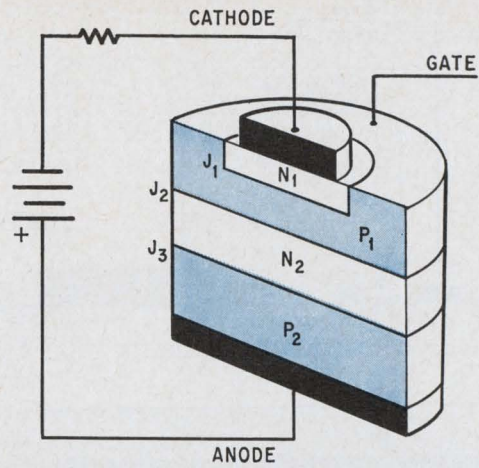
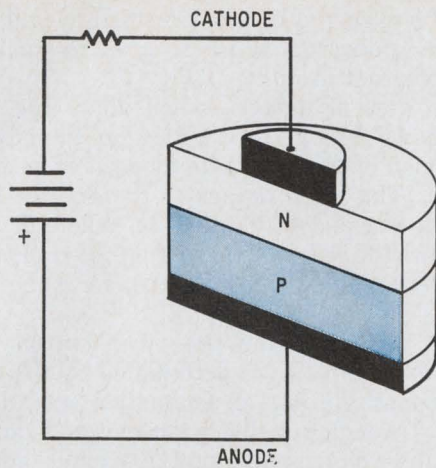

Difference. Diode has one junction that must be forward biased before it will conduct. SCR has three, but conduction begins in one small area of the first, J_1 , and burnout can occur there.

vent it, manufacturers have tried a variety of gating configurations other than the simple side-fire gate. The ring gate, multiple gate, and center-fire gate structures should all theoretically reach full area conduction about twice as quickly as a side-fired device, but, though technically ingenious, they haven't increased di/dt ratings appreciably.

Taking it on the lip

The regenerative-gate scheme takes advantage of another physical characteristic of an SCR that can be changed—the emitter lip. This is the portion of the N_1 layer that isn't covered by the cathode contact and is nearest the gate contact on the adjacent p region.

SCR's with large emitter lips are safe from di/dt failure at low pulse repetition rates because the lip initially limits the anode-circuit current.

However, the use of devices with large emitter lips is limited by their long turn-on delay time to circuits with low pulse repetition rates.

When a slow-rising anode current is applied to a conventional SCR, the gate continues to supply current to the device even after turn-on has been started, as shown at right, increasing the initial conduction area. But when a fast-rising anode current is applied as shown at right, the gate current is reversed and the gate loses control soon after conduction is initiated. This reduces the rate of spread of the initial conduction area and increases the heating stress on the device.

All the anode current flows through the emitter lip at the start of turn-on, producing a voltage drop, as shown on page 98. It's this self-generated voltage that overwhelms the gate supply and causes a reversal in the gate current. A high-power gate drive, if kept within the limitations of the device, can overcome this problem in SCR's with moderately high di/dt ratings—about 100 amps per μsec .

But the lip can't be eliminated. If the cathode contact overlapped the N_1 layer, the gate current would be shunted to the contact and the SCR would

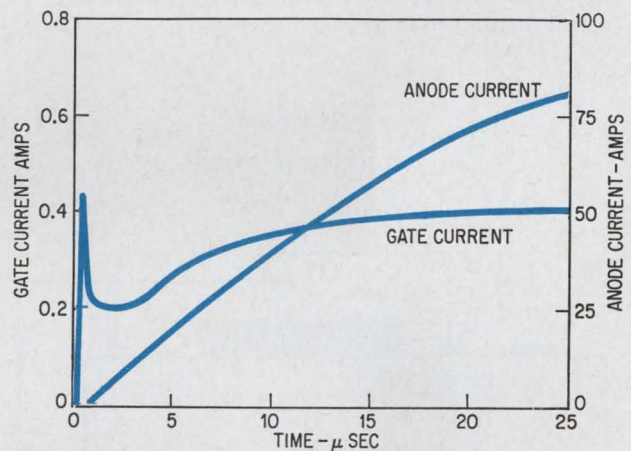

Slow ascent. Gate current remains positive with a slow-rising anode current, and device is kept under control.

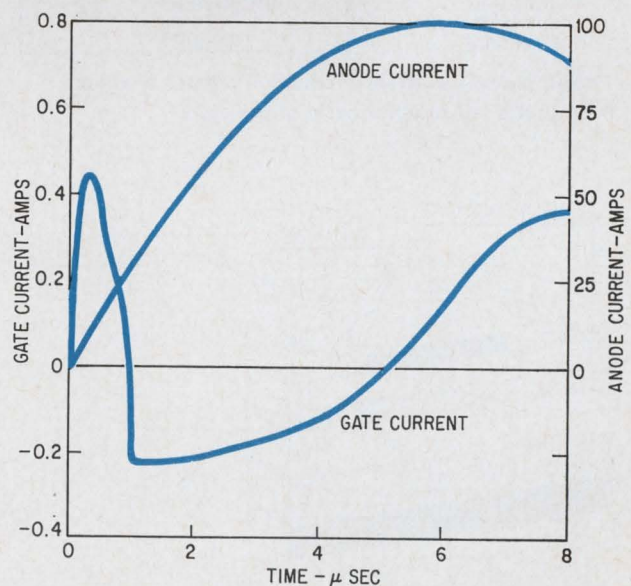

Fast climb. A fast-rising anode current causes negative gate current after about 1 μsec , slowing conduction.

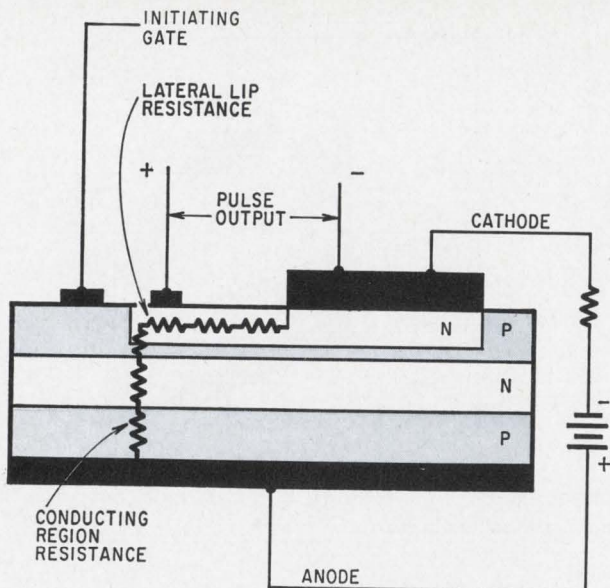

Lossy path. Conduction follows lateral lip resistance before passing down through the chip.

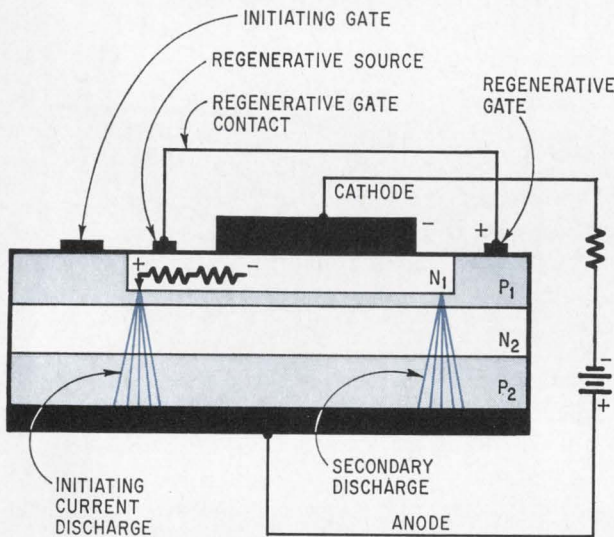

Pickoff play. The lateral conduction creates a voltage drop that's fed to other parts of the chip.

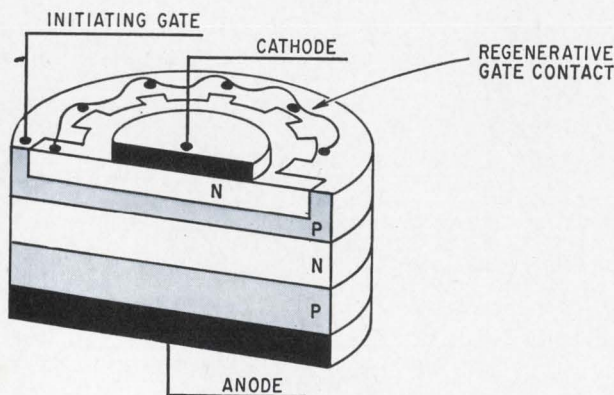

Around the chip. Connections are made from the N layer near the initiating gate to 10 spokes.

have to be triggered by amps instead of milliamps, if triggering occurred at all. So if we're stuck with the lip, why not use it?

At the start of turn-on, when all of the anode current flows through the emitter lip, the structure in the region of the lip can be thought of as a pulse generator. The pulse output of the emitter lateral resistance is equal to $Vr/(R+r)$, where R is the variable resistance of the conducting region, r is the emitter-lip lateral resistance, and V is the anode voltage.

During switching, the time that current flows through the emitter lip is determined by the length of the lip and the rate of conduction spreading in the SCR. Through suitable geometry and diffusion control, the voltage-pulse output can be adjusted to vary over a wide range. The voltage pulse's amplitude, which is positive with respect to the cathode contact, and its rate of rise both climb with increases in voltage across the SCR and di/dt .

To take advantage of the self-generated voltage, the pulse can be picked off the emitter lip, as shown at left, and fed to points on the P_1 layer, triggering those areas. Once conduction begins, the SCR feeds itself more regenerated gate drive, causing additional emitter spots to turn on; this is the regenerative-gate action.

Just a little shove

The advantage of this system is that the regenerative-gate supply is built into the SCR and adjusts itself to the circuit di/dt and the voltage stress imposed on the device. It's not necessary for the initiating gate signal to do anything more than start conduction.

Since this type of SCR uses the initiating gate only to start triggering, the problems normally associated with gate-signal rise rate, pulse width, and amplitude don't have to be considered. After the initiating signal, the job of turning on the SCR is handled by the regenerative gates.

The gate sensitivity of the regenerative-gate SCR is no different from that of a conventional device. However, the regenerative-gate SCR can tolerate the kind of spurious gate signals that could cause

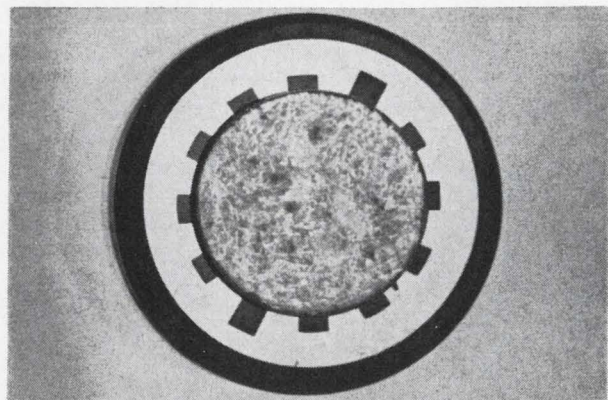

Clockwise. In working device, emitter lip takes form of 12 spokes around cathode contact.

failure in a conventional device.

The proper spot to initiate triggering is at the gate edge of the emitter lip. The resistance of this lip can be controlled by geometry and diffusion techniques so that some current limiting occurs. The resistance at that part of the lip where turn-on is initiated is made higher than the resistance at the other spots on the lip gated by the regenerative signal so that the anode current is forced to take a new path and is thus transferred away from the initiating spot. In this way, the maximum tempera-

ture reached at any one spot in the device is kept at a safe level. After turn-on is established, the various lateral lip resistances are automatically transferred out of the anode circuit, further reducing losses.

Failure to ensure that resistance at the initially turned-on spot is higher than at the other parts of the lip results in a relatively slow transfer of current to the regenerative gates, a situation that can lead to local burnout at the turn-on area.

SCR's with as many as 10 regenerative gates have

Geometric approaches

Attempts to improve SCR performance have led to several departures from the conventional configuration, among them the center-fired gate, the ring gate, and the multiple side-fired gate. But although these structures provide some advantages over the normal side-fired gate, they don't appreciably improve the SCR's ability to withstand inrush current.

The center-fired gate is theoretically supposed to turn on around its periphery at the same time. It doesn't. Just as in the side-fired gate, more current is carried at the initiating spot than elsewhere, and local burnout is a problem. Though the center-fired arrangement doesn't boost a device's di/dt rating, it does cut the time needed to achieve full area conduction to nearly half that of the side-fire device. This is an important advantage, particularly in high-frequency operation within safe di/dt levels. And this is where the structure is used.

The ring-gate setup seems a workable arrangement since the gate area—a ring around the cathode contact—increases as the contact is enlarged to handle higher currents. But the ring gate, like the side-fired and center-fired gates, takes the predominant part of the inrush current in the area of the initiating spot. And it isn't as sensitive as the side-fired gate.

However, the ring gate theoretically would give a huge area of conduction just after it's initiated if a major part of the initial current could be carried by spots other than the turn-on area. The fact that no ring-gate, high-current device can be found in manufacturers' catalogs attests to the fact that no practical method has been found to do this. But the theoretical action of the ring gate can now be approximated by the regenerative gate.

Big shot. Multiple side-fire gates have been used to improve SCR operation at high di/dt levels and to reduce turn-on losses, but they require a larger gate signal, or "hard firing."

The arrangement works best with either isolation between gates, such as that provided by a pulse transformer, or separate gate supplies—except when very-high-power gating circuits are used. These considerations add, of course, to the circuit designer's problems and expenditures. But for all this, the multiple-gate configuration doesn't increase the di/dt rating. One spot will always turn on first and be in danger of burnout. At safe levels of di/dt , the multiple-gate approach does reduce turn-on losses, however, and if the gates are on opposite sides of the cathode contact, it can almost halve turn-on time.

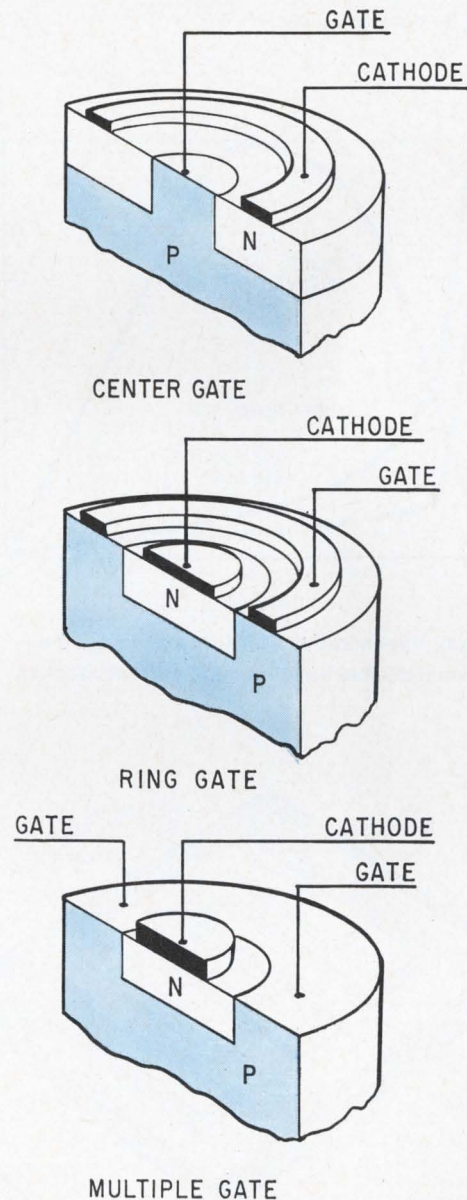

Three strikes. Earlier attempts to shorten turn-on time resulted in the center-fired, ring, and multiple gates. All failed to increase di/dt ratings. However, the center-fired gate structure is being used in low-power, high frequency devices, and the multiple side-fired arrangement cuts turn-on time in half.

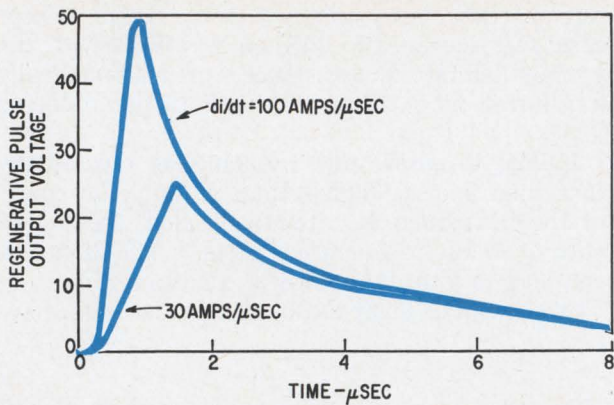

Output. The regenerative pulse output is a voltage spike that hits its peak in 2 μsec.

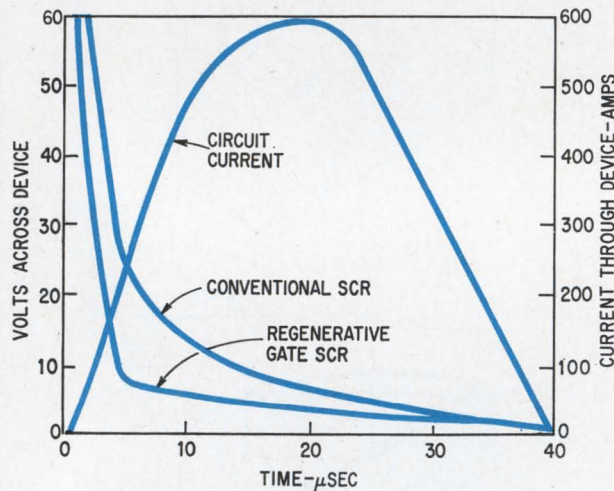

Sharp turn. Regenerative SCR turns on faster than conventional device, handling high currents sooner.

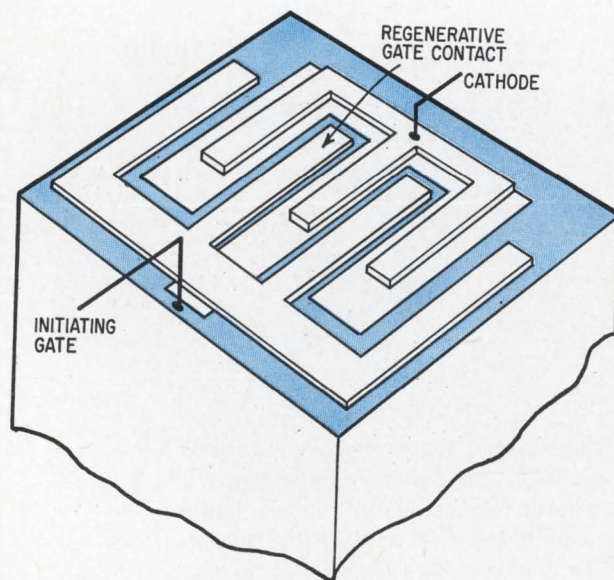

Next step. Interdigitation of the regenerative gate may lead to megahertz switching speeds.

been made, and measurements show that all the gates can be triggered at nearly the same instant. Good load sharing is achieved by keeping the emitter lateral resistance at each spot equal. This reduces the instantaneous temperature, the current density, and the impedance of the device in proportion to the number of spots turned on. Full area conduction is reached very quickly and turn-on losses are low.

Although a conventional SCR can be made with multiple gates and operated so that one gate supply initiates turn-on and a second, more powerful supply turns on additional spots a fraction of a microsecond later, this arrangement doesn't duplicate the action of regenerative gates. For one thing, the external high-power gate supply can add thousands of watts to the device for a brief time. Also, the multiple-gate conventional SCR cannot respond to changes in circuit voltage and di/dt .

Commercial devices

The regenerative-gate concept has been verified; 10-spot, 110-ampere, 1,000-volt devices are now on the market. They've achieved the 600-amps-per-microsecond di/dt rating at 1,000 volts, 1,200 amps peak, with a 125°C case temperature and a 60-hertz repetition rate. They've also been operated at 300 amps per microsecond, 3,000 amps peak, with the same case temperature and repetition rate.

Paralleling these devices is a simple matter; the regenerative signal of one device can be used to trigger others. It can also be employed as a timing signal or as an excitation source for oscillator circuits.

Efforts to speed the turn-on of conventional SCR's by interdigitating their emitter structures have been thwarted by gate-current reversal, local burnout, and reduced gate sensitivity. These limitations have been eliminated in regenerative-gate devices, and the way is now clear for an interdigitated SCR such as the one shown at the lower left.

This approach results in an extremely high rate of conduction spreading. Interdigitated regenerative-gate SCR's have been built to evaluate the concept, and they've readily achieved rise times of 0.3 μsec to 1,000 amps and 10 μsec to full area conduction; a conventional side-fired device with an equivalent emitter area takes 20 μsec to reach full area conduction.

There's no apparent reason why interdigitation can't be applied to very-high-frequency, high-current devices. Megahertz switching speeds seem reasonable with further device refinement.

References

1. F.E. Gentry, F.W. Gutzwiller, N.A. Holonyak Jr., and E.E. von Zastrow, "Semiconductor Controlled Rectifiers," Prentice-Hall, 1964.
2. N.E. Mapham, "The Rating of Silicon Controlled Rectifiers When Switching Into High Currents," IEEE Trans. Communications and Electronics, vol. 83, September 1964, pp. 515-519.
3. W.H. Dodson and R.L. Longini, "Skip Turn-on of Thyristors," IEEE Trans. Electron Devices, vol. ED-13, July 1966, pp. 598-604.

TWO NEW CERAMAG® 90° COLOR YOKE CORES FROM STACKPOLE

THE COMPACT

(Part No's 52-437, 52-506)



THE MINI

(Part No's 52-488, 52-489)

With deflection yoke cores that are 25% smaller, consider the savings in copper, hardware, labor and shipping costs, too. Both the Compact and Mini yoke cores are moulded from Stackpole's standard 7B ferrite material. Even though you benefit from smaller, more compact yoke size and appreciably lower prices, there is no sacrifice of nickel content with Ceramag® 7B. Curie is 160°C. $\pm 10^\circ\text{C}$. For specifications, samples, prices and delivery, call: D. L. Almquist, Electronic Components Division, Stackpole Carbon Company, St. Marys, Pa. 15857. Phone: 814-781-8521. TWX: 510-693-4511.



STACKPOLE
ELECTRONIC COMPONENTS DIVISION

ALSO A LEADER IN THE MANUFACTURE OF QUALITY FIXED COMPOSITION RESISTORS

Waiting for a home vtr? Don't hold your breath

Markets prospects are clouded by the problem of heavy tape consumption and limited bandwidth in fixed-head designs, the high price of helical-scan recorders, and the lack of tape standards and companion color tv cameras

By John D. Drummond

Consumer electronics editor

"If we ever get the urge to try and produce another fixed-head video recorder," says an engineering manager at the Ampex Corp., "we'll just lie down until the mood passes."

After more than two years of fruitless development work in this field, Ampex, the recording industry's leading company, is understandably gunshy. And this wariness is shared by the International Video Corp., the number two firm in the industry. But in some other quarters, hope for an inexpensive, high-quality, home vtr seems to spring eternal.

Many low-cost, longitudinal-scan video recorders have been demonstrated over the years, but each demonstration has been prefaced with the promise that a new head "under development" would vastly improve picture quality and reduce tape consumption in time for production "next year." That next year hasn't come yet. None of these machines is yet available from a dealer. But while many companies have become disillusioned, a few continue their development efforts in the hope of capturing what they see as a potentially huge consumer market.

The problems faced by the developers may be insurmountable. For having thus far failed to produce a fixed-head home vtr that can record and play back a limited-bandwidth monochrome picture on a standard monitor with good resolution, they are now being asked to design a low-cost machine that can handle color programs. The advent of color television has magnified the major disadvantage of fixed-head units: the high tape speed required to recover each megahertz of resolution.

It's clear that broad new concepts must be ap-

plied within the constraints of basic magnetic recording laws if a truly wideband, low-cost video recorder is ever to be developed. And it is conceivable that an engineer with a flair for innovation could come up with a simple solution to the complex problem of putting microwavelengths of information on a slow-moving tape.

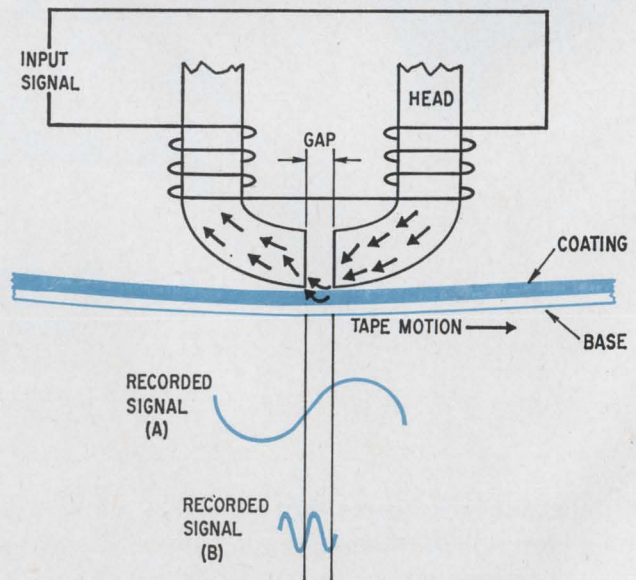

Magnetic recording. The reproduce head gap continuously spans a portion of the signal (A) recorded on the moving tape to produce an output voltage. For frequencies at which wavelength equals gap width (B), head magnetization remains constant and no output voltage is generated in the head.

Unlike audio recorders, which can cover the audio frequency spectrum at a nominal speed of about $7\frac{1}{2}$ inches of low-cost tape per second, fixed-head vtr's require expensive tape moving at speeds of 160 ips or more to achieve even a very marginal performance level.

However, with their simple electronic circuitry and tape transport, the fixed-head, longitudinal-scan design appears to be the best prospective candidate for low-cost recording. The advantages of a simple tape-threading path are considerable. For one thing, head-to-tape tracking is easily achieved. Costly servocontrol systems are used in rotating-head recorders to synchronize the rotational velocity of the spinning record-playback head with the longitudinal position of the tape, but fixed-head vtr's need only a capstan that runs at a uniform rate since the recording is continuous.

The obvious disadvantages of the fixed-head design—outside limited frequency response—are high tape consumption, difficulties in moving tape at the speed necessary to achieve even limited bandwidth, rapid head wear, poor picture stabilization, and poor signal-to-noise ratio. Before the potential of fixed-head video recording is realized, these problems must be overcome.

Some optimistic manufacturers predict that fixed-head home recorders will someday be produced cheaply enough to be retailed at about \$300 to \$400 for black-and-white models and \$1,000 for color versions. This would compare with the present \$1,000 to \$3,000 for helical-scan monochrome recorders and \$5,000 to \$6,000 for color units—prices considerably beyond the reach of most consumers.

False alarms

The Mastercraft Electronics Corp. of New York created some ripples in the consumer entertainment industry last year with its announcement that it would soon be offering a \$695 recorder and monitor made by the Maruwa Electronic & Chemical Co. of Japan. But only a crude demonstration prototype has shown up so far, and its performance is far from impressive.

The next bit of excitement was generated by the announcement late last year that Japan's Akai Electric Co. would be exporting a \$450 fixed-head recorder and monitor to the U.S. in December [Electronics, Nov. 27, 1967, p. 187]. But none of these machines have yet been shipped, and Akai last month announced that it was suspending production "until important technical difficulties are ironed out." Specifically, an Akai spokesman says production will be delayed until the company's engineers can reduce tape speed from the present 45 ips rate to about 15 ips.

Akai says it now has the know-how to achieve a 1.2-megahertz bandwidth at a tape speed of 30 ips, but that the picture quality isn't yet good enough for marketing. The firm says it will be ready when it can get a 2-Mhz response at 15 ips. This would represent a major advance, since domestic companies are only claiming that they can soon get tape

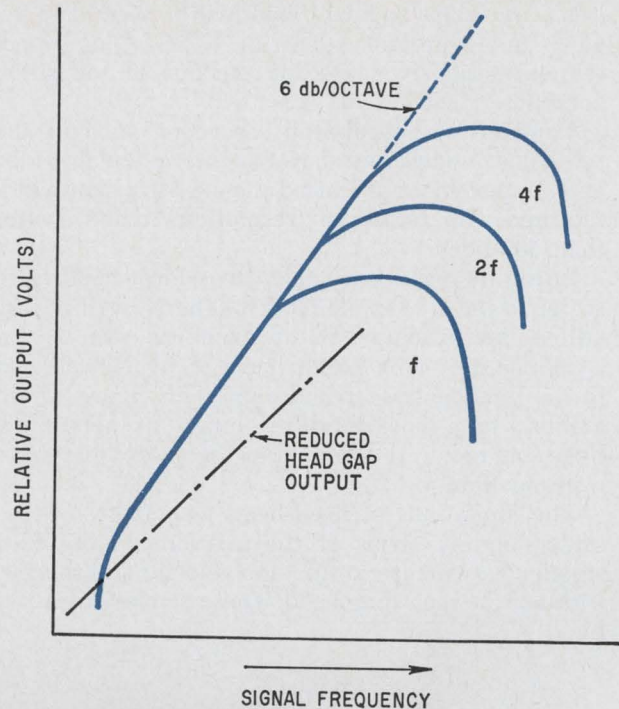

Reproduction range. With a given gap width, higher frequencies can be reproduced by increasing tape speed. Narrowing the gap reduces signal amplitude.

speed down from the present 160 ips to 120 without sacrificing picture quality—which isn't too good right now anyway.

Akai's experience with low-cost recorders isn't unique. Among the firms that have had to face up to similar "technical difficulties" are the Telcan Co. of England, Grundig Werke GmbH of Germany, and such U.S. concerns as the Fairchild Camera & Instrument Corp., the Illinois Institute of Technology, Par Ltd., and, as noted, Ampex. And the list will get longer.

This is not to say that longitudinal-scan recording technology hasn't progressed since the first prototype was introduced five years ago. There have been important contributions by Newell Associates Inc. and its licensee, Arvin Industries, as well as by such pioneers as Wayne R. Johnson of the Winston Research Corp. and Marvin Camras of IIT. But unless there are dramatic breakthroughs in head design and tape composition, it's unlikely that good-quality pictures will ever be recorded and reproduced economically by a fixed-head machine. This lack of optimism is rooted in the fundamentals of recording technology.

A few constraints

The quality of a video recorder is measured largely in terms of its ability to reproduce fine detail. And resolution is primarily a function of the system's over-all frequency-response characteristics and of the magnetic composition of the recording tape.

Regardless of cost factors, a video recorder for

home use must have the bandwidth needed to record and reproduce the full NTSC color signal without seriously degrading the hue or saturation content.

Commercial helical-scan recorders, such as the full-color models put out by International Video and Ampex, meet or exceed the 4.2-Mhz bandwidth required. In terms of resolution, that's better than 400 lines.

But in the fixed-head field, the widest bandwidth so far is the 2 Mhz claimed for the Newell design still under development at Arvin, as well as for a similar unit now being licensed by Newell and for a Winston Research design. This figure would amount to a horizontal resolution of about 200 lines, far below the minimum for acceptable color reproduction.

The limitations of fixed-head technology can be understood in terms of the relationship of video frequency response to the tape velocity and the gap width of the recording head. These can be expressed by

$$f \cong \frac{0.7 \times v}{\text{head gap length (in microinches)}}$$

where f is frequency in megahertz, and v is velocity in ips. In terms of wavelength, which is what the tape sees, the relationship of tape velocity to frequency response becomes

$$\lambda = \frac{v}{f}$$

Thus, keeping the wavelength constant, higher frequencies can be recorded by increasing the

tape speed or reducing the head gap. In the illustration of the relationship between wavelength and head gap on page 102, note that the playback voltage approaches zero as the wavelength approaches the width of the head gap.

As the tape moves pass the head gap, a different portion of the signal is spanned and the varying magnetic field generates a voltage in the head. If the recording frequency is such that its wavelength is equal to the gap width, the output signal will fall off sharply. Head designers therefore shoot for a head gap equal to about half the shortest anticipated wavelength.

Tough choice

In choosing between a small head gap and a high tape speed to achieve a certain resolution, a designer must weigh the disadvantages of each approach. High tape speed means high tape consumption. In a Newell instrumentation analog data recorder, for example, the tape runs at 960 ips to achieve the required 10-Mhz bandwidth. Also, increases in tape speed threaten picture stability and synchronization, a situation requiring costly and elaborate mechanical damping systems and electronic circuits. Further, head wear due to abrasion increases with tape speed.

As for the problems with small head gaps, if the gap is narrowed to a point well under the value calculated for the frequency of interest, the head output can be severely reduced, as explained previously. This will cause a deterioration of the signal-to-noise ratio, and will thus affect picture contrast.

Further, there are practical hurdles to the volume

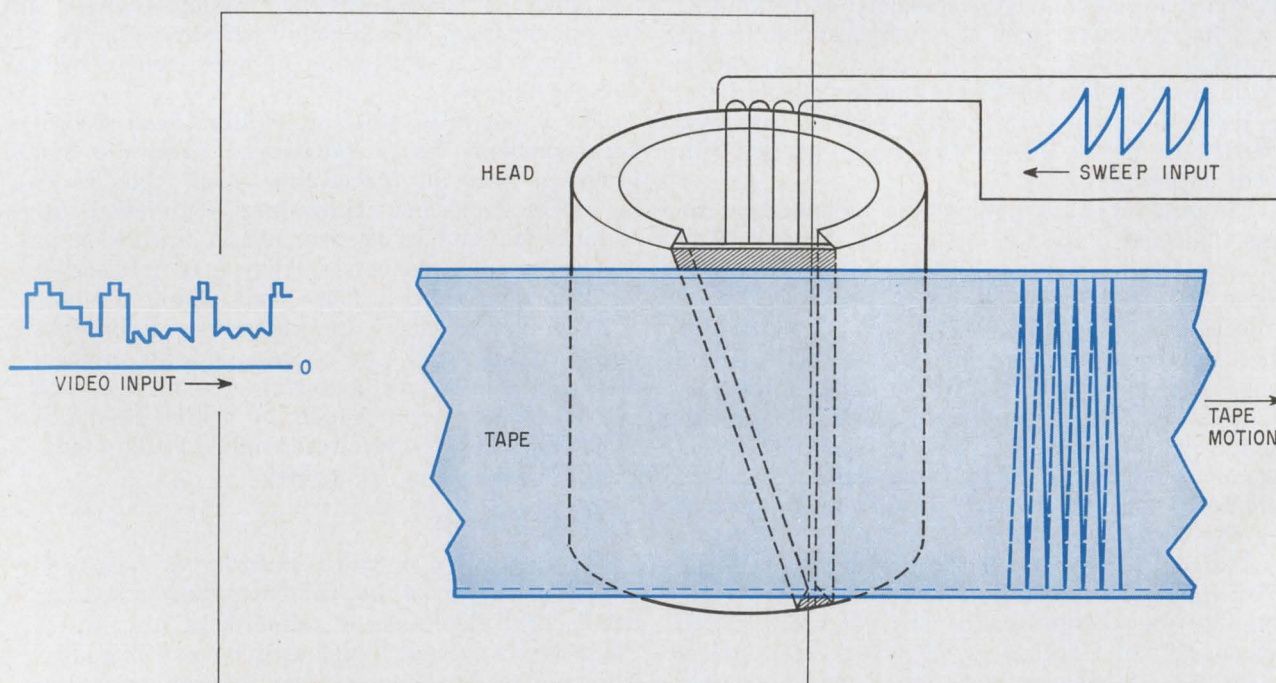

Roundhead. Honig's scheme for improving picture resolution employs a hollow cylindrical head with a scanning signal to "write" the video information on a tape as it moves across the cylinder face.

production of heads with very narrow gaps. Although heads have been built with gaps as small as 20 microinches (and Akai claims a gap of only 12 microinches), present mass-production methods just aren't suited to turning out heads with gaps of under 40 or 50 microinches.

Radical approach

Indications are that the present approach to head design cannot be pushed much farther, and it thus appears evident that an entirely new one is needed if longitudinal-scan recorders are to reproduce the shorter wavelengths of the color signal.

There may be a glimmer of hope in the radical design under development at Honig Laboratories Inc. in Westbury, N.Y. The Honig recording head is fixed, but it employs a transverse scanning technique that eliminates the frequency and output limitations on gap width.

According to William Honig, the developer, the device can record bandwidths of up to 8 Mhz on standard ferric oxide tape moving longitudinally across it at only 15 ips. The video scanning head is built around a hollow ferrite cylinder with a wedge-shaped gap extending across its entire face. The gap encloses a thin film of nickel-iron alloy that's magnetically saturated by the applied video signal. A sawtooth current applied across a coil wrapped around the cylinder generates a magnetic field that scans the video almost vertically across the edges of the tape.

Putting the head to use will be another matter, but based on preliminary information, Honig may have come up with a timely and highly important contribution to fixed-head technology.

Getting it on tape

Aside from the recording head, the tape has perhaps the greatest influence on picture quality. Such factors as resolution, signal-to-noise ratio, and dynamic range depend largely on the quality of the video tape.

Standard tapes consist of a nonmagnetic base material, commonly polyester or acetate, and a thin coating of a magnetic powder derived from iron oxide. The development of oxides with finer particles and greater magnetic moments than are currently available would undoubtedly enhance tape response and increase dynamic range.

Much work is being done to improve tape quality, but the only recent significant advance has been made by Du Pont with a chromium-diode tape now being marketed under the name of Crolyn. It provides greater bandwidth at conventional recording speeds, plus higher magnetic moments per unit of volume for greater dynamic range.

Chromium dioxide has two major advantages over iron oxide, according to Maurice L. Ward of Du Pont's photo products department. "It provides higher signal output at the same degree of resolution, and it offers better resolution at any given signal output level," he says.

Although Crolyn will improve picture quality,

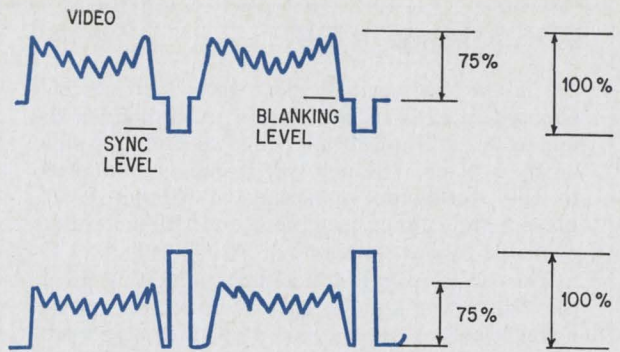

Processed video. To eliminate the need for a clamping circuit, Akai processes the video signal (top) to achieve positive sync pulses (bottom) before recording.

it isn't expected to bring down the high cost of video recording in the foreseeable future. On the average, the cost of an hour's recording on a helical-scan vtr runs from \$40 for half-inch tape to \$60 for 1-inch tape. The tape cost with longitudinal-scan recorders should be about the same or slightly higher.

Direct recording

Video information can be put on tape either by direct magnetization or by the use of a modulation signal. Although the standard practice is to use modulation, most low-cost fixed-head recorders use direct recording to cut costs, and this is often a factor in poor picture quality.

Modulation is done by a complex circuit, while direct recording requires the very minimum of signal processing to apply the video to, or recover it from, the tape. But it also limits the recording range of the vtr to less than nine octaves, far below the level required to reproduce a color signal. Another problem with direct recording is that the head's output falls at a rate of about 6 decibels per octave at low frequencies.

To avoid the expense of a modulating circuit, as well as to avoid licensing by Ampex, which has patented the use of f-m modulation, some companies have come up with ingenious methods of increasing the octave range and improving signal-to-noise performance with direct recording. For example, Akai inverts the video signal on a line-by-line basis and processes it to achieve a positive sync pulse before the signal is recorded. By doing this, the Japanese firm eliminates the need for d-c restoration circuitry to recover the negative sync pulse. According to Akai, the technique also results in a better signal-to-noise ratio.

However, any real answer to the problem will probably involve the adoption of some of the data-recovery techniques used in telemetry systems, such as pulse code, pulse duration, and low-frequency square-wave modulation. Since modulation eliminates crosstalk, it also permits the use of smaller track widths. And because tracks could be spaced closer together, more could be crammed on

The challenge of EVR

As if the technical hurdles they face weren't enough, makers of home vtr's must ponder the impact of CBS' electronic video recording system on their plans. The network is deeply committed to the worldwide marketing of "direct EVR" players and canned programs, and will have units available by late next year.

The EVR player attachment, which is about the size of an attache case, will project on the home television screen filmed or video-taped programs—either black-and-white or color—from a cartridge 7 inches in diameter and a half-inch thick. CBS estimates that a 20-minute program will be priced at about \$7, but a full hour program at not more than \$14. The player, which will cost around \$280 to produce and will retail for under \$400, will be hooked up across the antenna terminals of a tv set.

Unlike commercial vtr's, the EVR unit produces a high-quality picture. Also, users will be able to have 8- or 16-millimeter home movies transferred to EVR film. CBS will process these movies for customers in a cartridge-processing plant it is establishing in Stamford, Conn.

the same tape.

Promoters of longitudinal-scan recording are always quick to assert that the development of a low-cost home recorder would open up a mass market for canned programs that could be bought outright or rented by the consumer. The adoption of multitrack recording systems, they say, would facilitate high-speed tape duplication since all the tracks could be recorded at once.

But this is premature. If vtr's for the home market are to use prerecorded tape, makers will first have to establish recording standards. As things stand now, tapes recorded on one firm's longitudinal-scan machine wouldn't be playable on another's; differences in tape width, tape speed, number of tracks, track width and spacing, and recycle time for track stepping would cause partial or total loss of the video signal.

The instrumentation-recorder industry once faced the same problem. It was solved by the establishment of the Inter-Range Instrumentation Group, which sets standards for track width, track spacing, and head-stack configuration, and even keeps tabs on the definitions of technical terms. Unfortunately, standards for commercial video tape recorders would have to cover much more than the relatively simple matters of track dimensions and spacing. There are now more than 20 helical-scan tape formats and no two are compatible.

Great debate

Until standards are established, there will be no home entertainment market for vtr's. But there'll be no home market in any case until a machine capable of recording and reproducing good-quality color

pictures is placed within reach of the average consumer. So we return to the nub of the question. Spinning-head designs can meet the technical requirements; by rotating the head at a fast enough rate—typically 3,600 revolutions per minute—tape velocity can be held at about 7½ ips, for a bandwidth of more than 4 Mhz.

But proponents of fixed-head designs argue that prices on rotating-head vtr's cannot be reduced to the levels that might attract a mass market, that the need for complex circuitry in these machines cancels out all attempts to cut costs substantially. Citing the present prices for helical-scan vtr's, they assert that the industry's only chance to create a home-recorder market is to perfect fixed-head machines.

The complex and expensive circuitry referred to is used in helical-scan servosystems to position the rotating head so that it is off the tape just prior to the vertical interval, a scanning period corresponding to the bottom of the picture.

At least one firm has straddled the fence on this question of helical versus longitudinal scan. Akai, which two years ago said it was totally committed to producing fixed-head machines only, was quietly working all the time on spinning-head designs. The result of this work is the first combination video-audio recorder to be marketed, a helical-scan machine that was unveiled this summer at the Consumer Electronics Show in New York and is being sold under the Roberts trade name.

Outside of the technical problems to be overcome, vtr makers must face up to some very basic questions concerning the nature of their potential market. Are the predictions of a big market for home video recorders realistic? And if they are, what are the prospects of filling the needs of this market with fixed-head recorders?

For the foreseeable future, the only application for home vtr's will be to record tv programs for playback. But will the consumer plunk out \$50 for enough tape to record an hour's program? And if he does, how many programs will he record? But most important, will he buy a recorder that's going to eat up tape—and money—at that rate?

And will he also want a companion color tv camera? If he doesn't, he'll be limited to recording only the programs he gets on his television receiver. When Arvin earlier this year demonstrated a prototype of the recorder it's building from a Newell design, it rented a \$70,000 Norelco studio camera to avoid off-the-air recording. Admittedly, all color cameras aren't that expensive; a consumer could probably pick up one from International Video for just under \$15,000.

Perhaps from the industry's standpoint there is a mass market out there. But not even technical advances in fixed-head technology, or cost-cutting on helical-scan recorders, can bring it into being. Without low-priced companion cameras, interchangeable prerecorded tapes, and better and more inexpensive raw tape, the home vtr will be more a novelty gadget than a household fixture.

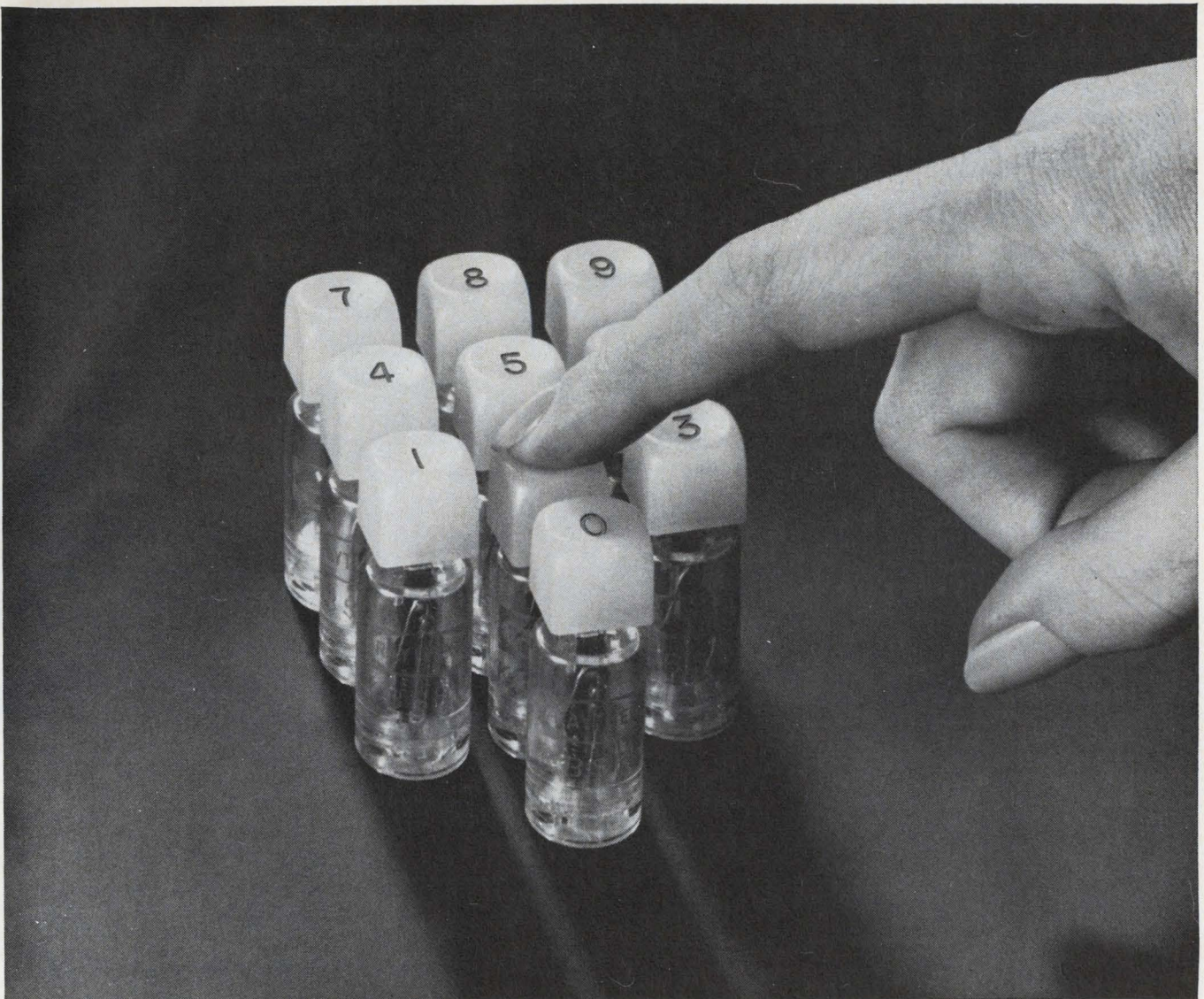

These new keyboard switches feature unusually precise action and low-cost mounting. See for yourself—write for samples.

These elegantly styled key switches—designed for handling switching at logic levels—are especially suitable for computers, learning and business machines, and advanced control equipment.

Designed by Raytheon, they have a featherlight touch that is precise and reliable. Just a 3-oz. touch activates the switch. Because of the unique design, this action can be repeated more than 10 million times. Yet the switches cost less than \$1 in production quantities.

A wide range of standard- and custom-cap shapes, sizes, colors, and alphanumeric characters are available. Char-

acters can be hot stamped, engraved or molded through. Bases can be flat or with 10° slope. Characters can be illuminated by backlighting. All switches are made of high-quality materials: stain-resistant caps; polycarbonate body parts; stainless steel springs; beryllium and stainless steel contacts. They are available in single- and double-level wipe-action types, and in dry-reed, hermetically sealed single- and double-level types.

For free samples, write on your letterhead describing your application to: *Raytheon Company, Industrial Components Operation, Dept. 2351-EL, Quincy, Massachusetts 02169.*

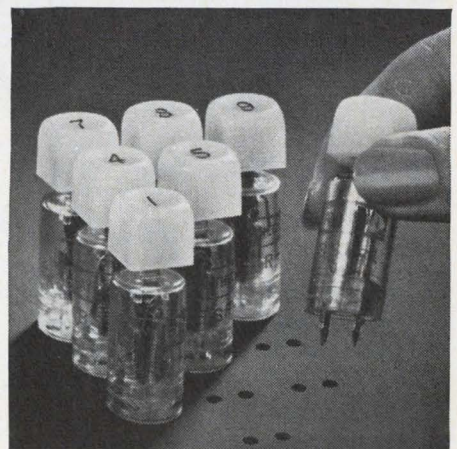

Simple, low-cost mounting. Raytheon switches plug into .125" PC board. Contact pins snap in, firmly lock switch in place for soldering. This permits you to use flow soldering techniques—cut keyboard assembly time and costs.



Quick response on Ram Air Turbine Systems.

Garrett now has 30 types of RATS (Ram Air Turbine Systems) to choose from, and more standard designs are on the way. That's how we can promise quick response.

But what if we don't have a model that meets your exact needs? No problem—we can design and build one that does, and we'll do it quickly.

Take a look at our lineup:

Electrical RATS—power outputs from 500 watts to 40 KW.

Mechanical RATS—ratings up to 60 shaft hp at speeds from 600 to 60,000 rpm.

Hydraulic RATS—reliable power at pressures and flow rates compatible with current hydraulic designs.

Combination RATS—versatile performance with any combination of electrical, mechanical, or hydraulic outputs.

We supply more than 90% of all Ram Air Turbines for externally-stored systems—applications that provide military aircraft with a mission flexibility unsurpassed by any other type of secondary power system.

Like to hear more about our RAT capabilities? Drop a line to AiResearch Manufacturing Division, 9851 Sepulveda Blvd., Los Angeles, California 90009.



AiResearch
Ram Air Turbine Systems

Garrett is one of The Signal Companies 

The turbot and wave analysis

The turbot belongs to the flounder family. It is a flatfish with both eyes on the top of its body—which gives it a rather narrow view of its surroundings.

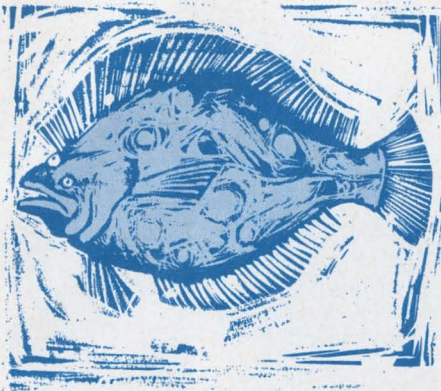

Wave analysis is a method of taking a "narrow look" at signals one at a time with a tunable bandpass filter connected to a wideband voltmeter—the wave analyzer.

While we cannot claim expertise in ichthyology or personal acquaintance with the turbot, we have had broad experience in the analysis of waveforms using wave analyzers.

Wave analysis measurement techniques were introduced some twenty-five years ago and are used more today than ever before. Continued improvement in sensitivity and dynamic range along with frequency resolution has opened many new application areas.

Today's wave analyzer measurements can be divided into three broad areas:

1. Selective measurements of signals with large differences in level. Examples are distortion analysis, measurements of low level signals very close in frequency to much larger signals, or identification of low level signals obscured by broadband noise.
2. Determination of noise characteristics (noise/ $\sqrt{\text{Hz}}$) by utilizing the well-defined bandwidth of a wave analyzer. Noise power spectral density can also be measured over the entire frequency range of the instrument.
3. Frequency response testing, using the tracking output as an excitation source to make tests at ultra-low threshold levels. The wave analyzer's high selectivity eliminates harmonic, spurious responses and ground loop effects.

Improvements Increase Utility.

Each generation of wave analyzers has seen increasingly useful improvements. First, there was the basic tunable filter and broadband voltmeter. Now there are features such as autoranging, automatic frequency control (AFC), electronic sweeping, counter digital readout, selectable bandwidths, recorder outputs. These convenience and performance features make the instrument easy to use, but, they are not the only considerations in selecting a wave analyzer.

Importance of Shape Factor. The selectivity of a wave analyzer is its greatest asset and most important specification. Selectivity is defined by the 3 dB bandwidth and the shape factor of the bandpass. The smaller the shape factor number, the more selective the instrument will be. Note the passband (dotted line) in the diagram. Specifying just the 3 dB bandwidth (bandwidth C) can be misleading—but by specifying the ratio of two selected bandwidths (usually -3 or -6 dB and the -60 dB points) provides further definition of the sharpness of the skirt (solid line in the diagram). A shape factor so defined gives a true picture of the bandpass. Today's wave analyzers have factors as low as 2:1. These are especially useful in making critical frequency measurements where signal density is high.

Dynamic Range and Sensitivity. Dynamic range is an important wave analyzer characteristic. It defines the range of the smallest to the largest signal the instrument can accommodate simultaneously. Some wave analyzers are capable of

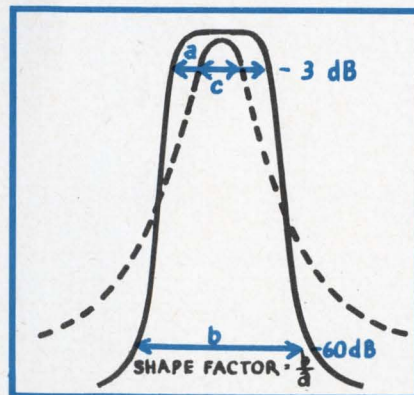

an 85 dB range. The relationship between dynamic range and attenuator range is shown below. The top end of the attenuator range is limited by the amount of attenuation

built-in, and the bottom end by the instrument's sensitivity. Dynamic range is limited by nonlinearity and noise.

Wave analyzers designed with two attenuators allow you to keep track of the dynamic range of the input. This helps you avoid input overloading that causes measurement inaccuracies. Autoranging further extends the capability of a wave analyzer to track the dynamic range of the input.

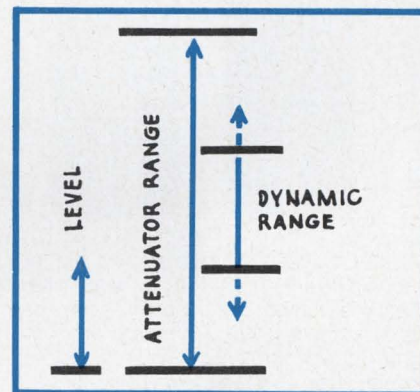

To obtain high sensitivity measurements without loading a low-level circuit under test, you need a wave analyzer with high input impedance. There is always a trade-off between high sensitivity and high input impedance. Trade-off optimization depends on the application. You'll find input impedances range from 10 k Ω to 1 M Ω while full scale sensitivities range from 3 μV to 50 μV .

You could be floundering around unless you're taking advantage of the advances in capability and performance of today's wave analyzers. Wave analysis could be the solution to your problem. Get yourself off the hook by calling your hp field engineer. He probably can't tell you much about the turbot—but, he does have information on four hp wave analyzers with frequency ranges up to 22 MHz and prices from \$1900 to \$4950. Or, request the free data package on wave analysis from Hewlett-Packard, Palo Alto, California 94304. Europe: 54 Route des Acacias, Geneva.

HEWLETT  PACKARD
SIGNAL ANALYZERS

The Plaisted Polar Expedition needed a battery that could come on strong at 20° below. Mallory made it. What can we do for you?

The arctic explorers of the Plaisted Expedition needed a battery. A battery reliable enough for their "diaries"—the portable tape recorders they used to record important events. A battery that could put out strong, steady power at -20° F. A battery that wouldn't crumble when the temperature reached -63° F.

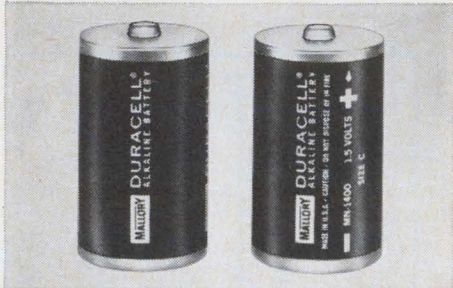

Mallory made it. The battery—a Mallory alkaline battery. Its ability to work when ordinary batteries are frozen is only one of its superior qualities. Some others: extraordinary shelf life—over 80% of original capacity after 2 years; exceptional performance under high current drains; low impedance—in standard sizes as low as 0.1 ohm per cell. And, of course, the Mallory alkaline battery has a very high energy density, up to 35 watt-hours per pound.

POWER PER POUND

The word "heavy" in "heavy-duty" batteries often throws people off. Because heavy-duty alkaline batteries often weigh a bit more than the same size ordinary battery, people feel they must be sacrificing lightness to gain power. Nothing could be further from the truth. Alkaline batteries actually enjoy quite an advantage over ordinary batteries when it comes to weight. The secret is size. Because Mallory alkaline batteries pack so much power in such a small space, the size of a battery needed for a given application can often be reduced. Pound for pound—size for size—Mallory alkaline batteries provide more capacity—more power than any ordinary battery.

OVER 1000 DIFFERENT TYPES

Chances are Mallory has the battery you need already in production. Right now we're making over 1000 different types and sizes. And if we're not actually producing the one you need, we'll be glad to sit down with you to design one to your specifications.

For more information, please write Technical Sales Department, Mallory Battery Company, a division of P. R. Mallory & Co. Inc., South Broadway, Tarrytown, New York 10591. Telephone: 914-591-7000. (In Canada: Mallory Battery Company of Canada Limited, Sheridan Park, Ontario.)

MALLORY

It's good business to do business with Mallory



One man's stability is another's slop.

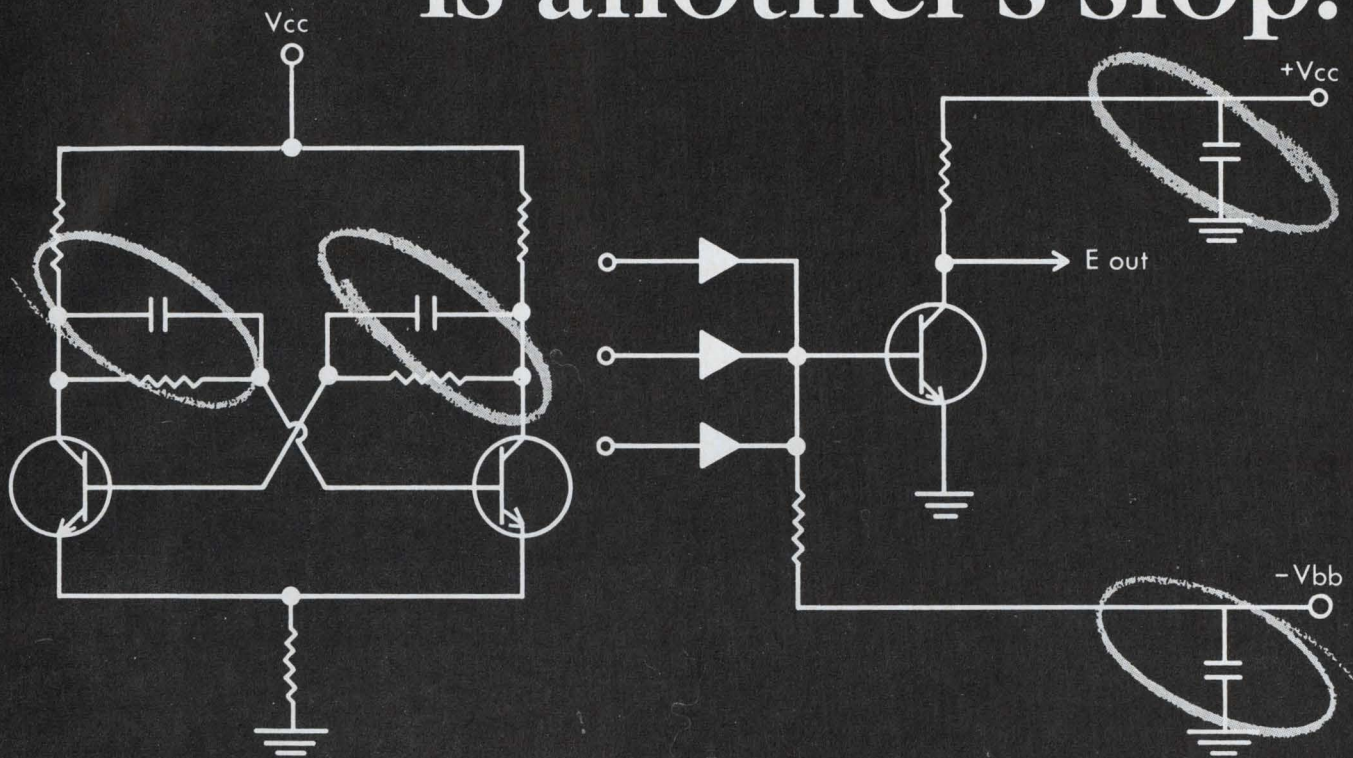

CORNING® Glass-K Capacitors provide both.

Needs vary with circuit function.

A filter can stand some slop. You buy for size and plain reliability.

But in timing or tuning, a capacitance change may not only foul up your signal, but the result may be more damaging than a total stop.

CORNING Glass-K answers both needs.

From 270 to 100,000 pf, just .250" long.

Stability? Choose from three characteristics, with ΔC with life as low as 2% max., at 125° C.

Reliability? Check Apollo, Centaur, Poseidon.

Get size, stability, sureness. Get the figures on Glass-K Capacitors.

Write: Corning Glass Works, Electronic Products Division, Corning, N.Y. 14830

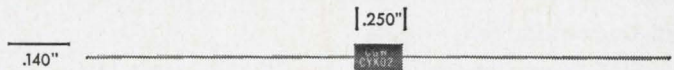

CORNING
ELECTRONICS

NOW!

1 1/4

rack models

available in Lambda LR High Performance Series for rack or bench use

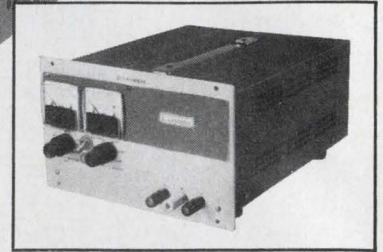
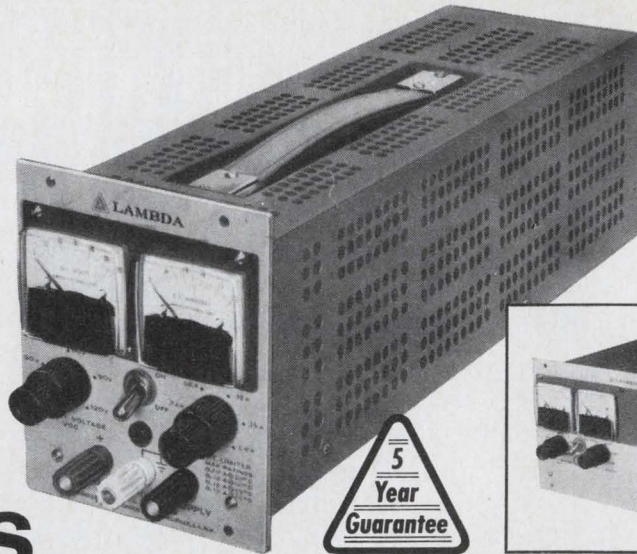

- **0.0005% plus 100 μ V regulation.**
- **35 μ V rms ripple.**
- **AC Input:** 105-132 VAC, 47-440 Hz (Ratings based on 55-65 Hz) 205-265 VAC on request at no extra charge ("-V" option).
- **2 meters** monitor both voltage and current simultaneously and continuously.
- **With Remote Programing**
Accuracy—0.01% plus 1mV
Stability—0.001% plus 100 μ V for 8 hours
Temp. Coeff.—0.001% plus 10 μ V/ $^{\circ}$ C
- **Guaranteed for 5 years.** The only 5-year guarantee that includes labor as well as parts. Guarantee applies to operation at full published specifications at end of 5 years.
- **Multi-Current-Rated.**
- **Only 5 1/4" high.** Convenient 1/4 and 1/2 rack sizes for rack or bench use.
- **All-silicon** design for maximum reliability.
- **Convection cooled** for convenience and reliability... no blowers or heat sinks.
- **Remote programing** by changes in voltage or resistance for convenience in systems, test equipment and automatic equipment applications.
- **Auto Series/Auto Parallel** with Master-Slave tracking
- **Constant I/Constant V** by automatic cross-over.
- **Completely protected:** short-circuit proof; continuously adjustable automatic current limiting.
- **Overvoltage protection** available as low cost add-on accessory.

FOUR 1/4-RACK MODELS

Model	Voltage Range	MAX. AMPS AT AMBIENT OF ¹				Price
		30 $^{\circ}$ C	40 $^{\circ}$ C	50 $^{\circ}$ C	60 $^{\circ}$ C	
LR-602-FM	0-20 VDC	1.1	.95	.80	.64	\$265
LR-603-FM	0-40 VDC	.60	.50	.42	.33	265
LR-605-FM	0-120 VDC	.23	.20	.17	.14	295
LR-606-FM	0-250 VDC	80ma	72ma	65ma	60ma	310

FOUR 1/2-RACK MODELS

Model	Voltage Range	MAX. AMPS AT AMBIENT OF ¹				Price ²
		30 $^{\circ}$ C	40 $^{\circ}$ C	50 $^{\circ}$ C	60 $^{\circ}$ C	
LR-612-FM	0-20 VDC	1.8A	1.6A	1.3A	1.1A	\$305
LR-613-FM	0-40 VDC	1.0A	0.9A	0.75A	0.6A	305
LR-615-FM	0-120 VDC	0.33A	0.29A	0.25A	0.21A	320
LR-616-FM	0-250 VDC	100ma	90ma	80ma	70ma	340

¹ Current rating applies over entire voltage range. Ratings based on 55-65 Hz operation.

² Prices are for metered models. LR Series models are not available without meters.

Prices F.O.B. factory, Melville, N. Y. All specifications and prices subject to change without notice.

OVERVOLTAGE PROTECTION

For Use With	Model	Adj. Volt. Range	Price
LR-602-FM, LR-612-FM	LH-OV-4	3-24 V	\$35
LR-603-FM, LR-613-FM	LH-OV-5	3-47 V	\$35

Write, wire, or call to order direct, for information, or for new Lambda Power Supplies catalog. LAMBDA Electronics Corp., 515 Broad Hollow Road, Melville, L. I., New York 11746, TEL. 516-694-4200, TWX 510-224-6484.

LAMBDA

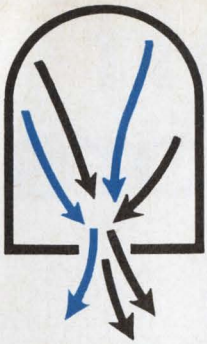

CVC

MEET THE DECISION MAKERS...

Four CVC High Vacuum Systems with AutoMateTM Control!

Just touch the start button, AutoMate does the rest. The AutoMate Control on your CVC system controls pumping cycles automatically—as fast and accurate as your best technician. The cycling decision is

made and carried out in response to pressure in the system—you get the same results in your pumpdown every time. For full details, write Consolidated Vacuum Corporation, Rochester, New York 14603.

	CV-144	CV-164	CV-18	CV-1104
APPLICATIONS	Electronic and Optical Thin-Film Deposition, Environmental Studies	Electronic and Optical Thin-Film Deposition, Environmental Studies	Electronic and Optical Thin-Film Deposition, Environmental Studies	Electronic and Optical Thin-Film Deposition, Environmental Studies
CHAMBER	14" Pyrex Bell Jar	18" Pyrex Bell Jar	18" Pyrex Bell Jar	24" or 30" Stainless Steel Bell Jar
DIFFUSION PUMP	4" BlueLine	6" BlueLine	6" BlueLine	10" BlueLine
BAFFLE	Choice of multi-coolant or liquid nitrogen	Choice of multi-coolant or liquid nitrogen	Choice of multi-coolant or liquid nitrogen	Choice of multi-coolant or liquid nitrogen
EVAPORATION POWER SUPPLY RATING (Continuous Duty/20% duty)	2 KVA/3.9 KVA	2 KVA/3.9 KVA	2 KVA/3.5 KVA	4 KVA/8 KVA

New CV-1104 System With AutoMateTM Control

Bendix **Electronics**



Tips on cooling off hot semiconductors and microcircuits

Read on. Find out how circuit designers use IERC heat dissipators to protect and improve circuit performance of semiconductors and microcircuits.

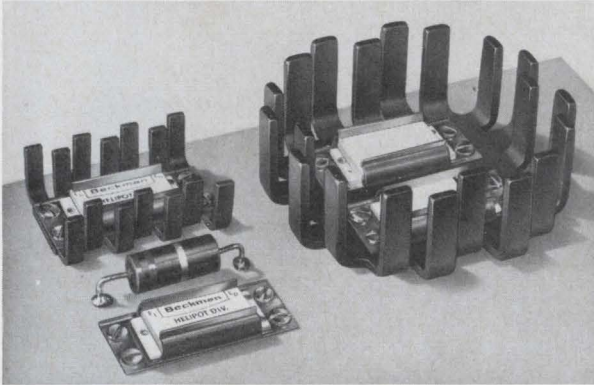

Cool off microcircuit devices with a choice of four new dissipator/retainers. Example: with natural convection, a typical microcircuit device dissipates 1.8 watts with case temperature rise of 103°C. Add IERC's model LBOC2-61B and retainer and you dissipate 5 watts with the same case temperature rise. Retainer-clip may also be used alone to mount package to conduction plane.

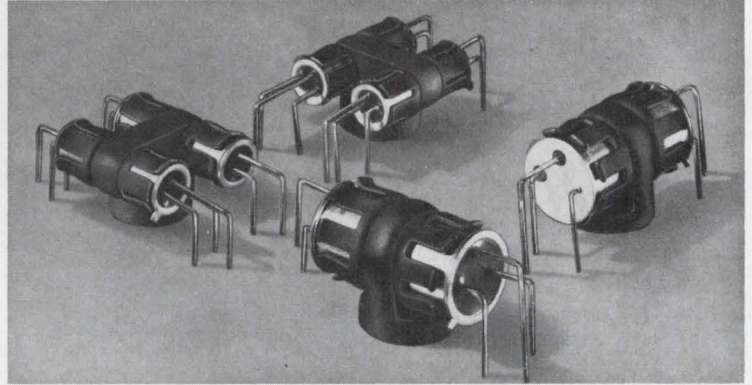

These special dual and quad Therma-Link dissipators permit thermal mating of matched transistors. Therma-Link retainers do exactly as their name says: They provide a thermal link between transistors and the chassis or heat sinks. They are also available with beryllium oxide washers which have the excellent thermal conductivity of aluminum, are electrically insulative and reduce normal mounting capacitance by 1/2 to 1/3. The washer is brazed to a brass slug or hex stud for mounting.

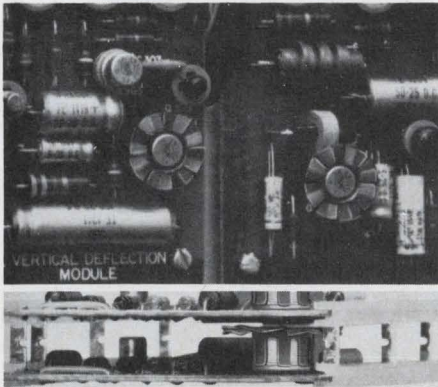

Fan Top Dissipators for TO-5 and TO-18 cases add almost nothing to board height. Don't need much room on the board either. Available for both metal and plastic cases. Spring fingers make installation simple. And Fan Tops cost just pennies.

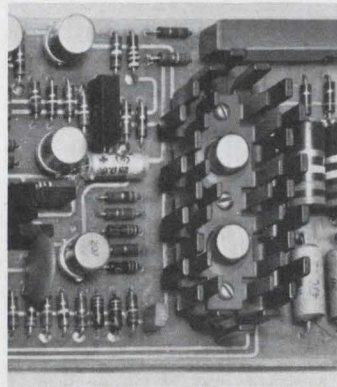

Help low-to-medium power transistors keep their cool with IERC's stagger-fingered LP's. Available in single or dual mounting for thermal mating of matched transistors. They fit both TO-5 and TO-18 cases.

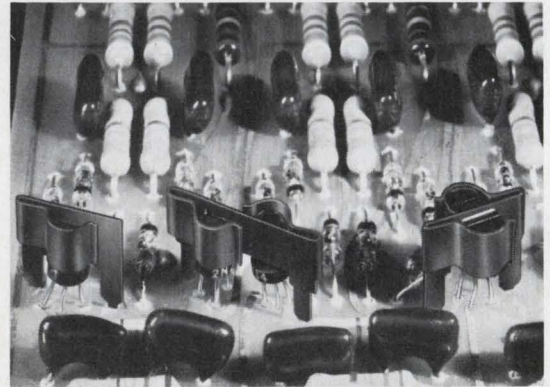

New "Universal" Spade Series for plastic transistors fits all D-case sizes. Spring clip allows for variation in case diameters. Excellent dissipation lets you boost operating power 33%. Both single and dual models as shown. IERC has heat dissipators for all popular epoxy and ceramic semiconductors.

Need a non-hygroscopic finish with excellent dielectric properties, 50 K megohms insulation resistance and high heat emissivity? Use Insulube® 448. It also protects against salt spray and fungus and other adverse environments.

Got a tough one? Our engineers welcome your inquiry for more specific information. Write us on your company letterhead, please.

ierc
SEMICONDUCTOR
HEAT DISSIPATORS

INTERNATIONAL ELECTRONIC RESEARCH CORPORATION  A corporate division of Dynamics Corporation of America • 135 West Magnolia Blvd. • Burbank, Calif. 91502

sweeps
5 to 1500 MHz
in 7.5 milliseconds
flat!



We can supply a sweep generator with rally stripes on special order, but the frequency range and the sweep rate are standard.

Telonic's 2003 Sweep Generator will cover that entire band—1495 MHz—in a single sweep, or in any segment down to 0.02 Hz wide. You can instantly see response characteristics over all, or any portion, of a circuit's operating frequencies.

And don't overlook that word "instantly." If you're still in the habit of using a signal generator for point-to-point testing, it's time to upshift into swept techniques. Let your local Telonic rep show you the '68 floor models.

Catalog 70-A and Supplements contain complete descriptions on all Telonic Sweep Generators plus a full section devoted to "how-to" applications. Get your copy today.

Model 2003 Sweep/Signal Generator System

- Frequency Range**
(Seven different plug-in oscillators available) 0.02 Hz-1500 MHz
- Sweep Width**
(F_1-F_2 or $F_c/\Delta F$) 0.02 Hz-1495 MHz
- Frequency Marking**
(Four different marker plug-ins available) Fixed or variable
- Attenuation**
(Eight attenuator plug-ins available) 1 db to 109 db (50 or 75 Ω)
- Sweep Rate**
(Select from two rate plug-ins) 0.001 to 60 sweep/sec.
- Log Amplification**
(One plug-in does it all) 105 db dynamic range
- Detection**
(Two detector plug-ins available) P-P passive, 50 and 75 Ω
- Display**
(Two display processing plug-ins) Amplitude and marker tilt control

TELONIC INSTRUMENTS



A Division of Telonic Industries, Inc.
60 N. First Avenue
Beech Grove, Indiana 46107
TEL (317) 787-3231 • TWX-810-341-3202

“Ministac”™

A New High Voltage High Frequency SILICON RECTIFIER

“Ministac” is a fast-recovery, *silicon*, microminiature rectifier that can replace vacuum tubes and selenium sticks. Offering easier mounting and a smaller package, “Ministac” is competitively priced. Due to Semtech’s high-volume production techniques, “Ministac” is being produced without sacrificing quality or reliability.

“Ministac” operates efficiently with all types of wave forms. Applications include:

- R. F. Power supplies
- Focus rectifiers
- High-voltage devices for —
 - CRT’s
 - Image intensifier tubes
- Voltage multipliers for —
 - Data display systems
 - Multivision equipment
 - Television receivers

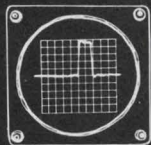

“Ministac” specifications:

Peak Inverse Voltage 3 kV to 7 kV
Average Rectified Current 10 mA
Leakage Current 100 nA
Junction Capacitance 1 pF max.
Recovery Time 100 ns

“Ministac” is small measuring only .400 x .120.

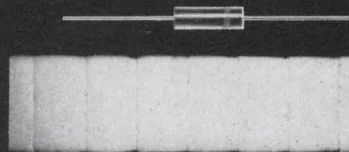

Enlargement of “Ministac” with solid internal construction using high temperature bond

“Ministac” junctions are metallurgically bonded at *high temperature* producing a high-strength multi-junction unitary stack. This process allows Semtech to use the Supratalaxial junction (liquid phase epitaxial) proven to be superior for high-voltage, fast-recovery devices.

For more information, contact Semtech or your nearest representative and get your copy of “Ministac — Design Freedom with New High Voltage-Low Current Rectifiers.”

San Francisco — 941 E. Charleston, Suite 10, Palo Alto, California 94303
(415) 328-8025
Chicago — 140 N. La Grange Road, La Grange, Illinois 60525
(312) 352-3227 / TWX: 910-683-1896
Dallas — 402, Irving Bank Tower, Irving, Texas 75060 / (214) 253-7644
New York — 116-55 Queens Blvd., Forest Hills, New York 11375
(212) 263-3115 / TWX: 710-582-2959

European Sales — Bourns A. G. Alpenstrasse 1, Zug, Switzerland
(042) 4 82 72/73



SEMTECH™
CORPORATION

652 Mitchell Road, Newbury Park, California 91320
(805) 498-2111, (213) 628-5392 / TWX: 910-336-1264



A Complete Family of Portable Oscilloscopes

a choice of performance and convenience features

TYPE 321A
6 MHz, 14 lb



TYPE 323
4 MHz, 7 lb



TYPE 422
15 MHz, 22 lb



TYPE 453
50 MHz, 30 lb



TYPE 454
150 MHz, 31 1/4 lb



Tektronix portable oscilloscopes provide performance and convenience features which span a wide variety of oscilloscope applications. Bandwidths to 150 MHz, dual-trace vertical amplifiers, delaying sweep and AC, DC or battery operation are some of the features. The Tektronix portable family is designed to permit you to choose the instrument that best suits your application.

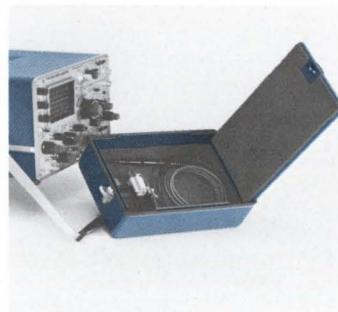

please turn page for additional information

Making the Measurement . . . with Tektronix Portable Oscilloscopes

Each Tektronix portable oscilloscope is a complete measuring system. Necessary accessory items such as probes, adapters, cords, filters, and manuals are included at no extra cost. Additional value is provided by a complete line of optional accessories—voltage probes, current probes, special adapters, cameras, protective covers, and Scope-Mobile® Carts. Your Tektronix Catalog lists all accessories with detailed descriptions.



TYPE 453
DC to 50 MHz
Dual Trace
Delaying Sweep
AC Powered

Dual-trace DC to 50 MHz bandwidth with sweep delay in a compact 30-pound instrument. Rugged environmental capabilities are combined with performance features normally found only in multiple plug-in instruments. Vertical amplifiers provide 7-ns risetime, DC-to-50 MHz bandwidth, from 20 mV/div to 10 V/div deflection factor. At 5 mV/div deflection factor, risetime is 8.75 ns and bandwidth is DC to 40 MHz. Cascading Channel 1 and Channel 2 provides 1 mV/div deflection factor, DC-to-25 MHz bandwidth. The included Type P6010 miniature 10X probes preserve system bandwidth and risetime performance right to the probe tip. Front panel switching logic permits making 5 mV/div X-Y measurements. Jitter, time coincidence, pulse width and other measurements are easily made utilizing the calibrated sweep delay. Sweep rates are 5 s/div to 0.1 μ s/div, extending to 10 ns/div with the X10 magnifier. Solid-state design, with FET vertical inputs, provide low drift and fast stabilization time. AC powered.

Type 453 Oscilloscope \$1950



TYPE 321A
DC to 6 MHz
AC, DC,
or Battery Powered

Bandwidth is DC to 6 MHz and deflection factor is 10 mV/div to 20 V/div. Sweep rates are 0.5 s/div to 0.5 μ s/div extending to 0.1 μ s/div with the X5 magnifier. Rugged mechanical and electrical design plus a choice of AC, DC, or battery power make the Type 321A ideal for field operations requiring accurate waveform measurements. With internal batteries, it weighs 17 pounds; without batteries, it weighs 14 pounds.

Type 321A Oscilloscope
without batteries \$950
Set of 10 NiCd batteries \$ 70

TYPE 454
DC to 150 MHz
Dual Trace
Delaying Sweep
AC Powered



DC-to-150 MHz bandwidth, 2.4-ns rise-time! This oscilloscope is currently the fastest real-time, general-purpose instrument available. Dual-trace amplifiers provide 150-MHz bandwidth at 20 mV/div deflection factor. At 5 mV/div, rise-time and bandwidth are 5.9 ns and 60 MHz respectively. Single-trace displays at 1 mV/div deflection factor permit viewing low level signals. The supplied P6047 10X probes preserve the 150-MHz bandwidth right to the tip of the probe. Sweep rates are 5 s/div to 50 ns/div, extending to 5 ns/div with the X10 magnifier. Calibrated sweep delay permits expanding specific portions of your waveform display for examination in detail. A photographic writing speed of 3200 div/ μ s (>2500 cm/ μ s) is provided by the Type 454 Oscilloscope, C-31 Camera, and 10,000 ASA film, without employing film-fogging techniques! X-Y displays, with calibrated deflection factors to 5 mV/div, are possible with the flick of two front panel switches. The Type 454 is mechanically designed to withstand environmental extremes and rough handling. AC powered.

Type 454 Oscilloscope \$2600
C-31-R (Roll-film back) \$ 550

U.S. Sales Prices FOB Beaverton, Oregon

Your Tektronix Field Engineer will demonstrate the performance of the Tektronix portable oscilloscope of your choice, on your premises at your convenience. Please call him or write, Tektronix, Inc., P.O. Box 500, Beaverton, Oregon 97005.

TYPE 422
DC to 15 MHz
Dual Trace
AC, DC,
or Battery
Powered



This compact, rugged oscilloscope combines small size and lightweight with 15-MHz, dual-trace performance. Two models are available. One is powered from AC; the other from AC, DC, or internal rechargeable batteries. The AC version weighs less than 22 pounds including accessories; the AC/DC model with built-in battery recharger weighs 30 pounds including accessories and batteries. Dual vertical input amplifiers cover major use areas with 23-ns rise-time and DC-to-15 MHz bandwidth over the 10 mV/div to 20 V/div deflection range. 1 mV/div deflection factor with 5 Hz-to-5 MHz bandwidth is provided on Channel 2. Sweep rates are 0.5 s/div to 0.5 μ s/div, extending to 50 ns/div with the X10 magnifier. The Type 422 is mechanically and electrically designed to withstand rugged environments.

Type 422 Oscilloscope
(AC version) \$1425
Type 422 MOD 125B Oscilloscope
(AC/DC without Battery Pack) . \$1775
Battery Pack for Type 422 MOD 125B
(order 016-0066-02) \$ 125

TYPE 323
DC to 4 MHz
AC, DC,
or Battery
Powered



Internal batteries provide up to 8 hours of continuous operation and are rechargeable from the AC line in approximately 16 hours. The Type 323 may also be powered from the AC line or external DC. Bandwidth is DC to 4 MHz and deflection factor is 10 mV/div to 20 V/div. 1 mV/div deflection factor at 2.75-MHz bandwidth is provided for viewing low-level signals. Sweep rates are 1 s/div to 5 μ s/div extending to 0.5 μ s/div with the X10 magnifier. A single-control knob permits automatic or manual level sweep triggering, positive or negative slope. The compact Type 323 weighs 7 pounds including batteries and is designed for field environments.

Type 323 Portable Oscilloscope
with batteries \$850



Tektronix, Inc.

committed to progress in waveform measurement

Probing the News

Management

Hogan takes hold at Fairchild

Semiconductor division is first stop for new chief executive from Motorola; he'll make its efforts provide greater support for other corporate activities

By Walter Barney

San Francisco bureau manager

If **C. Lester Hogan** can carry out his plans for the Fairchild Camera & Instrument Corp., the impact of the move that brought him and his management team into control of both the company's corporate structure and its Semiconductor division is likely to be a lot greater than anyone predicted. In addition to the presidency of the corporation, Hogan has temporarily assumed control of the Semiconductor operation as general manager. It is to this division that most outsiders look for changes.

Hogan does have some far-reaching, even drastic, plans. But none will change the basic stance of the Semiconductor division as a technological leader. Fairchild will not be remade in the image of Motorola Inc., where Hogan was executive vice president and general manager of the Semiconductor Products division.

What Hogan plans is far more significant: a remaking of the corporation around the Semiconductor division to take advantage of its strengths. "Semiconductor technology will be basic in all electronics," Hogan says. "And electronics itself will be basic to all other technologies. I want to couple the capabilities of the Semiconductor division to the other divisions, so that they can lead the parade instead of follow in it."

Helping hand. Specifically, Hogan will make the Semiconductor division's research and development laboratory—one of the most elaborate in the industry—available

to every other division. This is the significance of the naming of Leo F. Dwork to a staff position as corporate director of research. "Leo and I want to find a coupling mechanism between the R&D lab and the rest of the corporation," Hogan says. "For instance, the Graphic Equipment division makes a good phototypesetter, but could it be better with help from semiconductor R&D?"

Hogan also brought Joseph Van Poppelen from the International Telephone & Telegraph Corp. to be corporate director of marketing [Electronics, Sept. 16, p. 34]. Van Poppelen will have no direct responsibility for divisional activities, but he will advise Hogan on the feasibility of entering any new businesses or product areas.

Dwork was responsible for central R&D, as well as certain product groups, at Motorola. Van Poppelen is a former general manager of ITT Semiconductor. Thomas Hinkelman, in charge of corporate planning, had divisional responsibility in that area under Hogan at Motorola. These additions from the semiconductor world to the corporate staff, previously dominated by financial experts, leave no doubt that Hogan plans nothing less than a revolution at Fairchild.

Where the action is

If Semiconductor is to be boss, what happens to the division? The answer seems to be that Hogan has some tinkering to do. But he stresses that his plans are based on

Fairchild's strengths and weaknesses, rather than on any preconceived notion about how to run a business.

Hogan says he found just about what he expected when he arrived in Mountain View. "It's better than I had thought, but not much different," he says. "What really surprised me was the outstanding competence of the R&D work. Their ability to build tremendously complex circuits is far beyond anything I thought I'd find. Fairchild is unequalled in gallium arsenide research, for example. There are a lot of little tricks they're coming up



New broom. C. Lester Hogan heads Fairchild after having acquired a name in production at Motorola.

with in circuit design and processing techniques that I really didn't think were possible. And the skills in complex metal oxide semiconductor devices are way ahead of

anything that I've seen elsewhere. In fact, the technology is so good that if I had known about it, it would have given me ulcers in Phoenix."

Delivering the goods. On the other hand, Hogan echoes outside complaints about Fairchild's delivery record. "The company does not meet its commitments to custom-

Fairchild from the inside

The hiring of C. Lester Hogan as president and chief executive officer was a brilliant managerial coup that seems to have been fought all the way by the top officials of the Fairchild Camera & Instrument Corp. Reports now trickling out of the company indicate that Sherman M. Fairchild and his top advisers never intended to put a semiconductor expert in the top post. Only the resignation of group vice president Robert N. Noyce, a founder of the Semiconductor division, made them realize they'd better have one.

Between last November, when John Carter was forced out after a lengthy tenure as board chairman and chief executive officer, and June, when Noyce resigned after four months as acting chief, Fairchild conducted what amounted to a search for identity.

"Carter cowed the board; he did not bring it in as an informed body," says one insider. "But as long as things went reasonably well, no one could challenge him." Increasingly, however, signs of discontent on the board appeared as the financial community complained about some of Carter's maneuvers—particularly the acquisition of divisions that went sour.

Too loyal? Carter reportedly had a tendency to agree to shut down the losing operations, then back out at the last minute. "Division managers always won the arguments with the corporate staff," one highly placed source says. "That's okay if you have good division managers. But Carter was loyal to his people to a fault, and he was a sucker for a good salesman." The upshot was that a corporate recommendation to change divisional operations could be blocked by the division manager affected.

The setting up of a financial committee consisting of Fairchild, Walter Burke, a lawyer and Fairchild's financial adviser, and Joseph B. Wharton, a tax consultant, was the first step taken to oust Carter. This group found that he'd been too optimistic about some of his operations. When 1967 third-quarter earnings sank to 3 cents a share, it was able to force Carter's resignation. Then the comedy began.

"The board had not really thought through what it wanted to do next," one informed source reports. "Fairchild took over as chairman of the board; under the bylaws, the chairman was supposed to be the chief executive officer. But Fairchild didn't want to run the corporation; he decided that Richard Hodgson, who was already the president, should take over."

The almost casual elevation of Hodgson last November goes a long way toward explaining why he was eased out of the top spot five months later. At the time, the move mystified both outsiders and employees. Hodgson had proceeded to act on the recommendations of Wharton and Burke, with whom he fully agreed, and had dealt off losing operations. He sold the oscilloscope activity, the Davidson division, and the memory products department of the Semiconductor division. Most important, he wrote off tremendous amounts of inventory and obsolete equipment—resulting in a 1967 loss of \$7.7 million.

Surprise package. But the worst seemed to be over, and Fairchild even showed a per-share profit of 33 cents in the first quarter of 1968. This was 7 cents a share more than the company had budgeted for, but the management crisis was only beginning.

"Hodgson didn't like the committee," one insider says. "He conducted himself beautifully, but he couldn't help letting it be known that he considered himself a cut above the rest of the people. On the board's part, there was still suspicion. They had been fooled once before by Carter.

Hodgson also reportedly irritated the board by not doing everything he was told to do. He had been ordered, for instance, to beef up the corporate staff by hiring a new senior financial officer. Hodgson was unable, or unwilling, to follow this recommendation. And only this month was the position filled.

In April—despite his vigorous performance and the excellent first-quarter earnings—Hodgson was relieved of his duties and made vice-chairman of the board. Wharton, Burke, Fairchild, and Noyce were named to a committee to direct the company. Noyce wound up with the responsibility for day-to-day operations, and the hunt for a new president was on. There was speculation that Noyce himself might be given the job.

Noyce apparently speculated about that too. But when the board outlined its requirements for a new boss, it became clear that Noyce was not the man and he couldn't work for such an individual.

Management myopia? "The board was not looking for a semiconductor man," says an insider. "They figured they already had one in Noyce. What they wanted was someone to take care of the ailing divisions, the space and defense operation, and so forth. You have to understand that these are all brilliant men. But they saw management as a group of people who prevented others from making mistakes. The way to avoid mistakes, of course, is to do nothing. But what the company needed was not control—it was leadership."

Noyce apparently decided that he did not want to bid for the top job himself. And since he did not wish to stay under another 'finance committee' regime either, he told the board that he wanted to resign. That move may have triggered a switch in Fairchild corporate tactics. When the board realized that its chief link to the Semiconductor division—its big moneymaker—was leaving, it began a vigorous search for a semiconductor man as president. Hogan was the result. Even more important, probably, than the hiring of Hogan was the attendant transformation of Fairchild from an East Coast corporation with a strong western division to a West Coast enterprise built around a strong semiconductor operation.

For Hogan has beefed up his corporate staff with semiconductor experts—Joseph Van Poppelen, Leo Dwork, Thomas Hinkelman, et al—and leaves no doubt that he intends to integrate the corporate operations and those of the Semiconductor division.

Fairchild found—after trying for nine months—that it just could not live without the leadership it feared.

ers," he says flatly. The result has been that Fairchild has built an unenviable record for poor customer relations; many would-be customers suspect that the company has insoluble manufacturing problems and that they're getting a run-around from the sales department.

Why can't Fairchild deliver? Mainly, Hogan believes, because its current paperwork and scheduling practices aren't up to the task of getting the proper product mix. "There are thousands of items in the catalog," he points out. "And in the semiconductor business, you don't even know what you're making until you test it. We have got to change our information system; this is 90% of my problem."

Far and wide. The man who will handle this task is George Scalise, whose title is chief of manufacturing services. Scalise believes that the difficulties stem from the dispersal of Fairchild's production capacity. The company has plants in Portland, Me., Shiprock, N. M., Korea, and Hong Kong as well as Mountain View. Scalise apparently plans to simplify Fairchild's administration practices to improve scheduling, order handling, and dispatching. Scalise has named a veteran Fairchild hand, Patrick O'Haren, head of production control. O'Haren was already manager of information systems, but no one man ever had complete responsibility for production control.



Power play. Fairchild's new president kept the company in power transistors.

Fairchild also plans to computerize product specifications to make available information more accessible. Scalise says he thinks he can make significant inroads on the problems very quickly. The long-term outlook, however, remains a question mark. "Some things are obvious, but you really have to live with a system to see how to change it," he says.

Growth and expansion

But changing the system is simply a corrective measure. On the positive side, Hogan plans to strengthen Fairchild's product lines where they are weak, specifically in the discrete-component area, where Motorola is growing ever stronger. He'll consider expansion by acquisition, as well as by internal growth, and he intends to invest heavily in inventory and capital equipment.

Hogan definitely plans to capitalize on Fairchild's MOS capability, which has been known largely as a laboratory effort despite several abortive attempts to transfer it to the production area. Hogan has already reversed Fairchild's recent decision to get out of the industrial-commercial power transistor market. And he has looked at two or three small companies with an eye to picking them up. At present, he says, he is undecided about whether to buy all, none, or some. One that may be acquired is the Dickson Electronics Corp., Scottsdale, Ariz., a producer of zener diodes. Donald C. Dickson, who heads this company, built Motorola's zener business under Hogan.

Stephen E. Levy, Hogan's successor at Motorola, figures that his former boss will want to spend \$25 million to \$35 million on capital improvements in his first year at Fairchild. Levy doubts that anyone can spend so much so fast intelligently. Hogan will not confirm the figures, but he does concede that a lot of money will be going out the door. "For one thing, we must spend millions of dollars for inventory (to improve the delivery situation)," he says. "Anyway, I've spent that much money, in a short time and intelligently, before." But Hogan indicates he may spend so much on people and equipment that the bellwether Semiconductor division could well wind up as a money-



Model 79 Linear IC Tester

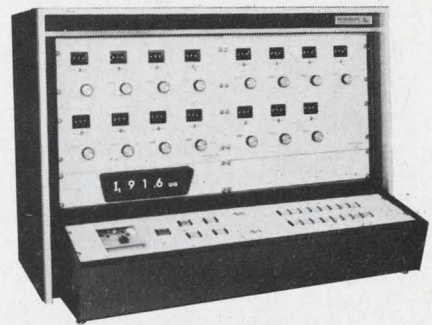

New automatic Linear IC Tester offers simple, preprogrammed operation

The simple operation of the new automatic Model 79 Linear Integrated Circuit (LIC) Tester from Test Equipment Corporation virtually eliminates costly operator training. This savings, combined with its low initial cost, makes the Model 79 an excellent buy for production, engineering and quality control applications.

TEC's Model 79 "LIC" Tester is completely automatic with the

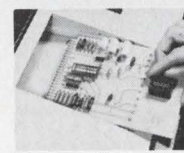

exception of test limits and range selections and is preprogrammed on performance boards (inset)

for up to 15 different test measurements. It provides five dc and eight dynamic tests. In addition, two auxiliary positions are available for customer-specified tests.

The Model 79 features low current measurements to 99.9 pa full scale, low voltage measurements to 99.9 μ v full scale, and high speed typically 100 ms or less per test. It accepts all IC package configurations.

Write today for full technical and pricing information on the new TEC Model 79 "LIC" Tester.

Test Equipment

CORPORATION
P.O. BOX 20215, DALLAS, TEXAS 75220 • 214/357-6271

Business as usual

In light of the upheaval going on in Mountain View, the changes planned by the new regime at the Motorola Semiconductor Products division appear minor. Stephen E. Levy, division chief, points out that his ideas on how to run the operation must have paralleled C. Lester Hogan's or he wouldn't have been given so much freedom as assistant general manager. Now that Hogan and his assistants have left for Mountain View, little is changed for Motorola except that its competition is stronger.

Levy does, however, plan to shift emphasis in certain areas. For example, he is permitting Michael Callahan, the new boss of integrated-circuit research and development to sell MECL 3 (a third-generation, subnanosecond emitter-coupled-logic family) from a pilot production line. Even though R&D reports to the IC production department, a new line would normally have to graduate to full production status before being announced for sale. In general, Levy indicates, Motorola will be a little more eager to get its newer products to the marketplace quicker.

Great expectations. Like Fairchild, Motorola plans a big effort in metal oxide semiconductor devices. Richard I. Abraham, head of advanced IC programs, indicates—ominously, perhaps, for the smaller companies that have successfully weathered Fairchild's MOS challenges—that Motorola plans to be top dog in MOS by the early 1970's. Wally Raisenan, head of MOS and memory products, feels that memories (both MOS and bipolar) will be a \$50 million business for Motorola by the late 1970's, though the division only got into the field this year.

More immediately, Motorola plans a big push in TTL. Robert H. Lyon, head of IC production, says that the division expects to zoom from a 4.5% share of market now to 20% in six months—a good performance in any league. It will do it the old-fashioned Motorola way—with production and delivery. “We're going flat out on TTL,” Lyon says. “We've been stocking TI's 54/74 series for about six weeks. And we also have Sylvania's SUHL 1 and SUHL 2 lines, plus our own TTL-2 line. We'll try to control 60% to 70% of the SUHL market on the basis of our big yields and low costs.” That sounds like the old Motorola.—Lawrence Curran

losing proposition during 1968.

Jelly beans. Hogan feels that Fairchild's technological leadership gives him more marketing flexibility than he had at Motorola. He says: “Sure, I built Motorola by copying. We second-sourced the whole industry. The idea was to learn to turn 'em out like jelly beans. Well, I won't change my personality completely, and you already know that I don't have any pride in the matter.

“But in copying, timing is very important. Maybe it's too late to copy the Texas Instruments line of transistor-transistor logic, for instance. We might be a hell of a lot better off not doing it. A year ago, there would have been no doubt, but now the question is whether to copy or to go to medium-scale integration. When I was at Motorola I had no choice; here, I do.”

Hogan indicates that he has not made the choice yet. Fairchild showed its entire MSI line to big customers last spring, and reports

that the reception was excellent. Hogan does say that he doubts Fairchild would second-source Motorola on MECL circuits. “Fairchild has already built emitter-coupled-logic circuits for the RCA Spectra 70 computer, and we have development programs for current-mode logic (of which ECL is an example) with the Control Data Corp., the General Electric Co., and Univac,” Hogan says. “These programs are well along, with thousands of devices made.”

The cup and the lip

It's clear that even if Hogan does not intend to change the basic nature of Fairchild Semiconductor, he has some bold plans for it. The question is now whether—and how quickly—they can be carried out. One continual problem at Fairchild, for instance, centers on the transfer of that vaunted technology from the lab to the production line. Some former employees think that the difficulty may be that product man-

agers have profit-and-loss responsibility and are therefore unwilling to attend to new items, which always lose money at first.

But Hogan will continue his Motorola policy of keeping profit responsibility at a low level, on the theory that “you can't force a man to do what you want him to do and then hold him responsible for the results.” He anticipates no real difficulties in mating R&D and production—a problem that gave his predecessors fits.

Another theory about this difficulty is that R&D isn't working in areas important to new products. But Hogan says: “The R&D work I've seen is extremely pertinent to what we're making.”

Us against them. One problem that Hogan decided himself concerns morale. “With nearly a score Motorola alumni in positions of responsibility, he'll have to work fast or there'll be a ‘we and they’ attitude in the plant,” says a former employee. The evidence suggests that Hogan is indeed working fast; the latest reports from insiders are that middle management is losing whatever distaste it had for the newcomers.

“If you had been around here in the first week, you'd have noticed there definitely was a morale problem,” Hogan says. “There must have been a dozen good people with their resignations written. But people really work for a challenge; if I can give them this, not frustrate them in their work, and make them respect me personally, there will be no morale problem.”

Hogan's own morale may depend on how free a hand he has to run the corporation. Board chairman Sherman M. Fairchild has ousted presidents before. “My power,” Hogan says, “is proportional to how I do the job.”

The job at the Semiconductor division is expected to take about six months. Hogan declines to say how soon he will give up the general managership, on the ground that too firm a date might give his would-be successors a case of ulcers. “The Semiconductor division has the greatest importance to and the greatest potential in the corporation,” he says. “Let's just say that I think I can build another machine that runs without me—like the one in Phoenix.”

You say you want a

low-profile snap-in mounting push button switch or matching indicator that is interchangeable with most 4-lamp displays . . . available in a full range of cap colors . . . with a choice of bezels with or without barriers in black, gray, dark gray or white.

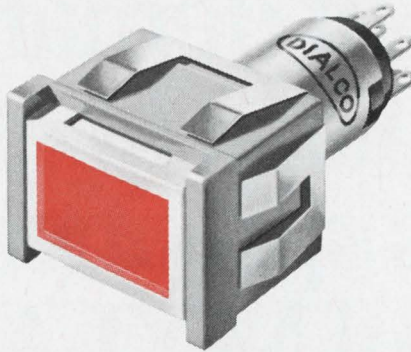

and a

legend presentation that's positive (like this one) or negative (like the one below) or just plain (like the one above) . . . one that's white when "off" and red, green, yellow (amber), blue or light yellow when "on" . . . or colored both "on" and "off."

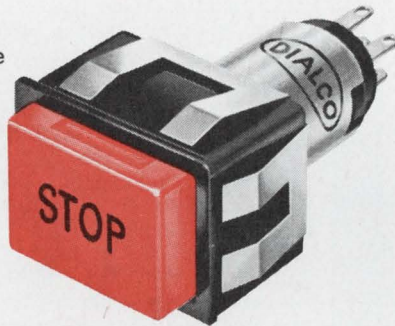

and a

highly reliable switch proven in thousands of installations . . . available in momentary or alternate action . . . N.O., N.C. or two circuit (one N.O., one N.C.) . . . that accommodates a T-1 $\frac{3}{4}$ bulb with midjet flanged base, incandescent, in a range of voltages from 6-28V.

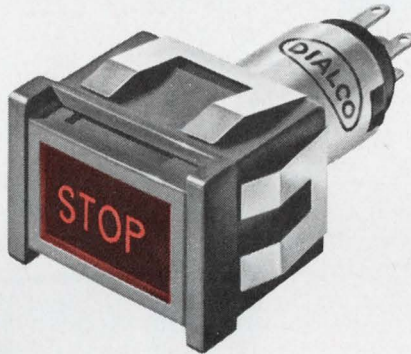

*etc.
etc.
etc.*

Now, Dialight gives you custom panel designing with a standard line of push-button switches and matching indicators

Dialight offers a broader range of switch and indicator possibilities than you'll find anywhere in a standard single-lamp line. Sizes: $\frac{3}{4}$ ", 1", $\frac{5}{8}$ " square and round. Send today for our new full-color catalog L-209.

DIALIGHT

Dialight Corporation, 60 Stewart Ave., Brooklyn, N. Y. 11237

Military and aerospace equipment demands proven reliability. That's why Dytronics specifies capacitors of MYLAR®

Dytronics Co., Inc., of Columbus, Ohio, makes Primary Phase Angle Standards that are used all over the world in all temperature extremes. Each precision unit uses 70 capacitors of MYLAR* polyester film. Why MYLAR? Here's what Paul Ryan, President, had to say: "Military and major aerospace facilities cannot afford equipment failure, and we must be sure of the

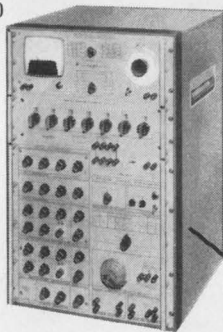

components we select. Hundreds of our Primary Phase Angle Standards are in military usage, and we are not aware of a single failure of capacitors of MYLAR...we feel that this is evidence of both the reliability and performance of MYLAR and we find that capacitors of MYLAR cost about the same as those made of paper."

MYLAR offers thermal stability from -70° to $+150^{\circ}$ C., plus excellent resistance to most chemicals and moisture.

MYLAR has high tensile and dielectric strength. Its unexcelled thinness has enabled manufacturers to reduce size and weight in capacitors.

Isn't that reason enough for you to consider capacitors of MYLAR in your designs? For additional information write to Du Pont, which offers the thinnest, most versatile range of capacitor dielectric materials available. Address: Du Pont Co., Room 5852B, Wilmington, Delaware 19898.

*REG. U. S. PAT. OFF.

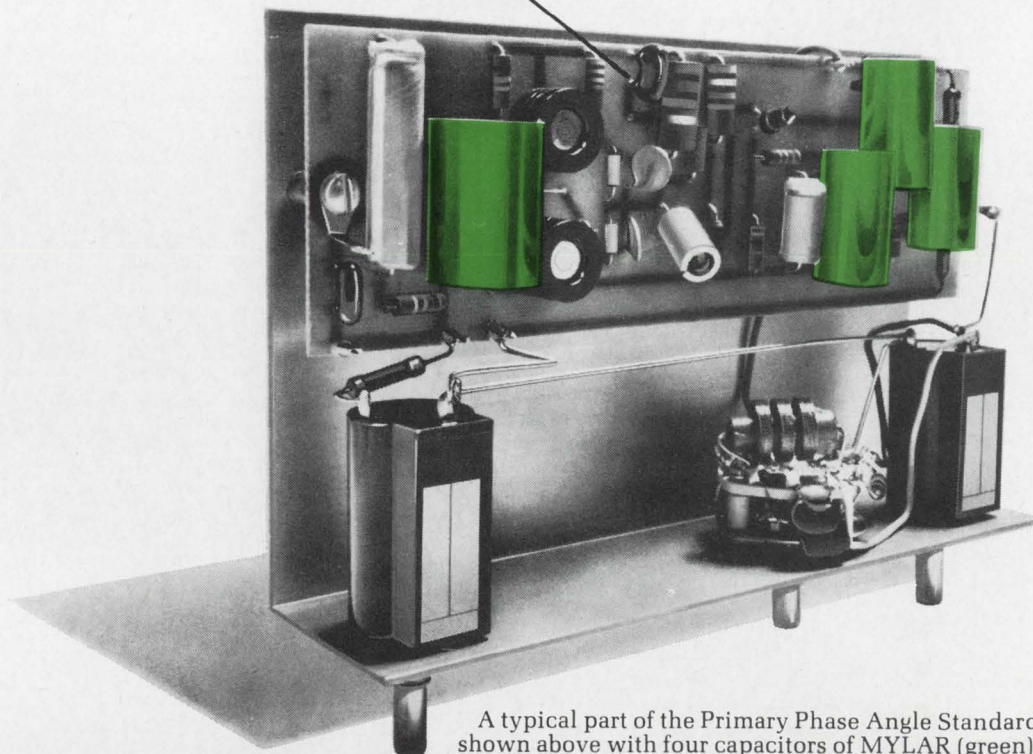

A typical part of the Primary Phase Angle Standard shown above with four capacitors of MYLAR (green).

Utilities go slow on automation

Power companies are good customers for displays and microwave gear, but they're still reluctant to use computers in closed-loop systems

By Peter J. Schuyten

Assistant editor

Almost three years after the massive power failure that blacked out over 80,000 square miles of the northeastern U.S. and parts of Canada, utility executives are still dragging their feet on automation. Prodding by Federal agencies has so far had little effect; power companies, which are among the electronics industry's steadiest customers, in the main, refuse to introduce computers into critical closed-loop operations on the grounds that available systems simply aren't reliable enough.

When accused of an unprogressive attitude, power company officials cite computer statistics—over 500 machines are now in use in the industry—and point to microwave communications links and real-time displays that provide second-to-second system overviews.

Among others, Alfred Gruhl, president of the Wisconsin Electric Power Co., traces his firm's commitment to electronic hardware back to the mid-1950's. And Elmer Kaprelian, manager of power control at the Pacific Gas & Electric Co., says PG&E began using electronic apparatus to improve control and reduce transmission losses as long ago as 1950.

Monitor. However, officials at the Federal Power Commission contend that, in light of the Nov. 9, 1965 blackout, there's plenty of evidence to suggest that utilities could be doing a lot more to avail themselves of electronic instrumentation and techniques.

In its final report on the blackout, the FPC strongly recommended more automated controls and instrumentation for power stations. "As recently as 15 years ago, a utility would never publicly admit that its load could possibly be interrupted," notes a source at the regu-

latory agency. "But the blackout changed all that. Companies are now willing to concede that unless loads are reduced during disturbances they run the risk of having a total interruption. More electronic systems—metering devices, displays, computers, and the like—in central control stations could minimize the possibility of failures."

Among the comparatively few utility executives who agree is Raymond C. Burt, chief of computer operations at the Los Angeles Department of Water & Power. He says: "We are doing things now we couldn't do without computers. Automation should minimize the chances of a major blackout because it enhances reliability."

Air of suspicion

But most power companies are cautious when it comes to really advanced technology. "Electronics equipment, particularly computers, is a tremendous tool in helping to

operate a power station," says Kenneth E. Wolters, manager of electrical operations at Wisconsin Electric. "But I wouldn't want to depend on the machines completely. There are just too many weak links—for example, peripheral equipment and communications."

This attitude is partially echoed by John F. McQuillan, assistant to the vice president for planning at Allegheny Power System Inc. He feels the FPC is wrong in assuming computers are a cure-all, and points out that just about every modern power company is using processors in some aspect of system control. But these machines, per se, won't stop blackouts, says McQuillan. "A power system is a large and complex operation, and power people are just not to the point where they're ready to start running a whole system by computer in a closed-loop operation."

Mixed bag. One of the problems with computer systems, as far as the

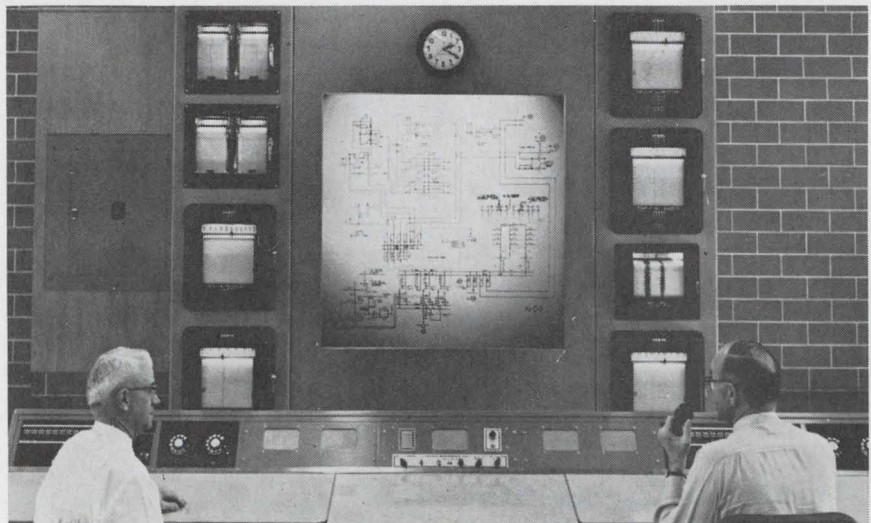

Last stand. In the power industry, display consoles like this one are gradually giving way to on-line color cathode-ray-tube systems.

... computers can handle routine tasks but can't manage system disturbances ...

power companies are concerned, is the lack of hardware standardization. For instance, E.D. Scarth, vice president of the Texas Electric Service Co., says, "Every machine you try to use represents an individual case, and you have to develop individual programs."

This concern over programing is heard again and again in the power industry. A spokesman for Chicago's Commonwealth Edison Co., while acknowledging growing pressure from the FPC for more computer controls, says: "This company doesn't subscribe to the belief that the closed-loop operation of an entire system is a viable way to prevent further blackouts. Not with the present state of the art. Programing for all conditions remains the number one problem."

Wolters of Wisconsin Electric goes a step further, maintaining that he doesn't believe absolute system security can be programed now or even in the near future. "Computers can be used to control most day-to-day operations, but not system disturbances," he says. "No two blackouts are the same; conditions vary, and computers are no better than the information programed into them."

Power play

But an official at another power company doesn't believe the complexities of power generation and transmission are the real issue. "Ultimate control is the question," he says. "And even the theoretically built-in reliability of the newer generation computers is insufficient for closed loops."

The question of computer reliability is even more critical in the case of power pools, or interconnected series of systems. Such networks generally use extra-high-voltage (345,000 volts) distribution lines, and most state-of-the-art electronic gear is not designed to deal with the huge surges of power that frequently occur. Since the advent of EHV lines a few years ago, a number of companies have had to rewrite their equipment specifications to take this factor into account. But a spokesman for Common-

wealth Edison, one of the companies affected, emphasizes that the problems involved in interfacing electronic equipment and EHV grids are surmountable.

Standing pat. In the final analysis, says an industry insider, the reluctance of the power companies to computerize their operations is based as much on a desire to preserve the status quo as on any real or imagined shortcomings in hardware and software. An official at the FPC assesses the situation this way: "It's true that electronic systems haven't yet proved reliable enough to justify a wholesale shift to closed-loop generation and transmission operations. But they soon will, and it behooves the industry to be ready."

This source believes the current state of affairs is rather like the one prevailing in the early 1950's, when power companies were first starting to install open-loop computer systems. "There were some pretty big problems that took a long time to solve," he says. "There's no question but what the difficulties made skeptics out of a lot of operators. And these memories are a long time dying. But as soon as computers prove beyond doubt that they will work and can provide safer operations, utilities will have to start using them extensively in closed-loop control systems."

Get-togethers

The FPC official notes that as a direct result of the blackout, a number of computer-based installations are planned around the country to improve network distribution. Among the programs in progress:

- The Northeast Power Coordinating Council is going to put a computer in its master control center to upgrade data-handling and monitoring activities throughout the region.

- The PJM (for Pennsylvania, New Jersey, and Maryland) interconnection has installed a processor in Philadelphia; the machine will be a central control and monitor unit for the entire network.

- ECAR (for the East Central Area Reliability Group), a large in-

terconnection made up of Indiana, Illinois, and Ohio power companies, is planning an installation similar to the PJM's.

- The New York Power Pool, an association of the state's eight largest utilities, broke ground in July for a computerized control center. This facility will oversee the statewide system and coordinate operations with neighboring pools in New England, Canada, and the PJM area.

In addition, a number of studies are being carried out on the application of electronic controls and computers to electrical power generation and distribution networks. For example, the New York State Department of Public Service has undertaken a survey of the field. On the corporate side, the International Business Machines Corp. is prepar-

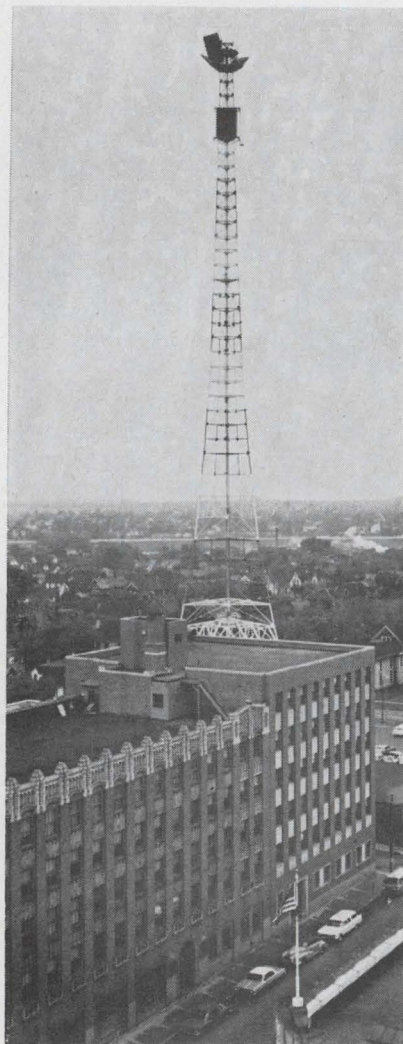

Tall order. This microwave tower anchors American Electric Power's 1,700-mile data network. Utilities try to avoid using common carriers.

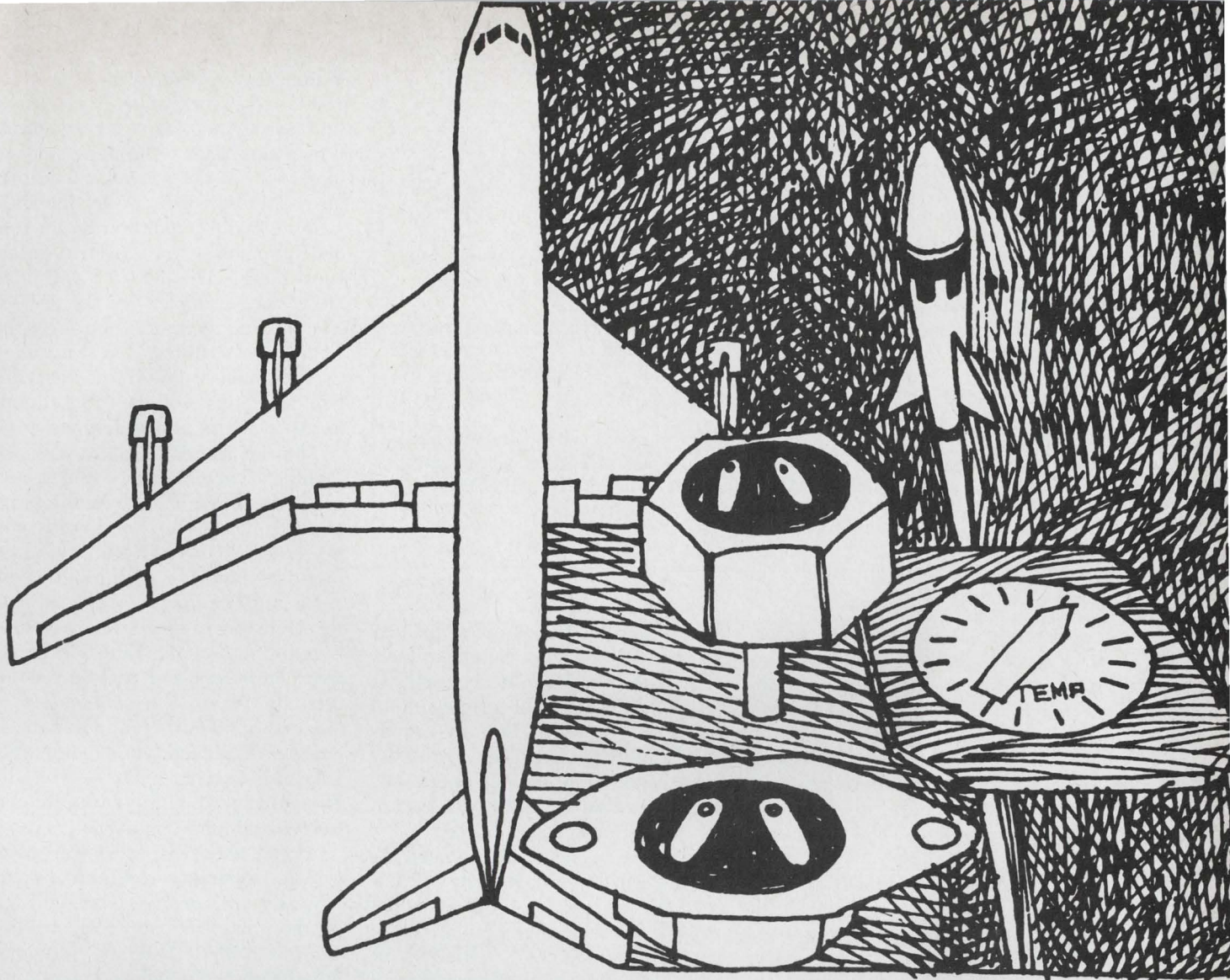

protect

Protect your critical functional systems against damage from temperature changes—whether in aircraft, missiles, space vehicles, military ordnance, aerospace ground equipment or industrial equipment. It's a snap, with United Control's inherently simple, snap-acting, bimetallic disc thermal switches. Refined and perfected to put maximum emphasis on precision, reliability and flexibility of application. For more information, call or write United Control.

Circle 127 on reader service card



UNITED CONTROL

A SUBSIDIARY OF SUNDSTRAND CORPORATION
REDMOND, WASHINGTON 98052 · PHONE: (206) 885-3711

Help wanted

One unusual problem faced by electrical utilities is their difficulty in getting qualified EE's to pass up more glamorous and generally higher-salaried jobs with electronics and aerospace firms. Glenn W. Stagg, assistant vice president for computer applications at the American Electric Power Co., says, "We can get all the control computers we want, but getting the people to run them is another story." Stagg and others in the power industry say most engineering students aren't aware that the power companies have anything at all to do with electronics.

Several utilities are trying to solve their manpower problems through intensified recruiting efforts and summer internships. The Los Angeles Department of Water and Power, for example, employed some 60 engineering students this summer; it hopes at least 18 or 20 will return after graduation.

Another approach being taken by some firms is to get faculty members, as well as students, involved in summer projects. And in a few cases, power company engineers themselves are taking leaves of absence to teach courses at engineering schools under programs sponsored by the industry.

ing a report, as is the North American Rockwell Corp. under a contract from the Bonneville Power Administration. These reports haven't been completed yet, but it's the guess of FPC insiders that when they are, there'll be more grist for the automation mill.

Shopping list

Bill Summers, a consultant with Ebasco Services Inc. and the architect of MARC (monitor and results computer), a series of computer specifications that have been generally accepted by the power industry, believes the field simply has to get over its distrust of the closed-loop concept. "We're going to have to go to the loop; most power systems—especially the large pools—

are getting far too complex for men to operate," he says. Summers feels that when the loop finally comes it will take the form of a time-shared logic system with built-in redundancy. The hard-wired systems now being used for open-loop operations aren't flexible enough to take care of every contingency, he says.

Summers also foresees a need for better transducers. He says it's impossible to get the 100% accuracy demanded of present equipment by a closed-loop system. "One way of obtaining this kind of precision is to have the meters cross-check each other on a real-time basis," he says.

Concept. One utility making progress toward a completely closed-loop system is the Los Angeles Department of Water and Power,

which is now installing two IBM 1800 processors. These machines will form the basis for real-time power operations in smaller closed loops within the network. The major calculations needed by the 1800 systems will be handled by an IBM 360/50 machine on a priority-interrupt basis. The 360/50 will also store data collected by the 1800's. Two analog computers built by the Leeds & Northrup Co. and now used to handle low-frequency control functions will be phased out in favor of the new machines.

The Los Angeles system will also include two real-time cathode-ray-tube consoles for load dispatching; all information and commands will be entered through an alphanumeric keyboard or with a light pen.

In another area of the country, the Houston Lighting & Power Co. is building a center that will house two computers and real-time color crt's on which the schematics of any one of 300 different substations can be displayed upon command. Like the Los Angeles system, the Houston setup will incorporate certain closed-loop operations.

Along with displays and computers, telemetry equipment—particularly microwave gear—is high on the power industry's electronics shopping list. William Gregory, who heads the meter and communications section at the American Electric Power Co., says the utilities have found that because of the size and complexity of their systems and their increasing need for reliability in data transmission, the common carriers just can't provide an adequate service.

His firm has one of the largest microwave networks in the industry—more than 1,700 miles. Readings from 40 generating units are brought to a central station in Canton, Ohio. Gregory asserts that common carriers just can't satisfactorily handle either the speed—up to 340,000 bits per second—or the size of the data load. AEP, like most public utilities, uses the 2- and 6-gigahertz bands.

A common complaint in the power industry, though, concerns the small number of manufacturers engaged in selling r-f heterodyne equipment and other microwave gear. There isn't much competition, officials say, and this results in high prices and poor quality control.

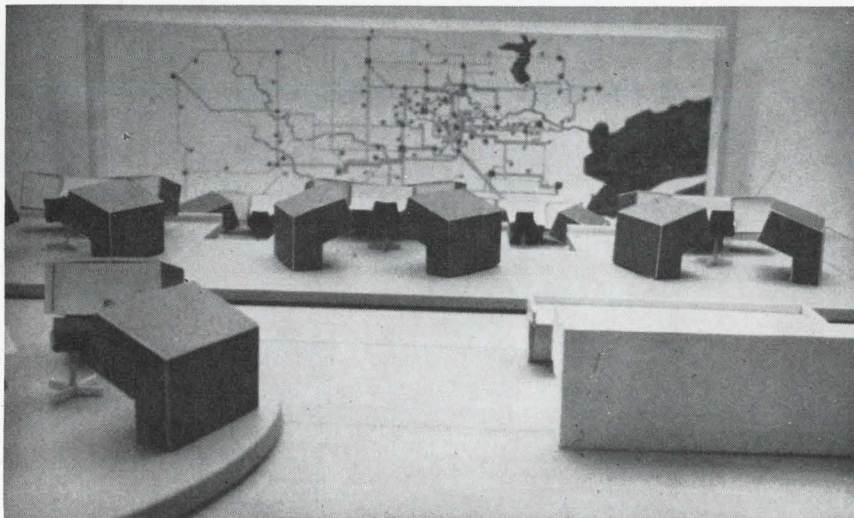

Leading light. This real-time color cathode-ray-tube display system being installed at Houston Light & Power will be completed next year.

Range 1 Hz to 2 MHz
Resolution to 1 Hz
Sweeps any decade
Fully programmable

Data Tech's digital oscillator is the new frequency source for testing in the lab and on the production line. Scarcely more expensive than the best continuously-tuned signal generators, it delivers precise, known frequencies and is built to be pro-

grammed for automatic tests. Frequency selection, sweep selection, and output level can be controlled by incoming logic signals. All features described here are standard at the standard price: \$2495. Send for complete data.

Frequency synthesizers come down to earth: \$2495



Data Technology Instrument Corporation
2370 Charleston Road, Mountain View, Calif. 94040
Phone (415) 964-2600. TWX: (910) 379-6476.

By habit, loose jobs got carbon comps.

Until Corning.

Now, you have another choice.

Glass tin oxide film.

Corning makes them.

In the general purpose range.

Makes them with a base of pure optical glass. And a fully oxidized metal film.

Environment can't degrade either. Film and substrate are molecularly bonded. Matching TC's do away with fatiguing stresses. Special silver-glass composition insures low termination noise.

Press-fitted end caps mean mechanical integrity. Tailored tough insulations wrap them up. It all adds up to long-term dependability.

General purpose, precision, or special, CORNING® Glass Tin Oxide Film resistors are a better buy—by design. From 1/10 watt in .150", up to 6000 watts in six feet, they're all shown in our new Resistor Design Guide.

Get your copy from:
Corning Glass Works,
Electronic Products Division,
Corning, N.Y. 14830.

CORNING
ELECTRONICS

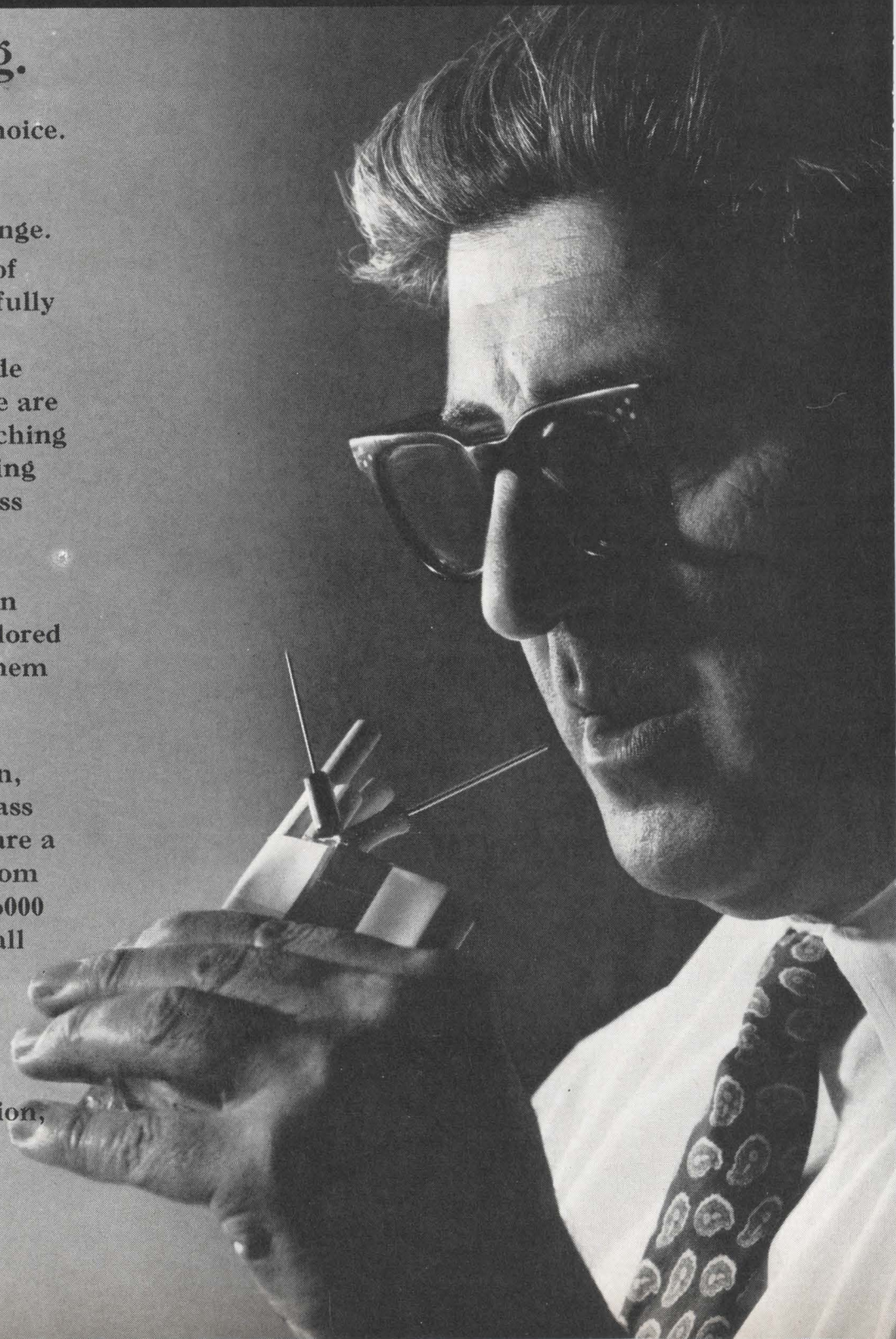

ARPA network will represent integration on a large scale

Agency hopes to tie about 1,500 remote terminals to 35 different computers across the country within two years; it will soon order the interface units

By Paul A. Dickson

Washington regional editor

Variety is vagary, not spice, as far as most computer users are concerned. Nevertheless, the Defense Department's Advanced Research Projects Agency is well along with its plan to link a motley assortment of multilingual machines in a coast-to-coast time-shared network by 1970 [Electronics, Sept. 16, p. 62].

"Almost every conceivable item of computer hardware and software will be in the network," says Lawrence G. Roberts, assistant to the director of information processing at ARPA. "This is the greatest challenge of the system, as well as its greatest ultimate value." Most—but not all—of the private organizations participating are enthusiastic about the prospects and potential involved in networking incompatible—or inhomogenous, in Pentagon parlance—computers.

Double duty. The ARPA network will eventually include about 1,500 remote consoles tied to 35 processors in 19 locations across the U.S. Roberts says ARPA has two principal goals in connecting machines of different designs and capabilities into a load-sharing net. For one thing, the agency wants to give a helping hand to its farflung research contractors. For another, it's anxious to develop new skills and techniques that might be applied to military computer systems.

According to plans, users will have instant, on-line access to all the programs at other remote centers. In theory, then, researchers will be able to avail themselves of the best possible means of attending to specific tasks. For example, a difficult matrix or simulation problem could be shuttled to the

high-speed Illiac 4 at the University of Illinois from a site with a slower machine. Roberts feels the eventual payoff in efficiency could be substantial as duplication is eliminated and experience gained.

As for the second goal, Roberts says: "One of our biggest jobs at ARPA is to create something of value for the military. In this case, the value is obvious. Officers using command-and-control systems need to communicate among different computers and equipment. This is one of the long-term assets of the network. But I can't say for sure when such concepts would be applied to command and control."

Timetable

Roberts identifies five basic functions the network will provide: load sharing, message transmission, data sharing, program sharing, and remote service. He feels that the project has been making good progress

since it was approved last year. Earlier this month, bids were received from companies wishing to build interface message processors (Imps), units that will provide store-and-forward switching for messages between the computers. The Imps, which will be ordered shortly, are, in effect, digital computers with channels for communications lines and the sites they serve.

The Imps will perform eight essential functions: breaking messages into packets; management of message buffers; routing messages; putting messages into proper format; coordination of activities with other Imps; coordination of activities with on-site users; measurement of network parameters and functions; and detection of faults.

The system will go through a dry run next year using the Imps. A subnet linking computers at the Stanford Research Institute in Palo Alto, Calif., the University of Cal-

Sharing technology

During the 10 or so years it has been in business, the Pentagon's Advanced Research Projects Agency has been in the forefront of advances in computer applications and techniques. Perhaps the most dramatic example of the agency's capacities in this field is the work it started in 1963 that led to time-sharing. Earlier development projects involved command-and-control systems, management information, and remote sensing. Because of the military's vast purchasing power, such activities necessarily have a strong impact on computer makers' design efforts.

The agency is also supporting work on computer hardware design and programing. Two projects of note in the first category are the macro-modular, or building-block, approach to computer construction now being investigated at Washington University in St. Louis, and the supercomputer, Illiac 4, being built at the University of Illinois. Besides sponsoring a number of software research projects, the agency is doing the programing for the National Military Command System, as well as for several advanced time-shared Defense Department nets.

The uses of diversity

The line-up of processors in the Advanced Research Projects Agency's computer network is notably varied. To wit:

- **University of California, Berkeley, Calif.**—SDS 940 and SCC 6700
- **Stanford University, Palo Alto, Calif.**—PDP-6 and PDP-10
- **Stanford Research Institute, Palo Alto, Calif.**—two SDS 940's
- **University of California, Santa Barbara, Calif.**—IBM 360/50
- **Bolt, Beranek & Newman, Van Nuys, Calif.**—SDS 940 and PDP-10
- **Rand Corp., Santa Monica, Calif.**—IBM 1800 and PDP-6
- **Systems Development Corp., Santa Monica, Calif.**—IBM 360/50 and 360/65
- **University of California at Los Angeles**—Sigma 7
- **University of Utah, Salt Lake City, Utah**—Univac 1108
- **Washington University, St. Louis, Mo.**—special equipment (macromodular)
- **University of Illinois, Urbana, Ill.**—B-6500 and Illiac 4
- **University of Michigan, Ann Arbor, Mich.**—IBM 360/67
- **Carnegie-Mellon University, Pittsburgh, Pa.**—IBM 360/67, Univac 1108, and G-21
- **Dartmouth College, Hanover, N.H.**—GE 635
- **Harvard University, Cambridge, Mass.**—IBM 360/50, SDS 940, and PDP-1
- **Massachusetts Institute of Technology, Cambridge, Mass.**—IBM 7094, GE 645, PDP-6, and PDP-10
- **Lincoln Laboratories (MIT), Cambridge, Mass.**—IBM 360/67 and TX-2
- **Bell Telephone Laboratories, Murray Hill, N.J.**—GE 645
- **Advanced Research Projects Agency, Washington, D.C.**—DEC 338

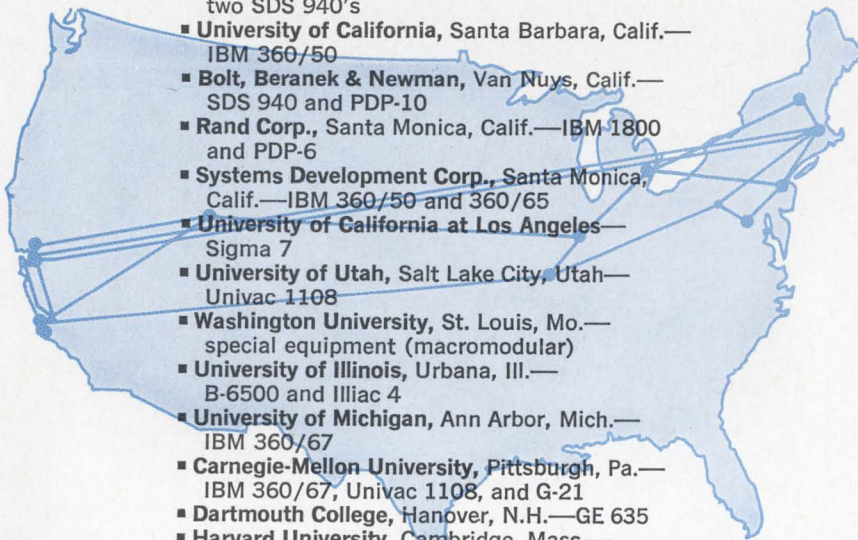

ifornia at Santa Barbara, the University of California at Los Angeles, and the University of Utah in Salt Lake City, will be put into operation. The contractor that's chosen will build, program, and install four Imps, as well as demonstrate the network's feasibility through the subnet. After evaluation and final design changes, Imps will be produced for the whole system.

Net worth. The completed network is designed to be fast, with 50-kilobit-per-second high-quality telephone lines between Imps. (These lines will be able to handle burst rates of 100 to 200 kilobits per second.) This means stations along the network line can get in touch with one another in no more than half a second. Though Roberts is still unable to put a price tag on the work involved in getting the system going, he does predict that in operation it will cost only about

10% more to run the computers as a network than individually. He adds that annual operating costs may average \$40,000 per site.

ARPA is convinced that the system will not be inordinately expensive to operate, but there are a lot of technical problems that must still be attacked. And, as Roberts notes, system users—or hosts as they are referred to around ARPA—will have as big a job to do as the contractor.

According to Roberts, the ARPA research contractors at universities and such organizations as the Rand Corp. and the Systems Development Corp. are generally agreed that the network is a good idea. He concedes, however, that enthusiasm varies among them in direct proportion to the relative size of their assigned work loads.

For one thing, users will have to adjust their operations to link them-

selves into the networks. The necessary changes aren't yet clearly defined, Roberts says, but at a minimum, the addition of new subroutines will be required. "As we get into the subnet we'll learn more about this situation," he goes on. "But one thing's for sure—the host will have to modify his software to interface satisfactorily with the Imp."

Some hosts will have more to do than others. For example, the Stanford Research Institute will perform the important role of librarian, cataloging the network's documentation. The SRI setup will permit users to search for key words to help them solve problems, browse through sources, and update the master file with the latest information on local programs.

Another host slated to perform yeoman service for the network is UCLA. The university's installation will analyze programs and study network performance. In the completed configuration, the Imps will be able to gather network data at the request of UCLA. Any user wanting such information can ask UCLA; it will be forwarded in raw, or analyzed, formats. The university will monitor and schedule all such work for both ARPA and individual users.

Vocal affiliates

The response to the project from ARPA contractors and those affiliated with the network ranges from eager testimonials to critical put-downs. Leonard Kleinrock, an investigator for the network at UCLA, says, "It's one of the freshest ideas to come along since time-sharing." But at the other end of the country, Malcolm M. Jones, assistant director of the Massachusetts Institute of Technology's Project MAC (for machine-aided cognition), which is to be part of the net, is reluctant to endorse the system. Jones is concerned about the network's effective use. He worries that while it will widen a user's data base and add new programs, there may be no efficient way of informing the network's users of what's available to them.

"How do users a nation apart find topics of mutual interest when talking across console rather than across a table?" Jones asks. Relating the situation to his own experi-



Component
space ?
stuffed ●

Get design room with the new space watchers' diet

Centralab's new, low cost SLIM TRIM Resistor is the ideal prescription for designers who have to make every fractional inch of space count. The Slim Trim takes so little room, it all but disappears in entertainment, military and industrial applications.

Out of sight, but not out of might. The Slim Trim is rated at 1/4 watt per section at 70° C, and offers resistance values ranging from 100 ohms to 15 megohms. Maximum voltage is 350 volts, which may be exceeded in special applications.

The unit is built on a .025" thick base plate of alumina to provide more effective heat dissipation. Carbon composition resistance is bonded directly to the plate for maximum reliability.

In addition to variable resistors, units can be supplied with fixed resistance as well. Multiple units with two, three or four sections are available. Single and multiple units are available with "hat" knobs, low profile knobs or without knobs. An edge adjust knob is available on single units only. Unit cost is as slim as under \$.07 in quantity.

When design spaces are bulging, a diet of Slim Trims is a space watcher's best friend.

FOR SAMPLES AND MORE INFORMATION ON SLIM TRIMS AND THE COMPLETE LINE OF CENTRALAB PRODUCTS, WRITE CENTRALAB. TODAY. CENTRALAB PRODUCTS ARE MARKETED THROUGH CENTRALAB INDUSTRIAL DISTRIBUTORS AND INTERNATIONALLY THROUGH GLOBE-UNION INC. — INTERNATIONAL DIVISION.

SPECIAL NOTE: Have you investigated the new, low cost of Centralab's 5TR miniature trimmer resistors?



CENTRALAB

Electronics Division
GLOBE-UNION INC.

5757 NORTH GREEN BAY AVENUE
MILWAUKEE, WISCONSIN 53201

M-6809

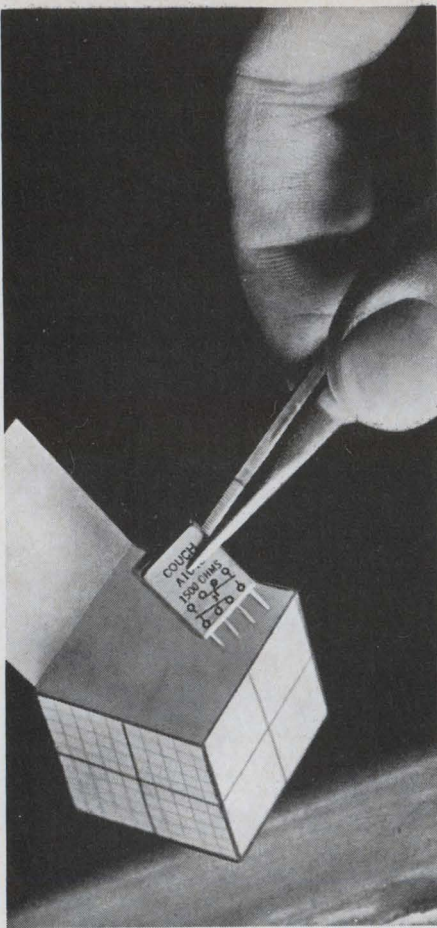

Couch 2X 1/7-size relays meet MIL-R-5757D/19 in 1/25th of a cubic inch

The new, third generation Couch 2X relays solve switching problems where space and weight are critical. Thoroughly field-proven in electronic and space applications. Relays are delivered *fully tested*. Additional screening tests available at your option.

	2X (DPDT)	1X (SPDT)
Size	0.2" x 0.4" x 0.5"	same
Weight	0.1 oz. max.	same
Contacts	0.5 amp @ 30 VDC	same
Coil		
Operating Power	100 mw 150 mw	70 mw 100 mw
Coil		
Resistance	60 to 4000 ohms	125 to 4000 ohms
Temperature	-65°C to 125°C	same
Vibration	20 G to 2000 Hz	same
Shock	75 G, 11 Ms	same

Broad choice of terminals, coil resistances, mounting styles. Write for detailed data sheets.

RUGGED ROTARY RELAYS  Dynamically and Statically Balanced

Couch
1894

COUCH ORDNANCE INC.

3 Arlington St., North Quincy, Mass. 02171
Area Code 617 CYPRESS 8-4147
A subsidiary of S. H. COUCH COMPANY, INC.

... sites with small computers could gang up on those with small machines ...

ence, he says: "Here at MAC, linked files are just about equal to, or greater in number than, unshared, private files. Most of these links were developed through personal contacts or discussions of common problems. It's hard for me to see how this might be carried out on a depersonalized national scale."

Hindsight. Others share Jones' concern about how humans will be able to interact effectively. Richard G. Mills, director of MIT's information processing services and a participant in the early planning for the ARPA network also feels that geographical separation and user isolation may limit the network's utility. Mills believes the problem may grow as the user population increases. "The systems engineering implications of such a computer network should have been investigated thoroughly," he says. "There should have been a definition of the relationship between a man and his program, as a unit, and the distant central machine or other data processing gear with which they are working." In other words, Mills believes ARPA put the cart before the horse by going ahead on interconnecting computers before determining what the benefits of such a network would be.

But others are quick to dismiss those doubts. One of those implementing the system at SRI expects "big problems" in programming, but he defends the system on the grounds that it will create new working relationships as people become aware of what others are doing through the sharing of functional data. He predicts that the net will act as a stimulus to research because of its capacity to enhance communications.

Roberts acknowledges the validity of questions about human interaction and feels ARPA is addressing itself to the problem. He says the on-line reference library at SRI will help in this area since it will keep everyone in touch with what is available. Users, he points out, will be expected to keep an up-to-date accounting of capabilities at their own centers and at SRI. In addition, Roberts says ARPA is planning to

have annual meetings to brief users on network capabilities.

But a number of problems may arise after the computers have been introduced to one another. For example, Roberts notes that sites with smaller computers could start "ganging up" on those with larger processors. This could mean that a lot of work could be thrust upon, say, the Univac 1108's in the network. Roberts says this issue will have to be resolved after the net is in operation; it may mean setting up availability schedules for the larger units. But Mills of MIT, for one, is worried about such allocations of computing power: "Our computer, as well as those of others, are in constant use, and resource allocation is a continual problem. There is some question as to who should be served first, an unknown user or our local researchers."

The problem of security is minimal in the network since neither classified nor proprietary information will be stored in the computers. But experimental or in-progress programs not suitable for use by the network are to be stored within the system. In addition, many of the sites are on college campuses and the computers are shared with these institutions; thus, there will have to be safeguards to prevent legitimate machine users who aren't part of the ARPA team from siphoning off the available computer power.

While there's little doubt that the network will have some impact on military systems of the 1970's, a case can also be made for its effect on civilian and commercial systems. Says Kleinrock of UCLA: "The net definitely represents a step forward in the state of the art in time-sharing. The ARPA experiment is vital in that a comparable setup is a likely candidate for any large Government or commercial computer time-sharing system of the future." Even the generally skeptical Jones is willing to concede this point. He believes that if the many compatibility problems posed by the network are solved, future time-sharing nets should be more efficient and less expensive.

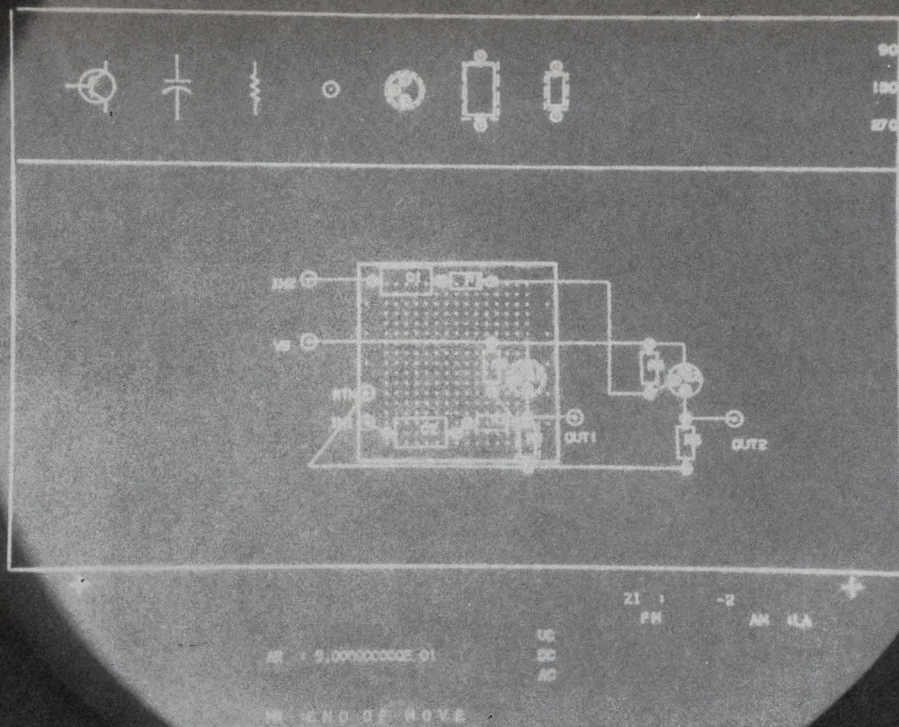

Readouts clear up problems.

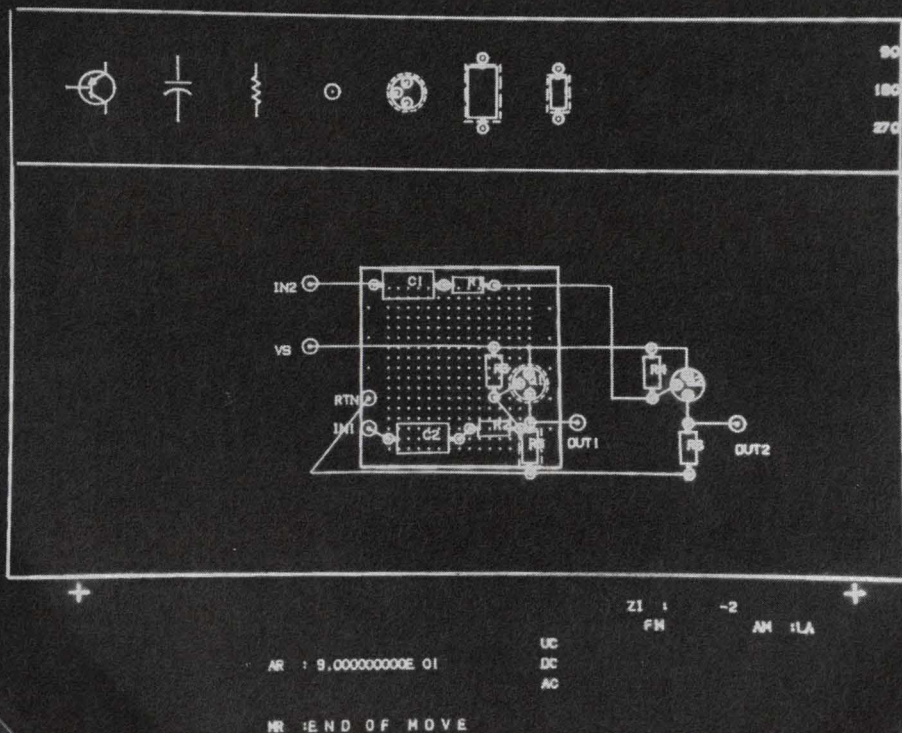

Polaroid circular polarizers clear up readouts.

Reading readouts is never a problem—if they're equipped with Polaroid circular polarizers.

Our polarizers improve readability from every angle by increasing contrast. In daylight. Or even in

brightly lighted rooms.

But now you don't have to take our word for it. Send for our new brochure, and we'll include a sample circular polarizer. It will help you see very clearly why many major display

and instrument manufacturers are now using Polaroid circular polarizers.

Write Polaroid Corporation, Polarizer Sales, Department 59, Cambridge, Massachusetts 02139.

Polaroid Circular Polarizers.

If your LSI performs like LSD...check for H₂O!

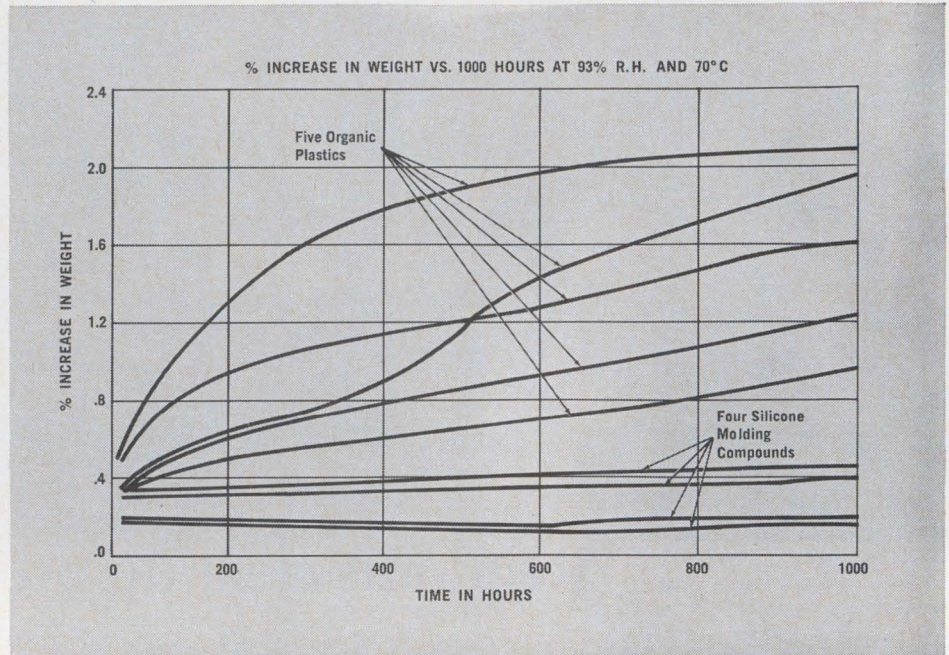
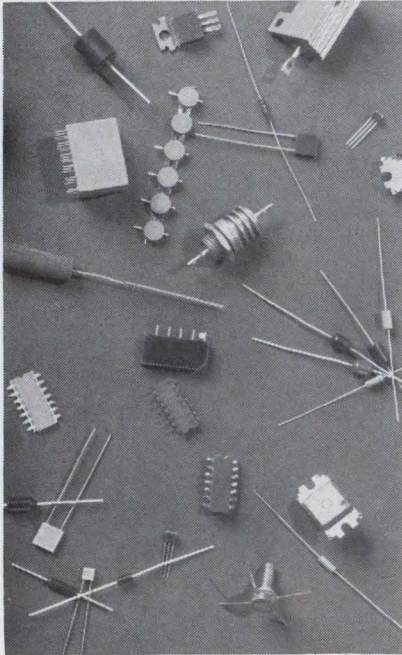

Moisture absorption of most plastics can lead to critical conditions in devices — whether LSI or simple diodes.

But, devices packaged in silicone molding compound are physically and electrically stable after long term exposure to both high humidity and operating temperatures—as shown by the graph above. This stability means more reliable operation at full rated device power without failure due to moisture absorption . . . less need to provide other circuit embedment or encapsulation.

This is just one of the many reasons why more and more equipment manufacturers are turning to devices packaged in Dow Corning® silicone molding compound — whether those devices are simple diodes, power rectifiers or integrated circuits. Some of the other reasons—

No derating necessary. Devices and components packaged in silicone molding compounds can be operated at their full power potential. This permits designs with higher density of devices and components. One manufacturer of glass packaged power diodes reduced his part's volume to 1/30th by using silicone molding compound. Compared to other plastics, size is from 1/5th to 1/3rd smaller since derating due to package material instability is not required with silicone molding compounds.

No cracking. Dow Corning silicone molding compounds—unlike other thermal setting plastics—are virtually unaffected by heat aging and thermal shock. For example, a power resistor molded in Dow Corning® 307 molding compound, was sub-

jected to repeated cycling from —65 to 350 C without damage to the packaging material or the component. Subjected to 1000 hours at 300 C (572 F) Dow Corning brand molding compounds show no significant change in physical and electrical properties.

Will not burn. Silicone molding compounds are inherently nonburning. Thus, components packaged in silicone molding compound will not constitute a fire hazard. No flame snuffers are needed . . . a source of ionic contamination for devices packaged in organic plastics. With silicone molding compound there are no ionic or polar constituents to affect junction performance when properly used.

Competitive price. Dow Corning silicone molding compounds cost only a fraction of a cent per device. Thus, they enjoy a substantial price advantage over metal cans and glass packages.

Manufacturing economies. Transfer molding enables devices and components to be packaged with a minimum of manual labor and supervision. Good mold release and minimum flash assure high production rates . . . reduced deflashing costs. These manufacturing advantages make silicone molding compounds totally competitive with organic plastics.

So, why chance a device failure because of a cheap plastic package? Put silicone molding compound protected devices and components into your electronic equipment. For technical data, write to: Dept. A-8467, Dow Corning Corporation, Midland, Michigan 48640.

Are you going to do something now about your identification problem?

If you're in the business of making things, you can't escape the business of marking things. And the business of identifying electrical and electronic components can be a messy (and costly) problem. But it doesn't have to be, with the right kind of help.

Markem can help by supplying the best machines, specialty inks, printing elements and other supplies you need. We can help by being there whenever you need service, whenever an operator needs training. But mostly we can help by coming up with new ways to give you better identification for less money. For example, we recently introduced an Instant Type Former which lets you make metal type in-plant, as needed. No waiting for delivery . . . you can form new type inserts in less than a minute by simply "dialing" the legend.

We can also show you how to combine sequential numbering with identification . . . how to print 14 characters plus trademark in an 0.125" diameter area . . . how to produce clear imprints on recessed, irregularly-curved and other difficult surfaces . . . how to safely mark flat-pack ceramic I.C.'s either in or out of carriers . . . how to color-band axial-lead components with up to 6 different bands at high rates of speed.

It doesn't cost a dime to have one of our analysts come to your plant to discuss your particular identification problems. His ideas could save you a lot of headaches. And a lot of money. Call your local Markem Sales office or Bernie Toomey at 603-352-1130. Write for our new "Problem Solver" booklet.

Markem Corporation,
305 Congress St., Keene, N.H. 03431.

MARKEM®

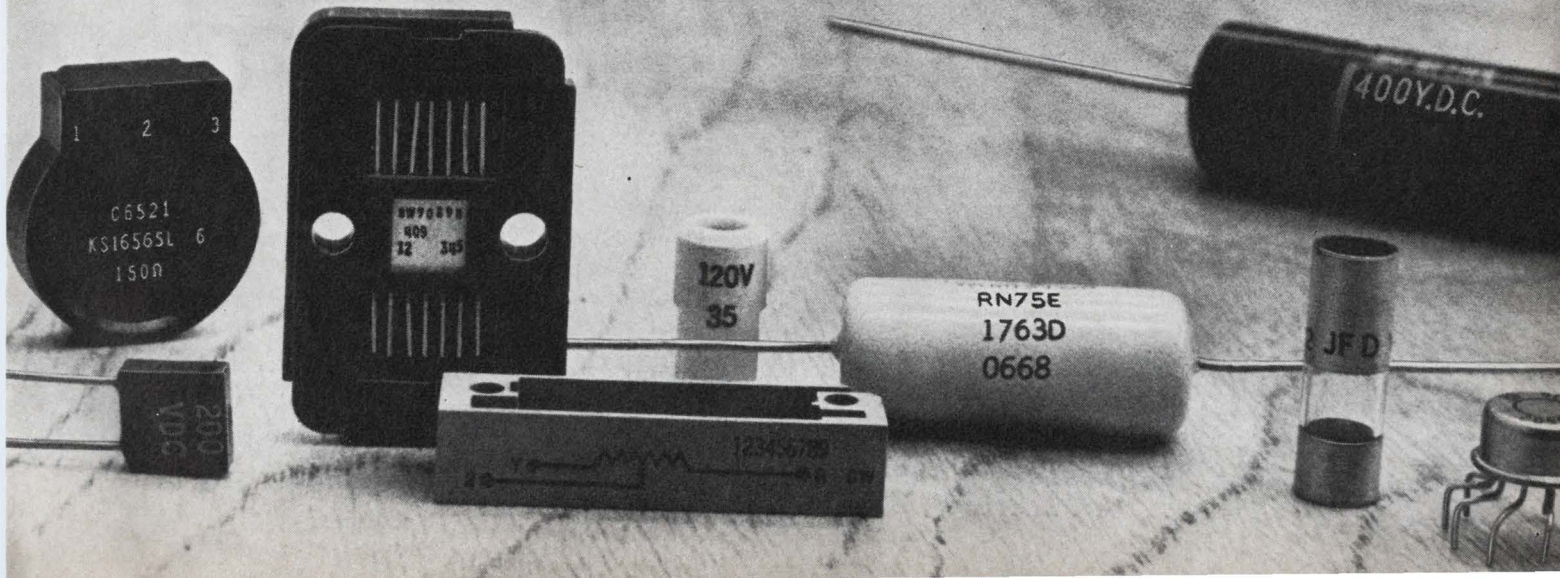

If you want to know what wire costs, don't look at a price list. Ask people.



Ask these London bobbies. Their mobile radios are smaller because the hookup wire is insulated with TEFLON, whose electrical properties permit thinner insulation. This is "value-in-use".

ASK A DESIGNER... He measures an insulation by what it lets him accomplish. Before you specify the insulation for your next design, make a value-in-use analysis of TEFLON*.

ASK A PRODUCTION MAN... He'll emphasize the cost savings that come from fast, trouble-free production. The resistance of TEFLON (TFE) to solder-iron heat speeds production, reduces rejects and minimizes rework.

ASK AN ACCOUNTANT... He'll give you an estimate of the cost of an insulation failure—a cost you may avoid by using TEFLON.

ASK YOUR SUPPLIER about the many wire and cable constructions insulated with TEFLON... including composite constructions... that offer extra value-in-use for your most exacting applications. For further information, write Du Pont Company, Room 6667-C, Wilmington, Delaware 19898.

*Reg. U. S. Pat. Off. for Du Pont fluorocarbon resins and film.

TEFLON...the sure one



REG. U.S. PAT. OFF.

Better things for better living
...through chemistry

Philbrick/Nexus DC log amplifier— a slip stick in 2.65 cubic inches

Quicker than you can operate your favorite slide rule, Model 4350 Log Amplifier will calculate the logarithm of a positive voltage or current, or solve the positive antilog of an input voltage. Model 4351 performs the same functions on negative voltage or current.

The combination of two Philbrick/Nexus log amplifiers multiplies and divides. Add scaling resistors and you can compute arbitrarily selected powers and roots. Units are fully temperature compensated for use over wide temperature ranges.

Units are fully encapsulated and measure 1.4" x 2.7" x .7". They feature fast response and a wide 6-decade dynamic range. Priced well below competition at only \$95. Contact your Philbrick/Nexus sales representative for complete details and specifications. Or write, Philbrick/Nexus Research, 22 Allied Drive at Route 128, Dedham, Mass.

Visit us at the ISA Show in Booth 2112.



PHILBRICK/NEXUS RESEARCH

A TELEDYNE COMPANY

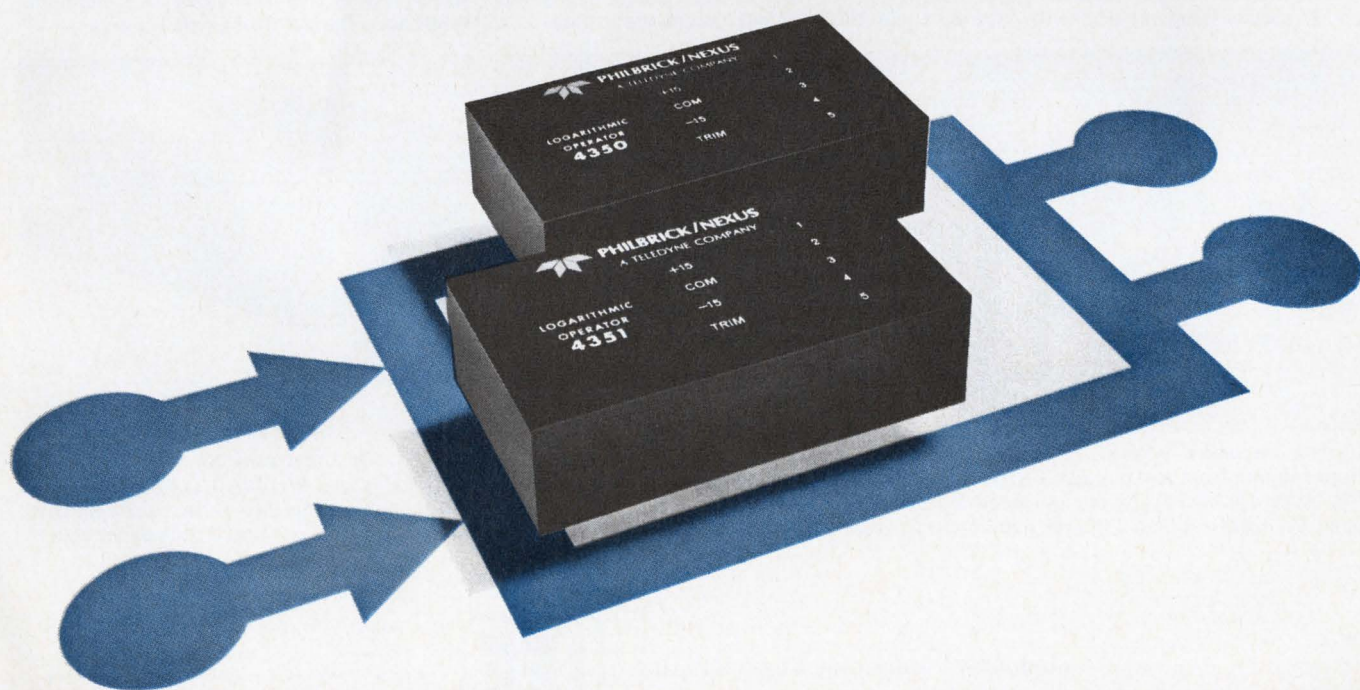

90-second look at IEE's wonderful world of readouts

Readouts are our special craft. Using any characters you want. Any colors or color combinations. Any input, BCD or decimal. Any input signal level. Any mounting, vertical or horizontal. Five sizes,

up to 3 $\frac{3}{8}$ ". Many configurations, options and accessories. Long lamp life (to 100,000 hours; up to 175,000 hours at reduced voltage). If it doesn't exist and you need it, we'll build it.

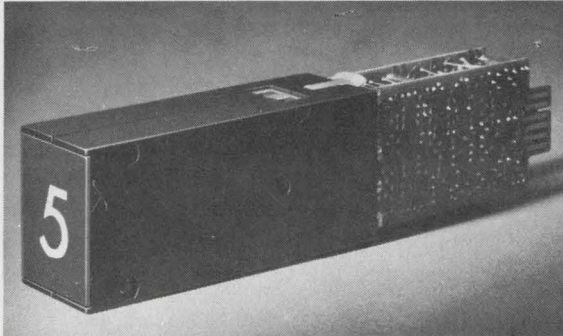

10H—World's most popular readout. And we've improved it. Double condensing lens provides exceptional character brightness. Greater clarity at wider angles and longer distances, even under high ambient light. .937" sq. viewing area. Mil-spec version available.

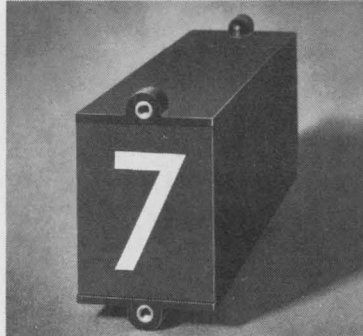

160H—Exceptionally large viewing area (1.56"H x 1.12"W) for overall size. 45 FL character brightness with a 6.3V \$.20 lamp. Displays messages simultaneously with symbols.



80—Large screen unit suited for annunciator applications such as factory call systems and production control. 3 $\frac{3}{8}$ " character height can easily be read at 100'. 160° viewing angle.

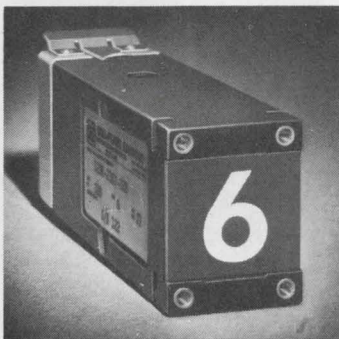

120H—Miniature rear-projection readout (.62" sq. screen) easily read from 30' under high ambient light. Quick-disconnect lamp assembly speeds lamp replacement.

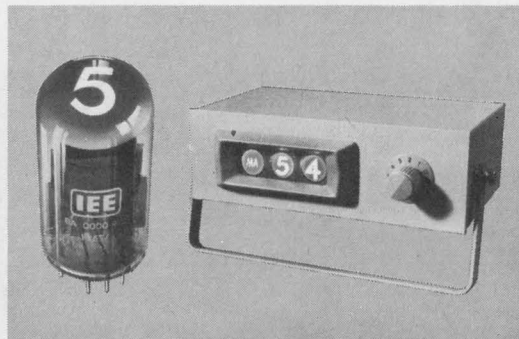

nimo™—First 10-gun CRT single-plane display. Projects numbers, letters and words onto a fluorescent screen. No image ambiguity. No external focusing required. No ambient light worries. Exceptionally wide viewing angle. Ideal for instrument application.

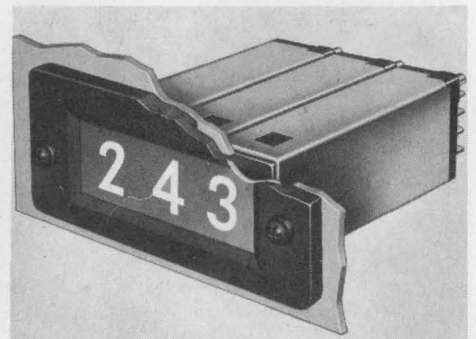

875—Miniature 24-position readout assembly with a cost per display of only \$1.45 each. .620 sq. in. viewing area with overall case size of 1.39"H x .90"W x 3.095"D. Exceptional brightness, clarity. Front panel access.

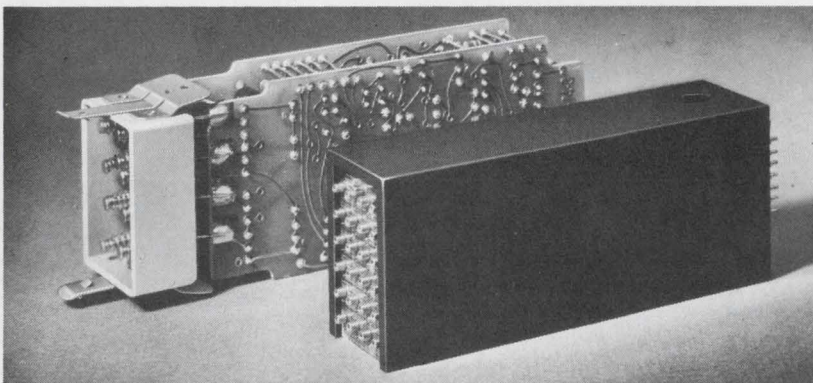

IC Driver/Decoders—Small, reliable units for driving IEE readout incandescent lamps ranging from 250 ma @ 6V to 40 ma @ 28V. Fully compatible with modern IC's. Accept a variety of binary codes for decimal conversion. Require normal signal V., draw less than 2 ma per data input. Internal data storage for pulsed oper.

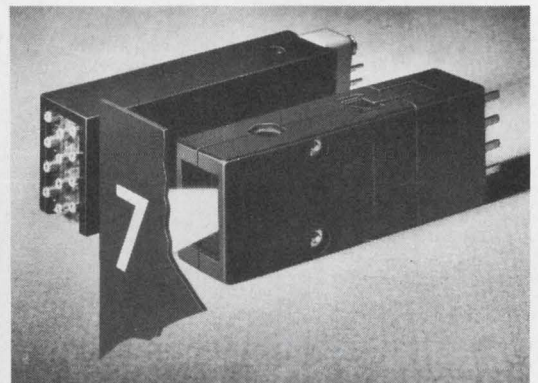

345—IEE's smallest rear-projection readout. Viewing area .38"H x .34"W. Based lamps. Low cost. Individual readouts plug into perm. wired housing for quick message change. Easy front panel access.

Industrial Electronic Engineers, Inc.



7720 Lemona Ave., Van Nuys, California



Burndy Vinylug™ The little cost saver.

The way it performs you'd never guess the price. This newly designed terminal puts a permanent crimp in your wire. And in your cost.

Engineered with all of Burndy's know-how, Vinylug delivers Burndy dependability in full measure. Tensile strength exceeds UL requirements and temperature rise is far below UL limits.

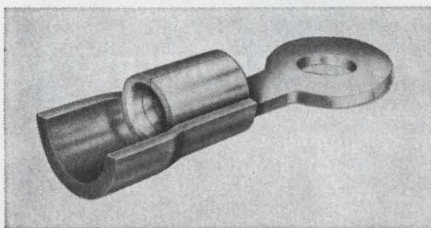

The vinyl insulation is color-coded for quick size identification, and the shroud is designed to provide a firm support for a wide range of cable diameters.

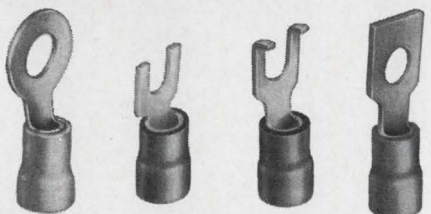

Vinylug one-piece body is constructed of high-conductivity copper, tin plated for lasting corrosion resistance. Chamfered edge permits easy entrance of stranded and solid wire into crimp area.

Four tongue styles: ring, fork, flanged fork and square are available in loose piece and continuous strip. Splices, too. Stud size: 1- $\frac{3}{8}$.

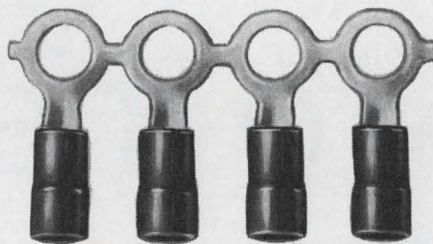

Burndy tooling is recommended as the quickest and easiest way to install Vinylug. Our plier and ratchet hand tools let you install all sizes and types without changing dies.

HYTOOL® Y10ME-4 Plier type tool featuring wire cutter, stripper, insulated and uninsulated crimp grooves to install terminals and splices. Excellent for hard to reach jobs.

HYTOOL MR8-89-1 Ratchet control production type hand tool of lightweight aluminum construction, featuring slide action locator, designed to install full range of terminals and splices, wire range: 22-10. Crimp grooves designed to

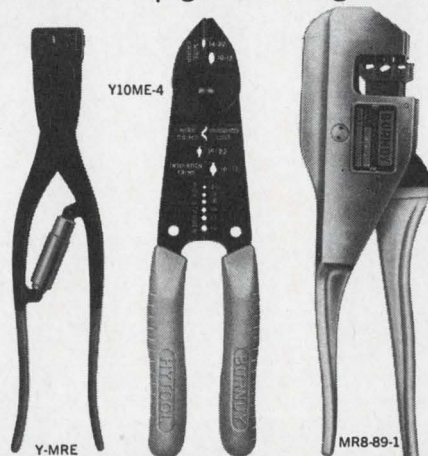

close insulation support at the same time it crimps.
Circle 141 on reader service card

HYTOOL Y-MRE Ratchet control type hand tool which installs terminals and splices covering a specific wire range. Designed for working in confined areas.

AVM2-1 for volume production, our Automatic Vinylug Machine installs up to 2,000 per hour.

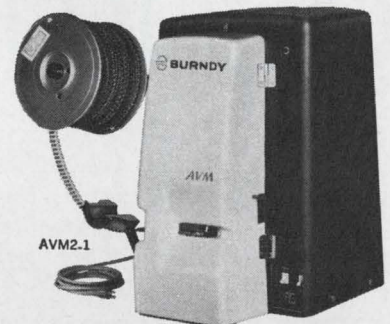

We proudly offer to send you free samples of our new Vinylug. We're sure you'll like the finished look it adds to your product. We know you'll like the price.

FREE SAMPLE
BURNDY/Norwalk, Connecticut
I am curious about the little cost saver. Please send me a free Vinylug Sample Pack and the new Burndy Vinylug/Vinylink™ catalog.

Name & Title _____
Company _____
Address _____

BURNDY
Norwalk, Connecticut

INTERNATIONAL SALES HEADQUARTERS AND
MANUFACTURING FACILITIES: CANADA: Scarborough, Ontario
ENGLAND: St. Helens, Lancs. / MEXICO: Naucalpan de Jaurez
BELGIUM: Mechelen / BRAZIL: Sao Paulo
JAPAN: Tokyo / Sales Offices in Other Major Cities

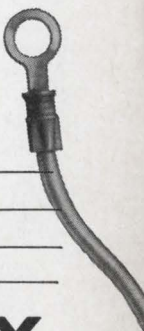

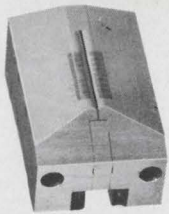

CEC digital recording heads don't exactly live up to their guarantee.

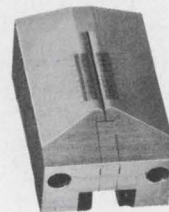

It's a matter of recorded history that they live far beyond it. Case on record: the *first* magnetic tape head replaced in a certain military data-processing installation in Germany logged more than 10,000 hours—or *five times the guaranteed life*.

An atypical performance perhaps? Yes. It was *subpar*. Unit records show an *average* utilization in excess of 12,000 tape passing hours. And a peak head life of 16,000 hours. The system operates around the clock at 120 ips.

CEC has conquered the tape head aging process through use of advanced materials developed by Bell & Howell's Research Center. The upshot has been outstanding magnetic properties, an extremely low wear rate...and Methuselahian life-span.

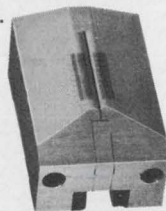

You're assured that, whatever make or model recorder you're using, we've got the head for it. Regardless of interface parameters. And, although we're alone in guaranteeing our heads for 2000 hours, you're assured we try never to live down to it.

That's why we're known as the old heads in the business. For all the facts on the complete line, call your nearest CEC Field Office. Or write Consolidated Electrodynamics, Pasadena, California 91109. A subsidiary of Bell & Howell. Bulletin Kit 1711-X3.

CEC/DATA INSTRUMENTS DIVISION

 **BELL & HOWELL**



Z-fold paper zip codes data for quick retrieval

Data recorded on Z-fold paper by the Hewlett-Packard 7800 Series Rectilinear Recorder is instantly retrievable. Each page is numbered to simplify reference to recorded data. Z-fold chart packs store easily in their original cartons.

Contactless pen tip sensing and a *modulated pressure ink system* produce traces of equal density from all signals and throughout the recorder's variable speed ranges of .025 to 200 mm. per second. *You get blue ink reproducibility compatible to diazo or any similar process.*

Designed with modular, solid-state electronics, the 7800 Systems provide high-resolution, permanent, rectilinear recording of up to eight variables from dc to 150 Hz.

Eight 8800 Series Preamplifiers provide signal conditioning to the driver-amplifiers which drive the recording pens. The recording system is available with eight different or eight identical preamplifiers of your choice. Frequency

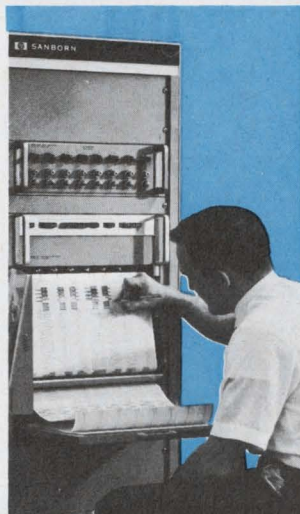

response of the recorder is 150 Hz for 10 div p-p deflection and 58 Hertz maximum for full scale deflection. Maximum ac or dc non-linearity is 0.5% full scale. Additional features include: choice of chart paper in Z-fold packs or rolls; 14 electrically-controlled chart speeds; built-in paper take-up; ink supply warning light; disposable plug-in ink supply cartridge that may be replaced while the recorder is in operation and modular construction for easy maintenance.

For complete information on the 7800 Series, optional and related equipment, contact your local HP Field Office or write Hewlett-Packard, Waltham Div., 175 Wyman St., Waltham, Mass. 02154. In Europe: 54 Route des Acacias, Geneva.

HEWLETT  PACKARD
RECORDING SYSTEMS

Breakthrough in watts per pound.

New High Power Lightweight TWT Offers Duty Factor up to 4% at S-Band.

Litton's new L-5135 TWT is designed for critical applications such as intermediate or final amplifiers in ECM systems, drivers for crossed field amplifiers or other higher power amplifier applications. It features high duty factor, long pulse capability, low cost alnico PPM magnets and high Mu grid for fast rise time/low voltage pulsing.



Shown approximately one-half actual size.

Weighing only 7 lbs, the L-5135 achieves up to 4% duty at 1.0 kilowatt minimum power output over the full 2.0 to 4.0 GHz frequency range. Performs reliably under the environmental extremes of MIL-E-5400, Class 2, and is ideal for airborne and other similarly demanding applications. For additional information on the new L-5135 and other Litton TWT's, write Electron Tube Division, 960 Industrial Road, San Carlos, California 94070 or call (415) 591-8411.

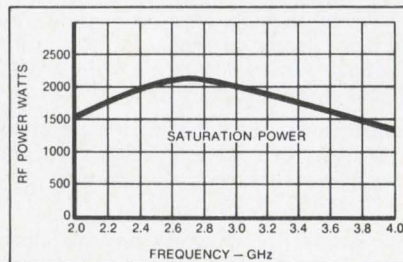
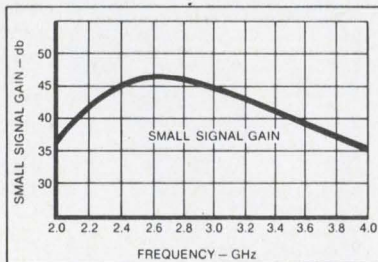

LITTON INDUSTRIES
ELECTRON TUBE DIVISION

$$\begin{array}{r} 1 \\ + 1 \\ \hline 2 \end{array}$$

Two for the Price of One . . . New Dual Op Amp from Amelco

COMPARISON GUIDE

THE AMELCO 810CJ \$5.90

The 810 consists of two complete, overvoltage and short circuit proof amplifiers on a single monolithic chip in a 14 lead dual in-line package. It is pin interchangeable with the dual 709. Typical specs for each amplifier are

Gain: 40,000	CMR: ± 13 V
Offset: 1 mV	CMRR: 90 db
100 nA	Input Current: 500 nA
Tracking: $10 \mu\text{V}/^\circ\text{C}$	Input Impedance: 200 $\text{K}\Omega$
1 nA/ $^\circ\text{C}$	

Compensation: single component with no power supply by pass necessary

Brand F	($\mu\text{A}709\text{C}$)	2 x 5.95	11.90
Brand N	(LM201)	2 x 8.80	17.60

Competitive prices based on best information available to us—quantity 100 pieces. Ask about our 811CE offering the performance above in the 709 pin configuration.

 Amelco Semiconductor, 1300 Terra Bella Ave. • Mountain View, Calif. 94040, Phone (415) 968-9241

Circle 145 on reader service card

1 mW-per-gate TTL now more economical than ever

Recent price reductions—plus the addition of MSI circuits—now bring TI's one-milliwatt-per-gate TTL line within the reach of even the most cost-critical industrial and commercial equipment designers.

New manufacturing techniques—plus high-volume production—have enabled TI to reduce prices by 25 to 40 percent. This means you can now obtain many of the same benefits that have helped to upgrade sophisticated military, avionic and space programs, at only about a 20 percent premium

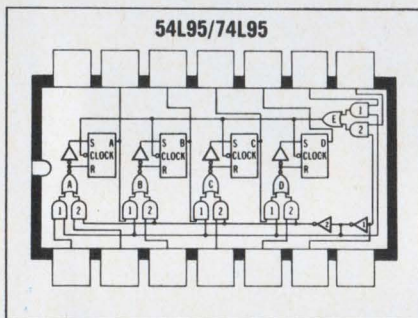
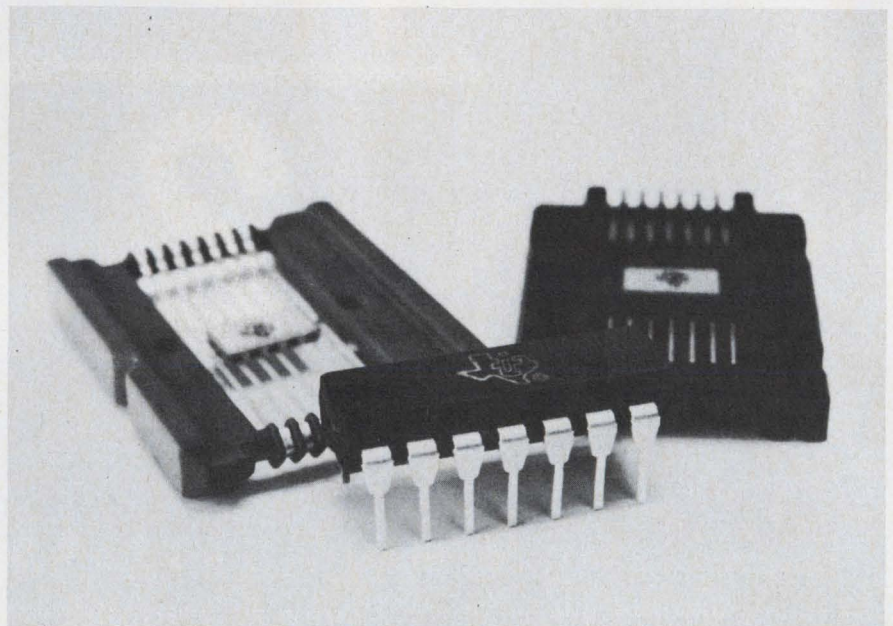

over standard Series 74 TTL.

Furthermore, the number of low-power circuits available has been expanded to 13. These include several new MSI functions, such as the 4-bit right-shift, left-shift register shown here. These new MSI circuits permit sizeable package count reductions, thereby increasing reliability while assuring you lowest cost per function. And you have your choice of package types—the hermetically sealed flat pack and the convenient, low cost plastic

plug-in package.

All 13 Series 54L/74L circuits feature power requirements less than one-tenth that of comparable standard ICs. For example, power dissipation is typically 1 mW per gate and 3.8 mW per flip-flop. Furthermore, with 54L/74L circuits low power does *not* mean low speed. These circuits are about twice as fast as other ICs with similar power dissipation.

Because of their low power requirements, Series 54L/74L circuits make it possible to significantly shrink size of power supplies and energy sources such as batteries or solar cells. Also, requirements for heat sinks and other heat-dissipation provisions are re-

duced...further reducing the size and complexity of installations.

Series 54L/74L TTL is fully compatible with both standard and high-speed versions of the 54/74 TTL family. All these circuits may be combined, in any proportion, to give almost any desired speed/power-dissipation combination. On any count—price, performance, selection—equipment designers are now turning, as a matter of course, to low power TTL from TI. Why not find out how you can benefit, too.

For data sheets on Series 54L/74L, just write on your company letterhead to Texas Instruments Incorporated, P. O. Box 5012, M.S. 980-C, Dallas, Texas 75222.



TEXAS INSTRUMENTS
INCORPORATED

Third-generation small computer to make its debut in December

Designers adopt architectural approach, proven in large machines; modules of read-only memory are interchangeable with those of main storage

By Wallace B. Riley

Computers editor

One new idea, plus two old ones that have been used only on large-scale computers, add up to one of the most exciting new designs in several years: the first small computer that can truly be described as third-generation.

The first old idea is the architectural approach: deciding how the functions are to be performed before thinking about hardware. And the second is multiple accumulators, now used in a small computer for the first time.

The new idea is a read-only memory whose modules can replace any of those in the main memory without affecting the computer's operation.

Called the Nova, the new computer is built by the Data General Corp., Hudson, Mass. The first production model will be shown at the Fall Joint Computer Conference in San Francisco Dec. 9-11. Deliveries are scheduled to start by the end of January. The company hasn't yet set a price, but it's expected to be about \$8,000 for the

basic machine plus teleprinter.

How it began. It was the design of the IBM System 360 that gave birth to the architectural approach, which is fundamentally a computer discipline independent of hardware work. The 360, introduced in 1964, had been designed years earlier without reference to the hardware that would be used to build it.

All of the 20-plus models of the 360 have followed the same architectural scheme, even though there have been a few significant changes in the hardware. Several other manufacturers have adopted the architectural approach, but only for large-scale machines. The advantages, it's been said, don't apply to small computers. But the designers of Nova disagreed.

One of the significant contributions of the architectural approach in design philosophy is the notion that machine performance can be improved by making several registers available to the programmer. These registers serve the same purpose as the accumulator that was

a prominent feature of many first- and second-generation computers; they store intermediate results for quick and easy access without returning to the main memory—a step that can take as much as four or five machine cycles.

These registers, called multiple accumulators, scratchpad memories, or local storage units, now appear in a wide variety of medium- to large-scale machines from many manufacturers. But up until now, it was thought that they wouldn't add enough capability to small computers to justify their cost.

MSI is key

Data General's design depends on the availability of medium-scale integrated circuits in production quantities. The architecture was designed with this in mind; the key idea was regularity of design. Accumulators, for example, are regular; random control logic is irregular. Every instruction tells the machine to do something different, so that the number of instructions is

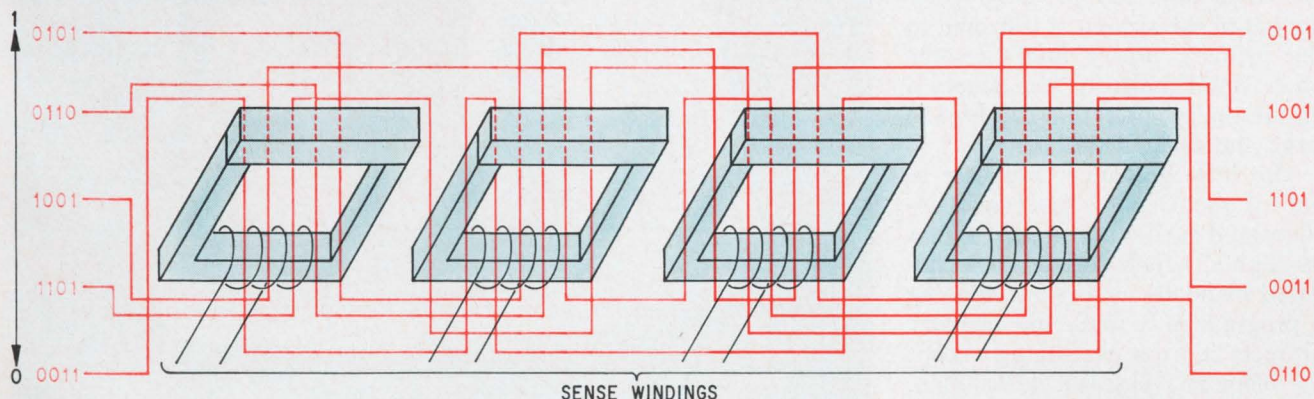

Winding pathways of memory. Using a variation on a theme—the braid memory—the read-only storage section in Nova adopts a design in which signals moving along wires from front to back of the U-shaped (and capped) cores represent 1's, and those from back to front of the core transmit 0's.

... read-only memory can be thoroughly debugged in main storage before being wired ...

related to the amount of random control logic.

By adding accumulators to the design, Data General was able to reduce the number of instructions, thus increasing regularity. This, in turn, permitted maximum use of MSI, reducing the cost and size of the machine but not its capability. More than half of the machine's circuits are MSI devices.

Edson D. deCastro, a founder of the company and one of the principal designers of the machine, defines MSI as "the greatest complexity commercially available without custom design." All of the MSI circuits in the Nova are transistor-transistor-logic devices. They include, for example, accumulator registers, which have 16 flip-flops in a package. Among suppliers of these units is Fairchild, which makes the 5330. TTL circuitry also includes 4-bit adders like the Texas Instruments 7483, and shift registers like the Fairchild 9300.

Like and unlike. The new kind of read-only memory is related to marketing plans. Data General expects most of its machines to be sold to manufacturers of systems in which the computer is a subassembly. In these systems, the program, once loaded into the memory, is likely to stay there indefinitely.

This is in contrast to computer installations where different programs are loaded, executed, and dumped, often once every few minutes. Where only one program is used over and over, any slight defect that develops in some component of the system, a transient in the primary power line or some other small difficulty, can create a bug in the program that can lead to large and difficult problems.

The little guidance computer in one of the Gemini spacecraft encountered such a problem in one of its flights, which had to be terminated manually as a result. Placing a program in a read-only memory protects it from everything except the memory's physical destruction, and this safeguard is used in the Apollo guidance computer. Although the Nova isn't designed for space work, its program could be

similarly disturbed.

A program in a read-only memory has to be completely debugged before it's committed to hard wiring.

Data General has neatly combined the advantages of indestructible read-only program storage with an easily-debugged main memory by making the two with interchangeable modules. Using this feature, the customer can write a program, load it into the main memory, and test it, doing as much debugging as is necessary, until it runs to his satisfaction. Then he orders a new memory module containing a read-only memory wired to his specifications; this module plugs into the Nova in place of one of the main memory modules.

Juggling act. The read-only memory comes in 1,024-word increments; the main memory comes in modules of 4,096 words, up to a maximum of 32,768, but a single module can be wired to hold 1,024 or 2,048 words of alterable memory. Thus a program that requires no more than 2,048 words can be wired into two read-only modules; these, mounted on a single printed-circuit board, together with another board with 2,048 words of alterable memory, would replace one original 4,096-word module.

The machine has room for up to

five modules, each containing either 4,096 words of memory or one input-output interface unit; these can be plugged in any order into any of the five connectors in the machine reserved for them. The five connectors are all wired identically in parallel, so that any module fits in any connector.

New pathways

Physically, the read-only memory is a variation on the old braid-memory idea [Electronics, May 1, 1967, p. 88]. A braid memory consists of a bundle of wires threaded through and around a series of cores of linear ferrite material. Each wire corresponds to a single stored word; it passes through cores corresponding to binary 1's and around cores corresponding to 0's. A current pulse in a wire generates pulses by transformer action in sense windings on cores through which that wire passes; these pulses are amplified and transmitted to the computer.

Data General's variation passes the wires from front to back through cores corresponding to 1's, and from back to front through cores corresponding to 0's. Thus, instead of a pulse or no pulse on a given sense winding, there is a positive or negative pulse. These pulses are much easier to discriminate and are less sensitive to noise.

Data General Corp., 275 Cox St., Hudson, Mass. 01749 [338]

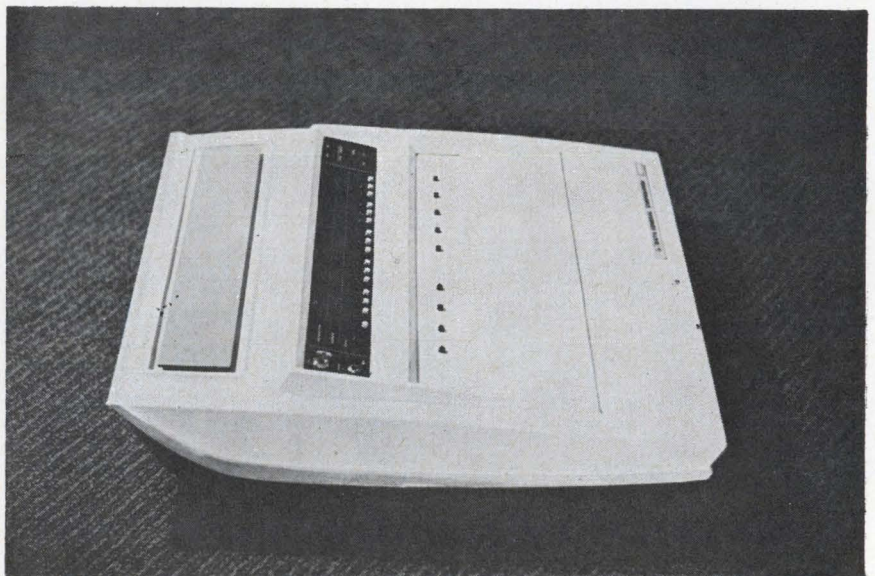

It's not a desk calculator. The Nova, a compact but fully-fledged computer, consists of a teleprinter in addition to the machine shown above.

Isolate with light...

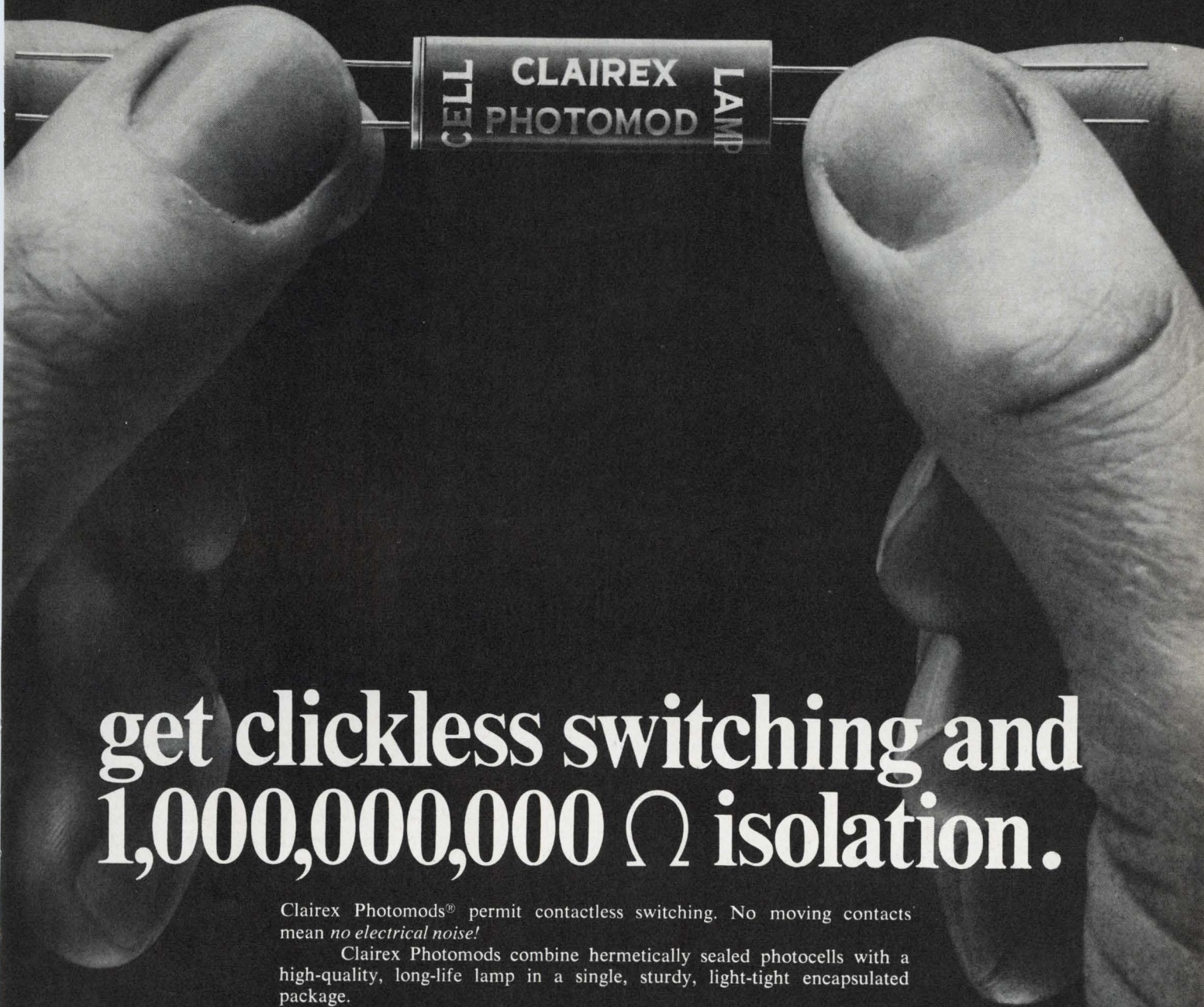

get clickless switching and 1,000,000,000 Ω isolation.

Clairex Photomods® permit contactless switching. No moving contacts mean *no electrical noise!*

Clairex Photomods combine hermetically sealed photocells with a high-quality, long-life lamp in a single, sturdy, light-tight encapsulated package.

The higher the voltage or current applied to the lamp, the brighter the lamp. The brighter the lamp, the lower the resistance of the cell. Thus, resistance of the cell is varied without physical contact, and no noise is generated in the signal circuit.

Let us show you how the "light touch in automation and control" can provide you with noiseless switching and control. Call (212) 684-5512 or write Clairex, 1239 Broadway, New York, N. Y. 10001.

CLAIREX ELECTRONICS, INC.®

We have something for no-nonsense design engineers

who want to make
the best investment
in IC logic assemblies.

Design with CAMBION® IC Logic Assemblies. You get more for your money . . . more functions on every logic card . . . an exclusive 70-pin input/output that lets you bring more functions through to the outside world.

With this unique connector capability, we've developed both standard and those hard-to-find cards . . . grey code logic, arithmetic logic, counters, decoders, registers, comparators . . . all the odd-ball assemblies you need.

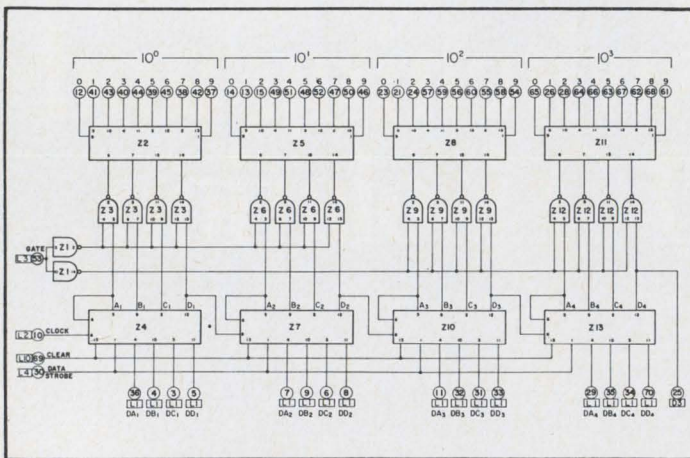
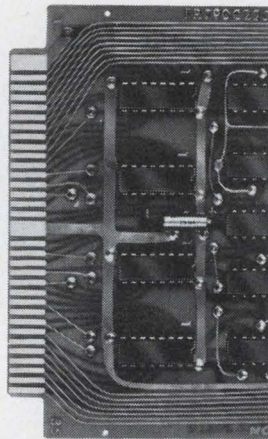

BCD counters with decoder/Nixie drivers

Look at these advantages:

SPEED — IC logic assemblies with speeds to 25 MHz.

NOISE — Exact component location with precision etched interconnections achieve "short-leads" and prevent signal cross-coupling. BCD counters with decoder/Nixie* drivers all on a single card are but one example.

PACKAGE DENSITIES — 70-pin input/output, plus a great array of complex functions and you've got what it takes for highest density packages. (You use fewer cards this way, too.)

VARIETY — Over 250 card types for difficult applications.

DELIVERY — Immediate . . . from stock . . . honestly.

DOCUMENTATION — CAMBION's new logic manual has the data, including application and helpful reference formulas.

NO-NONSENSE — Make the best investment in IC logic assemblies. Send for new manual. Cambridge Thermionic Corporation, 447 Concord Ave., Cambridge, Mass. 02138. Phone: (617) 491-5400. In Los Angeles, 8703 La Tijera Boulevard. Phone: (213) 776-0472.

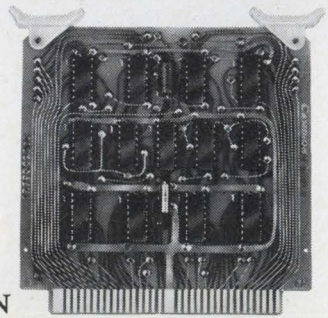

®Reg. U.S. Pat. Off.
*Trademark, Burroughs Corp.

CAMBRIDGE THERMIONIC CORPORATION
CAMBION®

Standardize on CAMBION . . . the guaranteed logic assemblies

New Components Review

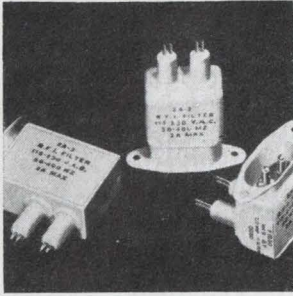

Miniature filter series 2A has a max. operating line current of 2 amps. It operates from a-c line sources of 115 or 230 v at frequencies of 50 hz to 400 hz. Capacitance between line and ground of 5,000 pf suits it for consumer electronics. Line resistance, in to out, is 0.03 ohm. Price is \$8.75 to \$20; delivery, 2 weeks. Components Corp., 2857 N. Halsted St., Chicago. [341]

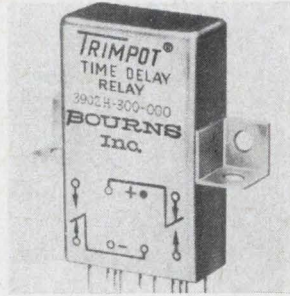

Fixed time delay relay model 3902 has a 1 amp, dpdt contact arrangement. It comes in time delays from 0.1 to 15 sec. Less than 0.5 amp is required for continuous operation from an input operating range of 20 to 30 v d-c. Operating temperature range is -55° to $+120^{\circ}$ C. Price in quantities of 100-249 is \$51.75 each. Bourns Inc., 1200 Columbia Ave., Riverside, Calif. 92507. [342]

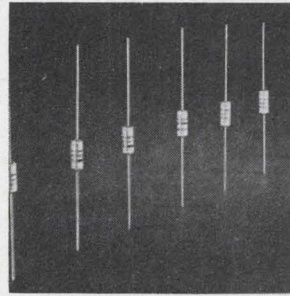

Molded shielded r-f chokes meet the requirements of MS90537. Inductance ratings range from 0.1 μ h through 10 mh in 61 values. Packaged in a 0.157 x 0.395 in. case, the axial lead chokes are color coded in conformance with MIL-C-15305C. Epoxy molding protects the devices against all environmental conditions. J. W. Miller Co., 5917 S. Main St., Los Angeles 90003. [343]

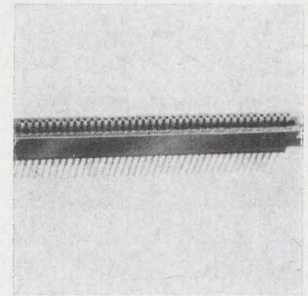

P-c connectors are available in 40 and 80 contact configurations and adaptable to standard 1/16 in. p-c boards with lands on 0.125 in. centers. Contacts, made of phosphor bronze with an electroplated gold finish, are suitable for automatic wire wrap termination, each capable of accepting 3 No. 24 wires. Methode Electronics Inc., 7447 W. Wilson Ave., Chicago 60656. [344]

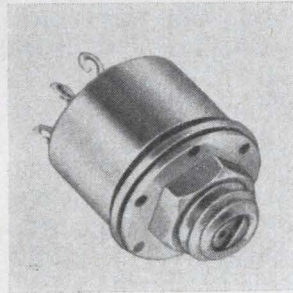

Rotary selector switch model SW37 is a panel mount unit that measures 0.350 in. in diameter. Contact arrangement is single pole with provisions of from 2 to 6 positive detents indexed every 60° . Contact rating is 28 v. d-c max. at 0.25 amp. The unit is designed for $\frac{3}{8}$ in. thick panel mounting. It meets the latest military specs. Minelco, 600 South St., Holbrook, Mass. [345]

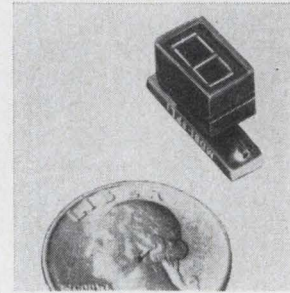

Single-digit readout device called Digi-Lite, which measures 0.446 x 0.306 x 0.530 in., utilizes a 7-bar incandescent display to produce digits 0-9. A nominal operating voltage of 4 v and operating current of 16.5 ma permits driving the readout directly from IC's. Characters have 8,000 ft lamberts of illumination. Chicago Miniature Lamp Works, 4433 N. Ravenswood, Chicago. [346]

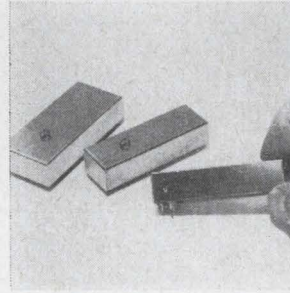

Reed relays series 30 are rugged devices produced in contact configurations and housing sizes to interchange directly with other standard industrial lines. All versions are available in either dry- or mercury-contact types. The line includes 6-, 12-, and 24-v versions with 1, 2, or 4 Form A or Form C contacts. Compac Engineering Inc., 810 East St., Hollister, Calif. 95023. [347]

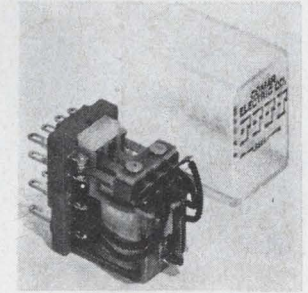

Opposite polarity relay CR-1900 provides up to 4 form C switching configurations, with contact ratings of 1/10 h-p at 120 v a-c, $\frac{1}{2}$ amp at 240 v a-c, 4 amps at 120 v a-c or 4 amps at 30 v d-c. Each relay incorporates a contact barrier and terminal board with a potential interlocking method to effectively isolate adjacent contacts. Comar Electric Co., 3349 W. Addison, Chicago. [348]

New components

MOS FET devices invade tube preserve

Solid state electrometers can be used in pH meters, other precision instruments; resistance is 10^{15} ohms and up

One of the few remaining holdouts against solid-state devices is the electrometer tube, which is still used extensively in precision instruments such as direct-reading digital voltmeters, pH meters and d-c voltmeters. Engineers at the Newport Beach, Calif., operation of

Hughes Aircraft Co. hope to stamp out electrometer tubes in this equipment with a line of metal-oxide-semiconductor field effect transistor electrometers.

The line consists of the HRN5886, HRN5886A, HRN5886B, HRN1886, HRN1886A and HRN

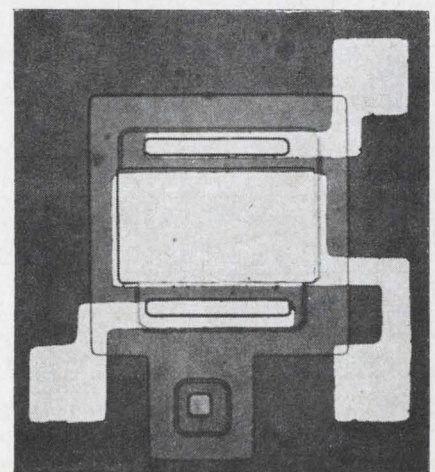

Solid. High impedance makes FET unit good performer in measurement jobs.

For Those Who Think Small

... hope to cut noise
still more in '69 ...

\$128 ————— ○ Low Cost

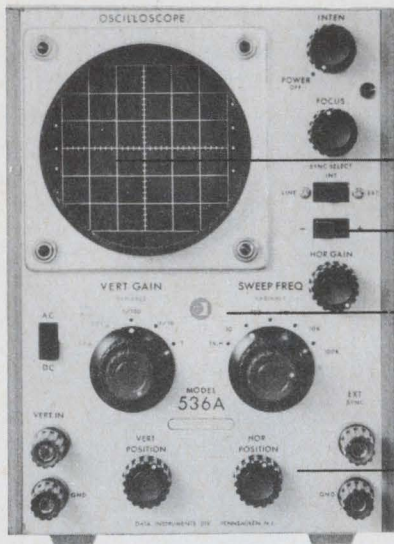

○ 20mv/cm Sensitivity

○ Small Size and Weight

○ Built-in Calibrator

○ Solid State Reliability

Here's Data Instruments 536A—proof that you can reduce the size of a scope without reducing its performance. The 536A is small. So small, in fact, that four of them take up little more than a square foot of panel space. This makes it desirable for field, production line, classroom and systems applications where panel and shelf space are critical. But there's more to it than that. The 536A matches their performance requirements in a way usually reserved for larger and more expensive instruments. The flat-faced 3" CRT, with a viewing area of 4 x 6 cm and a finely focused trace, provides it with excellent legibility; the 1.5 MHz bandwidth makes the 536A adaptable to a wide range of applications. And its unusual sensitivity—better than 20mv/cm—makes possible precise measurements of regularly recurring waveforms over its entire bandwidth.

Moreover, it has the features to back up its performance. All amplifiers are solid state, multistage, DC coupled and fully compensated. The attenuator has a variable trimmer, and a built-in calibrator stabilizes time and voltage. In addition, there is a full year's warranty and complete field and factory service.

The specifications:

VERTICAL AMPLIFIER				
BANDWIDTH DC-1 MHz	SENSITIVITY/CM 20mv	ATTENUATOR 3 pos + var.	ACCURACY ±.5 db	IMPEDANCE 1MΩ + 22pf
SWEEP/CM	HORIZONTAL AMP		CRT	PHYSICAL
10μs-10ms (4 ranges)	2Hz-500KHz 300 mv/cm		3"	5½" x 7½" x 12" 11 lbs.

But why not see it in action? We'll gladly arrange a demonstration in your plant. You'll find that everything about the 536A is designed for those who think small, Everything except the Price. That is for those who think microminiature.

Data Instruments Division • 7300 Crescent Blvd. • Pennsauken, N. J. 08110

1886B. All of these devices, says Carroll R. Perkins, can outperform electrometer tubes such as the CK5886. Perkins is manager of MOS marketing and applications at Hughes Newport Beach. He transferred from Raytheon Co. when Hughes bought the latter's MOS FET line. Raytheon had been sole source for MOS FET electrometers for selected instrument manufacturers. This is the first time the line has been made available off-the-shelf, Perkins says.

"The three most important characteristics you need for good electrometers," Perkins explains, "are extremely high input impedance, very low drift, and good low-frequency noise characteristics.

"Some people have used 'bootstrap' transistors to get the input impedance, but they didn't get it high enough and they still had noise. The best input impedance they were able to get was about 1,000 megohms. The noise figure for the transistor approach was about 100 microvolts," he continues. The Hughes family of devices delivers input impedances from about 10^{15} to 10^{18} , has a drift of less than 0.5 millivolt per day (vs. 1.0 millivolt per day for a tube), and a low-frequency (100 hertz) equivalent noise voltage of 30 microvolts over the entire bandwidth.

Perkins says two other MOS FET manufacturers—Motorola and Siliconix—have devices that come close to the Hughes family in stability and high input impedance. He adds, however, that the competing devices don't meet the performance characteristics of the Hughes line, particularly in low-frequency noise: "The noise figure of these other MOS FET's is twice that of ours, and we expect to cut our noise voltage in half by mid-1969. We've already demonstrated that we can cut it in half."

Buffer role. Perkins notes that instrument manufacturers need high input impedance electrometers as a buffer between high external impedances and the low impedances of their measuring equipment. They want low drift rates be-



“We had hoped to save \$12,000 with Sweet’s Microfilm File... but it’s probably closer to \$25,000 per year.”



Mr. Norman Wilkes, Technical Librarian of Reeves Instrument Division, is explaining the operation. That cartridge in his hand holds over 2500 pages of data.

Three years ago, Norm Wilkes installed Sweet’s Microfilm File at Reeves Instrument Division of DCA, a prime manufacturer of military guidance systems. He already knew about the microfilm approach to data storage and retrieval—he’d been using another system since 1962.

So if you’re already sold on the mechanics of microfilm for containing the data explosion, you’ll be interested in the reasons for the switch at Reeves. Norm Wilkes had to translate those reasons into retrieved engineering time... averaging \$25,000 per year. And the factors that speed data retrieval show up in time (money) retrieval: Completeness. Currency. Accessibility.

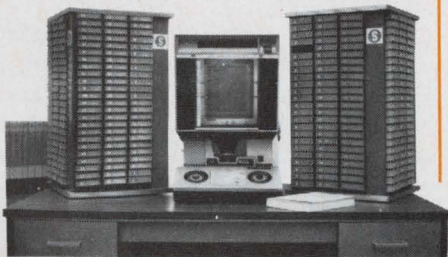

Estimate of Retrieved Engineering Time

How much can you save? Perhaps two hours per man per week? Make a rough calculation; be conservative; then, send in the coupon.

hours/man/week retrieved
x weeks
 hours/man/year retrieved
x no. of engineers
 hours/year retrieved
x \$ hourly cost of engineering time
\$ yearly saving

Sweet’s now has 800,000 pages of product/vendor data—and updates all of it every two months. And we have complete specifications packages too: all the MIL Specs, all the QPLs, all the military handbooks, and all but the most irrelevant Mil and Federal standards. All completely updated, incidentally, at intervals noticeably shorter than the official ones. All, including the viewer-printer, complete on a desktop.

Sweet’s speeds you to all this data with computer-printed (so we can do it every up-date) indexes. The Product indexing has more than 5,000 entries, in technically accurate language (we are a division of McGraw-Hill, a company that participates heavily in the industrial community’s communications).

Thus you will understand the basis for Mr. Wilkes’s appraisal: “We find the selection of catalogs in the Sweet’s System very complete... the catalog is there when you

need it, on film, to make a copy of, if needed—it’s not lost on someone else’s desk, or permanently borrowed. And the lookup of information is fast.”

On Sweet’s built-in capability for retaining superseded data in a historical file, Mr. Wilkes says: “With the original suppliers’ catalogs still available to us, we can ask manufacturers to find parts for us that no longer appear in the current literature.” Take note, retrofitters. The past is retrievable.

The Reeves engineer confidently goes to Sweet’s and finds what he wants better than 90% of the time—an impressive hit percentage which explains that impressive saving in engineering time.

Engineers need data. The quicker they find it, the quicker they can get back to work. **We make engineers out of engineers.**

SWEET’S INDUSTRIAL DIVISION
McGraw-Hill INFORMATION SYSTEMS COMPANY

Please send a complete information package on Sweet’s Microfilm File

Name _____
Title _____
Company _____
Address _____
City _____
State _____ Zip _____

Send to Sweet’s Microfilm File, Dept. EL 17
330 West 42nd Street, New York, N.Y. 10036
or call G. O. Stevens collect at 212-971-3586

Why fish around for transformers and inductors?



Your Triad Distributor probably has the one you want in stock.

Avoid costly delays in delivery of custom-designed components. Get your new product on the market faster, and get the jump on competition.

It's easy. Just call your nearest Triad distributor. He has hundreds of items in stock — many in depth for your production requirements. If you happen to ask for more than he has, we back him with quick service in larger quantities from our 280,000+ units here in Huntington.

Your distributor also has Triad's broad line of integrated circuit cards, with or without Winchester connectors, to help you breadboard your design quickly.

He has an illustrated cost-cutting guide, too. It's called the Triad catalog. Be sure and ask for your copy. Triad Distributor Division, 305 North Briant Street, Huntington, Indiana 46750.

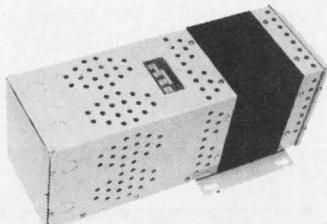

Voltage Stabilizer Transformers

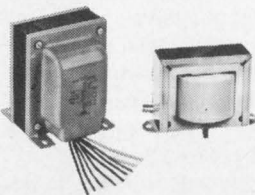

Commercial Grade Powers and Audios

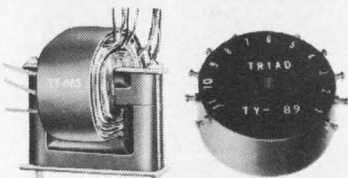

Transistor Power Supply Transformers

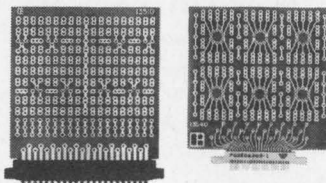

Integrated Circuit Cards

T Triad Distributor Division
of Litton Industries 

cause they want to minimize the need to recalibrate their instruments, and they need good low-frequency noise characteristics to prevent their meter readings from "bouncing around," as Perkins puts it.

He says that the Hughes MOS FET electrometer family is the best high-input impedance amplifier available for applications in which the input impedance is greater than 100 megohms. "If it's less than that, you'd want to consider junction FET's or bipolar transistors," according to the marketing manager.

The Hughes MOS FET's are available in three-lead TO-5 and four-lead TO-72 cans. Typical warmup time is 30 seconds, compared with about 30 minutes for a tube. Prices for quantities of 1,000 range from \$2.80 for the HRN5886 to \$4.80 for the HRN1886B. The company is quoting two weeks for delivery.

Hughes Aircraft Co., 500 Superior Ave.,
Newport Beach, Calif. 92663 [349]

New components

Washday blues eliminated

Sealed pressure transducer
can be cleaned, used again
without recalibration

Most pressure transducers made with bonded strain gages are too hard to clean and have to be recalibrated after cleaning. Many engineers find this cleaning and calibration so tedious that they sacrifice performance and buy less-expensive transducers which are discarded when they get dirty and less reliable.

To solve the engineers' washday problem, Kistler Instrument Corp. has built a transducer, the Model 404, which can be disassembled, cleaned in boiling solvent, reassembled and used again without recalibration.

Straining. In control systems, transducers—like the 404—convert

The following are the only integrated circuits approved as standard by the Minuteman Parts Control Board:

1. SE106J DUAL 5-INPUT GATE EXPANDER
2. SE111J DUAL 4-INPUT HIGH FAN-OUT NAND GATE
3. SE112J DUAL 3-INPUT HIGH FAN-OUT NAND GATE
4. SE116J DUAL 4-INPUT NAND GATE
5. SE124J RS/T BINARY
6. SE125J J-K BINARY
7. SE156J DUAL 4-INPUT CLOCK/CAPACITIVE LINE DRIVER
8. SE161J ONE-SHOT MULTIVIBRATOR
9. SE170J TRIPLE 3-INPUT NAND GATE
10. SE180J QUADRUPLE 2-INPUT NAND GATE
11. CS720J QUADRUPLE 2-INPUT NAND GATE
12. CS721J TRIPLE 3-INPUT NAND GATE
13. CS727J TRIPLE 2-INPUT NAND GATE
14. CS729J RS/T BINARY
15. CS731J QUADRUPLE 2-INPUT GATE EXPANDER

The following are the only companies that make them:

1. SIGNETICS

811 EAST ARQUES AVENUE, SUNNYVALE, CALIFORNIA 94086. A SUBSIDIARY OF CORNING GLASS WORKS.

How Bright is One Half Milliwatt?

That depends on how you look at it. The photograph below displays the San Francisco skyline seen from Yerba Buena Island. Located on top of the Wells Fargo Bank Building, at a distance of two and one quarter miles, the laser source appears to be the brightest thing under the sky. (In deference to the world's most valued noncoherent source, we waited until the sun had departed beyond the Golden Gate.)

We have worked on the development of our LAS-2002 for the past two years and we consider it to be a true second generation laser. (Many of our first generation lasers are now operating in the field in their third and beginning fourth year of trouble-free service.)

Regarding the use of lasers in classroom or laboratory, please inquire about our completely revised booklet 'Laboratory Experiments with Coherent Light', listing in detail more than 40 experiments. Our new Laser Experimenters Kit complements this text and features holographic exposure and display.

We also manufacture other gas lasers and related instruments.



The all-new LAS-2002 compact Laboratory Laser offers you the following outstanding features:



\$232

f.o.b.
Palo Alto,
California

- operation:** from ac-line (integral power supply), only requires the actuation of an on-off switch
- adjustments:** none during entire life
- tube design:** double-wall coaxial, heated cathode for exceptional life
- mirrors:** sealed in for permanent alignment, no effects from dust or humidity
- cover:** removable for demonstration of laser operation
- use:** ideal for classroom or school-laboratory
- power:** one half milliwatt (possibly an optimum compromise between visibility and operating safety) TEM_{00n} mode CW output of red coherent light at 6328Å, warranted for one calendar year
- dimensions:** 3 x 5½ x 9 inches, width-height-length; 5 lbs.

Electro Optics Associates 974 Commercial Street,
Palo Alto, California 94303 Tel. (415) 327-6200

LAS-2002
information
please

NAME _____
 COMPANY _____
 STREET _____
 CITY _____ STATE _____ ZIP _____

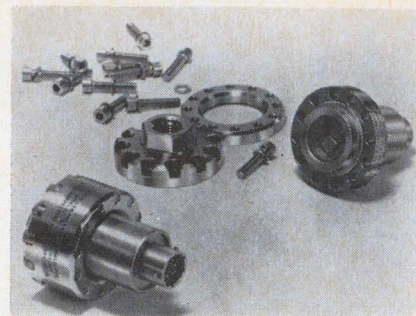

Cleanup. The 404 can be taken apart for cleaning. No recalibration is needed.

a change in pressure to a change in an electronic signal. Four strain gages are in the arms of a bridge. Pressure on the transducer's diaphragm deforms the gages, changing their resistance. The unbalance-signal's strength is proportional to the pressure.

In operation, this type of transducer is exposed to fluids like oils, gels, combustion products, and rocket fuels. When a residue builds up on the diaphragm, the transducer's sensitivity goes down and so does its usefulness.

The 404's gages are bonded to the underside of the transducer's diaphragm, and the housing that holds the diaphragm is sealed.

When it gets dirty, the 404 is put in water or other solvent at temperatures up to 300°F; and it can be scrubbed. Any cleaning technique compatible with 17-4PH stainless steel is okay for the 404. After it has been cleaned, the 404 doesn't have to be recalibrated. It doesn't even have to dry out before being reassembled.

Linear. The 404 is 1¾ inches in diameter, 2⅜ inches high, and weighs 9 ounces. It's available in 12 ranges from 0 to 0 to 5,000 per square inch up to 0 to 5,000 psi, and works with any fluid or gas compatible with 17-4PH stainless steel.

For excitations up to 18 volts d-c, the full scale output into an open circuit is 3 millivolts ±0.005 mv per volt. The output is linear within ±0.15% of the full scale output for ranges from 500 to 5,000 psi, and within ±0.25% for lower ranges. Zero balance is ±0.045 mv per volt.

Price of the 404 is \$380, and delivery time is 4 weeks.

Kistler Instrument Corp., 8989 Sheridan Drive, Clarence, N.Y. 14031 [350]

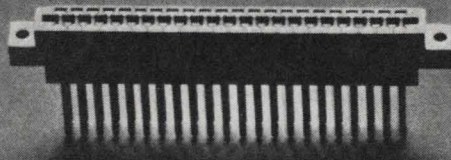

After 17 years Sylvania breaks with custom.

You probably never knew it, but Sylvania is one of the biggest makers of precision-built circuit-board connectors. For years we have been supplying the biggest names in the computer and communications fields. But strictly on a custom basis.

Some of our custom designs have become industry standards. And now we are making them available as off-the-shelf items. This means you can now get the benefits of cus-

tom design without tooling or set-up charges.

And it means you can buy in small quantities at low prices.

You get Sylvania's exclusive welded gold-dot contact design that puts the gold only where it's needed for low contact resistance (less than 50mV). And less gold means less expense.

You also get Sylvania's precision construction that puts wire-wrap terminals exactly in the right posi-

tion for programmed wiring systems.

Formats available include: 44-pin single position, 20-pin single position, 212-pin eight position, and 220-pin five position. Contact ratings up to 5 Amperes.

If these types won't fill your needs, remember we're still one of the biggest names in custom designs. Call us. Sylvania Metals & Chemicals, Parts Division, Warren, Pa. 16365.

CONNECTORS BY
SYLVANIA
A DIVISION OF
GENERAL TELEPHONE & ELECTRONICS

NEW 5/16" TRIMMER PACKS TIGHTER

Saves space without sacrificing performance

IRC's new 5/16" square trimmer gives you the performance and stability of larger units plus the opportunity to save board area and provide greater packaging density.

Two types are now available. The 850, with infinite resolution, is designed to meet the environmental requirements of MIL-R-22097. The 800, a precision wirewound trimmer, is designed to meet MIL-R-27208 environments. Both are priced significantly less than MIL styles.

The metal adjustment screw eliminates breakage or distortion of the screwdriver slot even after repeated use. Staggered pins provide strength and mounting stability.

Both types are fully sealed and impervious to common industrial solvents because of a silicone rubber shaft seal and epoxy bonding at all seams. They exceed MIL humidity cycling tests. For complete data and prices see your IRC Qualified Industrial Distributor. Or, write IRC, 401 N. Broad St., Philadelphia, Pa. 19108.

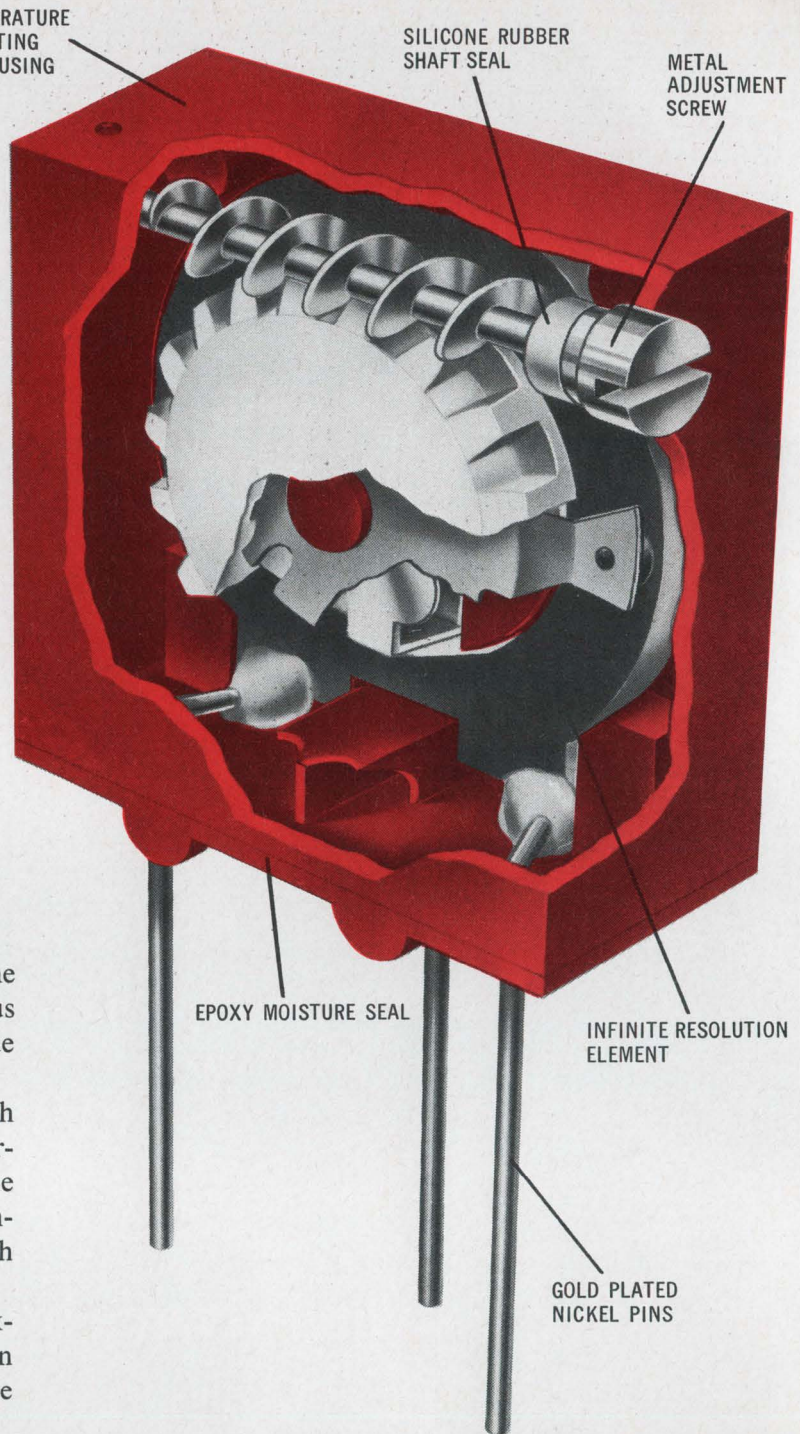

Actual size
Infinite Resolution
Circuitrim 850



Actual size
Precision Wirewound
Circuitrim 800

CAPSULE SPECIFICATIONS

POWER	0.3 Watt @ 70°C (300V max.)	0.6 Watt @ 70°C
TOLERANCE	±10% or ±20%	±5%
RESISTANCE	100Ω to 1 meg.	10Ω to 20K
TEMP. RANGE	-65°C to +125°C	-65°C to +150°C
INSULATION RESISTANCE	1000 megohms @ 500V DC	1000 megohms @ 500V DC
DIELECTRIC STRENGTH	900V AC	900V AC



DIVISION OF TRW INC.

New Instruments Review

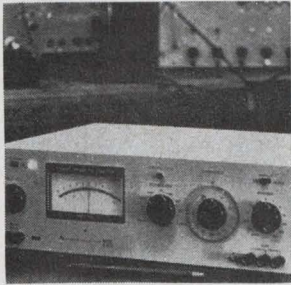

Phase angle voltmeter 212, by measuring in-phase, quadrature, fundamental, and total voltage components within 2% full scale accuracy, and phase angle with 1° accuracy, enables the true amplitude, phase angle, and harmonic content of a voltage vector to be accurately determined. Prices range from \$835 to \$950. North Atlantic Industries Inc., Plainville, N.Y. [361]

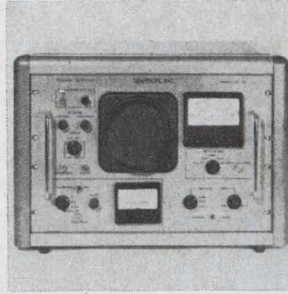

Test system series SR6000 provides quantitative and qualitative analysis of corona and insulation breakdown in high-voltage specimens. The corona detector has a high rejection ratio for spurious noise and sensitivity of 1 picocoulomb/cm with specimen capacitance up to 10 μ f. The SR6000 is priced from \$1,500. Sentron Inc., P.O. Box 70, Danbury, Conn. 06810. [362]

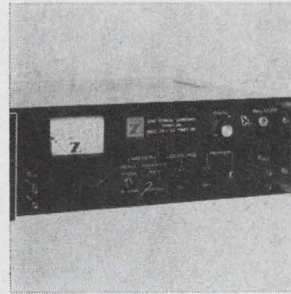

Versatile d-c power amplifier ZPA-1 is capable, under full load conditions, of swinging 80 v peak-to-peak. It can deliver up to 4.5 amps peak-to-peak before current limiting occurs. Automatic current limiting instantaneously clamps the output current to \pm 2.25 amps. Frequency response of ZPA-1 exceeds 35 khz. Zonic Technical Laboratories, 965 North Bend Road, Cincinnati. [363]



Megohmmeter model 2423 is designed for precise measurement in the range between 100,000 ohms and 10,000,000 ohms. It is also capable of accurate d-c voltage measurements from 0.01 to 2,000 v with high input resistance. It is stabilized against power supply fluctuations. The unit features a single range selection switch. B&K Instruments Inc., 5111 W. 164 St., Cleveland. [364]

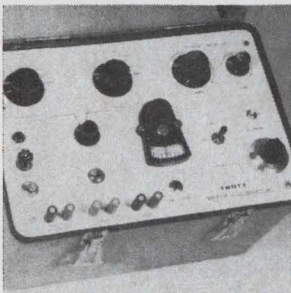

Portable meter calibrator TR-402A has a built-in standard cell for self-checking purposes and provides an accuracy of 1/2 of 1% for both a-c and d-c voltages and currents. Occupying less than 1 cu ft, the calibrator weighs about 25 lbs and has built-in overload protection. Price is \$695; delivery, stock to 6 weeks. Trott Electronics Inc., 30 Ridgeland Rd., Rochester, N.Y. [365]

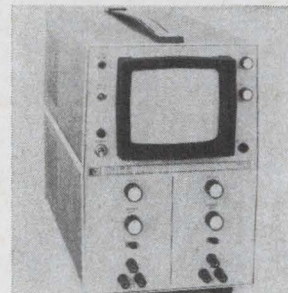

X-Y scope model 1208A uses two identical 600 khz amplifiers. Typical uses include plotting the frequency response of amplifiers or filters with a sweep signal generator, plotting the outputs of nuclear spectrometers, semiconductor curve tracers and analog computers. Price is \$540, cabinet or rack mount. Hewlett-Packard Co., 1501 Page Mill Road, Palo Alto, Calif. [366]

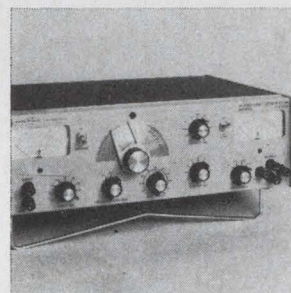

Audio sine generator model F370A provides up to 5 w output power into loads of 50, 200, 600 and 5,000 ohms over a frequency range from 20 hz to 20 khz. Output attenuation is up to -110 db in -1 db steps. Input attenuator extends meter range to +48 dbm and to 200 v rms in 5 db steps. Price is \$628. Data Royal Corp., 8014 Armour St., San Diego, Calif. [367]

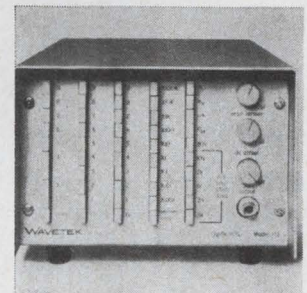

Digital voltage controlled generator model 113 generates sine, square, triangle and ramp waveforms over a frequency range of 0.001 hz to 1 Mhz. Frequency, function and amplitude are selectable by front panel pushbuttons. Amplitude is selectable in 10 db steps from 0.1 v to 10 v peak to peak. Price is \$595; delivery, 30 days. Wavetek, 8159 Engineer Rd., San Diego, Calif. 92112. [368]

New instruments

Troubleshooting made easy, painless

Portable volt-ohmmeter measures components in-circuit, eliminates unsoldering; limiter protects active elements

One of the most frustrating moments in troubleshooting electronic gear comes when the engineer has to unsolder components to measure their values. It usually has to be done to avoid measurement errors caused by associated circuitry.

A two-year-old Schenectady, N. Y., firm, Systomation Inc., has designed a direct-current volt-ohmmeter called Guardohm which should be popular with those engineers and technicians who have burned their fingers in frequent unsolderings.

Systomation's portable VOM measures the value of resistors in-circuit—no unsoldering is necessary because the meter "guards out" or cancels the effect of parallel resistances. According to the company's president, Norman F. Barnes, no other portable VOM offers this.

The meter also has a constant-current power supply, with test currents selectable from 1 micro-ampere to 100 milliamperes. This should endear the instrument to the many engineers who have blown out semiconductors while trying to check specifications with an overpowered meter. Using the

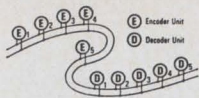

A single pair of wires, or a leased telephone line, can carry the audio signals for a complete control system.



For inaccessible areas or mobile installations, a radio transmitter and receiver system can carry the signals.

REMOTE CONTROL SWITCHING WITH AUDIO SIGNALS

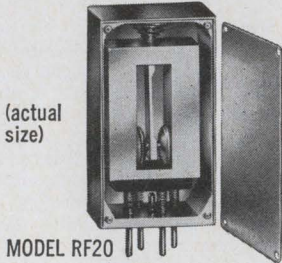

(actual size)

MODEL RF20
contactless resonant reed encoder/decoder
.395 x .620 x 1.100

An audio tone can be generated by an electronic oscillator or resonant reed encoder circuit, then transmitted by wire or radio. The tone activates a resonant reed relay to perform a control function.

Bramco reeds permit over 100 selective control frequencies within the 67 to 3000 Hz. spectrum. This is assured by: (1) the narrow response band-width of about 1% for decoders and (2) the high accuracy of Bramco reed encoders (1/10 of 1% of design frequency).

A big advantage of reeds in control switching is that they are ideally suited for simultaneous and sequential coded tone systems. The actual number of control functions possible in such a system is virtually unlimited. For example, over 3300 individual control functions are possible with only 16 frequencies coded sequentially in groups of three.

Compared to other types of tone filters, resonant reeds are small and inexpensive. They give more control functions per spectrum, per size, per dollar.

If you work with controls that select, command, regulate, or indicate, you should know how it can be done with audio signals. We custom design and stock a broad line of encoder/decoder components and modules. Bramco also custom designs LC filters from 0 to 200 KHz.

For literature write Bramco Controls Division, Ledex Inc., College and South Streets, Piqua, Ohio, or call 513-773-8271.



BRAMCO CONTROLS DIVISION
LEDEX INC.

College and South Streets, Piqua, Ohio 45356

new multimeter, currents encompassing the test levels specified on most diode and transistor data sheets can be set at the turn of a knob.

A by-product. In-circuit resistance measurement is an outgrowth of larger test systems built by Systomation. These tape-programed,



In-place tester. Meter is portable, but can make in-circuit measurements usually done only by large systems.

logic-controlled troubleshooting systems are capable of making a-c/d-c in-circuit checks of resistance, inductance and capacitance.

Guardohm is a three-terminal meter; two probes are placed at either end of the resistor to be tested, and a third at the far end of any parallel resistance (the meter can handle three or more parallel resistances). Since there's no voltage difference, there's no current flow through the parallel resistance. Thus the meter reads the tested resistor's actual value—not the combined value of the resistor and its parallel mate.

The VOM's other feature, its selectable constant-current power supply, uses the same differential amplifier to supply the required current regardless of the load across the test terminals. Whether with a short or a 10-kilohm resistor across the probes, current flow will be the same.

Because its job is troubleshooting, the meter has a linear scale. Most resistance-measuring instruments use logarithmic scales. Systomation's marketing vice president, Melvin E. Stanford, says that log scales can make it hard to determine whether a resistor is within tolerance when the tolerance

is very tight, say below five percent. A linear scale makes readings much less ambiguous.

The instrument's function and range selection panel uses an x-y matrix to make function selection and supply current selection a simple matter of turning two knobs. Thirty-nine ranges (including supply current) are made possible with this scheme.

Guardohm costs \$335; delivery takes about one month.

Specifications

Resistance measurements	13 overlapping ranges, 10 ohms to 10 meg
Current measurements	6 overlapping ranges, 1 μ a to 100 ma
Voltage measurements	9 overlapping ranges, 0.1 v to 1 kv
D-c current generation	11 overlapping sections, selection possible within ranges 1 μ a to 100 ma
Over-all accuracy	1% on both measurement and generation

Systomation Inc., 140 Erie Blvd., Schenectady, N.Y. 12305 [369]

New instruments

Nanovoltmeter's output is binary

Provides digital readout for researchers measuring very weak d-c currents

Test and compare, test and compare. That's the name of the game in research. Experimenters need fast and easy printouts of data to make comparisons, and they want instruments whose outputs can be fed directly into a printer.

For researchers measuring extremely weak d-c signals, a French company, Société Electronique et Nucléaire, has developed an ultra-sensitive nanovolt-ammeter with a binary output for direct printout of data. An added advantage is that direct numerical readings can be seen on the panel's digital display.

Potential uses of the solid state instrument are appearing in all of the sciences requiring measurement of weak currents. Biology and elec-

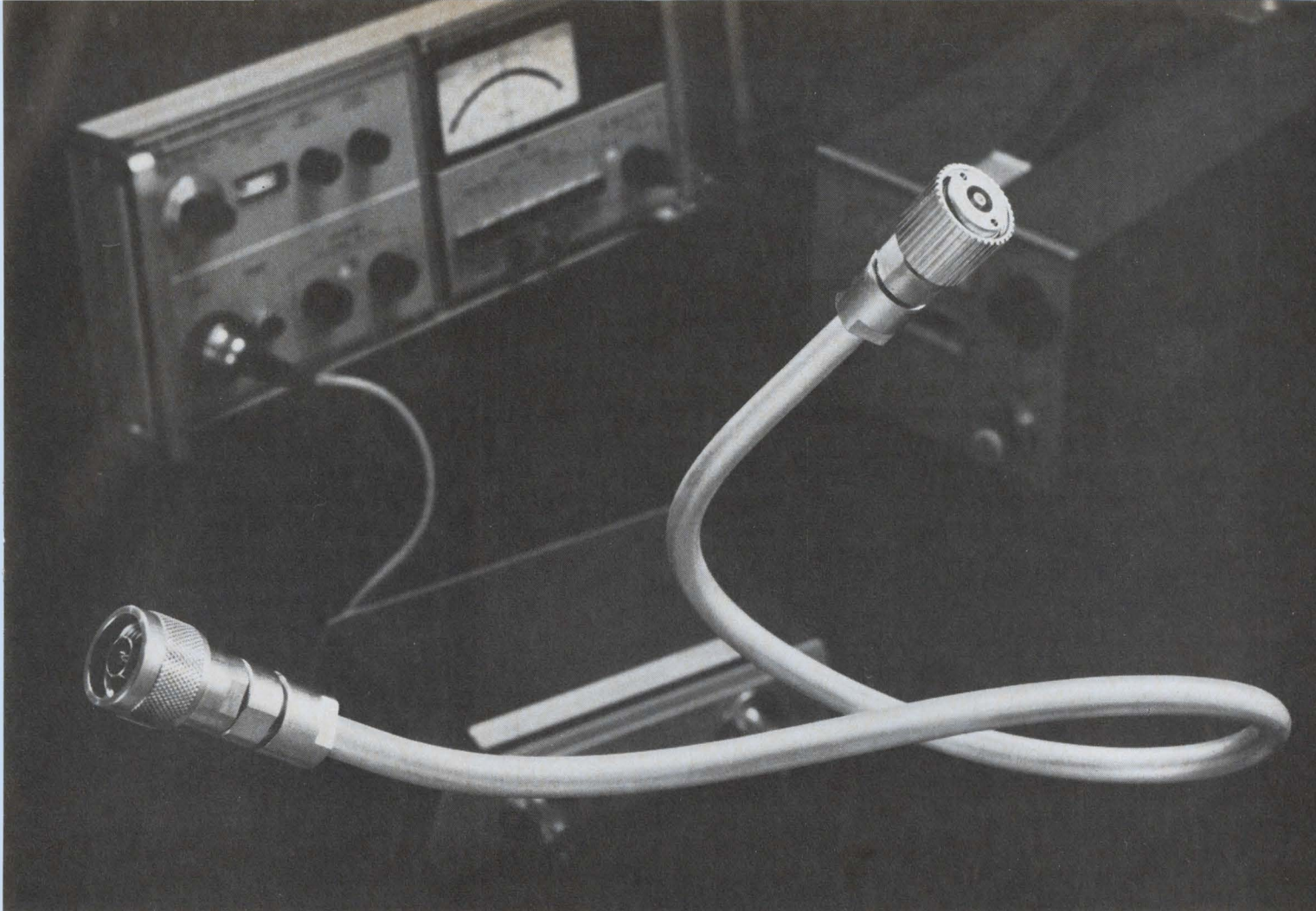

The first family of precision connectors and cable assemblies with virtually no signal loss at high frequency.

Amphenol guarantees it. Now, you can meet your complete range of performance and cost requirements for precision connector components with the Amphenol Precision-in-Coax Family.

PRECISION CONNECTORS	MAXIMUM SWR (for mated pair)		
	7mm AIR LINE	PRECISION .325 ALJAK	RG-214 CABLE
APC-7 (sexless coupling mechanism)	1.039 to 18 GHz	1.10 to 12.4 GHz	1.15 to 12.4 GHz
APC-7 Plug & Jack (economy version of APC-7)	1.039 to 18 GHz	1.10 to 12.4 GHz	1.15 to 12.4 GHz
Panel Receptacles (plug & jack)	1.039 to 18 GHz		
APC-N Plug & Jack (precision type N)	1.08 to 18 GHz	1.125 to 12.4 GHz	1.175 to 12.4 GHz

PRECISION CABLE & AIR LINE ASSEMBLIES	MAXIMUM SWR (for complete assemblies)		
	7mm AIR LINE	PRECISION .325 ALJAK	RG-214 CABLE
APC-7, Economy APC-7 Plug & Jack	1.042 to 18 GHz	1.15 to 12.4 GHz	1.25 to 12.4 GHz
APC-N Plug & Jack		1.175 to 12.4 GHz	1.30 to 12.4 GHz

Free Catalog. For a complete rundown on Amphenol precision cable assemblies, precision adapters, other precision accessories and components, write for "Precision-in-Coax."

Amphenol RF Division,
33 E. Franklin St.,
Danbury, Conn. 06810.



AMPHENOL RF DIVISION
THE BUNKER-RAMO CORPORATION

If you're concerned with Transistor Pads and Clips— Heat Sinks and Adapters . . .

JERMYN

ACCESSORIES

are worth
a closer
look . . .

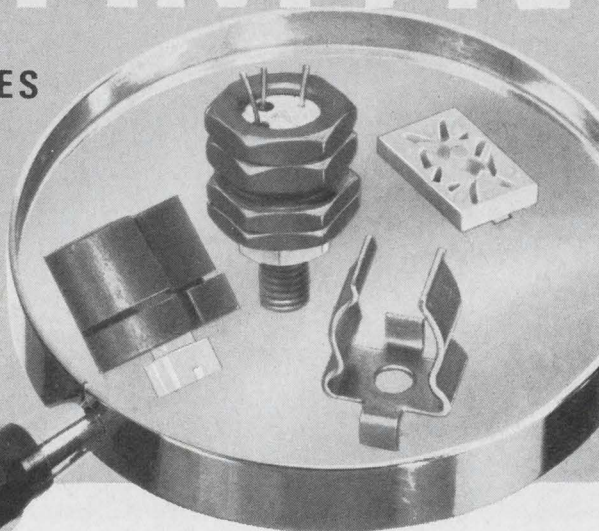

Precision made in Kent, England by JERMYN Industries, these important items of circuit hardware are manufactured with traditional English craftsmanship. They are stocked and sold exclusively in the U.S. by GUDEBROD. Ask for our new Catalog GJ100 which describes the full line—or tell us about your custom needs.

GUDEBROD
Electronics Division

Gudebrod Bros. Silk Co., Inc.
Founded 1870
12 South Twelfth Street
Philadelphia, Pa. 19107

trochemistry are in this group. The company also believes it could be useful in cryogenic and semiconductor research.

The meter has a static chopper, which gives it very low drift, 0.005 microvolt in 24 hours. It is the only nanovolt-ammeter on the market with this feature, the company says. It can be used as a comparator, offering infinite input impedance at null. With a resistance of

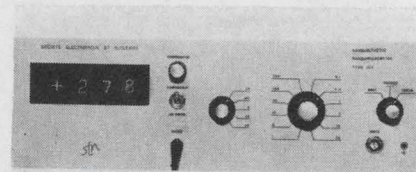

Nanorange. Instrument can be used as a comparator or null detector, besides measuring billionth-level volts and amps.

only 100 ohms, it can measure current from Hall-effect generators.

The nanovolt-ammeter sells for \$1,440 FOB Paris. A less expensive model, with a galvanometer for ordinary analog readings, is priced at \$1,120. An optional battery power source with automatic recharger sells for \$115.

The instrument is designed for rack mounting; it is approximately 5 inches high and 19 in. wide. A kit for converting to bench mounting is available. Power consumption is 3.6 watts; the supply voltage may be 110, 125, 220, or 250 volts, $\pm 10\%$, at frequencies from 50 to 1000 hz.

Société Electronique et Nucléaire, founded in 1960, is primarily a maker of industrial motor speed control devices and systems using thyristors.

Specifications

Voltmeter	
Range	0.1 μv to 30 v
Accuracy	2% of full scale
Input resistance	10 kohms to 100 megs
Noise	0.006 μv peak to peak
Temperature coefficient	0.002 $\mu\text{v}/^\circ\text{C}$
A-c rejection	80 db on 1 μv range
Ammeter	
Range	1 na to 300 μa
Accuracy	3% of end scale
Internal resistance	100 ohms
Noise	6×10^{-11} amp in 24 hours
Drift	5×10^{-11} amp in 24 hours
Temperature coefficient	4×10^{-12} amp/ $^\circ\text{C}$

Societe Electronique et Nucleaire, 2 Avenue Victor-Hugo, 92 Bagneux, France [370]



Aluminum Foil for Electronics

PLAIN FOIL

Republic has three types of standard purity (99.45% aluminum) capacitor foil available for the manufacture of paper and film wound capacitors.

ELECTRO-DRY®—A foil that has negligible organic and inorganic residues on the surface. This type can be used for high reliability and standard units. Electro-Dry is a superior dry foil.

SILWYND®—A foil that has a controlled lubricated surface made by a patented process. Silwynd is used for a free unwind and where a slight lubricant is essential to winding. The slip coating is a high grade silicone which makes Silwynd particularly suited to silicone impregnated capacitors.

ELECTRO-SLIK®—A foil that has a controlled residue produced from the rolling lubricant. The slight residue facilitates unwinding.

ELECTROGAGE®—Super-thin foil .00015" and .00017" features guaranteed gage for critical capacitor requirements. Available in Electro-Dry, Silwynd, and Electro-Slik.

Widths — Republic manufactures all commercial widths from 1/16" in .00015" thru .00035" gages, from 1/8" in .0004" thru .0007" gages, and from 1/4" in .00075" thru .005" gages.

Alloys — Plain capacitor foil is available in commercial alloys 1145, 1180, 1188, 1199 and 0191 (99.45%, 99.80%, 99.88%, 99.99% and 99.93% minimum aluminum content, respectively.)

HIGH PURITY FOIL FOR ETCHING

The following high purity alloys and gages are produced in commercial quantities at Republic:

Alloy	Gage in Inches
1180	.00040 — .0050
1188	.00065 — .0050
1199	.0010 — .0050
0191	.00065 — .0050

Widths — Widths are available in some alloys from 1/8".

FOIL FOR COIL WINDING

Republic supplies both precision slit* and edge contoured* aluminum strip conductor for coil winding.

Gages - up to .040" — **Widths** - from 1" **Outside Diameters** - up to 42" — **Alloy** - EC
* Depends on width and gage.

ETCHED ALUMINUM FOIL

Republic Foil produces a complete line of etched foils including high voltage, mid-range, low voltage and cathode. These foils are custom made to customer specifications and are available in several different alloys.

Gages — Etched foil is available in the following gages.

Cathode — .0011" thru .002"
Anode — .002" thru .0035"

Widths — Etched foil is available in all commercial widths from 1/8".

The consistent high quality of Republic's standard and high purity aluminum foils is maintained through the utilization of advanced test methods and meticulous inspection procedures.

Republic Foil Inc. is one of the world's leading producers of aluminum foils for the electronics industry and has the most complete line available from any one source. Experienced engineers are available to offer technical assistance and to tailor foil requirements to fill the most critical customer specifications.



REPUBLIC FOIL INC.

GENERAL OFFICES, DANBURY, CONN. 06810: TEL. 203-743-2731

BRANCH SALES OFFICES: Chicago, Ill. 312-545-2142 • Salisbury, N. C. 704-633-6020 • Cleveland, Ohio 216-871-6268

WEST COAST - Electrical Specialty Co., 213 E. Harris Ave., So. San Francisco, Cal.; 2820 E. 12th St., Los Angeles, Cal.

PLANTS - Danbury, Conn. - Salisbury, N. Carolina - Somerville, Mass.



**IN ATOMIC
FREQUENCY
STANDARDS**

six points make the difference



*GTC Model 304B
Rubidium Frequency Standard*

1. LONG TERM STABILITY: 5×10^{-11} (Std. Dev.) per year
2. DRIFT RATE: Less than 1×10^{-11} per month
3. RELIABILITY: Five years proven performance, more than 24,000 hours MTBF.
4. WARM UP: The 304B will meet specs 30 minutes after turn on.
5. POWER REQUIREMENTS: 35 watts AC, 30 watts DC (using optional battery supply).
6. AVAILABILITY: Within 30 days.

Write for complete technical and MTBF data on the GTC Model 304B Atomic Frequency Standard. TRACOR, Inc., 6500 Tracor Lane, Austin, Texas 78721, AC (512)—926-2800.

Specialized instruments from  to meet your specific needs

New Subassemblies Review

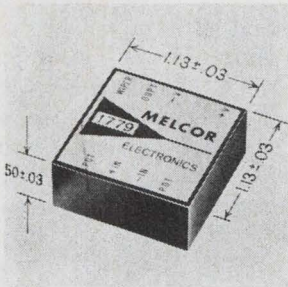

D-c differential amplifier model 1779 is for battery operated applications requiring very low quiescent current drain and high performance. It has a typical current drain of 90 μ a, open loop gain of greater than 75,000, and full power output to 15 khz. Slew rate is 0.5 v/ μ sec. The unit weighs less than 1 oz. Melcor Electronics Corp., 1750 New Highway, Farmingdale, N.Y. [381]



Solid state, high-voltage multiplier modules are for tv applications. Module replaces h-v rectifier tube and/or shunt regulator tube; has greatly reduced level of undesirable radiation, reduced size and cost. The unit multiplies the output of a flyback transformer to supply 25 kv d-c to the picture tube. Erie Technological Products Inc., W. 12th St., Erie, Pa. 16512. [382]

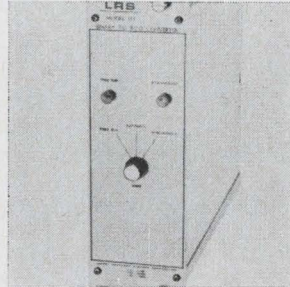

Binary to BCD converter model 153 is a peripheral device for use with data acquisition systems employing binary notation internally, but requiring the extra convenience of decimal readout. It accepts up to 24 bits of binary data from a parallel line input and decodes it into up to 8 decades of BCD. LeCroy Research Systems Corp., 126 N. Route 303, West Nyack, N.Y. [383]

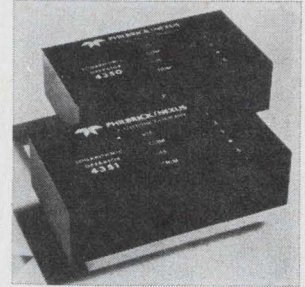

Log module model 4350 computes the logarithm of a positive voltage or current, or solves for the positive antilog of an input voltage. Model 4351 performs the same function on negative voltage or current. Each is complete in itself and requires only input, output, and operating power to perform its computations. Philbrick/Nexus Research, Allied Drive, Dedham, Mass. [384]

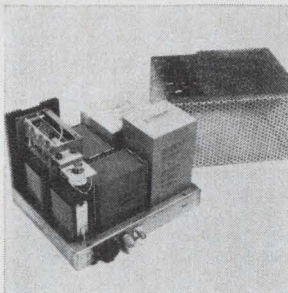

Power supply model 2.R4P20-1 is suited for use as a helix high d-c voltage source for backward wave oscillators in frequency converters or to meet other close regulated low ripple requirements. Nominal output is 2,400 v regulated to \pm 0.05% with a max. 10 mv peak to peak ripple at a rated load of 20 ma. Del Electronics Corp., 250 E. Sandford Blvd., Mt. Vernon, N.Y. [385]

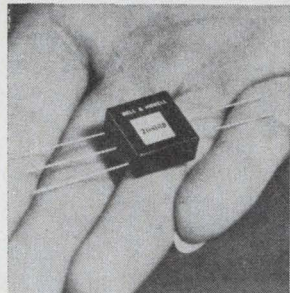

Hybrid FET-input operational amplifier model 20-008 comes in a package 0.250 in. high x 0.600 in. square. Input impedance is 10^{11} ohms; d-c open loop gain at rated load, 92 db; frequency for unity gain, 4 Mhz; frequency for full output, 80 khz; slewing rate, 5 v/ μ sec. Price in production quantities is \$24. Data Device Corp., 240 Old Country Rd., Hicksville, N.Y. [386]



Temperature compensated crystal oscillator C0-251 provides a stability of 1×10^{-6} per year over the 0° to 50° C range. This is achieved without use of an oven. With a supply voltage of 5 v d-c, the 2 x 2 x 3/4 in. package has a current drain of 5 ma. It provides a fixed frequency output in the 2.5 to 10 Mhz range. Vectron Laboratories Inc., 146 Selleck St., Stamford, Conn. [387]

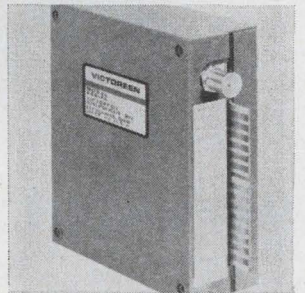

Electrometer operational amplifier model 5010 uses IC's and FET's. It combines over 1×10^{15} ohms input resistance, less than 5×10^{-15} amps max. current offset, and negligible drift of less than 1×10^{-15} amps/24 hrs. D-c open loop voltage gain is 30,000 minimum to 100,000 maximum, with 600 ohm rated load. Victoreen Instrument Co., 10101 Woodland Ave., Cleveland. [388]

New subassemblies

Smoothing difference signals for control

Digital comparator tracks changing discrete inputs, feeds analog output into industrial servo network

A newly formed Detroit company with five employees is stepping confidently into a field that has been largely ignored—building linear-output digital-to-analog comparators for control systems.

The company, Computer Central, was founded several months

ago by Robert W. Kearns, a former professor at Wayne State University and onetime owner of an engineering consultant company, who is now commissioner of buildings for the city of Detroit.

The run-of-the-mill digital comparator has two inputs and one

output. The output voltage is at one of two levels, depending on whether the input voltages are equal, which of them is greater, or which of them is positive—the exact function depends on the comparator design. The input voltages, which are basically analog quantities, may come from analog sensors in a process control system, or from digital-to-analog converters in an otherwise purely digital system. The output voltage may drive a digital network of some kind, or it may control a servosystem in what is known as the “bang-bang” mode—the servo can be ordered to run full speed ahead or

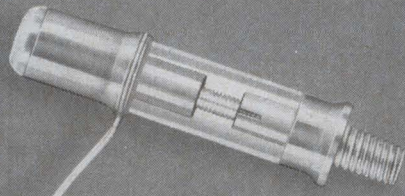

PISTON TRIMMER

(Illus. 1.25 X actual size)

HIGH RF VOLTAGE QUARTZ PISTON TRIMMER

JFD's High RF Voltage Piston Trimmer Capacitors feature high stability and small size. The VCJ1616H is applicable in communications equipment and wherever a small trimmer capacitor is needed to handle large voltage peaks and high power at elevated temperatures. It operates over a frequency range of from 1 to 30 MHz.

This trimmer has an especially designed fused-quartz cylinder which yields an extremely low dissipation factor and temperature coefficient.

The operating RF voltage level of this unit is 3100 volts peak at +25°C derated to 2500 volts peak at +200°C. Its capacitance is variable from 0.5 to 5 pf, and its operating temperature range is from -55°C to +200°C. Turning torque is 1-10 inch ounces in accordance with the Mil Spec. This unit is furnished for

panel mounting and measures 1 $\frac{3}{8}$ " long X $\frac{5}{16}$ " in diameter.

Even higher RF voltages can be handled by the VCJ1616E. This unit which is 1 $\frac{1}{2}$ " long X $\frac{5}{16}$ " in diameter has an operating voltage of 3500 volts peak at 2 MHz and +200°C. In other respects, it is similar to the VCJ1616H.

The aforementioned units are only two of industry's largest selection of piston trimmer capacitors. JFD offers over 3000 standard and special designs with a choice of six dielectric materials and matched metalizing for homogeneous bonds. Seven drive mechanisms offered are engineered for greatest tuning linearity without reversals and for the ultimate in repeatability.

Write for catalogs Hi RFV-67 and C-67-A.

"TODAY'S COMPONENTS BUILT FOR TOMORROW'S CHALLENGES"



JFD ELECTRONICS CO. / COMPONENTS DIVISION
15th Ave. at 62nd St. • Brooklyn, N.Y. 11219 / Phone 212-331-1000

Offices and subsidiaries in principal cities, world-wide.

come to a complete stop, but never anything between.

Kearns and his associates have designed a digital comparator with an analog output whose magnitude is proportional to the difference between two digital inputs—one might be a reference signal—each with an unlimited number of bits, in any code. The output is actually in the form of small stairsteps rather than in analog form, but with more than a few bits on the input the steps are so small relative to the total range that they can be considered pure analog. The device can track a changing digital input—for example, a counter output—at up to 2 $\frac{1}{2}$ megahertz.

Fast with numbers. Computer Central's comparator is based on a form of fast arithmetic in which carry propagation—the bugaboo of conventional binary adders—is reduced to a bare minimum. The comparator actually subtracts the digital input from a digital reference, runs the difference through a conventional resistor adder to con-

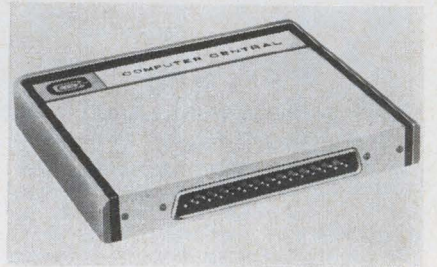

Leveler. Comparator looks at two digital inputs, puts out a difference signal which is virtually linear.

vert it to analog form, and buffers the adder output with a conventional operational amplifier.

The basic comparator accepts two 10-bit inputs in any of a wide variety of codes as specified by the purchaser, and generates an analog output that varies between -10.25 volts and +10.24 volts. This arrangement is equivalent to an 11-bit input, and is attainable because it depends on which input is all 1's and which is all 0's—the maximum difference.

Extender modules of seven bits each are available from Computer Central to increase the number of bits to any desired number; they have no effect on the analog output

ELIMINATE DOWN-TIME ON ROTARY & THUMBWHEEL SWITCHES

and also get accurate, precise control

UNLIMITED APPLICATIONS

CDI switches offer fast sure settings and quick read-out for computer, automated and control equipment, and for test and programming applications, etc.

QUICK SERVICEABILITY

Unique 5-second wafer replacement obsoletes other switches. Simply lift out old wafer, slip in new wafer. No unsoldering . . . no disassembling . . . no wire removing.

EXTREME VERSATILITY

Regardless of size or shape needed CDI is well prepared to meet your every switch requirement.

THUMBWHEEL SWITCHES

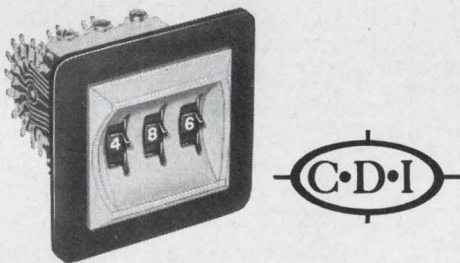

Digital and Binary. Meet MIL-S-22710. For critical reliability applications. Available with internal lighting MIL-L-25467A. Switch modules with panel and switching elements separately sealed for complete protection are available. Bezel types have no visible screws when rear mounted.

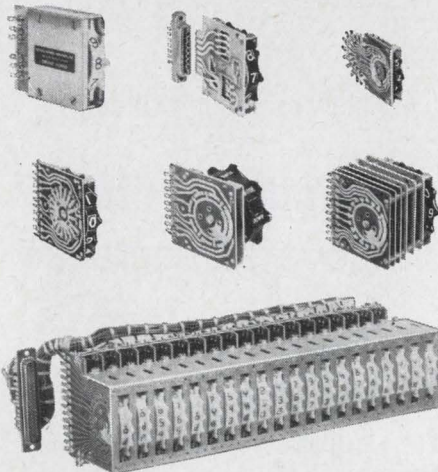
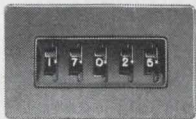

PUSHBUTTON SWITCHES

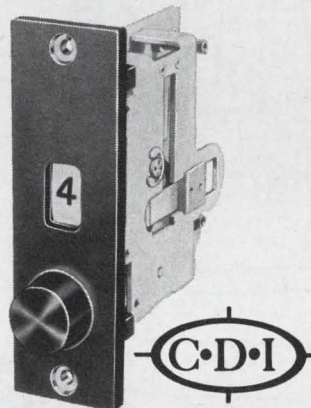

Completely impervious to dust and liquids with sealed front panels on Series PSB binary and decimal rotary push button switches. Ten Positions. Ideal for limited space requiring only 1" panel space per module. Simply press button to operate.

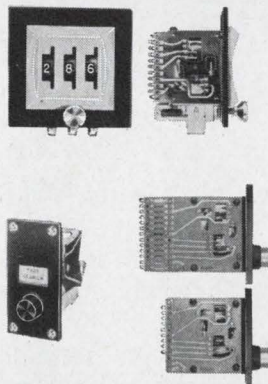

ROTARY SWITCHES

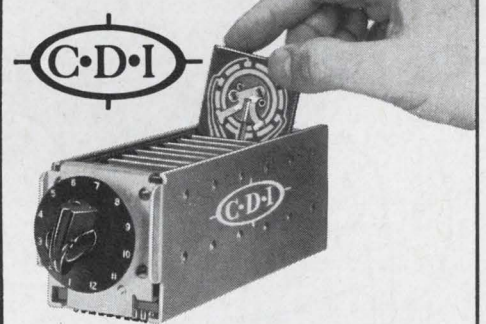

For critical reliability applications. Meet MIL-S-22710. Removable wafers permit quick changing of programs, configurations, circuits. CDI patented switches with dust covers available in sizes 2" x 2", 3" x 3" and 4" x 4" with lengths to accommodate up to 36 wafers. Operation may be manual, motor or solenoid.

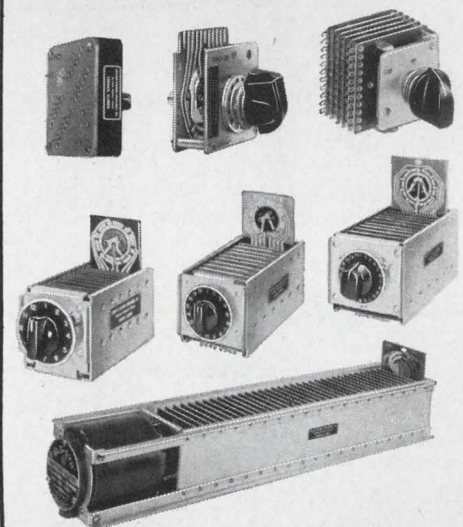

Mfd. under Tabel U. S. Patents 2,841,66D, 2,971,066, 3,015,000, 2,956,131, 2,988,607



CHICAGO DYNAMIC INDUSTRIES, INC.

PRECISION PRODUCTS DIVISION 1725 Diversey Blvd., Chicago, Illinois 60614. Phone 312, 935-4600



Our films cover the watt-er front

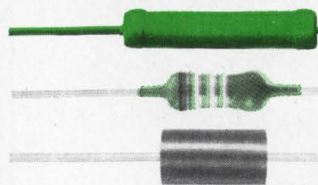

From $\frac{1}{8}$ watt to 7 watts, Mallory gives you fast delivery on a wide range of metal alloy and metal oxide film resistors. For high precision, Type MAF $\pm 0.25\%$, $\pm 0.5\%$ and $\pm 1\%$ in $\frac{1}{8}W$ and $\frac{1}{4}W$. For semi-precision, Type MAL $\pm 2\%$ and $\pm 5\%$ in $\frac{1}{2}W$. And for premium performance at low cost, Type MOL, $\pm 10\%$ 2W to 7W. All Mallory film resistors are 100% inspected. For details, write or call Mallory Controls Company.

MALLORY

MALLORY CONTROLS COMPANY

a division of P. R. MALLORY & CO. INC.
Box 231, Frankfort, Indiana 46041

range or on the size of the steps, but merely cause the output to saturate if the difference between the inputs is greater than can be expressed in 10 bits.

Each its own. These extenders can be piled on indefinitely with no degradation in the system's operation because they continue to work with the absolute digital difference between the inputs. Conceivably, even the fast carry could eventually build up to an objectionable level if enough modules were piled on, but because each extender module has its own op amp whose delay is greater than the carry propagation delay, this cannot become a problem.

Besides the extenders, Computer Central will also market encoders to generate appropriate binary codes from analog inputs, as in a process controller, and converters to translate these codes from one form to the other.

The company's first product is a 10-digit comparator priced at \$450. As if playing a longshot, the company dubbed the comparator, which is a complete subsystem, the 711.

But longshot or not, Kearns is optimistic about the market because of the need for digital control in industrial applications.

"The beauty of the 711," says Kearns, "is that it doesn't require a systems engineering job on the part of the user."

Computer Central, P.O. Box 5194, Detroit, Mich. [389]

New subassemblies

Bandpass filter covers 7 octaves

Device is made with pair
of hi/lo filters;
cutoffs set to within 2%

By mounting two identical filters side by side in a single unit, Rockland Laboratores Inc. has produced a versatile bandpass filter. Rockland calls its unit the Model 1022

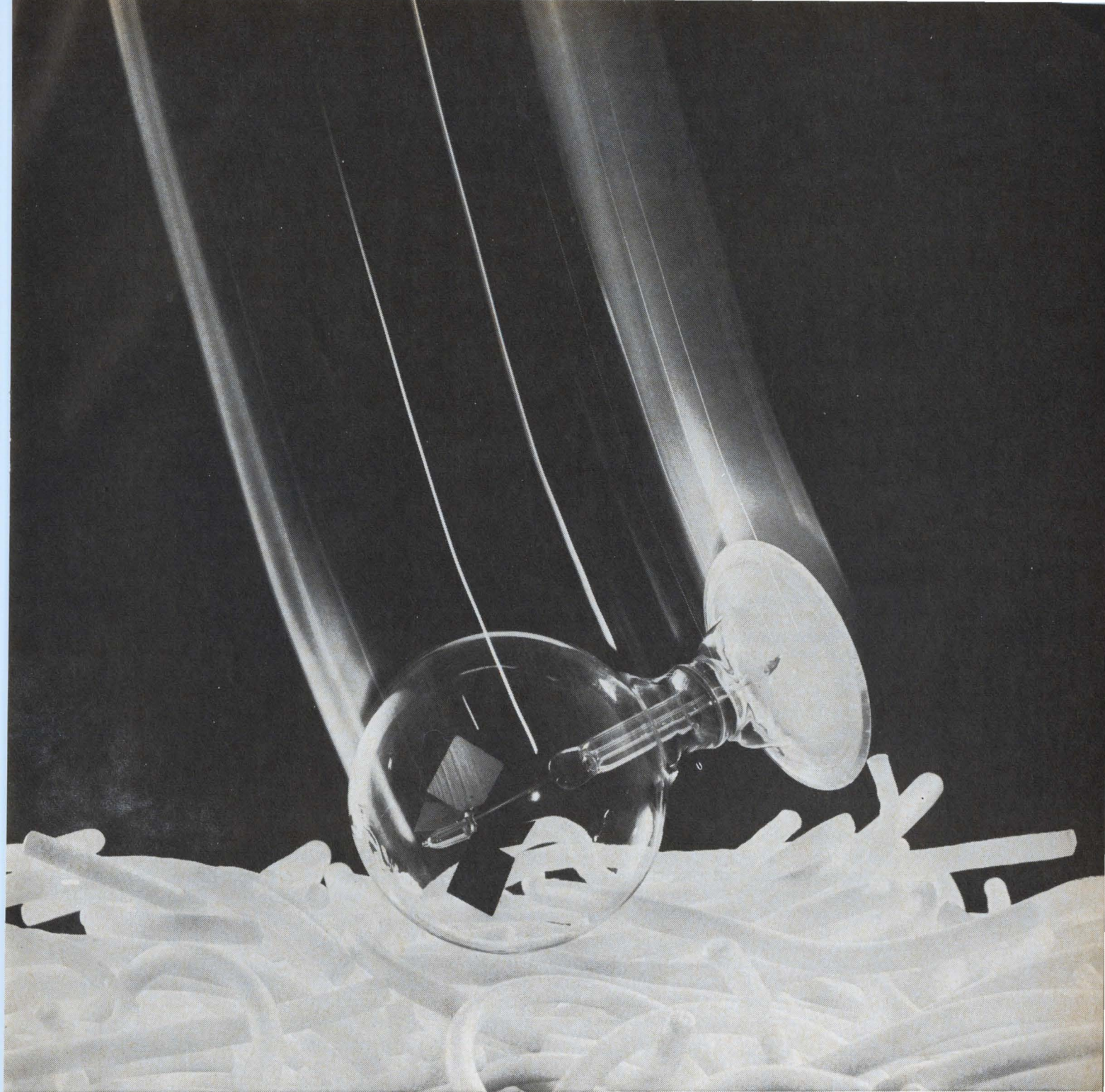

Packaging Sales, The Dow Chemical Company, Midland, Michigan 48640.

Try this on your fragile parts.

Pelaspac[®] loose fill packing. It weighs 3 to 6 times less than most other dunnage. It won't absorb water. It cuts shipping losses. Because it's highly shock-resistant, and it interlocks to prevent settling. It cuts cleanup, too. Because it's clean, nondusting and noncorrosive. Write for details.



Circle 169 on reader service card

WE TURNED ON THE IC INDUSTRY

No Wonder We're No. 1 in 1 MHz Capacitance Bridges



We can't say what the IC boys would have done without us. The fact is, we came along with a fine 1 MHz capacitance measuring tool that filled the bill precisely when it was needed. The measurement capability of our three-terminal bridges, under almost any conceivable conditions, still turns on the IC people . . . and the diode and transistor people . . . and the capacitor people . . . and lots of other people.

It's not surprising when you look into it: bridge, oscillator, and detector all in one handy box . . . low millivolt test levels and dual dc bias . . . a needle-sharp detector that gives balance direction even at extreme off-range settings . . . and, for good measure, a new differential detector for capacitance sorting. (By the way, our bridges have civilized panel meters rather than clumsy headphones).

We don't stop there either. We even make a 1 MHz Capacitance Limit Bridge with programmable tolerance settings that flashes out a "high," "go," or "low" indication in 50 ms and, with the flip of a switch, doubles as a regular manual bridge as well.

What's more, you can have all this over a capacitance range from 0.00005 pF to 1000 pF (or 0.1 μ F with our range extender).

If you've gotten this far, you must be interested. So, send for the specs* and see for yourself why we are No. 1 with the IC boys . . . and almost everybody else who measures capacitance at 1 MHz.

*We'll throw in specs on our other Capacitance Bridges and Meters, too.

**BOONTON
ELECTRONICS**
CORPORATION

ROUTE 287
PARSIPPANY, N.J. 07054
Telephone: 201-887-5110
TWX: 710-986-8241

dual hi/lo filter.

Each of the 1022's filters is a high-pass/low-pass (hi/lo) device with a seven-decade range—0.001 hertz to 11 kilohertz or 0.01 hz to 111 khz. Cutoff frequency, accurate to within 2%, is set with incremental switches. Toggle switches select 0 or 20-decibel gain, RC or Butterworth response characteristics, and high- or low-pass operation.

The 1022 is for the engineer designing communications and control systems. He can use its two filters separately; or he can connect them in series, switch one to high-pass operation and the other to low, and use the 1022 as bandpass filter.

He can also run the two in series and get 40-db gain by setting both to the same cutoff frequency. Each hi/lo filter's frequency response curve is flat almost up to cutoff; it

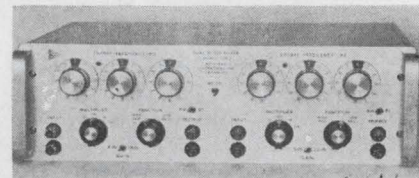

Apart or together. The 1022's two hi/lo's can be used separately, or can be connected to make a bandpass filter.

drops off 3 db at cutoff and past cutoff changes at the rate of 24 db per octave to a maximum attenuation of 80 db. When the hi/lo's work in this way, the 1022 is itself a high-pass or low-pass filter with a very steep falloff at the cutoff frequency—48 db per octave.

High resistance. Field effect transistors at the 1022's input raise the unit's resistance to 10 megohms and operational amplifiers, designed by Rockland engineers for the hi/lo filters, give the 1022 a temperature stability of ± 200 parts per million.

Output noise of each hi/lo filter, measured when its input is shorted, is 0.5 millivolts rms. The drift of each filter is 1 mv/ $^{\circ}$ C and each handles inputs as high as 20 volts peak-to-peak.

The 1022 is 5 $\frac{1}{4}$ by 19 by 14 inches, weighs 19 pounds, and can be used in a rack or on a bench. Delivery time is 30 days and the price is \$1,425.

Rockland Laboratories Inc., P.O. Box 57, Tappan, N.Y. 10983 [390]

We want our Scotchpar[®] film reviewed by every critic in the country.

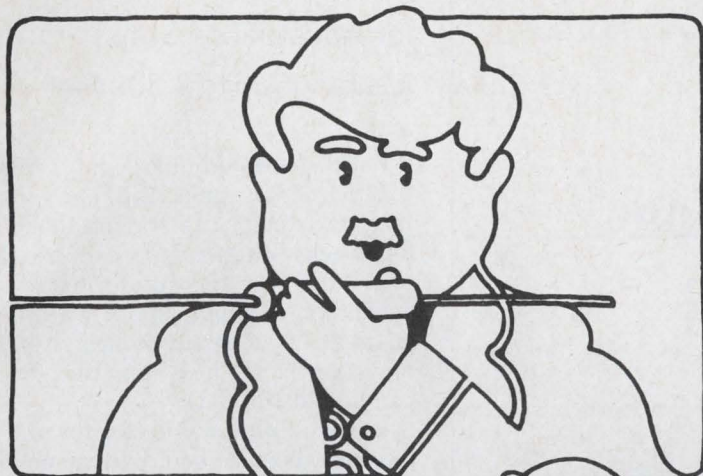

Many important "critics"—manufacturers of capacitors, transformers, motors, wire and cable—have already given 3M's SCOTCHPAR polyester film their highest praise: They bought it for insulation.

They bought a lot of it for capacitors, because 3M is in the capacitor business with thin films.

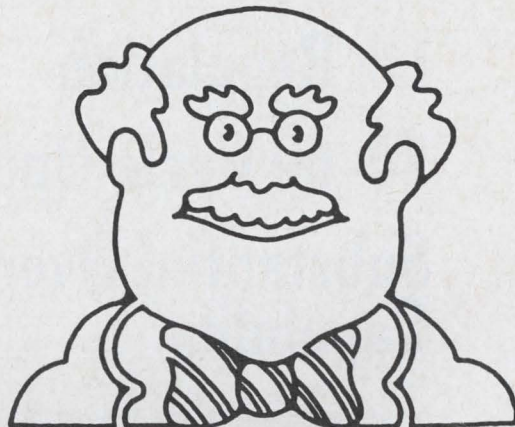

Or if they wanted a heat sealable version, they bought SCOTCHPAK[®] film.

We hope you'll give our film the same critical acclaim, because we've put a lot into our polyester film to help it win over some of the followers of the "big name" film.

SCOTCHPAR film combines excellent electrical strength and steel-like tensile strength with resistance to moisture and solvents. It's thin, tough, flexible and durable. And it comes in a variety of thicknesses and types.

With that much going for it, SCOTCHPAR may be the film of the year.

3M Company, Film & Allied Products Division, 3M Center, St. Paul, Minnesota 55101.

Scotchpar[®]
BRAND POLYESTER FILM

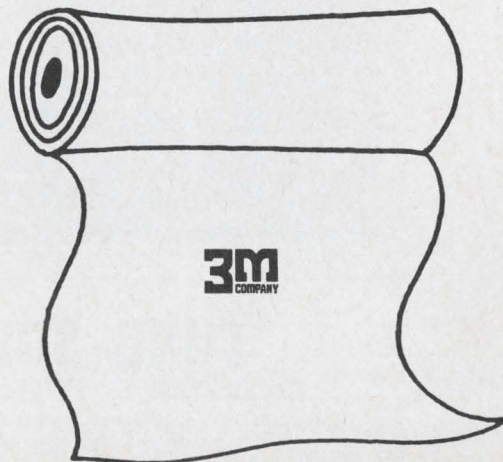

High Current Regulated Power Supply

Adjustable Output Voltage, 27-28 V.D.C.

1% Regulation

50-60 Cycle Operation

Substantial Overload Capability

Designed for communications equipment and available in 25 amp. stages from 25 to 150 amps, this unit can be operated in parallel, has remote sense feature, inverse time circuit breaker and internal fan cooling. Overload capacity is 200% for 5 minutes; 400% for 4 seconds. Environmental capability range from -20° to $+130^{\circ}$ F. This equipment is designed for standard rack mounting.

If you are interested in this, or a power supply to meet other specs, we would like the opportunity to demonstrate that a Tung-Sol designed unit would be your best buy.

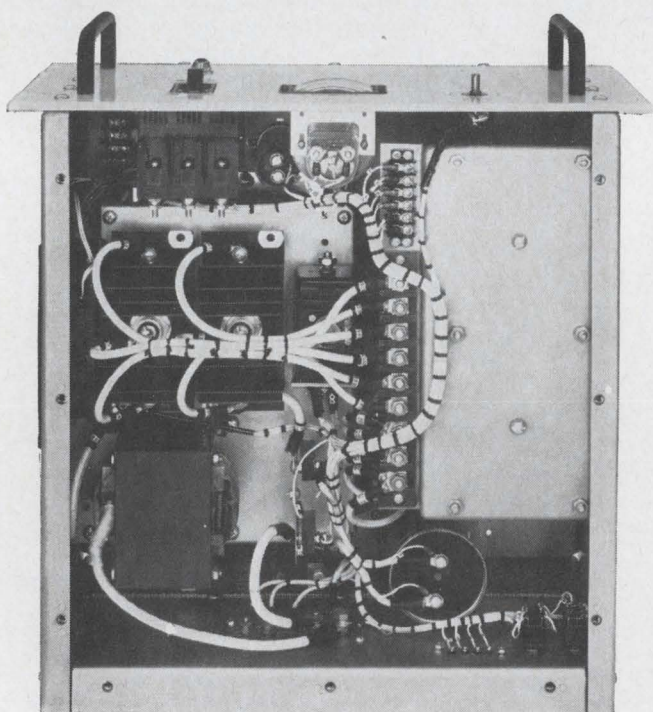

TUNG-SOL[®]
POWER SUPPLIES

Tung-Sol Division, Wagner Electric Corporation
Livingston, N.J. 07039. TWX: 710-994-4865. PHONE: 201-992-1100

New subassemblies

Sentry ready for civilian life

Infrared detector
for industrial security
has range up to 3,500 feet

It never gripes on guard duty. And the Barnes Engineering Co.'s intrusion detector can stay on the job for weeks unattended, can see a man 1,000 feet away and a truck at 3,500 feet, and can send a warning instantly over many miles. Most important, its heat-sensitive eye can see in the dark.

Barnes built the detector for military use. It is rugged, battery-powered, and easy to install, so troops can take it into the field. It can also be built into the complex security system of a permanent installation.

Now the intrusion detector is ready for civilian security duty. Barnes is making an industrial version, the 19-102B, that the company says will also fit into monitoring systems, such as those that count passing cars or ships.

See and tell. Like its cousin in uniform, the 19-102B comes in two parts: a detector and an alarm box. Packed into the head are an optical system, a bridge, a preamplifier, a gate, and a 13-volt battery. In the alarm box are amplifiers, four $7\frac{1}{2}$ -volt batteries, alarm circuits, and a test circuit.

The bridge has two thermistors that are sensitive to infrared energy. They share the optical system, but their fields of view diverge slightly; 1,000 feet away from the head, the fields have a center-to-center distance of 4 feet. At 1,000 feet, the field of each thermistor is 6 feet high and 2 feet wide.

If both thermistors receive the same amount of i-r energy, the bridge is balanced. So even if the ambient or other background temperature changes, the bridge remains balanced.

But if a man, a truck, or other high-intensity source of i-r energy enters one of the fields, the bridge goes off balance and sends a signal



The guys who wrote
the book on silicon
power transistors have
just published it.

Two bucks, from
Westinghouse.

Contents:

- | | |
|---|--|
| 1. Introduction | 6. Linear Applications |
| 2. Maximum Ratings, Characteristics and Testing | 7. High Frequency Measurements |
| 3. Cooling Power Transistors | 8. High Frequency Transistors |
| 4. Power Switching | 9. Specifying Transistor Reliability |
| 5. Transistor Inverters | 10. Power Transistor Procurement Data Sheets |
| | Forward Bias Safe Operating Area Index |

Years of Westinghouse power transistor experience are distilled in this new handbook. Fill in the coupon below and send it with \$2.00 to—Westinghouse Electric Corporation, Semiconductor Division, Youngwood, Pennsylvania. Attention: Marketing Manager. I enclose \$2.00 for my copy of the Westinghouse Silicon Power Transistor Handbook.

NAME _____

TITLE _____

COMPANY _____

STREET _____

CITY _____ STATE _____ ZIP _____

You can be sure... if it's

Westinghouse 

SC-2114

These RCA optical devices can be used effectively in your law enforcement, industrial safety, and military security applications. Developmental type TA2930, a laser diode array, offers 50 watts minimum peak output power at 30 A peak pulse current. Developmental type TA2628 is a single laser diode that offers 1 watt minimum peak output power at 30 A peak pulse current. RCA type 40598, an IR Emitting Diode, offers 0.3 milliwatts mini-

mum continuous power output at 50mA. All three types provide beams invisible to the human eye that do the job. Check into RCA lasing devices for your applications in communications, ranging, security systems, and fuse designs. For more information on RCA solid-state lasing units, see your RCA Representative. For technical data, write: RCA Electronic Components, Commercial Engineering, Section SN-92, Harrison, N. J. 07029.

RCA lasers and IR emitting diodes make spectacles of themselves in signaling and detection

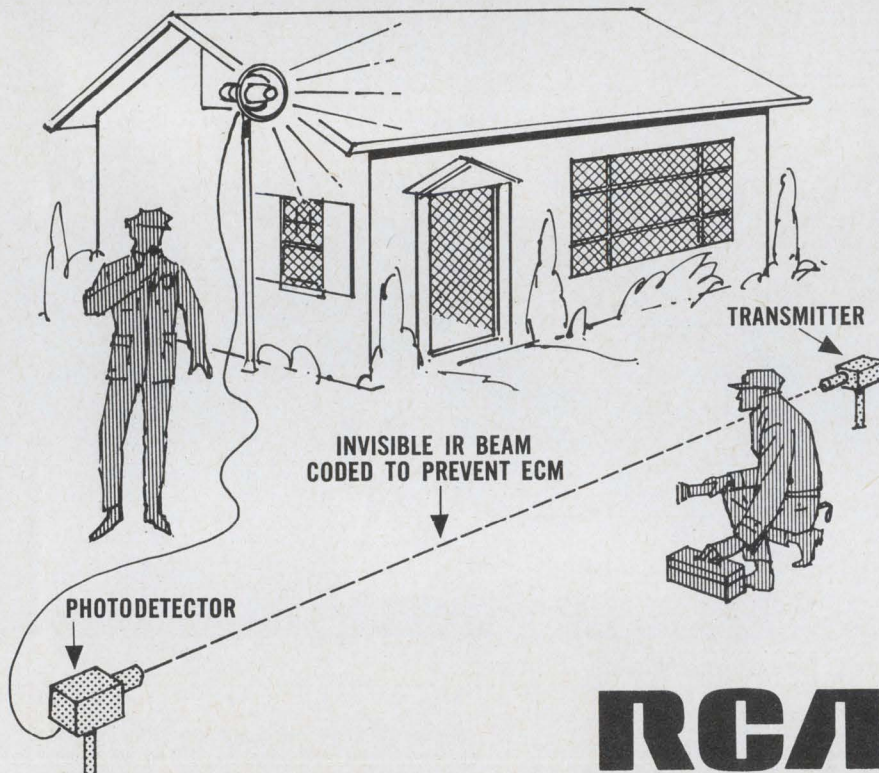

Circle 174 on reader service card

Upset stomach?

If you're looking for a remedy and you can't remember the name of a fast-acting brand, just consult the Trade Name Directory in your Electronics Buyers' Guide. You'll have your answer in seconds. EBG also has a Directory of Products and a Directory of Manufacturers and Sales Offices. Use it often.

Electronics Buyers' Guide
A McGraw-Hill Market Directed Publication,
330 West 42nd Street, New York, N.Y. 10036



through the gate to the preamplifier and on through a cable to the alarm box.

When the signal reaches the alarm box, a beep is sounded by an audio oscillator and a light turns on. Once the light goes on, it stays on until an operator turns it off with a button.

The test circuit allows remote check-out of the bridge. Pushing the test button on the alarm box turns on a small light in the head. If the system is working, the heat



On duty. Like the military model shown, the 19-102B consists of a detector head and an alarm box.

from this light unbalances the bridge, setting off the alarm.

Many heads. The new detector doesn't have military-specification ruggedness but can be used outdoors and in normal industrial environments. The military model links the head and alarm box by radio, and, by sensing which thermistor is receiving the most energy, tells from which direction an intruder came. These features are not part of the civilian model, which costs \$4,500, against \$6,000 for the older unit.

The 19-102B's detector head by itself costs \$2,900 in quantity; one alarm box can work with as many as 20 heads.

The head is 3 inches in diameter and 6½ inches long and weighs 3½ pounds. A detachable aiming sight mounts on top. When working with one head, the alarm box is 3 inches long, 4 inches high, and 5 inches deep.

Delivery takes 60 days.

Barnes Engineering Co., 40 Commerce Rd., Stamford, Conn. 06902 [391]

CHOOSE THE SURE THINGS: FIELD-PROVEN Telemetry Products from DEI

Why gamble with uncertainties? Late deliveries?
Or pay unnecessary R/D costs?
Here today is the quality line of DEI/Nems-Clarke telemetry receivers
and RF auxiliary products for
S and L-Band data acquisition systems.

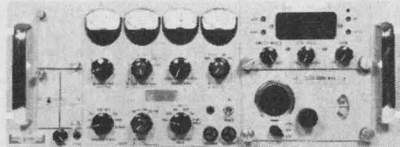

R-1074A-11 . . . 55-2300 mHz tuning ranges. Switch selectable IF filters and demodulators. Suitable for telemetry data reception and conical scan tracking. Automatic AFC reset carrier-operated relays.

Designed with sufficient space to allow installation of five or more additional modules. Options include predetection up/down converters, phase tracking demodulators, adjacent channel filters, and conical scan tracking filters. Completely solid-state and modular in construction. RF tuners, IF filter and demodulators used are quick-change, front panel plug-in assemblies.

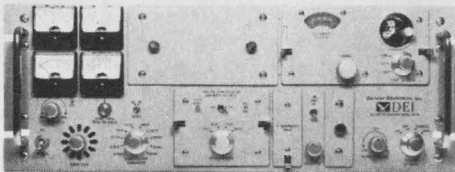

TR-711 . . . 55-2300 mHz tuning ranges. Solid state with switch selectable IF filters. All IRIG bandwidths. Plug-in record/playback converters, spectrum analyzer and oscilloscope.

Offers an order of magnitude improvement in strong signal handling capability and reduction of spurious responses common in previously available solid state receivers. Unit has extremely linear AGC for accurate signal strength recording and matched AGC performance curves for optimum diversity combiner operation. Multisection tunable preselectors are provided ahead of the first RF amplifier or mixer stages for maximum intermodulation and adjacent channel interference rejection.

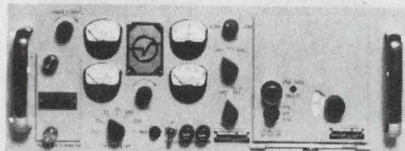

1037-G . . . 55-2300 mHz tuning range. Solid state with nuvistor and stripline tuners. Matched IF filter/demodulators. All IRIG bandwidths. Optional SDU and up/down converters.

A multi-range universal receiver designed for the reception of all known or projected telemetry formats. RF tuning range, bandwidth, and demodulation capability are all determined by plug-in modules providing the receiver with a high degree of flexibility. Twelve RF tuners, from 55 to 2300 mHz, are available. Options include front panel spectrum display unit, internal plug-in pre-D record and playback converters, and adjacent channel filters.



TPA-70 and TPA-73 S and L-Band Preamplifiers. S-band: 6 db. Maximum noise: 20 db. Minimum Gain/ L-Band: 5 db. Maximum Noise: 20 db. Minimum Gain/ No Parametric Oscillation with Signal Overloads/ High immunity to strong signal burnouts/ Power output for 1 db Amplitude Compression: -5 db minimum.

These solid state preamplifiers have been developed to provide compact, economical, high performance, low noise, broadband, stable, rugged lightweight preamplifiers with excellent dynamic range and increased immunity to large signal burnout, damage or instability to meet the increasing operational requirements resulting from expanded activities at S and L-Bands.

For further information on these and other field-proven products and systems, contact the DEI sales office nearest you.

Defense Electronics, Inc.

PRODUCERS OF
DEI AND NEMS-CLARKE
EQUIPMENT



DEI
RESEARCH
DEVELOPMENT
MANUFACTURING

ROCKVILLE, MARYLAND (301) 762-5700; TWX: 710-828-9783; TELEX: 089602 • LOS ANGELES, CALIFORNIA (213) 670-4815
INTERNATIONAL: ROCKVILLE, MARYLAND • CABLE: DEIUSA; INTELEX: 64102

Sales Representatives: Rome, Italy • London, England • Madrid, Spain • Tel Aviv, Israel • Bromma, Sweden • Rijswijk, Holland • Köln, Germany
• Paris, France • Zurich, Switzerland • Oslo, Norway

VOLTAGE SENSITIVE RELAY DRIVER

Am I wild? Adjustable trip point variable continuously thru zero with no discontinuity. Trip point range $\pm 20v$.



0.002% f.s./°C trip point stability!

Want to check my hysteresis all you smart engineers? When you start specifying, remember that I told you that the new Model 525 precision voltage relay driver has less than 0.01% hysteresis; less than 4 millivolts.



About external connections: Designed for PC card mounting. All leads on standard 0.1" grid spacing and are a

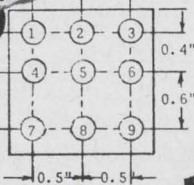

nominal 0.033" Dia. x 0.45" long. (Model 520 and Model 525 have same lead assignments so are interchangeable). Bottom view is shown.

Voltensor can be used for motor speed alarm, transducer monitor, battery or power supply monitor, medical transducer, etc.



I'm really encapsulated! Operating temp range -40° to +75°C. Shock: 100 G any axis 10 ms. Vibration: 15G p-p any axis. Humidity, altitude and other env. specs per MIL-E-5272 Airborne Equipment.



Talk about fast operators! Operating time less than 10 microseconds. Infinite resolution! Output rise & fall time 2 microseconds. The repeatability better than 1mv. Power: $\pm 25v$ to $\pm 15VDC$; VDC @ 12ma (25v) to 7ma (15v) + load. Output $\pm 20v$ @ 50ma nominal with 25v supply down to $\pm 2v$ @ 15ma with 15v.

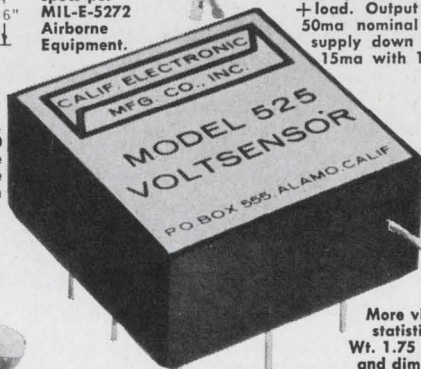

More vital statistics? Wt. 1.75 oz. and dimensions 1.5x 1.5x0.7.

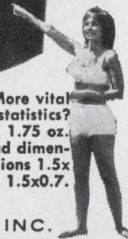

CALIF. ELECTRONIC MFG. CO., INC.

CALIFORNIA ELECTRONIC MANUFACTURING COMPANY, INC. P.O. BOX 555 * ALAMO, CAL. 94507 * TEL. 415-932-3911

Circle 225 on reader service card

New subassemblies

Phase detected automatically

Converter gives signal proportional to phase, without adjustments

A simple setup—a digital voltmeter connected to Dytronics model 222 phase-to-direct current converter—makes it possible to directly display phase difference. Unlike other phase-measuring instruments, no adjustment is required for amplitude or frequency of the signals. Phase angle can be varied or frequency can be swept while the converter gives a continuous readout of phase.

The model 222 accepts two signals and generates a precise d-c voltage proportional to the phase difference between the two signals. There are only two controls:

- A calibration switch that permits adjustment of the 0° and 360° voltage output levels. These are screwdriver adjustments that are needed only infrequently.

- A mode selection switch. In the 0/360 mode, the output is a positive voltage which varies from 0 volts (for 0°) to 3.6 volts (for 360°). As the phase increases past 360°, the output drops back to zero. In the 180/180 mode, the instrument operates as a phase deviation meter. The output at 0° is zero, and is positive or negative depending on whether the compared signal leads or lags the reference signal. For a 180° lag, the output is -1.8 volts; for a 180° lead it's +1.8 volts. As the phase goes through 180° in either direction, the output shifts to the opposite polarity in a step function.

The converter operates over a frequency range of 20 hertz to 500 kilohertz and an amplitude range of 300 millivolts to 100 volts. Below 20 hz, accuracy is $\pm 0.1^\circ$. The accuracy specification at higher frequencies is not yet firm, but the company expects it to be $\pm 2.5^\circ$ at 500 khz. Price is \$1,150.

Dytronics Co. Inc., 4800 Evanswood Drive, Columbus, Ohio 43224 [392]

STOP

Iron Core Problems Call **PERMACOR**® Iron Core Engineers

Whatever your iron core problems may be... space limitations, tolerances, delivery, or cost... PERMACOR can solve them quickly and efficiently.

Over the years, PERMACOR research, engineering, and production has solved countless military, commercial, miniature, and specialized applications. It can do the same for you.

Send us your problems today. Let us show you how PERMACOR "Engineered Economy" has made us the world's largest iron core producer. There's no obligation, of course!

PERMACOR®
A Division of Radio Cores, Inc.
9540 Tully Ave., Oak Lawn, Ill.
Phone: 312/GA 2-3353

KCK—

SPECIALISTS in CERAMIC CAPACITORS

Provides the highest stability, reliability and prompt delivery.

HIGH QUALITY CERAMIC CAPACITORS FOR TV & RADIO

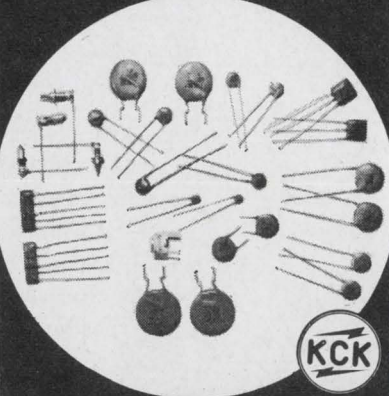

By the automated and quality-controlled mass production, the various lengths of lead wire available for automation of your sets assembling. Working Voltage (DC): 12V, 25V, 50V, 250V & 500V Capacitance Range: 0.05pF — 100,000pF

* For any other information, T.C. and dimension etc., ask for

KCK CO. LTD.

HEAD OFFICE: 16-1, 5-chome, Takinogawa, Kita-ku, Tokyo, Japan Tel. (916)3521

CHICAGO OFFICE: 528 West Wellington Ave., Chicago, Illinois 60657 Tel. (312)327-8392 Tlx: 25-4247 KAWACERA CGO

When you need data
about something too distant to reach
or too numerous to count,

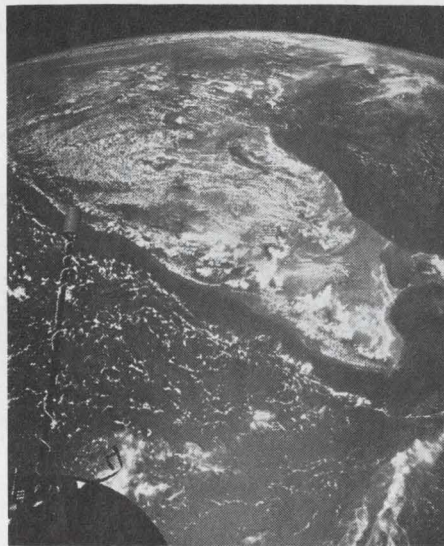

call Kodak

Call (716) 325-2000, Ext. 3257. This number is your pipeline to a large staff of scientists and engineers who specialize in *photographic* ways to collect, interpret, store, and retrieve information.

Systems of their design, or in which they participated, have furnished information about the moon and solar

system. They've provided detailed studies of debris on the ocean floor. They've even followed the complex tracks of subatomic particles.

There's a strong probability that photographic solutions to your problem are already available. There is just as strong a likelihood that the equipment, materials, and technology

can be taken right from the Kodak shelf. A conversation with us may save you time and money. Call.

Or, if you wish, write:

Instrumentation Sales,
Eastman Kodak Company,
Rochester, N. Y.
14650.



Kodak

TRW
announces

**50 W at
500 MHz**



ACTUAL SIZE

28 Volts...5dB Gain...60% Efficiency!

TRW announces a major breakthrough in communication transistor technology with the introduction of this high efficiency, high gain 50 watt/500 MHz device.

In high power military aircraft transmitters, a single 2N5178 will do the job formerly requiring vacuum tubes or multiple-transistor circuits. The 2N5178 is also

well suited for use in radar pulse circuits.

This state-of-the-art device employs a patented cellular construction in a grounded emitter strip-line package comparable in size to the TO-37. A 25-watt version, type 2N5177, is also available.

For evaluation quantities and complete technical details, con-

tact any TRW distributor or TRW Semiconductors, 14520 Aviation Blvd., Lawndale, Calif. 90260. Phone: 679-4561, TWX: 910-325-6206. *TRW Semiconductors Inc. is a subsidiary of TRW INC.*

TRW[®]

New Microwave Review



TWT amplifiers series 4000 come in 4 models. Model 4002 is for 1 to 2 Ghz; 4004, for 2 to 4 Ghz; 4006, for 4 to 8 Ghz; 4008, for 7 to 11 Ghz (to 12.4 Ghz at reduced power.) Rated c-w power output for all is 10 w minimum. Required drive level for rated output is 10 dbm. Gain at rated output is 30 db minimum. Servo Corp. of America, 111 New South Rd., Hicksville, N.Y. [401]

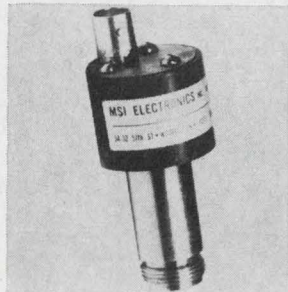

Coaxial mount model 561 is usable with generally available thermoelectric type power meters for measurements up to 10 mw in the range from 0.1 to 11 Ghz. Variation of output with ambient temperature is less than 5% from 0° to 85° C. Response time is below 1 sec, and sensitivity is better than 0.5 mv/mw. Price is \$215. MSI Electronics Inc., 34-32 57th St., Woodside, N.Y. [402]

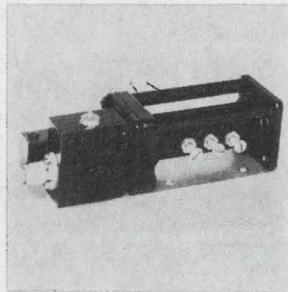

High ratio varactor multipliers offer multiplication factors from 8 to 20 times with output bandwidths up to 500 Mhz. They are of solid state design and operate in the S, C and X bands. Typical applications are in electronic countermeasures and radar systems where they would be used as transmitter exciters. Applied Research Inc., 76 S. Bayles Ave., Port Washington, N.Y. [403]

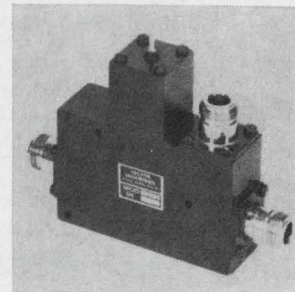

Microwave frequency translator 0307, for satellite communication bands, shifts 3.7-4.2 Ghz signals to 5.925-6.425 Ghz or vice versa using a local oscillator at 2.225 Ghz. Model 0627, for military communication satellite use, shifts 7.263-7.287 Ghz signals to 7.970-7.994 Ghz using a local oscillator at 362.5 Mhz. Vector Industries, 821 San Antonio Rd., Palo Alto, Calif. [404]

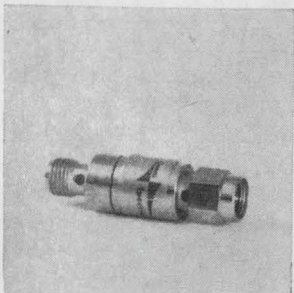

Schottky-barrier diode detector model 20750 is for the 1 to 12.4 Ghz range. Typical -48 dbm tangential sensitivity is featured along with voltage output of 10 mv minimum at -20 dbm input power level. Forward bias current is 50 μ a. Video output capacitance is 25 pf. Unit measures 1/32 x 3/8 in. Omni Spectra Inc., 24600 Hallwood Ct., Farmington, Mich. 48024. [405]

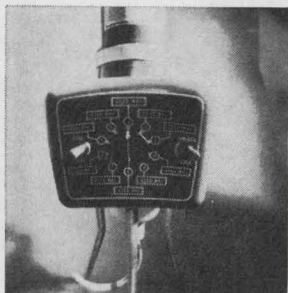

Automatic channel tuner for pulse and c-w klystrons permits changing klystron passbands in 4 seconds by tuning the selector switch. Up to 12 usable frequency channels are thus available from one tube. Each channel provides the usual klystron bandwidths, typically 1%, 1 db, and each can be set at a different center frequency. Varian, 611 Hansen Way, Palo Alto, Calif. [406]

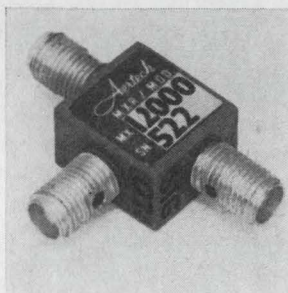

Double-balanced Schottky mixer model MX12000 operates over the 8- to 12- Ghz range. It features high port-to-port isolation of 17 db, 0 to 4 Ghz i-f bandwidth, a single channel noise figure of 10 db, and a maximum conversion loss of 9 db. Dimensions are 0.560 x 0.600 x 0.375 in. The standard connector available is 3 mm. Aertech, 815 Stewart Drive, Sunnyvale, Calif. [407]

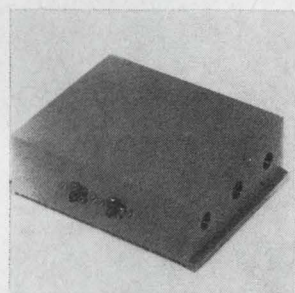

Low-loss preselector model 2155 is for a center frequency of 1090 Mhz, with female connectors mating with OSM or equivalent. The 3-db bandwidth is 10 Mhz and 60-db bandwidth is 20 Mhz. Insertion loss is 2 db maximum, within 10% of theoretical. Unit is tunable \pm 25 Mhz with self-locking, gold plated tuning slugs. Microwave Filter Co., W. Manlius St., E. Syracuse, N.Y. [408]

New microwave

Circulator suppresses echoes in 4-Ghz band

Inserted between waveguide and channel-separation network, device directs reflected signals into an absorber

Echoes are fine if you're a yodeler, but they're a hazard if you're a designer of communication systems. In a microwave setup, a received signal travels from the antenna through a waveguide to channel-separation networks; no matter how well the impedance of these

networks matches that of the waveguide, there is some reflection. The reflected signal returns to the antenna where it bounces back through the waveguide. This echo mixes with incoming signals and produces distortion.

Two engineers at Canada's

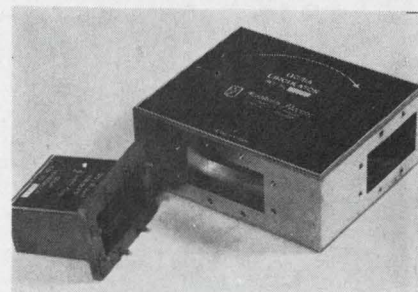

Silencer. From 3.54 to 4.20 Ghz the circulator's insertion loss is 0.2db and its isolation is 26db.

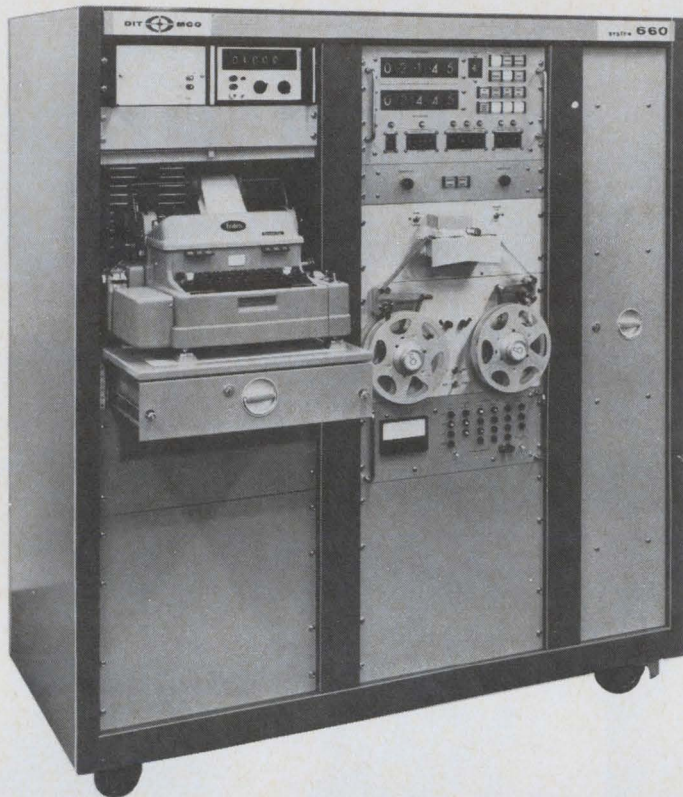

BREAKTHROUGH

Unique bar relay switching makes our DIT-MCO System 660 another in a series of major breakthroughs from the world's leading supplier of circuit testing equipment. Some people have no respect for the status quo.

For complete information, photos and spec sheets—write DIT-MCO INTERNATIONAL—A Division of Xebec Corporation—5612 Brighton Terrace—Kansas City, Missouri 64130.

EUROPEAN TECHNICAL REPRESENTATIVE
9, Dartnell Park Road
West Byfleet, Surrey, England
Telephone: Byfleet 45904



Circle 180 on reader service card

Our little black book has over 100,000 phone numbers.

You never had a black book like it. Over 1,500 pages. And those phone numbers! More than 100,000 telling you who to call/where to go, for the over 4,000 different product categories listed and advertised in the yellow pages of the Electronics Buyers' Guide.

It's the industry's one-stop shopping center that lets you find the products and services you need quickly. You can depend on EBG.



Electronics Buyers' Guide

A McGraw-Hill Market Directed Publication,
330 West 42nd Street, New York, N.Y. 10036

... termination comes off for system testing ...

Northern Electric Co. have found a way to keep these echoes down, at least in 4-gigahertz systems. John Elliot and Robert Devlin have developed a three-port circulator for antenna feeder systems that Northern Electric says is the first built in a WR229 waveguide to provide a good match over the 4-Ghz common-carrier band (3.54 to 4.20 Ghz).

The circulator's return loss is 30 decibels, its isolation 26 db, and its insertion loss 0.2 db.

Deflection. A circulator is a multi-port device. Its ports are usually numbered from one up. When a signal enters the device through any of the ports, the signal is steered by the circulator in such a way that it leaves the device through the port adjacent to the one it entered. For example, if a signal comes in through port four, it goes out through port five.

The device goes between the waveguide and the separation network. It passes the signal received by the antenna to the separation network, port one to port two, but directs the reflected signal into a termination that absorbs most of the signal's energy, port two to port three. Echo intensity is cut by a factor of 10 compared with intensity in systems without circulators; the only echo is generated at the waveguide-circulator interface.

Elliot and Devlin's device measures 5.6 by 4.75 by 2.20 inches, and is made of aluminum alloy. Inside passages are machined in the form of a curved tee, and at the junction of these passages is a ferrite element that's magnetically biased by a small permanent magnet.

Antenna return loss can be measured without removing the circulator. The user just unscrews the termination and replaces it with a flat metal plate.

The inventors are now developing a system in which their circulators are fitted with filters instead of terminations and are used as channel-separation networks.

Price for the circulator now available is \$330. Delivery time is 30 days.

Northern Electric Co., 1600 Dorchester St. West, Montreal [409]

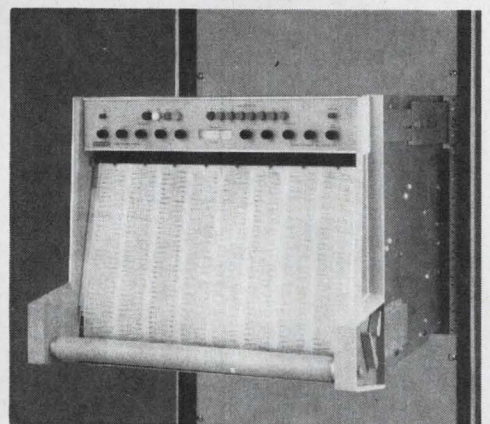
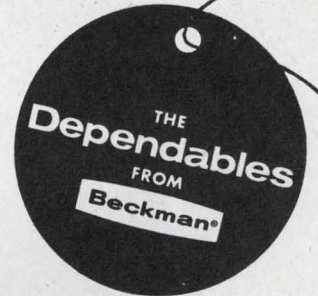
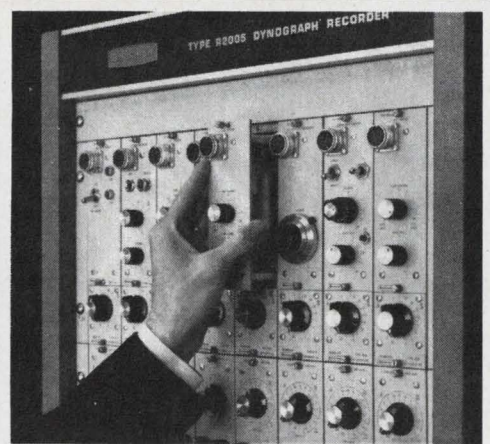
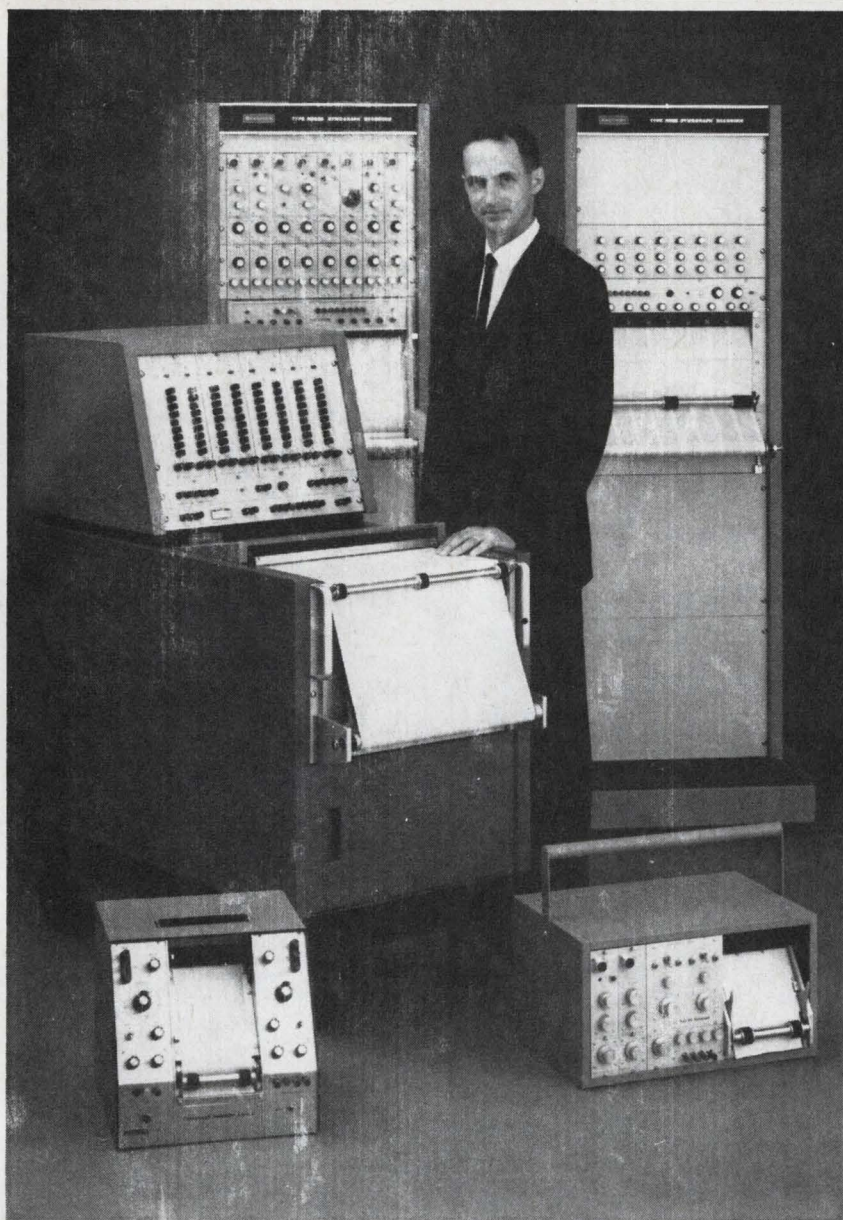

Presenting a complete family of direct-writing recorders . . .

Beckman Dynograph® Recorders. You'll find these versatile recorders used in scientific, industrial, and educational facilities everywhere. Their application-oriented design makes them easily adaptable to your specific analog measurement requirements whether you're in aerospace, seismology, communications, transportation, oceanography...or any industry with recording needs. All are served by the complete Beckman family of *Dependable* Dynograph recorders.

You can select portable or standard Dynograph recorders... from two channels up to 24, and choose any of three writing techniques: thermal, pressurized fluid, or capillary ink. In addition, you'll get our exclusive "Zero-Weave" chart drive that automatically aligns the chart paper.

You'll also like the economy and flexibility of Dynograph recorders achieved through the use of exclusive Beckman

Input Couplers and separate preamplifiers. There is a full range of input couplers for measuring such physical or bio-physical parameters as strain, pressure, temperature, flow, velocity, etc. The preamplifiers will accept any of the couplers which eliminates the need to purchase additional preamplifiers for each application.

Dynograph recorder prices start at less than \$1,200. For fast, expert assistance in selecting the *Dependable* Dynograph direct-writing recorder for your particular application, contact your local Beckman office, sales representative or the factory direct.

The Electronic Instruments Division develops and manufactures precision electronic measurement and test instrumentation for science and industry. Major product lines include: electronic counters, IC testers, oscillographic recorders, panel meters, system components, signal sources, time standards, and data acquisition systems.

Beckman® INSTRUMENTS, INC.
ELECTRONIC INSTRUMENTS DIVISION
 SCHILLER PARK, ILLINOIS • 60176

INTERNATIONAL SUBSIDIARIES: GENEVA; MUNICH; GLENROTHES, SCOTLAND; TOKYO; PARIS; CAPETOWN; LONDON; MEXICO CITY; STOCKHOLM; VIENNA

an-ten'na 1. A wirelike growth on the head of a lobster. 2. An elevated conductor of electrical waves; that which in log-periodic designs Granger has more of than anybody.

az'i-muth The desired direction in which G/A antennas concentrate your signal.

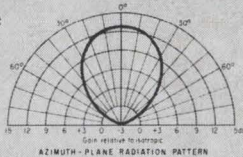

ba'lun 1. An impedance transformer; connects 50 ohm co-ax to open wire lines. 2. A non-porous bag filled with hot air or gas.

cur'tain 1. Opening of a great performance. 2. An ordered arrangement of wires precisely engineered and factory fabricated for easy installation and long life as part of a G/A log-periodic antenna.

dec'i-bel (pronounced dee-bee) A measure of what G/A's h-f products can contribute to your system performance; usually in groups of 40 or 50 in the important characteristics of G/A receivers.

ex-cit'er Any of the new G/A h-f products; specifically, our new solid-state h-f unit with LSB, USB, CW, AM, and with FSK-ability.

fast-switch A rapid change between two pretuned frequencies (e.g. in 50 milliseconds); a characteristic of one of G/A's new transmitters.

gain 1. That which our products contribute to your communications

system's performance. 2. A tag, benefit or profit to be concerned.

h-f 1. Typically the frequency from 3 to 30 MHz. 2. In G/A equipment the band between 2 and 32 MHz.

im'age A reflection; the signals receivers don't have; the antennas use to fullest.

i-on'o-sphere A fictitious layer used to bounce signals back to earth; its erratic behavior can be measured in real time (see *sounder*).

log per-i-od'ic The most versatile, compact precision h-f antenna design; available from Granger in many variations (e.g. rotatable, steerable, transportable, unidirectional).

mode 1. Ice cream on pie. 2. Method of doing (e.g. SSB, ISB, FSK, CW, AM); that which you have a full choice of in our equipment.



mon'o-pole 1. A game wherein you receive \$200 for passing GO. 2. A compact reliable omnidirectional antenna offered by Granger Associates.

om-ni-di-rec'tion-al Going off in all directions; a capability of certain G/A antennas.

po-lar-i-za'tion di-ver'sit-y A combination of vertical and horizontal antennas to overcome fade; a space-saver.

point-to-point From here to there

with no wires; done with ionospheric mirrors.

ra'di-o-tel-e-phone (pronounced TELETRANSCEIVER) A small but mighty G/A device that goes anywhere; specif. the Australian outback, remote Pacific islands, African veldt, etc.

ro-ta'ta-ble Capable of revolving; a new log-periodic antenna from Granger Associates offering reliable performance from 5.5 to 32 MHz.

re-ceive'r A new solid-state G/A unit that selects your message from many others and renders it clearly intelligible.

se-lec-tiv'i-ty The quality of careful discrimination, as in G/A receivers; pert. to elimination of extraneous signals.

sound'er 1. A device used in early telegraphy. 2. A precise instrument for measuring the ionosphere; an efficiency expert in h-f communications.

SSB 1. In aviation, the supersonic balloon. 2. In radio communications, what nearly everyone will be using by 1971; we can help.

trans-mit'ter A microphone-antenna interface device; available from G/A in 1, 3 and 5 kw versions.

VSWR Abbr. for voltage standing wave ratio; less than 2.0:1 in almost all of our antennas.

ze'nith 1. A vertical take-off angle. 2. The name of another famous radio company.

G/A knows h-f from A to Z

Send for complete information to learn how we can spell out solutions to your communications problems.

Granger Associates / 1601 California Avenue, Palo Alto, California 94304 □ Granger Associates Ltd. / Russell House, Molesey Rd., Walton-on-Thames, Surrey, England □ Granger Associates Pty. Ltd. / 1-3 Dale St., Brookvale, N.S.W., Australia

New Production Equipment Review

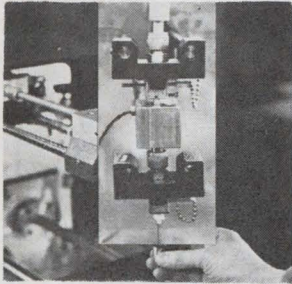

Microminiature metering system 707A is for use where potting and filling operations are critical as in miniature batteries and similar components. It delivers as many as 25,000 2-component epoxy shots per day with volumetric accuracy of $\pm 1.3\%$ and resin/catalyst mix ratio of 100:14. The unit saves manufacturers' costs. Kenics Corp., Danvers, Mass. 01923. [421]

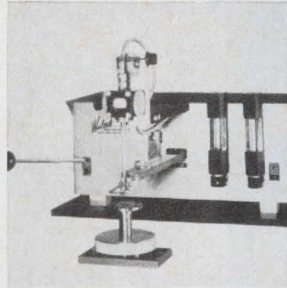

Pulse-heated head model 100/2 is for beam lead bonding. It has a hand actuated beam balance force system—extremely accurate in a range from 15 grams up to 226 grams. A long throat depth ($8\frac{1}{2}$ in.) permits work on large, unheated substrates. The unit is equipped with an integral wire feed and cutoff device. Wells Electronics Inc., S. Main St., South Bend, Ind. [422]

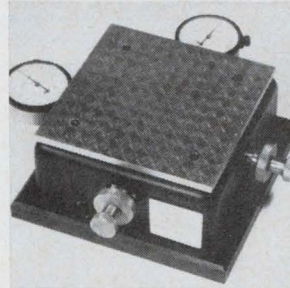

Differential stage is a positioning device with rapid placement approach and positive zeroing of the final stage position. It can be used in hybrid IC assembly, or be incorporated into component manufacturing equipment, including final probing, testing and measuring devices. Positioning accuracy is 0.00025 in. Engineered Technical Products, Box 1465, Plainfield, N.J. [423]

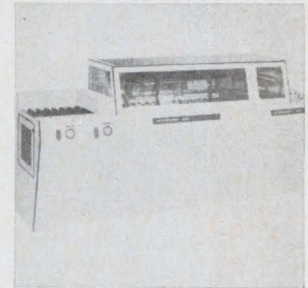

Horizontal conveyORIZED chemical etching system, Dynamil 500, is for production etching of p-c boards and chem-milled parts ranging from 4 x 4 in. to 18 in. by indefinite length. A remote wall-mounting unit contains a variable-speed controller for regulating conveyor speed from 0 to 2,400 production ft/hr. Western Technology Inc., 220 W. Central Ave., Santa Ana, Calif. [424]

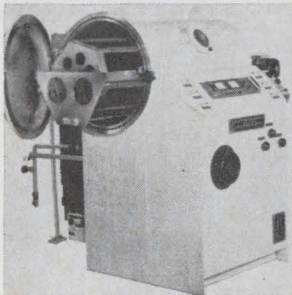

Vacuum coating system model C0024-HA is for thermal vapor deposition of electronic components. It consists of a 24 in. diameter x 39 in. vacuum chamber with a flanged, quick-opening door, mechanical and diffusion pumps, and a control console. It is capable of cycling from atmosphere to 5×10^{-5} torr in 5 minutes. High Vacuum Equipment Corp., Hingham, Mass. [425]

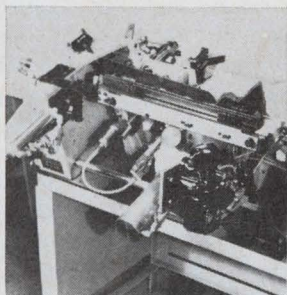

Automatic capacitor taper model TW-312 applies mylar or polyester film tapes to round, flat or oval capacitors at a nominal rate of 1,000 pieces per hour. Placing the capacitor into the tooling and pressing the start buttons automatically cycles the machine. The machine can be manually or hopper fed. Midland Engineering & Machine Co., 9630 W. Allen Ave., Rosemont, Ill. [426]

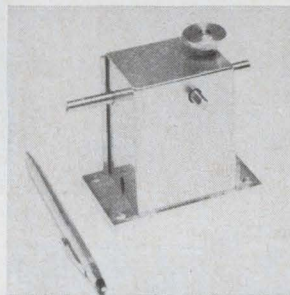

Positive drive wire feeder model WF-3 is constructed of stainless steel and designed for high vacuum applications. Capable of feeding wire up to $\frac{1}{8}$ in. diameter, it has a tension adjustment mechanism so changing wire is merely a matter of rethreading and tightening the tension adjust knob. Price is \$420. Air Reduction Co., 2850 Seventh St., Berkeley, Calif. 94710. [427]

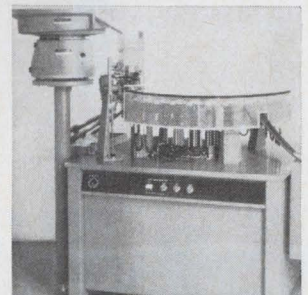

Capacitor sorter 3222 automatically feeds and sorts 3,600 pieces per hour. Sequence is breakdown charge, breakdown test; leakage charge, leakage test; capacitance test and classification. Modular charge and probe stations, with resistor networks, have insulation resistance greater than 10^{12} at 500 v. d-c; capacitance under 0.3 pf. Daymarc Corp., 40 Bear Hill Rd., Waltham, Mass. [428]

New production equipment

Laser takes routine job on assembly line

Ruby system can fire once a second for microfabrication; unskilled workers operate it after 5-minute training time

"Wanted. Laser operator. No experience necessary. Learn on the job in just a few minutes."

Biorad Inc. says this type of ad could be run by a company that uses one of its systems called LPM—laser for precision microfabrication. Designed for production-line

use, the LPM consists of a ruby laser and specialized work-positioning equipment packed into a cabinet, 2 feet by $1\frac{1}{2}$ feet by 1 foot, plus viewing optics specified by the customer.

Its makers say the LPM is the first laser system to be sold for produc-

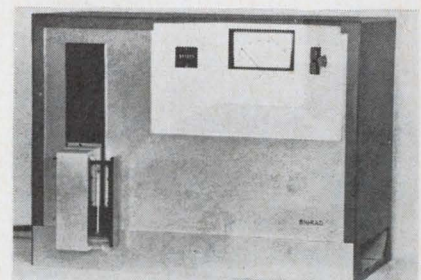

Repeater. Even when the LPM is used in an industrial environment, the system's laser can fire thousands of times daily.

IMPORTANT TO CRYSTAL USERS

Impartial documented tests show aging rate of crystals in coldweld beats aging rate in any other holder nearly 100%!

Write for the full report:

★ **FREE COPY** ★

Check reader service number below

A coldwelding pioneer, Reeves-Hoffman supplies crystals in many configurations to meet your needs, military or commercial.



REEVES-HOFFMAN

DIVISION, DYNAMICS CORPORATION OF AMERICA
400 WEST NORTH ST., CARLISLE, PENNSYLVANIA 17013 • 717/243-5929

Circle 227 on reader service card

DIFFERENTIAL TRANSFORMERS

For measurement and control use

Capable of obtaining output voltages exactly proportional to any kind of mechanical variation.

More than 500 types are available.

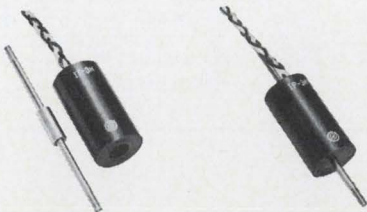

Features:

- *Outstanding interchangeability
- *Quite free from outer magnetic field
- *Insensitive to ordinary shock, water and heat

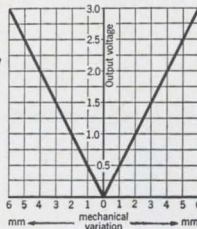

Manufacturers of Differential Transformers

NIPPON COIL CO., LTD.

Amakawa Bldg. 1, 1-chome, Hommachi, Higashi-ku, Osaka, Japan.

184 Circle 184 on reader service card

TOP TALENT: ANOTHER PROFIT PLUS

Scientists, engineers and administrators find in our Phoenix environment new intellectual stimulus — as well as new dimensions of personal fulfillment and enjoyment. That's why recruiting and keeping top talent is never a problem in this land of year-round sunshine — where our vigorous business climate and tax structure encourage profits/growth.

For FREE 40-page brochure, "PHOENIX: Environment for Science-Oriented Industries," write Stanton Allen, Manager, Economic Development Dept., Room E-32, Chamber of Commerce, Phoenix, Arizona 85004.

dynamic
Phoenix
PROFIT CENTER OF THE SOUTHWEST

Circle 228 on reader service card

tion-line use. "A lot of people say they have high-volume-use systems," says Raymond Forestieri, Biorad's sales manager, "but we're the only ones that can point to a system working day after day, 8,000 or 9,000 shots a day, in a shop."

Forestieri is pointing to Chase Instruments Corp., a maker of clinical thermometers. Last month, the first LPM was installed at Chase, and James Lawless, the company's vice president in charge of production, says he's satisfied with its performance.

Chase uses the LPM as part of its calibrating procedure. A thermometer is placed in a holder in the LPM, and the laser is fired. The beam splits the mercury column, forcing some mercury into an expansion chamber and leaving a predetermined amount of the liquid in the column.

And introducing the LPM into its production line was no problem for Chase. "I could bring anybody in here and train him to run it in five minutes," says Lawless.

The laser's maximum output is 5 joules and its pulse width is 800 microseconds. It can be fired at rates up to 1 pulse per second, and Biorad guarantees the system for 100,000 operations.

Biorad says the LPM can be used as a microwelder, a trimmer, a drill, or a dynamic balancer of gyros and rotors.

Price of the system, without positioning equipment, is \$9,000. Delivery time is 60 days.

Biorad Inc., 300 Shames Dr., Westbury, N.Y., 11590 [429]

New production equipment

**Tester takes
all comers**

**Modular system performs
variety of tests on diodes,
transistors, and rectifiers**

Who said this is the age of specialization? It surely makes sense to test diodes with a diode tester, rectifiers with a rectifier tester. But to

Electronics | September 30, 1968

Believe it or not...

THIS SIGNAL WAS

LOST IN THIS NOISE

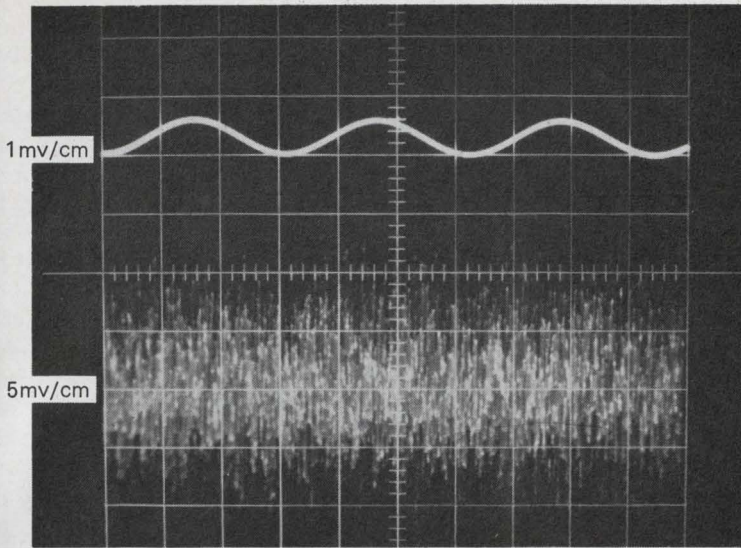

UNRETOUCHED PHOTO FROM SCOPE

Recovered by...

MODEL 304 TD

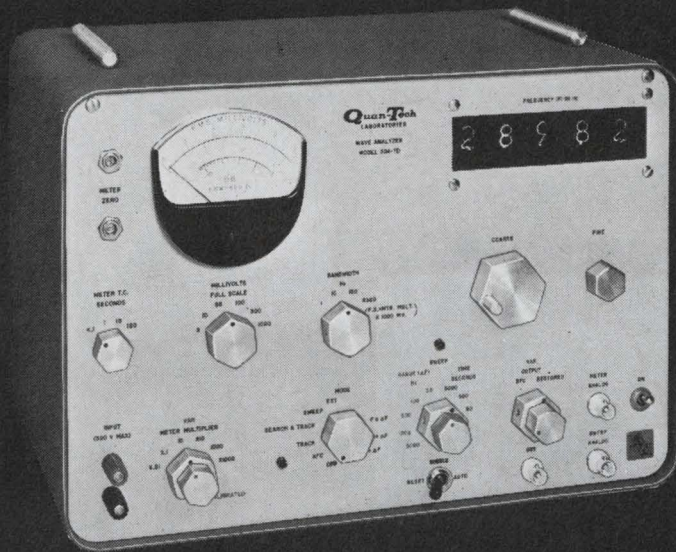

RANGE: 1Hz to 5kHz

AUTOMATIC TRACKING

DIGITAL READOUT

ELECTRONIC TUNING

No matter where, within its frequency range, that elusive signal is hiding, even under noise 20 times greater than itself, Quan-Tech's new Model 304TD will search for it; lock onto it and give you clear visual electronic display of its frequency and amplitude.

The 304TD features automatic tracking which enables it to lock onto, and track the fundamental or harmonics of a signal whose frequency is varying over narrow or wide limits, without requiring an external pilot or reference frequency.

Electronic, digital readout provides instant frequency determination of the tracked signal, or in manual operation, the frequency to which the analyzer is tuned. The 304TD offers a choice of three constant bandwidths: 1, 10 and 100Hz; also broadband 10Hz to 6500Hz. The unit also features electronic tuning (manual, internal automatic sweep or external) AFC, automatic tracking or search and track modes. Two Models 304TD may be connected together without modification to form a multi-channel, phase locked, master slave analyzer system suitable for mechanical impedance and transfer function analysis. Price: \$3250.

WRITE FOR COMPLETE TECHNICAL DATA

15

Quan-Tech LABORATORIES, INC. • 43 South Jefferson Rd., Whippany, N.J. 07981
QUAN-TECH® Phone (201) 887-5508 TWX 710-986-8251



New...a deposition thickness controller you can trust—always

Now, Airco Temescal has eliminated misleading readouts caused by elevated temperatures, sudden thermal shocks, electron beam sources, and close substrate-to-evaporant spacing. And, we have not added a cent to the sales price—\$1150. Available from stock. Airco Temescal manufactures a complete line of thickness con-

trollers, rate controllers, and accessories. For further information contact:

AIRCO Temescal

A Division of Air Reduction Co., Inc.
2850 7th St., Berkeley, Calif. 94710
Telephone 415 841-5720

Reliability Through Research.

Circle 229 on reader service card

ECONOMICAL Thin Film!

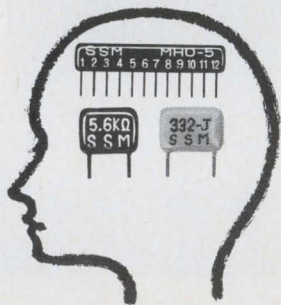

What's needed for memory system is everlasting high accuracy. SSM's components are the very ones satisfying superior reliability.

- Plate-ohm: evaporated metal film resistor
- Pla-module: thin film modulated C-R circuit
- Pla-con: organic thin film capacitor by plasma reaction

SUSUMU INDUSTRIAL CO., LTD.

Minami Bldg. 1-12 Ebisuminami
Shibuya-ku, Tokyo, Japan
TEL: Tokyo (03) 712-5990
TELEX: No. 246-6270

186 Circle 186 on reader service card

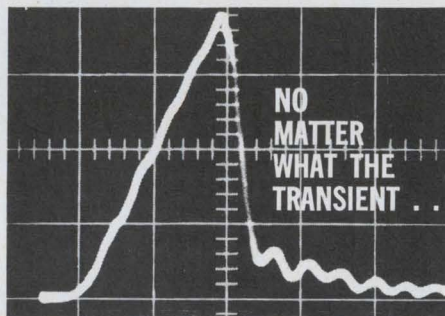

JOSLYN STOPS IT!

Joslyn Precision Spark Gaps act fast operate precisely at voltage breakdown specified every time no matter how long between transients will last virtually for the life of your product arresting capability spans wide current and voltage range complete protection . . . from stock or custom design. Just one of many surge arrester lines.

Write or call today for full information on these and other electronic surge protectors.



JOSLYN

ELECTRONIC SYSTEMS

Division of Joslyn Mfg. and Supply Co.

SANTA BARBARA RESEARCH PARK
P.O. BOX 817 • GOLETA, CALIFORNIA 93017
TELEPHONE (805) 968-3551 44

Circle 230 on reader service card

engineers at Burns & Towne Inc. it makes more sense to have one instrument that can test all the types of semiconductor components an inspector is likely to encounter.

And that's what the company's Inspector General System can do. It will make go/no-go tests on conventional and zener diodes, solid state rectifiers, and bipolar and field effect transistors.

The Inspector General is a modular system. Each of the modules plugged into the basic instrument performs two separate tests, some of which involve stepping a component through a voltage range after applying a constant current to it.

When a component fails a test, one of the front-panel lights comes on.

The system can make a test every 2.7 milliseconds, and can either be run directly by an operator or auto-

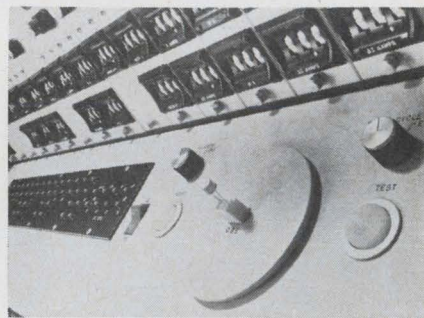

Double check. Each of the system's modules performs two separate tests.

matically. It's compatible with most handling and binning machines.

"At many inspection stations, it's the speed of the electronic test equipment, not the speed of the mechanical gear, that slows the operation," says Robert LeBlanc, a Burns & Towne vice-president. "Our unit can handle 20,000 components an hour, running 10 or 12 tests on each one."

Voltage levels, current levels, and tolerances are set with thumb-wheel switches. Ranges up to 2,000 volts and 10 amps are available.

A basic instrument that can take eight modules is priced at \$5,300. Since the average price of a module is \$1,000, a complete eight-module system will sell for about \$13,000.

Delivery time is six to eight weeks.

Burns & Towne Inc., 662 Cross St., Malden, Mass. 02148 [430]

Electronics | September 30, 1968

can't get away for evening classes?



here's a practical way to avoid technical obsolescence

Are irregular hours, travel and family obligations keeping you from attending classes—even though you worry about becoming technically obsolescent? Check into the Special Programs in Electronics for Engineers developed by CREI, the Home Study Division of the McGraw-Hill Book Company.

These are not simply courses, but comprehensive programs in advanced electronics offering major electives in such fields as :

Communications Engineering, Aeronautical and Navigational, Television Engineering, Automatic Control Engineering, Missile and Spacecraft Guidance, Radar and Sonar Engineering, Nuclear Instrumentation and Control, Computers.

Industry-recognized CREI Programs make it possible for you to catch up on new developments in electronics through study in your own home, at your own pace,

your own schedule. Free book gives complete information and details of technical material covered. For your copy, mail coupon below or write : CREI, Home Study Division, McGraw-Hill Book Company, Dept. 1838G, 3224 Sixteenth St., N.W., Washington, D.C. 20010.

Founded 1927



Accredited Member of the National Home Study Council



CREI, Home Study Division, McGraw-Hill Book Company
Dept. 1838G, 3224 Sixteenth St., N.W.
Washington, D.C. 20010

Send me free brochure describing CREI Programs in Electronics for Engineers.

NAME _____ AGE _____

ADDRESS _____

CITY _____ STATE _____ ZIP CODE _____

COMPANY _____

TITLE _____

Corning introduces the 2½ cent bit.

In the newest CORNING® Low Cost Digital Memory Modules for serial storage.

Each bit costs 2½ cents, for 4096 bits @ 16 MHz, in the 1000-module bracket.

More modules—less cost. And even for 100 units, your total cost is less than a nickel per bit.

CORNING modules plug in. TTL interface circuitry has been done for you. The medium is proven zero-TC glass from Corning. Stable. Rugged.

These modules are available now, off the shelf.

Specials on request.

For specs and to see a sample, write Corning Glass Works, Electronic Products Division, Advanced Products Dept., Raleigh, N.C. 27604. Telephone (919) 828-0511, Ext. 262.

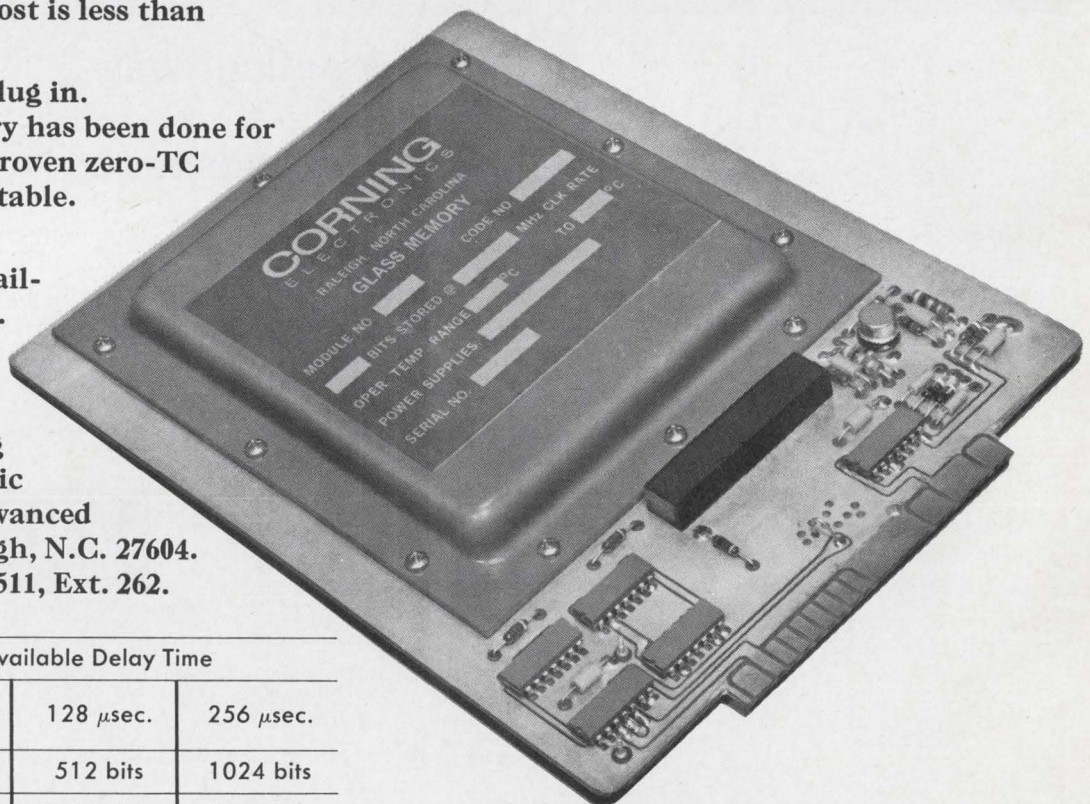

Available Frequencies	Available Delay Time		
	64 μ sec.	128 μ sec.	256 μ sec.
4 MHz	256 bits	512 bits	1024 bits
8 MHz	512 bits	1024 bits	2048 bits
16 MHz	1024 bits	2048 bits	4096 bits

CORNING
ELECTRONICS

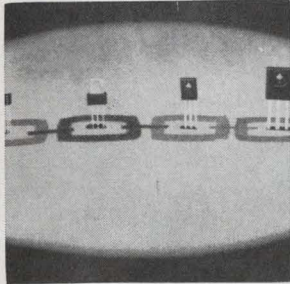

Silicon annular transistors now come in the Uniwatt plastic package which can dissipate 1 watt at an ambient temperature of 25° C. The first units in this line are complementary amplifiers for output stages up to 5 w and general purpose amplification, and amplifiers for video output and horizontal driver stages. Motorola Semiconductor Products Inc., Box 155, Phoenix. [436]

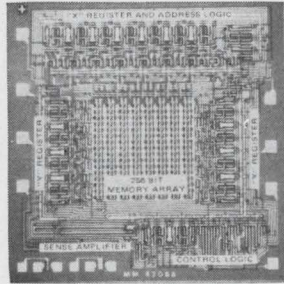

Monolithic, 256 bit read only memory MM420 contains the control logic and the memory packaged in 8-lead TO-5 configuration. On the chip are counter decoder, address logic and sense amplifier. An end of sequence output is provided to allow expanding serial bit length without using external components. National Semiconductor Corp., 2950 San Ysidro Way, Santa Clara, Calif. [437]

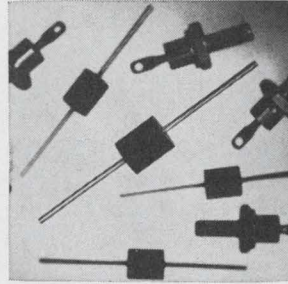

Three-watt zener diodes come in easy-to-mount, axial lead epoxy packages. They are available with zener voltages from 6.8 v to 150 v. Suggested applications include voltage regulation and limiting for power supplies, radio-tv computers, instruments and controls. Unit price at the 1,000 piece level is 70 cents. Transatron Electronic Corp., 168 Albion St., Wakefield, Mass. [438]

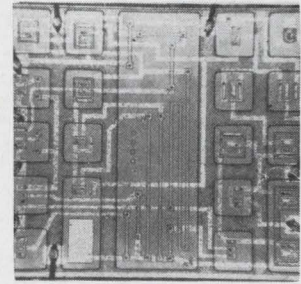

Monolithic buffer amplifiers are designated RA-244 in TO-86 flatpacks and RA-2244 in TO-99 packages (8-lead TO-5). The devices provide a guaranteed minimum slew rate of ± 50 v/ μ sec at a power dissipation of 170 mw max. Versatility is provided by a wide bandwidth of 20 Mhz and a full power frequency of 300 khz. Radiation Inc., Melbourne, Fla. 32901. [439]

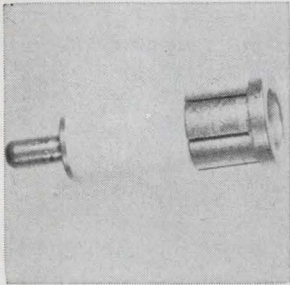

Bulk gallium arsenide diode CA4L2-E can furnish 100-w pulses at operating frequencies of from 1 to 1.5 Ghz. It is designed to handle pulse lengths up to 250 nsec with average powers of up to 25 mw. Dimensions are less than 1 in. x $\frac{1}{3}$ in., permitting use in high L-band power design in limited space. Cayuga Associates Inc., Parker Rd., Long Valley, N.J. [440]

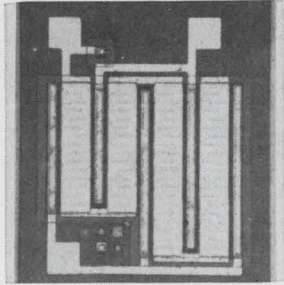

Large geometry discrete MOSFET type HRN8348D is for use in high-speed multiplexing and as a replacement for some types of relays. It has a typical channel resistance of 25 ohms when biased with the -10 v gate bias. Gate-to-drain and gate-to-source capacitances are typically 7 pf. Price is \$6.75 in 1,000 lots. Hughes Aircraft Co., 500 Superior Ave., Newport Beach, Calif. [441]

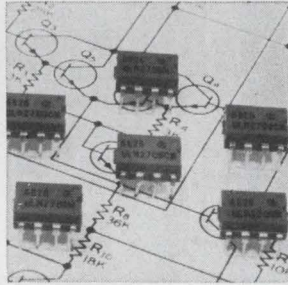

Operational amplifier series ULN-2709 is an 8-lead plastic dual in-line package half the length of the 14-pin package. The 2709M has input offset voltage 6 mv max., offset current 500 na max. The 2709 CM has input offset voltage 10 mv max., offset current 750 na max. Both operate at the 0° to 70°C range. Sprague Electric Co., Marshall St., North Adams, Mass. [442]

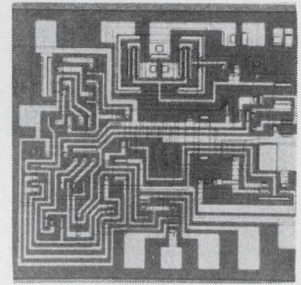

Precision voltage regulator μ A723 is a linear IC that features output current capabilities up to 150 ma and can be connected with an external npn or pnp pass element for higher output currents. Circuit design employs a process compatible N-channel J-FET that serves as a current source for operation independent of supply voltage. Fairchild Semiconductor, Mtn. View, Calif. [443]

New semiconductors

MOS memory to sell for 10 cents a bit

Aimed at desk calculator and peripheral equipment markets, first item in new line has 512 FET's on 80-mil-square chip

In memory devices, semiconductor or magnetic, the cost per bit stored rises rapidly as the memory size decreases. To counteract this trend, and to try to cash in on the big market predicted for low-cost memories in such things as computer peripheral equipment and desk cal-

culators, the semiconductor products division of Motorola Inc. will announce next month its first complex metal-oxide-semiconductor product—a 64-bit random access memory.

With it, says Wally Raisanen, newly named operations manager

for MOS and memory products, manufacturers of data processing or handling equipment will be able to make very small memories at low cost. "At 4,000 bits, you pay 25 cents to 50 cents per bit for magnetic memories," Raisanen says, "but our price per bit is constant down to 64 bits—less than 10 cents a bit in quantity orders." He says further that the closest competitive semiconductor memory—a 16-bit bipolar device—also has a cost per bit of about 50 cents.

The Motorola memory, called the MC1170, qualifies as a large-scale integrated circuit by most standards; it consists of 512 MOS

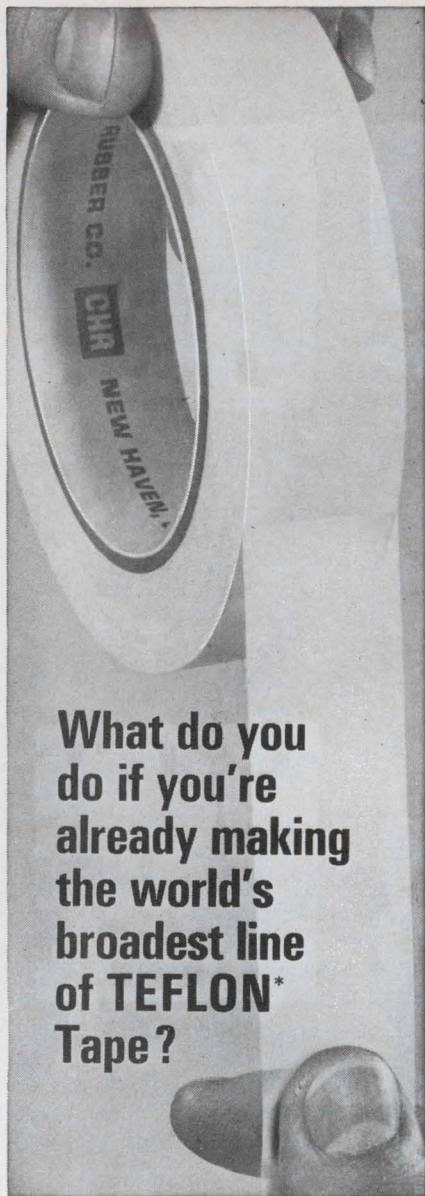

**What do you
do if you're
already making
the world's
broadest line
of TEFLON*
Tape?**

You broaden it.

CHR's new thin TEMP-R-TAPE® HM-350 has low elongation. Plus high breaking strength.

Plus all the advantages of other TEMP-R-TAPES. Like excellent electrical characteristics. And pressure sensitive silicone polymer adhesive. And reliability under a temperature range of -100 F to +500 F.

Find your distributor under CHR in industrial directories and microfilm catalogs. Or write for details and sample: The Connecticut Hard Rubber Company, New Haven, Connecticut 06509.



*T.M. OF DUPONT

Subsidiary of
U.S. Polymeric, Inc.

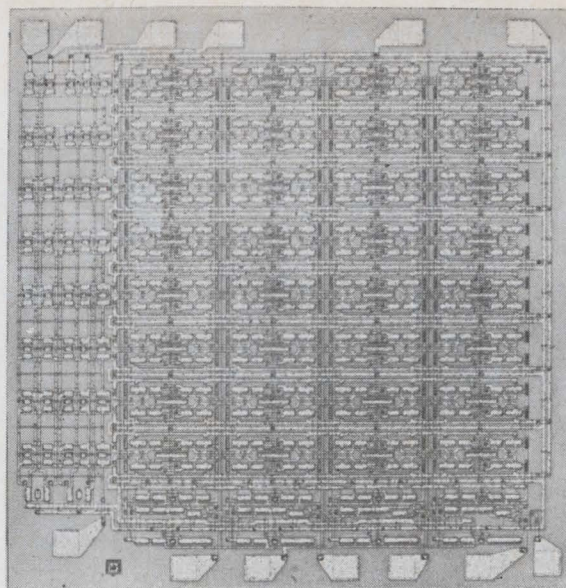

Gang of gates. The MC1170 has about 170 gates on its 80-mil-square chip. Decoder circuitry, at far left, selects one of 16 four-bit words in the array. Sense amplifiers and other peripheral circuitry are at bottom of chip.

field effect transistors forming the equivalent of about 170 gates on an 80-mil-square chip. Raisanen isn't pushing to put the LSI label on the device because his own definition of LSI is that "It's something I don't know how to do yet." Raisanen exudes confidence. He predicts that memories will be a \$50-million-per-year business for Motorola by the late 1970's and says the MC1170 is just the first in an evolving line of monolithic and hybrid semiconductor memories. There are 16 "X" or word wires in the MC1170, each storing four bits in a linear-select organization. Circuits that decode a four-bit address to identify one of 16 locations are also on the chip.

Raisanen says the linear-select organization gives a speed advantage over the more usual coincident-select organizations. Typical access time of the MC1170 is less than 400 nanoseconds. "This means that you can get four bits out of the device in one 400-nanosecond cycle with the linear-select organization. In coincident-select organizations, four cycles are required to get four bits out, and each cycle is about 300 nanoseconds," Raisanen explains. Coincident-select organizations dictate that an "X" and a "Y" wire be addressed to get at the bit stored at their intersection.

Shared lines. "We employ time-sharing on the bit lines," Raisanen notes. "This means that if you're reading, the output appears on four wires, and the same four wires are driven in writing." He says this feature allows use of a 14-lead

dual in-line package, either plastic or ceramic. The initial devices are ceramic.

Raisanen expects the product to compete with small core memories initially, and with magnetostrictive delay lines that are used for small memories. Eventually, however, he looks for the MC1170 to be used "anywhere that low speeds and low data rates are useful." In the latter category, he includes all kinds of digital instrumentation—oscilloscopes requiring a "fair amount of storage," digital voltmeters with arithmetically computed rms readings, aircraft instrumentation, and advanced-design cash registers.

Delay-line memories have a destructive readout. Raisanen believes the MC1170 will compete with them especially well because its readout is nondestructive. The device operates from ± 12.5 volts d-c. Further, Motorola's low-threshold (2 volts) MOS process—involving a proprietary silicon crystal orientation, a very clean gate oxide and limited access to the production area—delivers a better speed-power product in the MC1170 than other MOS processes, Raisanen maintains. At the 400-nanosecond speed, the device dissipates about 200 milliwatts.

Its low threshold puts the memory in the same range as the power swing of bipolar gates, allowing direct connection with bipolar circuitry.

Motorola Semiconductor Products Inc.,
Phoenix, Ariz. 85008 [444]

Printed circuit profits are in the holes

But Monarch/Edlund's NPB-S numerically controlled printed circuit drilling machine will put them in your bank account, where they belong. □ The NPB-S is a compact version of the famous Monarch/Edlund NPB, long the standard of the printed circuit board industry. □ The NPB-S can accurately produce 15 to 25,000 holes per hour when drilling 2 stacks of $\frac{1}{16}$ thick circuit boards, 4 to a stack. This rate can be achieved on all the common types of board materials. This is a productive rate of 30 to 50,000,000 holes per year on a 8 hour shift. □ If your annual hole drilling requirements are approaching this volume you should be looking at the NPB-S to give you the efficiency and quality that spells more profits and more satisfied customers. □ The NPB-S will automatically produce 4 different hole sizes in a single set-up. Fixtures are simple, set-up time is short, and the operator will have free time to permit inspection or loading preparations. □ Short, Medium, or Long runs, NPB-S drills them all. Accurately. Economically. Profitably. Get the whole story from your Monarch/Edlund representative. Or write: Edlund Division, Monarch Machine Tool Company, P. O. Box 749, Cortland, New York 13045.

Monarch

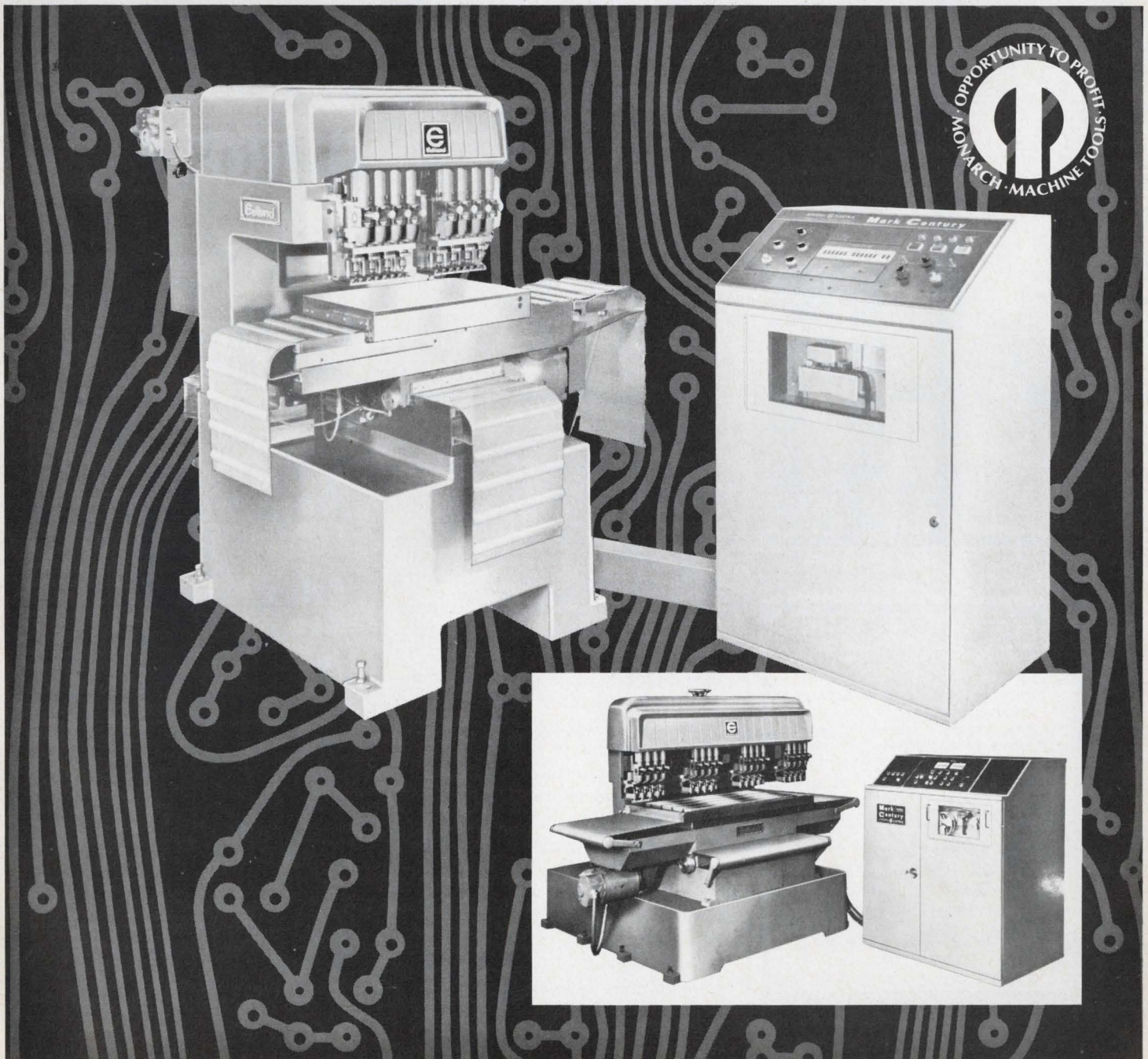

R. F. ATTENUATORS, ROTARY

Featuring the ultimate in precision craftsmanship and reliability, Texscan manufactures the most complete line of rotary attenuators in the industry.

Commercial and military manufacturers have chosen Texscan rotary attenuators almost exclusively for incorporation into their equipment.

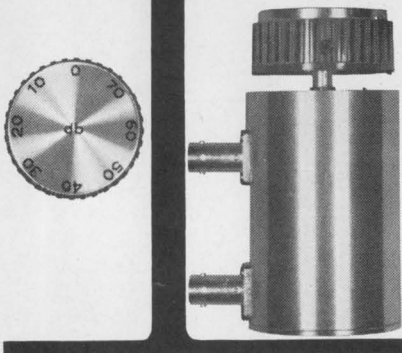

DC to 4000 MHz

is covered by 10db, 1db, and 0.1db step attenuators. Over 30 standard models are stocked. Specialized units upon request. Contact your local Texscan representative.



TEXSCAN CORPORATION

2446 N. Shadeland Avenue
Indianapolis, Indiana 46219
Telephone (317) 357-8781
TWX: 810-341-3184

New semiconductors

D-a converter runs at 2 Mhz

Kit of 8 flatpacks uses current summing for avionics jobs

Digital-to-analog converters are no longer the rack-sized devices commonly seen during the 1950's. An original equipment manufacturer can now buy the necessary parts and assemble converters on printed circuit boards as parts of computer-controlled avionic, production control, radar surveillance, and other systems.

Still, this assembly can be a big job, especially for medium to high resolution (8 to 10 bit) converters. Although the switching circuits needed are available on monolithic integrated circuits, an OEM has had to use 20 or more resistors with his IC to make a functioning d-a converter. Not only is this time-consuming, but it also prevents OEM's from getting the most accuracy out of the converter. As temperatures change, the resistors change value slightly, but not all of them change to the same degree.

The Sprague Electric Co. has simplified the assembly problem, at the same time improved performance over broad temperature ranges. Sprague's answer to the OEM's problems is a kit of eight flatpacks; five contain monolithic switches, the other three contain tantalum-nitride resistor networks on silicon substrates. The kit is designated a 10-bit current summing d-a converter.

Instead of having to install each resistor separately, and with a different technique than the one used for the IC, the OEM can repetitively install flatpacks. Not only is assembly easier, but the thin-film resistor networks keep tight mutual tolerances with changes in temperature, because of their common substrates.

Sprague has been making voltage-summing converters for years. In its new unit, Sprague has turned



*High Quality!
Low Cost!
Quick Delivery!*

★ HIROSE is Japan's leading manufacturer of electrical connectors.....



For detailed information, please contact to:

HIROSE ELECTRIC CO., LTD.

No. 23, 5-5chome, Osaki, Shinagawa-ku, Tokyo, Japan

Cable Address: BESELECONHIROSE

Circle 242 on reader service card

Cut Circuit Costs

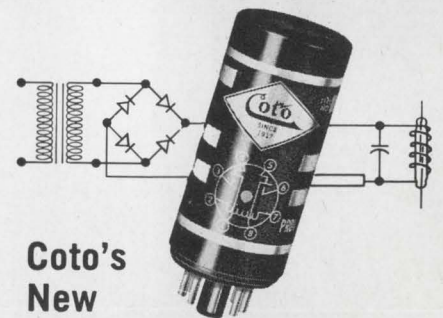

Coto's New

A.C. Reed Relay

Replaces Costly AC/DC Circuits!

Contacts: Forms A or C with single or multiple poles.

Ratings: to 3 amperes or up to 5000 volts D.C.

Inputs: 60-800 Hz voltages available.

Physical: Available in 8 and 11 pin plug-in housings with electromagnetic shielding. Electrostatic shielding available on order.

Write for complete specifications. For special requirements, give complete details for quotation.

Coto-Coil COMPANY, INC.
61 Pavilion Avenue
Providence, R. I. 02905
Phone (401) 941-3355

10 WATTS FROM YOUR SIGNAL GENERATOR

RF-805 AMPLIFIER



- 0.1 Volts In—22.5 Volts Out
- .05 MHz to 80 MHz Broadband
- Low Distortion
- Solid State
- Flat 47 db Gain

\$980

The RF-805 is a solid state amplifier, broadband from .05 to 80 megahertz, which produces ten watts with -30 db harmonic and intermodulation distortion. Lower distortion is available at lower output levels. Gain is 47 db minimum, constant within 1 db, so that full output is developed with less than 0.1 volt at the 50 ohm input. Accurate output metering and overload protection is provided.

The RF-805 will raise the power of most manual and swept tuned signal generators and thus extend the usefulness and versatility of available signal generators. Receiver testing, wattmeter calibration, antenna testing, RFI testing, attenuator measurements, and filter and component testing will be aided with the use of this equipment.



R F COMMUNICATIONS, INC.

1680 University Avenue • Rochester, N. Y. 14610

Circle 244 on reader service card



One Gift Works Many Wonders
THE UNITED WAY

Introducing the world's most advanced ICs for professional communications

The Plessey SL 600 series enables designers to produce a new class of transceiver equipment in terms of both size and performance.

This new Plessey series of communications circuits consists of six basic types, designed as a completely compatible family. Four of these ICs are the first of their type in the world. All meet the full Military temperature specification, offer low power consumption and require only a single +6V supply.

RF Amplifier SL610

The linearity of this circuit is unequalled by any normal transistor amplifier. Input signals of 100 mV (with no AGC) and 250 mV (with full AGC) at 10 MHz result in less than 1% cross modulation. The circuit has a gain of 10X.

SL611

Similar to the SL610 but with a gain of 20X.

IF Amplifier SL612

This low noise 15MHz amplifier has high gain low distortion and consumes typically only 20mW of power. Voltage gain of 50.

SSB AGC Generator SL621

The SL621 is the only circuit in the world able to provide this function and performance. It will follow fading signals but hold a fixed AGC level during pauses in speech as well as recovering rapidly from impulse noise interference. This circuit enables SSB performance to approach conventional AM behaviour.

Voice-Operated Gain Adjusting Device SL620

The only commercially available IC capable of this function. Provides an accurate audio AGC system, will hold microphone amplifier output between 70 mV and 87 mV for a 35dB range of audio input.

Audio Amplifier SL630

Provides an extremely versatile output capacity. Operates from any supply ranging from +6V to +15V. Maximum power output at +15V is 250 mW. Circuit includes wide range logarithmic AGC, automatic overload protection and will accept either single ended or differential inputs.

Double Balanced Modulator SL640

A unique circuit available only from Plessey. Replaces the diode ring for frequencies up to 76 MHz. Needs no transformers, saves power, cost, space and requires no external adjustment for balance. High stability inherent. Equally applicable for line communications - telephone channelling. A receiver mixer version, SL641, is also available.

For full information on any of these outstanding communication circuits, please write or telephone:

Plessey Incorporated

170 Finn Court, Farmingdale, Long Island, New York, 11735
Tel: 516MY4-7377 Telex: 126519 Cables: Plessey, New York



PLESSEY
microelectronics

CW SC62

**ECCOMAX HI-Q
LOW-LOSS
DIELECTRICS**



18 low loss systems are described in new folder and chart. Casting resins, impregnants, coatings, adhesives, rod & sheet — some foams — some Hi K — all with dissipation factors below 0.001. For RF, UHF, VHF and microwaves — capacitors, coils, etc.

Circle 500 on readers service card

**ECCOSIL®
RTV SILICONE
DIELECTRICS**



New illustrated folder describes and gives properties for 13 Eccosil RTV silicone dielectrics including new see-thru encapsulants, sealants, adhesives, mold-makers, coatings and even lightweight foams.

Circle 501 on readers service card

**ECCOCOAT®
SURFACE COATINGS
FREE WALL CHART**



Epoxyes, urethanes, alkyds, phenolics. Clear and in colors. Some are electrically conductive. Some are in aerosol cans. Electrical and physical properties and application notes are included.

Circle 502 on readers service card

Emerson & Cuming, Inc.



**CANTON, MASS.
GARDENA, CALIF.
NORTHBROOK, ILL.**
Sales Offices
in Principal Cities

EMERSON & CUMING EUROPE N.V., Oevel, Belgium

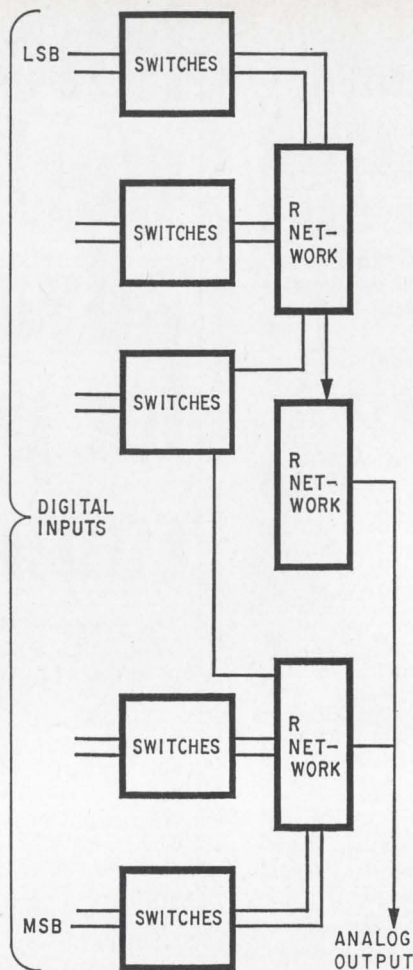

Hot or cold. The d-a converter has 10-bit resolution over a range from -55°C to $+125^{\circ}\text{C}$.

to current-summing to achieve speed and to increase the converter's versatility.

Instead of waiting for a signal to propagate through a ladder network, Sprague places switches at the 10 inputs of its converter and allows binary 0's and 1's to turn them on or off. The more switches in the "on" state, the greater the signal level at the converter output. With this current-summing approach, the company claims a 2-megahertz conversion rate, and says that this is about twice the speed claimed for the nearest competitive devices. Sprague also claims "one half least significant bit" accuracy with 10-bit resolution and says this too is an improvement over units now on the market.

Sprague's converter maintains its accuracy and 10-bit resolution over a temperature range of -55 to $+125^{\circ}\text{C}$.

The Sprague Electric Co., 125 Marshall St., North Adams, Mass. 02148 [445]

MICO

**NEW MODEL 885
SEVEN RATIO
WIDE-RANGE ENGRAVER**

NO. 885

FOR LONG AND MULTI-LINE WORK

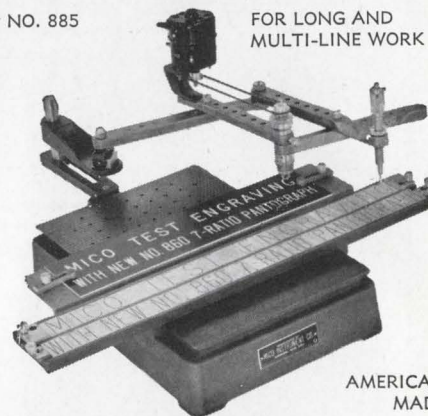

AMERICAN MADE

- A time-saver for large plate work
- Engraves 3" x 19" area in one set-up.
- Seven pantograph ratios—from 1:5:1 to 6:1.
- Choice of 3-ball-bearing spindle assemblies for 1/8", 3/16" or taper-shank cutters.
- HSS, COBALT and Solid Carbide Cutters.
- Single and multi-line copy carriers for holding, blanks 3/4" to 3 1/2" high.
- Accommodates Mico standard accessories.

Send for bulletins and prices

MICO INSTRUMENT CO.

77 Trowbridge St. Cambridge, Mass. 02138

Circle 194 on reader service card

Cartoon by Whitney Darrow, Jr.



Be a buddy!

**One gift works many wonders
THE UNITED WAY**

New, true dual-beam oscilloscope.



And only \$995*

True dual-beam, portable oscilloscope features line or battery operation. Choice of 15 or 30 MHz bandwidth plug-in Y-amplifiers (23 and 12 nsec rise times).** Solid state unit provides differential input, internal voltage calibrator, and both signal and time delay.

For complete data, write for Bulletin TIC 3318A to Motorola Communications & Electronics Inc., 4501 W. Augusta Blvd., Chicago, Ill. 60651.

*Exclusive of options. **15 MHz amplifier, \$395; 30 MHz amplifier, \$595.



MOTOROLA
Precision Instrument Products

Circle 245 on reader service card

WITH INSERTS, THE SAVINGS ARE IN THE HOLE

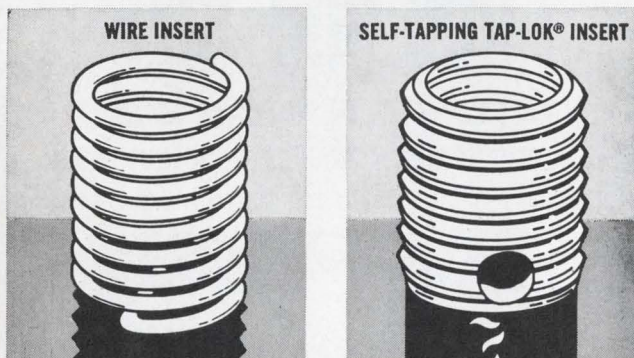

For the real bargain in inserts, look into the hole. You'll get a new view of what real counts—final installed costs. Check these approximate installation figures:

(Estimated Costs*)		Do Our Costs Agree With Yours? If Not, Fill in Your Own	(Estimated Costs*)	
Wire-Type Inserts			Self-Tapping Tap-Lok® Inserts	
Insert Cost	5¢		Insert Cost	4.4¢
Drill Hole	5¢		Drill Hole	5.0¢
Tap Hole	7¢		Tap Hole (Not Req.)	—
Gage Hole	3¢		Gage Hole (Not Req.)	—
Install Insert	8¢		Install Insert	8.0¢
Remove Tang	5¢		Remove Tang (Not Req.)	—
Per Finished Hole	33¢		Per Finished Hole	17.4¢

*Estimated cost for wire-type 4-40, .224" long, 25,000 quantity; Tap-Lok 4-40, .234" long, case-hardened steel, 25,000 quantity.

Estimated average costs will vary with user, equipment, overhead, and labor rates.

Self-tapping Tap-Lok inserts eliminate three operations which alone amount to about triple the cost of the insert itself. With Tap-Lok you need only one inexpensive installation tool. Wire inserts require special taps, gages, and a tang removal tool. Tap-Lok inserts conform to MS 35914-101 thru 166. Write for data—Groov-Pin Corp., 1121 Hendricks Causeway, Ridgefield, N.J. 07657, (201) WH 5-6780.

FASTENER DIVISION **GROOV-PIN CORP.**

Circle 246 on reader service card

What price performance in a quality filter?

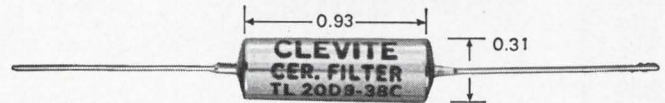

less than \$15
with Clevite's compact ceramic ladder filter.*

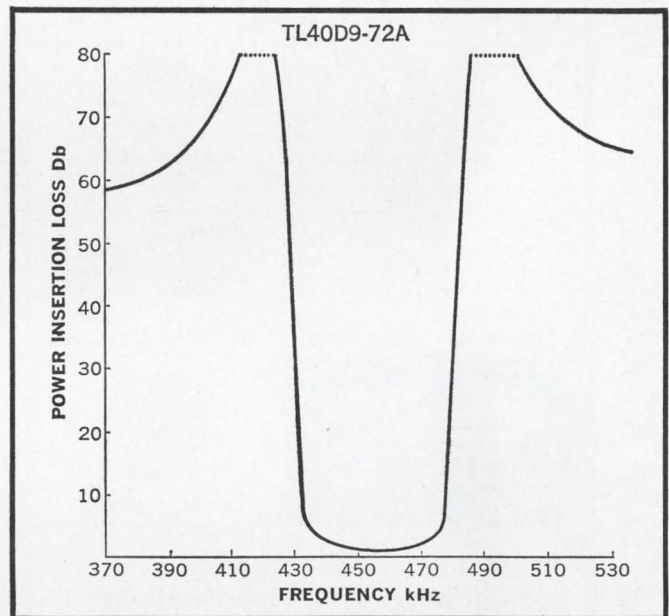

Here's the smallest (less than 0.07 cu. in.), most rugged fixed-tuned filter on the market today!

Clevite's 9-disc miniature filter is packaged in a hermetically-sealed cylinder, exceeds all military environmental specifications, is ideal for transistorized i-f amplifier circuitry in AM and FM sets plus many other applications that call for a fixed-tuned filter. Stop band rejection: 50 db. Center frequency tolerance: ± 3 kHz. Stability: within $\pm 0.2\%$ for 5 years; within 0.2% from -40°C to $+85^\circ\text{C}$. Impedance (in and out) 2000 ohms for B/W less than 12 kHz; 1000 ohms for broader bandwidths.

Following models standard at 455 kHz (A) or 500 kHz (C) (custom models on special order):

Model Number	B/W	
	min. @ 6db	max. @ 60 db
TL10D9-20 (A or C)	10 kHz	20 kHz
TL16D9-32 (A or C)	16 kHz	32 kHz
TL20D9-38 (A or C)	20 kHz	38 kHz
TL30D9-57 (A or C)	30 kHz	57 kHz
TL40D9-72 (A or C)	40 kHz	72 kHz

*PRICES: 1—\$25 ea; 25—\$20 ea; 100—\$17.50 ea; 500—\$15 ea; 1000—\$13.75 ea; 2500—\$12 ea.

(Prices subject to change without notice)

Send order or request for Bulletin 94021 to: Clevite Corporation Piezoelectric Div., 232 Forbes Rd., Bedford, Ohio 44014, U.S.A. Or: Brush Clevite Company, Limited, Southampton, England.

CLEVITE

Circle 195 on reader service card

When Only Excellent is Adequate TURN to Grayhill

for EXCELLENCE IN
MINIATURE ...
SUB-MINIATURE ...
ULTRA-MINIATURE
ELECTRONIC
COMPONENTS



BINDING POSTS



PUSH POST®



LAMP SOCKETS

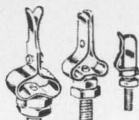

TEST CLIPS



TRANSISTOR SOCKETS



STAND-OFF INSULATORS

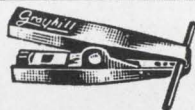

INSULATED TEST CLIPS



... the Difference Between
Excellent and Adequate

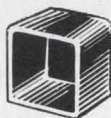

MODULE CASES

Select Materials

- Metal Parts — Steel, SS, Brass, Beryllium Copper
- Finishes — Silver Plate, Nickel Plate, Gold Plate
- Contacts — Fine Silver
- Insulating Material— Molded Phenolic, Diallyl, Epoxies to MIL-M-14

Typical Specifications

All Grayhill Components are designed for long life and high reliability under extreme environmental and operating conditions. Excellence, competitively priced.

Ask for
Catalog G-304-A
for full details



523 Hillgrove Avenue
LaGrange, Illinois 60525
Area Code 312, Phone 354-1040



"PIONEERS IN MINIATURIZATION"

NEW VISIBILITY PLUS JAMES C-RITE

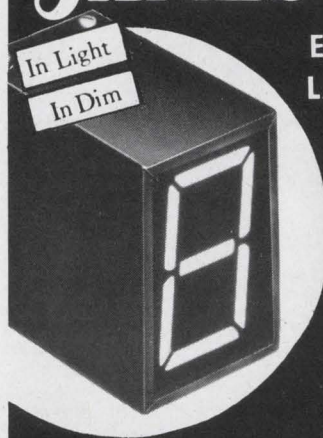

ELECTRO-MAGNETIC LATCHING MEMORY DISPLAY

Fully Electromagnetic seven segment readout for on line or portable commercial, industrial, and military applications. James can provide engineered systems of display incorporating C-Rite alpha-numeric digits and custom message and symbol presentations.

READABILITY... in all light conditions from bright sunlight to dimly lit rooms. Reads reliably in a full spectrum of extreme light conditions.

MAINTENANCE FREE... electromechanical teflon supported and dynamically balanced... cannot burn out or fail as do light actuated systems.

MEMORY AND MOMENTARY... Latching Memory from low power pulse control. Momentary operates like light segments and Nixes requiring continuing power application.

SHOCK & VIBRATIONS... patented balanced rotor magnetic segment is virtually unaffected by external shock and vibration. No bulbs to burn out.

For further information write:

JAMES ELECTRONICS, INC.

4050 North Rockwell Street • Chicago, Illinois 60618

Circle 247 on reader service card

OVER 1,000,000 SIZES MILITARY CASES

COMBINATION • TRANSIT • INSTRUMENT

MIL-T-945A, T-4734, T-21200, STD-108, C-4150



Choose from over 1,000,000 variations in dimensions, proportions, metals, finishes, and custom accessories. Whatever your need, the MM (multi-measure) method gives you high production savings even on custom runs as low as 25 units. Send your print or requirements. Manufacturers representatives in all major cities.

SEND FOR FREE CATALOG & DIMENSION SPECIFICATION SHEETS.

••mm ELECTRONIC ENCLOSURES, Inc.

111 Bloomingdale Rd., Hicksville, N.Y. 11801 • 516-935-9400

Circle 248 on reader service card

Meaningful math

Communication Theory: Transmission of Waveforms and Digital Information
David Sakrison
John Wiley & Sons Inc.
369 pp., \$12.95

Because there are few textbooks suitable for beginners in communications theory, Sakrison's work is welcome; doubly so because he strongly emphasizes the modern mathematics of signal theory.

Before the reader is introduced to modulation, he gets considerable grounding in signal representation, probability theory, and random processes. For example, Sakrison starts out by discussing expansion in terms of orthogonal functions, an area usually treated as a special topic in other texts. The Fourier series is then introduced as a particular facet of the general theory, rather than as its starting point.

After the mathematical introduction, amplitude and frequency

modulation are covered and an explanation of optimum, linear (Wiener) filtering is given. Next comes an important, large chapter on pulse modulation and phase-locked loops.

The order of the subjects can be changed; there is a flow chart of alternative chapter sequences, and the reader can choose his own way through the book.

This is in no sense a survey of communication theory. Topics frequently introduced in undergraduate-level texts—information theory, coding, statistical decision theory, nonlinear operations on random processes, and descriptions of communications systems and noise sources—are omitted. Sakrison concentrates instead on building a solid mathematical foundation based on modern signal theory.

R. W. Lucky

Bell Telephone Laboratories
Holmdel, N.J.

Recently published

Logic Design With Integrated Circuits, William E. Wickes, John Wiley & Sons, Inc., 249 pp., \$9.95

Highlighted are modern techniques for applying commercially available micro-digital circuits to special-purpose digital problems. Topics include number systems and codes, switching algebra and minimization techniques—especially the map method. In addition, the book presents original techniques for flip-flop analysis and synthesis, and the most up-to-date methods of handling NAND and NOR IC's. Throughout, it uses military standards logic symbols.

Circuit Design for Integrated Electronics, Hans R. Camenzind, Addison-Wesley Publishing Co., 266 pp., \$12.95

A bridge to the field of integrated circuits, this book should be useful to the electronics engineer with circuit design experience. It offers broad coverage of integrated circuit processes, detailed analysis of integrated components, and thorough discussion of design techniques for digital and linear IC's. In addition, it describes computer analysis and measurement methods.

Pulse and Logic Circuits, Angelo C. Gillie, McGraw-Hill Book Co., 401 pp., \$9.95

Aimed at the novice in the field, this book covers three major areas: passive pulse circuitry; switching circuitry; and matrix, counting, and register circuits. Problems are offered at the end of each chapter and answers given. Well illustrated with transistor circuits using practical values for components.

**this camera-
the VC-20-
will do
what other Vidicons
will not do**

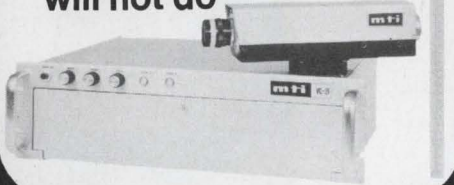

One example. The *Quantum Light Sensor* provides constant video output level over variations in light levels of 4000:1 — nominal change in video level over 20,000:1. Continuous sampling of Vidicon faceplate illumination on field to field basis. Automatically compensates to reduce glare from high light scene. Provided with manual override.

**no
noise!**



Fully solid state preamp uniquely attached to Vidicon tube minimized input capacity. Circuitry design provides constant low noise signal allowing high quality picture at low light level.

Local regulations

An integrated-circuit medium power 'local' voltage regulator
W.H. Williams, J.H. Parker
Westinghouse Molecular Electronics
Division
Elkridge, Md.

A new monolithic integrated circuit permits local regulation of voltage; it eliminates the need for a single large precision regulator for a system, and allows each circuit function to be powered independently, regardless of fluctuations in the main power bus. Interference between different parts of the system is minimized because of the high degree of board-to-board decoupling.

Applications are in both analog and digital systems. For example, the IC can provide regulated supply voltages to operational amplifiers and logic circuits used in numerical control equipment, data processors, calculators, and servomechanisms.

The monolithic chip contains a

temperature-compensated reference voltage, a sense and comparison amplifier, a Darlington series control element, a constant-current pre-regulator, a current-limiting transistor, and an SCR. The line and load regulation is determined primarily by the parameters of the differential amplifier and series control element.

The regulator operates by sampling the output voltage and comparing it with a fixed internal reference. The resulting differential signal is amplified and causes the series control element to increase or decrease the current to the load.

Because the comparison element is a differential amplifier, it minimizes the effects of temperature variations, since this configuration is degenerative toward common-mode signals like thermally induced currents, but not toward differential signals. The Darlington-connected transistor pair is the series control element of the regulator. It inter-

prets the signal from the differential amplifier and drives more or less current to the load as necessary to maintain a constant output voltage. The Darlington connection provides the high current gain necessary to generate the load current.

The SCR is part of the overload-protection portion of the circuit. The anode is connected to the base of the Darlington amplifier, the gate is connected through a resistor to the normal regulator output, and the cathode to the emitter of the Darlington through a sense resistor. When the current through the sense resistor establishes a voltage sufficient to fire the SCR, base current is drawn from the Darlington, thereby turning the regulator off and limiting the load current.

Output voltage is adjustable from 4 to 16 volts. Output current is 150 milliamperes; an external transistor can increase this to 5 amps.

Presented at Wescon, Los Angeles, Aug. 20-23.

**lightweight
champion:
lines to
match**



Camera weight — 3.5 lbs. Size — 2 $\frac{3}{4}$ " x 2 $\frac{3}{4}$ " x 9 $\frac{3}{4}$ ". Full 800 lines plus. Horizontal center resolution @ 0.5 faceplate illumination with 600 line corners. Overall linearity better than 1% — virtually undetectable by human eye. Unmatched flatness of field — no shading.

**more
specs**

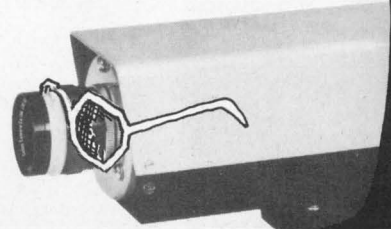

Camera head runs cool even during extended operation resulting in longer vidicon tube life and eliminates component failure due to heat. Regulated filament current further extends tube life by eliminating surge current (over voltage protected). Regulation precludes necessity for readjustments with changes in cable length. Full EIA on 525 line version or self-contained fully interlaced sync.

...these little stories
add up to
the big picture
in Vidicon cameras
the
VC-20

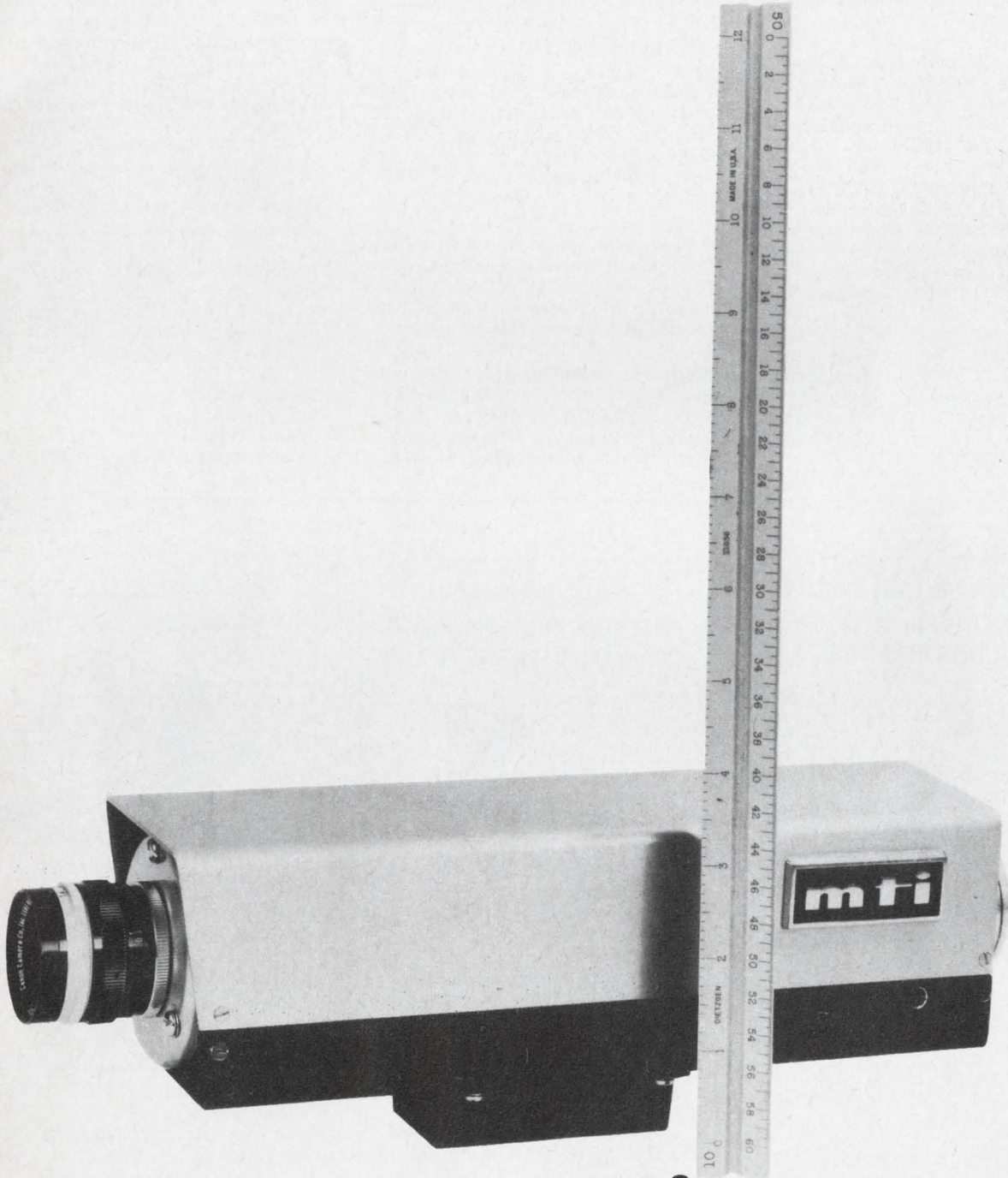

mti

MARYLAND TELECOMMUNICATIONS, INC.

York & Video Roads,
Cockeysville, Maryland/Area Code 301,
666-2727

WORLD'S LARGEST MANUFACTURER
of low light level image Orthicon cameras

New Literature

Solid state capacitors. Monolithic Dielectrics Inc., P.O. Box 647, Burbank, Calif. 91503. A four-page technical bulletin covers the type K1200 monolithic ceramic chip capacitors. Circle 446 on reader service card.

High-vacuum products. Veeco Instruments Inc., Terminal Dr., Plainview, N.Y. 11803, has issued a 24-page price list dealing with all its high-vacuum products. [447]

Microwave oscillators. Micro State Electronics, 152 Floral Ave., Murray Hill, N.J. 07974, has published a flyer describing its line of solid state microwave oscillators. [448]

Photomask production. HLC Manufacturing Co., 726 Davisville Rd., Willow Grove, Pa. 19090. A six-page technical bulletin describes the Polykon automatic step-and-repeat system for the production of multiple-image photomasks. [449]

Chip capacitors. Corning Glass Works, Corning, N.Y. 14830. Performance characteristics and a quick-selection guide for miniature Glass-K chip capacitors are included in a four-page brochure. [450]

Wire and cable. Rome Cable, Rome, N.Y. 13440. The company's full line of wire and cable literature, along with specification sheets, has been combined into an indexed loose-leaf catalog. To obtain a copy make a request on company-letterhead stationery.

Impulse totalizer. Ferranti Electric Inc., East Bethpage, Rd., Plainview, N.Y. 11803. An eight-page brochure describes in detail the type PE solid state impulse totalizer. [451]

Waveguide filters. I-Tel Inc., 10504 Wheatley St., Kensington, Md. 20795, has published bulletin 1929-18 describing series FBW (bandpass) and FRW (band-reject) waveguide filters. [452]

Repeat cycle timers. The A.W. Haydon Co., 232 N. Elm St., Waterbury, Conn. 06720. Bulletin MC200-R2 provides complete information on a line of basic repeat cycle timers. [453]

Precision potentiometers. Computer Instruments Corp., 92 Madison Ave., Hempstead, N.Y. 11550. A 20-page catalog covers a line of rotary precision film potentiometers. [454]

Semiautomatic wiring system. Product Improvement Corp., 150 Stevens Ave., Santa Ana, Calif. 92707. A four-page brochure describes the P/2/P system, a numerically controlled positioning unit for producing wire terminations at mass production rates on high-density circuit panels. [455]

Temperature controllers. Fenwal Inc., 400 Main St., Ashland, Mass. 01721. A detailed brochure discusses the 524 series indicating thermocouple temperature controllers. [456]

Ferrite devices. Calvert Electronics International Inc., 220 E. 23rd St., New York 10010. A 20-page report summarizes the theory of ferrite devices and examines in detail the relative merits of circulators, isolators and waveguide switches. [457]

Electrolytic capacitors. West-Cap Arizona, 2201 E. Elvira Rd., Tucson 85706. Bulletin 61568 contains operating characteristics for the MA series axial lead electrolytic capacitors. [458]

Cermet resistor module. CTS of Berne Inc., Berne, Ind. 46711. Data sheet 3760 covers the series 760 dual in-line cermet resistor module. [459]

GUARANTEED UNIFORMITY IN ELECTRICAL, PHYSICAL CHARACTERISTICS

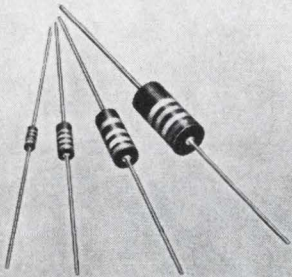

- Available in 2, 1, 1/2 and 1/4 watt sizes.
- Uniform from resistor to resistor, order to order.
- 100% tested for resistance value.
- Same day shipment on 9 orders out of 10.
- Solderability, load life and humidity-temperature characteristic checked.
- Impregnated to assure moisture resistance.
- Write for literature.



STACKPOLE
CARBON COMPANY
Electronic Components Division
Kane, Pa. 16735

SOLVE NOISE AND FILTERING PROBLEMS WITH CERAMAG® FERRITE BEADS

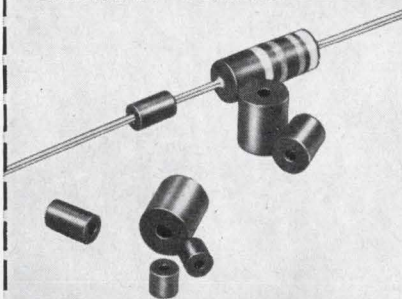

- Ceramag® ferrite beads are low cost, easy to install, and save space.
- Effective r.f. decoupling, shielding and parasitic suppression without sacrificing low-frequency power or signal level.
- Installed by simply sliding one or several over conductor leads.
- Beads can, but need not, be grounded.
- Sizes from .040" ID — .100" OD — 100" L.
- Sample quantities available.



STACKPOLE
CARBON COMPANY
Electronic Components Division
St. Marys, Pa. 15857

NEW SPECIAL PURPOSE RESISTOR PROTECTION

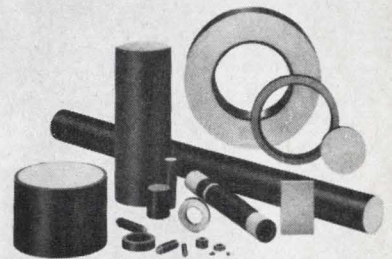

- Currently in use on lightning arrestors, circuit breakers, spark plugs.
- Available in rods, sleeves, rings, special shapes, up to 15" in length and 5" in diameter.
- Ceramic composition favors high voltage applications with high surges.
- Organic Special Purpose Resistors are inexpensive solution where heat dissipation is necessary.
- Both ceramic and organic available in wide range of resistivity values.
- Write for technical assistance.



STACKPOLE
CARBON COMPANY
Electronic Components Division
St. Marys, Pa. 15857

New Literature

IC catalog. Hughes Semiconductors, 500 Superior Ave., Newport Beach, Calif. 92663. A 260-page catalog describes a full line of bipolar monolithic circuits. [460]

Transformers. Abbott Transistor Laboratories Inc., 5200 W. Jefferson Blvd., Los Angeles 90016. A line of Mil-Spec 60-hertz power transformers is described in a six-page brochure. [461]

D-c power supplies. Raytheon Co., Sorensen Operation, Richards Ave., Norwalk, Conn. 06856. Eight-page catalog DC 111 describes the DCR series of wide-range, regulated solid state d-c power supplies. [462]

Relays and coils. Solid State Electronics Corp., 15321 Rayen St., Sepulveda, Calif. 91343, has available a 48-page catalog describing its line of relays and coils. [463]

Ceramic capacitors. U.S. Capacitor Corp., 2151 N. Lincoln St., Burbank, Calif. 91504. Miniature high-stability ceramic capacitors are described in a 12-page catalog. [464]

Multimeter. Non-Linear Systems Inc., P.O. Box N., Del Mar, Calif. 92014. A

four-page brochure contains complete specifications for the X-3A solid state digital multimeter with VTVM capabilities. [465]

Circuit protectors. Airpax Electronics Inc., Cambridge, Md. 21613. Bulletin 16E-12 covers a line of single- and multipole electromagnetic circuit protectors. [466]

Special-purpose tubes. ITT Electron Tube Division, P.O. Box 100, Easton, Pa., 18042. A 12-page brochure describes the characteristics and type numbers of a line of traveling-wave tubes, direct-view storage tubes, electro-optic tubes, high-power vacuum tubes, gas discharge tubes, and xenon lamps. [467]

Resistor chart. Corning Glass Works, Corning, N.Y. 14830. An application guide for ensuring performance and saving money with C-3 style resistors is featured in a four-page brochure. [468]

Incremental shaft encoders. Disc Instruments Inc., 2701 So. Halladay St., Santa Ana, Calif. 92705. Bulletin 477 includes features, prices, and ordering information for Rotaswitch incremental shaft encoders. [469]

Slip rings. Electro-Tec Corp., 1600 N. Main St., Blacksburg, Va. 24060. An eight-page brochure discusses the company's capabilities in the design and manufacture of every type of military and commercial slip-ring product. [470]

Ceramic capacitors. Vitramon Inc., Box 544, Bridgeport, Conn. 06601. A four-page catalog covers a new series of NPO ceramic capacitors. [471]

Components catalog. Cambridge Thermionic Corp., 445 Concord Ave., Cambridge, Mass. 02138. Catalog 700, in 228 pages, highlights an expanding line of miniature connectors, including sockets, patch cords, plugs and jacks. [472]

R-f techniques. Applied Research Inc., 76 S. Bayles Ave., Port Washington, N.Y. 11050. A 16-page catalog details state-of-the-art advances in r-f techniques. [473]

Adhesive selector chart. Emerson & Cuming Inc., Canton, Mass. 02021. A reference chart suitable for a notebook or wall mounting lists the important properties of the Eccobond lines of adhesives. [474]

ENVIRONMENT PROOF ROTARY SWITCHES

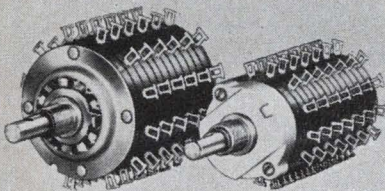

Series 600 1 1/2" Dia.—Series 100 1 1/8" Dia.

- Both index mechanism and electrical sections are completely enclosed.
- Corrosive atmospheres, dust, dirt and moisture are permanently sealed out, lubricants sealed in.
- Solder or quick-connect terminals molded permanently into position minimize production damage.
- Standard index angles include 15°, 30°, 36°, 60° and 90°, special angles available on request.
- Write for engineering bulletin.



STACKPOLE
COMPONENTS COMPANY
P. O. Box 14466
Raleigh, N. C. 27610

UNEXCELLED QUALITY FOR LESS THAN 4¢

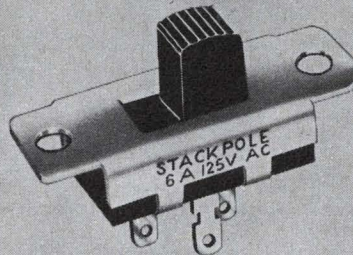

- Listed by UL AND CSA, 1 to 10 amps at 125V AC.
- 7960 slide switch combinations—23 basic types.
- New rugged solder lug terminal, designed for use with quick connectors.
- Uniform quality assured by automated assembly.
- Electro-silver plated terminals and contacts—shorting and non-shorting.
- Phenolic or nylon triggers in a variety of colors.
- Write for engineering literature.



STACKPOLE
COMPONENTS COMPANY
P. O. Box 14466
Raleigh, N. C. 27610

UNIQUE DESIGN ADDS VALUE AND APPEAL

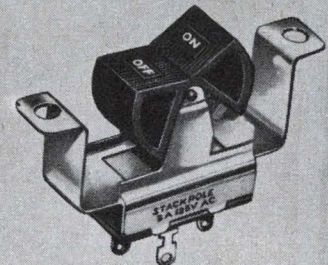

- 23 rocker switch configurations, including 2-3 positions, spring return and center-off.
- Variety of rocker designs available in a spectrum of colors and hot-stamped lettering.
- Listed by UL AND CSA, 1 to 10 amps at 125V AC.
- Solder lug, space saver, quick-connect or printed circuit terminals.
- Field-proven quality same as famous Stackpole slide switches.
- Prices start at less than 15¢.
- Write for engineering literature.



STACKPOLE
COMPONENTS COMPANY
P. O. Box 14466
Raleigh, N. C. 27610

Senior Analog-Digital Engineers

At Aerojet-General's Electronics Division, we need several hardware oriented Electronic Engineers with strong analog and/or digital design backgrounds. We are developing state-of-the-art signal processing circuitry for information acquisition systems, and we need engineers who can take charge of small task organizations and direct their work from sub-system design through development.

The primary application of our engineering is in the infrared field, however, a technical background in infrared is not mandatory. We're most interested in engineers with developed electronic design experience who have the desire and capacity to direct the work of others.

Specifically, we need lead engineers with experience in the following:

- High Frequency Signals (50-200 MHZ)
- Broad Band Log Amplifiers (100 MHZ)
- High Speed A/D Converters (750 nano secs for 6 bits)
- Slope Detectors
- Video Amplifiers
- High Speed Digital Timing and Logic (2 MHZ)
- High Speed Buffer Memory Circuits
- EMI/RFI

Submit resume, including salary requirement to:

D. L. Rowe
Mgr., Professional Placement

P.O. Box 303-J, Azusa, Calif. 91702



A subsidiary of
The General Tire & Rubber Co.

an equal opportunity employer

FOR INFORMATION

about classified advertising contact
the McGraw-Hill office nearest you

ATLANTA, 30309

1375 Peachtree St., N.E.—404-875-0523

BOSTON, 02116

607 Boylston St.—617-262-1160

CHICAGO, 60611

645 No. Michigan Avenue—312-664-5800

CLEVELAND, 44113

55 Public Square—216-781-7000

DALLAS, 75201

1800 Republic Nat'l. Bank Tower—214-747-9721

DENVER, 80202

1700 Broadway, Tower Bldg.—303-255-5483

DETROIT, 48226

856 Penobscot Building—313-962-1793

HOUSTON, 77002

2270 Humble Bldg.—713-224-8381

LOS ANGELES, 90017

1125 West Sixth Street—213-482-5450

NEW YORK, 10036

500 Fifth Avenue—212-971-3594

PHILADELPHIA, 19103

Six Penn Center Plaza—215-568-6161

PITTSBURGH, 15222

4 Gateway Center—412-391-1314

ST. LOUIS, 63105

7751 Carondelet Avenue—314-725-7285

SAN FRANCISCO, 94111

255 California Street—415-362-4600



The cost of all this to you? Absolutely nothing. No fees or charges at any time.

Other advantages of EMR:

- Your resume is sent only to those companies that have a genuine requirement for your particular skills.
- There is no general "broadcasting" in the hope "someone will be interested."
- Your identity is protected because your name is released only according to your prior instructions. Your name can be deleted on request.
- EMR's service is nationwide. You may be considered for job opportunities anywhere in the U.S.

The Electronics Manpower Register is a powerful tool and should be considered when you are seriously seek-

ing a new position. And, although you may be reasonably happy in your present position, chances are that you might have that ideal job in mind.

This is why EMR makes good sense for you. If that job does turn up, you'll be there.

To get your name in the EMR file, just fill out the resume form and return to:

Electronics Manpower Register
330 West 42nd Street
New York, N. Y. 10036

Please enclose a copy of your resume if you have one. A detailed brochure further describing EMR will be sent to you.

Electronics Manpower Register A computerized employment opportunity service

CONTINUED FROM OTHER SIDE					
Previous Position	Employer	City/State	From	To	
Duties and accomplishments					
Previous Position	Employer	City/State	From	To	
Duties and accomplishments					
GENERAL INFORMATION					
(Summarize your over-all qualifications and experience in your field. List any pertinent information not included above.)					
Current annual base salary	Total years of experience	Date available	U.S. Citizen <input type="checkbox"/> Non U.S. Citizen <input type="checkbox"/>		
My identity may be released to: Any employer <input type="checkbox"/>	All but my present employer	Have you security clearance? Yes <input type="checkbox"/> No <input type="checkbox"/>	If yes, What level		
Mail (with a copy of your resume, if you have one) to:					
Electronics Manpower Register 330 West 42nd Street, New York, N. Y. 10036			NO FEES OR CHARGES		
					EMR-4

In electronics it's Electronics magazine to sell used equipment!

Your advertisement will produce Results in Electronics. Engineers turn to Electronics magazine for the latest technical developments — and for the latest buying information. You can reach them inexpensively in Electronics Searchlight Section.

For information:
Searchlight Section
Classified Advertising Dept.
Post Office Box 12
New York 10036



ENGINEERS: ELECTRONIC & MECHANICAL

Who's Coming Up With a Great New Career in TELEVISION, Video & Audio Tape Recorders, Closed Circuit TV Systems, Cameras . . .
COULD BE YOU!

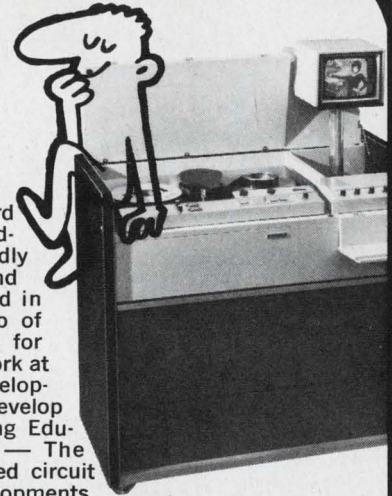

AMPEX, the world's leader and standard of excellence in video and audio recording, has immediate openings in the rapidly growing and diversifying Consumer and Educational Products Group located in attractive Elk Grove Village, a suburb of Chicago. These are growth positions for talented professionals who prefer to work at the top! You will participate in the development of the state of the art. You will develop or produce products for the expanding Educational TV or consumer markets — The emphasis is on advancement in closed circuit television and videotape. Today's developments, such as a color videotape recorder priced under \$5,000, are just the beginning of a dynamic new technological breakthrough.

CAREER EXPANDING OPPORTUNITIES IN Video Recorder Design CCTV or Camera Design
 Audio Recorder Design Industrial Engineering Manufacturing Quality Control

Excellent Starting Salary / Comprehensive Benefit Program / All Relocation Expenses Paid

It's an exciting way to grow . . . and a great place to bring your family. Our pleasant Chicago suburb offers all the advantages of metropolitan culture and recreation plus ideal suburb family living. Ampex can make you a better offer now and assure you of challenging, open end opportunity in the future.

Send your resume in confidence to: Professional Employment Center

AMPEX

Consumer and Educational Products Group
2201 Lunt Avenue, Elk Grove Village, Illinois 60007
An Equal Opportunity Employer

SEARCHLIGHT SECTION

CIRCLE 967 ON READER SERVICE CARD

NEW ENGINEERING COURSES STUDY AT HOME!

University-tested engineering correspondence courses in logic design, digital computer design, feedback control systems and circuitry. Send for free catalog.

EDUCATION FOR CAREER ADVANCEMENT
P.O. Box 31, Mineola, N.Y., 11501
(Licensed as a correspondence school
by the N.Y. State Education Dept.)

CIRCLE 968 ON READER SERVICE CARD

New **VACUUM PENCIL**
for picking up miniature parts
\$7.50 ea.
Selected Distributorships available.
PHILIP FISHERMAN COMPANY
7 CAMERON ST., WELLESLEY, MASSACHUSETTS

CIRCLE 969 ON READER SERVICE CARD

SALE OR LEASE

New factory, 32,000 sq. ft. 4321 N.E. 12th Terr., Ft. Lauderdale, Florida. FEC R.R. siding; sprinklers; five overhead doors; 14' ceilings; 10% of factory and nine offices air-conditioned. Heavy-duty electrical installation; city water and sewer; 1½-acre of parking; rent—\$2,500.00 mo. net. Ph. 565-7260. Owner—Lelash, 223 N. Tradewinds Ave., Lauderdale-by-the-sea, Fla.

CIRCLE 970 ON READER SERVICE CARD

RECONDITIONED ELECTRONIC EQUIPMENT

Nuclear, Microwave, Transducers, Lab Analyzers, Etc.

ISIS,
Box 622, Ogdensburg, N.Y. 13669
Tel: 315-393-5335 (24 hr svce)

CIRCLE 971 ON READER SERVICE CARD

RADAR SYSTEMS GROUND AND AIRBORNE AUTOMATIC TRACKING ANTENNA SYSTEMS NIKE AJAX NIKE HERCULES M-33 MSQ-1A MPS-19 MPS-9 SCR 584 TPS-1D TPS-28 FAA-ASR-2 AIRBORNE SYSTEMS APN-84 APN-102 APS-20 APS-27 APS-45 DPN-19. DIGITAL COMPUTERS IBM 650 IBM 704

LARGEST INVENTORY OF RADAR AND MICROWAVE EQUIPMENT IN THE WORLD.
RADIO RESEARCH INSTRUMENT CO.
45 WEST 45TH ST. N. Y. 10036 212-JU 6-4691

CIRCLE 972 ON READER SERVICE CARD

ELECTRONICS ENGINEER

Responsible opening for an engineer with experience in direct design and fabrication of one-of-a-kind electronic devices and systems to support scientific research activities. Administrative responsibility of instrument repair in calibration laboratory. Prefer 3 to 6 years of solid state digital and analog circuit design (IE, power supplies, amplifiers, pulse circuits), developing circuits from concept through fabrication. BS, EE required.

Please send resume of background, experience and salary requirements in strictest confidence to: Mr. R. C. Davis, Employment Manager.

SPERRY RAND
RESEARCH CENTER
SUDBURY, MASSACHUSETTS 01776

An Equal Opportunity Employer

CIRCLE 973 ON READER SERVICE CARD

Available now from Potter & Brumfield!

Dry reed/solid state time delays in one package for p.c. boards

*In this broad line there's
a time delay relay for
every application*

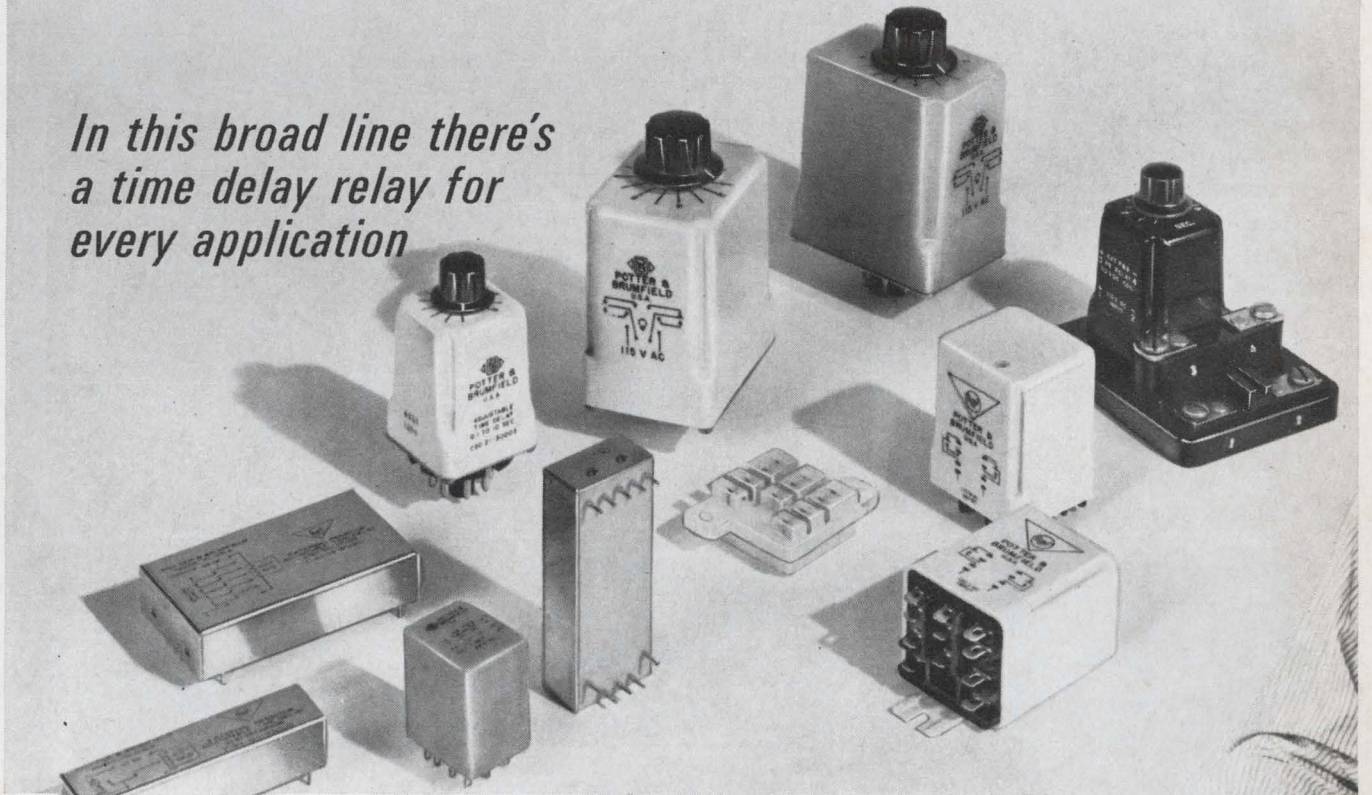

LEFT: CJ Series dry reed relay
with solid state time delay.

Dry reed/solid state hybrids are the newest members of our family of time delays. They are packaged the same as, and are completely compatible with, our regular line of dry reeds. You may get up to five reeds per package, plus the time delay circuit. Ask for our CJ Series.

Other P&B time delays include:

CU SERIES. Priced as low as \$12.50 in single lot quantities. Recommended for delay on operate applications in machine tool controls, copiers, office equipment and many others.

CH SERIES. A practical, low cost answer to many industrial time delay applications. Octal-type plug-in terminals. Accuracy is $\pm 10\%$ with repeatability $\pm 2\%$. For time delay on operate, on release and adjustable interval.

CD SERIES. For critical applications requiring accuracy of $\pm 5\%$ and repeatability of $\pm 1\%$. Many styles are available to switch relays rated at 3, 5, 10 and 25 amperes @ 115 VAC.

For complete information, call your local P&B representative or write directly to Potter & Brumfield, Division of American Machine & Foundry Company, Princeton, Indiana 47570.



FREE!

Our complete catalog
on Solid State Time Delays.

Write for it today.

Standard P&B Solid State Time Delay relays
are available from leading
electronic parts distributors.

AMF | POTTER & BRUMFIELD

International Newsletter

September 30, 1968

Fairchild drops SGS affiliation . . .

After months of negotiation, the Fairchild Camera & Instrument Corp. has finally sold its one-third interest in Societa Generale Semiconduttori, the Italian venture that—in theory—marketed Fairchild's semiconductor products in Europe and benefited from the U.S. firm's research and development. **The buyer was Roberto Olivetti, one of the original three owners. Another owner, Virgilio Floriani of Telettra, now has an option to buy as much as 49% control of the business, but insiders say he will sell out to Fiat.** This would give the big auto maker a second link to SGS; it acquired part of Olivetti International SA after bailing that company out of some financial troubles several years ago.

It's no secret that the eight-year Fairchild-SGS marriage was a stormy one, with SGS throttling Fairchild's attempts to penetrate the European market and Fairchild holding back on the technology it was supposed to be imparting. **But the association was profitable for Fairchild; it originally paid nothing at all for a one-third interest in a company that last year had sales of some \$30 million.** Assets were reportedly about \$40 million.

Fairchild did make some investments in SGS, including \$5 million for capital improvements in 1967 alone. It says it sold out "at a profit."

. . . and competition for markets starts

Hardly was the ink dry on the contract dissolving the Fairchild-SGS arrangement before Bernard T. Marren, the Fairchild Semiconductor division's international marketing manager, was on his way to Europe to set up a network of sales representatives to compete with SGS. **And SGS was hard at work itself prospecting in some new territories.**

Now that the Italian company is no longer confined to selling only in Western Europe, the Middle East, and Africa, as it was under the Fairchild agreement, **it's expected to seek markets in Asia and Eastern Europe, and possibly the U.S.**

Also in the works is the extension of R&D to the SGS factories outside Italy—in England, France, Sweden, and West Germany. Early in 1969, for instance, design and development of discrete devices and integrated circuits will start in the company's facilities in Britain.

Volume IC exports from Japan to U.S. to start next month

Volume shipments of Japanese integrated circuits to the U.S. are scheduled to begin in October. **The Mitsubishi Electric Corp. says that on Sept. 18 it signed a contract under which the Westinghouse Electric Corp. will market its 930 diode-transistor-logic line in the U.S., and that it will begin to export the product next month.**

The two companies are negotiating for the sale of other Mitsubishi devices as well. Among them are 10-ampere thyristors; thyristors with 2,000-volt reverse voltage and 500-amp forward current; diode rectifier chips with 4,000-volt reverse voltage and 600-amp forward current; and triacs in the 10-to-20-amp range. The final contracts for these items are expected to be concluded next month at a conference in Japan.

Negotiations between Mitsubishi and Westinghouse go back to 1964 when the firms signed an agreement to exchange technical information, components, and materials. **In the early part of 1967, Mitsubishi began shipping circuits to Westinghouse in lots of 3,000 to 5,000 for evaluation while the companies were negotiating the export and marketing agreement.**

International Newsletter

Japanese diode generates 129 Ghz

A research team at Tohoku University in Japan has developed a diode oscillator that promises to be a high-efficiency, low-noise frequency generator for millimeter- and submillimeter-wave applications. **There will be an increasing need for such a device in the future and nothing else now exists that operates in this range.**

The team, headed by Junichi Nishizawa, has obtained frequencies as high as 129 gigahertz in the lab. The diode has gallium-arsenide p-n junctions and uses both tunnel and avalanche electron injection.

Italy expects bigger slice of the Eldo pie

Italy expects to get a larger share of ELDO contracts after the current Paris meeting of the European Launcher Development Organization. **The Rome government has been piqued by the fact that its contributions to the 10-nation consortium have amounted to \$43 million, but Italian industry has received just \$30 million in orders from the group.** Italian representatives at the meeting have been saying they'll hold out for at least a \$4.8 million contract for development of an advanced satellite telecommunications system.

Three firms split air-control pact

Three of Europe's electronics heavyweights—West Germany's AEG-Telefunken, Britain's Plessey Radar Ltd., and France's Compagnie Generale de Telegraphie Sans Fil—have won a \$10 million contract from Eurocontrol. **The award, largest yet by the seven-nation organization set up to control most of Western Europe's upper air space, is for computers and displays at Eurocontrol's automated control center at Maastricht, the Netherlands.**

The three companies will split the award almost equally. About a year ago, they pooled their air-control experience in a Brussels-based subsidiary called Eurosystem SA [Electronics, Sept. 4, 1967, p. 202].

Scheduled for operation by 1972, the Maastricht center will have displays using digital primary and secondary radar input, plus digital input of flight-plan and weather data. The system will be based on two IBM 360/50 computers; six small Telefunken peripheral computers will be used for display processing. The three-company consortium will also supply about 130 display units to cover seven control sectors, plus associated keyboards, printers, light pens, and integration units. Computer software will be supplied by Eurosystem.

Norwegian-U.S. IC team likely

A Norwegian-American venture in integrated circuits now appears likely.

Akers Electronics, set up three years ago to cash in on IC knowhow developed in Norwegian Government Research Laboratories, expects to team up soon with a large U.S. semiconductor maker. **Under the deal, Akers would design and fabricate low-volume special IC's for its U.S. partner while continuing to produce special circuits for its current markets.** The planned joint venture is part of an effort to make a money-maker of Akers, which has yet to show a profit.

Addendum

Belgium's telephone company, Regie des Telegraphes et des Telephones, has scored a European first with its 10-year plan to change to an electronic stored-program control system. The changeover from electro-mechanical exchanges will begin early in 1970. **The first order, for an 8,000-line toll exchange, went to Bell Telephone Manufacturing in Antwerp.**

Electronics International

Japan

Quick curtain

In the conventional method of making monolithic integrated circuits, it takes a long time to isolate the components electrically. In the process—diffusion isolation—impurities are spread through the n-type layer; they join the p-type substrate and form p-n junctions between adjacent regions. This adds up to isolation, but at the price of a separate step—after growth of the epitaxial layer—in the fabrication process.

In an effort to skip that step, and at the same time make better IC's, a Kyodo Electronic Laboratories Inc. team headed by Yoshiko Kabaya and Heishichi Ikeda has perfected a polycrystalline isolation technique. It is a variation of the standard p-n method and is not dielectric. Reverse biasing is not needed at the sides; isolation at the bottom is conventional reverse biased isolation of the diode formed by the p substrate, the n buried layer, and the bottom of the epitaxial region.

Faster and smaller. Polycrystalline isolation is grown along with the epitaxial layer. This technique not only saves time and money but also eliminates spreading during later fabrication, making smaller transistors and diodes feasible. This, in turn, means lower capacitances, higher speeds, and smaller chips. And breakdown voltage, on

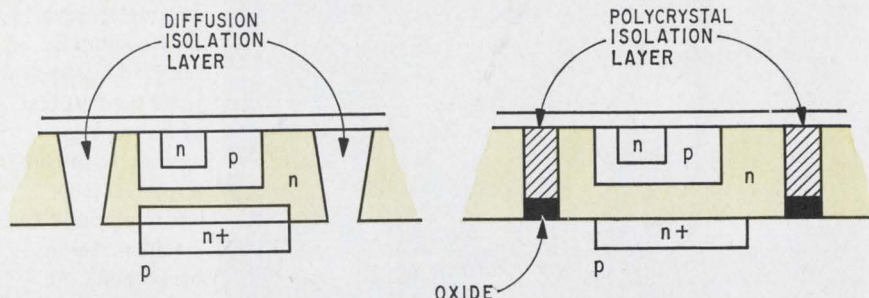

Skip step. Conventional diffusion isolation, shown at left, requires extra fabrication step. Kyodo's polycrystalline isolation eliminates that step. At the same time, it prevents upward displacement of the buried n+ layer occurring with conventional isolation technique.

the order of 100 volts, compares favorably with that of diffusion-isolation IC's.

Fabrication starts in the conventional way: an n+ buried layer is grown in a wafer of high-resistivity p material under each transistor collector. It's in the next step that the new technique differs. A polycrystalline layer—silicon oxide, say—is deposited or formed where the isolation is required.

The growth of the epitaxial layer then yields the usual single-crystal epitaxial material where circuit elements are to be fabricated and polycrystalline material where it's required. Elements within the IC are formed by the usual diffusion processes; metalization, bonding, and packing are also done in the ordinary manner.

The researchers sum up the process this way: single-crystal silicon can be grown epitaxially on a single-crystal substrate. Similarly, polycrystalline silicon can be grown

on a silicon dioxide insulating layer. Thus, single-crystal silicon can be grown on the unmasked areas, polycrystalline silicon on the masked areas. The single-crystal type stays off masked areas simply because there's no lattice to support it.

The future. While Kyodo is not in the monolithic business yet—most of its sales are in hybrid circuits, transistors, and diodes—it is engaged in trial production and life tests in preparation for the day it can sell monolithic IC's in volume.

Wave of the future . . .

It has become an article of faith that more room is needed in the communications spectrum for transmission of information, and that it must be found at higher frequencies. And, at least in Japan, the demand is most insistent for wideband services: what's needed is a carrier with many times the capacity of existing coaxial-cable and microwave systems. The answer, probably, is millimeter-wave systems.

Toward that end, the Electrical Communication Laboratory of the Nippon Telephone and Telegraph Public Corp. has completed what may be the first successful test of a complete wideband solid state

Broadening the world of Electronics

With this issue the Electronics Abroad section of Electronics magazine becomes Electronics International to reflect broader coverage of electronics activity throughout the world.

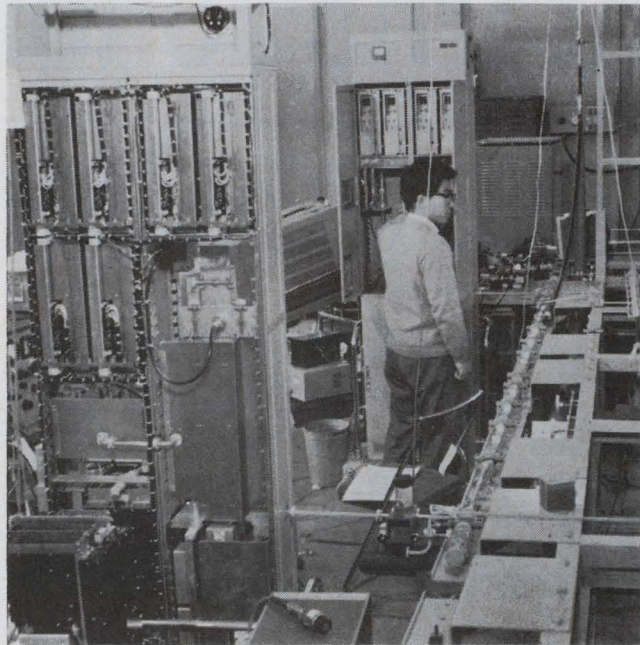

Lab talk. Nippon Telephone's millimeter-wave phone setup is believed by the firm to be the first test of a complete system. In the lab, a receiver is in left foreground and a transmitter in background. At right is waveguide.

millimeter-wave telephone system. Other phone labs—in the U.S., Britain, France, and West Germany—have put together most of the components needed and have installed experimental waveguide transmission lines, but the Japanese believe that theirs is the first complete system test including repeaters, branching filters, and lines.

Pcm used. In the test, two types of 51-mm cylindrical waveguides with a total length of about 4½ miles were used as the transmission line. It was found that repeaters would be needed about every 8 to 12 miles. The branching filters permit the many simultaneous signals on different carrier frequencies to be separated and boosted in different repeater channels.

One of the equal lengths of waveguide (they were connected at one end to provide a continuous link) contained helical insulated copper wire surrounded by a dielectric inside a steel pipe. The second length had four sections of steel pipe with an internal dielectric coating and one section containing a copper helix.

A pulse-code-modulated signal, amplitude-modulated onto a carrier, was used. While this type of modulation may not be best for a com-

mercial system, it was used because it's simple and enables researchers to obtain the data needed to design a commercial system. The system is one in which the carrier is switched on for 1's of the pcm signal and off for 0's. The pcm sampling rate of 225.47 megabits per second is equivalent to more than 3,000 voice telephone channels; operation was at approximately 48 megahertz.

Debit side. Signal loss was found high at frequencies below the millimeter band and then decreased to a minimum in the 50-to-60 gigahertz region, only to pick up again at higher frequencies. Loss at the higher frequencies depended on how the waveguide was made and installed. The minimum loss figure was about 2 decibels per half mile, and less than 2.5 db in the 40-to-80-Ghz range.

For the test, a 550-Mhz bandwidth was provided for each pcm channel. Over the 40-to-80 Ghz range, that gave a total of 64 wideband channels, 32 in each direction. The tests showed, though, that 420 Mhz per pcm channel was sufficient. Thus, the system provided a wideband medium with a capacity of at least 100,000 phone voiceband channels transmitted through one waveguide simultaneously.

... and diodes today

For the experimental microwave system described above, Nippon Telegraph has developed, with Hitachi Ltd., two types of gallium-arsenide microwave and millimeter-wave diodes, both p-n junction devices.

One, for multiplication of microwave signals to higher frequencies, has zinc diffused into the wafer to form a junction. Also usable in low-noise parametric amplifiers, the diode features operation over wide bandwidths and easy adjustment.

The other model, developed for mixer applications, has gold-zinc wire bonded to the chip to form a junction.

A special etching method was developed for the multiplier diode to yield a junction diameter on the order of several microns. This gives the low capacitance needed for multiplying microwave signals to millimeter-wave frequencies.

Lab results. A power output of up to 25 milliwatts at frequencies in the order of 48 gigahertz has been achieved in the laboratory, with a conversion loss (when the diode is operated as a quadrupler to 48 Ghz) of about 6.5 decibels. Some had a loss of only 5.7 db.

In the mixer diode, a large current is passed through the whisker and chip during bonding to weld them together. Impurities from the wire also diffuse into the chip, forming a junction.

About fifteen different versions of these diodes will be available initially at prices ranging from about \$28 for lower-frequency devices to around \$1,000 for the units used at millimeter-wave frequencies. The high prices reflect fabrication costs and the fact that production quantities are limited.

Mexico

One umbrella

Mexico's air-traffic control system is like a series of widely spaced umbrellas in a rainstorm: protec-

tion is provided for specific areas, but big gaps remain. The Ministry of Communications and Transport, through its General Office of Civil Aeronautics, has unfurled a \$7.5 million program to provide one big protective cover—a nationwide air-traffic control system.

The project, to be completed about mid-1970, has two parts. A communications system that will divide the country into four control zones is being handled under a \$4 million contract by NV Philips Telecommunicatie Industrie of Holland. And International Wilcox Electric of Kansas City, Mo., has a \$3.5 million contract to improve the navigational-aid system.

In addition, Mexico is spending about \$6 million to build or improve airports.

Handing off. The four zones will have control centers at Mexico City, Mazatlán, Monterrey, and Mérida, Yucatan. Each center will control aircraft in its zone. When an aircraft passes into another zone, that zone's center will be informed of the aircraft's position and course by telephone.

The present system was recently augmented but still covers only the central area around Mexico City and a handful of other cities. Mexico City International Airport controls corridors extending 150 nautical miles to the northwest; 55 nautical miles south; 135 miles east to Nautla, and 180 and 121 miles northeast to Tampico and Tuxpan, respectively. Tampico and Tuxpan, on the Gulf Coast, both have semicircular coverage inland for about 50 miles.

Since 1967, Acapulco has had 50-mile-radius control and radio communications with Mexico City. Two weeks ago, Guadalajara airport also extended its radio coverage to a 50-mile radius and established communications with Mexico City. In general, however, Mexico's airports control aircraft only within a five-mile radius.

Hardware. Philips is supplying high-frequency equipment for airport-to-airport communications; vhf gear for air-ground communications; 62 control consoles of 10 kinds; a semiautomatic telegraph-switching center to handle national



In charge. Air controllers at Mexico City will get new equipment.

and international communications at Mexico City, and 33 tape recorders.

Wilcox will supply, install, and check out 27 VOR's (vhf omniranges), nine DME's (distance measuring equipment), and nine NDB's (nondirectional beacons), plus test equipment, replacement parts, and emergency generators.

The system will put Mexico among the Latin American leaders in air-traffic control, and possibly make it No. 1. It will also move Mexico firmly into the jet age; the present system was designed for piston planes.

Links. Telephone communications between airports will generally be via the microwave network the ministry is establishing under a separate program. [Electronics, April 1, p. 95]. Four high-frequency transmission and four 800-watt reception sets are being installed at the control centers as backup equipment. Also, two high-frequency transmitters and two 300-watt receivers will be put in to link Mazatlán to Puerto Vallarta, which isn't in the microwave network.

In addition, 31 airports will have 25-mile-radius tower control using 50-watt vhf radios; 10 airports will have 50-watt vhf equipment for approach control from 75 miles; 24 250-watt sets and probably three

50-watt vhf sets will be installed for control of aircraft flying above 20,000 feet, and 11 250-watt sets will be put in for control of aircraft flying above 20,000 feet.

The Mexico City airport will have additional vhf equipment for control of airport aircraft on the ground. Other airports will control ground movement via the same frequencies they use for air control.

Mexico City will also have a Philips ES-2 semiautomatic telegraph switching center with a capacity of 26 duplex lines for International Civil Aviation Organization format. The system has two operators' positions and will include three printing reperforators, 10 printing reperforator monitors, eight printer receivers, a keyboard page printer with two perforators attached, and four tape transmitters.

Of the 33 tape recorders, 21 will have four channels, seven seven channels, four 15 channels, and one, for Mexico City, 31 channels. They will be used to record conversations between pilots and controllers and between controllers. They will be used mainly for investigation of accidents.

No further radar. The 27 VOR's will augment 17 now in operation. About 12 of these 17 have been operating for two years or less, the other five for six or seven years. Three of the older models are being removed. Of the 27 new VOR's seven are partially transistorized Wilcox 485-B models. The rest are all-tube 485-A's.

Great Britain

Unto the breach

The intervals between successive lines or fields in a television transmission are simply blanks—wasted microseconds in the case of lines, milliseconds in the case of fields. As such they present an opportunity to communicators and a challenge to engineers. Both Philips Gloeilampenfabrieken of the Netherlands and RCA have experimented with systems that transmit graphic

material during field flyback periods [Electronics, Nov. 13, 1967, p. 305], and now the research department of the British Broadcasting Corp. has devised a means of using the line flyback period to carry pulse-code-modulated signals.

The BBC is anxious to perfect such a system—and it has already tested a prototype—because it now uses separate cable links to get audio and video from studio to transmitter, and cable capacity is at a premium. Moreover, by cutting cable requirements in half, the cost of transmission can be cut despite the need for coding and decoding equipment.

Tight squeeze. In black-and-white systems, the line-blanking interval carries the line-synchronizing pulse; in color systems, it carries the color burst as well. With the 625-line, 50-cycle system soon to be universal in Britain (at present, some transmissions use 405 lines), the nominal width of the line sync pulse is 4.7 μ sec. The BBC researchers found that, allowing for space on either side, about 3.8 μ sec of this time can be used for the addition of a sound signal to the video waveform.

Safeguard. To prevent the sound signal from possibly degrading the video signal, and in particular the vulnerable "back porch" portion of the video wave after the sound signal, the pulse group is arranged to minimize variation in mean level. The two words are interleaved and the normal digit order is reversed—the least significant digits first.

After analog-to-digital conversion, the two words in each line period are stored in a shift register to await their synchronizing pulse period. The complementing and interleaving of the digits and the addition of the marker pulse is carried out in the shift register. The coded signal is shaped in a 2T pulse filter and gated into the video signal, with the bottom of the pulse 0.3 volts below black level.

At the receiving terminal, the sound pulses are switched out of the combined signal, sliced across the half-amplitude point, sampled at their epoch by pulses initiated by the marker pulse, and stored in

another shift register. A digital-to-analog converter extracts the stored sound digits and, after conversion, the sound signal is deemphasized.

Sharper look

The recent surge in air traffic has shown that the basic range and bearing information provided by primary radar systems is insufficient for adequate control. So in the last few years, secondary surveillance radar—to provide data on identification and on altitude—has become mandatory in some parts of the U.S. and Western Europe. And since most world airlines want to fly those lucrative routes, nearly all civil jets carry secondary-radar transponders.

But outside those crowded corridors, the equipment isn't used because ground gear—for interrogation, decoding, and data processing—isn't installed. Now, however, the International Civil Aviation Organization, after years of delay, has agreed on main system parameters. British companies are racing to get a chunk of the market, particularly after a Marconi-Elliott survey showed that only 30 of more than 1,000 international airports outside the U.S. were equipped and that many planned to buy the equipment by the early 1970's.

Lining up. The Raytheon Co.'s British subsidiary, Cossor Electronics Ltd., whose interrogator-responders and transponders have always dominated the British scene, introduced last spring a solid state interrogator-transponder that meets international requirements, and an integrated-circuit transponder, weighing less than six pounds, for civil requirements. Now the English Electric Co. and the Plessey Co. have joined Cossor. The two EE subsidiaries—the Marconi Co. and Elliott-Automation Ltd.—are producing a complete ground installation, and Plessey is to make two microcircuit transponders of its own design.

The Marconi-Elliott market study showed that the existing non-U.S. installations control the congested air routes in western Europe, but the rest of the world outside the

U.S. and the Soviet Union "is wide open" for sales, to quote a Marconi executive. The company hopes to make its first sales in Scandinavia, followed by southern Europe, the Middle East, and countries on the main routes to the Far East, in that order.

The EE ground installation uses a Marconi solid state 5-kilowatt interrogator-responder of a new modular design. It's linked to Marconi radar displays by an Elliott video processing system made up of a digital decoder, plot extractor, video generator and, for sophisticated systems, a small Elliott 900 Series computer. Elliott has until now supplied this video processing equipment for use with Cossor interrogators under a joint marketing agreement.

Soviet experiments. Similarly, the agreement between Marconi and Compagnie Française Thomson Houston-Hotchkiss Brandt—under which an older design of Marconi interrogator is matched with Thomson video processors—has been ended with the merging of Thomson and the Compagnie Generale de Télégraphie Sans Fil. The Marconi-Thomson agreement has resulted in about four of five orders, including an experimental installation at Moscow airport. CSF and Thomson will now probably develop their own complete system. However, Cossor now has to look outside England for a supplier of video processors under contract, or depend on Elliott's willingness to supply on an ad hoc basis.

Plessey has so far obtained one order for its ground equipment: the plot extractors and scan converters (CSF design) for the proposed southern England air traffic control center near London airport. One of Plessey's two microcircuit transponders weighs less than five pounds, has a 500-watt peak output, and is intended for military helicopters. The Government has ordered 500, worth \$2.25 million, for planes like Concorde. The device will work in any two of the four military operating modes over the full military temperature range of -35°C to $+70^{\circ}\text{C}$. Plessey says it's about a quarter the size and weight of similar transponders.

■ Acopian Corp. Mort Barish Associates	14	Data Instruments Division Technical Marketing	152	Hirose Electric Co., Ltd. Kyodo Adv. Co., Ltd.	192
Allen-Bradley Co. Fensholt Adv. Agcy.	27	■ Data Technology Bonfield Assoc., Inc.	129	■ Honeywell, Computer Control Div. Franklin P. Folts, Inc.	47
■ Amelco Semiconductor Serra Associates	145	Defense Electronics, Inc. Harry I. Clarkson Associates	175	■ Honeywell, PMD Div. Batten, Barton, Durstine & Osborn, Inc.	51
American Cyanamid Co., Plastics & Resins Div. Wilson, Haight & Welch, Inc.	56A	Dialight Corp. Michel, Cather, Inc.	123		
■ Amphenol Corp. Marsteller, Inc.	161	Discon Corp. Al Woodbury, Jr. & Assoc's	59		
□ Ancrona Corp.	14E	Dit-Mco International, Div. of Xebec Corp. Martin Fromm & Assoc., Inc.	180	Industrial Electronic Engineers Van Der Boom, McCarron, Inc. Adv.	140
Andrew Corp. Fensholt Adv., Inc.	62	Dow Chemical Co., The MacManus, John & Adams, Inc.	169	International Electronic Research Corp. Van Der Boom, McCarron, Inc. Adv.	114
□ ■ Anritsu Electric Co., Ltd. Diamond Agcy. Co., Ltd.	12E	Dow Corning Corp., Engineering Products Div. Church & Guisewite Advertising	136	I R C, Incorporated Gray & Rogers, Inc.	158
Arnold Engineering Co. Buchen Adv., Inc.	20, 21	DuPont de Nemours Co., Mylar Div. Batten, Barton, Durstine & Osborn, Inc.	124		
■ Augat, Inc. Horton, Church & Goff, Inc.	23	DuPont de Nemours Co., Teflon Div. Batten, Barton, Durstine & Osborn, Inc.	138		
				James Electronics, Inc. George Bond and Associates	196
Beckman Instruments, Inc., Electronic Instrument Div. Hixson & Jorgensen, Inc.	181	Eastman Kodak Co., PCIM Market Development Rumrill Hoyt, Inc.	177	■ JFD Electronics Co., Components Div. Delphi Adv., Inc.	166
■ Beckman Instruments, Inc., Helipot Div. Hixson & Jorgensen, Inc.	72	□ Eldorado Electronics Technometrics, Inc.	10E	Joslyn, Inc. Chace Company	186
Belden Corporation Fensholt Adv., Inc.	70, 71	Electro Optics Associates Jerry Steimle & Company	156		
Bendix Corp., Vacuum Div. MacManus, John & Adams, Inc.	113	□ Electrovac	209	KCK Co., Ltd. General Adv. Agcy., Inc.	176
Bissett-Berman Corp. S F Associates	41	Emerson & Cuming, Inc. Edwin F. Hall	194		
Boonton Electronics Corp. The Creative Group	170			■ Lambda Electronics Corp. Michel Cather, Inc.	112
■ Bulova Watch Co., Electronics Div. Levy Adv. Assoc.	22	■ Fairchild Semiconductor, Inc. Faust/Day, Inc.	10, 11, 68, 69	■ Ledex, Inc., Bramco Controls Div. Yeck & Yeck, Inc.	160
■ Burndy Corp. Don Kemper Co., Inc.	141	Farinon Electric Jack Herrick Adv., Inc.	7	Litton Industries, Inc., Electron Tube Div. MacManus, John & Adams, Inc.	144
		Fluke Mfg. Co., John, Bonfield Associates	15	Litton Industries, Inc., Triad Distributor MacManus, John & Adams, Inc.	154
		Forward Metro Denver Broyles, Allebaugh & Davis, Inc.	32		
California Electronic Mfg. Co., Inc. Alpha Adv. Assoc.	176			■ Mallory Battery Co., Div. of P.R. Mallory & Co., Inc. Needham, Harper & Steers, Inc.	110
Cambridge Thermionic Corp. Chirurg & Cairns, Inc.	150	Garrett Corp., Airesearch Mfg. Div. J. Walter Thompson Co.	108	■ Mallory & Co., P.R., Mfg. Div. Aitkin-Kynett Co.	168
Celanese Plastics Co., Celanese Corp. Div. MacManus, John and Adams, Inc.	60, 61	■ General Electric Co., Capacitor Div. Robert S. Cragin, Inc.	28, 29	□ Marconi Instruments Ltd. Taylor Adv. Ltd.	210, 211
Centralab Div. of Globe-Union, Inc. The Brady Co.	133	■ General Electric Co., Electronic Components Sales Operation Robert S. Cragin, Inc.	66, 67	Markem Corp. Creamer, Trowbridge Case & Basford, Inc.	137
■ Cherry Electrical Products Corp. K & A, Incorporated	53	General Radio Co. Horton, Church & Goff, Inc.	2nd Cover	Maryland Telecommunications, Inc. 197, 198, 199	199
■ Chicago Dynamic Industries, Inc. Burton Browne Advertising	167	Granger Associates West Associates	182	Raymond E. Finn Advertising	55
Cimron, Division of Lear Siegler, Inc. Phillips-Ramsey, Inc.	30	■ Grayhill, Inc. Merchandising Adv., Inc.	196	Mergenthaler Linotype Co. Merlin Advertising	55
Cinch Graphik, United Carr Fastener Co. Div. Reach McClinton & Co.	24	Groov-Pin Corp. Feeley & Wheeler, Inc.	195	Mico Instrument Co.	194
Clairex Corp. Michel-Cather, Inc.	149	■ Gudebrod Brothers Silk Co., Electronics Div. Ramsdell-Buckley & Co.	162	■ Microwave Electronics Corp., Sub. of Teledyne Bonfield Associates	216
■ Clevite Corp., Piezoelectric Div. Carr Liggett Adv., Inc.	195			■ Minnesota Mining & Mfg. Co., Scotchpar Div. Young & Rubicam, Inc.	171
Connecticut Hard Rubber Co. Chirurg & Cairns, Inc.	190	■ Heinemann Electric Co. Thomas R. Sundheim, Inc.	17	■ MM Electronic Enclosures, Inc. Berin/Pecor, Inc.	196
Consolidated Electrodynamics Corp., Sub. of Bell & Howell Hixson & Jorgensen, Inc.	142	■ Hewlett Packard, Colorado Springs Div. Tallant/Yates Adv., Inc.	3rd Cover	Monarch Machine Tool Co., Edlund Div. Sabatino Adv., Inc.	191
Corning Glass Works Electronic Division—Capacitors Warner, Bicking & Fenwick, Inc.	111	■ Hewlett Packard, Loveland Div. Tallant/Yates Adv., Inc.	12, 13, 84, 85, 109	Motorola Communications & Electronics, Inc. The Griswold-Eshleman Co.	195
Corning Glass Works Electronic Division—Glass Memories Warner, Bicking & Fenwick, Inc.	188	■ Hewlett Packard, Microwave Div. Lennen & Newell, Inc.	35 to 40	Mullard, Ltd. Parker-Rumrill International, Inc.	56B
Corning Glass Works Electronic Division—Resistors Warner, Bicking & Fenwick, Inc.	130	■ Hewlett Packard, Palo Alto Div. Lennen & Newell, Inc.	1		
Coto Coil Co., Inc. Williams Company, The	192	■ Hewlett Packard, Waltham Div. Culver Adv., Inc.	143	National Semiconductor Corp. Jay Chiat & Associates	57, 58
■ Couch Ordance, Inc., Couch Co. Div. Culver Adv., Inc.	134			Nippon Coil Co., Ltd. Dai-ichi International, Inc.	184
CREI, Home Study Div. of the McGraw-Hill Book Co. Henry J. Kaufman & Associates	187			■ North Atlantic Industries, Inc. Murray Heyert Associates	26
□ C.S.F. GTE S P I Agency	212				



Pamotor, Inc. Harry P. Bridge Co.	16
■ Philbrick/Nexus Research Culver Adv., Inc.	139
Philco Ford Corp., Sierra Electronics Operation Hal Lawrence, Inc.	6
Phoenix Chamber of Commerce Jennings & Thompson Advertising	184
□ Plessey Microelectronics Creative Workshop Ltd.	193, 2E
■ Polaroid Corp. Doyle, Dane, Bernbach, Inc.	135
■ Potter & Brumfield Div., American Machine & Foundry Corp. Grant, Schwenck & Baker, Inc.	206
Quan-Tech Laboratories Kniep Associates	185
Radiation, Inc. W. M. Zemp & Assoc., Inc.	49
Radio Cores, Inc. Sander Rodkin Adv. Agcy., Ltd.	176
Radio Corporation of America 4th Cover,	174
Al Paul Lefton Co.	
■ Raytheon Co., Components Div. Fuller & Smith & Ross, Inc.	107
■ Republic Foil, Inc. The Graphic Group	163
■ Reeves Hoffman, Div. of Dynamics Corporation of America Adams Assoc., Inc.	184
R F Communications, Inc. Beachner Adv. Agcy.	193
□ Schneider, R.T. Noirclerc Publicite	3E
Scientific Data Systems Doyle, Dane, Bernbach, Inc.	42
Semtech Corp. Burruss Advertising	116
Signetics Corp. Sub. Corning Glass Works Cunningham & Walsh, Inc.	155
□ Silec Electronique Publicite y Ch. Lambert	8E
■ Siliconix, Inc. Graphics West	95
Sinclair Radio Labs, Inc. John E. Hayes Co., Inc.	8
□ Solartron Electronic Group Ltd. Southern Adv., Ltd.	4E
■ Sorensen Operation, Raytheon Co. Urrutia & Hayes, Inc.	65
S. P. Electronica Publicitas SPA	7E, 9E, 11E, 13E
Sprague Electric Co., The Harry P. Bridge Co.	5, 9
■ Stackpole Carbon Co., Electronic Components Div. Meek & Thomas, Inc.	101, 200, 201
■ Susumu Industrial Co., Ltd. Sanko Sha Adv. Agcy. Co., Ltd.	186
Sweet's Industrial Information System J. J. Lane, Inc.	153
Sylvania Electric Products, Inc., Parts Div. Doyle, Dane Bernbach, Inc.	157
■ Tektronix, Inc. Hugh Dwight Adv., Inc.	117, 118
Telonic Instruments Jansen Assoc., Inc.	115
Temescal, Division of Aircro Allen & Dorward, Inc.	186
Tempress Research Co., Inc. Hal Lawrence, Inc.	25

Test Equipment Corp. Dean & Bain Adv., Inc.	121
Texas Instruments Incorporated Components Group Don L. Baxter, Div. of Albert Frank-Guenther Law, Inc.	146
■ Texscan Corp. Burton Browne Advertising	192
Times Systems Corp. Giulie, Smith & Beal, Inc.	18, 19
■ Tracor, Inc., Industrial Instruments Div. Winn-McLane Assoc., Inc.	164
TRW Electronics, Capacitors Div. Fuller & Smith & Ross, Inc.	178
■ Tun-Sol Div., Wagner Electric Corp. Feeley & Wheeler, Inc.	172
United Control Corp. Botsford, Constantine & McCarty, Inc.	127
Westinghouse Semiconductor Div. McCann/ITSM	173

Classified Advertising

F.J. Eberle, Manager

EMPLOYMENT OPPORTUNITIES

Aerojet-General Corp.	202
Ampex Corp.	205
Sperry Rand	205

EQUIPMENT (Used or Surplus New) For Sale

Education for Career Advancement	205
Fishman, P. Co.	205
Ind. & Sc. Inf. Serv.	205
Lelash, Keese Marie	205
Radio Research Instrument Co.	205

■ For more information on complete product line see advertisement in the latest Electronics Buyer's Guide

□ Advertisers in Electronics International

Electronics Buyers' Guide

George F. Werner, General Manager
[212] 971-2310

Robert M. Denmead,
Midwest Regional Manager
[312] MO 4-5800

Regina Hera, Directory Manager
[212] 971-2544

Thomas M. Egan, Production Manager
[212] 971-3140

Circulation Department

Isaaca Siegel, Manager [212] 971-6057

Research Department

David Strassler, Manager [212] 971-6058
Chloe D. Glover, Research Associate
[212] 971-6057

Advertising Sales Staff

Frank E. LeBeau [212] 971-6464
Advertising Sales Manager

Wallis Clarke [212] 971-2187
Assistant to sales manager

Donald J. Austermann [212] 971-3139
Promotion Manager

Warren H. Gardner [215] LO 8-6161
Eastern Advertising Sales Manager

Atlanta, Ga. 30309: Michael H. Miller, 1375
Peachtree St., N.E.
[404] 892-2868

Boston, Mass. 02116: William S. Hodgkinson
McGraw-Hill Building, Copley Square
[617] CO 2-1160

Cleveland, Ohio 44113: William J. Boyle, 55
Public Square, [216] SU 1-7000

New York, N.Y. 10036
500 Fifth Avenue
James R. Pierce [212] 971-3616
John A. Garland [212] 971-3617

Philadelphia, Pa. 19103:
Jeffrey M. Preston
Warren H. Gardner,
6 Penn Center Plaza,
[215] LO 8-6161

Pittsburgh, Pa. 15222: Warren H. Gardner,
4 Gateway Center, [412] 391-1314

Rochester, N.Y. 14534: William J. Boyle,
9 Greylock Ridge, Pittsford, N.Y.
[716] 586-5040

Donald R. Furth (312) MO 4-5800
Midwest Advertising Sales Manager

Chicago, Ill. 60611: Kenneth E. Nicklas
Ralph Hanning, 645 North Michigan Avenue,
[312] MO 4-5800

Dallas, Texas 75201: Richard P. Poole, 1800
Republic National Bank Tower,
[214] RI 7-9721

Houston, Texas 77002: Robert Wallin,
2270 Humble Bldg. [713] CA 4-8381

Detroit, Michigan 48226: Ralph Hanning,
856 Penobscot Building
[313] 962-1793

Minneapolis, Minn. 55402: 1104 Northstar
Center [612] 332-7425

St. Louis, Mo. 63105: Kenneth E. Nicklas,
The Clayton Tower, 7751 Carondelet Ave.
[314] PA 5-7285

James T. Hauptli [415] DO 2-4600
Western Advertising Sales Manager

Denver, Colo. 80202: Joseph C. Page, David
M. Watson, Tower Bldg., 1700 Broadway
[303] 255-5484

Los Angeles, Calif. 90017: Ian C. Hill,
John G. Zisch, 1125 W. 6th St.,
[213] HU 2-5450

Portland, Ore. 97204: James T. Hauptli,
Thomas McElhinny, 218 Mohawk Building,
222 S.W. Morrison Street,
Phone [503] 223-5118

San Francisco, Calif. 94111: James T. Hauptli,
Thomas McElhinny, 255 California Street,
[415] DO 2-4600

Pierre Braude Tel: 225 85 88: Paris
European Director

Paris: Ken Davey
88-90 Avenue Des Champs-Elysees, Paris 8

United Kingdom and Scandinavia
Brian Bowes Tel: Hyde Park 1451

34 Dover Street,
London W1

Milan: Robert Saidel
1 via Baracchini Phone 86-90-656

Brussels: F.I.H. Huntjens
27 Rue Ducale Tel: 136503

Frankfurt/Main: Hans Haller
Elsa-Brandstroem Str. 2
Phone 72 01 81

Geneva: Ken Davey
1, rue du Temple Phone: 31 95 60

Tokyo: Takeji Kinoshita 1 Kotohiracho
Shiba, Minato-Ku Tokyo [502] 0656

Osaka: Ryoji Kobayashi 163, Umegae-cho
Kita-ku [362] 8771

Business Department

Wallace C. Carmichael, Manager
[212] 971-3191

Stephen R. Weiss, Production Manager
[212] 971-2044

Thomas M. Egan,
Assistant Production Manager [212] 971-3140

Dorothy Carmesin, Contracts and Billings
[212] 971-2908

Frances Vallone, Reader Service Manager
[212] 971-2865

Authoritative. Accurate. Current.

Computer programming makes its entire contents as current as the week it went to press.

Comprehensive. 2,000 pages, 126,000 items. Including a complete list of trade names.

Easiest to use. Organized for speed. Locate

products and their sources in one reference.

In wide use. An industry standard. Makes phone to phone discussions more efficient.

Valuable. EBG can help you save time. Make more profit for your company. Meet deadlines. Improve products. Use it often.

Electronics Buyers' Guide

A McGraw-Hill Market Directed Publication, 330 West 42nd Street, New York, N. Y. 10036

integrated product listings—
product sources and specifications in the same section.

color coded readouts—
yellow section for product, green section for manufacturers and trade names.

The Black Box Explosion



pull here

shelf mounting—
keeps an entire industry within arms length.

current operation—
computer programming makes EBG the industry's most up-to-date directory.

wide band coverage—
EBG lists over 4,000 products and cross references: more than 6,000 manufacturers.

computerized dimensions—
computer programming provides cross references, eliminates duplication.

Just look at the difference in size and weight. MEC produces field-proven solid state fixed delay devices that operate from **UHF through X-band**. These rugged, nondispersive microwave acoustic devices are welcome replacements for bulky coaxial and waveguide delay lines. Make your own comparison: a typical MEC fixed delay device is only 2" long and weighs just 3 oz.

Designers of ECM, radar, and other systems are now using MEC's two-port, fixed delay devices with real time delays from **tenths of microseconds to tens of microseconds**. Insertion losses for microseconds delay are significantly lower than those encountered with conventional delay lines.

As originator and leader in solid-state delay techniques, MEC's capability spans variable and repetitive, as well as fixed devices. Call or write to let MEC know your special requirements.

MEC Two-Port Fixed Delay Devices

Frequency Band	Delay Time (μ sec)	Bandwidth/Insertion Loss		Available Delay Ranges μ sec (min - max)
		(narrow band)	(broadband)	
UHF	10	10% / 30 db	40% / 50 db	0.1-40
L	3	10% / 35 db	50% / 55 db	0.1-20
S	2	10% / 40 db	40% / 60 db	0.1-10
C	1	6% / 45 db	30% / 75 db	0.1- 6
X	0.5	3% / 50 db	20% / 75 db	0.1- 4

**Delay lines have gone solid state...
that's about the size of it!**

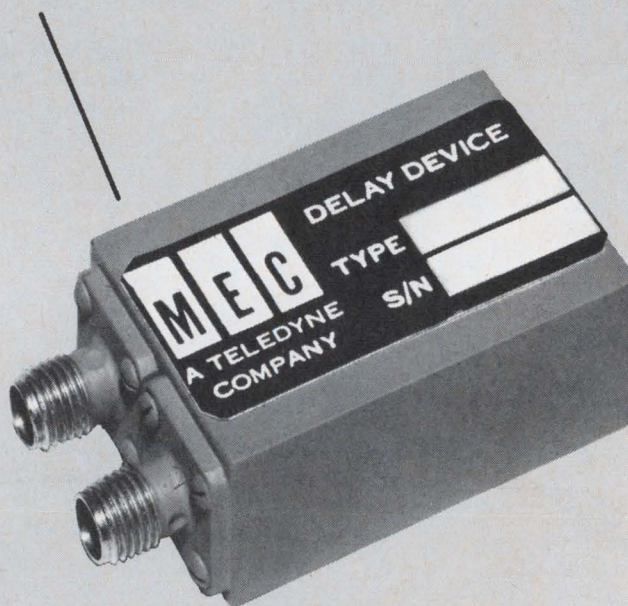

ACTUAL SIZE



3165 Porter Drive, Palo Alto, Calif. 94304 Phone (415) 321-1770



1300A X-Y DISPLAY
HEWLETT PACKARD

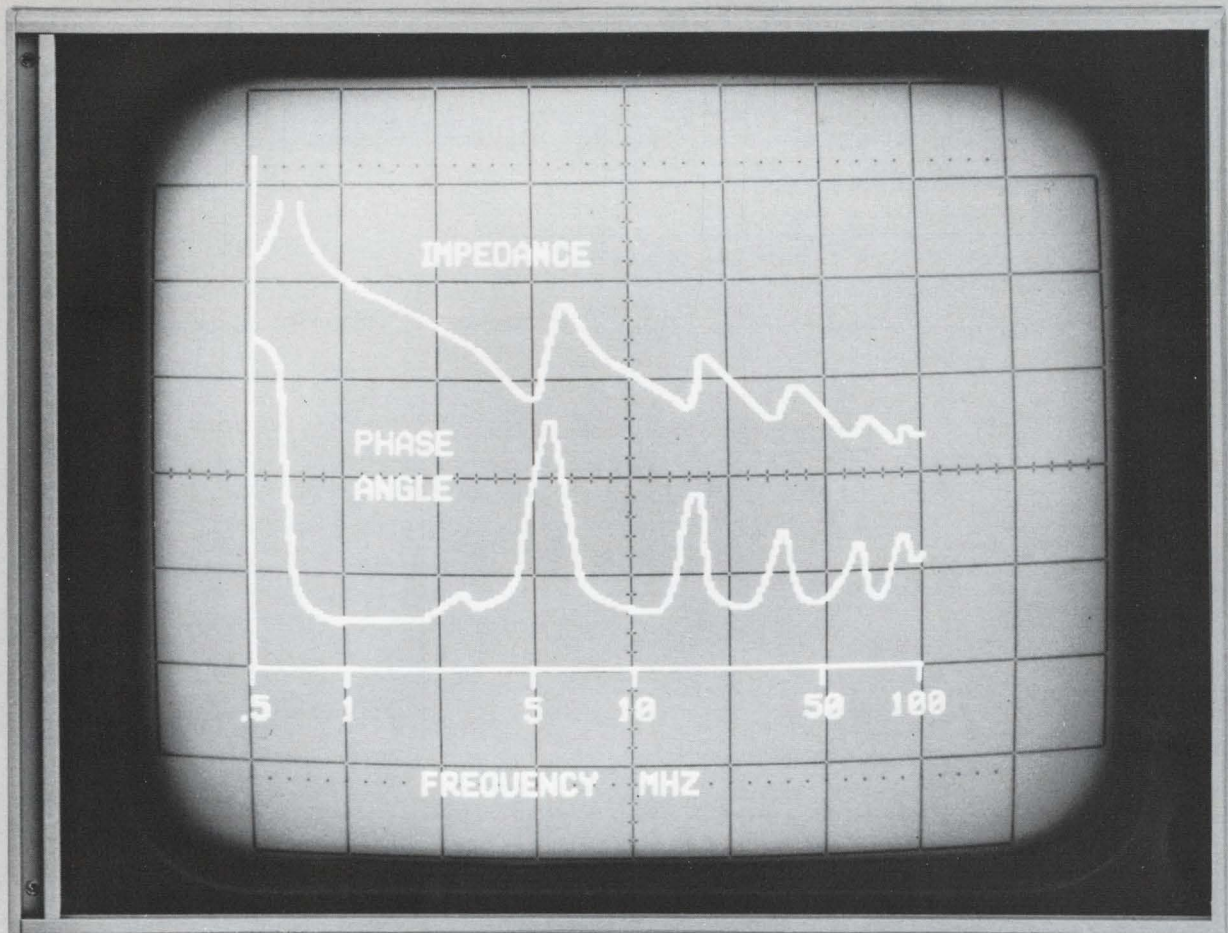

POWER

ASTIGMATISM

INTENSITY

FOCUS

TRACE ALIGN

NOW YOU CAN MATCH A MONITOR TO YOUR COMPUTER'S SPEED

Extraordinarily wide dc to 20 MHz bandwidth on all three axes of the hp 1300A X-Y Monitor gives you fast writing to display your alphanumeric and graphic computer readouts accurately—using a minimum of your computer's time. An internal graticule, 8 x 10-inch screen lets you see a big, sharp picture you can read across a brightly lighted room—without parallax error.

The electrostatically deflected beam in the 20 kV CRT, gives you bright, easy-to-read displays—even when observing low rep-rate signals. Standard sensitivity is 100 mV/in.

The hp 1300A is an inexpensive (\$1900) monitor, ideal for your computer applications. Its large screen CRT and all solid-state circuitry require only 175 watts and is packaged in a compact, 12" high cabinet weighing 47 pounds, including self-contained power supply.

Get the full details on the hp 1300A X-Y Monitor from your hp field engineer—he can help you select phosphors, filters and graticule options to match the monitor to your application. Or, write to Hewlett-Packard, Palo Alto, California 94304.

Europe: 54 Route des Acacias, Geneva.

HEWLETT  PACKARD

OSCILLOSCOPE SYSTEMS

Dual Differential Amplifiers—

DC to 120 MHz:

RCA - CA3026 @ \$1.25 (1,000 units)

Here—from RCA—is another Integrated Circuit “building block” —two differential amplifiers on a single substrate with uncommitted bases and collectors. Use them as differential and/or cascode amplifiers, IF amplifiers, limiters, video amplifiers, doubly-balanced modulators and demodulators. CA3026 brings the advantages of monolithic IC devices to a more comprehensive range of solid-state circuit applications.

Ask your RCA Representative for details or see your RCA Distributor for his price and delivery. For technical details, write RCA Electronic Components, Commercial Engineering, Section No. IC-N-9-2, Harrison, N.J. 07029.

Matched differential amplifiers with:

Independent inputs and outputs

Max. input offset voltage ± 5 mV

Max. collector to emitter voltage (V_{CEO}) 15 V

Max. collector current (I_C) 50 mA

Dynamic forward current transfer ratio
(h_{fe}) (typ) 110

Operating temperature range -55°C to $+125^\circ\text{C}$

RCA Integrated
Circuits

New Linear IC “Building Block”

